

COYNE
PRACTICAL APPLIED
ELECTRICITY

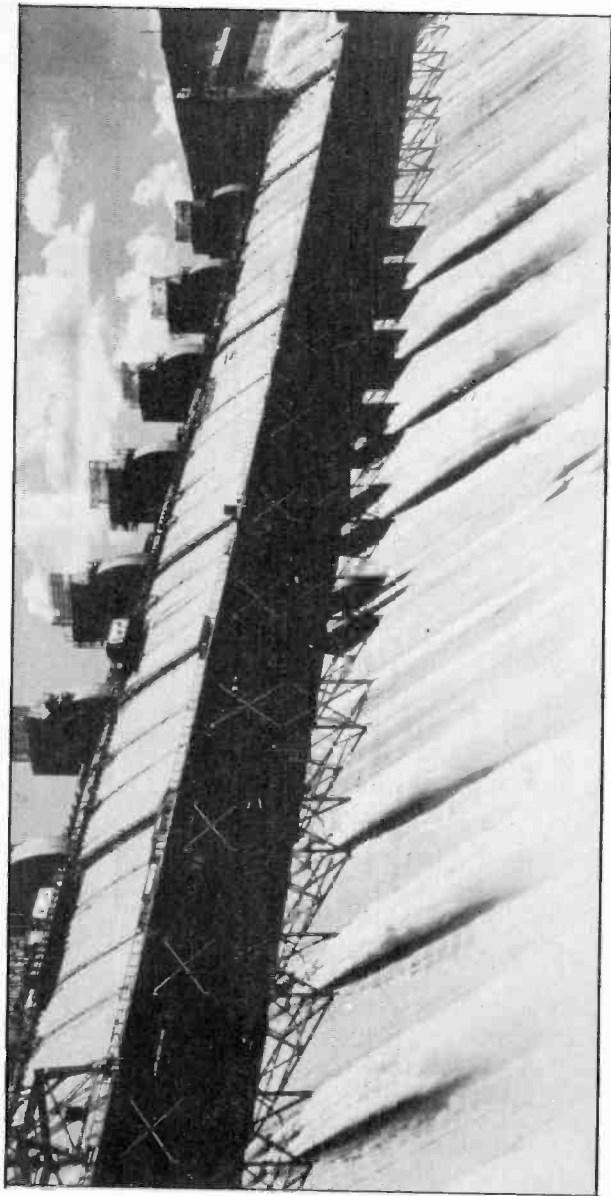

GRAND COULEE DAM: This unusual photo shows the spillway section of this great power project. When completed this dam will represent one of the largest power projects in the entire world.

COYNE PRACTICAL APPLIED ELECTRICITY

A Set of Complete Practical Books
For Home Study
and
Field Reference
On

Electrical principles, telephones, wiring, meters, D.C. and A.C. motors, controls, and equipment, household appliance repair, Rural Electrification, Armature winding, Generators, Diesel Electric Plants, Automotive Electricity, Batteries, Electrical Refrigeration and Air Conditioning, Industrial Electronics, Radio Electric Welding — laws, rules, etc. — Over 3,000 subjects, 5,000 Electrical facts, thousands of photos and diagrams.

By
THE TECHNICAL STAFF
of the
COYNE ELECTRICAL SCHOOL

Copyright 1945 by
COYNE ELECTRICAL SCHOOL
500 So. Paulina St.
Chicago, Illinois

All rights reserved. This book, or any parts thereof may not be reproduced in any form without written permission of the Publishers.

Printed in United States of America

FOREWORD

ELECTRICITY is the greatest force known to mankind.

ELECTRICITY is leaping ahead at an unbelievable rate. It is moving into practically every part of the world and has become **the most important factor in modern civilization**. Practically every month the Kilowatt hour demand sets a new high—it has been doing this for the past 25 years. **ELECTRICITY**, even though it is one of America's youngest industries, already employs directly and indirectly over 3 million people.

All of our marvelous developments in Radio, Television, Electronics, Radar, etc., employ **electrical power** and the principles of **Electricity**. It is truly **one of the world's greatest industries**.

Because of the tremendous opportunity in the field of **Electricity**, there have been many books written on the subject. Most treat with **one** specific phase of **Electricity**. This set of books—Coyne Practical Applied Electricity (of which this volume you now read is an integral part)—covers the entire field.

This set is **NEW**. It includes the very latest methods and explanations of Electrical installation, operation and maintenance.

COYNE PRACTICAL APPLIED ELECTRICITY WRITTEN BY A STAFF OF EXPERTS

Most Electrical publications are written by **one man** and can therefore **only** cover **his** own specific knowledge of a subject. **COYNE PRACTICAL APPLIED ELECTRICITY**, however, represents

FOREWORD

the combined efforts of the entire Coyne Electrical School Teaching Staff and the assistance of other authorities on the subject. These men have a wide field and teaching experience and practical knowledge in electricity and its allied branches.

HOW THIS SET WAS DEVELOPED.

In submitting any material for these books these experts kept two things in mind—1. MAKE IT SIMPLE ENOUGH FOR THE “BEGINNER”—2. MAKE IT COMPLETE, PRACTICAL and VALUABLE FOR THE “OLD TIMER”. All material that was submitted for these books by any individual was then rewritten by an editorial group so that added explanations for the benefit of clarity and easier understanding could be included.

Coyne Practical Applied Electricity can pay you big dividends every day “on the job”. However, if you only use the set occasionally when you **MUST BE SURE** before going ahead on a job—the set will pay for itself many times over.

Coyne Practical Applied Electricity is to an electrician what a set of complete law books is to a lawyer or a set of medical books is to a doctor. Regardless of whether a lawyer or a doctor is “just starting out” or is an “old timer” and has been practicing his profession for many years he has many occasions to refer to his reference books. Many doctors and lawyers spend thousands of dollars on complete sets of reference books—they find it a very wise investment.

In **ELECTRICITY** the need for good reference books is just as great. So, when you make a purchase of this set you are not just buying a set of books—you are making an investment in your future that can pay dividends all your life.



PRESIDENT
COYNE ELECTRICAL SCHOOL

CONTENTS

A. C. Circuits—Inductance	1 - 58
sine curves—generation of alternating current— voltage—cycle frequency—effective & maximum values & polyphase currents—questions—counter voltage—reactance—formulas—resistance.	
Power Factor — Power Measurement	59 - 86
formula — lagging — measurement — field prob- lems — questions.	
Generators & Alternators	87 - 134
field alternators—vertical & turbine types—field excitation—cooling—rheostats—control & ad- justment—synchronizing — phasing out — ques- tions.	
Transformers	135 - 256
designing — windings — types — construction — cooling methods — principles — power output — polarity—testing—paralleling—tap changing— voltage regulators—instrument transformers— maintenance—field problems—questions.	
A. C. Motors	257 - 378
types—voltage ratings & speeds—characteristics torque—efficiency & power factor—current rat- ings—applications—excitation—hunting—BTA variable speed motors—farm types—questions.	
Rectifiers & Converters	379 - 450
types—construction—maintenance—experiments —starting—operation—exciter anodes—field con- nections—correcting polarity—overspeed devices —questions.	
Controllers—Compensators & Auto Transformer Starters	451 - 512
overload time relay devices—across the line starters—thermal magnetic relays—counter volt- age starters — operation — circuits — protective features—remote controlled starters—time ele- ment devices—deion arc quencher—speed con- trol—installation—maintenance—questions.	
Generating Stations — Power Transmission	513 - 580
selecting a location—prime movers—boilers— pressures—condensers—steam cycle—turbines— hydro electric plants—water wheels—auxiliary equipment—underground lines—cable handling & splicing—conductors—insulators—questions.	
Substations & Switchboards	581 - 650
types—equipment—switchgear—layouts — wiring —operation—circuit breakers—oil switches—air break switches — high tension fuses — relays — questions.	
Installation & Maintenance	651 - 732
conduit & conductors — generators — motors — transformers — inspection schedule — records — tools & instruments—safety precautions—bear- ings stator troubles—overload & single phasing —tests with megger—questions.	

ACKNOWLEDGMENTS

We wish to acknowledge and express our appreciation for the assistance and co-operation given by the following companies, in supplying data and illustrations for the preparation of this Electrical Set.

GENERAL ELECTRIC COMPANY
WESTINGHOUSE ELECTRIC & MFG. CO.
ALLIS CHALMERS MFG. CO.
POWER PLANT ENGINEERING JOURNAL
AMERICAN BROWN BOVERI CO.
CUTLER HAMMER, INC.
PHILADELPHIA ELECTRIC CO.
EDISON STORAGE BATTERY CO.
PHILADELPHIA BATTERY CO.
WALTER BATES STEEL CORP.
FAIRBANKS MORSE CO.
HOSKINS MFG. CO.
ALLEN-BRADLEY CO.
DELTA STAR MFG. CO.
NATIONAL CARBON CO.
CENTRAL SCIENTIFIC CO.
OHIO BRASS CO.
GRAYBAR ELECTRIC CO.
WELSH SCIENTIFIC CO.
CENTRAL SCIENTIFIC CO.

You will note that in some places in this Set we have explained and shown illustrations of some of the earlier types of Electrical equipment.

WE HAVE A DEFINITE REASON FOR DOING THIS, namely, many of the earlier units are much easier to understand. An important point to keep in mind is that the BASIC PRINCIPLES of these earlier machines are the same as those of the modern equipment of today.

Modern equipment has not materially changed in principle—IT IS MERELY REFINED AND MODERNIZED. It is from the earlier basic theories and simple beginnings that the complicated mechanisms of today have been developed. IT IS TO THESE EARLY BEGINNINGS WE MUST OFTEN TURN IN ORDER TO GET A FULL UNDERSTANDING OF THE PRESENT ADVANCED TYPES OF EQUIPMENT.

In the early days many of the parts and mechanism of Electrical equipment were visible whereas today much of it is not. However, the PRINCIPLES OF THE EARLY EQUIPMENT ARE SIMILAR TO THOSE OF MODERN ELECTRICAL APPARATUS.

SO IN VARIOUS PLACES IN THIS SET, WE SHOW YOU SOME OF THIS EARLIER EQUIPMENT BECAUSE ITS CONSTRUCTION IS SIMPLER AND EASIER TO UNDERSTAND AS YOU STUDY THE MODERN EQUIPMENT. THEN FROM THESE EARLIER TYPES OF EQUIPMENT WE CARRY YOU ON TO THE VERY LATEST DEVELOPMENTS IN THE FIELD.

HOW TO USE THIS SET OF BOOKS

Coyne Practical Applied Electricity will be of use and value to you in exact proportion to the time and energy you spend in studying and using it.

A Reference Set of this kind is used in two distinct ways.

FIRST, it is used by the fellow who wishes to make Electricity his future work and uses this Reference Set as a home training course.

SECOND, it is especially valuable to the man who wishes to use it strictly as a Reference Set. This includes electricians, mechanics or anyone working at any trade who wishes to have a set of books so that he can refer to them for information in Electrical problems at any time.

You, of course, know into which group you fall and this article will outline how to properly use this Set to get the most value for your own personal benefit.

How To Use This Set As A Home Training Course In Electricity

The most important advice I can give the fellow who wishes to study our set as a home training course in Electricity is to start from the beginning in Volume 1, and continue in order through the other 6 volumes. Don't make the mistake of jumping from one subject to another or taking a portion of one volume and then reverting back to another. Study the set as it has been written and you'll get the most out of it.

Volume 1 is one of the most important of the entire Set. Every good course of training must have a good foundation. Our first volume is the foundation of our course and is designed to explain in simple language terms and expressions, laws and

How To Use This Set of Books

rules of Electricity, upon which any of the big installations, maintenance and service jobs are based. So, become thoroughly familiar with the subjects covered in the first volume and you will be able to master each additional subject as you proceed.

One of the improvements we made in this set was to add "review" questions throughout the books. You will find these questions in most cases at the end of a chapter. They are provided so "beginners" or "old timers" can check their progress and knowledge of particular subjects. Our main purpose in including the "review" questions is to provide the reader with a "yardstick" by which he can check his knowledge of each subject. This feature is a decided improvement in home study material.

Above all, do not rush through any part of these books in order to cover a large amount at one time. You should read them slowly and understand each subject before proceeding to the next and in this way you will gain a thorough understanding as you read and think it out.

For the special benefit of the fellow desiring to learn Electricity at home, we have prepared a great number of diagrams and illustrations. Refer to these pictures and diagrams in our books regularly.

How To Use Coyne Practical Applied Electricity Strictly As A Reference Set

The man who is interested in using these books mainly for reference purposes will use it in a little different way than the fellow who is trying to learn Electricity as a trade. Some of the types of fellows who use this set strictly for reference purposes are: home owners, electricians or mechanics, garage owners or workers, hardware store owners, farmers or anyone who has an occasional use for electrical knowledge. Those types of fellows should use this set in the following manner.

If some particular type of electrical problem presents itself, refer immediately to the Index—it will give you the section in which the subject is covered.

How To Use This Set of Books

Then, turn to that section and carefully read the instructions outlined. Also read any other sections of the set mentioned in the article. As an example, in checking over some information on electric motors, some reference might be made to an electrical law of principles contained in Volume 1 of the Set. In order to thoroughly understand the procedure to follow in working out the electrical problem, you should refer to Volume 1 and get a better understanding of the electrical law on principles involved.

Use The Master Index To Locate Electrical Subjects

Thousands of men use this Set in their daily problems, both on the job and around the home as well. If you follow the instructions outlined you will be able to locate any information you may want at any time on your own electrical problems.

And here's a very important point. Although this set of books starts in Volume 1 and proceeds through the other 6 volumes in order, it makes an ideal home study course—nevertheless, **any individual book in the series is independent of the others and can be studied separately.** As an example, Volume 3 covers D.C. motors and equipment. If a man wanted to get some information on D.C. machines **only** he could find it **completely covered in this volume** and it would not be essential to refer to any other volume of the set unless he wanted some additional information on some other electrical principle that would have a bearing on his problem.

This feature is especially beneficial to the "old timer" who plans to use the set mainly for field reference purposes.

We believe, however, that the entire set of 7 volumes should be read completely by both the "beginner" or the expert. In this way you get the greatest benefit from the set. In doing so the experienced Electrician will be able to get very valuable information on subjects that he may have thought he was familiar with, but in reality he was not thoroughly posted on a particular subject.

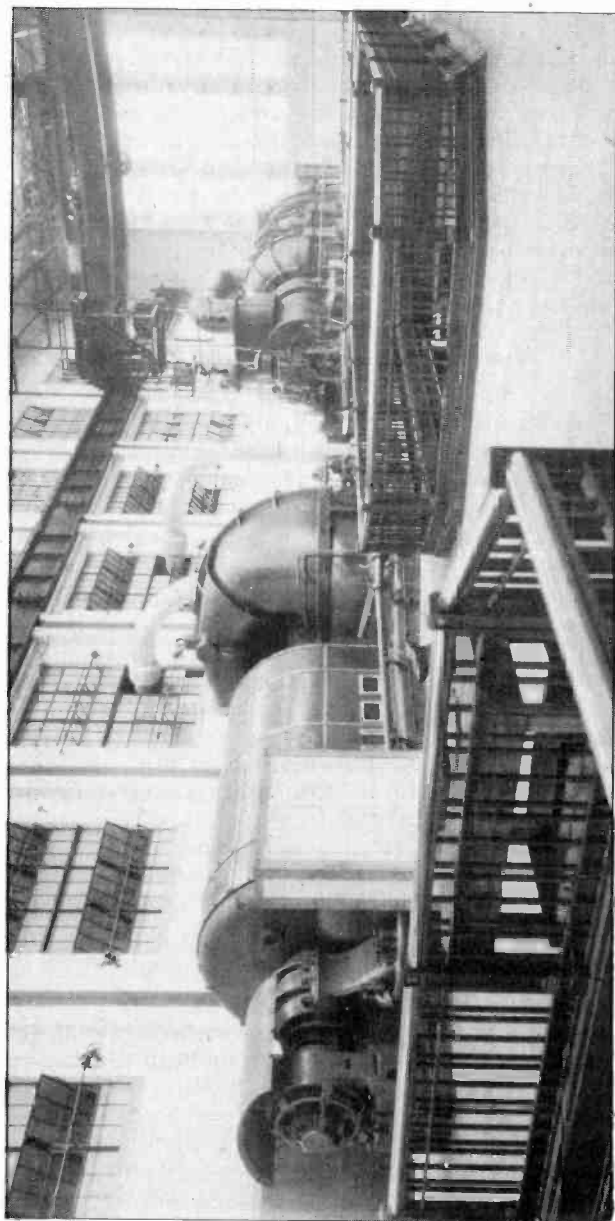

This view shows a large Turbine Room of a middle western generating station.

ALTERNATING CURRENT

Alternating current electricity provides one of the greatest fields of opportunity and one of the most fascinating branches of work and study in the entire electrical industry today.

In the last few years, alternating current and A.C. machines have come into such extensive use in nearly all industries that no electrical man can afford to be without a knowledge of this very interesting form of energy and equipment.

One of the greatest advantages of alternating current is that it can be much more economically transmitted over longer distances than direct current. This is due to the fact that the voltage of alternating current energy can easily be stepped up to very high values by means of transformers.

The economical high-voltage transmission of alternating current makes it possible to generate this form of energy more cheaply in large and efficient central generating stations or power plants, and then transmit it to towns and factories at considerable distances.

High tension transmission lines also make possible the use of water power produced in large hydro-electric plants which are often a long distance from the towns and places where the electrical energy is used.

Thousands of miles of high-voltage transmission lines, operating at voltages from 66,000 to 220,000, tie together the great steam and hydro generating stations in vast super-power networks throughout this country. These lines carry hundreds of thousands of horse-power of clean, silent, and efficient electric energy to turn the wheels in our great factories, to light our homes and city streets; and to operate electric railroads, etc.

Interconnection of huge power generating plants and centers by high voltage A.C. lines makes possible great economies of operation and increases the dependability of electric supply. It tends to balance or equalize the varying loads of the different towns,

Alternating Current

communities, and factories, into a more uniform average load on all of the interconnected generating plants; and thereby reduces the number of spare generators that must be carried in any of the plants for peak loads. Connecting a great number of power plants together also makes it possible for one generator, plant, or line to be shut down for repairs without interrupting the electric supply to the users, as the full load can be carried temporarily by the other plants on the system.

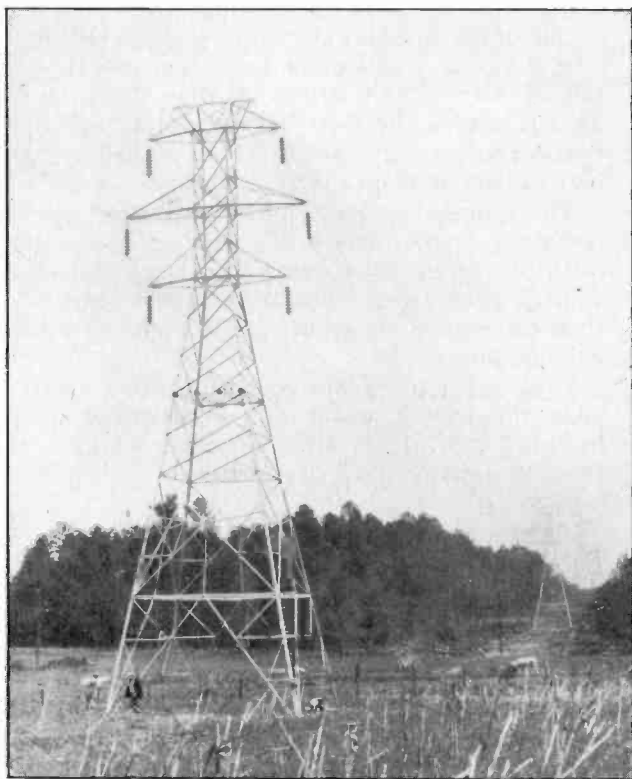

Fig. 1. This photo shows a high voltage power line of the type which carry thousands of h. p. of electrical energy throughout the country.

For these reasons, alternating current transmission lines have been developed with tremendous rapidity so that at present their voltages run as

Alternating Current

high as 290,000, and new power lines are constantly being installed in a great network throughout the entire country. Engineering tests and experiments are now being carried on toward the development of still higher voltage transmission lines.

Even with our present super-power lines it is possible to economically transmit many thousands of horse power over distances of several hundred miles.

Great generating plants in Chicago have supplied power to the city of Pittsburg, and have for a short test period supplied power to light the streets of Boston. Chicago has some of the largest generating plants in the world, and these plants are connected with others in a vast system with transmission lines reaching to the eastern and southern coasts of the U. S., and long distances north and west.

Great steam generating plants producing from 100,000 kw. to 500,00 kw. each feed the alternating current to the transmission lines; and new power plants are constantly being built to supply the ever-increasing demand for electric power.

It is almost impossible to comprehend the tremendous rate at which alternating-current electrical equipment has been developed, and the present rate of expansion of this great industry.

In 1889 an A.C. generating unit of 400 kw. capacity was put into operation, and was thought to be a very large unit at that time. The size of A.C. generators kept increasing until, in 1917, units of 45,000 kw. were in use, and a unit now operating in one of Chicago's large power plants is of 208,000 kw. capacity.

Hydro-electric plants have also developed rapidly. In 1890 only a few thousand h.p. were produced at Niagara Falls, but now its electrical output has been increased to over one million h. p.

A new hydro plant of the Philadelphia Electric Company, at Conowingo, Maryland, produces nearly

Alternating Current

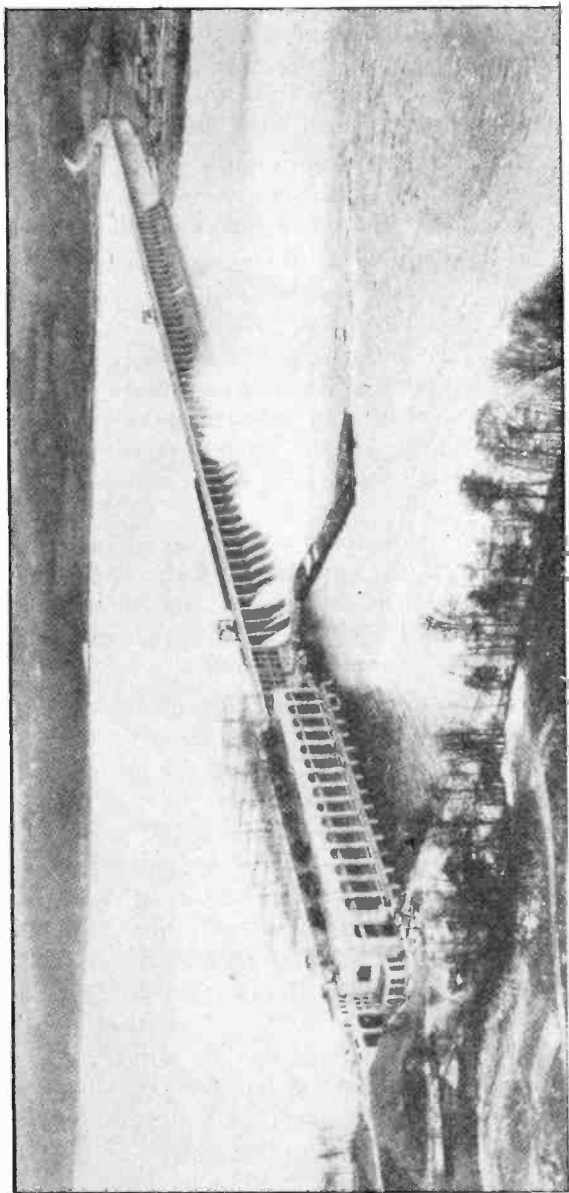

Fig. 3. Enormous hydro-electric generating stations also produce many millions of h. p. to supply the extensive needs for electrical energy. This hydro plant is at Conowingo, Md., and is one of the largest in this country. It produces several hundred thousand h. p. (Photo courtesy Philadelphia Electric Co.)

Alternating Current

one-half million h. p. of electric energy; and there are hundreds of other water-power plants which generate from 10,000 to 100,000 h. p. and more each. Fig. 3 shows a photo of the great dam and power house

The operating of all these steam and hydro-electric power plants provides steady jobs at good pay and clean, fascinating work, for many thousands of trained electrical men. The construction of new plants and power lines, and the inspection and maintenance of existing lines, employs thousands more.

Then there is the manufacture, installation, and maintenance of the vast number of A. C. electrical machines and devices that use the millions of h. p. generated by all these power plants.

Electrical manufacturers have produced approximately $2\frac{1}{2}$ billion dollars worth of electrical equipment in a single year. Try to imagine, if you can, the additional number of men required each year to produce, install, operate, and maintain that equipment.

Approximately 80% of all the money invested in the electrical industry in the U. S. is invested in sixty-cycle, A. C. equipment; and about 90% of all the electric power generated is A. C. So you can readily see the value of a good knowledge of this branch of electricity.

Manufacturing and industrial plants in this country are over 80% electrified at present. The machines in these plants are largely driven by A. C. motors, because of their practically constant speed, rugged construction, and low maintenance costs. Fig. 4 shows a typical example of A. C. motors used for individual drive of machines in a textile mill.

The most common type of A. C. motors have no commutators or brushes, which greatly reduces their wearing parts and the amount of care they require.

Special types of A. C. motors with high starting torque have been developed for certain uses for

Alternating Current

which D. C. motors were formerly considered necessary, and now there are A. C. motors available for practically every need.

Alternating-current synchronous motors are ideal for operating equipment where absolutely constant speed is required.

In addition to the hundreds of thousands of h. p. used in A. C. motors, factories also use alternating current very extensively for spot welding and butt welding machines, enameling ovens, heat-treating furnaces, and other processes, as well as for lighting.

Sixty-cycle alternating current is very suitable for lighting with incandescent lamps, as the periods of zero voltage between the alternations are so very short that they do not allow time for any noticeable dimming of the light from the lamp filaments. So wherever alternating current is used for power purposes it is also used for lighting; and in homes, offices, and stores alternating current is by far the most generally used for lighting.

Some very important branches of the electrical industry actually depend upon alternating current for their existence. Radio is one of these, and as the energy used in radio transmission is high-frequency A. C., the study of alternating current principles is very essential to anyone who plans to follow radio work.

The increase in the use of alternating current in the last few years and the thousands of uses which have been developed for it so far, make it almost impossible to over-estimate the extent to which A. C. will undoubtedly be used in the near future.

The high rate of development and expansion in this field requires many additional trained men yearly. There are thousands of electricians in the field today who have followed D. C. work almost exclusively and know almost nothing about the principles of alternating current and A. C. machines.

Alternating Current

Therefore, this branch offers the finest of opportunities to trained practical men who have a good knowledge of alternating current.

And let us emphasize again that, in addition to

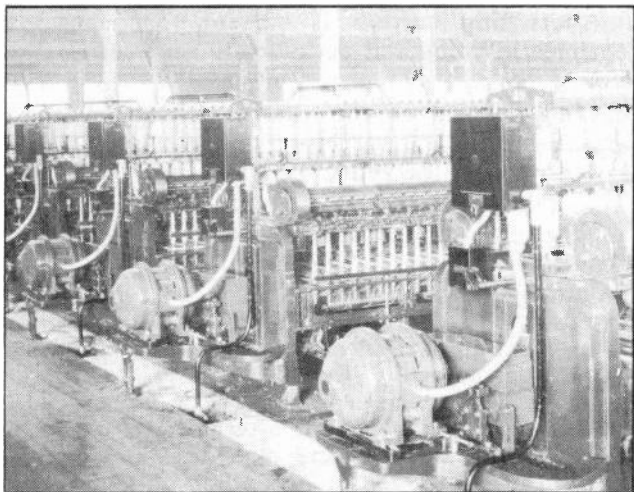

Fig. 4. This view shows a number of A. C. motors being used for individual drive on machines in a textile mill. Thousand of factories and industrial plants use electric motors in this manner for driving their various machines and equipment. (Photo courtesy G. E. Company)

being a very valuable subject to know, alternating current electricity is one of the most fascinating and interesting subjects any ambitious student can ever hope to find.

Alternating current differs from direct current in many ways, but practically all the principles of electricity which you have learned so far can, with a few modifications, be easily applied to A. C.

Alternating current is often thought to be a difficult subject to master. It does not need to be at all, when properly explained in a practical manner.

In the following pages the principles of alternating current and the operation and care of A. C. machines will be covered in a simple non-technical manner, for the needs of the practical man.

Nature of A. C.

Study these pages carefully for the sake of your future earning capacity, and to qualify yourself for some of the splendid opportunities in this field.

1. NATURE OF ALTERNATING CURRENT

Alternating current is current that constantly changes in value and periodically reverses in direction.

This reversal of the current is caused by the armature conductors passing first a north and then a south pole in the generator.

You have learned that A. C. is induced in the conductors of any ordinary generator armature, and that to obtain D. C. we must rectify the current from a generator armature by means of a commutator.

Alternating current can be made to produce heat, light, and magnetic effects just as D. C. can. The principal difference in the magnetic fields of A. C. and D. C. circuits is that alternating current produces a constantly varying flux, the lines of which are always in motion or expanding and contracting around the conductor. The alternating or moving magnetic field of alternating current is what makes possible the operation of transformers, to step the voltage up or down as desired.

2. INDUCTANCE AND CAPACITY IN A. C. CIRCUITS

The moving A. C. flux also sets up in any A. C. circuit, **self-induction** due to **inductance**. This inductance and also a condenser effect, or **capacity**, which is caused by the constantly varying voltage of A. C. circuits, are the two principal differences between A. C. and D. C. circuits.

We have learned that the important factors in any direct-current circuit are **pressure, current, and resistance**. We have the same three factors to consider in any A. C. circuit and also the two additional factors—**inductance and capacity**.

Ohms law applies also to A. C. circuits, with a slight modification to include the inductive and

Alternating Current

capacity effects on the current, as well as the effects of resistance.

Many of the most important advantages of A. C. and many of the greatest achievements in the electrical industry are based on these two additional factors in A. C. circuits—namely, **inductance** and **capacity**. They will both be thoroughly explained a little later.

3. GENERATION OF ALTERNATING VOLTAGE

The development or generation of alternating-current voltage is shown in Fig. 6. At the left of this figure is a sketch of a simple two-pole generator in which the progress of the conductor throughout one revolution is shown in eight steps of 45° each. The successive values of voltage which will be induced in this conductor are plotted or projected along a horizontal base-line at the right side of the figure.

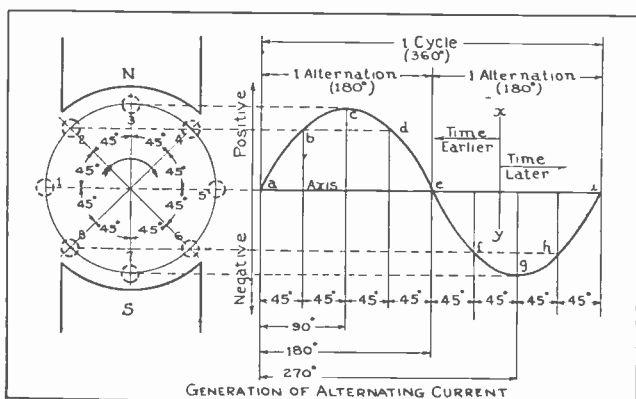

Fig. 6. The above diagram illustrates the manner in which alternating voltage is produced in a simple two-pole generator. The sine curve shows the variations and reversal of voltage for one revolution of the armature. Study this diagram very carefully with the accompanying explanation.

The values above the line are positive voltage values and those below the line are negative. Electrical degrees and time are also plotted along this axis line. The electrical degrees are represented

Generation of A. C.

by spaces of uniform length and drawn to scale, for example $\frac{1}{4}$ -inch for each 45 degrees, or $\frac{1}{2}$ -inch for each 90 degrees, etc.

Other spacing values can be used to suit the size of the drawing desired.

Time "later" is indicated in a right-hand direction and time "earlier" in a left-hand direction. To illustrate this, a vertical line "X Y" is drawn through the axis; and all values on the right-hand side of this vertical line are later in time, while all values on the left are considered to be earlier in time with respect to this point.

While the conductor shown at No. 1 is moving in the neutral plane of the magnetic field it will have no voltage induced in it. Therefore, the voltage value at this point will be as shown at "a" on the axis line. The axis line always represents zero voltage value.

As the conductor moves around the armature 45 degrees in a clockwise direction it comes to position 2, where it is beginning to cut into the field flux of the N pole, and at a more and more abrupt angle. At this point the voltage value will be as shown at "B", or the point where the dotted line running to the right from conductor 2 intersects the vertical line which is just 45 degrees later than the one at "a".

When the conductor moves another step, or 45 degrees, farther to position 3, it will then be cutting at right angles to the dense flux of the N pole, and will produce a voltage value as shown at "c", where the dotted line from the conductor intersects the time line, which is now 90 degrees later than the one at "a".

When the conductor moves to position 4 it is beginning to leave the flux from the N pole and its induced voltage will be somewhat lower, as shown at "d". As the conductor moves on to position 5 it is again passing through the neutral plane or at a point where it doesn't cut any appreciable amount of flux, and its voltage will again be at zero value, as shown at "e".

Alternating Current

The voltage values which this conductor will produce in passing from position 5 back to 1 will be the same as those from 1 to 5, except that the voltage will be in the reverse direction, as the conductor is now cutting in the opposite direction through the flux of the S pole. These negative values are represented at the points, f, g, h, and i, or below the axis lines.

The armature conductor has now passed through a complete set of positive and negative values and through one complete revolution or 360 electrical degrees.

4. SINE CURVES; ALTERATION, CYCLE, FREQUENCY

If we connect the points a, b, c, d, e, f, g, h, and i all together with a curved line, that line will form what is known as a **sine curve**. This curve gives us a clear mental picture of the manner in which the voltage varies in amount and reverses in direction in an alternating-current circuit.

The values from "a" to "e" are all positive and constitute 180 E° (electrical degrees) or one **alternation**. The values from "e" to "i" form the negative alternation. These two successive alternations, one positive and one negative, complete one **cycle**.

If we were to go on revolving the conductor rapidly it would produce one cycle after another of alternating current, provided the coil were connected to a closed circuit. The number of these cycles which occur in each second of time is called the **frequency** of an alternating current circuit, and is expressed in cycles per second. Nearly all A.C. systems in this country today use 60-cycle frequency.

Examine the diagram in Fig. 6 very carefully, until you are sure you know the number of electrical degrees in one alternation and in one cycle.

A conductor in a generator must always pass one pair of poles, or one north and one south pole, to complete a cycle. Therefore, the greater the number of poles in a generator the greater will be the number of cycles it will produce per revolution. The

Sine Curves

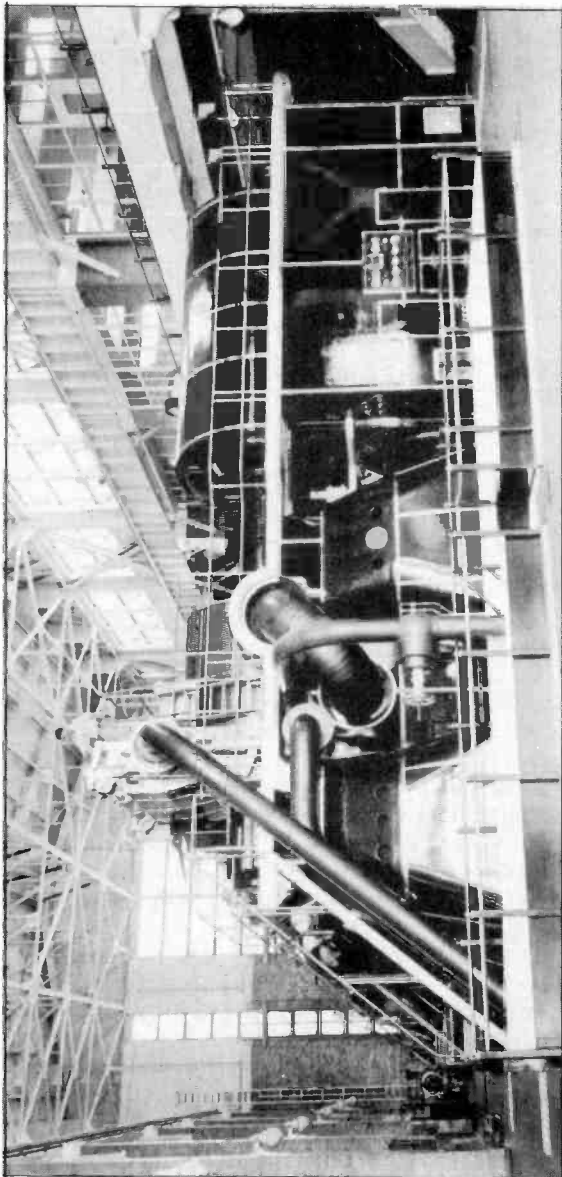

Fig. 7A. Third G-E Vertical-Compound Steam Turbine Generator Set, 110,000 kw, having hydrogen-cooled generators.

Alternating Current

frequency of any A.C. generator can always be determined by the following simple formula:

$$f = \frac{\text{RPM}}{60} \times N$$

In which:

f = frequency in cycles per second

RPM = revolutions per minute of generator

60 = no. of seconds per min.

N = no. of pairs of poles in generator.

5. FLOW OF ALTERNATING CURRENT

If an alternating voltage such as shown in Fig. 6 is applied to a closed circuit, alternating current will flow. The current will, of course, vary in amount and reverse in direction, just as the voltage does. These alternations or impulses of current can be shown by a curve similar to the one for voltage in Fig. 6. Current first starts to flow around the circuit in one direction, and continues in this direction during one alternation, or 180° . In a 60-cycle circuit this would be for $1/120$ part of a second.

During this period the current value or intensity keeps gradually increasing up to maximum during the first 90° , or one-half alternation. Then it starts to decrease in amount, but continues in the same direction for another 90° , or the last half of the alternation.

When the current in this direction has fallen to zero value, it then reverses and flows in the other direction for one alternation or $1/120$ part of a second, again rising and falling in value or amount.

6. MAXIMUM AND EFFECTIVE VALUES OF ALTERNATING CURRENT

Fig. 8-A shows a curve for one complete cycle of single-phase alternating voltage, and Fig. 8-B shows a curve for the current that we will assume is caused to flow by that same voltage cycle.

These curves show **maximum values** of one volt and one ampere for this circuit. You will note that

Sine Curves

these maximum values last for only a very short period during each alternation. So, if we were going to determine the heating effect or power that would be continuously produced by such an A.C. circuit with one volt maximum pressure and one ampere maximum current, we could not expect as great a result as from a D.C. circuit with one volt continuous pressure and one ampere continuous current.

By actual test we find the heat produced by the A.C. current is about 70%, or to be more exact .707

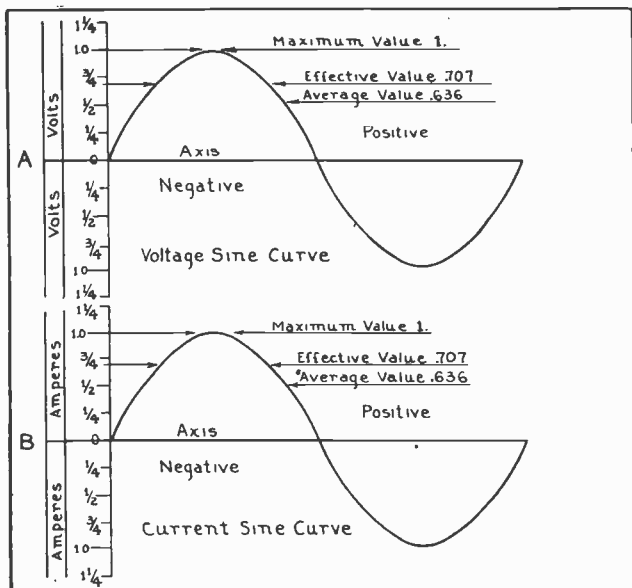

Fig. 8. These sketches show the maximum, effective, and average values of alternating voltage and current.

of that produced by the D.C. current when both currents have equal maximum values.

We therefore say that the **effective voltage** and **current values** of an A.C. circuit are .707 of the maximum values. It is this effective value that we consider in ordinary work and calculations with A.C. circuits. Ordinary A.C. voltmeters and ammeters are calibrated to read the effective values and not the maximum values.

Alternating Current

Therefore, if an A.C. circuit has meter readings of 100 volts and 100 amperes, we know these to be the effective values; and this circuit would produce just as much heating effect as a D.C. circuit of 100 volts and 100 amperes.

Compare carefully the effective and maximum values shown in Fig. 8. You will note that the effective value is nearly three-quarters of maximum value.

If an A.C. circuit has a maximum voltage value of 100 volts, the effective value would be $.707 \times 100$, or 70.7 volts.

7. CALCULATION OF EFFECTIVE AND MAXIMUM VALUES

The effective values of an A.C. voltage or current curve for any alternation, can be calculated by what is called the **root mean square (R.M.S.)** method.

This calculation is made by getting the instantaneous values of the curve at points one degree apart and squaring all these values. Next all these squares are added together and averaged, by dividing the sum by the number of squares. Then, taking the square root of this average, we would have the root mean square; or, in other words, the square root of the average square of the separate values.

This method of squaring the curve values and then getting the square root to obtain the effective value, is used because the **heating effect of any A. C. circuit is proportional to the square of current at any instant.**

The process just described may seem somewhat technical, but with a little reviewing you will find that the principle is quite simple.

You may not have occasion or need to use the R.M.S. method in any calculation in your ordinary electrical work for some time; but it may be very handy for some future reference, so it is given here for your convenience at any later time. It is also given as a matter of interest, so you may know

Waves

how the effective value is obtained and where the figure .707 comes from.

Remember that an A. C. circuit will perform just as much work per volt and per ampere as a D. C. circuit, because ordinary A. C. meters read the effective values only, and these are the values commonly considered in A. C. work.

One of the most important points to be considered, however, is that to produce a given effective voltage in an A. C. circuit, the maximum voltage for its short periods during each alternation will be considerably higher than the effective voltage registered by the meter. This places a higher voltage strain on the insulation of an A. C. circuit of a given effective voltage value, than on a D. C. circuit of the same voltage.

When either the maximum or effective value of an A. C. circuit is known, the other can be found by one of the following formulas:

$$\text{Effective value} = \text{Max. value} \times .707$$

$$\text{Maximum value} = \text{Eff. value} \div .707$$

It is often easier to multiply by the reciprocal of a number than to divide by the number itself, and the same result can be obtained by either method. You will recall that the reciprocal of a number is equal to 1 divided by the number. So, in the case of the effective value .707, its reciprocal is

equal to $\frac{1}{.707}$ or 1.414.

Accordingly, the above formula for finding maximum value can be changed to read:

$$\text{Max. value} = \text{eff. value} \times 1.414$$

The use of this formula is illustrated by the following example.

If we have a motor which is being rewound to operate on a 2200-volt circuit, what would be the maximum voltage stress on its insulation?

If the effective value is 2200 volts, then:

$$\text{Max. value} = 2200 \times 1.414, \text{ or } 3110.8 \text{ volts.}$$

This would be the maximum voltage impressed on the insulation of the motor winding and, al-

Alternating Current

lowing enough extra for safety factor to prevent possibility of puncture of the insulation, it would probably be insulated for 5000 volts or over.

8. AVERAGE VALUE OF ALTERNATING CURRENT

By referring again to Fig. 8, you will note that an **average value** of the curves is also shown. The average value is .636 of the maximum value. This figure is used in a few electrical calculations and in the design of electrical machines, but not a great deal in ordinary electrical work.

Because of the shape of the sine curves for alternating current and the fact that the heating effect is proportional to the square of the current values, the effective value is actually a little higher than the average value, as shown in Fig. 8.

The voltage alternations produced by an actual power generator would not be quite as smooth or perfect in shape as the curves shown in these figures. Instead they would have little irregularities or ripples in them; but as they follow the same general shape, all ordinary circuit calculations for A. C. are based on the true sine curves as shown.

9. SINGLE-PHASE AND POLYPHASE CURRENTS

You have already learned that A. C. circuits are of **single-phase**, **two-phase**, and **three-phase** types; and in the lessons on A. C. armature winding the method of generating single-phase and polyphase currents was explained. If you find it necessary to refresh your memory on these points, review Armature winding lesson No. 29.

You will recall that the term "phase" refers to the number of separate individual voltages set up in an A. C. circuit or the number of separate sets of alternations in the circuit.

Fig. 9 shows three sets of curves for single-phase, two-phase, and three-phase circuits. The single-phase curve at "A" has successive alternations of 180° each. The two-phase circuits have two sets of alternations occurring 90° apart; that is, they start, reach their maximum values, and finish always

Sine Waves

90° apart. Three-phase circuits have three sets of alternations, 120° apart, as shown at "C" in the figure.

You will recall that these alternations are generated with the various spacings in degrees, by spacing the armature conductors the same number of electrical degrees in the generators.

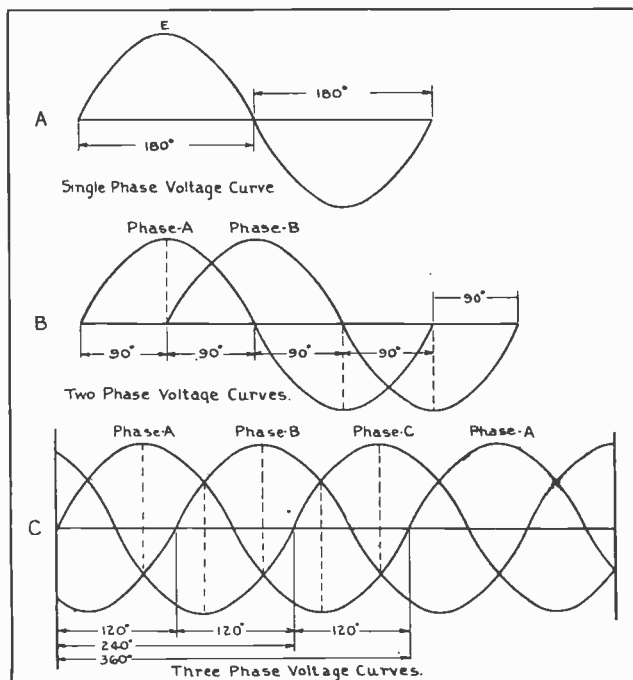

Fig. 9. The above diagram shows the sine curves for single-phase, two-phase, and three-phase alternating voltages.

Each alternation of any single-phase or polyphase circuit consists of 180° , and each cycle consists of 360° . Keep in mind also that the poles in an alternator are always spaced 180° electrical degrees apart, and that a pair of poles constitutes 360 electrical degrees.

Six-phase energy is also used in some cases, for converters and rectifiers. Fig. 10 shows a set of curves for six-phase energy. Two-phase circuits are still used to some extent in older installations. Single-phase and three-phase systems are by far the

Alternating Current

most commonly used. Single-phase systems are used extensively for incandescent lighting and small power motors, and three-phase systems are used almost exclusively for large motors, general power work, and transmission lines.

10. PHASE RELATIONS OF VOLTAGE AND CURRENT

The voltage and current of an A.C. circuit can both be shown in the same diagram by separate sets of curves drawn along the same zero or axis line, as shown in Fig. 11. This figure shows the curves for a three-phase circuit. The solid line represent the voltage impulses and the dotted lines represent the current impulses.

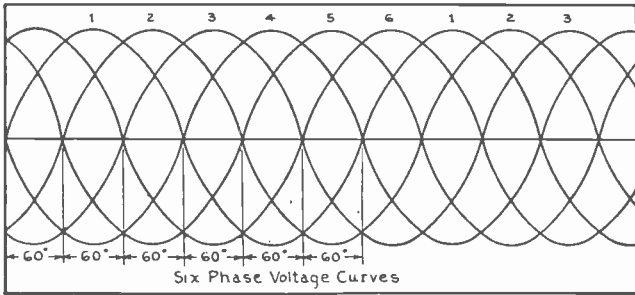

Fig. 10. This sketch shows the sine curves for the voltage of a six-phase A. C. circuit. Compare these sketches carefully with the ones in Fig. 9, and note the number of degrees spacing between each phase and the next.

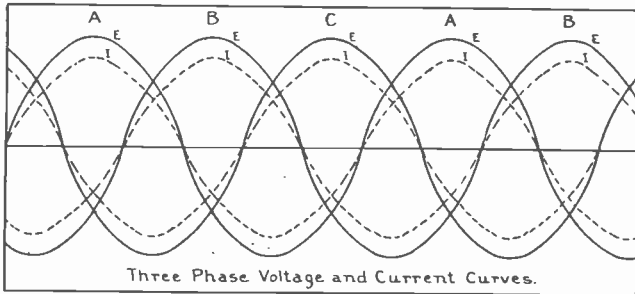

Fig. 11. Voltage and current curves of a three-phase circuit. The voltage is shown by the solid lines and the current by the dotted lines.

In this diagram the current value is shown to be slightly less than the voltage value by the lower

Sine Waves

height of the curves; but the current alternations are **in phase** or in step with the voltage alternations. In other words, the current and voltage alternations of each phase start together, reach their maximum values together, and finish together.

This seems to be the proper or natural condition, as you know that the current variations are caused by the variations in pressure or voltage; so it would seem quite natural that the two should be in step, or "in phase", as we say.

It is possible, however, to have the current impulses occur **out of phase** with the voltage impulses in A.C. circuits, due to the effects of inductance or capacity in these circuits.

The current may either lag or lead the voltage, according to whether the inductance or capacity is greatest in the circuit. These conditions will be fully explained a little later.

11. EFFECT OF LAGGING OR LEADING CURRENT ON POWER

When the current and voltage impulses are in phase with each other, or working together in the same direction, they will, of course, produce more useful power in watts when they are out of phase or working in opposite directions part of the time.

When current and voltage are in phase as shown in Fig. 12, the product of the voltage and current values at any instant will give the watts power at that instant.

The power curve in this diagram is shown by the heavy line, and is all above the axis line, representing useful power.

In Fig. 13 the voltage and current are slightly out of phase, and the current is lagging a few degrees behind the voltage. This causes short periods during each alternation when the voltage and current are in opposite directions, as shown between the lines "a" and "b". During this period there is no useful power in watts produced and the power curve is shown below the axis line, representing what is known as **wattless power**

This wattless power does not produce any useful

Alternating Current

power on the system, but merely produces additional heating of the conductors, and thereby limits

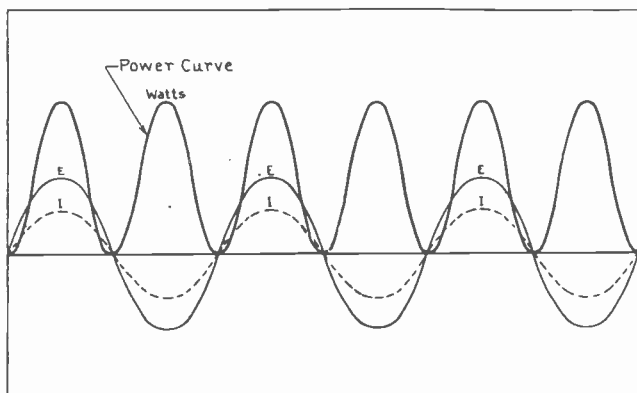

Fig. 12. This diagram shows the curves for the voltage, current, and power of single-phase A. C. circuit, in which the voltage and current are in phase with each other.

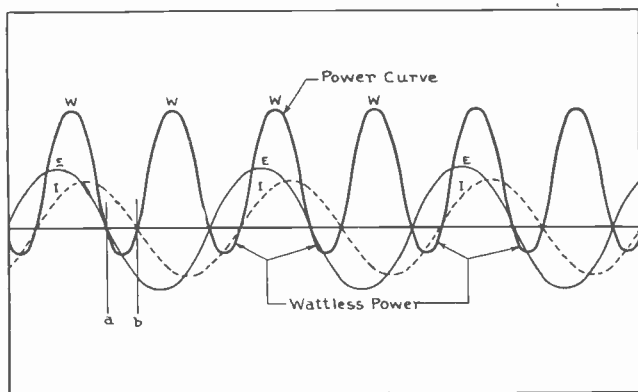

Fig. 13. Voltage, current, and power curves of a single-phase circuit in which the voltage and current are out of phase. The current, represented by the dotted curves, is shown lagging behind the voltage in this case.

the capacity of generators, motors, and lines in which this condition exists.

When multiplying the values of voltage and current curves to obtain the power in watts at any instant, the polarity of the curves must be carefully observed. When voltage and current curves are of

A. C. Circuits

the same direction or polarity, their product will all be positive or useful watts, and is shown by the power curve above the axis line. At points where the voltage and current curves are of opposite polarity, their product will give negative or wattless power, shown by the power curve below the axis line.

12. A.C. CIRCUITS

The practical man may often have occasion to make simple measurements and calculations with the voltage, current, and power of A.C. circuits, in his work in the field as an electrical construction man, power plant operator, or maintenance man.

These calculations can be made with A.C. circuits in very much the same manner that you have already learned for D.C. circuits; and just as easily, once you have a thorough knowledge of A.C. principles and the important factors which control the current and power in A.C. circuits.

It is sometimes difficult for a student to see how these calculations can be made with A.C., because of the manner in which the voltage and current are continuously and rapidly varying in value and reversing in direction. It is our purpose to simplify these points and avoid the unnecessary misunderstanding and difficulties which so frequently worry students and electricians who do not have a proper understanding of the simple fundamentals of alternating current.

An excellent fact to keep in mind at all times is that an **alternating current circuit can at any particular instant be compared to a D.C. circuit.**

As we usually work with the effective values of current and voltage in A.C. circuits and can always consider the circuit during a certain period of one alternation, or as the current is flowing in only one direction for the moment, this greatly simplifies tracing the flow of current in the circuit and making any calculations with the current or voltage.

Alternating Current

13. INDUCTIVE REACTANCE, CAPACITY REACTANCE, and IMPEDANCE

We have already mentioned that in A.C. circuits there are always two other factors besides resistance which control the current flow, and these are **inductance** and **capacity**.

The effects or opposition offered by inductance and capacity to the current and voltage of an A.C. circuit, are known as **inductive reactance** and **capacity reactance**.

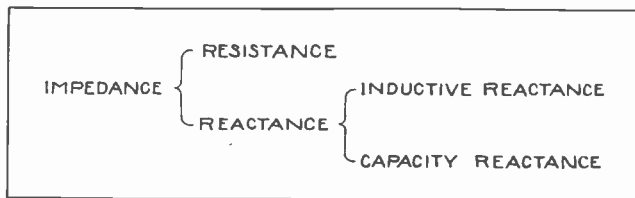

Fig. 14. This figure shows the several different factors which make up the impedance in an A. C. circuit.

If resistance, inductive reactance, and capacity reactance all tend to control the current flow in A.C. circuits, we should be able to sum these all up together to get the total controlling effect on the current and thus simplify our calculations and problems. That is exactly what we do.

The total opposition offered to the flow of current in an A.C. circuit, is called **impedance**. The impedance of an A.C. circuit therefore, compares with the resistance of a D.C. circuit.

The factors that make up the impedance can be illustrated in another way as shown in Fig. 14.

Impedance is here shown as being composed of the resistance and total reactance. The total reactance is then subdivided into its two classes, Inductive reactance and Capacity reactance.

The impedance and reactance of A.C. circuits are both measured in the unit ohm, to be comparable to the resistance in ohms.

The symbols used to indicate these very important factors of A.C. circuits are as follows:

A. C. Circuits

- Z = Total impedance in ohms
 X = Total reactance in ohms
 X_L = Inductive reactance in ohms
 X_c = Capacity reactance in ohms
 R = Resistance in ohms

14. OHMS LAW FOR A.C. CIRCUITS

Now that we know the factors that control the flow of current in A.C. circuits and also that they can all be grouped into impedance in ohms, it is easy to see how Ohms law can be applied to an A.C. circuit by simply substituting the ohms of total impedance for the ohms resistance used in D.C. Ohms law.

From Ohms law for D.C. circuits we learned that the current flow could be determined by dividing the voltage by the resistance in ohms. Then for **A.C. circuits, the current can be determined by dividing the effective voltage by the impedance in ohms.** Or,

$$I = \frac{E}{Z}$$

And from this we can obtain by transposition the other two very convenient formulas:

$$Z = \frac{E}{I}, \text{ and } E = I \times Z$$

As inductance and capacity are such important factors in A.C. circuits, and are the cause of inductive reactance and capacity reactance, it will be well to learn more about them. In addition to offering opposition to the current and voltage, inductance and capacity also cause the current to be out of phase with the voltage in most A.C. circuits.

Alternating Current

EXAMINATION QUESTIONS

1. Define alternating current.
2. In addition to current, pressure, and resistance, what two other factors are present in an A.C. circuit?
3. Define an alternation, a cycle.
4. Give the formula for use in determining the frequency of an A.C. generator.
5. Are ordinary A.C. voltmeters and ammeters calibrated to read effective or maximum values of an A.C. circuit?
6. What would be the maximum voltage value in an A.C. circuit where the effective value is 110 volts?
7. Draw a diagram showing three phase voltage curves.
8. When the current in an A.C. circuit is "in phase" with the voltage, does the maximum value of current occur at the same time as the maximum value of voltage?
9. When does Wattless power exist in an A.C. circuit?
10. Give the three Ohms Law formulas for use in A.C. circuits.

A. C. Circuits

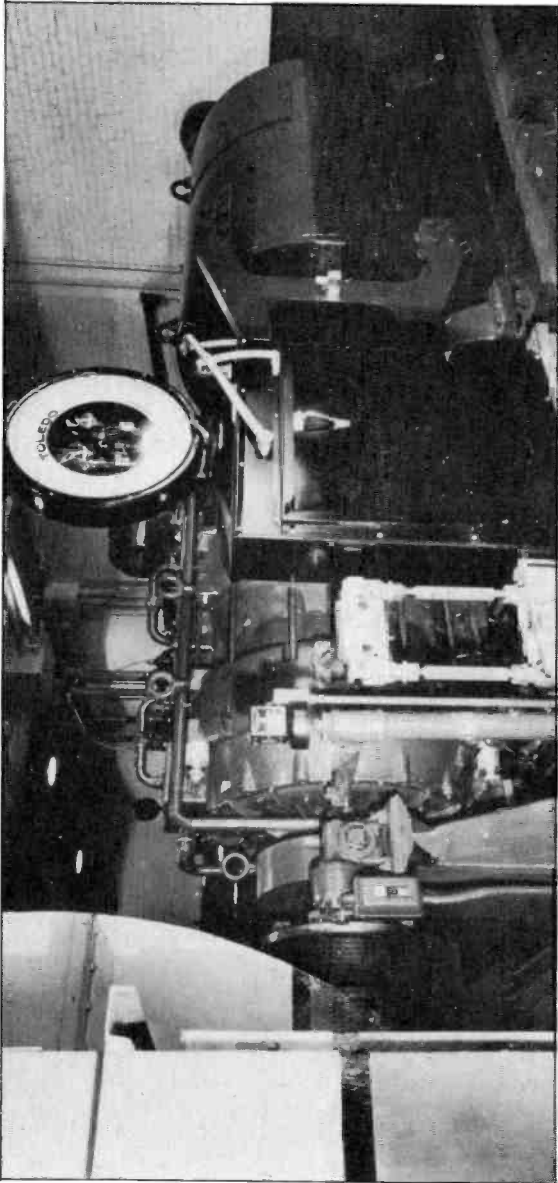

This Westinghouse dynamometer takes the measure of a high powered Pratt and Whitney air-cooled engine for fighting ships. The airplane engine is out of the picture, beyond the wall at the left. In the center is the eddy-current generator and at the right a 700-horsepower dynamometer. The outer frames of both can turn in bearings, motion being resisted by an arm resting on the scales, which indicates the engine torque.

Alternating Current

INDUCTANCE

Inductance is that property or ability which an electric circuit possesses for developing a counter electro-motive force within the circuit itself, by electro-magnetic induction.

The counter-E. M. F. due to inductance is caused by the variations or changes of current strength in the circuit, and the corresponding changes or variations in the magnetic flux around it.

All A. C. circuits will have a certain amount of inductance. In some cases this inductance is so small that it can be disregarded entirely in ordinary problems; while in other cases the inductive effect is so great that the whole operation of the circuit or device may depend upon it.

Inductance tends to oppose every change of current that occurs in any circuit, by generating or inducing a counter-voltage of self-induction as the changing flux cuts across the conductors of the circuit itself.

For this reason, A. C. circuits which have coils or machines windings connected in them, have a much greater inductance than straight wires or lines, or incandescent lighting circuits. This is because coils and windings set up very strong fields of concentrated magnetic flux, and as these lines of force cut across the turns of the coil they generate considerable counter-voltage of self-induction.

A. C. circuits to which are connected induction motors and transformers are very highly inductive, because of the windings of these machines and their location on the iron cores of the device in a manner which is ideal for establishing very strong magnetic fields.

Ordinary incandescent lighting circuits are considered as practically non-inductive because their inductance is so small that it is usually not considered in ordinary calculations.

The counter-voltage and inductive reactance which result from inductance in the winding of A. C. machines regulate or limit the current flow a great deal more than the ohmic resistance does. This is the reason why many A. C. machines and devices

Counter Voltage

will be burned out almost immediately if they are connected to a D. C. circuit of the same voltage.

The direct current, being constant in value, does not have a continually varying or moving flux to set up the counter-voltage of self-inductance.

The unit with which we measure inductance in a circuit is called the **henry**. **A circuit has an inductance of one henry when a current change of one ampere per second will induce one volt counter-voltage of self-induction in that circuit.**

The unit "henry" is sometimes known as the **coefficient of self-induction**, and the symbol for this unit, "henry", is the capital letter L. Therefore, the expression 10 L means 10 "henrys" of inductance in the circuit.

Sometimes the inductance of a circuit is much less than one henry, and is expressed in milli-henrys (M. H.), or 1/1000 part of a henry.

1. COUNTER-VOLTAGE OF SELF-INDUCTION

Fig. 1 illustrates the manner in which the counter-voltage is built up by induction in a coil in an A. C. circuit. The current flowing through the coil sets up a strong magnetic field around all its turns.

We know that with alternating current these lines of force will be constantly expanding and contracting, and reversing in direction, as the current varies in amount and reverses in direction.

As the lines of force expand and contract, and cut across the turns of the coil in first one direction and then another, they will induce a **voltage which opposes the applied voltage.**

It will be well to keep this fact always in mind—that the **electro-magnetically induced currents are always in such a direction that the field set up by them tends to oppose or stop the force which produced them.** This is known as **Lenz's Law**, as it was discovered by an early experimenter named Lenz.

The manner in which the counter-voltage is set up by induction is illustrated more in detail in Fig. 2. In this figure we have shown a sectional view of a coil of wire as though the turns were all cut in

Alternating Current

half, lengthwise through the coil. The current set up by the applied line voltage at the particular instant, is shown flowing in at the lower conductor ends and out at the top ends.

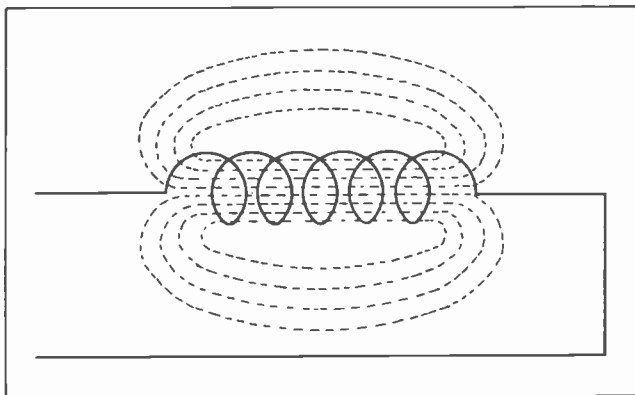

Fig. 1. The alternating flux around coils or wires of A. C. circuits produces voltage of self-induction and inductive reactance in the circuits.

The flux which will be set up by this current is shown around the lower end of the right-hand turn of the coil. Flux would, of course, be set up around all the turns but, for convenience in illustrating the principle of induction, is shown only around this one turn.

When the current of one alternation in the circuit builds up in the turns of the coil the flux shown around the conductor or single turn will expand more and more until the current reaches maximum value. During this building up of the current and flux, the lines will be cutting across adjacent turns of the coil in the direction shown, and will be inducing a voltage in them.

By applying the right-hand rule for induced voltages, we find that the direction of the voltage induced in the second turn of the coil, will be opposite to the applied voltage. This also checks with Lenz's law which says that the direction of the induced current will be such that its field will oppose the force that produces it.

When we consider that the flux of a coil in an A. C. circuit will be continually cutting across all turns of that coil, and that the counter-voltage it

Counter Voltage

will induce in all these turns will add together as the turns are all in series, we can then see that the

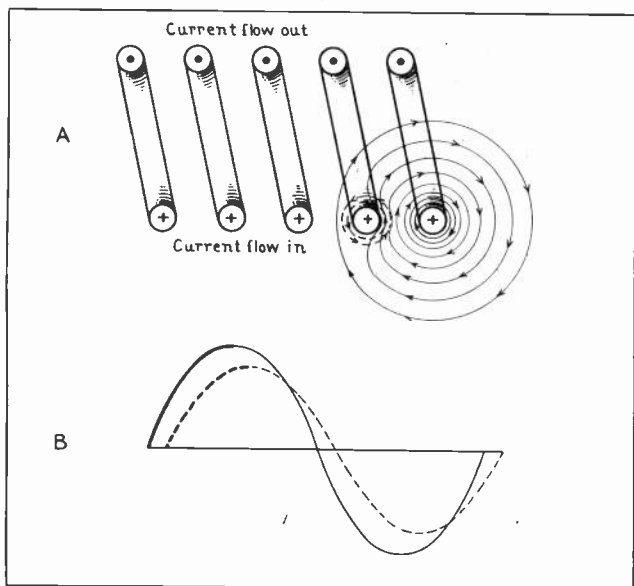

Fig. 2. The above diagram illustrates the manner in which the counter-voltage of self-induction is built up in an inductance coil.

counter-voltage of self-induction in such a coil may greatly limit the flow of current through it.

If we place an iron core in such a coil, and allow it to build up a much stronger field, this will greatly increase the inductance of the coil. Such coils are often called **choke coils** because of the "choking" or limiting effect which their counter-voltage has on the flow of alternating current through them.

A coil of several hundred turns wound on a large iron core and connected across a 110 or 220-volt, 60-cycle circuit, may produce nearly as much counter-voltage as the applied line voltage, and allow only a very small current to flow through the coil.

This explains why coils of A. C. devices or machines are usually wound with a much smaller number of turns than are D. C. devices for circuits of the same voltage; because on A. C. circuits the inductive reactance or counter-voltage controls the current even more than the ohmic resistance does.

Alternating Current

This self-induced voltage caused by the inductance of a coil as shown in Fig. 2-A, being in a direction which opposes the applied line voltage, actually tends to make the current in the coil lag behind its voltage. That is, the current alternation does not reach its maximum value until a few degrees later than the voltage does, as shown by the curves in Fig. 2-B.

When the voltage of the alternation reaches maximum value, the current tends to stop increasing, but this causes the flux around the conductor to stop expanding and also to stop generating the counter-voltage in the turns of the coil. This allows the current to rise to its full maximum a little later than the voltage reaches its peak.

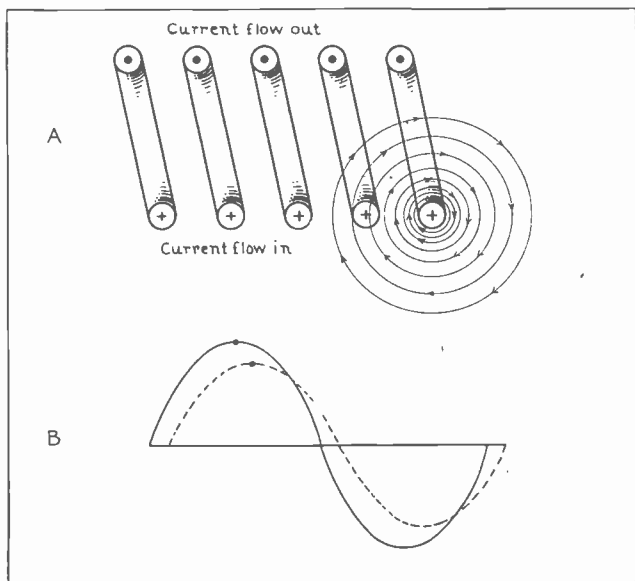

Fig. 3. This view shows the flux around one turn of a coil during the period when the current is at maximum value. The flux is neither contracting nor expanding at this period, and therefore produces no voltage of self-induction.

This is illustrated in Fig. 3-A, where the flux has stopped expanding and producing counter-voltage; and on the curves at "B" the current and voltage peaks are marked by the round dots.

Counter Voltage

As the voltage starts to reduce and causes the current to decrease, the lines of force around the turns of the coil will start to contract or die down as shown in Fig. 4-A. They are now cutting across the turns of the coil in the opposite direction to what they formerly were, and so they induce a voltage in the same direction as the applied voltage. This self-induced voltage now adds to, or aids, the applied voltage, which still further explains why the current flow reaches its maximum value after the voltage does.

As the voltage dies on down to zero and the current also tends to decrease to zero, the contracting lines of force keep on inducing voltage that tends to make the current continue in the same direction, even for a short instant after the applied voltage has reached zero.

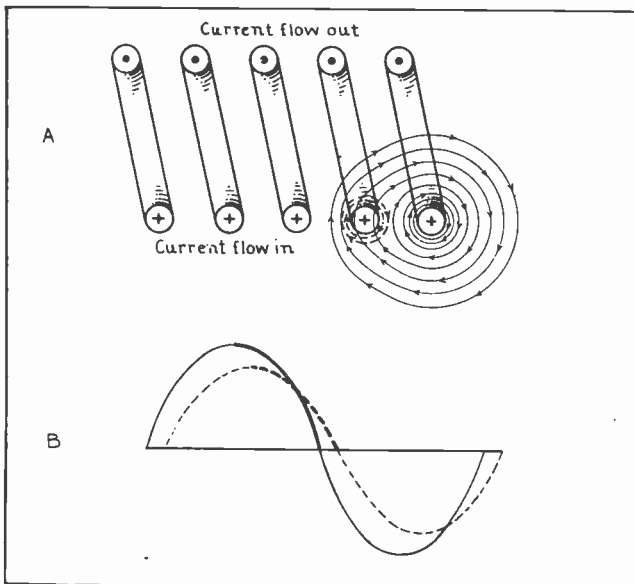

Fig. 4. This sketch shows the same coil as in Figs. 2 and 3 during a period when the current through the coils is decreasing from maximum to zero value. Note how the flux contracts and cuts across the turns of the coil.

Thus the current of the alternation reaches its zero value slightly later than the voltage does.

Alternating Current

2. LAGGING CURRENT CAUSED BY INDUCTANCE

From these illustrations we can see that inductance causes the current to reach its maximum and zero values a few degrees later than the voltage, or to lag behind the voltage. Inductance, therefore, causes the current to be out of phase with the voltage. **The greater the inductance of an A. C. circuit, the farther its current will lag behind the voltage.**

In circuit diagrams inductance is usually represented by turns of a coil, as shown in Fig. 1.

In a circuit that has practically all inductance and very little resistance, the current would lag almost 90 degrees behind the applied voltage. If it were possible to have a circuit with all inductance and no resistance, the current lag in that circuit would then be 90°. This condition is, of course, not possible, because all circuits have some resistance.

Fig. 5 shows the curves for the applied voltage E , counter-voltage of self-induction E_c , current I , and flux F , for a circuit that we shall assume has inductance only and no resistance.

The change in current value and the corresponding flux change are much more rapid as the current passes its zero point. This can be seen by noting the various amounts of current change along the curve I , between the vertical time lines which divide the alternation into even time periods of $\frac{1}{8}$ alternation each. You will note that the current change from "l" to "m" is much greater than in the next equal time period from "m" to "n".

This very rapid change of current and flux will cause the maximum counter-voltage to be induced at the time the current passes through its zero value. The curve E_c shows the counter-voltage at maximum during this period.

The current changes at the lowest rate when near its maximum value, or from o to p, and p to q. The correspondingly slower flux change at this point causes the induced counter-voltage to be at or near zero value during this period.

So we find that the counter-voltage of self-induction in this case lags behind the current by 90 degrees. The applied line voltage to overcome the

Lagging Current

counter-voltage is 180° out of phase with it, or in direct opposition to the counter-E. M. F.

The applied voltage therefore "leads" the current by 90° , or as we more commonly say, the current "lags" the voltage by 90° .

In actual circuits, the current would never lag this far but would be somewhere between this point and the "in phase" position, according to the amount of inductance in the circuit.

The curve E, which represents the applied voltage to overcome the voltage of self-induction, is shown 180° out of phase with the voltage of self-induction and 90° ahead of the current.

In any actual circuit the energy voltage would be a few degrees later than the voltage curve E in this figure, because there would be a little resistance to overcome.

The applied voltage in Fig. 5 is shown at zero value when the current is at maximum, while in an actual circuit having some resistance, the energy

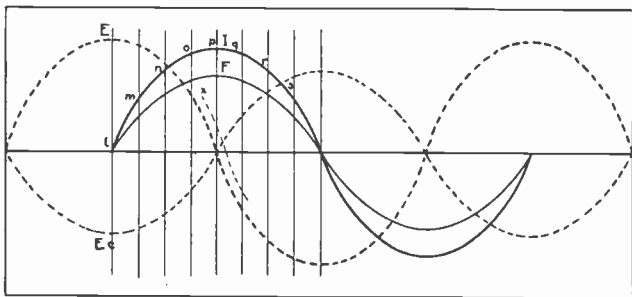

Fig. 5. Curves for a single-phase circuit in which the current and voltage are approximately 90° out of phase with each other, due to inductance in the circuit.

voltage would still be a little above the zero value, as shown by the short dotted section of the curve at "X".

3. SELF-INDUCTION IN D. C. CIRCUITS

While there is practically no inductive effect or counter-voltage of self-induction in a D. C. circuit as long as the current does not vary, there is often considerable voltage of self-induction set up in windings of large D. C. machines or magnets when

Alternating Current

the circuit is first closed or opened. This effect is encountered with the rotors or fields of large alternators, as their coils are excited by D. C.

When D. C. voltage is first applied to the field winding of large machines, it may actually require several seconds or more for the current to build up to its full value and overcome the effects of self-induced counter-voltage set up by the expanding flux.

When such circuits are opened, the sudden collapse of flux around the coils may induce very high voltage, which tends to oppose the decrease of current or keep the current flowing in the same direction. This accounts for the very severe arcs drawn when some highly-inductive D. C. circuits are opened.

The choking effect or counter-voltage of self-induction in an A. C. circuit will vary directly with the frequency of the current, or the rapidity with which the flux changes and reversals are made.

This fact is taken advantage of in constructing certain apparatus, such as choke coils for lighting arresters, load-limiting reactors, etc. These devices will be explained later.

4. CALCULATING INDUCTANCE AND INDUCTIVE REACTANCE

The amount of inductance which any coil or device may have in henrys can be calculated by the following formula:

$$L = \frac{\text{Maximum flux} \times \text{no. of turns}}{\text{Maximum current} \times 10^8}$$

In which:

$10^8 = 100,000,000$, or the no. of lines of force necessary to be cut in one second to produce one volt.

When the inductance of a certain device or circuit is stated or known in henrys, the inductive reactance in ohms can be found by the following formula:

$$X_L = 2\pi \times f \times L$$

In which:

X_L inductive reactance in ohms

Self-Induction

$\pi = 3.1416$, or ratio of circumference to diameter of a circle

$2\pi = 6.2832$

f = frequency in cycles per second

L = inductance in henrys

This formula is very important, as the inductive reactance is one of the factors we need to know in order to apply the A. C. ohms law for making any A. C. circuit calculations.

As most A. C. power circuits are highly inductive due to the machine windings, as previously explained, inductive reactance is the factor most commonly encountered in ordinary A. C. work in power plants and industrial plants.

5. CAPACITY

In alternating current circuits there is always a certain amount of condenser effect, or tendency to store an electro-static charge as the varying voltage of each alternation is applied. This condenser effect is known as the **capacity** of a circuit.

You will recall, from an explanation of condensers in the Lesson No. 1, that a condenser consists of two or more surfaces or areas of conducting material, separated by an insulator or dielectric. This condition exists in an electric circuit, as the wires form the conducting areas, and their insulation, or in some cases air only, forms the dielectric between them.

You have also learned in the earlier discussion of condensers that the amount of charge in coulombs which a condenser will absorb depends on the voltage applied.

On ordinary low-voltage A. C. circuits of short length, the condenser or capacity effect is so small that it need not be considered in every day problems. On high-voltage transmission lines of great lengths, the capacity effect is often very great and must be carefully considered in several ways.

For example, such lines may store such a charge that even after they are disconnected from the power plant they may hold a charge of thousands of volts and many kilowatts. In fact, they often

Alternating Current

hold so much of a charge for a short period after the voltage source has been disconnected from them, that the wires would be very dangerous to handle until after they have been shorted together or grounded by placing a ground wire across them. This discharges the capacity charge stored in the line and makes the wires safe to handle.

6. UNIT OF CAPACITY

Capacity of electric circuits or condensers is measured and expressed by the unit, **farad**. **A condenser has one farad capacity when a charge of one coulomb will raise the condenser potential one volt.**

The coulomb, you will recall, is a flow of one ampere for one second. A condenser of one farad capacity will take a charge of one coulomb when one volt is applied to its terminals.

Most condensers have capacities of only a few millionths of a farad: so the unit **micro-farad**, meaning $\frac{1}{1,000,000}$ of a farad, is much more commonly used than the larger unit.

Capacity is, however, always expressed in farads or fractions of a farad when used in calculations. For example, 50 microfarads would be expressed as .000,050 farad. The symbol for farads or capacity is the large letter "C".

7. CONDENSER CHARGING CURRENT

When voltage is first applied to the terminals of a condenser, as shown in Fig. 6, a current will at once start to flow into the condenser to store up its electro-static charge. If the direction of the applied voltage and current for the instant are as shown by the arrows in Fig. 6-A, the top plate of the condenser will become positively charged and the lower plate negatively charged, as shown.

When the voltage is first applied to a condenser and before its plates have had time to build up their charge of voltage, the current flow into the condenser will be very rapid and at maximum value, even though the applied voltage is still very low.

Capacity

This is illustrated by the curves in Fig. 6-B. The curve E represents the applied voltage; the curve I, the current flow to the condenser; and the dotted curve Ec, the counter-voltage of the condenser. These curves are shown for a circuit that has practically all capacity and very little resistance.

You will note at the first curve on the left that the current reaches maximum value just a little later than the applied voltage starts from zero

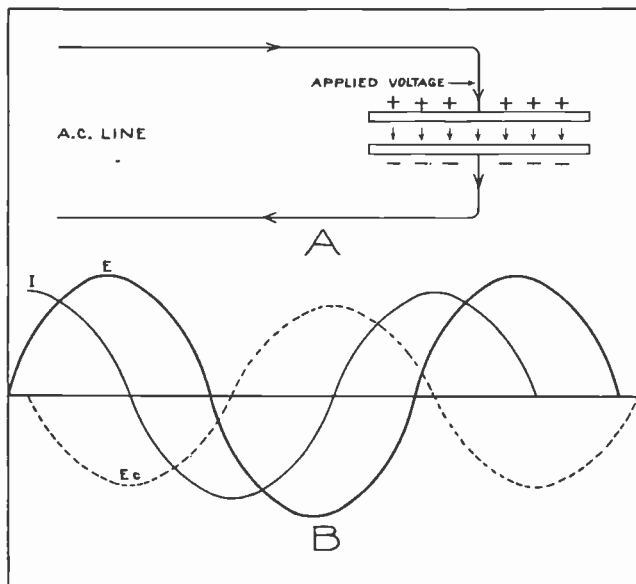

Fig. 6. This diagram shows the current leading the voltage by nearly 90° , due to capacity or condenser effect in the circuit.

value. Then, as the applied voltage keeps on increasing, the counter-voltage, Ec, of the condenser is building up and reduces the flow of current until it reaches zero value just after the applied voltage reaches maximum.

In this circuit, therefore, the current leads the voltage by nearly 90 degrees. If it were possible to have a circuit with all capacity and no resistance, the current would lead the voltage by 90° .

When the applied voltage passes its maximum value and starts to die down, the condenser starts to discharge, causing the current to start to flow in

Alternating Current

the reverse direction just after the applied voltage reaches maximum.

As the condenser discharges, its counter-voltage dies down as shown by the dotted curve E_c , until it reaches zero value just a few degrees later than the applied voltage does.

When the alternating voltage reverses, the current flows into the condenser in the opposite direction and charges its plates with opposite polarity.

In this manner a condenser receives its heaviest or maximum current, just as the applied voltage reverses and starts to build up in a new alternation, and then the condenser discharges its current ahead of the next voltage reversal, causing the current in such a circuit to lead the voltage.

Current does not actually flow through a condenser as long as its insulation is not punctured by too high voltage, but the rapid flow of alternating current in and out of a condenser as it charges and discharges, provides a flow of current that can be measured by an ammeter or used to operate devices, just as though it actually flowed clear through the circuit.

The amount of the charging current is proportional to the size or capacity of the condenser, and is also proportional to the amount and frequency of the applied voltage.

When a condenser is connected in a high frequency circuit it will allow a much greater flow of current than when in a low frequency circuit.

Condensers in a D. C. circuit do not allow any current flow except during the first instant that the voltage is applied, and while the condenser is taking its charge. If a condenser which has been charged in this manner is short-circuited, it will discharge its energy in one violent rush of current.

8. CAPACITY REACTANCE

Capacity of an A. C. circuit causes **capacity reactance**, or **condensive reactance**, as it is often called. This condensive reactance tends to oppose the flow of current similarly to resistance and inductive reactance.

Capacity reactance tends to oppose any change in the voltage of a circuit, and causes the voltage to

Capacity

lag behind the current, as previously explained.

We learned that inductive reactance causes the current to lag behind the voltage; so we find that in this respect capacity reactance is opposite to inductive reactance.

Lagging voltage can also be expressed as "leading current", as both terms express the same condition in the circuit. In describing the phase relations of the voltage and current, we usually say "lagging current" or "leading current"; and seldom refer to lagging voltage.

When the capacity of any circuit is known in farads, the capacity reactance in ohms can be determined by the following formula:

$$X_c = \frac{1}{2\pi \times f \times C}$$

In which:

X_c = capacity reactance in ohms

f = frequency in cycles per sec.

C = capacity in farads

$2\pi = 6.2832$

This formula is very important, as we want to be

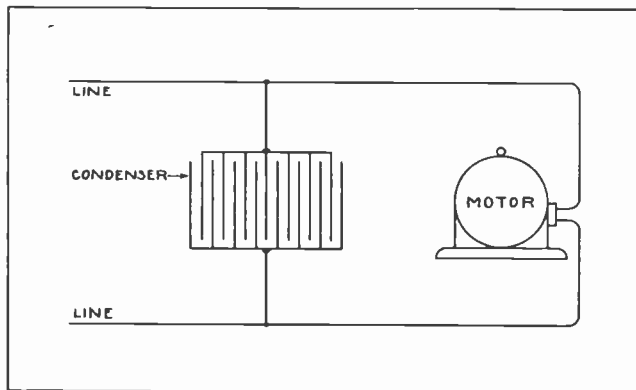

Fig. 7. A condenser connected in parallel with a motor will cause lagging voltage or leading current, and will neutralize effects of induction produced by the motor.

able to convert the apparent resistance effect of capacity into ohms capacity reactance, in order to apply Ohms law to any A. C. circuit problems.

Alternating Current

Capacity effect or condensers are usually shown in circuit diagrams by a symbol such as is used in Fig. 7. This symbol represents the plates of a condenser, the two groups of which are connected to the two wires of the circuit. In an actual condenser the insulation between the plates may be any convenient form of dielectric, such as fibre, glass, rubber, paper, or oil. In the case of A. C. circuits and lines, this insulation which forms the dielectric for the condenser effect may be the insulation on the wires, or, as in the case of transmission lines, merely the air between the wires

As capacity reactance is opposite in effect to inductive reactance, special condensers are often connected in A. C. circuits in industrial plants, to neutralize the effects of inductance and lagging current. The advantages of this will be explained later.

In Fig. 7 the condenser is connected in parallel with a motor. When the voltage of any alternation starts to build up on this circuit, the condenser takes a charge and its voltage opposes the building up of the applied energy voltage, thus causing it to lag.

When the energy voltage reaches maximum, the condenser will be fully charged and, as the energy voltage starts to decrease, the condenser voltage will then be applied to the circuit and will tend to oppose the dying down of the energy voltage, or will maintain it longer. This retards the dying down of the energy voltage and causes it to reach its zero value an instant later. After the energy voltage reaches zero the condenser will still be discharging or applying a little voltage to the circuit.

Thus we have another illustration of the manner in which a condenser causes the lagging voltage, or leading current as it is more frequently expressed.

The effects of capacity are very useful and valuable in many circuits.

Static condensers are often used on highly-inductive power circuits to improve the power factor by neutralizing the effect of excessive inductance.

Condensers are also used extensively in radio and telephone work to pass currents of certain frequencies and stop those of lower frequency or D. C. in various circuits.

Series A.C. Circuits

9. SUMMARY OF INDUCTANCE AND CAPACITY

Some of the most important points to remember about inductance and capacity are summed up briefly in the following:

Inductive equipment in A. C. circuits consists of coils, windings of transformers, motors, generators, choke coils of lightning arresters, current-limiting reactors, etc.

Capacity effects in A. C. circuits are produced by static condensers, over-excited synchronous motors, long transmission lines or underground cables, etc.

- (a) { Inductance opposes current changes
Capacity opposes voltage changes
- (b) { Inductance causes lagging current
Capacity causes leading current
- (c) { The effect of inductance is opposite to that of capacity, or their effects are 180° apart and tend to neutralize each other
- (d) { Excessive inductance is detrimental to the power-carrying capacity of a circuit
Excessive capacity is detrimental to the power-carrying capacity of a circuit
- (e) { Inductance may be used to neutralize the effect of excessive capacity
Capacity may be used to neutralize the effect of excessive inductance
- (f) { Inductance causes low power-factor, "lagging"
Capacity causes low power-factor, "leading"
- (g) { Lagging power-factor may be compensated for by static condensers or over-excited synchronous motors.

10. SERIES A. C. CIRCUITS

There are four classes of series circuits commonly encountered in alternating current work. These are as follows:

- (a) Circuits with resistance only
- (b) Circuits with resistance and inductive reactance

Alternating Current

- (c) Circuits with resistance and capacity reactance
- (d) Circuits with resistance, inductive reactance, and capacity reactance.

Incandescent lighting circuits and those supplying similar non-inductive equipment are considered to have resistance only. Actually these circuits have a slight amount of inductance and capacity, but it is so small that it is negligible.

Circuits of this type can be treated similarly to D. C. circuits, because the resistance is practically

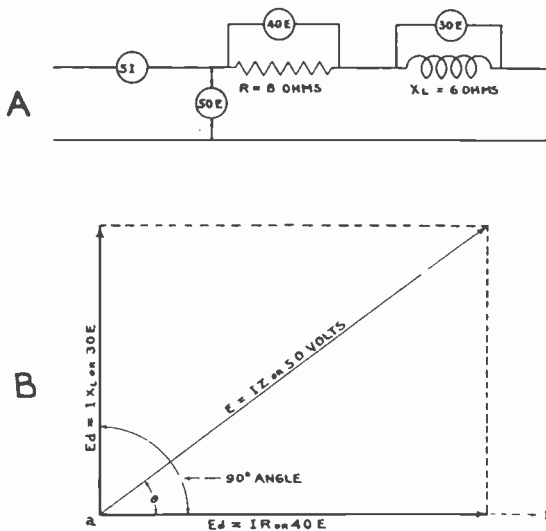

Fig. 8. "A." A resistance coil connected in series with an inductance coil in an A. C. circuit. "B". This sketch shows the method of determining the amount of impedance of the circuit shown at "A".

the only opposing force to the current and therefore the resistance equals the total impedance. To determine the current flow in such circuits it is only necessary to divide the applied voltage by the resistance or impedance in ohms.

The most common types of circuits encountered in alternating current power work are those which have resistance and inductive reactance. The method of determining the impedance and currents of such circuits will be covered in the following paragraphs.

Impedance Calculations

11. CALCULATION OF IMPEDANCE IN SERIES A. C. CIRCUITS

Fig. 8-A shows a resistance and an inductance connected in series. The resistance of 8 ohms is represented by the usual symbol, with which you are already familiar, and the inductive reactance of 6 ohms is represented by the coil symbol which is commonly used for showing inductance in circuits.

At first thought, it might seem that we can merely add the ohms resistance and ohms inductive reactance to get the total impedance in the circuit; because this was a method used in D. C. circuits with two or more resistances in series. This method cannot be used with resistance and inductive reactance, however, because their effects on the current are out of phase with each other.

If this circuit had only resistance, the current which would flow when alternating voltage is applied would be in phase with the voltage. If the circuit had only inductance, the current which would then flow would be 90° out of phase with the voltage, or lagging 90° behind it.

12. GRAPHIC SOLUTION FOR RESISTANCE AND INDUCTIVE REACTANCE IN SERIES

As the inductive reactance and resistance both tend to effect the flow of current and its phase position with respect to the voltage, we can determine these effects by the use of a diagram such as shown in Fig. 8-B. A current of 5 amperes is assumed to be flowing through circuit "A". In Fig. "B" we have a horizontal line used to represent the voltage drop E_d across the 8 Ohms resistance which is in phase with "I", and a vertical line at an angle of 90° with the horizontal line, to represent the voltage drop E_d across the 6 Ohms inductive reactance.

These two lines can be drawn to scale so that the length of each will represent the proper value in volts or ohms. In diagrams of this type, the lines are all considered to be revolving like the spokes of a wheel, in a counter-clockwise direction around the point where they join at "a".

Keep this fact well in mind whenever examining or working with such diagrams.

Alternating Current

If these lines are revolving counter-clockwise, then the shorter line representing the voltage drop across the inductive reactance "XL" will be 90° ahead of the long line which represents the "E d" across "R".

As the current which flows through the resistance "R" would be in phase with the voltage drop across "R" the horizontal line can also be allowed to represent the current which is in phase with the voltage drop across "R".

If we now draw dotted lines as shown, to complete the rectangle, we will have what is known as a **parallelogram** of forces and the length of the diagonal line IZ will indicate the total voltage drop across the circuit, and its position with respect to the line "I R" will indicate the angle of phase difference between the current and the applied voltage.

If the lines representing the voltage drop across the resistance and inductive reactance are carefully drawn to scale (in this case $1/20$ in. per volt) and at the proper angle, then by measuring the length of the line "IZ" we will get the total applied voltage.

The line "IZ" will also represent the total impedance with the scale drawn to allow $1/4$ in. per ohm.

This graphic method provides an exceedingly simple way of solving such problems. It would not, of course, be very accurate on large values or figures, because it would be difficult to make the lines long enough or to measure them with sufficient accuracy. This diagram will, however, show the manner in which the amount of current lag in degrees is determined by the proportion of resistance and inductive reactance in the circuit.

By examining the diagram in Fig. 8-B or by drawing another like it with a longer line to represent a greater amount of inductive reactance, you can readily see that this would swing the diagonal line "IZ" farther upward, or would cause a greater angle of phase difference between the current and voltage.

On the other hand, if we were to increase the amount of resistance and lengthen the horizontal line, this would swing the diagonal line down and nearer to the resistance line and bring the resulting current nearer in phase with the voltage.

Impedance Calculations

13. FORMULA FOR IMPEDANCE OF RESISTANCE AND INDUCTIVE REACTANCE IN SERIES

The impedance of such a circuit, with resistance and inductive reactance in series, can be calculated accurately by the following formula:

$$Z = \sqrt{R^2 + X_L^2}$$

We can obtain the impedance in ohms by squaring the resistance and inductive reactance in ohms, adding these squares together, and then extracting the square root of the sum, as shown by this formula:

In the case of the circuit shown in Fig. 8, where we have 8 ohms resistance and 6 ohms inductive reactance, our problem would be:

$$Z = \sqrt{8^2 + 6^2}, \text{ or}$$

$$Z = \sqrt{64 + 36}, \text{ or}$$

$$Z = \sqrt{100}, \text{ or } 10 \text{ ohms impedance}$$

This illustrates the various steps in solving such a problem with the exception of the details of finding the square root.

In case you have not practiced square root problems for some time it will be a very good plan to refer to your grade school arithmetic book and practice a few square root problems until you can handle them easily, because there are numerous opportunities in alternating current electric problems to use square root to excellent advantage.

On the great majority of ordinary electrical jobs it will not be necessary to use such problems; but, if you desire to work up to higher positions, you will want to be able to work out the problems pertaining to the various circuits and machines you may be operating.

14. RESISTANCE AND CAPACITY IN SERIES

Fig. 9-A shows a circuit in which a resistance and capacity are connected in series. The resistance of 4 ohms is represented by the usual symbol and the capacity reactance of 3 ohms is represented by the symbol for a condenser.

To find the impedance of this circuit we will draw a horizontal line of proper length to represent the 4

Alternating Current

ohms resistance, and a vertical line to represent the 3 ohms capacity reactance. This time, however, we will draw the vertical line 90° behind the horizontal line which represents the resistance. The line is drawn in this position because we know that capacity reactance tends to make the current lead the voltage.

If the circuit were all capacity and no resistance, this lead would be 90° ; but, as there are both resistance and capacity, we make the lines of proper length and space them 90° from each other, to determine what the angle of lead of the current will be.

By again completing the parallelogram with dotted lines and drawing the diagonal line through it cornerwise, this line "Z" will represent the total impedance and the angle between it and line "R" show the phase position or angle of lead of the current. The applied voltage would also be represented along this diagonal line. The lines in this figure are drawn to scale, using $\frac{1}{2}$ -inch per ohm, and you will find by measuring the line "Z" that it shows the total impedance to be 5 ohms.

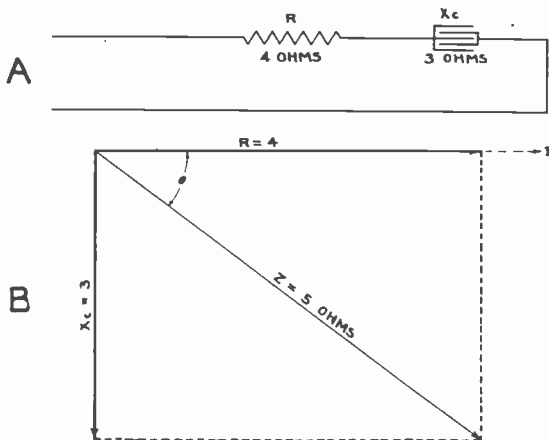

Fig. 9. "A". This circuit has a resistance connected in series with a Condenser. "B". The vector diagram shows the method of determining the impedance and angle of lead between the current and voltage for a circuit such as shown at "A".

This, of course, is not the sum of the two values 4 and 3, which would be obtained if they were

Impedance Calculations

added by arithmetic, but it is the correct vectorial sum of the two values when they are out of phase 90° as shown.

The impedance of the circuit shown in Fig. 9 can be calculated by the use of a formula very similar to that used for the circuit in Fig. 8. The formula is as follows:

$$Z = \sqrt{R^2 + Xc^2}, \text{ or, in this case}$$

$$Z = \sqrt{4^2 + 3^2}, \text{ or}$$

$$Z = \sqrt{16 + 9}, \text{ or}$$

$$Z \cong \sqrt{25}, \text{ which gives 5 ohms impedance}$$

15. RESISTANCE, CAPACITY, AND INDUCTANCE IN SERIES

Fig. 10-A shows a circuit in which we have resistance, inductance, and capacity all in series.

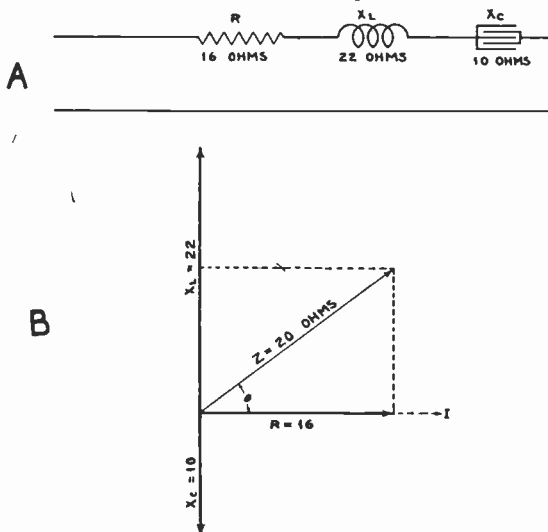

Fig. 10. "A". Resistance, inductance, and capacity connected in series in an A. C. circuit. "B". Note how the capacity reactance is subtracted from the inductive reactance, as the two neutralize each other in the circuit.

In Fig. 10-B, all three of these values are represented by the solid lines, R , Xc , and XL . In this case we have again drawn a horizontal line to represent the resistance. The line XL , representing in-

Alternating Current

ductive reactance, is drawn 90° ahead of the resistance line; and the line X_c , representing capacity reactance is drawn 90° behind the resistance line.

We know that inductive reactance and capacity reactance have opposite effects in the circuit and will therefore tend to neutralize each other. As the inductive reactance is the greater in this case, our first step will be to subtract the 10 ohms capacity reactance from the 22 ohms of inductive reactance.

This neutralizes or eliminates the 10 ohms capacity reactance and 10 ohms of the inductive reactance. The remaining 12 ohms of inductive reactance which are not neutralized by the capacity effect, and the resistance, will be the factors which determine the total impedance and the phase angle of the current.

Once more drawing our parallelogram with the remaining factors or values, we find that the current still lags behind the applied voltage and that the total impedance is 20 ohms. The scale to which the lines are drawn in this case is $1/16$ of an inch per ohm.

The total impedance of a circuit such as shown in Fig. 10-A can be more accurately calculated by means of the formula:

$$Z = \sqrt{R^2 + (X_L - X_C)^2}$$

In this case $X_L - X_C$ is $22 - 10$, or 12.

Then, $12^2 = 144$.

The next step indicated by the formula is to square the resistance. This will be 16×16 , or 256.

Then, $256 + 144 = 400$.

And the final solution of the problem will be:

$$Z = \sqrt{400}, \text{ or } 20 \text{ ohms.}$$

16. PARALLEL A. C. CIRCUITS

Parallel alternating current circuits are of the same four general types as series circuits. That is, they may contain resistance only, resistance and inductance in parallel, resistance and capacity in parallel, or resistance, inductance, and capacity in parallel.

Impedance Calculations

To determine the impedance of parallel A. C. circuits we must use the reciprocal method, somewhat similar to that which was explained for parallel resistances in D. C. circuits.

You will recall that with D. C. circuits when the resistances were in series we added the resistance in ohms of all the circuits to obtain the total resistance. But when resistances were in parallel we first added the conductances or reciprocals of the resistance to obtain the total conductance, and then inverted this or obtained its reciprocal, which is the total resistance.

This is the same general method used in determining the total impedance or parallel A. C. circuits.

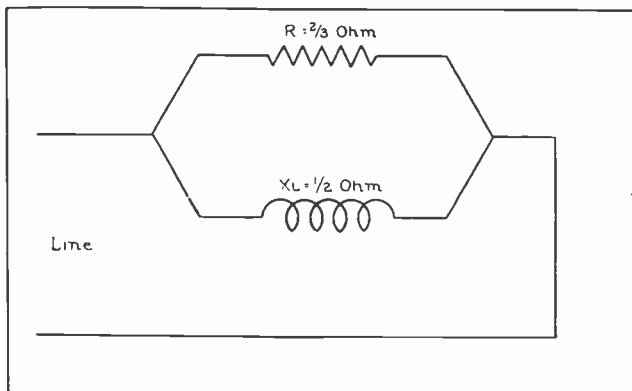

Fig. 11. Resistance and inductance in parallel. The impedance for this circuit can be determined by the formulas given on this page.

The opposite of impedance in A. C. circuits is the **admittance**. Admittance in this case means the same as conductance in D. C. circuits. Admittance is, therefore, always the reciprocal of the impedance and is expressed in **ohms**, the same as conductance for D. C. circuits.

17. RESISTANCE AND INDUCTANCE IN PARALLEL

Fig. 11 shows a resistance of $\frac{2}{3}$ ohm connected in parallel with an inductive reactance of $\frac{1}{2}$ ohm.

Alternating Current

The total impedance of this circuit can be determined by the following formula:

$$Z = \frac{1}{\sqrt{\left(\frac{1}{R}\right)^2 + \left(\frac{1}{X_L}\right)^2}}$$

According to this formula we must first obtain the separate reciprocals of the resistance and inductance by dividing the number 1 by each of these values in ohms. These reciprocals are then squared and added together and the square root of their sum next obtained. The final step is to obtain the reciprocal of this square root by dividing the number 1 by it, as shown by the formula.

Using with the formula the values given in Fig. 11, the problem becomes:

$$Z = \frac{1}{\sqrt{\left(\frac{1}{\frac{2}{3}}\right)^2 + \left(\frac{1}{\frac{1}{2}}\right)^2}}$$

Here we have substituted the $\frac{2}{3}$ ohm resistance for the "R" shown in the formula, and the $\frac{1}{2}$ ohm inductive reactance for the X_L shown in the formula.

We next divide the number one by each of these values, to obtain their reciprocals, and our problem then becomes:

$$Z = \frac{1}{\sqrt{\left(\frac{3}{2}\right)^2 + 2^2}}$$

Then by squaring these reciprocals as indicated by the formula, the problem becomes:

$$Z = \frac{1}{\sqrt{\frac{9}{4} + 4}}$$

Before we can add $\frac{9}{4}$ and 4, they must both be converted to like fractions, or:

Impedance Calculations

$$Z = \frac{1}{\sqrt{\frac{9}{4} + \frac{16}{4}}} \text{ or } \sqrt{\frac{25}{4}}$$

Then obtaining the square root of $\frac{25}{4}$, our problem is reduced to $\frac{1}{\frac{5}{2}}$,

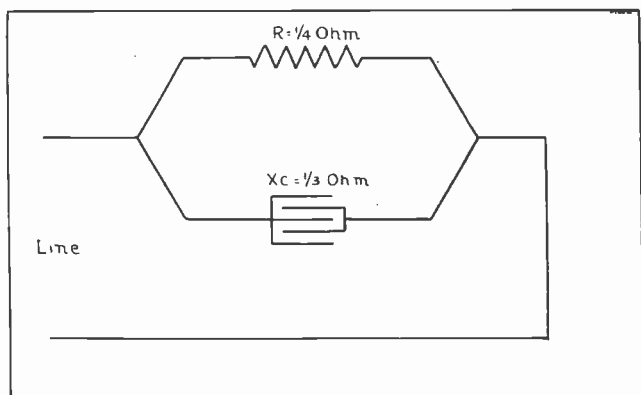

Fig. 12. Resistance and capacity in parallel in the A. C. circuit. Practice using the formulas given on these pages for determining the impedance of such circuits

We then divide 1 by $\frac{5}{2}$ to get the reciprocal, which equals $\frac{2}{5}$ ohms, total impedance.

18. RESISTANCE AND CAPACITY IN PARALLEL

Fig. 12 shows a circuit with a resistance of $\frac{1}{4}$ ohm and a capacity reactance of $\frac{1}{3}$ ohm, connected in parallel. The total impedance of this circuit can be determined by a formula similar to the one just used, or as follows:

$$Z = \frac{1}{\sqrt{\left(\frac{1}{R}\right)^2 + \left(\frac{1}{Xc}\right)^2}}$$

Alternating Current

Substituting the values given for the circuit, the problem becomes:

$$Z = \frac{1}{\sqrt{\left(\frac{1}{4}\right)^2 + \left(\frac{1}{3}\right)^2}}$$

When we divide the figure 1, in each case, by the resistance and reactance to get their reciprocals, we then have:

$$Z = \frac{1}{\sqrt{4^2 + 3^2}} \text{ or, } \frac{1}{\sqrt{16 + 9}}$$

As $16 + 9 = 25$, the problem now remains:

$$Z = \frac{1}{\sqrt{25}}$$

The square root of $25 = 5$, so this reduces the problem to:

$$Z = \frac{1}{5}, \text{ or } \frac{1}{5} \text{ ohm impedance}$$

19. RESISTANCE, INDUCTANCE, and CAPACITY IN PARALLEL

Fig. 13 shows a circuit with inductance, resistance, and capacity in parallel.

The total impedance of this circuit can be found by the formula:

$$Z = \frac{1}{\sqrt{\left(\frac{1}{R}\right)^2 + \left(\frac{1}{X_C} - \frac{1}{X_L}\right)^2}}$$

Note the similarity between this formula and the one which was used for impedance of series circuits having inductance, resistance, and capacity. The principal difference is merely that with parallel circuits we use the reciprocals of the values, instead of the values in ohms themselves.

You will also note that with parallel circuit problems we subtract the reciprocal of the inductive reactance from the reciprocal of the capacity reactance, as one of these effects tends to neutralize the other, as they did in series circuits.

In the circuit shown in Fig. 13 the inductive reactance in ohms is larger than the capacity reac-

Impedance Calculations

tance, but when the reciprocals of these values are obtained their relative sizes will be reversed, as shown by their subtraction in the formula.

In a circuit where the capacity reactance might be the greatest, we would reverse the order of subtraction, in order to subtract whichever reciprocal is smallest from the one that is largest.

Substituting the values from the circuit in Fig. 13, for the symbols given in the formula, the problem of determining the total impedance becomes:

$$Z = \frac{1}{\sqrt{\left(\frac{1}{1\frac{1}{3}}\right)^2 + \left(\frac{1}{\frac{3}{8}} - \frac{1}{1\frac{1}{2}}\right)^2}}$$

Our first step will be to convert the whole numbers and fractions, to fractions, as follows;

$$1\frac{1}{3} = \frac{4}{3}, \text{ and } 1\frac{1}{2} = \frac{3}{2},$$

$$\text{Then } Z = \frac{1}{\sqrt{\left(\frac{1}{\frac{4}{3}}\right)^2 + \left(\frac{1}{\frac{3}{8}} - \frac{1}{\frac{3}{2}}\right)^2}}$$

Then by dividing 1 by each of the fractions to obtain their reciprocals we have:

$$Z = \frac{1}{\sqrt{\left(\frac{3}{4}\right)^2 + \left(\frac{5}{3} - \frac{2}{3}\right)^2}}$$

Next subtracting $\frac{2}{3}$ from $\frac{5}{3}$ as shown in the latter part of the formula, we have:

$$Z = \frac{1}{\sqrt{\left(\frac{3}{4}\right)^2 + \left(\frac{3}{3}\right)^2}} \text{ or } Z = \frac{1}{\sqrt{\left(\frac{3}{4}\right)^2 + 1^2}}$$

Then $\frac{3}{4}$ squared equals $\frac{9}{16}$, and 1 squared equals

$$1, \text{ So, } Z = \frac{1}{\sqrt{\frac{9}{16} + 1}}, \text{ or } Z = \frac{1}{\sqrt{\frac{25}{16}}}$$

Obtaining the square root of $\frac{25}{16}$ gives $\frac{5}{4}$,

$$\text{So, } Z = \frac{1}{\frac{5}{4}}, \text{ or } \frac{4}{5} \text{ ohm impedance}$$

Alternating Current

Once more let us remind you that on your first electrical jobs you may not have much use for problems or formulas such as the foregoing. But as you may wish to be able to calculate the impedance of A. C. circuits at some future date, these problems have been worked out step by step in these pages to provide a guide or reference for you, in case you need them in the future.

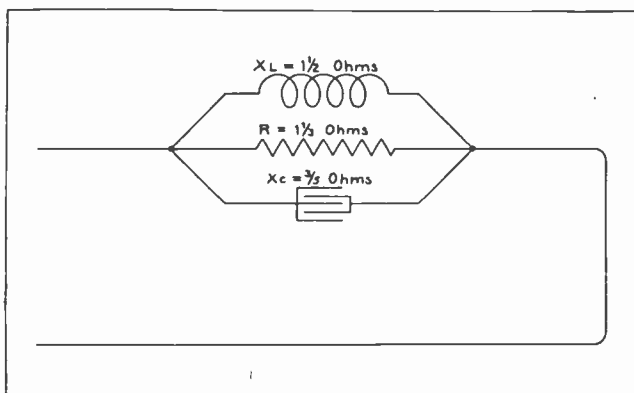

Fig. 13. This sketch shows inductance, resistance, and capacity connected in parallel. The method of determining the impedance of such a circuit is thoroughly explained in this lesson.

Working them out carefully and also applying these formulas to other similar circuit problems will be very good practice, and will also help you to more clearly understand certain points about impedance, admittance, and reactance in A. C. circuits.

20. CURRENT IN PARALLEL CIRCUITS

The total line current or resultant current as it is called, and also the amount of lag or lead of the current in parallel A. C. circuits, can be worked out by the use of vector diagrams such as those shown in Figs. 8, 9, and 10 for series circuits.

When using vector diagrams for parallel circuits, the lines can be allowed to represent the currents through the resistance, inductance, and capacity branches of the circuit.

The current through the separate branches of the circuit, or the devices which contain the resistance,

Impedance Calculations

inductance, and capacity, can be determined by the use of an A. C. ammeter, or by the use of Ohms law formulas for each branch, as follows:

$$I = \frac{E}{R}, I = \frac{E}{X_L}, I = \frac{E}{X_C}, \text{ etc.}$$

For example, in Fig. 14 is shown a circuit with resistance, inductance, and capacity in parallel. We can assume that these are a heater resistance, a transformer winding, and a condenser all operated from the same 40-volt line. Separate tests made with an ammeter in the circuit of each device show 8 amperes flowing through the resistance or heater, 4 amperes through the inductance or transformer coil, and 2 amperes in the condenser circuit.

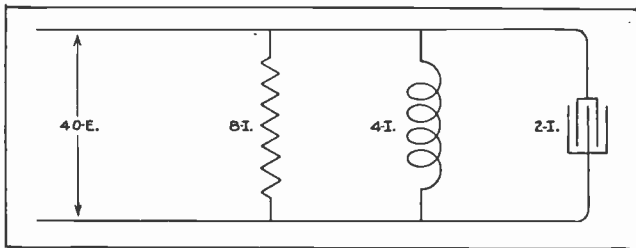

Fig. 14. Note the amount of current in each of the branches of the above circuit and compare sketch with Fig. 15, while determining the total current in this circuit.

By use of Ohms law formulas, we can determine

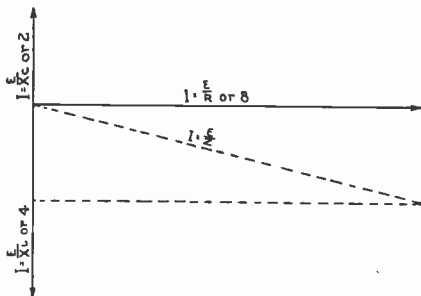

Fig. 15. This diagram illustrates the method of determining the current in parallel A. C. circuits which have all three factors; resistance, inductance, and capacity.

the resistance and reactance in ohms of each of these devices as follows:

Alternating Current

$$R = \frac{E}{I} \text{ or } R = \frac{40}{8}, \text{ or } 5 \text{ ohms}$$

$$X_L = \frac{E}{I} \text{ or } X_L = \frac{40}{4}, \text{ or } 10 \text{ ohms}$$

$$X_C = \frac{E}{I} \text{ or } X_C = \frac{40}{2}, \text{ or } 20 \text{ ohms}$$

We can represent the currents of this circuit by the vector diagram shown in Fig. 15.

The solid horizontal line represents the current through the resistance; and as this current will be in phase with the line voltage, this same line can represent the phase position of the voltage.

The vertical line, which is 90° behind the horizontal current and voltage line, represents the current through the inductance.

The shortest vertical line, which is 90° ahead of the horizontal line, represents the current through the condenser.

Now if we subtract the leading current from the lagging current, and draw dotted lines to form the parallelogram with the remaining lagging current and the current which is in phase with the voltage,

the diagonal line, $I = \frac{E}{Z}$, through this parallelogram will represent the total line current.

It may seem peculiar that the total line current or vectorial sum of the three currents is only slightly more than the current through the resistance. This is due to the fact that the leading and lagging currents, which are balanced, tend to neutralize each other, or actually circulate between the condenser and inductance in Fig. 14, and do not flow on the line wires from the generator. This interesting fact will be further discussed later in a section on power factor.

Impedance Calculations

EXAMINATION QUESTIONS

1. a. What is the unit of Inducance?
b. What is the symbol of this Unit?
2. State the Lenz's Law.
3. Will inductance in an A. C. circuit cause the current to lag or lead the voltage?
4. a. What is the unit of capacity?
b. What symbol do we use for this unit?
5. What would be the impedance in a series circuit containing an inductance of 4 Ohms and a resistance of 3 Ohms?
6. Give the formula for use in calculating the total resistance in a series circuit containing, resistance, inductance, and capacity.
7. Give the formula for determining the total impedance in a circuit containing capacity in parallel with resistance as shown by Fig. 12.
8. In a circuit containing resistance, inductance and capacity in parallel, will the sum of the currents through the parallel paths always equal the total line current? Why?
9. What type of electrical equipment causes inductance in a circuit.
10. In what type of circuit is capacity an important factor?

Alternating Current

POWER FACTOR

We have learned so far in our study of alternating current and A. C. circuits, that inductive reactance and capacity reactance often cause the current in these circuits to be out of phase with the voltage.

We have also found that this reduces the amount of effective or **true power** in watts and causes a certain amount of wattless energy.

In a D.C. circuit the power in watts can always be obtained by multiplying the volts by the amperes. It can also be obtained with a wattmeter. When the current and voltage of an A. C. circuit are in phase with each other the power can be determined by the same methods as used for D. C. circuits. That is, by obtaining the product of the volts and amperes.

1. TRUE POWER AND APPARENT POWER

When the voltage and current of an A. C. circuit are out of phase their product will not give the **true power** in the circuit, but instead gives us what we call **apparent power**. The apparent power of A. C. circuits is commonly expressed in **kilovolt amperes**, abbreviated kv-a.

Alternators, transformers, and certain other A. C. machines are commonly rated in kv-a. When an A. C. wattmeter is connected in a circuit which has lagging or leading current it will read the **true power** and not the apparent power. This is due to the fact that the coils which operate the pointer in the meter depend upon true or effective power for their torque which moves the pointer against the action of the spring.

It is very important to remember that you can always obtain the true power of an A. C. circuit by means of a wattmeter. The product of voltmeter and ammeter readings in the circuit will give the apparent power, and this figure will usually be more than the true power, because the current in

Power Factor

most A. C. circuits lags somewhat behind the voltage.

Keep in mind that true power is expressed in watts and kilowatts and apparent power in volt-amperes or kilovolt-amperes.

2. POWER FACTOR DEFINITION AND FORMULA

The ratio between the apparent power and true power in any circuit is known as the power factor of that circuit. This power factor is expressed in percentage and can always be found by dividing the true power by the apparent power, or this can be expressed as a formula in the following manner:

$$\text{Power Factor} = \frac{\text{True power}}{\text{Apparent power}}$$

The practical man, doing electrical maintenance work or power plant operating in the field, is likely to have many occasions to use this formula and method of determining the power factor of various machines or circuits with which he is dealing. Therefore, it is well to keep in mind that you can always determine the apparent power of a circuit or machine by means of a voltmeter and ammeter and obtaining the product of their readings; then obtain the true power by means of a wattmeter, and finally determine the power factor by means of the formula just stated.

If the apparent power in kv-a. is known for any circuit or machine, and the power factor of that circuit or machine is also known, then the true power can be determined by the following formula:

$$\text{True Power} = \text{App. power} \times \text{P. F.}$$

As many A. C. machines are rated in kv-a. and have their power factor stated on the name-plate, this formula will often be very handy for determining the amount of true power the machine will supply.

In case the true power and the power factor of a circuit are known, the apparent power can be

Alternating Current

determined without the aid of meters by the following formula:

$$\text{Apparent Power} = \frac{\text{True power}}{\text{P. F.}}$$

The greater the angle of phase difference between the current and voltage in an A. C. circuit, the less true power will be obtained and the lower will be the power factor. Therefore we find that power factor will always depend upon the amount of lag or lead of the current.

3. LAGGING OR LEADING CURRENT

Tests show that the power factor is mathematically equal to what is called the **cosine** of the angle of lag or lead between the voltage and current. When the voltage and current are exactly in phase this angle is zero, and its cosine is 1, so the power factor will then be 100%.

This condition is often called **unity power factor**. As the voltage and current get out of step or out of phase, the power factor starts to drop below 100%, and the greater the angle of phase difference becomes the lower the power factor will drop.

If the angle of phase difference was 90° either lagging or leading, the power factor would be zero, and, regardless of the amount of voltage or the amount of current flowing, there would be no true power developed.

A lag or lead of 90° is not encountered in electrical circuits, because there is always a certain amount of resistance, and no circuit is entirely made up of inductance or capacity.

The term "angle of phase difference" which will be used considerably from now on is represented by the symbol Θ or ϕ .

4. CAUSES OF LOW POWER FACTOR

As previously mentioned, the majority of A. C. circuits possess considerable inductance. Therefore, we usually find lagging current on most power circuits in the field.

Power Factor

Lightly loaded A. C. power equipment, such as motors, alternators, and transformers have much lower power factor than fully loaded machines. For this reason idle or lightly loaded A. C. machines should be avoided as much as possible, and all such equipment kept operating as nearly at full load as possible.

A great number of factories and industrial plants, using large amounts of A. C. equipment, fail to realize the importance of power factor and of having machines of the proper size and type so that they can be kept operating fully loaded. This results in low power factor on their circuits, and in the overheating of conductors and machines by the excessive currents set up by wattless power. This condition provides a splendid field of opportunity for the trained electrical maintenance man who has a knowledge of power factor, and the ability to measure the power required for various loads and select suitable motors and other equipment to handle these loads in the most efficient manner.

In many cases hundreds of dollars per month can be saved on power bills, machines and circuits relieved of current overloads, and frequent damage to windings prevented, by simply correcting the power factor in the plant. A great many untrained electrical men have little or no real conception of this subject and its importance. So you will find it very well worthwhile to carefully study and obtain a good understanding of these principles, and of the methods for correcting power factor, which will be covered later.

5. EXAMPLES OF LOW POWER FACTOR

The following problems, which are very typical of conditions often encountered in the field, should help you to more fully understand and appreciate this material given on power factor.

Let us suppose that on a certain job you have measured a circuit with a voltmeter and ammeter, and found 30 amperes flowing at 220 volts. Multiplying these two figures gives us 6600 watts of apparent power. A wattmeter connected in this

Alternating Current

same circuit shows a reading of only 3960 watts true power, which indicates that the power factor is rather low.

By the use of the formula :

$$\text{Power Factor} = \frac{\text{true power}}{\text{app. power}}$$
$$= \frac{3960}{6600}$$

which, in this case would be $\frac{3960}{6600} = .60$ P. F., it is

easy to see that a great deal of the current which is flowing in this circuit is not producing effective power.

If the company in whose plant this condition exists is generating its own power, the generators may be overloaded and overheated by wattless current, which doesn't produce power at the motors or equipment.

In case the power is being purchased from some generating company, we should keep in mind that these concerns very often give lower power rates if the consumer's power factor is kept up to a certain value. In other cases the customer may be charged a penalty rate for having low power factor.

Therefore it is often good economy to change the motors which are causing the low power factor, or to install power factor corrective equipment, such as synchronous motors or static condensers.

These devices provide condenser or capacity effects which neutralize the effects of induction motors and transformers, and thereby prevent excessive lagging current on the line and generators.

A. C. machines are commonly rated in kv-a., or kilovolt amperes, because **the heating effect in their windings is proportional to the square of the current in amperes** which these windings are caused to carry.

If these machines were rated in kw. and the power factor was exceedingly low, they might be forced to carry more current than their windings could stand, in an attempt to produce the proper amount of true power in kw.

This is exactly what happens in a number of cases

Power Factor

in various plants, where there are no trained electricians who understand or appreciate the importance of power factor, and the necessity for measuring the current in amperes as well as the watts or kw. shown by the wattmeters.

Suppose that in another case there is a transformer in the plant where you are employed, and this transformer is rated at 10 kv-a. and connected to a 440-volt line. A wattmeter in the circuit of the transformer shows the load to be only 9 kw., but the transformer continually operates at a rather high temperature, as though its windings might be overloaded.

An ammeter could be used to determine the current flow, but in this case let us assume that the test is made by a portable power factor indicator, and that it shows the power factor to be 75%

If we check up on these figures with the formula previously given for apparent power, it will soon show why the transformer is operating above normal temperature.

In the first place a 10 kv-a. transformer designed to operate on 440 volts would have a current capacity of about 22.7 amperes. This could be proven in the following manner.

10 kv-a. is equal to 10,000 volt-amperes or apparent watts.

Then, according to the formula $\frac{W}{E} = I$, from

Watts law, we find that in this case there would be:

$$\frac{10,000}{440} \text{ or } 22.7 + \text{ amperes,}$$

full load current for the transformer.

The actual load on the transformer we have found is 9 kw. at 75% P.F. $9 \text{ kw.} \div .75 = 12 \text{ kv-a.}$ apparent power.

Then, as 12 kv-a. is equal to 12,000 apparent watts, the current for this load can be determined as follows:

$$\frac{W}{E} = I, \text{ or } \frac{12,000}{440} = 27.3 \text{ amperes.}$$

Alternating Current

This shows that the transformer is carrying 5.6 amperes more than its full rated load, or is about 20% overloaded. This is not an excessive overload and would probably not cause any damage if the transformer is well ventilated and the load not left on too long.

This 10 kv-a. transformer would be fully loaded under each of the several following conditions.

- 10 kw. output at 100% P.F.
- 9 kw. output at 90% P.F.
- 8 kw. output at 80% P.F.
- 7 kw. output at 70% P.F., etc.

6. POWER IN SINGLE-PHASE CIRCUITS

Thus far we have only mentioned power in single-phase circuits.

With balanced polyphase circuits the power of the system will be the product of the power in one phase multiplied by the number of phases.

If the power is considerably unbalanced in the several phases, it should be calculated separately for each phase, and the power of the separate phases is then added together to get the total power on the system.

The apparent power in a single-phase circuit is determined by the usual Watts Law formula:

$$\text{App. W.} = E \times I$$

The true power in kw. for a single-phase circuit is found by the formula:

$$\text{True W} = E \times I \times \text{P.F.}$$

When the apparent power, or kv-a., and the voltage of a single-phase circuit are known, the current can be determined as follows:

$$I = \frac{\text{App. W}}{E}$$

7. POWER IN TWO-PHASE CIRCUITS

In balanced two-phase circuits, the power is calculated the same as for two single-phase circuits, that is, by the formulas:

$$\begin{aligned}\text{App. W} &= 2 \times E \times I \\ \text{True W} &= 2 \times E \times I \times \text{P.F.}\end{aligned}$$

To determine the current in either phase of a bal-

Power Factor

anced two-phase circuit when the voltage and total kv-a. are known, use the formula:

$$\frac{\text{App. W}}{2 \times E}$$

Two-phase power is used very little at present, but you may occasionally encounter some older installations of this type which are still in use.

8. POWER IN THREE-PHASE CIRCUITS

The power of balanced three-phase circuits can be determined by the formulas:

$$\text{App. W} = E \times I \times 1.732$$

$$\text{True W} = E \times I \times 1.732 \times \text{P.F.}$$

These formulas will apply to any balanced three-phase circuit, whether it is connected star or delta.

The constant 1.732 is used in three-phase formulas because the power of one phase of a three-phase circuit is always:

$$\text{App. W} = \frac{E \times I}{1.732}$$

This is due to the fact that in delta-connected systems the line current is always 1.732 times the phase-winding current of any device on the system; and in star-connected systems the line voltage is always 1.732 times the phase-winding voltage.

Therefore, part of the current in any phase wire of a three-phase, delta circuit is not effective in producing power in that phase, but is used in the other phases; and part of the voltage of any phase of a three-phase, star system is effective in producing power in the other phases.

So the apparent power in any one phase will always be:

$$\frac{E \times I}{1.732}$$

To obtain the power for all these phases we would then use the formula:

$$\text{Total 3-ph. app. W.} = \frac{3 \times E \times I}{1.732}$$

However, as 1.732 is also the square root of 3, it is not necessary to multiply the single-phase power

Alternating Current

by 3 and then divide by 1.732, as the same result is obtained if we simply multiply the single-phase power by 1.732, as shown in the first two formulas given for three-phase power.

These two formulas are well worth memorizing, as you will have frequent use for them in any work with three-phase power circuits or machines, and you can always depend upon them to quickly and easily determine the apparent power or true power.

To get the true power always use the formula which includes the power factor.

9. CURRENT IN THREE-PHASE CIRCUITS

To determine the current of any phase of a balanced three-phase circuit, when the apparent power in kv-a. and the voltage are known, the following formula can be used

$$I = \frac{\text{App. W}}{1.732 \times E}$$

When the voltage, true power in kw., and power factor are known, the current can be determined as follows:

$$I = \frac{\text{True W}}{1.732 \times E \times \text{P.F.}}$$

To determine the voltage when apparent power and amperes are known:

$$E = \frac{\text{App. W}}{1.732 \times I}$$

To determine the voltage when true power and amperes are known:

$$E = \frac{\text{True W}}{1.732 \times I \times \text{P.F.}}$$

The voltage and current can also be determined with voltmeter and ammeter, when they are available. Check these formulas by actual meter tests on the job whenever you have the opportunity.

10. PRACTICAL FIELD PROBLEMS

What will be the true power of a balanced three-phase circuit which has 20 amperes flowing at 440 volts, and at 80 per cent P.F.?

Power Factor

Using the formula:

$$\text{True power} = 1.732 \times E \times I \times \text{P.F.}$$

our problem becomes:

$$440 \times 20 \times 1.732 \times .80 = 12193.28 \text{ true watts.}$$

$$440 \times 20 \times 1.732 = 15241.6 \text{ apparent watts}$$

The apparent power in kv-a. will then be:

$$\frac{15241.6}{1000}, \text{ or } 15.24 \text{ kv-a.}$$

The true power in kw. will be:

$$\frac{12193.28}{1000}, \text{ or } 12.2 \text{ — kw.}$$

Suppose that in another case you have made a meter test on the circuit to a 65 h.p., three-phase induction motor. The voltmeter shows 230 volts across any one of the three phases, and an ammeter connected first in one phase and then the others, shows that the load is properly balanced and that 85 amperes is flowing in each wire. What is the apparent power of this circuit in kv-a?

Using the formula:

$$3 \text{ Ph. App. W} = E \times I \times 1.732$$

We find that $E \times I = 230 \times 85$, or 19,550

$$\text{Then } 19,550 \times 1.732 = 33,860.6 \text{ watts, and } 33,860.6 \div 1000 = 33.86 + \text{ kv-a.}$$

Testing this same circuit with a wattmeter, we find only 20,320 watts or 20.32 kw. of true power in the circuit.

Assuming that both the voltmeter and ammeter test and the wattmeter tests were made at the same time, and while the motor was operating under the normal mechanical load which it drives, what is the power factor of the circuit?

$$\text{P.F.} = \frac{\text{true power}}{\text{apparent power}}$$

or, in this case,

$$\text{P.F.} = \frac{20.32}{33.86}, \text{ or } .60 + \text{ P.F.}$$

Alternating Current

This is very low and undesirable power factor, and if we check the motor input in h. p., we will find the probable cause of the low power factor.

The motor is rated at 65 h. p., but is consuming only 20.32 kw. of true power when running with its normal connected load. As 1 kw. is equal to 1.34 h.p., then $20.32 \times 1.34 = 27.2+$ h. p., and this is less than half of the motor's full rating.

Lightly-loaded induction motors operate at a much lower P.F. than fully loaded ones, and are common causes of low power factor.

In cases such as the one in this problem, if the mechanical load on the motor is never more than 27.2 h. p. and not particularly difficult to start, the 65 h. p. motor should be changed to one of about 27 or 30 h. p., to obtain better P. F. and higher efficiency.

If the total true power in a balanced, 440-volt, three-phase system is 125 kw., and this system is operating at 90 per cent. power factor, what will be the current in each phase?

Referring back to the formula given for finding current in a 3 Ph. circuit, when the true power, power factor, and voltage are known, we find that:

$$I = \frac{\text{True watts}}{1.732 \times E \times \text{P.F.}}, \text{ or}$$

in this case, 125 kw. = 125,000 true watts; therefore

$$I = \frac{125,000}{1.732 \times 440 \times .90}, \text{ or } 182.2+ \text{ amperes.}$$

Work out this problem and prove the figures. Practice working problems with the formulas given in this lesson until you are quite familiar with their use and the manner in which the power factor affects such calculations on actual circuits and machines which you will encounter in your work.

POWER MEASUREMENT

In the preceding articles we have mentioned several times the use of meters to measure the voltage, current, or power of A. C. circuits.

Power Measurement

It is very important that you appreciate the great value of meters in such work, and also that you know how to properly connect and use them. This fact was emphasized in the Direct Current lessons and it is equally as important, or even more so, in connection with A. C. circuits and machines.

The intelligent use of the proper meters often helps to improve the efficiency of operation of various power machines, and also prevents damage to equipment by making sure that the voltage and current are right for the design and rating of that equipment.

In many cases very great savings can be effected by permanently connecting the proper meters to certain heavy power circuits or the circuits of individual machines, to allow frequent observation of voltage, load, and power factor conditions.

Frequently the saving effected in this manner will more than pay for the cost of the meters, in the first few months of their use.

On circuits where no meters are permanently installed, it is well to make periodic tests with portable meters, to see that the machines or circuits are operating at proper voltage, and that they are not overloaded. These tests will also show if certain machines are operating lightly loaded and causing low power factor and poor efficiency.

Many of the values for A. C. circuits can be easily calculated when certain others are known, by the use of the formulas which have been given in the preceding articles. In other cases, it may be much quicker and easier to use meters to determine these values. By using meters where necessary or most convenient and the simple formulas where meter readings are not obtainable, practically any problem can easily be solved.

11. CONNECTING INSTRUMENTS

When making any tests with portable meters or when installing permanent meters, it is very important to properly make all connections. Otherwise, incorrect readings will be obtained, and wrong connections may result in damage to the instru-

Alternating Current

ments, or danger to the person making the connections.

With A. C. voltmeters, ammeters, and wattmeters also, the same general rule applies as was given for D. C. meters: **always connect voltmeters and potential elements of wattmeters across the line, and always connect ammeters and current elements of wattmeters in series with the line — never in parallel.**

The coils or shunts of ammeters and of the current elements of wattmeters are of so low resistance that if they were connected across the line, a short circuit would result and probably burn out the instrument. In such cases there is also danger of the operator being burned by flying drops of molten copper, or of his getting "flashed eyes" from the blinding flash of the arc which may be caused by the short circuit, when wrong connections are made to live circuits.

The following connection diagrams and instructions for the use of meters on various tests are given

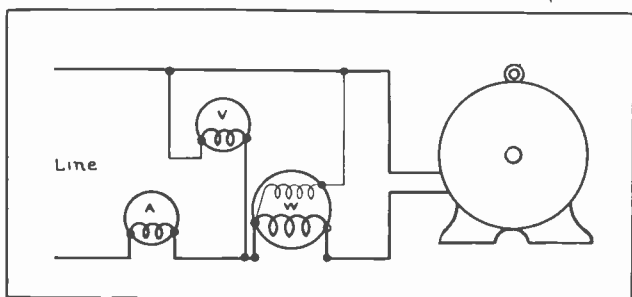

Fig. 1. This sketch shows the method of connecting the meters to measure voltage, current, and power of a single-phase motor.

to enable you to make such tests correctly and safely.

12. POWER MEASUREMENT ON SINGLE-PHASE CIRCUITS

Fig. 1 shows the proper connections for a voltmeter, an ammeter, and a wattmeter in a single-phase circuit. Note that the voltmeter and potential

Power Measurement

coil of the wattmeter are both connected **across** the line; and that the ammeter and the current coil of the wattmeter are both connected **in series** with the line.

It does not matter which side of the line the ammeter and wattmeter are connected in, as all the current to the motor must flow through each line wire, and correct total readings can be obtained from either wire.

The voltmeter in this case will indicate whether or not the line voltage is proper for the voltage rating of the motor as given on the name-plate of the machine.

Too low a voltage will cause reduced torque and poor efficiency of motors, and possibly also cause them to overheat.

The ammeter when connected as in Fig. 1 will indicate the current load on the motor and show whether the machine is overloaded, or possibly too lightly loaded. The full-load current rating of A.C. motors is usually stamped on their name-plates.

The wattmeter may be used instead of the ammeter to determine the load on the machine; but if the power factor is low, the wattmeter reading divided by the voltage is not a reliable indication of the current load on the machine; because with low power factor there may be considerable wattless current flowing.

The wattmeter can be used with the voltmeter and ammeter to determine the power factor of the machine. The wattmeter will read the true power, and the product of the voltmeter and ammeter readings will give the apparent power. Then, dividing the true power by apparent power will give the power factor, as previously explained.

The wattmeter reading gives the true power input to the motor, and enables one to calculate the h.p. the motor should deliver if it is operating properly.

13. METER CONNECTIONS FOR HIGH VOLTAGE CIRCUITS

Fig. 2 shows the meters and connections for measuring the voltage, current, and power of a high-voltage circuit, where **instrument transformers** are used.

Alternating Current

On circuits over 600 volts, meters are very seldom connected directly to the line, because of the danger to operators and the difficulty and expense of insulating the meter elements for the higher voltages.

Special transformers are used to reduce the voltage and current at the meters to a definite fraction of the voltage and current on the line. These transformers are called **current transformers** and **potential transformers**, and are designed to maintain on their secondaries a fixed ratio of the voltage or current on their primaries. The meters used with such

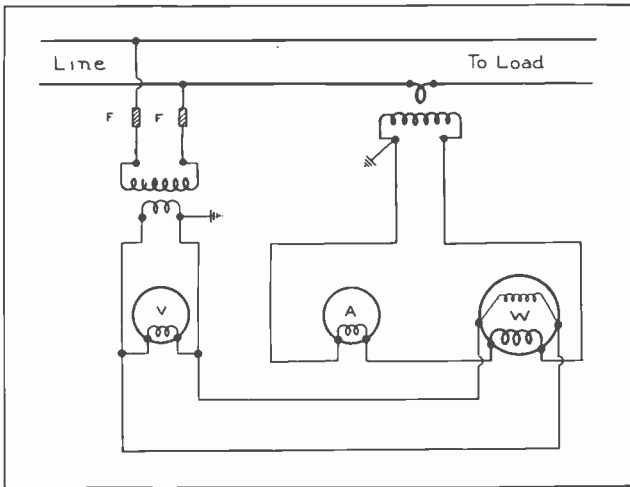

Fig. 2. When meters are used to measure the energy of high voltage lines instrument transformers are used to reduce the voltage and current to the meters.

transformers can, therefore, be calibrated to read the full voltage, current, or power on the line.

The potential transformer at the left in Fig. 2, has its primary winding connected across the line, and its secondary supplies both the voltmeter and the potential coil of the wattmeter, which are connected in parallel.

The current transformer on the right has its primary coil connected in series with the line, and its secondary supplies both the ammeter and the current coil of the wattmeter, which are connected in series.

Power Measurement

You will note that the secondaries of both transformers are grounded, to prevent damage to instruments and danger to operators in case the insulation between the high-voltage primary and the low voltage secondary coils should fail.

The potential transformer is equipped with fuses in its primary leads.

Never disconnect an ammeter from a current transformer without first short-circuiting the secondary coil of the transformer.

If the secondary of a current transformer is left open while its primary is connected to the line, dangerously high voltages may be built up in the secondary. This will be more fully explained in a later lesson on transformers.

14. DETERMINING RESISTANCE OF A. C. CIRCUITS

Resistance measurements on A. C. circuits can be made by use of a Wheatstone bridge or a megger, both of which were explained in lesson 39 on D. C. meters. The Wheatstone bridge is most frequently used for making accurate tests on lines or devices of various resistances, although the megger is very convenient for making tests where extreme accuracy is not required.

The resistance of an A. C. circuit or device can also be calculated from voltmeter and ammeter readings, by passing low-voltage direct current through the circuit under test. Inductance does not oppose the flow of D. C., so the current flow will be proportional to the voltage and resistance only.

When the voltage and current readings are obtained with D. C. meters and with D. C. voltage applied to the circuit, the resistance can then be determined by the formula $E \div I = R$, with which you are already familiar.

*It is well to remember that the resistance of wires and metallic circuits of copper, aluminum, iron, etc., will increase with any increase in the temperature of the conductors. This is particularly true of iron or resistance alloys in rheostats, and of the filaments in incandescent lamps.

Alternating Current

The resistance of lamp filaments when heated to incandescence may be from 4 to 10 times as high as it is at 70° F., or ordinary room temperature.

15. CURRENT MEASUREMENTS ON THREE-PHASE CIRCUITS

Fig. 3 shows a three-phase motor with an ammeter connected in one of its line wires to measure the current. If the motor is operating properly, the current should be very nearly the same, or balanced in all three phases.

The current rating on the name-plate of any three-phase motor is the amount of current that should flow in each of the three wires leading to the motor. Therefore, if the motor shown in Fig. 3 has a name-plate rating of 50 amperes, an ammeter should show 50 amperes in any of the three wires when the motor is operating fully loaded.

If the current is unbalanced to any great extent, it indicates that there is probably a fault in one or more of the phases in the motor winding.

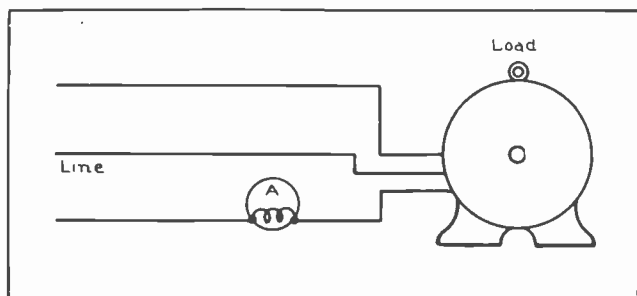

Fig. 3. Ammeter connected to measure the current in one phase of a three-phase motor.

Where the current of a three-phase system is known to be balanced at all times, one ammeter permanently connected in any of the three wires is all that is required to determine the current.

It is well, however, to occasionally test all three phases with a portable ammeter, to locate any possible unbalance which may occur due to faulty machine windings; or to locate unbalance which may

Power Measurement

occur on main wires by connecting more single-phase equipment on some one phase than on another.

All single-phase load connected to a three-phase system should be kept balanced as much as possible, by connecting an equal number of devices or equal loads in kv-a. to each phase.

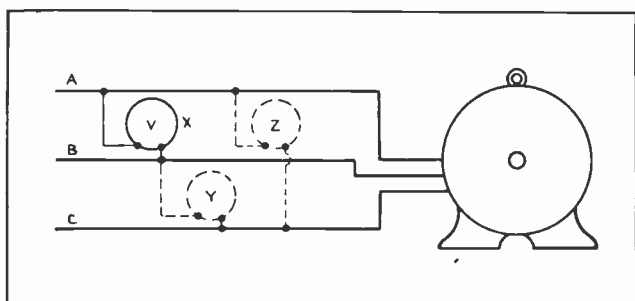

Fig. 4. This diagram shows three different connections for a voltmeter used to measure the voltage of each phase of the three-phase line to this motor.

Where the load is likely to be unbalanced and the amount of load on the different phases is varying, it is often well to have three ammeters, one connected in each phase.

16. VOLTAGE MEASUREMENTS ON THREE PHASE CIRCUITS

Fig. 4 shows the method of connecting a voltmeter to indicate the voltage of a three-phase system or motor. The voltmeter can be connected between any two of the three wires, and should show approximately the same reading on all phases.

Slight variations of voltage between the various phases generally do not harm, but if the voltmeter shows widely varying readings, when connected first at X, then at Y, and then at Z, it indicates that the circuit is unbalanced.

This unbalance and reduced voltage on certain phases will decrease the torque and efficiency of three-phase motors operating on the line.

Alternating Current

17. POWER MEASUREMENTS ON THREE-PHASE CIRCUITS

For measuring the power of three-phase circuits, either single-phase or polyphase wattmeters can be used. The readings of single-phase wattmeters can be totalled up to obtain the three-phase power, while a three-phase wattmeter will read directly the true power of all three phases.

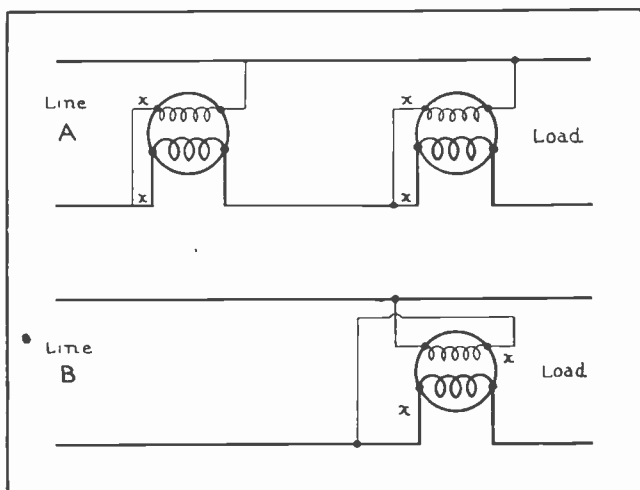

Fig. 5-A. Above is shown the method of connecting wattmeters to a single-phase circuit to locate the proper terminals of the potential and current coils.

Fig. 5-B. This sketch illustrates the method of reversing the leads to the potential coil if necessary, to make the meter read properly.

Where single-phase wattmeters are used, the **two wattmeter method** shown in Fig. 6 is very commonly applied.

In order to obtain correct results with the two meters, it is necessary to test them to make sure that, corresponding coil leads are brought out to the same meter terminals; or, if they are not, to get them correctly marked so that the meters can be connected properly to the three-phase wires to obtain the right polarity of the meter coils.

To test the meters, connect them both to a single-phase circuit, or to the same phase of a three-phase circuit, as shown in Fig. 5-A. Make sure that there is some load on the circuit to enable the meters to show a reading.

Power Measurement

If both meters give the same indication with their pointers moving across the scale in the right direction, then carefully mark or tag the terminal of the potential coil and the terminal of the current coil which are connected together and to the line. In this figure these leads are each shown with an "X".

If one of the meters reads "backwards" when connected as shown in Fig. 5-A, the potential coil leads should be reversed as shown in Fig. 5-B. The meter should then read "forward"; that is, its pointer should swing to the right across the scale. The terminals or leads should then be marked as shown.

With the two meters now connected to the three-

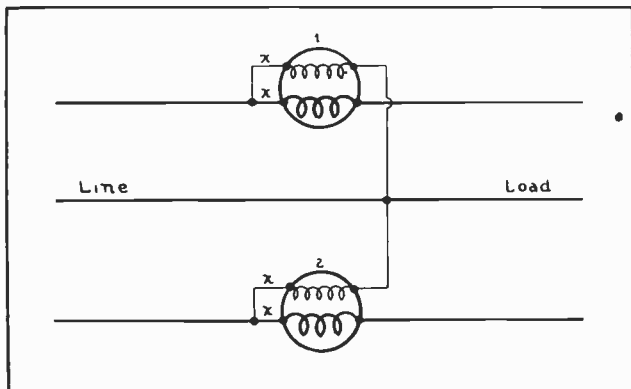

Fig. 6. This sketch shows the connections for using two single-phase wattmeters to measure the power in a three-phase circuit.

phase circuit as shown in Fig. 6 and with the proper terminals connected together and to the lines, the meter readings will be called "positive" readings. The sum of the two meter readings will be the total three-phase power of the circuit. If the meters are properly connected as shown in Fig. 6 and the pointer of one meter attempts to swing backwards, or below zero, the potential leads of that meter should be reversed, as shown on meter No. 2 in Fig. 7. Its reading is then called "negative," and should be subtracted from that of the positive meter to get the three-phase power.

Alternating Current

18. CORRECT CONNECTIONS NECESSARY FOR ACCURATE RESULTS

Fig. 8 also shows the connections for the "two wattmeter method" but shows the current coil of one of the meters connected in a different phase from what it was in Fig. 6. The current coils of the two wattmeters can be connected in any two of the three phases, and if the potential coil leads are properly connected the results should be the same. However, one of the potential coil leads of meter No. 2 is connected wrong in Fig. 8, as this connection will give correct readings only when the power factor is unity, or 100%.

As unity power factor is seldom found on any A. C. circuit, this connection should usually be avoided, and the potential coil lead should be connected as shown by the dotted line.

When the "two wattmeter method" is used, the ends of the potential coils which are not attached directly to the same wire with their current coils should connect to the line wire in which no current coil is connected; as shown in Fig. 7, or in Fig. 8 after the one lead is corrected as shown by the dotted line.

It may at first seem peculiar that two wattmeters

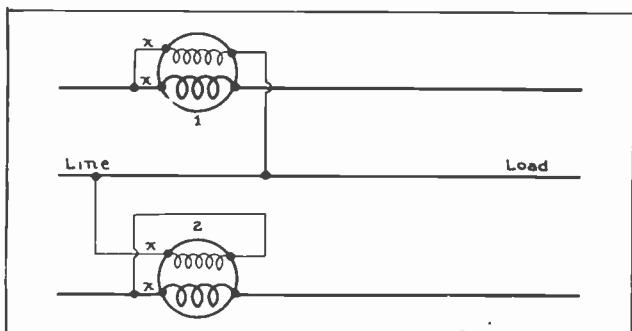

Fig. 7. This diagram shows the connections to the lower wattmeter reversed to obtain proper readings on circuits with low power factor.

used in this manner will give the total three-phase power of the circuit. This is true, however, because

Power Measurement

the current which flows to the load through the un-metered wire at any instant must be flowing back to the alternator through one or both of the other wires, thus allowing the two meters to read full 3 ϕ power.

The phase relations between the currents and voltages of a balanced three-wire system are such that the "two wattmeter method" will accurately give the total three-phase power, if the connections are properly made and the readings are added if they are both "positive", or subtracted if one is "negative" and the other "positive."

If wattmeter No. 1 in Fig. 6 reads 8000 watts and meter No. 2 reads 6000 watts, the total power will be $8000 + 6000$, or 14,000 watts.

If the meters must be connected as shown in Fig. 7 to obtain readings above zero, then the negative reading must be subtracted from the positive reading to get the total power.

For example, if meter No. 1 in Fig. 7 reads 20,000

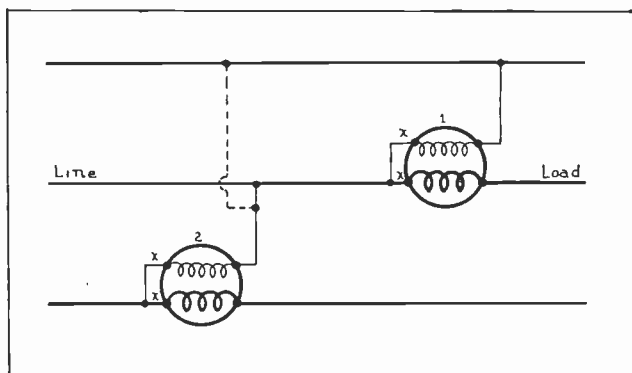

Fig. 8. This sketch shows the correct and incorrect methods of connecting one of the wattmeters when measuring three-phase power by the "two wattmeter method."

watts and meter No. 2 reads 6,000 watts, then the total power will be:

$$20,000 - 6,000 \text{ or } 14,000 \text{ watts.}$$

In all circuits where the power factor is less than 50 per cent., one of the two wattmeters will give a negative reading.

Alternating Current

On circuits where the load is quite constant, one wattmeter can be used to determine the three-phase power, by connecting it first in one phase and then in another, as shown at positions 1 and 2 in Fig. 9.

The reading of the meter in position 1 is noted, and the meter is then shifted to position 2, and the reading is again noted. If both readings are "positive", their sum will give the total true power. If one reading is "positive" and one negative, their difference will give the total true power.

One wattmeter should not be used to determine total three-phase power on circuits where the load varies much, as the load may change while the meter connections are being changed, and thus give an incorrect total.

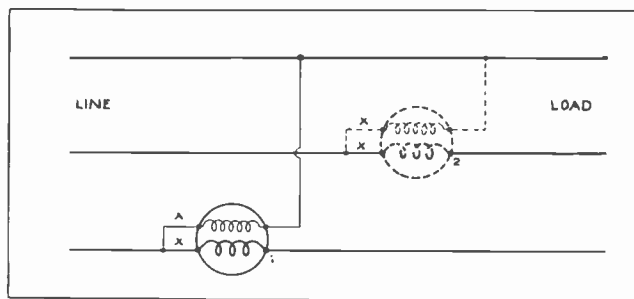

Fig. 9. The above diagram shows the manner of connecting one wattmeter in two different phases of a three-phase system in order to measure the total power.

19. POWER MEASUREMENT ON HIGH VOLTAGE CIRCUITS

Fig. 10 shows the connections for the "two wattmeter method" of measuring three-phase power on high-voltage circuits where instrument transformers are used.

Separate potential transformers supply the voltage from the two phases to the potential elements of the wattmeters. Separate current transformers supply the proportional current from the two phases to the current elements of the two wattmeters.

The same procedure of marking the potential and current coil leads and checking the positive or negative readings is followed in this case as when no instrument transformers are used.

Power Measurement

20. THREE METER METHOD OF POWER MEASUREMENT

Fig. 11 shows three wattmeters used to measure the total power of a three-phase system.

With this connection we use a "Y box" which consists of three separate resistances, connected together at one end to form a star connection and provide a neutral point to which one end of each wattmeter potential coil is connected.

When connected in this way, each wattmeter

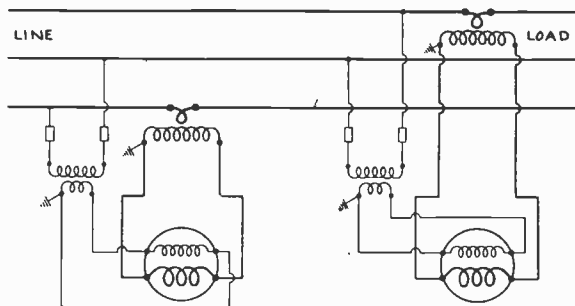

Fig. 10. Connections for two wattmeters on a three-phase circuit, using instrument transformers to reduce the voltage and current to the meters.

measures only the power of the phase in which it is connected, and the total power will be the sum of the three meter readings.

For example, if meter No. 1 reads 14,000 watts, meter No. 2 reads 16,000 watts, and meter No. 3 reads 17,000 watts; the total power will be 47,000 watts.

Wattmeters connected in this manner will always read "positive" regardless of the power factor.

This makes the method very simple and reliable and one which is very commonly used on large power circuits, where very accurate readings are important and all chance of error should be avoided.

For measuring the total power of a three-phase, four-wire system, the connections shown in Fig. 12 are used. In these systems the neutral wire is already provided by the fourth wire which is connected to the star point of the winding of the alternator or at the transformer connections, and therefore no Y box is needed.

Alternating Current

The total power of the three-phase four-wire system thus measured will be the sum of the three meter readings.

21. METERING ALTERNATOR OUTPUT

Fig. 13 shows the meters and connections for measuring the power output of an alternator, both

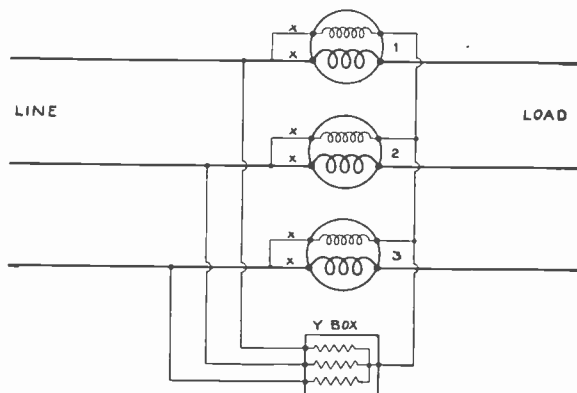

Fig. 11. Meter connections for a "three wattmeter method" for measuring the total power in a three-phase circuit. The Y Box shown in this diagram is explained in the accompanying paragraphs.

in true power and apparent power, and also for determining the voltage, current, and power factor.

We will assume that the meter readings are as follows:

$$\text{Voltmeter} = 440 \text{ E}$$

$$\text{Ammeter} = 60 \text{ I}$$

$$\text{Wattmeter No. 1} = 18,250 \text{ W}$$

$$\text{Wattmeter No. 2} = 21,750 \text{ W}$$

The total three-phase true power will then be $18,250 + 21,750 = 40,000 \text{ W}$, or 40 kw.

The total three-phase apparent power will be $E \times I \times 1.732$, or $440 \times 60 \times 1.732 = 45,724.8$ watts or approximately 45.725 kv-a.

The power factor will then be $\frac{\text{true power}}{\text{app. power}}$
or, $40 \div 45.725 = .874$, or 87.4% P.F.

22. METER TESTS, POWER PROBLEMS

The following practical examples are given to make you thoroughly familiar with the use of the

Power Measurement

formulas and methods commonly used on actual circuits in the field.

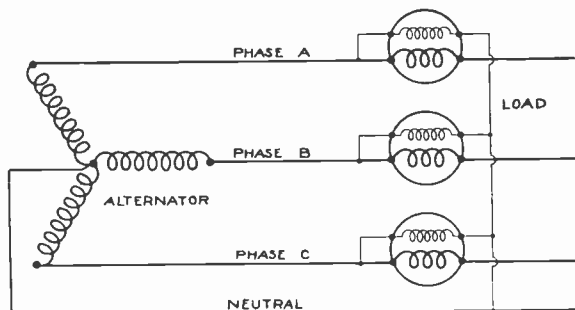

Fig. 12. This diagram shows the connections for three wattmeters to measure the power of a three-phase, four-wire system.

Men who can make these calculations as well as operate and maintain the machines intelligently are the men who become foremen, or chief operators.

Assume that a meter test of a single-phase circuit shows the following readings:

$$\begin{aligned}\text{Voltmeter} &= 220 \text{ E} \\ \text{Ammeter} &= 80 \text{ I} \\ \text{Wattmeter} &= 14,000 \text{ W}\end{aligned}$$

What will be the kw., kv-a., and P.F. of this circuit?

Use the proper formulas in each case, looking them up in the preceding articles if necessary, and work out each part of the problem step by step.

The answers are given here to enable you to check your results.

$$\text{kw.} = 14, \text{ kv-a.} = 17.6, \text{ and P.F.} = 79.5\%$$

In another case, assume you are testing an alternator and obtain the following meter readings:

$$\begin{aligned}\text{Voltmeter} &= 2200 \text{ E} \\ \text{Ammeter} &= 50 \text{ I} \\ \text{Wattmeter} &= 160,000 \text{ W}\end{aligned}$$

What will be the kw., kv-a., and P.F.?

Answers: kw. = 160, kv-a. = 190.5+, and P.F. = .839 or 84-%.

Alternating Current

On a two-phase system we find a voltage of 200 E on each phase, current of 60 I on each phase, and a wattmeter reading shows 9,000 watts on each phase. What will be the kw., kv-a., and P.F.?

Answers: kw. = 18, kv-a. = 24, and P.F. = .75

If a coil or winding of an A. C. machine has a flow of 5 amperes through it when connected to 200 E, A.C., and has 20 amperes through it when connected to 100 E, D.C., what will be the impedance, the resistance, and the P.F. of the winding?

On A. C. circuits:

$$\frac{E}{I} = Z, \text{ therefore } \frac{200}{5} = 40 \text{ ohms impedance}$$

On D. C. circuits:

$$\frac{E}{I} = R, \text{ therefore } \frac{100}{20} = 5 \text{ ohms resistance}$$

When both the resistance and impedance are known,

$\frac{R}{Z} = \text{P.F.}$, Therefore, $\frac{5}{40} = \frac{1}{8} = \text{---}$, or .125, or 12½% P.F.

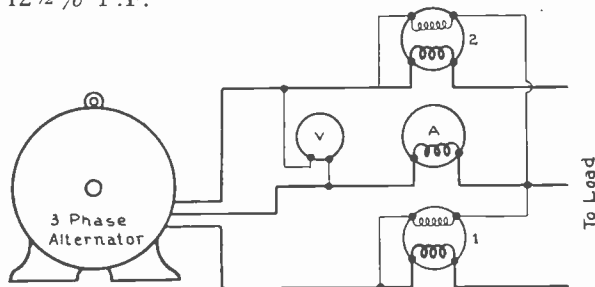

Fig. 13. Voltmeter, ammeter, and wattmeter connected to measure the voltage, current, and power output of a three-phase alternator.

If a circuit with a condenser or capacity effect, causing a capacity reactance of 20 ohms, is connected in series with a resistance of 12 ohms, what is the total impedance and the P.F.?

$$Z = \sqrt{R^2 + X_c^2}, \text{ or } Z = \sqrt{12^2 + 20^2}$$

$$12^2 = 12 \times 12 \text{ or } 144$$

Power Measurement

$$20^2 = 20 \times 20 \text{ or } 400$$

$$144 + 400 = 544$$

$$\sqrt{544} = 23.3+, \text{ ohms impedance}$$

$$\frac{R}{Z} = \text{P.F.}, \text{ or } \frac{12}{23.3} = .515, \text{ or } 51.5\% \text{ P.F.}$$

EXAMINATION QUESTIONS

1. (a) Define apparent power. (b) What unit do we use to express apparent power?
2. Define power factor.
3. What would be the power factor on an A.C. single phase circuit with meter readings as follows? 20 amperes, 110 volts, 2000 watts?
4. What would be the true power on a balanced three phase circuit with 10 amperes flowing at 220 volts with a power factor of 60 per cent?
5. Draw a sketch showing ammeter, voltmeter, and wattmeter connections for use in a single phase motor circuit.
6. How are meters usually connected to an A.C. line of over 600 volts?
7. Draw a sketch showing how you would connect two single-phase watt meters for measuring the total power on a three-phase circuit.
8. Draw a sketch showing one voltmeter, one ammeter, and two wattmeters arranged to measure the output of a three-phase alternator.

Alternating Current

A. C. GENERATORS

As most of the electrical power generated is alternating current, the operation and care of A. C. generators, or alternators as they are commonly called, is a very important subject. This lesson will deal principally with the common types of alternators; their construction, operation and care.

The windings used in alternators and the principles by which they generate alternating voltage have been covered in the Armature Winding lessons and in Alternating Current Lesson 44.

Alternators are made in sizes ranging from the small belt-driven or engine-driven types of from 1 to 50 kv-a. up to the mammoth turbine-driven units of over 200,000 kv-a.

Alternators can be divided into the following classes: (A) Revolving armature or revolving field types; (B) Vertical or horizontal types; (C) Turbine or engine types.

1. REVOLVING FIELD ALTERNATORS

Practically all A. C. generators of over 50 kv-a. capacity are of the revolving-field type, because this type of construction permits the generation of much higher voltages in the stationary armature windings, and also because it eliminates the necessity of taking high-voltage energy from a revolving member through sliding contacts. This greatly simplifies the construction of the machine and reduces insulation difficulties.

Revolving-field alternators are commonly made to generate voltages as high as 13,200, and some are in operation producing voltages of 22,000 directly from their stator windings. Alternators can now be constructed to produce voltages as high as 36,000. The generation of such high voltages makes possible very economical transmission of this energy, and also reduces the necessary winding ratio of transformers when the voltage is to be stepped up still higher for long distance transmission.

At the left in Fig. 1 is shown the **stator**, or sta-

A. C. Generators

tionary armature, of an alternator. The rotor, or revolving field, which has been removed from the stator, is shown at the right. Note the stator coils or windings which are practically the same for alternators as for A. C. induction motors.

These windings were thoroughly described, both as to construction and connections, under Three-Phase Stator Windings in lessons 30 and 31.

Note also the construction of the revolving field element and the manner in which the poles are mounted on the spider. The collector rings, through which the low-voltage direct current is passed to the field coil, can be seen at the end of the rotor.

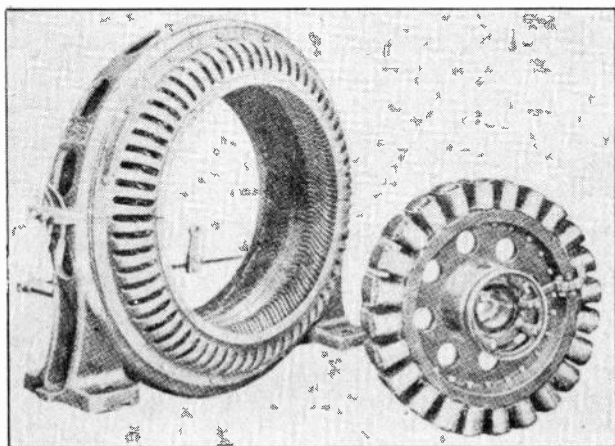

Fig. 1. Above are shown the complete stator of an A. C. generator on the left and the revolving field or rotor on the right. The field coils on the rotor are excited with direct current and revolved within the stator to generate alternating current in its windings.

Some of the smaller A. C. generators have revolving armatures which are wound very similarly to those for D. C. generators, and have connections brought out to slip rings so the generated energy can be transferred from the revolving armature to the line by means of these slip rings and brushes.

However, many of the smaller alternators are also built with revolving fields. Fig. 2 shows a belt-driven alternator of 125 kv-a. capacity, with a revolving field and stationary armature. This gen-

Alternating Current

erator is driven at 900 R.P.M. and produces three-phase, sixty-cycle energy at 2300 volts. Note the three leads which are brought out from the stator for permanent connections to the switchboard or line when the machine is installed. In this manner the load current flows directly from the stationary armature to the line without any slip rings or sliding connections in the circuit. Note the D. C.

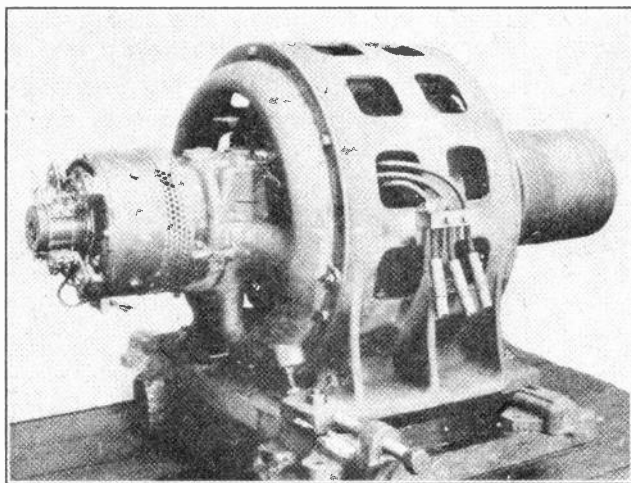

Fig. 2. This photo shows a 125 kv-a. alternator of the horizontal belt-driven type. Note the D. C. exciter-generator which is direct connected to the left end of the shaft. (Photo Courtesy Allis Chalmers Mfg. Co.)

exciter-generator which is attached directly to the end of the shaft of this alternator.

Fig. 3 shows the revolving field for a small alternator of the type shown in Fig. 2. Note carefully the construction of the field poles on this rotor, and also the slip rings and D. C. exciter-armature on the end of the shaft.

The direct current energy required to excite the field of an A. C. generator is very small in comparison with the A. C. output of the machine. This energy for excitation varies from three-fourths of one per cent. to two and a half per cent. of the total capacity of the alternator.

It is easy to see, therefore, that the revolving field will require much smaller and lighter conductors

A. C. Generators

than a revolving armature would; and also that the handling of this smaller amount of energy through brushes and slip rings at low voltage, is a much simpler proposition than to handle the total load current of the machine at the high voltages used on modern alternators.

Keep in mind that it makes no difference in the nature or amount of voltage generated by the machine whether the field poles revolve past the stationary armature conductors or the armature conductors revolve past the stationary field poles. As long as the same field strength and speed of motion

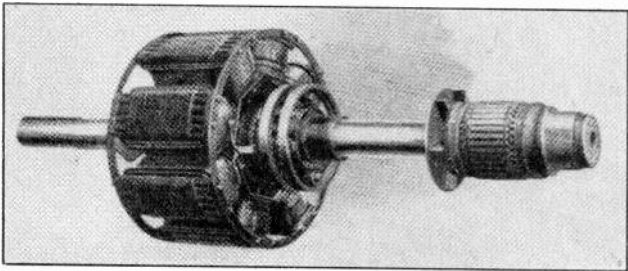

Fig. 3. This view shows the construction of the rotor or revolving field of an alternator similar to the one shown in Fig. 2. Examine its construction carefully and note the position of the collector rings and exciter-armature on the shaft.

are maintained, the cutting of the lines of force across the conductors will in either case produce the same voltage and the same frequency.

2. VERTICAL TYPE AND HORIZONTAL TYPE ALTERNATORS

The terms vertical and horizontal as applied to A. C. generators refer to the position of the shaft. Belt-driven alternators, or generators that are connected directly to steam engines, are usually of the horizontal-shaft type. The generator shown in Fig. 2 is of the horizontal type.

Large steam-turbine-driven generators are also more commonly made in the horizontal types, although some of these are in operation which have vertical shafts.

Water-wheel generators are more commonly made in the vertical type, as this construction al-

Alternating Current

lows the generator to be placed on an upper floor, with the water-wheel on a lower level and attached to the generator by means of a vertical shaft.

This reduces the danger of moisture coming in contact with the generator windings due to any possible leakage or dampness around the water-wheel.

Fig. 4 shows a large, vertical type, water-wheel-driven generator. This machine has a capacity of 18,750 kv-a. and produces 60-cycle alternating current at 6600 volts. Machines of this type usually operate at quite low speeds, this particular one having a normal speed of $112\frac{1}{2}$ R.P.M.

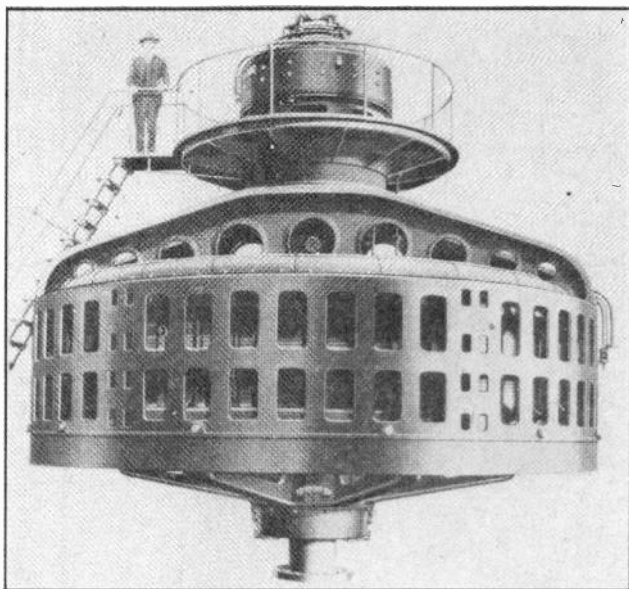

Fig. 4. Large vertical type alternator for water-wheel drive. The stator core and windings of this machine lay in a horizontal position just inside the lower frame work, and the field poles revolve on the vertical shaft within the stator. (Photo Courtesy Allis Chalmers Mfg. Co.)

Note the D. C. exciter-generator mounted on top of the shaft above the thrust bearing and main support members of the generator frame. The water-wheel attaches to this generator at the coupling which is shown on the lower end of the shaft.

A. C. Generators

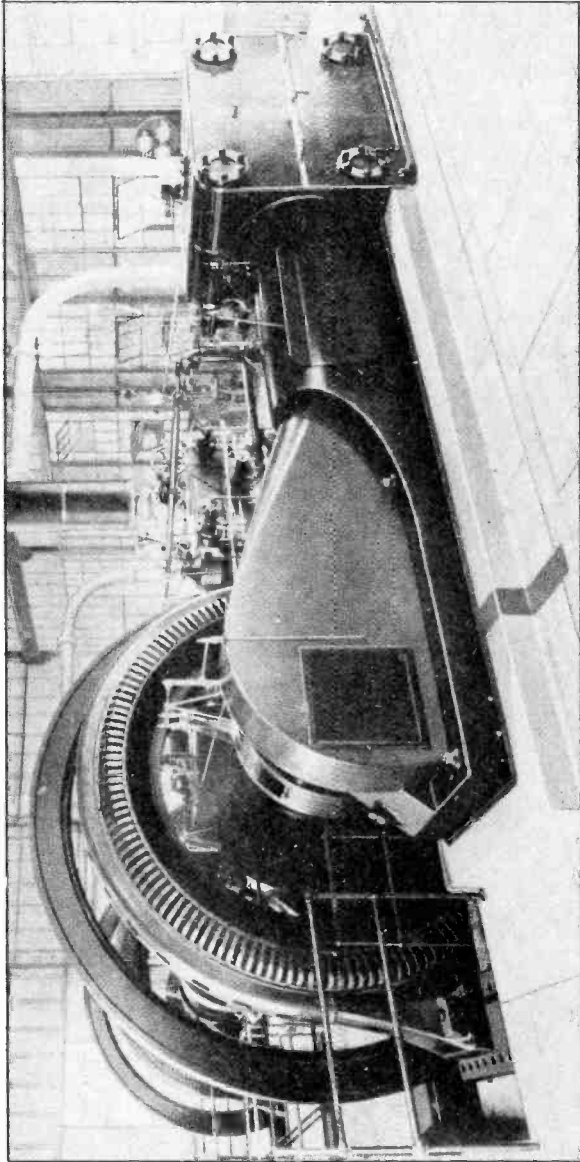

Fig. 5. This photo shows a view in a power plant equipped with horizontal type steam-engine-driven alternators. These alternators are made with large diameters because of the relatively low speed at which they are driven. (Photo Courtesy Allis Chalmers Mfg. Co.)

Alternating Current

Horizontal-type generators usually present a much simpler bearing problem, as the horizontal shaft lies in simple sleeve-bearings which support the weight of the revolving field at each end of the shaft.

Vertical-type generators require special thrust-bearings to support the weight of the shaft and rotor, and also a set of guide bearings to keep the rotor in proper alignment within the stator core.

Vertical-type machines require less floor space, which is one advantage in their favor where the power plant must be as small as possible.

3. TURBINE TYPE AND ENGINE TYPE ALTERNATORS

The terms "turbine" and "engine" type as applied to alternators refer to the type of prime mover by which the alternator is driven. As there is considerable difference between the speeds of ordinary reciprocating steam engines and those of steam turbines, the generators designed for engine drive are of considerably different shape and construction than those designed for high-speed turbine drive.

Engine-driven alternators are usually of quite large diameter and narrow in width from one side to the other of the stator core. The rotors for these machines usually have a rather large number of field poles, in order to obtain the proper frequency at their low operating speeds.

Steam-turbine-driven generators, or turbo-alternators as they are commonly called, are usually made with much smaller diameters and greater in length than the engine-type generators. The very high speeds at which steam turbines operate makes necessary the small diameter of the revolving field of the generator, in order to reduce centrifugal stresses.

These higher operating speeds also make possible the generation of ordinary 60-cycle energy with a very small number of field poles.

Turbine-driven generators are commonly made with two or four poles on the revolving field. Fig. 6 shows a large steam-turbine-driven alternator of

A. C. Generators

50,000 kw. or 62,500 kv-a. capacity. The generator is on the left in this view and the steam turbine on the right. The two are directly connected together on the same shaft.

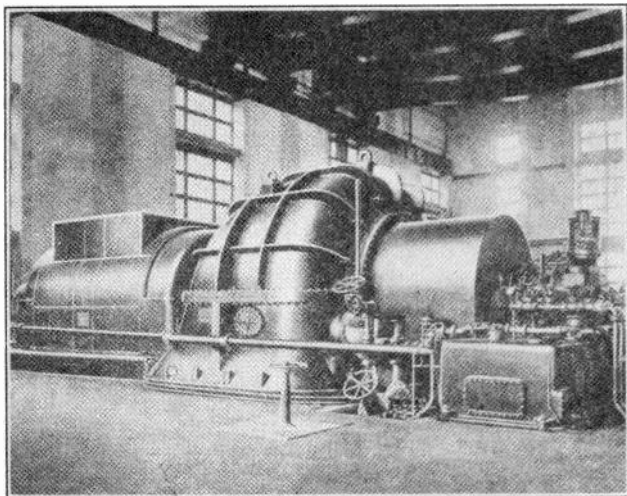

Fig. 6. Large steam-turbine-driven alternator. The turbine with its control mechanism is on the right. This alternator is enclosed in the air-tight casing at the left. This unit is typical of hundreds of great steam-driven generators in use in modern power plants throughout this country. (Photo Courtesy General Electric Co.)

This alternator is completely enclosed in an air-tight casing to keep out all dirt and moisture from its windings, and to allow cooling by forced air circulation within this casing.

4. CONSTRUCTION OF ALTERNATORS. ARMATURES

Regardless of the type or construction of the alternator, the two principal parts to be considered are the armature and the field. The main winding, whether it is placed on the rotor or in the stator, is usually referred to as the armature; and, as previously mentioned, these armature windings for ordinary A. C. generators are practically the same as those for the stators of induction motors. In fact, the same winding can be used for either a motor or

Alternating Current

generator, if the squirrel cage is exchanged for a revolving field with the proper number of poles, or vice versa.

On large machines there are enormous magnetic stresses set up between the conductors of the winding when the generators are heavily loaded or during times of sudden surges due to overloads or short-circuits. For this reason, it is necessary to securely anchor or brace the coils, not only by slot wedges but also by using at the coil ends, special supports which are rigidly connected to the stator frame.

The coils are securely tied or wrapped to these braces or supports and in some cases are mechanically clamped down on the supports to prevent distortion or warping of the coils due to magnetic stresses set up by the flux around them.

The view on the left in Fig. 7 shows the frame of a turbine-driven alternator with one of the first stator punchings or core laminations in place. This view shows the manner in which these core laminations are fitted in the stator frame and held in place by the dovetail notches in the frame.

When the complete core is assembled, the laminations are also held more firmly together by the use of clamping rings and bolts which apply pressure at the ends of the stator core.

The view at the right in Fig. 7 shows the same stator with the core completely assembled and the windings in place. Note the heavy connections which are made between the phases and coils of the winding and also the manner in which these connections are rigidly secured to the end of the stator core.

Fig. 8 shows an excellent view of the end of the winding in a large turbine-driven generator, and shows clearly the method of bracing and tying the coils in place. Note the comparatively small diameter and great length of the stator openings on the machine shown in Figs. 7 and 8.

The armature coils on large alternators are usually made of heavy copper bars and consist of only

A. C. Generators

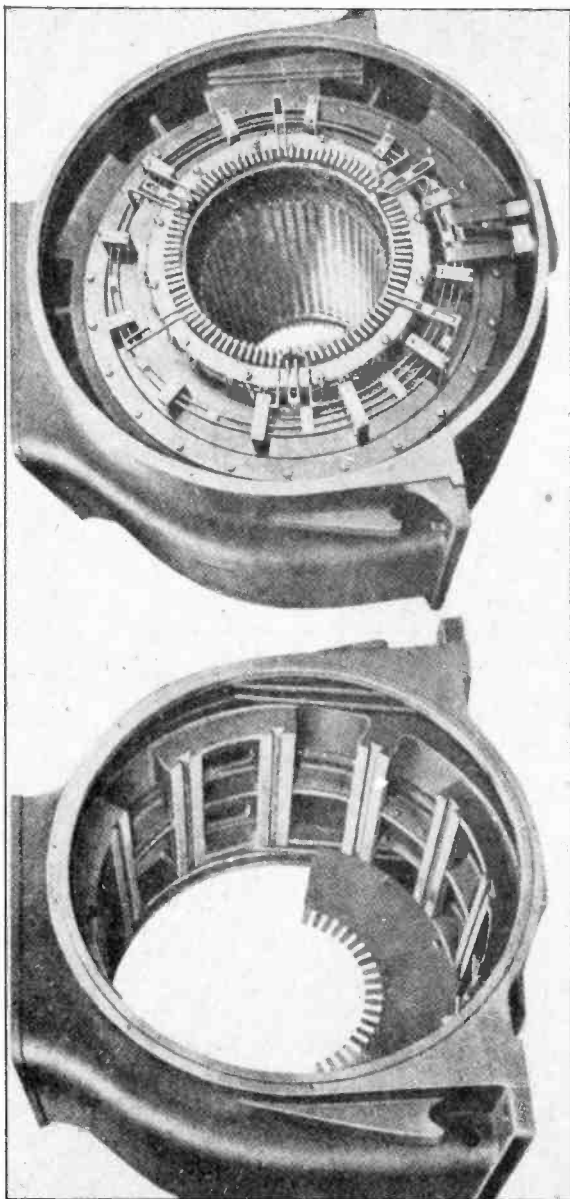

Fig. 7. The above two views show very clearly the method of construction of the stator core and windings of high speed steam-turbine-driven alternators.

Alternating Current

a few turns to each coil. These coils are heavily insulated according to the voltage of the machine, and are securely wedged into the slots.

Spaces or air ducts are left at intervals throughout the stator when the laminations are assembled, to allow free circulation of the cooling air throughout the windings.

5. FIELD CONSTRUCTION

The field of an A. C. generator is constructed very much the same as the field of a D. C. generator, except that the field of an alternator is usually the revolving element. Low-speed alternators of the large diameter engine-driven types usually have the field poles mounted on a spider or wheel-like construction of the rotor, as shown in Fig. 1.

Fig. 3 also shows the mounting of the field poles on a smaller rotor of the solid type which is used for a small diameter, medium-speed alternator.

The poles consist of a group of laminations tightly clamped together and equipped with a pole-shoe, or face, of soft iron. They are attached to the rotor core or spider, either by means of dovetail ends and slots or by means of bolts.

Fig. 9 shows several views of field poles of the dovetail type. These views also show the pole shoes and the rivets which hold the laminations together. The coils for field poles of this type may be wound with either round or square wire, or thin, flat, copper ribbon of the type shown in Fig. 11.

Field poles and coils of this type are sometimes called "spool wound", because of the shape of the poles and the manner in which the coils are wound on them.

The field coils are connected either in series or in series-parallel groups, according to the size of the machine and the exciter voltage which is applied. They are always connected to give alternate north and south poles around the entire field. Alternator fields always have an even number of poles.

On high-speed turbine-driven alternators which have long rotors of narrow diameter it would be very difficult to construct field poles of the "spool

A. C. Generators

wound" type, and also extremely difficult to hold the coils in place because of the great centrifugal force at these high speeds. For such machines the field coils are usually wound in the slots cut in the surface of a long, solid field rotor or core.

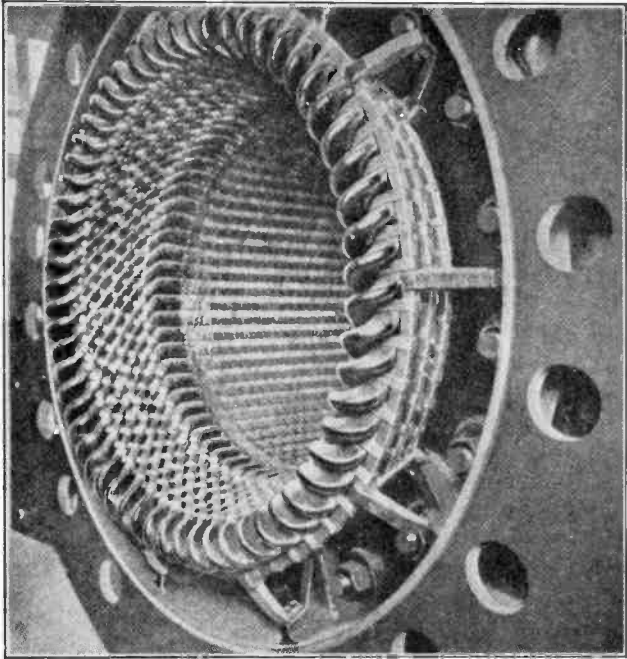

Fig. 8. This photo shows the end of a stator winding for a high speed turbo-alternator. Note the rigid bracing of the coil ends.

Fig. 12 shows a two-pole rotor of this type, in which the field coils can be plainly seen at the left end of the slots. These coils are wound with strap or bar copper. When the rotor is completed, a metal casing or sleeve is placed over both ends of the coils as shown at the right end of this rotor. This sleeve protects the coils from damage or mechanical injury and also holds them securely in place and prevents them from being thrown or bent outward by the high centrifugal force exerted upon them during operation.

Fig. 13 shows a closer view of the end of a rotor of this type, on which the slip rings and ventilating

Alternating Current

blades can be clearly seen. This type of rotor construction provides a very rugged field element and very secure mounting of the coils and is, therefore, ideally suited to the very high speeds at which steam-turbine alternators are operated.

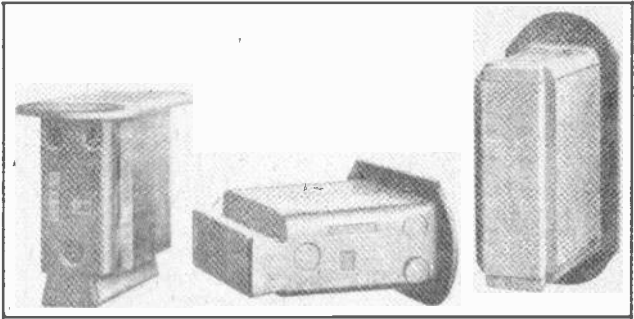

Fig. 9. Several views of laminated field poles such as commonly used in revolving field alternators.

6. COOLING OF GENERATORS

All electrical equipment produces a certain amount of heat in proportion to the losses which take place within the windings. Large A. C. generators produce considerable heat, even though their efficiencies often approach 98%. In the enormous sizes in which generators are built today the cooling of these machines becomes a serious problem.

The heat must be removed or carried away from the windings as rapidly as it is created or the windings would soon overheat to a point where the insulation would be damaged. As the resistance of copper conductors increases with any increase in temperature, the efficiency of the machine would also be reduced by allowing it to operate at temperatures higher than normal.

Natural air circulation is not sufficient for effective cooling of the windings of these large machines, as it is with smaller D. C. and A. C. generators. Therefore, it is necessary to use one of the several forms of artificial cooling or forced ventilation.

One very common method of cooling is to completely enclose the generator in a housing, such as shown on the machine in Fig. 6, and force a blast

A. C. Generators

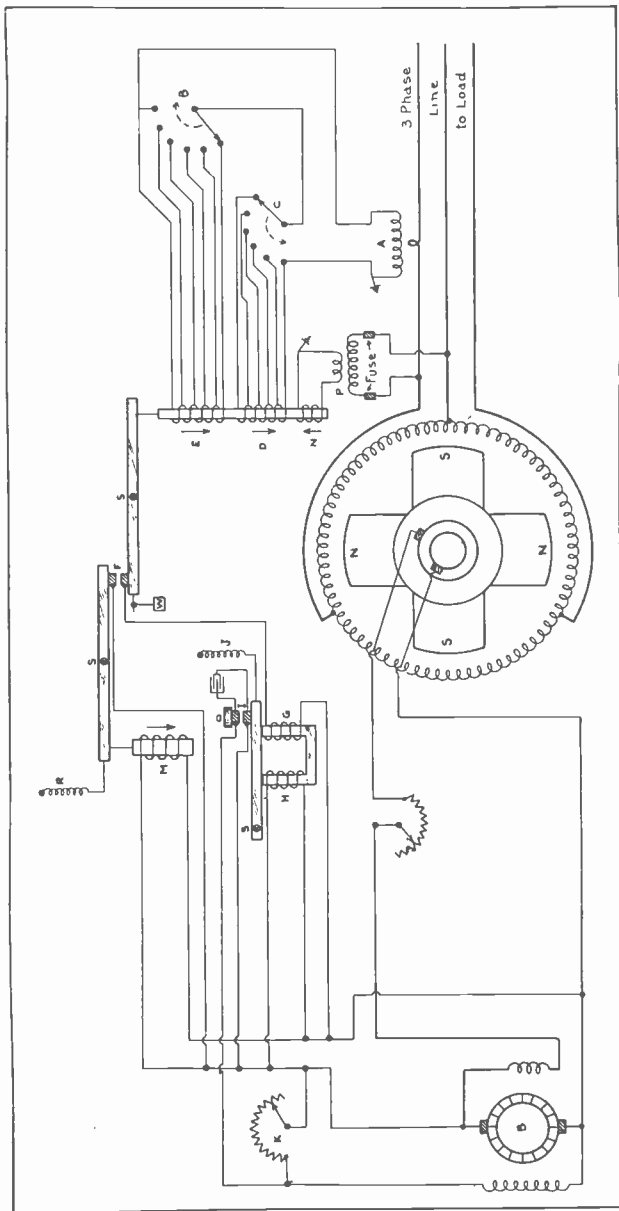

Fig. 10. The above diagram shows the wiring and illustrates the principles of a Tirrill automatic voltage regulator, properly connected to the exciter and line leads of a three-phase alternator.

Alternating Current

of air under low pressure through this housing and the machine windings. The air used for this purpose is first washed with a spray of water to cool it and clean it of all dust and dirt, and then the air is dried before being passed through the generator windings.

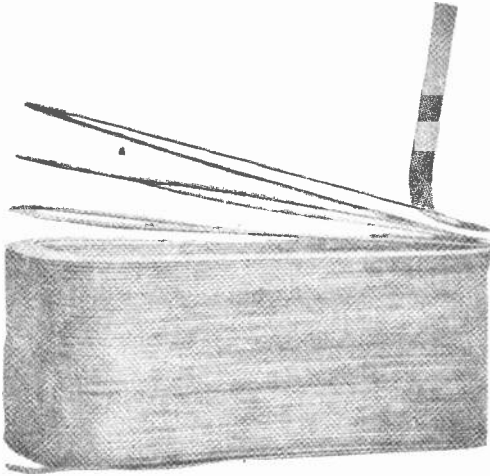

Fig. 11. Field coil which is wound with thin copper strip, making a coil which is very compact and easily cooled.

This clean air is then kept dry and is recirculated through the generator over and over again, being cooled each time it leaves the machine, by being passed over a set of cold water pipes.

It is of the greatest importance that this ventilating air be kept circulating constantly through large alternators during every moment of their operation, and also that the air be kept clean and dry.

Some other gases are more efficient than air for carrying off the heat from machine windings. Hydrogen gas is being successfully used for this purpose. Because of its efficiency in absorbing heat from the windings and transferring it to the cooling pipes through which the gas is circulated outside of the generator, the use of hydrogen in this manner makes possible increased efficiencies and reduced sizes of alternating current machines.

A. C. Generators

Hydrogen being an explosive gas, it is necessary to eliminate all possibility of its becoming ignited around the generator; otherwise an explosion and serious damage would result.

Large alternators are usually equipped with thermometers or electrical temperature indicators to show the temperature of their armature windings at all times during operation. Many large high-speed alternators have water-cooled bearings, with water circulating through passages in the metal around the bearings, to carry away the heat.

7. ALTERNATOR FIELD EXCITATION

The field of an alternating current generator is always excited or energized with direct current and in this manner constant polarity is maintained at each pole. As alternators do not produce any direct current themselves, they cannot be self-exciting, as many D. C. generators are.

The direct current for excitation of alternator fields is produced by a separate D. C. generator, known as the **exciter generator**. The exciter machine may be belt-driven from a pulley placed on the shaft of the main alternator, or it may be directly connected and driven by the end of the alternator shaft as on the machines in Figs. 2 and 4.

In some cases in large power plants the exciters are driven by separate prime movers. Sometimes

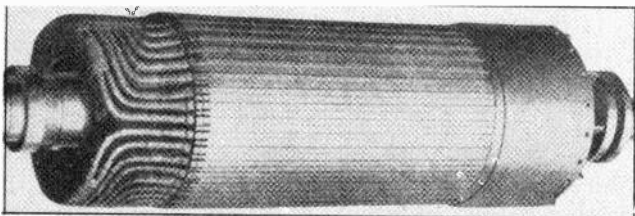

Fig. 12. This photo gives an excellent view of a high speed field rotor such as commonly used in turbine-driven alternators. Note how the field coils are placed in slots in the solid rotor so that when they are excited with D. C. they will create two field poles on opposite sides of the rotor. (Photo Courtesy Allis Chalmers Mfg. Co.)

one large exciter-generator is used to furnish direct-current field energy for several alternators,

Alternating Current

each of which obtains its field current from the exciter bus.

In other cases, there may be a number of exciter-generators which are all operated in parallel to supply the exciter bus with direct current; and any or all of the alternators can obtain their field current from this bus.

Exciter-generators are usually of the compound type and of a voltage ranging from 110 to 250 volts. It is not necessary to use high voltage for field excitation, as this current is only used to produce magnetic flux, the strength of which is determined by the number of ampere turns on the field poles.

The direct current from the exciter generator or busses is conducted to the revolving field poles of the alternator through brushes and slip rings, as previously explained. These slip rings can be plainly seen on the revolving field units shown in Figs. 3 and 12.

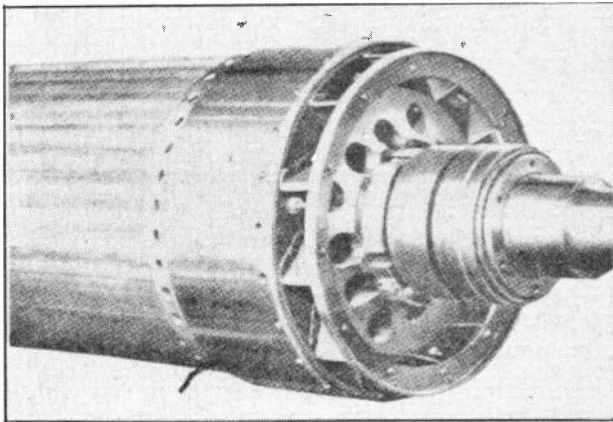

Fig. 13. End-view of high speed field rotor showing shield ring over the coil ends and also showing ventilating blades and slip rings.

8. CONNECTIONS OF EXCITER AND ALTERNATOR FIELD CIRCUIT

Fig. 14 shows the connection diagram and circuit of an exciter-generator connected to a three-phase alternator. This alternator has four poles on its

A. C. Generators

revolving field and in this case all of the poles are connected in series.

The stator winding is of the ordinary type which has been previously described in the lesson on A. C. Armature Windings, and in this diagram it is simply shown as a continuous winding around the stator, having three line leads which are connected to points 120 degrees apart around the winding.

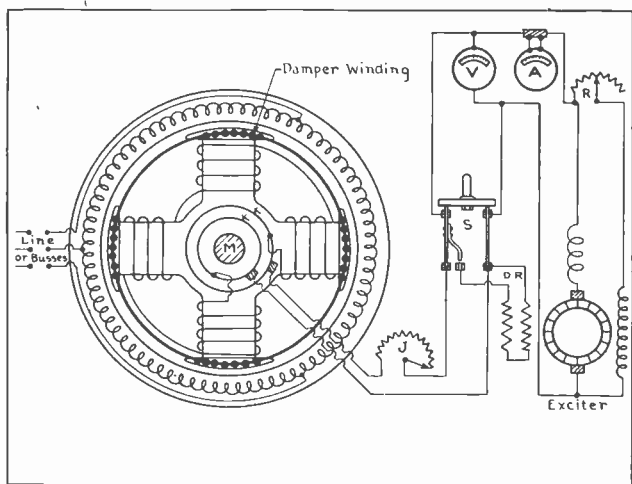

Fig. 14. This diagram shows the connections of the stator and rotor of a three-phase alternator with the exciter-generator, rheostats, meters, and field discharge switch.

When the field of this alternator is excited with direct current and the poles revolved so their flux cuts across the conductors of the stator winding, three-phase alternating current will be generated and supplied to the line or busses.

If this four-pole machine has its field revolving at 1800 R.P.M., the frequency of the generated A. C. will be 60 cycles per second, according to the formula given in Article 4 of A. C. lesson 44.

The exciter shown in this figure is a compound-wound D. C. generator and has its voltage controlled by means of a shunt-field rheostat, R. The exciter voltage can be controlled either by manual operation of the field rheostat or by an automatic voltage regulator in connection with the field rheo-

Alternating Current

stat. This regulator will be explained in later paragraphs and in this figure we shall consider the rheostat to be manually operated.

A voltmeter and ammeter are shown connected to the exciter circuit between the D. C. generator and the field discharge switch, S, of the alternator. They are connected at this point because it is desirable to know the exciter voltage before the field switch is closed, and also because of the high voltages which may be induced in the alternator field if the field discharge switch should accidentally be opened while the alternator is operating in parallel with others.

The ammeter indicates the amount of field current which is being supplied to the alternator at any time, and furnishes an indication of the field strength and normal or unusual operating conditions in the alternator

9. FIELD DISCHARGE SWITCH

The field discharge switch is a special type of switch which has a third or auxiliary blade attached to one of the main blades and is arranged to make contact with an extra clip just before the main blades of the switch are opened, and also during the time that this switch is left with the main blades open.

This places the field discharge resistance, D. R., across the collector rings and field winding of the alternator when its circuit to the exciter is open. The purpose of this discharge resistance is to prevent the induction of very high voltages in the field winding when its circuit is interrupted and the flux allowed to collapse across the large number of turns of the field winding.

Placing this resistance across the field winding allows the induced voltage to maintain a current through this closed circuit for a short period after the switch is open. This uses up the self-induced voltage and magnetic energy of the field, and allows the current to die down somewhat gradually.

If the flux of the alternator field were allowed to collapse suddenly by completely opening the circuit, the induced voltage might be sufficiently high

A. C. Generators

to puncture the insulation of the field windings and cause short-circuits or grounds between the winding and the core.

10. EXCITER AND ALTERNATOR RHEOSTATS

Between the field discharge switch and the slip rings is an alternator field rheostat, "J". This rheostat is used to obtain very fine and accurate adjustment of the alternator voltage, and its resistance is usually so proportioned that its full range of voltage operation is just equal to the change in voltage obtained by moving the arm of the exciter rheostat one point.

It is easy to see that the voltage of the main alternator can also be conveniently controlled by adjusting the voltage of the exciter generator. As the exciter voltage is varied, more or less current will be forced through the field winding. By the proper use of both the exciter field rheostat, R, and the alternator field rheostat, J, a wide range of voltage adjustment in very small steps can be obtained on the alternator.

For example, suppose that the exciter shunt field rheostat has 10 points, which will make it possible to obtain 10 voltage changes on both the exciter output and the alternator output. If the alternator field rheostat has 20 points, we can obtain 20 steps or variations in the alternator voltage between each two adjacent points of the ten-point exciter rheostat.

With this combination it is therefore possible to obtain 200 voltage variations, which will permit very accurate voltage adjustment of the alternator.

11. FACTORS GOVERNING VOLTAGE AND FREQUENCY OF ALTERNATORS

From the alternator field rheostat we follow the exciter circuit to the brushes which rest on the slip rings, K-K. The slip rings are mounted on the rotor shaft but are well insulated from the shaft and from each other. Leads are taken from these

Alternating Current

rings to the field coils. The slip rings and brushes form the sliding connection between the stationary part of the exciting circuit and the revolving alternator field.

Regardless of whether the alternator field is constructed with spool type coils on projecting poles as shown in Fig. 14 or with coils imbedded in the slots of the solid rotor as used on high-speed turbine generators, as long as direct current is passed through these coils a powerful magnetic field will be set up at each pole of the electro-magnets formed by the coils.

When the alternator field is thus excited or energized and is then revolved within the armature or stator core, it is evident that the lines of force from the field poles will be cut by the stationary armature conductors. In this manner a voltage is induced in the armature conductors and, as we have already learned, this voltage will be proportional to the number of lines of force in the field, and to the speed with which the field poles are rotated, as well as the number of conductors in series in the armature winding.

As the frequency of the alternator depends upon its speed and the number of field poles, we cannot vary the speed of the alternator to vary its voltage, as we can with direct current generators.

The frequency must be kept constant in order to maintain constant speed of the motors attached to the system, and if the speed of the alternator were to be varied it would, of course, change the frequency. For this reason, **the voltage of an alternator must be adjusted by means of the alternator field rheostat or the exciter field rheostat.**

The voltmeter in Fig. 14 is across the armature leads of the exciter generator and will show any variations in the voltage produced by the exciter when its rheostat is adjusted.

When once the setting of the alternator rheostat, J, has been established, the voltmeter will give somewhat of an indication of the variations brought about in the alternator field strength when varying the exciter voltage.

A. C. Generators

The ammeter provides a more accurate indication, because its readings will show the amount of current flowing through the alternator field with any adjustment or change in either the exciter or alternator rheostats.

12. CONTROL AND ADJUSTMENT OF ALTERNATOR VOLTAGE

It is often necessary to change the voltage produced by the armature of an A. C. generator while it is in operation, in order to compensate for voltage drop in the lines with increasing load on the system. In other words, when the load is increased, the added current flowing through the line will cause a greater voltage drop; and, in order to maintain constant voltage at the load, the alternator voltage should be increased.

We have already mentioned that the alternator voltage can be controlled either by manual operation of the rheostats by the plant operator, or by an automatic regulating device.

Manual or hand regulation is generally used only in small power plants which are not operating as a part of a large system.

The accuracy and uniformity of hand regulation depend upon the faithfulness and skill of the operator. This method is not usually satisfactory in large plants or on systems where there are frequent variations of considerable amounts in the load, because it requires almost constant attention on the part of the operators and even then doesn't prevent some voltage variation at the load.

It is very important to have constant voltage on most electrical machines and devices, in order to maintain their rated torque and speed. This is particularly true where any lighting equipment is connected to the system, because if the voltage is allowed to vary to any extent, it causes noticeable fluctuations in the brilliancy of incandescent lamps.

13. AUTOMATIC VOLTAGE REGULATORS

To obtain more accurate and immediate voltage adjustment for all variations in load, automatic

Alternating Current

voltage-regulators are generally used in connection with the exciter field rheostat. One of the most common types of these devices is known as the Tirrill voltage regulator. This device automatically regulates the alternator voltage within very close limits by means of a set of relays which cut resistance in or out of the field rheostat of the exciter-generator.

The relays are operated by variations in the voltage and current load on the lines leading from the main alternator.

Fig. 10 shows the connection diagram of a Tirrill automatic voltage-regulator. If you will trace out each part of this diagram very carefully, you will be able to easily understand the operating principle of this device.

Whenever the load on the alternator is increased, this will increase the amount of current flowing in each wire of the three-phase line, and the current transformer, A, will have an increased current-flow in its secondary winding.

The secondary of this transformer is connected through a set of multiple point switches, B and C, to the solenoid coils; D and E. When these two coils have their current increased, they tend to pull the plunger downward and operate the lever arm to close the contacts at F.

When the contact F is closed it completes a circuit through coil G of the differential relay which is energized by direct current from the exciter-generator. Coil H of this relay is connected directly across the exciter-armature and is normally energized at all times.

Coil G is so wound that when it becomes energized it neutralizes the magnetism set up in the core by coil H, and this allows the armature to release and be drawn upward by the spring, J, thus closing the contacts at I.

These contacts are connected across the exciter field rheostat, K, and can be arranged to short-circuit all or part of this resistance. When the re-

A. C. Generators

sistance of this rheostat is cut out of the shunt field of the exciter it allows the exciter voltage to increase, thereby increasing the field strength and the voltage of the main A. C. generator.

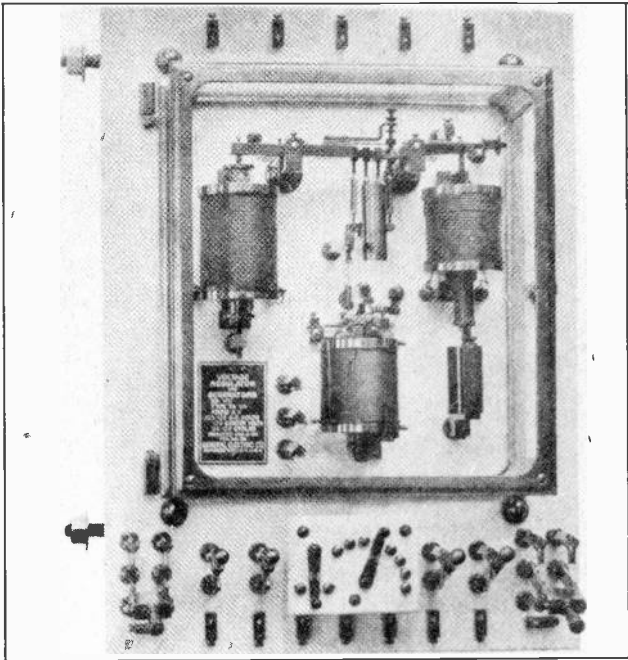

Fig. 15. This photo shows an automatic voltage regulator of a type similar to the one for which the wiring was shown in Fig. 10, and shows the arrangement of the solenoids and relays on the panel. (Photo Courtesy General Electric Co.)

If the A. C. generator voltage rises above normal, it will increase the voltage induced in the secondary coil of the potential transformer, P, thereby strengthening the solenoid coil, M, which will raise the plunger and open the contacts, F.

When the contact opens at F this de-energizes coil G of the differential relay, allowing the magnetism of coil H to draw the armature down and open contacts at I.

This removes the short-circuit from the exciter rheostat and places the resistance back in series

Alternating Current

with the shunt field. The contacts at F can also be opened by the coil M if the exciter voltage rises too high.

When using a regulator of this type, the exciter field rheostat K should be set at a point so that if it were used alone it would maintain a voltage slightly lower than that required by the system.

The automatic regulator will then short out the resistance of the rheostat often enough to maintain the voltage at its proper value. The arm which operates the lower contact at F continually vibrates or oscillates, and opens and closes the contacts at

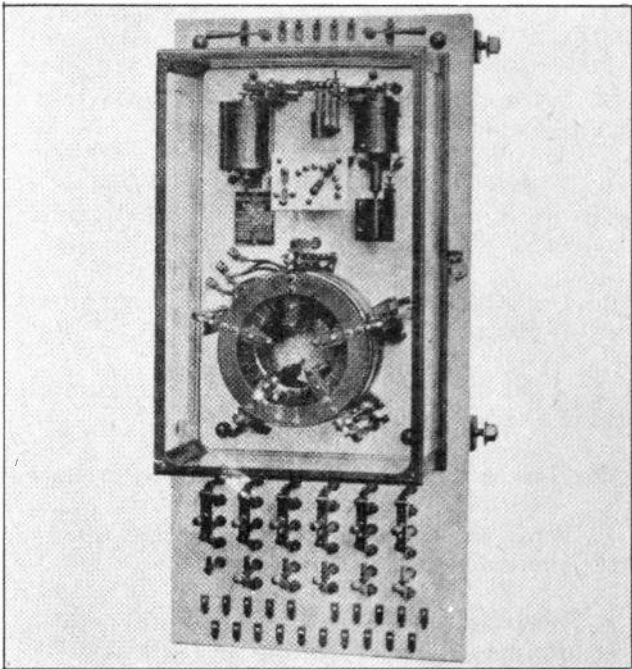

Fig. 16. Automatic voltage regulator for controlling the voltage of several alternators in parallel. (Photo Courtesy General Electric Co.)

frequent intervals during the operation of this device.

These contact arms are accurately balanced and adjusted by means of adjusting screws on the counter-weight, W, and the tension of the spring, R.

A. C. Generators

A condenser, O, is connected across the contacts I to reduce arcing and prevent burning and pitting of these contacts when they open and close the short-circuit on field rheostat K.

The relay armatures which operate the various contacts are pivoted at the points marked S. The switches, B and C, are used to vary the strength of the solenoid coils, E and B, and thereby adjust the regulator to operate at the proper amount of increased load current.

EXAMINATION QUESTIONS

1. Into what three classes may alternators be divided?
2. What per cent of the total energy output of an alternator is used in field excitation?
3. Which of the two elements, the field or the armature of an alternator, is usually the revolving element? Why?
4. Describe one method by which large alternators are cooled.
5. What kind of current is used for exciting the field of alternators?
6. How is the field excitation current produced?
7. Why are field discharge switches used on large alternators?
8. What would be the frequency output of a 4 pole alternator when operating at 750 R.P.M.?
9. Is it practical to adjust the voltage output of an alternator by varying the speed of the alternator? Why?
10. Name one common type automatic voltage regulator. Draw a sketch showing how this regulator is connected to an alternator.

OPERATION AND PARALLELING OF ALTERNATORS

It is only in very few cases, such as in small isolated power plants, that a single A. C. generator is operated alone. Usually several A. C. generators are operated in parallel in the same plant, and in a great many cases a number of power plants generating A. C. are all tied together in parallel.

In order to operate alternators in parallel we **must have their voltages equal** and in addition to this, the machines must be properly **phased out and synchronized**.

These three conditions are the principal ones which must be observed before connecting any alternator in parallel with another.

You have already learned how to adjust the voltage of A. C. generators. Voltage adjustment, of course, can only be used to vary the voltage within a limited range above and below that of the normal voltage of the machine. Therefore, alternators must all be designed for the same voltage in order to operate successfully in parallel. Then the final adjustments can be made with the rheostats to exactly equalize the voltage.

1. PHASING OUT ALTERNATORS

“Phasing out” consists of identifying the phases of polyphase generators, in order to get the corresponding phase of two or more machines connected together. For example, the three-phase alternator, which is by far the most common, usually has the phases marked or designated A, B, and C. When connecting an alternator to one or more others, or to the busses in a power plant in which other generators are operating, each phase must connect to the corresponding phase of the busses or other alternator: A to A, B to B, and C to C.

Phasing out is usually necessary only when a machine is first installed or after some changes have been made in the connections of the windings of the machine. Once the generator has been prop-

Phasing Out

erly phased out and the connections permanently made to the busses on the switchboard, it is not necessary to test the phases again unless changes are made in the generator or in the plant.

If a generator is disconnected even temporarily, the phases should be plainly and accurately marked, so that they can be connected back in the same manner when the machine is again attached to the busses or leads to the other alternator.

If an armature of an alternator has been rewound or if the connections have been changed in any way, the machine should always be phased out before reconnecting it to the busses or line.

Synchronizing is an operation which must be performed every time an A. C. generator is paralleled with other running machines. This will be explained in later paragraphs.

There are several methods that can be used for phasing out A. C. generators. Two of the most common are known as the **lamp-bank method** and the **motor method**.

Equally good results can be obtained with either method, and the choice of one or the other will usually depend upon the convenience or the adaptability of the available equipment.

2. LAMP-BANK METHOD OF PHASING OUT

Fig. 1 shows the connections and illustrates the principle of the lamp-bank method of phasing out alternators. In this diagram two alternators are shown properly connected and furnishing power to the busses and outgoing line. A third similar generator is shown suitably located and ready to be phased out and connected to the live busses. The lamps to be used in the phasing-out operation are shown connected around the oil switch.

A sufficient number of lamps must be connected in series in each phase to withstand double the voltage of the alternator. It can readily be seen, therefore, that if the voltage of the machine is

Alternating Current

higher than 440 volts, it would require a considerable number of lamps in order to use this method, that is if the lamps only were used.

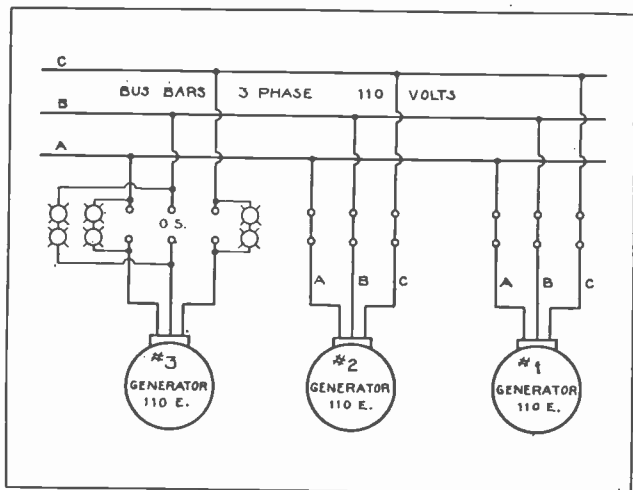

Fig. 1. This diagram shows the method of connecting lamps for phasing out an alternator which is to be operated in parallel with two others.

So, with higher voltage machines step-down transformers are often used to reduce the voltage to the lamps. Small power transformers or instrument transformers can be used.

In phasing out a new generator by this method it is necessary to bring it up to its rated speed and voltage. The lamps connected as shown in Fig. 1 will then alternately light up and go dark, due to the generator voltages being out of phase and in phase at different periods.

If all three sets of lamps become bright and dark together or at the same time, it indicates that the proper phases of the new generator are connected to corresponding phases on the opposite side of the oil switch. If the lights do not burn bright and dim together it is then necessary to interchange or reverse any two leads of the generator which is being phased out.

While this interchange can be made anywhere between the generator and the oil switch or be-

Phasing Out

tween the oil switch and the busses, it is usually best to reverse the leads right at the generator terminals. We should never reverse the leads of any other machine to make the phases match with the new generator, as this would reverse the rotation of all of the three-phase motors operating on the system.

Extreme caution should be used never to connect even a small generator in parallel with another one or to live busses, without first carefully phasing it out; because if one A. C. generator is connected in parallel with others when out of phase, it results in practically a short-circuit on the running machines, the same as though one D. C. generator of the wrong polarity were connected in parallel with others.

Care should also be used to see that the lamps are of sufficient number and resistance to stand double the voltage of the alternator, because at certain periods during the alternations they may be subjected to the voltage of the new machine plus that of the running machines in series.

When phasing out higher voltage machines and using lamps and transformers, the primary and secondary leads of the transformer should be carefully marked and tested if necessary, to determine whether they are of additive or subtractive polarity. These terms will be explained later, in the section on transformers.

Care should also be taken not to reverse either the primary or secondary leads of the transformer, but to have them all connected with the same respective leads both to the alternator and busses.

3. MOTOR METHOD OF PHASING OUT

Fig. 2 shows the connections for phasing out an alternator by means of a three-phase motor. To use this method conveniently and to avoid making mistakes in connections, it is usually best to connect the leads of the three-phase motor in uniform order to the blades of a double-throw, three-pole, knife switch.

Alternating Current

The outer contacts or clips of the switch on one side are connected to the busses or running generators, while the clips on the other side are connected to the machine which is to be phased out. With this connection the motor can be operated either from the new generator or the running machines. When the connections are properly made, the generator which is to be phased out is brought up to rated speed and voltage. The knife switch is then closed to operate the motor from this generator, and the direction of the motor rotation is carefully noted.

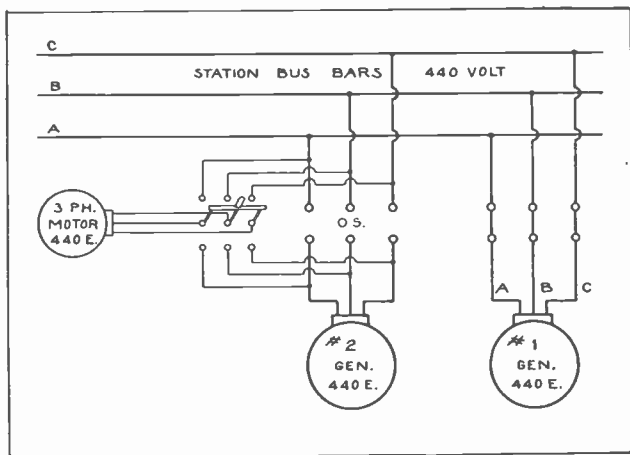

Fig. 2. The above sketch shows the connections and illustrates the method for phasing out an alternator by means of a three-phase motor.

To avoid mistakes, it is best to mark this clockwise or counter-clockwise direction of rotation with a chalked arrow, either on the pulley or the frame of the machine, on the side from which you are observing it. Then open the double-throw switch and allow the motor to come to a full stop. The switch is then closed in the opposite direction, to run the motor from the bus bars and running alternators, and the direction of rotation is again noted.

If the motor rotates in the same direction in both cases, the generators have like phases connected

Synchronizing

opposite to each other on the switch terminals. If these same leads are carefully connected to the oil switch in the same respective manner, the generators should operate satisfactorily in parallel after having been synchronized.

If the motor rotates in the reverse direction when the switch is in the second position, it will be necessary to **interchange or reverse any two leads of the generator which is being phased out.** The connections should then be tested again by running the motor from each side of the switch, and it should run in the same direction in both positions of the switch blades.

If the voltage of the alternator is too high for any available motor, small power transformers can be used to reduce the voltage for making this test of the phases.

4. SYNCHRONIZING OF ALTERNATORS

As previously mentioned, any A. C. generator must be carefully and accurately synchronized before being connected in parallel with other running generators.

Synchronizing is one of the most critical operations to be performed in a power plant, and should be given careful study.

This is an operation which you want to be sure you thoroughly understand before applying for any position as a power plant operator.

Synchronizing means to bring the generators into step or so that their positive and negative alternations occur at exactly the same time. On large machines this must be accurate to within a few degrees that is, the same alternations of each machine must have their maximum and zero values occurring at the same instant in each phase.

By referring back to the sine curves which were shown for the voltage alternations in the first A. C. lesson, and also by drawing a few curves for your-

Alternating Current

self, if necessary, you will soon see what is meant by having the alternations occur in phase or in step with each other.

If alternators were connected together when out of phase more than a very few degrees, it would result in very heavy surges of current between the two machines, because of the difference in their voltages at any instant. If two machines were connected together when they were 180° out of phase, this would mean that one generator would be producing positive voltage while the other was producing negative voltage, and it would result in a double voltage short-circuit, the same as though two D. C. generators were connected together with wrong polarity.

The nearer the two machines are to being in phase, the less will be the difference in their instantaneous voltages at any point of the cycle.

By careful adjustment of the speed of the "incoming" alternator, we can by means of a synchronizing device get the two machines exactly in phase with each other. A skillful operator can then close the oil switch at just the right instant and connect the machines in parallel with practically no resulting surge or current flow between the "incoming" and running generators.

If large generators are connected together when they are very much out of phase, it is likely to wreck the machine windings and possibly cause serious damage to the generators and other plant equipment.

The two most common methods for determining when alternators are in synchronism are by the use of either a synchroscope or lamp-bank. A voltmeter is sometimes used for this purpose also. A synchroscope is by far the more reliable and convenient, as it shows whether the incoming generator is running too slowly or too fast and indicates which way the governor or throttle of the prime mover should be adjusted in order to bring this machine to the same

Synchronizing

frequency as the running machines.

The pointer of the synchroscope also indicates more accurately when the generators are exactly in phase with each other.

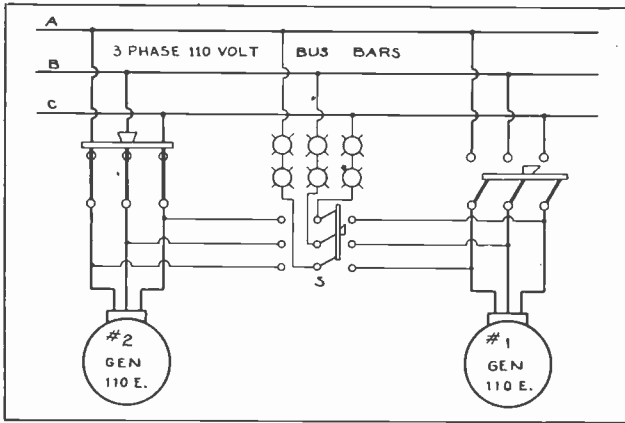

Fig. 3. Connection diagram for synchronizing either of two alternators with the bus bars by means of a lamp bank and double-throw switch.

The operation and connections of the synchroscope were explained in the lesson on A. C. Meters, and you may desire to review articles 7 to 10 in lesson No. 48 before continuing with this lesson.

When voltmeters are used, they are connected the same as the lamp-bank, which will be explained in the following paragraphs.

Voltmeters to be used for synchronizing should be of the "dead beat" type, or well damped so that their pointers do not oscillate or swing too far beyond the actual voltages. Voltmeters are seldom used for this purpose because of their cost and the fact that a synchroscope, costing very little more, is much more convenient and reliable.

5. SYNCHRONIZING WITH LAMPS

The lamp-bank method of synchronizing is used quite extensively in small plants, where the generators are not large and the cost of the synchroscope is considered prohibitive.

Alternating Current

Fig. 3 shows the connections for using lamps to synchronize two alternators. You will note that these connections are practically the same as when lamps are used to phase out an alternator, except that the lamps are arranged with a double-throw, three-pole switch, so they can be used to synchronize either alternator with the busses, according to whichever machine may be running at the time.

The incoming generator, which in this case is No. 1 in the figure, is started and brought up to speed and voltage. The synchronizing switch, S, is then closed to the right and the lamps will alternately become bright and dark, the same as in phasing out an alternator, except that in this case the alternators are presumed to have been phased out and the three sets of lamps should all go bright and dark together.

When the generators are 180° out of phase, or one machine positive and the other negative, their voltages will add together through the lamps and cause the two lamps in series in each phase to burn brightly.

When the generators are exactly in phase—that is, phase A of generator No. 1 reaches its maximum voltage at the same time phase A of generator No. 2 does—these voltages are then opposing each other on the busses and no current will flow through the lamps.

If the frequency of the incoming machine is only slightly different from that of the running machine, the lamps will brighten and darken very slowly; but if the frequency of the incoming machine is considerably different from that of the running machine, the lamps will flicker on and off very rapidly.

So, by adjusting the governor or throttle of the prime mover which drives the incoming generator and watching the operating of the synchronizing lamps, we can tell whether we are approaching the frequency of the running generator or if we are getting farther away from it.

When the speed of the incoming generator is properly adjusted and the frequencies are almost

Synchronizing

exactly the same, the lamps should go on and off very slowly, actually remaining dark for a second or two, and requiring several seconds to change from bright to dark each time.

During the middle of this dark period, the switch which connects the incoming generator to the busses should be closed. By watching the speed with which the lamps brighten and go dark throughout several of these periods, one can approximately time the length of the dark period so that the switch can be closed about the middle of this period.

This requires good judgment and skill, which can be obtained only by practice.

One of the disadvantages of using lamps for synchronizing is the fact that an incandescent lamp requires a considerable proportion of its rated voltage to cause the filament to light even enough to be noticeable. Therefore, there may be some small difference in voltage between the two alternators even when the lamps are dark. This is the reason for closing the switch at the middle of the dark period, when the voltage difference between the two machines should be zero.

Alternators should never be paralleled as long as the lamps are burning at all; or, in case a synchroscope is used, as long as it indicates any phase difference between the two machines. If the phase difference is small when the machines are paralleled, they may pull in step; and while there may not be any serious damage the first time this is done, if it is done a number of times the severe shock to the windings will sooner or later damage their insulation or the coil bracing.

The very heavy surges of current which result through the generator windings when they are paralleled slightly out of phase, set up enormous magnetic stresses which tend to distort the conductors at the end of the coils and also apply very heavy pressures against the insulation in the slots.

Alternating Current

This also results in severe mechanical shock to the entire machine.

6. SYNCHRONIZING WITH SYNCHROSCOPES

The lamp-bank method will probably be encountered in a number of small plants and may often be very handy to you in synchronizing small generators when no synchroscope is available. The synchroscope is, however, by far the most commonly used in modern plants of any size, and because of its extreme accuracy this instrument should be used whenever possible.

Another of the decided advantages of the synchroscope over the lamp-bank is that its pointer indicates whether the incoming generator is running too fast or too slow.

When the synchroscope is used, the governor or throttle of the prime mover is adjusted according to the indication of the synchroscope pointer and whether it is revolving in the direction showing that the incoming generator is running too fast, or in the opposite direction showing that it is running too slow.

When the speed of the incoming generator has been adjusted to a point where the synchroscope is revolving very slowly in the "fast" direction the knife switch or oil switch which connects the incoming machine to the busses can then be closed, just as the pointer reaches the mark on the center of the scale.

By connecting the alternators together when the incoming machine is running slightly faster than the running machines, it enables the incoming generator to pick up its share of the load more readily and smoothly.

When paralleling alternators by means of remote controlled oil switches it is often necessary to allow a fraction of a second for the actual closing of the

Alternator Operation

oil switch. This is done by closing the remote control switch just before the synchroscope pointer reaches the mark on the scale, so that the oil switch will close and parallel the alternators just at the time the pointer is on the mark and the machines are in exact synchronism.

7. STARTING UP ALTERNATORS

The procedure to be followed when starting an alternator and preparing to bring it on to the busses in parallel with others may vary in certain details with the operating policies of different plants, but there are certain general methods and precautions to be followed.

The following material on this subject applies only to alternators which are already installed and in operating condition. The procedure for starting new alternators which are to be operated for the first time will be covered in a later lesson on the installation and operation of electrical machinery.

When starting an alternator in a small plant, the electrician or switchboard operator may also have to start the prime mover. In large power plants the prime movers are usually started and controlled by the turbine engineers or men of the steam crew.

In either case, a certain amount of time must be allowed for the routine and preparations necessary in starting the prime movers. These points will be covered more fully in a later lesson on prime movers.

Before starting an alternator we should make sure that the armature and field switches are open. The field switch should be set in the discharge position.

If the exciter is separately driven, it should be started and brought up to full rated speed before the alternator is started. If the exciter is driven from the alternator shaft it will, of course, come up to speed at the same time the main alternator does.

In either case the exciter voltage should be kept low, usually at about 50% of its rated voltage, until after the field circuit to the alternator has been closed. This allows the voltage to be built up more

Alternating Current

gradually in the armature of the alternator.

The alternator field switch can next be closed, to energize the field poles. Then adjust the exciter voltage until the alternator armature develops its full rated voltage. If the generator is to operate alone and supply power to a line, the armature switch may then be closed. If the generator is to operate in parallel with others, it must first be properly synchronized before closing the armature switch.

In some cases, when starting a single alternator that is to be operated alone, it is desirable to close its armature switch to the line with the alternator voltage at about one-half its full rated value. This allows the generator to pick up any load which may have been left connected to the system, without such heavy current surges through the machine. The voltage can then be brought up to normal by means of the field rheostats, after the armature switch is closed.

Always remember that the three most important requirements before paralleling A. C. generators are: (A) They must be of equal voltage; (B) Generators must have been phased out and have like phases ready to connect together; (C) The generators must be in synchronism.

When these conditions have been obtained the armature switch may be closed and the incoming generator connected in parallel with the bus bars and running machines. The alternators should then operate satisfactorily in parallel, if they are of the proper design and characteristics.

8. ADJUSTING AND TRANSFERRING LOAD ON ALTERNATORS

The next step is to make the alternator which has just been connected pick up its share of the load on the system. This cannot be done by increasing the armature voltage, as is done with direct current generators.

Alternator Operation

Alternating current generators are caused to take more of the load by slightly increasing the power applied by the prime mover. This is done by adjusting the governor or throttle of the prime mover so it will deliver slightly more power to the alternator.

This, of course, tends to make that alternator on which the power is increased run slightly faster than the others, but the tendency of two or more alternators to hold together in synchronism after they are once paralleled prevents the machine from actually running any faster than the others.

Instead, the additional power applied by the prime mover merely causes this generator armature to advance a few degrees in phase ahead of the others, and this will cause it to pick up its share of the load.

The field rheostat can then be adjusted to reduce any cross currents or wattless currents between the armatures of the alternators in parallel. This is very important, and the field current should be adjusted until the armature current of each alternator is at the minimum for the load they are carrying at that time.

In other words, by having wrong field adjustment on alternators, it is possible to have the sum of the currents from the separate machines equal considerably more than the total load current being taken from the busses. These cross currents between the alternators may result in heating, if they are not kept at a minimum.

When the proper load distribution has been obtained between the generators operating in parallel, they should maintain this division of load, provided the governor of the prime movers is properly adjusted so that all machines respond alike to variations in the load.

9. SHUTTING DOWN AN ALTERNATOR

When the load on a certain power plant or group of alternators is reduced to such an extent that it

Alternating Current

is not economical to keep all of the alternators operating, one of the machines can be disconnected from the bus and shut down until such time as increased load may again require its operation.

Shutting down an alternator is a simple operation, but there are several important steps to be followed in order to perform this operation properly.

In some small plants A. C. generators are taken off the busses by merely opening their armature switches. This, however, results in a very sudden dropping of the load of the disconnected machine and may result in heavy current surges and fluctuations in the voltage of the other machines.

For this reason many power companies object to this practice, and require that the load be gradually dropped from the machine which is to be disconnected. This can be done in the following manner.

The throttle valve on the prime mover of the generator to be shut down is first closed little by little until the generator drops practically all of its load and the ammeter or wattmeter in its circuit shows its current output to be at a very low value. In up-to-date plants of medium or large size, wattmeters or watt-hour meters give the most reliable indication when the load is reduced to zero, as an ammeter might still show some flow of wattless current.

This load is, of course, automatically picked up by the other generators, or is in reality simply transferred by reducing the power applied to the alternator which is being shut down.

When by adjustment of field excitation the load on the machine as shown by the ammeter has been reduced to zero or a very low value, the armature switch is then opened, disconnecting the generator from the busses. The throttle valve of the prime mover is then closed all the way and the generator is allowed to drift to a stop.

After the armature switch has been opened, the field switch may be opened if desired; or the field can be left energized temporarily, in order to bring the generator to a stop in a little shorter time. Brakes are used for this purpose on larger ma-

Alternator Operation

achines. The field switch should never be opened before the armature switch has been opened.

When the generator comes to a complete stop and is standing idle, the field switch should always be open. It is also a very good precaution to open any disconnect switches which are between the generator, oil switch, and the bus bars. This will prevent any power flow from the busses to the generator armature if the oil switch should accidentally be closed when the machine is standing idle.

Different generating companies have various special rules to meet the operating conditions in their various plants, and any operator should make a careful study of these rules as well as the general rules and principles which are covered in this les-

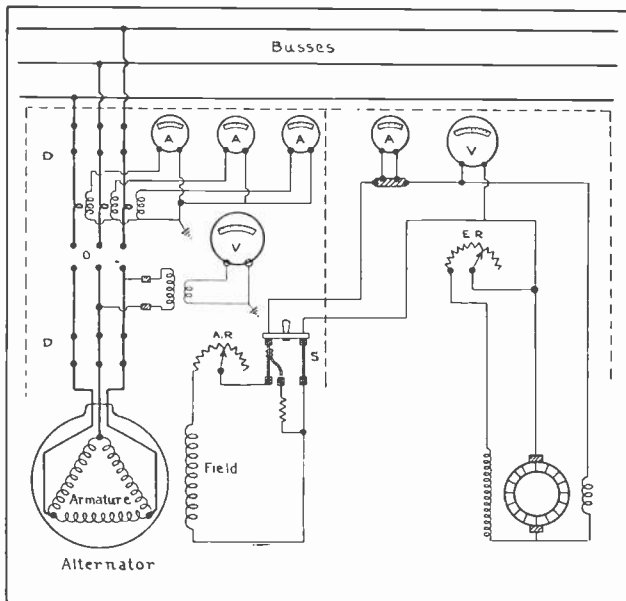

Fig. 6. This diagram shows the wiring and arrangement of a three-phase alternator, and the meters and equipment commonly used on the switchboard panels.

son. All such rules are made to provide safety for operators and machines, as well as to provide satisfactory service to the customers to whom the power is supplied.

Alternating Current

10. ARRANGEMENT OF INSTRUMENTS AND CONNECTIONS FOR ALTERNATORS

Fig. 6 shows a diagram of the connections for an alternator and its exciter. This diagram also shows the meters to measure the voltage and current of each machine. The three A. C. ammeters are connected, by means of current transformers, to measure the current in each line wire of the alternator.

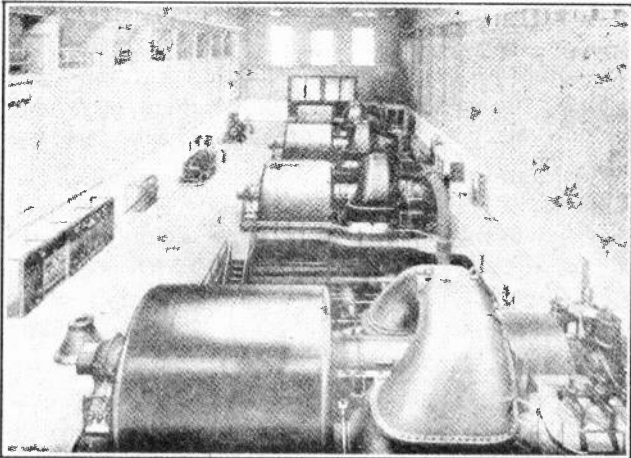

Fig. 7. Interior view of a large power plant showing several of the steam-turbine-driven alternators and also part of the switchboard and the exciter-generators.

The A. C. voltmeter is connected by means of a potential transformer to indicate the voltage of the alternator. This voltage, of course, should be the same on all three phases; so it is only necessary to measure it on one phase.

You will note that the voltmeter connections are made between the alternator and the oil switch, O; so that the voltage of the alternator can be read before the oil switch is closed to parallel this machine with any others which may be connected to the busses.

Two disconnecting switches, D, are provided, one on each side of the oil switch. After the oil switch

Alternator Operation

is open and the alternator shut down, these disconnecting switches can be opened with a switch pole, or by hand in the case of low voltage circuits, and thus the oil switch and instrument transformers are separated from the live busses.

This permits any necessary repair work to be done on these devices with safety. The alternator rheostat, A.R., and the field discharge switch, S, are mounted on the alternator panel of the switchboard. The alternator panel is also very often provided with a wattmeter and a watthour meter. The wattmeter is to indicate the power output of the machine at any instant and the watthour meter shows the power in kw. hours which is produced by the machine during any certain time period.

The alternator panels are often provided with switches or plugs for connecting the synchroscope or synchronizing lamps to any machine that is being started. These auxiliary devices are not shown in the diagram in Fig. 6, but they will be covered more fully in a later lesson on switchboards.

The exciter panel at the right in Fig. 6 contains the D. C. ammeter and voltmeter, for measuring the current to the field of the alternator and the voltage generated by the exciter. The exciter field rheostat, E. R., is also on this panel.

In some power plants the exciter panel is located adjacent to the alternator panels in this manner. In other large plants the direct current from the exciters may be metered and controlled from an entirely separate switchboard.

Among the more important features to be checked and watched in the care of alternators are the following. The temperature of both the windings and bearings should be frequently checked, and the meters watched to see that the machines are not overloaded. The speed and frequency of alternators should be accurately maintained, and the fields properly adjusted to keep cross currents

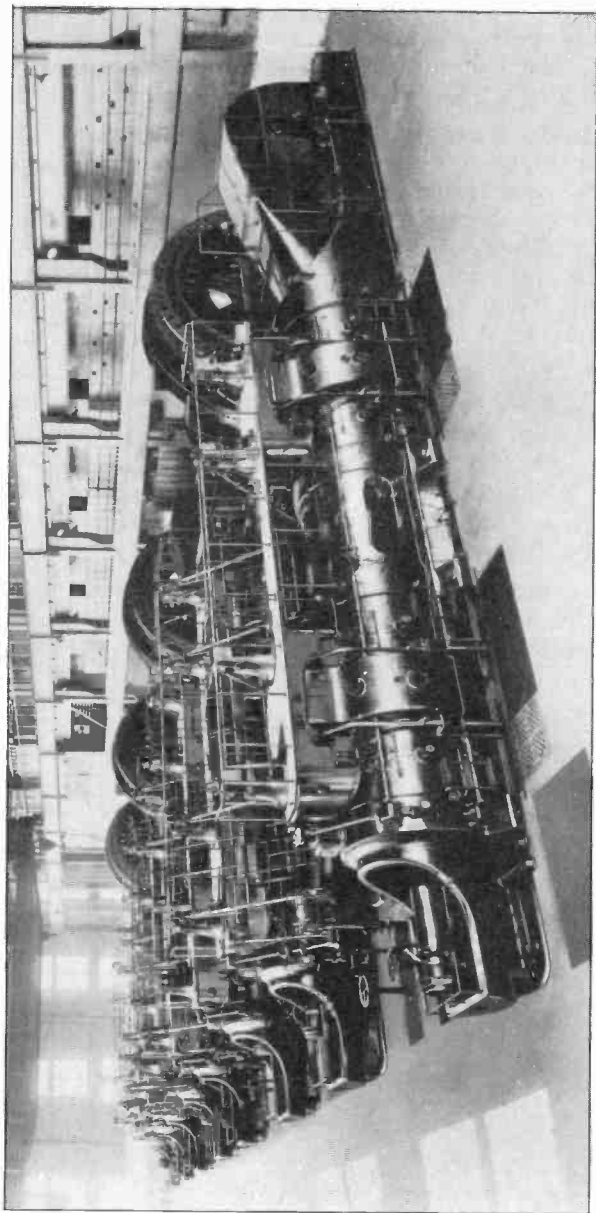

Fig. 8. Privately owned power plant producing alternating current for use in steel mill operations. These alternators are driven by gas engines which burn waste gases as a fuel. (Photo Courtesy Allis Chalmers Mfg. Co.)

Alternator Operation

at a minimum between parallel alternators. Tests should be made periodically on the insulation of alternator windings to note any weakness before it results in a complete failure of the machine.

Always see that there is plenty of cool, clean, dry air available for cooling the machines. All parts of the generators should be kept clean, and the windings should be cleaned with compressed air to keep dust or dirt from blocking ventilating passages and causing excessive heating. Additional material will be given on the care of generators in a later lesson on maintenance of electrical machinery.

Fig. 8 shows a section of a large industrial power plant in a steel mill. Waste gases from blast furnaces are used to operate twin tandem gas engines, and these engines in turn drive the alternators, which are operated in parallel to supply electricity used in the mill.

A great many of the larger factories and industrial plants have their own private power plants to generate the vast amount of electrical energy which they use.

Operation of electrical equipment in plants of this type as well as in the mammoth generating stations which are owned and operated by public utility companies, provides fascinating and profitable work for thousands of trained men.

To be able to qualify for a responsible position in a plant of this kind is well worth a thorough study of everything covered in your course.

Alternating Current

EXAMINATION QUESTIONS

1. What three important requirements are necessary in order to operate alternators in parallel?
2. When using the lamp-bank method of "phasing out" an alternator, what changes would be necessary when the lamps do not all burn at the same brilliancy at any one time?
3. Referring to Fig. 2 what would be the indication on the motor when the incoming gen. No. 2 is properly phased out?
4. What is meant by the term synchronizing when used in connection with alternators?
5. Draw a sketch showing how lamps may be used to indicate synchronism when paralleling alternators.
6. What will happen if alternators are paralleled without synchronizing?
7. What advantage does the synchroscope method have over the lamp-bank method of synchronizing alternators?
8. How are alternators caused to take more of the total load?
9. What procedure should be followed when shutting down an alternator where it is desired to prevent heavy current surges and voltage fluctuations on the line?
10. Name at least three important things to watch when operating alternators.

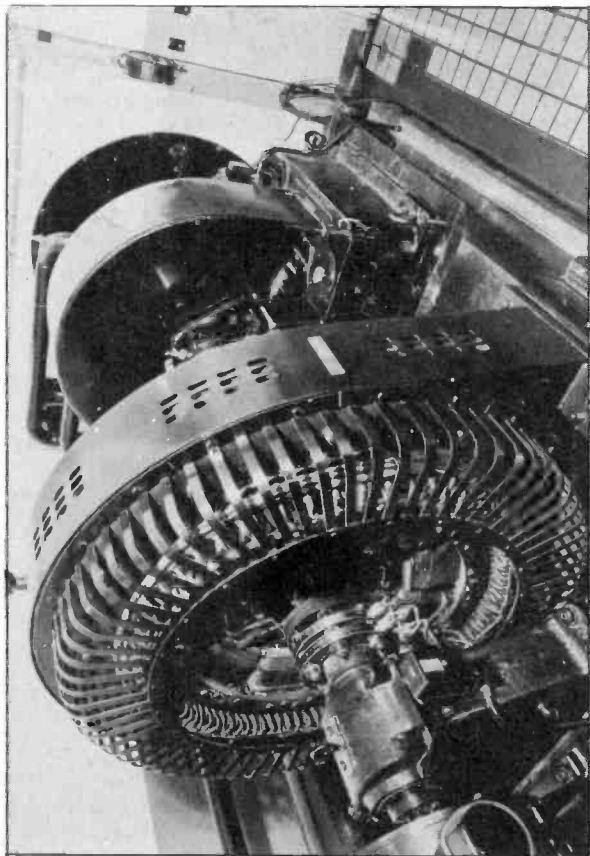

This Westinghouse generator is driven by an airplane engine on break-in run, to develop power to make more airplane engines. It is one of many such synchronous machines connected to a common bus in a plant of the Ford Motor Company.

Alternating Current

TRANSFORMERS

We have already mentioned that it is necessary to use high voltage in order to transmit large amounts of electrical power economically over long distance lines. This, you will recall, is one of the principal advantages mentioned for alternating current, because it is possible to economically increase the voltage of alternating current with transformers.

A transformer is a device by means of which alternating voltages may be stepped up or down as desired. When the voltage of a circuit is raised or lowered by means of a transformer, the current capacity is usually varied in the opposite direction by the same proportion.

If we raise the voltage the current is reduced or if we decrease the voltage the current is increased. For example, if we consider a circuit having 5,000 watts at 100 volts, the current in this case will be $W \div E$, or $5000 \div 100$, which equals 50 amperes.

If we were to raise the voltage of this same circuit to 1000 volts the current necessary to develop the same power would then be $5000 \div 1000$, or 5 amperes.

It is easy to see that a much smaller conductor could be used to carry the 5 amperes than would be needed for 50 amperes, so the same amount of power can be transmitted over smaller wires when higher voltage is used. This is the principle applied to modern transmission lines, and whenever a large amount of power is to be transmitted to some distant location the voltage is stepped up by means of transformers to some one of the standard high voltages, and the necessary current is thereby reduced a corresponding amount.

It is then possible to use a much smaller amount of copper in the conductors, and yet operate the transmission lines at a certain economical percentage of loss. These smaller conductors require much lighter supporting structures, such as the poles and steel towers and lighter insulators and fittings.

Transformers

As the cost of the copper in a transmission line is very great and the poles or towers also represent a large investment, the saving effected by the use of higher voltage is enormous.

For example, 50,000 kw. can be transmitted many miles at a potential of 100,000 volts over a copper conductor less than an inch in diameter; but if this same amount of energy were to be transmitted at 500 volts, it would require a conductor over a foot in diameter to carry the current with the same amount of loss.

From these points just mentioned, it is evident that alternating current provides a very convenient and economical means of transmitting large amounts of power for considerable distances, by stepping up the voltage at the generating plant with transformers and then stepping it down again to safe and suitable voltages for the equipment at the point where the energy is to be used.

By far the greater amount of electrical energy is used at voltages from 110 to 440. Some of the larger motors, however, are operated at voltages from 2300 to 6600, and in some cases as high as 12,000 volts or more.

Transformers are one of the most efficient pieces of electrical equipment that we have; the efficiencies of some of the very largest sizes ranging over 99%. These high efficiencies are obtainable because the transformer has no moving or wearing parts and therefore no friction or mechanical losses.

For this same reason, transformers require very little care and attention, except to maintain the proper insulation and cooling of their windings.

Power transformers are often referred to as **static transformers**, even though they have nothing to do with static electricity. This term is used because their parts are all stationary. We mention this term at this point because it is often confusing to the student or electrician to hear a transformer called by this term, if he doesn't know what it means.

Alternating Current

1. TYPES OF TRANSFORMERS

We have already learned that a transformer consists primarily of an iron core which provides a path for the magnetic flux and on which are placed the two windings; one called the **high tension winding** and the other the **low tension winding**. The high tension winding (H.T.) is the one which has the greatest number of turns, and the low tension winding (L.T.) is the one which has the smaller number of turns.

These windings are also commonly referred to as **primary** and **secondary** windings. The primary winding is always the one which is connected to the source of power. The secondary winding is always the one which receives its power from the primary by induction, and is the one connected to the load.

There are several common types of transformers and they are classified according to the manner of their core construction. These are known as: the **core type**, **shell type**, and **distributed type**.

It may help you to distinguish between these types by remembering the number of magnetic paths or circuits which each type of core provides for its flux. The simple core type provides one path; the shell type, two paths; and the distributed type, three or four paths.

The sketches in Figs. 1 and 2 shows the differences between these common types of transformer cores. Fig. 1 shows the plain core-type transformer, consisting of four sides, or legs as they are commonly called, arranged in the form of a square or rectangle. The primary and secondary coils can be wound on opposite legs, as shown in this figure, or they can both be wound on the same core leg if desired.

When the primary winding is excited with alternating current, it sets up an alternating magnetic flux which is carried by the core over to the secondary winding. As the lines of force expand and contract, due to the alternations of the current,

Transformers

they cut across the turns of the secondary winding, thereby inducing voltage in this winding by the

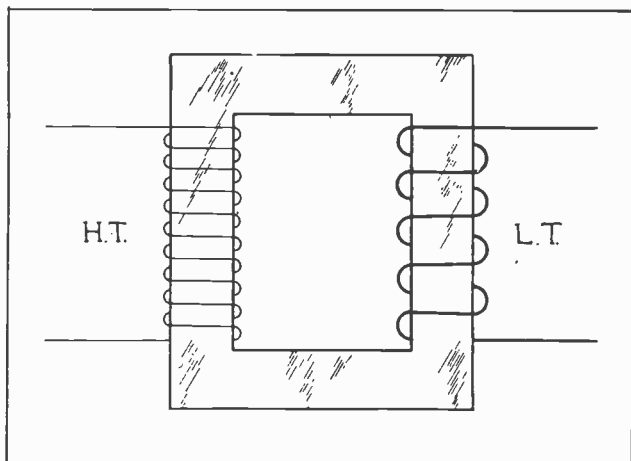

Fig. 1. This sketch shows the core and windings of a simple transformer. The winding on the left with the greater number of turns is the high tension winding, and the one on the right the low tension winding.

principles of electro-magnetic induction which were explained in your Elementary lesson.

The amount of voltage which will be induced in the secondary winding depends upon the ratio of the number of turns in the primary and secondary coils. If the secondary has fewer turns than the primary, the voltage will be stepped down; on the other hand, if the secondary has a greater number of turns, the voltage will be stepped up.

An ordinary transformer can be used to step the voltage either up or down, depending upon which of the windings is made the primary, or excited by the applied voltage. So we find that, in the case of step-up transformers, the primary is the winding with the fewer turns; while on a step-down transformer, the primary is the winding with the greatest number of turns.

2. TRANSFORMER CONSTRUCTION

The purpose of the transformer core is to provide a low reluctance path for the magnetic flux. Trans-

Alternating Current

former cores are therefore made of a special grade of soft iron or silicon steel, and are built up of thin laminations. These laminations are insulated from each other, either by a coating of insulating varnish or by an oxide scale which is formed on their surfaces by a heat-treating process.

This laminated construction reduces eddy currents which would otherwise be set up by the alternating flux and would cause the core to overheat.

The left view in Fig. 2 shows a sketch of a shell type transformer core with the primary and secondary windings both placed on the center leg. On the right in Fig. 2 is shown a sketch of the distributed type core on which the coils are also wound on the center leg and are surrounded by the four outside legs of the core.

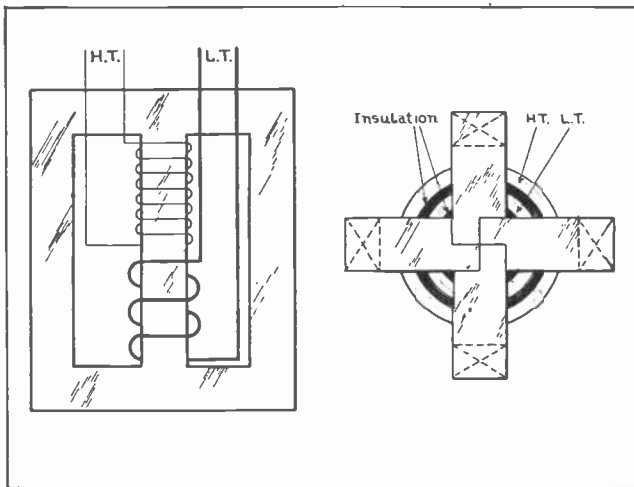

Fig. 2. The diagram on the left shows a transformer with a shell-type core, and on the right is shown the top view of a transformer with a distributed-type core. This view shows the top edges of the coils and insulation, while the sketch on the left shows a schematic diagram of the coils in their position on the core.

This distributed-type core is used principally for low-voltage lighting and distribution transformers in sizes under 50 kv-a. The large area of core iron, well distributed around the coils, makes the "no

Transformers

load" losses very low with this type of transformer, so that it is ideal for use on lighting circuits where the load may be very small at times.

The core-type and shell-type transformers are both suitable for large capacity and high voltage work. The core-type is best suited for the very high voltages, because its coils can be more easily wound and insulated than those of the shell-type. The windings of the core-type transformer, being located more on the outside of the core, can therefore radiate heat away from the windings more rapidly.

The shell-type core, because of its shape and the location of the windings on the center leg, provides

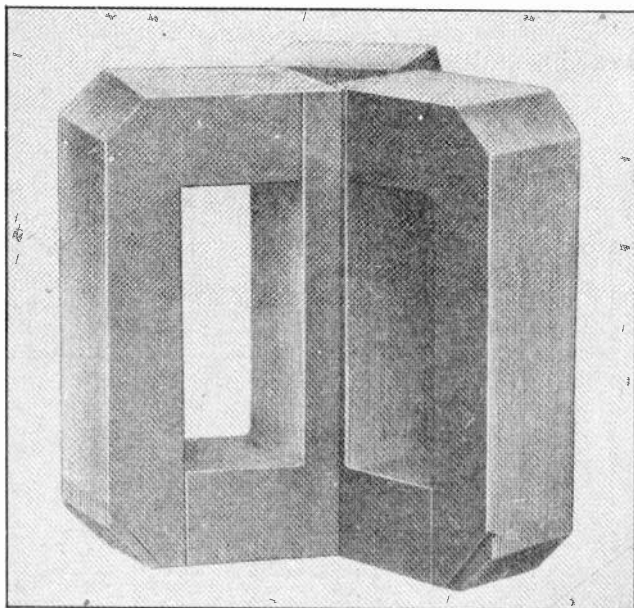

Fig. 3. The above photo shows a complete core of the three-sided type for a distributed core transformer. (Photo courtesy General Electric Co.)

somewhat better mechanical protection for the coils during handling in and out of the transformer case. The shell-type transformer is best suited for moderate voltages and heavy currents.

Alternating Current

Fig. 3 shows a complete distributed-type, transformer core of the three-leg construction. This view shows the manner in which the core legs are assembled from the thin laminations and also the manner in which the laminations are overlapped at the corners of the core, in order to provide a good magnetic path of low reluctance.

3. TRANSFORMER WINDINGS

Transformer coils are wound with insulated copper wire, some of the smaller sizes being wound with round wire while square or rectangular wire is used for practically all of the medium and larger sized units.

The square and rectangular wires form a more compact and solidly built coil and also provide better conductivity for the heat to flow out of the windings. The coils are usually built up in a number of carefully wound layers and each layer is well insulated from the preceding and following ones.

It is only in a few types of very small transformers that the coils are wound directly on the core legs. In practically all medium-sized and larger transformers the coils are form-wound and then slipped over the legs of the transformer core before the core is completely assembled.

The coils, after being wound, are thoroughly dried by being heated in ovens and are then dipped in hot insulating compound to thoroughly insulate every turn from the adjoining turns.

In many cases the dipping or impregnating process is performed in air-tight tanks, so that the coil can first be subjected to a high vacuum to draw out every bit of moisture and air from the windings. The hot insulating compound is then applied under pressure to force it into every crevice and space in the turns of the winding.

The coils are then thoroughly baked to dry out and harden the insulating compound so it will present a smooth, hard surface and prevent moisture.

Transformers

dust, and dirt from getting into the windings during operation of the transformer.

After the coils are thoroughly insulated and baked, they are placed upon the well-insulated legs of the iron core. The core insulation consists of several layers of fiber or fish paper; or, in some

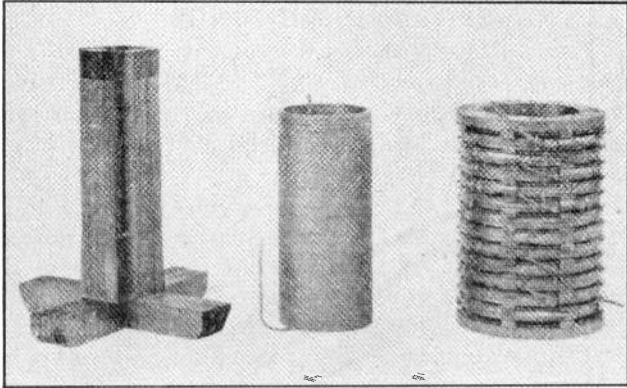

Fig. 4. This view shows a partly assembled core of the distributed type and the primary and secondary windings which are ready to be placed on the core. (Photo courtesy General Electric Co.)

cases on the higher voltage units, it consists of a special bakelite or composition tube.

Fig. 4 shows the partly assembled core for a distributed-type transformer, and the primary and secondary coils ready to be set in place over the center leg of this core as soon as it is insulated. The primary coil, shown in the center of this figure, is built up of several layers which have been form-wound and then thoroughly insulated by a wrapping of tape. The secondary winding, shown on the right, is built up of a number of separate coils, each of which is well insulated from the others.

These coils are then connected in series to form a complete high-voltage winding. This type of construction provides better separation and insulation of the sections of the secondary winding, between which very high voltages exist.

A heavy layer or tube of high-grade insulation is also placed between the low tension and high ten-

Alternating Current

sion windings to prevent a flash-over from the high-voltage winding to the low-voltage coil.

After the L.T. and H.T. coils are in place on the core, they are securely wedged and anchored, to prevent any possible moving or distortion due to heavy magnetic stresses set up around the coils when the transformer is loaded, or during the possible occurrence of short-circuits.

Fastening the coils securely in place also prevents them from rubbing against the core and having their insulation damaged by the slight vibration which is set up by the alternating fluxes in the core laminations.

Fig. 5 shows a completed transformer element with the windings in place on the core, the laminations of the outer and top sides of the core having been assembled after the windings were placed on the center leg. The whole core is then securely clamped by means of bolts to prevent excessive vibration of the laminations.

If these laminations are not clamped tightly together, the reversing magnetic fluxes will cause them to vibrate excessively and create a great deal of noise during the operation of the transformer. Loose laminations might also chafe the insulation of the windings.

In Fig. 5 you may also note the manner in which the leads are connected to the coils and brought up to a terminal plate of porcelain or insulating material. The heavy, stiff, copper leads are then carried on up to the point where they leave the tank or transformer case.

Fig. 6 shows another transformer winding, consisting of form-wound coils assembled in several layers. These layers are separated or spaced from each other by strips of wood, the ends of which can be seen around the left end of the winding. This type of construction not only insulates the sections of the coil from each other, but also provides spaces for the circulation of the cooling air or oil to carry away the heat from the inside of the winding more easily.

Transformers

A winding built up of a number of separate layers or sections in this manner may have these sections connected either in series or parallel, according to the voltage and current capacity desired from the transformer.

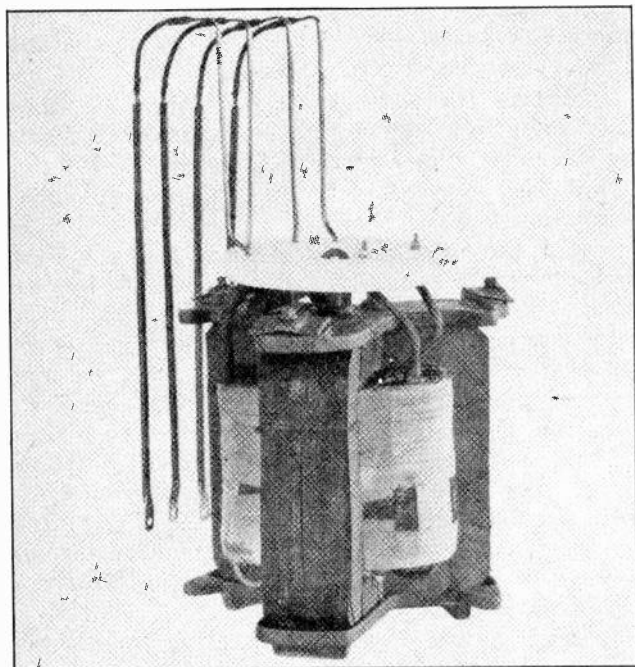

Fig. 5. Complete transformer core and windings. Note how the legs of the core are assembled to form complete magnetic paths around the coils. (Photo courtesy General Electric Co.)

4. SINGLE-PHASE AND POLYPHASE TRANSFORMERS

The transformers we have so far considered and shown in the figures have been of the single-phase type. Transformers are also made in polyphase types, as shown in Fig. 7. This photo shows a complete three-phase transformer element with the primary and secondary windings of each phase located on a separate leg of the core.

From this it is easy to see that a three-phase transformer is simply a combination of three single-

Alternating Current

phase transformers all assembled on one core. The low voltage windings of the transformer shown in Fig. 7 are inside the high voltage coils and next to the core legs. The high voltage coils which are placed over the others can be clearly seen in this view. Note carefully the manner in which the separate sections of the coil are insulated from each other, and also the insulating barriers placed be-

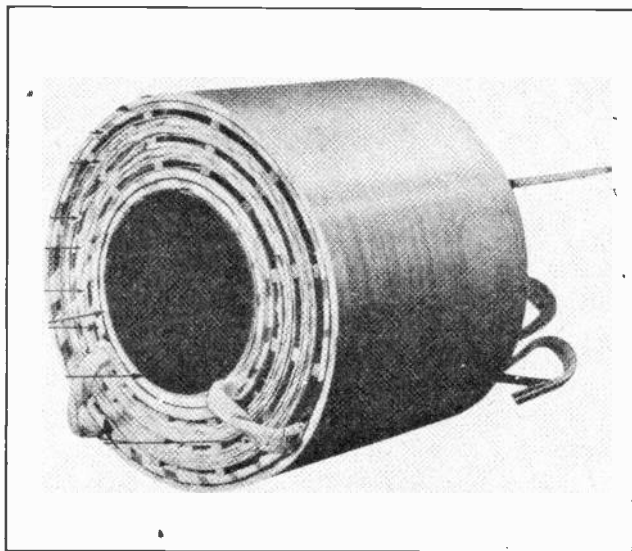

Fig. 6. This view shows a transformer winding which is built up in layers that are spaced apart with wood strips to allow circulation of cooling oil through the windings. (Photo courtesy General Electric Co.)

tween the three coils to prevent a flash-over from one winding to the next. The leads for connecting the coils to the line are shown carefully taped and marked, and brought up to separate insulating supports above the core.

A three-phase transformer requires less core material than three single-phase transformers of the same capacity. This is due to the fact that in the three-phase transformer the magnetic fluxes of each phase use the same core at alternate periods, as the alternations and fluxes of each phase occur 120°

Transformers

apart. Therefore, the advantages of polyphase transformers are: that they require less core material; are lighter in weight; and occupy less floor space in a power plant or substation than three single-phase transformers of the same capacity.

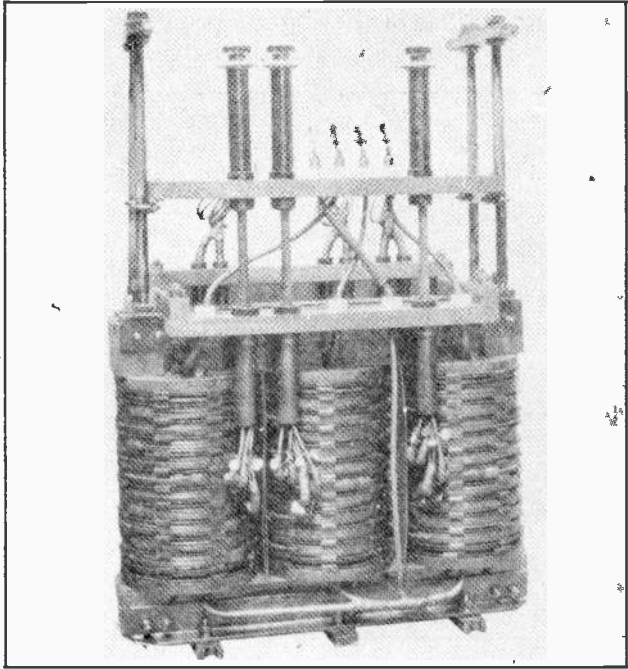

Fig. 7. Complete three-phase transformer core and windings ready to be placed in the tank and covered with oil. (Photo courtesy General Electric Co.)

One of the disadvantages of a polyphase transformer is that, in case of trouble or breakdown in the insulation or windings, all three phases must be cut out of service for repairs; while, in the case of single-phase transformers, the one defective unit can be disconnected for repairs, and service can be maintained to the customers either by substituting another single-phase unit or by a special open-delta connection to the remaining two units. This connection will be explained in later paragraphs.

Alternating Current

In modern transformers, however, the construction and insulation of the coils is such that under ordinary operating conditions there is very little chance of breakdown or failures.

5. TRANSFORMER LOSSES

Although transformers are very efficient devices, they have certain small losses which take place within their windings and cores during operation. These losses are commonly referred to as **copper losses** and **core losses**.

The copper loss is due to resistance of the coils, which causes a certain amount of the energy to be transformed into heat within the windings. This loss is proportional to the square of the current in the windings, and is therefore approximately zero at no load and maximum at full load.

The core loss consists of eddy current losses and hysteresis losses which are set up in the core by the reversing magnetic flux. Eddy currents, you will recall, are low-voltage short-circuited currents which are caused to flow in various areas of the core by the magnetic lines of force cutting across the core in varying intensities. These eddy currents are reduced and kept at a minimum by the laminated construction of the core; but the small amount which still exists, even in the best core construction, will cause a certain amount of heat to be developed in the iron.

Hysteresis loss is due to the reversal of the magnetic charges of the molecules of the iron as the alternating flux constantly reverses in the core. This loss also tends to produce a certain amount of heat in the core.

The core losses remain approximately the same at no load or full load of the transformer, because they are always proportional to the magnetizing current and flux.

These losses and tests to measure them will be more fully discussed in later paragraphs of this section.

Transformers

6. TRANSFORMER COOLING

In a transformer which is operating under full load, a considerable amount of heat is produced by the copper and core losses. This heat must be removed and carried away from the windings and core, because if it were confined and stored up within them it would soon cause the temperature to rise so high that it would burn or damage the insulation of the windings.

Transformers must also be kept cool to maintain their high operating efficiency, because the resistance of the copper in the windings increases with the temperature increase and thereby increases the I^2R loss.

In very small transformers, such as bell-ringing and toy transformers, instrument transformers, etc., the heat is carried away by the natural circulation of air around the core and windings.

On larger power transformers some additional means of cooling the windings must be provided. Transformers are often classified according to their methods of cooling, as follows: **natural air cooled**, **forced air-blast cooled**, **oil cooled**, and **oil and water cooled**.

Natural air cooling is used only in the smaller types, as previously explained.

7. AIR-BLAST COOLING OF TRANSFORMERS

Transformers that are cooled by forced air circulation have their core and windings enclosed in an iron case or jacket which is open at the bottom and top. Clean, dry air under low pressure is forced upward through the windings and, in this manner, carries away the heat much more rapidly than natural air-circulation would.

The air for cooling transformers of this type is supplied by motor-driven fans and is usually fed to the transformers through an air passage or chamber which runs under the floor on which the transformers are located.

Air passes up through the transformers and ex-

Alternating Current

hausts, into the room in which they are located, escaping through open windows or air-vents in the building.

Quite often a small ribbon or cord is attached to the top of the transformer casing, directly in the exhaust air system, so that it will be blown upward and kept fluttering in the air. This provides an indication of failure of the air supply.

It is very important that the air be kept circulating at the proper rate through transformers of this type or otherwise they would quickly overheat.

The air intake for supplying fresh air to air-blast transformers should be located where it will not draw any moisture or dust, as either of these would

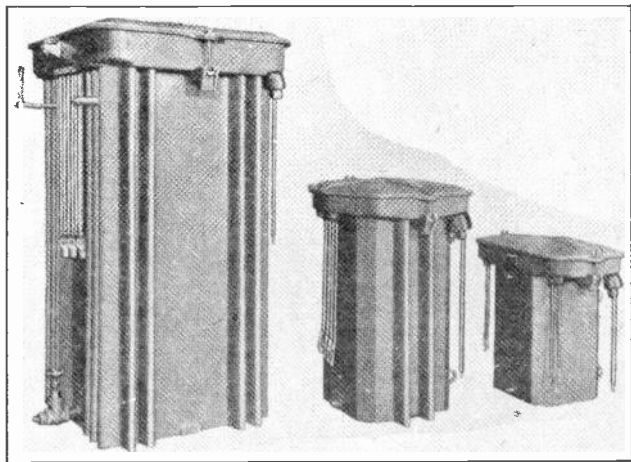

Fig. 8. This view shows three different sizes of common power transformers. Note the cooling flanges or ribs in the tanks of the two larger ones. (Photo courtesy General Electric Co.)

quickly deteriorate the insulation on the transformer windings, and dust would tend to clog the air passages between and around the coils.

Very often a cloth screen is placed over the air intake to stop the passage of fine dust and a certain amount of moisture.

8. OIL-COOLED TRANSFORMERS

The common oil-cooled transformers of the small and medium sizes have their cores and windings

Transformers

immersed in a tank of insulating oil. This is by far the most common type of transformer in use.

The oil, which is of a special grade known as transformer oil, not only serves as a cooling agent for the windings and core, but also serves as an excellent insulation between the layers of the winding and the core.

This oil flows into all crevices and passages between the windings and conducts the heat through

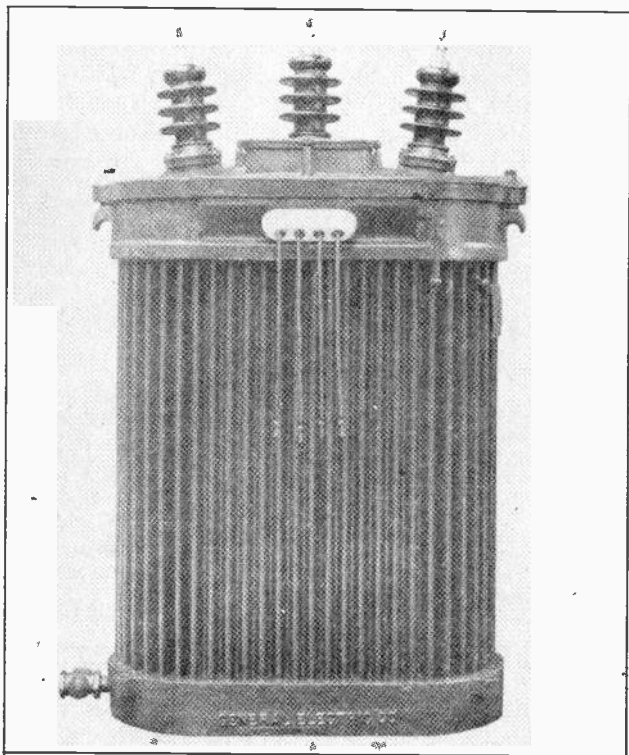

Fig. 9. Three-phase power transformer for high voltage operation. Note the large insulating bushings and also note the manner in which the entire tank is corrugated to provide a greater heat-radiating surface.

the liquid to the metal tank, from which it is given off to the outside air.

Fig. 8 shows several transformers of the oil-cooled type, the capacities of which, from left to

Alternating Current

right, are: 150 kv-a., $37\frac{1}{2}$ kv-a., and 15 kv-a. The tanks of these transformers are made of either cast iron or pressed steel. The pressed steel tanks are much lighter in weight and more durable mechanically; because, if they are dropped or bumped, it will usually only dent the tank instead of cracking it, as often occurs with cast iron.

On the small sizes of transformers, the tanks usually have a plain, flat surface on each side, as shown on the 15 kv-a. unit at the right in Fig. 8. On the larger sizes, the sides of the tank are usually corrugated or provided with projecting fins as shown on the two larger transformers in this figure. This construction greatly increases the area or surface of the metal which is in contact with the air, and thus enables the air to absorb and carry away the heat from the tank much more rapidly.

Note the manner in which the coil leads are brought out of the transformer case through insulating bushings, which are usually made of porcelain. The cases are equipped with covers which can be removed for inspection of the windings or for changing the connections at the terminals inside. These covers are provided with a washer or gasket around their edges so that, when they are clamped securely in place by the bolts and nuts shown in the figure, they seal the transformer tightly and keep out practically all dirt and moisture.

Transformers of this type and smaller, ranging down to 1 kw. in size, are the types commonly seen on poles throughout the cities and in many rural districts. They are used to step the voltages of the transmission or distribution lines down to that used in homes for lighting or in shops for power purposes.

Fig. 9 shows a complete three-phase transformer which has the entire surface of the case deeply corrugated to provide sufficient cooling area. The high-tension winding of this transformer is constructed for 25,000 volts, and you will note the much larger insulating bushings through which the

Transformers

high-voltage leads are brought out at the top of the case.

You will note also that the transformer cases shown in these figures are provided with drain plugs or valves at the bottom, so that the oil can be drained out and replaced whenever it becomes dirty or has absorbed too much moisture.

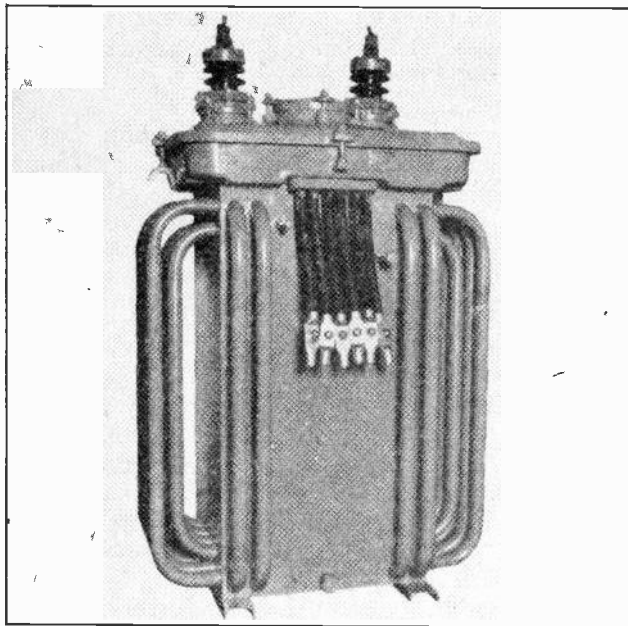

Fig. 10. This transformer is equipped with cooling tubes to allow the oil to circulate outside of the tank and give off its heat more rapidly to air.

During operation throughout a period of several months or longer the oil will often absorb a little moisture, and the presence of even very slight amounts of water in the oil greatly reduces its insulating qualities. It is therefore necessary at times to replace or dry out this oil. This will be more fully covered later under Care and Maintenance of Transformers.

9. COOLING TUBES OR RADIATORS

On very large power transformers, ranging from 300 kv-a. to 10,000 kv-a. and up, the cases are us-

Alternating Current

ually provided with a number of pipes or tubes on the outside, as shown in Fig. 10. Some smaller transformers are equipped with these cooling tubes, if they are to be located in places where it is difficult to cool them otherwise. These tubes connect to the top and bottom of the tank and allow the oil to circulate through them from top to bottom, by the natural movement of the oil caused by its being heated inside the transformer and cooled in the tubes.

The heated oil around the transformer coil and windings tends to rise to the top and pass out of the tank into the top ends of the tubes. In the tubes it is cooled off more rapidly, as they are completely surrounded by air, and the oil is thus caused to flow to the bottom of the tubes and back into the transformer.

The oil is kept continually circulating in this manner by the thermo-siphon principle just explained.

10. OIL AND WATER COOLED TRANSFORMERS

In some cases, where it is difficult to sufficiently cool transformers by means of natural oil circulation through cooling tubes, oil and water cooled transformers are used. In transformers of this type a coil of copper tubing or pipe is located in the oil, above the core and windings.

Cold water when circulated from the outside through this copper piping rapidly absorbs the heat from the top level of the oil, which is always the hottest in any transformer. Fig. 12, page 27 shows a transformer equipped with a cooling coil of this type.

The heat passes easily through the copper tubing because copper, as you will recall, is a good conductor of heat. The heat is thus absorbed by the water and continually carried away by the new supply of cool water which is circulated constantly through the cooling coil, by a pump or by a connection to a local water supply system.

12. TRANSFORMER OPERATING TEMPERATURES

Transformers are commonly designed to withstand temperature increases of 55° C. to 75° C.

Transformers

above normal temperature. This variation in maximum operating temperatures is due to the different classes of insulation which are used.

Transformer windings which are insulated with impregnated cotton, silk, and paper cannot be operated at such high temperatures as those which are insulated with mica and other special insulating compositions.

Practically all large transformers are provided with thermometers which indicate the operating temperatures at all times. When operating or caring for transformers which use forced air or circulating water in their cooling, it is very important to regulate the air and water so that the maximum temperatures for which the unit is designed will not be exceeded.

It is also well to remember always that the temperature ratings of electrical machinery are commonly given in the centigrade scale.

Cent.	Fahr.	Cent.	Fahr.	Cent.	Fahr.	Cent.	Fahr.	Cent.	Fahr.
-40	-40	15	59	70	158	150	302	800	1472
-35	-31	20	68	75	167	160	320	900	1652
-30	-22	25	77	80	176	170	338	1000	1832
-25	-13	30	86	85	185	180	356	1200	2192
-20	-4	35	95	90	194	190	374	1400	2552
-15	+5	40	104	95	203	200	392	1600	2912
-10	+14	45	113	100	212	300	572	1800	3272
-5	+23	50	122	110	230	400	752	2000	3632
0	+32	55	131	120	248	500	932	2200	3992
+5	+41	60	140	130	266	600	1112	2400	4352
+10	+50	65	149	140	284	700	1292		

Fig. 13. This convenient table gives the comparative temperature values in degrees centigrade and Fahrenheit. With this table it is easy to convert the degrees centigrade from the rating or temperature of any electrical equipment into degrees of the Fahrenheit scale.

When we say that a transformer is allowed to operate at 55 degrees centigrade above normal temperature, its temperature is considerably higher than 55 degrees Fahrenheit. The centigrade scale has its zero point at 32 degrees on the Fahrenheit

Alternating Current

scale, and its 100-degree point is at 212 degrees Fahrenheit. One degree of the Fahrenheit scale is equal to only $\frac{5}{9}$ of a degree centigrade.

So, to determine the value in degrees F. of any certain temperature above freezing, which is expressed in degrees C., we can use the following formula, or rule:

$$\text{Temp. F.} = (\text{C}^\circ \times \frac{9}{5}) + 32$$

Or, to determine the C. temperature of a certain F. value, we can use the formula:

$$\text{Temp. C.} = (\text{F}^\circ - 32) \times \frac{5}{9}$$

Fig. 13 gives a convenient table of comparative temperature values in both the centigrade and Fahrenheit scales. From the table we can quickly find that 55° C. is equal to 131° F., and 75° C. is equal to 167° F., etc.

13. SPECIAL TEMPERATURE AND LOAD INDICATOR DEVICE

For small and medium-sized transformers which are to be mounted upon poles, a device known as a **thermotel** is often used to indicate when the transformers are overloaded or operating at too high temperatures. This device can be read from the ground and therefore does not necessitate climbing the pole to determine the operating temperature of the transformer.

Fig. 14 shows a photograph of a thermotel unit which is equipped with an extension to be inserted under the cover of the transformer tank. These devices operate by the expansion of a liquid in a tube immersed in the oil. When the oil becomes heated the liquid expands and increases the pressure on the walls of a thin, curved, metal tube attached to the pointer of the device.

The increased pressure tends to straighten out the tube and thereby causes the pointer to move across the scale a certain distance, in proportion to the temperature of the transformer oil.

As this temperature is proportional to the amount of load, the scale of the thermotel can be marked

Transformers

so that the pointer will indicate the percentage of load or overload at which the transformer is operated.

If the transformer is overloaded and the pointer is caused to move beyond the 100% load mark, it trips a white vane or semaphore which falls into view in the window of the device. This indication is clearly visible to an inspector on the ground and shows that the transformer has been overloaded.

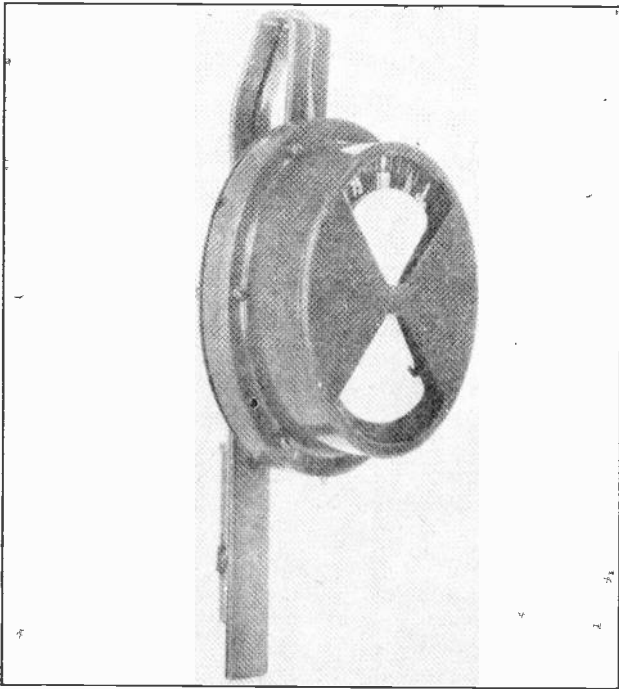

Fig. 14. This photo shows a temperature-indicating device for use with pole type transformers. This device is called a thermotest and indicates both excessive temperatures and overload of a transformer on which it may be installed.

These devices are exceptionally convenient because they can be read from the ground and can be installed on a transformer by simply hanging over the edge of the transformer case a hook-like extension which carries a tube of liquid.

14. INSULATING BUSHINGS

Where the primary and secondary leads of the transformer coils are brought out of the tank or case for connection to the line, these leads must be carefully insulated from the metal case, in order to prevent flash-overs and grounding of the circuit.

On low-voltage transformers, ranging from 110 to 2300 volts, the insulated wires are brought out through small porcelain bushings or collars, as shown in Fig. 8. On transformers operating at voltages from 2300 to 33,000 volts, much larger porcelain bushings are used. These bushings are equipped with flanges or petticoats to increase the creepage or flash-over distance which an arc would have to travel in order to jump from the lead-in wire to the tank.

Bushings of this type are shown on the high-voltage terminals of the transformers in Fig. 9 and 10. The low-voltage leads on both of these transformers are brought out through the ordinary small porcelain bushings.

On transformers operating at voltages from 50,000 to 220,000 volts or more, special oil-filled porcelain bushings or condenser-type bushings are used. The high-voltage bushings on the 220,000-volt transformers shown in Fig. 11 are of the oil-filled porcelain type. The porcelain of these bushings is hollow and is filled with oil, which is separated into layers by a number of thin insulating tubes.

High-voltage bushings of this type have a metal rod extending through them from one end to the other, to serve as a conductor. The coil and line leads are connected to the top and bottom ends of this rod by means of bolts or threaded connections.

The condenser-type bushing consists of a number of alternate layers of insulation and metal foil wrapped tightly around the conductor rod. The reason for using layers of metal foil in a bushing of this type, instead of using solid insulation, is that the metal distributes the voltage stress more evenly over the entire surface of the insulation layers and thereby reduces the tendency to puncture at one

Transformers

spot near the iron tank of the transformer.

Fig. 15 shows a polyphase transformer removed from its tank, but with the cover in place so the lower ends of the insulating bushings can be seen. The smaller bushings in the front are those of the low-voltage leads and the larger bushings in the rear are those of high-voltage leads.

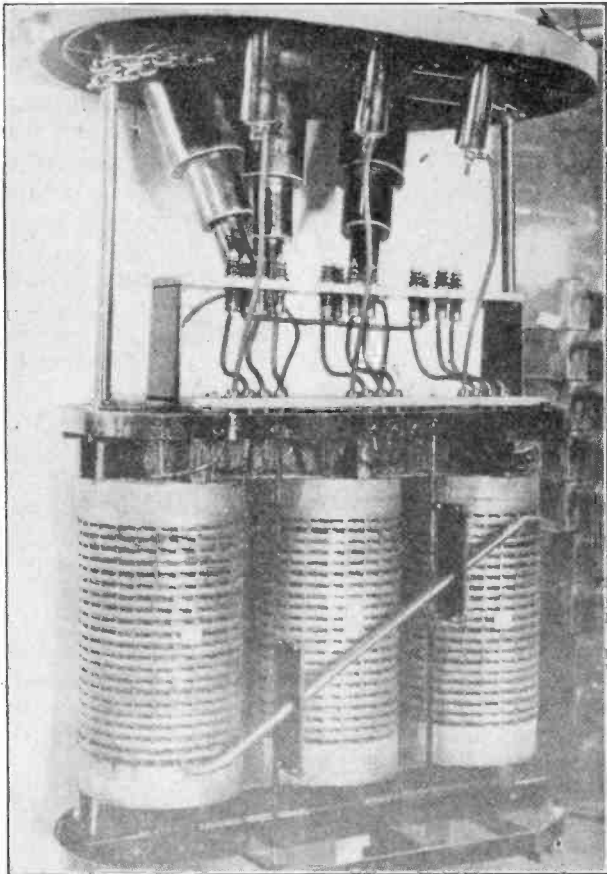

Fig. 15. This view shows the core and windings of a high voltage, three-phase transformer and also the lower ends of the insulating bushings through which the high voltage and low voltage leads are taken from the tank.

You will also note that the connecting lead between the two outer windings is carried across

Alternating Current

through a special tube of insulating material, to prevent flashing over to the center coil.

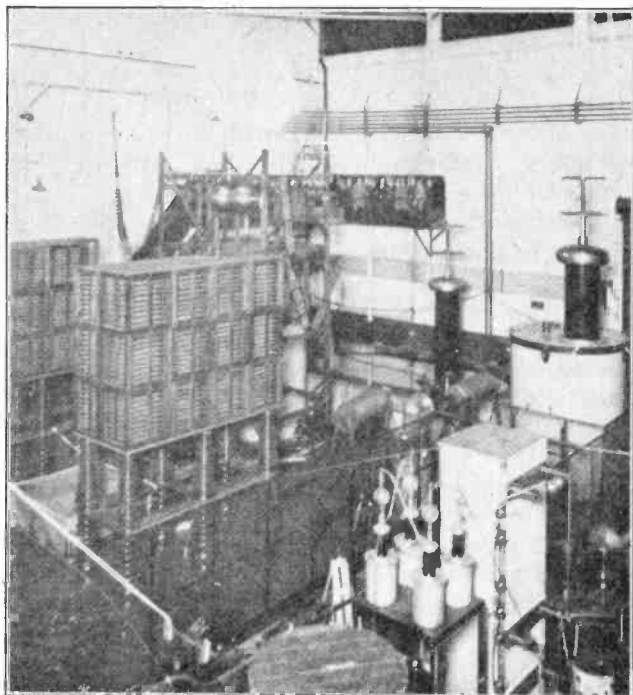

Fig. 16. The above photo shows a high voltage test room at the plant of the General Electric Company. Transformers in this room are capable of producing over one million volts and an enormous arc produced by this voltage can be seen above the sphere gap and condenser slightly to the left of the center of the picture.

Power transformers are built in voltages ranging from 110 to 220,000, while special testing transformers used in research and laboratory work are built to develop voltages as high as 250,000 or more from one unit.

A number of these transformers can be connected in series or cascade connection to obtain potentials as high as several million volts. Voltages of this order are used in making flash-over and puncture tests on line insulators, transformer bushings, high-voltage cables, etc. They are also used for determining the effects of lightning on transmission line

Transformers

equipment, electrical machinery, and buildings. Fig. 16 shows a demonstration of an arc from the high-voltage transformers which can be seen in the right rear of this photo.

Special industrial transformers are made to step voltages down as low as 1 or 2 volts and to produce many thousands of amperes from very low voltage secondary windings, to be used in butt welding, spot welding, etc.

Transformers are rated in kv-a. and are built in sizes from a fraction of one kv-a. to 40,000 kv-a. or more.

15. TRANSFORMER PRINCIPLES

When the primary winding of a transformer is excited with alternating current, the powerful magnetic field which is set up around this winding and through the core will cut across the turns of the secondary winding as the flux expands and contracts with the variations and reversals of the current in the primary winding.

As this flux cuts back and forth across the turns of the secondary winding, it induces a voltage in each of these turns by the principle of electro-magnetic induction which has already been explained.

As the induced voltage in the secondary coil depends upon the movement of the primary flux, and as this flux moves in synchronism with the alternations of the primary current, the secondary current will always be of the same frequency as that in the primary.

The secondary current will, however, always be approximately 180° out of phase with the primary current. This is due to the fact that the most rapid change of primary flux occurs during the period when the primary alternations are passing through or near their zero values, as was shown with the sine curves in the first lesson on Alternating Current.

It is at this point of most rapid flux change that the maximum voltage is induced in the secondary; therefore, the maximum secondary voltage occurs approximately 90° later than the maximum primary current.

Alternating Current

As a transformer winding is highly inductive and has very little resistance, the secondary current will lag approximately 90° behind the induced secondary voltage. Thus, the secondary current is approximately 180° behind the primary current. This is a very good point to remember because it means that when the current flows through the primary coil in one direction, as shown by the arrows in Fig. 17, it will be flowing in the opposite direction through the secondary coil.

Therefore, if the primary and secondary coils are wound alike, the voltage polarities produced at the ends of the secondary coil will be opposite to those applied to similar ends of the primary coil.

You will note in Fig. 17 that, while the greater part of the magnetic flux set up by the primary follows the iron core, a certain amount of this flux will be set up around the windings outside of the core and also across the opening between the core legs. This is called **leakage flux** and is considerably greater at full load of the transformer than at no load.

16. TRANSFORMER RATIOS AND SECONDARY VOLTAGES

In a simple transformer, all of the turns of the secondary coil are in series with each other, so their induced voltages will add together and the voltage at the terminals of the secondary winding will be the sum of the voltages induced in all the turns.

Therefore, **the greater the number of turns in the secondary winding of any transformer, the higher will be the voltage induced in this winding.**

From this, we find that in any transformer the amount of voltage change, or the ratio between the primary and secondary voltages, will be proportional to the ratio between the number of turns in the primary and secondary windings.

For example, if the primary winding of the transformer shown in Fig. 17 has fifty turns and the secondary winding has one hundred turns, the transformer will be a step-up transformer with a ratio of one to two.

Transformers

The first figure of a transformer ratio always refers to the primary and the second figure to the proportional number of turns in the secondary.

If, in another case, we have a step down transformer with a primary winding of 1000 turns and a secondary winding of 100 turns, the ratio of this

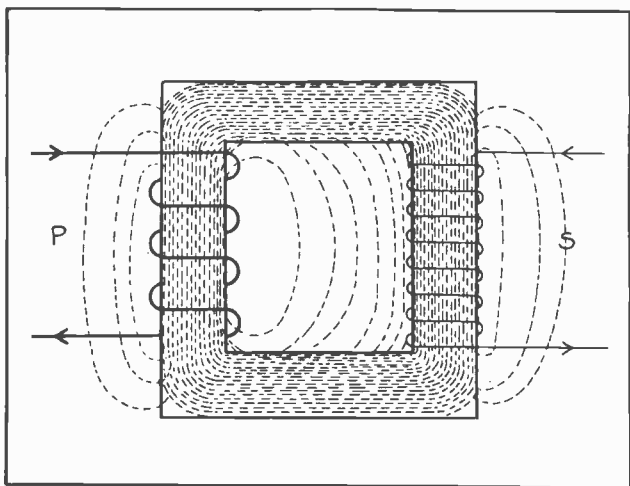

Fig. 17. This sketch illustrates the operating principle of a simple transformer and shows the manner in which the primary flux passes through the core and induces voltage in the secondary winding.

transformer would be expressed as 10:1; and if we were to apply 2200 volts to the primary winding, 220 volts would be produced by the secondary winding.

From these illustrations we can see that the following formula applies:

$$\frac{\text{Primary turns}}{\text{Secondary turns}} = \frac{\text{Primary voltage}}{\text{Secondary voltage}}$$

or, in the case of the transformer just mentioned,

$$\frac{1000}{100} = \frac{2200}{220}$$

If we know the ratio between the number of turns on the primary and secondary windings of any transformer and know the amount of primary voltage which is applied, we can easily determine the secondary voltage, because it will bear the same

Alternating Current

relation to the primary voltage as the number of secondary turns bears to the number of primary turns.

To find the secondary voltage of either a step-up or step-down transformer, divide the primary voltage by the ratio of primary to secondary turns, or in other words,

$$\text{Secondary } E = (\text{Primary } E \times \text{last figure of ratio}) \div \text{first figure of ratio.}$$

For example, if a step-up transformer with a ratio of 1 to 10, has 100 volts applied to its primary, the secondary voltage will be $(100 \times 10) \div 1$, or 1000 volts.

If, in another case, a step-down transformer with a ratio of 20 to 1 has 2200 volts applied to its primary, the secondary voltage will be $(2200 \times 1) \div 20$, or 110 volts.

The formula for finding the approximate secondary current is as follows:

$$\text{Sec. } I = (\text{Pri. } I \times \text{first figure of ratio}) \div \text{last figure of ratio.}$$

17. POWER OUTPUT OF TRANSFORMERS

If a transformer were 100% efficient, the amount of power in kv-a. that would be obtained from the secondary would always be the same as that supplied to the primary, regardless of the amount that the voltage might be stepped up or down.

Of course, no transformer can be 100% efficient, but the efficiency of large power transformers is so high that for simple illustrative problems we may ignore the slight loss.

If a step-up transformer produces a secondary voltage ten times as high as the voltage applied to the primary, then the full load current in the secondary winding will be just one-tenth of that in the primary winding.

For example, if a 10 kv-a. transformer with a ratio of 1 to 10 has 200 volts and 50 amperes applied to its primary and increases the voltage to ten times higher, or 2000 volts on the secondary, the full load secondary current will then be 5 amperes.

Transformers

If we multiply the volts by the amperes in each case, we will find the same number of volt-amperes or kv-a. in the secondary as in the primary. The primary voltage times primary current will be:

$$200 \times 50 = 10,000 \text{ volt-amperes, or } 10 \text{ kv-a.}$$

The secondary volts times the secondary amperes will be:

$$2000 \times 5 = 10,000 \text{ volt-amperes, or } 10 \text{ kv-a.,}$$

as before.

From this, it is evident that the high-voltage winding of any transformer can be wound with correspondingly smaller wire, according to the ratio between the high-voltage and low-voltage windings. Therefore, the high-tension winding of any transformer is always the one with the smaller wire and the greater number of turns; while the low tension winding is the one with the larger wire and the smaller number of turns.

This has been mentioned previously but it is repeated here as a reminder of a very simple way to determine which is the high-voltage coil and which is the low voltage coil of any transformer.

As power factor doesn't enter into the kv-a. rating of a transformer or into the calculations for volt-amperes, it is a simple matter to find the current rating of any transformer winding merely by dividing the volt-amperes by the voltage of that winding.

To obtain the volt-amperes, remember, it is only necessary to multiply the kv-a. rating by 1000, as one kv-a. equals 1000 volt-amperes.

One volt-ampere is the same as one watt of apparent power. For example, if we have a 10 kv-a. transformer with a ratio of five to one, and a primary voltage of 550, the secondary voltage would be 110 volts. If we multiply the kv-a. rating of 10 by 1000, we get 10,000 volt-amperes. The primary current will then be $10,000 \div 550$, or 18.2 amperes, and the secondary current will be $10,000 \div 110$, or 91— amperes.

If the power factor of a transformer were 100%,

Alternating Current

we could obtain the same number of actual kw. of true power as the kv-a. rating of the transformer. However, the power factor of a transformer and its attached load is usually much lower than 100%, so it is often possible to have a 10 kv-a. transformer fully loaded and yet supplying only 5 to 8 kw.

This is the reason transformer capacity is always rated in kv-a.

18. EFFECT OF SECONDARY LOAD CURRENT ON PRIMARY CURRENT

When a transformer is operating idle, that is, connected to the line but having no load connected to the secondary, only a very small amount of current will flow in the primary winding. This current is called the **magnetizing current** and is just the amount required to strongly magnetize the core.

As long as a transformer is not loaded, the lines of force of this very strong field set up by the magnetizing current are constantly cutting across the turns of the primary winding and thereby inducing a counter-voltage which is very nearly equal to the applied voltage. This limits the current flow to a very small amount.

As soon as the load is connected to the secondary, the primary current will automatically and immediately increase in proportion to the amount of this load. If the secondary is fully loaded, the primary current immediately comes up to full load value. If the secondary is overloaded the primary will also be overloaded, and it is thus possible to burn out the primary or both the primary and secondary windings by connecting too much load to the secondary of any transformer.

This automatic variation in the current taken by the primary whenever the load on the secondary is changed, is caused by the reaction of the secondary flux on the flux of the primary coil. When there is no load connected to the secondary winding there will, of course, be no current flowing through it, even though full voltage is induced in this winding. As soon as its circuit is closed by connecting some

Transformers

load to the secondary leads, current starts to flow through this winding and sets up a magnetic field around it.

We recall that the current in the secondary winding is always 180° out of phase or in the opposite direction to that in the primary; therefore, the magnetic flux set up by the secondary is in the opposite direction to the primary flux in the core.

This secondary flux neutralizes a certain amount of the primary flux and reduces the number of lines of force which are cutting across the primary turns. This reduces the counter-voltage set up in the primary and allows more current to flow through it.

The resistance of the primary winding is so low as to be almost negligible, so the transformer depends largely upon the counter-voltage of self-induction to limit the current flow through this winding.

If the secondary load is increased to such an extent that the flux of its currents almost entirely neutralizes the primary flux, the counter-E.M.F. generated in the primary winding will be so low that an excessive flow of current will result and possibly burn out the winding.

This is a very important principle to keep in mind in connection with transformers and certain other alternating current machines. It explains the reason why A. C. windings will usually be burned out very quickly if connected to a D. C. circuit; because direct current, with its constant and unchanging flux, doesn't develop counter-voltage to limit the current flow.

19. POLARITY OF TRANSFORMERS LEADS

Nearly all modern transformers have their H.T. and L.T. leads marked with polarity markings. These marks would be for example: H-1 and H-2 on the high-tension side of a single-phase transformer, and X-1 and X-2 on the low tension side.

On a three-phase transformer, the leads would be marked H-1, H-2, and H-3 on the high-tension side; and X-1, X-2, and X-3 on the low-tension side.

Alternating Current

These polarity markings indicate the order in which the leads are brought out from the windings, and also indicate the respective polarities of primary and secondary leads at any instant.

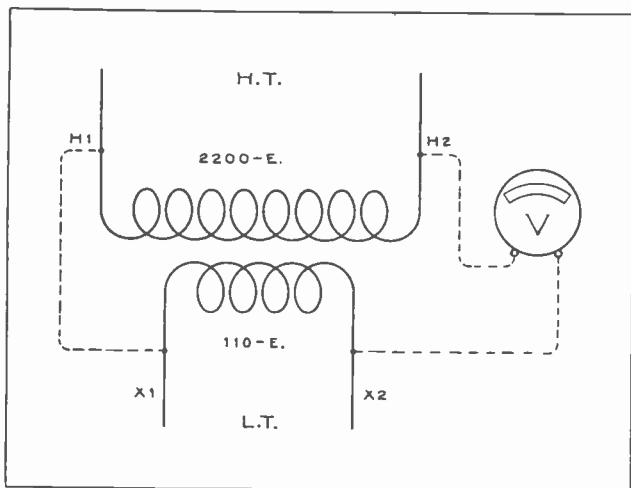

Fig. 12. This diagram shows the methods of connecting a shunt and a voltmeter to the high tension and low tension terminals of a transformer for making a polarity test.

We know, of course, that the polarity of alternating-current windings is continually and rapidly reversing; but, as the secondary always reverses with the same frequency as the primary and is always 180° out of phase with the primary, we can determine the respective polarities at any instant of any alternation.

These polarity markings aid in making the proper connections for transformers to be operated in parallel, as it is necessary to have similar leads connected together, in order to have the transformers operate with the proper phase relations for satisfactory parallel operation. If transformers are connected in parallel with wrong polarity they burn out or blow the fuses.

If a transformer winding is marked H-1, H-2, H-3, and H-4, it will usually be found that H-1 and H-4 indicate the end-leads or full-winding termi-

Transformers

nals, while H-2 and H-3 are intermediate taps taken off at certain sections of the winding.

The highest and lowest numbers are placed at the end-leads or full winding, while the intervening numbers are placed on the part-voltage taps. The H-1 lead is usually located on the right-hand side, when facing the high tension side of the transformer. With transformers marked in this manner, if the H-1 and X-1 leads are connected together, as shown by the dotted line in Fig. 18, then when the voltage is applied to the H.T. winding the voltage between the remaining X-2 and H-2 leads will be less than the full voltage of the high-voltage winding.

In Fig. 18 a voltmeter is shown connected across the H-2 and X-2 leads of the single-phase transformer. The reason its reading will be lower than the applied voltage on the primary winding is because the polarity of the low-voltage winding is opposite to that of the high-voltage winding, and the two voltages will therefore oppose each other; so that the voltmeter will read their difference; or $2200 - 110$ equals 2090 . A transformer with the

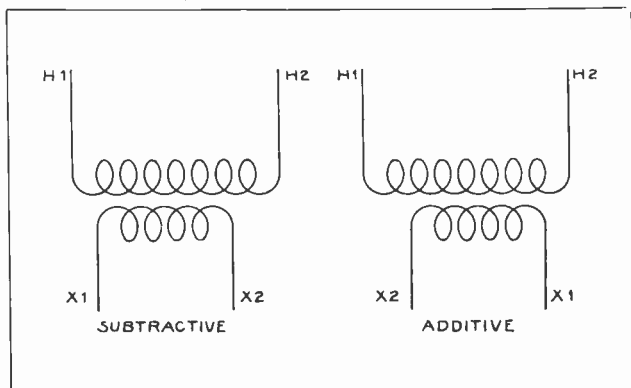

Fig. 19. This sketch shows windings of two transformers with their leads properly marked for subtractive and additive polarities.

leads arranged and marked in this manner is said to have **subtractive polarity**.

If the leads are brought out of a transformer so that the voltmeter when connected to the adjacent

Alternating Current

H and X leads, as shown in Fig. 18, reads the sum of the voltages of the high tension and low tension windings, then the transformer is said to have **additive polarity**. In this case the markings of the X-1 and X-2 leads would be reversed.

On transformers which have their leads properly marked, the markings indicate whether the leads are arranged for subtractive or additive polarity.

Fig. 19 shows on the left a transformer with the leads marked for subtractive polarity and on the right another transformer with the leads marked for additive polarity.

When facing the high-tension side of a transformer, if the X-1 lead is on the right-hand side,

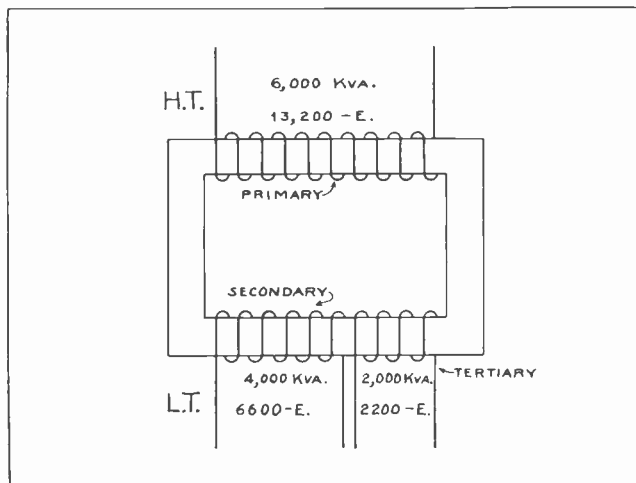

Fig. 20. Diagram of a transformer which is equipped with three windings. The high tension winding in this case is the primary, and the low tension winding is divided into two sections, called the secondary and tertiary windings.

it indicates that the polarity is subtractive; while, if the X-1 lead is on the left, it is then known to be additive polarity.

Leading transformer manufacturers have adopted standard connections and polarity markings for their transformers. Most power transformers are arranged with subtractive polarity, except distribution transformers of 200 kv-a. and under and with

Transformers

voltage ratings of 7500 volts and less; and these transformers are arranged with additive polarity.

20. VOLTMETER TEST FOR TRANSFORMER POLARITY

When the leads of a transformer are not marked in any manner, we can determine whether it has additive or subtractive polarity by simply connecting a jumper between the high-tension and low-tension leads on one side and a voltmeter of the proper rating between the high-tension and low-tension leads on the other side, as shown in Fig. 18.

If, when the primary is excited with its rated voltage, the voltmeter reads the difference between the voltages of the high and low voltage windings, the transformer has subtractive polarity, and the leads should be marked as shown in Fig. 18.

If the voltmeter reads the sum of the voltages of the high and low voltage windings, the transformer has additive polarity, and the leads should be marked as shown in the sketch at the right in Fig. 19.

21. TERTIARY WINDINGS

Sometimes a transformer may have on its core a third winding which really acts as an additional secondary winding and is for the purpose of supplying a separate circuit of a different voltage. This third winding is commonly called a tertiary winding.

Fig. 20 shows a transformer with primary, secondary, and tertiary windings. The primary winding is designed for 6000 kv-a. at 13,200 volts. The secondary winding, or larger of the two low-tension windings, is designed for 4000 kv-a. at 6600 volts. The tertiary winding, or smaller of the two low-tension windings, is designed for 2000 kv-a. at 2200 volts.

Some special transformers may also use tertiary windings to obtain certain power factor and voltage control characteristics.

Alternating Current

EXAMINATION QUESTIONS

1. a. What is a transformer?
b. What are the important parts of a transformer?
2. Name three types of transformers.
3. Why are transformer cores of laminated construction?
4. What are several advantages of polyphase transformers?
5. How are transformers cooled?
6. a. What are the small round tanks on top of the transformers in Fig. 11 called?
b. What is their purpose?
7. a. Explain the cause of the two principle classes of transformer losses?
b. Which of these losses varies most with load changes?
8. If a transformer with a 10 to 1 ratio is supplied with 2300 volts on its primary, what will be the secondary voltage?
9. Explain briefly the cause of variation in primary current drawn by a transformer when the load on the secondary is varied.
10. Why is it important to observe the polarity of transformer when connecting them in parallel?

Transformers

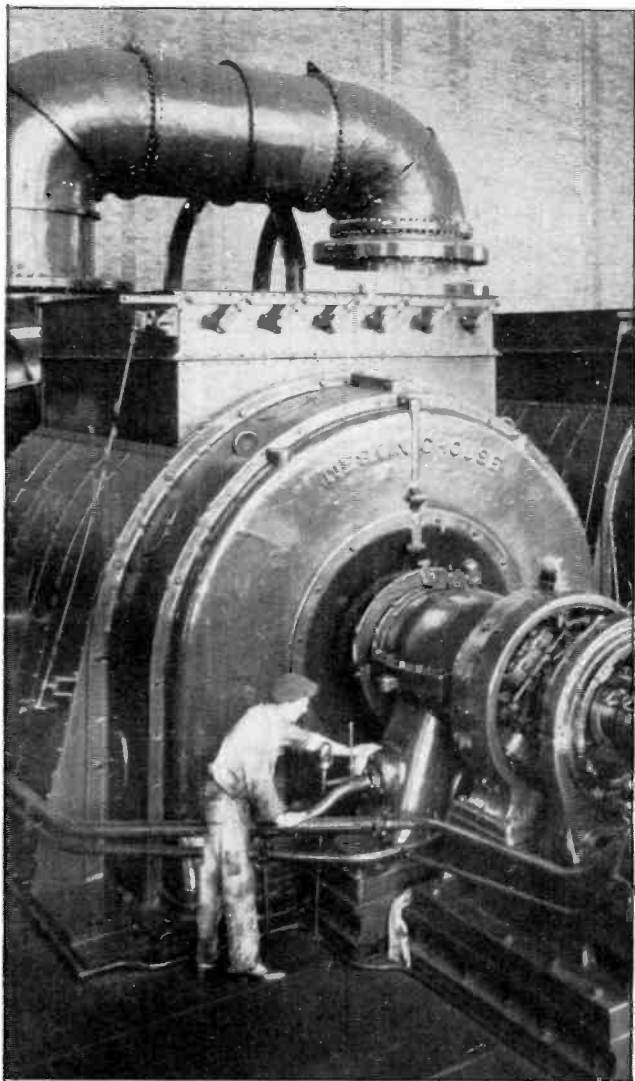

View in the turbine room of the Hell Gate Plant of the United Electric Light and Power Company showing a 50,000 kw tandem compound turbo-generator. Photo by Ewing Galloway, N. Y.

Alternating Current

TRANSFORMER CONNECTIONS

Transformers can have their primary and secondary windings connected in a number of different ways, using series and parallel connections to obtain different voltages, current capacities, etc. A number of the most common connections are thoroughly explained in the following paragraphs and illustrated with the accompanying diagrams. Observe each of these connections carefully and note the results obtained and the purpose for which each connection is used. Connections for single-phase transformers will be covered first and those for polyphase and special transformers will follow.

Fig. 1 shows a sketch of the windings and leads of an ordinary single-phase transformer, such as is commonly used for supplying current to lights and small motors. This transformer has a ratio of 20:1, with the primary winding designed for 2300 volts for connection to the regular 2300-volt distribution lines which are commonly run down streets or alleys to supply power to homes and small shops.

The secondary winding is designed for 115 volts and has two leads for connection to the service wires running to the house or shop. The outline of the tank is shown by the dotted line surrounding the windings.

The high-tension and low-tension leads are usually brought out on opposite sides of the tank, as shown in this diagram. The position and manner in which these leads are brought out was also clearly shown on the two smaller transformers in Fig. 8 in lesson 51. Refer back to this photograph so that you may note and have well in mind the manner in which these leads are brought out at the top of the transformer case.

In Fig. 1, one side of the low-voltage secondary winding is shown grounded. This is done for safety reasons and to provide the grounded wire for polarized lighting systems, as previously explained in the lessons on wiring for light and power. It is well to mention again that this ground affords a definite safety protection against damage to connected

Transformers

equipment or accident to persons, in case of failure of the insulation between the high-voltage and low-voltage windings.

For this reason, the ground wire which is attached to the secondary wire and carried down the pole to a ground rod should be carefully connected and protected from breakage or damage.

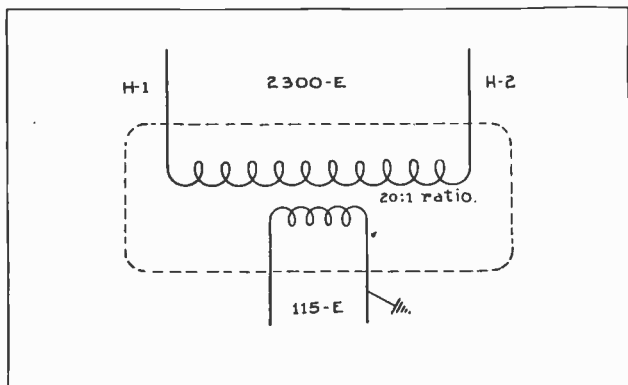

Fig. 1. The above sketch shows a schematic diagram of the primary and secondary windings of a single-phase transformer. This transformer has a step-down ratio of 20:1 and one side of the secondary is grounded, as is common practice.

1. SINGLE-PHASE TRANSFORMERS WITH SPLIT SECONDARIES

Most single-phase transformers are made with the secondary winding in two sections and have four leads brought out from this winding. This allows a choice of two voltages for light and power purposes, and also provides connections to obtain a three-wire Edison system with grounded neutral for lighting purposes.

Secondary windings arranged in this manner are known as split-secondary, or series-multiple secondary, windings. Fig. 2-A shows a diagram of a transformer of this type and also shows the manner in which the center leads of the split-secondary are usually crossed inside the transformer tank. This is done for convenience in connecting them in either series or parallel outside of the tank.

Fig. 2-B shows how the two sections of the

Alternating Current

secondary winding can be connected in series by simply connecting the two center leads together on the outside of the tank. Each half of the secondary is designed to supply 115 volts, so that when the two are connected in series, 230 volts will be obtained across the outside wires and 115 volts across either outside wire and the center wire.

If only 230-volt service is desired, the center wire can be left off and just the two outside wires used, but if three-wire, 115-volt and 230-volt service is desired, the center wire is connected to the point where the secondary coils are joined together, as

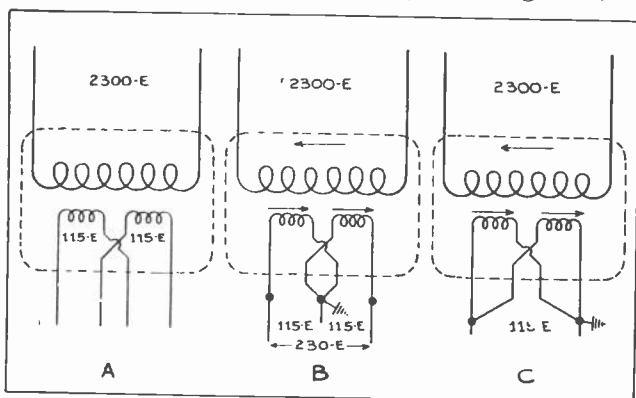

Fig. 2. A shows a single-phase transformer with the secondary winding in two sections. Note the manner in which the leads are crossed inside of the tank. B secondary windings connected for 115 and 230-volt service. C secondary windings connected in parallel for 115-volt service.

shown. The ground connection should be attached to the center point when the three-wire system is used, and can be attached either to the center or to one of the outside wires when 230-volt, two-wire service is used.

Fig. 2-C shows the manner in which the two secondary windings can be connected in parallel to supply 115 volts and double the current capacity of either winding. This makes the entire output of the transformer available at 115 volts.

You will note from this diagram that having the center leads crossed inside the transformer makes possible a very convenient parallel connection by

Transformers

simply connecting together the adjacent leads outside of the tank.

The connections shown in Fig. 2-B for providing 115 and 230-volt service, brings three wires from the secondary of the transformer. The circuit, however, remains single-phase and should never be confused with a three-phase transformer just because they both have three wires.

Keep in mind when connecting load to a three-wire system, that the load should be balanced as evenly as possible between each outside wire and the neutral, in order to prevent operating one side of the transformer secondary heavily loaded while the other is idle or lightly loaded.

The arrows shown above the windings in Figs. 2-B and 2-C indicate the direction of the voltage that would be induced in the secondary coils with respect to the voltage in the primary at a certain instant when the right-hand primary wire is considered to be positive.

These arrows will show how the voltages of the two secondary coils add together in Fig. 2-B and how the currents would add together in Fig. 2-C.

2. TESTING SPLIT-SECONDARY LEADS BEFORE MAKING CONNECTIONS

In connecting the two coils of the secondary winding of a transformer in either series or parallel, if there is any doubt as to the way connections have been brought out of the tank, the leads before being connected together should be carefully tested by means of test lamps or a voltmeter.

To test them for finding the proper leads to connect in series, connect together two leads, one from each coil, and then connect a lamp or voltmeter between the remaining two leads. If when the primary is excited, the lamps burn brightly or the voltmeter indicates the sum of the voltages of the two secondary windings, the connection is correct for series operation.

The first two leads which were joined can then

Alternating Current

be permanently connected together, and the line wires connected to the two wires to which the lamp or voltmeter were attached.

In testing the leads for parallel connection, again temporarily join together one lead from each coil and connect the lamps or voltmeter between the remaining two leads. If when the primary is excited, the lamps do not burn or the voltmeter shows no indication, the leads to which they are connected may be safely joined together to one of the line wires for parallel operation. The other leads can be permanently connected together and attached to the opposite line wire.

If the lamps light or the voltmeter indicates voltage, the leads are improperly connected and should be reversed before being permanently connected for parallel operation.

It is very important that the proper leads be used when connecting transformer secondaries in parallel; otherwise, the windings will probably be burned out when the primary is excited.

3. PARALLELING SINGLE-PHASE TRANSFORMERS

Two or more single-phase transformers can be connected in parallel to supply a greater current or kv-a. of power than the capacity of one transformer will provide. In this manner additional transformers can be installed to take care of increasing load which has grown beyond the capacity of transformers already installed, or two or more small transformers can be temporarily connected in parallel to replace one larger transformer in emergencies when the larger transformer is to be taken out of service for repairs.

In paralleling transformers it is necessary to connect together transformers of similar characteristics; otherwise, one transformer may assume more than its share of the load and possibly blow the primary fuses. This would throw all of the load on the remaining transformers and would either overload them, or blow the fuses in their primary leads.

Transformers

It is also very important to see that leads of the proper polarity are connected together; because, if the wrong secondary leads are connected in parallel, it would result in a double-voltage short-circuit, the same as though two single-phase alternators were connected in parallel when 180° out of phase.

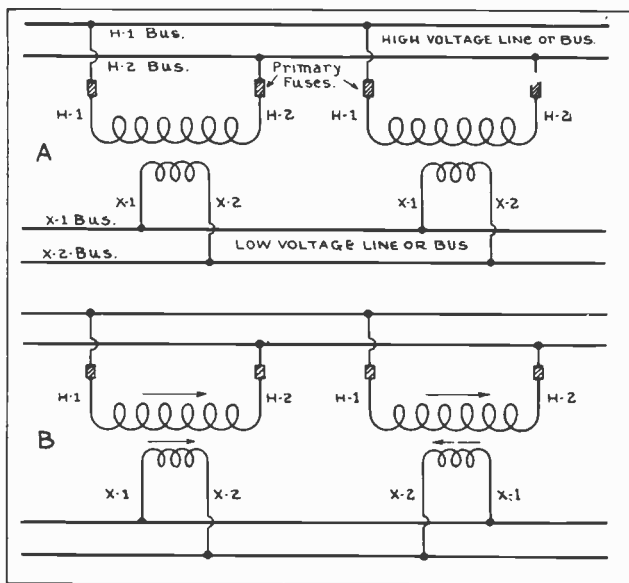

Fig. 3. A shows two single-phase transformers with like polarities connected in parallel. B shows the proper method of connecting two single-phase transformers in parallel when the polarity of one is subtractive and the other is additive. Note the polarity markings in each case.

Transformers with different ratios should never be connected in parallel, as even a small difference in the secondary voltages of two or more transformers would result in very heavy cross currents between the units if they were connected together.

When the primary and secondary leads are properly marked, it is a simple matter to connect two or more single-phase transformers in parallel, as leads with like polarity markings can then be safely connected together, as shown in Fig. 3-A.

In connecting together two transformers, one of which has additive polarity and the other sub-

Alternating Current

tractive polarity, the leads should be arranged in parallel, as shown in Fig. 3-B.

4. TESTING SECONDARY LEADS FOR PARALLELING SINGLE-PHASE TRANSFORMERS

If the leads of the transformers are not marked, then the secondary leads should be tested with a

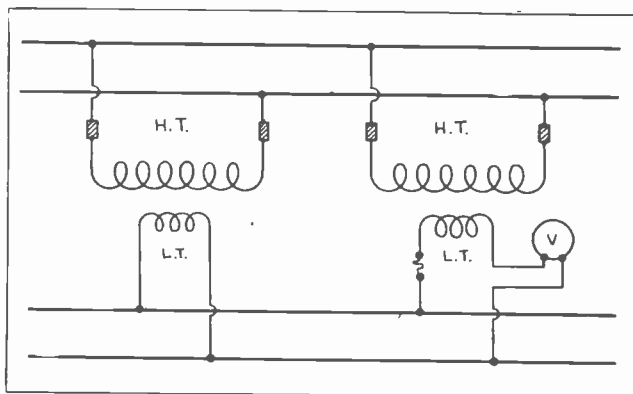

Fig. 4. This diagram illustrates the method of using a voltmeter to test the polarity of a transformer secondary before connecting it in parallel with another.

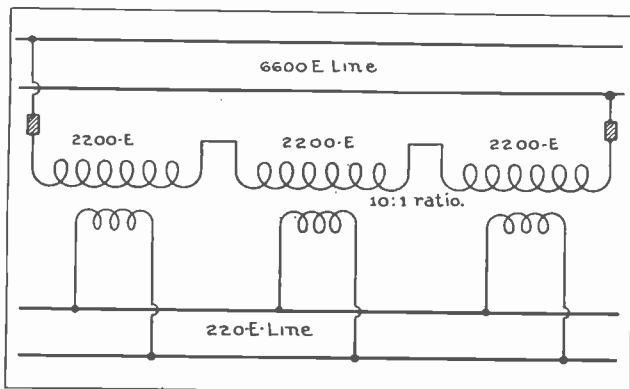

Fig. 5. Transformer primaries are sometimes connected in series to a line of higher voltage as shown above. The secondaries can then be connected for parallel operation.

voltmeter or lamp bank before being connected in parallel. This test is illustrated in Fig. 4, and is similar to the tests made for parallel connections of the two secondary windings of one single-phase transformer.

Transformers

The high-tension leads can be connected to the supply line in a uniform manner, as shown in the diagram. The secondary leads of one transformer can then be connected to the low-voltage line, and the secondary leads of the other transformer should have an instrument fuse connected in one and a voltmeter connected in the other; then they can be connected to the line in the same manner as those of the other transformer.

If the voltmeter shows no reading, the connections are correct for parallel operation and the fuses can be eliminated and the voltmeter removed from the circuit. If the voltmeter does show a reading, the connections are wrong and the leads of one transformer secondary should be reversed and then connected to the line after testing again with the voltmeter to make sure that they are right.

5. CONNECTING TRANSFORMER PRIMARIES IN SERIES

In certain cases it might be desired to connect a bank of single-phase transformers to a high-tension line which has a voltage higher than the voltage rating of the high-tension winding of the transformers. As the more common distribution and transmission voltages usually vary in multiples such as 2200 volts, 6600 volts, 13,200 volts, etc., it is often possible to connect the primaries of two or more transformers in series to the high-voltage line. The secondaries can then be connected in parallel or series as desired.

Fig. 5 shows three single-phase transformers with 2200-volt primary windings connected in series to a 6600-volt line. The impedance of the three windings in series is the same as that of one 6600-volt winding of the same kv-a. capacity and will therefore limit to the proper value the current which will flow through the windings at 6600 volts.

The secondaries of these three transformers are shown connected in parallel to the low-voltage line. If each of the transformers has a 10:1 ratio, the low-voltage line will be supplied with 220 volts

Alternating Current

and the power that can be taken from this line will be equal to the sum of the kv-a. ratings of the three transformers. The extent to which such series connections can be applied is limited to the insulation between the transformer coils and ground.

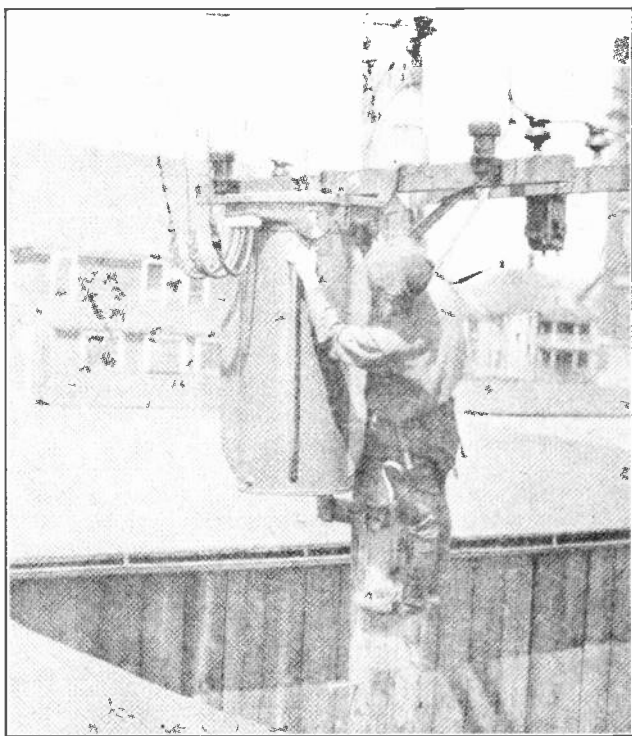

Fig. 6. This photo shows a pole type transformer and the method of making primary and secondary connections. Also note the thermometer temperature indicator near the hand of the electrician.

Fig. 6 is a photograph of a transformer installed on a pole, and shows the method of connecting the low-voltage secondary leads together and to the wires which run to the buildings for three-wire service. You will also note the lightning arresters which are attached to the high voltage wires have their lower ends grounded, and the fuse cut-outs which are mounted on the rear cross-arm are connected in series with the primary leads.

Transformers

This view also shows the installation of a thermometer temperature and load indicator which is inserted under the edge of the transformer tank cover.

6. THREE-PHASE TRANSFORMER CONNECTIONS

To step the voltage of a three-phase circuit up or down, it is necessary to use either a polyphase transformer or three single-phase transformers; except in certain cases where, by means of special connections, two single-phase transformers can be used.

Each method will be explained in the following paragraphs.

Polyphase transformers are quite commonly used where space is limited, because they are more compact and require less space than three single-phase transformers of the same kv-a. rating.

Where flexibility is desired, three single-phase transformers are frequently used because of the advantage in the fact that if one transformer is taken out of service the load can be temporarily carried by the other two, by making a slight change in the connections.

Fig. 7 shows the arrangement of the primary and secondary coils on the core of a three-phase step-down transformer. This sketch also shows the connections of the primary and secondary windings to high-voltage and low-voltage three-phase lines.

In each of the following connection diagrams three primary and three secondary windings will be shown without the cores, and these can be used to represent either three single-phase transformers or the three sections of a three-phase transformer.

When three single-phase transformers are connected together to a three-phase system they are commonly referred to as a **bank** of transformers.

Alternating Current

7. STAR AND DELTA CONNECTIONS, AND THEIR VOLTAGE AND CURRENT RATIOS

There are three types of connections commonly used with transformers on three-phase systems, and these connections are known as the star, delta, and open-delta connections.

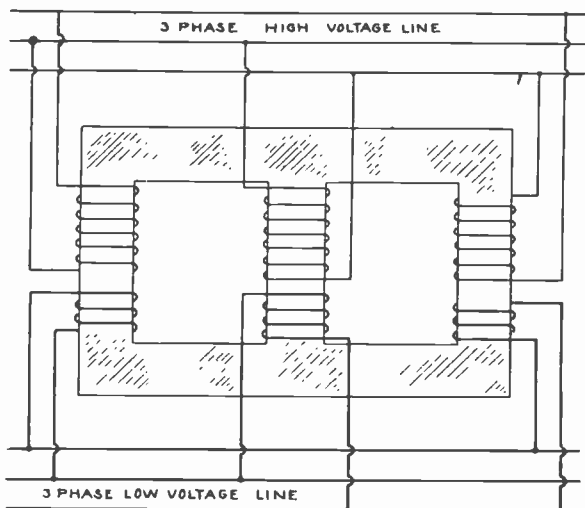

Fig. 7. The above sketch shows the primary and secondary windings of a three-phase transformer. Both primary and secondary are connected delta to the line wires.

Ordinary star and delta connections and their voltage and current ratios have been explained both in the lessons on Armature Winding and in the first lesson on Alternating Current, in connection with A. C. motor and generator windings. The same ratios and values for these connections apply to transformers as well as to motors or generators, and they will therefore be repeated here for convenience.

You will recall that the star connection provides a sort of series arrangement of the windings of any electrical machines connected in this manner; while the delta connection is a parallel arrangement of the windings.

The star connection always increases the line

Transformers

voltage above that of the phase windings, while the delta connection increases the line current above that of the phase windings.

When transformer or generator windings are connected star, the line voltage will be 1.732 times the phase-winding voltage and the line current will be the same as the phase-winding current.

When transformers or generators are connected delta, the line current will be 1.732 times the phase-winding current and the line voltage will be the same as that of the phase windings.

We recall that multiplying either the current or voltage by the constant 1.732 gives the actual sum of two values which are added together 60° out of phase. (Note: These values are 60° out of phase in the machine windings, but 120° out of phase with the line.) To make it very easy to determine the voltage or current that can be obtained by the use of star or delta connections with transformers, we can arrange the material from the preceding statements in the following simple rules.

Rules for Star connections:

- (A) Line I = Phase I
- (B) Phase I = Line I
- (C) Line E = Phase E \times 1.732
- (D) Phase E = Line E \div 1.732

Rules for Delta connections:

- (A) Line E = Phase E
- (B) Phase E = Line E
- (C) Line I = Phase I \times 1.732
- (D) Phase I = Line I \div 1.732

8. THREE-PHASE STAR CONNECTIONS

Fig. 8 shows a diagram of the connections for either three single-phase transformers, or the three sets of windings of a polyphase transformer, in which both the primaries and secondaries are connected star, or Y.

This connection is known as the star-star or Y-Y connection.

Alternating Current

You will note that, with this connection, the right-hand ends of each of the transformer windings are connected together to one common point or wire, and the left-hand ends are connected separately, one to each phase wire of the lines.

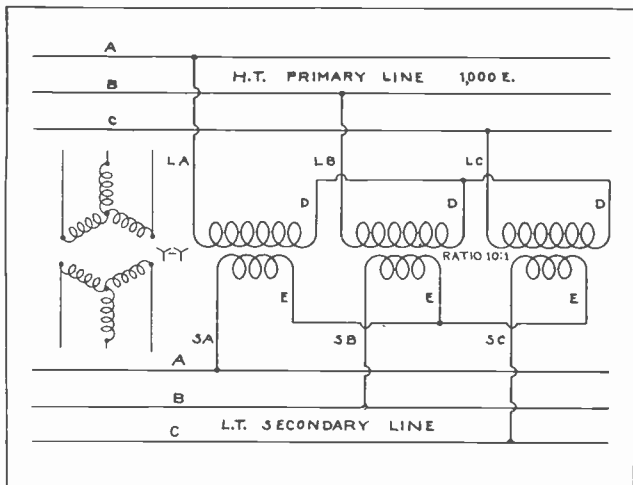

Fig. 8. Connection diagram for a bank of three transformers connected star-star.

Tracing out this connection from each line wire through the phase windings, you will find it results in a star-shaped connection, as shown by the small simplified sketch at the left in Fig. 8.

To remember how to make this star connection, it is only necessary to keep in mind that one end of each winding is connected to a common wire or neutral point and that the remaining ends are connected in order to respective phases.

Where transformers are placed in an ordinary row or bank and where they have their terminals arranged and marked symmetrically, the connections to the high-voltage and low-voltage lines can usually be made in the same neat and symmetrical order as shown in Fig. 8. Following a definite and orderly system in this manner whenever possible, will help you to avoid mistakes when making such connections.

Transformers

With this connection the primary line voltage will be found between L A and L B, L B and L C, and between L C and L A. This line voltage can also be found between any two of the three phase wires A, B, and C.

The primary phase voltage is the voltage between L A and D, L B and D, and L C and D.

The secondary line voltage can be measured between S A and S B, between S B and S C, or between S C and S A.

It can also be measured between any two of the three phase wires, A, B, and C.

The secondary phase voltage can be measured between S A and E, S B and E, or S C and E.

For the purpose of illustrating the various voltage and current values on the primary and secondary line leads and phases, we shall assume that the primary line voltage is 1000 volts and the primary line current 10 amperes; and that the step-down ratio of the transformers is 10:1.

Then, according to rule D for Y connections, the primary phase voltage will be: $1000 \div 1.732$, or 577 volts across each phase winding.

According to rule B for the current in Y connections, the primary phase current will be 10 amperes. Then, considering the 10:1 ratio, the secondary phase voltage will be $577 \div 10$, or 57.7 volts.

The secondary current will be increased in the same proportion that the voltage is decreased; so that the secondary phase current will be 10×10 , or 100 amperes through each phase winding.

The secondary line voltage will be 57.7×1.732 , or 99.9+ volts.

According to rule C for Y connections, the secondary line current will be the same as that in the phase windings, or 100 amperes. According to rule A for Y connections, the apparent power in the secondary line would be equal to the apparent power in the primary line, minus the very small percentage of loss in the transformers. When the

Alternating Current

transformers are operating at or near full load, this loss is so small that it is generally not considered in the ordinary approximate calculations used in field problems.

To calculate the power of the three-phase bank of transformers from the primary line voltage and current, we would use the three-phase power formula given in Section One of Alternating Current, or:

$$\text{Three-phase app. power} = E \times I \times 1.732$$

With the values given in Fig. 8 this would be:

$$1000 \times 10 \times 1.732, \text{ or } 17.3+ \text{ kv-a.}$$

Following the same rule for the secondary, we would have:

$$99.9 \times 100 \times 1.732, \text{ or } 17.3+ \text{ kv-a.}$$

If the primary line voltage used on a star connection such as shown in Fig. 8 were 4000 volts instead of the 1000 volts assumed in this problem, then the primary phase voltage would be $4000 \div 1.732$, or approximately 2309 volts across the primary winding of each transformer.

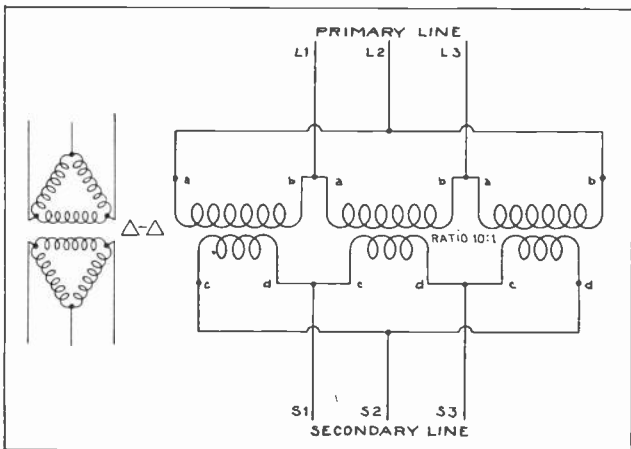

Fig. 9. Connection diagram for a three-phase bank of transformers connected delta-delta. Compare the large diagram with the small schematic sketch at the left and also with the explanation given in these paragraphs.

This voltage is very commonly used where the primaries of three transformers are to be connected

Transformers

in star and the secondaries used separately for supplying single-phase light and power load at 115 and 230 volts.

9. THREE-PHASE DELTA CONNECTIONS

Fig. 9 shows the connections for a bank of three single-phase transformers, or the three sets of windings of a three-phase transformer, which are connected delta-delta, or Δ - Δ . These transformers are also of the 10:1 step-down ratio, and we shall assume the same values of 1000 volts and 10 amperes on the primary line.

If the primary line voltage is 1000, then, according to the rule B for delta connections, the primary phase voltage is also 1000. According to rule D for delta connections, the primary phase current will

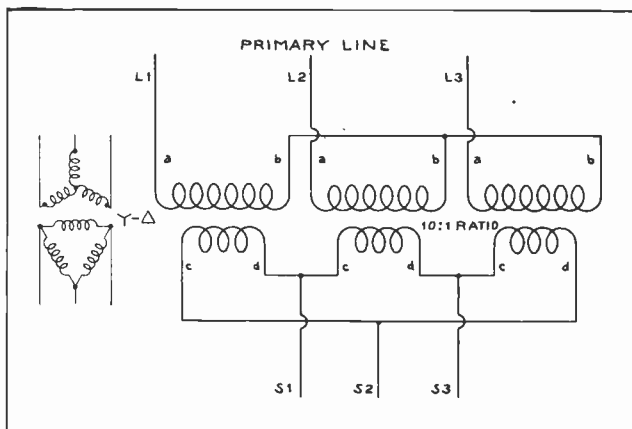

Fig. 10. Three-phase transformer bank with the primary connected star and the secondary delta. This connection is called "star-delta."

be $10 \div 1.732$, or 5.77 amperes through each phase winding.

With the 10:1 step-down ratio, the secondary phase voltage will be $1000 \div 10$, or 100 volts from "c" to "d" across each phase winding, and the secondary phase current will be 10×5.77 or 57.7 amperes through each phase winding.

According to rule A for delta connections, the secondary line voltage will be 100; and according

Alternating Current

to rule C for delta connections, the secondary line current will be 57.7×1.732 , or 99.9+ amperes.

The apparent power in kv-a. will again remain the same on the secondary as on the primary, with the exception of the slight loss in the transformers. So we find that it makes no difference in the amount of power the transformer will handle whether it is connected star or delta.

When a bank of transformers are connected either star-star or delta-delta, the difference between their primary and secondary line currents and voltages will only be that difference which is caused by the ratio between the transformer windings.

10. THREE-PHASE STAR-DELTA CONNECTIONS

Fig. 10 shows a bank of three transformers connected star-delta, or $Y-\Delta$. The phase winding leads and line leads are marked the same in this diagram as in Fig. 9, and this transformer is also a step-down transformer with a ratio of 10:1.

We shall again assume the primary line voltage to be 1000 and the primary line current to be 10 amperes. With this connection, the primary phase voltage will be $1000 \div 1.732$, or 577 volts between "a" and "b", or across each phase winding.

The primary phase current will be the same as the line current, or 10 amperes. With the 10:1 step-down ratio, the secondary phase voltage across each phase winding, or between "c" and "d", will be $577 \div 10$, or 57.7 volts. The secondary phase current will be 10×10 , or 100 amperes.

The secondary line voltage will be the same as the secondary phase voltage, or 57.7; because the secondary is connected delta. Check this with rule A for delta connections.

The secondary phase current will be 10×10 or 100 amperes, and the secondary line current will be 100×1.732 , or 173.2 amperes, according to rule C for delta connections.

11. DELTA-STAR CONNECTIONS

Fig. 11 shows a bank of three transformers connected just the opposite to those in Fig. 10. In

Transformers

this case, the primary is connected delta and the secondary is connected star. This is called a delta-star or Δ -Y connection.

You will note that in referring to these connections with the terms delta or star, the primary is

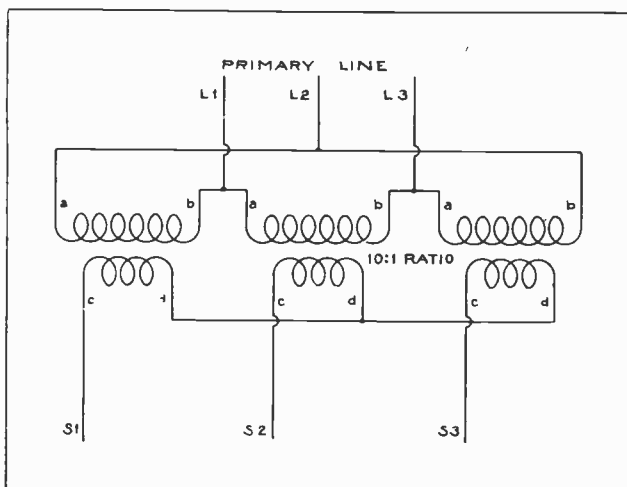

Fig. 11. Three-phase transformer bank connected delta-star. Observe carefully the methods of making the connections shown in each of the diagrams in this section.

always mentioned first; the same as when speaking of the ratio between primary and secondary windings.

Assuming the same figures of 1000 volts and 10 amperes on the primary line and a 10:1 step-down ratio for these transformers in Fig. 11, the primary phase voltage will be 1000 from "a" to "b" in any phase winding, according to rule B for delta connections. The primary phase current will be $10 \div 1.732$, or 5.77 amperes through each phase winding, according to rule D for delta connections.

With the 10:1 step-down ratio, the secondary phase voltage will be 100; and the secondary phase current will be 10×5.77 , or 57.7 amperes. The secondary is connected star; so, according to rule C for star connections, we find that the secondary line voltage will be 100×1.732 , or 173.2 volts.

Alternating Current

This voltage would be found between S-1 and S-2, or between S-2 and S-3, or S-3 and S-1.

The secondary line current will be the same as the phase current, or 57.7 amperes. Check this with rule A for star connections.

If you determine the apparent power in kv-a. of both the primary and secondary windings in either Fig. 10 or Fig. 11, by using the formula,

three-phase app. power =

$$\text{Line E} \times \text{Line I} \times 1.732,$$

and using the voltage and current values given for the lines in each case, you will find the power to be the same on the secondaries as on the primaries.

This will be very good practice and will help you to become more familiar with the use of the three-phase power formula and calculations.

The four transformer connections which have just been explained and illustrated are the ones most commonly encountered in the field. Some companies may make slight variations or changes in these, but the general principles involved remain the same.

12. ADVANTAGES OF STAR CONNECTIONS FOR TRANSMISSION LINES

One of the principal advantages of the star connection for transformers is that it provides higher voltages for use on long-distance transmission lines, with lower ratios between the primary and secondary windings.

When used in this manner, the transformer supplying the power to the line is usually connected delta-star, to step up the voltage as high as possible with a given transformer ratio. The transformer at the receiving end of the line can then be connected star-delta, in order to reduce the voltage the maximum amount with a given transformer ratio.

Fig. 12 illustrates the use of these connections with a transmission line. A power plant alternator develops 2300 volts which is fed to the delta-connected primary of the step-up transformer. This

Transformers

transformer, having a ratio of 1:10, will produce a phase voltage of 23,000 volts in each phase of the star-connected secondary. The line voltage, however, will be $23,000 \times 1.732$, or 39,836 volts.

If we had used either a delta-delta or star-star connection, the line voltage would only be 23,000 with a 1:10 transformer ratio. Knowing that the higher the voltage used on the transmission line the greater will be the economy of transmission and the saving in copper costs, we can readily see the advantage of this connection.

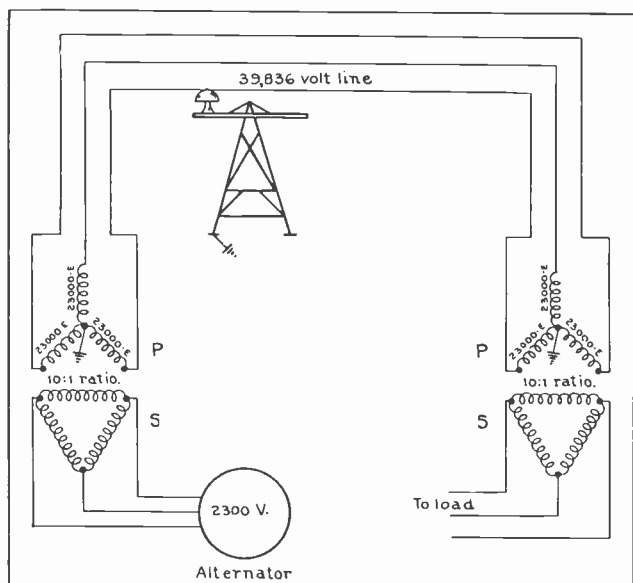

Fig. 12. This diagram illustrates the method and advantage of using star-delta and delta-star transformer connections with transmission lines.

At the receiving end of the line shown at the right, the step-down transformers use the opposite connection, or star-delta, to step the voltage down a maximum amount for a given ratio. Here a 10:1 ratio transformer with star-connected primary and delta-connected secondary will reduce the secondary line voltage to 2300 volts. This voltage can be used directly on large 2300-volt power motors, or

Alternating Current

it can be stepped down again with smaller banks of 10:1 transformers, using split secondaries to obtain 115 and 230 volts for lighting purposes.

When using transformers with the secondaries connected star and attached to high-voltage transmission lines, the neutral point of the star connection is commonly grounded. This provides another great advantage for the star connection because it makes possible the use of higher transmission line voltages with less voltage strain between the line wires and ground.

This greatly reduces the tendency to flash-over the line insulators and makes possible the use of smaller insulators, thereby reducing the cost of the transmission line.

You will note that, while the voltage between the line wires in Fig. 12 is 39,836 volts, the voltage between any line wire and ground or the steel tower supporting the insulator will only be 23,000 volts. or that of one phase winding of the step-up transformer secondary.

This is due to the fact that the neutral point of the star connection is grounded and will always be at approximately the same potential as the tower supporting the insulators.

13. OPEN-DELTA CONNECTIONS

One of the advantages of the delta connection for transformers is that one transformer can be taken out of service for repairs, and service maintained on the remaining two by what is known as the open-delta or V connection.

In other cases where it is desired to provide three-phase service with only two transformers, the open-delta connection is used for permanent installations. The total three-phase capacity of two transformers used in this manner will only be 57.7% of the capacity of three transformers of the same size.

An installation of this type is sometimes made where the average load to be supplied is rather light at the time, but is expected to become heavier

Transformers

as the plant or community expands. When the load increases beyond the capacity of the two transformers, a third one can be added and the connection changed to straight delta. The addition of this third transformer increases the capacity of the group 73% over what it was with the two transformers.

Fig. 13 shows the method of connecting two single-phase transformers in open-delta. The phase voltage in systems connected open-delta will be the same as the line voltages, or the same as with regular delta-delta connections.

The line current will be the same as the phase current, instead of being greater, as with ordinary delta connections. This is due to the fact that line 1 and line 3 have only one path through the phase windings, instead of two paths, as with the straight delta connection.

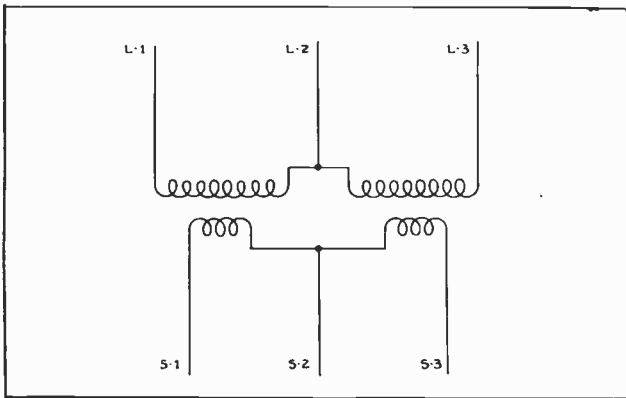

Fig. 13. Connections for using two single-phase transformers to provide three-phase service by what is called the "open-delta" connection.

Where three transformers are connected delta-delta, if one becomes defective it is a very simple matter to connect the remaining two in open-delta. By overloading the transformers to a certain extent, it is possible to maintain nearly full load service for short periods while the defective transformer is being repaired.

Alternating Current

Both the primary and secondary of the defective transformer should always be disconnected from the line when changing to open-delta connection with the other two transformers.

It is possible to use the open-delta connection on two of the phase windings of the three-phase transformer, in case one phase becomes defective. If the transformer is of the core type, both the primary and secondary coils of the damaged winding should be left open; but if the transformer has a shell type core, both the primary and secondary windings of the defective phase should be short-circuited upon themselves when the open-delta connection is made on the two good phases.

Fig. 14 shows three single-phase transformers connected delta-delta and equipped with disconnect switches in each of the primary and secondary leads. This arrangement permits a quick change-

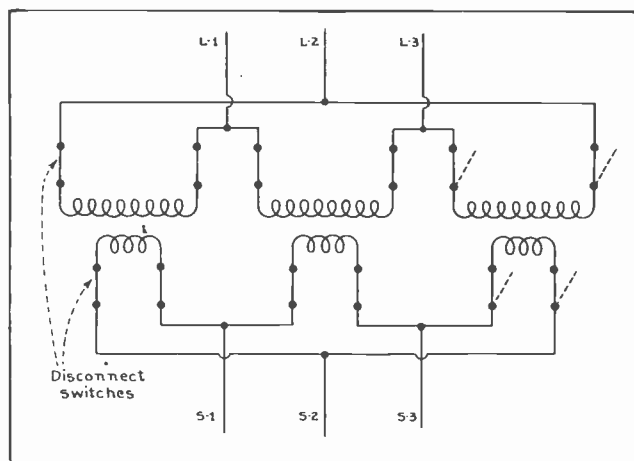

Fig. 14. This diagram shows a convenient method of arranging a bank of transformers with disconnect switches to quickly change over to open-delta operation in case of trouble on one transformer.

over to open-delta operation of two transformers if any one should become defective.

For example, if the right-hand transformer should become defective, the disconnect switches could be opened as shown by the dotted lines, and the re-

Transformers

maining two transformers would then be operating open-delta. The same change could be made on either of the other two transformers with the same result.

When three transformers are connected either star or delta or in any combination of these except the open-delta, the total kv-a. capacity on the secondary side is equal to three times the capacity of one transformer.

Transformers which are to be connected together in a star or delta on three-phase lines should have similar characteristics; that is, similar kv-a. and voltage ratings, and also similar ratios, impedance, reactance, etc. If the characteristics are not the same the result may be excessive heating of one or more of the transformers or unbalanced line conditions.

14. GROUNDING OF TRANSFORMERS

As previously mentioned, the high-voltage winding of star-connected transformers is frequently grounded at the neutral point, when these transformers are used in connection with transmission lines.

It is quite common practice also to ground the low-voltage secondary windings of step-down transformers connected either star or delta. As explained in earlier paragraphs, this protects the low-voltage circuit in case of failure or puncture of the insulation between the high-voltage and low-voltage windings.

It is well to keep in mind that the secondary windings and the circuits to which they are connected are only insulated for the low voltage, and the insulation is not heavy enough to stand the high voltage applied to high-tension primary windings. So, if it were not for the ground on the low-voltage side a flash-over of the high-voltage to the low-voltage secondary would tend to puncture the insulation of the low-voltage circuits or some of the devices connected to them.

Having the ground already on the low-voltage circuits provides an easy path for the high voltage

Alternating Current

to go to ground. This flow of current from the high-voltage winding through the fault to the ground will frequently blow the primary fuses, thus indicating the trouble at once, so that it can be repaired.

The larger sketch on the right in Fig. 15 shows the method of grounding the delta-connected secondary of a three-phase bank of transformers. This

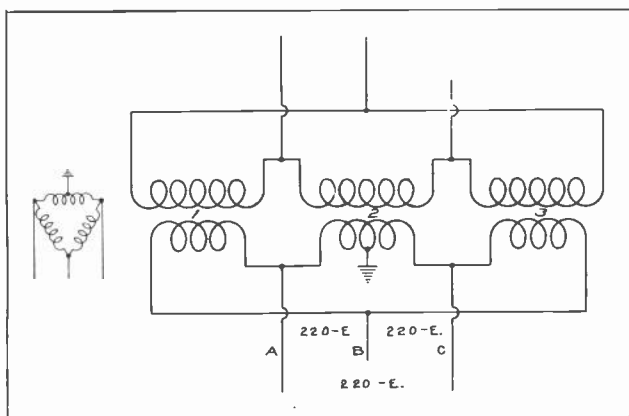

Fig. 15. This sketch shows the method of grounding the secondary circuit of a bank of transformers on which the secondary is connected delta.

ground is commonly made from the center tap, which is taken from the middle of one phase of the secondary winding.

The small sketch on the left in Fig. 15 shows a schematic diagram of the secondary connections and also illustrates the position of the ground.

Assuming that the secondary of these transformers has a voltage of 220 between any two phase wires, the voltage from the various phases to ground will be as follows: A phase to ground, 110 volts; B phase to ground, 190.5 volts; C phase to ground, 110 volts.

The reason for this variation in the voltage between the different phase wires and ground can be noted by careful observation of either of the connection diagrams shown in Fig. 15.

Transformers

You will note that only half of the center phase winding is between either phase A or phase C and the ground, so there will be only half the voltage of this winding, or 110 volts, between either of these phase wires and ground.

Tracing the circuit from phase B in either direction to ground, we must pass through the secondary winding of transformer No. 1 or No. 3 in series with one-half of the winding of No. 2 to get to ground. This adds the voltages of one whole winding and half a winding, together in series, but 120° out of phase.

To get the effective sum of 220 volts plus 110 volts when these two values are out of phase 120° , we add the two voltages and then divide by 1.732, which gives approximately 190.5 volts.

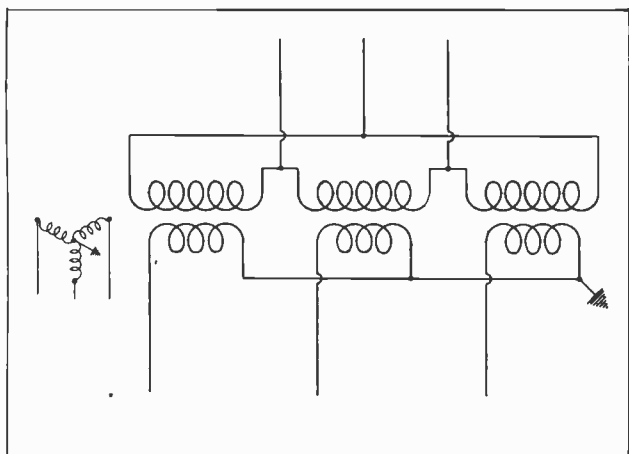

Fig. 16. This sketch shows the location of the ground connection on a bank of transformers with the secondary connected star. Read carefully the explanation of the advantages of this system which are given in the accompanying paragraphs.

Fig. 16 shows the common method of grounding the low-voltage secondary of a bank of transformers, when the secondary is connected star. The ground connection is made at the common connection, or neutral point, of the three secondary phase windings.

Alternating Current

This is illustrated both by the larger sketch at the right and the small schematic diagram at the left in Fig. 16.

If the ground connection were not used on a bank of star-connected transformers, the voltage from any line wire to ground would be the same as the voltage between any two line wires. When the ground is used, the voltage between any line wire and ground is only 57.7 of the voltage between any two line wires, as was previously explained for the high-tension side of transformers which were connected to transmission lines.

This reduces the voltage strain on the insulation of the conductors and devices connected to the secondary circuit and also reduces the shock hazard.

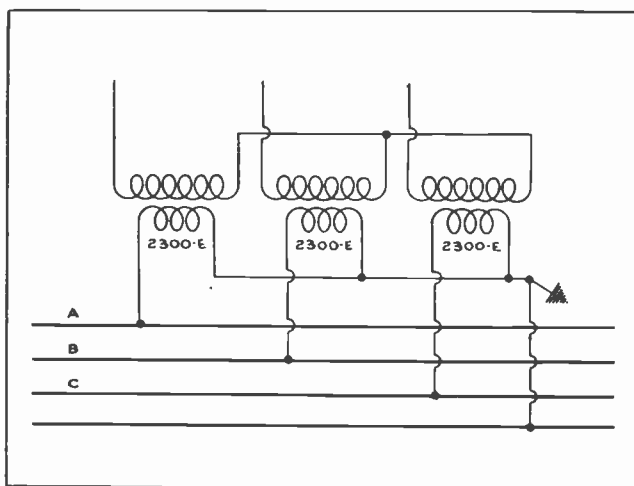

Fig. 17. Connections for three-phase, four-wire service from the star-connected secondaries of a three-phase bank of transformers.

15. PARALLELING THREE-PHASE TRANSFORMERS

When paralleling three-phase transformers the same precautions must be followed as when paralleling three-phase alternators. It is first necessary to phase out the leads and determine like phases.

Transformers

This can be done by the lamp-bank or motor method explained in the lesson on A. C. generators.

The two or more transformer banks should be operated from the same primary line. They will then have like frequencies and will operate in synchronism, once they are properly phased out and connected.

When all of the transformer primaries and secondaries are properly marked in the manner previously explained, it is a simple matter to connect leads of like polarity together. If they are not marked, or in any case where the marks are not known to be dependable, the leads should be tested by means of a voltmeter or test lamps, in order to get connected together the leads of like polarities and between which there is no voltage difference.

16. THREE-PHASE FOUR-WIRE SYSTEMS

The three-phase, four-wire system is obtained by bringing out the fourth wire from the neutral or grounded point of a star-connected bank of transformers as shown in Fig. 17. This system is used by a great many power companies for distribution circuits of 2300 to 4000 volts which feed power and lighting equipment.

The three-phase, four-wire system provides two different voltages, one of which is obtained between any two of the line wires A, B, and C; and the other between any of the line wires and the neutral wire.

Assuming the secondary phase voltage of the transformers in in Fig. 17 to be 2300 volts, the voltage between any two of the line wires A, B, and C will be approximately 4000 volts; while the voltage between any one of the line wires A, B, or C and the neutral wire will be 2300 volts. The voltage from any one of the line wires to ground will be 2300 volts, while the voltage from the neutral wire to ground will be zero.

In any four-wire, three-phase system in which the fourth or neutral wire is taken from the Y point,

Alternating Current

or common connection of the star-connected transformer windings, the voltage from any line wire to neutral is equal to the voltage between the line wires multiplied by .577, which is the same as dividing by 1.73.

Transformers

EXAMINATION QUESTIONS

1. Why are single phase transformers often provided with split secondary windings?
2. When testing transformer leads for paralleling, should any two wires be connected in parallel if lamps or voltmeter show voltage between them?
3. Name three common types of transformer connections used on three phase lines.
4. What primary and secondary connections would you use to get the highest possible secondary voltage from a bank of transformers?
5. For what purpose is the open delta transformer connection sometimes used?
6. What is the advantage of the star connection with grounded neutral for transmission lines?
7. Why should the secondaries of step down transformers be grounded?
8. Should transformers of different sizes or characteristics be connected in parallel?
9. What precautions should be taken before connecting 3 phase banks of transformers in parallel?
10. What is one advantage of the 3 phase four wire system?

Alternating Current

SPECIAL TRANSFORMERS

In addition to the common types of single-phase and polyphase transformers for which the connections were explained in the preceding lesson, there are several special transformer connections which are frequently encountered in the field.

These special transformers each have certain special applications and are very important in the particular work for which they are designed. You should, therefore, have a good understanding of the principles and uses of the more common types

1. TAP-CHANGING TRANSFORMERS

It is often desirable to make slight changes in voltage delivered by a bank of step-up or step-down transformers, in order to compensate for varying line drop. In other cases we may wish to change the ratio of the transformer slightly to adapt it to changed operating conditions with other transformers or line equipment.

For this purpose a **Tap-Changing** transformer is frequently used.

Transformers of this type are equipped with extra leads or taps brought out from a certain section of the winding so that, by shifting a sliding connection from one of these taps to the other, the number of turns in the winding can be varied.

This will, of course vary the ratio between the transformer primary and secondary and will thereby increase or decrease the voltage, according to whether turns are being cut out or added in the winding.

It is usually desirable to be able to accomplish this change without disconnecting a transformer or interrupting service.

There are several different ways of accomplishing this, and one common method is shown in Fig.

1. With this type of transformer, a certain portion of the end of the primary winding is divided into two sections or windings in parallel and marked M and N in the diagram. These sections are equipped with taps and provided with a set of slid-

Transformers

ing contacts, X and Y, which can be moved from one tap to another. Either of these tapped sections of the transformer winding will carry the entire load for a few seconds without overheating.

The tap switches should not be shifted or changed during the time that load current is flowing through them, or the contacts would be badly burned by the arc set up by the heavy current and high voltage.

To prevent this, an oil switch is provided in each of the parallel circuits or leads to the tapped sections of the winding.

In order to increase the voltage on the secondary we decrease the number of turns on the primary, thereby decreasing the step-down ratio between the two windings.

This is done in the following manner. Oil switch "A" is first opened to temporarily shift all of the load over to the section N of the tapped winding and thereby stop the current flow through section M. The movable contact X is then shifted from

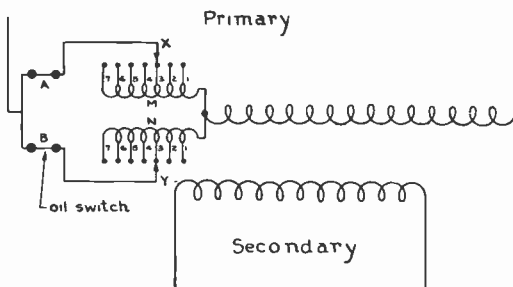

Fig. 1. This diagram shows a method of arranging adjustable connections on the primary of a tap-changing transformer.

stationary contact 3 to 2. Oil switch "A" is then closed and oil switch "B" opened to shift all of the load to section M.

Movable contact Y is then shifted from stationary contact 3 to 2 in order to balance the number of turns in the two parallel tapped sections. Then oil switch "B" is again closed allowing the load to divide between the two tapped sections of the winding.

Alternating Current

Quite a number of large power transformers are being built with tap changing switches or mechanisms which are installed either in the top of the transformer case or in an auxiliary box on the side of the transformer.

Some of these tap-changing switches are designed for hand-operation while others are operated by remote control motors or by an automatic voltage-regulating device.

The use of tap changers aids in keeping electric service to customers at the proper voltage and greatly increases the flexibility of transformers equipped with them.

2. SCOTT TRANSFORMERS

Sometimes it is desired to change two-phase energy to three-phase, or vice versa. This can, of course, be done with motor-generator sets, but in a number of cases it may only be desired to convert a small amount of power from one system to the other and, therefore, doesn't justify the installation of costly machinery.

In certain older plants which are equipped with two-phase motors it may be desired to change over to modern three-phase service; or it may be that the power company in changing over its equipment, can furnish only three-phase service.

In order to prevent scrapping or discarding all of the two-phase motors installed, it is often desirable to change the three-phase energy which is supplied, to two-phase energy to operate a number of the motors, until they are worn out and can be economically replaced with three-phase machines.

This change from three-phase to two-phase or the reverse can be economically made by means of two single-phase transformers, one of which is equipped with a center tap and the other with a tap at 86.6% of its winding.

Two transformers connected in this manner are shown in Fig. 2. This connection is known as the **Scott Transformer** connection and is named after its inventor Charles F. Scott, former consulting en-

Scott Transformers

gineer of the Westinghouse Electric and Manufacturing Company.

Two of the three-phase line leads are connected to leads L-1 and L-2 of the single-phase transformer which has the center tap. The third three-phase line lead is connected to the 86.6% tap on the remaining single-phase transformer winding.

The other end of this winding is connected to the center tap of the other unit, as shown in the diagram. When three-phase energy is applied to these three line leads, two-phase energy can be taken

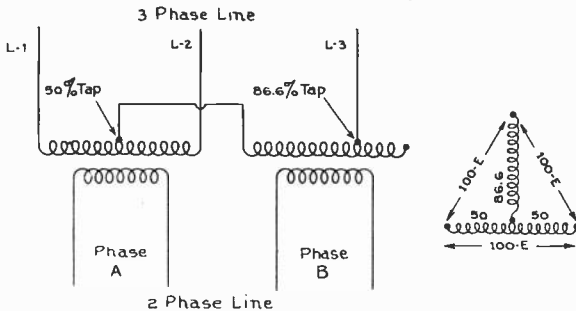

Fig. 2. The Scott transformer connection shown above is often used to change three-phase energy to two-phase or vice versa.

from the transformer secondaries at the leads marked "phase A" and "phase B".

On the other hand, if two-phase energy is applied to A and B phase, three-phase energy can be obtained from leads L-1, L-2, and L-3.

The small sketch at the right illustrates this type of transformer with a schematic diagram, and shows the manner in which the three-phase voltages and relations are obtained from the two transformers.

Assuming the voltage of each of the complete transformer windings on the three-phase side to be 100 volts we find that there will be 50 volts in each of the sections on either side of the 50% tap of the left winding, and 86.6 volts in the active section of the right-hand winding.

Connecting the end of the right-hand winding to the center tap of the left winding causes the voltages in these two windings to be 90° out of phase with each other.

Alternating Current

The 86.6% of the right-hand winding is in series with either half of the left winding when tracing from L-3 to L-1 or L-2.

When 86.6 volts are added in series with 50 volts, but are 90° out of phase the resultant voltage will be 100 volts. So we find that there will be 100 volts between L-1 and L-2, between L-2 and L-3, and also between L-3 and L-1.

Special single-phase transformers can be bought with taps arranged for this connection, or in some cases where it is desirable to change over a small amount of power, two small single-phase transformers can have either their primaries or secondaries rewound and equipped with taps at the middle of one and at 86.6% of the winding of the other.

3. AUTO TRANSFORMERS

The auto transformer is one in which a single tapped coil is used for both the primary and secondary, as shown in Fig. 3-A and B.

The principal application of auto transformers is for use with starting compensators, to reduce the starting voltage of A. C. induction and synchronous motors.

Auto transformers use somewhat less copper than the regular type of static transformer, but their efficiencies are usually somewhat lower.

The diagram at A in Fig. 3 shows an auto transformer used to step the voltage down while the diagram at B shows a step-up transformer.

When alternating voltage is applied to the terminals of the full winding in Fig. 3-A there will be a voltage drop across the entire coil which is equal to the amount of applied voltage.

As the resistance of the coil is very low, the self-induced counter-voltage of the full coil will also be nearly as high as the applied voltage. The induced counter-voltage in the small secondary section of the coil will be proportional to the number of turns included in this section. Therefore, the voltage obtained on the secondary leads will depend upon the point at which the tap, or wire A, is

Auto Transformer

connected to the winding, and the number of turns between wires A and B.

If the secondary section of an auto transformer is wound with heavier wire, a considerably greater current can be taken from this section than is supplied to the primary leads. This is due to the fact that the flux of the upper section of the main coil also cuts across the turns of the lower section, and will thereby induce added energy in this coil.

For starting induction motors this is ideal, because the heavy starting currents which are required can be obtained at low voltage from the secondary of an auto transformer without drawing such a heavy surge of current from the power line.

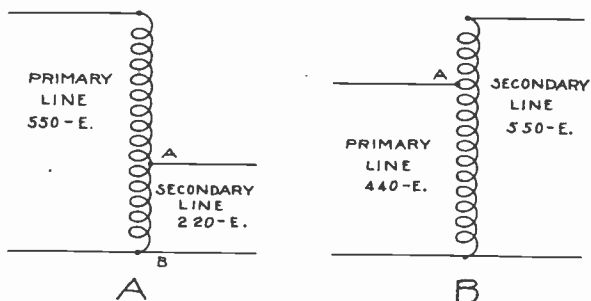

Fig. 3. A shows a step-down auto transformer. Note the reduction obtained in the voltage between the primary and secondary lines. B shows a step-up auto transformer to increase the secondary voltage.

In the step-up auto transformer in Fig. 3-B, the secondary voltage will be equal to the voltage across the primary coil plus the voltage induced in the secondary section by the flux of the primary coil. In this manner the voltage can be stepped up as much as desired by properly arranging the ratio of turns in the primary and secondary sections.

Auto transformers are frequently equipped with taps, so that the wire A can be moved back and forth to include more or less turns in the primary or secondary windings.

If wire A in diagram A is moved to a higher point it will include more turns in the secondary,

Alternating Current

thereby increasing the secondary voltage of the transformer.

Auto transformers of this type are very convenient for obtaining variable voltages for certain special applications.

Fig. 4 shows a diagram of an auto transformer connection that can be used to supply 110-volt and 220-volt energy from a 440-volt line, for operation of lights and 220-volt motors. It is also very convenient for obtaining various voltages for test purposes.

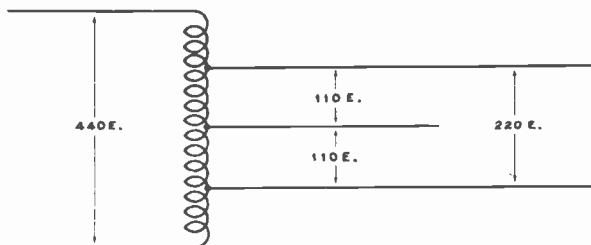

Fig. 4. Auto transformer connection for obtaining both 110 and 220 volts from a 440-volt line.

Auto transformers with low ratios such as 2 to 1, are sometimes used on very large installations because of their cost being much lower than that of two-coil transformers. They are not often used however for general light and power service because of the very high voltage to ground which they place on the secondary leads, and the danger that this would create to equipment and persons handling it.

Three-phase auto transformers are used for starting three-phase induction motors, as well as for certain other special applications.

Fig. 5 shows a three-phase auto transformer in which the three ends, one from each coil, are connected together to form a star connection at Y. The other end of each coil is connected to its respective line lead.

A little current will be flowing through the windings of an auto transformer as long as it is connected to the line, the same as the magnetizing current which exists in the primary of any transformer even when no load is on the secondary.

Auto Transformer

When the secondary of an auto transformer is loaded, the primary current of course increases; but, in the case of a step-down auto transformer such as commonly used with motor starters, if the step-down ratio is 2 to 1, then the primary current will increase only one-half as much as the secondary load current is increased.

Many auto transformers used for motor starters or compensators have their coils equipped with taps, so that the secondary leads to the motor can be changed to obtain higher or lower starting voltage and thereby increase or decrease the starting torque of the motor.

The diagram in Fig. 5 shows the windings equipped with three taps of this nature. It is quite common to have these taps arranged so that, when the secondary leads are placed on the terminals A, the secondary will deliver 40% of the line voltage to the motor. When the taps are placed on terminal B the motor will receive 50% of the line voltage. When they are placed on the terminal C the motor will receive 60% of the full line voltage, etc.

Added diagrams and further explanations of auto transformers will be given in a later lesson in connection with A. C. motor controllers.

4. INDUCTION VOLTAGE-REGULATORS

On distribution lines which feed energy to light and power equipment there is practically always a certain amount of load variation as the lights and motors of different buildings are switched on and off.

This variation in the load on the feeder wires also causes a variation in voltage drop on these wires, and a certain amount of variation in the voltage supplied to the load devices.

It is extremely undesirable to have more than a very few per cent. of voltage variation at the load—particularly on circuits which supply current to incandescent lights.

Low voltage causes reduced efficiency of incandescent lamps and reduces the torque and efficiency of motors, and sudden voltage variations cause ob-

Alternating Current

jectionable flickering of lights. For this reason it is necessary to have some means of automatically regulating the voltage of feeder and distribution

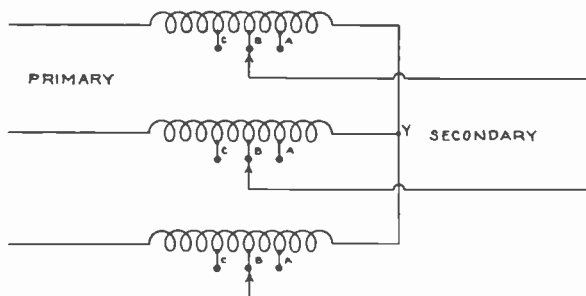

Fig. 5. Three-phase auto transformer in which each winding has several taps so that the secondary voltage can be varied.

circuits which supply energy from the substations to customers' premises.

As the various feeder lines running out from substations usually have different lengths and different amounts of load it is not possible to regulate the voltage of all of these circuits by controlling the voltage at the substation busses. These busses are therefore supplied with one uniform voltage of the proper value to compensate for the ordinary line drop in the feeders and distribution lines.

The voltage of each of the distribution circuits is then automatically regulated to compensate for the load and voltage variations by means of a device known as an **induction voltage-regulator**.

5. OPERATING PRINCIPLES OF INDUCTION REGULATORS

An induction voltage-regulator is simply a form of transformer which has a movable secondary winding which can be shifted or rotated with respect to the primary winding. The primary winding is called the **stator** and the movable secondary is called the **rotor**.

By turning the secondary winding into various positions with respect to the primary, the voltage induced in the secondary can be varied in amount over a wide range and, by turning the secondary

Voltage Regulators

winding far enough the voltage induced in it can actually be reversed.

In this manner the secondary voltage of the regulator can be made to either aid or oppose the line voltage. Fig. 6—A, B, and C shows the connections for an induction voltage regulator.

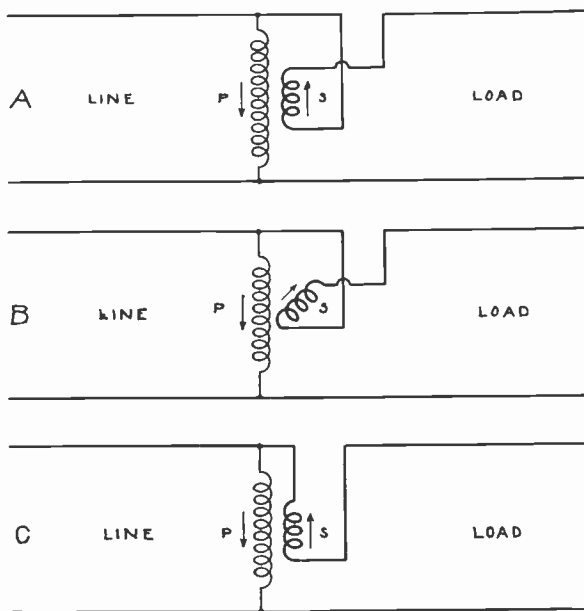

Fig. 6. The above three sketches show the connections and illustrate the principle of an induction voltage regulator. Study carefully each of the three diagrams while reading the explanations given on these pages.

The primary winding, P, consists of a large number of turns of comparatively small wire and is connected directly across the line. The secondary winding consists of a very few turns of heavy wire which is large enough to carry the entire load current, and this winding is connected in series with the load and one side of the line.

In Fig. 6-A the secondary rotor winding is shown in a position so that it is receiving the maximum induced voltage from the primary, and this voltage is in a direction to add to the primary voltage in series and thereby increase the line voltage.

Alternating Current

In this figure, it is assumed that the top wire is positive for the instant, and the arrows near the primary and secondary coils indicate the direction of the voltages in them.

You will recall that when current flows in one direction through the primary winding of an ordinary transformer, it will be flowing in the opposite direction, or 180° out of phase, in the secondary, provided the coils are wound alike.

In Fig. 6-B the secondary rotor is shown turned at somewhat of an angle with the primary winding, and in this position the secondary receives less induced voltage from the primary and therefore doesn't aid or increase the line voltage as much.

In Fig. 6-C the secondary has been turned to a position 180° from where it was in A. In this position it is receiving maximum induced voltage from the primary and its voltage is in a direction opposing the primary voltage, so that it reduces the voltage applied to the line.

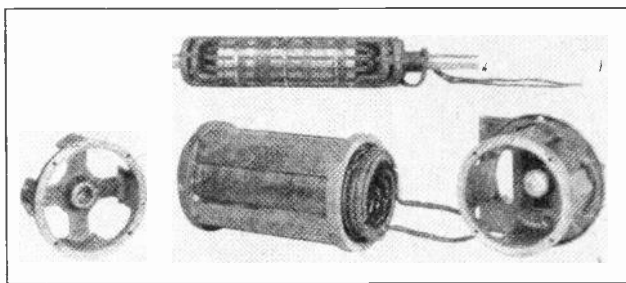

Fig. 7. This photo shows the stationary, primary, and rotating secondary windings of an induction voltage regulator. (Photo Courtesy General Electric Co.)

Fig. 7 shows the stationary primary winding, and also the movable secondary winding which is placed on the rotor. These units are shown removed from the voltage regulator case. This photograph shows very clearly the construction of these elements. Note how the flexible leads of the movable secondary are given a few turns around the shaft of the rotor so that they can be permanently connected in

Voltage Regulators

series with the line and yet allow the rotor to make one-half turn, or 180° of rotation. This eliminates the necessity for slip rings and brushes.

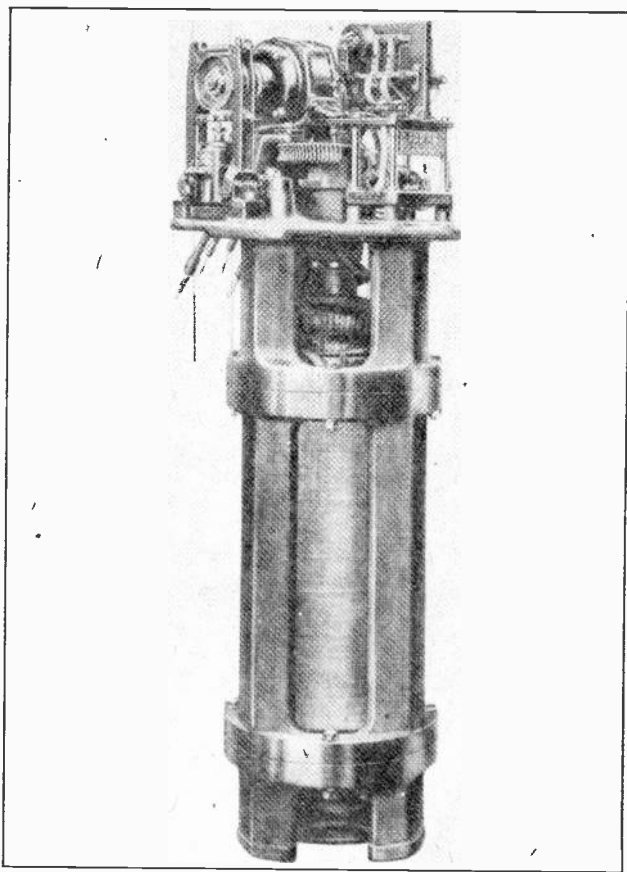

Fig. 8. Complete stator and rotor of a single-phase voltage regulator with the operating motor attached. (Photo Courtesy General Electric Co.)

6. AUTOMATIC OPERATION OF INDUCTION REGULATORS

The boosting or bucking effect of the induction voltage regulator usually ranges from 5% below normal line-voltage to 5% above line-voltage. These regulators are usually operated automatically by

Alternating Current

means of small A. C. motors which drive a worm gear and rotate the secondary of the regulator.

The motor is controlled or started, stopped, and reversed by a set of potential relays or contact-making voltmeters with auxiliary contacts on the movable element.

When the voltage on the distribution line drops below normal, the relays close the circuits of the motor to revolve the secondary winding of the regulator to a position where it will receive a greater induced voltage of a direction to aid and increase the line voltage. If the line voltage rises too high because of removal of practically all the load from the line, the relay contacts close another circuit to reverse the motor and rotate the secondary winding of the regulator to bucking position, where its voltage will oppose that of the line.

Fig. 8 shows a completely assembled primary and secondary unit of an induction regulator. The operating motor and part of the contacts are shown attached to the top of the stator frame in this view.

Fig. 9 shows a complete single-phase regulator with the primary and secondary enclosed in a tank of insulating oil. The sensitive voltage relay, adjustable tap-control, and resistance box and switch are shown mounted on a panel on the front of the regulator.

Induction regulators are also made for three-phase operation. These are wound similarly to the stator of the three-phase induction motor. Regulators of the induction type are in very common use in modern substations which supply alternating current to feeder and distribution circuits. Therefore, it will be well worth your while to obtain a thorough understanding of the principles of this device.

7. TRANSFORMER DESIGN DATA

We have found that transformers are made in many different sizes and types, and for almost any purpose or need. Very often the alert electrician can think of profitable uses for transformers other than the uses in which they are commonly found.

Transformer Design

In some cases, one may have a need for a special transformer which is not available or which may be too costly to buy for the particular purpose, and you may desire to build a unit from available core iron, and wire, which may have been salvaged from some other transformer. Or you can purchase core iron cut to specifications from various steel companies, and magnet wire from electrical supply houses, for building special transformers.

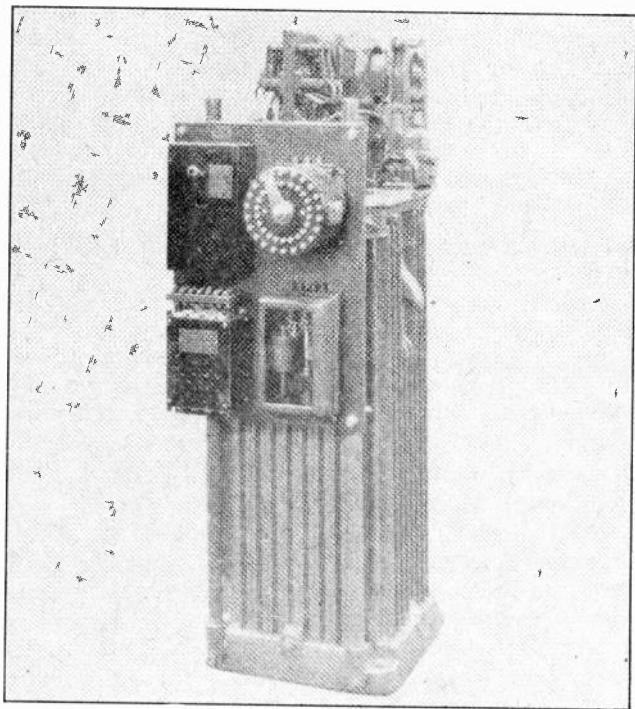

Fig. 9. This photo shows a single-phase regulator enclosed in its tank and equipped with the operating motor and control relays. (Photo Courtesy General Electric Co.)

The design of large power transformers for maximum efficiency and power factor is a job for technically trained engineers, and it is not the purpose of this course to go into such details or mathematical problems. However, it is not a very difficult matter for the practically trained electrician to build

Alternating Current

a simple transformer of small or medium size, which may be very satisfactory for some certain job or requirement. The following convenient transformer construction data is provided for this purpose.

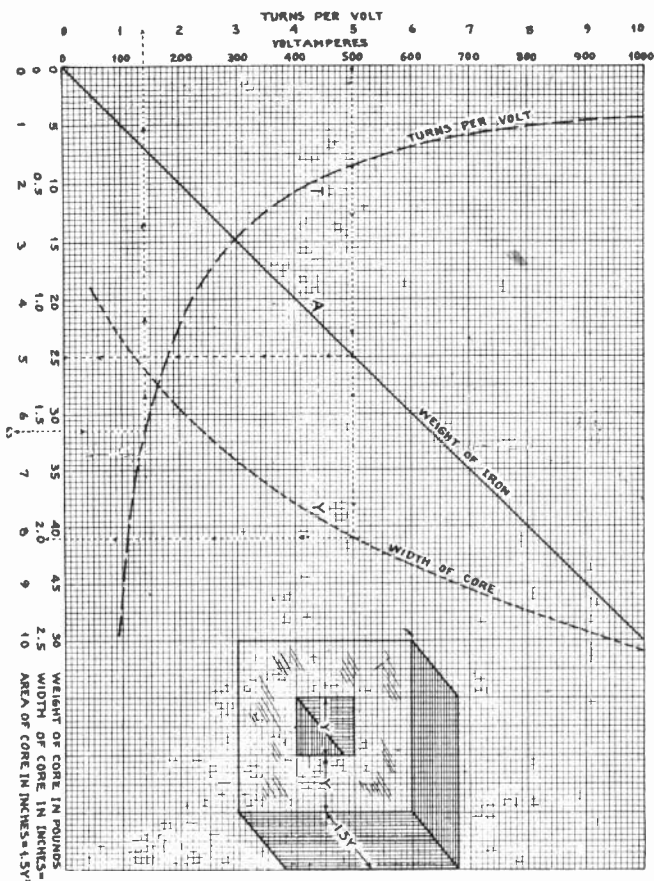

Fig. 10. Transformer design chart.

Before starting to design or construct any transformer, it will be well for us to have well in mind just what a transformer is, or what are its essential parts and what are they to do.

The important parts of a transformer are the core, the primary winding, the secondary winding.

Transformer Design

and the necessary insulation. The core, consisting of thin iron strips or laminations must be large enough to carry the required magnetic flux without saturation or too heavy losses. **The amount of flux to be carried by the core will depend on the size or wattage rating of the transformer.**

The primary winding is to excite or magnetize the core and provide a magnetic flux to induce the desired voltage in the secondary winding. The number of turns and size of wire in the primary winding will depend on the applied voltage and the desired power rating.

The secondary winding is to receive the induced voltage set up by the primary flux. The number of turns and size of wire in the secondary winding will depend on the desired voltage and power rating.

You have already learned that the secondary voltage of any transformer will depend on the voltage applied to the primary and the ratio of primary to secondary turns.

Therefore, the principal factors to be determined in building a transformer are the core size, area and weight; the number of turns and size of wire for primary and secondary windings, the number of turns per volt in the windings, and the amount and grade of insulation.

Important points to keep in mind in the construction of any transformer are—

Do not skimp on core iron, wire size or insulation. Liberal core size means higher efficiency and requires less turns of wire per volt. Ample wire size prevents overheating. Careful and sufficient insulation tends to prevent breakdowns due to short circuits or voltage flash overs.

Before trying to determine the size or area of the core we should decide which type of core we desire to use. The two best types for simple transformer construction are the "core type," and the shell type shown in Figures 1 and 2 of lesson 51.

The plain "core type" with four legs or sides, is often the easiest to build, and when voltages of 1,000 or over are desired on the secondary, it is much easier to insulate the winding on this type of

Alternating Current

core. The shell type core is somewhat more efficient and compact and not very difficult to build.

As a general rule, we should allow a core area of at least 6 square inches for a transformer of 1 kilowatt size. It is also customary to allow a flux density of 50,000 lines per square inch of core if the core iron is of a good grade of silicon steel. For continuous duty without overheating, we should allow 1,000 to 1,200 circular mils of wire area per ampere of load, on both primary and secondary windings. For intermittent or temporary duty, and on very small transformers that are easy to cool, and where efficiency is not so important, this allowance may run somewhat lower, from 600 to 800 C.M. per ampere.

The number of turns required in each coil will be proportional to the applied or induced voltage, and inversely proportional to the cross sectional area of the core. A convenient figure for rough design or checking of small transformers is 7 turns per volt, for a core area of 1 square inch, if the transformer is to be used continuously; or 4 turns per volt if it is to be operated for only a few minutes at a time.

The relations between volts, amperes and watts in transformer design can easily be determined by the use of ohms and watts law formulas with which you are already familiar.

Watts Input	Core Area	Turns Per Volt	Number of Pri. Turns	Size of Pri. Wire
50	$1\frac{1}{4} \times 1\frac{1}{4}$	4.8	530	23
100	$1\frac{1}{2} \times 1\frac{1}{2}$	3.3	365	20
250	$1\frac{7}{8} \times 1\frac{7}{8}$	2.25	250	16
500	$2\frac{1}{8} \times 2\frac{1}{8}$	1.66	185	13
1000	$2\frac{1}{2} \times 2\frac{1}{2}$	1.2	130	10
1500	$2\frac{3}{4} \times 2\frac{3}{4}$	1.	110	9

Fig. 11. Design data for 60 cycle transformers with 110-volt primaries

Now for extreme simplicity and convenience in securing practical design data for small transformers, we have prepared a table, Fig. 11, which gives all the necessary values on core area, wire size and number of primary turns for six sizes of transform-

Transformer Design

ers ranging from 50 watts to 1,500 watts.

This data is given for transformers that are intended for use on 110 volt circuits. That is, their primary windings are designed for 110 volts at 60 cycle frequency.

The above sizes of transformers would be convenient for the bell circuits, signal circuits, electrical toys, neon signs, testing insulation, small spot welders, tesla coil operation, etc. The three larger ones might be used for light and power purposes. The number of turns and size of wire for the secondary windings is not given, as this will depend on the desired secondary voltage, or whether the transformer is to be a step-up or step-down unit.

The number of secondary turns can be easily determined for any desired voltage by multiplying the turns per volt given in the table, by the desired voltage. The full load secondary current can be determined by dividing the wattage rating of the transformer by the secondary voltage. Then the C. M. area of secondary wire can be determined by multiplying the current by 1,000, and getting the gauge number to correspond from a wire table.

Another convenient method of getting the various design figures for small transformers of any size from 50 watts to 1,000 watts is by use of the chart or graphs shown in Fig. 10.

For example, suppose we wish to determine the values for a 500 watt, or 500 volt-ampere transformer.

The weight of the core is found by running horizontally along the 500 V. A. line to the solid line A, and then vertically down to the top row of figures, marked weight of core. We find the core weight to be 25 pounds.

The core width can be found by running horizontally along the 500 V. A. line to the curve Y, and then down to the middle line of figures, marked width of core, where we read slightly over 2 inches. Call it 2 inches.

In this particular design the core depth is as-

Alternating Current

sumed to be $1\frac{1}{2}$ times core width, or in this case, 3 inches. Then the core area will be $2 \times 3 = 6$ inches. This is somewhat more liberal core design than given in the foregoing table, but will make the required turns per volt a little lower, and the transformer efficiency a little higher. It will also change some of the other values slightly, but they are all close enough for practical purposes, whether taken from the table or the chart.

To find the turns per volt, locate the core area or 6 on the bottom line of figures and run vertically up to curve T, and then horizontally over to the left column of figures, and we find 1.4 turns per volt.

Then multiply this figure by the primary voltage to determine the number of primary turns, and by the desired secondary voltage to determine the secondary turns. If the primary voltage is 110 volts, then $1.4 \times 110 = 154$ turns. If the desired secondary voltage is 10, then $1.4 \times 10 = 14$ turns for the secondary.

The primary current at 500 V. A. will be $500 \div 110$ or 4.5 amperes. Assuming that this transformer is only intended for intermittent duty, and allowing 600 C. M. per ampere, we find that $600 \times 4.5 = 2700$ C. M. wire area required. From a wire table we find that a No. 15 wire is suitable.

The secondary full load current would be $500 \div 10 = 50$ amperes. Then $50 \times 600 = 30,000$ C. M. This would require a No. 5 wire, or two No. 8 wires in parallel for better flexibility than the heavy wire.

Values for transformers of other sizes such as 50, 100, 250, 750 or 1000 volt amperes, and any primary or secondary voltages can easily be determined from this same chart and the simple rules and calculations in the foregoing example.

8. TRANSFORMER FORMULAS

The following data and formulas may at times be very convenient for designing transformers of other sizes than those for which the data has been given in the accompanying table and chart.

Transformer Design

As previously mentioned, the size of a transformer core as well as the size of wire in the primary, depends on the wattage or volt-ampere rating. The primary wattage also has a bearing on the "volts per turn" of wire in the primary.

It is often desirable to have two or more separate secondary windings on a transformer, for obtaining different voltages and different amounts of current. In this case, the primary wattage can be determined by adding up the wattages of all secondaries and then adding about 10% more for losses in the transformer.

After the primary wattage has been determined, the volts per turn can be found by the formula

$$E = \sqrt{\frac{W_p}{50}}$$
 for 60 cycle transformer of the plain "core type",

or,
$$E = \sqrt{\frac{W_p}{83}}$$
 for 25 cycle transformers of the plain "core type",

or,
$$E = \sqrt{\frac{W_p}{25}}$$
 for 60 cycle transformers of the shell core type,

or,
$$E = \sqrt{\frac{W_p}{41}}$$
 for 25 cycle transformers of the shell core type.

In these formulas.

$E =$ volts per turn.

$W_p =$ primary watts.

The figures 50, 83, 25 and 41 are constants which have been worked out for your convenience, and to simplify the formulas.

As the "turns per volt" is often only a fraction, it is convenient to change this factor to "volts per turn" by simply inverting the fraction. For example, if the volts per turn should be $1/6$, then the turns per volt would be 6.

Alternating Current

After finding the turns per volt, the required number of turns for either the primary or secondary winding can be found by simply multiplying the turns per volt by the voltage to be applied to the primary, or the induced voltage desired in the secondary.

In other words:— $N = V \times Tv$

In which N = number of turns

V = voltage across the coil

Tv = Turns per volt.

The full load current of either winding can be determined by dividing its wattage rating by its voltage. Then the size of wire for either winding can be determined by multiplying the current in amperes by 600 to 800 C.M. for small well ventilated transformers, or those for intermittent duty; or by 1000 to 1200 C.M. for larger transformers with deeper windings, and for continuous duty.

The area of the core can be determined from the formula:—

$$A = \frac{E \times 100,000,000}{4.44 \times F \times B}$$

In which A = core area in sq. in.

E = volts per turn

100,000,000 = number of lines of force to cut in one sec. to produce one volt.

4.44 = a predetermined constant.

F = frequency of primary supply.

B = number of lines of force per sq. inch.

Allowing 50,000 lines of flux per square inch of core as previously mentioned, if we work out this formula for a 60 cycle transformer it becomes:

$$A = \frac{E \times 100,000,000}{13,320,000}, \text{ or } A = E \times 7.5$$

Transformer Design

For 25 cycle frequency the formula becomes:—

$$A = \frac{E \times 100,000,000}{5,550,000}, \text{ or } A = E \times 18$$

These formulas have been first given in full, and then reduced down, in order to show you the factors involved and to simplify the final formula for your use in designing transformers. With a little practice you should find it quite easy to determine core and winding data for various transformers by the use of the foregoing formulas.

9. GENERAL INFORMATION ON TRANSFORMER CONSTRUCTION

When we refer to core area, we mean the area of one leg only, or the area of the magnetic path at any point in its circuit.

The required area can be obtained by stacking laminations to form a square core, or a core $1\frac{1}{2}$ to 2 times as deep as it is wide, or other rectangular shapes.

The length of the core sides should be kept as short as possible and still allow the proper sized window or center opening to accommodate the windings. The shorter the core or magnetic path, the better will be the regulation of the transformer, but one must be careful not to get the window too small.

The required window size can be determined by taking the wire diameter (including insulation) from a wire table (see pages 28 and 29, lesson No. 26), and then calculating the number of turns per sq. inch, and allow a little extra space for insulation of the coil layers. On many small transformers the window size need not be any larger than the area of the core leg, but on other transformers for high voltages, the window may need to be two or three times the core area.

Transformers will be more efficient if only thin good grade laminations are used. No. 26 or No. 28 gauge are generally best for small units.

Alternating Current

When assembling the core laminations, be sure to carefully lap the joints as shown in Fig. 12-C, so that the magnetic leakage and reluctance will be kept as low as possible.

If old laminations are used, they should be cleaned, but be careful not to scrape the oxide film or insulation from them, as each lamination should be insulated from adjacent ones to keep down eddy currents. For this same reason, care should be

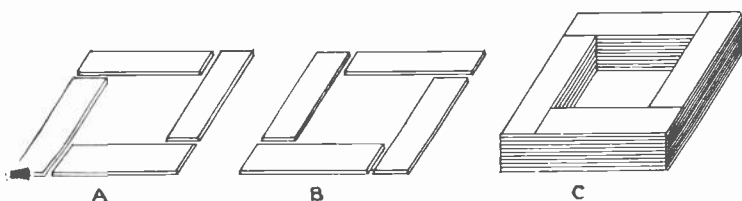

Fig. 12. A core type transformer core may be constructed with alternate layers of laminations as shown above.

taken not to leave rough or burred edges on the laminations.

When preparing to clamp the laminations, it is best to use clamps and external bolts as shown in Fig. 13, rather than to drill holes through the laminations and possibly short them together.

When using old core laminations, if their coating of oxide or varnish has been destroyed, they can be coated with a thin insulating varnish.

For best efficiency, the copper and core losses should be about equal.

In arranging the windings on the core, the primary and secondary coils may be placed on opposite legs of the core, or they can be placed one over the other on the same core leg. The closer they are together, the better will be the regulation of the transformer.

If several different voltages are to be obtained from the secondary, several separate windings can be used, or the secondary winding can be tapped at proper points and individual leads brought out for the different voltages.

Transformer Design

If the current load is to be different on the various sections of the secondary, then they are commonly wound separately and should use different sizes of wire according to their load in amperes. For example, we might have one secondary winding of 5000 turns of No. 30 wire, and another of 3 turns of 0000 cable on the same transformer.

When windings are placed one over the other on the same core leg, the lower voltage winding is often placed next to the core because of less difficulty in insulating it from the core. This is not always the case, however.

Windings should be carefully insulated from the core, preferably with a fibre spool, or at least with a wrapping of several layers of heavy oiled paper or tape. Fibre end collars help to hold the wires in place in the coil layers, and also insulate them from the core.

Each layer of wire should be wound neatly and evenly, avoiding crossed wires as they tend to cut through their insulation and short circuit if pressed too tightly together.

Each layer should be insulated from the others by a layer of oiled paper or varnished cloth. Great care should be used to prevent end turns of one layer dropping down near the turns of layers deeper in the winding as this will generally result in a short circuit and cause the entire winding to fail and necessitate rewinding. This is particularly true on high voltage windings. End turns can be held securely in place by placing short stubs of thin tape under the last several turns and then folding the free ends of the tape back over these turns and binding them down with the next layer.

Starting and finish leads of each coil should be protected and anchored by covering with spaghetti tubing several turns into the coil to prevent their being broken off. On windings using very small wires, short pieces of heavier wire are often soldered on at the ends and used for the several end turns, being well bound into the coil to relieve the small wires of any strain.

Alternating Current

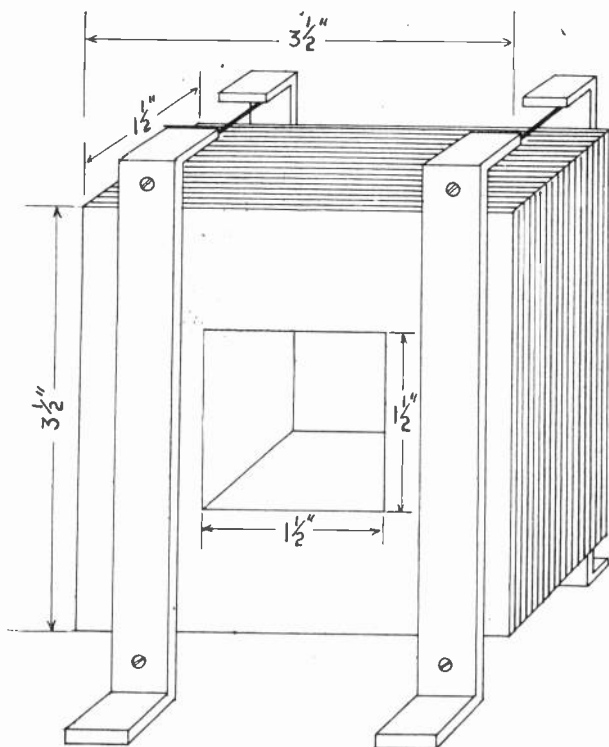

Fig. 13. A 50 w. transformer core constructed from strips $1'' \times 2\frac{1}{2}''$. Note the method of binding the strips together.

Don't skimp on insulation, or it will frequently result in breakdowns or shorts, and necessitate complete rewinding. On the other hand, don't pile up unnecessarily thick layers of insulation, as these tend to prevent the escape of heat to the outside of the winding and may cause hot spots. Mica is very good insulation for the core, and for high voltage windings.

Magnet wire for transformer winding is generally insulated with one or two layers of cotton, and sometimes a layer of thin enamel of high dielectric strength to prevent voltage breakdown or puncture. The cotton affords good mechanical protection to the enamel as well as some added insulation value.

Transformer Design

Where the wires are fairly large, or with smaller wires that are machine wound, plain enameled wire is sometimes used. This makes possible a very compact winding, and permits very free blow of heat to the outside of the winding. Cotton is much more of a heat insulator than is enamel.

After a winding is completed, it should be covered with one or two layers of tape, cloth or paper and shellaced or varnished for mechanical protection to the wires, for neater appearance, and to keep moisture and dirt out of the windings.

When convenient, it is often well to dip finished transformer coils in hot insulating wax or compound, to exclude moisture and to bind the turns more securely in place.

When winding coils, a wooden form just slightly larger than the core leg makes a convenient coil form. Slightly tapering this form, and wrapping with a layer or two of waxed paper makes it easy to remove the finished coil. Winding a layer of cord on the form first, and then pulling out this cord also simplifies removing the finished coil.

When repairing or rewinding damaged transformers always observe and carefully record the size of wire, number of turns, and the grade and amount of insulation removed so you can duplicate them in the new winding.

Careful workmanship and liberal or safe design allowances, on size of core and wire, and on insulation should enable you to do many profitable and satisfactory transformer construction or repair jobs. Building one or more small transformers is well worth the cost of time and materials just for the experience and confidence it will give you.

10. WELDING TRANSFORMER

A practical arc welding transformer can be built with a core such as shown in Fig. 14, using about 220 lbs. of iron, and 86 turns, or No. 3 wire on the primary, and 45 turns of No. 1 wire on the secondary.

This unit is for operation on 220 volts, and is capable of supplying secondary currents up to 200 amperes.

Alternating Current

Square wire should be used in these windings if possible to avoid waste space between turns. The layers of the winding should be spaced with $\frac{1}{8}$ " wood strips to permit ventilation. The secondary

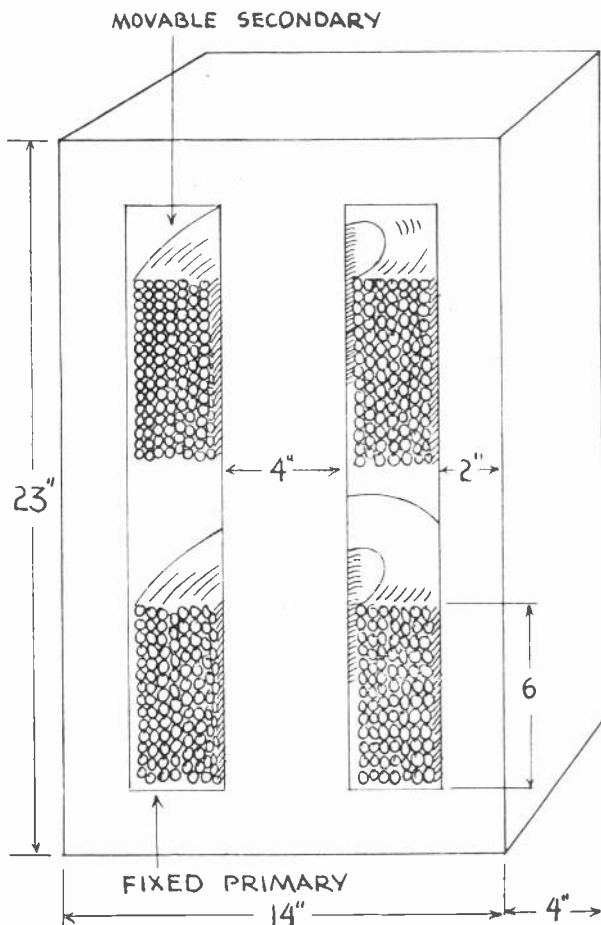

Fig. 14. A 19 Kv-a. welding transformer designed for operation on a 220 volt line.

coil should be arranged so it can be moved up or down on the core leg to permit varying the welding current for different jobs.

Transformer Design

Such a transformer can also be used for thawing out frozen pipes, by connecting its secondary leads to a length of frozen pipe, and adjusting the current to warm the pipe, but not to overheat it.

11. BELL RINGING OR TEST TRANSFORMER

A practical 50 W transformer may be constructed with core dimensions shown in Fig. 13, but for experience, let us work out the design from the information just covered.

Our first step is to determine the size of window opening necessary for the primary and secondary coils. So by referring to Fig. 11, we find that a 50 W transformer primary should have 530 turns of No. 23 wire. The number of secondary turns will be found by multiplying the desired voltage by 4.8 (the number of turns per volt shown in the table). Assuming that we desire a 12 volt secondary, we multiply 12 by 4.8 and obtain 57.6, (use 58) as the number of turns necessary.

The secondary current is found according to Watts law by dividing Wattage, which in this case is 50, by the volts. So the secondary current will be $50 \div 12$, or 4 + amperes.

We have learned that for intermittent use, 600 C.M. per ampere is required. Therefore, 600 C.M. \times 4 amperes = 2400 C.M. Referring to a wire chart, we find that No. 16 wire has a circular mill area of 2583 which should be ample.

The winding space may be determined by referring to the winding chart on page 29 of lesson 26. The chart shows that 1" will take 1293 turns of No. 23 wire so $\frac{1}{2}$ " will be ample for 530 turns. Number 16 requires 1" for 282 turns, so 58 turns will require about .3 of one inch. Adding .5" and .3", we obtain .8" or less than one inch actual winding space, but since we must allow for insulation, a window of 1" square would be rather crowded. In order to insure having plenty of room, let us use a window opening $1\frac{1}{2}$ " \times $1\frac{1}{2}$ ".

The length of the laminations will be equal to the length of the window, plus the width of the

Alternating Current

laminations. In this case, the window length of $1\frac{1}{2}'' + 1''$, (the width of the laminations) gives us a lamination length of $2\frac{1}{2}''$.

The chart in Fig 10 shows that about $2\frac{1}{2}$ lbs. of iron, will be required. The amount of wire may be estimated by multiplying the number of turns by the average length per turn, and then referring to wire charts which show the number of ft. per pound. In this case, $\frac{1}{2}$ lb. of No. 23 will be ample for the primary, and about 4 oz. of No. 16 will be required for the secondary.

The core may be stacked with alternate layers as shown by Fig. 12-A and B. The first layer may be arranged as at A and the second layer as at B, the third as at A, etc. This arrangement breaks joints so that the completed core may be bound rigidly together as shown at C.

After the core is assembled, three sides should be temporarily bound together with tape, and the remaining side should be removed so that the coils may be placed on the core.

After the core legs are insulated, and the coils placed on the core, the strips may be replaced and the completed core may then be permanently bolted together with strips of wood, or pieces of strap iron or angle iron. A piece of insulation material such as fibre or wood should be attached to the core to make a mounting base for the terminals.

The secondary coil may be tapped at the 29th turn to provide 6 volts.

Transformer Design

EXAMINATION QUESTIONS

1. For what purpose are tap-changing transformers used?

2. How may two-phase power be obtained from a three-phase line without the use of a motor generator?

3. Draw a sketch showing an auto-transformer tapped for a secondary voltage $\frac{1}{2}$ as high as the primary voltage.

4. Briefly describe the operating principle of the Induction Voltage regulator.

5. How is automatic regulation accomplished on the induction voltage regulator?

6. Referring to Fig. 11, how many turns and what size wire would be required for a 500 volt secondary on a 1000W Transformer?

7. According to the chart in Fig. 10, how many lbs. of iron would be required for a 700 volt-ampere transformer?

8. Using the formula on page 26, determine the core area for a 60-cycle transformer on which there are 3.3 turns per volt.

9. What precaution should be taken to prevent shorts or grounds between the coils and the transformer core?

10. What records should be made at the time an old transformer is prepared for rewinding?

INSTRUMENT TRANSFORMERS

While on the subject of transformers, it will be well to consider more fully the principles and construction of **instrument transformers** which are used in connection with meters on high - voltage A. C. circuits.

The use of these transformers has already been explained to some extent in the section on Alternating Current Meters. Those which are used to reduce the current of heavy-duty power circuits and to operate ammeters and the current elements of wattmeters and watt-hour meters, trip coils of oil switches, operating coils of current relays, etc., are known as **current transformers (C.T.)**

The other type, which are used to reduce the voltage of high-tension circuits and to operate voltmeters, potential elements of wattmeters and watt-hour meters; power-factor meters, synchrosopes, potential relays, etc., are known as **potential transformers (P.T.)**

Instrument transformers are carefully and specially designed to give very accurate ratios of transformation on voltage and current values within the range for which they are designed.

1. CURRENT TRANSFORMERS.

The primary of a current transformer is always connected in series with the line of which the current is to be measured as shown in Fig. 1-A. This primary winding usually consists of only one or two turns and in some cases of just a straight conductor passed through the core around which the secondary is wound. This produces the same effect and ratio as one loop or turn.

On circuits carrying very heavy currents, the flux set up by one turn, or even just a short section of the straight conductor, is sufficient to induce the proper voltage in the secondary winding, as the instruments require very little power to operate their moving elements.

Transformers

The secondary winding consists of a great many turns and its terminals are connected directly to the terminals of the ammeter, wattmeter, or relay which the transformer is to operate.

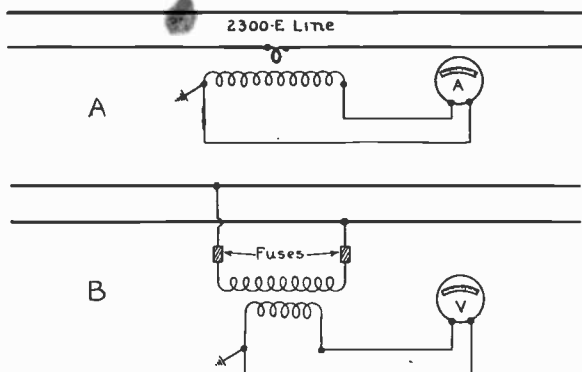

Fig. 1. A shows the connections for a current transformer which is used to operate A. C. ammeters, wattmeters, and current relays. B. Connections for potential transformer used to operate voltmeters, potential elements of wattmeters, potential relays, etc.

The secondary of the current transformer should always be grounded for safety in case of a breakdown of the insulation, which might allow the high voltage of the line to get to the low-voltage circuit.

Fig. 2 shows a current transformer which is designed for connecting in series with power cables or lines. The cables are connected to the leads of the heavy primary conductor by the copper lugs and bolts shown attached. The leads to the instrument are taken from the two small terminals on the connection block on the lower left of the transformer core.

Fig. 3 shows a current transformer which is designed for connection in series with a bus bar on a switchboard.

2. CAUTION.

As previously mentioned in the lesson on A. C. Meters, the current transformer which has its primary connected in a live line should never be left with its secondary open-circuited.

Alternating Current

Before disconnecting the meter leads or relay leads from the secondary of the current transformer, the transformer secondary should be short-circuited with a good secure connection. If this is not done, when the instrument is removed there will be a dangerously high voltage built up in the secondary winding of the transformer. This high voltage may puncture the insulation of the transformer secondary winding, or of the meter just as it is being disconnected or reconnected; or it may cause a serious shock to the operator who is making or breaking the connections.

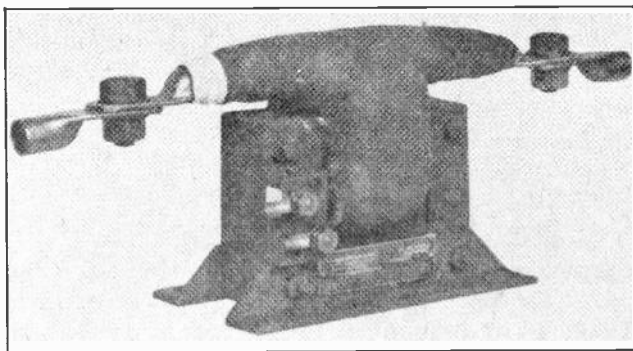

Fig. 2. This photo shows a common type of current transformer for use with cable lines or small bus bars.

You will note by observation of the diagram in Fig. 1-A that with one turn in the primary and a considerable number of turns in the secondary, a current transformer resembles a step-up transformer with the secondary as the high-voltage winding. It would act as such if it were not for the fact that the meters and devices connected to the secondary are of very low resistance, and the current which normally flows through the secondary sets up a flux that opposes the primary flux, and thereby limits the amount of induced voltage to a very low value.

This principle was explained in the lesson on Principles of Power Transformers.

The short-circuit should always be left on the

Transformers

secondary winding until after the meters or devices have been reconnected to it. This short-circuit will not cause the secondary winding to become damaged or burned by overload because the increased current which tends to flow through the secondary winding, when shorted, immediately sets up a

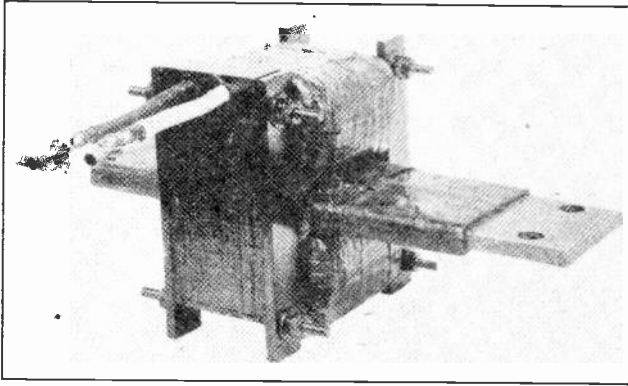

Fig. 3. Bus-bar type current transformer for use with large bus bars on switchboards. (Photo Courtesy General Electric Co.)

heavy flux that more completely neutralizes the flux of the primary and thereby allows very little voltage to be induced in the secondary as long as its circuit is closed.

If this circuit were left open, however, there would be no current flowing and no secondary flux to oppose the primary field, and this would allow the primary flux to build up to full normal value and induce in the secondary the very high voltage which has been mentioned.

3. POLARITY MARKINGS AND RATIOS.

The polarity of current transformers is usually indicated by permanent white markings placed on the primary and secondary leads.

The relative instantaneous directions of the current will be **into the marked primary lead, and out of the marked secondary lead.**

Current transformers ratios can be expressed in different ways. One common method is as follows: 80:5, 400:5, 250:5, etc.

Alternating Current

These respective indications or markings mean that the maximum secondary rating is 5 amperes when the primary is fully loaded by the number of amperes expressed by the first figure of the rating. In other words, transformers are designed with the various proper ratios so that 80 amperes through the primary will produce a flow of 5 amperes in the secondary; or, in the case of another transformer, 400 amperes flowing through the primary will produce a flow of 5 amperes through the secondary, etc.

With current transformers of this type it is possible to use ammeters which have windings with a maximum capacity of 5 amperes. The ammeter scale is then calibrated according to the ratio of the transformer so that the meter will indicate the full line current rather than the amount of current actually passing through the meter coil itself.

Another method of expressing current transformer ratios, is as follows: 80:1, 600:1, 1200:1, etc.

The principle involved in this method is the same as that of the transformer ratios previously explained; and ammeters of 5 ampere maximum capacity are used and have the scales calibrated according to the transformer ratio.

4. ADVANTAGES AND APPLICATIONS OF CURRENT TRANSFORMERS

Ammeters for use without current transformers and designed for a flow of more than 100 amperes through their coils, are usually not very accurate and require very heavy and bulky coils to carry the current.

As many alternating current power circuits carry loads of several thousand amperes, current transformers are very commonly used. They serve the same general purpose as ammeter shunts do in direct current circuits, even though the transformers operate on a principle of induced voltage entirely different from that of voltage drop due to resistance in the shunts.

Fig. 4 shows a portable current transformer which can be conveniently used with portable am-

Transformers

meters or wattmeters for making tests on heavy power circuits. This transformer is so constructed that the cable or line on which the current is to be measured can be passed through the hole in the center of the transformer core. The flux around the line conductor is sufficient to operate the transformer secondary and instruments attached.

In cases where the voltage of the line on which the current is to be measured exceeds 500 volts and possibly ranges up into the thousands of volts, it is much safer to use current transformers to operate meters and relays. By using a transformer,

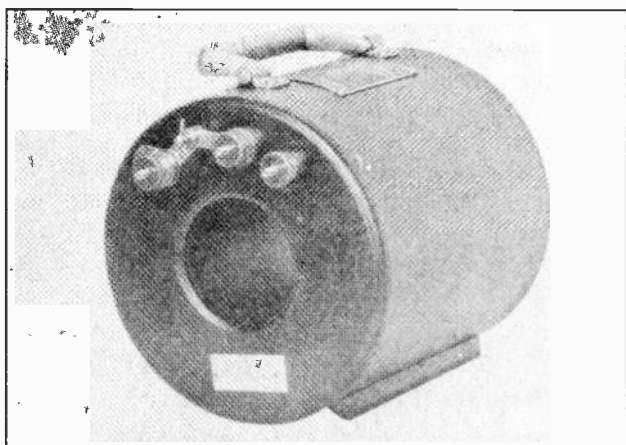

Fig. 4. Portable current transformers of this type are very convenient when making tests on lines or electric machines with portable ammeters and wattmeters. (Photo Courtesy General Electric Co.)

the windings of the ammeters or relays are kept insulated from the line voltage. Some power companies make it a general practice to use current transformers on all lines of 200 volts and over.

There is often a tendency on the part of operators and electrical men in the field to overload current transformers by connecting too many instruments on one transformer. This is not good practice, as it causes inaccurate meter readings particularly where the current elements of wattmeters are connected

Alternating Current

to the same transformer with ammeters.

Most meters are matched and calibrated to operate with certain current transformers and for accurate readings these should be kept together.

Other types of current transformers are designed to operate overload trip-coils, relays, etc., and these should not be used with ammeters or wattmeters.

5. POTENTIAL TRANSFORMERS

A potential transformer resembles an ordinary single-phase power transformer, except that it is of only a few watts capacity. The primary windings of potential transformers consist of a great number of turns, and are connected across the high voltage lines and protected with special fuses known as potential transformer fuses.

The secondaries are commonly wound for 100 or 110 volts. Fig. 1-B shows the connections for a potential transformer, and the voltmeter properly connected to its secondary. The secondaries of these transformers are also grounded for safety reasons and to immediately ground the high voltage in case of failure of the insulation between the primary and secondary windings.

Voltmeters and the potential elements of wattmeters which are designed for use with potential transformers are wound and constructed the same as voltmeters for lines of 100 or 110 volts, and their scales are calibrated according to the ratio of the potential transformer, so the meters will indicate the full line voltage.

It is quite general practice to use potential transformers for the operation of voltmeters, wattmeters, and potential relays on lines of 200 volts and over.

It is very seldom advisable or practical to use voltmeters directly connected to lines of over 600 volts.

On the left in Fig. 5 is shown a potential transformer for a primary voltage of 220 volts. The terminal markings, H-1 on the primary and X-1 on the secondary, can be seen in this photo.

Transformers

The view on the right in this figure shows a large oil-insulated current transformer for use with a line of 25,000 volts. The in-going and out-going leads to the primary are both carried through the

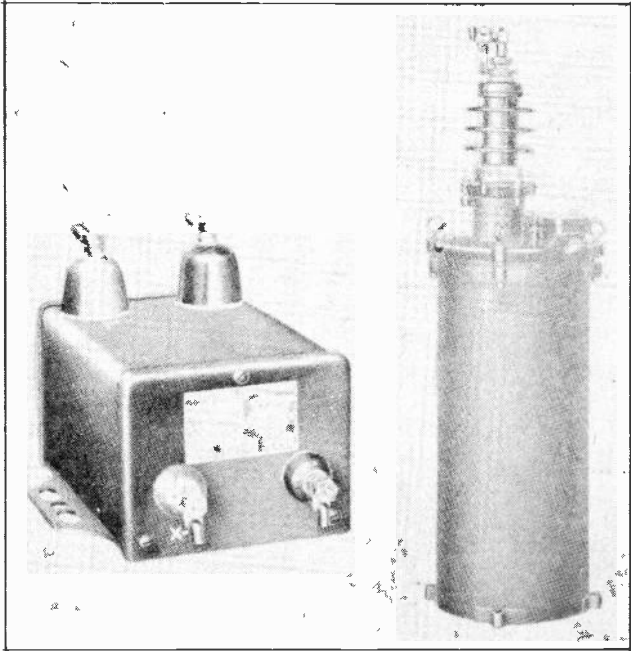

Fig. 5. At the left is shown a small potential transformer with the high-voltage terminals on the top and the low-voltage terminals on the end. Note the polarity markings on the case. On the right is shown a large oil-insulated power-type current transformer.

large porcelain insulating bushing. One lead is in the form of a small rod which goes down through the center of the bushing, and the other lead is in the form of a metal sleeve which surrounds the inner rod but is well insulated from it.

Potential transformers for use on very high voltage lines are also built with their windings immersed in tanks of oil and have two high-voltage insulating bushings for their primary leads, which are connected across the line.

Alternating Current

Oil-insulated instrument transformers of this type are commonly installed outdoors in the sub-station structure where the high voltage lines enter or leave the station.

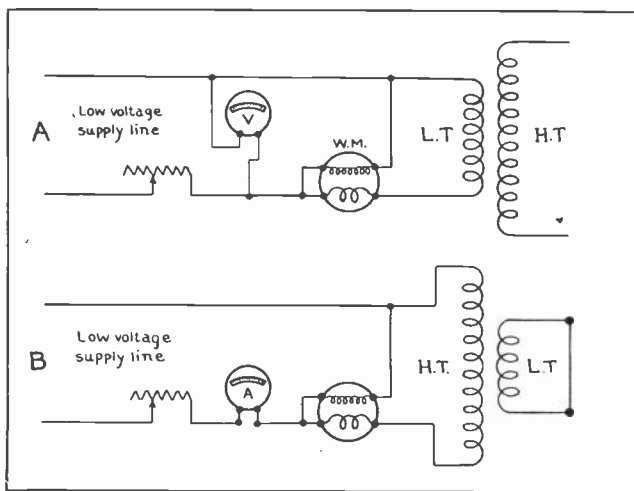

Fig. 6. A shows the method of connecting a voltmeter and ammeter to a transformer to make a core loss test. B shows the connections for making a copper loss test.

6. TRANSFORMER TESTS

Three very common tests which you may often be called upon to make on transformers are those for determining the core loss, copper loss, and the regulation of various power transformers.

These losses and figures on the characteristics of the transformer can usually be obtained from the manufacturers, but the tests for determining them are very simple and are often performed in the field.

The connections for making the core-loss test are shown in Fig. 6-A. When performing this test it is generally more convenient to use the low-tension winding for applying the power, thus avoiding unnecessarily high voltage on the instruments.

For making the core-loss test, the wattmeter and voltmeter of the proper ratings and some form of rheostat are required, and they should be connected as shown in the diagram. The secondary of the

Transformers

transformer should be left open-circuited during the test. The rheostat should be adjusted until normal voltage is applied to the primary winding, and the wattmeter reading will then indicate the core loss of the transformer in watts.

In other words, when the secondary of the transformer is open and not loaded the energy required to magnetize the core will be the core loss. As previously mentioned the core loss of a transformer is practically the same at no load as at full load.

The connections for making the copper-loss test are shown in Fig. 6-B. In this test it is usually more convenient to use the high-voltage winding of the transformer as the primary to be excited. The low-voltage secondary should be short-circuited during the test.

A low voltage is then applied to the high-tension coil and the rheostat is adjusted until the ammeter indicates that the current flow is equal to the full load current rating of the high-tension winding. When this current value is reached, the wattmeter reading will indicate the full-load copper-loss.

With the secondary short-circuited in this manner it is usually necessary to apply only 1 to 3 per cent. of the rated high-tension voltage to bring the current up to full-load value for the high-tension winding.

The regulation of a transformer may be determined approximately by the following method. First, measure the secondary voltage under full load, with the transformer primary supplied with rated voltage and frequency. When the secondary load is removed, the voltage will rise and the amount of increase should be noted.

This increase, or difference between the full load and no load voltage, divided by the full load secondary voltage will give the per cent. of regulation.

7. FIELD PROBLEMS

In each of the following problems except the last

Alternating Current

one, the answers are given; but you should carefully work them out, and also make in each case a connection diagram of the equipment mentioned, or that which would be required, just as you would connect it up right on the job.

Suppose that you were to install a bank of three single-phase transformers to supply current to a motor load of 150 h.p. What size transformers would you install?

It is considered good practice to install about 1 kv-a. of transformer capacity per h. p. of secondary load. This will allow for the loss in the transformers and motors and also for the power factor, which is usually somewhat below unity on a system loaded with motors.

So, as the exact power factor and current ratings of the motors in this case are not known, we should install transformers with a total three-phase capacity of 150 kv-a.

When 150 kv-a. is divided among three single-phase transformers, it will require transformers of 50 kv-a. each.

In another case, suppose you wish to determine the amount of current that can be taken from each secondary line wire of a three-phase bank of transformers which have a total capacity of 600 kv-a. and a secondary voltage of 440 volts.

We know that the apparent watts divided by (volts \times 1.732) will give the line current on any phase of the three-phase system.

Then, as apparent watts are equal to 600 kv-a. \times 1000, or 600,000 watts, the current will be found in the following manner:

$$I = \frac{600,000}{440 \times 1.732}, \text{ or } 787 \text{ amperes per line conductor.}$$

If on some future job you have a bank of transformers with a step-down ratio of 2:1, with the primary windings connected star to a 440-volt circuit and the secondary windings connected delta, what voltage will be obtained from the secondary line leads?

Transformers

This problem can be solved in the following manner:

If the transformer primaries are connected star to a 440-volt line, the voltage across each of the primary phase windings will be:

$$440 \div 1.732, \text{ or approximately } 254 \text{ volts.}$$

Then, if the transformer step-down ratio is 2:1, the voltage across the secondary phase windings will be:

$$254 \div 2, \text{ or } 127 \text{ volts.}$$

As the secondary windings are connected delta, the line voltage will be the same as the phase-winding voltage, or 127 volts.

If an alternator supplying 6600 volts is connected to the primary of a delta-star bank of step-up transformers which have a ratio of 1:11.55, what will be the high-tension line voltage obtained from the star-connected secondaries of the transformers?

This problem can be solved in the following manner:

If 6600 volts are applied to the delta-connected primaries of the transformers, then the voltages across each of the primary phase windings will be 6600. With a step-up ratio of 1:11.55 the voltage across each of the phase windings on the secondaries of the transformers will be 76,230 volts.

Then, if these secondaries are connected star, the line voltage will be $76,230 \times 1.732$, or 132,030 volts.

This same line voltage can be obtained with a bank of transformers connected in this manner and having an even ratio of 1:10, by simply increasing the alternator voltage from 6600 to a little over 7622 volts.

Which transformer connections could be used to raise the voltage of a 13,200-volt alternator to 132,000 volts for the transmission line, if the bank of transformers has a step-up ratio of 1:10? .

Alternating Current

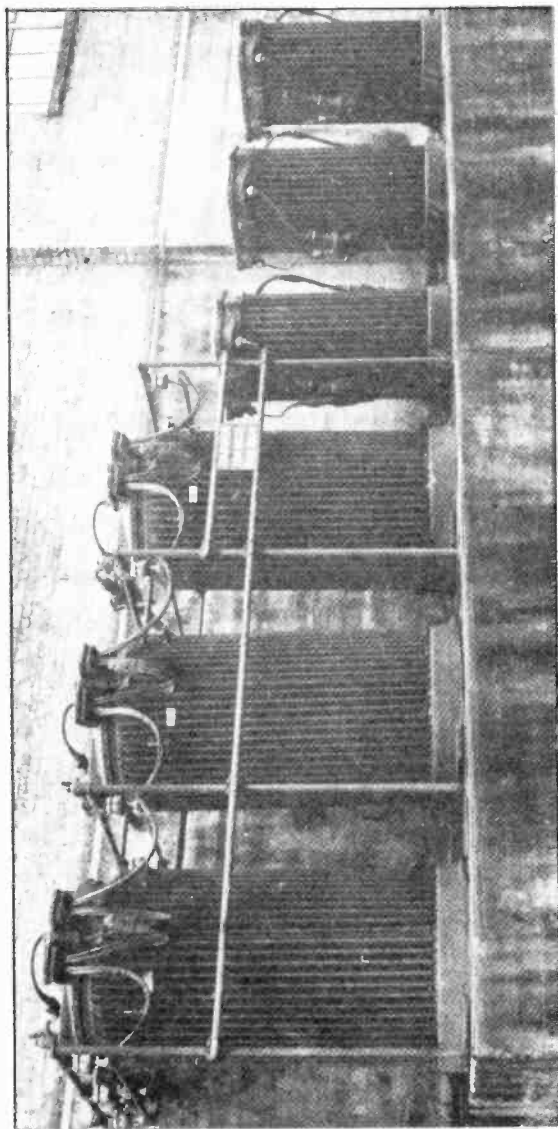

Fig. 7. This photo shows two three-phase banks of transformers of different sizes. Note the manner in which the connections are made. Connections from transformer banks are very frequently run through conduit or load-covered cables to the circuits they are to supply. In some cases connections are made to rigidly supported bus bars which may lead to a switchboard or switching station.

Transformers

8. MAINTENANCE AND CARE OF TRANSFORMERS

Transformers usually require considerably less maintenance than most other electrical machines; because transformers have no moving or wearing parts, such as bearings, etc.

There are, however, certain important features which should not be overlooked when installing new transformers and also in the regular inspection and care of these devices, to make certain that they are operating under proper conditions.

When installing transformers they should whenever possible be placed in a location where there is plenty of free circulation of fresh air to carry away the heat developed in the transformers.

Transformers are quite often installed in special rooms, known as **transformer vaults**, inside of various buildings. These rooms should be well provided with openings for ventilation, and in many cases it is advisable to have some sort of fan or blower system to constantly circulate fresh air through the transformer vaults.

Where transformers have water-cooling coils in the tanks, the circulation of air around the tanks is not so important; but, even with these types of transformers, a great deal of the heat will be carried away and their operating temperature kept lower if plenty of fresh air can come in contact with the tanks.

When transformers are installed out-of-doors, the air problem will usually take care of itself; but, if the transformers are equipped with water-cooling coils, they should be inspected frequently to see that the circulating water supply is not interrupted by failure of the pumps, and also to see that this water as well as the transformer itself are kept at the proper temperature.

In certain cases where transformers may be temporarily overloaded to maintain service during emergencies, or where conditions make their cooling difficult, they may be kept at safe temperatures

Alternating Current

by means of fans or blowers to direct air against their tanks or radiators. Sometimes a spray of water against the tanks from a set of perforated pipes will greatly aid in cooling them. The water should, of course, be kept away from high voltage lead-in wires and bushings.

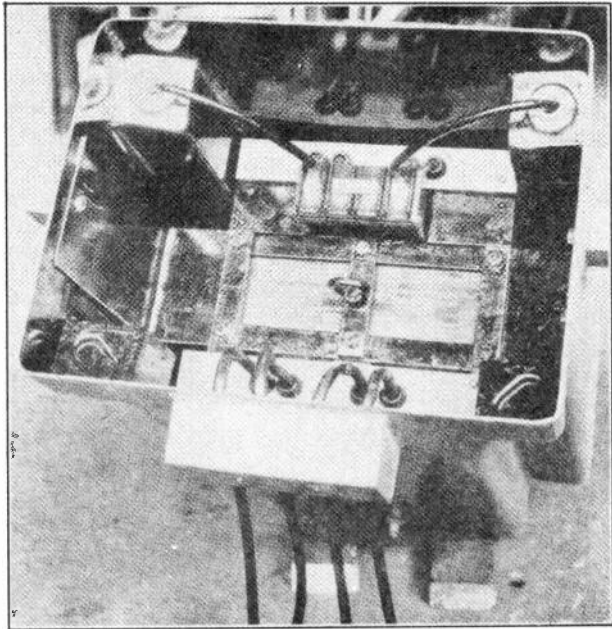

Fig. 8. This photo shows the inside of a small distribution transformer with the oil removed. Many transformers of this type are provided with a terminal block mounted on the core inside of the tank so that the connections can be changed to obtain different voltages.

As previously mentioned, most large transformers are provided with thermometers to indicate the temperature; and for highest operating efficiency, as well as for safety of the insulation of the windings, the temperature should be kept at or below the maximum rating which is usually marked on the transformer name-plate.

9. DRYING OUT TRANSFORMERS

When installing new transformers which have been shipped without the oil in the tanks, or used

Transformers

transformers which have become damp, it is very important to see that the windings and tanks are thoroughly dried out before the oil is placed in the transformers.

This is usually accomplished with some form of air heater and fan arrangement for blowing dry, heated air through the windings. Large transformers may require several days to thoroughly dry out.

In emergency cases the windings may be heated to dry them out by short-circuiting the secondary winding and applying from 1 to 2 per cent. of the normal rated voltage to the primary.

A rheostat is generally used in series with the primary winding to avoid too rapid temperature rises, and the actual drying temperature should not be reached for several hours after starting to apply the low voltage to the primary.

This method of drying out a transformer must be performed with great care at the start or the inner sections of the winding may reach dangerously high temperatures before the outside sections become warmed up.

The principal reasons for drying out transformers so carefully are both to prevent moisture from reducing the dielectrical strength of the insulation on the windings and to prevent any of this moisture from being absorbed by the oil when it is placed in the transformer tank.

The degree of dryness obtained can be determined by measuring the insulation resistance between the winding and core with a megger.

10. EFFECT OF WATER ON TRANSFORMER OIL

The presence of even a very slight amount of water in the oil will greatly reduce its dielectric strength or insulating qualities. The dielectric strength of good transformer oil is usually between 220 and 250 volts per mil. In other words, it will require a voltage of this amount to puncture or break through 1/1000 of an inch of good transformer oil.

Alternating Current

The common test for transformer oil is made by placing a sample of the oil in a testing cup or receptacle in which is submerged a pair of round test electrodes one inch in diameter, and with flat faces spaced $1/10$ of an inch apart.

When high voltage from a test transformer is applied to these terminals of the test gap, the $1/10$ inch layer of oil between them should stand a potential of about 22,000 volts before breaking down. If the oil flashes through at a much lower voltage than this, it indicates the presence of moisture or dirt in the oil.

If oil which has almost no water in it, or we will say not over $1/10$ part of water in 10,000 parts of oil by volume, has a breakdown voltage of over 20,000 volts, when water is added to the extent of one part of water in 10,000 parts of oil, the oil will usually break down at less than 10,000 volts; showing that its dielectric strength has been reduced more than one-half by even this very small moisture content.

Only a good grade of mineral oil should be used in transformers. The principal requirements are that such oil should be free from moisture, dust, dirt, and sediment. It should also be free from acid, alkali, and sulphur. It should have a low flash point, and should have the previously mentioned dielectric strength of about 220 volts per mil.

During normal operation of the transformer it is quite probable that the oil will absorb more or less moisture from the atmosphere.

Most transformer manufacturers equip their transformers with air-tight or water-tight insulating bushings around the conductors or leads where they leave the tank, and also with moisture seals under the tank covers. In spite of this, a certain amount of moisture may enter the tank by the "breathing" action which is due to expansion and contraction of the oil with changes of temperature in the transformer, and which causes air to be forced in and out of the transformer tank with these changes in temperature.

Transformers

Even when transformers are equipped with the air-dryer or moisture-absorbing units in the breather or ventilator previously explained, some moisture may gradually be absorbed by the oil.

The presence of this moisture may not be visible to the eye when the oil is examined, but it can be detected by the voltage-breakdown test.

If a pint of oil and a pint of water are vigorously shaken together in a container and then allowed to stand for a few minutes they will separate because oil is the lighter of the two. Most of the water will settle to the bottom, but a certain number of very small particles of water will be retained in suspension in the oil.

The same condition is met in the case of transformers. Most of the first moisture which enters

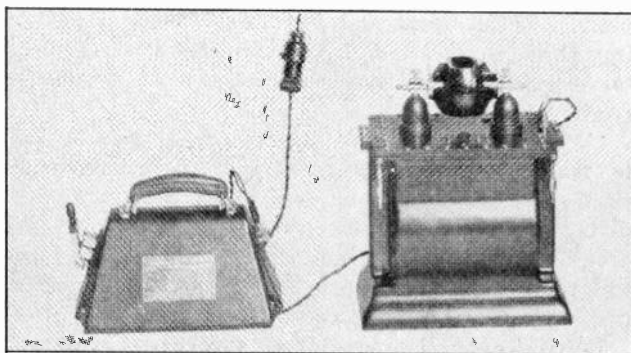

Fig. 9. Portable oil testing outfit consisting of high voltage transformer oil test cup and voltage adjuster. (Photo Courtesy General Electric Co.)

the tank remains suspended in the oil until the oil can hold no more water, and then the water begins to settle to the bottom of the tank.

11. TESTING TRANSFORMER OIL

We should never wait for water to appear at the bottom of the tank; but, instead, the oil should be periodically tested by removing small samples from the drain valve at the bottom of the tank and test-

Alternating Current

ing these samples in a high-voltage test gap such as previously described.

If, at any time, the oil removed from the bottom of the tank breaks down at voltages below 16,500 on a standard test gap, the oil should be both dried out and cleaned. If this is neglected it may result in the dielectric strength of the oil becoming so low that it will cause a flash-over between the transformer windings and result in serious damage.

Fig. 9 shows a convenient portable oil-testing device which consists of a small high-voltage transformer capable of producing secondary voltages of from 15,000 to 25,000 volts. The oil test cup or receptacle is mounted above the transformer and is attached to the high-voltage terminals. The oil cup is made of an insulating composition and has the metal electrodes inside the cup with their shafts extending through the ends to the transformer terminals.

One of the electrodes is adjustable so that the cup can be accurately set for various tests. There is also provided a voltage adjustment knob, located between the electrode posts. The power required by a test outfit of this kind is so small that it can be operated directly from an ordinary 110-volt lighting circuit.

When testing oil with such a test outfit, the cup is usually filled so that the oil is about an inch above the electrodes, and after allowing sufficient time for the oil to flow between the gap faces and for all bubbles to rise to the top, the voltage is applied, low at first, and gradually increased until the sample breaks down. Several samples are usually tested to obtain average results and avoid mistakes.

12. CLEANING TRANSFORMER OIL

There are three common methods of removing moisture and dirt from transformer oil. These methods are boiling, filtering, and the use of centrifugal separators.

Transformers

The first method is the least used of the three and is generally only resorted to in emergencies.

Oil filter presses are quite commonly used by a number of plants and power companies, and the centrifugal separator is very extensively used where large amounts of oil must be cleaned frequently.

To dry the moisture out of oil by boiling is a somewhat crude method but it may occasionally be

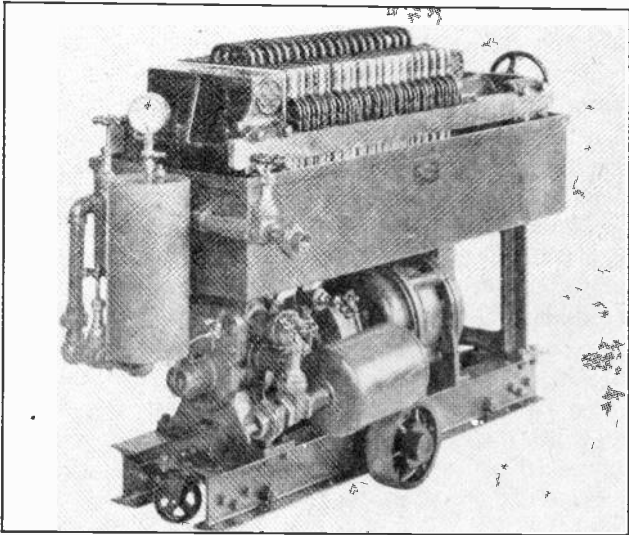

Fig. 10. This photo shows a filter press for cleaning and removing the moisture from insulating oil. Note the motor-driven pump mounted underneath the filter press. (Photo Courtesy General Electric Co.)

handy in emergencies. To do this, it is only necessary to heat the oil to a temperature slightly above the boiling point of water, or 212° F. Maintaining the oil at this temperature will gradually boil out the water.

The temperature of the oil should not be raised more than about 20° above the boiling point of water, or the excessive heat may injure the quality of the oil and lower its dielectric strength.

Oil filtering is accomplished by forcing the oil through a series of filter papers. These filter papers are similar to blotting papers. A number of them

Alternating Current

are held securely clamped in a special press, such as shown in Fig. 10; and oil is forced through these filter papers one after another, by means of an electrically-driven pump.

The filter papers will allow the oil to pass slowly through them, but will stop and hold most of the moisture. They will also stop most of the dirt and sediment which the oil may contain.

A pressure gauge is connected in the oil-circulating system between the pump and the filter press, so that the proper pressure may be maintained on the filter papers. After the pump has been started a few minutes, the pressure should be noted. If at any time during operation the gauge indicates a sudden pressure drop, the pump should be immediately shut down, because the reduced pressure is usually due to some of the filter sheets having been punctured by water.

It is then necessary to drain the oil from the filter and replace the punctured sheets as well as several adjacent sheets on each side of them. This is done in order to guard against missing a few sheets which have very small punctures that may not be easily seen.

The moisture-laden oil which is drained from the filter each time it is shut down, should be set aside and filtered at the end of the run. This will eliminate a lot of unnecessary shut downs, as a considerable amount of the water may have settled out of the bad oil during the time it was left standing.

Centrifugal oil separators such as the one shown in Fig. 11 separate the oil and water by whirling them at high speed, causing the two to leave the separator disks at different levels because of the different weights or specific gravities of oil and water.

This method is very rapid, convenient, and clean, and is very commonly used in large power plants and by power companies which have to clean large

Transformers

amounts of insulating oil from transformers, oil switches, etc.

Large transformers are usually provided with oil drain connections at the bottom of the tank and refilling connections at the top. It is not necessary to take a transformer out of service in order to

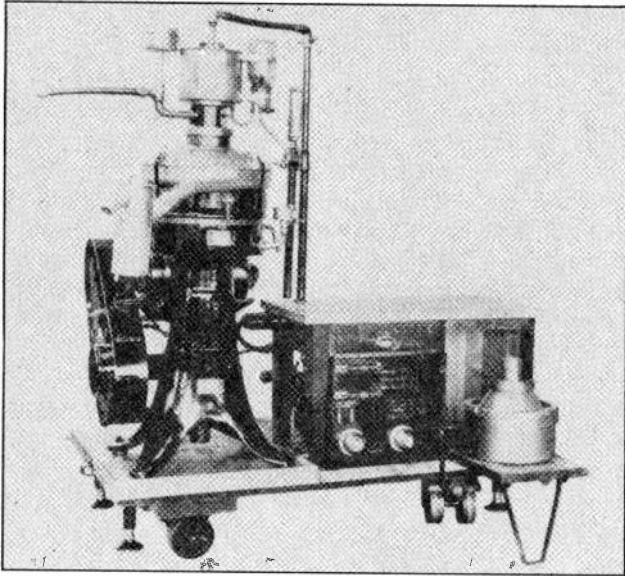

Fig. 11. Motor-operated centrifugal oil purifier which separates water and dirt from the oil by revolving them at high speeds. (Photo Courtesy General Electric Co.)

clean the oil, as connections can be made to both the bottom and top of the tank; so that the oil can be run through the filter press or centrifugal separator and the clean oil returned to the top of the tank as fast as the dirty oil is withdrawn from the bottom.

By this method some of the oil may, of course, be run through the cleaning process several times; but, as soon as the sufficient moisture and dirt have been removed so that a test sample of the oil in the transformer tests up to the proper voltage again, the cleaning process can be stopped and the filter

Alternating Current

or separator disconnected from the transformer.

Sometimes it is necessary to take a transformer out of service and thoroughly clean the tank and windings to remove all sediment and dirt from the bottom of the tank and also any accumulations of dirt or oil sludge which may be clinging to the windings and clogging up the oil circulation spaces, thus preventing proper cooling and causing the transformer to overheat.

There are many thousands of small and large transformers in use in power plants, substations, and industrial plants today; and it is because you will undoubtedly have frequent occasion to use a good working knowledge of these devices that their operating principles, connections, and care have been quite thoroughly covered in this lesson.

Transformers

EXAMINATION QUESTIONS

1. Draw a sketch showing how a current transformer and ammeter are connected for measuring the current in a power line.

2. How do the number of turns in the secondary of a current transformer compare to the number of turns in the primary?

3. What safety precaution should be taken before removing a meter from the secondary of a current transformer?

4. Draw a sketch showing a voltmeter and potential transformer properly connected together and connected to a power line.

5. Which transformer connection would you use for the problem given on the bottom of page 17?

6. Describe the procedure for making core and copper loss tests on transformers.

7. Describe two methods which may be used in drying out new power transformers that have been shipped without oil.

8. a. How does the presence of water in transformer oil affect the transformer?

b. What is the dielectric strength of good transformer oil?

9. a. What kind of oil is used in transformers?

b. What are the requirements of good transformer oil?

10. Name three methods by which transformer oil may be cleaned.

Alternating Current

ALTERNATING CURRENT MOTORS

By far the greatest part of all the electrical energy generated is used for power purposes, and most of this mechanical power is developed by alternating current motors.

A. C. motors are made in sizes from 1/1000 h. p. and less, up to 60,000 h.p. and over, and they can be built even larger if any need for more powerful motors arises.

A. C. motors are made to meet almost every conceivable need and condition in the driving of machinery and equipment of all kinds. Some of the latest type A. C. motors are designed to produce excellent starting torque and give a wide range of speed control, and many other desirable characteristics which it was formerly thought possible to obtain only with D. C. motors.

Alternating current motors have the advantage of practically constant speed; and the A. C. squirrel-cage induction motor, which is the most commonly used type, has no commutator or brushes and therefore eliminates all sparking and fire hazard and reduces the number of wearing parts.

A. C. motors are quiet, safe, and efficient in operation, and very convenient to control, and are therefore an ideal type of power device. An operator can start or stop a unit of several thousand h. p. by merely pressing a button of an automatic remote controller such as is used with many large A. C. motors.

A. C. electric motors are rapidly replacing steam and gas engines and other forms of power in older factories; and practically all new factories, mills, and industrial plants are completely operated by electric motors. Millions of A. C. motors are in use in machine shops, wood working shops, saw mills, automobile factories, and industrial plants of all kinds.

Motor installation and maintenance provides one of the greatest fields of opportunity in the entire electrical industry, for trained men to cash in on their knowledge in interesting and good paying work.

A. C. Motors

1. TYPES OF A. C. MOTORS

Alternating current motors are made in a number of styles or types, depending upon the class of service and type of power supply they are intended for. The most common of these are the **repulsion**, **induction**, and **synchronous** types.

Repulsion motors are used on single-phase circuits only, but induction and synchronous motors are made in single-phase, two-phase, and three-phase types.

Single-phase motors are most commonly made in sizes from $\frac{1}{2}$ to 10 h. p., although in a few cases larger ones are used. They are usually wound for circuits of 110, 220 or 440 volts.

Two-phase motors are still in use to some extent in a few older plants and factories, but the great majority of A. C. motors are three-phase. Three-phase motors are commonly made in sizes from $\frac{1}{2}$ h. p to several thousand h. p. each, and can be made as large as any present requirements demand.

2. VOLTAGE RATINGS AND SPEED

The majority of three-phase motors are operated at 220, 440 and 550 volts, but many of the larger ones of several hundred h. p. and up, are designed for voltages of 1100, 2300, and up to 12,000 volts.

Medium-sized A. C. motors are commonly made to operate at speeds ranging from 900 to 3600 R.P.M. and very large motors operate at lower speeds, from 200 to 600 R.P.M. Very small single-phase motors of the repulsion or series universal type are made to operate at speeds from 4,000 to 12,000 R.P.M.

Power motors of the higher speed types develop more h. p. for a given size than the low speed motors.

3. CONSTRUCTION FEATURES AND GENERAL PRINCIPLES

A. C. motors are also made with various types of open and enclosed frames, to adapt them to uses in different locations and under various conditions.

Fig. 4 shows a 5-h. p. three-phase, 220-volt, induction motor of a common type, such as is used by the tens of thousands in this country for turning the wheels of industry.

Alternating Current

Fig. 5 shows an A. C. motor with an enclosed-type frame, which keeps all dust and dirt from its windings.

The constructional features and general operating principles of A. C. motors have been covered in A. C. Armature Winding lessons, and so they need not be repeated in detail here. It will be a very good plan for you to carefully review lessons Nos. 29 and 30, particularly the last half of lesson 29, and get these points well in mind again before proceeding further with this lesson.

You have already learned that the principal parts of ordinary A. C. induction motors are the stator and rotor.

You will recall that the stator is commonly connected to the line and receives alternating current which sets up a revolving magnetic field around the inside of the stator winding. This revolving flux cuts across the bars or windings of the rotor, inducing a secondary current in them, and the reaction between the flux of the rotor currents and that of the revolving stator field produces the turning force or motor torque.

Fig. 6 shows the stator of an A. C. induction motor, and Fig. 7 shows a squirrel-cage rotor for the same type motor. Fig. 8 shows a sectional view of an induction motor, with the rotor in place inside the stator core.

Some A. C. induction motors have wire windings instead of bars such as are used on squirrel-cage rotors. These wire-wound rotors are called **phase-wound** rotors and will be explained in later paragraphs.

4. MOTOR CHARACTERISTICS

- Each of the different types of A. C. motors has certain different characteristics with respect to their starting torque, load "pull out" torque, speed regulation, power factor, efficiency, etc. It is very important for you to know these different characteristics and to be able to compare them for various motors, so you will be able to select the proper motors for the various power drives and applications you may encounter on the job.

Some of these motor characteristics you are already familiar with from your study of D. C.

A. C. Motors

motors; others of them apply only to A. C. motors and are covered for the first time in this lesson.

Motor characteristics depend largely on their design, and therefore the characteristics of any certain type of motor can be varied considerably by the manufacturers. Motors are available in common types with the required characteristics for most any power need, and for special requirements the designers and manufacturers can build motors of

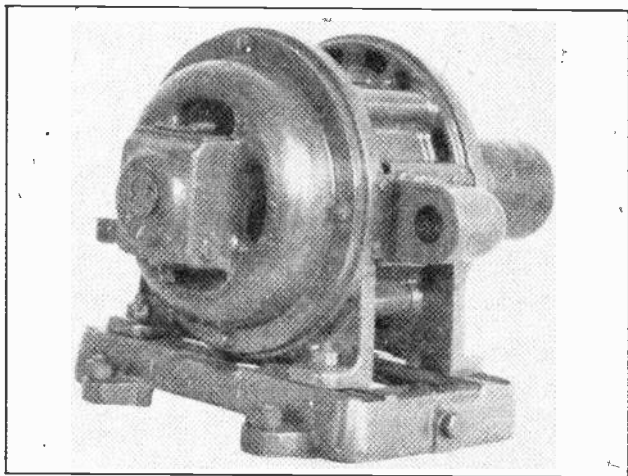

Fig. 4 Common type of 5-h. p. A. C. induction motor. Motors of this type are used by the thousands in factories and industrial plants throughout the country. (Photo courtesy General Elec. Co.)

just the proper type to fit the needs of most any job.

In the following pages we shall take up each common type of A. C. motor separately, and thoroughly explain its principles, characteristics, and applications.

Before doing this, however, there are a few general terms and expressions which apply to all A. C. motors and with which you should be familiar. These terms will be frequently used in explaining the various motors, and if you will carefully familiarize yourself with them now, it will make the following material much easier to understand.

Alternating Current

5. SYNCHRONOUS SPEED

The term **synchronous speed** as used in connection with A. C. motors refers to the speed in R.P.M. of the rotating magnetic field which is set up around the stator by the current supplied from the line.

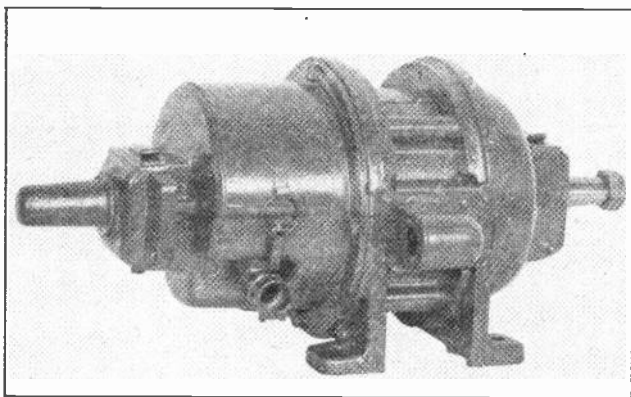

Fig. 5. A. C. induction motor with totally enclosed frame to keep out dust and dirt from the windings and also prevent fire and explosion hazard. (Photo courtesy General Electric Co.)

Synchronous motors revolve at the same speed as the rotating magnetic field in their stators, and thus maintain an absolutely constant speed as long as the frequency of the line current remains unchanged.

The speed of the rotating magnetic field of any A. C. motor and the operating speed of synchronous motors depend upon the frequency of the current on which they operate and the number of poles in their stator winding.

This synchronous speed can always be found by the simple formula:

$$S = \frac{120 \times f}{p}$$

In which:

S = synchronous speed in R.P.M.

f = frequency in cycles per sec.

p = number of poles in the motor.

120 = twice the number of seconds in one minute.

The constant 120 is used instead of 60 seconds per minute, because a pole of the rotor must pass one pair of poles during each cycle.

A. C. Motors

For example, if a four-pole motor is operated on a 60-cycle circuit, its synchronous speed will be:

$$S = \frac{120 \times 60}{4}, \text{ or } 1800 \text{ R.P.M.}$$

6. SLIP

A. C. induction motors never operate at exactly synchronous speed, as their rotors must always turn at slightly lower speed than the rotating magnetic field, in order that the lines of force will cut across the rotor conductors and induce the necessary current in them.

This difference between the actual operating

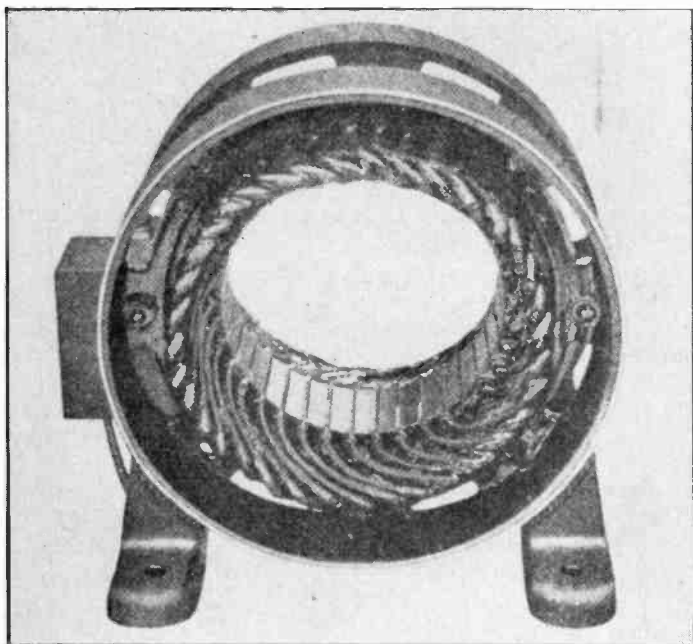

Fig. 6. This view shows a stator of an induction motor with the end shields and rotor removed. When A. C. is applied to the winding a revolving magnetic field is set up around the inside of the stator core.

speed of induction motors and the speed of their rotating magnetic fields is called the **slip** of the motor. The slip is generally expressed in per cent. of synchronous speed.

Alternating Current

For example, if a six-pole induction motor is operated on a 60-cycle circuit, it will have a synchronous speed of 1200 R.P.M., but its actual speed when fully loaded is only 1140 R.P.M.

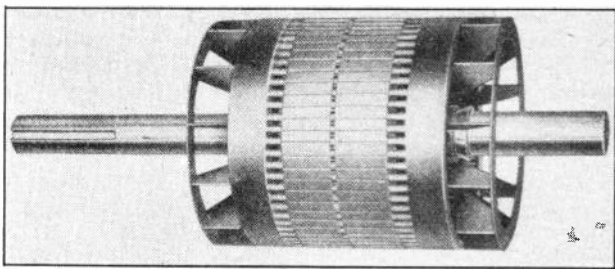

Fig. 7. Squirrel-cage rotor from an A. C. induction motor. Note the manner in which the bars are imbedded in the core slots and also note the ventilating fans at the ends of the rotor.

To find the per cent. slip, we can divide the amount of slip by the synchronous speed, or in the case of the motor just mentioned, $1200 - 1140 = 60$

R.P.M. of slip, and $\frac{60}{1200} = .05$, or 5%, slip.

The slip of a motor will vary with the amount of load. Increasing the load causes the rotor to slow down a little and allows the magnetic field to cut across the rotor conductors more rapidly, and thereby develop in the rotor the increased amount of induced current needed to maintain the added torque for the heavier load.

The slip of various induction motors usually ranges from 2 to 8 per cent., according to the size and type of motor and the amount of load connected to it. The larger motors have less slip than small ones.

7. TORQUE: STARTING, RUNNING AND PULL-OUT

You have already learned that the term **torque** applies to the twisting or turning effort developed by a motor. Torque is expressed and measured in **pounds-feet**; a torque of twenty pounds-feet being equal to a pull of 20 lbs. at a radius of one foot, or a pull of 10 lbs. at a radius of 2 feet, etc.

A. C. Motors

You have also learned that the important periods of torque to consider in selecting motors of proper characteristics, are: the starting torque, full load torque, and pull-out or stalling torque.

The full load torque of a motor is taken as a base and the starting and stalling torque are compared with it, and expressed as a certain percentage of the full load torque. For example, if a motor has a full load torque of 15 pounds-feet, and a starting

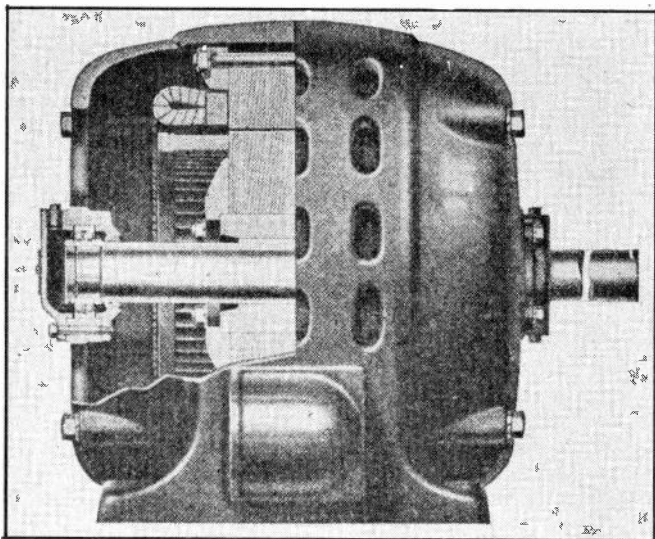

Fig. 8. Sectional view of a squirrel-cage induction motor showing the position of the rotor and bars with respect to the stator core and winding.

torque of 30 pounds-feet, the starting torque is two times the full load torque, or 200%.

As the full load torque is used as a base for comparison, it is important to have some means of determining this torque. The full load torque of a motor can be found by the following formula.

$$T = \frac{5252 \times \text{H. P.}}{\text{R.P.M.}}$$

In which:

- T = full load torque in pounds-feet.
- 5252 = constant.
- H.P. = horse power rating of motor.
- R.P.M. = motor speed in rev. per min.

Alternating Current

As an illustration, if a 10 h. p. motor has a speed of 1800 R.P.M., its full load torque would be:

$$\frac{5252 \times 10}{1800}, \text{ or } 29.2 \text{ -- pounds-feet}$$

The **starting torque** or turning effort exerted by a motor during starting is very important and should always be considered when selecting motors that are to start up under heavy loads. The starting torque of common induction motors will vary from 2 to 5 times the full load torque, according to the design of the motor and the amount of line voltage applied during starting.

The starting torque of an induction motor varies directly with the square of the applied voltage during starting.

The **pull-out torque** of a motor is the torque required to cause the motor to pull out of step with the line frequency, slow down, and come to a complete stop if the overload which exceeds the pull-out torque is left on the machine. In other words, the pull-out torque expresses the ability of a motor to carry overloads without stalling.

The pull-out torque of common A. C. motors ranges from 1½ to 3 times full load torque.

The starting torque, full load torque, and pull-out torque of an A. C. motor can be found by means of the brake horse-power test which was explained in Articles 29 and 30 in lesson No. 40 on Direct Current motors.

8. EFFICIENCY AND POWER FACTOR

As you have already learned, the efficiency of any motor is the ratio of its output to input, or

$$\text{eff.} = \frac{\text{Mech. h. p. output}}{\text{Elec. h. p. input}}$$

The mechanical h. p. output of any motor can be determined by means of the brake h. p. test, and the electrical h. p. input can be found by using a wattmeter or voltmeter, ammeter, and power factor indicator, and then dividing the watts by 746.

The efficiency of A. C. motors varies with their design and also with their size. The efficiency of common induction motors generally ranges from

A. C. Motors

about 78% to 82% on motors of 1 to 5 h. p., and up to 90% or better on motors from 25 h. p. to several hundred h. p.

The efficiency of any A. C. motor is always higher when the motor is operated at or near full load, and becomes much lower when the motor is operated lightly loaded.

This is also true of the power factor of A. C. motors. The power factor of large motors is usually higher, ranging from 78% to 85% for motors of 1 to 5 h. p. to 93% for motors of 200 h. p. and up. The power factor of an induction motor is much better when the motor is fully loaded, and is very poor when motors are operated lightly loaded or without any load.

The method of determining the power factor of any A. C. machine or device was explained in lesson No. 46.

Very often in ordinary field problems, where approximate figures are all that are required, if the power factor and efficiency of certain motors are not known, they are both assumed to be about 80% for induction motors of 1 h. p. to 10 h. p., and about 88% for motors of 10 to 50 h. p.

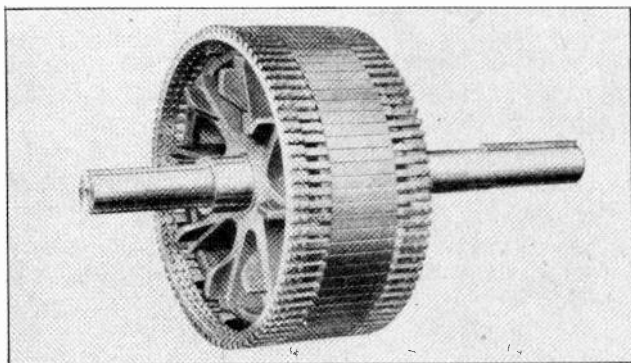

Fig. 9. This photo shows an excellent view of a squirrel-cage rotor using square bars which are riveted to heavy end rings.

Synchronous A. C. motors can be made to operate at 100% or unity power factor, or even at a leading power factor if desired, by properly exciting their D. C. fields. This will be explained in the lesson on synchronous motors.

Alternating Current

9. HORSEPOWER, VOLTAGE AND FREQUENCY RATINGS

Motors as well as other electrical machinery have their load ratings or maximum output capacity determined by the heat developed in them. A. C. motors heat up due to copper losses and core losses, as explained in the lesson on transformers. The horse power rating of any A. C. motor is the load it can carry continuously without overheating.

Unless otherwise specified, motors are usually rated at full load with a 40° C. rise in temperature. Most A. C. motors are designed to carry overloads of not over 25% for periods of 2 hrs. with a temperature rise not exceeding 55° C.

Nearly all modern motors have their h. p. ratings and temperature rise limits stated on their name-plates.

The voltage given on the name-plate of a motor is the proper voltage at which the motor should be operated. Practically all ordinary A. C. motors are designed to give full-load rating as long as the voltage does not vary more than 10% above or below normal, provided other conditions are normal.

A. C. motors will develop full rated h. p. on frequencies not exceeding 5% variation above or below the normal frequency for which they are designed, provided the voltage and other conditions are normal.

If the voltage and frequency of the line are both off normal, their combined variation should not exceed 10%.

10. CURRENT RATINGS

The name-plate current rating of an A. C. motor refers to the current required by the motor at full load. This current can also be found by placing an ammeter in any one of the line leads to the motor when it is operating at full load.

For example, a three-phase motor having a name-plate rating of 25 amperes should give an ammeter reading of 25 amperes in each of the three line leads to the motor, when operating at full load.

The approximate current of a three-phase motor can easily be determined by the following formula:

A. C. Motors

$$I = \frac{\text{h. p.} \times 431}{\text{eff.} \times \text{P. F.} \times E}$$

This is a simplified formula used to shorten the working of such problems. The current can also be found by first converting the h. p. into watts and dividing this by the product of efficiency and power factor to get the apparent power; and then using the three-phase current formula given in Article 8 in A. C. lesson No. 46.

The table in Fig. 10 gives the approximate currents for standard A. C. squirrel-cage induction motors of different h. p. and voltage ratings, and of single, two, and three-phase types.

Special squirrel-cage motors with high reactance rotors, and motors with phase-wound rotors may

Approximate Currents taken by Standard Squirrel Cage Motors (Full Load)															
SIZE OF MOTOR IN H.P.	110 Volts			220 Volts			440 Volts			550 Volts			2200 Volts		
	1 Ph	2 Ph	3 Ph	1 Ph	2 Ph	3 Ph	1 Ph	2 Ph	3 Ph	1 Ph	2 Ph	3 Ph	1 Ph	2 Ph	3 Ph
1/6	3.34			1.67											
1/4	4.8			2.4											
1/2	7.	4.3	5	3.5	2.2	2.5		1.1	1.3	.9	1.				
3/4	9.4	4.7	5.4	4.7	2.4	2.8		1.2	1.4	1.0	1.1				
1	11.	5.7	6.6	5.5	2.9	3.3		1.4	1.7	1.2	1.3				
1 1/2	15.2	7.7	9.4	7.6	4.	4.7		2	2.4	1.6	2.				
2	20	10.4	12	10	5	6		3	3	2.	2.4				
3	28			14	8	9		4	4.5	3	4				
5	46			23	13	15		7	7.5	6	6				
7 1/2	68			34	19	22	17	9	11	7	9				
10	86			43	24	27	21.5	12	14	10	11				
15					33	38		16	19	13	15				
20					45	52		23	26	19	21				
25					55	64		28	32	22	26			6	7
30					67	77		34	39	27	31			7	8
40					88	101		44	51	35	40			9	10
50					108	125		54	63	43	50			11	13
60					129	149		65	75	52	60			13	15
75					156	180		78	90	62	72			16	19
100					212	246		106	123	85	98			22	25
125					268	310		134	155	108	124			27	32
150					311	360		155	180	124	144			31	36
200					415	480		208	240	166	195			43	49

Fig. 10. The above convenient table gives the approximate current per phase required by common squirrel-cage motors of different sizes and different voltages.

take from 1 to 5 amperes more than the current ratings given in the table for the same h. p. and voltage.

Alternating Current

11. SINGLE-PHASE MOTORS

Single-phase motors are quite extensively used in small sizes, ranging from $\frac{1}{4}$ h. p. or less to 10 h. p. for general purposes. Special single-phase motors for railway service are sometimes made as large as several hundred h. p., but for general industrial power purposes they are seldom made larger than 10 h. p.

Small single-phase motors from $\frac{1}{6}$ to $\frac{1}{2}$ h. p. find a very wide application in the operation of small power-driven machines in homes and small shops, where it is desirable to operate these devices from the ordinary single-phase lighting circuits.

Washing machines, electric ironers, oil burners, refrigerators, fans, pumps, drill presses etc., are commonly driven by motors of this type.

Some idea of the great extent to which fractional h. p. single-phase motors are used can be obtained from the fact that several millions of new motors of this type are manufactured each year.

For operating machines or equipment requiring more than one h. p., it is seldom advisable to use single phase motors if three-phase service is available, as the efficiency and power factor of single-phase machines is considerably lower than with three-phase motors. For a given horse power, a single-phase motor must be considerably larger than a three-phase motor of the same rating.

Single-phase motors are made in several different types, the most common of which are: **split-phase**, **repulsion**, **repulsion-induction**, and **series universal motors**.

Another type sometimes used is known as the **shaded-pole**, single-phase, induction motor.

Straight single-phase motors can be made with just one winding in the stator, and a few of the older type motors were made this way. A motor of this type will not start itself, but if it is started by hand or by some other method, it will develop torque due to the reaction between the stator flux and the flux of the current induced in the rotor once it is started to run.

Single-Phase Motors

12. SPLIT-PHASE, SINGLE-PHASE MOTORS

The split-phase principle is used to make single-phase motors self-starting and is in reality a simple method of obtaining a sort of polyphase winding and field.

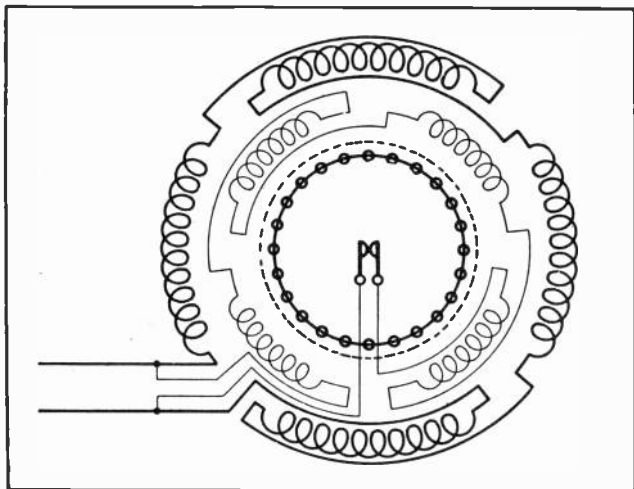

Fig. 11. This sketch shows the connections of the starting and running windings of a single-phase, split-phase A. C. motor.

One of the most common ways of obtaining this split-phase effect is by winding the stator with two sets of coils, the poles of which are displaced from each other by 90 electrical degrees. The main winding is known as the "running" winding, and the starting winding, which consists of fewer turns of smaller wire, is used only during the starting of the motor.

As soon as the motor is nearly up to speed, the starting winding is disconnected and cut out of service by a centrifugal switch, as explained in Article 15 of lesson 29 on Armature Winding.

Fig. 11 shows a simple schematic diagram of a single-phase, split-phase induction motor. The running winding is shown by the heavy lines and the starting winding by the lighter lines. The squirrel-cage rotor is represented by the circular ends of the bars which are shown arranged in the circle in the

Alternating Current

center of the diagram and are all short-circuited together by a ring. The dotted circle represents the air-gap or division between the stationary and rotating members of the machine.

13. SPLIT-PHASE MOTOR PRINCIPLES

You will recall from the explanation given in lesson 29 on Armature Winding that the current which flows in the starting winding of a split-phase motor is considerably out of phase with that in the running winding, because of the different amounts of inductance and resistance in these two windings.

This causes the maximum current and flux to occur in these poles a fraction of a second earlier than in the poles of the running winding and produces a sort of shifting or rotating magnetic field around the stator. This rotating flux cuts across the bars or windings in the rotor and induces in them a heavy secondary current at low voltage.

The reaction between the stator flux and the flux of the rotor currents sets up the starting torque required to rotate the motor and bring it up to speed. After the rotor is turning at full speed the split-phase effect and starting winding are not necessary, as the normal reaction between the flux of the moving rotor conductors and the alternating flux of the stator will then maintain the running torque. ■

The centrifugal switches of motors of this type are arranged with weighted contacts or segments which are thrown apart by centrifugal force when the motor reaches full speed. The contacts of these switches are connected in series with the starting winding, as shown in Fig. 11; so they keep this winding open-circuited as long as the motor continues to run at full speed.

When the motor is stopped or slows down below a certain speed, the centrifugal force on the switch elements is reduced and a spring causes the contacts to again close and bring the starting winding back into service.

14. ROTOR CONSTRUCTION

Fig. 12 shows the squirrel-cage rotor of a small single-phase motor, and also the centrifugal switch

Single-Phase Motors

which is attached to the plate on the right-hand end of the rotor. The copper bars of the rotor shown in this view are imbedded in slots in the laminated rotor core. The narrow openings of these slots can be noted in the figure.

The bars are, of course, too large to be inserted

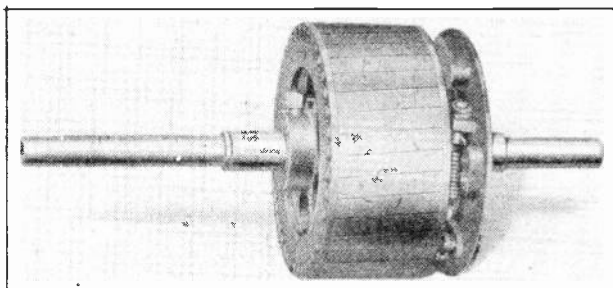

Fig. 12. Small squirrel-cage rotor such as used in single-phase induction motors. Note the centrifugal switch mechanism on the right end.

through these openings and are therefore inserted endwise through the slots. The end rings which short-circuit the bars to complete the closed circuits under each pole of the stator winding are shown fitted tightly to the sides of the laminated core. These end rings are securely attached to the bars by riveting the bar ends tightly into the holes in the rings or by brazing or soldering them in.

In some cases the squirrel-cage element complete, consisting of the bars and end rings, is cast from aluminum in one piece within the rotor core. On large squirrel-cage rotors the bars are sometimes bolted or welded to the end rings.

The bars of squirrel-cage rotors are usually not insulated from the slots, as the copper or aluminum from which the bars are made is of so much lower resistance than the core iron that the low-voltage induced currents practically all flow through the bars because they afford the easier path. In some cases, however, the rotor bars are insulated with a layer of stiff paper around them.

To reverse a split-phase motor of this type it is necessary to reverse either the starting winding or the running winding leads. Some single-phase

Alternating Current

motors have their windings arranged so the coils can be connected either in series or parallel for operation on either 110 or 220 volts, and motors of this type also have four leads brought out of the frame.

The standard direction of rotation is clockwise when the motor is viewed from the end on which the pulley is placed or the end which has the shaft extension for the pulley.

15. CONDENSER TYPE SPLIT-PHASE MOTORS

The split-phase principle can be applied to single-phase motors by the use of a condenser or an in-

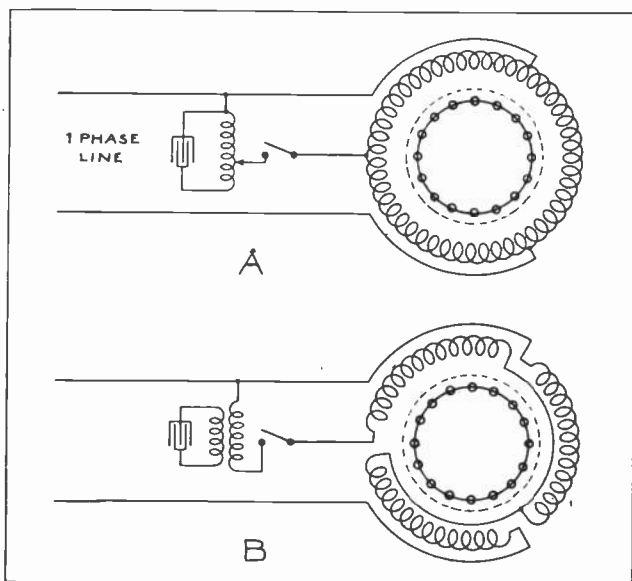

Fig. 14. The above two diagrams show the connections for two different types of single-phase, split-phase motors which use condensers and transformers to obtain the split-phase currents for their stator windings.

ductance placed in series with one section of the stator winding. The leading or lagging current which is set up in the circuit by the condenser or inductance produces the separation or split-phase effect of the magnetic fields which occur in the different sections of the motor winding.

Figs. 14, A and B show two different methods

Single-Phase Motors

used with split-phase motors of this type. These motors use a three-phase winding and depend upon the third wire from the condenser or inductance to supply current which is displaced in phase from that on either of the other two leads to the winding.

Another method which is quite often used with a later type of fractional h. p. single-phase motor is to use two windings displaced 90° from each other, one of which has a condenser connected in series with it. Both windings are left permanently connected to the line and the motor operates similarly to a two-phase motor.

This method entirely eliminates the use of the centrifugal switch. This is a particularly desirable feature because the operation of motors equipped with centrifugal switches often causes considerable interference with radio receiving sets, as when the motors of such devices as oil burners refrigerators, and washing machines are started and stopped.

By using the proper size of condenser the lagging current effects produced by the motor windings can be neutralized to quite an extent by the leading current produced by the condenser. In this manner it is possible to obtain with these new single-phase motors much higher power factor than the older types have.

Fig 15 shows a condenser-type motor for single-phase operation. This motor uses a poly-phase winding and has a regular squirrel-cage rotor, both of which can be clearly seen in this disassembled view. The condenser is shown completely enclosed in the metal box on the right.

16. SHADED-POLE MOTORS

Another method of producing torque in a single-phase A. C. motor is by the use of shaded poles similar to those explained under A. C. induction meters in Article 10 of lesson 47 on Alternating Current.

Fig. 16 A shows a diagram of a 6-pole single-phase motor of the shaded-pole type, and at B is illustrated the manner in which the shading coil distorts the magnetic flux of the main pole.

The shading coil consists of a small coil of a few turns of wire wound into a slot and around one side

Alternating Current

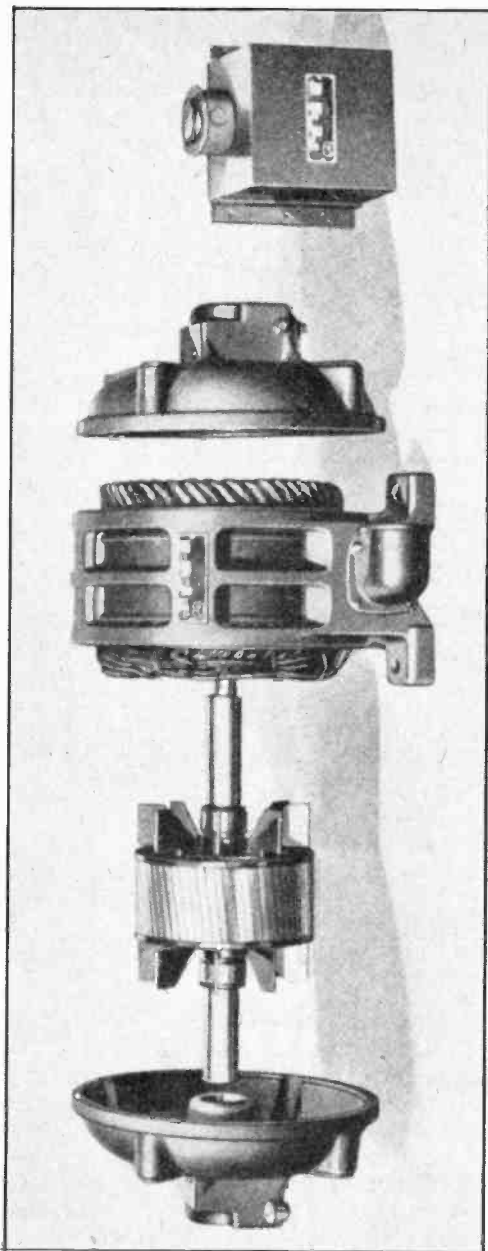

Fig. 15. This photo shows an excellent disassembled view of a squirrel-cage induction motor for single-phase operation and also the condenser by which it obtains the split phase currents for its stator winding.

Single-Phase Motors

of the main pole. This coil is short-circuited, so that it always forms a complete circuit and acts as a secondary winding, receiving induced current from the flux of the main pole winding.

When the main winding is excited with A. C. it sets up a powerful alternating magnetic field which induces current in the rotor bars and also in the short-circuited shading coil. The induced current in the shading coil sets up a flux approximately 90° out of phase with that of the main winding.

The flux set up by the shading coil will therefore distort the flux of the main pole as shown at B in Fig. 16.

The reaction between these two magnetic fields which are out of phase with each other causes a

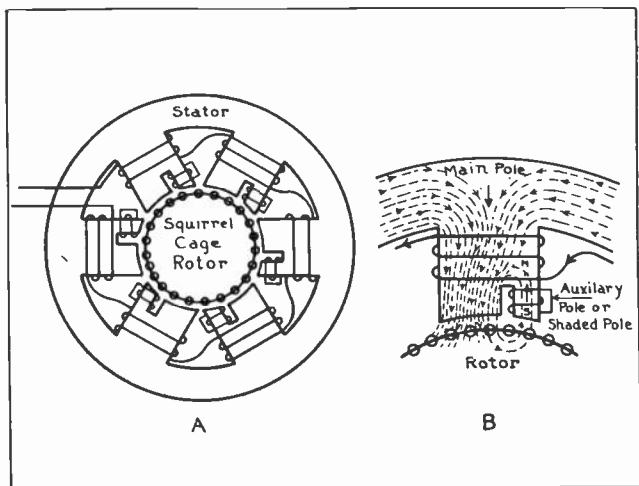

Fig. 16. The above two sketches show the construction and illustrate the principles of the shaded-pole type induction motor.

shifting flux across the face of the main poles, which produces a sort of rotating field effect.

This shifting or rotating field from the shaded stator poles reacts with the flux of the induced current in the rotor and sets up the torque required to operate the motor.

Motors of this type are self-starting and do not require any centrifugal switches or other circuit-breaking devices. They can be reversed by chang-

Alternating Current

ing ends with the stator or rotor, that is by removing the rotor, changing it end for end and replacing it in the stator.

Shaded-pole motors are used in some electrical fans and for certain other devices requiring fractional horse power motors, but they are not, used very often in larger sizes because of their rather low power factor and efficiency.

17. REPULSION MOTORS

Another type of single-phase motor very commonly used is the **repulsion** motor. This motor doesn't operate on the split-phase principle but obtains its torque by repulsion between definite poles induced in the rotor and the poles set up in the stator by the current supplied from the line.

Fig. 17 shows a simple diagram of a single-phase repulsion motor. The stator of this machine has only one winding which is excited by alternating current from the line and sets up an alternating field or reversing magnetic poles in the stator.

The rotor, which is represented by the symbol for the commutator has a wire winding of the wave type similar to that used in D. C. motors. The brushes which rest on the commutator are short-circuited together so they form complete circuits through various sections of the armature winding.

The alternating flux set up by the stator winding induces secondary currents in the rotor or armature winding, and these currents flowing through the paths created by the commutator bars and shorted brushes set up definite alternating poles at certain points on the rotor.

Only two brushes are required with ordinary wave windings but four brushes are quite commonly used on motors of four or six poles. The two small sketches at the right in Fig 17 show different methods of connecting the brushes for short-circuiting them together. In some cases the brushes are simply grounded to the frames or to a metal ring, as illustrated in the lower small sketch at the right in this figure.

The great majority of repulsion motors are made in the four-pole type, but a few of the two-pole and six-pole type are also made.

Single-Phase Motors

18. OPERATING PRINCIPLE

The location of the poles set up by the induced current in the rotor will depend upon the position in which the brushes are set. These brushes are located so that the centers of the induced rotor poles will be built up at a point a few electrical degrees to one side or the other of the center of the stator poles; and so that the polarity of the induced poles in the rotor will be the same as the polarity of the nearby stator pole.

The magnetic repulsion which takes place between these like poles which are only a few degrees apart from each other will exert a strong turning force on the rotor and thus develop the torque required to operate the motor.

By shifting the brushes a short distance, the in-

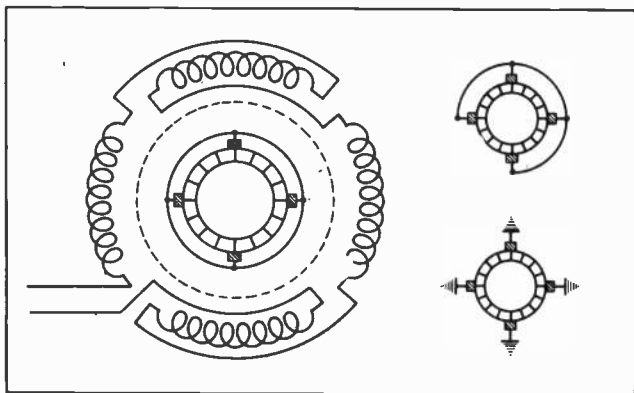

Fig. 17. This diagram shows the connections of the stator winding and brushes of a single-phase A. C. repulsion motor.

duced rotor pole can be set up on the opposite side of the stator pole and thus cause the motor to reverse its direction of rotation.

The speed of repulsion motors can also be varied widely by shifting the brushes so that the rotor poles are induced at a point closer to or farther away from the stator poles.

Repulsion motors produce very good starting torque and have fair efficiency and power factor.

19. COMPENSATING WINDINGS

In some cases they are equipped with an auxiliary winding which is connected to an extra set of

Alternating Current

brushes and is known as a **compensating winding**. Fig 18 shows the connections for the compensating winding of a motor of this type. The compensating winding is the one shown in lighter lines and is connected to brushes B and B-1. Brushes A and A-1 are the main brushes which short-circuit

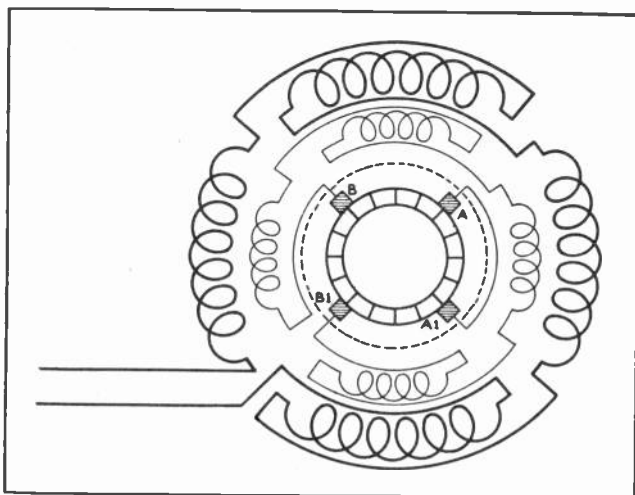

Fig. 18. Diagram of the connections for a repulsion motor with a compensating winding which improves the power factor of this type of machine.

the proper sections of the rotor winding to produce the regular motor torque.

The purpose of this compensating winding is to improve the power factor and stabilize the speed of the repulsion motor.

Repulsion motors are commonly made in sizes from fractional h. p. to 10 h. p. They, of course, have the disadvantage of requiring a commutator and brushes, which add extra wearing parts to the motor and at times cause a certain amount of sparking if they are not properly cared for.

Fig. 19 shows a disassembled view of a single-phase repulsion motor. Note the single-phase winding in the stator core and the typical D. C. armature winding on the rotor. The other parts shown are the end shields, bearing sleeves, rings, brush holders and ring, end-bracket bolts, brushes, and the rails upon which the motor frame is mounted for belt tightening adjustment.

Single-Phase Motors

20. REPULSION-INDUCTION MOTORS

Single-phase repulsion-induction motors are simply a combination of the repulsion and induction motor principles. A motor of this type starts as a repulsion motor and runs as an induction motor; thus, the name, repulsion-induction motor.

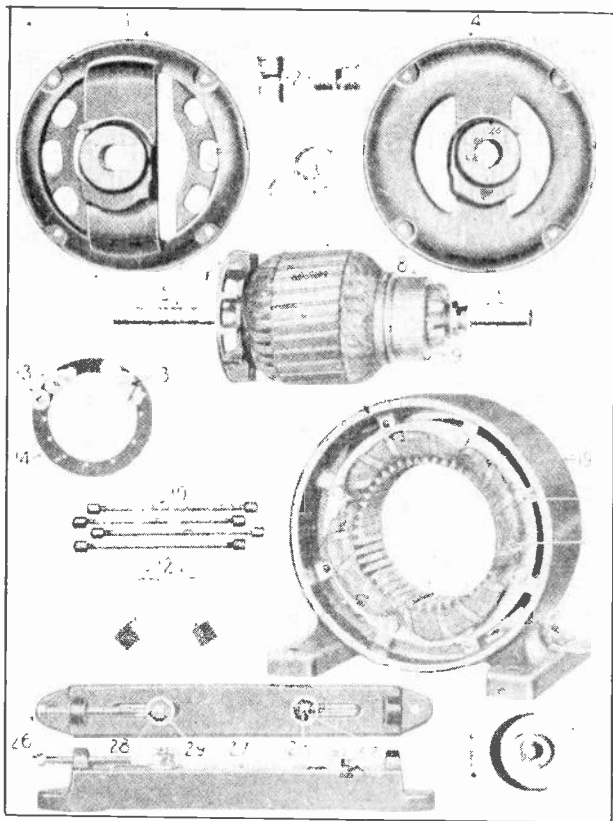

Fig. 19. Disassembled view showing important parts of an A. C. single-phase repulsion motor.

These motors have one winding in the stator and a wire-wound armature equipped with a commutator and brushes as shown in Fig. 20. During starting, the brushes rest on the commutator, thus short-circuiting only certain sections of the rotor winding, setting up like poles near the stator poles,

Alternating Current

and causing the repulsion torque, the same as the straight repulsion motor.

When the motor reaches nearly full speed a centrifugal device, shown at "A" in Fig. 20 short-circuits all the bars of the commutator together, thus shortening the entire rotor winding and making it act similarly to a squirrel-cage winding.

In some cases the centrifugal device also lifts the starting brushes off the commutator to reduce the wear on the commutator and brushes while the machine is running normally.

After the commutator is shorted, the machine runs as an ordinary single-phase induction motor. In this manner, good starting torque and moderate starting current of the repulsion motor are obtained

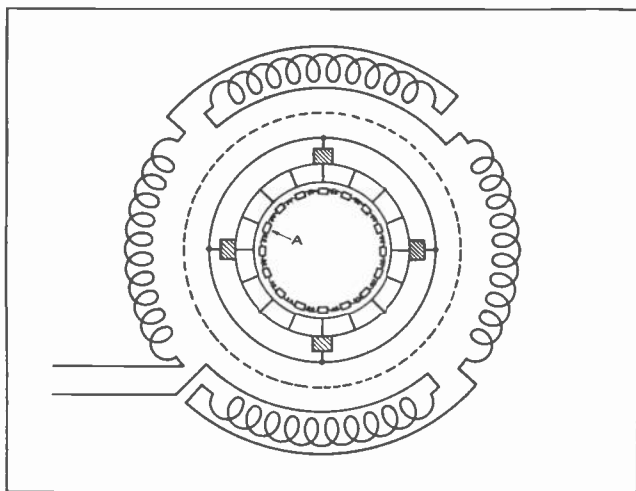

Fig. 20. This diagram shows the connections and arrangement of the short-circuiting device of a repulsion-induction motor. The short-circuiting mechanism at "A" lays around the inside of the commutator bars and short-circuits them all together when the machine comes up to speed.

during starting of the load, and the motor when running operates with the constant speed characteristics of an induction motor.

By equipping these motors with a compensating winding, their power factor can be kept very high when operating at full speeds. Repulsion-induction motors will develop from $2\frac{1}{2}$ to 5 times full load torque during starting and require only from about 2 to $2\frac{1}{2}$ times full load current for starting.

Single-Phase Motors

21. SERIES OR UNIVERSAL A. C. MOTORS

If a motor has a wire-wound armature and a commutator of the D. C. type connected in series with its stator winding as shown in Fig. 21 and is then connected to a single-phase A. C. line, the motor will operate very much the same as a series D. C. motor. This is due to the fact that when the armature and stator are connected in series, the alternating current reverses in both of these windings

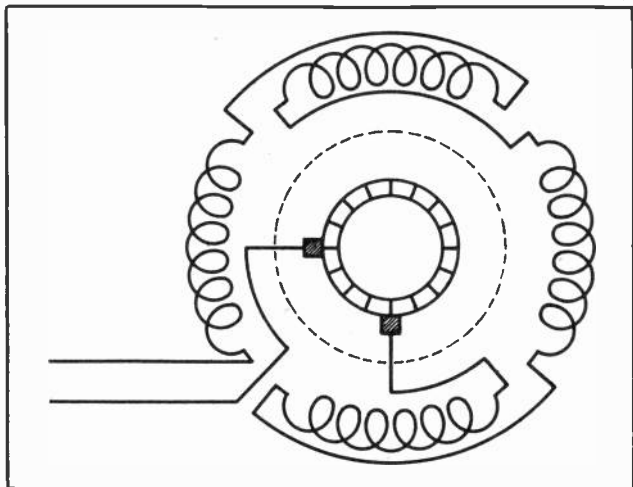

Fig. 21. Stator and armature connections for a series A. C. motor of the universal type which can be operated on either D. C. or A. C.

at the same time and causes the magnetic poles set up in the rotor and stator to also reverse at the same time and thereby retain a fixed relation to each other at all times.

As an illustration: We know that if we reverse both the armature and field leads of a shunt D. C. motor, the machine will continue to operate in the same direction; so we can see that if the polarity of both the armature and field are reversed continually but always at the same time, the motor will continue to develop torque in one direction.

Small ordinary D. C. motors can be operated in this manner on single-phase alternating current, provided the field poles are of laminated construction so they don't overheat due to eddy currents when alternating current is applied.

Alternating Current

It is because of the fact that this type of motor can be operated either on direct current or alternating current that it is very commonly called a **universal** motor.

A great many small, fractional horse power, universal motors are made for use with electric fans, household appliances, dentists' tools, and other equipment which may have to be changed from D. C. circuits to A. C. circuits.

The characteristics of series A. C. motors are very similar to those of D. C. series motor. The A. C. series motor will produce excellent starting torque but has very poor speed regulation.

The speed of these motors can be varied either by connecting a rheostat in series with them or by varying the applied voltage with an auto transformer.

Series A. C. motors of large sizes are quite commonly used in traction service on electrically-operated railway cars and locomotives.

Besides having the necessary starting torque and speed variation range which are ideal for railway work, these motors possess the added advantage of being able to operate on either D. C. or A. C. trolleys.

For example, the New York, New Haven & Hartford Railroad have been using motors of this type for many years. Their trains are operated on alternating current when outside of New York City, and when within the city they operate from direct current.

22. STARTING SINGLE-PHASE MOTORS

Single-phase motors of fractional h. p. and those up to 2 h. p. are commonly started by connecting them directly across the line. Snap switches are generally used for starting those under $\frac{1}{2}$ h. p., and small knife-switches of the enclosed safety type are used for starting those over $\frac{1}{2}$ h. p.

Single-phase motors of 2 h. p. to 10 h. p. are often started with a simple starting-box of the resistance or inductance type, to reduce the starting voltage and prevent too heavy surges of starting current.

Single-Phase Motors

The use of starting boxes is particularly desirable where the motors are operated from circuits to which lights are connected, as otherwise the heavy starting currents may cause objectionable voltage drop and dimming of lights.

Where the motors are operated from power circuits, even the largest single-phase motors are sometimes started directly across the line.

EXAMINATION QUESTIONS

1. Name two advantages of A. C. Motors.
2. What would be the synchronous speed of a 2 pole A. C. motor operating on a 25 cycle line?
3. What would be the percentage of slip on a 4 pole induction motor operating on a 60 cycle line and developing an actual speed of 1710 R.P.M.?
4. Give the formula for use in determining the full load torque of motor.
5. Under what conditions do A. C. motors operate at low power factor?
6. Name four types of single-phase A. C. motors.
7. Describe the construction of a squirrel cage rotor.
8. What type rotor is used in the repulsion motor?
9. When does the repulsion induction motor operate as an induction motor?
10. What type motor may be used on either D. C. or A. C.?

POLYPHASE A. C. MOTORS

Polyphase A. C. motors are the most extensively used of any form of power device. They are made in a wide range of sizes from $\frac{1}{2}$ h. p. up to thousands of h. p. each, and are designed to operate at speeds from less than 100 R.P.M. to 3600 R.P.M. on 60 cycles.

Polyphase motors are self-starting without the aid of auxiliary windings or centrifugal switches. The most commonly used type of polyphase motor has no commutator or brushes, and therefore has very few wearing parts and produces no sparking hazard.

Polyphase motors can be obtained to fit practically any class of drive or power need, and these are by far the most common type motors used for large power equipment. Fig. 1 shows a modern polyphase induction motor.

There are three general types of polyphase motors, known as: **squirrel-cage induction** motors, **slip ring** or **phase-wound induction** motors, and **synchronous** motors.

Any of these types can be obtained for either two or three-phase operation, but two-phase motors are not very extensively used any more.

1. OPERATING PRINCIPLES

The operating principles of both two and three-phase motors were explained and illustrated on pages 3 to 6 inclusive in lesson 30 of Armature Winding, and before proceeding farther with this lesson you should carefully review these articles and Figs. 1 and 2 of lesson 30.

You will recall that the stator winding of a polyphase motor sets up a revolving magnetic field, which induces secondary currents in the rotor winding or bars. The reaction between the flux of the stator winding and the flux of this rotor current causes a smooth and powerful torque which turns the rotor.

Polyphase Motors

As explained in Armature Winding, Lesson 30, two-phase motors have two windings which are displaced 90 electrical degrees from each other in the stator core.

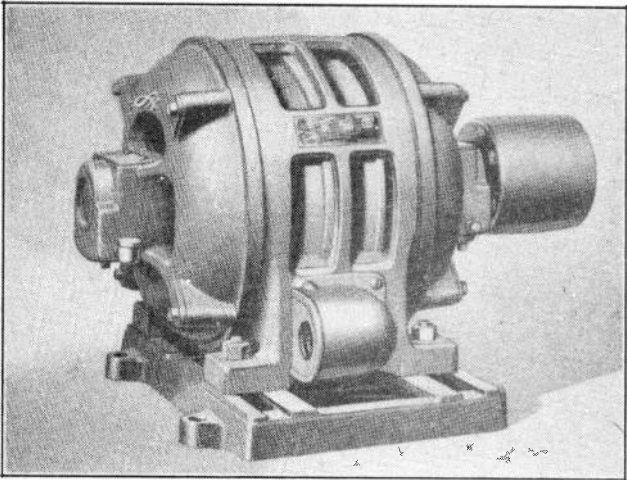

Fig. 1. This photo shows a modern polyphase induction motor. The three phase leads from the line are connected to the stator leads in the connector box shown on the side of the frame.

A simple method of representing the windings of a two-phase motor in electrical diagrams is shown in Fig. 2. The two small sketches in Fig. 2-B show the two-phase "mesh" or delta connection above, and the two-phase star connection below.

When two-phase motors are equipped with wound rotors, regular three-phase wound rotors are generally used. This eliminates the need for four collector rings, and the three-phase rotor winding works equally well on the induced current which it receives from the rotating magnetic field of the stator.

When the stator windings shown in Fig. 2-A are supplied with two-phase current, a rotating field is set up, as explained in lesson 30. This rotating magnetic field will induce secondary currents in the squirrel-cage, or in a wound rotor, whichever is used; and the reaction between the flux of the

Alternating Current

rotor currents and that of the stator field produces the motor torque.

The same squirrel-cage rotor can be used in either a two-phase or three-phase motor, provided they both have the same diameter of stator core opening.

Two-phase motors can be reversed by reversing the leads of either phase.

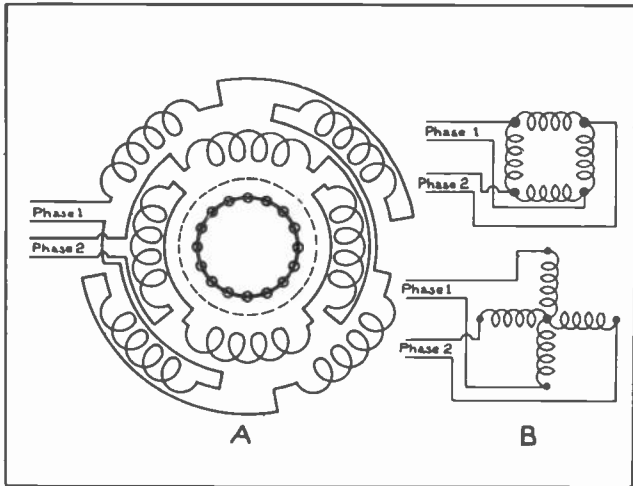

Fig. 2. A. This diagram shows the connections of the stator windings of a two-phase induction motor. At B are shown two schematic diagrams illustrating different methods of connecting two-phase windings.

2. THREE-PHASE MOTORS

As three-phase energy is so convenient and economical for power transmission purposes and as it is also ideal for producing a uniform revolving field in polyphase motors, three-phase motors are by far the most commonly used of any type of electric motor, for the heavier power needs.

In lesson 30 on Armature Winding we learned that the stators of three-phase motors have a uniform and continuous winding, to which the line leads are connected 120 electrical degrees apart.

Review carefully the manner in which these windings are arranged and connected for obtaining dif-

Polyphase Motors

ferent numbers of poles, and also the manner in which they set up the revolving magnetic field when the stator is supplied with three-phase energy.

It is easy to see that this revolving field will cut across the bars of a squirrel-cage rotor, or across the conductors of a phase-wound rotor, and induce in them the secondary currents which, by the reaction of their flux with the flux of the stator, produce the motor torque.

Fig. 9 on pages 15 and 16 shows two excellent cut-away views of a modern three-phase squirrel-cage induction motor. This figure shows clearly the important constructional features and the location of all the parts in the assembled motor. Note carefully all details of the construction of the rotor, stator, windings, frame, bearings, ventilating openings, etc.

The windings of a three-phase motor can be represented in simple schematic diagrams as shown in Fig. 3-A or B, according to whether they are connected delta or star.

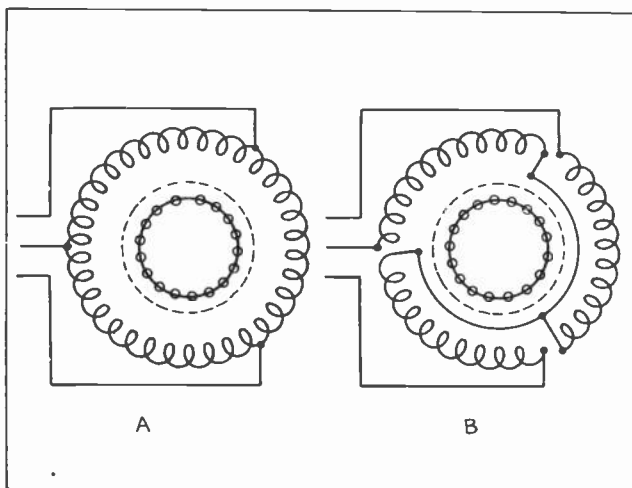

Fig. 3. A shows a delta-connected stator winding for an induction motor. The sketch at B shows a star-connected winding.

As three-phase motors are so extensively used, the following discussion of characteristics of the various types of motors will refer principally to

Alternating Current

three-phase machines. Many of the same characteristics are, however, also found in two-phase motors.

3. SQUIRREL-CAGE MOTOR CHARACTERISTICS

Squirrel-cage motors are commonly referred to as constant speed motors; but their speed is not quite constant, as they do not operate at synchronous speed and their "slip" varies with the amount of load applied to them.

When a squirrel-cage motor is not loaded, its speed will be very near to that of the revolving magnetic field, or synchronous speed. As load is applied to the motor, its speed is gradually reduced until at full load the slip is usually from 3 to 5 per cent. on large motors; and may be as much as 8 or 10 per cent. on small single-phase machines.

The full load torque of a squirrel-cage motor of any given size is the same as that of a slip-ring or synchronous motor of the same size; because the full load torque, you will recall, depends entirely upon the speed and horse power rating for which the motor is designed.

The load pull-out torque of the squirrel-cage motor should not be less than 150% of the full load torque, and with certain types of motors it will be as high as 250% of the full load torque.

Having a pull-out torque considerably greater than the full load torque enables the motor to carry momentary overloads without stalling.

4. STARTING TORQUE

The starting torque of squirrel-cage motors depends upon the design of the rotor and upon the value of the voltage applied to the stator winding during the starting period.

A very important rule to keep in mind when working with induction motors is as follows: **the starting torque of an induction motor varies with the square of the applied voltage.**

Polyphase Motors

Good starting torque can be obtained with squirrel-cage motors by starting them on the full line-voltage or the rated voltage of the machine. When started in this manner, the current taken by the motor will be several times the normal full load current; and if heavy loads are being started, the starting current may range from 4 to 9 times full load current.

If the load should require considerable time to come up to speed, the heavy starting current required during this time may overheat and possibly damage the stator windings. For this reason the type of load to be started must be taken into consideration when determining the starting voltage to be applied to the motor.

The very heavy surge of starting current which results when squirrel-cage motors are started at full line-voltage is often very objectionable, as it causes voltage drop in the line and this voltage drop may interfere with the operation of other power equipment or cause considerable variation in the brilliancy of lights that may be attached to the same circuit.

In some cases the supply lines may not be large enough to permit the starting of induction motors on full line-voltage. In many cases power companies object to or do not permit this method of starting motors which are connected to their lines. So, for these reasons, many squirrel-cage motors of 5 horse power and larger are started at reduced voltage by the use of some form of motor-starting devices.

A. C. motor starters are explained in a later lesson. Their principal function, however, is to reduce the voltage to the motor by means of resistance or inductance in the circuit of the stator winding during the starting period. When the starting voltage is reduced, the heavy surge of starting current will also be greatly reduced and, of course, the starting torque developed by the motor will also be considerably lower.

Alternating Current

The convenient table in Fig. 4 shows the effect which reduced starting voltage has on the starting current and starting torque of common induction motors. The various starting voltages shown in the table range from 33% to 100% of the rated

Starting voltage in percent of rated motor voltage	Starting current in percent of full load current	Starting torque in percent of running torque
33%	75%	22%
40 "	110 "	33.3 "
50 "	175 "	50 "
60 "	250 "	70 "
66 "	300 "	88 "
80 "	450 "	130 "
100 "	700 "	200 "

Fig. 4. The above table shows the effect of reduced starting voltage on both the starting current and starting torque of induction motors.

motor voltage, and the starting current and starting torque for each different voltage are given in percentage of full-load current and running torque of the machine.

Some induction motors are designed with special squirrel-cage rotors to improve the starting torque. These machines will be explained in later paragraphs.

Fig. 5 gives a set of curves which show the starting torque and starting current of a typical squirrel-cage motor. Curve A shows the starting torque on full line voltage, and curve A-1 shows the starting current for the same condition. Curves B and B-1 show the starting torque and current of a squirrel-cage motor with a high resistance rotor. Note how the added resistance increases the torque and decreases the current.

Curves C and C-1 show the starting torque and current when a starting compensator is used with an ordinary squirrel-cage motor. Note how the torque at reduced stator voltage is lower than with either of the other methods of starting, and also

Polyphase Motors

the interruption and sudden increase of torque when the compensator switches over to full voltage.

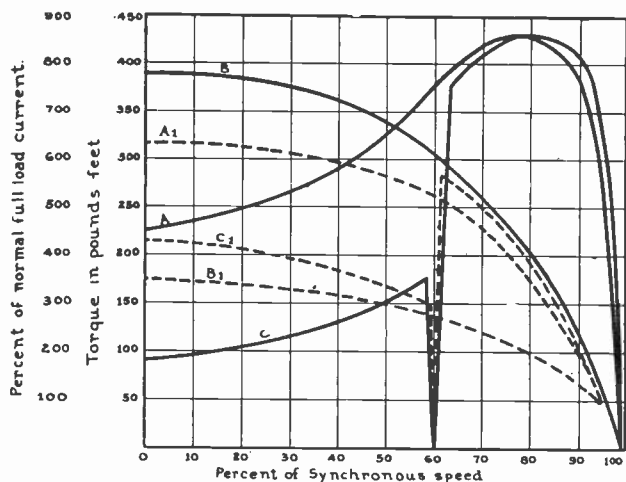

- A = Starting torque at full line voltage
 A1 = " " current " " " " with low resistance rotor.
 B = " " torque " " " " " high " " "
 B1 = " " current " " " " " " " " "
 C = " " torque on reduced E by means of compensator.
 C1 = " " current " " " " " " " " "

Fig. 5. The above diagram shows voltage, current, and torque curves of an ordinary squirrel-cage motor. A careful study of these curves will help you gain an understanding of these very important characteristics of squirrel-cage motors.

5. POWER FACTOR AND EFFICIENCY

The power factor of three-phase, squirrel-cage motors operated at full load may vary from 60 to 70 per cent. in the case of small low speed motors, to 75 to 90 per cent, for medium-sized motors; and as high as 90 to 96 per cent. for large motors of several hundred horse power and up.

Power factor is a very important characteristic to be considered when selecting large induction motors or a large number of small ones; because, as explained in an earlier lesson, a great deal of money can be saved on power bills by keeping the power factor of the system as high as possible.

It is also very important to remember that any

Alternating Current

induction motor operates at a much lower power factor when it is lightly loaded, and for this reason motors should be properly chosen so that during normal operation they will be running at or near full load a greater part of the time.

The efficiency of squirrel-cage motors varies similarly to the power factor. Small low-speed motors may have efficiencies ranging from 50 to 80 per cent., while the larger machines will operate at efficiencies from 90 to 95 per cent.

The efficiencies are usually best when the motors are operating above 75% of their full rated load. High-speed motors of the two and four-pole type generally have the highest efficiency and power factor.

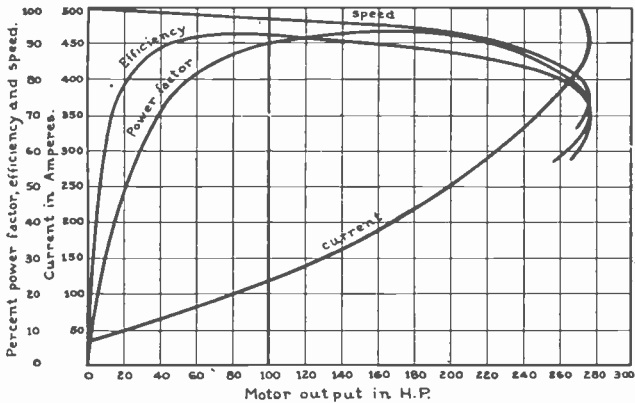

Fig. 6. This diagram shows the efficiency, power factor, speed, and current curves for a 100-h. p., squirrel-cage motor. Note carefully how the efficiency and power factor vary with different amounts of load up to full rated load, and also on various overloads.

Fig. 6 shows the power factor and efficiency curves for a 100 h. p. squirrel-cage motor. Note that the P.F. and efficiency are both very low at light loads, under 20 h. p., and then rapidly rise to high values on loads between 60 and 100 h. p., but fall off again when the motor becomes overloaded. This figure also shows the current and speed curves of the motor at various loads.

Polyphase Motors

6. FACTORS CONTROLLING SPEED OF INDUCTION MOTORS

As previously explained the speed of induction motors depends upon the number of poles in the stator winding and upon the frequency of the alternating current on which they are operated.

As induction motors are designed to operate on practically constant frequency, their speed should not be varied to any appreciable extent by varying the frequency.

The speed of squirrel-cage induction motors can be changed by changing the number of poles in the stator winding, as explained in A.C. Armature Winding. If the speed change is to be permanent, the stator can be reconnected for a different number of poles; while, if it is desired to frequently make a certain change in the speed during operation of the motor, the stator winding can have the pole leads brought out separately to terminals of a switching device by means of which the number of poles can be quickly changed by regrouping them. The switching device and connections for this method of varying the speed of squirrel-cage motors will be explained in a later lesson on A.C. Motor Controls.

The direction of rotation of a three-phase induction motor can be reversed by reversing any two of the three phase leads to the motor.

7. GENERAL APPLICATION

Because of their very rugged construction and small number of wearing parts, squirrel-cage induction motors find a very wide field of application. They require very little maintenance and repair, if they are operated under the proper conditions.

Having no commutator brushes or other sliding contacts they do not produce any sparking and can therefore be used in many locations where other types of motors cannot be used because of the danger of explosions. This applies to buildings or locations where explosive gases or dust may be in the air.

Alternating Current

When selecting and installing motors it is well to keep in mind that sawdust, coal dust, starch, flour, grain dust of any kind, sugar, etc., are very explosive when mixed with air in just the right proportions. This is also true of paint and varnish fumes, oil vapors, and vapors from certain chemicals.

To eliminate fire and explosion hazard, squirrel-cage motors are invariably used in modern plants manufacturing or handling materials such as those just mentioned. Fig. 7 shows a number of squirrel-

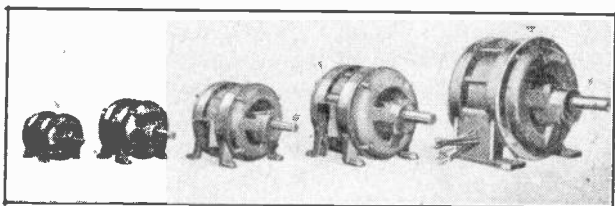

Fig. 7. This photo shows a group of polyphase induction motors of various sizes. Motors of this type are available in practically any size required.

rel-cage motors of various sizes,

Some of the uses to which squirrel-cage induction motors are commonly put are as follows:

Machine drives in industrial plants

Machine drives in wood-working plants

Operating machines in general manufacturing plants

Textile mill drives

Saw mills

Paper mills

Steel mills

Grain elevators

Flour mills

Mining machinery

Electric ship propulsion

Passenger and freight elevators

Motor-generator sets

Small hoists

Pumps and fans.

Polyphase Motors

4. SLIP-RING MOTORS

From the foregoing material on squirrel-cage motors, it is evident that they are not well adapted to variable speed service. **Where variable speed duty is required, slip-ring induction motors are commonly used.**

These slip-ring or phase-wound motors have stators and stator windings of exactly the same type as those used in squirrel-cage motors, but their rotor windings are made of insulated copper wire or bars somewhat similar to those used on direct current machines.

Generally these rotors are wave-wound and star-connected, although in some cases they are lap-wound and delta-connected. The star-connected wave-winding is somewhat easier to install and produces better mechanical strength and balance of the rotor.

Three leads are connected to the rotor winding at points 120 electrical degrees apart and are brought out along the shaft and connected to three slip rings.

Fig. 10 shows a wound rotor of a slip-ring motor and the slip rings can be clearly seen mounted on the shaft. These rings are usually made of brass and are well insulated from each other and from the shaft. This rotor in Fig. 10 has a winding of insulated copper wire.

Fig. 11 shows another phase-wound rotor which has a winding of insulated copper bars, which are properly connected to the slip rings on the shaft.

During operation of slip-ring motors the brushes slide on the rings and provide a connection for the induced currents to flow from the rotor winding to a control resistance in the external circuit. By varying this resistance the secondary current flow, in the rotor can be varied; and this will increase or decrease the amount of torque and slip, and thus vary the speed of the motor.

Controllers of the face-plate type or drum type are commonly used with variable speed, slip-ring motors.

Alternating Current

Fig. 12 shows a 440-volt induction motor of the slip-ring type. Note the brushes resting on the three slip rings and also note the three leads which are brought out from these brushes for connection to the controller by which the speed of the motor is varied.

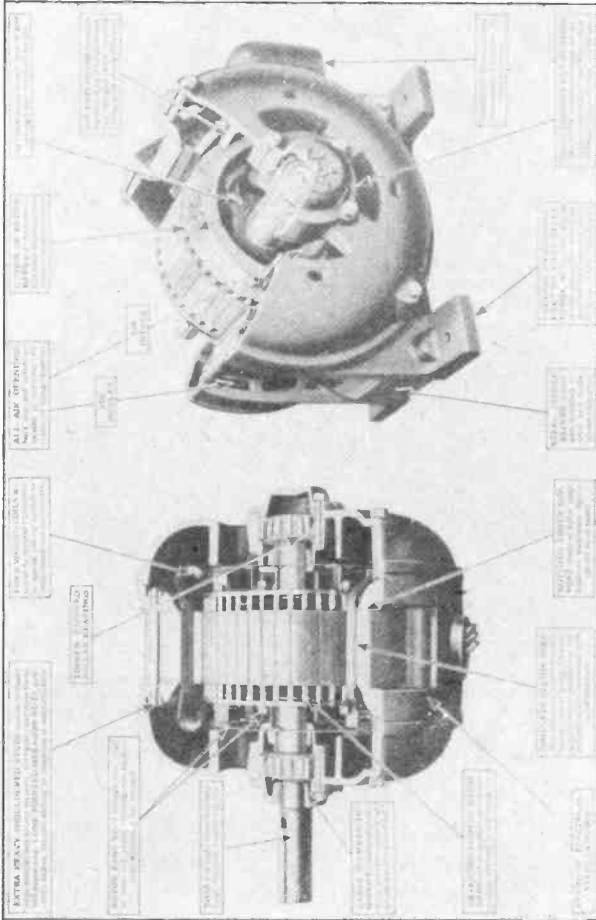

Fig. 9. The above photo shows two cut-away views of a polyphase squirrel-cage induction motor. The important parts of the motor are clearly shown in the two views and you should carefully note the description given for each part. A careful study of this figure will show a number of very important features of induction motor construction. (Photo courtesy Allis-Chalmers Mfg. Co.)

The connections of the stator winding are made at the hooded outlet shown on the side of the motor

Polyphase Motors

frame. The slots shown between the sections of the laminated stator core of this motor are provided for the circulation of cooling air.

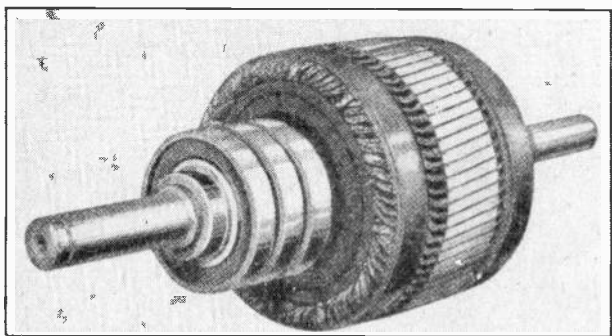

Fig. 10. Wound rotor of a variable speed slip-ring motor. This rotor has windings of insulated copper wire similar to those in D. C. armatures.

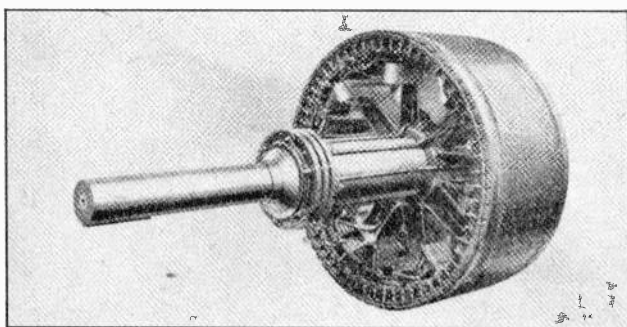

Fig. 11. Phase wound rotor of a large slip-ring induction motor. This rotor has heavy bar windings which are not shorted together like those of a squirrel-cage rotor, but instead have connections brought out from each phase to the slip rings.

9. STARTING AND SPEED CONTROL WITH EXTERNAL RESISTANCE

Fig. 13 shows a schematic diagram of the connections for the stator, rotor, and starting or speed-control resistance of a slip-ring motor. The resistance is shown connected star, the same as the rotor windings, and if you trace the circuit from each section of the rotor winding you will find that the complete resistance of two sections of the controller is in series with it.

Alternating Current

The three sliding-contact arms which are indicated by the arrows are connected together at the central point and are arranged to cut out this resistance as they are rotated in a clockwise direction.

This resistance is used for starting slip-ring motors as well as for controlling their speed, and if the amount of resistance is properly proportioned these motors have a very good starting torque with moderate starting currents.

Before starting the motor by closing the line switch, the controller should be set so that the maximum amount of resistance is in the rotor cir-

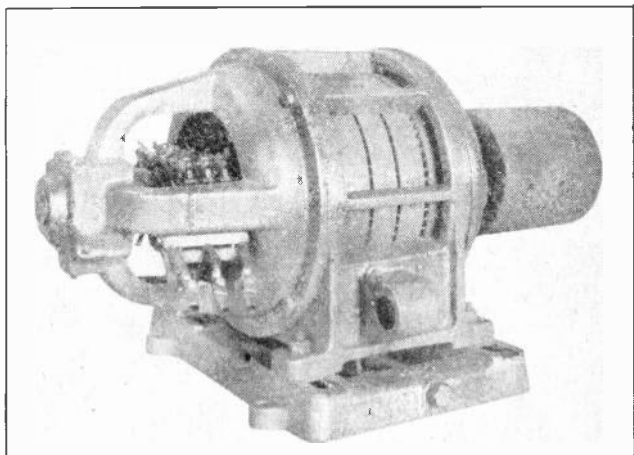

Fig. 12. This photo shows a complete slip-ring motor to which variable resistance can be connected for starting and speed-regulating duty. Note the slip rings and rotor connections on the left-hand end of the machine. (Photo courtesy General Electric Co.)

cuit. Then this resistance is gradually cut out as the motor comes up to speed.

In many cases slip-ring motors with resistance starters are used just because of their good starting torque and lower starting currents, even though they may not be required to give variable speed service.

If the resistance is only used for starting duty it can be much smaller and lighter than when used

Polyphase Motors

for speed-regulating duty. When used for regulating the speed of the motor the rheostat must have resistance elements large enough to carry the full load current continuously without overheating.

After the motor is up to speed, if resistance is again cut into the rotor circuit, the speed will be decreased in proportion to the amount of resistance inserted.

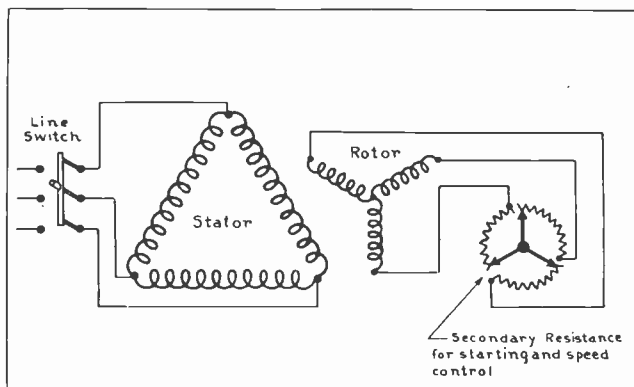

Fig. 13. The above diagram shows the connections of the stator and rotor of a slip-ring induction motor, and also the variable resistance used in the rotor circuit for starting and speed control.

Fig. 14 shows a diagram of a heavy-duty slip-ring motor with the starting and speed regulating resistance arranged so it can be cut in or out of the rotor circuit by means of short-circuiting switches.

The motor is started with all of the resistance switches open and the full resistance in the rotor circuit. When switch No. 1 is closed it shorts out the first section of resistance; switch 2 shorts the second section, and switch 3 shorts out the last of the resistance, bringing the motor up to full speed.

For starting and controlling the speed of large motors of this type magnetically operated contactors or breakers are used in place of the knife switches shown in Fig. 14.

The value of the induced voltage in the secondary or rotor winding of a slip-ring motor may vary between 25 and 60 per cent. of the stator voltage, according to the design of the motor.

Alternating Current

10. INTERNAL RESISTANCE MOTORS

On small motors with phase-wound rotors the secondary resistance is often mounted in the rotor

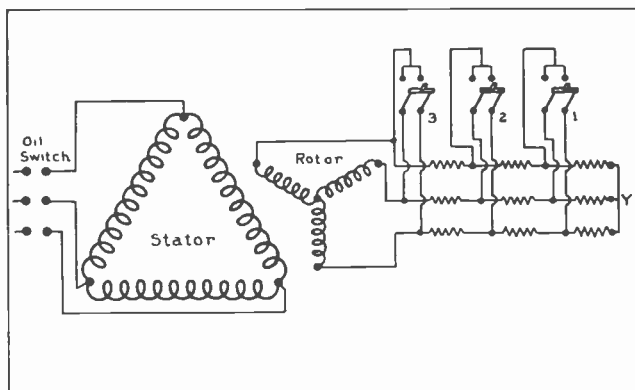

Fig. 14. Connection diagram of slip-ring induction motor with knife switches used to cut out the starting or speed control resistance step by step.

spider so that it revolves with the rotor winding and can be connected directly to it, thus eliminating the necessity for collector rings and brushes.

In such motors the resistance may be cut out or short-circuited by a centrifugal switch as the motor comes up to speed. In other cases motors of this type are equipped with a hollow shaft, through which a rod is run and connected to the mechanism which operates the contacts to cut the rotor resistance in or out of the circuit.

This rod is provided with a knob on the outer end and can be pushed back and forth by hand while the motor is operating. Motors of this type with the internal secondary resistance should not be used on loads which require too great a length of time to come up to speed, or the resistance units may be damaged by overheating.

Motors with internal rotor resistance are usually not made in sizes over 200 h. p. Motors larger than this are practically always equipped with slip-rings and external resistance and many of the smaller slip-ring motors also have external resistance.

Polyphase Motors

11. CHARACTERISTICS OF SLIP-RING MOTORS

Slip-ring motors can be designed to give a starting torque of 250% or more of the full load torque. A starting torque of 125% may be obtained with a stator current of 150% of full load current rating; and a starting torque of 200% can be obtained with 250% of full load current, etc.

This ability to produce good starting torque with moderate starting currents makes the slip-ring motor very desirable where loads must be frequently started and stopped, and where it is necessary to avoid heavy starting current surges of 4 to 6 times the running current value.

Figs. 15-A and B give a set of curves which show the starting torque and starting current of a slip-ring motor during the various steps of starting, and as the resistance is cut out of the rotor circuit step by step.

These curves may appear a bit complicated at first glance, but study them carefully for a few minutes and you will find them very simple to understand. You will also find that they give a lot of valuable information on the characteristics and performance of slip-ring motors.

12. EFFECT OF SECONDARY RESISTANCE ON STARTING TORQUE

The upper set of curves at A show the starting torque developed by the motor at various percentages of its synchronous speed, and with different amounts of resistance in the rotor circuit.

The heavy irregular line which jumps from curve T-1 to T-2, T-3, and T-4 shows the variations and amount of starting torque as the resistance is cut out and as the motor picks up speed during starting.

To read the value of the torque at any point on any curve, just follow the horizontal chart lines to

Alternating Current

the left edge of the figure, where the torque can be read approximately, in per cent. of full load torque of the motor. By following the vertical lines downward from any point on a curve, the per cent. of synchronous speed at that point can be found.

For example: The motor is started with full resistance in the rotor circuit, and curve T-1 shows the starting torque commencing at about 185% of full load torque and dropping off to about 160% as the motor reaches 35% speed. Here the first section of resistance is cut out, and the torque is increased to about 295%. Again it gradually reduces as shown by curve T-2, to about 220% when the motor has reached 70% speed.

Cutting out another section of resistance brings the torque back up to about 325% from where it decreases as shown by curve T-3 to about 125% when the motor reaches 92% speed.

Then cutting out the last step of resistance raises the torque once more to slightly over 200%, from which point it drops as shown by curve T-4 to 100% or full load torque as the motor reaches its actual running speed of about 97% synchronous speed.

By cutting out the resistance in this manner, the starting torque is kept high during the entire starting period.

The dotted line at the left end of the heavy line in curve T-2 shows the value of the starting torque that would be obtained if the motor were started with one section of resistance already out of the rotor circuit. The dotted line forming the left end of curve T-3 shows the starting torque when starting the motor with two sections of resistance cut out.

The dotted line forming the right-hand ends of the curves T-1, T-2, and T-3 show how the torque will continue to fall off very rapidly, if the resistance is not cut out as the motor picks up speed.

The light continuous curve T-5 shows the grad-

Polyphase Motors

ual variation in starting torque which would be obtained if the resistance was cut out very smoothly and gradually, instead of in sections or steps.

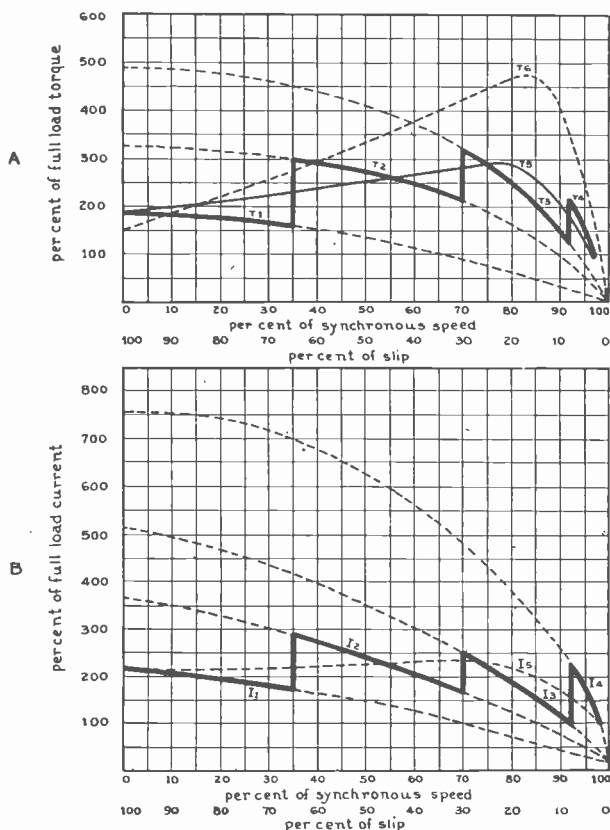

Fig. 15. "A" shows the torque curves of a slip-ring induction motor as the resistance is cut out of the rotor circuit and the motor comes up to speed. "B" shows the current curves of the same motor and corresponding to the various steps of the torque curves. Study these curves very carefully with the accompanying explanation.

The continuous dotted curve T_6 shows the starting torque obtained by starting the motor without any resistance and allowing it to come up to full speed in this manner. This curve shows the very important fact that the torque obtained by starting without any starting resistance in the rotor circuit is at first actually lower than when starting with resistance in the circuit.

Alternating Current

This corresponds with what has previously been mentioned, that the starting torque of induction motors can be increased by using the proper amount of resistance in the rotor circuit.

Note also from curve T-6 how the starting torque on constant voltage keeps increasing as the motor speed increases, becoming maximum at about 83% of synchronous speed, and then falling off as the motor approaches closer to synchronous speed.

This is due to the fact that when an induction motor is first started, the difference between the rotor speed and the speed of the revolving magnetic field is very high, and therefore the frequency of the induced rotor currents is high. At this high frequency the rotor currents lag considerably behind the induced voltage, and the torque or power produced is very low.

As the rotor speed increases, the difference between its speed and that of the revolving magnetic field of the stator is less, the frequency of the induced rotor currents is lower, and the power factor is higher; which results in increased torque.

Of course, when the rotor reaches nearly synchronous speed, the lines of force of the rotating magnetic field do not cut across the rotor conductors as rapidly, and the induced voltage and current in the rotor begin to decrease. This causes the torque to reduce somewhat as the motor approaches its rated speed and settles down to operate at its normal percentage of slip, which is always required to produce full load torque.

The percentage of slip is also marked from right to left along the lower side of Figs. 15-A and B. This slip, of course, decreases as the percentage of synchronous speed of the rotor increases.

13. STARTING CURRENT OF SLIP-RING MOTORS

In Fig. 15-B, or the lower set of curves, is shown the current during the various steps of starting a slip-ring motor. You will note that when the motor is started with full resistance in the rotor circuit

Polyphase Motors

the starting current as shown by curve I-1 is at first about 215% of normal full load running current. This current reduces gradually as the rotor increases its speed and reduces the slip.

When the motor reaches 35% speed and the first section of resistance is cut out, the current is increased to about 285%, as shown by curve I-2, and so on throughout the following steps of starting the motor.

After the last section of resistance is cut out at about 92% speed, the current decreases as shown by curve I-4, until at about 97% synchronous speed or actual operating speed of the motor, the current has reached 100% or normal full load current.

Note the very heavy starting currents which will be drawn by the motor if it is started without any resistance or with only one or two sections of resistance in the rotor circuit. This is shown by the dotted lines forming the left ends of curves I-1, I-3 and I-2. If this particular motor were started without any resistance the starting current at first would be about 750% or $7\frac{1}{2}$ times full load current, and it would then gradually decrease as the motor speed increases and the slip decreases.

Also note from curve I-5 the more uniform starting current which would be obtained by cutting out the resistance gradually instead of in steps.

The current shown by curve I-5 corresponds to the starting torque shown by curve T-5 in Fig. 15-A.

Each of the other current curves corresponds to the torque curve of the same number in the upper figure.

The efficiency and power factor of slip-ring motors are generally a little lower than those of squirrel-cage motors, but this small loss is frequently more than offset by the other advantages of the slip-ring motors.

When slip-ring motors are used for variable speed service and are being operated below normal speeds their power factor and efficiency will be correspond-

Alternating Current

ingly lower than when running at their full rated speed.

The horse power output of motors of this type varies in proportion to the speed at which they are operated. Slip-ring motors generally have approximately the same percentage of slip, or in some cases a little more than the squirrel-cage motors.

14. APPLICATIONS OF SLIP-RING MOTORS

Because of their very good starting torque with moderate starting currents and due to the fact that they can be used for variable speed duty, slip-ring induction motors have a large number of applications and types of service to which they are ideally suited.

They are extensively used for driving machines which require frequent starting and stopping, and which are hard to start because of the nature of the load. They are also used for operating devices which require speed variations over a greater range than can be obtained by changing the number of poles of squirrel-cage motors.

Some of the common uses for slip-ring motors are as follows:

- Pump and compressor drives
- Variable speed fans and blowers
- Hoists and cranes
- Rotary dryers and kilns
- Grinders and crushers
- Electric railways
- Electric ship drives.

Polyphase Motors

EXAMINATION QUESTIONS

1. Name three general types of polyphase motors.

2. Does a squirrel-cage motor operate at the same speed when fully loaded as it does when running idle?

3. What percentage of the full load current will be drawn by an induction motor during starting when the starting voltage is 33% of the rated motor voltage?

4. How may two-phase motors be reversed?

5. How may three-phase motors be reversed?

6. What kind of A. C. motors should be used in places where there is danger of explosions?

7. What kind of A. C. motors are commonly used for variable speed duty?

8. A. What effect does adding resistance to the rotor circuit of an induction motor have on the starting torque?

B. On the starting current?

9. Is the power factor and efficiency of induction motors best at light load or full load?

10. To what extent does the starting voltage affect the starting torque of an induction motor?

SYNCHRONOUS MOTORS

Synchronous motors operate at synchronous speed, or in exact step, with the applied frequency and rotating magnetic field of the machine.

When in normal operation, the synchronous motor has no slip, or "zero slip" as it is often called. The speed of these motors is inversely proportional to the number of poles in the stator and directly proportional to the frequency of the applied line voltage, and as long as the number of poles and frequency remain unchanged the speed will not vary.

Therefore, a **synchronous motor is a constant-speed motor** and can be used where a certain speed must be accurately maintained at all times.

Another great advantage of synchronous motors is that their power factor is very high, and they can actually be operated at leading power factor in order to improve the power factor on a system which is loaded with inductive equipment.

In many cases synchronous motors are used only for power factor correction, and are operated without any mechanical load attached. In such cases the motors are connected to the system or lines and allowed to run idle or float on the lines, with their D. C. field poles strongly excited; so that they actually generate and feed leading current into the line and thus help to neutralize the effects of the lagging current produced by induction motors or other inductive equipment on the line.

When these machines are used for power factor correction in this manner they are called **synchronous condensers**; because their effect on the system is the same as that of a static condenser, which also produces leading current.

Synchronous motors are made for power drives and power-factor-correction in sizes ranging from a few horse power to 50,000 kv-a. or more.

Power companies have synchronous condensers as large as 50,000 kv-a. connected directly to lines of 13,200 volts for correcting the power factor on their systems.

Synchronous Motors

Special synchronous motors are made in very small sizes for the operation of electrical clocks and such devices. Some of these small motors operate on a fraction of one watt of electrical energy.

1. CONSTRUCTION AND EXCITATION

Synchronous motors are constructed almost exactly the same as alternators; in fact, an alternator may in many cases be operated as a synchronous motor. Synchronous motors have the A. C. armature winding or element and a D. C. field the same as alternators.

Small synchronous motors are sometimes made with stationary field poles which are excited by direct current, and with a revolving A. C. armature to which the line current is fed through slip rings.

Most medium and all large-sized synchronous motors, however, are made with revolving fields, the same as large A. C. generators. On these motors the alternating current line-energy is fed to a stationary armature or stator winding which sets up a revolving magnetic field, the same as in induction motors. The field poles on the revolving field or rotor receive their D. C. exciting current through slip rings.

As synchronous motors are always operated from alternating current lines, it is necessary to have some source of direct current for exciting their fields. This field supply is usually obtained from small D. C. exciter-generators, which are either mounted directly on the end of the synchronous motor shaft or may be belt-driven from a pulley on the shaft.

Fig. 1 shows a 75-h. p. synchronous motor of the revolving field type. This motor has its D. C. exciter-generator mounted on the end bracket and driven by the end of the main motor shaft. Note the slip rings and brushes, which are located just inside the end-plate of the synchronous motor and through which direct current from the exciter-gen-

Alternating Current

erator is passed to the revolving field poles. This motor has six poles and is designed for 60-cycle operation, so its speed will be 1200 R.P.M.

Fig. 2 shows the stator of a large slow-speed synchronous motor, and Fig 3 shows a large di-

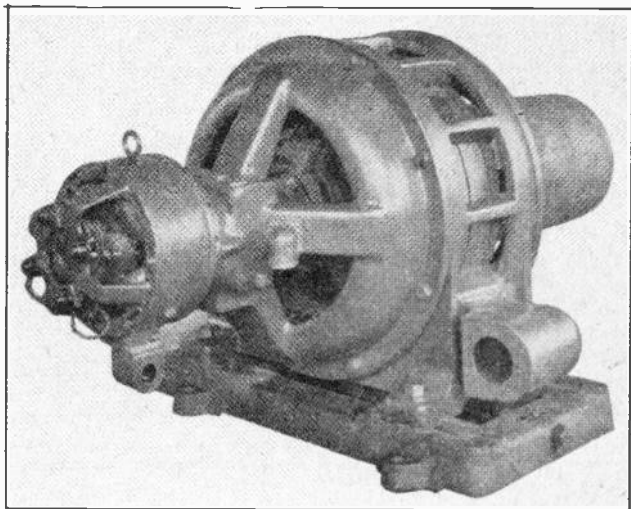

Fig. 1. This photo shows a 75 h. p. synchronous motor of the revolving field type. Note the small exciter-generator which supplies D. C. to the field of the large motor. (Photo courtesy General Electric Co.)

ameter revolving field for a synchronous motor of this type.

Large synchronous motors with a great number of poles can be made to operate at very low speeds and are, therefore, frequently used to drive slow-speed pumps or machinery by direct connection.

2. DAMPER WINDINGS

In addition to the D. C. windings on the fields of synchronous motors, they are usually provided with a **damp**er winding consisting of short-circuited bars, similar to the squirrel-cage windings used on induction motors. This damper winding can be clearly seen on the outer ends of the poles of the field rotor in Fig. 3.

Damper windings are provided on synchronous

Synchronous Motors

motors to obtain sufficient starting torque to enable the motors to start with some load attached, and

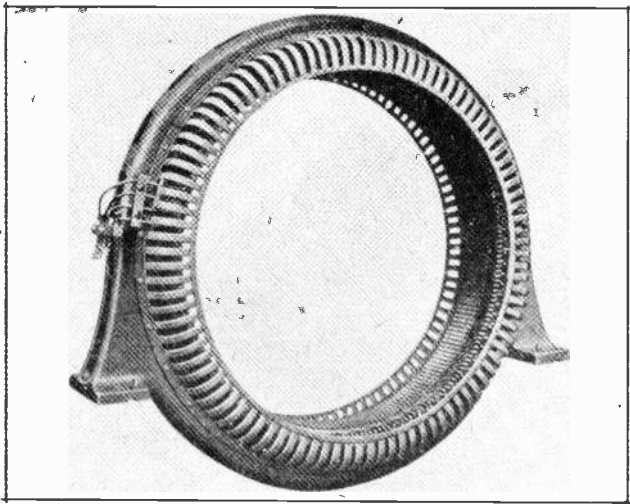

Fig. 2. Above is shown the stator of a large synchronous motor. You will note that the stator, frame, core, and windings are the same as those used for alternators.

also to prevent what is known as hunting. Hunting of synchronous motors will be explained a little later.

3. OPERATING PRINCIPLES

When synchronous motors are started, their D. C. fields are not excited until the rotor has reached practically full synchronous speed; so the starting torque to bring the rotor up to speed must be produced by induction.

When the stator winding of a synchronous motor is excited by being connected to the A. C. line, it immediately sets up the rotating magnetic field with which we are already familiar. The rotating flux of this field cuts across the damper winding of the revolving member or rotor and induces secondary currents in the bars of this winding.

The reaction between the flux of these secondary currents and that of the revolving stator field produces the torque necessary to start the rotor in motion and bring it up to speed.

Alternating Current

If no damper winding is provided a synchronous motor will have very poor starting torque, as it must then depend upon the induced currents in the high-resistance field coils and the slight eddy currents in other parts of the rotor. This, however, is sufficient to start some of the older type synchronous motors which were not provided with damper windings, or to start alternators when they are used as synchronous motors.

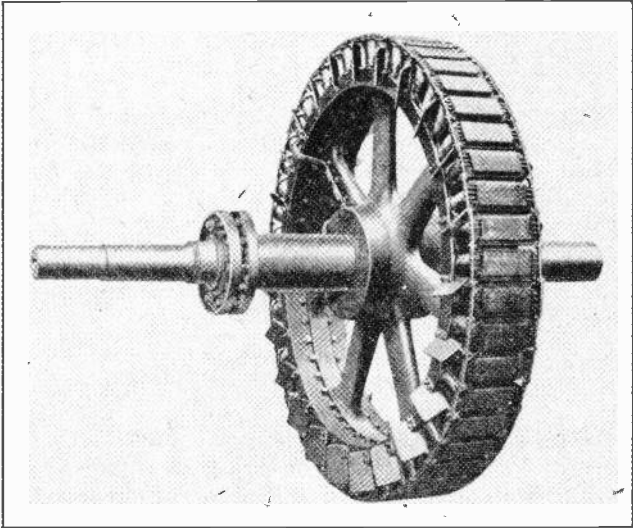

Fig. 3. Revolving field or rotor of a large slow-speed synchronous motor. Note the squirrel-cage damper winding attached to the pole faces and also the slip rings through which the D. C. is passed to the revolving field poles.

When some of the older type synchronous motors were used to drive machinery which had to be started under load, they were often started and brought up to speed by means of a separate induction motor just large enough for this purpose.

In other cases, the synchronous motor was attached to the load by means of a friction clutch or magnetic clutch, so that the rotor could be disconnected from the load during starting and then allowed to pick up the load by means of the clutch after the rotor had reached synchronous speed and its D. C. field poles were excited.

Synchronous Motors

This is not necessary with most modern synchronous motors which are properly adapted to their load; because it is possible, by properly proportioning the squirrel-cage damper winding, to design synchronous motors with fair starting torque.

When a synchronous motor has been brought up to nearly synchronous speed and is operating as an induction motor because of the damper winding, then the D. C. field poles are excited and the powerful flux of these poles causes them to be drawn into step or full synchronous speed with the poles of the rotating magnetic field of the stator.

During normal operation the rotor continues to revolve at synchronous speed, as though the D. C. poles were locked to the poles of the revolving magnetic field of the stator.

As a synchronous motor has no slip after the rotor is up to full speed, no secondary current is induced in the bars of the damper winding during normal operation.

4. PULL OUT TORQUE

If a synchronous motor is overloaded to the extent where the D. C. rotor poles are made to lag or pull out of step with the poles of the rotating stator field, the slip which results will again cause current to be induced in the damper winding and to develop torque by induction, as during starting.

If the overload is not too great or doesn't last for more than an instant, this torque developed by induction in the damper winding may enable the rotor to pull back into step; but if the overload is too great and lasts too long, the rotor will be pulled out of step with the revolving magnetic field, and the motor will lose its torque and will stall.

If the D. C. current supplied to the revolving field of a synchronous motor is interrupted during operation, the motor will, of course, lose its torque and will stop if there is any appreciable load connected to it.

Alternating Current

We have found that a synchronous motor develops its torque by the attraction between the poles of the revolving magnetic field set up by the stator and the D. C. poles of the rotor, which are maintained at constant polarity by direct current through their coils.

We know that magnetic lines of force are more or less elastic, so we can readily see that it is possible for the D. C. poles of the rotor to be pulled back a little or caused to lag slightly behind the center of the revolving poles of the stator, without actually being pulled out of step far enough to lose the attraction between the poles and thereby lose the torque. This might be caused by sudden surges of load of very short duration.

With a moment's thought we can also see that if a north pole of the revolving field is pulled back and caused to lag a little behind the center of an unlike pole or south pole of the stator field, this north pole of the rotor will be drawn closer to the adjacent north pole of the stator, which will tend to repel it and add to the torque, thereby keeping the rotor in step if the load is not too great.

5. HUNTING

If a heavy load is suddenly removed from the synchronous motor, the rotor will tend to surge ahead and, due to the elastic nature of the flux, the D. C. poles may for an instant actually surge a little ahead of the revolving poles of the stator.

Sometimes fluctuations in the mechanical load or in the line voltage may in this manner cause the rotor of a synchronous motor to surge or oscillate back and forth more or less irregularly. This is known as **hunting**.

The hunting of the synchronous motor can usually be noticed by a change in the normal operating sound or the smooth, steady hum which is given off by a motor when it is operating properly. The hunting causes a rise and fall, or sort of throbbing note, to come into this sound. This audible note may be of very low frequency, even as low as sev-

Synchronous Motors

eral oscillations per minute, or it may be of much higher frequency. This will be according to the size and design of the machine and according to the nature of the disturbance which causes the hunting.

Another indication of hunting may be had by watching the pointers of any ammeters connected in the line circuit to the motor. Hunting causes the stator current to increase and decrease, and this will cause the ammeter needle to swing back and forth at the same frequency as that at which the sound or hunting note occurs. During normal operation, the ammeter pointer should change only when the load is changed or when the field excitation is varied.

Hunting may be due to anyone of the following causes: (A) Fluctuations in mechanical load on the motor. (B) Surging of generators on the line. (C) Switching surges. (D) High or low frequency surges. (E) Irregular or pulsating electric loads on the line. (F) Hunting of other synchronous motors on the same line.

Hunting should not be allowed to continue, because it may set up very dangerous mechanical stresses within the motor, and it will also produce objectionable surges of current on the A. C. line supplying the motor.

Damper windings play a large part in the prevention of hunting, because, as soon as the rotor attempts to fall behind or surge ahead of the poles of the rotating stator field, the slip at once causes secondary currents to be induced in the damper winding, and thereby develops inductive torque which tends to hold the rotor at constant speed.

In some cases a synchronous motor may have a tendency to hunt, even though it is equipped with damper windings. Changing the voltage applied to the D. C. field may cause the motor to stop hunting, and if this doesn't stop it, it may be necessary to shut the motor down and restart it. This will often eliminate the hunting.

Alternating Current

Sometimes a slight increase or decrease of the mechanical load on the motor may help to stabilize its speed and prevent hunting.

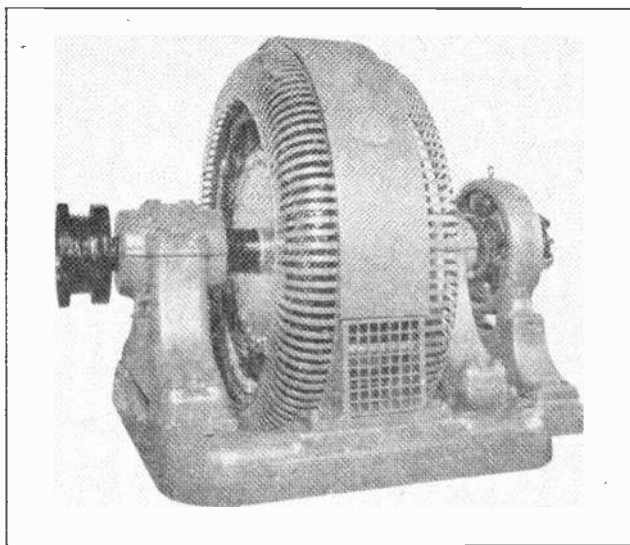

Fig. 4. This photo shows a 2000-h. p., 2300-volt, synchronous motor which operates at 100% power factor. The D. C. exciter-generator is shown on the right-hand end. (Photo courtesy General Elec. Co).

If none of these things will stop it, it will then be necessary to definitely locate and eliminate the cause; which may be in the A. C. supply line, in the exciter-generator, or in the mechanical load.

Fig. 4 shows a large synchronous motor of 2000 h. p., designed for operation on 2300 volts and at unity power factor. Note the exciter-generator, which in this case is mounted on a separate pedestal at the right of the motor. The armature of the exciter is mounted on the motor shaft and is directly driven at the same speed as the synchronous motor.

Fig. 5 shows a three-phase synchronous motor of 150 h. p. which has its exciter driven by means of a large pulley on the end of the motor shaft and a special rope belt. This makes possible the use of a small, high-speed, D. C. generator.

Synchronous Motors

6. CONNECTIONS OF SYNCHRONOUS MOTORS

Fig. 6 shows a diagram of the connections for a synchronous motor and its exciter-generator. You will note that the wiring and connections for this machine are practically identical with those for an alternator, with the exception that a rheostat is not always used in the field circuit of the synchronous motor.

Regardless of the A. C. voltage at which the synchronous motor may be operated, the exciter voltage is seldom higher than 250 volts. The capacity of the exciter-generator in kw. usually ranges from 1 to 3 per cent of the kv-a. rating of the synchronous motor.

By adjusting the exciter field rheostat, *f*, the voltage applied to the D. C. field of the synchronous motor can be varied. This varies the current flow

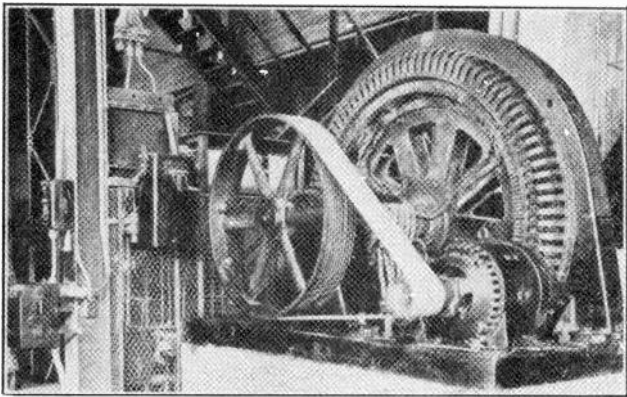

Fig. 5. 150-h. p., 2300-volt, low-speed, synchronous motor and exciter. The speed of the large motor is 144 R.P.M. (Photo courtesy Allis-Chalmers Mfg. Co.)

through the field coils and changes the magnetic strength of the poles. By means of this rheostat the strength of the motor field can be properly adjusted for the mechanical load which it is to drive, and for the amount of power-factor correction it is to perform.

The field discharge switch, *d*, and resistance, *E*, are for the same purpose as when used with alter-

Alternating Current

nators; that is, to prevent high induced voltages in the field winding when the circuit is interrupted.

The damper winding of the rotor is shown in this diagram by the short-circuited bars in the pole faces.

7. STARTING SYNCHRONOUS MOTORS

When starting the motor, the stator is supplied with alternating current by closing the knife switch or oil switch at "b". Some form of compensator is generally used with large synchronous motors to reduce the voltage applied to the stator when starting, and in this manner keep down the heavy surges of starting current which would otherwise occur.

When starting a synchronous motor, there are a certain number of steps or operations which should be performed in the proper order. This is particularly important when starting large motors. The procedure is as follows:

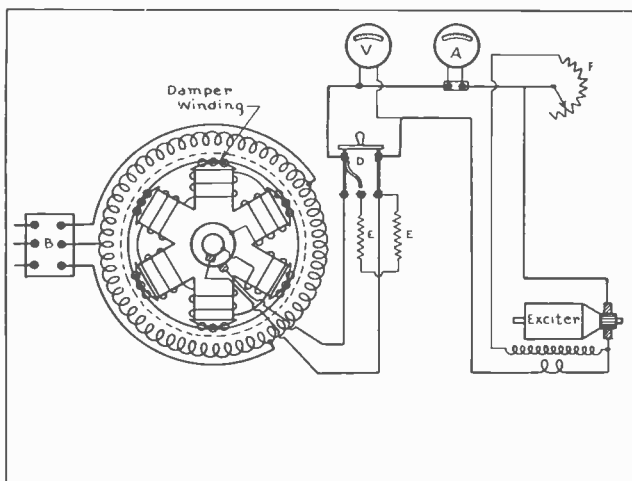

Fig. 6. The above diagram shows the connections for the stator and field of a synchronous motor and also the exciter-generator field discharge switch and instruments.

First, open all switches and see that the field switch is in the discharge position; then apply about 50% of the rated voltage to the stator winding. It

Synchronous Motors

may be necessary to apply higher voltage if the motor is to start heavy loads.

As soon as the rotor has reached nearly full speed, see that the exciter rheostat is properly adjusted so that the D. C. generator produces a low voltage as indicated by the voltmeter, V; and with this low voltage excite the field of the synchronous motor very weakly. Then apply full line voltage to the stator and gradually increase the field excitation until the motor pulls into step. Then adjust the field strength to the proper value to enable the motor to carry the mechanical load, in case it is driving any load of this nature, and for the proper power factor at which the motor is supposed to operate.

Large synchronous motors usually have A. C. ammeters connected in series with the line leads to the stator, and the current input to the motor should not exceed the name-plate current rating, except as per instructions furnished by the manufacturer in regard to the overload capacity of the motor.

Even though a synchronous motor is not driving any mechanical load, it is possible to overload the stator winding with A. C. by over-exciting the D. C. field and thus causing the motor to draw a large leading current. This, of course, tends to correct the power factor of the system to which the motor is attached, but the synchronous motor should not be overloaded for this purpose any more than it should for driving mechanical load.

8. ADJUSTING POWER FACTOR BY CHANGING FIELD EXCITATION

By adjusting the exciting current, the power factor of a synchronous motor may be varied in small steps from low lagging power factor to a low leading power factor. This makes it possible to vary the power factor of these machines over a wide range and places this characteristic of the motor under the control of the operator at all times.

If a synchronous motor which has normal field excitation were driven as a generator, it would de-

Alternating Current

velop the same armature voltage as that which is applied by the A. C. line when the machine is operating as a motor. If the field current is increased above this normal value, the motor will have a leading power factor; and if the field current is below normal value, the motor will have a lagging power factor.

When a synchronous motor is used to drive mechanical load and also to correct power factor, the field will require a small additional amount of exciting current.

9. STARTING COMPENSATORS AND PROTECTIVE DEVICES

Fig 7 shows a diagram of the connections for a large synchronous motor; including the starting compensator, A. C. ammeter, circuit-breaker, and protective devices.

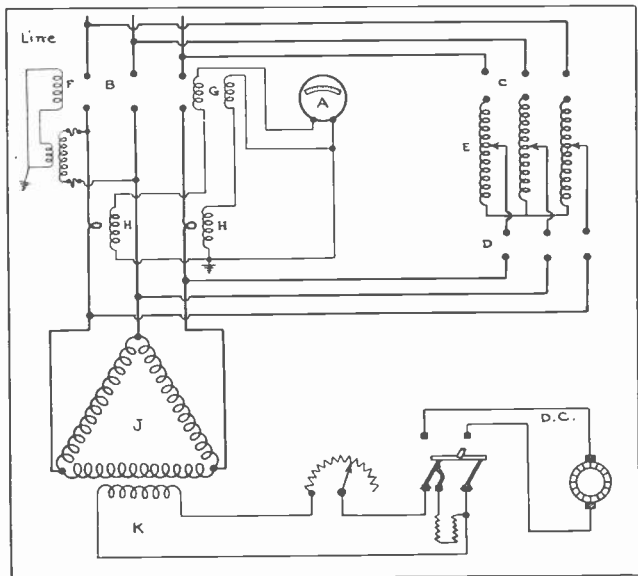

Fig. 7. Diagram of connections for a large synchronous motor with a compensator for starting at reduced voltage. Also note the protective device connected with a circuit-breaker in the line leads.

When starting, the contacts B are opened and contacts C and D are closed, thus supplying reduced

Synchronous Motors

voltage to the motor armature J by means of the auto transformer E.

After the motor comes up to speed, the contacts C and D are opened and B is closed, thus supplying the armature or stator winding with full line-voltage.

If at any time during operation the motor is overloaded and the current flow to the stator winding becomes too great, the current in the secondaries of the current transformers H will be increased and will energize the overload trip coils G and G strongly enough so that they will open the circuit-breaker contacts B.

If the A. C. line-voltage should fail or become too low during operation of the motor, this would also reduce the voltage of the potential transformer secondary and weaken the under-voltage trip-coil F, allowing it to release its armature and open the circuit-breaker B. The D. C. field of the synchronous motor is shown at K.

To stop a synchronous motor or condenser, first decrease the field excitation to normal and then open the line switch. Next open the field-discharge switch and leave it in the discharge position. This switch can be left closed until the machine stops if desired, but should always be opened then.

10. CHARACTERISTICS AND ADVANTAGES OF SYNCHRONOUS MOTORS

The efficiency of medium and large-sized synchronous motors ranges from 88% to 96%, depending upon the size, speed, design, etc. Some very large synchronous motors have been built with efficiencies of nearly 98%.

The starting torque of synchronous motors is usually slightly lower than that of induction motors, but many of the later type synchronous motors are designed with starting torques approximately equal to those of squirrel-cage motors.

These starting torques vary from 50% to 150%, according to the design of the machine.

The pull-out torque of synchronous motors varies from 150% to 200% or more of full-load torque.

Alternating Current

Several of the outstanding advantages of synchronous motors are: (a) their constant speed; (b) ability to correct power factor, which in turn results in better voltage regulation; (c) higher efficiency at low speeds than induction motors.

The ability of synchronous motors to correct power factor is one of the most important of their advantages.

Synchronous motors have several features which may be considered as disadvantages and these are:

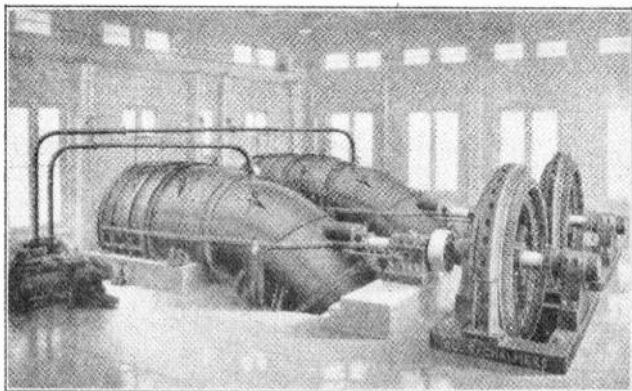

Fig. 8. This photo shows 2600-h. p. synchronous motors driving low-pressure, screw type water pumps. (Photo courtesy Allis-Chalmers Mfg. Co.)

(a) they are somewhat more complicated than induction motors; (b) lower starting torque of the older types; (c) tendency to hunt and therefore to fall out of step and stall; (d) they require more skilled attention than induction motors; (e) they require a supply of both A. C. and D. C.; (f) in case of shorts on the line, synchronous motors act as generators and supply current to the short as long as the inertia keeps the rotor moving at a fair speed. This latter disadvantage can, however, be eliminated with proper protective relays.

11. APPLICATIONS OF SYNCHRONOUS MOTORS

The advantages of synchronous motors for certain classes of service much more than make up for

Synchronous Motors

the disadvantages which have just been mentioned.

Fig. 8 shows two 2600-h. p. synchronous motors used to drive low-pressure water pumps of the screw-propeller type. Fig. 10 shows a group of synchronous motors driving compressors in an ice plant.

Synchronous motors have a very wide field of application and their use is being rapidly extended to other classes of power drives each year. A large number of power generating and public utility companies insist that all motors of 50-h. p. and larger which are connected to the lines must be of the synchronous type. This is done in order to improve the power factor of the system and thereby permit better utilization of the generator line and transformer capacities.

With lower power factors, a large portion of the generator, line and transformer capacities must be used for the circulation of lagging wattless currents.

A number of the more common uses or applications for synchronous motors are as follows:

Operation of compressors and pumps; operation of fans and blowers, motor-generators, and frequency changers; steel mill drives; paper mill drives; crushers and grinders; line-shaft drives; and as synchronous condensers for power-factor correction only.

12. SUPER-SYNCHRONOUS MOTORS

It has previously been mentioned that, in order to start with loads, synchronous motors are sometimes connected to the load by means of friction or magnetic clutches. A variation of this principle is used on a special synchronous motor which has been designed for starting heavy loads and is known as a **super-synchronous** motor.

This type of motor has the stator frame arranged so that during starting the entire frame and core can revolve on auxiliary bearings on the motor shaft. This allows the rotor, which is attached to the load, to remain stationary until the stator is revolving around it at full synchronous speed.

The field is then excited with D. C. and a brake is gradually applied to the stator frame, causing

Alternating Current

it to reduce speed and finally bringing it to a complete stop. This gradually exerts upon the rotor poles the full running torque of the synchronous motor, and as soon as the brake is applied the rotor begins to turn and drive the load, coming up to full synchronous speed by the time the stator frame is completely stopped.

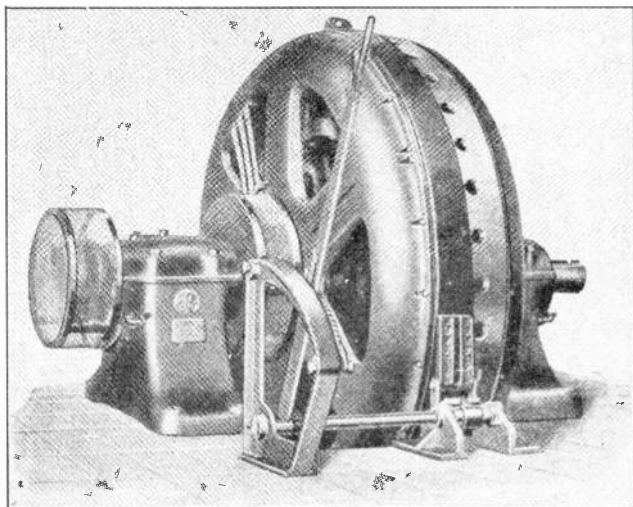

Fig. 9. Super-synchronous motor which is equipped with a revolvable stator and brake to obtain high starting torque. (Photo courtesy G. E. Company.)

This method permits the use of the full running torque to start the load and allows the starting to be accomplished at much higher power factor.

Fig. 9 shows a 300-h. p. super-synchronous motor of the type just described. In this figure you will note that the stator frame is not attached to the bearing pedestals but is instead mounted on its own bearings on the motor shaft. You will also note the brake-band around the outside of the stator frame and the brake-link and lever which are used to tighten the band and stop the rotation of the stator and thereby cause the rotor to start the load.

The slip-rings of this motor are mounted on the left end of the shaft inside of the protective screen,

Synchronous Motors

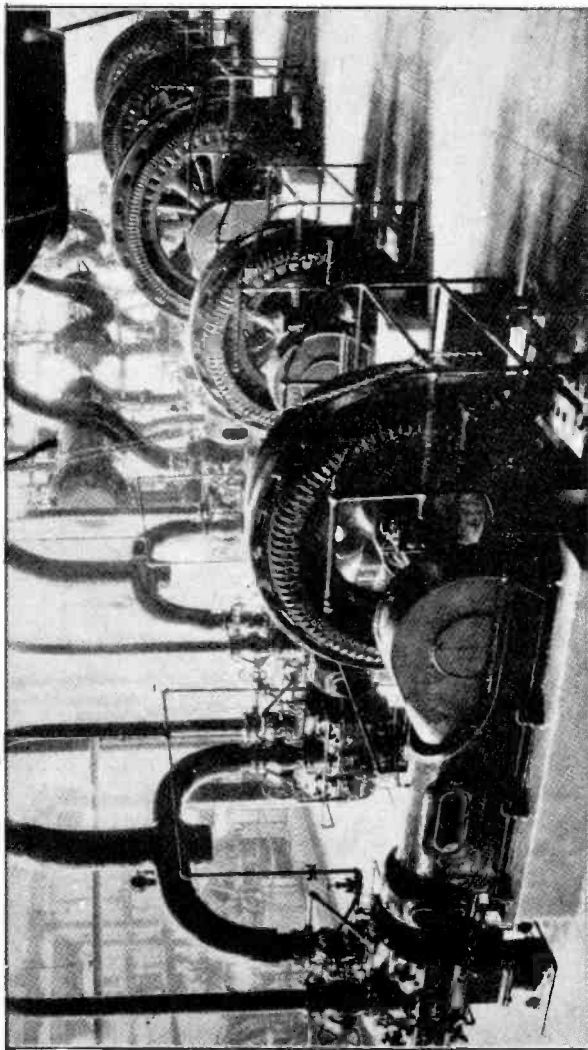

Fig. 10. Group of large synchronous motors used to drive compressors in an ice plant. Many large ice plants and refrigerating plants use motors of this type to operate their ice machines.

Alternating Current

and the leads are taken through the hollow shaft to the D. C. rotor poles.

Fig. 11 shows a group of large super-synchronous motors in use in a cement mill. Two sets of slip rings must be used with motors of this type; one set for conveying the alternating current energy to the stator or armature when it is revolving during starting period, and the other set for supplying the direct current to the rotor, which revolves all the time during the operation.

The method of calculating the proper size of synchronous condenser to use for correcting the power factor of a system, will be covered in the following lesson.

13. SPECIAL A. C. MOTORS

In addition to the common types of A. C. motors which have just been explained and which are in very general use throughout the entire electrical industry, there are also a number of special A. C. motors which are designed with certain characteristics to meet unusual requirements.

Several types of these which have been more recently developed are proving very satisfactory and have excellent advantages for certain classes of work. Some of these motors, or the principles involved in their design, will come into much more extensive use in the next few years, and for this reason they are worth a little special attention at this point.

The principles on which these motors operate are in general more or less similar to those of common types of machines with which you are already familiar. Therefore, it is not necessary to go into great detail in discussing them; so we shall merely explain the application of these principles to several of the most popular types of special motors and shall also explain the characteristics and applications of these machines.

14. DOUBLE SQUIRREL-CAGE MOTORS

We have already learned that it is possible to obtain much better starting torque from induction

Synchronous Motors

motors by the use of a certain amount of resistance in the rotor circuit. It is not always desirable to use a slip-ring motor with the auxiliary controls required; and, if squirrel-cage motors are designed with rotors of very high resistance, this resistance while improving their starting torque, will also decrease their running efficiency.

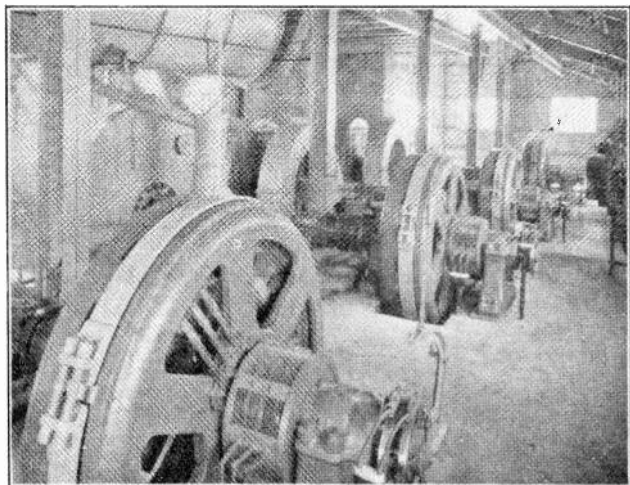

Fig. 11. This photo shows four large low-speed super-synchronous motors operating at 2200 volts and driving machines in a cement mill. (Photo courtesy G. E. Company.)

To obtain the very good starting torque of the high-resistance rotor and also the higher running efficiency of the low-resistance rotor, induction motors have been developed with what are called **double squirrel-cage rotors**.

These rotors consist of the usual core of laminated iron equipped with specially-shaped slots in which are imbedded the bars of two squirrel-cage windings. One squirrel-cage with large bars of low resistance is imbedded deeply in the iron core in the bottoms of the slots, and another squirrel-cage with smaller bars of higher resistance is located close to the outer surface of the rotor core with the bars placed just beneath the core surface.

Fig. 12 shows on the left a sectional view of such a rotor which has been cut in two to show the

Alternating Current

position of the high-resistance squirrel-cage at "A" and the low-resistance squirrel-cage at "B". On the right in this figure is another view of a double squirrel-cage of this type from which the iron core has been removed by acid. This view shows very clearly the construction of the inner or low-resistance element and the outer or high-resistance element.

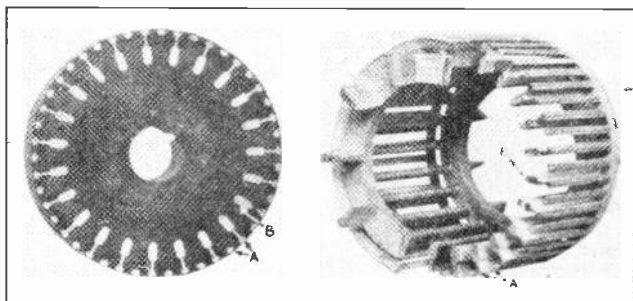

Fig. 12. This figure shows two views of a double squirrel-cage rotor. On the left is a sectional view and on the right the core iron has been eaten out by acid, clearly showing the construction and shape of the double squirrel-cage. (Photo courtesy General Electric Co.)

Fig. 13 shows a complete rotor of the double squirrel-cage type in which the bars and end rings of the squirrel-cages are cast of aluminum which has been poured directly into the openings in the iron core, thus making it one very solid unit when completed.

15. OPERATING PRINCIPLES

These motors have an ordinary stator winding the same as any polyphase induction motor. When the stator is supplied with A. C. from the line, the revolving magnetic field induces secondary currents in both of the squirrel-cage windings and sets up the torque which starts the motor.

During starting, however, the outer or high-resistance squirrel-cage is the one which is most active, and very little current is carried by the inner cage during this period. This is due to the fact that the smaller high-resistance bars are located near the outer edge of the rotor core and have

Special Motors

much less iron or magnetic material around them. This means that they provide a path of much lower reactance than the inner bars, which are completely surrounded with a heavy path of iron.

This outer winding of low reactance provides a much easier path for the high-frequency secondary currents which are induced during starting when

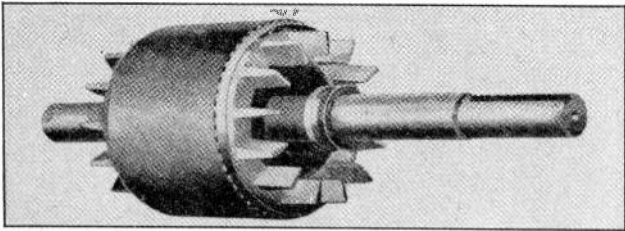

Fig. 13. Complete rotor of the double squirrel-cage type. Note that there are no open slots around the rotor core, the bars being cast into the rotor.

the slip of the motor is very great. After the motor is up to nearly full speed and the slip is very small, the frequency of the induced rotor currents is then much lower, and as low frequency A. C. can pass through an inductive circuit much easier than high frequency, the low-resistance bars of the inner squirrel-cage now offer an easy path for the flow of rotor current during normal running of the motor.

We find, therefore, that the changeover of the current from the high-resistance, starting squirrel-cage to the low-resistance, running cage is entirely automatic and requires no switches or moving contacts; being due entirely to the change of frequency and magnetic characteristics of the motor between the period of high slip during starting and reduced slip when running.

Double squirrel-cage motors are very suitable for jobs which require heavy starting torque and where simple, rugged motors requiring a minimum of maintenance are desired. The double-squirrel-cage principle is not altogether new, having been used in induction motors since their early development; but it is only in recent years that this principle has come into general use in commercial power motors.

16. DOUBLE-SQUIRREL-CAGE MOTORS WITH "CHOKER BARS"

Several different styles of double-squirrel-cage motors are in use at present. Some of these use different variations of the principle, but in general their operation is very much the same. One motor of this type which is made by the Fairbanks Morse Company, uses a set of loose iron bars or rods which are placed in the slots between the inner and outer squirrel-cage bars. These bars change their position by centrifugal action when the motor comes up to speed, thus changing the magnetic path and thereby varying the reactance of the squirrel-cage circuits.

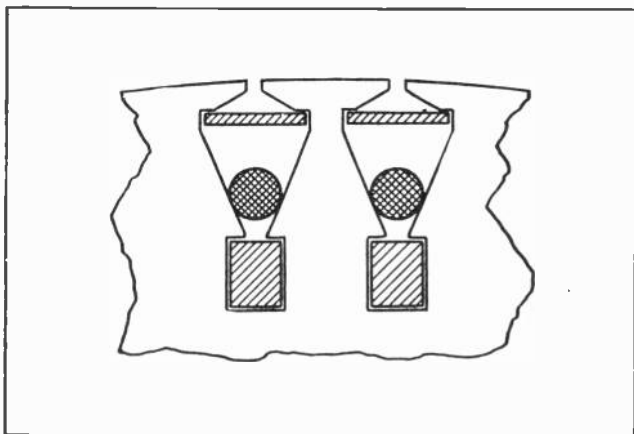

Fig. 14. This sketch shows the slot and bar construction of double squirrel-cage rotors using iron "choker bars" to change the resistance of the field and outer circuits.

Fig. 14 shows a cross-sectional view of two slots of a rotor of this type. The low-resistance squirrel-cage bars are located in the inner slots, and the high-resistance squirrel-cage bars are the thin flat ones shown near the outer edges of the slots.

When the motor is first started, the round iron bars are held in the bottom of the slots by the magnetic action of the flux set up in the rotor. This completely closes the iron path around the inner squirrel-cage, making this path one of very high impedance, so that only a very small amount of the

Special Motors

starting current flows in this winding.

When the motor reaches nearly full speed, the iron bars are thrown outward by centrifugal force, thereby decreasing the amount of magnetic material around the inner bars, and increasing the amount of iron around the outer bars.

This reduces the reactance of the inner squirrel-cage and increases the reactance of the outer one which, we recall, is already of high resistance. This

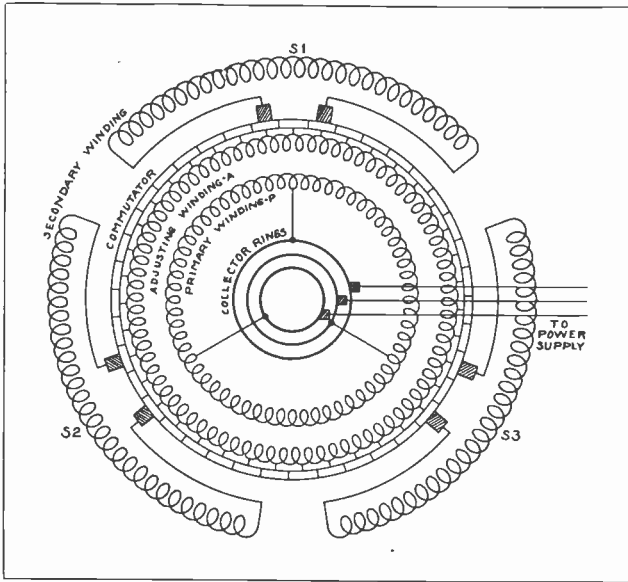

Fig. 15. This diagram shows the connections of the armature and stator windings of a BTA variable speed A. C. motor. Examine the diagram carefully while reading the accompanying explanation.

causes a very decided shift of the lower frequency currents induced in the rotor during running, from the high-resistance rotor to the one of low resistance.

17. BTA VARIABLE-SPEED A. C. MOTORS

Another type of A. C. motor, known as the BTA motor, has been developed by the General Electric Company to meet the needs of various power-driven machines which require adjustable speed A. C.

Alternating Current

motors with characteristics similar to those of the shunt D. C. motors.

These motors have a stator winding and two windings on the rotor, and also use a commutator and brushes similar to those of a D. C. machine.

Fig. 15 shows a diagram of the windings and connections of a motor of this type. You will note that the alternating current line connects to one of the rotor windings, "P", by means of the brushes and slip rings. When this winding is excited with A. C. from the line, it sets up a revolving magnetic field and also induces secondary currents in the stator windings: S-1, S-2, and S-3.

The winding in the stator is constructed similarly to stator windings of ordinary induction motors, except that the three phases are connected separately to the three pairs of brushes which rest on the commutator. These brushes are adjustable and can be moved closer together or farther apart. When they are resting on the same commutator segment the stator windings are short-circuited, so that a rather heavy flow of induced secondary current is set up in these windings.

The adjusting winding, "A", which is also carried on the revolving armature and is connected to the bars of the commutator, generates a certain amount of voltage which is applied to the brushes that connect to the stator winding.

When these brushes are moved farther apart, a greater amount of adjusting voltage is applied to the stator windings. By shifting the brushes and varying this voltage, the speed of the motor can be changed.

18. CHARACTERISTICS

These motors are usually built for a range of speed variation of three to one, and are designed to operate at constant torque at any speed within their range. This means that the horse power will be proportional to the speed at which they are operated.

The efficiency of these motors remains nearly constant over the greater part of their speed range, but is slightly lower at the lowest operating speeds.

Special Motors

Their average efficiency is high compared with that of wound-rotor induction motors having secondary resistance.

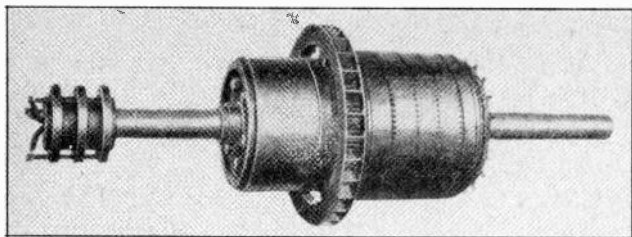

Fig. 16. Armature of a BTA motor showing the commutator, slip-rings, and ventilating fan. (Courtesy G. E. Company.)

The power factor of this type motor is about the same at synchronous speed as the power factor of an ordinary induction motor of the same size, and becomes higher when the motor is operated at higher speeds.

BTA motors will develop from 140 to 250 per cent. of full-load torque during starting and with starting currents of only 125 to 175 per cent. This ability to develop heavy starting torques with comparatively small starting current is one of the very desirable features of these motors.

When operating at their lower speeds, the pull-out torque of these motors is from 140 to 250 per cent. of full-load torque, and when operating at higher speeds the pull-out torque varies from 300 to 400 per cent. of normal-load torque.

Fig. 16 shows the armature of a BTA motor removed from the machine. The commutator is connected to the adjusting winding on the armature similarly to the connections for an ordinary D. C. motor armature and commutator. The slip rings on the left end of the shaft have leads taken from them through the hollow shaft to the A. C. winding on the armature.

You will note also the ventilating fan which is attached to the armature at the rear of the commutator.

Fig. 17 shows a complete BTA motor. The small hand-wheel on the upper arm of the end-bracket

Alternating Current

is used for adjusting the position of the brushes and thereby changing the motor speed. The collector rings on the end of the shaft are enclosed in a safety hood or guard, as shown. The line leads are brought out of this hood for connection to the three-phase A. C. line.

The small box on the side of the motor frame near the base contains an overload relay to protect the motor from too heavy overloads. This relay is connected to the starting switch or motor controller so that it will trip the starter and open the line circuit in case of excessive overload currents to the motor.

Fig. 18 shows the standard ratings of type BTA motors. These are made in six, eight, and ten-pole types for normal speeds of 1200, 900, and 720 R.P.M. You will note from the table that the six-pole machines can be varied above or below their nor-

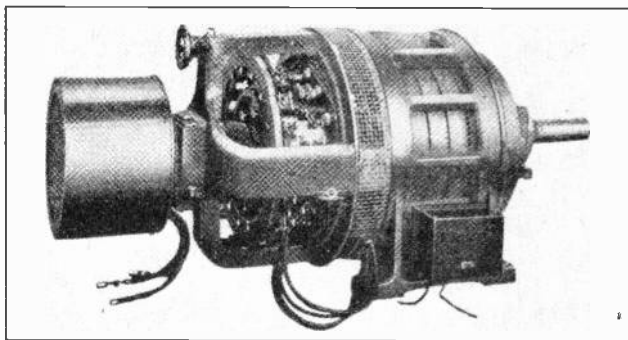

Fig. 17. This photo shows the completely assembled BTA motor. The brush-shifting wheel can be seen on the upper corner of the frame and the slip-rings are enclosed in the housing at the left end of the shaft. (Courtesy G. E. Company.)

mal speed of 1200 R.P.M., within a range of 550 to 1650 R.P.M. The normal speed of 900 R.P.M. for the eight-pole machines can be varied from 415 to 1215 R.P.M., and the normal speed of 720 for ten-pole machines can be varied from 333 to 1000 R.P.M.

You will also note from the center column of the table that the horse power varies in proportion to the speed. For instance, the 5-h. p. motor develops

Special Motors

only 1.67 h. p. at its lowest speed of 550 R.P.M. In other words, when the speed is reduced to one-third the horse power is also reduced to one-third.

The motor with maximum rating of 10-h. p. at high speed develops only $3\frac{1}{3}$ h. p. at its lowest speed, etc.

Rating of Standard BTA Motors

Number of Poles	H.P.	Full Load Speed
6	5/1.67	1650/550
6	7.5/2.5	1650/550
6	10/3.33	1650/550
6	17.5/5.83	1650/550
8	25/8.33	1250/415
8	35/11.67	1200/415
10	50/16.67	1000/333

Fig. 18. The above table gives the horsepower rating and speed ranges of standard BTA motors. Note how the h. p. varies with the speed.

19. FYNN-WEICHSEL MOTORS

Another special type of motor which is manufactured by the Wagner Electric Corporation, is known as the Fynn-Weichsel motor. These motors are really combination induction and synchronous motors, and have excellent starting torque and very high power factor when running fully loaded. They start as an induction motor and will start loads of 150% or more, of full load quickly bringing them up to full speed, and at this point the motor changes over and runs as a synchronous motor during normal operation.

If during operation the motor is overloaded beyond 160% of full load current it will pull out of synchronism and again operate as an induction motor up to overloads of approximately 250% or more before it will stall.

These characteristics have made this type of motor very popular in the last few years for certain classes of drives where motors with good starting torque, constant speed, and high power-factor are required.

Another decided advantage of the Fynn-Weichsel

Alternating Current

motor is that it supplies its own direct current for exciting the D. C. field winding, and therefore does not require separate exciter-generators as ordinary synchronous motors do.

20. CONNECTIONS AND OPERATING PRINCIPLES

Fig. 19 shows a diagram of the windings and connections for a Fynn-Weichsel motor. The revolving armature or rotor has a main A. C. winding connected to slip rings and to the A. C. line. In addition, it also has a small D. C. winding which is connected to the commutator and develops in the neighborhood of 24 volts of direct current for excitation of the D. C. field poles.

This field winding is placed in the slots of a stator and is uniformly distributed over the stator core, instead of being wound on projecting field poles as in the ordinary synchronous motor.

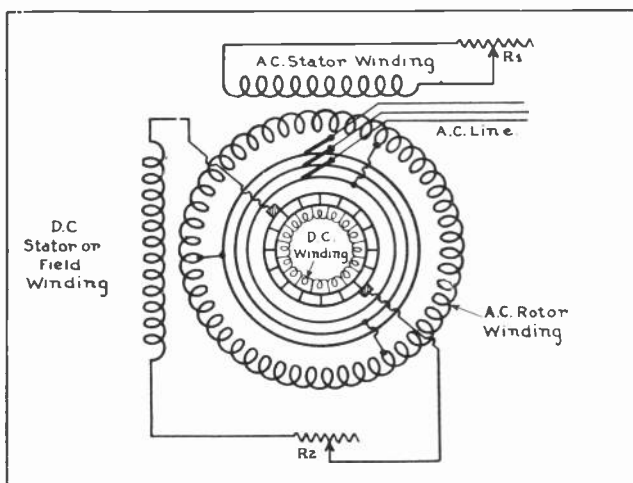

Fig. 19. Diagram showing the connections of the armature and field of a Fynn-Weichsel motor. Note that both the stator and armature have two separate windings.

The diagram in Fig. 19 shows the D. C. field-winding connected to the brushes of the commutator and equipped with a rheostat for varying the field strength. In this simple diagram the single coil or winding shown is used to represent the en-

Special Motors

tire field winding and whatever number of poles it may actually contain.

There is also an A. C. winding which is placed in the slots of the stator and is connected through a rheostat to form a closed circuit upon itself. This winding is located 90 degrees from the D. C. winding in the stator.

When alternating current is applied to the slip rings and the A. C. winding on the rotor, it sets up a revolving magnetic field and also induces secondary currents in both the A. C. stator-winding and the field winding.

The reaction between the flux set up around these windings and the field of the A. C. rotor winding, develops excellent starting torque and quickly brings the motor up to full speed. As the speed of the motor increases, the D. C. voltage obtained from the commutator and small winding and applied to the brushes becomes higher and higher; and when the motor reaches nearly full speed, the value of this voltage increases the strength of the D. C. field winding and causes the motor to pull into synchronism and operate as a synchronous motor during normal running conditions.

If the motor is overloaded beyond the pull-out torque capacity of about 160% full-load torque, it will then fall out of step and operate as an induction motor, once more continuing to carry the overload at slightly reduced speed.

During starting of the motor, rheostat R-1 is adjusted to include the proper amount of resistance in series with the A. C. secondary winding in the stator. This resistance is cut out as the motor comes up to speed and the winding is then short-circuited.

When the motor pulls into synchronous speed there is no more slip, so there will be no appreciable current induced in this stator winding as long as the motor operates as a synchronous machine.

If the motor is overloaded to a point where it pulls out of synchronous operation and slightly reduces its speed, this recurrence of the slip will immediately cause current to be induced in the stator

Alternating Current

winding once more and thus develop by induction the added torque which enables the motor to carry the very heavy overloads which it is capable of carrying as an induction motor.

21. LEADING POWER FACTOR AND P. F. ADJUSTMENT

Rheostat R-2 can be adjusted to obtain the proper strength of the D. C. field-winding according to the load the motor is required to carry and the power factor which it is desired to maintain.

At full load the Fynn-Weichsel motor generally has a power factor of about 92% leading. From

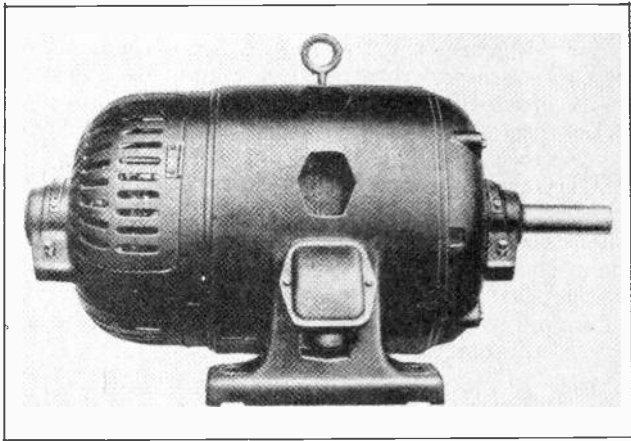

Fig. 21. This photo shows a completely assembled Fynn-Weichsel motor with a guard enclosing the slip-rings and commutator. (Courtesy Wagner Electric Corp.)

this we can see that if one or more motors of this type are used in a plant with induction motors and other inductive equipment they will improve the power factor considerably.

In fact, a 15-h. p. Fynn-Weichsel motor with its leading power factor will just about neutralize the lagging power factor of the 15-h. p. slip-ring, induction motor, thereby keeping the power factor at approximately unity on the line or system on which the two motors are operated in parallel.

Special Motors

While the power factor of squirrel-cage induction motors becomes very low when they are operating lightly loaded, the power factor of the Fynn-Weichsel motor remains practically constant with any decrease of load which ordinarily occurs on a motor properly selected for its drive.

Fig. 21 shows a complete Fynn-Weichsel motor with protective guards over the commutator, slip-rings, and brushes.

22. SPECIAL ENCLOSED-TYPE MOTORS

In certain plants and classes of work where motors must operate in an atmosphere that is filled with dust or vapors it is often very difficult to keep the ventilating spaces in the motor windings from clogging with dust or to prevent the insulation of the windings from being damaged by vapors.

To meet these conditions there are motors now being built with the winding, rotor, and bearings completely enclosed in an air-tight casing. These motors are so designed that the heat from the windings is conducted to the outside through the metal shell or casing. The regular motor casing is in turn enclosed in an outer jacket which guides a strong draft of cooling air directly over the surface of the motor casing, thus greatly aiding in the cooling of the machine.

Fig. 22 shows several views of a motor of this type. The upper left view shows the end from which the cooling air is exhausted from the jacket. The upper right view shows the air-intake end, with a screen which prevents coarse objects from getting into the fan and also protects an operator's hands from coming in contact with the revolving fan-blades. The lower view shows the motor and its enclosing frame removed from the air jacket and also shows the large ventilating fan used to form the strong draft of air over the motor casing. Motors of this type can be operated in extremely dusty places without injury to field windings or bearings by dust or vapors in the air, and also without the explosion hazard which accompanies the use of open commutator or slip-ring types.

There are a number of other special types of

Alternating Current

motors which have been developed to fit almost every requirement and class of service for which a power drive is required. However, the general

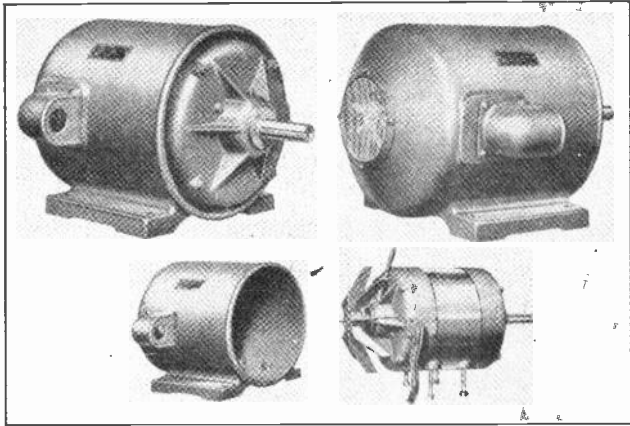

Fig. 22. Completely enclosed A.C. induction motor with special air-jacket to direct the cooling air over the surface of the motor casing. These motors are ideal for use in extremely dirty locations or in places where there are explosive vapors or dust.

principles of these machines are very much alike and are similar to those which have been described in this section; so you will have no trouble in understanding almost any type which you may encounter.

23. PORTABLE MOTORS FOR FARM USE

Fig. 23 shows a polyphase induction motor and push-button starter mounted on a convenient portable truck, with a heavily insulated extension cord for connecting the motor to a nearby line or transformer. Portable motors of this type are very convenient for certain temporary drives in industrial plants and factories, and are also coming into quite extensive use on farms.

There are numerous profitable uses for electric power on the farm, and many thousands of farms are well electrified and making excellent use of electricity for both light and power purposes.

Special Motors

24. ELECTRIC MOTORS FOR USE ON SHIPS

Electric motors are also used extensively in ships of all classes. Battle ships are using enormous electric motors for driving their propellers, and also numerous small motors for handling equipment aboard the ship. Merchant marine ships use numerous electrical motors for operating cranes, derricks, hoists, elevators, and conveyers in handling materials when loading and unloading the ship.

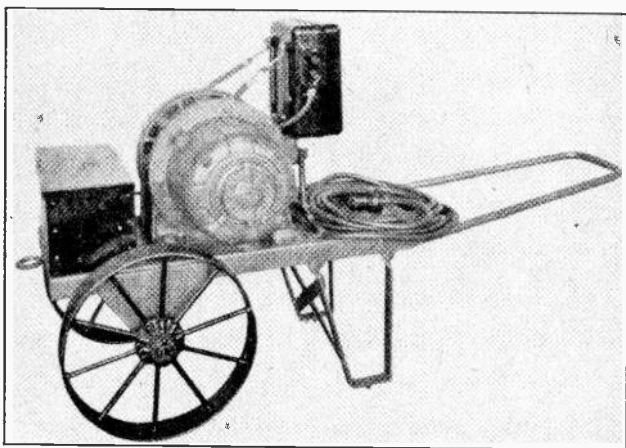

Fig. 23. Portable A.C. induction motor particularly adapted for use on farms and for driving portable machinery. (Courtesy G. E. Company)

Many of the smaller and medium sized motors for deck use on ships are enclosed in special air and water-tight casings, to exclude all salt water and vapor.

Electrical dredges use powerful electric motors to operate soil and rock cutting tools as well as the enormous suction pumps with which these dredges are equipped.

Modern passenger liners may have as many as several hundred medium and large sized electrical motors, in addition to the numerous small ones which are used for fans and convenience devices.

Alternating Current

Two of the large ships in the U. S. navy are each equipped with eight motors of 22,500 h. p. each, which are used for propeller drives.

So we find electric motors are the principal source of mechanical power in practically all classes of industry and even on the farms and ocean-going ships.

EXAMINATION QUESTIONS

1. Name two advantages in using synchronous motors?
2. Briefly describe the construction of a synchronous motor?
3. For what purpose are "damper windings" used in synchronous motors?
4. Name three causes of "hunting" in a synchronous motor?
5. How is the field strength adjusted to cause leading power factor?
6. How does the starting torque of a synchronous motor compare to the starting torque of an induction motor?
7. For what purpose are Super-Synchronous motors used?
8. What advantage does the Double-squirrel-cage motor have over motors with ordinary squirrel-cage rotors?
9. What is the operating speed range of a 10 pole BTA motor?
10. A. Briefly describe the construction of a Fynn-Weichsel motor?
B. Name two advantages of the Fynn-Weichsel motor?

POWER-FACTOR CORRECTION

Throughout the first section on A. C. and in a number of places in this section on A. C. motors, we have mentioned the desirability of maintaining good power factor on alternating-current systems.

We have also found that induction motors operate at lagging power factor even when fully loaded, and that they are particularly detrimental to the power factor when they are allowed to operate lightly loaded.

Some of the disadvantages of low power factor are as follows: It causes wattless currents to flow through the feeder lines and alternator windings, thereby requiring larger alternators, transformers, lines, switches and fuses, or causing overheating of those already in use. Low power factor causes increased voltage drop and poor voltage regulation on the lines and system in which it exists. This voltage drop may result in low voltage at the terminals of motors and other equipment and cause them to develop very poor starting torque.

So we find that low power factor makes necessary the use of expensive voltage-regulating equipment, larger alternators and transformers, larger conductors in the lines and feeder circuits, and increased size of motors to perform a given amount of mechanical work.

In addition to these things, low power factor is often the cause of increased power bills because some power companies have in their power contracts a penalty clause on low power factor.

We have learned that lagging power factor can be neutralized and the power factor of a system improved by the use of synchronous motors or static condensers, which operate at leading power factors and supply leading currents which neutralize the lagging currents of inductive equipment.

1. USE OF SYNCHRONOUS MOTORS AS CONDENSERS

Synchronous motors operating with over-excited fields and used as **synchronous condensers** are very

Power-Factor Correction

frequently installed for correcting the power factor in industrial plants and on the lines of power companies.

Synchronous condensers are generally used for power-factor correction where more than 500 kv-a. of corrective energy is to be handled, and they are also commonly used in sizes down to 50 kv-a.

In industrial plants where a large number of A. C. induction motors are in use, it is often advisable and economical to replace some of these with synchronous motors to drive certain machinery or equipment which is suited to the characteristics of synchronous motors.

In this manner the synchronous motors can be used to furnish mechanical power and also to correct power factor. In other cases, medium or large sized synchronous motors are connected to the lines or system wiring without any mechanical load and allowed to float on the system just for power-factor corrective purposes. They are then known as **synchronous condensers**.

Sometimes an idle A. C. generator can be used in this manner and allowed to run idle on the A. C. lines with its field strongly excited. This improves the power factor on the system and will often greatly reduce the amount of wattless current flowing in the lines and required from the other alternators which feed the system.

Synchronous condensers have the advantage of being of lower first cost than static condensers and also of being much smaller in size for a given kv-a. capacity on the larger units. They also possess the advantage of affording easy adjustment of the power factor by regulation of their field excitation, and their operating characteristics tend to maintain good voltage regulation on the circuits to which they are attached.

The disadvantages of synchronous condensers are that they have somewhat higher losses and require more care and maintenance than static condensers. Synchronous condensers are commonly installed where the power factor of a large system can be corrected from one central point.

Alternating Current

Fig. 1 shows a synchronous condenser of 5000 kv-a. capacity, for 2300-volt operation. This machine is enclosed in an air-tight casing and is cooled by clean, dry, ventilating air which is forced through this casing from openings in the bottom of the frame. The exciter-generator shown is mounted on a separate base on the end of the main condenser base and is driven by the end of the main shaft.

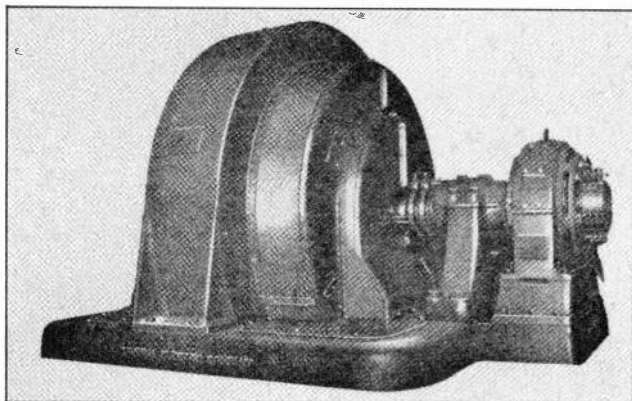

Fig. 1 5000-kv-a., 2300-volt, enclosed-type, synchronous condenser. The exciter for this machine is shown on the right. (Photo courtesy G. E. Company).

2. STATIC CONDENSERS

The use of static condensers for power-factor correction has become quite general during the last few years. These devices have the advantage of being simple to install and of requiring practically no care or maintenance, as they have no moving or wearing parts.

They are of somewhat higher first cost and have the additional disadvantage of not being adjustable except by changing the number of condenser units which are connected to the system.

Static condensers can be used in large banks or groups to correct the power factor of the entire system, by connecting them at the switchboard or transformer bank where the power enters the plant or buildings. Small condensers can be used to cor-

Power-Factor Correction

rect the power factor of individual induction motors by connecting them directly to terminals of these motors and locating the condenser within a few feet of the motor itself.

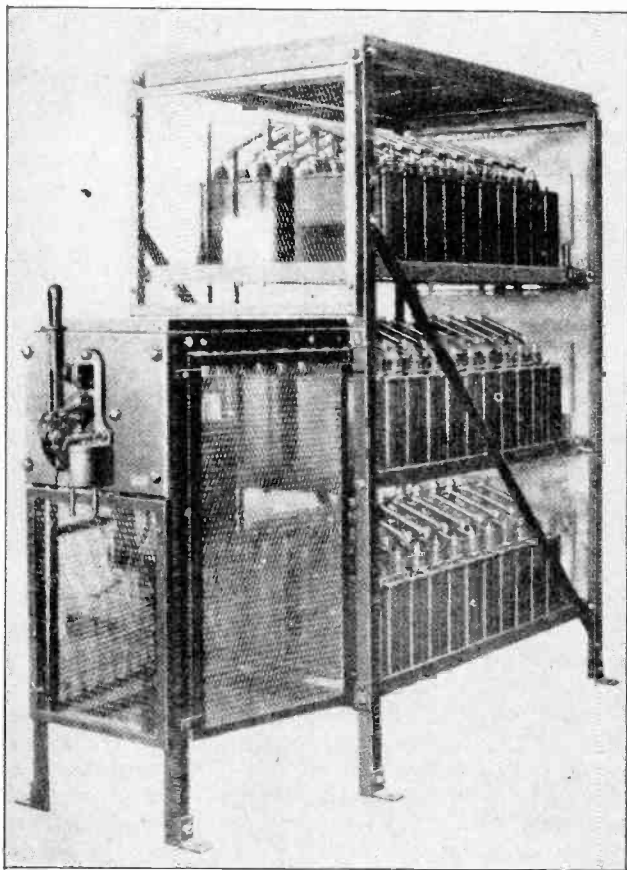

Fig. 2. 300-kv-a., three-phase, 2500-volt, capacitor or static condenser, used for improving power factor. (Courtesy General Electric Co.)

Fig. 2 shows a 300 kv-a. static condenser for operation on 2500 volts. This unit consists of a number of small condensers located in racks and properly connected across the three phases of the line. These condensers can be seen mounted in three banks in the three levels of the frame. The oil switch mounted on the front of the unit is for

Alternating Current

disconnecting the condenser from the system whenever necessary.

Fig. 3 shows a pair of condenser units, or capacitor units as they are often called. These units are equipped with resistors of the cartridge type for discharging them when they are disconnected from the line. If it were not for these resistors shunted across the condensers they would hold a charge of high voltage for a considerable period after being disconnected, and this would make them dangerous for an operator to work on.

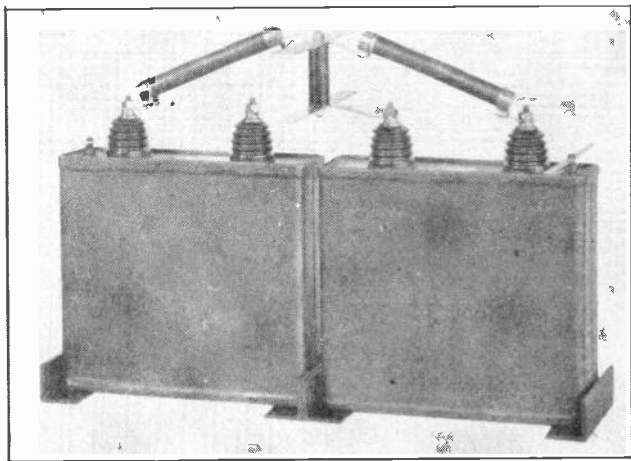

Fig. 3. Two single-phase condenser units connected together with discharge resistors in their circuit. (Courtesy G. E. Company).

It is also advisable to short-circuit any condenser with a piece of insulated wire, to make sure that it is discharged before working on it.

The resistance units are of high enough resistance so that they do not appreciably short-circuit the condensers or cause any considerable loss during operation. When the condensers are disconnected from the line, however, it requires only a few seconds for the energy stored in them to discharge through the resistance units.

3. CONSTRUCTION OF STATIC CONDENSERS

You are already quite familiar with the construc-

Power-Factor Correction

tion of condensers and have learned that they consist primarily of thin conducting plates of metal foil, separated by sheets of insulation or dielectric of the proper thickness and quality to stand the voltage at which the condenser is designed to operate.

These alternate sheets of metal and insulation can be arranged either in a flat stack with every other metal plate connected to opposite terminals, or in a roll with a good many square feet of each material rolled into one compact unit and these long metal strips then connected in parallel to the terminals.

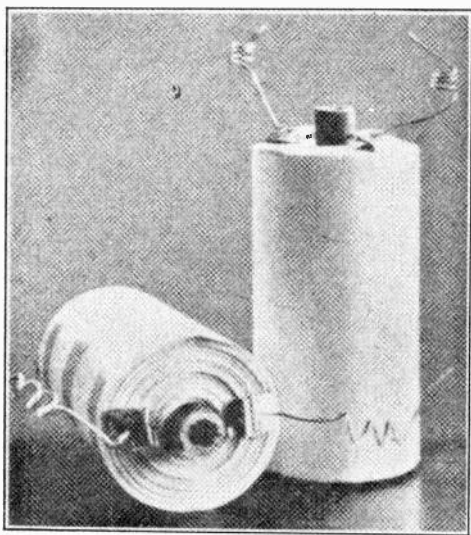

Fig. 4. Roll-type condenser units in which the long strips of metal foil and insulating paper are rolled into one compact condenser element. (Courtesy Electric Machinery Mfg. Co.)

Fig 4 shows two views of roll-type condenser units in which the strips of metal foil are rolled between strips of insulating paper. Note the terminals which are brought out on the ends of these units for connecting a number of them in series or parallel to obtain the proper voltage and capacity rating of the condenser.

Fig 5 shows a number of these roll-type condensers mounted in one tank or case and connected

Alternating Current

three-phase to the terminals in the box on the front of the tank.

The condenser tanks are generally filled with insulating oil or compound to add insulating strength and also to keep out all moisture and thereby preserve the quality of the insulation of the units.

Fig. 6 shows a complete condenser unit with an oil switch mounted on the front of the tank for

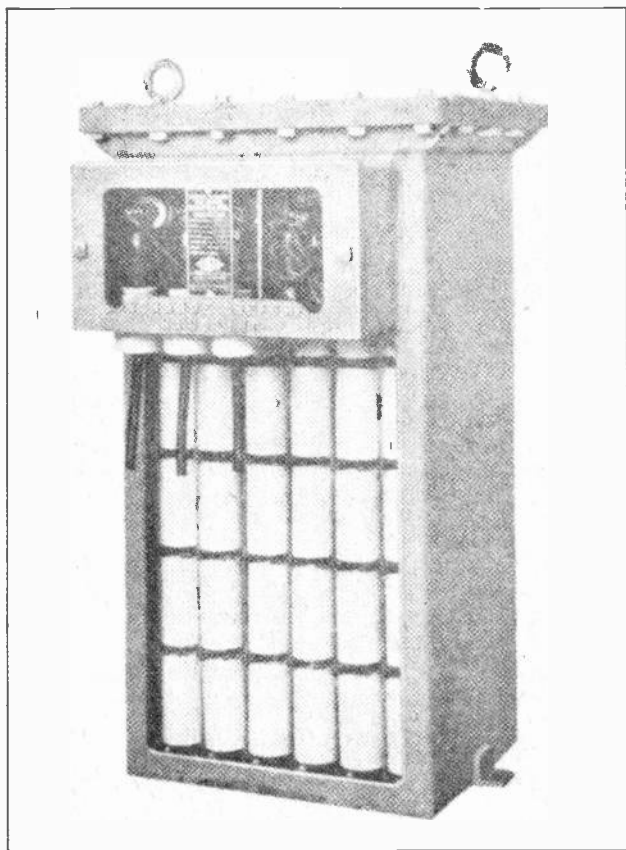

Fig. 5. Complete static condenser with side of tank cut away to show arrangement of roll-type condenser units. (Courtesy Electric Machinery Mfg. Co.)

making and breaking the connections between the condenser and line.

Power-Factor Correction

Condensers which are enclosed in water-proof tanks such as shown in Figs. 4 and 5 can be used either indoors or outdoors, and in some cases they are mounted on poles or platforms with the outdoor transformers.

4. OPERATION OF STATIC CONDENSERS

You have already learned that when a difference of potential is applied to the terminals of two parallel conducting surfaces which are located close together but insulated from each other, they will absorb or store up an electro-static charge. When the applied voltage is removed and the condenser short-circuited, this static energy will discharge in the form of dynamic current.

When alternating current is applied to a condenser it charges the unit during the period of the alteration when the voltage is increasing from zero to maximum, and allows the condenser to discharge back into the line when the voltage starts to fall from maximum to zero.

The current thus supplied by the condenser leads the applied line-voltage by approximately 90° and thereby neutralizes the effect of lagging currents in the circuit.

When a condenser is connected to terminals of an induction motor as shown in Fig. 7, the condenser supplies wattless current or magnetizing current to the motor so that this lagging current doesn't flow through the line between the transformers or alternators and the motor.

The opposite characteristics of the induction motor and the static condenser cause a continual circulation or interchange of current between the two during operation. By preventing this flow of wattless current through the lines, the static condenser reduces the voltage drop in the line and in many cases makes possible the use of smaller line or feeder conductors to the motor. It also reduces the amount of wattless current carried by the alternator windings.

Alternating Current

5. LOCATION OF CONDENSERS

When the motors are of medium or large size it is often desirable to correct the lagging power factor right at its source by connecting small con-

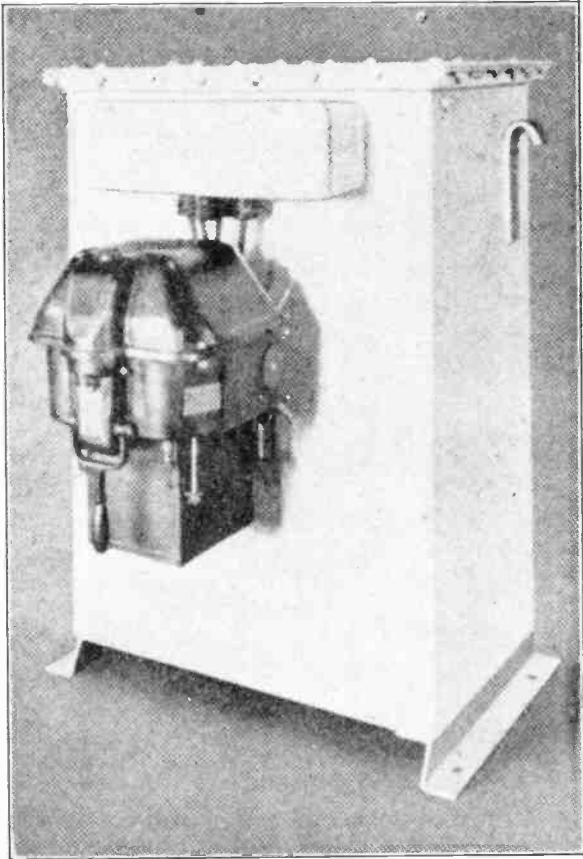

Fig. 6. This photo shows a static condenser enclosed in a moisture-proof metal tank and equipped with an oil switch for breaking the circuit between the condenser and the line. These condensers are made for both indoor and outdoor service. (Courtesy Electric Machinery Mfg. Co.)

densers to the motor terminals. This prevents the flow of wattless current or magnetizing current through the feeders in the plant and through the power line and alternators. In other cases, where

Power-Factor Correction

this is not convenient and there are a number of small or medium-sized motors connected to the

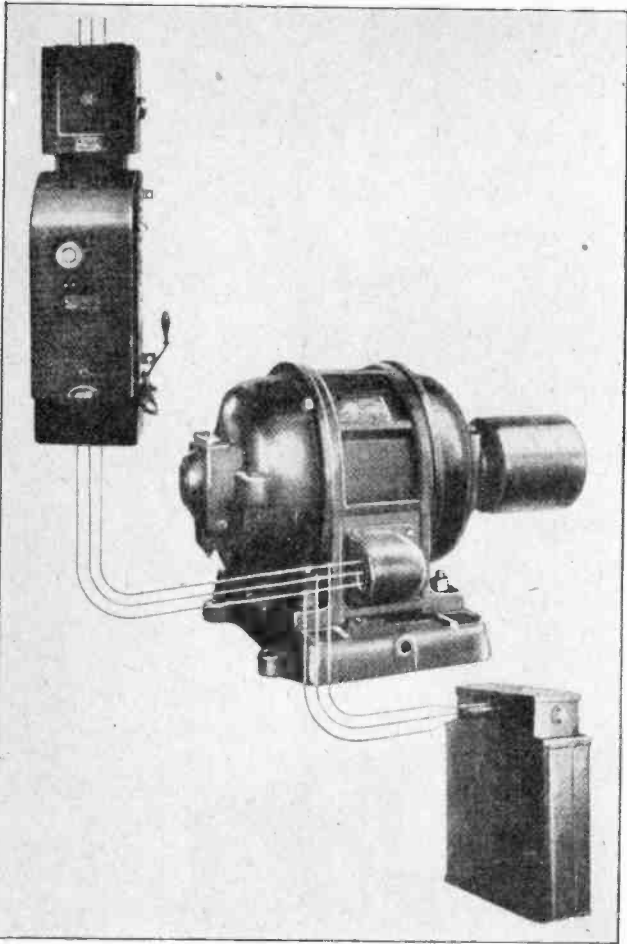

Fig. 7. Static condensers can be connected direct to the terminals of individual induction motors as illustrated in the above view. The condenser then supplies the magnetizing current to the motor and corrects the lagging power factor at its source. (Courtesy G. E. Company.)

wiring system in a plant, it may be better to attach a large condenser or bank of condensers to the line or feeders at a point as near to the load center as possible.

Alternating Current

In many cases the condensers are connected to the secondaries of the transformers which step down the voltage of the alternating current where the power enters the plant or building.

This relieves the transformers, power lines, and alternators at the generating plant from carrying the wattless current, but it doesn't remove this wattless current from the feeders and circuit within the plant where the low power factor exists.

Correcting the power factor in this manner may be satisfactory to the power company and relieve the customer of the penalty charge for low power factor, but it doesn't eliminate the voltage drop and losses which occur in the feeders and circuits of the customer's plant, nor the reduced efficiency of motors and equipment which may result from this voltage drop.

For this reason it is more desirable to correct the low power factor right at its source by using condensers at the terminals of individual large motors whenever practical. Where it is not possible or practical to locate condensers at the terminals of large motors or where a large number of small motors are used, it is often more practical to install one large condenser as near as possible to the center of the load, so that it will correct the power factor for a group of small motors and supply the magnetizing current to these machines through the shortest possible length of the feeder wires.

Fig. 8 shows three large motors, each equipped with an individual static condenser connected directly to its terminals and also a number of small motors with one condenser, "D," located approximately at the center of the small motor load. The condensers, A, B, and C, confine the flow of wattless current for the large motors to the short wires between the motors and condensers, and if these condensers are of the proper size, none of the magnetizing current for these machines will flow through the main feeder wires.

If condenser D is of the proper size to supply the magnetizing or wattless current for all of the small motors, then this wattless current will only flow through a very short section of the main feeders and in this manner will be prevented from caus-

ing voltage drop in the longer feeder lines.

Keep in mind, in the case of condenser D, that the wattless current for each of the small motors located near this condenser will only flow between the motors and the condenser.

If, for any reason, it were not desirable to use the small condensers A, B, C, and D distributed throughout this power wiring system, a large condenser could be located at "X," as shown by the dotted lines. While this would not remove the wattless current from the feeders throughout the plant, it would prevent the transformers, power line, and alternator from being overloaded by the wattless current.

In some cases synchronous condensers are used right at the power plant for the sole purpose of relieving the alternators of wattless current. Sometimes an idle alternator can best be used as a synchronous condenser just floating on the busses to supply magnetizing current, instead of using up steam to drive this alternator to make it carry its share of the total effective current and magnetizing current.

6. POWER FACTOR CORRECTION BY PROPER LOADING AND PROPER SELECTION OF MOTORS

Before installing any power factor corrective equipment, such as synchronous or static condensers, it is generally best to do everything possible to improve the power factor by changing or rearranging the existing motors.

Very often it will be found that oversize induction motors have been chosen to drive certain machines which require the starting torque of a large induction motor; but which, after they are running, keep this motor loaded at only one-fourth to one-half of its rating. Lightly loaded induction motors operate at very low power factor.

In such cases it would be better to replace these squirrel-cage induction motors if possible with slip-ring motors or special squirrel-cage motors with better starting torque, so that motors of the proper size can be used and then operated at approximately full load during running.

Alternating Current

In many instances it is possible to change motors around so that they are better fitted for the power requirement of the machines they drive, and in such

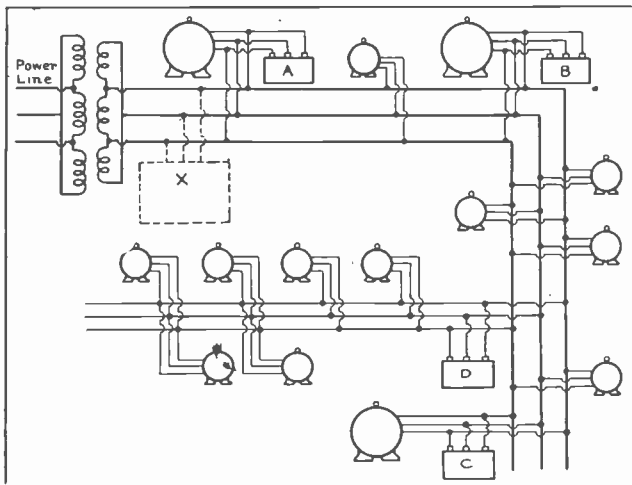

Fig. 8. This diagram illustrates the manner in which condensers can be connected to individual large motors and also at load centers to correct the power factor for a group of small motors.

cases it may not be necessary to discard or replace more than a few motors.

In a plant which is largely operated by squirrel-cage induction motors and is known to have a very low power factor, great care should be used in selecting additional motors whenever new equipment is added.

If synchronous motors are used to drive as much as possible of the new equipment or if synchronous motors are installed to drive some of the old equipment which may be better fitted to their characteristics, this will release induction motors from the old equipment to drive the new machines.

On any equipment that cannot be satisfactorily operated by ordinary synchronous motors, it will probably be possible to use special high-torque synchronous motors, or at least to use slip-ring motors in order to get the necessary starting torque with the best possible efficiency and power factor.

When inspecting or changing old motors, or installing new ones in any plant where you may be

Power-Factor Correction

employed, always keep in mind the great savings which can be effected by the proper selection and proper loading of A. C. motors.

7. SELECTION OF POWER FACTOR CORRECTIVE EQUIPMENT.

When everything possible has been done in this manner, the power factor may still be too low and may be causing serious overloading of existing feeders and circuits and excessive voltage drop at the motors and equipment to be operated. It may also be causing a penalty charge on the power bill, or overloading of transformers and alternators in case the company generates its own power. If this is the case then some other means of power factor correction should be considered.

The equipment used for this purpose should not be installed by guess work just because it is known that it will improve the power factor. Instead the entire system should be carefully gone over and tested to determine what the power factor actually is and what the extent of the load is on the alternators, transformers, and feeders in proportion to their capacity.

In many cases it is also advisable to check the power factor on different main branches of the system and the voltage drop at the terminals of equipment in different parts of the plant.

If the power is being purchased, the power bills should also be carefully checked to see how much can be saved by improving the power factor. In this manner the power factor corrective equipment can be intelligently selected to give results where they are most needed and to effect the greatest possible saving.

In determining the type of corrective equipment to use or in choosing between synchronous motors, synchronous condensers or static condensers, further care should be exercised.

If there are in the plant a number of machines or devices which are well suited to synchronous motor drive, and if there is some other use for the induction motors which will be replaced; or if these machines can be profitably sold or are old enough

Alternating Current

to be discarded, then synchronous motors of the proper size for driving the machinery and also correcting the power factor are generally a wise choice.

If the plant in which the power factor is to be corrected is a large one and has several centers of heavy load at low power factor, the installation of synchronous condensers at these load centers is often advisable.

Before choosing synchronous condensers, however, we should keep in mind that they require the same amount of skilled attention and maintenance that synchronous motors require.

If the plant is of small or medium size and if the motors and loads are widely scattered at the ends of long feeders and circuits, the installation of static condensers properly located throughout the plant may be most economical.

In numerous cases where alternators, transformers, and feeders may be overloaded to the point where it is necessary to replace them with larger ones or to add new ones to operate in parallel, it may be found that a considerable portion of this load is wattless current.

If correcting the power factor will relieve this condition and enable the existing equipment to be used for several years more, it is generally much cheaper to buy power-factor-corrective equipment and save the cost of the new generators and transformers.

Considerable copper cost can also be saved where the feeders or lines are of considerable length.

In some cases where the power is purchased and even though the power contract may not contain a penalty clause for low power factor, it may be possible to obtain a lower power rating or a rebate on the power bills by going to the power company with a definite proposal for improving the power factor of the customer's load to a certain amount.

8. DETERMINING THE PROPER SIZE OF CONDENSER REQUIRED.

It is a very simple matter to calculate the actual amount of saving that can be effected by correcting power factor a certain amount, and also to calculate

Power-Factor Correction

the size of the synchronous condenser or static condenser which will be required to correct the power factor the desired amount.

To determine the proper size of the condenser or the amount of corrective kv-a. required, it is first necessary to note the amount of actual load in kw. and the power factor of this load.

The next step is to decide to what new and higher value the power factor of the load should be raised. Generally it is not economical or practical to try to raise the power factor to unity or 100%, because the closer to unity the power factor is raised the greater will be the amount of corrective kv-a. required to increase the power factor any additional amount. So we reach a point where the very great cost of corrective equipment overbalances the saving and benefits derived from correction.

Furthermore, this unity power factor is not desirable on some systems, because a very small change in the load or power factor when the system is already at unity power factor, results in a considerable change in the current and tends to make the system unstable.

For these reasons a desirable power factor is usually somewhere between 85 and 95 per cent. When the load in kw. and the power factor of the plant or system are known, it is easy to calculate the apparent power in kv-a. and also the **wattless energy** or **reactive kv-a.** This latter is often called the **wattless component**, meaning the wattless portion or part of the energy.

9. PRACTICAL FIELD PROBLEMS.

For example, suppose we are considering an industrial plant in which the actual power load is 1440 kw. and we find that the power factor of this load is 60%. This power factor can be determined by tests with voltmeter, ammeter, and wattmeter, or with a power-factor indicator, as explained in an earlier lesson.

We shall assume that we desire to increase this power factor to 90%. Our first step is to find the kv-a. at the present power factor. This will be:

$$1440 \div .60, \text{ or } 2400 \text{ kv-a.}$$

Alternating Current

Now, to find the wattless component or reactive kv-a., we square both the actual power and the apparent power and then obtain the square root of the difference between these figures.

This can be stated in the following simple formula:

$$\text{Reactive kv-a.} = \sqrt{\text{kv-a.}^2 - \text{kw.}^2}$$

In the case of the problem we are considering, the reactive kv-a. will be:

$$\sqrt{2400^2 - 1440^2}, \text{ or } 1920 \text{ kv-a.}$$

This is the wattless power at 60% power factor.

The next step is to find what the wattless component will be at 90% power factor. This is found in the same manner as we have used for the 60% power-factor condition.

At 90% power factor, the apparent power of the system will be $1440 \div .90$, or 1600 kv-a.

Note the great reduction in the apparent power which is required to produce the same amount of actual power at the higher power factor. While at 60% power factor it required 2400 kv-a. to produce 1440 kw., at 90% power factor it requires only 1600 kv-a. to produce 1440 kw.

As we know that the current is proportional to the volt-amperes divided by volts, we can immediately see that the increased power factor will greatly reduce the current flowing in the circuits.

We can now determine what the wattless power or reactive kv-a. will be at the new power factor. This is found by the same formula as previously given, and, in this case, the reactive kv-a. equals:

$$\sqrt{1600^2 - 1440^2}, \text{ or } 697 \text{ kv-a.}$$

If the reactive kv-a., or wattless power, was 1920 at 60% power factor and is now only 697 at 90% power factor, then the difference between these two will be the reactive kv-a. required to increase the power factor from 60 to 90 per cent., or $1920 - 697 = 1223$ kv-a.; which will be the capacity of the condenser required to correct the power factor this amount.

Power-Factor Correction

In other words, the condenser must have a capacity of 1223 kv-a. with a unity power factor rating.

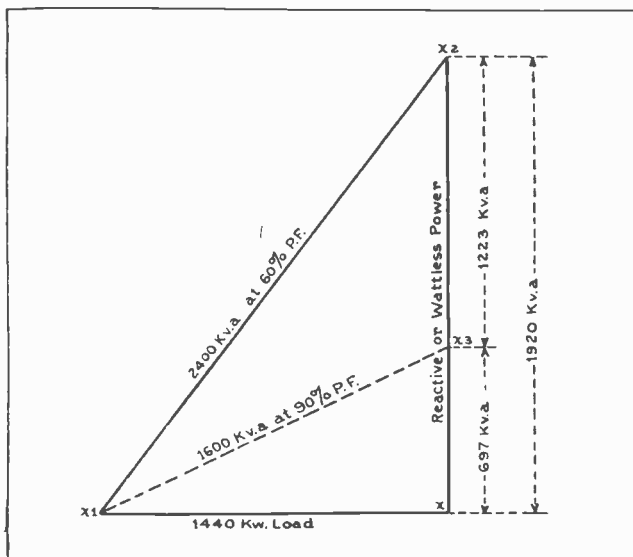

Fig. 9. The above sketch shows the simple method by which power factor problems can be solved graphically by drawing to scale the lines representing the various factors in the problem. Study this diagram very thoroughly with the accompanying explanations.

This problem is further illustrated by the diagram in Fig. 9. The horizontal line forming the base of the triangle represents the 1440 kw. of actual power or load. This line is drawn to a scale of $\frac{1}{8}$ of an inch per 100 kw.

The vertical line forming the adjacent side of the triangle represents the wattless or reactive kv-a. This line is drawn to the same scale and its full length represents the 1920 kv-a. of wattless power at 60% power factor. The lower section from X to X-3 represents the 697 kv-a. of wattless energy at 90% power factor.

The difference between these two, or the upper section of the line from X-3 to X-2, represents the 1223 kv-a. which will have to be neutralized by an equal amount of leading kv-a. from the condenser.

The long diagonal line from X-1 to X-2, or the hypotenuse of this large triangle, represents the

Alternating Current

2400 kv-a. of apparent power at 60% power factor. The lower diagonal line drawn from the point of 697 kv-a. on the reactive power line to the point of the angle represents the 1600 kv-a. apparent power which will be required at 90% power factor.

10. GRAPHIC SOLUTION OF POWER FACTOR PROBLEMS.

This same problem can be solved approximately with very few figures by laying out lines carefully measured to the proper length to represent the various values to scale.

For example, let us take a sheet of paper with square corners and, starting at the lower right-hand corner of the sheet as at "X" in Fig. 9, we shall first lay out to the left along the lowest edge of the sheet a line which is the proper length to represent the load in kw. Any suitable scale such as $\frac{1}{8}$, $\frac{1}{4}$, or $\frac{1}{2}$ inch, can be used to represent 10, 50, or 100 kw., according to the amount of load and the size of the paper available. The larger the scale used, the more accurate the measurements can be made.

If we next determine the apparent power by dividing the kw. load by the known power factor of the system, we can then lay out a line of the proper length to represent this apparent power in kv-a. on the same scale as that used for the base line representing the load in kw.

If we lay out a line of this length on the edge of the ruler or straight strip of paper, and then lay this line from the left end of the kw. line, or X-1, and so that the opposite end of the line falls at the right edge of the sheet of paper at X-2, we can then measure the distance along the edge of the paper from X to X-2, and thus find the wattless or reactive kv-a. for this load and power factor, by measuring this distance on the same scale as we used for both of the other values.

Then if we develop another line to represent the kv-a. of apparent power at 90% power factor and lay this line from X-1 to the edge of the paper at X-3, we can measure from X-3 to X and obtain the

Power-Factor Correction

approximate reactive kv-a. at the improved power factor.

11. SAVING EFFECTED BY POWER FACTOR IMPROVEMENT.

In the problem we have just considered, we find that increasing the power factor from 60 to 90 per cent. reduces the apparent power from 2400 to 1600 kv-a. This is a reduction of 800 kv-a. or, in other words, the alternators, lines and transformers can supply the same actual power with a reduction of 800 kv-a. load on their windings.

If the greater part of this energy is fed through-out the customer's plant at 440 volts, this will mean considerable reduction of the current load on the feeders.

This can be determined as follows:

$$\text{volt-amperes} \div (E \times 1.732)$$

or

$$800,000 \div (440 \times 1.732) = 1049 \text{ amperes}$$

Increasing the power factor will also reduce the current load by the same amount in the 440-volt secondaries of the transformers at the customer's premises.

If this energy is supplied to the primaries of the transformers by a 2300-volt distribution line from the power company's substation, the current on this line and primary winding of the transformers will be approximately 200 amperes less.

Of course, the actual reduction in current will not be quite this great if a synchronous motor is used for the power factor correction, because this machine will require a small amount of energy current to overcome the friction and windage-loss of the machine. This amount, however, is so small that it is hardly worth considering.

In case a static condenser is used for power-factor correction in this problem, the loss will also be extremely small; as the loss of this device is generally less than $\frac{1}{2}$ of 1%.

The method used to calculate the capacity of either a synchronous condenser or static condenser is the same, as long as the synchronous condenser

Alternating Current

is used only for power factor correction and not to drive any mechanical load.

To see the great importance of having a proper knowledge of power factor and its correction, we need only to note the amount of saving that can be effected by power factor improvement in the problem we have just considered.

The great reduction made in the current load on the transformers, lines, and alternators might enable a plant to avoid the installation of new transformers and alternators, and take care of expansion and growth for possibly several years longer, by this correction of power factor.

Considering it from the standpoint of monthly power bills in case the power is purchased from a generating company, the saving is also considerable.

For example, if the 1440 kw. load which was used in this problem is taken to be the average load throughout an eight-hour day in the plant of the customer, the total power consumed in one month of 26 working days would be 299,520 kw. hours.

At a cost of approximately 1 cent per kw. hour, the monthly power bill would be \$2,995.20. If the power company from whom this energy is purchased has a power-factor-rate clause in the contract, it is possible that the reduction in the rate between the 60% and 90% power factor conditions would be as much as 10% of the power bills.

This would result in a monthly saving of \$299.52, or a yearly saving of \$3,594.24. So we find that this would soon pay for the cost of a 1223 kv-a. synchronous condenser at approximately \$6,000.00.

12. PROBLEM.

As another illustration, suppose you are working as maintenance electrician in an electrical plant where the total load of induction motors, welders, and electrical ovens amounts to 560 kw. Let us assume that this is the normal true-power load shown by the wattmeter under average operating conditions in the plant.

If this energy is fed to the motors and equipment at 440 volts and a total of the ammeter readings

Power-Factor Correction

on the different feeder circuits shows the current load to be approximately 1130 amperes, then the apparent power is equal to $440 \times 1130 \times 1.732$, or approximately 861 kv-a.

Then, to determine the power factor of the system, we divide the true power by the apparent power, or $560 \div 861 =$ approximately 65% power factor.

We shall assume that you wish to raise this power factor to 90%. The present load in kw. can again be represented by the horizontal base line of the triangle in Fig. 10.

In this figure a scale of $\frac{1}{2}$ inch to 100 kw. is used. Now, assuming that the vertical line is the right-hand edge of a square sheet of paper and that the base line is on the lower edge of this same sheet of paper, we will lay out a line to the scale of $\frac{1}{2}$ inch per 100 kv-a. and of the proper length to represent the 861 kv-a. of apparent power.

Running this line from the point X-1 at the left end of the kw. line to X-2 at the right edge of the paper, we have represented the apparent power by the hypotenuse of the triangle.

Now, if you measure the line from X-2 to X-3 you will find it is slightly over $3\frac{1}{4}$ inches long and, on the basis of $\frac{1}{2}$ inch per 100 kv-a., this will equal approximately 654 kv-a. of wattless or reactive power. This we have marked "R kv-a."

Now, to find the amount of reactive kv-a. or wattless power which we will have when the power factor is improved to 90%, we must first determine the total kv-a. of apparent power at 90% power factor.

True power \div power factor = apparent power,
so,

$$560 \div .90 = \text{approximately } 622 \text{ kv-a. apparent power at } 90\% \text{ p. f.}$$

Using the scale of $\frac{1}{2}$ inch per hundred kv-a., we shall represent the 622 kv-a. with a line slightly under $3\frac{1}{8}$ inches long. Marking off this line on the edge of a ruler or straight piece of paper, set one end of the line at X-1, and swing the other end

Alternating Current

over to the point where it touches the right edge of the paper, or line X-2 to X-3. We find that the end of the line meets the vertical line at X-4.

Now measuring the portion of the vertical line from X-4 to X-3, we find that it represents approximately 271 reactive kv-a. according to the same scale of $\frac{1}{2}$ inch per 100 kv-a.

Now, to determine the amount of corrective kv-a. required, we subtract 271 from 654 and find 383 R kv-a., which is the amount to be corrected and which will be required capacity of the synchronous or static condenser to use for this job.

We can now check these figures by the more accurate method, using the formula:

$$R \text{ kv-a.} = \sqrt{\text{kv-a.}^2 - \text{kw.}^2}$$

with which we obtained the values in the previous problem.

In the first condition, with 65% power factor and 861 kv-a., the total reactive kv-a. or wattless power will be:

$$\sqrt{861^2 - 560^2}, \text{ or } 654$$

$$861^2 = 741,321$$

$$560^2 = 313,600$$

$$\text{and } 741,321 - 313,600 = 427,721,$$

The square root of 427,721 is 654; so we find that the value of the reactive kv-a. shown by the vertical line from X-2 to X-3 is correct.

We shall next find the reactive kv-a. at 90% power factor; which will be:

$$\sqrt{622^2 - 560^2}, \text{ or } 271 \text{ R kv-a.}$$

$$622^2 = 386,884$$

$$560^2 = 313,600$$

$$386,884 - 313,600 = 73,284.$$

The square root of 73,284 is approximately 271, which proves that the value of the reactive kv-a. shown by the vertical portion of the line from X-4 to X-3 is also correct.

With just a little practice to get the steps of these power factor problems well in mind, you will find it very simple to determine the size of con-

Power-Factor Correction

denser required for correcting the power factor of any given load at low power factor and to bring it up to the desired higher power factor.

It will be well worth your time to practice both the approximate method with the triangle diagram and also the accurate method using the formula.

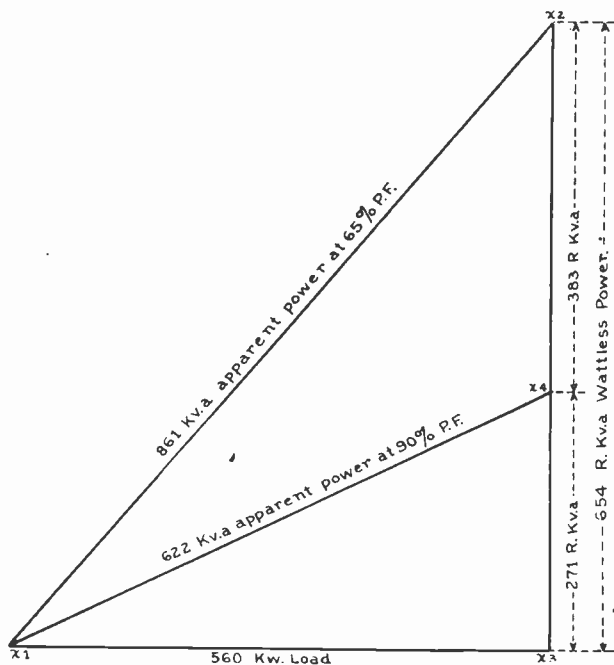

Fig. 10. This diagram also shows the reduction obtained in the apparent power and wattless power by improving the power factor of a system. By carefully measuring the top section of the vertical line in the diagram we can find the size of the condenser required to correct the power factor.

By improving the power factor from 65% to 90% in the plant we have considered in this last problem, we shall have reduced the apparent power from 861 to 622 kv-a. or by 239 kv-a. This means that the alternators, transformers, and feeders will be relieved of this amount of load. On the 440-volt feeders this will amount to approximately 314 amperes, as can be determined by the following formula:

Alternating Current

$$I = \frac{\text{volt-amperes}}{E \times 1.732}$$

or, in this case,

$$I = \frac{239,000}{440 \times 1.732}, \text{ or } 314\text{— amperes}$$

You can readily see that relieving the feeder cables of this amount of current would decrease the voltage drop in them considerably—especially if they were already overloaded at the low power factor. Relieving the transformers of this load would enable them to carry an increased load of useful power; and the same thing applies to the alternators of the power company, or the alternator which may be owned and operated by your employer, if the plant in which you work generates its own power.

13. USE OF SYNCHRONOUS MOTORS FOR P. F. CORRECTION AND MECHANICAL LOAD.

When it is desired to use a synchronous motor both for driving a certain amount of mechanical load and for correcting the power factor of the load already on the system, we must, of course, allow sufficient capacity of the machine for both of these duties. The actual problem or calculation, however, remains very much the same.

Let us assume that in a certain plant there is an existing load of 600 kw. at a power factor of 60%. We wish to improve this power factor of 90% by the use of a synchronous motor and we also wish to operate with this motor a new mechanical load of 300 kw.

We shall represent the existing load by the horizontal line from X to X-1 in Fig. 11, and the additional new mechanical load of 300 kw. by the addition to this line from X-1 to X-2. The scale in this diagram is $\frac{1}{4}$ inch per 100 kw.

At 60% power factor the apparent power of the existing load will be $600 \div .60$, or 1000 kv-a.

We shall represent this kv-a. by the same scale of $\frac{1}{4}$ inch per 100 kv-a. and by a line $2\frac{1}{2}$ inches

Power-Factor Correction

long, running from X to a point where its opposite end strikes a vertical line which we have drawn up from the base line at X-1.

This hypotenuse line, representing the 1000 kv-a. of apparent power, will strike the vertical line at X-3, and if we measure the line from X-3 to X-1, we find it is two inches long. On the same scale used for the other values, it will therefore represent 800 R kv-a. of reactive or wattless power

Checking this calculation by the more accurate method of using the formula:

$$R \text{ kv-a.} = \sqrt{1000^2 - 600^2}$$

we find the answer is exactly 800 kv-a.

The next step will be to determine the kv-a. of apparent power of the existing load plus the new mechanical load at the desired power factor of 90%. The entire load will be 900 kw., and at 90% power factor the kv-a. will be:

$$900 \div .90, \text{ or } 1000 \text{ kv-a.}$$

It is interesting to note at this point that with the improved power factor we can obtain a 50% increase in the true power load with the same kv-a. as existed with the 600 kw. load.

Representing this 1000 kv-a. on the scale of $\frac{1}{4}$ inch per 100, or by a line $2\frac{1}{2}$ inches long, we shall first run this line from X to the point where it strikes a vertical line above X-2. This vertical line from X-2 to X-4 will represent the reactive kv-a., or wattless component, for the entire load of 900 kw.

Measuring this line to scale, we find that it represents approximately 436 reactive kv-a.

We shall now check this figure by the more accurate method with the formula:

$$R \text{ kv-a.} = \sqrt{1000^2 - 900^2}, \text{ or } 436 - R \text{ kv-a.}$$

Subtracting this from the former reactive kv-a., we find $800 - 436 = 364$ R kv-a., which must still be corrected to bring the power factor to 90%.

The capacity of the synchronous motor must therefore be:

$$\sqrt{300^2 + 364^2}, \text{ or } 472 - \text{kv-a.}$$

Alternating Current

This capacity or kv-a. of the synchronous motor can also be found by measuring the distance from

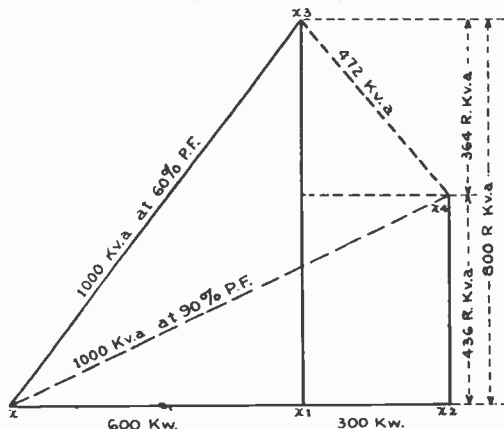

Fig. 11. This diagram shows the graphic solution of a problem in which the synchronous motor is used for mechanical power purposes as well as power factor correction. The figure should be easily understood by referring to the explanations in the accompanying paragraphs.

X-3 to X-4, as shown by the dotted line in Fig. 11, and using the same scale of $\frac{1}{4}$ inch per 100 kv-a.

The power factor rating of the synchronous motor, or the power factor at which it will need to operate to carry this mechanical load and also correct the reactive kv-a., will be found by dividing its true power or mechanical load by its total kv-a. rating, or:

$$300 \div 472 = \text{approximately } 64\% \text{ leading power factor.}$$

14. TABLE FOR DETERMINING 'REQUIRED SIZE OF CONDENSERS

The convenient table in Fig. 12 greatly simplifies the method of determining the proper capacity of the synchronous or static condenser to correct the power factor a certain desired amount for any given load.

This table gives figures which can be used as constants to be multiplied by the kw. load to obtain the leading reactive kv-a. required to improve the

Power-Factor Correction

power factor from one value to another.

For example, if the kw. load, as indicated by the wattmeter in a plant, is 200 kw. at an existing power factor of 65% and we desire to increase the power factor to 90%, we look in the table under the column heading "Original Power Factor" and find 65; then, reading to the right under "Desired Power Factor" in the column for 90%, we find the figure .685.

We now simply multiply this figure by the load in kw., or:

$$200 \times .685 = 137 \text{ kv-a. capacity}$$

or the size of condenser required to bring lagging power factor from 65 to 90 per cent.

If, in another case, we have a load of 525 kw: at a power factor of 70% and we wish to increase the power factor to 85%, we find in the middle column under "Original Power Factor", figure 70. Then reading to the right in the fourth column under "85% Desired Power Factor", we find the figure .400. Mutlplying this figure by our load of 525 kw. gives 210 kv-a. as required size of the condenser.

15. PROBLEM.

Next, suppose that you have an induction motor on which a wattmeter shows 41 kw. input during operation of the motor at its normal load; a voltmeter shows 220 volts at the motor terminals; and an ammeter shows approximately 144 amperes in any one of the three phase leads to the motor. To determine the power factor at which the motor is operating we must first determine the kv-a. input.

$$\text{Three-phase kv-a.} = I \times E \times 1.732$$

or, in this case,

$$144 \times 220 \times 1.732 = 54,869, \text{ or approximately} \\ 54.9 \text{ kv-a.}$$

Now, to determine the power factor of the motor, we can divide the true power input by the apparent power, or:

$$41 \div 54.8 = .75 \text{ — power factor.}$$

Let us say that we wish to raise the power factor of this motor to 95% Then, from the table in Fig. 12 we select the power factor of the motor,

Alternating Current

or 75, found in the middle column under "Original Power Factor"; then, in the column under "95% Desired Power Factor", we find the corresponding figure, .553.

ORIGINAL POWER FACTOR %	DESIRED POWER FACTOR					ORIGINAL POWER FACTOR %	DESIRED POWER FACTOR				
	100 %	95 %	90 %	85 %	80 %		100 %	95 %	90 %	85 %	80 %
20	4.899	4.570	4.415	4.279	4.149	61	1.299	.970	.815	.679	.549
21	4.656	4.327	4.171	4.036	3.906	62	1.266	.937	.781	.646	.515
22	4.433	4.104	3.949	3.813	3.683	63	1.233	.904	.748	.613	.482
23	4.231	3.902	3.747	3.611	3.481	64	1.201	.872	.716	.581	.450
24	4.045	3.716	3.561	3.425	3.295						
25	3.873	3.544	3.389	3.253	3.123	65	1.169	.840	.685	.549	.419
26	3.714	3.385	3.229	3.094	2.964	66	1.138	.810	.654	.518	.388
27	3.566	3.238	3.082	2.946	2.816	67	1.108	.779	.624	.488	.358
28	3.429	3.100	2.944	2.809	2.679	68	1.078	.750	.594	.458	.328
29	3.300	2.971	2.816	2.680	2.550	69	1.049	.720	.565	.429	.298
30	3.180	2.851	2.693	2.550	2.420	70	1.020	.691	.536	.400	.270
31	3.067	2.738	2.583	2.447	2.317	71	.992	.663	.507	.372	.241
32	2.961	2.632	2.476	2.341	2.211	72	.964	.635	.480	.344	.214
33	2.861	2.532	2.376	2.241	2.111	73	.936	.608	.452	.316	.186
34	2.766	2.437	2.282	2.146	2.016	74	.909	.580	.425	.289	.158
35	2.676	2.347	2.192	2.056	1.926	75	.882	.553	.398	.262	.132*
36	2.592	2.263	2.107	1.972	1.842	76	.855	.527	.371	.235	.105
37	2.511	2.182	2.027	1.891	1.761	77	.829	.500	.344	.209	.078
38	2.434	2.105	1.950	1.814	1.684	78	.802	.474	.318	.182	.052
39	2.361	2.032	1.877	1.741	1.611	79	.776	.447	.292	.156	.026
						80	.750	.421	.266	.130	
40	2.291	1.963	1.807	1.671	1.541	81	.724	.395	.240	.104	
41	2.225	1.896	1.740	1.605	1.475	82	.698	.369	.214	.078	
42	2.161	1.832	1.676	1.541	1.410	83	.672	.343	.188	.052	
43	2.100	1.771	1.615	1.480	1.349	84	.646	.317	.162	.026	
44	2.041	1.712	1.557	1.421	1.291	85	.620	.291	.136		
45	1.985	1.656	1.501	1.365	1.235	86	.593	.265	.109		
46	1.930	1.602	1.446	1.310	1.180	87	.567	.238	.082		
47	1.877	1.548	1.392	1.257	1.128	88	.540	.211	.056		
48	1.828	1.499	1.343	1.208	1.077	89	.512	.183	.028		
49	1.779	1.450	1.295	1.159	1.029	90	.484	.155			
50	1.732	1.403	1.248	1.112	.982	91	.456	.127			
51	1.687	1.358	1.202	1.067	.936	92	.426	.097			
52	1.643	1.314	1.158	1.023	.892	93	.395	.066			
53	1.600	1.271	1.116	.980	.850	94	.363	.034			
54	1.559	1.230	1.074	.939	.808	95	.329				
55	1.518	1.189	1.034	.898	.768	96	.292				
56	1.479	1.150	.995	.859	.729	97	.251				
57	1.442	1.113	.957	.822	.691	98	.203				
58	1.405	1.076	.920	.785	.654	99	.142				
59	1.368	1.040	.884	.748	.618	100					
60	1.333	1.004	.849	.713	.583						

Fig. 12. The above table gives some very convenient figures by which we can simply multiply the kw. load of a plant with lagging power factor in order to obtain the amount of leading kv-a. or condenser capacity required to correct the power factor any desired amount.

To determine the size of static condenser required to make this power factor improvement on the motor, we simply multiply .553 by the kw. input of the motor, or 41; and this gives 22.67 kv-a. for the condenser. Connecting a condenser of this size to the motor terminals doesn't actually improve the power factor of the motor within the motor itself, but it does bring the power factor of the two units in parallel to 95% on the feeder to which they are connected

16. CONDENSER TABLE.

Fig. 13 shows another convenient table which

Power-Factor Correction

gives the approximate sizes of condensers required for use with squirrel-cage induction motors to bring their power factors up to either 90% or 95%, as may be desired.

Capacitor Kv-A. for Squirrel-Cage Induction Motors
(To correct to .95 or .90 at one-half load)

MOTOR		Capacitor Kv-A. for Desired Power Factor		MOTOR		Capacitor Kv-A. for Desired Power Factor		MOTOR		Capacitor Kv-A. for Desired Power Factor	
H. P.	Volts	.95	.90	H. P.	Volts	.95	.90	H. P.	Volts	.95	.90
1800 R. P. M.											
1/2	Low	1/2	1/2	75	Low	10	7 1/2	40	Low	10	7 1/2
3/4	Low	1/2	1/2	75	2300	10	7 1/2	40	2300	15	15
1	Low	1/2	1/2					50	Low	15	10
1 1/4	Low	3/4	1/2					50	2300	15	10
2	Low	3/4	1/2	900 R. P. M.							
3	Low	1	3/4	1/2	Low	1	1	60	Low	20	15
5	Low	1 1/2	1	3/4	Low	1	1	60	2300	20	20
7 1/2	Low	2	1 1/2	1	Low	1	1	75	Low	20	20
				1 1/4	Low	1 1/2	1	75	2300	25	25
10	Low	2	1 1/2	2	Low	1 1/2	1 1/2	100	Low	30	20
15	Low	3	2	3	Low	2	1 1/2	100	2300	25	20
20	Low	4	2	5	Low	3	2	125	Low	30	20
25	Low	4	3	7 1/2	Low	3	3	125	2300	30	20
25	2300	4	3	10	Low	4	3	150	Low	35	25
30	Low	5	3	15	Low	5	4	150	2300	40	35
30	2300	7 1/2	4	20	Low	5	5	200	Low	35	20
40	Low	7 1/2	4	20	2300	10	7 1/2	200	2300	40	25
40	2300	7 1/2	4	25	Low	7 1/2	5	600 R. P. M.			
50	Low	7 1/2	5	25	2300	10	7 1/2	.5	Low	4	3
50	2300	7 1/2	5	25	Low	10	7 1/2	7 1/2	Low	5	4
60	Low	7 1/2	5	30	Low	10	7 1/2	10	Low	5	5
60	2300	10	7 1/2	30	2300	10	7 1/2	15	Low	7 1/2	5
75	Low	10	5	40	Low	10	7 1/2	20	Low	10	7 1/2
75	2300	10	7 1/2	40	2300	10	7 1/2	25	2300	10	7 1/2
1200 R. P. M.											
1/2	Low	1/2	1/2	50	Low	15	10	20	Low	10	7 1/2
3/4	Low	1/2	1/2	60	2300	15	10	25	Low	10	7 1/2
1	Low	1/2	1/2	75	Low	15	10	30	Low	10	7 1/2
1 1/4	Low	3/4	1/2	75	2300	15	10	30	2300	20	15
2	Low	1	3/4	100	Low	20	10	40	Low	15	10
3	Low	1 1/2	1	100	2300	20	10	40	2300	20	15
5	Low	2	1 1/2	125	Low	25	20	50	Low	20	15
7 1/2	Low	3	1 1/2	125	2300	30	20	50	2300	20	15
10	Low	3	2	150	Low	25	20	60	Low	20	15
15	Low	4	3	150	2300	25	20	60	2300	25	20
20	Low	5	4	200	Low	30	20	75	Low	25	20
25	Low	7 1/2	5	200	2300	35	20	75	2300	40	30
25	2300	7 1/2	5	720 R. P. M.							
30	Low	7 1/2	5	5	Low	2	2	125	Low	30	20
30	2300	10	7 1/2	7 1/2	Low	4	4	125	2300	35	30
40	Low	10	7 1/2	10	Low	4	3	150	Low	50	40
40	2300	10	7 1/2	15	Low	5	4	150	2300	50	50
50	Low	7 1/2	5	20	Low	7 1/2	5	200	Low	50	35
50	2300	10	7 1/2	25	Low	10	5	200	2300	50	40
60	Low	10	7 1/2	30	Low	10	5				
60	2300	10	7 1/2	30	2300	15	10				

Low means 220, 440, or 550 volts

Table above gives the nearest standard capacitor kv-a. ratings to correct power factor of squirrel-cage induction motors to .95 or .90. Although the magnetizing current requirement of the induction motor varies somewhat from no load to full load, if the motor is corrected to the desired power factor at 1/2 load (values in the table above) it will be corrected approximately to this power factor at all loads. Actually the power factor will be somewhat higher at no load and slightly lower at full load.

Inasmuch as the power-factor characteristics of induction motors of the same rating vary considerably with different manufacturers the values above are necessarily approximate. The capacitor sizes indicated will be proper however, in the majority of cases.

Fig. 13. This table gives the approximate sizes of condensers required for use with individual squirrel-cage motors to correct the power factor to either 90 or 95 per cent. as desired. It will be well worth your time to become thoroughly familiar with the use of this table and the one in Fig. 12.

Of course, the power factors of various types of squirrel-cage motors vary considerably; so these figures are necessarily only approximate. They are usually close enough, however, for the selection of

Alternating Current

condensers to use with motors that normally operate at loads between 50% and 100% of their full-load rating.

This table gives the condenser sizes for motors from $\frac{1}{2}$ h.p. to 200 h.p. at various speeds, and at both the ordinary low and high voltages. Referring to this table, we find that to increase the power factor of a 30-h.p., 440-volt, 1800 R.P.M. motor to 90% we require a 3-kv-a. condenser, and that it will require a 5-kv-a. condenser to bring this power factor up to 95%.

A 30-h.p., 2200-volt motor requires a 4-kv-a. condenser to increase its power factor to 90%; or a $7\frac{1}{2}$ -kv-a unit to increase the power factor to 95%.

The discussion of power factor correction which has been given in this lesson, and also the examples of practical problems and calculations along with the convenient tables, should be given very careful consideration and you should not leave this subject until you are quite sure that you have a good general understanding of the application of these principles and calculations to problems which you may encounter in the field.

In a great number of industrial plants, factories, and other places where electric power equipment is in use and where you may be employed, the owners or even the men in charge of the electrical work may not realize the importance of power factor or the great amount of savings which can in many cases be effected by improving the power factor.

It is not uncommon to find plants with loads of several thousand kw. operating at a power factor ranging from 50 to 90 per cent. In some cases feeder conductors are seriously overloaded and transformers and alternators are overloaded and operating at excessive temperatures, which can be avoided by improving the power factor.

In other cases transformers, alternators, or feeders may be loaded to their utmost capacity and

Power-Factor Correction

the management may be planning to install additional units and circuits.

If the power factor of the system is very low, it may be possible to avoid the expense of the new alternators and transformers by installing power-factor corrective equipment of much lower cost than new machines. This is particularly true in cases where the company generates its own power and the addition of another alternator would also require added boiler-plant capacity and a turbine or engine to drive the alternator.

The trained man very often has splendid opportunities to suggest and lay out the method of correcting power factor in the plant where he is employed and thereby saving substantial sums for his employer.

For this reason, we suggest you review this material and be sure to keep it well in mind for reference and to use in any job where you may have a chance to apply it to your employer's advantage and your own credit.

Alternating Current

EXAMINATION QUESTIONS

1. What are two disadvantages of low power-factor?
2. a. How do induction motors affect the power-factor?
b. How do synchronous motors affect power-factor?
3. Name two pieces of equipment that may be used to correct power-factor?
4. In what part of the circuit should power-factor corrective equipment be connected?
5. Is it possible in certain cases to improve the power-factor in a plant without installing new power corrective equipment?
6. a. Is it generally advisable to try to obtain unity power-factor?
b. What would you consider as a good average power-factor?
7. Give the formula for use in determining Reactive Kv-a.
8. Referring to the problem in art. 9, determine what capacity condenser we must have to increase the power-factor from 60% to 80%?
9. Using the chart in Fig. 12, determine the condenser capacity necessary to increase the power-factor from 50% to 85% when the load is 100-Kw.
10. Using the table shown in Fig. 13, what would be the condenser capacity necessary to correct the power-factor to 90% on a 220-volt 10-h.p. squirrel cage motor operating at a speed of 600 R.P.M.?

Power-Factor Correction



Regrinding mill, in copper plant. These machines grind ore bearing rock that was regarded as waste years ago.

Photo by Ewing Galloway, N. Y.

Alternating Current

RECTIFIERS

While the greater part of the electrical energy used today is generated and transmitted in the form of alternating current, there are a number of special power uses which require direct current.

In plants where a large amount of D.C. is used, it is often produced in this form by D.C. generators, as previously explained. In other cases, where it is cheaper to buy A.C. from a power company or where only very small amounts of D.C. are required, it is common practice to rectify or convert A.C. to D.C.

The most common devices used for this purpose are rectifiers, converters, and motor-generators.

There are several types of rectifiers in common use. These are as follows: **Vibrating, Electrolytic, Bulb Type, Oxide Film, and Mercury Vapor.**

The vibrator, electrolytic, and bulb types of rectifiers are generally used only for converting small amounts of energy to D.C., for such work as battery charging and furnishing D.C. for radio sets, electromagnets, D.C. arc lights, bell and signal systems, experimental and laboratory work, etc.

Mercury arc rectifiers are used in small sizes for the above purposes, and also in large sizes of 1000 kw. and more for supplying D.C. to electric railways, etc.

Rotary converters are also used for changing A.C. to D.C. and are made in large sizes from 100 kw. to several thousand kw., for supplying D.C. to railways and for industrial-power motors and equipment.

Motor-generators are sometimes used in large sizes of several thousand kw. for supplying D.C. for steel mill motors and such uses, where the service and load variations are very severe; and in smaller sizes for arc welding, etc.

Rectifiers

1. VIBRATING RECTIFIERS.

Vibrator-type rectifiers are generally used only on low voltage and very small currents. One of their disadvantages is that they have a number of wearing parts and require considerable care and maintenance.

These vibrating rectifiers are synchronous switching devices which reverse the circuit connections at each reversal or alternation of the A.C. supply. They generally operate by the repulsion and attraction of a permanent magnet armature by a pair of A.C. electro-magnets. The moving armature operates the contacts which rapidly reverse the connections of the circuit.

Fig 1 shows a diagram of the connections and parts of a common type of vibrating rectifier. This rectifier is shown connected to a low-voltage battery which, of course, requires direct current to charge it.

The transformer, T, steps down the voltage from the 110-volt A.C. line to the proper value for operating the magnets of the rectifier and charging the battery.

As the alternating current reverses through the coils of the two electro-magnets M and M-1 which are both wound in the same direction, the polarity of these magnets is rapidly reversed and causes the permanent-magnet armature to vibrate back and forth in synchronism with the alternations of the current.

The secondary of the transformer is provided with a center tap and only half of its winding is used to magnetize the coils. Only half of this winding is used at any instant to charge the battery.

2. OPERATION.

When the right-hand end of the secondary is positive, both magnets will have north poles on the lower ends; and the right-hand end of the armature will be repelled, closing the circuit at the adjustable contact X-1.

Alternating Current

This allows current to flow from the right-hand end of the transformer winding through resistance R-1, contacts at X-1 through the armature, and to the positive terminal of the battery. This current returns from the negative side of the battery to the center tap of the transformer secondary, thus completing the charging circuit.

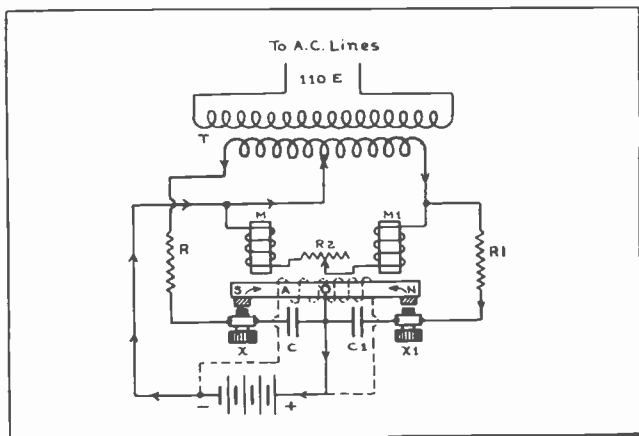

Fig. 1. The above diagram shows the parts and connections of a simple mechanical rectifier of the vibrating type. The synchronous operation of the contacts delivers pulsating D.C. to the battery circuit.

Direct current doesn't flow through the small condensers C and C-1 which are merely shunted across the contacts to prevent arcing and burning of the points.

When the alternating current reverses and the left-hand end of the transformer secondary is positive, the lower ends of both electro-magnets will then be south poles and the left-end of the armature will be repelled, closing the contact at X.

The current then flows from the left-end of the transformer secondary through resistance R, contact X, and armature A, to the positive side of the battery, and again returns from the negative terminal of the battery to the center tap of the transformer winding.

Rectifiers

The resistance R-2 is used to adjust the strength of the electro-magnets.

You will note that with this type of rectifier both halves of the cycle are used in charging the battery; so it is known as the "full wave" type.

The pulsating direct current always leaves the armature terminal and re-enters the center tap of the secondary winding, so that with a rectifier of this type it is important to get the battery connected with the proper polarity in order to charge it.

Some vibrating rectifiers have a small winding around the movable armature and connected to the terminals which lead to the battery, as shown by the dotted lines in this diagram. This winding reverses the polarity of the armature in case the battery is reversed and thereby makes the direct current flow through the battery in the proper direction, regardless of which way it is connected.

A number of vibrating rectifiers are made, and some of them use different connections and arrangement of parts than those mentioned, but in general their principles are all very much alike.

The high speed at which the armature is required to vibrate and the continual opening and closing of the contacts causes them to become worn and in some cases burned and pitted by the arc formed when the current is interrupted.

For this reason the contact may require frequent cleaning and adjustment if the rectifier is used for very long periods.

3. ELECTROLYTIC RECTIFIERS.

The electrolytic type of rectifier is also limited to small capacities, due to its low efficiency and general tendency to heat up under load because of the large resistance losses which take place within the rectifier itself.

Alternating Current

Fig. 2-A shows a simple electrolytic rectifier connected in series with a lamp bank to limit the current flow, and in series with the battery which is to be charged by the pulsating current.

This type of rectifier consists of a jar containing a strong solution of ammonium phosphate, sodium phosphate, or just a mixture of water and common borax. In this solution are immersed a plate of either lead, carbon or iron, and one of aluminum.

The electrolytic action which is set up between the surface of the aluminum electrode and the electrolytic solution will allow the current to flow from the solution into the aluminum, but will immediately build up a very high resistance film when the current is reversed and tries to flow from the aluminum into the electrolyte.

This high-resistance film shuts off the greater part of the current flow during every other alternation, and thus allows the impulses of current to get through the rectifier in only one direction; so that the current applied to the battery is pulsating D.C.

A lamp bank consisting of several lamps in parallel, or some other form of resistor, is often used in series with these rectifiers to limit the current to the proper low value.

The resistance of the rectifier itself is often so low that if it and the battery were connected in series across the line it would result in practically a short circuit and blow the fuses.

4. HALF WAVE AND FULL WAVE RECTIFIERS.

A rectifier such as shown in Fig. 2-A uses only every other alternation and is therefore known as a **half-wave rectifier**. This is because the current flow in one direction is blocked except for a small amount of leakage which is required to build up the resistive film on the electrodes.

Fig. 2-B shows another electrolytic rectifier which is of the full-wave type and in which both alternations are used to supply impulses in the

Rectifiers

same direction through the battery. With this device an auto transformer or choke coil is connected across the 110-volt leads and equipped with taps near the ends of its winding, so that the voltage applied to the rectifier and battery can be varied or adjusted.

When the left end of the transformer is positive, current will flow through that half of the auto transformer winding to the center tap, where a part of the current branches off through the battery and through the rectifier cell from the lead or carbon electrode to the aluminum electrode on the

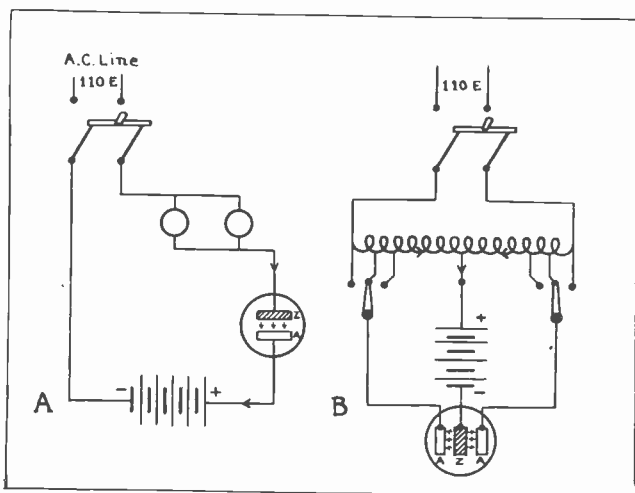

Fig. 2. A shows a half-wave, electrolytic rectifier and B shows an electrolytic rectifier of the full-wave type. Current can only pass through these devices in one direction.

right, and then back to the right-hand line wire. No current can flow from the left-hand line wire to the aluminum electrode A and then to the center lead electrode, because the current cannot pass through the rectifier in this direction.

When the polarity of the A.C. line reverses and the right-hand end of the auto transformer becomes positive, current will then flow from the line through the right section of the winding to the center tap. At this point part of the current again

Alternating Current

branches off through the battery and flows from the lead plate of the rectifier to the aluminum electrode A on the left, and back to the left side of the line.

At all times during the operation of this rectifier a certain amount of current is wasted by passing directly through the winding of the auto transformer which is connected across the A.C. line.

5. CONSTRUCTION AND CARE.

This simple electrolytic, valve-type, rectifier can be purchased in various small sizes, or can be easily and simply made from a few inexpensive materials.

A glass jar of about one-quart size or larger can be used to contain the solution of borax and water, and the strips of lead or aluminum are very easily obtainable. An iron rod or carbon rod can be used in place of the lead strip, if desired.

These electrodes should be suspended or held in the solution in such a manner that they cannot fall together and short-circuit the rectifier.

In mixing the electrolyte with borax, a saturated solution should be made: in other words, stir into the water as much borax as it will hold in suspension after being well stirred.

Very small rectifiers of this type are quite often used as "trickle chargers", to keep batteries up to fully charged conditions at all times.

Fig. 3 shows another type of full-wave electrolytic rectifier using four separate jars to obtain a more positive valve effect by causing the current to pass through two jars in series, one in the positive lead and one in the negative lead of the battery.

During the time that the left line-wire is positive, the current flow through the rectifier and battery is in the direction shown by the solid arrows. When the polarity of the A.C. line reverses and the right line-wire becomes positive, the current flows through the circuit indicated by the dotted arrows.

If rectifiers of this type overheat seriously they should be placed in larger containers so that they

Rectifiers

will have more area to radiate the heat.

After an electrolytic rectifier is used for a considerable length of time, heavy deposits will form

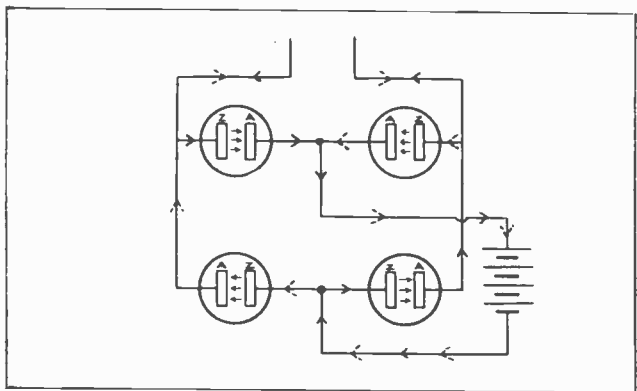

Fig. 3. Full-wave, electrolytic rectifier using four cells connected in a "bridge" circuit.

on the electrodes and interfere with the proper action of the rectifier. The electrodes should then be scraped clean or renewed, and the solution should also be renewed occasionally.

6. BULB-TYPE RECTIFIERS.

Rectifiers using gas-filled bulbs with a heated filament for the rectifying valve are very extensively used for battery charging and the operation of radio sets, as well as for other miscellaneous uses where only small amounts of direct current are required.

The valve element in these rectifiers consists of a gas-filled bulb such as shown in two different sizes in Fig. 4. These bulbs are evacuated and are generally filled with argon gas. They enclose a filament which is heated by passing low-voltage alternating current through it, and an electrode of graphite to which is connected the other terminal to complete the circuit through the bulb.

Alternating Current

7. OPERATING PRINCIPLES.

When the filaments of these bulbs are heated, electrons are thrown off into the gas and form a conducting path so that current will flow between the graphite electrode and the filament.

Due to the nature and action of the electrons thrown off by the filament, the current can pass in only one direction through the arc thus formed, or **from the graphite electrode to the filament**. It cannot flow in the opposite direction to any appreciable extent; so when the A.C. reverses, the opposite half of the wave is shut off by the valve action of the bulb.

Fig. 5-A shows a simple half-wave rectifier of the bulb type. An auto transformer is used to sup-

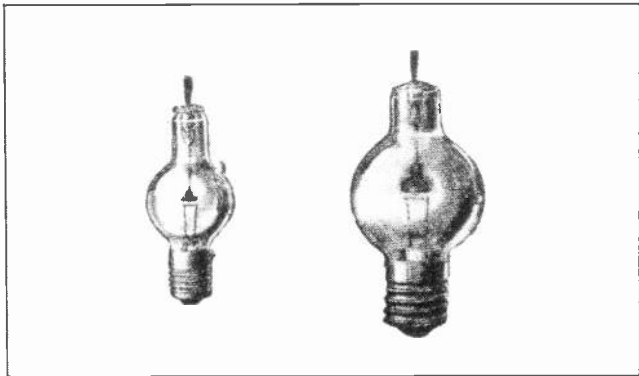

Fig. 4. The above view shows two different sized rectifier bulbs such as commonly used in battery chargers and other small rectifiers.

ply the low voltage at about 2 or 3 volts to light the filament, and also to reduce the voltage applied to the battery and rectifier bulb.

As long as the filament is lighted, negative electrons are thrown off from it continuously. During the time that the graphite electrode is positively charged it attracts these negative electrons, causing them to stream across the space and complete

Rectifiers

a path or arc through which current can flow to charge the battery.

When the graphite electrode is negatively charged it repels the negative electrons from the filament and prevents the majority of them from getting across the gap, and thus they are prevented from forming a path over which the low-voltage current can flow.

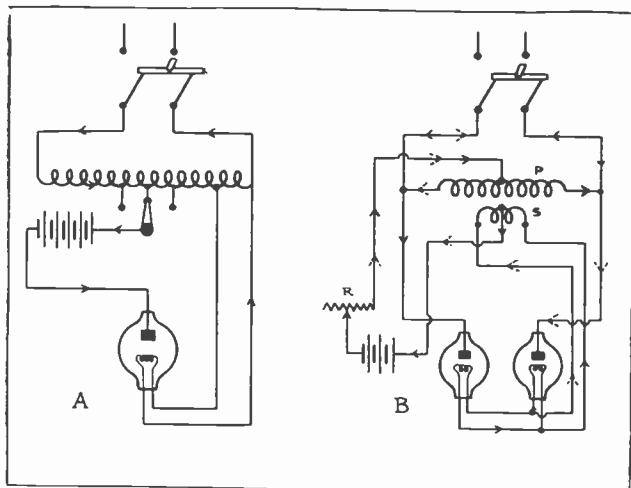

Fig. 5. A shows a circuit of a simple half-wave rectifier of the bulb type, and B shows the circuit of a full-wave rectifier using two bulbs. Trace each of these circuits very carefully.

The bulb in this manner acts as a valve, shutting off every other alternation of current. The taps provided on the winding of the auto transformer permit the adjustment of the voltage applied to the battery to allow changing the rate of current flow and the rate at which the battery is being charged.

During the operation of a rectifier of this type it is necessary for the secondary of the auto transformer to apply to the battery and bulb circuit a voltage high enough to overcome the counter-voltage of the battery, plus about 20 to 26 volts drop through the bulb. The voltage drop through the arc in the bulb varies with the amount of load or

Alternating Current

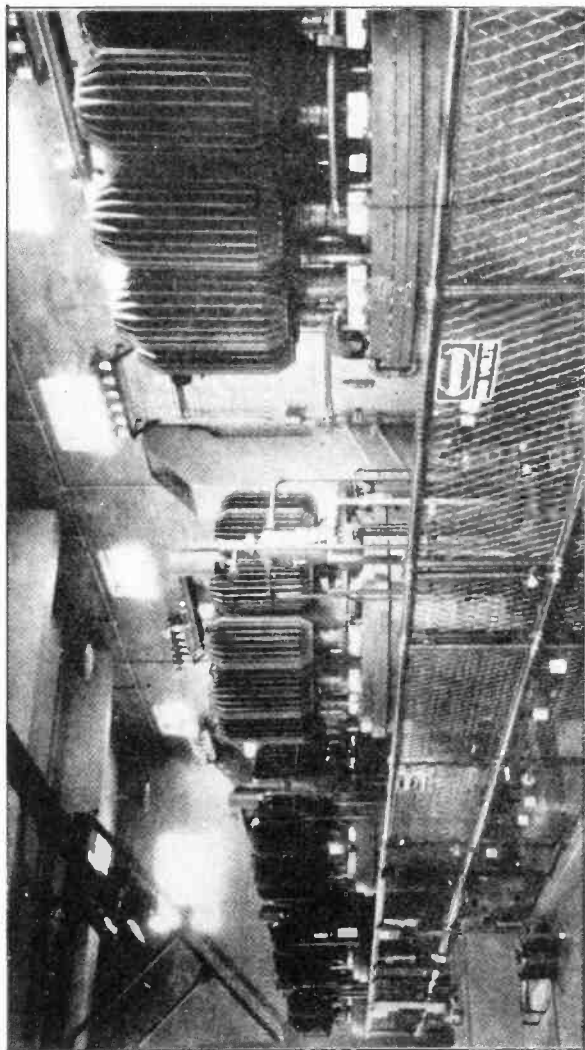

Fig. 6. Five 1200-kw., 600-volt, mercury arc rectifiers in use in a sub-station. This station has a capacity for producing 6000 k.w. of rectified D.C. from the alternating current supplied. This type of rectifier is fully explained in the following lesson. (Photo courtesy of American Brown Boveri Co.)

Rectifiers

charging current which is flowing. The counter-voltage of the battery depends upon the number of cells in series which are being charged at one time.

8. FULL-WAVE BULB-TYPE RECTIFIERS.

Fig. 5-B shows a full-wave, bulb-type rectifier using two bulbs to make use of both alternations of the A.C. supply. The transformer primary winding, P, is connected directly across the 110-volt line, and induces the low voltage in the secondary winding, S, to light the filaments of both bulbs in parallel.

When the left line-wire is positive, the current flows in through the left rectifier bulb, passing through this bulb from the graphite electrode to the filament, out along the filament lead to the transformer secondary, and leaves this winding at the center tap, then passing through the battery and rheostat R, back to the center tap of the primary winding and through the right-hand side of this winding to the negative line-wire. This circuit is shown by the solid arrows.

When the line polarity reverses, current flows as shown by the dotted arrows: through the right-hand bulb to the secondary of the transformer, from the center tap of this winding through the battery in the same direction as before, then to the center tap of the primary winding, and out through the left section of this winding to the line wire.

The resistance R in this case is used to control the flow of current through the battery and thereby regulate the charging rate.

While bulb-type rectifiers of this class are not very efficient because of the voltage drop and resistance losses through the bulbs, they are nevertheless very popular because they have no moving or wearing parts and no electrodes to accumulate deposits. Therefore, bulb-type rectifiers require very little attention, except the occasional replace-

Alternating Current

ment of a bulb when they burn out after a certain number of hours of use.

Two common types of these rectifiers are made under the trade names "Tungar" and "Rectigon". The first named is made by the General Electric Company and the other by the Westinghouse Electric & Manufacturing Company.

9. WIRING AND CIRCUITS OF BULB-TYPE RECTIFIERS.

Fig. 7 shows a wiring diagram for a Tungar rectifier for charging from 1 to 10 six-volt batteries in series. By carefully tracing this circuit you will find that the 110-volt line-leads pass through the switch S and connect to leads A and B of the auto transformer winding, so that this winding is connected across the line and is excited by 110-volt A.C.

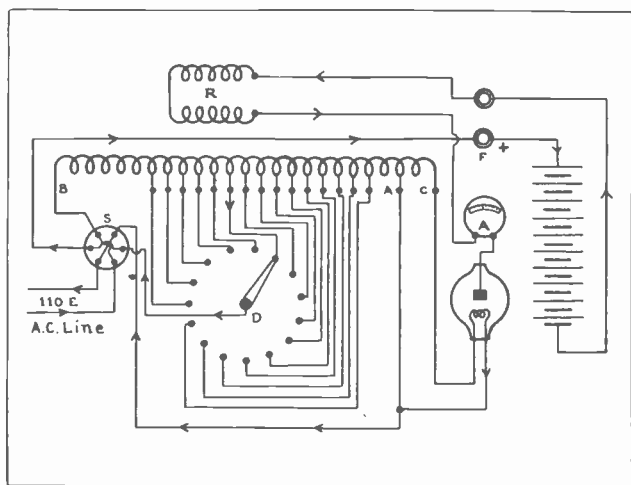

Fig. 7. Wiring diagram of a Tungar type bulb rectifier showing the taps on the auto transformer winding for varying the charging voltage.

This acts as a primary winding and induces the low voltage current in the secondary section from A to C to supply the filament current. When the

Rectifiers

filament is lighted, current passes during every other alternation from the bottom A.C. line-wire up through the switch and through that portion of the primary winding to the tap on which the rotary arm D may rest.

The current then passes through this arm and back through another bar of the switch, through the fuse F to the positive terminal of the battery, through the battery and back through the reactance coil R, through the ammeter A which indicates the charging current, through the bulb, out of the right-hand filament wire, and back to the top A.C. line-wire.

When the current attempts to flow in the reverse direction the valve action of the tube prevents it from doing so. The taps on the primary winding and the adjustable arm D provide a wide range of voltage variation to properly adjust the charging rate for any number of batteries from 1 to 10 which may be in the circuit at the time.

Fig. 8 shows a Tungar rectifier of this type with one side of the case removed, showing the bulb and fuses inside. On the front panel of this unit can be seen the line switch, ammeter, and voltage adjustment knob.

When operating rectifiers of the bulb type, care should be used not to overload them; because if they are allowed to carry more current than the bulbs and windings are made to stand, it will burn out the bulbs almost immediately and may also overheat and burn out the windings of the transformers and choke coils.

The bulbs are commonly made in the 2 and 6-ampere sizes, and fuses of the plug type are generally provided with these rectifiers to protect them from overload. These fuses should always be replaced with those of the proper size in order to protect the rectifier.

It is a good precaution to locate these rectifiers in a place where plenty of fresh air can circulate through them and this will help to prevent them from overheating.

Alternating Current

Fig. 9 shows the simplified diagram of a full-wave Rectigon charger, of the type made by the Westinghouse Electric & Manufacturing Company.

10. KENOTRON RECTIFIERS.

The type of gas-filled bulb rectifier just described is particularly designed for operation on comparatively low voltages such as from 110 and 220-volt A.C. supply lines.

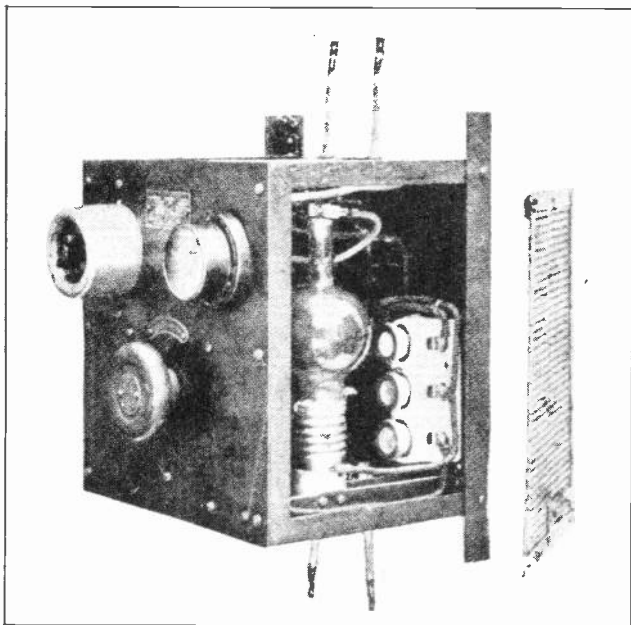

Fig. 8. The above photo shows a side-view of a Tungar rectifier with the bulb in place in the socket and the tap adjusting knob on the front panel. (Courtesy General Electric Company).

For rectifying high voltages from 5000 to 100,000 volts or more, the Kenotron rectifier tube is used. These are larger tubes which have a vacuum instead of being gas filled. They also have a filament which is heated by low-voltage A.C. and a plate or anode in the form of a metal cylinder surrounding the filament.

These tubes or valves also operate on the elec-

Rectifiers

tron principle, but have a much higher resistance and greater voltage drop through the space between the filament and plate. They are suitable for rectifying very high voltage and high-frequency A.C., such as radio energy.

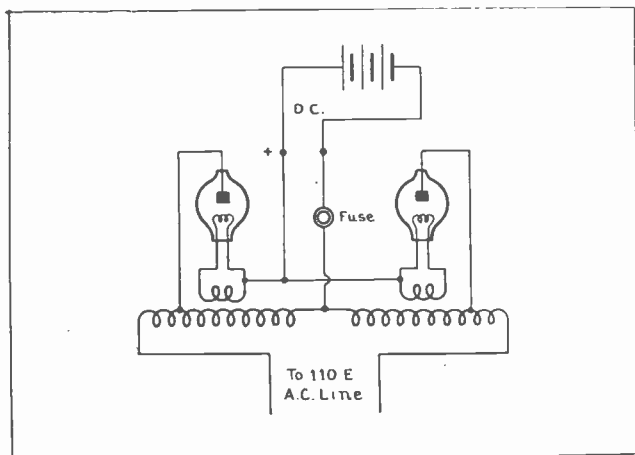

Fig. 9. This diagram shows the circuit of a full-wave Rectigon charger of the type made by Westinghouse Electric & Manufacturing Company. By carefully tracing this circuit you can get a very good idea of the principle of its operation.

11. COPPER OXIDE RECTIFIERS.

Another type of rectifier which is quite extensively used is one which uses a film of copper oxide on the surface of a copper disk, to act as a valve and pass current through it only in one direction.

These devices provide a very convenient portable type of rectifier for use where small or moderate amounts of current are required. They are very commonly used in radio sets and for the operation of certain D.C. signalling equipment, battery charging, etc.

They are also used to provide direct current for the operation of electro-magnets, magnetically-operated oil switches, and similar equipment in power plants and substations.

Alternating Current

These rectifiers operate on a principle similar to that of the copper oxide lightning arrester, and the current can pass through them only in one direction, that is, from the oxide to the metal plate.

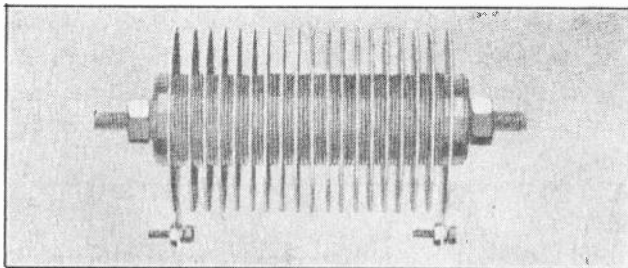

Fig. 10. Single unit of a copper oxide rectifier, consisting of a number of copper disks coated with copper oxide and clamped into one series group. Current can only pass through these devices in one direction. (Courtesy of Westinghouse Elec. & Mfg. Co.)

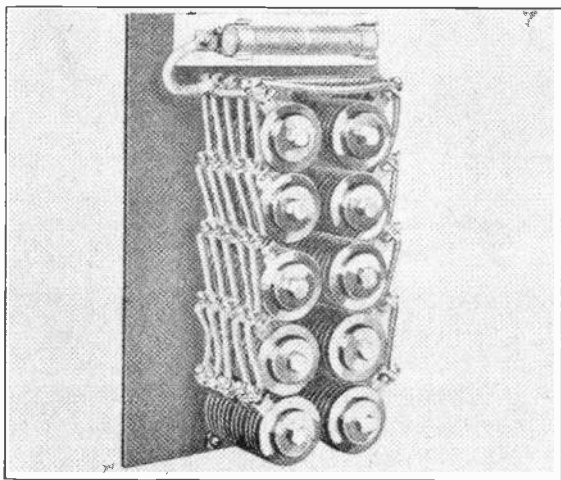

Fig. 11. Copper oxide rectifier consisting of a number of units connected in series and parallel to obtain increased voltage and current capacity. (Courtesy Westinghouse Elec. & Mfg. Co.)

These disks can be made in different sizes according to the current capacity desired, and a number of them can be stacked or clamped in series to build up the proper resistance according to the voltage which is to be used on them.

Rectifiers

Fig. 10 shows a group of the rectifier disks clamped together and equipped with projecting metal disks of larger diameter to assist in radiating the heat from the unit.

Fig. 11 shows the manner in which a number of these units can be connected in series or parallel and mounted in a panel or bank to provide a rectifier of the proper voltage-rating and current capacity.

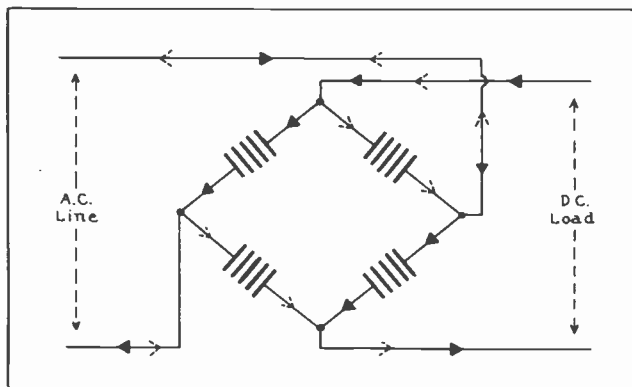

Fig. 12. Connection diagram of a full-wave, copper oxide rectifier with four units connected in a "bridge" type circuit.

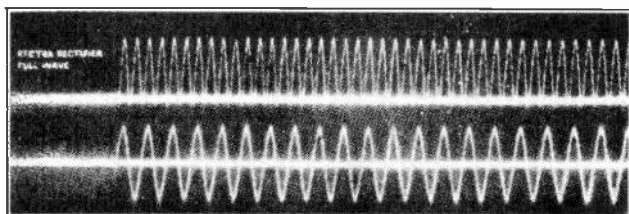

Fig. 13. Photo taken from an oscillograph record, showing the alternating current wave below and the rectified, pulsating D.C. wave above. (Courtesy Westinghouse Elec. & Mfg. Co.)

Fig. 12 shows a diagram of the connections of a full-wave, copper oxide rectifier using four groups of disks connected in a "bridge" circuit. The solid arrows show the direction of current flow through the rectifier during one alternation, and the dotted

Alternating Current

arrows show the direction of current flow during the opposite alternation.

Rectifiers of this type can be made in capacities from a fraction of an ampere to 100 amperes or more. Having no moving mechanical parts to wear out and no liquid electrolyte to spill or leak, they provide a very convenient and popular type of rectifier.

The maximum life of the copper oxide disks seems to be undetermined, for a number of these units have been operated for several years without any noticeable reduction in efficiency.

Fig. 13 is a photo made by an oscillograph showing the alternating current wave on the lower line and the rectified, pulsating, direct current on the upper line.

ELECTROLYTIC RECTIFIER EXPERIMENTS.

A number of very interesting experiments may be performed to prove the working principle of the electrolytic rectifier.

The material required may be an ordinary pint size fruit jar, aluminum rod or strip of aluminum, a lead strip, and an electrolytic solution.

The aluminum should be chemically pure metal, if such is available, if not, regular commercial aluminum will many times work satisfactorily for experimental purposes.

The aluminum will act as a valve and allow current to enter it from the electrolyte, but will not allow current to leave the aluminum and flow thru the electrolyte in the opposite direction.

The other element does not act as a valve, and is used only as a means of completing the electrical circuit between the external circuit and the electrolyte. This element may be either lead or carbon although lead works slightly better than carbon. It is also possible to use iron for this element.

The two elements used in the rectifier should be long enough to extend thru the top of the jar far enough to allow electrical connections to be made to the external circuit.

Rectifiers

A Non-metallic support of some kind may be placed across the top of the jar to keep the elements from coming in contact with each other, and to hold them a fraction of an inch above the bottom of the jar.

There are different solutions which may be used as an electrolyte, but the one which is very easy to obtain may be made by mixing an ammonium borate solution as follows:

Add 4 tablespoonfuls of ordinary Borax and 4 tablespoonfuls of household ammonia to 1 pint of water.

The water should be as nearly pure as possible. It is desirable to use distilled water so that it will be free from impurities. The more pure the solution, the better will be the rectifying action. Impurities tend to allow current to flow in the opposite direction.

When completed, the rectifier may be tested by connecting it to an A. C. line thru a lamp bank as shown by Fig. 2-A, or it may be connected to a step down transformer.

The load may be either a battery which requires a charge, a rheostat, or any other resistance so that a direct short circuit does not exist. You should connect your D.C. Ammeter in the circuit so that you will obtain a reading of the amount of current flowing.

If it is desired to increase the capacity and make a full wave rectifier, 4 cells may be constructed and connected together as shown by Fig. 3.

Alternating Current

EXAMINATION QUESTIONS

1. For what purpose are rectifiers used?
2. Are vibrator type rectifiers used as extensively as other types? Why?
3. Briefly describe how rectification takes place in an electrolytic rectifier.
4. Draw a sketch showing a full-wave electrolytic rectifier used as a battery charger and with power supplied by an auto-transformer.
5. Briefly describe how the charging circuit is completed between the filament and the graphite electrode in a bulb type rectifier.
6. What advantage does a full-wave rectifier have over a half-wave rectifier?
7. Which type of rectifier described in this lesson would you recommend for use on a 50,000 volt line?
8. In which direction does the current flow thru the copper oxide rectifier?
9. Draw a sketch of a full-wave copper oxide rectifier connected in a "bridge" type circuit.
10. Copy Fig. 9 and trace the circuits thru which the battery charging current flows. Use a large arrow for the circuit thru the left hand bulb and a small arrow for the circuit thru the right hand bulb.

Rectifiers

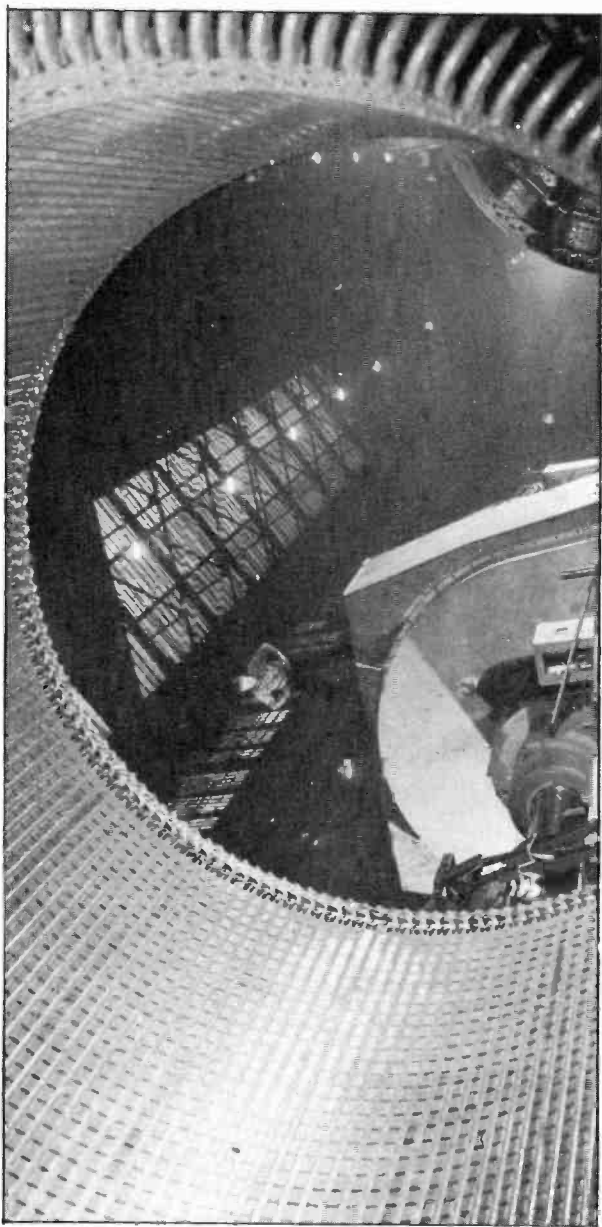

Unusual view of a mammoth stator under construction at Westinghouse plant.

Alternating Current

MERCURY ARC RECTIFIERS

Rectifiers using the valve effect of electrodes and an arc in mercury vapor can be made in sizes ranging from those of a few amperes at low voltage for battery charging purposes, to those of 1000 kw. or more which are used for converting A.C. to D.C. in electrical railway and industrial substations.

Rectifiers of this type which are used for battery charging and D.C. arc lighting purposes are designed to operate on A.C. voltages from 110 to several hundred volts, and to produce rectified D.C. in amounts from 2 or 3 amperes to 50 amperes or more.

These small units often use a glass bulb in which a small pool of mercury is enclosed and which has the required electrodes sealed into the bulb at the proper locations.

Several common types of these mercury-arc rectifier bulbs are shown in Fig. 1.

Larger rectifiers for power use are designed to operate on voltages from 200 up to 5000, and to handle currents of several hundred to a 1000 amperes or more. These units have the mercury enclosed in an iron tank from which the air is exhausted and into which are sealed the insulated electrodes to conduct the current to and from the tank.

1. VALVE EFFECT.

In Lesson 25 covering Illumination and dealing with the mercury vapor lamp, we learned that current can flow in only one direction through a mercury-vapor bulb or tube of this type; that is, **from the anode to the mercury.**

The current will not flow in the reverse direction from the mercury pool to the anodes or positive metal electrodes. The mercury vapor forms a path of moderate resistance through which the current

Rectifiers

flows in the space between the metal anodes and the mercury cathode (negative electrode). This valve effect can be used to form a half-wave or full-wave rectifier for single-phase circuits; and, by adding the proper number of electrodes, mercury-vapor rectifiers can also be used on polyphase circuits.

In Fig. 1 the pool of mercury can be seen in the lower neck or extension of the glass bulb. The anodes or metal electrodes are sealed into the ends of the arms or extensions on the sides of the bulb.

These electrodes and the mercury pool are connected to the metal caps or ferrules on the outside by means of lead-in wires which are sealed into the glass.

The air and foreign gases are withdrawn from these bulbs, so that they operate under a partial vacuum with only the mercury vapor inside them.

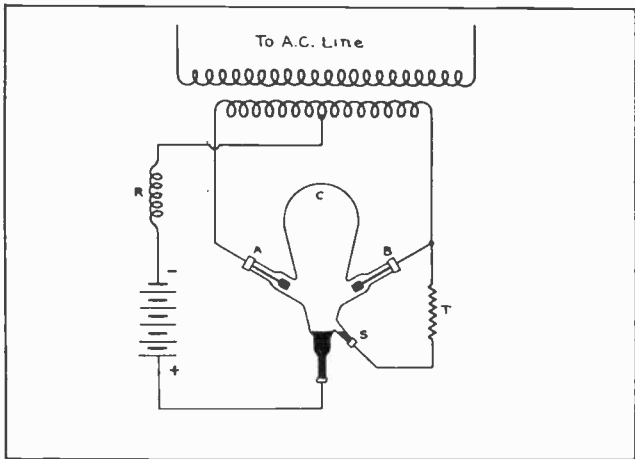

Fig. 2. Circuit diagram of a bulb type mercury arc rectifier used for battery charging purposes. Trace this circuit carefully with the accompanying explanation.

2. CONNECTIONS AND OPERATION.

Fig. 2 shows a diagram of the connections for a full-wave mercury-arc rectifier of the type used for battery charging. The transformer supplies

Alternating Current

alternating current at the proper voltage to the two anodes or electrodes in the glass extensions or arms on the side of the bulb.

When the left lead of the transformer is positive, current passes down from the left electrode to the mercury, and then from the terminal at the bottom of the mercury pool through the battery and choke coil or reactor R, returning to the transformer secondary at the center tap, completing the circuit through the left half of the secondary winding.

During the next alternation, when the opposite wire is positive, current flows down from the right-hand electrode to the mercury pool and again through the battery in the same direction, returning to the center tap of the transformer and completing the circuit through the right half of this winding. In this manner both halves of the cycle are used, thus making the unit a full-wave rectifier.

3. STARTING.

To start a mercury arc rectifier of this type, it is necessary to first establish the mercury vapor in the tube and to form the hot spot on the surface of the mercury pool. In some cases this is done by means of high voltage applied through an auxiliary electrode above the surface of the mercury and used to draw an arc or apply high voltage from a spark coil. More commonly, however, rectifiers of the bulb type, such as shown in Fig. 2, have an auxiliary starting electrode in the small projection or leg, S, at the lower right. When the bulb is in normal operating position the level of the mercury in the main cathode stem and in the starting arm is such that the two pools are separated by the glass neck between them.

To start these rectifiers, the tube is tilted a little to one side so that some of the mercury from the main pool runs into the starting arm, momentarily bridging the gap and connecting the two pools together. This closes a circuit from the right half of the transformer winding through the resistor T,

Rectifiers

through the mercury, and out of the main cathode terminal at the bottom, then through the battery, reactor R, and back to the center tap of the transformer.

This allows current of the proper amount to flow through the mercury, so that when the tube is tilted back to normal position and the two pools are separated an arc is drawn between them. This arc sets up the required hot spot on the mercury cathode or pool and vaporizes sufficient mercury to start the flow of current from the anodes A and B.

Keep in mind that the anodes are always the positive terminals or the ones from which current flows into the mercury and that the cathode, or negative, in this case is the mercury pool. This applies to the internal circuit of the rectifier. The current leaves the rectifier at the terminal attached to the mercury, so this is the positive terminal of the external D. C. circuit.

Current cannot flow directly across between anodes A and B because of the valve action of the mercury vapor, and due to the shape and characteristics of these electrodes in contact with the mercury vapor. Therefore, current cannot flow from the mercury vapor into either anode, and this prevents any short circuit between them. The current actually flows alternately from first one anode and then the other into the mercury pool and out to the battery, but during normal operation it never flows in the reverse direction.

The large upper part of the bulb C forms a condensing chamber or dome in which the surplus mercury vapor cools and condenses, running back down the sides of the glass into the pool at the bottom.

Fig. 3 shows a complete mercury-vapor rectifier. The bulb and transformer are shown mounted on the back of the frame. The bulb can be arranged

Alternating Current

for tilting either by hand or by means of a magnet when starting.

Sometimes when the bulb is cold it may be necessary to tilt it several times and repeat the forming of an arc in order to get the unit to start. As soon as the current flow from the anodes starts and the rectifier begins to operate, the interior of the bulb glows with a peculiar bluish tint characteristic of the mercury-vapor arc formed when current is passed through the vapor in the bulb.

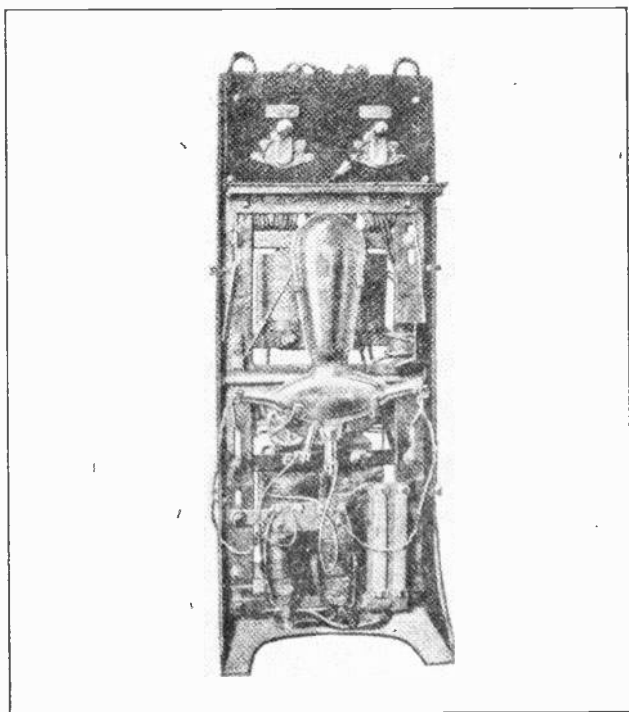

Fig. 3. Rear view of a complete mercury arc rectifier showing the bulb and also the auto transformers, resistors, tap adjusters, etc.

Numerous units of this type are in use for battery charging in large garages or places where fleets of electric trucks are used, and also in older substations supplying direct current to D.C. arc lights.

Rectifiers

These rectifiers are also used in motion picture theatres for supplying direct current to the arc lights of projector machines.

4. CARE AND TESTING OF BULBS.

It is absolutely necessary to maintain the proper vacuum in the rectifier bulb, in order that the rectifier may operate properly. For this reason the bulbs should be handled very carefully, because the slightest crack anywhere in the glass or at the point where the terminals are sealed into the ends of the glass arms will allow air to leak into the bulb and prevent its operation.

A simple test to determine whether the bulb is good or whether it has lost its vacuum is similar to the one described for mercury-vapor lamps in the section on Illumination. If the bulb is removed from its clamps or holder and is tilted enough to allow the mercury to splash a little, a sharp clicking sound will be heard if the vacuum is good. If air has leaked into the bulb through a crack or if foreign gases have been formed inside of the bulb, the sound of the mercury running from one point to another will be very dead and soft, indicating that the vacuum in the bulb has been destroyed.

These rectifiers should not be overloaded beyond their current capacity for any great length of time or the bulbs may overheat and become damaged. A good mercury-arc rectifier bulb, if handled and operated properly, will often have a useful life of many years.

5. POWER RECTIFIERS.

Large mercury arc rectifiers for power purposes have the mercury and electrodes enclosed in an iron tank as previously mentioned.

Fig. 4 shows a 600-kw. mercury-arc rectifier for operation at 575 volts. The mercury is in a small pool or insulated pot at the bottom of the large iron tank, and the tank contains the mercury vapor and the arc during operation of the rectifier.

Alternating Current

This large tank also serves to condense the mercury vapor which is continually being generated by the arc, and allows the condensed mercury to run back to the pool at the bottom.

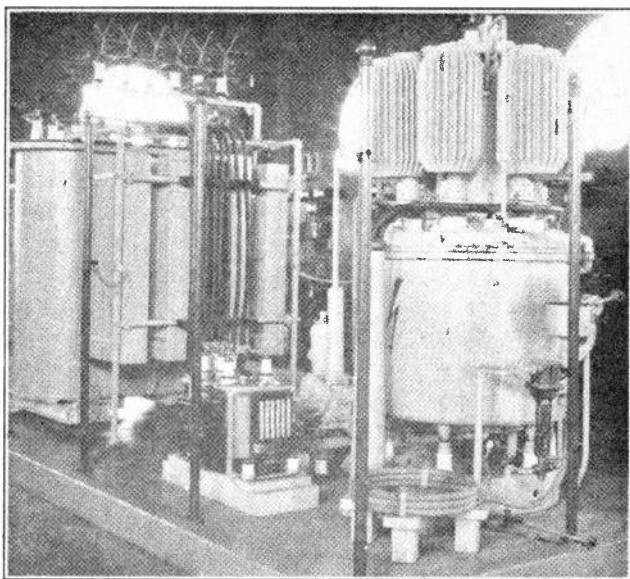

Fig. 4. The above photo shows a 600-kw., 575-volt, mercury arc power rectifier with the transformer and auxiliaries at the left. Note the cooling fins for radiators on the anodes. (Photo courtesy American Brown Boveri Co.)

The rectifier shown in Fig. 4 is for 6-phase operation and the six anodes or positive terminals enter the tank through specially constructed and sealed insulating bushings, clearly shown on top of the tank in this view. The large ribbed elements on each of these six leads are provided to radiate the heat and aid in cooling the anodes.

The mercury pool at the bottom of the tank acts as the cathode and has a heavy cable or conductor connected to it by means of a terminal which projects into the bottom of the mercury pool. This conductor leads to the positive D.C. line.

Because it is practically impossible to avoid all leakage of air to the inside of the tank, these large rectifiers are equipped with an auxiliary vacuum

Rectifiers

pump which operates from time to time to remove air and gases from the tank and to maintain the vacuum necessary for proper operation of the rectifier.

The transformer, which supplies six-phase alternating current at the proper voltage, is shown at the left of the rectifier and vacuum pump equipment.

6. OPERATION.

The operating principle of these large rectifiers is practically the same as that of the smaller ones using the glass bulb.

The current flows in turn from each of the six anodes at the top of the unit, through the mercury vapor in the lower chamber, to the hot spot on the mercury pool.

During normal operation the currents from the six separate phase anodes do not interfere with each other but all flow in the proper direction to the mercury.

An auxiliary electrode in the form of a metal rod is generally provided for starting these rectifiers. This rod passes into the top of the tank at the center through a special bushing which allows the rod to be moved up or down.

7. STARTING.

To start the unit, the rod is lowered until it touches the surface of the mercury, closing the circuit for the proper amount of current required to form the starting arc. The rod is then lifted, causing the lower end to break contact with the surface of the mercury and draw the arc. This arc forms a hot spot on the surface of the mercury and starts the formation of mercury vapor necessary for the unit to commence operation.

The starting rod or electrode is generally operated by means of a solenoid which draws it into contact with the mercury, and a spring which again raises the rod to draw the arc.

Alternating Current

8. COOLING AND TANK INSULATION.

The main tank generally consists of two separate tanks, one within the other. The inner tank contains the mercury and maintains the vacuum around the mercury and the anodes, while the outer tank serves as a cooling shell and contains water which completely surrounds the inner tank.

During operation a small amount of water is continually circulated through this shell to carry away the heat developed.

The entire unit is mounted on insulators on the bottom of the outer tank, because the tank and the metal parts of the rectifier are always at slightly higher voltage than the mercury and cathode terminal which forms the high-voltage direct current lead that connects to the trolley in case of railway service.

9. EXCITER ANODES.

To maintain the operating arc requires a certain small amount of current passing through the rectifier at all times. For this reason rectifiers of this type are generally provided with auxiliary exciter anodes which keep up a small flow of current to maintain the hot spot on the surface of the mercury during any periods when the entire D.C. load may be removed from the rectifier.

Fig. 5 shows two 500-kw., 600-volt, 60-cycle mercury-arc rectifiers in a substation. In this photo you can see clearly the insulating bushings through which the anodes enter the tank and also the A.C. and D.C. leads to and from the rectifier. The vacuum pumps and gauges are located between the two rectifier units. This view also shows the manner in which the tanks are supported on steel posts, with insulators between the tops of the posts and the tanks.

Fig. 6 shows a sectional view of a six-phase mercury-arc rectifier. This view shows clearly the location of the mercury in the metal container, which is insulated from the bottom of the main

Rectifiers

tank; and also the positions of the starting rod or anode and one of the main A.C. anodes. The rest of the main anodes are not shown in this view.

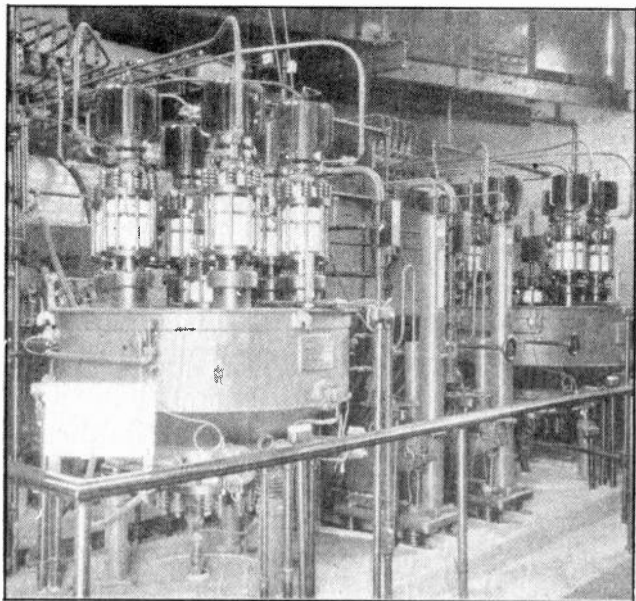
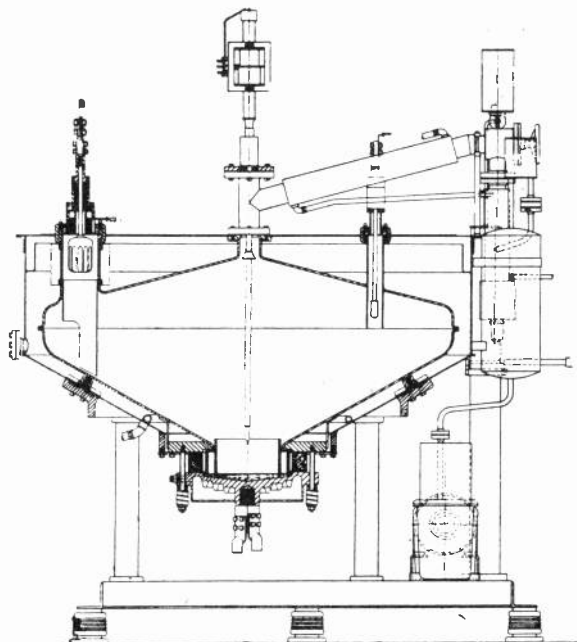

Fig. 5. This photo shows an excellent view of two 500-kw., 600-volt mercury arc rectifiers. Note the insulators on the tank supports and also the insulating bushings through which the anodes enter the tank at the top. The vacuum pumps and a number of pieces of auxiliary equipment can be seen between the two units and in the background of the photo. (Courtesy General Electric Co.)

Note the barrier provided around the lower end of the main anode to prevent flashovers during unusual operating conditions. This view also shows the separation between the inner and outer tanks, the manner in which the tanks are mounted on insulated bases, and the connection terminals for the positive D. C. lead to the bottom of the rectifier.

Alternating Current

The small anode shown on the right is one of the exciter anodes used for maintaining the arc during the removal of the D.C. load. On the right in this figure is shown also some of the auxiliary vacuum-pump equipment.



**Cross Section of 1000-kw.,
600-volt Rectifier**

Fig. 6. This diagram shows a sectional view of a six-phase, mercury arc rectifier. Note the small pool of mercury which forms the cathode beneath the starting electrode.

Fig. 7 shows a sectional view of another rectifier of slightly different construction. This rectifier and the one shown in Fig. 6 are made by different manufacturers but they both operate on the same general principle. This view shows one of the main anodes on the left and one of the smaller exciting anodes on the right.

Rectifiers

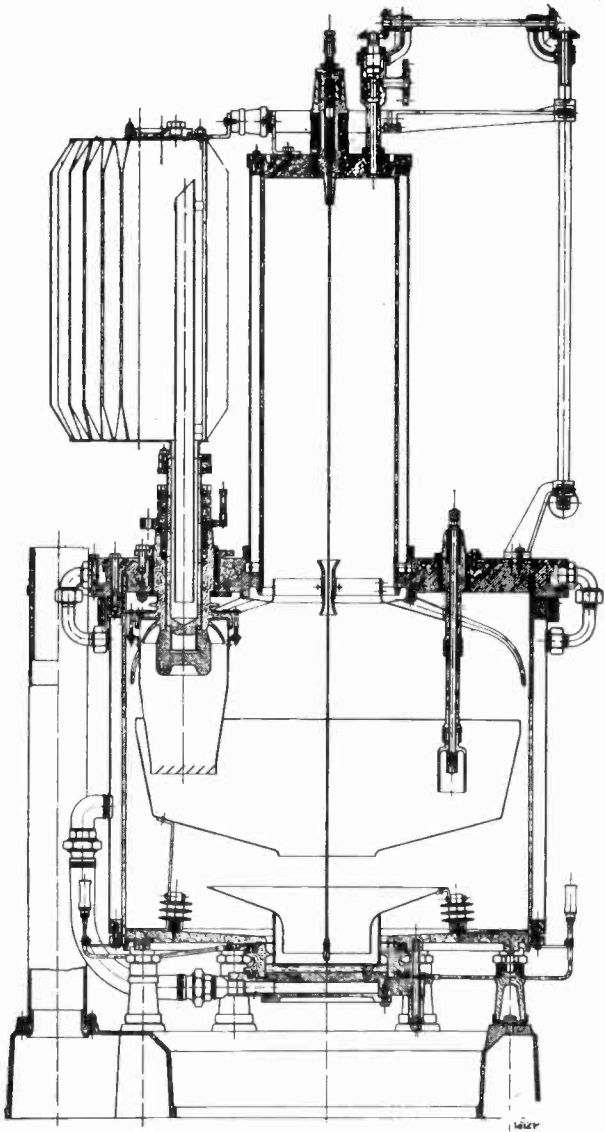

Section through Brown Boveri mercury-arc power rectifier.

Fig. 7. Sectional view of another type of six-phase, mercury arc rectifier showing one of the main anodes on the left and one of the smaller exciter-anodes on the right. The ignition anode or rod is shown in the center.

Alternating Current

10. CONNECTIONS AND CIRCUITS.

Fig. 8 shows the starting and exciting circuits only for a mercury-arc rectifier such as made by

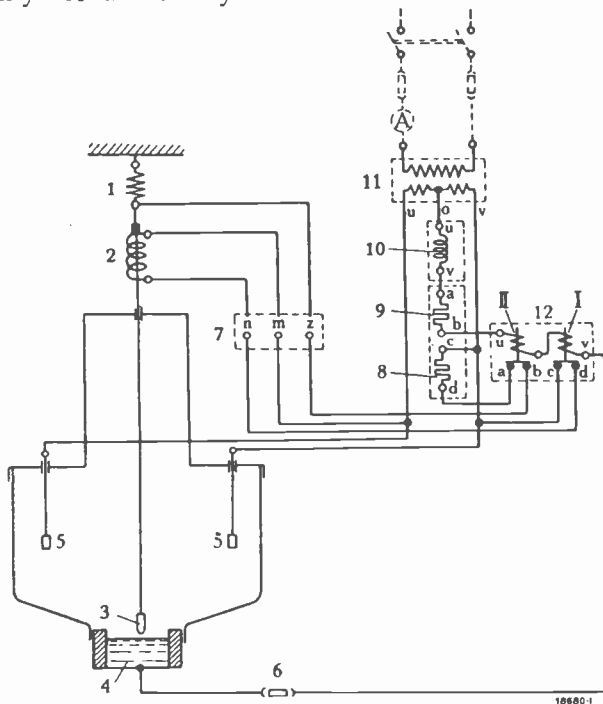

**Connections of the ignition device
for alternating current.**

1. Spring.
 2. Ignition coil.
 3. Ignition anode.
 4. Cathode.
 5. Excitation anode.
 6. Fuse.
 7. Terminal board on rectifier.
 8. Ignition resistance.
 9. Excitation resistance.
 10. Excitation choke coil.
 11. Excitation transformer.
 12. Relay casing.
- I and II. Relays.

Fig. 8. Connection diagram for a single-phase, full-wave, mercury arc power rectifier. (Courtesy American Brown Boveri Co.)

the American-Brown Boveri Company, and Fig. 9 shows both the excitation circuit and the main

Rectifiers

Wiring Diagram of a Rectifier Plant

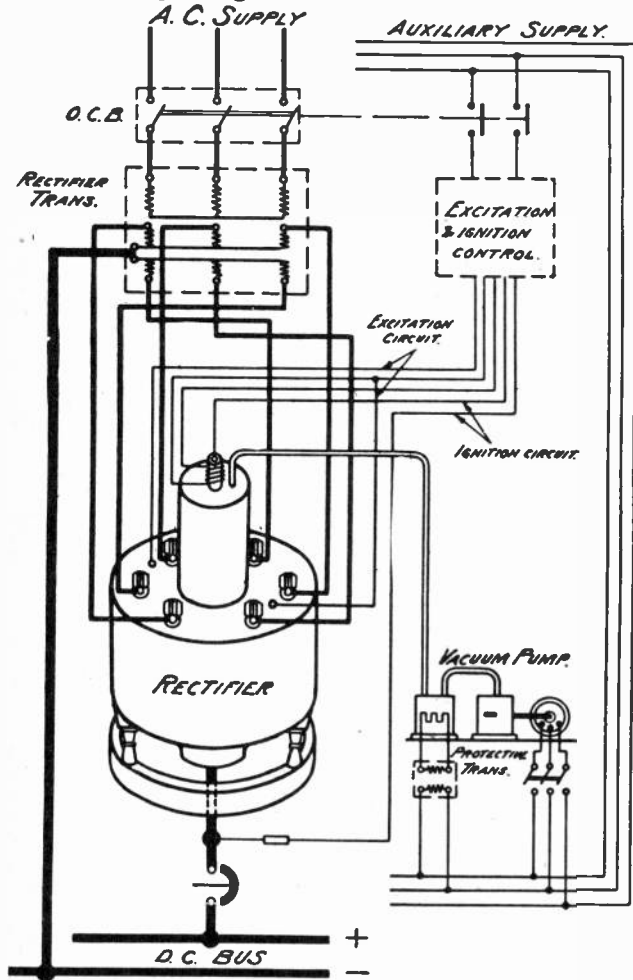

Fig. 9. Wiring diagram showing the power and auxiliary circuits for a six-phase mercury arc power rectifier. (Courtesy American Brown Boveri Co.)

power-circuit through a rectifier of this type.

You will note that the transformer secondaries are divided in two sections each, and have the six-phase A.C. leads taken from the respective ends of each of these sections.

Alternating Current

The opposite ends of each winding are connected together to one common point and then to the negative or grounded D.C. bus. The positive D.C. bus is connected through a circuit-breaker to the bottom of the rectifier tank and to the cathode, or mercury pool.

Fig. 10-A shows a simple schematic diagram of the power-circuit connections for a three-phase mercury-arc rectifier. The primary of the transformer is connected delta to the A.C. supply. The secondary is connected star, with one end of each phase-winding connected to its respective anode of the rectifier unit. The center or neutral point of

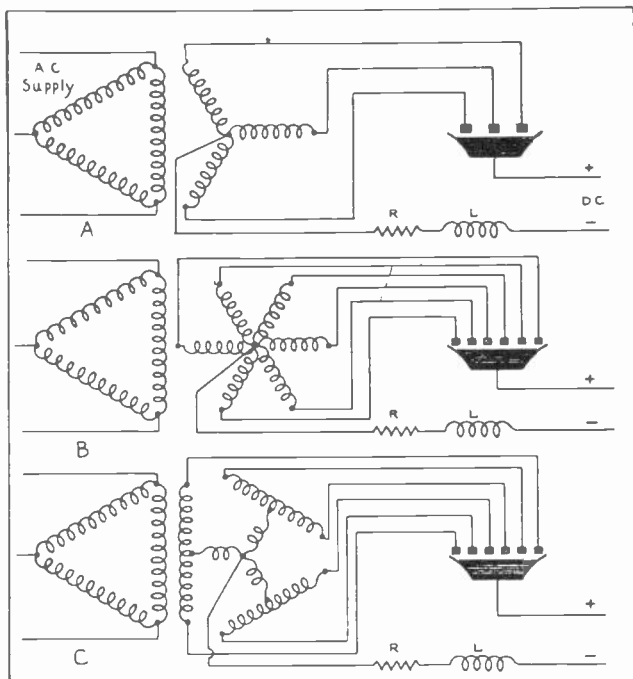

Fig. 10. The above diagrams show three different types of transformer connections which are commonly used with three-phase and six-phase mercury arc rectifiers.

the star connection is taken through a resistor unit R and a reactor or inductance coil L, to the negative

Rectifiers

D.C. lead. The positive D.C. lead connects to the mercury pot of the rectifier.

Fig. 10-B shows the connections for a six-phase rectifier-transformer primary, connected three-phase delta to the A.C. supply; and the secondary windings are connected six-phase star to the mercury arc rectifier.

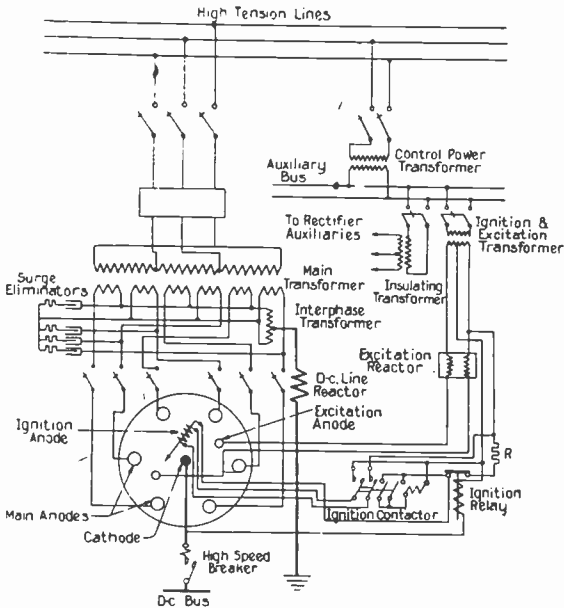
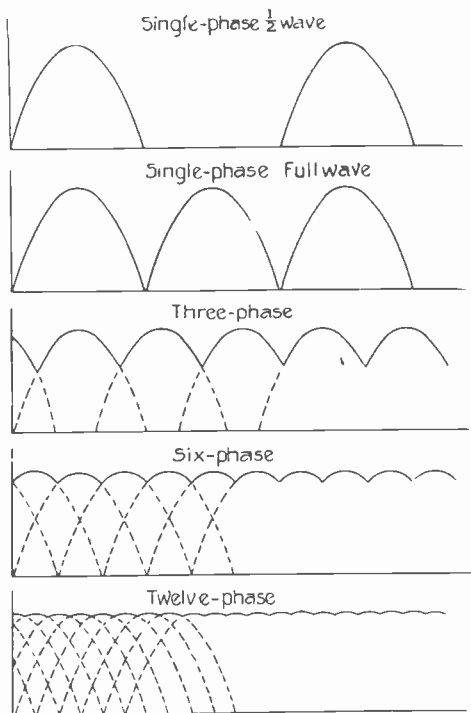

Fig. 11. Wiring diagram of a six-phase rectifier showing transformer connections and auxiliary control circuits. (Courtesy American Brown Boveri Co.)

Another connection sometimes used is the triple single-phase connection shown in Fig. 10-C. This connection uses the opposite ends of each single-phase secondary winding to connect to separate anode terminals and thereby provides six-phase operation of the mercury arc rectifier. The center points of each phase of the secondary winding are

Alternating Current

connected through reactors to a common or neutral terminal which in turn is connected to the negative D.C. bus.



COMPARISON OF RIPPLE IN D.C. OUTPUT
FOR VARIOUS NUMBER OF PHASES

Fig. 12. These sine wave diagrams show the amount of pulsation or ripple in rectified D.C. from units operating on different numbers of phases. Note the much smoother voltage curve obtained with the six and twelve phases.

Fig. 11 shows a diagram of the connections for a six-phase rectifier, including the main A.C. and D.C. power circuits, ignition and excitation circuits, etc. Trace out this diagram carefully and observe the descriptions which are printed in the diagram for the various parts.

Rectifiers

11. VOLTAGE, EFFICIENCY AND POWER FACTOR

There are numerous other connections that can be used to obtain three-phase or twelve-phase operation of these rectifiers. The reason for commonly using six-phase connections to these units and sometimes twelve-phases, is because the greater the number of phases used, the more frequent will be the impulses of rectified D.C.

This reduces the amount of fluctuation and smooths out the voltage of the D.C. supply. The reactance coils which are used in series with the D.C. leads also serve to choke down the ripples or pulsations and thereby smooth out the voltage wave. Fig. 12 shows the differences between the D.C. voltages of 1, 3, 6, and 12-phase units.

Mercury-arc rectifiers have a number of decided advantages, such as high efficiency, high power

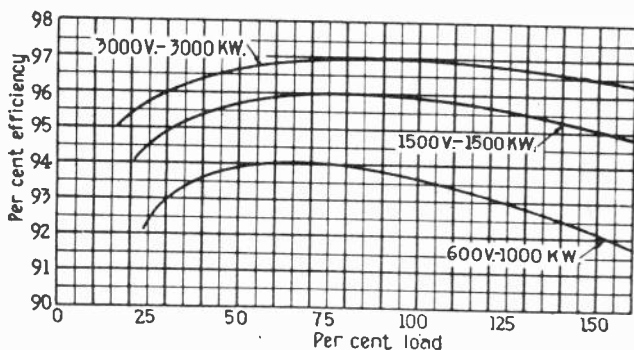

Over-all Station Efficiencies for Rectifiers for 600, 1500, and 3000 Volts

Fig.13. The above curves show the efficiencies of mercury arc power rectifier stations operating on different voltages and at different percentages of rated load.

factor, absence of moving parts to wear out, and very quiet operation.

Power rectifiers of the type just described have efficiencies ranging from 90 to 97 per cent. and

Alternating Current

power factors which range from 75 to 95 per cent. at the various loads.

Fig. 13 shows the efficiency curves of several rectifiers designed to operate on different voltages. These curves show the variations in efficiency from below 25% to over 150% of the rated load of the units.

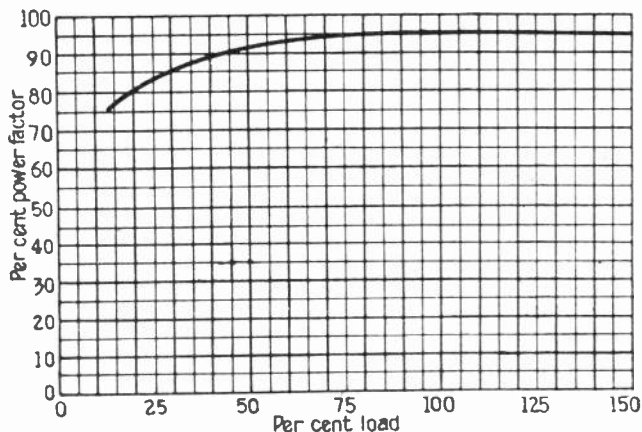

Power-factor of Rectifier
at Various Loads

Fig. 14. This curve shows the power factor of a mercury arc rectifier at various percentages of its full rated load.

The higher efficiencies of mercury arc rectifiers are obtainable only with those designed for operation at above 400 volts. Below this voltage synchronous converters are more efficient.

Fig. 14 shows the power-factor curve of a rectifier and shows the variation in the power factor from under 25% up to 150% load. You will note that the power factor increases gradually with the load, from 25 to 75 per cent. of the rated capacity of the unit, and from this point on up the power factor is practically constant at 95%.

These rectifiers are not as seriously affected by short circuits on the D.C. leads as are rotary converters and motor-generators, which are used for the same purpose; that is, changing A.C. to D.C.

Rectifiers

The output-voltage of mercury arc rectifiers with common connections can be determined from the following ratios:

single-phase — 2 anodes —	.636
three-phase — 3 anodes —	.827
quarter-phase — 4 anodes —	.900
six-phase — 6 anodes —	.955

The figures given are the ratio of the average D.C. pulsating voltage output to the maximum A.C. voltage input. For example, if we apply 100 volts A.C. to a six-phase unit, the D.C. voltage will be $100 \times .955$, or 95.5 volts.

The greater the number of phases, the higher is the D.C. output voltage.

12. OPERATION AND CARE.

If the pressure of the mercury vapor in these rectifiers is allowed to become too high, the rectifier will have a tendency to arc back, or lose its valve action or rectifying property, allowing current to flow in either direction.

If the pressure becomes too low, the voltage drop through the arc becomes excessive.

For these reasons it is very important in operating mercury arc power rectifiers to maintain the proper temperature for condensation of the vapor, by proper adjustment of the cooling water and to maintain proper vacuum by means of the vacuum pump.

The water and vacuum pumps are often controlled automatically by means of temperature and pressure relays.

When the units are manually operated the pressure and temperature gauges should be carefully watched and the proper adjustments made, in order to secure satisfactory operation.

Mercury arc rectifiers can be operated in parallel with each other or in parallel with synchronous converters by the use of the proper reactors and resistance units to obtain the proper voltage regulation and division of load currents.

Alternating Current

EXAMINATION QUESTIONS

1. On what voltages do large mercury-arc rectifiers operate, and how much current will they handle?

2. Which direction does the current flow through a mercury-arc rectifier?

3. Copy Fig. 2 and trace the two secondary circuits through which current flows in charging the battery. Use large arrows for one circuit and small arrows for the other.

4. Briefly describe how the bulb type mercury-arc rectifier may be set in operation.

5. How may mercury-arc rectifier bulbs be tested to determine the condition of the vacuum?

6. How are large tank type mercury-arc rectifiers cooled?

7. What provision is made to maintain the proper vacuum in tank type rectifiers?

8. Briefly describe how mercury vapor is formed to set the large tank type rectifiers in operation.

9. Draw a simple schematic diagram showing how a three phase mercury-arc rectifier should be connected to a three phase power line through a transformer, having its primary connected delta and the secondary connected star.

10. What would be the D.C. voltage output of a three phase mercury-arc rectifier operating on a 600-volt A.C. line?

Synchronous Converters

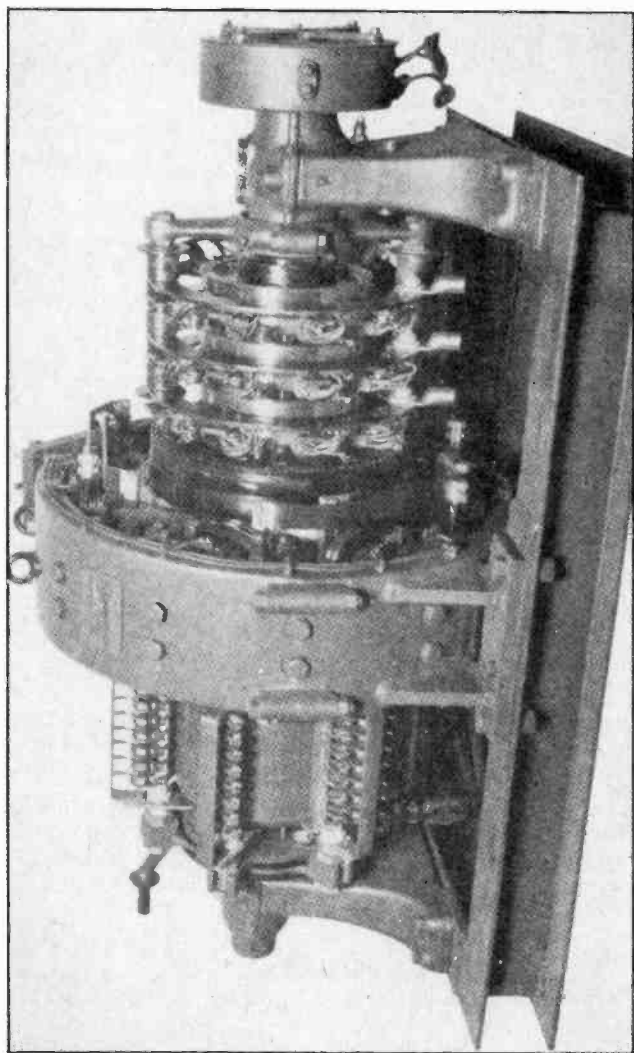

Alternating Current

SYNCHRONOUS CONVERTERS

A synchronous converter is a rotating machine used for changing A. C. to D. C. In construction these machines are a sort of combination of a D. C. generator and an A. C. synchronous motor of the revolving-armature type.

Synchronous converters always have stationary filed poles, and their fields are constructed the same as those of D. C. generators. A few converters are made with shunt field-winding only, but the great majority of commercial machines have compound field-windings, the same as compound D. C. generators.

Converter armatures have one ordinary winding the same as the winding used in a D. C. generator. These windings can be connected to the commutator bars either lap or wave, although most synchronous converters use lap windings.

In addition to the connections which are made to the commutator bars, converter armatures also have taps taken at equally spaced points around the winding and leading to the collector rings, which are generally placed on the end of the shaft opposite from the commutator.

The picture on the following page shows a modern synchronous converter. In this photo the commutator and D. C. brushes are on the left and the slip rings and A. C. brushes are on the right. The end of the armature winding can be seen extending from the right side of the opening between the field poles.

You have already learned that the voltage generated in an ordinary winding when it is revolving in the flux of field poles can be taken off to the line in the form of D. C. by use of a commutator, or A. C., by means of slip rings..

If the armature of a synchronous converter is driven by mechanical power, the machine can be used as either a D. C. or A. C. generator, or both.

Direct current can be taken from the brushes on

Synchronous Converters

the commutator, and three-phase alternating current from the brushes on the slip rings of a machine such as shown on the preceding page; or both D. C. and A. C., up to the capacity of the armature winding, can be taken from these machines when driven by mechanical power.

As a motor, this machine can be operated either by D. C. or A. C. If direct current of the proper voltage is applied to the brushes on the commutator, the machine will run as a D. C. motor; or if three-phase A. C. is applied to the slip rings, it will run as a synchronous motor with a stationary field and revolving armature.

Most synchronous converters are operated from A. C. and produce D. C., although in some cases they are supplied with D. C. and change it to A. C. When used in this manner they are called **inverted rotary converters**.

1. CONSTRUCTION

Fig. 2 shows another synchronous converter and gives a better view of the D. C. end. The field poles with their shunt and series windings can be plainly seen in this view, and you will note that this machine is also provided with interpoles to improve commutation on the D. C. end. The D. C. brushes are provided with **arcing shields** or **flash barriers** to prevent flash-overs between the positive and negative sets of brushes in case of short circuits or severe overloads on the machine.

Fig. 3 shows the field frame and poles of a synchronous converter with the armature removed. In this view you may note the damper winding which is built into the faces of the field poles. This winding is used both in starting the machine as an induction motor and to prevent hunting during operation.

Fig. 4 shows the armature of a 500-kw. rotary converter which is equipped with six slip rings on the A. C. end for operation on six-phase A. C. The commutator of this machine, being rather long in order to accommodate the necessary brushes and carry the large amounts of direct current, is equip-

Alternating Current

ped with a banding ring in the center, to hold the bars in place against the action of centrifugal force.

2. OPERATING PRINCIPLES

When alternating current of the proper frequency and voltage is applied to the slip rings of a syn-

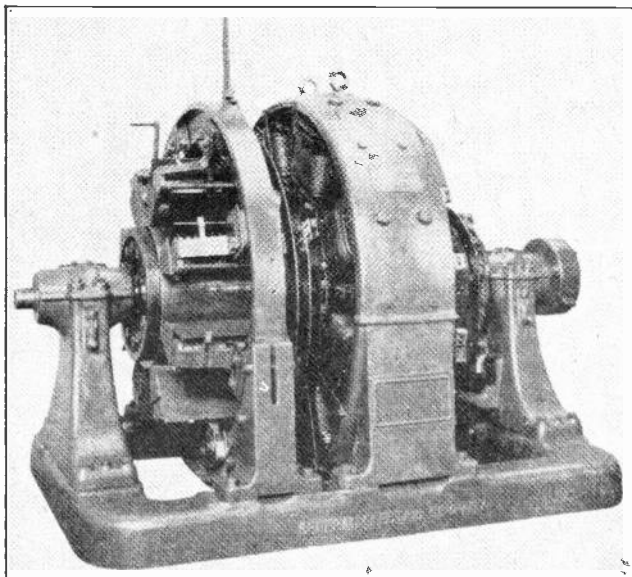

Fig. 2. D. C. end of a large synchronous converter showing brush-lifting mechanism, and flash barriers around the brushes. (Courtesy General Electric Co.)

chronous converter this excites the armature winding with A. C. and sets up a revolving magnetic field around the armature. This field induces secondary currents in the squirrel-cage damper winding, and the reaction between the flux of these secondary currents and the flux around the armature conductors sets up torque and causes the machine to start as an induction motor.

When the armature comes up to nearly synchronous speed, the D. C. field poles are excited and the machine then pulls into step and operates at synchronous speed, the same as any synchronous motor. Direct current can then be taken from the brushes at the D. C. end.

Synchronous Converters

From this description alone one might conclude that the machine operates purely as a motor-generator, using alternating current to drive the motor

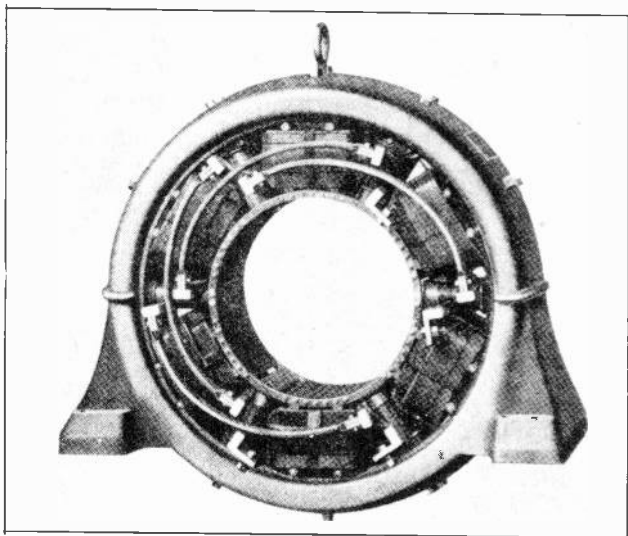

Fig. 3. Side-view of the field of a synchronous converter. Note the squirrel-cage damper winding in the faces of the main poles. Also the interpoles located between the main poles. (Courtesy Allis-Chalmers Mfg. Co.)

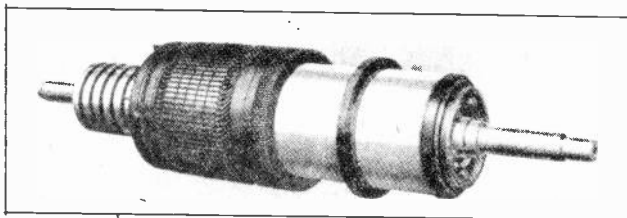

Fig. 4. Photo of converter armature clearly showing the armature winding, slip rings and commutator. A.C. enters at the slip rings and D. C. is taken off from the commutator when this armature is revolved at synchronous speed in the flux of D. C. field poles. Courtesy Allis-Chalmers Mfg. Co.)

and thereby generating D. C. in the windings. This, however, is not the case, as when synchronous converters have their armature windings supplied with A. C. of the proper voltage, this current merely passes through the windings of the D.C. end, where it is commutated or rectified into D. C.

Alternating Current

A small amount of the energy derived from the alternating current is used up in overcoming the friction and losses in the machine, but by far the greater part of the A. C. energy is simply passed through the armature winding from one end to the other and commutated into D. C. at the D. C. end.

For this reason commutators on converters are much larger than those on D. C. generators of the same armature size.

The voltage at the D. C. end of a synchronous converter is generally a little higher than the A. C. energy supplied, because the current in passing through the few turns which it does in the armature winding has a little generated voltage added to it as the armature conductors revolve through the flux of the D. C. field poles. But it is much better to think of a synchronous converter merely as a **synchronously-driven commutator**, instead of considering it as a motor-generator set.

Converter armatures do not require as many turns as would a D. C. generator to produce the same D. C. voltage. This is because the alternating current supplied to the A. C. end of the armature from the line or power plant generators is already at quite high voltage.

For this reason converters do not have as great an armature resistance or copper loss as motor-generators do and therefore converters operate at much higher efficiency. This is one of the reasons for their very extensive use in substations supplying D. C. to electric railways or for industrial power purposes.

A three-phase synchronous converter will develop only 59% of the heat produced in a D. C. generator of the same capacity, and a converter of a given size will have 131% of the capacity of a D. C. generator of the same size. A six-phase converter develops only 27% of the heat and has 194% of the capacity of a D. C. generator of the same size.

3. CHARACTERISTICS

As converters of this type operate at synchronous speed, their A. C. characteristics are similar to those of a synchronous motor, and the power factor of

Synchronous Converters

synchronous motors under ordinary operating conditions is very high.

The efficiency of these machines is best when they are operated at unity power factor. If desired they can be operated at leading power-factor by over-exciting the field poles, and in this manner they can be made to correct the power factor of the A. C. lines.

As the efficiency and desired characteristics of synchronous converters fall off very rapidly when they are operated at less than 90 or 95 per cent. power factor either leading or lagging, these machines are not generally used to perform much power factor correcting duty.

As most motors, generators, and converters operate a greater part of the time at about 75% load, synchronous converters are usually designed and

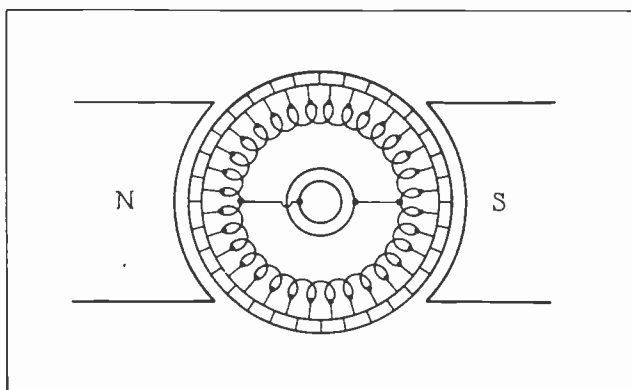

Fig. 5. Diagram of the armature connections for a simple two-pole, single-phase, synchronous converter. Note that the slip ring connections are taken at points 180 electrical degrees apart on the winding.

adjusted for 100% power factor at three-fourths of their rated load. This provides very good operating characteristics at loads from about half to full load.

4. ARMATURE CONNECTIONS

Some small converters are made for single-phase operation but most of them are designed for operation on either three or six-phase A. C. circuits. A greater number of the larger sizes and modern

Alternating Current

power converters are operated on six-phase A. C.

Fig. 5 shows a diagram of the armature connections to the commutator and slip rings of a two-pole, single-phase, synchronous converter. Note that the connections from the A. C. rings to the armature windings are made diametrically opposite, or at points 180 electrical degrees apart on this two-pole machine.

Fig. 6 shows the connections for a six-pole, three-phase converter. This machine has three slip rings, one for each phase, and each ring has as many connections to the winding as there are pairs of field poles. These connections to the same ring

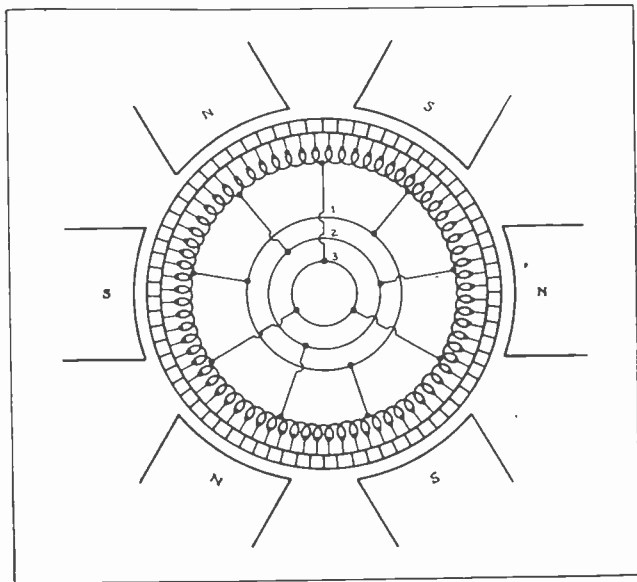

Fig. 6. Diagram of armature connections for a six-pole, three-phase, synchronous converter. The slip ring connections for each phase are taken at points 120 electrical degrees apart.

are made at points 360 electrical degrees apart, so that they come under the same positions under like poles throughout the entire machine.

Examine this carefully on the connections shown to ring No. 1. Now checking around the winding clockwise we find that the connections to ring 2 are taken at points 120 electrical degrees from those to ring 1. The same applies to the taps or connec-

Synchronous Converters

tions for ring 3, which are taken at points 120 electrical degrees from those of ring 2.

A good rule to remember in connection with the A. C. taps to a synchronous converter armature winding is as follows:

There are taken from the armature winding to each slip ring as many equally-spaced taps as there are pairs of poles.

On single-phase machines the taps to each ring are always made 180 electrical degrees apart on the armature winding, or the distance between the center of a north pole and the center of the adjacent south pole. On three-phase machines the taps to each separate ring are taken at points 120 electrical degrees apart. On six-phase machines these taps are taken at points 60° apart.

Fig. 7 shows the armature connections for a six pole, six-phase converter.

5. FIELD CONNECTIONS

Converters with compound field-windings have the usual shunt winding, consisting of a large number of turns of comparatively small wire wound next to the core on each pole.

The series winding generally consists of a very few turns of large cable or copper bars wound around the outside of the pole or over the shunt winding. The series coils are connected in series with the D. C. brushes and load, so that the compounding effect will be proportional to the load at all times.

On machines which have interpoles or commutating poles these are also connected in series with the D. C. brushes and load. The shunt field coils can be connected either in series or parallel, or grouped into series-parallel combinations according to the voltage applied and the resistance of their windings.

The shunt field coils are often connected to a field break-up switch which when opened separates the connections between the shunt field coils to prevent the induction of very high voltages during starting of the converter as an induction motor. See Figs. 9 and 11.

Alternating Current

If these shunt field coils were left connected in series, dangerously high voltages would be induced in this circuit by transformer action when the alternating current is first applied to the armature and

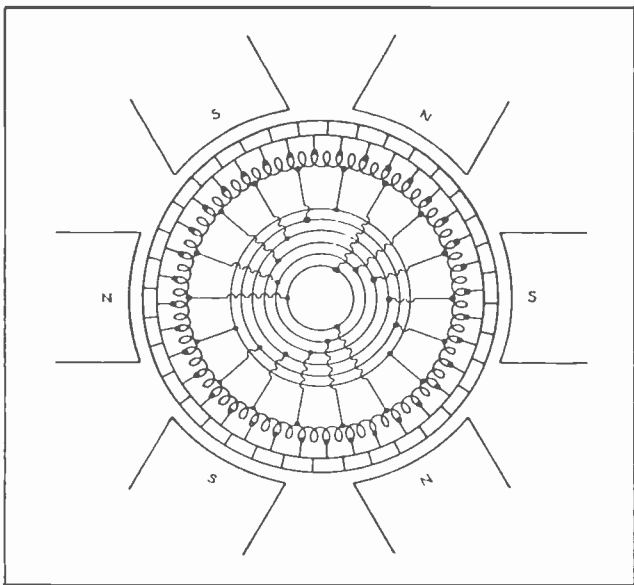

Fig. 7. Diagram showing the armature connections for a six-pole, six-phase, synchronous converter. The connections of the different phases of this winding are made 60 electrical degrees apart.

during the starting period when the slip is greatest and the frequency of the alternating flux is highest.

This flux from the armature cuts across the field windings at full line frequency during the first period of starting, but when the armature comes up to synchronous speed there is no longer any slip and therefore very little voltage is induced in the field windings from the armature flux during normal operation.

6. FIELD EXCITATION

The field poles usually receive their excitation from the D. C. brushes of the converter, although in some cases small separate exciter-generators are used. These separate exciters, when used, serve as a protection against the converter building up with

Synchronous Converters

wrong polarity when started, and also as a protection against dangerous overspeeding which might otherwise occur in case of a D. C. feed-back during failure of the A. C. supply to the slip rings.

When a number of converters are operated in parallel, if the A. C. supply to one machine is interrupted this causes the D. C. voltage of that machine to drop, and the other converters will then feed direct current in the reverse direction through the armature and the series field and cause this one machine to operate as a differential D. C. motor.

Reversing the current through the series field weakens the field flux by this differential action and will tend to cause the converter to overspeed and act as an A. C. generator if it is left connected to the A. C. supply from the transformers. The flux of the A. C. further weakens the field poles and may cause the machine to overspeed dangerously and possibly wreck the armature and commutator by centrifugal force, if the machine is not immediately disconnected from the D. C. circuit.

When the converters are equipped with separate exciters driven by the main armature shaft, the exciter also speeds up with any increase in armature speed and thereby strengthens the shunt field, which helps to keep the speed of the converter down.

Synchronous converters are usually equipped with an overspeed contact device which is attached to the end of the armature shaft. In case the machine overspeeds, centrifugal force causes a small weighted arm to fly outward and close a circuit to a relay, which trips the main D. C. breaker, thus stopping the back feed of direct current to the armature. The box or casing which contains this overspeed device can be clearly seen in Figs. 1 and 2.

7. EFFECT OF FIELD STRENGTH ON VOLTAGE AND POWER FACTOR

The strength of the shunt field of synchronous converters is generally controlled by means of a rheostat placed in series with one of the D. C. supply leads to the field coils.

By adjusting the strength of the field with the shunt-field rheostat the D. C. output voltage of the

Alternating Current

converter can be varied within a very limited range. The shunt-field rheostat is more commonly used, however, for adjusting the power factor of the machines. The effect on the power factor is the same as that obtained by the field rheostat on synchronous motors.

When the field strength is increased the power factor is advanced from lagging toward unity, and if the field is overexcited the machine can be made to develop leading power factor.

8. CONTROL OF D. C. OUTPUT VOLTAGE. VOLTAGE RATIOS

The adjustment of the D. C. output voltage of synchronous converters over any considerable range is generally accomplished by means of voltage regulators or tapped transformers on the A. C. side, or by means of a D. C. booster generator attached to the same shaft and connected in the D. C. circuit. A. C. booster converters or generators are also often used in series with the A. C. supply.

The D. C. output voltage of synchronous converters depends almost entirely on the applied A. C. voltage and upon the type of armature connections used.

In a single-phase converter the D. C. voltage is equal to the maximum value of the applied A. C. voltage.

For example, if 100 volts A. C. is applied to the slip rings, the D. C. voltage at the brushes will be

equal to $\frac{100}{.707}$, or 141.4 volts.

The ratios of A. C. to D. C. voltages which are obtained with different converter connections are as follows:

Connections	Ratio of A. C. to D. C. voltage
One-phase	.707
Two-phase diametrical	.707
Two-phase adjacent taps	.5
Three-phase	.612
Six-phase diametrical	.707
Six-phase adjacent taps	.354

Synchronous Converters

The three-phase and six-phase diametrical connections are the ones most commonly used in power converters. To determine the D. C. voltage output of a three-phase machine we simply divide the A. C. voltage applied to the slip rings by the figure .612.

For example, if 370 volts A. C. is used to operate the converter, we will obtain $\frac{370}{.612}$, or approximately 604 volts D. C.

If we apply 440 volts A. C. to a six-phase diametrical converter, we will obtain $\frac{440}{.707}$, or approximately 622 volts D. C.

9. TRANSFORMER CONNECTIONS TO CONVERTERS

Synchronous converters are designed and insulated for the voltages at which they are intended to operate, and the proper A. C. voltages for application to their slip rings are usually obtained by means of step-down transformers. The A. C. power is usually sent from the power plants over transmission lines at rather high voltage.

Fig. 8-A shows the transformer connections for a simple two-pole, single-phase converter. The taps are connected to the armature 180 electrical degrees apart, as previously explained.

Fig. 8-B shows the transformer and the armature tap connections for a two-pole, two-phase diametrical connection. The opposite leads of each phase of the transformer secondaries are connected diametrically opposite, or 180 electrical degrees apart, on the armature winding.

In these simple diagrams the connections are shown made directly to the armature winding, while on the actual machines the transformer leads of course go to the brushes on the slip rings, and the rings connect to the armature winding.

Fig. 8-C shows a diagram of the transformer and armature connections for two-phase adjacent

Alternating Current

taps. In this connection the opposite ends of each phase of the transformer secondaries are attached to the winding at points 90° apart.

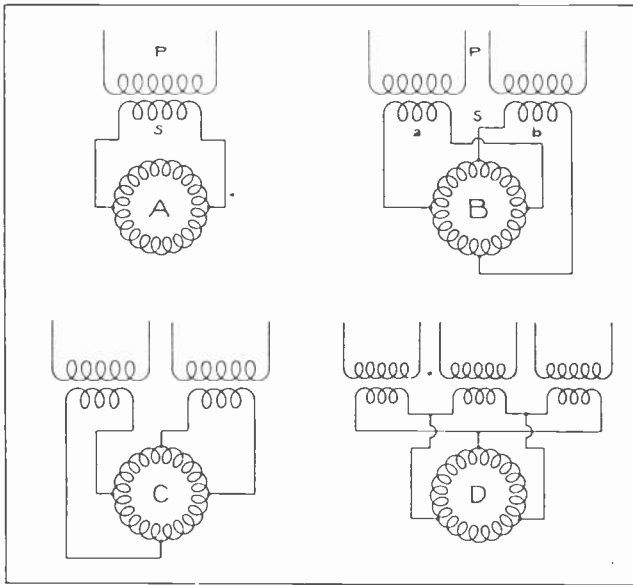

Fig. 8. A. Transformer connections for a single-phase converter. B. Transformer connections for a two-phase, diametric converter. C. Transformer connections for a two-phase, adjacent tap converter. D. Transformer connections for a three-phase converter. The armature connections in all of the above diagrams are for two-pole machines.

Fig. 8-D shows the connections for a two-pole, three-phase converter armature, with the leads of the delta-connected transformer secondaries tapped on the winding at points 120° apart.

Fig. 10-A shows the connections for a two-pole, six-phase converter with the transformer secondaries connected to the armature winding six-phase diametrically. Note that the starts, or left-hand leads of the transformer secondaries, connect to the converter winding at points 120° apart; and the finishes, or right-hand leads of these same secondaries connect 180° electrical degrees or diametrically opposite on the armature winding from the point where the starts connect.

Synchronous Converters

On machines with more than two poles this series of connections would be repeated for each 360° or the space covered by each pair of poles. So there would be as many A connections to each slip ring as there are pairs of poles; also as many B and C connections.

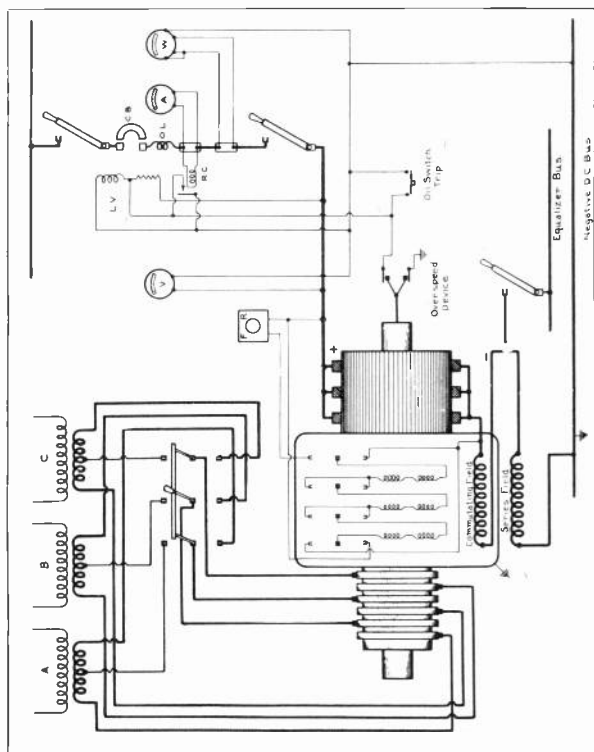

Fig. 9. This diagram shows the connections of the transformer secondaries to the A, C, slip rings of a six-phase, synchronous converter and also shows the starting switch used for obtaining half voltage to start the machine from the A, C, end. Note the connections of the short field windings to the low-voltage trip coil, L.V., which will open the circuit breaker in case of voltage failure, and the overload trip coil, O.L., which will open the breaker in case of D. C. overload. The reverse current relay, R.C., will short-circuit the low-voltage trip coil and open the breaker in case of a D. C. feedback to the converter.

Fig. 10-B shows the connections for a two-pole, six-phase converter using the six-phase adjacent tap system of connecting the transformer leads to the winding.

Fig. 10-C shows the connections for a six-phase, double-star-connected converter.

Fig. 11 is a diagram of a four-pole synchronous converter and shows the D. C. connections to the

Alternating Current

brushes on the commutator, the A. C. connections to the brushes on the slip rings, and also the field "break-up" switch which is used to break-up the shunt field circuit during starting of the machine.

The connections for a shunt-field rheostat are also shown in this diagram. The series field and commutating field are not shown in this figure; but

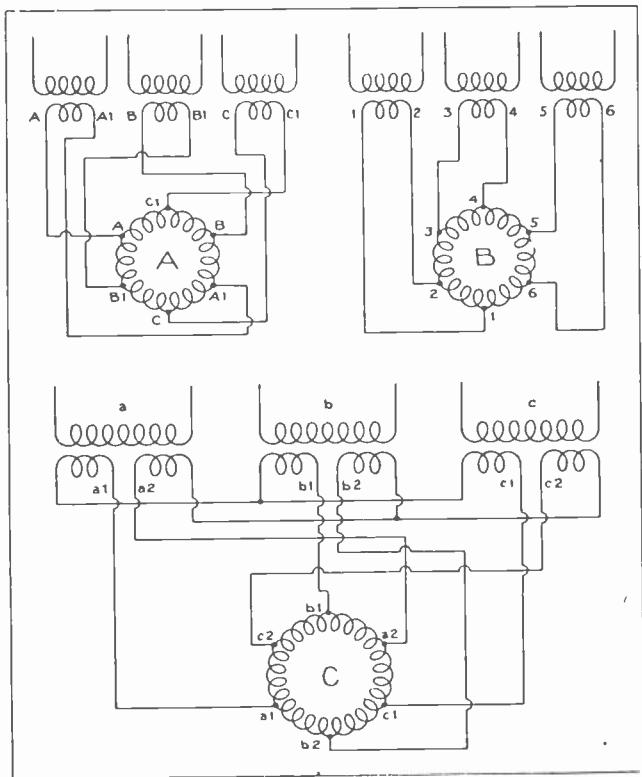

Fig. 10. A. Transformer connections for a six-phase, diametric converter. B. Transformer connections for a six-phase adjacent tap converter. C. Transformer connections for a six-phase, double star-connected converter. Each of these diagrams show the connections for a two-pole machine.

when they are used they are connected in series with one of the D. C. leads.

Synchronous Converters

10. STARTING SYNCHRONOUS CONVERTERS

Synchronous converters may be started in several different ways, three of which are as follows: 1. By applying reduced A. C. voltage to the armature and starting the machine as a synchronous motor. 2. By applying reduced D. C. voltage to the armature and starting the machine as a D. C. motor. 3. By using a starting motor to bring the armature up to the proper speed before synchronizing with the A. C. line.

The first method mentioned is by far the most commonly used and is so similar to the method previously explained for starting synchronous motors that it doesn't require much additional explanation here.

Reduced A. C. voltage, generally about 50% of the normal operating voltage, is applied to the armature at the slip rings. This causes alternating current to flow through the armature winding and sets up a revolving magnetic field which induces secondary currents in the damper winding which is mounted in the faces of the field poles.

The reaction between the flux of these secondary currents and that of the armature conductors causes the machine to start as an induction motor. The reduced voltage for starting can be obtained from an auto transformer but it is more often obtained from an extra set of leads which are brought out from the center taps in the middle of each phase of the transformer secondary windings, as shown in Fig. 9.

When the three-pole, double-throw starting switch is thrown to the upper position, the left-hand leads and center taps of each transformer secondary are connected to the slip rings and supply only half voltage to the converter-armature. When the machine has reached approximately full speed the switch is thrown quickly to the lower position to apply full voltage to the armature. Carefully trace the circuits from the transformers and starting switch to the converter rings in Fig. 9.

In modern substations magnetically-operated remote control circuit-breakers or contactors are used instead of the hand-operated knife switch. One set

Alternating Current

of these contacts opens the circuit to the starting taps just a fraction of a second before the other set closes the circuit to the full voltage taps, thus performing the switching operation very quickly.

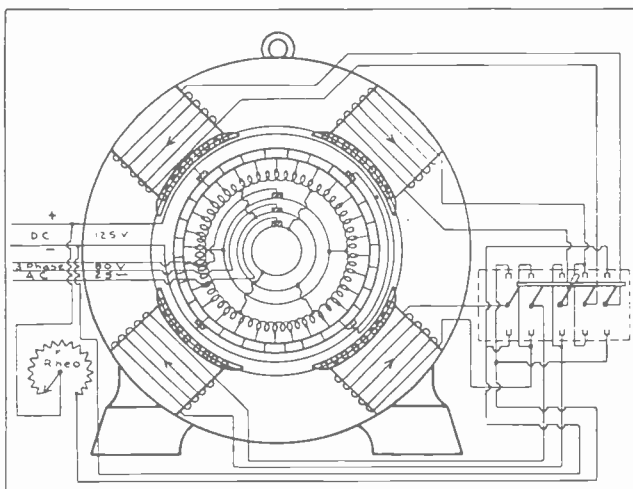

Fig. 11. Wiring diagram showing armature and field connections, and also the field break-up switch and rheostat for a four-pole, three-phase converter. Trace out the field circuit both with the switch in the upper and lower positions and note that the polarity reverses when the switch is changed.

11. BUILDING UP D. C. VOLTAGE

If the D. C. voltmeter indicates that the polarity on the D. C. end of the converter has built up in the right direction when the machine comes up to speed, the D. C. circuit-breaker can be closed to the D. C. busses and load as soon as the converter is running at full speed and full voltage.

In case the converter is operating in parallel with others it is necessary to see that its voltage is properly adjusted for paralleling before closing the D. C. breaker. It is also necessary to close the equalizer switch before paralleling a compound converter.

A synchronous converter when started from the A. C. side in the manner just described will often build up voltage with the wrong polarity at the D. C. brushes. This polarity which will be built up depends upon whether the converter-armature pulls into step on a positive or negative alternation.

Synchronous Converters

So, with some machines the polarity is just as likely to be built up wrong as to build up right. Some machines, because of certain characteristics in their design, will nearly always build up with right polarity while others will almost always build up the wrong polarity. This polarity must, of course, be corrected before the converter can be connected to the busses or trolley in parallel with any other machines.

12. CORRECTING POLARITY

Several of the more common methods of correcting this polarity are as follows:

- (a) "flashing" the field
- (b) separate excitation
- (c) field-reversing switch
- (d) strengthening field at the instant of correct polarity.

"Flashing" the field consists of sending D. C. in the correct direction through the shunt-field winding when the converter is nearly up to full speed. This causes the armature to pull into step at the right field poles.

If the polarity has been built up wrong flashing the field will cause the armature to slip back one pole thus causing the converter to reverse polarity. The converter will then properly excite its own field from the commutator and brushes.

The direct current for flashing the field is generally obtained from a small constant-polarity motor-generator which is usually not over 1 to 5 kw. in size.

Converters which are separately excited from a small D. C. generator on the shaft of the main unit or from a small motor-generator will practically always build up the right polarity because of the residual magnetism of the poles of these small D. C. generators.

The field break-up switches that are used with synchronous converters are often made double-throw as in Fig. 11, for the purpose of reversing the polarity of the shunt-field poles. Trace the shunt field circuits in Figs. 9 and 11 with the switches

Alternating Current

in both positions, and note that the current through the field coils reverses when the switches are reversed.

Converters normally operate with this switch in the upward position, but if they build up with wrong polarity the switch can be thrown downward for a short period to reverse the polarity. When this is done the polarity of the field poles becomes the same as that of the magnetic poles set up in the armature directly under them.

This causes a strong repelling action which tends to retard the movement of the armature. This repelling action, windage, and the friction of the brushes on the commutator soon cause the armature to drop back one pole, or 180 electrical degrees.

This reverses the polarity of the D. C. voltage at the brushes and would also reverse the polarity of the field which is connected to these brushes if nothing more were done.

By watching the voltmeter at the time the field-reversing switch is thrown to the lower position you will note that the voltage decreases to zero and then reverses.

At the instant the voltmeter needle passes over the zero point the field-reversing switch should be closed into the upward or running position. This again reverses the field poles, bringing them back to their original polarity and with the polarity at the D. C. brushes now in the right direction to excite the field poles properly.

The whole operation simply causes the armature to slip back one pole and thereby causes the reversal of polarity of the D. C. circuit.

When a converter is approaching synchronous speed the D. C. voltmeter will often oscillate to the right and left of zero, showing a sort of faltering or reversing action of the D. C. voltage just as it starts to build up.

A polarized relay can be connected in the D. C. circuit so that it will close a circuit to the shunt field at the instant the voltage is in the right direction. This will cause the converter to retain the correct polarity.

Synchronous Converters

13. CONVERTER AUXILIARIES

Modern synchronous converters generally have a number of auxiliary devices to aid in securing proper operation and to protect the machine against damage from various causes. Some of the most common of these auxiliary devices are as follows:

1. Field-reversing or break-up switch, which has already been described.
2. Brush lifting mechanism.
3. Armature oscillator.
4. Armature overspeed centrifugal switch.
5. Arc chutes and barriers.
6. Separate exciter or field "flashing" generators, when used.
7. Flash-over relays.
8. Temperature relays.

14. BRUSH LIFTING MECHANISM

When a converter is first started from the A. C. end, the currents flow directly through the low-resistance conductors of the armature and through the circuits which are completed at the commutator by alternate sets of D. C. brushes being connected together.

If these brushes are left on the commutator during starting it results in heavy cross-currents flowing in certain sections of the armature and through the brushes, and this tends to cause severe sparking during the starting of the machine.

For this reason many of the larger machines which have interpoles are equipped with brush-lifting devices, which lift all of the brushes from the commutator except one brush of the positive group and one of the adjacent negative group.

These two brushes are known as **pilot** brushes and they are used to give the D. C. voltmeter polarity readings and to supply the direct current to excite the field for obtaining the correct polarity.

The brush groups are all mechanically connected together by means of a steel cable and operating gear so they can be raised and lowered by means of an operating lever which, in turn, may be either manually or motor operated.

All brushes except the pilot brushes should be

Alternating Current

raised before starting the converter and they should be lowered as soon as the machine is up to speed and the correct polarity has been established.

15. ARMATURE OSCILLATOR

If the armature and commutator were allowed to run with the brushes at exactly the same position at all times, the brushes would tend to wear grooves and ridges in the surface of the bars. Such wearing increases commutation troubles and makes more difficult the proper care of the commutator and the proper fitting of the brushes.

To avoid the grooving or "tracking" of the brushes on the commutator, converters are often equipped with an armature oscillator which keeps the entire armature unit oscillating slightly back and forth endwise so that the brushes will wear evenly over the entire surface of the commutator.

To accomplish this oscillation the converter is set with one end slightly higher than the other so that the armature and shaft tend to slide to the lower end as they rotate.

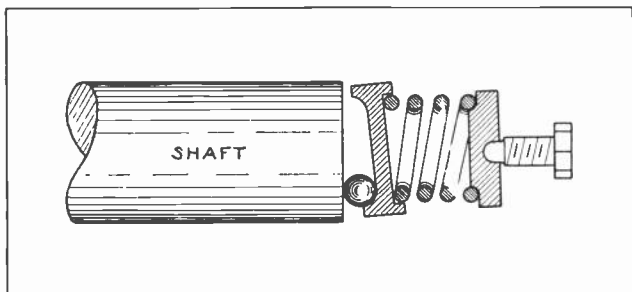

Fig. 12. Diagram showing ball and spring oscillator to cause converter armature to move endwise and promote even wear on the commutator.

One type of oscillator uses a steel ball placed between the end of the shaft and a plate which is set at a slight angle as shown in Fig. 12. As the shaft drifts to the lower end it pinches the ball between the shaft end and the plate and causes the ball to rotate or roll around in the direction the shaft turns.

This wedges the ball up into the narrower opening between the tilted top of the plate and the shaft

Synchronous Converters

end, compressing the heavy spring behind the plate and pushing the shaft and armature back toward the high end of the machine. The ball then drops down and repeats the operation again and again as long as the armature rotates.

Other machines are equipped with a powerful electro-magnet placed near the high end of the shaft, to draw the armature back each time it slips to the low end of the machine.

A set of contacts can be arranged at the low end of the shaft so that they close the circuit to the electro-magnet each time the shaft reaches the end of its oscillation in the low direction.

16. OVERSPEED DEVICE

As previously explained, any synchronous converter will tend to overspeed dangerously if the A. C. supply is interrupted and D. C. is fed into

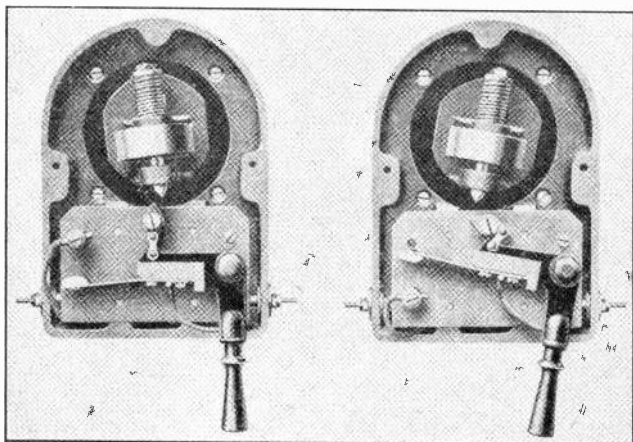

Fig. 13. Two views of a centrifugal overspeed switch showing two possible arrangements of the contact for either an open or closed circuit system.

the armature from the trolley or other converters with which it is operating in parallel.

Converter armatures are generally designed and tested to stand only about 50% overspeed. When operated as a differential motor by D. C. feed-back, and if allowed to generate and feed A. C. to the

Alternating Current

transformers, they will quickly exceed this speed limit if some means is not provided to interrupt the D. C. circuit to the armature.

Fig. 13 shows two views of a centrifugal speed-limit device which can be used to either make or break a circuit to trip the main D. C. circuit-breaker, thus stopping the converter when it is operating from the D. C. end.

The revolving element is attached to the end of the converter shaft and if it is revolved at about 25% above normal speed, the weighted pin is thrown outward by centrifugal force against the action of the coil spring, which can be clearly seen in this view.

This causes the end of the pin to strike the toggle or cam on the contact arm, and make or break the operating circuit to the breaker trip coil. Fig. 9 shows the connection of the over-speed switch and the circuit by which it shorts and weakens the low-voltage release-coil, LV, thus tripping the D. C. breaker. Fig. 9 also shows the connections of a reverse current relay, RC, which attracts its polarized armature if the current reverses.

The small hand-lever extending from the case of this overspeed device is for resetting the contacts in normal position before the machine is again started.

17. ARC CHUTES AND BARRIERS

When converters are subject to occasional heavy overloads or possible short circuits, the sparking is likely to cause flash-overs or arcs between positive and negative sets of brushes, or between the commutator or brush rigging and the frame of the machine.

Barriers of fireproof insulating material, such as asbestos composition, can be provided around the brush groups and between positive and negative groups. This insulation considerably reduces the tendency to flash-over and helps to extinguish any arcs which may occur in this manner.

Fig. 14 shows a section of a commutator and illustrates the manner in which the arc barriers, B,

Synchronous Converters

and arc chutes, C, are placed around and between the brushes.

The lower edges of the barriers around the brush groups clear the commutator by only about $1/32$ of an inch, and tend to confine sparking or arcing to the neighborhood of the brush and prevent the arc from travelling around the commutator to the next set of brushes.

The lower edges of the arc chutes are also very close to the surface of the commutator, and the

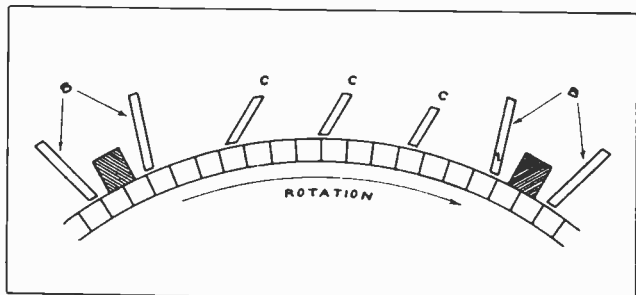

Fig. 14. This diagram shows the position of the flash barriers and arc chutes used to prevent flash-overs between positive and negative sets of brushes on the D. C. end of converters.

strips of insulating material are set at an angle against the direction of rotation. In this manner they deflect outward the currents of air which tend to follow the surface of the commutator and this helps to prevent the arc from being carried or blown from one set of brushes to the other.

Fig. 2 clearly shows the position of the flash barriers on the D. C. or commutator end of the synchronous converter.

18. FLASH OVER RELAYS AND TEMPERATURE RELAYS

In some cases the frames of converters are insulated by a leatheroid or fiber plate from the floor or base on which they are mounted so that any currents which may flow from the commutator to the frame during a flash-over must pass through the coil of a relay to get to ground.

This causes the relay to operate and cut the machine out of service in case of severe flash-overs.

Alternating Current

If the flash-overs were allowed to continue they would seriously burn and pit the commutator bars, brush rigging, or parts of the frame from which the arc is drawn.

Synchronous converters are often equipped with temperature relays operated by small tubes of liquid which are placed at different points in or near the windings and are connected to an expansion bellows in the relay.

When the liquid in these tubes is overheated it expands, forcing the bellows to close the relay contacts and operate the circuit-breaker to remove the load from the machine or shut the machine down entirely as desired.

19. AUXILIARY BRUSH FOR BEARING CURRENTS

Sometimes the bearings of converters are seriously damaged and rapidly worn by the flow of induced eddy currents from the armature core and shaft to the bearing metal and frame of the machine.

The portion of the shaft which rests on the bearings is, if properly lubricated, surrounded by a thin film of oil during operation. When the induced currents arc through this oil film they pit and burn the surface of the shaft and bearing metal.

To prevent this a carbon brush is often mounted to rest on the end of the shaft and then this brush is securely grounded to the frame of the machine with a low-resistance connection. This provides an easier path for the circulation of induced eddy currents and prevents them from flowing through the oil film and pitting the bearings and shaft.

20. CARE AND OPERATION

A great many of the general rules which you have already learned for the care and operation of D. C. generators and A. C. synchronous motors can be applied to the operation and care of synchronous converters. Commutators, slip rings, and brushes should be kept clean and in good condition, and the insulation of windings should also be kept clean

Synchronous Converters

and should be occasionally tested for dielectric strength.

Oil rings and oil in the bearings should be frequently inspected, the oil should be changed whenever necessary, and the bearing temperature should be frequently observed during operation to make sure that the bearings are not overheating.

The load on the machine should be frequently checked by means of an ammeter or wattmeter, and the temperature of the machine windings should be carefully watched to see that it doesn't rise above the maximum rated temperature for which the machine is designed.

The care of the commutator and D. C. brushes on synchronous converters is of the greatest importance, because these parts are usually required to carry very heavy currents during full-load operation of the machines.

If the commutator is allowed to become dirty or covered with copper-dust in the grooves between segments or if the brushes are poorly fitted or set off neutral, the sparking which results is likely to cause serious flash-overs and troubles.

All dirt and dust, and particularly copper-dust which wears off the commutator, should be kept well cleaned from all parts of the converter by wiping with a cloth and occasional blowing out with compressed air.

All protecting devices, such as overload, over-speed, temperature, and flash-over relays: circuit-breakers, etc., should be kept in good operating condition and frequently tested to make sure that they will protect the machine in case of faults or troubles.

Alternating Current

EXAMINATION QUESTIONS

1. For what purpose are Synchronous converters used?
2. Briefly describe the construction of synchronous converters.
3. Why are Field Break-up switches used on synchronous converters?
4. From what two sources may D. C. be obtained to excite the field of synchronous converters?
5. What is the most common use for the shunt-field rheostat used on synchronous converter?
6. On what does the D. C. output voltage of synchronous converters depend?
7. What would be the D. C. output voltage of a synchronous converter operating on a 440 volt three-phase line?
8. For what purpose is "Flashing" the field used?
9. How are converters protected against over-speeding, if the A. C. supply is interrupted?
10. Briefly describe how converter bearings may be protected against pitting caused by eddy currents flowing thru the bearing from the armature shaft to the frame of the machine.

Synchronous Converters

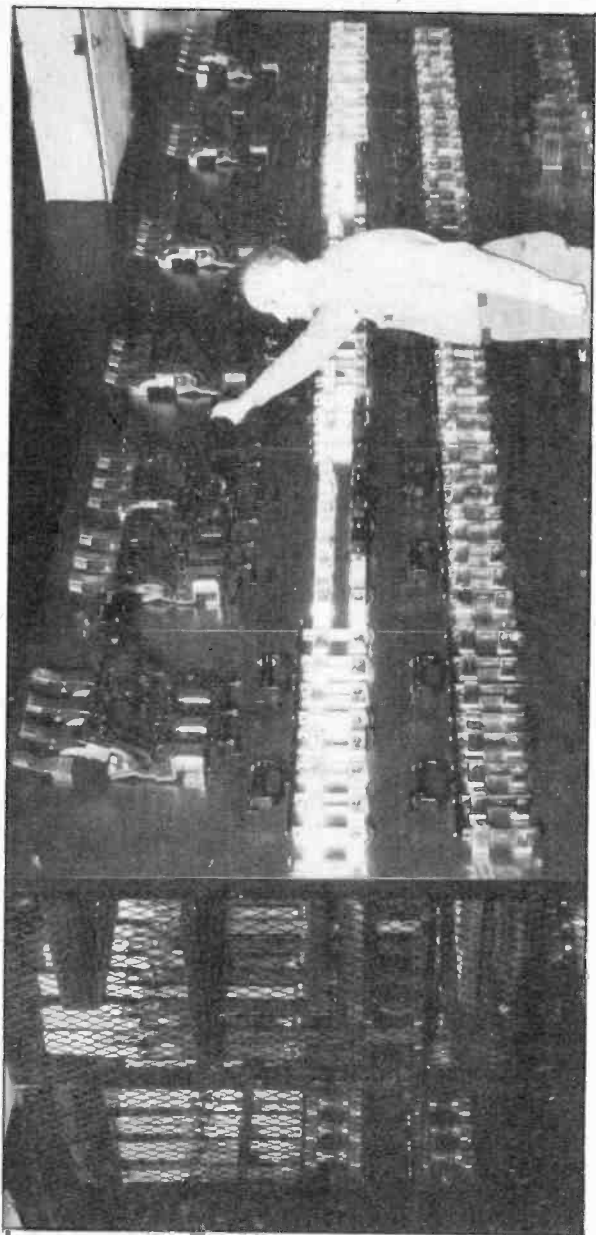

One of the twin switchboards in the subbasement of the Empire State Building, N. Y. The two boards take care of the operation of all electrical equipment up to the 20th floor. Controls in the building are in sections. Photo by Ewing Galloway

A. C. MOTOR CONTROLLERS

Large alternating current motors require starters and controllers in order to protect the motors themselves from excessive currents and mechanical stresses during starting; to limit current surges on the lines to which they are connected; and to obtain the proper performance of the motors in connection with the machines or equipment they are used to drive.

A. C. industrial controllers are, therefore, of great importance and every electrical man should have a good understanding of their operation and care. You will also find the mechanical principles and electric circuits of many of these devices very interesting.

In general, the functions of controllers are as follows:

- (a) To conveniently start and stop motors, either by manual or automatic control.
- (b) To limit the current flow in the line during starting.
- (c) To provide overload protection for the motor
- (d) To provide uniform acceleration of the motor and driven machinery.
- (e) To provide definite procedure and time delay during starting.
- (f) To protect the motor against failure of voltage.
- (g) To provide speed control and reversing of motors.
- (h) To provide safety to operators.

The simplest of controllers may provide only one or two of the above named functions, namely, starting and stopping. More complete controllers which provide the additional protective features are often used even with small and medium sized A. C. motors, and nearly always with larger A. C. motors.

The speed regulating and reversing controllers are used only with motors which drive machines that require this performance.

Motor Controllers

1. CONVENIENCE AND SAFETY

All forms of motor controllers provide a much greater degree of convenience and safety for the operators than when the motors are started by ordinary knife switches.

Most manually-operated controllers have their contacts enclosed within a metal box or, in some cases, in an oil tank. These contacts are operated from the outside by a handle or lever and the operator is thus protected from the danger of arcs or flashes when the circuit is made or broken.

Magnetically-operated controllers can be operated from push buttons either on the controller or located at a distance. This also adds a great deal to the convenience and safety features of controllers—especially when they are used with large motors operating at high voltages.

The use of controllers having resistance units or auto transformers to reduce the voltage to the motors during starting greatly reduces the heavy surges of starting current which would otherwise be drawn by the motor. These surges are very objectionable because of the voltage drop and variations which they cause in the line voltage. This voltage drop may interfere with the satisfactory operation of the other power equipment connected to the same lines and will usually cause very bad flickering or dimming of any incandescent lamps connected to the same lines with motors.

2. OVERLOAD, TIME DELAY AND NO-VOLTAGE DEVICES

Practically all controllers are equipped with some form of overload-protective device to open the circuit to the motor in case it is overloaded. These devices prevent the motor winding from being burned out or damaged by overheating in case an overload is left on the machine too long.

In this manner the overload devices on controllers, if they are kept in proper condition and adjustment, will often save very costly "shut-downs" and repairs.

Alternating Current

Controllers which reduce the voltage to the motor during starting by means of auto transformers or resistance allow the torque to be applied gradually to the rotor and driven machinery, thereby relieving the motors and other machines of unnecessary mechanical stresses.

Certain types of machinery require very smooth and gradual starting, either because of the delicate nature of some of the machine parts or because of the material which the machines are handling. This is particularly true of textile machines, printing presses, paper-making machinery, etc. Special controllers using resistance which is very gradually cut out of the circuit are used to start motors which drive such equipment.

Automatic controllers are generally equipped with dash pots or some form of time-delay element which regulates the time allowed for the motor to come up to speed. Such controllers can be adjusted and set to provide definite starting procedure or the same rate of acceleration each time the motor is started.

Many controllers are also equipped with **no-voltage** release coils to protect the motor in case of failure of the line voltage. If the line voltage drops too low or fails entirely, these coils release a plunger or arm and trip the main contacts open, thus stopping the motor.

If it were not for the no-voltage protection the line voltage might fail and allow the motor to come to a complete stop, and then when the line trouble is corrected and the voltage reapplied, the motor controller would still be in running position and the motor would receive full line-voltage which would result in a very heavy starting current and possibly severe mechanical stresses on the motor or driven machinery.

No-voltage trip coils prevent this by returning the starter or controller to the off position at any time the voltage fails.

Motor Controllers

3. FULL VOLTAGE OR ACROSS-THE-LINE STARTING

Small A. C. motors under 5 h. p. in size are often started at full line-voltage by connecting them directly across the line, but larger motors generally require some form of starter which reduces the voltage to avoid excessive starting current surges in the line and to relieve the motor and driven equipment of heavy mechanical stresses during starting.

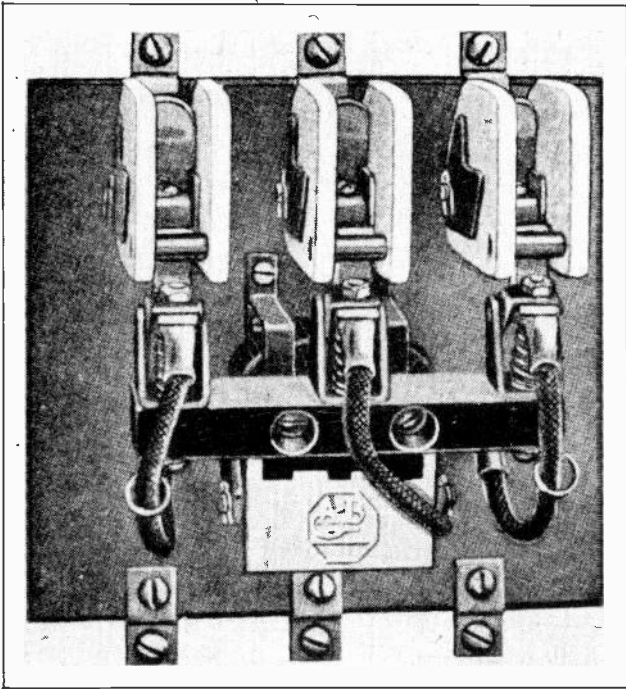

Fig. 1. Contactor mechanism of a magnetically operated across-the-line starter for A. C. motors. (Courtesy Allen Bradley Co.)

However, when motors are connected to circuits which supply current to power equipment only and have no lighting equipment on them, quite large motors are often started directly across-the-line.

This is often done with squirrel-cage motors of several hundred horse-power where they are used to drive pumps and auxiliaries in power plants, etc.

Alternating Current

When motors are started directly across-the-line their circuits can be closed by means of a knife switch, generally enclosed in a safety switch box; or by means of a magnetically operated set of contactors known as an **across-the-line starter**. Fig. 1 shows a set of magnetically-operated contactors, such as are used in across-the-line starters. The strips of fireproof insulating material on each side of the contacts are **flash barriers**, which are used to prevent flash-overs due to the arc formed when the contacts are opened.

4. THERMAL AND MAGNETIC OVERLOAD RELAYS

Across-the-line starters are usually equipped with fuses or some form of thermal or magnetic release

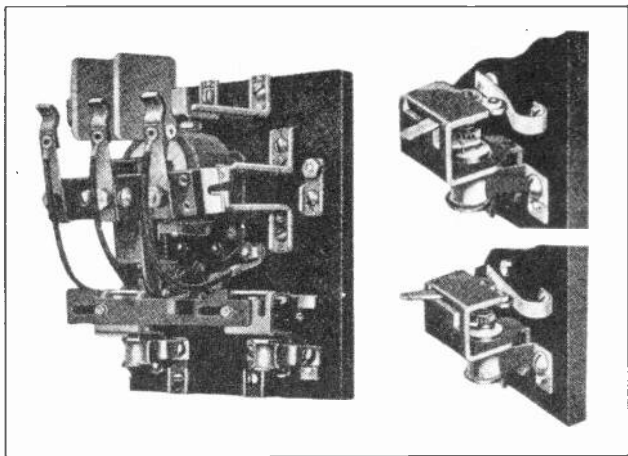

Fig. 2. This view shows on the left another type of an across-the-line starter, the mechanism being removed from the cabinet to show its construction. Also note the thermal overload-relays shown at the bottom of the panel on the left and in larger views on the right. (Courtesy Allen Bradley Co.).

to provide overload protection for the motor. The view on the left in Fig 2 shows the mechanism of another across-the-line starter equipped with **thermal relays** or overload-trip devices, located beneath the contactors. On the right are shown two views of these thermal relays, the top one being closed and the bottom one open.

Motor Controllers

All or part of the motor current is passed through a strip or element which overheats when the motor current becomes excessive, and this heat causes the spring or strip to expand and warp so that it releases or opens a set of contacts in the circuit of the magnet coil which holds the contactors in the motor circuit closed. When the circuit to this magnet is broken by the thermal relay contacts, the magnet releases the main contactors and opens the line circuit to the motor.

After the overload has been removed from the

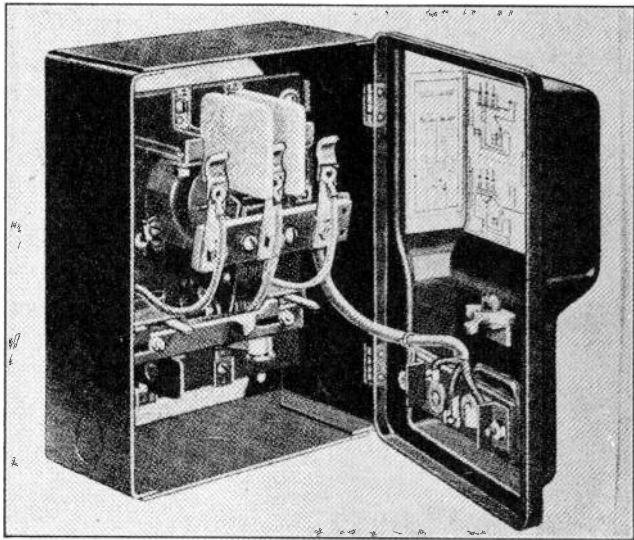

Fig. 3. This view shows a complete across-the-line starter for a three-phase, A. C. motor. The mechanism is enclosed in a safety cabinet with push button control attached to the cabinet cover. (Courtesy Allen Bradley Co.)

motor, the thermal relay can be reset by means of a small lever or handle shown in the views on the right in Fig. 2.

There are many different types of thermal relays used on motor starters, but many of them work on the same general principle of expansion of a metal strip or element by the excessive heat when the motor current becomes too great. One type uses a small quantity of low melting point metal to release a trigger or spring and open the circuit when the soft metal becomes heated and melts.

Alternating Current

Magnetic overload relays or trip devices are also used with motor starters. These devices were explained in the Lesson on D. C. Controllers, and you will recall that their coils are connected in series with one or more of the leads to the motor, so that when the motor current becomes excessive the mag-

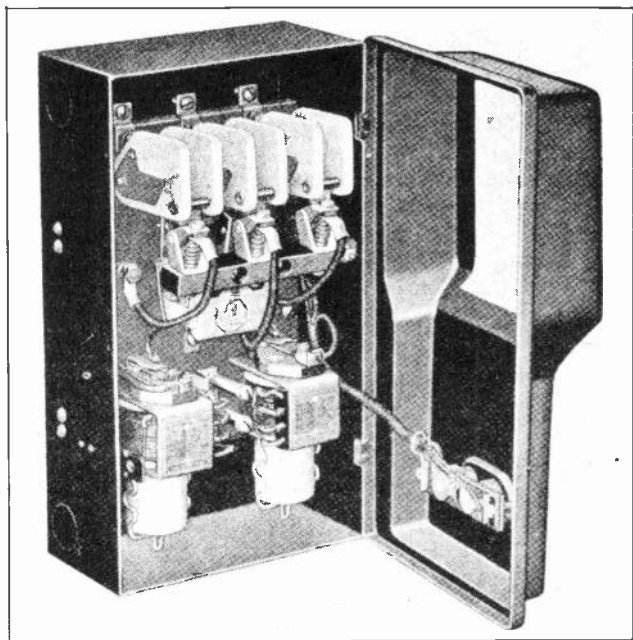

Fig. 4. In this view are shown the overload-relays located beneath the magnetic contactors of an across-the-line starter. (Courtesy Allen Bradley Co.)

nets are strengthened and caused to raise a plunger which trips the line contactors.

The overload devices on any motor controller are very important, as they protect the motor winding from being burned out when the machine is overloaded. Every motor starter should have fuses or some form of thermal or magnetic overload protection.

Fig. 3 shows a complete across-the-line starter in its metal box, and equipped with thermal overload (O. L.) releases. For convenient control the

Motor Controllers

operating magnet is wired to push buttons in the cover of the starter box.

Fig. 4 shows another across-the-line starter equipped with magnetic overload release coils.

5. ACROSS-THE-LINE STARTER CONNECTIONS

Fig. 5 shows a connection diagram of a simple across-the-line starter. The main line-circuit to the motor can be traced by the heavy lines, through the contactors, C, overload elements, R, to the motor terminals.

When the start button is pressed current flows from line 3 through this button, through the closed stop button, to the operating magnet; then back through the thermal trip contacts, T, to line 2.

The magnet draws up the armature and bar shown by the dotted lines, and this bar closes the contactors C, starting the motor.

At the same time the magnet closes contacts C it also closes an auxiliary contact A, which maintains a circuit from line 3 through the magnet after the start button is released.

To stop the motor the closed circuit stop button is pressed, de-energizing the magnet and allowing all the contacts to open.

If the motor becomes overloaded during operation, the excess current flowing through the thermal elements R, causes heat enough to expand strips T and open the circuit of the magnet at this point, thus releasing main contactors C and stopping the motor.

6. COUNTER-VOLTAGE OF A. C. MOTORS

In our study of D. C. motor starters and controllers we learned that resistance units were inserted in the armature circuit to cause a voltage drop and thereby reduce the applied voltage and amount of current during starting.

After the armature of a D. C. motor comes up to speed it generates counter-voltage which opposes the line voltage and thereby limits the current to the proper full-load value.

Alternating Current

With A. C. induction motors of the common type the line voltage is applied to the stator winding. This winding doesn't generate counter-voltage by being revolved in the field flux as does a D. C. armature, but it does have generated within it counter-voltage of self-induction due to constant expanding and contracting of the alternating current flux.

Before an induction motor is started and while its rotor is stationary, the counter-voltage generated in the stator is much lower than when the rotor comes up to speed and is revolving at nearly synchronous speed.

When the motor is running the flux set up by the induced secondary currents in the rotor is being whipped rapidly across the stator conductors and helps to generate higher counter-voltage in the stator winding.

This is the reason that the surge of starting current to the stator winding of an induction motor is several times greater than the full-load running current after the motor comes up to speed.

7. METHODS OF REDUCING VOLTAGE IN A. C. CONTROLLERS

Resistance can be used in series with the line wires to the motor to reduce this starting current on A. C. motors, just as it is used with D. C. machines.

Many simple A. C. motor starters use resistance units connected in series with one line wire, in the case of single-phase motors; or in series with two or all three of the line wires, on polyphase motors.

Most A. C. motor starters, however, use auto transformers instead of resistance to reduce the starting voltage. With resistance starters the voltage reduction is obtained entirely by voltage drop through the resistance, and they cause considerable power loss by the energy which is converted into heat in their resistance units.

Auto transformers are much more efficient and reduce the voltage by magnetic action through the step-down ratios of their windings.

Another decided advantage of the auto transformer is that by stepping down the voltage on the

Motor Controllers

secondary winding it is possible to obtain the required starting currents for the motors from the secondary winding with less current flowing from the line to the primary. When resistance starters are used the full amount of starting current must be taken from the line.

Auto transformers and their principles and connections were described in detail in Article 3 of Lesson 53. It would be well to review this article before going farther in the study of this type of A. C. motor starter.

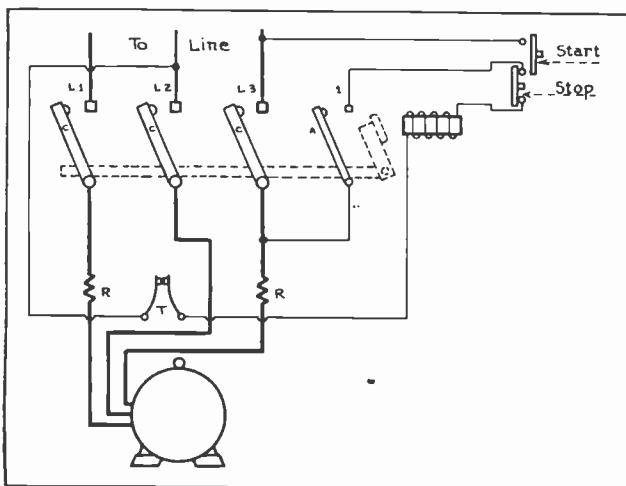

Fig. 5. Circuit diagram showing the connections for a simple across-the-line starter with the contactors operated by an electro-magnet which in turn is controlled by the stop and start buttons. Also note the thermal overload contacts, T, which are operated by expansion from the heat of resistors, R.

Some types of starters for small A. C. motors use plain choke-coils to reduce the current during starting or to obtain speed control. Even these are more economical in A. C. circuits than resistance units are, because the voltage drop in a choke coil is caused by the induced counter-voltage which opposes the line voltage, instead of being caused by resistance which produces the $I^2 R$ loss.

So keep in mind that in general it is much more economical to use choke coils or auto transformers rather than resistance units to reduce the voltage

Alternating Current

in A. C. circuits. Resistance controllers are often used, however, where very gradual starting or a wide range of speed regulation in smooth, gradual steps is required.

8. RESISTANCE TYPE STARTERS

Resistance can be used in the line leads to the stator of an A. C. motor, or, as previously explained, in the secondary leads from the rotor in the case of slip-ring motors.

As the torque of an induction motor varies with the square of the voltage applied to its stator, slip-ring motors with secondary resistance are generally

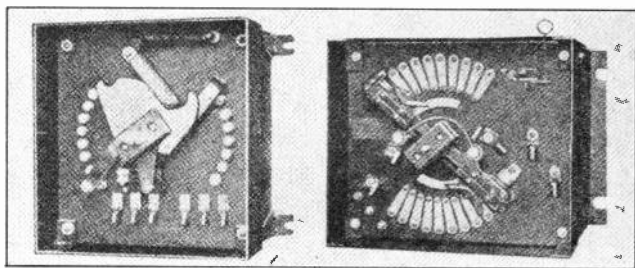

Fig. 6. This view shows two different face plate starters of the resistance type for use with either single-phase or three-phase A. C. motors. (Courtesy Cutler Hammer Mfg. Co.)

used where frequent starting or speed regulation and good torque are required.

For the gradual starting of ordinary squirrel-cage motors, resistance-type starters are often used and connected in the primary or stator circuit.

Fig. 6 shows two types of resistance starters which use sliding contacts to cut out resistance as the motor comes up to speed. These controllers have two sets of contacts to cut resistance out of two line-leads to a three-phase motor.

The controller shown in Fig. 7 has three sets of contacts, one for each phase of a three-phase motor.

Non-inductive resistance coils or grids can be used with these controllers, and they can be used

Motor Controllers

either in the primary stator circuits or secondary rotor circuits of motors, by proper arrangement of contacts and selecting the proper sized resistance units.

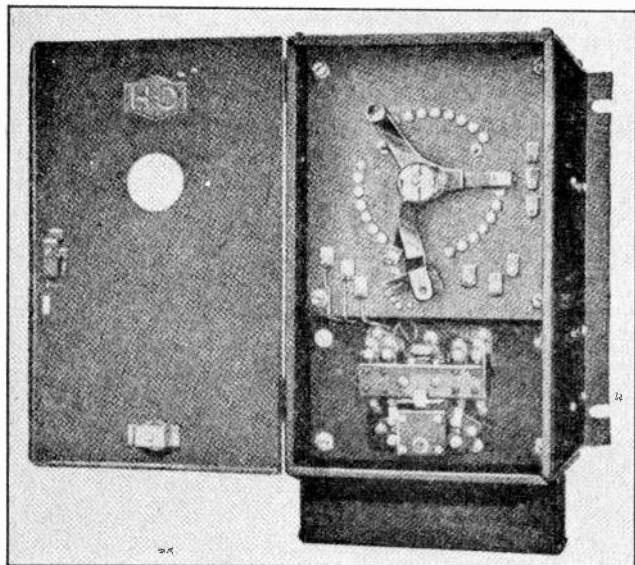

Fig. 7. Three-phase resistance starter of the face plate type. When the rheostat armature is rotated, resistance is cut out of all three phases at once. (Courtesy Cutler Hammer Mfg. Co.)

Fig. 8 shows several styles of resistance units which are commonly used with resistance starters.

Controllers of this type with small contacts and resistance can be used for starting duty only; or, with heavier contacts and resistors, for both starting and speed-regulating duty.

Fig. 9 shows the connections of a simple resistance starter used in the primary circuit of a three-phase squirrel-cage motor. The movable arm carries two metal strips which are placed one at each end and are insulated from the arm and from each other.

As the arm is moved the sliding metal strips make contact between the long metal segments, B, and the small contacts which cut out the resistance step by step as the arm is moved in a clockwise direction.

Alternating Current

Fig. 10 shows the connections of a resistance controller used in the secondary or rotor circuit of a slip-ring motor. The sliding arms in this case are

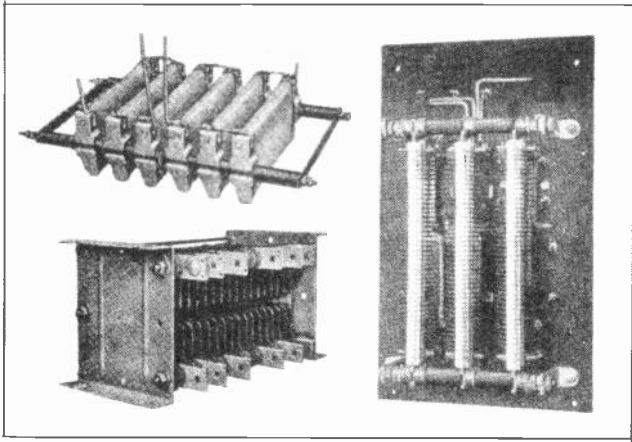

Fig. 8. This photo shows several types of resistance units used with A. C. motor starters. On the upper left are shown non-inductive, coil-wound resistors; on the lower left grid type resistors; and on the right edge-wound resistors made of strips of resistance metal wound edgewise around non-combustible cores.

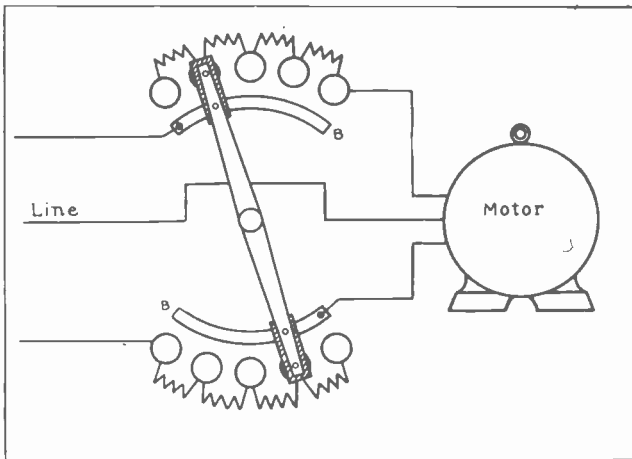

Fig. 9. Diagram showing the connections and circuit through a three-phase resistance type starter.

all connected together so that they short out the resistance as they are rotated clockwise.

Motor Controllers

Either a plain starting-switch or a starter with resistance or auto transformer coils can be used at A, according to whether it is desired to start the motor at full-line voltage or with reduced voltage on the primary.

Fig. 11 shows a magnetic controller for remote push-button operation. This controller uses magnetically-operated contactors to cut out the resistance in two steps only.

9. CARBON PILE STARTERS

Carbon-pile starters, such as were described in the section on D. C. Controllers, can also be used

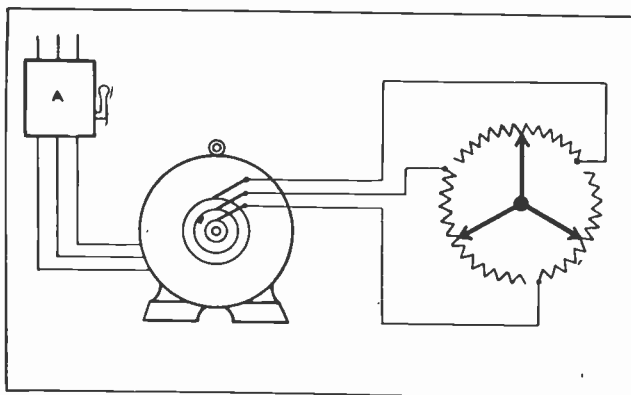

Fig. 10. Diagram showing the connections of a resistance starter in the secondary or rotor circuit of a slip-ring motor. The line switch at "A" is used to energize the stator circuit.

for A. C. motors by equipping them with the proper number of carbon resistor units, one for each phase.

The view on the left in Fig. 12 shows a three-phase carbon-pile motor-starter of the manually-operated type and on the right in this same figure is shown a rear view of the starter mechanism. The columns or tubes containing the carbon disks can be clearly seen in this view.

When the handle on the outside of the box is moved in an upward direction it first closes the circuit from the line to the motor through the full-resistance of the carbon piles with the disks in their loose condition.

Alternating Current

As the handle is gradually moved farther upward it applies more and more pressure to the disks in the tubes, thus gradually reducing the resistance in the motor circuit. The pressure is applied to these disks by means of the rod and top bar connected to the starter handle, and arranged to apply even pressure to the springs shown on top of each resistance element.

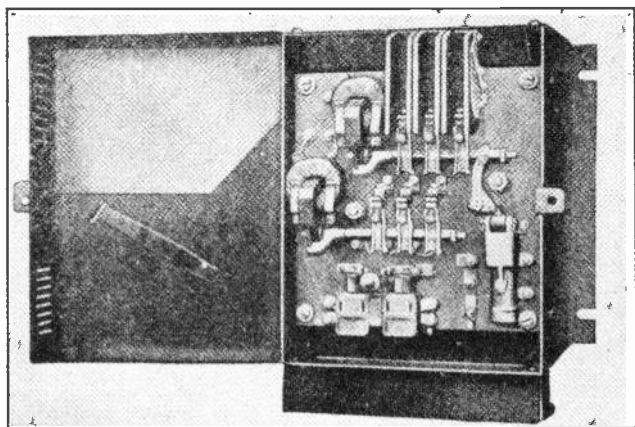

Fig. 11. Automatic controller which uses magnetically-operated contactors to cut the resistance out of the motor circuit in two steps. (Courtesy Cutler Hammer Mfg. Co.)

When the handle has reached the running position it closes a circuit to the magnet which operates the main contactors shown on the front of the panel in the left view in Fig. 12. These contactors then close and short-circuit the remaining resistance of the tubes completely out of the motor circuit.

The magnetic overload coils and dash pots can be clearly seen on the front of the panel in this figure, and you will also note the connections running to the push button in the front of the starter cover. This push button can be used to trip or release the starter and stop the motor.

10. CIRCUIT AND OPERATION

Fig. 13 shows a diagram of the connections for a manually-operated carbon-pile starter. Trace this circuit through carefully until you thoroughly understand its operation.

Motor Controllers

When the handle is pushed up it forces the set of three top contacts down on to the carbon disks, closing the line circuit through the carbon piles to

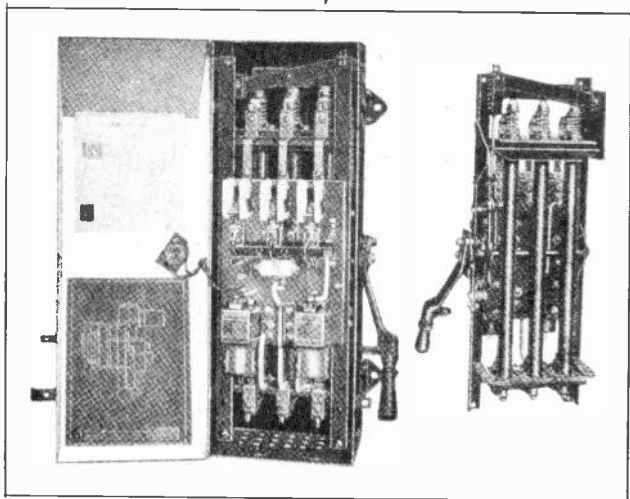

Fig. 12. On the left is shown a complete three-phase resistance starter of the carbon pile type for A. C. motors. On the right is shown the starter mechanism and tubes of carbon disks removed from the cabinet for a rear view. (Photo courtesy of Allen Bradley Co.)

the motor. When the motor is up to speed and the handle has been pushed clear up to running position, the auxiliary contact at "A" closes a circuit from line 1, through the trip contacts of the left overload coil, through the closed circuit stop switch to the coil C of the holding magnet; then back through the trip contacts of the right overload coil to line 3.

When this holding magnet becomes energized it closes the running contactors and completes a circuit directly from the line through these contactors, through the overload coils, and to the motor. This shunts out the carbon piles entirely, thus removing all of their resistance from the circuit during running.

As the main running contactors close they draw up an auxiliary contact, B, which closes the "stick" circuit through the holding coil; so it is not necessary for "A" to remain closed any longer.

Alternating Current

In case of overload on the motor the increase of current strengthens the overload coils and causes them to lift their plungers, which strike the tripping contacts and open the circuit to the holding magnet. This causes the magnet to de-energize and release the running contactors, thus breaking the line circuit and stopping the motor.

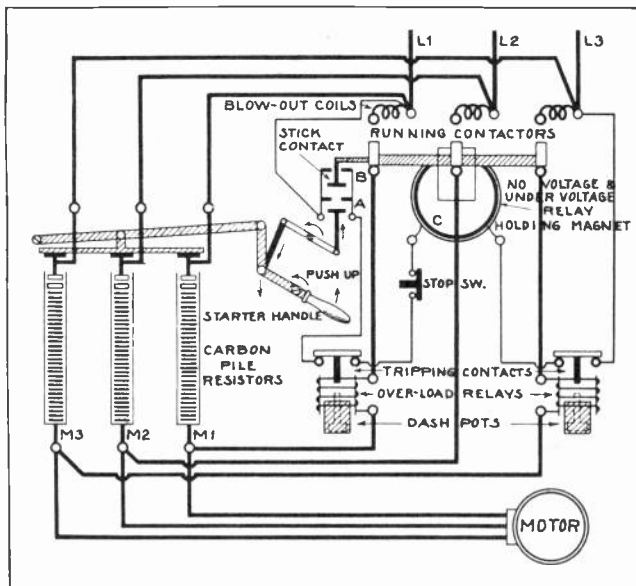

Fig. 13. Diagram showing the wiring and connections of a manually-operated, carbon pile resistance starter for three-phase A. C. motors. Trace this circuit carefully with the accompanying explanation.

The overload coils are equipped with dash pots to slow the action of their plungers, so that a momentary overload which lasts only for a very short period will not cause the plungers to rise high enough to trip the holding magnets and stop the motor. But if the overload remains on the motor long enough to cause the machine to begin to over-heat, this period is also long enough to allow the plungers to lift to the top of their stroke and trip open the contacts to stop the motor.

When it is desired to stop the motor by hand it is only necessary to push the stop switch, as this switch is also connected in series with the holding magnet.

Motor Controllers

The holding magnet in this case also acts as the no-voltage and under-voltage relay. This magnet is across-the-line from wire L-1 to L-3; so that if the line voltage drops or fails the magnet is weakened and allows the running contactors to fall open, thus requiring the motor to be properly started through the resistance again when the line voltage returns.

The blow-out coils which are marked in this diagram consist of a few turns of heavy wire wrapped around a strip of iron, the ends of which project on either side of the running contacts. The strip can be seen on the outside of the arc barrier in the left view in Fig. 12.

As these blow-out coils are connected in series with the line wires, they carry the full load current at all times and maintain strong alternating magnetic poles at the ends of the iron strips on which they are wound.

When the running contactors open, the flux from these blow-out coils and strips quickly extinguishes the arcs, thereby eliminating unnecessary burning or damage to the contacts.

Carbon-pile motor starters and controllers are quite often used on motors up to 50 or 75 h. p. where very gradual application of starting torque is required. These controllers are not so often used on motors larger than those mentioned because of their $I^2 R$ losses and the reduction in starting torque which occurs when the voltage to the stator or primary of an induction motor is reduced.

11. AUTOMATIC CARBON PILE STARTERS

Carbon-pile motor starters and controllers are also made in automatic types, as shown in Fig 14. The view on the left in this figure shows a complete automatic starter of the carbon-pile type for a three-phase A. C. motor.

The panel of this controller has two sets of contactors, two overload coils, and one timing relay coil which can be seen below. The timing relay is the one in the center.

Alternating Current

On the right is shown a rear view of the controller mechanism and carbon-pile tubes.

Controllers of this type cut out all the resistance in one step when the motor is up to speed. You will

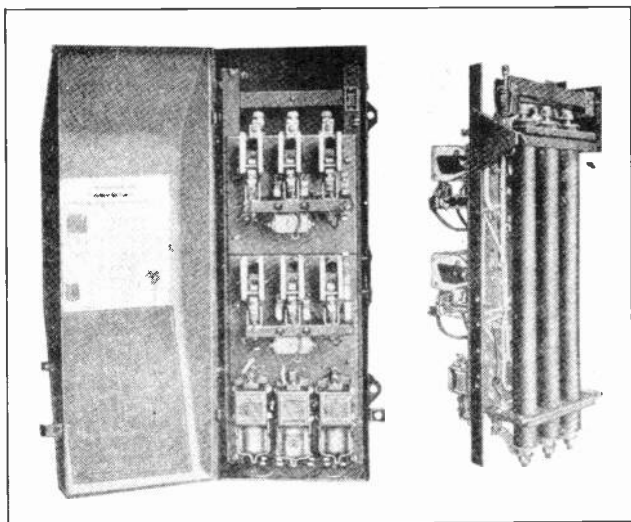

Fig. 14. Front and rear views of an automatic, three-phase, carbon pile starter. The magnetically operated contactors cut the resistance out of the motor circuit as it comes up to speed. (Courtesy Allen Bradley Co.)

note at the top of the right-hand view in Fig. 14 an adjusting screw by means of which the pressure on the three carbon piles can be properly adjusted or set for the motor with which the controller is being used.

These controllers are operated entirely by push buttons. When the starting button is pressed the top set of contactors closes and completes a circuit through the carbon resistance elements to the motor.

You will recall from the studies in an earlier lesson on the resistance of various materials, that the resistance of carbon decreases with increase of temperature. This causes the resistance in the motor circuit to be reduced a certain amount as the start-

Motor Controllers

ing current warms up the resistor elements. Then, when the motor is nearly up to full speed, a slow-acting timing relay closes the operating magnet of the second set of contactors. When these running contactors close they short-circuit the carbon resistance units out of the motor circuit and apply full line-voltage.

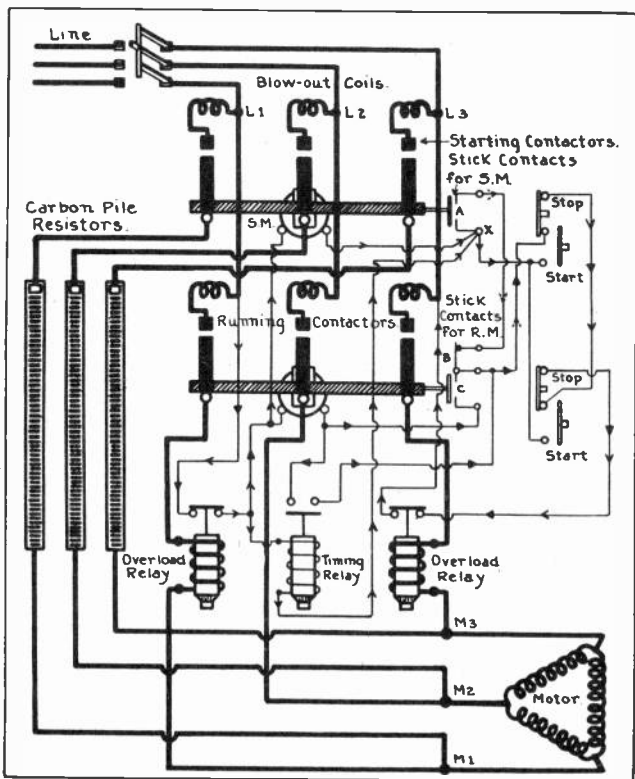

Fig. 15. Diagram showing wiring of an automatic, three-phase, carbon pile starter. Note the main power circuit traced in heavy lines from the line switch to the motor and also the auxiliary control circuits traced in light lines.

12. CIRCUIT AND OPERATION

Fig. 15 shows the connection diagram for an automatic carbon pile controller of this type. Trace this diagram carefully and step by step, until you

Alternating Current

are sure you understand the operation of these controllers. In this diagram are shown two push-button stations for controlling the motor from two different points.

Note that the open-circuit start buttons are always connected in parallel and the closed-circuit stop buttons are always connected in series. This

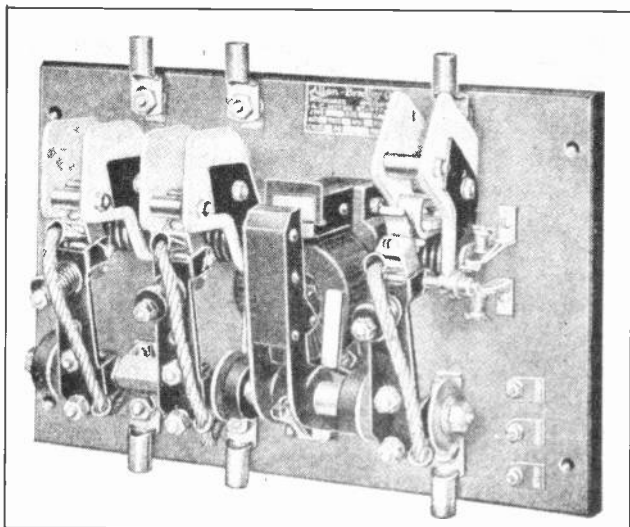

Fig. 16. This photo shows a good view of the magnetically operated contactors used with an automatic, carbon pile resistance starter. Note the arc barriers and blow-out coils on each contactor. (Photo courtesy Allen Bradley Co.)

rule holds true regardless of the number of push-button stations which may be used to control any single motor.

When either of the start buttons is pressed, a circuit is closed as shown by the small open arrows, from line 1 through the closed contacts of the left overload relay; then dividing through both the timing relay and the starting magnet, S.M., and joining again at X; through the start button (the top one in this case), through both stop buttons, through the contact of the right-hand overload relay; and back to line L-3.

Motor Controllers

This energizes both the starting magnet and the timing relay. The starting magnet immediately closes the starting contactors and completes a circuit which is easily traced by the heavy lines through these contactors, through the carbon-pile resistors, to the motor. All three lines can very easily be traced through this circuit at the same time.

When the starting magnet closes the starting contactors it also closes the auxiliary holding contact "A." This provides a holding circuit for the starting magnet, so that the starting button can now be released and opened. The circuit for the starting magnet and timing relay can then be traced from point X by the dotted arrows, up through contact "A," down through contact "B," which is still closed; then back up through the stop button, and on back to line 3 as before.

The timing relay is slowed in its action by a dash pot, and therefore requires a longer period to close its contacts. This period of time can be regulated by adjusting the dash pot of the timing relay according to the length of time which should be allowed for the motor to come up to speed.

When the timing relay reaches the top of its stroke and closes its contacts this completes a circuit as shown by the solid arrows, from line 1 through the contacts of the left overload relay, through the running magnet, down through the timing-relay contacts, on through the stop buttons and contacts of the right overload-relay, back to the line 3.

This energizes the running magnet and causes it to immediately close the running contactors. These contactors shunt out the carbon-pile resistors and close a circuit, as shown by the heavy lines, directly from the three-phase line through the running contactors, through the overload relay coils, to the motor.

As the running contactors close they also close the auxiliary contact at C and open the one at B.

Alternating Current

When B is opened it breaks the circuit of the starting magnet and allows these contactors to fall open. When C is closed this completes the holding or "stick" circuit for the running magnets, so that this current no longer needs to pass through the contacts of the timing relay.

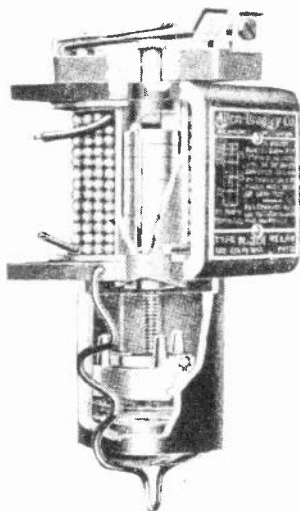

Fig. 17. Sectional view of a magnetic overload-relay and dash pot. When the core is lifted the rod above it forces open the spring contacts which break the circuit to the holding magnet. (Courtesy Allen Bradley Co.)

You will find, however, that the circuit for the running magnet still continues through both of the stop buttons in series and also through both of the overload-relay contacts, so the motor can be stopped either by pressing one of the stop buttons or by an overload which causes the overload-relay plunger to rise and open its contact. Blow-out coils are shown above both sets of contacts in this diagram.

13. CONSTRUCTION OF CONTACTORS AND O. L. RELAYS

Fig. 16 shows an enlarged view of a set of contactors for a heavy-duty automatic controller of this type. In this view you will note the operating mag-

Motor Controllers

net and armature which closes the contactors. The arc barrier on the right-hand contactor has been

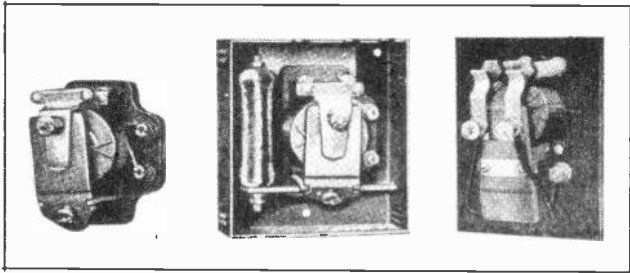

Fig. 18. Three different types of A. C. relays used with motor controllers. (Courtesy Cutler Hammer Mfg. Co.)

raised so the contact shoes are in plain view. You can also see the three large turns of the blow-out coils which are wound around an iron bar directly beneath each pair of contacts. The black iron strips which are attached to the ends of this bar or core, and project up along the sides of the arc barrier, form the poles to direct the flux of the blow-out coils across the arc when the contacts are opened.

Fig. 17 shows a sectional view of an overload-trip coil and its dash pot and contacts. When the plunger is lifted by an overload of current through the coil, it strikes the small pin above it and this pin pushes open the copper strip or spring-like contact at the top of the relay. The dash pot or oil cup can be removed by pushing to one side the wire clip which is plainly shown in this view.

Fig. 18 shows several other types of A. C. relays which are used with motor controllers.

Alternating Current

EXAMINATION QUESTIONS

1. Why do some A. C. motors require starters and controllers?
2. On what size and type A. C. motors may across-the-line starters be used?
3. Name two types of overload relays used on motor starters.
4. Why is the auto transformer method of starting an A. C. motor more efficient than the resistance method?
5. Draw a sketch showing a simple resistance starter connected in the primary circuit of a three-phase motor.
6. Draw a sketch showing a resistance controller connected in the rotor circuit of a slip-ring motor.
7. Why are carbon-pile starters and controllers not often used on motors over 75 H. P.?
8. How is the resistance of a carbon-pile starter affected by an increase of temperature?
9. Are the open-circuit start switches shown in Fig. 15 connected in series or parallel with each other?
10. Is the counter voltage of an A. C. motor stator highest when the rotor is standing still or when it is rotating at full speed?

Motor Controllers

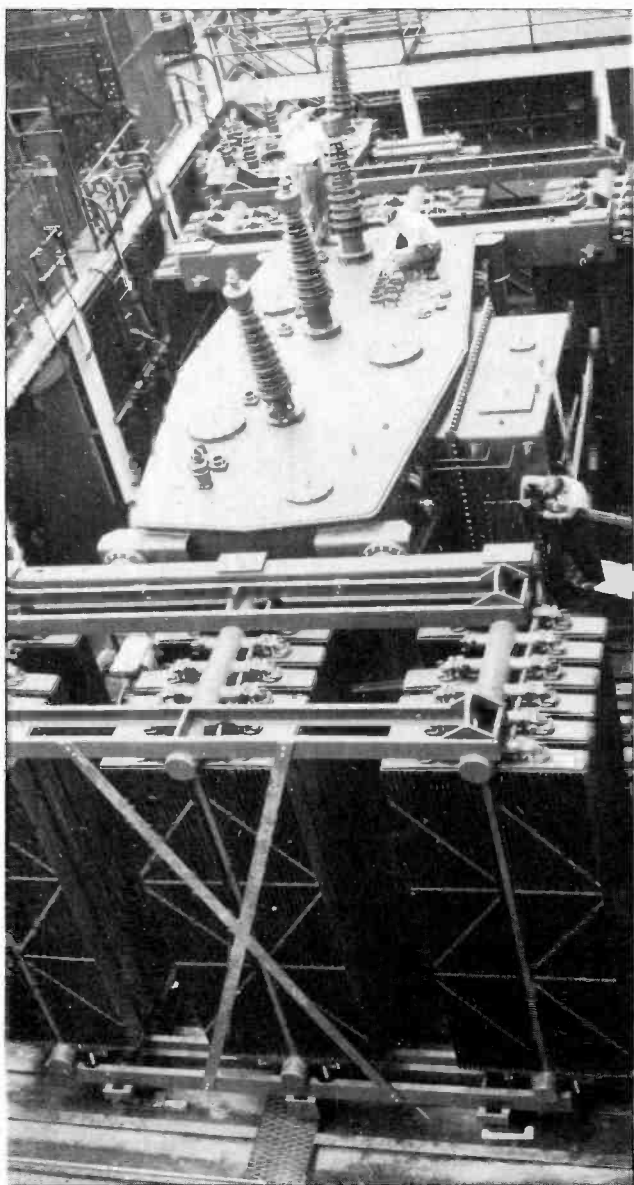

Westinghouse power equipment in a large eastern power plant.

Alternating Current

COMPENSATORS OR AUTO TRANSFORMER STARTERS

Auto transformers are by far the most common device used in reducing the voltage to A. C. motors during starting. As previously mentioned, these devices are much more economical and efficient than are resistance starters.

Auto transformers reduce the voltage by transformer action and the loss caused by resistance and heat is not as great as that of resistance starters.

An auto transformer which reduces the voltage to one-half of line voltage will deliver from its secondary, to the motor, twice as much current as is drawn from the line.

Auto transformers used for A. C. motor starters almost always have on their coils a number of taps for varying the secondary or starting voltage. The number of these taps may vary from 1 to 5, or more, depending upon the number of starting voltages or steps in which it is desired to start the motor.

The taps usually provided are for 50%, 65%, and 80% of line voltage.

Auto transformer starters which have only one tap in use and start the motor with only one step of reduced voltage are commonly called **compensators**.

These compensators are made in both manual and automatic types, and are very extensively used on motors from 5-h.p. to 100-h.p., and sometimes larger.

Fig. 1 shows a compensator of the manually-operated type, with the front cover removed to show the transformer coils, no-voltage release, and magnetic and overload relay.

Fig. 2 shows another compensator with the oil tank removed to show the stationary and moving contacts which are operated by the handle or lever on the side of the box. During operation these contacts are immersed in oil, so that the arcs which are drawn when the circuit to the motor is broken will

Motor Controllers

be quickly extinguished by the oil, and unnecessary damage to the contacts will thereby be prevented.

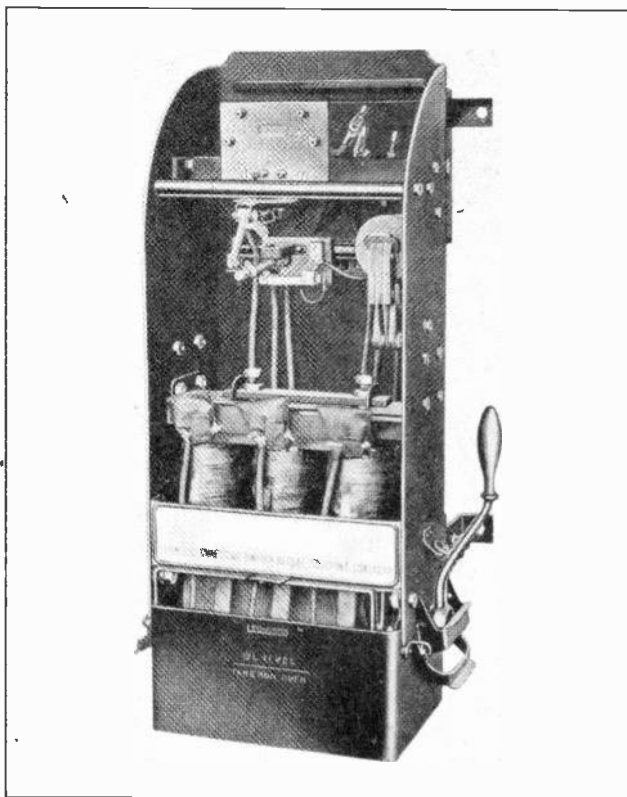

Fig. 1. This photo shows a front view of a three-phase, auto transformer starter or compensator used for starting squirrel-cage motors at reduced stator voltage. (Photo courtesy General Electric Co.)

1. PROCEDURE FOR STARTING A MOTOR WITH A COMPENSATOR

To start a motor with a compensator of this type, the starting handle or lever is first pushed in one direction as far as it will go, and is held in this position by the operator until the motor comes up to speed.

When the motor reaches full speed the handle is

Alternating Current

quickly pulled in the opposite direction as far as it will go, and locks in this position.

In the first position the handle closes the starting contacts to the reduced voltage taps of the auto transformer, applying low voltage to the motor during starting.

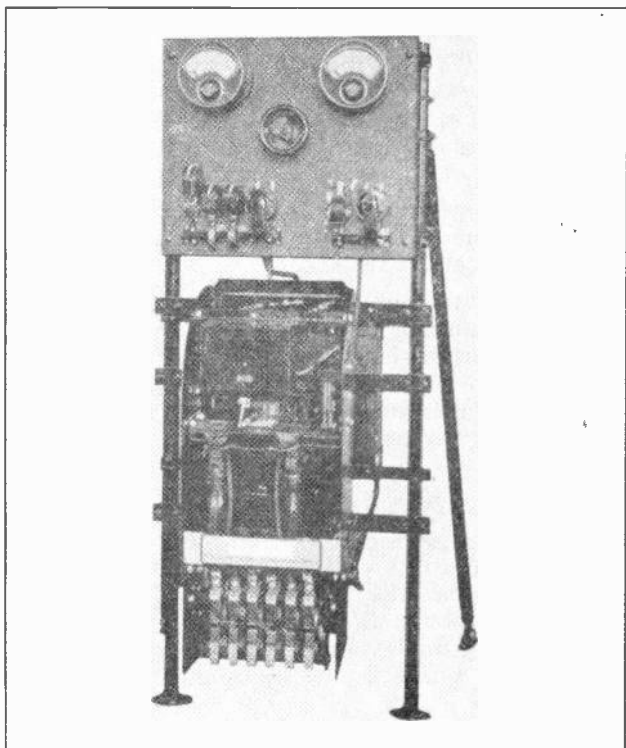

Fig. 2. This photo shows another view of a compensator with both the front cover and the oil tank removed. The contacts which operate under oil can be seen at the bottom of the controller. (Courtesy General Electric Co.)

When the lever is swung to the second position, the starting circuit is broken and the contacts to the full line-voltage are immediately closed, thereby completing the running circuit.

These compensators are generally provided with a latch, so that the starting handle cannot be moved into the running position first, but must first be

Motor Controllers

moved into the starting position and then drawn quickly over to the running position, after the motor is up to speed.

This last operation should be performed quickly because during the time the lever is being moved from starting to running position the motor circuit is momentarily broken, so if the lever is brought back slowly the motor will lose considerable speed before the running contacts are closed.

In some cases slow operation will also allow the latch to fall in place again, thereby requiring the starting operation to be repeated.

During starting the lever should be firmly held in the starting position to keep the contacts tightly together; otherwise they may arc and seriously burn or pit the contact shoes.

The lever and contacts of these compensators are held in the running position by a mechanical latch which is often provided with a hand trip on the outside of the controller. In other cases the controller may have a push button for breaking the circuit of the no-voltage release coil in order to stop the motor.

2. PROTECTIVE FEATURES

The no-voltage release coil and the overload-trip coil in compensators of this type are usually so arranged that when they raise or drop their plungers the plungers strike the trigger or release on the latch, allowing the lever and contacts to be returned to normal or open-circuit position by means of a spring.

The contacts in starters of this type are generally mounted in rows and fastened on bars of wood or a fibre-like composition of good insulating quality. The operating handle is also attached to the movable contacts by an insulating bar, and this eliminates the chances of shock hazard to the operator when starting high-voltage motors.

Making and breaking circuits under oil and inside the metal case eliminates the danger of burns and flashed eyes which might occur to operators if large motors were started and stopped by means of ordinary knife-switches.

Alternating Current

3. CIRCUIT AND OPERATION

Fig. 3 shows a connection diagram for a simple Western Electric compensator or auto transformer starter for a three-phase motor. When the compensator handle is thrown to the starting position all of the moving contacts on the center bar are carried into action with the lower set of stationary contacts.

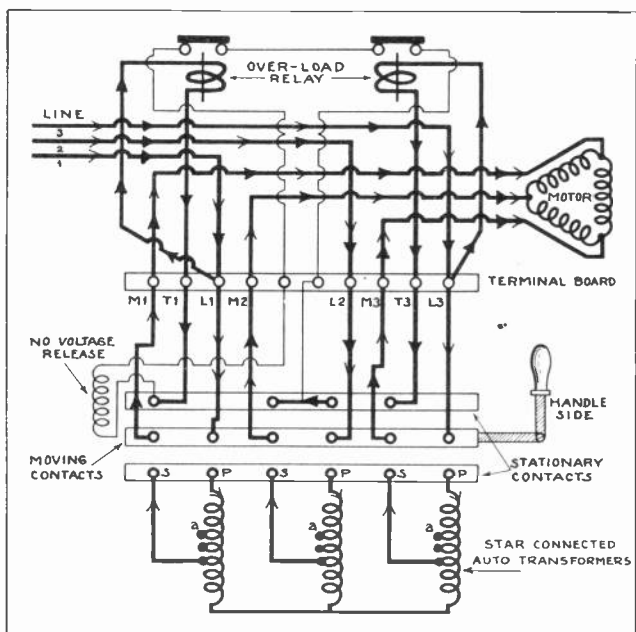

Fig. 3. Wiring diagram of a manually-operated compensator used for starting three-phase, squirrel-cage motors. Carefully trace the starting and running circuits with the accompanying explanation and also note the overload protective circuit.

This completes a circuit as shown by the open arrows, from the three line wires to the primary terminals, P, of the auto transformer; and also from the secondary terminals, S, of the auto transformer to the motor terminals, M-1, M-2, and M-3 and to the motor winding. The motor is thus supplied with reduced voltage from the auto transformer secondary.

In tracing this circuit you will note that the starting current doesn't pass through the overload relay

Motor Controllers

coils because this starting current is much heavier than normal full-load running current and would be likely to cause the overload relays to trip out before the motor could reach full speed.

When fuses are used in connection with compensators of this type they are also placed so that they are only in the running circuit and not in the starting circuit.

When the handle is thrown to the reverse position the moving contacts on the center bar are brought into action with the upper set of stationary contacts. This completes a circuit from each line wire to the motor, supplying full line-voltage for running.

The running circuit from line 1 can be traced by the solid arrows from line wire 1 to terminal L-1, then up through the left overload coil, and down to terminal, T-1, through the controller contacts, and up to M-1, and to the top lead of the motor.

The circuit from line 2 can also be traced by the solid arrows to terminal L-2, through both bars of the center controller contacts, and back up to terminal M-2, then to the center wire of the motor.

The circuit from line 3 can be traced to terminal L-3, then up through the right-hand overload coil, down to T-3, through the controller contacts, and back up to M-3; then to the lower wire of the motor.

While in this diagram all of the arrows have been shown leading toward the motor, we know, of course, that with A. C. applied, the current in these motors would be rapidly reversing in direction, first flowing in on one wire and out on the other two; then in on a different wire and out on the remaining two; etc.

We have found in tracing this running circuit that the currents of two of the phases pass through the overload relay coils, so we know that if the motor becomes overloaded the strength of these coils will increase and raise their plungers, tripping open the contacts which are in series with the no-voltage release coil.

This de-energizes the no-voltage release, allowing its plunger to fall and trip the latch which releases

Alternating Current

the controller handle and contacts, and allows them to move to the off position.

The no-voltage release coil will also trip the compensator if the line voltage becomes too low or fails entirely.

The circuit for this coil can be traced from line 1 to L-1, up through the left overload coil, down to T-1, through the N.V. release coil, and up through both of the overload relay contacts in series, down through the controller contacts, and back up to line 2.

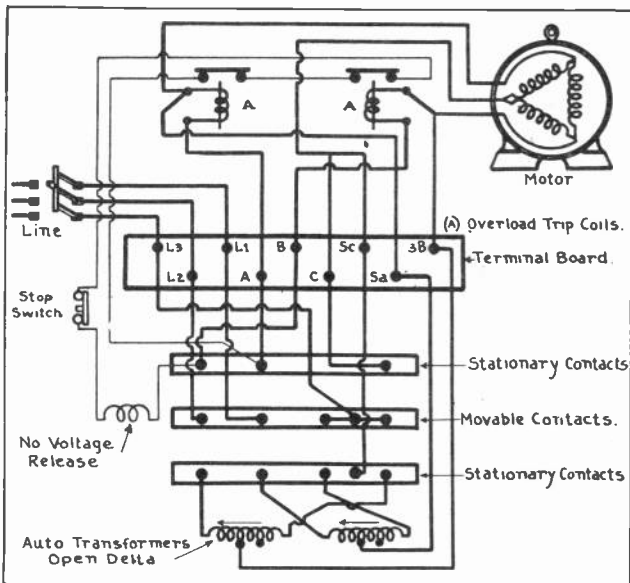

Fig. 4. Wiring diagram of a three-phase Westinghouse compensator using open-delta-connected auto transformers, and a stop switch in series with the no voltage release.

4. STARTING VOLTAGE ADJUSTMENT

On compensators that are equipped with several taps on the coils of the auto transformer, if the motor doesn't start as rapidly as it should (ordinarily 10 to 30 seconds) with the secondary leads on the low voltage tap, these leads can then be shifted to a tap of higher voltage.

Motor Controllers

Compensators should not be operated with the secondary leads on different voltage taps, such as for instance one lead on a 40% tap, another on a 60% tap, etc. The leads should all be carefully connected to taps of equal voltage.

Fig. 4 shows the diagram of another starting compensator such as is made by the Westinghouse Electric & Manufacturing Company. The auto transformer coils of this starter are connected open-delta, instead of star as they are in Fig. 3.

Trace this circuit in the same manner as the one in Fig. 3 was traced, making sure that you can follow the circuit of the three line wires to the auto transformer connections when the compensator is in the starting position; also from the auto transformer secondary to two of the motor leads, and from one line wire direct to the center motor lead during starting.

Then trace the circuit from the line through the overload trip coils to the motor when the compensator is in running position.

5. AUTOMATIC REMOTE CONTROLLED STARTERS

Compensators of the types just described can be arranged for remote operation by using such mechanical connections as rods, light-weight piping, or steel cables; or they can be arranged for electrical remote operation by using electro-magnets to move a laminated armature which takes the place of the ordinary hand-operated starting lever.

In other cases the leads from the line, motor, and auto transformer are connected to two sets of special magnetically-operated contactors mounted on a panel similar to those described for resistance starters.

These contactors are then operated by their magnets, which are in turn controlled by push buttons used to start and stop the motor.

Fig. 5 shows a connection diagram for a General Electric automatic starter of this type.

The starting and running circuits from the line to the motor can easily be traced through the controller by the heavy lines, and the auxiliary control circuits are shown by the lighter lines.

Alternating Current

This controller has a motor-operated timing element which regulates the period of time that the motor will be kept on reduced voltage during starting. This timing element is operated by the small

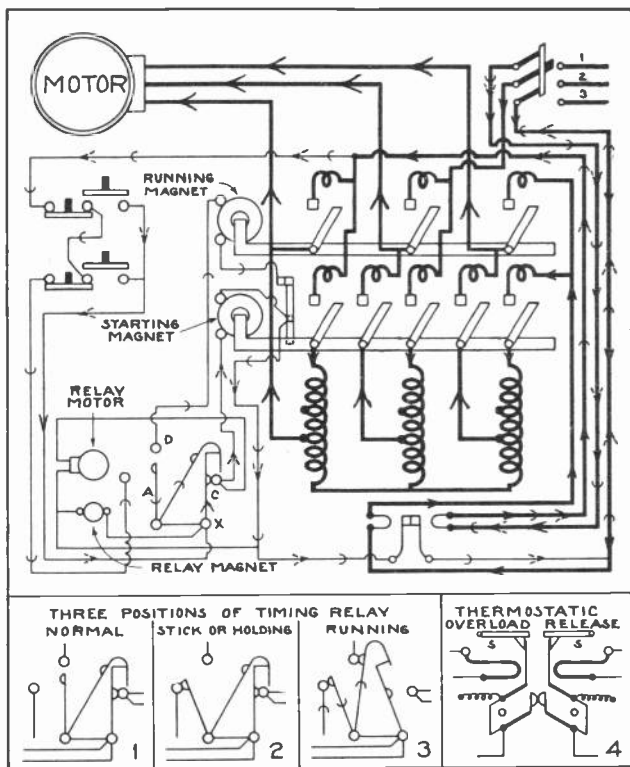

Fig. 5. This diagram shows the complete circuits of an automatic controller with magnetically-operated contactors in the starting and running circuit, and a motor-operated timing relay to regulate duration of the starting period. Trace all parts of this circuit carefully with the accompanying explanation.

relay motor shown in the lower left section of the main diagram.

The four small sketches beneath the main circuit diagram show the several positions of the contacts in the timing element. Examine these carefully and compare them with the timing element contacts in the main diagram while tracing out the circuit for normal, starting, and running positions.

Motor Controllers

6. CIRCUIT AND OPERATION

When either of the start buttons is pressed, a circuit can be traced as shown by the dotted arrows, from line 1, through the heater element of the thermal overload relay, through the start button to the terminal X.

With the timing element contacts in the normal position as shown in the main diagram, the current divides at this point, part of it flowing to the left and through the relay magnet, back to the right through the thermal overload contacts to line 3; which completes this circuit.

When the relay magnet is energized it attracts the armature "A", causing it to make contact with the holding circuit through the closed-circuit stop buttons. This position of the relay contact is shown in the lower diagram No. 2.

Going back to point X, the other part of the current which divided at this point flows up through the relay contacts C and divides again; part going through the relay motor starting it in operation, and the other part going up to the starting magnet and then back through the thermal overload contacts, and to line 3.

When this starting magnet is energized it closes the starting contactors. A circuit can then be traced as shown by the small open arrows, from line wires 1 and 3, down through the heater elements of the thermal overload relay, back up through the blow-out coils and contactors, and to the primary terminals of the auto transformer.

The circuit from line 2 is traced directly through the blow-out coil and contactor to the center primary lead of the auto transformer.

The reduced-voltage circuit to the motor can be traced by the large open arrows from the taps on the auto transformer coils, up through the other starting contactors to the motor. The left-hand wire from the transformer tap runs directly to the motor without passing through any contactor.

The auxiliary contacts B near the starting magnet are normally closed when the controller is in

Alternating Current

the off position and are opened at the same time the starting magnet closes the starting contactors. This acts as an electrical interlock and prevents the running magnet from being energized until the starting magnet releases and opens the starting contactors and again closes these contacts.

A mechanical interlock in the form of a bar is also very often provided between the operating mechanisms of the starting and running contacts, so that the running contacts can never close until the starting contacts are open. This precaution must be taken in order to prevent short-circuiting the auto transformer windings.

After the relay motor is started it runs at a definite speed and operates a chain of small gears which very slowly turn the timing disk. When this disk makes a certain part of one revolution it brings around a trip pin that snaps the hook-shaped contact assembly of the timing mechanism over into the position shown in the small diagram 3 at the bottom of Fig. 5. This opens the circuit at "C", de-energizing the relay motor and the starting magnet; allowing the starting contactors to fall open and at the same time closing the auxiliary contact at D to complete the circuit to the running magnet.

This circuit can be traced by the round arrows from line 1, through the heater element of the thermal relay, through the closed circuit, stop buttons, armature A and contact D, of the timing device, through the coil of the running magnet, auxiliary contacts, thermal relay contacts and back to line 3.

When the running magnet is thus energized it closes the upper set of running contactors and completes a circuit directly from the line to the motor. You will note, however, that the circuit from line wires 1 and 3 passes through the heater elements of the thermal overload-relay, so that any excessive overload on the motor will cause the contacts of this relay to open and break the circuit of the running magnet holding-coil. This will

Motor Controllers

open the running contactors and stop the motor.

The two closed-circuit stop buttons are also in series with this magnet, so pressing either of these will stop the motor.

7. TIME ELEMENT DEVICE AND O. L. RELAY

A motor-operated timing device such as used with this controller can be set to give the desired period of time during which the motor is operated at reduced voltage while it comes up to speed, and according to the amount of load connected to it.

Fig. 6 shows a photograph of a motor-operated timing relay of this type. The cover is removed, showing the relay magnet on the left and the adjusting dial on the right. By moving the small arm on this dial in one direction or the other the length of the starting period can either be increased or decreased as desired. The operating motor is enclosed within the case of the relay.

The advantage of timing relays of this type is that they are very accurate and will always start the motor in exactly the amount of time for which they are set.

On certain other types of controllers small motors are sometimes used to drive a set of drum contacts similar to those on a sign flasher. As the drum slowly revolves, the contacts close circuits in the proper order to the operating magnets, which close the main contactors, cutting out resistance and increasing the motor voltage step by step as the machine comes up to speed.

The small diagram number 4 at the lower right in Fig. 5 shows the thermal overload relay in more detail. When excessive current flows through the curved heater elements the heat produced in them warms up the expansion strips, S, directly above them, causing these strips to warp upward until their ends slip off the tops of the vertical springs and allow the relay contacts to fly apart.

Fig. 7 shows an excellent photograph of one of these thermal overload-relays. The expansion strips are partly covered by the two small metal

Alternating Current

hoods at the upper left and right. The relay contacts are clearly shown in the center of this photo, and you can also see the adjusting pointers projecting out in either direction from the insulating members which carry the relay springs.

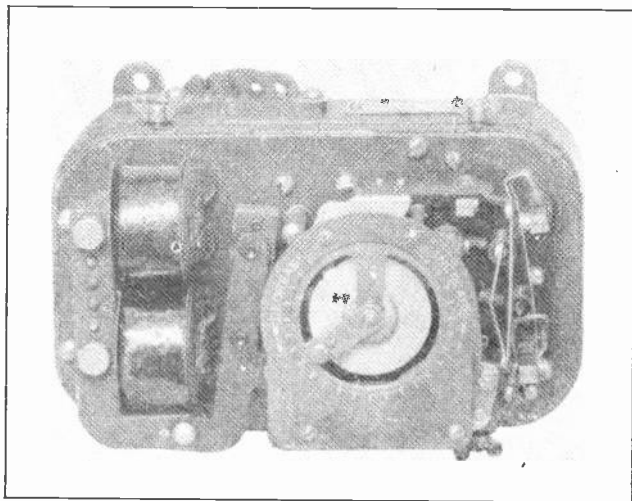

Fig. 6. This photo shows a front view of the motor-operated timing relay for which the connections were shown on Fig. 5. Note the relay magnet and time-setting dial on this unit. (Photo courtesy General Electric Co.)

This particular relay is equipped for resetting by pulling on the cord to draw the contacts back together. Other relays of this type can be reset by means of a push button which raises the V-shaped wedge, forcing the bottom ends of the contacts apart and closing them at the top.

It is very important that the thermal overload relays as well as the motor-operated timing device be properly adjusted according to the current rating of the motor and the nature of the load attached to it, in order to properly protect the motor from overheating during running or starting.

Automatic controllers with properly adjusted time element devices have the decided advantage of accurately regulating the period of time allowed for starting the motor each time the operation is performed.

Motor Controllers

The life of motors is generally much longer when they are started in this manner than when they are carelessly started with manual controllers.

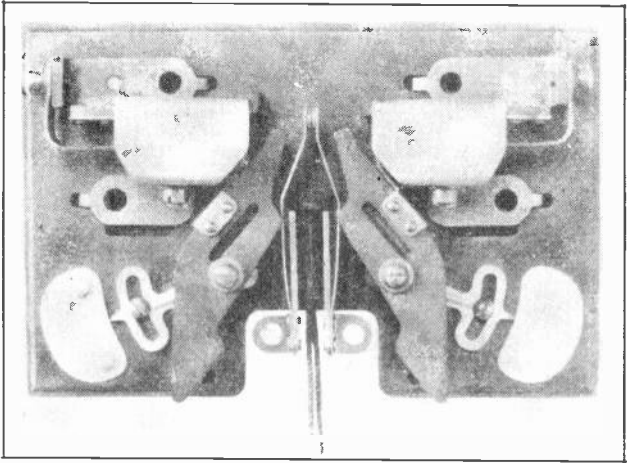

Fig. 7. Excellent view of thermal overload-relay such as used on automatic controllers manufactured by the General Electric Co. Note the current setting pointers and also the resetting cord on this device. (Courtesy General Electric Co.)

Unless the operators of manual controllers are very careful there is likely to be a considerable variation in the periods of time allowed between the steps of starting, and this may result in very heavy surges of starting current and heavy mechanical stresses on the motor and driven machines.

8. AUTO STARTERS AND PRINTING PRESS CONTROLLERS

Automatic starters which apply the voltage more gradually in several steps during starting are commonly called auto starters. Starters of this type have auto transformers with several taps, each of which is connected to a separate set of contactors.

These contactors operate in the proper order to apply the voltage to the motor in gradually increasing amounts during starting. For example, the auto transformer may have taps providing starting voltages of 50%, 65%, and 80%, and if these voltages are applied in order as the motor comes up to speed it will result in a fairly uniform rate of

Alternating Current

acceleration and will greatly reduce the starting current surges in the line and motor winding.

Fig. 8 shows an automatic controller for use with printing press motors. This controller has a variable resistance which can be set by hand for any speed at which it is desired to operate the motor. The contacts and arm of this rheostat can be seen at the lower left corner of the controller panel. The rheostat can be set for the desired speed before the motor is started, or it can be adjusted during operation.

On the face of the panel are shown the contactors which cut out the various steps of resistance, bringing the motor up to speed. Controllers of this type are operated by push button stations located at a number of different points on the printing press.

Automatic motor controllers can be arranged for operation by floats in tanks, by pressure or tempera-

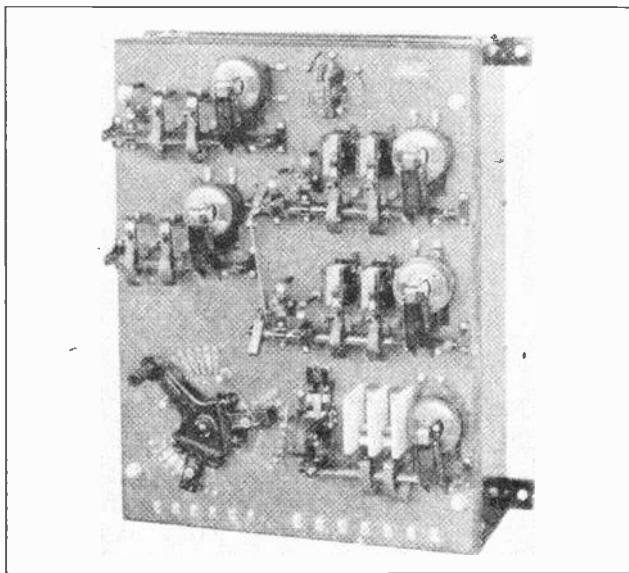

Fig. 8. This photo shows a front view of an automatic, panel type controller with a hand-operated, speed-regulating rheostat. (Photo courtesy General Electric Co.)

Automatic controllers using large contactors on panels are commonly used to control very large

Motor Controllers

A. C. motors, even up to several thousand h.p. For such large motors as these the contactors used must be quite large air circuit breakers in order to handle the heavy currents.

ture relays and in many other ways, so that they start, stop, and vary the speed of pump motors and other equipment entirely automatically whenever the water level, pressure, or temperature requires it.

9. DEION ARC QUENCHERS

Controller contacts are always subject to more or less damage by the arcs formed when the circuits are broken. On controllers which have the contacts immersed in oil the arc is extinguished or quenched much more quickly by the oil, thus considerably prolonging the life of the contacts.

Controllers of the panel type with contacts which break the circuit in air, generally have the arcing greatly reduced by means of blow-out coils, as previously explained.

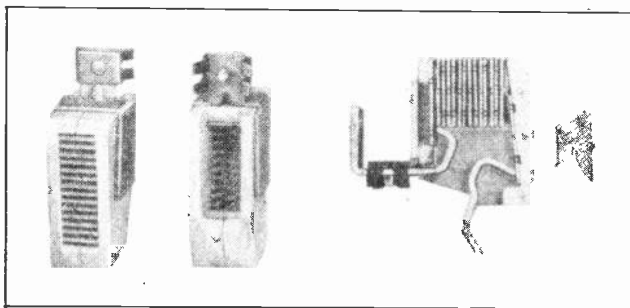

Fig. 10. This photo shows several views of Deion arc quenchers. The sectional view on the right shows the manner in which these devices are placed over the contacts, to quickly extinguish the arc when it passes up into the metal blades. (Courtesy Westinghouse Elec. & Mfg. Co.)

Another form of device which has been developed for quickly extinguishing the arcs at contacts of air breakers is known as the Deion arc-quenching device. This device consists of a hood made of fireproof insulating material and containing a set of metal grids or slotted blades into which the arc is blown when it is formed.

On the left in Fig. 10 are shown two views of one of these Deion hoods, and on the right in this same figure is a sectional view showing the manner

Alternating Current

in which the hood is placed over the contacts of the breaker. The effect of these grids is to quickly separate the arc into a number of small arcs in series and thereby break it up.

These devices are used not only on small contactors on motor controls, but also on large circuit-breakers on high-voltage power lines. They are very effective in extinguishing arcs and actually break up the arc and interrupt the current flow within one-half cycle from the time the contacts are opened.

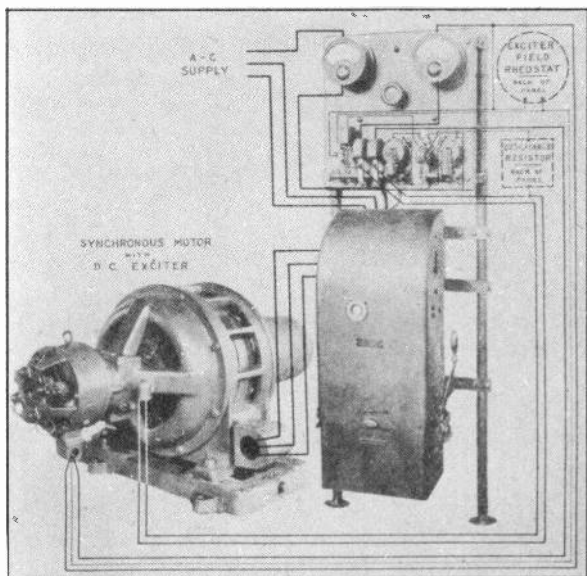

Fig. 12. This photo-diagram shows the arrangement of the connections between a synchronous motor and its exciter, and the controller and instruments used with it. On an actual installation these wires would, of course, be run in conduit or B.X. The three-phase line circuit through the compensator to the stator of the synchronous motor is shown by the heavy lines. The exciter and field circuits are shown by the lighter lines. (Courtesy General Electric Co.)

10. DRUM CONTROLLERS

Drum controllers are very extensively used for starting and speed control of A. C. motors of the slip-ring type. You are already familiar with the general construction and operation of drum controllers from the material covered in the Lesson on D. C. Motor Controls.

Motor Controllers

When used with A. C. motors, the drum controller contacts can be used to cut out step by step the resistance of the secondary or rotor circuit, or to shift the connections from one tap to the next of the auto transformer in the stator circuit.

On small motors up to 10-h.p. face-plate type resistance-starters, such as described earlier in this section, are commonly used, but with motors larger than this drum controllers are generally preferred because their contacts are much heavier and more

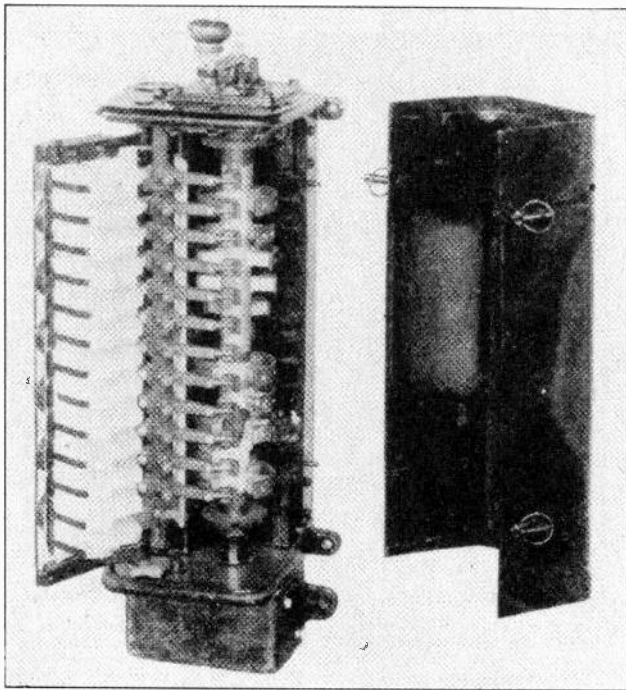

Fig. 13. This view shows an A. C. drum controller with the cover removed. Note the rotating segments, stationary contact fingers, arc barriers, and blow-out coils. (Courtesy General Electric Co.)

capable of handling the heavy currents required.

Fig. 13 shows an A. C. drum switch or controller with the cover removed. In this view the revolving segments, stationary contact fingers, arcing barriers, and blow-out coils can all be clearly seen.

The sliding motion with which the revolving segments are brought into contact with the stationary

Alternating Current

fingers tends to keep the contact surfaces worn bright and smooth, thereby providing good low-resistance connections as long as the contacts are kept in proper condition and are not allowed to become too badly burned or pitted by the arcs.

Fig. 14 shows three different sizes and types of A. C. drum controllers. By observation of the controllers shown in this figure you will see that it is possible to make drum controllers with almost any

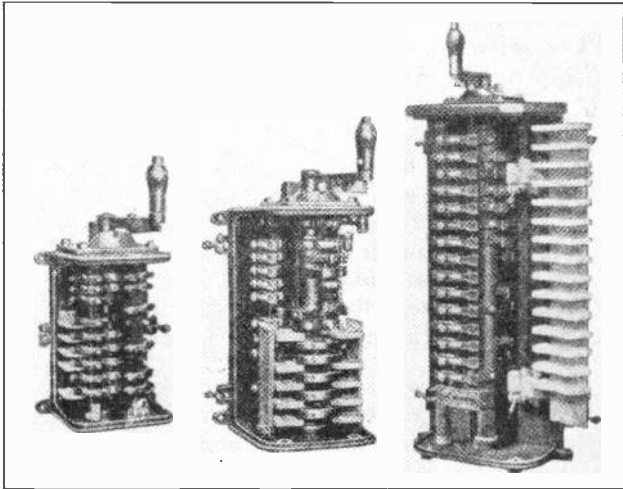

Fig. 14. Three drum controllers of different types and sizes showing the variety of arrangements that can be made with their contacts and segments. (Courtesy Cutler Hammer Mfg. Co.)

desired number or arrangement of contacts. For this reason drum controllers can be used with A. C. motors to perform a wide variety of switching operations for gradual starting or wide ranges of speed variation.

Where very large A. C. motors, ranging from several hundred to several thousand horse power, are to be controlled by drum controllers, the drum will be used merely as a remote control for large magnetically-operated contactors located on a panel.

When used in this manner, the drum and contacts handle only small amounts of current at low voltage and these currents in turn operate the magnets which close the heavy current circuits at high

Motor Controllers

voltage. This provides a much greater degree of safety for the operators.

11. STARTING, REVERSING AND SPEED CONTROL

In addition to starting and varying the speed of A. C. motors, drum controllers are commonly used for reversing the machines as well. You will recall from previous articles that a three-phase A. C. motor can be reversed by reversing any two of the phase leads.

This operation can be performed by one set of contacts on the drum, while another set is used to vary the resistance or voltage from the taps of the auto transformer.

Fig. 15 shows a simple type of drum controller used for starting and reversing a three-phase A. C. motor. Two of the line leads running to the stator winding of the motor are taken through the contacts and segments of the drum for reversing the connections to the stator and thereby reversing the direction in which the motor will start.

The six upper sets of contacts and segments are used for gradually cutting out the resistance during starting, or if the resistance elements and contacts are made heavy enough they can also be used for varying speed during operation of the motor.

When the drum is moved to the left the segments strike their contacts in the order 1, 2, 3, 4, 5, as shown by the numbers on the segments. Each additional step cuts out a little more resistance; until, on the fifth step, the resistance units are all short-circuited and are cut entirely out of the secondary or rotor circuit of this slip-ring motor.

During the process of cutting out this resistance it is not always evenly cut out of each phase, as at certain times there is little more resistance left in one phase than in another.

During starting, however, these periods are generally very short and the slight unbalance in the rotor currents does not seriously affect the operation of the motor.

Alternating Current

When the controller drum is moved to the right, or in the opposite direction, the segments pass clear

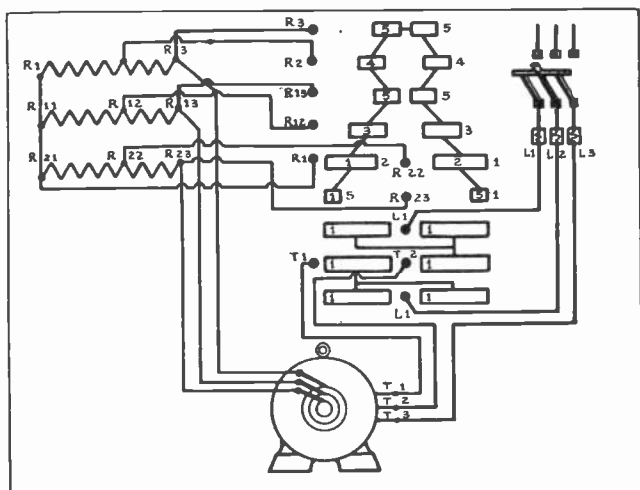

Fig. 15. Circuit diagram of a simple drum controller for starting and reversing three-phase, slip-ring motor. Trace the circuit carefully with the accompanying explanation.

around and approach the stationary contacts from the opposite side in the order shown by the numbers which are placed near the ends of these segments.

In tracing the circuits through this controller and the resistance units, when the drum contacts are in the various positions, it will be easier to trace the secondary circuit by starting each time on the center wire from the motor and going through the proper sections of resistance, first to the left wire and then to the right wire.

It is not extremely important to trace out each circuit on the different steps of operation of controllers of this type because, when new drum controllers are being installed, the manufacturer generally supplies a connection diagram.

The connection diagrams shown here are used to show general operating principles, but it is well to remember that changes are continually being made in machines and methods of connections, and that correct diagrams for latest types of

Motor Controllers

equipment can generally be obtained from the manufacturers.

12. DRUM CONTROLLER CONNECTIONS

It is particularly important to make the connection of the resistance to the proper stationary contacts on the drum controller so that the segments will cut out the resistance in the proper order.

Most new controllers and resistors have their terminals marked with corresponding letters and numbers, as shown in Fig. 15, thus making it a comparatively simple matter to properly connect them if the markings are carefully followed.

The resistance for three-phase drum controllers is generally divided into three equal sections, the ends of which are connected together in a star or Y connection as shown in Fig. 16.

One commonly used method of numbering the terminals of the resistance is to allow the numbers from 1 to 10 to represent one section of the resistance from Y to A; the numbers from 11 to 20 to represent the next section from Y to B; and the numbers from 21 to 30 to represent the third section from Y to C.

This plan can be followed even though each section doesn't use the whole ten numbers. The lowest number of each group is placed at the star connection. In the resistance shown in Fig. 16 there are only three divisions or four taps to be numbered on each section; so the numbers 1 to 4 are used on the upper section, 11 to 14 on the center section, and 21 to 24 on the lower section.

The resistance shown in this figure is for a controller which provides ten different speeds of the motor. The number of speeds which controllers are arranged to provide is usually a multiple of 3, plus 1; as, for example, 4, 7, 10, 13, 16, etc.

When motors are arranged for a number of speeds which is other than a multiple of 3, plus 1, they cut out two or more sections of resistance at once.

In connecting up a resistance such as shown in Fig. 16, or any other resistance using this system

Alternating Current

of marking, the points marked 1, 11, and 21 are connected together to form the star or Y connection.

The opposite ends, or lines A, B, and C, are then connected to respective brushes on the slip-rings of the motor and also to the proper corresponding contacts on the drum control.

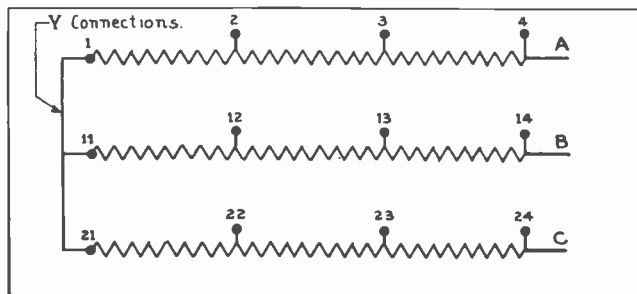

Fig. 16. The above sketch shows a common method of marking resistance units for use with drum controllers.

If you have to connect a resistance which is not marked, it is comparatively easy to place small tags on the terminals and then mark them in the manner shown in Fig. 16.

The marked secondary resistance of this type for use with slip-ring A. C. motors can be properly connected to a drum controller by the following procedure, even though no blue print is available.

First, place the controller handle in the off position and then move it to the first step or starting position. Note which of the controller fingers now rest upon the segments of the drum. There will usually be two in contact in this first position on non-reversing drums, and more on drums of the reversing type.

Ignoring the contacts which are used for reversing, connect to one of the other two a wire from the Y connection of the resistance, and to the remaining contact connect a wire from terminal 2 of the resistance.

Next, place the handle of the controller in the second position, note the contact which is thus brought into connection with the segment, and connect to it a wire from terminal 12 of the resistance. At each successive step or position of the controller

Motor Controllers

handle another finger will be brought to rest upon a new contact, and to each of these successive fingers connect wires from the resistance terminals in the order—2, 12, 22; 3, 13, 23; 4, 14, 24; etc.

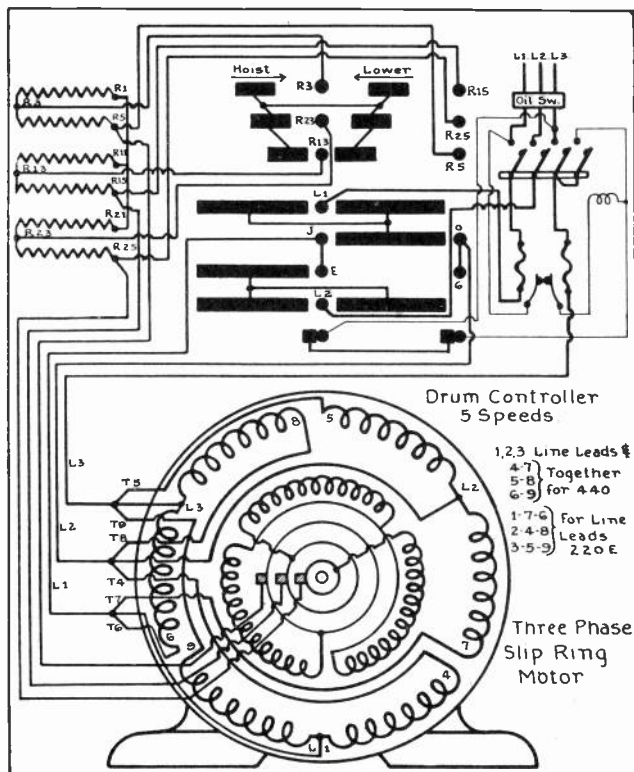

Fig. 17. Wiring diagram of a speed-regulating controller connected to a slip-ring motor. Carefully trace the circuits both to the stator and rotor of this machine.

If the controller is of the reversing type there will sometimes be only one finger resting upon a segment in the first position. In this case, attach the Y connection to this finger and for the remaining connections proceed as previously explained.

Be careful to note that as the controller handle is moved, the contact for each new position may be found on either the right or left-hand finger-board of the controller. In other words, the contacts

Alternating Current

which are made in order—1, 2, 3, 4, etc., may not all be on the same finger-board. The finger-board is the strip on which the contact fingers are mounted.

This general method of procedure of connecting resistance to drum controllers is often very handy and valuable for a man to know when out on the job, because in many cases the diagrams for certain controllers may have become lost or resistances may be used which are not marked when supplied.

Fig. 17 shows a connection diagram for a three-phase drum controller used with a hoist motor for providing five speeds and for reversing duty. This diagram shows, in addition to the drum controller, a line oil switch and magnetically-operated contactor, thermal overload-relay, and the motor windings, which are equipped with separate leads so that the machine may be operated on either 440 or 220 volts.

Fig. 18 shows a connection diagram for another type of drum control. This diagram is of the type furnished with equipment manufactured by the General Electric Company and uses a different system of numbering. However, if you follow the numbers on any diagram or blue print of this type, it is a very easy matter to make the proper connections between the resistance and controller, and also to the motor and line.

This particular diagram also shows the terminals of a line switch or contactor which is operated by remote push-button control.

The wiring diagram for this switch is also furnished by the manufacturers upon request from customers who may be installing such equipment.

13. STAR-DELTA STARTERS

Squirrel-cage induction motors which have their stator windings connected for delta operation sometimes have the start and finish leads of each phase brought out to a three-pole double-throw switch so that the windings can be changed to star for starting the motor at reduced voltage.

Motor Controllers

This reduces the voltage applied to each phase of the winding of 57.7% of the normal line voltage. This provides a very simple and economical method of starting motors at reduced voltage.

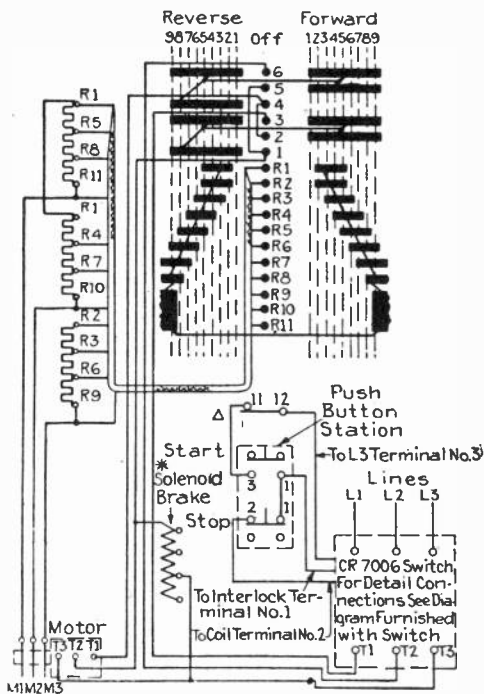

Fig. 18. Wiring diagram of a General Electric drum controller for starting, reversing, and speed regulation of a three-phase, slip-ring motor. Note how the numbers simplify the making of proper connections, even though the wires from the resistance to the drum contacts may be bunched in a cable.

However, this method is not extensively used because it only provides one starting voltage and because it can only be used on motors that are to be operated with the stator windings delta-connected. Nevertheless, it is often a very convenient method of starting squirrel-cage induction motors in an emergency when no compensator is available.

Fig. 19 shows a method of connecting the start and finish leads of a stator winding to the three-pole switch for star-delta starting of an A. C. motor. The

Alternating Current

clips on one side of the switch are all shorted together to form the Y or star connection for starting.

The starts of all three phases are connected in rotation to clips on the opposite side of the switch, and the finish leads of the three phases are connected to the blades in such a manner that when the switch is thrown down in the running position the start of one phase will connect to the finish of the next, etc.

To start a motor in this manner the switch is first closed in the upper position which connects the phase windings in star and applies 57.7% voltage to them. When the motor speed has increased as much as it will with this connection and no further increase of speed can be noted, the switch is then quickly thrown to the lower position connecting the windings delta so that they receive their full rated voltage from the line.

14. INSTALLATION OF CONTROLLERS

When installing controllers it is general practice to locate them near the motor, in order to shorten the leads between the controller and motor as much as possible

In many cases, however, it may be much more convenient to have the controller located at some distance from the motor, where it is within easier reach of the operator of the machinery which is driven by the motor.

Controllers are frequently mounted upon a post or pillar or on the wall of the building in which they are installed. In other cases they are mounted on frames of angle iron or steel piping.

Regardless of whether the controller is located within a few feet of the motor or at some distance from it, the circuits between them should generally be run either in rigid conduit, flexible conduit, or B. X.; and good, secure connections should be made between the conduit and the frame of the motor and also between the conduit and the controller box. This insures a complete ground circuit be-

Motor Controllers

tween the devices and is a necessary safety precaution.

Flexible conduit is a very convenient material for running the wires between motors and controllers because it is easily bent to fit the openings and attachment fittings on the machines, and to run along motor frames or bases or along the walls or machines to which it is attached.

Fig. 12 shows a photo-diagram of a synchronous motor and its exciter-generator, starting compensator, overload-relays, and meters; and the various connections or wires between them. These wires

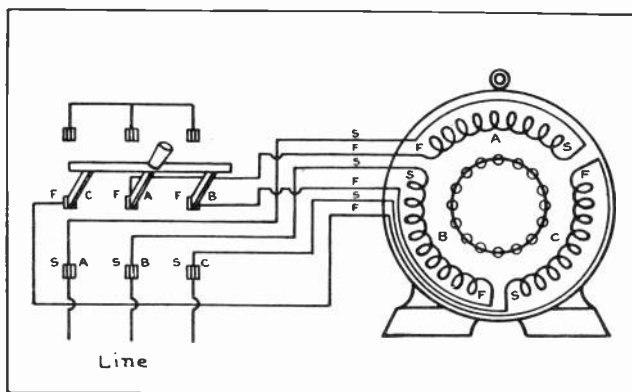

Fig. 19. This diagram shows the method of using a three-pole, double-throw switch for star-delta starting of squirrel-cage induction motors.

are merely drawn in the photograph to show their position in this figure, but in an actual installation they would be enclosed in rigid or flexible conduit; or B.X. which has the right number of wires for the different runs can be used.

Fig. 20 shows two views of induction motor installations, but doesn't show the supports for the controllers. On the left is a squirrel-cage induction motor equipped with a starting compensator; and the wires running between them are enclosed partly in rigid conduit and partly in flexible conduit.

On the right is shown a slip-ring induction motor with an oil switch in the line circuit to the stator, and a drum controller and resistance in the rotor

Alternating Current

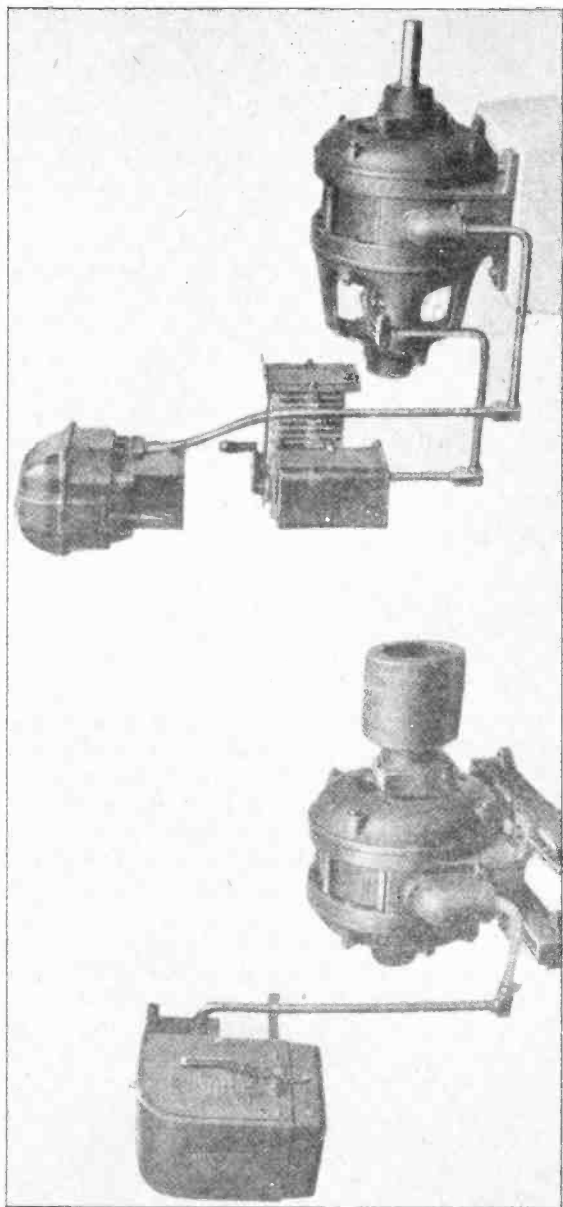

Fig. 20. The above two views show methods of connecting compensators and drum controllers to induction motors by means of rigid and flexible conduit. While in some temporary installations open wires which are properly supported and protected may do very well, in general a neat, permanent installation of the wires in conduits is a much safer and better arrangement.

Motor Controllers

circuit for starting and speed variation.

The wires between these units are run in rigid conduit which is attached to the motor and controller by proper fittings.

Three-hole porcelain covers are used in the fittings on the ends of the conduit where the connections are made to the slip-rings and to the oil switch.

The use of flexible conduit where the leads attach to the motor is a decided advantage when the motor must occasionally be shifted to loosen or tighten the belt. The flexible conduit allows this to be done without changing any of the wiring or piping.

Controllers should always be securely mounted so that they will not sway or vibrate when the handles are operated.

15. CARE AND MAINTENANCE OF CONTROLLERS

There are several parts and devices on motor controllers that require frequent inspection, adjustment, and maintenance to secure the best operation of the controllers.

Controller contacts are always subject to a certain amount of burning or pitting from the arcs which are formed when the contacts make and break the circuit. This is true even though they may be operated in oil or with blow-out coils and other devices to quickly extinguish the arcs, and it is particularly true where the controller is used frequently for starting and stopping or varying the speed of the motor.

To provide efficient operation of the motor, the controller contacts must be kept clean and bright, and of the proper tension and contact adjustment. When these contacts become pitted or burned they should be smoothed off, first with a coarse file and then finished down with a fine file.

This operation can be most easily performed by removing the contacts from the controller and holding them in a vise, and a better job can usually be done if a new contact is used as a pattern for reshaping the old ones.

Alternating Current

Sharp corners and edges on sliding contacts or segments of drum controllers should be carefully

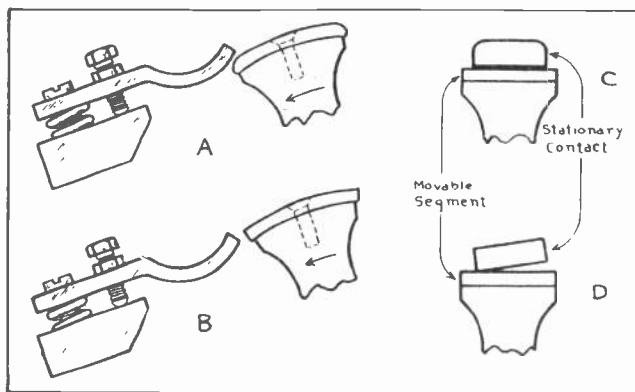

Fig. 21. At "A" is shown the proper shape and position of the segment and contact finger of a drum controller. At "B" is shown the wrong position and unrounded corners of these contacts. At "C" and "D" are shown the right and wrong positions of the stationary contact on the movable segment.

smoothed and rounded off, as shown at A in Fig. 21.

At B in the same figure is shown a set of contacts which are not properly rounded off on the corners; and the stationary contact finger in this view is not set in the proper position. When the controller segment is moved in the direction indicated by the arrows it will jam against the tip of the contact finger and probably bend this contact out of shape.

When placing a new or repaired contact back into service its surface should be given a thin coating of vaseline. This will prevent excessive wear and scratching and cause the contacts to wear with a smooth surface.

Contact faces or surfaces should always be parallel with the faces of the segments or other contacts against which they fit or slide, as shown in Fig. 21-C.

If these contacts are allowed to get out of alignment as shown in Fig. 21-D it will result in high-resistance contacts and probably in serious overheating or burning of the contacts.

Motor Controllers

The contacts should be carefully adjusted as to position and spring tension. When adjusting the tension on the contacts of drum controllers it is a good plan to move the controller handle occasionally and determine by the feel whether or not the tension is too great. One should be able to move the handle freely with one hand and yet be able to feel a reasonable amount of pressure when the segments make contact.

Sometimes controllers which operate hard or stiffly should have a few drops of oil placed on the controller shaft where it rubs on the bearings at each end, and a light application of vaseline to the contacts will often make them wear smoother and run more easily. If the controllers are allowed to operate hard or stiff it often results in their being abused or jammed by the operators.

All terminals should be frequently inspected, cleaned and kept securely tightened, so that they make good contact with the wires at all times.

If a thin coating of vaseline is applied to the terminals after they are cleaned it will prevent corrosion and keep them in much better condition.

Arcing barriers that are badly burned or broken should always be promptly replaced to prevent the serious damage which might otherwise result from flash-overs between the different sets of contacts.

16. CARE OF OIL USED ON OIL-IMMERSED CONTACTS

On controllers in which the contacts are operated under oil the oil should be frequently inspected, and renewed whenever it becomes dirty or blackened by the burned materials from the contacts.

Dirt and carbonized contact material, if allowed to remain in the oil, greatly reduces its insulating quality and also reduces the ability of the oil to extinguish or quench the arcs at the contacts.

Dirty oil is also likely to cause flash-overs between phases and to the grounded metal case of the controller. One severe flash-over of this kind is likely to be much more expensive than the cost of several changes of oil.

Alternating Current

After removing dirty oil from a controller the tank should be thoroughly cleaned and again filled to the oil level marking before it is replaced on the controller.

The oil used in controllers and oil switches is of a grade similar to that used in transformers and, in fact, transformer oil is very frequently used for this purpose.

17. PROTECTIVE RELAYS AND AUXILIARY CIRCUITS

All relays for overload and under-voltage protection should be kept properly adjusted and in good condition, in order to protect both the motor and controller from serious damage in case of overloading or failure of voltage. These protective devices generally give very little trouble except for occasional breakage of the small wires connected to them or the working loose of terminal nuts and connections.

Their contacts should be inspected occasionally to see that they are not burned or stuck together but are working freely and making a good contact and have bright, clean surfaces.

The auxiliary circuits of controllers do not carry power or load current, but are the ones which connect to the start and stop buttons, starting and running contactor magnets, overload and under-voltage relays, etc.

For these circuits No. 12 wire is generally used, although in some cases No. 14 or No. 16 is used. Asbestos-covered wire insures greater reliability and longer life on these circuits. These wires should require very little attention or care, provided they are located where they don't vibrate and where they are not rubbed by the moving parts of the controller.

18. CARE OF DASH POTS AND TIMING DEVICES

Dash pots and other forms of time elements on controllers should be carefully adjusted to allow

Motor / Controllers

the proper time for starting the machine. The oil in dash pots should be kept clean and occasionally renewed, and these devices should be filled only with oil intended for use in them, as other oils of different thickness or consistency may cause them to operate much slower or faster than intended.

Dirty oil in dash pots will often close by-pass valves or cause the piston or plunger to stick and fail to rise. The oil should be kept at the proper level so that it completely covers the piston when it is in its highest position.

If the piston stem becomes bent or the casing of the oil pot becomes dented, it will often result in sticking and failure of the dash pot to operate.

Careful study of Controllers is very important because of the very great convenience and time saving and the economies which can often be effected by the selection and use of proper motor control equipment, and because of the added safety which these devices provide for operators as well as the protection they give to the motors and driven machines.

A great deal of your future success may depend upon your ability to properly install and maintain A. C. motor-control equipment, as this is one of the most important duties of the electrical maintenance man in many large industrial plants.

Alternating Current

EXAMINATION QUESTIONS

1. What is the purpose or function of a compensator when used to start A. C. motors?
2. Briefly describe the proper procedure to follow when starting a motor with a manually operated compensator.
3. In what direction must the moving contacts shown in Fig. 3 be moved in order to supply full line voltage to the motor?
4. How many remote operation can be accomplished on compensators?
5. What is one important advantage of using automatic controllers equipped with time element attachments.
6. What is the name given to automatic starters designed to apply voltage in several gradual steps during starting?
7. Briefly describe three methods by which controller contacts may be protected against damage by arcs.
8. On what kind of A. C. motors are drum controllers extensively used?
9. Draw a sketch showing how a three-pole double throw switch may be connected for use as a star-delta starter.
10. In the maintenance of controllers, which parts in your estimation, require the most attention?

Motor Controllers

GENERATING STATIONS

By far the greatest part of the electrical energy used in this country is generated in large power plants called **central stations**, although there are also a large number of smaller privately-owned power plants supplying electricity in industrial plants, hotels, office buildings, etc. In a number of small and medium sized towns and cities there are also municipally owned and operated plants.

Electricity can usually be generated much cheaper in large plants which have large highly efficient generators and equipment. So, in most cases the small user can buy power from the power company cheaper than he can generate it himself.

There are many cases, however, where electric power can be produced very cheaply in a privately-owned plant, if some other use is available for the low-pressure exhaust steam from the turbines or engines used to drive the generators.

In other cases waste gases or materials which are by-products of manufacturing plants, can be used as cheap fuel for generating steam to run steam-driven electric generators.

The lowest rates obtainable from the public utility or generating company and the dependability of their service should be carefully considered in comparison with the costs of fuel, operation, overhead, and interest on the investment of a privately-owned plant before recommending its installation.

Considerably more than two-thirds of the electric power generated in this country is produced by steam plants, and less than one-third by the hydro-electric plants or water power.

Many people think that electric energy can be produced much more cheaply by water power than by steam plants. This is not always the case, because the cost of developing some water power sites is very high.

Another great drawback in the use of much of the available water power is that the best sites for

Generating Stations

its development are frequently long distances from any large towns or heavy users of power and very great losses would be involved in transmitting power over these great distances.

Some of the larger and more modern steam plants produce a kw. hr. for each $1\frac{1}{2}$ lbs. of coal burned, and under other low operating costs, and these steam plants can therefore in many cases deliver power to their customers much cheaper than it could be generated and sent from the nearest water-power source.

Small privately-owned power plants which supply electrical energy to just one factory or building often generate their power at 220 or 440 volts, or the same voltage as that of the equipment which uses the energy. In plants supplying very large factories the generators are often operated at 2300 volts. Some large motors in the factory are then operated directly on this voltage, and smaller motors and lights operate on reduced voltage from transformers.

1. SELECTION OF THE LOCATION OF A POWER PLANT

Steam plants can usually be located in or near some large town, and very close to the **load center**, or heaviest users of electric power. In this manner a large portion of the electric energy produced can often be sold within a radius of a few miles of the power plant.

It is, of course, desirable to locate any power plant as close to the load center as possible and thereby avoid unnecessary losses in transmission. There are, however, a number of other very important factors which enter into the selection of the location for a steam power plant. Some of these are: the availability or transportation of fuel, preferably by rail or boat; the availability of good boiler feed-water, and sufficient condenser water; ground values on the land required for the plant and fuel yards, switching equipment, etc.; and local building or zoning restrictions.

Alternating Current

Large power plants which use coal for fuel are generally located at a railroad, river, canal, or body of water that accommodates boats or barges; as too much re-handling or hauling by trucks will add too greatly to the cost per ton of the coal.

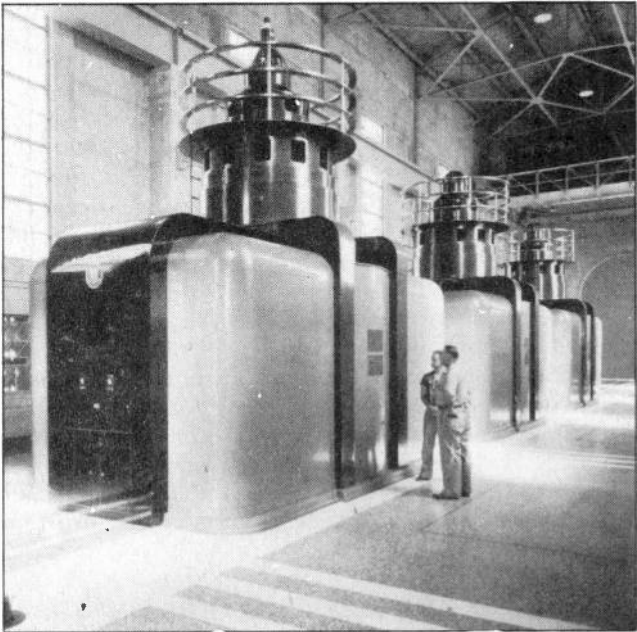

Fig. 1. This photo shows some of the latest Westinghouse Equipment for generating stations.

Boiler feed water should preferably be of a grade that does not cause excessive scale formation in the boilers or corrosion of engines or turbines; although difficulties due to water impurities can often be largely eliminated by filtering and chemical treatment of the feed water.

Where condensing engines or turbines are used, a large volume of water is required for cooling the condensers which convert the exhaust steam back into water for the boilers to use again.

In some parts of large cities ground values are so high that taxes and interest on the money invested in the land would make it impractical to locate a

Generating Stations

power plant there. In such cases the generating plant is usually located near the edge of town or in some manufacturing district where property values are lower.

Zoning laws often prohibit the location of any buildings of the nature of a power plant or factory in certain sections of cities. Many of the more recently built power plants and substations are very attractive buildings and thereby a great deal of the objection which was formerly raised against the appearance of power plants has been eliminated.

Fig. 2 shows at P.H. a power house near the river and railroad, for its supply of coal and condensing water, and feeding power at high voltage into substations in the city. The substations step the voltage down and distribute the energy to the various sections of the city.

A modern central-station, steam-power plant will produce less smoke while burning 100 tons of coal than an ordinary steam locomotive or small factory produces in burning one or two tons. This is because of the highly efficient stokers and boiler furnaces used, and the carefully regulated draft to the furnaces, etc.

2. CHOICE OF PRIME MOVERS

The choice of prime mover to be used in a power plant depends on the type and price of fuel available, whether or not condenser water can be had, and upon the class of service the plant is intended for.

In large central stations **steam turbines** are the most common form of prime mover, as they are very efficient and are well adapted to operation at high speeds and high steam pressures. They are also very compact and small in size for the tremendous amount of power they deliver.

Coal is by far the most common form of fuel used for producing steam, although there are in the western and southwestern states some generating stations that are operated with oil and gas fuel.

Alternating Current

In large plants the coal is fed to the boiler furnaces by automatic stokers or traveling grates; and in many of the later type plants the coal is pulverized and blown into the furnaces with air, being practically exploded or burned instantaneously as it enters the white hot furnace. This method of burning powdered coal is a very efficient one and creates very little smoke or ash.

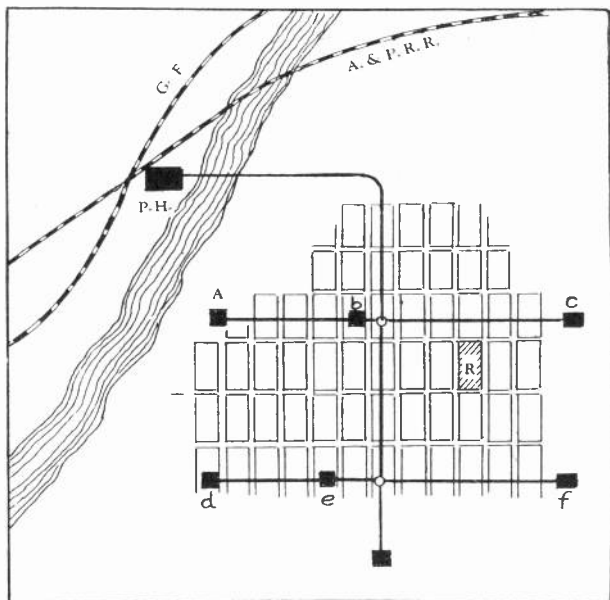

Fig. 2. This diagram shows how a power plant should be located near a convenient source of fuel supply and condenser water. Transmission and distribution lines then carry the energy from the power plant to the substations and consumers.

Fig. 3 is a view of the interior of a large steam-operated generating station and shows four large turbine-driven generators in operation.

In smaller privately-owned plants either steam turbines or **reciprocating steam engines** are used. The steam engine, being well adapted to operation on lower steam pressures, lower speeds, and simple to operate, is often used to drive low-speed generators of the open type, as shown in Fig. 4.

In localities where coal and condenser water are

Generating Stations

difficult to obtain, and where oil is plentiful and cheap, **Diesel Engines** are often used as prime movers in generating plants. They are also very well suited for use in stand-by plants which are used only during certain hours of the day to help carry peak loads on other plants.

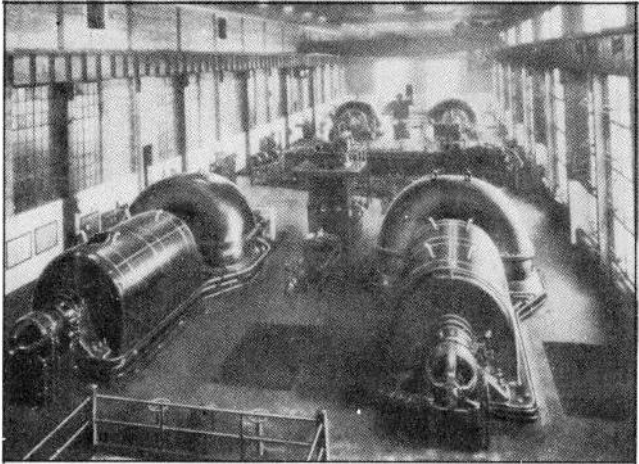

Fig. 3. Interior view of a large power plant showing several modern steam turbine-driven alternators.

A Diesel engine operated unit can be quickly started and does not require previous firing up of boilers or the carrying of stand-by boilers to enable it to be quickly started and placed in service.

Diesel-operated plants require no condensing water, no boiler feed-water, no large fuel storage yards, and very little care and repair, as these engines are simple in operation and rugged in construction. Fig. 5 on page 10 shows two large Diesel engine-driven generators in a power plant.

Diesel-operated plants require very little space and operate on low cost fuel oil, producing power at very low cost. Plants of this type are extensively used in oil field regions and are also coming into very general use for privately-owned and municipal plants. Diesel engine-driven generators are extensively used on electrically operated ships.

3. BOILERS, STEAM TEMPERATURES AND PRESSURES

In this lesson no attempt has been made to cover all of the details of the steam and mechanical equipment and operation in power plants. This work does not fall in the field of the electrical operator, but we do cover here certain points of general interest and importance which any electrical operator

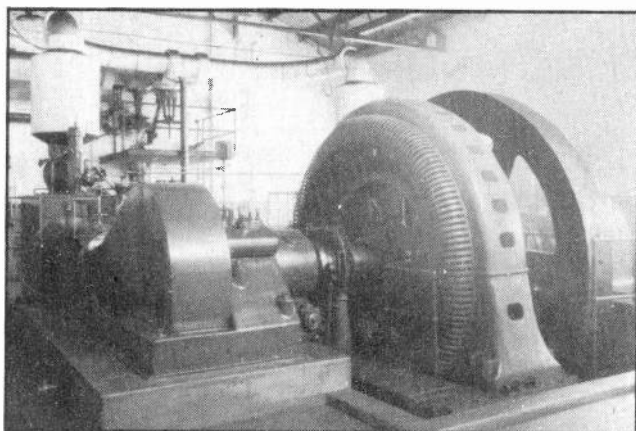

Fig. 4. This photo shows a direct connected steam engine-driven alternator in a small power plant. Note the flywheel used to stabilize the alternator speed and smooth out the pulsations of the engine strokes. Courtesy Allis-Chalmers Mfg. Co.

should know about the plant in which he may be working.

Boilers for producing steam are of two general types called **fire-tube** and **water-tube** boilers. Fire-tube boilers are those in which the hot gases from the fire box or combustion chamber pass through steel tubes which are surrounded by the water in the boiler. This type of boiler is used very little nowadays, except in smaller and older plants.

Water-tube boilers are those which have a large number of tubes connected to **drums** or **heads**, the water being contained in the tubes and lower drum, and steam in the top of the upper drum. The fire and hot gases from the combustion chamber pass upward between these water tubes and all around

Generating Stations

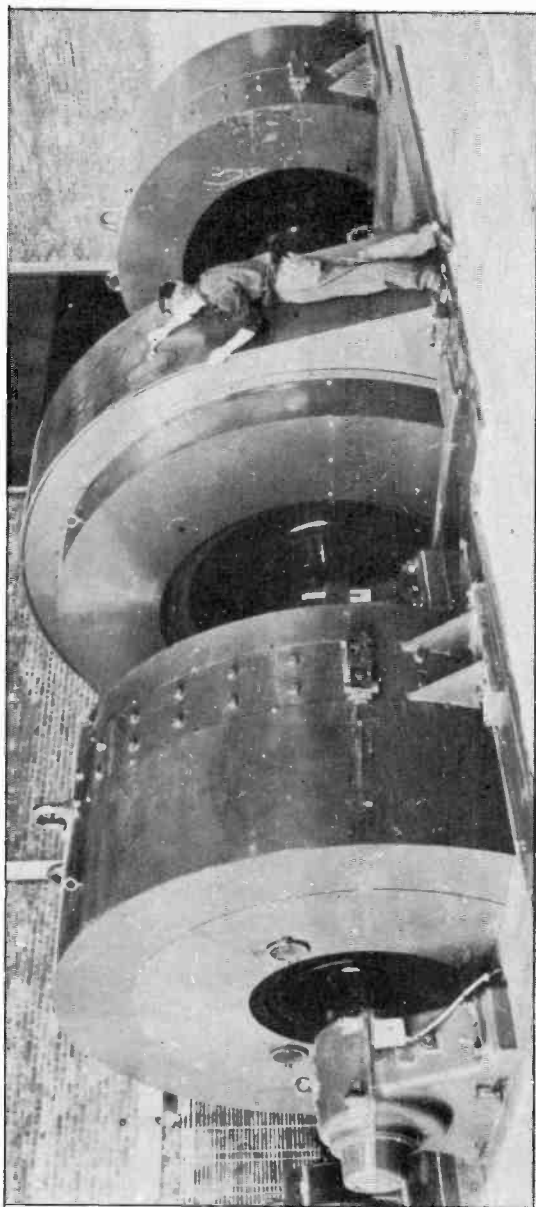

Fig. 5. This 8300-kw Westinghouse synchronous motor generator set, the largest ever built for such service, supplies power for the mill and reel motors of a new high speed 54-inch wide fourstand tandem cold reduction strip mill. It consists of two 4000-kw, 750 volt, direct current, main power generators; a 300-kw, 450 volt, reel booster generator; and 11,250 horsepower, 0.9 power factor, 11,000 volt, 3 phase, 60 cycle, 300 rpm, synchronous driving motor. The machines are ventilated by a downdraft air cooling and recirculating ventilation system.

Alternating Current

their surfaces, thus imparting the heat to the water inside the tubes.

Fig. 6 shows a sectional view of a modern water tube boiler and combustion chamber. The coal hopper and stoker mechanism are shown at A, the grates and fuel bed at B, the combustion chamber or fire box at C, and the ash pit at D. The hot gases first pass upward between the boiler tubes, and then to the right and slightly downward over the baffles and on out to the smoke stack.

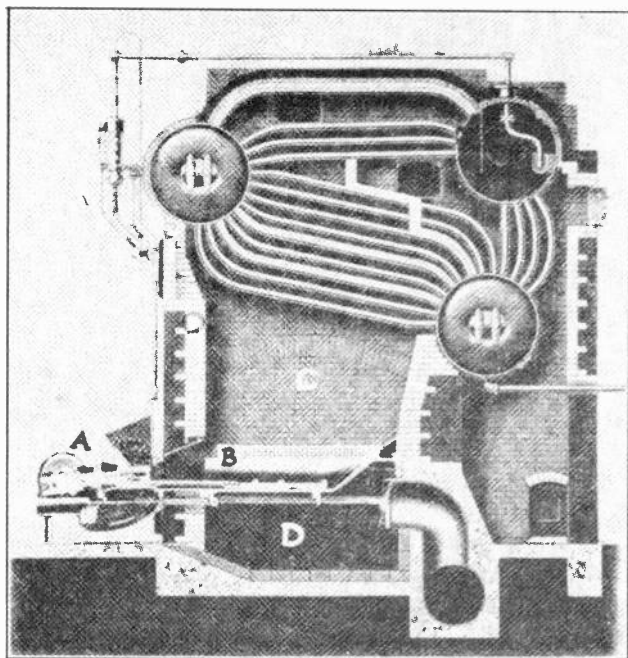

Fig. 6. Sectional view of a water tube boiler with an automatic stoker to feed the coal to the burners or combustion chamber "C".

Fig. 7 shows a diagram of another type of water-tube boiler in which the tubes are straight and are fastened to flat vertical "headers" at each end. The furnace of this boiler has a water-cooled inner wall, in the tubes of which the boiler feed-water is heated to quite an extent before entering the boiler proper.

Generating Stations

This boiler is fired with pulverized coal, and the coal hopper, pulverizer, and chute or pipe which carries the powdered coal to the boiler furnace, can all be seen in this diagram. The hot gases pass up between the right-hand ends of the boiler tubes, then

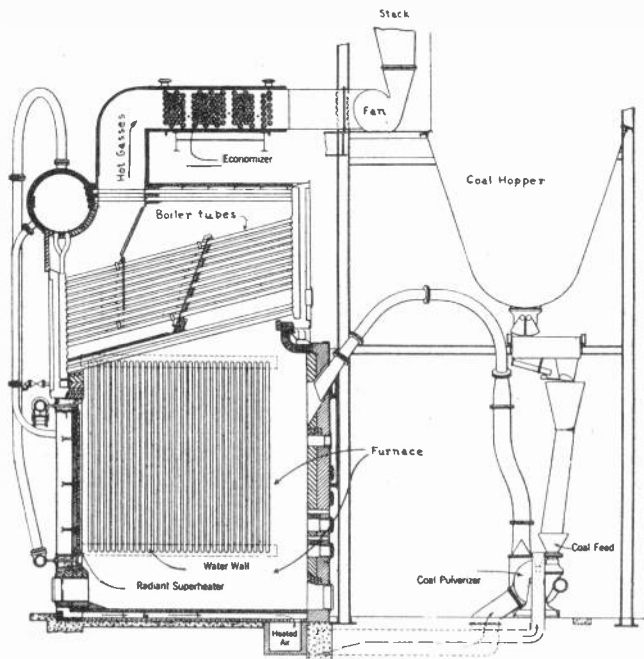

Fig. 7. Diagram of a modern power plant boiler using pulverized coal for fuel. Note the coal hopper, pulverizer, furnace feed tube, and also the economizer which is located above the boiler.

down, between a set of baffle plates and through the center section of the tubes, and finally up between the left ends of the tubes. From here the gases pass through an economizer, or another set of tubes, where they give up still more of their heat to the boiler feed-water, before passing on out of the stack.

Fig. 8 shows a sectional-view diagram of another modern type of power plant boiler using pulverized coal and having multiple sets of tubes and drums above the combustion chamber. In this boiler the powdered coal is blown downward into the combustion chamber from the tube at the upper

Alternating Current

left corner, and literally explodes as it strikes the white hot, roaring interior of this furnace.

Modern power-plant boilers have motor-driven draft fans operated by variable speed motors for accurate control of the draft, and in some cases the

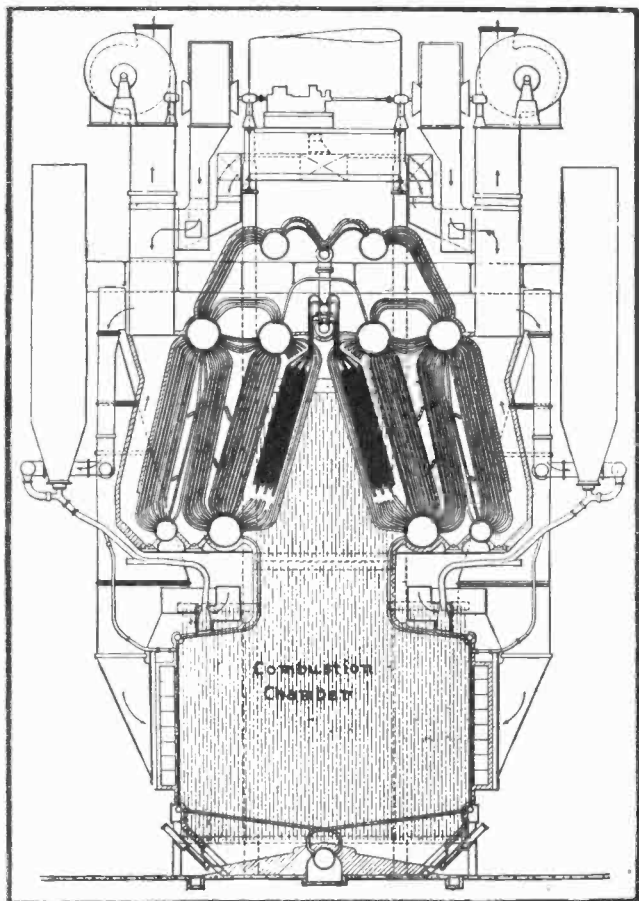

Fig. 8. Another type of large modern power plant boiler showing the combustion chamber, boiler tubes, super-heater, draft fans, etc.

draft air is preheated by stack gases before being fed to the furnace. Some plants use exhaust steam from the turbines and also the partly-cooled furnace gases to preheat the boiler feed water. By these

Generating Stations

methods very high efficiency is obtained.

Power-plant boilers commonly produce steam at pressures ranging from 200 to 600 lbs., and in some cases as high as 1200 lbs. or more, per square inch; and at temperatures ranging up to 900 degrees F. and higher.

To obtain steam at such high temperatures extra tubes and drums are provided in the upper section of the boiler just to heat the dry steam after it has

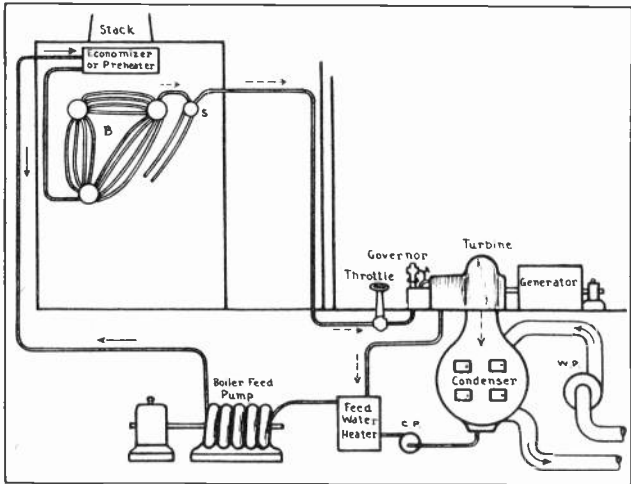

Fig. 9. This simple diagram illustrates the steam cycle or method of recirculating the boiler feed water in a modern power plant.

been produced in the main boiler. These extra heater elements are called **superheaters**.

4. EXHAUST STEAM CONDENSERS

In modern power plants the steam which is exhausted from the turbines or engines is condensed back into hot water and is used over and over again in the boiler. This saves a great deal of heat energy that would otherwise be wasted in exhaust steam and also reduces the cost of filtering and treatment of the boiler water.

In some plants this last item alone is quite a large one because the boiler feed-water has to be chemically treated to prevent it from depositing large amounts of scale in the boiler tubes. This

Alternating Current

scale, if allowed to accumulate, interferes with the transfer of heat from the tube walls to the water and greatly reduces the efficiency of the boilers.

The water which is taken from the condensers is much warmer than fresh feed water would be and is frequently heated up still more before being passed back to the boiler.

5. STEAM CYCLE

Fig. 9 shows a simple diagram of the steam cycle in a power plant. The water in the main boiler, B, is evaporated into steam and the steam is then heated to very high temperature by means of the superheater, S. From here the dry steam is fed through an insulated pipe line to the turbine. Expanding through the blades of the turbine it delivers mechanical power to drive the generator and then exhausts from the lower side of the right-hand end of the turbine casing and into the condenser.

Here the steam passes over many hundreds of small copper tubes through which cold water is kept constantly circulating. The contact of the hot steam with these cool pipes causes it to condense back into warm water and run to the bottom of the condenser to a collector called the **hot well**.

In Fig. 9 the rotary pump, W.P., circulates a large volume of cold water from a river, lake, or pond, through the cooling tubes of the condenser. The small pump, C.P., takes the **condensate** or warm water from the hot well and sends it through a feed-water heater where the temperature of the water is considerably increased by a small amount of live steam which is bled off from one of the stages of the turbine.

From the feed-water heater the water goes to a multiple stage, high-pressure boiler-feed pump which forces it on through a **preheater** or **economizer** where the water is still further heated by the hot gases leaving the furnace, and passing to the stack.

After this final heating the water again re-enters the boiler at high enough temperature so that it only requires the addition of a little more heat energy to once more evaporate it into steam.

Generating Stations

A steam cycle of this kind greatly increases the thermal efficiency of a power plant, and it is such engineering as this along with improved design of modern generators which has kept the cost of electricity low, and in many localities reducing year by year.

It is a very interesting fact that over a period of years in which the price of food, clothing, and most

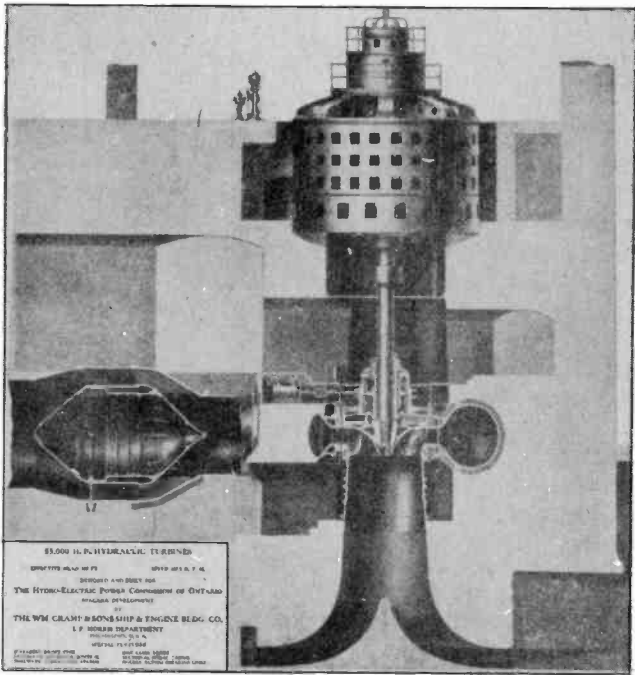

Fig. 11. Excellent sectional view of a large hydro-electric generator unit. Note the casing and runner of the water wheel and also the draft tube through which the water discharges to the tail race. The valve controlling the water flow through the wheel or turbine is shown on the left. The main part of the generator is set down in the concrete so that just the top of the unit and its exciter project above the operating floor. Courtesy Wm. Crampton & Sons Co.

all other commodities have increased considerably, the cost of electricity has not increased but instead has considerably decreased.

6. STEAM TURBINES

Most everyone knows the general operating principles of an ordinary steam engine, in which the steam is admitted by a valve to first one end of the

Alternating Current

cylinder and then the other, so that its expansion pushes the piston back and forth. This piston is attached to the drive rod which in turn fastens to the crank pin on the shaft which rotates the fly wheel.

As the intake valve is opened admitting steam to one end of the cylinder, the exhaust valve on the opposite end is opened, allowing the expanded steam which has just finished its work in that end to escape. These valves operate in synchronism with the travel of the piston and with the proper timing to admit the steam each time to the end of the cylinder at which the piston has just completed its stroke, thus forcing it back again in the other direction.

In this lesson we shall not attempt to cover in detail the mechanical construction or operation of all the parts of steam engines. But there are a great many students who have very little conception of the operating principle of a steam turbine, and as this device is so commonly used in modern power plants, a brief general explanation of its operation will be of interest.

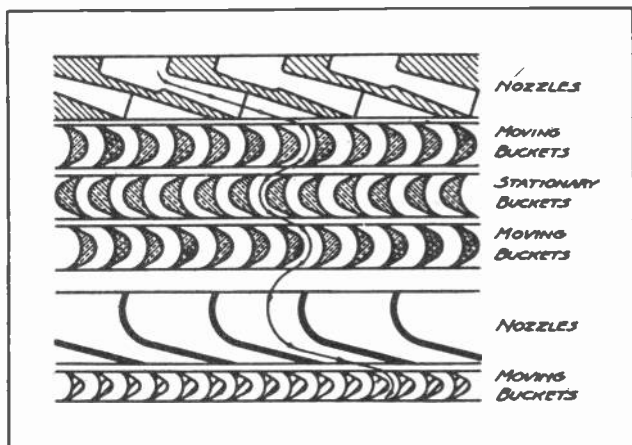

Fig. 12. This sketch illustrates the operating principles of a steam turbine. Note the nozzles and stationary and moving blades or buckets. Courtesy of Elliott Company.

Steam turbines are of two general types, called the **impulse** type and **reaction** type. In the impulse

Generating Stations

turbine live steam is directed from small nozzles directly against the blades or buckets of the rotating members of the turbine. In the reaction turbine the steam is first passed through a set of stationary blades or vanes which direct it at an angle against a set of rotating blades located close to the stationary ones.

Large turbines are often made up of a number of these sets of stationary and rotating blades which are called **stages**; the several stages in the turbine being arranged so that the steam must pass through all of them before it finally exhausts to the condenser.

In this manner almost the very last bit of power can be extracted from the steam as it expands through one stage after another, with a loss of pressure and velocity at each stage.

Fig. 12 shows a set of turbine nozzles and several sets of moving and stationary blades or buckets.

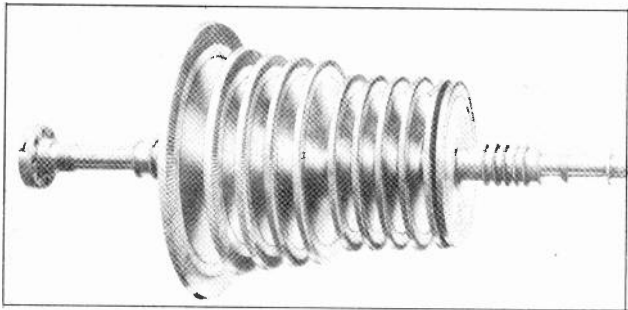

Fig. 13. Complete rotor of a modern steam turbine, showing several sets of moving blades through which the steam passes in succession. Courtesy of Elliott Company.

By following the path of the steam as traced with the arrows in this sketch you will note that it is directed against the first set of moving buckets by the nozzles and then as it leaves the edges of these moving buckets it is redirected by the stationary blades against the next set of moving buckets, thus rotating them all in the same direction.

The same action is again repeated by the next set of nozzles and moving buckets, and so on throughout the several stages of the turbine.

Alternating Current

Fig. 13 is a turbine rotor removed from its casing and shows the several sets of moving blades which are mounted on the outer edges of disks that are fastened securely to the shaft.

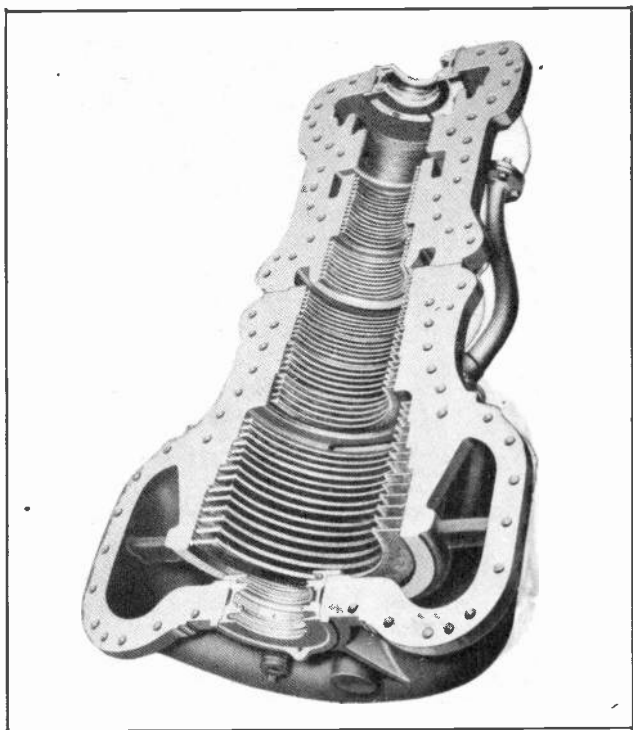

Fig. 14. One-half of a steam turbine casing showing a series of stationary blades between which the movable blades or buckets revolve. Courtesy of Allis-Chalmers Mfg. Co.

Fig. 14 shows one-half of a turbine casing with the sets of stationary blades for each stage.

You will note that the casing is smaller in diameter and the blades shorter in length at the high pressure end where the steam is first admitted to the turbine, and that both become larger as the steam expands toward the low pressure or exhaust end.

Fig. 15 shows a sectional view of a turbine, which clearly illustrates the manner in which the

Generating Stations

steam enters the turbine at the right and then passes through the several sets of stationary and rotating blades or buckets which become larger toward the exhaust end. At this end the steam discharges from the enlarged portion of the casing to the condenser, which is usually connected directly beneath the turbine

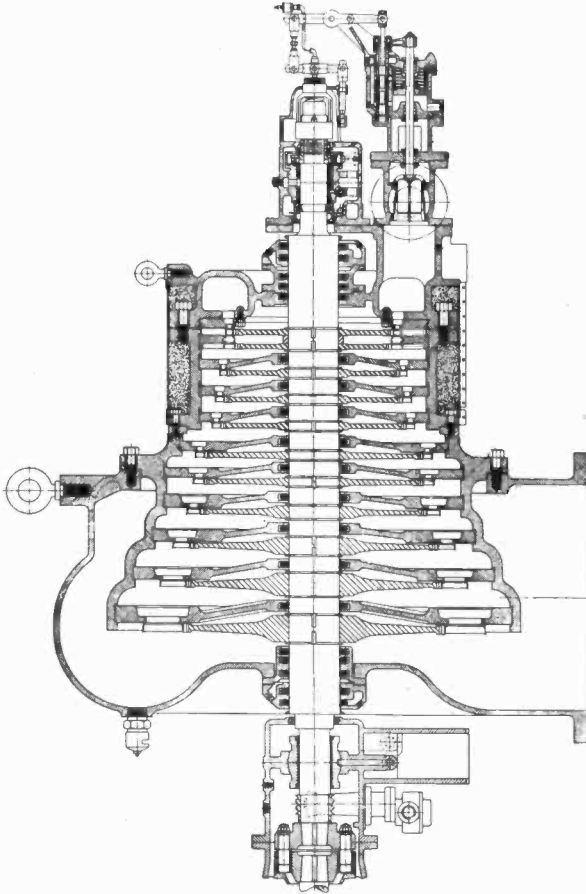

Fig. 315. An excellent sectional view of a modern steam turbine showing how the steam enters the high pressure end at the right and passes through one set of blades after another as it expands toward the exhaust end on the left. The stationary blades redirect the steam to apply its force against each successive ring of movable blades. Courtesy of Elliott Company.

Fig. 316 shows a view in a large steam-driven power plant and in the fore-ground is a 165,000-kw. generator consisting of two units operated together

Alternating Current

as one. The turbines are both shown on the left and the generators on the right. The large tubes or ducts rising from the top of the generators and passing down through the floor at the right are air passages for cooling the generators. The unit in the rear is driven by the smaller high-pressure turbine, and the steam exhausts from this turbine through the larger low-pressure turbine which drives the unit in the fore-ground.

7. HYDRO-ELECTRIC PLANTS

There are throughout this country numerous hydro-electric generating stations producing millions of horse power. These plants are located along various streams and rivers where the water has considerable fall or drop within reasonable distances, and where it is practical and economical to erect power plants, and usually where dams can be erected or natural reservoirs obtained in which to store reserve water during high-water seasons, to keep the plant operating through low-water periods.

Hydro plants are also located near to or within economical transmitting distance of the cities or markets which will consume their power.

Fig. 17 shows the interior of a large hydro-electric generating station with five large vertical type, water-wheel-driven generators. The generator units and exciters are above the power plant floor and the water wheels are located below the floors and connect to the generators by means of vertical shafts. Hydro-electric developments usually require some form of dam. The dam may be a large one and produce the total fall by raising the level of the water from the base to the crown of the dam. In other cases only a small dam may be required to close off the flow of some stream high up in a mountainous region and store water in a natural reservoir at this elevation.

In either case the water is taken under pressure from the dam through a **penstock** or large pipe

Generating Stations

leading down to the turbine or water wheels at the power house, which may be located at the base of the dam or at the foot of the mountain, whichever

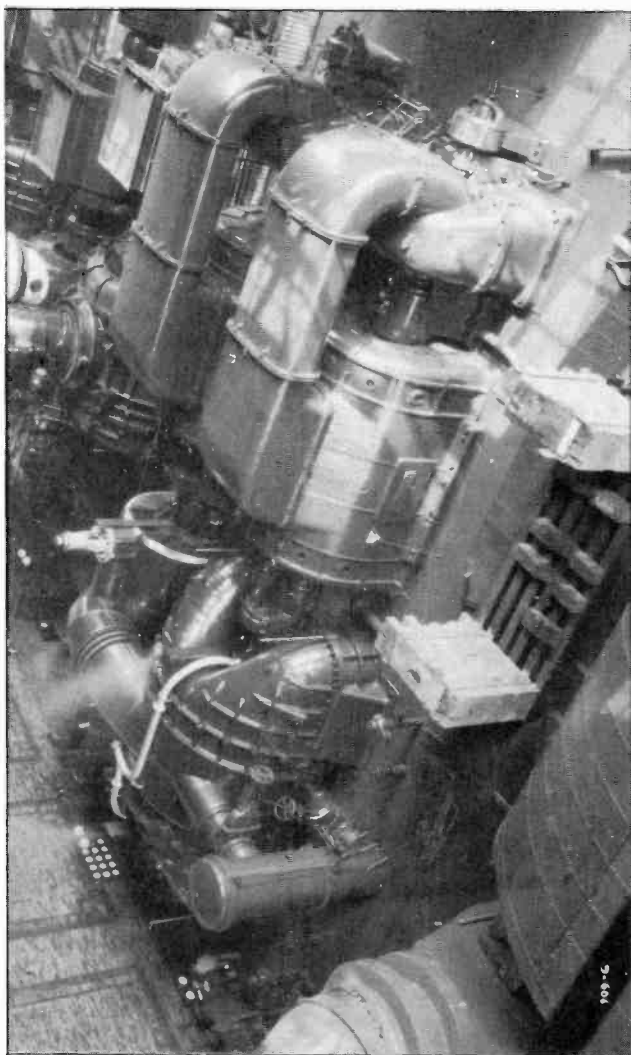

Alternating Current

the case may be. The water is then delivered through the proper valves and guide vanes to the blades or runner of the water wheels.

The horse power developed will be proportional both to the height in feet, or pounds pressure developed by this height, and to the volume of water which passes through the wheel. Some large water-power plants operate on a head or fall of only 10 or 12 feet, where enormous volumes of water are available at all times of the year.

In other cases some of the hydro plants in operation in the Rocky Mountain region of the western part of the United States utilize a height or fall of over 2,000 feet. This delivers the water to the buckets of impulse-type water wheels under terrific pressure and bullet-like velocity, and requires a much smaller volume of water to deliver a given amount of horse power.

8. WATER WHEELS AND TURBINES.

Water wheels for operation with large volumes of water at lower pressure are generally of the reaction type, having blades somewhat similar to those of a ship's propeller and operating within a casing and set of guide vanes which direct the water against the blades of the runner at the proper angle to produce maximum efficiency and power.

Fig. 11 on pages 18 and 19, shows a sectional view of a large water wheel of this type. The generator is shown above and connected to the runner of the water wheel by a large vertical shaft. On the left can be seen a large floating valve which admits the water to the turbine. The water discharges from the turbine downward through the **draft tube** and out into the **tail race** in the stream below the plant.

In "high head" plants, where the water pressure and velocity are much greater, the water is often delivered from a tapered nozzle in a hard jet which strikes against the blades or buckets of an **impulse wheel** or Pelton turbine, and rotates the wheel and generator at much higher speed than those in low head plants.

Generating Stations

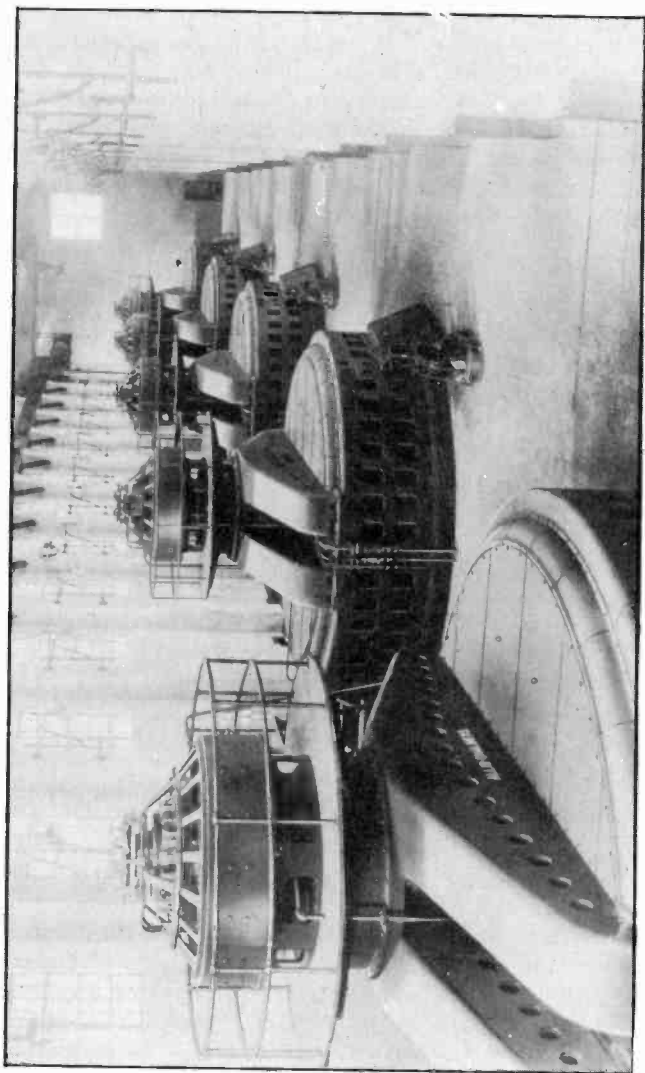

Alternating Current

Fig. 18 shows a row of generators which are driven by water wheels located beyond the wall at the right and coupled to the generators by horizontal shafts. This view is in one of the older plants at Niagara Falls. On the left can be seen the operating gallery and control board.

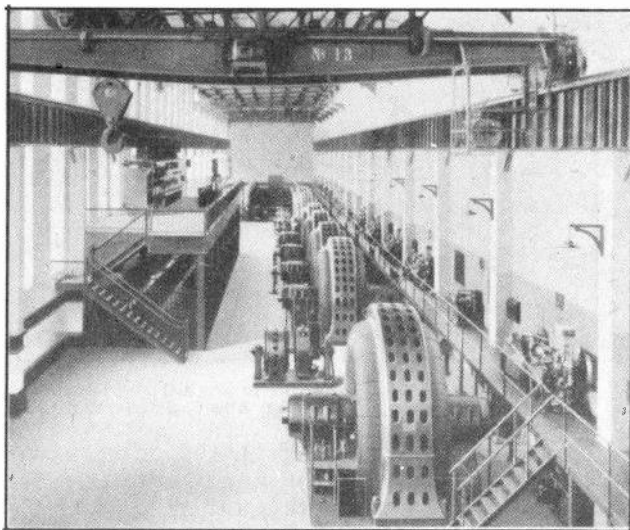

Fig. 18. Interior view of one of the power plants at Niagara Falls showing horizontal type water-wheel-driven alternators manufactured by Allis-Chalmers Mfg. Co. Also note the operating gallery and switchboard on the elevated platform at the left.

Fig. 19 shows a view in a smaller water-power plant with 560-kw. generators on the right and the switchboard on the left.

Fig. 20 shows a view in a small automatic hydroelectric plant in which the vertical-type generators are driven by water wheels beneath the floor and controlled automatically by relays on the switchboards shown in the background. Plants of this type are coming into quite extensive use for supplying power to small towns or to industrial plants which are located near to a convenient source of water power.

9. STARTING AND CONTROL OF PRIME MOVERS

In all power plants, whether they are operated

Generating Stations

by steam engines, steam turbines, Diesel engines or water wheels, the prime movers are equipped with throttle valves and governors. The throttle

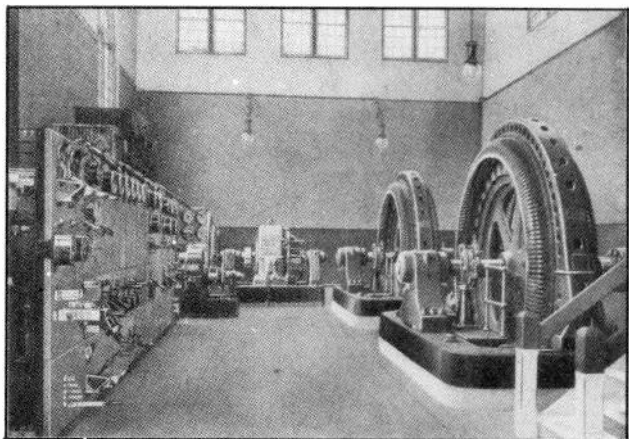

Fig. 19. View showing two small alternators and the switchboard in a hydro-electric station. Courtesy Allis-Chalmers Mfg. Co.

valves are used for starting up the prime mover and generator, and for adjusting the speed when paralleling one machine with another.

The governors are adjusted to maintain the proper speed-regulation with variation of load on the generator and thereby prevent the generator from over-speeding when load is removed, and from slowing down when the load is increased.

The proper operation of governors is therefore very essential in maintaining satisfactory parallel operation and proper voltage regulation to customers.

In some small plants the electrical operator may be required to start and take care of the prime movers as well as the generators. In large plants the prime movers are generally operated and maintained by a separate crew and the switchboard and electric operation is handled by the electrical crew.

Great care should always be used in starting prime movers and generators to start them gradually and give them the proper time to accelerate,

Alternating Current

and also in watching for any abnormal operation or indications during starting.

One should carefully check all switches in the generator circuit to see that they are in the proper positions before starting the machine, and the voltmeter and sometimes other instruments should also be carefully watched during starting.

Thorough attention should also be given to the lubrication of the prime mover before starting it, and if pressure lubrication is used the oil pumps should be started before starting the prime mover and generator. Some of the rules and steps to follow when starting generators were given in the

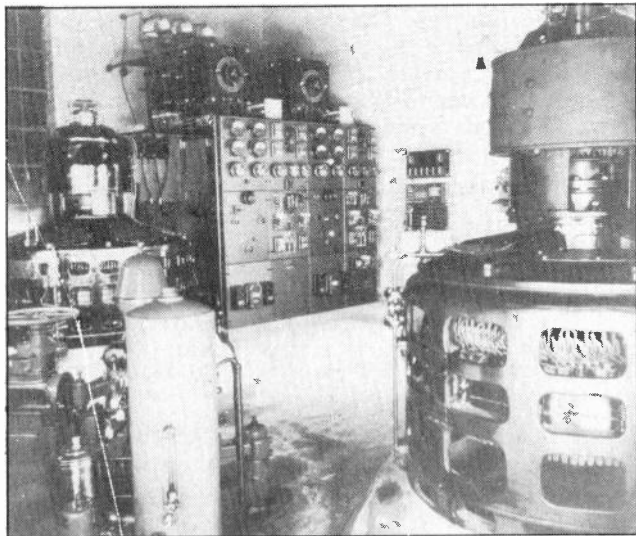

Fig. 20. Interior view of a small automatic hydro-electric generating station. The two generators can be seen in the foreground, and the switchboard in the background of this photo. Courtesy Allis-Chalmers Mfg. Co.

lesson on A. C. Generators, and others will be given later in the lesson on Operation and Maintenance

10. AUXILIARY EQUIPMENT IN POWER PLANTS

In addition to the prime movers, main generators

Generating Stations

and switchboards in power plants, there is usually also a certain amount of auxiliary equipment such as motor-operated boiler feed pumps, condensate pumps, vacuum pumps, circulating pumps, fans or blowers for cooling generators, and for boiler furnace draft, etc.

Many power plants also have step-up transformers, oil switches, and lightning arresters in an outdoor transformer and switching station, in addition to the bus oil switches inside the plant.

The care of switchboards, meters, transformers, oil switches, and auxiliary motor and control equipment in power plants often forms a very important part of the operator's duties.

In addition to the exciter-generators, power plants are often equipped with small D. C. or A. C. auxiliary generators called **house generators**, for supplying power to the auxiliary motors and equipment, at lower voltage than that produced by the main generators.

Large power plants are usually operated by remote control switchboards both for convenience and safety reasons. The remote control boards are equipped with the proper meters and instruments, and a number of small push-pull switches, knife switches, rheostats, etc., which operate low-voltage circuits which in turn energize and operate the large high-voltage oil switches, motor-controlled rheostats, throttles, governors, etc.

The low-voltage energy for operating the oil switches and remote-controlled equipment is generally obtained from operating busses supplied with low-voltage D. C. from a small D. C. generator.

Large storage batteries are also included in many power plants for supplying energy for the operating busses, exciter busses, emergency lighting equipment, etc., in case of trouble with the D. C. generators or plant circuits.

11. POWER PLANT RULES

In all large plants there are rigid operating rules and safety rules to be followed in order to protect expensive equipment, to protect operators, and to

Alternating Current

provide satisfactory and uninterrupted service to customers.

These rules vary somewhat according to the type of plant and the policies of the power company or owners. The majority of the more important rules have been covered in preceding lessons; and careful application of your knowledge of the operation and care of electrical equipment, and good common sense combined with a desire to learn and co-operate with any special rules which may be maintained by any power company for whom you may be employed, will be of greatest importance to your success in this field.

Power plant operation is one of the most fascinating and interesting branches of electrical work and offers splendid opportunities to the man with thorough practical training who will perform his operating duties thoughtfully, cautiously, and intelligently, and who is willing to study conscientiously all phases of plant operation and companies' policies in order to obtain promotion. By following this policy you can reach positions of excellent pay and considerable responsibility in this field.

Generating Stations

EXAMINATION QUESTIONS

1. What are the important factors to be considered in selecting a location for a power plant?
2. Name three types of prime movers commonly used for operating Electric generators.
3. Briefly describe the operation of a steam turbine.
4. What is the advantage of condensing the exhaust steam from a turbine?
- 5A. What is the principle advantage of a water turbine over a steam turbine?
- 5B. Under what conditions is a steam plant more economical than a hydro plant?
6. What items should be carefully checked when starting power plant generators?
- 7A. What is a "house generator" used for in a power plant?
- 7B. What are storage batteries used for in some power plants.
8. Why are power plant operating rules important?
9. What steam pressures and temperatures are commonly used in modern steam electric generating stations?
10. Which type water wheel is usually selected for use with large volumes of water at low heads?

POWER TRANSMISSION

Electrical power transmission and distribution provide a very great field of opportunity for trained electrical men in one of the most interesting and profitable branches of work in the electrical field.

We have already learned that one of the principal advantages of A. C. electricity is that it can be transformed to very high voltage for more economic transmission over long distances.

Many thousands of miles of high-voltage transmission lines span this country today, and silently and efficiently carry thousands of horse power of electrical energy from large steam and water-power generating plants to the various towns and industrial plants where it is used.

Many recently installed lines are supplying low cost electrical energy to small towns and communities which formerly were entirely without electricity or which had only a limited supply at almost prohibitive cost to the users.

Fig. 2 shows a high-voltage transmission line running across the country on steel towers. One three-phase circuit is already in operation on this line and space for another circuit is provided on the opposite side of the same towers.

The construction of electrical transmission lines has progressed even beyond the towns and larger load centers to a point where hundreds of thousands of farms are now connected to electrical lines and supplied with the great conveniences and economical benefits of electricity.

Economical transmission of electrical power has played a very large part in the industrial progress and general prosperity of this country and Canada, as well as many others of the more progressive countries in the world today.

It is difficult to find in this country a town of any size that is not supplied with electricity or even to find a rural district of very large area in which some of the farms are not already supplied with electricity.

Power Transmission

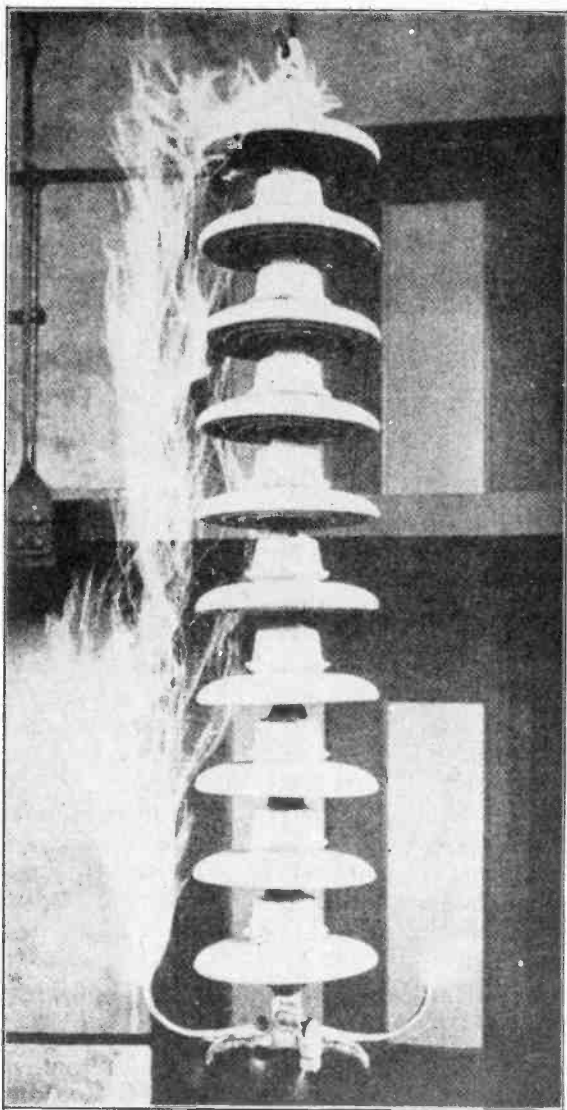

Fig. 1. This very interesting photograph shows an actual flashover or high-voltage arc on a string of 10 suspension insulator units. This flashover was made with 500,000 volts in a test laboratory, but similar flashovers occur on line insulators in service, due to lightning. Courtesy Ohio Brass Co.

Alternating Current

Electrification is rapidly progressing throughout all parts of the country and the trained man who has a good knowledge of power transmission and distribution can find numerous opportunities for

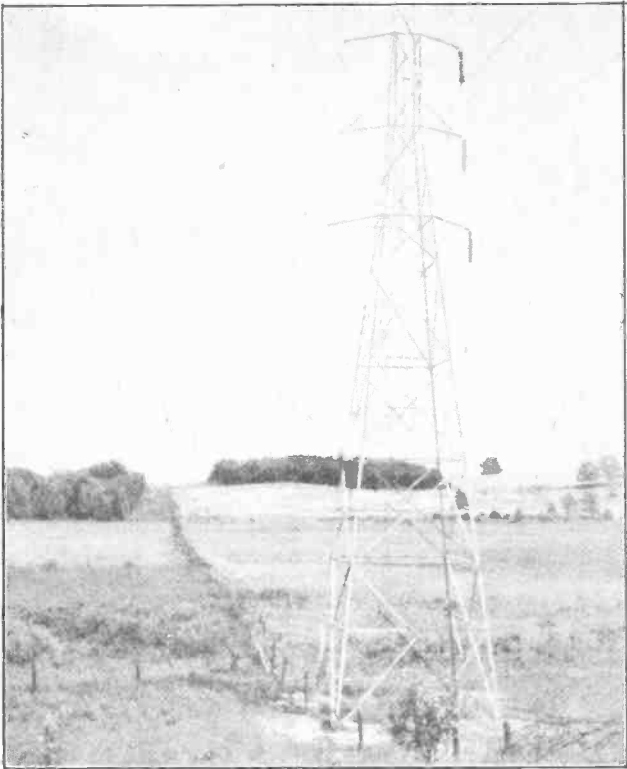

Fig. 2. Modern high-voltage transmission line carrying thousands of horsepower silently and efficiently across the country on small copper conductors.

interesting and profitable work with power companies who are constantly building new lines and extending their present ones. There is also a tremendous field of opportunity for trained men to go into various rural districts and promote farm electrification.

Power Transmission

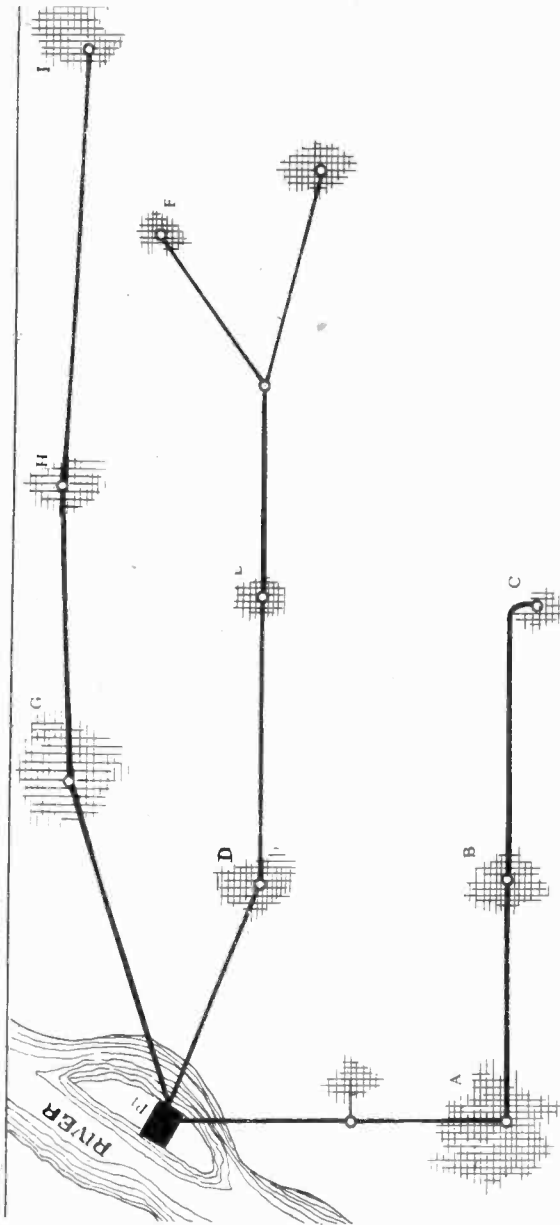

Fig. 3. This diagram shows the location of a central station power plant and the layout of a transmission system. The power plant is located at the river where fuel and condensing water are easily available and the transmission lines feed the generated energy to sub-stations located in the various towns.

Alternating Current

1. TRANSMISSION VOLTAGES AND SYSTEM LAYOUT

The electrical power generated in central stations is generally transmitted at high voltages to substations, from which it is distributed at lower voltage to the customers.

Large towns may have a number of substations located in various sections of the city, and small towns and large factories may each have their individual substations.

Large power plants generate most of their power at voltages ranging from 2,300 to 13,200 volts, or more. These voltages are high enough for economical transmission and distribution over distances from 3 to 15 miles and can be reduced to the voltage used for light and power by means of transformers at the substations or customer's premises.

Where power is to be transmitted greater distances the voltage is stepped up by transformers at the power plant to values ranging from 22,000 to 290,000 volts, according to the distances the power is to be transmitted.

Practically all large transmission lines in this country are 3-phase and most of them are 60 cycle, although some still operate on 25 cycle energy.

A number of large central stations as well as many of the smaller power plants are commonly tied together into one vast super-power system or network, greatly improving the operating efficiency of many of the plants and also improving the dependability of service to the customers.

Connecting a number of plants together in this manner makes it unnecessary to carry so much reserve equipment at each plant for peak loads and enables all of them to operate at nearer full-load capacity. The peak loads on various plants often come at different periods of the day and are distributed over all the stations connected in such a network.

These interconnections also provide a much greater total generating capacity on the system and

Power Transmission

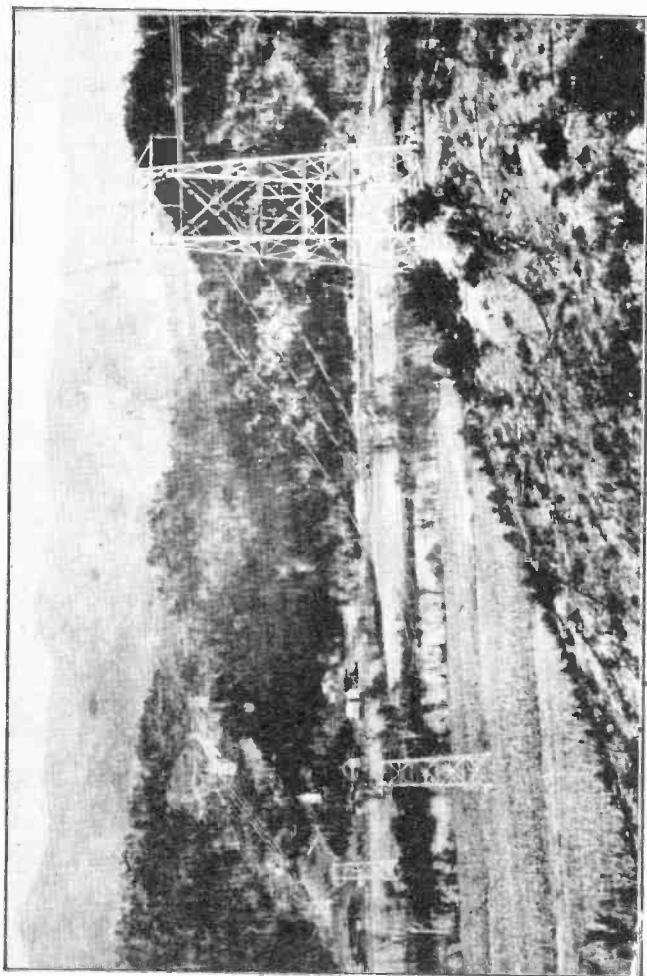

Alternating Current

decrease the liability of service interruption in case of failure of any one generator or plant.

The figure on the opposite page shows an excellent view of another high-voltage transmission line running through a mountainous region in one of the southern states.

2. UNDERGROUND TRANSMISSION

There are two general methods of electrical power transmission, namely the underground and overhead systems. The overhead system costs a great deal less per mile and is therefore generally used for lines extending through the country.

Underground systems are used principally in large cities where it would be very undesirable to have a network of high-voltage wires overhead. One can readily see that running high-voltage power lines on poles, along with all the wires used for lighting, telephone, and telegraph service in large cities would not only create a bad appearance but would also cause inconvenient obstruction and actually be dangerous.

For this reason in practically all large cities electrical power wires are run through underground conduits or tunnels. Underground conductors are generally run through **ducts** or conduits which are laid several feet below the street level and have outlets provided at small underground rooms or compartments located at intervals of several hundred feet apart.

Access can be had to these underground compartments by means of **manholes** provided in the streets and equipped with heavy, iron covers. Lengths of cable can be spliced together and branch runs attached in these manhole compartments, and in some cases small transformers or other equipment may also be located in them.

Underground ducts are commonly made of vitrified clay or tile, which is obtained in standard lengths and laid in a ditch or trench. The ends of the short lengths are cemented together to prevent

Power Transmission

dirt or water from entering at the joints and the tile is then covered over with dirt and pavement.

In some cases ducts made of concrete and special fibre are also used for underground work.

Ducts for underground wiring are laid with a small amount of slope toward the manholes, so that if any water leaks into the ducts it will drain to one end where it can be run off into a sewer or pumped out so that it doesn't ground the electrical conductors.

These ducts are provided with 2, 4, 6, 8, or more, separate openings or compartments, as shown in Fig. 5. On large important circuits just one cable

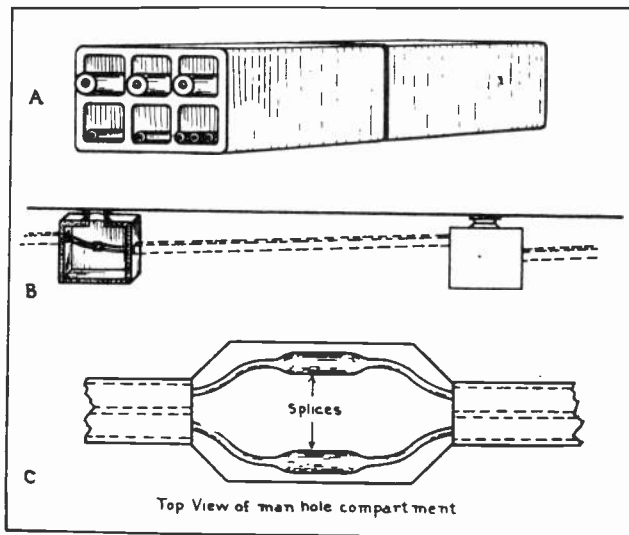

Fig. 5. "A" shows underground conductors run in tile ducts. "B". This sketch shows the arrangement of man holes and cable ducts underground. "C". Cables spread apart and supported in racks on the walls of man holes allow working room for making splices, tests, etc.

is often run in each duct or compartment, while with smaller circuits at lower voltage the several conductors of the complete circuit may be run in one compartment.

3. PULLING IN UNDERGROUND CABLES

To get the wires and cables into an underground duct a fish tape or pilot line is first passed through

Alternating Current

the duct and then used to draw in the cables by pulling them in a section at a time from one manhole to the next.

In some cases the fish tape is pushed through the duct from one manhole to the next by use of joined sections of wooden rods which can be attached together one section at a time in the manhole compartments as the rod is pushed through the duct.

It is then taken apart and removed one section at a time from the next manhole opening, except in cases where it may be desired and possible to push it on through for several more runs.

In other cases a small cord is blown through the duct by compressed air and then used to pull in a heavier rope, which in turn is used to draw in the cables. The cable is usually supplied in large reels which are placed close to the manhole opening at which the end of the cable is to be started into the duct.

Proper guides or protection should be provided to prevent excessive friction and damage to the cable sheath or insulation where it rubs on the corners of the manhole.

Pulling in large underground conductors requires considerable power, and a hand or motor-operated winch is generally used for this purpose. Liberal application of powdered soapstone or mica will tend to lubricate and greatly aid the passage of the conductors through the conduit. When the sections of conductor have been pulled into the ducts their ends can then be spliced at the manhole compartments.

4. TYPES OF UNDERGROUND CABLES

There are many different kinds of cable in use for underground work. Some of them have heavy insulation with a moisture-proof covering, and most of them also have a lead sheath over the surface of the insulation. Lead sheath cables are much more moisture-proof and less subject to mechanical injury to the insulation.

The thickness of the lead sheath ranges from about $1/32$ of an inch on small conductors to well

Power Transmission

over $\frac{1}{8}$ of an inch on larger cables. Some underground cables have only one conductor, while others

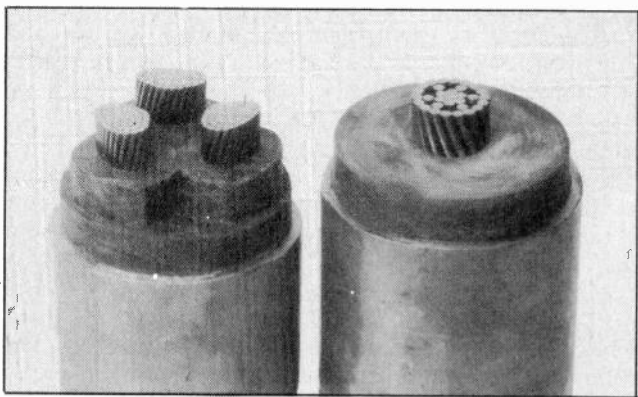

Fig. 6. These views show sections of high-voltage three conductor and single conductor, underground transmission cables. Note the arrangement of conductors and insulation inside of the lead sheath. Courtesy General Electric Co.

have two or three conductors separately insulated but enclosed within the one lead sheath.

A section of each of these types of lead-covered cable is shown in Fig. 6.

Various types of insulation are used on underground cables, some of the most common being rubber, varnished cambric or empire cloth, oiled paper, and various insulating compounds.

Cables with a solid group of stranded conductors twisted into one and insulated with these materials, can be designed for voltages as high as 66,000 by applying the proper thickness of insulation between the conductor and lead sheath.

For quite a number of years it was thought that 66,000 volts was the highest practical voltage for underground cables, but within the last few years the General Electric Company of this country and the Parelli Company of Italy have each developed a special type of cable which is capable of withstanding pressures of 132,000 volts. Sections of this cable several miles long are in operation at 132,000 volts both in Chicago and in New York, and other installations are being planned.

Alternating Current

In these cables the insulation consists of 23/32 of an inch of special paper between the conductor and the lead sheath. The copper conductor is of the stranded type, which is twisted or built up around an inner brass spiral which serves to provide a hollow opening throughout the conductor from one end to the other.

This opening allows the free circulation of insulating oil throughout the cable at all times, and this is one of the important factors in its successful operation at this very high voltage.

When this cable is installed in the ducts the ends are joined in special oil tanks located every few hundred feet apart. The air is then exhausted from the cable by vacuum pumps and insulating oil allowed to enter to fill all spaces not occupied by the conductor and insulation.

All cables are subject to a certain amount of expansion and contraction due to changes of temperature and load during operation. This expansion and contraction produces one of the most serious difficulties encountered in the operation of high-voltage cables.

In ordinary cables the expansion causes the forcing out of insulating compound and possible bulges in the cable sheath and insulation. Then when the cable cools and contracts air pockets are formed at these points. These air pockets provide weak spots at which the insulation is much more likely to puncture or break down.

In the new high-voltage cable just described this condition is prevented by allowing the free circulation of oil throughout the cable's length. When the cable expands the oil is forced out of the cable and into the reservoirs. When the cable cools and contracts the oil is again drawn in. This prevents the formation of air pockets and also presents the breathing in of any moisture as would occur if air were allowed to enter the cable.

5. CABLE HANDLING AND SPLICING

When installing any lead-covered cable great care should be exercised not to allow the sheath to be-

Power Transmission

come damaged in any way. The cables should not be bent in sharp curves or angles at any time during their handling, as this greatly weakens the dielectric strength of the insulation and is also likely to crack the lead sheath.

In making splices in underground cables the joint in the conductor must be carefully and thoroughly insulated with special tapes of rubber, paper, or varnished cloth, which is carefully and tightly lapped back over the insulation on the cable ends to provide insulation over the joint as good as that along the cable.

A large lead sheath which has been slipped over one end of the cable before making the splice is then drawn into space over the insulated joint and securely soldered to the lead sheath on the cable ends. The joint can then be boiled out by pouring hot compound through it, and finally filled with hot insulating compound and sealed to exclude all moisture.

Figs. 13 and 14 in Lesson 16 showed several very good views of cable splices in the process of being made.

6. OVERHEAD TRANSMISSION LINES AND COMMON VOLTAGES

Overhead transmission lines as previously mentioned are much more extensively used for transmitting power over long distances across the country, because of their cost being much lower than underground construction. There are a number of different voltages in use on high-tension transmission lines today, but there is a general tendency at present to standardize on the more common and convenient of these voltages.

Newer installations of both transmission and distribution lines will generally be found to have one of these more or less standard or preferred voltages. This greatly reduces the variety and number of different voltage designs of transformers and electrical equipment used with the lines, and greatly increases the convenience and economy of interconnection between different lines.

Alternating Current

Standardization of generators, transformers, lightning arresters, insulators, and line equipment means that more devices of one kind can be produced and thereby reduce their cost.

The table in Fig. 7 shows a number of the different voltages which are in common use, except the last one of 330,000 volts which is planned for future transmission line developments. The small stars in the columns following these voltages indicate the uses to which they are most commonly put, and those in the last column under "preferred voltages" indicate the voltages which are more generally used and are becoming standard.

Common voltages	Industrial Plant motor voltages	Generating voltages	Transmission voltages	Preferred voltages
110	*			*
220	*			*
440	*			*
550	*			
2200 or 2300	*	*	*	*
4000			*	*
4400		*		
6600		*		
11000		*	*	
12000		*		
13200		*	*	*
22000		*	*	
33000		Developing	*	*
44000			*	
66000			*	*
88000			*	
110000			*	
132000			*	*
140000			*	
165000			*	
220000			*	*
330000			future	

Fig. 7. The above table shows the more common voltages in present day use for lighting and power purposes and for electric power distribution and transmission.

Whenever you may be placed in a position to select new equipment or plan a transmission line installation, it will be well for you to select the equipment for one of these preferred voltages, unless existing equipment and conditions make it impractical. You should at least give one of these voltages considerable thought before selecting any other.

Power Transmission

The method of calculating the proper voltage to use for a given transmission line will be covered in the next lesson.

Overhead transmission lines consist primarily of the proper conductors to carry the current; insulators to support the conductors and give them the required insulation according to the voltage used; line supports, such as poles or steel towers; and the proper protection from lightning, overload, and short circuits.

Each of these important items will be considered separately.

7. CONDUCTORS

There are now in use for transmission lines several different types of conductors, the most common of which are copper, aluminum, and copper-clad steel. Each of these has its advantages for different applications.

Copper conductors are used on the great majority of lines because copper is an excellent conductor, is reasonably cheap, and is available in large quantities.

We know that silver is a slightly better conductor of electricity, but because of its very high cost it would be prohibitive for use in a transmission line conductor.

Copper is the next best conductor and it is therefore generally used, even though its cost is high enough to make it one of the major items of cost in the construction of a line.

8. HARD DRAWN COPPER CONDUCTORS

There are two forms of copper wire, namely hard drawn copper and annealed or soft copper. Hard drawn copper has approximately twice the tensile strength of annealed copper, and for this reason is most generally used on transmission lines, where considerable strength is required to support the long spans between poles and towers.

Hard drawn copper has a tensile strength of about 55,000 lbs. per square inch of conductor cross-sectional area.

Alternating Current

Annealed copper has a conductivity within two or three per cent of that of silver, while hard drawn copper has a conductivity just slightly less than annealed copper.

For lines of small capacity solid hard drawn copper conductors are commonly used, but on lines requiring wires larger than No. 2 or No. 4 B. & S. gauge stranded copper conductors are generally used. The stranded conductors are more flexible and provide better heat radiation.

In handling and installing hard drawn copper wire great care must be exercised not to make any deep scratches or nicks in the wire, or it is likely to break off at these points.

PROPERTIES OF BARE AND INSULATED STRANDED COPPER WIRE

American Wire Gauge (B. & S.)	Area		Number of Wires in Strand	r in Inches				Weight in Pounds per 1000 Feet				Resistance Ohms per 1000 Feet at 20°C. (68° Fahr.) Standard Annealed	Area in Square Millimeters	Metric Wire Gauge B & S
	Circular Mils	Square Inches		Bare		Over Insulation		Bare		Insulated				
				3-Braid	3-Braid	3-Braid	3-Braid	3-Braid	3-Braid					
2,000,000	1.3706	91	1.630	1.875	2.000	6206	6090	7008	.005,289	1013.5				
1,750,000	1.3744	91	1.526	1.781	1.906	5429	5394	6193	.005,045	886.8				
1,500,000	1.1781	91	1.412	1.656	1.781	4654	5098	5380	.007,062	760.1				
1,250,000	.9817	91	1.299	1.531	1.656	3878	4284	4506	.006,463	635.4				
1,000,000	.7854	61	1.182	1.406	1.531	3100	3456	3674	.010,578	508.7				
900,000	.7069	61	1.094	1.312	1.437	2790	3127	3332	.011,753	456.1				
800,000	.6283	61	1.031	1.260	1.375	2480	2799	2992	.013,223	406.4				
750,000	.5891	61	.998	1.218	1.343	2325	2635	2822	.014,104	380.1				
700,000	.5498	61	.964	1.187	1.312	2170	2471	2650	.015,112	354.7				
600,000	.4712	61	.893	1.109	1.234	1860	2093	2235	.017,631	304.0				
500,000	.3927	37	.813	1.000	1.109	1548	1765	1894	.021,157	253.4				
450,000	.3534	37	.772	.937	1.062	1393	1601	1724	.023,506	228.0				
400,000	.3142	37	.728	.906	1.031	1239	1436	1553	.026,447	202.7				
350,000	.2749	37	.681	.843	.968	1083	1248	1345	.030,225	177.4				
300,000	.2356	19	.629	.796	.921	926.0	1063	1174	.035,262	152.9				
250,000	.1963	19	.574	.750	.876	771.7	897	985	.042,315	128.7				
211,800	.1962	19	.528	.687	.812	653.1	745	800	.049,59	107.2	0000			
000	167,800	1318	19	.470	.671	.734	512.1	604	.053,04	85.94	000			
0	133,100	.1045	7	.413	.625	.687	407.0	482	.079,49	67.42	00			
0	105,500	.09289	7	.368	.578	.640	322.4	388	.100,24	53.48	0			
1	83,900	.08573	7	.328	.531	.593	255.5	308	.1296	42.41	1			
2	66,370	.08213	7	.292	.468	.531	202.5	246	.1694	33.83	2			
3	52,640	.04134	7	.260	.421	.468	160.6	190	.2009	26.67	3			
4	41,740	.03278	7	.232	.390	.437	127.4	155	.2535	21.16	4			

For weight or resistance per mile multiply values per 1000 feet by 5.28.
 Weight and resistance of actual strand may vary from calculated quantities in table.
 Due to twist in strand weight and resistance increases about 2% over solid wire.

Fig. 8. This table gives a lot of valuable data on stranded copper wire for transmission line conductors and will be very convenient for reference in making calculations for any transmission line.

Joints or splices in hard drawn solid copper are frequently made by means of a splicing sleeve or short piece of twin copper tubing known as a Mc-Intyre sleeve. The conductor ends are placed in this short section of tubing from opposite ends and both the conductors and the tubes are then twisted around each other, resulting in a joint which is secure both mechanically and electrically.

These joints do not require soldering and thereby avoid the heat of the soldering operation, which would tend to soften the hard drawn copper and reduce its strength.

Power Transmission

One of the advantages of copper conductors over aluminum is that they can be readily soldered when necessary and this is often a great advantage in localities where the conductors are subjected to corrosive gases or salt mist.

Special splicing devices in the form of short pieces of heavy copper tubing are often used, and are gripped securely to the ends of the conductors by means of special threaded wedge grips or by squeezing under hydraulic pressure.

CONDUCTOR DATA—COPPER (H. D.)

A. W. Gage	Area Cir. Mills	OUTSIDE DIAM.—INCHES			STRENGTH—LBS.	
		Solid Bare	Cable Bare	Cable T.B.W.	Solid Bare	Cable Bare
	2000000		1.630	2.125		
	1750000		1.526	2.000		
	1500000		1.412	1.875		
	1250000		1.289	1.750		
	1000000		1.152	1.656		
	950000		1.123			
	900000		1.094	1.609		
	850000		1.063			
	800000		1.031	1.563		
	750000		.998			
	700000		.964	1.469		
	650000		.929			
	600000		.893	1.328		
	550000		.853			
	500000		.813	1.108		22500
	450000		.772	1.070		20500
	400000		.728	1.020		18300
	350000		.678	.978		15600
	300000		.628	.930		13500
	250000		.573	.862		11400
0000	211690	.460	.527	.785	8100	9100
000	167772	.410	.470	.728	6700	7400
00	133079	.365	.413	.662	5500	5900
0	105625	.325	.368	.605	4500	4700
1	83694	.289	.328	.518	3600	3800
2	66358	.258	.291	.440	3000	3000
3	52624	.229	.260	.408	2400	2400
4	41738	.204	.231	.379	2000	1900
5	33088	.182	.206	.351	1500	1500
6	26244	.162	.183	.327	1300	1200

Fig. 9. This table gives convenient data on hard drawn copper conductors of both the solid and stranded types and also on insulated cables.

The table in Fig. 8 gives some very convenient data on large stranded copper conductors, and Fig. 9 gives additional comparative data on solid and stranded conductors. These tables will be very convenient for reference on transmission line construction problems.

9. ALUMINUM CONDUCTORS

Aluminum conductors are also quite extensively used for overhead transmission lines. Aluminum has less than $\frac{1}{2}$ the tensile strength of copper and for this reason aluminum line conductors are generally made with a steel core or wire in their center to provide the added strength necessary for supporting the long spans. Such conductors are usually referred to as A.C.S.R., meaning "aluminum cable—steel reinforced."

Alternating Current

Very few all aluminum conductors are used, because of their low tensile strength and due to the fact that a very small amount of swaying will cause the cable to break at points where it is fastened to insulators.

CONDUCTOR DATA—A. C. S. R. BARE

(Aluminum Cable, Steel Reinforced)

A.C.S.R. Area in C.M. or A.W.G.	Copper Equivalent C.M. or A.W.G.	Diam. Ins.	USUAL STRANDS			Tens. Limit Lbs.	Ult. Strength Lbs.
			AJ.	St.	Diam.		
1590000	1000000	1.544	54	7	1716	38500	55900
1510500	950000	1.506	54	7	1673	36600	53200
1431000	900000	1.465	54	7	1628	34700	50300
1351500	850000	1.424	54	7	1582	32700	47400
1272000	800000	1.382	54	7	1535	30800	44600
1192500	750000	1.337	54	7	1486	28800	41900
1113000	700000	1.292	54	7	1436	26900	39000
1033500	650000	1.246	54	7	1384	25000	36300
954000	600000	1.196	54	7	1329	23100	33500
900000	560000	1.162	54	7	1291	21800	31600
795000	500000	1.093	54	7	1214	19250	27950
715500	450000	1.036	54	7	1151	17360	25200
636000	400000	977	54	7	1085	15400	22300
605000	380500	953	54	7	1059	14675	21270
500000	314500	904	30	7	1291	17400	24080
477000	300000	883	30	7	1261	16600	22600
397500	250000	806	30	7	1151	13800	19170
336400	0000	741	30	7	1059	11715	16200
266800	000	633	6	7	0795	6470	9385
211600	00	564	6	1	1880	5940	8435
167805	0	501	6	1	1670	4690	6660
133079	1	447	6	1	1490	3730	5300
105534	2	398	6	1	1327	2960	4200
83694	3	355	6	1	1182	2355	3340
66373	4	316	6	1	1052	1860	2660
52634	5	281	6	1	9938	1480	2100
41742	6	250	6	1	9834	1170	1665

Fig. 10. Convenient data on sizes, number of strands, and strength of steel cored aluminum cable. Refer to these tables frequently when working the transmission line problems on the following pages, and also for data to simplify your problems in the field.

An aluminum conductor of a given size weighs only about $\frac{1}{3}$ as much as a copper conductor of the same size, and the aluminum conductor has about 62% of the conductivity of the copper conductor.

Considering both of these factors, we find that of two lines of equal current capacity, one being made of copper and one of aluminum, the aluminum conductor will have a weight of only 48% of that of the copper conductor.

For this reason steel-core aluminum conductors are frequently used for long spans where transmission lines are required to cross rivers, lakes, or valleys in which it is difficult to place towers.

Aluminum also has the added advantage that sleet ice will not cling to its surface as it does to a copper conductor. This greatly reduces the weight on aluminum conductors and the strain on insulators and towers during sleet storms.

One of the disadvantages of aluminum conductor is that it is very difficult to solder. For this

Power Transmission

reason most of the splices or joints in these conductors are made with special clamps or mechanical grip devices.

One method of splicing these conductors is to place their ends in an aluminum sleeve, which is then subjected to a pressure of about 100 tons by means of a hydraulic jack. This great pressure causes the aluminum of the conductor and that of the splicing sleeve to actually flow together, thereby making a solid joint.

Characteristics	Annealed Copper	Hard Drawn Copper	Aluminum	Steel
Conductivity in per cent	100	98	62	12.2
Tensile Strength in lbs. per sq. in.	34000	55000	26000	65000
Expansion Coefficient per deg. F.	.0000096	.0000096	.0000128	.0000064
Weight in lbs. per cu. ft.	555	558	167	490
Weight in lbs. per cu. in.	.321	.323	.0967	.284

Fig. 11. Comparative data on conductivity, strength, weight, and expansion of copper and aluminum conductors.

The table in Fig. 11 gives a comparison of a number of the important characteristics of copper aluminum, and steel conductors.

Fig. 12 shows another table which gives dimensions, resistances, weight, and other characteristics of aluminum conductors of different sizes. Observe these tables carefully and note the data given, and then remember where to refer to this information on any future line problems which you may have.

10. INSULATORS

The conductors of low-voltage overhead distribution lines within city limits are often covered with weather-proof insulation, while the conductors of high-voltage transmission lines outside of the city limits are practically always bare.

Whether these conductors are insulated or not, they must be supported on special insulators to keep them permanently and well insulated from the poles or towers on which they are mounted.

Alternating Current

The size and shape of these insulators depends upon the voltage used and they must always be large enough to prevent a flashover of the high-voltage energy from the conductor to wet poles or steel towers which are grounded.

Transmission line insulators are commonly made of porcelain or glass which is molded into the proper shapes and sizes.

Pyrex glass has become quite commonly used in the last few years, particularly for insulators of the smaller sizes. This glass possesses the advantage of being transparent so that any small defects can easily be noted, but it has the disadvantage of being easily broken or shattered if bumped against any hard object.

Porcelain is somewhat more rugged and a light bump will usually only chip the insulator instead of shattering it as is more likely to occur with the glass.

For these reasons porcelain is by far the more commonly used for line insulators. Porcelain is made chiefly from non-metallic rock known as feldspar, and silica. Sometimes these materials after being finely ground are mixed with other forms of clay and the entire mass is then molded into the proper shapes and baked or fired in a kiln.

After this first baking or firing the insulators are given a coat of glazing material which is evenly distributed over their surfaces. They are then replaced in the kilns and again heated to a temperature which melts the glazing material, causing it to flow evenly over the surface and unite with the porcelain.

This glazing material forms a hard glassy surface on the outside of the insulators and prevents moisture, dust, and dirt from entering the pores of the porcelain. The glazing greatly improves the dielectric strength of the insulator and increases its life under outdoor weather conditions.

Great care should be used in handling porcelain insulators not to crack or chip the protective glazing on the surface.

Power Transmission

Line insulators are made in several different forms, the most common of which are the Pin type, Suspension type, Strain type, Pedestal type, and Bushing type.

11. PIN TYPE INSULATORS

Fig. 13 shows two common types of pin insulators designed for different voltages which are

ALUMINUM CABLE STEEL REINFORCED

(A.C.S.R.)

A.C.S.R.		ALUMINUM AREA		COPPER EQUIVALENT		USUAL STRANDING (INCHES)		ELASTIC LIMIT, LBS.	ULT. TENS. LBS. STR. TENS. LBS.	OHMS PER 1000 FEET (61%)	DIAM. INS.	WEIGHT—POUNDS						
		CIRCULAR MILS.	SQUARE INCHES	C. M. OR NO.	SQUARE INCHES	ALUMINUM	STEEL					TOTAL	PER 1000 FEET	PER MILE				
B. & S. GAGE NO.	(A.W.G.)											AL.	STEEL	TOTAL	AL.	STEEL	TOTAL	
.....	900000	.7080	586000	.4442	54 x .1291	7 x .1291	21800	31800	.0193	1.182	1158.0	844.0	314.0	6120	4462	1658	
.....	785000	.6244	500000	.3927	54 x .1214	7 x .1214	19250	27850	.0217	1.083	1024.0	747.0	277.0	5407	3944	1463	
.....	715000	.5820	450000	.3532	54 x .1151	7 x .1151	17360	25200	.0241	1.038	920.0	671.0	249.0	4857	3542	1315	
.....	605000	.4750	380500	.2987	54 x .1059	7 x .1059	14675	21270	.0286	.953	779.0	568.0	211.0	4113	2999	1114	
.....	500000	.3927	314500	.2468	30 x .1291	7 x .1291	17400	24080	.0347	.904	783.0	469.0	314.0	4135	2477	1658	
.....	397500	.3122	250000	.1962	30 x .1151	7 x .1151	13250	19170	.0435	.806	622.0	373.0	249.0	3284	1969	1315	
.....	336400	.2642	N.G. 4/0	.1662	30 x .1059	7 x .1059	11715	16200	.0515	.741	527.0	316.0	211.0	2783	1669	1114	
.....	266800	.2094	N.G. 3/0	.1318	6 x .2108	7 x .0705	6470	9385	.0848	.633	343.0	250.0	93.0	1811	1319	492	
No. 4/0		211600	.1662	N.G. 2/0	.1045	6 x .1880	1 x .1880	5940	8435	.0816	.564	265.0	199.0	96.0	1556	1052	504	
No. 3/0		167805	.1318	N.G. 1/0	.0829	6 x .1670	1 x .1670	4690	6660	.1026	.501	232.5	157.0	75.5	1227	830	397	
No. 2/0		133079	.1045	No. 1	.0657	6 x .1490	1 x .1490	3730	5300	.1294	.447	185.0	125.0	60.0	977	660	317	
No. 1/0		104534	.0829	No. 2	.0521	6 x .1327	1 x .1327	2960	4200	.1639	.398	147.0	99.5	47.5	776	525	251	
No. 1		82694	.0657	No. 3	.0413	6 x .1182	1 x .1182	2355	3340	.2070	.345	117.0	79.0	38.0	617	417	200	
No. 2		66373	.0521	No. 4	.0328	6 x .1052	1 x .1052	1890	2680	.2610	.316	92.4	62.5	29.9	488	330	158	
No. 3		52834	.0413	No. 5	.0260	6 x .0938	1 x .0938	1480	2100	.3291	.281	73.4	49.7	23.7	387	262	125	
No. 4		41742	.0328	No. 6	.0206	6 x .0834	1 x .0834	1170	1665	.4150	.250	58.0	39.3	18.7	306	207	99	
No. 5		33102	.0260	No. 7	.0163	6 x .0743	1 x .0743	930	1315	.5217	.223	46.0	31.0	15.0	243	164	79	
No. 6		26250	.0206	No. 8	.0130	6 x .0661	1 x .0661	735	1045	.6577	.198	36.4	24.6	11.8	192	130	63	
No. 7		20816	.0163	No. 9	.0103	6 x .0586	1 x .0586	573	820	.8293	.176	28.5	19.3	9.2	151	102	49	
No. 8		16509	.0130	No. 10	.0082	6 x .0525	1 x .0525	465	660	1.0450	.158	23.0	15.6	7.4	121	82	39	

Fig. 12. This table also gives very valuable and convenient data on size, number of strands, strength, resistance, and weight of steel cored aluminum cable. You will also note in the third and fourth columns the comparative sizes of copper conductor which would have the same carrying capacity in amperes of any of the aluminum conductors.

marked above them in the figure. This figure shows part of each insulator cut away to provide a sec-

Alternating Current

tional view which clearly shows the shape and construction of each unit.

You will note that the 13,000-volt insulator on the left has several ribs and grooves on its under side, to provide surfaces which will be free from dirt and water even during storms and thereby increase the **creepage** distance from the line conductor to the pin.

The high-voltage insulator on the right is built up of three separate sections securely cemented together. This cement has very high mechanical strength and forms a secure bond between the surfaces of the insulator sections.

You will note that the center section is larger than the bottom one and the top one still larger than either of the others, thus creating an overhanging or umbrella effect which provides the clean, dry undersurface in the grooves which are protected from dirt and moisture.

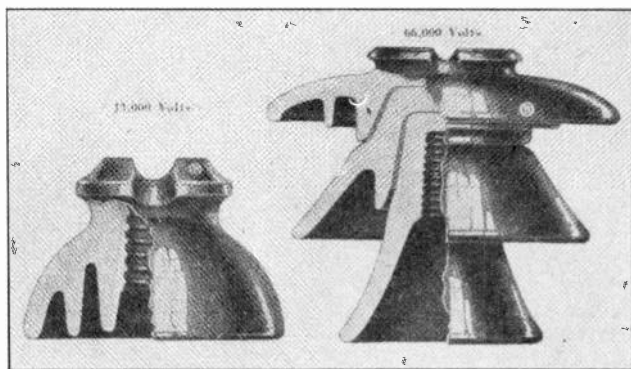

Fig. 13. The above photo clearly shows the shape and construction of both small and large pin type insulators of the type used on high-voltage lines. Courtesy of Ohio Brass Co.

These outer flanges on insulators of this type are commonly called "skirts" and make it much more difficult for the line voltage to flash over the surface of the insulator.

Pin insulators of this type are provided with grooves on the top or cap section, in which the line conductor is laid and then tied in place with a tie

Power Transmission

wire which is wrapped around the groove in the sides of the knob on the insulator cap.

Pin type insulators are provided with threaded holes on their under sides or in their lower sections that enable them to be screwed onto wood or iron pins by which they are attached to the **cross arms** on the poles or towers.

Fig. 14 shows several different styles of metal insulator pins. The one on the left has a flat base for use on wood cross arms with flat tops. The next pin to the right has a curved base for use on wood cross arms with curved or "roofed" tops. The pin with the short bolt is for use on metal cross arms. These three pins all have lead tips to enable them to screw snugly into the porcelain insulators

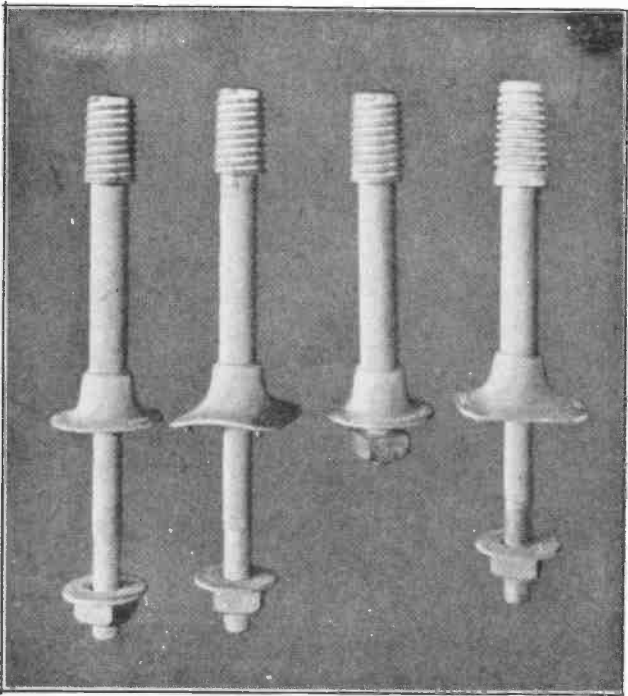

Fig. 14. Several styles of insulator pins used for attaching pin type insulators to wood and steel cross arms. Courtesy of Ohio Brass Company.

without splitting them. The last pin on the right has a separable lead thimble

Alternating Current

Fig. 15 shows the method of mounting pin type insulators on wood or metal cross arms, and also shows several of the pin fittings.

Pin type insulators are extensively used on lines with voltages up to 50,000, and occasionally on lines of 80,000 volts or more.

Fig. 16 shows a three-phase, 33,000-volt transmission line on pin type insulators and wood poles.

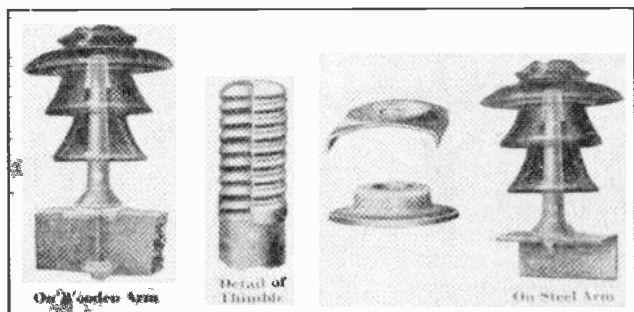

Fig. 15. Above are shown the methods of mounting insulators on pins and attaching the pins to wood and metal cross arms, and also the soft lead thimble which enables the insulator to be securely tightened on the pin without damaging the threads in the porcelain. Courtesy of Ohio Brass Company.

12. FASTENING CONDUCTORS TO PIN TYPE INSULATORS

Line conductors are generally laid in the grooves on the caps of pin type insulators as long as the direction of the line carries them straight across the top of the insulators. When lines make a turn or bend at certain poles, the conductors are generally drawn into the groove on the side of the cap, and on the outer side of the line curve. Both of these methods are clearly shown in Fig. 17; top ties being shown in views 4, 5, 6, 7 and 9, and side ties in views 1, 2, 3, and 8.

On poles where the line curves, two insulators per conductor are often used as shown in views 2, 3, and 8 in Fig. 17. This is done because of the increased side strain placed on the insulators and pins at such points.

Line conductors are attached to pin type insulators by means of **tie wires** of soft drawn copper

Power Transmission

or aluminum. The tie wires should be of the same material as the conductor, and are usually a little smaller than the line conductors. Insulated tie wires are generally used for fastening insulated conductors.

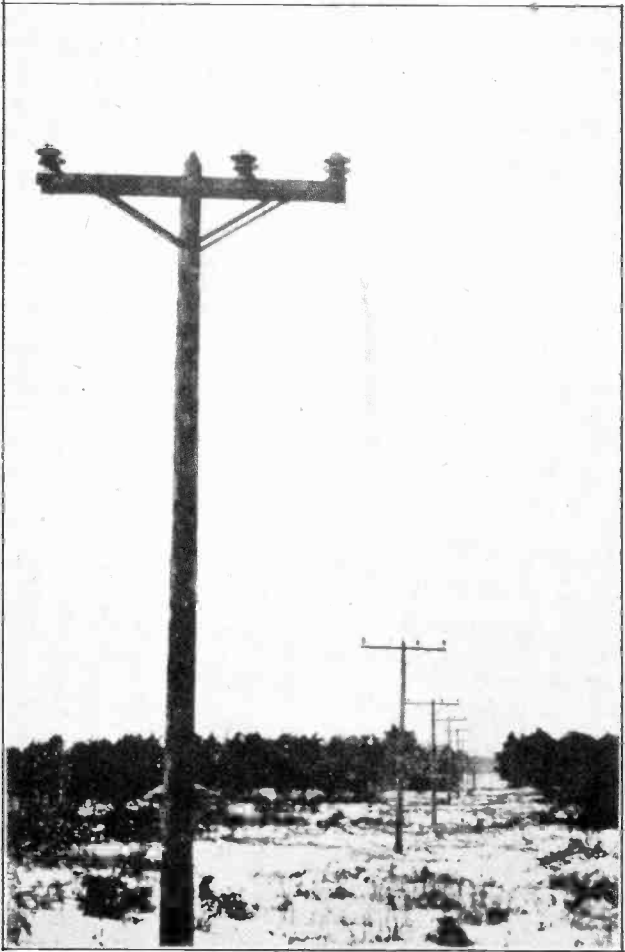

Fig. 16. Photo of a very neat pole type transmission line carrying the conductors of a three-phase line on pin type insulators.

Fig. 18 shows a number of types of ties in common use, and also the names of each. These sketches show top views of the line conductor and tie wires,

Alternating Current

the loops being shown in the same position as they would actually be in the groove around the side of the insulator cap. Careful observation of each of these ties will clearly show the manner in which they are made.

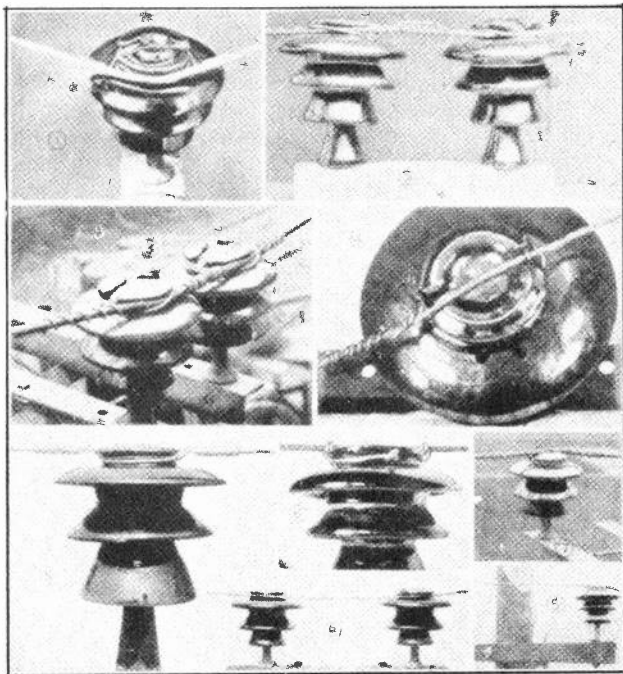

Fig. 17. Above are shown a number of common types of line ties used for attaching conductors of transmission and distribution lines to pin type insulators. Examine each type very carefully as you read the accompanying descriptions and also compare them with the sketches in Fig. 18. Courtesy Lapp Insulator Company, Inc.

The "cross top" and Western Union ties shown in this figure are very good ones and very commonly used. The looped Western Union ties are also frequently used.

In some cases, before the tie is made the conductor is first wrapped with an armor of flat, metal ribbon at the point where it rests on the insulator cap. This prevents scratching or wear of the cable at the point of contact with the insulator.

Tie wires will vary from three feet to twenty-five feet in length according to the size of the insulators and the type of tie that is used.

Power Transmission

Fig. 17 shows several photographs taken in the field, of actual line ties on pin type insulators. View No. 1 shows an armored, looped Western Union tie on an insulator at which the line makes a bend. View No. 2 is a looped Western Union tie which is not very neatly done, as you will note from the general looseness of the turns and the down-hanging pig tail at the right. No. 3 shows a looped Western Union tie which is well done. No. 4 is a poorly done "Mongrel" tie and has very little mechanical security. No. 5 shows a very well made armored "stirrup" two-piece tie. No. 6 is a special tie of rather poor design and very carelessly made. Note the projecting or "flying" pin-tail. No. 7 shows a well made cross-top tie, and No. 8 shows a carelessly made looped Western Union tie. No. 9 shows a poorly made cross top tie.

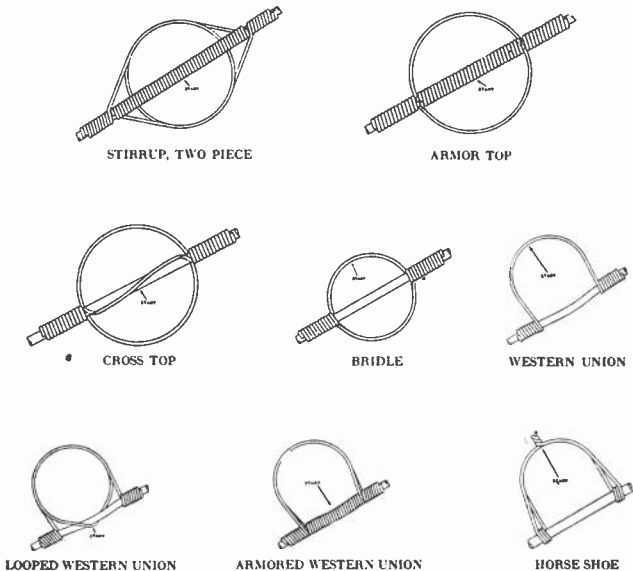

METHODS OF TYING LINE WIRE TO INSULATORS

Fig. 18. The above sketches show the methods of making some of the most common types of line ties. Note carefully how the tie wires are wrapped around the insulator cap and around the conductor. Courtesy Lapp Insulator Company, Inc.

In making line ties pig tails or sharp ends which are allowed to project down are very bad and re-

Alternating Current

duce the flash over voltage of the insulator from 5 to 20%. If planned to save the conductor in case of arc-overs, they are quite useless unless carefully designed and uniformly installed.

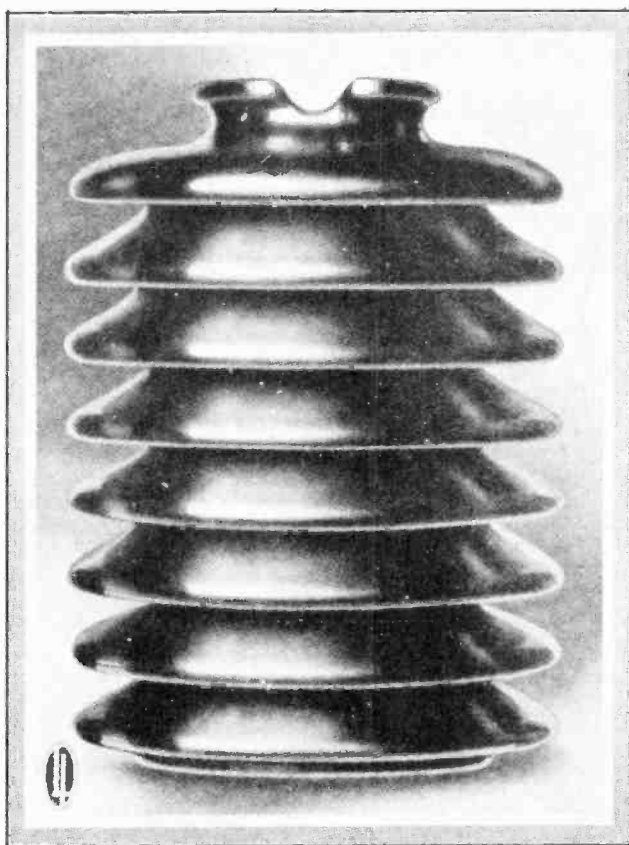

Fig. 19. Large special fog type pin insulator having a number of extra skirts to prevent flashover in districts subject to heavy salt fogs, mist, dirt, etc. Courtesy Lapp Insulator Company, Inc.

In general it is better practice to turn all pig tails up or "serve" them tightly around the conductor. All tie wires should be tightly "served" around the insulator because loose tie wires may cause considerable radio interference, by very poor contact with the insulator surface and sparking which occurs when a very small amount of high-

Power Transmission

voltage energy leaks off to a wet or dirty insulator surface.

Fig. 19 shows a special design of pin type insulator for use on lines which are subject to salt fog

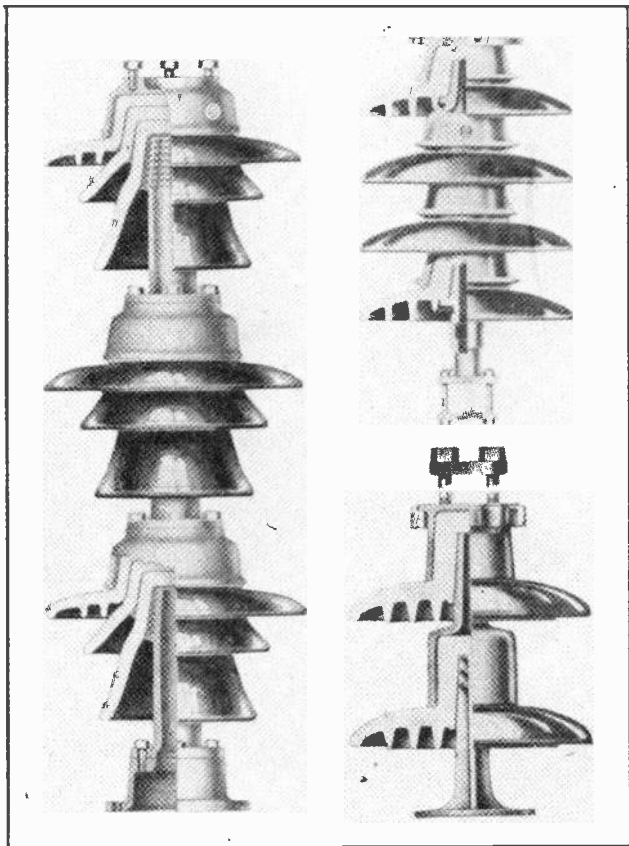

Fig. 20. Three styles of pedestal type insulators which can be built up in rigid pedestal or pillar form to support high-voltage bus bars and switching equipment.

or mist, and had accumulations of dirt or dust which tend to make the insulator surface more or less conductive.

13. PILLAR TYPE INSULATORS

Pin type insulators are often fitted with metal caps and special metal pins having bolt holes in

Alternating Current

them so the insulators can be mounted one above the other as shown in Fig. 20. These are called **pillar type** or **pedestal type** insulators and are used for supporting high-voltage busses on the switching stations and in places where there is very little side strain placed on the insulators.

Insulators of this type can be built up with the proper number of units to provide the necessary insulation for very high voltages.

Pillar type insulators will not stand excessive side strains, however, and are therefore not used on transmission lines where the long conductor spans are subject to wind stresses and the strain of unequal sag on the spans.

14. SUSPENSION TYPE INSULATORS

For insulating conductors of transmission lines using very high voltages suspension type insulators

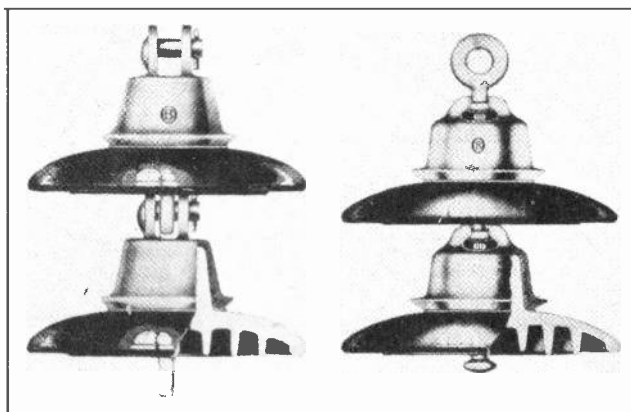

Fig. 21. Suspension insulators which can be fastened together in long strings to insulate high-voltage conductors. Note the two different types of fasteners used for attaching these insulators together. Courtesy of Ohio Brass Co.

are more commonly used. These insulators obtain their name from the manner in which they are suspended in strings from the cross arms.

Fig. 21 shows two pairs of suspension insulator units which use different methods of attaching the units together in the strings. Those on the left are fastened together with short, heavy pins which

Power Transmission

project through the bottom eye of one insulator and the top eyes of the other. The units on the right are fastened together by means of a large headed metal pin on the under side of the top unit, which fits into a properly shaped cavity on the top cap of the unit below.

Each insulator consists of a single piece of porcelain with grooved under sides and a bulge or crown projecting upward from its center. A malleable iron cap is securely cemented to the top of the insulator and a bolt or plug which is equipped with the proper eyes or enlarged head is securely cemented into the center cavity on the under side of the insulator.

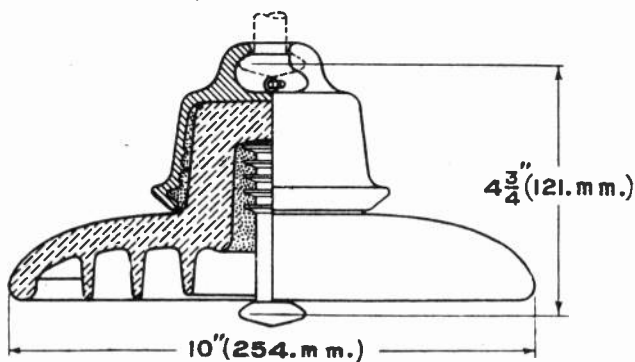

Fig. 22. Sectional view of a suspension type insulator unit showing how the metal cap and pin are securely cemented to the porcelain insulator disk. - Courtesy Ohio Brass Co.

Fig. 22 is a sketch showing a sectional view of a common type of suspension insulator, illustrating the manner in which the cap and pin are cemented to the top and bottom of the porcelain and completely separated from each other by the porcelain.

Fig. 22 also gives the dimensions both in inches and millimeters of this particular insulator shown.

As porcelain has a much higher dielectric strength than air, it is not necessary to have the metal pin and cap of the insulator separated by a thickness of porcelain as great as the flash-over distance around the extended flange of the insulator.

Suspension insulator units are usually made to withstand voltages of from 10,000 to 30,000 volts

Alternating Current

per unit. For higher voltages than this two or more units can be connected in series, and in fact, by connecting a sufficient number of these insula-

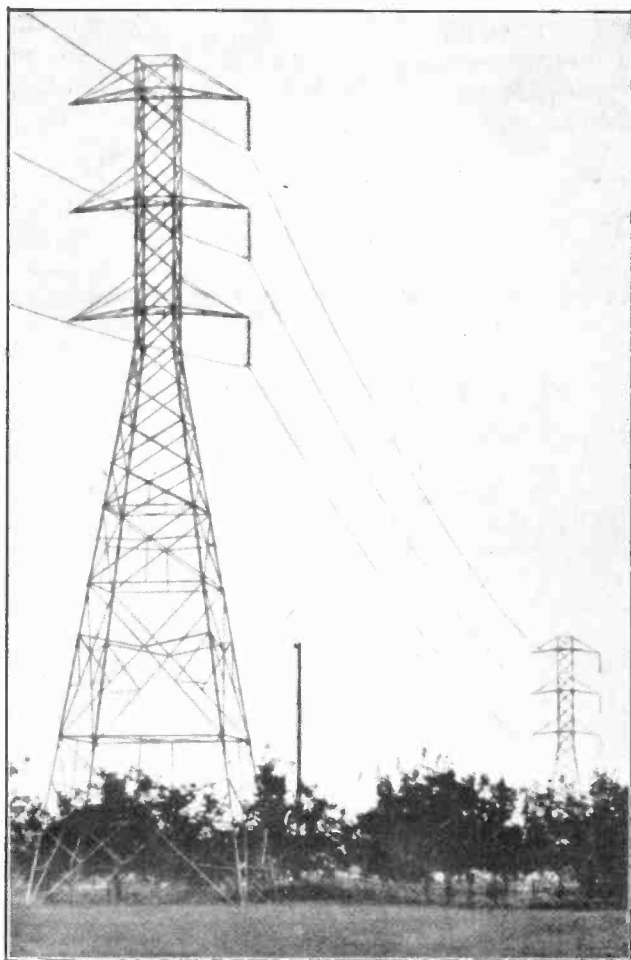

Fig. 23. 220-kv. line on which each conductor is supported by a string of 14 suspension insulator units. Note the arrangement of the three conductors on one side of the towers allowing space for another three-phase line to be put on the opposite side of the towers in the future.

tors in series in a string, it is possible to insulate a line for practically any commercial voltage.

Power Transmission

Strings of suspension insulators have the decided advantage, in that they are flexible and cannot be broken off by ordinary swaying or side stresses of the line. Suspension insulators are used almost exclusively on lines of over 66,000 volts, and in a great many cases on lines as low as 22,000 volts.

Fig. 23 shows a three-phase, 220,000-volt transmission line using suspension insulators with 14 units in each string.

Fig. 1 on page 2 shows a string of 10 suspension insulators flashing over on a test in which nearly 500,000 volts was applied. Tests of this kind are frequently made to determine the actual flash-over voltage of insulator strings before installing them on transmission lines.

15. STRAIN INSULATORS

Strain-type insulators are constructed almost the same as the ordinary suspension type and in fact resemble them so closely that in some cases it is difficult to tell them apart by ordinary observation. The principal difference between them is that the strain-type insulator is generally made much stronger mechanically.

These insulators are used where lines are **dead ended**, or where the lines make sharp or right-angle bends and at other places where there is considerable horizontal stress or strain placed upon the insulators.

Fig. 24 on the following page shows strain insulators in use on 132,000-volt line having two three-phase circuits. You will note that the insulator strings are pulled out into almost horizontal position by the strain placed upon them by the dead ended sections of the line on each side of the tower. The line conductor is looped around the insulators by means of the suspended jumper, as shown.

Fig. 25 shows a heavy strain tower used for "dead ending" a 132-kv. line by means of the strain insulators at the upper left on each line conductor.

Alternating Current

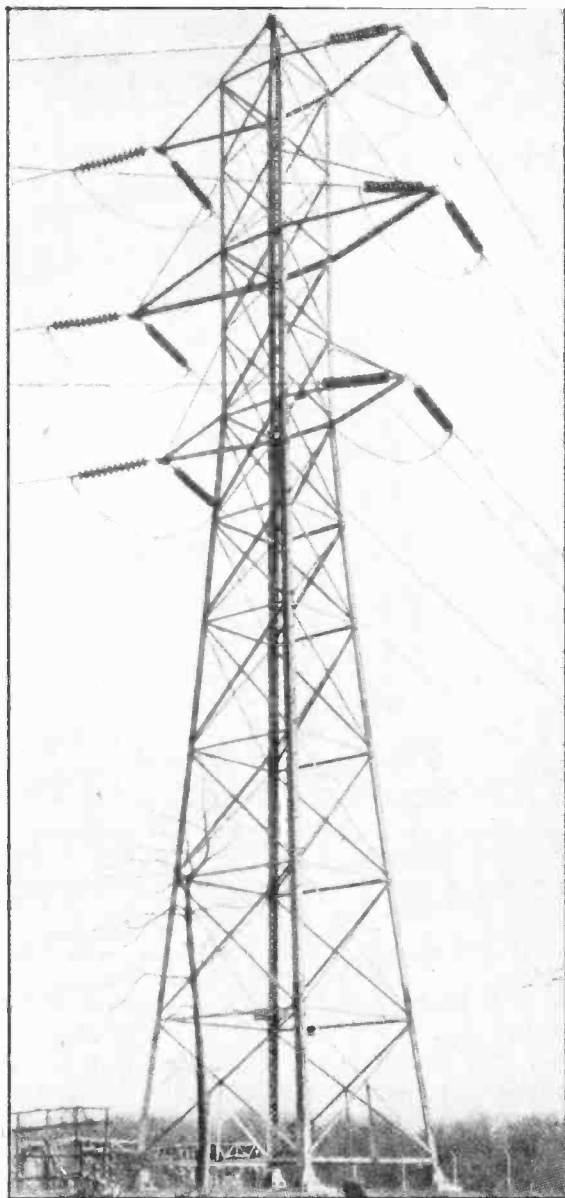

Power Transmission

Suspension insulators are used on this same tower to support the line where it runs down at an angle to the switching equipment, which is not shown in this view.

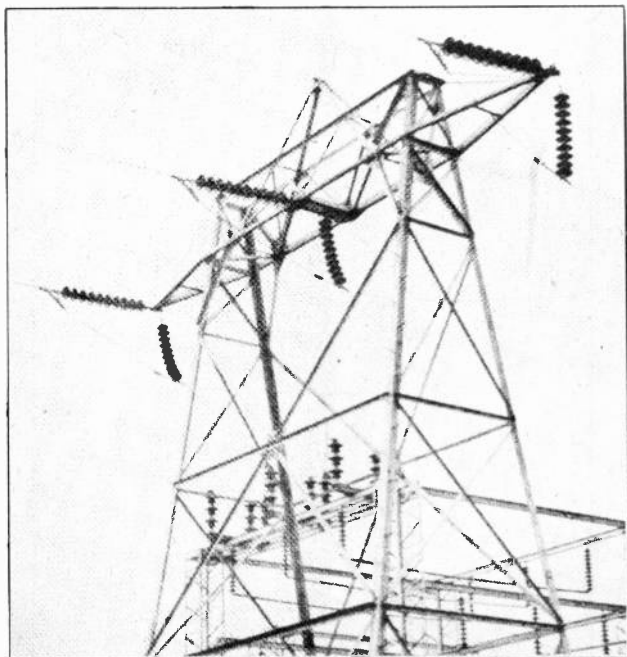

Fig. 25. This photo shows a heavy strain tower with strain insulators supporting the tension of the conductor span, suspension insulators supporting the conductor loops which run down to a substation, and pedestal type insulators in the background supporting high-voltage air break switches. Courtesy Ohio Brass Co.

Pillar-type insulators can also be seen on the structure in the background, where they are used to support blades and clips of high-tension air-break switches.

Fig. 26 shows sketches of strain insulators used to anchor the conductors where a line is dead ended to the wall of a power plant or substation building.

The strain insulators are used in these installations to take all strain of the conductor off from the insulating bushings where the conductor runs through the wall.

Alternating Current

Where extremely long or heavy conductor spans must be supported and dead ended, if the strength

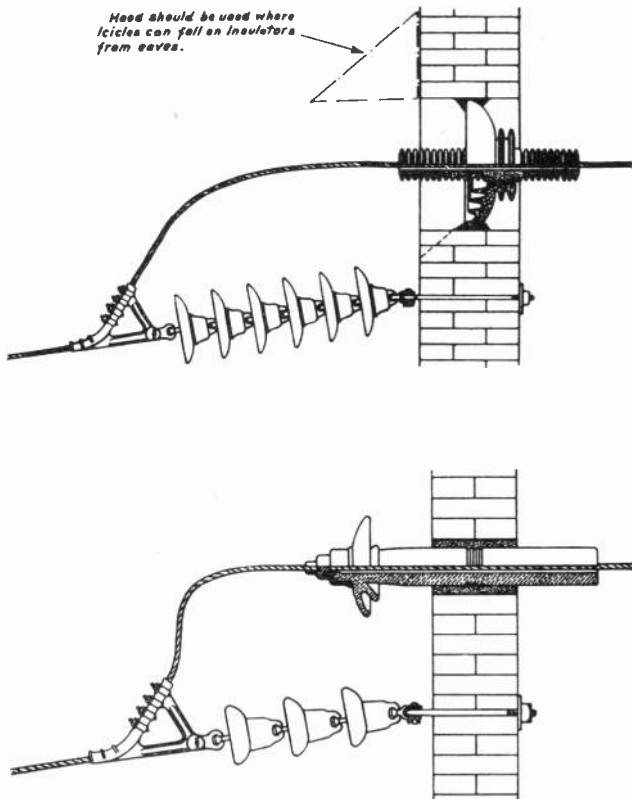

Fig. 26. The above diagrams show methods of using strain insulators to attach line conductors to the walls of substation buildings and keep the strain from the conductor where it enters the building through wall type insulator bushings. Courtesy Ohio Brass Company.

of one string of ordinary strain insulators is not sufficient two or more strings can be used, the strain being divided evenly between the two strings by means of special "evener" yokes, as shown in Fig. 27.

Fig. 28 shows an excellent view of a heavy strain tower with six strings of strain insulators used to support each cable of the long span on the

Power Transmission

right-hand side. This tower is used on a 110,000-volt line of the Northern States Power Company, where it crosses the St. Croix River at Afton, Min-

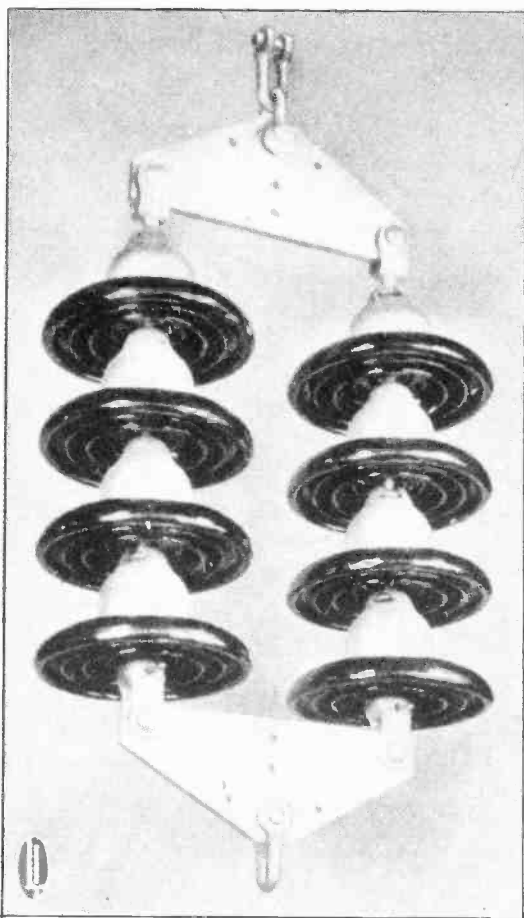

Fig. 27. Two strings of strain insulators fastened together with evener bars to take the strain of a very heavy conductor span. Courtesy Lapp Insulator Co., Inc.

nesota. The length of the span across the river is 3,800 feet and it has a sag of 160 feet.

Steel-core aluminum cables are used and they carry a maximum load of 30,000 lbs. per cable. This

Alternating Current

tower was designed and erected by the Byllesby Engineering and Management Corporation. Ordinary strings of strain insulators can be seen on the cables leading to the left, and suspension insulators

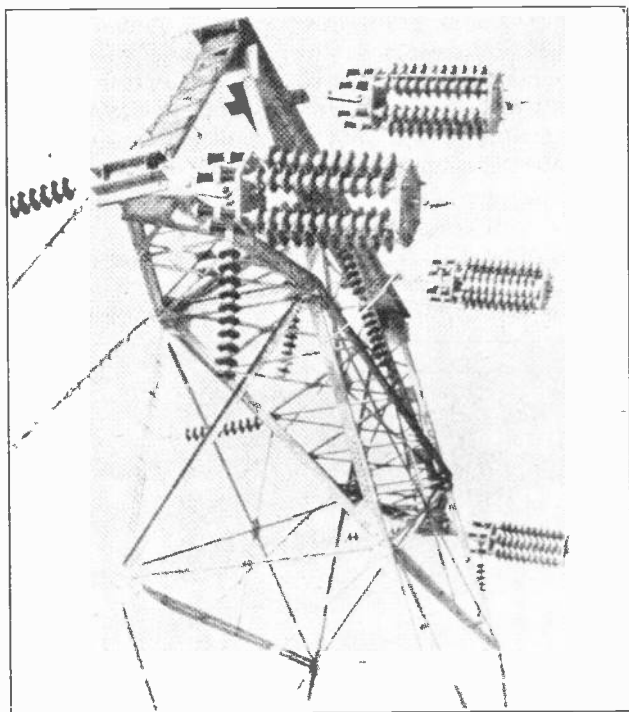

Fig. 28. Extra heavy strain tower with six strings of insulators grouped together on evener plates for each conductor. Note the heavy coil springs on the left evener plates to allow the heavy tension of these 3800-ft. river spans to equalize on all six insulator strings. Courtesy Lapp Insulator Co., Inc.

are used to support the jumper or connection between the river span and the cables at the left.

For dead ending small low-voltage conductors and also for insulating guy wires small porcelain strain-insulators of the types shown in Fig. 29 are often used. These insulators have no metal fittings but are simply provided with holes through them on opposite ends and sides so that the conductors can be looped through and tied as shown in the upper view.

Power Transmission

16. BUSHING INSULATORS

Bushing-type insulators are used where conductors pass through the roofs or walls of buildings or into cases of transformers, oil switches, etc.

Several bushings of this type are shown in Fig. 30. You will note that they are made with a sort of tubular construction so the conductor can be passed through their centers, and insulated from the surrounding wall or metal tanks by one or more porcelain cylinders of the insulator.

On the left in Fig. 30 is a wall or roof bushing for 6600-volt conductors. The diameter of the skirts on this insulator is approximately five inches, while the length of the unit is about 25 inches. The center view in this figure shows a wall or roof bushing

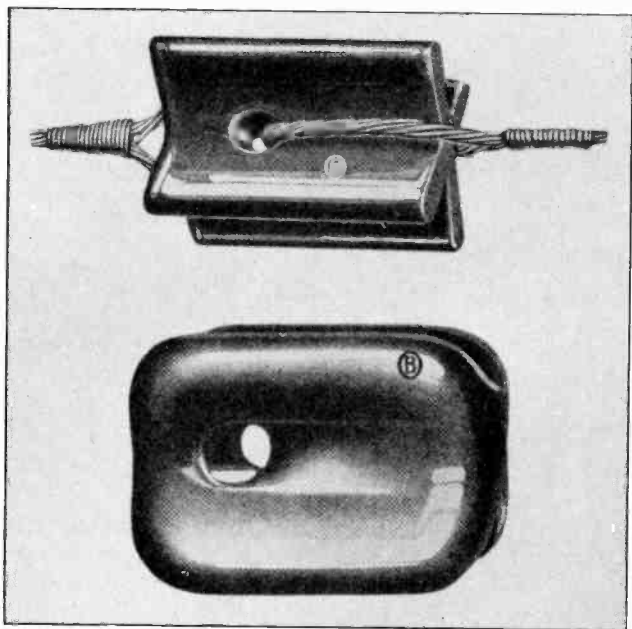

Fig. 29. Two types of small porcelain strain insulators for use on guy wires and low-voltage conductors. Courtesy Ohio Brass Co.

for use on conductors of 100,000 volts. This insulator has a diameter of approximately 16 inches and a length of over 66 inches.

Alternating Current

On the right in Fig 30 is shown a bushing of the oil-filled type, such as used on tanks of oil switches and transformers. Insulators of any type or size are rated in voltage according to actual flash-over tests made by the manufacturers on both wet and dry insulators.

In ordering insulators for any line it is only necessary to specify the line voltage and the type of insulators desired, and any reputable manu-

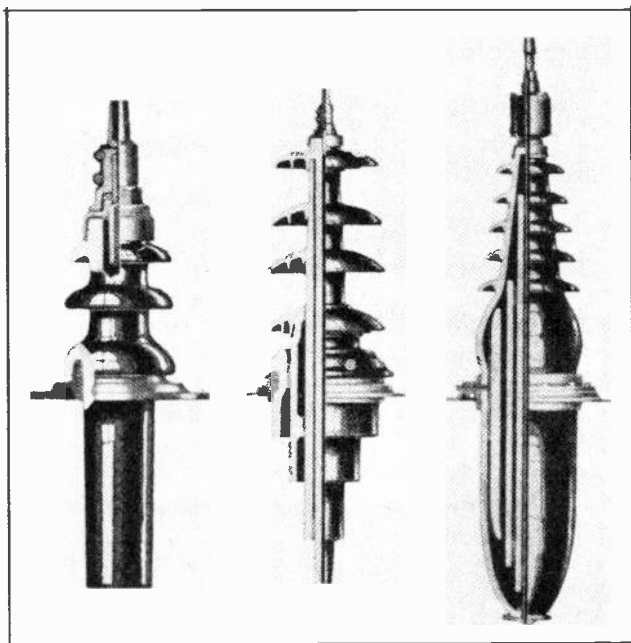

Fig. 30. Three different types of insulator bushings used for transformers and oil switches where the high-voltage conductors enter the metal tanks. Courtesy Ohio Brass Co.

facturer will select the proper size and give you prices on them.

In some cases where lines are subject to unusually bad storms, salt or alkali vapors, or highly conductive dust, it may be necessary to over-insulate or use larger insulators or a greater number of units per string than are ordinarily used.

Power Transmission

In general, however, insulators that are rated for a given voltage are designed with a certain safety factor or allowance which enables them to stand considerably more than the rated voltage before they will flash over.

EXAMINATION QUESTIONS

1. Which of the two general methods of transmitting electrical power is used in large cities? Why?

2. Briefly describe how underground power cables are constructed.

3. Name at least three standard voltages used for transmission of electrical power.

4. Name three common types of conductors used for transmission lines.

5. Name two advantages of using aluminum conductors.

6. What method is usually used when splicing aluminum conductors?

7. What is the resistance per 1000 ft. of No. 1 Steel cored aluminum cable?

8. A. Name three kinds of material which may be used for insulators?

B. Which kind is most commonly used?

9. On what kind of lines are suspension type insulators used?

10. How are strain insulators constructed, and where are they used?

Alternating Current

SUBSTATIONS

Substations have already been mentioned frequently in previous lessons and in this lesson they will be more fully described. In general a substation may be said to be a station which receives electrical energy over a transmission line from a generating plant and changes this energy to a voltage, frequency, and form suitable for distribution to the customers and consumers in the district.

Substations may be roughly divided into two general classes: Alternating current step-down stations, and alternating to direct current converting stations.

Alternating current substations may also be divided into two classes: (a) Transformer or step-down station for distribution. (b) Frequency changer stations.

A. C. to D. C. converter stations can be divided into three types, according to the equipment used: (a) Motor-generator stations. (b) Synchronous converter stations. (c) Mercury-arc stations.

Any substation may be either of the manually or automatically operated type. In manually operated substations operators are in attendance at all times to start and stop the machines; perform switching operations; regulate load and voltage; check meter readings; keep station records; and perform minor repairs.

In automatic substations the starting, stopping, and switching operations are performed by sensitive relays which operate air circuit-breakers or oil switches in the machine and line circuits.

The relays themselves are caused to operate by changes in the voltage or current of the lines leading from the station. For example, in stations that start up when the load demand becomes great enough, a current relay or contact-making ammeter can be used to close the circuit to a motor-driven drum control.

This control in turn will close the various circuits in order, for starting up a converter or other equipment in the plant. In other cases the starting re-

Substations

lays may be operated by a contact-making voltmeter or potential relay whenever the line voltage becomes low enough, due to voltage drop that is caused by increasing load on the line.

Various auxiliary and protective relays are operated by changes in the speed of rotating machinery, changes in the temperature of equipment, or by certain faults occurring in the station.

Many automatic substations have what is called **supervisory control**, which enables the relays to be operated by remote control over telephone or signal wires from a master substation or the generating plant. Such stations are usually given a thorough inspection and checking once a day by an expert operator who may have charge of several stations.

1. DISTRIBUTION SUBSTATIONS

Distribution or transformer substations are by far the most numerous and common because the greater part of electrical energy used in this country is A.C. and therefore doesn't require conversion, as it is transmitted as A.C.

In distribution stations transformers are used to step the voltage down from that of the transmission lines to voltages ranging from 110 to 440 for nearby customers, and from 2300 to 4000 or more for distribution feeders supplying customers who are more than a few hundred feet from the station.

The transmission line wires are usually brought into such substations through an outdoor structure containing the lightning arresters, high-voltage air break switches, oil circuit-breakers, etc.

In some cases this equipment is located inside the substation building.

Some substations are supplied with power from two or more transmission lines and the switching equipment of each station is arranged so the station can be connected to any one of these lines in cases of trouble on others.

There may be one or more banks of transformers in a substation, according to its kv-a. capacity and

Alternating Current

the number of different voltages it is to supply. Transformer secondaries feed to various bus bars, which in turn feed through the proper circuit breakers to the separate distribution lines running from the station.

In case of trouble on any of these distribution lines their circuit breakers can be opened either automatically or by the operator, and thus prevent interference with the operation of the substation and other lines.

Substations supplying energy for lighting are frequently equipped with automatic induction voltage-regulators, as described in a previous lesson.

Distribution substations are generally equipped with a switchboard on which are mounted the various meters and instruments for checking and recording the load on different circuits. These boards often contain automatic relays for overload protection, reverse power, under-voltage, etc.

High-voltage oil switches or air break switches in the transmission line circuits feeding the substation, may be remotely controlled by small push buttons or knife switches on the board in the station, or they may in some cases be manually operated.

Small transformer substations such as those located in industrial plants may not require an operator at all times. Such stations are usually equipped with watt-hour meters and in some cases with other recording instruments which can be read once a day or less often when the equipment is given inspection by the plant electrician.

Fig. 1 shows one-line diagram of the circuit through a simple transformer substation. Diagrams of this type show only one of the three phase wires and therefore do not show all of the connections of the equipment completed, but they do show the general arrangement of the more important devices and connections, and they are much simpler to trace than complete wiring diagrams.

Substations

Study this diagram carefully to become familiar with its use, as most substation and power plant operators are supplied with single-line diagrams as well as complete wiring diagrams of their stations.

In Fig. 1, the transmission line which feeds the substation is shown at the upper left. The lightning arrester, L.A., and the disconnect switch, D.S., are the first devices connected to the line. The choke coil is in series with line and all other station equipment.

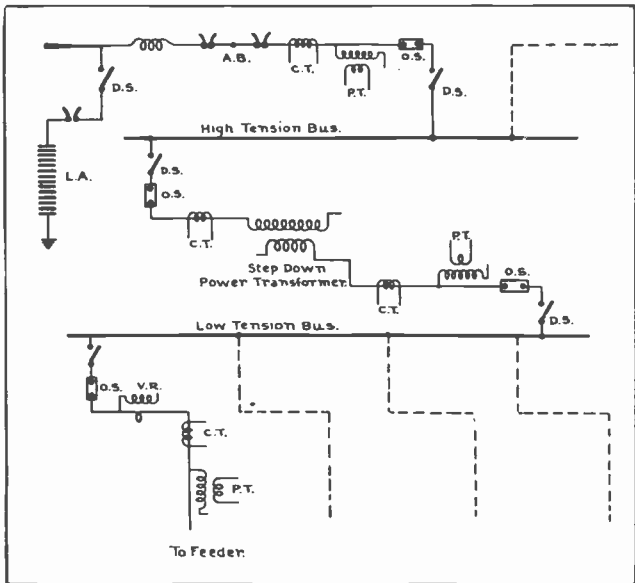

Fig. 1. Single line diagram of a distribution substation with one main power transformer for reducing the voltage from the transmission line. Trace this diagram carefully and familiarize yourself with each part from the explanations given on these pages.

Current and potential transformers are provided for metering the energy supplied by the line, and in some cases another line might also be supplying energy to the high-tension bus of the station through a connection such as shown by the dotted line.

The oil switch, O.S., is to disconnect the line from

Alternating Current

the bus. The air break switch, A.B., can be used to "kill" the oil switch and instrument transformers when it is desired to work on them.

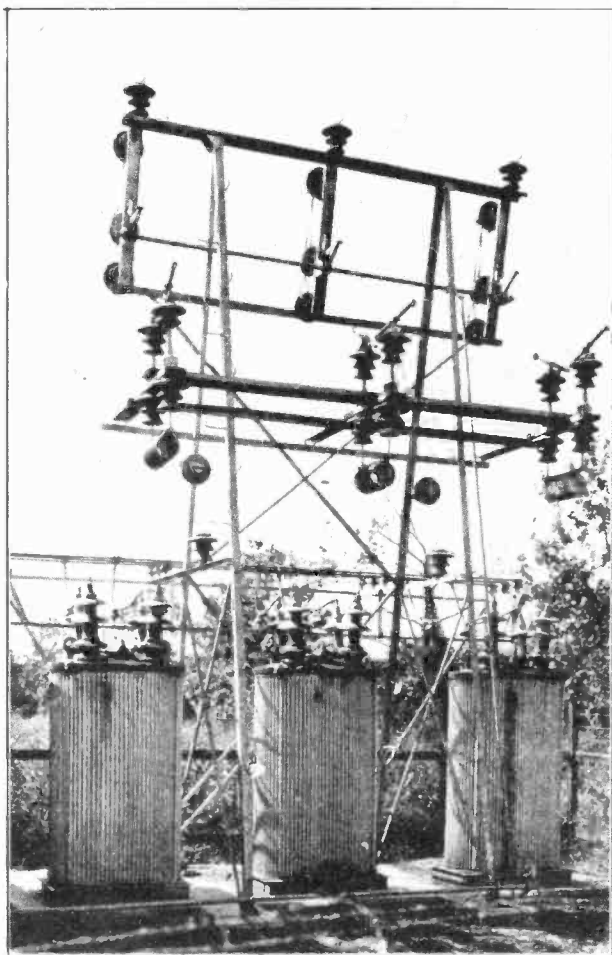

Fig. 2. Small outdoor transformer substation with transformers located on a base on the ground, and choke coils, fuses, and disconnect switches on the steel tower above them.

The current feeds from the high-tension bus through a disconnect, oil switch and current transformer to the step-down power transformer; then

Substations

on through instrument transformers, oil switch and disconnect to the low-tension bus.

More than one bank of power transformers may be connected between the high-tension and low-tension busses in large substations. In such cases the separate sets of instrument transformers permit the load on each bank of transformers to be read and checked, and the separate oil switches allow any bank of transformers to be temporarily disconnected during light load periods, without shutting down the station.

From the low-tension bus the energy is taken off to the distribution feeders through disconnects, oil switches, voltage regulators, V.R., and metering transformers.

These switches allow any certain feeder to be disconnected from the L.T. bus in case of trouble, and the instrument transformers allow the separate metering of the load on each feeder, as well as providing overload protection by overload relays operated by the current transformer to trip the feeder oil switch. These relays are not shown in this diagram; and only one feeder circuit is shown, the rest being indicated by the dotted lines.

The complete connections of the various pieces of equipment shown in the diagram in Fig. 1 have all been explained in earlier lessons.

In some cases small isolated outdoor substations consist of just the transformer arresters, and high-voltage air break switches, as shown in Fig. 2.

Still smaller pole-type transformer installations are often made as shown in Fig. 3.

2. CONVERTER STATIONS

Steel mills, mines, electrified railways and also certain industrial plants use large amounts of direct current which is usually supplied from substations which change A.C. to D.C. by means of synchronous converters, mercury-arc rectifiers, or motor-generators. In converting A.C. to D.C. by any of these methods considerable power is lost, because in the

Alternating Current

average substation the load throughout a period of 24 hours varies considerably, with the result that during part of the time the equipment is likely to be operating lightly loaded and at reduced efficiency.

In synchronous converter or motor-generator stations the loss during light-load periods may be anywhere from 20 to 30 per cent or more.

Mercury-arc rectifiers are much more efficient when operating at light loads than converters or motor-generator sets are.

For these reasons, some of the plants and rail-ways which were formerly operated by D.C. are gradually changing over to A.C. motors, and other new plants and electrical railroads are using A.C. equipment entirely.

Synchronous converters are still the most commonly used machines for changing A.C. to D.C. in large amounts, although mercury-arc substations are rapidly coming into more general use.

The equipment of a complete converter substation generally consists of **arresters, high-tension switching equipment, step-down transformers, synchronous converters, switchboard, oil switches, meters, protective relays, D.C. busses, etc.**

The transformers reduce the voltage from that of the transmission line to that for which the A.C. ends of the converters are designed to operate on.

In most modern converter stations the transformer secondaries are connected so that they supply six-phase energy to the converter slip rings, as was shown in a preceding lesson on Synchronous Converters.

In most cases some form of switching equipment is provided for starting the converters from the A.C. end at reduced voltage from the transformer secondaries. This equipment may be either manually or automatically operated, according to the type of station.

The D.C. leads from the converter to the direct current busses are generally equipped with high-speed air-circuit breakers, to quickly disconnect the machines from the trolleys or feeders in case of

Substations

severe overloads or in case of D.C. feed backs to the converters during periods of failure of the A.C. supply.

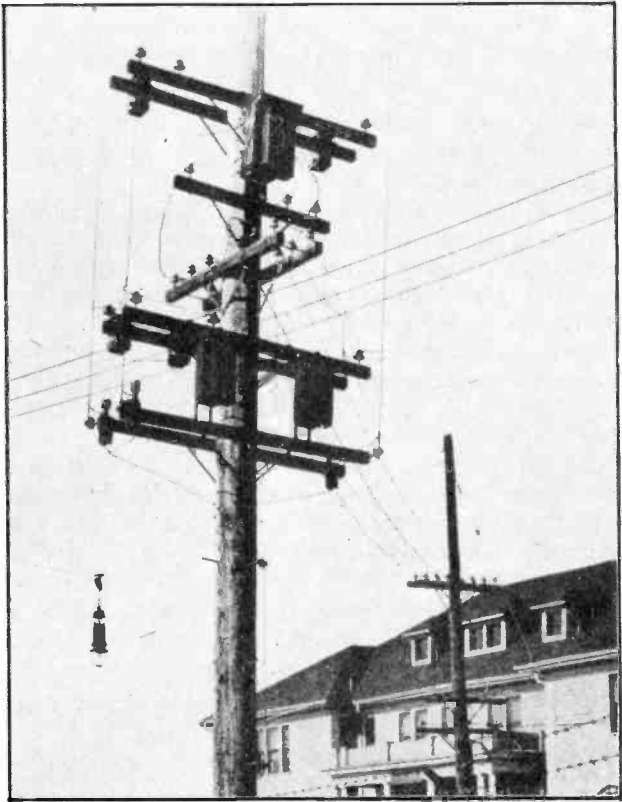

Fig. 3. Group of transformers mounted on heavy cross arms on an extra heavy pole.

3. CONNECTIONS OF A CONVERTER SUBSTATION

Fig. 4 shows a one-line diagram of a converter substation. You will note that the high-tension lightning arrester, air break switch, oil switch, instrument transformers, and high-tension bus circuits are practically the same as for the transformer

Alternating Current

substation, down to and including the step-down power transformer.

Between the step-down transformer secondary and the converter is shown the starting switch, S.S., for supplying reduced voltage to the A.C. end of the converter during starting.

The converter, slip rings, and commutator are shown by simple symbols in this diagram; and the negative brush is shown connected through the commutating and series fields and negative knife switch to ground.

In the case of a D.C. industrial substation the negative lead instead of being grounded would connect to a negative bus. The positive lead from the converter passes through a wattmeter or watthour meter, W; positive knife switch; ammeter shunt; overload trip coil; and circuit breaker, C.B., to the positive bus.

From the positive bus one or more feeders or trolley connections can be taken; and these are usually provided with circuit breakers, with overload trip coils, and with ammeters for measuring the load on the separate trolleys or feeders. Note the small D.C. lightning arrester connected to the outgoing trolley or feeder wire.

If more than one converter is in operation in the station the equalizer connection and bus would be used as shown.

Fig. 9 in lesson 61 shows in greater detail the connections for a six-phase rotary converter. It will be well to refer back to this diagram and keep it well in mind in connection with your studies of converter substations.

Fig. 5 shows a view of the inside of a synchronous-converter railway substation. The converter is shown in the foreground and the negative switch and field break-up switch can be clearly seen mounted on the side of the converter frame. Note the arc barriers around the brushes, and note also the motor which operates the brush-lifting mechanism. This motor is shown beneath the right-hand end of the machine shaft. The panel on the left contains the starting and running contac-

Substations

tors for switching from low to full voltage during starting of the converter. The small field-flashing motor-generator set is also shown on the bottom of this panel. The leads from the transformer secondaries can be seen entering the substation through the wall bushings and leading to the starting panel. The transformers at this station are located outdoors.

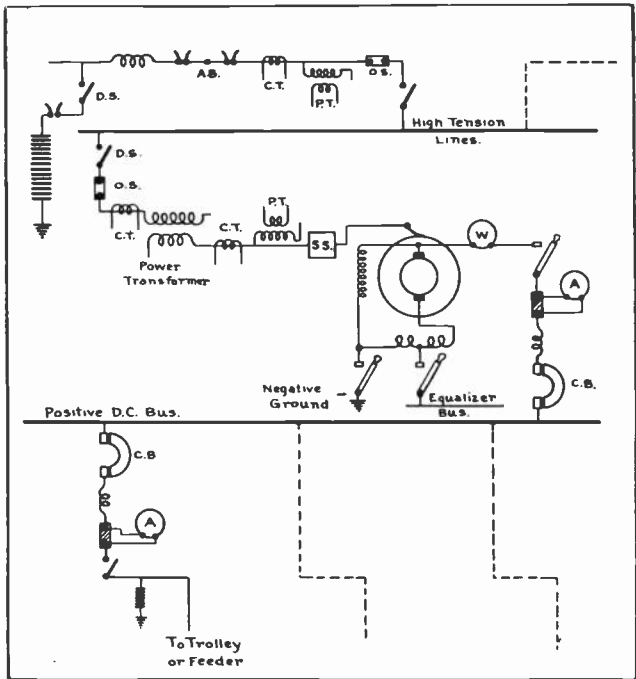

Fig. 4. Single line diagram of a synchronous converter substation, showing main step-down transformer, converter, and auxiliary equipment.

The main switchboard panel contains the positive breaker, feeder switches and breakers, motor-operated drum control for automatic starting of the station, and the various meters and relays.

The converter shunt-field rheostat wheel can be seen at the center left of the panel. The positive bus can be seen at the top of the board, and behind these are large banks of armature protective resistors which are automatically cut into the armature

Alternating Current

circuit of the converter in case of short circuits or overloads on the trolleys or feeders.

In case these overloads are left on the machine too long the resistor grids overheat, causing thermostats which are mounted above them to close circuits to the proper relay on the board; and this relay in turn trips the breakers, shutting the converter down.

The duties of an operator in a manually-operated converter station are to start and stop the machines as the load requires and as described in lesson 61 on Synchronous Converters.

The operator should also make frequent inspection of the bearing lubrication and the temperatures of the machine windings; take meter readings at regular intervals; keep the station records; reclose breakers in case of trip outs; and see that all circuit breakers, relays, and protective equipment are kept in proper adjustment.

Further details have been outlined under the operation and care of the various devices previously explained.

4. MOTOR-GENERATOR SUBSTATIONS

In certain classes of substations motor-generators are used instead of synchronous converters for the purpose of changing A.C. to D.C. Such motor-generator sets may consist of either a squirrel-cage induction or a synchronous A.C. motor directly connected to a D.C. generator.

A considerable number of motor-generator substations have been installed in the past and are still in use, although converter substations are generally favored for present day installations because of the higher efficiency of synchronous converters.

There are, however, certain classes of very severe service, such as the widely varying loads in steel mills and certain industrial plants, where motor-generators are to be preferred because of their greater stability in operation and their very rugged mechanical construction.

Rotary converters are rather sensitive to sudden load fluctuations and are sometimes difficult to op-

Substations

erate in parallel under severe service conditions.

In operating motor-generators there are to be considered the losses in both the motor and the generator. For example, if both the motor and the generator of an M.-G. set have efficiencies of 90% at full load, then the over all full-load efficiency of the unit will be 81%. At light loads this efficiency will be considerably lower.

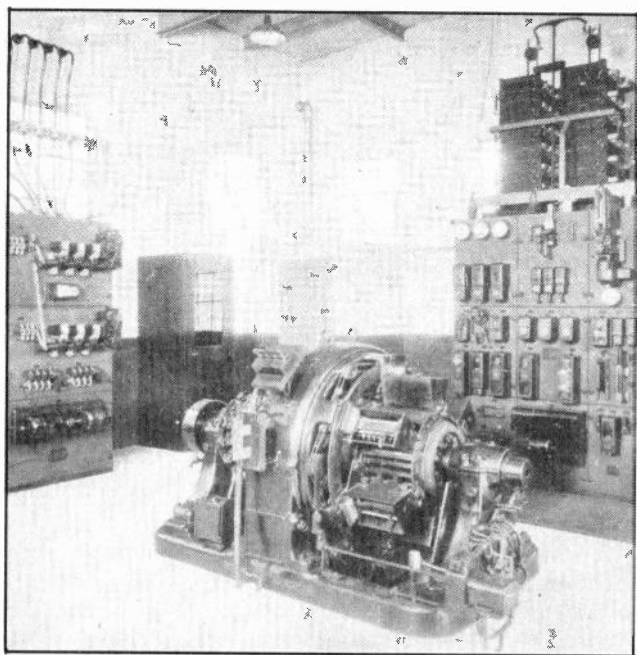

Fig. 5. This photograph gives an excellent view of the inside of an automatic converter substation. The converter is shown in the foreground, the starting panel at the left, and the main switchboard with the automatic control relays and circuit-breakers in the right background. Courtesy of General Electric Co.

Fig. 6 shows a large motor-generator with the A.C. motor on the left and the D.C. generator on the right. Both armatures of this machine are

Alternating Current

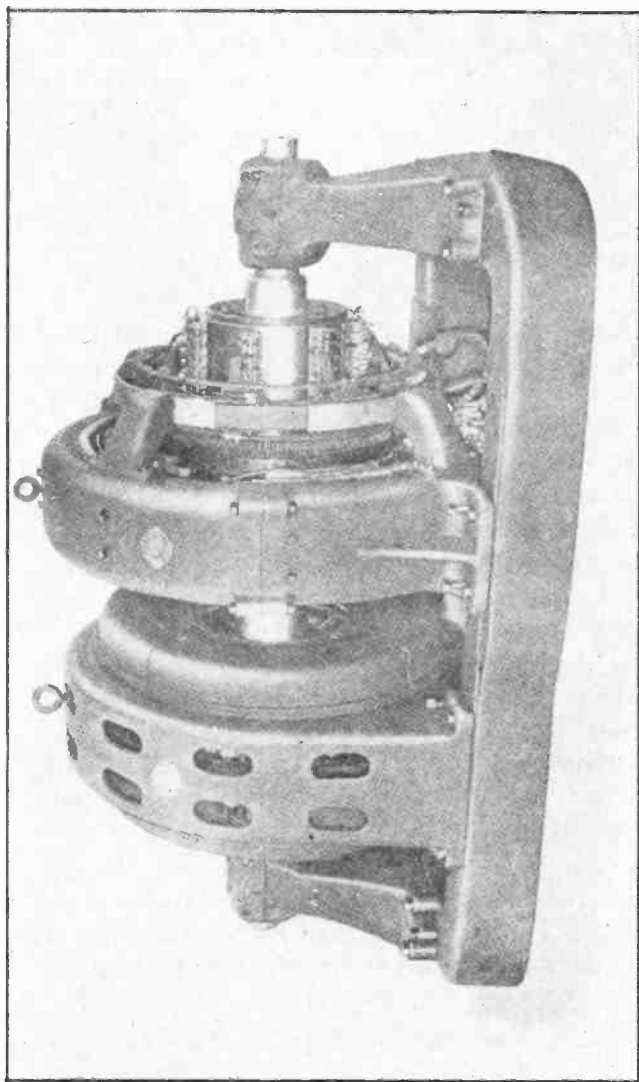

Fig. 6. Motor-generator set for converting alternating current to direct current. The A. C. motor on the left is directly connected to the D. C. generator on the right.

Substations

mounted on the same heavy shaft, and both the stator of the A.C. machine and the field frame of the D.C. generator are mounted on the same bed-plate.

Fig. 7 shows a 1000-kw. motor-generator set driven by a 4000-volt three-phase, synchronous motor. The exciter-generator for supplying the direct current field energy for the synchronous motor can be seen on the left.

In this unit the motor and generator armatures are mounted on separate shafts which are direct coupled and supported by a bearing between the machines as well as the two end bearings.

Where motor-generator substations are fed from high-voltage transmission lines they are equipped with arresters, step-down transformers, oil switches, etc., similar to those used in transformer or converter substations.

The starting equipment for the A.C. motor depends upon whether it is of the squirrel-cage induction or synchronous type. The methods of starting each of these machines have been described in previous lessons on A.C. Motors and Controllers.

The D.C. energy from a motor-generator set is usually passed through the proper switches, circuit breakers, and meters on a D.C. switchboard in the substation and then to the various feeder circuits throughout the plant, or to trolleys in case of railway substations.

Motor-generator stations for steel mill use are often equipped with large, heavy fly-wheels as shown in Fig. 8, in order to enable the unit to carry heavy momentary overloads without using an excessively large A.C. motor.

During periods when the load on the D.C. generator is comparatively light the A.C. motor very slightly increases the speed of the fly-wheel and stores a considerable amount of energy in it.

Alternating Current

When sudden, heavy overloads are placed upon the D.C. generator by large steel mill motors the speed of the motor-generator is slightly reduced, thus absorbing the mechanical energy from the fly-wheel.

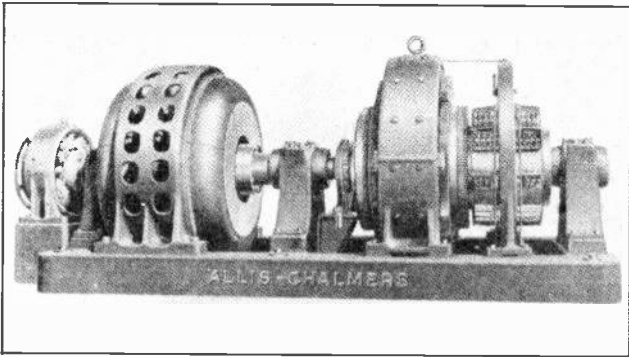

Fig. 7. 1000-kw. motor-generator set with an A. C. synchronous motor and exciter on the left, and the D. C. generator on the right. Courtesy of Allis-Chalmers Mfg. Co.

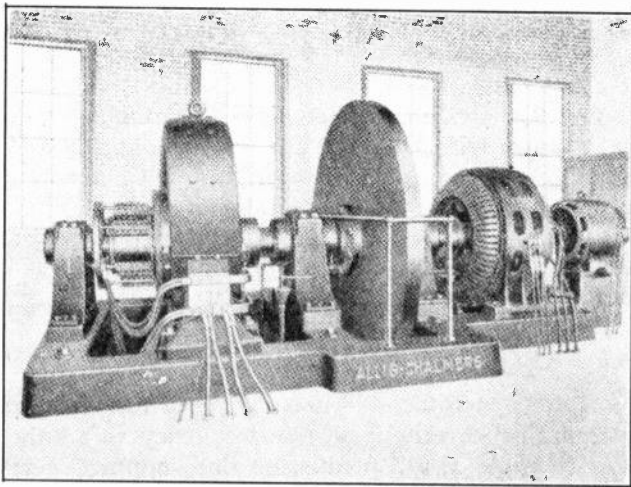

Fig. 8. Motor-generator set with large flywheel for carrying heavy momentary overloads in steel mill work and other classes of severe service. Courtesy of Allis-Chalmers Mfg. Co.

On large units several thousand additional horse power can be delivered for periods of a few seconds by the energy in the fly-wheel.

Substations

In addition to supplying direct current in steel mill and railway substations motor-generator sets are commonly used for supplying small amounts of direct current for electro-plating, arc welding, or other special uses in industrial plants which are largely operated by A.C.

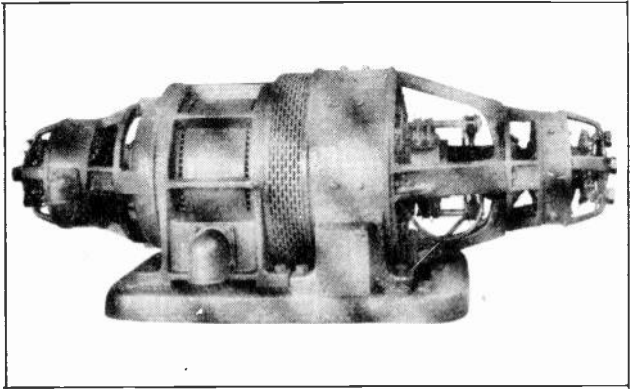

Fig. 9. Compact type of motor-generator set used for operating D. C. elevator motors. Courtesy of G. E. Company.

Fig. 9 shows a compact type of motor-generator set for use with D.C. elevator equipment. In addition to the main A.C. motor and D.C. generator units this machine also has a small exciter-generator, shown on the left, and a speed regulating generator, shown on the right, for controlling the D.C. field of the elevator machines.

5. FREQUENCY-CHANGER SUBSTATIONS

Motor-generator sets are also used for changing alternating current from one frequency to another. For example, if a transmission line supplies energy at 25 cycles to a factory or plant which has equipment that operates on 60 cycles then a motor-generator frequency-changer is used to convert the 25-cycle energy into 60-cycle energy. A set of this type would use a 25-cycle synchronous motor to drive a 60-cycle A.C. generator.

Alternating Current

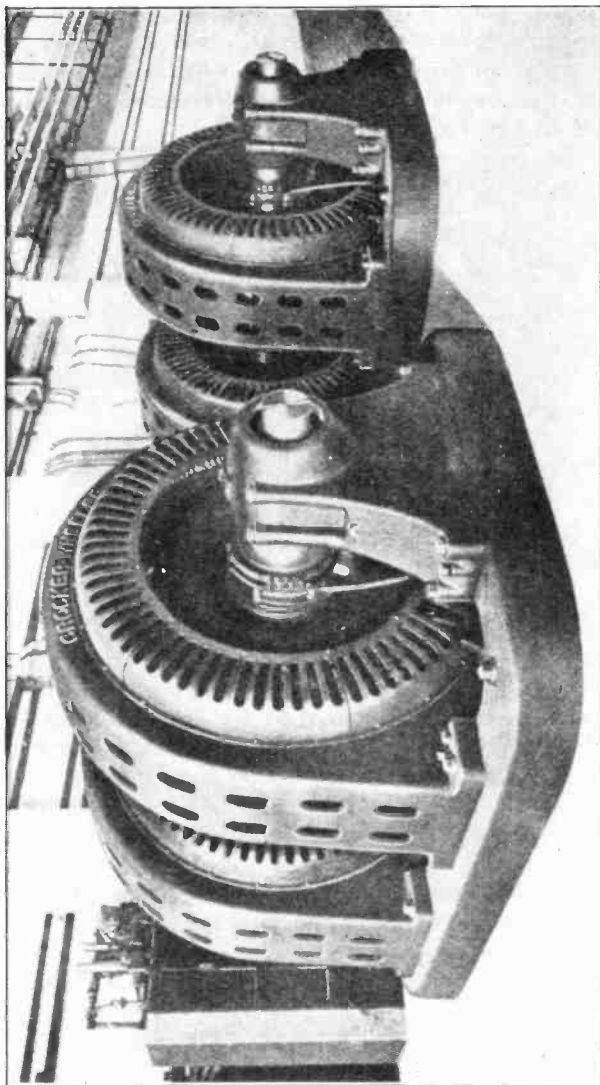

Fig. 10. This photograph shows two large motor-generator sets in a frequency converter substation. Machines of this type are used where it is necessary to change the frequency of the alternating current supply to another frequency required for the operation of certain motors or other electrical equipment.

Substations

Frequency changers are also used to tie 25 and 60 cycle lines or power systems together.

In directly connected frequency-changer sets the motor and generator must both revolve at the same speed; so, in order to obtain the different frequencies, it is necessary to have different numbers of poles in the two units.

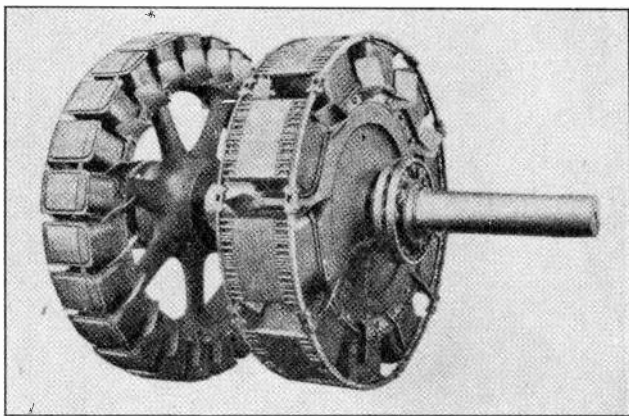

Fig. 11. Double rotor of a frequency changer motor-generator set. The ten-pole rotor operates on 25 cycles and the 24-pole rotor produces 60-cycle energy. Courtesy of Allis-Chalmers Mfg. Co.

For example, a machine to convert 25-cycle to 60-cycle energy and designed for operation at 300 RPM would have to have a synchronous motor with 10 poles and an alternator or A.C. generator with 24 poles.

The rotors for a 1200 kv-a. machine of this type are shown in Fig. 11, the 10-pole D.C. field of the synchronous motor being on the right and the 24-pole alternator field on the left.

A number of motor-generators of this type can be operated in parallel if they are properly phased out and synchronized just as alternators would have to be.

Frequency changers are built in sizes ranging from those of a few kv-a. to 50,000 kv-a.

Fig. 10 shows two A.C. motor generator units in a frequency-converter substation.

Alternating Current

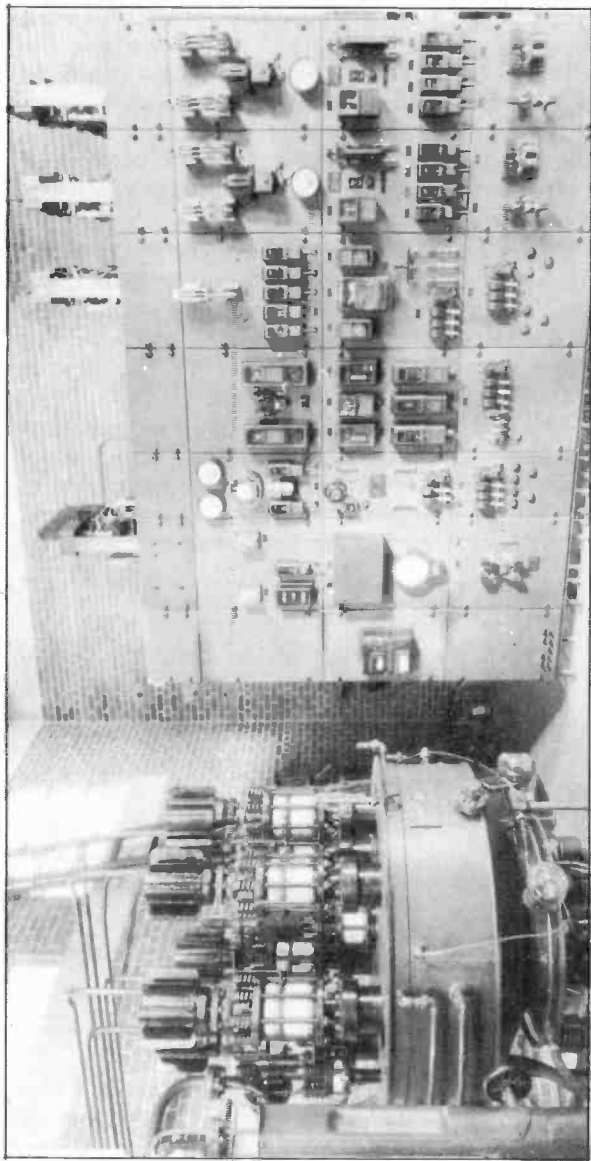

Fig. 12. This photo shows an excellent view of the interior of an automatic mercury arc rectifier substation. The rectifier is shown on the left and the automatic control switchboard with its relays and circuit breakers is shown on the right. Courtesy of General Electric Co.

Substations

6. MERCURY-ARC SUBSTATIONS

As explained in a previous lesson, mercury-arc rectifiers are coming into quite extensive use for converting A.C. to D.C. in railway substations as well as for certain industrial uses. Mercury-arc rectifiers are in many cases preferred to either synchronous converters or motor-generator sets, because of their very quiet operation and their higher efficiency when operating lightly loaded.

In addition to the rectifier unit, mercury-arc substations include the usual lightning arresters, oil switches, circuit breakers, meters, relays and the step-down power transformers which are used for reducing transmission line voltage to the proper operating voltage for the converter.

Fig. 12 shows a view of the inside of an automatic mercury-arc rectifier substation. This photograph shows the mercury-arc rectifier on the left; and also shows the automatic-control switchboard

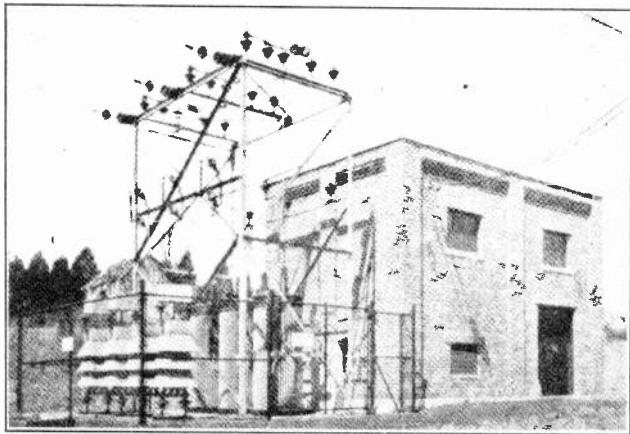

Fig. 13. Exterior view of a modern substation showing incoming line, choke coils, fuses, disconnects, lightning arresters, and power transformers outside of the building. The synchronous converters are located inside of the building.

with its meters; circuit breakers, and relays. The transformers, lightning arresters, and high-tension switching equipment are located outside the station building.

Alternating Current

The operation and care of mercury-arc rectifiers have been covered in a previous lesson, and the general features of the other equipment and the circuits for these substations are very similar to those of synchronous converter stations.

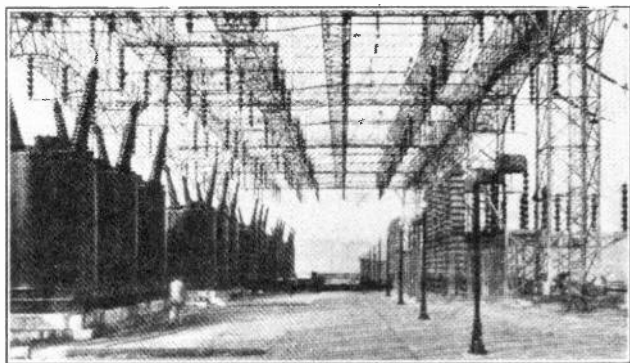

Fig. 14. View of large oil switches and lightning arresters underneath the bus and switching structure of a 220,000-volt outdoor substation. Courtesy of Philadelphia Electric Company.

7. COMBINATION SUBSTATIONS

In many cases large substations may combine two or more of the types of equipment and service already described. For example, a single substation may include step-down transformers for reducing the voltage from high-tension transmission lines to the proper value for local A.C. distribution; synchronous converters, with their separate transformers and equipment for supplying D.C. to local street railways or industrial plants; possibly also a later type mercury-arc rectifier operating in parallel with the synchronous converters; and even one or more motor-generator sets for supplying D.C. or A.C. of a different frequency for special purposes.

Fig. 13 shows the power transformers, lightning arresters, and disconnect switches, all of which are commonly located outside the substation structures. Such equipment as synchronous converters, mer-

Substations

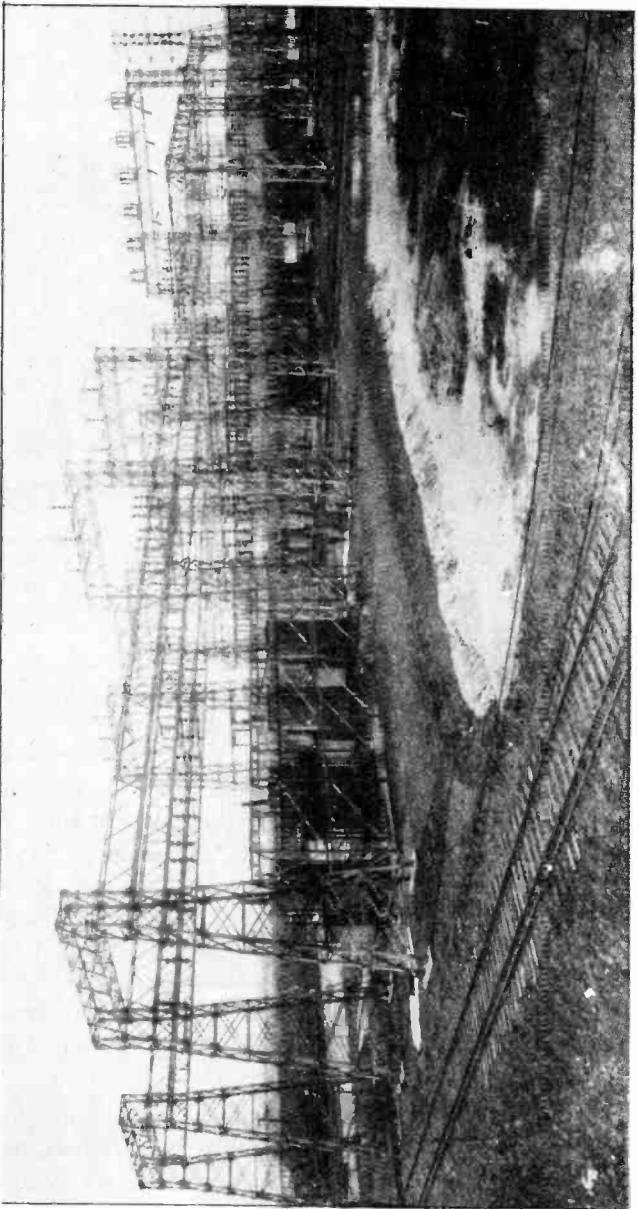

Alternating Current

cury-arc rectifiers, and motor-generators are placed inside the building.

Switching stations or transformer stations such as shown in Fig. 14, and in Fig. 15 on page 29 are often used where transmission lines of different voltages or operated by different companies are joined together. Such stations contain transformers, oil switches, air break switches, and disconnects; and also high-tension transformer busses for shifting the connections from one line to another.

In Fig. 15 the transformers are shown in the left foreground. The oil switches are shown in the background. The high-tension air-break and disconnect switches and the high-voltage transformer busses are supported in the steel structure overhead.

Fig. 14 shows a 220,000-volt switching station with lightning arresters on the right and huge oil switches on the left. Note the high-tension busses and connections supported by pillar-type insulators in the steel framework overhead.

Substations

EXAMINATION QUESTIONS

1. For what purposes are substations used?
2. Name three types of equipment used in substations for converting A.C. to D.C.
3. How is the equipment in automatic substations started and stopped?
4. Which type of substation is most common and why?
5. In what industries are converter substations extensively used?
6. Name at least six important pieces of equipment used in a modern converter substation.
7. What are some of the duties of an operator in a manually operated converter station?
8. What type of equipment would be used in a substation where the frequency of the A.C. power must be changed?
9. What are some of the advantages of motor generators over synchronous converters for steel mill service?
10. What are some of the advantages of mercury arc rectifiers over either motor generators or synchronous converters?

Alternating Current

SWITCHBOARDS

In converter and motor-generator substations switchboard equipment is often connected in the circuits on the A.C. ends, as well as from the D.C. ends of the machines. You are already familiar with D.C. switchboards.

Switchboards in A.C. power plants may be either of the vertical panel type, bench type, or truck type, all of which were previously described in lesson 37.

The general construction features, bus bar arrangements, etc., are practically the same for A.C. boards as for D.C.

Meters on A.C. boards are generally operated from current and potential transformers, instead of from shunts and direct connections to the busses as on D.C. boards.

On manually-operated switchboards in A.C. generating stations oil switches are more commonly used than knife switches in the main circuits. The oil switches, being mounted behind the board and operated by a lever or handle on the front of the panel, provide a much safer arrangement for high-voltage circuits than would open knife-switches on the face of the board.

Fig. 1 on the opposite page shows an excellent view of a manual switchboard in a 2300-volt A.C. generating plant. The three main-generator panels are shown in the center, with their oil switches, meters, rheostat controls, and plug-type instrument switches.

On the right are shown four feeder panels equipped with oil switches, relays, and watt-hour meters. On the left are shown the controls for the exciter-generators and voltage regulator; and also the station ammeters, voltmeters, and synchroscope mounted on a hinged bracket at the extreme left of the board.

Switchboards

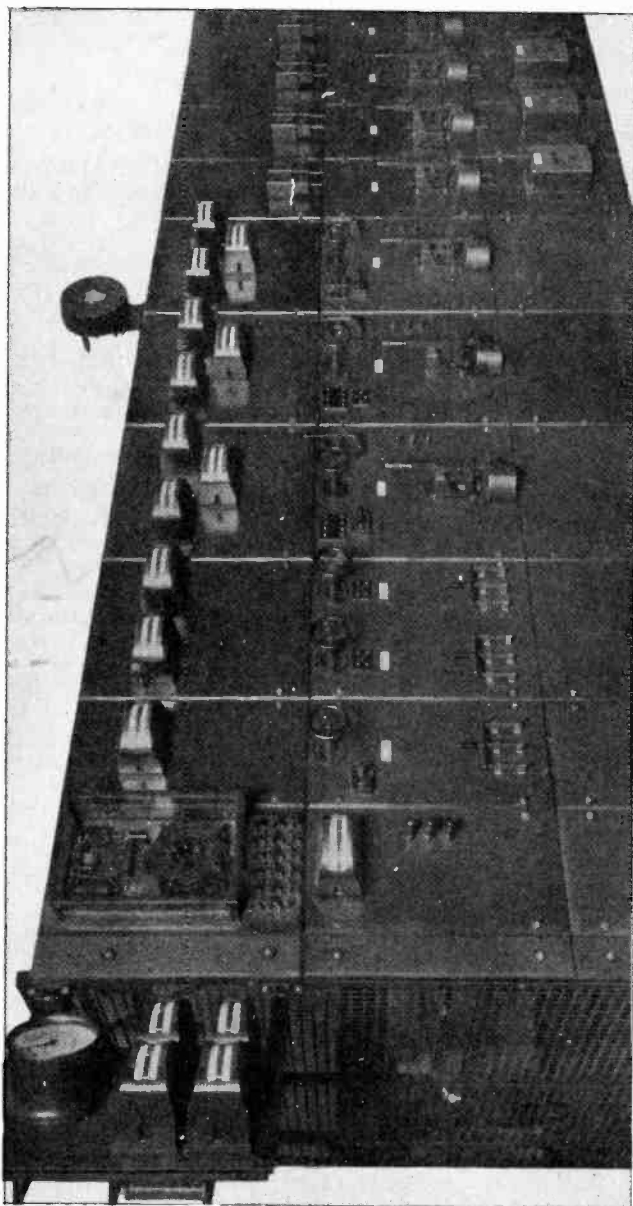

Alternating Current

This switchboard is typical of the vertical-panel type, with all wiring and bus bars mounted on the rear and enclosed by a screen guard.

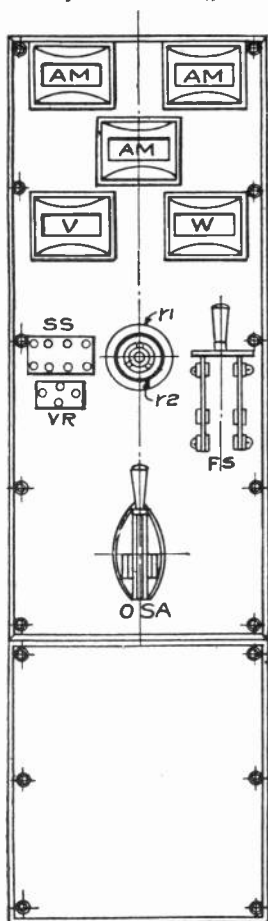

Fig. 2A. This figure shows the front view of a single panel of an A. C. switchboard. See Fig. 2B for the side view, and the wiring diagram.

1. SWITCHGEAR

As previously mentioned in lesson 37, the switches and controls used on these boards are all classed as "switchgear" and are for the purpose of

Switchboards

opening, closing and controlling the various generator and feeder circuits in the plant.

The switches on the generator panels control the generator-armature circuits and are used in starting, stopping, and paralleling these machines. The switches on the feeder panels control the energy which is distributed from the main busses through these feeder sections to the various loads.

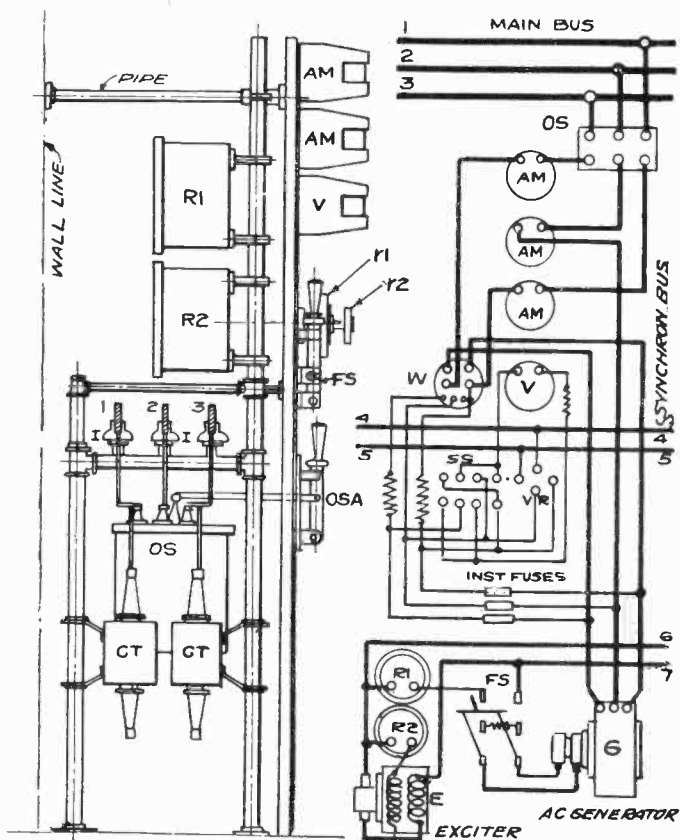

Fig. 2B. Side view and wiring diagram of the panel shown in Fig. 2A.

Fig. 2A shows a front view of a single switchboard panel, and Fig. 2B shows an end-view of a board on the left, and some of the principal circuits

Alternating Current

on the right. Note the arrangement of the meters, switches, and controls on the front of the panel in Fig. 2A; and also the side-view of this equipment, including the current transformers, oil switch, busses, and the instrument resistors shown on the left in Fig. 2B.

Fig. 3 on the opposite page shows a remotely-controlled, bench-type switchboard such as is commonly used in large A.C. generating stations. The meters for the various generators are mounted on the vertical panel above the control board.

The push-button and push-pull type switches and the small hand wheels shown on this board are used to control circuit breakers, oil switches, and motor-operated rheostats which are located in another part of the plant.

In some cases the throttle and governor controls for the generator prime movers are also placed on these switchboards.

With boards of this type the heavy-duty oil switches handling large amounts of current at very high voltages can be located in a switching vault or room, thus keeping the operators safely away from all high-voltage circuits and the dangers of bad flashes or arcs.

Remote-control switchboards also permit grouping the controls of a large plant closely together, for convenient operation. The large oil switches and rheostats used in a central station would be too bulky to mount at the rear of any ordinary sized switchboard.

These remotely-controlled oil switches can be opened or closed by pushing or pulling the small switch knobs on the board.

These switches generally close circuits to powerful solenoids, electro-magnets, or small motors which operate the oil switches. Some oil switches are operated by compressed air or hydraulic cylinders, but these are not nearly as common as the solenoid-operated type.

Switchboards

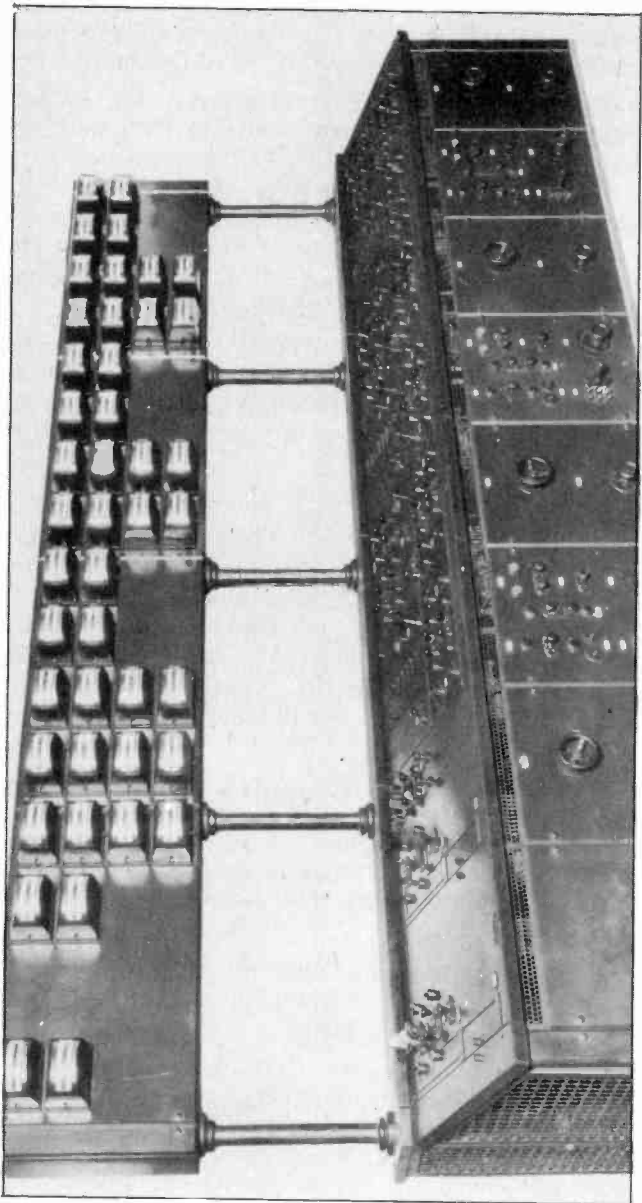

Alternating Current

The large generator and exciter rheostats can be controlled by switches which start, stop, and reverse the small motors which drive them.

Pilot lamps are commonly used on remote control boards to indicate when certain switches or breakers are open or closed and to show which circuits are alive.

Fig. 4 shows a modern truck-type switchboard, such as is coming into quite general use in substations and small industrial power plants. One panel or unit of this board is shown withdrawn from the main group, illustrating the great convenience with which the oil switch, meters, and devices can in this manner be entirely disconnected and removed from the main board and live circuits.

When the unit is pushed back into place the spring clips or prongs shown at the rear are again automatically connected with the live bus bars and circuits. The increased convenience and safety features of this type of board are causing it to become very popular in many plants.

2. SWITCHBOARD LAYOUT AND ARRANGEMENT OF INSTRUMENTS

As the switchboards in generating stations or substations form the heart of the control for all machines and circuits in the plant, as well as for the power lines and circuits radiating from the plant, it is very important to make a careful study of the circuits and operation of the switchboard in any plant in which you may be operating.

Central stations of large capacity often combine a certain amount of distribution with higher voltage power-transmission. This is particularly true of stations located in or near large cities.

The switchboards should provide a convenient arrangement of generator and feeder panels for controlling the various machines and feeders.

For example, a central station may have five generators of 30,000 kv-a. capacity and 11,000 volts

Switchboards

each. The output of any one of these generators may be controlled through one of a group of generator panels at the switchboard, where their outputs are all combined together in one main bus. From here it may be fed to step-up transformer banks.

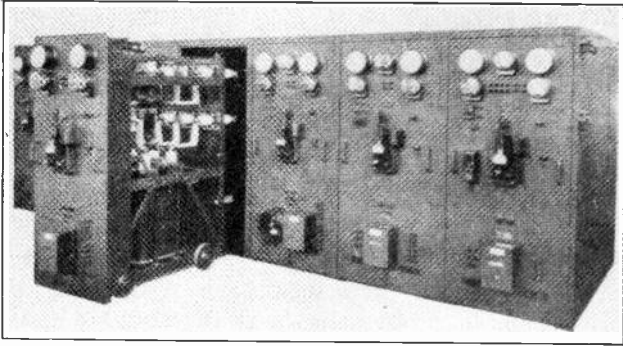

Fig. 4. View of truck-type switchboard showing one section removed to allow repairs or adjustments to be conveniently and safely made. Boards of this type are very popular in modern industrial plants as well as in certain power plants and substations. Courtesy of G. E. Company.

Let us assume that there are three separate banks of transformers, one of which increases the voltage to 22,000 volts, another to 66,000 volts, and the third to 132,000 volts.

Energy may be taken from the 22,000-volt bus through feeders to a number of local substations. The 66,000-volt bus may be used for an interconnecting tie with another power line of this same voltage. The 132,000-volt bus may feed one or more long distance transmission lines to carry energy to some distant city or industrial center.

Switchboard meters are made in several different styles, such as round, square, and edgewise types, so that the desired spacing and appearance can be obtained on the panels.

Meters should never be crowded too closely together on switchboard panels, as sufficient room should be provided for working on any individual meter without interference with adjacent ones.

Alternating Current

The several views of switchboards shown on these pages show very neat and logical arrangements of meters.

Multiple instruments consisting of several meter elements within one case are often used to save space on switchboards. For example, three separate ammeter elements—one for each phase of a three-phase generator and each having its own scale—can be built in one case to take the place of three separate ammeters.

Meters should be properly mounted and illuminated so that they can be easily read by the operators from a convenient position.

Watt-hour meters and recording instruments are sometimes exceptions to this rule and are quite often located near the bottom of switchboard panels as they usually don't have to be read as frequently as voltmeters, ammeters, and wattmeters.

3. SWITCHBOARD CIRCUITS AND WIRING

Fig. 6 in lesson 50 shows a wiring diagram for the main generator and exciter panels of one three-phase alternator in a small power plant.

Fig. 5 in this lesson shows a wiring diagram for two three-phase alternators and the instruments and equipment of a modern power plant switchboard to be used with these machines.

Examine this diagram very carefully and become thoroughly familiar with the circuits and equipment shown, and study out the operation and function of each circuit and device. A diagram of this kind is well worth several hours of your time, as it is quite typical of the arrangement of switchboard circuits in a great many modern power plants.

The main A.C. bus and alternator leads are shown in heavy lines so that they will be very easy to trace. Current passes from the alternators through

Switchboards

a set of reactor coils, then through the instrument transformers, oil switch, O.S., and disconnect switches, D.S. to the main bus.

This circuit, of course, is completed only after the disconnect and oil switches are closed.

The upper set of current transformers are used to operate the overload relays, O.L.R., any one of which will close a circuit to the oil switch trip-coil in case of overload.

The current for the oil switch trip-coil is supplied from the D.C. operating bus, which runs the length of the switchboard and supplies direct current for the various devices which can be conveniently operated with D.C.

The lower set of current transformers are used to operate the three ammeters and the current elements of the polyphase wattmeter, W. M., in series. The potential transformer operates the voltmeter and the potential elements of the polyphase wattmeter.

This transformer also supplies the synchronizing bus when the machine starting plug is in place in the synchronizing receptacle, S.R.

You will note that the synchronizing bus runs the length of the board and connects to a receptacle for synchronizing either alternator with the other, and also to a third receptacle at the right for synchronizing either alternator with the live line from outside the plant in case this station is operating in parallel with others.

The oil switch, meter, and synchronizing circuits of the second alternator are exactly the same as those of the first. The synchroscope is shown at "Syn"; frequency meter at "F.M."; power factor meter at "P.F."; station voltmeter at "S.V."; station ammeters at "S.A."; and a totalizing station wattmeter at "T.W.M."

The main line or bus oil-switch, O.S., is shown at the right with its overload trip coils, relays, and dis-

Alternating Current

connect switches. The exciter bus supplies current through the alternator field ammeters, field-discharge switches, and field rheostats to the slip rings on the revolving field of the alternator.

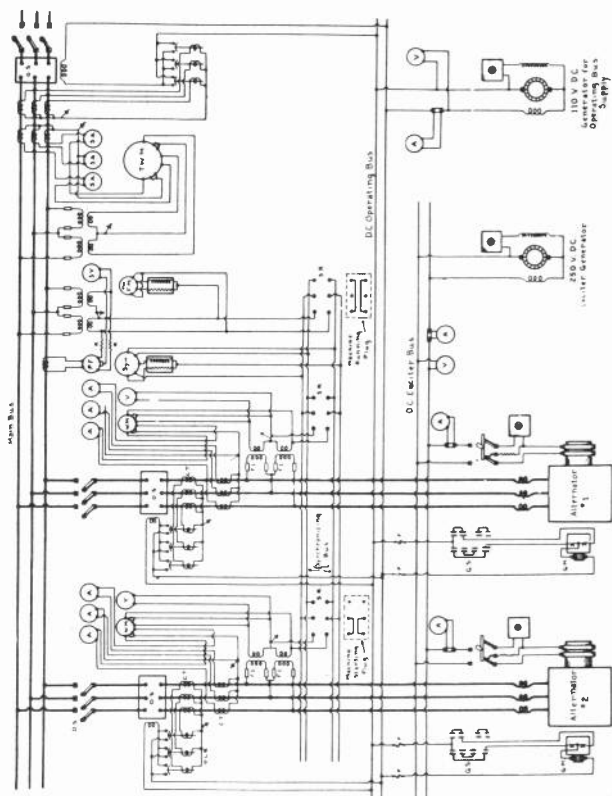

Fig. 5. Complete wiring diagram for a modern power plant switchboard, showing the connections of two three-phase alternators and their various auxiliaries, and also the connections of the meters, relays, and oil switches. Trace this diagram very carefully and locate each part referred to in the accompanying explanation.

The governor control motors, G.M., which operate the governors of the alternator prime movers, are also shown in this diagram. They are operated by the governor control-switch, G.S., by current supplied through the fuse, F., from the D.C. operating bus.

Switchboards

The power circuits on switchboards are usually run with heavy copper busses or cables, while the instrument and control circuits are wired with regular switchboard wire having heat resisting insulation, as explained in the Section on D.C. Switchboards.

All switchboard wiring should be done neatly and with a systematic arrangement of wires and circuits, in order to facilitate tracing the circuits and making repairs or additions to the wiring.

4. SWITCHBOARD OPERATION

In order to qualify for a position as switchboard operator in either a power plant or substation one should be thoroughly familiar with the principles, care, and operation of generators, transformers, motors, converters, rectifiers, meters, switches, circuit breakers, relays, lightning arresters, etc.

So, in preparing for a position of this kind, you should make a very thorough review of your notes and also of the lessons which cover these devices.

Even though you feel well qualified to step in and operate a station, very few companies will allow any newly hired man to assume the full responsibility of an operator during the first few days, even though he may have had previous experience or training.

This is due to the fact that there are certain variations in the construction and arrangement of equipment in different plants and also variations in the operating rules and procedure of different companies.

You should, therefore, willingly and faithfully perform any minor and seemingly unimportant duties to which you may at first be assigned, and pay strict and alert attention to every operation and bit of instruction you can observe from those who may be instructing you or breaking you in.

Large power companies are always looking for

Alternating Current

intelligent, ambitious, young men with practical training and good character, and the chief operators, plant foremen, and superintendents usually observe new men very closely; so it pays to be thoughtful, patient, and careful at all times when assigned to any duties in a power plant or substation.

During your first few weeks in a station you should in every way possible thoroughly familiarize yourself with all of the various pieces of equipment and the general plant layout. Read and make a note of the data on the various machine name-plates and memorize the capacity and voltage rating of the various machines.

Determine the sizes of the conductors leading from the generators to the switchboard and locate the proper switches and meters for each machine.

It is excellent practice to start by making a diagram showing the outline of the switchboard and all instruments and controls, completing the main panel first and then adding another panel to the diagram each day. In this manner you can very soon become familiar with the entire front of the switchboard.

Don't attempt to show any wiring in the diagram until you have all the instruments and devices in their proper location and thoroughly understand what each one is for in the operation of the plant.

It is good practice to lay aside your copied diagram and practice making sketches of the switchboard layout from memory.

Some power companies allow their operators to spend a certain amount of time on the job making diagrams and thorough studies of the plant, as well as to study any books or material which will help the operator in his work. Keep in mind that such studies should never be allowed to interfere with your work or alertness when on duty.

After completing diagrams of the switchboard equipment and plant layout a thorough study should be made of any wiring diagrams supplied by the

Switchboards

company, and you should then make your own diagrams from the actual wiring on the board and in the plant, carefully checking and marking each wire so that you know its voltage and current and the instrument or device to which it leads.

A thorough step-by-step study of the plant equipment and circuits made in this manner will soon enable you to have in your mind a complete simplified picture of the entire plant and this will be of great help in trouble shooting or in time of emergency operation, as well as in your ordinary everyday operating duties.

Almost all power companies periodically examine their men with written, oral, and practical operating tests. Try to be well prepared for these examinations, but don't worry too much about the possibility of failing in them as the company is merely trying to find out what progress you are making and to stimulate your thought and energy and develop your ability for promotion to positions of greater responsibility.

Always try to remain cool-headed and calm, whether during examinations or during emergencies which may arise in the operation of the plant. Think clearly and apply the principles of electricity, circuits, and machines which you have learned, and in this manner you can solve practically any problem or difficulty.

The responsibility of an operator in a large power plant or substation is very great and the safety of the lives of fellow workers, the safety of costly machines owned by the company, and the satisfaction of customers with the service they receive depend to such a large extent upon plant operators that it pays to always be thoughtful and careful and to **use your head as well as your hands at all times.**

A few very good general rules or tips for the substation or power plant operator are as follows:

1. Always be careful and think before acting.
2. Practice safety-first and attend safety-first meetings.
3. Protect yourself and fellow operators with proper safety appliances.

Alternating Current

4. Determine the functions of your station.
5. Keep accurate station records, such as daily meter or log sheets, repair sheets, trouble sheets, hold-cards, etc.
6. Keep the station and all equipment clean and orderly, and tools, safety appliances, etc., in their proper places at all times.
7. Learn thoroughly the procedure for starting and shutting down all machines.
8. Report to your superior all doubtful or unusual occurrences.
9. Never allow anyone except properly authorized persons inside of the station.
10. Never close a feeder switch without first being authorized to do so, and then make a record of the operation with the authorizer's name.
11. Repeat all telephone orders received from the chief operator or dispatcher.
12. Properly tag all outgoing lines which have been "killed" for workmen to make repairs on them. The tag should preferably be of red cardboard and should carry the date, your name, the name of the foreman of the repair crew, reason for or nature of repairs, etc. See that the switches of such circuits are locked open and grounded.
13. See that danger signs are placed on all high-voltage equipment and guard rails around dangerous places. High-voltage outdoor equipment should be fenced in.
14. Consider all wires and equipment to be alive unless you are sure they are disconnected and thoroughly grounded.
15. Take pride in the proper care and condition, and in the operating efficiency of every piece of equipment in your plant, as well as the plant as a whole.
16. Attend first-aid meetings and learn the location of first-aid kits and equipment in your station.

Switchboards

17. Practice resuscitation.

18. Be co-operative, cheerful, and good-natured with both fellow employees and superiors, even in the face of discouraging circumstances.

19. Study carefully all company rules and encourage fellow workers to do the same.

20. Keep up-to-date by frequently reviewing your lessons and notes, reading good electrical books, and subscribing to one or more good trade journals or electrical magazines.

5. CIRCUIT-BREAKERS

A.C. circuit-breakers are constructed very much the same as those used for D.C. circuits, except for the difference in the number of poles and a slight difference in the construction of their operating coils.

Ordinary air circuit-breakers are frequently used on A.C. circuits ranging from 110 to 600 volts, but on higher voltage circuits carrying heavier currents in large substations or power plants, oil switches are generally used because they are much safer in operation and more effective in quickly interrupting high-voltage circuits.

Fig. 6 shows a single-phase, 100-ampere, 600-volt, A.C. circuit-breaker. Each of the two poles is equipped with main contacts and auxiliary arcing contacts, as previously explained for D.C. breakers. The flash-barriers shown between the tops of the two contactors are for the purpose of preventing flashovers between the two poles of the breaker when an arc is drawn in interrupting heavy current overloads in the circuit.

Alternating Current

The series overload trip-coil and hand-trip button can be clearly seen in this photo. The small adjusting device is provided underneath the trip coil for setting the amount of load on which the breaker will trip open.

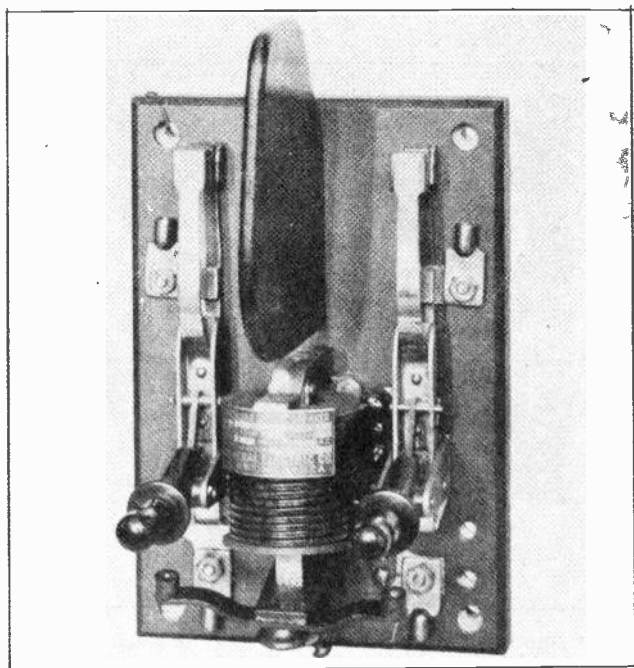

Fig. 6. Small air circuit-breaker for use on circuits of 600-volts and loads up to 100 amperes. Note the flash barrier placed between the two poles of the breaker. Courtesy of G. E. Company.

Fig. 7 shows a 500-ampere, 250-volt, three-phase A.C. circuit-breaker. This breaker has three poles, one for each phase; and two overload trip coils, one of which is connected in each of the outer phase wires.

Circuit-breakers of this type can be equipped for instantaneous opening or with time-delay devices in the form of dash pots or bellows on their tripping mechanisms.

Circuit-Breakers

The care of A.C. breakers is similar to that of those used for D.C. in that the contacts should be kept tight and in good condition, operating springs in good condition, and overload adjustment properly made to give desired protection to the equipment on the circuits in which the breakers are installed.

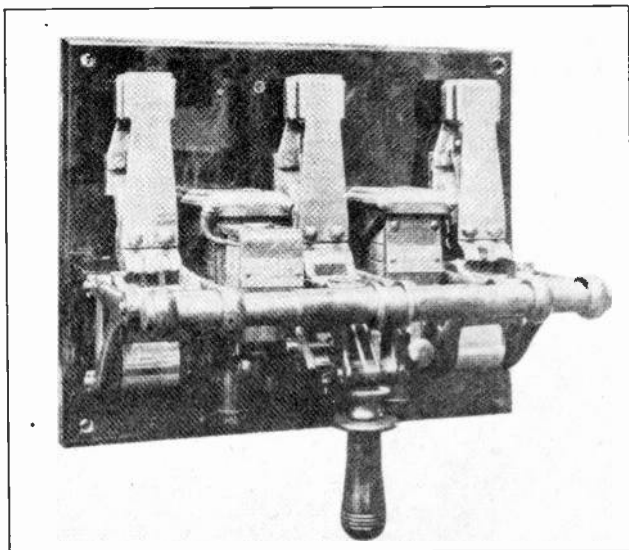

Fig. 7. Three-pole, 500-ampere, 250-volt A. C. air-breaker. Note the intermediate and arcing contacts and also the series overload trip coils. Courtesy of G. E. Company.

Alternating Current

EXAMINATION QUESTIONS

1. In what respect do A.C. switchboards differ from D.C. switchboards?
2. What provision is made for manual operation of large oil switches mounted back of the switchboards?
3. What is meant by the term "switchgear"?
4. Briefly describe how truck type switchboards are constructed.
5. What is the upper instrument on the hinged bracket at the left in Fig. 1 used for?
6. What is the purpose of the OLR relays shown in Fig. 5?
7. (A) What instruments are operated by the potential transformers FI and FI in Fig. 5? (B) What is the purpose of the TWM instrument in Fig. 5?
8. What items should you be thoroughly familiar with to qualify for work as a power plant operator?
9. State five important rules for power plant operators.
10. What is the purpose of the auxiliary contacts on air circuit breakers?

Circuit-Breakers

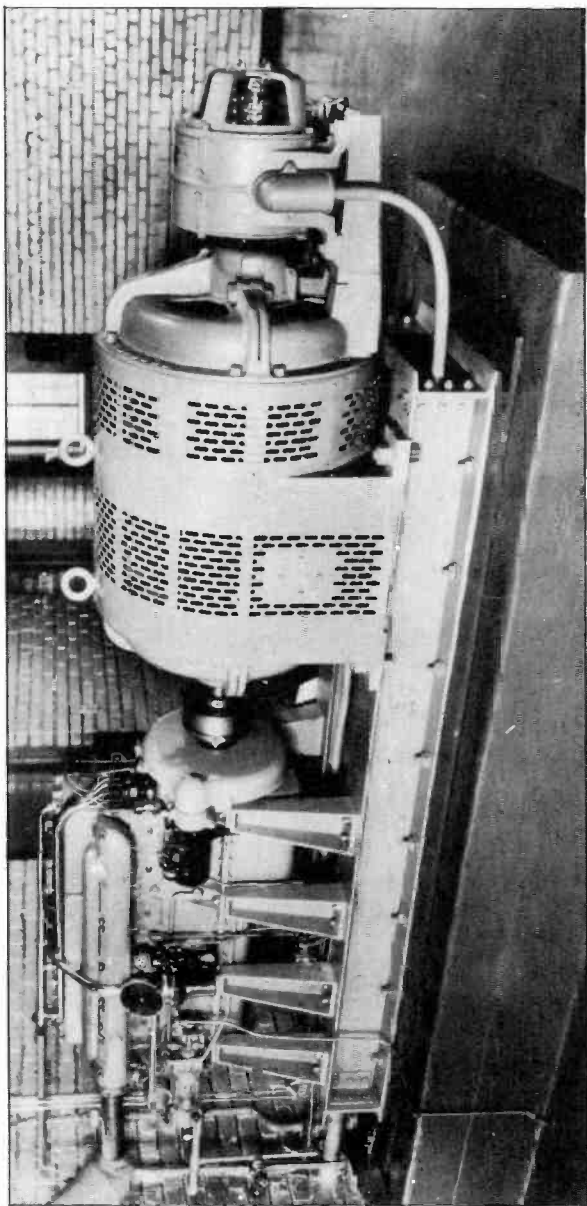

Auxiliary power generator at a large Michigan Radio Station. Electricity and Radio are very closely allied branches.

OIL SWITCHES

Oil circuit-breakers consist of breaker contacts which are operated under oil within a metal tank. The great advantage of breakers of this type lies in their greater safety and their ability to quickly interrupt high-voltage circuits because of the action of the oil in quenching out the arcs at the contacts as they are opened underneath the oil.

As soon as the switch is opened the insulating oil immediately flows into the space between the movable and stationary contacts and snuffs out the arc. This preserves the life of the contacts by preventing them from being so severely burned by the arc; helps to obtain speedy circuit-interruption in case of overloads, thus providing better protection for the equipment on the circuits; and greatly increases the safety of operators because the circuits are interrupted within the metal tank.

For this reason, oil circuit-breakers are used on practically all A.C. circuits of 2300 volts or over.

Fig. 1 shows a small oil switch for use on three-phase circuits of not over 3300 volts and 200 amperes capacity. The switch mechanism is shown removed from the tank in this view, so that the stationary and movable contacts can both be clearly seen. The stationary contacts are supported by the insulating bushings through which the conductor leads are run. There are six of these bushings and terminals, and the line enters through the three on one side and leaves through the three on the other side.

The movable copper contacts, which are in this case shown dropped down or opened, are supported by the wooden insulating rods which are attached to the operating mechanism and lever on top of the switch. When these contacts are drawn up they press tightly into the spring fingers of the stationary contacts, thus making a good low-resistance connection. When the movable contacts are dropped they open the circuit in two places in series

Oil Switches

in each phase, thus very effectively interrupting the current flow.

Small oil switches of this type are generally

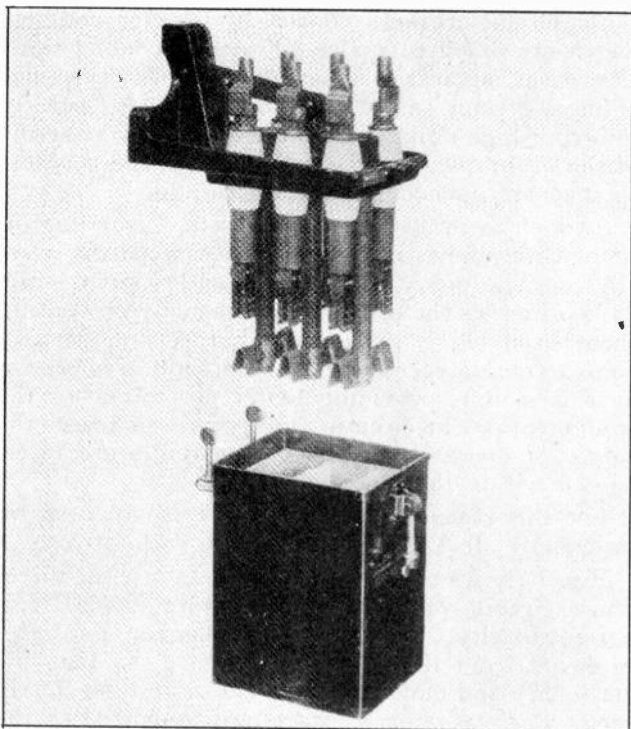

Fig. 1. View of a three-pole, 3300-volt, 200 ampere oil switch with oil tank removed to show contacts. Courtesy of G. E. Company.

manually-operated by handles or levers placed on the front of the switchboards or panels, as shown in Fig. 1 in lesson 70. In some cases it is desired to locate the oil switches a few feet back of the switchboard, or perhaps behind the wall in another room. In this case they can still be operated by remote mechanical control through a system of bell-cranks and rods, as shown in Fig. 2.

Oil switches should not be used in circuits with greater current loads than the capacity for which the switch is designed, and for effective operation

Alternating Current

and long life the contacts should be kept in good condition and the oil renewed frequently enough to maintain good insulating properties.

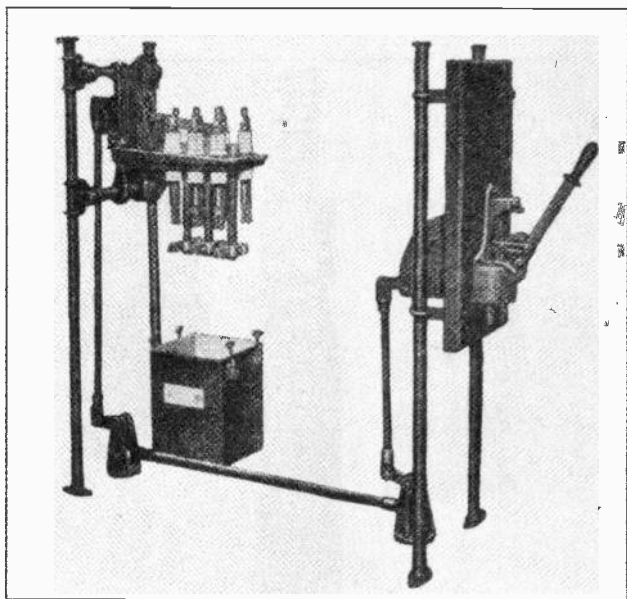

Fig. 2. This figure illustrates the method of obtaining remote mechanical control for an oil switch located several feet back of the switchboard. Courtesy of G. E. Company.

When oil switches are tripped open under heavy overloads or short circuits the contacts are likely to be burned to a certain extent in spite of the arc extinguishing properties of the oil. This means that the contacts should occasionally be inspected and resurfaced or replaced with new contact shoes or fingers when necessary.

The tank for the oil switch shown in Fig. 1 is provided with a set of inner barriers made of insulating and fire-resisting material. These barriers separate the oil into three different wells or cells in each of which a set of contacts is placed. This tends to prevent flashovers between phases when the switch is opened.

Oil Switches

You will note that the tank can easily be removed to provide convenient inspection and care of the contacts as well as easy renewal of the oil.

Fig. 3 shows a larger view of a set of stationary and movable contacts for a manually-operated

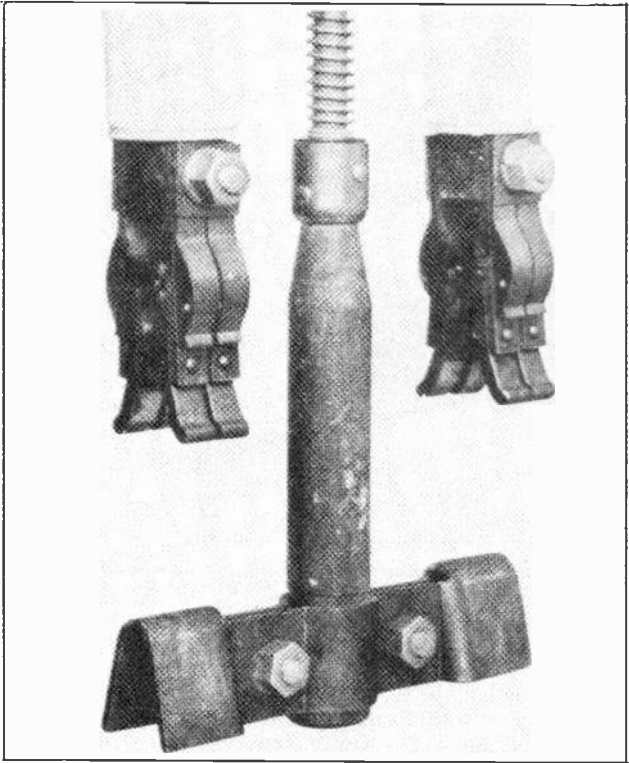

Fig. 3. Close-up view showing the details of construction of stationary and movable contacts of an oil switch. The upper stationary contacts are supported on porcelain bushings and the lower movable contact on a wooden insulating rod. Courtesy of G. E. Company.

oil switch. This view clearly shows the manner in which the contacts can be removed for replacement by merely loosening the proper bolts and nuts.

The view at the upper left in Fig. 4 shows the operating mechanism of a three-phase oil switch of somewhat different construction from the one in Fig. 1. In this switch the main movable contact

Alternating Current

is made of a number of thin strips of copper arranged in a leaf construction that provides a good-fitting, low-resistance contact with the stationary

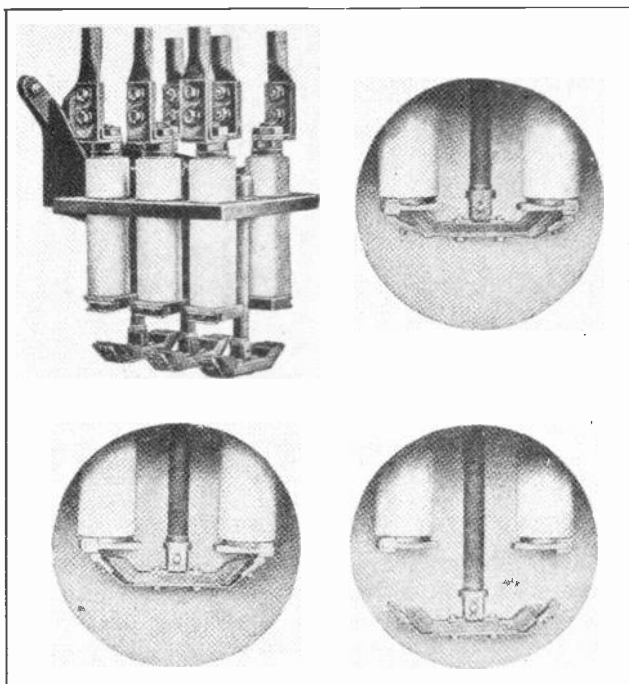

Fig. 4. At the upper left is shown the mechanism of a different type oil switch, and in the three other views are shown the steps or movement of the contacts during the opening of a switch of this type.

contact surfaces. The movable contact is also equipped with renewable arcing tips on each end. These arcing tips open last and the arc is therefore drawn from them, thus preventing the burning of the main-contact tips.

The view on the upper right in Fig. 4 shows an enlarged view of one set of these contacts in fully-closed position. At the lower left in the figure the contacts are shown partly opened; the main contact element having broken away from the stationary

Oil Switches

surfaces, leaving only the arcing tips in contact. At the lower right the switch is shown fully opened.

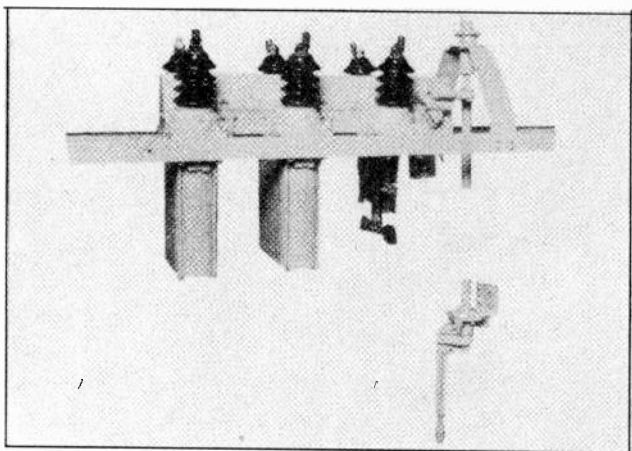

Fig. 5. 15,000-volt, 400-ampere, triple-pole oil switch with one tank removed. Note that the pole elements of this switch are each enclosed in a separate tank. Courtesy of G. E. Company.

2. HEAVY-DUTY OIL SWITCHES

High-voltage, heavy-duty oil switches are usually made with each set of contacts enclosed in a separate oil tank, to avoid all possibility of flashover between phases when the circuit is interrupted.

Fig. 5 shows a 15,000-volt, 400-ampere, three-phase oil switch of this type, with the oil tank removed from the right-hand set of contacts. This view shows clearly the porcelain insulating bushings with the conductor terminals attached to their top ends and the stationary switch contacts attached to their bottom ends.

All three of the movable contacts can be moved at once by means of an operating shaft and lever, which are also shown in this figure.

Indoor-type oil switches used in power plants and high-voltage substations often have their separate phase units built into regular fireproof concrete cells or compartments, as shown in Fig. 6. This serves as additional protection to operators and also against interference with other circuits in the plant in case of a defect in, or explosion of, one of the oil

Alternating Current

switch units. It also makes convenient the connection of high-voltage conductors, which are also very often run through fireproof concrete ducts and cells throughout the plant.

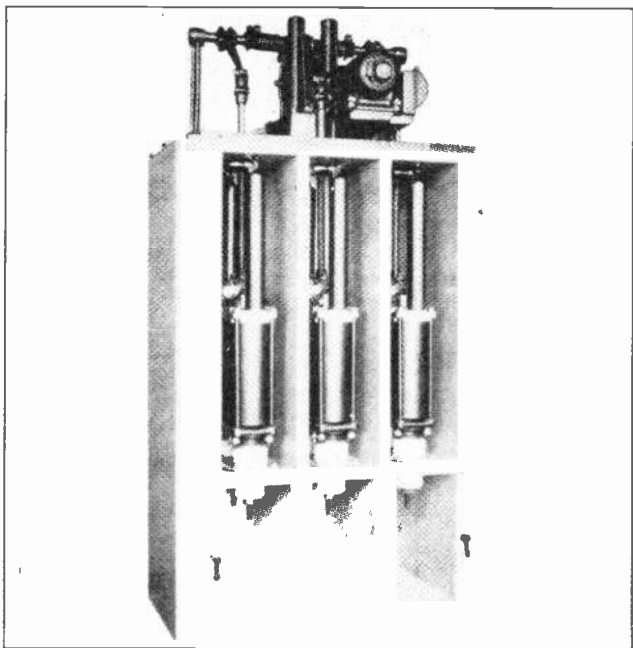

Fig. 6. Modern three-pole oil switch with expulsion type contacts and with pole units located in separate cells or compartments. Courtesy of G. E. Company.

The switch shown in Fig. 6 is of the remote-controlled, motor-operated type. The motor shown on top of the switch unit drives a gear which closes the switch and winds the heavy coil springs at the same time. When the switch is tripped these coil springs quickly open the contacts.

Fig. 7 shows a huge outdoor oil-switch designed for operation in a three-phase, 150,000-volt circuit and to carry a load of 600 amperes. This switch has an interrupting capacity of 1,500,000 kv-a. in case of severe overloads or short circuits on the transmission line in which it is installed.

Oil Switches

Fig. 13 in lesson 69 shows a large group of 220,000-volt oil switches. Practically all of these

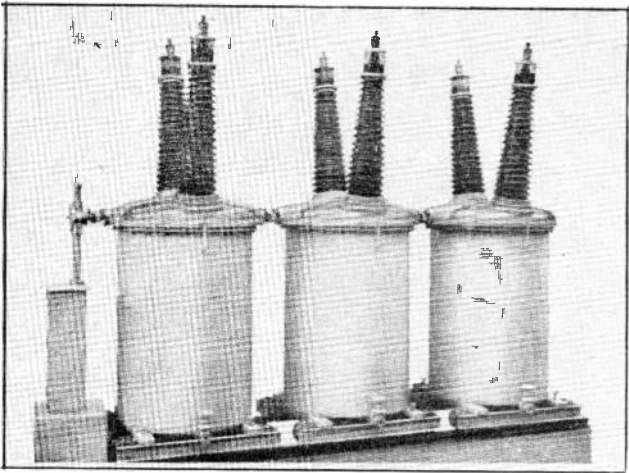

Fig. 7. Large outdoor oil switch for use in three-phase, 150,000-volt circuits. Courtesy of Condit Electric Mfg. Co.

large type oil switches are operated automatically by motors or powerful solenoids.

In addition to the ordinary movable and stationary contacts operated under oil, some oil switches have contact prongs which open the circuit within an expulsion chamber. In switches of this type the gases created by the arc are temporarily confined within a special chamber and then blown violently out through a small opening through which the movable contact rod is withdrawn as the switch opens. The oil and gas which are forced out through this small opening quickly snuff out the arc.

On the left in Fig. 8 is shown a sectional view of one type of expulsion chamber for an oil switch of this type. In the center is a sectional view of a complete expulsion-type oil-switch with a slightly different chamber, and on the right is a view showing this switch in action just as the circuit is being opened.

Alternating Current

A recent development in connection with oil switches is the use of deion grids on the stationary contacts and immersed in oil, to help extinguish

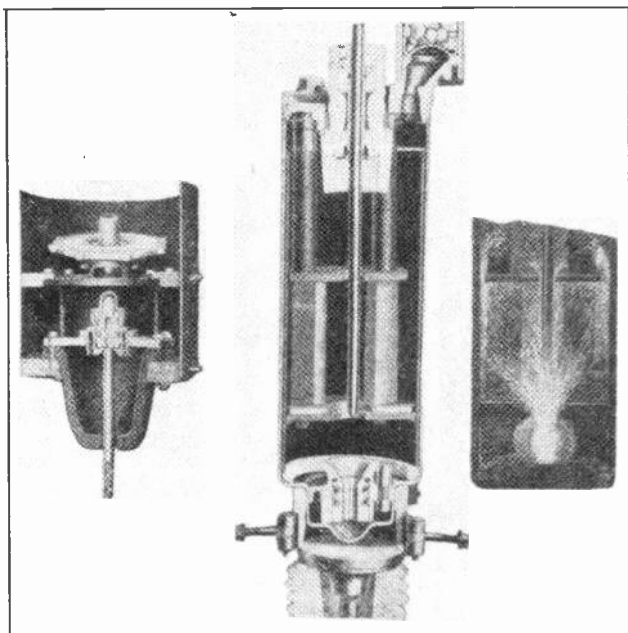

Fig. 8. The above views shows two types of expulsion contacts used in modern oil switches and also one of these contacts in action opening a circuit.

the arc more quickly. These deion grids were previously described in the lesson on Controllers. Fig. 9 shows the inside of a large oil switch equipped with deion grids which can be seen on the lower ends of the stationary contacts.

Oil switch tanks should be thoroughly grounded to prevent the possibility of shocks due to leakage through their insulation, or due to capacity charges which may be built up on the tanks of high-voltage breakers.

The tanks of oil switches should also be provided with some small opening or vent to allow the escape of gases generated within the tank by the

Oil Switches

arcs when the circuits are opened. Very heavy arcs may generate considerable gas when the circuit is required to open under heavy short-circuits.

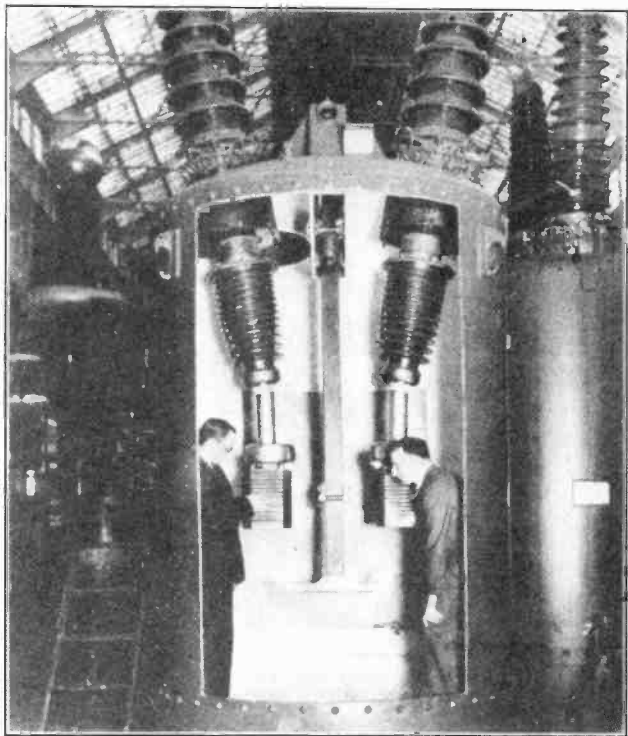

Fig. 9. This unique photograph clearly shows the inside of a large high-voltage oil switch equipped with Deion grids on the stationary contacts. Note the size of the contacts, insulators, and tanks required for handling the currents of high-voltage power lines. Courtesy of Westinghouse Elec. & Mfg. Co.

In addition to their use in substations and power plants oil switches are also used extensively for starting large high-voltage motors.

The operator who has charge of oil switches should always see that they are well filled with clean oil of the proper insulating quality; keep the insulating bushings clean by brushing or wiping them off with a brush or mop with a long wooden

Alternating Current

handle; and keep the contacts in proper condition and repair.

When performing on oil switches any work that

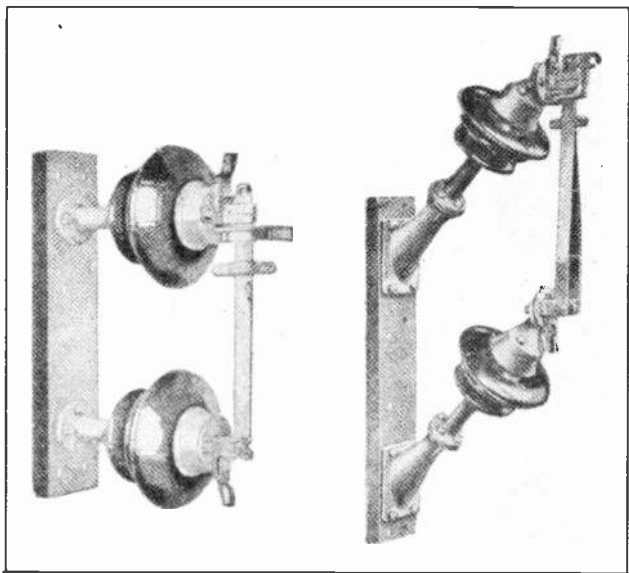

Fig. 10. Two types of disconnect switches for operation by means of a switch hook or pole having an insulated handle.

involves the possibility of the operator's coming in contact with live parts, the switch should first be completely disconnected from the line by means of disconnect switches on either side of the oil switch. It is also a good added precaution to thoroughly ground the oil switch terminals.

3. HIGH-TENSION AIR-BREAK SWITCHES

Disconnect switches are used extensively both on inside busses in power plants and in outdoor substation structures. High-voltage air-break switches are also commonly used in outdoor switching and substation structures. Ordinary disconnect switches generally consist of a hinged blade and clips

Air-Break Switches

mounted on the proper insulators for the voltage of the line on which they are to operate.

Two switches of this type are shown in Fig. 10. You will note that the blades have eyes or holes

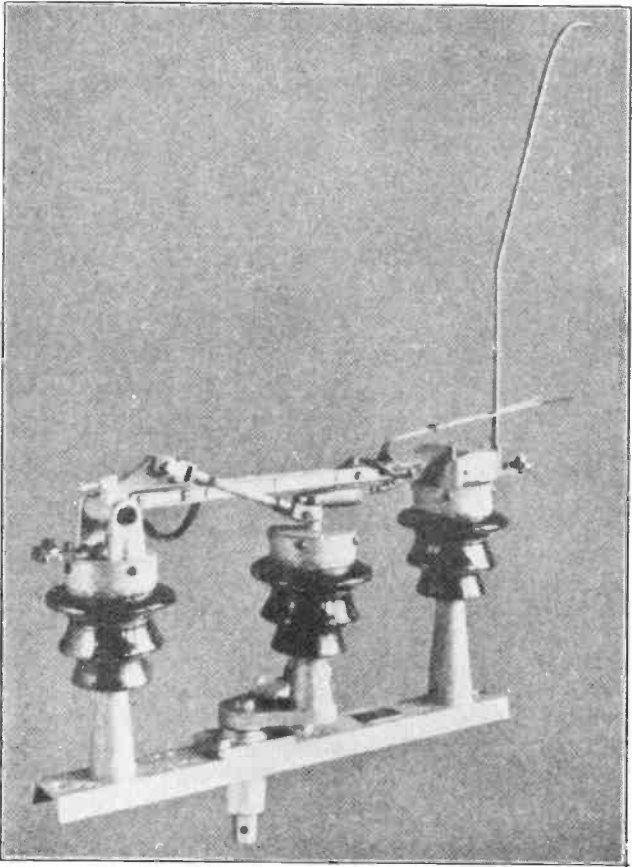

Fig. 11. High-voltage air break switch for pole top mounting or use in substation structures. Note the arcing horns used to prevent pitting and damage to the switch contacts. Courtesy of Hi-Voltage Equipment Company.

at the top ends so that they can be operated by wooden switch sticks, or poles which have a small metal horn that can be placed in the eyes of the switchblade to pull it open.

Alternating Current

Disconnect switches of this type should never be used to open a circuit under load but should be opened only after an oil switch in series with them has opened the circuit and interrupted the current flow to the principal power load.

The disconnect switches can then be opened by means of the safety stick to completely disconnect the oil switches, lightning arresters, instrument transformers, and other equipment from the line.

Both of the switches shown in Fig. 10 are for 300-ampere, 37,000-volt circuits.

Special high-voltage air-break switches are made to open line circuits under load. These switches are generally equipped with arcing horns to carry the arc away from the current conducting blades and contacts as soon as the switch is opened.

The movable blades of air-break switches are often equipped with springs which snap them open quickly when the operating handle is moved.

Fig. 11 shows a switch of this type in closed position. Note the large vertical horn attached to the stationary clip and the small horns attached to the movable blade.

Switches of this type can be mounted on the tops of poles or on the steel framework of substation structures and operated by a long shaft running down to a handle within reach of an operator on the ground.

The switch in Fig. 11 is opened by rotating the center insulator, causing it to push on the small rod attached to the hinge of the movable switch blade and thus snap the switch open. Fig. 12 shows the same switch in open position.

Fig. 13 shows an air-break switch mounted on the top of a pole and being opened after dark. The long arcs which are drawn from the horns when the switch interrupts the load current of the high-tension line can be clearly seen in this view.

Fig. 14 shows a one pole unit, heavy-duty, 600-ampere, air-break switch of somewhat different con-

Air-Break Switches

struction from those in Figs. 11 and 12. This switch is for use in a 120,000-volt circuit.

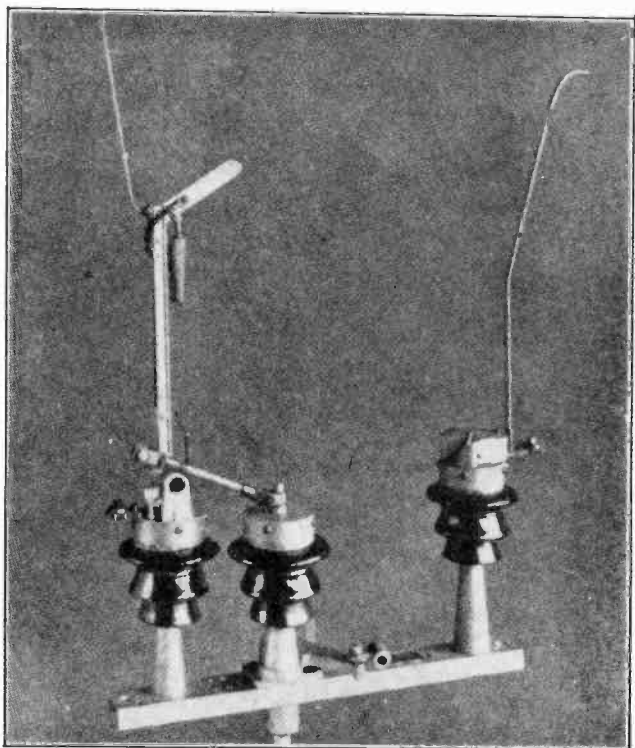

Fig. 12. This is another view of the same air break switch shown in Fig. 11. In this figure the switch is shown open. Note the movement of the center insulator by comparing the two views. Courtesy of Hi-Voltage Equipment Company.

When the insulators at the right are rotated either by a motor or hand crank the long tubular blade is quickly raised, thus opening the circuit. When the movable blade is connected to the live incoming line and the stationary clip connected to the substation equipment, the grounding blade which is clearly shown in this view can be swung up to the ground clip after this switch has been opened, thus grounding the dead end of the line for safety to operators who may be working on the equipment attached to it.

Alternating Current

Most air-break switches are designed so they can be opened even when coated with ice. To make this

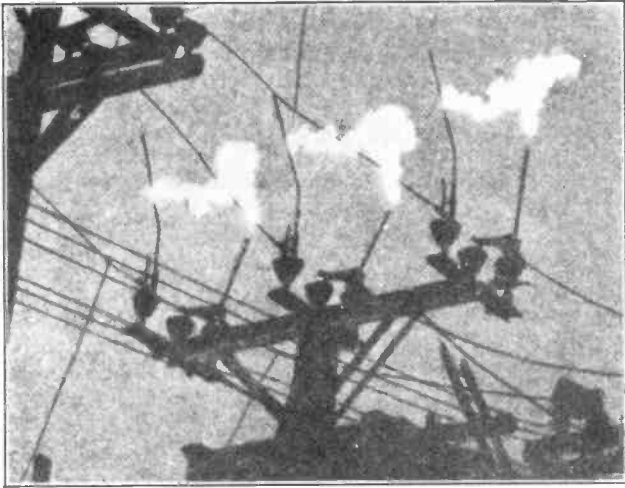

Fig. 13. This night photo of an air break switch opening under load shows the arcs which are drawn from the arcing horns just as the switch opens. Courtesy of Hi-Voltage Equipment Company.

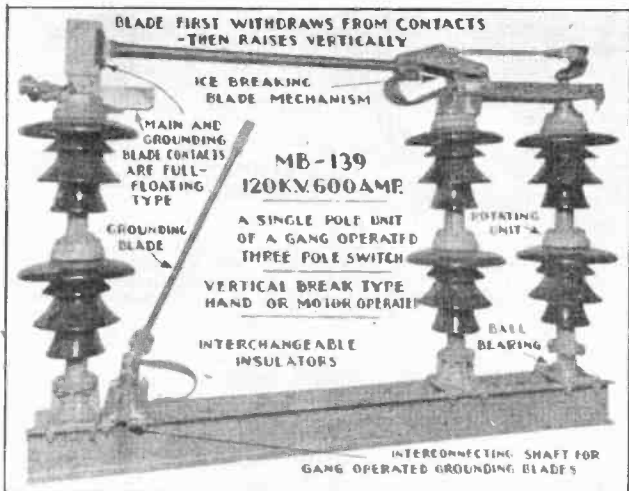

Fig. 14. Single pole unit of 120,000-volt, 600-ampere air-break switch with auxiliary grounding blade. Note the description of the various parts in this figure. Courtesy of Delta-Star Manufacturing Company.

High-Tension Fuses

possible the mechanism is usually arranged so that the blade first makes a short twisting or lengthwise pulling movement to break loose or shear any coating of ice which may be over the contact and clips. After this first shearing movement the blade swings freely into open position.

4. HIGH-TENSION FUSES

It is often desirable to protect small transmission lines or branch lines which run off from main lines from local overloads so that these overloads will not affect the entire line and system.

Special high-tension fuses for mounting on the tops of poles or towers have been designed for this purpose and serve to quickly disconnect a branch or section of the line in case of severe overloads, short circuits, or insulator flashovers caused by lightning.

Fig. 16 shows an expulsion-type of high-tension

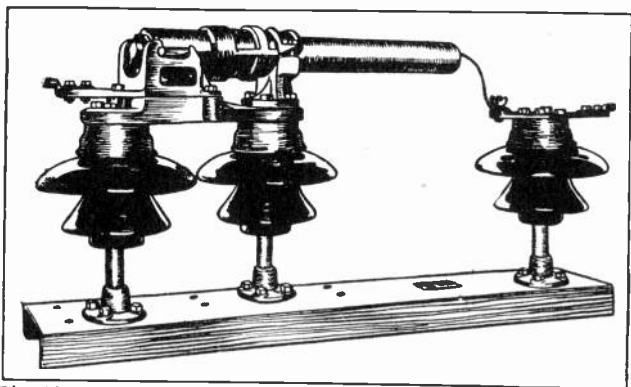

Fig. 16. Expulsion type high-voltage fuse. The fuse strip is violently blown out of the tube or barrel, thus quickly interrupting the circuit when this fuse blows. Courtesy of Hi-Voltage Equipment Co.

fuse. This fuse has a small tube or barrel like a gun, into which is fastened the piece of lead fuse wire shown protruding from the right-hand end. When the fuse blows inside this tube, the gases formed by the arc quickly blow the remaining end of the fuse away from the end of the tube and actually blow out the arc, thus interrupting the line circuit.

Alternating Current

Another type of high-voltage fuse which is very extensively used has a fusible strip and long coil spring enclosed in a glass tube which is filled with arc-extinguishing fluid. This fuse is so designed that when in normal condition the spring is held under tension, and when the fuse strip melts due to an overload, the spring is released and quickly draws the lower arcing terminal downward, thus making a long gap which tends to extinguish the arc.

As the spring moves downward it also moves a liquid director or plunger which compresses the liquid in the tube and squirts it through an opening in the plunger and directly into the arc, thus effectively extinguishing the arc.

Fig. 18 shows a diagram of a fuse of this type, in which all the essential parts can be clearly seen. Note the coil spring and the flexible copper cable which carries the current, and also note the liquid director attached to the arcing terminal at the upper end of the spring.

The spring is normally held extended by a small piece of strong tension wire that is connected in parallel with the fuse strip, but when the fuse strip blows the current load is shunted through the tension wire causing it to melt and release the spring.

Fig. 19 shows a photo of a complete fuse of this liquid-filled type in the view on the left. The top center view shows one of the fuses after it has blown and the spring has drawn down and broken the arc.

The lower center views show two types of clips in which the fuses are mounted and locked by the clamping rings.

On the right are shown two views of such fuses equipped with weather-proof housings for outdoor use and for convenient mounting on poles or substation structures.

One of the great advantages of these fuses is that they will open the circuit, extinguish the arc, and clear an overload or short circuit in from $\frac{1}{2}$ to $1\frac{1}{2}$ cycles.

They are made in sizes from $\frac{1}{2}$ to 400 amperes and for voltages from 2200 to 138,000.

High-Tension Fuses

The fuse is provided with a vent cap to allow the escape of the gases formed by the arc when the fuse blows, and thus prevent damage to the tube.

These fuses can be refilled at a nominal cost by

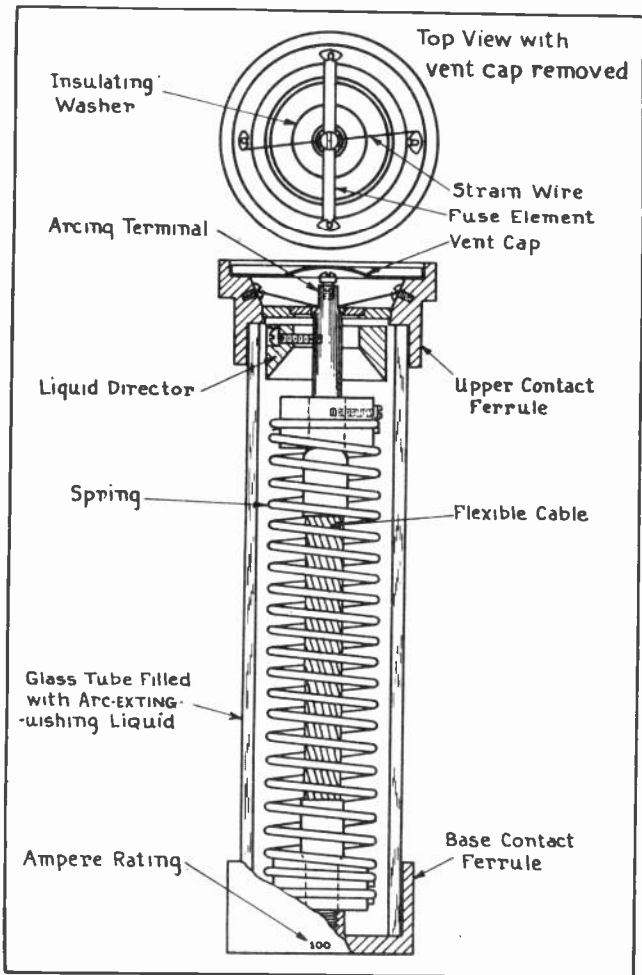

Fig. 18. The above sketch shows the principal parts of a high-voltage fuse of the liquid filled type. Examine each part carefully and compare with the explanations given on these pages. Courtesy of Schweitzer & Conrad, Inc.

returning them to the manufacturer after they have blown.

Alternating Current

Fig. 20 shows two types of wooden fuse tongs for removing and replacing high-voltage fuses, and also a switch hook for opening and closing disconnect switches.

Oil switches and disconnect switches in the circuit should always be opened before removing or

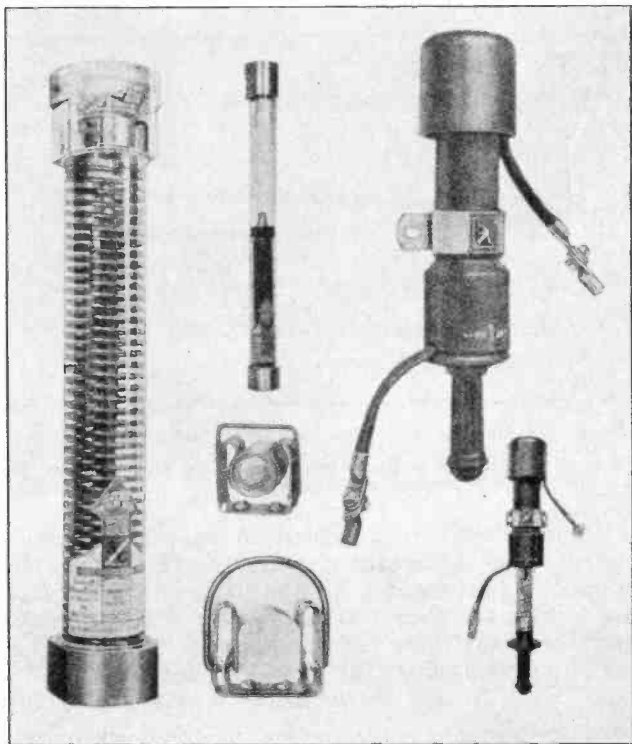

Fig. 19. The above views show high-voltage fuses of the liquid filled type both in normal and open condition, and also shows clips for mounting them. On the right are fuses of this type in waterproof housings for outdoor use. Courtesy of Schweitzer & Conrad, Inc.

replacing fuses, in order to avoid drawing arcs at the fuse ferrules and clips.

5. A. C. RELAYS

There are a number of different types of A.C. relays in common use in alternating current power plants and substations. Keeping in mind at all

A. C. Relays

times that any relay is simply a magnetically operated switch, it is comparatively easy to understand their operation and care, as well as their purpose in the circuits in which you may find them.

A.C. relays are used in many of the same ways as the D.C. relays which were explained in an earlier lesson.

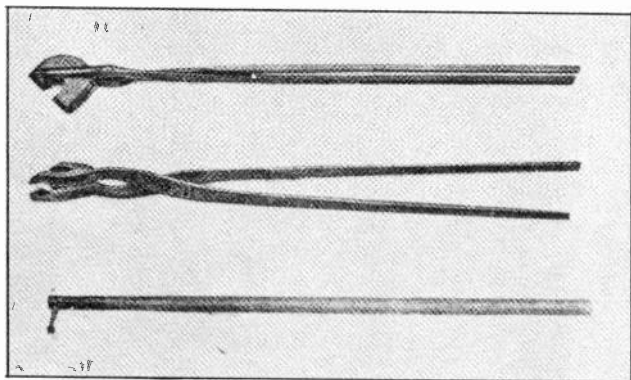

Fig. 20. At the top are shown two wood handled fuse tongs for removing and replacing high-voltage fuses, and below is shown a wood handled switch stick or pole for operating disconnect switches. Courtesy of Schweitzer & Conrad, Inc.

Some relays are designed to operate whenever the voltage of certain circuits to which they are connected becomes too high or too low. Such relays are known as over-voltage or under-voltage relays, and are sometimes called potential relays. They are connected across the phases of low-voltage A.C. circuits or to the secondaries of potential transformers which are connected to the high-voltage A.C. circuits.

Current relays are designed to operate whenever the current in certain circuits falls below or rises above a certain value for which the relay is set. These relays are generally operated from the secondaries of current transformers, as the relay itself is usually a rather delicate device and is not designed to carry much current.

Current relays are often called overload or underload relays, according to the use for which they are intended.

Alternating Current

Many relays are designed with very small contacts which are intended only to make or break the circuits to the coils of heavy-duty relays. These main relays in turn operate heavy contacts which

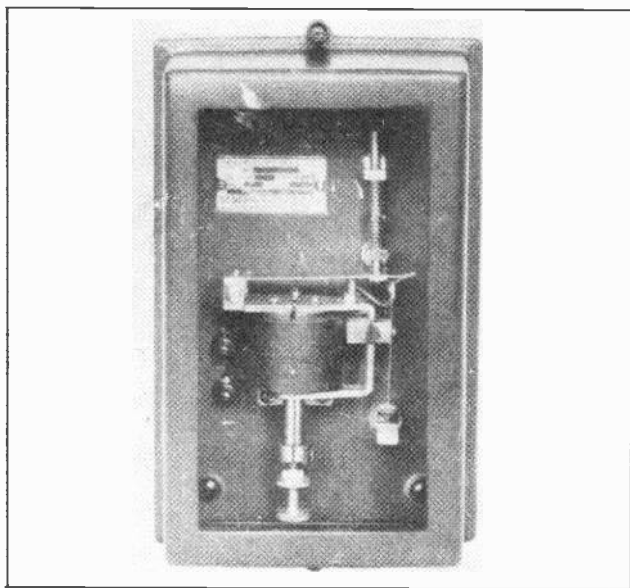

Fig. 21. Photo of a high-voltage cutout relay clearly showing the coil and contacts. Courtesy of G. E. Company.

open or close the circuits to large oil switches of the solenoid or motor-operated type.

Fig. 21 shows a high-voltage cut-out relay. The operating coil, movable contacts, and relay adjustment screw can be clearly seen in this view.

Fig. 22 shows a solenoid-operated instantaneous overcurrent relay, with the cover removed from the contacts. The solenoid coil is in the casing to which the name-plate is attached, and the plunger adjustment by which the relay can be set to trip at various loads is shown at the bottom of the device. Relays of this type can be made to open or close one or more circuits, as desired.

A. C. Relays

Many relays of the magnet or solenoid-operated type are instantaneous in their action or, in other words, they are designed to operate and close their contacts immediately, as soon as the voltage or current reach the values for which the relays are set.

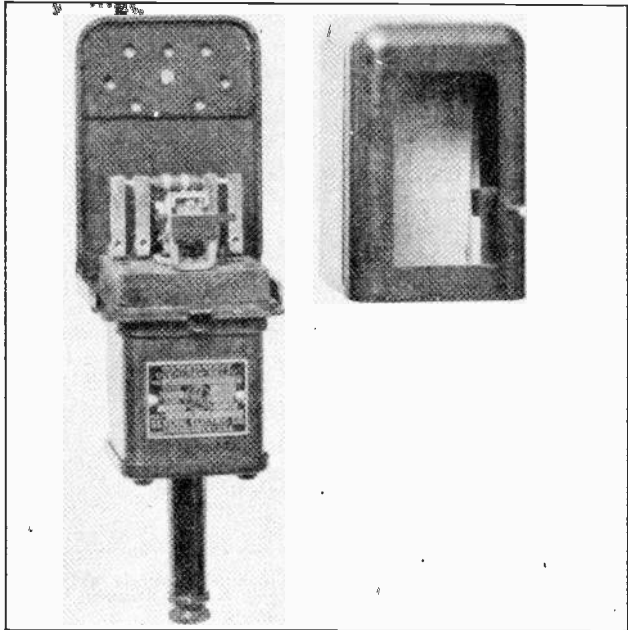

Fig. 22. This view shows an instantaneous operating overcurrent relay with contacts for closing three circuits. Courtesy of G. E. Company.

Other relays are equipped with time relay devices, such as oil dash-pots or air bellows, so that they can be adjusted to open or close a circuit, provided the overload or excess voltage for which they are set remains on the circuit for a period of several seconds.

The purpose of relays of this type is to protect equipment from continued overloads or undesirable conditions, and yet not to trip out the breakers and interrupt the service on momentary overloads which would do the machines no harm.

An **inverse time delay relay** is one on which the period of time delay is inversely proportional to the

Alternating Current

amount of overload. In other words, the greater the amount of overloads the shorter will be the time delay and the quicker the relay will act to open and protect the circuit.

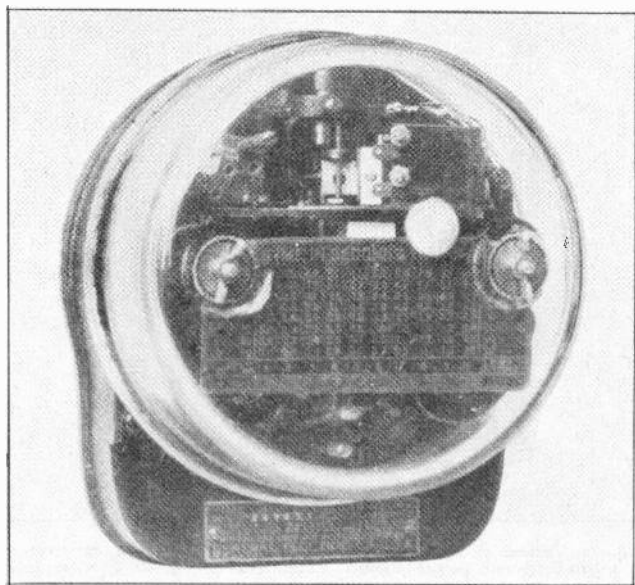

Fig. 23. Modern induction type overload relay such as very extensively used in A. C. power plants and substations. Courtesy of G. E. Company.

Great numbers of relays of different varieties are used in performing the various operations in automatic substations and power plants.

Fig. 23 shows an A.C. overload relay of the induction type. This relay operates on very much the same principal as an induction watt-hour meter, and has a disk in which eddy currents are induced by the current flowing through its coils. The movement of the disk is retarded by a spring which holds it in normal position during normal conditions on the circuit.

In case of overload the increased current increases the torque on the disk, causing it to turn

A. C. Relays

slowly until a small lug or projection is rotated around to where it opens or closes the relay contacts.

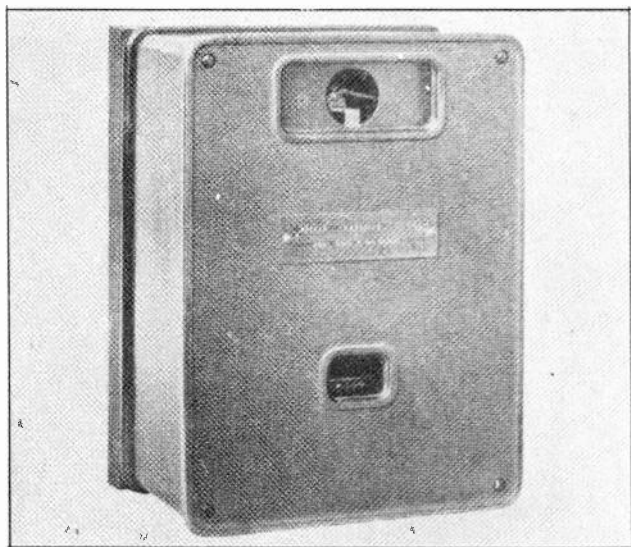

Fig. 24. Photo of a polyphase reverse-power relay for A. C. circuits in substations and power plants. Photo Courtesy of G. E. Company.

By setting these relays so that the disk must rotate a smaller or greater distance before closing the contacts, the time-delay of the relays can be adjusted over quite a wide range. This is one of the very popular types of modern relays.

Fig. 24 shows a reverse-power relay which is used to operate circuit breakers in case the power flow on A.C. circuits is reversed in direction. This may at first seem queer to you, since you know that A.C. is constantly reversing in direction.

However, as long as power is flowing in one direction in an A.C. circuit, the voltage and current bear a certain phase relation to each other; while if the power flow reverses because of some fault

Alternating Current

on the line, the voltage and current will then have opposite phase relations to each other.

Reverse-power relays have both current and potential coils, which hold the relay disk in normal position as long as the power flows in the right direction; but as soon as the direction of power flow reverses, the relay disk starts to rotate and closes the contacts which operate the circuit-breakers.

Automatic substations and power plants use numerous relays of various types, to start and stop the machines and perform various switching operations either entirely automatically or by remote control from a master operator or load dispatcher at some other station.

Always be on the alert for opportunities to provide better protection for electrical machines, and to secure more economical operation of them by the application of the proper relays.

A. C. Relays

EXAMINATION QUESTIONS

1. What are two advantages of oil circuit breakers over air breakers?
2. What care and service should oil switches have?
3. What is the purpose or advantage on constructing large oil switches with the contacts of each phase in separate tanks or compartments?
4. By what means are heavy duty, high voltage oil switches usually operated?
5. What is meant by the term expulsion type oil circuit breaker?
6. What is the purpose of disconnect switches in series with oil switches?
7. Why are arcing horns used on high voltage air break switches?
8. Briefly explain the operation of the Schweitzer Conrad liquid filled high voltage fuse.
9. What are relays used for in A.C. power plants and substations?
10. What is meant by the term "inverse time delay relay"?

INSTALLATION AND MAINTENANCE

A certain amount of instruction has been given on the Care and Maintenance of various pieces of electrical equipment in preceding lessons, and a great deal of the material covered in the lessons on Electrical Wiring can be applied to the installation of electrical machinery.

However, there are certain general important items pertaining to the installation and maintenance of electrical equipment that can well be emphasized and explained in detail in this lesson, now that you are familiar with the various types of machines and their uses.

Proper installation of electrical motors, controllers, generators, transformers, instruments, and other equipment is very necessary to secure the best operation and to avoid frequent and costly shut-downs and repairs after the devices are in service.

1. GENERATORS AND MOTORS

When installing electrical generators or motors of any size, care should be taken to see that they are mounted upon rugged and secure foundations to prevent vibration and trouble with misalignment of shafts and belts. Very large machines are practically always fastened to solid concrete foundations, and for the largest types of power plant generators these foundations are usually reinforced with steel.

Medium sized motors and generators can be mounted upon wooden beams or bases and securely fastened to them by means of lag screws or bolts of the proper size. The bases in turn can be mounted on the floor of the building in which the machines are used.

In some cases small or medium sized motors are mounted on substantial brackets on factory walls or columns, or even suspended from the ceiling. In such cases particular attention should be given to

Maintenance

the fastenings to make sure that they will not pull loose, even after years of operation and the normal vibration to which the motors and belts may subject the fastenings.

It is very important to see that motors and generators are properly leveled to secure even wear on bearings and prevent leakage of bearing oil. In leveling up machines small wedges or shims made of wood, steel, or paper can be used under the feet or bed-plates. Extreme care and accuracy on this point is required in setting very large generators or motors.

Whenever possible, motors and generators should be located away from all moisture and dirt, and in places where they will have free circulation of clean air to carry away the heat the machines develop and not clog the windings with dirt or moisture. If motors must be located in damp places or where water is likely to drip upon them, a cover or small roof of sheet metal, tarpaulin, or water-proof roofing material should be used above them.

2. CONTROLLERS AND SWITCHING EQUIPMENT

Motor controllers should always be mounted on solid angle-iron or pipe-work frames, or parts of the building structure where they are free from excessive vibration from other surrounding equipment and so that they will not vibrate when operated.

Controllers should be placed as near as possible to the motors they operate and yet, in the case of manually-operated controllers, they should be located within most convenient reach of the operators who may have to frequently start and stop the motors.

The tops of controllers should be carefully leveled and the controllers should as far as possible be placed in cool, clean, dry locations.

Controllers and switching equipment should be installed according to the instructions usually pro-

Alternating Current

vided by the manufacturer and connected according to the diagrams which are also usually supplied.

Small starting switches enclosed in metal safety boxes are generally provided with knock-out openings for the attachment of conduit or BX.

When installing motors, generators, controllers, or any other electrical equipment, the rules of the National Electric Code should be carefully followed. One of the most important of these rules is that the frames of machines and the metal boxes of controllers must be securely grounded to prevent the danger of shock to operators in case of failure of the insulation on some part of the machine windings or connections.

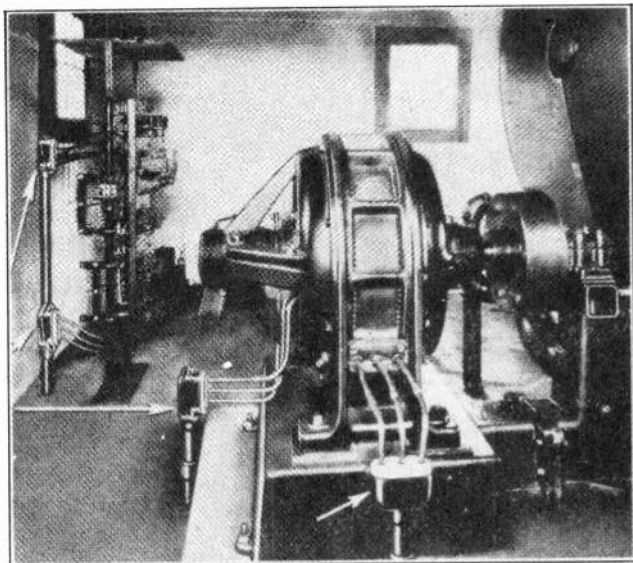

Fig. 1. This photo shows a very neat installation of the wiring to a slip ring motor and its controller. Courtesy of Crouse Hinds Co.

It is generally best whenever possible to have the wires between controllers and motors, and between generators and switchboards, run in either rigid or flexible conduit or approved cable.

On small machines BX is sometimes used for

Maintenance

these connections, and in certain types of factory buildings, where it is allowed by the local inspection department, the wiring may occasionally be run open.

Fig. 1 shows a large slip-ring motor and the panel-type controller used with it. Note that in this

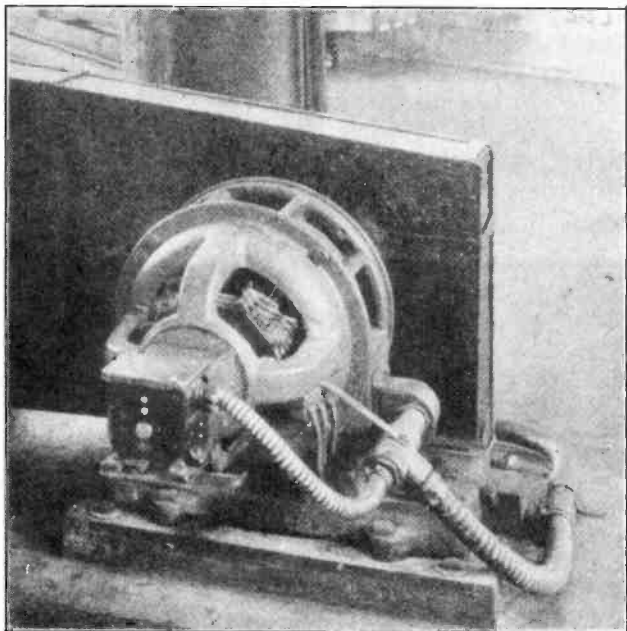

Fig. 2. Induction motor installation, using rigid conduit to bring the wires up to the motor, and flexible conduit to attach to the motor to allow it to be moved slightly for belt adjustment. Courtesy of G. E. Company.

installation conduit was apparently run through the cement floor at the time the building was erected. These conduits were equipped with the proper outlet fittings and covers so that the cables from the controller to the motor can be neatly installed as shown. Note the drip-shield above the controller, to keep any water from the ceiling from dripping on live parts of this device. The large motor shown in this figure is mounted on a specially-cast iron base which is a part of the machine to which the motor is directly connected.

Alternating Current

Fig. 2 shows a motor installation in which the machine is set on wooden beams and securely bolted to them. The leads from the controller are run through rigid conduit up to a point near the motor and then through flexible conduit and the proper fittings to the motor. This keeps practically all wires completely enclosed and is a very good type of installation.

The flexible conduit permits the motor to be moved a slight distance on its bed rails in order to tighten or loosen the belt or chain by which it drives the connected machinery.

Fig. 3 shows another motor installation in which the wires to the controller and motor are brought down from above through rigid iron conduit. Between the motor and controller box is shown a small capacitor or static condenser for power-factor correction. Above the starting box are shown the line switch and push-button control for the motor.

3. CONDUIT AND CONDUCTORS

The lessons on Electrical Wiring thoroughly covered the methods of installing wiring in conduit and should be carefully reviewed before you install any wiring to motors or power equipment.

Power wiring generally requires much larger conductors and conduit than those used for lighting installations, and a few special features pertaining to this heavier wiring will be repeated here.

In running large conduits from the supply to controllers and motors, the run should be kept as straight as possible, avoiding all unnecessary bends. This will make a neater installation and will greatly facilitate the pulling in of large cables.

Bends can be made in conduit of from 1 to 4 inches in diameter by means of bending machines, and sizes up to 3 inches can sometimes be bent by bending the length of conduit around a substantial post or part of the building framework. The strength of several men or the use of a block and line may be required to do this and great care should be taken to make the bends smooth and uniform and to avoid crushing or flattening the pipe.

Maintenance

Capping one end and filling the pipe with dry sand and then capping the other end will greatly aid in making bends or offsets without flattening the conduit. It is often necessary to heat large pipes to bend them by hand.

A bend on which the pipe has been flattened even a small amount should be discarded, as it is likely to cause great difficulty when pulling the conductors in. It is usually cheaper and better to buy ready made bends and elbows for large conduit, and the work can also be simplified by the liberal use of proper junction or pull boxes and fittings.

The ends of conduit sections should be well threaded, carefully reamed, and securely tightened

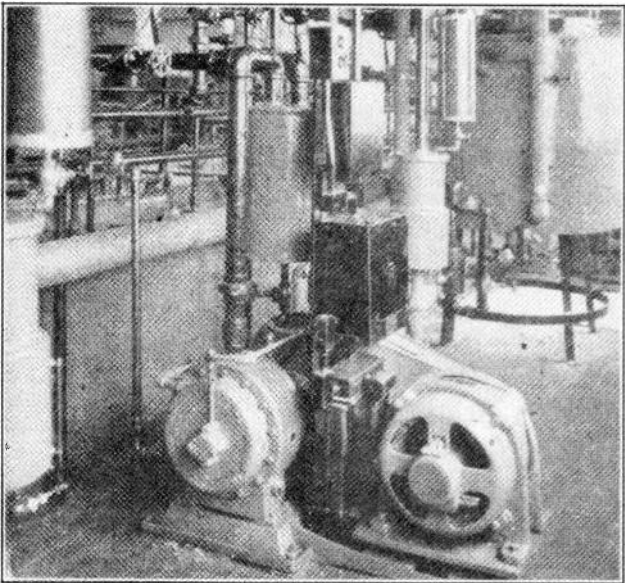

Fig. 3. This view shows a motor, push button control and a static condenser for power factor correction, all wired in conduit. Courtesy of G. E. Company.

into all fittings and boxes. All conduit, whether rigid or flexible, and all BX runs should be thoroughly grounded.

Alternating Current

4. PULLING IN CONDUCTORS

Large wires or cables can be pulled into conduit runs having not more than 4 right-angle bends by the use of steel fish tape or pilot line, as previously explained in Electrical Wiring.

In heavy power wiring a light cord or line is often blown through the conduit by attaching a wad of paper or cloth to its end and applying compressed air behind this at the end of the pipe. This light line is then used to pull through a strong Manila rope or fish tape, or in some cases a small steel cable.

On short runs of small cable one man may be able to pull in the conductors alone, but on longer runs consisting of several heavy cables it may require several men or a block and tackle or even some form of power winch.

Liberal use of powdered soapstone, mica or talc, rubbed on the insulation of the conductors or blown into the pipe will greatly ease the passage of the conductors through the conduit. Never use grease or oil of any kind, as it is injurious to the insulation of the conductors.

Careful and straight feeding of the conductors into the end of the conduit at which they are entering and steady even pulling on the pilot line or fish tape are both of the greatest importance in pulling in heavy conductors. **The conductors should be fed in perfectly parallel without allowing them to kink, twist, or cross each other.**

Sometimes feeding the conductors through a small piece of thick fibre with as many smooth-edged holes as there are conductors will help to keep the wires straight in feeding them into the conduit.

If conductors become stuck or jammed in some bend of the pipe it is often better to pull them out and start them over again, using more lubricant and keeping them straighter. If too much strain is placed upon them they are likely to be broken or the insulation may be damaged by excessive friction.

Maintenance

In many cases it is necessary to use a large junction box at each corner or turn in the conduit and to pull the wires through one section at a time, looping them back to start in again at each of these junction boxes.

All splices in large stranded conductors or cables should be neatly and carefully made and well soldered, or otherwise they may be of high-resistance and overheat when the conductors are subjected to heavy current loads, and this overheating may melt out the solder and burn off the taping, thus causing the cable to become grounded or open.

Never pull a splice of any kind into a run of conduit, but instead see that all splices are made at the proper junction boxes or fittings.

Splices can often be more conveniently made by sweating or soldering copper lugs of the proper size on the cable ends, and then bolting the flat tips of these lugs securely together. Such joints should be thoroughly and carefully taped to prevent the corners of lugs or bolts from puncturing the insulation and grounding a conductor against the junction box.

Where power conductors are connected to machines and equipment, properly soldered cable tip lugs should be used.

In selecting conductors for motors or power equipment of various kinds their current load should be carefully calculated, as previously explained, from the horse power and voltage rating of the machines.

The size of conductors should then be determined by the rules of the National Code and also by the use of the voltage drop formula given in lesson 19.

Conductors should be plenty large enough so they will not overheat or cause too great a voltage drop, which will result in low-voltage at the machines. It is generally much better to have conductors a little too large than to have them under size.

Alternating Current

5. TRANSFORMERS

Small power transformers are very commonly mounted on the tops of poles just beneath the line conductors to which they are attached. For mounting transformers in this manner two flat pieces of heavy strap-iron, having square hooked top ends to hang over the cross arms, are used.

Transformer cases are bolted to these strap-iron hooks and hung from the cross arms. When two or more medium or large sized transformers are installed outdoors for lighting service they are frequently placed on a platform supported by either one or two poles, as shown in Fig. 4.

Larger transformers for outdoor use are generally installed on concrete foundations or heavy wooden beams which have been properly treated to resist the action of the weather, and which are supported slightly above the ground by blocks or pole stubs.

Transformers which are located down low in this manner should be protected by strong, high, wire mesh fence with several barbed wires around the top to prevent the possibility of shocks to meddlesome or curious people who might otherwise come in contact with some of their high-voltage terminals.

Signs warning of high voltage and danger should also be placed upon the transformers or fence.

Transformers should always be set with their bases level and in positions to allow the best possible circulation of air around them to facilitate their cooling. It is desirable, when possible, to select the shady side of a building for the location of transformers, as this will make a great deal of difference in their summer operating temperatures and efficiency.

Transformers for use inside substations or power plant structures should be provided with plenty of circulating air through the room or vault in which they are located.

On transformers that are air and oil cooled, fans or blowers to circulate air through the room or over their cooling radiators will often assist materially in

Maintenance

keeping the transformers operating at proper temperatures.

Transformers which have water cooling coils should have an unfailing supply of cool circulating water at all times.

It is usually best to see that transformers are securely anchored to the floor or platform on which they are mounted, in order to prevent them from

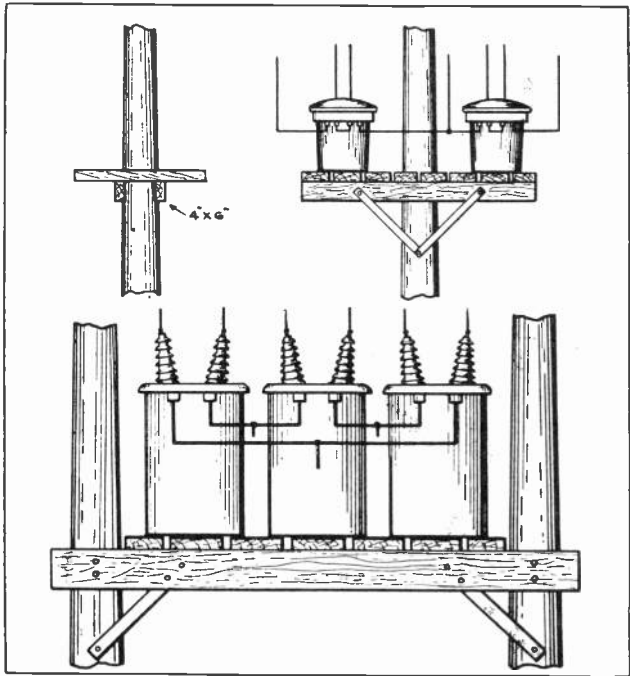

Fig. 4. The above sketches illustrate methods of mounting transformers on platforms on one or two poles.

slowly creeping out of position due to their own vibration or that of other equipment around them. This is particularly essential with transformers mounted on platforms up on poles.

Connections to both the high-voltage and low-voltage leads of transformers should be made as neatly and symmetrically as possible, and in a manner to facilitate any necessary work or maintenance which may have to be done around the transformers.

Alternating Current

Fig. 5 shows a single transformer on the left and a bank of three transformers on the right, suspended

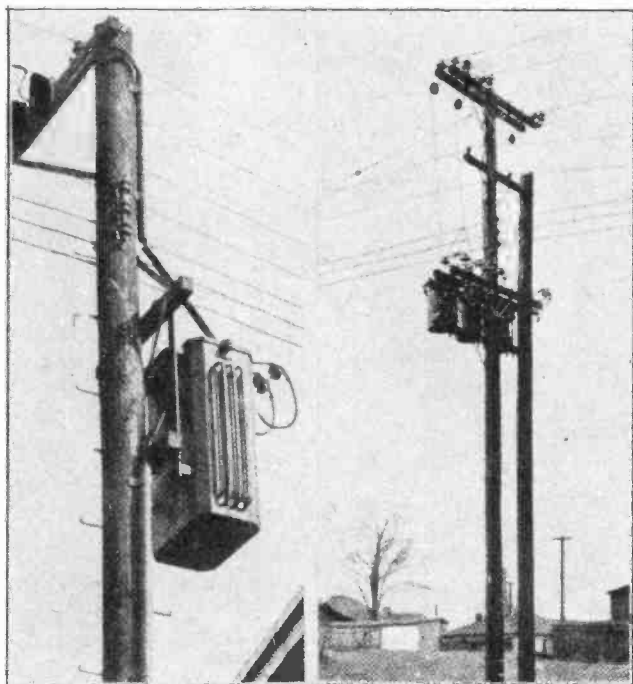

Fig. 5. These photos show transformers supported by heavy iron hooks over the cross arms from pole cross-arms by means of the mounting hooks previously mentioned.

Fig. 6 shows a bank of three transformers mounted on a substantial platform and supported by two poles. Also re-examine Fig. 6 in lesson 52 and Fig. 7 in lesson 54.

Where outdoor space is not available, transformers for factories and industrial plants are often located in small fireproof rooms in basements or other parts of the plants. These rooms are commonly known as **transformer vaults**. They should be well ventilated and drained in order to keep the transformers cool and free from water.

Transformer vaults should never be used as store rooms, but should be kept clean and free of obstruc-

Maintenance

tions, so that the transformers are accessible for inspection and testing and so that emergency repairs can be made safely and conveniently.

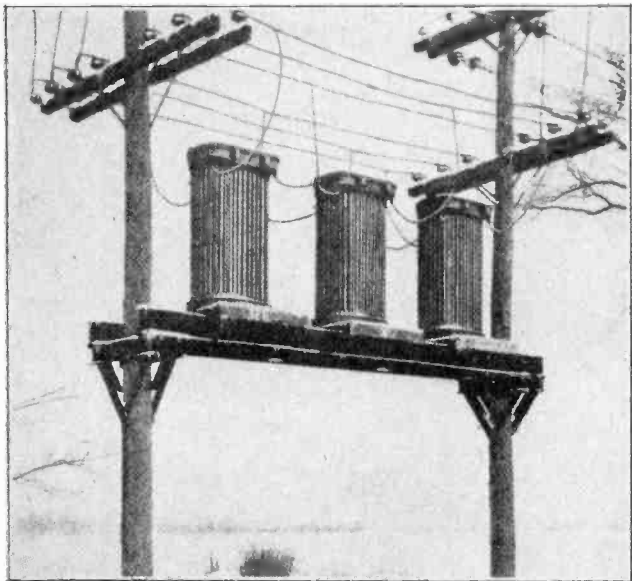

Fig. 6. Bank of three power transformers mounted on a neat platform between two strong poles.

Transformer vault doors should be locked or plainly marked with such signs as "high voltage", "dangerous", "keep out", so that unauthorized workmen other than the electrical crew will be warned against the danger of injury from contact with live wires or connections.

When installing any electrical equipment always remember that work which is neatly, thoroughly, and carefully done will result in a more reliable and efficient installation and in much better satisfaction to your employer or customer than work carelessly done. Make every job of electrical installation or wiring which you may ever do one in which both you and your employer can take just pride, regardless of whether it is a small or large installation; and above all else make sure that the wiring and equipment are made as safe as possible from the standpoint of fire and shock hazard.

Alternating Current

6. ELECTRICAL MAINTENANCE

The term "electrical maintenance" includes the inspection, care, and repair of all kinds of electrical equipment, and this field forms one of the largest and finest branches of work in the entire electrical industry, providing splendid opportunities for any well-trained electrical man.

The great variety of maintenance work in practically all factories, industrial plants, and office and commercial buildings makes this work very interesting and fascinating.

When we consider that there are several billion dollars worth of new electrical equipment and devices installed every year and that the life of this equipment ranges from 10 to 50 years or more, we can readily see that electrical maintenance is a rapidly growing and expanding field of steady and profitable work.

A great deal of instruction has been given on the care and maintenance and also on the trouble shooting and testing of various D.C. and A.C. electrical devices, in the lessons in which these devices were separately covered.

There is a certain amount of general information and knowledge which the electrical maintenance man should have, and this material is covered in this section along with the instructions on maintenance and care of A.C. machinery.

In some of the older plants the practice and policy used to be to allow electrical machinery to run with very little care or repair, until it refused to run any longer and required a complete shut down to make the necessary repairs to put it back in operating condition.

In modern power plants and industrial plants this practice has become entirely out of date and the electrical equipment is given frequent and regular inspection, cleaning, testing, and minor repairs to keep it running at the highest possible efficiency and to prevent the necessity of shut downs and loss of time for major repairs which could have been avoided by taking care of the little things in time.

Maintenance

The aim of a successful maintenance electrician should be to keep all of the electrical equipment in his charge in such condition that shut downs and lost time will be at an absolute minimum, and he should try to correct every small defect or fault before it develops into a more serious trouble or causes complete failure of the equipment.

Intelligent employers and owners of large industrial plants realize that shut downs and the tying up of machinery, employees, and production, or the failure of electrical equipment, is very costly and they appreciate and are willing to pay well for the services of a well-trained and capable maintenance electrician

In some of the smaller or older plants where these facts are not yet fully realized trained men are frequently stepping in and putting modern maintenance methods into practice, thus convincing the employers of the great savings which can be effected in this manner and creating splendid positions for themselves, even in plants where a regular maintenance electrician was not formerly employed.

7. INSPECTION SCHEDULE AND MAINTENANCE RECORD

In the maintenance of electrical motors and other equipment in large plants it is very important to maintain a regular inspection schedule for all of this equipment and keep notations or records of the results of tests and the condition of each machine or device on the date of each inspection period.

These regular, systematic inspections help to catch small troubles before they grow to be large ones; and occasional reviewing of the maintenance records and test data on important machines will often show up approaching troubles far enough in advance so that the machine can be shut down and repaired during some holiday or period when the plant is not in operation, instead of at a time when it is very badly needed.

Inspection periods may vary from daily inspection of very important expensive machinery to weekly or monthly inspection of less important equipment. In

Alternating Current

some cases certain devices may not need to be inspected more often than once every three to six months.

Experience in various plants will soon show how frequent the inspection of various equipment should be. The following list of items to be checked in connection with the inspection of A.C. motors is given as an example of inspection sheets or schedules which can be developed for various types of equipment throughout any plant.

1. Clean off the motor
2. Check condition of stator windings
 - (a) general condition of insulation
 - (b) oil soaked coils
 - (c) hardened oil or grease on coils
 - (d) bare or skinned conductors
 - (e) poor taping
 - (f) clearance between coils and rotating parts
3. Condition of rotor windings (wound rotors or armatures)
(Items a, b, c, d, e, f, as above)
4. Bearing-oil level
5. Condition of oil
6. Leakage of oil, if any
7. Free movement of oil rings
8. Condition of oil well covers and drains
9. Condition of bearing dust-seals
10. Tendency of one bearing to heat more than the other
11. Tightness of bearing retaining set-screw
12. Amount of end play
13. Tightness and condition of gear, pulley, key, and key-way
14. Tightness of lugs and connections
15. Tightness of squirrel-cage bars
16. Condition of ground wire and ground connections
17. Tightness of motor on foundation
18. Tendency of motor to vibrate when running

Maintenance

19. Condition of centrifugal switch (if used)
20. Condition of slip rings
21. Condition of brushes and holders
22. Tightness of connections to brushes and holders
23. Check brush setting
24. Slant or angle of brushes with respect to direction of rotation
25. Condition of commutator (on repulsion or series motors)
26. Condition of short-circuiting devices (when used)
27. Investigate any unusual sounds or noises when the motor is running
28. Investigate any local heating of certain coils or groups
29. Note time required for motor to accelerate when starting
30. Tighten all mechanical parts, nuts, bolts, screws, etc.
31. Test insulation resistance of machine windings with Megger or Wheatstone bridge.

In many cases a detailed inspection such as outlined in the preceding list may be made only at intervals of once a month or less often, while more frequent daily or weekly inspection is made of a few more important items.

The most important of these items in connection with A.C. motors are the following: Clean windings, temperature of windings, open air ducts and ventilating ports, condition of insulation on windings, bearing temperatures, condition of bearing oil, free movement of oil rings, etc.

8. INSPECTION RECORDS. AIR GAP MEASUREMENT

A simple form of maintenance record for individual motors is shown in Fig. 7. If a form of this type is used for each inspection of individual motors, particularly on those of the larger sizes, it helps to prevent overlooking certain items of importance and greatly simplifies the keeping of intelligent maintenance records.

Alternating Current

The numbers shown in this form refer to the items given in the motor inspection list. The form shown in Fig. 7 has spaces at the top for the description and serial number which identify the machine, so that its monthly maintenance records can be filed together and accurately kept, no matter what part of the plant the machine may be moved to.

MAINTENANCE RECORD OF <u>3 ph Slip ring Mtr</u> Serial # <u>182173</u>			
Name of Manufacturer <u>C.E.S.</u> H.P. <u>20</u> R.P.M. <u>1140</u>			
Volts <u>440</u> Amperes <u>26</u> Cycles <u>60</u> Date <u>Nov. 15 1929</u>			AIR-GAP
1 <u>Completed</u>	13 <u>total set screw tightened</u>	25 <u>Balance O.K.</u>	25 <u>Does not apply</u>
2 <u>All items O.K.</u>	14 <u>All tight & secure</u>	26 <u>Does not apply</u>	26 <u>Does not apply</u>
3 <u>All items O.K.</u>	15 <u>Does not apply</u>	27 <u>Motor runs normal</u>	27 <u>Motor runs normal</u>
4 <u>O.K.</u>	16 <u>O.K.</u>	28 <u>No local heating</u>	28 <u>No local heating</u>
5 <u>Drained & refilled</u>	17 <u>O.K.</u>	29 <u>5 seconds</u>	29 <u>5 seconds</u>
6 <u>None</u>	18 <u>None</u>	30 <u>all mechanical parts tight</u>	30 <u>all mechanical parts tight</u>
7 <u>O.K.</u>	19 <u>Does not apply</u>	31 <u>450,000 ohms</u>	31 <u>450,000 ohms</u>
8 <u>O.K.</u>	20 <u>All rings clean</u>	32	32
9 <u>O.K.</u>	21 <u>Yarn & brush in holder. Balance O.K.</u>	33	33
10 <u>Both normal</u>	22 <u>O.K.</u>	34	34
11 <u>O.K.</u>	23 <u>O.K.</u>	35	35
12 <u>Normal</u>	24 <u>O.K.</u>	36	36
Inspectors Name <u>John Doe</u>			

Fig. 7. Sample of convenient motor inspection chart or form, to be kept in maintenance records.

Note the space provided in the upper right-hand corner of this form for marking the air gap readings. Four of these readings should be taken around the inside of the stator core in the position shown at the top, bottom, and right and left sides of the rotor.

Air gap readings are taken with an air-gap gauge, which is provided with several long, narrow, steel blades or leaves similar to those of a machinist's feeler gauge. Air-gap readings should always be taken when the motor is standing idle. The reading is taken from the largest gauge which can be pushed in between the rotor and stator in the same direction as the slots of the machine run.

Large air gaps may require measuring with two or more blades together, in which case the reading

Maintenance

is the sum of the numbers on the blades used to fill the gap.

As an example of the usefulness of inspection records, suppose it is found that on a certain motor the oil level is very low at each inspection, although no definite trace of leakage can be found. This would indicate that the bearing was either leaking a small amount of oil or using it up quite rapidly in some manner and that it should be refilled more often.

Suppose that in another case the inspection record shows a certain section of the stator winding to be slightly warmer than the balance of the winding. If each successive record shows this heating to be continuing in the same spot and apparently somewhat increased each time, it would indicate defective insulation or a partial short or ground in the windings at this point, meaning that the machine should be taken down for reinsulation or repair of that section of the winding as soon as it can be done without interfering with production in the shop.

Suppose in another case that the Megger test one month shows the insulation resistance of a certain machine to be 1,250,000 ohms, 1,150,000 ohms three months later, and 1,000,000 ohms six months later. These reports would indicate that the insulation of that machine is deteriorating or failing as a result of moisture, oil soaking, or old age, and it would mean that the machine should be dried out, have the oil washed out of the windings; or, if neither of these faults is to blame, the winding would need to be reinsulated or replaced as soon as the machine could be taken out of service for a sufficient period.

9. TOOLS AND INSTRUMENTS

The small hand tools and more common devices required for maintenance work were covered in Direct Current lesson 43. In addition to these items the maintenance shop will require other tools, such as vises, dies, wrenches, block and tackle, gear pullers, drill presses, etc.

Several portable test instruments should always be available for general testing purposes, as they are

Alternating Current

of the greatest importance in maintenance of electrical machinery. Among these instruments should be included voltmeters, ammeters, wattmeters, Megger, test lamps, test magnetos, dry cell and buzzer testers, etc.

10. GROUND DETECTORS

Ground detectors can be used if the system is not of the normally grounded type. An accidental ground on a normally grounded system immediately results in a short circuit and in such cases the ground detector would be useless. These devices are very useful, however, in indicating the presence of grounds on ungrounded systems. When such a ground is indicated it should be immediately located and cleared.

Ground detectors generally consist of a simple meter similar to a voltmeter, which is connected between the line and the ground.

When a ground detector is not available a simple and inexpensive arrangement of lamps may be used to take its place. Fig. 8 shows in the upper sketch the connections for a continuous-type ground indicator using a bank of six lamps with two connected in series between each phase and ground.

A snap switch and fuse are also provided in series with each set of lamps. With this type of ground indicator all of the lamps will remain burning at about half voltage as long as there are no grounds on any phase, but as soon as a ground occurs on any phase the lamps between this phase and ground will go out, or become very dim if the ground is of high resistance. The remaining lamps will then burn at full brilliancy.

This action is due to the fact that some of the lamps are shunted or paralleled by the ground circuit whenever an accidental ground occurs on any phase.

Where it is desired to avoid the small cost of operating such a set of lamps continually, an intermittent ground detector can be used by connecting lamps with a selector switch, as shown in the lower

Maintenance

sketch in Fig. 8. With this type of detector the lamps are normally switched off and a test is made once or twice a day by switching on the lamps and moving the selector switch from one phase to the other to determine if there is a ground on any phase.

11. SAFETY PRECAUTIONS

When doing any kind of maintenance or repair work around electrical machinery **extreme care should be used to protect both yourself and your fellow workmen.** All companies consider the safety of their employees above everything else, and the man who always practices safety first not only eliminates a great deal of danger of injury to himself but also has a much better chance to become a foreman or chief electrician.

Protective apparatus such as rubber gloves, rubber blankets, hook sticks, and insulated platforms should be used in all cases when working on or around high-voltage equipment.

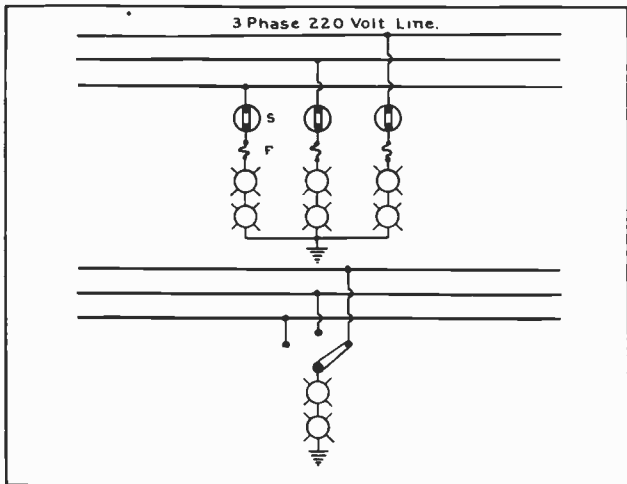

Fig. 8. Two methods of connecting lamps to serve as simple ground detectors on three-phase power circuits.

Fig. 9 shows a sketch of a simple insulated platform which can easily be made from short pieces

Alternating Current

of strong, dry board mounted upon four pin-type insulators as shown. Small pin-type insulators can be used in the inverted position as shown in the upper sketch, or larger pedestal type insulator units can be mounted on short pieces of board and attached to the under side of the platform as shown in the lower sketch. This latter method protects the insulators from breakage by being bumped on concrete floors.

When working on circuits of low and moderate voltages thick rubber mats can also be used to insulate a worker from a damp concrete floor. Mats of this type are usually tested to withstand voltages or pressures of 15,000 to 20,000 volts but are generally not depended upon entirely for the safety of operators working on equipment of over 1000 volts.

Stools or platforms on raised insulators should be used on circuits having voltages from 500 to 1000 volts and up.

Never attempt to operate by any other means disconnect switches or any equipment which is supposed to be operated with an insulated hook stick.

Always use rubber gloves and rubber blankets when working on live circuits over 550 volts and in many cases it is advisable to use them on any circuits of over 220 volts.

When working around live circuits, one should always be on the alert to avoid making a contact with the wires of two opposite phases or with one phase and ground, and allowing current to pass through any part of the body. When working around very high-voltage conductors one should always keep several feet away from them.

Be extremely careful not to make short circuits, even on low-voltage equipment, because short circuits are very dangerous regardless of the voltage of the circuit. Shorts on 110-volt circuits, or even on five or ten-volt battery or electro-plating circuits which have considerable generator or battery capacity attached to them, can be very dangerous and destructive by the terrific flashes and scattering of

Maintenance

molten metal in case they are short-circuited with some low-resistance tool.

When handling conduit, ladders, or anything of this nature around live circuits be extremely cautious in moving them, as they are easily swung into live wires or rotating machinery.

All circuits should be considered as being alive until they have been proven otherwise and are thoroughly grounded. Persons working around rotating machinery should wear closely fitting clothes to reduce the chance of becoming entangled in the

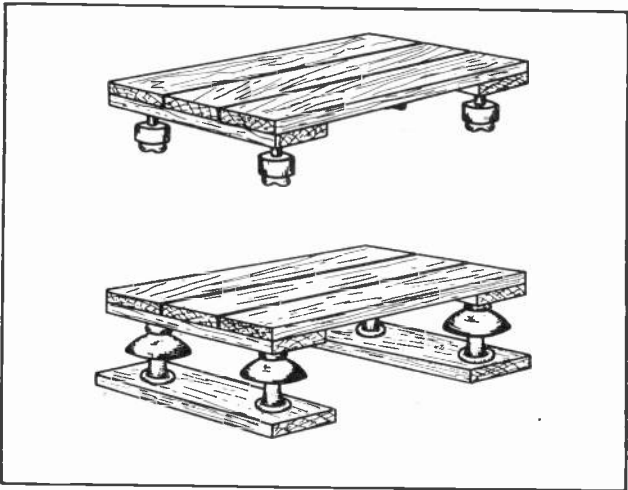

Fig. 9. The above sketch show two types of insulated stools or platforms for safety in working around live wires. These are very simple and inexpensive to make.

running parts. Be careful not to allow tools or loose parts of equipment to fall into running machines, and never leave tools lying on or around electrical machinery when it is started up, as the magnetic field of the machine may draw the tools into the rotating parts and not only damage the machine but possibly injure a workman by throwing the tool violently out of the machinery.

When switches are opened to allow men to work on any line or circuit, the switches should be care-

Alternating Current

fully tagged or labeled with a warning not to close them because men are working on the circuits or machines attached to them. Whenever possible such switches should be locked open by means of a padlock or clamp. The circuits which are thus "killed" for repairmen to work on should be carefully grounded by means of flexible copper cable equipped with clamps.

Maintenance

EXAMINATION QUESTIONS

1. State two important requirements in connection with locating and mounting electrical machinery.
2. Why should the frames of electrical machines be grounded?
3. How would you lubricate heavy cables before pulling them into conduit?
4. Should splices in cables be pulled into conduit?
5. What type of signs should be placed at transformer banks or around high voltage equipment?
6. Why is good air circulation or ventilation of electrical equipment important?
7. What should be the aim of a good electrical maintenance man?
8. What are several advantages of regular systematic inspection and records in electrical maintenance?
9. Why are air gap measurements of importance on electrical motor maintenance?
10. Draw a sketch of a continuous indicating ground detector using lamps.

Alternating Current

BEARINGS

In the Armature Winding lessons the more important methods of testing and repairing windings for either D.C. or A.C. motors or generators were covered; and considerable instruction was given on electrical repairs and maintenance for D.C. motors and generators in the Direct Current lessons; and on alternating current motors, generators, and transformers in the Alternating Current lessons.

Up to this point, however, very little has been said about the bearings of motors and generators except the instruction regarding their lubrication and temperatures. Bearings are about the only part of electric motors or generators aside from the commutators, slip rings, and brushes on which there is any mechanical wear or need of maintenance and repair.

For this reason bearings will be considered in detail at this point. If bearings are properly lubricated they will often last for many years without any great amount of wear, but if they are not kept properly oiled and free from grit, dirt, etc., they will wear very rapidly and soon make it necessary to shut down the machine for replacing or repairing the bearings.

Even with the best of lubrication and care, ordinary sleeve bearings will wear out in time and allow the rotors of machines to get out of center in the stator core or between the field poles. When the bearings are badly worn the rotor may even rub the teeth of the stator or the ends of field poles. This condition should not be allowed, but when it is noticed the bearings should be repaired at once. Unequal air gap between stator and rotor, due to badly worn bearings, reduces the efficiency and interferes with proper operation of motors.

There are three general classes of bearings, which are known as sleeve bearings, ball and roller bearings.

Sleeve bearings consisting of a babbit or bronze sleeve in which the shaft turns have been by far the most commonly used in the past, and there are still in service considerably more of this type than

any other. During recent years, however, ball and roller bearings have become very popular and they are quite extensively used in newer type machines.

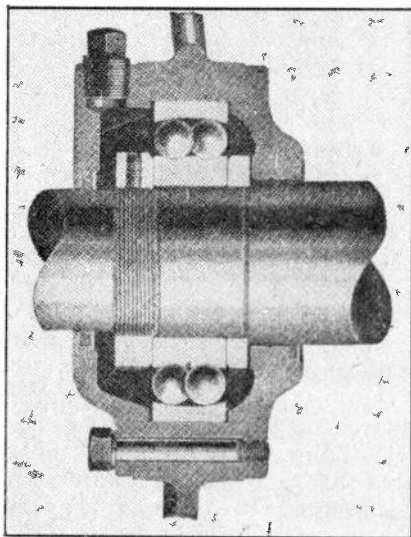

Fig. 1. Sectional view of a double-row ball bearing, showing inner and outer bearing races and some of the balls.

1. BALL AND ROLLER BEARINGS

As ball and roller bearings generally require much less care and attention than sleeve bearings they will be covered here first.

Ball and roller bearings both have inner and outer rings or **bearing races** made of hardened steel, and between which the balls or rollers run.

Fig. 1 shows a sectional view of a ball bearing in place around the shaft and within the bearing housing of a motor. The inner ring or bearing race is pressed tightly on the shaft and is held in place against the shoulder on the shaft by the clamping or retaining nut shown on the left.

This inner ring turns with the shaft at all times. The outer ring or bearing race is held securely in the bearing housing in the motor end-shield. This ring should always be stationary and it should not be allowed to rotate in the bearing housing.

Alternating Current

The balls of bearings of this type are made of very hard steel, and if properly lubricated they are capable of withstanding many years of wear. These balls are spaced and held in their proper positions by light metal **cages** to prevent them from bunching up and jamming in the race and to keep them rolling freely and evenly around the bearing.

These cages should always be kept in good condition, or otherwise the balls will roll together and wear on the surfaces of each other, and also rapidly wear away the surface of the bearing race.

Fig. 8 in lesson 55 shows a sectional view of a squirrel-cage motor equipped with ball bearings.

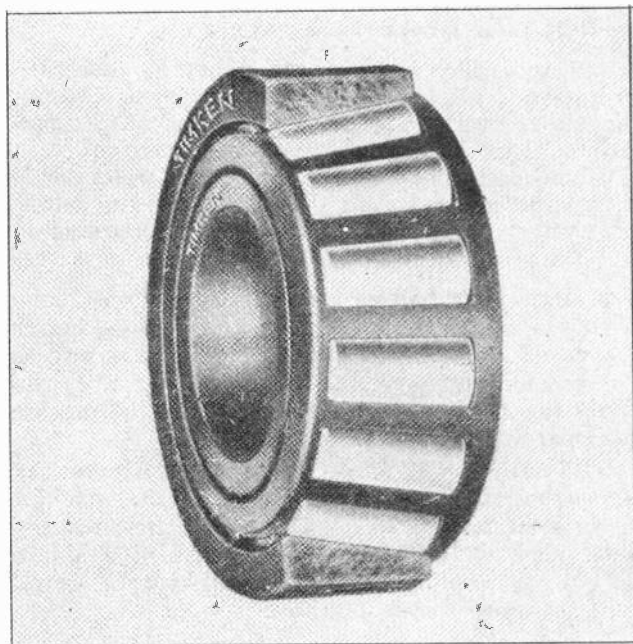

Fig. 2. Cutaway view of a Timkin tapered roller bearing such as commonly used in high grade motors.

Fig. 9 in lesson 56 shows an excellent sectional view of a motor equipped with roller bearings. Refer back to these figures and note carefully the manner in which the bearings are constructed and mounted in the motor.

Maintenance

Fig. 2 shows a larger view of a tapered roller bearing, such as is very commonly used in some of the modern motors. The hardened steel rollers are firmly held within the center ring, which rotates as the rollers run around between the inner and outer rings. The inner ring in this case also fits securely to the motor shaft and revolves with it, while the outer ring is held securely and stationary in the bearing housing in the motor end-shield. This tapered bearing construction prevents end-play of the motor shaft and rotor.

2. LUBRICATION OF BALL AND ROLLER BEARINGS

Ball and roller bearings are generally lubricated with a good grade of light grease such as vaseline, and under ordinary conditions two or three applications of fresh grease per year are sufficient.

When motors are operating in very dusty places it may be necessary to grease the bearings more frequently. Grease guns are usually provided for filling bearings of this type.

Motors with ball or roller bearings cost somewhat more than those with sleeve bearings, but the longer life of the ball and roller bearings and the reduced maintenance cost will generally more than offset the small additional first cost of the machine equipped with ball or roller bearings.

Ball and roller bearings produce less friction than sleeve bearings and therefore make the machines slightly more efficient. The fact that these bearings wear very little also allows the use of a smaller air-gap, improving the characteristics of certain types of motors considerably.

Complete new ball and roller bearings can be obtained from the manufacturers of the motors or from bearing manufacturers, when it is necessary to replace worn bearings of this type. These bearings are generally made in standard sizes so that, by specifying the inner and outer diameters of the rings or races or the bearing numbers which are plainly stamped on them, new bearings or repair

Alternating Current

parts can be ordered from bearing manufacturers as well as from the motor manufacturers.

3. SLEEVE BEARINGS

Sleeve bearings are made in both the solid and split sleeve types. In either case the bearing forms a cylinder or sleeve with a uniform diameter and very smooth inside surface in which the shaft rotates on a thin film of oil.

Bearing metals must be different from the metal of the shaft in order to run freely and prevent excessive friction and wear. Bearing metals are generally an alloy of two or more metals, such as copper, lead, tin, zinc, and antimony, and are made in different degrees of hardness. This metal is commonly known just as bearing metal, and certain alloys are called **babbitt**. Other bearings are made of soft bronze.

The inner diameters of bearing sleeves are always just a few thousandths of an inch larger than the shaft. This clearance is generally approximately .005 of an inch on shafts about 2 inches in diameter.

When installing new sleeve bearings it is very important to obtain a good fit on the shaft. If the new bearings are ordered from the motor manufacturers or to exact size from a bearing maker, they will generally fit very well when received. Occasionally, however, a bearing sleeve may fit the shaft too snugly, in which case its inside diameter must be increased very slightly until the shaft will just rotate freely without friction or binding.

Bearings can be enlarged by use of a **bearing scraper**, which is used to scrape out what are called the "high spots" on the inside of the bearing sleeve. Bearing scrapers are very common tools in electrical maintenance shops, industrial plants, and auto repair shops. They consist of a curved shoe or blade of hollow ground steel which is equipped with a handle. These hard steel blades are used to scrape a very thin layer of soft metal from the inside of the bearing. It is not usually

Maintenance

necessary to scrape the entire inner surface of the bearing, because in most cases only a few spots are high.

To locate these high spots which must be scraped a thin film of Prussian blue, or what is known as "bearing blue," can be applied over the entire area of the shaft where it is normally supported by the bearing.

The bearing is then slipped on the shaft to its proper location and turned, and when it is again removed the high or tight spots can easily be located by the blue color on and around them.

These are then scraped down very slightly by means of the bearing scraper and the bearing is then

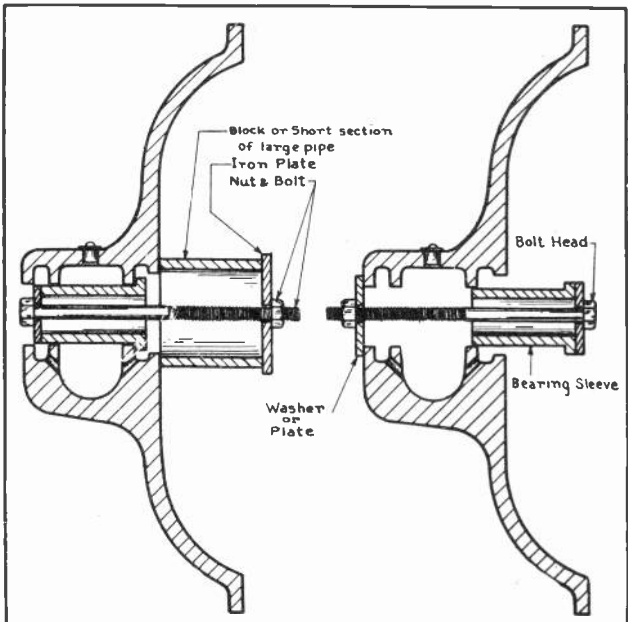

Fig. 3. The sketch on the left illustrates a convenient method of removing a sleeve bearing; and on the right is shown the method of replacing the bearing.

again tried on the shaft. Proceed in this manner until the bearing turns freely on the shaft, but be careful not to enlarge it too much at a time and cause it to fit too loosely.

Alternating Current

4. INSTALLING BEARINGS

Solid sleeve bearings must be placed in the end-shield bearing housings before the end shield is placed on the motor or generator frame. The oil rings should be placed in the housings before forcing the bearings down into their proper location.

If the bearing fits in the housing quite loosely it may be forced into place by laying a wood block on the top end of the bearing and gently tapping it down in place with a hammer.

Always use a wood block for this purpose and never allow the hammer to strike sharply on the bearing, or the bearing metal may become badly dented or bruised.

Bearings which fit rather tightly may be pressed into their housings or pulled in by means of a long threaded bolt and several washers which will not slide through the bearing. This method is illustrated by the sketch on the right in Fig. 3, which shows a sectional view of a sleeve bearing being drawn into the bearing housing by means of such a bolt.

Care must be taken to start the bearing squarely into the bearing housing in a straight line with the bore, or otherwise the bearing may become jammed and pulled out of shape. Bearing sleeves may be very easily ruined in this manner.

Another very important precaution is to see that the top of the bearing sleeve is in line with the top of the end shield, or otherwise when the bearing is pulled in place the oil ring opening will be out of line and prevent the ring from resting on the shaft, resulting in a poorly lubricated and burned out bearing.

When the bearing sleeve has been carefully started and lined up in the bore of the housing, the nut of the draw bolt can be turned with a wrench, causing a pull upon the washers, which will force the bearing into place.

Bearings can also be removed from housings by the use of a draw bolt and blocks or a short section of pipe which is large enough to set on the end of the housing and allow the bearing sleeve to be drawn out of the housing and into the pipe stub, as shown on the left in Fig. 3.

Maintenance

Fig. 4 shows sectional views of two complete bearing housings with the bearing sleeves in place. These views also show the oil rings in proper posi-

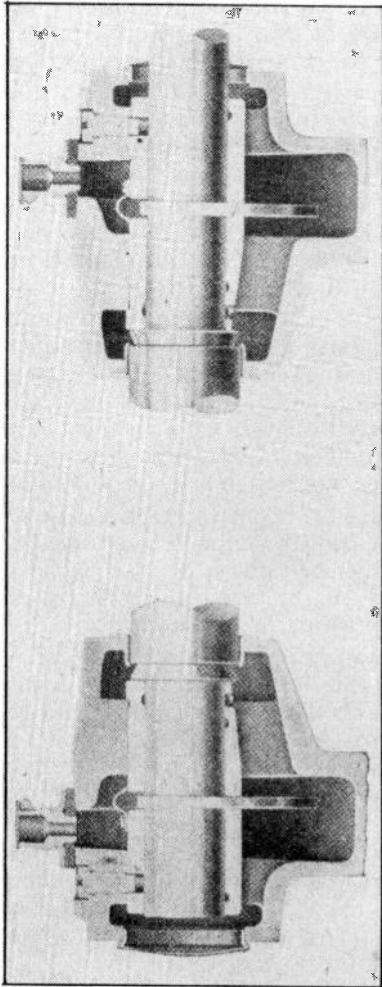

Fig. 4. Sectional views of two sleeve bearings, clearly showing the oil wells, oil rings, filler cups, etc.

tion on the shaft. Note how the lower side of the oil ring hangs down into the oil well, so that as the shaft revolves the ring will carry the oil up to the top of the shaft.

Alternating Current

The oil then runs from this point down over the shaft, maintaining a thin film of oil all around it between the surface of the shaft and that of the bearing.

The filler opening or cup at which new oil is poured into the bearings is shown on the top of the bearing housing in this case. The inner surfaces of sleeve bearings are usually provided with oil grooves to allow the oil to flow more freely to all parts of the bearing sleeves.

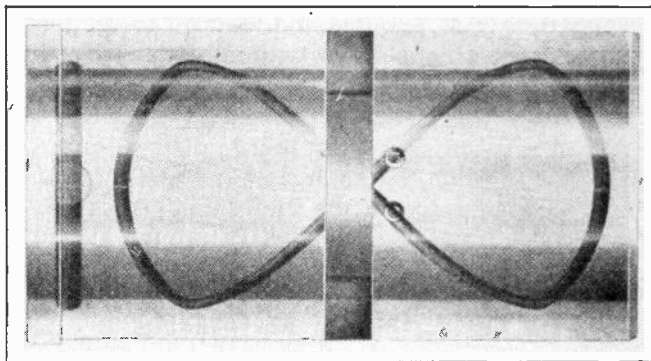

Fig. 5. Phantom view of sleeve bearing, showing oil grooves and oil ring slot.

Fig. 5 shows a phantom view of a bearing sleeve and the position of the oil grooves. In new bearings supplied by manufacturers these oil grooves are already cut and are generally about $1/8$ to $3/16$ inches in width and from $1/16$ to $1/8$ inch in depth, according to the size of the bearings.

When fitting a machine with Babbitt bearings the oil grooves can be cut in this soft metal by hand with a small tool designed for this purpose.

5. REASSEMBLING MOTORS AND GENERATORS

After new bearing sleeves have been placed in the end shields of motors or generators the rotor is placed in the stator or field frame and the end shields and bearings are slipped over the ends of the shaft and up to the motor frame, **being careful**

Maintenance

to get, the end shields right side up so that the bearing housings and oil wells are in the proper position.

The bolts or cap screws which are used to hold the end shields in place are next turned in by hand as far as they will go. A wrench is then used to uniformly tighten the bolts and draw the bolts up to the motor frame.

The bolts should be tightened alternately so that they are all drawn up together. **Never draw up one bolt as tightly as possible and then go to the next,** because this practice will generally result in the shaft becoming bent or sprung or in warping or damaging the bearing.

When the end shield has been pulled securely in place try turning the shaft and if it fails to turn freely check to see if the end shield is squarely against the frame or shoulder all around the machine. If it is and the bearing still remains tight it will be necessary to remove the end shield and scrape the bearing until a free running fit is obtained.

In replacing end shields on motor or generator frames it is a good plan to see that the machine surfaces or shoulders on both the end shield and frames are clean and free from dirt and grease. Sometimes it may be necessary to lightly tap the end shield with a mallet or wood block to get it to draw up tightly on the frame.

6. LUBRICATION

Sleeve bearings are generally lubricated with a medium grade of lubricating oil instead of grease such as used in roller and ball bearings. A good grade of oil should always be used, as poor or cheap grades of oil often have a tendency to turn rancid or to "gum up" in use.

The use of good oil is of the greatest importance in obtaining satisfactory service and long life from bearings on electrical machinery. Reliable oil companies, such as the Standard Oil Company, Sinclair

Alternating Current

Oil and Refining Company, Cities Service, Vacuum Oil Company, Pennsylvania Oil Company, and others, supply good lubricating oil for various machines, and are usually glad to furnish the service of a lubrication expert to specify the proper grades of oil for any ordinary machinery or special requirements that the electrical maintenance man may have.

Fig. 6 shows a sectional view of a bearing housing and sleeve-type bearing in which the proper level of the oil can be noted in the oil well. The amount of oil required for various sleeve-type bearings may range from a few teaspoonfuls in very small motors up to several quarts on the larger machines.

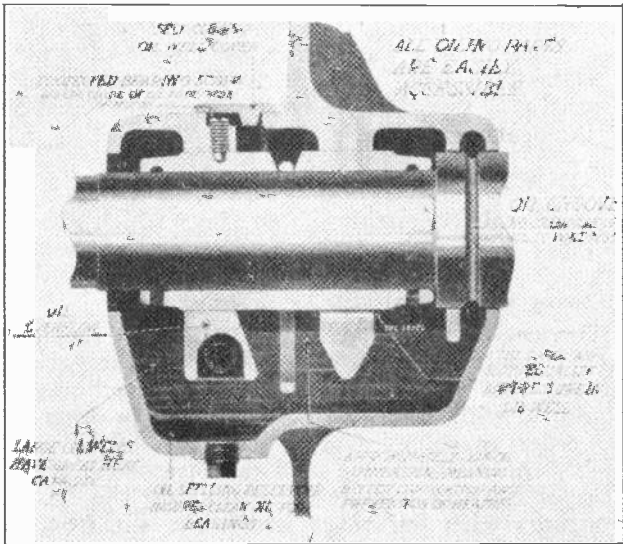

Fig. 6. Another excellent sectional view of a sleeve type bearing, showing oil level, oil ring, oil well cover, drain plug, bearing set screw, etc.

The oil should always be kept clean and free from dirt and at the proper level.

The oil ring can also be seen in Fig. 6 with its lower side hanging in the oil and the upper side resting on the top of the shaft at the slot in the bearing sleeve.

Maintenance

Oil rings should always run freely whenever the machine is in operation and should never be allowed to bind or stick even for short periods, as the shaft and bearings depend entirely upon the rings for their constant supply of oil.

If oil rings become bent or bruised by careless inserting of the shaft into the bearings the rings will probably not turn. So considerable care should be used when replacing bearings and end shields on the shafts.

If there is no oil in the bearing at the time it is replaced, the end shield and bearing housing can be turned upside down to allow the oil ring to fall out of the way and clear the inside of the bearing sleeve while the end of the shaft is being inserted.

If the bearing housing is filled with oil and must be kept in an upright position, the oil rings can be lifted out of the way either by means of a small wire hook inserted through the filler opening or by means of a small stick inserted from the open end of the bearing sleeve.

7. DUST SEALS

Dust seals consisting of felt rings which are held in place around the shaft on either end of the bearing are often used to prevent dust and dirt from entering the bearing oil.

Devices of this kind help to maintain the lubricating qualities of the oil and greatly increase the life of the bearing. Most modern machines are equipped with dust seals of some form or other, but on older machines which are operated in dusty places the maintenance man can often save a great deal of bearing trouble by equipping the bearing housings with felt rings which are cut from felt having a thickness from $1/8$ to $3/8$ of an inch, and fitting them tightly to the shaft.

These felt rings can be held in place by thin metal rings or plates which are secured to the end shield or bearing housing by means of small machine screws threaded into small tapped holes in the iron frame around the shaft openings.

Ball and roller bearings often have what are known as labyrinth dust seals consisting of a special

Alternating Current

metal casing which fits around the shaft with a very small amount of clearance where the shaft enters the bearing housing.

The insides of this cylindrical casing are provided with a number of small grooves which are filled with grease by the overflow or squeezing out of grease from the bearing when it is filled. These little ridges of grease rotate with the shaft and, as their points or edges project up into the grooves in the metal casing, they form quite an effective barrier to dust which might otherwise be blown into the bearing.

When the dust and dirt comes into contact with the grease it is collected and held and is prevented from passing on into the vital wearing parts of the bearing. As new grease is forced into the bearing occasionally the old dirty grease is forced on out of the dust seal rings.

Seals of this type provide another good reason for frequent and sufficient greasing of ball and roller bearings.

8. CHANGING BEARING OIL

After oil has been in the wells of ordinary motor or generator bearings for a time it becomes dirty with dust and metal particles worn from the shaft and bearings.

The presence of dirt and foreign matter in lubricating oil can be detected by examining a drop of the oil on one's finger or hand, or on a bright nickel-plated metal surface. Another good way is to place a sample of the oil in a small glass bottle or test tube. By holding the bottle or tube up to a bright light or so that sunlight can shine through it, any dirt in the oil can usually be seen.

Dirty oil should not be left in a bearing, because the grit and dust in it causes rapid wear of the shaft and bearing.

The dirty oil should be drained from the bearing by removing the drain plug in the bottom of the oil well. See Fig. 6.

Next flush out the dirt which may have settled in the bottom of the well, by running gasoline or flush-

Maintenance

ing oil through the oil well.

The insides of oil wells are sometimes painted white to enable any dirt settlings to be seen, and so one can tell when the well is flushed clean.

Refill the bearings with clean new oil, to the proper level according to oil mark or gauge. Do not fill them too full or oil will leak out and get onto the windings or commutators. Always fill oil wells, at the filler ports when they are provided, and not at the top of the bearing except when this cannot be avoided.

9. BREAKING IN NEW BEARINGS

When a new motor or generator is started up for the first time, or when starting a machine in which the bearings have just been replaced, the bearings are likely to heat more than usual because the surfaces of shaft and bearings are not yet worn as smooth as they are after a period of service.

For this reason, it is advisable to watch the bearings of such machines very closely for the first thirty minutes to one hour of operation, and to continue to give them very frequent attention during the first few days. After this period the bearings and shaft usually become highly polished and smooth or get the "whiskers" worn off, as is often said; and thereafter they run with much less friction and heating.

When inspecting new bearings for high temperatures, merely holding the hand on the bearing housing is not always a good indication of the bearing metal temperature. It is best to place the finger tips on the bearing sleeve itself, where the temperature can be more accurately determined. Thermometers are often used to show the temperatures of bearings of very large motors or generators.

Never wait until a bearing smokes before taking steps to cool it, because by that time it may be seriously damaged.

When starting up new machines or those with new bearings the following several steps are very important.

- (a) Fill oil wells with good clean oil
- (b) See that oil rings are turning freely
- (c) See that shaft turns freely and easily

Alternating Current

- (d) Test for end-play
- (e) Test for heating at bearing sleeve (not at outside of housing)
- (f) Watch bearing closely for one-half hour or more
- (g) If bearing overheats, cool it with fresh oil; or shut machine down if it continues to overheat.

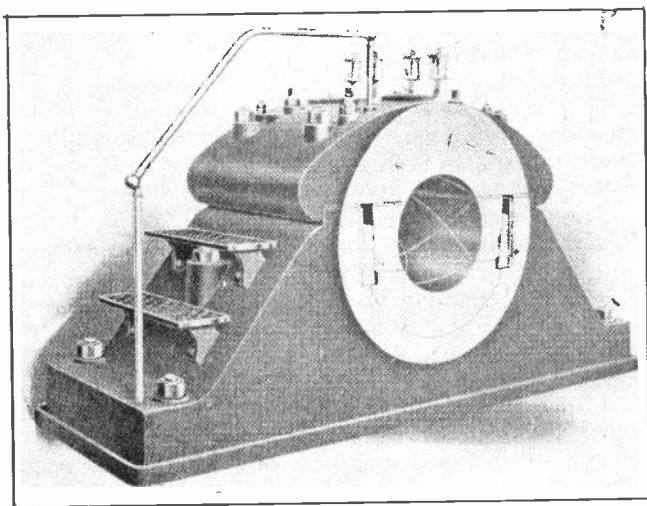

Fig. 7. Very large special sleeve bearing for use with steam engines. Note the adjustable sections in the sides of the bearing to prevent pounding due to bearing slack and engine thrust.

10. LOSS OF OIL FROM BEARINGS

Bearings sometimes lose oil from one of the following causes: siphoning by air currents, worn or loose bearings, and leaks in oil wells around drain plugs or filler connections, or at cracks or sand holes in the iron.

Siphoning of oil from bearings is caused by the strong draft of air which is set up around and through open-type bearing housings by the rotation of motor and generator armatures and by the action of ventilating fans used on them.

This air passing over the surface of the oil carries away oil particles with it, often quickly reducing the oil level to a dangerously low point and also damaging the insulation on windings through which the oil-laden air passes.

Maintenance

As much as one-fourth to one-half pint of oil per week may often be carried from bearings in this manner.

Loss of bearing oil by air siphoning can be prevented by the use of felt seal rings, as previously described.

Loose bearings allow the shaft ends to whip around with load fluctuations and thus cause oil to be splashed out from between the surfaces of the shaft and bearing.

In addition to lowering the oil level in the oil well, the oil escaping in this manner often causes considerable damage to paper pulleys and rubber or leather belts, as well as making dangerous and unsightly oil pools or spots on the floor.

Loose bearings on 900-R.P.M., 25-h.p. motors have been known to throw out more than a teacup full of oil per hour in this manner.

The best remedy in such cases is the installation of new bearings, although the trouble may be temporarily remedied by the use of felt seal rings to keep the oil in the bearing housings.

Loose drain plugs, drain cocks and oil gauges also cause loss of oil in many cases.

Sometimes rather mysterious loss of oil occurs through very small cracks or sand holes in the cast-iron oil well casing. Such cracks or holes can be closed by welding or soldering. A small sand hole can often be closed by tapping it shut with a round headed hammer, or by drilling out the hole and then driving or threading a metal plug tightly into the hole.

11. OVERHEATED BEARINGS

Bearings practically always produce a small amount of heat because of the slight friction even when they are operating properly. Excessive bearing temperatures are commonly caused by one or more of the following items:

- Tight bearings
- End shield out of alignment
- Bent shaft
- Rough shaft or bearing surface
- Dirty oil or poor grade of oil
- Insufficient oil

Alternating Current

Bearing up-side-down

Excessive belt tension

Misaligned gears

Insufficient end play

Motor not level

Heat transfer from hot commutator or brushes.

Bearings will sometimes turn bottom-side-up if the bearing set-screw becomes loose. This causes the oil ring to be lifted off the shaft and will often, result in a burned-out bearing if it is not noticed and corrected promptly.

In an effort to prevent belt-slip, belts are often drawn up too tight. Excessive belt tension places unnecessary friction on one side of the bearing, and causes excessive wear and heating.

Proper care and arrangement of belts makes excessive tension unnecessary. Vertical belt drives should be avoided whenever possible, as they are often the cause of bearing trouble.

When motors drive machines by means of gears and pinions the gears should be carefully lined up so that their teeth mesh squarely and on their pitch lines, or otherwise they cause side-thrust and wear similar to that caused by tight belts.

Insufficient end-play is often caused by bearing sleeves not being properly drawn into the bearing housings, or by improperly machined end shields or shoulders on shafts. The result is pinching of the shaft between the ends of the bearings, and this causes excessive friction and heating.

The end-play should be checked on new machines or those on which bearings have been changed. The end-play movement will vary from $1/32$ in. in small motors to $1/4$ in. on large machines of 50 h.p. or more.

In a motor or generator which is not set level the rotor will slide to one end, causing the shaft shoulder to rub on the inner side of the bearing housing and heat up the bearing.

Sparking commutators or incorrect brushes sometimes produce so much heat that enough of it is transferred through the metal to the shaft to over-heat a bearing.

12. FROZEN BEARINGS

The term "frozen bearings," while sounding rather contradictory, is commonly used in the field to indicate a bearing which has become stuck or locked due to overheating. When a bearing becomes overheated beyond a certain point a thin layer of bearing metal surface becomes soft and partly molten. If the shaft stops turning when the bearing is in this condition, the bearing will cool and grip the shaft very tightly, often making it impossible to start the machine again.

When a bearing becomes smoking hot before its overheating is noticed, freezing can sometimes be prevented by applying heavy steam-cylinder oil to the top of the oil ring slot as the machine is carefully slowed down to allow the bearing to cool gradually. Never allow the machine to stop completely until the bearing has cooled somewhat, or it will be almost certain to immediately "freeze" to the shaft.

The heavy oil recommended for such emergencies provides much better lubrication at such high temperatures.

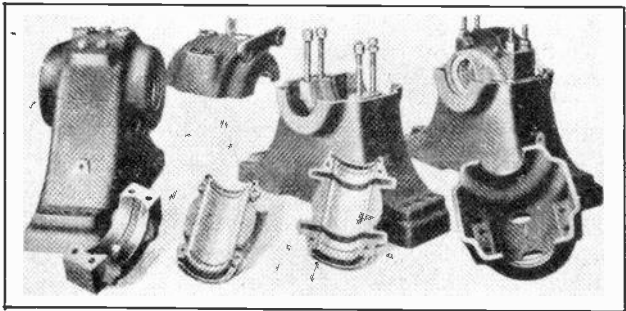

Fig. 8. Pedestal type sleeve bearings, showing parts of one bearing and housing disassembled.

If an overheated bearing is not noticed in time and the motor or generator is allowed to continue running, the bearing will burn out or melt out completely and also cause serious damage to the surface of the shaft by scoring and roughening it.

The difficulty of removing frozen bearings from a shaft makes it well worth considerable precaution to avoid this condition.

Alternating Current

Frozen babbitted bearings can be removed by applying enough heat from a blow torch to melt the babbitt out entirely, and the bearing shell can then be slipped off the shaft.

Brass bearings may be turned off in a lathe or split and pried off in pieces with a dull cold chisel, being very careful not to damage or nick the shaft.

13. CARE IN HANDLING END SHIELDS

When removing end shields to repair or replace bearings, great care should be used to avoid bumping or roughening the face of the shield where it fits to the motor or generator frame. Care is also necessary to draw the bearing straight off the shaft and replace it straight in order to avoid damage to the ends of bearings.

See that all dirt and dust are removed from the shaft and bearings before replacing end shields.

End shields can be removed from small and medium-sized machines by hand, by one or two men; but large ones are usually of the sectional type and should be handled with a block and tackle, or proper blocking beneath them to allow them to be swung or slid freely on and off the shaft.

Many large machines have bearings in separate pedestals mounted on the end of the machine base, instead of having them in end shields. Fig. 8 shows several bearings of this type.

Note that the bearing housings are split and bolted to permit easy removal of bearings without driving or forcing them.

Bearings on small motors are sometimes oiled by means of cotton wicks or yarn packing which rub on the shaft and carry oil to its surface. Fig. 9 shows a bearing with cotton oil-feed packing.

14. SHAFTS

Motor and generator shafts of the cheaper type are made of cold-rolled steel, while those of better grade machines are made of nickel-steel or steel which is specially heat treated and hardened to get high strength and toughness as well as hard wearing surface.

Maintenance

On very large machines the shafts are often of drop-forged steel and are made hollow. This makes them lighter without materially decreasing their strength. For example, a 10-in. diameter shaft with a 4-in. hole has the same strength as a solid shaft 9.91 ins. in diameter.

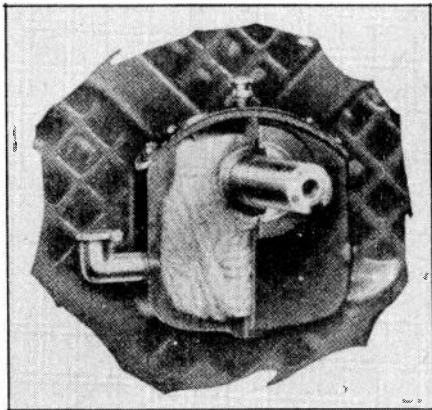

Fig. 9. Bearing with cotton filled oil well, for wick oil feed action to shaft.

The bearing surface of shafts should always be kept bright and clean and should not be allowed to rust. When rotors or shafts are out of the machines and are to be laid away out of service for a time, the shaft can be coated with heavy grease to prevent rust. They can also be coated with white lead, which can be carefully cleaned off when the shafts are needed again.

It is well to wrap shafts with cloth or paper to prevent their surfaces from becoming bumped and damaged while they are out of machines.

Dents and rough spots on shafts can be filed off carefully and smoothly with a fine smooth file. Do not attempt to file out the dents or hollows but just the raised edges or burrs which would score the bearing.

A badly damaged shaft can be turned down in a lathe or reground with a grinding machine. Rust or very slightly roughed surfaces can be smoothed off by polishing the shaft with crocus cloth. Crocus cloth is similar to emery cloth but has a coating of

Alternating Current

extremely fine cutting material of dull red color. Its cutting action is very slow, but it gives the smooth surface required for good bearing operation.

The use of emery cloth on shafts should be avoided, as it leaves rough scratches in the surface of the shaft.

If a shaft requires turning or grinding down to a smaller size, a new bearing sleeve or bushing can be used, giving a smaller bearing opening to fit the shaft. Or, in other cases this shaft can be built up by electric welding and then reground to original size.

15. KEYS, KEYWAYS, PULLEYS, AND GEARS

Keyways in shafts are accurately machined so that the keys will fit snugly and tightly in them, and this tight fit is necessary to keep keys in place and to prevent the movement of pulleys or gears and the shearing or twisting of keys. For this reason, keys of the proper size should always be used, and keyways should not be filed except to remove from their corners slight burrs or dents which tend to prevent the insertion of the key.

Ordinary square, cold-rolled steel, key stock can be purchased in 10-ft. lengths or less, and in any of the standard sizes which are commonly used by motor manufacturers. In a large shop it is well to always have a little key stock on hand.

Pulleys and gears should fit snugly on the shafts, to prevent slipping, rattling, and wearing of the shaft and the inside of the pulley opening. Never expect a key to hold a loose pulley or gear in place if there is any load on them.

Coating the shafts and keyways with a little flake graphite before pulleys and gears are put on makes it much easier to remove them later. Small pulleys and gears may be driven onto shafts with a hammer or a small sledge. Always use a block of wood between the hammer and gear or pulley to avoid battering or cracking the metal, and always tap them evenly, first on one side and then the other, to prevent binding on the shaft.

Large pulleys or gears may be forced onto shafts

Maintenance

with braces or jack screws. Pulleys and gears can be removed from shafts by loosening their set screws, driving out the keys, and then lightly tapping the pulley of the shaft with a hammer and block, as previously mentioned.

A better device for this purpose is a regular gear puller such as shown in Fig. 10. The hooks of this device are placed against the back of the gear or pulley and the large screw is then tightened against the center of the end of the shaft, thus drawing the gear or pulley off.

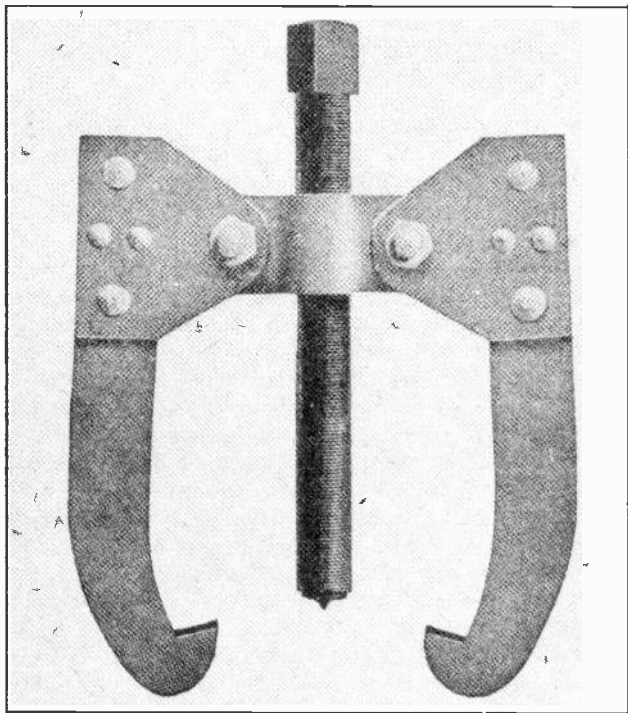

Fig. 10. Simple gear or pulley remover, commonly called a gear puller. Tight fitting gears and pulleys can be removed from shaft ends with such a device.

If possible, the keys should be driven out before removing pulleys or gears, but when it is difficult to remove the keys first they can often be taken out after the pulley or gear is off.

Alternating Current

16. AIR GAPS

A perfect motor should have the same air gap all around the rotor, or the same gauge reading at the top and bottom and right and left sides of the rotor. It is difficult, however, to machine rotors and stators as accurately as this and the air gap of a new motor may vary as much as .005 inch between the four gauge readings.

When the variation becomes considerably greater than this due to bearing wear, it causes an unequal

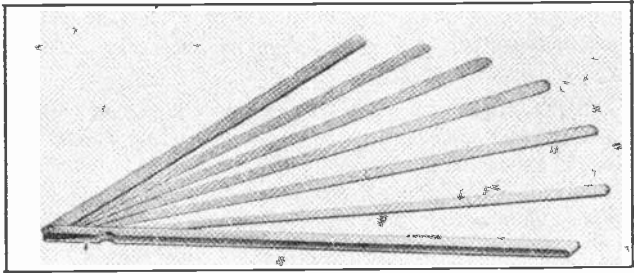

Fig. 11. Common motor air gap gauge, for measuring clearance between the armature or rotor and the field poles or stator. Note the several different "feelers" or blades which are of different thicknesses.

air gap, reducing the efficiency of the motor or generator and in some cases causing excessive heating of certain coils in the stator. For this reason, it is very important to make frequent inspection of air gaps of motors and generators, using the convenient air gap gauges previously described.

Fig. 11 shows an air-gap gauge having a number of blades of different thicknesses and each 16 in. long. All of the blades can be folded within the handle for convenient carrying and protection of their surfaces.

Small motors will generally have air gaps ranging from .005 to .015 of an inch, while motors of 10 to 50 h.p. have .020 to .035 of an inch. Larger machines may have clearances of .040 to .060 of an inch or more. Machines with ball or roller bearings usually have slightly less clearance than those with sleeve bearings.

If a motor when new has a gauge reading of .030 of an inch all the way around, it should have new

bearings before the gauge readings become less than .015 on one side and more than .045 on the other.

17. SQUIRREL-CAGE ROTOR TROUBLES

The rotors of modern squirrel-cage motors are very ruggedly built and are not subject to very many troubles. The bars are generally welded, riveted, brazed, or cast to end rings which short circuit them together; and, while it doesn't very often happen with this type of construction, it is possible that occasionally a bar may become broken or loosened from the end ring by excessive mechanical strains or vibrations.

With older types of rotors on which the bars are soldered or bolted to the end rings they quite often work loose and develop open circuits. With the soldered construction this may be due to poor soldering and workmanship or to overheating of the rotor at some time or other, thus causing the solder to melt out.

If solder splashings are found on the end of the stator windings opposite the rotor bar ends, it is usually an indication of loosened rotor bar connections. Bolted bars may loosen from strain and vibration and loose bars in rotors of this type can often be noticed by a series of small sparks at the end ring when the rotor is started. They can also be detected by a blackened or burned appearance of the bar or ring at the contact, or a slight rise in temperature at a loose contact after the machine has been running a short while. If the rotor bars are tapped lightly a different sound will be given off by those which are loose than by those which are tight and secure.

Loose bars of the bolt-connected type should be thoroughly cleaned and tightened, and those of the soldered or brazed type should have the joints cleaned and carefully resoldered or brazed to the end ring.

Loose or high-resistance joints between the rotor bars and end rings cause reduced starting torque and reduced operating efficiency of the motors, as well as increased heating.

Alternating Current

Unusual noises in squirrel-cage rotors may be caused by the vibration of bars which have become loose at the end ring connections or loose in the slots of the rotor core.

Rotor heating may sometimes be caused by poor insulation between the laminations of the rotor core, allowing the circulation of heavy eddy currents.

18. SLIP-RING ROTOR TROUBLES

Slip-ring motors have rotor windings of the phase-wound type with the same number of poles as the stator winding. Whether these rotors are of the wire-wound or bar-wound type, they are subject to the same troubles as stator windings. The most common of these troubles are defective insulation, shorts, grounds, opens, and loose connections. These troubles have been fully covered in the Armature Winding lessons.

Faults sometimes occur in the insulation or connections of the three leads which run from the rotor winding to the slip rings, or in the insulation of the slip ring themselves.

Oil leakage from bearings may be the cause of failure of the insulation between the slip rings and shaft or between the three separate rings. This may cause the rings to loosen or to become grounded to the shaft or short-circuited to each other.

In some cases this trouble can be corrected by cleaning and drying out the insulation or by building it up slightly larger to make the slip rings fit tightly again, and in other cases it may require complete new insulation rings under the metal slip rings.

Small burned spots in the insulation which have been caused by a ground or short-circuit can often be scraped out and plugged with fiber or insulating compound to make temporary and even more or less permanent repairs.

Lightly burned surfaces on the insulation may be scraped and cleaned, and then after the oil or moisture is dried out the insulation can be covered with several coats of shellac to keep out moisture

Maintenance

and oil and preserve its insulating quality in the future.

Oil will sometimes cause an accumulation of dust and dirt on the brushes or brush holders and may cause brushes to stick in the holders or to build up on the contact faces of the brushes a dirty, greasy film of high-resistance.

Brushes in this condition can be cleaned by soaking and washing them in gasoline or benzine. Brush holders should be kept tight and in the proper position to prevent brushes from running over the edges of rings and causing uneven wear of both the brush and ring.

Slip rings that have been badly grooved or worn may need to be trued or turned down flat and smooth again in a lathe.

19. SECONDARY RESISTANCE TROUBLES

Secondary starting or speed control resistances which are used with slip-ring motors sometimes develop opens or high-resistance connections which cause considerable trouble in the starting or operation of the motor.

An open or high-resistance connection in one phase of this resistor will prevent the proper amount of current from flowing through that phase of the machine rotor, and thereby considerably reduce the starting and running torque.

Cast-iron grids are commonly used as resistance elements in these rheostats, and the brittleness of the cast iron makes them more or less subject to breakage by vibration or rough handling.

Sometimes tools or metal parts are carelessly allowed to drop into resistance grids, either breaking or short-circuiting them. A sheet-metal cover placed a foot or two above a bank of such grids will serve to prevent objects falling into them and also keep out any possible moisture drippings. The cover should not be too close to the grids or it may prevent the free circulation of cooling air through them.

A further protection of coarse wire screen can often be used to very good advantage around the sides of such resistance grids.

Alternating Current

Fig. 12 shows sketches of a separate iron grid, an insulated clamping rod, and a complete assembled unit of grids for resistors of this type. In the sketch of the complete unit an "open" or "break" is shown in one of the grids at "B."

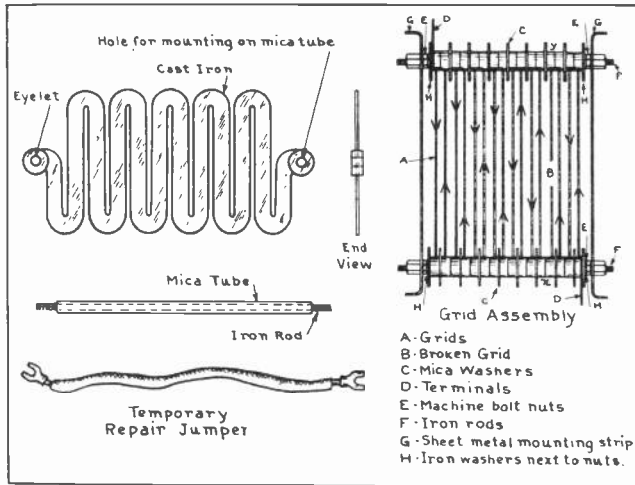

Fig. 12. Sketches showing construction of iron grid type secondary resistors for slip-ring motors. Also note the jumper used for making temporary repairs to open circuited units.

Temporary repairs for breaks of this kind can be made by the use of jumpers made of heavy flexible copper wire equipped with terminals, as shown by the sketch in the lower left corner of Fig. 12.

A repair of this kind can be made by loosening the nuts which clamp the grids together and inserting the lugs of the jumper between the points marked "X" and "Y." When the nuts are again tightened the jumper is clamped securely in parallel with the broken grid.

Shortening the grid out in this manner slightly reduces the resistance of that section of the rheostat, but usually not enough to materially affect the operation of the motor. The broken grid and jumper should, however, be replaced as soon as possible with a new grid.

Maintenance

The nuts which clamp resistors of this type together should be frequently inspected and tightened, as they occasionally work loose by vibration and thus cause poor contacts of high resistance between the ends or eyes of the grids.

This may cause burning and pitting of the contact surfaces of the eyes and necessitate the grids being removed and having the eyes ground or filed clean and smooth.

Careful observation of the sketch of the complete assembled grid on the right in Fig. 12 will show that the mica insulating-washers are properly placed to separate the ends of every other pair of grids on opposite sides, leaving the remaining ends together so that the complete circuit is formed

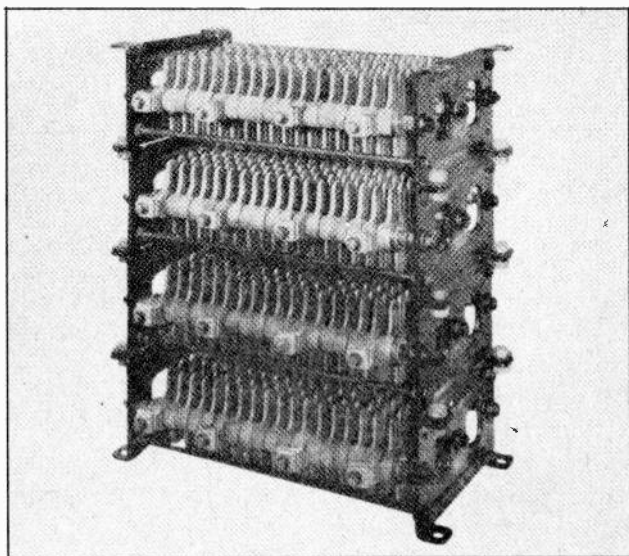

Fig. 13. Photo of complete grid resistor unit for slip-ring motor controllers.

through all of the grids in series in this one unit. Also note the mica insulating-tube which prevents the iron clamping rod from short-circuiting the grids together.

Alternating Current

Fig. 13 shows a photograph of several resistance grid units assembled in a compact bank or framework.

20. TESTS FOR LOCATING FAULTS IN SECONDARY RESISTORS

An ammeter can be conveniently used for locating opens in secondary resistors by placing the ammeter first in one phase lead and then another and starting the motor each time. The phase in which the broken grid is located will be indicated by a zero current reading when the motor is started.

If three ammeters are available, one can be connected in each phase as shown in Fig. 14, thus making the test a little more quickly. With the open at the point marked "X," the center ammeter would show no reading when the motor starting switch is closed.

If the motor is loaded it will probably not start, while if there is no load connected to it may start up slowly.

If the starting rheostat handle is moved gradually around to cut out the resistance, the center ammeter will suddenly show a reading when the sliding contact passes the break at "X," and if the motor has not started up to this time it will probably start rather suddenly when this point is reached; or if the motor has been running, its speed will increase as the break is passed.

By carefully watching the ammeter as the controller handle is moved, the exact location of the break can thus be determined.

High-resistance joints or cracks which are hard to find on resistors by ordinary inspection can be located by testing across the ends of the resistance grids with a voltmeter.

This test should be made while the motor is running and has its stator excited, and with the secondary-resistance controller on the first point. When the voltmeter leads are connected across good grids in the phase elements which are closed, only a very small voltage drop will be read.

When it is connected across good grids in the phase element which is open no reading will be obtained; but when the leads are connected across

Maintenance

the grid which is broken or has the high-resistance connection, a higher reading will be obtained with the meter.

Intermittent opens which are caused by small breaks that are jarred open and shut by vibration, are sometimes the cause of rather mysterious troubles and are a little more difficult to locate.

By leaving an ammeter in each circuit for a time and watching the instrument for fluctuations in its readings, these intermittent or floating opens can be found.

Brushes which occasionally stick in the holders may also cause intermittent opens in the secondary circuit of slip-ring motors and these brushes can be located by connecting an ammeter in series with their leads and watching it for fluctuations.

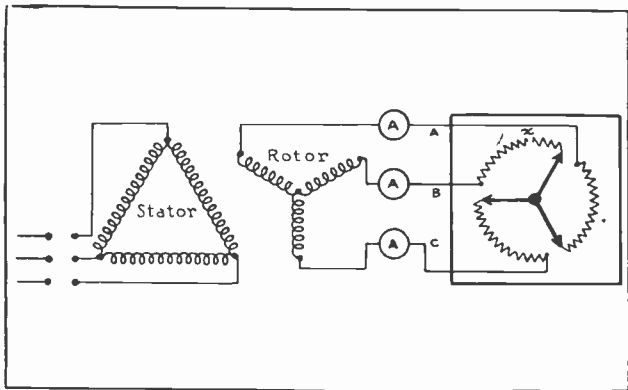

Fig. 14. Diagram showing methods of testing with ammeters to locate an open circuit in a secondary resistance.

A slip-ring motor with a properly wound rotor which is free from faults will give the same ammeter readings on each of the three secondary leads when all control resistance is shortened out of the circuit.

A rotor with slightly unbalanced currents may give good service with slightly lower efficiency and power factor. If the rotor currents in each line are considerably out of balance, the rotor winding should be checked for shorted coils, reversed poles, open circuits, etc.

Alternating Current

A rotor which has balanced currents with all the secondary resistance cut out should also have balanced currents when all of the secondary resistance is in the circuit, provided the resistance is equally divided between the secondary phase leads and the resistance units are all in good condition.

If the ammeter readings vary considerably with a balanced rotor and all the resistance in the secondary circuit, it indicates that the secondary resistance is unbalanced or that part of the resistance is short-circuited.

EXAMINATION QUESTIONS

1. Name three types of bearings in common use on electric motors.
2. A. What type of lubricant should be used on sleeve bearings?
B. On ball bearings?
3. How is oil conveyed from the oil well to the shaft and bearing surfaces?
4. Describe briefly how you would remove and replace a sleeve bearing.
5. Why should bearings not be over oiled?
6. Describe the procedure for "breaking in" new bearings on a motor.
7. What are common causes of overheating of bearings?
8. What would you do in case of a badly overheated sleeve bearing that had not yet stuck?
9. A. How would you check a motor to determine the amount of bearing wear?
B. In what way does an unequal air gap effect the operation of motors?
10. A. What is one common trouble in squirrel-cage rotors of induction motors?
B. What troubles occasionally occur in the secondary or rotor circuits of slip ring motors?

STATOR TROUBLES

A number of the troubles or defects which occur in the stators of A. C. machines have been covered in Lesson 32 on A. C. Armature Winding, and Articles 5 to 20 inclusive should be reviewed in connection with your study of maintenance.

In addition to the actual faults which may occur in stator windings there are a number of other things which relate to the stator and its current supply which may prevent an A. C. motor from starting.

Some of the most common of these troubles are as follows:

- (a) No voltage
- (b) Low voltage
- (c) Unbalanced voltage
- (d) Improper frequency
- (e) Overloaded motor
- (f) Polyphase motor attempting to start single phase

In connection with the first item (a), a motor, of course, cannot start without voltage because there will be no current flowing in either the stator or rotor windings. It is a very simple matter to determine whether or not a motor is supplied with voltage by testing at the stator leads with a voltmeter or test lamps.

Test lamps connected in series can be used on 550 volts and under, and ordinary voltmeters can also be used on such circuits. On higher voltage motors or where the voltage is above the range of the voltmeter, potential transformers should be used.

Fig. 1-A shows a method of using either lamps or a voltmeter to test for voltage at the terminals of a 440-volt motor. Whichever the device used for testing, the test should be made from A to B, B to C, and A to C, to make sure that all phases are alive or supplied with the proper voltage.

Maintenance

Fig. 1-B shows a method of testing the leads of a high-voltage motor using a potential transformer with the voltmeter.

Failure of voltage at the stator leads to a motor may be caused by an open circuit in the line, such as blown fuses, open circuit breakers or switches, failure of the entire power supply, loose connection, or bad contact on the controller, etc.

In testing for low voltage, a voltmeter should be used at the motor terminals. As the starting torque of an induction motor varies with the square of the applied voltage, the motor will be unable to start its load if the voltage is considerably below normal or that voltage for which the machine is rated.

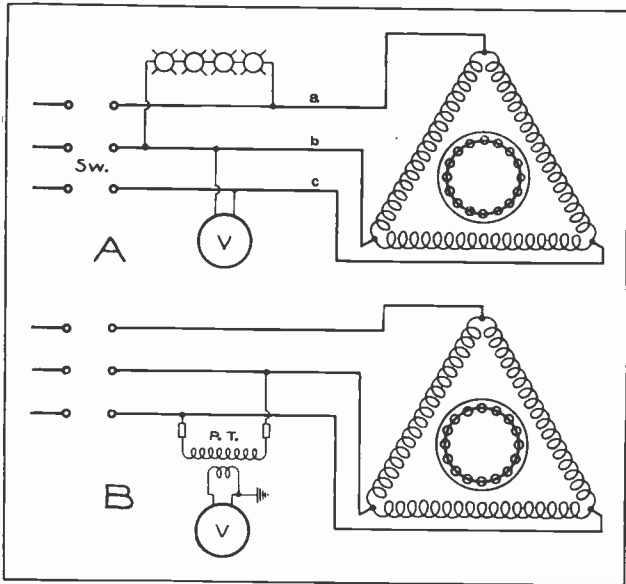

Fig. 1. The above sketches show connections for voltage tests on leads of three-phase squirrel cage motors.

If the line voltage is found to be correct the trouble may be that the starting compensator or resistance is reducing the voltage to the stator terminals too much. This can be corrected by changing the taps on the auto transformer or, in the case of rheostat starters, by cutting out more resistance.

Alternating Current

Badly unbalanced voltages will considerably reduce the starting torque, running torque, and efficiency of a polyphase motor. A voltmeter can be used to detect this condition by a test across each phase as shown in Fig. 1-A.

Unbalanced voltages may be caused by any of the following:

1. Unequally distributed single-phase loads on a three-phase system. (See Fig. 2-A).
2. Entire system supplied with single-phase power but alive with three-phase power, due to phase converter action of three-phase motors. Fig. 2-B shows how this may occur with an open in one phase as shown and a

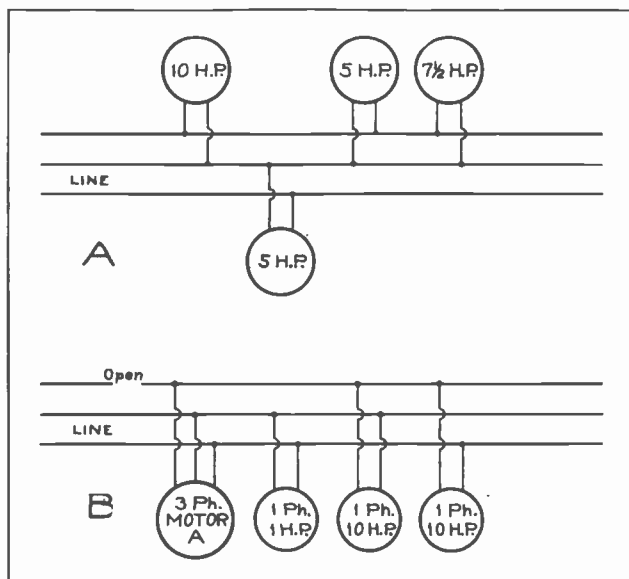

Fig. 2. Unbalanced voltage on three-phase circuits can be caused by unbalanced loads as at "A," or by an open on the line side of a polyphase motor as at "B."

three-phase motor operating lightly loaded from one phase. The phase wire which is open will be supplied by a certain amount of voltage through the stator windings of the running three-phase motor.

3. Transmission-line voltage unbalanced because of no transpositions.

Maintenance

4. Wrong connections on transformers or use of transformers having widely different characteristics.

Improper frequency is not very often the cause of motor failure, except in cases where motors have just been installed and are being started for the first time. In such cases motors of one frequency may have been installed on a supply line of another frequency.

Check the name-plate frequency of the new motors with that of older motors which have been successfully operated on the system, or make a frequency meter test on the line.

1. OVERLOAD AND SINGLE-PHASING

A motor suspected of not starting on account of overload should be tested for other troubles to make sure that the cause actually is overloaded. If the motor tests okay in other respects and is supplied with the proper voltage and frequency it will make a good attempt to start and will generally produce a loud humming noise.

Place an ammeter in each phase lead to the motor. If these instruments register currents considerably greater than the full load current rating of the machine it is fairly safe to assume that the motor is overloaded. Try to turn the load by using a wrench on the shaft, and compare the pressure required on a one-foot wrench handle with the rated starting torque of the motor in foot pounds.

Three-phase motors which are loaded will not start unassisted when single-phase power is applied. Single-phasing may be due to a blown fuse, broken line-wire, loose connection, broken lead at the controller or motor, bad contacts on controllers, etc.

It might seem at first thought that a three-phase motor with one wire open would still be supplied with two-phase power. This, however, is not the case; with one wire open there are only two wires remaining closed and over two wires it is possible to get only single-phase energy. A third wire is needed to complete the circuit for the impulses of the other two phases at alternate periods.

One of the best ways to test for single-phasing

Alternating Current

is to place an ammeter in each line wire at the motor terminals. The line which is open will give a zero reading on the ammeter.

Testing with voltmeters or lamps will locate a dead phase if the leads are disconnected from the stator winding; but these tests may be somewhat misleading if the line leads are connected to the stator, because the voltage drop due to current flowing through the windings from the live phase will cause voltmeters or test lamps to give an indication on the dead phase as well. (See Fig. 3).

While the voltmeter on the left would give higher readings than the others, they would all indicate some voltage. For this reason an ammeter test is the most dependable.

2. REASONS FOR MOTORS OVER-HEATING

Winding troubles, such as shorts, grounds, opens, reversed coils, oil soaked coils, etc., which cause

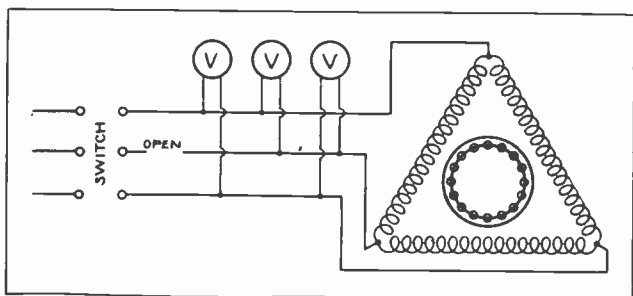

Fig. 3. Sketch illustrating wrong method of testing for an open phase. Ammeters provide a more dependable indication.

overheating of A. C. motors, have been covered in the A. C. Armature Winding Lessons.

In addition to these troubles within the windings, motors may be caused to overheat by any of the following:

- (a) Low voltage
- (b) High voltage
- (c) Improper frequency

Maintenance

- (d) Single-phasing of three-phase motors
- (e) Overloaded motors
- (f) Poor ventilation.

If the voltage applied to the terminals of an A. C. motor is either considerably below or considerably above that for which the motor is rated the machine will overheat.

As the torque of an A. C. induction motor is proportional to the square of the applied voltage, when the voltage is low the machine cannot produce its rated torque and drive the load without drawing excessive current.

If the line voltage is too high it will force an excessive amount of current through the motor windings, whether the machine is loaded or not. A voltmeter can be used to easily determine whether the line voltage is correct for the design of the motor, by comparing the meter reading with the voltage marked on the name-plate of the motor.

Attempting to operate a motor designed for one frequency on a line of another frequency will cause the machine to overheat if the difference in frequency is more than five or ten per cent.

Frequency can be checked by comparing the reading of a frequency meter, or the name-plate frequency ratings of other motors on the line, with the frequency given on the name-plate of the motor which is heating.

A three-phase motor which is operating on single-phase due to some defect in the line or stator winding will overheat considerably if the load on the machine is much more than 50% of its full load rating. This fault sometimes occurs because of defective running contacts on the controller or starting compensator.

If the starting contacts are in good condition they may supply three-phase energy during starting and thus bring the motor up to speed. If the running contacts are defective the motor may receive only single-phase energy when the controller is thrown to running position.

If the load is not too heavy the motor may con-

Alternating Current

tinue to run at slightly reduced speed, but it is very likely to overheat in a short time. The test for locating an open phase or determining whether or not the machine is running single-phased has already been explained.

Motors are designed for a certain normal operating temperature at full load, and the full load current is practically always stamped on the name-plate. If this name-plate current rating is exceeded by placing too great a mechanical load on the motor the heating effect will increase approximately with the square of the current increase.

Ammeters placed in the line leads to a motor will quickly show whether or not it is overloaded, by comparing the meter readings with the name-plate current rating.

Badly worn bearings which allow the rotor to rub or run very close to the stator teeth on one side will also cause overheating.

As all motors develop a certain amount of heat during normal operation this heat must be allowed to escape by radiation or be carried away by circulation of air through the machine, in order to prevent building up excessively high temperatures. If either the radiation of heat from the machine or the circulation of air through it are interfered with, the motor will overheat seriously.

Sometimes, in an attempt to keep moisture or dirt from a motor, the machine is improperly covered in a manner that also prevents the circulation of air and the radiation of heat. In other cases, the ventilating ducts through the winding and core may have become badly clogged with dirt, thus preventing the proper circulation of cooling air.

3. INSULATION TESTS WITH MEGGER

A megger test of the insulation resistance of any electrical machine is usually a fair indication of the condition of the insulation.

Machines on which the windings are soaked with oil or moisture or have old and defective insulation will give a much lower reading in megohms than

Maintenance

machines of the same type and size with good new insulation.

As the insulation resistance should depend on the size and voltage rating of any machine, these factors should be considered in determining the proper resistance standard with which to compare test readings.

The following simple formula can be used for this purpose:

$$\text{Megohms should} = \frac{\text{rated voltage}}{\text{kw. rating} + 1000}$$

For example, a 20-h. p., 440-volt motor with good insulation should test .433 megohms or 433,000 ohms or more.

As:

20 h. p. = 20×746 , or 14,920 watts, or 14.92 kw.
then,

$$\text{Megohms} = \frac{440}{14.92 + 1000}, \text{ or } \frac{440}{1014.92}, \text{ or } .433 +$$

As previously explained, if megger readings taken at successive inspection periods show continually decreasing insulation resistance on a certain machine, it indicates failing insulation due to aging, overheating, moisture, oil, or some such cause.

When drying out machines with damp windings, megger tests should show higher and higher resistance readings as the moisture is removed.

When further drying will not increase the insulation resistance any more, it indicates that the moisture is practically all out of the windings.

Megger tests are made by connecting one lead of the instrument to the machine winding and the other lead to the frame. Then turn the hand generator crank until the voltmeter element indicates proper D. C. voltage, and read the resistance in megohms from the ohmmeter scale.

4. DIELECTRIC TEST

Another common test for the insulation of electric machines is the dielectric test, which is made by applying a certain excess voltage to the windings and frame of the equipment to see if the in-

Alternating Current

sulation will break down and ground the winding, or if it is good enough to stand the voltage without puncturing.

The standard voltage to use for the dielectric test is found as follows:

$$2 \times \text{rated voltage} + 1000$$

For example, the voltage to use for the dielectric test on a 20-h. p., 440-volt motor, would be:

$$2 \times 440 + 1000 = 1880 \text{ volts.}$$

Small portable test transformers with adjustable taps or rheostats used in their primary circuits to vary the secondary voltage can be used for making dielectric tests.

5. SINGLE-PHASE MOTOR TROUBLES

As certain types of single-phase motors use commutators and short-circuiting devices, centrifugal switches, etc., their failure to start or operate properly may be due to defects in one of these devices as well as to faults in the windings or failure of line supply.

On single-phase motors of the repulsion-induction type the centrifugal commutator short-circuiting device is supposed to leave the commutator free of the short circuit during starting and then to short circuit the commutator when the motor is fairly well up to speed.

If this short-circuiting device fails to operate properly the motor may not start or it may not come up to full speed. Failure of the short-circuiting device may be due to its becoming clogged with hardened oil and dirt, to worn out parts, burned or pitted contacts, dry or unlubricated moving parts, or the weakening or breaking of springs.

All single-phase commutator-type motors use brushes which are subject to the same troubles as those of D. C. machines. These troubles and their remedies were thoroughly covered in the Direct Current Section, Lesson No. 36:

Repulsion-induction motors are the most common type which have commutator and brushes, and on these machines the brushes are short-circuited together and must be placed at a certain definite setting.

Maintenance

If loose or high resistance connections develop in the short-circuit path between these brushes or if the brushes slip out of their proper setting, the motor will not operate properly or may not even start.

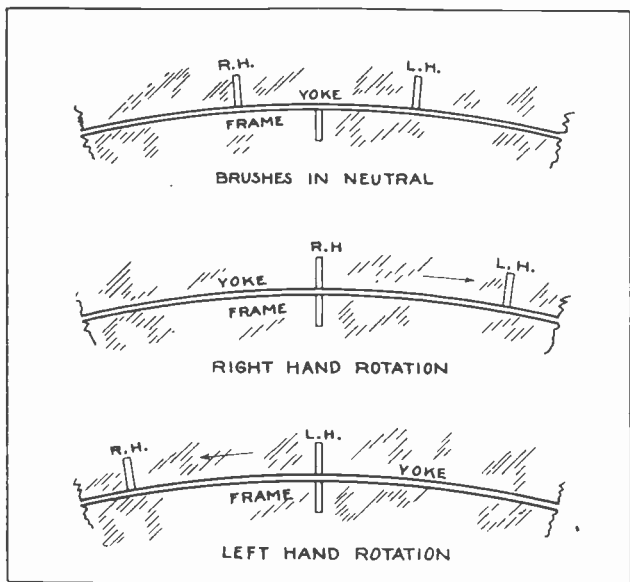

Fig. 4. The above sketches show markings on motor frame and brush yoke, for setting repulsion motor brushes for right or left-hand rotation.

The proper brush setting for these machines is usually marked on the frame and brush-holder yoke. One common type of marking is as shown in Fig. 4. In the upper sketch there are shown two small marks, "R H" and "L H", on the brush holder yoke; and one small mark on the frame.

When these marks bear the relative positions shown in this sketch the brushes are at neutral and the motor would probably not start in either direction. With the brush yoke shifted until the "R H" mark lines up with the mark on the frame, as shown in the center sketch, the motor should rotate in a right-hand direction and should give its full rated speed and torque.

When the brush yoke is shifted so that the "L H"

Alternating Current

mark lines up with the mark on the frame, as shown in the lower sketch, the motor should run in a left-hand direction.

Other troubles, such as dirty brushes, poorly fitted brushes, brushes stuck in the holders, poor brush tension, loose pig tails or connections, high mica, etc., apply to commutator type A. C. motors as well as to D. C. machines.

The centrifugal switches of fractional horsepower, single-phase, split-phase motors often cause failure of these motors to start or run properly, due to these switches becoming stuck with dirt and grease, developing loose or burned contacts, improper spring tension, broken or bent parts, etc.

6. TESTING SINGLE-PHASE, SPLIT-PHASE MOTORS

A convenient method of testing single-phase, split-phase motors to locate most of their common troubles is shown in Fig. 5. A set of test lamps and fuses are shown connected to a pair of test leads, "X" and "Y," with insulated handles.

The test lead "Y" should be connected in series with a fuse to the ground wire of the single-phase system, and the test lead "X" should be connected in series with a pair of test lamps and a fuse to the "hot" wire.

In testing for grounds, place Y on the frame of the motor making sure that it is not insulated from the iron by paint or grease. If the motor is not grounded the lamps should not light when X is touched to either A, B, C, D, or E.

If the lamps do light when X is touched to A or B, it indicates that the running winding is grounded. If the lamps light when X is touched to C, D, or E, it indicates that the starting winding or switch is grounded.

In testing for crosses or shorts between the starting and running windings, connect Y to either A or B. When X is touched to C, D, or E, the lamps should not light. If they do, it indicates a cross or shorted connection between the two windings.

Maintenance

In testing for "opens" in the running winding, connect Y to A and X to B. If the lamps fail to light it indicates that the running winding is open-circuited.

In testing for opens in the starting winding, first test the entire winding circuit by connecting X to C and Y to D. If the lamps do not light the circuit is open.

Next connect X to C and Y to E. If the lamps light the centrifugal switch is closed as it should

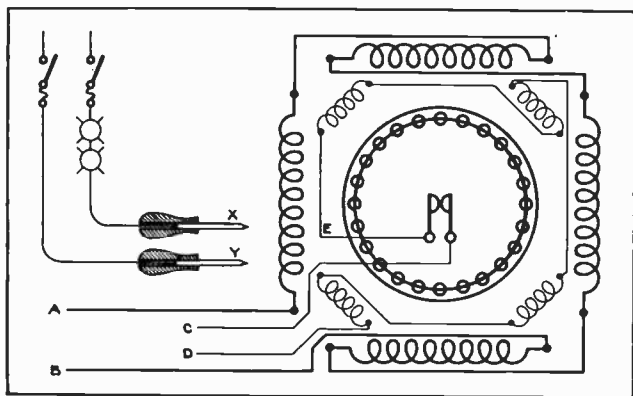

Fig. 5. Diagram illustrating connections and methods for convenient trouble tests on single-phase split-phase A. C. motors.

be when the motor is idle. Then connect Y to D and X to E, and if the lamps do not light it indicates that the starting winding is open regardless of the position of the switch.

7. PRECAUTIONS IN STARTING NEW MACHINES

When starting up for the first time new machines such as motors, generators, converters, transformers, etc., you should exercise particular care and observe carefully a number of important items. No properly trained electrician with any respect for his job or the equipment of which he is in charge will ever start up a new machine and leave it to run unobserved.

Alternating Current

Before the machine is started its entire circuit and all switches and connections should be carefully checked over, and care should be taken to see that no foreign objects or dirt are anywhere in the machine.

Check carefully the oil in bearings, the movement of oil rings, and also the ventilating air or cooling water supply to the machine. If these things are not carefully done it may result in considerable damage to the new equipment as well as danger to yourself or other workmen.

All new electrical machinery that has had any chance to become damp, and particularly that of high voltage and large capacity, must be thoroughly dried out before operating. This applies also to old equipment which has not been used for some time and may have absorbed considerable moisture.

The windings may be dried out by means of electrical heaters or steam coils and fans, or by allowing current not much in excess of full load value to flow through the windings at low voltage until the heat thus caused has evaporated the moisture.

One or more electric fans used to circulate the warm air from heaters through and around the windings will greatly reduce the time required for drying. Small machines or windings can be dried out conveniently in ovens, if they are available.

In some cases the drying out of large machines can be speeded up by building a temporary enclosure around them and placing heaters of some sort inside this enclosure. Sheet metal will serve very well for such enclosures and asbestos board is excellent because of its heat-resisting and insulating qualities.

Never fail to have plenty of clean, dry air circulating through any ovens or enclosures used for drying out electrical equipment, as this circulating air is necessary to carry away the evaporated moisture.

New machinery or machines which have not been running for some time should always be carefully watched for unusual sounds or vibration which may

Maintenance

be caused by single phasing; reversed phases; loose mechanical parts such as end shields, bearings, pulleys, rotor bars, coil wedges, etc. Loose laminations in stator or rotor cores will often set up loud humming noises.

Excessive vibration of the entire machine may be caused by improperly balanced rotating parts. Unusual vibration and noises are often caused by shorted coils or other defects in the windings on either rotors or stators.

All machinery should be carefully and frequently observed for signs of overheating. Overheated windings or bearings will generally give off an odor of hot or burning insulation or oil, and when any odors of this nature are first noticed the machine should immediately be shut down and the source of trouble located and corrected.

By shutting down motors and feeling the various parts of stator and rotor windings any spots which are particularly hotter than others can be located, thus helping to determine where the trouble is.

8. USE OF TEST INSTRUMENTS

We have previously mentioned and will again emphasize here, the fact that any up-to-date plant should have a sufficient number of proper meters for testing and checking electrical machinery and circuits, and the electrical maintenance man should do everything in his power to see that these instruments are on hand and in good condition.

Much trouble and lost time can be saved by making the proper tests on new machinery and its circuits when the machines are installed, and also by testing machines for overloads and abnormal circuit conditions after they are running. Additional money can also be saved by making occasional efficiency and power factor tests on various machines and circuits, if the proper meters for this work are available.

9. IMPORTANCE OF CLEANING

Always remember that it is very important to keep all electrical machinery well cleaned and free

Alternating Current

from collections of dust, dirt, and oil. Regular and thorough cleaning will greatly prolong the life of insulation and will help to reduce operating temperatures and increase the efficiency of any electrical equipment.

Dust can be blown out of windings by means of portable electrical blowers such as shown in Fig. 6; or, if blowers are not available, by wiping and brushing out windings with rags and soft brushes having long insulated handles.

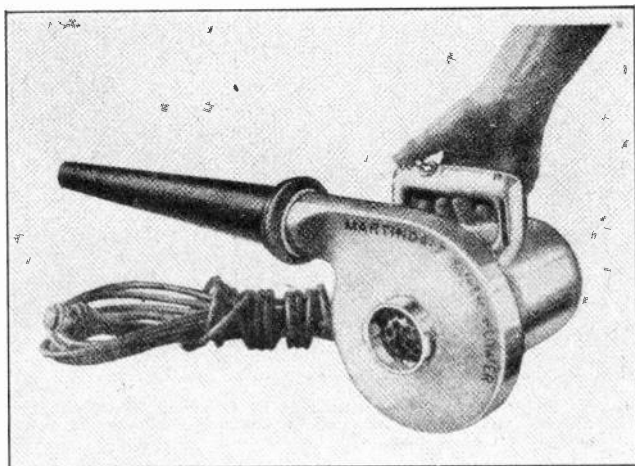

Fig. 26. Convenient portable electric blowers of the type shown above are often used for cleaning dust from electrical machines.

Oil or grease can be wiped off windings with rags or waste, and the windings can then be washed with gasoline or benzine to thoroughly cleanse them of all oil or grease which may have started to soak into the insulation.

Mixing carbon-tetra-chloride with gasoline or benzine in mixtures of about half and half, will greatly reduce the fire hazard and the possibility of an explosion when using these solutions for cleaning.

After washing with such solutions to remove grease and oil, windings should be thoroughly dried and then given one or more coats of good air-dry insulating varnish. Varnish of this kind can be

Maintenance

obtained in small or large cans from electrical supply houses and should always be kept on hand in any electrical maintenance shop. It helps to fill small cracks which develop in the insulation and thereby keeps out dirt, oil, and moisture and thus greatly increases the life of the equipment.

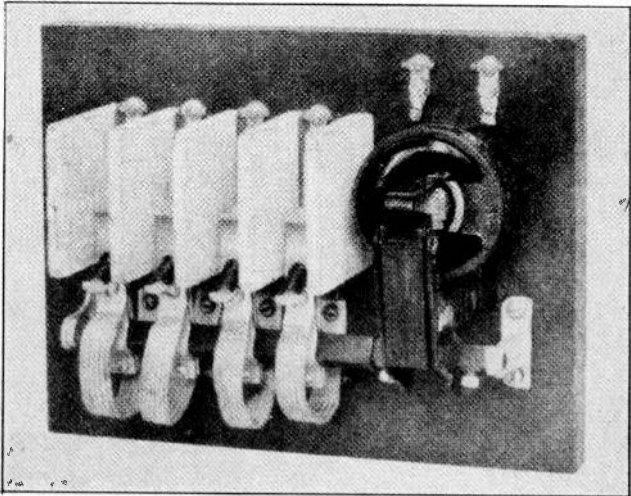

Fig. 7. Photo of contactor panel of an A. C. motor controller. These contacts and their connections require frequent attention by the maintenance electrician.

10. CONTROLLERS

In order to secure proper starting and operation of A. C. motors it is necessary to keep their starters and controllers in good condition. Controllers should be given the same regular inspection as motors, and a regular form similar to the one shown for motor inspection on page 21 Lesson 72 can be used to cover the inspection of all moving or wearing parts, contacts, terminals, relays, overload protective devices, etc.

Controller terminals should be frequently inspected to see that they have not worked loose by vibration, and all contacts at which circuits are made and broken should also be frequently inspected to see that they are not partly burned and making poor or high-resistance connections.

Alternating Current

As soon as contacts become severely burned or pitted they should be carefully filed smooth and

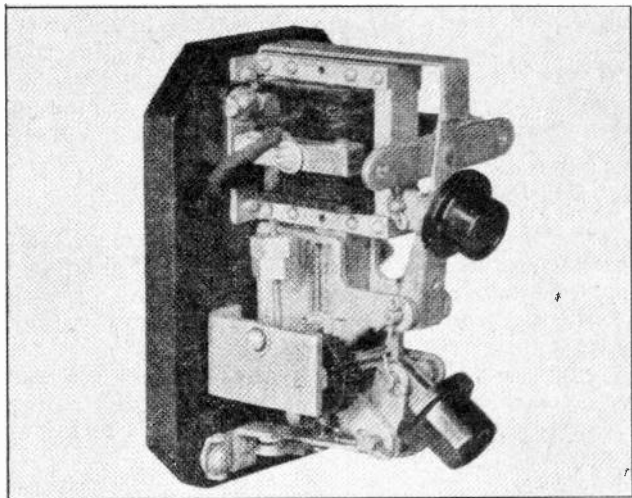

Fig. 8. Push button station with cover removed to show contacts and relay magnet.

bright, and when worn or pitted beyond the possibility of efficient repair by this method the contact faces or shoes should be replaced with new ones.

Flexible connections and pig tails to movable controller contacts should be inspected frequently to see that they are not partly or wholly broken off due to repeated bending. These flexible connection can easily be replaced with new ones obtained from the manufacturer or by short pieces cut from a stock of flexible copper braid of the proper sizes, which should be kept on hand for just this purpose.

Contact springs, arcing tips, arc barriers, etc. should also be given frequent inspection and repaired when necessary.

It is particularly important that all overload-release coils, no-voltage coils, time-element devices, and other protective relays and equipment on controllers be kept in good adjustment and condition, in order to protect both the controller and the motor which it operates.

Maintenance

On starters of the remote control type the push buttons and their contacts should also be inspected and kept properly maintained, as these little devices may otherwise be the source of considerable trouble and may cause the controller and motor both to fail to operate, just because of some dirty contact or loose connection at the push button station itself.

11. GENERAL

Some form of convenient speed indicator or revolution counter such as shown in Fig 10 should be kept on hand among the maintenance man's tools for the purpose of checking the speed of various motors and driven machinery.

Reduced speed below that of the name-plate rating is often an indication of an overloaded motor, reduced line-voltage; or of some trouble which may be developing in the machine.

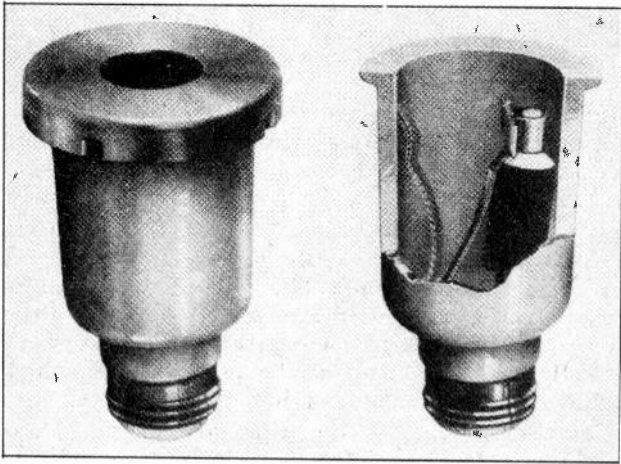

Fig. 9. Convenient plug type thermal relay for protection of circuits to small motors and other equipment.

A convenient portable trouble lamp with an insulated handle, lamp protecting guard, and extension cord as shown by Fig. 11 should also be available for making emergency repairs on machines located in dark corners and for examining the insides of controllers or large motors.

Alternating Current

The small hook shown on the end of the guard provides a convenient means of supporting the lamp in place where work is to be done. Lamps of this kind are often provided with an extra wire on the extension cord for grounding the lamp socket and guard, thus affording added protection from shock hazard in case of a defect in the socket.

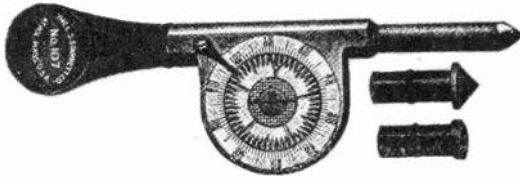

Fig. 10. Revolution counters or speed indicators of the above type are very convenient for checking the speeds of motors and generators.

Another very convenient device for the electrician to have is one of the small pocket-size circuit testers of either the magnetic or neon tube type, for testing to see if low-voltage circuits are alive or not and approximately what their voltage is.

12. STOCKING OF SPARE PARTS

A maintenance man should always give considerable thought to stocking or keeping on hand at least a few of the spare parts most commonly needed for repairs and replacement on the motors, controllers, and other devices which he may be maintaining. Even in plants where this has not been the practice a trained man can make his services much more valuable and save a great deal of time and money for his employer by determining as quickly as possible what parts are most often needed for repairs and replacement, and then recommending the purchase of a small supply of these parts to have on hand at all times.

This is a particularly great advantage when the plant or equipment is located at some distance from the supply house or manufacturers from whom repair parts can be obtained, as in such cases having the parts on hand saves considerable time in repairing and putting the machines back into service.

In large plants such stock parts should be neatly and systematically located and arranged in bins or

Maintenance

shelves which are marked so that any particular part can be located.

Attaching to the repair parts themselves proper tags with complete markings and data will often help to quickly select the proper part for a certain machine.

A few of the small parts more commonly required may be carried in the tool kit of the maintenance man.

What spare parts should be kept on hand depends a great deal upon the amount and type of equipment in use in the plant. They may range all the way from small screws, springs, bolts, nuts, pig tails, contact shoes, brushes, relay coils, field coils, fuses, etc. to complete spare rotors or armatures, or even complete spare motors, transformers, oil switches, etc.

Small companies could not, of course, afford to carry these larger spare parts and machines; but in large plants, where dozens or hundreds of machines of one type may be in use, having on hand a spare motor or controller which can be used to quickly replace one of the others which has become defective, allows the defective unit to be taken out of service and repaired at leisure without very much loss of time due to shut-down of the driven equipment.

Some of the parts most commonly carried in stock are as follows:

1. Bearings
2. Controller and switch contacts
3. Brushes
4. Bearing oil
5. Oil for starters and oil switches
6. Fuses (plug and cartridge type)
7. Supply of the most commonly used sizes of wire
8. Cable lugs
9. Insulators and pins
10. Solder, flux and tape
11. Fish paper and varnished cloth

12. Air-dry insulating varnish
13. Wire for rewinding coils, or spare factory-made coils
14. A few lengths of most commonly used sizes of conduit
15. Sandpaper and crocus cloth
16. Screws, nuts, bolts, springs, etc.
17. Condulets, outlet boxes, lock nuts, and bushings
18. Lamps and sockets
19. A few feet of copper bus bar
20. Brush holders.

13. FIRE PROTECTION

The maintenance man should also give some thought to proper fire protection of at least the electrical equipment in his charge. Small portable fire extinguishers located at points near equipment using quantities of oil, or equipment which may cause a certain amount of sparking or flashing, will generally be sufficient protection.

Carbon-tetra-chloride extinguishers can be safely used to extinguish fires on live electrical parts because this liquid is not a conductor of electricity. Most other extinguishers, such as the soda and acid type, and also any water bucket or water hose should never be used until you are absolutely certain that all wires and machine parts have been disconnected and grounded.

One of the most modern and efficient methods of fighting fire around electrical equipment is the use of fire-extinguishing gases contained under pressure in metal cylinders equipped with a short length of hose and a tube for directing the gas into the fire or machine which may be burning.

Fig. 12 shows an extinguisher of this type being used to put out a fire in the oil pan of a voltage regulator.

14. SECURING HELP FROM MANUFACTURERS

A great deal of cooperation can be secured from

Maintenance

the manufacturers by any maintenance man who will take the trouble to write to them for it. Manufacturers are generally very glad to cooperate with users of their equipment and will furnish internal

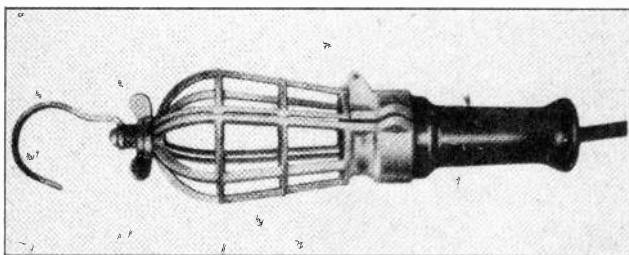

Fig. 11. Convenient trouble lamp with hook, guard, and insulating handle.

and external connection diagrams; instructions for installation, care and operation; data and prices on spare parts; or even to supply one of their expert engineers to help solve certain operating or repair problems with which the maintenance man may have exceptional difficulty.

In writing to manufacturers for any information of this kind you should always give complete name-plate data on the machines or devices for which the information is requested.

Never hesitate to ask the manufacturers any questions about their equipment because they are usually glad to help the maintenance man or operator produce the best possible results with their machines.

15. KEEP UP-TO-DATE

It is also exceedingly well worth while to keep up-to-date as to modern operating and maintenance practice in different plants throughout the country. One way to do this is to subscribe to one or more of the best trade journals covering the class of work you may be doing.

These journals contain interesting articles by leading operating and maintenance engineers and by practical men of long experience in the field. The articles often show actual photographs and illustrations of certain installations and machines,

Alternating Current

and in many cases they give excellent shop hints and suggestions for improvements, and tools and devices with which a great deal of time can be saved in making certain repairs.



Fig. 12. This photo shows the use of a modern gas type fire extinguisher for fire protection in electric plants.

Keeping yourself up-to-date in this manner and always looking for new ideas to use to the advantage of your employer is bound to result in more rapid promotion both in responsibility and in salary.

16. OPPORTUNITIES

Always use your head as well as your hands continually on any electrical work you may be doing, and in this manner you will get a great deal more enjoyment out of your work each day; and you are also sure to get more pay out of your envelope if you strictly follow this practice.



Fig. 13. This photo shows an installation of A. C. motors in a copper mill. Hundreds of thousands of motors in thousands of electrified factories and plants require the services of trained electrical maintenance men.

The field of electrical construction, operation, and maintenance in all of the various lines such as power plants, industrial plants, telephone com-

Alternating Current

panies, railroads, and also in radio, automotive ignition, air craft ignition, etc., offers splendid opportunities to the practically trained man. Very few people fully realize or appreciate these opportunities when they are told about them, and usually not until they have obtained training and made the necessary effort to establish themselves in this great field of fascinating and profitable work.

A knowledge of the principles of alternating current and A. C. devices covered in these lessons will be of great value to anyone planning to enter the radio field, because radio equipment utilizes high-frequency alternating current, and many of the fundamental principles of alternating current and A. C. power machinery are so closely related to those of radio circuits and equipment.

Keep in mind at all times that your lessons should be used for frequent reference to refresh your memory on any principle of which you are in doubt, or to obtain specific help and instruction on any problem of electrical construction, operation, maintenance, or trouble shooting which you may ever encounter.

The more frequently and constantly you refer to them for help of this kind the more familiar you will become with the exact location of each subject and the more quickly and easily you will be able to locate practically anything you wish to find within these pages.

EXAMINATION QUESTIONS

1. What are some of the common troubles or reasons for an A. C. induction motor to fail to operate properly?

2. A. What devices would you use and how would you test a three-phase motor to detect voltage failure or unequal phase voltage?

B. For "single-phasing" or over-loading?

3. What are some of the most common reasons for A. C. motors overheating?

4. A. State the formula for determining proper insulation resistance rating for electrical equipment.

B. The formula for dielectric test voltage.

5. Name several common faults or troubles of single-phase motors of the commutator type.

6. What are several important precautions to observe when starting up new electric machines?

7. What two methods are commonly used for cleaning dust, dirt and grease from machine windings?

8. What are several important items of controller maintenance?

9. Name ten most important repair parts or items for a maintenance man to keep on hand.

10. By what two methods other than your E. I. course and service can you keep up-to-date and obtain special information on electrical equipment and methods?

INDEX

A

- A.C. Motors, 257-343
- Alternating Current,
 - average value—current, 17
 - circuits of, 22-26
 - capacity, 36
 - effective & maximum values, 13
 - effect of lagging, 20
 - flow of, 13-14
 - generation of, 9-11
 - history of, 1-6
 - nature of, 8
 - phase relation, 19
 - relays, 643-647
 - reassembly of motors, 683
 - sine curves, 11
- Alteration, 11
- Alternators,
 - adjusting loads of, 125
 - operation & paralleling
 - of, 113-133
 - operation of, 130-132
 - starting up, 124
 - revolving field, 87
 - shutting down, 126
 - turbine types, 93
 - vertical & horizontal types, 90-92
- Armatures—alternator types, 94

B

- Bearings, 675-682
 - dust seals, 686
 - breaking in new, 688
 - loss of oil, 689
 - overheating of, 690
 - frozen, 692
 - ball & roller types of, 676
 - lubrication of, 678
 - sleeve types of, 679
 - installation of, 681

C

- Capacity, 36
 - units of, 37
 - summary of, 42
- Circuits, paralleling AC, 49
- Condensers, location of, 353
- Controllers, 451-475
 - auto carbon pile starters, 468
 - auto remote starters, 484
 - construction of contactors
 - on Overload relays, 473
 - circuit & operation, 465
 - carbon pile starters, 464
 - counter voltage, 458
- Controllers convenience & safety, 452
 - drum types—connections, 498
 - drum types, 493-495
 - Deion arc quenchers, 492
 - full voltage and across the line starting, 454
 - installation of, 503
 - method of reducing voltage, 459
 - photos of, 450-470
 - printing press type of, 490
 - resistance type starters, 461

Controllers—Cont'd.

- starting voltage & adjustment, 483
- star delta starter, 501
- starting reversing & speed control, 496
- thermal & magnetic overload relays, 455
- time element device, 488
- Converters, 423-450
 - armature connections, 428
 - arc chutes & barriers, 445
 - characteristics, 427
 - construction of, 424
 - oscillator, 443
 - auxiliaries for, 442
 - building up DC voltage, 439
 - brush lifting mechanisms, 442
 - correcting polarity, 440
 - control of DC output voltage, 433
 - flash over relays, 446
 - field connections, 430
 - field excitation, 431
 - operating principles, 425
 - overspeed device, 444
 - starting of, 438
 - transformer connections, 434
- Coils, field, 101
- Condensers, static, 349
- Counter voltage, 28-32
- Current, condenser charging, 37
 - parallel circuits, 55
- Cycle, 11

D

- Diagram, wiring rectifier plant, 414

E

- Excitation, alternator field, 102
 - connections, 103

F

- Factor, power, 59-68
- Formula, power factor, 60
 - resistance, 50-55
- Frequency, alternators, 100-107
- Fuses, high tension, 640-643

G

- Generators, 87-112
 - cooling of, 99
- Generating stations, 513-540
 - auxiliary equipment, 537
 - boilers for, 519
 - exhaust steam condensers, 524
 - hydro electric plants, 431
 - prime movers, 516
 - rules, 538
 - selection of location, 514
 - starting & control of prime movers, 535
 - steam turbines for, 526
 - steam cycle, 525
 - views of plants, 515-520
 - water wheels & turbines, 533

I

- Impedance, calculation in AC series circuit, 44
 - formula, 46
- Inductance, 27
 - calculating, 35
 - in AC circuits, 8
 - summary, 42
- Installation & Maintenance, 657-706
 - air gaps, 698
 - measurement, 667
 - controllers, 722
 - conduit & conductors, 655
 - control & switching equipment, 652
 - di-electric testing, 714
 - fire protection, 727
 - generators & motors, 651
 - insulation tests with megger, 713
 - inspection & maintenance record, 664
 - keys, pulleys, & gears, 695
 - overload & single phasing, 710
 - precautions in starting machines, 718
 - reasons for overheating, 711
 - shafts, 712
 - secondary resistance troubles, 700
 - single phase motor troubles, 715
 - safety precautions, 671
 - tests to locate faults in secondary resistors, 703
 - testing single phase motors, 717
 - tools & instruments, 668
 - transformers, 659
 - use of test instruments, 720
- Instruments, connecting of, 70

L

- Lagging, caused by inductance, 33
- Low power factor causes of, 61

M

- Meter, connections, 72
 - tests, 83-84
- Measurement, high voltage, 81
 - power, 70-86
 - power in single phase circuits, 71
 - 3 meter methods, 82-83
 - 3 phase circuits, 75
- Motors, applications of slip ring, 307
 - BTA photo, 335
 - variable speed, 332
 - construction features, 258
 - characteristics, 259
 - condenser type split phase, 273
 - controlling speed—
 - induction motors, 294
 - connections, 337
 - double squirrel cage, 331
 - efficiency & power factor, 265
 - effect of secondary resistance on starting torque, 302
 - Flynn Weichel, 336
 - Hp—voltage & frequency ratings, 267

Motors—Cont'd.

- internal resistance, 301
- polyphase, 285-288
- power factor—AC, 292
- portable type for farms, 341
- photo Flynn Weichel, 335
- procedure for starting with compensator, 478
- resistor—induction, 280
 - compensating windings, 278
 - operating principles, 278
- rotor construction, 271
- split phase, 270
- single phase, 269
- slip, 262
- shaded pole, 274
- split phase principles, 271
- series & universal, 282
- slip ring characteristics, 302
- starting & speed control, 298
- slip ring types, 296
- squirrel cage types, 289
- starting single phase types, 283
- synchronous, 309-328
- starting current slip ring, 305
- synchronous—construction, 310
- special AC, 327
 - enclosed types, 340
- torque, 263
- 3 phase types, 287
- types for ships, 342

O

- Ohms law, 24
- Oil switches, 625-640
 - high tension types of, 635
 - heavy duty types of, 630
 - photos, 633-640

P

- Parallel—AC circuits, 49
- Parts, repulsion induction motor, 280
- Phasing, 113-116
 - lamp bank method, 114
 - motor method, 116
- Photo, AC motors, 7
 - power line, 2
 - stator, 98
 - steam driven alternator, 129
 - mercury arc rectifier, 407
- Power, measurement of, 70-86
 - current in 3 phase circuit, 67
 - 3 phase circuits, 66
 - single phase circuits, 65
- Power Factor—example
 - of low, 62
 - explanation & examples of, 345-377-59-68
 - table of condenser sizes, 371
 - use of synchronous motor for PF correction, 369
 - graphic solution, 363-365
 - field problems, 67-68-360
 - selection of corrective equipment, 358
- Power transmission, 541-580
 - bushing installation, 578
 - conductors used in, 554
 - cable handling & splicing, 551
 - chart of methods of tying wires, 566

Power transmission—Cont'd.

- fastening conductors, 563
- insulators, 558
 - strain type of, 572
- overhead, 552
- putting in underground cable, 548
- pin type insulators, 560
- pillar type insulators, 568
- system layout, 545
- suspension type insulators, 569
- table for sizes insulated wire, 555
- table for voltages, 553
- table for conductor data (bare), 557
 - copper, 556
- underground cables, 549
- underground systems, 547

Q

- Questions for personal examinations, 25-58-86
 - 112-133-171-202-
 - 232-256-284-308-
 - 344-377-399-421-
 - 449-475-511-540-
 - 580-604-623-650-
 - 674-706-732

R

- Reactance, 35
 - capacity of, 39
 - Relays, 643-648
 - Rectifiers, 379-398
 - bulb type of, 386
 - construction & care of, 385
 - copper oxide, 394
 - connections & circuits, 413
 - cooling installations, 409
 - electrolyte types, 382
 - fullwave bulb types, 390
 - half wave & full wave types, 383
 - Kenotron, 393
 - mercury arc starting
 - principles, 402
 - operation, 380
 - power, 406
 - voltage, efficiency & power factor, 418
 - wiring circuits bulb type, 391
- Regulators, operating principles
 - induction types, 211
 - automatic operation of, 214
 - induction, voltage of, 250
- Resistance, 40
 - automatic voltage, 108
 - determining, 74
 - in parallel with inductance, 50
 - capacity & inductance in series, 48
- Rheostats, exciter & alternator, 106
- Rotor, 102

S

- Self induction, 28
- Sine waves, 16
- Starters, 477-480
- Stators, 707-730

- Substations, 581-604
 - combination, 601
 - connecting converter station, 588
 - converter stations, 586
 - distribution types, 582
 - frequency changer, 596
 - mercury arc, types of, 600
 - motor generator types, 591
 - photos, 585-597
 - field discharge, 105
- Switchboards, 605-623
 - circuit breakers for, 620
 - circuits & wiring, 613
 - layout for, 611
 - operation of, 616
 - switchgear, 607
- Synchronizing, alternators, 118
- Synchronous, motors, 309-328
- Synchronous motors,
 - applications, 323
 - advantages of, 322
- Synchronous motors, adjusting
 - power factor, 320
 - connections, 318
 - damper windings, 311
 - hunting, 315
 - operating principles, 312
 - pull out torque, 314
 - super synchronous, 324
 - starting compensators, 321
 - starting, 319
- Synchroscope, 123

T

- Table capacitor KVA—
 - squirrel cage motor, 374
- Transformers, 135-171
 - air blast cooling, 148
 - advantages star connection for transmission lines, 191
 - automatic, 207
 - advantages current transformers, 237
 - bell ringing types of, 230
 - construction of, 138
 - cooling, 148
 - tubes, 152
 - connecting primary in series, 180
 - design chart, 217
 - data, 215
 - drying out of, 247
 - effect of secondary load on primary, 165
 - effect of water in transformer, 248
 - formulas, 221
 - field problems, 242
 - grounding, 196
 - insulating bushings, 157
 - instrument types of, 233
 - losses in, 147
 - maintenance & care, 246
 - principles of, 160
 - polarity of leads, 166
 - power output, 163
 - paralleling 3 phase, 199
 - single phase, 177
 - potential, 239
 - polarity markings & ratios, 236
 - operating temperatures, 153
 - oil cooled types, 149
 - open delta connection, 193

Transformers—Cont'd.
ratios & secondary
voltages, 161
single & polyphase, 144
single phase with split
secondaries, 174
star & delta connections, 183
Scott type, 205
special types of, 203
types of, 137
temperature & load indicator
devices, 155
tertiary windings, 170
testing split phase
secondaries, 176

Transformers, 3 phase-4 wire
systems, 200
3 phase star delta
connections, 189
3 phase delta connection, 188
3 phase star connection, 184
testing secondary leads for
paralleling single
phase, 179
tap changing, 203
testing of, 250
windings for, 141
welding types of, 228
diagram, 229