

**COYNE**  
**PRACTICAL APPLIED**  
**ELECTRICITY**

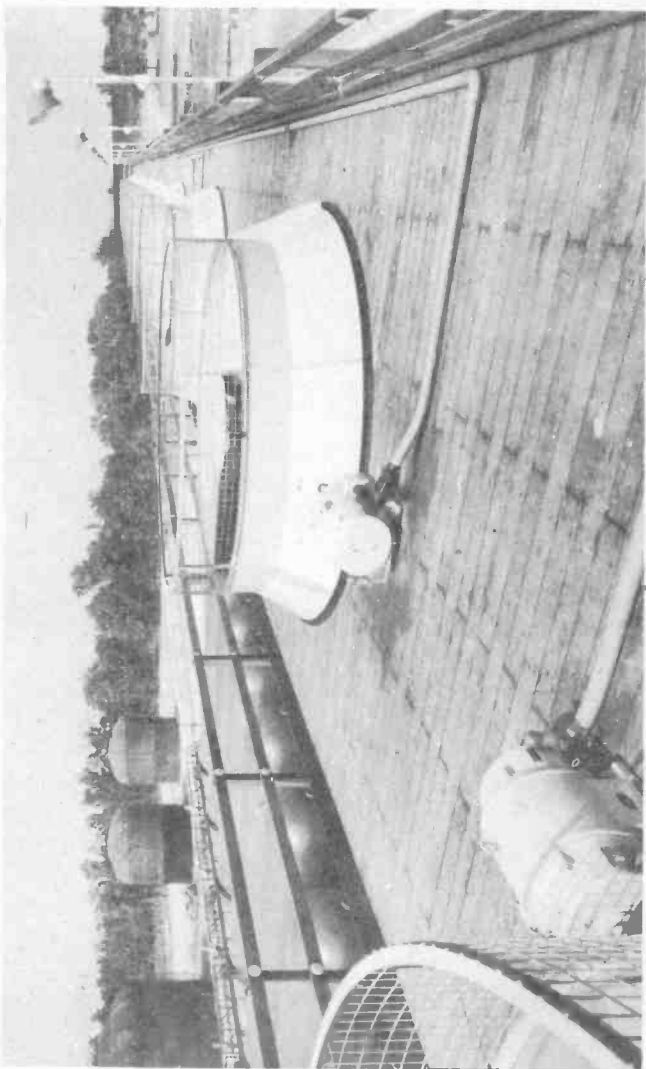

**Modern Store Lighting:** In the retail sales field modern lighting has found one of its greatest uses. Here is an ultra-modern shoe shop with well-planned lighting installation.





Hundreds of these rugged, totally enclosed motors built to weather of all kinds are used by large refineries.

# COYNE PRACTICAL APPLIED ELECTRICITY

---

---

A Practical Book For  
Home Study  
Or  
Field Reference  
On

Electrical Construction  
Illumination  
Fluorescent Lighting  
Flood and Street Lighting  
Neon Lighting  
Mercury and Sodium Vapor Lamps  
Farm Wiring  
Motor Driven Household Appliances

By  
THE TECHNICAL STAFF  
of the  
COYNE ELECTRICAL SCHOOL

Copyright 1946 by  
COYNE ELECTRICAL SCHOOL  
500 So. Paulina St.  
Chicago, Illinois

---

All rights reserved. This book, or any parts thereof may not be reproduced in any form without written permission of the Publishers.

Printed in United States of America

## FOREWORD

This book is one of several written by the Technical Staff of Coyne Electrical School on specific electrical subjects under the heading of **Applied Practical Electricity**. The subjects covered in this book are Electrical Construction, Lighting, Farm Wiring and Household Appliances.

The object of the writers is to present facts and information in a straightforward easy to understand way for self study or for practical reference on the job.

The book starts with Electrical Construction, outlining its scope and the opportunity in this branch of electricity. It covers latest code rulings, splicing, 3 wire systems polarization and trouble shooting. From these practical phases of Electrical Construction this book then covers the great field of Illumination. This broad subject is covered from all angles including Fluorescent lighting, mercury and sodium lamps, neon lighting with special emphasis on installation and trouble shooting. Home lighting, aviation and airport lighting are given special attention. At this point in the book a complete chapter is devoted to Farm Wiring and electrical equipment for the farm and rural communities. This is one of the most practical chapters of the book and actual time and labor saving electrical devices are explained in detail. Although this chapter is especially valuable for farming communities, most of the information can likewise be used for city dwellings and home wiring problems.

The last chapter in our book is devoted to Motor Driven Household Appliances. Vacuum cleaners, irons, washing machines, oil and gas burners and stokers as well as other household appliances are covered in detail. The emphasis in this chapter is on repair of these appliances. New and improved

## ACKNOWLEDGMENTS

We wish to acknowledge and express our appreciation for the assistance and co-operation given by the following companies, in supplying data and illustrations for the preparation of this Electrical book.

GENERAL ELECTRIC COMPANY  
WESTINGHOUSE ELECTRIC & MFG. CO.  
ALLIS CHALMERS MFG. CO.  
POWER PLANT ENGINEERING JOURNAL  
AMERICAN BROWN BOVERI CO.  
CUTLER HAMMER, INC.  
PHILADELPHIA ELECTRIC CO.  
EDISON STORAGE BATTERY CO.  
PHILADELPHIA BATTERY CO.  
WALTER BATES STEEL CORP.  
FAIRBANKS MORSE CO.  
HOSKINS MFG. CO.  
ALLEN-BRADLEY CO.  
DELTA STAR MFG. CO.  
NATIONAL CARBON CO.  
CENTRAL SCIENTIFIC CO.  
OHIO BRASS CO.  
GRAYBAR ELECTRIC CO.  
WELSH SCIENTIFIC CO.  
CENTRAL SCIENTIFIC CO.



methods of testing are thoroughly explained and illustrated.

In every paragraph of the material in this book you will note we have striven for simplicity of explanation. The sections have been arranged so the development of different ideas is consecutive and logical. The idea at all times has been to "dove tail" the explanations so that one chapter leads into another in perfect sequence.

This book can be used as either a home study book for a beginner who is interested in these fields or as a reference book for the experienced electrician who is interested in the newer and more efficient methods of electrical construction, wiring and appliance repair.

A handwritten signature in cursive script, reading "A. C. Lewis". The initials "A. C." are written in a large, stylized font, and "Lewis" is written in a smaller, more fluid cursive.

President

COYNE ELECTRICAL SCHOOL

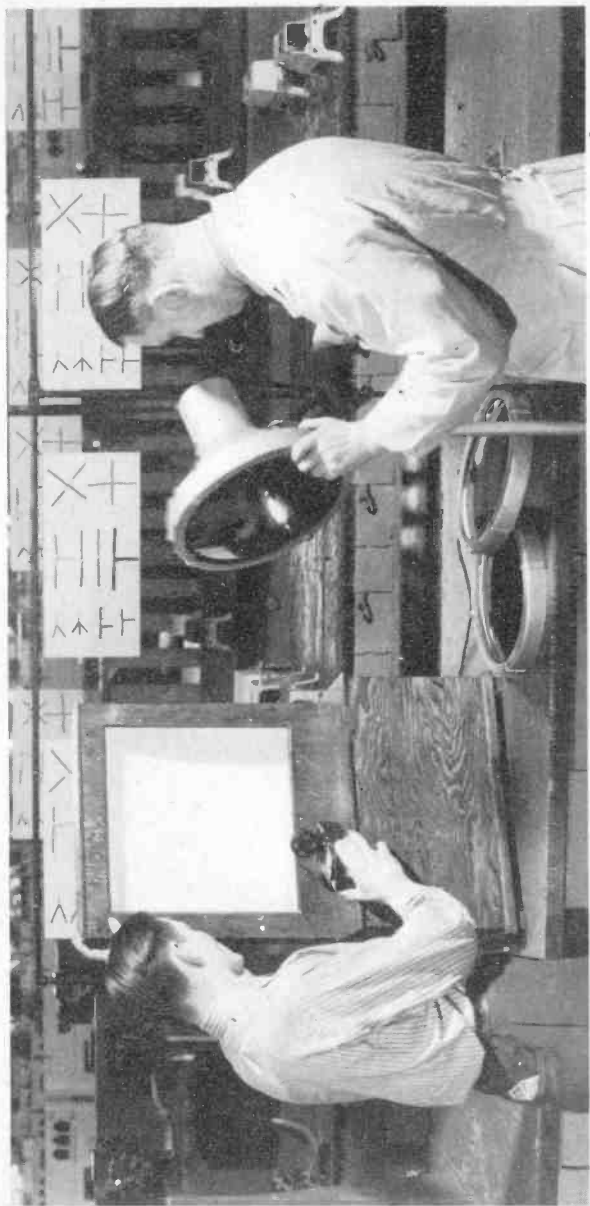

Testing the intensity of a flood light with a Light Intensity Meter. Various types of lighting fixtures are covered in this book.

# TABLE OF CONTENTS

<b>Electrical Construction —</b>	1 - 208
definitions of terms — national, state and local codes — wiring systems — splicing — cables — wire sizes — soldering — equipment installation — methods — bending conduit — fuses — switches — 3 wire systems — polarizing — circuits — loads — estimating — symbols — trouble shooting — questions.	
<b>Illumination —</b>	209 - 281
lamps — reflectors — principles — inverse law fixtures — coefficient of utilization — intensities — factory & office lighting — problems — questions.	
<b>Fluorescent Lighting —</b>	282 - 312
lamps — starters — switches — operation — thermal starters — power factor — transformers — DC operation — trouble shooting.	
<b>Flood &amp; Street Lighting —</b>	313 - 325
units — installation — operation — types — equipment — motion picture lighting.	
<b>Aviation Lighting —</b>	326 - 343
equipment — beacons — landing field lights — approach, obstruction & boundary lights — illuminated wind direction indicators — hangar & shop lighting — questions.	
<b>Mercury &amp; Sodium Vapor Lamps —</b>	
<b>Home Lighting</b>	346 - 371
tubes — mechanism — installation — operation — maintenance — circuit characteristics — living, dining, bedroom, bathroom and kitchen wiring & fixtures — lamps — questions.	
<b>Neon Lighting —</b>	373 - 386
construction — gases — electrodes — tubing — voltage & currents — flashers — transformers — trouble shooting.	
<b>Farm Wiring &amp; Electrical Equipment —</b>	397 - 418
wiring the farm house and buildings — plans — trouble shooting — circuits — electric fences — portable motors for farm jobs — 200 uses for electricity on the farm.	
<b>Motor Driven Household Appliances —</b>	419 - 475
vacuum cleaners, irons, washers, etc. — oil & gas burners — electrical controls — automatic stoker controls — regulators — fractional hp appliance motors — drive mechanisms — trouble shooting — testing equipment.	



**Motion Picture Lighting:** Dozens of high-powered lights are needed for motion picture production. Here is a typical studio set completely lighted with a scene actually being filmed. Thousands of electrical workers are employed in the motion picture industry.

## **ELECTRICAL CONSTRUCTION**

Electrical construction and wiring offers a tremendous field of opportunity for practically trained men, both in interesting jobs at good salaries with various companies and employers, and also to enter a business of their own.

Naturally, every piece of electrical equipment manufactured and sold each year, must have wiring and circuits to carry the current to it, when it is installed. This includes the billions of dollars worth of electrical machinery and apparatus made each year, and also the millions of electric lights and lighting fixtures.

In thousands of old buildings and existing plants, new wires and extensions to the circuits must be run each time additional equipment is installed; and in the new buildings erected, complete new wiring systems must be installed.

Today almost every new home erected in any city or small town, is wired for electric lights and appliances when it is built. Thousands of old houses are being wired and thousands of others rewired or having improvements and additions made to their wiring, to provide better lighting and more complete use of electrical convenience devices.

Plans are being made to rapidly electrify the last few small towns, which have not yet had electricity, and even the farms are now rapidly electrifying. Nearly one million farms already have their buildings wired, and electric supply from their local power companies' lines, or their own private light plants.

### **1. GOOD KNOWLEDGE OF WIRING NEEDED IN MAINTENANCE WORK**

Factories and industrial plants throughout this country are over three-fourths electrified at present, and thousands of them employ from one to a dozen or more electrical wiremen, just to take care of their electrical construction and continual expansion.

The few old plants which have been operated by steam or other power, are rapidly changing over

## **Electrical Construction**

to electric power and machines, and modern electric lighting.

Pactically every new factory or industrial plant built nowadays, is completely wired and electrified.

These plants keep thousands of trained electrical men constantly employed in interesting and good paying work, maintaining and repairing their electrical machines, lights, and wiring circuits; and installing the new motors, lights and wiring as it is required.

The field of **Electrical Maintenance** work requires men who know the principles and methods of modern wiring thoroughly, so every electrical man should obtain a thorough knowledge of the material covered in this section, whether he intends to specialize in wiring and electrical construction or not.

The electrical maintenance man in any plant will usually have a great variety of interesting work to do, and an opportunity to use every bit of general knowledge he can obtain.

### **2. VALUE OF GENERAL KNOWLEDGE OF WIRING**

The electrician in the small town will also usually be called upon to wire door bells, lights, and power motors; and to shoot trouble and make repairs on everything from a burned out fuse or dead dry cell, to shorts in wiring or faults in power machinery. And even the man who specializes in one line of electrical work, can always use a good general knowledge of electricity, and particularly of methods of wiring.

### **3. IMPORTANT POINTS IN WIRING**

The important things to be considered in any electrical wiring job are: First, the selection of wires of the proper size to carry the amount of current required by the equipment, and with the proper insulation according to the voltage of these wires; Second, proper mechanical support and protection for the runs of wire; Third, secure and permanent splices and connections; Fourth, protection and precautions to eliminate all danger of fire or shock.

## Electrical Construction

Each of these features will be covered thoroughly in the following sections. When installing any wiring system these points should be constantly kept in mind, and all work done accordingly.

In former years a lot of electrical wiring was installed rather carelessly, mainly with the idea of supplying current to the devices requiring it, but without proper consideration for permanence, and safety from fire and shock hazard. As a result many fires originated from defective wiring, causing short circuits, sparks, and flashes, or just overheated wires. In other cases, people received electric shocks or injuries by coming in contact with wires that were not properly insulated.

### 4. INSPECTION—AN ADVANTAGE TO THE TRAINED MAN

Nowadays there is a general tendency in all electrical construction to follow certain very high standards in the selection of materials, quality of workmanship, and precautions for safety. A great deal of the old wiring is being entirely replaced, and new wiring in most towns and localities must be done according to very strict inspection requirements. This is not at all a handicap, but rather it is a decided advantage for the trained electrical man who knows how to do this work as it should be done, and according to these rules. It makes his services much to be preferred to those of the man who does not know modern methods, or will not recognize the value and importance of safety-first rules in electrical wiring.

### 5. NATIONAL ELECTRIC CODE

To standardize and simplify these rules and provide some reliable guide for electrical construction men the **National Electric Code** has been provided. This Code was originally prepared in 1897, and is kept frequently revised to meet changing conditions, and improved equipment and materials. It is a result of the best efforts of electrical engineers, manufacturers of electrical equipment, insurance experts, and architects.

This Code book is now published by the National

## Electric Codes

Board of Fire Underwriters, and contains simple specific rules and instructions which, if followed, all tend to make electrical wiring and construction safe and reliable. Every electrician should have an up-to-date copy of the National Code at all times, and should familiarize himself with the more important rules pertaining to his work, and if he does he will find them of great help in making certain decisions on the job, and performing his work in a manner that will always be a credit to himself and his profession.



Chicago's theatrical row at night. Looking west of State and Randolph Sts. you will see practically every type of electric sign.

Kaufman-Fabry Photo



### 6. STATE AND LOCAL CODE RULES

Most states now require that all electrical work be done in accordance with the National Code, and even in the few states where this may not be required throughout, most of the towns and cities do require that all wiring within their limits follow the Code.

Throughout the following pages we shall quote occasionally some rules of the National Code.

The Underwriter's laboratory also tests various electrical materials and supplies, such as wire, switches, fuses, insulations, etc. If these are deemed safe and reliable, and meet the laboratory standards for quality, they carry the underwriters stamp of approval.

This is a good indication for the conscientious electrical man to follow in selecting the best of materials.

Some states have prepared special codes and rules of their own, usually applying to wiring in schools, auditoriums, theatres, and other public buildings, and also to transmission lines, and outdoor construction where the public is involved. These rules, however, are similar to those of the National Code.

A number of towns and cities have their own local code or rules, which in general may be based upon or similar to the National Code, but will have a few specific rules on certain classes of work, which are more rigid than the National Code.

In addition to the National Code and local codes of certain cities, the power companies to whose lines the wiring system may be connected may have some special rules regarding service wires, meter connections, size and type of devices, and class of equipment connected to their system. So, in starting to do wiring in any town, it is well to familiarize yourself with these local rules if there are any.

In addition to these important rules, if you will also follow the instructions given in the following pages, and apply your knowledge of general principles of electricity, along with good common sense and careful workmanship you should be able to do practically any kind of electrical wiring quite successfully.

## Electric Codes

Certain things in electrical wiring are done according to what might be termed "standard practice." That is, while there are no set rules for them, experienced electrical men have found that certain ways or methods are generally best, and these have been more or less generally adopted by men on the job.

For example, when installing single pole push button switches, the white button is always placed at the top. Following general rules of this kind simplifies the work a great deal and avoids confusion, both in the wiring, and to the owners of the buildings in which it is installed.

Every electrician should always be on the alert to notice and remember these little details or "wrinkles" of the trade. A number of them will be mentioned in this section.

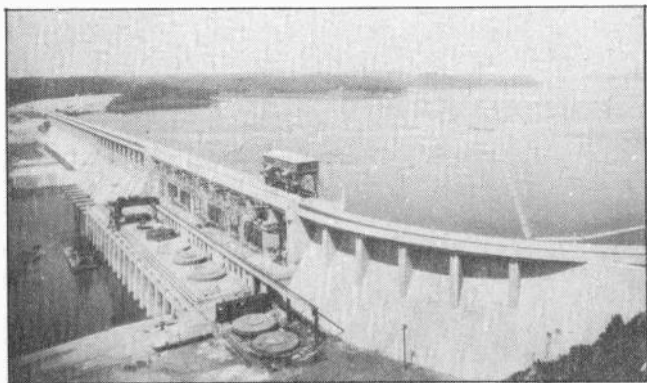

The Bagnell Dam in Missouri. Big power projects like these provide the power for thousands of miles of electrical wiring.

## 7. CLASSES OF WIRING SYSTEMS

Wiring systems can be separated into the following classes:

D. C. or A. C. systems, and two wire or three wire

## Wiring Systems

systems.

Whether direct or alternating current is to be used depends entirely on which is available from the power companies' lines; or, in the case of a private plant, which type of plant is used.

Direct current is generally used only where it is not to be transmitted over distances greater than one-half mile. It has certain advantages for the operation of special types of variable speed motors, and motors requiring extra heavy starting power for frequent starting and stopping; also where storage batteries are to be charged from the lines, or where arc lamps, and other special D. C. equipment are in use.

Alternating current is equally as good for lighting with incandescent lamps and much more desirable and economical where the energy has to be transmitted considerable distances. In such cases, it can be transmitted at high voltage for line economy, and then the voltage reduced at the customer's premises by use of step-down transformers.

For power purposes, recently developed alternating current motors will also meet almost every condition that direct current motors formerly were needed for. By far the greater number of wiring jobs which you will encounter will probably be on alternating current systems.

The materials and methods used are just about the same for either D. C. or A. C. systems, except for a few precautions on A. C. circuits which will be covered later.

The simple two wire system is in common use for wiring small homes and buildings where only one voltage and small amounts of power are required. The circuits and connections for such a system are extremely simple, and consist merely of running the two wires to each lamp or device to be used, and of course with the proper fuses and switches. Fig. 1 shows the important parts of a two wire lighting system.

This system consists of the **Service Wires** which lead to the power supply, **Service Switch** and **Fuses**,

## Wiring Systems

**Meter, Main Wires or Feeders, and Branch Circuits.** Each branch circuit has its own switch and fuses. The separate light switches are not shown in this diagram. All of the circuits marked "B" are branch circuits, while "A" and "A1" are the main wires which feed the branch circuits. The Watthour meter is connected in the mains, near the service

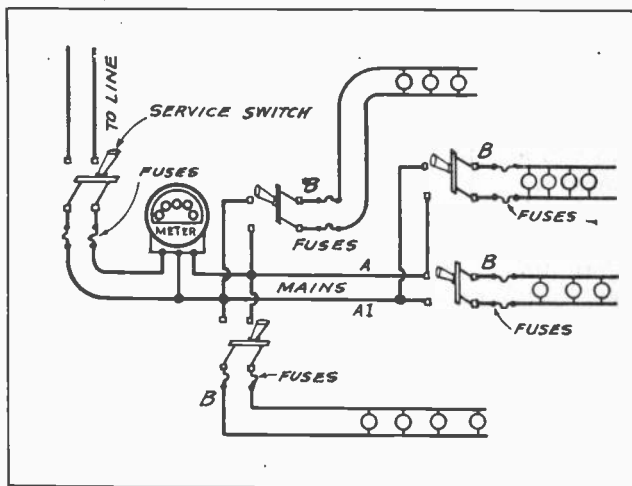

Fig. 1. This sketch shows a simple two-wire system with the service wires, mains and branch circuits.

switch, to measure all the energy used in the entire system.

The **Edison Three Wire System** can be applied to either A. C. or D. C. installations. It provides two different voltages, one for lights and one for motors, and also effects a considerable saving in wire size, where used for lighting and power. This system will be explained in detail later.

### 8. WIRING MATERIALS—CONDUCTORS

Before going farther into the methods of wiring it will be well to consider some of the materials used.

Conductors used in wiring for light and power must be somewhat different from those used for low voltage signal wiring, as they usually carry much heavier currents and at higher voltages. They are of course made of copper, as this we know is

## Insulation

one of the best conductors of electric current, and its softness and flexibility make it very desirable for use in inside wiring.

The very low resistance of copper enables it to carry the current with much less voltage drop and heat loss. So copper wires and cables are used almost entirely for wiring for light and power. Copper wires for interior wiring are usually "annealed" or softened by a heating process as this makes the copper much more flexible and improves its conductivity.

We found that No. 18 or 16 B. & S. (Brown & Sharpe) gauge wires were used for bell wiring, but **No. 14 is the smallest sized wire allowed in wiring for light and power.** Sizes 14, 12, 10 and 8 are used in solid wires, but when used in conduit the larger sizes are stranded to obtain greater flexibility.

### 9. INSULATION

Bare conductors can be used in a few places such as on switchboards and distribution panels where they can be rigidly supported and held apart on proper insulators, or insulating panels. For general wiring, however, the wires must be **properly insulated to prevent persons from coming in contact with them,** and also to **prevent short circuits and grounds** which would not only interfere with operation of the attached equipment, but also cause fire hazards.

**Rubber and braid coverings** are the most common forms of insulation. The rubber being of extremely high resistance to electricity provides excellent insulation to confine the current to the wires and prevent leakage to the other wires or metal objects. The cotton braid covering is used over the rubber to protect it from mechanical injury. This is called ordinary rubber covered (R.C.) wire, sometimes designated by the letter "R" only.

It is made with both single and double braid coverings, and is very generally used in interior wiring. Fig. 7 shows three forms of rubber and braid insulation on solid wires, and Fig. 2 shows both a solid and a stranded wire with their insulation.

## Insulation

For outdoor use, we have wires with weather proof (W.P.) insulation, consisting of three or more layers of braid, soaked or impregnated with moisture resisting compound of a tarry nature.

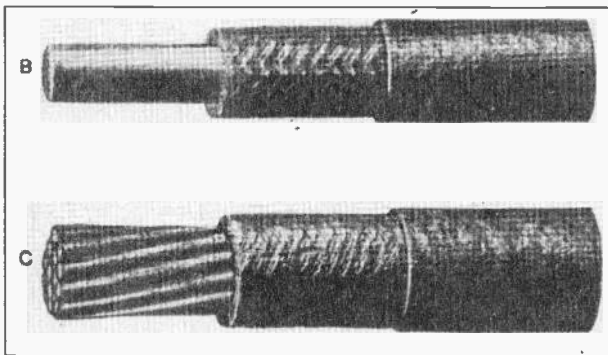

Fig. 2. Examples of solid and stranded conductors with their insulation. The stranded conductors are used in the large sizes because they are more flexible.

This kind of insulation is much cheaper than rubber, and is required for outdoor use in many cases, and in some damp locations inside buildings. It should not be used where it is subject to heat or fire, as it is inflammable.

Fig. 3 shows three pieces of wire with weather proof insulation.

For places where the wire is subjected to heat but not moisture, **Slow Burning** (S.B.) insulation with fire resisting braids is used.

Some wires for use in very dry hot places, or for heater cords, are covered with a layer of asbestos fibres for maximum heat and fire resisting insulation.

Conductors are also prepared with a combination of slow burning and weather proof insulation (S. B. W.). Two such wires are shown in Fig. 4.

Insulated wires are often made up in twisted pairs as shown in Fig. 5, for lamp cords and leads to portable devices. Such wires are usually made of many strands of very fine wires for good flexibility.

The copper wires are usually "tinned" or coated with a thin layer of lead and tin alloy, to prevent corrosion from contact with the chemicals in the

## Insulation

rubber, and to make it easier to solder them when splicing.

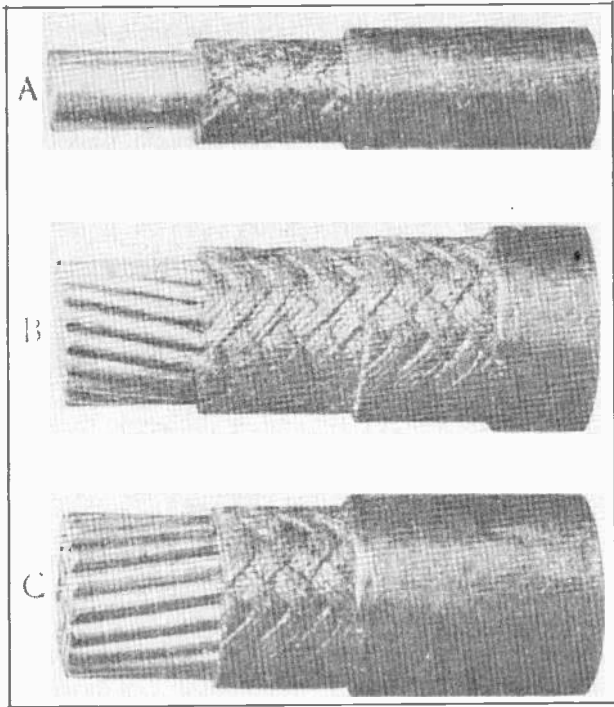

Fig. 3. These wires have what is called "water-proof" insulation, or braid filled with tarry water-proof compounds. They are for use outdoors or in damp locations.

The outer braid coverings on wires are sometimes made in different colors, particularly black and white, or light gray; or with a colored thread woven into them in order to **easily mark or identify** certain wires. Reasons for this will be explained later.

For extremely damp places or where wires are to be run under ground we have wires and cables with a lead sheath over the insulation.

### 10. WIRE SIZE VERY IMPORTANT

Copper wires can be obtained in almost any de-

## Wire Sizes

sired size and with a variety of insulations for various uses

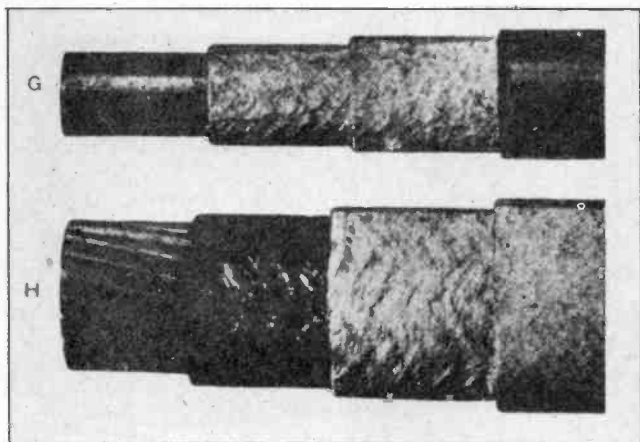

Fig. 4. In this view the upper conductor has a special fire resisting covering known as "slow burning" insulation. The lower conductor has a combination covering of both water-proof and slow burning insulation.

It is very important to use wires of the proper size for any wiring job, because if they are too small for the current load they have to carry, they will overheat. Excessive heat not only increases the resistance of the wire and creates a greater voltage drop and energy loss, but it also damages the insulation and in some cases results in completely burned out wiring or causes fires.

If wires that are too small are used, the excessive voltage drop causes the lights or equipment to receive less than their rated voltage, which usually results in unsatisfactory operation. This is particularly true of lighting systems, as a very few volts drop will cause an incandescent lamp to deliver much less than its rated light.

The National Code specifies the maximum amount of current that shall be allowed on the common sized wires, and this should be followed closely for safe and satisfactory results in any wiring system.

Fig. 6 shows a convenient table which gives the maximum current capacity of each size of rubber



## Wire Sizes

insulated wire from No. 18 up to 2,000,000 C.M.

If wires are allowed to carry more than these amounts of current for any length of time, they will heat up and the rubber will rapidly lose its insulating quality at these higher temperatures.

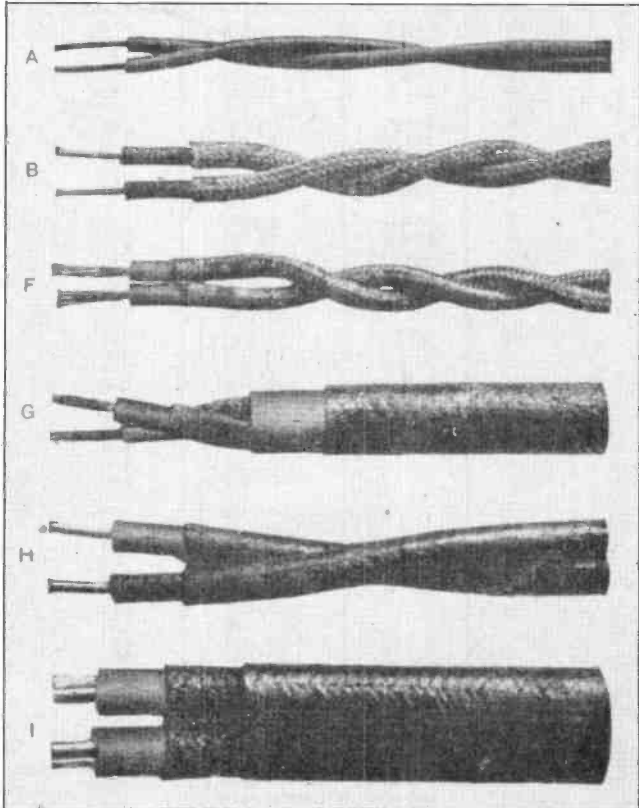

Fig. 5. Conductors are often arranged in pairs for convenience in running two-wire circuits. Several types of these are shown above.

For wires with other insulation such as slow burning or weather proof coverings, you can allow from 25 to 50 per cent more current, as these insulations will stand slightly higher temperatures without damage.

Examine the table in Fig. 6 very carefully, and become familiar with its use, as it will be very con-

## Wire Sizes

venient to you many times from now on.

The first column gives the wire sizes in B. & S.

B. & S. Gage	Diam. of Solid Wires in Mils.	Area in Circular Mils.	Table A Rubber in- sulation Amperes
18	40.3	1,624	3
16	50.8	2,583	6
14	64.1	4,107	15
12	80.8	6,530	20
10	101.9	10,380	25
8	128.5	16,510	35
6	162.0	26,250	50
5	181.9	33,100	55
4	204.3	41,740	70
3	229.4	52,630	80
2	257.6	66,370	90
1	289.3	83,690	100
0	325.	105,500	125
00	364.8	133,100	150
000	409.6	167,800	175
		200,000	200
0000	460.	211,600	225
		250,000	250
		300,000	275
		350,000	300
		400,000	325
		500,000	400
		600,000	450
		700,000	500
		800,000	550
		900,000	600
		1,000,000	650
		1,100,000	690
		1,200,000	730
		1,300,000	770
		1,400,000	810
		1,500,000	850
		1,600,000	890
		1,700,000	930
		1,800,000	970
		1,900,000	1,010
		2,000,000	1,050

Fig. 6. This very convenient table gives the current carrying capacity for the various sizes of wire, and also their diameter and area in circular mils.

gauge numbers from 18 to 0000 or "four ought" as it is called. From this size up the larger cables have their sizes given in circular mil area and can be followed on down the third column to 2,000,000 circular mils.

The second column gives the diameter of the bare wires in mils (thousandths of an inch), and the third column, as before stated, gives the cross sectional area of each size in circular mils. Then in

## Wire Sizes

the last column can be found the proper maximum current allowed for any wire.

The term **Circular Mil** means the area of a round wire one thousandth ( $1/1000$ ) of an inch in diameter. This is the common term for rating and calculating sizes of electrical conductors, and will be covered more fully in a later section on wire calculations.

The longer a wire, the greater is its resistance, and the **Voltage Drop** is proportional to both the **Resistance** and the **Current** carried. Therefore, where the wire runs are quite long, we may not

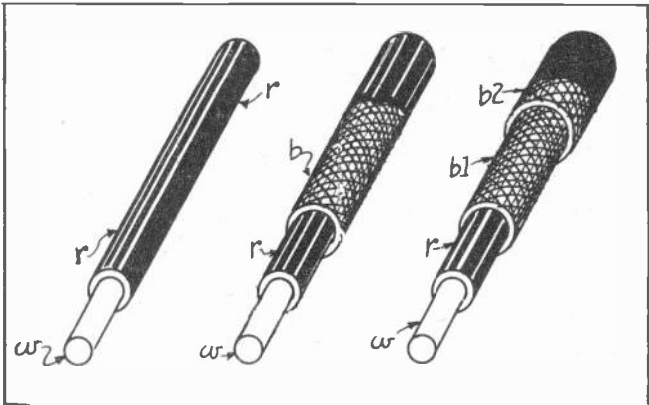

Fig. 7. Three samples of insulated conductors. The wire at the left is covered with rubber only. The one in the center has a layer of rubber and one of cotton braid. The one on the right has one layer of rubber, and two layers of braid. These would be called respectively: Rubber covered (R. C.), Rubber and braid covered, and Rubber and double braid covered.

wish to allow even the amount of current that the code table does, because the voltage drop would be too great.

In such cases we can determine the exact size of wire to use for any given current load and any desired voltage drop, by use of a simple formula which will also be given and explained in the section on wire calculations.

Referring again to the table in Fig. 6, you will note that the **larger the gauge number the smaller the wire**. This is a good point to keep in mind so

## Wire Sizes

you will not become confused on the sizes and numbers.

Fig. 8 shows a wire gauge often used to determine the exact size of a wire by slipping the bare end of the wire in the slots until one is found that it just fits snugly. The gauge number is marked on the disk at that slot. Be sure to fit the wire to the straight slot and not in the circle at the end of the slot.

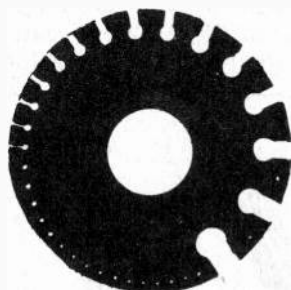

Fig. 8. A wire gauge of this type is commonly used to determine the size of wires for various uses.

It often comes in very handy to remember that when you have a wire of any certain size, another wire three sizes larger will have just about double the area; or one three sizes smaller, about one-half the area. For example, a number 3 wire is just about double the area of a number 6; or a number 2 wire just half the area of a number 00.

Another very handy fact to remember is that a number 10 wire has approximately one Ohm resistance per thousand feet, and a number 14 wire has about 2.5 Ohms per thousand feet.

## 11. SPLICING

In running wires for any electrical system, it is necessary to make numerous splices of various kinds, and a good knowledge of proper methods of splicing and soldering is of the greatest importance for any electrician to have, whether he follows new wiring or maintenance and repairs.

The old saying, "that a chain is no stronger than its weakest link," applies in slightly different words

## Splicing

almost as well to a wiring system or "the circuit or system is no better than its splices."

Splices properly made and soldered will last almost as long as the wire or its insulation, but

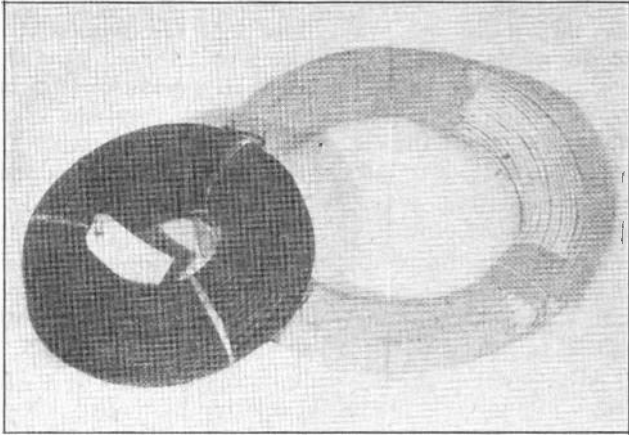

Fig. 9. Two coils of ordinary rubber and braid covered No. 14 wire, such as commonly used in house wiring jobs. The advantage of having the insulation in black and white colors will be explained later.

poorly made splices will always be a source of trouble and will overheat, burn off their taping, and cause high resistance circuits and sometimes fires.

A good test of an electrician is in the kind of splices he makes.

The requirements for a good splice are; that it should be **Mechanically and Electrically Secure** before the solder is applied. Solder is then applied, not only to strengthen the splice or improve its conductivity, although it does do both to some extent, but for the real purpose of **preventing corrosion and oxidization of the copper.**

### 12. COMMON TYPES OF SPLICES

Several of the more commonly used splices are the Pigtail, Western Union, Tee or Tap, Knotted Tap, Fixture Splice, and Stranded Cable Splice. Each of these will be explained in detail.

### 13. STRIPPING AND CLEANING WIRES

The first very important step in making any

## Splicing

splice is to properly strip and prepare the ends of the wire. Stripping means removing the insulation from the wire a proper distance back for the splice to be made. This may range from  $1\frac{1}{2}$  inches to 3 or 4 inches for various splices.

The rubber and braid should be removed with a knife, as shown in the upper view in Fig. 10. The knife and wire should be held in a position similar to that used when sharpening a pencil, and the braid and rubber cut through at an angle as shown. **Be very careful not to cut or nick the wire**, as it reduces the conducting area, and makes it very easy to break at that point.

Never cut the insulation as in the lower view in Fig. 10, as one is almost certain to nick the wire in cutting in this manner, and it makes a more difficult splice to properly tape.

After cutting through the insulation and down to the wire, let the blade slide along the wire, stripping the insulation to the end; keeping the blade almost flat against the wire, so it does not cut into the copper.

After removing the insulation with the knife the wire should be scraped with the back of the blade, to remove all traces of rubber and until the wire is thoroughly clean and bright. If the wire is tinned do not scrape deep enough to remove the tinning, but leave on as much as possible, as it makes soldering easier.

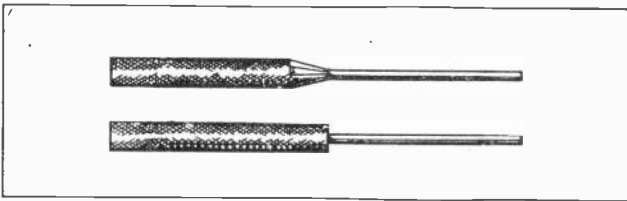

Fig. 10. This sketch shows the proper method of stripping the insulation from a wire in the upper view. The lower view shows the wrong way.

It is impossible to do a good job of soldering if the wires have bits of rubber, dirt, or grease left on them, and as they are very difficult to clean after

## Splicing

they are spliced, be sure to do it properly before starting the splice.

A number of wire stripping tools are made and on the market, and some of them are quite fast in operation, but for rubber covered wire and for doing the work right on the job, nothing is much handier than a good sized electricians' knife with a sturdy blade of good steel. A piece of sandpaper can be used to clean the wire if desired.

### 14. "PIG TAIL" SPLICE

To start a **Pig Tail splice**, strip and clean about two inches on the end of each wire, then hold the wires as in Fig. 11-A, and twist them together a few turns with your fingers; then finish the ends with a pair of pliers. Be sure that both wires twist around each other, and that one does not remain straight while the other wraps around it. They should appear as in Fig. 11-B.

This splice should have at least five good tight turns, and then the end should be bent back as in Fig. 11-C to prevent it from puncturing the tape.

Three or more wires can be connected together by a pig tail splice, and it is **commonly used in making splices of wire ends in outlet boxes**, and at places where there is no strain on the wires.

In making any splice, always be sure to wrap or twist the turns tightly around each other, as they should not be able to slip or shift upon each other when the splice is complete but not yet soldered. Make the splice itself tight and strong, and don't depend on the solder to do this.

### 15. WESTERN UNION SPLICE

For splicing straight runs of wire the **Western Union splice** is one of the oldest and most commonly used. It is a very strong splice and will stand considerable pull and strain on the wires. It can be used for splicing large solid conductors and line wires as well as the smaller wires

In starting a Western Union splice, strip and clean about four inches of the end of each wire.

Hold the ends together tightly with your hand or pliers as in Fig. 12-A, gripping them at the point

## Splicing

where they cross. Twist them together a couple of gradual or spiral turns as in Fig. 12-B. These are often called "neck" turns. Then wrap the end of each wire around the other wire in five or six neat, tight turns as in Fig. 12-C. A little practice will be required to get the knack of wrapping these ends tightly and smoothly by hand. If one or two turns do not grip the straight wire tightly, pinch

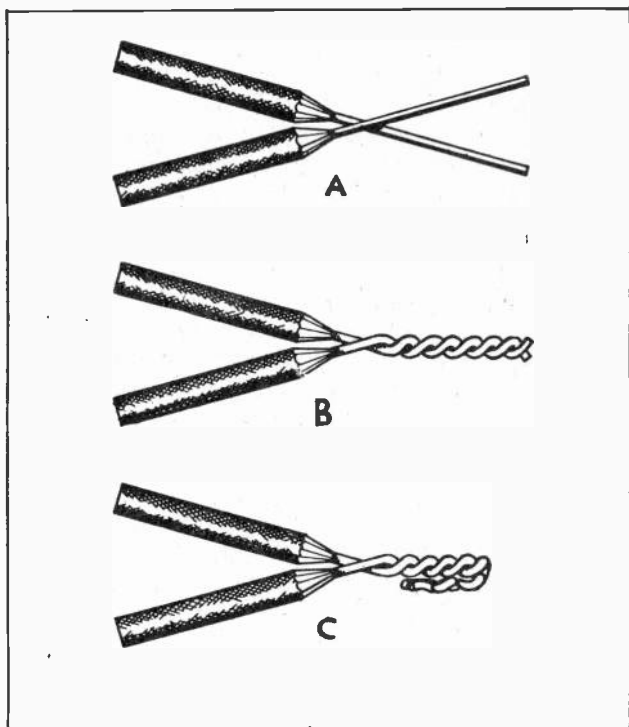

Fig. 11. This diagram shows very clearly the several steps in making a "Pigtail" splice. Examine it very carefully.

them down carefully with the pliers.

To finish this splice, trim the the ends off and pinch them down tight with the pliers, so they will not project and damage the tape later. The splice should then appear as in Fig. 12-D.

Practice making this splice a number of times, as it is one of the most common and important ones



## Splicing

used, and every practical man should be able to make it well. Each time you make it examine it carefully and try to improve until it is perfect.

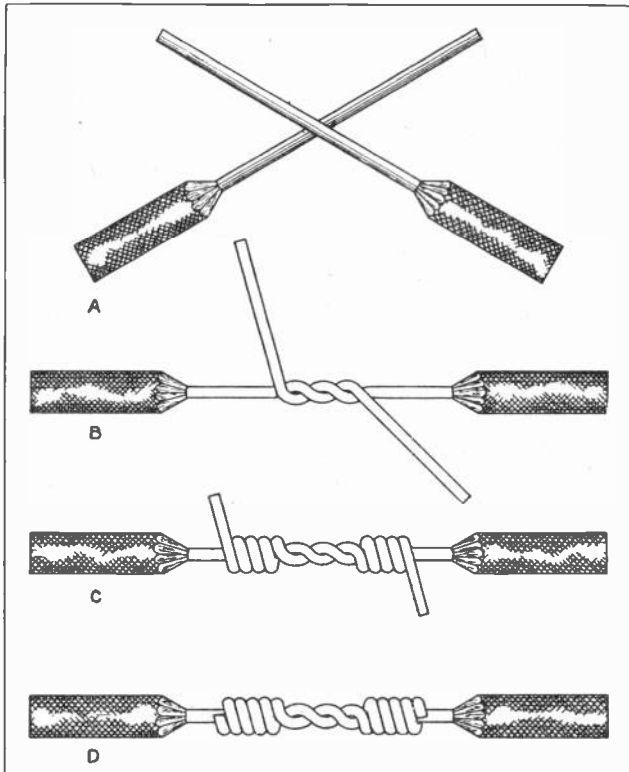

Fig. 12. The above four sketches show the steps and procedure in making a "Western Union" splice.

Be careful not to nick or mar wires any more than necessary with the "bite" of your pliers, when gripping them during splicing.

When making a double Western Union splice in a pair of wires together, **always stagger them** as shown in Fig. 13, so each splice lies near to undisturbed insulation of the other wire, and so they do not make a large bulge when taped.

Fig. 13-A shows how the ends of the wires should be cut in uneven lengths for such a splice. In 13-B

## Splicing

is shown the method of spreading them apart to make the splices, and in 13-C the appearance of the finished splice, before soldering and taping.

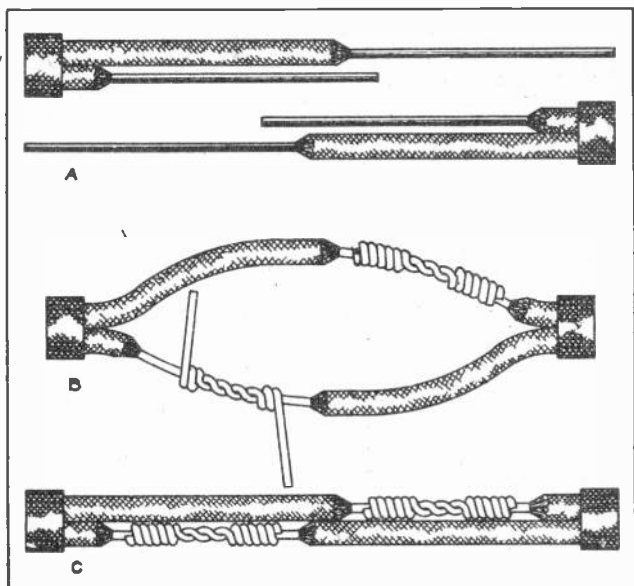

Fig. 13. When making splices in pairs of conductors they should be staggered as shown above so each splice will be near to good insulation on the other wire.

### 16. TAP OR TEE SPLICE

When a tap or branch is to be connected to a main or "running" wire, we use the **Tap** splice shown in Fig. 14. For this splice, bare about 1 inch on the main wire, and about 3 inches on the end of the tap wire. Then wrap the tap wire tightly about the main wire from five to eight turns, as shown in the figure. The turns should be tight enough so they cannot be slid along the straight wire.

### 17. KNOTTED TAP SPLICE

Where there is a possibility of some pull or strain on the tap wire, we can use the **Knotted Tap** splice which cannot be pulled loose as easily. This splice

## Splicing

is shown in Fig. 15, and is very easily made, by simply giving the wire one turn on the side of the

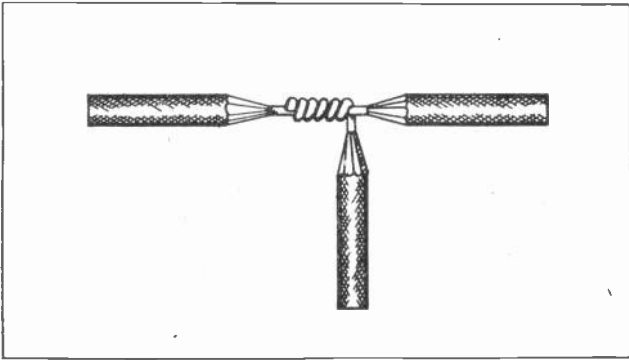

Fig. 14. Simple "Tap" splice used for tapping a "branch" wire to "main" or "running" wires.

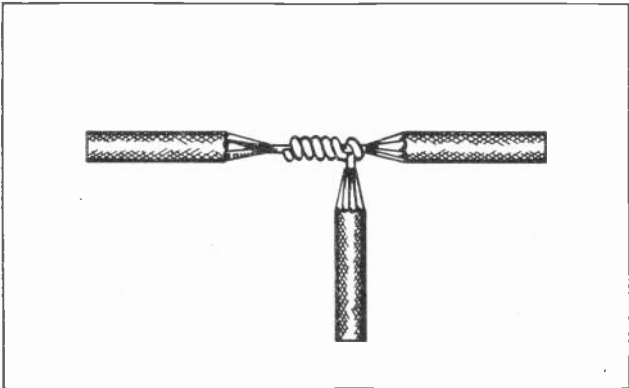

Fig. 15. "Knotted Tap" splice. Note carefully the manner in which the wire is first looped around the branch conductor to lock it securely in place.

tap wire opposite to the side on which the main group is to be, and then doubling back around the tap wire, and winding the balance of the turns in the opposite direction around the main wire. This locks the first turn so it is very secure and hard to pull loose.

### 18. FIXTURE SPLICE

The **Fixture Splice** which is often used to fasten together two wires of different sizes, is shown in

## Splicing

Fig. 16. The various steps in making this splice are as follows: First bare about 5 inches of the end of one wire, and 3 inches on the other wire: then

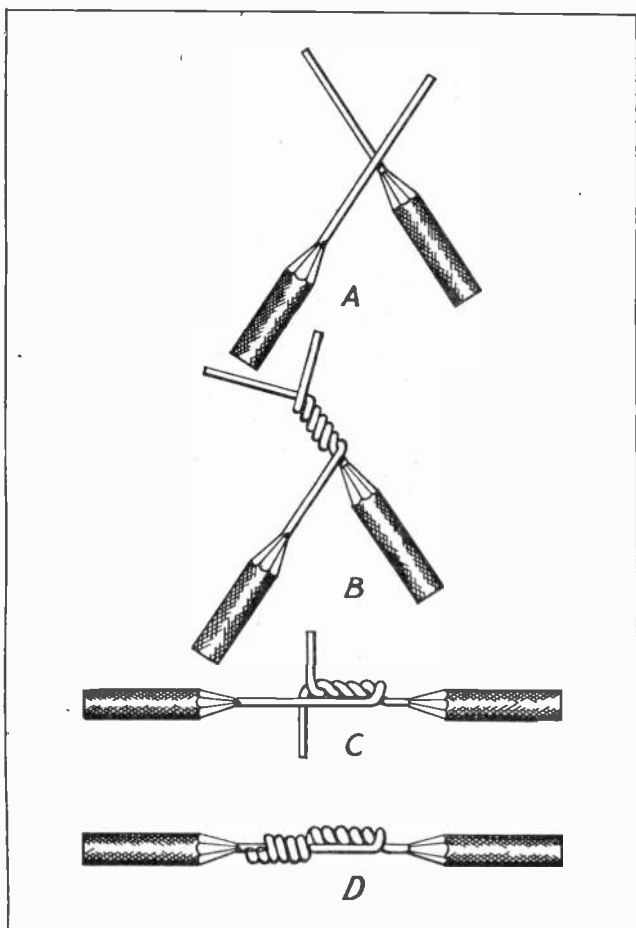

Fig. 16. The above views shows the method of making a "Fixture" splice, which is used for connecting together two wires of different sizes.

place them together as shown in Fig. 16-A, with about half the length of the longer bared end crossing the other end, near the insulation. Then twist them both together, as in "B", being sure that they both twist about each other evenly. Then spread

## Splicing

the wires apart and bend the twisted ends down tight to the longer remaining bare strips as at "C", and wrap both ends tightly around the wire at this point. The finished splice is shown at "D".

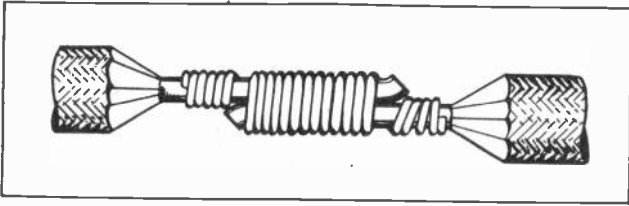

Fig. 17. A very convenient splice to use on large solid conductors. By wrapping them in this manner with the smaller wire we don't have to bend or twist the stiff heavy wires.

### 19. CONVENIENT SPLICE FOR LARGE SOLID WIRES

Another splice that is very handy for connecting large solid wires together is the one shown in Fig. 17. This splice is made by simply laying the ends of the two large wires together, overlapping from 2 to 4 inches according to their size, and then wrapping them both with a smaller wire. The smaller wire is much easier to bend, and can be quickly and tightly wound around the large ones. In addition to winding the small wire around both the large ones where they overlap, also wind a few turns around each wire at the end of the splice, as shown in the figure. The ends of the large wire should be slightly bent outward to hold the smaller wire wrapping in place, and prevent the large ones from being pulled out; but be careful not to bend them out far enough to puncture the tape. This splice when well soldered makes one of good conductivity, because of the great area of contact between the small wire turns and the two large ones.

### 20. STRANDED CABLE SPLICE

There are a number of methods used in splicing stranded cables, but the most important points to keep in mind are to be sure to secure enough good contact area between the two groups of wires to carry without overheating the same load of current that the cable will, and to keep the diameter of

## Splicing

the splice down as much as possible.

The wires should be stripped back about ten or twelve times the cable diameter, and each strand separately cleaned. Then spread the strands of each cable out fan-wise, as in Fig. 18-A, and butt the

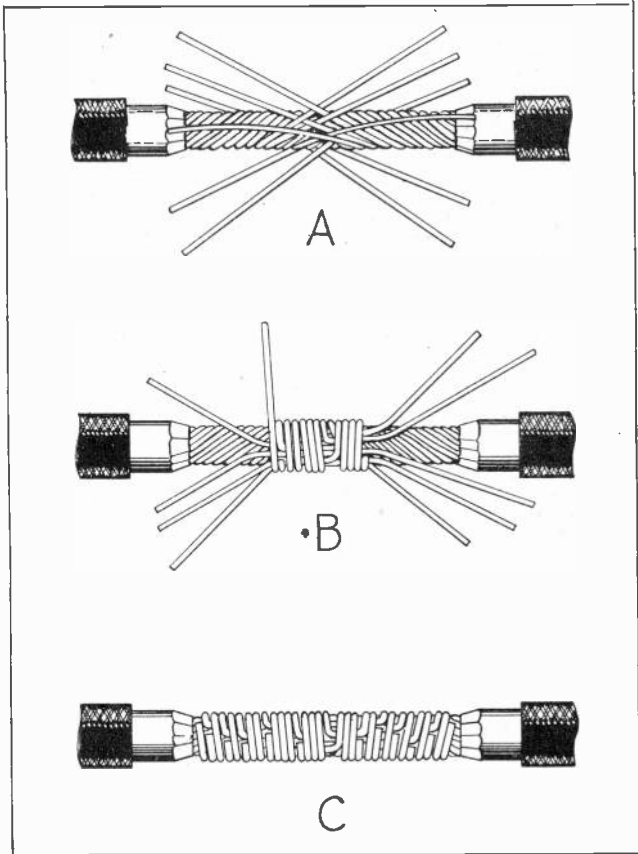

Fig. 18. Examine this diagram very closely and it will be a great help to you in making neat and efficient cable splices.

cable ends together. Sometimes it is well to cut off the ends of a few of the center strands at the point where they butt together, in order to reduce the diameter of the finished splice. A few less than half of the strands can be removed without reducing the current carrying capacity of the joint

## Splicing

below that of the cable. This is because the wires of each cable overlap each other, maintaining an area equal to that of the cable anyway.

Next wrap one strand at a time around the cable, starting with strands from the outer surface of the

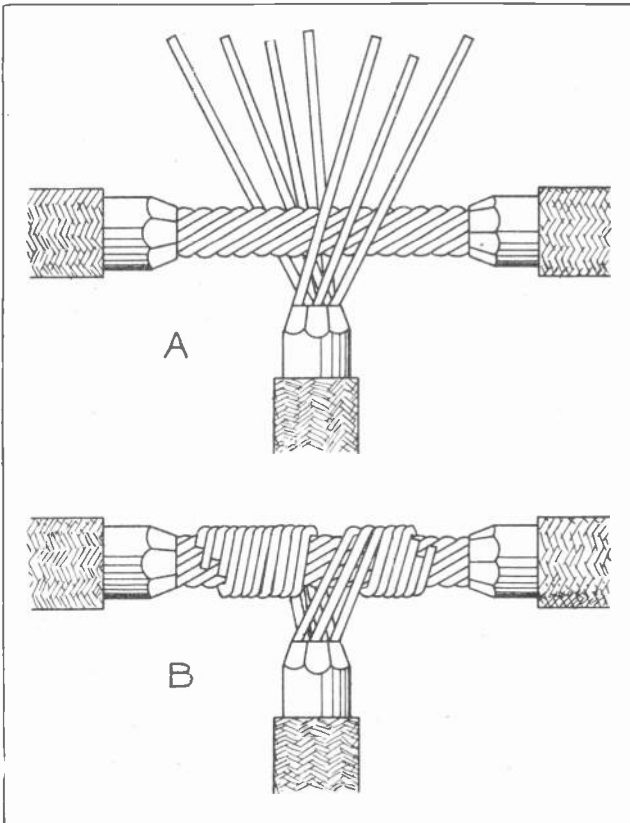

Fig. 19. Method of making a "tap" splice with stranded cables. Note how the wires of the "tap" cable are divided and each group wrapped in opposite directions around the "running" cable.

cable, and wind these over the others which are laid tight along the cable. See Fig. 18-B. When one strand is all wound up, start with the next tight to the finish of the first, but continuing to wrap them all in one layer if possible.

The finished splice should appear neat and compact as in Fig. 18-C.

## Splicing

In making a tap cable splice, bare several inches of the main cable and thoroughly clean all the outer strands, removing all rubber from the grooves with a wire brush or pointed tool or knife. Then spread the cleaned strands of the tap cable, dividing them in half and butt them against the main cable in the center of the bare spot as in Fig. 19-A. Then wrap them in opposite directions around the main cable in one layer or as few layers as possible, as in Fig. 19-B, which shows the completed splice.

### EXAMINATION QUESTIONS

1. Give four important things to be considered on an electrical wiring job.
2. In what places may bare conductors be used?
3. What is the most common form of insulation on wires used for house wiring?
4. What kind of insulation is used for outdoor work?
5. What is the current carrying capacity of No. 14 R. C. Wire?
6. What are the requirements of a good splice?
7. Where is the "pig tail" splice commonly used?
8. What rule should be followed when making a Western Union splice in a pair of wires run together?
9. In your opinion what advantage is there in following the National Electrical Code?
10. What is the smallest size wire allowed by the Code in wiring for Light and Power?



## SOLDERING

All splices made in permanent wiring should be carefully soldered, to preserve the quality and conductivity of the splice.

We have already mentioned that, altho soldering does improve the strength and conductivity of a splice somewhat, the main reason for soldering is to prevent corrosion or oxidization from spoiling the good contact of the wires.

### 1. COPPER OXIDE AND ITS EFFECT ON JOINT RESISTANCE

Copper rapidly oxidizes or "rusts" when exposed to air or moisture, and also corrodes very quickly if certain chemicals or chemical vapors come in contact with it.

A bright copper wire soon forms a thin brownish film of oxide on its surface if it is not tinned or covered in an air-tight and moisture-proof manner. This film will even form between the wires where they are in contact with each other. Copper oxide is of a very high resistance to electric current flow, and a very small amount of it which may be almost unnoticeable, greatly increases the resistance of a splice. This would be likely to cause serious heating of the joint, after a period of possibly a few weeks or months from the time it was made, even though the splice was of low resistance when new.

A very thin layer of solder, properly applied so that it actually unites or alloys with the clean copper surface, will prevent this oxidization or corrosion, and maintain almost indefinitely, the original low resistance of the splice.

In order to obtain this proper bond between the solder and the copper, the copper **must be absolutely clean**, then treated with a **Flux** which makes the solder flow freely; and the splice and soldering copper **must both be well heated**.

If these rules are all kept in mind and carefully followed, you can easily do a good job of soldering that will be a credit and source of pride to you on every job.

### 2. SOLDERING COPPERS

To heat the splice and melt the solder we use a

## Soldering Coppers

Soldering Copper of the proper size, and which must be kept well cleaned, tinned, and heated. These tools are often called "soldering irons," but they are made of good copper because copper can be readily tinned so the solder will adhere to it and flow over its surface or point; and also because

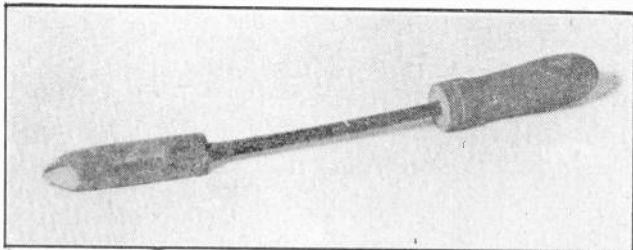

Fig. 1. An ordinary soldering copper of the type commonly used in electrical work.

copper will quickly absorb heat from a torch or flame, and easily give up its heat to the splice and solder. Copper is an Excellent Conductor of Heat, as well as electricity, and if you keep in mind that the function of the soldering copper is to impart its heat to the splice, as well as to melt the solder, you will find it much easier to understand soldering and will make a much better job of it. Fig. 1 shows a common soldering copper of the type that is heated in the flame of a blow torch or gas soldering furnace. Such coppers must be reheated frequently, and where much soldering is to be done, it is often well to use two of them so one can be heating while the other is in use. Fig. 2 shows a blow torch in use for heating an "iron."

Soldering coppers can be obtained in various sizes, the smaller ones being more convenient for some classes of work, and the large ones holding the heat longer. A half pound copper and a one pound size are generally very good for ordinary wiring.

Wherever electricity is available an electric soldering "iron" can be used very conveniently, as they remain hot while in continual use. They are made in different sizes and with various sized and shaped tips for use on different sized splices and various types of work. Two of these electric "irons" are shown in Fig. 3. -

## Cleaning and Tinning

### 3. CLEANING AND TINNING

The point of any soldering "iron" must be kept bright and clean and well tinned, or it will not "flow" the solder properly or convey its heat readily to the splice.



Fig. 2. This photo shows a gasoline blow torch such as commonly used for heating soldering coppers, and splices in electrical conductors.

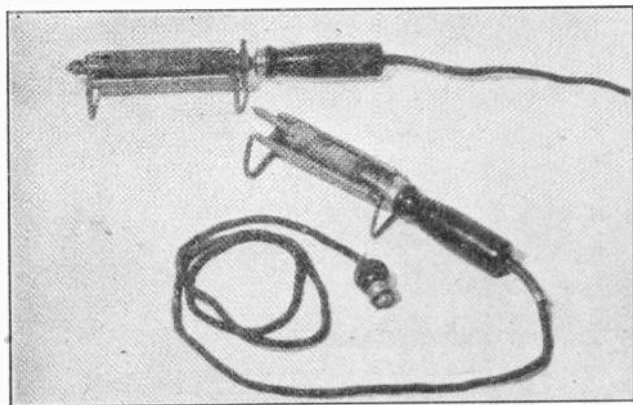

Fig. 3. Electric soldering irons are very convenient where electric current is already available.

When irons are dirty or covered with a heavy scale, or pitted, they should be smoothed and

## Cleaning and Tinning

cleaned with a file. When in use on the job they require occasional "brightening up." It can be done by rubbing the point on a block of salammoniac which is obtainable in small cakes from electric shops and hardware stores. See Fig. 4.

Rub the heated point on the block and immediately apply a little solder to it in an even thin coating. Or when a small hole is worn in the block, place a little solder in this hole or pocket and melt it with the "iron," while rubbing it in the solder and against the salammoniac at the same time. This is called "tinning" the "iron."

Dipping the point of the hot soldering copper into the flux occasionally, helps to keep the tinning bright.

### 4. SUFFICIENT HEAT IS IMPORTANT

Never try to solder a slice without a well tinned, well heated "iron" as it will only waste time and result in a poor job.



Fig. 4. This photo shows the method of cleaning and tinning a soldering copper with a block of salammoniac.

If the iron is not hot enough the solder will melt very slowly and become pasty, instead of flowing freely as it should. The iron should be hot enough so the solder will melt almost instantly when

## Cleaning and Tinning

touched to its point.

When heating an iron with a blow torch or gas furnace, be sure the flame is blue and clean, otherwise it will blacken and dirty the iron.

### 5. SOLDER FOR ELECTRICAL USE

Solder as used for electrical work is usually made of about half lead and half tin. It can be bought in the form of long bars, solid wire solder, and "resin core" wire solder.

The wire solder is most commonly used for applying to small splices, and the bar solder for large cable splices and for melting in a solder pot.

The resin core solder is very convenient as the resin carried in the hollow wire acts as a flux, automatically applied as the solder is melted.

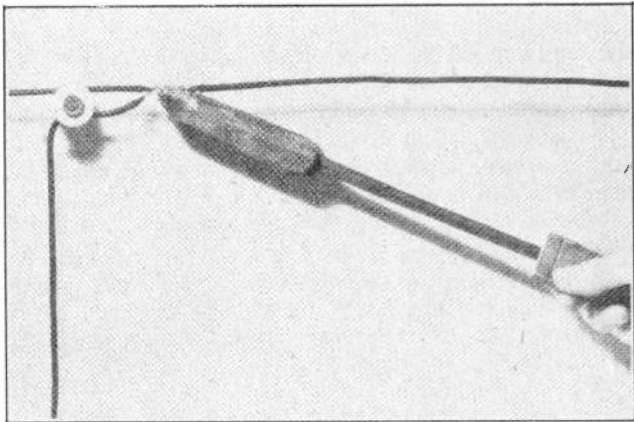

Fig. 5. Soldering copper should always be applied to the under side of the splice, as the splice can be heated much quicker in this manner. A drop of solder should be placed on the tip of the iron and pushed against the under side of the splice. This helps to conduct the heat into the splice very rapidly.

### 6. SOLDERING FLUX

Flux should always be used on any splice before applying the solder, as it dissolves the oxide on the metal and causes the solder to flow and unite with the metal much more readily.

Resin is a very good flux and can be used in bar form or powder, and melted on the hot splice. Muriatic acid was formerly used, and while it is a

## Applying Solder

very active and effective flux, it should not be used on electrical work, as it causes corrosion of the wires. No acid flux should be used on electrical splices.

Several kinds of good flux are prepared in paste form which is very convenient to apply.

These fluxes should be applied to the splice and melted on it with a good hot iron. Excessive flux should not be used, and none should be allowed to remain in the splice, as resin and some of the other fluxes act as insulators if they are not well melted out or "boiled out" of the solder with plenty of heat.

### 7. PROPER METHOD OF APPLYING SOLDER TO SPLICE

When the splice is "fluxed" the solder should be evenly applied and well melted so it runs into the crevices between the wires. It should not be dripped on the splice by melting it above with the iron. Instead the splice should be hot enough to melt the solder when it is rubbed on top of the turns.

The proper place for the soldering copper is **underneath the splice**, as heat naturally goes up, and this will heat the splice much quicker. See Fig. 5.

Many beginners have a great deal of difficulty heating a medium sized splice before the copper becomes cold, because they do not understand the principle of **heat transfer** from the copper to the splice.

### 8. CONDUCTING THE HEAT TO THE SPLICE

Always remember that heat will travel or flow through metals much easier than through air, and while copper is an excellent conductor of heat, there is very little actual contact area between the soldering copper and the rounded turns of the splice.

Here is a simple little trick of the trade which, once you have tried it, you will never forget, and you will be surprised to see how much it speeds up any soldering job on a splice. Place the heated copper under the splice with one of the flat faces of the tip held fairly level and in contact with the turns

## Applying Solder

of the splice. Then melt or "puddle" a little drop of solder on the copper, by pushing the solder wire in between the copper and the splice. This drop should melt almost instantly, and will provide a much greater area of metal-to-metal contact between the copper and the splice, and the heat will flow into the splice many times faster, heating it well in a very few seconds.

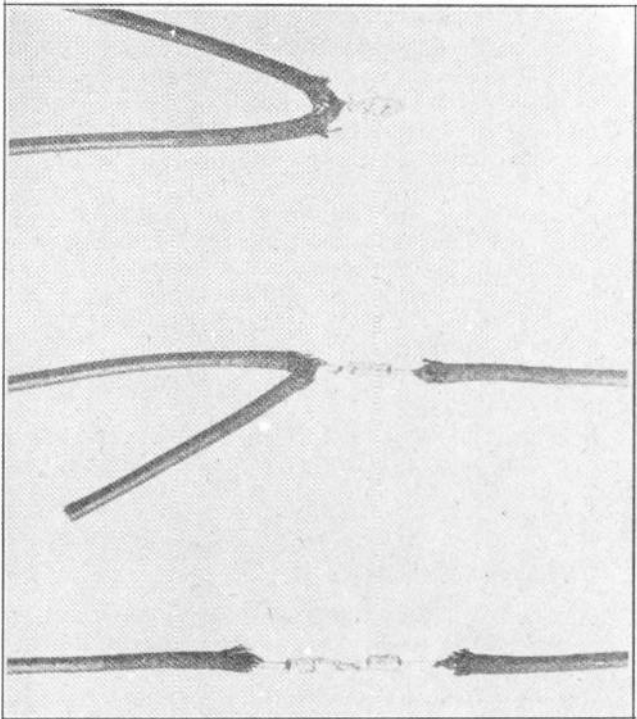

Fig. 6. The above three views shows soldered splices of the Pigtail type and Western Union type. Note how the solder thoroughly covers and adheres to the entire splice.

Then, while still keeping the good contact of the soldering copper on the bottom of the splice, run the solder on the top, allowing it to run down through the turns. Examine Fig. 5 again, and you will note the drop or puddle of solder on the iron, and the correct method of applying the solder to the splice.

## Blow Torches

Do not leave a large bulge of solder on any splice, but melt it off so that just a good coating remains on all turns.

Pigtail splices can be quickly and easily soldered by dipping them in a small ladle of molten solder.

Convenient small ladles or pots with long handles are made for this use. See Fig. 16.

### 9. SOLDERING LARGE SPLICES

When soldering cable splices it is often difficult to get the entire splice hot enough before the soldering copper gets cold. The copper of the splice, also being a good conductor of heat, carries it away along the cable nearly as fast as the soldering copper can supply it.

For soldering the larger cable splices, a blow torch is used to heat them, or they are dipped in hot solder, or have the molten solder poured over them and the excess caught in a pan below the splice.

If the insulation near the splice gets too hot, it should be kept cool by wrapping a wet rag around it while soldering.

In using a blow torch care should be taken not to overheat or burn the copper strands, as it weakens them greatly, and also makes a poorer job of soldering.

### 10. BLOW TORCHES

Fig. 7 shows a common gasoline blow torch of the type usually used when soldering large cables.

To start such a torch, a small amount of gasoline should be run into the drip cup and lighted with a match. This flame heats the burner nozzle directly above, and as soon as it is hot the valve can be opened allowing a fine jet of gasoline to spray into the nozzle, where it immediately vaporizes and burns with a clean blue flame of very high temperature.

If the flame is white and unsteady, the burner is not yet heated enough.

These torches have a small air pump built in the gasoline can, and the air pressure thus supplied



## Blow Torches

forces the liquid up to the burner in the form of a spray.

The valve is of the needle type and should not be closed too tightly or it will damage the needle and valve seat. After extinguishing the torch it is well to loosen the valve just a little so it will not stick when the metals become cold.

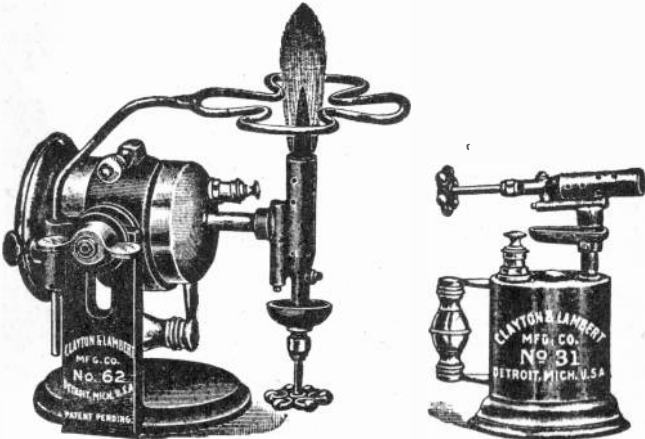

Fig. 7. This view shows a blow torch on the right, and at the left the method of using a blow torch in a special stand for heating a lead melting pot.

The left view in Fig. 7 shows a torch mounted in a bracket and stand for heating a lead pot.

Fig. 8 shows a regular gasoline lead pot, used for melting larger quantities of lead for large cable work.

## 11. CABLE LUGS

For attaching large cables to the terminals of machines or switchboards, and also for conductor connections which may need to be disconnected occasionally, we use copper cable lugs as shown in Fig. 9.

These lugs are made in different shapes, and for single cables or a number of cables as shown. They have a hollow cup on one end for attaching to the cable, and the other end is flattened and has a hole through it, so it can be securely bolted to a terminal or another lug.

## Cable Lugs

### 12. ATTACHING AND SOLDERING LUGS TO CABLE

To attach a lug to a cable, first strip just enough of the insulation from the end of the cable to allow the bare end to go fully down into the cup. Do not remove too much insulation, as it should cover the cable close to the end of the lug when it is attached.

Clean the bared end well, and also **make sure the lug cup is clean**. Then flux and tin the cable tip and

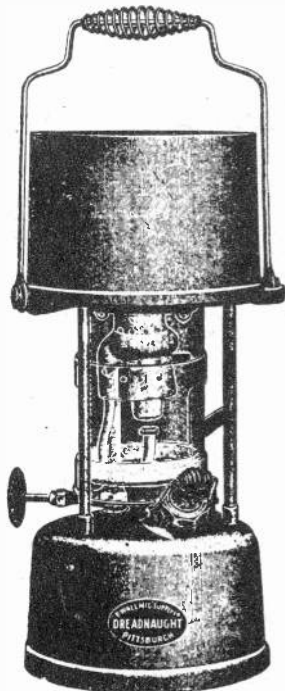

Fig. 8. Gasoline lead melting pot for use in soldering large cables, and cable sheaths.

inside of the cup, and melt enough solder in the cup to half fill it. Hold the lug in the flame of a torch until hot and then melt the solder in it. Be careful not to burn your pliers when heating lugs, as it destroys the temper of the steel if the pliers are held in the edge of the flame. The lug can easily be held in the flame with a wire hook, and then taken in the pliers when heated and ready to be

## Cable Lugs

soldered.

When the cup is heated and half full of molten solder, push the cable tip down in it, and hold it there while the lug is cooled. A wet rag, may be used to cause the solder to harden quickly. Do not move the cable while the solder is hardening.

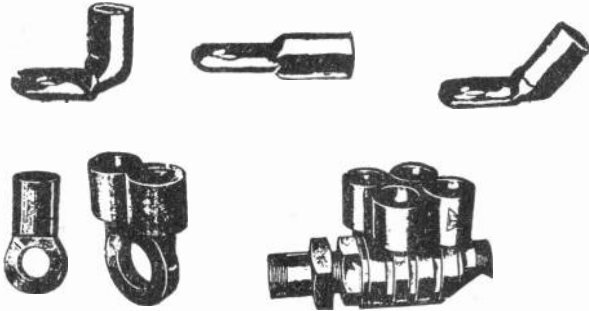

Fig. 9. Several types of soldering lugs used for connecting cable ends together or to the terminal of electrical equipment.

### 13. SOLDERLESS CONNECTORS

Solderless connectors such as shown in Figs. 10 and 11 are sometimes used for connecting cables. These connectors have a sort of sleeve or clamp that is squeezed by the threaded nuts causing them to grip the cable very securely. These are much quicker to use and very good for temporary connections, but are not allowed for permanent connections in some places.

Solderless connectors can also be obtained in several very good forms for smaller wires, and are great time savers on jobs where they can be used.

Another method of splicing solid wires is by the use of the tubes shown in Fig. 12. The wires are slipped into these tubes and then the whole thing twisted into a splice.

### 14. LEAD COVERED CABLE SPLICING

When splicing large lead sheath cables, the lead is split back from 10 to 36 inches according to the cable size, and a large lead sleeve slipped over one of the cable ends for use in covering the splice when

## Cable Splices

it is finished. The one or more conductors in the cable are then spliced and taped.

If paper insulation is used on the conductors the moisture is boiled out of them by pouring hot molten paraffin over them. See Fig. 13.

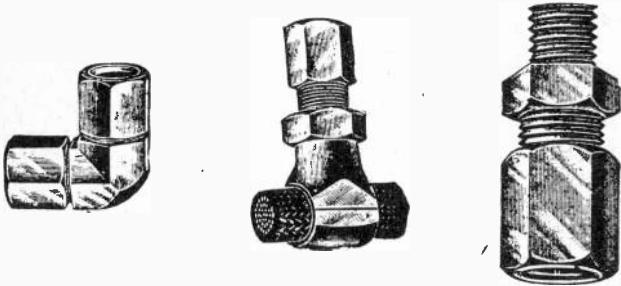

Fig. 10. Several styles of solderless connectors used for splicing cables. These connectors grip the cable very securely when their nuts are tightened with a wrench.

When the splice in the conductors is finished the lead sleeve is slid over it and its ends are joined to the cable sheath by pouring hot lead over them and "wiping" it on with a pad as it cools. This is a very critical job and one that requires a lot of practice to get the lead on smoothly and obtain a tight junction without melting the sheath. The

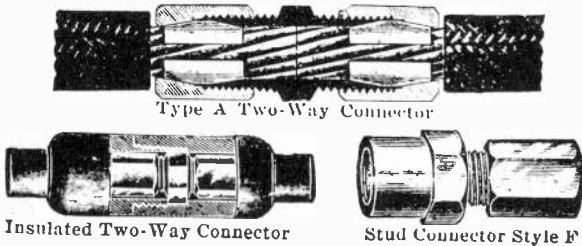

Fig. 11. Several other types of solderless connectors, showing a sectional view of the upper one which illustrates the method in which it grips the cable.

whole joint is then poured full of hot paraffin or insulating compound, through a small drilled hole in the sleeve. Then this hole is plugged tight to exclude all air and moisture.

Fig. 14 shows some of the steps in making such a splice.

## Cable Splices

### 15. TAPING OF SPLICES

All splices on wires with ordinary rubber and braid insulation should be taped carefully to provide the same quality of insulation over the splice as over the rest of the wires.

Two kinds of tape are used for this, one a soft gum **Rubber Tape**, and the other known as **Friction Tape**, which consists of cloth filled with sticky insulating compound.

The rubber tape is applied to the splice first to provide air and moisture tight insulation of high

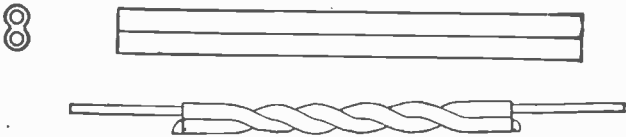

Fig. 12. Twin metal tubes of the above type are often used for splicing large solid conductors.

dielectric strength, and equal to the rubber which was removed. The friction tape is then wrapped over the rubber tape as well as  $\frac{1}{2}$ " over the insulation to provide mechanical protection similar to that of the braid which was removed and to prevent the braid from unraveling.

In applying rubber tape, cut from 2 to 4 inches from the roll and peel off the cloth or paper strip which separates it in the roll. Then start the end of this strip at one end of the splice tight to, or slightly overlapping, the rubber on the wires. Stretch it slightly while winding it on spirally. Press or pinch the end down tightly onto the last turn to make it stick in place. See Fig. 15.

A short time after this tape is applied, it becomes very tightly stuck together in almost a continuous mass, so it cannot be unwound, but would need to be cut or torn off. This is ideal for proper insulation.

The friction tape is "peeled" from the roll and applied in a spiral winding of two or more layers. Each turn should lap well over the preceding one. Sometimes where one has working room to allow it the friction tape can be started on the splice without tearing it from the roll, and the roll then

## Cable Splices



Fig. 13. This view shows several of the important steps in splicing lead covered cables.

## Cable Splices

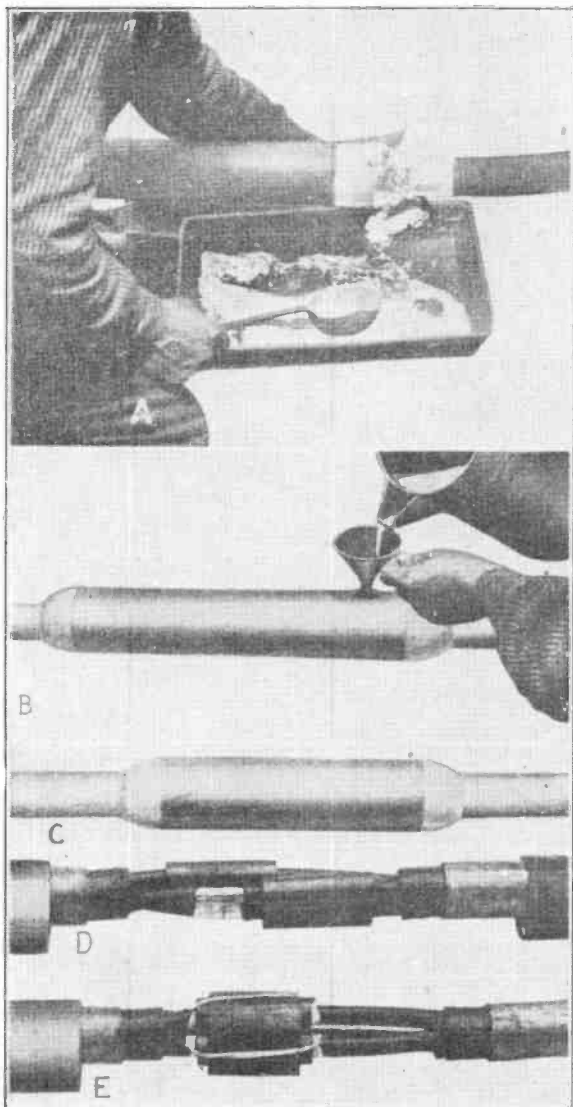

Fig. 14. "A" wiping a joint, "B" pouring insulating compound, "D" and "E" Insulating Sleeves, "C" finished joint.

## Taping Splices

passed around the wire, allowing the tape needed to unwind as it is wrapped on the splice.

Friction tape can be torn off the roll, or it can be split in narrower strips by simply tearing it.

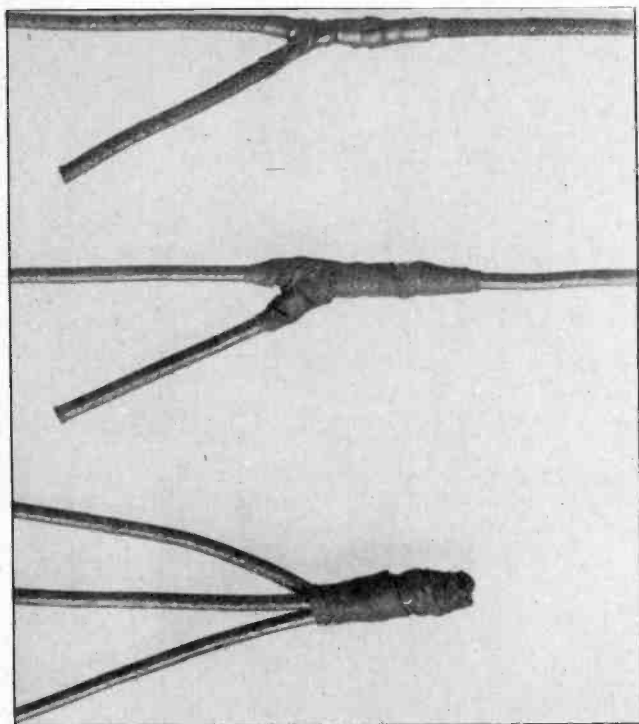

Fig. 15. The upper view shows a "tap" splice covered with rubber tape. The center and lower views show "tap" and "pigtail" splices completely taped with both rubber and friction tape.

## TYPES OF WIRING SYSTEMS

While we have found that the conductors for light and power wiring have good insulation on them, we can also see that this insulation is not sufficient to protect the wires from the mechanical injury and damage they would receive if they were just run loosely and carelessly about the buildings.



## Types of Wiring

For this reason and also for the sake of appearance, all wiring must be run on proper supports, and with proper additional protection to its insulation where necessary. It should be located where it cannot be bumped with moving objects, and out of the way as much as possible.

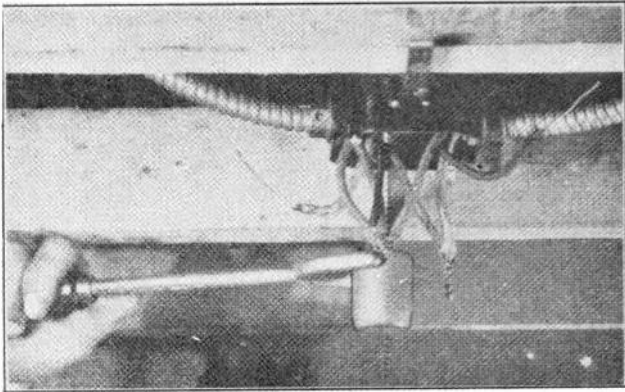

Fig. 16. Pigtail splices can be quickly and conveniently soldered by dipping in molten solder as shown.

In addition to the several general classes of wiring systems we have already mentioned, this work is also divided into several types of systems according to the method of installation, and kind of materials used.

Two general divisions are: **Open or Exposed Wiring**, and **Concealed Wiring**.

In open wiring systems the wires are run on the surfaces of the walls, ceilings, columns and partitions, where they are in view and readily accessible.

Concealed wiring systems have all wires run inside of walls and partitions, and within the ceilings and floors, where they are out of view and not easily reached.

Open wiring is often used in mills, factories, warehouses, and old buildings, where appearance is not important, and where it may often be desirable to make changes in the wiring. One of its advantages is that it is always easy to inspect or repair.

## Types of Wiring

Concealed wiring is generally used in all new buildings for homes, offices, stores, etc.; and also for many modern factories. It is much to be preferred where good appearance is important.

Another way of classifying wiring systems is based on whether or not the wires are run in metal.

### NON-METAL SYSTEMS

1. **Knob and Tube Work**, where the wires are supported by porcelain knobs and tubes. This system may be either open or concealed, and is a very low cost system.

2. **Cleat Work**, where wires are supported by cleats and knobs. This system is also very low in cost but cannot be concealed.

3. **Non-Metallic Sheathed Cable**. This is one of the newer systems to be permitted by the Code, is reasonable in cost, very convenient to install, and can be run concealed or open.

4. **Wood Moulding**, where wires are run in grooves in wood strips. This is a very old system and is rapidly becoming obsolete.

### METAL SYSTEMS

5. **Rigid Conduit**. Wires are run in iron pipes. This system is somewhat higher in cost, but is considered the best of all systems, and can be either open or concealed.

6. **Flexible Conduit**. Wires are run in flexible steel tubes. A very reliable system and very convenient to install in certain places. Can be either concealed or open work.

Both of the above are considered as one system by the National Code.

7. **Electrical Metallic Tubing**. Wires run in steel tubes, lighter in weight than regular conduit, and equipped with special threadless fittings. A very good system, and very convenient to install, but has certain code restrictions. Can be used for open or concealed work.

8. **Armored Cable (B.X.)**. Wires are encased permanently in a flexible steel casing at the factory.

## Knob and Tube Wiring

A very reliable system and very convenient to install. May be run either open or concealed.

9. **Surface Metal Raceways.** (Often called metal moulding. Wires are run in thin flat or oval metal tubes, or split casings. Low in cost, but can only be used for open work.

10. **Underfloor Raceways.** Wires run in metal casings or ducts under floors. Used in factories and offices but under certain Code restrictions.

This list of the various types of wiring systems will also give you a good general idea of their applications and the materials used. We will now cover each system in detail with its materials, advantages, and methods of installation.

### 16. KNOB AND TUBE WIRING

The Knob and Tube system is one of the oldest and simplest forms of wiring, and while not as reliable as conduit, it is allowed by the National Code, and is still used to some extent in small towns and rural homes. If carefully installed it will give very good service and at very low cost of installation.

The principal materials required for a wiring job of this type, are the **Porcelain Knobs**, **Porcelain Tubes**, and flexible non-metallic tubing known as "Loom."

The knobs are used to support the wires along surfaces or joists of the building. The tubes are to protect the wires where they run through holes in joists or walls, and the loom to protect the wires through holes, or where they enter outlet boxes or run close together.

### 17. KNOBS

Fig. 17 shows an excellent view of a split knob of the type commonly used, and also a porcelain tube in the lower view.

You will note that the knob has grooves on each side, with ridges in them to grip the insulation on the wire. The wire can be run in either groove, but do not run two wires of opposite polarity on one knob.

The nail has a leather washer under its head to prevent splitting the knob caps when driving it

## Knob and Tube Wiring

tight. Care should be used, however, as it is possible to split the knob cap if it is tightened too much.

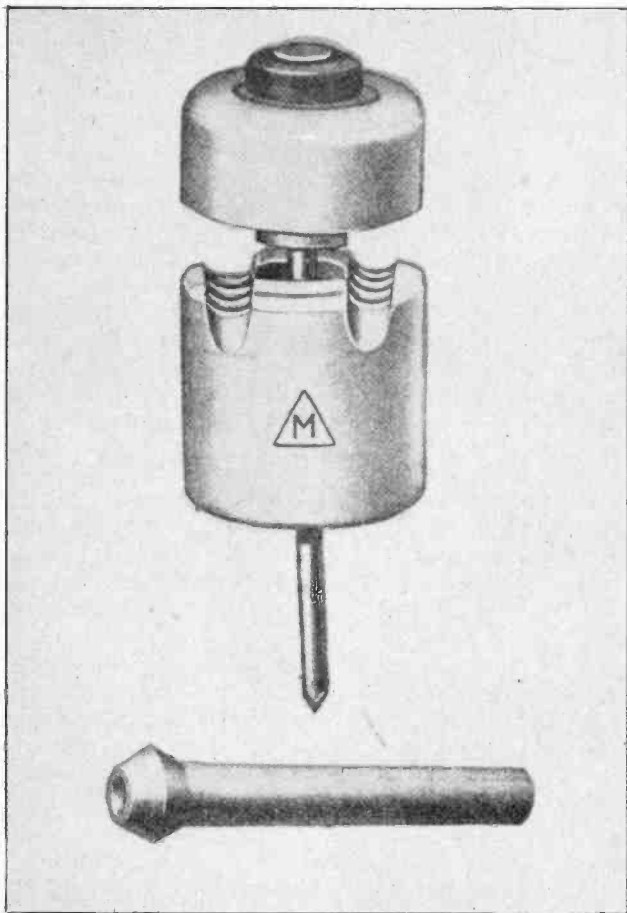

Fig. 17. The upper view shows a common type of split knob with the nail and leather washers which are used with them. Below is a porcelain tube of the type used in Knob and Tube wiring.

Knobs should be placed along the wire not farther than  $4\frac{1}{2}$  feet apart, and in some cases should be more frequent to provide proper support.

Before tightening the knobs, the wires should be drawn up tight so they will not sag and touch the wood, or present a bad appearance.

## Knob and Tube Wiring

Wires of opposite polarity supported on knobs, must be spaced 3 inches or more apart.

Knobs can be used to support either horizontal or vertical wires, as long as the wires are drawn up tight.

The one piece knobs with the grooves around them must have the wires tied to them with a short piece of wire of the same size and insulation as the running wire.

Knobs must hold the wires at least an inch away from the surface wired over.

Sometimes knobs are fastened with screws instead of nails, and the ordinary split knob, such as shown in Fig. 17, would require  $2\frac{1}{2}$ " or 3" No. 10 flat head wood screws.

### 18. TUBES

Wherever the wires are to run through holes in joists or walls, the porcelain tubes must be used to prevent damage to the insulation by rubbing or vibration.

The standard tube is 3" in length and about  $\frac{5}{8}$ " in diameter, and has a bulge or head on one end. Where the tube must run at a slant, the head should always be placed upwards to prevent the tube from dropping out of the hole. An exception to this is where wires enter an outlet box and the tube is held in place by the wire being bent back toward the nearest knob. The head should then be on the end which will prevent the angle of the wire from pushing it out of the hole.

Either a  $\frac{5}{8}$ " or  $11/16$ " wood bit can be used for boring the holes for standard porcelain tubes, and it is well to bore them with a little slant so the tubes will not tend to work out of the holes.

Other tubes can be obtained, both longer and larger than the common 3" size.

### 19. LOOM

Fig. 19 shows a piece of the flexible "loom," and Fig. 20 shows a larger view of a small piece, in

## Knob and Tube Wiring

which you can see the inside construction of this woven insulation.



Fig. 19. A piece of "loom" or flexible insulation used to protect wires in certain places in Knob and Tube wiring.

Wherever wires enter an outlet box for a switch or lamp, a piece of loom must cover the wires from within the outlet box to the nearest knob outside the box. Fig. 21 shows a metal clamp used for fastening the end of the loom into the box. This clamp grips the loom with small teeth and wedges it tightly in the hole to prevent it from ever slipping out.

Where wires must be closer than 3 inches apart or where they must be run inside a wall, ceiling, or floor; or for more than four and a half feet without knobs, **they must be completely covered with loom.** By protecting the wires in this manner they can be fished through difficult places in old house wiring, where knobs cannot be placed.



Fig. 20. Enlarged view showing the fabric and construction of a piece of "loom".

Some electricians occasionally try to cheat the Code and the customer by placing short pieces of loom only at each end of such a wire run and not clear through. But when caught by a careful inspector or when it causes a fire such work as this costs the electrician far more than the extra loom for a good job would have cost.

In some places even in new house wiring it may be desired to run five or six wires or more between the same two joists. This cannot be done with knobs and still keep them all five inches apart. It

## Knob and Tube Wiring

can be done however, by covering the wires with loom and running them all between two joists, or by grouping them all one one joist under loom straps.

Where one wire crosses another, or crosses a pipe of any kind; if it cannot be supported well away by a knob, a porcelain tube, or piece of loom five or six inches long can be slid on the wire and taped in place, to hold it directly over the wire or pipe to be crossed.

Wherever wires are attached to switches, enter outlet boxes, or where a tap is taken from a wire, a knob should be located close to this point to take all possible strain off from the splice or switch, or edge of the outlet box. See Fig. 22-A, which shows how a knob can be used both to support the running wire and to secure the tap wire and keep any strain off the splice.

Fig. 22-B shows how an extra knob should be placed near the point where a splice is made to a running wire which is not supported by a nearby knob.

Fig. 23 shows a section of a knob and tube wiring system in which you can observe a number of the parts and methods which we have mentioned for this type of work.

Examine this photo closely and note the important points shown.

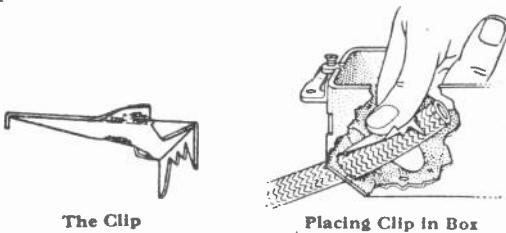

Fig. 21. "Loom" can be fastened securely in the outlet box with clips as shown above.

## 20. RUNNING THE WIRES

When wiring a new building with a knob and tube system, it is quite easy to install the wiring between the joists in walls and ceilings before the

## Knob and Tube Wiring

lath and plaster are put on.

The wires should be run for the mains and branch circuits, and the outlet boxes for switches and lights should be installed. The boxes should be set so their edges will be about flush with the plaster surface, or a little beneath it. They should not be "recessed" or set in, more than  $\frac{1}{4}$  inch at the most. These outlet boxes will be explained later.

When running wires in old buildings advantage can usually be taken of unused attics or basement ceilings, making it quite simple to run the wires in these places. Where the wires are likely to be

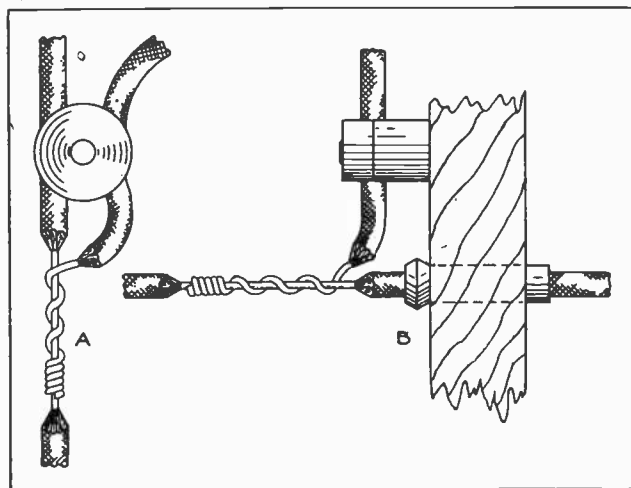

Fig. 22-A. Sketch showing a Knob used both to support the "running" wire and to keep the "tap" wire from putting any strain on the splice.

Fig. 22-B. When no Knob is near on the "running" wire an extra one should be placed on the "tap" wire close to the splice in the manner here shown.

disturbed or injured, if run on protruding knobs, it is well to protect them by running a board along them, or by running the wires through the joists in tubes.

Where the wires are run through walls to switch boxes or wall light outlets, they can usually be pushed up or dropped down between the vertical joists and pulled out through the outlet opening.

A "mouse" and string, as formerly described in the lesson on signal wiring can be used to good



## Knob and Tube Wiring

advantage to pull the wires through vertical walls.

Where they must be run horizontally through hollow floors or ceilings a steel fish tape can be pushed through first, and used to pull in the wires. These fish tapes are long, thin, flat pieces of springy steel and obtainable in different sizes and lengths. They can be pushed and wiggled quite a distance through spaces between joists and even around cor-

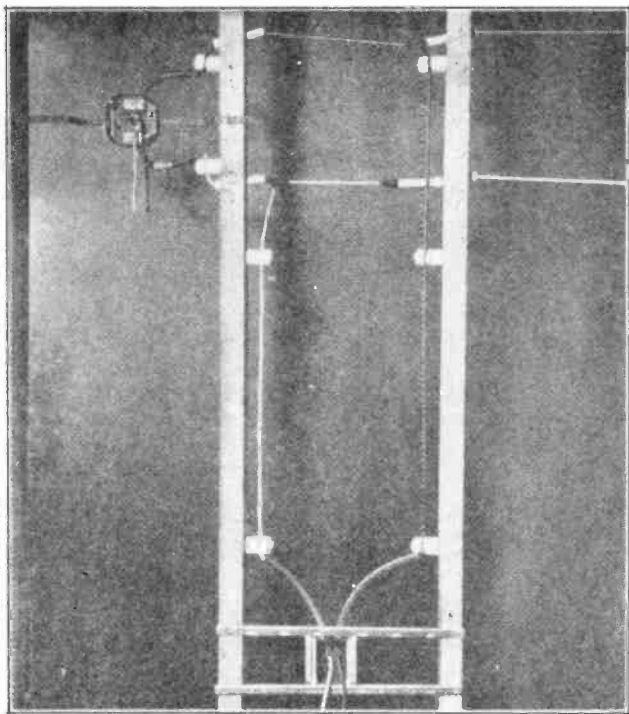

Fig. 23. This photo shows several of the most important features in a Knob and Tube wiring system. Note particularly the manner in which the "loom" extends from the outlet box, the use of the porcelain tube where the wires cross, and position of tubes in the joists when they are near to knobs as shown.

ners and obstructions to quite an extent. They are also used for pulling wires in conduit, as will be explained later.

Fig. 24 shows a piece of fish tape rolled in a coil for convenient carrying.

## Knob and Tube Wiring

An ordinary jointed steel fishing rod, or a long thin stick with an eye in the end, can often be used very well to push wires into difficult places, or to push a string through for use in pulling in the wires.

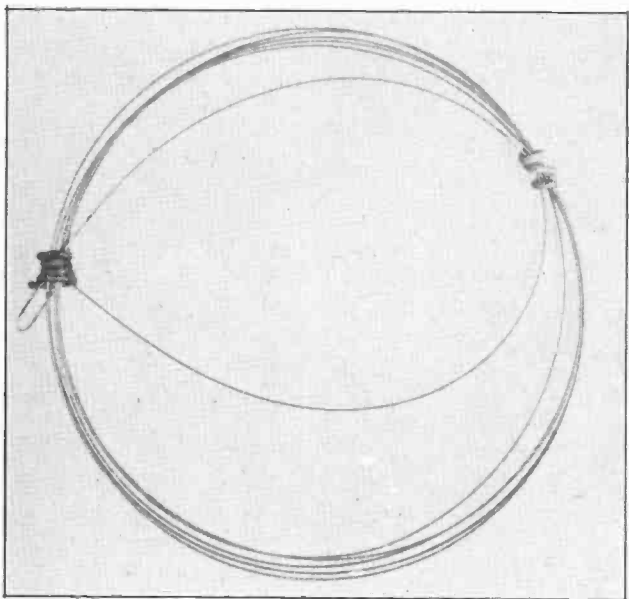
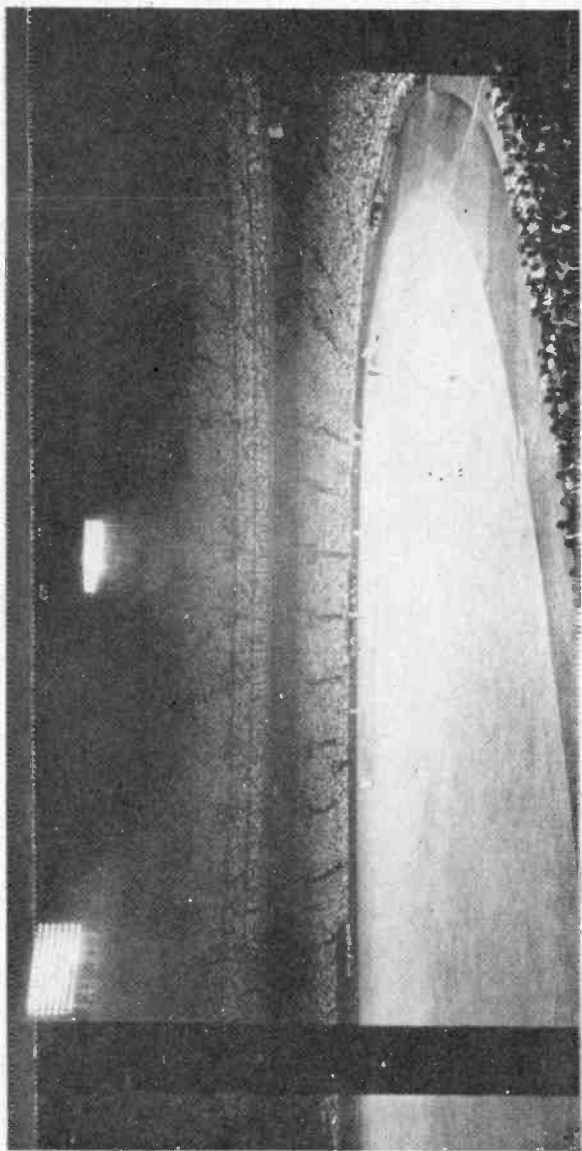

Fig. 24. A coil of steel fish tape, such as used for pulling wires into difficult places in a building, or through conduit.

## EXAMINATION QUESTIONS

1. What happens to a splice when allowed to stand without being soldered?
2. What kind of metal is used in a soldering iron?
3. What do we mean by the expression "tinning a soldering iron?"
4. What kind of soldering flux should be used for electrical work?
5. a—Which kind of tape is applied first to a splice? b—Which kind do we use for the outer covering?
6. What is the minimum distance allowed between wires of opposite polarity in knob and tube wiring?
7. What protection must we use where open wires enter an outlet box?
8. In cases where wires must be run closer than 5 inches to each other or run more than  $4\frac{1}{2}$  feet without knobs, what protection must be used?
9. What protection is used where wires are run thru holes in joists?
10. Assuming that the soldering iron is not large enough to heat a large cable, in what way may enough heat be applied to the cable to cause solder to combine with the metal?



Cleveland Municipal Stadium illuminated by General Electric. This crowd of 55,000 attended first night baseball game

## OUTLET BOXES

Where wires are attached to switches or fixtures, proper outlet boxes should be used. Fig. 1 shows a common type of outlet box for use with switches or convenience outlet receptacles. This box is made of thin steel and in sections, so it can be made wider to hold several switches or receptacles if desired.

The small detachable "ears" on each outer end are to fasten the box to the lath or wall, and they are adjustable so the box can be set out farther by merely loosening the screws in the "ear." These boxes have "knockout" pieces or round sections cut nearly through the metal, so they can be punched or knocked out with a hammer. These openings are for the loom and wires to enter the box for connecting the switch.

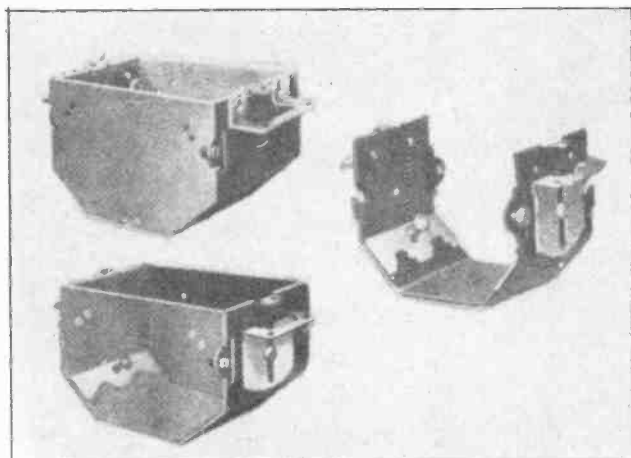

Fig. 1. Several views of a sectional outlet box of the type used for mounting switches and receptacles.

Such outlet boxes provide a rigid support for the switches or receptacles, and a protection around the back of the devices where the wires are connected.

The center and lower views in Fig. 1 show a clamping plate and screw inside the box with special shaped notches for gripping the loom or

## Outlet Boxes

flexible conductor sheath where it enters. Note that the notches in this plate come directly over two knockout slugs.

Outlet or knockout boxes of this type can be obtained with the small knockouts to fit loom, or with larger ones for conduit, but the boxes are standard size to fit all push button or lever switches.

Fig. 2 shows a double outlet box for two switches or receptacles. The screws in the small "lips" at the center of each end are for fastening the switches or receptacles in the box.

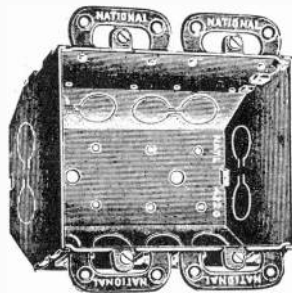

Fig. 2. Double outlet box for mounting two switches, two receptacles, or a switch and receptacle.

Fig. 3 shows a type of ceiling outlet box, used to attach wires to lighting fixtures, and also to support the fixture in wiring of old houses. Boxes of this type, but at least  $1\frac{1}{2}$  inches deep are commonly used for ceiling outlets in new buildings.

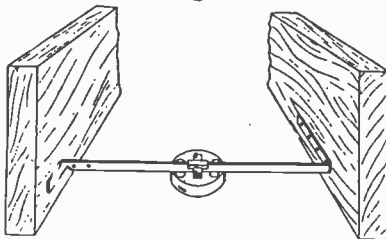

Fig. 3. A metal bar or hanger is used to support outlet boxes between the joists.

Fig. 4 shows some of the various types of outlet boxes and covers available. You will note that some of these have both small and large knockouts, so

## Outlet Boxes

they can be used either with loom, for knob and tube wiring, or with conduit.

Fig. 5 shows an outlet box with bar hanger used to support it between joists, and you can see the fixture stud in the center of the box for attaching a lighting fixture. This box also contains two new style clamps.

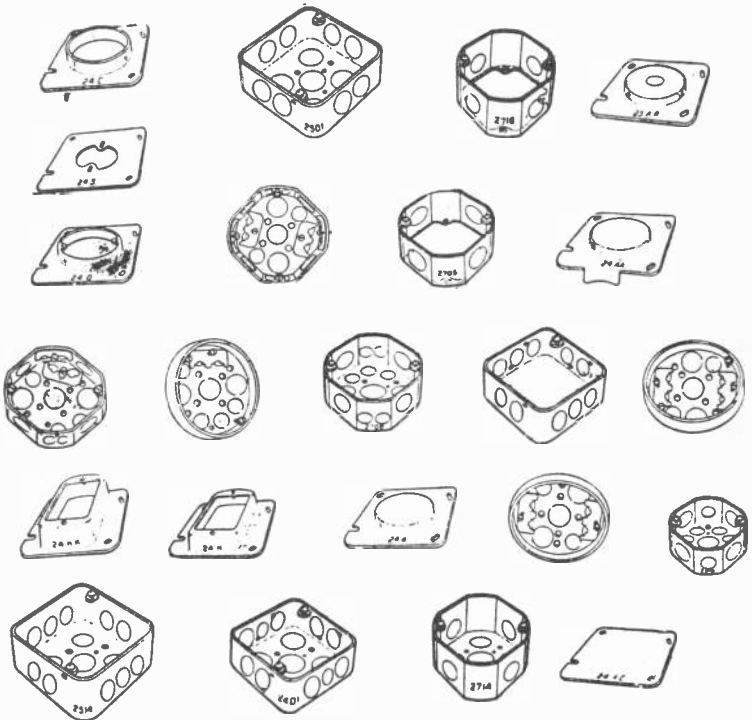

Fig. 4. Several types of outlet boxes and covers. Note the arrangement and size of the "knock-out" openings.

Fig. 6 shows how large solid knobs are often mounted on racks to support various numbers of power cables.

## 2. CLEAT WIRING

In cleat wiring systems the wires are run in pairs and supported in grooves in the ends of porcelain

## Cleat Wiring

cleats such as shown in Fig. 7. This view shows a two-wire and three-wire cleat wires.

These cleats are fastened to the walls or ceilings with two screws through the holes shown. They must support the wires at least  $\frac{1}{2}$ " from the surface wired over, and keep them at least  $2\frac{1}{2}$ " apart. Cleats should not be placed farther apart than  $4\frac{1}{2}$  feet along the wires, and in many places should be closer.

Cleat wiring may be used as part of a knob and

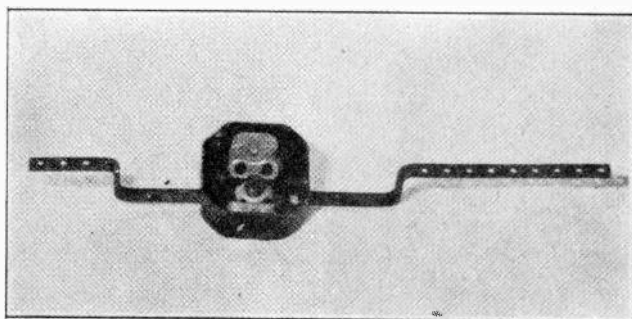

Fig. 5. This photo shows the inside of a common outlet box with fixture stud and "loom" clamps in place, and also the bar used for mounting the box.

tube or other system, but must always be run exposed.

Tubes or loom must also be used where the wires pass through walls or partitions.

### 3. CLEAT FITTINGS

To attach fixtures to a cleat wiring system we can use an outlet box that fastens to the ceiling or wall with screws and is covered by the canopy of the fixture. Loom must be used where the wires enter the box.

For installing plain lamps with reflectors only, cleat receptacles or rosettes, such as shown in Fig. 8, are used. The two in the upper row are to be mounted on the same surface the cleats are on, and the wires should be attached directly to the terminals of the receptacles. Lamp bulbs can be screwed into the openings shown. The two in the center



## Non-Metallic Cable

row are called "rosettes" and are used to suspend lamps on drop cords. The two below are other types of drop cord rosettes, and the one at the left can be used either with cleat or moulding work.

Surface type snap switches are commonly used in cleat work, and a porcelain **Switch Back** is used to hold the switch base and wires  $\frac{1}{2}$  inch away from the mounting surface.

The same general rules are followed in cleat work, as were given in knob and tube work, for protecting wires where they may cross pipes or each other. We should also use cleats near splices or connections to devices, as we do with knobs, to remove any possible strain from the splices.

### 4. NON-METALLIC SHEATHED CABLE

This system of wiring consists of wires encased in a covering of protective fabric. Fig. 9 is a sketch

Fig. 6. Large solid knobs on special brackets of the type shown here are often used to support runs of several large wires or cables. Open wiring systems in factories and industrial plants often make use of knobs or cable racks of this type. They are very convenient to install, and the knobs can be removed by withdrawing the rod which runs through them, thus making it easy to place the wires on the inside of the knobs if desired, or in other cases they are tied to the outside of the groove with a tie wire.

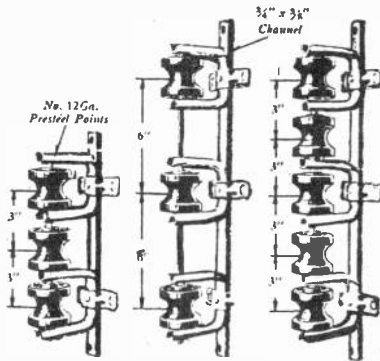

of a piece of this cable of the two-wire type, and shows the extra insulation on the wires as well as the outer covering, which is somewhat similar to loom.

This material is known by several different trade names such as "Romex" and "Loomflex." It can be obtained in either two-wire or three-wire cables. Fig. 10 shows a piece of each kind, and the method of fastening them to the walls or partitions with metal straps.

This type of cable is very flexible and very easy to install and, as before mentioned, it can be run

## Non-Metallic Cable

either exposed or concealed. In concealed wiring it can be run between joists or through holes without any additional protection, and simply fastened in place by the small metal straps, such as shown

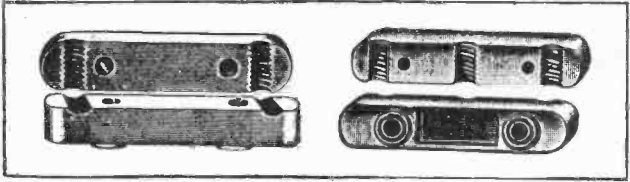

Fig. 7. Porcelain cleats of the type used for holding two or three wires in cleat wiring systems.

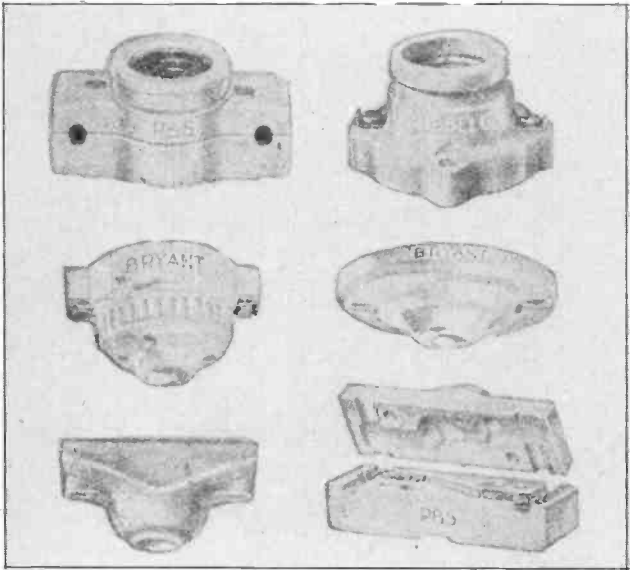

Fig. 8. Several types of porcelain receptacles used for attaching lamps or drop cords to a cleat wiring system.

in Fig. 10. This cable is very popular for use in wiring old buildings.

### 5. INSTALLING ROMEX

The holding straps must not be spaced farther apart than three feet, and the cable should always be run along some supporting surface such as a

## Non-Metallic Cable

joist, wall, or ceiling. When run across joists or in open spaces it should be supported by a board.

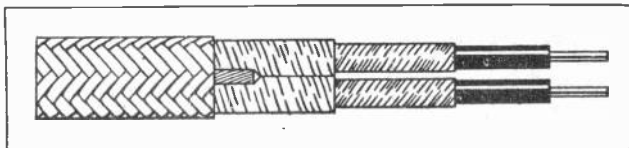

Fig. 9. This sketch shows the construction of a piece of non-metallic sheathed cable or "RomeX". Note the heavy layers of extra insulation on the wires, and also the strong outer braid covering.

When it is being run concealed in new buildings the straps can be placed  $4\frac{1}{2}$  feet apart, and in old buildings, where it is impractical to support the cable with straps, it can be fished from one outlet to another, similarly to wires covered with loom.

Even though the original cost of this material is somewhat higher than that of the same number of feet of wire with knobs and tubes, the ease with which it can be installed makes the finished system very reasonable in cost.

Any bends in such cable runs should be carefully done so as not to injure the covering and insulation of the cable, and the bends should have a radius of not less than five times the diameter of the cable.

Regular outlet boxes of the type already explained are used where switches and fixtures are to be installed. All cable runs must be continuous and without splices from one outlet box to the next.

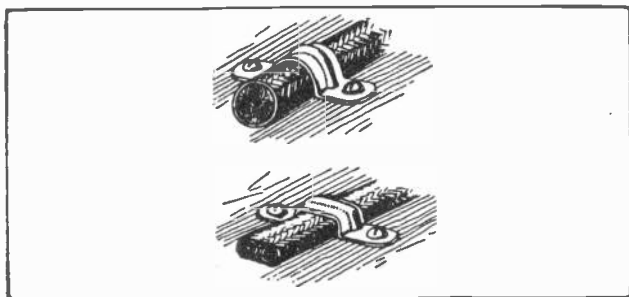

Fig. 10. This view shows a piece of three-wire and one of two-wire non-metallic sheathed cable, and also the method of attaching this cable to a surface with metal straps and screws.

Where the cable comes through the floor, or is run along a partition within six inches of a floor,

## Non-Metallic Cable

it should be protected by running it through rigid conduit or pipe.

### 6. GROUND WIRES AND FITTINGS

One form of this sheathed cable has a bare copper wire run under the outer covering, parallel to the insulated wires. This wire is used for grounding the various outlet boxes and fixtures, and it should be securely grounded at the service switch, or entrance to the building.

Fig. 11 shows several methods of attaching the

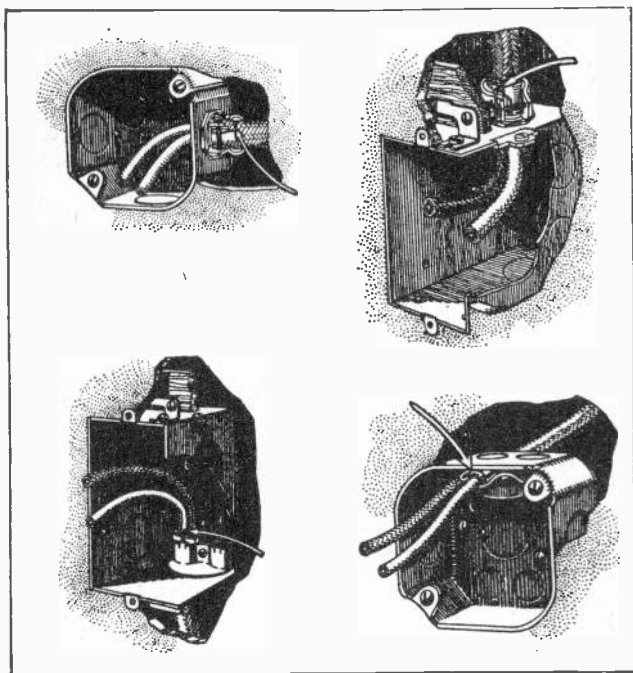

Fig. 11. The four views above show methods of attaching Romex to outlet boxes with special clamps for this purpose. Note the ends of the wires, which are to be stripped back to allow the splicing or connection.

cable to common outlet boxes. The two upper views show the use of a "squeeze" clamp, which is attached to the outlet box with a lock-nut, and into which the cable is inserted and then gripped

## Non-Metallic Cable

by tightening the screw of this clamp. The two lower views show another type of clamp similar to those used for fastening loom.

The ground wires should be stripped back six or eight inches through the outer covering of the cable to allow the wires to be stripped for connections in the box, and then this ground wire is attached to the cable clamp, as in Fig. 12, thus effectively grounding the outlet box. **The ground wire must not in any case be left inside the box.**

Fig. 13 shows a method of installing non-metallic cable in the joists of a new house, and Fig. 14 shows how it can be installed in the attic of either a new or old building.

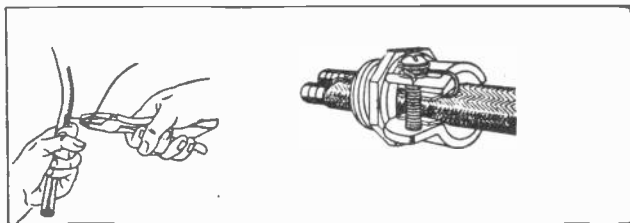

Fig. 12. This sketch shows the method of stripping back the extra ground wire in non-metallic sheathed cable, and also the manner in which it is attached to the outlet box clamp.

In general, the installation of non-metallic cable is very similar to that of armored cable, or B.X., which is covered in a later section.

## 7. WOOD MOULDING

As previously mentioned, this system of wiring is not used much any more, but you will probably still find some installations of it, where an extension in the same type of wiring might be desired. Even then, it would probably be better to install metal moulding or raceway, unless the other system had to be matched exactly.

Fig. 15 shows a sketch of a piece of this moulding, and the manner in which the wires are run in the grooves, and the wood cap placed over them.

When installing switches or fixtures on this system, the moulding is either cut to allow the mounting of a special porcelain block or fitting to

## Wood Moulding

which the wires are attached, or in some cases connection may be made direct to the switches,



Fig. 13. A section of an installation of RomeX, showing how it is run through and along joists of a building.

which can be mounted flush with the surface of the moulding. A special fitting is also required where tap splices are made to running wires.

We would not advise using this type of wiring in any case, except where absolutely necessary to match some existing system. In many old systems

## Wood Moulding

of this type the wiring can be made a great deal safer and more dependable if it is entirely removed and replaced with a more modern system.

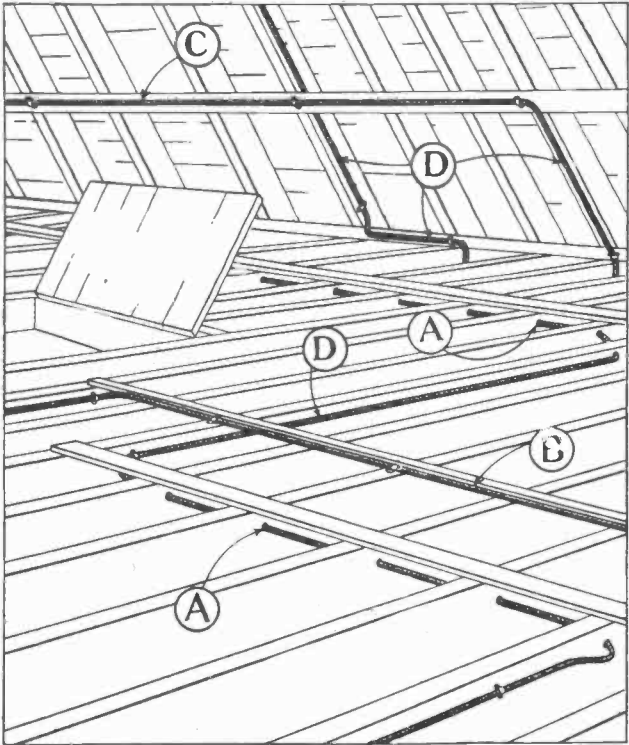

Fig. 14. RomeX is a very convenient type of wiring to install in the attics and walls of finished buildings.

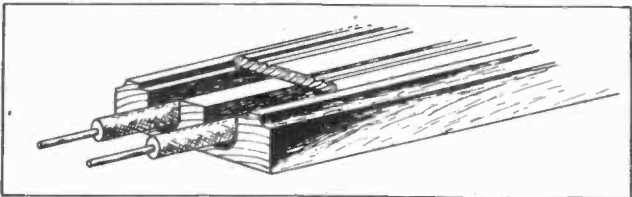

Fig. 15. A piece of wood moulding of the type sometimes used in making additions to old systems of this type.

## RIGID CONDUIT WIRING

While this system is a little more expensive to install, it is usually by far the safest and most satisfactory type of wiring. In this system the wiring is enclosed throughout in rigid steel pipe, which can be run either exposed or concealed in wood building partitions, or even embedded in the concrete or masonry of modern fire-proof buildings.

Concealed conduit must, of course, be installed in either frame or masonry buildings while they are being erected, although additional runs of exposed conduit are sometimes added or installed in finished buildings.

### 8. ADVANTAGES OF CONDUIT WIRING

With the conduit system grounded as required by Code rules, there is practically no chance of fire or personal injury, due to any defects in the wire or insulation, because in such cases the wire becomes grounded to the pipe, and will immediately blow the fuse and open the circuit as soon as the fault occurs. In case of any momentary grounds or short circuits in such systems, the fact that the wires are enclosed in metal pipe makes it almost impossible to start any fires.

Some of the general advantages of conduit wiring are as follows:

1. The wiring is much more compact, and takes up less space than when strung out on knobs.

2. The grounded metal conduit shields the conductors magnetically, and prevents them from setting up external magnetic and electro-static fields that would otherwise interfere with telephones or radio equipment.

3. Conduit forms an absolutely rigid support for the wires without placing any strain on them, and also affords excellent protection from any mechanical damage or injury to the conductors.

4. It provides a very convenient method of grounding the circuit at any desired point

5. It is suitable for both low voltage and high voltage wiring, depending upon the insulation of the wires or cable used; while the other systems



## Rigid Conduit Wiring

mentioned can be used only for voltages under 600, and several of them under 300.

In addition to the above advantages, rigid conduit can be made absolutely water-proof and is, therefore suitable for wiring in damp locations.

In wiring new homes the slight extra cost is well worth while, because a conduit system will certainly be the most dependable and permanently satisfactory one obtainable. Many of the larger cities require that all new homes have conduit



Fig. 16. Piece of rigid conduit or pipe, in which wires are run in conduit systems.

wiring installed. Practically all modern apartment buildings, offices, hotels, and department stores use conduit wiring exclusively, and industrial plants and buildings of fire-proof construction use it very generally. Many towns require the use of conduit for the entrance of service wires to the buildings, even though the building itself may use some other form of wiring.

Conduit pipe is very much like ordinary gas or water pipe in general appearance, except that it is somewhat softer, so it can be more easily bent for making turns and offsets in the runs.

Fig. 16 shows a piece of rigid conduit, and a sectional view of the end, as well as the threads on the right hand end.

Conduit is made in standard sizes from  $\frac{1}{2}$ -inch to 6-inch inside diameter. These standard sizes are  $\frac{1}{2}$ -inch,  $\frac{3}{4}$ -inch, 1-inch,  $1\frac{1}{4}$ -inch,  $1\frac{1}{2}$ -inch, 2-inch,  $2\frac{1}{2}$ -inch, 3-inch, 4-inch,  $4\frac{1}{2}$ -inch, 5-inch, and 6-inch. These dimensions are approximately the actual inside diameter, usually being a little larger in each case. The  $\frac{1}{2}$ -inch size is the one most commonly used for ordinary house wiring, and  $\frac{3}{4}$ -inch is used on some of the main runs.

The inside surface of conduit piping is smoothed by the manufacturers, so it will have no rough spots

## Rigid Conduit Wiring

that might cut or damage the insulation on the wires. It is also enameled to prevent rusting.

The outside surface is usually coated with water-proof enamel, or galvanized. One process for treating both inside and outside is called "Sherardizing", and is a process whereby zinc is applied to the surface while hot, in such a manner that it actually alloys with the pipe.

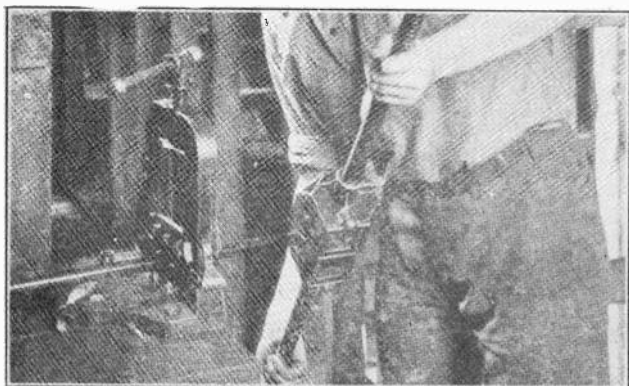

Fig. 17. Threading the ends of rigid conduit. Note the method of holding and operating the die.

### 9. CONDUIT FITTINGS AND METHODS OF INSTALLING

Conduit is made in ten-foot lengths for convenient handling and installation. Where longer runs are required between outlets, it is necessary to couple the ends of the pipe together by threading them with a die, and using a pipe coupling. Such joints should be thoroughly tightened to make them as water-tight as possible, and to provide a good electrical circuit, as the Code requires that the entire conduit system be continuous for the purpose of having a complete ground circuit.

Fig. 17 shows the method of using a die to thread the end of a piece of conduit, and the proper position to hold the die stock handles.

Fig. 18 shows a sketch of a pipe coupling at the left as it would be used to attach two straight lengths of conduit together. The view at the right

## Rigid Conduit

shows a coupling used with a nipple to attach runs of conduit to an outlet box.

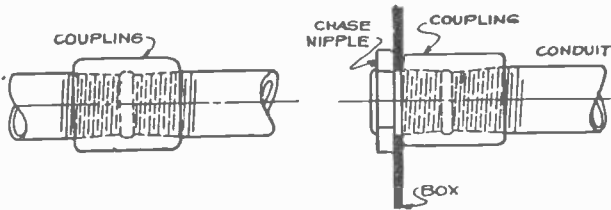

Fig. 18. Threaded couplings are used to connect lengths of conduit together, and in some cases to connect them to outlet boxes with a special nipple.

Standard outlet boxes of the type already shown and described, with knockouts of the proper size, are used with conduit systems.

The common method of attaching the conduit to the outlet box is to thread the pipe end and screw a lock-nut well back on the threads. Then insert the threaded end in the box and screw on the end bushing. By tightening the lock-nut on the outside, the conduit is then securely fastened to the box. The box also becomes a part of the complete grounded circuit, and for this reason the lock-nuts



Fig. 19. A bushing and lock nut of the type most commonly used in attaching conduit to outlet boxes.

should be well tightened with a wrench, to insure good connections.

Fig. 19 shows a conduit bushing on the left, and a lock-nut in the center view.

The bushing not only helps to secure the pipe to the box, but also has a smooth, rounded end to protect the wires from damage against the edges of the conduit.

Never attach a small conduit to a hole that is too large in the outlet box, without using proper reducers or washers to get a secure connection.

## Rigid Conduit

### 10. REAMING, CUTTING AND BENDING OF CONDUIT

The ends of all lengths of conduits are reamed at the factory to eliminate sharp corners that might otherwise damage the insulation on the wires. When you cut shorter lengths they should be reamed, as shown in Fig. 20 before coupling them together, or attaching them to outlet boxes. This removes any possible sharp edges on the inner corners, and protects the insulation of the wires from damage when drawing them in.

When a piece of conduit shorter than ten feet is required, it can easily be cut to the desired length with a hack-saw, as shown in Fig. 21. Considerable care should be taken in measuring the length of conduit runs, so that the piece will be cut the proper length to fit the location of the outlet box, and avoid mistakes that will waste time and conduit.

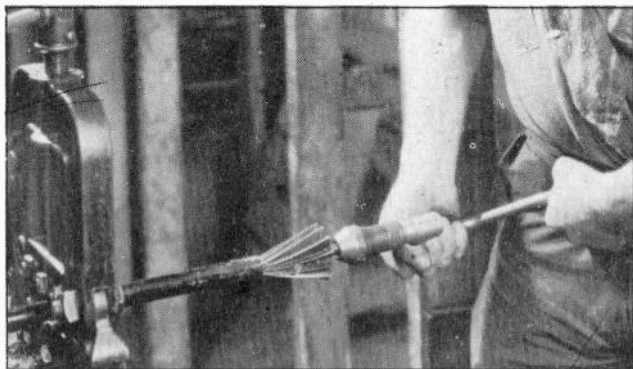

Fig. 20. Reaming the end of a piece of conduit after cutting to remove sharp edges, which might damage the insulation on the wire.

Where a conduit run must turn a corner or go around some obstruction, the smaller sizes can be easily bent with a tool called a "hickey."

### 11. SIZES AND TYPES OF BENDS, AND NUMBER ALLOWED

In making conduit bends care should be used not to bend them too sharply and cause the pipe to flatten, as this will reduce the inside opening, and

## Rigid Conduit

make it difficult or impossible to draw the wires through it. The 'inside radius of any bend should not be less than six times the rated diameter of the conduit. This means that the bend would form part of a circle with a radius six times the conduit diameter. (Radius is distance from center to outside of a circle.)

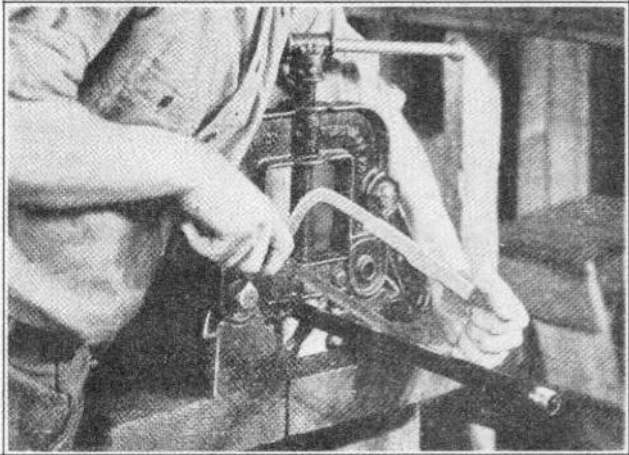

Fig. 21. Cutting a piece of rigid conduit with a hack saw. It should always be cut squarely as otherwise it is difficult to properly ream and thread it.

Thus, if we were bending  $\frac{1}{2}$ -inch conduit, the inner radius of any bend should not be less than three inches, which would mean that the curve of the pipe should conform to, or fit the outer edge of a circle six inches in diameter.

Fig. 24 shows several of the more common bends made in conduit, and the names by which they are called. Not more than four right angle bends are allowed in any single run of conduit between outlet boxes. This is because the greater the number of bends the harder it is to pull the wires through the pipe.

## 12. CONDUIT FITTINGS

While the sizes from  $\frac{1}{2}$ -inch to  $\frac{3}{4}$ -inch can be quite easily bent, on the larger sizes it is quite customary to buy manufactured elbows. However,

## Rigid Conduit

the larger conduits can be bent on the job with power bending equipment, or by use of block and tackle, and some secure anchorage for the pipe. Sharp turns in conduit can be made by the use of fittings commonly known as **condulets** and **unilets**. These fittings are also made for attaching one length of conduit to another, and for crossing conduits, and for practically every need that can arise in a conduit installation.

Fig. 25 shows a number of these fittings with their proper letters, by which they are marked and specified when buying. Examine these fittings and note their various applications carefully. The letter L denotes an elbow or fitting used to make a right angle turn. An L.R. fitting is one that is used to make a turn to the right, while an L.L. fitting is one used to make a turn to the left.

These directions are determined by holding the condulets up with the opening toward you, and the short L. on the lower end. Then, if this short

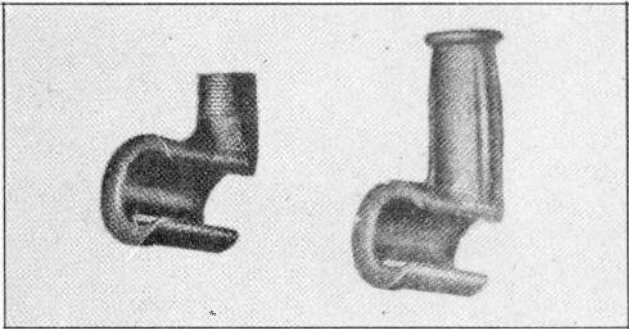

Fig. 23. These views show two types of grips or "hickeys" used with a pipe handle for bending conduit.

extension points to the right, it is an L.R., or if it points to the left it is an L.L. fitting.

An L.B. is one with a pipe opening in the back. An L.F. is one with the pipe opening to the front.

There are also Tee fittings with a tap opening on the back or either side desired, and cross fittings with openings on both sides, as well as the ends. The fittings here mentioned are the ones more commonly used and, along with the special fittings made, will fill almost every need that can arise.

## CONDUIT BENDING

The use of a bending hickey, and the procedure for making conduit bends is shown in the accompanying diagrams. Assuming a rightangle bend to be required, first measure the distance from the point where the conduit is to start to the outside of the bend that is to be made, and then mark this distance off on the floor by a line drawn as shown in figure A. Place the conduit on the floor with one end against the wall or some other back stop that will prevent the pipe from moving while the bend is being formed. Place the hickey on the conduit about two inches beyond the floor mark, put one foot on the pipe at the point where the bend is to start and bend the conduit up about 30 degrees, as in figure B, then move the hickey slightly closer to the wall end of the conduit and increase the bend. This procedure is repeated until the outer edge of the raised end of the pipe is vertical. If the bend has been successfully completed, the outer edge of the raised portion will be aligned with the mark on the floor as shown in figure C.

If the outer edge of the conduit falls beyond the mark as in figure D, move the hickey back toward the wall from its last position about  $\frac{3}{4}$  inch and bend the pipe still further as in figure E; then reverse the hickey, move it close to the center of the bend, and by pulling up on it, bring the raised portion back to the vertical position.

Should the raised portion of the conduit fall short of the line as indicated in figure F, reverse the hickey and, placing it at the center of the bend, unbend the conduit slightly. Then slide the hickey further up the bend as shown in figure G bring the raised section to a vertical position. Just how much the hickey must be slid one way or the other when making these bends or adjustments on bends is a problem that can quickly be solved with a little practice.

Small radius bends at the end of the conduit are made by first placing a coupling on the end of the pipe to protect the threads; then the bend is made in the usual way, the coupling removed, and the pipe threaded down toward the bend as far as is necessary, and the surplus length cut off. Other

bends such as offsets, saddle bends, goosenecks, etc. can be made by following the procedure given above. With these bends, it is a good idea to lay

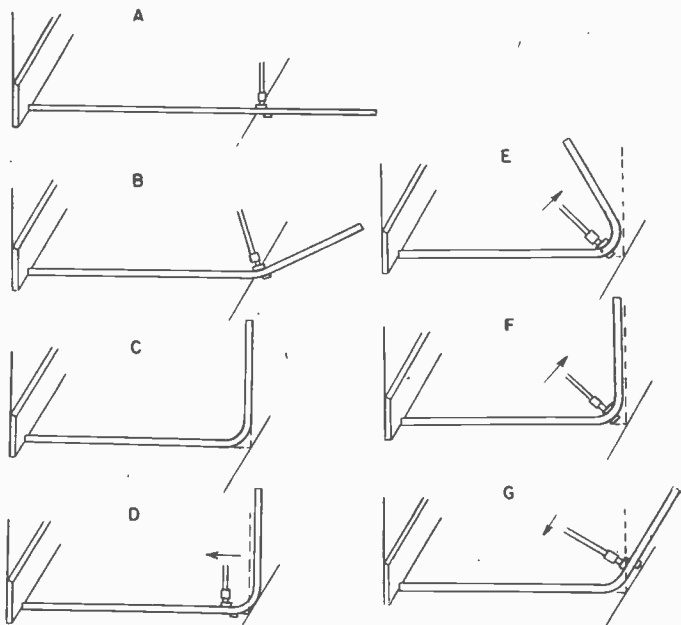

### BENDING THIN WALL CONDUIT ACCURATE STUBS

TO MAKE 11" - 90° BEND WITH 1/2" ELECTRUNITE STEELTUBES, ALLOW 5" FOR TAKE-UP AS SHOWN.

WITH 3/4" STEELTUBES ALLOW - 6"  
WITH 1" STEELTUBES ALLOW - 8"

KEEP FOOT ON BENDER

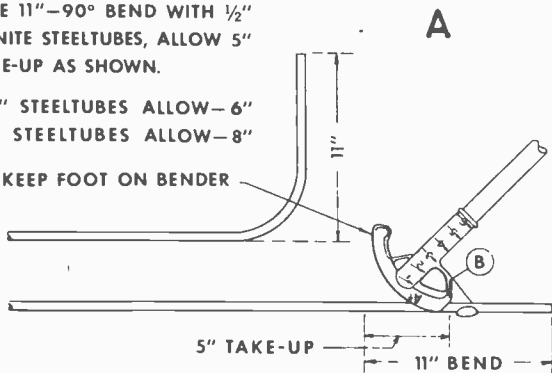



## TO STRAIGHTEN

PLACE HANDLE OF BENDER OVER STUB AND PUSH DOWN TO FLOOR IN ONE FULL SWEEP.

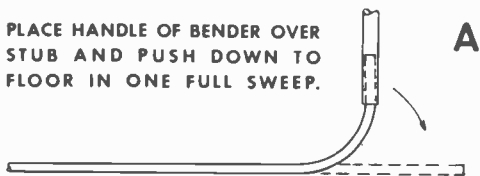

## TO MAKE A SADDLE BEND

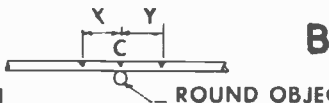

FIG. NO. 1

ROUND OBJECT

"C"—CENTER OF FINISHED SADDLE.

"X"—2 TIMES DIA. OF ROUND OBJECT FROM—"C"

"Y"—2 TIMES DIA. OF ROUND OBJECT FROM—"C"

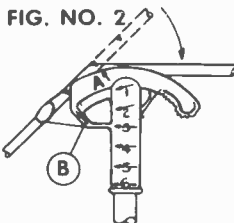
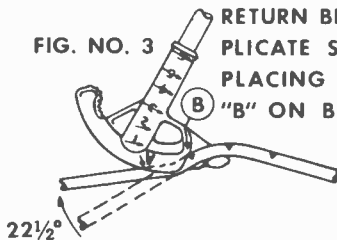

FIG. NO. 2

PLACE TUBE IN BENDER SO THAT "C" ON TUBE IS AT "A" ON BENDER AND MAKE 45° BEND.

REVERSE TUBE IN BENDER AND PLACE "X" ON TUBE AT "B" ON BENDER AND MAKE

FIG. NO. 3



RETURN BEND OF 22½°. DUPLICATE SAME PROCEDURE PLACING "Y" ON TUBE AT "B" ON BENDER AND THIS WILL COMPLETE SADDLE SHOWN IN FIG. NO. 4.

FINISHED SADDLE—NOTE THAT ROUND OBJECT FITS NEATLY UNDER SADDLE.

FIG. NO. 4



## PERFECT BACK TO BACK BENDS

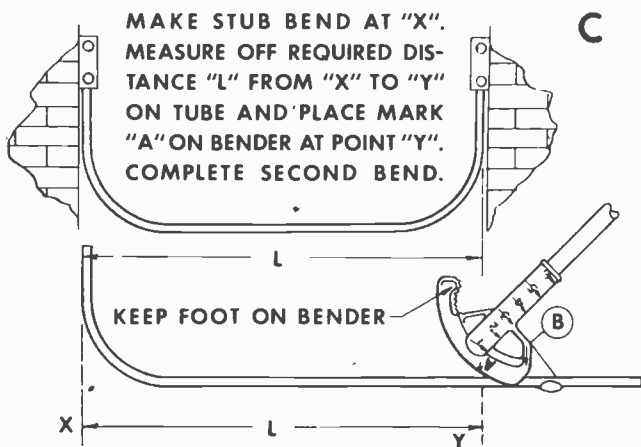

## TRUE OFFSETS

FIRST MAKE 45° BEND IN TUBE. REVERSE TUBE IN BENDER AND ADJUST SO THAT POINT "X" IS IN ALIGNMENT WITH INCH MARK ON HANDLE CORRESPONDING TO DEPTH OF OFFSET DESIRED. THEN MAKE SECOND BEND 45° AND A TRUE OFFSET WILL RESULT BETWEEN POINTS "X" AND "Y".

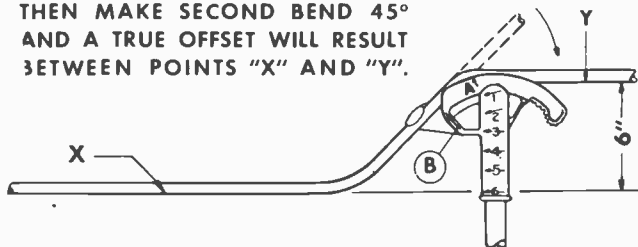

out the shape to be made on the floor with chalk, and then to bend the pipe to fit the chalk pattern. On this basis, measurements are made where the pipe is to be installed, and the angle required of the various bends determined; these values are then transferred to the chalk drawn pattern, and the bends executed one at a time in accordance with the requirements.

## Rigid Conduit

### 13. PULL BOXES AND JUNCTION BOXES

In addition to these fittings, and the regular outlet boxes used for mounting switches and fixtures, there are also **pull boxes**, which are used at various points in long runs of conduit to make it easier to pull in the wires in shorter sections at a time.

Sometimes the run of conduit is so long, or has so great a number of bends, that it is impossible to pull the wires through the whole distance at once without running the risk of breaking them or damaging the insulation. In such cases the wires can be pulled through as far as the first pull box along the run, and then looped back, and pulled through the following section.

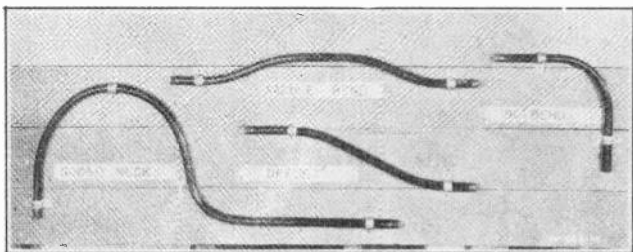

Fig. 24. This photo shows several of the more common bends frequently made in conduit. Note the names given to each. The saddle bend can, of course, be made much deeper in the form of a "U" when required.

In other cases boxes are used where there are junctions in the wiring system and a number of splices must be made. These are called "**Junction**" boxes. Several of the more common types of outlet boxes are shown in Fig. 25. There are many types of special boxes for almost every possible requirement, but those shown and mentioned here will fill the need in 95 per cent or more of the cases in ordinary wiring jobs. Fig. 26 shows a number of the covers used on these boxes. Some are blank for merely closing the boxes, and others have openings and screws for attaching switches or receptacles, or for leading out wires to other terminals, or systems.

### 14. SUPPORTS FOR CONDUIT

Conduit is supported and fastened with pipe straps, which may have either two holes for nails

## Rigid Conduit

or screws, or a single hole. Fig. 25 shows several different types and sizes of straps.

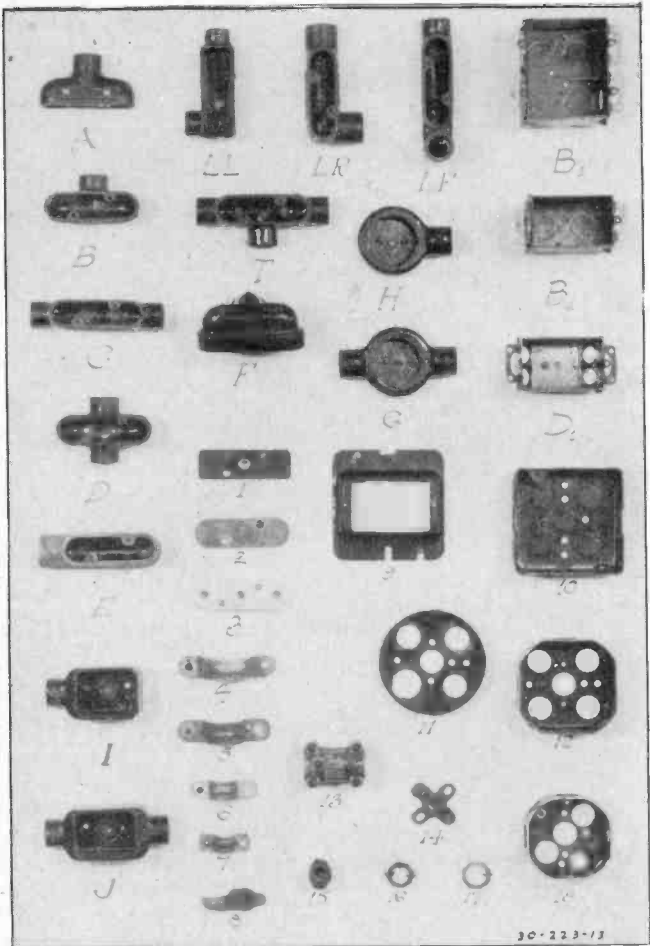

Fig. 25. This photo shows a number of the more common types of conduit fittings and outlet boxes, also porcelain covers for the fittings, conduit straps, fixture stud and lock nuts.

When these straps must be attached to brick or masonry it is necessary to first drill holes in the masonry with a star drill, such as shown in Fig. 27. These drills can be obtained in different sizes, and

## Rigid Conduit

are used to make holes of any desired depth by simply tapping them with a hammer and gradually rotating them in the hole. Those of the larger size can be used to make openings clear through a wall for the conduit to pass through.

When holes are made for conduit fasteners a special plug can be driven tightly into these holes to receive wood screws or nails; or a more desirable method is to use expansion bolts, similar to those shown in Fig. 28. For expansion bolts the star drill holes must be made the proper size to fit the bolt, and when the expansion shell is inserted, and

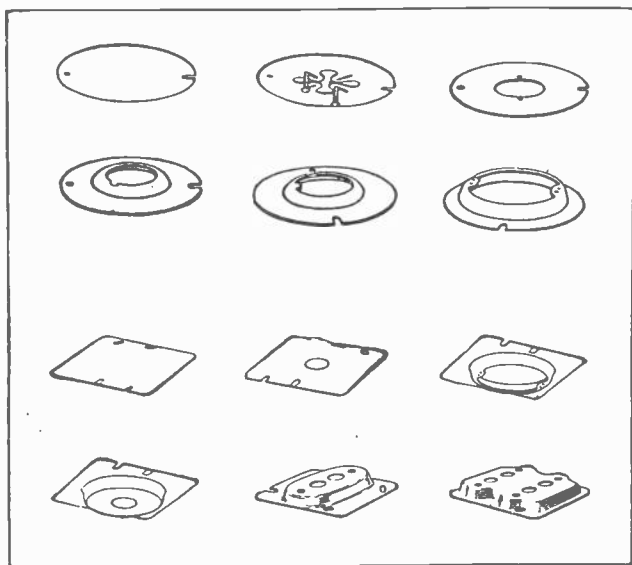

Fig. 26. Various types of covers can be obtained for outlet boxes and for mounting switches, lamp receptacles, etc.

the bolt screwed into it, it causes the shell to spread and tightly grip the sides of the hole.

For fastening conduit or wiring materials to tile, a **toggle bolt** such as shown in Fig. 29 is used. These bolts have a hinge bar or cross-piece, which can be folded against the side of the bolt so they can be pushed into a small hole in the tile. Then, by turning the bar crosswise, the ends of this bar

## Rigid Conduit

catch on the inner side of the hole, making a very secure anchorage.

In buildings of concrete or masonry construction the pipe is embedded in the cement, brick, or tile and requires no supports, except to hold it in place temporarily while the concrete is being poured, or the masonry erected around it.

The Code requires that in all conduit installations the pipe and fittings must be installed complete before any wiring is put in, and the wires should not be run until all mechanical construction work around the building is finished. This rule is made to avoid the possibility of the wires being damaged.

Ordinary rubber covered wire, with either single or double braid, can be used in conduit systems; but double braid must be used on wires larger than No. 8. In special locations where it is particularly dry and hot, wire with slowburning insulation can be used.

For use in conduit, wires No. 6 and larger must be stranded for better flexibility and ease in pulling them in.



Fig. 27. This view shows the cutting nose of a star drill, such as used for drilling holes in masonry for attaching or running conduit in buildings of masonry construction.

### 15. PULLING WIRES INTO CONDUIT

To pull wires into a conduit system we first push a steel "fish tape" through the pipe. This can be forced through the allowed number of bends quite easily, as a rule. The wires are then attached to the end of the fish tape and pulled in the conduit. **All the wires in any one run should be pulled in at one time.** It is possible but very difficult to draw wires into pipe that already has several in it, because of the friction of the sticky insulation of the moving wires rubbing against the stationary ones.

This same rule applies when repairing or replacing wires in conduit. You may wish to replace only

## Rigid Conduit

one or two wires, but it will often be better to remove the entire group, and then pull the new ones in with the old wires.

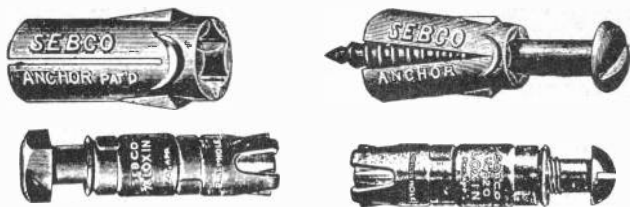

Fig. 28. Several types of expansion bolts and shells used for fastening conduit strips to holes and masonry.

No splices are allowed in wires in the conduit, or at any place except in the proper fittings or outlet boxes.

If we were to attempt to pull spliced wires into a run of conduit, the tape might be pulled off at some bend or corner, leaving the bare splice to cause a ground or short circuit.

As each section of the wiring is pulled into runs of conduit, the ends can be cut off at the outlet box, always allowing enough to make the necessary splices and connections. It is much better to

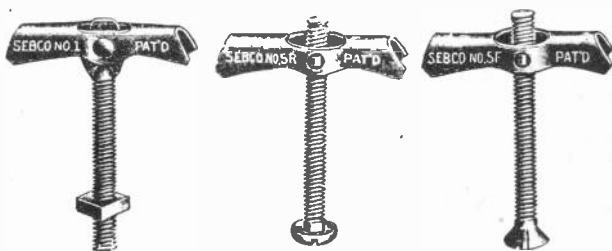

Fig. 29. Toggle bolts of the type used to attach conduit to tile walls or ceilings.

allow a couple of inches extra and cut these off when installing the switches and fixtures, than to have the wires too short, and have to replace them or draw them up in a manner that places a strain on them.

Sometimes considerable difficulty is experienced in pulling wires into long runs with a number of

## Rigid Conduit

bends, but a great deal of this can be eliminated by proper care. If a large number of wires are to be pulled into any conduit, or if they have been started and don't come through easily, it is well to withdraw them and blow some powdered soap stone, or powdered mica, into the conduit. This lubricates the wires, and eliminates a great deal of the friction, without doing any damage to the insulation. This is particularly useful when pulling in large cables.

Never use oil or grease of any kind on the wires, as it is very injurious to the insulation.

While pulling on the wires from one end, it is a very good idea to have someone feed them carefully in to the point where they are drawn in. Keeping the wires straight and free from kinks and twists will help considerably to make them pull in with the least possible friction.

Sometimes in vertical runs of conduit, instead of using a steel fish tape, a "mouse" consisting of a small steel ball or piece of steel chain, is dropped through the pipe with a string attached, and this cord can then be used to pull in the wires; or a large rope which in turn can be attached to the wires.

Wires in long vertical runs of conduit in high buildings should be supported at various intervals, either by driving wood wedges into the pipes at outlet boxes, or by looping the wires around strain insulators in special boxes. This is done to remove from the wires near the top the strain of the weight of a long vertical run.

### 16. NUMBER OF CIRCUITS AND WIRES ALLOWED IN ONE CONDUIT

Wires of different voltages, such as bell wires and wires for light or power, must never be run in the same conduit for safety reasons.

When running wires for alternating current systems, the two wires of a single phase, or three wires of the three phase system, must all be run in the same conduit; otherwise, they will set up magnetically induced currents in the iron pipe, which will cause it to overheat.



(11-12-11)	346	346
(11-5-11)	321	321
(10-27-11)	296	296
(10-22-11)	176	176
(10-13-11)	245	245
(10-8-11)	241	241
(10-1-11)	210	210
(9-24-11)	210	210
(9-17-11)	158	158
(9-11-11)	177	177
(9-3-11)	169	169
(8-1-11)	1	1

346  
 321  
 296  
 176  
 245  
 241  
 210  
 210  
 158  
 177  
 169  
 150  
 1

346  
 321  
 296  
 176  
 245  
 241  
 210  
 210  
 158  
 177  
 169  
 150  
 1

150 . 155

141 - 130

(8-6-48)

(8-1-47)

~~141 - 141 - (7-25-47)~~

~~113 - 124 - (7-17-47)~~

~~163 - 114 - (9-10-47)~~

~~93 - 102 - (7-3-47)~~

~~86 - 93 - (8-18-47)~~

~~63 - 74 - (6-11-47)~~

~~57 - 68 - (7-22-47)~~

~~39 - 52 - (7-7-47)~~

~~26 - 39 - 5~~

## Rigid Conduit

Running all the wires of the same circuit through the one pipe causes their magnetic flux to be neutralized, because the currents flow in different directions through the different wires.

The following tables apply only to complete conduit systems, and do not apply to short sections of conduit used for the protection of exposed wiring from mechanical injury.

### TWO-WIRE AND THREE-WIRE SYSTEMS.

Size of Wire		Number of Wires in One Conduit								
		1	2	3	4	5	6	7	8	9
		Minimum Size of Conduit in Inches								
No.	14	1/2	1/2	1/2	1/2	3/4	3/4	3/4	1	1
	12	1/2	1/2	1/2	3/4	3/4	3/4	1	1	1 1/4
	10	1/2	3/4	3/4	3/4	1	1	1 1/4	1 1/4	1 1/4
	8	1/2	3/4	3/4	1	1 1/2	1 1/2	2	2	2
	6	1/2	1	1 1/4	1 1/4	1 1/2	1 1/2	2	2	2
	5	3/4	1 1/4	1 1/4	1 1/4	2	2	2	2	2 1/2
	4	3/4	1 1/4	1 1/4	1 1/4	2	2	2	2	2 1/2
	3	3/4	1 1/4	1 1/4	1 1/2	2	2	2 1/2	2 1/2	2 1/2
	2	3/4	1 1/4	1 1/2	1 1/2	2	2	2 1/2	2 1/2	2 1/2
	1	3/4	1 1/2	1 1/2	2	2	2 1/2	2 1/2	3	3
	0	1	1 1/2	2	2	2 1/2	2 1/2	3	3	3
	00	1	2	2	2 1/2	2 1/2	3	3	3	3 1/2
	000	1	2	2	2 1/2	3	3	3	3 1/2	3 1/2
	0000	1 1/4	2	2 1/2	2 1/2	3	3	3 1/2	3 1/2	4
	200000 C.M.	1 1/4	2	2 1/2	2 1/2	3	3	3 1/2	3 1/2	4
	225000	1 1/4	2 1/2	2 1/2	3	3	3 1/2			
	250000	1 1/4	2 1/2	2 1/2	3	3	3 1/2			
	300000	1 1/4	2 1/2	3	3	3 1/2	3 1/2			
	350000	1 1/4	2 1/2	3	3 1/2	3 1/2	4			
	400000	1 1/4	3	3	3 1/2	4	4			
	450000	1 1/2	3	3	3 1/2	4	4 1/2			
	500000	1 1/2	3	3	3 1/2	4	4 1/2			
	550000	1 1/2	3	3 1/2	4	4	4 1/2			
	600000	2	3	3 1/2	4	4 1/2	5			
	650000	2	3 1/2	3 1/2	4					
	700000	2	3 1/2	3 1/2	4 1/2					
	750000	2	3 1/2	3 1/2	4 1/2					
	800000	2	3 1/2	4	4 1/2					
	850000	2	3 1/2	4	4 1/2					
	900000	2	3 1/2	4	4 1/2					
	950000	2	4	4	5					
	1000000	2	4	4	5					
	1100000	2 1/2	4	4 1/2	6					
	1200000	2 1/2	4 1/2	4 1/2	6					
	1250000	2 1/2	4 1/2	4 1/2	6					
	1300000	2 1/2	4 1/2	5	6					
	1400000	2 1/2	4 1/2	5	6					
	1500000	2 1/2	4 1/2	5	6					
	1600000	2 1/2	5	5	6					
	1700000	3	5	5	6					
	1750000	3	5	5	6					
	1800000	3	5	6	6					
	1900000	3	5	6	6					
	2000000	3	5	6	6					

Fig. 30. This table gives the proper number of wires of different sizes which can be allowed in various conduits. It is very convenient to use in selecting the proper size of conduit for certain number of wires of any desired size.

## Rigid Conduit

Fig. 30 shows a table which gives the proper number of wires that are allowed in conduit of any given size; or, in other words, this table can be used to determine the sizes of conduit required for any number of wires of a certain size.

RUBBER-COVERED WIRE—OUTSIDE DIAMETER

Size Wire	Diameter Outside Insulation		Circumference, Inches	Size Wire	Diameter Outside Insulation		Circumference, Inches
	Diam. of Bare Copper, Inches	Inches			Near est 64th	Diam. of Bare Copper, Inches	
14*	.064	.19	$1\frac{1}{64}$	250,000	.575	.89	$2\frac{51}{64}$
12*	.080	.21	$1\frac{1}{64}$	300,000	.630	.94	$2\frac{63}{64}$
10*	.102	.24	$1\frac{1}{64}$	350,000	.681	.99	$3\frac{3}{64}$
8*	.128	.27	$1\frac{1}{64}$	400,000	.728	1.03	$3\frac{15}{64}$
6	.184	.40	$2\frac{3}{64}$	450,000	.772	1.08	$3\frac{33}{64}$
5	.206	.42	$2\frac{1}{64}$	500,000	.814	1.12	$3\frac{33}{64}$
4	.232	.45	$2\frac{1}{64}$	550,000	.855	1.18	$3\frac{46}{64}$
3	.260	.48	$2\frac{1}{64}$	600,000	.893	1.23	$3\frac{53}{64}$
2	.292	.51	$2\frac{1}{64}$	650,000	.929	1.27	$3\frac{63}{64}$
1	.332	.58	$2\frac{1}{64}$	700,000	.964	1.30	$4\frac{5}{64}$
0	.373	.62	$2\frac{1}{64}$	750,000	.998	1.33	$4\frac{12}{64}$
00	.418	.67	$2\frac{1}{64}$	800,000	1.031	1.36	$4\frac{17}{64}$
000	.470	.72	$2\frac{1}{64}$	850,000	1.062	1.40	$4\frac{26}{64}$
0000	.528	.78	$2\frac{1}{64}$	900,000	1.093	1.44	$4\frac{33}{64}$
				950,000	1.123	1.47	$4\frac{40}{64}$
				1,000,000	1.152	1.50	$4\frac{46}{64}$
				1,250,000	1.322	1.68	$5\frac{18}{64}$
				1,500,000	1.412	1.78	$5\frac{37}{64}$
				1,750,000	1.552	1.92	$6\frac{3}{64}$
				2,000,000	1.631	2.00	$6\frac{13}{64}$

Fig. 32. This table gives the diameter of various sized wires in inches and fractions. These diameters are given both for bare and insulated wires.

For example, from 1 to 4 No. 14 wires will require  $\frac{1}{2}$ -inch conduit, while 5 to 7 can be run in  $\frac{3}{4}$ -inch conduit, and from 7 to 9 in 1-inch conduit. To run 5 number 10 wires requires 1-inch conduit, or to run 3 number 6 wires requires  $1\frac{1}{4}$ -inch conduit.

This table is very easy to read and use, by simply noting the sizes of the wire in the left-hand column and the number of wires desired in the row across the top, and then reading down under this number to the line for that size of wire, where the proper size of conduit will be found.

Examine this table carefully and become familiar with its use because it will prove very convenient.

## Rigid Conduit

For wire groups and combinations not shown in the table, it is recommended that the sum of the cross sectional areas of the wires to be run in any conduit should not be more than 40 per cent of the area of the opening or bore in the conduit.

Under such conditions, however, it is usually well

Dimensions of Rubber-Covered Wire.

Wire	Area	Wire	Area	Wire	Area
14	.031	225,000 C.M.	.55	1,000,000 C.M.	1.75
12	.038	250,000 C.M.	.58	1,100,000 C.M.	2.04
10	.045	300,000 C.M.	.67	1,200,000 C.M.	2.16
8	.071	350,000 C.M.	.75	1,250,000 C.M.	2.22
6	.13	400,000 C.M.	.83	1,300,000 C.M.	2.27
5	.15	450,000 C.M.	.91	1,400,000 C.M.	2.40
4	.16	500,000 C.M.	.99	1,500,000 C.M.	2.52
3	.19	550,000 C.M.	1.08	1,600,000 C.M.	2.63
2	.21	600,000 C.M.	1.16	1,700,000 C.M.	2.78
1	.27	650,000 C.M.	1.23	1,750,000 C.M.	2.85
0	.31	700,000 C.M.	1.30	1,800,000 C.M.	2.89
00	.35	750,000 C.M.	1.38	1,900,000 C.M.	3.05
000	.41	800,000 C.M.	1.45	2,000,000 C.M.	3.14
0000	.48	850,000 C.M.	1.52		
		900,000 C.M.	1.60		
		950,000 C.M.	1.68		

Fig. 33. Table of areas of various wires and cables in square inches. These figures are very convenient when calculating the area of a number of conductors to go in conduit. Areas given include insulation.

### DIMENSIONS OF CONDUIT

Conduit	Area	40% of Area	Conduit	Area	40% of Area
$\frac{1}{2}$	.306	.122	3	7.34	2.93
$\frac{3}{4}$	.516	.206	$3\frac{1}{2}$	9.94	3.97
1	.848	.339	4	12.7	5.08
$1\frac{1}{4}$	1.49	.596	$4\frac{1}{2}$	15.9	6.36
$1\frac{1}{2}$	2.03	.812	5	19.9	7.96
2	3.32	1.328	6	28.8	11.52
$2\frac{1}{2}$	4.75	1.9			

Fig. 34. This table gives both the total area of the inside opening in conduit, and 40% of the area of the different sizes, which is the amount that can be occupied by the conductors.

to consult the local Inspection Department before going ahead with the work.

The table in Fig. 32 gives the diameter in fractions of an inch for the different sized wires, both bare and with insulation, while table 33 gives the area in thousandths of a sq. inch of the more common sized wires. These tables will make it easy to determine the total area of a number of wires of

## Rigid Conduit

any size that you might desire to run in conduit. Then it will be easy to tell whether this is more than 40 per cent of the size of the conduit, by referring to table 34, which gives the area in sq. inches of the different standard sizes of conduit.

### SIZE OF CONDUIT FOR THE INSTALLATION OF WIRES AND CABLES

Lead Covered Wires (0-600 Volts)												
Size of Conduit to Contain Not More than Four Cables												
Size of Conductor	Single Conductor Cable				2-Conductor Cable				3-Conductor Cable			
	1	2	3	4	1	2	3	4	1	2	3	4
	Cables in One Conduit				Cables in One Conduit				Cables in One Conduit			
14	½	¾	¾	1	½	1	1	1½	¾	1½	1½	1½
12	½	¾	¾	1	½	1	1½	1½	1	1½	1½	2
10	½	¾	1	1	½	1	1½	1½	1	1½	2	2
8	½	1	1½	1½	1	1½	1½	2	1	2	2	2½
6	¾	1½	1½	1½	1½	1½	2	2½	1½	2½	3	3
4	¾	1½	1½	1½	1½	2	2½	2½	1½	3	3	3½
3	¾	1½	1½	2	1½	2	2½	3	1½	3	3	3½
2	1	1½	1½	2	1½	2	2½	3	1½	3	3½	4
1	1	1½	2	2	1½	2½	3	3½	2	3½	4	4½
0	1	2	2	2½	2	2½	3	3½	2	4	4½	5
00	1	2	2	2½	2	3	3½	4	2½	4	4½	5
000	1½	2	2½	2½	2	3	3½	4	2½	4½	4½	5
0000	1½	2½	2½	3	2½	3	3½	4½	3	5	6	6
250,000	1½	2½	3	3	...	...	...	...	3	6	6	...
300,000	1½	3	3	3½	...	...	...	...	3½	6	6	...
350,000	1½	3	3	3½	...	...	...	...	3½	6	6	...
400,000	1½	3	3	3½	...	...	...	...	3½	6	6	...
450,000	1½	3	3	4	...	...	...	...	4	6	6	...
500,000	1½	3	3½	4	...	...	...	...	4	6	...	...
600,000	2	3½	4	4½	...	...	...	...	...	...	...	...
700,000	2	4	4	5	...	...	...	...	...	...	...	...
750,000	2	4	4	5	...	...	...	...	...	...	...	...
800,000	2	4	4½	5	...	...	...	...	...	...	...	...
900,000	2½	4	4½	5	...	...	...	...	...	...	...	...
1,000,000	2½	4½	4½	6	...	...	...	...	...	...	...	...
1,250,000	3	5	5	6	...	...	...	...	...	...	...	...
1,500,000	3	5	6	6	...	...	...	...	...	...	...	...
1,750,000	3	6	6	...	...	...	...	...	...	...	...	...
2,000,000	3½	6	6	...	...	...	...	...	...	...	...	...

The above sizes apply to straight runs or with nominal offsets equivalent to not more than two quarter-bends.

It is recommended that bends have a minimum radius of curvature at the inner edge of the bend of not less than 10 times the internal diameter of the conduit.

Fig. 35. This table gives the number of lead covered wires of different sizes that can be contained in various sized conduits.

This latter table also shows in two of the columns, 40 per cent of the area of each size conduit, which makes it a very handy table. As an example of its use, if we were required to run six number 6

## Rigid Conduit

wires and four number 2 wires all rubber covered, we would multiply the area of a number 6 wire, which is .13, by 6; or  $.13 \times 6 = .78$ . Then also multiply the area of a number 2 wire which is .21, by 4; or  $.21 \times 4 = .84$ . Then .78 plus .84 equals 1.62 square inches, total area for all the wires.

Now in the column headed "40 per cent of the area", it will be found that a 2½-inch conduit will be required, as it is the next larger, and 40 per cent of its area will be 1.90 square inches.

Ordinarily the Code doesn't permit more than nine wires of any size in one conduit. Sometimes it is not advisable to allow even this many, not only because of the difficulty in pulling them in but also because if one wire breaks down or develops a short or ground, the arc is likely to damage the insulation of all the others and cause trouble in other circuits as well.

Where lead covered conductors are to be run in conduit, the table in Fig. 35 will be very convenient for determining the proper size of conduit for any number of lead covered wires of a given size.

### 17. GROUNDING CONDUIT SYSTEMS

When the entire conduit system is installed, complete from the service switch and meter throughout the entire building, it **must be thoroughly grounded** as near to the source of current supply as possible. This ground connection should be made at a waterpipe whenever available. If no piping systems are in the building which can be depended upon for a good ground connection, then a good ground rod or piece of pipe can be driven into the ground eight feet deep to make sure that it is always in contact with moist earth, or a large plate of metal can be buried several feet in the earth, and covered with charcoal and salt as well as earth.

All conduit systems are required to be grounded, whether any part of the wiring within them is grounded or not. These ground connections from the conduit to the waterpipe or ground rod should be as short as possible, and always accessible for inspection, as they must be maintained in good,

## Grounding Conduit

unbroken condition at all times.

Where the wiring system is not polarized and none of its wires are required to be grounded, the conduit can be grounded by use of copper ground strips, as shown in Fig. 36, or by extending a piece of conduit from the regular conduit system to the waterpipe and attaching it securely at both ends with special clamps.

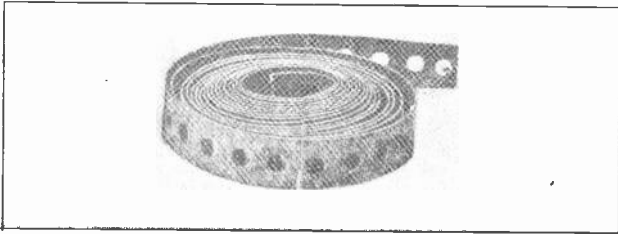

Fig. 36. Copper grounding strip of the type shown above is often used to ground conduit systems to the waterpipes or earth grounds.

Fig. 38 shows three styles of grounding clamps, the upper one of which is equipped with a cable lug, into which the heavy ground wire or cable should be securely soldered. The lower view shows two clamps that are used to attach both the ground



## Grounding Conduit

wire and a piece of conduit to the waterpipe. These are used for polarized wiring systems, which will be explained later, and in which it is required to ground the neutral wire of the system with a

ground wire, which is run through a short piece of conduit that is also connected to the waterpipe. This conduit not only acts as a ground for the conduit system, but also as protection for the ground wire of the electrical system. Always scrape all paint or rust from any pipe before attaching the ground clamp.

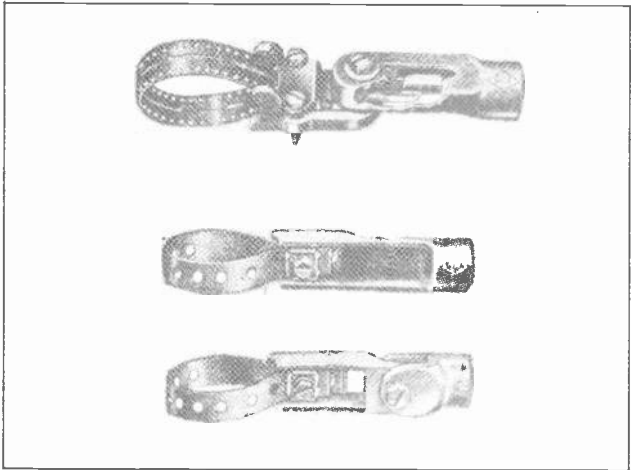

Fig. 38. Several approved type ground clamps used to attach both the conduit and ground wire to waterpipes.

This thorough grounding, as previously mentioned, is an essential requirement for maximum safety from fire and shock hazard in a wiring system, and should be done with the greatest of care by the electrician when installing such systems.

## Grounding Conduit



This view in a modern trade school shows many types of lighting fixtures and signs.

## Metallic Tubing

### 18. ELECTRICAL METALLIC TUBING

This is a lightweight pipe, much like rigid conduit, which has recently been approved by the Fire Underwriters. It is made with very thin walls, so thin in fact that we are not permitted to thread it. This means that threadless fittings are used, which saves considerable labor.

Fig. 40 shows one of the fittings in a sectional view which shows the manner in which the tapered split sleeves are drawn in by the threads to grip the pipe.

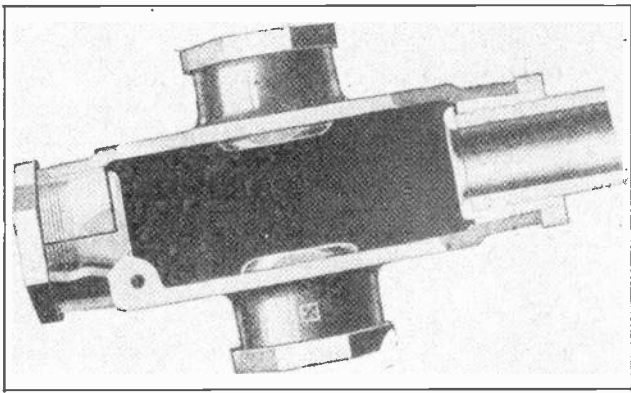

Fig. 40. Sectional view of a fitting for threadless conduit, showing the special gripping sleeves inside its ends.

Fig. 41 shows how easily the fittings can be placed on or removed from the pipe, by slipping the lock-nuts on the pipe and the grip-nuts inside the fitting. This tubing is lighter and easier to handle than regular conduit and is lower in price. It can be bent with less effort, and the cost of installation, due to the saving of time, is also less. Special couplings and fittings of all types are supplied for this tubing, similar to conduit fittings but with the grips for threadless pipe. Fig. 42 shows a coupling used for threadless tubing.

Split bushings are also made for use of standard conduit fittings with metallic tubing.

In most cases the same rules apply to this metallic tubing as to the standard conduit, except that it

## Metallic Tubing

cannot be threaded.

This tubing and its special fittings must be so finished that it will never be mistaken for rigid conduit. It may be finished in either enamel or zinc

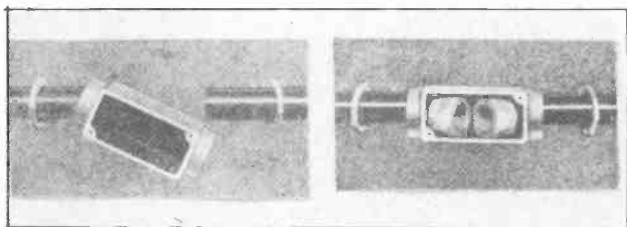

Fig. 41. This view shows the convenient manner in which threadless fittings can be installed with conduit.

and in standard sizes is approved in sizes from  $\frac{1}{2}$ -inch to 2 inches in diameter. Its use is restricted to voltages of 600 volts or less, to No. 0 wire or smaller and no circuit therein shall be fused for over

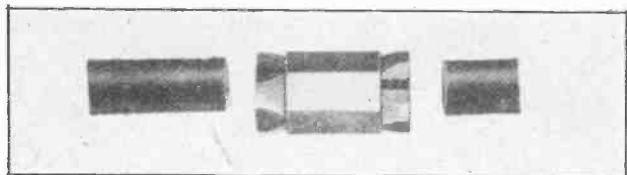

Fig. 42. Special coupling used for connecting together lengths of threadless conduit or electric metallic tubing.

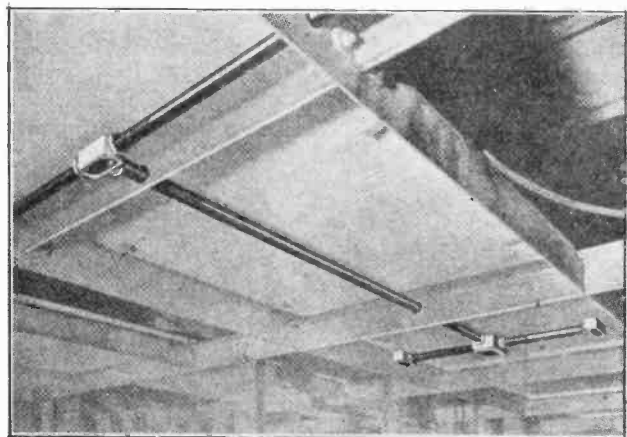
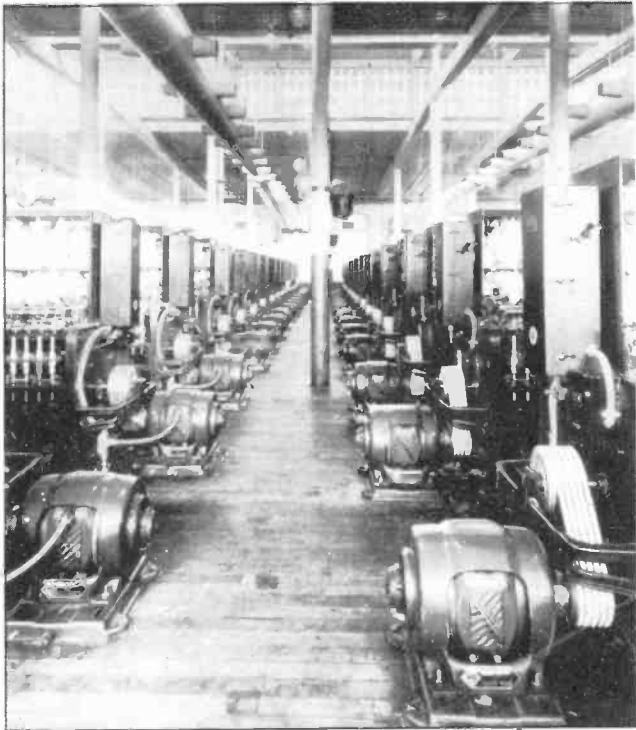

Fig. 43. Section of an installation of electric metallic tubing with threadless fittings.

## Flexible Conduit

100 amperes. Furthermore, it can be used concealed or exposed in dry places where it cannot be subjected to mechanical injury or corrosive vapors.

Even with these restrictions, its advantages, as noted above, make it a desirable system when put to its intended use. Fig. 43 shows a section of an installation of threadless tubing.



Flexible conduit is used for connections in these motors and controllers because it allows some movement of the motors for belt adjustment. These are Allis-Chalmers motors used in a large textile mill. They are equipped with the latest "Texrope" drives.

### 19. FLEXIBLE CONDUIT

Flexible conduit is used very much the same as rigid conduit, except that its flexibility permits it to be fished into walls and partitions in old buildings, where rigid conduit cannot be conveniently installed.

## Armored Cable

As mentioned before, flexible conduit consists of tubing made of spirally wound steel strips, the turns of which are securely locked together to form a continuous metal casing in which the wires are run. Fig. 44 shows pieces of flexible conduit of different types, which will give you a general idea of its construction.

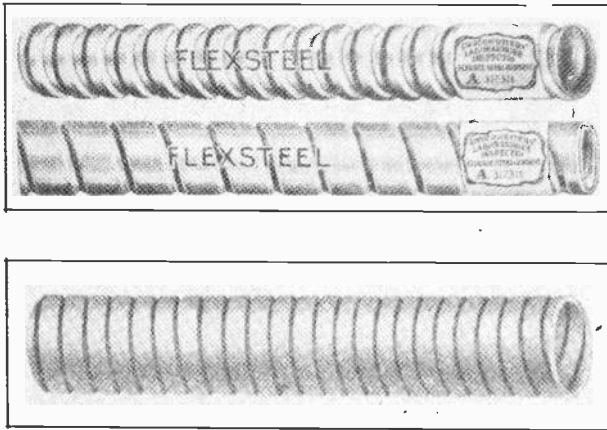

Fig. 44. Pieces of several types of flexible conduit, showing how it is constructed of narrow steel strips wound spirally.

Like rigid conduit, this system **must be run continuously from one outlet to the next, and the entire system grounded.**

Fig. 45 shows several types of couplings used in connecting lengths of flexible conduit together, and also to attach it to outlet boxes. The upper left view shows an ordinary straight coupling and the grooves which enable it to grip the turns of the conduit when it is bolted on. The lower left view shows a fitting for making sharp turns with flexible conduit, where it attaches to an outlet box. The upper right hand view shows a coupling that can be used for attaching flexible to rigid conduit, or for attaching flexible conduit to an outlet box, with an added nipple. The lower right view shows a very common connector used for attaching either flexible conduit or armored cable to outlet boxes.

**Flexible conduit is not as waterproof as rigid conduit is, and should not be used in very damp**

## Armored Cable

places, unless rubber covered wires with lead sheaths are used, and it should not be imbedded in concrete.

Its particular advantages are ease of installation, getting through difficult places with a number of bends, and for running flexible leads from rigid conduit to motors or other electrical machines.

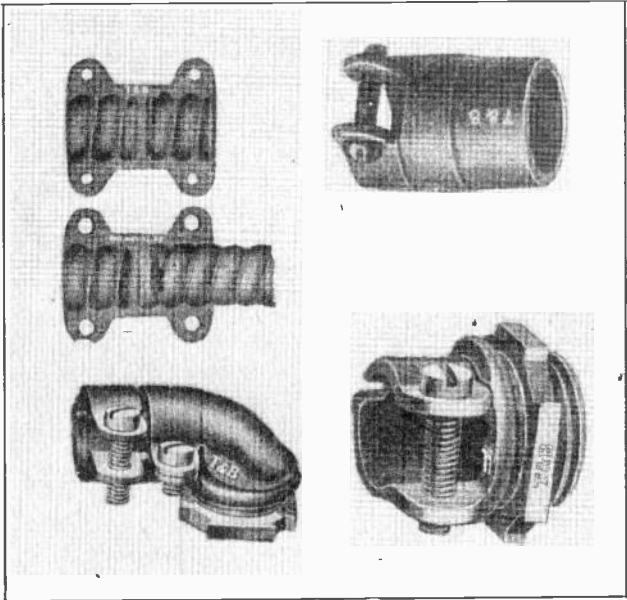

Fig. 45. Several types of couplings used for connecting flexible conduit together or to outlet boxes.

The same type of outlet boxes, conduit straps, and many of the same general rules for rigid conduit are also used for flexible conduit.

The more important points of conduit wiring systems have been carefully covered in this section, and it will be well for you to get a good general understanding of this system, as it is one of the most important of all and is in very extensive use.

### 20. ARMORED CABLE

On the outside, armored cable looks much like flexible conduit. But there is this difference; while the latter has the wire pulled in after it has been

## Armored Cable

installed, armored cable has the wires already in when purchased. It is made in two types and is frequently known as BX or BXL. The former con-

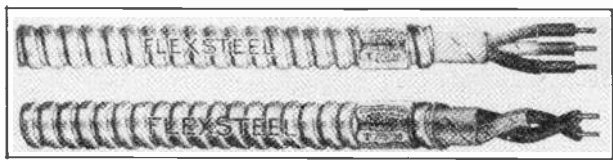

Fig. 47. Pieces of two different types of two-wire and three-wire armored cable. This material is supplied with the wires already in the armor.

sists of one, two, three or four conductors with rubber insulation and heavy waxed braid, and then an addition of an armor of steel ribbon.

Fig. 47 shows a piece of 3-wire BX and one with two wires. Note the color markings of the wires and the extra twin braid over each group.

BXL is made in a similar way but has the addition of a lead sheath just under the steel armor. This makes it waterproof and permits it to be used where there is moisture, or where it is exposed to the weather. BX may be obtained with wires from No. 4 to No. 14.

### 21. ADVANTAGES OF ARMORED CABLE WIRING

Armored cable wiring is a very convenient system for use in old wood construction buildings. While rigid conduit is usually used for concrete work, and sometimes used for other types of buildings, it is occasionally found too expensive for certain jobs.

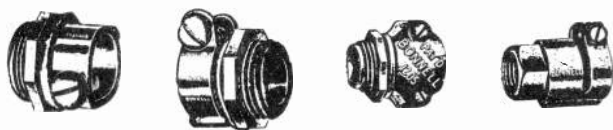

Fig. 48. Several types of fittings used for attaching armored cable to outlet boxes or rigid conduit.

The use of armored cable or BX gives us a first class job at low cost, can be installed almost as cheaply, and is much better than Knob and Tube work. It makes a good job on all new work, and is absolutely the best system for old house wiring. It is very convenient and economical to install be-



## Armored Cable

cause its flexibility makes it easy to run in difficult places and because, when BX is installed, the wires are in also and do not have to be pulled in later.

The same outlet and switch boxes are used for BX as for conduit, and are installed with BX fittings made for the purpose and clamped securely to the BX armor, and then fastened to the boxes with a lock-nut. Fittings are also made so that BX can be used in conjunction with the other systems of wiring. Several of these fittings are shown in Fig. 48.

Where possible BX should be fastened to the surface wired over with the proper size pipe straps. BX must be continuous from outlet to outlet. A

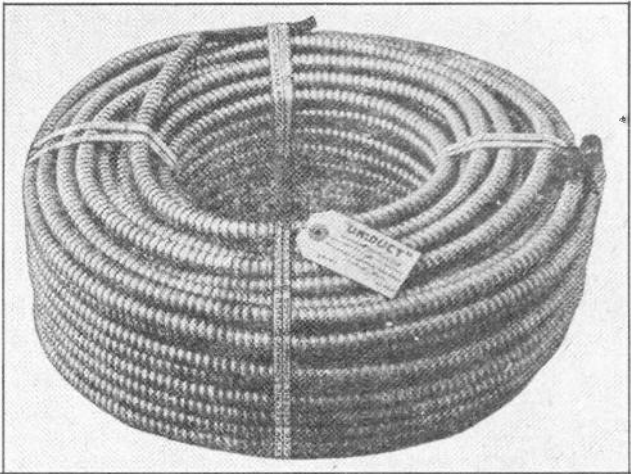

Fig. 49. A coil of armored cable or "BX" showing its convenient flexibility, which is one of the decided advantages of this material for wiring systems.

violation of this would mean that you would have splices outside the outlet boxes, which is against the rule for metal systems, and then besides, you would increase the chance of not having a perfect ground throughout the system. The braids over the insulation of the different wires have different colors so the wireman can trace the "hot" or grounded wires, as will be explained later.

## Armored Cable

BX can be bought in rolls of 250 ft. or less, and then cut into the desired lengths with a hack saw. Fig. 49 shows a coil of BX as it would be bought.

### 22. CUTTING AND STRIPPING BX

To cut BX, simply hold it firmly in a vise or against your knee or a piece of wood, and cut across one turn of the spiral steel wrapping, being sure to

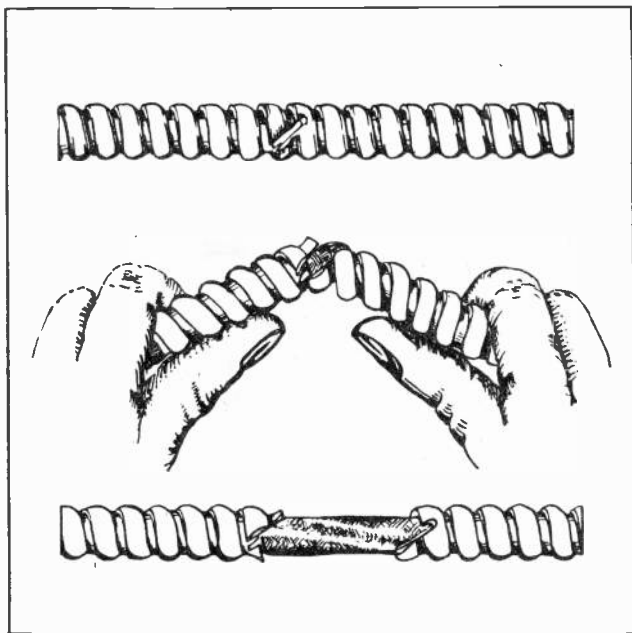

Fig. 50. The top view shows the proper method of cutting BX armor with a hack saw. The center view shows how it can then be broken apart without damaging the conductors or insulation inside. A short section of the armor can then be pulled off the end of the cable as shown in the lower view.

cut clear through one turn or strip of this steel, but do not cut into the insulation of the wire underneath.

To cut clear through the one turn it is necessary to cut partly thru a neighboring turn. Practice this cutting and you will soon find just the proper angle to hold the hack saw, and it will become very easy to make a neat cut. See Fig. 50.

## Metal Moldings

When the armor strip is cut through, bend the BX to open the cut and the armor will separate, and then the wires can be cut through squarely and easily with the hack saw.

To attach BX to an outlet box make the cut as described about 6 inches from the end, but only through the metal. Then bend the BX at the cut and separate the armor, and the short length can be easily pulled off from the ends of the wires. This leaves them ready to split the outer braid and strip the insulation for splicing. Fig. 51 shows a piece prepared in this manner. A special fibre bushing should be used to protect the wire insulation from the sharp end of the armor.

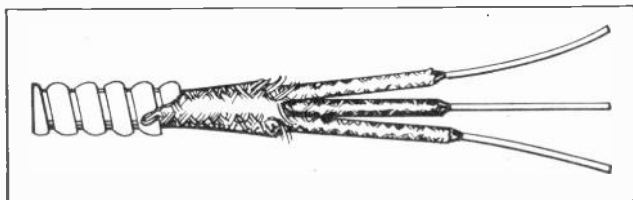

Fig. 51. This sketch shows how the ends of conductors in armored cable can be stripped for connection and splicing.

### 23. USE OF BXL

BXL or lead sheath BX is a very good system to use in underground work, running from one building to another, such as from a residence to a garage in the back end of the house-lot. A ditch of the proper depth, say 2 ft., can be dug. As the cable is flexible, this ditch does not necessarily have to be absolutely straight, but may be around any obstacle that might be in the way. Where galvanized rigid conduit is used more care has to be taken, and the joints where the lengths of conduit are coupled together must be leaded to keep out moisture. **Great care should be taken in handling BXL, so as not to crack the lead.** This precaution, of course, should be taken with all lead covered cables, but it is very necessary with BXL, as damage to the lead cannot be detected by inspection, and will only show up possibly weeks afterwards when moisture has time to leak through and cause a short.

## Metal Moldings

### 24. METAL RACEWAYS OR MOLDING

Metal Raceways or metal molding is one of the exposed wiring system that is quite extensively

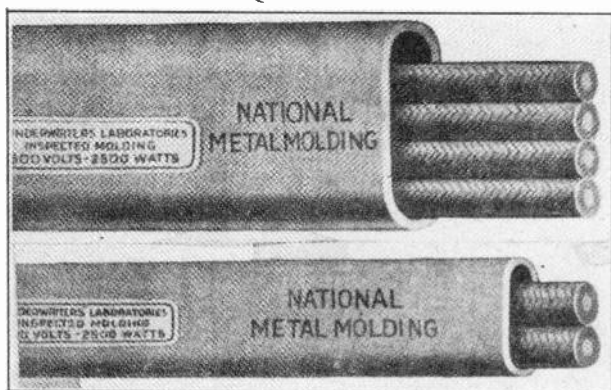

Fig. 52. Two pieces of metal molding of a very neat appearing type for exposed wiring systems.

used. Although it does not afford such rugged and safe protection for the wires as conduit and armored cable does, it is a very economical and quite dependable system, and is very convenient to install in finished buildings where new wiring or extensions to the old are to be installed. One of the advantages of metal molding is its neat appearance where wiring must be run on the surface of walls or ceiling in offices, stores, etc.

**It must never be run concealed or in damp places**

Two of the leading manufacturers of metal raceway materials call their products respectively, **wire mold** and **metal molding**, and they are quite commonly known by these names.

Fig. 52 shows two pieces of one style of molding called "Ovalduct", and in which the wires are drawn after it is installed, similarly to conduit.

Fig. 53 shows another style that comes in two strips. The back strip is installed and then the wires are laid in it and the cap snapped in place over them

Various types of fittings for couplings, corner turns, elbows, outlets, etc., are provided to fit these moldings. Fig. 54 shows a number of these fit-

## Metal Moldings

tings, and Fig. 55 shows a closer view of a common elbow fitting.

Many of the rules for BX systems apply also to metal raceways, such as: it must be continuous from outlet to outlet, must be grounded, and all wires of an A.C. circuit must be in one raceway, etc.

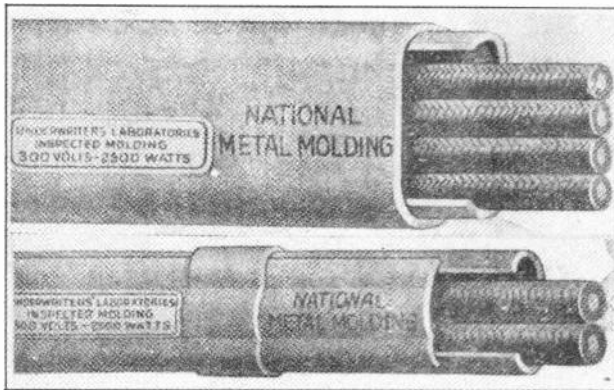

Fig. 53. Another type of metal molding with a removable cap or cover strip, which can be placed on after the wires are insulated.

You will note from the Figures 52 and 53 that metal raceways are made in two sizes for either two or four wires. Another size is available now for 10 wires, but is to be used only in certain places as allowed by the Code or local authorities. Wires sizes No. 14 to No. 8 can be used with these moldings and the wire must be rubber and braid covered, and installed with no splices except at proper boxes or fittings.

Fig. 56 shows a fitting that can be used as a junction box and for splices, or for an outlet box when a cover is used with an opening as shown.

Fig. 57 shows several sizes of boxes to be used with metal raceways for mounting switches and receptacles. Note the wall plates which are to be attached to the surface wired over, and have slots in their edges for the moulding to be slipped under to anchor it to them. Fig. 58 shows how these

## Metal Moldings

boxes are installed and the switches mounted in them.

Fig. 59 shows a number of other fittings for various uses as their descriptions indicate.

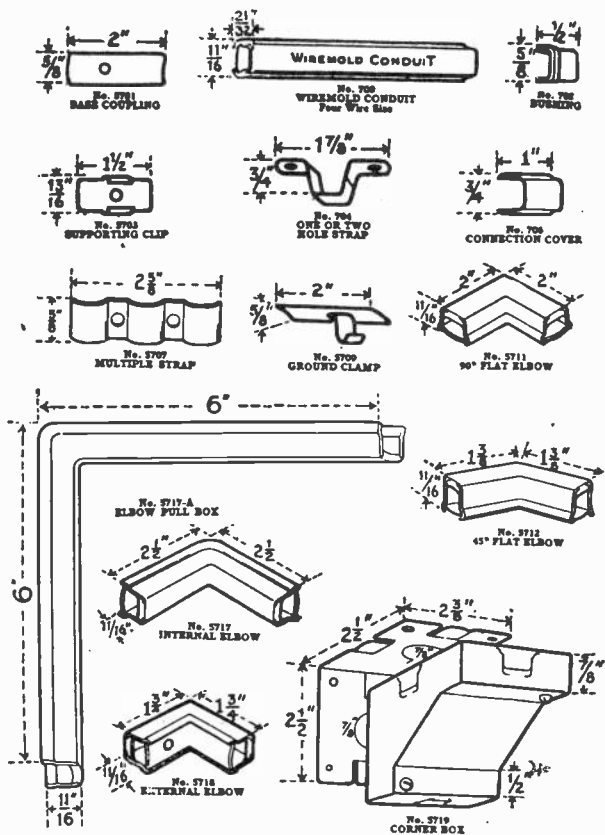

Fig. 54. A number of various types of fittings are provided for use with metal molding in making turns in the corners of walls and ceilings.



Fig. 55. A common form of elbow used with metal raceways or moldings.

## Metal Moldings

Metal molding can also be bent to fit or go around various corners or obstructions. For this

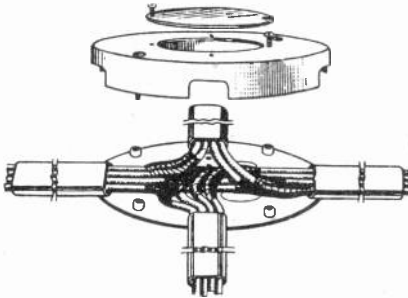

Fig. 56. This view illustrates the use of a junction box in which splices can be made, and various runs of metal raceway attached together. We can also attach lights or receptacles to the smaller opening in the cover of this box.

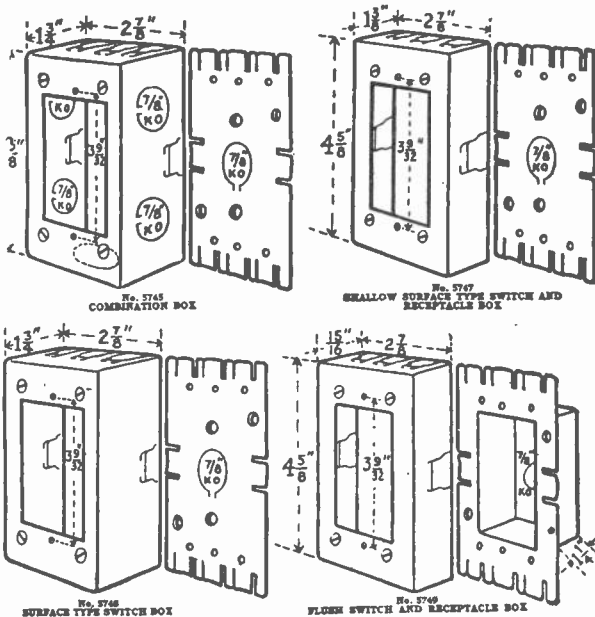

Fig. 57. Several styles and sizes of outlet box for use with metal molding and in which switches or receptacles can be installed.

purpose a bending tool, such as shown in Fig. 60 is used. This device has a rounded fitting on its

## Metal Moldings

handle, to make the molding bend in a neat curve of the proper size and without flattening. Molding is easy to bend because of its thin walls.

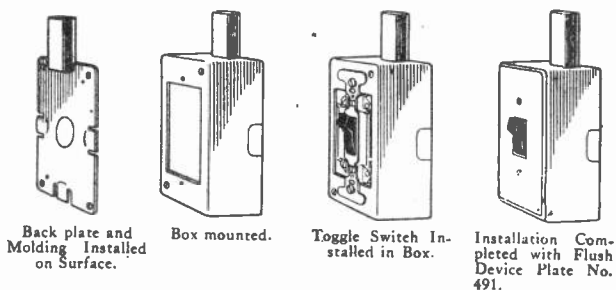

Fig. 58. These views show the various steps in installing a switch in the outlet box of a metal raceway system.

## 25. NEAT APPEARANCE

Fig. 61 shows the neat appearance of a run of metal molding to two ceiling light fixtures. This view shows that it is one of the best appearing of all exposed systems of wiring.

The method of attaching a fixture canopy to the ceiling plate and fixture stud, is shown in Fig. 62, and Fig. 64 shows how connections are made to the running wires, for drop cords and light fixtures. Note the porcelain connector block used to attach the fixture wires to the running wires by terminal screws instead of splices.

Fig. 63 shows the installation of a convenience outlet and the method of attaching a piece of BX to the same box, to run to a wall light fixture.



## Metal Moldings

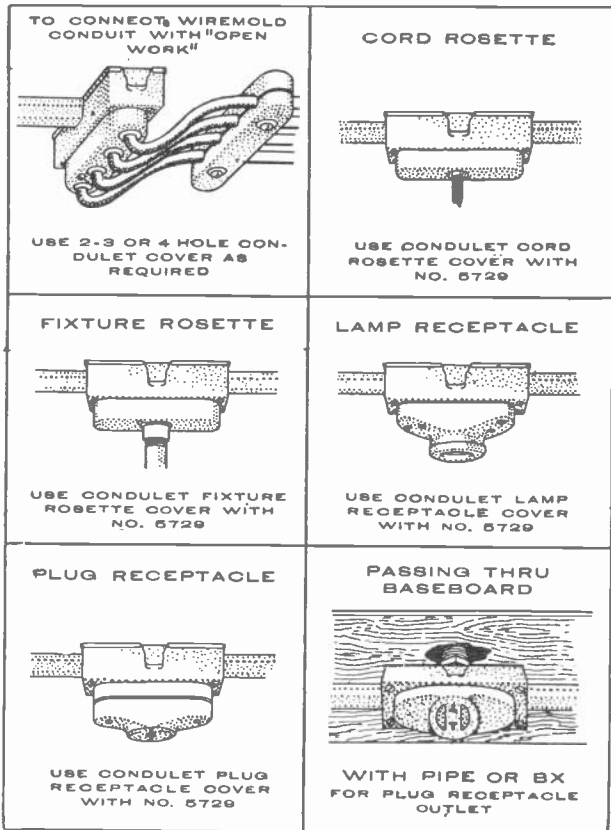

Fig. 59. Above are shown a number of fittings used with metal molding and an explanation of the use of each.

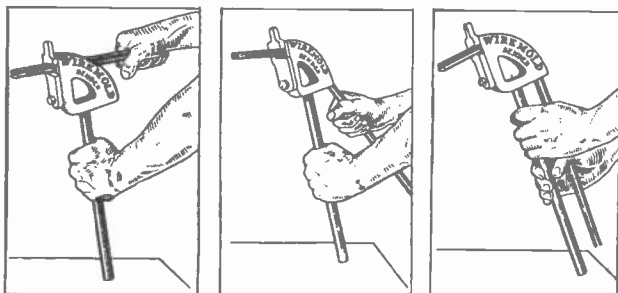

Fig. 60. This view shows a bending tool, and the method in which metal molding can be bent into different shapes for turns and corners.

## Metal Moldings

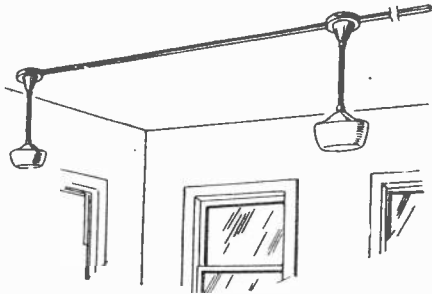

Fig. 61. Section of a metal raceway wiring system with two light fixtures attached. Note the neat appearance of this type of wiring for exposed work.

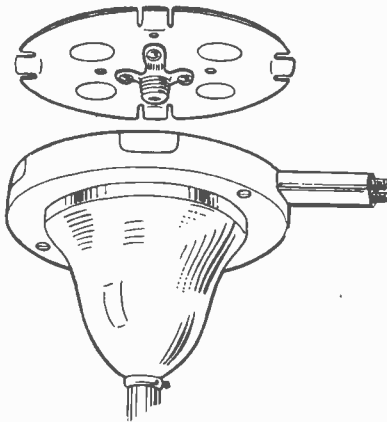

Fig. 62. This sketch shows the ceiling plate and fixture stud to which the light fixture and canopy are attached, and also the slots for attaching the molding to this plate.

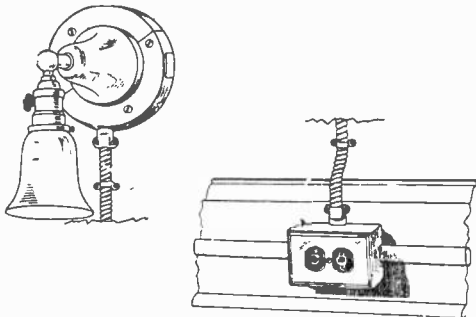

Fig. 63. Convenience receptacle and box on a metal molding system, showing BX attached for a branch circuit to a light.

## Duct System

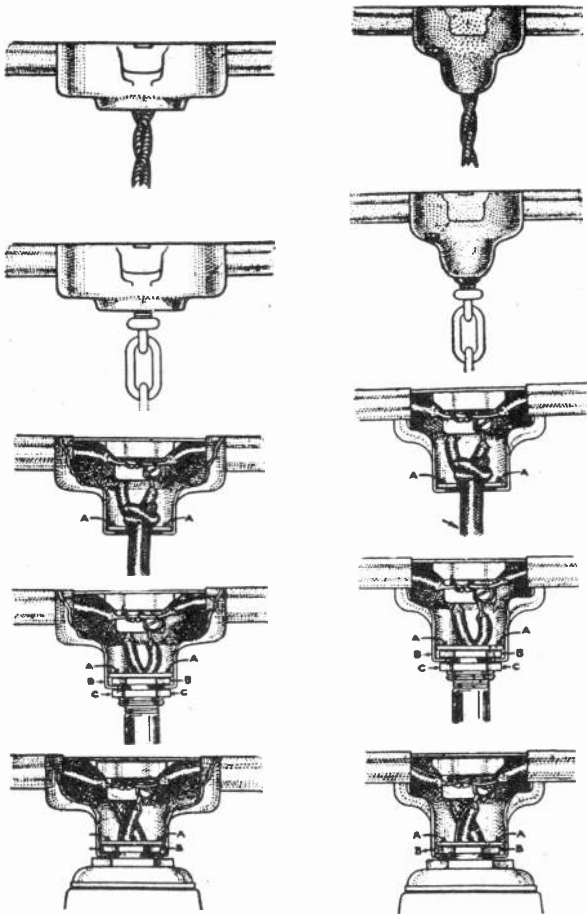

Fig. 64. The above views shows a number of styles of fittings used with metal molding and the method of making connections for fixtures. Note the connector blocks used for attaching fixture wires to the running wires.

## 26. DUCT SYSTEM

Another modern type of wiring which is becoming quite common in large industrial plants and office buildings is known as duct wiring. Instead of using iron pipe or conduit the wires are run in round or oval fibre ducts or tubes, as shown in Fig. 65.

## Trough Wiring

Advantages of this type of wiring system are the ease and economy of installation and the large number of wires that can be installed in the ducts. These ducts, with their joints properly sealed with waterproof cement, can be imbedded in concrete of new buildings. They can also be interconnected with conduit systems by means of proper fittings.

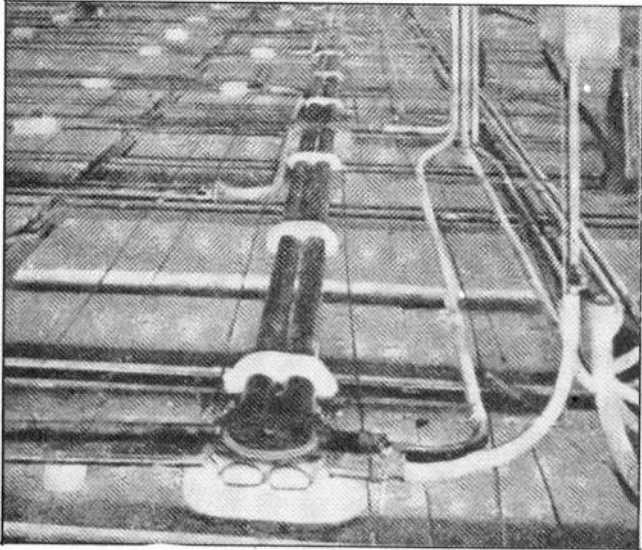

Fig. 65. This picture show an installation of oval duct just before the concrete is poured.

### 27. TROUGH WIRING

Square metal troughs such as shown in Figs. 66 and 67 are convenient in industrial plants where flexibility is desired for frequent wiring changes when machines are moved from one location to another. Another advantage is that these ducts are permitted to carry up to a maximum of 30 wires per duct. However, not more than 20% of the duct area should be filled with wires.

Removable cover strips and frequently spaced knockouts permit convenient accessibility of wires and changes of outlets. Suitable fittings are ob-

## Trough Wiring

tainable for turns, junctions, tees, and for coupling to extension circuits in conduit or B.X. Metal-

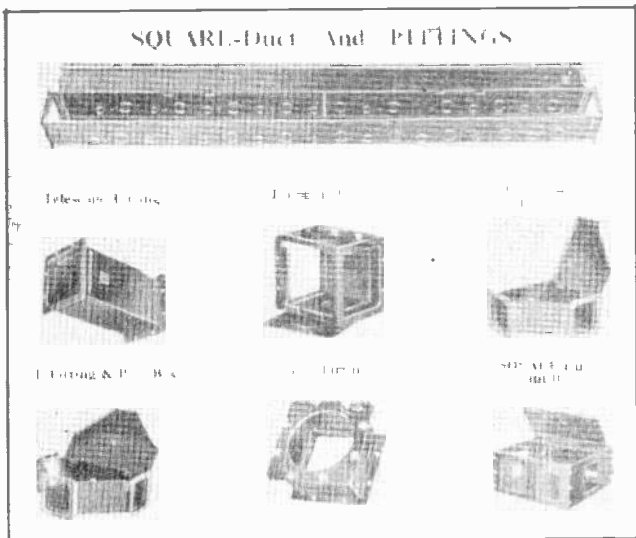

Fig. 66. Square duct as shown above comes under the classification of "wireways and busways."

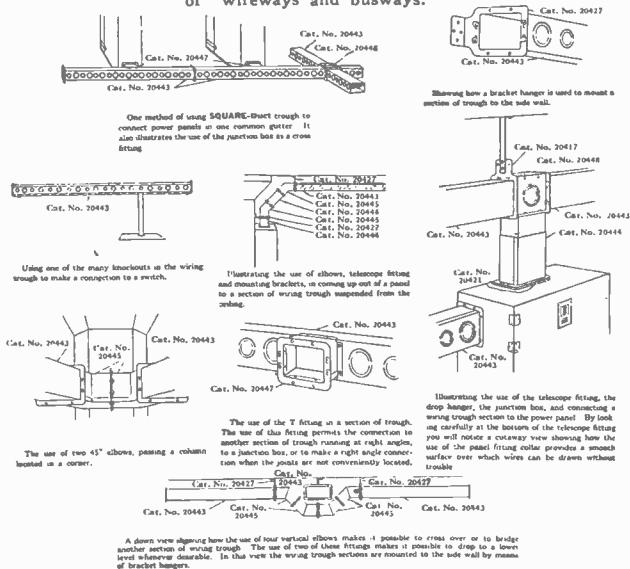

Fig. 67. The above drawings show several different arrangements for using square duct.

lic trough systems must be continuous throughout their length, and must be grounded the same as conduit systems. They can be run through walls, but must not be concealed or imbedded in concrete.

## EXAMINATION QUESTIONS

1. Can cleat wiring be concealed the same as knob and tube wiring?
2. What is the maximum distance allowed between cleats?
3. (A) Describe Non-Metallic sheathed cable. (B) Give at least one "trade name" used for this cable.
4. Is it possible to ground the outlet boxes and fixtures in a system using Non-Metallic Sheathed Cable? If so, how is it accomplished?
5. Is rigid conduit used for wiring finished buildings? Why?
6. What is the name of the tool used in bending conduit?
7. How many right angle bends are allowed in a single run of conduit between outlet boxes?
8. Give the names of four different bends commonly made in conduit.
9. What is the maximum number of No. 14 wires allowed in  $\frac{1}{2}$  in. conduit?
10. What is the difference between B.X. and B.X.L.?
11. What are several advantages of conduit wiring?
12. What are two important aids to pulling wires into conduits?
13. Explain how you would ground a conduit system.
14. What is the difference between flexible conduit and armored cable?
15. What is one of the best wiring systems to use in wiring old finished buildings?

## FUSES AND SWITCHES

Every wiring system, no matter what type it may be, must be properly fused. This is a strict requirement of the National Code, and an absolute necessity, both to protect the wiring and equipment on the circuits as well as persons who might handle them.

Fuses in electrical circuits are similar in purpose to safety valves on steam boilers. With a boiler, whenever the steam pressure rises so high that it is unsafe and more than the strength of the boiler should stand, the safety valve opens and relieves this pressure. In electrical circuits, whenever the current load becomes more than the wires can stand without overheating and burning their insulation, the fuse blows and opens the circuit. So we can readily see the great importance of having in every electrical system fuses of the proper size and type.

Fuses are made in many different styles and sizes for different voltages and current loads, but they all operate on the same general principle, that is, opening the circuit by melting a piece of soft metal which becomes overheated when excessive current flows through it.

The temperature rise which melts a fuse depends upon the amount of excess current, the duration of excess current, and the ease with which heat escapes from the fuse.

### 1. LEAD LINK FUSES

Early types of fuses were simply a piece of lead wire connected in the circuit, through which current flowed to the lines and equipment to be protected. This lead wire, being soft and easy to melt, would blow out as soon as the current load in amperes went above a certain amount. These pieces of wire were kept short and fastened securely under terminal screws, so that their resistance would not be high enough to cause much voltage drop in the circuit. By selecting the proper size of lead wire they could be made to open the circuit at almost any desired current load. This type of Link or lead

## Fuses

wire fuse is not very safe or dependable. Such fuses have a tendency to oxidize and corrode, and become quite inaccurate after being in service a while. In addition to this, when they do blow out, the molten metal spatters over equipment, and is likely to injure persons if they are nearby.

### 2. CARTRIDGE FUSES

You will still find lead link fuses in use in some places, but in general they have been replaced by the modern **Cartridge Fuses** on all circuits of over 30 amperes capacity, and some of less; and by the **Plug Fuse** on circuits with under 30 amperes load.

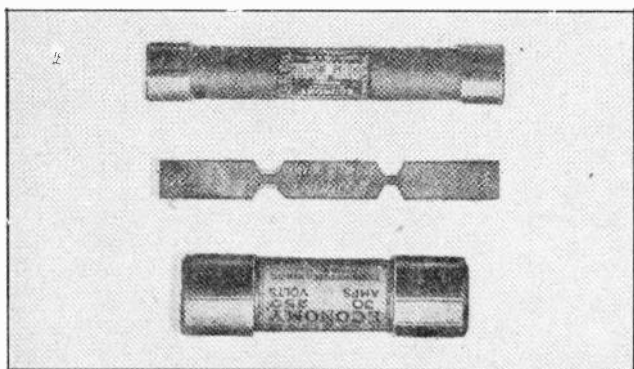

Fig. 1. The above view shows two types of cartridges fuses and one of the fusible lead links which are used inside these cartridges.

Fig. 1 shows two types of cartridge fuses and the renewable fuse link used with them. This type of fuse consists of a hard fibre cylinder in which the fuse strip of soft metal is contained. This strip is gripped tightly by the brass screw caps on the end of the fuse chamber, so the entire cartridge can be conveniently mounted in a **Fuse Block**. Several types of fuse blocks are shown in Fig. 2.

The fuses are held in the block by spring clips which grip the metal cap or ferrule at the end of the cartridge. This makes them very easy and quick to renew when one blows out. The cartridge fuse is much more reliable and accurate because the fuse



## Fuses

link is enclosed in the cartridge, and its temperature is not affected by air currents as in the case of the open fuse link.

With a cartridge fuse, when the link blows out the arc or flame and molten metal are all confined within the cartridge, except in very rare cases when a heavy short circuit may cause the cartridge to explode.



Fig. 2. These porcelain fuse blocks are equipped with spring clips in which the cartridge fuses are held.

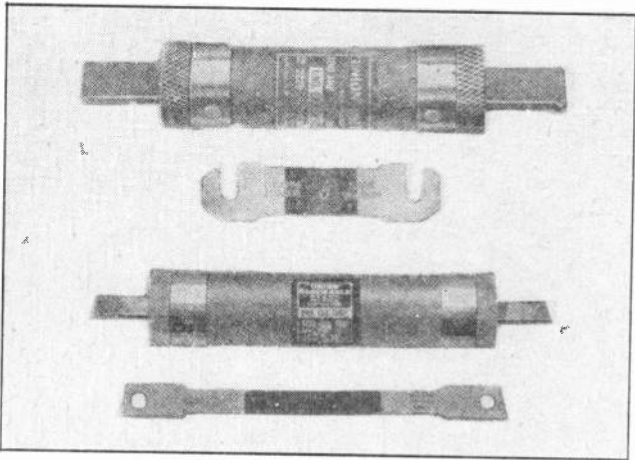

Fig. 3. For the heavier loads of current, knife blade type cartridge fuses of the above type are used.

Most cartridge fuses are of the renewable type in which the burned out link can be quickly replaced by unscrewing the ferrules or caps at the ends. The burned piece can then be removed and a new link inserted, the ends being folded over and securely gripped by the caps when they are screwed back on, or held under bolts on the knife blade type. The cost of this renewal link is very small, and as the cartridge very seldom needs to be re-

## Fuses

placed, the proper fusing of circuits is of very small expense compared with its protection value.

### 3. "CUT-OUT" BLOCKS AND KNIFE BLADE FUSES

The porcelain blocks for holding the fuses are often called **Cut-Out Blocks**. The smaller fuses are used in circuits up to 60 amperes and are made in the ferrule type, or with the round end caps. Large sizes for from 65 to 600 amperes are made in the knife-blade type, with short flat blades attached to the end caps. These blades fit into clips on the fuse block, which are similar to regular knife switch

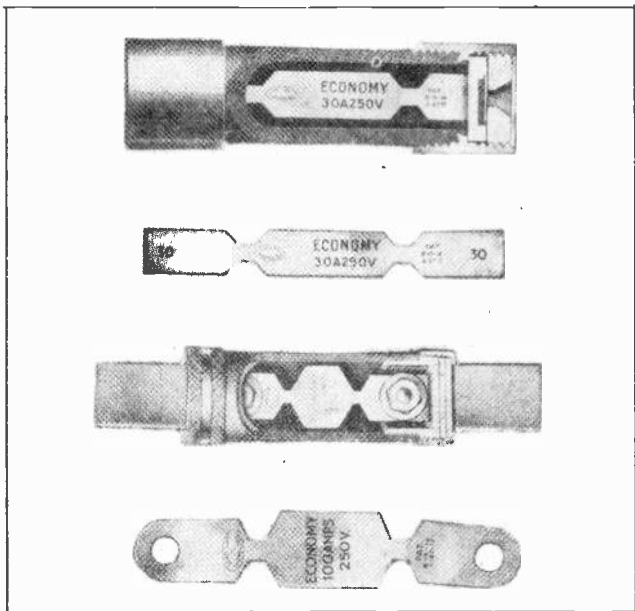

Fig. 4. These sectional views show the construction and arrangement of cartridge fuses and the manner in which the fuse strips are fastened in them. Note the difference in the mounting of this strip in the upper and lower cartridges.

clips. This type of construction is used on the heavier sizes because it gives a greater area of contact surface at the clips for heavy currents to flow through. Fig. 3 shows two knife-blade type cartridge fuses.

## Fuses

Ferrule type fuses for voltages from 250 to 600 are commonly made in the following ampere ratings: 3, 5, 6, 10, 20, 25, 30, 35, 40, 50, and 60.

Knife-blade type fuses for the same voltages are made with current ratings of 65, 70, 75, 80, 90, 100, 125, 150, 175, 200, 225, 250, 300, 350, 400, 450, 500, 550, and 600.

### 4. PLUG FUSES

Plug fuses are made with ampere ratings as follows: 3, 6, 10, 12, 15, 20, 25, 30. These plug fuses are the type most commonly used for fusing branch circuits in house wiring systems. They are made with a threaded base to screw into sockets in the cut-out block, similar to lamp sockets. Several types of plug fuses are shown in Fig. 5. Those in the top row are ordinary fuses with small mica win-

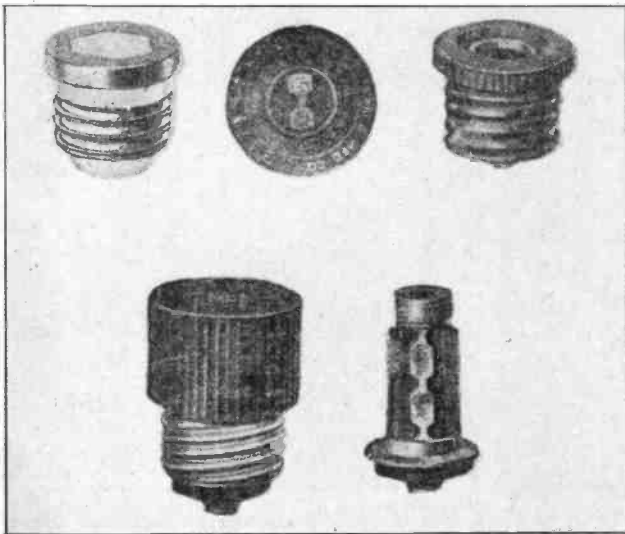

Fig. 5. The three fuses in the upper row are of the ordinary plug type with fusible windows to show when the link is blown out. The lower view shows a refillable plug fuse and one of its refill elements.

dows, so it is easy to see when they have been blown. The fuse shown below with an extra element is of the renewable plug type. These fuses when blown can be taken apart and the small link replaced similarly to the renewal of the cartridge

## Fuses

fuses.

Fig. 6 shows several types of cut-out blocks for plug fuses.

When any circuit is overloaded a small amount beyond the capacity of its wires and fuses, the fuses gradually become warmer and warmer, until the link melts out and opens the circuit. When a circuit becomes severely overloaded or a short circuit occurs the fuse blows instantly, and sometimes with considerable flash. This is as it should be because, if fuses didn't blow at once, a short circuit would very quickly ruin the insulation of the wires with the intense heat caused by the great rush of current.

### 5. NATIONAL CODE RULES ON FUSES

In general, every electrical circuit and system should be protected by fuses of the proper size connected in series with its lines, and care should be used **never to allow fuses to be replaced with others that are too large.** The National Code is very strict in the matter of fusing circuits and a few of the most important rules are as follows:

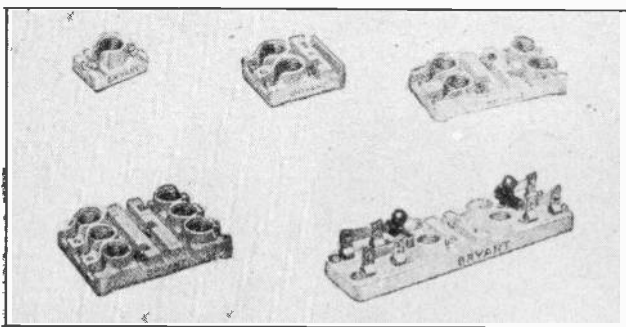

Fig. 6. Several types of "cut-out" blocks or fuse blocks for plug fuses are shown above.

1. Fuses must be provided at every point where the wires of a system change in size, except when fuses closer to the service are small enough to protect these wires.
2. Fuses on fused switches must be placed on the dead side of the switch when it is open.
3. Every ungrounded service conductor should

## Fuses

be provided with a fuse, except the neutral wire of a polarized system, which must never be fused at any point.

4. All ungrounded wires of branch circuits should be protected by fuses.

5. Two-wire branch circuits on ungrounded systems must have both wires protected by a fuse in each wire.

6. Ordinary branch circuits, using No. 14 wire, must be protected by fuses not larger than 15 amperes at 125 volts, or 10 amperes at 250 volts.

Sometimes, when a fuse blows, some person who doesn't understand the function and safety value of a fuse may replace it with a piece of copper wire or in some cases even put pennies behind plug fuses. This is exceedingly dangerous practice and should never be used under any circumstances, as it is practically treating the wires of an electrical system, as if the safety valve of a boiler were locked.

When the size of fuses for any certain circuit is not specified by the Code, it can easily be determined by the use of the Watts law formula. If we know the voltage of any circuit and the load rating in watts of the equipment on any circuit, we can easily find the current in amperes by dividing the watts by the volts. This will indicate the proper size of fuses, providing we are also sure that the size of the wires is large enough to carry this load.

The table previously given, showing the current capacity of rubber covered wires, will also be a convenient guide to the selection of proper fuses. More about fuse troubles and maintenance will be covered in a later section on trouble shooting, and in the advanced sections on motors and power machinery, additional information will be given on the proper sizes of fuses for machines of different horse-power ratings.

## 6. PANEL BOARDS AND FUSE CABINETS

In small house-wiring systems, the fuses are usually placed at the place where the supply wires enter the house and near the service switch and meter.

In some small homes there may be only one cir-

## Fuse Cabinets

cuit and one pair of fuses, and in larger homes or those better equipped with complete electric wiring there may be from 2 to 6 or more branch circuits

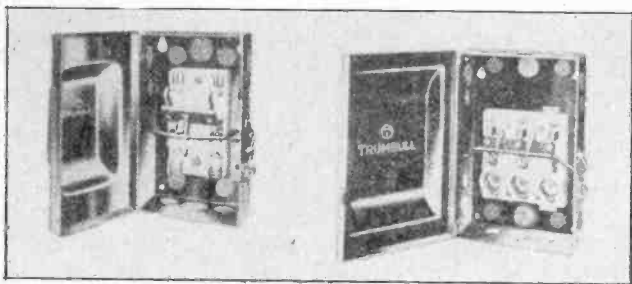

Fig. 7. Fuse blocks of either the cartridge or plug fuse type are commonly mounted with a safety switch in metal boxes.

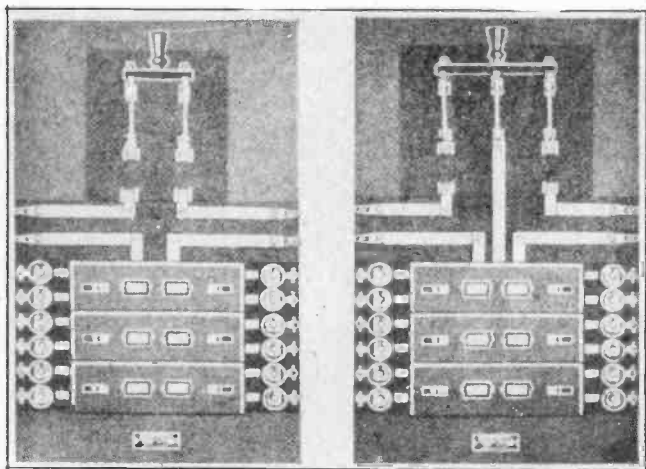

Fig. 8. On the left is shown a two-wire "cut-out" panel, and on the right one for three-wire circuits. Note the arrangement of the safety switch, plug fuses, and branch circuit switches.

and fuses. Fig. 7 shows two types of fuse blocks and safety switches in metal boxes. This is the modern and approved way to install them.

In larger buildings—such as apartment houses, stores, and offices—there may be from a dozen to a hundred or more branch circuits, all requiring separate fusing.

## Fuse Cabinets

In such cases it is common practice to install in one central cabinet all the fuses for a large group of circuits. Fig. 8 shows two such cabinets, one for a two-wire system and one for three wires. Both have main service switches which disconnect the entire cabinet and all circuits from the supply wires, and also separate switches and fuses for each circuit. The branch circuit switches in these cabinets are enclosed under safety panels through which only the handles protrude.

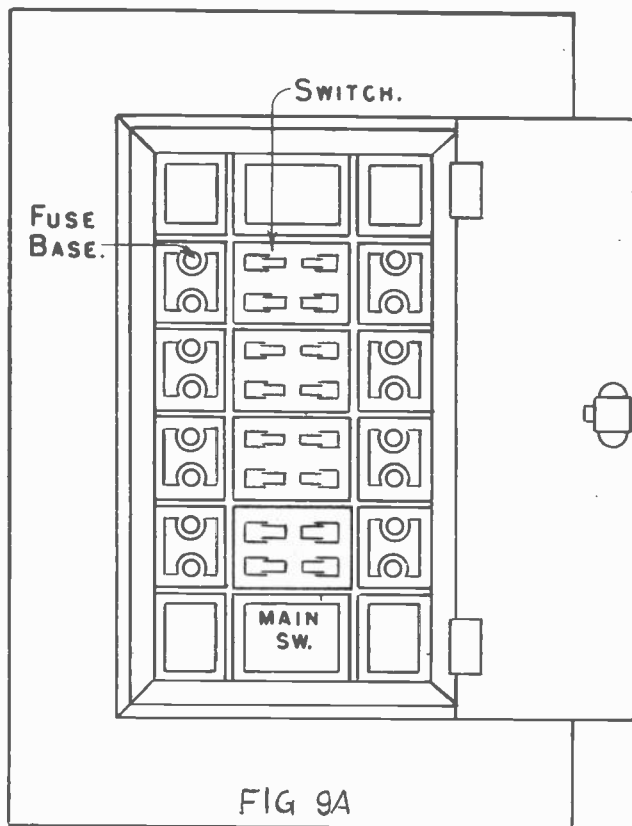

### 7. SWITCHES

There are numerous types of switches used in electrical wiring. It is very important to select the

## Switches

proper types for various applications and to properly understand their use, operation and care.

The purpose of any switch is to conveniently and safely make and break an electrical circuit and start or stop the flow of current, thereby controlling the operation of the equipment on that circuit.

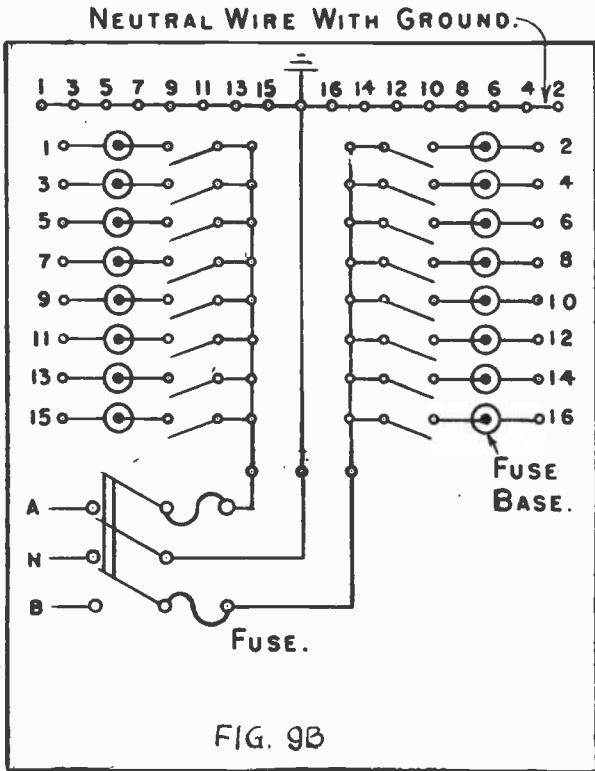

Figure 9A shows the front view of a fuse cabinet or distribution cabinet designed for a three-wire, solid and grounded neutral supply. This cabinet will accommodate 16 separate two-wire circuits, each circuit being equipped with a fuse and switch in the hot or ungrounded wire. The wiring connection and terminal arrangement used on this cabinet are shown in figure 9B. Note there is no fuse in the neutral, but that all switches and fuses are connected to the ungrounded wires. Note also that the



## Switches

numbering system used in such as to insure that the two-wire circuits are equally balanced across the three-wire supply. For example, circuit number 1 is connected from line wire A to the grounded neutral, circuit number 2 from line wire B to neutral; therefore, as additional circuits are connected in order, they are attached first to one and then to the other side of the system; in this way, load balance on the system is maintained.

### 8. KNIFE SWITCHES

**Knife Switches** are one of the most common types and are used for opening and closing the heavier circuits, such as main service wires in light and power wiring systems, and also branch circuits to motors and equipment using large amounts of current.

Knife switches consist simply of one or more copper blades hinged at one end and with clips at

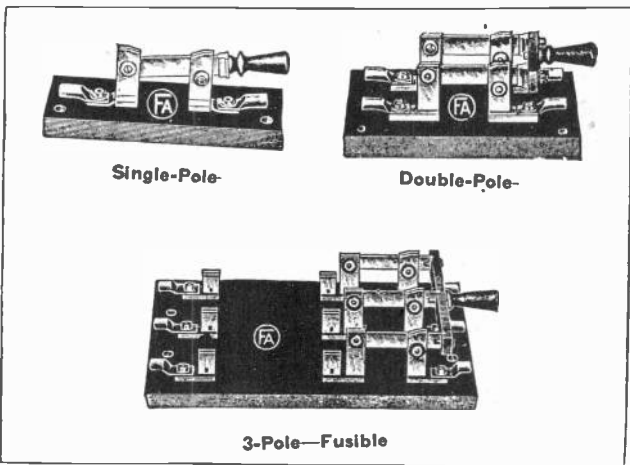

Fig. 11. Three common types of knife switches. The lower one is equipped for knife blade type fuses. Note the lugs which are used for attaching large wires or cables to these switch terminals.

the other, and proper terminals for connecting the wires to them. Fig. 11 shows three common types of knife switches. One is called a **Single Pole**, one a **Double Pole**, and one a **Three Pole** switch. The number of poles indicates the number of blades, or the number of wires the switch can open. They are

## Switches

also made with 4 poles or more, and **Single** or **Double Throw**. Those shown in the figure are all single throw. Double throw switches have two sets of clips, one at each end, so the blades can be thrown either way into either set of clips, thus shifting from one circuit to another.

Knife switches are made with or without fuse clips as desired. The three pole switch in Fig. 11 is of the fusible type, while the other two switches are not.

When installing knife switches, they should be mounted so that the blades when opened cannot fall closed by gravity, and they should be connected so that when opened the blades as well as any fuse

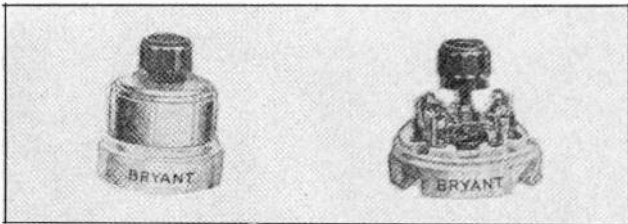

Fig. 12. Above is shown an ordinary surface type snap switch. The view on the right shows the cover removed.

that may be on them will be dead. The blades of knife switches should always be enclosed, except when the switches are mounted on approved switch boards or panel boards.

Knife switches that are enclosed in a safety box and used for service switches in wiring systems should have a handle on the outside of the box, so the switches can be opened or closed without opening the door, and some indication or marks should be on the box to show when the handle is in the open or closed position.

Switches used for motor circuits should have a current capacity or continuous duty rating of 125% of the motor current rating.

It is very important that the clips of knife switches be kept properly fitted to the blades, so as to secure proper contact and prevent overheating of the switch due to high resistance.

## Switches

### 9. SNAP SWITCHES

For the control of lights and branch circuits the **Snap Switch** is commonly used. There are several types of snap switches made, and their name comes from the quick snapping action with which they break the circuit. This action is obtained by a small spring and is a very important feature of such small switches, as the speed and suddenness with which it opens the circuit extinguishes the arc much more rapidly and effectively, thus to a great extent eliminating fire hazard and preventing burning of the switch contact.

Snap switches are made in **Single Pole, Double Pole, Three Way, Four Way,** and **Electrolier** types. Each of these types will be explained.

### 10. SURFACE TYPE SNAP SWITCHES

One of the very common and simple types of these switches is the **Surface Type Snap Switch**. Fig. 12 shows two switches of this type, one of them having the cover removed to show the working parts.

These switches have a small rotating blade that is snapped in or out of stationary clips set on the porcelain base. When the button is turned it first winds a small coil spring on its shaft, and as it is turned farther this spring snaps the rotating blade in or out of the stationary clips.

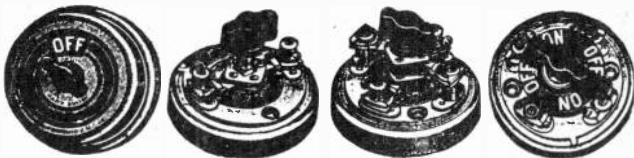

Fig. 13. Several types of snap switches. Note the "off" and "on" markings used on indicating switches.

For convenient connection of the wires, terminal screws are provided. These screws are of soft brass. While they should be tightened enough to hold the wires securely, they should not be forced too tight or their threads are likely to be stripped.

## Switches

Fig. 13 shows several types of surface type snap switches.

Surface type **Toggle** or **Tumbler** switches are being installed in preference to rotary button snap



Fig. 14. Toggle and tumbler switches of the above type are very commonly used for surface mounting.

switches in many places today. Fig. 14 shows a surface type toggle switch on the left and two of the tumbler type on the right. These switches are more convenient to operate, as it is only necessary to push their levers up or down, instead of twisting a button as on the rotary snap switch.

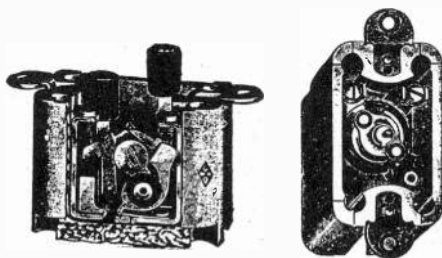

Fig. 15. These two views show the construction and mechanism of push button type snap switches.

### 11. FLUSH TYPE SWITCHES

The snap switches mentioned so far are called "surface" type, because they are made to mount right on the surface of the wall. This is often not as desirable in appearance as the **Flush Type** switch, which mounts in an opening cut in the wall, has a neat flush cover plate, and is a very popular type. Fig. 15 shows two views of a **Push Button** type switch. The left view shows an open side view and the manner in which the two buttons are

## Switches

used to rock a small blade back and forth. The right view shows the top of a switch of this type.

Fig. 16 shows another type of push button switch on the left, and a toggle switch on the right. The metal extensions or "lips" on these switches are used to fasten them in the switch box, which is mounted in a hole cut in the lath and plaster. Then the switch plates, or covers, are placed over them and fastened in place with small screws, presenting a finished appearance as in Fig. 17.

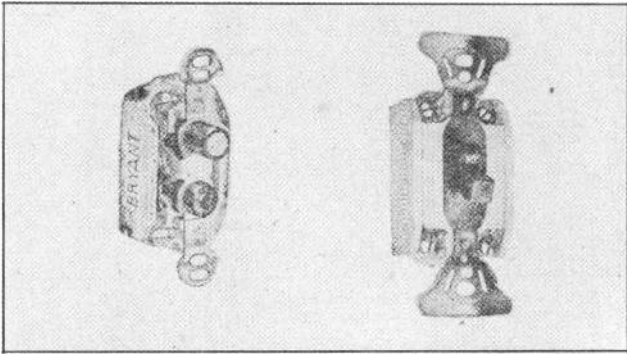

Fig. 16. Above are shown a push button switch on the left and a toggle switch on the right. Both are for flush mounting in switch outlet boxes.

Where it is desired to control a separate light by means of a switch on the ceiling near that light, a ceiling pull-cord switch, such as shown in the left view in Fig. 18, is used. The one on the left is made to mount right on the surface of the ceiling, while the one on the right is made to mount in the side of the outlet box or fixture canopy and is called a Levolver switch.

There are also small snap switches which are enclosed in lamp sockets called **Key Sockets** or **Pull Chain Sockets**. Fig. 19 shows a key socket on the left and a pull chain socket in the center.

### 12. SINGLE POLE SWITCHES

**Single Pole Switches** are used to break only one wire of a circuit, and **must always be connected in the ungrounded wire**. They are used to con-

## Switches

trol a light from one place only, and are the most commonly used of all switches in residence lighting systems. Single pole switches can always be easily distinguished from the others because they have only two terminals for the wires, and only one blade.

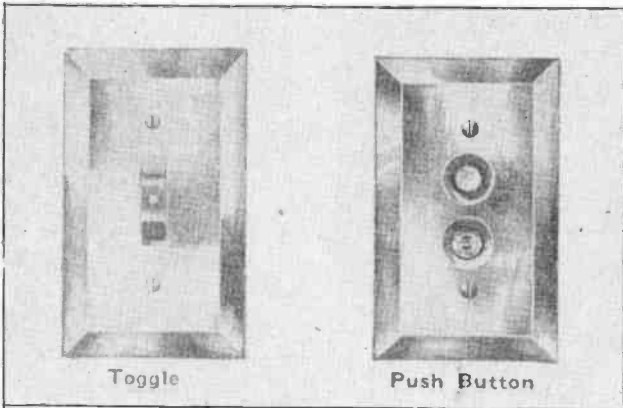

Fig. 17. This shows the finished appearance of properly mounted flush type switches with the covers placed over the outlet boxes.

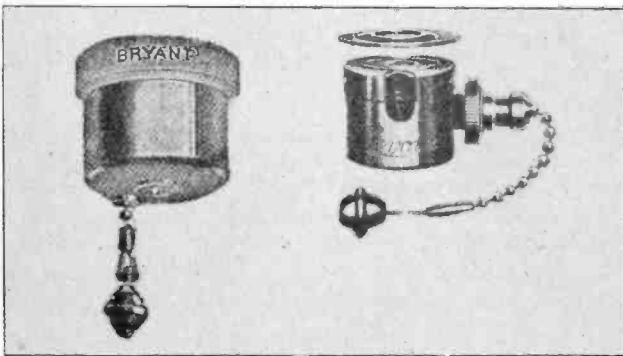

Fig. 18. Two types of pull cord switches for ceiling mounting and used to control individual lights.

### 13. DOUBLE POLE SWITCHES

Double Pole Switches are used to open both wires to a light or device, and thus break all connections from it to the line. Opening both sides of the circuit at once also more quickly extinguishes the

## Switches

arcs at the switch points. A double-pole surface-type switch always has four terminals and two blades. These blades are mounted one above the other on the shaft, and are insulated from each other. On this type of switch, **never connect the line wire to opposite terminals, but always to terminals on the same side of the switch.**

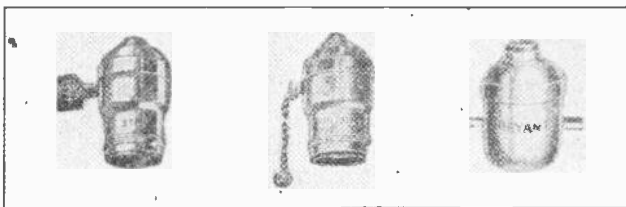

Fig. 19. On the left is a key socket or switch for controlling lights on drop cords. The center view shows a pull-chain socket, and on the right is a push button switch that can be mounted on the end of a suspended pair of wires.

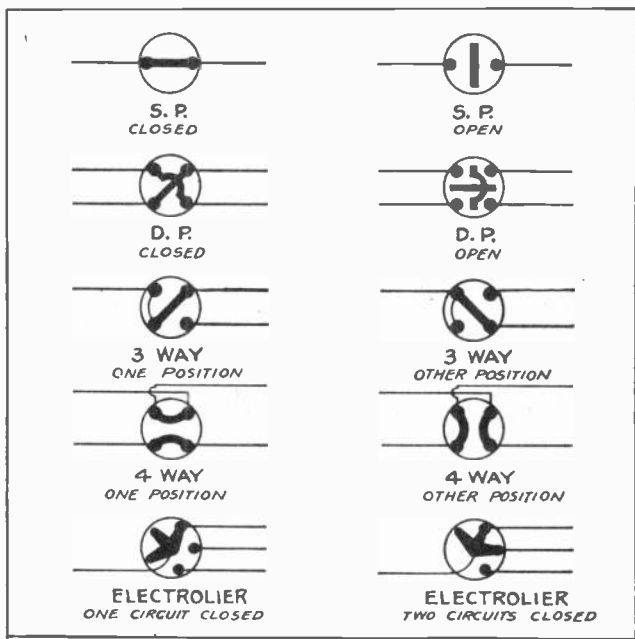

Fig. 20. The above symbols will be used to represent various types of switches in the following connection diagrams. Close examination of these symbols will also help you obtain a better understanding of each of these switches.

## Switches

Fig. 20 shows some of the symbols used for common surface-type snap switches, so you will be able to recognize them in the following connection diagrams.

Fig. 21 shows the connections of a single pole switch and a double pole switch for controlling the lamps, "L" and "L."

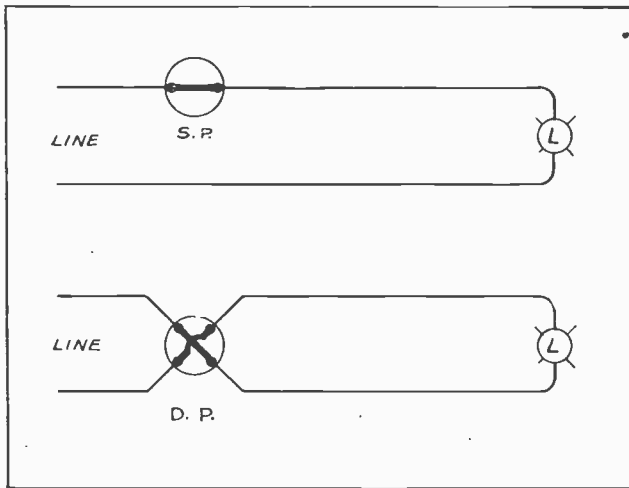

Fig. 21. The top diagram shows a simple single-pole switch connected to control one light. The lower diagram shows a double-pole switch connected to break both sides of the circuit to a light.

### 14. THREE-WAY SWITCHES

**Three-Way Switches** are used to control a light or group of lights from two different places, so they can be turned on or off at either switch. This is a connection very commonly used in all modern homes for lights in halls, on stairways, and other places. It is also very convenient for controlling garage, barn, or yard lights, as the lights outside can be turned on at the house and off again at the garage or barn. Or the lights can be turned on at the outer buildings and turned off at the house.

Three-way surface-type switches have four terminals and usually one blade. Sometimes there are two blades in one line. Two of the terminals are permanently connected together in the switch with



## Switches

a shunt wire. Usually these terminals can be located by a strip of sealing wax in a groove between them on the base of the switch. This wax covers the shunt wire. This construction is one means of telling a three-way switch from other types of surface snap switches. On flush type switches, the three-way is the only one which has just three terminals.

Fig. 22 shows the connection diagram for two three-way switches used to control a light from two different points. Note that the line always connects to the shunt terminal of one switch and the lamp to the shunt of the other switch. The other two terminals of each switch are connected together as shown. This is a good rule to remember in connecting up three-way switches. Trace this diagram carefully and you will find the circuit to the lamp is closed. Shifting either switch blade will open it, and again shifting either one will close it once more.

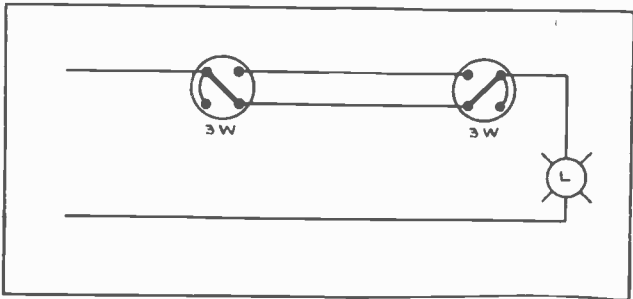

Fig. 22. Two three-way switches used for controlling a light from two different places. Note carefully the manner of connection.

Fig. 23 shows another method of connecting three-way switches, known as the **Cartweis** system. This method is not approved by the Code as it places line wires of opposite polarity on adjacent terminals of the switch. This is in contradiction to the rule given for the common approved connection and is not considered as safe.

However, this method is sometimes used on 32 volt systems and saves one wire where both switches are to be located near the line wires, as in a case where a live line is run from a house to the garage or barn to operate other devices there in addition to the light.

## Switches

Where three-way switches are used, the first system as shown in Fig. 22 should always be followed in interior wiring in houses with 110 volt circuits.

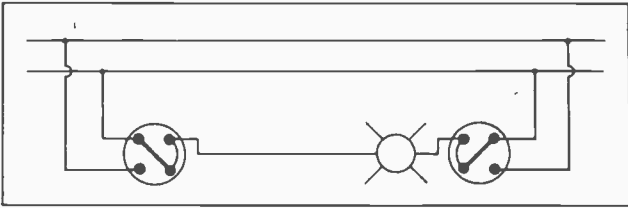

Fig. 23. This sketch shows the Cartweis system of connecting three-way switches. This method should not be used on 110-volt circuits in interior wiring.

### 15. FOUR-WAY SWITCHES

**Four-Way Switches** are used where it is desired to control a light or group of lights from more than two places. By their use in combination with three-way switches we can control a light from as many places as desired.

The four-way surface-type switch has four terminals and two blades, and can be quite easily distinguished from the other switches because its blades always connect to adjacent terminals on the sides of the switch. No matter which position the switch is in, the blades always connect together one or the other set of adjacent terminals.

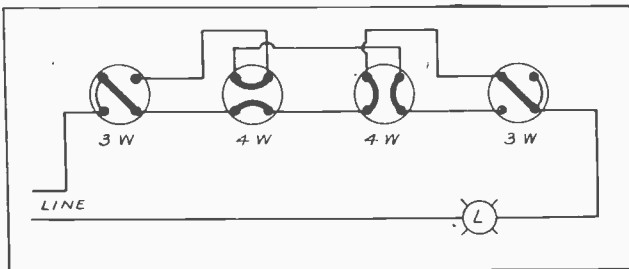

Fig. 24. This diagram shows two three-way and two four-way switches connected to control a light from four different places. Note carefully the connection and arrangement of the three-way switches at the ends, and the manner in which the wires to one side of the four-way switches are crossed.

Fig. 24 shows a method of connecting two three-way switches and two four-ways to control a light from four different places.

## Switches

The important points to note in this connection are as follows: The two three-way switches are always connected at the ends of the control group, with their shunts to the line and lamp, as before mentioned. Any number of four-way switches can then be connected in between them as shown. With surface-type snap switches, the one wire connecting the three-way and four-way switches together should **always be crossed at each switch** as shown, but the other one just connected straight through from terminal to terminal on the same side of the switches as shown. With some flush-type switches it is not necessary to cross the wires on one side of the four-ways, as they are already crossed inside the switches.

Trace the diagram in Fig. 24 very carefully and you will find that, with the switch blades in their present position, the circuit to the lamp is closed. Moving any one of the switch blades into its other position will open the circuit, and moving any other one will close it again.

This type of connection is a very valuable one to know, and you will find it much easier to understand and remember the rules for its connection if you try drawing several combinations with different numbers of switches and tracing them out to see if they give the desired results.

A very important rule to remember in installing three-way and four-way switches is that they **must all be connected in the ungrounded wire** of the line, and never to the grounded wire. This is a Code rule, as it is with single pole switches, to make sure that the "hot" or ungrounded wire to the light is always open when the switch is turned off.

### 16. SUBSTITUTING VARIOUS SWITCHES

Sometimes in emergencies you may not have the proper switches on hand and certain others can be substituted temporarily if desired. For example, you can use either a three-way or four-way switch in place of a single pole switch. To use a three-way in place of a single pole, connect the line wire to

## Switches

the shunt terminal and the lamp wire to either of the separate terminals, as in the upper view in Fig. 25.

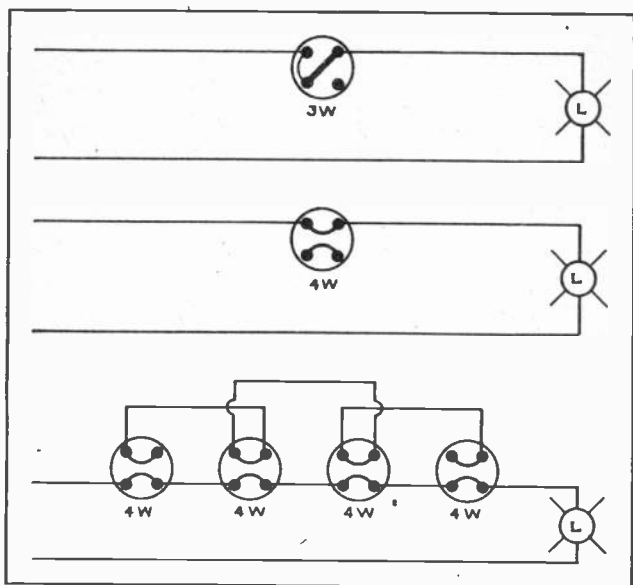

Fig. 25. The above three diagrams show methods of substituting various switches when the proper ones are not available. The top and center connections show the use of three-way and four-way switches in place of single-pole switches. The lower connection shows four-way switches used in place of three-way switches at the ends of the group.

To use a four-way switch in place of a single pole, connect the line and lamp wires to any two adjacent terminals, as in the center view in Fig. 25.

To use four-way switches in place of the usual three-ways at the ends of a group for controlling a light from several places, connect them as shown in the lower view of Fig. 25.

Some of these switches will cost more than the proper ones for which they are substituted—for example, three-way and four-way switches cost much more than single pole switches—so these substitutions should only be made in emergencies.

## Switches

### 17. ELECTROLIER SWITCHES

**Electrolier Switches** are used to control one or more circuits, such as several lights on a chandelier, or the several sections of a heater element in an electric range, etc. These switches are obtainable with two or three circuits. Fig. 26 shows a method of connecting a three-circuit electrolier switch to turn on one, two, or all three of the lamps; or turn them all off, if desired. In the upper view all lamps are out, in the center view only one lamp is on, and in the lower view two lamps are on. If the rotating element of the switch were turned one more point to the right all three lamps would be on.

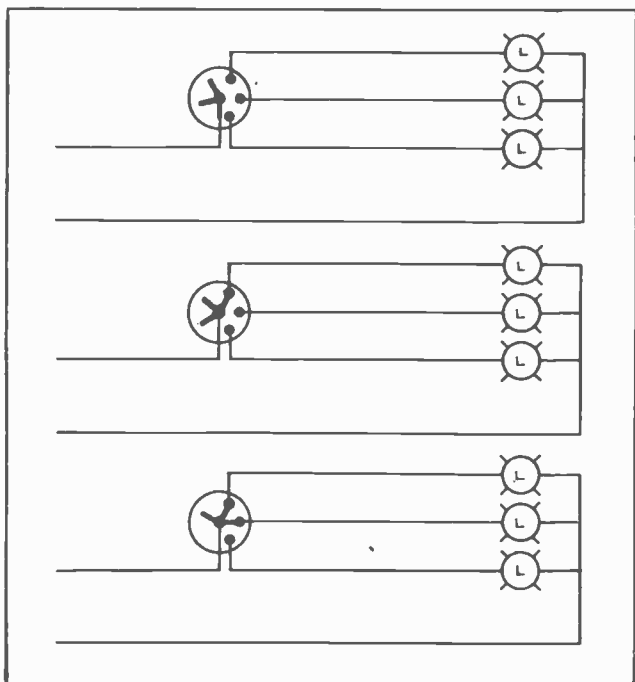

Fig. 26. These three diagrams show the manner in which an electrolier switch can be used to turn on one or more lights at a time.

These switches are very commonly used on electric ranges and heaters, to get low, medium, or high heat.

## Switches

Fig. 27 shows several of the connections for push button and toggle-type flush switches. The sketch at "A" shows the terminal location and connections of a single-pole push button switch connected to control one lamp. "B" shows the terminals and connections of another type of flush single-pole switch. "C" shows a double-pole switch connected to control one lamp. "D" shows two flush-type, three-way switches connected so that either one can turn the light on or off. "E" shows two three-way switches and one four-way switch connected to control a light from three places. The wires are

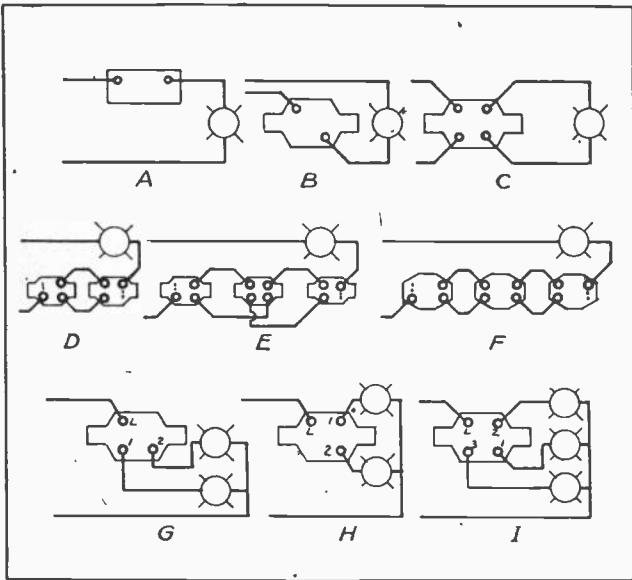

Fig. 27. The above sketches show methods of connecting flush type switches as represented by manufacturers' symbols. Check each connection with its explanation in the accompanying paragraphs.

crossed at the four-way switch, as is necessary with some types of flush four-ways. "F" shows the connection of two three-ways and one four-way, using the type of four-way switch that has its terminal connections crossed inside, so the wires are run straight through. "G" shows a flush-type two-circuit electrolier switch with connections made to its marked terminals for turning on first one light,

## Convenience Outlets

then both lights, then both off. "H" shows a two-circuit electrolier switch connected to first turn on one light, then turn it off; next turn on the second light, and then turn it off. "I" shows a three-circuit electrolier switch connected to first turn on one light, next turn on two lights, next all three lights on; then all off.

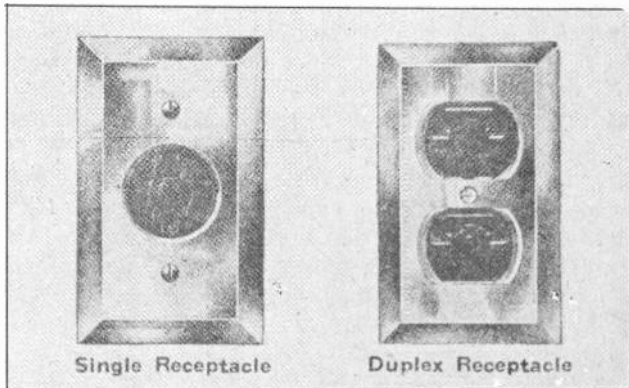

Fig. 28. Every home that is wired for electricity should have a sufficient number of convenient outlets or receptacles of the types shown above.

A great many types of special switches are made for different applications. However, with a good understanding of these more common types, and a careful examination of the blades, terminals, and parts of any switches you may encounter, you should be able to understand them quite easily.

Sometimes the small copper blades and clips of snap switches become badly burned from the arcing when the circuit is interrupted, or, because they don't fit properly and make good contact with each other.

Snap switches are made in different current ratings according to the load they are supposed to control, and they should never be placed in circuits where they have to carry more current than they are rated for, because this will overheat them, burning and softening the blades and clips until they are useless. When a snap switch arcs badly or

## Convenience Outlets

sticks frequently it is usually an indication of a defect in the switch or an overload on it.

### 18. CONVENIENCE OUTLETS AND RECEPTACLES

In the preceding pages we have occasionally mentioned outlet boxes for convenience receptacles. A modern house-wiring system is not merely to supply proper lights and convenient control for them, but should also include in all rooms a sufficient number of convenience outlets for the attachment of portable household electrical devices, such as fans, heaters, curling irons, toasters, sewing machines, vacuum cleaner, and the many other electrical devices used in the home today. These convenience outlets, may be installed in the baseboard, or mounted higher up in the walls, or even in the box with the switches.

The same outlet boxes as are used for flush-type switches can be used for convenience receptacles, and either a single or double plug receptacle can be installed. Fig. 28 shows both a single and a double receptacle of this type, with the cover plates which fit over the outlet boxes.

Fig. 29 shows the receptacles without covers and ready to be installed in the outlet boxes. The metal "lips" on the ends of each one are for attaching them to the outlet boxes with screws. These receptacles are generally connected to wires that are always alive and are not controlled by switches. All that is necessary to obtain from them current for portable devices is to push the prongs of the plug, which is on the end of the cord, into the slots in the receptacle, where they are gripped by spring contacts inside the receptacle.

### 19. ATTACHMENT PLUGS

Small receptacle plugs can be obtained for screwing into threaded lamp sockets, and to receive the prongs of the regular cord plug. These are commonly known as attachment plugs. Fig. 30 shows



## Convenience Outlets

both sections of an attachment plug; close together in the left view, and separated at the right. The upper or male cap section in the right-hand view has two connection screws on its prongs, and can be quickly and easily attached to the cord of a portable device.

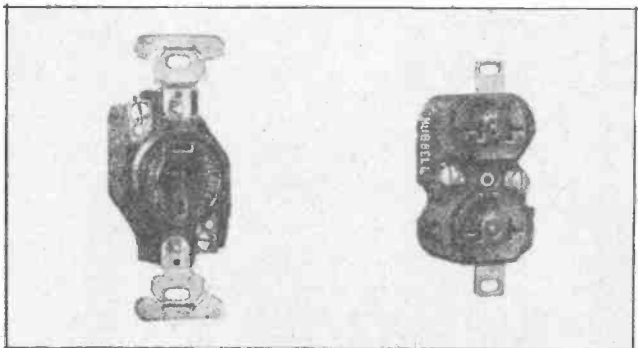

Fig. 29. These receptable units are mounted in ordinary outlet boxes similar to those used for flush type switches. Note the terminal screws for connection of the wires to the receptacle, and also the metal "ears" for attaching the receptable to the outlet box.

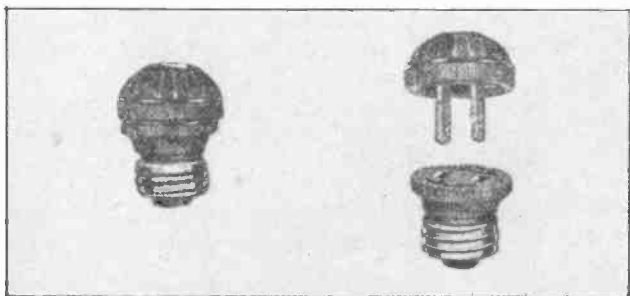

Fig. 30. Two views of an attachment plug of the type which can be screwed into a socket. The male element with the two brass prongs is attached to the cords of portable devices, and can then be plugged into any receptacle of this type.

For certain portable tools requiring three and more wires, special plugs can be obtained. Some of them also have an extra wire for grounding the portable tool to the conduit system for safety to the operator.

## EXAMINATION QUESTIONS

1. Why are fuses necessary in Electrical circuits?
2. What kind of fuses are most commonly used in house wiring systems?
3. What kind of fuse would you select for use in protecting a circuit which carries a load of 200 amperes?
4. What kind of switches should be used in controlling a light from two different places, such as on stairways where it is desirable to have one switch at the top and another at the bottom of the stairs.
5. What are electrolier switches used for?
6. What kind of switches would you choose to control one light from three or more different places?
7. Should switches be connected in the grounded or the ungrounded wire?
8. Draw a sketch showing how a "three-way" switch is connected to take the place of a single pole switch.
9. Is the "Cartweis" system of connecting "three-way" switches considered a good method? Why?
10. How could you tell the difference between a three-way and a four-way switch?

## THREE-WIRE SYSTEMS

We have already mentioned that wiring systems can be either two-wire or three-wire types.

The two-wire system does not need very much explanation as its connections and principles are very simple. This is the system commonly used in small homes, and consists of two main wires brought into the building from the power company's lines, and properly equipped with service switch, fuses, and meter.

From this point several branch circuits with two wires each can be run to the various groups of lights or outlets. Two-wire lighting circuits are usually of 110 to 125 volts, and two-wire D. C. or A. C. power circuits are commonly of 220 or 440 volts.

It is a very simple matter to connect lights or motors to these circuits, with the proper switches and fuses where needed. The load devices are all connected in parallel, and while usually we need pay no attention to positive or negative polarity, we do need to know which wire is the grounded one and which the ungrounded. This will be explained a little later in this lesson.

### 1. EDISON THREE-WIRE SYSTEM

The three-wire system is used extensively by power companies on their lines to the customers' buildings, and in most all of the larger homes and modern office buildings, hotels, stores, and factories.

This system is often thought to be somewhat complicated but in reality it is very simple to understand for anyone with a knowledge of the principles of electric circuits, such as you have already obtained.

The Edison three-wire system gets its name from the fact that it was originally used by Thomas Edison, who connected two 110 volt D. C. generators in series to obtain 220 volts between two outside wires, and 110 volts between each outside wire and the center or **neutral** wire. See Fig. 1.

You will recall that when any two generators or sources of current supply are connected in series,

## Three-Wire Systems

it adds their voltages; so it is easy to see how the two different voltages are obtained in this system.

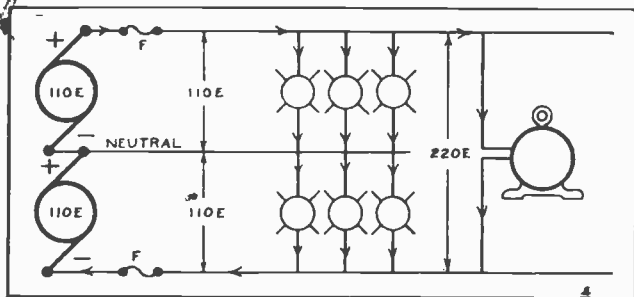

Fig. 1. This diagram shows the arrangement of two generators in series to supply an Edison three-wire system. Note that this arrangement provides both 110 volts for lamp circuits and 220 volts for motor circuits.

The advantages of the three-wire system are that it provides 110 volts for lights and 220 volts for motors, with only three wires, and it effects a great saving in the size of conductors and copper costs even when used for lighting alone. This is because when there is an equal number of lights on each side of the system, they all really operate on 220 volts, with two groups of lamps in series across the outside wires.

The current tends to flow through both generators in series and through both groups of lamps in series; and no current will flow in the neutral wire, as long as the number and size of lamps is equal on each side of the system.

### 2: SAVING IN COPPER BY USE OF THREE-WIRE SYSTEM

With the lamps operating at 220 volts and two in series, they require only one-half as much current in amperes to supply their rated wattage, as they would if they were operated on 110 volts. Therefore, smaller wires can be used and we find that this system saves over 50 per cent of the wire cost, except on certain small circuits where the Code requires a certain minimum size of wire.

The simple sketch and problem in Fig. 2 will illustrate how this reduction of current is obtained.

## Three-Wire Systems

We will use even figures of 100 volts and 200 volts to make them easy to follow. In "A" we have six 100 volt lamps of 200 watts each. The total wattage of the six lamps will be  $6 \times 200$  or 1200 watts. The current required for this wattage will be  $W \div E$  or  $1200 \div 100 = 12$  amperes, which will be the load on the wires. In "B" the lamps are connected two in series and each of these pairs connected across the 200 volt wires.

The total wattage of the lamps remains the same, or 1200 watts, and now the current will be  $W \div E$  again or  $1200 \div 200 = 6$  amperes. So with this connection the wires only need to carry one-half as much current.

This can also be checked in another way as follows: We know that the current required by each 100 volt, 200 watt lamp will be  $200 \div 100$  or 2 amperes. So when they are all connected in parallel it will require 12 amperes to operate them. But when they are connected as at "B," the same two amperes which lights the upper lamps must pass on through the lower one as well, so it now requires only  $3 \times 2$  or 6 amperes, at 200 volts.

### 3. UNBALANCED SYSTEMS

So far we have considered only a balanced load condition where no current flows in the neutral wire. Now let's see what will happen if the load is unbalanced or if one of the lamps is turned out on the upper side of the system in Fig. 2-B. We will illustrate this separately in Fig. 3. In this case the lower side will require 6 amperes and the upper side only 4 amperes. Two amperes will now flow out along the neutral wire from the lower generator, to make up this shortage. The upper generator supplies 4 amperes which flow through both groups of lamps and through the lower generators as well; and the lower generator supplies 6 amperes, four of which still flow through the outer wires and both groups of lamps, and two of which flow through the neutral and lower wires and lower groups of lamps only. The generators automatically assume their proper share of load whenever the load balance changes. Note the size of the current

## Three-Wire Systems

arrows which show this division of current. This is due to the fact that the resistance and the voltage drop of each group of lamps vary with their number.

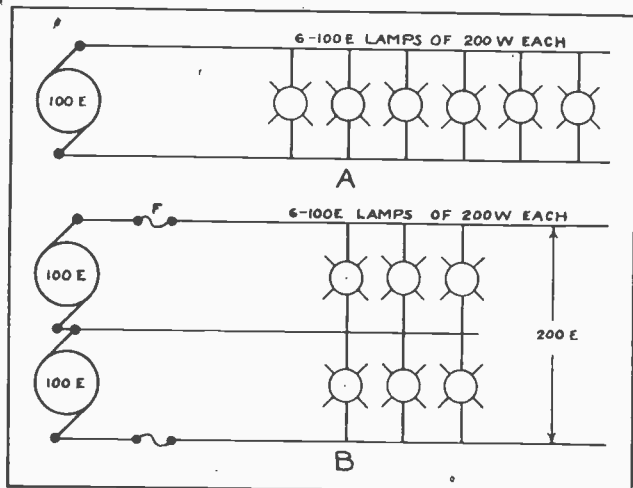

Fig. 2. By the use of Watts law determine the current required for the six lamps on 100 volts in the upper circuit; then determine the current required on the three-wire system below with the lamps operating on 200 volts in groups of two in series. This will show the reason for considerable saving in the size of the wires on three-wire systems.

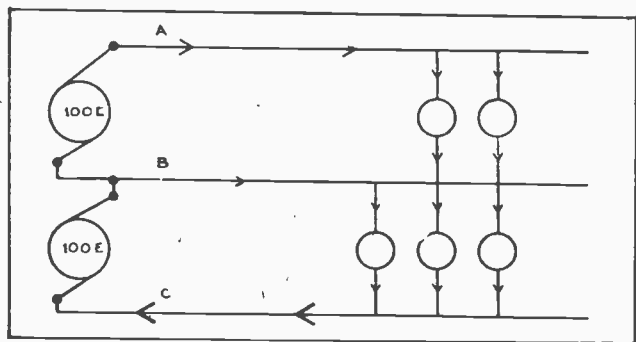

Fig. 3. This sketch shows an unbalanced three-wire system. Note carefully the division of current between the two generators and circuits and the direction of current flow in the neutral wire.

For example, if the lamps in Fig. 3 are all 100 volt, 200 watt lamps their resistance will be 50 Ohms each. Then, according to our rule for finding the total resistance of a parallel group, that of the

## Three-Wire Systems

two upper lamps will be  $50 \div 2 = 25$  Ohms resistance between wires "A" and "B." The total resistance of the three lower lamps in parallel will be  $50 \div 3$  or  $16\frac{2}{3}$  Ohms between wires "B" and "C."

Each generator delivers 100 volts, so that is the voltage applied to each group of lamps. The current through the upper group will be  $E \div R$  or  $100 \div 25 = 4$  amperes. The current through the lower group will be  $100 \div 16\frac{2}{3} = 6$  amperes. So we find that a simple application of Ohms law explains why the generators will each automatically supply their proper share of the current load.

The amount of current flowing in the neutral wire will always be in proportion to the amount of unbalanced load, and it may be in either direction according to which side of the system is the more heavily loaded.

The equivalent circuit of Fig. 2 is shown below. The value of the current in each line wire, the resistance of each group of lamps, and the voltage across each side of the system is indicated. The equality of voltage across either side of this unbalanced, three-wire system, is due to the effect of the neutral wire B.

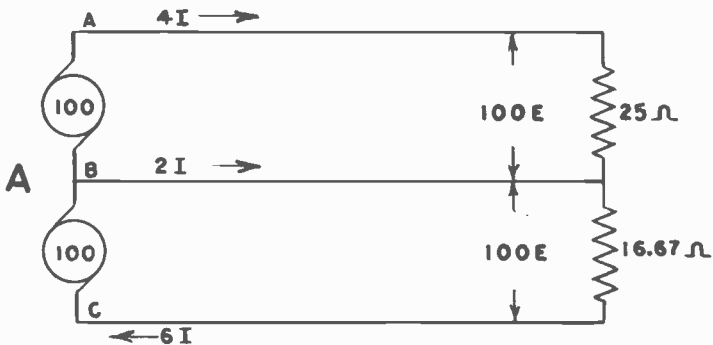

### 4. "SOLID NEUTRAL" FOR THREE-WIRE SYSTEMS

The ideal condition for a three-wire system is to have no current flowing through the neutral, so we should always try to keep the load as evenly balanced as possible when connecting up the two-wire branch circuits to the three-wire mains.

## Three-Wire Systems

Of course, it is impossible to keep such a system perfectly balanced at all times, because of lights and devices on the different circuits being turned on and off. This is the reason we need the neutral wire, and also one of the reasons the Code requires that on the modern polarized system the neutral must not be fused. This is the reason it is often termed a **Solid Neutral**. Many of the older non-polarized systems, however, have fuses and switches in the neutral.

### 5. EFFECTS OF OPEN NEUTRAL AND UNBALANCED LOAD

Now let's see what will happen in such a system if the neutral were fused and this fuse blew out while the load was unbalanced. In Fig. 4 we normally have a balanced load of eight lamps when all are turned on, but at present two in the upper group are turned off and the fuse in the neutral has blown.

Assume that the lamps are each of 100 Ohms resistance, and let's find out how much current will be flowing through the six lamps with 200 volts applied by the two generators in series, and their neutral open.

The resistance of the upper and lower groups of lamps being unequal, we must first figure that of each group separately and then, as the two groups are in series, we will add them to obtain the total resistance of all the operating lamps.

The resistance of the upper two lamps in parallel will be  $100 \div 2$  or 50 Ohms. That of the lower four in parallel will be  $100 \div 4$  or 25 Ohms. Then  $50 + 25 = 75$  Ohms, total resistance.

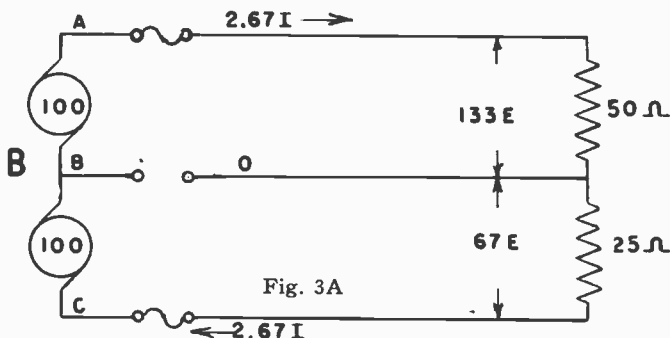



## Three-Wire Systems

Fig. 3A shows the equivalent circuit for Fig. 4.

Note that the two banks of lamps are now connected in series across the 200 volts and, that while the current in line A and the current in line C are equal, the voltage across the two sides of the system are very much unbalanced due to open in the neutral wire.

Now, according to Ohms law, we find that with 200 volts applied the current will be  $200 \div 75$  or  $2\frac{2}{3}$  amperes. This current will all flow through the upper two lamps, and then divide out through the lower four, so the upper lamps will burn much brighter than the lower ones.

The reason for this can also be checked by our knowledge of Ohms law and voltage drop principles. We know that the voltage drop across any device or group of devices in parallel is proportional to the resistance of the devices and the current flowing through them, or  $E_d = I \times R$ . Then, with a current of  $2\frac{2}{3}$  amperes flowing through the upper two lamps, which have a combined resistance of 50 Ohms, we find we have  $2\frac{2}{3} \times 50$ , or  $133\frac{1}{3}$  volts drop across them, which accounts for their burning much too brightly. On the lower group with the same current flowing through a resistance of 25 Ohms, we will have  $2\frac{2}{3} \times 25$ , or  $66\frac{2}{3}$  volts drop across the lamps, which accounts for their burning very dim.

This over voltage applied to the upper group will cause their filaments to be severely overheated, and possibly burned out if they are left long in this condition.

From this we see that a common indication of a blown neutral fuse or a non-polarized three-wire system would be when part of the lamps burn excessively bright and others burn very dim.

This cannot happen on the modern polarized system where the neutral has no fuse and is always closed, allowing the generators to balance up the load by applying 100 volts at all times to each side of the circuit. If this had been the case in Fig. 4,

## Three-Wire Systems

the lamps would have remained at normal brilliancy, as  $100\text{ E} \div 50\text{ R}$  of the upper group would cause just two amperes, or one ampere for each lamp, to flow through them; while  $100\text{ E} \div 25\text{ R}$  of the lower group would cause four amperes, or one ampere for each lamp, to flow through them. The neutral wire would carry the difference.

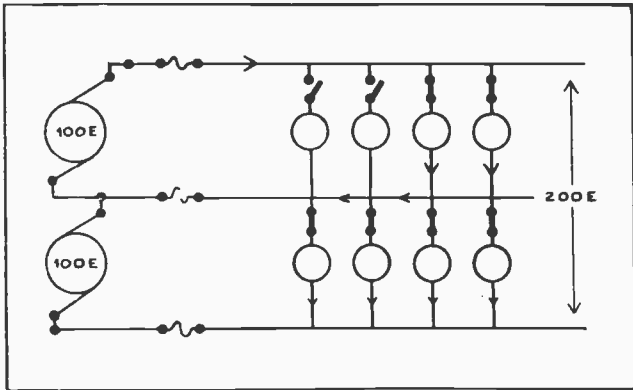

Fig. 4. This diagram illustrates what would happen if the neutral wire was to become opened on an unbalanced three-wire system. The upper two lamps would then burn excessively bright, and the lower four would burn very dimly.

While it is not likely that the neutral will often have to carry as much current as the outer wires, on a properly balanced three-wire system, it is possible for it to happen occasionally, so the Code requires that the neutral wire be the same size as the others, except on loads over 200 amperes, where we can reduce the size of the neutral 30%. This reduction is allowed either from the maximum connected load, or by applying what is known as a **Maximum Demand Factor**, which will be explained later.

We have illustrated the principles of the three-wire system with two D. C. generators as the source of the two different voltages, because it is easy to understand and was the first method of obtaining this system. In a number of places this method is still in use, where 110 and 220 volts D. C. are used. In other cases a special three-wire generator is used, having a connection to a center point in its arma-

## Three-Wire Systems

ture winding to obtain the neutral or half voltage wire.

This system can also be used just as readily on A. C., by using two transformers connected in series, or merely a center tap from the 220 volt secondary winding of one transformer, as shown in

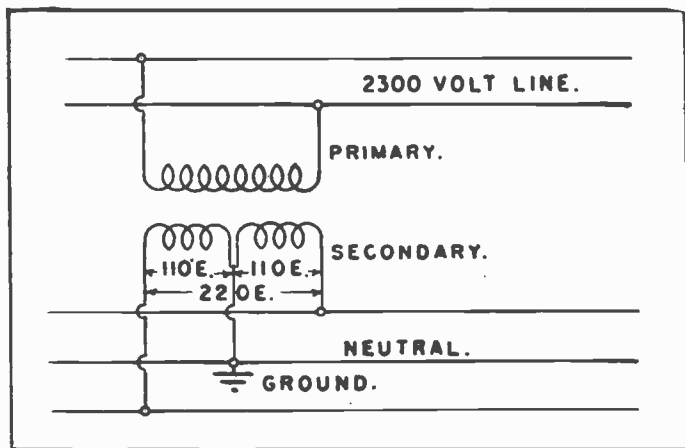

Fig. 5. Three-wire A.C. systems can be conveniently obtained by the use of a center connection to transformer windings as shown above.

Fig. 5. This is by far the most common type of three-wire system in use today, and is applied to power systems at 220 or 440 volts A. C., as well as to house wiring systems of 110 and 220 volts.

## 6. POLARIZED WIRING SYSTEMS

This system has been mentioned several times so far, particularly with reference to the grounding of various circuits and equipment. The term **polarized** in this case refers to the grounding and marking or identification of the neutral wire.

The modern polarized wiring system is one that has the **neutral wire thoroughly grounded at the service switch**, and this grounded wire distinguished throughout the entire system by a different color from the "hot" or ungrounded wire.

In order to understand the effects of grounding and identifying one wire in any given wiring system, let us consider the result of touching the

## Polarized Wiring

wires of a given electrical system under various circumstances. Fig. A shows a little "fellow"—we'll call Mr. Sparks touching the positive wire of a 110 volt ungrounded system. Since electricity cannot flow through human body unless there is established between two points in the body a difference in pressure, it is obvious that "Sparks" will feel nothing.

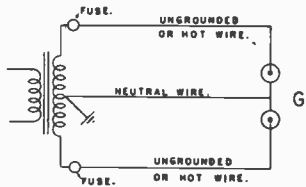
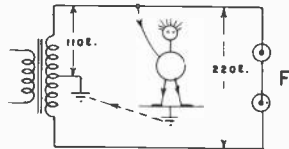
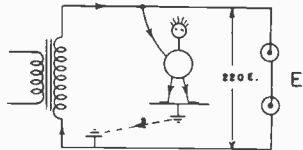
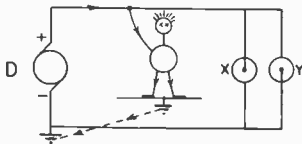
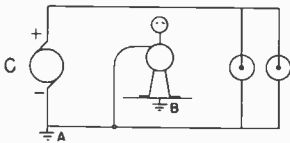
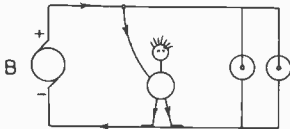
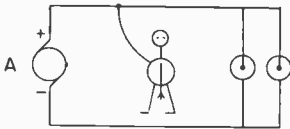

**FIG 5-A**

Fig. B shows "Sparks" making contact with both sides of the circuit, since he is grasping the positive wire and standing on the negative wire. There is thus established between his hand and his feet a difference in pressure of 110 volts, and current will flow through the body as indicated. If the resistance of Sparks body is such as to permit more than

## Polarized Wiring

ten milliamperes of current to flow through it, Mr. "Sparks" is in for a shocking experience.

Fig. C shows the effect of touching a grounded wire when standing on the ground. As there is no difference in pressure between the hands and feet under these circumstances, there is no danger of shock. Therefore, while standing on the ground, "Sparks" may touch any ground wire without being electrically affected. If, on the other hand, he stands on the ground and touches the ungrounded wire, as shown in Fig. D, he is immediately subjected to the full voltage of the circuit, and current will flow as indicated. Note that touching the shell of lamp Y would produce the same result, although to get a shock from lamp X, "Sparks" would have to touch the center contact.

It is evident from a consideration of the effects obtained with the different lamps in Fig. D that polarizing or identifying the wires on a grounded system is of considerable importance. Since most wiring systems for power and light must be grounded to effect maximum protection to the user against lightning, and against the possibility of some high voltage circuit making contact with the relatively low voltage power and lighting networks, it follows that polarizing of the low voltage circuits by identification of the grounded wire is imperative. By positively identifying the grounded wire, and then connecting this wire to those parts of the electrical devices that are most likely to be touched, the possibility of getting a shock from the electrical system can be reduced to a minimum.

Although the diagrams studied thus far have indicated D.C. systems, a little thought on the subject of grounding and polarizing will show that the same principles apply to the A.C. circuit. If the source of power in Fig. D for example, were A.C. instead of D.C., then during one alternation current would flow as indicated, and during the next alternation the current would reverse in direction, flowing up through the feet and out of the hand. So long as there is a difference in pressure established between any two parts of the body, current will flow between those parts and if the current be strong enough an electric shock will result.

## Polarized Wiring

In Fig. E the result of touching the ungrounded wire would be to impress between the hand and foot a difference in pressure of 220 volts; however, if the midpoint of the transformer secondary were grounded, (Fig. F) the maximum voltage of either ungrounded wire with respect to ground would be 110 volts. This shows that grounding the midpoint of a 220 volt current reduces the shock hazard in systems of this type.

Most of the three-wire systems used for the distribution of light and small power applications are of the 110-220 volt grounded neutral type shown in Figure G. Note the result of polarizing in this system; First of all, observe that the shell contact of the lamps are connected to the grounded wire; note also that the ungrounded wires are attached to the relatively inaccessible center contacts of the lamps. Observe that each ungrounded wire is fused. Should the ungrounded wire come into contact with the lamp shell, the lamp would be short circuited, the protective fuse in the associated ungrounded wire would blow, and the circuit and fixture would be electrically dead. If, on the other hand, the grounded wire should come into contact with the shell of the lamp—it is normally insulated from it—no shock would result upon touching this shell because the system has been polarized; this is, the shell is now connected to ground and, since the individual is standing on the ground, there is no voltage across his body and no shock results.

Thus it is seen that by grounding certain wires in a network, and by identifying and connecting the wires to certain parts of the electrical equipment to be operated from the network, the dangers from lightning, adjacent high voltage circuits, and personal shock may be reduced to a minimum.

The amount of current that can be forced through the body depends upon the voltage applied to it and the resistance of the skin at the time of contact. The skin resistance will vary with conditions from 1000 ohms when wet to 500,000 ohms when dry. If the skin resistance is low due to water, perspiration, or some other cause, a relatively low voltage may become extremely hazardous; in fact, under

## Polarized Wiring

such conditions a voltage of 100 volts may prove more dangerous than 1000 volts because the higher voltage produces a stronger muscular convulsion that may throw the individual clear of the circuit. Under the circumstances cited, 100 volts may force through a wet skin a current of one-tenth ampere, and this current value can be fatal. It is evident therefore that proper precautions are imperative when live circuits must be worked on. Remember that the voltage of the circuit is only one factor, and that the conditions under which the work is done, particularly with regard to skin condition, are of paramount importance. Wherever a survey of the conditions indicate that a hazard is involved, adequate precautions should be taken before the circuit is worked on. Whenever possible, the circuit should be disconnected from the source of supply before repairs or reconnections are attempted.

Generally, we use a wire with black or red insulation for the ungrounded wire, and one with white or light gray insulating braid for the grounded wire. This applies to wires from 14 to 6 in size. On larger wires and cables, other methods of marking the grounded wire are used. The ends can be coated with white paint or tagged, or at the service entrance the ends left for the power company's man to connect his wires to, can have the insulation stripped off the grounded wire for a short distance. The identification of the grounded wire should be carried on through every branch circuit, fixture wire, etc., right up to the device using the current.

The other very important rule for a polarized system, as previously mentioned, is that the neutral or grounded wire must not be fused at any point, but must always be complete and unbroken from the service box to the very tip of light sockets or devices to which it is attached. Or, in other words, it must be what is called a **Solid Neutral**.

### 7. SAFETY FEATURES AND ADVANTAGES OF POLARIZED WIRING

Another advantage of maintaining this unbroken grounded wire, and having it plainly

## Polarized Wiring

marked, is so that it can always be connected to the threaded or outer element of lamp sockets and receptacles; while the "hot" or ungrounded wire must always be connected to the inner or center terminal of such sockets. This eliminates practically all danger of anyone getting a shock by touching the socket, even if the insulation of the outer element failed, allowing it to touch the shell or casing.

You will find the terminal screws of the latter type sockets, receptacles, and switches are also

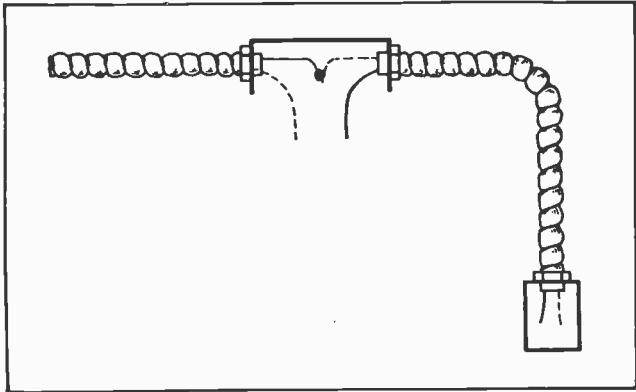

Fig. 6. This sketch shows the manner in which the white and black wires in a polarized system are connected at the outlet boxes for ceiling lights and wall switches.

identified by one screw having a yellow or brass color, and the other a white or silvery color.

The grounded wire should, of course, attach to the lighter colored screw, and the "hot" wire to the brass colored screw.

When using BX as switch leads we must make an exception to the rule. In this case we sometimes connect the black and white wires together.

This is because we must have one black wire and one white one coming out of the outlet for connection to the light fixture, as in Fig. 6. In order to do this, we must connect the white wire of the BX, which runs to the switch, to the black wire in the ceiling outlet.

We should then remember that the white wire at the switch is the "hot" one, and the black wire



## Polarized Wiring

at the ceiling outlet is the return wire from the switch, and it should be connected as usual to the yellow screw on the fixture.

In order to make this protection positive and dependable, you can readily see that the grounded wire must always be complete clear-back to the transformer, and we should never place any switch in this side of the circuit unless it also opens the ungrounded wire at the same time it opens the grounded one. Double pole snap switches, for example, open both wires at the same time. Single pole switches, when used, **must always be placed in the ungrounded wire.**

Having this neutral wire grounded, as well as the conduit, gives us added protection against fire or shock hazard from the conduit system.

In case the insulation of the "hot" wire becomes defective, and allows it to touch the conduit, this causes a short circuit and immediately blows the fuse, indicating a defect on the circuit, which can be repaired at once. Using this system with a solid neutral also eliminates the possibility of having an open neutral and burned out lamps when the load is unbalanced.

### 8. GROUNDING NEUTRAL WIRE OF POLARIZED SYSTEMS

At the transformers you will generally find three wires coming from the secondary winding. The center one of these is the neutral, and is grounded by the power company. The ground inside the building at the service switch should be heavy copper wire not smaller than No. 8, as previously mentioned, and this wire should be protected from possible breakage by being run inside the piece of conduit to the waterpipe, where it is attached by use of a ground clamp, previously described.

The end of this ground wire at the service box is usually connected to the "neutral strap" in the switch box, and also to a brass grounding screw that will be found in the modern steel switch cabinet.

We do not ground the service switch or any part of an interior D. C. wiring system, but one wire of the D. C. line is grounded at the power plant.

## Service Wires

On all alternating current systems, however, this additional grounding of the neutral wire as well as the conduit, and the identification of this wire throughout the system are great safety features and advantages, and make the polarized system a very desirable one to use.

### 9. PARTS OF WIRING SYSTEMS

Every wiring job consists of at least two, and sometimes three, important parts. They are the **Service, Feeders, and Branch Circuits**. All jobs must have the service and branch circuits. On the larger installations the main circuits feeding from the service to the branch circuit panels are called feeders.

The service can be divided into two parts also. One part is the running of the wires from the transformer or line to the building service entrance, which would be the **Drip Loops** or weather cap on the building. The other part is the running of the wires from the drip loop into the service switch.

### 10. SERVICE WIRES

The service wires from the pole are usually run by the power company from whom the power is to be purchased. These wires should have weather-proof insulation, and be attached to insulators at the house in a manner to keep all strain off from the drip loop and weather cap.

See Fig. 7, which shows how these wires would be attached to the building, and also a method of bracing a porch, or part of a building, to stand the strain that long heavy service wires might place upon it.

The **Drip Loop**, or slack loops of wire from the insulators to the weather cap, are used to prevent water from running down the wires into the conduit.

The electrician wiring the house can use either conduit or service cable for running the service on into the service switch. The Code recommends the use of conduit, and it is much the best.

## Service Wires

The service wires must be at least No. 8 and rubber covered. This requires  $\frac{3}{4}$ " conduit, which can be run from a point near the outside insulators,

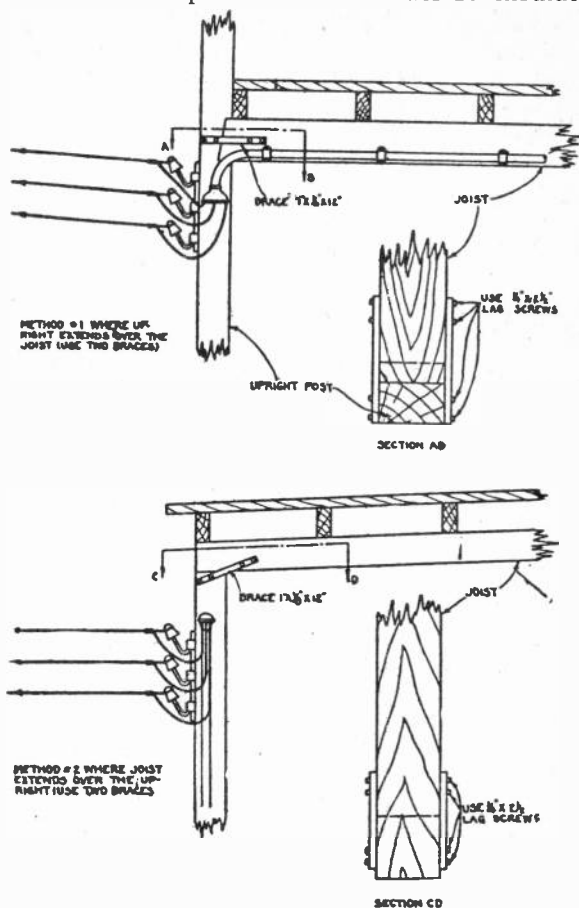

Fig. 7. The above two sketches show the method of arranging the connections of service wires to a building with strain insulators, drip loops, and weather heads. Also note the method of bracing a porch or corner of a building to stand the strain of a long run of service wires.

either up or down the outside wall, or along horizontally, to a convenient place for entrance to the service switch inside. The wires and conduit should be larger if the load requires.

This conduit should always be equipped with a

## Branch Circuits

**Weather Cap**, such as one of the types shown in Fig. 8, so the wires enter from the under side and no water can enter the conduit.

In some cases a "B" conduit fitting can be used, or the upper end of the conduit bent in an inverted "U," and an "A" conduit used to form the weather protection. The strain insulators and weather cap should be located 15 to 18 feet from the ground if possible.



Fig. 8. Weather head fittings of the types shown above are used on the end of conduit at the service entrance to prevent water from entering the conduit.

Service wires should enter the building at a point as near as possible to the service switch, and this switch should be located near a door or window if possible. This location of the switch is to make it more easily accessible in case of fire.

### 11. FEEDERS

On larger jobs, such as apartment buildings, stores, and offices, cut-out blocks, or fuse cabinets are often located on the various floors or in various sections or apartments. The **feeders** are run from the service switch to these branch circuit panels, and the wires must be of the proper size according to the load in amperes which they are to carry.

Sometimes several buildings are connected together by feeders, in which case there must be a suitable **Feeder Control** switch at one end or the other, to separate the systems in each building when necessary.

## Branch Circuits

Service or feeder wires when passing over any buildings must clear the roofs 8 ft. at their nearest point.

### 12. BRANCH CIRCUITS

Practically all wiring systems have **Branch Circuits**, which may be referred to as the wires beyond the last set of fuses.

Most branch circuits are two-wire circuits, although some are three-wire. On all ordinary two-wire branch circuits of under 125 volts, we must use at least No. 14 wire, and generally fuses of not over 15 ampere size.

In addition to lamps, we may connect appliances of not over 660 watts or 6 amperes each to these branch circuits.

### 13. TYPES OF BRANCH CIRCUITS

Branch circuits are sub-divided into:

**Lighting Branch Circuits**, which are intended to supply energy to lighting outlets only, and are governed by the rules just given.

**Combination Lighting and Appliance Branch Circuit**, which as its name implies is a combination of lighting and power outlets with limits as previously mentioned.

**Appliance Branch Circuits**, which supply energy to permanently wired appliances or to attachment plug receptacles.

Appliance Branch circuits are further sub-divided into:

**Ordinary Appliance Branch Circuits**, using as a rule receptacles and plugs rated at not over 15 amperes at 125 volts, using at least No. 14 wire and fused not to exceed 15 amperes. On these circuits we may use appliances rated at not over 1320 watts.

**Medium Duty Appliance Branch Circuits**, wired with No. 10 wire, and fused for 25 amperes, where we may use appliances rated not to exceed 15 amperes or 1650 watts each

**Heavy-Duty Appliance Branch Circuits**, wired and fused as above, for appliances between 15 and 20 amperes.

## Branch Circuits

Appliances using over 20 amperes should be supplied by individual circuits.

### 14. LOADS ON WIRING SYSTEMS, AND SIZE OF SERVICE WIRES

The total connected load on any wiring system can easily be calculated by adding up the rating in watts of all the lamps and devices connected to the system.

Then, by dividing this wattage by the voltage of the system, we can determine the current in

**Gauge Equivalents—Weights—Resistances of Standard Annealed Copper Wire**

B & S Amer. Wire Gauge No.	Diameter in Inches	Area Circular Mils.	ft/m at 68 deg. Fah.			Feet		Pounds			B & S Amer. Wire Gauge No.
			Per 1,000 Ft.	Per Mile	Per Pound	Per Pound	Per Ohm	Per 1,000 Ft.	Per Ohm	Per Mile	
0000	0.480	211800	0.04006	0.25903	0.00077	1.56127	20497.7	640.51	17987	3580	0000
00	0.4064	167805	0.06186	0.32664	0.00117	1.9087	10353.23	501.95	8533	2800	000
000	0.3648	137079	0.07801	0.41187	0.0019	2.4824	12801.57	407.83	5763	2150	00
0	0.3248	105534	0.09831	0.51009	0.0031	3.1303	10223.08	319.45	3223.	1680	0
1	0.2893	81094	0.12404	0.63490	0.0049	3.9474	8107.40	253.34	2041.	1340	1
2	0.2563	66371	0.1563	0.8258	0.0078	4.9722	6429.58	200.91	1282.	1060	2
3	0.2262	52634	0.19223	1.0414	0.0123	6.2765	5098.61	159.32	800.	840	3
4	0.2043	41743	0.24059	1.313	0.0198	7.9141	4043.6	126.33	593.	660	4
5	0.18194	33102	0.31361	1.655	0.0314	9.9703	3208.61	100.70	518.	528	5
6	0.16202	26231	0.39546	2.088	0.0499	12.5847	2542.80	79.462	300.	420.	6
7	0.14429	20817	0.49871	2.633	0.06767	15.8605	2013.31	63.013	226.	333	7
8	0.12849	16310	0.6329	3.3	0.1125	20.0097	1599.3	49.976	80.	264	8
9	0.11443	13094	0.7892	4.1	0.167	23.270	1268.44	39.635	50.	200	9
10	0.10189	10382	0.8441	4.4	0.270	31.0712	1035.66	31.425	37.	166	10
11	0.09072	8234	1.234	6.4	0.301	40.1202	797.649	24.924	20.	132	11
12	0.08068	6530	1.580	8.3	0.370	50.3006	632.555	19.266	12.65	103	12
13	0.07194	5178	1.905	10.4	0.427	63.7948	501.63	15.874	7.07	82.9	13
14	0.064084	4107	2.504	13.2	0.500	80.4415	397.822	12.453	5.00	65.3	14
15	0.05708	3237	3.172	16.7	0.570	101.4365	313.482	8.859	3.12	32.1	15
16	0.05082	2582	4.001	23	0.512	127.12	250.184	6.199	1.93	41.3	16
17	0.045237	2048	5.04	26	0.611	161.72	198.409	4.190	1.23	32.7	17
18	0.040303	1624	6.38	33	0.720	203.374	157.35	4.916	0.771	26.0	18
19	0.03589	1288	8.25	42	0.842	256.468	124.777	3.890	0.473	20.6	19
20	0.031961	1021	10.17	53	0.977	322.399	98.6533	3.084	0.305	16.3	20
21	0.028462	810	12.76	68	1.120	407.615	78.473	2.452	0.192	12.6	21
22	0.025347	642	16.25	85	1.273	514.193	62.230	1.943	0.119	10.24	22
23	0.022571	509	20.30	108	1.433	648.452	49.3504	1.542	0.075	8.13	23
24	0.0201	404	23.60	135	1.600	817.688	39.1365	1.223	0.047	6.44	24
25	0.0179	326	32.2	170	1.773	1031.038	31.0381	0.9090	0.030	5.12	25
26	0.01594	254	40.7	214	1.950	1300.180	24.6131	0.7092	0.0182	4.06	26
27	0.014195	201	51.3	270	2.130	1636.49	19.5191	0.6099	0.0118	3.22	27
28	0.012641	158.8	64.8	343	2.310	2067.264	15.4793	0.4837	0.0074	2.56	28
29	0.011237	126.7	81.6	432	2.500	2606.939	12.2854	0.3835	0.0047	2.03	29
30	0.010025	100.5	103	538	2.690	3287.084	9.7355	0.3002	0.0029	1.61	30
31	0.008928	79.7	130	685	2.880	4414.09	7.72143	0.2413	0.0018	1.27	31
32	0.00795	63	164	963	3.070	5726.913	6.12243	0.1913	0.0011	0.91	32
33	0.00708	50.1	206	1333	3.260	7390.00	4.85373	0.1517	0.00078	0.693	33
34	0.006304	39.74	260	1789	3.450	9521.8	3.84966	0.1204	0.00048	0.434	34
35	0.005614	31.5	328	2321	3.640	12481.77	3.03303	0.0936	0.00028	0.304	35
36	0.005	25	414	3000	3.830	16214.18	2.4517	0.0737	0.00018	0.200	36
37	0.004453	19.8	523	3745	4.020	20919.97	1.92066	0.06023	0.00011	0.137	37
38	0.003965	15.72	660	4896	4.210	27772.25	1.52292	0.04758	0.00007	0.091	38
39	0.003531	12.47	832.	6395	4.400	36480.237	1.20777	0.03755	0.00004	0.069	39
40	0.003146	9.88	1048.	8342.	4.590	47823.63	0.97084	0.02992	0.000025	0.038	40

Fig. 9 This complete table will be very valuable to you and will save you much time in estimating coil sizes, weights, etc.

amperes which would flow if all the devices were all operated at once. This would be called the maximum load.

## Demand Factor

In the ordinary building there is almost never a time when all lights or devices are turned on at once. However, careful tests and measurements on various classes of buildings show certain average loads which represent the usual case. In various types of buildings, these loads vary from 25 per cent to 85 per cent of the connected load.

Until 1928 the National Code required the installation of service wires and feeders large enough to take care of the **Maximum Connected Load**. If there was a total connected load of 500 amperes in the building, the service wires had to be large enough for this load, even though there was practically no chance of 500 amperes ever being used at any one time.

### 15. DEMAND FACTOR

The Code now permits us, under certain conditions, to consider the **Maximum Demand** instead of the **Maximum Connected Load**, when figuring the size of service and feeder wires. To do this we use what is called the **Demand Factor**. This figure is obtained from the **ratio of the maximum demand to the connected load** of the type of system we are considering. It is based on the area, as determined by the outside dimensions of the building and the number of floors; and it may be applied to interior wiring systems supplying both lights and appliances. This demand factor also varies with the use to which the building is put.

Let us consider an example for a large single-family dwelling. If the house is 30' x 45' and two stories high (not counting unoccupied basements or unfinished attics or porches) then its area will be  $30' \times 45' \times 2 = 2700$  sq. ft.

For the first 2000 sq. ft. of such buildings, we allow one watt per sq. ft. or 2000 watts; and for the balance .60 watts per sq. ft. The balance in this case is  $2700 - 2000$ , or 700 sq. ft.

With this balance we can use the demand factor, which is .60 for this type of building. Then  $.60 \times 700 = 420$ . We must always add an extra 1000 watts for appliances.

The total load, or maximum demand, will then

## Demand Factor

be 2600, + 420 + 1000 or 3420 watts. If this is to be on a balanced three-wire system we can divide the watts by 220 volts, or  $3420 \div 220 = 15.5 +$  amperes, to allow for on the service wires. If it is to be a 110 volt system then  $3420 \div 110 = 31.9 +$  amperes. (Note—Wherever the + sign is used after an answer figure, it indicates this figure is approximate and not carried out to long decimal fractions.)

In residence buildings of the apartment type, for from two to ten families, we use .70 as the demand factor, and add 1000 watts for each apartment for appliances. The demand factor can also be applied to the total allowance for appliances.

In stores, including department stores, we allow 3 watts per sq. ft., except for display cases and show windows. For counter display cases, allow 25 watts per linear ft. (per ft. of length); for wall and standing cases, 50 watts per linear foot; and for show windows, 200 watts per linear ft. In such buildings 1.00 is used as a demand factor.

In garages, allow  $\frac{1}{2}$  watt per sq. ft., and use 1.00 as the demand factor.

In industrial plants and commercial buildings, the service wires are calculated for the specified load of the equipment. This takes into consideration the average load factor, which will be covered in a later section on motors.

Other kinds of installations are covered in the Code and can easily be referred to when required.

Keep in mind that the demand factor applies only to services and feeders, and not to branch circuits.

## WIRE CALCULATIONS

A great deal of valuable information on the size of copper wires, their resistance, and current carrying capacity can be obtained from convenient tables; and they should be used whenever possible as they are great time savers.

There are certain cases, however, when tables are not available or do not give just the needed information, and a knowledge of simple wire calculations is then very important.



## Wire Calculations

For example, the table in the National Code which gives the allowable current carrying capacities is based on the **heating of the wires** and does not consider **voltage drop** due to resistance of long runs or lines. Both of these considerations are very important and should always be kept in mind when planning any electrical wiring system.

The wires must not be allowed to heat enough to damage their insulation, or to a point where there will be any chance of igniting nearby materials. If wires are allowed to heat excessively, it may cause the solder at joints to soften and destroy the quality of the splices; and in other cases it may result in expansion of the wires and resulting damage. Heat is also objectionable because it increases the resistance of the wires, thereby increasing the voltage drop for any given load.

### 16. VOLTAGE DROP

Whether or not the wires heat noticeably, the resistance and voltage drop on long runs may be great enough to seriously interfere with the efficient operation of the connected equipment. Incandescent lamps are particularly critical in this respect and a drop of just a **very few volts below the voltage for which they are rated, greatly reduces their light and efficiency**. In the case of lighting circuits, the current reduces when the voltage at the lamps is below normal.

Motors are not affected by small voltage variations quite as much as lamps are, but they will not give their rated horsepower if the voltage is below that at which they are rated. When loaded motors are operated at reduced voltage, the current flow actually increases, as it requires more amperes to produce a given wattage and horsepower at low voltage than at the normal voltage. This current increase is also caused by the fact that the opposition of the motor windings to current flow reduces as their speed reduces. The reason for this will be explained later.

From the foregoing we can see that it is very important to have all wires of the proper size, to avoid excessive heating and voltage drop; and that,

## Wire Calculations

in the case of long runs, it is necessary to determine the wire size by consideration of resistance and voltage drop, rather than by the heating effect or tables alone.

To solve the ordinary problems requires only a knowledge of a few simple facts about the areas and resistance of copper conductors and the application of simple arithmetic.

### 17. GAUGE NUMBERS BASED ON RESISTANCE

You have already learned that wire sizes are commonly specified in B. & S. gauge numbers. This system was originated by the Brown & Sharpe Company, well known manufacturers of machine tools. The B. & S. gauge is commonly called the American Wire Gauge and is standard in the United States for all round solid electrical wires.

These gauge numbers are arranged according to the resistance of the wires, the larger numbers being for the wires of greatest resistance and smallest area. This is a great convenience, and a very handy rule to remember is that **increasing the gauge by three numbers gives a wire of approximately half the area and twice the resistance.** As an example—if we increase the gauge from No. 3, which has .1931 Ohms per 1000 ft., to No. 6, we find it has .3872 Ohms per 1000 ft., or almost double.

Brown & Sharpe gauge numbers range from 0000 (four aught), down in size to number 60. The 0000 wire is nearly  $\frac{1}{2}$  inch in diameter and the number 60 is as fine as a small hair.

The most common sizes used for light and power wiring are from 0000 down to No. 14; and also, of course, the Nos. 16 and 18, which are used only for fixture wiring.

### 18. CIRCULAR MIL, UNIT OF CONDUCTOR AREA

In addition to the gauge numbers, we have a very convenient unit called the **Mil**, for measuring the diameter and area of the wires. The mil is equal to

## Wire Calculations

1/1000 of an inch, so it is small enough to measure and express these sizes very accurately. It is much more convenient to use the mil than thousandths or decimal fractions of an inch. For example, instead of saying a wire has a diameter of .055", or fifty-five thousandths of an inch, we can simply say or write 55 Mils. So a wire of 250 Mils diameter is also .250", or  $\frac{1}{4}$  inch, in diameter.

As the resistance and current-carrying capacity of conductors both depend on their cross-sectional area, we must also have convenient small units for expressing this area. For square conductors such as bus bars we use the **Square Mil**, which is simply a square 1/1000 of an inch on each side. For round conductors we use the **Circular Mil**, which is the area of a circle with a diameter of 1/1000 of an inch. The abbreviation commonly used for circular mil is C.M.

These units simplify our calculations considerably, as all we need to do to get the area of a square conductor in **Square Mils**, is to multiply one side by the other, measuring them in mils or thousandths of an inch.

To get the area of a round conductor in **Circular Mils**, we only need to square its diameter in mils (square a number by multiplying it by itself).

### 19. CONVERSION OF SQUARE MILS TO CIRCULAR MILS

In comparing round and square conductors, however, we must remember that the square mil and circular mil are not quite the same size units of area. For a comparison see Fig. 10. At "B" we have shown a circle within a square. While the circle has the same diameter as the square, the corners of the square make it the larger in area. So just remember this little illustration, and it will be easy to recall that the area of one **Circular Mil** is less than that of one **Square Mil**. The actual ratio between them is .7854, or the circle has only .7854 of the area of a square of the same diameter.

Then if we wish to find the **Circular Mil Area**

## Wire Calculations

from the number of Square Mils, we divide the Square Mils by .7854. If we wish to find the Square Mil Area from Circular Mils, multiply the Circular Mils by .7854.

For example, if the conductor at "A" in Fig. 10 is a No. 0000 and has a diameter of 460 mils, what is its area both in circular mils and in square mils? The C.M. area is  $460 \times 460 = 211,600$  C.M. Then the sq. mil area is  $211,600 \times .7854 = 166,190.64$  sq. mils.

If the bus bar at "C," in Fig. 10, is  $1\frac{1}{2}$  inches high and  $\frac{1}{4}$  inch thick, what is its area in square mils, and what size of round conductor would be necessary to carry the same current that this bus bar would? First, the dimensions of a  $\frac{1}{4}$ " x  $1\frac{1}{2}$ " bus bar stated in mils, are 250 mils  $\times$  1500 mils. Then the area in sq. mils is  $250 \times 1500 = 375,000$  sq. mils.

To find what this area would be in circular mils we divide 375,000 by .7854, and find it would be 477,463.7 C.M. The nearest size to this in a round conductor is the 500,000 C.M. size, which we would use in this case.

Bus bars of the shape shown at "C" in Fig. 10 are commonly used in wiring power plant or large distribution switchboards. These bars ordinarily range in thickness from .250" to .375"; and in height, from 1" to 12". On voltages under 600 they can be used bare, when properly mounted on switchboard panels. On higher voltages they are usually taped to avoid shock hazard.

It is quite common practice to allow about 1000 amperes per sq. inch on such busses when they are located in well ventilated places. This is a very convenient figure and should be remembered.

When heavier currents than one of the thin bars can carry, are to be handled on a switchboard, several bars are usually mounted in parallel with small spaces between them for air circulation and cooling.

Stranded conductors, such as shown in Fig. 10-D, are used on all sizes larger than 0000. As



1-28 - (12-10-47)

29-55 (12-19-47)

55-112 (1-7-48)

112-140 (1-14-48)

140<sup>APT. 5</sup>-161 (1-21-48)

329-404 - (11-26-47)

## Wire Calculations

stranded conductors are not solid throughout, we cannot determine their area accurately by squaring their diameter. This diameter also varies somewhat with the twist or "lay" of the strands.

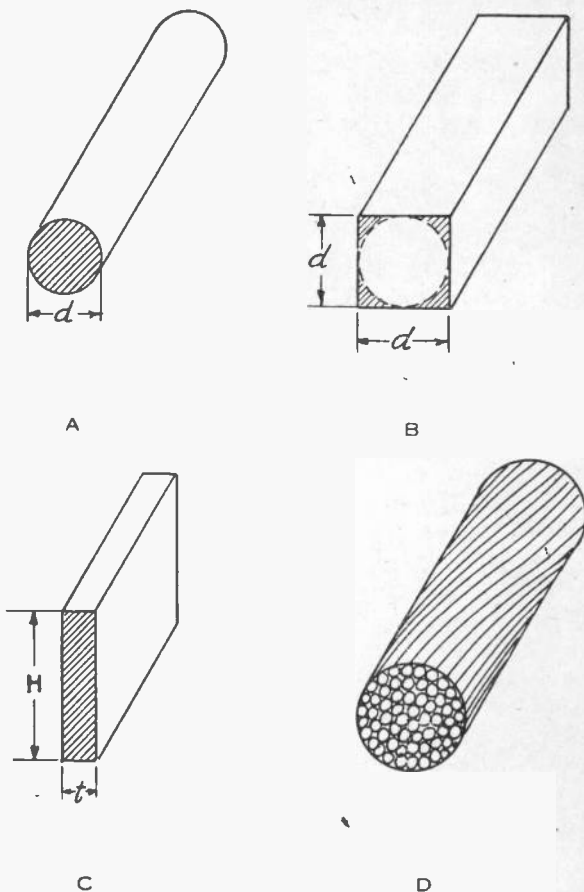

Fig. 10. Electrical conductors are commonly made in the several shapes shown above. Note particularly the comparative areas of round and square conductors as shown at "B", and refer to these illustrations when making the calculations explained in the accompanying paragraphs.

To determine the cross-sectional area of such conductors, we get the area of each strand, either from a wire table or by calculation from its dia-

## Wire Calculations

meter, and then multiply this by the number of strands, to get the total area of the cable in C.M.

The following wire table gives some very convenient data and information on the common sizes of conductors, and will be very helpful for future reference as well as during your study of this section.

### 20. RESISTANCE OF CONDUCTORS

As previously mentioned, it is often necessary to determine the exact resistance of a conductor of a certain length, in order to calculate the voltage drop it will have at a certain current load.

The resistance per 1000 ft. of various wires can be obtained from the wire table given on the next page, and from these figures it is easy to calculate the resistance of smaller or greater lengths.

Suppose you wish to find the total resistance of a two-wire run of No. 10 conductors 150 ft. long. First multiply by 2, to get the entire length of both wires; or  $2 \times 150 = 300$  ft. Then, from the table, we find that the resistance of No. 10 wire is .9792 Ohms per 1000 ft. Our circuit is less than 1000 ft.; or  $300/1000 \times .9792 = .29226$  Ohms; or approximately .29, which would be accurate enough for the ordinary job.

In another case, we wish to run a short outdoor line between two buildings, a distance of 1650 ft., and using No. 1 wire. What would its total resistance be? The total length of both wires will be  $2 \times 1650 = 3300$  ft. From the table, we find the resistance of No. 1 wire is .1215 Ohms per 1000 ft. Then as 3300 ft. is 3.3 times 1000, we multiply  $3.3 \times .1215 = .40095$  or approximately .4 Ohms.

The National Code table for carrying capacities of wires, allows 100 amperes for No. 1 R.C. wire. We find, however, that if we have this much current flowing through our line, the voltage drop ( $E_d$ ) will be  $I \times R$  or  $100 \times .4 = 40$  volts. This is too much to be practical, because even if we applied 120 volts to one end of the line, the lamps or devices at the other end would receive only  $120 - 40$ , or 80 volts.



## WIRE TABLE.    B & S Gauge

Size B&S Gauge	Diameter in Mils	Area in Circular Mils	Lbs. per 1000 feet Bare Wire	Resistance (Ohms) per 1000 feet at 60° F.
<b>Solid Wire</b>				
26	15.94	254.1	.77	40.75
25	17.90	320.4	.97	32.21
24	20.10	404.01	1.22	25.60
23	22.57	509.5	1.54	20.30
22	25.35	642.4	1.95	16.12
21	28.46	810.1	2.45	12.78
20	31.96	1022.	3.10	10.14
19	35.89	1288.	3.90	8.04
<b>Solid Strand</b>				
18	40.30	1624.	4.917	6.374
16	50.82	2583.	7.818	3.936
14	64.08	4107.	12.43	2.475
12	80.81	6530.	19.77	1.557
10	101.9	10380.	31.43	.9792
9	114.4	13090.	39.63	.7765
8	128.5	16510.	49.98	.6158
7	144.3	20820.	63.02	.4883
6	162.	26250.	79.46	.3872
5	181.9	33100.	100.2	.3071
4	204.3	41740.	126.4	.2436
3	229.4	52630.	159.3	.1931
2	257.6	66370.	200.9	.1532
1	289.3	83690.	253.3	.1215
0	324.9	105500.	319.5	.09633
00	364.8	133100.	402.8	.07639
000	409.6	167800.	508.	.06058
0000	460.	211600.	640.5	.04804
<b>Stranded Cable—Circular Mil Sizes</b>				
Approximate Diameters	500.	250000.	756.8	.04147
	547.7	300000.	908.1	.03457
	591.6	350000.	1059.	.02963
	632.5	400000.	1211.	.02592
	707.1	500000.	1514.	.02074
	774.6	600000.	1816.	.01729
	836.7	700000.	2119.	.01481
	866.	750000.	2270.	.01382
	894.4	800000.	2422.	.01296
	948.7	900000.	2724.	.01153
	1000.	1000000.	3027.	.01036
	1118.	1250000.	3784.	.00839
	1225.	1500000.	4540.	.00692
	1323.	1750000.	5297.	.00593
	1414.	2000000.	6054.	.00518

The above table of diameters, areas, weights, and resistance of copper wires will be very convenient whenever you have a problem of wire sizes or calculations.

## Wire Calculations

The watts loss in the line would be  $I \times Ed$ , or  $100 \times 40 = 4000$  watts, or 4 KW.

So we find that the practical load for such a line would be about 25 amperes, which would give a voltage drop of  $25 \times .4$  or 10 volts. If we now apply 120 volts to the line, the equipment at the far end will receive 110 volts, and the loss will only be  $25 \times 10$  or 250 watts.

### 21. RESISTANCE OF COPPER PER MIL FOOT

In many cases we may need to calculate the resistance of a certain length of wire or bus bar of a given size.

This can be done very easily if we know the unit resistance of copper. For this we use the very convenient unit called the Mil Foot: This represents a piece of round wire 1 mil in diameter and 1 ft. in length, and is a small enough unit to be very accurate for all practical calculations. A round wire of 1 mil diameter has an area of just 1 circular mil, as the diameter multiplied by itself or "squared", is  $1 \times 1 = 1$  circular mil area.

The resistance of ordinary copper is 10.4 Ohms per Mil Foot. This figure or "constant" is important and should be remembered.

Suppose we wish to determine the resistance of a piece of No. 12 wire, 50 ft. long. We know that the resistance of any conductor increases as its length increases, and decreases as its area increases. So, for a wire 50 ft. long, we first multiply, and get  $50 \times 10.4 = 520$ , which would be the resistance of a wire 1 C.M. in area and 50 ft. long. Then we find in the table that the area of a No. 12 wire is 6530 C.M., which will reduce the resistance in proportion. So we now divide:  $520 \div 6530 = .08$  Ohms approximately.

In another case we wish to find the resistance of 3000 ft. of No. 20 wire, for a coil winding perhaps. Then,  $3000 \times 10.4 = 31,200$ ; and, as the area of No. 20 wire is 1022 C.M., we divide:  $31,200 \div 1022 = 30.5 +$  Ohms.

Checking this with the table, we find the table gives for No. 20 wire a resistance of 10.14 Ohms per 1000 ft. Then for 3000 ft. we get  $3 \times 10.14$

## Wire Calculations

= 30.42 Ohms. The small difference in this figure and the one obtained by the first calculation, is caused by using approximate figures instead of lengthy complete fractions.

### ALLOWABLE CURRENT CARRYING CAPACITY OF WIRES

B. & S. Gauge Number	Area in Circular Mils	Allowable Current in Amperes		
		Rubber Insulation	Varn. Cloth Insulation	Asbestos Insulation
18	1,624	3	....	5
16	2,583	6	....	10
14	4,107	15	23	32
12	6,530	20	29	42
10	10,380	25	38	54
8	16,510	35	50	71
6	26,250	45	68	95
5	33,100	52	78	110
4	41,740	60	88	122
3	52,630	69	104	145
2	66,370	80	118	163
1	83,690	91	138	188
0	105,500	105	157	223
00	133,100	120	184	249
000	167,800	138	209	284
0000	211,600	160	237	340
	250,000	177	272	372
	300,000	198	299	415
	350,000	216	325	462
	400,000	233	361	488
	500,000	265	404	554
	600,000	293	453	612
	800,000	340	514	720
	1,000,000	377	583	811
	1,500,000	434	698	

The capacities above are based on copper having 98 per cent of the conductivity of pure copper wire. For insulated aluminum wire the capacity will be taken as 84 per cent of the values given in the table. Wires can be connected in parallel for greater capacity only by the consent of the inspection department of the National Board of Fire Underwriters.

We can use the mil ft unit and its resistance of 10.4 to calculate the resistance of square bus bars, by simply using the figure .7854 to change from sq. mils to C.M.

Suppose we wish to find the resistance of a square bus bar  $\frac{1}{4}$ " x 2", and 100 ft. long. The dimensions in mils will be  $250 \times 2000$ , or 500,000 sq. mils area. Then, to find the circular mil area, we divide 500,000 by .7854 and get 636,618 + C.M.

## Wire Calculations

area. Then,  $100 \text{ ft.} \times 10.4 = 1040$  Ohms, or the resistance of 100 ft. of copper 1 mil in area. As the area of this bar is 636,618 C.M., we divide:  $1040 \div 636,618 = .00163 +$  Ohm, total resistance. According to the allowance of 1000 amperes per sq. inch, such a bus bar could carry 500 amperes, as it is  $\frac{1}{4}'' \times 2'' = \frac{1}{2}$  sq. inch area. With a 500 ampere load, the voltage drop would be  $I \times R$ , or  $500 \times .00163 = .815$ , or approximately .82 volts drop.

The table on page 171 gives the allowable current carrying capacities of wires with rubber insulation; also those with varnished cloth and other insulations, such as slow burning, etc. This table gives the current allowed by the National Code.

### 22. ALLOWABLE VOLTAGE DROP

We must remember, however, that this table does not take into consideration the length of the wires or voltage drop. For this reason we may often wish to use larger wires than the table requires.

In lighting installations, we should never use wires so small that there will be over 2 per cent drop on branch circuits, or 3 per cent drop on feeder circuits. Generally the voltage drop should not be more than 1 to 2 per cent. On power wiring installations, there should usually not be over 5 per cent drop. This means that on a 110 volt branch circuit we should not have over  $.02 \times 110$  or about 2.2 volts drop; on 220 volt feeder circuits, not over  $.03 \times 220$  or 6.6 volts drop; and on 440 volt power circuits, not over  $.05 \times 440$  or 22 volts drop, etc.

### 23. SIMPLE FORMULA FOR CONDUCTOR AREA

The size of wire required to connect an electrical load to the source of supply is determined largely by:

1. The load current in amperes.
2. The permissible voltage drop between source and load.
3. The total length of the wire.
4. The kind of wire; iron, copper, etc.

To carry out the calculation correctly, it is furthermore necessary to recall

1. The resistance of a wire varies directly with its length or:

## Wire Calculations

$R$  = resistance per foot  $\times$  length in feet.

2. The resistance varies inversely with its cross sectional area or:

$$R = \frac{1}{\text{Area}}$$

Combining both statements

$$R = \frac{K \times L}{A} \quad \text{or} \quad A = \frac{K \times L}{R} \quad \text{or} \quad L = \frac{R \times A}{K}$$

Where  $A$  — Area in C. M.

$L$  — Length of wire in feet

$R$  — Total resistance of wire

$K$  — Resistance per mil foot

$K$  is a constant whose value depends upon units chosen and the type of wire. Using the foot as the unit of length and the circular mil as the unit of area the values for  $K$  represent the resistance in ohms per mil foot. Some values of  $K$  are:

For copper  $K = 10.4$

silver  $K = 9.8$

aluminum  $K = 17.2$

iron  $K = 63.4$

German silver  $K = 128.3$

Now let's see how we would use this handy formula for choosing the size of wire on a certain job. Suppose we wish to run a feeder 200 ft. to a branch panel on which the load consists of: Twenty-six 60 watt, 110 volt lamps; ten 200 watt, 110 volt lamps; and one 10 h.p., 220 volt motor.

First, we will find the total load in watts. Twenty-six 60 watt lamps will use  $26 \times 60$ , or 1560 watts. Ten 200 watt lamps will use  $10 \times 200$ , or 2000 watts. As there are 746 watts in 1 h.p., the 10 h.p. motor will use  $10 \times 746$  or 7460 watts. (Assuming 100% efficiency.)

Then  $1560 + 2000 + 7460 = 11,020$  watts. Assuming this load to be balanced, the current will all flow over the two outside feeder wires at 220 volts.

To find the line current we use the formula

$$I = \frac{W}{E} = \frac{11020}{220} = 50 \text{ amperes}$$

## Wire Calculations

Assuming a 6 volt drop between source and load to be allowable we find the total resistance R of the line to be:

$$R = \frac{E}{I} = \frac{6}{50} = 0.12 \text{ ohm}$$

Since we know L to equal 400 feet, R to be 0.12 ohm and K, since the wire is copper, to be 10.4, we may use the formula:

$$A = \frac{K \times L}{R} = \frac{10.4 \times 400}{0.12} = 34666' \text{ C.M.}$$

Looking this up in the table we find that the next size larger is No. 4 wire, which has 41,740 C.M. area. As the Code table allows 70 amperes for this wire with rubber insulation, we find we are quite safe in using it from this standpoint.

Try out the foregoing formulas on some imaginary problems of your own, until you can use it easily, because it is very commonly used in electrical layouts and estimating.

### 24. VOLTAGE DROP FORMULA

If we wish to determine what the voltage drop will be on a certain installation already made, or on the wires proposed for a job, we can simply find the resistance of the line by the formula.

$$R = \frac{K \times L}{A}$$

and then use  $E = IR$  to determine the voltage drop. For example suppose we have a two wire, 110 volt installation where the load is 25 amperes and the feeder is 120 feet long, and only supplied with 110 volts.

The Code allows us to use a No. 10 wire for 25 amperes, and the area of No. 10 wire is 10,380 C.M. Then, substituting these values in the formula, we have

$$R = \frac{K \times L}{A} = \frac{10.4 \times 240}{10,380} = 0.24 \text{ ohms.}$$

The total line resistance is therefore 0.24 ohms and the volt drop in the line is:

## Wire Calculations

$$E = IR = 25 \times 0.24 = 6 \text{ volts.}$$

The voltage at the load =  $110 - 6 = 104$  volts.

In another case, suppose an electrician used No. 14 wire for a 110 volt branch circuit in a factory and this circuit had twelve 100 watt lamps and two 60 watt lamps connected to it, and was 90 ft. long. The total watts in this case would be 1320 and at 110 volts, this would be a load of 12 amperes. It would be quite natural to use No. 14 wire, as the Code allows 15 amperes for this size, and it is the size so commonly used. But checking it with our formula we find that No. 14 wire has an area of 4107 C.M., and that

$$R = \frac{K \times L}{A} = \frac{10.4 \times 180}{4107} = .456 \text{ ohms approx.}$$

The total line resistance is 0.456 ohms and the line voltage drop is found as before  $E = IR = 15 \times 0.456 = 5.47$  volts.

As a voltage drop of 5.47 volts may be greater than desired, we choose a larger wire. Assuming that with the 12 ampere load in the above example we wish to keep the voltage drop to 2 volts, we may determine the C.M. area of the desired wire by first finding its resistance thus:

$$A = \frac{K \times L}{R} = \frac{10.4 \times 180}{0.167} = 11210 \text{ C.M.}$$

Knowing the length and resistance of the wire we now find the C.M. area for:

$$R = \frac{E}{I} = \frac{2}{12} = 0.167 \text{ ohms approx.}$$

As the next larger wire is No. 9, this should have been used; or as a No. 10 wire has 10,380 C.M. area, it could be used, with slightly over 2 volts drop.

So we find that it is very important to be able to do these simple wire calculations on certain jobs, and you will find this material of great value, both in learning how to use the formulas, and in using them and the tables for future reference.

The following table of voltage drop per 1000 ft., per ampere, with various sized conductors is also very convenient.

## Wire Calculations

### TABLE OF VOLTAGE DROP.

Size B. & S. Gauge	Volts drop per 1000 feet per ampere	Size B. & S. Gauge	Volts drop per 1000 feet per ampere
18	6.374	250,000.	.04147
16	3.936	300,000.	.03457
14	2.475	350,000.	.02963
12	1.557	400,000.	.02592
10	.9792	500,000.	.02074
9	.7765	600,000.	.01729
8	.6158	700,000.	.01481
7	.4883	750,000.	.01382
6	.3872	800,000.	.01296
5	.3071	900,000.	.01153
4	.2436	1,000,000.	.01036
3	.1931	1,250,000.	.00829
2	.1532	1,500,000.	.00692
1	.1215	1,750,000.	.00593
0	.09633	2,000,000.	.00518
00	.07639		
000	.06058		
0000	.04804		

Volts Lost Per 1000 Feet per Ampere.



## EXAMINATION QUESTIONS

1. What are two advantages of the Edison 3-wire system?
2. Why should the neutral wire of a 3-wire system never be fused?
3. On a 3-wire, 110 and 220 volt circuit having a balanced load of 3740 Watts, what would be the current flow? Would there be any current flowing in the neutral wire?
4. What is meant by Polarized Wiring?
5. What is one important advantage of polarized wiring?
6. How would you ground the neutral wire at the service in a building? What size ground wire should be used?
7. Explain what is meant by "Service Wires," "Feeders," and "Branch Circuits."
8. What is meant by the term "Demand Factor"? What demand factor should we use in determining the load for a 3 flat, or 3 family apartment building?
9. What is the ratio between a circular mil and a square mil? What is the square mil area of a number of 6 round wire?
10. Using the formula given in article 23, determine the proper size of conductor to carry a load of 20 amperes over a 2 wire circuit 100 ft. in length, with not more than 3 volts drop.

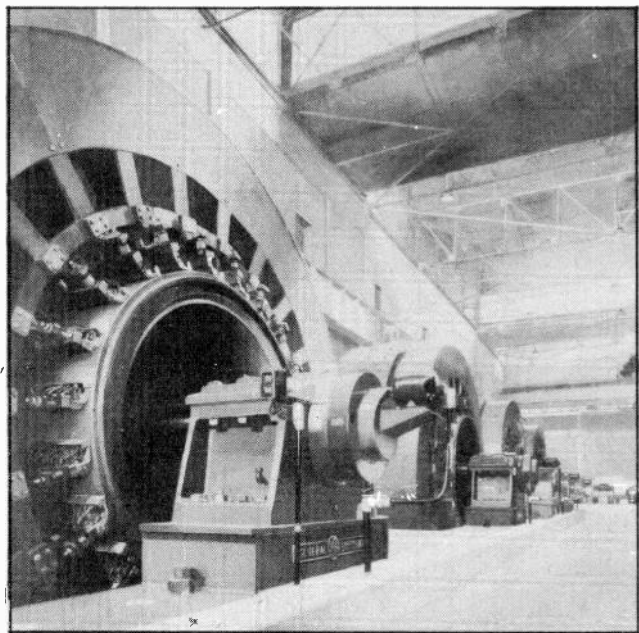

**Giants of Industry.** This artist's sketch shows some of the tremendous electrical equipment used in steel mills. Note conduit fittings on this massive equipment.

## INSTALLATION METHODS

In starting any wiring job, whether you are working for a contractor or in business for yourself, there are certain general steps to be followed. Regarding simple knob and tube installations, it is not necessary to say much more about the details of this work than has been previously covered. However, remember that before running any wires, one should have the location of all outlets well in mind, and preferably sketched on a plan; and then marked on the frame work of the new building if it is such; or upon the walls and ceilings of an old building in which the wiring is being installed after the house has been built.

### 1. LOCATION OF LIGHT AND SWITCH OUTLETS

Ceiling outlets for lighting fixtures should be carefully located and centered to give a balanced appearance in the room, and to afford the best distribution of light.

Wall light outlets should be placed about the walls with proper regard for locations of doors, windows, and large permanent pieces of furniture. Outlets for wall bracket lights should be approximately **66 inches from the floor**, if the fixture turns upward from the outlet. If it is of the type that hangs downward, the outlet should be about **72 to 74 inches from the floor**. These heights, of course, will depend somewhat upon the ceiling height in various rooms, and the scheme of decoration used. Outlets for **wall switches** should be about **52 inches from the floor to the bottom of the outlet box**, and their locations should be carefully chosen to give the greatest convenience in control of the lights. For example—it is common practice to have the control switches for one or more lights near the front door or entrance to the house, so they can be turned on as soon as the person enters at night. In other rooms of the house, switches can be placed either near doors, or in the most convenient locations, to save as many steps as possible.

## Installation Methods

The owner of the building should of course be consulted on such matters, in order to give the best possible satisfaction in the finished job.

After the outlets have all been located, the shortest and most direct runs should be chosen for the various wires to fixtures and switches. Then if there is no blue print already provided for the job, a complete wiring diagram of each floor should be laid out on paper to be sure to get the proper circuits and control of lights and equipment with the fewest possible wires.

### 2. KNOB AND TUBE INSTALLATION

If knob and tube wiring is being installed in a new building, the holes for the porcelain tubes can be drilled through the center of the joists, as these holes are not large enough to materially weaken the woodwork. Knobs can be placed along the joists for circuits to be run in the walls, and also along the joists in unfinished attics and basements. Before determining the location of the meter and service switch, we should locate the probable point at which the power company will bring the wires from their pole line into the building, and the service switch and meter should be located near this point if possible.

In knob and tube installation in new buildings, the wiring should, of course, all be installed before the lath and plaster are put on the walls. The thickness of lath and plaster that are to be used should be carefully considered, so that the edges of the outlet boxes will be about flush with or about an eighth of an inch under this surface.

### 3. MAKING CONNECTIONS TO SWITCHES AND FIXTURES

When the wires are attached, and the ends brought out in the box, it is well to plug the outlet box with a wad of newspaper to keep the wire ends from becoming damaged or the box clogged with plaster. After the plaster is on and has hardened, the fixtures can be hung and connections made to them and the switches.

## Installation Methods

In making all such connections, be sure to strip enough of the end of the wires to make a good hook, or one complete turn under the terminal screws, but don't strip an excessive amount so there would be more bare wire than necessary around the switch terminals. See that these wires are bright and clean before placing them under the screws, and always bend the hook in the end of the wire to the right, that is, clock-wise or in the same direction the screw head turns. This causes the screw to wrap the wire hook tightly around it; while if the hook is made in the opposite direction it often opens up and works out from under the screw head when it is tightened. Don't twist these screws too tight, because they are usually of soft brass and the threads can be easily stripped.

### 4. BX AND NON-METALLIC CABLE INSTALLATION

The same general rules apply to wiring a new building with BX or non-metallic sheathed cable. Either of these materials can be run along the joists and through holes in the framework as required. Before cutting the various lengths of wire, BX, or cable for any run, be sure to measure them accurately and allow a few inches extra for stripping the ends and making splices and connections. It is always much better to allow a few inches over and trim this off when making the final connections, rather than to find the wires or cable too short and then have to replace them. Always tighten BX and cable clamps securely in the outlet box openings to effect a good ground.

When wiring old buildings, great care should be used not to damage the plaster or decorations, and not to make any unnecessary dirt or mess around the building. When cutting holes in the plaster on walls or ceilings to locate outlet boxes, a cloth or paper should be spread underneath to catch all plaster dust. Sometimes an old umbrella can be opened and hung or held up side down under the place in the ceiling where the hole is being made,

## Installation Methods

so it will catch all of this dirt and keep it off from rugs and furniture.

### 5. LOCATING AND CUTTING OUTLET BOX OPENINGS

Be careful not to cut any of these holes so large that the fixture canopies or switch plates will not cover them neatly. In case the plaster cracks or a mistake is made so that the hole cannot be completely covered, it should be filled with plaster of paris, or regular patching plaster, to make a neat appearance.

Outlet box holes can be cut through the plaster with a chisel. The size of the holes should be carefully marked by drawing a pencil around the outlet box held against the plaster. In locating the exact spot to cut these openings in the plaster, it is well to first cut a very small hole in the center of the spot where the larger one is to be made, using this to locate the cracks between the lath. Then it is possible to shift the mark for the larger hole up or down a little so the lath can be cut properly, to leave a place in the wood for the screws which fasten the box to the wall. If this method is not followed, sometimes two complete laths are cut away, and the metal ears on the box, which have the screw holes in them, will not reach from one remaining lath to the other.

On wall outlet openings we should always try to cut clear through one lath and a short distance into two adjacent ones. Fig. 1-A shows the wrong way that laths are sometimes cut, and "B" shows the proper way in which they should be cut.

For cutting round holes a regular plaster cutter can be obtained, which fits into an ordinary brace and can be rotated the same as a drill.

For ceiling outlets never cut the lath any more than necessary to bring the wires or BX through.

### 6. RUNNING WIRES AND BX INTO DIFFICULT PLACES

A number of methods have already been described for pulling and fishing wires, cable, and

## Installation Methods

BX into walls and openings in finished buildings; so that, with a little ingenuity and careful thought, you will be able to solve almost any problem of this kind that you may encounter.

In pulling wires into spaces between the joists in walls, a flashlight placed in the outlet box hole is often a great help in feeding the wires in, or in catching them with a hook to draw them out of the outlet opening.

Where it is necessary to remove floor boards, it should be done with the greatest of care, so as not to split the edges and make a bad appearing job when the boards are replaced. A special saw can be obtained for cutting into floors without drilling holes to start the saw. Then, if the beading or tongue is split off with a thin sharp chisel driven down in the crack between the boards, the board from which the tongue has been removed can be pried up carefully without damaging the rest of the floor.

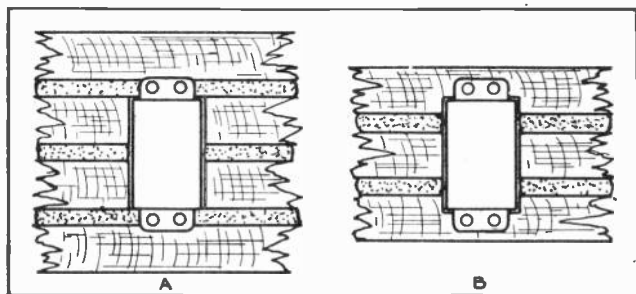

Fig. 1. The view at "A" shows the wrong method of cutting lath to install an outlet box for switches. Note that the metal "ears" do not reach over the lath to provide any anchorage for the screws. At "B" is shown the correct method of cutting the lath to make a secure mounting for boxes of this type.

If it is necessary to run wires or BX crosswise through a number of floor or ceiling joists, it can usually be done by boring the holes through them at a slight angle, and then working the wires or cable through. Where tubes are used, be sure to place the heads up in these slanting holes, so the tubes cannot work out.

Sometimes it is necessary to remove baseboards and cut holes behind these, to aid in fishing the

## Installation Methods

wires or cable up or down through floors and into the walls at this point. In other cases, a channel can be cut in the plaster behind the baseboard, and BX or non-metallic sheathed cable run in this channel, and the baseboard replaced to cover it.

Whenever removing baseboards in this manner, be very careful not to split the "quarter-round" wood strips or trimming that is often fastened along the edges of the baseboard. A broad putty knife is a very good tool to use in removing these strips.

A key-hole saw is very useful in cutting through laths to make outlet openings. Let us emphasize once again that in installing old house wiring, thoughtfulness, care, and neatness are the greatest essentials in leaving the customer satisfied.

### 7. CONDUIT INSTALLATION

When installing conduit wiring systems in new buildings, the entire plan should be carefully gone over first, to make sure that proper number of wires for each circuit and the proper sizes of conduit have been selected. A great deal of time and money can be saved by planning these things in advance and thereby avoiding costly mistakes.

After the outlets have been located and the boxes carefully installed on their proper supports and hangers, the lengths of conduit can be cut, bent, and fitted in place.

In running conduit in wood frame buildings, care must be taken not to damage or weaken the building structure. In some cases a conduit run cannot be made in the shortest and most direct line, because it would necessitate the notching of joists at some distance from any support. This should not be done, as it is likely to weaken them too much. Instead, it is better to run the conduit along between the joists for some distance and then **make the cross run near a wall or partition support**, so the notches in the joists can be near the ends where the strain is not so great.

Fig. 2 is a view looking down on a group of ceiling joists and which illustrates the proper



## Installation Methods

method of running conduit in such cases.

In certain types of frame-building construction, finished floors are laid on strips an inch or more thick over the soft-wood floors. In such cases, with the permission of the contractor or architect, the conduit can often run between these floors, thus saving considerable labor and materials.

All lengths of conduit should be screwed into their couplings as tightly as possible, to make the conduit ground circuit complete and the entire system secure and tight.

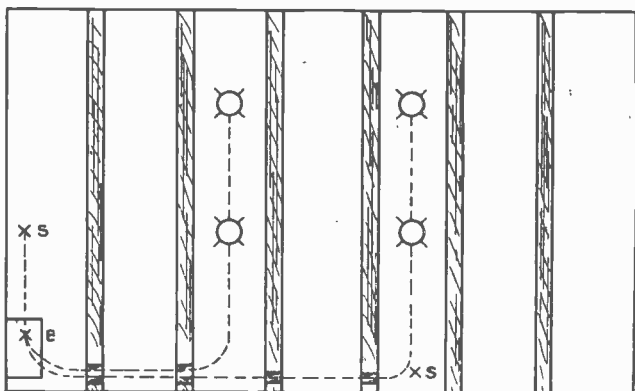

Fig. 2. Ceiling joists should not be notched in their centers in order to run conduit by the shortest path to outlets. Instead the joists should be notched near walls or supports, and the conduit bent to run through these notches, and then back between the joists to the outlets as shown in this diagram.

In attaching the conduit to outlet boxes, screw the lock-nut well back on the threads, insert the threaded end of the pipe in the knock-out opening, and screw the bushing on this end as far as it will go. Then tighten the lock-nut securely with a wrench.

### 8. SPECIAL PRECAUTIONS FOR CONDUIT IN CONCRETE BUILDINGS

When installing conduit in concrete buildings, there are sometimes fewer problems than with wood construction, but there are a number of different details which must be observed. In this type of building, conduit generally runs directly by the

## Installation Methods

shortest path from one box to the next; and when the concrete is poured around it, the conduit, instead of weakening the structure, has a tendency to strengthen it.

Just as soon as the wood forms for a certain section of the building are set up, the electrician must be on the job to install the conduit and outlet boxes. In most cases he must be on hand practically all the time these forms are going up, as there are certain places where it is necessary to install the boxes or conduit as the carpenters are placing the wood forms.

The locations of outlet boxes, particularly those for ceiling lights, should be lined up carefully and straight, so the fixtures will present a neat appearance when they are installed. If these boxes are carelessly located, it is almost impossible, and certainly a mighty costly job, to correct them after the concrete is poured.

After the locations for the outlets have been carefully marked on the boards, the conduit can be cut to the proper lengths, reamed, threaded, and fitted to the outlet boxes.

Before the boxes are nailed in place, the ends of all conduits should be tightly plugged, either with wood plugs or with special disks which are held in place by the bushing. These plugs are to keep soft concrete from running into the pipes. Then the outlet boxes should be packed tightly with newspaper, so that there is no possibility of their filling up with wet concrete. Then the boxes should be nailed securely in place so that there is no chance of their being moved before or during the time the concrete is being poured. If these precautions of plugging conduit and outlet boxes are not observed, you will often encounter a very difficult and expensive job of drilling hard concrete out of the boxes or pipes.

The installation of the complete conduit system is what we term "roughing in." None of the wires should be pulled in until all mechanical work on the building is completed. Sometimes on big buildings this requires weeks or months after the conduit has been installed, so you can see how im-

## Installation Methods

portant it is to have complete and accurate sketches and plans of the whole electrical system.

### 9. PULLING IN THE WIRES

When we are ready to pull the wires into the conduit the outlet boxes should be cleaned out and all plugs removed from the ends of the pipe.

On very short runs, the ends of the wires can sometimes be twisted together and the group simply pushed through from one outlet to the next. More often, however, we will need to push the steel fish tape through first, and then pull the wires through with it, as previously described. This is usually a job for two men, one to **feed the wires into the conduit straight and even, without allowing them to cross or kink**, and the other man to pull on the fish tape.

We should not forget to use **powdered mica or soap stone** to lubricate the wires when necessary on long runs.

On short runs where the wires pull in rather easily, it may only be necessary to hook them through the loop in the fish tape and twist them together a few times. On more difficult runs, it is sometimes necessary to solder these twisted loops so there will be no chance of their pulling loose from the fish tape.

### 10. FINAL TESTS

When the wires are all pulled in and the ends cut off at the outlet box, allowing the extra length for splices and connections, these ends can then be stripped and cleaned. **Before any connections are made, all wires should be thoroughly tested** with a dry cell and buzzer or magneto and bell, **to make sure there are no shorts or grounds** which might have occurred through damaging the insulation when the wires were pulled in.

After the splices are made, it is a good idea to make another thorough test before they are soldered, to see that all connections are proper and that no faults have developed.

The soldering should then be done immediately, before the bare copper has time to oxidize or corrode. Then all splices should be thoroughly and

## Estimating

carefully taped, both with rubber and friction tape. Never slight this part of the job because, if you do, shorts or grounds are likely to develop when the poorly taped splices are pressed back into the outlet boxes.

In hanging fixtures care should be taken to make a neat job of it, and not to dirty the light-colored ceiling by rubbing hands or black materials against it. In some cases the fixture splices are soldered, while in others solderless connectors can be used. These connectors are especially desirable in buildings where no smoke or soot from the soldering operation can be allowed.

After all wiring is complete and all devices connected up, make a final test at the fuse box to be sure there are no shorts or grounds on the "hot" wire. If the system tests clear, then if the service has been connected to the power line, insert the fuses, close the switch and test all switches and lights for satisfactory operation.

### ESTIMATING—TIME AND MATERIAL BASIS

When it comes to giving a price on a job, there are several ways in which this can be handled. The time and material basis is ideal for the electrician, and can usually be made satisfactory to the customer. When a job is done in this manner, the customer pays you by the hour for the work of installing the system, and also pays you for the material, which you may buy wholesale and sell to him at retail prices, thus making a reasonable profit in addition to your wages.

If you merely make fair wages on the first several jobs this should be quite satisfactory, for you will be obtaining experience, not only in doing the actual work and gaining confidence in your knowledge and ability, but also in the time required for each type of work, and the costs of various items. You should keep a very careful record of these things, as they will be of great assistance in making accurate estimates on future jobs.

## Estimating

### OVERHEAD EXPENSE AND PROFIT

After you obtain a start and are doing larger jobs, a certain percentage should be added to the cost of materials and labor for overhead expense and profit. These things may sometimes need to be explained to customers, so they do not get the impression that you are overcharging them for certain items.

There is always certain to be some overhead expense or cost of doing business, regardless of whether you have a shop or merely operate your business from your home. This overhead consists of certain small items of expense which you cannot charge directly to the customer, but should properly proportion over the charges for each job.

Some of these items are as follows:

- Telephone Bills
- Electric Light and Water Bills
- Rent; or Taxes, if you own a building
- Insurance, both Fire and Liability
- Non-Productive Labor
- Advertising
- Truck and hauling expenses
- Depreciation of stock and materials you may carry on hand
- Bad or uncollectable bills
- Bookkeeper, or any office help
- General office and shop expense

The item of profit on medium and large sized jobs is one that you are justly entitled to. If you buy your supplies and materials from a large dealer at wholesale prices and charge the customer the regular retail price, this is one source of profit, and a certain reasonable percentage can be added to your wage allowance on any job to complete your per cent of profit.

In other words, there is no use of operating a business if you cannot show at the end of each year a substantial profit or gain. The cost of any job, then, should be divided into at least four items:

1. Net Cost of Material
2. Net Cost of Labor
3. Overhead Expense
4. Profit

Experience has shown that on a small business of under \$20,000.00 gross per year, the overhead

## Estimating

will frequently run as high as 30 to 35 per cent. The larger the volume of business, the less the percentage of overhead should be; and with a gross business of \$60,000.00 per year we would usually figure about 20 to 25 per cent. Your profit should certainly be at least 10 per cent above all expenses, and this should be in addition to a fair salary for your time.

If you do a total of \$40,000.00 worth of business in a year, at the end of the year, your income tax report should show that, after paying all bills and your salary and considering all debits and credits, there remains a clear profit of 10 per cent, or \$4,000.00.

By adding all your overhead items together you should get about 25 per cent, or \$10,000.00. If your overhead is more than that amount it shows that there is something wrong in your methods, and you should try to reduce it during the next year, by looking over each item to see where economy can be effected.

### 11B. METHOD OF FIGURING OVERHEAD AND PROFIT IN AN ESTIMATE

When figuring on any certain job we don't know, of course, what the gross price is going to be, and, therefore, have to make allowances for these extra items. For example, suppose we consider a job where we find the material will cost \$32.00. The next item to consider will be the labor. While this varies a great deal in different sections of the country, we might estimate it to be about equal to the cost of the material, or slightly more, and we will say it is \$33.00. This makes a net cost, so far, of \$65.00 for material and labor. If we are going to allow 25% for overhead and 10% for profit to make the total cost, or 100%, this leaves 65% for the net cost. If \$65.00 is 65% of the cost, then 100%, or the total cost, would be \$100.00, which should be the price quoted for this job. If you multiply the net cost for labor and materials by .54 it will give the approximate total cost, including the extra 35% for profit and overhead.

In some cases, of course, a job can be quoted at a figure which doesn't cover these extras. For

## Estimating

example, where you have a chance to sell equipment which you buy direct from a dealer for a certain job and do not have to carry in stock yourself, this reduces your overhead. In fact the more of this class of business you can do and the less idle stock you carry, the greater your profit will always be. However, in an active business of any size some standard items must always be kept on hand.

### 11C. ALWAYS DO FIRST-CLASS WORK

Never make a practice of trying to get a job by cutting your price so low that you have to install poor materials, or do a poor job of the installation. Always do first-class work at a fair price, and explain to your customers that you are certain they will remain better satisfied with this kind of work than if you cut the price and give them a poor job.

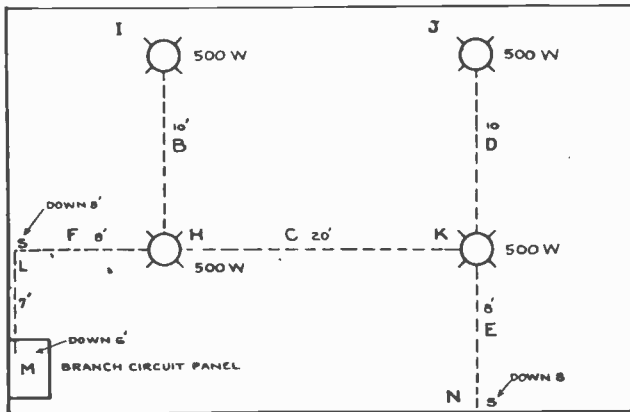

Fig. 3. Layout of a wiring system for four large lights, showing the measurements to be taken in preparing a list of the materials for such a job. Note the explanation and list given in the accompanying paragraphs.

### 12. COST PER OUTLET

Totaling the entire expense of any job of a certain class of wiring and then dividing this by the number of outlets, will give you a basis on which to estimate jobs of this type in the future. After experience on several installations, you can quote prices at so much per outlet on jobs of any type,

## Estimating

such as knob and tube, BX, or conduit wiring. These different classes of wiring are, of course, to be done at different prices per outlet.

### 13. PRACTICAL ESTIMATING PROBLEMS

As an example of laying out a job and materials for the estimate, let's consider the installation shown in Fig. 3.

This diagram shows a room in a finished building, such as a store or shop, where the customer desires an installation of exposed conduit. As this is not a new building and there are no blue prints, you should make a rough sketch of the proposed wiring system; and, after locating the outlets and switches, measure the room carefully for the necessary lengths of material. We have four outlets, each for a 500-watt lamp, which means we will need two branch circuits. We will assume that the layout is such that outlets "H" and "I" can be on one circuit, and "J" and "K" on the other. With the distance shown No. 14 wire and 1/2-inch conduit can be used. The wires for both circuits from the cut-out box to the outlet "H" can be run in one conduit. At the point marked "L" one circuit will have a wire looped down for a switch connection to control lights "H" and "I". Where the conduit changes direction to run down the walls to the cut-out boxes and switches, condulets can be used.

From this lay-out we find the approximate list of materials will consist of the following (not including the cut-out box or fuses):

- 85 feet 1/2-inch conduit
- 4 4-inch Octagon outlet boxes
- 4 Fixture studs
- 2 Type L 1/2-inch condulets
- 1 Type L BR 1/2-inch condulets
- 3 1/2-inch blank condulet covers
- 2 Flush switch condulets
- 2 Flush switch condulet covers
- 2 Single-pole flush switches
- 9 1/2-inch conduit bushings
- 9 1/2-inch lock-nuts



## Estimating

20 1/2-inch pipe straps  
225 feet of No. 14 R.C. wire

Also the necessary solder, tape, and screws.

After making up an estimate from the above, it is generally a good plan to add 5% to cover small items that cannot be foreseen in advance.

In another case, suppose we consider a house-wiring job where our records show that we can figure by the outlet. Assume this to be a knob and tube installation in a new building under construction, and that there are to be 50 outlets, half of which are lighting outlets and half are flush switches or flush receptacles. If our records show that on this size job we should get \$2.75 per lighting outlet and \$3.25 per switch or convenience outlet, then the estimate should be \$150.00, plus the service price, which the records may show will average \$15.00; thus we make the total estimated price \$165.00. In such cases as this your records of previous jobs of similar type will be of great assistance in making an accurate and intelligent bid.

### 14. WIRING PLANS AND LAYOUTS

Figures 4 and 6 show the basement and first floor plans of a one-story bungalow, with a layout of the wiring system. This is a very simple system with just the ordinary number of lights and convenience outlets, and could quite easily be installed in an old house, using BX or non-metallic sheathed cable. (Before checking these layouts examine symbols shown in Fig. 8.)

The heavy dotted lines show the circuits feeding to the lights and outlets, while the light dotted lines show the wires from the lamps to the switches which control them. The wiring does not need to run exactly as the lines are shown here, but could, of course, be altered somewhat to suit the building.

In the basement, which in this case is wired with conduit, the equipment is as follows:

"A" is the service switch and branch circuit fuse box.

## Estimating

"B" and "C" are lights controlled by a switch at the head of the stairs.

"D" is the laundry light, controlled by a switch at the door to the laundry room.

"E" is a convenience outlet for washing machine, flat iron, etc.

"F" and "G" are lights on drop cords, controlled by switches on the light sockets.

"H" is a bell transformer which is connected to the junction box "J".

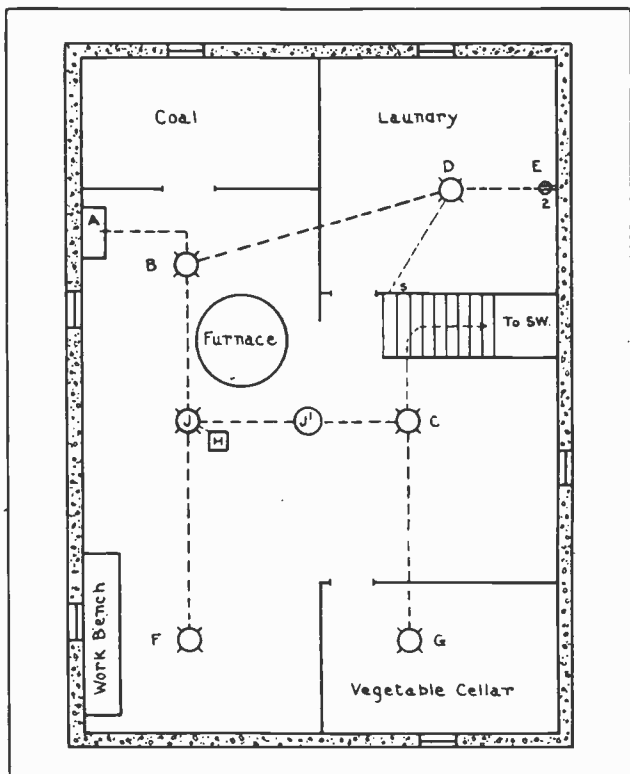

Fig. 4. This diagram shows the basement wiring plan for a one-story building. Check carefully each of the circuits and outlets shown with the explanations given.

"J-1" is a junction box from which BX will be run up through the partition to feed the branch circuits on the floors above.

## Estimating

The number of wires which we will have in each of these runs will be as follows:

"A" to "B"—six wires, three black and three white.

(One two-wire circuit for the basement, and two circuits for upstairs)

"B" to "J-1"—seven wires, four black and three white.

"J" to "F"—two wires, one black and one white.

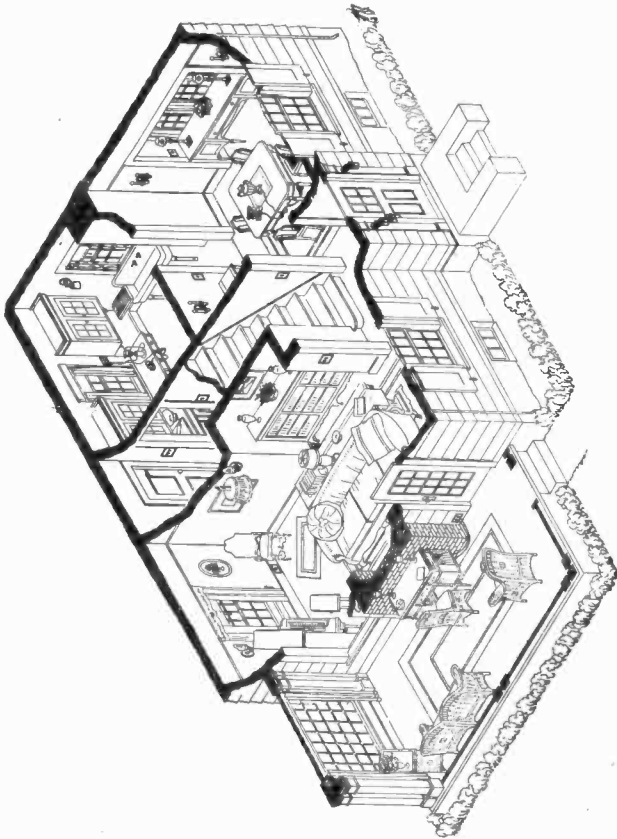

Fig. 5. Sectional view of ground floor of a house, showing the location and arrangement of lights, switches, and convenience outlets.

"C" to "G"—two wires, one black and one white.

"B" to "D"—two wires, one black and one white.

"D" to "E"—two wires, one black and one white.

## Estimating

"J-1" to "C"—three wires, two black and one white.

"D" to switch outlet—two black wires.

"C" to switch outlet—two black wires.

Here again, we can see one of the advantages

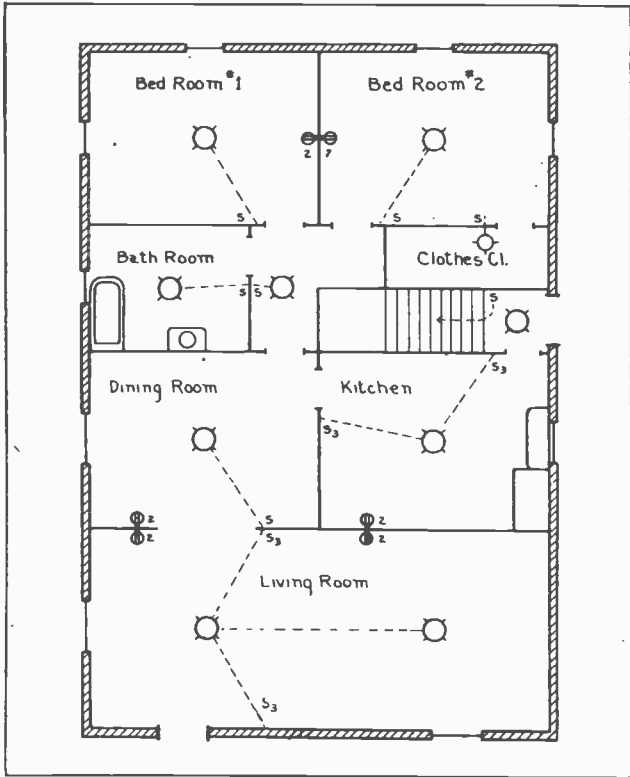

Fig. 6. Wiring diagrams for a bungalow residence. Note the location of lights, switches, convenience outlets, etc.

of polarized wiring, as white wires can be connected to white, and black to black, leaving much less chance for mistakes and wrong connections than if we use all black wires.

In the floor above we have one ceiling light in the center of each room except the living room, which has two; and one in the hall near the bathroom. There is also a light at the head of the

## Estimating

stairway. The living room and kitchen lights are each controlled from two different places, by three-way switches. This provides the convenience of being able to turn them on or off at either door at which one might enter these rooms.

The six double convenience-outlets shown represent just a minimum for an installation of this type; so it might be desirable to install several more of these while wiring the house.

ROOMS	CEILING OUTLETS	WALL BRACKETS	CONVENIENCE OUTLETS	SWITCH OUTLETS	REMARKS
BASEMENT	2			1	AT HEAD OF STAIRS
LAUNDRY	1		1	1	
VEG. CELLAR	1				
WORK BENCH	1				
BELL TRANSE	1				
LIVING RM.	2		2	2	3 WAYS
DINING RM.	1		1	1	
KITCHEN	1		1	2	3WAYS
BATH	1			1	
BED RM. #1	1		1	1	
BED RM. #2	1		1	1	
HALL	1			1	
CLOSET		1		1	
ALL CONVENIENCE OUTLETS ARE DOUBLE					

Fig. 7. Simple forms of this type are a great help in totaling the number of outlets for any job. Other forms are used for listing the materials for each room and the total wiring job.

The dotted lines in this view show only the runs from the lights to the switches which control them. The branch circuits to the lights are not shown; as their position would be a matter of choice and convenience, according to the construction of the house and the points at which they could be best

## Estimating

carried through partitions, floors, and ceilings.

Fig. 7 shows a sample form for listing the outlets used on a job, such as shown in Figures 4 and 6. The lighting, switch, and convenience-outlets for this particular job are shown listed on this





























STANDARD SYMBOLS FOR ELECTRICAL EQUIPMENT OF BUILDINGS			
Ceiling Outlet		Automatic Door Switch	$S^D$ Feeder Run Exposed
Ceiling Fan Outlet		Key Push Button Switch	$S^K$ Feeder, Run concealed under Floor
Floor Outlet		Electrolier Switch	$S^E$ Pole Line
Drop Cord		Push Button Switch and Pilot	$S^P$ Push Button
Wall Bracket		Remote Control Push Button	$S^R$ Annunciator
Wall Fan Outlet		Motor	
Single Convenience Outlet		Motor Controller	M.C. Public Telephone
Double Convenience Outlet		Lighting Panel	
Junction Box		Power Panel	
Special Purpose Outlet: Lighting, Heating and Power as Described in Specification		Heating Panel	
Special Purpose Outlet: Lighting, Heating and Power as Described in Specification		Pull Box	
Special Purpose Outlet: Lighting, Heating and Power as Described in Specification		Cable Supporting Box	
Exit light		Meter	
Pull Switch		Transformer	
Local Switch- Single Pole	$S^1$	Branch Circuit, Run concealed under Floor Above	
Local Switch- Double Pole	$S^2$	Branch Circuit, Run Exposed	
Local Switch- 3 Way	$S^3$	Branch Circuit, Run concealed under Floor	
Local Switch- 4 Way	$S^4$	Feeder, Run concealed under Floor Above	
This Character Marked on Top Circuits Indicates 2 No 14 Conductors in 1/2 in. Conduit		3 No 14 Conductors in 1/2 in. Conduit	

Fig. 8. The above wiring symbols with their explanations should be very carefully studied so you will be able to recognize the more common of these symbols readily and easily when working with wiring diagrams or plans. Make a practice of referring to these symbols every time you find one you cannot recognize in a diagram.

form. Forms of this type are a great help in getting an accurate list of all the parts and fittings needed for the various rooms of any house-wiring job.

## House Wiring Plans

In wiring a new home we would undoubtedly put in a greater number of lights and convenience outlets, as well as two or more three-way switches. Fig. 5 shows a cut-away view of the first floor in a modern home, which gives some idea of the arrangement of wall bracket lights, convenience outlets, and switches. In addition to those shown, there would probably also be a ceiling light in the living room, dining room, and kitchen.

### 15. WIRING SYMBOLS

Fig. 8 shows a number of the more common symbols used in marking various electrical outlets on the building plans. Examine each of these carefully and become familiar with them, as they will be a great help to you in reading any blue prints supplied either by contractors or architects where the electrical wiring of any building is laid out in advance. A knowledge of their use will also be very handy to you in drawing up a sketch or plan for a building in which you may be laying out the wiring system yourself.

### 16. NEW HOUSE WIRING PLAN

Figure 9 shows the wiring plans for the first and second floors of a modern home. These plans show a more complete system of lights, convenience outlets, three-way switches, etc., such as we would be most likely to install in a new building. Some home-owners might not care to go to the expense of quite as complete an installation as these plans show, but whenever possible the customer should be sold on the idea of wiring the house complete for every possible need when it is erected, as it is so much cheaper to install these things when the house is being built than to put them in afterward. With the ever-increasing use of electrical appliances and light in the home, the owner is likely to regret it later if the home is not quite completely wired. However, it is very easy

## House Wiring Plans

to leave out a few of the items in a suggested plan of this type, if desired.

By referring to the chart of wiring symbols in Fig. 8, you will be able to recognize each of the outlets in this wiring plan. Check each of them carefully until you have a thorough understanding of the location of each outlet and what they are for.

The dotted lines in these diagrams only show which outlets are connected together, and the runs from the switches to the lamps which they control. The plans do not show where the conduit or BX runs come up from the basement or from one floor to the other.

Several different organizations, such as the General Electric Company and the National Contractors' Association, have some very valuable printed forms, which can be obtained to aid you in listing materials for an estimate; and also sample forms for contracts with the customer. The Society for Electrical Development furnishes valuable material and information, such as the Franklin Specifications and Red Seal Plan for good lighting, which should be of great value to anyone in business for himself.

### 17. TOOLS

Perhaps you will wonder how many and what type of tools will be required to start in electrical wiring. It is not necessary to have such a complete or elaborate layout on tools to start your first jobs with. A list of the more common and necessary ones for this type of work are as follows:

Several screw drivers  
of various sizes.

Side-cutting pliers.

7 or 8-inch diagonal  
cutting pliers.

Long-nosed pliers.

6-inch combination  
pliers.

8-inch gas pliers.

Claw hammer.

Ballpeen hammer.

Wood chisels, one nar-  
row and one wide.

Cold chisel.

Hack-saw frame and  
blades.



# House Wiring Plans

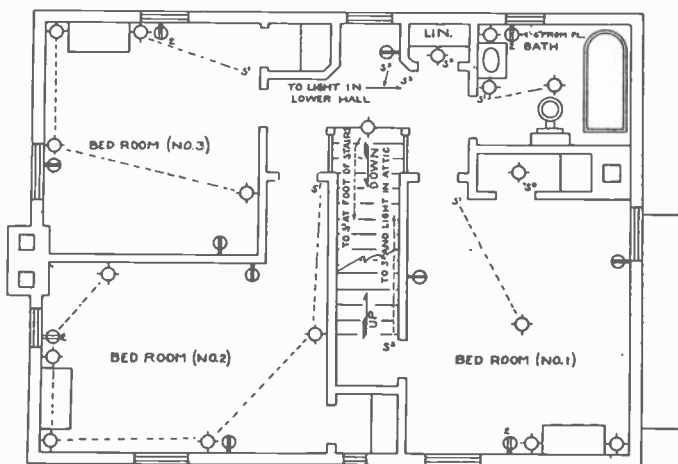
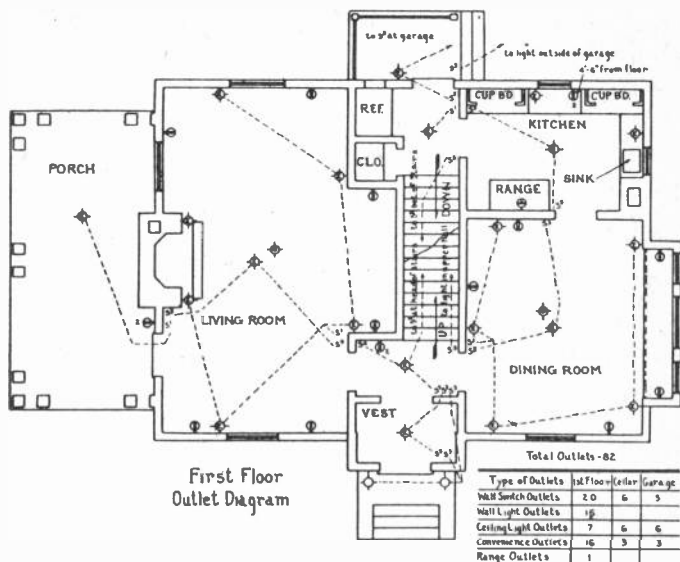

Fig. 9. First and second floor plans. Note the location of lights switches and convenience outlets. Observe the use of 3-way switches for controlling lights from different places.

## Trouble Shooting

Hand saw.	Six-foot rule.
Key-hole saw.	Blow torch and soldering iron.
Corner brace and wood bits.	Two or three putty knives, for prying off wood strips.
Hand drill or push drill.	
Stillson pipe wrench.	100 ft. steel fish tape.

In addition to this list an electrician who owns his own shop should acquire as soon as possible a boring machine, step ladders, conduit bender, vise, pipe cutter, pipe reamer, stock and dies for threading pipe, and set of star drills. A number of other items will be found convenient as the shop or business grows, and these can be purchased as the profits of the business will pay for them.

## TROUBLE SHOOTING

Whether you are employed as an electrical wireman or maintenance man, or in the business for yourself, a great deal of your work may often be what is commonly known as "**Trouble Shooting.**"

This covers a wide range, from such small jobs as finding a short circuit in a domestic flat iron to tracing out troubles in a power circuit of some large shop or factory. In any case, it usually requires merely a thoughtful application of your knowledge of circuit tracing and testing. We have previously recommended and will emphasize here again the necessity of **keeping cool** when emergencies of this sort arise and going about the location of the trouble in a systematic and methodical manner, testing one part of the circuit or system at a time, until the trouble is cornered.

Keep in mind that every trouble shooting problem can be solved, and someone is certainly going to solve it. If you succeed in locating and remedying the trouble, it will always be to your credit, and it may be the source of new business for you or a promotion on the job.

In general, the same methods can be followed for trouble shooting and testing in light and power circuits as have previously been explained in the section on signal wiring. A dry cell and buzzer, taped

## Trouble Shooting

together and equipped with a pair of flexible leads five or six feet long, is always a handy device for this work.

Where part of the system is still "alive," or supplied with current, a pair of test lamps are very handy. These can be connected together in series for 220-volt tests or one can be used separately for testing 110-volt circuits. They are particularly handy when testing for blown fuses, and this test will often locate the source of trouble. A test lamp will light when connected across a burned out fuse, if there is a load on the line.

### 18. FUSE TROUBLES

In testing wiring circuits we should first start at the service switch or fuse box. Test to see if the line is alive from the outside service wires, and if it is, then test the fuses. The fuses may be checked by testing across diagonally from the service end to the house end. This test will show which fuse is blown. If the contact springs or clips which hold cartridge fuses are blackened or burned, this is likely to be the cause of the trouble. Sometimes these springs become bent and do not make a good contact to the ferrule on the fuse. This results in a high-resistance connection and heating, which softens and destroys the spring tension of the clips. When clips or springs are found in this condition they should be renewed.

Fig. 10 shows several conditions that will often be found with cartridge fuse clips. When fuses of the cartridge type are found to be blown, it is well to examine them a little before replacing. If the fuse link is found to be blown in the manner shown at "A" in Fig. 11, it is probably caused by a light overload, which gradually heated the fuse to a point where one end melted out. Occasionally you may find the fuse burned in two at the middle and not at the narrow points where it is supposed to blow. This condition is shown at "B," and is sometimes caused by the slow heating of the fuse and from the heat being conducted away from the ends by the fuse clips thus causing the center to melt first. When a fuse has been blown from a severe over-

## Trouble Shooting

load or short circuit it will often be found melted in two at both of the narrow spots, allowing a whole center section to drop out as in Fig. 11-C. In such cases there will be a tremendous rush of current that may melt the first point open in a fraction of a second, but the extremely heavy current flow may maintain an arc across this gap, long enough to melt out the other weak point also.

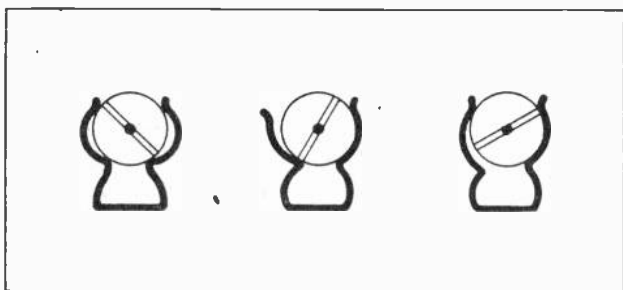

Fig. 10. Fuse clips that are bent out of shape in the manner shown above very often cause heating of the ferrules which results in blown fuses, and other fuse troubles. Burned or weakened fuse clips should be replaced and new ones adjusted to fit the ferrule of the fuse outlet.

With plug fuses, we can also very often tell something of the nature of the trouble by the appearance of the window in the blown fuses. If the window is clear and shows the strip melted in two it was probably a light overload which blew the fuse. But if the window is badly blackened by a violent blowing out of the fuse, it is usually an indication of a severe overload or short circuit.

### 19. COMMON CAUSES OF SHORT CIRCUITS

Wherever blown fuses are encountered it is well to check up on possible causes and conditions in the circuits before replacing the fuses. Sometimes we may find that someone had just connected up and tried out some new electrical appliance which may have been defective or of too great a load for the circuit and fuses. Frequently these devices will be found connected up wrong. Sometimes by inquiring of the people on the premises we can find the probable cause of the trouble.

## Trouble Shooting

For example, the lady of the house may have been ironing when suddenly there was a flash at the iron, the lights went out, and the iron cooled off. This would probably indicate a defective cord on the iron or a short circuit on the plug or element. In another case one of the children may have stumbled over a cord to a floor lamp causing all the light to go out, which would indicate that wires were probably jerked loose and shorted at the lamp or plug; or that the insulation of the cord may have been broken through, causing the wires to short within the cord.

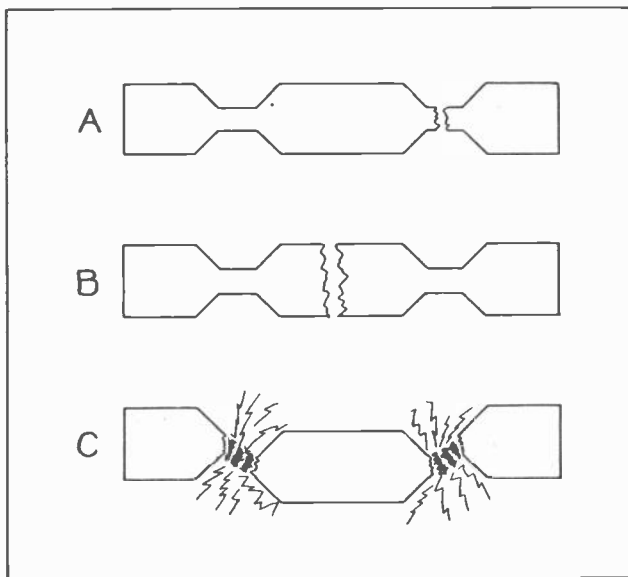

Fig. 11. The above views show several ways in which fuse links may blow. Note particularly the lower view which is the manner in which fuses are often blown by short circuits or severe overloads.

If fuses are blown frequently, it is usually an indication of an overload circuit, and in such cases another circuit and set of fuses should be installed. If the circuits are already fused for 15 amperes and are ordinary ones with No. 14 wire, they should certainly not be equipped with larger fuses, as it is in violation of the Code, and the wires might be overheated.

## Trouble Shooting

A very handy test for "shorts" is to remove the fuse from the socket and screw a lamp bulb in its place. Then, if the lamp still burns when all the equipment on this circuit is turned off, it indicates a short circuit on the wires.

### 20. LOCATING SHORT CIRCUITS AND GROUNDS

In locating a short circuit, it is well to see that each light on the circuit is turned off, and each plug removed from any convenience outlets which may be on the circuit. If this clears the trouble it indicates that one of these devices is at fault. By having someone watch the test lamp in the fuse sockets as these devices are plugged in one at a time and switched on again, the one causing the trouble can be found by watching for the lamp to light up to full brilliancy. The lamp will burn dimly if the circuit is O. K. This is because it is in series with the load on the line. A great majority of fuse troubles in homes can be traced to defective cords of portable devices.

If removing these devices from the circuit doesn't clear the trouble, then it must be in the wiring. Then we should go along the circuit and open up the outlet boxes, pulling out the splices and even disconnecting them, if necessary, to locate the trouble within one section. In a great majority of cases shorts in the wiring system will be found at poorly taped splices in the outlet boxes. It is very seldom that any defects occur in the wires themselves, especially if they are installed in BX or conduit. Sometimes, however, if repair or construction work has been going on around the building, the trouble may be caused by someone having driven a nail into a piece of non-metallic sheathed cable, metal molding or even through the light-walled electric metallic tubing, or they may have cut the wires in two with a saw or drill.

Here is another place where inquiry as to what has been happening just before the trouble occurred may help you to locate it.

In shops or factories, blown fuses may be caused by installing additional equipment on certain cir-

## Trouble Shooting

cuits until they are overloaded, or by the addition of a motor that is too large for the circuit on which it is installed. In other cases a belt may be tightened too much, or the bearings of some machine not properly lubricated, causing a rather severe overload on the driving motor. If the voltage at the service box is too low this will cause motors to draw more than the normal load of current and will blow the fuse.

Whenever some of the lights on any system are found to be burning excessively bright and some of the others very dimly, remember that the cause is likely to be a blown-out neutral fuse on one of the older installations of non-polarized wiring.

The troubles which have been mentioned are some of the most common and are the most frequently encountered. A number of others will come up in your experience, but if you always follow the general methods given in this material and apply your knowledge of circuits and principles of electricity you should have no trouble in locating them. Every time you find and correct some source of trouble which you have not met before, it should be a source of pleasure and satisfaction to you, because of the added experience it gives and the greater ease with which you will probably be able to locate a similar trouble the next time. So, let us once more recommend that you **always welcome any trouble shooting problem** as a test of your ability and a chance to get good experience.

## EXAMINATION QUESTIONS

1. What is the proper mounting height for wall switches?
2. What precaution should be taken when cutting lath for mounting a switch box?
3. What substance is sometimes used to lubricate wires so they will pull into the conduit with less friction?
4. Show the symbol usually used for each of the following: a — Convenience Outlet; b — Local Switch 3 Way; c—Motor; d—Ceiling Outlet.
5. When a lamp is substituted for a fuse will it burn at full brilliancy when other lights on the same circuit are turned on?
6. Assuming that on a certain circuit, lights are turned on, will a test lamp light up when connected across a good fuse in the circuit?  
b—Will the lamp light up if the fuse is burned out?
7. Why is there no danger of burning the wires in a circuit when a test lamp is inserted in place of the fuse?
8. Name two common causes of short circuits in a home lighting system.
9. Where would the trouble most likely be in a case where a fuse was immediately blown when the vacuum cleaner was switched on.
10. What precaution should be taken when notching joist for conduit?



## ILLUMINATION

Artificial illumination, plays such an important part in our homes, factories, theatres, sky-scrapers, sports arena's, etc., that we can hardly imagine what conditions would be without it.

The first light used by man as far as we are able to determine dates back to the discovery of fire. Sticks, or bundles of sticks, known as fagots were arranged in the form of a torch and used as a light source. Then came the first oil burning lamps, consisting of an open vessel in which certain vegetable or animal oils were burned.

An improvement was made in the oil burning lamps by adding a wick, and later oils and fats were solidified around a wick to form the candle. The next important improvement in lamps did not come until the latter part of the nineteenth century, when a chimney was added to the oil burning lamp.

Oils and fats have been replaced by kerosene, and the kerosene lamp is still in use in parts of the country not yet supplied with electricity.

Many improvements have been made on kerosene and gasoline burning lamps, but none of these lamps are comparable in efficiency or quality of light to our electric lights of today.

### 1. EARLY ELECTRIC LIGHTS

Up to the time of the development of electric batteries and generators, and less than one hundred years ago, there were no very powerful or steady sources of artificial light.

Electric arcs or flames drawn between two carbon electrodes were one of the first types of electric light, and while they were not entirely steady or free from smoke, they were able to produce great amounts of very bright light.

The first arc lamp to be used commercially was one installed in the Dungeness light house in England in 1862, and from this time on arc lights came into quite general use for lighting interiors of large buildings and for street lighting.

## **Electric Lamps**

Powerful arc lights of a highly improved type are used today for search lights, flood lights, and in motion picture work; while some of the older types are still in use in street-lighting systems.

### **2. EDISON'S INCANDESCENT LAMP**

From 1840 on a number of experiments were made with incandescent lamps, or the heating of high resistance metal or carbon strips to a glowing temperature by passing electric current through them. But none of these were successful or practical until Thomas A. Edison invented the carbon filament incandescent lamp in 1879.

Edison's first lamps consisted of very thin filaments of carbonized thread, then paper, and later bamboo; all sealed in glass bulbs from which the air was removed by vacuum pumps, to eliminate oxygen and prevent the filament from burning up.

Later lamps of this type were developed with thin metal wire filaments, and the modern incandescent lamp has a tungsten filament, which can be heated to temperatures of 2800 to 3000 degrees centigrade before it will melt. This enables it to operate at glowing white or incandescent heat and give off great amounts of clean steady light.

Edison also developed the first efficient electric generators to supply current for his lamps, and in 1882 built in New York City the first central station generating plant for supplying electricity for light and power. From that time on the development of electric lighting has been rapid, and today modern electric illumination is one of the greatest advantages of our civilization, and one of the greatest fields for the trained electrical man to enter.

### **3. USES AND ADVANTAGES OF ELECTRIC LIGHT**

Electric light in the home greatly improves the appearance, increases comfort, speeds the work of the housewife, and reduces eye strain and makes it a pleasure for members of the family to read or

## Illumination

study during evening hours. The cost of electric light is low enough to be within the means of almost every family today. It is cleaner, safer and more convenient than any other form of artificial light we have.

In shops and factories, electric light speeds up production, reduces errors, increases safety and generally improves the morale of employees.

In stores, hotels, and office buildings electric illumination is used on a vast scale and makes the rooms as bright at night as at noon day, whether they have outside windows or not.

The outsides of buildings in cities are beautifully flood lighted and streets are lighted brightly with electric lamps; and now great airplane landing fields have their special lighting equipment which makes them nearly as bright at night as during the day.

Practically every new building erected in any town or city is wired for electric lights, and many older buildings which have not had lights are rapidly being wired for them today.

Thousands of homes, offices, and industrial plants with the older wiring systems are being rewired for modern and efficient electric illumination.

Almost everyone today realizes the value of better lighting; and its advantages and economies are so apparent, when properly presented, that this is one of the greatest fields of opportunity for the trained electrical man who knows the principles of modern illumination.

This field also provides some of the most fascinating and enjoyable work of any branch of the electrical profession.

### 4. NATURE OF LIGHT

In commencing our study of practical illumination, it will be well to get a general understanding of the nature of light.

**Light is energy in wave form**, and can be transmitted through space and through certain transparent objects. When these waves strike our eyes, they register through our eye nerves and upon our

## Nature of Light

brain cells an impression which we call light. We are familiar with sound waves and how they are set up by disturbance or motion of air and transmitted by vibration through air, water, and some solids. We also know that electro magnetic waves are set up around conductors carrying electricity. In the case of radio energy, these waves are of very high frequency and short wave length. Light waves are considered to be of an electro-magnetic nature, and are known to be of extremely high frequency and much shorter wave length than the shortest radio waves.

Light is generally the result of intense heat, and the sun is, of course, our greatest source of light.

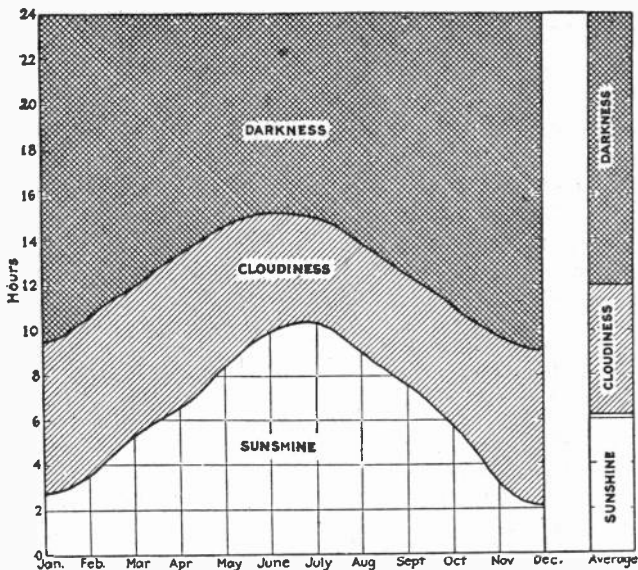

*This chart shows how little actual daylight we have over a considerable period of the year*

Fig. 1. Examine this chart carefully and note the number of hours per day that daylight is available, and you will see how necessary some form of efficient illumination becomes, in order to make good use of the hours of darkness.

## 5. LIGHT COLORS, WAVE FREQUENCIES

The different colors of light are due to the different wave frequencies. Ordinary sunlight, while it

## **Illumination**

appears white, is really made up of a number of colors. In fact, it is composed of all the colors of the rainbow, and a rainbow is caused by the breaking up or separation of the various frequency waves of sunlight by the mist or drops of water in the air at such times.

White light or daylight is generally the most desirable form for illumination purposes, but it must contain certain of the colors which compose sunlight, as it is the reflection to our eyes of these various colors from the things they strike that enables us to see objects and get impressions of their color. Certain surfaces and materials absorb light of one color and frequency, and reflect that of another color; and this gives us our color distinction in seeing different things.

White and light colored surfaces reflect more light than dark surfaces do.

The ordinary incandescent lamp supplies a good form of nearly white light that is excellent for most classes of work, but for color matching and certain other jobs requiring close separation of colors, a light of more nearly daylight color is needed. For this work lamps are made with blue glass bulbs to supply more of the blue and white light rays, and less of the yellow and red rays of the ordinary electric light bulb. More on the units and measurement of light will be covered later.

### **6. PRINCIPLES OF GOOD LIGHTING**

To secure good lighting, or effective illumination, we must not only have sufficient light of the proper color, but must also avoid glare and shadows.

No matter how much light we may have, if there are sources of bright glare in range of the eyes, or definite black shadows from standing or moving objects, it is still not good illumination.

Glare is very tiring to the human eye and we all know that if we look directly at the sun or a bright unshaded light bulb, it is painful to the eyes. The pupils of our eyes must change their openings or adjust themselves to different intensities of

## Nature of Light

light, and as they do not do this instantly, we cannot see things as well when we first look away from a bright light to objects or spaces less brightly lighted.

The same thing applies with shadows which cause dark areas intermixed with the light ones. The eyes cannot change rapidly enough to see well or be



Fig. 2. Various types of lamps for which there are millions of uses today.

comfortable when they must be continually moving from light to shadow, etc.

Glare and shadow are both caused by very bright sources of light concentrated in small spots, or a "point source" of light, as we say.

The more the light from a source is concentrated at one point, the brighter will be the glare if we look at this point, and the more distinct will be the shadows of objects illuminated by this source.

## 7. REFLECTORS

While the incandescent lamp is a wonderful, clean, efficient, and convenient source of light, those

## Illumination

of the larger sizes are bad sources of glare if they are within the normal range of vision. This can be avoided by the use of proper shades and reflectors.

Because these lamps have their light produced at one small source, the filament, they are also producers of very definite shadows, unless they are covered with diffusing globes to soften and spread out the light over a broad area.

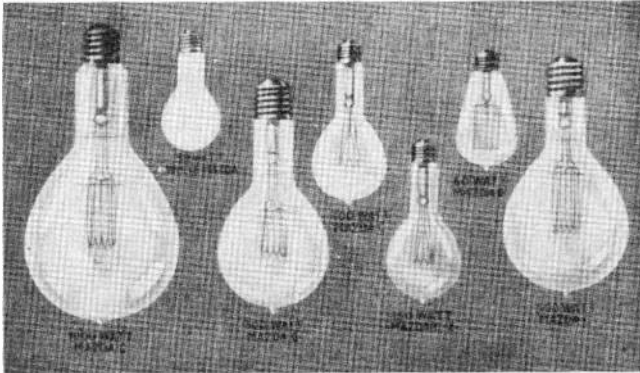

Fig. 3. This view shows various types and sizes of Mazda lamps, ranging from 50 to 1000 watts each.

### 8. TYPES OF INCANDESCENT LAMPS

Now that we know something of the nature of light and the most important fundamentals of good illumination, let us return to our common source of electric light, the incandescent lamp.

These lamps are now made in sizes from a fraction of one watt to 50,000 watts each, and will fit practically every conceivable lighting need. Extremely small lamps are made for surgical instruments, telephone switchboards, flashlights, etc.

Carbon filament lamps are not used much any more, although they can still be obtained for certain uses where they are desired.

The **tungsten filament lamp**, which is commonly known as the **Mazda Lamp**, is the one most generally used.

## Lamp Types

Fig. 3 shows a number of bulbs of different shapes and sizes, such as are commonly used in general lighting.

One of the newest styles of lamps is the type "A", which are made in sizes from 10 to 200 watts and are frosted on the inside of the bulb. This is a very great improvement as it softens the light and reduces glare without materially reducing their efficiency. These new bulbs have stronger filaments, and present a beautiful pearl-colored appearance. They are ideal for use where reflectors or bowls are not used over them. Fig. 4 shows four of these type "A" lamps of the more common sizes for home and general lighting use.

The larger Mazda lamps of 150 watts and over are usually made with clear glass bulbs and known

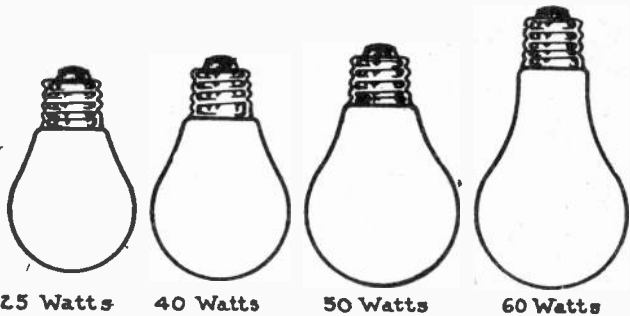

Fig. 4. These four lamps are the sizes very commonly used in general home lighting, and show the shape of the newer type bulbs.

as the type "C". As these larger lamps are generally enclosed in diffusing bowls or mounted high up and out of range of ordinary vision, their clear glass bulbs are not so objectionable. Fig. 5 shows two of these type "C" lamps, and you will note that they have long necks to keep the heat of the filament farther away from the base and sockets. Some of the larger ones even have a mica heat barrier in the neck, as shown in the right-hand lamp in Fig. 5.

The smaller sized lamps have the air withdrawn from the bulbs before they are sealed, so the fila-



## Illumination

ments operate in a vacuum to prevent their burning up, as before mentioned. The larger sizes are filled with an inert gas, such as nitrogen, to keep the filaments from burning up and also to keep the intense heat away from the glass bulbs and permit the lamps to be operated at higher temperatures.

### General Lighting Service

110, 115 and 120 Volts

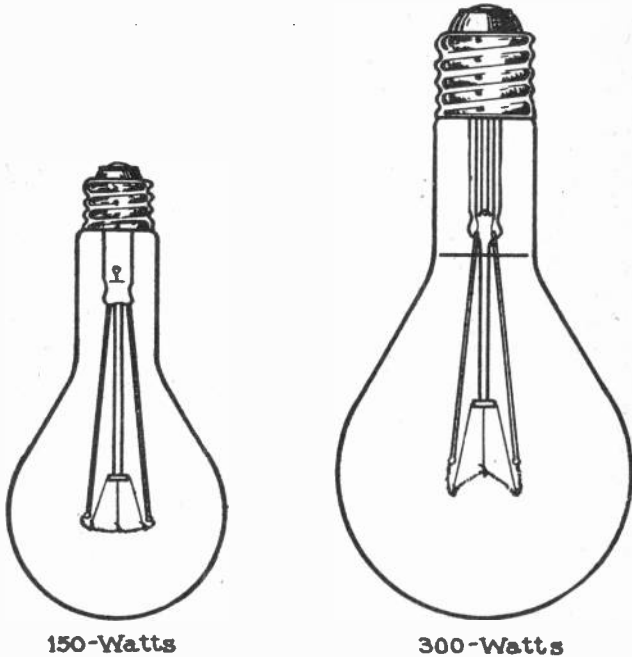

Fig. 5. Two of the larger Mazda lamps, such as used for office and factory lighting. Note the shape of the filament wires and the manner in which they are attached to the heavy "lead-in" wires, and supported by small brace wires.

Fig. 6 shows several types of special bulbs for decorative lights in homes, hotels, theatres, etc. The bulb on the left is an ordinary type "A" in shape, but can be obtained with orange or other colored glass, to give a soft colored light. The others are known as "flame tip" bulbs for candle type fixtures.

## Lamp Types

The blue glass lamps for producing the "daylight color" for color matching etc., are called the "C-2" type. While this color is very desirable in department stores, art studios, dye plants, etc., the yellow light of a clear bulb would be more desirable in foundries or forging shops, as rays of this color will penetrate a dusty, smoky atmosphere better.

Lamps of 500 watts, 1000 watts, and up are gen-

## Decorative Lamps

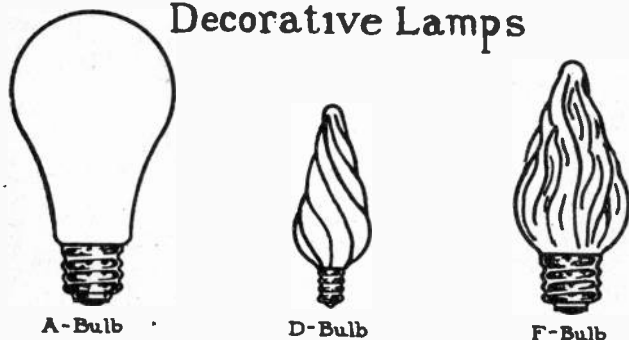

Fig. 6. Lamps of the above type are used for decorative lighting in homes, offices, theaters, etc. The type "A" lamp on the left has the ordinary shaped bulb but can be obtained in various colors.

erally used for street lights, flood-lights, motion picture photography, lighting airplane landing fields, etc.

## 9. LAMP LIFE AND RATED VOLTAGES

The life of the average Mazda lamp is about 1000 hours of burning time. Many of them will last much longer, as shown by the test data in Fig. 7, but others burn less time and, therefore, make about 1000 hours the average. After lamps have been operated a long time, their light output becomes less until in some cases it is better to discard them than to wait for them to burn out.

Hours Burned	0	200	400	600	800	1000	1200	1400	1600	1800
Number lamps remaining.	100	97	94	89	77	60	39	17	3	0

Fig. 7. These figures, taken from an actual test on 100 lamps, show the life in hours, or the number of hours which the various lamps burned.

These lamps are commonly made for voltages of 110, 115, and 120; and some are made for 220,

## Illumination

240, and various other voltages. The 110 volt lamp is, however, the most common type. These various voltage ratings are obtained by slight changes in the filament resistance of the lamps.

### 10. EFFECT OF VOLTAGE ON LIFE AND EFFICIENCY OF LAMPS

Incandescent lamps should always be operated at their rated voltage. If they are operated on lower voltages they will not give nearly as much light or be as efficient in the amount of light produced per watt of energy consumed. If they are operated at voltages above their rating, they will burn very bright and operate at higher efficiency, but the life of the filament will be materially shortened. So the best balance between efficiency and lamp life is obtained by operating lamps at their rated voltages.

For Lamps operated at 5% below normal voltage

Lumens will be	17% below normal
Watts " "	8% " "
Efficiency " "	10% " "
Lamp Life " "	Double

Fig. 8. This little table shows how important it is to have incandescent lamps operated at their proper rated voltage.

A small change in voltage will make a considerable change in the lamp's efficiency and life, as shown by the table in Fig. 8 for lamps operated 5% below rated voltage. The term "Lumen" is the name of the unit used to measure light delivered by the lamp, and will be explained later.

Fig. 9 shows another illustration of the changes that take place in the watts used and the light produced at different voltages below normal. This test data also shows the amount of electric energy in watts which is wasted when the lamp is operated at lower voltage and lower efficiency.

## Lamp Efficiency

### 11. UNITS OF LIGHT MEASUREMENT

Now, before we undertake to plan illumination layouts or select equipment for certain applications, let us find out a little more about actual quantities of light, units of measurement, etc. An understanding of these units and principles is just as important in illumination as Ohms Law is in general electrical work; and you will find them very interesting, as they show us still more about the nature of light.

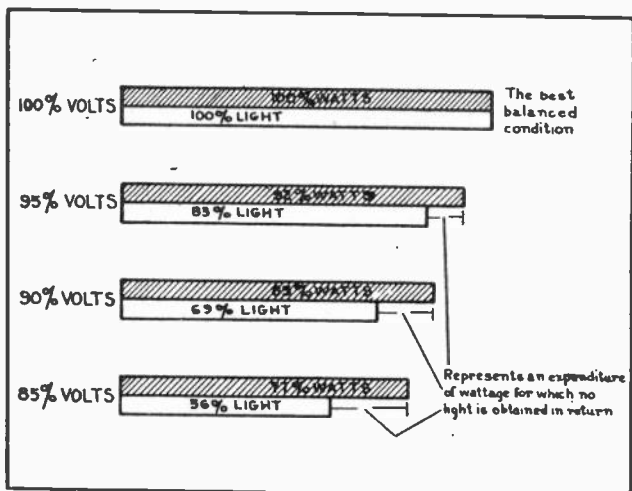

Fig. 9. This chart shows the actual amount of light lost and energy wasted when lamps are operated at less than their rated voltage.

We have been speaking of incandescent lamp sizes and their rating in watts, which is a very convenient term for general use and for buying lamps, etc. While the rating in watts will give us a general idea of the sizes of the lamps, it does not tell us just how much light a certain lamp can be expected to produce.

### MEAN SPHERICAL CANDLE POWER

This method of measuring or comparing sources of light which we have just described, only takes into consideration the light coming from the source in one direction, or striking an object in one certain

## Illumination

spot. For example in Fig. 12 we have a photometer at "P" to measure the light from a candle.

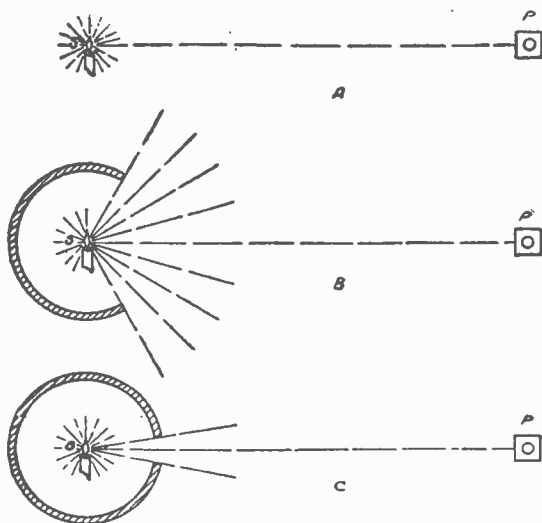

Fig. 12. If we have a photometer or light measuring device at "P," it shows that the amount of light coming in one direction from the candle to the instrument, will remain the same in all three of the above tests.

In view "A" the candle is entirely exposed and the photometer gets its reading only from the very small cone of light that comes in its direction.

In "B" we have the candle partly enclosed in a sphere, the inside of which is dead black, so that it absorbs all the light which strikes it and reflects none. The photometer will still read the same, however.

Again at "C" we have the opening closed still more, but the photometer will still read the same as long as the direct beam to it is not interfered with.

So these devices measure only the light coming from a source in one direction, and take no account of that escaping in all other directions.

The light around a lamp may not be quite as bright in all directions, because of the shape of the flame or filament as the case may be. If we measure the candle power in a number of places at equal dis-

## Light Measurements

tances all around a lamp and average these readings, the result is known as the "Mean Spherical Candle Power". This comes somewhat closer to giving the total light emitted from the source.

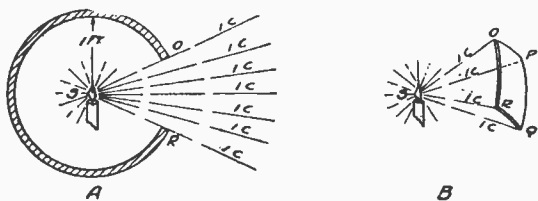

Fig. 13. The "lumen" or unit of light quantity is the measurement of a definite amount of light, such as that which escapes from the opening in the above illustration.

### 14. LUMENS, UNIT OF LIGHT QUANTITY

For stating the total amount of light actually given off by a source we use the unit **Lumen**.

Let us enclose a light which gives off 1 candle power in all directions, in a hollow sphere which has a radius of 1 foot, or diameter of two feet, and the inside of which is dead black so it will reflect no light. See Fig. 13. Now, if we cut a hole in the sphere 1 foot square as shown at OR, the amount of light that will escape through this hole will be 1 lumen. If the area of the opening was  $\frac{1}{4}$  sq. ft., then the light emitted would be  $\frac{1}{4}$  lumen; or if the opening was  $\frac{1}{2}$  sq. ft., the escaping light would be  $\frac{1}{2}$  lumen; etc. A sphere with a 1-foot radius has a total area of 12.57 sq. ft., so if we were to remove the sphere the total light emitted would be 12.57 lumens, from a 1 candle power source.

**A Lumen may be defined as the quantity of light which will strike a surface of 1 sq. ft., all points of which are 1 foot distant from a source of 1 candle power.**

From this we find that we can determine the number of lumens of any lamp by multiplying its mean or average candle power by 12.57.

We can now rate or measure in lumens the total light of any lamp, and also compare the number of lumens obtained with the number of watts used by

## Illumination

a lamp. All Mazda lamps of a certain size and type will give about the same number of lumens each, but the lumen output per watt, and their efficiency, varies with their size. The larger the lamp the higher the efficiency, and it ranges from about 10 lumens per watt for small lamps to 20 or more lumens per watt on lamps of 1000 watts and larger.

The table in Fig. 14 gives the lumen output of common Mazda lamps and their wattages. These values vary a little from time to time, with the improvement made in lamps, but this table will serve as a convenient guide in selecting the proper size of lamps to get a certain desired amount of light.

**LUMEN OUTPUT OF MULTIPLE MAZDA LAMPS**

110-115-120 Volt Standard Lighting Service Clear Lamps		Standard Lighting Service 110-115-120 Volt MAZDA Daylight Lamp		220-230-240-250 Volt Service Clear Lamps	
Size of Lamp in Watts	Lumen Output	Size of Lamp in Watts	Lumen Output	Size of Lamp in Watts	Lumen Output
100	1530	100	990	100	1100
150	2535	150	1650	.....	.....
200	3400	200	2210	200	2920
300	5520	300	3590	300	4560
500	9800	500	6370	500	8350
750	14550	.....	.....	750	13125
1000	20700	.....	.....	1000	19000
1500	33000	.....	.....	1500	27300

Fig. 14. This table shows the number of lumens of light delivered by various sizes and types of Mazda lamps, and will be very convenient for future reference on any lighting problems.

### 15. FOOT CANDLES. UNIT OF ILLUMINATION INTENSITY

Electric lamps are a source of light, and the result of this light striking surfaces we wish to see is illumination.

While the lumen will serve as a very good unit to measure the total light we can get from any source, we must also have a unit to measure the intensity of light or the illumination on a given surface, such as the top of a desk or work bench, or at the level of work being done on a machine, etc. The unit we use for this is the **Foot Candle**.

## Light Measurements

A foot candle represents the intensity of illumination that will be produced on a surface that is one foot distant from a source of one candle power, and is at right angles to the light rays from the candle. See Fig. 15. The foot candle, then, is the unit we use in every day illumination problems to determine the proper lighting intensity on any working surface.

Referring again to Fig. 13, we find that the surface  $O P Q R$  is illuminated at every point with an intensity of 1 foot candle, and we also know that the total amount of light striking this surface is 1 lumen. This shows the very simple and convenient relation that has been established between these units, in their original selection by lighting engineers. This relation can be expressed as follows: **When one Lumen of Light is evenly distributed over a surface of 1 sq. ft., that area is illuminated to an intensity of 1 foot candle.**

This is a very convenient rule to remember. It shows that, if we know the area in square feet that is to be lighted and the intensity in foot candles of desired illumination, we can then multiply these and find the number of lumens that will be required to light the area. For example, if we desire to illuminate a surface of 50 sq. ft. to an average in-

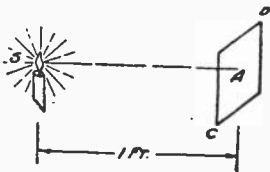

Fig. 15. The unit of foot-candle refers to the intensity of illumination on a surface one foot distant from the standard source of one candlepower, as shown above.

tensity of 5 foot candles, 250 lumens must be utilized at a distance of one foot from the surface. More light will be required as the distance is increased, as explained in Art. 18.

### 16. FOOT CANDLE METER

There are a number of large and elaborate devices used in laboratories for making exact tests



## Illumination

and measurements on light and lighting equipment; but for practical convenient use right on the job, the **Foot-Candle Meter** is extensively used.

Fig. 16 shows a foot-candle meter with its carrying case, and Fig. 17 shows a view of the back of one of these meters opened up. They consist of a flash-



Fig. 16. A foot-candle meter is a very convenient instrument used for measuring illumination intensities right on the job.



Fig. 17. This view shows the important parts of a foot-candle meter. Note the arrangement of the standard lamp behind the paper screen, and also the rheostat and voltmeter used in making proper adjustments.

light battery, small standard lamp bulb, rheostat for adjusting the lamp voltage to proper value, and a voltmeter to check this voltage and make sure the lamp is being operated at proper voltage and brilliancy.

## Light Measurements

In front of the lamp is a long square chamber, over the side of which is placed a piece of tough white paper. Along the center of this strip of paper is a row of uniform grease or oil spots which allow more light to show through them than the rest of the paper.

We all know that the farther any object is from a certain source of light, the less light will strike it. So the oil spots appear quite bright near the lamp, and are gradually dimmer as they get farther away from the lamp. Those still farther away appear darker than the paper, because, with normal light striking the paper from outside the instrument, there is less light behind these spots than on the observer's side, so they appear dark.

This, we find, is the same general principle of the photometer explained earlier. Between the bright appearing spots and the dark appearing ones, there will be one or two that appear the same color as the rest of the paper around them. This is the point at which the light within the instrument is exactly equal or balanced with that striking it from the outside, and at this point we can read the intensity of the outside light in foot candles, on a scale printed along the paper strip.

To use a foot-candle meter, the rheostat switch should be turned on and the knob rotated until the voltmeter needle comes up to a mark on its scale, which indicates that the lamp is operating at proper voltage and brilliancy. Then the meter is held face up toward the light source, and at the level of the working surface where the illumination is required. The shadow of your body should not be allowed to fall on the face of the meter during tests. A number of such tests at various places in a room will give the average foot candle intensity and show us whether the illumination is sufficient for the class of work being done.

Tables of proper illumination standards for various classes of work will be given later.

The standard foot-candle meter is made to read intensities from 1 to 50 foot candles. It is possible to test intensities lower and greater than this by

## Illumination

operating the lamp in the meter at less or more than its rated voltage, by setting the rheostat to hold the voltmeter needle at the extra marks which are provided for this purpose on the scale.

Ordinary daylight is far too bright to measure with these meters and is of a color that does not match the meter lamp accurately.

On a normal summer day with the sun shining, the intensity of illumination outdoors may be 500 foot candles even in the shade, and 5000 to 8000 in the direct rays of the sun.

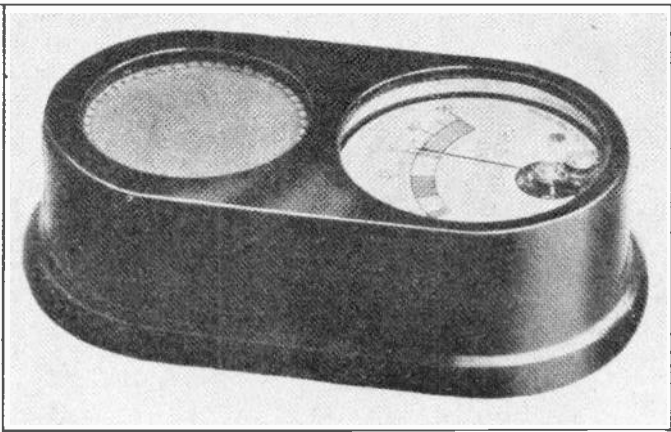

Photo Courtesy Weston Electrical Instrument Co.

Fig. 18. A light-sensitive foot candle meter using the Weston Photronic Cell.

### 17. DIRECT READING LIGHT METER

A direct reading light meter is made possible by the use of a light sensitive cell connected to a sensitive meter. The meter is calibrated to read the amount of light available at any location.

Fig. 18 shows a Foot-candle Meter of the light-sensitive type. This instrument is equipped with a Weston Photronic Cell connected to a sensitive meter and mounted in one single case.

The photronic cell operates on the principle of a Photo-Electric cell (electric eye) except that

## Light Measurements

it is the self generating type and requires no battery. The amount of current generated by a cell of this type is proportional to the amount of light which enters the cell. The more light which enters the cell, the more current will flow through the meter. It is then a simple matter to calibrate the meter to give a direct reading of the amount of light at any one point.

This type of light meter has become very popular because of simplicity of operation, and also because it enables the Electrical man to show a prospective customer exactly the amount of light available.

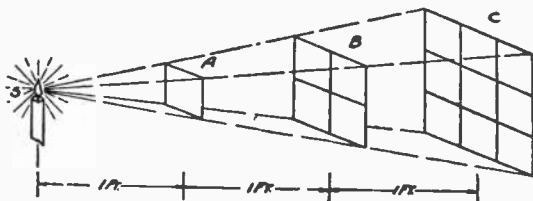

Fig. 19. Note how the illumination intensity becomes less on any surface as its distance from the light source increases. The farther the surface is from the source, the greater the area a given number of light rays must be distributed over.

### 18. INVERSE SQUARE LAW FOR LIGHT

We have already mentioned that the farther any object is from a source of light, the less light it receives from that source.

A very important rule to remember is that the illumination on a surface varies directly with the candle power of the source of light, and inversely with the square of the distance from the source.

So we find that a small change in distance from a light will make a great change in the illumination on an object. The reason for this is illustrated in Fig. 19. Here we have a standard candle, and if the surface at "A" is 1 foot from the candle, its illumination intensity will be 1 foot candle. If we move the surface or plane to "B", which is two feet from the source, the same number of light rays will have to spread over four times the area, as that area increases in both directions. Then the illumi-

## Illumination

nation intensity at double the distance is only  $\frac{1}{4}$  what it was before, as the distance or 2 squared is 4, and this is the number of times the illumination is reduced.

If we move the surface to "C", which is 3 feet away from the light source, the rays now are spread over 9 times the original area, and the intensity of illumination on the surface will now be only  $\frac{1}{9}$  of its former value, or  $3^2$  equals 9. So we call this the **Inverse Square Law for Light**.

## EXAMINATION QUESTIONS

1. When and where was the first Electric Arc lamp used?
2. What is the most common metal used for the filament in modern electric lamps?
3. (A) What is the average life of a Mazda lamp?  
(B) Does an electric lamp maintain the same high efficiency throughout its entire life?
4. (A) What unit do we use for measuring the total amount of light actually given off by a light source?  
(B) Define this unit.
5. What unit is used for measuring light intensity? To what is it equal?
6. Does the efficiency of a lamp increase or decrease when the lamp is operated on less than the rated voltage?
7. What is the Lumen output of 200 Watt 110 volt Standard Clear Lamp?
8. What is the scale reading range of a Standard Foot Candle meter?
9. What governs the amount of current generated by the Photronic cell?
10. Will an increase in light cause the light-sensitive cell meter to read higher or lower?

## LIGHT REFLECTION

We all know that light can be reflected from certain light-colored or highly-polished surfaces. This fact is made good use of in controlling and directing light in modern illumination.

Some surfaces and materials are much better reflectors than others. Generally the lighter the color, or higher the polish of a surface, the more light it reflects, and the less it absorbs.

The percentages of light that will be reflected from some of the more common materials are as follows:

Highly polished silver.....	92%
Good silvered-glass mirrors.....	70% to 80%
White blotting paper.....	82%
Yellow paper.....	62%
Pink paper.....	36%
Dark brown paper.....	13%

Reflectors are used for directing or reflecting light to a desired point or over a given area. The colors of walls and ceilings, and their reflecting ability should also be considered in lighting interiors of buildings.

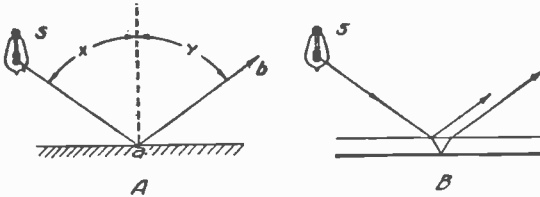

Fig. 1. Note the angle of light reflection from a smooth surface as shown at "A." The illumination at "B" shows how light is reflected from both surfaces of a piece of silvered glass.

### I. CONTROLLING AND DIRECTING LIGHT WITH REFLECTORS

Bare incandescent lamps are splendid sources of light when we consider the quantity and quality of light they produce, but they may also be rather wasteful of light unless proper reflectors are used

## Reflectors

to direct or distribute the light to the desired places. This waste of light is caused by the fact that the light given off by the lamp travels out in

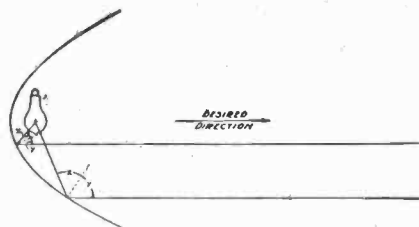

Fig. 2. This illustration shows how a curved reflector can be made to send all the light rays from a source in one direction. The shape of such a reflector is called a "parabola."

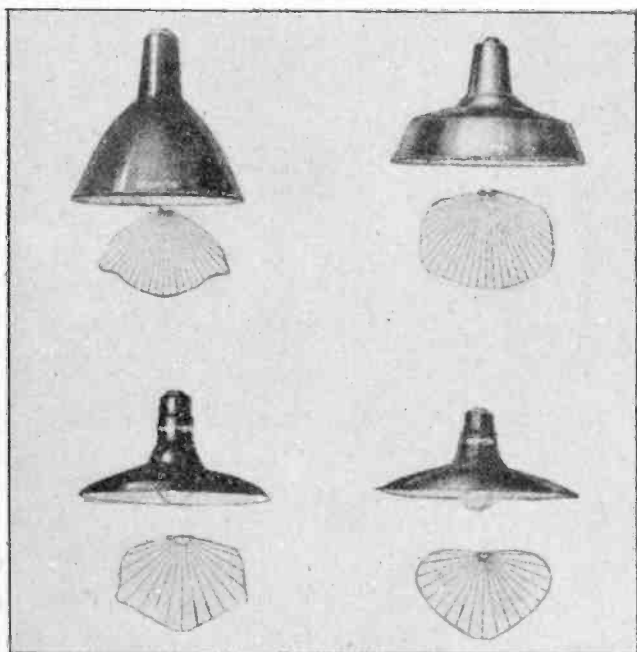

Fig. 3. Above are shown several types of porcelain enameled, metal reflectors. Note how their various shapes give different distribution of the light, as shown by the curves under each reflector.



## Illumination

all directions from the lamp, and the light which travels upward is of no value below the lamp unless it is reflected back from its upward course.

So, to direct the light as desired, we use reflectors with the proper shapes and curves. These reflectors turn back the light that would otherwise go up and sidewise, and send it down either in a broad or narrow beam as desired.

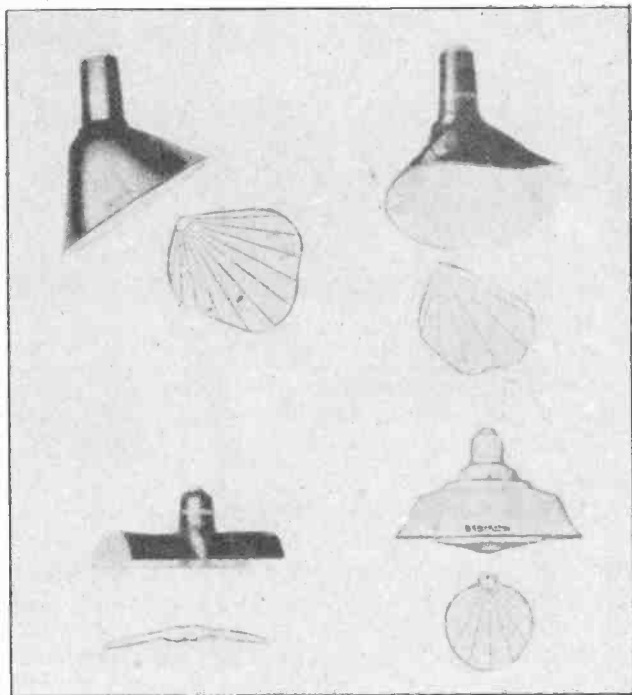

Fig. 4. The two top reflectors and the one at the lower left show how light can be controlled in any direction desired, by using the proper shape of reflector. The unit at the lower right shows a reflector which also has a glass diffusing bowl.

## 2. TYPES OF REFLECTORS

Fig. 3 shows several types of metal reflectors of different shapes, and beneath each one is shown the characteristic curve of light distribution for that type of reflector. From these curves it will be seen

## Reflectors

that the curvature of a reflector can be made to spread or concentrate the light more or less, as desired.

Fig. 4 shows several other types of reflectors. The upper two are used for throwing the light to one side and downward, and the lower left one for spreading the light in two narrow horizontal beams. The lower right hand unit is a combined reflector and glass diffusing bowl.

The ordinary reflectors direct the light downward and shield the eyes from side glare of the

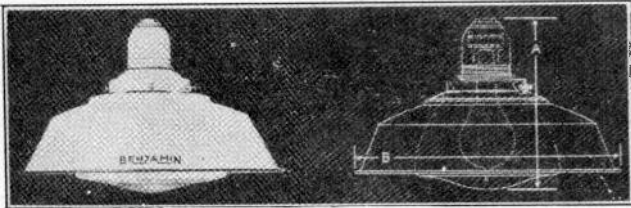

Fig. 5. This larger view of the diffusing unit shows the position of the bulb and glass bowl in the reflector. This is a very efficient and popular type unit for factory lighting and other similar work. (Illustration Courtesy of Benjamin Electric Co.)

lamps. This is often sufficient when the lamps are mounted high enough to be above the ordinary line of vision.

The reflector unit with the glass bowl reflects the light downward, and the bowl enclosing the bulb has a milky white color and spreads or softens the light from the bulb so there is no bad glare even when looking up at the unit from underneath. Broadening the source of light in this manner also softens the shadows a great deal, making this type of lighting unit a very popular one for commercial and industrial buildings.

Fig. 5 shows a larger view of this unit and also a sketch which shows the shape of the glass bowl and the location of the lamp. These units have ring-shaped slots in the top of the reflector to allow a small amount of light to reach the ceilings, and eliminate the dark spots that would otherwise be above a metal reflector and cause quite a contrast to the lighter areas around them.

## Illustration

### 3. ENAMELED METAL REFLECTORS

The inside surfaces of metal reflectors of the types here shown are covered with heavy white porcelain

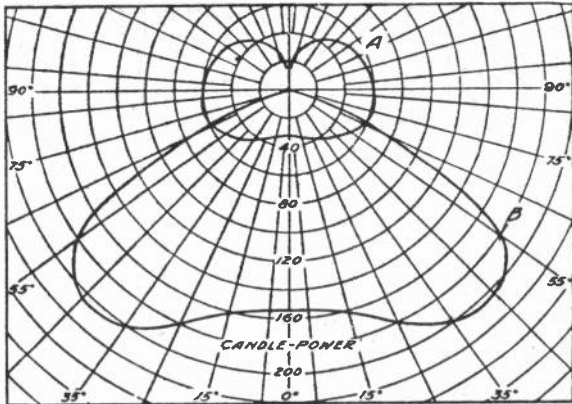

Fig. 6. This shows the manner in which the light distribution from a lamp or reflector can be plotted on a chart, to give a characteristic curve for that light or reflector.

enamel, to give them a high reflecting efficiency. While polished metal can be used as a reflector it usually tarnishes in a short time and is then not much good. So porcelain enamel or glass is better.

Fig. 6 shows a curve of light distribution, and also the manner in which the various candle-power measurements are plotted on the chart to indicate the illumination intensities at different points along the curve.

### 4. MIRRORED GLASS REFLECTORS

Glass shades and reflectors are also used extensively where there is not too great danger of breakage. Some glass reflectors have the outside silvered and then covered with dark paint. The silvered surface makes the inside of the unit of higher reflecting efficiency, and the dark paint stops all side light and glare.

Fig. 7 shows several types of glass reflectors of this kind. You will note that the glass is corrugated to break up the light rays, diffusing them enough to prevent reflection of the sharp outlines of lamp filaments. If this is not done the light from such a

## Reflectors

reflector might cause spots of glare on glossy paper or bright metal surfaces if they were worked upon under these lights.

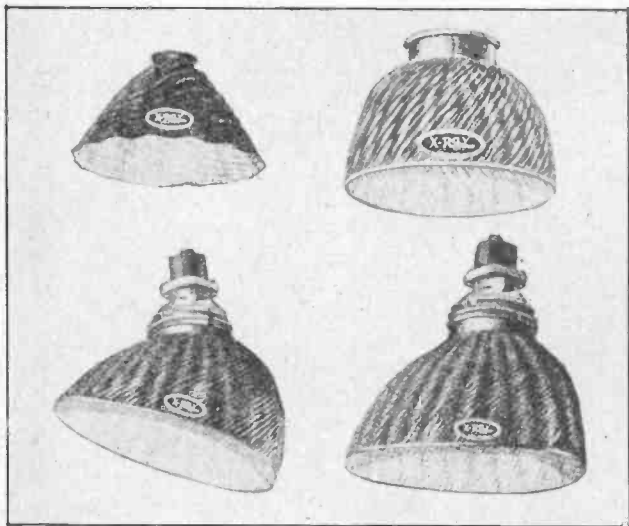

Fig. 7. Corrugated, mirrored glass reflectors of the above type are very efficient in preventing side glare and directing light downwards to the surface where it is desired.

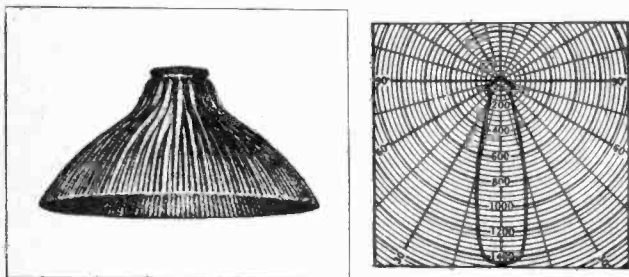

Fig. 8. Corrugated glass reflectors of this type break up or diffuse the side rays from a lamp and also reflect a greater portion of the light downwards, as shown in the curve at the right.

Another type of glass reflector in quite common use is the sharply corrugated type shown in Fig. 8. These reflectors break up the light from the bulb enough to reduce the side glare considerably. While they don't soften the light source as much as some of the other types, they are very good for

## Illumination

certain applications. Note the curve of light distribution for the reflector in Fig. 8 which shows that this type of unit directs a greater part of the light downward.

Fig. 9 shows one of these glass reflectors with a special type of holder which allows them to be easily removed for cleaning. This reflector has a different shape from the one in Fig. 8, which you

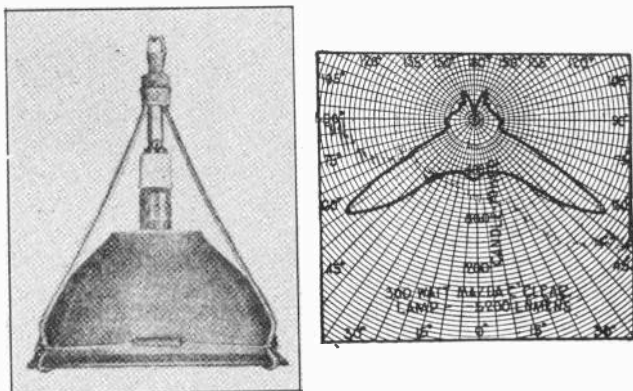

Fig. 9. These glass reflectors mounted in convenient hangers, as shown above, are very commonly used in factory lighting and in some classes of general office lighting.

will note changes its light distribution curve considerably.

### PRISMATIC REFLECTORS

This type of glass reflector is made with grooves running in both directions, so that its outer surface in reality consists of a number of little prisms, which very effectively break up or diffuse the light. These reflectors present a very good appearance and are quite frequently used in office and store lighting. Fig. 10 shows three units of this type. You will note that the bulbs are entirely enclosed with these fixtures, so there is no chance of any direct glare from the lamp.

### OPAL GLASS REFLECTORS AND DIFFUSING BOWLS

Glass lighting fixtures using white or opal-colored glass are made in a great variety of shapes and sizes for general lighting and offices and stores.

## Diffusing Bowls

Opal-colored glass diffuses the light very effectively, and thus softens the source so there is very little glare or shadow if the fixtures are properly installed.

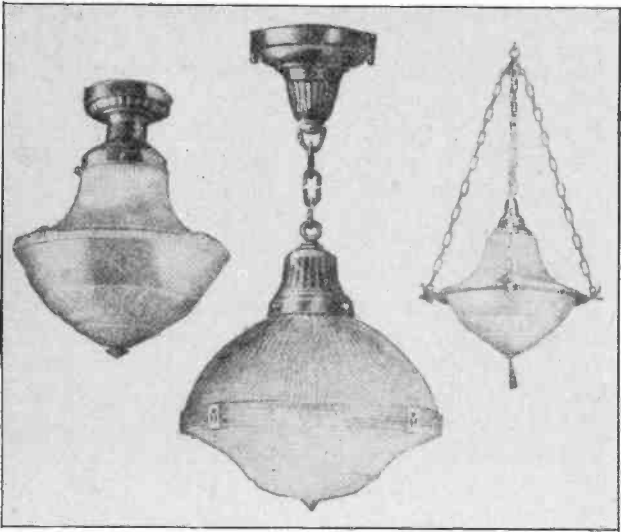

Fig. 10. Several styles of prismatic glass lighting units. Note that these units completely enclose the lamp so that all light is diffused or softened before reaching the eye.

There are two different grades of opal glass, known as light opal and dense opal, either of which will, of course, absorb or stop a certain amount of light from the bulb. But this small loss is more than made up by the greater efficiency of lighting which is free from glare and shadows. Persons can actually see much better with a little less light if these effects which are so tiring to the eye are not present.

Fig. 11 shows two types of glass bowls of a very popular style. These are fastened in the metal canopy with thumb screws, which can be seen in this illustration. This enables the globes to be easily removed for cleaning and replacing the bulbs. When attaching the globes to a fixture of this type, the thumb screws should be tightened firmly and evenly; but not too tight, as it is possible to crack the glass globe in this manner.

## Illumination

Fig. 12 shows two styles of glass fixtures which are made for mounting closer to the ceilings.

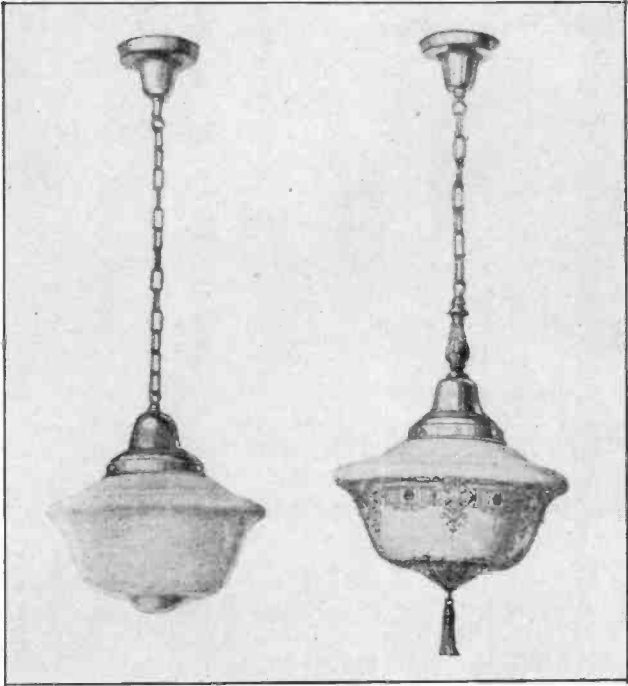

Fig. 11. Enclosing glass bowls with milky white or opal colored glass, make very efficient units for office lighting.

Glassware or fixtures of the types here described can be plain opal-colored, or made more ornamental with decorative painting on the outside. These decorations, of course, reduce the efficiency of the fixture somewhat by absorbing a certain amount of light. Fig. 13 shows another popular type of glass fixture in which the lower part of the bowl is opal-colored and the upper part is clear glass. Then, above the bowl, is suspended a broad opal reflector. The clear glass in the top of the bowl allows considerable light to go upward and strike the under side of the opal reflector, from which it is again deflected downward to the working surface. Glass lighting fixtures of these types allow a cer-

## Diffusing Bowls

tain amount of light to go upward, lighting the ceilings more or less uniformly, and present a very cheerful appearance as well as softening the light generally and reducing shadows.

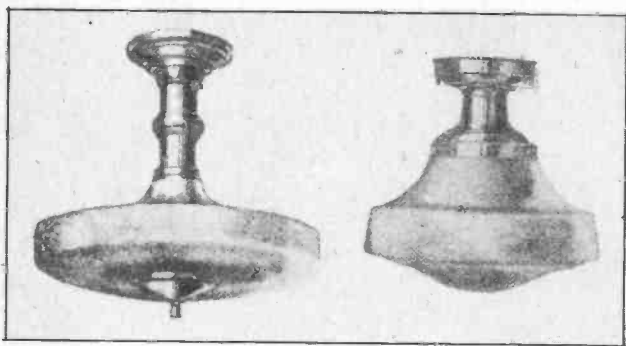

Fig. 12. Short fixtures of the type shown above can be used for mounting close to the ceiling in low rooms.

## 7. GENERAL CLASSES OF LIGHTING UNITS

Lighting fixtures are often classed in three general divisions called:—**Direct, Indirect, and Semi-Indirect.** The direct lighting fixture is one from which the greater part of the light comes directly from the bulb down to the working plane. The metal and glass reflectors of the first type described come in this class. The indirect lighting fixture is one in which no light comes directly down from the bulb to the working plane, but instead is all first thrown upward to the ceiling or to a broad reflector above and then directed downward. Lights of this type are used where it is very essential to avoid even the slightest glare and to eliminate shadows almost entirely. With such fixtures we might say that the ceiling is our secondary source of light; and as we know that shadows are more pronounced when the light comes from small "point" sources, we can readily see that light coming from the broad area of a ceiling would produce almost no shadows.

Fig. 14 shows a view in a drafting room which is lighted with indirect fixtures of this type. You



## Illumination

will note that the light is all directed first to the ceiling and produces a very uniform light throughout the entire room. While this type of light is a little more expensive and requires more lamps and current than a direct lighting installation, it is one of the very best classes of installations where exacting work is to be done.

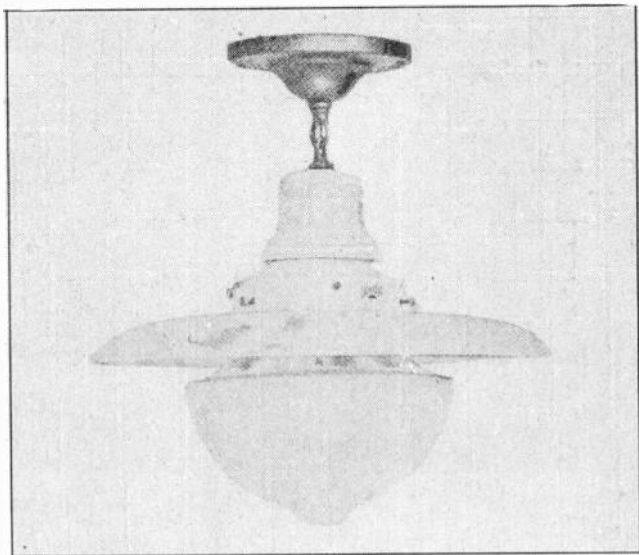

Fig. 13. This fixture has a bowl, the lower part of which is white to diffuse the light, and the upper part is clear to allow the light to go upward and strike the reflector, from which it is directed back to the working surface in a well diffused manner.

Semi-indirect fixtures are those from which part of the light is directed downward through a diffusing globe, and the balance is thrown upward, and then reflected back by the ceiling. Some fixtures are also classed as **Direct Diffusing**, because while practically all of their light is thrown directly down to the working plane, it must pass through a diffusing bowl as with some of those previously described.

### 8. DEPRECIATION FACTOR

Almost all lighting fixtures are subject to a very definite reduction in efficiency from the collection of dust and dirt on their light transmitting or re-

## Depreciation Factor

flecting surfaces. Few people realize what an effective absorber of light a thin film of dust actually is.

In some installations where a beautiful selection of fixtures has been made and the lighting is of very sufficient intensity when the installation is new, after a few months the dirt that is allowed to accumulate on the fixtures absorbs from  $\frac{1}{4}$  to  $\frac{3}{4}$  of the light. This is particularly true in certain industrial plants where smoky, oily, and dusty atmos-

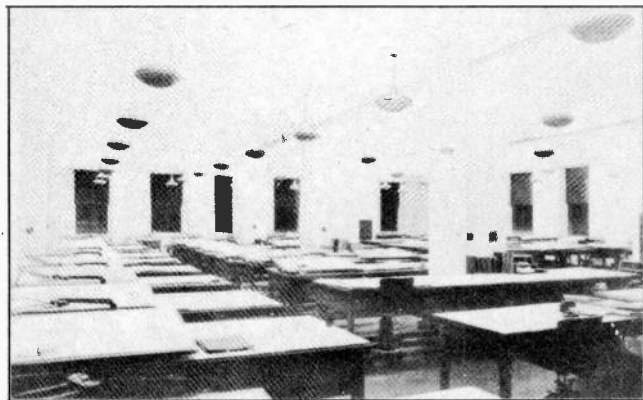

Fig. 14. This drafting room is lighted with indirect fixtures which throw their light to the ceiling first. The ceiling then reflects it downward to the working surface.

pheres exist. Fig. 15 shows an actual view of a fixture of which one side has been cleaned and the other side left with the remaining accumulation of oil and dirt. This is undoubtedly a worse case than is ordinarily encountered, but it serves as a good illustration of the necessity of keeping fixtures clean. Regardless of the amount of money spent in purchasing fixtures that will eliminate glare and shadow, a great deal of the electricity used will be wasted and the lighting will be unsatisfactory if the fixtures are not kept clean. An occasional washing with soap and water will remove ordinary dust and dirt from lighting fixtures, and where necessary special cleaners can be employed.

Of course, it is impossible to prevent some dust and dirt from accumulating, even if the fixtures are cleaned frequently; so when we are selecting

## Illumination

fixtures we generally allow a certain amount for this Depreciation Factor. This will vary from 1.2 to 1.6, and a good, safe average value to use is 1.4. This means that in planning a lighting installation, after determining the foot candles of lighting intensity that would be required to produce the desired illumination, we should then multiply this by the figure 1.4, to have enough light reserve to

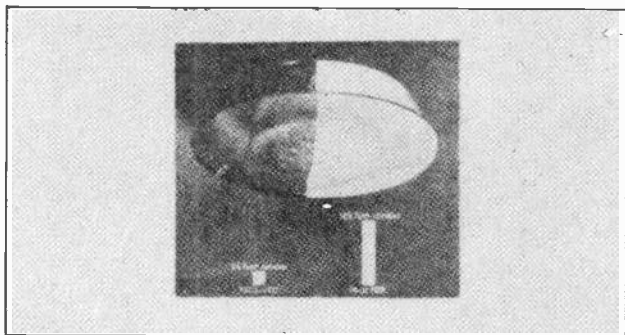

Fig. 15. This is an actual photo showing how much of the light can be lost if the reflectors are not kept cleaned.

keep the lighting satisfactory in spite of ordinary depreciation.

Some fixtures, of course, collect more dust than others in the vital places where it interferes with their light distribution. In some cases when buying fixtures, the depreciation factor for that particular type will be given by the manufacturer or dealer, but when this value is not known, the average factor of 1.4 can be generally used.

### 9. COEFFICIENT OF UTILIZATION

Another very important item to consider in planning a lighting installation is what is called the **Coefficient of Utilization**. You will recall that we mentioned that, if we knew the number of square feet that had to be illuminated and the foot-candle intensity to which it was desired to illuminate the area, the product of these values would give the lumens that would have to be utilized to produce the desired illumination.

## Coefficient of Utilization

When we say these lumens must be utilized we mean that they must be effectively used and not absorbed or wasted in other places besides the working surfaces. Only a part of the total light emitted by any lamp reaches the working plane, as a certain amount will be absorbed by the re-

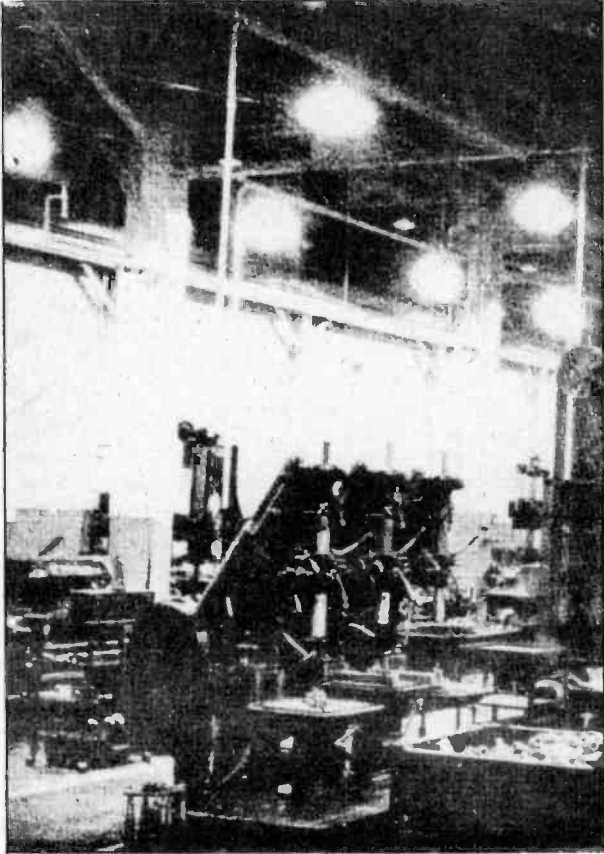

Fig. 16. This photo shows a view in a well lighted machine shop. It is easy to understand why production can be increased and greater safety obtained in a shop which is lighted in this manner. (Photo Courtesy Light Magazine).

flector or enclosing glassware of the fixture, and some will be absorbed by the walls, ceilings and other objects. In some cases part of the light that

## Illumination

is directed upwards and sidewise from the fixture is again reflected to the working surface.

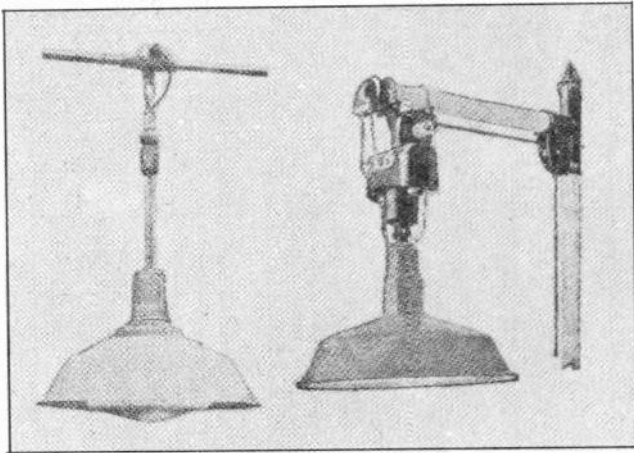

Fig. 17. Special hangers of the above type are often used with lamps which are mounted very high in shops or factories. They allow the lamps to be lowered with a chain for convenient cleaning and repairing.

The coefficient of utilization therefore refers to the percentage of light used at the working plane.

So we find that the coefficient of utilization depends on the type of fixtures; and on the color of walls and ceilings to quite an extent, as the darker colors absorb and waste much of the light from the source, while light colors reflect back to the working surface more of the light which strikes them.

Under average conditions a unit of the type shown in Fig. 5, has a coefficient of utilization of about .70.

Fig. 18 shows a table of coefficient of utilization for various types of reflectors. You will note that the figures given vary for light or dark walls and ceilings.

The ratio of the room width to its ceiling height is also considered, because in narrow high rooms more of the light strikes the walls. In wide rooms which are not obstructed by partitions, the light from the several lamps overlaps and not as much of it is absorbed by walls; thus the utilization factor

## Coefficient of Utilization

is raised somewhat. Fig. 19 shows a sketch of a room and what the effect on the light would be, both with and without the center partition.















COEFFICIENTS OF UTILIZATION									
This table applies to installations in square rooms having sufficient lighting units symmetrically arranged to produce reasonably uniform illumination. To obtain the coefficient for any rectangular room, find the value for a square room of the narrow dimension and add one-third of the difference between this value and the coefficient for a square room of the long dimension.									
Reflection Factor	Ceiling		Light 7%			Medium 35%		Dark 20%	
	Walls		Light 50%	Medium 35%	Dark 20%	Medium 35%	Dark 20%	Dark 20%	
Reflector Type	Light Output	Ratio = Room Width Ceiling Height							
Prismatic Glass 	90° to 180°—22%	1	.42	.38	.35	.36	.34	.33	
		1½	.50	.46	.43	.44	.42	.41	
		2	.56	.52	.49	.50	.47	.45	
		3	.63	.59	.55	.56	.53	.51	
		5	.70	.66	.63	.63	.60	.57	
Bowl-Frosted Lamp 	0° to 90°—45%	1	.31	.27	.24	.24	.21	.18	
		1½	.37	.33	.30	.30	.27	.24	
		2	.43	.39	.35	.34	.31	.27	
		3	.49	.45	.41	.39	.36	.31	
		5	.56	.52	.48	.45	.42	.36	
Light Opal 	90° to 180°—15%	1	.41	.37	.34	.35	.33	.32	
		1½	.49	.45	.42	.43	.41	.39	
		2	.54	.50	.47	.48	.46	.44	
		3	.60	.56	.53	.53	.51	.49	
		5	.67	.63	.59	.59	.57	.54	
Bowl-Frosted Lamp 	0° to 90°—50%	1	.41	.37	.34	.35	.33	.32	
		1½	.49	.45	.42	.43	.41	.39	
		2	.54	.50	.47	.48	.46	.44	
		3	.60	.56	.53	.53	.51	.49	
		5	.67	.63	.59	.59	.57	.54	
Dense Opal 	90° to 180°—20%	1	.38	.36	.34	.35	.33	.33	
		1½	.45	.43	.41	.42	.40	.40	
		2	.49	.47	.45	.46	.44	.44	
		3	.54	.52	.50	.51	.49	.49	
		5	.59	.57	.55	.56	.54	.54	
Bowl-Frosted Lamp 	0° to 90°—60%	1	.43	.40	.38	.39	.37	.37	
		1½	.52	.49	.47	.48	.46	.46	
		2	.57	.54	.52	.53	.51	.51	
		3	.63	.60	.58	.59	.57	.57	
		5	.69	.66	.64	.65	.63	.63	
Steel Bowl 	90° to 180°—0%	1	.22	.19	.17	.14	.12	.07	
		1½	.27	.24	.22	.17	.15	.09	
		2	.31	.28	.26	.20	.18	.11	
		3	.36	.33	.31	.24	.22	.13	
		5	.42	.39	.37	.28	.26	.16	
Porcelain Enamelled 	0° to 90°—45%	1	.27	.24	.21	.20	.17	.14	
		1½	.34	.30	.27	.25	.22	.18	
		2	.39	.35	.32	.29	.26	.21	
		3	.45	.41	.38	.34	.31	.25	
		5	.51	.47	.44	.40	.37	.29	
Indirect 	90° to 180°—80%	1	.24	.21	.19	.16	.14	.10	
		1½	.30	.27	.24	.20	.18	.13	
		2	.34	.31	.28	.23	.21	.15	
		3	.39	.36	.33	.27	.25	.18	
		5	.45	.42	.39	.32	.30	.21	
Mirrored Glass 	0° to 90°—0%	1	.23	.20	.17	.18	.16	.14	
		1½	.30	.26	.23	.24	.21	.19	
		2	.35	.31	.28	.28	.25	.22	
		3	.41	.37	.34	.33	.30	.26	
		5	.48	.44	.41	.39	.36	.31	
Semi-Indirect 	90° to 180°—60%	1	.32	.28	.26	.27	.25	.23	
		1½	.40	.36	.33	.34	.32	.30	
		2	.45	.41	.38	.39	.37	.35	
		3	.52	.47	.44	.45	.42	.40	
		5	.59	.54	.51	.51	.48	.46	
Enclosing 	90° to 180°—35%	1	.32	.28	.26	.27	.25	.23	
		1½	.40	.36	.33	.34	.32	.30	
		2	.45	.41	.38	.39	.37	.35	
		3	.52	.47	.44	.45	.42	.40	
		5	.59	.54	.51	.51	.48	.46	
Light Opal 	0° to 90°—60%	1	.32	.28	.26	.27	.25	.23	
		1½	.40	.36	.33	.34	.32	.30	
		2	.45	.41	.38	.39	.37	.35	
		3	.52	.47	.44	.45	.42	.40	
		5	.59	.54	.51	.51	.48	.46	
Semi-Enclosing 	90° to 180°—70%	1	.23	.20	.17	.18	.16	.14	
		1½	.30	.26	.23	.24	.21	.19	
		2	.35	.31	.28	.28	.25	.22	
		3	.41	.37	.34	.33	.30	.26	
		5	.48	.44	.41	.39	.36	.31	
Opal Bowl 	0° to 90°—60%	1	.32	.28	.26	.27	.25	.23	
		1½	.40	.36	.33	.34	.32	.30	
		2	.45	.41	.38	.39	.37	.35	
		3	.52	.47	.44	.45	.42	.40	
		5	.59	.54	.51	.51	.48	.46	

Fig. 18. This table shows the percentage of light which we can expect to obtain at the working surface from lamps used in different types of reflectors, and in rooms of different shapes. Note that the color of walls and ceilings also influences this percentage.

Fig. 20 shows the amount of light absorption and reflection obtained from painted walls and ceilings of different colors, and from this we can see that

## Illumination

in many cases it would pay to coat them with white or light colored paint, to reduce light waste by absorption. The white or lighter colored paints greatly improve the utilization factor by increasing reflection.

### 10. WORKING PLANE

Now that we have considered some of the more common types of lighting units for industrial and commercial lighting and some of the important points governing their efficiency, let us find out something about the proper location and arrangement of lights to obtain best results and efficiency.

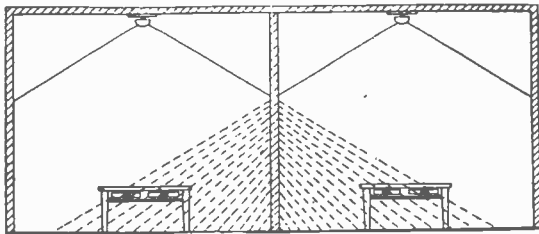

Fig. 19. This sketch shows how the walls of narrow rooms absorb a certain amount of the light. If the wall in this case was removed and the room was twice as wide, note how the light beams from the two lamps would overlap and produce more light on the benches.

In mounting fixtures for industrial or commercial lighting we must consider the distance the light will have to travel from them to reach the **Working Plane**. This term refers to the level at which the light is used. In an office, it may be the top of the desk; or in a drafting room, the top of the tables; in a store, the counter top; and in a machine shop, the height of the machine or bench at which the operator works.

As it is very seldom that the maximum light is wanted at the floor, we must plan to obtain the proper intensities at the working plane.

Examination of the equipment or work in a room or building, will readily show at what height from the floor the working plane is; but if no measurements can be made, it is usually assumed to be about  $2\frac{1}{2}$  feet from the floor.

## Locating Lights

### 11. MOUNTING HEIGHT

The next important point to consider in the location of the fixtures is the proper **Mounting Height**. This is the perpendicular distance from the working plane to the source of light; and it is, of course, this distance that affects the coefficient of utilization and the light intensity obtained at the working plane.

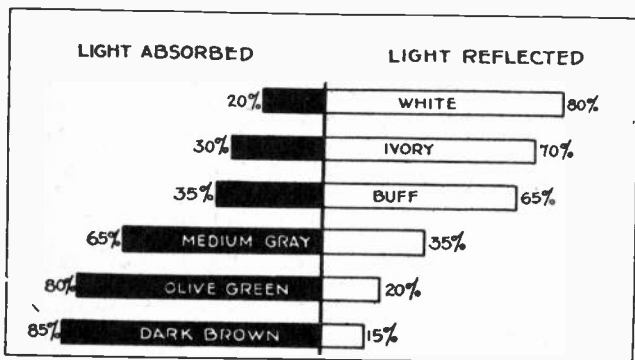

Fig. 20. The above chart shows the percentages of light that will be absorbed and also the percentage that will be reflected, by walls and ceilings painted with different colors.

The distance from the floor to the ceiling in any room is called the **Ceiling Height**.

With direct lighting the source of light is the lamp itself and its reflector. In indirect and semi-indirect lighting the source is considered to be at the ceiling. Fig. 21 illustrates this.

### 12. NUMBER AND LOCATION OF LIGHTS

In general, we should never try to skim on the number of lights or lighting circuits when planning a lighting installation. If good lighting is economy, then it is certainly false economy to try to save on wiring materials or fixture costs by cutting down on the number of lighting outlets or trying to spread them as far apart as possible.

At the rate standards of lighting are improving today in all classes of up-to-date buildings, it is far better to plan for the future and to put in adequate lighting while it is being installed.



## Illumination

Best results can be obtained by having sufficient outlets close enough together to give even distribution and uniform lighting.

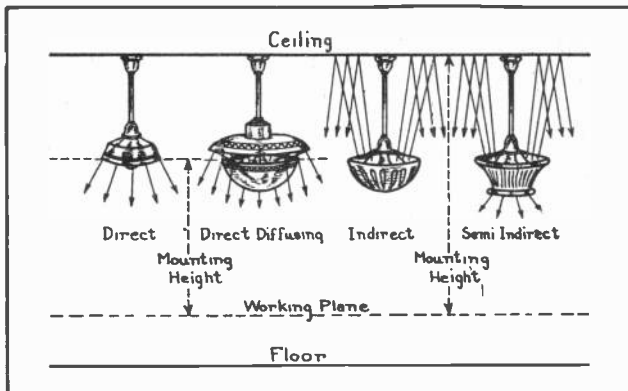

Fig. 21. This sketch shows how the mounting height is obtained with different types of fixtures.

### 13. SPACING DISTANCE

In small rooms that are enclosed by permanent partitions and where one lamp is sufficient, it is, of course, a simple matter to locate this unit in the center of the ceiling. In large rooms where a number of lamps are necessary, we need some rule or standard by which to determine the number and spacing of the lights.

The distance between lights or lighting outlets is known as the **Spacing Distance**. This distance will vary somewhat with the shape and height of the room, but it can easily be determined by the following simple rule: **For best efficiency the spacing distance should be the same as the mounting height.**

In some cases this may seem unnecessarily close, but if good illumination is desired, lights should seldom be spaced more than  $1\frac{1}{2}$  times the mounting height. There may be certain cases where a building when it is first erected will not need that much general lighting, but it is later changed to some other use, the standard amount of illumination may become very necessary.

## Locating Lights

### 14. LIGHTING BAYS

In large rooms where a number of lights are to be installed they should be lined up as neatly as possible for good appearance. In some buildings the larger rooms have posts or supports at uniform distances throughout them, which sort of divide them into **Bays**. If possible, the lights should be arranged uniformly in these bays.

In planning an illumination layout, however, we should divide the room or space into imaginary bays or squares, as soon as the mounting height and spacing distance have been determined. The width of each bay should be made the same as the spacing distance, and each bay should have a light in the center. See Fig. 22.

### 15. PRACTICAL ILLUMINATION PROBLEM

Let us assume that the size of the room shown in Figure 22 is 30x40 ft., and 13 ft. high. We will assume that the working plane is  $2\frac{1}{2}$  ft. from the floor, and that the lighting units will hang down  $2\frac{1}{2}$  ft. from the ceiling. In this case our mounting height will be 13' — 5', or 8'. Then, for maximum efficiency, the spacing distance should be about 8 ft., and not over 12 ft., if good lighting is desired. As the building is 30 ft. by 40 ft., a spacing distance of 10 ft. will give us 10-foot light bays, which will fit this space evenly. So we will adopt the 10-foot spacing distance, and bays 10'x10', as shown by the dotted lines. This layout will require 12 lights.

Spacing the rows of lights 10 ft. apart leaves 5 ft. between the outside rows and the walls; which should be all right, unless some special bench work is to be done along the walls.

Now that we know the number of lights to use and that the area of the bays to be supplied by each light is 10x10, or 100 sq. ft., our next step is to choose the desired illumination intensity.

The required intensity in foot candles will vary considerably for various classes of work. For example, a shop doing nothing but coarse assembly work may only require 5 to 8 foot-candles (F.C.),

## Illumination

while another shop doing very fine machine work may require 10 to 20 F.C. A store or office may need only 10 to 15 F.C., while a drafting room or sewing room requires 15' to 25 F.C.

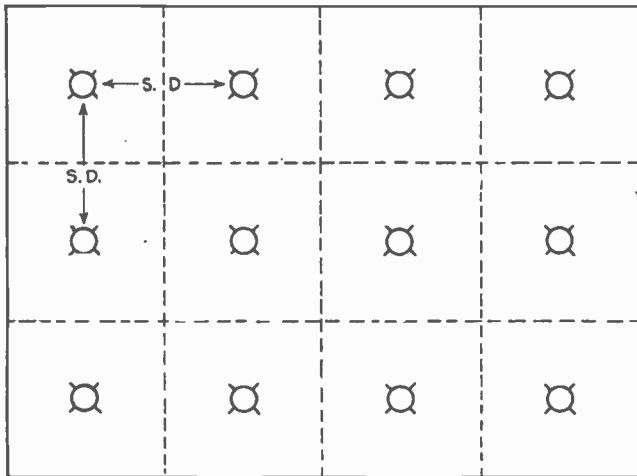

Fig. 22. Dividing the area which is to be illuminated into "light bays," as shown by the dotted lines, greatly simplifies an illumination problem.

Let us assume that our problem is for an office building where the owner desires 15 F.C. intensity.

Now, in order to determine the required lumens to produce this intensity, we recall that we must consider the utilization factor, according to the type of fixture and the color of the room walls and ceiling. We will use for this job a light opal-glass unit of the semi-enclosed type, and assume our walls and ceilings are both light colored.

Looking up this fixture in the table of utilization coefficients in Fig. 18, and in the column for light walls, light ceilings, and a room with a ratio of width to height of about 2, we find the coefficient is .45.

If we wish to assure the proper lighting intensity after the fixtures are installed a while, we must also consider the depreciation factor of, say 1.4.

Now we are ready to lay out all this data in a simple formula to make our final calculation of required lumens as follows:

## Locating Lights

$$L = \frac{F.C. \times B. A. \times D.F.}{C.U.}$$

In which :

- L. = Lumens required per bay
- F.C. = Foot-candles desired intensity
- B.A. = Bay area (one bay)
- D.F. = Depreciation factor
- C.U. = Coefficient of utilization

So, substituting our values, we have :

$$L = \frac{15 \times 100 \times 1.4}{.45}, \text{ or } 4666 + \text{ Lumens per bay.}$$

It will be well to review this problem until you thoroughly understand each step of it and the reasons for using each of the factors we applied in calculating the spacing distance, size of bays, number of outlets, size of lamps; as these are the important factors in any commercial illumination problem. Once you have obtained an understanding of these fundamentals and a little practice in using them in the simple formula given here, you should be able to lay out a practical illumination job very easily.

### 16. STANDARD ILLUMINATION INTENSITIES IN FOOT-CANDLES

For your convenience in determining the proper illumination intensity to use for various classes of work and different buildings, a list of the standard foot-candle intensities for the most common classes of lighting is given here :

#### RECOMMENDED FOOT-CANDLE INTENSITIES

##### COMMERCIAL INTERIORS

Auditoriums .....	3 to	5
Automobile showrooms .....	10 to	15
Banks .....	6 to	15
Barbershops .....	10 to	15

## Illumination

Bowling alleys (general).....	5 to	8
On pins .....	15 to	25
Pool and billiards (general).....	5 to	8
On tables .....	15 to	25
OFFICES (private and general).....	4 to	15
Close work .....	10 to	15
No close work .....	8 to	10
File rooms .....	4 to	6
Vaults .....	4 to	6
Reception rooms .....	4 to	6
RESTAURANTS .....	5 to	8
SCHOOLS .....	8 to	25
Auditoriums .....	5 to	8
Drawing rooms .....	15 to	25
Laboratories .....	8 to	12
Manual training rooms.....	8 to	12
Study rooms and desks.....	8 to	12
STORES		
General .....	8 to	15
Automobile .....	8 to	12
Bakery .....	8 to	12
Confectionery .....	8 to	12
Dry goods .....	8 to	12
Grocery .....	8 to	12
Hardware .....	10 to	20
Meat .....	10 to	20
Clothing .....	10 to	20
Drugs .....	10 to	20
Electrical .....	10 to	20
Jewelry .....	10 to	20
Shoe .....	10 to	20
SHOW WINDOWS		
Large cities		
Downtown.....	100 to	200
Outer districts .....	50 to	100
Neighborhood stores .....	30 to	50
Medium-sized cities		
Downtown .....	50 to	100
Outer districts .....	30 to	50
Small towns .....	30 to	50

## Light Intensities

### THEATRES

Auditoriums .....	3 to 5
Foyer .....	8 to 10
Lobbies .....	10 to 20

### CHURCHES

Auditorium .....	8 to 10
Sunday-school rooms .....	10 to 20
Pulpit or rostrum.....	10 to 20
Art-glass windows .....	30 to 50

### INDUSTRIAL INTERIORS

#### ASSEMBLING

Rough .....	8 to 10
Medium .....	10 to 20
Fine .....	20 to 30
Extra fine .....	50 to 100

#### MANUFACTURING

Screw machines .....	10 to 20
Tool making .....	12 to 20
Inspecting .....	25 to 100
Drafting rooms .....	15 to 40

#### ELECTRICAL MANUFACTURING

Battery rooms .....	6 to 10
Armature winding .....	12 to 20
Assembly .....	8 to 15

#### FOUNDRIES .....

5 to 15

#### MACHINE SHOPS

Rough work .....	6 to 10
Grinding and polishing .....	10 to 15
Fine machine work and grinding.....	15 to 50

#### ENGRAVING .....

25 to 100

#### JEWELRY MANUFACTURING .....

25 to 100

This list of recommended illumination intensities will give the proper values for most any kind of ordinary illumination. While it does not, of course, mention every possible class of work, a general study of the intensities required for the various types of work covered will enable you to determine the proper intensities to use on almost any problem you may encounter.

## **Illumination**

The lower values given in the list are the minimum values for efficiency in the class of work for which they are given. The higher values are recommended as the best practice where maximum efficiency is desired.

When we sum up the recommendations given in the foregoing list, we find that a good general division of proper intensities to keep in mind is as follows:

### **5 to 10 FOOT-CANDLES**

Suitable for coarse work, such as rough assembly and packing. Sufficient for warehouses, stockrooms, aisles, etc. This is enough light to prevent a gloomy appearance.

### **10 to 15 FOOT-CANDLES**

Considered good lighting for most kinds of work on light-colored surfaces, but is not sufficient for fine details on dark-colored surfaces.

### **15 to 25 FOOT-CANDLES**

Excellent lighting. Permits quick and accurate work, and stimulates workmen and speeds up production enough to more than pay for the small extra cost of the light.

### **50 to 100 FOOT-CANDLES**

Needed only for extremely fine and accurate operations, inspection, etc. Generally used only at local spots where needed, and along with general lighting of lower intensities.

Another good general rule to remember is that, for ordinary factory lighting, 200-watt lamps in standard R.L.M. reflectors and spaced 10 ft. apart will usually give very satisfactory lighting. The R.L.M. dome is a common type of unit which is approved by the Reflector and Lamp Manufacturers Association, and is very commonly used in industrial lighting.

If there are certain sections which require more light, larger bulbs can be used in the units at these points, provided the outlets are wired to stand the increased load. For this reason it is usually better to install wires plenty large enough to carry a certain increase of load in case of future improvement in the lighting.

## Light Intensities

Observing the lighting needs and selecting and recommending the proper illumination intensities for various buildings and classes of work is a very interesting and profitable field, and should prove very easy and enjoyable work for the man with a good understanding of the fundamental principles of illumination covered in this section. Practice using the tables and simple formulas, until you can use them easily in planning any ordinary illumination system. Fig. 16 shows a splendid example of good illumination in a machine shop.

### EXAMINATION QUESTIONS

1. (A) For what purpose are reflectors used with illumination equipment? (B) What are several good reflecting materials?
2. What is meant by diffusion of light, and how is it accomplished in lighting fixtures?
3. What are the three general classes of lighting fixtures or systems?
4. What is meant by "depreciation factor" and what average value or figure is often used?
5. (A) What do we mean by the term "coefficient of utilization"? (B) How would you determine these values for various types of fixtures?
6. What is the "working plane", and about what distance from the floor is it generally assumed to be?
7. Explain how you would determine the mounting height and spacing distance for fixtures in a lighting installation.
8. What illumination intensities would you recommend for a barber shop? For close office work? For a school study room? For a dry goods or grocery store?
9. What is the Lumen output of 500 W 110 volt standard clear lamp?



# ILLUMINATION

## 1. FACTORY LIGHTING PROBLEM

The following problems are worked out to give you a good understanding of the formulas used in estimating the number and size of lamps to be installed.

Suppose we have a job of lighting a factory room 55 ft. wide, 100 ft. long, and 17 ft. high. The work to be handled is medium fine, the material is light-colored, and the owner desires very good illumination, which in this case should be obtained with an intensity of about 12 foot-candles.

Let us say the average working plane is about 30 inches, or  $2\frac{1}{2}$  feet, from the floor; and that the lighting reflectors chosen will hang down  $2\frac{1}{2}$  feet from the ceiling. Then if the room is 17 ft. high, the mounting height will be  $17 - 5 = 12$  ft.

We decide to use the maximum efficient spacing distance, which we have learned is  $1\frac{1}{2}$  times the mounting height. Then  $1\frac{1}{2} \times 12 = 18$  ft. spacing distance.

Each light bay will then be  $18' \times 18'$  or 324 sq. ft. This figure will be approximate and may need to be corrected to suit the shape of the room, for even rows of lights. Then, to find the number of outlets, we can divide the total floor area by the square feet per bay. The floor area will be  $55' \times 100' = 5500$  sq. feet. Then  $5500 \div 324 = 16.9+$ ; or, we will say, 17 outlets.

Now, as our room is nearly twice as long as it is wide, a good uniform arrangement will be the three rows of 6 outlets in each, or 18 outlets. This will be one more than our figures call for, but when balancing up the rows for appearance, it is always better to add a light or two than to remove any. See the layout for this problem in Fig. 1. This arrangement will give a spacing of  $18\frac{1}{3}$  ft. between the rows of lamps, and  $16\frac{2}{3}$  ft. between the lamps in the rows. It also leaves a space of  $9\frac{1}{8}$  ft. between the rows and the walls on the sides, and  $8\frac{1}{2}$  ft. at the ends.

Now that we have decided upon the number of outlets, our next step is to determine the exact

## Factory Lighting

number of sq. ft. per bay. So we will divide the total floor area by the number of outlets, or  $5500 \div 18 = 305.5+$  sq. ft. per bay.

Before we can complete our problem and determine the number of lamp lumens required per bay to maintain 12 foot-candles of illumination, we must consider our utilization and depreciation factors.

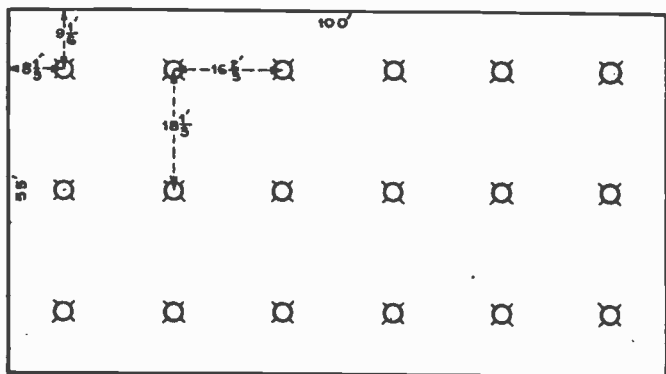

Fig. 1. This sketch shows the arrangement and spacing of lights for a practical factory lighting job.

We will assume that we are going to use steel dome, porcelain-enameled reflectors, and that the walls and ceilings of the room are both light-colored.

By referring to our previous tables, we find that for this fixture used with light walls and ceilings, and in a room whose ratio of width to height is about 3, the utilization factor is .63. Then,

using 1.4 as our average depreciation factor, our problem can be completed by the formula for lumens, which we have previously used.

$$L = \frac{12 \text{ F.C.} \times 305 \text{ B.A.} \times 1.4 \text{ D.F.}}{.57 \text{ C.U.}}$$

In which we will recall—

F.C. = Desired foot-candles

B.A. = Bay area in sq. ft.

D.F. = Depreciation factor

C.U. = Coefficient of utilization

## Illumination

Working out this formula with our figures for this job, we find it gives  $8989.4+$  lumens required. We find that a 500-watt lamp gives 9600 lumens, so it will be plenty large enough for this job.

If the glare from bare bulbs in these units should be objectionable to any of the operators, we can install bowl frosted lamps.

The upper view in Fig. 2 shows what happens when lighting units are spaced too far apart. This produces contrasting spots of bright light with shadows in between, and is very poor practice. The lower view shows the more uniform illumination obtained by proper spacing of the units at distances not to exceed  $1\frac{1}{2}$  times their mounting height.

### 2. OFFICE LIGHTING PROBLEM

In another problem, suppose we have a room 92 ft. square and 13 ft. high which we wish to illuminate to an intensity of 10 foot-candles, with indirect lighting fixtures. Assume the working plane to be 3 ft. from floor.

When using indirect fixtures, we will remember, our source of light is considered to be at the ceiling, so in this case we do not subtract the length of the fixture from the ceiling height to obtain the mounting height. Instead, we subtract just the height of the working plane; so  $13 - 3 = 10$  ft., which will be the mounting height.

In this case we will use the proper spacing distance for maximum efficiency, which is the same as the mounting height, or 10 ft. Then the first estimate for the bays will be  $10' \times 10'$  or 100 sq. ft.

The total floor area is  $92' \times 92' = 8464$  sq. ft. Then the estimated number of outlets will be  $8464 \div 100 = 84.6+$ .

As the room is square, we can use 9 rows of 9 lights each, or a total of 81 outlets; which is close enough, because we are using close spacing anyway.

Now to get the accurate number of sq. ft. per bay, we divide the total floor area by the chosen

## Office Lighting

number of outlets, or  $8464 \div 81 =$  approximately  $104\frac{1}{2}$  sq. ft. per bay.

We will assume the walls and ceilings to be light-colored, as the ceilings should certainly be to get

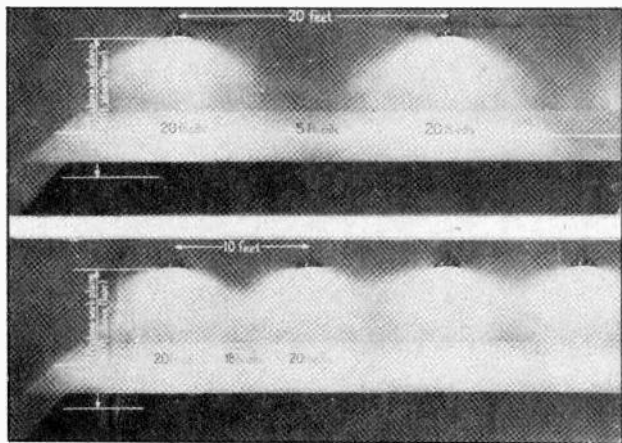

Fig. 2. Note in the upper view the very undesirable effect of uneven illumination, which results from spacing lighting units too far apart. Below is shown the much more efficient lighting obtained with proper spacing distance.

reasonable efficiency from indirect fixtures, with which the light must be reflected from the ceiling.

We find the coefficient of utilization for indirect fixtures and light-ceilings and walls is .42. This is for a room of 5 to 1 ratio of width to ceiling height; as the one in our problem has a ratio of about 7 to 1, or  $92 \div 13$ . But the table only gives these ratios up to 5, and we will recall that on ratios above 5 the difference is very little anyway.

With indirect fixtures, the depreciation factor is likely to be rather high unless both the fixtures and ceiling are kept very clean; so we will use 1.6, or the maximum average depreciation factor.

Then our final problem can be stated in the formula:

$$L = \frac{10 \times 104.5 \times 1.6}{.42}, \text{ or } 3981\text{-lamp lumens required.}$$

## Illustration

From the table, we find that the next size larger than this is a 300-watt lamp, which gives 5520 lumens. This is more than our



Fig. 3. This photo shows a view in a well lighted store. Plenty of good light always pays in such places as this.

estimate calls for but it is a good general rule always to select a lamp with the next larger rating in lumens, rather than to use one smaller.

Of course, if we find that for a certain layout the next larger lamp has a considerably greater lumen output than is actually required, we can, if desired, rearrange the layout to slightly increase the spacing distance and size of bays. But, in general, it is a good plan to have a little extra light, to keep it up to standard after the bulbs and fixtures start to depreciate.

Another thought to always keep in mind, is that while a certain illumination system may be considered excellent today, in a year or two it may be desired to increase the intensity considerably with improving standards.

Fig. 3 shows a well-lighted store in a medium-sized town, using 500-watt lamps on 10-ft. centers.

For store and office lighting, it is general practice to use direct-diffusing, indirect, or semi-indirect fixtures. Both the opal glass bowls and prismatic glass are quite popular.

## Office Lighting

In office lighting jobs, one should always inquire whether the present layout of desk, equipment, and small private offices is permanent or not. Many offices change these things around quite frequently, and in such cases good general lighting which is sufficient for almost any work or condition in the office will save a lot of trouble and remodeling of the lighting system.



Fig. 4. This office is lighted with indirect units which are ideal for avoiding all glare and shadow effects. (Photo Courtesy Light Magazine).

Fig. 4 is an installation of indirect lighting units, which shows the soft even light distribution obtainable with such fixtures and the absolute freedom from glare or noticeable shadows.

### 3. SHOW-WINDOW LIGHTING

Show-window lighting is a branch of store lighting which has proven to be one of the best sales stimulants that the modern store has. On busy streets where large numbers of people pass by, a well lighted show window with goods interestingly displayed will attract a great amount of attention to a store that many people might otherwise pass by

## Illumination

A number of tests made on stores with various show-window lighting intensities showed the interesting average results listed in Fig. 5.

Effect of lighting intensities on show window results

Foot candles intensity	Increase in no of people stopping	Estimated hourly profit on sales	Hourly lighting cost	Merchants net hourly gain
15		7.50	3.5 cents.	
40	35%	10.00	7.5 "	2.46
100	73%	13.00	18. "	5.36

Fig. 5. The above table shows the results obtained with different lighting intensities in show-windows. Such tests as this certainly prove that good show-window lighting pays.

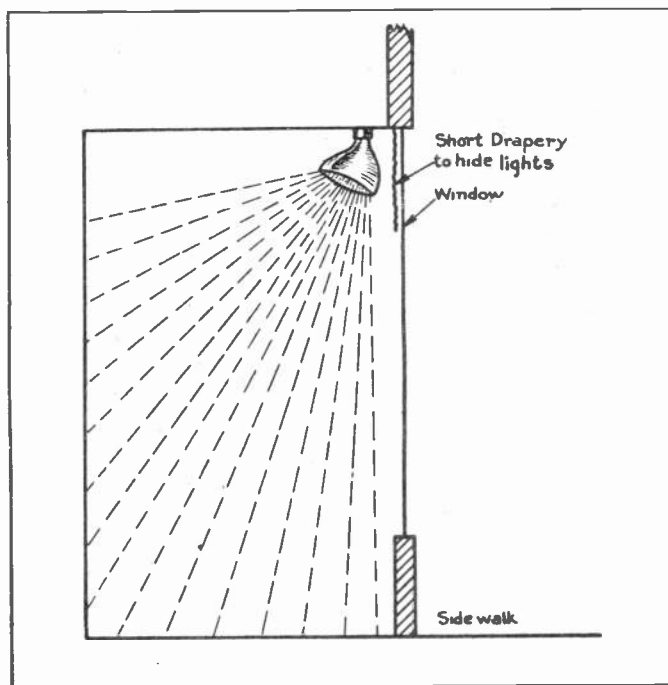

Fig. 6. This illustration shows how the light should be directed on the objects displayed, and not toward the window or observers.

In show-window lighting the light sources should be concealed, as we must remember it is not the

## Show Window Lighting

lights the store owner wants to sell, but rather the goods the light is to shine on.

The reflectors should be set so their light shines downward and back into the window, in order to put proper light on the side of the objects which faces toward the customer. **The light should never be directed toward the window glass or passers by,** as it would then have a tendency to cause glare in people's eyes and defeat its entire purpose. Fig. 6 shows how a lighting unit can be concealed in the front top corner of the window, and the manner in which it should distribute its light rays over the depth of the window.

### 4. SHOW-WINDOW REFLECTORS

Fig. 7 shows a typical show-window reflector of the corrugated glass type, and also its curve of light distribution and the manner in which its shape directs the light to fit show-window needs.

Fig. 8 shows two of the corrugated glass show-window reflectors with silvered and painted outer surfaces. The one on the left is shaped to throw the light down and slightly back into a shallow window, while the one on the right is curved to direct the light farther back into deep show-windows.

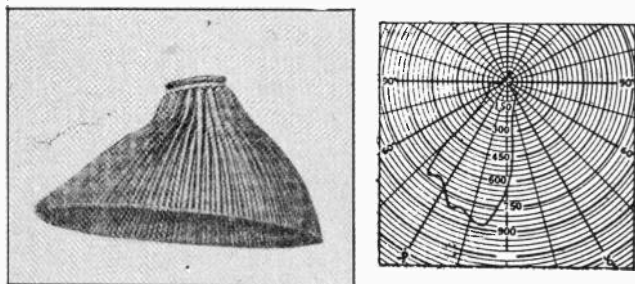

Fig. 7. A common type corrugated glass show-window reflector. Note how the light distribution curve compares with the desired angle of light shown in Fig. 195.

Fig. 9 shows a group of show-window reflectors mounted behind the concealing curtain, as mentioned before. A row of 150-watt lamps in such reflectors as these, spaced on 12-inch centers, will



## Illumination

give excellent show-window lighting. If the same sized lamps and reflectors are spaced on 18-inch centers, it will give good lighting, and on 24-inch centers fair lighting.

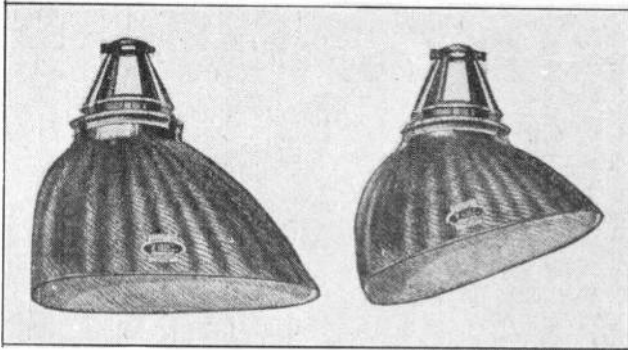

Fig. 8. Mirrored glass show-window reflectors with different shapes, to properly direct the light in windows of different depths.

### 5. SPOT AND COLOR FLOOD LIGHTS

Proper use of special show-window flood lights and colored spot lights on certain objects will give very beautiful and attractive effects that in practically every case will pay well for the cost of installing and operating. Fig. 10 shows an adjustable show-window flood light with a detachable color screen which can be fitted over it. A number of different color screens can be obtained at very low cost, to make changes in color effect, and to

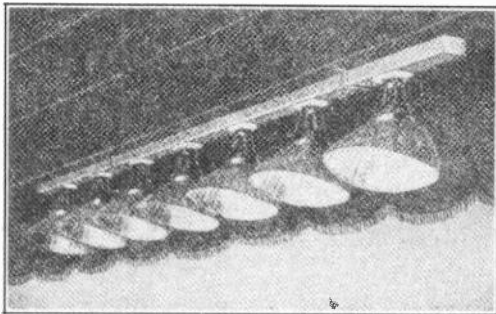

Fig. 9. This photo shows the manner in which show-window reflectors should be mounted and concealed for best results.

## Counter Lighting

keep up interest in a window display. Fig. 11 shows a spot light on the left, and on the right is a small reflector used for lighting display cases in store interiors.

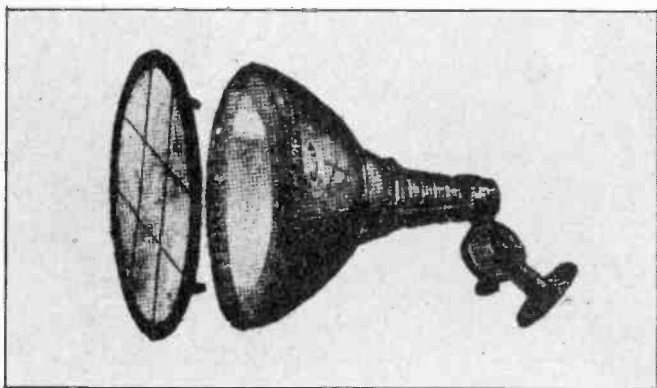

Fig. 10. Adjustable flood lights with colored screens can be used to produce beautiful and decorative effects.

### 6. COUNTER LIGHTING

For lighting display cases and interiors of glass counters we can also use compact tubular reflectors

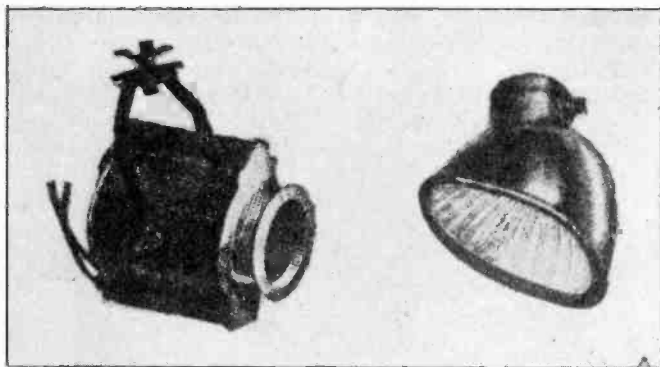

Fig. 11. On the left is shown a spotlight for concentrating bright light on certain objects in show-windows. The small reflector on the right is of the type commonly used in glass counters and display cases.

with special long slender bulbs made for the purpose. These reflectors fit neatly under the wood or metal corner frames of the counters, so they do not

## Illumination

obstruct the view or create a bad appearance in the case. Fig. 12 shows the method of installing this material in a glass show-case. Fig. 13 shows several different lengths of these trough-like reflectors and

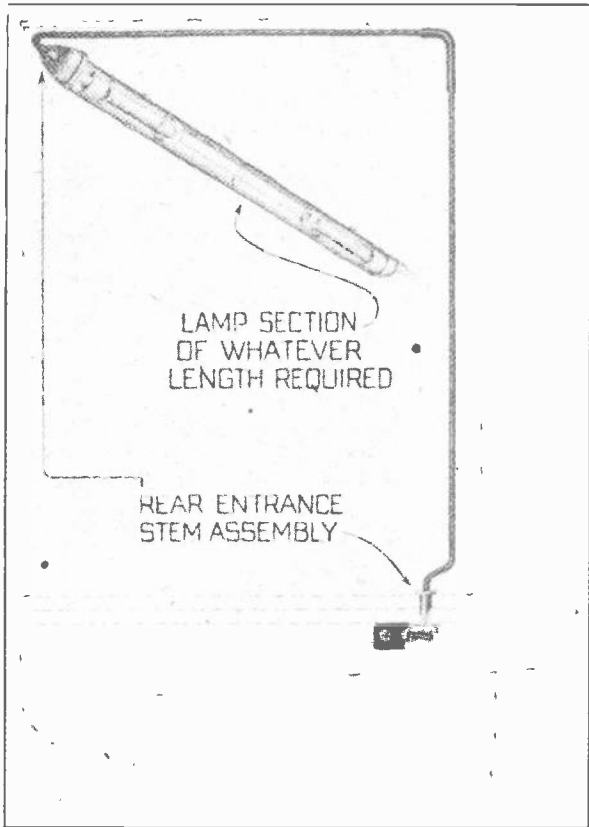

Fig. 12. Long trough-shaped reflectors with special tubular lamps are obtainable for convenient installation in glass counters as shown above.

a number of the fittings used with them. The wires can be run in special small tubing, some of which is also shown.

Fig. 15 shows what remarkable effects can be obtained with properly concealed show-window lights, and properly distributed illumination in the window.

## Billboard Lighting

### 7. ELECTRIC SIGNS AND BILLBOARDS

Electric signs today are made in such a great variety of styles and types and to produce such beautiful and life-like effects in some cases, that one might think them very complicated devices. While some of the larger ones are marvelous pieces of mechanical construction and use very ingenious arrangements of electrical circuits, they are really not hard to understand for one who knows the principles of electric circuits and the general principles of sign construction and operation.

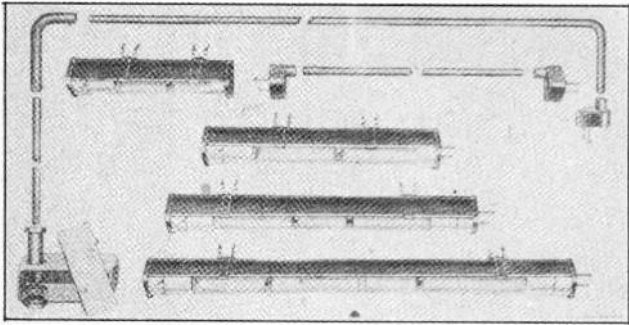

Fig. 13. Show case and counter lighting units are made in convenient sections which can be easily plugged together for lighting cases of different lengths.

### 8. BILLBOARD LIGHTING

One of the simplest forms of illuminated signs is the billboard type which consists simply of large flat panels on which are painted the pictures and words of the advertisement. Many of the illustrations for such signs are made up on large paper sections and pasted on the boards. This makes it economical to change or renew as desired.

Billboards of this type are quite commonly equipped with electric lights, because, in many cases, they actually attract the attention of more people when lighted at night than they do during daylight hours.

Fig. 14 shows the common method of mounting the reflectors on conduit extensions out over the top edge of the board. With the reflectors in this position they do not obstruct the view of observers, and they direct the light toward the sign and away from

## Illumination

the observers' eyes, so that the lights themselves are hardly noticeable.

This is ideal, because it is the sign we want people to see and not the lights. This principle is a very good one to keep in mind in illuminating problems, as the best results are often obtained by having the light sources practically concealed, or at least very inconspicuous; leaving the illuminated object to be the principal attraction to the eye.

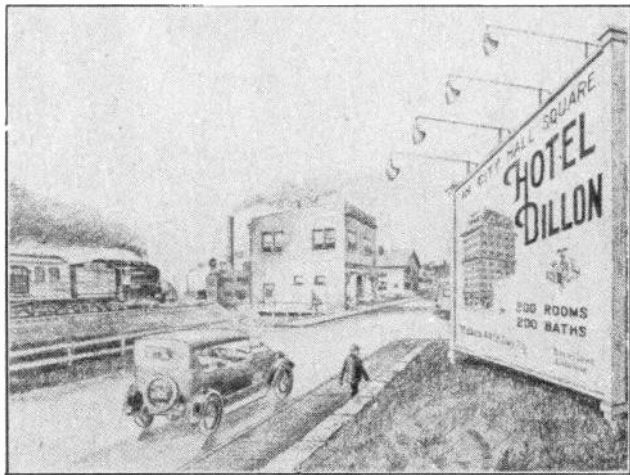

Fig. 14. This view shows the manner of mounting reflectors on conduit extensions for billboard lighting. Note how the reflectors are curved to direct the light on the board, but away from the observers.

Billboard lights should be mounted several feet out in front of the boards as shown in Fig. 14, because if they are placed close to the top edge, the light strikes the board at a sharp angle and causes glare and shadows. Mounting them out the proper distance from the board allows their light to diffuse evenly over the board.

In some cases where reflected glare from the lamps above the board comes at just the exact angle to strike the eyes of observers who are slightly below the board, the lights can be arranged out in front of the bottom edge of the board and pointed upward, as shown in Fig. 16-B. This method of mounting can also be used where billboards are

## Window Display Lighting

viewed from above, and we desire to keep the reflectors out of the direct range of vision.

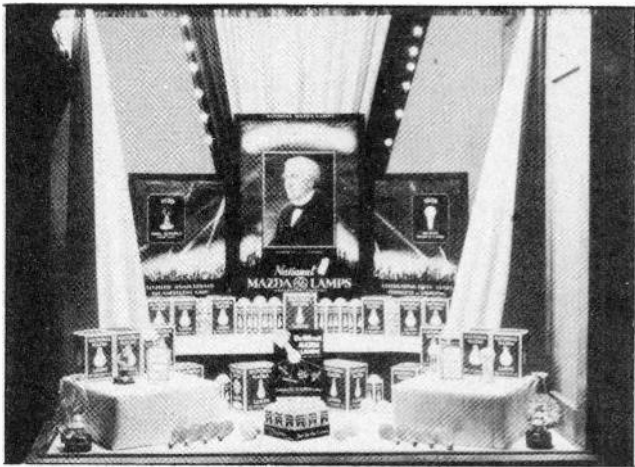

Fig. 15. This exhibit of Mazda lamps in a show-window of an electric store, shows the very beautiful and decorative effects which can be produced by proper show-window lighting. (Photo Courtesy of Light Magazine).

The mounting as shown in Fig. 16-A is to be preferred whenever it is possible to use it, because the position of the reflectors keeps their inside surfaces and the bulbs more free from dirt and rain.

Billboard reflectors mounted on conduit extensions should usually be braced with steel wires running to the top of the board, to prevent the wind from blowing the reflectors sidewise.

### 9. ELECTRIC SIGNS, CONSTRUCTION AND OPERATION

Many electric signs are made of steel frame work covered over with sheet metal. These can be made in square, round, high narrow, or long horizontal shapes; as well as ornamental designs. Some signs of this type merely have letter shapes cut in the sheet-metal on both sides and covered with opal or colored glass. Light bulbs inside them cause the glass letters to show up brightly at night.

Other signs have lamp receptacles screwed into small round holes in the sheet metal, and bulbs

## Illumination

screwed in these receptacles and projecting out from the face of the sign. These bulbs can be obtained in various colors, and arranged in rows to form letters or patterns of almost any desired shape.

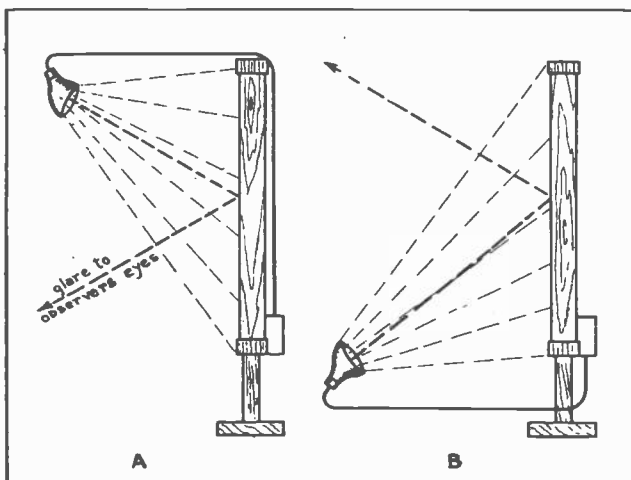

Fig. 16. If objectionable glare is produced by mounting the units above the board as in "A," they can be reversed and mounted below as shown at "B."

Beautiful action effects can then be obtained by connecting the bulbs to motor-driven flashers. By causing groups in sign borders to light up and go out progressively or in numerical order, they can be made to appear as though they are actually moving, thus giving the "chaser" and "fountain" border effects, and other action displays so commonly used on large signs.

### 10. FLASHER CIRCUITS

Fig. 17 shows how a flasher can be connected to light a row of lamps in order, and then extinguish them in the same order. A motor-driven drum has a number of circular metal segments attached to it, and arranged with their ends staggered, or one behind the other in a slanting row. A number of spring-brass or copper brush contacts slide on these

## Electric Signs

segments as the drum is rotated. The metal strip on the left end of the drum may be continuous, or nearly so, in the form of a ring around the drum. The ring is connected by a "jumper" to all other segments, so with one line wire connected to the left brush contact, all segments are kept alive or in contact with the lower live wire throughout rotation of the drum.

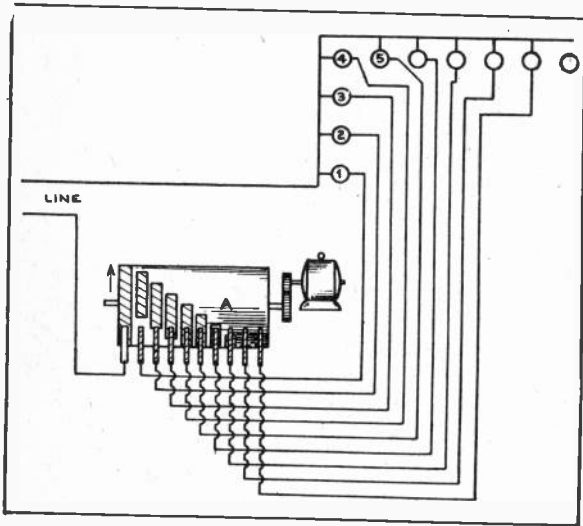

Fig. 17. This diagram shows connections for a sign flasher to be used to light the lamps 1, 2, 3, 4, etc., in rotation.

If the drum rotates in the direction shown by the arrow, the segments will strike the stationary contacts in order, from left to right, closing the circuits to the lamps in order—1, 2, 3, 4, 5, etc. All lamps are connected by a common wire back to the top line wire.

Flashers of this type can be obtained with many dozens of contacts, to be used to gradually spell out whole words composed of lamps on the sign.

Several flashers of this type with different numbers of contacts and operated at different speeds may be used together on one large sign to get the various combination effects desired. Fig. 18 shows how two flashers are used, one to provide a



## Illumination

“chaser” border effect, and the other to flash the letters of the word “Eat” on in rotation, and then all off.

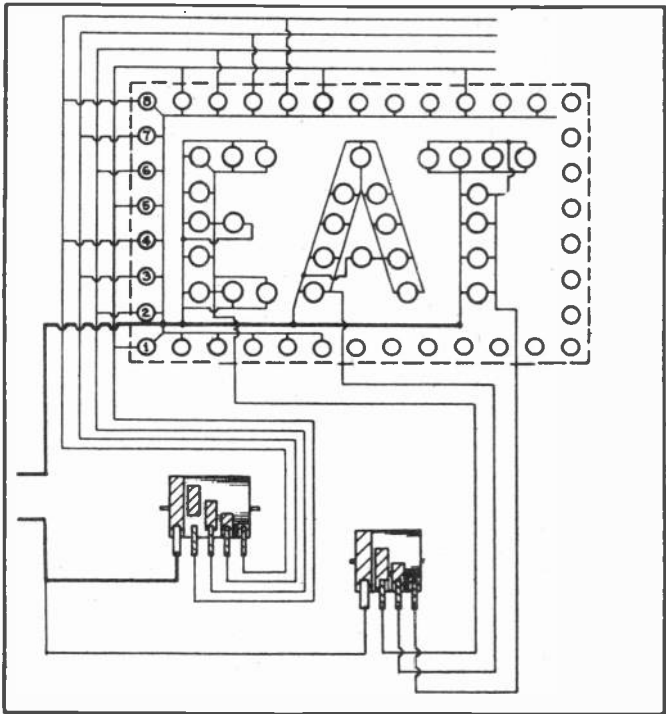

Fig. 18. Wiring diagram for two flashers used to obtain combination effects on an electric sign. The flasher at the left controls the border lamps only, while the one on the right controls the letters of the sign.

You will note that to produce the motion effect in the border, it is not necessary to use a flasher with as many contacts as there are lamps. Instead, these lamps are connected in parallel groups, so that every fourth one is connected to the same flasher contact. This makes the lamps come on in the order 1, 2, 3, 4, and also 5, 6, 7, 8, coming on at the same time; or lamps 1 and 5 together, 2 and 6 together, etc. The segments on the drum are usually of the proper length so that one lamp of the four is out all the time, and as the drum rotates, the dark lamp is first No. 1, then 2, 3, 4, and repeat.

## Electric Signs

This matches up with the next group, as all groups are operated from the same flasher; so it produces an appearance of continuous motion around the sign border.

A large sign may have several thousand lamps on it, connected in groups to several branch circuits or return wires, and one wire from each lamp connected to its proper flasher wire.

You can see, however, from Fig. 18, that the manner of grouping the connections simplifies them, and makes it an easy matter of circuit testing to connect each wire to its proper flasher brush.

Fig. 19 shows a photo of a sign flasher such as commonly used with signs of the type just described. Note that this flasher has two separate sections, and rotating segments made of strips of brass or copper bent to shape and attached to the shaft like

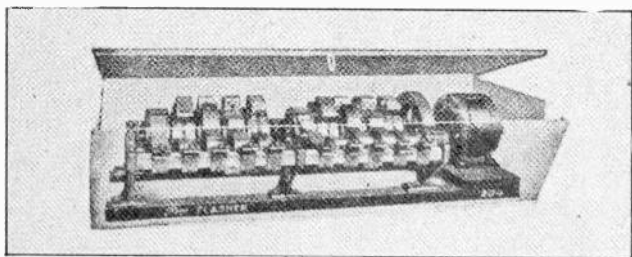

Fig. 19. Motor-driven sign flasher mounted in weather-proof box. Flashers of this type are made with different numbers of drum units and contacts, to produce a great variety of effects.

separate wheels. Fig. 20 shows a large sign which uses this type of flasher.

Sign lamps are often mounted in sheet metal channels or troughs which have the inner sides and back painted white. This gives a more sharply defined shape to letters and figures, as it prevents the light from spreading so much. Very striking effects can also be produced by using lamps under black inverted trough-shaped letters, mounted so they stand out slightly from a white background as shown in Fig. 21.

Many large flasher signs also have lighted billboard areas combined with the motion effects. Some

## Illumination

of the largest flasher signs which have special "moving letters," or continuous reading effects, use a paper roll with holes punched in it, similarly to a player piano roll. This paper is in the form of an endless belt, and is drawn slowly along between a large metal plate and a "bank" of small contact "fingers." The holes in the paper are arranged in the form of letters or shapes which are to travel



Fig. 20. Large signs of the above type often use several flashers, and a combination of lamps and Neon tubes to produce very beautiful effects.

across the sign. The sign face has a bank of lamps arranged in rows both ways, the same as the contacts are; so as groups of contacts drop through the holes in the moving paper and strike the metal plate completing their circuits, corresponding lamps light up on the sign.

Fig. 22 shows the arrangement of the contacts and lamps, and the method of connecting them. The wires are grouped or cabled together but can be easily traced from the contacts to the lamps and you can see that any contact that is allowed to touch the metal plate will close a circuit to a corresponding lamp.

The sketch in this figure shows only a comparatively few lamps, but on a sign of this type they are so numerous and close together that almost any letter or figure can be made to light up by having the groups of holes punched in the paper in the desired

## Electric Signs

shape. Then as the paper moves and the holes slide from one set of contacts to another, the lighted let-

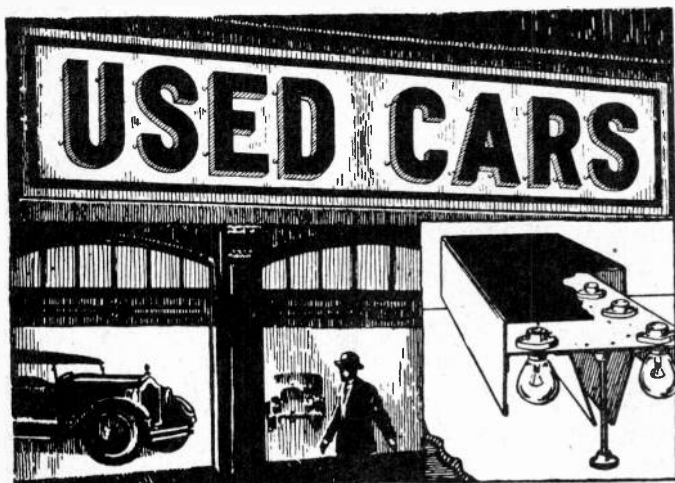

Fig. 21. Very attractive signs can be made with inverted trough units, to produce outstanding black letters on white background as shown above.

ter on the sign shifts from one set of lamps to the next and moves across the sign.

### 12. SIGN WIRING, AND CONSTRUCTING SMALL SIGNS

Electric signs are one of the most profitable forms of advertising illumination, and in many localities offer a very good field for the trained man to install or service them.

Sign manufacturers will make almost any type or design of metal sign to the specifications of the customer or electrician. You can also build the smaller ones very easily in your own shop if you desire.

The frame should be of angle iron, and covered with substantial sheet metal to form a box of the desired shape and size. The letters and figures can be painted on, after the sign has had a coat of weather-resisting paint.

## Illumination

A color combination that serves well both for day and night visibility is a dark blue background with white letters. If the sign is to be lighted with bulbs, cut  $1\frac{1}{2}$ " round holes in rows along the letter shapes.

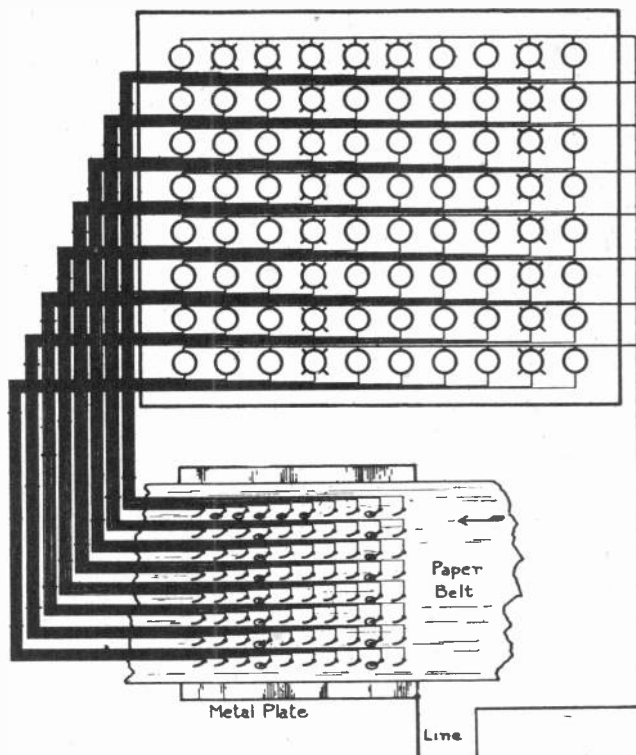

Fig. 22. The above diagram illustrates the principle of signs with traveling reading matter. Note how each contact on the paper belt is wired to a lamp in a corresponding position on the sign above.

Two-piece threaded sign receptacles can be screwed tightly into these openings. Then wire up the receptacles, either in parallel or with one common wire and separate wires to a flasher if desired. All connections, including the binding screws on receptacles, should be soldered to prevent corrosion.

Then the connections, backs of receptacles, and all exposed metal edges should be covered with a good coat of weather-proof paint or sealing compound. If the sign is large its circuits should be

## Electric Signs

divided so that none carries over 15 amperes, and each circuit should be fused separately.

In small towns one can often have the local tinsmith or metal shop build the sign bodies, and a sign painter decorate them. In this case the electrician can wire and hang them, and share the profits.

In hanging signs over sidewalks, they should be fastened very securely so there will be no chance of their ever falling and injuring anyone. They should be bolted to a substantial part of the building and braced with chains from above and both sides.

The local authorities should also be consulted on their rulings before any signs are hung over public walk-ways.

## EXAMINATION QUESTIONS

1. What are the advantages of an indirect lighting system over direct lighting?
2. What are two important points to keep in mind in planning a show window lighting job?
3. How many 150 watt lamps should be used to provide good lighting in a show window 18 feet long and of average depth and height?
4. What other types of lighting units, besides regular show window fixtures, can be used to improve show window lighting in many cases?
5. Where are bill board lights generally placed and how mounted, with respect to the board?
6. Explain briefly how you would construct a small simple electric sign.
7. Briefly explain the construction and operation of a simple electric sign flasher.





# FLUORESCENT LIGHTING

## FLUORESCENT LAMPS

Fluorescent lighting is one of the developments in electricity which fairly may be classed as revolutionary. So far as the field of illumination is concerned, fluorescent lighting doubtless is the most important advance since incandescent lamps replaced the early arc light. Much of the importance is due to the wide acceptance and adoption of this new kind of lighting in industrial work, in commercial establishments, and in home lighting. Fluorescent lighting became known to the general public only during the Chicago Centennial Exposition of 1933, yet today we see it everywhere. The advantages of obtaining light through fluorescence had been apparent to scientists for many, many years, but as a practical application it had been classed with the "impossibles".

One of the reasons for the popularity of fluorescent lighting is that so much of the power produces light and so little, relatively, goes into heat. A 40-watt incandescent lamp delivers about 760 lumens, while a 40-watt fluorescent lamp delivers 2100 lumens. Even when we consider the additional power for control equipment required with the fluorescent, and not with the incandescent, the fluorescent lamp still produces about 90 per cent more light than the small incandescent lamp for the same power consumed. This power efficiency not only saves on the cost of lighting and on wiring, but lessens the heat and makes it more comfortable for those working under bright lights during warm weather.

Among other advantages of fluorescent lamps are that they will produce the most economical close approach to daylight effects, that they are the first lamps to produce colored light with reasonable efficiency, and that their large surface areas compared with incandescent lamps permit getting lots

## Fluorescent Lighting

of light from a source that is not too bright to look at.

### THE FLUORESCENT LAMP

Fluorescent lamps are made with long glass tubes having at each end metal caps with two contact pins. Fig. 1 shows several such lamps, the ratings, from top to bottom, being 20, 40, 30 and 15 watts. Fig. 2 illustrates several types of fixtures in which the lamps are used.

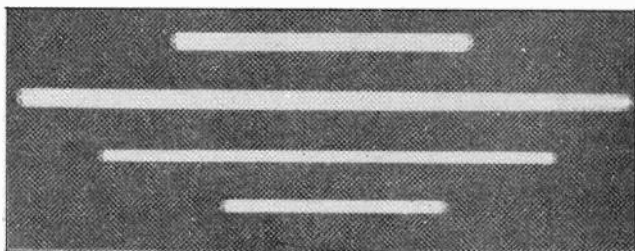

Fig. 1. Fluorescent Lamps of 20-, 40-, 30- and 15-watt Ratings, As Shown From Top to Bottom.

The construction of a lamp as it would appear broken open is shown by Fig. 3. At each end is a small coiled wire filament connected through the gas-tight glass press to the two contact pins carried in phenolic insulation by the end cap. The filament is coated with materials such as used on filaments of radio tubes, to provide a large emission of electrons at fairly low temperatures. The inside of the lamp tube is filled with argon gas, and there is a small drop of mercury which is vaporized by heat from the filaments and which then provides a path of fairly low resistance through which electrons may pass from one filament to the other after the lamp is in operation.

The inside of the lamp tubing is coated with a thin layer of materials called **phosphors**. A phosphor is a substance which becomes luminous or which glows with visible light when struck by streams of electrons which are caused to pass through the space between filaments inside the lamp. When the

## Illumination

phosphors are thus made luminous the action is called fluorescence, which gives this kind of lamp its name, fluorescent. Were there no fluorescent materials coated on the inside of the glass tubing there would be practically no visible light with the

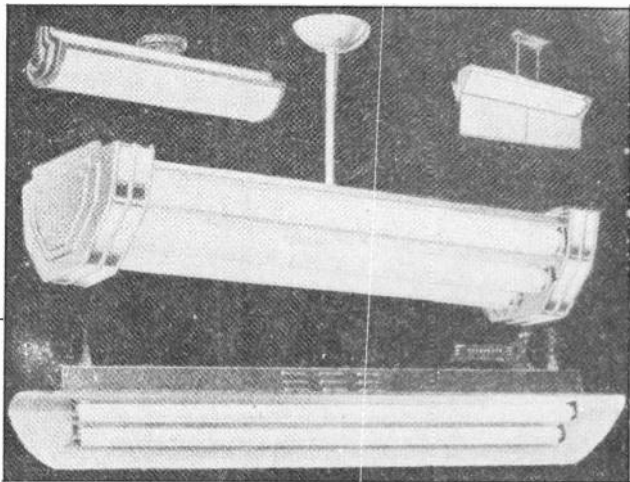

**Fig. 2. Fluorescent Lamp Fixtures.** The Three At the Top Are Used In Stores, Offices and Residences. The Bottom Fixture Is an Industrial Type.

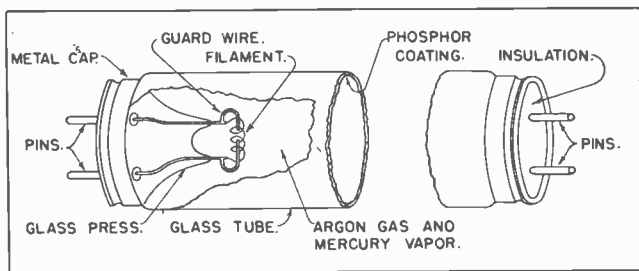

**Fig. 3. Construction of a Fluorescent Lamp.**

lamp in operation. In fact, there wouldn't be even as much light as you see inside a radio tube, for during normal operation of the fluorescent lamp the filaments carry no current which would cause them to glow. Now let's see how such a lamp as this can be made to operate.

## Fluorescent Lighting

### FLUORESCENT LAMP OPERATION

The basic principle of fluorescent lamp operation is shown by Fig. 4, where we have the two filaments connected together on one side through a switch and on the other side connected to the alternating-current supply line. In diagram A the switch is closed. Current from the line flows through the two filaments and the switch in series, heating the filaments to a temperature at which they will readily emit great quantities of electrons and at the same time vaporizing the mercury to fill the tube with the low-resistance mercury vapor.

After a few seconds of filament preheating the switch is opened as in diagram B. This opening of the switch gives, in effect, the arrangement of diagram C where one filament remains connected

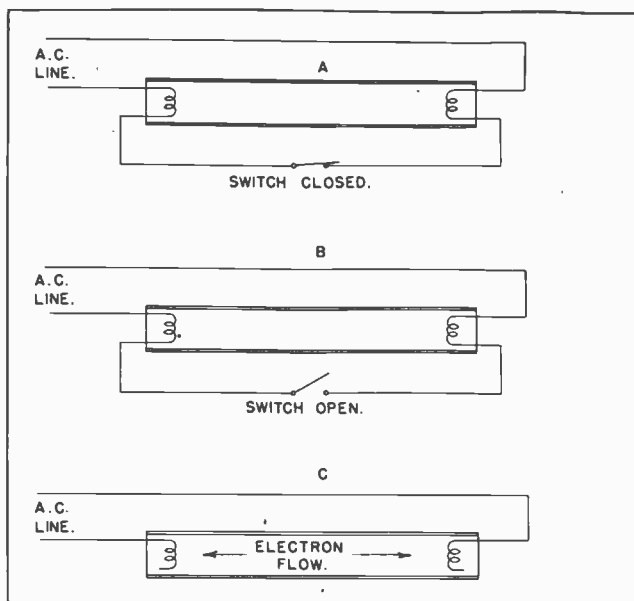

Fig. 4. Fundamental Operating Principle of Fluorescent Lamps.

to each end of the a-c line but to nothing else. As you know, in an a-c supply the voltage will be highest at one end while lowest at the other, then

## Illumination

will reverse to become lowest at the first end and highest at the second. These voltages are sufficient to cause flow of electrons, and current, through the low-resistance mercury vapor from the filament which, at any moment, is of higher voltage to the one which is of lower voltage. When the voltage reverses there is a similar flow of electrons and current in the opposite direction. Since, on a 60-cycle supply, there is a flow in each direction 60 times each second the reversals follow one another so rapidly as to produce a practically continual flow or discharge of electrons inside the tubing.

The streams of electrons strike against the phosphor coating inside the tube and this coating glows brightly to make the lamp "light." To turn off the lamp we need only open another switch, the usual off-on type, in the a-c supply line. The switch shown in Fig. 4 is called the starter switch or simply the starter. It may be operated either by hand (manually) or automatically.

### MANUAL STARTER SWITCHES

Although the great majority of fluorescent lamps are controlled by automatic starter switches, we shall consider the manual type first because it is simpler. All manual or hand-operated switches do three things in order. First, they close the line circuit through the filaments to heat the filaments and vaporize the mercury. The operator keeps the switch in this first position for from two to three seconds while the filaments glow, or until he notes that they are glowing.

The second movement of the manual switch opens the connection between the two filaments so that they are left connected to the two ends of the line. On this motion of the switch the lamp should light. The third motion of the manual switch opens the line circuit to extinguish the light and may also re-close the connection between filaments ready for the next start.

In one style of manual switch a button is turned progressively clockwise through the three posi-

## Fluorescent Lighting

tions. In another style a button or lever is pushed down until the filaments glow, then is released and the bulb lights. The lamp is turned off by pushing the button down and releasing it immediately. This latter type of switch may be mounted on an overhead fixture and operated with a pull cord.

The manual starter switch acts also as the off-on switch for the line current. The automatic starter switches act only as starters to open and close the connection between filaments, and require that some type of off-on switch be connected in the line as for any other kind of lamp.

### AUTOMATIC STARTERS

There are three general classes of automatic starters. The first to be used was the magnetic starter which operated on the principle of a magnetic relay to open the filament connection after a time interval. This type is no longer being applied. The other two classes include switches that are operated by heat, utilizing the principle of the thermostat to open and close their contacts.

The thermal starter includes a resistance element which carries the filament current and is heated by this current. The heater element heats a bimetallic thermostat blade and causes this blade to bend and open the filament connection after the filaments have been heated enough to glow.

The glow type starter also uses a bimetallic thermostat blade, but instead of using a heater element the blade is heated by a glow discharge that takes place through neon, argon or helium gas that fills the glass bulb containing the switch. The glow type is the one most commonly used on alternating-current supply.

### LAMP HOLDERS

The fluorescent lamp is supported in the fixture by some form of insulating lampholder through which connections are made from the operating circuit to the contact pins on the end of the lamp. Two

## Illumination

styles of lampholders are illustrated in Fig. 5. With the push type of holder the end of the lamp with its pins is pushed into slots where it is held by spring contact members. The style shown on the left in Fig. 5 has J-shaped slots which form a sort of bayonet lock for the lamp pins. A variety of the push type called the ejector lampholder has extended parts of the contact springs or holding springs which may be pressed to force the lamp out of the holder.

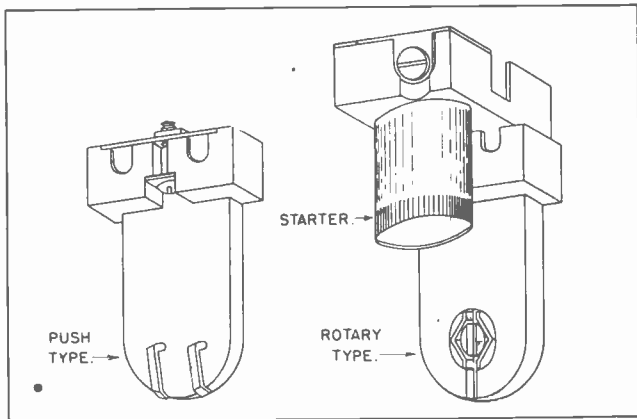

Fig. 5. Lampholders for Supporting the Lamp and Making Contact With the End Pins.

With rotary types of lampholder the pins on the ends of the lamp are inserted into a vertical slot, then the lamp is rotated a quarter turn to make the electrical contacts and at the same time lock the lamp securely in place. See right hand view in Fig. 5. Rotating the lamp another quarter turn in either direction releases the locks and permits it to be withdrawn from the holder. Both styles of lampholders are produced with different mechanical details by different makers, but the illustrations of Fig. 5 show the two general principles followed.

The rotary lampholder of Fig. 5 is attached to a base in which is a socket for holding an automatic starter switch and making the necessary electrical contacts to the switch. These automatic

## Fluorescent Lighting

switches when made for this style of mounting are enclosed in small cylindrical metal shells with contact pins on the end that goes into the socket. Both the thermal and glow types of starter are made in this style for socket mounting, and such a mounting may be used with any style of lampholder. Since a separate starter is required for each lamp, one of the holders will have a starter socket and the other will not.

Starters sometimes are mounted with other parts of the lamp operating equipment instead of in one of the sockets, but the replaceable type (socket mounted) is now generally used.

The starter mounted as in Fig. 5 may be replaced when defective by taking the lamp out of its holders, removing the starter by twisting it through part of a turn and lifting it out of its socket, then replacing it with a new one. Fig. 6 shows how a

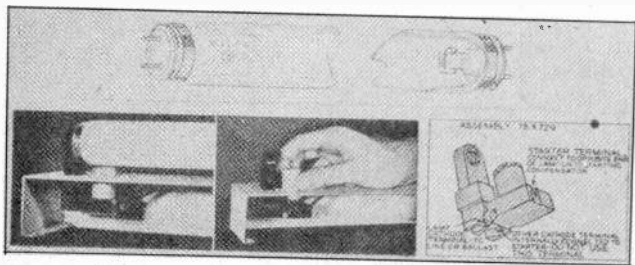

Fig. 6. How a Replaceable Starter Is Mounted On One of the Lampholders Which Are in the Fixture

starter is mounted underneath one end of a lamp and how the starter is removed from its socket. Starter sockets for large lamps often are placed on the side of the holder opposite the lamp, so that the starter may be replaced without taking out the lamp.

### GLOW SWITCH STARTER

Fig. 7 shows the parts of a glow type starter switch as they appear after taking off the metal cylinder that enclosed them. Inside the small glass



## Illumination

enclosure is the bimetallic blade that bends one way when heated and the opposite way when cooled. The glass is filled with neon, argon or helium, according to the size of the lamp and the voltage that

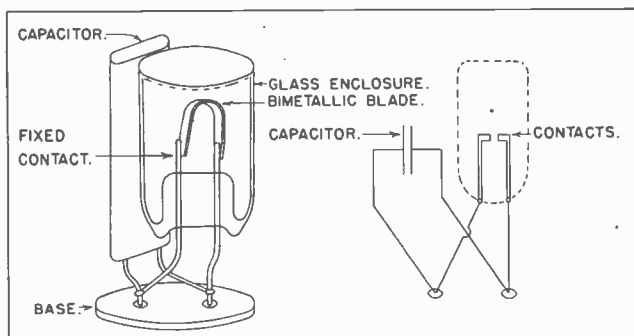

Fig. 7. Construction and Connections of a Glow Switch Starter.

will be applied to the switch. Before the lamp is turned on by its off-on switch the bimetallic blade is contracted to separate the blade end from the fixed member of the switch. Thus the connection between the two lamp filaments is open, and we have the conditions represented by Fig. 8.

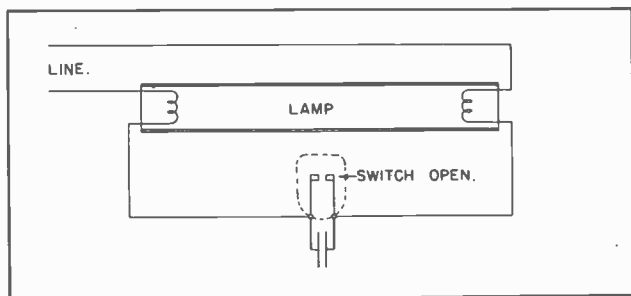

Fig. 8. How the Glow Starter Is Connected To the Lamp.

In Fig. 8 voltages from the line pass through the lamp filaments and to the switch contacts and the capacitor connected across the contacts. The capacitor is thus connected in order to lessen interference with radio reception as the switch contacts open while carrying current. The voltage difference

## Fluorescent Lighting

across the neon or other gas inside the switch causes the separated parts to the switch to be covered with a glow as electrons flow through the gas. This glow is exactly like that which takes place in the small neon-filled night lamps or signal lamps which doubtless you have seen. Heat from the glow discharge warms the bimetallic blade in the switch so that it bends to close the contacts and allow preheating current to flow through the lamp filaments.

With the switch contacts closed there no longer is a voltage difference between them, so the glow discharge ceases, and the bimetallic blade commences to cool. As the blade cools it bends to separate the switch contacts. This leaves the lamp filaments connected only to the line and not to each other, so the lamp lights. The switch contacts remain open while the lamp is lighted and also while it is turned off by opening the regular off-on switch to cut off the current supply.

If either filament of the lamp should be burned out no voltage difference reaches the glow switch, there is no glow discharge, and the switch contacts remain separated. If the lamp is worn out from use or otherwise is in a condition which prevents it from lighting even with the filaments complete, the glow switch continues to close and open its contacts as the glow discharge is established with the contacts separated and is stopped by their closing. This generally causes a flashing or blinking in the lamp as the filaments are heated and cool off.

A no-blink type of glow starter prevents the switch from opening and closing when the lamp fails to light. This no-blink type is like the one of Fig. 7 except that, as shown by Fig. 9, there is an added heater-operated bimetallic switch. This extra switch ordinarily remains open, but should the glow switch continue to close and open, the pulses of current through the heater finally bring

## Illumination

it to a temperature that bends its enclosed bimetallic blade and closes the auxiliary contacts. This short circuits the glow switch so that it no longer operates. Current continues to flow through the lamp filaments, keeping them heated, and through the switch heater to keep the contacts closed until the lamp is turned off and the heater cools.

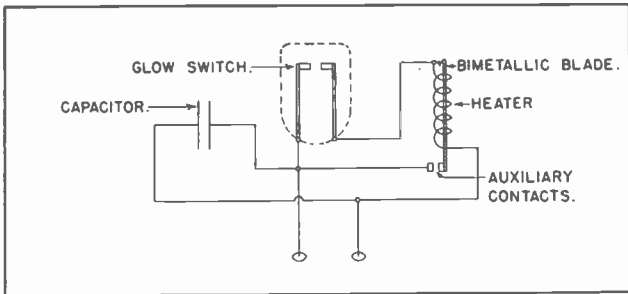

Fig. 9. The No-blink Type of Glow Starter.

## THERMAL STARTER

Fig. 10 shows the parts of a thermal starter and Fig. 11 shows how this type of starter is connected to the lamp. Inside the glass bulb of the switch is a fixed contact, another contact carried by a bimetallic blade that bends with heating and cooling, and a heater element for heating the bimetallic blade. Outside the glass is the usual capacitor con-

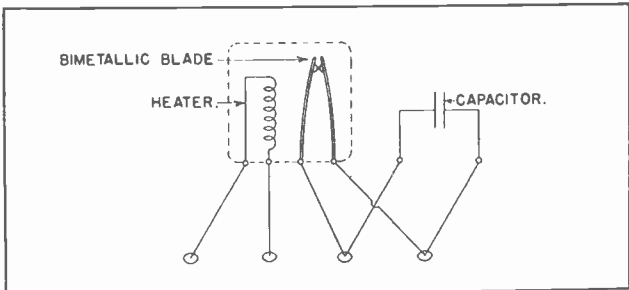

Fig. 10. The Parts and Connections In a Thermal Starter.

nected across the switch contacts to reduce radio interference.

## Fluorescent Lighting

As shown by Fig. 11 the switch is connected so that current from the line passes through the heater element, one of the lamp filaments, the switch contacts, the other lamp filament, and back to the line. The switch contacts are closed to begin with so that this circuit is completed. Within two or three seconds after the current is turned on by the regular off-on switch, the heater element has warmed the bimetallic blade of the switch enough to bend it and open the contacts. This opens the connection between the two filaments, leaves each connected to one side of the line, and the lamp lights.

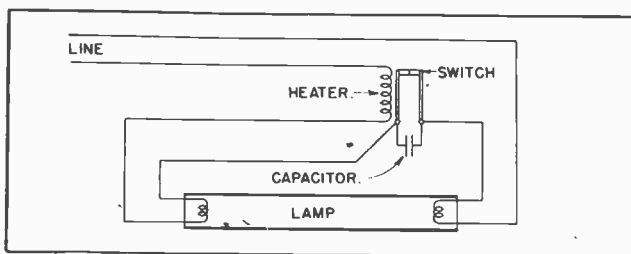

Fig. 11. How the Thermal Starter Is Connected To the Lamp.

So long as the lamp remains lighted current that flows to one of the filaments, and maintains the electronic discharge through the lamp, flows through the heater element and keeps the switch blade warm enough so that the contacts remain open. With this type of starter enough heat is retained in the switch to keep the bimetallic blade bent and the contacts open for some little time after the current is turned off at the off-on switch in the line. Consequently, with a thermal switch, it usually is impossible to immediately relight the lamp after it has been turned off.

### BALLAST COILS

In the simple circuits shown up to this point we have included only a lamp and a starter switch. With only these parts the lamp filaments would

## illumination

be subjected to the full voltage of the line after the starter opens. The line voltage always is higher than the voltage at which fluorescent lamps should be operated. Operating voltages across the filaments are from 40 to 90 per cent of the average line voltage or the "design voltage," which is assumed to be 118 volts on a nominal 110-125 volt alternating current circuit.

Before going on to discuss how the lamp voltage is controlled it may be well to explain that the lamp filaments really act as filaments only while they are carrying the preheating current. Once the connection between filaments is opened, leaving them to carry only the electronic discharge current, they should be called **electrodes** rather than filaments. An electrode is an element through which current enters or leaves a gas.

Now back to the matter of lamp voltages. In addition to requiring an operating voltage lower than that from the line, fluorescent lamps require for starting, a momentary voltage quite a bit higher than that from the 110-125 volt lines in order to establish the electronic discharge through the gas inside the tubing. Thus we have the problem of supplying a voltage higher than that from the line at the instant of starting, and a voltage lower than that from the line while the lamp continues in operation. Both of these things are accomplished by inserting in series with one side of the line an inductance coil or a choke coil which is called the fluorescence lamp ballast.

A coil having many turns wound on an iron core has high inductance. When current has been flowing in such a coil and suddenly is stopped the magnetic lines of force which have existed around the winding collapse and cut back through the turns. This cutting of the conductor by lines of force induces a voltage which is much higher than that which was sending current through the coil. It often is spoken of as the "inductive kick."

## Fluorescent Lighting

By connecting a ballast as shown at A in Fig. 12 for a glow starter or as at B for a thermal starter, we will obtain an inductive kick and a high starting voltage at the instant the starter switch opens the connection between the electrodes. In these diagrams, and in others to follow, we indicate the starter by a circle enclosing a letter S. This is an accepted symbol in diagrams for fluorescent lamp circuits, and since we now understand the construction and operation of starters the symbol will help to simplify the following diagrams.

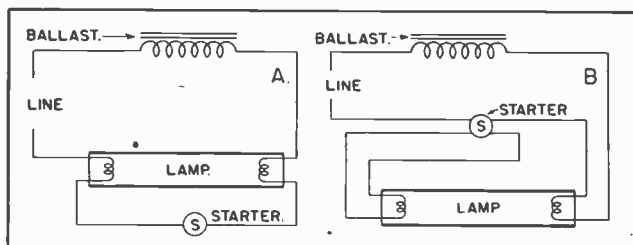

Fig. 12. How the Ballast Is Connected In Circuit With the Lamp and Starter.

Once the ballast has furnished the instantaneous high voltage for starting the electronic discharge within the lamp tubing the ballast acts as an inductive reactance or choke coil to use up some of the line voltage and deliver only the correct value to the lamp electrodes. Inductive reactance is the opposition to flow of alternating current that results from induction in a coil winding. It provides impedance to flow of alternating current just as resistance furnishes opposition to flow of both alternating and direct current. The inductance of the ballast makes its opposition to alternating current much greater than would result only from the resistance of the wire in the winding. The impedance of the ballast is such that the remaining voltage is just right for the lamp being used.

The ballast must be designed especially for the line voltage, for the number of lamps operated in its circuit, for the wattage rating of the lamps, and for the frequency of the supply circuit. A rela-

## illumination

tively high frequency, such as 60 cycles, causes a much greater inductive reactance in a given ballast than does a lower frequency such as 25 cycles.

### POWER FACTOR

Whenever we include in an alternating-current circuit a coil or winding having large inductance, such as the fluorescent ballast, something rather peculiar takes place in the circuit. If it were possible to construct a coil having inductance but having no resistance, and to connect this coil into an alternating-current circuit, no power would be used in sending current through this coil. The rapidly changing current (alternating current) would produce changes of magnetism and changes of voltage in the coil that would return to the circuit just as much power as was taken from the circuit.

If this coil with inductance but no resistance were on a circuit with an electric meter such as used to measure energy consumption, just the ordinary kind of kilowatt-hour meter, current would flow into and out of the coil, but the meter would register no energy consumption. The electric service company to whose lines the coil and meter were connected would have to supply the current going into and out of the coil, but would collect no money because no power would be used.

It is impossible to build a coil having no resistance, because there is resistance in the wire with which the coil is wound. However, it is entirely possible to build a coil having large inductance and comparatively little resistance. It also is possible to use in the same circuit with the coil a capacitor. The relation between the inductance of the coil, the capacitance of the capacitor, and the resistance of the conductors in all the parts determines how much power will be used in the circuit and how much will be returned to the line.

With a fluorescent ballast used as in Fig. 12 the lamp circuit will take from the supply line some cer-

## Fluorescent Lighting

tain amount of current which we may measure in amperes, and will operate at the line voltage. If this were a direct-current circuit the power in watts being used would be equal to the number of amperes multiplied by the number of volts. But in an alternating current circuit containing inductance or capacitance or both inductance and capacitance the power being used is not equal to volts times amperes, or to volt-amperes, but is equal to something less because of the peculiar action by which part of the power is returned to the supply circuit. Only part of the current that flows does useful work, or furnishes power. The rest of the current is wasted so far as power production is concerned.

The percentage of the "apparent power" (volts times amperes) that actually produces power and does useful work in the circuit is called the power factor of the circuit. The power factor of a fluorescent lamp circuit with a ballast, as in Fig. 12, is between 50 and 60 per cent. This means that only 50 to 60 per cent of the current is useful. We must have wires large enough to carry the entire current without overheating, but if our power factor were not so low we might get along with much less current and use smaller wires.

If we connect a capacitor in series with the ballast coil, or introduce capacitance into our inductive circuit, the capacitance will counteract some of the effect of the coil inductance and we will raise the power factor. With a certain relation between the values of inductance and capacitance the two will balance. Then the circuit would act as though it contained neither inductance nor capacitance, but had only resistance. All the current would be used in producing power, and we would have a power factor of 100 per cent. If the inductance and capacitance were nearly balanced we might have a power factor of 90 per cent or maybe 95 per cent. This is what actually is done in many fluorescent lamp circuits.



## Illumination

Ballasts, starters and other control elements are mounted inside the lamp fixtures. Fixtures which have no capacitor, no power factor correction, are specified as of **low power factor**. Those in which a capacitor or capacitors bring the power factor to 90 per cent or better are specified as of **high power factor**. The cost for electric power is the same for both types with given lamps in them. Since low power factor units take more current it is necessary to use larger circuit wiring than for the same wattage of lamps in high power factor units. This becomes important in large installations, but means nothing when only two or three small lamps are used. Some power companies require that all fluorescent fixtures be of high power factor types, since this avoids carrying useless current in the lines.

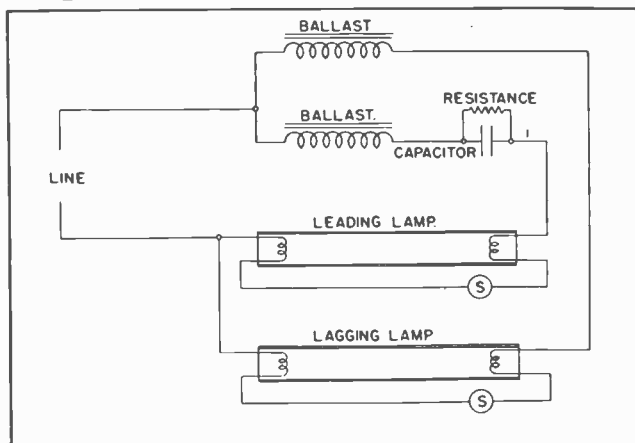

Fig. 13. A Two-lamp Circuit With Power Factor Correction.

Fig. 13 shows connections in a two-lamp circuit having power factor correction. The lower lamp, marked "lagging lamp" has only a ballast between it and one side of the line. In series with the ballast for the other lamp, marked "leading lamp" is a capacitor bypassed by a small high-resistance unit. The two lamps and their ballasts are in parallel with each other. In the parallel path for the lagging

## Fluorescent Lighting

lamp there is only inductance (the ballast) and resistance. In the other path there is inductance, capacitance (the capacitor) and resistance.

With only inductance and resistance in a circuit or a branch of a circuit the peaks of alternating current occur slightly later in the cycle than do the peaks of alternating voltage that causes the current to flow. Such a circuit is said to have a lagging current, and we have marked the lamp as being the **lagging lamp**. With enough capacitance in a circuit to overbalance the effect of the inductance the peaks of alternating voltage occur somewhat later in the cycle than do the peaks of current produced by the voltage, hence we say that such a circuit has a leading current, and we mark the lamp in that circuit as being the **leading lamp**. The power factor of the entire circuit, including the two lamps, their ballasts and the capacitor, will be better than 90 per cent.

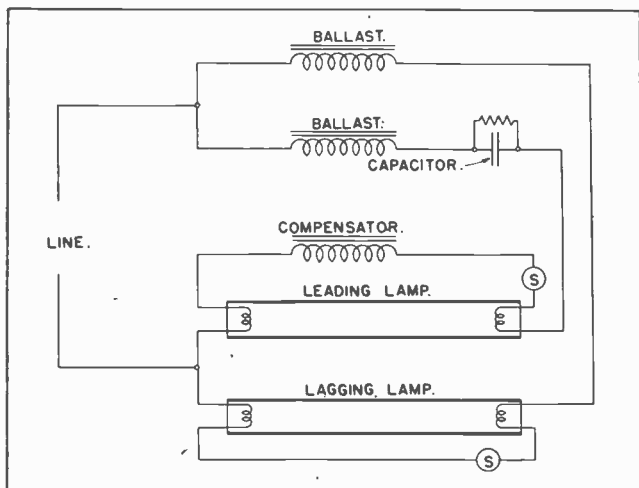

Fig. 14. How the Compensator Is Connected In a High Power Factor Circuit.

### COMPENSATOR

In Fig. 14 we have added another inductance coil, called the **compensator**, in series with the starter of the leading lamp. In the circuit of Fig. 13 there

## Illumination

may be so little current in the path containing the capacitor and the leading lamp that this lamp lights with difficulty because of insufficient filament pre-heating. To overbalance the effect of the capacitor and allow more current for starting, we connect additional inductance in this branch, the additional inductance being the compensator. As soon as the lamp is lighted the starter switch is open, and since the compensator is in series with the starter the compensator carries no current after the lamp lights. Compensators are not required with 65- and 100-watt lamps, but are used with all smaller lamps in high power factor circuits.

### STEP-UP TRANSFORMER

The voltage required to start the electron discharge through, 30-, 40-, and 100-watt lamps is too high to be furnished even from the inductive kick of the ballast when operated from a 110-125 volt supply line. With these lamps it is necessary, when using this supply line voltage, to provide a

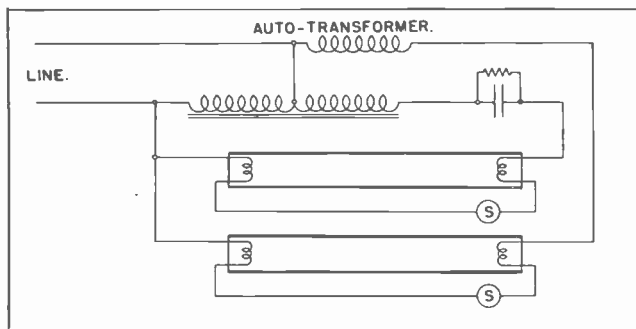

Fig. 15. A Transformer Used To Increase the Voltage From a 110-125 Volt Line.

transformer which will increase the starting voltage. Fig. 15 shows a two-lamp circuit with a step-up transformer. The transformer is of the auto-transformer type in which part of a winding acts as the primary and the whole winding acts as the secondary. In Fig. 15 we have two sections which act as secondaries, one for each of the lamps. All the windings are on one core.

## Fluorescent Lighting

The transformer is designed with windings and core of such proportions that while the lamps are operating the voltage from the transformer is dropped low enough to suit the lamp requirements. Technically, the transformer is said to have high leakage reactance and poor voltage regulation, which is just what we need in this case. The voltage regulation secured with the transformer makes it unnecessary to include ballasts in the lamp circuits.

### AUXILIARIES

Starters, ballasts, compensators and auto-transformers are called auxiliaries. Whichever of these parts are used, and in whatever combination they are used, the whole collection of control devices for a lamp fixture is called an auxiliary. Two ballast coils often are wound on a single core but wired separately as shown in the preceding circuit diagrams. Starters, ballasts, compensators, and auto-transformers may be mounted together within a single case and called the lamp auxiliary, or any of them may be separate units and separately mounted. The grouping, mounting, and wiring circuits vary with different manufacturers. The circuit diagrams which have been shown represent typical connections between units, but different arrangements may be used and still produce fundamentally the same electrical circuits.

It is a general rule that the watts of power consumed in the auxiliary for a lamp or lamps must not exceed one-third of the rated watts for the lamp or lamps. Thus, the auxiliary for a 30-watt lamp may consume as much as 10 watts of power, making the total power requirement, or the power taken from the line, equal to 40 watts. The wattage required for operating fluorescent lamps and their auxiliaries always is greater than the wattage of the lamps themselves.

Auxiliaries may be marked with the "design voltage" at which they are designed to operate most

## illumination

efficiently. The design voltage for 110-125 volt supply is 118 volts, and for 220-250 volt supply is 236 volts. In certain three-phase circuit connections found on industrial supply lines the nominal line voltage is 199-216, and the design voltage is 208. Auxiliaries must match the supply lines on which they are to be used.

### LAMP CHARACTERISTICS

The accompanying table shows the normal operating characteristics of fluorescent lamps in general use. The lamps are listed according to their nominal wattage, which does not include the watts loss in the auxiliaries. The values given in the table apply when the lamps are operated from lines supplying the design voltage and when operating at a suitable room temperature, which is a temperature allowing the lamp tubing to be between 100° and 120° F.

The 3500° white lamp is the type furnished when only "white" is specified, and is the lamp often used for ordinary illumination. The "soft white" lamp gives light with more red, so produces a "warmer" effect as often desired in residences. Daylight lamps are used chiefly where it is important to distinguish colors as they would appear under natural daylight. The colored lamps are used for decorative work, although the green lamp sometimes is employed in photographic processes where maximum illumination is desired.

### STROBOSCOPIC EFFECT

When a fluorescent lamp is operated on alternating current the current and voltage drop to zero twice during each cycle, and at these instants the electron discharge ceases within the tubing. Were it not for the hold-over effect of the phosphor coating the light would go out twice during each cycle, or 120 times per second on a 60-cycle supply line. The light does not go completely out, but it does drop very decidedly. Our eyes do not distinguish variations of light occurring more than

## Fluorescent Lighting

20 times a second, so the effect discussed means nothing for ordinary purposes of illumination.

If a rapidly moving object is viewed by light that increases and decreases at a rapid rate, you see the object only while it is brightly illuminated. As the object moves at a constant rate you see it as a succession of images along the path of motion. This is called **stroboscopic effect** because it is the effect utilized with devices called stroboscopes which are used for observing the action of moving objects by making them appear to stand still at certain speeds and positions. The stroboscopic effect of fluorescent lamps may be objectionable when they illuminate moving objects such as the work revolving in lathes and other machine tools. You can observe the effect by moving any bright object rapidly back and forth under the light from a fluorescent lamp.

Stroboscopic effect is worst with the daylight and blue lamps, and is almost as bad on the white lamps. The effect is relatively small with green and other colored lamps. Using high power factor auxiliaries such as illustrated in Figs. 13, 14 and 15 reduces the stroboscopic effect to relatively low values, so that it is but little more pronounced than with incandescent lamps. This happens because the peak illumination from one lamp comes in between the peaks from the other lamp. Three fluorescent lamps operated in the three phases of a three-phase circuit produce a negligible stroboscopic effect. When operated on direct current there is no stroboscopic effect whatever, since the voltage and current are of constant values.

### DIRECT CURRENT OPERATION

When fluorescent lamps are operated on a direct-current supply line the ballast is used in series with a resistor as shown in Fig. 16. The ballast produces the high voltage for starting the electric discharge through the lamp. The induced voltage caused by stopping direct current in the ballast causes collapse of the magnetic lines of force through the winding just as does stopping an alternating current. How-

## FLUORESCENT LAMP CHARACTERISTICS

	6	8	14	15	20	30	40	65	100	
Nominal Watts.....	T-5	T-5	T-12	T-8	T-12	T-8	T-12	T-17	T-17	
Bulb Type Number.....	5/8	5/8	1 1/2	1	1 1/2	1	1 1/2	2 1/8	2 1/8	
Tubing Diameter.....	9	12	18	18	24	36	48	36	60	
Length, Inches.....	750	750	1500	2500	2500	2500	2500	2000	2000	
Average Life, Hours.....	.15	.18	.37	.30	.35	.34	.41	1.35	1.45	
Lamp Amperes.....	45	54	41	56	62	103	108	50	72	
Lamp Voltage.....	Lumen Output, Average:									
3500° White.....	180	300	460	615	900	1450	2100	2100	4200	
Soft White.....			325	435	640	1050	1500			
Daylight.....	155	250	370	495	730	1200	1700	1800	3350	
Green.....				900	1300	2250				
Gold.....				375	540	930				
Blue.....				315	460	780				
Pink.....				300	440	750				
Red.....				45	60	120				

**Illumination**

## Fluorescent Lighting

ever, opposition to current flow caused by reactance in an alternating current circuit does not exist with direct current, and the only opposition of the ballast to flow of direct current is the resistance in the winding. Consequently, to reduce the current to that required by the lamp, it is necessary to use the series resistor. The resistor is mounted in a shield or case of perforated metal. It operates at temperatures which are 70° to 90° F. above room temperature.

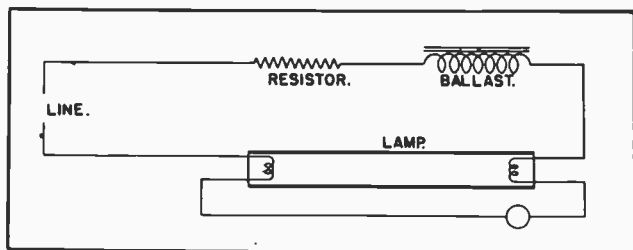

Fig. 16. The Connection for a Voltage Dropping Register Used With Direct-current Supply.

The added ohms of resistance in the resistor must be enough so that the number of ohms multiplied by the number of amperes of lamp current equals the required drop of voltage in the resistor. The operating lamp current flowing continually in this series resistance causes a power loss in watts equal to the number of ohms of resistance multiplied by the number of amperes of lamp current. This power loss is so great in comparison to that in the ballast alone on an a-c current that direct-current operation of fluorescent lamps is relatively inefficient. The total power consumed usually is more than double the number of watts taken by the lamp.

Inasmuch as a transformer cannot be used with direct current to step up the voltage for starting there is no economical way of raising the voltage from the line to start the larger lamps. Lamps of the 20-watt and smaller sizes may be operated from 110-115 volt d-c lines, but larger sizes must be run from 220-230 volt lines.



## Illumination

The glow starter seldom works satisfactorily on d-c circuits because there is no relatively high peak voltage (as with alternating current) to establish the glow in the switch. For direct-current operation it is usual practice to use thermal starters for lamps up to and including the 40-watt size, and to use manual starters for larger sizes. The thermal starter continues to heat the bimetallic blade of the switch until it operates.

Direct current causes an electronic discharge always in the one direction through the lamp tube with the result that a relatively dark space may appear at one end. This fault may be overcome by using a reversing type of off-on switch that reverses the direction of current flow each time it is turned off and then on again. Operating such a switch two or three times a day will usually keep the tubing uniformly bright.

### LAMPS IN SERIES

Two of the 14-watt fluorescent lamps may be operated in series with each other and with a special incandescent lamp with the circuit shown in Fig. 17.

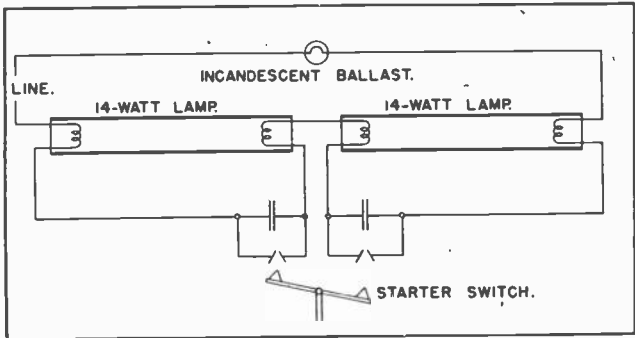

Fig. 17. Circuit for Two 14-watt Lamps In Series and a Manual Sequence Switch.

The incandescent ballast lamp has the usual screw base and a white glass bulb, giving light while reducing the voltage from the line to that required by the two fluorescent lamps in series. The starter

## Fluorescent Lighting

switch is of the manual type, constructed so that both lamp circuits are closed for preheating the filaments and so that the circuits are opened one after another so that the two fluorescent lamps light in sequence. This provides the maximum starting voltage for each lamp, whereas were they started at the same instant only half as much voltage would be available for each one. This circuit is used on 110-125 volt a-c lines or on 110-115 volt d-c lines.

Three of the 65-watt fluorescent lamps may be operated in series on a 220- or 236-volt a-c supply line with the circuit shown in principle by Fig. 18. Between one side of the line and the fluorescent lamps are two tungsten-filament incandescent lamps connected in parallel with each other. These incandescents act as resistors to reduce voltage from the line to that suitable for the fluorescents. The starter switches for the three fluorescent lamps are built in one unit. All three close for preheating the filaments, then they open one at a time to start the lamps in sequence, just as with the series circuit of Fig. 17.

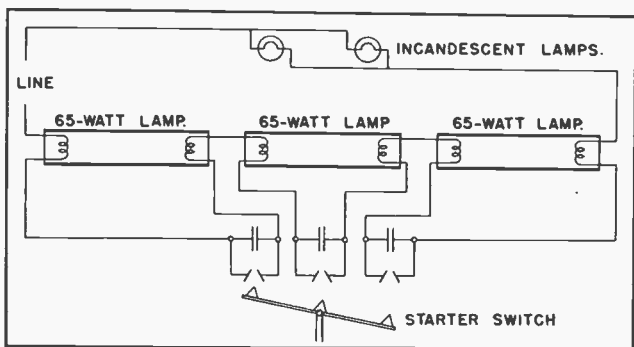

Fig. 18. Connections for Three 65-watt Lamps In Series With a Manual Sequence Switch.

Single 6-watt or 8-watt fluorescent lamps some times are operated in series with a voltage-dropping resistor and without any ballast on 110-125 volt a-c lines or on 110-115 volt d-c lines. The small currents taken by these lamps do not cause an exces-

## Illumination

sive power loss in the resistor while the lamps operate. The total power is much greater than that used in the lamps themselves, but still is comparable with that taken by a 15- or 25-watt incandescent lamp, which gives fewer lumens than the two small fluorescents.

### FLUORESCENT LAMP OPERATION

Fluorescent lamps start most easily and operate most satisfactorily in delivering steady light when the room temperature is between 50° and 90° F. The light from standard fluorescent lamps falls off quite rapidly as their temperature drops, and falls off to some extent as the temperature rises above the range mentioned. There are some special types of lamps which will start and operate in temperatures as low as zero F.

When standard lamps must be used where temperatures are low, trouble may be lessened by doing everything possible to maintain a fairly high supply voltage. It also helps in starting to use thermal starters rather than the glow type. Lamp temperatures may be raised by covering the open side of the fixture with glass or with transparent pyroxylin sheets to retain the heat produced by the lamps and the auxiliaries.

The life of the fluorescent lamp depends more than anything else on the condition of its filaments. If the line voltage is low the filament coating material is rapidly dissipated, so that the lamp becomes more and more difficult to start. Low line voltage with incandescent lamps merely lessens the light, and increase the life of the lamp. With fluorescent lamps, low voltage does decided harm. Every time the fluorescent lamp is started some of the coating is taken off the filaments. The fewer the starts during a given number of hours of operation the longer the lamps will last. The best life ordinarily is obtained with lighted periods of three or four hours each.

The end of the useful life of a lamp usually is

## Fluorescent Lighting

indicated by a rather rapid falling off in illumination or in lumen output. The lamp finally will refuse to start, or may flash on for a moment and then go out for good.

Lamp requirements for a desired distribution and level of illumination with fluorescent lamps are calculated just as they are when using incandescent units. The lumen output from a new fluorescent lamp drops quite rapidly during the first 100 hours or so of operation, then levels off to the average values given in our table of characteristics and remains with little further drop until near the end of the life of the lamp. After planning and installing fluorescent equipment the illumination level at first will be higher than that calculated, but soon will fall to normal. Because the fluorescent lamp emits light from a long tube rather than from what amounts almost to a point with incandescent lamps, spacing center-to-center between fluorescent lamps may be greater when they are in line than when side by side.

### FLUORESCENT LIGHTING TROUBLES

The accompanying "Check List" lists practically all the troubles, and apparent troubles, which occur during the operation of fluorescent lamps, gives the reasons and explanations of each kind of trouble, and makes suggestions for remedies.

## CHECK LIST

# on Fluorescent Lamp Operation

Here's how to use the check list. Find the "symptom" in the list below which indicates your problem and note the reference number. Locate this number in the reference section for possible causes and suggested remedies. Service problems may result from one or a combination of these causes.

## Fluorescent Lighting

Just a word of warning. Don't neglect lamps that blink or whose ends remain lighted. Correct such trouble *at once*,\* or remove a lamp or the starter to avoid damage to lamp, starter or ballast.

### SYMPTOMS

#### Normal End of Life

—Lamp won't operate; or flashes momentarily then goes out; or blinks on and off, perhaps with shimmering effect; ends probably blackened.—1-a.

#### End Blackening

—Dense blackening at one end or both, extending 2"-3" from base.—1-b.

—Blackening, generally within 1" of ends.—1-i.

—Blackening early in life (indicates active material from electrodes being sputtered off too rapidly).—2-a, 2-b, 3-a, 3-b, 5-a, 6-a.

**Dark Streaks**—Streaks lengthwise of tube.—1-j.

#### Rings

—Brownish rings at one or both ends, about 2" from base.—1-c.

#### Dense Spots

—Black, about  $\frac{1}{2}$ " wide, extending about half way around tube, centering about 1" from base.—3-d.

**\*Ends Remain Lighted**—2-b, 6-b.

#### \*Blinking On and Off

—Accompanied by shimmering effect during "lighted" period.—1-a.

—Blinking of relatively new lamp.—1-k, 2-a, 3-c, 4-a, 4-b, 5-c, 6-a.

—With two-lamp ballasts: if one lamp starts, one end of the other may blink on and off without starting; occasionally, both lamps may start.—6-c.

#### No Starting Effort, or Slow Starting

—1-l, 1-m, 1-n, 2-c, 2-d, 3-a, 3-c, 3-e, 3-g, 5-c, 6-d.

#### Flicker (not stroboscopic effect)

—Pronounced, irregular flicker on looking directly at lamp (spiraling, swirling, snaking, etc.).—1-g, 2-e, 3-a, 3-b, 5-b.

—Flicker suddenly occurring.—1-h.

—Persistent tendency to flicker.—1-k.

#### Dark Section of Tube

— $\frac{1}{3}$  to  $\frac{1}{2}$  of tube gives no light (tubes longer than 24").—6-e.

**Short Life**—1-f, 3-f, 5-a, 7-a, 3-a, 2-a, 2-b, 3-b, 6-a.

**Decreased Light Output**—4-b, 4-c, 4-d, 5-c, 7-b.

—During first 100 hours' use.—1-d.

#### Color and Brightness Differences

—Different color appearance in different locations of same installation.—1-e, 7-c.

—Lamps operate at unequal brilliancy.—5-c.

#### Noise

—Humming sound, which may be steady, or may come and go.—3-h, 3-l.

**Overheated Ballast**—3-i, 3-j, 3-k, 6-f.

**Radio Interference**—1-o, 6-g.

## Fluorescent Lighting

Reference Guide at a Glance:		
	Possible Causes	Suggested Remedies
<b>1. LAMPS</b>		
1-a	Normal failure; active material on electrodes exhausted; voltage needed for operation exceeds voltage supply.	Replace lamp (remove old lamp promptly)
1-b	Normal—end of life.	Replace lamp.
1-c	Likely a natural development during life, though improper starting may have some effect.	New lamp, if appearance is too objectionable, or shield tube ends from view; check for proper starting.
1-d	Light output during first 100 hours is above published rating, sometimes as much as 10%. (Rating is based on output at end of 100 hours.)	
1-e	Actual slight differences (in white or daylight lamps) may be discernible; perhaps wrong color lamp used; possibly lamp outside limits of color standards; or apparent color difference may be only difference in brightness between old and new lamp.	Replace lamps if objectionable. (If warranted, color temperature can be checked in laboratory to determine whether there is a difference, and how much.)
1-f	Mortality laws (i. e., for 2500-hr. avg. life, some will fail at shorter life, others last much longer than rated hours. 2500-hr. life based on operating lamp 3-4 hours for each start.)	
1-g	New lamp may flicker.	Flicker should clear up after lamp is operated or turned on and off a few times.
1-h	May suddenly develop in any lamp in normal service.	Should clear up by itself.
1-i	Mercury deposit, common especially with 1" lamps.	Should evaporate by itself as lamp is operated.
1-j	Globules of mercury on lower (cooler) part.	Rotate tube 180°. Mercury may evaporate by increased warmth, though it may condense out again on cool side.

## Fluorescent Lighting

1-k	Possibly lamp at fault.	Replace lamp. Investigate further if successive lamps blink or flicker in same lampholders.
1-l	Open circuit in electrodes, due to broken electrode, air leak, open weld, etc.	If open circuit is shown by test or inspection, as in 3-g, replace lamp.
1-m	Burned-out electrode (might be caused by placing one end of lamp across 115 volts).	If open circuit is shown by test or inspection as in 3-g, replace lamp.
1-n	Air leak in lamp. In test with test lamp (see 3-g) leak is indicated by absence of glow, though electrode lights up.	Replace lamp.
1-o	Lamp radiation "broadcasts" through radio receiver.	Locate aerial 9 ft. from lamp; or shield aerial lead-in wire, provide good ground, and keep aerial proper out of lamp and line radiation range.

Possible Causes		Suggested Remedies
<b>2. STARTERS</b>		
2-a	Starter defective, causing on-off blink or prolonged flashing at each start.	Replace starter.
2-b	Ends of lamp remain lighted; starter failure due to: Short-circuited condenser in starter, or Switch contacts welded together.	Replace starter. Replace starter.
2-c	Starter at end of life.	Replace starter.
2-d	Starter sluggish.	Replace starter.
2-e	Starter not performing properly to pre-heat electrodes.	Replace starter.
<b>3. AUXILIARIES AND FIXTURES</b>		
3-a	No starting compensator in leading circuit of two-lamp ballast.	Install compensator in series with starter in leading circuit. None required for 65- and 100-watt lamps.
3-b	Ballast improperly designed or outside specifications for lamp wattage, or wrong ballast being used.	Use ETL approved ballasts of correct rating for lamp size.

## Fluorescent Lighting

### 3. AUXILIARIES AND FIXTURES

<b>3-c</b>	Low ballast rating.	Check ballast.												
<b>3-d</b>	Normal—but if early in life indicates excessive starting or operating current.	Check for ballast off-rating or unusually high circuit voltage.												
<b>3-e</b>	Remote possibility of open-circuited ballast.	Check ballast.												
<b>3-f</b>	Improper ballast equipment on D-C.	Check ballast equipment.												
<b>3-g</b>	<p>Burned-out lamp electrodes due to:</p> <ul style="list-style-type: none"> <li>broken lampholders.</li> <li>lampholders with attached starter sockets, surface-mounted on metal.</li> <li>one strand of conductor touching grounded fixture.</li> <li>improper wiring.</li> </ul> <p>D-C operation without necessary additional resistance.</p> <p>ground from some other cause.</p>	<p>To determine necessity for replacing lamp, examine electrodes by viewing end of bulb against pinhole of light. (Or test by connecting base pins in series with test lamp† on 115-v circuit. Fluorescent glow means intact electrodes and active electrons.)</p> <table style="width: 100%; border: none;"> <thead> <tr> <th style="text-align: left;">† Correct Test Lamp Size</th> <th style="text-align: center;">for</th> <th style="text-align: right;">Various MAZDA F Lamps</th> </tr> </thead> <tbody> <tr> <td style="text-align: left;">60-w</td> <td style="text-align: center;">14-w to 40-w.</td> <td></td> </tr> <tr> <td style="text-align: left;">25-w</td> <td style="text-align: center;">Small diameter or miniature.</td> <td></td> </tr> <tr> <td style="text-align: left;">200-w</td> <td style="text-align: center;">65-w and 100-w.</td> <td></td> </tr> </tbody> </table>	† Correct Test Lamp Size	for	Various MAZDA F Lamps	60-w	14-w to 40-w.		25-w	Small diameter or miniature.		200-w	65-w and 100-w.	
† Correct Test Lamp Size	for	Various MAZDA F Lamps												
60-w	14-w to 40-w.													
25-w	Small diameter or miniature.													
200-w	65-w and 100-w.													
<b>3-h</b>	Slight transformer hum inherent in ballast equipment; varies in different ballasts. Objectionable amount may be due to improper installation or improper ballast design.	Mount ballasts on soft rubber, Celotex, etc., to prevent transferring vibrations to supporting members, and to reduce hum to a minimum.												
<b>3-i</b>	Short in ballast or capacitor.	Replace ballast or capacitor.												
<b>3-j</b>	High ambient temperature inside fixture housing.	Refer to fixture manufacturer.												
<b>3-k</b>	Prolonged blinking tends to heat ballast, and heating is aggravated under high ambient temperature inside fixture housing.	See "Blinking On and Off," and correct the cause.												
<b>3-l</b>	Overheated ballast.	See 3-i, 3-j, 3-k, 6-f.												
<b>4. TEMPERATURE</b>														
<b>4-a</b>	Low temperature (difficulty may be experienced below 50° F). See Note A.	With thermal starter, can be operated at lower temperatures.												



## Fluorescent Lighting

Possible Causes		Suggested Remedies
4-b	Cold drafts hitting tube.	Enclose or protect lamp.
4-c	Where heat is confined around lamp, light output is lower.	Better ventilation of fixture.
4-d	Low temperature operation. (Below 65° light loss is 1% or more per degree F.)	Enclose.
<b>5. VOLTAGE</b>		
5-a	Too low or too high voltage.	Check voltage with range on ballast nameplate.
5-b	High voltage starting.	Check voltage.
5-c	Low circuit voltage (Decreased ease of starting; also 1% change in light output for each 1% change in voltage, with output of "lagging" lamp—in two-lamp circuit—decreasing much faster than that of "leading" lamp.)	Check voltage and correct if possible.
<b>6. CIRCUIT</b>		
6-a	Loose circuit contact (likely at lampholder) causing on-off blink.	Lampholders rigidly mounted; lamp securely seated.
6-b	In new installation, circuit may be incorrectly wired.	Check circuit wiring.
6-c	Individual starter leads from the 2 pairs of lampholders may be crisscrossed. (If this is case, one lamp will not make starting effort unless the other is in its lampholders.)	Rewire starter leads.
6-d	Possible open circuit.	Test lamp in another circuit, being sure of proper contact in lampholders. Check voltage from one lampholder to the other. (Use voltmeter or 220-v, 100-w test lamp. Only one connection at each holder should be alive; hence 4 ways to check 2 live ones.) If no voltage indication from lampholders, check circuit leads to lampholders. If still no voltage, check circuit connection.
6-e	D-C operation without having and using reversing switches.	Install reversing switches.
6-f	Short in wiring.	Correct wiring.

## Fluorescent Lighting

6-g	Line radiation and line feedback.	Apply line filter at lamp or fixture; sometimes possible to apply filters at power outlet or panel box.
<b>7. OPERATION</b>		
7-a	Too many lamp starts.	Average life rating <sup>7</sup> based on operating periods of 3-4 hours.
7-b	Dust or dirt on lamp, fixture, walls, or ceiling.	Clean.
7-c	May be due to reflector finish, wall finish, other nearby light, room decorations, etc.	Interchange lamps before assuming color difference.

NOTE A—For satisfactory starting and operation at low temperatures: (1) Keep line voltage up. (2) Conserve lamp heat (e. g., by enclosure). (3) Use starters which provide higher induced starting voltages and longer electrode heating periods—i. e., thermal switches.

# FLOOD LIGHTING

Flood lighting of building exteriors is another interesting branch of advertising illumination. It is a particularly attractive form of display on buildings having light-covered walls and good appearing architecture.

Flood lights on buildings are usually concealed on a ledge or balcony of the building so their rays are directed upward and at the proper angle against the sides of the structure.

They should never be placed in a position where they can shine into the eyes of passers-by.

Fig. 1 shows several styles and sizes of flood light **Projectors**. Note their weather-proof housings and adjustment feature, to allow them to be "aimed" or pointed at the area to be lighted.

Fig. 2 shows the shape of the concentrated beams thrown by shallow-type reflectors and also those from deeper reflectors which spread the beams over a greater area.

In many cases where it is not convenient or possible to locate flood light projectors on the same building they are to light, they are located on some other building nearby, and perhaps across a street.

For best efficiency, the beams must be able to come from a short distance away from the vertical walls, rather than be directed too nearly parallel with the walls they are to light. Certain effects, however, can be produced by units quite close to the walls or columns to be lighted.

Fig. 3 shows a row of powerful flood lights on the parapet of a skyscraper, and used to light the narrower portion of the building which projects upward from this level.

Beautiful effects can be obtained by properly using mixed colors on buildings of striking architecture, and also by use of "dimmer rheostats" automatically operated by small motors in connection with automatic tilting mechanisms, to cause changing and moving colors to play over the building.

The deeper-colored lights such as red and blue are, of course, not as efficient as the white or amber

## Flood Lighting

ones, because the color lenses absorb some of the light. The effects obtained with colors, however, are well worth the extra cost.

Fig. 4 shows the effect of flood lighting on the top of a large office building

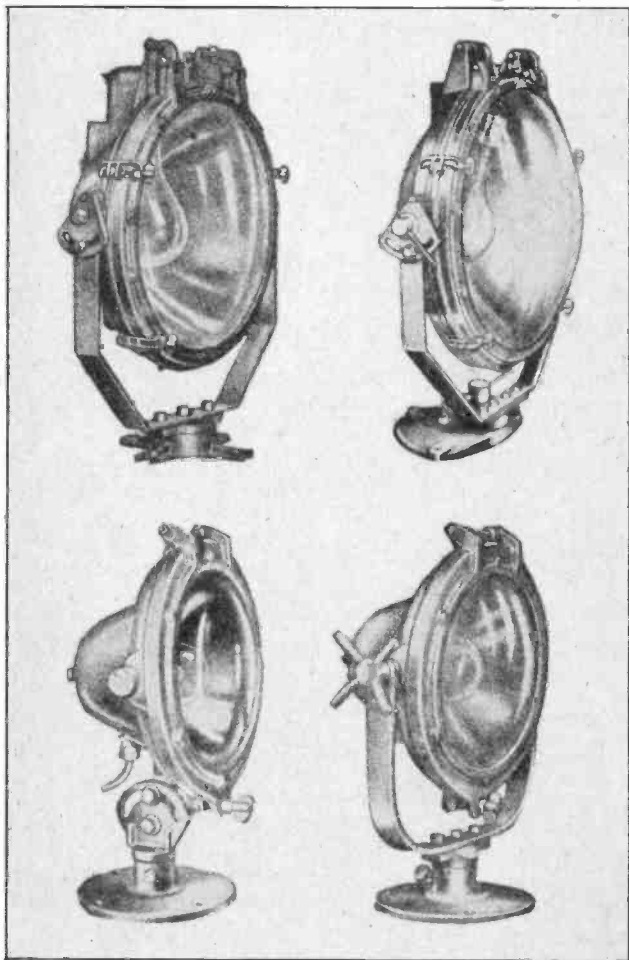

Fig. 1. Several types of flood light projectors. Note the weather-proof construction and adjustment features of these units.

Flood lights are also very extensively used for lighting railway yards, race tracks, bathing beaches,

## Illumination

and places where construction work is being done at night. In public parks flood lights are often used to illuminate fountains and monuments, with very

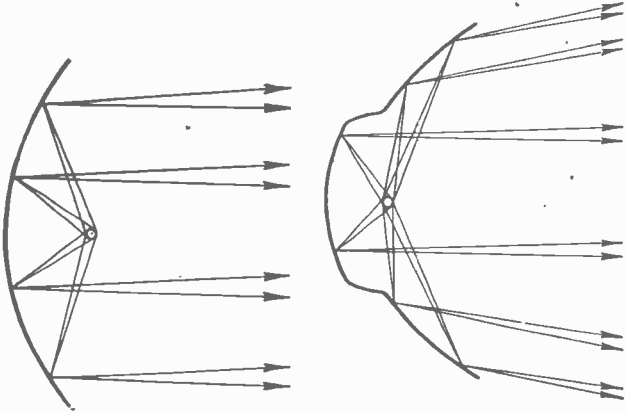

Fig. 2. This diagram shows how reflectors with shallow or deeper curves can be made to concentrate or spread the beams of light as desired.

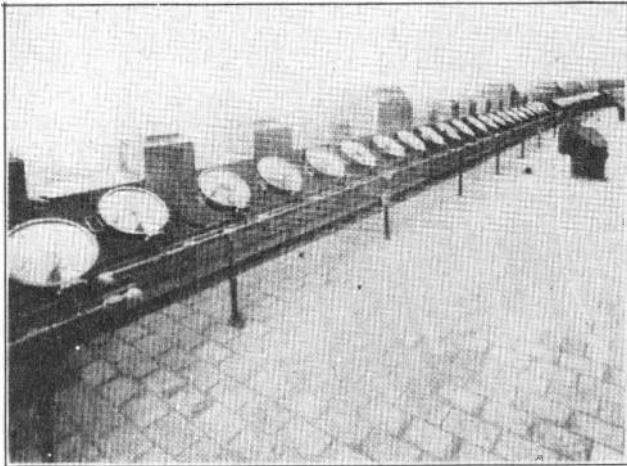

Fig. 3. This photo shows a row of flood light projectors in use on the top of a skyscraper office building. (Photo Courtesy Light Magazine).

beautiful results. Fig. 5 shows an illuminated fountain which uses water-proof projectors mounted right in the water. In the background is a beautiful example of flood lighting on a tower.

## Street Lighting

### 1. STREET LIGHTING

Street lighting is becoming so common that many of us fail to notice or appreciate it any more. But

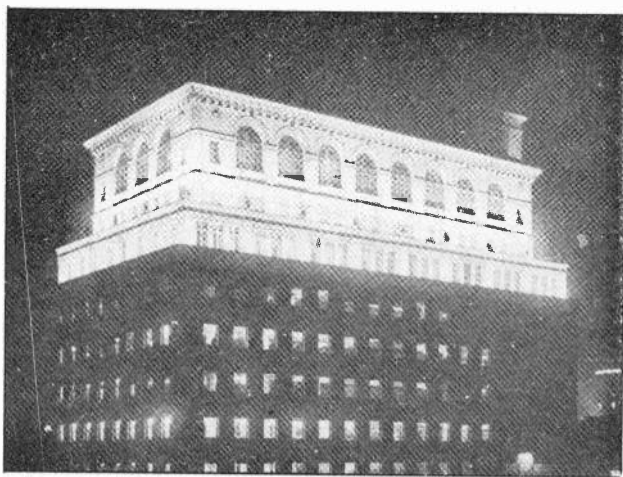

Fig. 4. This building is a very good example of the beautiful effects obtainable with modern flood lighting. (Photo Courtesy Light Magazine).

when we think of the benefits derived, in the reduction of accidents and increased business on well lighted streets, and that in many of the larger cities great lamps of 1000 to 3000 watts each light the streets nearly as bright at night as in the daytime, we find it is really a wonderful branch of electric illumination. The installation and maintenance of street lighting systems furnish profitable employment to great numbers of trained electrical men, and in the small and medium-sized towns often provide a worthwhile contract for some alert electrician who can convince the officials of his home town that better street lighting 'pays.

Arc lamps, which were formerly extensively used, are being rapidly replaced by Mazda lamps, because of their greater simplicity and reliability.

Where arc lamps are still in use, it is a simple matter for the trained man to make any necessary adjustments on their coils and mechanisms which feed the carbons as they burn away, or to locate any trouble on the system.

## Illumination

Incandescent lamps of from 200 to 2500 watts or more are commonly used for new street lighting installations.

### 2. SUSPENSION TYPE UNITS

For overhead lighting systems in small and medium-sized towns, clear lamps of 200 to 500 watts or larger are often placed in simple reflectors of the type shown in the lower left view in Fig. 6. These units are then suspended from overhanging arms.



Fig. 5. The foundation in the foreground is illuminated by flood lights placed within its bowl, and in weather-proof projectors. In the background is shown a well flood-lighted tower.

The porcelain insulators on the ends of the arm are

## Street Lighting

for the purpose of attaching the wires of the lamp circuit.

On the right in Fig. 6 is shown a street lighting unit of the medium-priced, enclosed type which is also for overhead suspension.

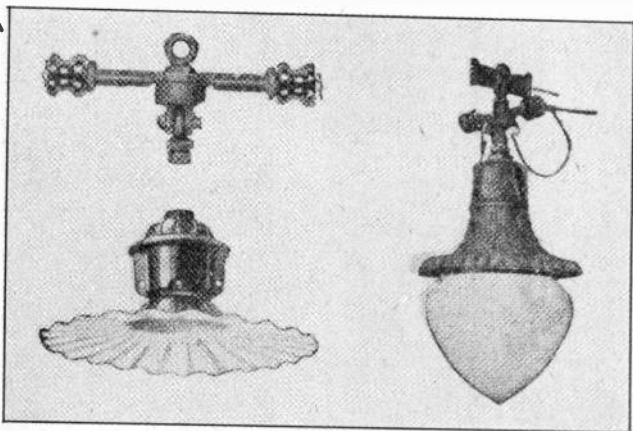

Fig. 6. Above are shown two types of street lighting units and also a swivel cross arm or hanger used in their mounting.

Fig. 7 shows two types of "cutout" or "disconnect" pulleys for use with overhead street lights. These pulleys allow the lamp to be lowered for cleaning, inspection, and repairs. When the lamp is lowered by releasing its supporting chain or rope, it is disconnected from the line by the prongs of the cutout pulley dropping out of their sockets. This makes the lamp safe to work on, and when it is pulled back in place, a guiding device causes the connecting prongs to slip back in their clips as the lamp unit is drawn up tight in the cutout head.



## illumination

### 3. POST TYPE UNITS AND STREET LIGHT CIRCUITS

Where more elaborate street lighting is desired, enclosed glass units on top of posts at the side of the streets are commonly used. Fig. 8 shows several styles of these units both for single and double lamps.

Street lights are commonly connected in series on high-voltage circuits, to make possible the use of

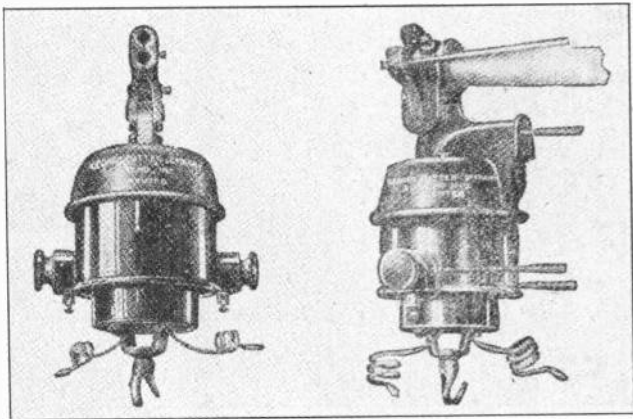

Fig. 7. Cut-out pulleys used for disconnecting and lowering street lights for cleaning and inspection.

smaller wires. You will remember that when devices are connected in series the current is the same in all parts of the circuit, and that which flows through one device flows through all the others as well. These circuits are often operated on 2300 volts and higher, so the wires must be well insulated, and considerable care should be used in working around such circuits. We can now see the advantage of using cut-out pulleys when working on these lamps.

### 4. SERIES LAMP "CUTOUTS"

On the older series street-lighting circuits, if one lamp burned out, all lamps on that circuit went out, because they were all in series. Nowadays there are in use special sockets which have short-circuiting springs that cut out the lamp if it opens the circuit. Fig. 9 shows a sectional view of a socket

## Street Lighting

of this type front which the operation of prongs can be easily understood. A thin film or strip of insulating material is placed between the tips of these spring contacts and remains there as long as the lamp is in good condition.

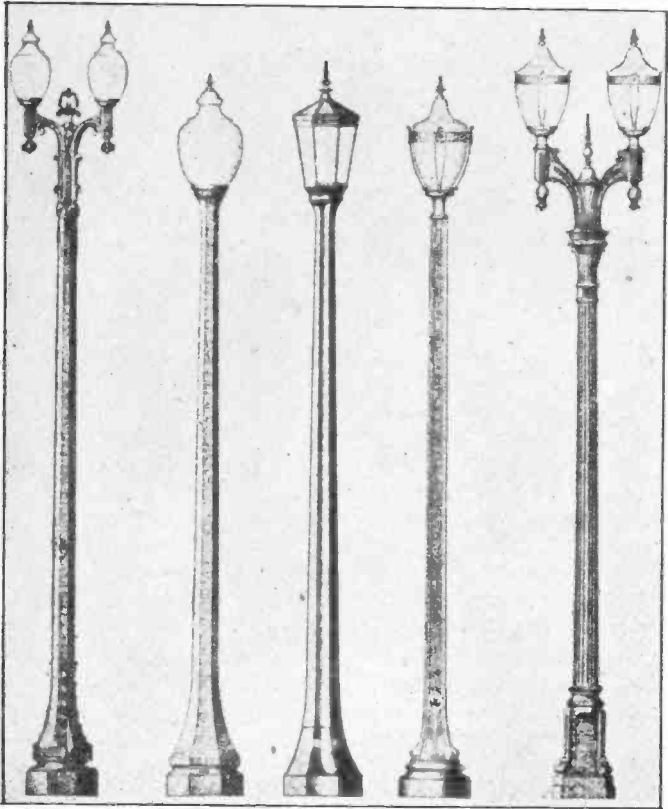

Fig. 8. Hollow concrete or metal posts with large globes, as shown above, are used in many street lighting installations.

If we have, for example, a circuit of 100 lamps in series and 2300 volts is applied to this circuit, the voltage drop across each lamp when operating will be about 23 volts. This voltage drop we know is proportional to the current flow and to the lamp resistance. This low voltage will send current through the lamp, but will not puncture the insulat-

## Illumination

ing film in parallel with the lamp. However, if a lamp burns out and opens the circuit, all current momentarily stops flowing. With no current flow-

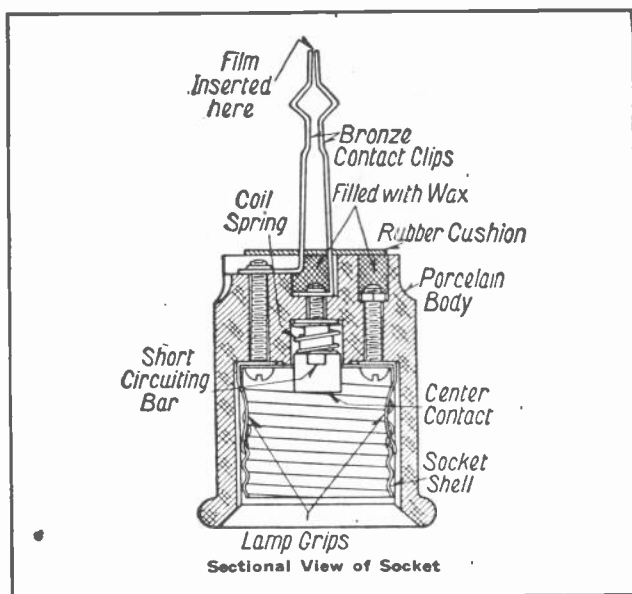

Fig. 9. This sketch shows a sectional view of a socket and "film cut-out" used with series street lamps. Note how these cut-out springs on contact clips short circuit the shell and center terminals of the lamp socket. The insulating film is not shown between the contact clips in this illustration.

ing there is no voltage drop at any of the lamps, and the full 2300 volts will be applied for an instant across the springs of the lamp which has opened the circuit. This voltage is high enough to puncture the insulating film and burn it out, thus shorting the defective lamp out of the circuit, and allowing the others to operate once more.

Special transformers at the sub-station compensate for the reduced resistance and voltage drop due to the loss of the one lamp. These will be explained later in the lessons on transformers.

Instead of applying the high voltage of the line circuit directly to the lamps and sockets, many modern series street lighting systems use small transformers at each lamp to reduce the voltage for

## Street Lighting

the filament. All of these transformer primaries are connected in series, as in Fig. 10. This increases the safety and reduces lamp socket insulation costs. It also permits the use of lamps with filaments of larger diameter and lower resistance. They are, therefore, stronger and more rugged and also of higher efficiency.

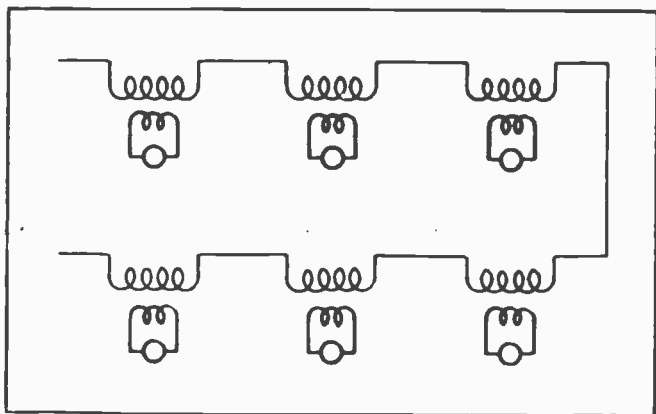

Fig. 10. This diagram shows the manner of connecting series street lighting transformers which are used to reduce the voltage at each light.

The current through these low-voltage lamps may be from 6 amperes to 20 amperes, or more on the different sizes; and they are made for voltages from 6.6 to 60.

Wiring for street lights can be run on the poles where suspension type units are used, and underground for better appearance with post type units. Underground wiring can consist of lead covered cable buried in a trench and run up through the hollow poles to the lamps, or of rubber covered wires or lead covered wires in underground ducts of tile or fibre conduit.

### 5. MOTION PICTURE LIGHTING

Electric light is used on a tremendous scale in the motion picture industry, both in the photography and in the operation of projector machines in theatres; and the lighting of the theatres themselves.

## Illumination

In the taking of motion pictures there are used some of the highest foot-candle intensities that are encountered in any branch of illumination. While it was formerly thought that such pictures had to be taken in sunlight, powerful electric lights now reproduce effects of sunlight or daylight in almost any required intensity.

Arc lamps were formerly used very extensively and still are to some extent, as the color of their light rays is particularly good for exposing the older types of film. However, there has been developed a new type of film that is sensitive to the yellow and white rays of incandescent lamps, and, therefore, these lamps because of their quieter and cleaner operation are rapidly replacing many of the arc units. Mazda lamps require much less attention and adjustment than arc lights, and provide a steadier light. Their quieter operation is a great advantage in their favor for the filming of talking pictures.

The constantly changing lighting requirements on various movie "sets" and the care and maintenance of the lighting units provide a great field of fascinating work for trained electrical men who know practical illumination.

Single lamps of 10,000 watts each and larger are commonly used in motion picture photography, and "banks", or portable units, consisting of 4 to 12 or more lamps are used.

An interesting problem, and one which will help you to realize the size of this equipment, will be to calculate the current that will be required by two banks of six 10,000 watt lights each, and two single 20,000 watt lights if they are operated on a 110-220 volt, three-wire circuit. Also determine the size of cable necessary to carry this current to the lights in a temporary location 150 feet from their generator, with not over 5 volts drop.

## Aviation Lighting

### AVIATION LIGHTING

The aviation industry is fast becoming one of the heavy users of modern and efficient electric illumination.

A great deal of night flying as well as daylight flying must be done to maintain fast air-mail and passenger schedules, and the safety of night flying depends on electric illumination in many ways.

Aviation lighting can be divided into the following classes:

Airport lighting—Route beacons—Lights on planes.

Many millions of dollars have already been spent in airport lighting, and it is undoubtedly safe to say that within a very few years every town of any size in this country will have a lighted airport.

#### 6. AIRPORT LIGHTING EQUIPMENT

A well-lighted airport requires the following equipment:

Illuminated wind-direction indicator	
Landing field beacon light	Approach lights
Landing field flood lights	“Ceiling” projector
Boundary lights	Hangar lights
Obstruction lights	Shop lights

Many of these lights are rated by government standards, and the airports are given ratings by the government according to the type and completeness of lighting equipment used.

#### 7. AIRPORT BEACONS

The purpose of the airport beacon is to direct pilots to the airport. These beacons are rotating or flashing searchlights of 15,000 to 100,000 candle-power, and are usually mounted on a tower or on the top of one of the hangars, so their beams will be unobstructed in all directions. If a flashing light is used, the flashes should not be less than 1/10 of a second in duration, and should be frequent enough to make the light show 10 per cent of the time. Beacon lights for airports or route beacons usually have two bulbs mounted on a

## illumination

hinged socket base, so if one bulb burns out the other is immediately swung into place by a magnet. This is necessary to make these units dependable at all times.

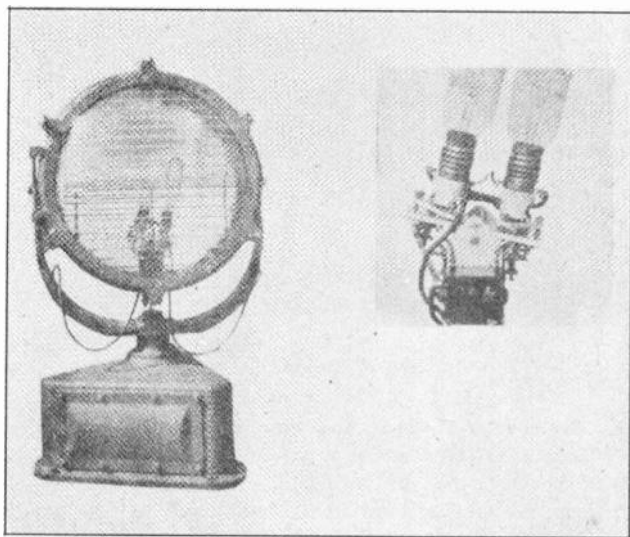

Fig. 11. On the left is shown a typical rotating beacon, such as used at airports and along air routes. On the right is a view of the double lamp mechanism, which swings a new lamp in place if the one in use burns out.

Fig. 11 shows on the left a beacon light unit mounted on the case which contains the revolving motor and mechanism. On the right is shown the double lamp unit which can also be seen inside the light at the left. This light has a 24 inch diameter, and uses a 1000 watt, 115 volt bulb, and develops 2,000,000 beam candlepower. Such a light can be seen by the pilot from a distance of 10 to 35 miles in fair weather, and is a great help in guiding him to the airport.

### 8. LANDING FIELD FLOOD LIGHTS

Landing field flood lights are used to illuminate the surface of the landing field, in order to enable pilots to land their planes safely. In landing a plane it is very important for the pilot to be able

## Aviation Lighting

to see the ground and judge his distance from it, also to see the length of the field or runways on which he has to bring the plane to a stop.

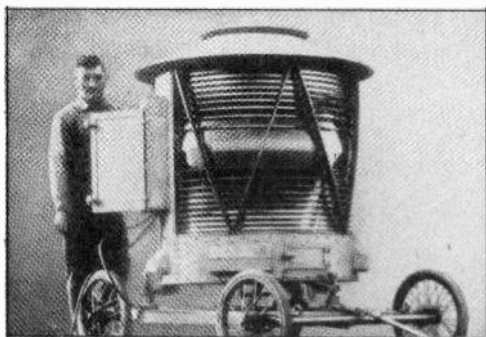

Fig. 12. This large landing field light has a lens similar to those used in lighthouses, and is mounted on a light truck for portable use at airports.

Flood lights should also illuminate the field well enough to show up any uneven surfaces. Some fields are lighted by several different flood lights located on opposite sides of the field, while others use a bank or group of lights located near the

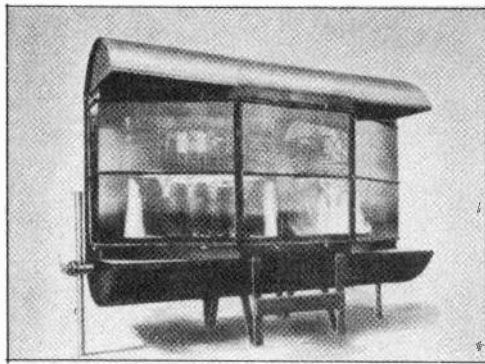

Fig. 13. A landing field lighting unit which has a number of powerful lamps mounted behind the glass front, in a manner to spread their light over a wide area.

hangars. Sometimes a large portable light is used, so it can be moved about by hand on a light weight



## Illumination

wheeled truck. Fig. 12 shows a unit of this last mentioned type.

Fig. 13 shows a large unit in which a number of lamps are mounted, and you will note that its shape allows the beams from the several lamps to spread over a wide angle in order to cover the entire field from this one light source.

Fig. 14 shows a number of smaller flood lights arranged to throw their separate beams over the field in a wide spread fan shape. Whatever type of flood lights are used, they should light the field uniformly and without harsh shadows, and their color should be such that they do not distort normal

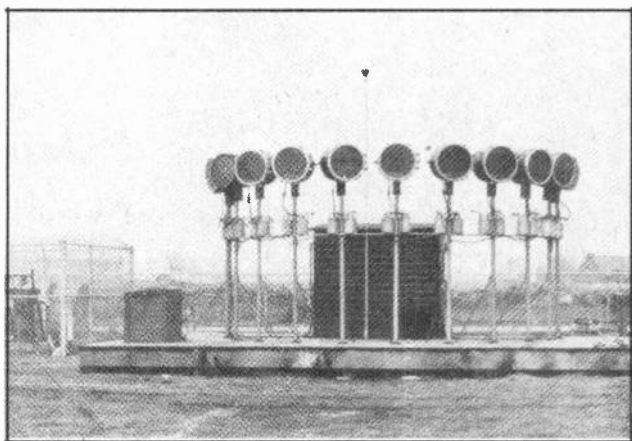

Fig. 14. A number of smaller projectors, arranged as shown, provide very effective distribution of light over the field.

colors or appearance of objects. They should keep all light in an upward direction at an absolute minimum, to avoid glare in the pilots' eyes. For this reason flood light units are equipped with reflectors and lenses which spread their beams in a wide angle horizontally, but very narrow in the vertical plane.

The vertical beam spread is usually not over 5 or 10 degrees, and the units should be so adjusted that the top edge of this beam does not point above a horizontal line. Flood light units should be kept down close to the ground, preferably within 10 feet. If the top of their beams is higher than this it often

## Aviation Lighting

makes the ground surface appear closer to the pilot than it really is, when he views it from above the beam.

Fig. 15 shows a well lighted landing field which is illuminated by a 24 KW floodlight. Fig. 16 shows a bank of smaller 3000-watt flood lights in action at night.

The four lamps on the left in Fig. 17 are some of the types and sizes commonly used in airport



Fig. 15. This photo shows a well-lighted airport at night, and illustrates the great advantage and safety feature of such lighting for night flying.

flood lights, while the one on the right is of the type used in beacon lights. Note the special construction of the filaments and sockets of the larger lamps, and the peculiar shaped bulb of the middle one, which keeps the glass farther from the heat of the filament.

Planes should always be landed against the wind, so as the wind changes the pilot must change his direction of approach and landing run. For this reason it is best to have either portable lights, or lights located on two or more sides of the field, so the direction of the light beams can be changed with the wind and avoid making it necessary for the pilot to ever face the beams.

Fig. 18 shows an excellent layout for permanent field lights located around the field and remotely

## Illumination

controlled by switches in a control room at the hangar. The devices marked "remote controllers" are magnetically operated switches which close the circuits to these large lights, as their current would be too heavy to handle with the push buttons.



Fig. 16. This landing field is lighted with a group of small flood lights such as shown in Fig. 14.

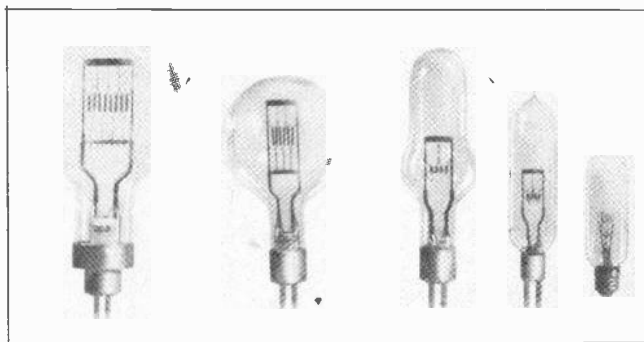

10,000  
Watts

5000  
Watts

3000  
Watts

1500  
Watts

1000  
Watts

Fig. 17. Here are shown a number of powerful lamps of the type which are used in airport flood lights and beacons.

Note that parkway cable is used to supply high voltage to step-down transformers at each light. This circuit is shown in a "one line" diagram until it reaches the remote control switches, where the

## Aviation Lighting

two conductors are shown separated.

Parkway cable of this type can be buried under the ground surface 10" or more, and makes a very good system of wiring for airports, where of course no overhead wires should be used.

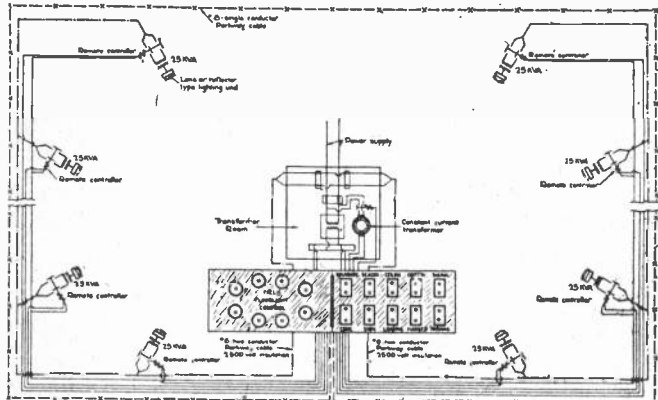

Fig. 18. Wiring diagram for a very practical and efficient airport flood lighting system. The lights are fed by individual transformers, and all remotely controlled from one central point.

### 9. BOUNDARY LIGHTS

Boundary marker lights are used to indicate to the pilot, the location of the edges of the landing field, and are very essential in order to enable him to judge the length of the field and the proper place to approach the ground. These lights are white in color and should be either 25 watt lamps if connected in parallel, or 600 lumen series lamps. They should be spaced from 75 to 125 feet apart for best efficiency, and never more than 300 feet apart. Boundary lights are to be mounted 30 inches above the ground, and the circuits must not have over 5 per cent voltage drop at the farthest points.

Fig. 19 shows three common types of boundary lights. The one in the center is simply a lamp of the proper size enclosed in a weather proof glass globe, and mounted on a special pipe fitting on a 30-inch pipe.

These units on the pipe stems are not very visible in the day time, so it is well to have a circle of

## Illumination

whitewashed gravel or crushed rock about 3 ft. in diameter around their bases.

The unit shown at the left in Fig. 19 has a white metal cone base, which makes it very visible.

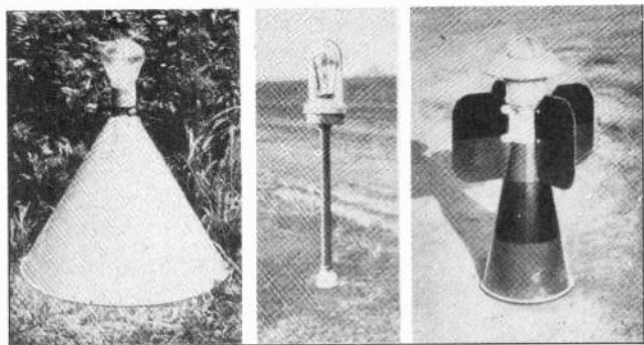

Fig. 19. Several types of boundary lights used for indicating the outline and extent of the landing field at night.

This unit uses a prismatic glass globe which is more efficient than the clear glass, as it directs a stronger beam of the light upward.

Units such as this and also the one on the right in the figure can be merely set on the ground and connected to the circuit by detachable plugs. This makes an added safety feature in case they are struck by a plane, as they will tip over easily without doing so much damage to the plane.

### 10. APPROACH AND OBSTRUCTION LIGHTS

Approach lights are simply certain boundary lights that are equipped with green globes to indicate good points of approach to the runways of a field. They can also be used to indicate wind direction by turning on only those which are on the proper side of the field to bring a plane in against the wind.

Approach lights should have 50 watt parallel lamps or 1000 lumen series lamps, because their green globes absorb more of the light.

Obstruction lights are red and should be placed on tops of all trees, chimneys, water tanks, power

## Aviation Lighting

or telephone poles or radio towers which are near to the landing fields. They should also have 50 watt parallel or 1000 lumen series lamps, and 100 watt lamps are recommended in some cases.

We have mentioned several times the possible use of either parallel connected lamps or series lamps for airport lights. Both systems are in use.

The series system has the advantages of lower cost of copper wire and less voltage drop, particularly in the longer circuits such as those to boundary lights or flood lights located on far edges of the field.

The parallel system has the advantages of being somewhat safer due to its lower voltage, using lower cost lamps, and being a somewhat simpler

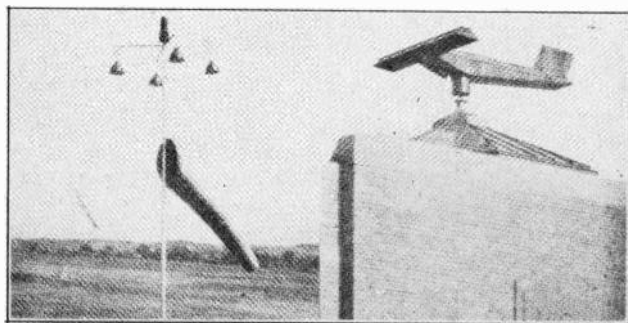

Fig. 20. On the left is shown a wind-cone, with four lights mounted above it, for illuminating the cone at night. On the right is a wind tee made in the shape of a small airplane. This can also be illuminated by rows of lamps on its wings and body.

system, as it doesn't require sockets with film cut-outs or constant current transformers.

The selection or choice of one system or the other would depend to some extent upon the size or area of the field, the number of lights to be operated and the distance from the source of current supply.

### 11. ILLUMINATED WIND DIRECTION INDICATORS

It has already been mentioned that planes should be landed against the wind in order to reduce their landing speed. Wind direction indicators are,

## Illumination

therefore, used at airports to show an approaching pilot the direction of the wind. These are very necessary, as his own air speed may make it difficult for him to tell the wind direction accurately unless he can see moving clouds or smoke.

A "wind cone" or tapered cloth sack with an opening in the small end is commonly used for a wind direction indicator. In other cases a large wind vane shaped like an arrow or sometimes like a small plane may be used.

These devices should be mounted on a pole or tower, or on the top of hangars in some conspicuous place. To be effective at night as well as during the day, they should be illuminated from above by one large reflector and light, or better still by four reflectors mounted on 2 ft. brackets as shown in the left view in Fig. 20. These reflectors should have 150 watt lamps in them, and a 60 watt red lamp above the unit to serve as an obstruction light.

In some cases wind cones are lighted from the inside by a 200 watt lamp and reflector pointed in their mouth, and free to revolve with the cone as the wind direction changes.

The right hand view in Fig. 20 shows a "wind tee" shaped like a plane, and lighted by rows of bulbs on its wings and body.

## 12. "CEILING" PROJECTORS

The "ceiling" projector light is used to determine the "ceiling" height. This term applies to the height of clouds or fog above the landing field. It is quite important to know this "ceiling" height and be able to report it by radio to aviators approaching from a distance. This gives them an idea of how close they will have to approach the ground in order to see the landing field or its lights.

This information regarding "ceiling" heights can also be transmitted to various other airports along the route, either by telephone or radio, thus keeping the pilot informed of weather conditions at various airports which he may have to use.

## Aviation Lighting

For a "ceiling" light a 500-watt, narrow beam projector can be used. If this unit is tilted upward at an angle of 45 degrees with the horizon, then the spot where its beam strikes the under side of clouds or fog will be directly above a spot on the ground, which is the same distance from the light unit as the bright spot on the cloud is above the earth. This can be proven by the fact that the diagonal of a square is at an angle of 45 degrees with either its base or vertical side, and, of course, the base of a square is the same length as its vertical side. See Fig. 21.

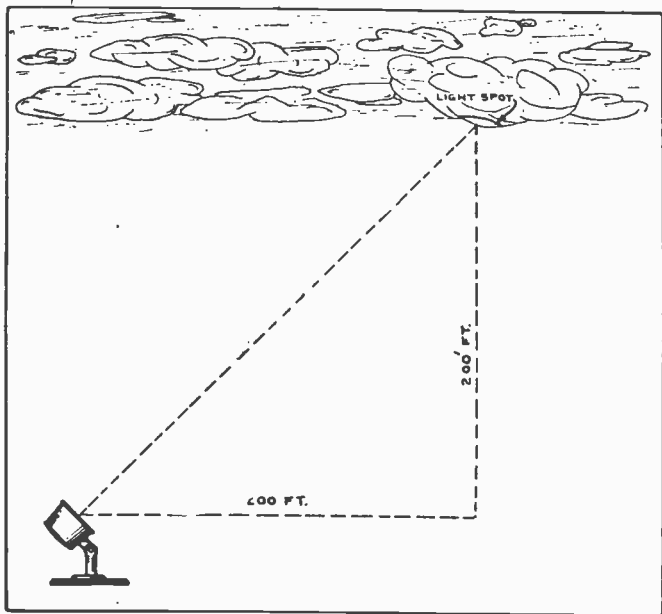

Fig. 21. This diagram illustrates the method of calculating the height of clouds or fog with a ceiling projector.

Other angles can be used, and then with a simple quadrant and pointer set in the same plane as the projected beam, and a definite distance away from the projector; we can by sighting along the pointer toward the point where the beam strikes the clouds, obtain a direct reading of the "ceiling" height.

### 13. HANGAR AND SHOP LIGHTING

The interior lighting of airport hangars and re-



## Illumination

pair shops is another very important use for electric illumination. In the handling of planes in and out of the hangars, and in making repairs on them, good lighting is a great time saver and promoter of safety.

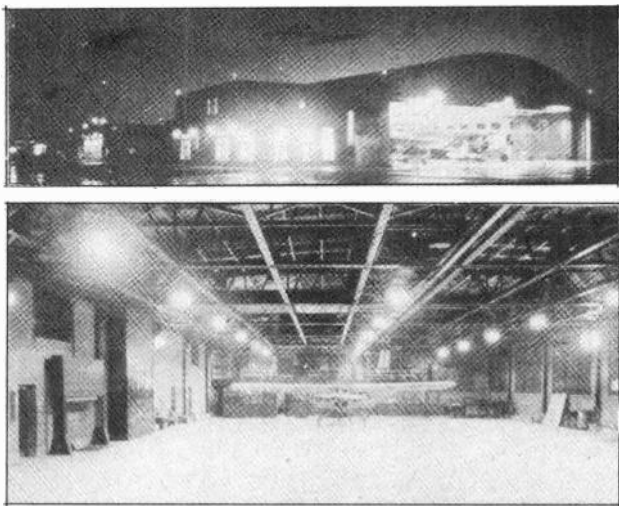

Fig. 22. The top view shows the outside appearance of a well lighted hangar, and below is shown the inside of the hangar and the arrangement of the lighting units.

In the shops where some of the very critical repair and adjustment of engine or plane parts must be made, it is equally important to have efficient illumination. Fig. 22 shows an exterior view of a well-lighted hangar in the upper part of the figure, and an inside view below. Industrial lighting fixtures and principles can be applied to these buildings.

### 14. AIRWAY LIGHTING OR ROUTE BEACONS

The Federal Government requires airway beacons approximately every ten miles along principal flying routes. These beacons should consist of projectors at least 24 inches in diameter, using 1000-watt lamps and producing 2,000,000 beam candlepower. These units are kept continually revolving at a speed of six revolutions per minute by a small motor and gear mechanism.

## Aviation Lighting

In addition to the revolving beacon there should be two "On Course" lights with 18-inch, 500-watt projectors to indicate to the pilot the direction of the next airport. These course lights can be equipped with a mechanism to keep them continuously flashing the number of that particular beacon in the Morse Code. This also indicates to the pilot the distance he has progressed along the course. These lights can be fitted with amber or red cover glasses, while the rotating beacon uses a white beam.

Fig. 23 shows a typical airway beacon on a tower which is also equipped with a "wind-cone". This particular beacon is located at an intermediate landing field. Where beacons of this type are near to power lines they can obtain the energy for their lights from these lines. In other cases they must be equipped with an independent lighting plant similar to farm lighting plant installations. These beacons and plants have to be maintained

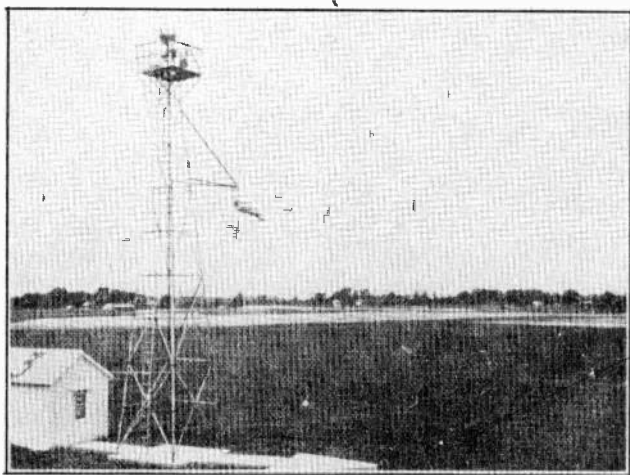

Fig. 23. This photo shows a typical airway beacon mounted on a steel tower, and also provided with a wind-cone for day-light use only.

and inspected by trained men, as their condition and dependable operation are very important. Imagine yourself in the place of a pilot, and the great comfort you would receive from being able to see

## Illumination

at least one beacon ahead at all times along your route. These airway beacons are a great safety factor in night flying.

### 15. AIRPLANE LIGHTS

It may seem rather surprising to talk of lights on airplanes, as probably a great many people don't even realize that planes carry lights. Government regulations require, however, that every plane which flies between sunset and sunrise must be equipped with flying lights, to indicate its position and direction of flight to other pilots.

These lights consist of small automobile-type lamps of 18 or 21 candlepower, mounted in streamlined pyralin shells. These are mounted on the tip of each wing, and one on the top of the tail or rudder. The left wing light must be red and the right one green, while the tail-light shows clear white. Government specifications can be obtained governing the proper angles between these lights. Airplanes also require lights on the control-board in the pilot's compartment. These lights are usually equipped with a small rheostat so they can be adjusted to just the right brilliancy to show the instruments, and in this manner avoid glare in the pilot's eyes and enable him to see better in the darkness ahead.

Many of the larger planes, or planes intended for night flying, are equipped with powerful landing lights for use in landing on unlighted fields. These units use a lamp with a concentrated filament which requires about 35 amperes. They are, therefore, kept switched off when the plane is flying, and turned on only when need for use in making a landing. Otherwise they would place a very heavy drain on the battery.

Ordinary flying lights and landing lights can be supplied from a light-weight battery carried aboard the plane. Fig. 24 shows a wiring diagram for the commonly used lights on a plane, and Fig. 25 shows the mounting of wing tip and rudder lights, as well as landing lights. The upper part of this figure shows the tail-light mounted on top of the plane rudder, in its stream-lined shell. You

## Aviation Lighting

will note that the front end of this shell is painted black while the rear end, or more sharply tapered end is clear and allows the light to escape in this direction. The lower left view shows a wing tip light for the right wing, and also a landing light which is built in, or stream-lined, with the forward edge of the wing. The lower right view shows a different form of mounting for the wing light, and

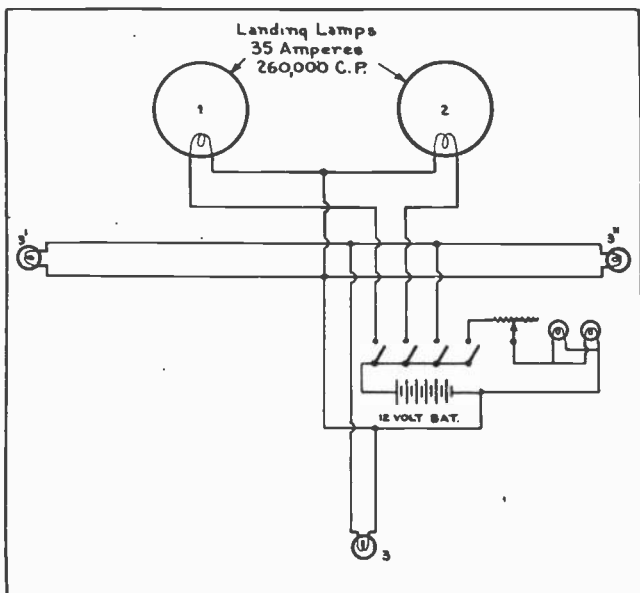

Fig. 24. Simple wiring diagram for lights on an airplane. Trace this circuit and note which lights each of the switches control.

also for the landing light, which in this case is hung underneath the wing in a stream-lined shell.

This stream lining is exceedingly important, and every device of an electrical nature or otherwise, that is attached to the outer surface of any airplane, should be stream-lined to prevent air resistance to the forward motion of the plane. The greater part of this resistance occurs at the trailing ends or edges of such devices where violent whirling eddy currents are set up in the air causing a sort of vacuum at these ends or edges; so you will notice that all of these devices taper most

## Illumination.

toward the rear. This is a very good point to keep in mind when installing any equipment on airplanes.

Where large numbers of lights are used in this manner the plane is usually equipped with a wind-driven generator mounted on the outside of the

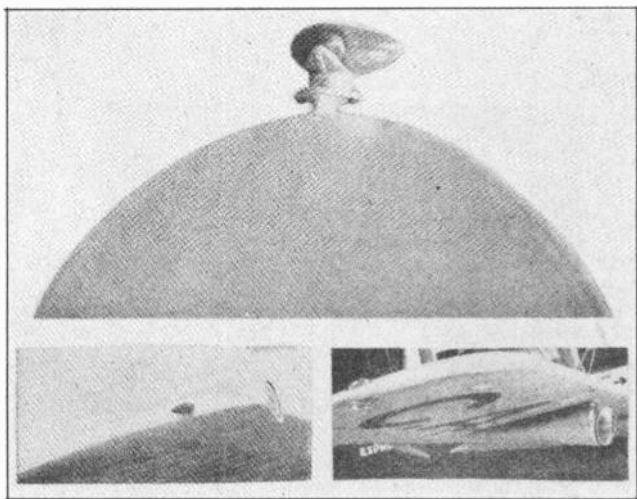

Fig. 25. The top view shows a tail-light mounted on the rudder of an airplane. The two views below show two methods of mounting wing tip lights and landing lights.

fuselage, or between the wings, in a stream-lined casing and driven by a small wind propeller.

From the foregoing material on aviation lighting, we can see that this is developing into a tremendous field for trained electrical men who have a good knowledge of the principles of electric wiring and testing, as well as the fundamentals of illumination.

## Aviation Lighting

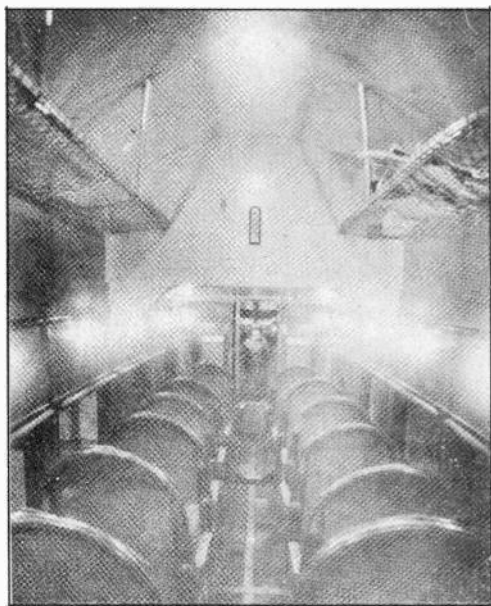

Fig. 26. The insides of large cabin-type planes are often lighted to give many of the same comforts and conveniences as a Pullman coach.

## EXAMINATION QUESTIONS

1. State several common uses for flood lights.
2. What important precaution should be observed in locating flood lights.
3. Why have incandescent lamps replaced arc lamps in most street lighting systems?
4. What is the advantage of using series lights on street lighting systems?
5. State two important advantages of using cut-outs or disconnect units on overhead street lights.
6. What is the purpose of the series lamp cutout as shown in Fig. 9?
7. (A) How much current will be required to operate the lamps in the problem given in Art. 5?  
(B) What size conductors should be used?
8. Name six important uses of electric lights in aviation.
9. What is a "ceiling" light used for at airports?
10. What color and size of lamps are commonly used for airport "approach" lights.





## MERCURY VAPOR LAMPS

A special type of lighting unit, which has become very popular and generally used in industrial plants and large machine-shops, is the Mercury Vapor Lamp.

Its particular advantage lies in the yellow-green color of the light it produces. This light is particularly good for certain machine-shop operations, and the handling and assembling of small bright metal parts, as well as in textile mills.

Lamps of this type are not intended for commercial or home lighting, but only for such special applications as mentioned, and where its peculiar color is not objectionable. Ordinary Mazda lamps produce a light which, as before mentioned, is largely white in color, but also contains a considerable percentage of violet and red rays. These rays are somewhat tiring to the eyes in certain classes of work.

The Mercury Vapor lamp produces light with a predominance of yellow and green rays and a small percentage of violet and blue. In light of this color small objects, such as screws, pins, bolts, nuts, etc., stand out very sharply. Therefore, the use of this type of lighting unit increases production speed in machine shops, with less eye-strain for employees. Large automobile manufacturing plants have installed many thousands of these units.

### 1. MERCURY VAPOR TUBES

The source of light in a Mercury Vapor lamp is a long glass tube, approximately an inch in diameter and 50 inches long, in which there is sealed a small quantity of mercury. The tube is suspended at a slight angle so that mercury runs down to the lower end, at which there is a bulb equipped with a metal electrode sealed into the glass and in contact with this pool of mercury.

Fig. 1 shows a view of a complete unit with the tube mounted in its trough-shaped reflector. The lamp mechanism, which will be explained later,

## Mercury Vapor Lamps

is in the metal housing above the reflector. The upper end of the tube has two bulb-like horns or extensions on the glass, with a metal electrode sealed into each one. Wires from each end of the

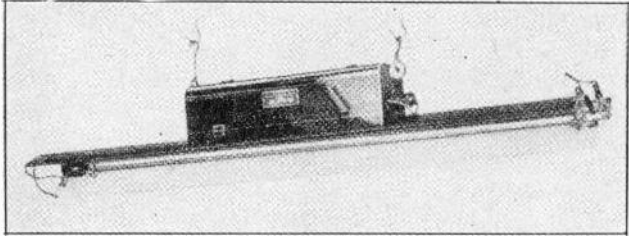

Fig. 1. This view shows a complete mercury vapor lamp. Note the mounting of the tube under the long reflector, and the manner in which the lamp is hung at a slight angle.

tube connect to proper coils in the lamp mechanism and from this to the supply line. Most of the air has been exhausted from the tubes of these lights, leaving them to operate in a vacuum. When they are cold most of the mercury is condensed and runs to the pool at the lower end of the tube, so it is necessary to use a spark or impulse of rather high voltage to vaporize a small amount of the mercury.

We should understand that a high voltage spark will pass through a much greater distance in an ordinary vacuum than through open air, so by applying about 2000 volts from an induction coil in the lamp mechanism, we can start an arc through the tube.

As soon as a little mercury vapor is built up it forms of soft green arc or light throughout the full length of the tube. Thus the name Mercury Vapor Arc.

As long as the lamp is operated this arc continues to agitate the surface of the mercury pool and create sufficient vapor to keep it going. After the vapor forms and the arc is established, the resistance of the lamp tube is low enough so the arc can be maintained with from 70 to 100 volts, and about 3.8 amperes on the common sized lamp. The total

## Illumination

wattage rating of the lamp is about 450 watts, part of which is used up in the resistors and coils. The voltage from the lamp coils is about 120 to 130 volts, but not all of this is applied to the tube.

The source of light from these units, being spread over such a long tube, distributes the light softly and evenly with very little glare and shadow effects, which is one of their decided advantages.

The average life of the tubes is two years or more if they are properly cared for, but they should be very carefully handled as it is easy to crack them and allow air to leak in, if the tubes are strained or bumped. For this reason they are protected by long metal bars running full length of the tube and attached to the ends of the reflector.

### 2. LAMP MECHANISM

Fig. 2 shows a top view of the lamp mechanism and coils. This consists of a pair of resistance units at the left end, and next to these are the coils of an auto transformer which raises the line voltage, and has taps brought out to terminals to obtain the proper voltage adjustment for the operation of the tube. The pair of coils at the right of the center are those of an induction coil which generates the high voltage for the starting spark to ignite the tube

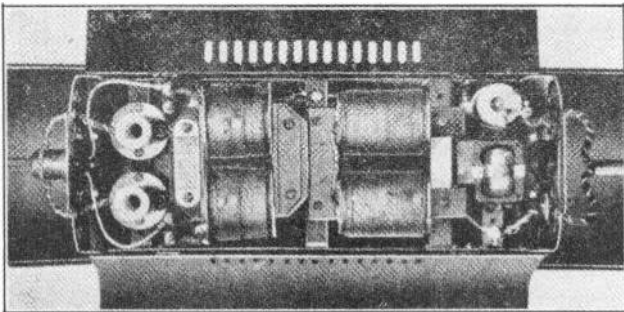

Fig. 2. Above is shown the mechanism and coils of a mercury vapor lamp. Also note the mercury shifter switch at the extreme right end.

or start the lamp. Just to the right of these coils is a small mercury switch in a glass tube. This

## Mercury Vapor Lamps

switch is mounted on a pivot so when the coils are energized and the ends of their cores become magnetized they attract a small iron plate on the mercury switch, tilting it up and causing a "V" shaped depression in the glass to separate the pool of mercury and break the circuit.

When this circuit is broken and the flux around the induction coils is allowed to collapse, it induces a high voltage of about 2000 volts in these coils. There is also an added resistance unit just above this tilting or "shifter" switch in this view.

### 3. LAMP CIRCUIT AND OPERATION

Fig. 3 shows a simplified wiring diagram for an A. C. mercury vapor light. Examine this diagram carefully and note the connections and circuits through the various coils and the tube.

We know that alternating current is constantly reversing in direction, but let's assume for the moment that the current is entering at the lower line wire as shown by the small arrows. We can trace this flow of current through the lower half of the auto transformer—A.T., then through both wind-

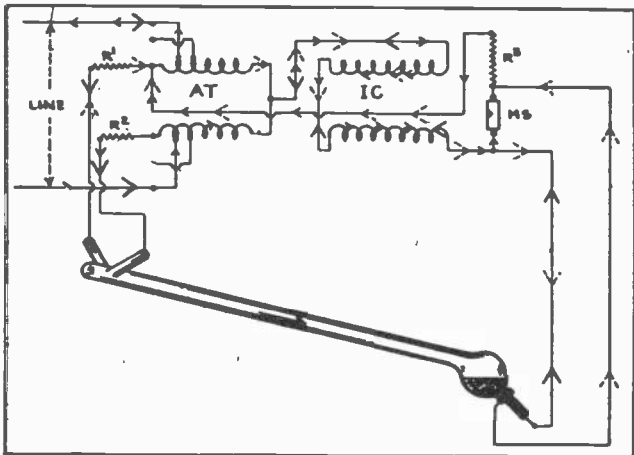

Fig. 3. Wiring diagram of a mercury vapor lamp, showing the various circuits traced through the tube and coils.

ings of the induction coil—I.C., through the mercury switch—M.S., and protective resistance—R3; then back to the upper line wire.

## Illumination

This flow of current energizes the induction coils and magnetizes their cores. This magnetism attracts the metal plate or armature on the mercury switch, causing it to tilt and break the circuit we have just traced.

When this current stops and the flux around the induction coils collapse, it induces the high voltage previously mentioned, and this is applied to the ends of the lamp tube as shown by the dotted arrows.

We also find that this high voltage is applied across the two terminals at the lower end of the tube. One of these wires we know is connected to the electrode in contact with the mercury, and the other one is connected to a thin **metal starting band** which is clamped around the stem of the tube, and also attaches to a strip of metal foil which is pasted to the under side of the bulb.

The high voltage across these two points sets up a capacity charge through the glass to the mercury, exciting the surface of the mercury and emitting the first mercury vapor. As soon as this vapor is started, the high voltage cross the ends of the tube establishes the arc. After the arc is started the line current will flow alternately through resistance R1 and R2, and into the two horns or electrodes at the upper end of the tube, as shown by the large arrows, down through the tube and back through both windings of the induction coil, to the center tap of the auto transformer. From here it returns to either line wire, according to the polarity of the A.C. line at that instant.

The auto transformer A.T. serves to increase the voltage of the tube slightly above the 110 volts on the line.

You will note that the current flows through the tube in only one direction, so we find that this tube also acts as a rectifier as well as a source of light. In other words, current can flow from the metal electrodes at the top of the tube, into the mercury vapor, but it cannot flow from the vapor back into these electrodes, because of the high resistance film built up at their surfaces the instant the reverse current attempts to flow. This principle will be more fully explained in a later section.

## Mercury Vapor Lamps

These mercury vapor lights are also made to operate on direct current, and those for D.C. operation have no transformer, but merely the pair of induction coils and mercury switch in addition to the tube; so their circuit is much simpler than the one we have just traced.

### 4. INSTALLATION

When installing lighting units of this type they should be suspended by two pieces of chain or strong rope, and hung with the tube at the proper angle; or otherwise they will not operate satisfactorily. This angle can easily be determined by leveling the tops of the hooks provided with the unit, as these hooks are made in uneven lengths to obtain the proper slope for the tube. **The upper end of the reflector should be about 8 inches higher than the lower end when the mounting is finished.**

The next step is to insert the shifter switch in its mounting and connect its terminals to the binding posts provided. This shifter when mounted, should rotate freely, and it should not be possible for it to slip to either side far enough so that the metal armature can touch either of the iron cores of the induction coils. Next, the tube should be unpacked and washed clean before mounting. Remember to handle these tubes very carefully to avoid cracking them. To **test** new tubes before placing them in the lamp, or for testing old tubes that are thought to be defective, the condition of the **vacuum can be determined by the sound** of the mercury in the tube when it is allowed to run slowly from one end to the other. Tilt the tube up so the mercury runs slowly down to the opposite end, and if it produces **sharp-sounding metallic clicks** like shot rolling in the tube, this indicates that the vacuum is good. If the mercury slides to the bottom end of the tube without producing these clicks it is an indication that the tube has leaked air and the vacuum is destroyed.

The end with the two horns should be at the higher end of the reflector. Place the tube in the holding clamps and tighten them securely, but not

## **Illumination**

too tight, or the glass may be cracked when heated. It should be possible to rotate the tube with the fingers after the clamps have been fastened. Be sure that the single negative terminal points straight down from the black bulb. Observe the mercury to see that it covers the metal contact which is sealed in the glass at this terminal. If these lamps are operated without sufficient mercury in the bottom end the tube may be ruined.

After the tube is installed, it is a very simple matter to connect its terminals to the wires provided on the lamp unit and reflector.

### **5. OPERATING VOLTAGE**

The tubes are rather critical as to their operating voltage, and if the line voltage is considerably lower than normal because of voltage drop, the lamps may not start promptly. In this case, when they are turned on the mercury switch may keep operating and clicking repeatedly, without starting the lamp. When this happens the voltage at the line terminals should be tested with a volt meter, and if it is found too low the connections can be shifted to the inner taps shown on the auto transformer coils. This will enable the transformer to raise the voltage on the tube.

These terminals are usually marked for the different voltages, so it is easy to tell where to connect the line wires. When these lamps are connected on circuits from 95 to 125 volts, wires not smaller than No. 12 should be used, and each circuit for a single lamp should be fused for 15 amperes.

For each additional lamp placed on any branch circuit, the fuse should be increased by 10 amperes per lamp.

### **6. CARE AND MAINTENANCE**

If mercury vapor lamps are installed in cold rooms they may be somewhat slow in starting and also give less than normal candlepower. In such cases it may also be necessary to change the line connections to apply higher voltage to the tube; or even to increase the line voltage somewhat.

## Mercury Vapor Lamps

The resistance units used with these lamps occasionally burn out but they can be very easily replaced, as they are screwed into standard sockets on the unit, the same as a lamp or plug fuse would be.

In maintaining a group of these lamps it is very important to keep the tubes clean by washing them occasionally with soap and water, and also to keep the negative terminal and starting band free from dust and dirt. An accumulation of dirt around the starting band will often allow the high voltage starting current to flash over at this terminal and cause the lamp to fail to start.

If a lamp fails to start after several operations of the shifter switch it should be turned off until the trouble is located, so that this switch will not be damaged by continuous operation. Failure to start is usually due to one of the following causes: low line voltage, very cold tube, blown fuses, burned out resistance unit, stuck or broken shifter switch, loose connection, cracked tube, or dirt accumulated at the starting band on the negative terminal. Checking each of these items systematically will usually locate the trouble.

The transformer or induction coils can easily be tested for open circuits, shorts, or grounds, as explained in previous sections.

**Be very careful not to connect an A.C. lamp on a D. C. circuit, or a 60 cycle A. C. lamp on a 25 cycle circuit, or it will be burned out.**

Extra tubes and resistance units can be obtained from the lamp manufacturers and kept on hand for convenient and prompt repairs.

The extensive use of this type of lamp in manufacturing plants will make this material very valuable for any maintenance electrician to know, and have on hand for future reference.

### 7. HIGH INTENSITY MERCURY VAPOR LAMPS

A recently developed mercury vapor lamp, known as the high intensity mercury vapor lamp, is shown in Fig. 4. This lamp produces a bluish white light



## Illumination



Fig. 4

which is excellent for machine shop or other industrial operations where metal parts are to be handled.

This lamp has a very high efficiency, of about 40 lumens per watt, as compared with 15 to 18 lumens per watt for ordinary incandescent lamps. These lamps are made in 250 and 400 watt sizes.

The larger size is constructed with two bulbs, one within the other as shown in Fig. 4. The inner bulb contains mercury vapor, and a small amount of argon gas, two main operating or arc electrodes, A and B, and one auxiliary starting electrode C.

An evacuated space between the inner and outer bulbs helps to retain enough heat for best operation of the lamp.

These lamps start on about 5 amperes at 20 volts, and after heated up, they operate on about 2.9 amperes at 150 volts. These special voltages are supplied by individual auto transformer or reactor units used with each lamp. This permits operation of the lamps on regular 110 or 220 volt A. C. circuits.

When these lamps are first turned on they produce a faint blue glow from a small arc started between electrodes A and C. After a warm up period about 10 or 12 minutes, the main arc forms between electrodes A and B, producing very intense blue-white light. **The larger sized lamps of this type must be operated in a vertical position to prevent the arc from bowing and melting the glass bulb.**

### 8. SODIUM VAPOR LAMPS

One of the newer types of lamps which is coming into use for highway and street lighting, uses sodium vapor in which an arc is set up by means of special electrodes connected to an individual transformer for each lamp.

## Mercury Vapor Lamps

The sodium vapor and electrodes, as well as the starting filaments are located within a sealed inner glass bulb. (See Fig. 5.) An outer sealed bulb maintains an evacuated space or "vacuum envelope" around the inner bulb, to help retain the heat required for these lamps to operate at best efficiency.

The filaments in each end of the bulb are used to heat the vapor and throw off electrons to start the lamp, after which an arc is maintained between the anodes in opposite ends of the tube. A small amount of neon gas is included in these lamps to aid in starting the arc.

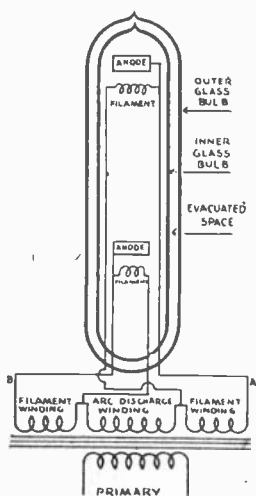

Fig. 5

The lamps produce a light of yellow color which is very good for clear vision on highways and streets. The efficiency of these sodium lamps is about 45 lumens per watt, or almost 3 times as high as that of ordinary incandescent lamps.

They operate on from 2 to 28 volts and 5 to 10 amperes. The special voltages required for the filaments and electrodes are supplied by separate windings of a special small transformer for each lamp as shown in Fig. 5.

## HOME LIGHTING

With the vast number of homes in this country that are wired for electricity, there are still hundreds of thousands of old houses to be wired, as well as the many thousands of new ones that are built yearly.

Another very important fact to consider, from the standpoint of opportunities for the trained electrical man, is that actually a majority of the homes that have been wired a few years do not have efficient

## Illumination

or adequate lighting. This is partly because the old style fixtures installed years ago were not made very efficient, and partly because it used to be the opinion that home-lighting fixtures should be chosen for beauty and appearance, rather than for lighting efficiency.

This idea is out-of-date, and the most important essential in modern home-lighting is first to see that the wiring and fixtures are planned and chosen to give **adequate light of the right quality**; and second to give proper attention to the **appearance and artistic features**.

We should keep well in mind that good fixtures are now made to provide ample and proper lighting, as well as pleasing appearance and decorative effects.

Properly designed lighting is one of the greatest comforts and conveniences that any home owner can enjoy, and in building new homes or remodeling old ones, the lighting should be considered equally as important as many pieces of the furniture, and as one of the most important features of the decorations.

Home lighting does not require any elaborate calculations, but the illumination for practically any room can be easily planned by application of the simple fundamentals of illumination, and the general rules on the following pages. Furthermore, the great number of homes which really require improved lighting and more modern fixtures, offer splendid opportunities right in his own neighborhood, to practically every trained man who wishes to take advantage of them.

### 9. LIVING ROOM LIGHTING

The living room is, of course, one of the most important rooms to have well lighted, as in the average home this room is the one in which the members of the family spend much of their time, and also one that we wish to have most attractive when guests are present.

Proper lighting units for the living room are the ceiling shower or cluster, wall bracket lights, and portable floor or table lamps. The ceiling fixtures

## Home Lighting

are often called chandeliers or by the more modern name **Luminaire**. No one of these types of lights is alone sufficient for a well-lighted living room, but



**Fig. 6.** This photo shows a living room lighted only by the ceiling fixture. There is plenty of light in the center of the room, but you will note the room appears very plain.

two or all three of them should be combined to obtain the varied or complete lighting effects desirable.

### 10. CHOICE OF CEILING, WALL, OR PORTABLE UNITS

The ceiling fixture for the average sized living room should consist of four or more lamps of 40 watts each or larger, and they should be equipped with glass shades to soften the light and prevent glare.

The purpose of the ceiling fixture is to provide general light throughout the room, and it should provide sufficient light to give the room a bright and cheerful appearance.

Ceiling fixtures should, of course, be chosen of a design and color to harmonize with the room furnishings and decorations, and they can be hung either quite close to the ceiling in low rooms, or suspended down farther in higher rooms.

## Illumination

Usually they will shed a more even light on the ceiling if they are down from 18 to 30 inches from it. The bottom of the fixture should be at least 6 ft.



Fig. 7. The same living room as shown in Fig. 6, lighted only with portable lamps, for reading directly under these lamps.

6 in. or more from the floor; and preferably 7 ft. or more, even if it is necessary to use a very short fixture close to the ceiling.

Fig. 6 shows a living room lighted by a ceiling fixture only, and while the room is fairly well lighted, the general appearance is plain and drab and the light is centered too much above and below the fixture.

Portable floor and bridge lamps, as well as table lamps, are very good for local spots of light and for reading in a chair directly beneath them without lighting the rest of the room. They also add a great deal to the decorative appearance, with their local spots of light and their colored shades.

There is in many homes, however, a wrong tendency, to depend on portable lamps almost entirely for living room light. Portable lamps are not intended for this, and do not give sufficient general illumination for many occasions.

Fig. 7 shows a room using only the portable lamps and while the effect is restful and fine for a

## Home Lighting

quiet evening alone with a book, it would not do at all for a room full of company, with card games or social gatherings.



Fig. 8. Here we have the same room lighted by the ceiling unit, wall lights, and portable lamps. Compare carefully the different effects in this photograph and the two preceding ones.

Floor lamps with open tops, and in some cases extra lamps and reflectors to direct light to the ceiling, are very useful and beautiful in their effects.

Fig. 8 shows a room well lighted by the ceiling luminaire and portable lamps, and with the walls "livened up" by wall bracket lights. A combination of lighting units of this kind provides wonderful decorative possibilities and comfort, by the use of all or certain ones of the lights at proper times.

Novelty table lamps, concealed cove lights, and artificial electric windows, can also be added to produce beautiful effects and increased attractiveness of the living room. Some of these are shown in Fig. 9.

Sun parlors or porches should also be well equipped with outlets for floors and table lamps; and ceiling fixtures of a type that give a soft light are desirable.

### 11. I. E. S. STUDENT LAMPS

A very excellent and efficient new type of lamp for reading, student's use, or office desk work is

## Illumination

called the I. E. S. (Illumination Engineering Society) student lamp. This lamp has been carefully designed to meet best lighting standards, and to provide ample lighting intensity with a minimum of glare and shadow.

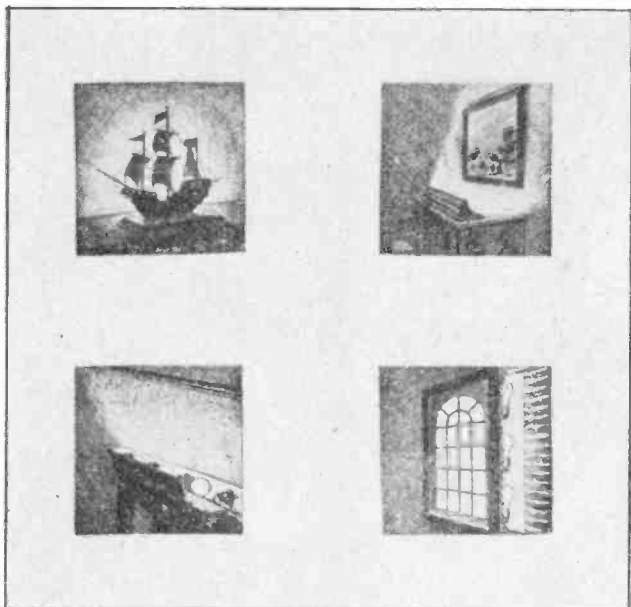

Fig. 9. These four views illustrate some of the effects obtainable with lights placed behind decorative objects, concealed coves, and artificial windows.

A view of this lamp is shown in Fig. 10. The exact diameter of the shade and its height from the table have been carefully determined. The color and reflecting quality of the shade material are also important. The dense opal glass inverted bowl on which the shade rests is also an important feature in the efficient operation of this lamp. This bowl softly diffuses the downward light and blends the bowl brilliancy nicely with the light from the reflecting surface of the shade. The bowl also permits enough light to go up to the ceiling to provide some general illumination in the room and thus avoid sharp contrasts.

A very interesting feature of one model of this I. E. S. lamp is that it is equipped with a special

## Student Lamp

3-light bulb to permit control of the amount of light for various purposes. These lamps are made in 50-100-150 watt, and also 100-200-300 watt size. They have two filaments controlled by an elec-

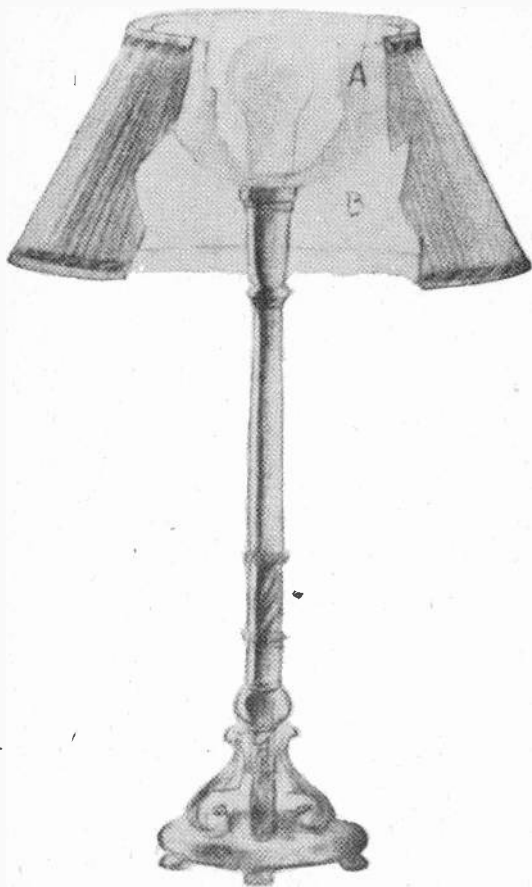

Fig. 10. Sectional view of new type student or reading lamps, showing diffusing bowl, shade and stand.

trol switch in the lamp. On the smaller size one filament is of 50 watts and one of 100 watts. Either of these can be operated separately. Another position of the switch puts both filaments in operation in parallel, using 150 watts.



## Illustration

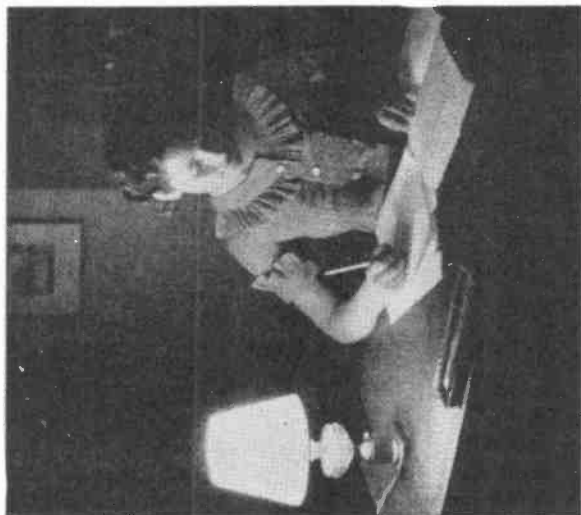
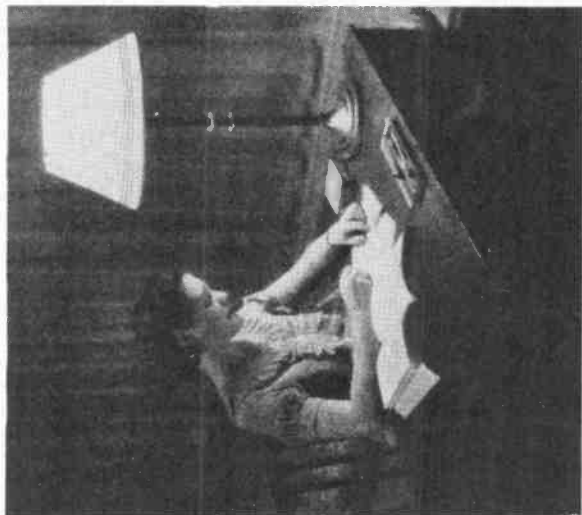

Fig. 11. Note the contrast in these two photos. The new I. E. S. lamp on the right provides more adequate light with much less shadow and glare, and greatly reduces eye strain and fatigue.

## Home Lighting

### 12. DINING ROOM FIXTURES

In the dining room we should have a flood of soft white light on the table, and sufficient light on the walls and ceiling to prevent them from appearing dark and depressing. There should also be a reasonable amount of light on the faces of the diners. Here we can use a good-looking ceiling fixture with four or more shaded lamps of about 50 watts each or larger. This fixture should be hung low enough to center its light well on the table, and yet not low enough to shed too much light in the eyes of persons seated at the table. About 30" to 36" above the table is generally a good height.

Buffet lights add to the appearance, and provide part of the extra light needed for the walls. A very well-lighted dining room is shown in Fig. 12.

Beautiful effects in dining room lighting can also

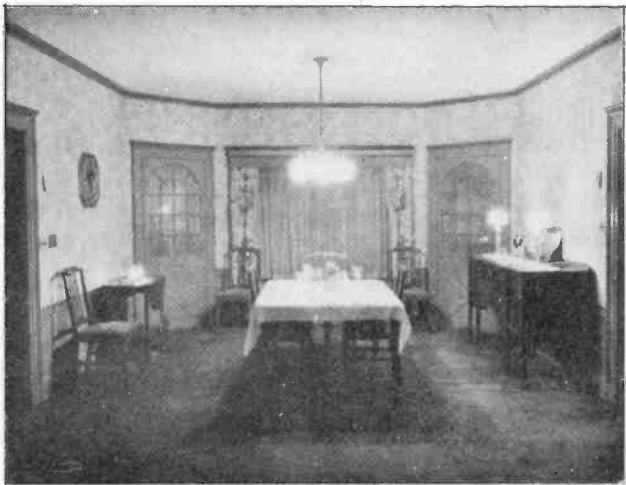

Fig. 12. The above dining room photo shows the manner in which the light should be principally centered on the table, and yet should light the walls and ceiling sufficiently to prevent a dark appearance in the room.

be obtained with a semi-indirect ceiling fixture and wall lights of the types shown in Fig. 13.

Semi-indirect ceiling luminaires of this type shed soft white light on the table to make the dishes,

## Illumination

food, and silverware show up to excellent advantage; and they also direct sufficient light on the ceiling to give a cheerful and well-lighted appearance to the room.

The inverted bowl wall lights of the type shown in Fig. 13, add the small fountains, or touches of light on the walls, which just complete the good appearance of this room.

Fig. 14 shows a number of popular fixtures which are both efficient and beautiful in appearance. These units deliver a sufficient quantity of well diffused light, and add to the comfort, appearance, and actual value of a home enough to be worth many times their cost.

The semi-indirect unit in the upper right corner of

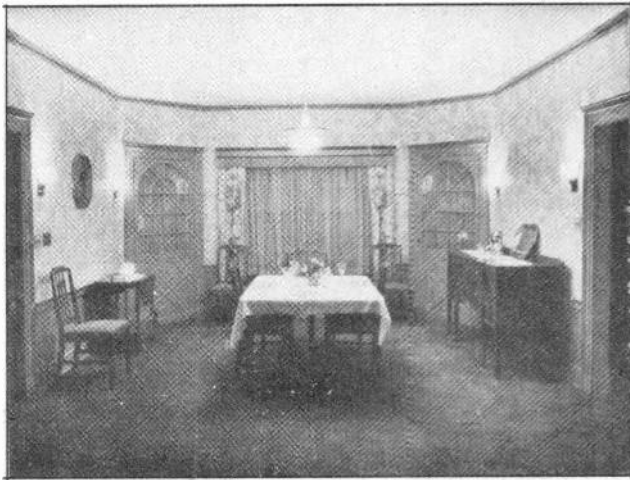

Fig. 13. A combination of semi-indirect ceiling fixture with shaded wall lights of the type shown, produces a very beautiful lighting effect.

Fig. 14 is typically a dining room fixture, and the one in the center of the top row is particularly good for use in low living rooms. The others are typical living room fixtures.

Fig. 15 shows several styles of fixtures that are commonly used for dining room lighting.

## Home Lighting

### 13. BEDROOM LIGHTING

Bedrooms should also be well lighted with soft light that is not tiring to the eyes of one lying in bed. Ceiling units of the types shown in Fig. 16 and mounted close to the ceiling are very good.

It is very important to have sufficient light at dressing tables and on mirrors; and wall bracket

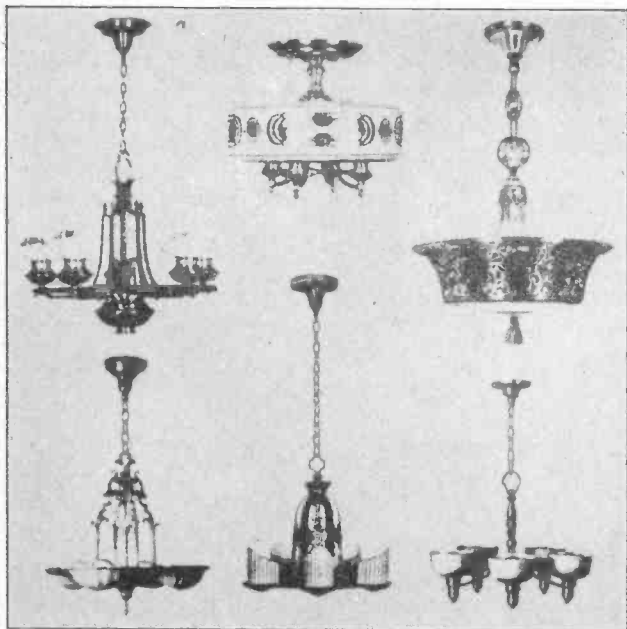

Fig. 14. Several very efficient and popular types of dining room and living room fixtures.

lights or attachable brackets for clamping on each side of the mirrors should be provided.

Portable lamps on small tables by the beds, or clamp lights to mount on the heads of beds are ideal for reading lights.

Plenty of convenience outlets should be provided around the walls of bedrooms, for the attachment plugs of portable lamps, curling irons, fans, etc.

A switch controlling one of the lights in the room should be located near enough to the bed to be within easy reach of a person either in bed or right at its edge.

## Illumination

The clamp lights on the head of the bed will accomplish this, or in some cases a small light is mounted under the bed with a switch at the head of the bed. These lights will shed sufficient light on the floor to enable one to move about the room easily, and yet they do not throw light in the faces

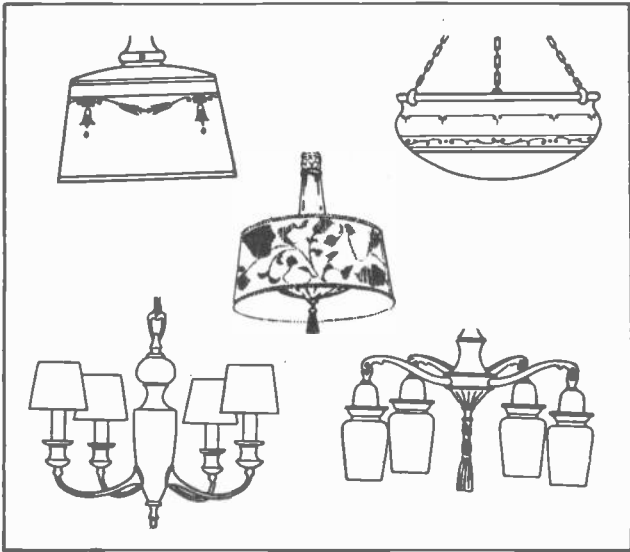

Fig. 15. Units of the above type are very appropriate for dining room lighting.

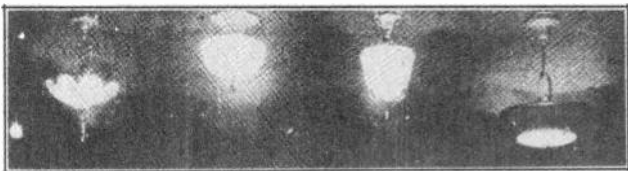

Fig. 16. Several types of bed room fixtures which are mounted close to the ceiling and produce soft, well-diffused light.

of other sleepers. Fig. 17 shows a well lighted bedroom.

### 14. KITCHEN UNITS

The kitchen is one of the simplest rooms in a house to properly illuminate and yet it should always receive careful attention, because it is the one in which the housewife spends a great deal of her time.

## Home Lighting

A low hanging fixture should never be used in a kitchen, but instead a short unit which is high up and close to the ceiling should be used. It should be of the enclosed type with a dense white glass bowl, and equipped with at least a 100-watt lamp.



Fig. 17. This photo shows a well lighted bedroom, using the dome light in the ceiling and portable lights on the dresser and table.

Such a unit will provide well diffused light of good intensity throughout the ordinary kitchen. In addition to this overhead unit, it is usually well to have a wall bracket light with a white glass shade mounted over the sink, and possibly one over the range. Fig. 18 shows how cheerful a kitchen can be made with proper lighting and light colored walls and ceiling.

The left view in Fig. 19 shows more clearly, the shape of the kitchen unit and wall light and on the right is shown a very good unit of the porcelain enameled, metal dome type, to be used in the laundry room in basements.

Lighting units of this type are so low in cost compared to their value in the home, that it is often very easy to sell the home owner modern kitchen and laundry lighting equipment and get the job of replacing his old ones with the new.

Clothes closets should be equipped with a wall bracket light over the door, and enough to one side so if a pull-cord switch is used the cord will not

## Illumination

hang directly in the doorway. A wall switch at the door or just inside may also be used.



Fig. 18. A well lighted kitchen, such as shown above, is one of the greatest conveniences in any home.



Fig. 19. At the left is shown the arrangement of ceiling unit and wall bracket light for kitchen. On the right a very efficient type of reflector for laundry rooms and basement lighting.

## 15. BATH ROOM LIGHTS

Bath rooms should have two wall bracket lights above the wash stand, one on each side of the mir-

## Home Lighting

ror. Another above the mirror is also very convenient for general light in the room and for combing one's hair. Bath room lights can be controlled by key sockets or pull chain sockets on the bracket lights at the mirror or by wall switches for lights out of reach. If chain sockets are used on non-polarized wiring systems, insulator links should be put in the chains to reduce chances of persons obtaining shocks by touching the chain when one hand is on a faucet.

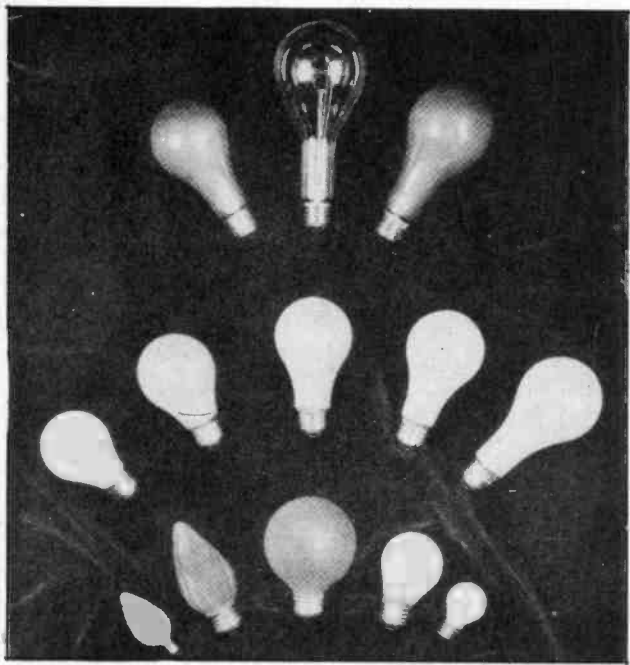

Fig. 20. Above are shown a number of modern Mazda lamps of the types commonly used in home lighting.

The mirror lights should be low enough to illuminate one's face and the under side of the chin for shaving, and should use 50-watt inside frosted bulbs.

Large dark colored bath rooms may also require a ceiling light.



### 16. PORCHES, ATTICS, BASEMENTS, AND GARAGES

Porches and entrances can be made safer and much better appearing at night, by the use of ceiling lights of lantern design on the porch, or bracket lights of suitable weather proof type at each side of doors.

Attics and basements should be lighted with drop-cord lights or other low cost units, and in sufficient number to enable one to work conveniently in any part of them. Where basements are used for children's play rooms ceiling fixtures similar to kitchen units can be used, and controlled by pull-cords or wall switches.

Garages should not be forgotten, and the light should be controlled by three-way switches both from the house and garage as previously explained. One or more attachment plug receptacles should also be provided, to permit the use of portable trouble lights or vacuum cleaners around the car. Fig. 20 shows a number of the various types and sizes of Mazda lamps commonly used in home lighting.

In wiring any home for lights remember to install plenty of convenience outlets in all rooms, and three-way and four-way switches where they will add to the convenience in controlling the lights.

### 17. QUALITY WORK PAYS

Always recommend lighting equipment that will be a permanent satisfaction to your customer as well as a credit to yourself. The home owner's pride in the appearance of his home, and his concern for the comfort, convenience and safety of his wife and children, are points that should not be forgotten in selling good lighting.

In completing this simplified practical material on illumination you can readily see that it is one of the greatest fields of opportunity for profitable and interesting work that the electrical industry offers to the trained man. We are certain that whether you choose to specialize in this line of

## Home Lighting

work, either as an employee of a contractor or fixture dealer, or in business for yourself, you will find the material covered in this section of great value to you. No matter what line of electrical work you may follow, a practical knowledge of these principles of good illumination will prove handy to you many times in the coming years.

### EXAMINATION QUESTIONS

1. What are two advantages of the mercury vapor lamp over ordinary incandescent lamps for industrial lighting?
2. What is the purpose of the shifter switch and induction coil in a mercury vapor lamp?
3. About what voltage is applied to the tube of the ordinary mercury vapor lamp for starting?
4. Describe a simple practical test to determine whether or not a mercury vapor lamp tube has lost its vacuum.
5. What are several causes of a mercury vapor lamp failing to start?
6.
  - a. What is the efficiency in lumens per watts, of the high intensity mercury vapor lamp?
  - b. What is the starting voltage?
  - c. What is the operating voltage?
7. For what class of lighting are sodium vapor lamps used?
8. What are two important requirements of a good home lighting system?
9. About what height should a dining room ceiling fixture be mounted above the table?
10. What type of portable lamp would you recommend for student use?
  - b. What are several of the advantages of this lamp?

# NEON SIGNS

The principal parts of a neon sign are shown by Fig. 1. Although here we show only a single letter formed by the luminous tubing connected to the transformer, ordinarily the one transformer would furnish current for several letters or words, and possibly for ornamental borders and other features of the sign.

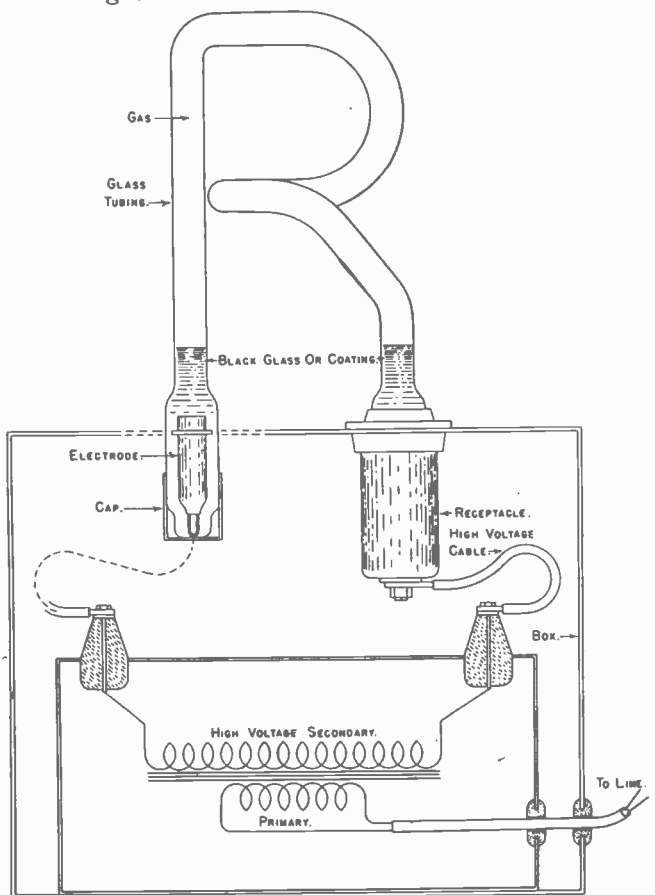

Fig. 1. The Principal Parts of a Neon Sign.

The exposed and visible parts of the sign consist

## Neon Signs

of glass tubing in which is neon or other gases which become luminous when high voltage from the secondary of the transformer forces current through the gas. The tubing is continuous from one transformer connection to the other, with portions which are to be invisible formed with black glass or coated with black paint.

In each end of each section is a metallic electrode through which the alternating current enters and leaves the gas. Wires from the electrode pass through a gas-tight glass press and are soldered or welded to a metallic cap. The capped ends of the tubing section fit into receptacles to which are attached the high voltage cables from the secondary terminals of the transformer. The tubing is mounted on the sign panel or framework with supports which usually consist of a glass extension on a metal base, with the sign tubing wired onto the glass of the supports.

The high voltage secondary of the transformer furnishes a potential difference of from 2,000 to 15,000 volts for its section of tubing, the voltage depending on the length and diameter of tubing and on the kind of gas or gases in the tubing. Current through the tubing usually is between 15 and 50 milliamperers, or between 0.015 and 0.050 ampere.

### HOW A NEON SIGN IS BUILT

The first step in building a neon sign is to lay out the letters in full size on a sheet of asbestos or other heat-proof material. Then the tubing is heated in gas flames, is bent to the shape of the letters, and is spliced together to make lengths suitable for connection to a transformer. A small piece of tubing, called the tubulation, is attached to each section of sign tubing so that air may be pumped out and the gas admitted.

To each end of the tubing section is then attached

## Neon Signs

an electrode. As shown by Fig. 2, the electrode with its wire lead comes made up into a short piece of glass tubing. This glass jacket of the electrode is welded (melted) to the ends of the sign tubing. The tubing section now is checked for air-tightness by using the tubulation opening, then is connected to a vacuum pump through the tubulation and enough air pumped out to lower the internal pressure.

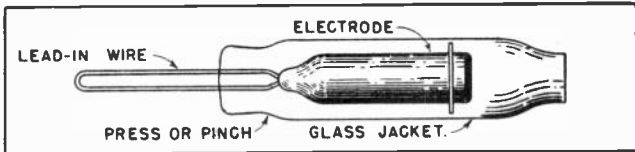

Fig. 2. An Electrode in its Glass Jacket for Attachment to Tubing.

The next step is to connect the electrode leads to a bombarding transformer, which is a transformer that furnishes a voltage as high as or higher than the regular operating voltage and furnishes a current larger than that which will be used during normal operation. The bombardment current passing through the air remaining in the tubing produces brilliant light and a great deal of heat. The electrodes become red hot and the tubing gets so hot it will scorch paper. The combination of high temperature and reduced pressure inside the tubing allows all kinds of impurities to come out of the glass and the electrodes and to be pumped out of the tubing as the pressure is further reduced by the vacuum pump after the bombarding transformer is turned off.

The tubulation now is disconnected from the vacuum pump and attached to the glass flasks or flasks in which are the gas or gases to be used in the sign. Enough gas is admitted to bring the pressure up to the desired operating value and the tubulation opening is sealed off by melting the glass. The final step may be that of aging the sign by running it for a few minutes with a current that is about the same or somewhat greater than the normal operating current, continuing this aging

## Neon Signs

for a few minutes until the gas inside the tubing shows normal brilliancy. The sign now is ready for mounting.

### GASES USED IN LUMINOUS SIGNS

The tubing of luminous signs, which generally are called neon signs regardless of the gas actually used, are filled with neon, helium or argon, with a mixture of all three, or with a mixture of neon and argon or one of helium and argon. In addition to these gases the tubing may contain mercury vapor which is produced by evaporating a drop of liquid mercury by means of the heat of the discharge through the gases.

In clear glass tubing, neon alone produces the orange-red glow that is characteristic of neon signs. With a little mercury vapor added to the neon the light becomes blue. Mercury vapor by itself produces green light. Helium produces a pinkish-white light.

Argon alone in a clear glass tube produces a pale blue light which is not intense enough or brilliant enough for sign work. Argon is mixed with the other gases because it has much lower electrical resistance than the others and permits the discharge to commence at voltages considerably lower than would be needed for neon or helium. Argon in a tube containing mercury allows the initial discharge whose heat vaporizes the mercury. Argon often is called "blue gas" in the sign trade. Neon and argon give deep lavender, helium and argon give pink, while neon, helium and mercury vapor give blues and greens.

The quantity of gas in the tubing is proportional to the pressure of the gas. The higher the pressure the more gas is in the tubing, just as a higher pressure in an automobile tire means more air in the tire. Gas pressures always are far below the pressure of open air. Average pressure in the air at sea level is 14.7 pounds per square inch, which is equal to the downward pressure per square inch of a column of mercury 760 millimeters, or approxi-

## Neon Signs

mately 30 inches in height. Gas pressures in luminous tubing usually run from 10 to 20 millimeters of mercury, which means pressures per square inch equal to that of mercury only 10 to 20 millimeters in height. This means that the gas pressure inside the tube is roughly about 2% of normal atmospheric pressure.

The opposition to flow of current through the gas is least when the pressure is about three millimeters of mercury. At still lower gas pressures the opposition increases very rapidly and the current drops off accordingly with a given voltage difference across the tubing. At higher gas pressures the opposition to current flow increases slowly, and, of course, the current decreases slowly for a given voltage difference.

With a given current in the tube the more gas that is present the more light will be produced, so as to obtain desirable amounts of light it is necessary to have in the tubing more gas and a higher pressure than would provide the least opposition to current flow. Another reason for having more gas is that the gas gradually disappears from the space inside the tubing while the sign operates.

### ELECTRODES

The electrodes must be made of materials which will not deteriorate rapidly when heated in the gases used inside the tubing, and the materials must not combine chemically with the gases. Heating depends on the current carried by the electrode and on the drop of voltage which occurs at and near the surface where current enters and leaves the gas. The size of the electrode, or its surface area, varies in accordance with the current and with the kind of gas. The kind of gas also affects the operating voltages.

Electrodes generally are made from iron, copper, aluminum or nickel, any of which must be in a highly purified condition. Surfaces may be treated with chemicals that retard combination of the elec-

## Neon Signs

trode material with the gases and that retard oxidation. Copper electrodes may be treated with borax for this purpose. The wires that pass through the glass press or the pinch usually are made of an iron-nickel alloy that expands and contracts at the same rate as the glass when heated and cooled, thus preventing cracking of the glass.

During operation of the sign the action of gas molecules striking the electrode surface causes electrode metal to be detached, an action called sputtering of the electrodes. The detached metal lodges on the inside of the tubing near the electrodes. The end blackening and the slight loss of metal from the electrode are of no particular consequence, but as sputtering continues the gas gradually disappears from the space within the tubing. The useful life of the sign comes to an end when the amount of gas and the gas pressure drops so far that there no longer is sufficient light emitted or when the rising opposition to current prevents a further flow with voltage furnished by the transformer. Sputtering and "cleanup" of the gas is retarded by higher gas pressures and by the use of electrode materials adapted to the kind of gas used.

### SIGN TUBING

Luminous sign tubing varies in outside diameter from 5 to 45 millimeters. There are 25.4 millimeters in one inch, so we have tubing from about 1/5 inch to nearly two inches in diameter. Sizes most commonly used are from 6 to 20 millimeters in outside diameter, between which there are standard sizes at each millimeter. Fig. 3 shows comparisons between a few sizes of tubing.

Tubing may be transparent and colorless, or it may be made with various colored glasses, may contain uranium which gives light by fluorescence, or may be coated with fluorescent materials. With clear glass tubing the color of the light depends on the gases used, as previously explained.

Neon in red glass gives a light of nearly pure red, while in purple glass it gives a lavender-red



## Neon Signs

and in yellow glass gives orange. Helium in amber or yellow glass produces shades of yellow, tan and gold. Many other colored glasses may be used. Neon used in fluorescent tubing will produce such colors as orange, rose, gold, salmon, lilac or deep pink. The same tubings filled with mercury and argon will give white, blue, green, daylight effect, deep blue or orchid. Argon in uranium glass gives a clear green. The subject of Fluorescence is explained in the section on fluorescent lamps.

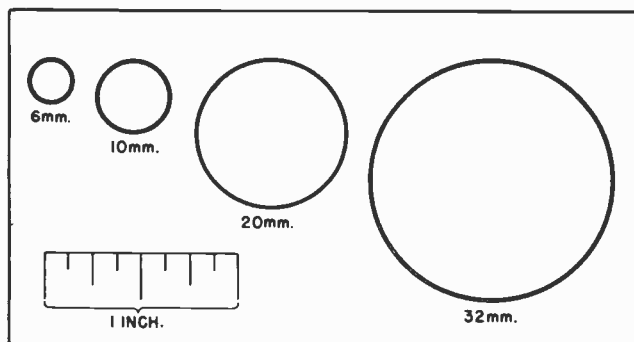

Fig. 3. Relative Sizes of Some Luminous Sign Tubing.

### VOLTAGES AND CURRENTS

The gas inside the sign tubing is an electrical conductor. As with any other conductor, the resistance increases with length, so the greater the length of tubing the higher the voltage required to send a given current through it, or the less the current for a given voltage. Again, as with other conductors, the greater the cross sectional area, which is proportional to tubing diameter squared, the less is the resistance. The greater the diameter of the tubing, the more current will flow with a given voltage difference; or the lower will be the voltage required to produce a given current.

The statements just made with reference to tubing length and diameter, and the corresponding voltages and currents, apply for any given gas at some certain pressure, or apply when the gas and

## Neon Signs

its pressure remain unchanged. Different gases offer different resistances to current flow. Of the three commonly used gases, argon has the least resistance, neon has more than argon, and helium has much more than neon. As mentioned once before, the resistance is least when the pressure is

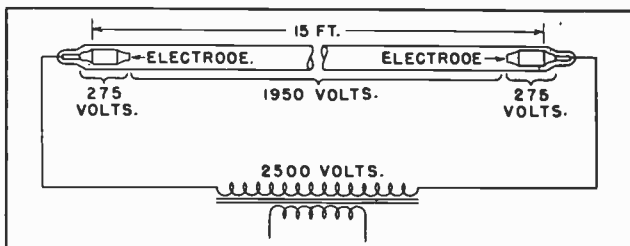

Fig. 4. Voltage Distribution in Sign Tubing.

about three millimeters of mercury, and it increases with either less pressure or more.

The light emitted by the tubing depends on the relation between gas pressure and current. More pressure, which means more gas, with a given current means more light. More current with the same gas pressure also means more light. These relations are true because light results from collisions between electron and atoms. More gas in a given space, or more current in the given space, then must mean more collisions and more light. This explains why a certain current produces more light in a tube of small diameter than in one of larger diameter when the gas pressure is the same, we simply are crowding the electrical action into a smaller space and so have more action and more light. Small diameter tubing, with its high "current density," heats to a higher temperature than does larger tubing. This is a decided advantage of small tubing when using mercury, for the mercury must be vaporized by heat in the tubing.

In a typical sign with a tubing section 15 feet long the potential difference across the ends may be 2,500 volts, as shown by Fig. 4. The total volt-

## Neon Signs

age drop is made up of 1950 volts drop along the length of the tubing and of 550 volts drop at the electrodes where current is entering and leaving the gas. If we make the tubing shorter the electrode drop will remain the same but the tubing drop will decrease as the length decreases. The result is that we are using a greater percentage of the total voltage at the electrodes and a smaller percentage for producing light in the tubing. This is wasteful of power, so as a general rule it is not advisable to use very short lengths of tubing. On the other hand, if we go to extremely long lengths, the voltage difference required for operation becomes too high to be easily produced by ordinary transformers, or too high to be insulated by the usual kinds of insulation used on high-voltage conductors.

### TRANSFORMERS FOR LUMINOUS TUBES

The transformer for operating a luminous tube sign must furnish a very high voltage for breaking down the resistance of the cold gas and starting the discharge of current through the tubing. But if this high starting voltage were maintained after the discharge commences and the resistance drops, the current through the tubing would be excessive. Consequently we need a transformer that automatically limits the current, by lowering its voltage, once current commences to flow. Such a transformer is secured with a design that permits high leakage reactance. The general principle of one such design is shown by Fig. 5.

In a transformer we ordinarily desire that as many as possible of the magnetic lines of force from the primary winding cut through the turns of the secondary winding, thus producing the greatest possible induced voltage in the secondary for given changes of current in the primary. Magnetic lines which do not cut both windings are called leakage lines. With little leakage, or with good linkage of primary and secondary, the secondary voltage drops but little as the current increases.

## Neon Signs

In the transformer which is to have high leakage we build extensions or magnetic shunts on the core so that many of the magnetic lines from the primary are kept away from the secondary winding.

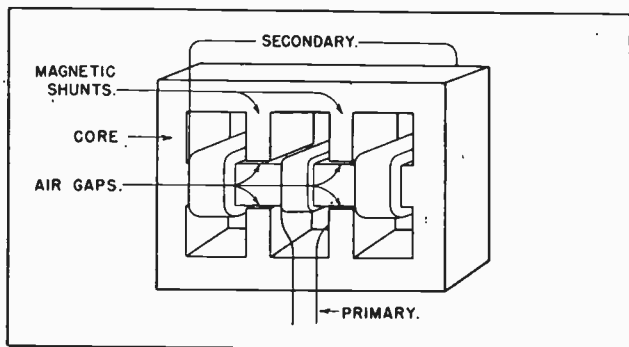

Fig. 5. Sign Transformer Having High Leakage Reactance, Showing the Magnetic Shunts Between Winding Sections.

Thus the greater the secondary current, the greater will be this magnetic leakage. The effect is as though we were to increase the reactance of the secondary winding as the current increases, so that the increasing reactance to flow of alternating current would sharply limit the increase of current. Even when the secondary terminals of a luminous tube transformer are short circuited on each other the secondary current will be only 20 to 60 milliamperes, depending on the type of transformer.

Luminous tube transformers usually are rated according to their open circuit secondary voltage, which is the voltage available for starting the discharge, and according to their short circuit secondary current, which is the maximum current that will flow under any conditions in the tubing circuit. The short circuit secondary current in these transformers may be only 15 to 20 per cent more than the normal operating current for the sign.

In transformers rated at 7,500 secondary volts and above, a connection or tap is brought out from the center of the secondary winding and, as in Fig. 6, is grounded through the metal case of the

## Neon Signs

transformer, which itself is connected to some good electrical ground. The maximum potential at either end of the secondary then is only half the secondary voltage, so the highest external voltage to ground is half that of the secondary winding. This reduces the hazards in using these very high voltages. When testing such a transformer for faults you will find a ground on the secondary, but this indicates no defect.

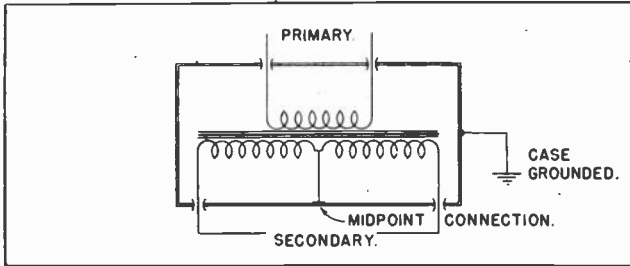

Fig. 6. How the Secondary Midpoint is Grounded.

Transformers of standard types usually are available on secondary open circuit voltage ratings of 2,000, 3,000, 4,000, 5,000, 6,000, 7,500, 9,000, 12,000 and 15,000 volts. Each voltage will be available in several ratings of short circuit currents, such as 18, 24 or 30 milliamperes. The higher the voltage of the transformer the greater the number of feet of tubing it will operate. After allowing for the voltage loss at the electrodes, which does not vary with tubing length, the number of feet of tubing on any transformer varies almost directly with transformer voltage. The larger the diameter of the tubing the greater is the length that may be handled with any transformer voltage. The kind of gas has much effect on the tubing length handled by a transformer. Where 30 feet of neon tubing might be placed on a given transformer, the same transformer would handle about 36 feet with mercury and argon, but only about 13 feet with helium.

Because of the high reactance of the luminous tube transformer, which is necessary in producing

## Neon Signs

the needed voltage regulation, this transformer has a very low power factor—usually something between 45 and 60 per cent. As explained in the section on fluorescent lamps, the power factor shows the percentage of current that is useful in producing power. A capacitor connected on the primary side of the transformer is often used to raise the power factor to 90 per cent or even better.

### SIGN FLASHERS

As you know from observing luminous tube signs the great majority, other than in the smallest sizes, are of the flasher type in which various letters, words, and decorative parts light alternately or in some definite order. This method of operation not only attracts more attention to the sign but also saves power, because only part of the tubing is lighted at one time.

Flasher switches are of two general types, one of them operating on the primary sides of transformers for each section of tubing, as in Fig. 7, and the other operating on the secondary side of a single transformer which lights several sections of tubing, as in Fig. 8. Switching on the primary

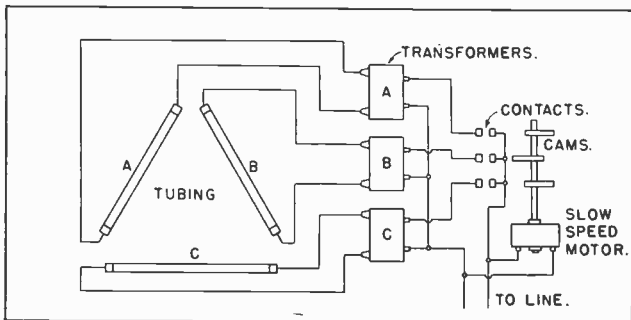

Fig. 7. Sign Flasher on Primary Side of Transformers.

side requires a separate transformer for each section of tubing whose lighting is to be separately controlled. With the high voltage flasher on the secondary wiring the single transformer is connected at different times to any tubing sections

## Neon Signs

or combinations of sections which provide a load suited to that transformer.

Note that in Fig. 8 the tubing sections are connected in parallel with one another, but that only one section is lighted at one time. If two sections were in parallel and an attempt were made to light both at once, the one having even slightly lower resistance than the other would light first and then the voltage would drop so low due to flow of current that the other section never would light.

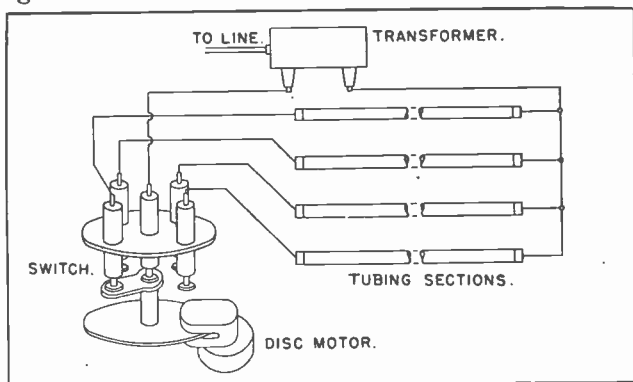

Fig. 8. Sign Flasher Operating in the High Voltage Secondary Circuit of a Single Transformer.

The high voltage flasher of Fig. 8 operates similarly to the high tension distributor of an automobile ignition system which sends current successively to the spark plugs. There is quite a bit of sparking in this type of switch, so it is completely enclosed by a ventilated housing. In some styles of high voltage flasher there are additional contactors which cut off current from the primary of the transformer at the moments when the high voltage circuit is being switched from one point to the next. Thus the high voltage switching takes place with no current flowing and there is no sparking.

## LUMINOUS SIGN TROUBLES

It already has been mentioned that the sign

## Neon Signs

eventually will fail, due to loss of gas from the space inside the tubing, because of normal sputtering. Among the more common causes for premature failure are tubing leaks at any splices which were made during construction, as at points between letters, or leaks at joints between the electrode cover and the tubing. Leaks may occur also at the sealed-off tip of the tubulation, or anywhere along the tubing. Leaks at and near the electrodes sometimes are caused by a broken or defective electrode housing. A style of housing having a spring contact for the electrode cap is illustrated in Fig. 9.

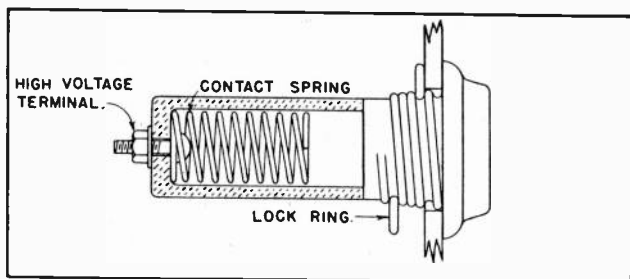

Fig. 9. A Receptacle for Luminous Tubing.

Excessive blackening of the tubing near the electrodes, before the sign has operated for very long, usually indicates excessive sputtering which is caused by low gas pressure. A flasher-operated tube in which there is a faint glow during periods when no current should go to this section may indicate that there is enough capacitance between parts of the flasher to permit some current to pass through the capacitance and tubing section.

It is highly important that the supply line voltage remain within its normal range. A low line voltage will cause the sign to flicker, especially when the transformer is operating a length of tubing near the maximum which may be handled with that transformer. If line voltage is persistently low the remedy is to install a larger transformer or else to use a shorter length of tubing. A booster transformer is sometimes connected between the reg-



## Neon Signs

ular transformer primary and the low voltage line. The booster is an auto-transformer that raises the voltage from the supply line by seven or eight volts before it reaches the sign transformer.

A transformer that is too small for the kind and length of tubing in its sign will run hot, will cause the sign to flicker, and eventually will burn out. Such a transformer causes much trouble in wet weather when there is more than the usual leakage of current across wet and dirty surfaces of insulation. An underloaded sign transformer, or one much larger than required for the connected tubing, also will run hot. This is because the voltage secondary current is too low to provide proper regulation; therefore, the operating primary current remains too high. As a general rule it is advisable to connect to each transformer a length of tubing almost equal to the maximum length of that kind and size of tubing that the transformer normally should operate.



## **Electricity on The Farm**

### **BUILDING ELECTRICAL EQUIPMENT FOR THE FARM**

The numerous uses for electricity on the farm, and the widespread increase in rural electrification during the past few years have turned the attention of farmers to the building of certain equipment designed to utilize electricity.

If the farm boys of today are to develop into successful farmers, able to found and maintain satisfying farm homes and to advance agriculture so that it keeps pace with modern industry, they should be equipped with certain knowledge and skills relating to electricity. The same is true with regard to adult farmers already established in their occupations.

The growing demand for new ways of using electricity on the farm is directly related to the increase of rural electrification since 1935, the date of the establishment of the Rural Electrification Administration.

The rapid increase in the number of farms using electricity, coupled with the change in rural living standards and production methods, is reflected in the desire of both present and prospective farmers to learn more about new and better ways of doing various farm jobs with electricity.

If a farmer has to purchase all of the electrical equipment desired or is forced to hire others to build it, his use of electricity will either be limited or more costly. There are many pieces of simple equipment that a farmer can make by following the procedures outlined in this section.

This section contains subject matter material supplied by the Rural Electrification Administration. It includes: (1) Hints on farm wiring, maintenance, and repair; (2) analyses of operative training content for special electrical jobs; (3) statements of certain interpretive science and related information of importance in connection with the jobs; (4) illustrations; (5) a list of uses of electricity.

### **HINTS ON PLANNING FARM WIRING, MAINTENANCE, AND REPAIR**

The first step toward the efficient and satisfactory

## Farm Wiring

use of electric current on a farm is a safe, properly installed, and adequate job of wiring intelligently planned to meet present as well as future needs.



**Electricity modernizes the farm and opens new opportunity**

In many instances rural people spend money to wire for lights only, and then find it will cost twice

## Electricity on The Farm

as much later on to extend or revise the entire system so they can get enough electricity to operate additional home appliances and farm equipment. Often it costs only half as much to install adequate wiring in the beginning for all future electrical needs.

To be able to use electricity effectively, convenience outlets should be provided for plugging-in floor lamps, radio, vacuum cleaner, toaster, coffee percolator, electric room heater, refrigerator, electric iron, washing machine, and the like. Special outlets are necessary for electric range and water heater as well as for the many pieces of equipment used in barns and other farm buildings.

In planning a farmstead wiring installation, the first thing to do is to determine where electricity can be used to advantage; then determine the type of an electric outlet required at the various locations.

Persons who have never used electricity and are wiring their homes for the first time usually think in terms of installing only a drop-cord in the center of each room. Then, if they want to use a radio, floor lamp, vacuum cleaner, washing machine, electric iron, refrigerator, or any other appliance, they simply screw into the lamp socket a plug-in receptacle containing a light outlet.

The first difficulty encountered by following such a procedure is that of having entangling wires spread all over the room. To overcome this, wires are tacked around the walls and doors. This creates a fire hazard, as in time the tacks are apt to break the insulation on the wires, thus causing sparks and short circuits.

The wire to a drop-cord outlet is only No. 16 or 18. This wire is not heavy enough to supply the required amount of power to operate properly any of the appliances, and may decrease the operating efficiency. The large amount of current that necessarily flows over these wires heats the insulation to an unsafe degree; sometimes causing it to break down. Short circuits result and may cause costly fires.

A convenience receptacle should be installed at every point on the premises where there is a future possibility of a motor-operated appliance of  $\frac{1}{4}$

## Simple Wiring Plans

horsepower or less being used, or wherever an appliance rated at 1,650 watts or less is to be used. Appliances with ratings above 1,650 watts require a special type of receptacle, and these receptacles should be connected to circuits larger than No. 12

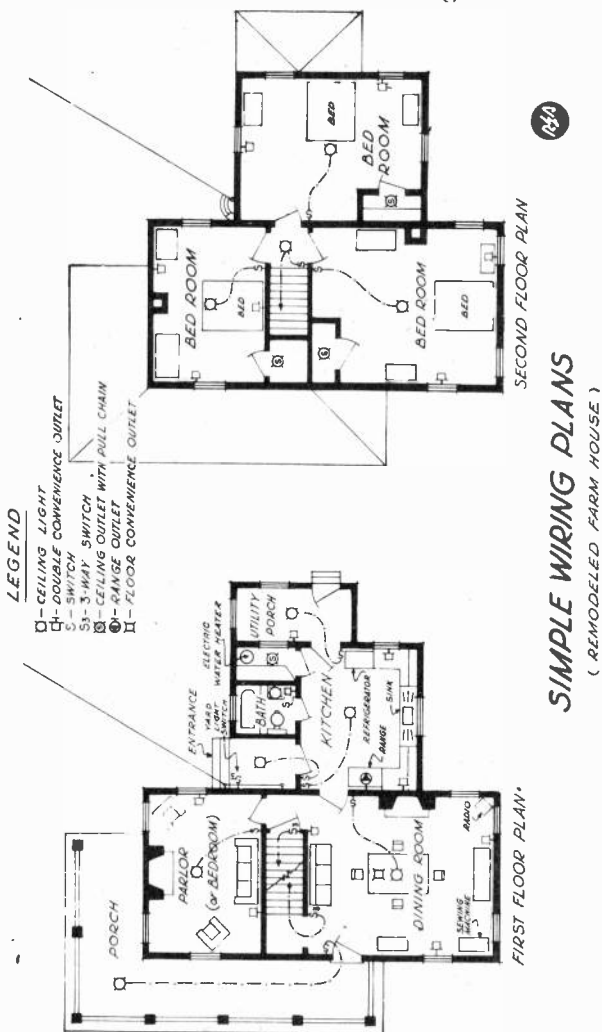

Figure 1

wire, as is explained later. No. 14 wire is satisfactory for ordinary branch circuits, other than the circuit for convenience outlets in the kitchen, dining

## Electricity on The Farm

room, laundry, and pantry, which should be of No. 12 wire.

### The House

In Figure 1\* is shown the plans of an average farm home which has been wired for electricity. This home is typical of old houses in which wiring was not installed at the time of building. Part of the remodeling here consisted of placing the bathroom on the side porch, since there was no other place available for it. When remodeling the kitchen, the old coal range was removed and an electric range installed in its place; also, a new kitchen sink and new cupboards. The following description refers to the various rooms shown on these plans and it is suggested that the plans be referred to while reading the following paragraphs:

In each bedroom, a ceiling light is provided and controlled from a switch at the door. A convenience receptacle is installed near the bed for a bed light, and one near the dresser for a lamp. Some prefer to use "pin-it-up" lamps in the convenience outlets—eliminating the ceiling outlet. If possible, receptacles should be located so that electric service could be used in two places from one duplex receptacle. Note that lights with pull-switch control have been provided in the closets.

In hall and stairway, three-way switches are provided for the lights, so they can be turned on or off from either floor.

In the dining room, there is a ceiling light over the table. As shown in the drawing, if desired, this light can be controlled by a switch at the door most frequently used to enter the room. There is a convenience receptacle under the table to operate toaster, waffle iron, or percolator; also a convenience outlet near the sideboard or serving table to connect the same equipment when not placed on the dining-room table, or to connect sideboard lights, vacuum cleaner, and the like. The dining room shown in the plan is used as dining room and general living quarters for the family. A receptacle

\*This typical farm wiring layout is a modification of a farmstead layout prepared by the Indiana Agricultural Extension Service, Purdue University, La Fayette, Ind. The plans of farm buildings are used by permission of the Committee on the Relation of Electricity to Agriculture, Chicago, Ill.

## Simple Wiring Plans

has been placed near the couch, as the farmer desired to rest and read after work. The receptacle mentioned as serving the vacuum cleaner or possible sideboard lights also supplies current for the radio. The receptacle near the serving table takes care of the sewing machine.

**In the kitchen**, in addition to the ceiling light controlled by a switch at the door, there is a convenience receptacle located so as to care for an electric refrigerator. A convenience receptacle is provided near the kitchen cabinet for the use of a toaster, waffle iron, broiler, or food mixer. A convenience outlet is also provided for the operation of a kitchen ventilating fan on hot, sultry days.

Although it is not always intended to install an electric range at once, it is wise to provide a range outlet so that wiring will not have to be changed later on. Also, the main switch should be large enough to take care of the electric water heater, which is usually permanently installed.

**In the parlor or bedroom** shown on the accompanying plans a ceiling light with a switch at the inside door has been installed. Two receptacles are sufficient here as there is no possibility of placing furniture near the French doors opening on the outside porch. Note that the receptacles have been placed so that lights could be had for either divan or chair from one receptacle and on the other side of the room lights could be had at the chair or service could be provided for other appliances and devices.

In addition to providing the proper number of light, switch, and convenience outlets, it is also necessary to put in the proper number of branch wiring circuits in the house and out-buildings. The number of circuits installed in the beginning should be sufficient not only for present needs, but should anticipate future uses.

On all electric systems financed by the Rural Electrification Administration, all wiring must be installed in accordance with the REA wiring specifications which are drawn to meet the requirements of the 1940 National Electrical Code. The wiring installations must be inspected and approved before electric service can be obtained. Section 2107-08



## Electricity on The Farm

of the National Electrical Code define the method of providing the proper number of branch circuits, regardless of the number of outlets installed. The method used is as follows:

Multiply the total floor area of the house (using the outside dimensions and including all floors) by 2 watts per square foot. Divide the total obtained by 1,650 (the allowable number of watts per circuit) and the result will be the total required number of branch circuits required for all lighting outlets and all convenience receptacles (with the exception of the convenience receptacle in the kitchen, dining room, pantry, and laundry; or, if there is no laundry, wherever else laundry equipment will be used).

All of the convenience receptacles in all portions of the house, with the excepted locations mentioned above, and all light outlets would, of course, be evenly distributed over these circuits.

Now add to these circuits, one No. 12 wire, 20-ampere circuit to supply only the convenience receptacles in the kitchen, dining room, pantry, and laundry, or where laundry equipment will be used. No light outlets can be connected to this circuit. This special circuit is necessary since the amount of current required to operate efficiently the heavy duty appliances used in these locations cannot be supplied with No. 14 wire.

### Yard and Outbuildings.

Careful provisions should be made for the use of electricity in the yard and outbuildings. A typical farm wiring lay-out is shown in figure 4.

The electric water pump is usually installed first to provide an ample supply of water for both home and farm use. The yard light can be turned on or off from either the barn or the house and provides illumination for doing chores and other work early in the morning or after dark.

Two different sets of plans of farm buildings are also shown in order to provide examples of farm wiring and lighting under varying conditions. (See figs. 2 and 3.) Every part of each barn is provided with electric lights. These lights have switches to prevent unnecessary fumbling in the dark. Outlets are provided for the operation of small motors, tool grinder, feed grinder, fanning mill, corn sheller, drill press, potato grader, and many other similar pieces of equipment.

## Wiring Yards & Out Buildings

In the cow barn a row of ceiling lights is provided over each row of stalls and a row of ceiling lights in the center aisle. In every building ample light is a great convenience but the most suitable number and location of lighting outlets will vary with conditions. (See fig. 2.) Several convenience outlets are provided on the wall behind each row of stalls for the use of such equipment as clippers or a portable milking machine. If a pipe-line milking machine is used, a safety switch is needed at the place where the vacuum pump will be located. Power outlets are sometimes provided in the cow barn for ventilating fans, however, most barn ventilating fans can be plugged into a regular convenience receptacle.

In the milk house convenience outlets are provided for cream separator, bottle washer, water heater, and milk cooler.

Where there is a silo, a conveniently located portable motor power outlet should be provided.

In the poultry house it is common practice to install a light for every 200 square feet of floor space. These lights are controlled by a time switch so that they will be automatically turned on at the proper time in the morning. This automatic switch can be an ordinary alarm clock. There should be convenience outlets for poultry water warmers.

Among the various systems of poultry-house lighting, "all-night lighting" and "morning lighting" are by far the most popular. In the former a small light is placed over the feed hopper, the convenience outlet for the poultry water warmer also being provided within the better lighted area. One light is provided about 6 feet above the floor for each 200 square feet of floor area, the outlets being located half way between the dropping board, or pit, and the front of the house. With these two systems dimmers are not required.

If 60-watt CX Mazdas are used for all-night lighting, the outlet is generally placed close to the dropping boards and as low as practicable, exposing the chickens to a maximum of "irradiation." It is essential that the voltage be close to that for which the lamps are designed; for example, when operating at only 10 percent below the voltage for

## Electricity on The Farm

which they are designed the ultraviolet output is so reduced as to make the lamps of questionable value except as a source of ordinary light.

**In the home farm shop** good lighting is one of the first essentials. If possible the shop should be of a size to accommodate the larger implements found on the farm and comfortable enough to work in during cold weather. Time, money, and inconvenience can be saved in a shop equipped with a bench, a few well-selected tools, electric lights, and convenience outlets.

A central ceiling light with switch just inside the door, lights with reflectors over benches controlled from individual wall switches conveniently located, and at least two convenience outlets for an extension light and appliances will usually satisfy the lighting and convenience requirements.

One power outlet for heavy motors, drills, or other heavy electric tools should be provided. The farm shop can also be equipped with a direct-current generator for use with a portable motor for battery charging; or small rectifier type chargers may be used.

### Wiring in General

The wire for service entrance in each building should be made sufficiently large to take care of both present and future uses. Service entrances to residences must not be smaller than No. 8 wire. It is recommended that 3-wire 60-ampere service entrances be installed in all cases so that 230-volt current will be available for cooking, water heating, and motor operation. Barns and all major out-buildings, in which there is any possibility of using electric power, should not have a service entrance of less than 3 No. 8 wires.

In many instances, meters are located on the yard pole. Where a main disconnect switch is mounted on the yard pole, it should be provided with a lock to prevent tampering. Services to residences should be as near the kitchen as possible because, generally speaking, this is where the greatest amount of current is used. By locating the service entrance as near the load center as possible, voltage drop is lessened and the installation is made less costly through the use of smaller wire.

# Plans for Wiring Farm Buildings

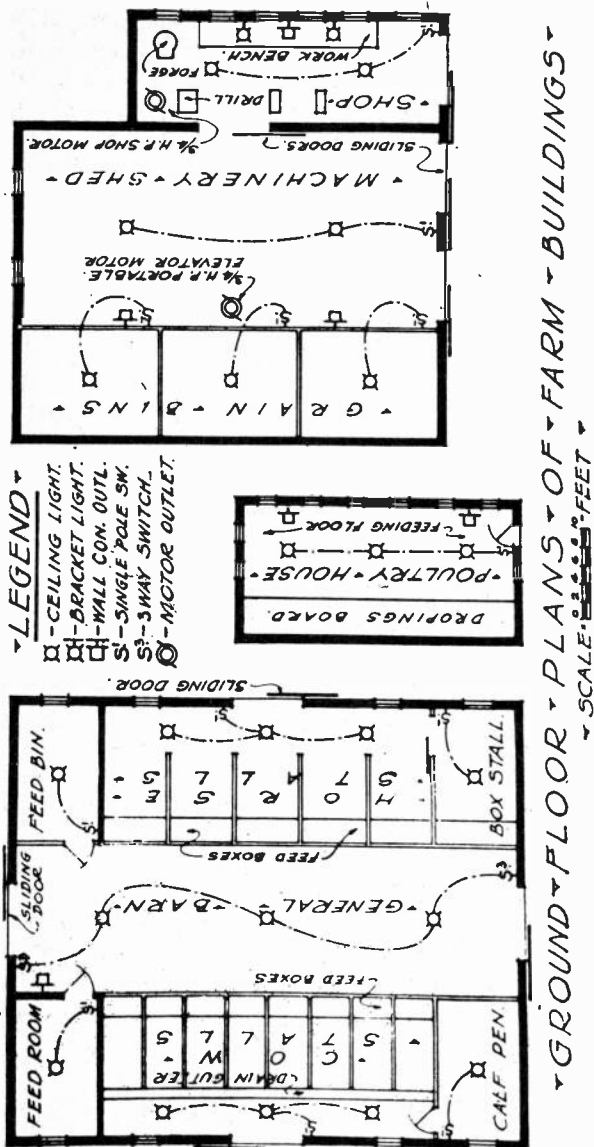

Figure 2.

## Electricity on The Farm

Proper grounding for protection against hazards from lightning is one of the most important safeguards of any wiring installation. The ground must be connected to the neutral wire of the service. In farm installations, a separate ground must be installed at the yard pole service and at the service entrance to each major building. If this is not done, the individual building would not have protection

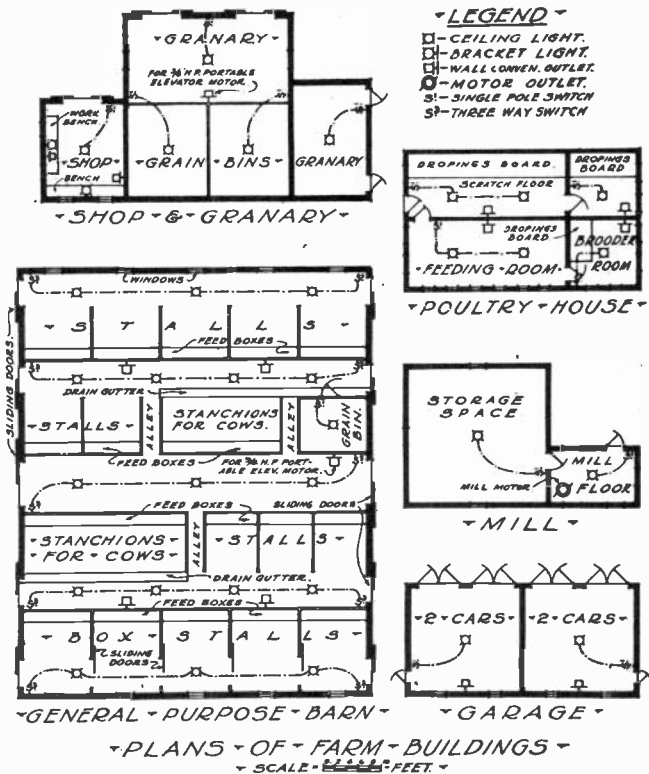

Figure 3.

in case storms broke the neutral wire between the building and the location of the ground. Since the average farm water system is not a good ground, it is required on all work financed by Rural Electrification Administration that standard grounds of the driven type be used. These grounds may be

## Plans for Wiring Farm Buildings

either  $\frac{3}{4}$ -inch galvanized iron pipe or patented copperweld rods. All grounds must be a minimum of 8 feet 6 inches long, driven to a depth of 8 feet.

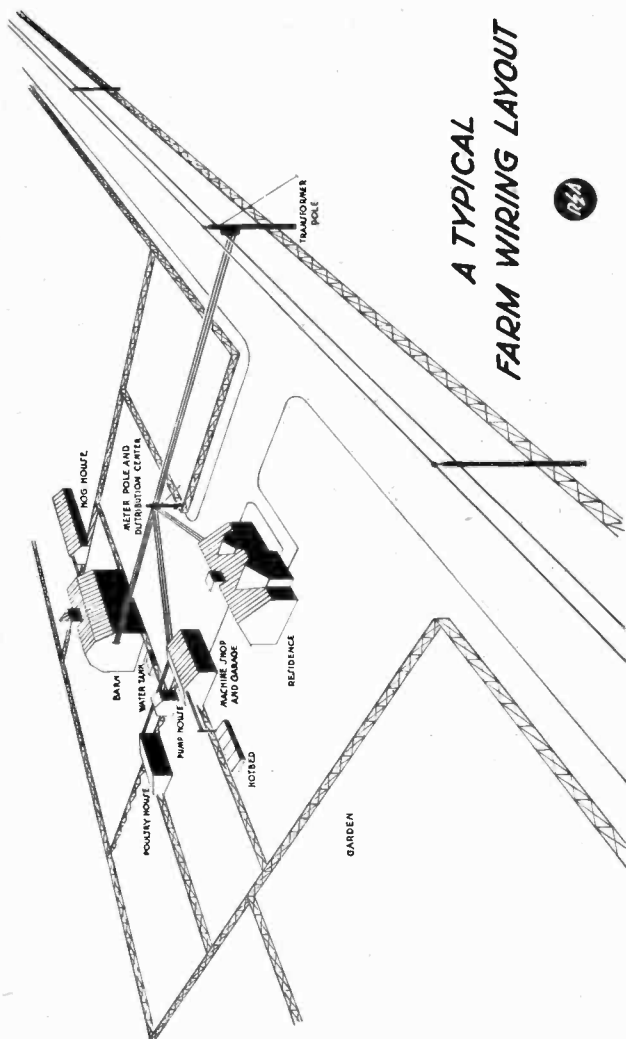

Figure 4.

Of course all these suggestions on how to plan farm wiring are variable according to the specific needs of different farms and farmhouses. But the

## Electricity on The Farm

general principle of adequate wiring for adequate use of electricity always holds good.

### Simple Electrical Repairs.

Electricity is one of the safest, most economical, and most convenient sources of light, heat, and power when wiring and equipment are properly installed and properly maintained, providing the cost of current is not excessively high. All wiring

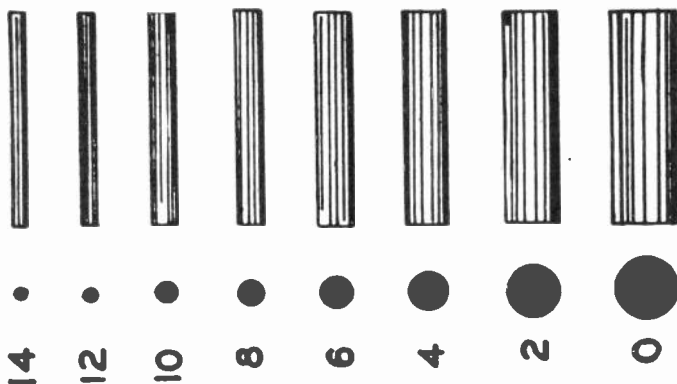

Figure 5.—Actual wire sizes

The wire size to use depends upon the load in amperes and the length of the circuit. Wire sizes for the farm range from No. 0 to 14. The larger the number, the smaller the size of the wire. No. 14 wire is used for light and small-appliance circuits in the home, but the larger sizes are needed for the large-sized motors and heating equipment. No. 12 wire should be used for lighting with 32-volt farm electric plants. For circuits used exclusively for appliances in kitchen, laundry, or dining room, No. 12 wire is required. The greater the distance from the transformer to the equipment, the larger the size of wire required.

served by highlines should be correctly installed and passed by accredited inspectors, so as to meet every safety requirement of the National Electrical Code.

Most hazards in correctly installed electrical systems develop because the owners do not maintain properly the electric wiring and electrical equipment connected to the system. Many other hazards develop because owners make unsafe extensions to the original wiring installation, or purchase and use electrical lamps and appliances that are not constructed safely. Buying only lamps and appliances which carry underwriters approval will help to assure the purchaser of proper protection.

### Maintenance and Repair of Wiring System.

## Simple Electrical Repair

The following instructions on simple repairs may help the users of electricity to keep their wiring installations safe for life and property.

Minor repairs to extension cords, lamp cords, portable equipment connections, and the like can generally be made without any special training. But

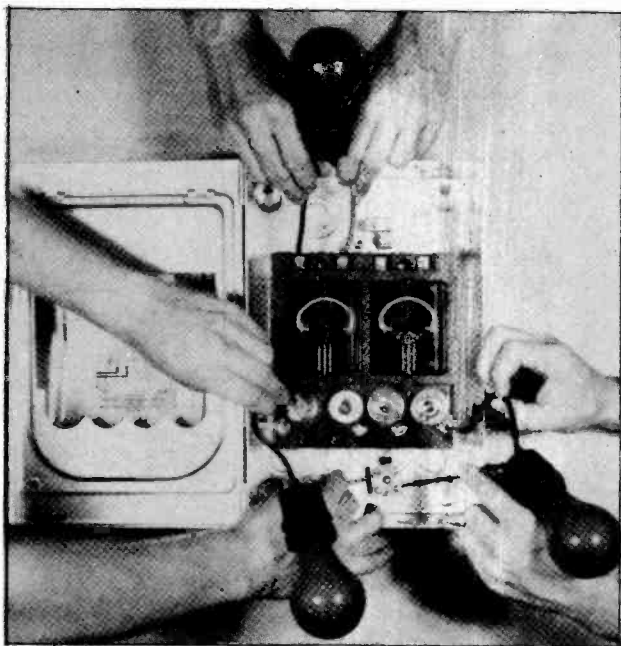

Figure 6.—Use of the trouble lamp.

- Step No. 1—Lower right hand corner. Test to determine whether branch circuit fuse is alive or blown out. One wire on fuse terminal and one on neutral buss.
- Step No. 2—Lower left hand corner. Test to determine if main fuses are alive or dead. Remove fuse. Put one wire on center contact fuse holders and one wire on neutral buss.
- Step No. 3—Upper left hand corner. Test to determine if central station power is on or off. Wires of test lamp connected to 2 left hand main terminals.

**CAUTION** is necessary. Since much of the success of using electricity depends upon safe and adequate circuits correctly routed, the importance of good farmstead wiring is evident. When trouble is located in the major wiring system between permanently installed outlets and the main service switch, a competent electrician should be called in to locate and correct the trouble.



## Electricity on The Farm

After the circuits have been planned and installed certain maintenance and repair are frequently taken care of by the owner. At least during the early years of the installation few, if any, repairs will be required except those due to accident such as a "short circuit," a broken insulator, or similar cause. The copper wire will not deteriorate unless badly overloaded, and the insulation should last for years. It is good practice to inspect the circuits frequently and have all damage repaired. The load should be checked from time to time as new loads are added to prevent an overload on the circuit. Trees will often grow up and interfere with the wires. These should be topped, or the wires moved. Appliance cords may pull out of the plug or wear through near the appliance. These must be reconnected. The circuit wires themselves may come loose from the binding screws or a wire may become broken. Most of these may be repaired safely and satisfactorily by the householder. The owner should, therefore, know how to locate the common wiring troubles and how to correct them, regardless of whether he does any electrical work himself.

### Trouble Shooting.

**Fuse Service.**—Trouble must be located before it can be removed from the electrical circuit. Locating this trouble is called circuit "trouble shooting," and is usually accomplished by the aid of a "trouble lamp." (See fig. 6.) Every electrified farm should have one. The trouble lamp consists of a weather-proof non-metallic lamp socket into which a 25-watt, 220-volt lamp is screwed and to which short, well insulated wires are attached. The insulation at the end of each wire should be removed for a distance of an inch.

To illustrate how circuit trouble is located by the use of this trouble lamp, assume that neither the light in the kitchen nor dining room come on when the switch is turned. This indicates that the trouble is probably not due to a burned-out bulb. The most probable sources of trouble in this case are: (a) A blown circuit fuse, (b) power off, (c) an "open" in the lighting circuit.

The first thing to do in connection with almost any trouble of this nature is to determine whether

## Trouble Shooting Procedure

the house distribution panel is "alive" or not. To do this, take one of the insulated wires of the trouble lamp in each hand, stand on a dry box or dry board, and touch the bare ends of these leads to the bare binding screws on the panel where the leads from the meter terminate. **CAUTION:** Be sure to keep the hands or fingers well back on the insulated handles and do not allow them to touch metal current-carrying parts. Be sure the board or box and shoe soles are dry. Should the lamp light up, the panel is alive and the trouble is in the branch lighting circuit. Disconnect all portable appliances that are connected to the circuit. The trouble may be "blown" fuses. They may be checked by touching the wires on the trouble lamp to the binding screws on the branch circuit side of the fuses. If the trouble lamp lights, the fuses are good and the branch circuit is "open" somewhere; if it does not light up, the fuse is blown. Blown fuses may be due to a short circuit somewhere on the branch circuit, a defective or burned-out appliance, or an overloaded circuit. If fuses are blown by a defective appliance, new fuses will also be blown when the appliance is again plugged into the convenience outlet. Also, if blown fuses are due to a short on the circuit or to an overloaded circuit, renewing the fuses will do no good. The cause must first be located and remedied.

Going back to our first test at the main distribution panel, suppose the lamp failed to light up. This indicates that the panel is "dead." The power is then off the line or there is a blown service-entrance fuse. In this case open the service-entrance safety switch, then open the safety switch cabinet door, and touch the lamp leads to the switch jaws on the line side of the switch. Should the lamp fail to light up, the highline is dead and the utility or electric co-op should be notified at once. If it lights up, one or more of the service-entrance fuses are blown, or there is a loose connection. In this case do not renew the fuses until a check has been made of the circuits and appliances, and the trouble found and repaired.

**Circuit-Breaker Services.**—If the service switch is of the circuit-breaker type instead of fuse type, it is necessary to use the trouble lamp at the serv-

## Electricity on The Farm

ice switch. When any lamp fails to burn or appliance fails to operate, look at the breaker controlling the circuit to which the lights or appliances are connected. If the breaker is in trip position it is evident that either the circuit has been overloaded

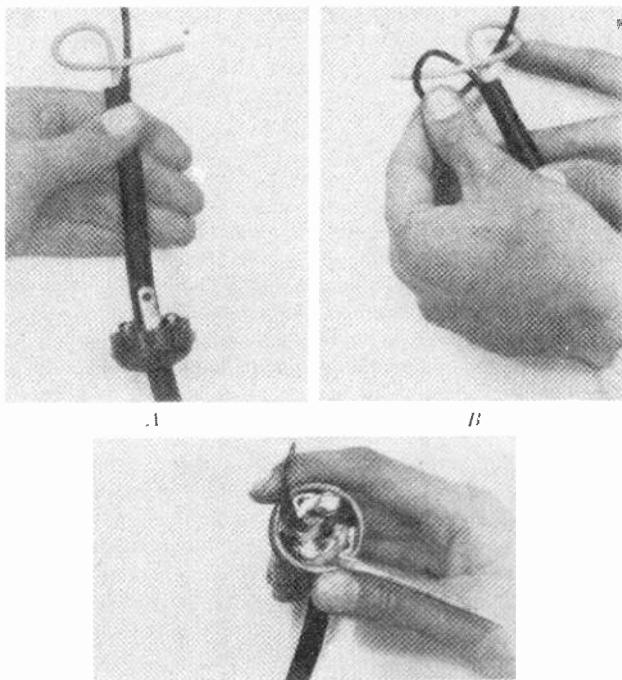

Figure 8.—Attaching a plug to an appliance cord. A and B show how to tie an electrician's knot. C shows knot in place.

or a short circuit has occurred on the connections to lights or appliances. If the breaker is in operating position, then either the lamp has burned out, wires have become broken or disconnected, the appliance element has failed, or the highline power is off. Attention is called to the fact that certain types of circuit breakers do not indicate when they have been tripped. In such cases they must be thrown out and back into operating position before there can be certainty they are not "out."

First, see if lights on other circuits will burn. If not, remove cover on breaker panel and connect test light to terminals of main service on line side.

## Trouble Shooting Procedure

If test light will not burn, then the highline power is off, and the utility or electric co-op should be notified. If test light does burn, then examine all lamps and appliances to locate the source of trouble. After the trouble has been corrected, reset the breaker to operating position.

### Short Circuits.

A "short circuit," or more briefly a "short," occurs when current accidentally flows by a relatively low resistance path from one conductor to the other or to ground. The common causes of short circuits are bare wires touching each other, lack of good insulation, poorly connected service plugs and outlets, wet appliances and motors, salt film, metal filings, and the like. A short once started will continue until the circuit fuses blow, the circuit switch is opened (it opens automatically in a circuit-breaker type) or until equipment or circuit are destroyed. Before being put back into service the damage should be completely and correctly repaired.

### Fuses.

Fuses are used to protect the wiring from possible overloads and short circuits which may result in fires or damage to wiring and appliances. They are purposely made the weakest link in a system or circuit in order to protect, by their weakness, the equipment and other more expensive parts of the circuit. Each wire in a building was installed to carry a certain load. A larger one may be dangerous. When a fuse blows, eliminate the cause of its blowing before replacing it with a new one of the proper ampere rating, or resetting circuit breaker if protection or panel is of this type. A larger fuse would permit more current to flow in the wires than they can carry safely. The size in amperes is stamped on the small end of plug fuses, near the ends of cartridge fuses.

Only the nontamperable type of fuses should be used, so there will be no opportunity to meddle with the old fuse or replace with larger fuses than the circuit should have.

No fuse larger than 15 amperes can be put in any lighting circuit, regardless of the size of wire, and meet the safety requirements of the National

## Electricity on The Farm

Electrical Code. Other circuits supplying only heavy-duty electrical appliances, and special motor circuits, must not be fused above the capacity of



Figure 9.—Lamp cords should go through an insulated bushing in the lamp base to keep the base from wearing the cord. Frayed cords are dangerous.

the size of wire installed in the circuit. Never increase the size of the fuse over the wire capacity, or the efficiency of the "safety valve" will be lessened.

## Circuits

When making repairs to appliance cords, necessitating removal of the socket or plug from the cord, care should be taken when reconnecting the wires. In making such plug connections to cords, be sure to tie an electrician's knot as shown in Figure 8. The screw connections are further protected against strains from accidental jerks by making a half turn of the wire around the prongs of the plug before it is fastened under the screw connections. (See fig. 8c.)

Only one wire should be placed under each screw, never more. A lamp cord should never be left so that the base of the lamp can wear off the insulation. (See fig. 9.) This wire should run through an insulating bushing in the lamp base. Electrical toys should be carefully watched for any defect which would be hazardous to children.

### THE ELECTRIC FENCE

Along with the increase in electricity available to rural areas, farmers have turned increasingly to use of the electric fence. They have done this despite repeated warnings from many sources that the electric fence, when improperly constructed and under certain other conditions, can be dangerous.

Since farmers have demonstrated that they definitely intend to use both the single-and double-wire fence, because of its low cost and convenience, precautions are here stated. The electric fence materially reduces fencing costs (by 80 percent or more for larger areas), and simplifies the use of temporary fence for pastures and crops that are to be harvested by animals. Likewise, operating requirements are low, usually under 10 kilowatt-hours per month.

On the other hand, instances may be cited in which animals, and in a few cases human beings, have been killed by such equipment. Most of these casualties, however, have been traced to home-made or makeshift devices. It should be recognized that there is extreme danger in making and using any electrical device which limits the current supplied to the so-called electric fence. This is true whether the current is supplied by a 6-volt battery, the 32-

## Electricity on The Farm

volt home electric plant, or from a 115-volt service line; hazard likelihood increases with supply voltage.

It is worthy of note that it is amperage (flow) and not voltage (pressure) that is so dangerous. However, unless equipment is so designed that the amperage is definitely limited, higher voltages are more dangerous. Home-made transformers or current-limiting devices are not dependable. It is not considered safe to use transformers that will deliver more than about 5 milliamps on dead-short unless some sort of dependable current-interrupting arrangements are incorporated.

### SUMMARY

1. Farm wiring should be planned to meet future as well as present needs.
2. Determine where electricity can be used to advantage and the type of electric outlet required at each location.
3. Provide an adequate number of branch circuits.
4. All wiring on electric systems financed by the R. E. A. must be installed in accordance with the National Electrical Code.
5. Three-wire, 60-ampere service entrances to residences are recommended.
6. Service entrances to barns and outbuildings where power is to be used should be not less than three No. 8 wires.
7. Grounds may be either  $\frac{3}{4}$ -inch galvanized iron pipe or patented copperweld rods and must be at least 8 feet 6 inches long, driven to a depth of 8 feet.
8. It is good practice to inspect the circuits of an electric system frequently and have all damage repaired.
9. Use a trouble lamp to locate circuit trouble.
10. Use only nontamperable fuses so there will be no opportunity to meddle with the old fuse or replace with a larger fuse than the circuit should have.
11. If wires in lamp cords become broken or the insulation wears off, never splice for permanent use. Throw the old cord away and buy a new one.
12. Home-made transformers or current-limiting devices for electric fences are dangerous.

## Electric Fence

We thank the Rural Electrification Administration for the material appearing in the article "Building Electrical Equipment for the Farm." Through the increasing effort of this organization the Farms of America are becoming more and more modernized. Electrification on farms leads to greater production of crops, dairy products and poultry—it also makes the life of the hard working farmer (the bulwark of America) a little easier. The Coyne Electrical School is proud of the opportunity to add its share to the continuation of the great Rural Electrification program.

### RIGGING UP A PORTABLE ELECTRIC MOTOR ANALYSIS

Operation	Standard or accepted practice
1. Provide materials .....	Secure the following materials: 1 piece of No. 10 rubber-covered wire 36" long. 2 pieces $\frac{3}{4}$ " galvanized gas pipe, lengths equal to over-all width of motor. 4 $\frac{1}{4}$ " x $1\frac{1}{2}$ " flat-head stove bolts. 4 locknut washers to fit bolts. 4 plain washers to fit bolts. 1 piece rubber-covered extension cord equipped with plug, federal bushing for $\frac{1}{2}$ " knockout and, if desired, a combination switch with thermal cutout. 1 5" 4-step V-pulley with shaft opening same size as shaft of motor. 1 standard with bearings and shaft. See speed reducers, figure 26. 1 12" V-pulley to fit shaft of standard. 1 2" V-pulley to fit shaft of standard. 2" x 12" plank for holder and speed-reducer bases. 2 $\frac{3}{4}$ " pipe straps. See figures 26 to 34.
2. Mount pulley on shaft .....	Push 5" 4-step V-pulley on shaft of motor. Tighten set screw. See figure 28.
3. Mount handle on motor .....	Cut a 36" piece of No. 10 rubber-covered wire into two 18" lengths.





## Portable Motors

See figure 26. Remove the insulation from both ends of the wires to form hooks. Flatten these hooks into washer form. Twist the 2 pieces of wire tightly together until about 6" extend on each end. Fasten wire to motor to form handle as shown in figure 28.

4. Mount motor on gas pipe rails..... Mark points on both pieces of gas pipe at correct distances so that, when bolted to base of motor, the ends of the pipe are flush with or extend slightly beyond the ends of the motor shaft and pulley. Bore  $\frac{1}{4}$ " holes and bolt rails to base of motor with stove bolts,

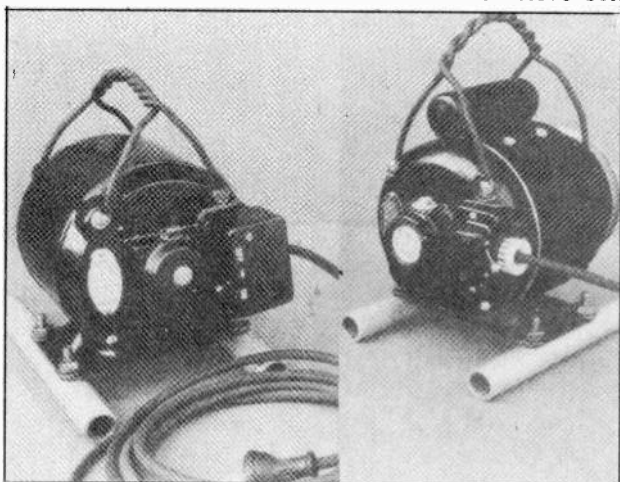

Figure 27.—A shows portable motor equipped with a combination switch and thermal cut-out for protecting motor against overload. B shows capacitor-type portable motor.

### ANALYSIS—Continued

- | Operation   | Standard or accepted practice  |
|---|--|
| 4. Mount motor on gas pipe rails.....                           | putting plain washer next to and on top of motor base, the locknut washer on top of the plain washer and then follow with the nut  |
| 5. Install the optional combination switch with thermal cut-out | Mount the combination switch with thermal cutout on the side of the motor where the terminals are located some motors are made so the breaker may be mounted without making special provisions; otherwise, holes will have to be |

## Electricity on The Farm

drilled and tapped to correspond to the mounting holes on the circuit breaker.

6. Make motor rail-holders ..... Fasten two  $\frac{3}{4}$ " pipe straps to a piece of 2" plank as shown in figure 28. This type holder will allow the motor to be slipped into place and will keep the motor in place even when the driven equipment is directly overhead.

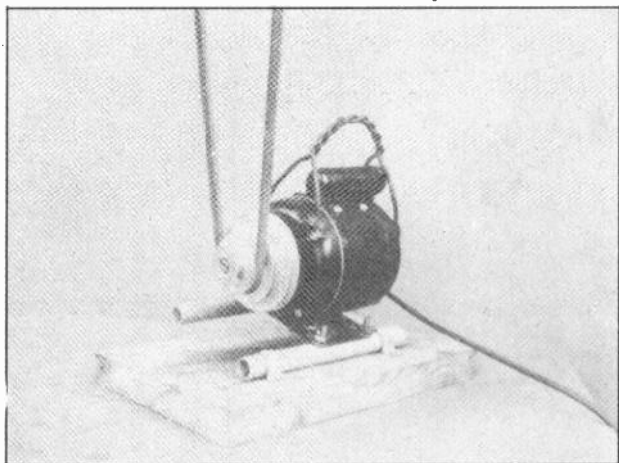

Figure 28.—This motor base is kept in place by pipe straps. Note that the driven equipment is at a high angle above the motor.

Make a similar holder for each piece of equipment on which the portable motor is to be used. See figures 31, 32, and 33.

The distance of the holders from the driven appliance should be such that the rear rail of the motor will not touch the floor when the belt is in position on the pulleys. If the motor tends to work out of the holder, a nail may be driven in the base at the end of the rail toward which the motor "walks."

7. Assemble speed reducer ..... Mount the 12" and 2" V-pulleys on either end of the shaft as close to the bearings as possible. Tighten down the set screws provided for that purpose.

Make a platform for each machine with which speed reducer is to be

## Portable Motors

used, fitting platform with threaded bolts on which the base of the speed reducer may be placed and fastened down either with winged nuts or regular square nuts. See figure 31.

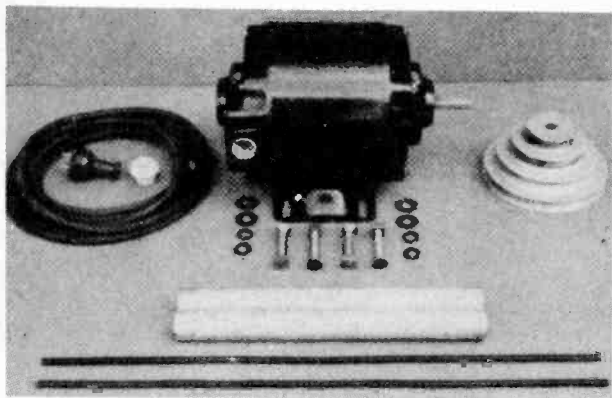

Figure 29.—A  $\frac{1}{4}$ -horsepower repulsion-induction motor and the materials for making it portable.

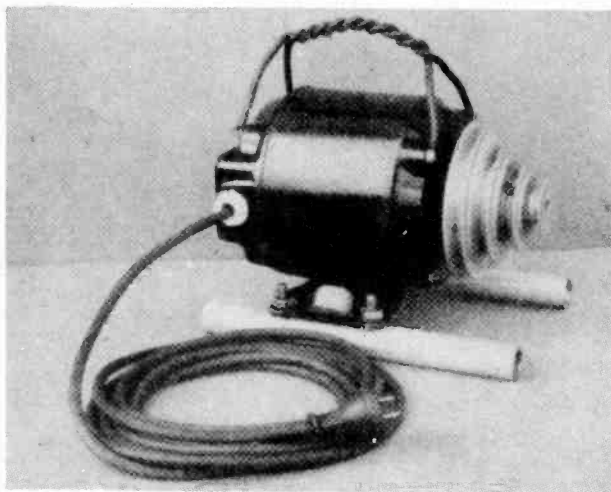

Figure 30.—The completed portable motor.

Note that one of the standards is not as high as the larger V-pulley. Build a platform so that the large pulley may overhang.

## Electricity on The Farm

Selecting the motor.—A motor that can be carried by hand is a great convenience on the farm. Very little work is required to arrange a small electric motor so that it can be moved quickly from one piece of equipment to another, thus making unnecessary the purchase of a number of

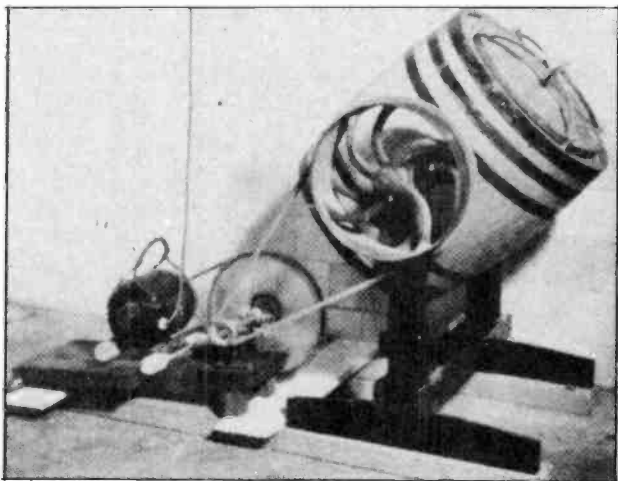

Figure 31.—A portable motor operating a barrel churn by means of a simple speed reducer.

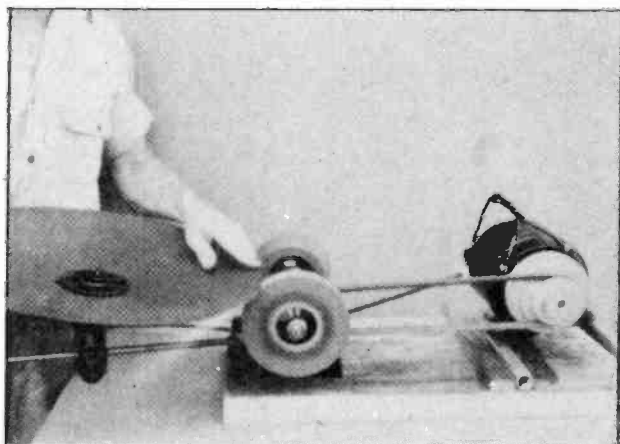

Figure 32.—Sharpening a disc with a portable motor. Note that part of the weight of the motor rests in the belt and that as the load increases the belt tightens.

motors each attached to a different machine. In some cases, a  $\frac{1}{2}$ -horsepower motor should be made portable, since it

## Electric Barrel Churn

is the smallest that can be used on some specific job, such as a deep-well pump or feed grinder. However, a  $\frac{1}{4}$ -horsepower motor is much lighter, is less expensive, and will do most of the odd jobs on the farm adapted to electric-motor drive.

Making a motor portable, with wooden or pipe rails and twisted solid-wire handle, adds only about 60 to 75 cents to its cost, as compared with the cost of a ready-to-operate stationary motor of the same type and size. A piece of garden hose may be slipped over the handle before fastening to the motor to make the handle easier on the hands. A  $\frac{1}{4}$ -horsepower motor (without cord, pulley, or other accessories) will cost from \$5.00 to \$17.00, and complete with overload protection, switch, cord, step-pulley, etc., a portable motor will cost from about \$8.00 to \$20.00 depending on the type of motor purchased. The cheaper motors are not built for starting heavy loads such as those in connection with pumps. The more expensive motors are of the capacitor or repulsion-induction type which will safely handle a starting load several times the regular working load.

**Jobs a portable motor can do.**—Among the equipment a portable motor will operate are: A band saw, milk-bottle washer, churn, egg- or incubator-tray cleaner, fanning mill, small concrete mixer, corn sheller, drill press, forge, ice-cream freezer, fruit grader, fruit washer, green-feed cutter, sickle grinder or grindstone, lathe, sausage grinder, and seed treater. In fact, any of the many small devices that depend on hand power on most farms lend themselves to operation by this electric "hired hand" which works for an average of not more than 1 cent per hour when current can be purchased at reasonable rates.

**Speed of operation.**—It is important that equipment operate at its proper speed. This speed can be determined for many items by referring to the Pulley Selection Chart. (See fig. 34.) Since motors operate at a much higher rate of speed than do barrel churns, ice-cream freezers, and similar farm devices, a speed reducer, such as shown in figure 31, operating a churn, must be used. By reducing the speed the mechanical advantage is increased, or in other words the motor is given the capacity to pull heavier loads.

The formula for pulley speeds and diameters is  $D_1:D_2::R_2:R_1$ , when  $D_1$  is the diameter of the drive pulley,  $D_2$  the diameter of the one driven,  $R_2$  the number of revolutions of the driven, and  $R_1$  the revolutions of the drive pulley. Assuming that a motor with a 2-inch pulley and an R. P. M. (revolutions per minute) of 2,000 were to be used to run a fanning mill that should run at 500 R. P. M., the size of pulley for the fanning mill would be found by substituting in the above equation as follows:  $2:D_2::500:2000$ . From this we find  $D_2=$

$$\begin{aligned} & \frac{2 \times 2000}{500} \\ & = 8 \text{ inches.} \end{aligned}$$

## Electricity on The Farm

When a speed reducer is used the same principle is applied but the formula is used twice, once to find the revolutions of the speed reducer, and then from that result to determine the size of pulley required on the machine to be driven.

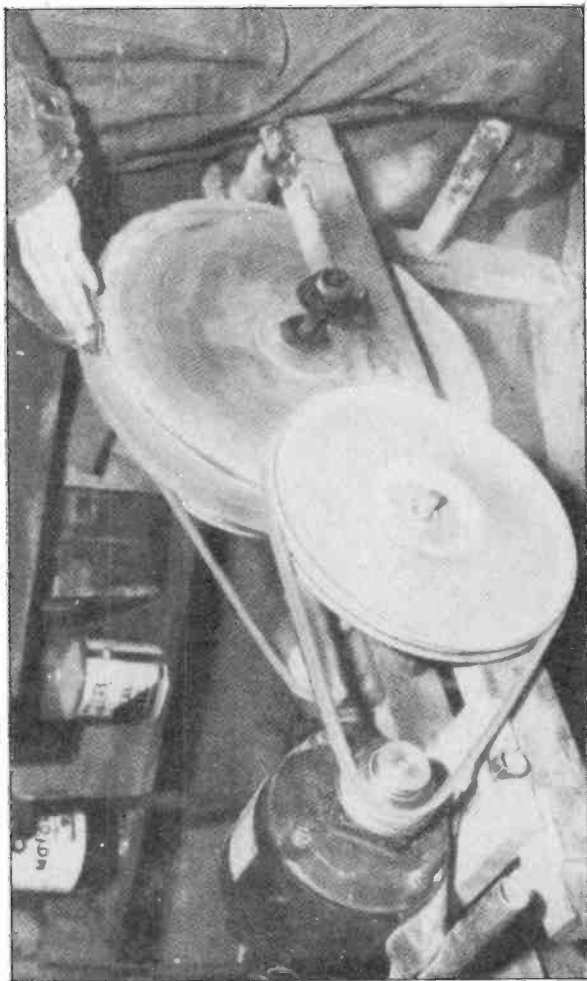

**Figure 33.**—A portable motor operating a grindstone by means of a simple speed reducer.  
(CAUTION! There is danger of grindstones flying apart when operated at speed in excess of 75 revolutions per minute.)

A 2-pedestal speed reducer complete with 12-inch and 2-inch pulleys will cost about \$4.50. A single-pedestal 2-bearing speed reducer will cost at least a dollar less, but it is not as sturdy as the former. Should it be desirable to operate a grindstone, the 12-inch pulley on the speed

## Uses For Electricity on The Farm

reducer should be replaced by a 15½-inch pulley. (See fig. 33.)

The V-pulley type of speed reducer has many advantages over the flat-pulley type. The belt is not so likely to come off, slips less, and the reducer does not take up so much room.

### PULLEY SELECTION CHART

FOR USE WITH ALL ELECTRIC MOTORS WHICH RUN AT 1750 REVOLUTIONS PER MINUTE

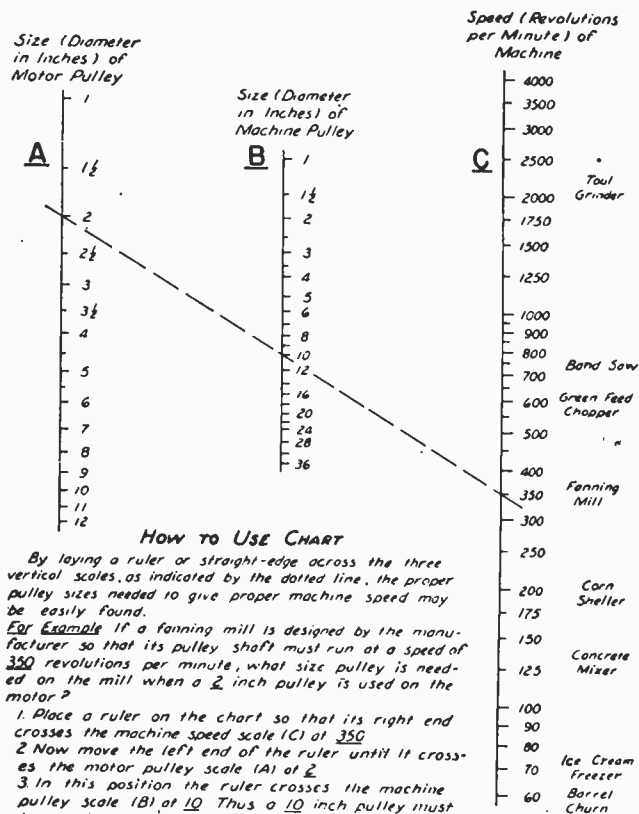

#### HOW TO USE CHART

By laying a ruler or straight-edge across the three vertical scales, as indicated by the dotted line, the proper pulley sizes needed to give proper machine speed may be easily found.

**For Example** If a fanning mill is designed by the manufacturer so that its pulley shaft must run at a speed of 350 revolutions per minute, what size pulley is needed on the mill when a 2 inch pulley is used on the motor?

1. Place a ruler on the chart so that its right end crosses the machine speed scale (C) at 350.
2. Now move the left end of the ruler until it crosses the motor pulley scale (A) at 2.
3. In this position the ruler crosses the machine pulley scale (B) at 10. Thus a 10 inch pulley must be used on the mill.

Also, with the right end of the ruler on any desired machine speed, any needed combination of pulley sizes to give this speed may be quickly found by moving the left end of the ruler up or down.

Figure 34.—A handy chart to use in finding pulley sizes or machine speeds.



## Electricity on The Farm

### A LIST OF OVER 200 USES FOR ELECTRICITY ON THE FARM

Plan ahead. Use this check list to provide adequate wiring for today's needs and anticipated uses for electricity in the future.

#### HOUSEHOLD EQUIPMENT

Air conditioning  
Bath cabinet  
Battery charger  
Burglar alarms  
Call bells  
Chafing dish  
Cheese maker  
Christmas tree lights  
Churns  
Cider press  
Clocks  
Cooker  
Corn popper  
Croup kettle  
Dishwasher  
Door bell  
Door latch  
Door (garage) operator  
Dryer, hair  
Electric blanket  
Electrotherapy  
Elevator  
Exerciser  
Fans, kitchen ventilator  
Force-draft blower  
Fumigator  
Grills  
Hair clipper  
Heaters, auto engine  
Heaters, bottle  
Heaters, immersion type  
Heaters, unit  
Heaters, water  
Heating pads  
Hedge trimmer  
Hot plate  
Ice-cream freezer  
Ironer  
Irons, curling  
Irons, flat  
Lawn mower  
Lighting  
Massage machine  
Moving-picture projectors  
Operating oil-burning furnace  
Ovens  
Pants presser  
Percolator

#### HOUSEHOLD EQUIPMENT— Continued

Photograph  
Piano and instruments  
Polisher, floors  
Radio sets  
Ranges  
Razor, electric  
Refrigerators  
Sander  
Sawing firewood  
Sausage grinders  
Sewing machines  
Stokers  
Sump pump  
Thermostat  
Tie presser  
Toasters  
Toys  
Vacuum cleaner  
Vibrator  
Waffle iron  
Washing machine  
Water cooler  
Water pump

#### FARM EQUIPMENT AND MACHINERY

Aerators, milk  
Agitator, cooling can  
Agitator, pasteurizer  
Agitator, starter can  
Air compressor  
Air conditioning, fans  
Air conditioning, humidifier  
Baler, hay  
Bottling milk  
Brooders  
Bunch tyer  
Candlers, egg  
Cattle stunner  
Cauterizer, electric  
Charging batteries  
Cheese making  
Chopping fruit  
Churning  
Cleaning containers  
Cleaning grain  
Cleaning vegetables

## Uses For Electricity on The Farm

### FARM EQUIPMENT AND MACHINERY—Continued

Clipping cows  
 Clipping horses  
 Cold storage  
 Concrete mixer  
 Conveyors, fruit and vegetable  
 Conveyors, grain  
 Conveyors, silo-filling  
 Cooling milk  
 Corn sheller  
 Coring fruit  
 Cotton gin  
 Cream separator  
 Cutters, ensilage  
 Cutters, feed  
 Cutters, hay  
 Cutters, straw  
 Dehydrating fruits  
 Dehydrating vegetables  
 Doughnut kettle  
 Drying feed  
 Drying hay  
 Drying seed  
 Electric fences  
 Elevators.  
 Forge blower  
 Frost-preventer fan  
 Fruit buffer  
 Grading fruit  
 Grading vegetables  
 Grinding bone and shell  
 Grinding feed  
 Grinding fertilizer  
 Grinding forage  
 Grinding grain  
 Grinding limestone  
 Grinding meat  
 Hammers  
 Heating buildings  
 Heating poultry water  
 Heating seed  
 Heating soil  
 Heating stock-tank water  
 Hedge trimmer  
 Hoist, hay  
 Honey extractor  
 Ice-making machine  
 Incubators  
 Insect control  
 Irradiator, milk  
 Irradiator, seed

### FARM EQUIPMENT AND MACHINERY—Continued

Lathe  
 Lighting  
 Milking  
 Mill, flour  
 Mixers, feed  
 Oat huller  
 Onion topper  
 Packing fruit  
 Packing vegetables  
 Pasteurizer  
 Pea viner  
 Peeling fruit  
 Planers, lumber  
 Plow and cultivator  
 Polishing fruit  
 Pump jack  
 Repair shop, band saws  
 Repair shop, circular saws  
 Repair shop, fixed drill  
 Repair shop, fixed grinders  
 Repair shop, glue pot  
 Repair shop, grindstone  
 Repair shop, portable drill  
 Repair shop, portable grinder  
 Repair shop, soldering iron  
 Root shredder  
 Saws, circular  
 Saws, jig  
 Shaper  
 Sheep shearing  
 Slicing fruit  
 Solder pot  
 Spraying paint  
 Sprouting seed  
 Sterilizing soil  
 Sterilizing utensils  
 Stump removing  
 Tester, egg  
 Tester, milk  
 Threshing  
 Time clocks  
 Treating seed for smut  
 Ultra-violet-ray machines  
 Vulcanizer  
 Worm attractor  
 Washing bottles  
 Washing eggs  
 Washing fruit  
 Washing vegetables

## MOTOR DRIVEN APPLIANCES

In homes, offices, stores and factories the heating during cold weather is coming more and more to be controlled automatically so that the desired indoor temperatures are maintained without any attention having to be given to the heating plant itself. The three kinds of fuel in general use are oil, gas and coal and for each of these there have been developed automatic control systems which increase the combustion rate when indoor temperature falls below the desired point and which decrease the combustion when the temperature rises above this point.

In all the automatic heating controls we require first of all a device which closes and opens the electric circuits for motors, valves and other elements when temperature falls or rises. This device is the **thermostat**. No matter what kind of fuel is used, changes of temperature cause accompanying changes in operation of the electrical units through action of the thermostat.

### THERMOSTATS FOR AUTOMATIC HEATING

A typical "room thermostat" for control of indoor heating is illustrated in Fig. 1. The thermostat is mounted on a wall and is enclosed by a cover on the outside of which may be a thermometer, and above or below which is a pointer and dial or a rotary member which may be adjusted to the temperature that it is desired to maintain.

The part of the thermostat of Fig. 1 which moves when temperature changes is the bimetallic element, the construction and operation of which are shown in Fig. 2. A bimetallic element is a strip composed of two different metals welded or brazed together. One metal is a kind that expands and contracts little or not at all with moderate changes of temperature, while the other is a kind that expands and contracts a great deal with the same changes of

## Thermostats

temperature. The non-expanding metal usually is invar, an alloy of nickel and iron, and the other frequently is brass.

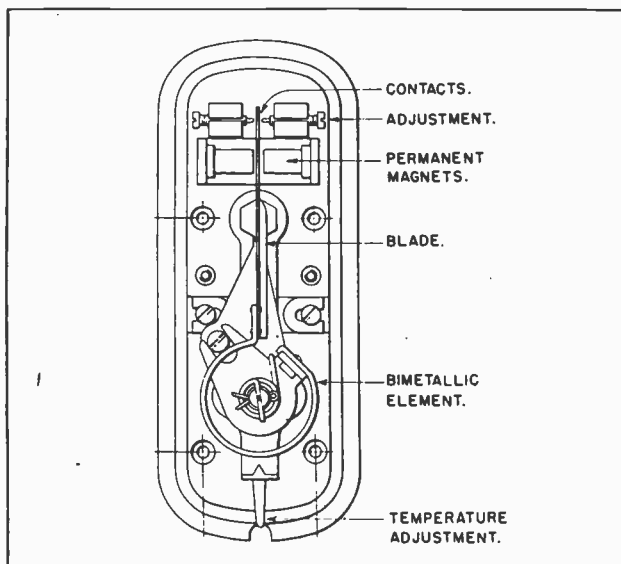

Fig. 1. The working parts of a room thermostat.

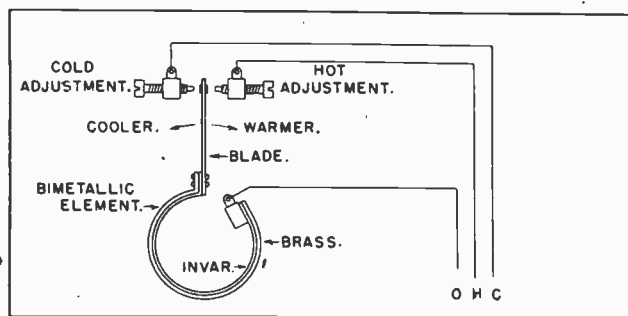

Fig. 2. The bimetallic element and contacts.

When temperature rises, the brass expands more than the invar and, with the construction of Fig. 2, the element tends to contract and moves the contact blade to the right. When temperature falls, the brass contracts, the element tends to open up,

## Motor Driven Appliances and Equipment

and the contact blade is moved to the left. When the temperature rises a certain amount of the right-hand contacts close and complete a circuit between wires **O** and **H**, and when the temperature falls a certain amount the left-hand contacts close to complete a circuit between wires **O** and **C**.

When someone moves the graduated temperature control of Fig. 1 the bimetallic element and contact blade are shifted bodily one direction or the other so that the contacts close and open at a temperature determined by their new position. The adjustment screws inside the thermostat case are used only to make the contacts operate at the temperature indicated by the setting of the external adjustment. The internal adjustment is made by observing the room temperature with an accurate thermometer, setting the external control to this temperature, then turning the screw so that the contacts just close or just open, depending on the kind of adjustment being made.

The bimetallic element is formed into part of a circle rather than being left straight, so that the necessary movement may be obtained within a limited overall size of thermostat. As shown in Fig. 3, some bimetallic elements are formed into spirals having several turns to obtain still more motion with a given temperature change.

In Fig. 2 current flows from wire **O** to wires **H** or **C** through the bimetallic element. The heating effect of the current flowing through the resistance of the element tends to heat the element and to close the contacts on the warm side. With the construction of Fig. 3 the contact blade is electrically separated from the bimetallic element by insulation that supports the blade, consequently current in the control circuit does not pass through the bimetallic element.

The two-wire type of thermostat shown in Fig. 3 is the style generally used for simple controls in which an oil burner, gas burner or coal stoker is turned on when the temperature falls and turned

## Thermostats

off when the temperature rises enough to open the thermostat contacts. The three-wire thermostat of Fig. 2 may be used for operation of both heating equipment and cooling apparatus, may be used for reversing the direction of rotation of damper motors, and for other control systems which cannot be handled by simply closing and opening a single circuit.

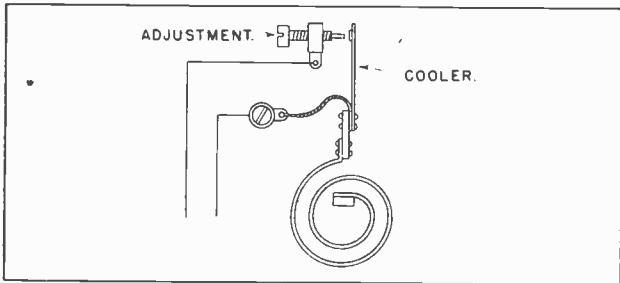

Fig. 3. Insulated spiral bimetallic element.

### THERMOSTAT DIFFERENTIALS

With thermostats having only the parts shown in Figs. 2 and 3 the contacts would close at the adjusted temperature, heat would enter the space from the heating plant and, as soon as the temperature rose the least bit the contacts would open to shut off the heat. Then, with the least fall of temperature, the contacts again would close to place the heating plant in operation. Such rapid turning on and off of the heating plant is undesirable. As actually constructed, thermostats are designed to let heating continue until the temperature rises slightly above the adjusted temperature, or to let the heat source remain turned off until the temperature falls a little below the adjusted temperature. The difference between the highest and lowest temperature in the heated space is called the temperature differential.

The thermostat itself is designed to close its contacts at a certain temperature and to keep them closed, and the heat turned on, until the tempera-

## Motor Driven Appliances and Equipment

ture rises from one to five degrees. The difference between the temperature of closing and opening the contacts is the thermostat differential. Temperature differential will be somewhat greater than thermostat differential because, first, the temperature in the space continues to fall after the heating plant is placed in operation and until added heat can overcome the rate of temperature drop, and second because with nearly all kinds of heating equipment some heat is added to the space after the

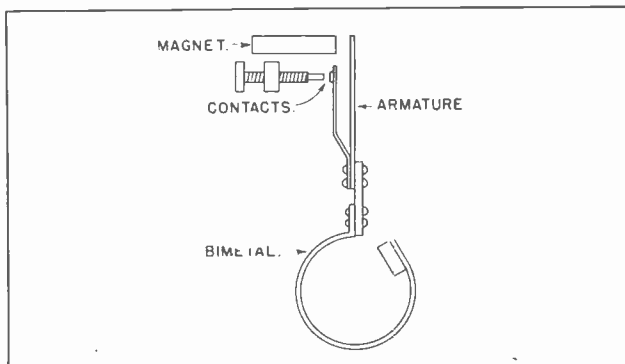

Fig. 4. Permanent magnet for producing snap action as contacts open.

plant is turned off. That is, there is a certain amount of additional heat stored in the furnace or boiler, and most of this heat will come into the rooms.

In Fig. 4 the bimetallic element carries a magnetic armature together with the contact blade. Near the upper end of the armature is rigidly mounted a small permanent magnet. As the blade contact and armature move to the left with falling temperature the armature comes closer to the magnet until finally the attraction overcomes the springiness of the bimetallic element and the contacts are pulled closed. When temperature rises, the bimetallic element tends to move the contact blade and armature to the right, but cannot do so until the force developed in the bimetals overcomes the attraction between magnet and armature. The additional temperature rise required for the

## Thermostats

bimetal force to overcome the magnetic attraction forms the thermostat differential. The thermostat of Fig. 1 employs a similar system utilizing two permanent magnets, one on either side of the contact blade just below the contacts. These magnets act to hold the blade to whichever side it is moved by the bimetallic element.

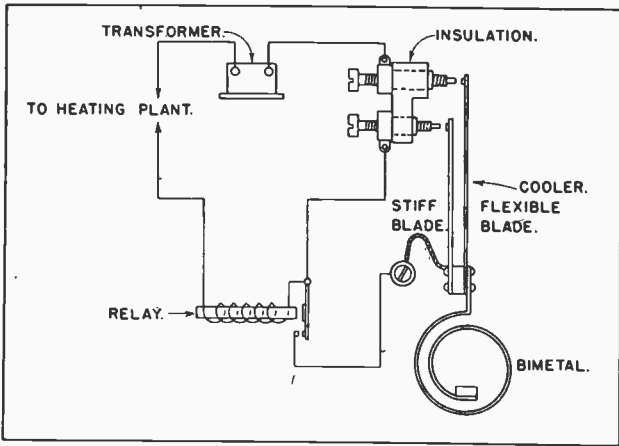

Fig. 5. Holding relay used with double-blade thermostat.

Permanent magnets used as in Figs. 1 and 4 have the further advantage of insuring that the contacts separate with a snap when the bimetal force becomes great enough to overcome the magnetic attraction. This lessens arcing and prolongs the working life of the contact surfaces.

Another method of obtaining a differential is shown by Fig. 5. There are two thermostat contact blades, one flexible and the other stiff. With falling temperature the contacts of the flexible blade close first, but the circuit is not completed by this closing. Further movement of the bimetallic element closes the contacts for the stiff blade as the flexible blade is bent. This completes the circuit through the transformer, the motor or other device to be operated in the heating plant, the relay winding, and the two sets of contacts and blades in the thermostat. The relay closes its own contacts, thus completing a path from the relay wind-



## Motor Driven Appliances and Equipment

ing to the common terminal of the thermostat.

When temperature rises the contacts for the stiff blade open, but the operating circuit still is completed through the upper relay contacts held closed by current continuing to flow in the relay winding. The heating plant is turned off only when the temperature rises high enough to open the thermostat contacts for the flexible blade. The differential is the difference in temperatures for closing the stiff blade contacts and opening the flexible blade contacts.

### BONNET AND DUCT THERMOSTATS

In addition to operating the heating plant controls in accordance with temperatures in the heated rooms these controls in some cases must respond to changes of temperature in warm air ducts and in the housings or bonnets of warm air furnaces. For use in ducts or bonnets the bimetallic thermostat usually is made in the form illustrated by Fig. 6.

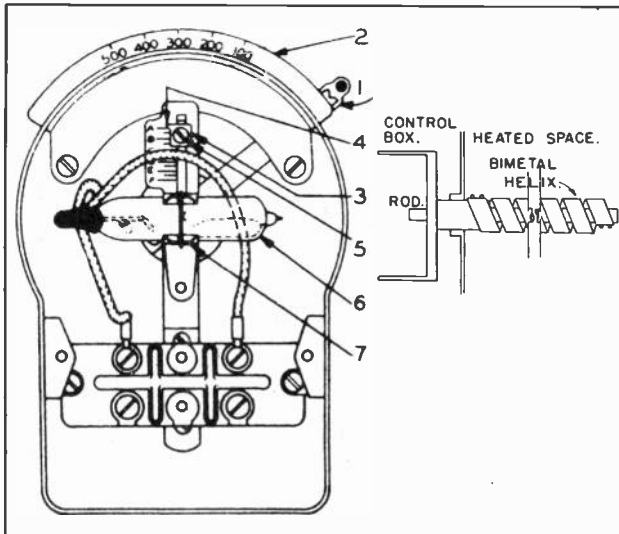

Fig. 6. The bimetallic helix used as a thermostat in bonnets, ducts and stacks: 1. Temperature indicator. 2. Temperature dial. 3. Differential adjustment. 4. Differential pointer. 5. Lock screw. 6. Mercury switch. 7. Clip for mercury tube.

The bimetallic element of Fig. 6 is in the form of a long helix or hollow screw fastened at one of

## Bonnet & Duct Thermostats

its ends to the housing of the box containing control switches and at its other end to a rod that extends back through the center of the helix to inside the control box. As the helix twists more closely or opens farther with changes of temperature around it the rod is rotated one way and the

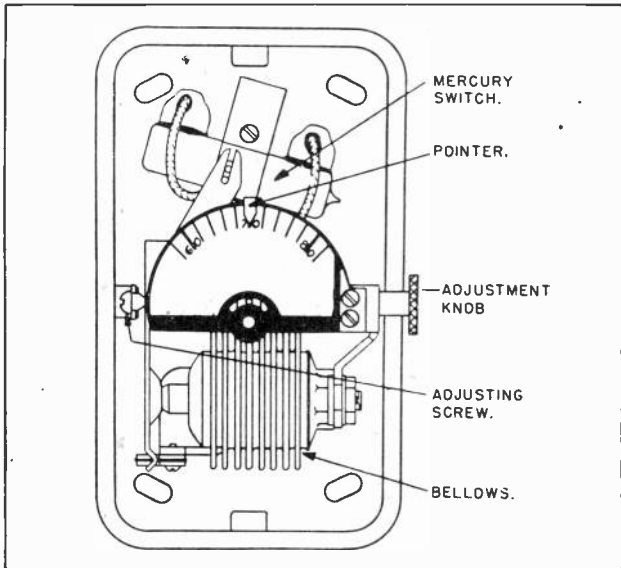

Fig. 7. Thermostat operated with bellows.

other on its axis. To the end of the rod inside the box are fastened switch-operating parts through which control circuits are closed and opened as temperature changes in the heated space carrying the bimetallic helix. Fig. 6 also shows a mercury switch operated from the helix and rod.

Instead of having temperature-responsive elements made of bimetals, heating control thermostats frequently employ an expanding and contracting bellows such as illustrated in Fig. 7. The bellows is partially filled with a highly volatile liquid such as some of those used in refrigeration systems. With increase of temperature some of the liquid changes to vapor and expands to lengthen the bellows, while

## Control Relays

with falling temperature some of the liquid condenses and allows the bellows to contract and shorten. Such lengthening and shortening of the bellows is used to operate the control switch or switches in the unit.

It should be noted before leaving the subject of thermostats that the simplest test of whether a thermostat is closing its contacts is to temporarily connect a short-circuiting wire to the thermostat terminals. If this causes the heating plant to start, when it failed to start normally, the indication is that the thermostat is failing to act.

Thermostats which operate switches in direct-current systems have small capacitors or condensers connected across their switch contacts in order to lessen radio interference when the contacts open the circuit. Sometimes these capacitors become short-circuited so that the equipment acts as though the thermostat remained closed all the time.

### CONTROL VOLTAGES

What is called a low-voltage control system operates at 25 volts, or less, from a transformer such as included in the control box of Fig. 8. A low-voltage system may use as high as 50 volts from

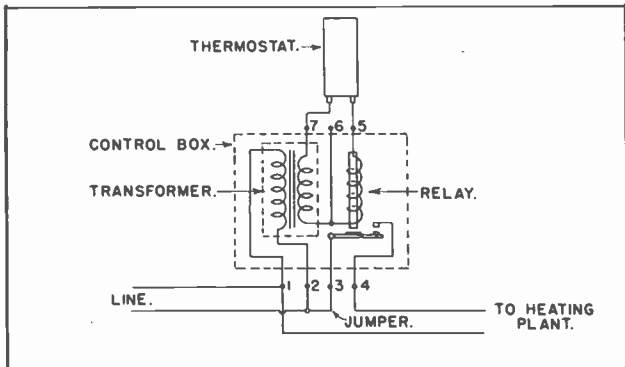

Fig. 8. Internal and external connections of control box with relay.

batteries. High-voltage systems are those operating at any voltages higher than those just men-

## Oil Burners

tioned, usually at supply line voltage. Terminals 6 and 7 in Fig. 8 may supply current to any low-voltage circuit in the heating system.

### OIL BURNERS

The principal operating parts of a commonly used type of oil burner are indicated in Fig. 9. This is the pressure atomizing type, often called the gun type. Oil from the supply tank passes through the oil filter, the oil pump and the pressure regulating valve, then to the oil nozzle through which it is ejected as a fine spray which almost instantly vaporizes in the air. Air is taken in through a rotary fan or blower driven by an electric motor, and is forced through the burner housing into the combustion space as it mixes with the vaporized oil.

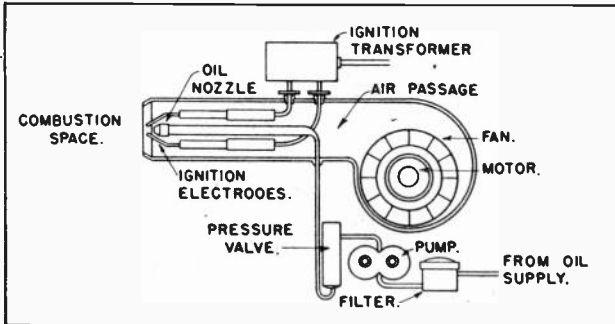

Fig. 9. Principal parts of gun type oil burner.

The mixture of vaporized oil and air is ignited by sparks passing between two metal points called ignition electrodes, which are just outside the vaporizing oil spray. The gap between electrodes is about  $1/16$  to  $3/16$  inch. The spark discharge between the electrodes is produced by high alternating voltage from the secondary winding of the ignition transformer whose primary winding is connected to the A-C lighting and power line through the ignition switch. There are many variations in the design of pressure-atomizing oil burners, but with all of them we find the electric driving motor, the ignition transformer and electrodes, and controls for the motor and transformer.

## Oil Burners

In a second general class of oil burners the oil is atomized as it is thrown off the edge of a rapidly

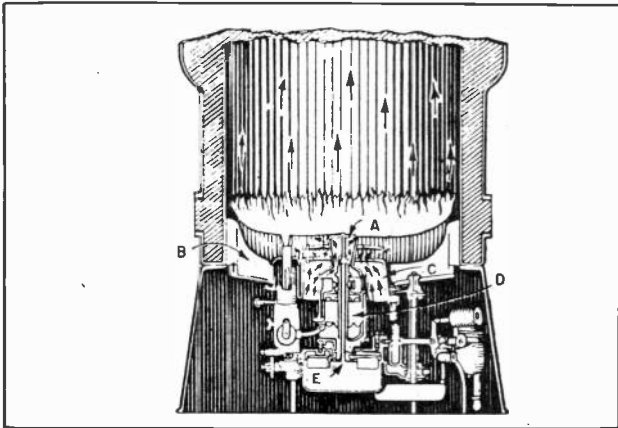

Fig. 10. Rotary centrifugal atomizing oil burner with vertical shaft: A. Atomizer. B. Chamber lines with refractory material. C. Air space. D. Electric motor. E. Hollow shaft.

whirling disc or cup. In one such burner, shown by Fig. 10, the cup rotates on a vertical axis with the driving motor down below. Ignition electrodes are near the edge of the cup. In another type, shown by Fig. 11, the cup rotates on a horizontal

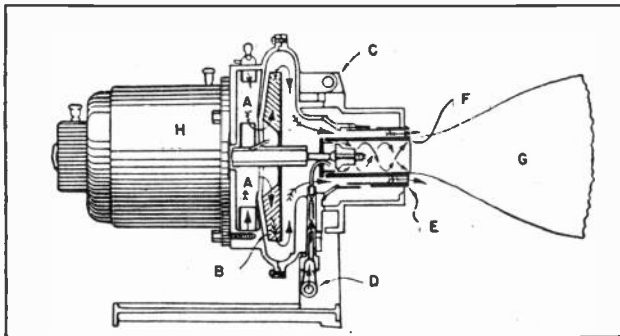

Fig. 11. Horizontal rotary cup type of atomizing oil burner. A. Air path. B. Fan. C. Hinged hanger for burner. D. Oil inlet. E. Air nozzle. F. Rotating atomizing cup. G. Flame. H. Electric motor.

axis, which allows placing the driving motor to one side of the combustion space—usually out in

## Oil Burners

front of the furnace or boiler. In still another rotary burner, shown by Fig. 12, oil is sprayed from revolving tubes against a target wall around the

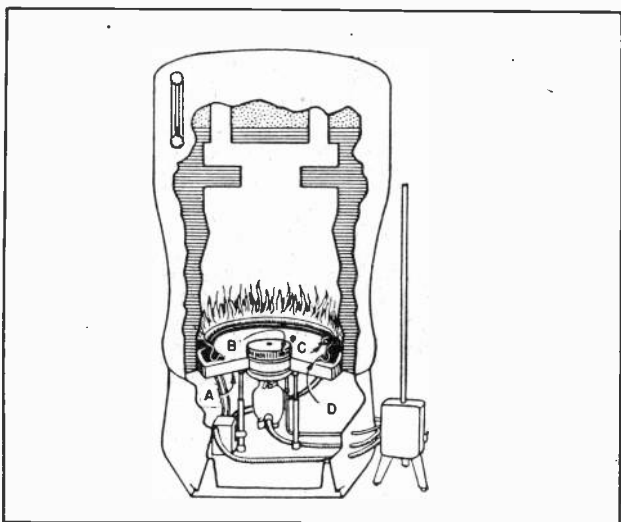

Fig. 12. Rotary burner of "blue flame" type: A. Hearth. B. Revolving tubes. C. Igniter. D. Refractory lining. The ignition electrodes are located near the target wall.

With any type of burner the ignition spark may be turned on only long enough to ignite the oil-air mixture and then cut off while the burner continues to operate, or a spark may be maintained all the time that the burner is in action.

### OIL BURNER MOTORS

Motors for driving the fans, oil pumps, and other moving parts of oil burners are from 1/12 to 1/6 horsepower for domestic installation. These motors, for alternating-current supply are of single-phase type, starting by split phase action or sometimes by repulsion-induction. Capacitor-start induction-run motors are quite generally used in the larger sizes.

### OIL BURNER IGNITION

The secondary voltage from oil burner ignition transformers may be anywhere between 5,000 and

## Oil Burners

15,000, although voltages of 10,000 to 12,000 are the most common values. The heavier the oil being burned the higher must be the ignition voltage, although for any given oil a higher voltage permits using a relatively small gap between electrodes, while a lower voltage requires a wider gap in order to get enough heat from the sparks.

Secondary windings of ignition transformers usually have the midpoint grounded, so that voltage to ground from either electrode is only half the full secondary voltage. To reduce radio interference the transformer usually is enclosed within a grounded steel case, and the high voltage wires are run through metal conduit from the transformer to the burner tube.

When oil burners are operated on direct-current lines, alternating current for the ignition transformer may be taken from extra collector rings connected to the winding of the motor armature. Spark coils using vibrating contacts to produce fluctuating current for ignition sparks are not considered reliable enough in operation to be used in oil burner service.

Fig. 13 shows typical connections for an oil burner ignition system with which the ignition is turned off after the burner starts. When room temperature drops, the thermostat closes to complete the low-voltage circuit through the relay winding. The relay contacts close, connecting the driving motor across the line and placing the fan and oil pump in operation. The relay also closes the circuit through the mercury switch (in its "cold" position) and the primary of the ignition transformer so that sparks pass between the ignition electrodes in the secondary circuit.

The mercury switch of Fig. 13, if used in a warm air heating plant, may be operated by a thermostat of the type shown in Fig. 6. As soon as the oil flame has continued long enough to furnish heated air, the thermostat tilts the mercury switch to the "hot" position, thus opening the primary circuit

## Safety Controls

of the ignition transformer and cutting off the spark. The ignition circuit will not again be closed until the fire is out and the switch returns to its cold position. In a system having continuous ignition as long as the burner is in operation, the mercury switch of Fig. 13 would be omitted and the ignition transformer primary connected directly between the relay and one side of the line.

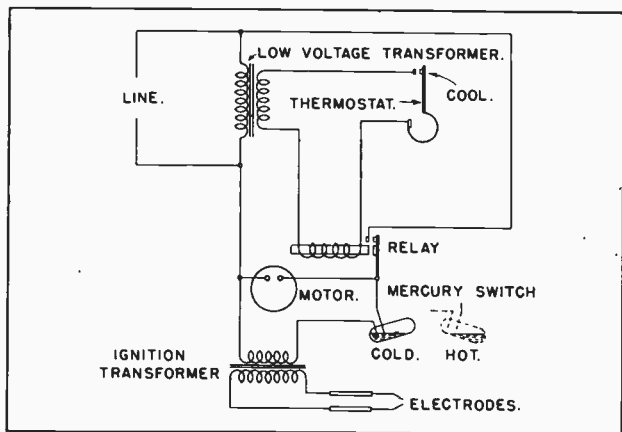

Fig. 13. Control system for an oil burner.

## SAFETY CONTROLS

With the arrangement of Fig. 13 there can be no ignition so long as parts are warm enough to keep the mercury switch in its hot position, so it might be possible for oil to be pumped through the burner into the furnace without being ignited. Such a possibility is avoided by using continuous ignition so that there is an ignition spark whenever the oil pump and fan are running. Another method of avoiding oil flow without ignition, and of adding other safety features, is shown by the diagram of Fig. 14.

In Fig. 14 we have a thermostat with flexible and stiff blades and two sets of contacts, just as in Fig. 5. The motor for driving the fan and oil pump, also the ignition transformer, are connected across the line when the relay closes its larger



## Safety Controls

contacts shown closest to the relay winding and magnet. This relay has three additional sets of contacts. As actually constructed all the contact arms of the relay are moved together so that all four sets of contacts close and open together. The mercury switch, operated from the bonnet or duct thermostat of Fig. 6, has two pairs of contacts. The contacts in one end of the tubes are connected by the mercury when the switch is in its cold position, and the contacts in the other end are connected in the hot position. The mercury switch is, in effect, a single-pole double-throw type connecting one end of the relay winding through either of two circuit paths.

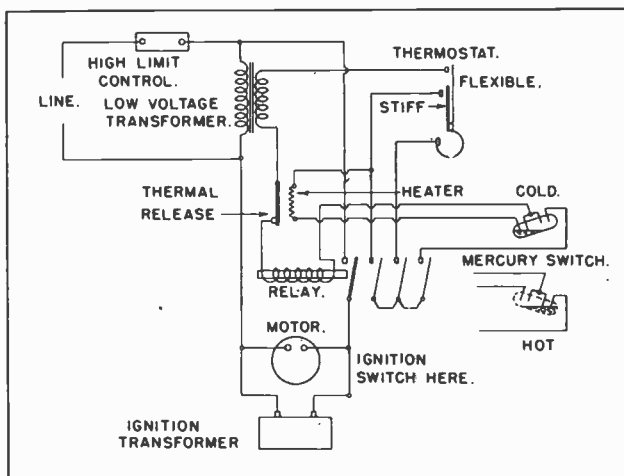

Fig. 14. Control system with safety features.

With falling room temperature the thermostat of Fig. 14 closes its flexible blade contacts and then the stiff blade contacts to complete a circuit from the low voltage transformer through the two sets of thermostat contacts, the heater element of the thermal release, the left-hand contacts of the mercury switch, the relay winding, the contacts of the thermal release, and back to the low voltage transformer. The relay then closes all four sets of its contacts.

## Control Voltages

Line current now flows through one pair of relay contacts to the motor and ignition transformer to start the burner in operation. If the ignition were to be controlled by the system of Fig. 13, the extra mercury switch of the type shown in Fig. 13 would be connected between the ignition transformer and relay as noted on the diagram of Fig. 14. This ignition switch would be operated from the same bonnet or duct thermostat that operates the mercury switch shown in Fig. 14.

When the oil ignites and produces heat to warm the thermostat for the mercury switch this switch moves to its hot position. The line from the room thermostat stiff blade through the thermal release heater now is opened by the mercury switch, but current continues to flow through the relay winding because the three auxiliary sets of relay contacts are closed and because the relay winding circuit is closed through these contacts and the right-hand contacts of the mercury switch in its hot-position.

Had the oil failed to ignite, the mercury switch of Fig. 14 would not have moved to its hot position. Then the circuit would have been maintained through the heater element of the thermal release. After a few moments this element would get hot enough (because of current flow) to open the contacts of the thermal release, thus opening the relay winding circuit, allowing the four sets of relay contacts to open, and cutting the motor and ignition transformer off the line. With all these circuits open there would be no current in the heater of the thermal release, and after enough time for the heater to cool off the release contacts again would close and the whole cycle of events would repeat, giving the burner another chance to ignite. This on and off action would continue at intervals until the burner ignited or until the system were shut off for repairs.

If the oil fire should go out, as from lack of oil, with the room thermostat still calling for heat, th

## Variation in Control Systems

mercury switch would return to its cold position which places the heater of the thermal release in circuit. If there still were no fire the heater would open all the circuits as previously explained.

The high limit control shown in one side of the line in Fig. 14 is a switch that opens whenever the temperature in the surface exceeds a safe maximum. For instance, the system might be adjusted to produce a maximum bonnet temperature of 175 degrees, and if the actual temperature should exceed this value by something like 50 degrees the high limit control switch would open to shut off the entire system.

### VARIATION IN CONTROL SYSTEMS

The control system just explained is typical of those used with oil burners, but there are many other types operating with different electrical elements to produce the same general results so far as automatic control is concerned. Switches may be of the open contact type instead of the mercury type. Any type of switch may be operated by any form of thermostat suited for the location where heat is to affect the operation.

With warm air systems the thermostats operating the control switches are placed in the furnace bonnet, the main warm air duct, or sometimes in the combustion space or the stack. With hot water systems the thermostats are located in the hot water riser or in the top of the boiler space, and, of course, may be in the stack or the combustion space. Control for steam heating systems may be by means of temperature, but more often is effected by pressure devices which regulate the heating to produce certain desired steam pressures. In all cases it is possible to make adjustments for the temperature or pressure at which heat is turned on and off, and to adjust the differential in temperature degrees or pressure.

The systems which have been explained are of the intermittent operating type, meaning that the heating plant is placed in operation when heat is called

## Controls of Gas Burners

for by the room thermostat and is shut off completely when heat demands have been satisfied. In other systems having continuous operation the burner remains lighted at all times, the combustion rate being increased when the heat is called for and decreased as the heat demand is satisfied. Usually there are three or four steps of heating, or combustion rates, with these continuous systems.

### CONTROLS FOR GAS BURNERS

Fig. 15 shows the parts and their connections for the simplest possible automatic control for a gas-fired heating plant. Between the gas meter and the gas burner is a magnetic valve or solenoid valve which opens when current flows in its winding to lift the plunger and attached poppet. The valve winding is wired in series with a room thermostat and the secondary of the low-voltage transformer. When the thermostat calls for heat by closing the circuit, gas is allowed to flow to the burner where it is ignited by a pilot flame that remains lighted at all times during the heating season.

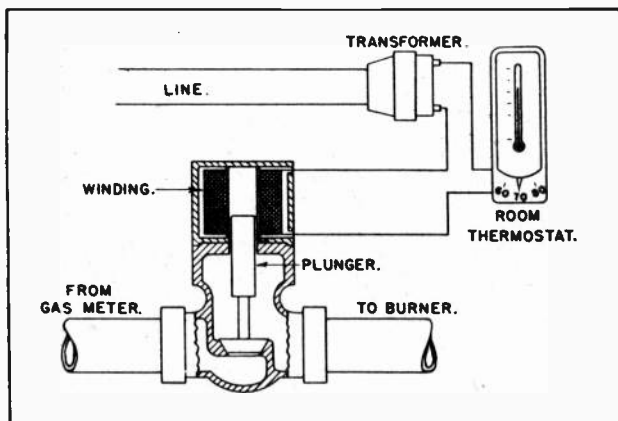

Fig. 15. Magnetic valve or solenoid valve in line to gas burner.

Fig. 16 shows the parts and their connections in an automatic gas heating system having the usual safety features and designed for operating a motor-driven air circulating fan whose operation is tied

## Controls of Gas Burners

in with operation of the gas burner. In Fig. 16 gas from the meter flows through a hand operated burner shut-off valve, an automatic pressure regulating valve, a magnetic valve of the kind shown in Fig. 15, and to the burner or burners in the furnace.

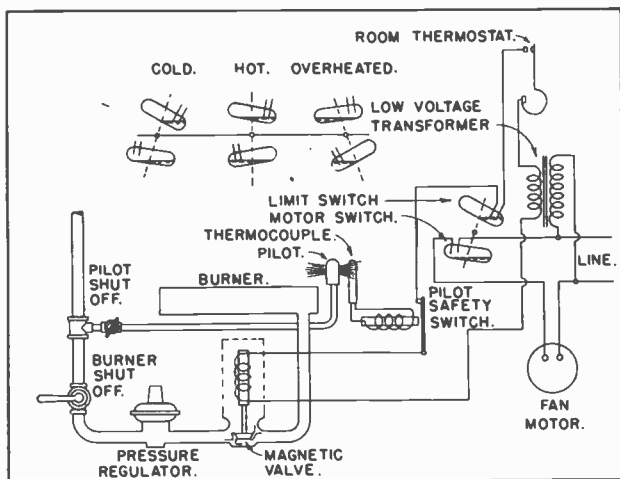

Fig. 16. Complete automatic control system for gas burning plant.

The pilot is supplied with gas through a separate shut off valve and a line taken from above the burner shut off. The pilot, which burns continually throughout the heating season, has two jets or two flames. One flame is directed toward the burner to light the main flame when the magnetic valve opens, and the other pilot flame is directed against the tip of a tube which contains a thermocouple. Current generated by the thermocouple while heated flows in the electromagnet of the pilot safety switch and keeps this switch closed. This safety switch is in series with the magnetic valve. Unless the pilot is lighted and is heating the thermocouple; the safety switch opens and prevents current from reaching the magnetic valve and the main burner cannot get gas. Thus any failure of the gas supply prevents collection of unburned gas in the burner compartment.

## Controls of Gas Burners

The limit switch and motor switch of Fig. 16 are of the mercury type, tilted by a bonnet or duct type of thermostat such as illustrated in Fig. 6. Both switches tilt together as shown by the small sketches. In the cold position the low voltage circuit for the thermostat is completed through the top switch. When the thermostat calls for heat and closes this circuit the magnetic valve opens and admits gas to the burner. As the furnace warms up the switches tilt to the hot position, which completes the motor circuit through the lower switch and starts the fan. If heating continues and produces a temperature higher than the upper limit for which the control is adjusted, the motor circuit is kept closed through the lower switch but the circuit to the magnetic valve is opened to shut off the burner.

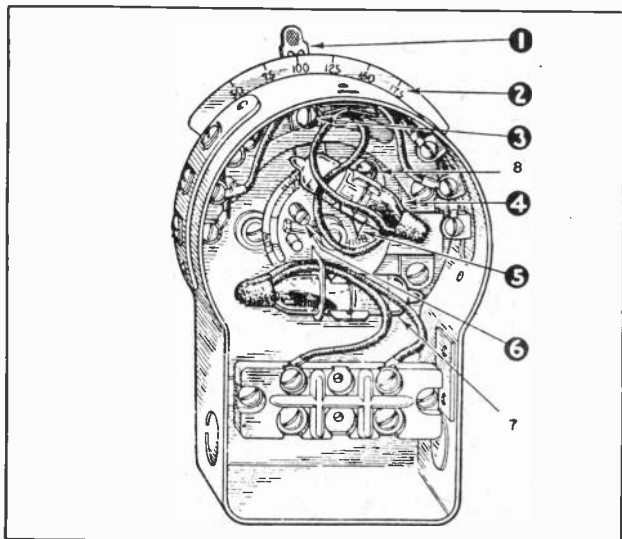

Fig. 17. Control unit with mercury switches: 1. Temperature setting pointer. 2. Temperature dial. 3. Lock screw. 4. Limit switch. 5. Limit control adjustment pointer. 6. Eccentric adjustment screw. 7. Fan motor switch. 8. Lock screw (Minneapolis-Honeywell).

A control unit incorporating the two mercury switches is illustrated by Fig. 17. A pointer may be adjusted on the dial at the top of the control for the

## Pressure Regulators

temperature at which the fan is to start. The limit switch will turn off the burner at 20 to 75 degrees above this temperature, depending on the limit control adjustment. The drop in temperature (or differential) between the limit control temperature and the temperature at which the burner again will be turned on may be adjusted to between 20 and 40 degrees by the eccentric adjustment screw.

### PRESSURE REGULATOR

Maintaining a burner flame which supplies a maximum of heat and the least possible sooting depends on maintaining a certain relation between air and gas entering the burner. Since atmospheric air pressure is practically constant it is necessary that gas pressure be maintained constant at the burner even though the supply pressure fluctuates, as it generally does. Uniform gas pressure is maintained by the pressure regulating valve. One construction for such valves is shown in Fig. 18.

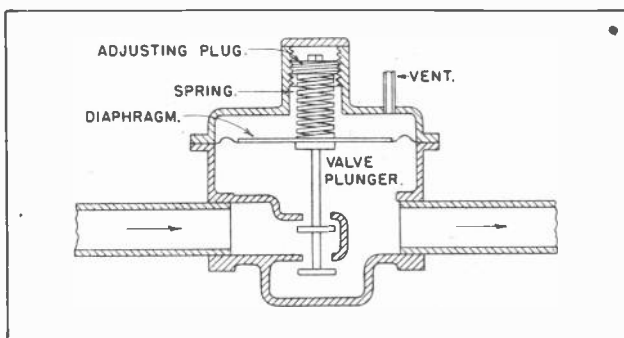

Fig. 18. Automatic pressure control gas valve.

Gas entering from the supply passes through the open valves mounted on the plunger which is attached to the flexible diaphragm, thus admitting the supply pressure to the under side of the diaphragm. When this pressure reaches a value corresponding to the tension of the spring that bears on the top of the diaphragm the diaphragm rises and closes the valves. Only when pressure on the outlet side of the valves, and on the side where the diaphragm

## Automatic Coal Stokers

is located, only when this pressure falls to a value corresponding to the spring tension will more gas be admitted. Thus the burner pressure is maintained nearly constant. The burner pressure may be changed by adjusting the tension of the spring above the diaphragm. Some pressure-regulating valves have a weight instead of a spring above the diaphragm.

### AUTOMATIC COAL STOKERS

An automatic stoker feeds coal to a furnace or boiler and usually supplies air at the same time and in correct amount by means of a blower or fan. The stoker most commonly used for installations of small and medium size is the underfeed type such as illustrated in Fig. 19.

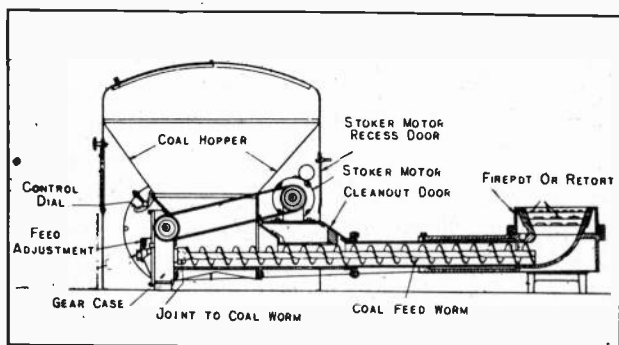

Fig. 19. Operating parts of an automatic coal stoker (Norge).

The underfeed stoker takes coal from a hopper or bin and carries it to the retort in the furnace by means of a large screw or by combinations of rams, plungers and screws. The coal-carrying device is driven by an electric motor through gearing or other drive elements which allow adjustment of the rate of feed.

As with all automatic heating systems, the primary control for the stoker is the room thermostat which causes coal feed to commence or stop or which determines the rate of coal feed. Safety controls are generally similar to those which have been described for oil burners and gas burners.



## Automatic Coal Stokers

The coal stoker requires an additional control which will increase the fire for a short period when furnace temperatures fall to a predetermined point, even though the thermostat is not calling for heat. This control is necessary because a coal fire will go out if deprived of draft for a considerable length of time in spite of the fact that plenty of unburned coal may be present. This control does not send heat into the room spaces but merely increases the combustion rate for a short time.

Low limit controls are operated from a thermostat in the bonnet, in a duct, in the stack (usually), or in the hot water, or may be operated from steam pressure. They act to increase the rate of coal feed or to supply forced draft, or both if needed, when temperatures drop, in much the same way that automatic controls stop operation of a heating plant with excessive temperature. For low limit control the necessary switches are closed with falling temperature while with high limit control the switches are opened with rising temperature.

### TROUBLES IN HEATING CONTROLS

Faulty operation or failure to operate at all does not necessarily mean that the trouble is in the automatic control system. For an oil burner the oil and air supply should be checked, with a gas burner the gas valves and pilot should be checked, and with a coal stoker, the coal supply and feed should be looked at before assuming that there may be electrical trouble.

Unless the trouble is of such nature as to clearly indicate the parts at fault, one of the first steps should be to measure the line voltage and the voltage at the motor terminals when the plant should be operating. No voltage or low voltage may mean a blown fuse or an opened circuit breaker in the supply leads. The cause for the overload should be looked for before replacing the fuse or setting the breaker. Voltage failure may be due to broken, loose or dirty terminal connections anywhere in the wiring. The secondary terminals of

## Automatic Coal Stokers

the low-voltage transformer may be checked for voltage, although transformer failure is of rare occurrence. Other electrical troubles which are more or less common may be as follows:

Room thermostat contacts dirty or rough. Temperature or differential settings not suited to requirements.

Relay completely inoperative due to loose or broken connections. Some or all of the relay circuits remain open due to dirty, rough or pitted contact points.

Mercury switches may have cracked glass tube, otherwise these units operate without trouble for long periods.

Heater of thermal switch in relay unit may be burned out or disconnected.

Helix type of thermostat may be loose on its rod or its support. If used in the stack, the helix may be covered with soot and should be cleaned.

High temperature or pressure limit controls may have been adjusted to operate at temperature or pressures which are so low as to interfere with normal operation.

Ignition electrodes in an oil burner may have an incorrect gap, either too wide or too narrow, or the points may be covered with soot.

Magnetic valves in a gas burning system may fail to operate, or safety switches may remain open due to failure or wrong adjustment of the pilot.

Troubles which may occur in motors of heating systems are no different than motor troubles in any other field. If voltage reaches the motor terminals and the motor fails to run, it should be checked for internal trouble.

Careful checking of thermostat contacts, circuits and switches, fuses, etc., will locate the most common troubles and indicate the remedy.

## MOTOR DRIVEN APPLIANCES

Many men who are in electrical work fail to appreciate the importance of household electrical appliances.

It is somewhat astonishing to learn that the electric utility companies get more revenue from residential consumers of electric power than from any other one class of users, and that more than a third of their total income is from the domestic field. In ten years the use of electric power in homes increased by two-thirds, chiefly because of more and more electric appliances, and more and better lighting. This two-thirds increase in electrical comforts and conveniences cost the users only ten per cent more than they paid before, because the cost of electric power is continually decreasing. The more appliances that are used the cheaper becomes the power to operate them, the cheaper the power the more appliances come into use.

Here is a list of the more common motor-driven electric appliances together with horsepowers of the motors generally used:

Cleaners, vacuum .....	1/6 to 1/2 hp.
Clocks .....	1/300 hp.
Dryers, hair .....	1/30 hp.
Fans .....	1/20 to 1/12 hp.
Humidifiers, room .....	1/20 to 1/12 hp.
Ironers, clothes .....	1/20 to 1/6 hp.
Mixers, drink and food.....	1/12 to 1/6 hp.
Phonographs, electric .....	1/30 to 1/20 hp.
Projectors, motion picture.....	1/20 hp.
Sewing machines .....	about 1/8 hp.
Washers, clothes .....	1/4 hp.
Washers, dish .....	1/4 hp.

The motor horsepower listed for each appliance are merely representative of common practice. Either more or less power might be used for any

## Types of Appliance Motors

one of them. Among these motor-driven appliances are several which depend for their action on heating units as well as the motor drive, these including

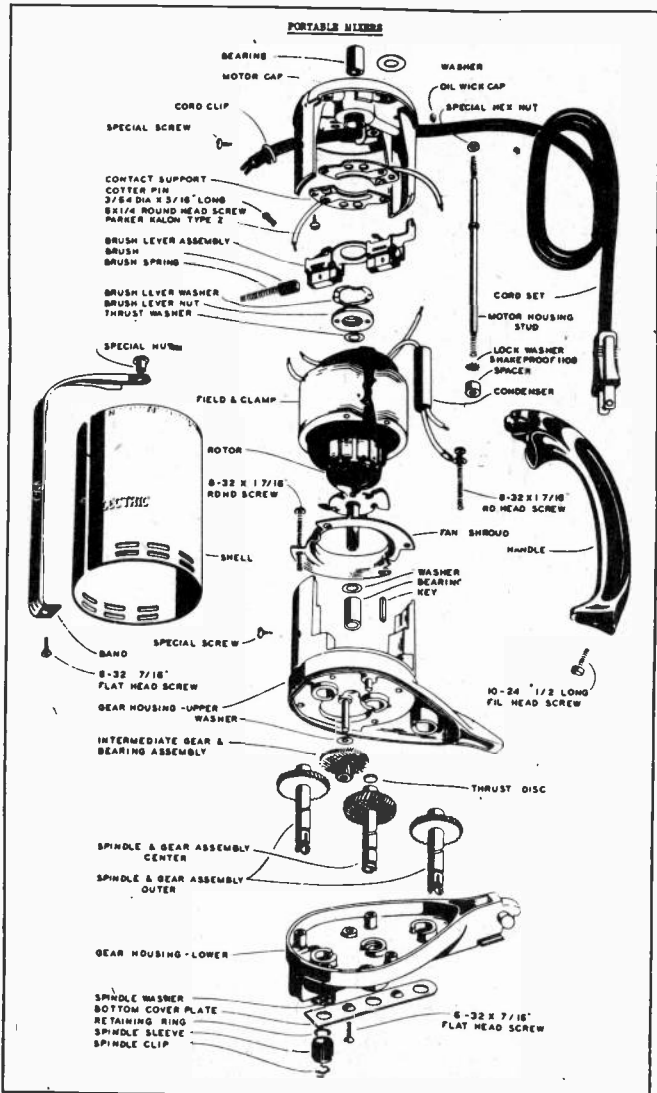

Fig. 1. The Parts of an Electric Food Mixer (General Electric).

## **Motor Driven Appliances and Equipment**

ironers, humidifiers, hair dryers, and some dish washers.

### **TYPES OF MOTORS**

All appliance motors are of fractional horsepower sizes, meaning that they are of less than one horsepower. Considered from the standpoint of electrical operation we find induction motors which usually are of the split-phase starting type and often of the capacitor-start or capacitor start and run varieties. Then we find a great many universal motors of the series-wound type with commutator and brushes, for operation on either alternating or direct current supply. There are many midget or miniature motors, including split-phase types, shaded-pole types, and the very small synchronous motors.

Each type of motor is important in the appliance field. The three most generally used motor-driven appliances are clothes washers, clocks and vacuum cleaners. Clothes washers ordinarily have induction motors, clocks have midget synchronous motors, and vacuum cleaners have series-wound motors. All alternating-current appliance motors are of single-phase types because residential service always is single-phase.

### **SPLIT PHASE MOTORS**

The split-phase motor has two stator windings as shown by Fig. 2. The running winding is connected across the line at all times while the motor is in operation. The starting winding is in circuit while the motor starts and until it comes nearly to running speed, then this winding is opened or disconnected from the line by an automatic cutout switch. The cutout switch usually is of a centrifugally operated type located inside the motor.

The split-phase principle allows the single-phase motor to start because the currents in the two windings are slightly displaced in phase or are slightly out of time with each other. The result is somewhat similar to that of a two-phase current

## Types of Appliance Motors

and there is rotating field which causes the rotor to revolve. The phase displacement results from the

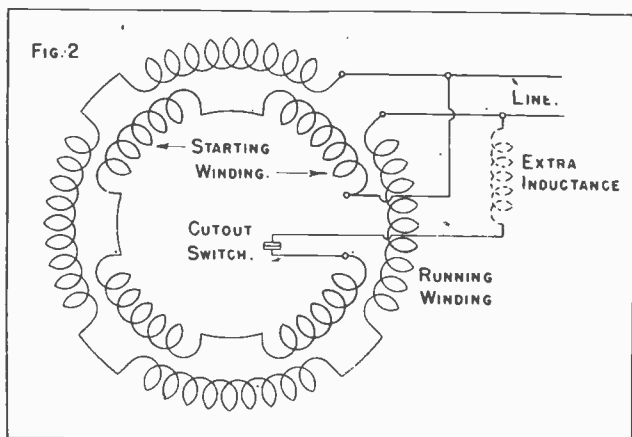

Fig. 2. Connections in a Split-phase Motor.

starting winding having more inductance than the running winding. The greater inductance in the starting winding causes current in this winding to lag behind current in the running winding with both windings connected to the same supply. The extra inductance for the starting winding usually is provided by having more turns on this winding than on the running winding, by placing the starting winding so that its magnetic circuit includes more iron than that of the running winding, by including an extra inductance coil in series with the starting winding, or by combinations of these methods. Anything that displaces the current in one winding with reference to the current in the other winding "splits the phase" and allows the motor to be self-starting.

### CAPACITOR MOTORS

Since anything that displaces the currents in the two windings of a split-phase motor allows the motor to start we may use capacitance in series with one winding so that the current in this winding will lead that in the other winding. This is the

## Motor Driven Appliances and Equipment

principle of the capacitor motors, which are of the split-phase type. Fig 3 shows how a capacitor may be connected in series with the starting winding instead of the extra inductance shown by Fig. 2. The capacitor and the starting winding are disconnected after the motor comes up to speed. This arrangement makes what is called a capacitor-start motor.

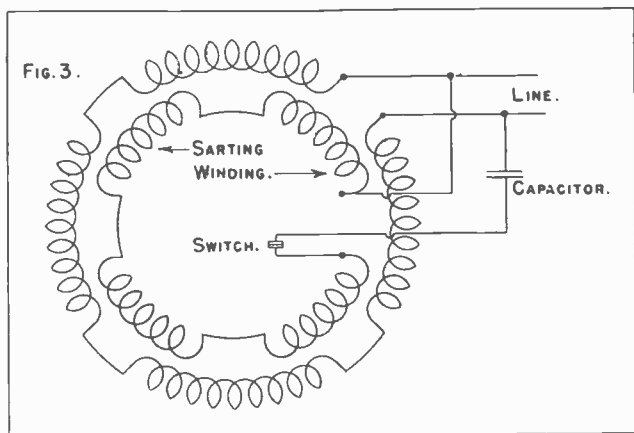

Fig. 3. Connections in a Capacitor-start Motor.

The connections for the capacitor-start motor which are shown in Fig. 3 are shown again at **A** in Fig. 4, here in a diagram that allows easier tracing of the circuits.

The diagram at **B** in Fig. 4 shows one variety of capacitor run motor, which means a split-phase motor that not only starts with capacitance in series with the starting winding, but which continues to run with capacitance in series with that winding and with the winding connected to the line. With the capacitor-run motor at **B** in Fig 4 we have two separate capacitors which are connected in parallel with each other and in series with the starting winding for starting. One of the capacitors is cut out by the automatic switch after the motor comes up to speed. Since both windings remain in circuit at all times we now shall call one the main wind-

# Capacitor Start Motors

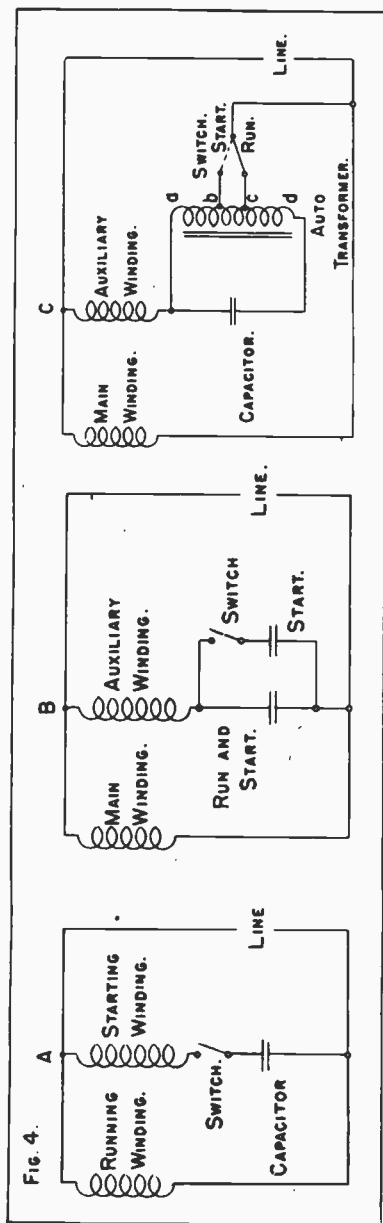

Fig. 4. The Connections for (A) an Ordinary Split-phase Motor, (B) a Capacitor Run Motor with two Capacitors, and (C) with a Capacitor Run Motor with one Capacitor and an Auto-transformer.



## Motor Driven Appliances and Equipment

ing and the other the auxiliary winding.

The two capacitors in parallel add their capacitances, so for starting we have a large capacitance which allows a relatively large current in the auxiliary winding. This large current is just what we need for starting, but it would overheat the motor if allowed to continue. The starting current in the auxiliary winding is reduced to a safe running value by cutting out one of the capacitors, which lessens the capacitance, increases the capacitive resistance, and lowers the current.

An advantage of the capacitor motor over the straight split-phase type is a much improved power factor. Any highly inductive circuit, such as that containing the stator windings, causes a large phase difference and a low power factor, meaning that much more current flows than is useful in producing power. By adding capacitance to an inductive circuit we counteract the inductance to a greater or less extent, bring the current and voltage more nearly together (into phase), use more of the total current in producing power, and have a better power factor.

At C in Fig. 4 is shown an arrangement that permits using only one capacitor yet retains the advantages of the two capacitors used at B. Between one side of the line and the auxiliary winding is an auto-transformer. With the automatic switch in the **start** position, current from the line goes through the switch to **b** on the transformer winding, then through the winding from **b** to **a**, through the auxiliary winding, and back to the line. Now the section of the transformer winding between **b** and **a** acts as the primary, while the entire winding from **d** to **a** acts as the secondary. The turns ratio between primary and secondary is a high one and the auto-transformer applies its high secondary voltage to the capacitor. This high voltage causes a large current to flow through the capacitor, this being the large current needed for starting the motor and bringing it up to speed.

## Appliance Motors

As soon as the motor speed reaches nearly the running value the automatic switch moves over to the run position. Now line current passes through the transformer from c to a on its way to the auxiliary winding, while the entire transformer winding from d to a still acts as the secondary. The turns ratio with c-a for primary is much lower than with b-a for primary, so we have a lower voltage from the secondary winding and a smaller current through the capacitor. This is the smaller current that is suitable for running.

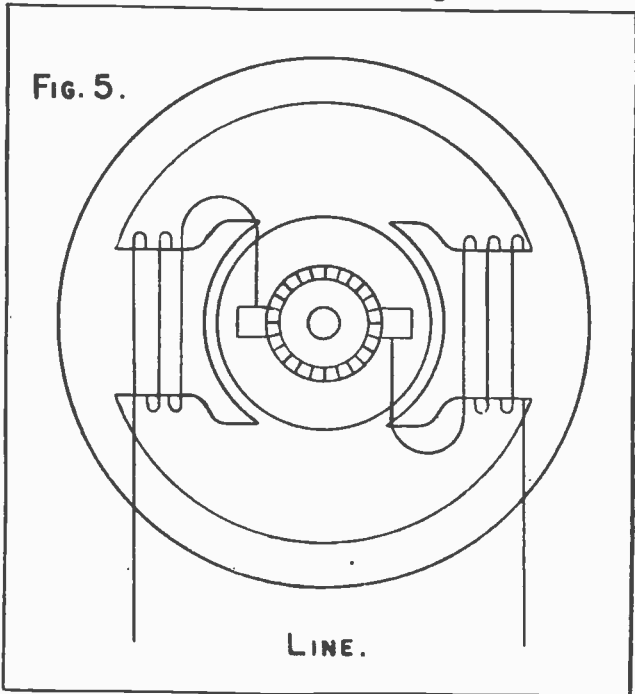

Fig. 5. Fields and Armature for a Universal Series-wound Motor.

### UNIVERSAL SERIES-WOUND MOTORS

The universal series-wound motor which operates equally well on either alternating or direct current has armature, commutator, brushes and fields whose connections are the same as in the

## Motor Driven Appliances and Equipment

d-c series motor. The fields are wound with large wire and are in series with the armature and line as indicated by Fig. 5. Like the d-c series-wound motor, the universal type has very high starting torque and the speed varies within wide limits with changes of load. Small universal motors frequently have full-load speeds between 4,000 and 9,000 r.p.m. and no-load speeds of from 10,000 to 20,000 rpm. The no-load speed is limited only by friction of the bearings and drag of the surrounding air on the armature and other moving parts. Universal motors used in mixers like that of Fig. 1 have normal running speeds of 9,000 rpm, and these motors in domestic vacuum cleaners normally run at 9,500 to 14,000 rpm.

While a universal series motor operates about the same on alternating and direct current, a d-c type of series-wound motor will not operate satisfactorily on alternating current. Compared with d-c types the universal motor will have thinner laminations in the field magnet cores and will have field windings of very few turns of large wire in order to lessen the self-inductance and improve the power factor. Air gaps between field poles and armature core are very small in the universal motor, thus lessening magnetic reluctance. To reduce brush sparking on alternating current the universal motor operates with relatively low field flux and armature coils have only a few turns, sometimes only one. Resistors sometimes are connected between armature coils and armature segments to further lessen brush sparking. Compensating windings may be used to neutralize the armature field.

Any electrical apparatus in which current is being rapidly switched will cause radio interference unless the leads to such apparatus are connected through an interference capacitor, are grounded directly or through a capacitor, are well protected with a grounded shield, or are fitted with some other effective type of radio interference filter. Consequently, all appliances containing commutator

# Universal Type Motors

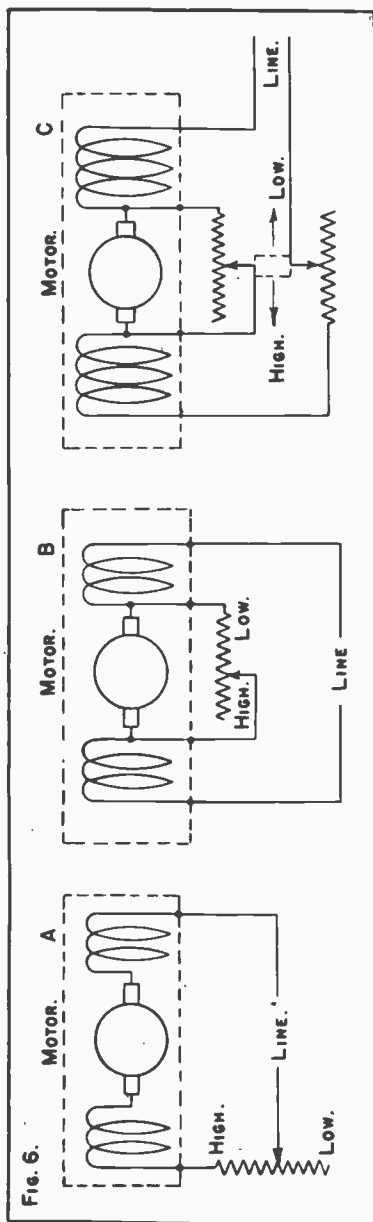

Fig. 6.

Speed Controls for Series Motors. A. Line Rheostat. B. Armature Shunting Rheostat. C. Line and Armature Rheostats.

## Motor Driven Appliances and Equipment

types of motors must be equipped with some means for suppressing radio interference. Alternating current induction motors seldom cause interference and require no filtering.

### UNIVERSAL MOTOR SPEED CONTROL

One of the advantages of the universal motor over the usual types of induction motors is that the universal type may be fitted with an adjustable speed control. This control is necessary or desirable for such appliances as sewing machines, mixers and fans.

The simplest speed control is a rheostat in series between the line and the motor as shown at **A** in Fig. 6. The more is the resistance in series with the the motor the slower it will run. A disadvantage of the series resistance is that the torque or turning force from the motor is greatly lessened at the lower speeds. Another method of speed control is shown at **B**, where a rheostat is shunted around the armature so that the less the resistance of the rheostat the more current flows through the rheostat and the less through the armature.

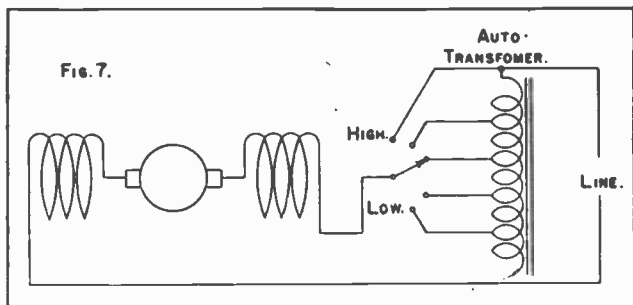

Fig. 7. Auto-transformer Speed Control for a Universal Motor Operated on Alternate Current.

The control methods of **A** and **B** in Fig. 6 often are combined as shown at **C**, with the sliders of the two rheostats moved in unison by a single control handle or knob. This combination control reduces the range of speed which may be had, but

## Speed Controls

changes in the load do not have so much effect on speed as with the other controls.

Fig. 7 shows the connections for operating a universal motor on alternating current with a tapped auto-transformer for speed control. The ends of the transformer winding are connected across the line and the tap switch supplies to the motor various voltages from that of the line down to the lowest that may be used. Lowering the voltage to the motor lowers its speed. The auto-transformer does not affect the low-speed torque as does a rheostat control.

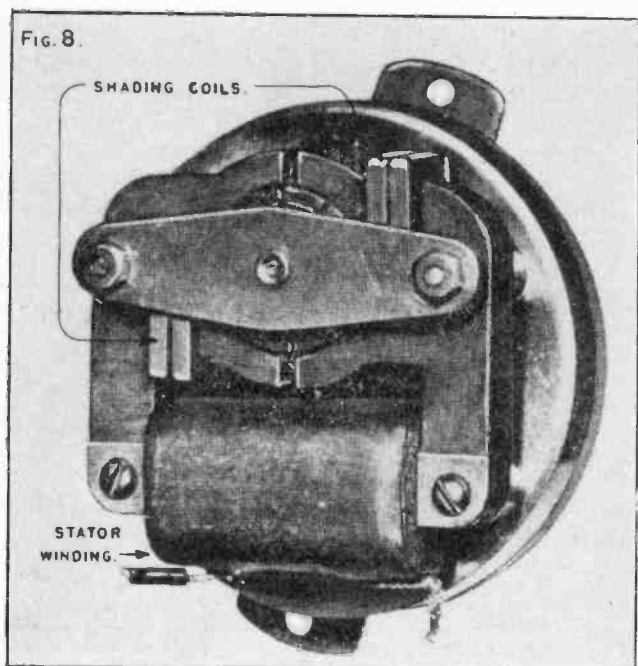

Fig. 8. A Shaded Pole Motor (Electrocon).

## SMALL SYNCHRONOUS MOTORS

Many of the very small appliance motors are of the synchronous type with a permanent magnet rotor and a laminated field magnet core carrying

## Motor Driven Appliances and Equipment

the winding. Some of these motors, such as used in many clocks, are not self-starting and have to be spun by hand after the current is turned on. Self-starting styles usually are of the shaded pole type, of which one example is illustrated by Fig. 8.

A shaded motor is one having closed copper rings or closed coils around about one half of each field pole face. The magnetic lines of the field cutting these coils produce currents in the coils, and the currents produce additional flux that alternately assists and opposes the main field flux in the pole. The result is a displacement of flux that causes the rotor to turn.

Many small synchronous motors are enclosed in a sealed casing which is oil-tight and dust-proof and which contains enough lubricating oil for an indefinite length of time, often for the life of the appliance. When the rotor speed is to be reduced, as usually is the case, a reduction gearing may be in the same or a separate similar case. Drive shaft speeds may be anywhere from a few hundred revolutions per minute to one revolution in 24 hours. The drive shaft for clock motors turns at one revolution per hour and drives the minute hand directly.

### MOTOR SPEEDS

Induction motors operate at practically constant speeds which are a little bit less than synchronous speed with normal loads. If these motors are overloaded they do not slow down and continue to run as does a universal motor, but they stall and will burn out unless the current is turned off within a few minutes. Usually running speeds for induction motors are as follows:

	Synchronous	Full-load
Frequency	speed	speed
60 cycles	900 rpm	860 rpm
60 cycles	1200 rpm	1135 rpm
60 cycles	1800 rpm	1720 rpm
60 cycles	3600 rpm	3440 rpm
25 cycles	1500 rpm	1420 rpm

## Motor Speeds

Small synchronous motors run at speeds strictly proportional to the supply line frequency in cycles and the number of poles on the motor. When overloaded to any extent these motors stop completely. The speed of the rotor shaft in revolutions per minute is equal to 120 times the frequency in cycles, divided by the number of motor poles. On 60-cycle supply a two-pole synchronous motor runs at 3,600 rpm, a four-pole type at 1,800 rpm, and so on.

### REMOVING MOTORS FROM APPLIANCES

The methods of enclosing and supporting driving motors vary widely between different types and makes of machines. Careful examination must be made before loosening any bolts, nuts or screws. A typical operation with a washing machine requires taking out the agitator which is in the tub, taking off the wringer, removing the centrifugal extractor if one is used, plugging the transmission case vent openings so that oil cannot spill, turning the machine on its side, loosening the motor drive coupling, and taking out the bolts that hold the motor base. This frees the motor.

In other cases the inside or working parts of the motor are exposed by taking off a sheet metal or pressed metal cover, after which it is possible to remove the brush supports and brushes, take off the motor end plate, lift out the armature or rotor, then pull out the field or stator.

Brushes, and usually the brush holders, always are quite easily removable, as are also rotors or armatures. It is of utmost importance when taking out an armature or rotor to make certain that none of the thrust washers or spacers are lost, and that they are identified so that they may be placed back in their original positions. Motor shafts must have some end play, but not too much, and the amount is governed by the spacers

Vertical shaft motors which are above the unit they drive have a ball bearing at the upper end of the shaft to take thrust both up and down. This



## Motor Driven Appliances and Equipment

bearing may also carry the radial load or there may be a separate bearing of the sleeve type. The lower bearing will be either a ball type or a sleeve type.

The coupling between the motor shaft and the machine drive or transmission often is of a universal or flexible type which permits some misalignment without damage to bearings, but in other cases it is most important that the motor shaft be exactly aligned with the shaft it drives.

In removing a motor do not commence by disconnecting all the wires in sight. On the other hand, separate just as few as possible, leaving parts hanging by their leads if they do not have to be disconnected for the job being done. Every time a wire is taken off a terminal the wire end should be tagged or otherwise identified so that it may go back in the right place. Sometimes a machine has to remain disassembled while waiting for repairs, and it is not safe to trust to memory for wiring arrangements.

### DRIVE MECHANISMS

Service and repairs on driving mechanisms of appliances are purely mechanical matters, not electrical, yet sometimes it is necessary to disassemble some of these mechanical parts in order to reach electrical ones. A typical washing machine drive, such as is underneath the tub, is illustrated in Fig. 9. This, and many similar mechanisms, are enclosed in oil-tight housings in whose joints are glued gaskets of composition materials, corks, sheet metal, or asbestos sheathed with thin metal. None of these types of gaskets require shellac or other treatment to make them oil tight when they are new or in good condition. Paper gaskets usually are shellaced with orange shellac which has been allowed to evaporate until it becomes quite thick.

Transmission parts are held together with such fastenings as straight pins, taper pins, locking nuts and set screws. Many transmissions contain various

## Drive Mechanisms

thrust balls, spacing washers and springs, all of which are easily lost or, what is almost as bad, easily put back in the wrong places. It should be

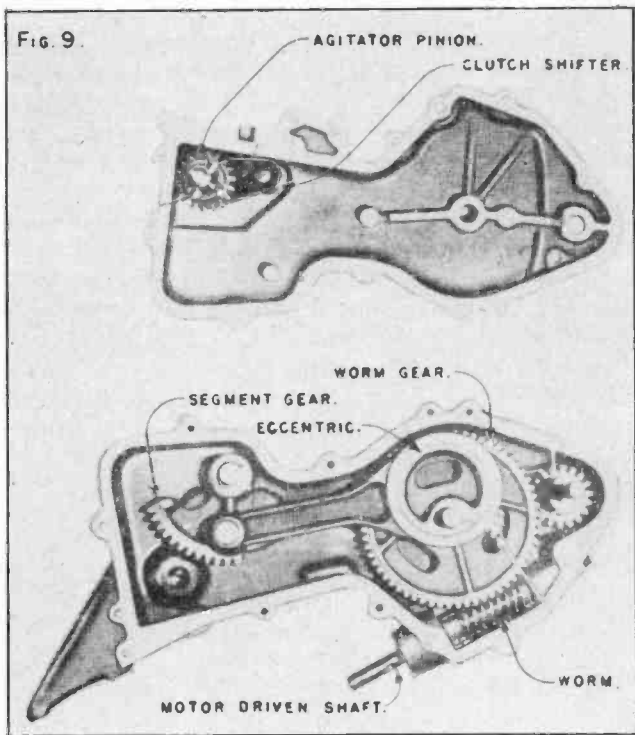

Fig. 9. Gears and Gear Case for a Clothes Washer (Easy).

remembered that all shafts which rotate must have some end play, usually only a few thousandths of an inch, but highly important if binding is to be avoided when parts get warm and expand. End play may be adjusted or maintained with spacing washers, or often by thrust balls and adjustable screws at the ends of shafts.

Before taking out a clutch spring, compress it as far as possible and then tie it with wire or place heavy wire hooks from end to end so that when the spring comes out it won't expand and be dif-

## Motor Driven Appliances and Equipment

hicult to replace. A new clutch spring may be compressed in a vise, then wired, put in place, and the wires cut.

In case one of a pair of gears that mesh together must be replaced its mate should be replaced at the same time unless the machine is nearly new. Installing one new gear to mesh with a worn one always results in noisy operation.

### V-BELT DRIVES

Many appliances have a V-belt drive of the type shown in Fig. 10, with the sheave or smaller pulley on the motor shaft and the large pulley on the driven shaft. The things that cause the most

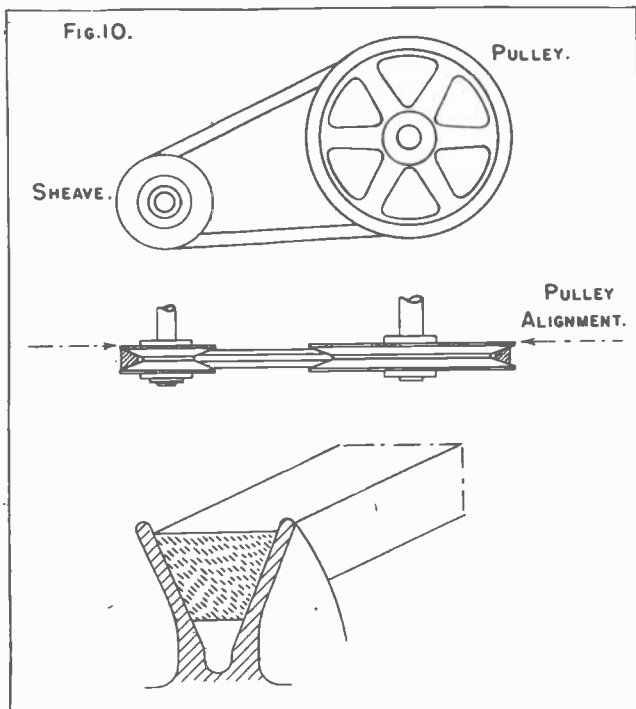

Fig. 10. V-belt Drive.

trouble with V-belts are oil on the belt and misalignment of the pulleys. No kind of oil or belt

## Drive Mechanism, V-Belt Drive

dressing should be applied to a V-belt, it should be cleaned and left dry when it becomes dirty. Unless the motor shaft and driven shaft are exactly parallel and the grooves of the pulleys exactly in line with each other the belt soon will fray, wear and probably break.

The tension of a V-belt should be such that it springs back to a straight line when pressed midway between the pulleys, but it should be no tighter than just will keep it straight. Belt tension may be adjusted by loosening motor base bolts and sliding the motor on its support, by swinging the motor on a pivoted support, by inserting or removing washers or shims on the motor hanger, and by other equivalent means. A new belt usually stretches a small amount after running for the first few days and may need readjustment. When removing a belt from the pulleys or when replacing it, never force the belt over the pulley rims. To avoid stretching the belt and possibly breaking some of its cords the tension adjustment should be loosened before a belt is taken off or put on the pulleys.

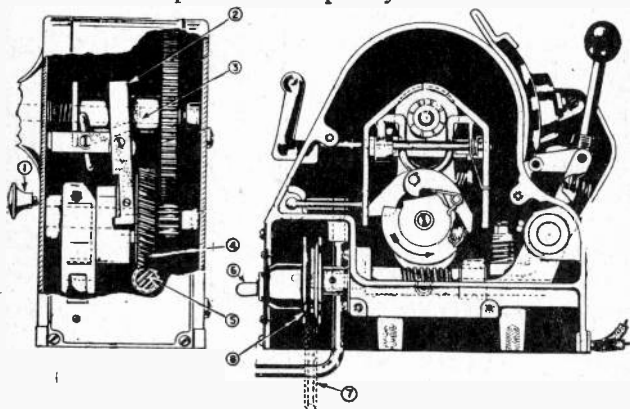

Fig. 11. Drive Mechanism for an Ironer (Kelvinator). 1. Shifter knob. 2. Shifter. 3. Jaw clutch. 4. Worm gear. 5. Worm. 6. Switch. 7. Motor belt. 8. Belt pulley.

The small pulley or sheave often is so constructed that one side may be moved farther from

## Motor Driven Appliances and Equipment

or closer to the other side. This is an adjustment for speed ratio between driving and driven pulleys and shafts. When the sides of the sheaves are moved farther apart the belt will ride lower in the groove and will follow a smaller circle. With the sheave on the motor end of the drive this will lessen the speed of the driven shaft. Bringing the sides of the sheave closer together increases the speed of the driven shaft in relation to that of the motor.

Fig. 11 shows all the parts in the drive gearing or transmission of an ironer which is operated through a V-belt from a motor down below the mechanism illustrated.

### LUBRICATION OF APPLIANCES

Appliance motors have small cups in which should be put five to ten drops of medium oil about every three months during ordinary use of the machine. Cups lead to oil reservoirs which have overflow vents to prevent overfilling. Ball bearings may be cleaned in gasoline or any grease solvent, then repacked with vaseline or other light grease every six months to one year in most cases. Some ball bearings are lubricated for the life of the machine.

Bearings of types called self-lubricating are made with materials which are impregnated with oil or graphite. This will prevent damage if routine lubrication is neglected. Wooden bearings, used on many wringers, should not be oiled but may be lubricated with soap or soapy water. Sliding parts which are enclosed should be wiped with graphite and oil when being reassembled, but exposed sliding parts should be lubricated only with paraffin wax. The driving members inside the casings of flexible shafts should be wiped freely with graphite grease when the shaft is being put back together. The wicks of wick oilers used on fans and other small appliances occasionally should be cleaned in gasoline and worked until they become soft and pliable.

## Lubrication of Appliances

Medium oil is used in all oil holes for sleeve type bearings, or felt oilers, and on cams or eccentrics. Gear cases are filled with only enough heavy oil to let the lubricant be picked up by the lowermost gear. If the gearing is of the high speed type the oil should be of medium grade rather than heavy. Grease is used on all gears and pinions when assembled, also on jaw clutches, thrust collars and washers, spacers and pivot pins.

Oil may be prevented from leaking out around shafts by means of leather oil seals. When these seals tend to get hard the rawhide should be soaked for about 15 minutes in neatsfoot oil.

Gear cases and other tight enclosures which contain oil usually are fitted with vent openings which relieve the internal pressure when the oil and working parts expand due to heating while operating. Before a machine is tilted more than a few degrees the vents should be closed with screw plugs or with wooden pegs to prevent escape of the lubricant.

### TROUBLES WITH APPLIANCES.

If an appliance fails to start the first test should be for voltage at the motor terminals or at leads going into the motor. No voltage calls for examination of fuses, circuit breakers and overload releases, and if any of these are found open the motor or the driven parts of the machine should be turned by hand while locating the cause for the overload that caused opening of the circuit. There are thermal overload releases on practically all appliances using motors of one-quarter horsepower or larger, and on many which use smaller motors. Switches located on the appliance should be tested for open circuits or examined for contacts which have become loosened, worn or bent. Troubles in the motor itself may be any of those mentioned in the sections on motors.

Induction motors require little routine care other than oiling. Commutator types of motors require periodic dressing or turning of the commutator and

## Motor Driven Appliances and Equipment

undercutting of the mica. The undercut on these motors should not exceed  $3/64$  inch. The motor should be thoroughly cleaned of dirt, oil and carbon dust. Brush life usually is from 300 to 500 hours of service. Motor bearings should last for at least 1500 service hours. Where an appliance is used for only a few minutes a day these service lives may run into several years

Line voltage much more than five per cent above or below the motor rated voltage will lead to overheating on normal loads and to generally unsatisfactory operation. If the line voltage is outside these limits the motor should be changed to one of suitable rating. This frequently is necessary when appliances have been moved from one locality to another. Normal temperature for appliance motors is as high as 195 degrees Fahrenheit.

Permanently connected appliances having motors as large as one-quarter horsepower should be on appliance circuits which are separate from lighting circuits. Otherwise there will be objectionable flickering of lights whenever the appliance is started.

One of the most common service complaints about appliances is that they are noisy. Some causes for noise are as follows:

Belt worn, split or swollen from oil, or the pulleys may be "wobbling" or the grooves may be narrower at one place than at others. These things cause thumping noises.

Dry bearings at any point, or oil level low in transmission cases.

Gears may be chipped, broken, badly worn, or a new and an old gear may be mated.

Loose driving or driven parts, such as the agitator of a washing machine, or excessive looseness in couplings or clutches. Excessive end play of shafts will cause noise, this applying to motor rotor and armature shafts as well as to all others.

### TESTING EQUIPMENT

One of the simplest and yet the handiest pieces of test equipment for working on appliances is il-

## Testing Equipment

illustrated in Fig. 12. A 10-watt test lamp is cut into one wire between a wall plug and a plug receptacle into which may be placed the plug tip of the appliance cord. When looking for short circuits or accidental grounds the test lamp will remain lighted until the trouble is located and cleared,

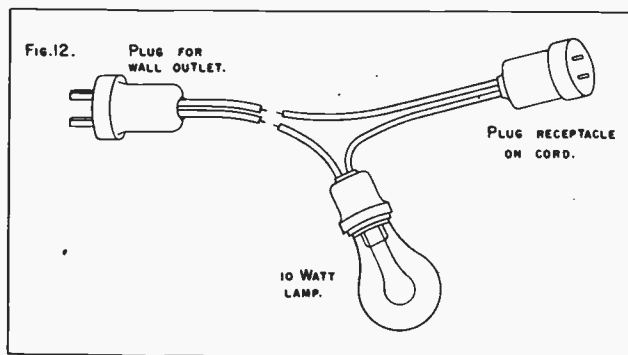

Fig. 12. Test Lamp and Plug Connectors.

while the small current through the lamp prevents opening of fuses or breakers. While looking for open circuits and points of high resistance the test lamp will remain out or will barely glow until the trouble is cleared, after which the lamp will light brightly.

Among the essential pieces of test equipment for appliance work are a 150-volt voltmeter for checking line and motor voltages, also a wattmeter and a revolution counter. The revolution counter is used for checking motor speeds and possible overloading of induction motors. The wattmeter is the quickest method for determining whether there is excessive friction, which always causes excessive power to be taken from the motor.

The number of watts normally taken by a motor in good condition cannot be calculated directly from the horsepower because the efficiencies of these small motors are well below 100 per cent. The following table, based on usual minimum acceptable efficiencies, shows the maximum watts



## Motor Driven Appliances and Equipment

that should be taken by split-phase motors. This will give a good idea of what to expect from appliance motors in general.

### NORMAL MAXIMUM WATTS TAKEN BY APPLIANCE MOTORS

Horse- power	Synchronous Speeds,				25-Cycle 1500 rpm 2-pole
	1800 rpm 4-pole	3600 rpm 1200 rpm 6-pole	60-Cycle Types 2-pole 900 rpm 8-pole	900 rpm 1500 rpm 2-pole	
1/8	175	210	245	210	
1/6	215	250	295	250	
1/4	300	350	420	350	
1/3	395	460	540	460	
1/2	575	680	795	680	
3/4	835	980	1140	980	

# Simple Electrical Repair

*Proper care will make them last longer*

**E**



**Electric iron**

Polish bottom with very fine steel wool. Rub frequently with waxed paper. Always plug in at outlet; keep the iron plug in place. If arcing occurs at plug, take plug apart and squeeze contacts lightly with pliers. Keep cord in good condition.

**F**



**Toaster**

Have a long bristle brush handy for wiping out crumbs. Never immerse toaster in water—clean only with damp cloth. Breaks in heating element can be repaired the same as described for irons (see text). Never use a fork to remove toast.

**G**

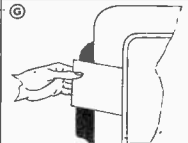

**Refrigerator**

Replace door seal if it does not hold sheet of paper with door closed. Keep condenser clean by brushing or vacuum cleaner attachment—dirt and dust make motor run overtime. Allow room at back and over top so that refrigerator can breathe.

**H**



**Coffee maker**

Never dip electric parts in water. Percolator has fuse in bottom to prevent overheating if it boils dry—remove with screw-driver and replace if needed. Glass vacuum coffee maker should be cleaned once a week with baking soda in water just as if you were making coffee.

**I**



**Motors**

Oil regularly and keep clean so that motor can breathe. See that pulleys are properly aligned and tight on shaft. Be very careful not to stall split phase motors. If motor is universal type, check brushes regularly and clean commutator. Use proper size fuse to protect motor.

**J**



**Washing machine**

Don't overload. Always clean after using and release pressure on wringer rolls. If stored in cold place, give it time to warm up in warm location to soften grease in gear case. Be sure that all moving parts are well lubricated. Check periodically for loose bolts and screws.

**K**

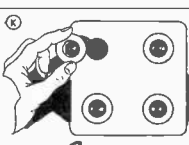

**Fuses**

Under average conditions, circuits with lights should not have fuses larger than 15 amperes. Convenience outlets take 20 ampere fuses. Large fuses are no protection—the house wiring itself will burn up before the fuse blows. When installing new fuses, play safe—pull the switch.

**L**



**Cords and plugs**

If plug does not make contact at outlet, bend prongs slightly outward. Avoid overloading outlets—the maximum load on any one circuit should not exceed 1400 watts. Keep all cords free of kinks. Hang cords on round peg when not in use—don't throw them in a drawer.

**M**



**Lamps**

Keep lamp bulbs clean for maximum illumination. Use one large bulb instead of several small ones—a 100-watt lamp gives 50% more light than four 25-watt lamps. Do not use fuses larger than 15 amperes when there are lamps on the circuit. Use proper type of shade.

# REPAIRING HOUSEHOLD APPLIANCES

The average American home runs smoothly by virtue of a host of electrical servants. Although numerous, these servants readily classify themselves into three big families: (1) The Lighters, such as a floor lamp or any type of lamp bulb, (2) The Heaters, including toasters, irons, percolators, waffle irons, etc., (3) The Runners, covering all motored devices such as refrigerators, washers, mixers and vacuum cleaners. It will be apparent that although mechanical construction may vary, certain ills of any one group affect all items in that group, thereby greatly simplifying the needed "know how" to make necessary repairs.

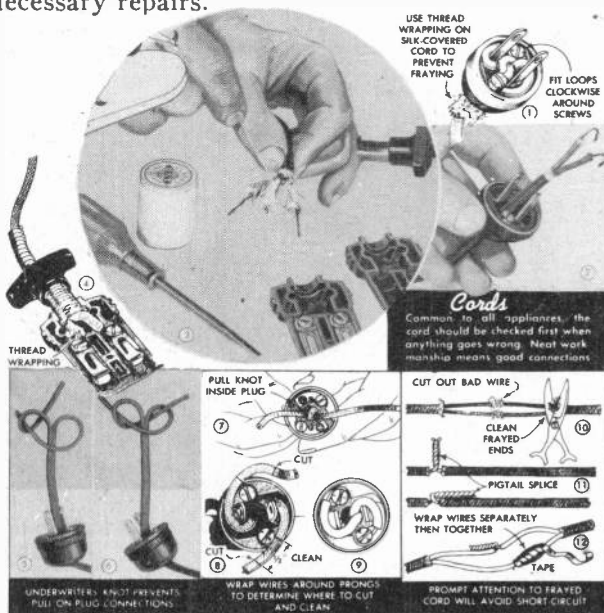

**Cords and plugs:** Cords and plugs are basic and apply to all electrical equipment. Most persons know how to make necessary repairs, but the few ideas pictured on this page may serve as a "refresher" course. Silk-covered cords and asbestos-insulated cords should always be wrapped with thread when making plug connections to prevent fraying, as shown in Figs. 1, 2 and 3. The insulation should be

## Simple Electrical Repair

intact right up to the point of contact, Fig. 4. The underwriter's knot for plugs as shown in Figs. 5 and 6 takes the strain of pulling on the cord and prevents strain on the connections. It is especially good with the popular parallel-wire rubber cord. Steps in making plug connections after tying the knot are shown in Figs. 7 and 8. The best practice is to leave the wire long and the insulation intact until actual fitting. Fig. 8 shows where to cut and clean. Fig. 9 shows a plug properly connected—the wire is pulled around the prongs and fitted clockwise under the

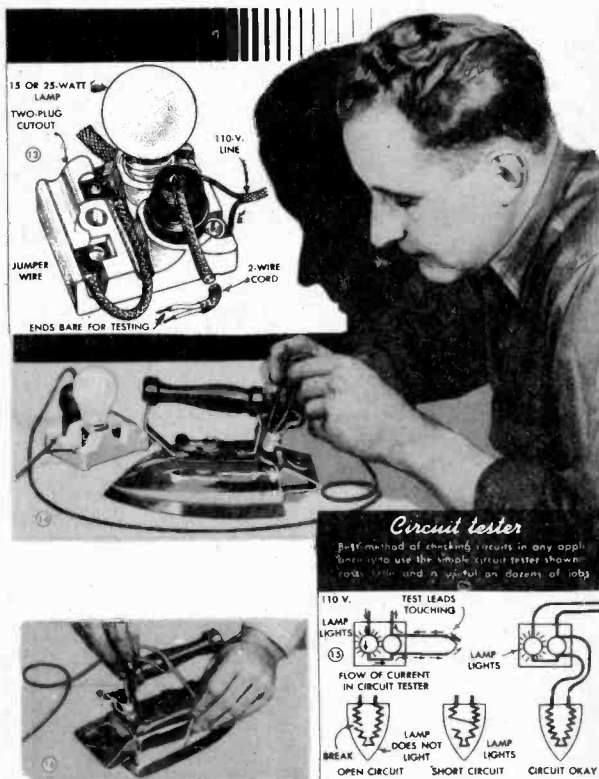

screw heads. A frayed weak spot in a cord should be spliced promptly instead of waiting until the wire or fuse burns out due to a short circuit. The com-

## Electrical Appliances and Equipment

mon splice joint is best made with pigtail splices, as shown in Figs. 10, 11 and 12. Each joint is wrapped separately with friction tape; then the two wires are wrapped together.

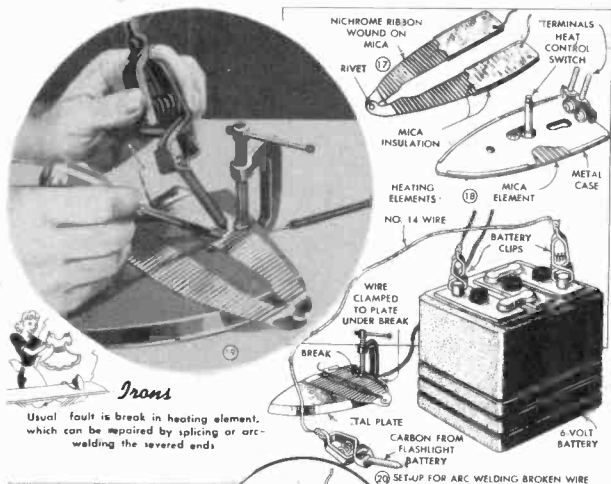

Usual fault is break in heating element, which can be repaired by splicing or arc-welding the severed ends

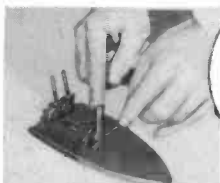

27 LAMP SHOULD LIGHT WHEN TEST LEADS ARE TOUCHED TO SWITCH TERMINALS

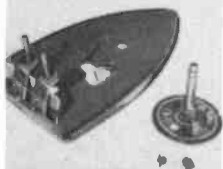

28 DEFECTIVE SWITCH CAN BE DISCARDED. ELEMENT WILL WORK WHEN WIRES ARE SPLICED

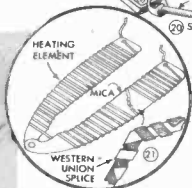

**Circuit tester:** While breaks in an electrical circuit usually can be traced visually, it is quicker and better to use a circuit tester. This is made up as shown in Fig. 13 and costs less than fifty cents. How it works is shown in Fig. 15—if you touch the two test leads together you make a complete circuit,

## Testing Equipment

causing the lamp to light. Likewise if you apply the test leads to any circuit, such as a flatiron, as shown in Figs. 14 and 15, the lamp will light if the circuit in the iron is not broken. Also, it should be noted that the lamp will light if a short circuit exists, Fig. 15, but positively cannot light when the circuit is broken. The current passed by the bare wires of the circuit tester is limited to the size of the bulb used, and is not sufficient to actually heat the irons, run a motor, or do anything else which the straight 110-volt line would do. This doesn't mean that you shouldn't be careful—play safe and treat the two test leads as "hot."

**Checking electric iron:** Using the circuit tester, apply the leads to the prong terminals, as shown in Fig. 14. If the heating element is all right, the lamp will light. Apply one lead to the prong terminal and the other to the sole plate, Fig. 16. The lamp should not light. If it does the circuit is grounded, that is, some part of the wiring is bare of insulation and touching the sole plate or cover. No light across the terminals shows that the circuit is broken. In this case, remove the handle, cover, and any other parts necessary to expose the heating element. The most common type of heating element is ribbon Nichrome wire wrapped on mica and insulated on either side with mica, as shown in Fig. 17. Better grade elements are covered with a metal case, Fig. 18, and it is necessary to pry off the case. Still other elements are built right into the sole plate in a solid mold; this type is not repairable except by obtaining a new replacement part.

**Patching Nichrome wire:** A break in the Nichrome ribbon or wire can be patched by twisting the two ends together, as shown in Fig. 21. A better method is to fuse the broken ends together with a small makeshift arc-welding outfit, as in Figs. 19 and 20. In use, the pointed carbon should be touched to the break delicately and only for an instant. You will get a flash of white hot wire and the two ends will fuse together. Prolonged contact generates too much heat and burns the wire completely. No flux is needed although borax can be used if desired. Sometimes the break is within a few turns of the

## Electrical Appliances and Equipment

post terminals, and in this case it is practical simply to unwind the broken section and make a new connection.

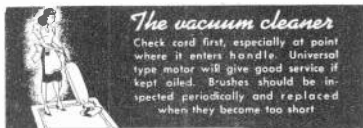

22 CLEAN COMMUTATOR WITH FINE (8-0) SANDPAPER

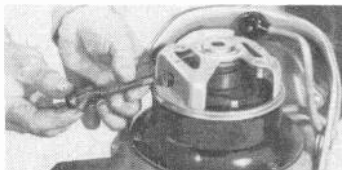

23 INSPECT BRUSHES AND FIT NEW ONES IF NEEDED

**Electric-iron switch:** If the iron has a heat-control switch, test it across the terminals, as shown in Fig. 22, to determine if the fault is in the heating element or the switch. If the switch is defective and a replacement not available, the iron can be made usable by twisting or welding the two ends together, as indicated in Fig. 23. There is little that can be done with a defective switch; make certain, however, that the thermostatic disk is not jammed open (saucer shape). Try mild pressure with your fingers in manipulating the disk—it should have a curved bell shape when the iron is cold.

**Other heater-type appliances:** Apply the same general tests as described. Always check the cord first (use test lamp and run current through both wires separately), and then proceed systematically until the fault is discovered. Some appliances, such as inexpensive toasters, can be checked visually since the heating element is in full view. Breaks in round Nichrome wire can be spliced much the same as described for ribbon wire. In all cases, press the

## Simple Electrical Repair

splice flat and make it as tight as possible — any slight amount of arcing from a loose joint will immediately burn the wire.

**Vacuum cleaners:** With so many different makes and styles, about the only thing vacuum cleaners have in common is the motor. This is usually a

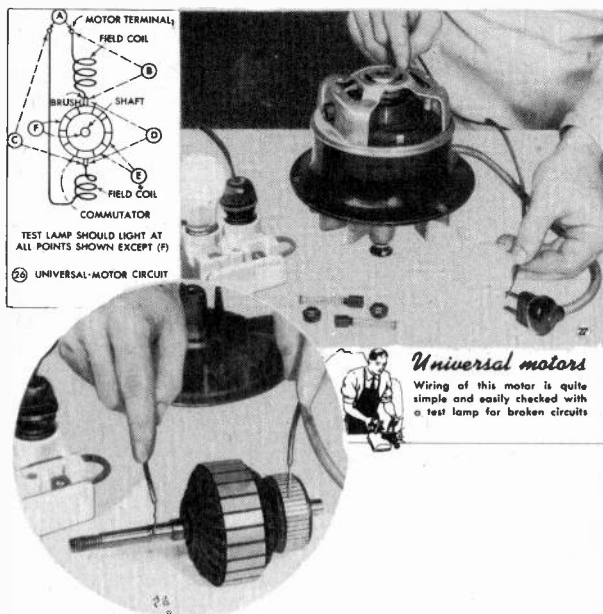

series-wound universal type, a high-speed motor suitable for sweepers, mixers, fans and other light duty applications. If the motor goes bad, the first check point should be the brushes. These can be removed by unscrewing the caps which hold them in place, as shown in Fig. 25. Replace the brushes if they are worn too short. Test the spring tension to make sure that the springs keep the brushes in contact with the commutator, (part against which the brushes bear). When replacing old brushes, be sure to fit them properly to the curve of the commutator. If new brushes are fitted, break them in by slipping a piece of fine sandpaper under a brush with the sand facing the end of the brush, then swing the rotor



## Electrical Appliances and Equipment

back and forth until the brush is ground to fit. Clean the commutator with gasoline, or sand it bright with fine (8/0) sandpaper, as shown in Fig. 24. If the commutator is grooved, the rotor should be removed to permit turning the commutator down smooth on the lathe. Other than motor failure, the most common causes of trouble are dirt and lint tightly wound around the motor shaft or the belt-driven brush, lack of oil, and poor bearings.

**Universal motors:** When checking a vacuum cleaner's universal motor with the test lamp, remove the motor from the cleaner. Fig. 26 shows the simple circuit of a universal motor. In testing across the lettered points, a light shows that the circuit is continuous. Fig. 27 illustrates test B of Fig. 26. A light shows that this field coil is continuous, but although the wiring is intact, the insulation may be burned off. Test D of Fig. 26 checks the coils of the rotor or armature. If no light is obtained, test each adjacent pair of commutator segments all around, as at E of Fig. 26. Each pair should light; no light indicates that the coil is burned out between these two segments. This condition will cause considerable sparking at the commutator, also the motor will be dead if it stops with the dead coil in contact with the brush. A repair job can be done by "jumping" the segments together by soldering a copper wire across the ends. If the test lamp lights when making test F of Fig. 26 also shown in Fig. 28, insulation has been scraped or burned from armature coil or coils, and the wire is touching the shaft causing a "ground."

When the test lamp does not light when it should, careful inspection should be made of the circuit being tested. Unless the motor is burned out, breaks usually will be found at the ends of the wires and can be repaired. When it is definitely determined that the motor is burned out, it should be junked or turned over to a service shop for rewinding.

# INDEX

## A

- Aviation lighting, 326-343
  - airplane lights, 339
  - beacons, 326
  - boundary lights, 332
  - hangar & shop, 336
  - illuminated wind direction indicators, 334
  - landing field lights, 327
- Appliances, 465
  - normal maximum watts taken by appliance motors
  - testing equipment, 463
  - troubles, 462
  - lubrication, 461
  - motors, split phase—capacitor universal series wound, 445-451
  - synchronous motor, 454
  - thermostat differentials, 422
  - thermostat for starting, 419

## B

- Bends, conduit, saddle—true offset back, 76-78
- Boxes, outlet, 57-60
- BX, cutting & stripping of, 100
- BXL, use of, 101

## C

- Cable, lugs, 37
  - armored, 97
  - advantages of, 98
- Charts, wire, 85-88
- Circuits, branch, 159
  - short, 204
  - locating short circuits & grounds, 206
- Codes, national, 3
  - state & local, 5
- Coefficient of utilization (chart), 246
- Conduit,
  - advantages of, 68
  - allowable number of wires & circuits, 84
  - allowable wire chart, 85
  - bending of, 75-80
  - armored cable, 97
  - fittings for, 73-80
  - flexible, 95-97
  - grounding systems, 89
  - installing of, 70
  - junction boxes for, 79
  - pulling wires in, 82
  - sizes & types of, 72
  - supports for, 79
- Conductors, 8
  - resistance in, 168
- Connectors, solderless, 39
- Covers, 81

## D

- Ducts, use of square, 111
- Drive, mechanisms, 457

## E

- Electrical construction,
  - BX, 100
  - causes of short circuits, 204
  - cost per outlet, 191
  - conductors for, 8
  - conduit bending, 75-80
  - demand factor, 161
  - estimating job costs, 188-193
  - fuses, 113-118
    - troubles in, 203
  - grounding polarized systems, 155
  - housewiring plans, 201
  - insulation, 9
  - illumination, 209-229
  - important points in, 2
  - lamps, 209-229
  - loads, (chart) 160
  - method of installing conduit, 70
  - national electric code, 3
  - outlets, 137-140
    - boxes for, 57-60
  - practical estimating problems, 192
  - questions, 55-112-140-177-208
  - raceways, metal, 102
  - reflectors, 214
  - sectional view of house wiring, 195
  - state & local codes, 5
  - soldering, 29-30
  - splicing, 16-28
  - switches, 122-136
  - symbols, 198
  - tools, 200
  - trouble shooting, 202-208
  - voltage drop formula, 174
  - wiring materials, 8
    - plans, 193
- Estimating, 188-193

## F

- Farm wiring & electrical equipment, 387-419
  - diagrams for wiring, 390-398
  - electric fence, 406
  - motor operated churn, 413
  - pulley selection chart, 416
  - planning the wiring, 387
  - rigging up a portable electric motor, 408-412
  - trouble shooting, 401-405
  - uses of electricity on farm, 417-418
  - yards & farm buildings, 393
- Fittings, 104
- Fluorescent lighting, 281-314
  - automatic starters, 286
  - auxiliaries, 300
  - ballast coils, 292
  - compensators, 298
  - check list on operation, 308-314
  - direct current operation, 302
  - glow switch starters, 288
  - knife blade, 116
  - lead link, 113
  - lampholders, 286-287

lamp characteristics, 301  
lamps in series, 305  
manual starter switches for,  
285  
operation, 284  
power factor, 295  
step up transformer, 299  
thermal starter, 291  
Fuses, 113-120  
rules on, 118  
plug type of, 117  
cartridge type of, 114  
cabinets for, 119-120

## G

Gas Burner controls, 436-437  
Gauges, 16

## H

Home lighting,  
bathroom, 367  
bedrooms, 364  
dining room, 362  
living room, 355  
kitchen, 365  
porches, attics, basement and  
garage, 369  
questions, 370  
Household appliances, 419-475

## I

Illumination, 209-229  
controlling lights with  
reflectors, 231  
classes of units, 240  
coefficient of utilization, 243  
depression factor, 241  
early lights, 209  
Edisons incandescent lamp, 210  
effect of voltage on life and  
efficiency of lamps, 219  
experiments, 229  
foot candles, 223  
factory lighting, 257  
good lighting principles, 213  
lamp life rated voltages, 218  
lumens, 222  
light reflection, 231  
measurement, 225-226  
mounting height, 248  
mercury vapor lamps, 345-354  
Illumination nature of light, 211  
office lighting, 259  
practical problems, 250  
questions, 230  
reflectors, 214  
recommended foot candle  
intensities for various  
installations, 252-255  
spacing distance, 249  
types of incandescent lamps, 215  
inverse square law for, 228  
units of measurement, 220  
wave frequencies, 212  
working plane, 247  
Insulation, 9  
Installation,  
BX & non metallic cables, 181

BX running wires in difficult  
places, 182  
conduit, 184  
estimating, 188  
final tests, 187  
knob & tube, 180  
locating light & switch outlets,  
179  
locating & cutting outlet box  
openings, 182  
methods, 179-187  
precaution on installations, 185  
pulling the wires, 187

## L

Lamps, 209-229  
mercury vapor, 347  
IES Student, 358

Lighting,  
bays for, 250  
factory, 257  
office, 259  
show window, 262  
counter, 266  
aviation, 326  
flood, 315  
motion picture, 324  
post type units for, 321  
suspension type units, 319  
street, 318  
home, 354-370  
Loads, (chart) 160  
Lugs, cable, 37  
Lumens, 222

## M

Mercury vapor lamps, 245-354  
care & maintenance of, 351  
operating voltage, 351  
installation of, 350  
circuits & operation, 348  
foot candles in, 224  
direct reading type, 227  
Mixer food, 444  
Motion picture lighting, 324  
Motors  
capacitor type, 445-451  
removing from appliances, 456  
split-phase, 445-451  
speeds, 455  
synchronous, 454  
universal series wound,  
445-451  
Motor appliances, 419-465

## N

Neon signs, 371-385  
construction of, 372  
electrodes for, 375  
flashers for, 382  
gases used in, 374  
transformers used in, 379  
troubles in, 383  
tubing, 376  
voltages & current, 377

## O

- Oil burner, 428-430
- safety controls, 432
- ignition, 430
- motors, 430

## R

- Raceways, metal, 102
- Receptacles, 138
- Reflectors, 214
  - mirrored glass types, 235
  - opal glass types, 237
  - prismatic types, 237

## S

- Signs, 268-272
  - construction, 270
  - flasher circuits, 271
  - neon, 371-385
  - questions, 279
  - wiring & installation, 276
- Soldering, 29-30
  - applying solder, 35
  - cleaning & tinning, 31
  - conducting heat to splice, 34
  - flux for, 33
  - proper method, 34
- Sodium vapor lamps, 353
- Splicing, 17-28
  - common types, 17
  - diagrams, 20, 26
  - large solid wires, 25
  - types—pig tail, tap or tee,
    - fixture, 19-23
  - lead covered cable, 39
  - stranded cable, 25
  - taping of splices, 41
  - Western Union type, 19
- Stokers, 430-447
  - troubles in controls for, 440-441
- Switches, 122-136
  - double pole, 128
  - flush type, 126
  - 4 way types, 132
  - knife, 123
  - substituting, 133
  - symbols for, 129
  - single pole, 127
  - 3 way, 130
  - snap type, 125
  - single—double—3 pole, 123
- Symbols, 129, 198
- Systems
  - duct type, 109-110
  - Edison 3 wire, 141
  - effects of open, neutral and unbalanced loads, 146
  - grounding polarized systems,
    - 155
  - polarized, 149
  - saving copper with 3 wire systems, 142
  - safety feature of polarized system, 153
  - 2 wire, 8
  - unbalanced, 143
  - wiring, 7-8

## T

- Tables
  - wire B&S gauge, 169
  - allowable current carrying capacity, 171
  - voltage drop, 176
  - bonnet & duct types, 425-426
- Tubes, mercury vapor, 345
- Tools, 200
- Torches, blow, 36
- Trouble shooting, 202-208
- Tubing, metallic, 93-94

## V

- Voltage, table of drop, 176
- drop in, 163

## W

- Wire
  - sizes of, 11-16
  - resistance in conductors, 168
  - resistance of copper per mil ft., 170
  - table B&S gauge, 169
  - current carrying capacity, 14
  - allowable voltage drop in, 172
  - conversion of, square mils to cir. mils, 165
- Wiring
  - cleats, 59
  - fittings, 60
  - conduit fittings, 70
  - conduit method of installation,
    - 70
  - calculations, 162
  - circular mil. unit of conductor area, 164
  - feeders, 158
  - formula for conductor area in wire, 172
  - grounded wires, 64
  - insulation, 9
  - knob & tube type of, 47
  - looms, 49
  - materials, 8
  - metal systems, 46
  - non metal systems, 46
  - photos, 12-17
  - polarized systems, 150
  - parts, 156
  - running the wires, 51
  - rigid conduit, 68-71
  - reaming conduit, 72
- splicing, 16
  - tools, 200
  - types of systems, 44-55
  - trough, 110
  - voltage drop formula, 174
  - wood mouldings, 65
- Wiring systems, 7-8



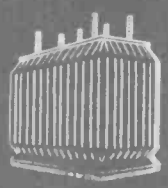

PRACTICAL  
Electrical and Radio  
Books  
for  
PRACTICAL MEN

