

7
521.38
V527

**WESTERN
UNION**

Technical Review

R. P. I.
LIBRARY

RECEIVED

APR 4 1950

Engineering Library

Microwave Propagation

•

Submarine Cable Carrier

•

**Western Union Switching
Systems**

•

Magnetic Materials

•

**Television Relay for
Navy Training**

**VOL. 4
APRIL**

**NO. 2
1950**

WESTERN UNION

Technical Review

VOLUME 4
NUMBER 2

Presenting Developments in Record Communications and Published Primarily for Western Union's Supervisory, Maintenance and Engineering Personnel.

APRIL
1950

CONTENTS

	PAGE
A Microwave Propagation Test <i>J. Z. Millar and L. A. Byam, Jr.</i>	49
A Two-Channel Carrier Telegraph System for Short Submarine Cables <i>E. L. Newell and C. H. Cramer</i>	61
The Development of Western Union Switching Systems <i>M. D. Adams</i>	69
Magnetic Materials <i>A. Boggs</i>	79
A Microwave Television Relay for Navy Training Programs <i>Harry Cook</i>	87

Published Quarterly by

THE WESTERN UNION TELEGRAPH COMPANY COMMITTEE ON TECHNICAL PUBLICATION

F. B. BRAMHALL, Development and Research Dept., *Chairman*
I. S. COGGESHALL Internat'l Communications Dept.
W. H. FRANCIS Plant and Engineering Dept.
G. HOTCHKISS Development and Research Dept.
G. P. OSLIN Public Relations Department
M. J. REYNOLDS Patent Department
H. M. SAUNDERS Commercial-Traffic Dept.
NELL ORGAN, *Secretary*

Address all communications to THE WESTERN UNION TELEGRAPH Co.,
Committee on Technical Publication, 60 Hudson St., New York 13, N. Y.
SUBSCRIPTIONS \$1.50 per year PRINTED IN U.S.A.
(Copyright 1950 by The Western Union Telegraph Company)

A Microwave Propagation Test

J. Z. MILLAR and L. A. BYAM, JR.

General

ALTHOUGH THE TERM MICROWAVE is generally considered to designate frequencies of 1000 mc and higher (wavelengths of 30 cm and lower), there is no fixed point in the frequency spectrum separating the microwave region from other regions; the division may fall anywhere between about 300 mc and 1000 mc.

Some of the more important advantages which obtain for radio communication systems operated at microwave frequencies are virtual freedom from external noise created by electrical and magnetic disturbances, considerable power gain from relatively small antenna systems, highly directional radiation at low elevation angles, and complete absence of ionospheric reflections.

The successful application of microwave techniques to communication systems requiring a high degree of circuit continuity and stability involves a reasonable knowledge and understanding of the behavior of microwave signals under the influence of varying atmospheric conditions, especially under unfavorable conditions, and particularly with respect to their relative effects at different wavelengths. The microwave propagation test described in this paper was undertaken for the purpose of investigating such behavior.

In order properly to evaluate the effect of atmospheric conditions upon signal strength, a very considerable quantity of related data must be made available for examination. To insure that an adequate volume of suitable data would be obtained, four widely separated frequencies were selected for the test and the test itself was continued for a period of well

over a year, beginning in December 1946. Although, undoubtedly, every person who undertakes a test of this nature entertains the fond hope of establishing a definite relationship between variations in weather conditions and variations in signal strength, no attempt was made to provide a system for recording meteorological data since the primary purpose of the test was to study the effects of, rather than their relation to, variable weather conditions. It was thought, however, that a qualitative analysis of a general nature could be made using the U. S. Weather Bureau daily weather map and data.



Figure 1. Neshanic propagation tower

A paper presented before the National Convention of the Institute of Radio Engineers in New York, March 1950.

The Test Path

Observations were made on signals transmitted from a specially constructed tower at Neshanic, N. J., and received atop the Western Union building at 60 Hudson St., New York City, a distance of 41.7 miles, entirely overland. At Neshanic, the transmitting antennas were 665 feet above mean sea level and beamed toward the New York receiving antennas which were elevated 400 feet above mean sea level. A picture of the 100-foot Neshanic tower, with the four transmitting antennas facing New York, is shown in Figure 1. The intervening terrain is characterized by a series of hills, as indicated by the profile in Figure 2, most of which are densely wooded. The first Fresnel

set up and operated as indicated in Table I. Only the carrier wave was transmitted, i.e., the carrier was not modulated in any way. Transmission on Channels 3 and 4 was vertically polarized for convenience purposes only; otherwise horizontal polarization would have been employed on all four circuits. The fact that the type of polarization was not the same for the different wavelengths is considered unimportant in the light of ample experimental data which reveal that a change in the type of polarization from horizontal to vertical, or vice versa, does not produce a significant difference in transmission characteristics for conditions similar to those under which this test was conducted, i.e., microwave transmission, an overland optical path, and small grazing angles.

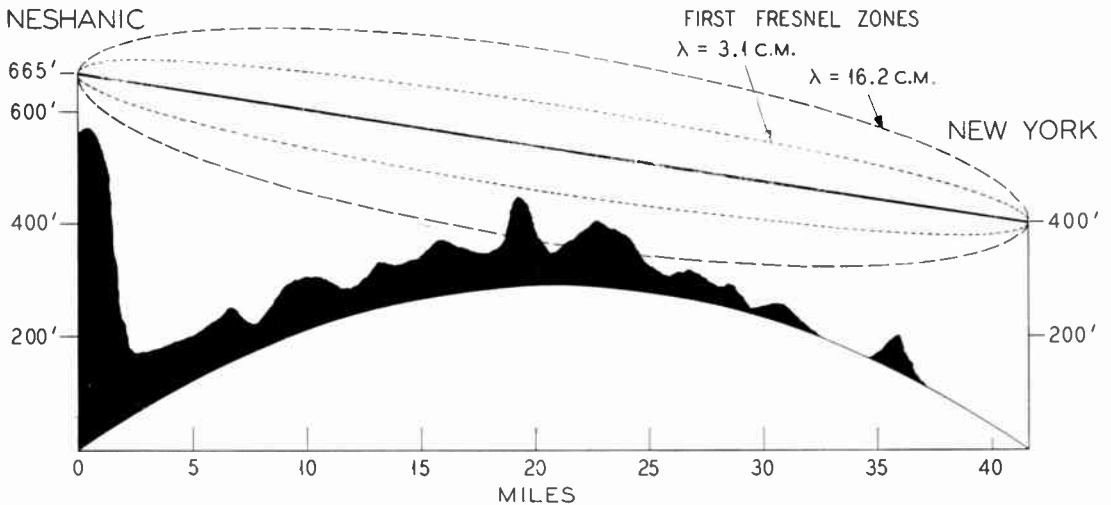

Figure 2. Profile of propagation test path (true earth radius)

zone for 3.1 cm and for 16.2 cm, representing the lowest and highest wavelengths tested, are also shown. Minimum clearance from the line-of-sight test path to ground was approximately 93 feet. The clearance at this point of the path very closely agreed with the clearance needed to produce a first Fresnel zone maximum for 7.2 cm, one of the four wavelengths used in the test.

Wavelengths Tested

For comparative purposes, as explained, four individual circuits or channels were

Equipment

Each of the four transmitters consisted essentially of a reflex klystron oscillator tube for generating r-f power, together with its associated cavity, a matching section and a wave meter for tuning purposes. These components, comprising the "head-end" unit, were enclosed in a temperature-controlled transmitter box. The 3.1-cm transmitter is shown in Figure 3. To minimize frequency drift, special attention was given to the design of the regulated power supply and to the thermostatically-controlled oven tempera-

TABLE I

Channel No.	Frequency mc	Wavelength cm	Transmitter Power milliwatts	Beam Width Measured at Half-Power Points degrees	Polarization
1	1850	16.2	137	9.0	Horizontal
2	4150	7.2	159	4.7	Horizontal
3	6325	4.7	13.6	2.6	Vertical
4	9550	3.1	7.4	1.9	Vertical

ture regulation system. Each "head-end" unit was mounted back to back with its corresponding antenna reflector. A portion of the reflector may be seen in the background.

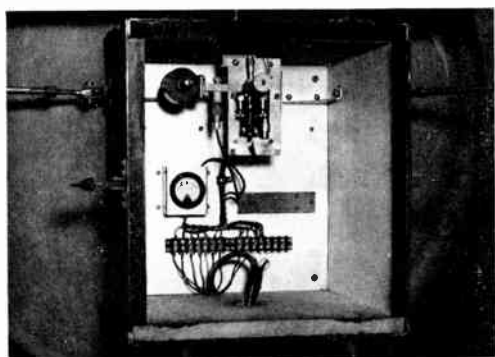

Figure 3. Transmitter for 3.1 cm

The antenna reflectors were of the parabolic type, 48 inches in diameter and physically identical at both the transmitting and receiving terminals. The radiating elements were conventional half-wave dipoles which were mounted at the focal point within the reflector. The dipoles were excited by coaxial line in the case of Channels 1 and 2, and by wave guide for the other two channels.

In order that a continuous record of the relative transmitter power would be obtained, a small portion of the transmitted energy was rectified in a crystal and this rectified portion of the output power fed to a four point electronic recorder. The recorder is shown in Figure 4 mounted below the transmitter control unit. This control unit permitted adjustment of the r-f power output, frequency,

cavity current and repeller voltage of the transmitting tube without opening the ovens.

Each of the four individual receiving installations consisted essentially of an

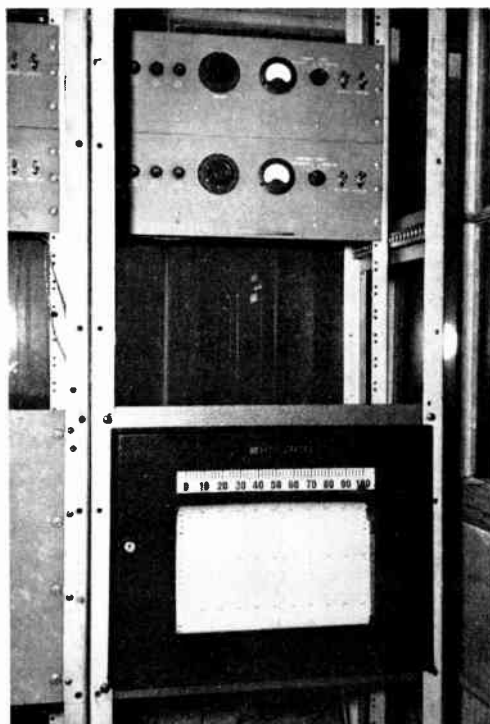

Figure 4. Control unit and recorder

antenna system, as described, a temperature-controlled "head-end" receiving unit, mounted in the immediate vicinity of the antenna, and an i-f amplifier unit and recording equipment located about 300 feet distant. The recording equipment consisted of four Brown Instrument Company

strip recorders, one for each channel, which were calibrated in terms of signal strength at the input terminals of the receivers. The recorders were operated at a strip speed of 6 inches per hour.

Weekly Charts

Although the strip record proved to be useful in examining specific cases of abnormal fading, this record was not in a form suitable for analyzing fading effects

receiver performance. Particular care was exercised in the calibration procedure to insure that the recorded data would reflect variations in transmission characteristics of the medium only.

Carrier/Noise Ratios

Information relating to path attenuation and received carrier-to-noise ratio is shown below in Table II, separately for each channel.

TABLE II

<i>Channel No.</i>	<i>Frequency mc</i>	<i>Wavelength cm</i>	<i>Free Space Attenuation db</i>	<i>Net Attenuation db</i>	<i>Received Carrier-to-Noise Ratio db</i>
1	1850	16.2	134	83	26
2	4150	7.2	141	76	34
3	6325	4.7	145	73	27
4	9550	3.1	149	69	28

on a statistical basis. Due to the high recording speed, a 24-hour interval involved a strip 12 feet in length. A more convenient and useful representation of the essential data was obtained by transferring the maximum, minimum and average value of signal strength for each hourly interval from the strip record to weekly charts. Examples of these charts have been included to illustrate certain fading conditions which will be discussed in a later paragraph. It should be noted, however, that signal strength is expressed in terms of decibels above or below a fixed reference level, designated as the normal signal level. The normal signal level, which was determined separately for each channel, represents the average signal strength for periods during which fading was absent or negligible, i.e., periods when transmission was highly stable.

Once established, the value of the normal signal level was considered fixed except that adjustments to this reference level were made whenever it was found necessary or desirable to recalibrate the equipment in order to compensate for changes, such as tube replacements, affecting either the transmitter power level or

Attenuation data appearing above were determined by means of the well-known Friis' transmission formula,¹ using an assumed efficiency of 65 percent for each antenna. Although the paraboloidal type of antenna has a theoretical efficiency of about 80 percent, in practice the efficiency is usually limited to approximately 65 percent due to losses introduced by phase and polarization characteristics and certain sources of interference associated with the method of feed.² The difference between the value shown for free space attenuation and that for the corresponding value of net attenuation represents the power gain of the antenna system. Carrier-to-noise ratios were calculated on the basis of a receiver band width of 4 mc and receiver noise power approximately 17 db above thermal.

Daily Fading Ranges

During periods when conditions for reception were favorable, i.e., periods when fading was entirely absent or negligible, the received signal approached the calculated value within a few decibels, on each channel. At other times, the signal

wandered from peaks of several times the calculated value to levels below the measuring capabilities of recording instruments. The extent of these variations in signal strength is reflected in Figure 5

fading generally was more pronounced during the summer months as compared with the winter months and more severe on the higher frequencies than on the lower.

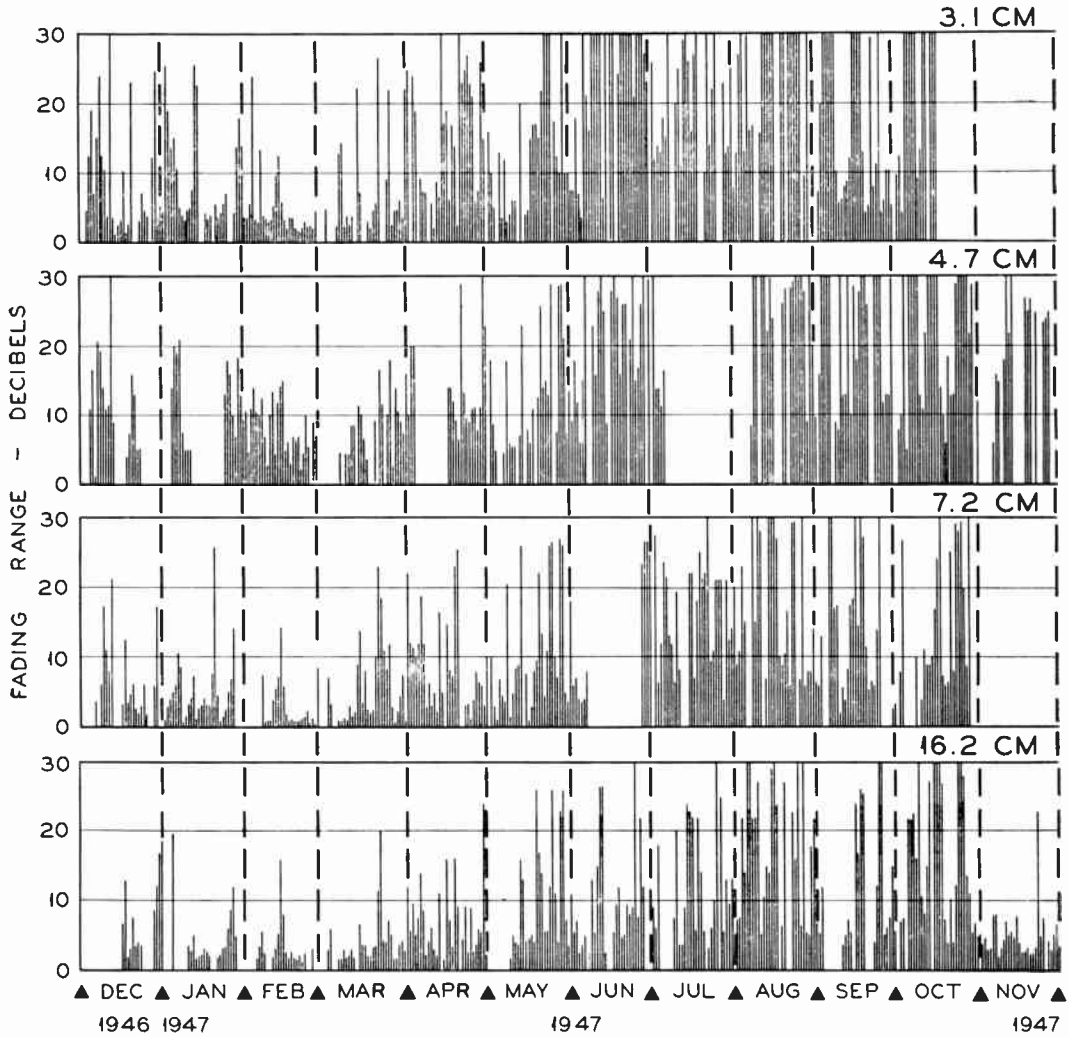

Figure 5. Daily fading ranges from December 1946 through November 1947

which shows the daily fading range separately for each channel from December 1946 through November 1947. The daily fading range, as used here, is the ratio of the maximum signal occurring during a 24-hour period to the minimum signal for the same period, expressed in decibels. As may be observed from the chart,

Seasonal Fading

To provide a comparison of fading ranges at different wavelengths, and in order to demonstrate inherent seasonal characteristics of fading, the daily fading ranges were averaged by months for each channel and the results represented graphically in Figure 6. The general trend

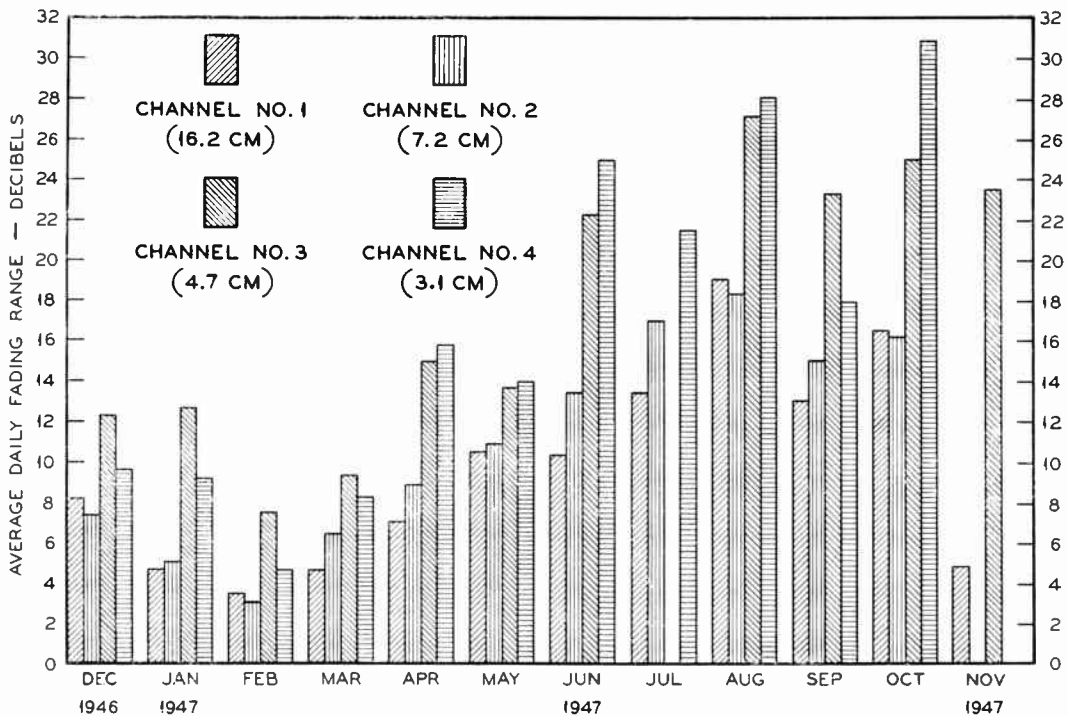

Figure 6. Seasonal variations in fading at different wavelengths

of increasing fading range with frequency and increasing fading range between spring and fall is evident. In order to accentuate somewhat the seasonal trend, the average daily fading range is shown separately in Figure 7 for 7.2 cm.

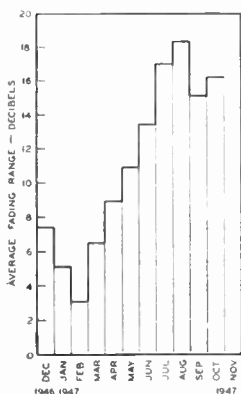

Figure 7. Seasonal variation in fading at 7.2 cm

Diurnal Fading

Fading exhibits not only seasonal characteristics but diurnal as well. Figure 8 illustrates diurnal variations in fading which occurred during the months of

February and July of 1947 on 7.2-cm transmission. Here, the average fading range, in decibels, is shown graphically for each hour of the day. Average fading range values were obtained by averaging the hourly fading ranges separately for each hourly period. The fading range for any one hour represents the ratio of maximum to minimum signal strength for that hour. Figure 8 reveals a difference in fading with respect to different periods of the day, i.e., that maximum fading generally occurred during the night and early morning hours while minimum fading occurred in the late morning and afternoon, usually between 10 a.m. and 6 p.m., local standard time. Although diurnal effects are illustrated for only one summer and one winter month and for only one wavelength, a similar definite diurnal tendency was found to exist throughout the year on all four wavelengths examined. The pronounced difference between winter and summer fading is again evident. Diurnal effects are also reflected in Figure 11, which will be explained in a later paragraph.

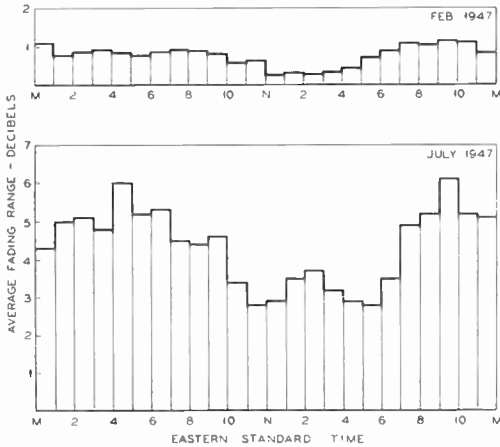

Figure 8. Diurnal variation in fading at 7.2 cm during months of February and July 1947

Relative Circuit Performance

Up to this point, the general nature of fading at microwave frequencies has been illustrated. The various charts presented have revealed, for example, that fading is inherently variable between wide limits, that fading increases with decreasing wavelength and that fading exhibits both diurnal and seasonal patterns. These characteristics, of course, are reflected by the manner in which variations in fading range, or in average fading range have occurred, and by the extent of such variations. Average fading range data are use-

ful and essential in dealing with system design problems bearing on fading tolerance considerations, although such data obviously are not sufficient. These data, for example, furnish no information with respect to the relative frequency of occurrence of abnormal fades or to the duration of such fades, both of which are important considerations since they are related to circuit continuity which in turn determines circuit performance.

Relative circuit performance may be gauged fairly well from distribution curves of instantaneous received signal levels. For this purpose, distribution curves of instantaneous received signal strengths have been prepared for the wavelengths employed in the test, as shown in Figures 9 and 10. The curves shown in Figure 9 represent a period of five months, from June 1, 1947 through October 1947; the curves shown in Figure 10 represent a period of three months, from January 1, 1947 through March 1947. Data on which these curves are based were obtained by selecting a number of signal levels and determining the relative time the received signal was below each level during the periods shown. The month of October was included in the summer period since fading during that month corresponded very closely with typical summer fading, as may be seen from a glance at Figure 6.

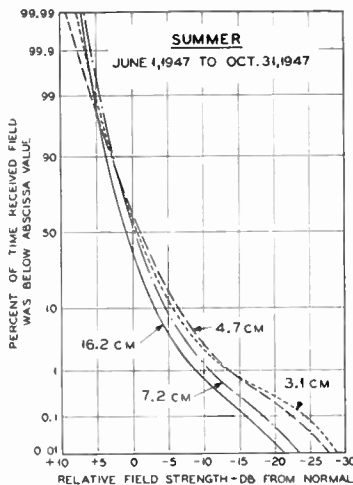

Figure 9. Relative field strength—summer

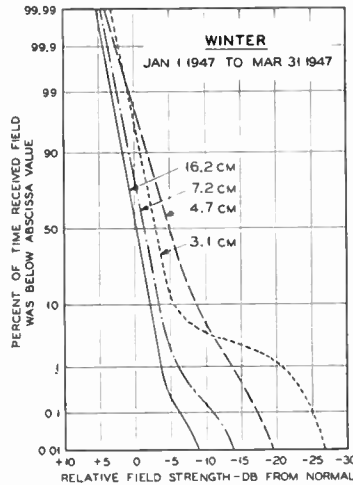

Figure 10. Relative field strength—winter

In using these curves, one should remember that the reference level represents normal signal strength, as explained earlier, and that this reference is usually about 2 or 3 db below the free space value. Also, high accuracy is not claimed for these curves, particularly for those portions appearing below the 0.1 percent level, which may be in error by as much as 20 percent.

The superior performance of the longer wavelength circuits is evident in both summer and winter. A comparison of the curves in Figure 9 with those of Figure 10 reveals several interesting characteristics with respect to performance at the different wavelengths tested. The summer curves are generally similar and the spread is not very great. This similarity is particularly evident for the two lower frequency curves, exhibiting a well-defined mutual relationship which does not appear to exist for the two higher frequencies. The winter curves will be seen to indicate a definite normal probability distribution, at least down to a given signal level. The spread for the winter curves is more pronounced. Again, a well-defined relationship occurs between the two lower-frequency curves. Greater variability in signal strength is evident on all four wavelengths during the summer. Summer signal strengths were often more than 5 decibels above normal for several hours at a time, occasionally as high as 10 decibels above normal for shorter periods on the two higher-frequency channels, whereas during winter months signal levels greater than 3 or 4 decibels above normal were rare and of very short duration. As will be observed, upward swinging of the signal during the summer season was more pronounced at the shorter wavelengths. On the other hand, it was not unusual for the received signal to drop into the noise region during the summer months whereas such occasions were comparatively rare during the winter period, except that for a few days in January the 3.1-cm signal was abnormally low.

The unusual behavior of Channel 4, 3.1 cm, during the winter months is particularly interesting, especially in the light of its favorable performance relative to Channel 3 during the summer months. Like the other three channels, Channel 4 exhibits normal-probability characteristics over part of its decibel range, i.e., down to about 5 db below normal. Below this point, the distribution departs radically from normal probability and indicates that the signal was at disturbingly low levels for long intervals of time. In fact, that is precisely what happened and was brought about by conditions which ad-

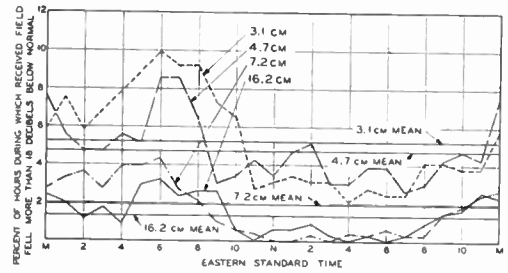

Figure 11. Diurnal variations in fading from January 1, 1947 to December 31, 1947. Percent of hours during which received field fell more than 18 decibels below normal

versely affected this channel but which had a disproportionately less effect on the other three. The extreme fading indicated for 3.1 cm is attributed to heavy fog which occurred in January 1947 and continued over a period of several days. Most of the time during this period, the signal was in or near the noise level.

Fading Below Critical Levels

Although the curves in Figures 9 and 10 furnish a fairly representative picture as to relative circuit performance at different wavelengths, in certain applications of microwave radio transmission, such as commercial telegraph operation, information bearing on the frequency of interruptions in service, due to fading conditions, however short they may be, and the approximate time of the day when such interruptions are most likely to occur, is particularly instructive. Interruptions in service will result whenever fading conditions cause the received signal to vanish or to fall below some nominal critical level. This fact suggested that an examination into minimum signal levels, particularly those which fall below what might be considered as a safe operating level, would indicate those hourly periods of the day during which interruptions in service are most likely. Accordingly, four arbitrary signal levels, -6, -12, -18 and -24 db were selected, and the number of hourly minima falling below each of these levels was recorded for each of the four wavelengths, according to the hour of the day and month, for the entire year of 1947. By number of hourly minima is

meant the number of hourly periods during any portion of which the signal fell below the level considered. Since these data were arranged in tabular form and are extremely voluminous they are not included in this paper. Figure 11, however, shows the manner in which the hourly minima were distributed with respect to the -18-db level for each hour of the day and for each of the four wavelengths. These curves illustrate the superior performance of the longer wavelengths and again reflect diurnal effects on all four circuits.

Data were also obtained as to the number of hourly occasions in which the received signal fell into the noise region and these data suggest that the number of such occasions varied roughly as the square of the frequency during summer

months and nearly linear with frequency during winter months, again excluding the abnormal period mentioned earlier. Usually, the received signal was in the noise region for very short intervals of time, generally a matter of seconds, and when integrated represented virtually negligible percentage of the total time considered.

Fading Extremes

The four charts of Figure 12 provide an interesting comparison of fading effects on transmission at 7.2 cm and 3.1 cm. These charts are intended to reveal the marked contrast between unusually favorable conditions which occurred during an entire week in February and exceptionally unfavorable conditions encountered during a week in August.

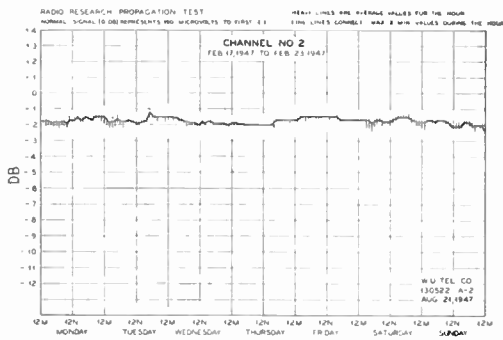

(a) Hourly fading data on 7.2 cm, February 17-23, 1947

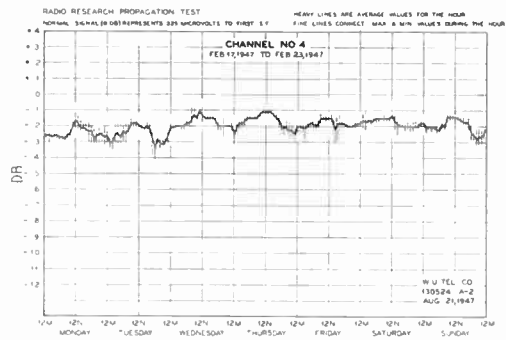

(b) Hourly fading data on 3.1 cm, February 17-23, 1947

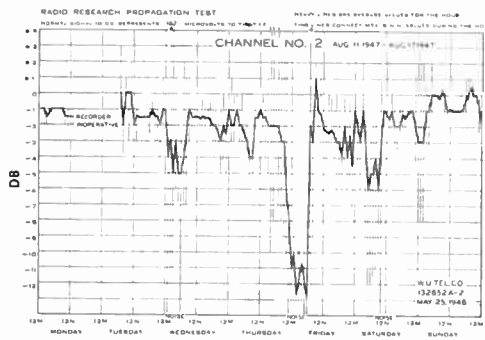

(c) Hourly fading data on 7.2 cm, August 11-17, 1947

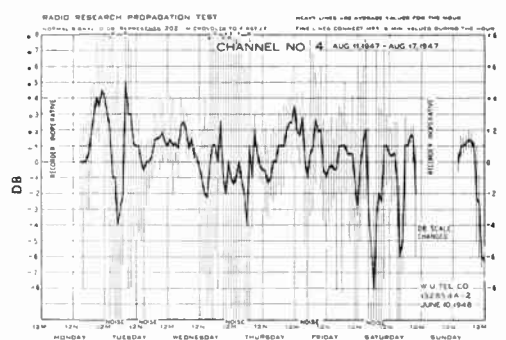

(d) Hourly fading data on 3.1 cm, August 11-17, 1947

Figure 12.

DISCUSSION OF METEROLOGICAL FACTORS

The discussion which follows is intended to describe briefly, and rather generally, the manner in which the physical properties of the lower atmosphere influence microwave transmission with respect to an unobstructed path entirely over land. Actually, the mechanics of fading is extremely intricate and has not yet been fully explained. For that reason, this discussion should be regarded as an obvious understatement of the fading problem.

Variations in transmission at microwave frequencies for an unobstructed overland path are caused primarily by variations in the distribution of the dielectric property, or dielectric constant, of the lower atmosphere. The manner in which this property is distributed in a region of space at any instant of time depends almost wholly upon the manner in which the air pressure, temperature and water vapor content, enclosed in this region of space, are distributed with respect to height above the earth's surface at that instant. Ground reflections and diffraction effects also influence microwave transmission, but to a lesser degree. This last statement is far from true, of course, for transmission paths that lie partially or wholly over water and for paths that are obstructed.

Bending of Wave Front

Assuming, for the moment, that air pressure, temperature and water vapor density were continuously constant with height throughout the propagation path, then the refractive index of the atmosphere throughout the path would be constant, the phase velocity would be constant and no distortion or bending of the wave front would take place. The assumed condition never occurs in nature since air pressure, temperature and water vapor density usually decrease in some manner with increasing height above the surface of the earth. The refractive index therefore usually decreases with increasing

height, and the resulting increase in phase velocity introduces a slight distortion in the wave front tending to bend the wave toward the earth. When the air and water vapor are thoroughly mixed the refractive index decreases gradually and nearly linearly with height, i.e., the vertical gradient of the refractive index is essentially constant. Under this condition, bending of the wave front is uniform. Although complete mixing seldom occurs, a fair degree of mixing is produced by light rainfall, turbulence, and by high winds. Better mixing is produced by thermal agitation and by convection currents resulting from solar heating of the earth's surface. Transmission was generally found to be steady when conditions conducive to good mixing were in evidence.

Duct Formation

Since complete mixing seldom obtains, the refractive index usually does not vary either linearly or smoothly with respect to height throughout the many planes along the transmission path. When the air is calm or motionless, a condition conducive to stratification, the temperature of the air may change rapidly with height. Whenever rapid changes in temperature occur, due to stratification or to conditions producing temperature inversion, and particularly if these changes are accompanied by a rapid decrease in water vapor content with height, very steep vertical gradients in the refractive index may result. These steep gradients exert a marked influence on microwave propagation, especially those forming in the transmission path or a short distance above it. Under these conditions, the refractive index may vary with height in such a manner that one or more inflections will occur, resulting in trapping of the energy, a condition commonly known as ducting. Inflections may occur simultaneously at several points along the transmission path, and ducts of various sizes and shapes may be formed and they may extend for con-

siderable distances along the surface of the earth. Ducting effects often result in very high signal strength, usually in the summer months. This type of transmission would produce interference at distant points beyond the normal transmission path, were it not for careful planning of the circuit layout.

Multipath Transmission

The same conditions under which ducts are formed generally produce multipath transmission, i.e., the originally transmitted wave energy may be split into two or more discrete components which follow slightly different paths. Under the influence of varying duct height and varying refraction within the duct, these components may arrive at the receiving antenna in such a variety of relationships with respect to the direct wave and the reflected or refracted waves as to result in extremely variable transmission.

Diurnal Aspects

Conditions for good mixing generally occur during the daytime whereas conditions for duct formation usually occur during the nighttime. Together they constitute a diurnal pattern which gives meaning to the existence of diurnal fading illustrated in Figure 8.

Seasonal Aspects

The refractive index gradient, which determines the characteristics of propagation, depends for its value not only upon the gradients of atmospheric quantities but upon their magnitude as well.³ This fact accounts, primarily, for the marked contrast between winter transmission, as illustrated in Figure 12 (a) and (b), and summer transmission, as illustrated in Figure 12 (c) and (d). For the month of February the mean temperature in the New York City area was 28.7 degrees; for August 74.2 degrees. The mean water vapor density, or specific humidity, was 2.5 grams per cubic meter for the month of February and 15.9 for August. Variations in temperature and specific humidity also fall into a seasonal pattern which suggests the seasonal trend illustrated in

Figures 6 and 7. Of possible interest, the hourly values of temperature during February and of specific humidity during August were found to be normally distributed whereas the hourly values of specific humidity during February and of temperature during August were not normally distributed but yielded a Pearson Type 3 curve in both cases.

Fading attributed to multipath transmission was usually slight during winter months; complete cancellations were very rare. During summer months, however, the effects of multipath transmission were pronounced; complete cancellations were observed on many occasions, particularly on 4.7- and 3.1-cm transmissions. It appears that in the winter months the interfering wave or waves generally reinforced the direct wave because of small changes in the refractive index. For the summer season, reinforcement of the direct wave appeared to be about equally probable with reduction, but the magnitude of the effect was much more severe. For the summer months, the mean signal level was about 2 db higher than the winter months for 16.2 and 7.2 cm, and approximately 4 db higher for 4.7 and 3.1 cm. Refraction varies over wide ranges in the summer months and frequently such variations are extremely rapid, as observed by rapid changes in signal level. An examination of fading records suggested that in some instances these changes occurred at a rate of 3 to 4 db per second.

Effects Versus Wavelengths

Down to about 1 cm, the atmospheric index of refraction is independent of wavelength;³ i.e., for a given index the bending of the wave front is the same and hence the difference in length between the refractive path and the direct path would be the same, assuming that the refractive index remains constant throughout the length of the path. However, if this difference in path length is measured in terms of wavelength, the phase displacement would be found to be greatest for the shortest wavelength. In other words, for a given index, the phase difference between direct and refracted wave would increase with decreasing

wavelengths. The tendency for cancellation during multipath transmission is thus seen to be accentuated for the shorter wavelengths.

Deviations in the path of the wave due to refraction resulted in a greater effect at the shorter wavelengths because the beam width decreased as the wavelength was decreased, since the size of the antenna system was the same for all four wavelengths. Thus a greater proportion of the first Fresnel zone for the shorter wavelengths was affected by the presence of ducts or areas in which steep gradients had formed. Except on 3.1 cm, there was no evidence of attenuation due to rain or snow on any of the wavelengths tested. At 3.1 cm, however, rain attenuation was apparent.

Conclusion

Microwave radio communication systems operating on wavelengths down to about 5 cm may be expected to perform in a highly satisfactory manner throughout the year under properly selected conditions of path length, path clearance and transmitter power. Circuit performance will deteriorate appreciably and progressively at shorter wavelengths and at wavelengths of about 3 cm and below, shorter

path lengths together with nominal increases in transmitter power are indicated if a high degree of circuit continuity is required. Fading is observed with greater prevalence during the summer months, and at nights, as a result of changing meteorological conditions. Diversity reception will prove beneficial in reducing the effects of multipath transmission.

Acknowledgment

This test was made possible through the combined efforts of engineers from the RCA Victor Division of RCA and the Radio Research Division of Western Union. The RCA engineers provided valuable assistance in formulating the test program, in designing the test equipment and in placing the test into operation. To these men and to members of our Radio Research Division who participated in the operation of the test, the authors express their sincere appreciation.

References

1. A NOTE ON A SIMPLE TRANSMISSION FORMULA, HARALD T. FRIIS, *Proceedings of IRE*, May 1946, pages 254-256.
2. PARABOLIC-ANTENNA DESIGN FOR MICROWAVES, C. C. CUTLER, *Proceedings of IRE*, November 1947, pages 1284-1294.
3. PROPAGATION OF VERY SHORT WAVES, Part II, DONALD E. KERR, *Electronics*, February 1948, pages 118-123.

THE AUTHOR: J. Z. Millar: For photograph and biography of Mr. Millar, who is now Director of Research of the Development and Research Department, see the July 1949 issue of **TECHNICAL REVIEW**.

THE AUTHOR: L. A. Byam, Jr., served a year as Morse operator with the Western Union Telegraph Company, and three years as a radio operator with the Radiomarine Corporation before entering the University of Delaware. He was graduated in 1932 with the degree of B.E.E., and then enrolled in a special course of study at M.I.T., completing that course in 1933. Mr. Byam rejoined Western Union in July 1933; on January 1, 1937 he was appointed Division Commercial Manager in charge of Operation, and served in that capacity until May 1941, when he was called to active service with the Navy. During the war he was engaged in radar installation and maintenance under the direction of the Bureau of Ships. Mr. Byam resumed service with Western Union in January 1946 and is now engaged in radio research with the Development and Research Department. He is a member of Phi Kappa Phi and Tau Beta Pi.



A Two-Channel Carrier Telegraph System for Short Submarine Cables

E. L. NEWELL and C. H. CRAMER

THE NARROW USEFUL FREQUENCY SPECTRUM on submarine telegraph cables restricts the use of frequency-division methods of channelization. This is evident when it is noted that, of the transatlantic cables, the nonloaded types have attenuations of about 100 decibels at 15 to 20 cycles per second and the loaded cables have attenuations of the same order at 100 cycles. Where channelization is desirable on long cables, use is made of electromechanical time-division multiplex methods.

The submarine telegraph cable network also includes cables of shorter lengths, ranging down to 100 nautical miles or less, which serve as connecting links in long circuits or provide direct traffic facilities such as those to or between islands. The connecting links originally were, and in some cases still are, operated at the speeds of the related long cable sections and thus below their potential signaling capacities. The direct facilities have been more fully developed under the compulsion of increasing traffic loads.

In recent years signal-shaping amplifiers have been installed rather generally on the connecting cables of some cable systems, making higher physical-circuit operating speeds available. As a result channels of separate long cables may be combined for transmission on the connecting links through use of modern time-division multiplex methods, involving devices such as the channel repeater. Low frequency carrier circuits are also in use on a number of short cables in various cable systems. The limited use of carrier in the Western Union cable plant includes one early installation in which the cable is 326 nautical miles in length; the physical circuit can be operated at dot frequencies up to 30 cycles; the superposed circuit, in one direction only, with a

carrier frequency of 90 cycles, is operated at a speed of 31 cycles. Another application of carrier, to which further reference is made in this paper, involves cables about 100 nautical miles in length and provides a one-way channel with a carrier frequency of 300 cycles and an operating speed of 35 cycles.

Although the traffic requirements prevailing from time to time have been satisfied in the manner outlined above, the present utilization of the useful frequency spectrum of the short cables cannot be regarded as efficient. Consideration of means for attaining optimum efficiency inevitably leads to time-division multiplex methods. Because of mechanical limitations the multiplex system long in use on land-line and cable d-c telegraph circuits is not suitable for the high speeds implied. Perfection of electronic time-division systems, currently under intense development for radio applications, may well provide the ultimate solution at the bottom of the frequency spectrum also. In the meantime, modern frequency-division methods and equipment are already available in an advanced stage of development, and a recent carrier installation on the Western Union Key West-Havana cables has yielded a substantial increase in message capacity.

The Key West-Havana Cables

Western Union wire facilities to Cuba consist of three single-core submarine cables between Key West and Havana, each about 100 nautical miles in length. The physical circuits are operated as ground-return polar differential duplexes. Because of the high cable attenuation, the receiving terminals utilize the principle of the well-known Gulstadt vibrating relay to insure adequate sensitivity for the

A paper presented before the Winter General Meeting of the American Institute of Electrical Engineers in New York, N. Y., January 1950.

low-level received signals. The normal assignments are three-channel multiplex circuits.

For some years the physicals were supplemented with two one-way southbound carrier channels, each having a carrier frequency of 300 cycles per second and utilizing amplitude modulation. One channel was superposed on two of the cables as a metallic circuit, the second as a ground-return circuit on the third cable. The high attenuation of the cables and the state of the carrier art when the original system was installed made it impracticable to provide additional channels through the use of higher frequencies.

Recently a need for additional telegraph facilities to Cuba became evident. In view of improvements in carrier telegraphy it

with the existing differential duplex equipment or as four-channel multiplexes with resistance-bridge duplex circuits and signal-shaping amplifiers.

3. Be capable of operation as a metallic circuit over any two of the three cables, thus providing some protection against cable failure.

Cable Characteristics

The three Key West-Havana cables, 2, 3 and 4 KZ-HVA, are single-core, nonloaded cables lying about ten miles apart over most of their length. Each is a composite of several different types of cable. The general characteristics are given in the following table:

<i>Cable</i>	<i>Length Nautical Miles</i>	<i>*Major Core Types</i>	<i>Total Resistance Ohms</i>	<i>Total Capacity Microfarads</i>
2 KZ-HVA	105	107/140	988	31.2
3 KZ-HVA	98	160/166	675	35.2
4 KZ-HVA	96	130/130	775	30.5
Key West Undergrounds	0.89	—	23	0.15
Havana Undergrounds	4.44	—	70	2.0

*Pounds per nautical mile
of copper and gutta percha

was decided to undertake the development of a new system which would provide two two-way channels of higher transmission quality. The Type C-3 carrier system resulting from that development, and described in this paper, was installed at Key West and Havana in the early part of 1949.

Carrier System Requirements

When this project was initiated, traffic considerations required that the proposed carrier system should:

1. Provide two two-way channels, each suitable for 35-cycle multiplex operation or for teleprinter operation.
2. Permit operation of the physical circuits as three-channel multiplexes

The receiving earth in all cases is carried back from the office through the underground to the cable hut at the beach on a conductor paired with the cable conductor.

The attenuation and impedance characteristics of the three cables, including the undergrounds, are shown in Figures 1 and 2. The attenuation characteristic of any two cables taken as a metallic circuit may be approximated by averaging the values of the selected cables. With attenuations of 38 to 46 decibels at 300 cycles, and 70 to 82 decibels at 1000 cycles, these cables approach the attenuation characteristics of 16-gauge paper-lead cable. The total attenuation is about three times that encountered in a typical land-line carrier section. As a metallic circuit, the conductors of the submarine section are unbal-

anced and unpaired, conditions which, in a land-line carrier system, usually result in intolerable interference levels but are here largely offset by the shielding effect of the sea water.

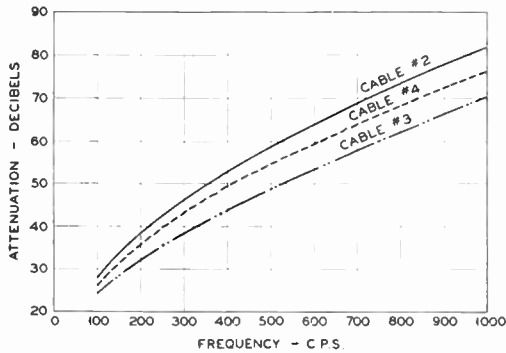

Figure 1. Attenuation of Key West-Havana cables

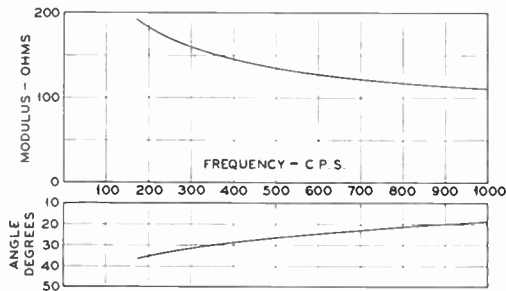

Figure 2. Sending-end impedance of Key West-Havana cables—Key West end

Description of Carrier System

The C-3 carrier system is shown schematically in Figure 3. It utilizes the frequency-modulation channel terminals standardized by Western Union and widely installed in the land-line carrier systems.

The channel terminal comprises two units, one a sending-receiving filter panel, and the second a "transceiver" which combines the electronic transmitting and receiving functions. Standard mid-channel frequencies are used, 375 and 525 cycles for southbound transmission, and 825 and 975 cycles for northbound transmission. The channels have a band width of 80 cycles and are spaced at 150-cycle intervals, with one channel omitted to facilitate

directional separation. Frequency modulation of the transmitted carrier is accomplished by raising and lowering the mid-channel frequency 35 cycles to send spacing and marking impulses, respectively. This type of channel terminal is designed for operation at a maximum dot frequency of 35 cycles per second in land-line installations where two or more carrier systems may be operated in tandem. In such cases, the additive effects of successive channel filters narrow the channel band width and thus limit the maximum signaling speed. The present application involves only a single carrier section and the channel band width is sufficient under these conditions for a dot frequency of 50 cycles per second provided other factors, such as interference levels, are favorable.

The channel terminals as used in the C-3 system are standard in most respects. Minor wiring modifications in the transceivers adapt them to the power supplies at Key West and Havana and discard the half-duplex and repeater facilities which are not required in this instance. In the standard channel terminal, the sending and receiving channel carrier frequencies are alike, while in the C-3 system the sending and receiving frequencies differ.

Other components of the C-3 system are: the hybrid coils which couple the carrier equipment to the cables, and the receiving amplifier, both of standard land-line type; sending amplifier, directional separation filters, impedance equalizer, anti-noise set and composite, and leg circuit equipment, all of special design.

Directional separation of the channels is secured in part by frequency discrimination and to a lesser degree by the duplex balancing action of the hybrid coils. With different channel frequencies in the two directions, some directional discrimination is provided by the channel filters. The additional frequency discrimination required is obtained by the use of separation filters with cutoff in the 150-cycle guard band, located between the northbound and southbound channel frequencies. Characteristics of the channel receiving filters and the receiving separation filters are shown in Figure 4. The characteristics of the corresponding sending

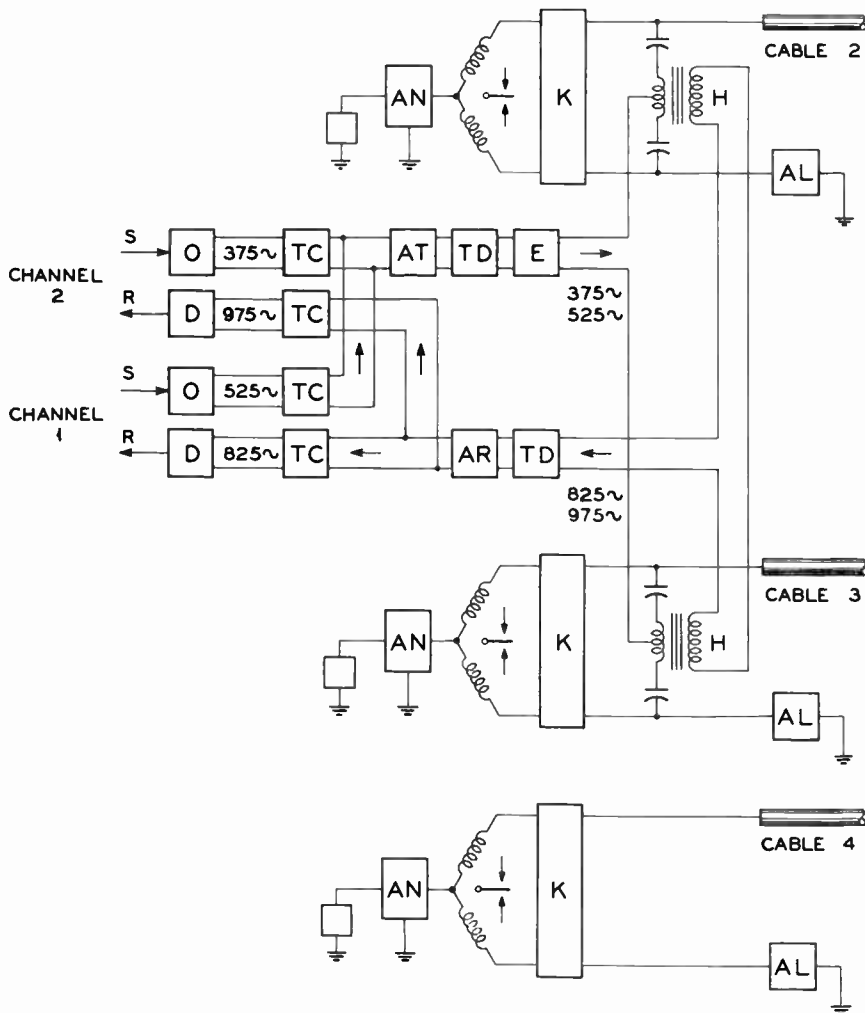

- | | |
|---------------------------------------|---------------------------|
| AL - ARTIFICIAL LINE | H - HYBRID COIL |
| AN - ANTI-NOISE SET | K - COMPOSITE |
| AR - RECEIVING AMPLIFIER | O - OSCILLATOR, MODULATOR |
| AT - TRANSMITTING AMPLIFIER | TC - CHANNEL TUNERS |
| D - LIMITER, DISCRIMINATOR, RECTIFIER | TD - DIRECTIONAL TUNERS |
| E - IMPEDANCE EQUALIZER | |

Figure 3. Block diagram of carrier system terminal

filters are generally similar. With cable attenuation up to 80 decibels, it is necessary to provide a total maximum discrimination of 110 decibels between sending and receiving channels to maintain crosstalk interference at 30 decibels below the received signal level. Under practical operating conditions, the discrimination resulting from the balanced hybrid coil arrangement may not be more than 10 decibels. The discrimination supplied by

the channel filters amounts to about 80 decibels, nominally leaving 20 decibels to be provided by the separation filters. However, the channel filters do not protect the receiving amplifier, common to both channels, against overload by the sending frequencies and their modulation products. As shown in the system power level chart, Figure 5, the sending power level is high, about plus 38 decibels per channel or a total of 42 decibels (referred

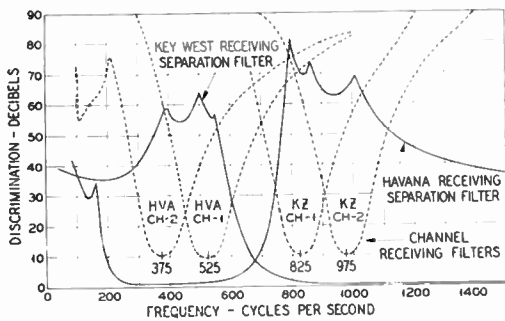

Figure 4. Receiving filter characteristics

to zero power level of 1.0 milliwatt), and for that reason the separation filters must actually provide discrimination of some 60 decibels.

To provide the high sending carrier level, the transmitting amplifier has greater gain and power output than the corresponding amplifier standard in the land-line system. It consists of two push-pull stages, with three 25C6 tubes in parallel on each side of the output stage, and delivers 17 watts. By using about 20

decibels of combined voltage and current feedback, the total harmonic distortion is limited to one percent and most of this is at frequencies outside the pass bands of the channel filters.

The cable capacitance combined with the capacitors used to couple the carrier system to the cables result in a highly reactive sending-end impedance at carrier frequencies. For efficient transfer of carrier power to the cables, an impedance equalizer is used which provides a resistive load for the sending amplifier and filter and matches the reactive cable input impedance.

The low carrier receiving levels and the small permissible degradation of the physical circuits impose severe requirements in the suppression of noise from the physical circuits. For this purpose use is made of anti-noise sets and composites having the characteristics shown in Figure 6. The anti-noise sets are low-pass filters in the apexes of the physical circuits with cutoff at about 200 cycles and providing discrimination of over 60 decibels

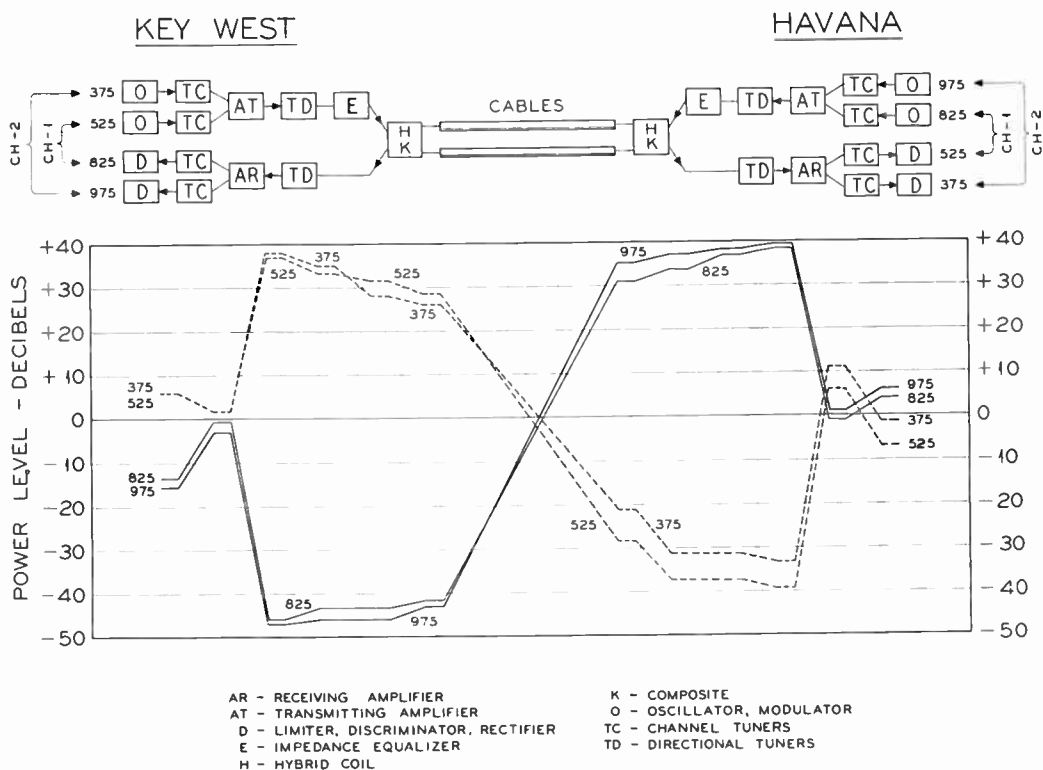

- | | |
|---------------------------------------|---------------------------|
| AR - RECEIVING AMPLIFIER | K - COMPOSITE |
| AT - TRANSMITTING AMPLIFIER | O - OSCILLATOR, MODULATOR |
| D - LIMITER, DISCRIMINATOR, RECTIFIER | TC - CHANNEL TUNERS |
| E - IMPEDANCE EQUALIZER | TD - DIRECTIONAL TUNERS |
| H - HYBRID COIL | |

Figure 5. System power levels

against carrier-frequency components of the physical circuit signals. The composites provide maximum discrimination against the physical circuit signals at the frequencies of the carrier channels. A total discrimination of over 100 decibels is thus obtained while the insertion loss in the physical circuits for frequencies below 150 cycles is less than 3 decibels. Corresponding values in land-line circuits are 50 decibels and 10 decibels.

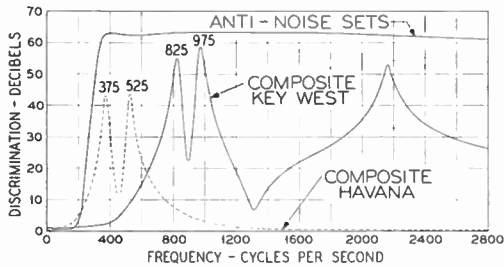

Figure 6. Frequency characteristics of composites and anti-noise sets

High-frequency noise components are generated by the motion of the armatures of the receiving relays of the physical circuits. This noise, unless suppressed, may overload the carrier receiving amplifier. The band-pass separation filter at Havana provides the necessary suppression which, however, is lacking in the high-pass separation filter at Key West. At that terminal the suppression is accomplished by including in the composites an attenuation section centered at about 2150 cycles.

In the land-line system, relays for transmitting and receiving have been eliminated in the channel terminals and the transceivers function entirely electronically with single-current telegraph impulses in the leg circuits. This simplification became practicable in the domestic telegraph plant with the vast expansion of carrier operation and the concurrent decline in d-c grounded and metallic facilities. Circuit extensions at Key West and Havana are not yet compatible with such simplification and the C-3 system includes intermediate relays in both the sending and receiving legs, so that leg-circuit operation may be either single-current or polar. As shown in Figure 7, each leg circuit is provided with sounder

and key and means for connecting a teleprinter for monitoring purposes. Jacks in the leg and intermediate relay circuits permit the insertion of a meter for measurements of current and signal bias.

While the C-3 system is designed primarily for operation on a metallic circuit, it is evident that in the event of interrup-

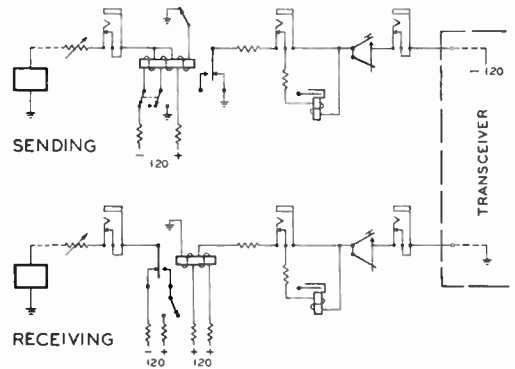

Figure 7. Schematic of telegraph leg circuits

tion of two of the three cables, ground-return operation on the remaining cable is greatly to be desired. Networks simulating the cable and artificial line impedances are provided at each terminal and arranged to be substituted for the second cable to maintain proper impedance relations for ground-return operation.

At each terminal, all of the carrier equipment and the anti-noise sets and composites are mounted on the two sides of a standard rack. Figure 8 shows the Havana installation.

Test and Performance Data

In Cuba, the submarine cables land at Cojimar and are extended to Havana in underground cable, a distance of 4.44 nautical miles. The receiving earths are carried back to Cojimar, paired with the corresponding cable conductors. In this situation, satisfactory duplex balances for both the physical circuit and carrier frequencies could not be obtained with any normal adjustment of the Havana artificial lines. The difficulty was solved by inserting in the earth-return conductor at Cojimar a simple resistance-capacitance



Figure 8. Havana installation

network which partially matches the impedance of the submarine cable section. Identical networks were installed for each cable. Under this condition, normal adjustments of the Havana artificial lines produce adequate balances at all significant frequencies. An additional advantage of the networks is that the cable and earth conductors of the underground section are more nearly balanced against extraneous interference. At Key West, where the undergrounds are short, no duplex balance problem was encountered.

With metallic circuit connections, the noise level from all sources at the input to the receiving side of the transceiver is 35 to 40 decibels below the received signal at Havana, and 40 to 45 decibels below the

received signal at Key West, depending upon the combinations of cables used. With the carrier superposed on any two of the three cables, excellent margins are provided for teleprinter, 33-cycle polar ticker and 3-channel multiplex operation. With 50-cycle 3-channel multiplexes on both channels, the margins are better than those obtained on the physical circuits of the cables.

Set up as a ground-return circuit, the carrier noise level ranges from 30 to 40 decibels below the received signal at Havana, and 20 to 30 decibels below the received signal at Key West. Compared with Havana, the received signal level is low at Key West, since the northbound channels utilize the top frequencies and are more heavily attenuated; also noise from extraneous sources is higher because the cables are in shallow water for a greater distance at the Key West end of the route. The noise measurements were made during the month of February; somewhat higher levels of natural disturbances, such as lightning, may be expected in the summer months.

For the greater part of the year, ground-return operation on 3 KZ-HVA and 4 KZ-HVA provides excellent transmission quality on both carrier channels for teleprinter, ticker or 3-channel multiplex. Under similar conditions, 2 KZ-HVA is less effective by reason of its higher attenuation. Some deterioration of ground-return operation during the summer months is caused by the lightning disturbances.

The performance of the new system in traffic service has amply confirmed the excellent test results. Since completion of the installation, there have been several cable interruptions. During one period, two of the cables were out of service. Through use of the new carrier, all essential services to Cuba were maintained on the single remaining cable. On another occasion with one cable interrupted, the new system was superposed on one cable while an old-type 300-cycle channel was operated southbound on the second cable, with excellent performance of all facilities.

Traffic experience with ground-return operation of the new system has developed a special circuit arrangement of some

practical importance. When a cable is out of service because of an interruption or fault, that cable, under favorable conditions, may be utilized with an operating cable to provide a regular metallic circuit connection for the carrier, thus retaining the low interference levels normal with metallic operation. The nature and location of the fault and its effect on the duplex balance of the faulty cable determine the suitability of this arrangement in specific situations. If the fault is so near to one terminal that the carrier duplex balance cannot be restored readily, the ground-return connection would be used for the carrier at that terminal while the metallic connection could be used at the distant terminal. If the fault is in the mid-section of the cable, the metallic connection can be utilized at both terminals.

Operation of the polar differential duplex physical circuits is not affected

appreciably by the new carrier equipment. The field tests indicate that 4-channel 66-cycle multiplex operation will be feasible as a resistance-bridge duplex with signal-shaping amplifiers.

The Key West-Havana cables utilize core types (see table) typical in general of short submarine telegraph cables. Although the C-3 carrier system was developed for specific conditions, it is applicable to similar cables for distances not exceeding about 100 nautical miles or attenuations not greater than 80 decibels at 1000 cycles per second. Modified systems such as one two-way channel or one to four one-way channels would be suitable for cables of somewhat greater attenuation.

Reference

1. A FREQUENCY MODULATION TELEGRAPH TERMINAL WITHOUT RELAYS, F. H. CUSACK, A. E. MICHON, *AIEE Transactions*, Volume 66, 1947, pages 1165-1171.

THE AUTHOR: E. L. Newell received his B.S. in Electrical Engineering from Union College in 1921 and the E.E. degree from Columbia University in 1922, his studies having been interrupted by two years' service in the U. S. Navy. He joined the Transmission Research Division in 1922 where his work has been largely in the field of submarine cable transmission. His knowledge of this field led naturally to the assignment as project engineer on the cable operated carrier system. He has also been active in the development of equipment for elimination of radio interference originating in the telegraph system. Mr. Newell is a Member of AIEE, Tau Beta Pi and Sigma Xi.



THE AUTHOR: C. H. Cramer: For photograph and biography, see the January 1948 issue of *TECHNICAL REVIEW*.

The Development of Western Union Switching Systems

M. D. ADAMS

(Continued from TECHNICAL REVIEW, January 1950)

THIS ARTICLE continues the description of the Plan 21-A Reperforator Switching System, and describes the switching center facilities provided for way circuits that connect very lightly loaded tributary offices to the switching center. A way circuit may serve two or three stations (i.e., tributary offices), but the two-station way circuit is the type most generally used. All stations of a way circuit are, in effect, connected in series, and share the line connecting them to the switching center. Unlike the "duplex operated" tributary and branch office line circuits described in previous TECHNICAL REVIEW articles, a way station line circuit is "single operated", or in other words transmission can be in only one direction at a time. However, from a message handling standpoint, way circuits function in the same manner as duplex operated circuits that terminate in line finder facilities at the switching center.

Separate sending and receiving legs, accomplished through the use of leg combining equipment, are provided at the switching center for way circuits, thus permitting a way circuit to be terminated in separate sending and receiving equipments in practically the same manner as duplex operated circuits. The leg combining equipment is generally located at the switching center office, but in some cases it is remotely located with the separate sending and receiving legs being extended to the switching center office over carrier current facilities.

At the switching center, the receiving leg terminates in a line finder while the sending leg terminates in a way circuit line sending position mounted on a Reperforator Sending Rack 5106. These terminations are indicated on the block diagram covered by Figure 55.

The line finder termination for the receiving leg of a way circuit is essentially the same as that for the receiving leg of

a duplex operated (single station) circuit, the principal difference being that the way circuit termination is provided with two or three sequence number indicators depending upon the number of stations on the way circuit. When the line finder responds to an incoming call from one of the stations on a way circuit, it connects the receiving leg to a receiving distributor and, at the same time, the sequence number indicator associated with that particular way station is readied for use. The switching and transmission of the message then proceed in the manner described in an earlier article for line finder operation. Upon the receipt of the selection characters from the way station, the receiving leg is connected through the receiving distributor to a sending position of the desired outgoing trunk. Transmission of the message takes place from tape transmitting apparatus at the way station directly into the intra-office reperforator at the trunk sending position. The code combinations for the call letters of the way station and the sequence number of the message, as punched into the tape by the intra-office reperforator, are compared with the code combinations for the characters set up in the sequence number indicator that was readied for use when the line finder responded to the incoming call. The end-of-message signal, two periods, releases the connections set up for that message.

In the other direction, messages for the various stations of a way circuit are manually switched at the switching center to a line sending position at which the sending leg of the way circuit is terminated. The switching turrets are equipped with a separate push button for each station of the way circuit, each push button controlling an associated intra-office circuit. At the line sending position, each intra-office circuit is equipped with an automatic numbering machine but the several intra-

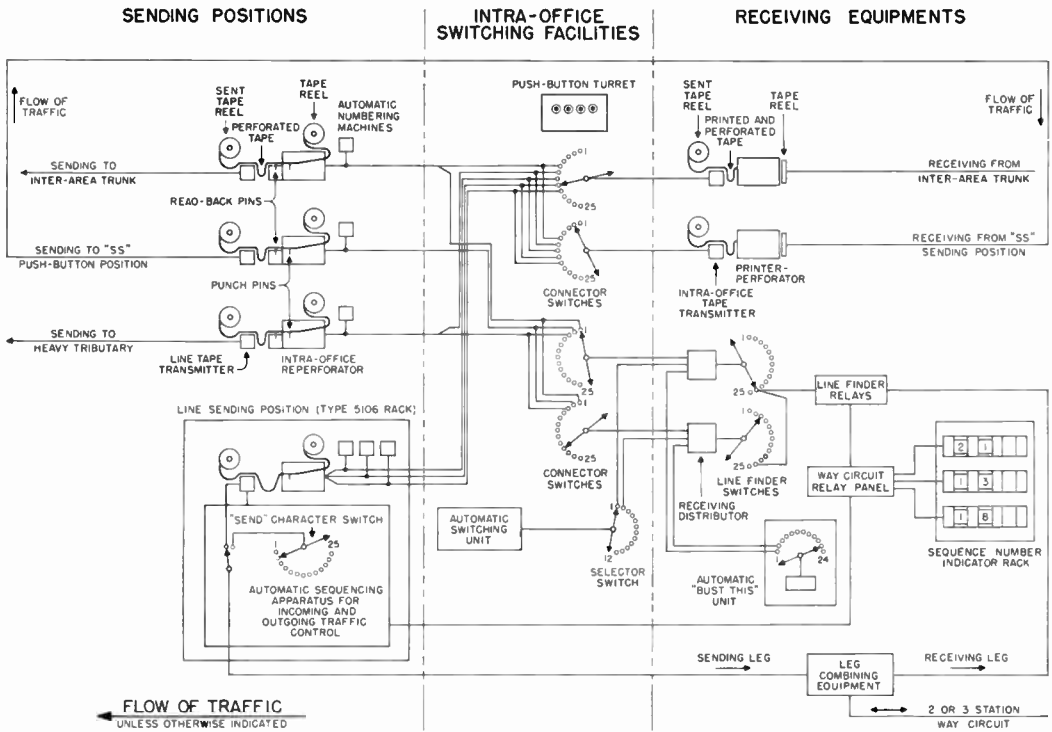

Figure 55. Automatic switching for way circuits

office circuits terminate in one reperfors which reproduces all switched message traffic in a single, continuous perforated tape. This tape passes through the associated line transmitter when transmission takes place to a way station.

The primary purpose of the individual intra-office circuits is to allow selection of the particular automatic numbering machine assigned to the station for which a switched message is destined. These machines transmit a preamble into the line sending position reperfors in advance of the address and text of each switched message. The preamble contains a character (or characters) that identifies the switching center, a character that identifies the way station of destination, and the proper message sequence number for that station.

Figure 56 is a front view of a 5106 Rack showing the general arrangement of the equipment units for two separate way circuit line sending positions, which is the maximum capacity of the rack. Since

the need for three-station circuits is limited, a space and equipment saving is obtained by making only the lower position capable of accommodating a three-station circuit, while the upper position is restricted to a two-station circuit. On the automatic numbering machine shelf at the top of the rack, the first two machines are associated with the upper position, and the two remaining machines are associated with the lower position. In this illustration, both positions are used for two-station circuits, hence the third numbering machine for the lower position has been omitted from the shelf. A signal and control panel is also associated with each position for manual supervision and control of the way circuits when necessary.

Figure 57 is a rear view of a 5106 Rack. Mounted on this side of the rack are the relay banks and other apparatus associated with the two line sending positions for controlling both the intra-office circuits and the automatic operation of the way circuits.

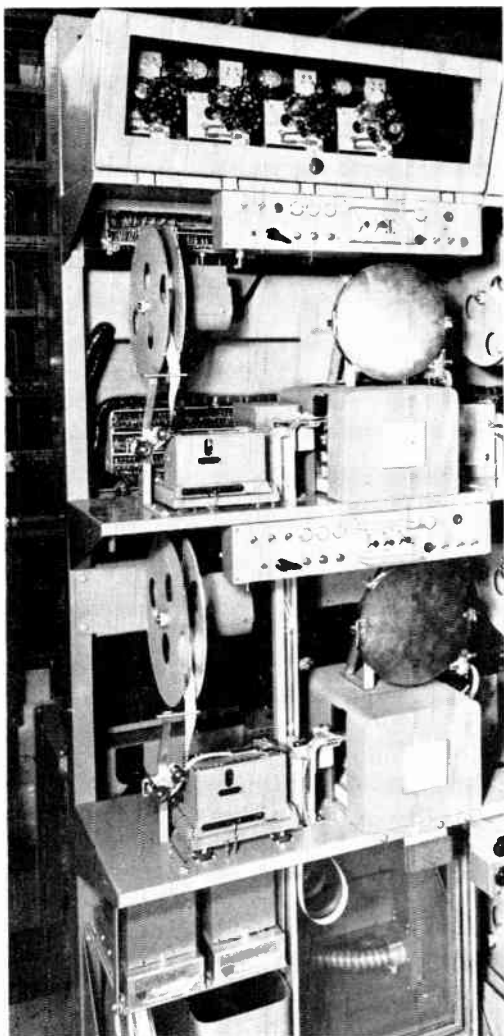

Figure 56. Front view of Type 5106 rack equipped for two 2-station way circuit line sending positions

Review of Way Circuit Operation

Way circuits are not new in the telegraph art, dating back to the early days of Morse communication. One method of operating teleprinter way circuits is to connect all stations actively in series on the circuit at all times. Thus, each station copies all message traffic passing in either direction over the circuit. The operator at each station, therefore, has to sort out of the total message traffic accumulation those messages intended for delivery at her station. This is the method employed in plug and jack (Plan 2) and push-button

(Plan 20) Reperforator Switching Systems.

That a better appreciation of the new system may be had, it is thought appropriate to review briefly the method of operation of the old Plan 2 and Plan 20 centers. In these, the receiving legs of way circuits are terminated in receiving concentrators which permit as many as 12 line circuits to be served by 4 or 5 receiving positions. In response to an incoming call, the concentrator connects the receiving leg to the printer-perforator on one of the concentrator receiving positions where the incoming message is recorded in a printed and perforated tape. Each way station operator transmits directly from the keyboard of her teleprinter and uses a separate number sequence for messages originating at that station. The heading, or preamble, of each message also contains identification characters for the station of origin. At the switching center, a switching clerk reads the address and destination of each message, as printed on the tape, and then manually performs the switching operation in accordance with the prescribed routing. She also maintains a separate number sheet for each station of the circuit and checks off the message number on the proper sheet as each message is switched.

At the switching center, messages destined for the various stations on a way circuit are switched to the line sending position assigned to that way circuit over intra-office circuits that are similar to those just described for Plan 21-A switching centers. The message traffic for all of the stations on the way circuit is reproduced at the line sending position in a single, continuous perforated tape. Each message has a preamble, inserted by an automatic numbering machine, which contains a character (or characters) that identifies the switching center, a character that identifies the way station of destination, and the proper message sequence number for that station. An automatic control between the receiving concentrator termination and the line sending position assigned to the way circuit regulates the action of the line transmitter. Any perforated tape at the line sending position is allowed to pass through the line trans-



Figure 57. Rear view of Type 5106 rack

mitter whenever there is no transmission in progress from a station to the switching center. While all the stations on the way circuit copy all messages in either direction, the station identification characters and separate number sequences serve to indicate to each station operator the messages for which she is responsible.

With this way circuit arrangement, a

station operator is free to initiate a call whenever the circuit is observed to be idle. It sometimes happens that the operator at more than one station starts transmitting at the same time, or that a station operator starts transmitting just as transmission starts from the central office. This sometimes results in one or more of the characters in the preamble of a message being mutilated. However, with constant manual attention available at the central office, in the person of either a supervisor or a switching clerk, these difficulties are straightened out without too much trouble when they do occur.

General Requirements for Plan 21-A Way Circuits

In the Plan 21-A Reperforator Switching System, the outstation operators on tributary and branch office circuits prefix each message with selection characters which cause the messages to be switched automatically through the switching center to any one of a maximum of 73 possible destinations. Thus, the manual attention of switching clerks that is given in the older reperforator offices to incoming messages is eliminated and their switching functions have been replaced by automatic means. In an automatic system of this nature, it is evident that no normal operating procedure can be tolerated which could result in mutilation of the message selection characters.

It becomes essential, therefore, in the case of Plan 21-A way circuits to eliminate any possibility of more than one station starting to transmit into the switching center at a time. It is equally essential to eliminate the possibility of a station starting to transmit at the same time that the switching center starts to transmit to a station. This is accomplished by an automatic arrangement at the switching center which constantly assigns the line to each of the stations for incoming messages, and to the switching center for outgoing messages, in a regular sequence.

In general terms, this sequencing apparatus functions to give the first way station an opportunity to send a message into the switching center. If there is one or more messages awaiting transmission at the first

station, the exclusive use of the line is given to that station until the completion of one message. Then the sending position at the switching center is given an opportunity to transmit a message. If there is one or more messages awaiting transmission at the sending position for any of the way stations, the exclusive use of the line circuit is given to the switching center until the completion of one message. Then, in turn, the second station is given an opportunity to send a message, then the switching center, then the third station, then the switching center; after which the cycle starts over again with the first station being given an opportunity to send a message. When any of the stations or the switching center is given an opportunity to send, and there is no message awaiting transmission, the sequencing apparatus automatically proceeds within a few seconds to give the next station in the sequence an opportunity to send a message. Thus, there can be no operating conflict between the stations, or between a station and the switching center, since the entire operation of the way circuit is, in effect, automatically programmed from the switching center.

The Plan 21-A way circuits have the desirable feature that when one of the stations is transmitting a message into the switching center, the other stations on the line and the teleprinter at the transmitting station are locked out and do not copy the message. Also, when transmission is from the switching center, the station for which the message is destined is automatically selected and only that station copies the message, the other stations on the line being locked out.

Each station on a way circuit is assigned two characters that are individual to that station. The reception of one character gives the station an opportunity to send a message into the switching center while the reception of the other character locks the station in for receiving a message from the switching center. These characters, which are sent out from the switching center, are always followed by a *figure shift* character. Actually, the character that locks in the station for receiving a message and the following *figure shift* character are a portion of the preamble

which is inserted by an automatic numbering machine ahead of each message switched into the way circuit line sending position at the switching center.

The printers of all stations are actively in the line circuit when the circuit is idle. When a "send" character is transmitted, the designated station is conditioned to send a message. The following *figure shift* character locks out the other stations and indicates to the conditioned station that it has exclusive use of the line circuit for the transmission of one message. When a "receive" character is transmitted, the designated station is locked in for the reception of a message. The following *figure shift* character locks out the other stations.

The end of transmission of a message in either direction is denoted by the end-of-message signal consisting of two periods. Immediately, the exclusive use of the line circuit by the designated station is terminated by the switching center transmitting a long (2-second) "spacing" signal. When the designated station receives an opportunity to send and there is no message awaiting transmission, the long spacing signal is transmitted almost immediately. In any event, the long spacing signal causes the printers of all the way stations again to be connected actively into the line circuit in readiness to receive the next "send" or "receive" character.

Control of Message Transmission From Way Stations

The station designation characters usually used for the "send" characters are Q for the first station, W for the second station, and X for the third station. However, if one of these characters is included in the switching center identification, it cannot be used. In such cases, the remaining two letters are used for the first and second stations respectively, and Y is used for the third station. Thus, the usual complete designation signal for the first station is *Qfigure shift*, for the second station *Wfigure shift*, and for the third station *Xfigure shift*. The code combinations for these character groups are set up by strapping the studs of five levels of the "send" character switch (see Figure 55),

which consists of a conventional 25-point 10-level rotary switch that is included in the way station automatic sequencing apparatus mounted on the rear of the line sending position rack. The transmission of these character groups is obtained by diverting the sending leg from the line tape transmitter to the wipers of these switch levels and causing the wipers to be advanced one stud at a time over two studs for each such transmission. The strapping is arranged so that the "send" designation signals for the various stations are transmitted in a definite sequence.

When transmission of any designation signal occurs, the teleprinters at all stations are actively in the line circuit. All of them, therefore, respond to the two characters and print the particular station designation character. Generally the upper case equivalent of the character is actually printed. The printing operation results from the vertical motion of a pull bar associated with the character, and this motion may be utilized to operate a set of contacts added to the teleprinter. Such a contact set is placed over the Q pull bar at the first station, over the W pull bar at the second station, and over the X pull bar at the third station. Thus, only the contact set at the station designated by the particular character transmitted becomes operated, and this prepares that station for transmitting a message. The following *figure shift* character, in addition to performing the shift function, also operates a teleprinter pull bar at each station, which in turn operates a contact set at each station. At the designated station, this conditions the local circuits for initiating a call to the switching center if there is a message awaiting transmission, while at the other stations the operation of the contact set locks the teleprinter and local circuit functions out of the line circuit so that they can neither transmit nor copy the transmission of the designated station. Following the transmission of the *figure shift* character, a 1-second interval is allowed to elapse before any further operation can take place over the way circuit from the switching center.

When a station operator has prepared one or more messages in perforated tape form for transmission, she depresses a

push button. This establishes a calling condition at the station. When that station is designated to transmit, this calling condition causes a spacing signal to be sent over the way circuit to the switching center, resulting in a calling condition being set up on the way circuit receiving leg line finder termination. This occurs within the 1-second interval allowed for the purpose, and in responding to the calling condition, the line finder automatically prevents any further functioning of the way circuit sequencing apparatus for the duration of the message transmission from the way station. The general procedure for establishing a selective connection through the line finder and other associated switching equipment at the switching center was described in the January TECHNICAL REVIEW for other line finder operated out-offices, but will be summarized for convenience in the case of way circuits.

In response to the calling condition, the line finder connects the way circuit receiving leg to a receiving distributor, which in turn makes an electrical request for an automatic switching unit. When the latter unit answers this request, the receiving distributor equipment sends an 0.65-second spacing signal over the way circuit to start the message transmitter at the designated station. The transmitter sends into the switching center the two selection characters and the following space character which are a part of the preamble of each message, and then stops. The automatic switching unit acts upon these selection characters and sets up a potential connection between the receiving distributor and the line sending positions of the desired destination. If one of the line sending positions is idle, or when one becomes idle, the potential connection is converted into an actual connection.

Upon establishment of an actual connection, the automatic numbering machine at the selected line sending position sends into the associated intra-office reperforator a nine-character preamble which contains the proper identifying information for the message which is to follow. Completion of these functions causes the receiving distributor equipment to send a second 0.65-second spacing signal over the way circuit to restart the message transmitter at the

designated station. Since the selection characters have already been sent, transmission resumes with the remainder of the message preamble which consists of the area switching center call letter, a period character, the way station identification characters, and the message sequence number. This is followed by the message text. The entire transmission normally is continuous until the two period characters which terminate the message are reached, whereupon the message transmitter stops so that no portion of any following message will be transmitted over the same switching center connection.

At the switching center, all of this transmission passes through the receiving distributor equipment and into the intra-office reperforator at the selected line sending position. The first nine characters received from the transmitting station, which comprise the station identification characters and the message sequence number, are read by feeler pins probing the tape punched by the intra-office reperforator and are transmitted over a read-back circuit arrangement to the receiving distributor equipment. At that point the code combination for each of these characters, except for the hundreds digit of the message sequence number, is compared with the code combination of the characters which should have been received from that station at this time. The comparison code combinations are obtained from a sequence number indicator individual to that station. Assuming this comparison to be correct, the sequence number indicator is advanced to the next message number to be in readiness for the next message transmission from that station, and reception of the message at the selected line sending position continues without interruption until the two period characters terminating the message are received.

Since each station on a way circuit is provided with an individual sequence number indicator at the switching center, it is necessary that the proper indicator be selected for the comparison operations. The control circuit from the line finder which is preventing further functioning of the way circuit sequencing apparatus at the line sending position during recep-

tion of the message from the station, passes through a group of relays individual to this way circuit, which are located on a Way Circuit Relay Panel, and then passes through certain studs and the wiper of a sixth level on the "send" character switch at the way circuit line sending position. Following each designation signal transmission, this switch wiper rests on a stud associated with the station which was just designated to transmit. If the station does transmit, the line finder control circuit then terminates on the switch stud for that station. This results in the operation of the proper combination of the associated Way Circuit Relay Panel relays to select the sequence number indicator assigned to that station for the read-back comparison functions.

When the two period characters terminating the message are read at the selected line sending position, the receiving distributor equipment is disconnected from the line sending position, freeing that position for the acceptance of another intra-office connection. Upon this disconnection, the receiving distributor equipment sends a 2-second spacing signal over the way circuit, just as it does for any other line finder connection, and then is released from its way circuit connection to be available for answering another line finder call. The long spacing signal is utilized to restore the local circuits at the way stations to their idle condition, preventing any further transmission from the previously designated station until it is redesignated at a later time, and bringing the other locked-out stations back into the line circuit again.

Final disconnection of the receiving distributor equipment at the switching center removes its stop control over the way circuit sequencing apparatus at the line sending position, permitting the sequencing apparatus to resume its normal operating functions. However, a 1-second interval is allowed to elapse before any further transmission takes place over the way circuit from the switching center. Since the way station teleprinters are not equipped with open-line stops, their mechanisms run free during a long spacing signal. A closed-line interval of some length is, therefore, necessary as a sort of

phasing signal to allow the teleprinter mechanisms at all stations to stop in their normal "rest" position. The 1-second interval provided is, of course, more than ample for this purpose.

Had there been no message available at the designated station there would have been no calling signal sent into the line finder within the 1-second interval allowed for this occurrence. The way circuit sequencing apparatus at the line sending position would then send a 2-second spacing signal over the way circuit. As above, this long spacing signal would restore the local circuits at the designated station to their idle condition and would bring the other locked-out stations back into the line circuit. This long spacing signal is also followed by a 1-second closed-line interval, to phase the station teleprinters, before any further transmission takes place over the way circuit from the switching center.

Control of Message Transmission to Way Stations

Messages received at the switching center for the way circuit stations are push-button switched over intra-office circuits to the line sending position assigned to the way circuit. The switching turrets are equipped with one push button for each station of the way circuit, and each push button controls an associated intra-office circuit. Thus, all messages for the first station pass over one intra-office circuit, those for the second station pass over another intra-office circuit, and those for the third station over still another intra-office circuit. However, all messages for any of the stations are reproduced as one continuous punched tape by the line sending position intra-office reperforator. Each intra-office circuit is equipped with an automatic message numbering machine so that messages switched over each path will be prefixed by the sequence number series individual to the assigned station.

A way circuit numbering machine prefix consists of nine or ten characters, depending upon whether the switching center identification consists of one or two call letters. These are *letter shift*, switching center call letter (or letters), way sta-

tion designation character, *figure shift*, the three digits of the message sequence number, *letter shift* and *space*. The first station numbering machine is usually set up for station designation character A, the second for station designation character B, and the third for station designation character C. However, if one of these characters is a part of the switching center identification, the remaining two characters are used for the first and second stations respectively, and D is used for the third station. Thus, while messages for the various stations are in one continuous tape in whatever order they are switched into the intra-office reperforator of the line sending position, each is identified with respect to its station of destination by the use of these different characters.

Except when actual message transmission to a way station is in progress, the line tape transmitter is disconnected from the sending leg circuit. When disconnected, blank tape is stepped through the transmitter until the tape becomes taut or until some character other than *blank* appears over the feeler pins of the transmitter. The first such character normally encountered is the *letter shift* of an automatic numbering machine message prefix. An automatic indication is then provided to the way circuit sequencing apparatus that a message is awaiting transmission to a way station.

As previously stated, the sequencing apparatus gives the line sending position an opportunity to send a message alternately with each opportunity given to a way station. If no messages are awaiting transmission at the line sending position, the opportunity to send is quickly passed on to the next way station in the sequence. When the sequencing apparatus extends to the line sending position an opportunity to send a message and there is an indication that a message is awaiting transmission, the line transmitter is connected to the sending leg circuit, and transmission of the message prefix and body follows as a continuous operation until the two periods which terminate the message are reached.

Since the teleprinters of all stations are in the line circuit at this time, all stations receive the *letter shift*, switching center

call letter (or letters), way station designation, and the *figure shift* characters of the prefix of the message, printing the letter characters on their tape. The teleprinter at each station is equipped with a contact set over the pull bar of its assigned designation character, and as previously mentioned, the teleprinters at all of the stations are equipped with a contact set over their *figure shift* pull bars. Thus, during this portion of each outgoing message transmission, only the designation contact set at the station of destination will be operated. This conditions the local circuits at that station to leave the teleprinter in the line circuit for the remainder of the message, while the following *figure shift* character locks the teleprinters at the other stations out of the line circuit so that they cannot copy any further portion of the message.

At the switching center, each transmitted character of the message is read as the tape passes through the line transmitter. When the two period characters which terminate the message are detected, further passage of tape through the line transmitter is stopped. The sending position control circuits then disconnect the line transmitter from the sending leg and send a 2-second spacing signal over the way circuit. This restores the local circuits at all stations to their idle condition, bringing the teleprinters at the locked-out stations back into the line circuit again. The usual 1-second closed line interval then elapses to phase the teleprinters. Thus, only one message at a time is transmitted from the line transmitter of the sending position.

At the conclusion of the 1-second closed line interval, the sequencing apparatus proceeds to designate the next station in the sequence order to give it an opportunity to transmit a message. Should another message be available at the line sending position for transmission to any station, its transmission will follow the conclusion of that sequence of functions. Use of the way circuit is thus on an evenly divided basis as possible between the stations and the switching center for both incoming and outgoing message transmission.

Protective Facilities

The January 1950 TECHNICAL REVIEW article described the major protective facilities provided for duplex operated circuits that terminate in line finder facilities at the switching center. That article covered the operating functions resulting from a wrong comparison during the read-back checking of incoming message preambles, and from abnormal conditions arising during the course of setting up a connection through the switching equipment. The article also covered certain of the testing and monitoring facilities provided in conjunction with the out-office line circuits. One additional protective facility is required in the case of way circuits.

The out-office on a duplex operated circuit may initiate a call and transmit a message to the switching center even though the switching center is in the process of sending a message to the out-office. On the other hand, no station on a way circuit can initiate a call or transmit a message whenever the line sending position transmitter becomes connected to the sending leg at the switching center, since all functions of designating the stations for transmitting opportunities have ceased. As a result, it is impossible for any station to communicate with the switching center until the line sending position transmitter becomes disconnected and the station designating functions are resumed.

The line sending position transmitter normally becomes connected to the sending leg only when there is an actual message for transmission to one of the stations, and becomes disconnected when the two periods terminating that message pass through the transmitter. However, there are conditions under which the line sending position transmitter may become connected to the sending leg, but perforated tape containing the message termination of two periods does not pass through the transmitter. For example, the tape may tear, the feed holes may strip, the tape latch may not be closed tightly, or an incomplete message may be received at the line sending position.

In any of these trouble conditions, it would be impossible for any station to

notify the switching center supervisory personnel of the difficulty as long as the trouble persisted. To guard against such an occurrence, the line sending position circuits are arranged so that when the transmitter is connected to the line and no transmission takes place, or when there is continuous transmission of the same character, for a period of 1.5 minutes, the line transmitter will be disconnected from the sending leg automatically. The sequencing apparatus can then resume its normal function of designating the stations for incoming transmitting opportunities, thus eventually providing the station which was affected by the trouble with an opportunity for notifying the switching center.

In addition to being disconnected, the line transmitter is locked in an auto-stopped condition, which prevents it from being reconnected to the sending leg, and a local "sending stopped" signal light is operated as a visual indication to the supervisory force of an abnormal condition at the line sending position. Locking the transmitter in its auto-stopped condition has a further advantage in that it retains the sending position trouble condition at the exact spot at which it occurred. Manual release of the locked transmitter is, of course, required before any further message transmission can occur to the way stations.

Subsequent articles will continue the description of the Plan 21-A Reperforator Switching System.



THE AUTHOR: Myron D. Adams of the Development and Research Department joined Western Union upon his graduation from Worcester Polytechnic Institute with the degree of B.S. in E.E. in 1929. After a short assignment to the office of the Research Engineer he transferred to the office of the Engineer of Automatics where he was engaged in development work associated with the terminal operation of multiplex printing telegraph systems. His major assignment has been in connection with varioplex and he took a prominent part in the development of the various systems. During the war he assisted in the development of multiplex and cryptographic facilities for the Army and Navy. He afterwards participated in the development of the Plan 21-A way circuit arrangement described in this paper. In August 1949, Mr. Adams was transferred to the office of the Switching Development Engineer. He is a Member of the AIEE and a Senior Member of the IRE.

Magnetic Materials

A. BOGGS

SUCCESSFUL APPLICATION OF ELECTRICITY as a means for communication dates from Professor Morse's use of an electromagnet to detect the presence of current in a circuit connecting the sending and receiving stations. Other inventors had appreciated the inherent possibilities and had found it easy enough to establish current in a circuit, but had difficulty in devising any very practical means for recognizing its presence or for interpreting its presence, or absence, in terms of the symbols of a written language.

Progress in telegraphic art since Morse, has introduced many changes. Automatic printers gradually took over the major portion of the telegraph load but the type of signal transmitted remained the same, a series of d-c pulses, and the electromagnet continued in its original role as the detector of these signals. At the present time, carrier currents have largely supplanted direct current as the agency for transmission of telegraphic signals, while printers with their electromagnets persist as the principal intermediary between electrical impulses and the English language. But with the advent of carrier a new use for coils with magnetic cores appeared. Such coils were now used, in combination with condensers, to make frequency selecting filters and frequency originating tank circuits in oscillators. Coupling transformers in amplifiers, choke coils in rectifier power supplies, loading coils, and many other inductive devices used in the supplementary paraphernalia introduced by the conversion from Morse to carrier current deserve mention, but a detailed listing would take up too much space and it is unnecessary anyhow. The point is that to date the evolution in telegraphic methods has continually expanded the use of magnetic materials, whether in translation of intelligence into information or the transmission of this information, and at the same time the magnetic materials themselves have undergone changes almost as radical as those observed in the telegraph method.

When the need for devices other than simple electromagnets arose, the original soft iron core became quite inadequate. To understand why this is so, it is necessary to inquire why magnetic materials are used in devices other than electromagnets. The simple answer is that magnetic cores amplify the magnetic field. The magnetic field is the agency that accomplishes the desired results and magnetic fields can be produced without recourse to magnetic cores. A coil of wire carrying an electric current produces such a field and conceivably most of the inductive devices, other than electromagnets, now used in the telegraph plant could get along with nothing more complicated than this. The fundamental fault in such an arrangement is that too much wire, too many turns, and too much housing space is required. It is much better to use far fewer turns in reduced space and then amplify the relatively weak field so produced by means of a magnetic core. The vacuum tube amplifier performs a comparable function in voltage or current



Figure 1. Section of permalloy tape loaded ocean cable (see page 83)

amplification although the analogy is not perfect in all respects. In the vacuum tube, small grid voltages can produce large changes in plate current because the electrons constituting the plate current are not supplied from the grid but are already present in the tube waiting to be used after having been emitted from the hot cathode. In a magnetic core, millions of small permanent magnets lie waiting ready to cooperate and add, each its own small contribution, to a large total result-

ant field when urged to align themselves in the direction of the weak field produced by the current in the winding. The amount of urging required determines the permeability of the material; when the elementary magnets are easily influenced by the applied field the permeability is said to be high. The Greek letter "Mu" is used as an abbreviation for permeability in technical literature. In a vacuum tube, the extent to which grid voltage influences the number of electrons flowing through the tube is known as the amplification factor and is also called "Mu" in technical literature.

The permeability of a magnetic material might reasonably be regarded as its amplification factor although the elementary magnets through which this effect arises differ radically from the electrons in a vacuum tube. However, since all physical properties of matter are ultimately determined by the behavior of electrons in the atom, we are forced to call upon electrons to aid in explaining what these elementary magnets are.

Theory of Magnetism

According to presently accepted theories, each electron in an atom spins about some axis of its own and this spin will, so to speak, magnetize the atom. In other words, the atom becomes a small permanent magnet. This is a step in the right direction but only a first step. The elementary magnets in a magnetic material are not individual atoms but collections of large numbers of atoms so arranged that the magnetic axis of all atoms in an aggregation are parallel and poled in the same direction. These groups of mutually cooperative atoms are called domains and it is these domains that are identified as acting like elementary permanent magnets when the material is subjected to a magnetizing force.

In the absence of any applied magnetizing force the orientation of any particular domain is largely a matter of chance, and since the number of domains in even a very small volume of material is quite large, the probability is almost unity that

for any domain with its magnetic axis pointing in some one direction there will be another with its axis pointing in the exactly opposite direction. The net effect is that although the material is full of these small permanent magnets no appreciable magnetization of the material as a whole is observed. Probability theory does not predict that there will be complete cancellation even if the number of domains were infinite and no influence other than pure chance were acting, but rather the opposite. It is more likely that some slight magnetization will exist. Brownian movement in liquids and X-ray diffraction patterns obtained from powdered crystals illustrate a comparable effect. The possibility of this slight magnetization is not important and is mentioned only to keep the record straight. We are not so much interested in what happens before a magnetizing force is applied as we are in what happens afterward.

The simplest theory of what happens when a magnetizing force is applied to a magnetic material visualizes this force as disturbing the zero average condition by forcing a certain number of domains, not initially oriented in the direction of the applied force, to relinquish their original orientation and align themselves with the force. This preponderance of domains with a common orientation that coincides with the direction of the magnetizing field constitutes a source of added field with the end result that the total field will exceed the applied field. Thus amplification is accomplished and, as was indicated before, the permeability of a material is a measure of the number of domains that will respond to a given magnetizing force and hence may be thought of as being its amplification factor.

Since amplification of weak fields is the first purpose to be accomplished through the use of magnetic cores, a prodigious amount of time, effort, and ingenuity has been expended to achieve higher and higher permeabilities. But quite early in the game it became apparent that high permeability was not the only property requiring attention.

Eddy Currents and Hysteresis

If the magnetizing force is produced by direct current, that is, if a steady state field is all that is required, only permeability need be considered. However, the cases in which a steady state condition suffices are few. In by far the larger number of uses the actuating current is an alternating current, as in transformers or inductors, or a direct current which is suddenly changed in magnitude or in direction as in relays. In these circumstances, two other characteristics of the core material begin to impose limitations upon the desired performance. These factors, which are always associated with change in magnetization of the core, are hysteresis and eddy currents. Eddy currents are local currents which circulate in the core and use up energy for no useful purpose. A changing magnetic field induces voltages in any circuit surrounding the field, and every part of the field in the core is surrounded by some area of the core itself. It is, therefore, impossible to avoid the presence of induced voltages in the core, but fortunately it is possible to limit the parasitic currents which these induced voltages can produce. High resistance material or restricted area of any cross section normal to the direction of magnetic flux in the core, or a combination of both, are the means available.

Hysteresis is a term used to denote the fact that the alignment of the domains does not keep up with the applied magnetizing force when this force is changing. Here again a rough analogy with vacuum tube amplifier performance is suggested. A class A vacuum tube amplifier operated at low frequency does not absorb energy in the grid circuit. But as the frequency is increased, the time required for the electrons to pass from cathode to plate becomes appreciable relative to the length of time the input signal is positive, and this phase lag due to transit time produces an effect called electron loading of the grid. This is only another way to express the fact that the grid circuit absorbs energy. This transit time loading limits the effective use of conventional triode tubes to frequencies of a few hundred megacycles and below. If in a mag-

netic material there were no lag in response to the applied magnetizing force no energy would be expended in hysteresis. No such material is known although there are some in which the effect is surprisingly low.

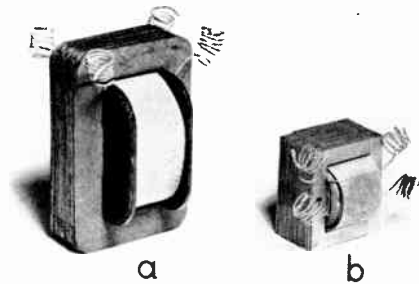

Figure 2. Carrier system transformers

- a. Style 4 silicon steel core
- b. Style 6 mumetal core

When it became evident that in a solid soft iron core the virtues of a good permeability were overshadowed by the handicaps of eddy current and hysteresis loss, the first efforts toward improvement were directed toward reducing eddy currents. The first method adopted was lamination of the core. This works because of the relation between area and periphery in a rectangular section. The distance around the periphery of the section determines the resistance offered to current flow, and the area determines the amount of magnetic flux included and therefore the induced voltage. For any given total length of periphery a square cross section has the greatest area and, conversely, a very thin rectangle tends toward no area at all.

Take a piece of string one inch long and form a square by passing the string around four pins set at the four corners of a $\frac{1}{4}$ -inch square. The enclosed area is $\frac{1}{16}$ (0.0625) square inch. Rearrange the pins to occupy the corners of a rectangle 0.499 inch on the long side and 0.001 inch on the short side. The sum of the lengths of the four sides is still one inch, but the enclosed area is now only 0.000499 square inch, approximately 0.8 per cent of the square area. This looks like a remarkable improvement but the argument is specious

if abandoned at this point. A fixed core area is required and this thin lamination reduces the area to 0.8 per cent of the original area, and although the current in the lamination is also reduced to 0.8 per cent it will require 125 of these laminations to regain the required total core area. The current per lamination multiplied by the number of laminations remains the same, so where is the profit? There would be none if watts loss were proportional to current, but since loss is proportional to current squared, the loss in the 1-mil lamination is 0.0064 per cent of that in the 1/4-inch lamination. But 125×0.0064 per cent = 0.8 per cent which indicates that the total loss with 125 thin laminations is still only 0.8 per cent of that in one 1/4-inch lamination. The thickness ratio is 250 to 1 and the loss ratio is 125 to 1, which seems to establish the rule that eddy current loss is proportional to one-half the thickness ratio. This is actually not the case; our analysis has been somewhat too elementary in the interest of simplicity, and the true state of affairs is that the loss is proportional to the square root of the thickness. This is somewhat disappointing since the square root of 250 is 15.81 and not 125.

It appeared then that some other means for limiting eddy currents was needed, since the improvement with decreasing thickness was so gradual, and the mechanical difficulties encountered in rolling and handling extremely thin laminations presented problems not easily solved. An increase in resistivity of the material would, of course, reduce the eddy currents and so this was tried. Since small percentages of impurities can be depended upon to increase the resistivity of almost any material to which they are added, silicon was introduced into the relatively pure mild steel then being used in laminations with gratifying results. Added silicon amounting to 4.75 per cent increased the resistivity by a factor of nearly six, and as an added attraction also reduced the hysteresis to one-third of its original value. The benefits of increased resistivity suffer from the same square root handicap that affects gain from reduced thickness, but a very substantial improvement resulted from this simple expedient never-

theless. As an example; a prominent manufacturer of magnetic materials lists mild steel laminations as having 1.82 watts loss per pound at 60 cycles while 4.75 per cent silicon steel has 0.58 watts. These figures apply to 0.014-inch laminations operated at a flux density of 10,000 gauss.

This excellent material satisfied the requirements of the electric power industry quite well, but when the communication people began to use a-c signals silicon steel left much to be desired. This was so since 60 cycles was no longer the top frequency. Hysteresis loss increases directly with frequency, and eddy current loss is proportional to frequency squared. For this reason we find the communication people also first attacking the eddy current problem. In some of the earliest attempts to make loading coils for telephone circuits, a technique made its appearance which has continued in favor to the present time. The British engineer, Sir Oliver Heaviside, who was the original advocate of loading to improve telephone transmission, made coils having powdered iron cores. Finely divided particles effectively restrict eddy current but they have a serious fault. They break up conduction paths in planes perpendicular to the direction of flux in the core, which is all to the good, but at the same time they break up the continuity of the magnetic circuit along the flux path. This latter effect is bad, especially at lower frequencies, since it lowers the over-all magnetic response of the core by introducing so many air gaps. It is for this reason that the first loading coils used in this country employed cores formed from small diameter iron wires wound into a toroidal core. It was much easier to draw fine wires than to roll thin sheet and the toroidal wound core provided an uninterrupted magnetic circuit.

This provided at least an interim solution to the eddy current problem but did nothing to improve the hysteresis situation; moreover another pertinent difference between power and communication practices, other than the matter of frequency, now showed up to demand attention. The permeability of silicon steel is good at the high magnetizing forces used in power transformers but is poor at the

low levels typical of communication systems. In power transformers the magnetizing force will be found to lie between 0.5 and 1.0 oersted, while in a loaded ocean cable the average force in the loading material may vary from 0.05 oersted at the sending end to 0.00005 at the receiving end.

Nickel-Iron Alloys

The loaded ocean cable may be an extreme example but it is cited since it marked the first large-scale application of a totally new magnetic material. In the early 1920's the very unusual magnetic properties of an alloy consisting of 78 per cent nickel and the rest iron, with a trace of chromium, were announced by the Western Electric Company. This remarkable material with proper heat treatment and careful mechanical handling may have a permeability as high as 8000 even at vanishingly small magnetizing forces and a maximum permeability of 100,000. In the years 1924 and 1926, the Western Union Telegraph Company laid 5732 nautical miles of ocean cable loaded with this "permalloy" tape wound in a continuous helix over the central copper conductor. In 1928, 1021 additional miles of cable loaded with an alternative high permeability material known as "mumetal" were laid. In this total of 6753 miles, approximately 210 tons of loading material were used. The latter material, mumetal, was developed in England and differs from the original Western Electric permalloy principally in the inclusion of 5 per cent of copper in the alloy. The resistivity of mumetal is substantially higher than that of 78 per cent permalloy, and initial permeabilities as high as 30,000 have been obtained under carefully controlled laboratory conditions. Manufacturing 1000 miles of cable, storing it on shipboard, and laying it on the bottom of the ocean is hardly a laboratory project, but permeabilities in the order of 6000 were obtained with the cable in place on the ocean floor. Loaded cables are not laid every day but Western Union has continued to use mumetal in another application. Practically all transformers in carrier equipment, except where used as filter

elements, are constructed with mumetal cores built up from 20-mil or 6-mil laminations. Figure 2 depicts in a graphic fashion the difference in size between a standard transformer of this type and the older silicon steel cored transformer which it has so largely displaced.

Admiration of the remarkable permeabilities of these nickel-iron alloys should not be allowed to obscure a second valuable property they possess. Adding silicon to iron in the production of magnetic steel reduced both eddy current and hysteresis loss. (It also raised the permeability but not to any important extent.) The alloys of nickel and iron have permeabilities many times greater than that of the best silicon steels, but this is not all. The hysteresis loss is much lower than in silicon steel. This is a rather unusual circumstance. More frequently, spectacular improvement in some one property is accompanied by impairment of other desirable characteristics.

In recent years the original permalloy has been improved by the addition of varying percentages of molybdenum. A 4 per cent molybdenum alloy resembles mumetal rather closely and a 2 per cent molybdenum permalloy in powdered form is widely used for cores in loading coils and for coils in filters.



Figure 3. Carbonyl iron powder ($\times 300$)

Substitutes for Nickel-Iron

It might seem that these nickel-iron alloys should have no competitors, so excellent is their performance. However, this is not the case. Excellent though they

be in respect to permeability, the eddy current and hysteresis losses, while low, still persist. Where such losses must be minimized, the compressed powder cores still represent the standard solution. The finely divided material is required to control eddy currents and, while small particle size does not affect the hysteresis properties of the material itself, the large number of attendant air gaps does reduce the total hysteresis loss of the core since air is free from this disease. In effect, a dilute solution of magnetic material in air has been used. Some idea of the amount of this dilution may be gathered from the coincident reduction in effective permeability. The highest effective permeability found in powdered permalloy cores is 125 and it ranges down to 14 for coils intended for use above 50 kilocycles.

It is seen that the value of a high permeability has almost disappeared in the effort to avoid, to the fullest possible extent, the pernicious effects of core losses at high frequencies. For this reason, it is not surprising that other materials having low losses may be used to advantage, even if their natural permeabilities do make a very poor showing when compared with permalloy. One such material which has been extensively used by Western Union in filter coils is carbonyl iron. This iron is prepared in a quite interesting process. Oxide scale from steel rolling mills is subjected to an atmosphere of heated carbon monoxide at high pressures. The carbon monoxide absorbs iron, and practically nothing else, from the scale. The compound of iron and CO appears in liquid form which is drawn off from the pressure cooker, conducted to the top of a high tower, and allowed to evaporate inside the tower. In the evaporation process the iron separates from the CO and settles to the bottom of the tower like tiny hailstones from a suddenly cooled storm cloud. The CO is led back to the pressure stage to repeat the cycle.

The iron particles so produced are almost perfectly spherical in shape, average 0.0003 inch in diameter, and are extremely hard. Figure 3 is a microphotograph of carbonyl iron, Type E. This is the iron as it comes from the tower without any subsequent treatment. The minute size of

these particles successfully combats eddy currents and moreover this iron, for some as yet unexplained reason, is practically free from hysteresis. In the production of cores, the iron is mixed with a thermosetting binder and formed in a die under high pressure. Figure 4 shows a carbonyl iron core of the type used in carrier system filters by Western Union along with two silicon steel cores previously used. However, this picture does not tell the whole story by any means; the silicon steel cores were never used at frequencies above 7 kc while the carbonyl iron cores are still good at 150 kc.

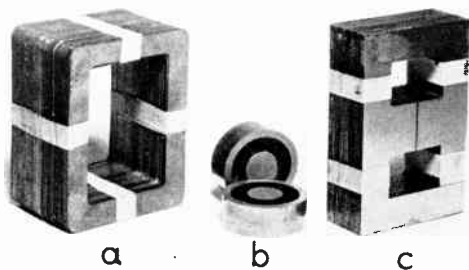

Figure 4. Cores used in filter coils

- a. Style 8 silicon steel
- b. Style 50 carbonyl iron
- c. Style 3 silicon steel

Another competitor of powdered permalloy of recent origin is thin permalloy or mumetal tape wound into a core on a mandril, either circular or rectangular in shape. After winding, the core is cemented with some thermosetting compound to form a mechanically firm structure. The finished core may then be cut in two pieces to permit insertion into a previously prepared winding. Strip only 2 mils thick is conveniently handled by this technique. The thin section, plus the opportunity to introduce an air gap spacer between the two members of the core, makes this an attractive material for voice frequency filters, although at the present time production is limited and the cost is too high for economical utilization.

The forerunner of this development was the so-called hipersil core developed by Westinghouse as an improved core for

power transformers. Silicon steel in strip form is used and the wound core type of construction insures that, throughout, the magnetizing force is applied parallel to the rolling direction. It has long been recognized that permeability is higher and hysteresis loss lower in the direction of rolling, but with laminations punched from sheet only a portion of the magnetic path in the core could utilize this preferred direction. Figure 5 shows a carbonyl iron core, a hipersil core, and a mumetal strip core of the hipersil type of construction. Either of the latter two could replace the carbonyl iron core, with equal or better performance if not used above 1000 cycles. If the mumetal core were increased to the size of the hipersil core its useful frequency range would probably be extended to three or four kilocycles.

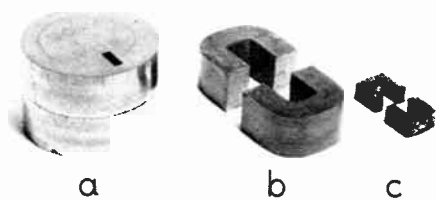

Figure 5. Compressed powder core and wound strip cores

- a. Carbonyl iron
- b. Hipersil—oriented silicon steel strip
- c. Mumetal strip

The last material we shall mention is one which, while it is one of the newest developments, makes use of the oldest magnetic material known. This material is the lodestone which since ancient times has been known to be a natural permanent magnet. The scientific term “magne-

tite” has replaced the colloquial expression “lodestone” but until quite recently very little else of any great importance had transpired. Magnetite is a complicated oxide of iron exhibiting magnetic properties because of the presence of iron, and having very high resistivity since it is not a metal. It is classified as being a ceramic material, meaning clay-like, although it does not occur in the finely divided state of typical clays. Aluminum hydroxide (bauxite), the principal source of metallic aluminum, or aluminum silicate (kaolin), used for making porcelain, are better examples of clays containing a metallic ingredient. Since magnetite is practically nonconducting, it is ideal in respect to elimination of eddy currents but its hysteresis is high and the permeability is mediocre. For these reasons, relatively little use was made of magnetite until quite recently when metallurgists rescued it from obscurity through the familiar device of adding selected percentages of some other materials. In one combination, the added materials are copper and zinc oxides and the resulting alloy has been given the name “Ferroxcube” by the producer, The Philips Lamp Company of Eindhoven, Holland. As with other magnetic alloys, the properties obtained vary widely with percentage compositions and heat treatment. Permeabilities ranging from 300 to 1000 have been obtained without sacrifice of the nonconductive feature, and hysteresis loss has been so drastically reduced that this material was successfully used in the filters of a 48-voice-band carrier system recently developed in the Netherlands.

This short story has by no means exhausted the subject of magnetic materials, either in theory or in practice, but it is hoped that the information here presented may contribute to an understanding of the principles involved in the selection of a core material most likely to succeed.

THE AUTHOR: For photograph and biography of Mr. A. Boggs, see the January 1949 issue of TECHNICAL REVIEW.



Young visitors see Western Union's display at the Morse memorial exhibition in New York, sponsored by the National Academy of Design founded by Samuel F. B. Morse, artist and inventor



MORSE MEMORIAL EXHIBITION OF ARTS AND SCIENCES

In commemoration of its 125th Anniversary and in honor of its founder and first president, Samuel Finley Breese Morse, artist and inventor, a memorial exhibition of arts and sciences was held in New York by the National Academy of Design. Many paintings by Morse were on display.

Included in the exhibit were historical telegraph devices such as galvanometers, relays, and an early recorder which had belonged to Mr. Morse.

A display of modern telegraph equipment was in sharp contrast with the apparatus of the Morse era. This display, shown in the illustration, comprised printing and facsimile telegraph machines, and photographs depicting scenes in the present high-speed Western Union system.

A Microwave Television Relay for Navy Training Programs

HARRY COOK

TELEVISION as a medium of instruction had its conception just prior to the start of the war when instruction in air-raid warden procedure, decontamination techniques, and the like were televised to hastily assembled groups. This substantially successful experiment led to inquiry into TV techniques by many groups with specialized educational problems. Foremost among them were members of the armed services who saw a chance to speed up the training required by a modern war. However, during the war, the lack of time and equipment prevented any further development, study or use of television for training purposes.

As time became a less pressing factor in post-war days, opportunity to investigate the possibilities of television in the educational field was presented. In early 1945, plans for using television in education were formulated by one of the pioneers. E. A. Hungerford of the Navy Special Devices Center, located at Sands Point, Long Island, N. Y. Funds were made available in 1946 for an experimental television laboratory there to study the problems and the feasibility of the educational program under the direction of the Office of Naval Research.

Studio Equipment

Contracts were let with General Electric to install modern TV equipment in the proposed studio. Under the guidance of James Tharpe and Mr. Hungerford, the studio took form and live cameras, monoscope, program console, film chain, pulse generator, overhead fluorescent banked lighting, and so on were installed. In conjunction with the studio development, a viewing lab was installed, complete with Rauland projector, a 21- by 19-foot view-

ing screen, and a variant lighting system. Figure 1 shows one of the camera techniques used in the studio to simulate a pilot's view from a falling plane.



Figure 1. Use of a terrain model in camera techniques

The nature of the program was wholly changed after it became known to others and an agreement had been made by the Special Devices Center to present instruction in Naval Armaments to the Kings Point Merchant Marine Academy. The problem of transmitting to Kings Point from the Sands Point studio arose, and in narrowing down possible methods, the medium of microwave relay was considered first because of its major advantages. After looking over a number of proposals, the Navy contracted with Western Union to furnish the test equipment and the engineering services in connection with installing and maintaining the 6000-mc microwave TLR-2 prototype television relay equipment which was obtained on a rental basis from the Philco Corporation.

A paper presented before the Midwest Meeting of the American Institute of Electrical Engineers at Cincinnati, October 1949.

Antenna Towers

At Sands Point the Navy erected a 125-foot tower on which was mounted the transmitting antenna. The height of the tower was determined taking into consideration the possibility of transmitting from Sands Point to New York and from there to other sections of the country. A small frame building was constructed at the base of the tower for housing the rack and test equipment which is shown in Figure 2. The monitor rack is located in front of the transmitting rack, and the coaxial line is the video feed from the studio. A pressurizing unit is used at the transmitter to keep the pressure-tight waveguide lines dry at all times for stable operation. The system is also used to locate any wave-guide break by indications of pressure leakage. Figure 3 is a view of the completed Sands Point site showing the tower and the transmitting antenna with the Electronics Building housing the TV studio in the background.

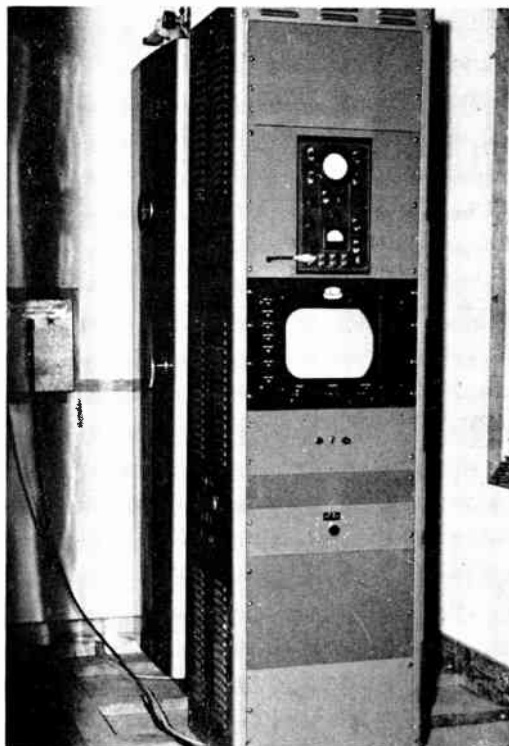

Figure 2. The transmitter and monitor racks at Sands Point

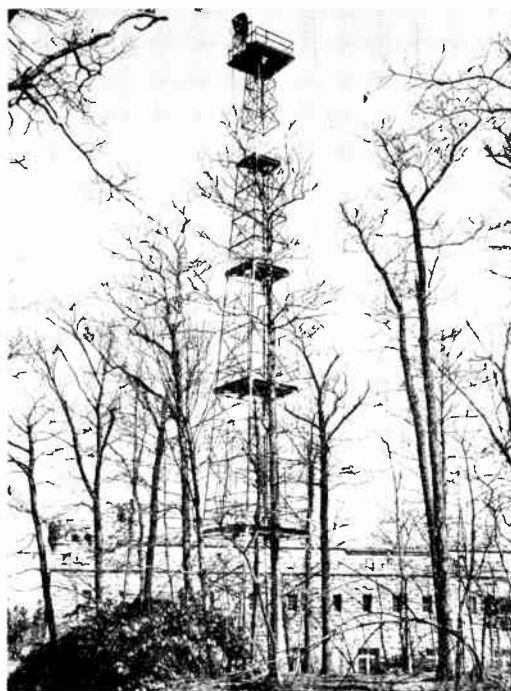

Figure 3. The Sands Point tower and transmitting antenna

A terrain profile prepared to estimate the height of the tower required at Kings Point, and a field survey made to check accurately the height of trees and other obstacles in the line-of-sight path, determined that a tower 90 feet above ground level was necessary for first Fresnel zone clearance. Limitations of the receiving tower brought about by its location restricted construction to a temporary scaffold type tower, 50 feet high, installed on top of the gymnasium building ventilator shaft.

Figure 4 shows the assembled receiver rack in the classroom with a 12-inch DuMont monitor installed for monitoring purposes in conjunction with an oscilloscope. On top of the rack is the waveguide feed from the antenna. A coaxial feed brings the audio FM from the whip antenna.

Signal Generation

The operation of this 6000-mc microwave relay link can best be described by reference to the following block diagrams.



Figure 4. The receiver rack with conjunctive monitor systems

In the typical terminal transmitter, shown in Figure 5, a standard composite television signal input to the deviator unit is used to deviate two 2K28 reflex klystrons in an opposite frequency sense. This action is accomplished by means of a cathode follower phase inverter circuit consisting of two video amplifiers tied together in an unby-passed common cathode resistor to ground with the grid of one tube by-passed

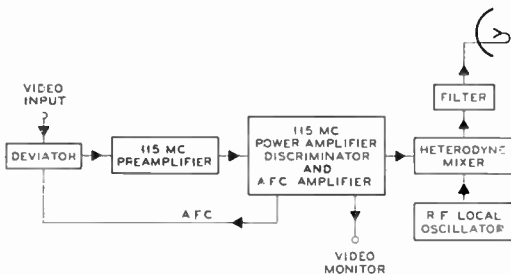

Figure 5. Block diagram of the terminal transmitter

to ground as to signal. The grid-driven amplifier develops the impressed signal across the common cathode resistor, which in turn drives the grid by-passed amplifier so that it is effectively cathode driven. The phase inverted output voltages are then impressed on the reflectors of the klystron oscillators which cause them to be deviated push-pull and produce frequency-modulated signals.

The outputs of these microwave oscillators, set 115 mc apart, are mixed in a crystal to produce a difference frequency of 115 mc, which is frequency modulated in accordance with the input video signal to give a maximum deviation of 12 mc, corresponding to the video voltage difference between the tip of the synchronizing signal and peak white. The tip of the synchronizing pulse is established and held at a difference frequency of 123 mc by the action of two diode levelers in the reflector circuits of the oscillators. Simultaneous action of an automatic frequency control circuit, in conjunction with a diode leveler in one of the deviator oscillator circuits, controls and holds constant this synchronizing tip frequency reference regardless of oscillator drift or picture

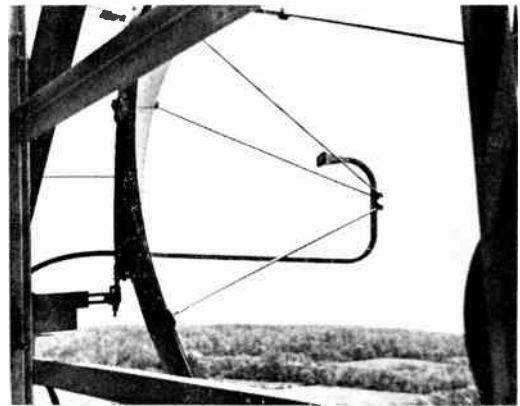

Figure 6. The horn fed truncated parabolic reflector antenna

content. The resulting signal band is then amplified in the stagger-tuned 115-mc preamplifier and power amplifier stages having a pass band of 105 to 125 mc until approximately an 80-volt peak-to-peak output is attained from the driver stage. A developed signal from this stage feeds an FM discriminator circuit provided for

monitoring purposes and for the development of the AFC signal to the deviator, while the power output from the driver tube is fed into the cathode circuit of an SAC-19 klystron, with the purpose of driving the cathode so that it will energize and modulate the transmitter RF section with the 115-mc frequency-modulated signal. The double frequency-modulated output from a Sperry SAC-19 synchrondyne is then fed through 1½- by ¾-inch pressure-tight wave guide to a vertically polarized horn, which in turn feeds a 4- by 8-foot truncated parabolic reflector antenna as is shown in Figure 6. This antenna has a gain of 7500, a horizontal directivity of 3 degrees, and a vertical directivity of 1.5 degree.

Figure 7 shows the Sperry SAC-19 synchrondyne tube which is a two-cavity klystron, tunable throughout most of the 6000-mc common carrier band having a 20-mc band width at each cavity setting. When operated as an oscillator, both cavities are tuned to the same frequency so that the tube acts as an amplifier with feedback derived through a loop contain-

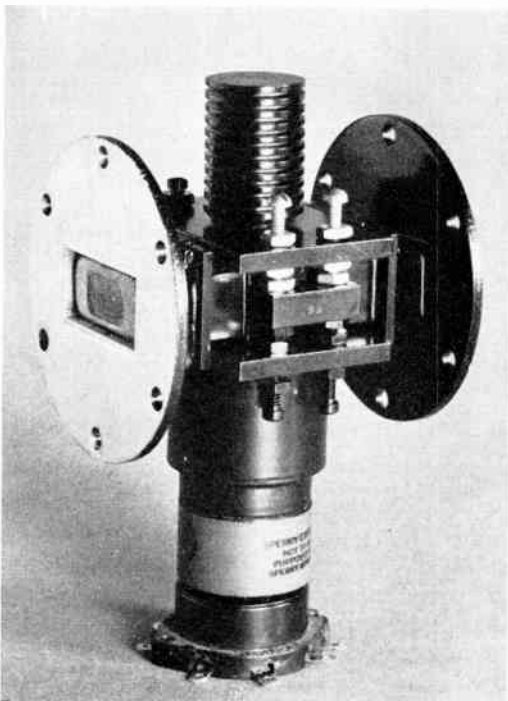

Figure 7. The Sperry SAC-19 synchrondyne tube

The TV transmission and recording system described by the author is essentially similar to that used in the Western Union TV relay arrangement detailed by Messrs. Millar and Sullinger in "A Microwave System for Television Relaying", which appeared in the REVIEW for July 1949. Some of the material presented therein necessarily is included in this article.

ing a high Q stabilizer cavity feeding the buncher cavity of the synchrondyne. When operated as a heterodyne mixer, the buncher cavity of the klystron is tuned to the local oscillator frequency, and the catcher cavity is tuned 115 mc above or below this frequency. With an accelerating potential of 500 volts applied to the tube, the 80-volt 115-mc signal modulates the velocity of the electron beam which varies the transit time of the electrons through the drift space of the klystron, and consequently modulates the energy fed into the catcher cavity, producing sidebands spaced at 115-mc intervals from the RF carrier and carrying the 115-mc signal intelligence. Thus tuning the catcher 115 mc above or below the carrier frequency produces the desired intelligence while the carrier and the undesired sidebands are suppressed.

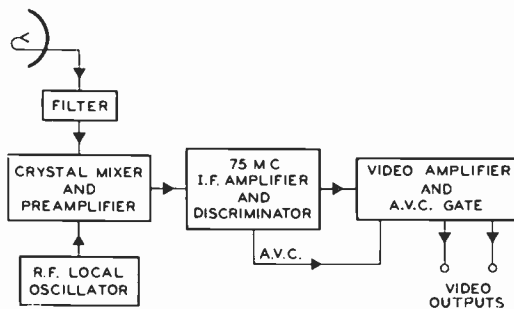

Figure 8. A block diagram of the terminal receiver

At the terminal receiver, as shown in Figure 8, the incoming modulated RF signal energizes the same type horn-fed antenna and this energy is then fed down the wave-guide run into a crystal mixer which produces a 75-mc intermediate frequency signal by beating the incoming signal against the receiver synchrondyne local oscillator. The 75-mc intermediate frequency signal is then amplified by a 14-stage stagger-tuned amplifier, followed by a single limiter stage which then feeds

a conventional discriminator circuit. The video output of this discriminator is then amplified by a three-stage video amplifier to provide a 2-volt peak-to-peak video signal for driving both a video monitor at the receiver rack and the video equipment in the classroom.

The equipment for the audio circuit was installed under the direction of Robert Mellor of the Special Devices Center Laboratory at Sands Point and consisted of whip antennas on both towers with a modified Link audio transmitter at Sands Point and a Hallicrafter receiver at Kings Point. A telephone was used for talk-back purposes.

The quality of the first pictures transmitted was excellent. Figure 9 is a photo-

transmitted appeared as three-dimensional objects on the viewing screen.

Adjustment and Maintenance

The equipment itself required practically no attention during operation, except on the rare occasions when minor trouble developed in the circuits of this original prototype equipment. With protective relays installed, the operation of the equipment resolved itself into throwing in the circuit breaker or power switch and then monitoring the shows for possible failure in the relay equipment or the studio feed. No daily peaking of circuits was required nor was there need to compensate continually for frequency drift. The variable elements to the equipment are few in number and required practically no adjustment at all once the equipment was initially peaked for operation. However, a close tab was maintained on the equipment for engineering purposes by thorough daily checks, weekly sensitivity tests, and notations of irregularities that gave pertinent information as to the operation of the circuit. Snow formation on the dishes and damp rainy days, usually factors for signal interference, had no noticeable effect on the received picture quality, other than causing slight drops in the signal strength reading. Ample time and opportunity were afforded the cooperating groups to glean other valuable information as to the operation of the equipment under actual broadcast conditions. The circuit proved itself easy of

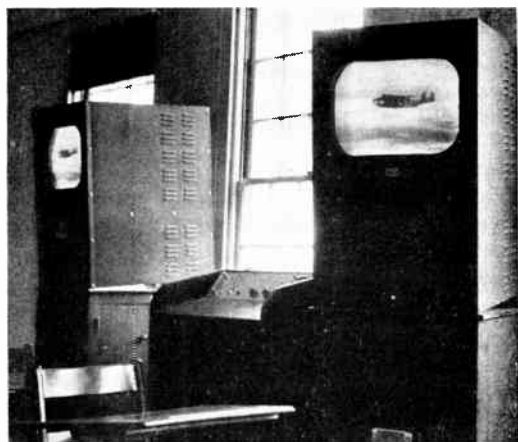

Figure 9. An actual picture transmitted from Sands Point to Kings Point

graph of an actual picture derived from the studio film chain and sent over the link. The opening program was transmitted with initial success and programming continued unabated and without any loss of time through the entire scheduled broadcast period of over four months. The picture quality of the program transmitted was excellent but for the limited occasions when the studio feed was poor because of camera trouble, blower noise, or low, unstable synchronizing and video levels. Charts, films, models and other visual aids and techniques showed up to advantage and were produced with excellent results, so that at times some of the aids



Figure 10. Examination time in a typical TV classroom

operation, unexacting as to maintenance, and a feasible medium for all TV relay programs.

An evaluation of the TV program as an educational medium was carried on throughout the period by the Fordham Psychology Group, under Dr. Robert T. Rock, who were highly impressed by the performance of the equipment and by the work accomplished by the group in the program. They were also entirely satisfied with the results, as measured by educational tests, that they were able to obtain with the classes conducted by TV, as compared to the results obtained with the regularly instructed cadet sessions. Figure 10 is a view of a typical TV classroom taken during one of the test examinations conducted by the Fordham Psychology Group. Figure 11 shows the unique dial-operated "answer" equipment designed by the group to conduct and record multiple-choice type examinations transmitted from Sands Point.

Television Proven Adaptable

The Special Devices Center was equally pleased with the educational results and with the operation of the relay equipment, so much so that they conducted programs to teach Naval Air Reserve personnel by means of commercial TV furnished by the National Broadcasting Company, through their link system to New York, Philadelphia, Baltimore and Washington, on Saturdays and Sundays throughout the



Figure 11. The Fordham Group and their test equipment

summer of 1949. Simultaneously, plans have been completed and arrangements made to give instruction to the Kings Point cadets on a slightly modified Navy microwave circuit.

These forerunning results and indications give ample proof as to the success and feasibility of the relay system to carry TV educational programs to units of the Armed Forces, either through commercial TV networks if the material is for wide distribution, or over individual linkages if restricted military matter is to be transmitted for individual classroom work.



THE AUTHOR: Harry Cook was graduated from the University Heights College Branch of New York University with a B.A. degree in January 1941. After attending a number of government-sponsored engineering courses, he entered the Signal Corps and served as a Radar Crew Chief and Radar Instructor. Leaving the service with a commission, he went to Ohio State University, where he graduated in Electrical Engineering in December 1947. Mr. Cook then joined the Radio Research Staff of the Development and Research Department where he assisted in installing and testing the Philadelphia terminal of the TV microwave relay link between New York and Philadelphia. He also had charge of the installation and operation of the TV microwave relay link between Sands Point and Kings Point, L. I., N. Y. At present, he is working on radio relay transmitters employing high power magnetrons to run experimental propagation tests at different power levels.

