

# SENCORE NEWS

All American designed, produced, sold and serviced.

Issue #136 Jan./Feb. 1988

Your "Partners  
In Progress"  
For Success In  
Video Servicing



Call 1-800-843-3338  
In Canada Call 1-800-851-8866

# Cut Your Servicing Time By 54%\* With The Ultimate Video Troubleshooting Team.

Discover how two Sencore analyzers can reduce the amount of time you spend servicing today's video circuits. The SC61 Waveform Analyzer and The VA62 Video Analyzer have been proven to reduce the amount of time you spend troubleshooting by at least 54%.\*

The SC61 and VA62 team up to identify tough problems so you can be confident that the component is bad before you replace it. This means less troubleshooting time and quicker turn around since you don't have to wait for parts you think are bad . . . that you discover are good after you replace them. Bottom line, it means you'll have happier customers, and your business will be more profitable.

100% American Made and backed by Sencore's 100% "Made Right" Lifetime Guarantee.



**VA62 Video Analyzer™**  
**\$3495 Patented**  
U.S. Funds

**SC61 Waveform Analyzer™**  
**\$3295 Patented**  
U.S. Funds

The VA62 Universal NTSC Video Analyzing System delivers the power of functional analyzing so you can track down tough problems in today's complex electronic circuits. The VA62's unique style of troubleshooting eliminates the hunt and peck way of troubleshooting that so many technicians use to track down defects. The secret is signal substitution, it is used to eliminate good, operational stages as potential sources of the problem.

The VA62 is also expandable. With easy to add accessories, you can update your service center to handle VCRs, MTS Stereo TVs, and now RGB monitors.

\* Based on a nationwide survey of users who reported an average time savings of 54% compared to their previous test equipment.

The SC61 with one probe connection and digital accuracy eliminates the frustrating errors and interpretation that are common to conventional oscilloscopes.

The SC61 gives you every test measurement that you see on a schematic, peak-to-peak AC volts, DC volts and frequency. All at the push of a button, all through one probe, and all automatically.

**SENCORE**

Call 1-800-843-3338 and put the ultimate troubleshooting team to work for you!  
In Canada 1-800-851-8866



## How You Can Use Your SC61 Waveform Analyzer And VA62 Universal Video Analyzer To Speed VCR Adjustments . . .

by Greg Carey, Application Engineer, CET

**A** technician at a recent Sencore VCR Service Clinic commented, "Oh, I never touch the internal adjustments on VCRs because they never go out of alignment."

A second technician commented, "Sure, the new decks drift a lot less than the old ones. But, you should at least double-check the main test points or you'll have trouble with some decks."

Why are many VCR servicers ignoring alignment checks? It seems there are two reasons. First, many do not understand the purpose of each adjustment because the brief instructions in the service literature do not explain how each affects the VCR's performance. Second, many find the procedures too time consuming because several pieces of test equipment must be used with an assortment of leads, operating instructions, and tolerances.

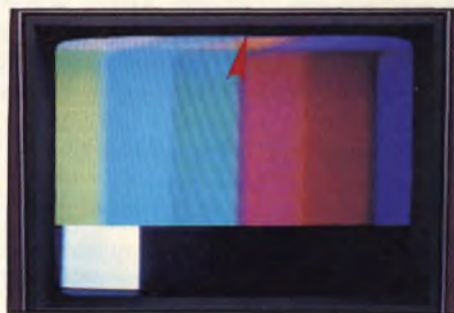

**Fig. 1: A tear appears on the picture if the VCR switches between heads at the wrong time.**

We will help you understand VCR alignment better by looking at five of the VCR adjustments that cause the biggest questions for VCR servicers. We will explain what each adjustment does in the circuit and then show how the fully integrated tests of the Sencore SC61 Waveform Analyzer let you quickly make every measurement or adjustment.

### Setting Head-Switch Timing

All VCR alignment instructions require adjustment of the head-switching signal. Let's be sure we understand the purpose of the head-switch signal. The VCR circuits produce a visible horizontal noise bar when they switch from one video head to the other. If the circuits switched between heads half way between vertical sync pulses, the picture would have a noise bar right in the middle of the screen. Or, if the circuits switched during vertical sync, the TV receiver would show rolling or vertical jitter.

To prevent these problems, the circuits switch the heads during the last few lines of each vertical field. This places the noise at the very bottom of the screen, often below the viewable picture. The switching happens three or four horizontal lines before vertical blanking to prevent sync problems.

The "Head Switch" adjustment changes the timing of the head-switch square wave relative to vertical sync. Some VCRs have only one control, which affects the timing during playback. Others have two controls; one for recording and one for playback. Still others have three controls; one affecting the position of the positive recording transition, the second affecting the position of

the negative transition, and the third affecting playback timing. All three types use identical alignment procedures.

Many people fear that they must use a delayed-sweep oscilloscope to set the "Head Switching" control (sometimes called the "Head PG" or the "Head Shifter"). Some early VCR service manuals referenced a delayed-sweep scope, but today's service literature rarely calls for delayed sweep. Still, the rumor persists that this adjustment needs delayed sweep.

Refer to Figure 3 as we discuss how to use your SC61 to make head-switch timing adjustments.

1. Connect the probes to the test points specified in the VCR alignment instructions.

2. Set the TRIGGER MODE switch to "Auto" and the TRIGGER SOURCE switch to the channel ("CHA" or CHB") with the head-switching signal. (Set the TRIGGER LEVEL control to zero.)

3. Set the TIMEBASE-FREQ switch to the "1 m sec" position. (Be sure the sweep is not expanded by pressing the HORIZ POSITION knob.)

(continued on page 8)

## Contents

Setting VCR Speed Adjustments . . . pg. 3

How To Make Your Own VCR Test Tape . . . pg. 4

Workshops Mean Success For You . . . pg. 6

POWERITE® Protects You And Your Equipment . . . pg. 10

Sencore Buyers Guide — Your Ultimate Success Team . . . pg. 13

How To Service The New VCR Hi-Fi Systems . . . pg. 24

Learn To Test IHVTs With Confidence . . . pg. 26

Testing VCR Switching Power Supplies . . . pg. 28

TP	ADJ.	MODE	INPUT
TP2005 TP3001	R2023	SP PLAY	
TAPE	M. EQ.		SPEC.
ALIGNMENT TAPE (VFMS0001H6) Color Bars	OSCILLO- SCOPE		T = 6 ± 1 H

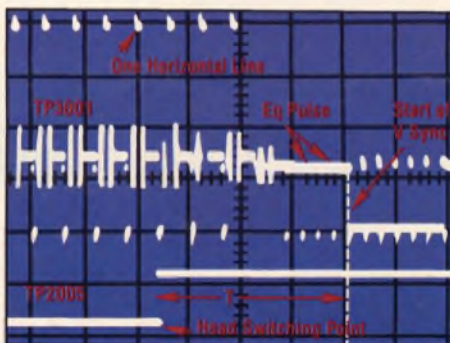

Courtesy of Panasonic

**Fig. 2: The alignment instructions call for head switching to take place 6.5 to 7 lines before the vertical sync pulse.**

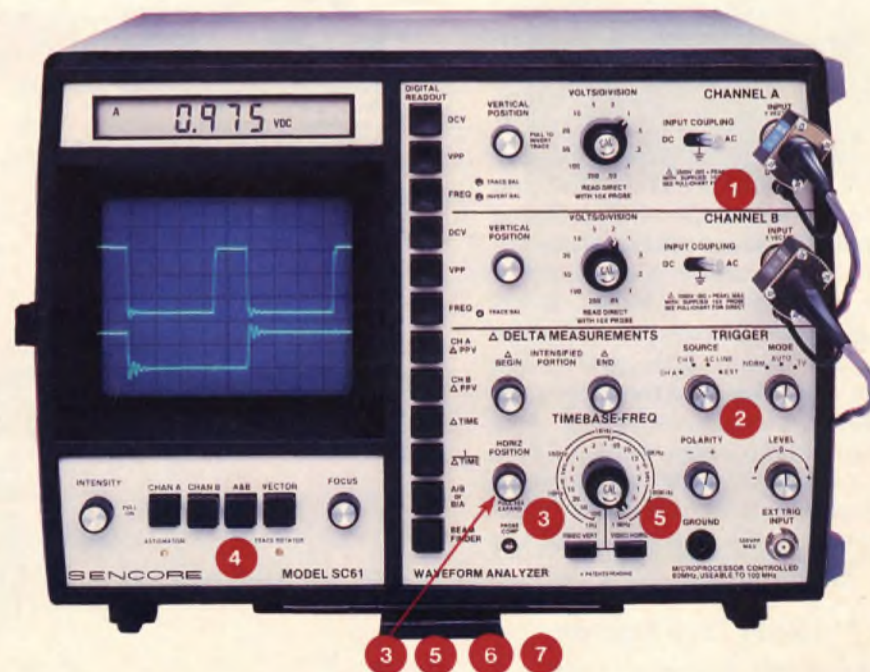

**Fig. 3: The SC61 Waveform Analyzer's numbered controls match the paragraphs above. Use them as a time-saving guide for successful head-switch timing adjustments.**



## You Can Boost Your Efficiency And Increase Profits With Your VA62 Universal Video Analyzer And An Easy-To-Record Test Tape

by Tom Schulte, Application Engineer, CET

**M**any of you, who are servicing VCRs, have asked at Sencore workshops across the United States and Canada, "Is there a way to troubleshoot VCR electronic problems as efficiently and profitably as you can troubleshoot mechanical problems?"

Yes, there is a way; here's what you'll need: A readily available source of channel and cable RF signals, special IF/trap setting signals, test patterns, and the FM, luminance and chroma video signals found in VCR stages. You'll need the ability to substitute these signals into circuits that have only a few ohms input impedance and swamp out bad signals as you replace them with known good ones. And, a way to quickly and easily check out and troubleshoot any electronic stage in VCRs, without guesswork or error. Your VA62 Universal Video Analyzer can help you meet these challenges.

You'll want to learn to use all the VA62's features and make a test tape to performance test and troubleshoot difficult circuits. In this article, we'll show you how to use the VA62's special video patterns and drive signals for VCR troubleshooting and point out easy to make performance tests that you can do in minutes with a home recorded VA62 test tape.

Study the VCR playback circuit block diagram (Figure 1); we'll refer to it throughout this article by calling out the numbers of the applicable blocks. Refer to this diagram as you apply your VA62's array of performance testing and troubleshooting signals. Let's begin with a quick look at a sample of the VCR "trouble tree" (Figure 2).

### VCR Trouble Tree Speeds Troubleshooting

Use the trouble tree and a test tape as you troubleshoot tough playback problems. When you play a test tape

on a defective VCR, you see symptoms on the monitor that can tell you which stage is defective. The trouble tree helps you analyze these symptoms and reveals whether the problem is in the servo, luminance, or chroma circuits.

**Servo symptoms** include tearing, rolling or pulsating in the picture and sound that is "too fast" or "too slow".

**Luminance symptoms** show as poor detail, snow, lack of contrast, loss of picture, or . . . tearing and rolling.

**Color symptoms**, ranging from complete loss of color to intermittent or poor color can be caused by the chroma circuits or improper servo speed.

Look closely at each of the above symptoms; it's often difficult to tell

whether the trouble is caused by the servo circuits, the signal circuits or is mechanical.

This problem is simplified when you can performance test the entire VCR playback system's luminance and chroma response by playing back a special VA62 test tape that you can record yourself (Ask your Sales Engineer for Tech Tip #107). After recording your test tape, you'll have a special arrangement of three special video patterns to help simplify VCR work, the Multiburst Bar Sweep, the Chroma Bar Sweep, and the 10 Bar Staircase.

The VA62 patterns let you identify problems with greater confidence than with other generators or alignment tapes. Plus, an advantage of recording your own VA62 test tape is that you don't risk damaging expensive manufacturers' alignment tapes while troubleshooting VCRs. Repair the VCR using your VA62 test tape, then use your expensive alignment tape for final adjustments. Learning to use your test tape effectively will take some practice, so let's walk through a VCR troubleshooting problem together.

### Troubleshooting A Typical VCR Playback Problem

Your customer just brought in a VCR with the symptom of "no video on playback". First, you must determine whether the problem is "servo" or "video circuit" related, so check the VCR over; put it on the bench, and play your VA62 test tape. This VCR gives you a blank picture on the video monitor. The blank raster tells you there is a video circuit problem. Now, you must decide if the trouble is in the direction of the heads, or the video stages.

Here's how to tell which way to go: Keep the VCR operating in playback and inject a video signal at the output of the FM detector, point 48 (Figure 1). The signal here is standard baseband video, rather than the special FM VCR signal, so use the VA62 DRIVE OUTPUT for your signal source. Select the CROSS HATCH video pattern on the VA62. Since the cross hatch pattern is not recorded on your test tape, it will be easy for you to tell if a picture on the monitor is from the tape or from the signal you are injecting. Connect the VA62

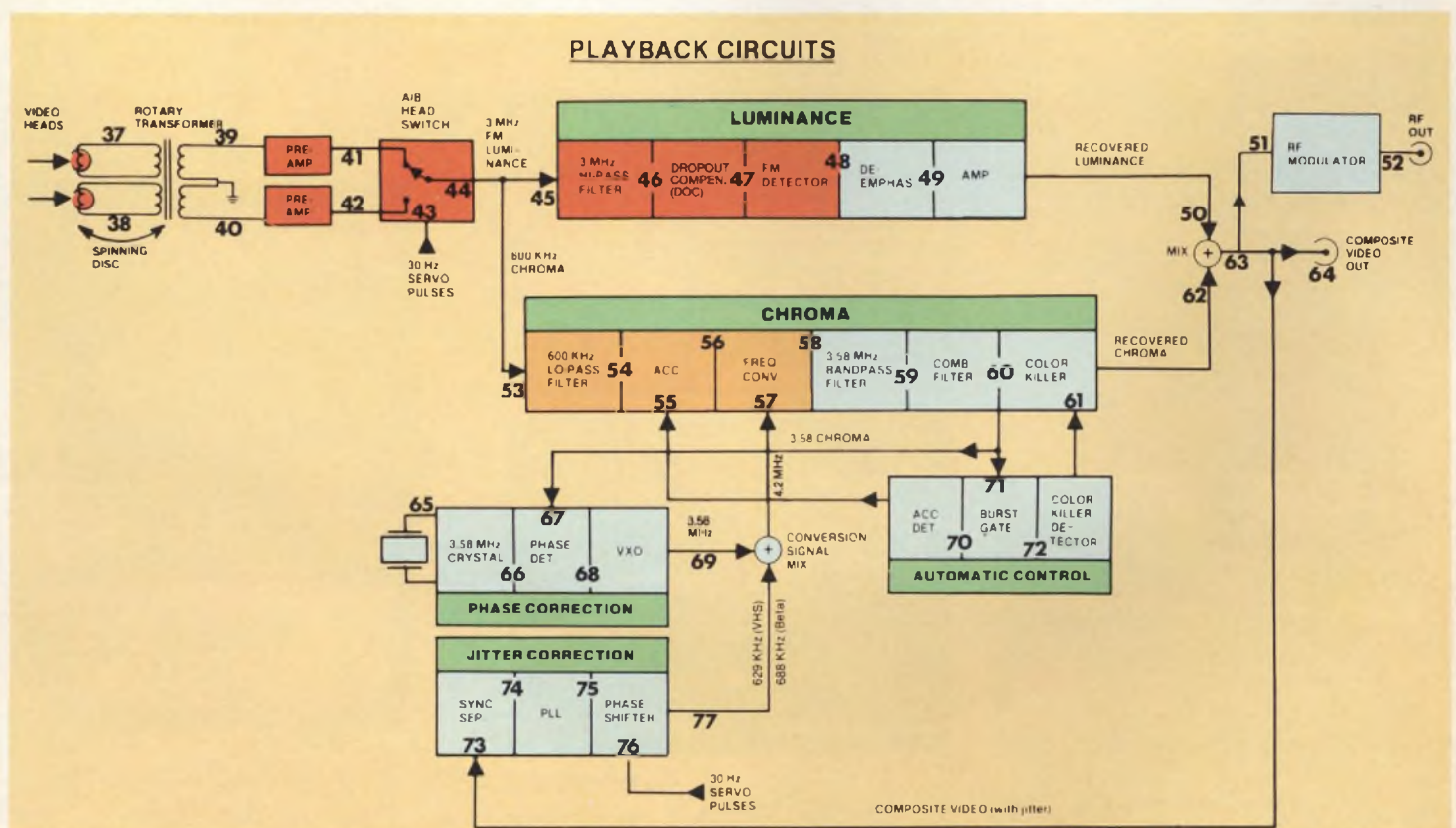
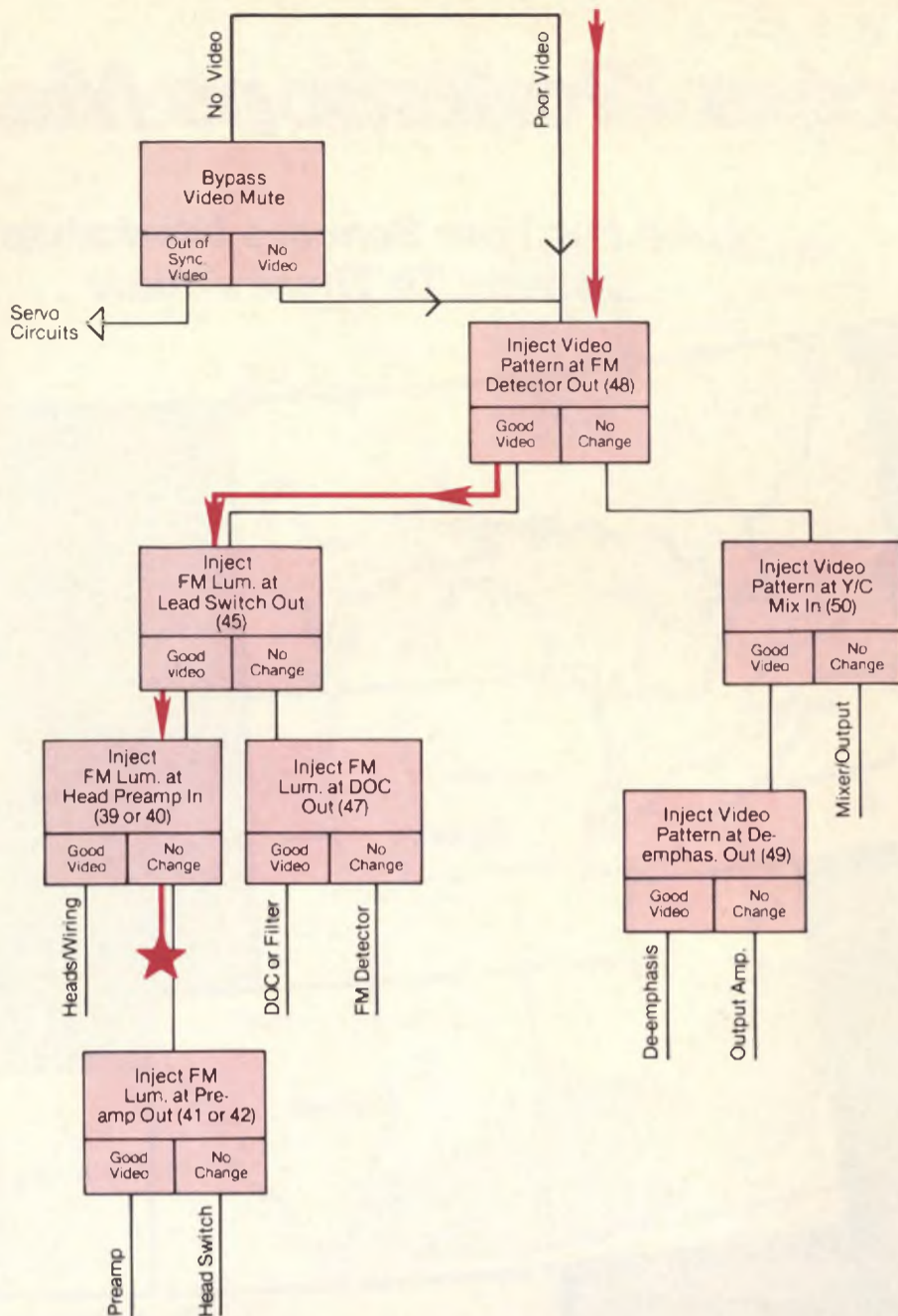

Fig. 1: Use the simplified block diagram with your VA62 test tape and special VA62 signals to simplify VCR troubleshooting.



**Fig. 2: The VCR trouble tree is an important "divide and conquer" troubleshooting guide that helps you pinpoint the defective stage in minutes. The trouble spot in our example is either the preamps or head switch.**

DRIVE OUTPUT to the FM detector output (Figure 1, point 48), and increase the DRIVE LEVEL. At just above 0.3 volts, a CROSS HATCH pattern pops onto the monitor. Remember, your test tape doesn't have a CROSS HATCH pattern!

This is a very important clue. It tells you that the video circuits following the FM detector function correctly and that the problem lies in the direction of the heads. (If the picture had not appeared when you injected a known good signal after the FM detector, you would use the VA62 to inject into the video stages between points 48 and 52 to find the defective stage.)

Now, which of the suspected circuits, (a) the FM detector, or (b) the video heads, is working? Let's find out. Inject an FM luminance signal into the output of the A/B head switch, point 45 (always use the special FM VCR signals from the VC63 VCR Test Accessory to inject signals before the FM detector, point 47). For our VHS VCR trouble, set the SPECIAL SIGNALS switch on the VC63 to the VHS LUM position. This setting provides an FM luminance signal without the down-converted color signal. The "LUM &

CHROMA" position provides the special color-under signal when you troubleshoot color circuits.

Injecting at point 45 cuts the suspected stages in half, letting you quickly narrow in on the problem. Point 45 is the combined output of both video heads after the preamplifiers. For this substitute signal, set the VC63's OUTPUT LEVEL control to X.1. Increasing the OUTPUT LEVEL control between 1 and 2, in our example, brings a clean cross hatch pattern onto the monitor, proving that all the stages after point 45 are working.

Look at the trouble tree (Figure 2); the next logical step is to inject a signal into points 39 and 40. These points are the outputs of the video heads. The signal level here is very small (1 to 3 millivolts). The PLAYBACK HEAD SUB (X.001) setting of the VC63 OUTPUT LEVEL switch provides this low level signal. In the X.001 position, some setting of the OUTPUT LEVEL control should produce a picture. But, in our example, increasing the control all the way to 5 mV doesn't produce a picture on the monitor from either test point. This tells you the trouble lies between points 39/40 and 45.

You can further isolate the trouble to either the preamps or the A/B head switch by injecting a signal into points 41 and 42. But, in many recent VCRs, the preamps and the head switch are contained in the same IC. Before you replace the chip, however, check that it is receiving B+ and the 30 Hz head switching signal.

When you use the full capability of your VA62 in performance testing and/or troubleshooting, you can get the job done faster and make more profit. However, this calls for a thorough understanding of the applications of each VA62 feature. We'll start you on the road to success by showing you how to use the test tape you make using the VA62's exclusive patterns.

### VCR Performance Testing With Your Test Tape And The VA62's Exclusive Video Patterns

With just three VA62 patterns, recorded on your test tape, you can totally analyze any VCR's playback operation. Simply connect a scope to the video output of the VCR and select playback. (Remember to terminate the VCR's video output with a 75 ohm resistor.)

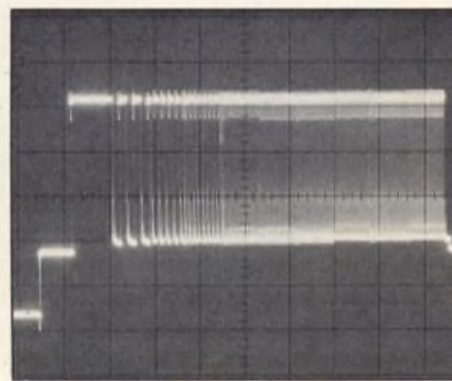

**Fig. 3: The Bar Sweep pattern's video frequency range gives you a complete response check of the VCR video circuits.**

The Multiburst Bar Sweep and 10 Bar Staircase patterns let you check the playback system's video performance. Use the Bar Sweep to check for normal frequency response and the Staircase pattern to check for good signal linearity. The patented Chroma Bar Sweep pattern lets you check the playback system's three important chroma parameters in seconds: saturation, hue, and frequency. No other test checks all the chroma circuits so completely in so short a time. Let's look at each of these important time saving patterns and the tests you can perform with them.

### Multiburst Bar Sweep Pattern Checks Luminance Circuits

Use the Multiburst Bar Sweep for all VCR luminance work. The Multiburst Bar Sweep pattern includes ten frequency bars, beginning with a zero reference and

extending to 4.5 MHz. Each bar is 0.5 MHz higher in frequency than the one before it (Figure 3). All the bars are generated at the same amplitude, alternating from pure black to peak white. This gives you a dynamic check of each video stage through the entire range of operating frequencies. Any stage that restricts the VCR's record or playback frequency response will reduce the amplitude or distort the shape of one or more of the bars.

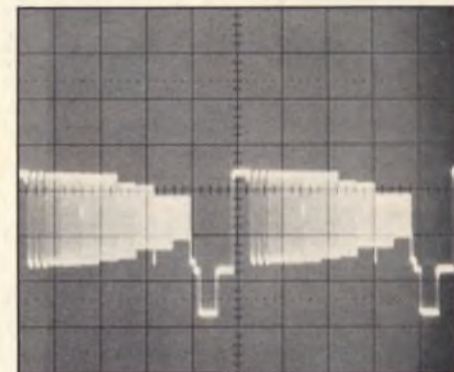

**Fig. 4: This is a typical VCR playback circuit response. Note the rolloff in the high frequency bars.**

Higher video frequencies normally show some rolloff, as shown in Figure 4. Notice that the output is flat to the 3 MHz bar and then drops off at higher frequencies. It's normal for both Beta and VHS decks to attenuate these higher video frequencies.

The video heads and video head preamplifiers must have enough frequency response to recover all of the luminance detail recorded onto the tape. The high frequency Multiburst Bar Sweep bars are usually affected before the low frequency bars when there is a problem in the heads or the

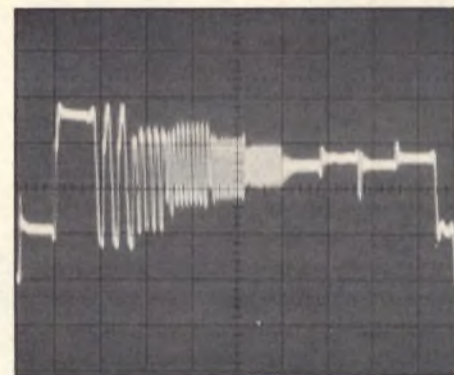

**Fig. 5: This video circuit check indicates problems because of the excessive high frequency rolloff.**

preamps. Figure 5 shows how the rolloff increases with head or preamplifier problems. Since the 3.5 MHz is also affected by rolloff, one of the first effects of poor frequency response is loss of color.

### How The Chroma Bar Sweep Checks Chroma Circuits

You can perform a dynamic test of the VCR's chroma bandwidth as well with the Chroma Bar Sweep signal. The Chroma Bar Sweep

(continued on page 12)

# Sencore Workshops Mean

Look For Your Sencore Workshops Coming To These Areas:



Jay Schwans

### Montana

Mar. 7 Great Falls  
8 Helena  
9 Butte

### Idaho

Mar. 10 Pocatello

### Wyoming

Apr. 4 Cheyenne



Brent Johnsen

### Utah

Mar. 21 Brigham City  
22 Ogden  
23 Salt Lake City  
24 Provo



Brad Johnson

### Colorado

Apr. 5 Greeley  
6 Denver  
7 Denver  
18 Colorado Springs  
19 Pueblo



Rick Akey

### New Mexico

Apr. 20 Santa Fe  
21 Albuquerque

### Wisconsin

Mar. 2 Eau Claire  
3 Madison  
14 Milwaukee



Bob Searcy

### Kansas

Apr. 25 Wichita  
26 Junction City  
27 Lawrence

### Oklahoma

Apr. 12 Oklahoma City  
13 Tulsa



Dave Plaff

### Texas

Mar. 1 San Antonio  
16 Ft. Worth



Dale Fier

### Texas

Mar. 2 Austin  
3 Waco  
15 Garland  
28 Abilene  
29 San Angelo  
30 Big Spring  
31 Lubbock



John Tassava

### Missouri

Apr. 27 Kansas City  
28 Kansas City



Dave Jockheck

### Minnesota

Feb. 29 Bloomington  
Mar. 1 St. Paul

## Plan To Attend The All New Sencore VCR/TV Instrument Demonstrations.

### What You'll See Demonstrated:

- **How to tame any tough dog VCR/TV problem in half the time:** See a proven troubleshooting technique that is guaranteed to cut your VCR/TV "Tough Dog" troubleshooting time in half.
- **How to isolate frustrating shutdown problems in 5 steps or less:** See how you can locate tough shutdown problems with pin-point accuracy. Exclusive troubleshooting techniques will bring any chassis out of shutdown and turn those "tough to find" shutdown problems into a quick servicing job.
- **How to dynamically analyze any VCR head or head circuit problem with 100% reliability:** See how special substitution signals isolate VHS, BETA, or U-Matic problems with 100% proof positive results.
- **How to walk through any VCR system control problem with a simple 5 step microprocessor troubleshooting technique.**
- **How to determine if a cap or coil is simply good or bad, easily and with 100% reliability:** See how the NEW triple patented, microprocessor controlled LC77 "AUTO-Z" locates bad caps or coils at just the push of a button.

# Success In Electronic Servicing

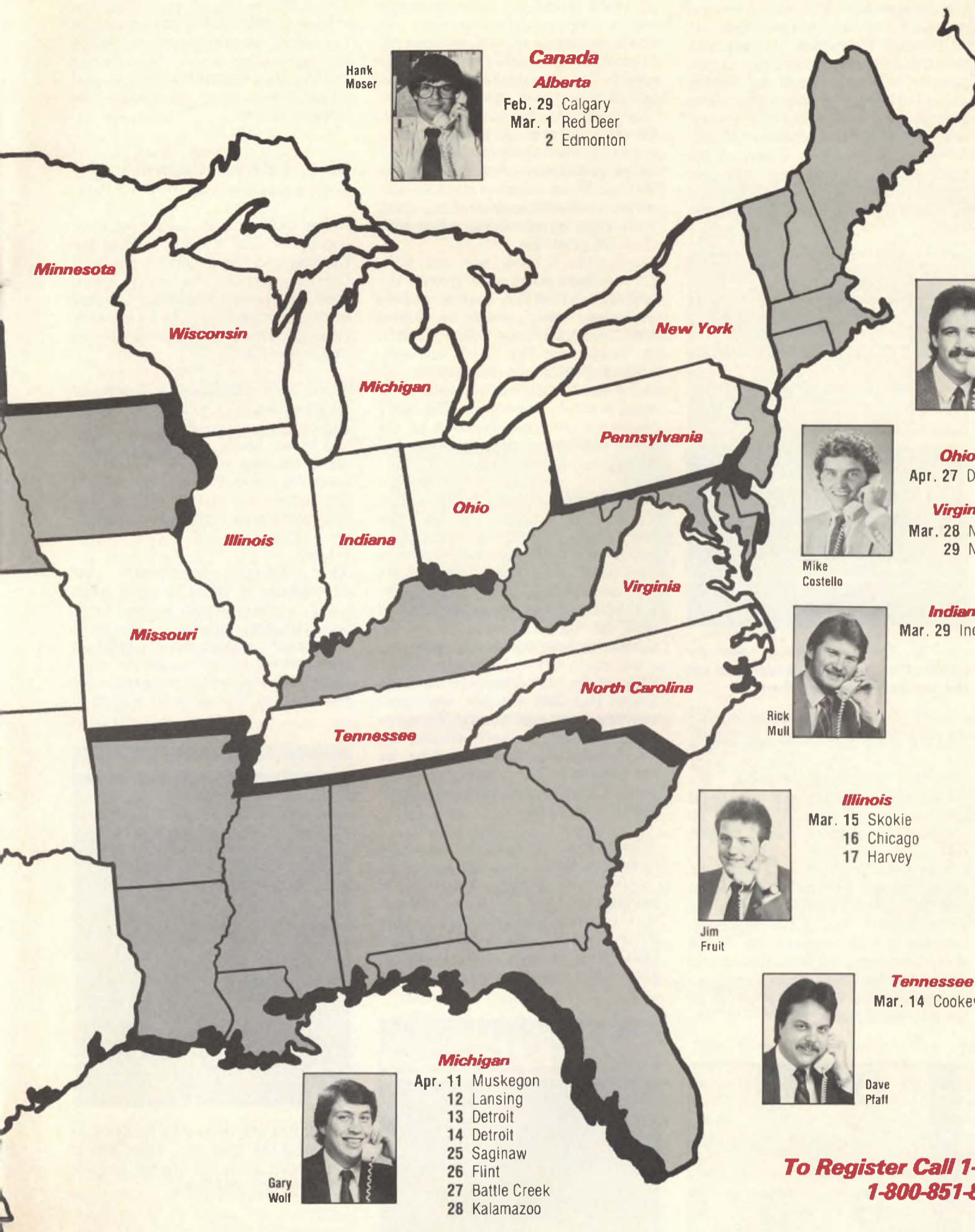

Hank Moser



**Canada**  
**Alberta**

- Feb. 29 Calgary
- Mar. 1 Red Deer
- 2 Edmonton



Dwain Robinson

- New York**
- Mar. 14 Hempstead
  - 15 Hauppauge
  - 16 Medford
  - 17 Plainview
  - 28 New Rochelle
  - 29 Flushing
  - 30 Brooklyn
  - 31 White Plains



Jim Russell

- New York**
- Apr. 18 Poughkeepsie
  - 19 Albany
  - 20 Schenectady
  - 21 Glens Falls



Trent Litten

**Pennsylvania**

- Feb. 29 Wyomissing
- Mar. 1 King of Prussia
- 2 Levittown



Mike Costello

- Ohio**
- Apr. 27 Dayton

- Virginia**
- Mar. 28 Norfolk
  - 29 Norfolk



Rick Mull

- Indiana**
- Mar. 29 Indianapolis



Gary Wolf

**Indiana**

- Mar. 28 Gary
- 30 Ft. Wayne
- 31 South Bend



Jim Fruit

- Illinois**
- Mar. 15 Skokie
  - 16 Chicago
  - 17 Harvey



Chuck Griffin

**North Carolina**

- Feb. 29 Charlotte
- Apr. 13 Asheville



Dave Pfaff

- Tennessee**
- Mar. 14 Cookeville



John Tassava

- Tennessee**
- Mar. 17 Knoxville

Gary Wolf



**Michigan**

- Apr. 11 Muskegon
- 12 Lansing
- 13 Detroit
- 14 Detroit
- 25 Saginaw
- 26 Flint
- 27 Battle Creek
- 28 Kalamazoo

**To Register Call 1-800-843-3338 U.S. or 1-800-851-8866 Canada**



**1** Ask Your Area Sales Engineer to reserve a seat at your scheduled workshop.



**2** Check "yes" I plan on attending the Sencore Workshop on the enclosed seminar return card. (See page 28.)



**3** Next mark your calendar so you don't forget. Even if you do, we'll remind you a few days before your scheduled workshop. (P.S. Bring a technical friend.)



**4** Then be sure to attend to receive your Free Sencore Workshop attendance gift — two specially prepared Video Servicing Workbook Study Guides. A \$40.00 value.

Your servicing success is our success. Please join us and your technical friends at Sencore's all new workshops.

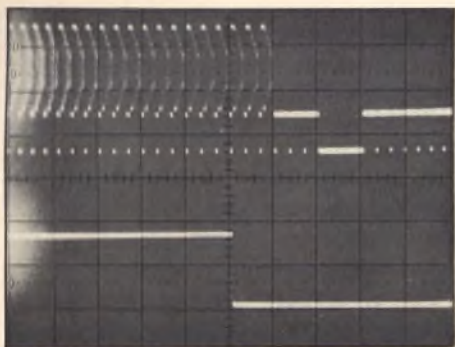

**Fig. 4: The SC61 expands the waveform with plenty of detail to follow the alignment instructions directly.**

4. Press the A&B (dual trace) button under the CRT and adjust the VOLTS/DIVISION switches and VERTICAL POSITION controls for each vertical input until both waveforms appear on the CRT.

5. Adjust the HORIZ POSITION control to view the right-hand edge of the CRT trace, and then adjust the horizontal vernier (the small knob in the center of the TIMEBASE-FREQ switch) until a square-wave transition and vertical sync pulse appear at the right edge of the waveforms.

6. Adjust the HORIZ POSITON control until the square-wave transition lies on the CRT's center, calibrated, graticule line.

7. Pull the HORIZ POSITION control to expand the waveform ten times.

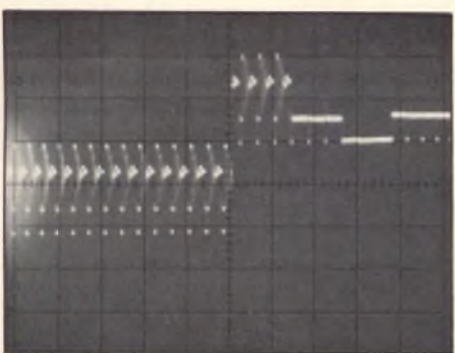

**Fig. 5: The head-switch signal causes a jog in the composite video signal when viewed with the SC61's ADD function. Simply adjust the timing until the jog takes place 3.5 lines ahead of vertical blanking.**

The waveform will look like the one in Fig. 4. Notice that we can easily see the horizontal sync pulses ahead of the vertical sync interval. Simply adjust the VCR control for the correct timing between signals.

The SC61's "ADD" function makes it even easier to compare the timing of the two signals. To add the two input signals together, press the CHAN A and the CHAN B CRT selector buttons simultaneously. Now, the head-switching square-wave causes a "jog" to appear in the composite video signal, as shown in Figure 5. Most people find this makes comparison easier than placing one waveform next to the other.

## Setting "Tracking Fix" Adjustments

The "Tracking Fix" or "Tracking Centering" adjustment insures that the front-panel "Tracking" control produces the best picture when set to its center position. Adjustment procedures vary, according to the specific VCR. Most call the correct delay between a square-wave at one test point and a pulse at a second test point. Some Panasonic VCRs, for example, need a delay of 0.4 milliseconds for machines with two video heads but need a delay of 7.3 milliseconds for four-head machines.

TP	ADJ	MODE	INPUT
TP2006 TP2005	R2024	SP SELF RECORDING	VIDEO SIGNAL
TAPE	M. EQ.	SPEC.	
BLANK TAPE	OSCILLOSCOPE	(a) T = 0.4 ± 0.4msec. (b) T = 7.3 ± 0.5msec.	



**Fig. 6: The instructions call for careful CRT graticule counting to set the Tracking Fix adjustment.**

Making these measurements with a conventional scope calls for very attentive graticule counting. We must measure the time on one signal relative to the second signal. To complicate matters, the second waveform contains "jitter" (it moves back and forth as the tape plays) caused by the tape motion and the constant correction from the servo circuits. We must remember how many little squares one signal should be displaced from the second signal on the CRT, while we try to interpolate the average position of the moving signal.



**Fig. 7: Pressing the Delta time button activates the Delta Begin and Delta End controls which position an intensified bar on the CRT waveform.**

The SC61's "Delta Time" function eliminates these problems. We read the time delay between signals directly on the SC61's digital readout. The Delta Time test provides accurate time measurements directly on the waveform. We don't multiply switch settings or count CRT graticule markings. The results are accurate, whether the horizontal sweep speed is in the "Cal" or the uncalibrated mode. Parallax errors or interpretation errors between the two signals don't cause problems either because the Delta Time test marks the waveform itself, instead of requiring us to align waveform segments with the CRT graticule.

To measure time, we press the DELTA TIME button. This activates two controls called DELTA BEGIN and DELTA END, as shown in Fig. 7. These two controls position an intensified zone, called the "Delta Bar", anywhere we want it on the waveform. The SC61 measures the time duration of the Delta Bar and displays the time on the digital readout.

To measure the delay between two signals, we simply adjust the beginning of the Delta Bar until it just touches the transition in the first waveform. Then, we adjust its end until it just touches the transition in the second trace and read the digital readout to see the time delay between the signals.

The reason this works is that the Delta Bar has exactly the same starting point and exactly the same time duration in both traces. By simply adjusting the Delta Bar, we are measuring the time between the signals, even though they come from separate test points.

When we need to set the circuits for a certain delay, we use the Delta Bar "backwards". We adjust the beginning of the Delta Bar until it just touches the reference square wave. Then, we adjust the end of the Delta Bar until the digital readout shows the delay called for in the

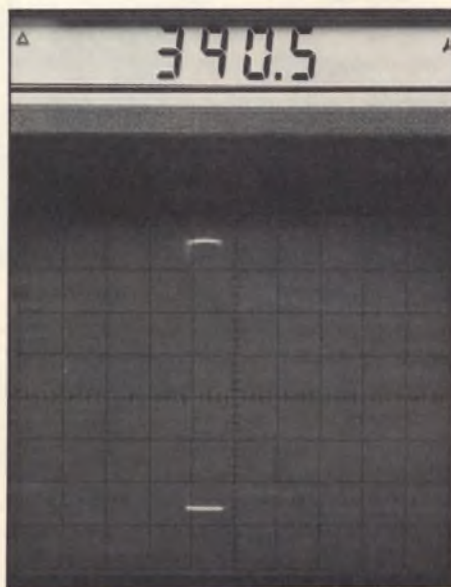

**Fig. 8: Adjust the Delta Bar until the digital readout shows the specified amount of delay. Then adjust the circuit until the pulse touches the highlighted bar.**

alignment instructions. Finally, we adjust the circuit until the pulse in the second trace just touches the bright zone on the CRT.

We don't even worry about the effects of playback jitter, since the Delta Bar remains referenced to the stable square wave. We simply watch the intensified area and center the moving signal over the intensified area.

## Setting Record Current Adjustments

A few millivolts of measuring error become critical when adjusting the Chroma and the Luminance Record Current controls. The typical signal level for Chroma Recording Current is only 30 millivolts. The Luminance Record Current has a level around 100 millivolts.

These two adjustments determine whether the VCR will record a clean signal. If the signals are too large, the video heads will saturate the tape, causing a noisy picture or incorrect colors during playback. If the signals are too small, the tape will have a poor signal-to-noise ratio.

Two things complicate the adjustment of these controls when using a conventional scope. First, the trigger circuits of most competitive scopes have a difficult time locking to the composite video signal. Second, we must measure the peak-to-peak voltage level of a small

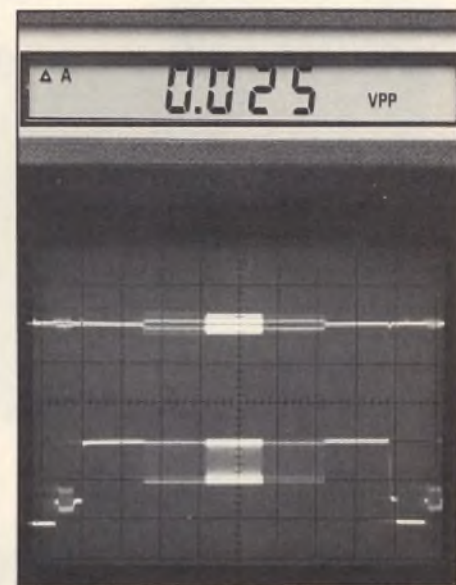

**Fig. 9: Use the Delta PPV function to highlight the cyan bar. Then adjust the circuit until the digital display shows the correct level.**

part of the complete signal, meaning we must carefully count graticule divisions.

We will rely on the special SC61 sync separators to grab onto the video sync pulses and hold the waveforms in perfect synchronization. We will use the special "Video Preset" position of the TIMEBASE-FREQ switch to instantly switch from the horizontal to the vertical sweep rates at the push of a button.



We use the Delta PPV mode of the digital readout for these adjustments. This function displays the amplitude of any part of a waveform on the digital readout. We measure the cyan bar of a color pattern for the Chroma Record Current adjustment and the vertical sync pulse for the Luminance Record Current adjustment, as specified by the alignment instructions.

To use Delta PPV, we simply press the CHA DELTA PPV or the CHB DELTA PPV button. Just as with

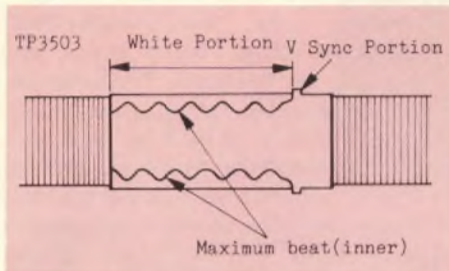

**Fig. 10: The instructions for setting the FM deviation adjustment varies with manufacturers.**

the Delta Time measurements (covered earlier), these buttons activate the intensified Delta Bar controlled by the DELTA BEGIN and DELTA END controls. We adjust the controls until the Delta Bar just covers the part of the waveform the alignment instructions tell us to measure.

To adjust the Chroma Record Current control, we display the signal at the horizontal sync rate and highlight the cyan bar of the NTSC split-field video pattern or of the VA62's Chroma Bar Sweep pattern (both video patterns produce the same results). For the Luminance Record Current, we display the signal at the vertical sync rate and highlight the vertical sync interval. Then, we simply adjust the VCR circuits until the digital readout shows the correct peak-to-peak amplitude.

## Understanding The FM Deviation Controls

Few people understand the procedures used to set the FM modulator in VHS recorders. Even if we understand the procedures, the manufacturer's procedures produce confusing results because of the overlap of several signals. Let's take a minute to understand how the settings of the Sync Tip Frequency and the Deviation Frequency controls affect the VCR's performance and then see how to adjust them.

The frequency-modulated carrier used to record the luminance signal must have the correct amount of swing from the lowest to the highest modulation frequency. If the frequencies are different from the VCR standards, the playback circuits cannot properly detect the video signal. Most VCRs contain an adjustment for the lowest modu-

lation frequency (the modulation during sync pulses) and a second adjustment for the highest modulation frequency (the modulation for pure white pictures) in the recording circuits.

A few alignment instructions call for a frequency counter to measure the unmodulated sync-tip frequency. But, we cannot use a frequency counter to measure the frequency during modulation because the frequency is constantly changing. Most alignment instructions call for beating an external generator with the modulated carrier to determine frequency indirectly.

We use the SC61's auto-ranging frequency function when the instructions call for a frequency reading. We simply connect the SC61 probe to the test point, press the **FREQ** button, read the frequency on the digital readout, and adjust the VCR control for the specified value.



**Fig. 11: The white bar of the split field pattern is on the same line as the "-I" and "Q" bars, causing an overlap when viewed on an oscilloscope.**

Few servicers understand the heterodyning method used to determine the peak-white modulation frequency. The service manual says to observe a scope waveform from one test point, while injecting a signal from an external signal generator into a second test point, and watching for a beat pattern on the waveform. The instructions warn that the beat may appear at a "correct" and at an "incorrect" point of the control adjustment. What does all that mean? Let's be sure we understand the procedure.

We set the generator until it produces VHS's 4.45 MHz peak-white frequency and then mix its output with the FM modulator output. The signals beat together to produce the sum and difference frequencies. If the two signals are very close in frequency, the beat becomes visible on the scope as amplitude modulation. We adjust the circuit until only one cycle of amplitude modulation shows, indicating the frequencies are the same.

But, why do the instructions warn of a "correct" and an "incorrect" beat? Because of the video pattern specified. The procedures always tell us to use the split-field NTSC color bar pattern and to set our scope to display waveforms at the vertical rate. We then observe the area just

to the left of vertical sync, which contains the peak-white bar, as shown in Fig. 11.

The problem, however, is that the same part of the waveform also contains the black bar and the two samples of the color subcarriers, "-I" and "Q". These extra bars cause the "right" and the "wrong" places to set the modulation control. The zero-beat might represent the white bar or one of the other bars.

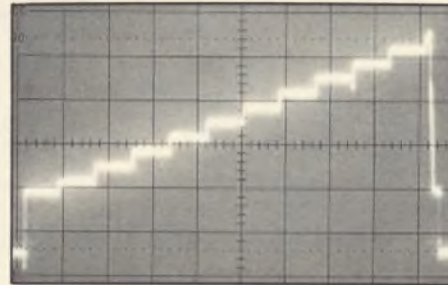

**Fig. 12: The VA62 10-Bar Staircase video pattern (top) provides samples of ten different video levels (bottom), producing different VCR modulation frequencies.**

There is little that can be done to improve the manufacturer's procedures when using the NTSC split-field video pattern because of the way the white window overlaps with the -I and Q bars when viewed at the vertical rate. Viewing at the horizontal rate causes even more overlap, as the white bar blends with the color bars. There is, however, a way to simplify the heterodyning methods if we use a different video pattern.

## Simplifying Deviation Adjustments

The first step to simplifying the deviation frequency adjustment is to use the VA62's 10 BAR STAIRCASE pattern instead of the NTSC color bar pattern. As we will see shortly, this pattern eliminates the overlapping signals during the zero-beating procedure. This pattern offers an added advantage because it does not contain color information. This feature eliminates the need to turn the Chroma Record Current adjustment to zero while adjusting the deviation frequency.

Each of the ten staircase steps causes the FM modulator to produce a different frequency. When we observe the waveform at the TV horizontal rate, the externally applied signal zero-beats with only one frequency at a time, as we see in Fig. 13. We adjust the Deviation control until the zero-beat lines up with the top (pure white) bar.

Fig. 13 shows why we want to use the dual-trace display mode. The first trace shows the combination of the FM and the generator signals. The second trace displays the composite video signal, from the VCR's "Video Out" jack, which provides sync and a convenient way to tell which part of the FM signal contains each video modulation level.

Using the staircase, viewed at the horizontal rate, eliminates the overlap of modulation levels caused by the NTSC split-field pattern. But, be careful if you have a scope other than the SC61. When we set other scopes to display the FM signal at the horizontal line rate, the CRT nearly always displays a little of the FM present during vertical sync and blanking. This brings us back to the overlapping modulation levels we saw with the split-field pattern.

The SC61 video triggering circuits remove the vertical blanking and sync signals when observing signals at the TV horizontal sweep rate. The circuits detect vertical sync and then hold off the CRT trigger circuits during each vertical sync interval so that we don't become confused by the vertical sync or blanking. Other scopes do not have these special circuits.

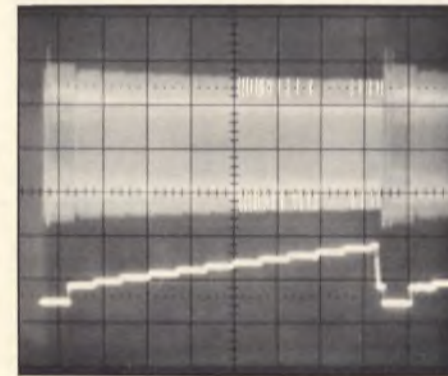

**Fig. 13: Using the staircase pattern, adjust the modulation control until the area of minimum beat lines up with the top (10th) bar. Here, the zero-beat agrees with the 9th bar.**

## Alignment Gets Easier With Practice

You can see why it's important to check the alignment of the internal VCR controls. If you check alignment, you will probably find most controls will be right on the nose. Some will need a minor touch-up, while others will be further out of adjustment.

Do you have questions about this article or need more VCR service information? Call 1-800-843-3338 and ask your Sales Engineer about Sencore's new Tech Tips. ■



## Use Your PR57 POWERITE® For Equipment And Personal Protection. Why Learn Safety The Hard Way?

by Paul Nies, Application Engineer

If you ever connected a meter or scope ground lead to the metal chassis of a TV and watched in horror as the lead melted or the circuits went up in smoke, you are familiar with "Hot Grounds." Hot ground circuits are ones in which one side of the power supply ties directly to the AC power line. Nearly every TV and equipment which uses switching power supplies contains hot grounds.

chassis and earth ground, and reverse the AC plug if the chassis is hot. This works when servicing half wave, hot ground chassis, but most TV chassis today use full wave bridge rectifier power supplies because of their increased efficiency.

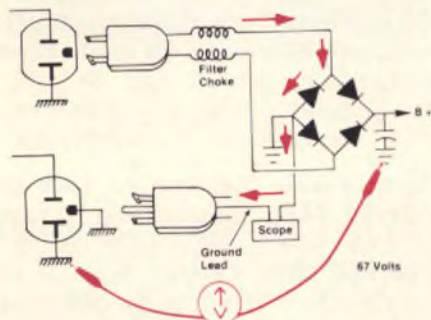

Fig. 2: Half of the AC line potential (67 volts) is always present between the chassis ground and earth ground in a full wave power supply. Connecting the ground lead from a piece of test equipment shorts out half of the power supply.

### The Full Wave Supply

Here lies the real problem. Take a look at the bridge rectifier power supply illustrated in Figure 2. No matter how the AC plug is connected in this supply, half of the AC line potential will always exist between circuit ground and earth ground. When you connect the ground lead of an oscilloscope, or other piece of grounded equipment, to the bridge rectifier power supply, half of the bridge is shorted out. The resulting current flow, shown in red,

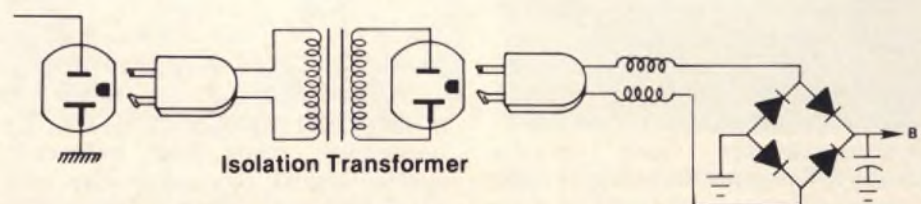

Fig. 3: An isolation transformer breaks the direct connection to earth ground, allowing the circuit connected to the secondary of the transformer to float to earth ground potential.

damages the power supply, and possibly the test equipment you connected to it.

One solution is to defeat the third wire ground on the test equipment. While this prevents the hot ground power supply from being destroyed, it causes two serious problems:

1. Exposed metal on the test equipment is now hot, forming a serious shock hazard between the metal case and any metal object connected to earth ground.
2. The earth ground of the test equipment is necessary for proper operation and shielding of sensitive circuits. Defeating the third wire ground causes excess ripple, noise, and unstable readings.

### Why Not Use Just An Autotransformer?

One answer is to use an isolation transformer to break the direct AC line ground return path and allow the ground of the circuit under test to float. Many technicians have a variable voltage transformer, or an auto-transformer, which they think provides the required isolation. But an autotransformer, as shown in Figure 4, has a direct connection from the AC line to the secondary. You can't use an autotransformer in

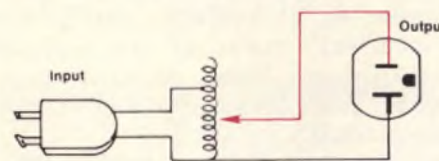
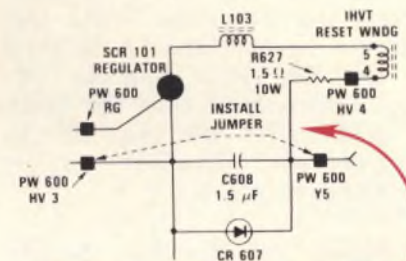

Fig. 4: A variable transformer does not provide isolation between input and output.

place of an isolation transformer, since the autotransformer provides no ground isolation. The continuously variable AC voltage

provided by an autotransformer however, is an important troubleshooting tool that you shouldn't be without. Without the aid of a variable transformer, think how difficult it would be to find a voltage-dependent problem, such as a chassis which works at normal line voltage, but fails to start or operates poorly when the AC line voltage drops. Variable transformers are also a necessary tool for troubleshooting regulator circuits, safety shutdown circuits and chopper power supply circuits.



ADJUST TO APPROX. 90V AC INPUT. APPLY POWER. MONITOR B+ AT PW 600 HV 3 AND ADJUST AC INPUT TO PRODUCE APPROX. +114V ON METER. OBSERVE OPERATION.

Fig. 5: Most service literature recommends the use of a variable AC supply for troubleshooting regulator, shutdown, and chopper power supply problems.

As you can see, you need both the isolation transformer to protect you and your test equipment, and the variable AC provided by an auto-transformer. Sencore's PR57 POWERITE® combines both of these important transformers in one unit. Simply plug the chassis into the AC outlet on the PR57, and you have a fully variable, completely isolated AC voltage source and a Safety Leakage Analyzer, to protect you, your test equipment, and the chassis you're working on.

### The PR57 POWERITE® In A Nutshell:

- It's an Isolation transformer
- It's a variable AC supply
- It's a power line monitor
- It's an amp/watt meter
- It's a safety leakage tester

To find out more about the PR57 POWERITE®, give your Sales Engineer a call at 1-800-851-8866. ■

POWERITE® is a registered trademark of Sencore, Inc.

### The Half Wave Supply

The simple half wave power supply is illustrated in Figure 1a. As shown, the AC plug is polarized and properly connected, tying the circuit ground directly to earth ground. But pay careful attention to Figure 1b. Here the AC plug is reversed. Now the full AC line potential appears between the chassis and earth ground, making the circuit ground "hot."

Connecting your scope's ground lead (which is tied directly to 3rd wire, earth ground) to the hot chassis shorts out the AC line, frying the lead. Many technicians measure the potential between the



## 1988 Outlook: You Can Share In Exciting Growth Opportunities As "Partners In Progress" With Sencore

by Doug Bowden, V. P. Sales and Marketing

**A**s Vice President of Sales and Marketing at Sencore, it is my responsibility to see that Sencore watches the industry, on your behalf, identifies trends, and designs test equipment that meets your needs. Perhaps you've wondered what becomes of the comments you make in letters, on warranty cards, etc. They are

VCRs. At year end, 1986, VCR and camcorder sales had increased to \$5,257,776,000 or a 46% increase for VCRs alone. Look back at 1982 and 1983 (Figure 1) to see an even larger increase in VCR sales of 66%.

Over the same three year period, notice that color television receiver sales have increased 8.7%. Many of

Secondly, we are now developing a new line of audio test equipment that will be designed with your time in mind. Look for these products toward the end of this year.

What does all of this mean to you as a Sencore customer? We want you to look to Sencore, not only for our high quality products and customer service, but we also want to be your test equipment consultants and help guide you toward a successful future by providing you with what we see as the new trends in servicing. We are staying ahead of the industry, so you can stay ahead of your competition. We think of you as our "partners in progress" as well as valued customers.

Application Engineering department will support you with the Sencore News, video tapes from our new video studio, and new Application "Tech Tips." We'll give you service that's second to none in the industry. More importantly, we will support you with our exclusive "Pay As You Grow" Investment program that makes owning any Sencore instrument easy - instruments that pay for themselves through innovative time saving features that increase your profits. And, we pledge to continue our commitment to building the highest quality instruments for you, our customer.

Your partner in progress,

*Doug Bowden*

Doug Bowden,  
V. P. Sales and Marketing,  
Sencore, Inc.

As we go into 1988, we pledge to you our commitment of being there when you need us. We will be there with our toll free number and with knowledgeable Sales Engineers. Our

Factory Sales\* of VCRs (Thousands of Units and Dollars)  
United States, 1983-1986

YEAR	VCR		CAMCORDER		TOTAL	
	UNITS	DOLLARS	UNITS	DOLLARS	UNITS	DOLLARS
1983	4,127	2,162,309			4,127	2,162,309
1984	7,881	3,585,021			7,881	3,585,021
1985	11,269	4,173,288	517	565,268	11,786	4,738,556
1986	12,334	3,978,443	1,199	1,279,333	13,533	5,257,776

\* Includes factory sales to distributors and factory direct sales to dealers.  
SOURCES: EIA Marketing Services Department, U.S. Department of Commerce

**Table 1: The steadily increasing number of VCR sales has created a reservoir of profitable service opportunities that you can take advantage of in 1988.**

included in our research, along with input from 115 other sources. The end result is a complete market analysis of recorded sales and service performance (history), plus projections for the future (forecasts). I want to share our analysis and forecast of the most promising service opportunities for 1988.

### What Are Your Growth Opportunities For 1988?

Refer to the graph (Figure 1); you'll see the total sales of color TV receivers, color cameras, VCRs, audio systems, and separate audio components in the United States from 1977 to the present. In our review of this research, we will concentrate on 1984 to 1986, because for the most part, excluding warranty, service follows sales by three years. As you can see, since 1984, the sales of these key consumer products has grown considerably. One particular product that has experienced the most growth during this time period is Video Cassette Recorders (VCRs). At year end, 1984, consumers had purchased \$3,585,021,000 worth of

these are equipped for Multichannel Television Sound (MTS). Audio System sales have increased 40.3% with separate audio component sales recovering 48.7%. Keep an eye on camcorders (See Table 1); notice that camcorder sales have more than doubled since 1985.

Color TV, VCRs, and audio are Sencore's picks as growth opportunities for you, our customers, in 1988. Let's talk about what Sencore is doing to support you as your service operation expands to meet these challenging opportunities.

First, as I mentioned earlier, it is my job to see that data from our industry is researched and analyzed for both you, our valued customer, and Sencore. This provides direction for us to develop innovative equipment for your needs. Let's get more specific. Currently, we provide the number one video analyzer on the market today. We have developed the necessary accessories to completely analyze MTS Stereo TV, RGB monitors, and VCRs, which we project as the number one growth area for service centers and Sencore customers this year.

Factory Sales of Consumer Electronic Products (Including Imports)  
(\$1 Million; United States, 1977-1986)

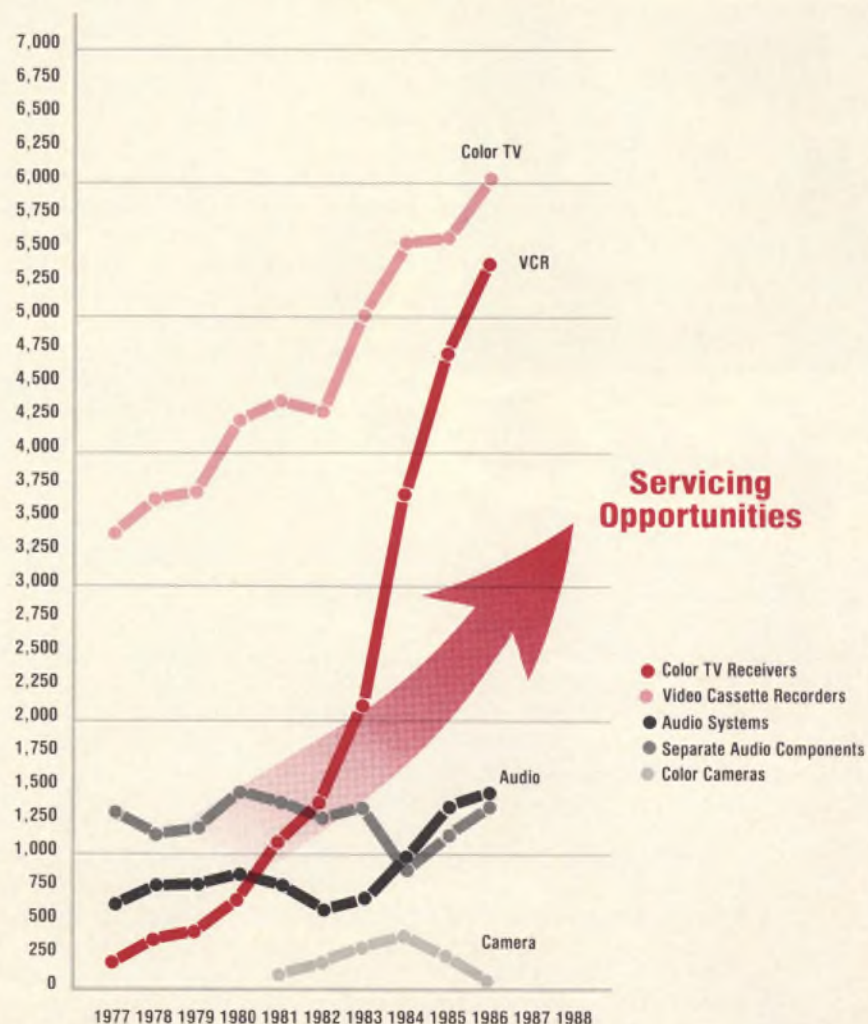

SOURCE OF DATA: EIA Marketing Services Department

**Fig. 1: This graph, prepared from data provided to us by the Electronics Industry Association, shows the tremendous growth in color TV and VCR sales.**

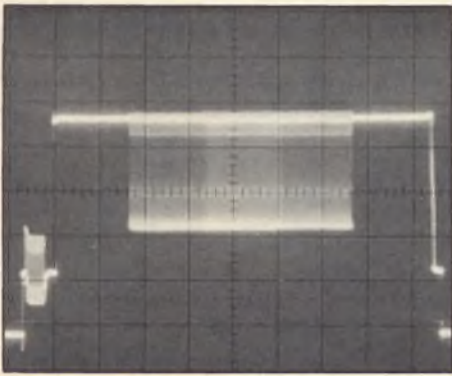

**Fig. 6: The 1MHz frequency range of the Chroma Bar Sweep gives you a complete response check of the chroma circuits.**

consists of three frequency bars (Figure 6). The center (3.58 MHz) bar provides a reference level at the color subcarrier frequency. The left-hand bar is 3.08 MHz, or 500 kHz lower than the subcarrier. The right-hand bar is 4.08 MHz, or 500 kHz higher than the subcarrier. The VCR will reproduce all three bars at the same amplitude if the chroma amplifiers have a full 1 MHz frequency response.

If, on the other hand, the circuits have less than the ideal bandwidth, as VCRs normally do, one or both of the outer bars drop in amplitude compared to the middle bar. As with the luminance circuits, the VCR chroma circuits normally restrict the amplitude of the higher frequencies.

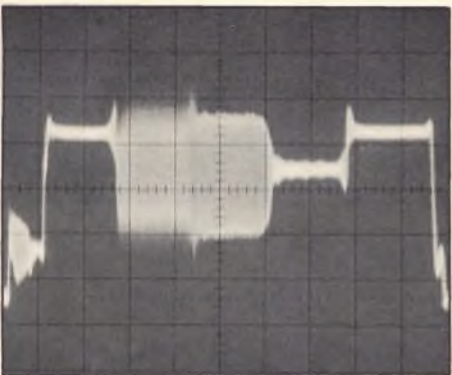

**Fig. 7: This normal VCR chroma response shows enough signal in the lower sideband to produce good color.**

Figure 7 shows the normal high frequency losses produced by a good VCR. Notice that the VCR's chroma circuit frequency response affects the right-hand bar more than the others. The left-hand bar, however, indicates sufficient bandwidth to produce color in small objects on the TV screen.

An important feature of all three of the bars is that they are phase-locked to horizontal sync and have the NTSC standard 180 degree phase shift every horizontal line, unlike the original RCA color bar pattern. This means that all VCR comb filter circuits, used to cancel color crosstalk during playback, operate properly with the Chroma Bar Sweep signal.

Also, the Chroma Bar Sweep signal includes a true 3.58 MHz color burst at the NTSC standard amplitude. VCR color circuits require the correct burst amplitude to operate the automatic chroma control (ACC) circuits properly and the correct 3.58 MHz frequency to reference the color oscillators. The VA62 Chroma Bar Sweep pattern meets NTSC standards and allows the VCR circuits to work correctly.

### 10 Bar Staircase Pattern Checks Amplitude Circuits Dynamically

The 10 Bar Staircase pattern consists of 10 levels of brightness, equally spaced between black and white. You can use this pattern to troubleshoot and align VCR luminance circuit amplitude and dynamic operating range. Luminance circuits include the VCR's synchronous detector, record circuits up to the FM modulator circuit, and playback circuits after the FM detector.

### Test The Record Circuits With The VA62's VCR Standard 1 VPP Video Signal

You can troubleshoot VCR record circuits by using your VA62 to supply a VCR Standard signal to the VCR's video input in the record mode. You then use the VA62's digital peak-to-peak meter or an oscilloscope to signal trace through the record circuits.

The VCR tuner's video detector output is fed to the video input of the VCR record circuits. The signal is fed to two filters (or a comb filter) to separate the color from the luminance signal (Figure 8). The inputs to these filters require a standard one volt peak-to-peak, negative sync video signal like that supplied by the VCR Standard output jack on the VA62.

### How To Isolate Record AGC Problems

The first recording stage is the AGC amplifier. You test this stage with a reference input level of 1 VPP to be sure that the amplifier output is the proper level. Simply inject the output of the VCR Standard jack directly into the video input of the tape deck and check the AGC amplifier for the proper output level using the 10 Bar Staircase pattern. Signal levels you measure will correspond directly to those shown on the schematic for the EIA "NTSC" Color Bar pattern.

You can also use your VA62's adjustable DRIVE OUTPUT instead of the VCR Standard jack.

Monitor the DRIVE SIGNAL level with the VA62's digital peak-to-peak meter while you vary the adjustable output from 0.5 V to 2 V. At the same time, observe the output of the VCR's record AGC amplifier with an oscilloscope. The AGC output should not vary if the AGC circuit is operating properly.

### Test The Record Clipping Circuits With The Multiburst Bar Sweep

The clipping circuits, located between the pre-emphasis network and the FM modulator, must be properly adjusted to prevent over-modulation by overshoots created by the pre-emphasis network. (On some VCRs the clipping circuits are not adjustable.) Overmodulation causes the picture to tear during playback.

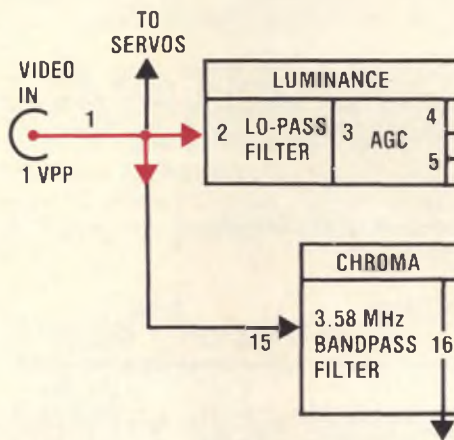

**Fig. 8: The record circuits accept standard 1 VPP video at the input and use separate filters or a comb filter to separate the Y and C signals.**

The adjustment of these circuits requires both a reference white level and a reference black level. These references are necessary to make sure that both the white and black peaks are being clipped to the proper levels and, thus, preventing over-modulation in the FM modulator. (Clipping adjustments are especially critical in the new High Quality (HQ) decks.

The Multiburst Bar Sweep pattern is ideal for checking or adjusting the clipper levels. The sharp transitions between black and white over a wide range of video frequencies gives you a complete check of the clippers. Monitor clipper action with your oscilloscope.

To check the clipper action, you must first establish a reference level on the clipper output signal. Adjust your scope display for two divisions of deflection between the sync and white levels (Figure 9). Check the level of the white overshoots compared to the sync level. Then check the level of the black overshoots compared to the white level. Compare each of these levels to the manufacturer's specifications and adjust if necessary.

### How To Check The Special VCR 3.58 MHz Trap Switch

Most VCRs have a special 3.58 MHz trap in the luminance recording circuits. This trap switches into the circuit when recording a color signal (activated by the presence of color burst) to prevent interference between color signals in the luminance channel and the processed color signals in the 600 kHz "color-under" stages. The trap switches out of the circuit during black and white programs (activated by the lack of color burst) to provide better frequency response during B&W programs. Some low-cost VCRs do not have this feature. Check the schematic to confirm whether or not the VCR you are servicing uses the 3.58 MHz trap switcher.

You can quickly test the trap switcher and the trap action with the VA62 video patterns. The Multiburst Bar Sweep pattern is a full B&W pattern with no color burst. The Chroma Bar Sweep, on the other hand, has a color burst. Thus, the trap switcher should switch to the B&W mode (trap out of the circuit) for the Multiburst Bar Sweep.

This is easily confirmed by connecting your scope to the trap switcher output. Watch the 3.5 MHz bar as you switch between the two patterns. The 3.5 MHz signal should be present in the Multiburst Bar Sweep pattern, but not in the Chroma Bar Sweep video pattern.

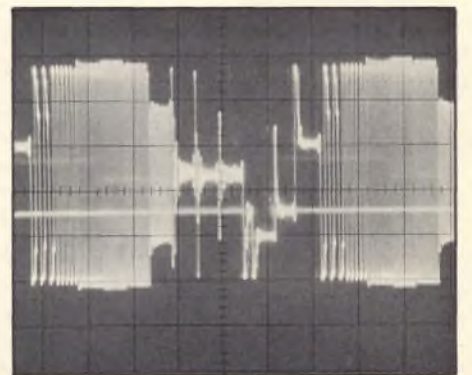

**Fig. 9: The black-to-white and white-to-black transitions in the Bar Sweep pattern make it easy to set the white and black clippers.**

Boosting your troubleshooting efficiency is as simple as hooking up your VA62 and making a test tape. Read about how to make and use a test tape in your VA62 manual, page 76, and in Tech Tip 107. Call your Area Sales Engineer 1-800-843-3338, and ask for a copy of Tech Tip #107 and while you're at it, be sure you still have a copy of the "VCR Functional Analyzing Troubleshooting Guide" (Form #3093) and "Universal VCR Block Diagram" (Form #3038), which were packed with your VA62. ■

# Sencore Buyer's Guide

Your Success Is  
Only A Phone Call  
Away...  
Call WATS FREE  
1-800-843-3338

In Canada 1-800-851-8866



CRT NUMBER	SET	CRT TYPE	A1	F2	FL	REG. MAG.	Q48	R	GL	GL2	CRT NUMBER
210A01	1	V100	1.14	6.3	682	0.74	18	11	11	11	210A01
210A02	2	V100	1.14	6.3	682	0.74	18	11	11	11	210A02
210A03	3	V100	1.14	6.3	682	0.74	18	11	11	11	210A03
210A04	4	V100	1.14	6.3	682	0.74	18	11	11	11	210A04
210A05	5	V100	1.14	6.3	682	0.74	18	11	11	11	210A05
210A06	6	V100	1.14	6.3	682	0.74	18	11	11	11	210A06
210A07	7	V100	1.14	6.3	682	0.74	18	11	11	11	210A07
210A08	8	V100	1.14	6.3	682	0.74	18	11	11	11	210A08
210A09	9	V100	1.14	6.3	682	0.74	18	11	11	11	210A09
210A10	10	V100	1.14	6.3	682	0.74	18	11	11	11	210A10
210A11	11	V100	1.14	6.3	682	0.74	18	11	11	11	210A11
210A12	12	V100	1.14	6.3	682	0.74	18	11	11	11	210A12
210A13	13	V100	1.14	6.3	682	0.74	18	11	11	11	210A13
210A14	14	V100	1.14	6.3	682	0.74	18	11	11	11	210A14
210A15	15	V100	1.14	6.3	682	0.74	18	11	11	11	210A15
210A16	16	V100	1.14	6.3	682	0.74	18	11	11	11	210A16
210A17	17	V100	1.14	6.3	682	0.74	18	11	11	11	210A17
210A18	18	V100	1.14	6.3	682	0.74	18	11	11	11	210A18
210A19	19	V100	1.14	6.3	682	0.74	18	11	11	11	210A19
210A20	20	V100	1.14	6.3	682	0.74	18	11	11	11	210A20
210A21	21	V100	1.14	6.3	682	0.74	18	11	11	11	210A21
210A22	22	V100	1.14	6.3	682	0.74	18	11	11	11	210A22
210A23	23	V100	1.14	6.3	682	0.74	18	11	11	11	210A23
210A24	24	V100	1.14	6.3	682	0.74	18	11	11	11	210A24
210A25	25	V100	1.14	6.3	682	0.74	18	11	11	11	210A25
210A26	26	V100	1.14	6.3	682	0.74	18	11	11	11	210A26
210A27	27	V100	1.14	6.3	682	0.74	18	11	11	11	210A27
210A28	28	V100	1.14	6.3	682	0.74	18	11	11	11	210A28
210A29	29	V100	1.14	6.3	682	0.74	18	11	11	11	210A29
210A30	30	V100	1.14	6.3	682	0.74	18	11	11	11	210A30

## INDEX

- Capacitance and Inductor Analyzers — pg. 14
- SCR/Triac Test Accessory — pg. 14
- Waveform Analyzer — pg. 16
- TV-RF Signal Analyzer — pg. 17
- CRT Analyzer and Restorer — pg. 18
- Color Bar Generator — pg. 18
- Frequency Counter — pg. 19
- Transistor and FET Tester — pg. 19
- Video Analyzer — pg. 20
- MTS TV Analyzer — pg. 21
- RGB Monitor Adaptor — pg. 21
- VCR Test Accessory — pg. 21
- NTSC Pattern Generator Accessory — pg. 21
- Stereo TV Readout — pg. 21
- Isolation Transformer — pg. 22
- DVMs — pg. 22

# LC77 AUTO-Z™ Capacitor And Inductor Analyzer

**New**



**Automatic Microprocessor Controlled For Accurate Error Free Cap/Coil Analysis**

**All New Portable Automatic Features:**

- All capacitor and inductor tests display a simple good or bad readout to eliminate errors!
- Fully automatic/autoranged capacitor value test with percent tolerance calculator.
- Automatic 1000 volt applied leakage test with current or megohm readout. Test capacitor leakage to EIA standards.
- New dielectric absorption test eliminates interpretation.
- ESR tests eliminate tough capacitor problems.
- Fully automatic/autoranged inductance test with percent tolerance calculator.
- Patented Ringing Test gives effective Q of coils.
- Dynamically test resistance up to 1000 megohms.
- Automatic shutoff, battery test and lead zero.

**LC77 AUTO-Z Automatic Capacitor And Inductor Analyzer**  
**\$1895 Patented** U.S. Funds

On GSA Contract  
 NSN 6625-00-557-0399



**LC77 AUTO-Z - The Only Dynamic, Portable, Automatic Capacitor/Inductor Analyzer Guaranteed To Help You Quickly Find Any Defective Capacitor Or Inductor That Other Testers Miss, Anywhere, Without Calculations, Look-up Tables, Or Error.**

Discover the Z Standard that eliminates the guesswork, interpretation and calculation errors in capacitor and inductor testing. The LC77 AUTO-Z makes testing any capacitor or coil simple, without having to make calculations or pull out look-up charts to determine if the component is within standards. Its advanced digital technology completely analyzes capacitors and inductors for all the ways they can fail. You simply enter the parameters: value with the tolerance you require, the rated voltage of the device and the type of device. The LC77 AUTO-Z takes over from there and compares the actual readings to standards tables stored in its memory, and simply displays if that component is good or bad based on EIA and industry standards. It's like having a Standards Engineer with you all the time.

Thoroughly and automatically analyze any capacitor from 1 pF to a massive 20 farads. Only the LC77 AUTO-Z allows you to test today's high tech components. The AUTO-Z tests capacitors for every parameter in which a capacitor can fail. It reads out the capacitor's value and whether it's good or bad based on the tolerances that you want. Plus the LC77 gives tests no one else gives you. Tests for leakage, dielectric absorption and ESR, and it tells you if the cap is good or bad based on EIA and industry standards.

Finally, test inductors reliably from .1 uH to 20 henrys. The LC77 AUTO-Z tests inductors dynamically so you have a way to finally track down tough-to-find coil problems. The LC77 automatically reads out the inductor's value, and if it is good or bad based on your tolerances. It also gives you an automatic ringing test

that allows you to test down to one shorted turn, and find inductor problems that other testers miss.

Portability allows you to take the AUTO-Z anywhere you need to troubleshoot. The full power and potential of the LC77 AUTO-Z is packed into a light-weight, portable (battery and AC) package. The AUTO-Z is designed with CMOS logic, LCD technology and automatic shut-off feature for low-power consumption (the LC77 operates over eight hours on one battery charge). Take the LC77 AUTO-Z wherever you check capacitors and inductors - in the field, shop or factory.

IEEE488 compatible for automated testing and data collection. Use Sencore's optional IB72 to control the AUTO-Z over the IEEE488 Bus for data collecting, incoming inspection, and quality assurance tests.

## SCR250 SCR and Triac Test Accessory™

**New**

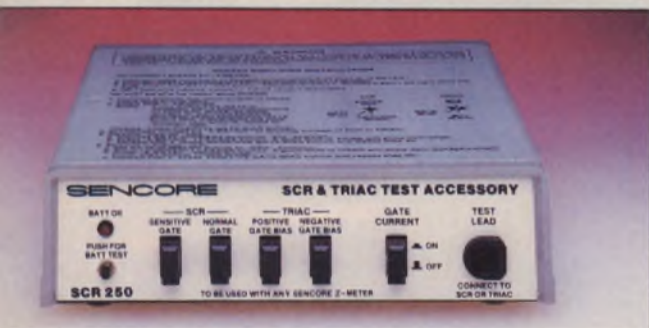

**Now You Can Test SCRs And Triacs With Any Sencore Z Meter.**

- Tests All SCRs and Triacs
- Exclusive Dynamic Leakage Test
- New Sensitive Gate Test

• Easy To Use, No Setup Or Specifications Needed

• Tests Industrial And Protected Gate SCRs And Triacs, Too

**SCR250**  
**SCR And Triac Test Accessory**  
**\$168** U.S. Funds

**Dynamically Test All SCRs And Triacs For Leakage And Turn-on With 100% Reliability.**

Tests all SCRs and triacs. The SCR250 tests all SCRs and triacs in both directions. It's completely isolated and the controlled internal battery supply protects sensitive gates while guaranteeing turn-on of the most demanding high current industrial SCRs and triacs. No more missing those triacs that check good in one

direction but are leaky in the other.

Exclusive dynamic leakage test. SCRs and triacs are dynamically tested at their full working voltage. You'll never again get caught guessing whether or not an SCR or triac is good.

Easy to use. The SCR250 was designed with your time in mind, to allow you to easily test SCRs and triacs. There is no complicated setup, or need to look up specifications. Just select SCR or triac and gate configuration and push the button to test. The SCR250 mounts on any Z Meter with Velcro® strips.

# LC76 PORTA-Z™

## Capacitor And Inductor Analyzer

- Rugged All Steel Construction
- LCD Display
- Full Day's Operation On Battery; Auto Shut Off After 30 Minutes
- Double Patented Inductor Analyzer
- Patented Capacitor Analyzer With Dynamic Leakage Tests To 1,000 Volts
- Tests L/C Components, SCRs, Triacs, Hi-Voltage Diodes, Cables And Transmission Lines
- NBS Traceable Accuracy; Capacitors 1.0%, Inductors 2.0%
- Special Test:  
Transmission Line Distance To Open Or Short

**New**

### LC76 PORTA-Z Portable Capacitor And Inductor Analyzer \$1395 Patented

U. S. Funds



### The LC76 Brings Portability To Cap And Coil Testing - Get Lab Accuracy Anytime, Anywhere.

**Increase your troubleshooting confidence anywhere, on the bench or in the field.** The LC76 PORTA-Z cap/coil analyzer gives you the time tested and proven Z tests with portability. With the LC76 PORTA-Z you get the know-how and expertise gained from Sencore's years of Z Meter experience. You also get NBS traceable accuracy on the bench or in the field.

**Locate capacitor and inductor failures that all other testers can't find.** Measure capacitors from 1pF to 200,000 uF and test them at voltages up to 1,000 volts. Test for value, leakage, dielectric absorption and

ESR. Test inductance values from 1 uH to 10 H. Test the effective quality of coils, yokes and flybacks with Sencore's patented ringing test.

**Exclusive high potential testing to 1000 volts in a portable tester.** Isolate leakage problems fast with an unheard of portable 1,000 volts. A new power circuit gives you all the power you need, yet still gives you 9 hours of portability on one battery charge.

**The LC76 gives you true versatility in capacitor and inductor analyzing.** The Sencore Z-METER family has

been the standard by which capacitor/inductor analyzers are measured. No other equipment performs total dynamic tests. Now with the LC76, you get the Z-METER tests anywhere, anytime and anyplace.

**Locate faults in transmission lines or buried cable.** The LC76's portability allows you to track down cable breaks in remote areas. Simply measure capacitance of an open line (or inductance of a shorted one), and calculate the distance to the fault.

# LC75 Z METER 2™

## Capacitor And Inductor Analyzer

### Add These New Test Features To Your Shop In 1988

- **Capacitor Tests:**  
Capacitor Value  
Capacitor Leakage  
Electrolytic Dielectric Absorption  
Electrolytic Equivalent Series Resistance (ESR)
- **Inductor Tests:**  
Inductor Value  
Inductor Ringing
- **Special Tests:**  
Leakage in Switches, PC Boards, Connectors, Etc.

On GSA Contract  
NSN 6625-01-118-8016

### LC75 Z METER 2 \$995 U. S. Funds Exclusive Triple Patented Plus One Patent Applied For.



### The First Tester Designed To Solve New High Tech Cap And Coil Challenges.

**Solve capacitor challenges accurately and quickly.** The LC75 gives you proven tests; value from 1 pF to 200,000 uF, leakage with applied voltage up to 600 volts, dielectric absorption, and ESR test. Find the other 75% of defective capacitors that "value only" testers miss. The LC75 is guaranteed to cut your troubleshooting time and boost your troubleshooting confidence.

**Test inductors in or out of circuit with the time proven Z-Meter inductance tests.** The LC75's double patented inductor tests check for true inductor value, and tests

the effective quality of the coil with a special ringing test, in or out of circuit. Find shorted turns and problems that "value only" testers can't find. The patented ringing test even finds just one shorted turn. Just push the button and read inductor value from 1uH to 10H and read the quality of the inductor with 100% reliability.

**Check for insulation breakdown and troublesome leakage paths in areas where isolation is critical.** The LC75 is a hi-potential leakage tester for testing switches, PC boards, connectors and contacts. Read

leakage as low as one microamp at voltages as high as 600 volts.

**Eliminate costly errors.** The LC75 allows you to locate potential problems that otherwise could go undetected, and cost you money down the line. The LC75 is autoranged, so it's easy to use, and has a handy pull chart to guide you in your testing. For your safety, and to keep from damaging sensitive components, the LC75 flashes a warning when 50 volts or more is applied to a device. Capacitors are automatically discharged when the leakage button is released.

**Call WATS Free 1-800-843-3338 15**

# SC61 Waveform Analyzer™

60 MHz (usable to 100 MHz) Dual Trace Waveform analyzer

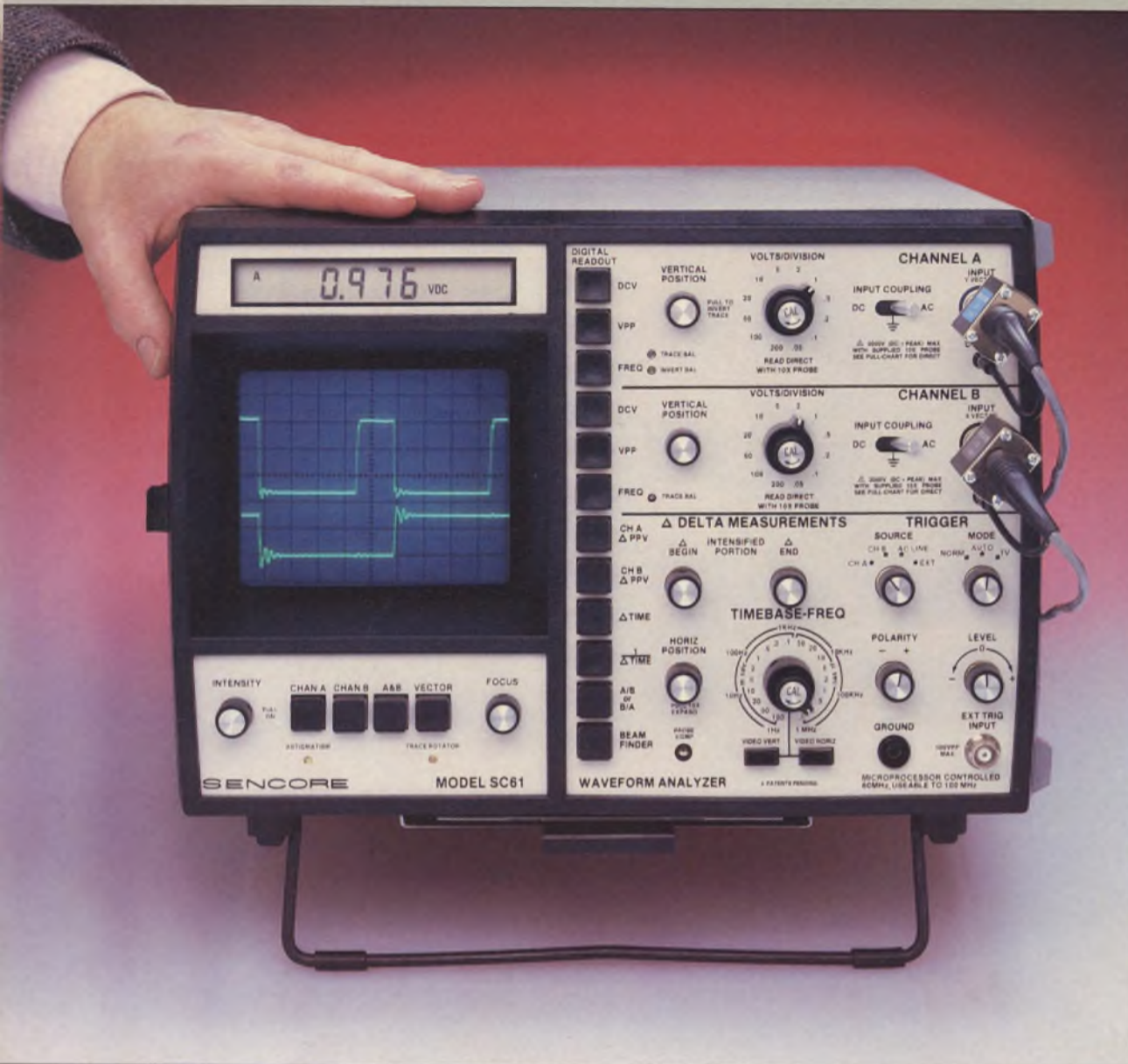

## Meet The Triple Patented SC61 Waveform Analyzer

- 60 MHz high performance scope that will put confidence back into your waveform measuring.
- 100% automatic AUTO-TRACKING™ digital read-out of all key waveform parameters at just the push of a button.
- Faster, more accurate, easier than you ever dreamed possible.
- Rock solid sync eliminates frustrating fiddling with complicated controls.
- 4 times the measuring capability of any conventional scope for true peace of mind.
- Plus many extra, exclusive high performance features that will save you time.

## SC61 Waveform Analyzer

**\$3295 Patented** U.S. Funds

On GSA Contract  
NSN 6625-01-169-2318



**"I've used about every scope on the market at one time or another and I've got to say the SC61 is the easiest and fastest of them all."**

**Kerry L. Haught**  
Audio/Visual and Video Repair  
Mentor, OH

At first glance the SC61 Waveform Analyzer may look like an ordinary conventional oscilloscope: high performance, dual trace, 60 MHz bandwidth (usable to 100 MHz). But when you pick up the probe and connect to a test point, that's when the SC61's special ECL sync circuits and auto-tracking digital readout begin working for you to save you valuable time and effort.

There are other scopes on the market that have digital readouts, but none of them have completely eliminated graticule counting, interpretation and extra lead hook ups. The SC61 was designed to integrate the features of a high performance scope with exclusive sync circuits and digital display to give you automatic, rock solid measurements through one probe. You simply hook up the probe to the circuit, then view the locked in waveform on the CRT. To read DC voltage, peak-to-peak voltage, and frequency of the waveform you simply push a button and read it directly on the auto-ranged LCD digital display — all through one probe, and without interpretation. It obsoletes other scopes like the calculator obsoleted the slide rule.

The SC61 Waveform Analyzer also gives you exclusive DELTA functions that allow you to analyze any part of a waveform in just seconds. Measure peak amplitude of part of a waveform, time of an event, or frequency of part of the waveform. Now you can easily locate the source of ripple on DC supplies, catch the frequency of a small glitch, or check the duty cycle on a digital waveform. Just lock in the waveform on the CRT, and adjust the DELTA BEGIN and DELTA END to intensify

the portion of the waveform you need to analyze. Then simply push a button and read out the corresponding peak-to-peak voltage, time or frequency. It makes troubleshooting defective waveforms easy, so you can locate the problem circuit quickly.

**It's high performance.** The SC61 gives you 60 MHz usable to 100 MHz bandwidth to troubleshoot even the latest digital circuits. The SC61 also gives you dual delayed signal trace so you can see the leading edge of the waveform on both channels. You can also add, subtract or view both channels separately.

**It's digitally accurate.** The SC61 Waveform Analyzer eliminates inaccurate and frustrating graticule counting. The internal microprocessor monitors the signal that is applied to the CRT, and digitally tracks the important parameters you need. Peak-to-peak volts, DC volts and frequency. You get measurements that are 10 times more accurate than conventional scopes.

**Its waveforms are rock solid.** The SC61 Waveform Analyzer, with its special circuitry, has the ability to lock quickly onto waveforms all the way to 100 MHz. This has been achieved through exclusive ECL (emitter coupled logic) circuits in the front end and noise cancelling differential amplifiers throughout the sync circuits. The SC61 Waveform Analyzer provides "rock solid" sync that allows you more time to troubleshoot, and less time fiddling with the trigger control to lock in a waveform.

**It safely handles 4 times the signal level of any conventional scope.** Most conventional scopes are able to handle only up to 600 volts on their input circuitry. The SC61, however, provides you with 5mV to 2000 volts (protected to 3000 volts) measuring ability to give you the extra versatility you need. Perform high voltage measurements without worrying about overloading the front end and causing you additional expense and down time.

**Plus many extra high performance features.** Post deflection, high intensity, blue phosphor 8 X 10 cm CRT provides easy-to-view trace, even under high ambient lighting conditions. • IEEE488 Bus Compatible. • Push button X-Y vector display with 4 MHz response for accurate phase comparisons. • Z-Axis input. • Beam finder. • TV Vertical and TV Horizontal video preset positions with sync separators.





# FS74 CHANNELIZER SR.™ TV-RF Signal Analyzer

**New**



- All Channel (Cable, HRC, ICC, VHF, UHF, FM) Digital Tuner And LCD Channel Readout
- Exclusive 5 Microvolt Sensitivity On All Channels With Autoranged Attenuator
- Exclusive, Automatic Or Manual Fine Tuning With Off-Channel Frequency Readout
- Exclusive, Automatic Hum And (Patented) Signal-to-Noise Tests On Any In-Use Channel
- Exclusive Picture Quality Check With Integrated Wide Band Monitor
- Exclusive ACV/DCV Measurements Through RF Input Or Special DVM Input

## FS74 CHANNELIZER SR. TV-RF Signal Analyzer \$3495 Patented U.S. Funds

On GSA Contract

**Now, locate any problem in any CATV, SMATV or RF distribution system quickly and accurately, plus test to full FCC specifications.** The FS74 gives you every test you'll need to FCC specifications. RF level, Signal-to-Noise, Audio/Video separation and Hum tests are performed 100% automatically. Plus, the FS74 has an exclusive wide-band monitor that allows you to see system problems and trace them to their source.

**Tune in all cable, off-air and FM channels with digital ease and accuracy.** The FS74's digital tuner lets you tune in all sub-band, cable, VHF, UHF, and FM frequencies that range from 5MHz to 890MHz. The FS74 also gives you a special AFT that locks onto the exact carrier frequency and displays the amount of offset to 1kHz resolution. HRC and ICC offset lets you track cable system shifts at the flip of a switch.

**Super sensitivity brings in the weakest signals with 100% automatic attenuators.** The FS74 gives you 5

**Finally You Can Thoroughly Analyze And Pinpoint Any RF Video Trouble In Any RF Video Distribution System - Accurately And Automatically - In 1/2 The Time.**

microvolt sensitivity that allows you to troubleshoot back to the head-end or antenna. The RF input is fully autoranged. The FS74 automatically selects the proper attenuator range so you can measure signal level instantly, from -46 dBmV to +60 dBmV.

**Microprocessor control makes all performance tests fast and simple.** Exclusive microprocessor technology allows all tests to be performed on any in-use channel without removing or decreasing modulation, or adding special carriers. A patented signal-to-noise test automatically compares the signal level to the actual in-channel noise level. Making audio-to-video level tests are simple. The FS74 automatically tunes both carriers and automatically reads out the separation in dB. Hum tests are made directly also, another Sencore exclusive.

**Exclusive built-in wide band monitor gives you picture quality checks anytime, anywhere.** The FS74's integral

wide-band monitor lets you see tough system problems like ghosting and interference and track them quickly to their source. Just turn on the monitor and view any channel in full detail. The 4 MHz bandwidth means you can isolate problems that would go unnoticed on a portable TV.

**Built-in autoranging AC/DC voltmeter and ohmmeter means you'll never be caught short.** Your troubleshooting edge is enhanced with AC and DC voltage measurements and a special low range ohmmeter right at your fingertips. Plus, measure up to 200 volts AC or DC right through RF input!

We guarantee the FS74 will cut your RF distribution System servicing time, or your money back. Call **1-800-843-3338** and locate system problems faster than you imagined possible.

# FS73 CHANNELIZER JR.™ TV-RF Performance Tester



**Make Difficult Performance Tests In Any RF Distribution System 100% Automatically**

- NEW All Channel Digital Tuner
- NEW Exclusive 5 Microvolt Sensitivity And Automatic Attenuator/Ranging
- NEW Automatic Microprocessor Controlled:
  - Fine tuning with readout of frequency off channel
  - HRC and ICC cable system shifts
  - On-channel Signal-to-Noise test

- Audio-to-Video carrier ratio test
- Hum test on any in-use channel

## FS73 CHANNELIZER JR. TV-RF Performance Tester \$2395 Patented U.S. Funds

On GSA Contract

**New**



**Now You Can Completely Performance Test Every Single TV Channel, In Any RF Distribution System, To FCC Specifications, 100% Automatically And 100% Faster Than Ever Before.**

**Discover fully automated performance tests on all channels to FCC specifications.** The FS73 CHANNELIZER JR. gives you the same performance tests that its big brother, the FS74, offers you. RF

level, Signal-to-Noise, Audio/Video separation and Hum tests are performed 100% automatically on any channel. No more tuning to unused carriers for your performance tests.

**Super sensitivity and digital tuning make performance tests quick and easy.** Measure from -46dBmV to +60dBmV with autoranged attenuators; eliminates error prone "attenuator pads." Plus, you can test all channels from 5MHz to 890MHz.

**Automate your system tests.** A special IEEE 488 interface allows you to computer control your performance test for remote and long-term monitoring with the optional IB72 interface accessory.

# CR70 "BEAM BUILDER"™ Universal CRT Analyzer and Restorer

For The First Time Ever . . . Test Every CRT On The Market—Now And In The Future—Plus Restore 90% Of All Weak Or Shorted CRTs . . . Or Your Money Back. (Includes Color/B & W TVs, Scopes, Computer Displays, Camera Tubes And More.)

- Guaranteed To Test Every CRT (Old Or New)
- Guaranteed Dynamic Tests You Can Trust
- Guaranteed To Safely Restore 9 Out Of 10 Weak Or Shorted CRTs
- Guaranteed To Be Totally Protected From Damage From Charged CRTs

## CR70 "BEAM BUILDER"™ Universal CRT Analyzer and Restorer

\$1295 Patented U.S. Funds

NSN 6625-01-187-4395

*"The CR70 is a great instrument and has saved us money on camera tubes."*

**Eddie H. Sills**  
Chief Engineer (Maintenance)  
Roswell, New Mexico



**Stop wasting valuable time and profits by replacing CRTs.** Today's electronics in the latest TVs are getting more and more reliable, but there is still one area of the TV that is guaranteed to fail, the CRT. However, most CRTs that do fail can be successfully restored with a reliable restoring system. The CR70 gives you the most reliable system anywhere that allows you to restore tubes that you would otherwise replace. The CR70 is a breakthrough in CRT restoration, here's why . . .

**Test every CRT on the market.** The CR70's unique selectable switches, universal adaptor and its wide restoration current range allows you to test every type of CRT in use today.

- All B & W and Color Video CRTs
- Projection CRTs
- Computer Display CRTs
- Closed Circuit Video CRTs
- Camera pickup tubes - broadcast, industrial and surveillance
- Even scope, radar and other industrial CRTs

**You'll never have to buy another socket again.** There are thousands of different types of CRTs that are being used today, and with them comes a lot of different socket configurations. However, most of the CRTs use one of ten basic designs in their socket basings. The pins might change position, but the general design stays the same. The CR70 takes advantage of this fact by allowing you to select the pin configuration with switches, rather than having to buy a new socket. Simply connect the socket that fits the neck, and select the grids, filaments and cathode with the selectable switches. If you do run across an "oddball" CRT, the CR70 gives you a universal adaptor that allows you to connect and test those non-standard CRTs.

**Dynamic tests you can trust.** The CR70 tests the CRT over its entire operating range, from black (cutoff) to white. It's the only tester that does. The CR70 tests emission as "true beam current" (current that passes through the control grid to the screen grid). Plus, its exclusive cutoff test accurately identifies CRT problems related to bad contrast that other testers miss. A patented color tracking test gives a direct good/bad

comparison of all three guns of a color CRT or all three CRTs of a projection system to confirm they will balance properly for any color or B & W picture. The CR70 also tests for shorted elements.

**Restore CRTs safely and effectively.** Many technicians know what a conventional CRT rejuvenator can do to a CRT. Most of the time it's "push the button and pray." The CR70's exclusive controlled current system means you never again have to worry about losing a CRT again by zapping it too hard. The CR70 is guaranteed to restore 9 out of 10 weak or shorted CRTs. This saves you thousands of dollars by extending the life of the CRT compared to replacing the CRT, or by restoring a CRT that is no longer available. Only the CR70's progressive restoration gives you this ability.

**Full protection from overload damage.** Many CRT testers are damaged by the high voltages left on the CRT. The CR70 is fully protected, however, to eliminate the possibility of this with special MOVs (metal oxide varistors).

## CG25 Little Huey™ Portable, Digital Color Bar Generator

Rock-Solid Patterns In A Pocket Size Generator

- Push Button Ease—Caddy Size
- Jitter Free Patterns
- Battery Saving Shutoff
- Test Leads Built In

CG25 Little Huey \$198 U.S. Funds

**Rock-solid digital patterns:** Just push the buttons for jitter-free standard color bars, horizontal and vertical lines, crosshatch, and white dot patterns.

**Built rugged for field use:** Lasts and lasts on the road with tough acrylic case.

**Big generator features:** Dot size, color level, and RF channel controls just like the deluxe generators.



# FC71 Portable 10 Hz To 1 GHz Frequency Counter™



- 10 Hz - 1 GHz Portable Frequency Counter
- Five Times More Accurate Than FCC Requirements Even On The Toughest Job; 0.5 Parts Per Million
- Exclusive Microprocessor Time Base For Super Stability From -12°F to 122°F
- Measures All Signals, Even Complex And Noisy Signals, With Exclusive Sensitivity Control
- Super 5 mV Average Sensitivity Over Full Range
- Automatic Crystal Check Tests The Fundamental Frequency Of Any Crystal
- Frequency Ratio Compares Two Frequencies And Displays The Ratio Directly
- Double Shielded For Interference Free Frequency Measurements Anywhere
- Automatic Readings When Used With IEEE 488 Computer Interface

**FC71 Portable 10 Hz To 1 GHz Frequency Counter**  
**\$1295 Patented** U.S. Funds

NSN 6625-01-076-2695



**FC71 Frequency Counter—The Only Portable Counter Especially Designed With An Exclusive Microprocessor Controlled Timebase To Measure 10 Hz To 1 GHz To 0.5 PPM Accuracy In High RF Environments**

*The only truly portable 1 GHz counter that makes every reading better than FCC requirements.* The FC71 uses a unique, new, microprocessor-controlled timebase. This patented counter provides (0.5 ppm/yr aging) from 10 Hz to 1 GHz. With the 8 1/2 digit LCD display, you get superior accuracy on the high end while allowing .01 Hz resolution for low end and audio work.

Since there is no power robbing oven, the FC71 gives nine hours of continuous operation. Take it wherever it's needed: broadcast towers for FCC documentation, repeater sites for troubleshooting, or airplane cockpits for avionics tests.

*The most sensitive frequency counter available allows you to count signals other counters miss.* The FC71's 5 mV input sensitivity lets you count signals in more circuits than with any other counter - without external amplifiers. It will even measure the output of RF

generators and communications monitors that can't be tested with other counters.

*The highest stability available lets you count the toughest signals.* The FC71 is guaranteed to be the most stable counter you can buy. Its uniquely designed input circuits allow you to count signals that are otherwise unmeasurable. Signals like AM or FM, digital signals with ringing, or signals with noise. The FC71's stability means you never have to guess at frequencies again.

*Fully RF shielded so you can measure anywhere, even in high RF fields.* With most counters, you cannot make measurements near a broadcast or 2-way transmitter because the counter picks up the transmitter signal through the case. The FC71's double shielding lets you measure signals in RF fields that are impossible to measure with other counters.

*Additional tests make the FC71 more than a counter.* An exclusive frequency-ratio test simplifies troubleshooting in digital and RF multiplier and divide circuits. Simply measure the input, press the frequency store button, measure the output, and push the ratio read button to find the exact ratio. The FC71 also has a unique crystal test to check any crystal at its fundamental operating frequency to eliminate guesswork in oscillator repairs.

*IEEE 488 instrument bus interface automates the FC71 for extended tests.* Sencore's optional universal IEEE interface, the IB72, allows you to use the FC71 with a computer for automated testing and data collection. Perform system stability tests over long periods of time, or document frequencies in quality control tests.

## TF46 Portable Super Cricket™ Portable Transistor/FET Tester



**Test Any Transistor Or FET With 99% Reliability In Less Than 15 Seconds—In Or Out Of Circuit**

- Needs No Set-up Book Or Instructions
- Patented In-Circuit "go/no-go" Transistor/FET Test
- Now More Automatic Than Ever, Identifies Transistor Leads
- Portable Operation With Auto Shut Off To Save Your Batteries.
- Tests All Possible Leakage Paths
- Dynamic Gain Test

NSN 6625-01-058-9564

**TF46 Portable Super Cricket Portable Transistor/FET Tester \$495 Patented**

U.S. Funds

*Instantly test any transistor or FET without set-up books.* The TF46 is the latest in a long line of "cricket" testers that gives you a patented "good" or "bad" test in or out of circuit. The TF46 is completely automatic, simply hook up the three leads in any configuration, and the TF46 tells you if the device is good or bad with an audible chirp, and on the meter. It also identifies the transistor's base, emitter and collector, or the FET's gate, drain and source.

*Test for gain at the push of a button to match transistors and speed troubleshooting.* The TF46 also allows you to test for leakage on transistors that show good gain, but have leaky collector-to-base or collector-to-emitter junction. Plus it has a diode test too, for more versatility.

**Trademarks of Sencore, Inc.:** Little Huey, Super Cricket, MICRORANGER®, POWERITE®, Waveform Analyzer, AUTOTRACKING, BEAM BUILDER, CHANNELIZER JR., CHANNELIZER SR., PORTA-Z, AUTO-Z.

**Pricing Note:** All prices shown are U.S. dollars. Canada must add applicable Duty, Freight, and F.S.T. Prices and specifications subject to change without notice.

**Call WATS Free 1-800-843-3338**

# VA62 Video Analyzing Package



## The Only NTSC Video Servicing System Guaranteed To Cut Your Servicing Time By 54% Or Your Money Back.\*

### Isolate Video Troubles In Half The Time With The Only Universal Video Analyzer.

- Identify tuner problems with all-channel, VHF, UHF, and cable RF generator.
- Pinpoint IF troubles with modulated trouble-shooting signal and exclusive programmable IF generator.
- Isolate any trouble with patented video and standard color-bar patterns.
- Find defective stages, without disconnecting parts, with exclusive phase-locked drive signals.
- Test yokes and flybacks plus measure signal levels with autoranged digital meter.
- It's obsolete proof; update for new technology with exclusive phase-locked accessories.

### VA62 Universal Video Analyzer \$3495 Patented U.S. Funds

On GSA Contract  
NSN 6625-01-187-5516

\* Based on a nationwide survey of users who reported an average time savings of 54% compared to their previous test equipment.

The VA62 Universal Video Analyzer is the only system that equips you for successful servicing in the expanding video market. It ends expensive parts substitution (especially when working with large-scale ICs) and eliminates embarrassing, costly callbacks by allowing you to quickly, confidently, and dynamically check every repair.

**Eliminate aggravating tuner questions.** The all-channel VA62 gives you the confidence of complete RF testing. The "Standard TV" generator produces every VHF and UHF channel, the "Standard Cable" generator every cable channel and "Programmable Cable" function lets you duplicate any cable carrier shift to test lock in range.

**Dynamically isolate IF troubles quickly and easily.** The VA62 isolates any IF trouble with a fully modulated, crystal referenced 45.75 MHz IF signal, matched to inject into any IF stage. Both video and audio modulation identify any trouble. It's a real troubleshooting confidence builder.

Patented signals let you set IF traps—a must for cable—by simply looking at the CRT. Plus, the VA62 lets you do full IF alignments without confusing cables or complicated adjustments.

**Isolate troubles without disconnecting a single component with VA62 drive signals.** No need to unsolder components because the VA62's output circuits automatically "swamp out" the original signal before injecting the substitute signal. These special

signals let you troubleshoot any video or sync stage, as well as vertical or horizontal circuits. Separate drive outputs allow simultaneous injection into the tricky closed-loop servo circuits or color oscillators.

### Digital Meters Add Confidence:

**Ringin Test:** The digital meter makes the VA62 a complete analyzer. Start by testing deflection yokes and flyback transformers, in-or out-of-circuit, with Sencore's reliable (patented) good/bad ringin test.

**Drive Level Monitor:** Internal monitoring measures the true peak-to-peak level of any drive signal to prevent overdriving and to show when feeding into a shorted component.

**Peak-to-peak and DC Meter:** Autoranged external meter includes peak-to-peak and DC to a full 2 kV. Compare peak-to-peak and DC directly to the schematic.

**DC Power Supply:** The 0 to 35 volt DC power supply blocks confusing feedback loops in AGC, AFT, ACC or servo circuits or isolates problems in direct coupled (DC) circuits, such as vertical amplifiers.

**Integrate phase-locked accessories into your video analyzing system to increase your service potential.** The accessory jack and the composite video output let you add new technology as you need it. Phase-locking means the accessory signal returns to full sync when used with the other VA62 signals.

## VC63 VCR Test Accessory™

Add The Effectiveness Of Signal Substitution To VCR Circuits.

Find defective heads without expensive substitution in VHS, Beta, and U-Matic VCR formats. Plus, pinpoint defective stages with exclusive substitution signal and troubleshoot color problems with special reference signal.

**VC63 \$495**

## NT64 NTSC Pattern Generator™

Produces the EIA RS 189 standard full-field and split-field color bar patterns that meet all VCR manufacturer's requirements for a color bar generator. These two patterns are fully phase-locked to all other VA62 signals. The NT64 is one-fifth the cost of competitive stand alone NTSC generators.

**NT64 \$495**

## ST65 Video Analyzer Stereo TV Adder™

Update your VA48 or VA62 Video Analyzer to an integrated Multichannel Television Sound (MTS) Stereo TV analyzing system. The ST65 makes stereo and second audio program (SAP) performance tests on any MTS stereo TV system. Exclusive adjustable RF/IF, COMPOSITE SIGNAL, and AUDIO levels match and isolate troubles in any stage — including the decoder. It's the only tester guaranteed to tie troubles down to any and all stages.

**ST65 Video Analyzer Stereo TV Adder \$995 Patent Pending**

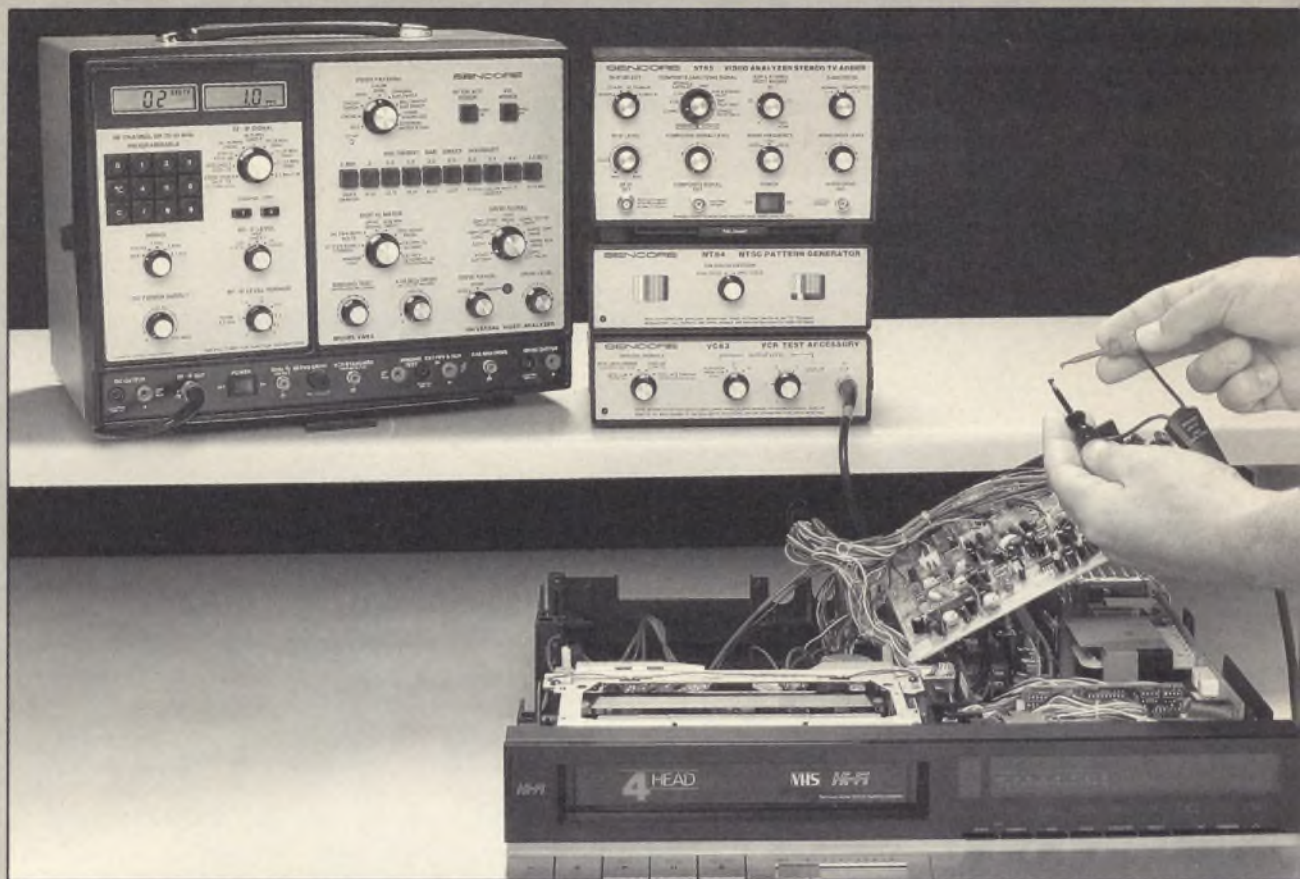

## RG67 NTSC Video Monitor Adaptor

Updates Your VA48 or VA62 Video Analyzer — Helps You Expand Into Analog/Digital Monitor Service.

The RG67 provides phase-locked R, G, B, and I signals to drive any NTSC analog or digital monitor. Match any input with selectable signal and sync polarity and adjustable amplitude to 5 VPP. Fast hookup to R, G, B and I inputs with E-Z HOOK® leads.

**RG67 \$890**



## ST66 Stereo TV Analyzer™

The Only Complete Analyzer For MTS Compatible Stereo TV.

The ST66 is a complete MTS stereo TV and VCR analyzer that provides all of the special signals you need to successfully service MTS stereo TV from the antenna to the speakers with one simple connection. It has exclusive video patterns for total analysis and variable pilots for threshold testing. Plus it's portable—works two hours continuous on one battery charge.

**ST66 Stereo TV Analyzer \$1395 Patent Pending**

## SR68 Stereo TV Readout™

Dual Meters And Loads To 100 Watts Solve Stereo Servicing Challenges.

Analyze stereo TV Audio Line or speakers in dB or watts. Loads to 100 watts provide dynamic testing and speaker substitution. Automatic channel separation measurements to -40 dB without calculations. The SR68 is battery operated—use in the shop or in the field.

**SR68 Stereo TV Readout \$595**

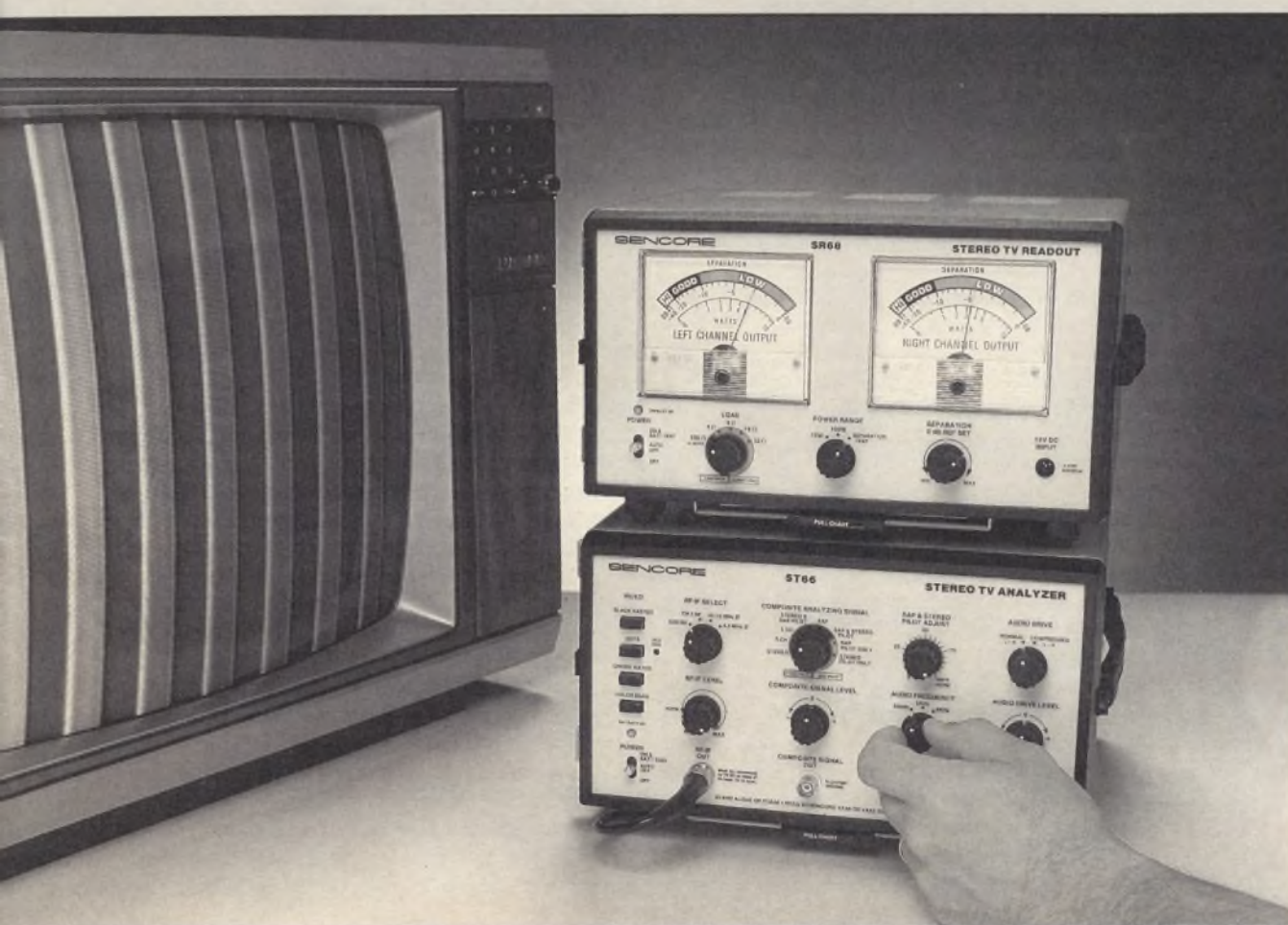

# PR57 "POWERITE"®

Variable Isolation Transformer And Safety Analyzer

**Avoid Embarrassment And Risk—Know Beyond A Doubt That Your AC Power (And The Equipment You Service) Is Right And Safe**

The PR57 "POWERITE" lets you know your AC power is right and includes a variable isolated 470 Watt power transformer to isolate your AC line and vary the output voltage from 0 to 150 volts. You'll monitor voltage, current, and wattage to prove that the equipment under test isn't drawing too much current at any voltage setting.

**Variable output supply is isolated for your protection.** The "POWERITE" 470 Watt AC variable output transformer provides a continuously variable output voltage from 0 to 150 volts; a must for troubleshooting shutdown circuits. It protects you and your test equipment from shocking overloads by isolating you (and the equipment under test) from the AC line.

**Solve challenging shutdown problems and eliminate callbacks.** Lower the line voltage to solve tough shutdown problems. Raise the line voltage to sweat out intermittents or sensitive parts. Test every

**Five Ways You Can Make Sure Your Power Is Right With A "POWERITE"®**

- It's an isolation transformer.
- It's a variable AC supply.
- It's a power line monitor.
- It's an amp/watt meter.
- It's a safety leakage tester.

**PR57 "POWERITE"®**  
**\$495 Patented** U.S. Funds

NSN 6625-01-124-6296

set at high or low line voltage to avoid embarrassing callbacks. Identify AC line related problems like picture width, sync, and intermittents in the customer's home or test in the shop at their line voltage.

**Safety leakage test means safe repairs and additional profits.** Safety checks for current leakage are



easy with the PR57's patented tests. Leakage tests are now required from all manufacturers, and you decrease your liability and increase your profits when you perform this test. Since it's a service you offer, you can charge \$3 - \$5 to perform the test, and make a profit on a quick, but vital test.

# DVM37 3 1/2 Digit, 0.1% Bench/Portable Digital Multimeter™

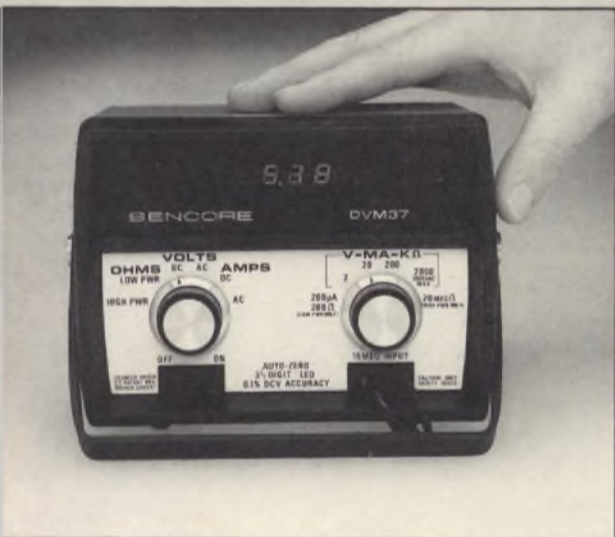

**For Confidence And Success In Troubleshooting, You Need A DVM That Holds Lab Accuracy Under The Most Rugged Conditions.**

**One super rugged digital voltmeter for every use.** If you like to use one meter and use it everywhere and anywhere, you'll want the super, reliable DVM37. You can drop it, kick it, carry it by the test leads, and it will keep right on operating at lab accuracy.

**Fully protected inside.** Unheard of 8 kV transient protection on every function and range, including ohms means unmatched internal protection.

**0.1% DCV accuracy into 15 Megohm input.** 15 Megohm input impedance means 50% less loading than other meters with 10 Megohm input impedance. Therefore, you get 50% greater accuracy than other 0.1% DVMs.

- Automatic .1% accurate DVM for bench or field for measurements you can count on.
- 15 Megohm input impedance for least loading and error, especially in high impedance circuits.
- Protected inside, too, better than any other DVM on the market, to 2 kV DC with 8 kV transient protection and to 10 kV with TP212 probe.
- An Indestructible DVM For Both Bench And Field

**DVM37 3 1/2 Digit, 0.1% Bench/Portable Digital Voltmeter**  
**\$395** U.S. Funds

# DVM56A "MICRORANGER"® Digital Voltmeter



**DVM56A: The Most Versatile Time Saving Bench DVM You Will Ever Own.**

- 100% Automatic, designed to save you time; simply touch and test and "MICRORANGER"® does the rest.
- Lab Accuracy - .075% 4 1/2 digit with 15 Megohm Input Impedance
- Versatile - 16 Microprocessor Controlled Measuring Ranges
- Tough - Fully protected to 7.5 kV overload and RF interference free.

**DVM56A "MICRORANGER"®**  
**Digital Voltmeter \$995 Patented** U.S. Funds

**The most versatile meter on the market.** If you want the best, then the DVM56A "MICRORANGER" is the meter for you. The DVM56A gives you all the tests you'd ever want to perform with a DVM. The internal microprocessor automatically ranges the "MICRORANGER", and gives you these exclusive tests:

- AC and DC current up to 20 amps with the optional CS233 current shunt
- High and low power resistance
- .075% accurate DC to 10 kV
- AC Volts peak-to-peak
- AC Volts true RMS
- AC Volts average RMS
- dBm and programmable dB

**Super accuracy and error-free readings every time.**

4 1/2 digit readout with .075% DCV accuracy. 15 Megohm input impedance means less loading and more accurate tests. Microprocessor control means no errors.

# Are You Looking For Success In Electronic Servicing?

## Here's How Sencore Can Help You Attain Your Goals For A Successful Servicing Future

For over 37 years, Sencore has been dedicated to just one goal - making you more successful in Electronic Servicing. You see, we realize that your success truly will mean a successful future for Sencore as well.

When you say "yes" to Sencore, you're saying "yes" to good old American ingenuity at its finest. With 93% of Sencore's product line holding at least one patent, you're assured of exclusive, time-saving, money-making features not available anywhere else. Sencore instruments are designed by practical troubleshooting pros - for practical troubleshooting pros. That's why you can count on Sencore for test equipment that saves you that all-important analyzing time.

Sencore's engineers know that every time you have to fiddle with a knob, connect and reconnect leads, or come up with an inconclusive or misleading test result, it costs you dearly. That's why as you review the Sencore product line, you'll notice that each Sencore instrument has a fresh, uncluttered, easy-to-use look. Computer aided design and manufacturing puts the complex electronics on the inside to help keep your operation simplified on the outside.

Your service after the sale is second to none in any industry. Our standard 72-hour turn-around on service repairs and 48 hours on parts, means maximum up-time and productivity from each instrument. Plus, since our Engineering, Service, and Quality Assurance organizations are under one roof, your serviced instrument is renovated to better-than-new performance with the latest engineering updates; is refurbished to like-new appearance; and undergoes final aging and quality checks just like our new units - all at no extra cost. Best of all, you can be sure your serviced instrument is right on

specifications, as each unit is calibrated against Sencore's NBS traceable Prime Standards Laboratory.

Sencore's industry exclusive Sencore News, Application Bulletins, Field Workshops, and helpful Application Engineers guarantee that you'll be getting the most from your investment. Our newly added, state-of-the-art video production studio will even add a new dimension to your after the sale application support, with both operation and training tapes. Our obligation and support is just beginning, instead of ending, when you say "yes" to test equipment from Sencore. You're not investing in just an instrument; you're investing in your own piece of an entire organization dedicated to making you more successful.

The same WATS Free success number, 1-800-843-3338, that connects you to a fast, friendly Sales Engineer, also connects you to our Application Engineers for technical consultation, Service Technicians for quick field repair tips, and our Telemarketing Engineers for after the sale follow through - all at no added expense to you. You simply need to pick up the phone and ask.

Only Sencore offers you a 100% Made Right Lifetime Guarantee. This exclusive Buyer Protection Plan assures you that your unit was engineered and manufactured right the first time - or we'll make it right - for the lifetime of the instrument, at no cost to you. It even guards your instruments for a lifetime against rusting out - so plan on profiting from your Sencore investment for a long time.

Finally, Sencore's no nonsense 30 Day Money Back Guarantee assures you that you've made the right choice. Simply stated - if you're not 100% satisfied with your Sencore instrument, return it for a full refund - including

freight both ways - and owe nothing. You're always sure that you've "bought right" when you say "yes" to a Sencore investment.

Start up the road to success right now, by calling us at 1-800-843-3338 and let us put you in your own Sencore Dream Shop.

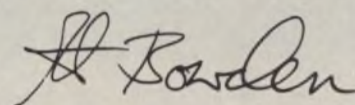

Al Bowden/President

### Special 6.9% Investment Plans Make Owning Your Sencore Instruments Easy!

Sencore is offering a special 6.9% "Pay As You Grow" Investment Plan for the 1988 New Year. \*With this exclusive plan, owning any Sencore instrument is easy!

This special low rate is being offered for a limited time only, so call WATS FREE 1-800-843-3338, and ask your Area Sales Engineer how to save big in 1988!

\* 6.9% rate good on 12 and 24 month contracts. Call for our other low rates!!

### Use this form to renew your Sencore News Subscription

The Sencore News is available to our customers at no cost if they own Sencore products. To qualify for a free Sencore News subscription, simply fill in below the instruments you own. If you do not own Sencore products, but wish to receive the News, you can qualify by indicating what Sencore instruments you will invest in during the next 12 months. If you do not plan on investing in Sencore instruments in the next 12 months, you can receive the News by enclosing \$20.00 with this form.

MAIL TO: Sencore, Inc.  
ATTN: Promotion Dept.  
3200 Sencore Drive  
Sioux Falls, SD 57107

CUT HERE AND MAIL TODAY

CUT HERE AND MAIL TODAY

**YES**, I own these Sencore products, please send me my free subscription.

1. \_\_\_\_\_ Serial # \_\_\_\_\_
2. \_\_\_\_\_ Serial # \_\_\_\_\_
3. \_\_\_\_\_ Serial # \_\_\_\_\_

Additional: \_\_\_\_\_

**YES**, I plan on investing in the following Sencore instruments, please send me my free subscription. \_\_\_\_\_

This is the type of work I perform: \_\_\_\_\_

**YES**, I would like a subscription to the Sencore News, but I do not plan on investing in Sencore instruments in the next 12 months. Enclosed is \$20.00 for my 12 month subscription.

Please send me a current catalog.

1. Name \_\_\_\_\_  
Address \_\_\_\_\_  
City \_\_\_\_\_  
State \_\_\_\_\_ Zip \_\_\_\_\_  
Phone \_\_\_\_\_

2. Company \_\_\_\_\_  
Address \_\_\_\_\_  
City \_\_\_\_\_  
State \_\_\_\_\_ Zip \_\_\_\_\_  
Phone \_\_\_\_\_

Send my subscription to:  Address #1  Address #2

Please send an additional catalog to:  
Name \_\_\_\_\_  
Address \_\_\_\_\_  
City \_\_\_\_\_  
State \_\_\_\_\_ Zip \_\_\_\_\_

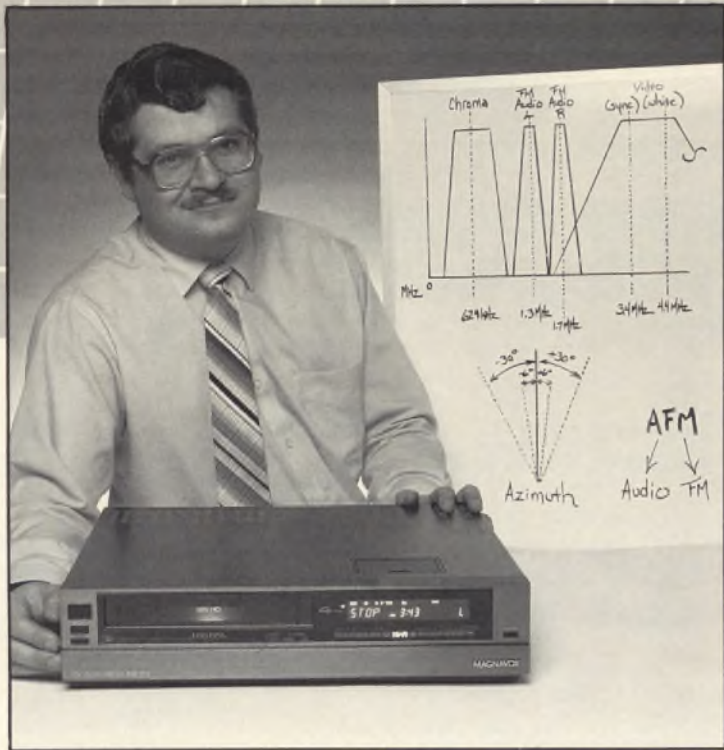

## Understanding VCR Hi-Fi Is Important To Your Success In Consumer Electronics Servicing.

by Paul Nies, Application Engineer

Tape Speed	Inches/Sec.	Freq. Response	Wow & Flutter
VCR: (SP)	1.3125	(-6dB) 50Hz - 8 kHz	0.2%
(LP)	0.6562	50Hz - 6 kHz	0.3%
(SLP)	0.4375	50Hz - 5 kHz	0.3%
Cassette Deck	1.8750	30Hz - 13kHz	0.07%

Fig. 1: Although a VCR and audio cassette use the same recording principles, VCR audio is much worse due to the slower tape speeds.

If you want good, "concert hall" sound, would you want to record the audio with a VCR? A conventional VCR? Let's face it, the VCR is for recording video, not audio. However, VCR sound technology has changed drastically with the introduction of Hi-Fi. In this article we'll take a look at the development of VCR audio, plus learn a few tips on how to keep a Hi-Fi VCR in top sounding condition.

### Audio Depends On The Tape Speed In A Conventional VCR

The luminance and chroma sections of a VCR have many special circuits and enhancements for the video signal. But, nothing special is designed into the conventional VCR

for audio recording. The same technique used in all basic audio recorders is simply plopped into the VCR - a single stationary head records and plays the signal as the tape passes by it.

Figure 1 shows how the sound from an audio cassette deck and conventional VCR compare. Notice how poorly the VCR compares in wow, flutter and frequency response. But, if the audio in a VCR is recorded by a stationary head, just like in an audio recorder, why is VCR audio so much worse? Look again at the tape speed column. Notice that wow and flutter gets worse at slower tape speeds. This is because wow and flutter is a measure of small speed variations compared to the overall tape speed. Small speed variations represent

a larger percentage of change at slower tape speeds. Also notice that the frequency response degrades as the tape speed slows. This is because the head-to-tape speed is a major factor in establishing the frequency response of a magnetic tape recording system; faster tape speeds mean better frequency response.

Head-to-tape speed was a problem that had to be solved before the first consumer VCRs were practical. To record the high video frequencies using conventional methods, the tape must move past the head at a rate of 19 feet-per-second. This isn't too practical, since 13 miles of tape would be needed for a 1 hour recording! A related problem was how to record 18 octaves of video information using a recording

system which has a practical limit of 9 octaves.

Do you remember how these problems are solved in the VCR? First, the video information is converted to an FM signal, which reduces the signal to less than 1 octave. This allows a flat response of the FM signal when the tape is played back. FM signals are also less affected by tape irregularities and signal amplitude variations, and have very good noise immunity. The second problem, the need for a head-to-tape speed of 19 ft/sec., is solved by spinning the video heads. Spinning the heads at 1800 RPM allows a slow tape speed of about 1 inch/second.

That takes us back to why conventional VCRs have such

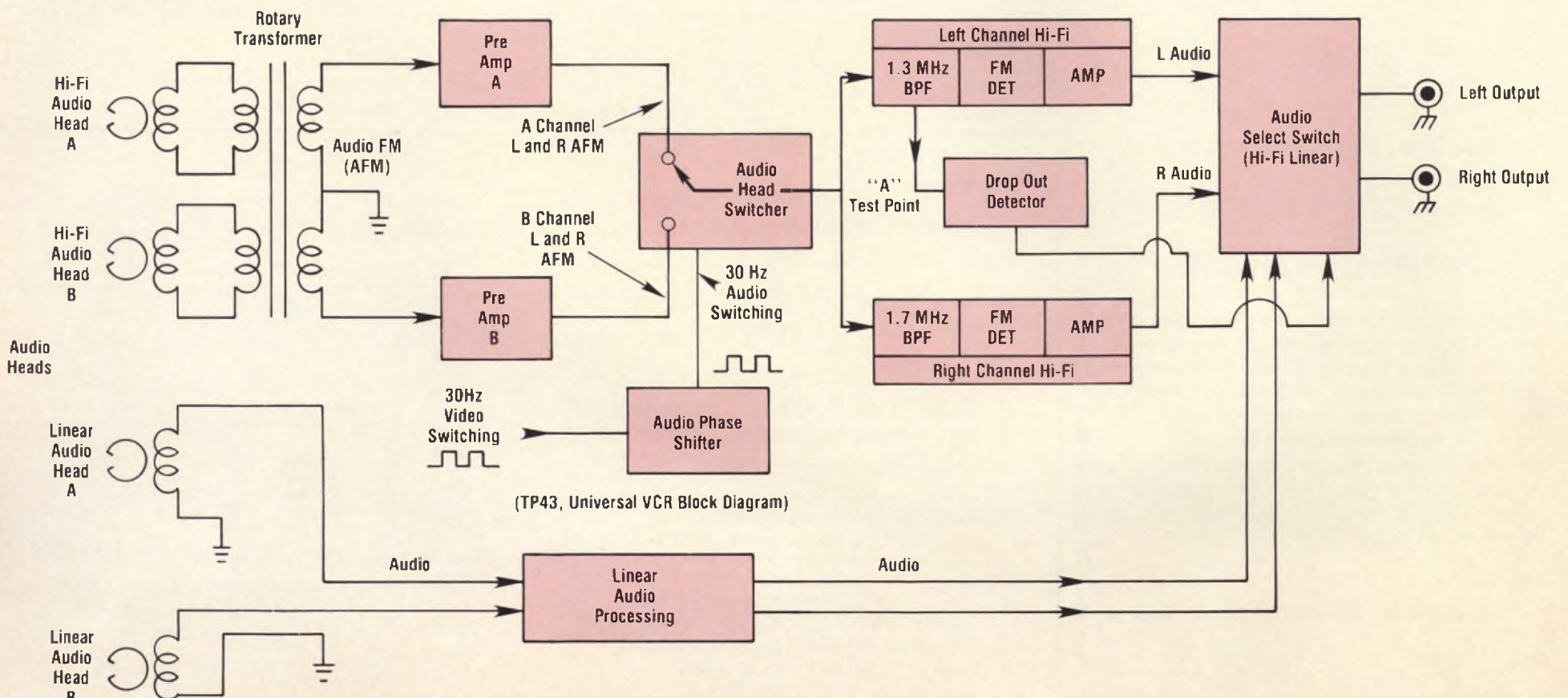

Fig. 2: The typical VHS Hi-Fi audio circuit includes two separate audio heads on the head cylinder, plus the two linear stereo audio heads.



terrible sound; slow tape speed. Conventional VCRs are optimized for long record/playback times at the sacrifice of audio. They aren't audio recorders, they are video recorders!

## Stereo Sound

The first improvement in VCR audio was stereo. Stereo VCRs add a second audio head (Stereo) for separate left and right audio tracks. An improvement yes, but the audio quality still depends on the tape moving slowly past a stationary head. All that a stereo VCR really accomplishes is to provide the same poor frequency response and wow and flutter of a conventional VCR, but now it is in stereo!

Stereo compatibility with mono machines is achieved the same way as it is in audio tape machines. The single, mono head is the same width as the combined width of the audio heads in a stereo machine. Thus, when playing a stereo tape, mono VCRs pick up both the left and the

## Tech Talk: Making A Hi-Fi Test Tape

A Hi-Fi test tape lets you check the operation of the Hi-Fi audio circuits, including the dropout compensator and Audio Select Switch. To be most useful, the audio should have two sections for each tape speed. In the first section put a dual audio tone on both the Hi-Fi and linear tracks. The dual tone allows you to check if both left and right channels are working by simply listening to the output. On the second section of the tape, use dual audio tones on the Hi-Fi track, and some other audio (music or voice) on the linear track. This will quickly tell you if the VCR switches to the linear track.

You can make a Hi-Fi test tape using a Hi-Fi VCR with an audio dub feature and your VA62, ST65 or ST66 (or 2 VA62's). Begin by connecting the VA62's "VCR OUTPUT" jack to the VCR's "Video In" jack. To make it

easier to find each section of tape, use a different video pattern for each tape speed and audio section.

Connect the VA62 AUDIO DRIVE output to the VCR's "Left Audio Input" through a resistive attenuation pad. Set the audio drive frequency to 333 Hz. Connect the AUDIO DRIVE output of the ST65 or ST66 to the VCR's "Right Audio Input" using a resistive attenuation pad. Set the audio drive frequency to 1 kHz.

The attenuation pad helps you set the audio level into the VCR much easier. Connect a 150 kilohm and a 47 kilohm resistor. Set the DRIVE LEVEL CONTROLS for 3 VPP (maximum clockwise rotation).

signal to the VCR input off the 47 kilohm resistor. set the DRIVE LEVEL CONTROLS for 3 VPP (maximum clockwise rotation).

Set the VCR to record the dual tones on both the Hi-Fi and linear tracks and record the entire audio section for each tape speed. After recording the dual tones on both tracks, go to the section of tape where you want to have different linear and Hi-Fi audio. Use the VCR's "audio dub" to re-record the linear track, while keeping the dual tones intact on the Hi-Fi track.

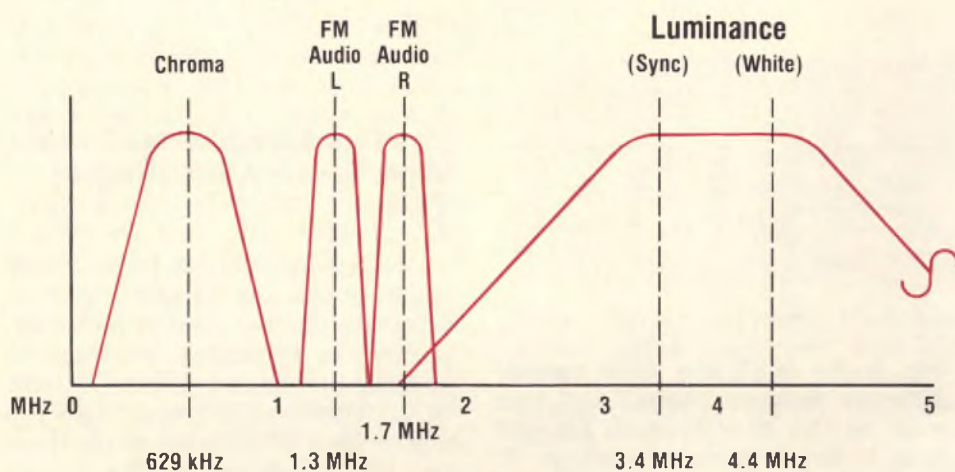
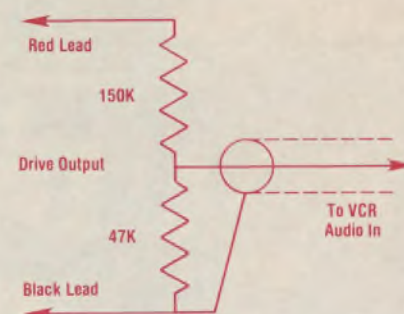

Fig. 3: The FM audio frequencies fall between the sidebands of the down-converted chroma and the FM luminance. Some of the AFM sidebands and FM luminance sidebands overlap, so VHS Hi-Fi must use head azimuth to keep the signals separate.

right track to produce L+R audio. Likewise, the audio track recorded by a mono machine is wide enough for both the left and right stereo heads to pick up during playback. The output is mono.

## Hi-Fi Stereo

The real improvement in VCR audio is Hi-Fi. VHS and Beta Hi-Fi systems got to the root of the audio problem, the slow head-to-tape speed. If spinning the video heads solved the video head-to-tape speed problem, why not spin the audio heads? That's exactly what Hi-Fi VCRs do. The audio heads are placed on the spinning head cylinder. In addition, both VHS and Beta Hi-Fi systems convert the audio to FM ("AFM") before recording to further optimize the sound potential.

## VHS Hi-Fi

A simple block diagram of the Hi-Fi portion of a VHS VCR is shown in Figure 2. VHS Hi-Fi uses two separate audio heads mounted on the head cylinder. Each audio head

records both left and right audio (AFM carriers) simultaneously. (L and R, not L+R). To keep the channels separate, the left audio carrier is centered at 1.3 MHz and the right audio at 1.7 MHz. This puts the Hi-Fi AFM signal between the down-converted chroma and FM luminance in the recorded frequency spectrum, as shown in Figure 3. In reality, the sidebands of the AFM overlap a bit with the sidebands of the luminance and the down converted chroma. Although the VHS Hi-Fi concept looks easy, the actual process is a bit more complex.

To begin with, the video tape is already filled up with the luminance and chroma signals, plus the linear audio and control tracks. The only place remaining to put the AFM signal is underneath the video signals. The audio is recorded first with the video information recorded on top. This is called "depth layer recording". Different track azimuths are used to keep the FM luminance, and FM audio separate for playback.

VCRs already use azimuth recording to prevent crosstalk between the A and B video tracks.

(Head A is tilted +6 degrees and head B is tilted -6 degrees). In VHS Hi-Fi, one audio head is tilted +30 degrees and the other -30 degrees. This azimuth difference keeps the luminance and audio separate, and prevents crosstalk.

Like the video heads, the audio heads must be switched on and off during playback. The audio heads are positioned on the head cylinder to contact the tape after the corresponding video head does. The 30 Hz video head switching pulses are delayed a small amount by the Audio Phase Shifter for the audio head switching pulses.

Incorrect audio head switching affects the audio, much like incorrect video head switching affects the picture. Incorrect audio head switching commonly results in the loss of Hi-Fi audio, or in noisy Hi-Fi audio.

VHS Hi-Fi VCRs have a dropout compensator which senses the absence of the AFM signal. If the AFM signal is missing, the Audio Select Switch selects linear audio for playback. Figure 4 shows the AFM signal at block diagram test point "A" when the audio head switching is properly adjusted. Note that the

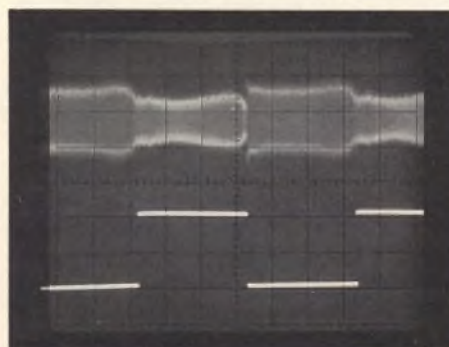

Fig. 4: When the audio head switching is correct, the AFM envelope is continuous, with no gap between the signal from the A head and the signal from the B head.

envelope is continuous, with no gap between the signal from head A and B. Figure 5 shows what happens when audio head switching is incorrect. Note the gap in the envelope between where the A head signal stops and the B head signal starts. The dropout compensator senses this signal loss and triggers the Audio Select Switch. If the dropout compensator is set incorrectly, and allows some of the dropout through, the Hi-Fi audio will sound "raspy".

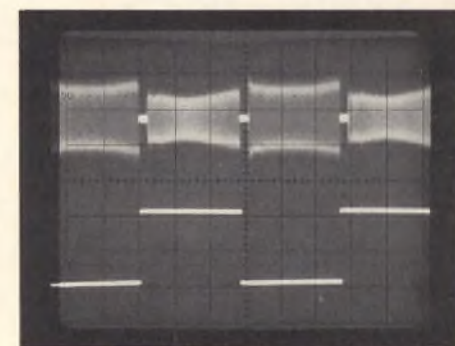

Fig. 5: Incorrect audio head switching causes the signal from one head to drop out before the other audio head picks up the signal. This results in no or poor Hi-Fi audio.

You can easily check the operation and setting of the dropout compensator. Begin by playing back a Hi-Fi alignment or test tape. (The "Tech Talk box" above explains how you can make a Hi-Fi test tape.) Set the VCR to play back the Hi-Fi track. Connect one of your SC61 scope probes to the output of the 30 Hz Audio Phase Shifter and trigger from this signal. Connect the other probe to test point "A" (the output of the audio head switcher).

Adjust the Audio Phase Shifter until a gap begins to appear in the AFM envelope. At this point, the dropout compensator should activate and switch to the linear

(Continued on page 27)



## Time-Saving Methods You Can Use To Successfully Test Integrated High Voltage Transformers With Your VA62 Universal Video Analyzer

by Brian Phelps, Application Engineer

**W**hat single component is replaced most often in the modern television set? Most servicers will suggest that it's the integrated high voltage transformer (IHVT), because the IHVT causes easily recognized symptoms like: no high voltage, mechanical squeal, noisy picture, shutdown, etc. Why does this particular component spell trouble for so many servicers? To answer this question, we'll review the ways IHVTs fail and then show how you can test them accurately and confidently. Let's begin by seeing how the IHVT differs from the familiar flyback transformer.

An IHVT is similar to the flybacks used in older TVs with an important exception: the IHVT includes the high voltage diodes, multiplier, and focus divider circuits. Like the familiar flyback, the IHVT is made up of primary and secondary windings on a common core. Secondary windings either step-up or step-down the flyback pulse to form the scan derived B+ and high voltage. For efficiency, the windings are wound tight and close together. The close coupling makes the operation of each low resistance winding dependent upon the other windings in the transformer. Just one shorted turn in any winding will affect the operation of all the other windings.

### Shorted Turns Are Common IHVT Failures

The shorted turn is probably the most common IHVT failure. The short can be one turn shorted to another or many turns shorted together. Even one shorted turn can reduce the efficiency of the IHVT and cause shutdown. Or, the effect of the short may cause easy to recognize damage to the IHVT, such as a cracked case or a melted or discolored housing. Internal heat from excess current in the shorted turn is the most likely cause of

failure. More often than not, however, the shorted turn causes no visible damage and you're left with the task of proving the IHVT good or bad.

**Shorts Between Windings Are Easy To Overlook:** Insulation failures (often caused by high internal heat) can cause a shorted turn in one winding, or may cause shorts between windings. Shorts can also develop between the winding and the transformer core or to ground. Although not the most common, shorts between windings are easy to overlook. That's why they have stumped some of the most experienced servicers!

### A Cracked Core Is Hard To Isolate

The IHVT core can be damaged in shipping or handling, stressed during installation, or may simply crack during operation. The result of a cracked core is lower voltage output levels (inefficiency). The set may show unusual and hard to recognize symptoms ranging from infrequent shutdown, to excessive horizontal output transistor failure. Unfortunately, hairline cracks in the core aren't easy to see. You'll only find this problem with a dynamic operational test of the IHVT.

### Open Windings May Cause Confusing Symptoms

When one of the IHVT's windings opens, you'll lose an important pulse or scan derived voltage. For most windings, this means the TV won't operate at all. In some chassis, however, an open winding may only affect one circuit (blanking, tuner, voltage regulator, etc.).

### The IHVT Includes High Voltage Diodes

The high voltage diodes, responsible for creating the second anode

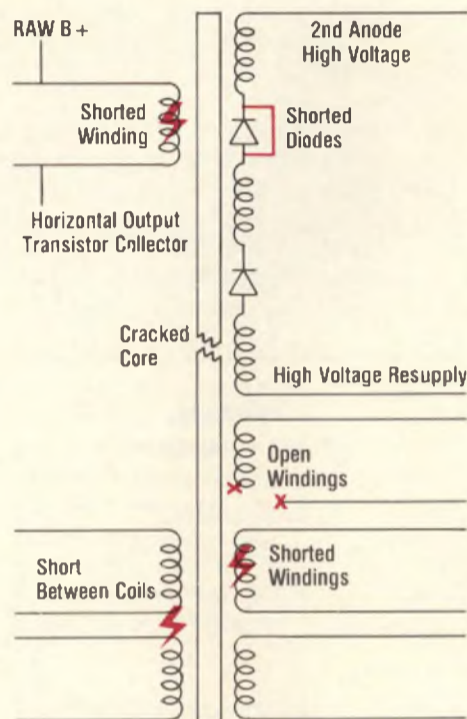

**Fig. 1: An IHVT can have several different failures occur, and you must test for all of them. 1. Shorted turn. 2. Short between windings. 3. Open windings. 4. Cracked core. 5. High voltage circuit problems.**

high voltage are included in the IHVT. These diodes can open, short, or become leaky. If the resulting high voltage is low, the picture may be dim or out of focus. Higher than normal voltage causes shutdown and can damage other components.

Once you suspect an IHVT, you need a way to prove that it's good (or bad) without swapping it with a known good one. You'll want to check for open windings, leakage between windings, cracked cores and shorted turns, plus you'll want to check those high voltage diodes, voltage multiplier and focus components. Proving whether it's good or bad saves troubleshooting time and parts costs, plus helps you keep IHVT inventory down. Your VA62 Universal Video Analyzer lets you test IHVTs without error.

### Dynamic VA62 Tests Let You Prove Whether IHVTs Are Good Or Bad

Why can't you simply check the IHVT with an ohmmeter? Because, aside from continuity checks, your ohmmeter will leave you guessing on IHVTs. Here's why: A shorted turn

represents only a few hundredths of an ohm difference in the coil's resistance, plus the high voltage diodes in the IHVT won't turn on with the voltage from your ohmmeter. To thoroughly test an IHVT, you'll need to check for shorted turns (RINGING TEST), and actually operate the IHVT to dynamically test the high voltage diodes, multiplier, and focus components (DRIVE TEST). Your VA62 provides both of these proven tests.

### You Can Find Shorted Turns With Your VA62's Ringing Test

The patented RINGING TEST shows if shorted turns are present (even one shorted turn) in either the primary or secondary windings. It includes a special IMPEDANCE MATCHING switch which lets you match the VA62's testing circuits to the IHVT you are testing. Here's how the test works:

The RINGING TEST pulses the primary winding and then counts the number of oscillations (rings) that occur before the ringing

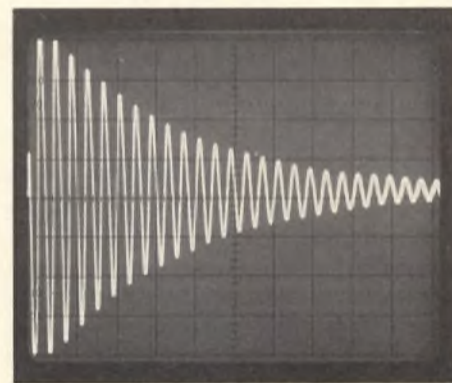

**Fig. 2: The ringing test pulses the primary winding and then counts the number of rings to a preset dampening point.**

waveform decays to 25% of the original level. Our engineers proved, in the laboratory and the field, that a good coil or IHVT rings 10 or more times and one with a shorted turn rings less than 10. This critical "Good/Bad" point has been further proven by thousands of servicers who routinely use the RINGING TEST in video troubleshooting.

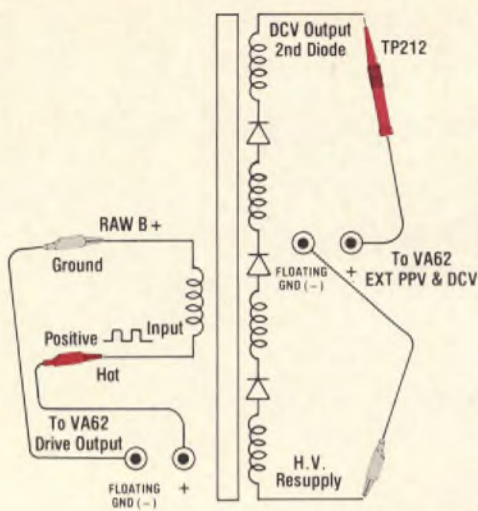

**Fig. 3: The drive test dynamically tests the IHVT by substituting for the horizontal pulse and measuring the DC voltage at the second anode lead.**

### You Can Test IHVTs Dynamically With VA62 Drive Signals

By driving the primary winding with a pulse similar to the horizontal output pulse, you can dynamically operate an IHVT to prove that the drive pulses are rectified and multiplied. A bad diode, winding, or cracked core will reduce the IHVTs output voltage. By selecting the same drive voltage each time you test an IHVT, you can compare known good IHVTs to the suspected bad one. Sencore Engineers performed these tests for you. The result is a table of voltages which tells you the output voltage to

expect from an IHVT under test (Table 1).

### You Can Save Time By Analyzing IHVTs In-Circuit

In-circuit testing can help you troubleshoot the TV. If when ringing the IHVT you do not have 10 or more rings, start disconnecting the IHVT circuit loads one at a time. If at any point the rings exceed 10, you know the IHVT has no shorted turns. The last circuit disconnected may point to the actual problem within the TV.

1. Connect the RINGING TEST input leads to the primary of the IHVT. This is the same two points you used for the ringing test. The positive lead should go to the horizontal output transistor input and the negative lead to the raw B+ supply input.

2. When ringing an IHVT in-circuit, disconnect the IHVT loads until you see a readout of 10 or more. Replace IHVTs that ring less than 10 when all the loads are disconnected.

Collector PPV	CRT High Voltage			
	20	25	30	35
500	1000	1250	1500	1750
700	700	890	1000	1250
900	550	690	830	970
1100	450	560	680	790

**Table 1: Match the normal horizontal output pulse amplitude and the normal high voltage to find the DC voltage value to expect from the driving test.**

### You Can Drive The IHVT With Your VA62 Universal Video Analyzer

Check your schematic, then match the peak-to-peak voltage of the horizontal output pulse and the CRT's high voltage in Table 1, to find the voltage to expect when driving the IHVT. Measure the DC voltage on the second anode lead while driving the IHVT to check the high voltage diodes and multiplier circuit (Figure 4).

1. Connect the DRIVE SIGNAL test leads to the primary winding of the IHVT. This is the same two points you used for the ringing test. The positive lead should go to the horizontal output transistor input and the negative lead to the raw B+ supply input.

2. Connect the VA62's EXT PPV & DCV input leads to the high voltage resupply (ground) and second anode lead (positive) on the IHVT. For accurate voltage readings, you must use the optional TP212 10 kV Transient Protector Probe probe to increase the VA62's measuring circuit input impedance.

3. Select the HORZ KEY PULSE with the DRIVE SIGNAL switch, and adjust the level for 25 volts peak-to-peak, positive polarity. Select EXT DCV on the DIGITAL METER knob.

4. Multiply the readout on the VA62's LCD readout by 10 to compensate for the TP212, and compare the reading with the

expected results in Table 1. The voltage should be equal to or greater than the value listed.

Be sure to test the IHVT for continuity and shorts between windings, plus check the high voltage diodes and multiplier circuits in the IHVT by driving it and comparing its output voltage to those in Table 1. Finally, knowing the ratio of the high voltage to the focus voltage for the chassis you are servicing, you can check the IHVT's focus divider quickly using the same drive procedure.



**Fig. 4: The same connections to the primary are used for the driving test as were used for the ringing test.**

Tech Tip #117 "Testing HV Rectifiers With The VA62" and Tech Tip 118 "How To Analyze The Horizontal Output Pulse With The SC61 Waveform Analyzer" will help you become more proficient in troubleshooting high voltage and horizontal circuits. Call 1-800-843-3338 and ask your Sales Engineer about these helpful Tech Tips. ■

### Understanding VCR Hi-Fi Is Important To Your Success In Consumer Electronics Servicing (continued from page 25)

Audio Equipment	Freq. Response	Wow & Flutter	Dynamic Range
Conventional VCR	50 Hz - 8 kHz	0.2%	45 dB
Cassette Deck	30 Hz - 18 kHz	0.05%	58 dB
Reel to Reel Tape	40 Hz - 25 kHz	0.04%	65 dB
Beta & VHS HiFi (SP, LP & SLP)	20 Hz - 20 kHz	0.005%	80 dB
Compact Disc	5 Hz - 20 kHz	0.001%	95 dB

**Fig. 6: A properly adjusted Hi-Fi VCR is capable of reproducing audio that is nearly equal to that of a compact disc.**

track or mute the audio (depending upon the VCR) before you hear any audio distortion. If it doesn't, adjust the dropout level control for proper switching. Do not adjust the dropout level too high, or the VCR will not switch back to the Hi-Fi track. Be sure to readjust the audio head switching so you see no gap in the AFM envelope, as in figure 4.

### Beta Hi-Fi

Beta Hi-Fi uses AFM and spinning heads much like VHS Hi-Fi,

However, it is slightly more complex. Again the AFM frequency is between the chroma and FM luminance. But in Beta Hi-Fi, the FM luminance frequency is moved up a small amount so that the sidebands of the AFM will not overlap with the sidebands of the FM luminance and down converted chroma. Consequently, different head azimuths are not needed to keep the AFM separate from the video FM, as in VHS Hi-Fi. Therefore, Beta elected to use the video heads to also record and playback Hi-Fi audio.

But the video head azimuth can't be altered, and without a difference in azimuth, how do you prevent crosstalk between the audio tracks? To solve this problem, Beta Hi-Fi uses four different AFM frequencies. Like VHS, both left and right audio channels are recorded simultaneously, each at a different frequency. The difference is that in Beta Hi-Fi the A head AFM frequencies are 1.38 MHz left and 1.68 MHz right, and the B head AFM frequencies are 1.53 MHz left and 1.83 MHz right. Filters are switched in during playback to keep the audio tracks from interfering.

### Compatibility

To ensure compatibility with stereo and mono machines, audio is recorded onto the Hi-Fi (rotating heads) and linear tracks (stationary heads) simultaneously. Non-Hi-Fi VCRs simply play the linear track. Of course when a Hi-Fi VCR encounters a non-Hi-Fi tape, the Audio Select Switch selects the linear track for playback.

You might think that the linear track recorded by a Hi-Fi VCR would be in stereo, however, that is usually not the case. Most Hi-Fi VCR linear tracks are mono.

### Multichannel Television Sound (MTS) Audio

One final improvement in VCR audio is MTS stereo. An MTS VCR is simply a Hi-Fi VCR with an MTS decoder ahead of the record circuits. The MTS decoder functions the same as in a stereo television receiver and produces left and right audio. The separate left and right audio is then recorded by the Hi-Fi heads.

### You Can Hear The Difference

So how good is Hi-Fi stereo? It would be great if we could close by letting you listen to a Hi-Fi VCR. But since we can't, we'll have to simply close with this comparison chart (Figure 6), and tell you that a properly adjusted Hi-Fi VCR is surpassed in sound quality only by a compact disc! ■



## How The LC77 Helps You Identify VCR Switched Mode Power Supply Component Failures That Are Often Missed Using Standard Test Methods

by Rick Meyer, Application Engineer

**P**ower supplies are simple, aren't they? A transformer, a few diodes, a capacitor and that's it. That was the past. Enter the switched mode power supply. On the surface, these new power supplies look extremely complicated. Once you understand how they work, however, you will find that they are quite simple.

Switched mode power supplies aren't really new, they have been around for quite a few years. They were first used by the military and in aerospace. These industries were looking for lightweight, compact power supplies to power sophisticated electronic circuits. Soon the switched mode power supply became popular in the computer industry. Their use continued to flourish until we now see them being used in televisions, VCRs, cameras and other consumer electronic products.

There are three major advantages that make switched mode power supplies popular. The greatest advantage is efficiency. Standard power supplies operate with efficiencies of 40% to 50%. Switched mode power supplies have typical efficiencies of from 60% to 90%. This is very important for battery powered devices and other devices needing low power consumption. In addition, switched mode power supplies operate over wide variations of loads.

Another benefit of these power supplies is their smaller size. They use much smaller transformers, capacitors, and other filtering components compared to traditional power supplies. This benefit is especially important for equipment such as portable computers, portable VCRs, and camcorders. The cost to build switched mode power supplies has also come down. In 1975, switched mode power supplies were cost effective only for systems requiring more than 500 watts. Today, this break-even point is down to 5 watts.

A switched mode power supply is very similar to the scan derived power supplies used in televisions. Recently, we have seen scan derived voltages being replaced by switched mode power supply voltages. VCRs are also beginning to use more switched mode power supplies.

As you can see, switched mode power supplies are here, now! Let's see how these power supplies work and how to more efficiently service them.

Some of the similarities are:

- Both use a flyback transformer.
- Both operate at a relatively high frequency.
- Both use a transistor to switch power on and off to the transformer.
- Both have a damper diode to reduce the inductive kickback from the transformer.
- Both regulate the operation of the circuit to control the output voltage levels.

There are also a few differences between the scan derived supplies used in televisions and the switched mode power supplies. They are:

- The switched mode power supply is not restricted to 15,734 Hz for its operating frequency.

• The regulator may change either, or both, the frequency and the width of the pulse, whereas the scan derived power supply varies the DC voltage to the stage.

• The switching transistor and associated circuitry, in the switched mode power supply, is often also the oscillator circuit. The scan derived power supply uses a separate oscillator circuit.

Let's now take a look at how a basic VCR switched mode power supply works. Figure 2 shows a functional block diagram of a typical VCR switched mode power supply.

To start with, the switched mode power supply needs a source of power. This is supplied by a conventional power supply. Raw unregulated B+ is supplied, through the switching transformer, to the collector of the switching transistor. The switching transistor alternately connects and disconnects the bottom side of the transformer to ground. This results in the alternate creation and collapse of a magnetic field in the switching transformer. This changing magnetic field supplies the transformer, or flyback action.

Figure 2 shows a second winding on the input side of the transformer. This winding generates a signal that alternately turns the switching transistor on and off. This sustains the oscillator action and forms a loop for the oscillator circuit. Several windings are contained on the secondary of the switching transformer. These supply varying amplitude pulses to high speed

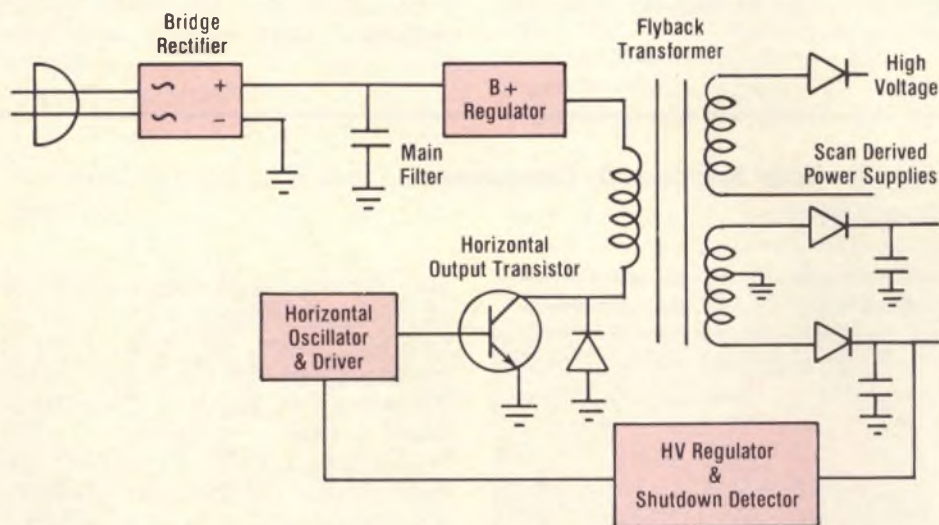
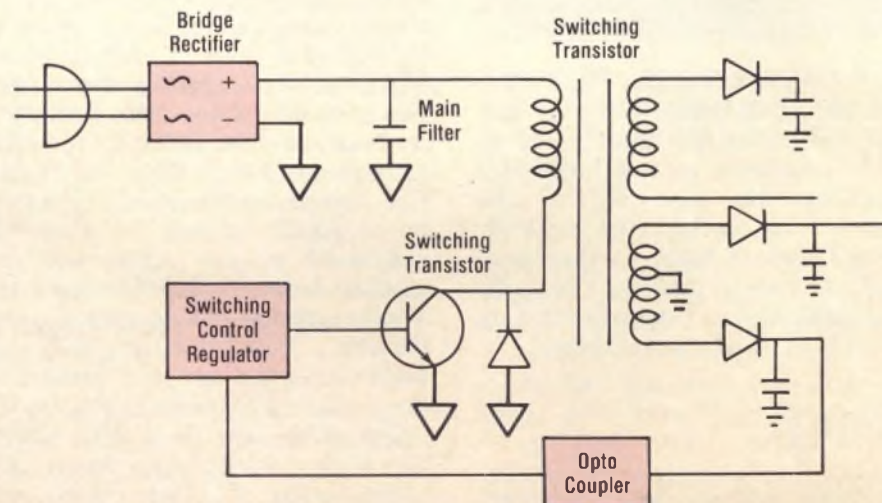

Fig. 1: The scan derived power supply for a television looks functionally similar to the switched mode power supply shown below.

### Knowing The Basics Of Switched Mode Power Supplies Helps To Increase Your Troubleshooting Efficiency

There are three basic types of switched mode power supplies: the step-down, step-up, and the inverting, or flyback type. The flyback type is used, primarily, in consumer products so we will look at this type, only.

There are many similarities between the flyback type switched mode power supply and the scan derived power supplies of modern day televisions (Figure 1).



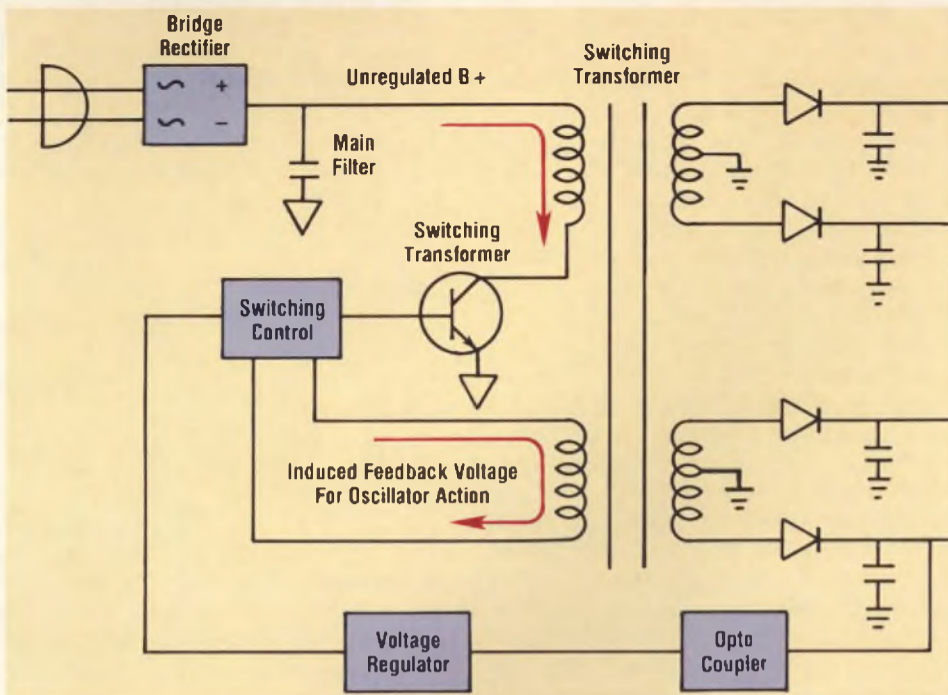

**Fig. 2:** A typical VCR switched mode power supply combines the switching transistor and transformer to form the oscillator circuit.

switching diodes and their associated filtering circuits. These are the DC output voltages of the switched mode power supply.

One advantage of a switched mode power supply is the efficiency that can be achieved in its regulation. Traditional power supplies often regulate the output voltage by dumping the excess energy into resistors which convert the energy into waste heat. In a switched mode power supply, only the amount of energy needed is used. This is the reason for its higher efficiency.

Voltage regulation is achieved by sampling the DC output voltage and comparing it to a reference voltage. This comparison is then used to adjust the amount of time the switching transistor is turned on, ultimately regulating the output voltage. An opto-coupler is used in the regulator circuit to maintain good isolation between the primary and the secondary portions of the power supply.

There are two basic types of regulators: the pulse width modulated regulator and the pulse rate modulated regulator. Switched mode power supplies in televisions use either type. The pulse rate modulated regulator is often used in VCRs, but, this is by no means universal.

A pulse width modulated regulator maintains a constant rate at which the switching transistor is turned on and off. This often requires a separate oscillator to maintain the correct frequency. The amount of time the switching transistor is turned on (the pulse width) is varied, to control the amount of energy applied to the switching transformer. See Figure 3. As the width of the pulse is increased, the switching transistor stays on longer and, thus, more energy is applied to the switching transformer. This results in an increase in the DC output voltage. Likewise, a narrower pulse turns the switching transistor on for a shorter length of

time. This results in less energy being applied to the transformer with a resultant lower output voltage.

The pulse rate modulated regulator varies the rate at which the switching transistor is turned on and off. Figure 4 shows an example

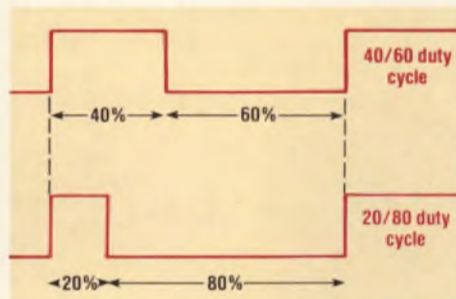

**Fig. 3:** A pulse width modulated regulator varies the output voltage by varying the width of the pulses applied to the switching transistor.

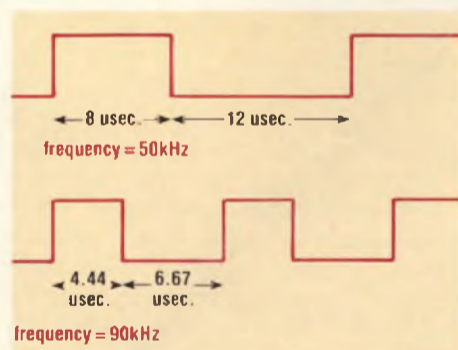

**Fig. 4:** A pulse rate modulated regulator varies the frequency of the pulses being fed to the switching transistor. This frequency change results in a change in the pulse width.

of pulse rate modulation. If the output voltage is too high, the rate at which the switching transistor is turned on is increased. At first this would seem to result in more energy being applied to the transformer. This does not happen, however, since the on-time of the transistor is relatively short compared to the off-time. As the frequency increases, the width of the pulses decreases as shown in Figure 4. Thus the effective amount of energy applied to the transformer decreases. This

ultimately causes the DC output voltage to decrease.

In a typical VCR using pulse rate modulation, the switched mode power supply may operate at frequencies as high as 90 kHz, while the VCR is in the off mode. When the VCR is turned on, more energy is required and the frequency of the switched mode power supply drops to 40 to 60 kHz. This lower frequency results in wider switching pulses and, thus, more energy is supplied to the switching transformer. As different functions are selected on the VCR, the energy needs change and the frequency of the switched mode power supply changes.

Now that we understand the basics of how the switched mode power supply works, let's see how to troubleshoot it.

### Knowing What Signals And Components Are Needed Helps Determine What To Check When Servicing

A VCR symptom of "no power supply voltage" could be caused either by a problem in the switched mode power supply or a short on one of the output lines. Before troubleshooting the switched mode power supply, disconnect the power supply from the rest of the VCR and use an ohmmeter to check for direct shorts. If no shorts are detected at either the outputs of the switched mode power supply or the VCR circuits they are feeding, reconnect the plugs and service the switched mode power supply.

As we learned earlier, the switched mode power supply needs a source of raw B+ to work with.

When a switched mode power supply isn't working, first check for raw B+. You can easily do this with the Sencore SC61 Waveform Analyzer. Simply connect the SC61 test probe to the collector of the switching transistor. This transistor will be fairly easy to locate because it is the largest transistor in the power supply. Use the digital DC voltmeter on the SC61 to check for the presence of B+. If no DC voltage is present at the collector of the switching transistor, check the low voltage power supply. These supplies are very simple and are of the conventional diode supply type. Check for a blown fuse first. If the fuse is blown, look for a shorted B+ power supply diode or a short in the switching power supply.

One of the main components in a switched mode power supply is the switching transistor. All the power is controlled by this transistor and, thus, it controls relatively high currents. In addition, most present day VCR switched mode power supplies use the switching transistor as part of the oscillator circuit. Failure of this transistor will stop all actions within the power supply. If the input fuse is blown,

and the B+ power supply diodes are good, suspect a shorted switching transistor.

Once the B+ is working, look at the waveform on the collector of the switching transistor. The SC61 Waveform Analyzer is excellent for this since you do not have to worry about exceeding the voltage input capability of the SC61. In addition, you can quickly analyze the switching pulses using the digital meter on the SC61.

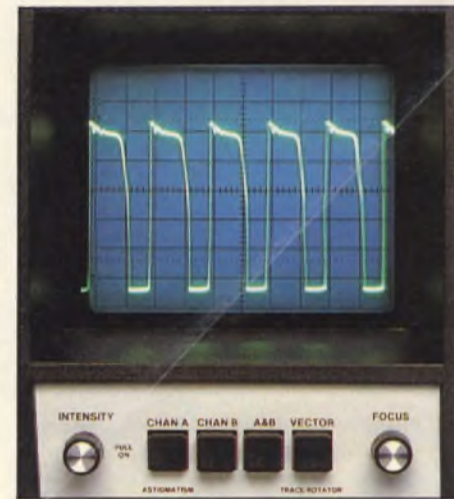

**Fig. 5:** A normal switching transistor collector waveform will often show some ringing. The frequency of the pulses varies with the load applied to the switched mode power supply.

Check the frequency of the switching pulse using the digital frequency counter on the SC61. With the VCR in the off position, the switched mode power supply should still be operating, to supply voltage to the clock and microprocessor. Check the frequency of the pulse and record it. For example, the waveform shown in Figure 5 is for a typical Quasar VCR. The frequency of the switching pulse, for this particular VCR is 98 kHz with the VCR in the off mode.

If a switching pulse is present at the collector of the switched mode power supply, check to see if the regulator section is working properly. Simply turn on the VCR, or select a function, and watch for a change in the switching pulses. In a pulse width modulated regulation system, the width of the pulses should change. In a pulse rate modulated regulation system, the frequency of the pulses should change.

Finally, check the output DC voltages from the switched mode power supply, using the SC61. It is important to check these voltages with a scope since you want to check the DC voltage and see if there are any voltage spikes. The SC61 Waveform Analyzer is excellent for this. Simply press the DCV button on the SC61 and read the DC voltage on the supply line. Then press the VPP button, on the SC61, and read the peak-to-peak amplitude of any spikes on the power supply line. Typically you should see 0.1 volt peak-to-peak or less. You can also look at the CRT on the SC61 to

determine what type of spikes are present. Any power supply spikes will be at a high frequency, 30 kHz or above, and can cause the VCR microprocessor to do strange things.

A malfunctioning switched mode power supply is the result of one or more defective components. Let's now look at how to check some of the most troublesome and sometimes difficult to test components.

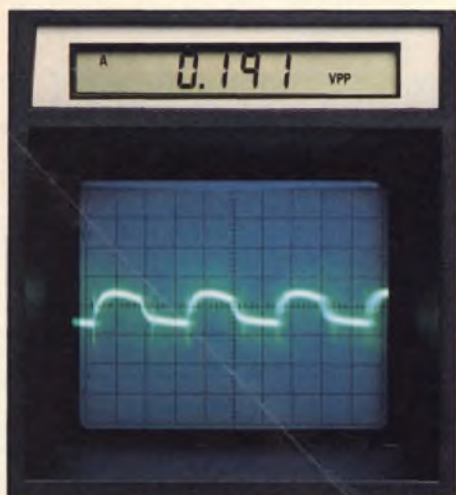

**Fig. 6:** A defective power supply capacitor can result in high frequency noise on the DC lines. This noise can affect the operation of VCR circuits, especially the microprocessor.

### The LC77 Can Help Identify The Defective Component Causing A Switched Mode Power Supply To Fail

One of the most important components in a switched mode power supply is the switching transistor. This transistor can be tested with a transistor tester for a "go/no go" test. Occasionally these transistors may test good at the low voltages used by transistor testers, but fail at the higher circuit voltages used in these power supplies. The reason for this is that a transistor acts like a zener diode when a voltage is applied between its collector and emitter. The transistor blocks any flow of current between the collector and emitter until the voltage becomes larger than the transistors' breakdown voltage. It then conducts heavily. If the transistor begins to conduct at a voltage lower than the operating voltage of the circuit, it will stay on and dynamically act like a shorted transistor.

You can check the switching transistor for too low a breakdown voltage using the leakage test on the LC77 AUTO-Z. Use a 1 kohm current-limiting resistor to limit the current applied to the transistor. You will also need a DC voltmeter or the SC61 to monitor the transistor's breakdown voltage.

First remove the transistor from the circuit. Next, connect a 1 kohm resistor to the collector of the transistor. Then connect up the LC77 AUTO-Z, as shown in Figure 7. The correct connection will

depend on whether the transistor is an NPN or a PNP type. Program the LC77 to the same voltage supplied by the input power supply of the switched mode power supply. Perform the LC77 leakage test and note if current is being drawn as shown by a current reading on the LC77. If the current shows only a few microamps, the transistor is not breaking down at that voltage level. Increase the LC77 voltage by 50 volts and test the transistor again. If a current reading is now obtained, use a voltmeter or the DCV function of the SC61 to measure the voltage across the collector to emitter of the transistor. This is the breakdown voltage. This technique determines the actual breakdown voltage of the transistor. It must be higher than the voltage applied to the switching transistor. If it is not, the transistor is bad and should be replaced.

If you find a shorted switching transistor, it may have been damaged because of a shorted switching transformer. The INDUCTOR RINGER on the LC77 quickly checks these transformers for a single shorted turn. With the

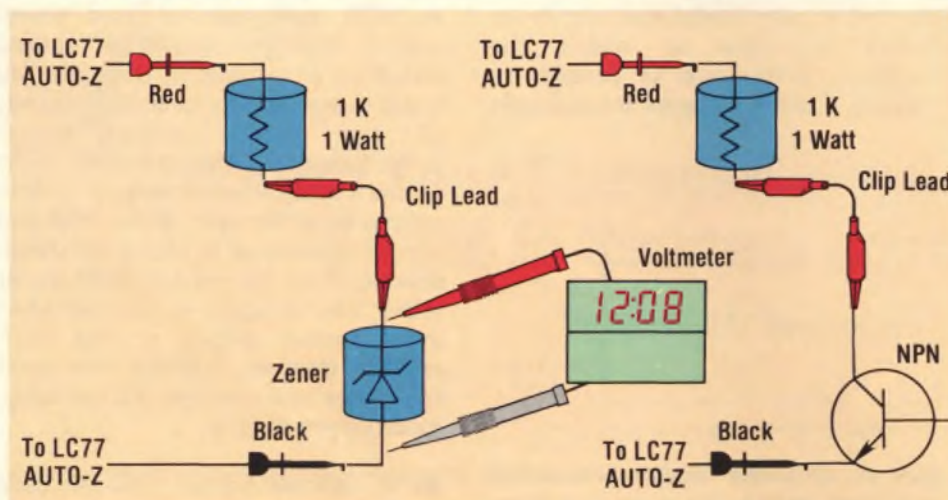

**Fig. 7:** You can easily find the breakdown voltage of a transistor or the zener voltage of a zener diode with your LC77 AUTO-Z. Use a resistor to limit the current through the transistor or zener you are testing.

switching transistor removed, perform the LC77 ringing test at the primary winding of the switching transformer. If the transformer rings 10 rings, or more, it has no shorted turns. If not, remove the transformer and again perform the ringing test. If any of the windings on the transformer ring 10 or more, the transformer is good. If not, then the transformer has a shorted turn and it will ruin a new switching transistor immediately. Replace it!!

Regulation of switching mode power supplies requires the comparison of the output voltage to a reference voltage. The reference voltage is often obtained using a zener diode. A defective zener diode will result in a wrong reference voltage and cause either poor regulation, or, a total shutdown of the switched mode power supply. Zener diodes can be easily tested using the LC77 AUTO-Z.

To test a zener diode, connect the LC77 AUTO-Z to the zener diode as shown in Figure 7. Apply a voltage higher than the zener's rated voltage, through a current limiting

resistor, and check the voltage drop across the zener diode. To perform this test, set the LC77 about 5 volts higher than the rated voltage of the zener diode. This ensures proper diode turn-on through the current-limiting resistor. Press the LC77 leakage test button. The LC77 should indicate that current is being drawn. If the current reading, on the LC77, shows only a few microamperes, the diode is not conducting. Increase the voltage setting of the LC77 by an extra 5 volts and test the zener diode again. When the LC77 shows current flow, measure the voltage drop across the zener diode with a voltmeter. This is the zener voltage and should correspond to the voltage value listed in the schematic.

Other components that fail in switched mode power supplies are the filter capacitors used in the various DC power supply outputs. These capacitors are typically aluminum electrolytic and are operating at high frequencies (up to 100 kHz). Due to the makeup of these capacitors, they all have some internal resistance called Effective

electrolytic capacitor dries out. In addition, this excessive ESR effectively isolates the capacitor from the circuit it is trying to filter. The end result is excessive ripple or high frequency spikes on the DC power supply line.

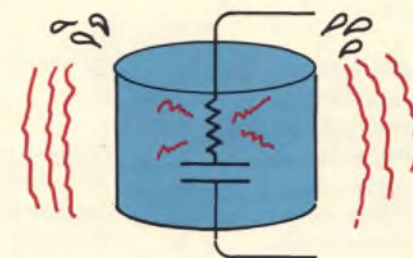

**Fig. 9:** Excessive ESR in an electrolytic capacitor will cause the capacitor to get hot and dry out. In addition, the resistance isolates the capacitor from the signal it is filtering.

A capacitor with too much ESR will often check good for capacitance. You can use the LC77 AUTO-Z to test the filter capacitor for excessive ESR. Simply connect the capacitor to the LC77 and enter the capacitor value and working voltage into the LC77 using the keyboard. Next, press the ESR button. The LC77 automatically tests the capacitor, compares the readings to EIA standards, and tells you if it is good or bad.

As you can see, the LC77 AUTO-Z gives you several tests to locate defective components in switching mode power supplies that you cannot find any other way. It will help you:

- Locate transistors that break down at high working voltages.
- Identify shorted switching transformers.
- Test reference zener diodes.
- Locate bad filter capacitors with high ESR.

With the knowledge you have learned in this article and modern test equipment like the SC61 Waveform Analyzer and the LC77 AUTO-Z, you are now ready to tackle that next power supply problem with confidence. Call your Area Sales Engineer at 1-800-843-3338; he'll answer your questions about this article, plus bring you up-to-date on the helpful new Tech Tips. ■



**Fig. 8:** The LC77 will identify shorted turns in the switching transformer. A shorted turn will destroy the switching transistor.

**For the first time in the history of electronics, with the information that's provided on the component itself, you can determine if a capacitor or inductor is good or bad — anywhere without calculations, look-up tables or error.**

- All capacitor and inductor tests display a simple good or bad readout to eliminate errors!
- Fully automatic/autoranged capacitor value test with percent tolerance calculator.
- Automatic 1000 volt applied leakage test with current or megohm readout. Test capacitor leakage to EIA standards.
- New dielectric absorption test eliminates interpretation.
- ESR tests eliminate tough capacitor problems.
- Fully automatic/autoranged inductance test with percent tolerance calculator.
- Patented Ringing Test gives effective Q for coils.
- Dynamically test resistance up to 1000 megohms.
- Automatic shutoff, battery test and lead zero.



**NEW**  
**LC77 AUTO-Z™**  
**Automatic Capacitor And**  
**Inductor Analyzer**  
**\$1,895 Patented**



It's like having your own Standards Engineer with you at all times.

AUTO-Z is a trademark of Sencore, Inc.

**CALL WATS Free 1-800-843-3338**  
**In Canada Call 1-800-851-8866**

# Track Down Tough To Find CATV, MATV And RF Distribution Troubles

- All Channel (Cable, HRC, ICC, VHF, UHF, FM) Digital Tuner And LCD Channel Readout
- Exclusive 5 Microvolt Sensitivity On All Channels With Autoranged Attenuator
- Exclusive, Automatic Or Manual Fine Tuning With Off-channel Frequency Readout
- Exclusive, Automatic Hum And (Patented) Signal-to-Noise Tests On Any In-Use Channel
- Exclusive Picture Quality Check With Integrated Wide Band Monitor
- Exclusive ACV/DCV Measurements Through RF Input Or Special DVM Input

With The ...  
**FS74 CHANNELIZER SR.™**  
TV-RF Signal Analyzer  
\$3495 Patented

**New**



**SENCORE**

3200 Sencore Drive, Sioux Falls, SD 57107  
Address Correction Requested

Call 1-800-843-3338

BULK RATE  
U.S. POSTAGE  
PAID  
PERMIT NO. 170