

"HOW TO" WITH INSTRUMENTS THRU PIX FACTS

SENCORE NEWS

**FE27
BIG HENRY
FIELD EFFECT
MULTIMETER**

FIELD ENGINEERING REPORT FOR APR./MAY, 1974



**ENJOY THAT HAPPY,
PROFITABLE BIG HENRY
UPTIME - HE'S TOUGH**



**ELIMINATE THAT COSTLY
MULTIMETER DOWNTIME**

**THE MOST DEPENDABLE MULTIMETER
ON THE MARKET TODAY -
BECAUSE BIG HENRY IS**



Tough Outside

BUILT TO WITHSTAND 10 FOOT DROP TESTS

An indestructible acrylic case, specially designed spring loaded meter movement, plus sliding meter cover makes Big Henry the toughest meter available anywhere - foreign or domestic.

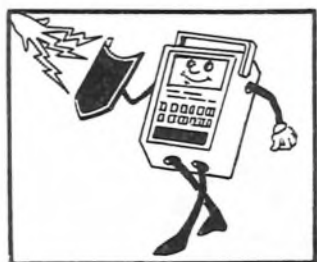

Protected Inside

1000V INPUT PROTECTION ON ALL RANGES

No more worry about blowing your meter with an excessive voltage. All ranges, including low volts, current and ohms ranges, are protected to 1000V. Double circuit protection with hefty 1 amp fuse to back you up.



Accurate & Sensitive

1.5% FET ACCURACY

That's only a half percent off expensive lab standards. Big Henry offers you all the accuracy you'll need for any job - anywhere. A minimum of loading with a high 15 megohm input impedance for even more accurate readings.

Only \$150

introduction

Have you ever dropped a multimeter and seen the case shatter to pieces? Or maybe you have burned out the multiplier resistors by "zapping" a low voltage range with the boost voltage from a TV set. Frustrating, isn't it? If you ever have had any of these catastrophes happen to you, then you know what we mean by costly and frustrating downtime. Downtime that shouldn't happen, but it does!

The Sencore engineers felt that technicians and engineers should have a meter that they could depend on for accurate readings without being plagued by that frustrating downtime. We are taking this issue of the Sencore News to introduce our answer to this need for dependability: the FE27 Big Henry Field Effect Multimeter. Big Henry is a high

accuracy multimeter that is virtually downtime - proof, with internal and external protections to guard against all of those downtime dilemmas that shouldn't happen, but do.

We hope you agree after reading this News, that Big Henry is the most dependable meter on the market today.

Due to the large, favorable response we received from the last edition of the Sencore News, we are again using a filmstrip for our presentation. This film can be seen at any Sencore Tech-A-Rama. Check the meeting schedule inside and plan to attend the next Tech-A-Rama, at any Sencore Full Line Promotional Distributor (FLPD) in your area



Bob Bowden
Technical Marketing

Sencore Presents

IT SHOULDN'T HAPPEN... BUT IT DOES!



1

Now if I check these voltages on this new replacement transistor, and they come out ok, I should be in business. Man . . . this set has been a real dog. I've been on it for half a day. Really shot my time on this one. Well . . . let's see. .6 volts to ground there. That's good. Now if I only move this chassis to get at that test point.



2

Oh no! (crash, boom, bang).
Oh brother . . . why did that have to happen?



3

The Sencore Technical Marketing Department would like to take a few minutes and talk about all of those servicing dilemmas that should never happen but always do. We would like to show you how to avoid many of these problems so you have more uptime, with less downtime of your equipment for more servicing time and greater profits as Sencore proudly presents their line of Henry multimeters in . . .

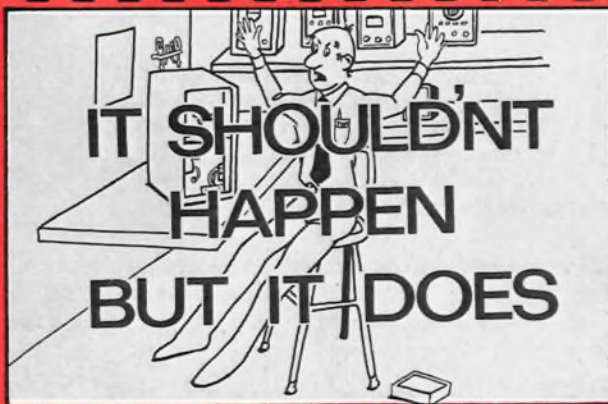

4

"IT SHOULDN'T HAPPEN . . . BUT IT DOES"



5

If you have been servicing for any period of time you soon realize the necessity of a dependable multimeter. The multimeter is probably the most basic piece of test equipment any technician or engineer uses.

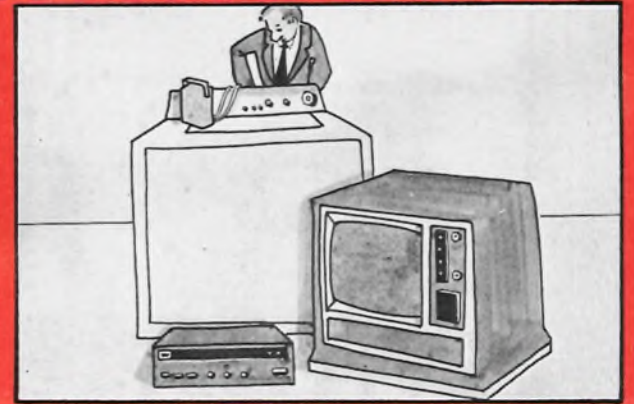

6

Why, can you imagine servicing a TV without using a meter? How long would it take to locate a DC problem in an audio amp without the use of a meter? Continuity checks in motors would be pretty darn tough without that old multimeter right next to you. When you come right down to it, the multimeter is probably the most useful piece of gear a technician owns.

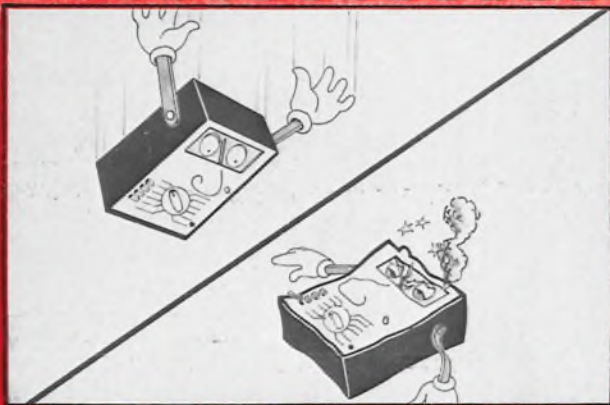

7

But what is the greatest problem with multimeters? I think we all know the answer to that one, they break down. It's either a mechanical or electrical failure in the meter, that shouldn't happen, but they do. And the real frustrating thing is - it's usually an accident. Just one of those things we've all experienced, like voltage on the wrong range, or a shattered case or bent needle after an accidental drop. The list goes on and on.

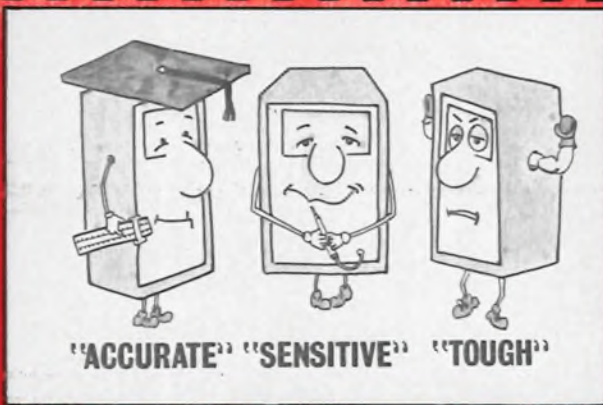

8

Now it's true that we expect a lot from our multimeters. We all want accuracy and sensitivity, yet need meters that are portable and tough enough to make house calls, travel with the maintenance techs in factories, ride in vans . . . in all of this our sensitive meters take a lot of abuse. And what do you do if your meter breaks down?



9

You have downtime. Downtime that costs you big in repair charges, lost profits, angry bosses and frustrated customers. This downtime shouldn't happen . . . but it does. But it doesn't have to happen any longer.



10

The marketing and engineering team at Sencore felt that you should be able to depend on your multimeter for accurate measurements, and not have to worry about downtime. So we sat down to design the most dependable multimeter on the market today. You may not believe that all your problems with downtime on meters could be over, but they are if you simply put your old meter aside and step up to more profitable uptime with Sencore's new FE27 Big Henry FET multimeter.



11

The Big Henry is the toughest, most dependable multimeter available today. Big Henry was designed with one thought in mind . . . dependability. Dependability so all that downtime that slowed you down before won't be a problem for you anymore. It was designed with protection against electrical and mechanical hazards that every multimeter experiences. Big Henry's tough - and he's accurate too, with 1.5% FET accuracy. Is it possible that Sencore has designed the downtime proof meter? Well let's spend the next few minutes finding out.



12

To help put Big Henry to the test I have requested the assistance of a service tech friend of mine who has always had a problem keeping his gear in operating condition. I would like to introduce you to Tom Thumbs. Tom is a good technician, but things just don't ever seem to go his way. We all have a bad day now and then, when things just don't seem to be going smoothly, but Tom seems to have more than his share. We felt Tom could really show us what a technician demands from his meter during a day's servicing. I hear Tom's phone ringing now - let's listen.



13

Tom Thumbs Electronic Service, you break it, we remake it, Tom speaking.
Yes Tom . . . this is Mrs. Jones over at 222 Park Avenue. I am having some terrible trouble with my TV set. I turn the television on and its ok for about 15 minutes, then it just goes out. It really doesn't look like it would be too difficult to fix to me. When can you come out? My soap opera is on at one o'clock and I really have to see this episode. Can you make it right away?
Well, I'm pretty busy at the shop Mrs. Jones, but I'll try to get there by 10:00. See you then.



14

Hey is that great, I knew today was going to be my lucky day. That Mrs. Jones lives in the best neighborhood in town. If I get a foothold in that area, I'll have service customers from now until doomsday. I'd better hurry.

LOOKS LIKE THIS MIGHT BE TOM'S LUCKY DAY!



15

(TOM LATER THAT MORNING)

Let's see, 222 Park Avenue. Hey that's it right there. (squeaky brakes, crash, boom, bang, WHAMO . . .)
Oh No!

And what does Tom find when he opens up the back of the van?



16

Oh brother! The meter face is cracked and the knob is shattered. It must have fallen flat on it's face. Wonder if that knob pushed through and busted up the inside. This shouldn't have happened to me today.

But it did Tom . . . and you know it really didn't have to happen.



17

Who's that?

It's just some fellow technicians and engineers who have been watching you today Tom.

Yea?, well ok, but what do you mean, it didn't have to happen. Sure I probably hit the brakes too hard, but the meter hit flat on it's face. That will damage any meter.

Not this one Tom.

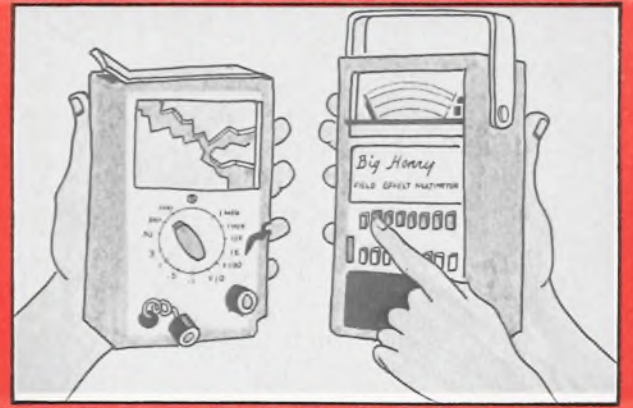

18

This is Sencore's new FE27 Big Henry FET multi-meter. You see this sliding meter cover? It protects the meter face in transit. No more cracked meter faces. Notice the recessed pushbuttons too. They are not only easier to use than a conventional knob, they can't be broken, cracked or pushed through because they are recessed. These features right here would have saved you a damaged meter today.



19

That sliding meter cover would have come in handy. I hate to tell you how many meter faces I've broken. You know, I really like that recessed pushbutton idea too. They are a lot easier and faster to use, but what I like most is the fact that they can't break. That looks like a tough case too. What did you call this - - - Big Henry? Not bad at all, but listen, I gotta go. I just happen to have another meter in the van and I am in a hurry, so maybe I'll see you fella's a little later. OK? Feel free to tag along if you want.



20

Is that you Mr. Thumbs? Come on in - I'm in the living room.

Coming in Mrs. Jones.



21

Oh no. Not again!

What was that Mr. Thumbs? Are you alright?



22

I'm ok Mrs. Jones, but my meter really took a beating. Shattered case, the needle is bent and it looks like the meter movement jumped off pivot. Why do these things always happen to me?

Tom . . . they shouldn't happen . . . but they do. You need to guard yourself against accidents like this. If you would have had Big Henry, you'd still be in business.



23

How's that?

Well, in the first place, Big Henry has a lead storage compartment, so you'll never have to worry about draggy leads. But, even if you did happen to drop Big Henry, nothing would happen. Just watch this.



24

Hey, don't do that - what's wrong with you?

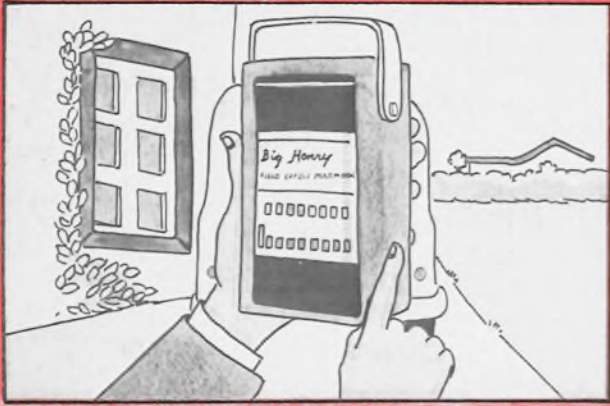

25

You see, Tom. The molded acrylic case is virtually indestructible. It's the same material that football helmets are made of and you know that's tough stuff. Do you realize they drop test these at the factory 10 feet onto concrete - and they have to hold up or they don't pass them. And as far as that meter movement jumping off pivot - it can't happen with Big Henry. It has a spring-loaded meter movement. The needle actually floats on a spring that absorbs any shock from a fall. Less chance for bent needles too.



26

Tom - I'd think after losing two meters today you'd need Big Henry by your side.

Mr. Thumbs? Who are you talking to out there? And what's taking so long. It's almost one o'clock.

Listen, I gotta go back to the van. I just happened to bring another meter on this trip. I came prepared for something like this, but catch me later. You're making sense with that Big Henry.

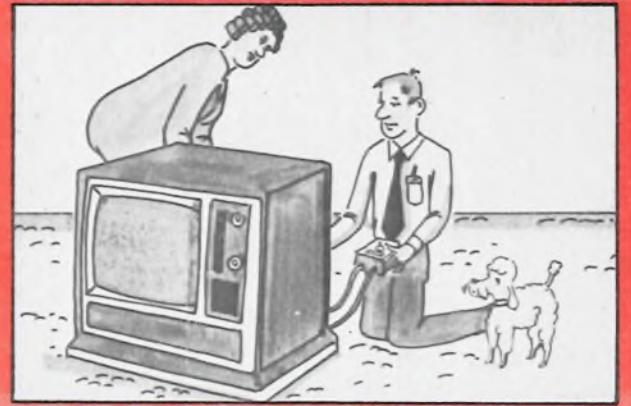

27

INSIDE THE HOUSE:

No picture at all, heh? Well, let's start with the circuit breaker to see if it's ok. Put the meter on ohms and that checks good, so we have power going into the set. Better turn the set on and test some voltages.

Mr. Thumbs, how's it going. It's getting pretty close to 1:00 o'clock. Are you going to be done by then?

It's going fine Mrs. Jones, be done in a jiffy. Now, where was I? Oh yeah, set turned on and check the line voltage.

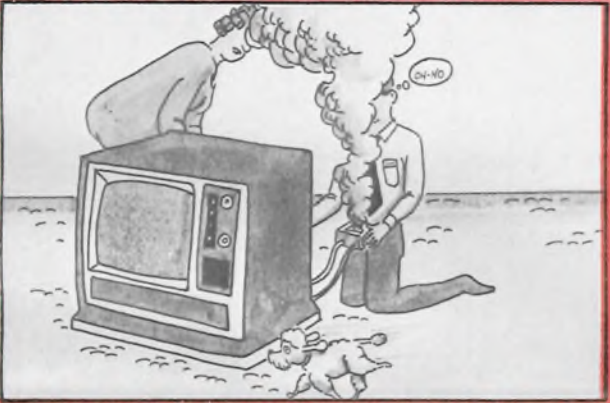

28

Oh no, I turned the set on but left the meter on ohms. I'll bet those precision resistors have turned to charcoal. I'm really cooked now.

Excuse us again Tom, but we couldn't help but see what just happened.

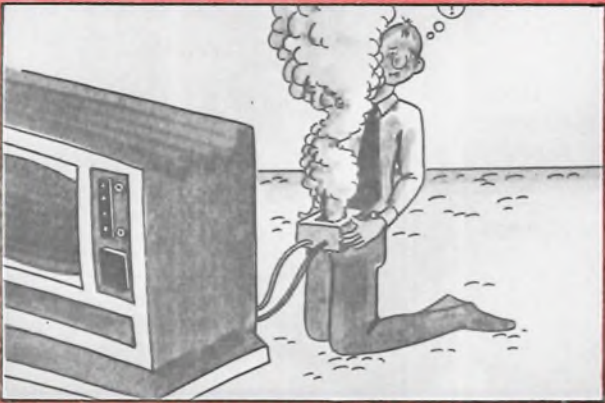

29

Now wait a minute! Are you going to tell me that I could have measured the line voltage with Big Henry on ohms and nothing would have happened?

That's right Tom. Just look at this.



30

Line voltage right out of the wall and into the ohms ranges on the meter. Would you do this to any other meter? More than that, Big Henry is protected to 1000 volts on all of its ranges. Diodes protect those delicate FET's. You won't blow 'em if you happen to apply a high voltage on a low voltage range. You can even apply 1000 volts to the .3VDC range. Now that's protection. The current ranges are protected by a fuse so you won't be blowing any more shunt resistors. And the ohms resistors are double protected by the diodes and fuse.



31

And look Tom, it calms right up after a jolt like that, just like nothing had happened. 1000V on every range Tom, that's Big Henry.

Hey that really is something, 1000 volts on any range. That's what I call real protection. You know, none of those problems would have happened to me if I had Big Henry. Say do you mind if I use that Big Henry to finish this job. I'd really appreciate it.

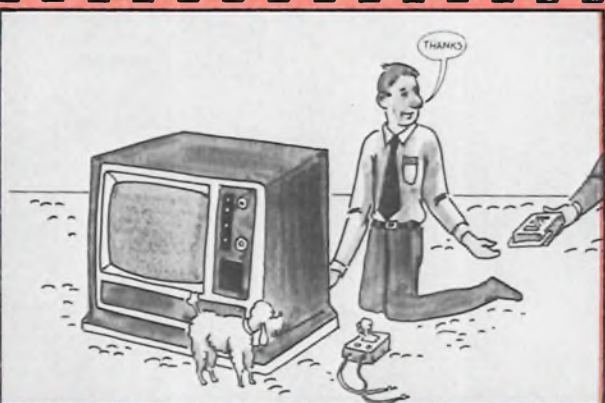

32

Sure thing Tom. Here you go. Tell you what, take as much time as you need and we'll meet you back at the shop after this job. You're in good hands with Big Henry, Tom, so don't worry about any of those untimely accidents. Remember, you're protected. Good luck on that set. See you back at the shop.



33

Hi Tom - how did it go over at the Jones's?

No problem after you gave me Big Henry. You know this is some meter! It's a technician's dream. That internal protection has to be the greatest thing since the electron. I was measuring the low grid voltage on a tube when the probe accidentally slipped over to the pin connected to the plate. Whamo . . . I thought I was done for, but Big Henry took it. It's amazing. Would you mind taking some time and showing me this internal protection on Big Henry? That's gotta be some circuitry!

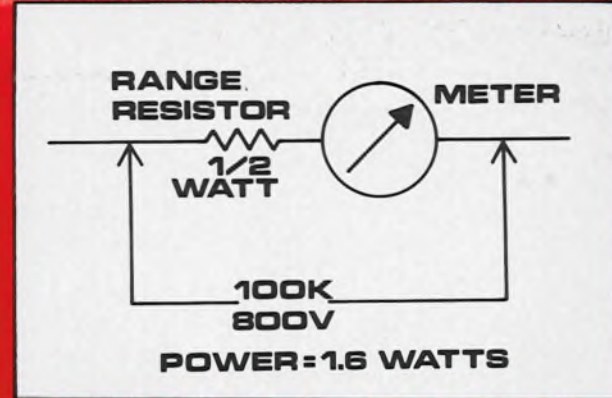
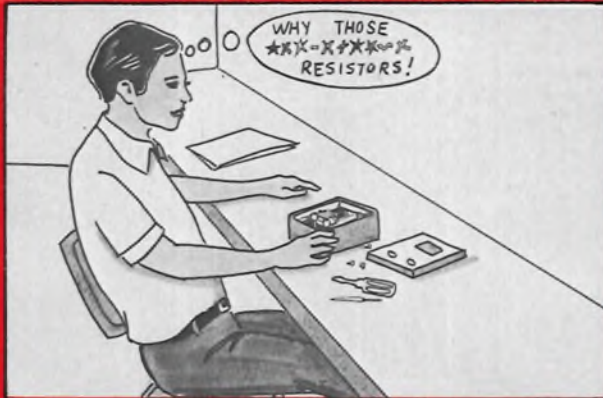
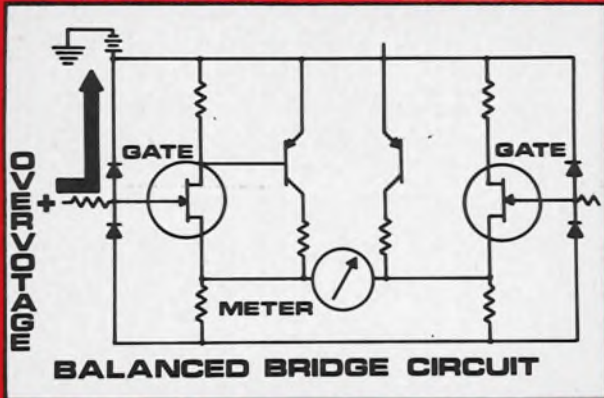

34
Don't mind at all Tom.

The "heart" of Big Henry is a balanced bridge circuit which is used to drive the meter movement. The gate of each FET is protected against any overvoltage by two husky diodes. Before an overvoltage drives a current through the gate, and damages the FET, the diodes will divert the current through the battery to ground. With two diodes at each gate, you can be sure that the transistors will remain intact and will be continuously operational. The diodes are the key in preventing blown FET's.

35

You have probably faced the problem of replacing damaged divider resistors in a VOM and are wondering what an overload will do to the resistors in Big Henry. No problem. His big 15 megohm input impedance is connected across the input on all ranges. Even if you apply 1000 volts, the power dissipation on the largest resistor is less than one tenth of a watt. There's no way that you'll be back on the bench frustrating yourself with those divider resistors with Big Henry.

36

Not so on the inexpensive VOM. Such meters use the range resistors in series with the meter movement. Let's use an example of a 10,000 ohms per volt meter on the 10 volt range. This would require the meter and the series range resistor to total 100K. Now if 800 volts were accidentally connected across the input, the power dissipation would be over 1½ watts. Those poor little half-watt resistors won't last long under those conditions.

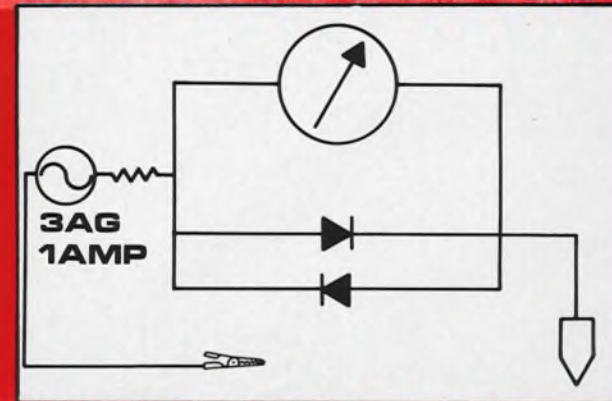
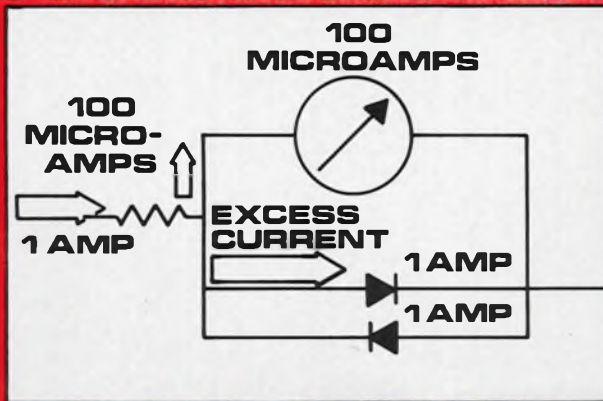
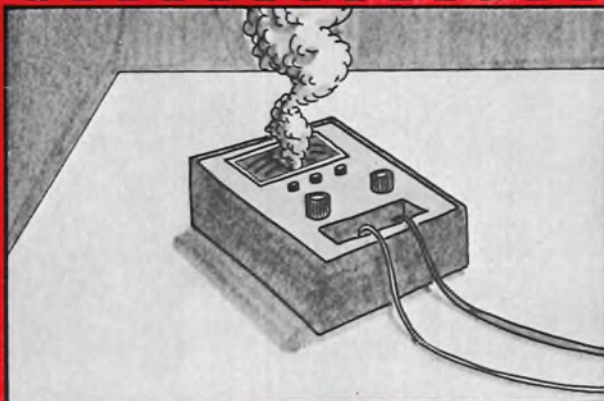

37

If the divider resistor were of higher power the current would pass on to the meter and the meter coil could burn out, resulting in more serious and more costly problems. Is there any way that can happen on Big Henry? Take the DC current function for example. What if we try to measure a high current on the 10 milliamp range? Will the coil go up in smoke? Not with Sencore dependability.

38

The meter movement is protected by hefty one amp diodes on all functions and ranges. Here's how it works. The meter movement is rated at 100 microamps full scale. If the input current exceeds 100 microamps, the diodes will conduct to bypass the excess current around the meter.

Say, that's pretty good protection, but what if the input current is more than one amp? Then you're going to burn out the diodes, right?

39

Wrong! The one amp fuse is also in the circuit to protect the diodes. That's right, we have protection on top of protection, a protective fuse to protect the protective diodes. Any current greater than 1 amp will be stopped at the fuse. The fuse is easy to get to if this should happen and you'll be back in business in minutes. Are you convinced yet? Let's show you one more, this time in the ohms multiplier resistors.

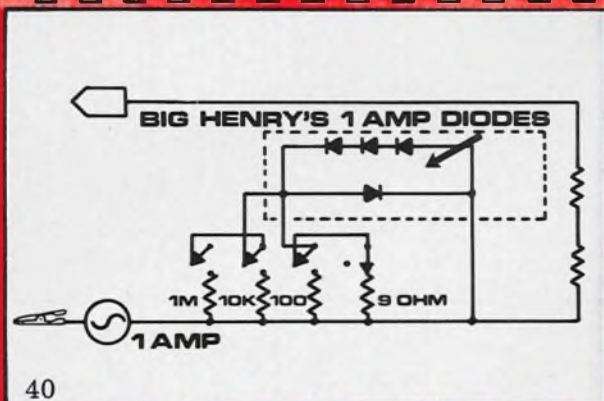

Here's what happens when you try to measure the resistance in a set that has the power on. Normally, the current supplied goes right through the 9 ohm resistor and burns it out. Not with Big Henry. The current supplied by the set does not burn out that little 9 ohm resistor, but instead is bypassed through the one amp diodes, and the fuse again protects the diodes against currents greater than 1 amp. Well, that covers them all: volts, amps, and ohms. See now why Big Henry can take 1000 volts on any range? The worst that can happen is a burned out fuse. It's easily replaced, a standard 3AG 1 amp, available anywhere.

41

That's really something, you guys really thought of it all when you designed this one. But let me ask you something. If Big Henry is so tough, is it still accurate? Will I be able to rely on the readings for critical measurements? I've had several meters in here before that loaded circuits down, didn't have the sensitivity I needed and really didn't match up to the specs I thought I was buying.

42

Tom, I think the best way to answer that is to do some comparing. You take that foreign made VOM with 3% DC accuracy, and I'll use Big Henry and we'll just see what happens. You know that a good method you can use to see if a transistor is operating correctly in an amplifier is to compare emitter and base voltages. The difference between these voltages should be about .6 volts for most transistors. Let's see if we can find such an example in this Admiral K10 chassis you have here on your bench.

CHOOSE FROM SENCORE'S MOST POPULAR INSTRUMENTS

COLOR GENERATORS

CG25 Little Huey Color Bar Generator (Digital)

- **DIGITAL TIMING** for locked in patterns that just can't bounce.
- **BIG GENERATOR FEATURES** with color adjust and channel tuning.
- **LOW POWER DRAIN** for long battery life. Automatic shutoff after 15 minutes to back you up.
- **CABLE STORAGE COMPARTMENT.** No messy cords to untangle.
- **"POCKET SIZED"** measuring the size of two 5U4 tubes.
- **PUSHBUTTON OPERATION** for fast and easy pattern selection.

\$99.00



STANDARD RCA LICENSED PATTERNS

CG169 Deluxe Color King Color Bar Generator (Digital)



\$180.00

- **EXCLUSIVE ALL - CHANNEL TUNING** for operation in any part of the world.
- **EXCLUSIVE TEMPERATURE CONTROL** to warm unit up on cold days or dry out moisture in humid areas.
- **EXCLUSIVE CONVERGENCE PATTERNS.** Moveable single dot and single cross makes convergence a snap.
- **75 OHM OUTPUT** for MATV, CATV systems, with 300 ohm balun for conventional antenna systems.
- **100% DIGITAL** for Rock Solid patterns.

ONLY ALL - CHANNEL, ALL - WEATHER COLOR GENERATOR.

TIME SAVING INSTRUMENTS

- **HIGHLY SENSITIVE** all the way down to 30 micro-volts.
- **COMPLETE COVERAGE** of all VHF, UHF, and FM bands.
- **STANDARD REFERENCE** of zero DBJ. 1000 microvolts into 75 ohms for CATV and MATV work.
- **ACCURATELY CALIBRATED** in microvolts for direct signal strength reading, 3DB VHF and FM, 6DB UHF.
- **COMPLETELY PORTABLE** to go where you need it without extension cords.
- **BOTH 75 AND 300 ohm inputs.**

FS134 Portable Field Strength Meter

EQUIP YOURSELF FOR CATV, MATV AND ADDITIONAL ANTENNA WORK.



\$250.00

PM157 Power Monitor

THE MOST PRACTICAL SERVICE TOOL EVER DEvised.



\$75.00

- **AC VOLTMETER** from 65 to 135 volts. Calibrated at 115 volts for more accuracy than VOM.
- **AC AMMETER** up to 10 amps. Check fuse and circuit breaker currents in a flash.
- **AC WATTMETER** up to 1150 watts. A real troubleshooter.
- **DC AMMETER** up to 10 amps.
- **FUSE RESISTOR CHECKER** with special scales for each resistor.
- **MAKE ALL TESTS** with interrupted line cord or test leads.
- **FULLY PROTECTED** against shock hazard to appliance, instrument and operator.

SS137 Sweep Circuit Analyzer

- **HORIZONTAL OSCILLATOR** substitutes directly for any horizontal signal.
- **VERTICAL OSCILLATOR** for direct substitution of any vertical signal.
- **HORIZONTAL YOKE** substitutes directly for horizontal deflection yoke.
- **VERTICAL OUTPUT SIGNAL** for direct substitution.
- **FLYBACK DYNAMIC TEST** determines capability of horizontal output transformer.

ALL SIGNALS NECESSARY FOR TROUBLESHOOTING HORIZONTAL AND VERTICAL SWEEP CIRCUITS.



\$125.00

COMPONENT SUBSTITUTORS

RC24 Parts Pak Caddy Component Substitutor

IT'S A TUBE CADDY JANITOR

- **PROVIDES THE MOST OFTEN USED VALUES** of resistors, capacitors and electrolytics in one small, neat handsized unit.
- **24 VALUES OF RESISTORS** from 10 ohms to 5.6 megohms. 1 watt to 10K, ½ watt over 10K.
- **9 CAPACITOR VALUES** 100pf to .5mfd at 600 volts.
- **ELECTROLYTICS:** 10mfd and 100 mfd at 450 volts, 1000mfd at 75 volts.



\$38.00

RC167 Component Substitutor

IT'S A LEG SAVER



\$90.00

- **EXCLUSIVE parts** in a drawer to help you save time and leg strain.
- **24 RESISTOR VALUES** from 10 ohms to 5.6 megohms. 1 watt up to 10K, ½ watt over 10K.
- **10 VALUES OF CAPACITORS** from 100pf to .5mfd at 600 volts.
- **ELECTROLYTICS:** 2mfd, 5mfd, 20mfd, 50mfd, 100mfd, 200mfd at 450 volts. 500 mfd, 1000mfd and 2000mfd at 750 volts.
- **RECTIFIERS:** Universal selenium and silicon, ½ amp forward; 800PIV.
- **SURGE PROTECTION SWITCH** with over-voltage warning light.

CRT TESTER

CR168 Big Mack Automatic CRT Tester



\$225.00

IT'S YOUR NUMBER ONE
CUSTOMER CONVINCER

- **TESTS THEM ALL** including new RCA 110^o color tube, the thin neck, in line tubes and the 17" Japanese Trinitron.
- **PATENTED AUTOMATIC TRACKING:** You simply read tracking on the big meter after making emission tests.
- **COMPUTER MEMORY CIRCUITS** store CRT information for the tracking test.
- **LARGE 7 INCH METER** with easy to read "GOOD-BAD" test that convinces your customer "she" needs a new CRT.
- **SAFE REJUVENATION** with RC timed voltages. Takes all the guesswork and hazard out of rejuvenation.

FIELD EFFECT



FE23 Little Henry FET Multimeter

\$90.00



FE27 Big Henry Field Effect Multimeter

\$150.00



THE MOST DEPENDABLE MULTIMETERS ON THE MARKET TODAY OFFERING THESE FEATURES:

- **INDESTRUCTIBLE ACRYLIC CASE** that can withstand 10 foot drop tests.
- **FULL INTERNAL PROTECTION** to 1000V on all ranges.
- **MINIMUM CIRCUIT LOADING** with 15 megohm DC input impedance.
- **AUTOMATIC SHUTOFF** when lead storage compartment is closed. Prevents run down batteries.
- **ILLUMINATED METER** is fully protected with exclusive sliding cover.
- **ALL WITH 1.5% DC ACCURACY - 3% AC.**

FE23 SPECIFICATIONS

5 DC VOLTAGE RANGES of 3, 30, 300, 1KV and 6KV full scale.

4 AC VOLTAGE RANGES of 3, 30, 300 1KV full scale.

4 RESISTANCE RANGES for 1K to 100 megohms full scale. 10 ohms center scale.

DC CURRENT RANGE of 0 to 1 amp full scale.

FE27 SPECIFICATIONS

9 DC VOLTAGE RANGES from 0 to 3000 volts full scale, both positive and negative.

9 DC ZERO CENTER RANGES from .15 to 1.5KV.

8 AC RMS VOLTAGE RANGES from .3 to 1KV full scale.

8 AC PEAK-TO-PEAK RANGES from .3 to 1KV full scale.

5 RESISTANCE RANGES from 1K to 1000 megohms. 10 ohms center scale.

3 DC CURRENT RANGES of 1 milliamp, 100 milliamp and 1 amp full scale, both positive and negative.

TUBE TESTERS



\$120.00

TC162 Mighty Mite VII Tube Tester

MIGHTY MITE - THE WORLD'S MOST POPULAR TUBE TESTER.

- **NEW PIN ELIMINATION SWITCHES** eliminate normal shorts caused by internal connections.
- **CHECKS MORE TUBES THAN EVER BEFORE.** Pin elimination allows tubes to be tested which could not be checked before.
- **FULL RATED CATHODE EMISSION TEST.**
- **100 MEGOHM GRID LEAKAGE TEST.**
- **SENSITIVE STETHOSCOPIC SHORTS TEST.**



\$290.00

MU150 Continental II Gm Tube Tester

WORLD'S ONLY TUBE ANALYZER

- **TRUE MUTUAL CONDUCTANCE TEST** using a 5000 Hertz square wave for true tube test.
- **TWO TESTERS IN ONE.** The MU150 can be used to make the Mighty Mite tests as well as mutual conductance.
- **FULL RATED CATHODE EMISSION TEST.**
- **100 MEGOHMS GRID LEAKAGE TEST.**
- **SENSITIVE STETHOSCOPIC SHORTS TEST.**



PATENT PENDING

\$220.00

TC28 Hybrider Tube and Transistor Checker

THE ONLY HYBRID AMPLIFIER CHECKER ON THE MARKET TODAY FOR TUBE, SOLID STATE AND HYBRID CIRCUITS

- **IT'S AN AMPLIFIER CHECKER** that totally equips you to troubleshoot tube, solid state or hybrid circuits.
- **IT'S A MIGHTY MITE** that checks over 3000 tubes, foreign and domestic.
- **IT'S A CRICKET** for in and out of circuit transistor and FET testing - without a set-up book.
- **ONE BIG METER** for all tube and transistor tests. No more indicator lights to confuse you or your customers.

MULTIMETERS



FE21
4 1/2"
Hi/Lo
FET
Multimeter

\$120.00



FE20
6" Portable Hi/Lo
Field Effect Meter

\$150.00



FE160
Senior
Hi/Lo
Field
Effect
Meter

\$195.00



NOW . . . MEASURE RESISTANCES IN CIRCUIT IN SOLID STATE DEVICES WITH THESE HI-LO FIELD EFFECT MULTIMETERS.

- **LOW POWER OHMS** using .08 volts to make in-circuit resistance measurements accurately. Allows you to use latest Howard Sams service information. Sams specifies it, only Sencore has it.
- **HIGH POWER OHMS** for routine resistance measurements and to check front-to-back ratios of diodes. Meters would not be complete with low power ohms only.
- **ONE-TENTH VOLT FULL SCALE** sensitivity on both AC and DC voltage. A must when servicing in solid state circuits with critical low voltage biases.
- **PROTECTED TO 1000 TIMES OVER-LOAD.** A truly burnout proof multimeter. Tested in production with 1,000 volts on .1 volt range. Multimeter resistors protected by

.6 amp fuse to save these valuable and expensive components. No more trips to factory when you accidentally measure volts on ohms range.

SPECIFICATIONS
FE20 AND FE21

- 9 DC Voltage ranges from .1 to 1000 volts full scale.
- 3 High Voltage ranges of 3, 10, and 30KV
- 9 DC Zero Center ranges from .05 to 500 volts
- 9 AC Peak-to-Peak ranges from .28 to 2800 volts
- 9 DC Current ranges from 100 microamps to 1 amp full scale

7 Hi Power ohms ranges from 1000 ohms to 1000 megohms

FE 160

- 10 DC Voltage ranges from .1 to 3000 volts full scale
- 10 DC Zero Center ranges from .05 to 1500 volts
- 9 AC Voltage ranges from .1 to 1000 volts
- 9 AC Peak-to-Peak ranges from .28 to 2800 volts
- 10 DC current ranges from 30 microamps to 3 amps full scale
- 8 Hi Power ohms ranges from 600 ohms to 6000 megohms
- 7 Lo Power ohms ranges from 600 ohms to 600 megohms

TRANSISTOR TESTERS



TF26 Touch Tone Cricket
Transistor and FET Tester

- **HOP THROUGH SOLID STATE CIRCUITS IN SECONDS**
- **COMPLETE IN-CIRCUIT PUSHBUTTON TEST** in one simple operation.
- **NO SET-UP DATA** or technical knowledge required. Hook leads up any way you want and push the buttons. For simple GOOD - BAD readout.
- **CHECKS THEM ALL** - both NPN, PNP transistors and N-channel, P-channel FET's, in or out of circuit.
- **SENSITIVE LEAKAGE TEST** in microamps for out of circuit testing to back you up.

PATENT PENDING \$140.00



TF166
Automatic Transistor Analyzer

- A COMPLETE ANALYZER FOR ALL TRANSISTOR PARAMETERS
- **AUTOMATIC PUSHBUTTON OPERATION** All you do is select the button and push.
 - **GAIN TEST**, both in and out of circuit, measured as good - bad or in Beta for transistors and Gm for FET's.
 - **SENSITIVE LEAKAGE TEST** in microamps measures I_{cb0} in transistors and I_{gss} in FET's.
 - **I_{dss} ZERO BIAS TEST** for industrial culling and power amplifier matching.
 - **DAMAGE PROOF:** Guaranteed not to damage transistor, circuit or tester on any test.

\$190.00



POWER SUPPLY



UPS164
Universal Power Supply

- THE MOST RUGGED, PROTECTED POWER SUPPLY ON THE MARKET.
- **REGULATED**, low ripple supply for every servicing need.
 - **MONITORS VOLTAGE AND CURRENT** at all times to speed troubleshooting and design work.
 - **MONEY SAVING** current limiting on all outputs - it can even take a dead short.
 - **VOLTAGE RANGES:** 6 volts to 20 amperes fixed. 12 volts to 10 amperes fixed. 0 to 35 volts variable to 2 amperes.
 - **CURRENT ADJUST:** 0 to 2 amps adjustable to any in-between level. Protects supply and circuit under test.

\$240.00

STEREO ANALYZER

SG165 AM-FM Stereo Analyzer



\$495.00

ONLY COMPLETE STEREO ANALYZER WITH SPECS BETTER THAN YOUR FM STATION

- 12 SIGNALS that you need to completely service every stage of any FM, FM stereo or AM receiver.
- CHECKS EVERY STAGE OF a receiver, from antenna to speaker, with a complete front to back check, all from a single output cable.
- SWEEP AND MARKER for alignment and IF band width check.
- PATENT PENDING phase - locked 19KHz pilot guarantees you are aligning to a signal identical to your station.
- FM RF COVERAGE: 86 to 110 Megahertz; unmodulated, MPX or 400Hz sine modulation.
- AM RF COVERAGE: 525 to 1625 Kilo-hertz; unmodulated or 400Hz sine modulation.
- FM IF COVERAGE: 10.7 Megahertz crystal controlled CW, MPX or 400Hz sine modulation.
- AM IF COVERAGE: 262 or 455 Kilohertz; unmodulated or 400Hz sine modulation.
- FM IF SWEEP: 10.7MHz fixed with markers at 10.7, 10.6, and 10.8MHz.
- MARKER INJECTION: Post injection method with two simple leads; from detector and to scope.
- MULTIPLEX SIGNAL: FCC regular stereo or IHF (institute of high fidelity) modulation.
- SUBSCRIPTION SIGNAL: 67 Kilohertz SCA signal for setting traps.
- AUDIO SIGNALS: 400Hz square and sine for final amplifier distortion test.
- DUAL MONITORING METERS for a constant check on outputs of each stereo channel separately.
- METERS: 3 1/4" D'Arsonval calibrated from 0 to -40DB, 0 to 10 watts, and 0 to 100 watts.
- OUTPUTS: RF, IF sweep and audio . . . all one common cable.
- SPEAKER DUMMY LOADS: Speaker direct, 4, 8, 16 and 32 ohms switchable for receiver being tested. Up to 100 watts for testing purposes.

SWEEP-MARKER EQUIPMENT

SM158 Speed Aligner Sweep and Marker Generator

- SWEEP OUTPUT: Chroma, IF, or RF with front panel fine tuning.
- CRYSTAL CONTROLLED MARKERS for alignment accuracy.
- 15 MEGAHERTZ SWEEP WIDTH to cover the entire IF band.
- PUSHBUTTON MARKERS for the 8 most often used IF frequencies: 39.75, 41.25, 41.67, 42.17, 42.67, 44.25, 45.75, 47.25. Trap and carrier markers listed right on front panel. 3.08, 3.58, 4.08, and 4.5MHz for chroma.
- HORIZONTAL MARKERS available at the flip of a switch.
- 2 EXTRA RF CHANNELS to assure interference - free response curves on RF - 4RF channels in all.



\$275.00

THE INDUSTRY'S EASIEST TO USE SWEEP AND MARKER.

BE156 7-in-1 D.C. Bias Supply

\$29.95



- 3 SEPARATE SUPPLIES for fast alignment work.
- NEGATIVE 75 VOLTS for sets requiring high negative bias in chroma amplifiers.
- NEGATIVE AND POSITIVE SUPPLIES for both tube and solid state work.

PROVIDES THE BIAS YOU NEED FOR ANY SET - IN ANY STAGE.

OSCILLOSCOPES

PS148 Wide Band Oscilloscope/Vectorscope



\$295.00

THE FIRST REALLY COMPLETE SERVICE SCOPE - IT'S A WORKHORSE.

- WIDE BAND 10Hz to 6MHz \pm 6DB.
- HIGH SENSITIVITY 17mv RMS per inch.
- HIGH INPUT IMPEDANCE 27 megohms shunted by 11pf low cap.
- SEVEN THOUSAND VOLT input rating with low cap probe, not 600 volts like other scopes.
- DIRECT VERTICAL PEAK - TO - PEAK VOLTAGE READING with input controls calibrated directly in volts p-p.
- CONVERTS TO PROFESSIONAL VECTORSCOPE with the flip of a switch. A truly complete scope with this feature.
- FULL RANGE HORIZONTAL SWEEP frequencies from 5Hz to 500KHz in five overlapping ranges.
- POSITIVE SYNC with variable control locks complex waveforms with triggered ease.
- EXTERNAL INPUTS for sync, sweep, Z axis and direct connections to deflection plates.

PS163 Dual Trace Triggered Scope



\$695.00

- LAB SPECIFICATIONS that compare to scopes costing 3 times as much.
- PHASE - LOCKED MATCHED CHANNELS allow you to compare simultaneous waveforms within 1% laboratory accuracy.
- TRIGGERED SCOPE with absolute positive sync, backed by TV sync separators.
- TRUE SERVICE SCOPE with 8MHz bandwidth and 5 millivolt sensitivity on both channels.
- EXCLUSIVE 5KV INPUT PROTECTION. No blown front ends and trips back to the factory for this scope.
- VERSATILITY with pushbutton selection of free running, manual or automatic triggering, AC or DC coupled.
- PUSHBUTTON VECTORSCOPE: High sensitivity, direct hookup from front of scope.

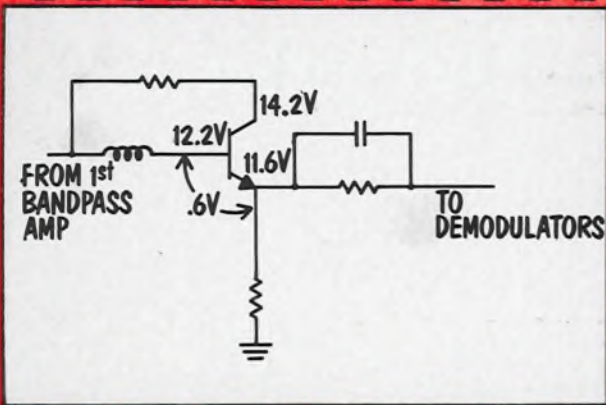

43

Here's an emitter follower circuit we can use. First you check the voltages. Sam's Photofact shows the emitter - base voltage difference to be the normal .6 volts. So what do you come up with?

Well, checking the emitter voltage I get 11.4 volts. That looks pretty close to what we should get. Since this meter has a 12 volt full scale range I'll have to switch to the 30 volt range to measure the base voltage. Hmmm, 12.4 volts.

44

That's a 1 volt difference between base and emitter. This transistor must be bad.

Now wait a minute, Tom. The voltages that we measured are within 3% of the values on the schematic. Could the lack of accuracy have led us to the wrong conclusion? Let's check it with Big Henry and see.

45

Big Henry's improved accuracy measures the voltages at 11.7V and 12.3V. That's a difference of .6 volts exactly. Tom - can you be led in the wrong direction by the inaccuracy of your multimeter in solid state circuits. I'm afraid so.

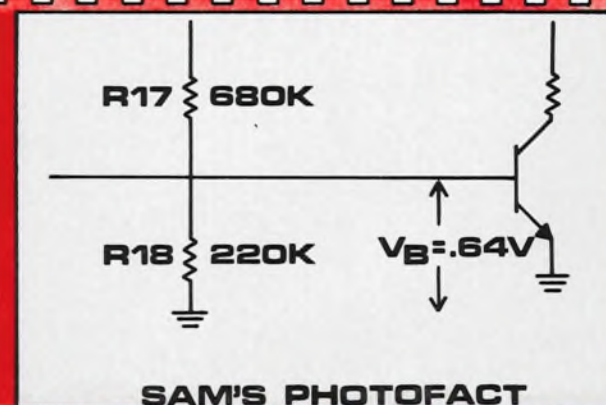

46

Check these specifications and see for yourself that Big Henry has the accuracy you need. You'll never be led astray by his 1.5% DC accuracy. The Big Henry's 3% AC accuracy will give you dependable readings, not like other meters with AC reading errors as high as 5%. Now add DC current accuracy of 3% and ohms measurements with 2 degrees of arc and you have dependable accuracy for any servicing job. Tom - you'll never need more accuracy, and you shouldn't settle for less! Big Henry will give you the dependable accurate readings you need.

47

This really is some meter, lab specs in a rugged portable multimeter. But I have another question that's just as important. Am I going to have problems with loading? You know loading of the circuit being tested is directly related to accuracy. The impedance of some meters placed in parallel with a large resistor in a circuit will change the current through other parts of the circuit and completely upset the circuit operation. Here's a set that I had in here the other day that is a beauty of an example.

48

This is the sync separator circuit in an RCA CTC 41XP Hybrid chassis as shown in Sam's Photofact. The bias on the transistor is determined by a voltage divider consisting of R17 and R18. Under normal operation we have .64 volts across R18. Now look what happens when I attempt to measure the base voltage with a 10,000 ohms per volt VOM.

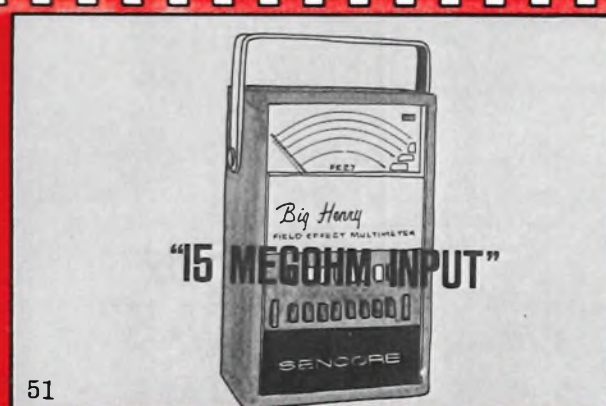
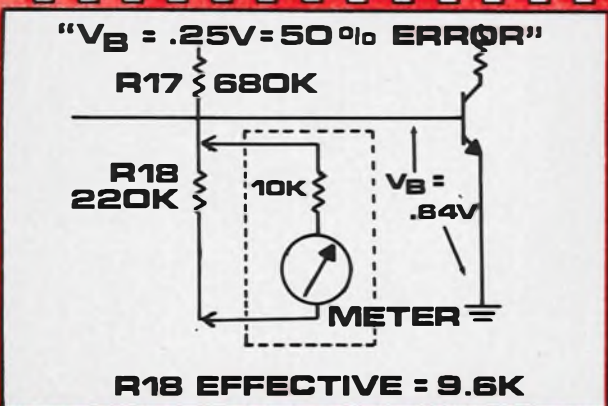

49

When I touch the meter probe to the base terminal, the 220K resistor is shunted by the 10K resistance of the meter, which changes the effective value of R18, to 9.6K. This changes the circuit completely. How does this affect my voltage reading? Instead of reading the .64 volts, which is given on the schematic, we read .25 volts. Now that's over 50% error and I sure can't depend on that reading to be accurate. How does the Big Henry stack up in this situation.

50

Well let's just see Tom. We check the same point and read .64 volts on Big Henry. That's almost exactly as specified. How's that for accuracy and reliable readings that you can depend on every time? Are you starting to believe in Big Henry?

51

Big Henry will never load down a circuit, because he has 15 megohm input impedance on all DC ranges. The input impedance does not change as you switch from one range to another. This is why you can depend on Big Henry for accurate, error free troubleshooting every time. Many field effect multimeters, VTVM's and even the digital multimeters have only 10 megohm input impedance. Although this is better than the VOM, with its variable input impedance, they can still change the bias values on high impedance circuits. They can even kill the normal operation of some circuits. Big Henry is just another step ahead with a big 15 megohms input.



52

You know, you fellas have some meter here. Toughness designed into the meter for less downtime and accuracy that I can always rely on. Now I see what you mean by dependability. How about one more question? You really have me interested now. I believe that this Big Henry is tough, and accurate, but a multimeter has to be sensitive too, if it's going to be any good for me. How about it, does Big Henry have the sensitivity I need?

That is a very fair question Tom. More and more of the circuits you service are becoming solid state and this means low voltage levels. This is particularly true in the new integrated circuit technology where we are talking tenths of volts.

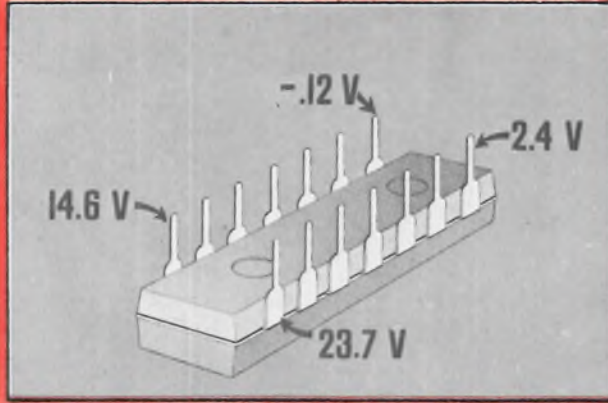

53

Let's talk about voltages on the pins of this complex integrated circuit. Sam's Photofacts shows us voltages from $-.12$ to 23.7 volts on the IC pins in a Panasonic CT27 chassis. You really need a meter with sensitive low voltage ranges to measure these values accurately. Tom, could you really measure that $-.12$ volts accurately if the most sensitive range on your meter was 1 volt? How can you read two digit accuracy when the meter pointer is way down in the mud?

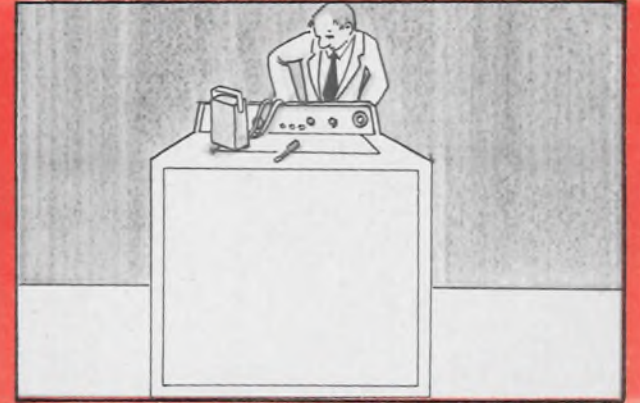

54

Hey, what about appliance technicians? They measure low resistance values all the time in motor and relay windings. And how about leakage tests? I serviced a washer the other day and oh brother! My phone was ringing off the hook by the time I made it back to the shop. A leakage problem to ground that really set that housewife back a couple of feet. That inexpensive VOM I was using had an RX1K for the highest range and sure enough, it missed the problem. But let's get a little more specific. What kind of sensitivity are we talking about with Big Henry?

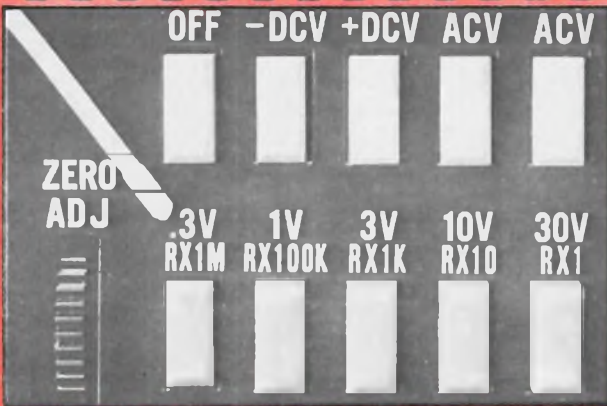

55

First, the lowest range on either DC or AC volts is $.3$ volts. That $-.12$ volts on the IC pins will be right up in the middle of the scale, and not down in the mud. It would be a snap to measure. Just push the $-$ DCV and the $.3V$ buttons. That's right, Big Henry has a polarity reversal switch for your convenience. No more switching leads - just push the buttons.

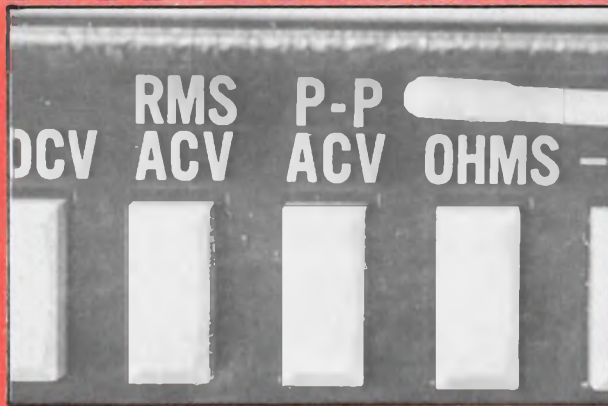

56

AC measurements are possible, from $.3$ volts to 1000 volts full scale in either peak-to-peak or RMS values. It's your choice with the simple push of a button. Pretty simple, isn't it? There's a lot more here than meets the eye though, Tom. You realize that some TV set manufacturers have introduced voltage regulated power supply transformers in their new model sets. These transformers supply a 60Hz square wave rather than a sine wave. However, the schematic values are given in RMS, and they must be measured in RMS to compare meter to schematic values. Don't believe it? Think this will not apply to you?

No. voltage is... former, but the VRT... ment voltage. The voltage on the winding will be approximately 6.79 volt RMS since this winding is in series with the CRT transformer secondary, the voltage on the filament will be 6V RMS $\pm .2V$. This voltage now is a square wave, and therefore cannot be measured with a conventional D'Arsonval meter movement where the RMS voltage is derived from a peak-detector. A true RMS reading meter or a Dynamometer movement should be used.

The total B+ change on the 128V line is approximately 5V with brightness varied from minimum to maximum and approximately the same amount on a line voltage variation from 100V to 132V load con Courtesy of Zenith

57

Here is an excerpt from a Zenith Service Manual. "This voltage now is a square wave, and therefore cannot be measured with a conventional D'Arsonval meter movement where the RMS voltage is derived from a peak-detector. A true RMS reading meter or a Dynamometer movement should be used." Do you see that a conventional meter is not going to give you dependable readings? Now, how can you accurately measure the RMS value of a square wave voltage when all meters are calibrated for sine waves? The errors can be between 10 and 20%.

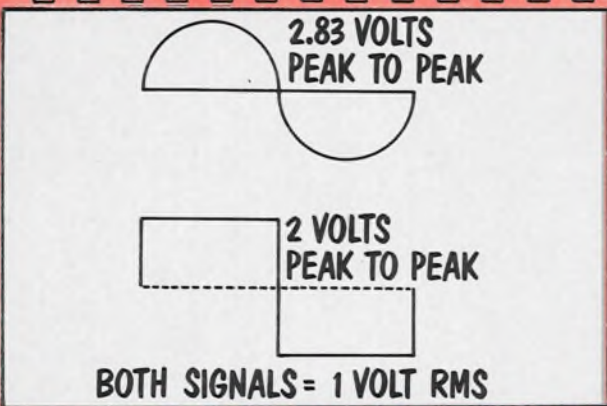

58

Again Sencore has come through with a new innovation. These two signals shown here will read the same on Big Henry because they have the same RMS value. However, they would be quite different if measured with a peak detecting meter. Big Henry has a specially designed AC RMS circuit to read accurate RMS voltages for either sine waves or square waves. This, of course, provides better RMS accuracy for any other non-sinusoidal waveforms as well.

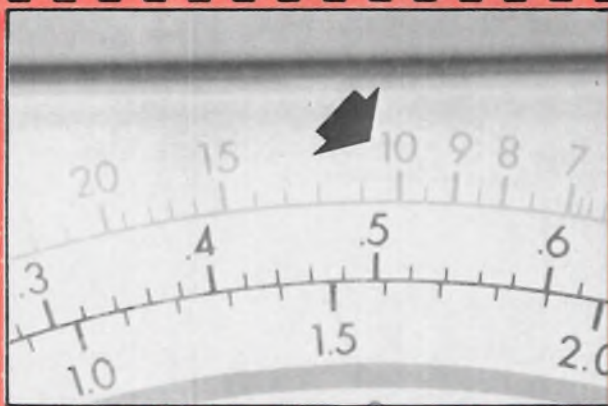

59

Big Henry has sensitivity on ohms ranges too, with measurements down to $.1$ ohm. Now you can accurately measure the resistances of those motor and relay windings on the 10 ohm center scale RX1 range. Large value focus resistors or leakage checks are no problem on the 10 megohm center scale RX1 Meg range. Big Henry measures them all, large or small, $.1$ ohm to 1000 megohms.



60

Hey - I'm convinced! Big Henry is really the meter for me. He's tough for those portable jobs, yet has the accuracy and sensitivity that I can rely on. You know, Big Henry is the most dependable meter I have ever seen, and that's what it's all about, dependability in your test instruments for reliable readings everytime, without being hampered by costly downtime. . . and when I say costly, I mean costly.



61

Look at these three meters I broke down this morning. That bill alone would pay for a Big Henry several times over. It's funny, I've heard so much about the high accuracy of digital volt meters lately, but when I stop and think about it, I don't need that lab-precision accuracy. Big Henry offers 1.5% accuracy and that's plenty for any servicing situation. Why should I pay more for specifications I don't need, and not get the portability and toughness I have in Big Henry, and let me tell you friend, that toughness is important to me.



62

There is just one more thing. There are times when I make calls, either in homes, or out at factories and my hands get full quick, with the different testers and caddies I have to haul around. Have you ever had to climb to the top of a three story building to check air conditioning units with what seems like half of your service shop in your arms? A real answer would be a smaller meter that could fit inside a caddy along with my other equipment, yet have the same dependable toughness and accuracy. Does Sencore have an answer for this one?



63

Say no more Tom! Sencore originated the FET multimeter many years ago, and they have been designing them with the technician in mind ever since the first meter. We do have an answer to your problem. It's the Sencore Little Henry. The little brother to Big Henry, designed with the same dependability and accuracy. But it's smaller. Little Henry is a completely portable, hand held multimeter, weighing only 2½ pounds. It's small enough to easily fit into a tube caddy, tool box, glove compartment or brief case. This portability is its biggest feature. Little Henry will go anywhere with you.

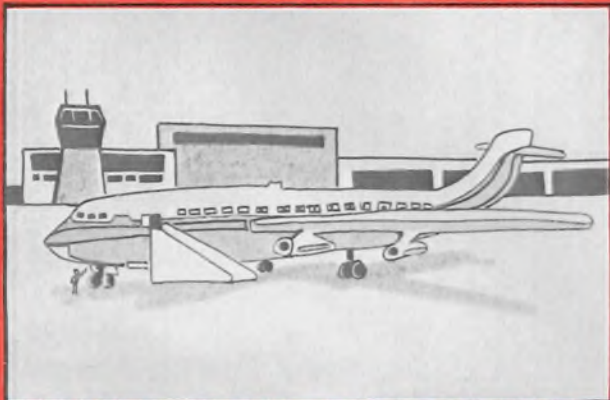

64

Technicians have used them to check out complex electrical systems from automobiles to aircraft. Imagine Little Henry perched up in the landing gear compartment of a 747. Now imagine any other meter falling from that far. Remember all those things that shouldn't happen, but do? Little Henry was designed to withstand these hazards, just like Big Henry. No more burned out meters or precision resistors either. Little Henry has the same 1000V input protection.



65

Hey, it's all pushbutton, just like Big Henry. I remember what a benefit that is from my problems this morning. Looks like quite a few ranges for such a little meter. Is it as accurate as Big Henry on all of these ranges?

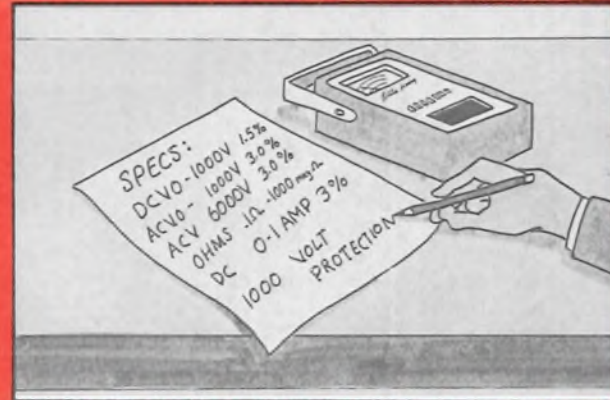

66

You bet Tom. Let's run through this for you. DC capabilities from 0 to 1000V at 1.5% accuracy. Same AC ranges apply at 3% accuracy. There's a separate 6000 volt DC range at 3% accuracy that really extends your measuring capabilities. Resistance measurements from .1 ohm to 1000 megohms are available at the push of a button. Little Henry even has a 0 to 1 amp DC current function. All these ranges and the same Big Henry protection up to 1000 volts on all ranges.



67

Hey it's a little Big Henry! You know, you fellas make it pretty hard for a guy to make up his mind. What would you suggest I do? I could really use both of these Henry meters.

Well Tom, all we can tell you is what many other technicians have done. Over 10,000 Little Henrys went to the field the first year. This proved that technicians were looking for dependability, in small, portable equipment. We received many requests for additional features technicians and engineers wanted with the same dependable internal and external design.

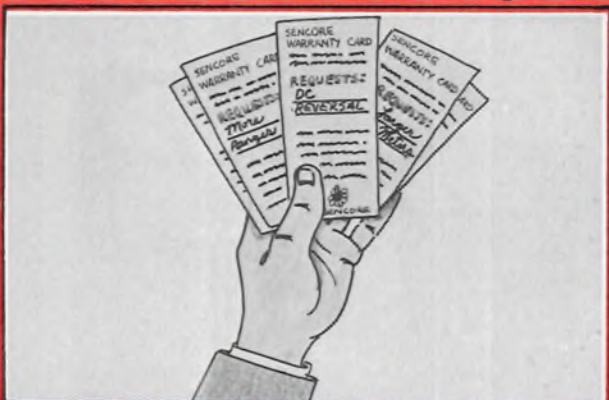

68

Some requests are shown here on warranty cards that we received. They asked for such things as more ranges, particularly the higher sensitivity of low ranges for solid state work. Others wanted a DC reversal switch so that you would not need to switch leads when measuring negative voltages or currents. Also requested was a larger meter scale and zero center scales. All of these requests were incorporated into Big Henry, for an easier unit to operate with greater capabilities.



69

And don't forget Tom that both Sencore Henry meters come equipped with lighted meter scales, so you can see the readings more clearly in those dark corners behind TV sets. They also have their own built-in storage compartment to keep them out of the way during transit. You'll put an end to all your lead hang-ups with a Sencore Henry meter. Both Sencore Henry multimeters are battery operated, a must for outside field use. No need to look for an electrical outlet with a Henry along. The instant-on characteristics of solid state design never keep you waiting for the unit to warm up like you do with a VTVM.

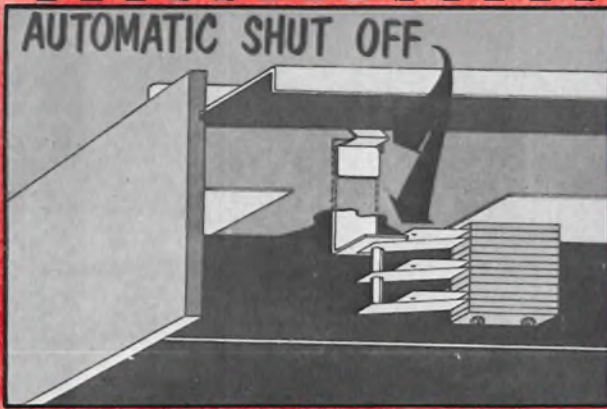

70

Battery replacement is kept to a minimum too, because the Henry's turn themselves off, automatically. This exclusive Sencore feature is a real temper saver. The latch on the lead storage compartment is really an actuator for a switch. Pack up the leads and close the door when you finish a job and the multimeter is automatically turned off. When you are ready to use it on the next job, the batteries will be fresh and Henry will be ready to go as soon as you open the door.

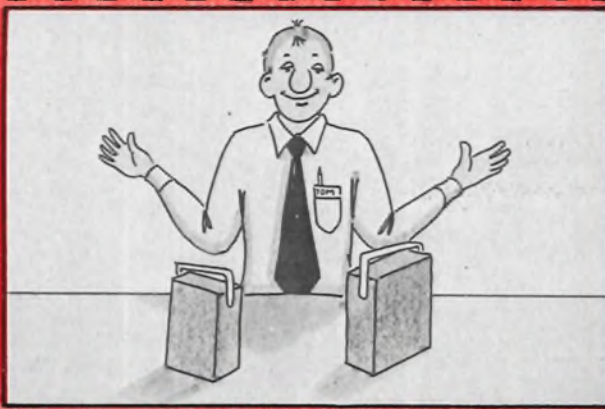

71

Hold on a minute, I've decided - a Little Henry for my outside man and a Big Henry for in the shop and an occasional outside call. But, one last question, where do I pick my Henry meters up?



72

That's the easiest question you've asked all day Tom. All you have to do is visit your local Sencore FLPD distributor. He carries the full Sencore line and will be happy to demonstrate either Big or Little Henry to you. In fact - - if you want to really prove it to yourself, hook up one of the Henry meters to the demonstrator you'll see on your distributor's counter. Apply 1000V to any or all of the ranges. Then check Big Henry against the calibrated check points for accuracy. Drop him on the floor, then check his accuracy again.



73

We want you to believe that Sencore Henry multi-meters are the most dependable meters produced. Finally, take a Sencore Henry home with you for a 10 day free trial and run it through its tests again.

Fellas - I'm going to do just that, and I really want to thank you for your time and patience. I've learned a lot today, and I know I'll enjoy better, more profitable servicing because of Big Henry. By the way, you better take your meter with you before I keep this one.



74

Oh - oh, sorry fellas.

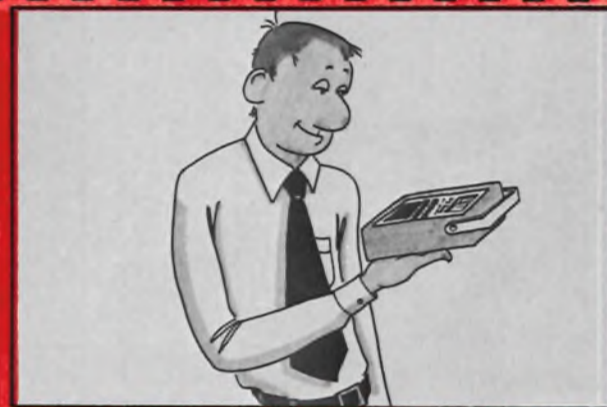

75

Don't worry Tom. You just dropped the dependable Big Henry. You see, nothing wrong with it at all. However, you better get down to your Sencore FLPD distributor as soon as possible and pick up a Big Henry for yourself. Thanks for your time today Tom, it's been a most interesting day.



76

We hope it has been interesting for you too and we hope we have shown you the need for a dependable multimeter that protects you against that costly downtime. We have poked some fun at some of the problems Tom Thumbs encountered, but let's not kid ourselves. Downtime shouldn't happen . . . but it does. It is costly and frustrating, and you know, it really doesn't have to happen. Why don't you find out for yourselves by trying one of the Sencore Henry meters? Then take one home for 10 days and begin increasing your uptime.



77

Profitable uptime that you can depend on with Sencore.

Editors Note:

The technical information presented in this slide film is documented by actual tests performed in the Sencore labs.

The Sencore News is written, edited and published by the Field Engineering Department of Sencore, Inc., 3200 Sencore Drive, Sioux Falls, So. Dak. 57107. The Sencore News is distributed without charge to all individuals or companies who have registered the purchase of any Sencore instrument by means of the warranty card packed with the instrument. The information herein has been taken from one or more sources which we consider reliable. Although such information has been carefully prepared, we make no representations as to its accuracy or completeness. Prices and specifications are subject to change without notice.

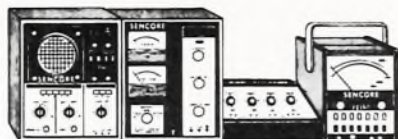

**BOB
AND
NORM'S**

SHOP

- SERVICE TIPS
- SHORT CUTS

Good morning, Norm. How are you this morning?

I'm fine Bob, but I can't say the same for this color picture tube. Emission is really weak on the red gun, and tracking tests bad on the CR168 Big Mack automatic tracking test. I was just wondering if I should try to rejuvenate the red gun with Big Mack's rejuvenation capability.

Why not? You know it is completely safe and cannot do any harm to the tube, because it's automatically timed so that you can't overdo it. Big Mack's timed circuit won't let you hurt the tube.

Yeah, that's right. I'll give it a try on the first rejuvenate position. All I need to do is push the red gun button and turn the function switch to the REJ 1 position. There, now let's see how the CRT checks. Looks like the emission has improved. How about tracking?

It still shows bad tracking according to Big Mack. Maybe I should try to rejuvenate again. This time I'll try to hit it a little harder, using the REJ 2 position. There we are, emission has improved even more and tracking now shows GOOD on the meter. Looks like that has done the job. I guess I've just given our customer some more service out of this old CRT. That should please her.

Right, Norm. That Sencore rejuvenation on Big Mack is really a customer saver. Usually I can delay the purchase of a new CRT for a year or so by rejuvenation. I can charge a nominal fee for rejuvenation, and tell the customer that this charge will apply to the purchase of his new CRT later. The customer is happy because he doesn't need to lay out the big expense of a picture tube, and we have a future CRT sale sewed up.

Yeah, but I'm still a little skeptical. I wonder if this rejuvenation always works. I know the Big Mack's rejuvenation is safe, because the high grid to cathode voltage is timed by a capacitor. But will it be adequate to rejuvenate the really weak tubes? Maybe it's too safe, and does not have enough power for those really bad ones.

Well, maybe. I know there are some rejuvenators on the market that do not have this timing feature. They allow the user to time the rejuvenation or adjust the current manually. Maybe that would be better, even though it is more risky.

Say, I know how we might be able to get some information on this. I remember a note on our distributor's bulletin board that said the Sencore Tech-Rep would be in today. Let's go ask him. I have some parts to pick up anyhow.

Later that morning at their local Sencore FLPD Distributor's —

Say, Mr. Sencore, I'd like to ask you a question about Big Mack. Why don't you have a rejuvenate position on the function switch so that it can be controlled manually rather than timing it automatically? Other rejuvenators can pump more rejuvenation power into the tube because they are manually controlled. Your automatic timing kind of limits the amount of power that I can apply.

That's right, sir. That's the idea. We want to limit the power so that the tube will not be damaged. It protects the tube, and that protects you from an irate customer. We know there are other testers on the market with rejuvenation that must be timed manually, but have you seen what can happen to a tube when it is hit too hard or rejuvenated too long with unprotected rejuvenation? The tube may show good on a CRT checker, but you may see a considerable loss of focus when it is operated in a set. We have run into a number of picture tubes where this has happened. Our engineers at the factory did a lot of testing on CRT guns with the Big Mack and competitive units. Here, let me get some pictures to show you what happens. I think I can show you why the CRT will not focus properly after being hit too severely.

Our engineers started with a brand new CRT with zero hours of use on it. They did this so they could be relatively sure that all three guns would be identical at the beginning of the

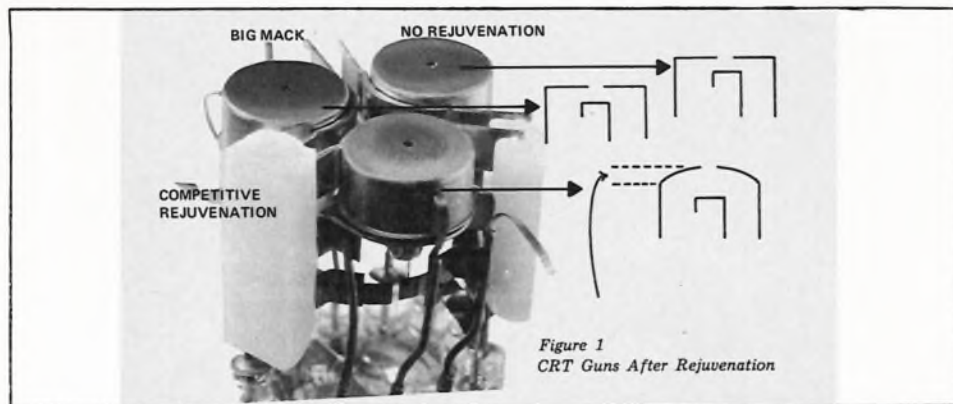
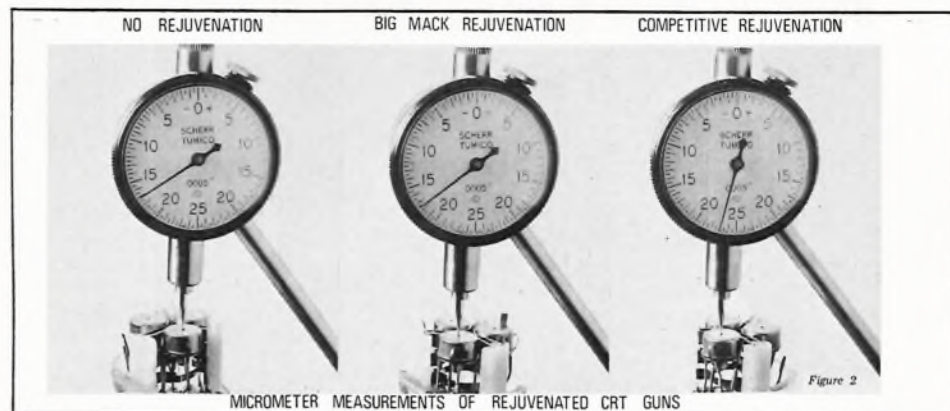

Figure 1
CRT Guns After Rejuvenation

test. All testing that took place followed the procedures described in the manuals that came with each unit. The test began with one gun being rejuvenated with a competitive untimed unit, using the manufacturer's instructions. The second gun was rejuvenated with Big Mack on REJ 3. The third gun was left in new condition to be used as a standard to compare against. Figure 1 shows the G₁ surfaces after the guns were removed from the glass envelope. Notice how the untimed rejuvenation caused the G₁ surface to bulge out changing the distance from grid to cathode while the other two surfaces remained the same as before the test. Our engineers wanted to see exactly how much the gun was affected by the manually operated unit, so they took some measurements.

A micrometer depth gauge was used to see how much the grid to cathode distance had changed. Each G₁ surface was set at zero reference on the micrometer. Then the steel point was injected through the G₁ hole until it rested on the cathode surface. The cathode



MICROMETER MEASUREMENTS OF REJUVENATED CRT GUNS

in the untested gun is very close to the grid surface, only .017 inches, as can be seen in the photo. However, the deformed gun has the cathode .023 inches from the grid surface. This may not appear to be a significant difference, but percentage-wise it is a 35% error in spacing. That error is enough to cause some real control problems, and could affect tracking as well. Do you want to take the chance of this same thing happening to one of your customers picture tubes? Notice the gun that was rejuvenated with Big Mack. It measures the same as the gun that was not rejuvenated at all.

The effectiveness of the rejuvenation of a CRT gun is dependent on the amount of power that is dissipated through the gun. Of course, you can shoot more power through the tube for a longer period of time but you run the risk of tube damage with either of these approaches. Sencore designs instruments that are risk-free. We want no part of this forced power risk, so we use the automatic timed approach.

Now if you want to assume the risk of a higher voltage setting you can do it with Big Mack, but then it's your responsibility, not ours. You can increase power through the tube by rejuvenating on a higher filament voltage setting. If Big Mack doesn't bring back a tube by several charges of the REJ 3 function, raise the filament setting and try it again. You still retain the safety of a timed pulse, but you will shoot more power through the tube. This can actually give you six different rejuvenation conditions, three on the normal filament setting and three on the increased setting.

If you think that still isn't enough power through the tube, you can increase the size of the timing capacitor in the CR168 or connect another capacitor in parallel with the one in the unit: This would increase the amount of charge, and hence the power, through the rejuvenated gun. We don't really recommend this, but we have heard of some technicians that are doing it. Again, if they want to assume the responsibility of possible damage to a tube, that's their business, but we know that when Big Mack leaves the factory it is safe for rejuvenating any tube.

Well, Mr. Sencore, I know now that I'm going to keep my Big Mack just like he is. He's done a good job for me, and I don't want to take any chances of damaging an expensive picture tube. If none of those six different rejuvenation settings on Big Mack bring a tube back up to good operation, it is probably too far gone to hold up anyway.

That's right. There will always come a time when a tube should simply be replaced. Rejuvenation of a tube that is too far gone may look good when you first check it, but may not last. We've seen some really old tubes that went down again only 12 hours after rejuvenation, even after an extreme untimed rejuvenation. When you try to rejuvenate a CRT that is too far gone, you're just going to get a quick call-back. Now that is time and profits out the window for that second call. The real beauty of Big Mack is that it's a total picture tube tester. If a tube is too far gone, after you try the rejuvenation, you simply show your customer the results on the easy to read GOOD-BAD scale. The Big Mack is a CRT sales-



Figure 3 Big Mack's Customer Convincing "GOOD-BAD" Scale

man because it convinces your customer that "she" needs a new picture tube and saves you the headaches of a quick call-back just to replace a CRT that should have been replaced the first time.

Well thank you for your time. It looks like you Sencore people have studied this out pretty thoroughly. I realize now that I need a total tester that will safely rejuvenate worn out CRT's, then tell me exactly how well the rejuvenation worked. I don't need the added problems of possible damage to a customer's picture tube, plus the wasted time of a call back. Big Mack is the tester for me.

MEET THE MOST DEPENDABLE MULTIMETER ON THE MARKET TODAY

DEPENDABLE 1000V INTERNAL PROTECTION ON ALL RANGES FOR MORE PROFITABLE UPTIME – LESS DOWNTIME.

DEPENDABLE EXTERNAL PROTECTION WITH INDESTRUCTIBLE ACRYLIC CASE, SLIDING METER COVER AND HANDY LEAD STORAGE COMPARTMENT.

DEPENDABLE 1.5% FET DC VOLTS ACCURACY.

Specially designed spring loaded jewel pivot meter movement built to absorb the shock from any fall and go right on working for more dependable uptime.

Handy scale illumination for easy viewing - especially in those dark corners behind TV sets, appliances or large automated industrial machines.

Indestructible acrylic case that protects you against the downtime of shattered cases after those rough rides in the van or an accidental fall.

Exclusive sliding meter cover for complete meter face protection while you go from job to job.

1.5% DC accuracy for readings that you can depend on for every servicing situation.

Time saving Peak to Peak and RMS AC volt functions for accurate voltage comparisons direct from meter to schematics without any time consuming calculations.

Sensitive .3V DC range that allows you to confidently troubleshoot solid state circuits accurately.

Dependable recessed pushbuttons for fast, easy, accurate operation that does away with knobs that break and shafts that push through the unit.

Convenient lead storage compartment for a totally self-contained unit that eliminates the headaches of draggy or missing leads.

Dependable 1000V internal protection on all ranges - no more blown FET's, resistors or damaged meter coils.

Versatile 3KV jack that extends your measuring capabilities into high voltage circuits such as boost voltages in TV sets.

High 15 megohm input impedance for true measurements without the loading problems you'll encounter with other meters.

SENCORE'S FE27 BIG HENRY FIELD EFFECT MULTIMETER