

SENCORE NEWS

FEATURING
UPS164
UNIVERSAL POWER SUPPLY

3200 SENCORE DRIVE, SIOUX FALLS, SOUTH DAKOTA 57107

HOW TO WITH INSTRUMENTS THRU *PIX FACTS*

World's Largest Technical Publication — 500,000 Per Month

WRITTEN BY
SENCORE FIELD ENGINEERS
APRIL, 1972

SERVICING with a POWER SUPPLY

1. **New Universal Power Supply does it all - large or small.**
Read how the UPS164 was designed to cover all your needs. Page 2
2. **Servicing tomorrow - Modules.** Are you ready?
Find out what the modules can mean to you if you prepare. Page 4
3. **Servicing today - Solid State.** Learn how you can
make your servicing easier and faster. Page 6
4. **Pinpoint your problems quickly.** Tips on how the UPS164
can aid you in your troubleshooting. Page 7
5. **Big servicing boom coming in Automotive Electronics.**
Read how you can prepare for this money-making field. Page 8
6. **For Designers only! Increase your engineering efficiency.**
See how a \$240 investment can save you thousands. Page 10
7. **Vocational Schools - Help your Electronics students learn faster**
. . . and pamper your budget too. Find out the answer. Page 11

BULK RATE
U.S. POSTAGE
PAID
SIOUX FALLS, SD DAK.
PERMIT NO. 731

**PRODUCT
OF THE
MONTH**

Just one supply to fill all your needs

UPS164

UNIVERSAL POWER SUPPLY

Only **\$240.00**

it's tough man



SENCORE INC. SIOUX FALLS, SD 57107 USA 105/120VAC 60Hz

Servicing with a Power Supply

INTRODUCTION



Keith Boese
Design Engineer

The Field Engineering department has just finished testing one of the most remarkable and versatile instruments we have ever seen. The UPS164 Universal Power Supply is really a worksaver and may very well prove to be your job saver.

We would like to take you with us through our tests, to point out some of the many reasons for its design, what has been built into the UPS164 for you, and some of its hundreds of different applications in servicing, design, and education. We will also introduce some new servicing ideas, especially regarding the module receivers. We think you will come to share our feelings about the UPS164, and we encourage you to try one the first chance you get. They are waiting for you now at your Sencore distributor.



Norm Pedersen
Chief Field Engineer

We found a wide variation in the voltage and current requirements of the different products and circuits tested. Circuits such as a transistor radio and simple design breadboards need only a low voltage and a few milliamps of current to operate. The modules, amplifiers, and tuners needed both higher voltage, up to 30 volts, and a higher current from the power supply. Car radios and tape players, as well as control circuits, usually require a lower voltage but have a high current drain, sometimes as much as 20 amps. This finding posed an even more interesting problem than the regulation and filtering. How do you design a supply that will provide the range of output voltages to cover all these different items and still have current capabilities up to about 20 amps? Obviously the engineers would have their hands full designing this supply.

One area that the Field Engineering department felt very strongly about was the need to have monitoring capabilities built into the supply. The use of external meters to determine output voltage and load current is very cumbersome and involves a great deal of time, not to mention the fact that you must have additional meters on hand to do it. We therefore stressed the need for an output meter, or preferably two output meters, to allow rapid checking of the power supply output and the load condition.

1 NEW UNIVERSAL POWER SUPPLY DOES IT ALL!

The transistor, the FET, and most recently the Integrated Circuit have created many changes in the electronics field, not only for the designer but for the instructor and the service technician as well. The use of low voltages, very low biases, and the sensitivity of these devices to even minor voltage changes, has created some new problems for those working with electronics. The design parameters must be watched very closely for, unlike a vacuum tube which can withstand a wide range of operating currents, the transistor must operate with a limited range of collector current variations. The biasing is more exacting as is the power supply regulation and filtering required for reliable operation. And the number of units in use is mounting rapidly.

To emphasize this fact, let us look at some figures compiled by the Electronic Industries Association. There were over 77 million color television receivers in use as of Jan. 1, 1972, with an additional 7.5 million increase expected this year. Black and white receivers, in use, should reach somewhere near 115 million sets by the end of 1972. The majority of these sets, both black and white and color, are now using solid state circuits,

how you will provide the power to work on them?

With this question in mind, and a large number of requests for a high quality power supply, we set out to do some research to determine if a power supply was needed and, if so, what its requirements would have to be. We began by looking at all the different areas that had need for a DC power supply to operate electronic circuits and devices. We found the need existing in every area; servicing, field engineering, design engineering, industry, maintenance, manufacturing and Vocational schools. The research and testing was now centered on determining the requirements of the supply. We tested television receivers, radios, phonographs, tape recorders, closed circuit cameras and video recorders, tuners, amplifiers and many of the new modules to check the need in the service area. Control circuits, design breadboards, sub-assemblies, components and many other areas were tested for engineering and industrial applications.

Field Engineering tested many products to determine supply needs.

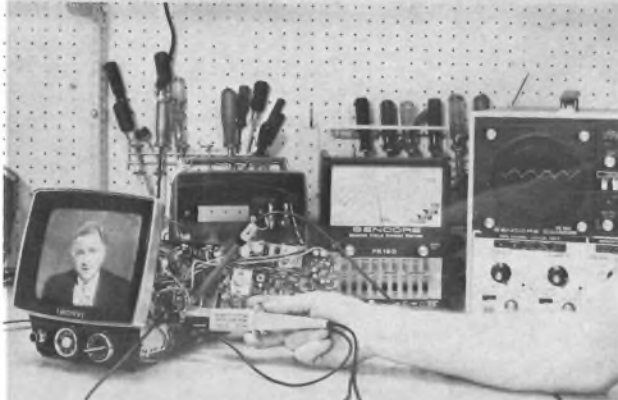

The results pointed to some very definite needs in a versatile "universal" power supply. Two areas came out on top as being "must" requirements for any new power supply. One was that of regulation. Solid state devices, especially integrated circuits, are quite sensitive to voltage changes, and must be powered by an unchanging DC source if reliable performance is to be realized. The gain will change, output signals will vary, and control functions will not be reliable if the voltage varies. This means good regulation would have to be used to hold the steady output demanded by the solid state circuits.

Second was the area of filtering. Much of the solid state equipment to be serviced is battery operated and, therefore, contains very little or no filtering. Modules and panels in newer television receivers do not have filtering incorporated within the panel. These and most other circuits proved to be just as susceptible to ripple in the power supply as they were to voltage changes. Thus the second requirement of the power supply must be excellent filtering which would provide pure DC output.

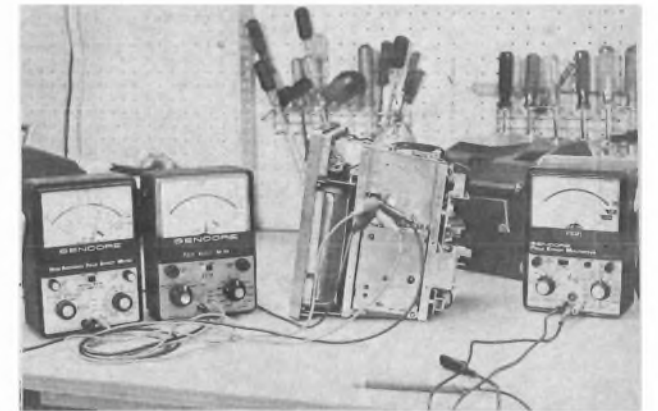

Extra meters to measure voltage and current are a costly nuisance.

Another major requirement evolves because of the sensitivity of solid state devices to bias changes and overloads. We found many troublesome situations which could be vastly improved if the maximum current output of the power supply could be limited. We have been aware for some time, and you probably have too, that something as simple and common as a test probe slipping or improper connections can cause a great deal of destruction in solid state circuits. Add to this the damage caused when a unit is operated with shorted or leaky components and you have a very strong case for some means of current limiting. Our discussions with engineers and service technicians bore out our suspicions that many, many profit dollars are lost each year, due simply to component damage during servicing and testing. The power supply, therefore, must have current limiting protection for the circuit being powered to make it the quality supply that is needed for solid state work.

Along with the protection of the circuit is the protection for the supply itself. A short or incorrect connection can destroy most types of power supplies, causing delays in design or servicing, and costly repairs. The final area for design consideration should be protection for the power supply itself.

Armed with this mountain of facts, figures, and opinions, we presented our case to the engineering department. You can well imagine what their thoughts were when many of our seemingly impossible requirements were presented.

We are fortunate in having an engineering force with enthusiasm directly proportional to the size of the problem. They immediately went to work with their slide rules and breadboards. The result of this undertaking is the new UPS164 Universal Power Supply. Here is our answer to your problems of powering solid state circuits and modules.

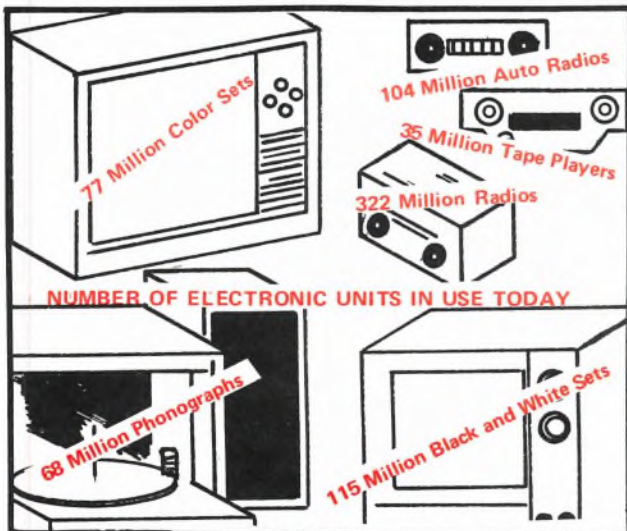

with many of the latest models using the modular design concept. Radios in use today have reached a level of 322 million units, the greatest majority being solid state. There are over 68 million phonographs, and 104 million auto radios, again mostly solid state. In just the past three years alone, 24 million tape recorders, and 35 million tape players were sold to American consumers. These units were all solid state.

What do all these figures mean? Simply this. The majority of the 630 odd million entertainment units now in use are using solid state circuitry. As part of the total servicing industry, you will be called upon to service many of these units. Many of them are portable and battery operated, and now there are a large number of replaceable panels and modules being used. Have you ever considered



The UPS164 is the ultimate in solid state power supplies and incorporates all the features and outputs which are needed for solid state design and servicing. The output voltage is fully regulated to assure a constant, steady DC source. The output is also variable from 0 to 30 volts, with 2 amp current capability to handle circuit requirements.

VARIABLE 2 AMP HIGH FILTERED REGULATED CONTROLS

VOLTAGE RANGE
15V 30V

VOLTAGE ADJUST



CURRENT RANGE
200mA • 500mA
50mA • 2000mA (2A)

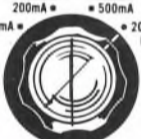

The Variable output features dual regulation utilizing a ferroresonant constant voltage power transformer, and a fast, accurate series regulator.

The constant voltage transformer prevents line voltage changes from affecting the output and the series regulator serves to maintain constant output voltage under varying load conditions. The Variable output boasts extremely high filtering to eliminate the possibility of ripple on the output.

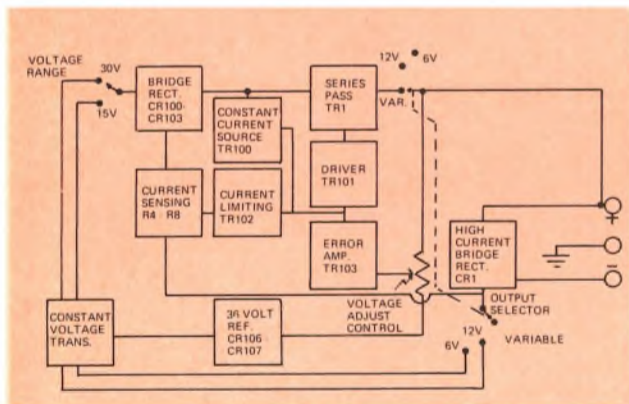

Block Diagram of UPS164

The degree of ripple is less than .018% at full voltage and full load and typically is less than 5 millivolts peak to peak. The ripple level is so low that most scopes are not sensitive enough to even see it! This is of paramount importance when dealing with circuitry containing integrated circuits.

The UPS164 incorporates dual D'Arsonval meters to enable you to monitor both the output voltage of the UPS164 and the current drawn by the circuit being powered.

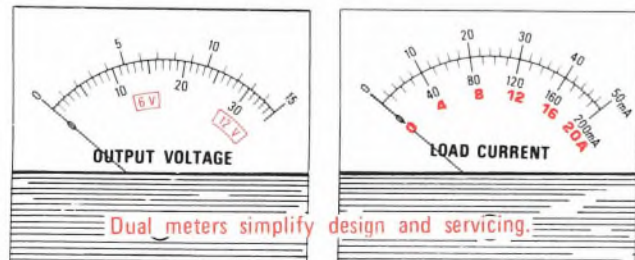

The 3% full scale accuracy of the meters gives you the precise measurements you need when working on the critical and sensitive solid state circuits. The meters provide constant monitoring of the Variable Output as well as the high current 6 and 12 volt outputs. The high current 6 and 12 volt outputs are included to make the supply complete and universal.

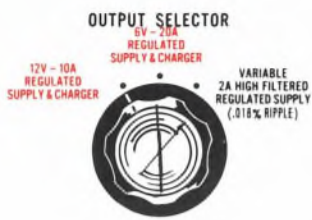

USE 2 AMP SUPPLY FIRST. CURRENT LIMITING WILL PREVENT DAMAGE. HIGHER CURRENT WILL BE REQUIRED ON 6 AND 12 VOLTS FOR WET CELL REPLACEMENT AND BATTERY CHARGING

The 6 volt supply delivers a maximum of 20 amps and the 12 volt supply is capable of a continuous 10 amp drain. To top it all off, the 6 and 12 volt supplies are regulated and filtered, something entirely new in high current supplies. You can work on a small transistor radio requiring 9 volts at 12 milliamps and switch to a tube type car radio operating at 12 volts and requiring 5 amps. It's all there in one attractive unit when you have the UPS164 on your service bench.

Then there is the matter of protection, both for the circuit and the power supply itself. The Variable Output of the UPS164 provides fully adjustable current limiting from 10 milliamps to 2 amps, offering the protection needed for the unit being powered.

MAXIMUM CURRENT SET



SHORT OUTPUT LEADS AND SET FOR MAXIMUM REQ. CURRENT ON METER FOR FULL PROTECTION

Simply short the leads together, set for the maximum current you wish the supply to deliver, and hook up. Ho-o-oLD it! "Did you say short the output leads? Won't you

burn up the supply if you do that?" We did say short the output leads and that's exactly the procedure you follow when adjusting the current limiting. The supply is fully protected against overloads or short circuits by virtue of the current limiting feature. You can short a screwdriver across any output of the UPS164 and no damage will result.



Would you dare do this with any other supply?

This unheard of protection for a power supply has been provided for you to make sure that you will have a power supply that you can rely on for years to come.

If some of you wish to get into the nuts and bolts of the UPS164, we have included a full list of specifications for you. Read them over, compare them against any power supply on the market and you will find no equal. There is only one Universal Power Supply and its at your distributor now; The Sencore UPS164.

Specifications	UPS164 Output Section		
	Variable 2A High Filtered Regulated Supply	6V-20A Regulated Supply and Charger	12V-10A Regulated Supply and Charger
Voltage Output	.5-15, .5-30 volts DC Regulated and continuously variable (35 volts available at less than 1 amp load)	7.5 volts (no load)	15.0 volts (no load)
Current Output	0-2 amps continuous with adjustable current limiting protection	20 amps continuous at 4.5 volts, 28 amp max limit	10 amps continuous at 11.5 volts, 14 amp max limit
Ripple	5.4mV p-p or less (less than .018%) independent of load	.10 volts p-p or less 2.5 volts p-p or less 4.0 volts p-p or less	.20 volts p-p or less 2.0 volts p-p or less 4.0 volts p-p or less
Degree of regulation with line voltage change from 105 to 130VAC	100uV or less (less than .3%)	.3 volts or less .3 volts or less .6 volts or less	1 volt or less .1 volt or less 1.5 volts or less
Degree of regulation with load change with constant 115VAC line (shown as voltage change vs amp change)	.15V/A	.15V/A	.35V/A
DC output impedance at full load	.15 ohm	.15 ohm	.35 ohm
Current limiting protection	Adjustable, with no overshoot above set limit. 2 amp maximum	28 amp maximum (Ferro-resonant constant voltage transformer and 30 amp fuse)	14 amp maximum
Battery Charger		General	
Type	Taper charge principle	Meters	Voltage and Current
Fully charged voltage	7.5 volts (6 volt system) 15 volts (12 volt system)		Switched for either 0-30 volt regulated supply, 6 or 12 volt supply
Maximum charge rate (charging rate decreases as battery charges until battery leakage level is reached)	Determined by battery condition to maximum of 28 amps at 6 volts or 14 amps at 12 volts	Accuracy	± 3%
		Leads	Power Supply
			Banana plug to alligator clip 48" (2 supplied)
			Battery Charger
			Lug terminal to heavy duty clip 48" (2 supplied)

Now that we have covered what the UPS164 is and some of the reasons we have designed it, we should point out a few of the hundreds of applications for it. The UPS164 will power virtually every solid state circuit you may be required to design, service or explain in the classroom. It will serve as a substitute power supply when servicing or designing modules, or plug-in panels, and it does

so without a trace of ripple to upset the circuit. When you are working with battery powered items such as radios, tape recorders, portable phonographs, car radios, tape players, and portable communications equipment the UPS164 is at your side and ready to provide the power you need. The circuit is fully protected too, as the current limiting takes over if an overload exists.

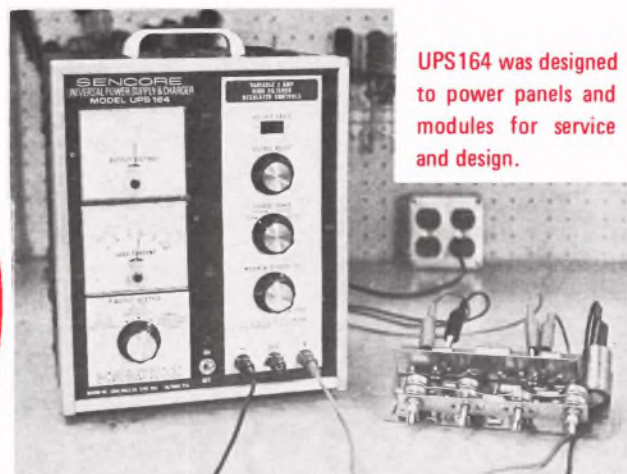
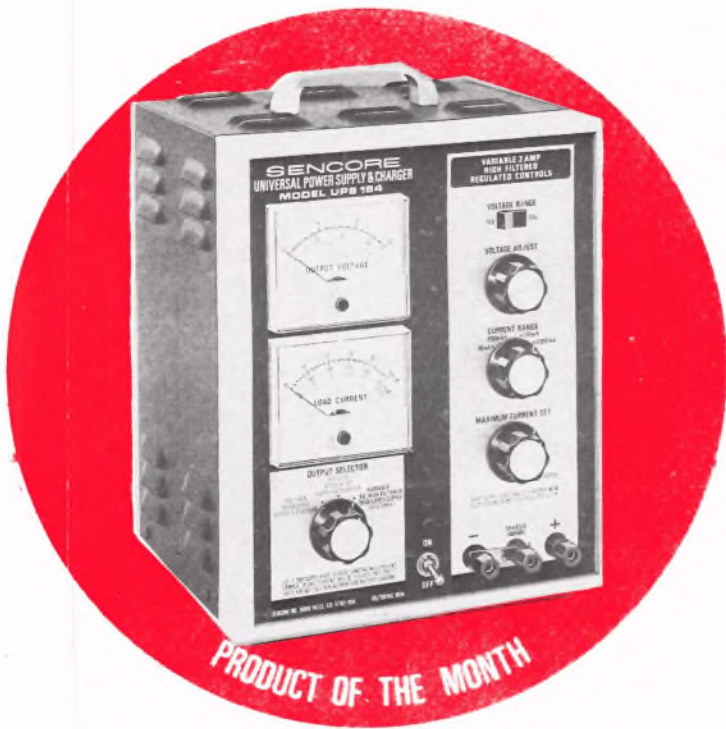

UPS164 was designed to power panels and modules for service and design.

battery to do the job. In addition, the dual meters provide constant monitoring of the output and the load, freeing your regular meter for troubleshooting. It's just like having two additional meters in your shop, and the 3% accuracy is even better than most VOM's.

The list of uses for the UPS164 is literally endless but we will give you just a few more ideas. The UPS164 is ideal for operating remote controls,

garage door openers, solid state audio amplifiers, tuners, DC control circuits, public address systems, portable TV, military, aircraft and marine electronics, design breadboards, student vocational trainers and experimental circuits.



The UPS164 will power any of these items for you.

It will even charge the battery in your car, boat, snowmobile, fork lift, motorcycle, portable TV, or radio receiver. We could go on and on, but you should be able to easily see the universal application for the UPS164 and recognize the value of having it in your shop or lab, ready to work for you.

Read on and follow us through some of our testing of the new UPS164.

The UPS164 is as easy to operate as turning on a radio, and much faster than searching for the right

2 SERVICING TOMORROW - MODULES.

Many years ago, the television receiver was considered a pipe dream and some technicians failed to educate and equip themselves for this new contraption. They are no longer with us. Then came the transistor and again there were those who failed to prepare. They, too, have gradually dis-



This could be you if you don't prepare!

appeared from the servicing area. Now we have FET's, Integrated Circuits, and the modular concept in electronic design. Almost inevitably, some of you who are reading this article will not take the steps necessary to educate yourselves and make sure you have the equipment which will be required to continue in the service business. This is unfortunate, but it will undoubtedly prove to be true.

Have you really sat down and given serious thought to what impact the modular type of television receiver will have on your servicing business? What role will you play? What do you do with a defective panel after you replace it? What kind of investment is needed? Can you service the panels yourself? These are very important points to consider if you are planning ahead for what is the trend in television receiver design.

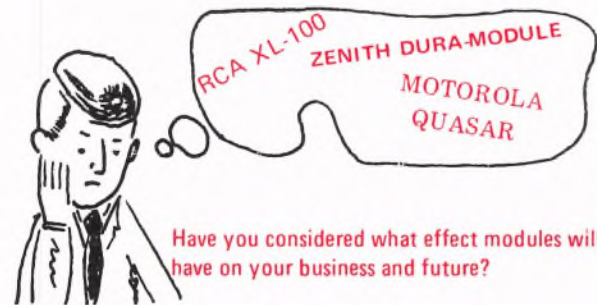

Have you considered what effect modules will have on your business and future?

We would like to take a couple of minutes and look over some of these points with you. The last two or three years have seen the creation of the plug-in module or panel to simplify service and eliminate much of the task of bringing the receiver into the shop. This is undoubtedly the best thing to happen in servicing in many years. The replacement of a panel to repair a receiver solves the customer's service problems quickly and makes your job easier. Rather than locate and replace the defective components, you simply replace the entire panel and all of the circuitry contained on it.

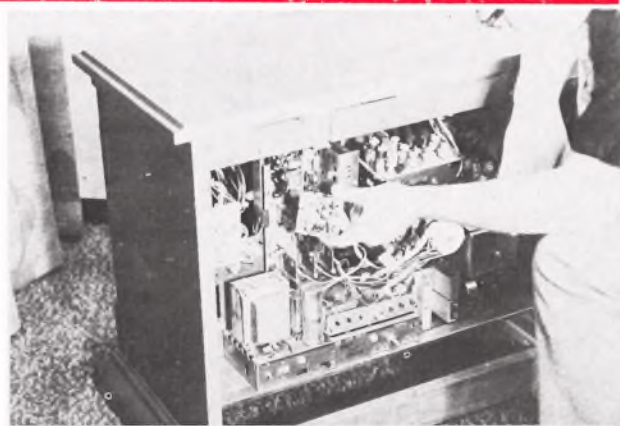

Replaceable panels or modules make in-home servicing easy.

The majority of the set manufacturers either have a modular-type receiver on the market or have it in their design department. To get the full impact of the modular set and its importance to you, we should look at a few figures. At the present time, with only 3 manufacturers, RCA, Zenith and Motorola, using modules or panels, there are over 65 different panels in use.



The number of modules is increasing rapidly as more manufacturers convert to this new design concept.

This concept was not in existence 3 or 4 years ago so the change has been very rapid. With 16 different major electronics manufacturers swinging over to the module concept, stocking modules for replacement purposes could become a very expensive business.

Current sets using the modular concept have from 3 to as many as 13 panels in their chassis, not counting tuner assemblies. If each of the 16 major manufacturers were to use an average of only 8 panels, that would mean a stock for you of 130 panels. This stock does not give you any backup for the panels which you replace on your calls. In many cases, you will probably want to stock at least two or three each of the panels. By now your inventory has jumped to nearly 400 panels. Another inventory problem is the changes which will surely occur from one model year to the next. This will require additional stock to keep up to date. It is not unlikely that 2 or 3 new modules

will be added each year by the manufacturers, not only in television, but other products as well. Looking into the future about 5 years, you could be faced with an inventory of 1000 or more different panels. At the current average cost price of \$8.00, you would have an investment of over \$8000 in panels.



To help complicate matters even more, some manufacturers indicate that they plan to offer service on out-of-warranty panels. This may look like the perfect answer at first, BUT what happens to your job if the manufacturers take over the service for you?

It is time to decide your future! The new modules can open a brand new service opportunity for you if you prepare to service them. With modules selling to the customer for as much as \$40, you can certainly replace the few parts needed to restore operation and make a good profit on the repair. You already have an investment of up to \$25 in the panel based on your original cost price. You certainly don't want to throw this money away or reinvest the same amount again to have the panel repaired or exchanged. Most panels can be repaired quite easily out of the set if you are properly equipped. The circuitry is no different than a conventional set so you should not face many troubleshooting problems.

The big problem is providing power for the panel. The power source must deliver a regulated voltage, since many of the modules contain integrated circuits requiring constant regulation of the supply. In addition, no filtering is provided on the panels so the supply must deliver a DC output free of any ripple. The current being drawn by the panel is a good indication of its condition, therefore meters to monitor supply output would speed servicing. Since all panels do not operate at the same voltage, you will need a supply which can provide all the output voltages you will encounter. This is best done with a variable supply rather than an inexpensive supply with fixed taps. The fixed tap supply can be outdated very easily when another new voltage is needed. In other words, you would need a supply that matches the supply the designer used when building and testing the panel.

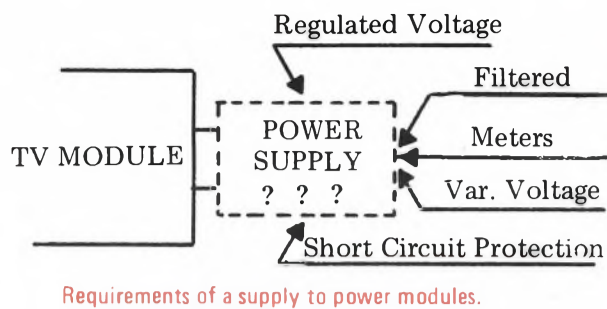

Requirements of a supply to power modules.

Sencore has designed this supply for you and its here now. This gives you the opportunity of getting into the module servicing business for a very small investment. It is certainly something very important for you to consider before this profitable business passes you by. The UPS164 will also give you additional security by equipping you to service all solid state equipment as well as the Integrated Circuit electronics which are on the way. Never before has a single instrument been as important to the servicing field as the UPS164 is today.

The UPS164 Universal Power Supply was designed with the necessary regulation and filtering to "mother" the panels or modules outside the set for servicing. It is a designers supply, of the same type used by engineers who design and build the panels. The Variable Output allows you to set the voltage to any level needed to power a module. The constant regulation provides a steady DC output to insure correct module operation. The high degree of filtering designed into the UPS164 makes it ideal for solid state module servicing. The pure DC output, with ripple level of less than five millivolts peak to peak, has been provided with the Integrated Circuit in mind. Many set manufacturers, including RCA, Motorola, and Zenith are currently using IC's. Others are planning to incorporate IC's into their new set design. It is our opinion that the supply you buy should not only be able to handle the present solid state sets and modules, but also equip you to handle the service

The requirements of a power supply are more exacting when IC's are used.



The dual meters for monitoring the supply output and load current have been included specifically so you could quickly determine the operating condition of the IC or module. More and more manufacturers are adding these current measurements to their schematics to aid you in your servicing.

Courtesy of Howard W. Sams & Co. Inc.

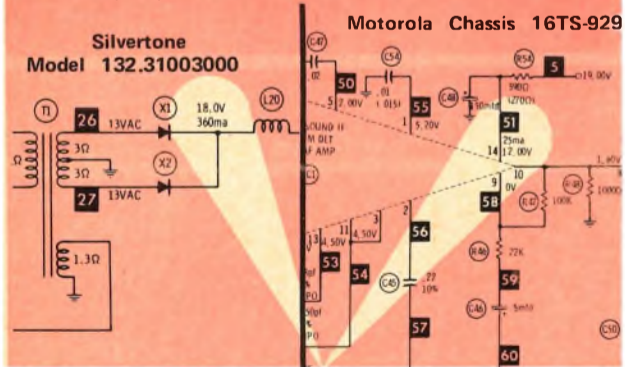

Current levels listed on schematics are a big help in solid state servicing.

Howard W. Sams, in their Photofact service publications, have been including this information for some time and have been setting a trend for others to follow. The UPS164 will make this valuable information useful to you and help speed and simplify your job of module servicing, in addition to supplying the necessary power. The UPS164 is very inexpensive at \$240, compared to the thousands of dollars which you can tie up in modules.

Sencore News

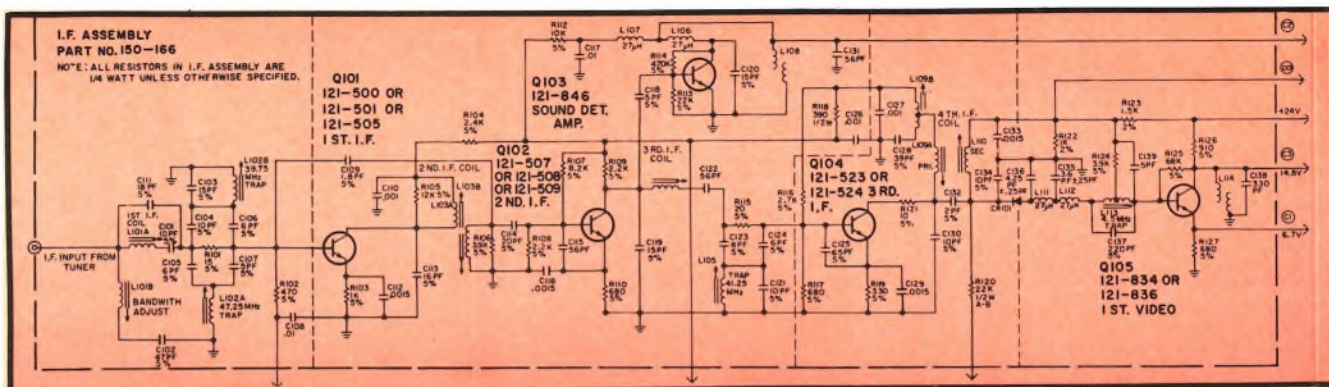

Schematic of Zenith IF subchassis from 4B25C19 color chassis

Courtesy of Zenith Radio Corporation.

Let us look at a couple of typical modules or panels and show you how the UPS164 can put you in the module servicing business. Our first example will be the IF sub-assembly used in the Zenith 4B25C19 color chassis. The set had no picture or color, and all indicators pointed to the IF's as the problem. The IF assembly was replaced and the set was restored to proper operation. Now we will set about the task of troubleshooting the sub-assembly.

First, we calculate the voltage requirements and the normal level of current drawn by the sub-assembly. We then adjust the UPS164 to deliver the required 24 volts, short the output leads, and adjust for the maximum current we wish the supply to deliver. This will not damage the power supply, as current limiting takes over and provides supply protection. The current limiting of the UPS164 will keep the maximum current below the level which will damage circuit components even if a short should be present in the sub-assembly.

We determine that the panel will draw about 50 milliamps, so we set the Maximum Current Set to 60 milliamps to allow for the normal variations caused by signal and component tolerances.

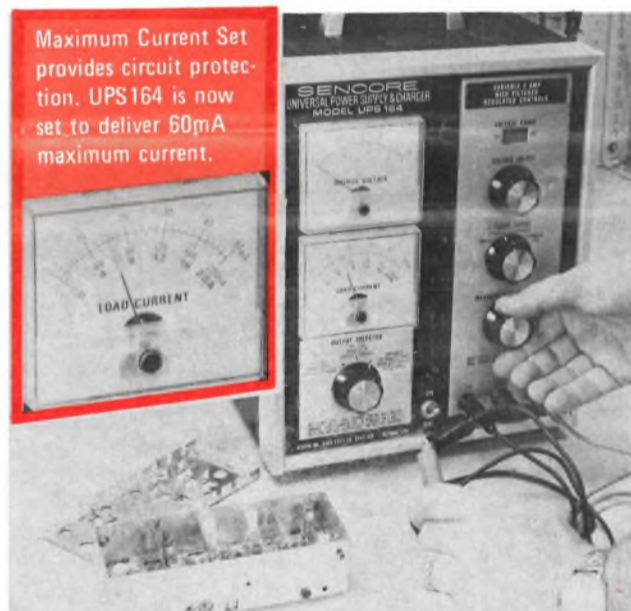

The schematic indicates that the 24 volt B plus is applied to two points on the panel so a jumper is connected between the two points labels 24V W/BRN. Only one other hookup to make and that is the AGC bias. We handle that the same as if the panel were still in the set by connecting the BE 156 Bias Supply to the AGC test points. We apply power from the UPS164 to the panel and set the AGC bias to 8 volts. Snap off the sub-assembly cover and we are all set to check out the panel.

The UPS164 meters show 24 volts and a current drain of 45 milliamps, indicating that nothing in the panel is shorted or causing a low resistance path for the B supply. Several methods of isolating the trouble could be used, but which ever we

select the procedure would be the same as if the IF were an integral part of the TV receiver. With a sweep generator connected to the IF input and set for IF sweep, we check for a response curve at the video detector test point C1. No signal here so we switch to a detector probe and try the output of the 3rd IF. Still nothing so we move to the 2nd IF output. Still no signal, so we go to the 1st IF stage. The output of the first IF stage shows a response and so does the base of the second IF. This indicates that the 2nd IF stage is the place to look. We grab our FET meter and check the bias voltages. The emitter is zero and the base is at 4.9 volts. This is far above the normal .6 volts usually present on the emitter-base junction of silicon transistors, so the transistor should be our problem. After confirming our suspicions with the TF 151 Transistor Tester, we replace the transistor, and now obtain a response at the video detector.

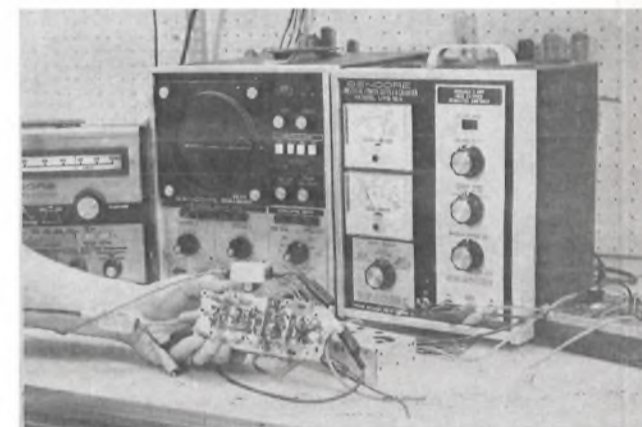

Zenith IF module is easily serviced with normal equipment and UPS164.

The sub-assembly contains the first video amplifier stage as well as the IF's, so we can just as well check it too. We just add a 20mfd capacitor and an 820 ohm resistor in series from test point C1 to chassis and check the output. The addition of the two components is all that is necessary to make a complete check of the panel. These components are added to simulate the total emitter circuit of the video amplifier, much of which is on the main chassis. You should begin to see how easy most of the modules can be to service.

Our next job was a Motorola Quasar color set with no sound. Replacing the "BA" IF/Sound panel corrected the trouble and satisfied the customer's complaint. Now we will try to troubleshoot this and see how it works out. According to the schematic, the IF's and the sound IC use a 20 volt supply, and the audio output stages use 21.5 volts. Since these are very close, we should be able to get it to work nicely with 20 volts for all points. Before connecting the UPS164, we will add a couple jumper wires to tie the B plus points on the board connectors together. Pins 1 and 5 are jumpered, and a lead is connected between pins 3 and 10. This will complete all B plus connections so the entire panel will be powered.

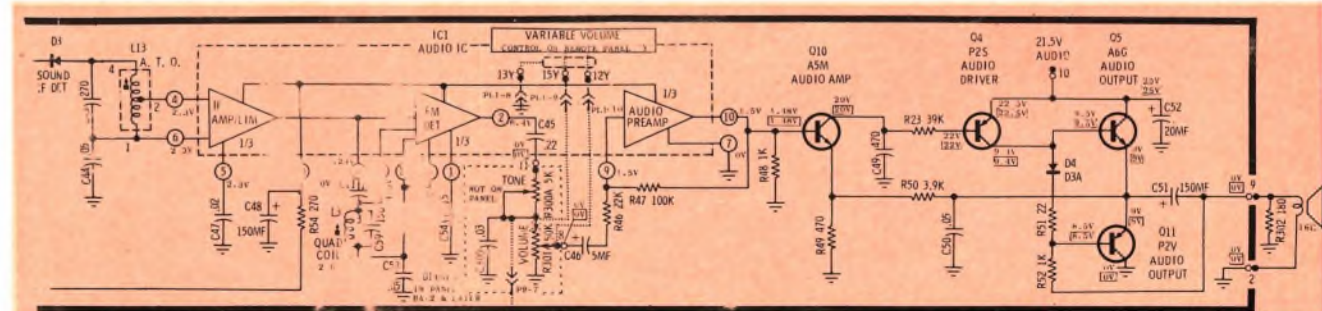

Partial schematic of IF/Sound panel of Quasar receiver.

Courtesy of Motorola, Inc.

The only thing left is to make sure we have a load for the output stage, and a volume control circuit, since they are not part of the panel. A 16 ohm resistor is added between connector pin 9 and ground for speaker load and two 27K resistors are added to serve in place of the volume control. One is connected between pins 11 and 8, the other between pin 8 and ground. We set the UPS164 for 20 volts and adjust the current limiting for 80 milliamps, the anticipated drain of the panel. When the UPS164 was connected to pin 3 and ground, the Output Voltage meter immediately dropped to zero volts and the Load Current meter indicated current limiting at 80 milliamps. Since our calculations indicated normal current should

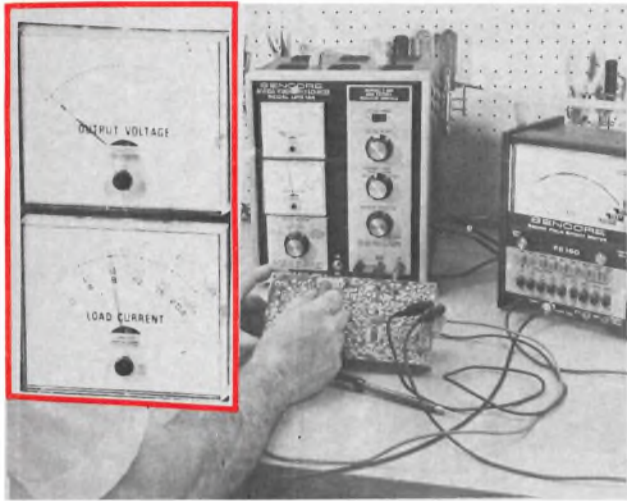

Output meters give immediate indication of circuit condition and current limiting prevents circuit damage.

be about 60 milliamps, something must be way off base in the panel

A quick check of the audio output transistors shows them both to be shorted. The other transistors check ok so we replace the outputs and try again. The current settles at 65 milliamps now with the full 20 volts applied. The UPS164 with its full protection and current limiting is a real help. The shorted transistor could easily have caused other parts to be damaged if the supply had been able to deliver unlimited current.

The final check is to inject a 4.5MHz modulated signal at the sound detector diode and check for output signal. It looks good, with no distortion, so our problems should be solved.

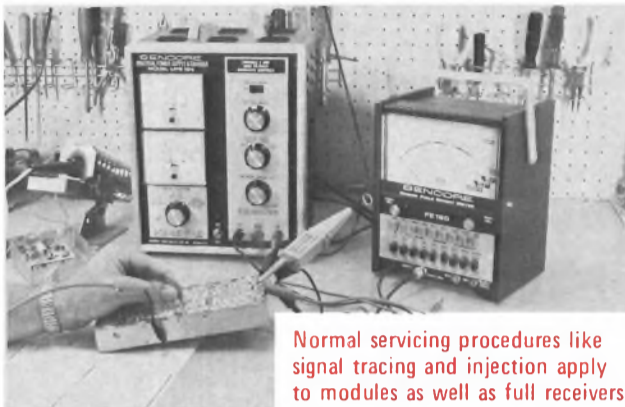

Normal servicing procedures like signal tracing and injection apply to modules as well as full receivers.

As you have already noted, some components may have to be added to complete circuits which are not included on the panels. It may also be necessary to provide several different voltages to some panels. This can be accomplished with a simple

voltage divider connected across the UPS164 if you only need one additional source. Regulation and current limiting will be provided by the UPS 164 for both outputs. The combined current will be indicated on the Load Current meter. If you need more than two voltages, it is suggested that you construct a means of providing regulated and current limited outputs. The circuit shown here will give you a variable, regulated output with current limiting at 280mA. You simply parallel as many as needed to give you additional outputs.

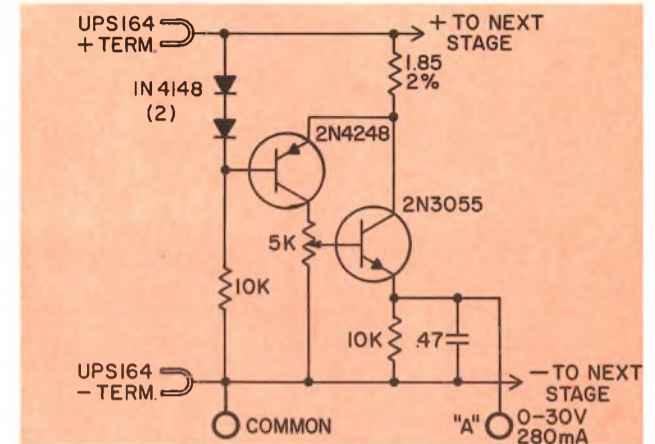

One section of 'Voltage Tripler', a handy accessory item.

A three section "Voltage Tripler" is available as part number 39G42 from the Sencore Service Department in Sioux Falls. The price is \$20. This accessory is a valuable asset when working on boards and modules requiring more than one input voltage.

3 SERVICING TODAY - SOLID STATE.

The servicing of solid state equipment such as radios, phonographs, remote controls, and portable tape recorders is not exactly new to most of us. However, many service shops are still not actively involved in solid state servicing. As we mentioned earlier, many million new units are sold each year, adding to the service load you now have. There are profits to be made servicing these units, and more profits are in the offing with the increased number of units in use. You should be seriously looking at what this can mean to you in actual time and dollars and cents.

In order to increase your income, you may find it to your advantage to add some additional equipment to your present stock so you are fully equipped to handle all of the units brought to you. The lack of equipment to adequately service these items, and the problems and frustrations resulting, is one of the greatest reasons many shops turn away this additional business.

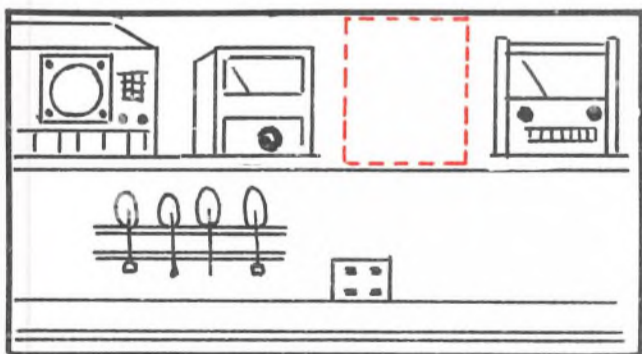

Lack of equipment can cost a shop many service dollars.

The problems which appear to be most frequent and the most frustrating are connected with the battery powered units. The battery is usually weak or completely dead when the unit is brought in for service. This means you have to dig up a new set of batteries before you can make any tests. If you don't have the correct battery, or batteries, then you must make up some battery arrangement or power supply to power the unit. This takes time which could be better used for actual servicing.

Many times the batteries for shop testing will be used batteries, kept specifically for this purpose. This may be convenient, but can lead to additional problems for you, as a weak battery can give some very deceiving results. For example, remember

the time you spent over half an hour trying to track down the motorboating in that AM-FM portable radio only to find that it was caused by a weak battery? Or the tape recorder that seemed to have everything wrong that finally turned out to be the motor pulling down the battery voltage?

Then there are the portable phonographs and tape recorders that are designed with a disappearing battery compartment. You know the kind; you disassemble the case to get at the thing, and the battery holder disassembles right along with it. It's just about impossible to get those "C" and "D" cells to work setting end to end on the service bench.

Another frustration are those portable phonographs with the top-mounted amplifier and tilt-down changer. You inevitably end up trying to service the amplifier while it is sitting on top of the rotating turntable. If this isn't bad enough, some of them also use an additional winding on



Units such as this can sometimes be very frustrating to work on.

the changer motor as a power transformer secondary for powering the amplifier. Now you are definitely stuck having the changer connected and turned on to do any servicing. It would be far simpler if you could take the amplifier out, forget the changer and motor and work on the amplifier on the bench.

The same holds true for tape recorders. These electro/mechanical monsters always seem to have 10 pounds of hardware packed into a 5 pound

box. No matter what you do, you just can't seem to get at the circuit board to check it out.

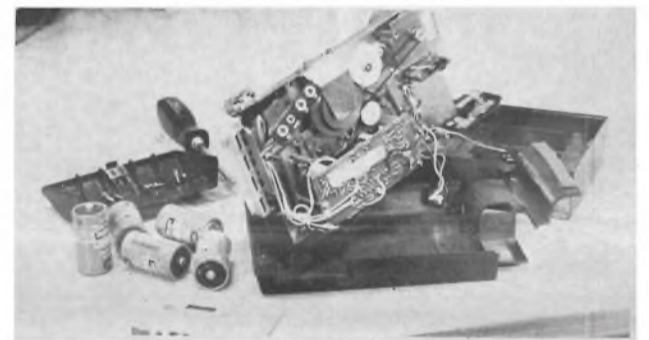

Tape recorders can be difficult to power and service if you're not properly equipped.

The console stereos and home entertainment centers can add to your problems too. You check the unit in the home and find the AM-FM tuner to be defective. It must be taken into the shop, but how much do you have to take? Will the lady of the house still be able to watch her TV so she doesn't call you every half hour wondering when it will be back? In many cases, you find yourself removing the tuner, the separate amplifier chassis and a power supply just to be sure the danged thing will be complete enough to operate when you get it to the shop. If the tuner could just be powered by itself, you could make your job easier and the customer more satisfied. To make matters worse, the next customer brings in a battery powered television receiver with a totally dead battery and you don't have an AC adapter, or a battery charger. How in the world do you fix the set and get out of this problem?

What about the special items that are brought to you for service, such as portable battery operated cameras and video recorders?

These are becoming more popular and many are now priced low enough that they will be used more in schools, business and industry for training and formal presentations. As they become more popular, they can become an important part of your service business if you are equipped to handle them. Having worked with battery powered equipment for some time, you have probably learned not to trust the battery condition when servicing these units, but really don't have much choice in the matter. You would probably feel much more confident about your diagnosis and final adjustments if you had a good, regulated supply to work with.

These are just a few situations which develop when working on solid state equipment and we're sure you could add many of your own. The point is you can be spending far more time than necessary with any of these problems, and since time is money, you are cutting down your profits.

The UPS164 is your profit-maker. It will put an end to most of your solid state servicing problems by providing the source of power you need to service and adjust today's solid state equipment. The constant output voltage provided by the dual regulation of the Variable Supply assures accurate test results. No more guessing about battery condition or spending time to find the right battery for the job. The UPS164, with its 0 - 30 volt Variable output, will provide the power you need. The constant regulation assures you of an unchanging voltage for all your testing. Just connect the UPS164, adjust the output voltage to the level required, and go to work. Whether it is a small transistor radio or a battery powered combination portable TV and AM/FM radio, the UPS164 will handle it with ease and make your work easier as well.

The high level of filtering provided in the UPS164 is a must when working on battery powered equipment. These units do not have provisions for filtering, so the power supply has to do the job. The UPS164 has less ripple in the output than you will find present across most batteries when they are operating under normal signal variations. This means you will not be misled by ripple in the supply or voltage variations caused by normal load conditions. This eliminates the wild goose chases you often encounter and saves you valuable time.

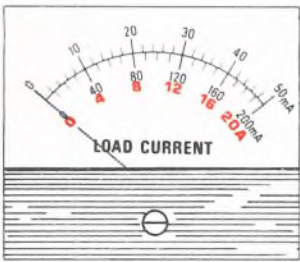
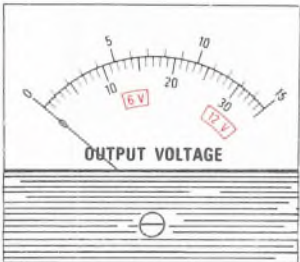

The dual output meters are a real timesaver too. You have a constant indication of supply voltage and current drain without the inconvenience and bother of switching meters back and forth, or tying up an additional meter for monitoring. The current indication can serve as a valuable troubleshooting asset, allowing you to make fast and accurate current checks, comparing results against the value which is listed on the schematic.

We have stated that the UPS164 will help you with your solid state servicing, so let us give you some examples of its use. Since it will serve as a battery replacement it can be put to work anytime you have a transistor radio, tape recorder, or television receiver to service. Just open the back, pop out the battery and you're ready to hook up. All that is required to ready the UPS164 is to set the level of voltage needed and adjust the current limiting

to provide protection for the unit being operated. Hook up and you now have a constant, ripple-free voltage for your troubleshooting. The meters will indicate any leakage or shorts which may exist and lead you right to the problem. After repairs are completed, you simply glance at the current meter to make sure the current drain is correct.

The problem with the tape recorder that loses its battery compartment when disassembled is no longer a concern. Just connect the UPS164 and you have quickly eliminated your frustrations. If the circuit board is difficult to get at to check, just remove the head connections, the B plus and ground leads, and take the board out. It can be serviced easily on the bench with the UPS164 supplying the power.



Recorder servicing is easy when board can be removed and powered with UPS164.

A simple signal generator connected to the input will provide the signal necessary. The fact that you have greater accessibility to the board and components will save you much time and you will be able to turn out more units.

The phonograph with the motor/power transformer combination is just as easy. Disconnect the motor leads, lift the board out and connect the UPS164.



Phono servicing is greatly simplified when you have a UPS164 to provide operating power.

The UPS164 is a real aid in tying down problems associated with the dc coupled amplifiers too. In most cases, you will find that when one transistor fails, it will take a couple more with it. If you don't find them all the first time, and power it up at full power, you will just pop more transistors.

This problem can easily be avoided by powering the amplifier with a reduced output from the UPS164. Just lower the voltage to about 50% of the normal operating potential with the current limiting set for the normal value of current drain. If a problem still exists in the amplifier, the reduced output voltage and the current limiting will prevent transistor damage. If current limiting results, you have determined that operation is not correct without damaging any other parts. A good quick-check on most dc coupled amplifiers is the voltage present between the two output transistors for each channel. This voltage will normally be about 50% of the applied voltage if the amplifier is operating correctly. Any major variation from this value indicates problems. DC voltage checks made with the unit operating at reduced power should point out the problem quickly. Just keep in mind that the voltages you measure will be proportionately lower than listed on the schematic because of the lower applied voltage.

One word of caution: Be sure you have speakers or a dummy load connected when working on the DC coupled amps. If you don't have a load, the result can be damage to the transistors in the amplifier. The current limiting will save most of them, but the presence of a load will be the most positive prevention.

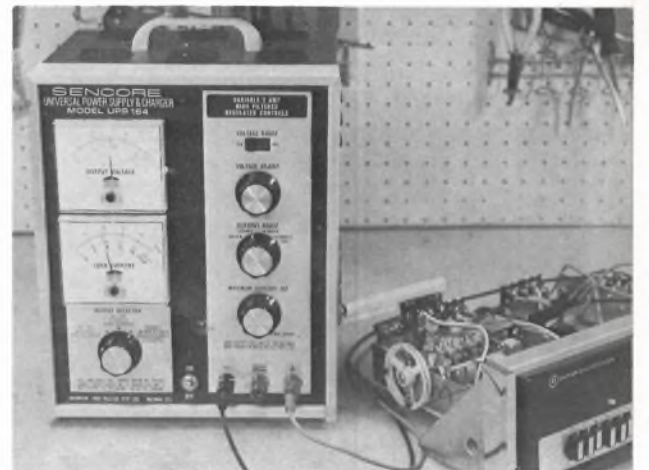

The UPS164 makes servicing tuners and amplifiers a snap.

The tuners in AM/FM Stereo consoles or home theatres can be serviced as easily as a normal radio if you have the UPS164. Just connect the UPS164 in place of its power supply output and you're in business. You can make the normal troubleshooting tests without the annoyance of the amplifier and power supply chassis in your way. The ripple-free output of the UPS164 will give you an unchanging source voltage to allow accurate testing and rapid diagnosis.

Other solid state equipment is handled just as easy. Whether its a camera, video tape recorder, radio, TV receiver, or a garage door opener you must service, the UPS164 is ready.

4 PINPOINT YOUR PROBLEMS QUICKLY.

We have mentioned some important uses for the UPS164, such as powering modules and solid state equipment for servicing. While it will certainly do this, and do it well, there are other time and work saving features too. Connected with the powering of units being serviced is the need to monitor the power drawn by the unit. This can often give valuable information on the condition of the unit which may otherwise go unnoticed. We are referring to some of the less noticeable problems which may not really affect the operation at the time you service the unit, but will return later to haunt you.

Most of you have faced the customer who recently picked up a radio or tape recorder you had serviced, and has now returned it with the complaint that the batteries have run down in a short time.

What do you do now? In most cases, you are stuck with a unit to repair on a "no charge" basis.

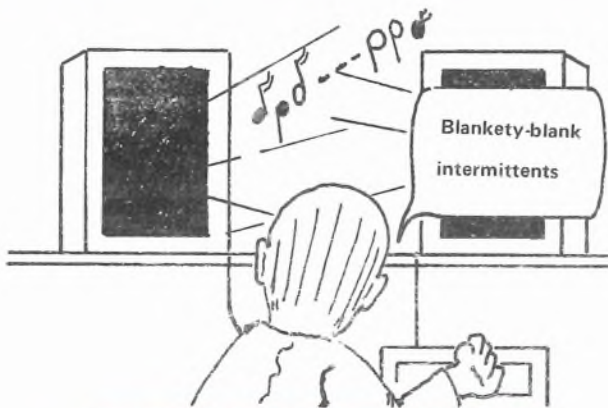

Intermittent units can be very difficult to repair.

You certainly cannot expect to make any profit when you have this type of recall to deal with.

Then there are the intermittent units which will sometimes drive you up the wall trying to locate the problem. Since anything which occurs within the unit will show up in some way on the amount of power being drawn, monitoring the supply voltage and current would seem to be a logical means of helping to isolate an intermittent.

You also encounter AC operated solid state units from time to time with the fuse blown. Several different methods can be used to try to track down the problem but one of the most common seems to be just to put in another fuse and see what happens. In some cases the fuse used for replacement ends up many times larger than the original, and the result can be instant disaster. A much safer way to isolate the source of the problem would be to bypass the AC supply (transformer, rectifiers, etc.) by connecting a DC supply directly

to the B-plus line. Now, using a supply that will limit the maximum current below dangerous and damaging levels, we can monitor the level of current being drawn.

The UPS164 Universal Power Supply has been designed with two high quality, high accuracy D'Arsonval meters to allow instant and accurate determination of load condition. The current being supplied by the UPS164 is constantly shown on the Load Current meter and the Output Voltage meter tells you the exact supply voltage. The meters have full scale accuracy of 3%, better than many of the VOM's currently being used to measure circuit current. The meters serve not only to give you additional convenience in solid state servicing, but provide accurate indications to aid in troubleshooting. Just compare the current drain to that listed on the schematic and you can isolate the problems quickly.

It's time we put the meters to use to show you how they can help you work out some of your solid state problems. The tape recorder or radio with the run-down batteries is the first to tackle. Open up the battery compartment, take out the battery and connect the UPS164. The average tape recorder, cassette variety, will draw around 130 milliamps of current with no signal, so we will set the current limiting to 160 mils to afford some circuit protection for the tape recorder.

Set the output voltage and fire it up. The current meter goes to the preset current limiting level and the voltage swings down from the 6 volts we had preset. This instantly indicates current limiting taking place.

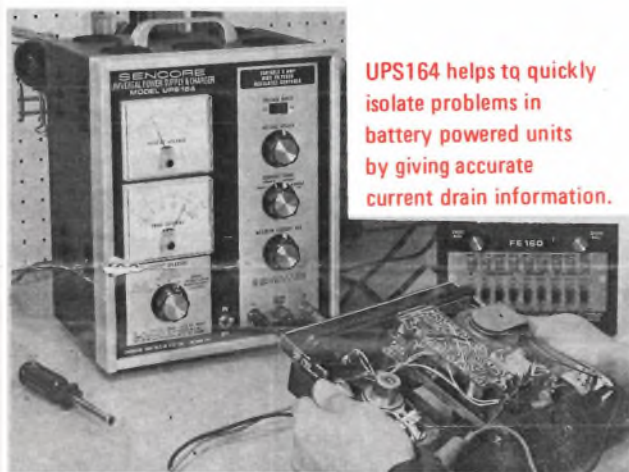

The voltage only dropped down to about 4 volts so it would appear that nothing is dead shorted. (If a low resistance short were present, the output voltage would drop to near zero.) Let's turn up the current limiting and see just how much current this thing does draw. We find out that it settles at 200 milliamps, about 50% higher than it should be. What can be causing the problem? A leaky capacitor or incorrect bias on the output transistors can give this type of indication, but the tape recorders and record players have a motor which is battery powered. It would be our first suspect as dry bearings, defective governor, or ex-

cessive drag will cause some rather drastic increases in current drain.

The belt is handy to get at so let's take it off and see what happens. With the motor running without load, the current drops to 100 mils. This indicates drag or friction of some sort, but where do we start looking? Just for the heck of it we put the belt back on and try the rewind function. Hmm, current slightly higher, but not the 200ma we had on play/record. This means the problem must be in the take-up reel drive or capstan.

A little more checking and we find the capstan pressure roller is very stiff and difficult to turn. A drop of oil, work it into the bearing, and we're back to normal current again. This lesson will surely teach me to check the current on these things before I send them out; all that time wasted because somebody didn't check it out thoroughly.

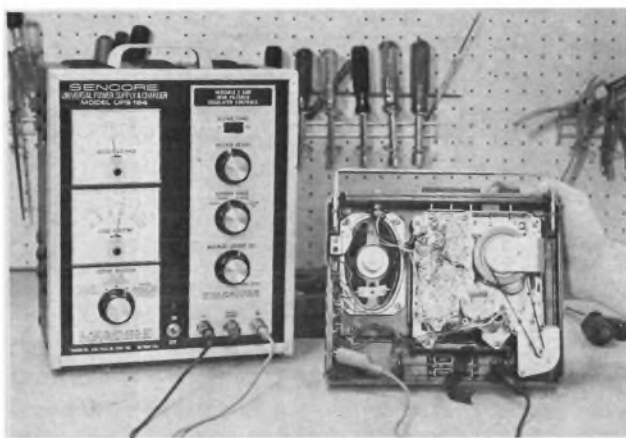

Meters indicate proper operation and help eliminate call-backs.

If the motor checked out OK or it had been a radio, we would probably have checked the electrolytics and transistor biases as mentioned before. Another point of interest regarding the transistor radios - after checking them out, just connect a signal generator and touch up the alignment. It's simple and fast with the UPS164 as it will even show the minor current changes which occur during alignment. Just peak for maximum current drain and it's done.

Now the unit with the blown fuse. This happens to be a solid state AC-DC, AM-FM TV combination. After taking the back off, we locate the DC input connections and set up the UPS164. The set is supposed to draw 730 milliamps as indicated on the schematic, so we short the UPS164 output leads together, with the current range switch set to 2000mA, and adjust for 800 milliamps. Next, we set the UPS164 output voltage for 12 volts, connect the leads to ground and the positive DC input terminal, and turn the UPS164 on.

The current immediately goes up to 800 milliamps and the voltage drops to 1 volt. Looks like there is a good reason for the fuse to blow. At least with the current limiting of the UPS164, nothing else was damaged. Now to find out where the trouble is. With the voltage dropping as low as it did there must be something shorted or very low resistance.

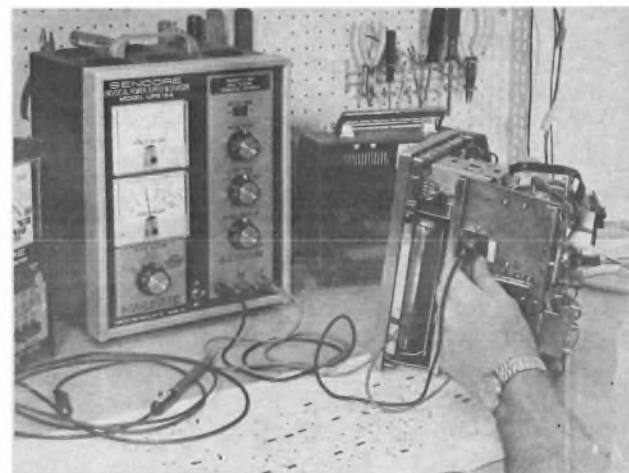

Output voltage drop indicates current limiting and problems in unit being powered.

The most likely suspects are the horizontal output transistor, vertical output transistor, or a shorted electrolytic. Since we have an AM-FM radio operating off the same supply, let's see if it works.

Sure does, which means that the main electrolytic and power supply diodes are good and the problem will probably be in one of the output stages. The horizontal output stage has the highest pulse voltage present and usually fails more frequently than the vertical so we will check it first. Using the TF151, In or Out of Circuit Transistor Tester, we check the horizontal output transistor. It checks bad in circuit, so just to be sure we disconnect base and collector leads and check it again. Now it checks good. Why would it check bad in circuit and good out of circuit?

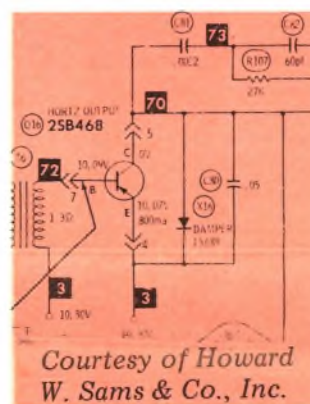

Looking at the schematic again, we see a damper diode connected directly across the output transistor. If that were shorted, it would cause the in-circuit test to be bad. Lift one lead, check it and it does test shorted. Replace the diode, try the set again, and it's back in working condition. Only one thing left to check and that is the

power supply regulator in the set to see if the short damaged anything here. The power transformer is supposed to deliver about 17 volts to the regulator and the output of the regulator is to be 10.5 volts. If we run the UPS164 up to 17 volts and check the output of the regulator, we will find out if it is working right. 10.5 volts output, right on the nose, so everything should be OK. Replace the blown fuse and check it on AC. Still good. Put the thing back together and we're done.

Using the UPS164 sure beats blowing fuses or running down batteries, and that current limiting feature is great. You can connect to a set without worry of damaging components, even if a low resistance short is present. Solid state servicing is starting to look much easier now.

5 BIG SERVICING BOOM IN AUTOMOTIVE ELECTRONICS.

The introduction of FM stereo and cartridge tape players in cars has presented new profit opportunities for those shops equipped to handle these items. AM/FM, AM/FM/FM Stereo radios and tape players are available as optional equipment on most new cars today. Add-on units which can easily be installed are experiencing tremendous sales increases. With the greater availability and use of these automotive entertainment items, increased need for service of these units exists.

These units are essentially the same as their counterparts used in 'the home, so the same service procedures would apply. The only item needed to work on auto products, in addition to the ordinary

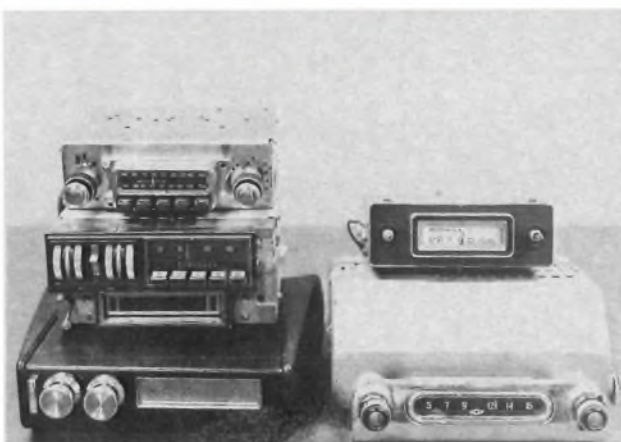

Many different types of auto units require service.

equipment, is a power supply to provide the power.

Before you rush out to buy a power supply to start capitalizing on auto radio and tape servicing, consider carefully the requirements of the power supply.

The first consideration is quite obvious, it must provide sufficient power output at 6 and 12 volts to handle the various radios and tape players you may be apt to encounter. This requirement can vary from around 1 amp at 12 volts for a small AM radio to 6 or 7 amps for the older tube-type radios with a vibrator supply. If you are to have a supply that will meet all your needs, you must also consider the "Wonder-bar" type of radio with automatic tuning and solenoid return. These types can draw as much as 12 to 15 amps during the on time of the solenoid. If the current output of the supply is not sufficient, the return will not be completed. Many of you have probably experienced

this problem in the past. You initiate the dial return and it starts across the band and hangs up two-thirds of the way across. The only way to get it to go all the way is to give it a push manually. This will accomplish the return, but does not give you the chance to check its operation completely to know that it will complete its return in the car. These car radios are tough enough to get in and out without the need to do it a second time just to lubricate or adjust the automatic tuning.

There is also the intermittent transistor radio that causes you to pull your hair out. It would help if you were able to increase or decrease the voltage to help make it act up. This is hard to do when all you have for power is a big wet-cell battery. The wet-cell battery does provide power for radio operation, but you can't vary the voltage and it also seems to have a tendency to discharge while

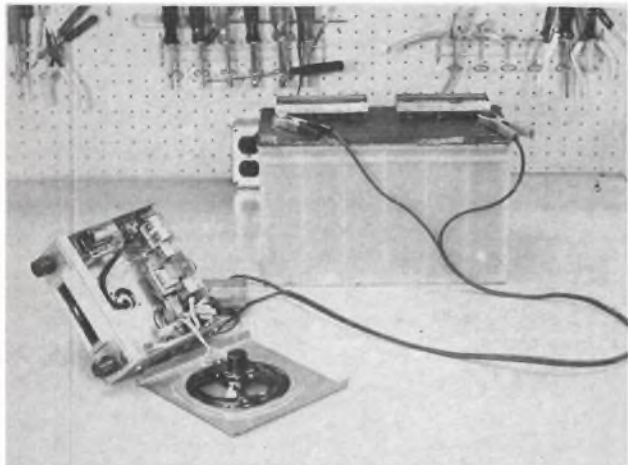

Wet-cell batteries are a cumbersome, unreliable source of power.

it is being used. This usually shows up at exactly the same time you have a rush job to get out and then you are sitting there with a bum radio and no way to check it out. The only quick answer is to pull the battery out of your car or run to the corner gas station and get a fast recharge.

A power supply designed to handle car radios would be much less trouble and would always be ready when you needed it.

As with other solid state units, the condition of a car radio, or tape player, can be checked quickly by monitoring the current drain. Shorted driver or output transistors will show up as an excessive current drain, aiding you in troubleshooting the unit. As the radios, tape players and combination units become more complex, the ability to monitor the current drain accurately and quickly would greatly speed your work.

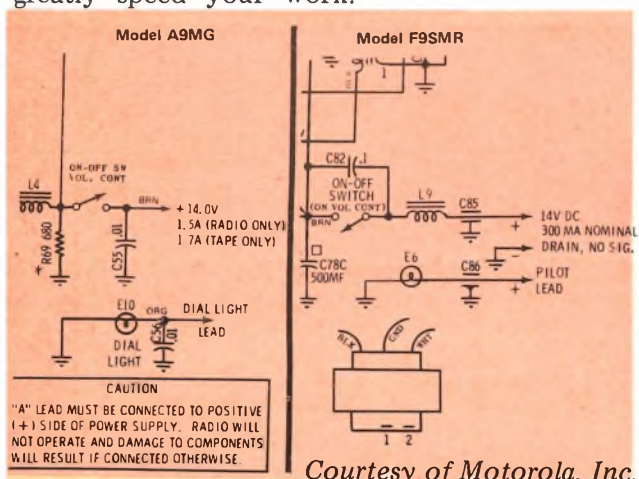

Courtesy of Motorola, Inc.

Power supply needs meters to allow use of schematic current information.

The more complex AM/FM/FM Stereo units also require a steady source of power to assure proper stereo performance. A simple, inexpensive battery eliminator or charger may do the job on the smaller AM units but these can give you fits when you are trying to dog out an FM stereo problem. The changing voltage can cause the FM stereo decoder to do some very strange things. This is true with excessive ripple present on the output as well.

Tape recorder repair also demands a steady dc source, especially if you are to make any meaningful wow and flutter checks. Wow can be caused by a relatively minor change in power supply out-

put as well as by problems connected with the tape drive mechanism. The battery eliminator/charger type of supplies do not incorporate sufficient regulation or filtering to give you a steady dc output. The need for good filtering is a "must" and should be considered one of the most important specs in the power supply you purchase.

The Sencore UPS164 Universal Power Supply comes through again to fill your needs. The Variable output provides up to two amps to handle most car radios and tape players. This supply provides constant regulation and very high filtering to maintain a pure dc output for servicing these units. The 6 and 12 volt regulated high current outputs step in to take over on the radios and combination units which demand greater current than available on the Variable supply.

These outputs are both regulated and filtered, something entirely new in high current supplies. The 6 volt output will deliver 20 amps continuous with surge capability up to 28 amps. The 12V output will maintain a steady 10 amp output with surge current capability of over 14 amps to handle the big loads like the Wonder Bar type of radios or mobile communications equipment. Regardless of the output used, the two accurate D'Arsonval meters are constantly monitoring the output of the UPS164 to help guide your troubleshooting.

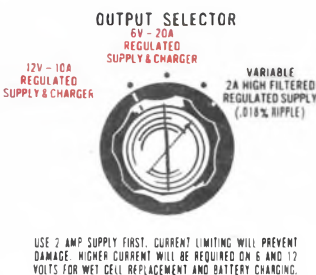

All outputs provide current limiting protection for the supply and the load with the Variable supply providing adjustable current limiting. The 6 and 12 volts supplies provide current limiting by virtue of the ferroresonant constant voltage transformer. Additional protection is afforded with the 30 amp fuse in circuit when the 6 and 12 volt outputs are used. This is provided to give protection to the high current rectifiers should a battery be connected in reverse when charging. Yes, the UPS164 is also a battery charger. It operates on a true taper charge principle to charge a bat-



Universal Power Supply would not be complete without battery charging capability.

tery safely and quickly. The UPS164 does it all, and at a modest price you can't afford to pass up.

We gathered some car radios and tape players from the people working in our plant to test it and give you some examples of its applications.

The first unit is an AM/FM/FM Stereo tape player combination from a 1969 Chrysler. One look at the mass of mechanics and electronics inside told us this may be tough. The problem is no output on the tape player function, so let's see what we find. We connect the Variable Output of the UPS164 with the current limiting set at 2 amps.

The AM and FM portions of the radio work fine, so the output amplifiers should also work for the tape. Plug in a tape cartridge and no output. In fact, the tape player motor doesn't even start up. The UPS164 meters show us that the current drain has not reached current limiting as it should to start the motor. This tells us that no power is being applied to the motor. We check the track

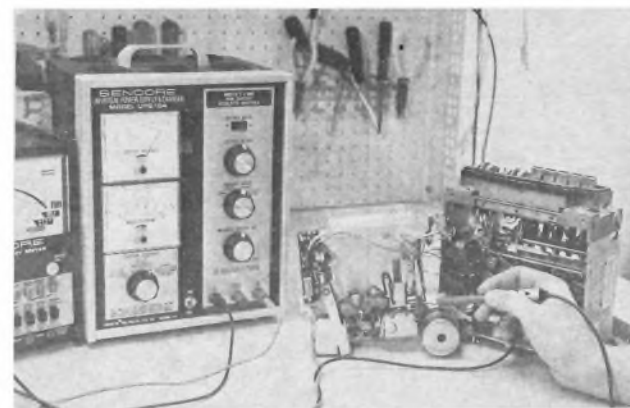

UPS164 simplifies servicing of complex combination auto units.

change switch and the Load Current meter goes immediately to the current limiting set and the voltage drops. We have power that far at any rate.

A couple of quick checks and we find that the governor transistor is open, breaking the circuit to the motor. We install a replacement and try again. This time the Load Current meter indicates current limiting when the cartridge is inserted. We switch to the 12 volt high current output so the current capabilities are high enough to handle the motor. The running current for the tape function proves to be 1.2 amps, within the specs which call for a 4.5 amp maximum. Track change and cartridge eject functions work fine so we have mastered another one.

The last item we will mention is a two-way citizens band radio. This unit, a Johnson Messenger mobile job, was supposed to have no transmit but would receive ok. We connect the 12 volt high current output of the UPS164 and an antenna to the radio.

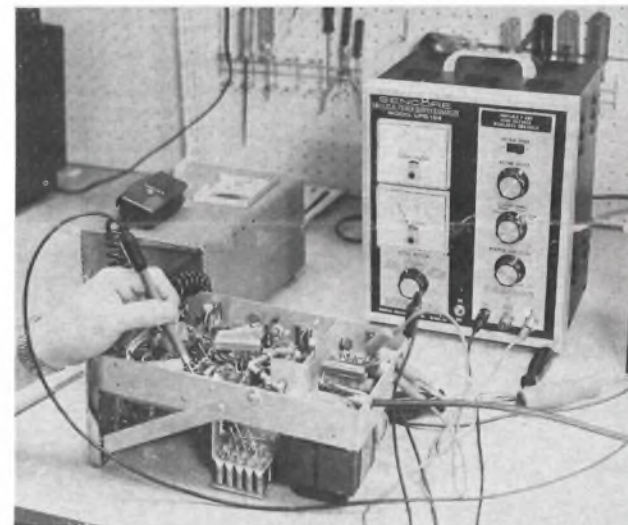

Communications equipment servicing is no problem when you have the UPS164.

Local calls are coming in loud and clear so there is no problem with any section common to both transmit and receive. We press the transmit button on the mike and watch for a current increase to appear on the Load Current meter. Nothing changed! This can't be right since the transmit function will draw considerably more current than receive. A few quick checks brings us to the transmit relay which we find to be open. After replacing the relay, we try it again. This time things look better. The Load Current meter indicates 4 amps on receive and 5 amps on transmit, a more normal situation. We run the routine power checks and wrap it up.

In our examples, we found uses for both the Variable and Fixed outputs of the UPS164. Regardless of the output required for the load, the output is filtered and regulated to maintain steady voltages for easier troubleshooting. The problems we encountered were not difficult or complex, rather very typical of the problems you encounter each day. In every case, the UPS164 gave us the power we needed and helped to isolate the problems by giving us the all important current drain information. The UPS164 will speed your auto radio and tape servicing, or equip you for this profitable field if you are not currently servicing these units. Pick one up today, try it and prove to yourself that the UPS164 is the only supply you need for all your servicing.

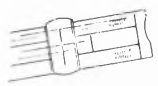

DESIGNERS—INCREASE YOUR ENGINEERING EFFICIENCY.

The engineering and design time spent on a project is an important factor, not only in making sure that it is completed on time, but it is also figured into the final pricing of the item. Any delays or unnecessary work will definitely serve to raise the final cost of a product. On many occasions, engineers have found themselves spinning their wheels due to something as simple as a power supply problem. Let us point out a couple examples that were related to us while discussing our proposed power supply with engineers.

The first situation involved an engineer who was working on the design of a mobile single sideband transmitter. Since the unit would be used in mobile service, the car or truck battery would provide the power. As a result, our friend started his design work using a wet cell battery and a battery charger/eliminator to power the breadboarded circuit. The problem he was encountering was that of incorrect drive to the RF transistor, which would occasionally go into saturation and be destroyed. The engineering costs, not including time wasted, were soaring because the particular transistor being used cost in the neighborhood of \$15 each.

He realized that the greatest reason for his problem was the fact that he had no way of limiting the current from his supply, other than building a complete supply just for this purpose. The total for the design time and components involved in doing this amounted to just over \$650 dollars, plus a weeks time lost on the transmitter. The power supply served well for this project, but will it be usable on the next project to be considered?

The second case was that of an engineer working



Damaged components can cause engineering costs to soar.

on control circuitry utilizing primarily all digital integrated circuits. A power supply was laid out on the breadboard along with the circuitry common to all stages. As each IC was added to the circuit, the regulation of the power supply and the percent of ripple present would change, causing some peculiar behavior in those stages already tested. In addition, some of the IC's required very stable voltage and a separate regulator was designed for each of these IC's. To top it all off, the original current requirements were exceeded by a substantial amount, necessitating a complete redesign of the power supply section.

If we stop for a moment and consider the cost of this type of engineering, we would find it to be enormously high. Let us consider that the engineer is receiving a salary of \$13,000 per year. In addition to his salary, the company has other engineering expenses such as technicians wages, equipment, components, special made parts, and overhead for the space and utilities. Conservative estimates would place the actual cost for this engineering area to be over \$25,000 per year. This means an expenditure of \$12.50 an hour for any work done or time spent by the engineering team, whether it is directly related to the project or not. If time and effort are used to build power supplies, other than the supply to be used in final design, the project engineering costs can become very high. Considering the time that is normally involved in designing, building and testing a temporary power supply, we would be talking a minimum of at least 30 hours total. This would

amount to \$375 just for time, and most supplies, with good filtering and regulation, will involve at least \$120 worth of parts. This makes the "temporary" supply worth \$500.

Temporary lab-constructed power supplies can be very costly.

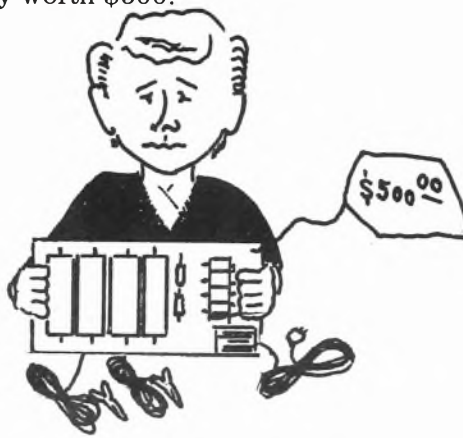

If this is repeated for each of 4 or 5 projects done in a year, at least \$2000 to \$2500 of the engineering cost is being used just for power supplies. This is enough money to buy at least 10 of the Sencore UPS164 Universal Power Supply!

The UPS164 Universal Power Supply is a designers supply, providing the high degree of regulation and ripple free output needed for today's solid state engineering. The 0 to 30 volt variable and regulated output will power virtually any engineering project, whether it be a relatively simple amplifier circuit or a complex control circuit using many transistors and integrated circuits.

The engineer working with these circuits requires a ripple free output so the performance of the circuit will not be degraded.

The UPS164 has been designed to meet this need, delivering up to 2 amps of output current with less than .018% ripple at full load. The UPS164 provides current limiting as well, to enable all changes and tests to be made without worry about component damage due to overloads. This is a very important point since many of the transistors and integrated circuits used are very fragile and extremely costly. The UPS164 could pay for itself just on the cost of parts saved by the current limiting feature, not to mention the time and money saved by having the engineering supply available for any project you are called on to direct.

Designers Supply with Designers Specs



The dual meters provide the engineer the important information regarding the current drain of the design being powered. This, too, will increase the engineering efficiency, as you can tell immediately whether or not the circuit is performing as anticipated. The current drain information gained from the UPS164 during the circuit testing will give you many of the parameters for the final power supply design.

To be sure the UPS164 would cover all of the projects you encounter, high current outputs capable of up to 20 amps have been included. The 6 volt supply will deliver up to 20 amps and the 12 volts supply up to 10 amps, both regulated and filtered to provide steady output. The high current supplies are also current limiting protected, to protect the circuit being powered and the supply as

well. The UPS164 is UNIVERSAL to cover all your engineering power requirements, and it costs you less than the temporary supplies you must now build for each project.

We would like to point out some other uses and applications for the UPS164 which have been brought to our attention during our research. The most obvious use would be that of simply providing the power needed to operate the circuit being designed and tested. This is necessary and very important, but the UPS164 can be used to aid you in other testing as well. The Variable output makes it ideal for performance testing circuits both above and below the design rating.

Simply set the voltage to the level desired and proceed with your tests. The dual meters will give



UPS164 is a valuable asset to the engineer working with solid state design.

you a constant monitor on the load condition during these and any other tests.

The output meters will also serve to give you an indication of the on or off state of logic flip-flops and similar circuits, saving the time of connecting the scope to check the circuit. The steady, ripple free output allows you to perform accurate gain and distortion tests in amplifiers and other circuits, even before final design has been completed.

The UPS164 would certainly be a valuable addition to the assembly line to aid in testing and adjusting the various sub-assemblies.



UPS164 powers production line test fixture in large electronics manufacturer.

No need to spend hours to design and build a power supply for just one application when the UPS164 can serve as the power source for any test fixture.

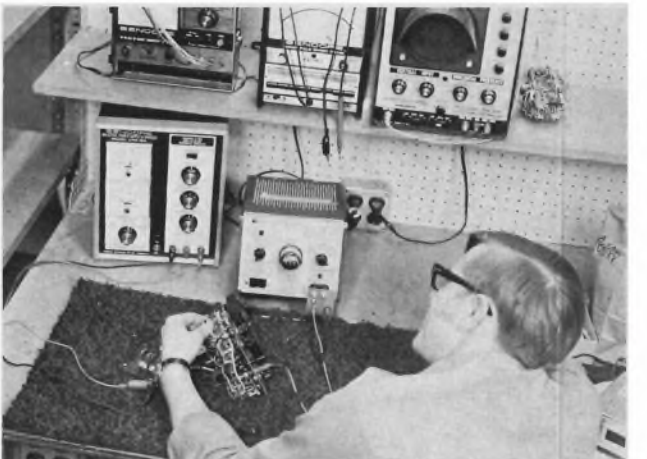

Sencore Service Department uses UPS164's to power equipment for test, service, and calibration.

Over and under voltage tests in quality control couldn't be easier when you are using the Variable, fully regulated output available on the Universal Power Supply. The service department will find many uses too, for this versatile supply. Any operation from troubleshooting and repair of sub-assemblies or circuit boards to equipment alignment and calibration can be handled by the UPS164. The constant current output provided by the current limiting of the UPS164, for example, can even be used as the constant current source for meter calibration.



Midwestern firm uses UPS164 to power meter tester in incoming inspection.

Whatever phase of electronics you work with, whether its consumer products, industrial design or communications equipment, the UPS164 is the only supply you need.

Inspection and quality control departments will also find many uses for the UPS164. Over and under voltage tests in quality control couldn't be easier when you are using the Variable, fully regulated output available on the Universal Power Supply.

7 VOCATIONAL SCHOOLS — HELP YOUR ELECTRONICS STUDENTS LEARN FASTER . . . AND PAMPER YOUR BUDGET TOO.

We, at Sencore, are very interested in Vocational education for our young people. Job oriented education will help them to become productive members of society. As a result of this interest, we have worked with many different Technical-Vocational schools throughout the nation to learn of the problems facing our Vocational instructors and students. One of the areas of greatest concern for the instructor is the necessity of presenting a great deal of technical information to the students in a short period of time. In the electronics area particularly, a wide variety of theoretical topics are covered, many of them with lab activities to support the classroom presentation. The lab experiments are a vital part of the learning process as this activity serves to prove out the theory presented. Most instructors feel that many of the problems associated with poor understanding of theory or slow learning can be attributed to the results of some of the lab experiments. If the results calculated in the classroom are not realized in the lab, the proof of the theory is missing.

Many of the lab problems can be introduced inadvertently if the power source for these experiments is not accurate, regulated and well filtered.

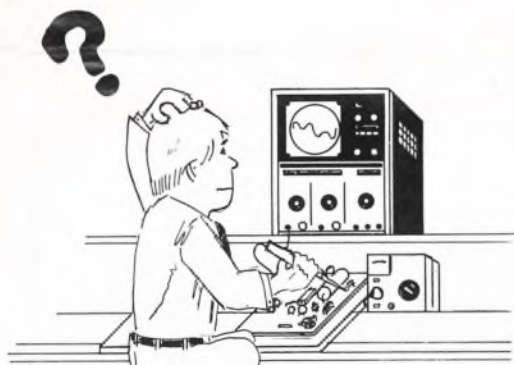

Ripple present in power supply output can often mislead student.

Variations in output voltage during the testing of an amplifier circuit will certainly add confusion for the student when the test results are compiled. The same confusion can result if the power supply is not adequately filtered. High gain solid state amplifiers and integrated circuits are very susceptible to even the minor voltage changes introduced by ripple in the power source.

The action of the circuit may be entirely different than expected or calculated when ripple is present. The proof of theory of calculations is in the lab exercises, and if they are not accurate, the all important proof of circuit action and performance is missing.

Another area of the lab that may slow the progress of some students is the error resulting from incorrect load voltage and current measurements. The students are learning test equipment as well as electronics theory and the possibility of a mistake in meter reading is relatively high. If the power supply used provided accurate voltage and current readings as well as the power needed, the possibility of error would be greatly reduced.

An area of great concern to the instructor is that of maintaining power supplies and other equipment damaged as a result of improper connections or overload.

Power supplies are particularly prone to this type

Fully protected equipment would save many dollars in repairs each year.

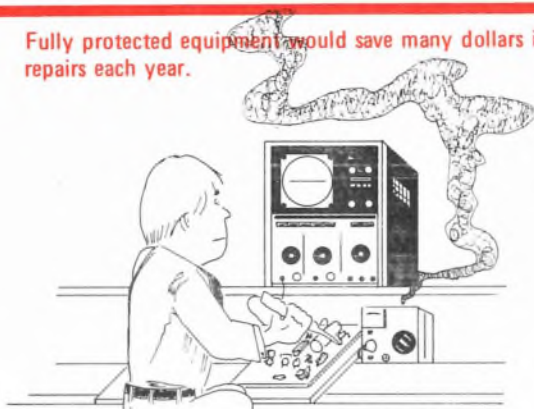

of problem, as it is quite easy for the student to connect wrong or accidentally short the output of the supply. This means either you must have additional supplies on hand to cover the needs of the students if a unit should fail, or someone will not have a supply for his experiments. This is costly both in repair dollars and the valuable time of the student.

Also in the area of cost and inventory are the components used for the experiments. Because the students are still learning, errors will be made and many dollars are spent replacing transistors, integrated circuit, and other components.

A power supply which provided current limiting would certainly help reduce the damaged components and reduce the amount of money spent for replacements.

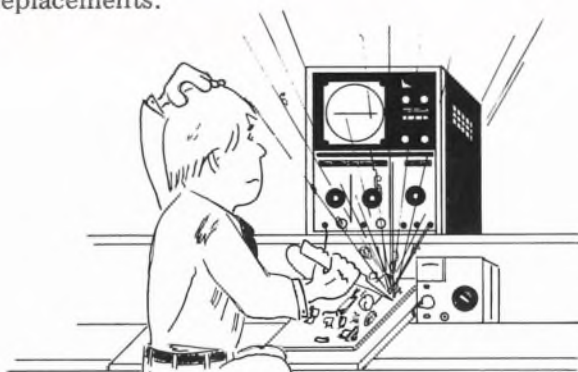

Components need not be damaged during experiments if you have the right supply.

Then there is the problem of having several power supplies with different outputs available for the various lab experiments needed for thorough training. It is often necessary to have one supply for the low voltage, high filtered supply requirements of integrated circuits, another for the higher voltages used in conventional solid state circuits, and still another for any high current 6 and 12 volt applications.

A single supply which would provide all outputs would greatly simplify the training program. All in all, the power supply can prove to be a very vital part of the vocational lab and the overall training program.

The UPS164 Universal Power Supply has been designed to provide the range of voltages and currents necessary for the vocational electronics lab as well as the requirements of the service industry. The variable 0 - 30 volt high filtered supply covers the requirements of all solid state devices from standard junction transistors to field effect transistors to the latest of the integrated circuits. The high degree of regulation incorporated in this supply assures constant, steady dc output for even the most critical of lab experiments. To further provide accuracy in experiment results, the ripple on the output of the variable supply is held to

.018% or less. This means you have a more constant output, with less ripple, from the UPS164 than you can obtain from a battery! The results of the tests, whether they be in servicing or experimentation, will be meaningful and accurate.

An aid to the budget is the total current limiting feature of the UPS164. The unit cannot be damaged by shorts or overloads caused by improper connections or shorted circuits. The current limiting also helps save dollars on the components used for the experiments. It will prevent much of the component damage caused by incorrect circuit connections or wrong value parts.

6 and 12 volt high current supplies are also available at the flip of a switch to provide up to 20 amps of DC current for experiments with power devices and control circuits. This is all important to the vocational instructor with the tremendous number of solid state controls finding their way into industrial applications. 6 and 12 volt supplies are regulated and filtered to assure proper and reliable circuit operation. These outputs are also fused for additional protection of the supply and the circuit being powered. Even if a student should leave the supply on with the leads shorted for an extended period of time, no damage will result.



Full protection, simple operation and easy-to-read meters make the UPS164 ideal for student use.

One of the single biggest plus features of the UPS164 for student use is the ability to constantly monitor both the voltage output and the load current of the UPS164. There is no need to break the circuit and insert meters, or constantly check the power supply output with a separate meter to maintain a precise output voltage. You and the student can see at a glance the condition of the load circuit and quickly determine if the operation is correct. The students using a UPS164 will appreciate the simple operation and reliable output, which will give them more time to work with their experiment.

When you equip your labs with the UPS164, you have just one supply, fully protected, that will do it all; and the price will help pamper your budget, too. Let us give you an example of just how the UPS164 can serve you and your students.

The example we will use is a two stage, solid state audio amplifier which would be constructed in a basic circuits lab. We have determined that the total current drain should be about 20 milliamps, depending on component tolerances. The circuit is all set up to go so we will set up the UPS164.

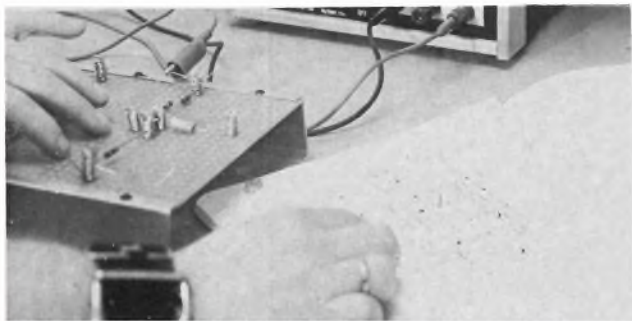

Basic lab experiments must be correctly powered for accurate results.

Allowing for circuit tolerances, we will set the Maximum Current Set for about 10% higher current drain than expected. We set the Current Range switch to the 50mA range, short the output leads together and adjust the Maximum Current Set control until the Load Current meter indicates 22 milliamps.

Hey, this is pretty clever. You can actually short the leads and not hurt the supply. Sure is different than those old supplies we had. Unshort the output leads, set the Voltage Adjust to read 14 volts on the meter and we're all ready. Connect the output leads to the circuit and What the?

The voltage has dropped to 2 volts and the current is up to 22 milliamps, the setting of the current limiting adjustment.

Maybe we had better check to see what went wrong. Too much current means we either have a short or one or both of the transistors is conducting like mad. Let's check the wiring against the schematic and . . . well I'll be doggone. Wonder if that resistor disconnected between base and emitter of TR2 would have something to do with the problem. We reconnect the resistor and try again. That's better, the voltage holds right at 14 volts and the current is just under the 20 milliamps we expected. I sure hate to think what would have happened to that poor transistor if that UPS164 didn't have the current limiting feature!

The instructor said that the UPS164 would provide a steady output regardless of line voltage changes so let's see if it does. I'll plug it into a variac and see what happens.

There, we have 105 volts line and the meters still read the same. Well, we'll try the high side then and set the variac for 130 volts. Still right where it was. I guess he was right after all. Now I know that the readings I get will be right. Let's see now. The theory this morning said that an increase in voltage applied to the amplifier would cause a corresponding increase in current. So, if I turn the supply voltage up to 18 volts, the current should go up too. Now just a minute, the

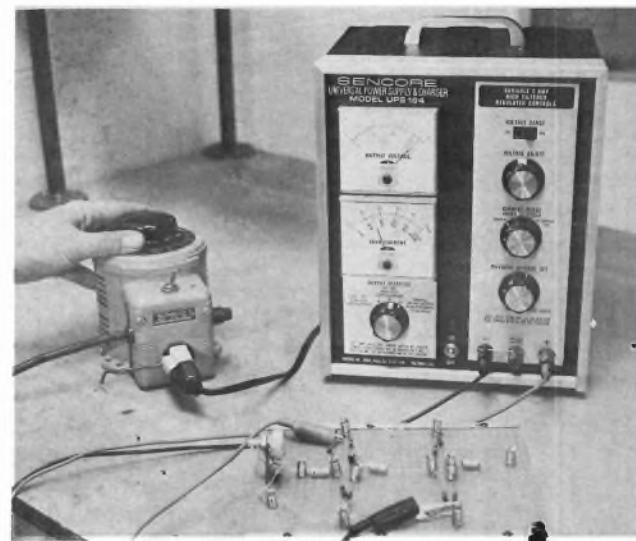

Even severe line changes created by variac do not upset the regulation of the UPS164.

voltage will only go up to 16 volts. Yeah, that's right - the current limiting. Guess I had better set that up a little higher. That's better, I can get the 18 volts now. The current did go up just like the book said. Now what will happen if I connect a signal generator and throw a little signal into this circuit. Would you look at that. The current didn't change, so the book must be right. You know, I just realized I have made all these tests and haven't touched a voltmeter yet. This UPS164 is some kind of power supply. It's right on, man.

HUNTERS

Pheasant population is up again in South Dakota due to efforts of

PHEASANTS UNLIMITED



ACT NOW!
Pheasant chicks for 1972
can be purchased until July 15. Of
course we can set you up
for '73, too.



3200 SENCORE DRIVE, SIOUX FALLS, SOUTH DAKOTA 57107 • 605-339-0100

SENCORE

Dear Sencore Customer:

We in Pheasants Unlimited have helped the state of South Dakota bring back the Ring Neck like days of old - and they are increasing about 10 percent each year.

If you like to hunt like I do, here is what Sencore can do for you through Pheasants Unlimited.

I will see that 100 baby chickens are placed with a friendly farmer in South Dakota. He will raise them to six weeks and turn them loose on his farm. I will give you the name of the farmer and he will have you as his sponsor (generally his son, through 4H). You can correspond and be as good friends as you choose. Now, you'll know where to hunt, you'll have a new friend in South Dakota and you know there are birds. No more dry runs! This program is limited to the number of cooperating farmers. Your money will be returned if we can't find the farmer, although we have many who want to cooperate now. In addition, you will become a member of Pheasants Unlimited free of charge. First come, a member who want to cooperate now. What's in it for me? I just want you to visit the Sencore plant while you are here--Fair enough?

TO: Sencore, Incorporated
3200 Sencore Drive
Sioux Falls, South Dakota 57107

Mr. Bowden: Here is my check for \$100, please have Chuck Kilburn, Field Director of Pheasants Unlimited set me up. I agree that I will read your book on gun safety in South Dakota before coming.

FROM: Name _____
Address _____
State _____ Zip _____

Herb Bowden
Sencore President
Director, Pheasants Unlimited

*Donation tax deductible - Non-Profit Organization

