

SENCORE NEWS

1st ISSUE
JUNE 1971

HOW TO WITH INSTRUMENTS THRU *PIX FACTS*

World's Largest Technical Publication — 250,000 Per Month

PUBLISHED BY SENCORE
3200 SENCORE DRIVE
SIOUX FALLS, SOUTH DAKOTA 57107



PRODUCT
OF THE
MONTH

FE160 SENIOR HI-LO FIELD EFFECT MULTIMETER

\$190⁰⁰

Here are 10 reasons why the FE160 belongs on your want list



FULL PUSHBUTTON DESIGN . . . Read why Bob Baum, Chief Engineer, designed them Page 2



112 RANGES . . . We have finally won the "range" war! Page 2



BOTH HI and LO POWER OHMS . . . See what Howard W. Sams Co. Inc. has to say about this Page 2



0.1 VOLT FULL-SCALE ON AC AND DC . . . Measures an unbelievable 0.01 volt accurately Page 4



MEASURES DC CURRENT FROM 30 MICROAMPS to 3 AMPS. . . Fills every current need Page 5



LESS CIRCUIT LOADING THAN VTVM . . . See how the Sencore FET circuits load less than any other meter on the market Page 5



LAB ACCURACY . . . 1.5% DC - 2.5% AC. You have to go to a high priced lab standard to get just .5% better Page 6



UNIT COMPLETELY PROTECTED AGAINST BURNOUT . . . Read about the tests. You will be convinced that nobody protects their meter like Sencore Page 6



CALIBRATED ZERO CENTER RANGES . . . No more time consuming switching of leads in transistor circuits Page 6

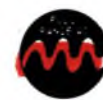

FULL RANGE AC COVERAGE INCLUDING CURRENT . . . See why it's needed. Page 7

Ten Most Often Asked Questions About the FE160 Explained in Simple Technical Language You Can Understand.



Introduction

We in field engineering at Sencore have completely field tested the NEW FE160 and have found it to be the most complete, most versatile and easiest to use multimeter on the market, at the date of this printing. We are writing this Sencore News directly to you, whether you are student, technician or engineer because the new FE160 will serve all and has something special for all.

We ran into many interesting things during our comprehensive field testing and were asked many questions. Therefore, we decided to write this tabloid directly to the "most often asked questions" and in "story form" as we were confronted with them. In this way, we hope that you will feel that you have gone through this experience with us and will come to trust our future product analysis after you have purchased the new FE160 and found it to be just what we say.

Norm Pedersen
Field Engineer and
Narrator of this report.

everyone was the same. "You'll need at least 3 switches to do it." "Nobody will want a meter with that many switches." Well, Bob was way ahead of us in this area as he had already solved the problem. By using simple pushbutton switches, he could easily provide the 112 ranges needed. That was one point for Bob, so we then

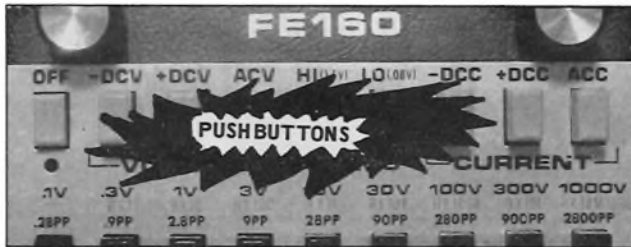

asked about the reliability of the switches. Again, he was ready. The pushbutton switches had already been recycled over a million times by Quality Control without failure. These are the same switches being used in sophisticated lab gear costing several thousand dollars! We in field engineering would not be outdone

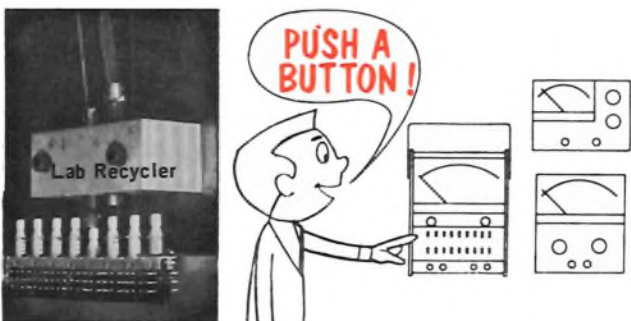

and asked another question. Will it be easy to operate? His reply was a question for us. "Stop for a moment and ask yourself; which is easier, turning a knob or pushing a button?" We had to agree that pushing a button would be easier. At this time the meeting was adjourned and Bob set about designing the new FE160 meter.

Why 112 Ranges?

Semi-conductor devices such as Field Effect Transistors (FET) and Integrated Circuits (IC), plus new circuit designs, are posing some new problems. Everyone working with electronics is finding it more difficult to obtain circuit measurements with conventional VTVMs and VOMs. This knowledge plus the information gathered from engineering surveys provided the necessary background for the development of the FE160. Here is a complete list of all ranges that we found necessary to test all electronic circuits. Read them over now or refer back to them later.

- DC VOLTS**
10 positive ranges: 0—.1, .3, 1, 3, 10, 30, 100, 300, 1000, and 3000 volts
10 negative ranges: 0—.1, .3, 1, 3, 10, 30, 100, 300, 1000, and 3000 volts
10 zero center ranges: —.05 to .05, —.15 to .15, —.5 to .5, —1.5 to 1.5, —5 to 5, —15 to 15, —50 to 50, —150 to 150, —500 to 500, and —1500 to 1500 volts
Input resistance: 15 megohm, shunted by 90pf in probe "NORM," 10 pf in 100K "ISOLATION"
Accuracy: ±1.5% AC rejection: 30db minimum
- AC VOLTS**
9 RMS ranges: 0—.1, .3, 1, 3, 10, 30, 100, 300, and 1000 volts
9 P-P ranges: 0—.28, .84, 2.8, 8.4, 28, 84, 280, 840, and 2800 VP-P
Input resistance: 12 megohm compensated
Frequency response 1DB: 10Hz to 150KHz 3 DB: 5Hz to 500KHz
Accuracy: ±2.5%
- DC CURRENT**
10 positive ranges: 0—30 microamps, 100, 300, 1 milliamp, 3, 10, 30, 100, 300 and 3A
10 negative ranges: 0—30 microamps, 100, 300, 1 milliamp, 3, 10, 30, 100, 300, and 3A
10 positive zero center ranges: —15 to 15 microamps, —50 to 50, —150 to 150, —500 to 500, —1.5 to 1.5 milliamps, —5 to 5 milliamps, —15 to 15 milliamps, —50 to 50 milliamps, —150 to 150 milliamps, and —1.5 to 1.5A
Internal drop: 0.1v to 0.4v Accuracy: ±2%
- AC CURRENT**
10 RMS ranges: 0—30 microamps, 100, 300, 1 milliamp, 3, 10, 30, 100, 300, and 3A
Accuracy: ±3% Internal voltage drop: 0.1v to 0.4vRMS
- OHMMETER**
8 high power ranges (1.5V) 0-600 ohms, 6K, 60K, 600K, 6M, 60M, 600M, and 6000M ohms
7 low power ranges (0.08V) 0-600 ohms, 6K, 60K, 600K, 6M, 60M, and 600M ohms
Accuracy: ±2 degrees arc
- DECIBEL (DB)**
9 ranges: —20DB, —10, 0, 10, 20, 30, 40, 50, and 60DB
Reference: 1mw into 600 ohms
Total: 112 Ranges

To accomplish this fantastic feat, the Sencore FE160 had to incorporate transistors and FETs in a balanced bridge circuit similar to conventional VTVMs. The advantages of using FETs (over tubes) are greater reli-

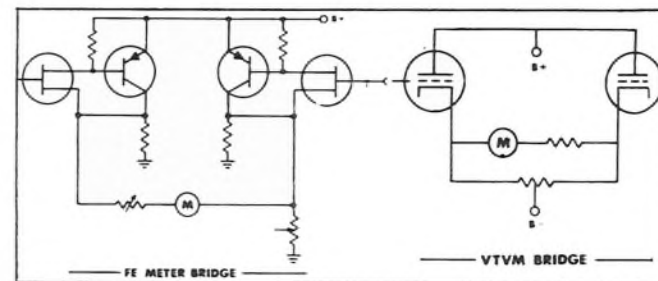

ability, higher accuracy, better stability, and they provide instant-on action with no annoying warm-up time. The operating characteristics of FETs do not change, as do the characteristics of vacuum tubes, eliminating zero drift and time consuming re-calibration. Further,



VTVM's need constant zero adjustment. This is a time consuming nuisance.

the increased amplification achieved by the circuitry employed increases the sensitivity of the instrument, allowing much needed lower voltage and current ranges.

Why Two Ohms Ranges?

Last year Howard W. Sams Co. Inc. announced to the test equipment industry "we want a meter designed that will permit in-circuit resistance measurements in solid state circuits — nothing on the market will now do it." They felt that "in-circuit" circuit resistance charts for solid state equipment, similar to the resistance charts they now provide for tube-type equipment, would be a great asset to service technicians working with solid state equipment. Sams had been unable to provide this information because (quoting them directly from their literature) "readings varied all over the place by reversing the meter probes and from various voltages supplied by the different scales and meters being used to take the measurements." If you have ever tried measuring resistors in circuit with a conventional ohmmeter that uses 1.5 volts or higher to power the ohms portion, you know how frustrating it is. A typical example of this problem is shown using the resistance from base to ground on this transistor stage used in the Motorola Quasar.

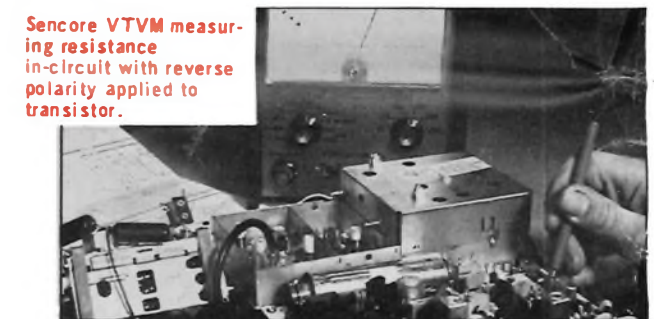
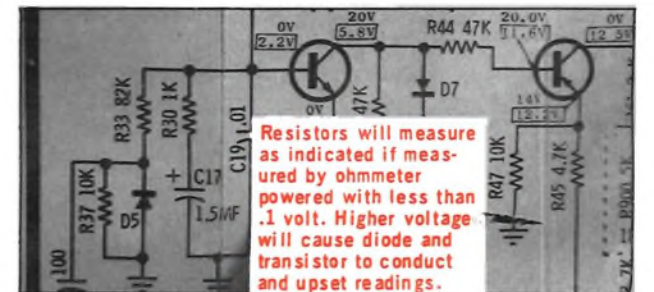

The actual resistance to ground is 92K. An older model Sencore VTVM placed in this circuit measures 50K on the RX10K range and 10K on the RX1K range.

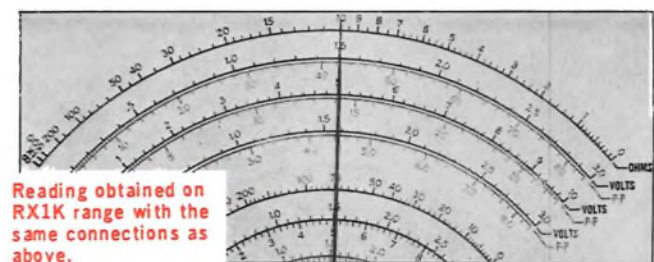

Reading obtained on RX1K range with the same connections as above.

Which reading would you believe? Neither value is anywhere close to the actual schematic value so it is virtually impossible to know whether a problem exists or not. Both are incorrect as 1.5 volts are used to power the ohmmeter. The transistor is being turned on (caused to conduct) by the voltage supplied by the meter and is upsetting the readings.

Why Pushbuttons on a Multimeter?



When Bob Baum, chief engineer at Sencore, was assigned the task of making a deluxe Hi-Lo Field Effect Meter, he came up with some good but unusual ideas. He wanted to produce the first really complete multimeter ever! The meter he envisioned would serve the needs of the service industry, engineering and vocational education.

It would provide virtually every range and function that would be needed for evaluating circuit performance. Bob wanted to eliminate the need for a second or third meter, as is now so often required for all tests.

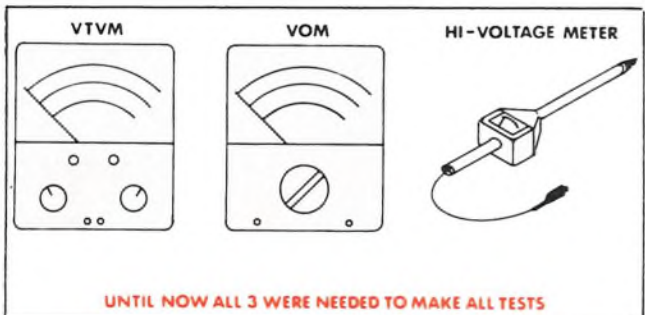

To start with, engineering surveys were made in the areas mentioned. The information we received back definitely indicated a new meter was wanted and needed. Dissatisfaction was expressed with virtually every meter currently available. VOMs have the greatest limitations. Insufficient number of ranges, inaccuracy, circuit loading and unreliability were pointed out as their major limitations. The lack of ranges, instability, and inability

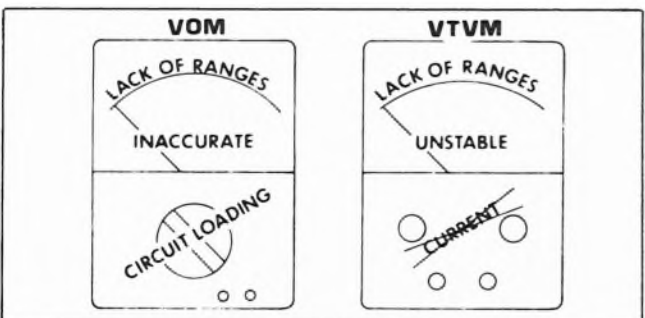

to make current measurements were most often mentioned about VTVMs. Some brands of FE meters were criticized because of inadequate protection and short battery life. In addition, several mentions were made to the fact that very few of these meters allowed the serviceman to make use of the in-circuit resistance measurements in transistor equipment now being provided by Howard W. Sams.

The results of these surveys were compiled; and much to our surprise, Bob reported that the multimeter would require an unbelievable 112 ranges. The reaction by

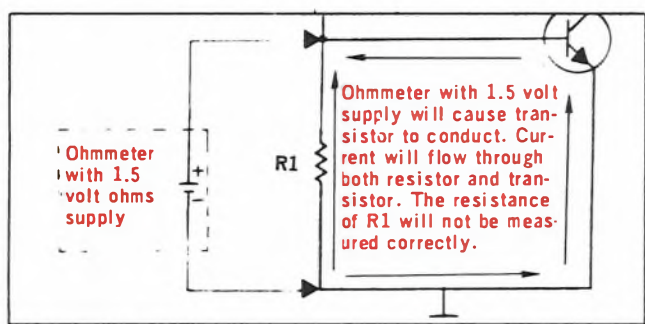

Servicemen, too, were pointing out problems in this area. "We're getting tired of removing components for checking. It takes a lot of time and causes us other problems besides. Half the time when a component is removed from the circuit board, the circuit board is damaged by the soldering iron. Some of the boards

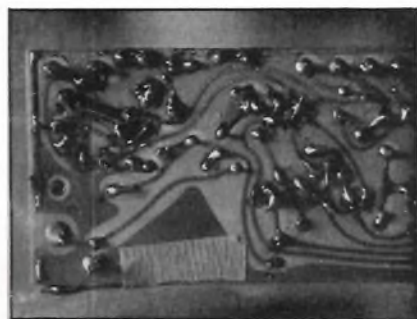

A circuit board that serviceman has worked on disconnecting and connecting transistors.

have the components placed so close together that we can't get at them to take them out to test. It seems there should be an easier way."



Integrated circuits, such as the one shown here used as the color demodulator in the Motorola Quasar chassis, are finding their way into all types of electronic circuits. They normally have between 9 and 14 leads and are soldered into the circuit. You can't afford to fool around for 15 minutes getting the IC out of the circuit to make component tests; obviously resistance measurements will have to be made with the IC circuit. With more and more ICs being used every day, it became apparent that the new meter had to have the capability of making in-circuit resistance measurements in solid state circuits.

How do we measure resistance circuitry accurately without causing semi-conductors to "turn on" and upset the readings? Simple. Every semi-conductor has a threshold level where it will start to conduct. Generally, this is believed to be 0.1 volt for most semi-conductors.

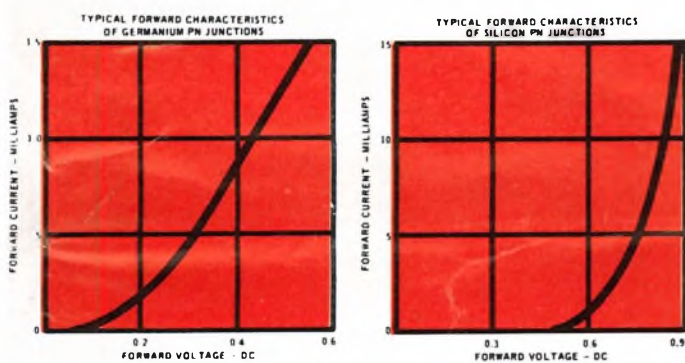

Our new meter must now have an ohmmeter power supply of a tenth of a volt or less if it is not to "trigger off" the semi-conductor.

To substantiate this theory, field engineering surveyed semi-conductor manufacturers' data such as Texas Instruments, Motorola, G.E., and RCA. We also made exhaustive tests in our field engineering lab. All information and tests concluded that semi-conductors, transistors and diodes, would not conduct with a voltage of 0.1 volt or less applied (unless they are out of specs or are defective).

The FE160 Lo-Power ohms function is designed to provide a maximum of 0.08 volts at the probe tips. The 0.08 volts will not turn transistors and diodes on to upset resistance measurements. In-circuit resistance measurements can now be made accurately. We did find in our tests that an isolated case of a germanium diode or transistor (particularly high power handling types) would conduct slightly at 0.08 volts. Should this be encountered or even suspected, the voltage at the probe tips may be lowered even more by placing the probe switch in the 100K "ISOLATE" position.

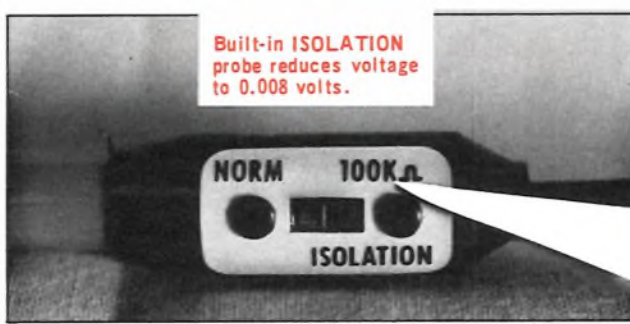

Delivering into a normal 10K circuit, you now have a potential of only 0.008 volts at the probe tips.

One might now think that the Lo-Power ohms section of the FE160, particularly with the isolation probe in circuit, can be used for any and all resistance measurements. This is true in most cases, but there are times when we in field engineering found it necessary to have the 1.5 volts. Service technicians, in particular, test diodes, rectifiers and even some husky transistors for conductivity. Front-to-back ratios are often shown on

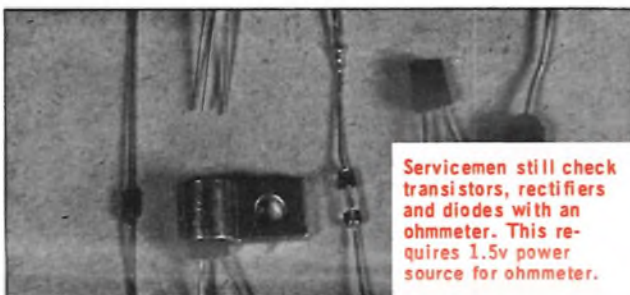

schematics and even in engineering data. The FE160 would not be complete if it did not make this test. The Hi-Power ohms position produces 1.5 volts to make these all important tests.

Howard W. Sams immediately began using the Lo-Power ohms function for in-circuit resistance measurements in Photofact. *The Photofact Servicer* shown here was sent to all subscribers by Howard W. Sams in April, 1971.

If you don't have a multimeter incorporating the Lo-Power ohms function you will not be able to make use of this valuable information. When you begin using this information, you'll find transistor servicing or circuit design much faster and easier.

Using the Hi-Lo Meter

Let's get back to the resistance measurement in that Motorola receiver. The resistance is supposed to be 92K. We'll measure it with the Lo-Power ohms function of the FE160 and see what we get. First, we depress the Lo-Power ohms pushbutton and then the pushbutton for the RX10K range. The measurement obtained is shown. We reversed the leads and the reading is still 92K. Either way the reading is accurate.

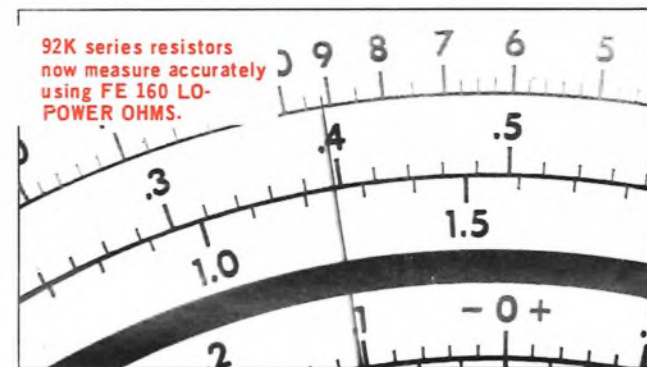

Another example. Ever try to accurately measure a 0.47 ohm resistor as shown in this schematic? It's diffi-

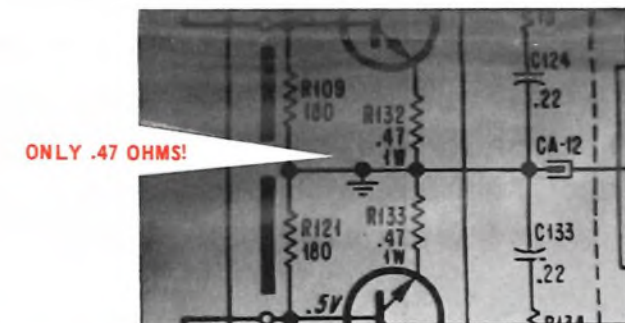

PHOTOFACT ADDS RESISTANCE MEASUREMENTS FOR TV TRANSISTORS

SAMS Photofact Servicer
 PUBLISHED FOR PHOTOFACT-OF-THE-MONTH CLUB MEMBERS
 VOLUME 5, NO. 4
 APRIL, 1971

For the first time PHOTOFACT includes resistance measurements for TV modules. Incidentally, as you look at our schematic presentations, you'll find arrows indicating direction of signal or control voltage paths as well as some schematics to simplify troubleshooting.

ONE WORD OF CAUTION! Notice the note on the Resistance Measurements chart "Measurements Below Taken With Meter Having .08V MAX BETWEEN PROBE TIPS." Meters with this capability are readily available and have meter positions identified as LP or Low Power Ohms. UNLESS your meter has this design feature, the readings given will be as meaningless as ever.

FIVE BUCK COUPON

As an incentive to buy the FE160 in June, merely purchase the FE160 and send in this coupon with the warranty card that is packed with your FE160 direct to Sencore Inc., Promotion Department, 3200 Sencore Drive, Sioux Falls, South Dakota 57107

Name _____

Address _____

City, State, Zip _____

Sencore will send you five bucks cash. No Strings as long as your letter is postmarked before July 1, 1971. Another Sencore News will be packaged with your FE160.

circuit, for two reasons. First, the transistors in the circuit can conduct and upset the reading. Second, the ranges on the ohmmeter usually do not permit accuracy at this low value. Sencore thought of this too, when the FE160 was being designed. The ohms scales are expanded with 6 ohms center scale. This allows resistance measurements as low as 0.1 ohm. Measuring the resistor shown above with the FE160 on RX1, Low-Power ohms, the value comes out right on the nose.

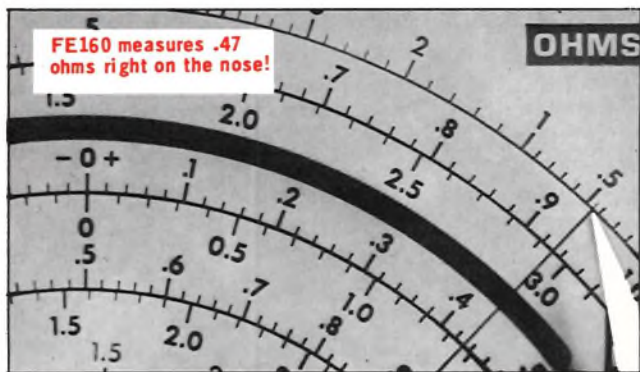

Let's use the RCA Model VPT82S solid state stereo for another example for low power ohms usage. The tuner used is modular in design. If one of the inter-

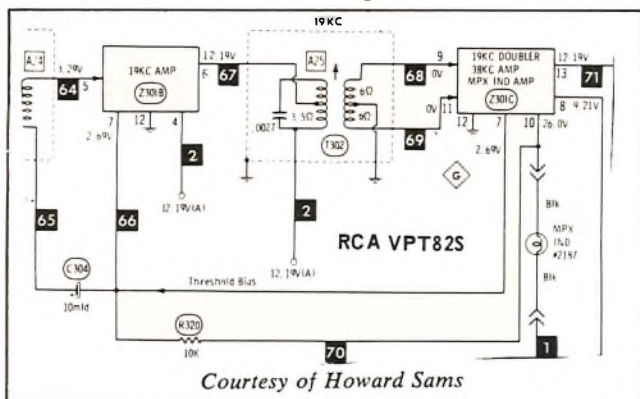

stage transformers is suspected as being the problem, the resistance can be easily checked using the Lo-Power ohms function of the FE160. Using a conventional ohmmeter, either the transformer or the module would have to be removed for a positive measurement because semi-conductor conduction would occur and the readings would be meaningless. You should begin to see where the Lo-Power ohms function will save you a lot of time and work and is a must for all electronics of the future. Only Sencore has the Hi-Lo meters.

An engineer who wrote in gave us in field engineering another good tip which we will pass along to you. Measuring the value of thermistors must be done when they are cold. Using a conventional ohmmeter, enough current is flowing through the thermistor to heat it and change the reading. By using the Lo-Power ohms, the resistor will remain cold and the reading will be correct.

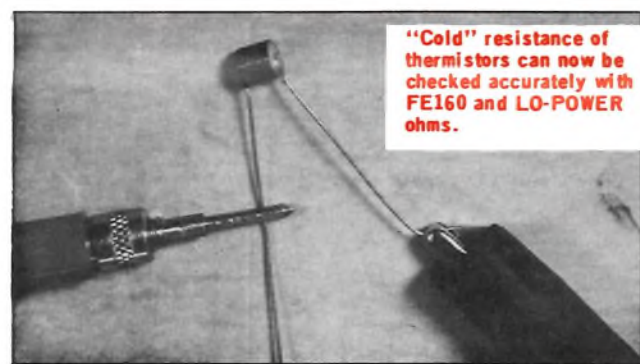

The engineer and student will also find the Lo-Power to be a time-saver. Vocational schools are training their students with current, up-to-date solid state equipment. The design engineer is working almost exclusively with solid state components, including FETs and integrated circuits. After the circuit is constructed, tests must be made. Should the circuit not perform as desired, components will have to be checked. It is much easier to check the resistors and coils in circuit than to disassemble to test components.

The student will find a similar use for the FE160 when working with lab trainers. A typical example is the student pictured troubleshooting an experimental circuit. He is using the Lo-Power ohms to find a defective resistor purposely inserted by his instructor. Getting any ideas of your own where the Lo-Power ohms features can be used? In schools? Training new employees? Beginning service technicians? And still good enough for a research scientist.

Why 0.1 Volt DC Range?



Why 0.1 Volt DC Range?

Service technicians, engineers and vocational instructors all pointed out the need for lower voltage ranges. A service technician told us about an Airline Model GEN-11741A receiver he was working on. As shown on the schematic, the collector voltages on the horizontal and vertical oscillators were only 30 and 40 millivolts.

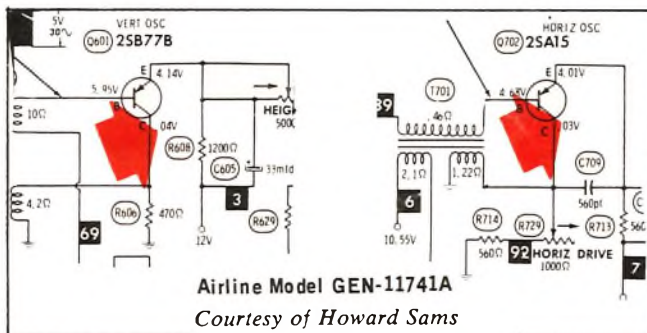

"How can I be sure the stage is working correctly if I can't measure the voltage? The meters I've been using won't read that low." A similar situation was brought up by another man on a Motorola Model MP11FN stereo phonograph. The emitter voltage on the output transistors is again a tiny 20 millivolts.

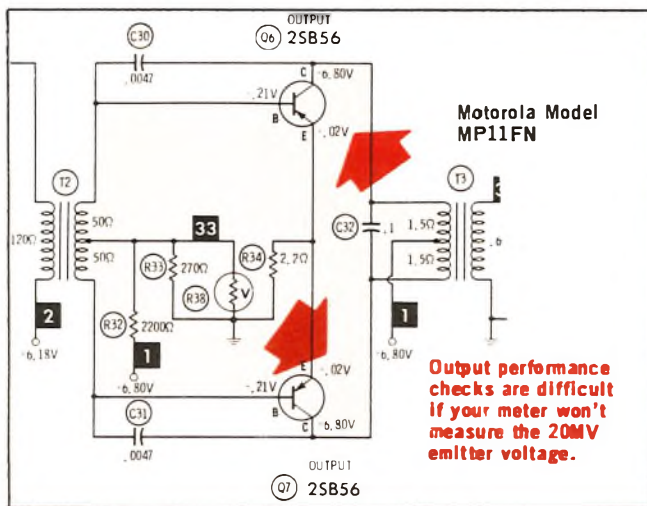

Typical examples of other circuits using very low voltages are shown.

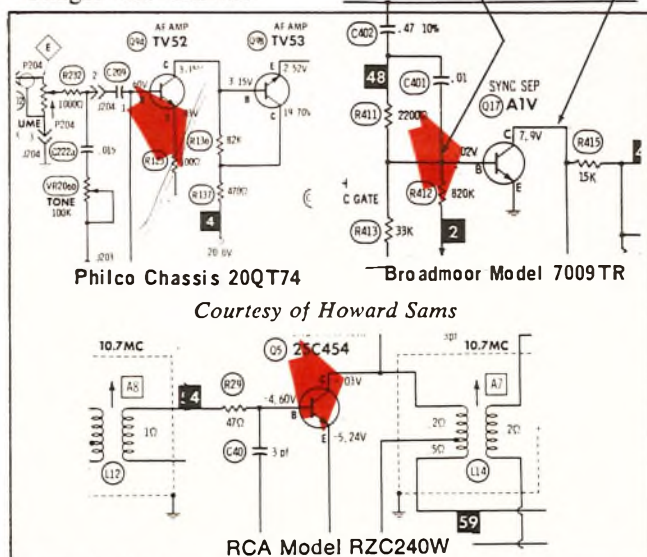

Sylvania in their service bulletin #R45-1-7 specify that the output transistor operating point be adjusted to obtain a 50 millivolt drop across one of the emitter resistors. This adjustment changes the transistor bias to set the correct current level through the transistors. The correct adjustment will eliminate distortion which may be present in the output stage and also prolong the transistor's life. Tape players, too, will use low voltages

as shown in this schematic of a Motorola Model STD-174J cartridge player. Will your meter give an accurate reading at these voltages? Probably not.

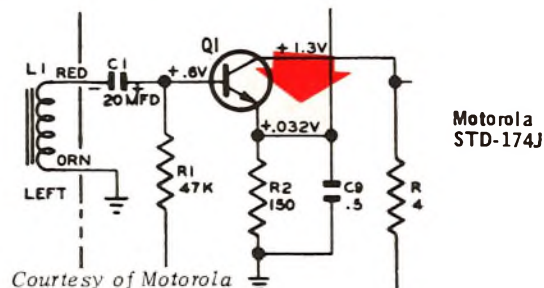

This information left no doubt in field engineering that the DC voltage ranges would have to be made very sensitive so low voltages could be measured accurately. When the dust settled in the engineering lab, the FE160 emerged with an unbelievable DC sensitivity of 0.1 volt full scale. To top it off, Bob designed around a 7" meter! Voltages can be measured as low as 2 millivolts. That isn't all! We found by using 0.5% precision resistors instead of 1% resistors, we could get DC accuracy of 1.5%. This is lab accuracy in a low cost instrument! Like all that? Well, let's see what we can do with it.

First, we'll go back to those troublesome low voltages listed on the schematics. To measure the 30 millivolts at the emitter of the horizontal oscillator in the Airline receiver, we depress the +DCV function pushbutton and the .1 volt range pushbutton. When the probe was connected to the emitter of the stage, the reading on



the FE160 was 32 millivolts. You can see that a 32mv reading is well upscale and easily read. The 7" meter is a big help as it spreads out the scale divisions making precise measurement possible.



The Motorola stereo is next on the list. The same function and range is used so all we have to do is make the connections. As the photo shows, the emitter voltage is 19 millivolts. The FE160 sure makes measuring low voltages easy, doesn't it?

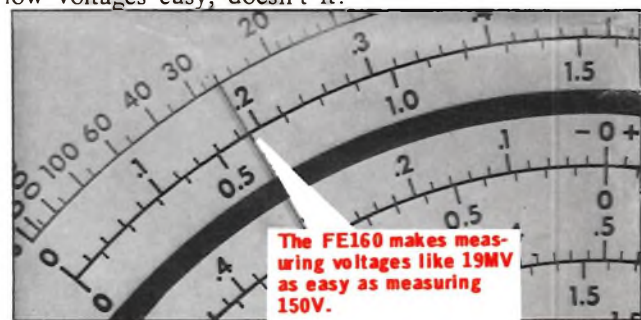

Here's a tip you may be able to use when working on solid state equipment. The voltage present at the emitter (or collector, depending on which element is returned to ground through a resistor) is a good quick check of stage operation. This voltage is a direct indication of the total current drawn by the solid state device — use a little Ohm's Law and you have the actual current without disconnecting any element. A typical example of this check would be the transistorized Zenith IF stages shown here. Each of the emitters returns to ground through a

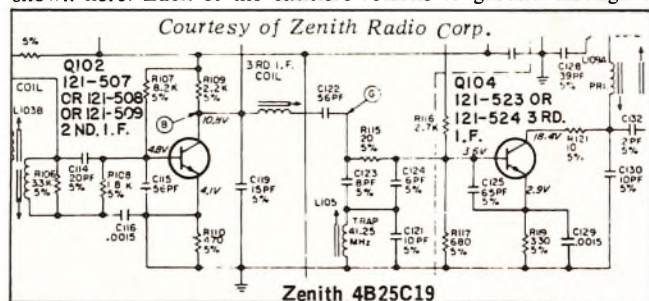

resistor. If the stage is operating correctly, current flow will be normal, providing the correct voltage at the emitter. Any substantial deviation either above or below this voltage indicates trouble.

(IMPORTANT NOTE!) When making these measurements, be sure the conditions stated on the schematic notes are adhered to. If the notes state no signal conditions for voltage measurements, set the tuner between channels. An incoming signal will cause AGC action which can make a big difference in the emitter voltages. This could cause confusion if you are not aware that the change will take place.

On to the next item. The Sylvania stereo mentioned before is a good example of a critical adjustment using a very low voltage as a check. The bias adjustment is

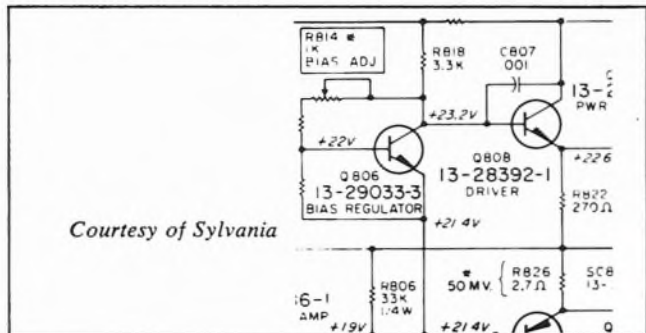

important because of the distortion which will result if it is improperly set. The bias should be checked anytime a component is changed in the output section to assure proper operation. If the bias is set too low, distortion will result. If the bias is set too high, excessive current will be drawn, the output will be low and distortion will be present. To adjust the bias, connect the FE160 (on the .1 volt range) across resistor R826 and adjust the bias control, R814, until the meter indicates 50 millivolts. Use the same procedure for the other channel.



Engineers and students will encounter the same low voltages as found in servicing. Many of the transistor circuits in their labs will have voltages present as low as 5 millivolts. The fast pushbutton operation, the large easy-to-read 7" meter and the high accuracy are a boon to the engineer. The student will be able to spend less time operating test equipment and more time in his study of electronic circuits if he is using the FE160.

How About Higher Voltages?

Higher voltages must also be measured. A good example is the boost voltage in television receivers. This can range from 400 volts in a black and white set to over 1200 volts in a color receiver. The FE160 is designed to measure voltages as high as 3,000 volts. The boost voltage of a Magnavox color receiver is being measured here.

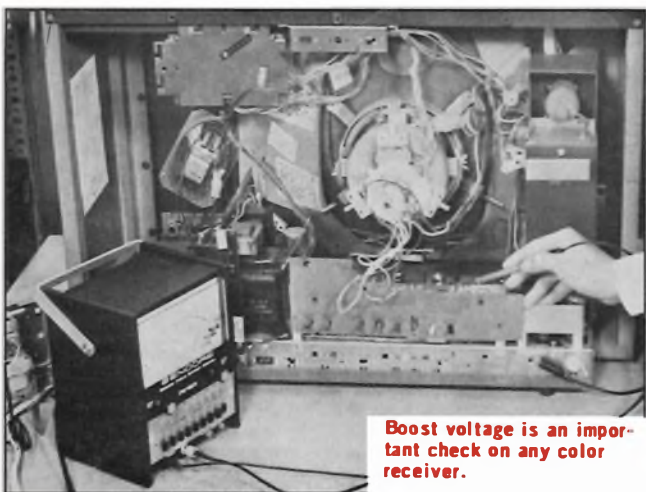

The DC voltage ranges can be extended with the optional 39A30 high voltage probe. This probe allows measurements to be made as high as 30KV to cover the all-important focus and anode voltages in color receivers. Improvements have been made in the high voltage probe too. The body of the probe has been greatly reduced in size making it easier to insert under the large rubber anode cap. A hook has been added to the probe tip to allow you to make the connection with the set off. The probe will stay put and positive connection will be assured. No more misadjusted re-

Minimum Circuit Loading. Why Is It Important?

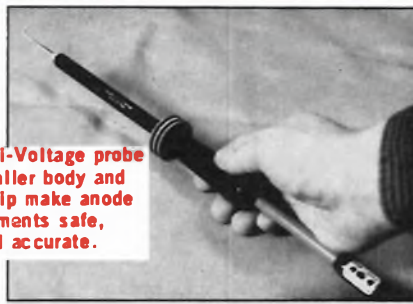

ceivers because of poor contact with the anode. The high voltage can be set more accurately as well. The high voltage probes which use a small 1½" or 2" meter will not give you the accuracy you need! With the large 7" meter on the FE160, you set the high voltage right on the nose the first time, every time.

Why DC Current Ranges from 30 Microamps to 3 Amps?

VTVMs being used for servicing are not adequate today because they do not provide current ranges. Much of the circuit testing done presently is measuring current. For example, newer receivers using ICs list current measurements for troubleshooting as shown in this Philco schematic. Every color receiver and many black

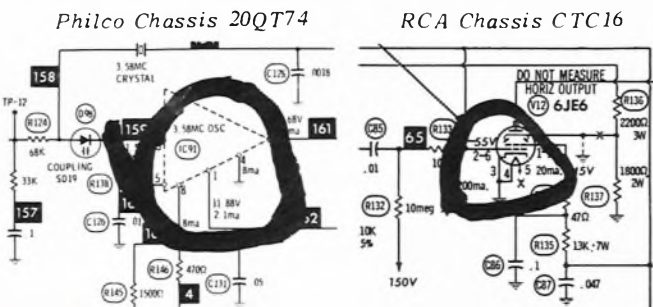

and white sets specify a horizontal output current setting right on the schematic. Engineers and students need the low current ranges to check operation of transistor circuits. A typical example would be the base current measurement to confirm calculated values. These values will range from 5 to 50 microamps.

A much improved system for current measurements is employed in the FE160. The external circuit does not drive the meter as in a conventional VOM. The meter and its usual loading are completely isolated from the circuit being measured. The sensitivity of the FE160 permits the measurement of the voltage drop across a small value precision resistor to determine current flow. This allows a more accurate reading as the meter current does not affect the circuit. The voltage drop is only 100 millivolts on most ranges.

The FE160 is designed to cover all possible needs in measuring current. Measurements as low as 1 microamp and as high as 3 amps may be made with pushbutton ease. The low, 100 millivolts internal drop of the instrument plus 2% accuracy assure correct measurements every time! With pushbutton operation, and large meter with clearly marked scales, current measurements are a breeze. Shall we run it through its paces?

The lowest current measurements will probably be encountered by the engineer and student. Emitter and base current measurements are a must for determining correct operation. In the circuit shown below, the base current is 6 microamps. A current this low cannot be measured with conventional meters. The FE160 was built to measure low currents and performs like a champ. The meter indication for this current is shown. Even currents as low as 6 microamps are easily read. Let's try another one.

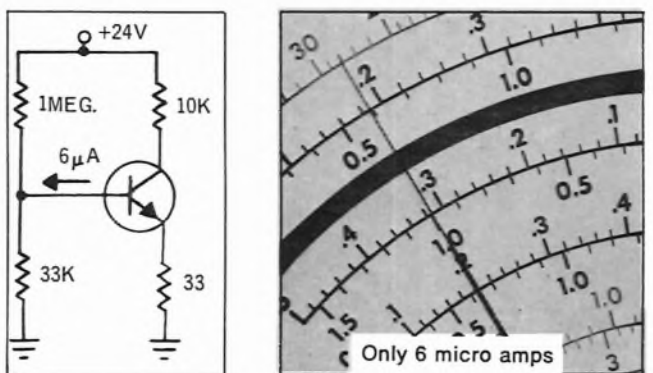

The service technician has many current measurements to make. One area is the shunt regulator current in older color receivers. A typical circuit from an RCA CTC16 color chassis is shown.

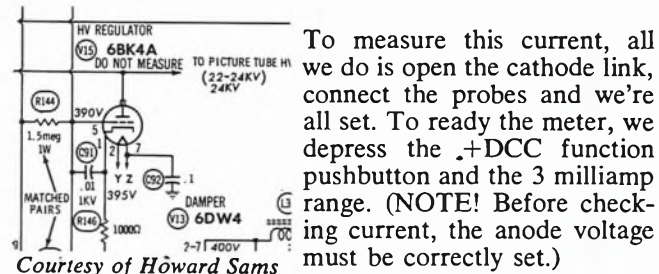

To measure this current, all we do is open the cathode link, connect the probes and we're all set. To ready the meter, we depress the +DCC function pushbutton and the 3 milliamp range. (NOTE! Before checking current, the anode voltage must be correctly set.)



horizontal output current next. Again, we open the cathode link, connect the meter and place a .5mfd capacitor across the meter leads. This is specified in the section of the service manual related to output circuit adjustments. The capacitor is necessary to obtain a correct reading and also bypass the RF which is present at this point. We turn the receiver on and the current measures 230 milliamps. A little high, so we adjust the horizontal efficiency coil for minimum current. The dip occurs at 180 milliamps which is normal. The output circuit is performing correctly so we can remove the meter and close the cathode link. Not too hard is it? Not if you have the right meter.

Minimum Circuit Loading. Why Is It Important?

A few years ago the VOM played an important role in servicing and laboratory design work. As circuits became more sophisticated, the VOM began to introduce troubles and cause many problems for its users.

Let's use a transistor amplifier for an example. We wish

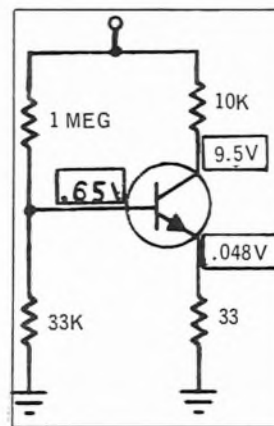

to measure the base voltage to determine if it is properly biased. If the 20,000 ohms per volt VOM were used to measure the voltage, it would not read correctly, and would give a false indication of trouble. This is due to the loading effect the meter has on the circuit. The meter looks like a 50,000 ohm resistor placed across the 33,000 ohm base resistor on the 2.5 volt range (2.5 volt range times 20,000 ohms per volt). Using Ohm's Law, we can determine the effect the meter has on the base circuit. 50,000 ohms in parallel with 33,000 ohms figures out to:

$$\frac{R1 \times R2}{R1 + R2} = \frac{50K \times 33K}{50K + 33K} = \frac{1650(M)}{83K} = 19.891K$$

or 20K for convenience.

The effective value of the base resistance now becomes 20,000 ohms which greatly upsets the bias applied to the transistor. This problem, caused simply by the type

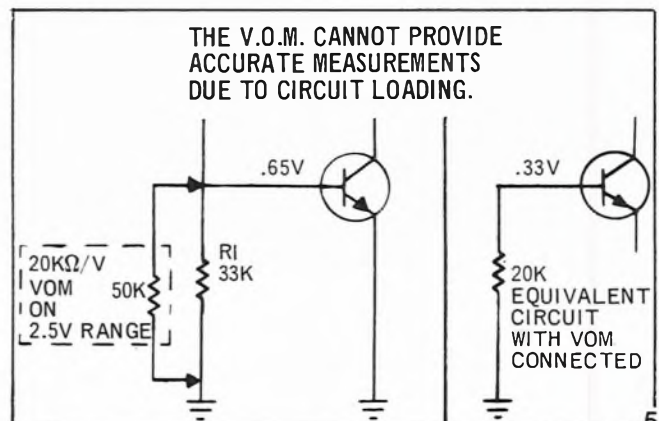

of meter being used, can send you on a wild goose chase. Another example is the sync separator circuit shown. The input capacitor C1 and the base resistor R1 form a time constant which determines the clip-

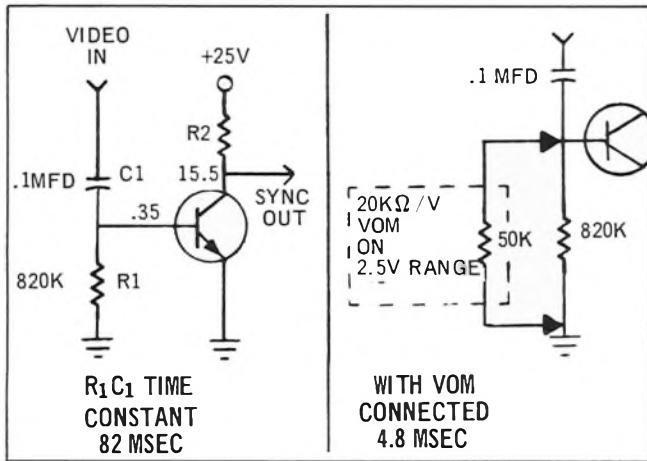

ping level. If a conventional VOM is used to measure this base voltage, the shunting or loading effect of the meter will change the RC time constant of the circuit. The results will be an unstable picture on the CRT because of the change in clipping level, possibly causing you to misinterpret the symptoms.

The FE160 was designed to overcome these problems. By using FETs in the design, the input impedance can be made very high. The impedance of an FET input is somewhere in the neighborhood of 100 megohms. This high input impedance to the FET permits a higher value of input divider to be used for the AC and DC voltage ranges. The input impedance of the FE160 is 15 megohms on ALL DC ranges and 12 megohms on ALL AC ranges. In addition, a 100K isolation resistor can be added in series with the probe by flipping a

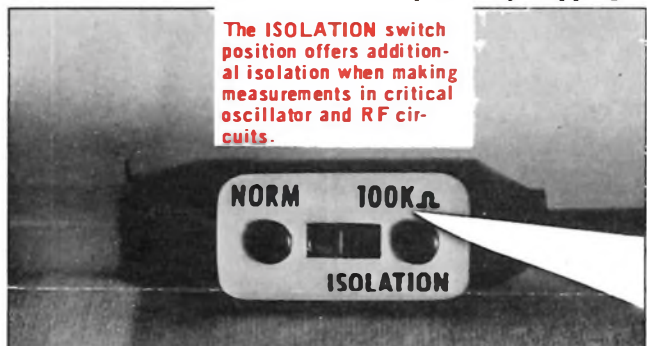

switch. This will offer additional isolation from the input capacity of the FE160 when making measurements in critical oscillator and RF circuits.

In the example with the transistor amplifier using the 33K base resistor, (above) the FE160 and its 15 megohm input impedance will not reduce the base resistance. The voltages measured will be correct and the circuit operation will not be affected. Let us go through our math again to show why.

$$\frac{R1 \times R2}{R1 + R2} = \frac{33K \times 15M}{33K + 15M} = \frac{495 \times (KM)}{15.033M} = \frac{495K}{15.033} = 32.928K$$

or 72 ohms less than the coded value of the resistor. This represents a change of only .22% and can be ignored. For the sync separator circuit, the same conditions prevail. The FE160 will not affect the circuit and the measurements will be correct. Also, the picture shown on the screen of the CRT will not be changed by connecting the meter.

The input impedance of the FE160 can be increased to over 1500 megohms should a situation develop where it is needed. All that is required is the optional Hi-Voltage, number 39A30. Simply slip the Hi-Voltage probe over the standard probe supplied with the FE160.

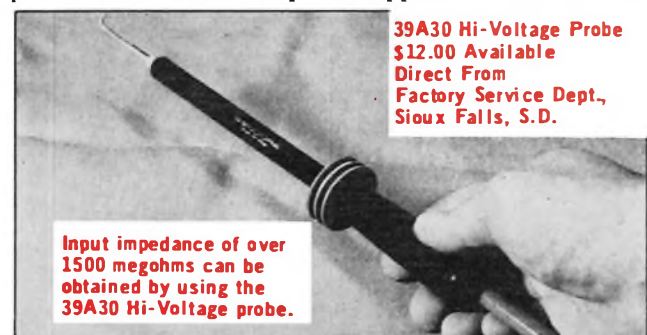

The DC voltage measurement would be made in the same manner as with the standard probe and the reading would be multiplied by 100 to obtain the actual voltage being measured.

Just how accurate is the FE160?

The point stressed most in the survey returns was the accuracy of the instrument. Engineers, service technicians, and students make circuit measurements to determine the performance of a circuit. When circuit measurements are made, the individual must rely on the meter to provide correct circuit information. If the instrument cannot be trusted as being accurate, the reading obtained will have no value.

The Sencore FE160 provides accuracy unequalled by any VTVM, VOM or FE meter, domestic or imported. Lab accuracy has been built in throughout the instrument. More costly 0.5% precision resistors are used to assure the greatest possible accuracy. FETs are employed to maintain constant reliability and eliminate the need for recalibration. The large, American made,

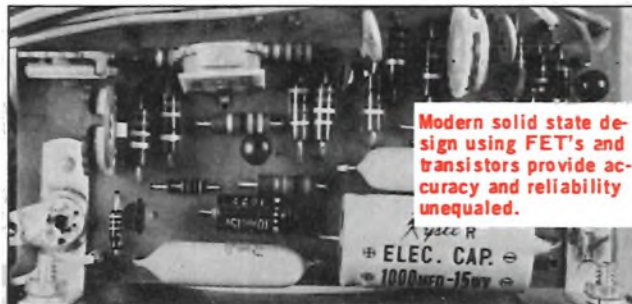

7" meter movement with 0.5% tracking accuracy provides the most accurate readings ever. The 7" meter allows greater expansion of the scale divisions for more precise measurements. The 1-3-10 range sequence allows a full 1/3 overlap between ranges. This also increases scale expansion when compared to meters using the 1.5-5-15 sequence. The 112 ranges available mean

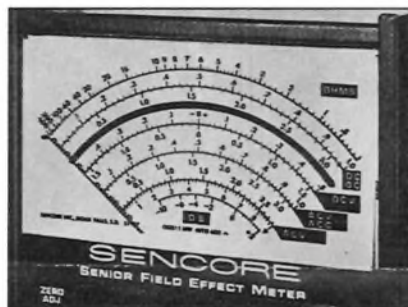

a much greater flexibility than with any other meter on the market today. The clearly marked, color keyed scales on the meter (corresponding to the pushbutton identification) speed the location of the correct scale to use for the measurement. Each FE160 is checked for calibration twice. They are first calibrated on the production line, then aged and life tested for 24 hours (3 days operation). At the completion of the aging,

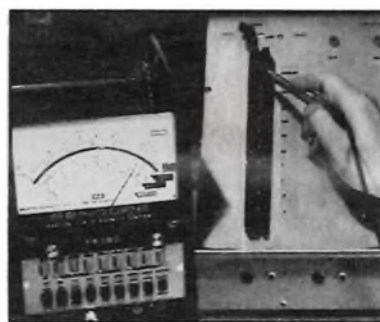

they are again recalibrated, if necessary. This double check on calibration plus DC accuracy of 1.5% and AC accuracy of 2.5% make the FE160 the finest FE multimeter available!

Is the Sencore FE160 really protected to 1000 times overload?

One of the most aggravating, time consuming and costly problems with VOMs, VTVMs and other FE meters is the damaged unit. This has been a universal problem and it can happen easily. For example, have you ever had the meter set on a low voltage range and accidentally made contact with 300 volts B+? Or attempted to measure B+ without checking the range setting of the meter? One of the most common results of this experi-



ence is shown here. What happens when you try to measure the AC line voltage or B+ without changing from the ohms position? The results are usually similar to that pictured here.



The problem of meter damage is present in all electronic areas; servicing, engineering, industry and vocational education. The problem is probably greater in vocational education because inexperienced people are operating the equipment. Regardless of the area, a damaged meter means lost time, lost work, and lost profits. This will not happen with the FE160.

Sencore set a goal to produce a multimeter that would withstand any abuse anyone could give it, accidentally or on purpose! The FE160 is designed to withstand an overload of 1,000 times. It is tested on the production line by applying 1,000 volts to the 0.1 volt range. That's an overload of 10,000 times! 10 protective circuits or devices are used in the FE160 to provide the first true burn-out proof multimeter. Each of the transistors and FETs employed in the FE160 is protected. The meter movement is isolated from the external circuit for every test. To further protect the meter movement, a shunt diode is placed across it. The meter pointer will not be

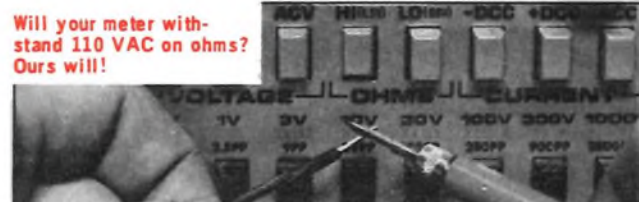

bent by overload because of the special heavily damped meter used in the FE160. The input is fused for protection when used on current and ohms functions. Shunt diodes are incorporated to provide additional protection for the precision resistors used on the current ranges. The high input impedance serves to protect the precision resistors used for the divider on AC and DC voltage ranges.

The meter has been checked under various extremes by the field engineering department. 1,100 volts B+ boost from a color receiver has been applied to the 0.1 volt range repeatedly without damage to the meter or components. The AC line voltage has been applied to the ohms function with nothing happening other than the fuse opening. Currents as high as 1 amp have been applied to the 30 microamp current range resulting in only the protective fuse opening. Every possible overload normally encountered has been applied and the FE160 has yet to fail! Anyone, novice or professional, can use the FE160 with the assurance that it will continue to function accurately regardless of the accidents which may happen.

Why the Calibrated Zero Center Ranges?

Zero center ranges are needed in many different areas. To align the discriminator or ratio detector in FM receivers and television sets, a zero adjustment of the transformer secondary is required. Receivers using auto-

FM alignment is easy and accurate with the FE160.

A7, A8 A9, A10	maximum.	<p>FIG. 1</p>
A11	Adjust for zero reading. A positive or negative reading will be obtained on either side of the correct setting.	

Olympic Model S100

IN FM POSITION

side to ground. Use only enough modulated signal with 450KC sweep. deflection.

matic fine tuning require a similar adjustment. Null or zero balancing is called for by some manufacturers to correctly set the bias on the audio output amplifiers. Calibration of various testing and monitoring equipment in industry requires zero center ranges.

An interesting point was brought up by a service technician in the Midwest. "Be sure you have the calibrated zero center ranges as you do on the FE149. It is the handiest part of the meter. I use it all the time when I make voltage measurements in solid state circuits. I can make all the measurements without the constant switching between positive and negative polarity as I have to do on other meters."

The FE160 provides 20 calibrated zero center ranges. The zero center ranges on DC voltage provide coverage from —50 millivolts - 0+50 millivolts to —1500 volts - 0+1500 volts. These ranges have the same 1.5% accuracy as the other DC ranges. Zero center DC current ranges from —15 microamps - 0+15 microamps to —1.5 Amp 0+1.5 Amp are also available. These are fully calibrated ranges, not just a zero center mark as used on other meters!

How do you use the zero center ranges?

We'll give you a few ideas to get you started. The idea mentioned earlier is great. We'll use this RCA VPT82S stereo which is a typical solid state circuit.

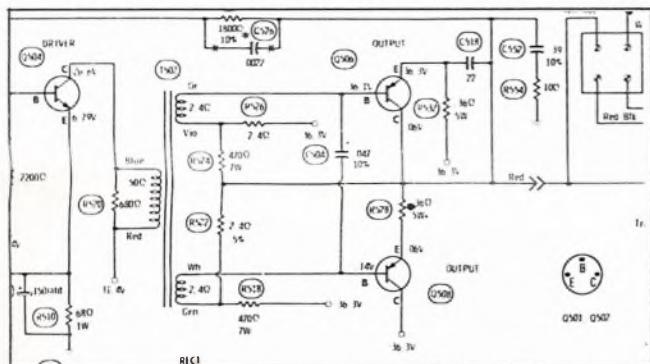

RCA Model VPT 82 S uses positive and negative power supplies.

Courtesy of Howard Sams

You will notice the output transistors have both positive and negative voltages applied. To speed the measurement of these voltages, simply depress the +DCV function pushbutton and place the meter needle over the zero center mark with the zero adjust control. The only thing left to do is select the proper range and go to work. A reading to the left of center or downscale will indicate a negative voltage. A reading to the right of center or upscale will be a positive voltage. Let's make a couple of measurements so you get the swing of it. You can follow along on the schematic if you wish. With the meter set to zero center and the 100 volt range selected, we measure the voltage at the emitter of Q506. The needle swings right (positive)

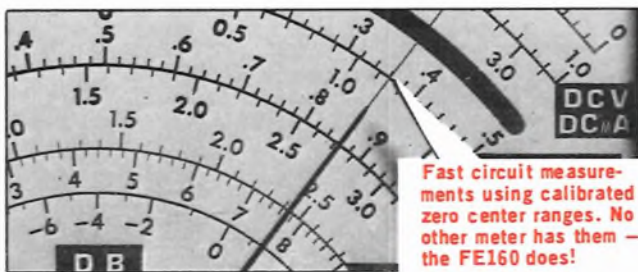

Fast circuit measurements using calibrated zero center ranges. No other meter has them — the FE160 does!

and stops at 36 volts. Next the collector of Q508. The needle now swings left (negative) and comes to rest at about 36.5 volts. To measure the base and emitter

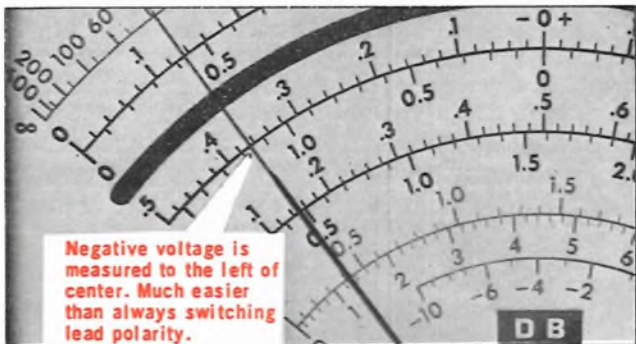

Negative voltage is measured to the left of center. Much easier than always switching lead polarity.

voltages on Q508, we depress the 0.3 volt range pushbutton. The base voltage measures —.15 volts and the emitter is —.07 volts. Get the idea now? Sure is faster than changing polarity all the time.

The FE160 will permit more accurate adjustment of FM detectors and similar circuits than any other instrument. To prove this, we adjusted the ratio detector in the RCA Model RZC240W radio as accurately as possible using a VTVM with 1 volt full scale sensitivity. We then checked the secondary adjustment using the —.05-0+.05 volt center scale (0.1 volt) range on the FE160. The results are shown. The first adjustment was off by 5mv! The secondary was retouched and the alignment was completed.

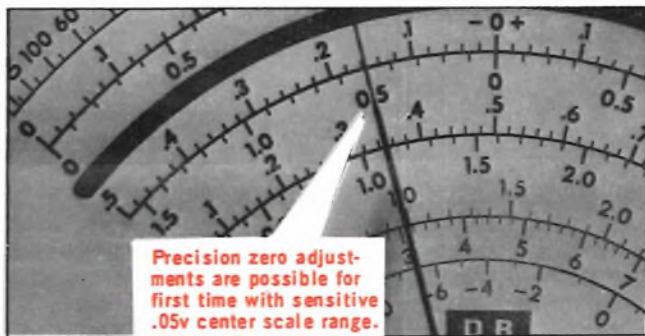

Precision zero adjustments are possible for first time with sensitive .05v center scale range.

Why AC Voltage and Current Ranges?

The use for the AC ranges is limited only by the number of items that operate from the AC line or require AC signal for proper performance. Most VTVMs and VOMs have AC voltage ranges 'so they will be available' but usually are low impedance and inaccurate. AC current ranges are not even present on most meters! The number of uses for AC voltage ranges is virtually limitless. We'll take time to mention just a few.



Any piece of equipment that operates from the AC line requires a specific level of voltage to operate correctly.

One example is the television receiver with insufficient width or height. Besides circuit problems, this condition could very easily be caused by low line voltage. In some rural areas, high line voltage can cause premature failure of electronic components as well as critical parts of appliances and machinery. You must be able to accurately check the line voltage to isolate the problem. In series television receivers, many problems can develop in the filament string. Since the filament is AC operated, an AC voltage range must be used to measure the voltage distribution on the filament string. Other areas in servicing where the AC voltage ranges are essential is the testing of cartridges

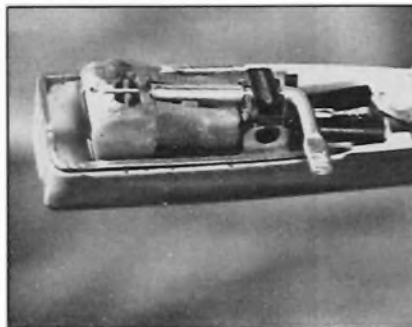

The FE160 is sensitive enough to measure the low output of a ceramic cartridge.

and tape heads for output. Some manufacturers require tape head adjustment to be made while monitoring the AC output.

In the school and engineering lab, AC potentials such as transformer output must be checked. The engineer-

Here are the main technical points of the "last presented" Sencore Instruments. Read these over as a memory jogger to see your Sencore Distributor for a trial.

LAST MONTH'S PRODUCT REMINDER

ALL NEW COLOR KING III AT NO INCREASE IN PRICE \$169.50



Sencore keeps making the Color King better and better. Now it is more stable than digital circuits; has dots so small that you know you are right on the mark on convergence; and will operate over wide, wide temperature ranges. See these new outstanding features and then see your Sencore distributor!

Now! Giant Size Trade In...

\$25.00 for any old color generator—or any other piece of equipment. See your Sencore distributor for this special one-time deal.



NEW "PERMALOCK" CIRCUITS
Digital stability without the complex circuits! Modern, solid-state circuit design using many less components than digital circuits means greater reliability—less chance for part failure. Unbelievable stability from 60 below zero to 140 in the shade.



NEW "PAINTED" PATTERNS
Patterns so rock-solid and steady that you'll think they are painted on the screen. Guaranteed to outperform so-called "digital circuit" generators or your money back.



NEW ULTRA-SHARP PATTERNS
Dots and lines only one scan line wide. Sharpest and finest dots ever produced by a color generator plus exclusive dot size adjustment. A must for converging new CRT tube types.

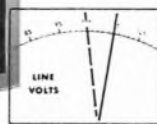

NEW GREATER LINE VOLTAGE RANGE
Line voltage is being lowered due to power shortages. Don't get caught with a generator that won't work. The Color King III is ready to go regardless of line voltage.



NEW TRUE INSTANT LOCK-IN
Patterns are locked and rock-solid the instant you flip the off-on switch. New all solid state circuits mean no more wasted time waiting for the patterns to stabilize.



THERMOSTATIC TEMPERATURE CONTROL
Internal heater quickly brings unit to operating temperature, even when taken from your car in coldest weather. Drives out component damaging moisture in warm humid climates too.



TWO EXTRA PATTERNS
Industry standard, RCA licensed patterns PLUS movable single dot and single cross. You can position them anywhere on the screen—a real dynamic convergence timesaver.



EXTRA RF CHANNELS
All low VHF channels available on the front panel at the flick of a switch. Eliminates co-channel interference as you can choose any channel between 2 and 6, not just one or two as on other units.



REGAL STYLING AND APPEARANCE
Smart, professional-looking case of rugged vinyl-clad steel. Makes you look like the professional you are. Extra plus—high quality plate glass mirror shock mounted in cover so it's always with you.



AMERICAN MADE
The Color King is American engineered. American built to guarantee you the finest quality and most dependable service.

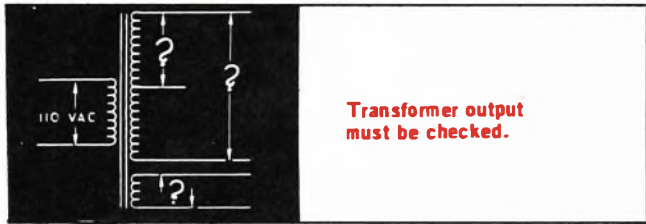

ing lab especially will require precise information about the transformer output to determine if it corresponds to the specifications. The AC performance of amplifiers (audio for example) must be checked by monitoring both input and output signals. Normally this test requires the use of the decibel (DB) ranges for the input/output comparison.

AC current measurements are equally important. The serviceman must be able to monitor line current drawn by a television receiver or other electronic equipment to assist in tying down power supply troubles. Anytime

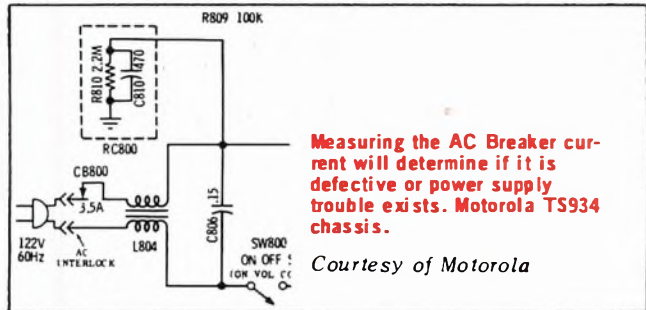

Measuring the AC Breaker current will determine if it is defective or power supply trouble exists. Motorola TS934 chassis.

Courtesy of Motorola

the filament resistor or fuse opens in a television receiver, the filament drain should be checked to determine the reason for the failure.

AC voltage ranges not only 'have to be there,' they have to be dependably accurate. A full function multimeter is not complete unless AC current ranges are available for the testing that must be done. *Not only are both AC voltage and current ranges provided on the FE160, they are more sensitive and more accurate than ever before!* The 9 AC RMS voltage ranges have 2.5% accuracy and cover a range from 0.1 volt full-scale to 1,000 volts. AC peak-to-peak voltages can be measured on 9 ranges from 0.28 volts peak-to-peak to 2800 volts peak-to-peak. To assure accuracy the input impedance

is 12 megohms, higher than any comparable meter. AC current functions, not even provided on most other meters, cover a range from 30 microamps to 3 amp RMS in 10 overlapping ranges! Unbelievable? Possibly, when compared to other meters, but not when Sencore engineers like Bob Baum get an idea. We've got the functions you need and we'll show you how to use them.

Measuring AC line voltage is nothing new, but the ease and accuracy of the FE160 is. To check the 117 volt line, we simply depress the ACV function push-button and the 300 volt range pushbutton. Regardless of the line voltage reading obtained, you know it's right!



You can now get an accurate AC line voltage check. Just use the FE160.

The constant regulation of the power supply in the FE160 is not affected by line changes or by exceptionally high or low line voltages.

Let's look at an example involving the series filament string. You get a dead set to service and quickly locate the problem as an open filament dropping resistor. Normal procedure is usually to get a replacement, install it and see if the set works. If it burns out again, we'll look for trouble. That's one way but it may cost you a resistor plus some tubes if you pop the filament. A much more positive method is to check the current drain on the filament string. Connect the FE160, set to AC current (ACC) and, to be safe, start with the 3 amp range. "Hold it" you say, "how am I going to know if the current measurement I get is right?" The answer is really quite simple. All tubes must operate at the same current level in a series filament string. Grab a tube manual and look up the normal filament current for any of the tubes. If excessive current is being drawn, look for a heater-cathode short or a shorted bypass capacitor. If the current checks out, based on the value stated in the tube manual, the dropping resistor probably failed from old age. The

only other reason left is high line voltage and this you can check with your FE160 when you take the set back.

Ever have hum bars in the picture on a set and were trying to decide if it was video or power supply trouble? No problem if you have the FE160. Just make a quick check of the power supply ripple and compare with the value shown on the schematic. This you can do

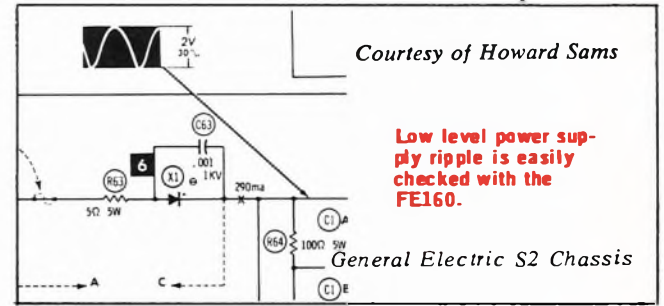

Courtesy of Howard Sams

Low level power supply ripple is easily checked with the FE160.

General Electric S2 Chassis

with a sensitive AC meter like the FE160. If the ripple is high, check the filters in the power supply. If it's normal, you better start looking for a tube with heater-cathode leakage.

Engineers and students, too, are finding it hard to get along without the FE160. No other low priced instrument will give the accuracy and versatility of the FE160 for lab use. The decibel ranges provided on the FE160 allow direct stage gain measurements without the need for calculations. The current ranges are a must when power supply drain figures are needed. Simply connect the FE160, push two buttons and you have your information.

We have tried to give you some ideas where the FE160 will help you in your work. We suggest you pick one up the next time you visit your parts distributor and try it out. Besides being the most versatile meter available, you'll find it is handsome and professional looking. The case is the same as our other equipment, rugged, 20-gauge vinyl-clad steel.

By the way. If you like our little publication, send us the warranty card from any Sencore instrument and we'll put you on the mailing list. The SENCORE NEWS will be published 10 times per year by the Field Engineering Department. WAIT 'TIL YOU SEE THE SURPRISE WE HAVE FOR YOU IN AUGUST!

How Does the FE160 Compare to Digital Voltmeters?

FEATURE	FE160	DIGITAL BRAND "A"	DIGITAL BRAND "B"	DIGITAL BRAND "C"
PRICE	\$190.00	\$354.00	\$575.00	\$695.00
MEASURES TO 3000 VOLTS DC	YES	NO	NO	NO
MEASURES TO 1000 VOLTS AC	YES	NO	YES	YES
MEASURES DC CURRENT TO 3 AMPS	YES	NO	NO	YES
MEASURES AC CURRENT TO 3 AMPS	YES	NO	NO	UNKNOWN
BOTH HI & LO POWER OHMS	YES	NO	NO	NO
MAXIMUM RESISTANCE MEASUREMENT TO 6000 MEG	YES	NO	NO	NO
NUMBER OF RANGES	112	13	37	22?
COST PER RANGE	\$1.70	\$27.30	\$15.50	\$31.60

We, in field engineering, have been asked many times how the FE160 compares to the "digital" type voltmeters. First, you should be aware that the digital voltmeters are intended primarily for limited application in engineering labs. The digital meters do not offer the versatility of the FE160 and cost several times more. The limited number of ranges and functions of the digital voltmeters, plus the lack of protection against overloads, makes them an expensive luxury. The nature of their operation also makes measurements more time consuming than the FE160. You must wait for the display to "settle down" to a steady reading before you even know what potentials you are measuring. There is no guesswork with the FE160. You can always tell instantly what voltage is present on the FE160 simply by glancing at the meter.

A comparison chart has been included so you can see how digital meters can cost you many times more than the FE160 and give you so many less measuring capabilities.

How Does the FE160 Compare with Other FE Meters?

You certainly want to know before you purchase an instrument, a car, a boat or any other item, how it compares with others available. Only through comparison of similar items are you able to determine which will best serve your needs and be the best value. We have included a chart for you to make this comparison. You will see, after you have compared specifications and features, that the FE160 is the best value in FE multimeters today.

FIELD EFFECT MULTIMETER COMPARISON CHART					
FEATURE	SENCORE FE160 ALL AMERICAN MADE	BRAND "T"	BRAND "R"	BRAND "D"	BRAND IMPORT "L"
BOTH HI & LO POWER OHMS FUNCTIONS	YES	YES	—	—	—
Hi-Power ohms ranges	8	7	7	7	7
Lo-Power ohms ranges	7	7	—	—	—
Accuracy	±2° Arc	—	±3° Arc	±3° Arc	±5° Arc
DC VOLTAGE	Number of ranges: 20	18	16	16	16
Lowest range	100 millivolt	.1 volt	.5 volt	.5 volt	.5 volt
Highest range	3000 volts	1500 volts	1500 volts	1500 volts	1500 volts
Accuracy	1.5%	2%	3%	2%	3%
DC CURRENT	Number of ranges: 10	4	8	6	—
Accuracy	2%	3%	3%	2%	—
AC VOLTAGE	Number of ranges: 9	11	7	8	7
Accuracy	2.5%	3%	3%	3%	3%
AC CURRENT	Number of ranges: 10	4	—	—	—
Accuracy	3%	4%	—	—	—
INPUT IMPEDANCE	DC: 15 Meg, AC: 12 Meg	11 Meg, 11 Meg	21 Meg, 1.5 Meg	11 Meg, 10 Meg	11 Meg
DIVIDER RESISTOR TOLERANCE	0.5%	—	—	1%	1%
CALIBRATED ZERO CENTER SCALES	DC: 20	—	—	—	—
DIVIDER FUSE PROTECTION	YES	NO	NO	YES	NO
OVERLOAD PROTECTION	1000 times	—	—	—	—
COMPLETE UNIT PROTECTION	YES	—	METER ONLY	????	METER ONLY
METER	Size Mirrored: 7 inch YES	4½ inch NO	7 inch YES	4½ inch NO	4½ inch NO
BATTERIES	NONE—ALL AC OPERATED	10—"AA"	4—#216 1—"D"	2—#216 1—"C"	6—"C"
TOTAL NUMBER OF RANGES	112	66	50	53	44
COST PER RANGE	\$1.70	\$2.52	\$2.56	\$1.89	\$2.03



Sencore isn't against the salesman making a buck either. Answer the "BUCK" question correctly (without referring to the tabloid) when asked by a Sencore Representative or Field Engineer and receive a buck right from his pocket. Answers are stated clearly within this publication. 1. How many ranges does the FE160 have? (See page 2) 2. What is the accuracy of the FE160 on DC volts? (See page 4) 3. What allows in-circuit resistance measurements in transistor circuits? (See page 3) 4. What is the lowest full-scale voltage range? (See page 4) 5. What is the lowest full-scale current range? (See page 5) 6. What is the highest DC voltage that can be measured with the FE160? (See page 5) 7. How is the precision resistor circuitry protected on ohms and current ranges? (See page 6) 8. What is the rated overload that the FE160 will withstand without damage? (See page 6) 9. How does the FE160 compare with other meters on a cost-per-range basis? (See page 8) 10. What is the DC input impedance of the FE160? (See page 6).

FOR VOCATIONAL INSTRUCTORS ONLY:

You can be placed on the Sencore mailing list for free issues of the Sencore news if you can prove that you are a vocational electronic instructor. You can teach your students the latest of the industry. This will keep you far out front. Simply fill in this form and send it to Sencore, 3200 Sencore Drive, Sioux Falls, South Dakota 57107.

Name _____
 Address of school _____
 Position held _____
 Feel free to check the following person at my school to verify that I am a bona fide electronic Instructor .