

SCOTT



NEWS

NEWS OF LATEST DEVELOPMENTS IN THE SCOTT RESEARCH LABORATORIES

Vol. 10

JULY, 1937

No. 4

THE NEW SCOTT SIXTEEN

The Radio Sensation of the Year

FOR several years many hundreds of people have been prevented from owning a Custom Built Scott, first, because of the cost, and second, because they have been larger than they could conveniently install in their homes.

The announcement of the 30-tube Scott Philharmonic created such widespread comment that we received far more orders than we had anticipated. As a matter of fact, our sales last month were the largest in the history of the Laboratories. But along with these orders I have received hundreds of letters and have talked with a large number of visitors to the Laboratory who have urged me to design a receiver for them, smaller in size, and lower in price, but with the famous Scott performance, quality, and tone.

The development of the new Scott Sixteen has been quietly going on behind the locked doors of our Research Laboratory for many months, and this issue of the "Scott News" gives you complete information on one of the most beautiful pieces of radio design that has ever come out of our Research Laboratory. The New Scott Sixteen.

New Sixteen a Scott Receiver in Every Way

The first thing that will impress you when you see the New Scott Sixteen is that it is a SCOTT receiver in every sense of the word; built with the fine precision workmanship for which Scott receivers are world-famous.

It is constructed with the same high quality parts and with the same careful craftsmanship that has gone into every Scott receiver for the past 14 years. In fact, it is only because of the experience we have gained here in the Laboratories during the past 14 years in designing and building nothing but fine radio receivers, that it has been possible to produce the new Custom-Built Scott Sixteen at the very reasonable price that is being asked for it.

Remarkable DX Performance

As you know, the Allwave receiver to provide not merely local, but world-wide reception, was pioneered largely by the Scott Laboratories, and for years Scott Allwave

receivers have been generally recognized as the World's Finest Long Distance Receivers. The New Scott Sixteen will not only live up to the reputation for DX reception which Scott Receivers have established, but I feel sure will actually add to it.

A few weeks ago when the final acoustical tests were being made on the very beautiful and distinctive console that has been designed for the New Scott Sixteen, we had very convincing proof of the tremendous power and extreme clarity with which this amazing new receiver brings in foreign stations.

These tests, to determine whether a console is acoustically correct and has no resonant periods, were made with the receiver connected to a Beat Frequency Oscillator and conducted in the open air on the roof of the Laboratory.

Europe Like Local with Short Piece of Wire

After the acoustical tests were completed, I noticed a piece of wire about 3 feet long lying on the roof so picked it up and connected it to the antenna binding post on the Sixteen. With this short piece of wire I tuned in broadcast stations all over the country, then switched to the short wave bands and immediately brought in England and Germany with literally as much volume and as clearly as I received our local Chicago stations.

Of course, our precise tests in the Laboratory had proved the Scott Sixteen was perfectly shielded, but to make certain there was no signal being fed into the receiver outside of that picked up on the short piece of wire, I left England tuned in, disconnected the piece of wire from the antenna binding post and put a tube shield top over the post. Instantly, all sound from the loud speaker disappeared. Connected to our regular Scott Super Antenna, I don't believe there is a short wave broadcast station, including even the very lowest in power, that cannot be tuned in on this remarkable receiver.

Marvelous Tone at Any Degree of Volume

Equally important, to me at any rate, is pure tone, and when you hear the tone of the New

Scott Sixteen your enthusiasm is going to reach new heights. It has TONE—beautiful, clear tone that is just as perfect at low volume as it is at full volume. It is a delight to tune in a good program from a local station, turn the volume down and hear the solid bass and the delicate higher tones and overtones coming thru clearly and cleanly.

Then you can turn up the volume so that the program can be heard clearly in every room in the home, and you will find every note just as perfect, clear, and undistorted as it was at the lower volume.

A Real High Fidelity Receiver

The remarkable feature about this receiver, and one which will undoubtedly intrigue radio engineers, is the fact that it is a true High Fidelity Receiver. Although the frequency response is practically flat from 30 to 7,500 cycles, it has very remarkable Selectivity. This combination has been made possible by an entirely new design in the band-pass I.F. amplifier for which patents have been applied.

The Radio Hundreds of Enthusiasts Have Been Waiting for

This is really the kind of receiver that hundreds, who cannot afford a large amount of money for a radio receiver, have dreamed some day of possessing. I have produced many fine radios during the many years I have been in the radio business, but never have I been more proud of any model than I am of this one.

I am confident every owner of the New Scott Sixteen will, within an hour after he switches the receiver on, be just as enthusiastic about it as I am.

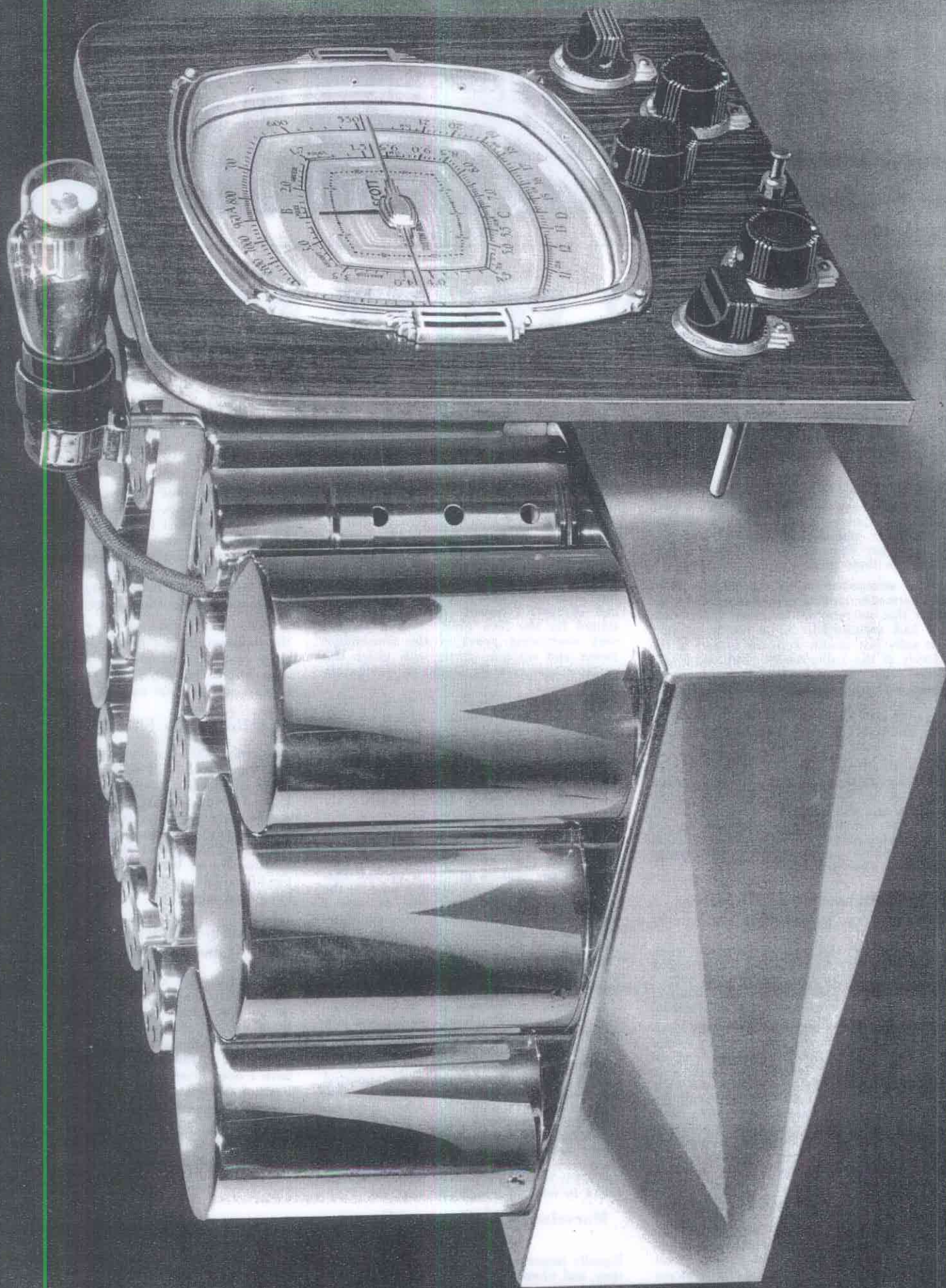



A NON-TECHNICAL DESCRIPTION OF THE NEW SCOTT SIXTEEN

For those who are not technically trained, the detailed specifications of the new SCOTT SIXTEEN may be confusing, but the summary which follows will give the non-technical radio enthusiast a clear idea of just why its performance is so much better than that of the ordinary type of radio.

Wave Length Range

The four wave bands cover every frequency from 550 Kc to 22 Megacycles, bringing in every foreign and domestic station on these bands which broadcasts radio entertainment.

High Fidelity Reproduction

This is a true High Fidelity receiver with a fidelity range approximately 50% greater than that of the average radio receiver, extending from 30 to 7,500 cycles. In musical circles Scott receivers have long been recognized as providing a perfection of tone unequalled by any other receiver. That is why Arturo Toscanini of the New York Philharmonic Symphony Society; Genaro Papi, Musical Director of the Metropolitan Opera, as well as many other outstanding figures in the musical world have been Scott owners for years.

Continuously Variable Independent Treble Control

This control, either on voice or music, enables you to bring out perfectly the higher tones or overtones. Frequently, especially when listening to a chain broadcast, the higher tones of the string and wind instruments come through so weakly that they are practically inaudible. In such cases, a turn of the Treble Control enables you to bring up or amplify the higher tones or overtones so that you hear them with all their original brilliance.

Independent Bass Control

This control is of extreme importance if you are to get the best bass reproduction, especially when the volume of the receiver is turned down to lower levels. If the bass does not come through clearly and naturally it gives all music a thin sound, lacking the richness and depth that is supplied by the lower tones. The Bass Control incorporated in the new SIXTEEN is unlike any other system used for this purpose in other

radio receivers, in that our Bass Control does *not* make either music or voice sound deep and boomy, even when turned to maximum, but merely amplifies the bass tones without in any way affecting their original natural quality.

This control is of great value when broadcast stations have a very bad transmitter hum, when an artist stands too near the microphone which tends to give his voice a boomy sound, or when some of the instruments in the orchestra, particularly those rich in the lower tones, are placed too near the microphone. In this case, a mere turn of the Bass Control enables you to exactly correct these conditions and restore perfect tone quality.

The SCOTT SIXTEEN will be a revelation to those who desire accurate reproduction of really fine detail in the bass, for its fidelity range extends down to 30 cycles. As a result, each bass note is a well rounded musical *tone* with definite pitch, and you hear the bass instruments in their proper volume relationship to the other instruments in the orchestra.

The Bass Control incorporated in the new SCOTT SIXTEEN will be a constant source of enjoyment to those who appreciate full and *natural* bass reproduction.

Tone Balanced Volume Control

The system incorporated in the new SCOTT SIXTEEN does much more than merely decrease or increase the amount of volume. You will note on the ordinary type of radio receiver that when the volume is turned down, immediately the lower tones and the higher tones are lost, leaving only the tones in the middle register. When you turn down the volume on the SCOTT SIXTEEN, to the point where it is soft enough to provide background music, both the lower tones and the higher tones come through just as perfectly as they do at normal volume. This feature will be especially appreciated by those who live in apartments, or by those who do not desire to listen at the higher volume levels. You can choose the exact degree of volume you desire, and yet retain full high fidelity reproduction at all times.

Pure Undistorted Reception

There are certain types of music, such

as symphonies, that are more thoroughly enjoyed when the volume is turned to a higher point than would be used on an ordinary program. So perfectly designed is the SCOTT SIXTEEN that there is no distortion, either on music or voice, even though the volume is turned up to the point where it fills every corner of the largest room in which the receiver may ever be used.

Extreme Selectivity

To bring in stations in every part of the world, it is absolutely necessary that a receiver be very selective. The selectivity curve on page 16 shows that the selectivity of the SCOTT SIXTEEN is obviously more than enough for the 10 Kc required to separate broadcast stations on adjacent channels, and actually *exceeds* every present day requirement on either the broadcast or short wave bands.

Perfected Automatic Gain Control System

Two separate and independent automatic Gain Control systems are incorporated in the SCOTT SIXTEEN which accurately control both the radio frequency and the intermediate frequency amplifiers, instead of the usual single system which must be a compromise and thus performs neither function correctly. Non-technically this means that the SCOTT SIXTEEN holds badly fading signals remarkably constant, or even in volume, and avoids considerable interference and noise during difficult reception conditions.

Greater Usable Sensitivity

To bring in stations clearly, especially from great distances, a receiver must have a high degree of Usable Sensitivity; that is, the sensitivity of the receiver must be smooth and free from noise generated in the receiver itself. In other words, it must be *Usable* Sensitivity. One of the most enjoyable features of the new SCOTT SIXTEEN is the very great *clearness* and *quietness* with which distant foreign stations are received. Many receivers will bring in programs from foreign stations, but the programs are often accompanied with so much noise that they are not worth listening to.

One of the reasons why Scott Receivers have been purchased, for use in so



many of the American Consulates abroad, is because they are superpowered for tuning in remote stations at tremendous distances. The SCOTT SIXTEEN is so sensitive that under reasonably good conditions you can tune in foreign stations that are quite beyond the receiving range of ordinary receivers.

When you hear foreign stations for the first time coming in on the SCOTT SIXTEEN you will find it very difficult to realize that what you are listening to is a program from a foreign station, for it will be received so clearly and quietly that these programs will be a constant source of pleasure.

More Noise-Free Reception

Few homes are free from a certain amount of interference caused by the electrical wiring system, ignition from oil burners, etc. This interference very often makes it quite impossible to bring in, on the ordinary receiver, with any degree of satisfaction, the European, Oriental, and South American short wave broadcasts.

Incorporated in the SCOTT SIXTEEN is a new and improved Scott Supershield Antenna Coupling System. It prevents any interference in the vicinity of the antenna lead-in being fed into the receiver, making possible the quiet reception of stations whose programs will often be obliterated by local interference picked up by the lead-in on the ordinary type of receiver. If, however, the interference is so strong that it even reaches as far as the flat top of the antenna, it can be reduced very often to the vanishing point by means of the Treble Control, which enables you to tone down the bursts of interference or

static so that they are hardly noticeable.

Silent Tuning Between Stations

A Silent Tuning button is located on the instrument panel. When reception conditions are such that you hear loud crackling noises when tuning between stations, you simply pull out this button. Instantly, this noise between stations is virtually eliminated, enabling you to tune from one end of the dial to the other silently, and to bring in the stations quietly.

High Fidelity Phonograph Reproduction

One of the reasons why hundreds of the world's First Families, such as the Rothschilds of France, the von Bismarcks of Germany, and the Vanderbilts, Mellons, and Armours of the United States, have bought Scott receivers, is because they provide what has been called the World's Finest Interpretation of Recorded Music. All tone adjustments, and the full fidelity range of the SCOTT SIXTEEN is available to you in playing phonograph records. This simply means that when you hear the latest high fidelity records reproduced through this instrument, they are in every way equal to the finest high fidelity broadcasts.

Improved Reproduction of Voice

Hearing the spoken voice through the SCOTT SIXTEEN will be a revelation to you. Instead of a metallic voice coming from deep down in a cabinet, the speaker or soloist seems to have moved directly before you, for the voice does not seem to be coming from the loud speaker at all. You will find you can relax in your favorite easy chair and

listen to news reports, market quotations, sport events, lectures, dramatics, vocal selections, and other voice broadcasts with as much pleasure as if the speaker were giving you a private performance right in your home. This extreme naturalness will be easily understood by the technical radio enthusiast after he has studied the very remarkable fidelity chart which will be found on page sixteen.

Improved Cathode Ray Tuning Indicator

The Cathode Ray Tuning Indicator (located directly above the dial) enables you to tune in every station perfectly from the very weakest to the strongest, and has been developed to such a high degree that the annoying flutter, so often noticeable in other tuning indicators, is practically eliminated.

Precise Calibration

Today a number of log books are published showing the wave lengths of both broadcast and short wave stations in various parts of the world. The calibration of the new SCOTT SIXTEEN is so precise that once you know the wave length of a station, this frequency can be located instantly on the dial without going through the tedious process of "fishing" for it.

In calibrating the new SCOTT SIXTEEN very precise equipment is used, and this careful calibrating of each receiver gives you a radio receiving instrument that is as precise and dependable as the finest watch.

Those who demand precision down to the finest detail have bought SCOTT receivers year after year. That is why we number among Scott owners Chair-

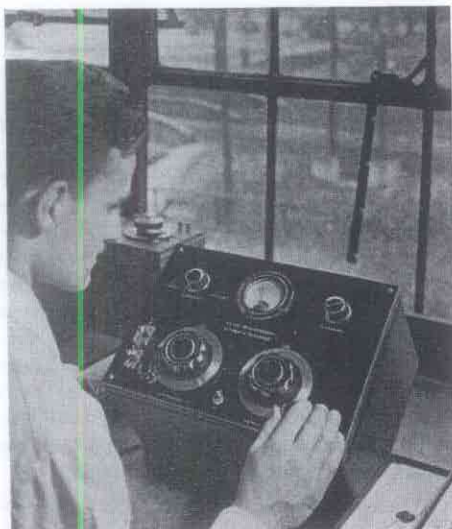

SPECIAL INSTRUMENT USED TO TEST CONDENSERS

While all high frequency circuits in the SCOTT SIXTEEN are tuned with special low loss air condensers, numerous high value mica by-pass condensers are used instead of the usual paper type to obtain highest efficiency, especially on the short waves. However, all mica condensers used in Scott Receivers are tested first for leakage at 1000 volts and then for power factor at radio frequency, on the special instrument shown at left, which was designed and built especially for this purpose in the Scott Laboratories and detects minute defects in condensers which might cause trouble months later in the receiver.

When the picture was taken, a 6000 micro-microfarad condenser was being tested for capacity and power factor. Special high voltage oil impregnated tubular by-pass condensers are used in Scott Receivers where mica has no advantage. These units are all tested for capacity and for leakage at 3000 volts. That this tremendous safety factor (the highest working potential to which they are subjected in the receiver is only 250 volts) is valuable to our owners is attested by the fact that *not one of these oil impregnated by-pass condensers has ever failed in a Scott Receiver.*



men of Boards, Presidents, or Directors of the world's leading business organizations such as Eastman Kodak, Douglas Aircraft, General Motors, Packard Motor Company, Westinghouse Electric, U. S. Steel, Elgin Watch, Lincoln Motor Company, N. Y. Central Railroad, I. T. and T., Western Union, and hundreds of other builders or users of fine equipment.

New Advanced European Type Dial

On the new SCOTT SIXTEEN you will find one of the richest looking dials in any radio receiver being built today. The graduations are extremely detailed for accurate logging of stations. In addition to the calibration of each of the four wave bands, there is also an auxiliary logging indicator which greatly spreads out the scale of the main tuning dial. Many broadcast stations, especially those on the short waves are located within only a fraction of a division on the ordinary dial, but tuning on the SCOTT SIXTEEN under such conditions is simple, easy and accurate, because the detailed reading of the auxiliary indicator enables you to instantly tune in any station you have logged.

Custom Built Throughout

The SCOTT SIXTEEN is built with a watchmaking precision which could never be held if it were built on the usual type of production-line assembly. These standards are so high that Scott receivers are used by laboratories for various kinds of experimental and research work where high sensitivity, keen selectivity, and a low noise level are imperative. The U. S. National Bureau of Standards at Washington, D. C. has used a Scott receiver for years.

It has never been the boast of the Scott Laboratories that they can build a thousand receivers a day, for a really high quality precision instrument can only be produced in limited numbers. In the SCOTT SIXTEEN the layman listener has an instrument that will enable him to obtain results even superior to those secured by radio enthusiasts using professional laboratory equipment.

All Parts of Finest Quality Found Only in Laboratory Instruments

Only the very highest quality of parts and material are used throughout in the SCOTT SIXTEEN, and we believe that the instrument represents *more actual radio per dollar* than any other receiver you can buy today. When you buy a SCOTT SIXTEEN there is only one profit between you and the builder of

the instrument itself, for it is sold direct to you from the Laboratory where it is designed and built. There are no distributors' or dealers' profits to be added, for it is not sold through dealer stores.

Economical Operating Costs

So efficient is the design of the SCOTT SIXTEEN that only 135 watts of electricity are required to operate it. This means that the receiver costs considerably less to operate than most of the common electrical appliances used in the home and that it may be operated for more than seven hours on only one kilowatt hour of electric power.

Trouble-Free Operation

The large safety factor, the high quality rugged parts used throughout, and the precision building has resulted in a receiver which is practically trouble-proof. However, in case service is required by those who are not located in the vicinity of Chicago, New York, or Los Angeles, they have at their immediate command at reasonable cost, the services of nearly 700 Scott Installation and Service Representatives, located in every state from Coast to Coast. But this new instrument is so carefully tested, checked, and calibrated before it leaves the Laboratory, that service is rarely required.

Directors of large-scale news gathering organizations such as Time, Literary Digest, News Week, Universal News Reel Service, and some of the world's largest daily newspapers both in U. S. A. and abroad, buy Scott receivers for their dependability in operation.

Protected Against Extreme Climatic Conditions

All coils, chokes, transformers, etc. are specially impregnated, and metal parts of the chassis and amplifier are chromium plated to prevent breakdown of these parts in humid climates, or in locations near the sea coast where salt air and dampness break down the ordinary type of transformers, or rust and corrode metal parts which are not protected. This assures practically indefinite life of these parts in locations where the ordinary receiver often breaks down after only a few weeks of service.

Guaranteed Five Years—Twenty Times as Long as the Average Radio

Compare the usual 90 day guarantee given with other radios, with the Scott Five Year Guarantee against any defects or part failure (except tubes, which are guaranteed by the tube manufacturer) and you will get some idea of the qual-

ity of parts built into the SCOTT SIXTEEN.

Expensive Extras Included Free

The SCOTT SIXTEEN incorporates as *standard equipment* many features which ordinarily are sold on many other radio receivers as "extras." For example: (1) A phonograph input system which usually costs as high as \$20.00, is included in the SCOTT SIXTEEN. (2) A special headphone jack is installed in the amplifier chassis which enables you to listen through ear phones, automatically cutting out the speaker. A special jack of this kind ordinarily costs about \$6.00 to install in any other radio receiver, but is included as standard equipment in the SCOTT SIXTEEN. (3) Where it is desired to use additional loud speakers in another part of the home, there is no charge for altering the wiring, for the SCOTT SIXTEEN is so designed that these extra speakers can be attached within three minutes to terminals provided. Ordinarily these alterations cost from \$10.00 to \$15.00 extra on the ordinary receiver.

Compact Size

Although the SCOTT SIXTEEN is powered with 16 tubes, it is so compact that it can be conveniently moved about from one place to another. It is the ideal instrument for those who desire to use several radios in different rooms of the home.

30-Day Trial Period

The usual 10-day trial period is not long enough to thoroughly test a radio receiver in your home. So certain are we that the SCOTT SIXTEEN will completely satisfy you in every way, that it is sold to you with the distinct understanding that you are to be allowed a full 30 days (in U.S.A. only) after delivery to test it out in your home. If it does not *outperform* any other make of receiver, regardless of price—regardless of circuit used—regardless of the number of tubes used—or if you are not absolutely satisfied with it for any reason whatsoever, *and you are to be the sole judge*, you are at liberty to return it any time within the 30 day period and we will promptly refund the purchase price you paid for it.

Liberal Time Payments

The SCOTT SIXTEEN can be purchased on extremely liberal time payment terms if desired. These easy payments are strictly private, and you deal directly with the Scott Laboratories. Full details of our liberal time payment plan appear in the order blank which accompanies this issue of the "Scott News."

BRIEF SPECIFICATIONS OF THE NEW SCOTT SIXTEEN

- (1) High Fidelity Superheterodyne, Featuring Unusual Sensitivity, Remarkable Selectivity, and Fine Tone Quality.
- (2) Sixteen Latest Type Octal Base Tubes—Two of Them Double Purpose, and One of Them Triple Purpose, Giving Performance Equal to Twenty Tubes.
- (3) High Powered Undistorted Output.
- (4) Continuously Variable High Fidelity Control.
- (5) Continuously Variable Bass Control.
- (6) Four Bands Covering All Radio Entertainment on Frequencies Between 550 Kc. and 22 Mc.
- (7) High Gain R.F. Amplifier Stage on All Bands.
- (8) Highly Stabilized Electron Coupled Oscillator, Equalized for Maximum Efficiency on All Frequencies.
- (9) Newly Developed Band Pass I.F. Amplifier. (Scott Patents Applied For.)
- (10) Separate R.F. and I.F. Automatic Gain Control Systems.
- (11) Specially Developed Second Detector.
- (12) New Inverse Feed Back System Using Latest Type Beam Power Tubes.
- (13) Self-Balancing Phase Inverter.
- (14) New Type High Fidelity Loud Speaker Using Curvilinear Cone and Exponential High Frequency Sound Diffuser.
- (15) Quiet Tuning on All Stations Above the Noise Level Even in Noisy Locations.
- (16) Silent Tuning Between Stations.
- (17) Highly Efficient Cathode Ray Tuning Indicator Which Gives Good Indication on Both Weak and Strong Stations.
- (18) Terminals Provided to Connect Phonograph Jack for High Fidelity Phonograph Reproduction.
- (19) Phone Jack Provided to Plug in Headphones When Headphone Operation Is Desired.
- (20) Terminals Provided for Extension Speakers When Desired.
- (21) New European Type Dial with Auxiliary Logging Dial.
- (22) Eight Kilocycle Selectivity—More Than Ample for Present Day Broadcasting.
- (23) Exclusive Improved Scott Super-shield Antenna Coupling System.
- (24) New Heater Type Rectifier Tubes and Massive Hum-Free Filter System with Over 90 Mfd. of Filter Condensers.

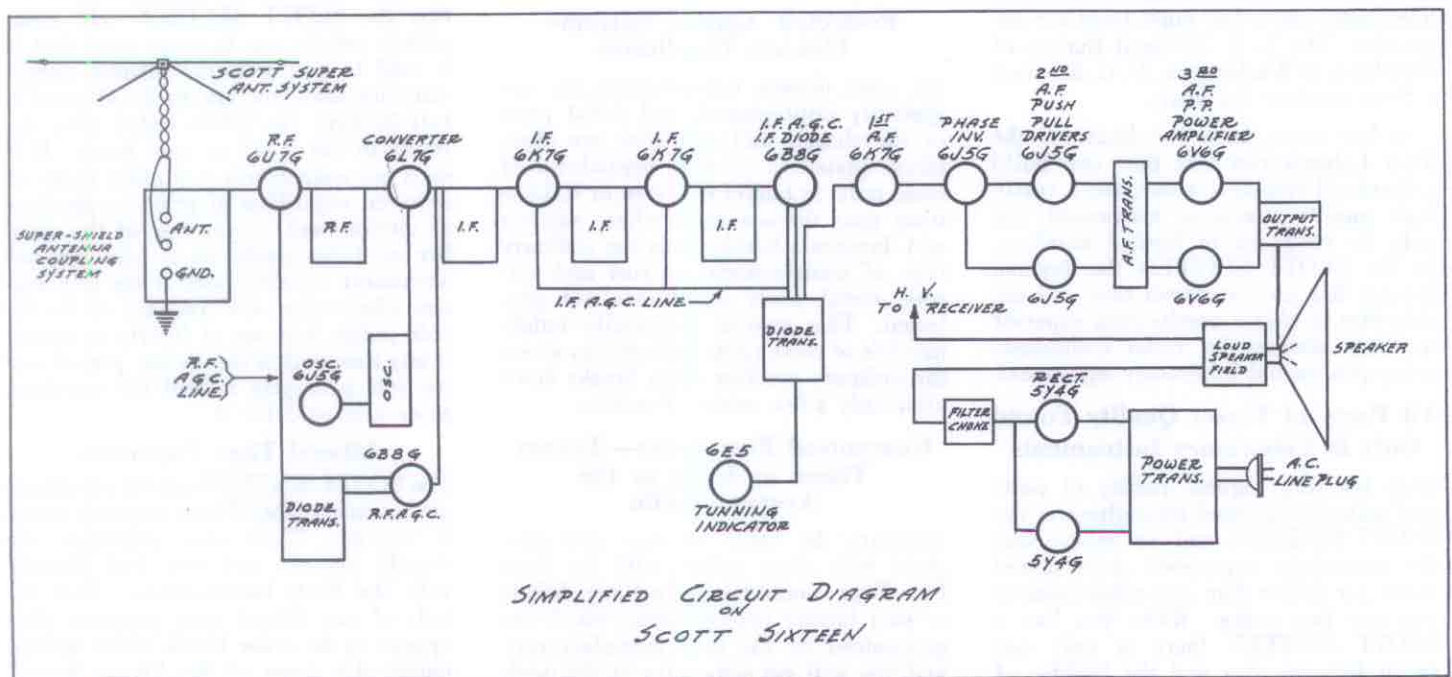



COMPLETE TECHNICAL DETAILS

Description of Tubes Used and Their Functions in Circuit

A 6U7G Amplifier tube is used in the High Gain R.F. Amplifier Stage, with two tuned R.F. circuits.

A separate 6J5G Oscillator tube is used, electron coupled to the special purpose 6L7G Converter tube.

Two 6K7G and one 6B8G tubes are used in the newly developed three Stage Band-Passed I.F. Amplifier (Scott Patents Applied For).

A 6B8G tube is used in the permanently air-tuned separate R.F. A.G.C. System.

A 6K7G tube is used in the First Audio Stage in a special circuit allowing a wide range of tone adjustment.

A 6J5G tube is used as a distortionless exact-balancing Phase Inverter.

Two 6J5G tubes operating as distortionless push pull audio drivers are fed into the Power Output stage using two of the newly developed 6V6G beam power tubes operating in a special Inverse Feed-back system which neutralizes distortion, equalizes loud speaker frequency response, and eliminates "hang-over" in bass note reproduction.

Two super-power 5V4G Rectifier tubes operating well below their maximum handling capacity, supply a perfectly regulated flow of power to the receiver.

A 6E5 Amplified Cathode Ray Tuning Indicator is used in a special circuit which assures accurate tuning of all signals from the weakest to the strongest.

Wave Lengths Covered

The SCOTT SIXTEEN covers all frequencies from 550 Kc. to 22 Mc. by means of four wave bands. The Wave Band Switch selects each of the four bands, and in addition switches to phonograph operation. The Wave lengths covered are as follows:

Band No. 1	550 Kc. to 1500 Kc.
Band No. 2	1500 Kc. to 4000 Kc.
Band No. 3	4 Mc. to 9.6 Mc.
Band No. 4	9 Mc. to 22 Mc.

The Antenna Circuit

The New SCOTT SIXTEEN has incorporated in it the exclusive Noise Reducing Supershield Antenna Coupling Sys-

tem developed in our Research Laboratories (Scott Patents Applied For) to eliminate noise and electrical interference picked up on the antenna lead-in. At the same time, *this system effectively increases the Sensitivity or distance getting ability of the receiver approximately 100%* by providing a maximum transference of energy from the flat top of the antenna to the amplifying circuits of the receiver.

New Antenna Input System

A new Antenna Input system is used on the broadcast and police bands to eliminate sub-frequency resonance which frequently causes code interference from stations below the frequency of the band at which the receiver is tuned. *This will be of particular interest to owners located near the sea coast where most receivers experience interference from ship-to-shore code transmitters.*

A Suppressor is used in the grid circuit of the R.F. tube on all wave bands to eliminate tube hiss due to parasitic oscillation, and is one of the reasons for the extremely quiet operation of the SCOTT SIXTEEN on all wave bands. *It is possible to entirely disconnect the antenna and ground from the receiver, turn the Volume Control on full with the control button out for quiet tuning and not hear the tube hiss or the noise usually so noticeable on less efficiently designed radio receivers.*

Any Type Antenna May Be Used

A very valuable feature for those who do not have space to put up a large antenna is the fact that the SCOTT SIXTEEN is so designed that any type of antenna may be used. Three binding posts are provided at the back of the chassis to which can be connected either the recommended Scott Super double-doublet Allwave Antenna which assures maximum reception results, or by rearranging the jumper connection at the Ant. Binding Posts, the receiver can be connected to any regular type straight-wire antenna.

To give you some idea of how really non-critical this receiver is to antennas, England and Germany have been received during the past few weeks with

good volume with only a few feet of wire on the floor.

New Type Radio Frequency Amplifier System

The 6U7G Amplifier tube, having an unusually high mutual conductance, is used in the R.F. Amplifier. Because of its low input and output capacity, (being approximately one-half that the 6K7G tube ordinarily used for R.F. amplification) we are able to use larger tuning inductances, which results in additional Sensitivity.

The mass production type receivers generally use R.F. tuned circuits with separate primary and secondary coils between the R.F. Amplifier tube and the Converter, thus extremely weak short wave signals must go thru the air from the primary to the secondary in order to reach the R.F. Amplifier tube, causing a loss of signal strength on weak signals. In the SCOTT SIXTEEN highly efficient tuned circuits operate directly in the plate circuit of the R. F. Amplifier tube and connect directly into the grid of the following tube. This completely overcomes the usual loss in signal strength and considerably increases the amount of amplification in the Radio Frequency tube.

This additional amplification is especially valuable in foreign short wave reception, and as a result of its greatly increased Sensitivity the SCOTT SIXTEEN is able to bring in stations which are ordinarily quite beyond the receiving range of most receivers.

Highly Stabilized Oscillator

The SCOTT SIXTEEN uses an extremely efficient electron coupled oscillator system which employs the new low capacity, high mutual conductance 6J5G oscillator tube.

Instead of tuning only the grid circuit in the Oscillator system, as is usually done, leaving the plate circuit entirely untuned, (thereby causing harmonics, whistles and tweets in the receiver due to random oscillations in an untuned coil) the entire Oscillator coil of the SCOTT SIXTEEN is tuned to the frequency desired by the tuning condenser.



The voltage for injection of the oscillator potential into the Converter system is taken from a tap which is close to the ground end of the oscillator inductance, instead of being taken directly from the grid of the oscillator tube where even the slightest change in the characteristic of the converter tube and circuit reflects into the oscillator circuit, causing frequency drift, resulting in distorted short wave reception.

Oscillator potentials are completely by-passed and filtered at the oscillator tube to prevent their indiscriminate surging thru the receiver, causing erratic operation. The tube noise inherent in frequency conversion is kept to an absolute minimum in the Converter tube in the SCOTT SIXTEEN by the optimum fixed bias on its grid, instead of the tube being subjected to widely fluctuating grid potentials due to changes in A.G.C. voltages.

The design of the oscillator system in the SCOTT SIXTEEN is such that the utmost stability is maintained at all times, resulting in smoother operation of the receiver on all wave bands under all conditions. Advanced engineering design such as incorporated in our oscillator circuit is just another one of the great differences between the ordinary radio receiver and a finely designed custom built receiver like the SCOTT SIXTEEN.

Separate R.F. A.G.C. System

Coupled directly to the plate of the 6L7G converter tube is a separate R.F. A.G.C. tube and circuit which supply A.G.C. voltages to the first R.F. tube.

The R.F. Automatic Gain Control system is designed to operate in the presence of strong signals, either above or below the frequency at which the receiver is tuned. The importance of this feature cannot be overemphasized, for by its use it is possible to operate the R.F. amplifier tube at maximum possible gain under all conditions. This increases the signal strength applied to the Converter System, greatly reducing the usual tube hiss on weak signals. Furthermore, this separate R.F. A.G.C. protects the first tube from overloading and distorting the program when the receiver is tuned to a weak distant station which is near in frequency to a powerful local.

The R.F. A.G.C. system incorporated

in the SCOTT SIXTEEN is designed to maintain optimum bias and maximum R.F. gain on all input signals up to 1,000 microvolts. Above 1,000 microvolts input the R.F. A.G.C. system comes into operation, preventing overloading and distortion.

Two Separate A.G.C. Systems Used

In the SCOTT SIXTEEN we actually have two A.G.C. systems, one in the R.F. the other in the I.F. amplifier. Most receivers have only a single Automatic Gain Control system operating from the I.F. system, and an explanation of why we have incorporated this dual A.G.C. system in the SCOTT SIXTEEN may be interesting.

Advantages of Dual A.G.C. System

When a receiver using only a single Automatic Gain Control System is tuned to a weak distant station which is close in frequency to a powerful local, there is practically no Automatic Gain Control action on the weak signal, as the grid of the first R.F. tube is supplied with Automatic Gain control voltage only from the I.F. Automatic Gain Control System, and therefore receives practically no bias voltage. On such receivers a powerful local station—even if it is 20 or more Kc. removed from the desired weak station—will practically obliterate the weak station you want to receive, and in addition will distort the signal because the considerable signal voltage from the strong station may exceed the small R.F. grid bias.

In the SCOTT SIXTEEN, using a separate A.G.C. System for the R.F. Amplifier, a considerable R.F. A.G.C. voltage, proportional to the strength of the undesired local station, will be developed in the separate R.F. A.G.C. system, and applied to the R.F. Amplifier tube, thus preventing the powerful local station's signal from exceeding the R.F. tube bias. *This permits clean reception of the desired signal without being marred by the strong local signal.*

This feature, which has recently appeared in other receivers, was developed in the Scott Research Laboratory and we believe that, operating in conjunction with the highly developed I.F. A.G.C. system where many important refinements have been made, the SCOTT SIXTEEN will provide steadier, quieter and

cleaner reception even under the most difficult reception conditions than any other make radio available today.

The Intermediate Frequency Amplifier

A newly developed Band-Passed I.F. Amplifier (Scott Patents Applied For) provides High Fidelity reception with a high degree of Selectivity. The SCOTT SIXTEEN uses three I.F. Amplifier stages employing two 6K7G tubes and one 6B8G tube. Each I.F. transformer consists of two large low loss litz wire four pi coils, each permanently tuned by a combination fixed and adjustable capacity air condenser.

I.F. Transformers All Tuned By Air Condensers

In most radio receivers the I.F. transformers are tuned by very cheaply constructed mica or bakelite condensers which easily get out of adjustment when subjected to heat or humidity. Air tuned I.F. transformers maintain their adjustment indefinitely after they have once been tuned, and this, with the newly developed, highly idealized Band-Passed I.F. system (Scott Patents Applied For) is another reason why we are able to provide excellent Selectivity, and 7,500 cycles High Fidelity reproduction with the SCOTT SIXTEEN.

By referring to the I.F. Amplifier Curve it will be seen that the top of the curve is practically flat, thus providing High Fidelity reception, while the sides of the curve drop off very sharply, thus cutting off interference from stations even quite close to the desired signal.

In addition to the low loss air condensers which are used for tuning the I.F. System to resonance, it is permanently band-passed by the use of a circuit incorporating a newly developed precision type condenser consisting of all metal and mica, with absolutely no insulating material which is susceptible to change in the presence of heat and humidity. On account of the elimination of all dielectric loss, except the very small amount in the low loss mica, this new type condenser has an amazingly low power factor which results in increased circuit efficiency.

I.F. Band Pass System Permanently Adjusted with Extreme Precision

The I.F. Band Pass system is perma-



nently adjusted with extreme precision to exactly the correct band width for high fidelity reception. In addition, the steep sides of the I.F. Selectivity curve show that good Selectivity is maintained for adjacent station reactivity. This highly idealized—practically perfect—band pass effect is obtained without the use of resistors which impair the Selectivity, and its efficiency, we believe, is not even approached today by the I.F. Amplifier system incorporated in any other make of receiver.

Specially Developed Second Detector—Combining Third I.F.—I.F. A.G.C.—Audio Diode

A distortionless double-diode Second Detector using a 6B8G tube is used. This tube is designed to handle high percentage modulation with considerably less distortion than even the better broadcast stations provide at high modulation. This diode is operated from a specially designed iron core, tuned, highly efficient diode transformer, driven from the pentode section of the 6B8G.

The amplifier circuit has been specially designed to provide peak power handling efficiency without distortion.

The 6B8G tube really performs three functions in that it, (1) Acts as an I.F. Amplifier tube. (2) Provides the I.F. A.G.C. voltages (the second A.G.C. System). (3) Acts as the audio diode and supplies audio frequencies to the A.F. amplifier. It is a new tube and has been especially selected for use in the SCOTT SIXTEEN because of its excellent characteristics, and its reliable performance in a receiver of advanced design.

Improved First Audio Stage

Following the second detector 6B8G tube is the First Audio Stage which utilizes the highly efficient 6K7G tube, which, not being a "quick cut-off" tube is capable of handling a wide range of signal strength over the linear portion of its characteristic curve. This avoids the usual distortion experienced with high gain first audio tubes due to curvature of the tube characteristic.

Second Audio Push Pull Stage—Bass Control—Audio Output Stage

Following the First Audio Stage is the exact-balancing Phase Inverter, the purpose of which is to convert the signal to Push Pull to give distortionless amplification. One important advantage of the phase Inverter circuit used in the SCOTT SIXTEEN is that it is not susceptible to unbalance due to changes in tube characteristics.

Phase Inverter systems used in most other receivers employ a regular amplifier stage the output of which is applied to the grid of a second audio tube where the signal phase is reversed supplying the other side of the push pull system.

How Ordinary Phase Inverter System Causes Distortion

In such a system, if the auxiliary tube is either weaker or stronger than the amplifier tube with which it operates, the signal in one side of the push pull

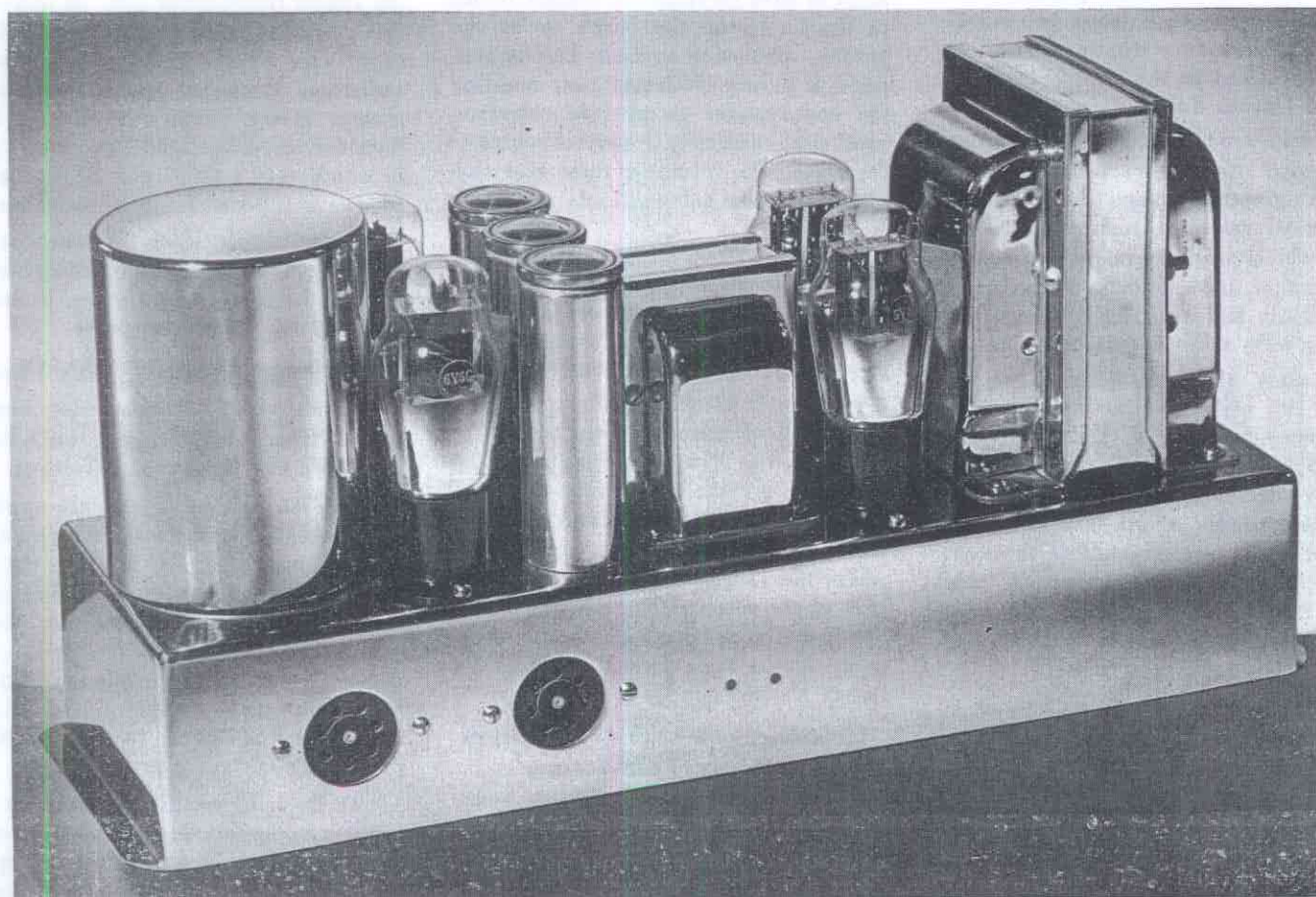

The New Scott Sixteen Power Amplifier



system will be weaker or stronger than that on the other side, and this lack of balance results in annoying distortion. Unbalance is also apt to occur in ordinary phase inverter circuits due to the use of a number of resistors which may not be sufficiently accurate to maintain exactly balanced push pull.

How Phase Inverter System Used in Scott Sixteen Eliminates Distortion

This common defect is overcome in the SCOTT SIXTEEN by the use of only one tube for this purpose in a circuit which is practically independent of the resistor values used. This improved phase inverter system engineered into the SCOTT SIXTEEN is inherently self-balancing and trouble-free since it is obviously impossible for a single tube to get out of balance with itself.

New Inverse Feed Back System

Following the Phase Inverter are the two 6J5G high mutual conductance, low plate resistance, driver tubes which operate into the balanced primary of a special driver circuit using two exactly identical secondary windings which apply the signal to the new 6V6G Beam Power Output Tubes.

This Power Output stage incorporates a special Inverse Feed Back system which greatly flattens loud speaker acoustical response, reduces peaks and dips which result in raspy, strident reproduction, and automatically maintains practically flat acoustical response over a very wide audio frequency range.

A study of the Fidelity curve (see page 16) will show the very excellent frequency response of the SCOTT SIXTEEN from 30 to 7,500 cycles, and the highly developed Inverse Feed Back system used results in very firm round bass reproduction, entirely unlike the usual loose fluttering bass reproduction. This power output stage provides 13½ watts of distortionless output and approximately 16 watts peak power.

New Type High Fidelity Loud Speaker Used

The SCOTT SIXTEEN is equipped with a new type High Fidelity loud speaker which was specially developed for this receiver. Its curvilinear cone uses a specially developed long fibre acoustical material. A small exponential high fre-

quency cone acts as a resonator and diffruser, improving the high fidelity reproduction to a considerable degree, and makes high note reproduction pleasing to listen to irrespective of where the listeners may be seated in the room.

This auxiliary cone is located exactly on the axis inside the main curvilinear cone. *Note particularly that this speaker in no way resembles the older type dual cone speaker which contained a very small cone as an integral part of the outer cone.* This special High Fidelity speaker consists of two separate cones, and as a result the distribution of the higher frequencies is considerably better than that of the usual type of dual cone speaker.

Extension Speakers Easily Connected

A very efficient totally encased output transformer is incorporated in the loud speaker housing where terminals are provided for the operation of extension speakers without the necessity of additional equipment. Very often it is desired to have reception in several rooms in the home, on the porch, or in the garden. Extension speakers can be supplied at a very moderate cost, enabling the one receiver to provide entertainment simultaneously in several rooms of the home. The volume of these extension speakers can be independently regulated.

Heavy Duty Power Supply

In order to secure maximum efficiency and performance, the Power Amplifier and power supply unit is separate from the chassis. There are a number of very good reasons for this.

If the bass response of the receiver is good down to 30 cycles, hum picked up from the power transformer is practically unavoidable if this unit is an integral part of the chassis. In receivers where the Power Supply is an integral part of the chassis the response on the low frequencies must be limited in order to avoid the hum picked up from the Power transformer.

Advantages of Thermal Isolation of Power Transformer and Rectifiers

Heat arising from the power transformer and the Rectifiers may seriously affect the many delicate adjustments of a radio. Thermal isolation of the power

transformer and rectifiers is just one more factor which contributes to the accuracy and permanency of the circuits and dial calibration of the SCOTT SIXTEEN.

By mounting the heavy power units, such as the power transformer, chokes and audio transformers, etc. on a separate chassis, strains encountered in shipping are not imposed on the tuner chassis, thereby assuring arrival of the receiver with all of its delicate adjustments in perfect condition.

Power Transformer Designed for Long Life in Humid Climates

The Power Transformer is wound with extra heavy wire thruout, and has special high voltage insulation tested at 3000 volts for permanent operation even in the hottest and most humid climates.

In the Power Transformer is incorporated the SCOTT Chimney Draft cooling principle in which a rise of temperature in the transformer results in a current of cool air being drawn in thru vents provided for this purpose, thus assuring longer transformer life. In addition this power transformer is of the vertical core type, which provides better heat radiation, therefore cooler operation, greater safety factor, and longer life than the usual horizontal mounted type in which only a small part of the transformer is exposed for heat radiation.

An electrostatic shield is incorporated between the primary and all other windings on the power transformer, in order to avoid AC line interference.

New Type Rectifier Tubes Used

Two of the new 5V4G heavy duty heater type rectifier tubes are used, which have a number of advantages, as follows:

(1) The plate voltage is not applied to the receiver and the electrolytic condensers until after the tubes in the receiver have been heated up. This avoids the surge of high voltage which would otherwise subject the electrolytic condensers, resistors, and insulators thruout the receiver to a considerable overload before the tubes in the receiver begin to draw their normal current.

(2) By using rectifier tubes which are rated considerably in excess of the voltage and current at which they are operated in the receiver, trouble-free operation and long life is assured.



(3) These new tubes are so designed that they will develop only about 25% as much heat as other type rectifier tubes. Since the customer has to pay for this heat in the form of electric light bills, the fact that these tubes waste only one-quarter of the electricity and heat that is wasted in other type rectifier tubes will be appreciated by those who desire economical operation.

Super Quality Electrolytic Condensers Used

A weak point in any radio receiver is the type of electrolytic condensers used. The use of the ordinary type of electrolytic condenser is probably the most frequent cause of receiver breakdown. The electrolytic condensers used in the SCOTT SIXTEEN are chromium plated, both inside and out, to assure complete freedom from corrosion. The three specially constructed wet type, high capacity, self-healing, electrolytics used, will provide a perfectly smooth supply of power to the receiver, practically indefinitely.

Complete Filtration of Power Supply Assures Quiet Operation

A heavy duty filter choke operating in conjunction with the three electrolytic condensers and loud speaker field, completely filters out the last trace of ripple in the power supply to the receiver and thus assures quiet operation of the receiver at all times. In addition to this filtration, the bias voltages supplied to the receiver from the power supply are further filtered with a 50 microfarad electrolytic condenser.

Laboratory Type Air Condensers

The variable tuning condenser is one of the most important units in any radio receiver. The SCOTT SIXTEEN uses an extremely rugged, three gang, low loss variable air condenser, having widely spaced plates. Every variable condenser, before being built into the SCOTT SIXTEEN, is carefully tested for torque to assure precision fit of the

condenser bearings, and must pass a very high standard in this respect before it is allowed to go into the finished receiver, thus reducing the possibility of condenser disalignment which causes change of calibration and microphonism.

High Circuit Efficiency in Tuning Circuits

We believe the variable condenser used in the SCOTT SIXTEEN has a lower total capacity than that used in any other allwave receiver on the market today. The importance of this fact can be better appreciated when it is pointed out that the efficiency of a tuned circuit (and therefore the overall Sensitivity of the receiver) depends to a great extent on the size of the inductances used to cover all wave bands. By using an unusually low capacity tuning condenser, we are able to use extremely high inductances thus improving tuned circuit gains and in turn, receiver sensitivity to a remarkable degree.

Instead of trying to cover a wide range of frequencies in each band, thus crowding dial calibration which is extremely confusing and requires a high capacity tuning condenser with resultant low circuit efficiency, the new SCOTT

SIXTEEN uses an extremely low capacity tuning condenser, (15 plates with max. capacity of approximately 230 mmfd) in conjunction with a large inductance tuning coil, which *increases the receiver's Sensitivity and at the same time spreads out the dial calibration so that the receiver is extremely easy to tune and log.*

The 15 plates in each condenser section results in a maximum capacity of approximately 230 mmfd. Less efficient receivers usually have condensers with 27 plates or more, with a maximum capacity of approximately 416 mmfd. Where such a large number of plates are used in the tuning condenser, they must necessarily be thin and closely spaced. Such plates bend easily in shipping, causing the receiver to go off calibration and easily short-circuit, rendering the receiver inoperative.

The wide spacing of plates used on the variable condenser on the SCOTT SIXTEEN assures permanency of calibration and practically eliminates the possibility of microphonism.

New Variable Bass Control System

The extremely effective Bass Control system incorporating a specially designed high "Q" bass resonator circuit provides a boost of approximately five times (15db) in the maximum position, without appreciably increasing the lower voice frequencies, thereby avoiding the unnatural, boomy quality of the voice which is obtained from ordinary bass boosting systems.

The bass response is continuously variable over a wide range and provides, in the minimum position, an extremely effective cut-off of the lower frequencies allowing the bass to be reduced enabling station hum to be eliminated, or the lower tones to be reduced when they are too strong in comparison to the other frequencies, and in the maximum position to increase and amplify the bass when a program is coming thru on which the lower tones are not sufficiently strong.

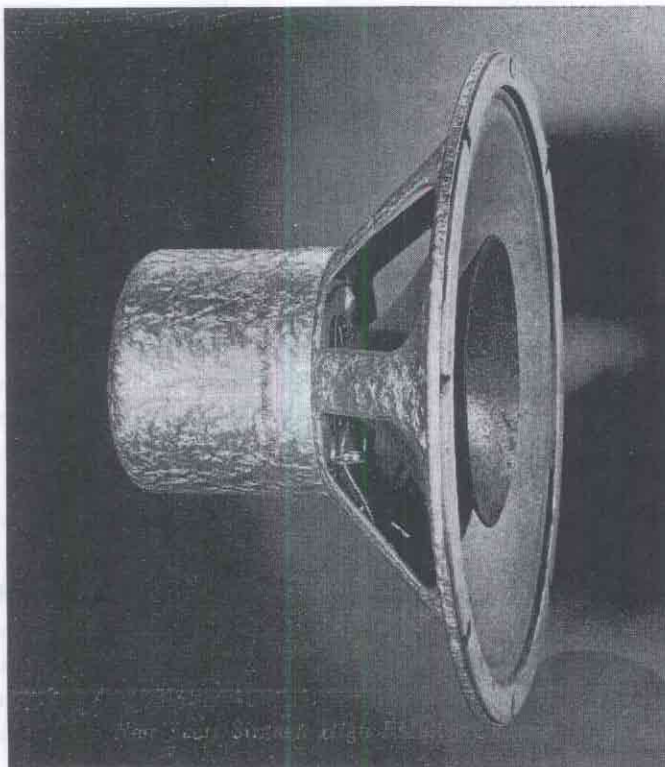

New Scott Sixteen High Fidelity Speaker



The Variable Treble Control

The High Fidelity Treble Control is also continuously variable and provides a wide range of high frequency response. In its maximum position it completely compensates for the slight amount of side band cutting in the R.F. and I.F. systems in the extremely high audio frequency range, thereby providing full high fidelity reception. As a matter of fact, the overall fidelity of the SCOTT SIXTEEN, as will be noted on studying the Fidelity Curve, is actually better than the overall fidelity of the better high quality broadcast stations on the broadcast band.

During periods of the year when static or atmospheric and man-made electrical interference are bad, the minimum position of this control is very effective in reducing the annoyance of this type of interference.

The Tone Balanced Volume Control

The very effective tone balanced Volume Control and circuit incorporated in the SCOTT SIXTEEN assures perfect bass response even at very low level reproduction. All musicians who have critically listened to the tone on most radio receivers, will undoubtedly have noted that when the volume is turned down, the lower bass notes are practically inaudible. In the SCOTT SIXTEEN you will find one of the most perfect Tone Balanced Volume Controls ever incorporated in a radio receiver. Turn down the volume to the point where the music can just barely be heard in the room and you find even at this low volume, the lower tones come thru perfectly balanced with the middle and the higher tones and overtones. *This feature of our new receiver will be particularly appreciated by those who habitually listen to programs at lower than the normal volume. The SCOTT SIXTEEN will also be appreciated by those who live in small apartments where the volume of the receiver must be kept down to avoid annoying neighbors. In these locations, owners will especially appreciate the very beautiful quality of both bass and higher tones at the lower volume levels.*

Silent Tuning Between Stations

Directly below the main tuning knob you will notice a small push-pull switch. This is the Quiet Tuning Button, by the use of which it is possible to receive all

of the stations which are coming in free from serious interference, without receiving the usual static and man-made electrical interference, whistles, etc. while you tune from station to station.

The extremely effective operation of this system is obtained by limiting the maximum Sensitivity of the I.F. System in the Quiet Tuning position, *without in any way affecting the action of the A.G.C. system* on stations, which are louder than the noise level.

Silent Tuning System Does Not Affect A.G.C. Action

It is to be particularly noted that this system does not in any way affect the R.F. Amplifier, or the efficient operation of the Converter system. This can easily be tested by removing the antenna from the receiver with the silent tuning button in the quiet tuning position, and it will be noted that no sound whatsoever can be heard from the receiver even with the volume control turned on full.

New Silent Tuning System

This silent tuning between stations is another new feature specially developed in our laboratories, and is accomplished by delaying the bias system of the I.F. A.G.C. to approximately 30 volts, thus limiting the sensitivity of the I.F. system to a value which would correspond to an A.G.C. level of 30 volts. However, in the presence of a stronger signal corresponding to say 40 or 50 volts developed bias in the A.G.C. system, this circuit acts to further control the I.F. Sensitivity. This provides perfect signal equality when tuning from station to station, as long as these stations are above a certain strength.

Sensitivity Automatically Adjusted for Optimum Operation on All Wave Bands

The quiet tuning system is arranged so that it is automatically adjusted for optimum operation on each of the bands for which the receiver is set, thus providing perfect reception of stations on all bands, including the foreign short wave bands, when these stations are sufficiently strong to exceed the noise level. However, when it is desired to get the maximum possible reception from the very weakest stations from all over the world, the full sensitivity of the receiver can be instantly obtained by

merely pushing in the silent tuning button.

Perfect Shielding

The efficiency of the shielding of the SCOTT SIXTEEN can be checked in less than two minutes. Simply disconnect the antenna, cover the antenna and ground binding posts with a metal cap, turn the volume control full on, then rotate the tuning dial from one end of the scale to the other, and you will not hear the slightest sound of a signal from any station. All R.F. and I.F. circuits inside the receiver are heavily metal shielded, isolated and filtered.



Final Precision Alignment of Receiver

Hear This Amazing New Receiver in Any of the Three Scott Salons

NEW YORK CITY: The Scott Salon is located in the International Building, Rockefeller Center, at 630 Fifth Avenue, on the 33rd floor, Suite 3362, Telephone: Circle 7-0574.

LOS ANGELES: The beautiful Scott Salon, containing five comfortable "living room" studios, is located at 115 North Robertson Boulevard (just 1½ blocks north of Third Street and ½ block south of Beverly Boulevard). Telephones: Crestview 5158 or Woodbury 62401.

CHICAGO: There are four fully equipped studios in our main laboratories located at 4450 Ravenswood Avenue on Chicago's North Side. Telephone: Longbeach 5172. *All salons are open until 9 P.M. every day except Sunday.*

Advanced Precision Testing Instruments Used in Scott Research Laboratories

How Undistorted Output is Checked

Scott Receivers are carefully checked "overall" (from antenna posts to dummy voice coil) at a number of different frequencies for harmonic distortion. When the picture was taken the magnitudes of each of the several harmonics at full power output were being checked. In this case a 2000 cycle voltage from the beat oscillator (partially obscured by the head of the engineer on the left) was applied through one of the several band pass wave filters (just to the left of the engineer's left hand) to the special signal generator (in front of engineer) which is specially designed to handle up to 100% modulation without distortion and to cover the entire audio frequency range. The output of this special signal generator at approximately 600 Kc was applied through a standard dummy antenna to the antenna posts of the receiver. A special high power load box (observed by the engineer in the foreground) takes the output from the power amplifier of the receiver.

The large cathode ray oscillograph (slightly to the left of the engineer in the foreground) is used for visual inspection as a rough preliminary check on the output wave form. However, no cathode ray equipment has ever been built which can show the extremely minute wave form distortion resulting from the presence of one percent total harmonics. But even if such a machine were constructed its results would be only qualitative and would not indicate the exact magnitude of each component. The exact magnitude of each harmonic component is accurately measured by the remarkable precision instrument in the foreground which is an accurately calibrated A.F. superheterodyne having a balanced modulator followed by two quartz crystal I.F. filters in cascade, enabling the instrument to select and measure A.F. components only a few cycles apart.

New Scott Instrument Results in Important Improvements in A.F. Inductances

While some phases of radio engineering are rather well standardized, the radio industry is



R.F. Inductances Tested on Precision Instruments

prone to consider too many of its phases beyond improvement. This is one of the reasons why the Scott Radio Laboratories have gained such wide reputation for startling and important new developments—nothing is taken for granted.

Many months ago, a need arose for some very precise audio compensation requiring audio frequency inductances having an unusually high reactance to effective resistance ratio at the high frequency end of the audio spectrum. Authorities consulted outside the Laboratories prescribed prohibitively large iron core types or hopelessly critical high permeability iron cores. Nevertheless, a practical solution was needed to attain the exact compensation required.

Accordingly, a new instrument was designed, constructed, and calibrated in the Scott Laboratories to read instantly the exact inductance and "Q" (reactance to effective resistance ratio, or figure of merit) at any applied signal level, with a wide range of magnetizing current, and at any frequency from 1 to 50,000 cycles. With this unique instrument (we believe that it is

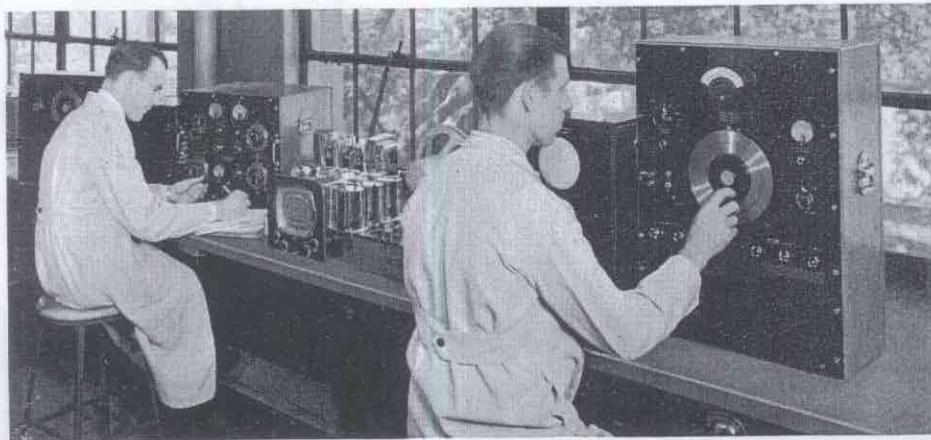

The Precise Laboratory Measuring Instruments Used to Check Undistorted Output

the only one in existence) a thorough study of all types of audio frequency inductances was made and many things discovered, among them the desired solution to the aforementioned problem. For example, a special type air core inductance was found to have over ten times the figure of merit of a high quality iron core unit when operated above 6,000 cycles. Also, of course, the air core unit was entirely free of the hysteresis, third harmonic distortion and variation of inductance with level, characteristic of usual iron core coils.

However, iron core coils naturally held their preference at very low audio frequencies though a number of important improvements were made and by careful design it was found possible to make good use of a properly controlled variation of inductance with signal level. In order to assure the high standard of performance made possible by this unique instrument, all audio frequency inductances are tested on a compact duplicate of the larger laboratory instrument. The picture shows one of the special iron core bass compensating inductors being tested on this duplicate instrument.

Thus, by being continually critical of the conventional, by rigorously testing the orthodox, the Scott Laboratories have been able not only to solve the urgent problems of the moment, but to uncover new improvements which have frequently been more important than the original objectives.

R.F. Inductors Tested on Precision Instruments

Perfect receiver alignment depends on accuracy of all circuit elements. The picture shows antenna, R.F., and oscillator inductors being adjusted to exact values on a precision inductance bridge. This new type instrument is capable of measuring inductances with an accuracy of one part in 10,000. A standard signal from the oscillator behind the bridge is applied to the bridge through a band pass filter under the oscillator. The bridge output is amplified 1,000 times by the shielded amplifier next to the oscillator before going to the sensitive crystal headphones worn by the operator in order to assure a perfect balance. In the foreground is a universal laboratory power supply which was being used temporarily to operate the equipment.

On the far side of the inductance bridge is a special precision capacity bridge which is capable of measuring to a precision of 1 part in 10,000 and reads directly in tenths of a micro-micro-farad. The range of this instrument can be extended practically indefinitely by the use of the specially calibrated precision capacitors which may be seen in the background.

All condensers whose values must be exact are measured on this instrument by the substitution method.

Many pages would be required to even briefly describe the large number of tests applied to all parts which go into Scott receivers in order to maintain their high standard of quality.

These individual parts tests are double checked when the completed chassis, amplifier,

and speaker are given complete alignment and performance tests before and after a twelve hour aging process in which the receiver is alternately heated and cooled for one hour periods. Each receiver is finally tested on local broadcast and many foreign short wave stations before it is packed for shipment in specially designed cartons.

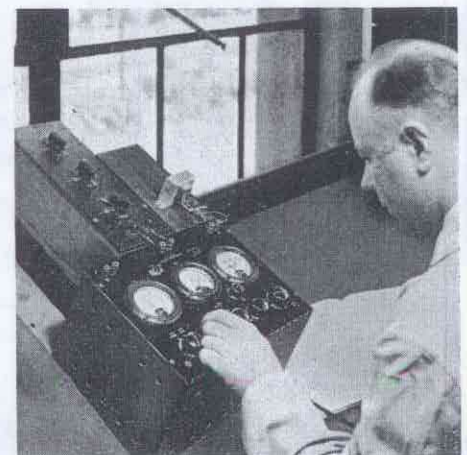

A.F. Inductances Tested for Low Frequency "Q"

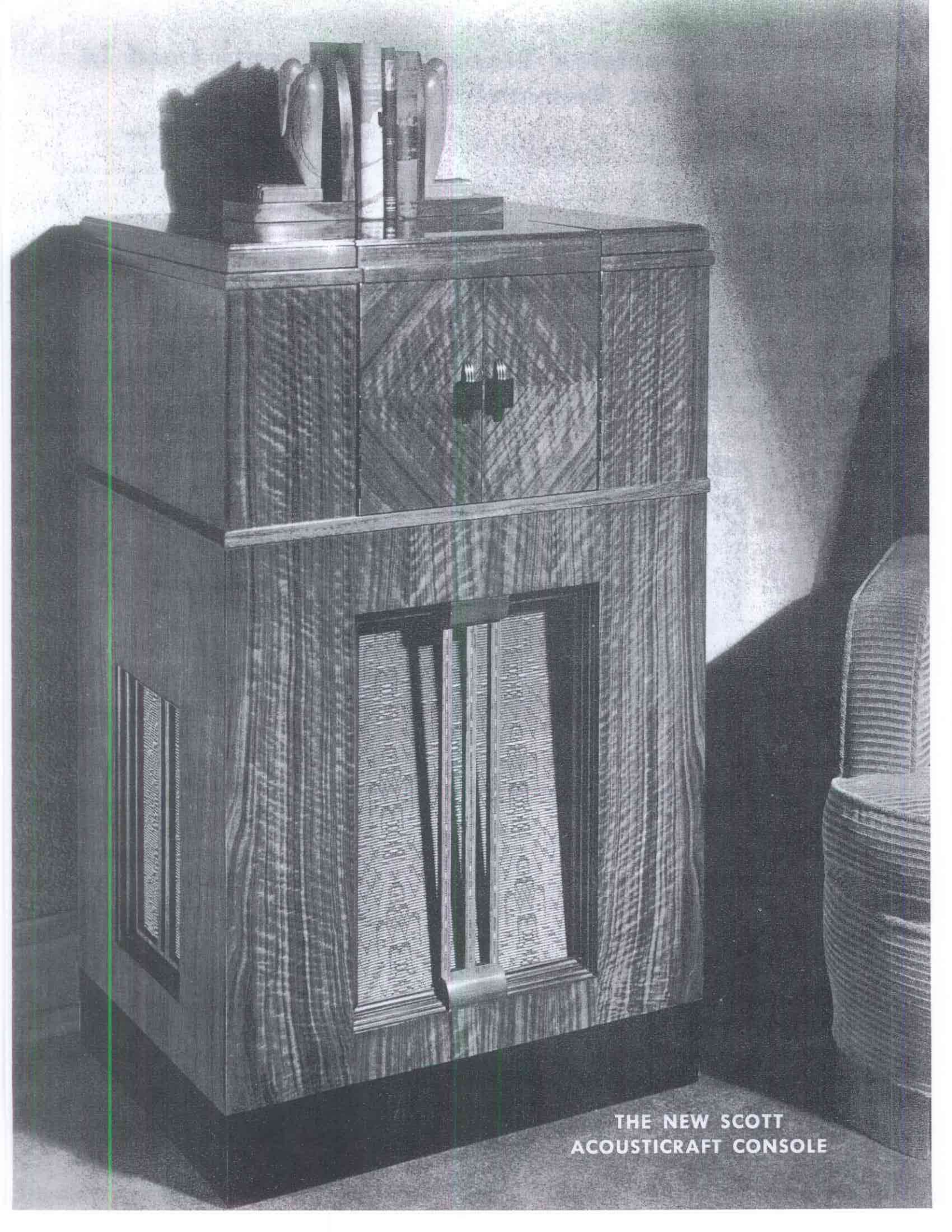

THE NEW SCOTT
ACOUSTICRAFT CONSOLE

NEWLY DESIGNED ACOUSTICRAFT CONSOLE

AN OUTSTANDING ACHIEVEMENT IN

ACOUSTICAL ENGINEERING

The console for a high quality radio receiver is usually regarded as a fine piece of furniture, and should be designed to harmonize as closely as possible with the other furnishings of the home. However, the console plays a very large part in the quality of reproduction from the loud speaker; it can make voices sound "boomy" (due to resonances in the lower voice frequency range from 100 to 250 cycles); it can cause annoying rattles if parts are loose; it can fail to reproduce the lower bass frequencies of musical instruments due to insufficient minimum length of air path from the front to the back of the loud speaker cone; and it can considerably absorb and fail to distribute the brilliant, but delicate, higher audio frequencies, overtones and harmonics due to use of improper grille cloth.

Acoustical Tests Described to Develop Perfect Console

Accordingly, a series of exhaustive acoustical tests were made which has resulted in the design of the new ACOUSTICRAFT console, with acoustical properties which we believe are unlike those of any radio console designed up to this time.

In order to eliminate all cabinet resonances, the SCOTT SIXTEEN High Fidelity speaker was installed in variously designed cabinets, and actuated from a laboratory calibrated Beat Oscillator, which was repeatedly run slowly thru the entire audio range. These acoustical tests were made outdoors on the roof of our laboratory to eliminate the usual standing waves which are present in a room. Even though the new ACOUSTICRAFT console was designed to be as acoustically perfect as possible before these acoustical tests were made, a number of resonance points immediately appeared,

showing vibrations of excessive amplitude in some parts of the cabinet.

It was found possible, by moving the bottom shelf, changing the depth of the top shelf, altering the ratio of cabinet dimensions slightly, and varying the thickness of the wood in certain places, to gradually eliminate each resonant period. This process was continued

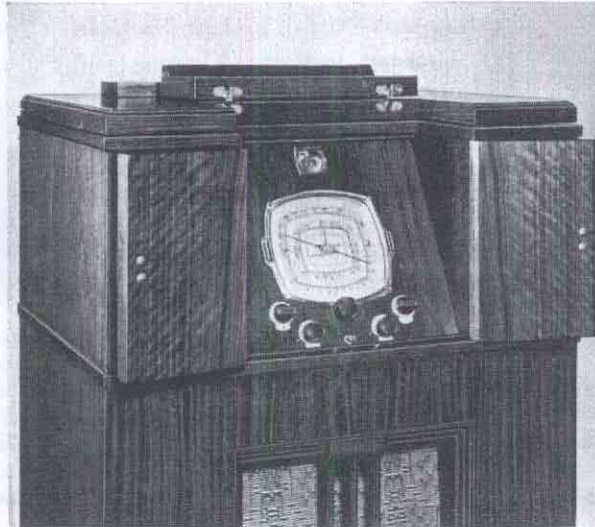

View of Inclined Instrument Board

until a console was evolved which eliminated objectionable "boomy" voice reproduction, yet maintained excellent low bass reproduction; which was free from resonant vibrations, and which with the aid of the specially designed SCOTT High Fidelity loud speaker, directs the delicate overtones and harmonics upward toward the normal height of the ear, where, instead of being lost in floor coverings, they

are heard distinctly in all parts of the room.

Designed for Convenience, Too

In designing this console, we have also taken into consideration very seriously the matter of convenience. It is of just the proper height to allow you to tune comfortably while seated in your chair, yet the slanted instrument panel enables you to easily tune the SCOTT SIXTEEN while standing and without stooping over.

Beauty of Wood— Custom Built

This handsome cabinet is constructed from American Walnut veneer, fiddle-back figured in front with diamond matched walnut veneered doors. Sides and top are also of selected Walnut veneers and the bottom rail is lacquered in lustrous black. Delicate inlays in the strips in front of the grille add to its fine cabinetry appearance. The door hinges are gold plated, with Catelin and gold plated door pulls, and custom constructed thruout.

In designing this new ACOUSTICRAFT console, we have perfected a radio cabinet that is as much a laboratory product as the instrument it houses. Our tests have proved that this beautiful piece of Custom cabinet work is a truly scientific sound amplifying unit that brings out to full advantage the perfect tonal fidelity of the receiver.

For those who do not care for too large a radio console, or when the lack of space makes a smaller console necessary, the ACOUSTICRAFT is ideal. It measures 40 inches high, 25 inches wide, and 18 inches deep. Lustrous, hand-rubbed finish. The design is such that it harmonizes perfectly either with modern or traditional furniture.

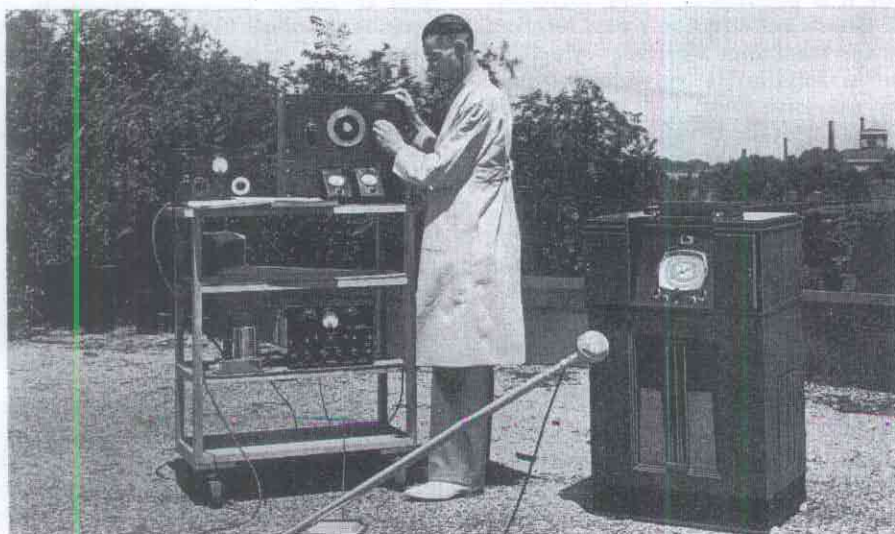

Testing Acoustics of Console



Convenient Arm-chair Tuning

LABORATORY CURVES OF SCOTT SIXTEEN

The I.F. Selectivity Curve

The curve entitled "I.F. Selectivity and Band Pass Characteristic" shows a reactivity ratio for stations on adjacent channels of approximately 30 to 1, while stations two points off on the dial

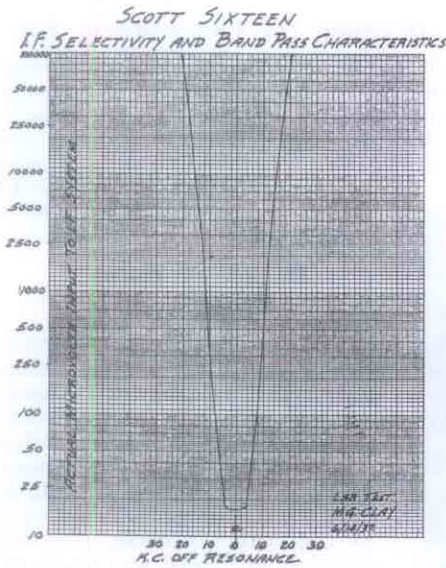

(20 Kc.) are rejected by a ratio of 4,500 to 1. The actual effective Selectivity is even greater than this, since the I.F. Selectivity Curve does not include the additional Selectivity of the two highly efficient tuned R.F. circuits.

While the Selectivity of this system would be considered remarkable for an I.F. System providing fair tone quality, the "flat nose" of the curve, being 8 Kc. broad, indicates that with the audio compensation provided by the High Frequency Control, true High Fidelity reproduction is obtained.

The Automatic Gain Control Action

This curve, which shows in decibels the variations of sound level from the loud speaker with widely varying signal input level, was measured with precise laboratory instruments on the SCOTT

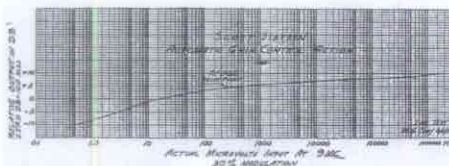

SIXTEEN, with a 30% modulated signal at 9 Mc. in order to show the A.G.C. action where it is most important; that is, on the short waves.

One of the most remarkable facts indicated by this curve is the ability of the set to respond cleanly, and without distortion, to varying ranges in strength

from 1/2 microvolt to 2,000,000 microvolts, (a ratio of 4,000,000 to 1!) with a change in the output not exceeding 20 decibels.

While a receiver is rarely subjected to such extremes in signal strength, the SCOTT SIXTEEN is designed to perform outstandingly even under exceptional conditions. The curve shows that during the frequent fading conditions experienced on the short waves when the signal may vary between say, 50 to 5,000 microvolts, the signal level from the loud speaker will change only 4 db.

Undistorted Output and Audio Gain

The curve of undistorted output and audio gain shows that the audio system has more than sufficient gain, (giving full power output with only 0.66 volts input) and that at the full rated output of 13.5 volts the total harmonic distortion is just over 2%. Since it is a customary practice to rate the power output of the receiver at the value which produces 5% distortion, and since 5% distortion is hardly noticeable to the aver-

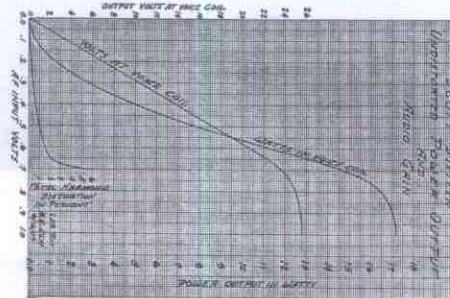

age ear, it will be appreciated that the power output rating for the SCOTT SIXTEEN is very conservative and that the lack of distortion will delight the ear of the most critical musician.

Remarkable Usable Sensitivity

While it is possible to obtain extremely high theoretical sensitivity in a receiver, only the maximum sensitivity which results in intelligible reproduction free from excessive tube and circuit noise can be rated as USABLE sensitivity; other rating systems are generally misleading. Accordingly Scott receivers are rated in terms of usable sensitivity at which the total noise output voltage with an unmodulated carrier does not exceed the signal output voltage with a 30% modulated carrier.

The remarkable usable sensitivity of the SCOTT SIXTEEN is shown by the curves which indicate that on all wave bands the receiver will respond clearly to signals weaker than one microvolt.

Note particularly that on all the important short wave bands, where the best

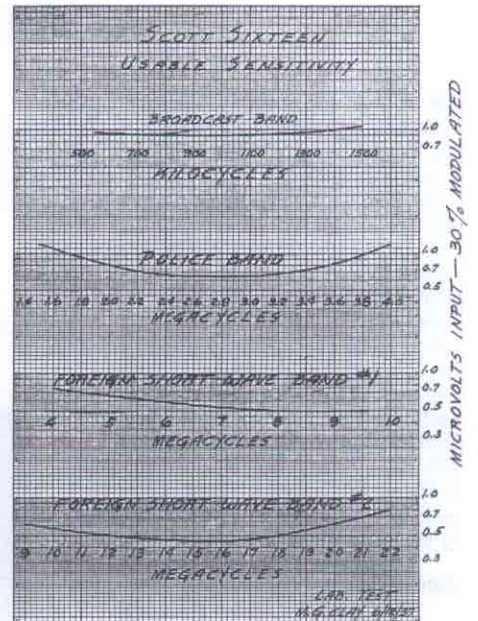

possible usable sensitivity is highly desirable the sensitivity is better than 0.6 microvolt. As a matter of fact a special shielded attenuator had to be added to the finest available signal generator before it was possible to accurately measure such extremely weak signals.

Overall Fidelity Characteristics

The Fidelity Characteristic curves shown are not merely audio response curves, but were measured overall at 1000 Kc. from the antenna posts to the dummy voice coil and show some of the various degrees of compensation, from plus 12 D.B. (boosted 4 times) to minus 9 D.B. (cut nearly 3 times) at 50 cycles, obtainable by rotating the continuously variable bass control. Likewise several of the degrees of continuously variable high frequency response obtainable by rotating the High Frequency control are shown, indicating a maximum range at

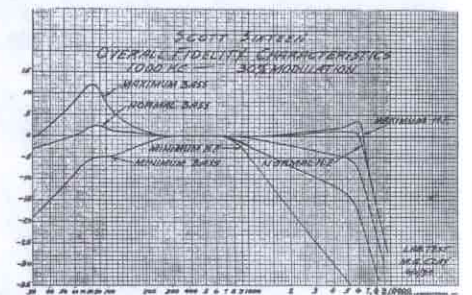

6000 cycles from plus 3 D.B. to minus approximately 38 D.B. Note particularly that the middle frequency "intelligibility" range is not affected, the lower voice frequencies are boosted very little, and the high frequency cut off is extremely sharp.

THE E. H. SCOTT RADIO LABORATORIES, INC.

4450 RAVENSWOOD AVENUE, CHICAGO, ILLINOIS

630 Fifth Avenue, New York City

115 N. Robertson Boulevard, Los Angeles