

PHILCO

TECHREP DIVISION BULLETIN



TRANSISTOR

**JUNE
1953**

PHILCO TECHREP DIVISION BULLETIN

Published Monthly by
The TechRep Division of Philco Corporation
Philadelphia, Pennsylvania

Volume III

JUNE, 1953

Number 6

CONTENTS

Editorial	2
<i>By John E. Remich</i>	
The Transistor	3
<i>By Gail W. Woodward</i>	
Bulletin Binders	22
Circuitry "Packages" for Electronic Computers ..	31
Telephone Handset Intercom System	34
<i>By David T. Armstrong</i>	
What's Your Answer?	36
Low-Voltage Operation of the PE-215A	37
<i>By Arthur G. Rakosnik</i>	
Solution to Last Month's "What's Your Answer?"	44

Editor
John E. Remich

Managing Editor
Robert L. Gish

Technical Editors
Francis R. Sherman
Gail W. Woodward

EDITORIAL OFFICE:
TECHREP DIVISION
PHILCO CORPORATION
22nd and LEHIGH AVENUE
PHILADELPHIA 32, PA.

If any information contained herein conflicts with a technical order, manual, or other official publication of the U.S. Armed Forces, the information in the official publication should be used. Views expressed in this publication are the opinions of the authors and do not necessarily represent those of Philco Corporation. All technical information and circuits are presented without responsibility as to patent infringement.

Editorial

A NEW CHALLENGE TO THE FIELD ENGINEER

by John E. Remich, Manager, Technical Department

A new challenge is now in the process of showing itself on the field engineers' horizon. This challenge is the natural outgrowth of a vast amount of engineering effort that has been directed toward design and development of new electronic equipment. Until recently, the average field engineer has had little chance to become familiar with recent laboratory developments—rare indeed has been the opportunity to even see laboratory models of new equipment.

Some new equipments are now being delivered to the field while others are scheduled for the latter part of this year. The user will shortly be faced with equipment complexity to a degree that would have been considered fantastic only a few years ago.

The importance of the field engineer in this picture is quite evident. To a large degree, the success or failure of the new design will depend upon the ability of the field engineer to train personnel in all phases of installation, operation, and maintenance of the equipment. An added responsibility is the discovery and reporting of those weaknesses which can only be discovered in the field. Alert action on the part of the field engineer in reporting evidence of recurrent or incipient failure can be of tremendous value to a manufacturer in the process of getting the "bugs" out of a new design. At this stage, even a short delay can be very costly both to the user and to the manufacturer, in terms of optimum design.

When the deluge of new devices is put into service the field engineer becomes the key to success, but only if he is prepared to handle the job. To be able to cope with the problems that must inevitably arise requires a constant program of self-education. Keeping up to date is extremely difficult in the face of a rapidly advancing technology unless it is done on a daily basis. The old idea of an hour a day invested in self-improvement has never been more applicable. It is up to each field engineer to maintain individually a high standard of proficiency, for he will be put to a crucial test in the very near future.

THE TRANSISTOR

by Gail W. Woodward
Headquarters Technical Staff

The basic nature, construction, and use of transistors. This article is designed to give the reader a general understanding of the background of transistors so that he can better handle them in their circuit applications.

(Editor's Note: Those BULLETIN readers who have been closely following the current series of "transistor" articles by Mr. John Buchanan will note that while in some respects this article appears to duplicate certain material previously published, its over-all coverage is slanted in a different direction. The goal of the Buchanan series is the development of all aspects of the basic theory underlying transistor and certain other solid-state phenomena — a project which requires considerable discussion of many associated theories, including the thermodynamics of gases, the free-electron theory, the quantum theory, and even portions of the theory of relativity. Obviously, such a development, while highly desirable, precludes the inclusion of specific data on transistors in the early articles of the

series. Therefore, to satisfy the field need for immediate specific information on transistors, we have launched a parallel series of articles supplying this type of data to our readers.

During the preparation of this and subsequent articles of this second transistor series, the author has worked closely with members of the Philco Research Division investigating transistor phenomena, and has received much valuable assistance from that group, particularly from Mr. William Forster and Mr. Irving Wyman. In fact, this second group of articles was originally proposed by Mr. Forster as a training course for Philco engineering personnel, and the project has been planned and conducted jointly by the TechRep Division and the Research Division.)

THE FACT THAT CERTAIN CRYSTALLINE materials display the property of rectification has been known for many years. From about 1925 to 1940, crystals were used in the laboratory in an ever-increasing variety of applications. Early research into the mechanism of crystal properties contributed a great deal to our present knowledge of atomic behavior and incidentally to the electron theory—the accuracy of this knowledge which bids strongly to replace the

vacuum tube in many applications.

is evidenced by the fantastic transistor

The first theory used to explain rectification was advanced in 1932, and used the concept of a barrier layer. The electrons were assumed to penetrate the barrier by virtue of the "tunnel effect" which indicates that the electron behaves as a wave. The wave propagates through the crystalline lattice in a fashion similar to the propagation of

microwaves through a waveguide. However, since the electron's wavelength was considered to be very large as compared to lattice structure, propagation was said to be similar to that in a waveguide at cutoff. The attenuation a waveguide presents when cut off would be equivalent to the resistance encountered by the electron in traversing the barrier layer. However, to meet this theory the barrier layer would have to be impossibly thin to account for observed characteristics. The theory received the final blow when it was pointed out that it predicted rectification opposite to the observed direction.

In 1939, the first workable theory (which allowed the existence of reasonable barrier-layer thicknesses) found wide acceptance. This theory used the mechanism of thermal electron motion to account for the passage of current through the barrier layer. In essence, the theory shows how electrons can pass through the barrier much more easily in one direction than the other. This action will be more fully explained in a later portion of this article. Furthermore, as will be shown, the barrier-layer concept is necessary to explain the action of the transistor.

Much impetus was added to solid-state-electronics research during World War II. In 1942, it was clearly seen that microwave radar had many desirable features. It was found that microwave tubes could be built, but also it was noted that crystals could be employed as converters with as much success as tubes. Because of their greater simplicity and ease of manufacture, the crystal was decided upon and thereby became the major target of an intensive development program. The result of this program is well known to radar technicians — microwave converter crystals (such as the 1N21 and 1N23 series) produced toward the end of the War were remarkable achievements in improvement. In addition to having excel-

lent conversion-loss and noise characteristics, these crystals were much more resistant to burnout than earlier units, and were quite uniform.

From the extensive wartime investigations came a number of noteworthy findings. The theory of rectification was advanced to a point where a few farsighted researchers could begin to intelligently extrapolate results, methods of producing semiconductor materials with heretofore impossible purities were found, crystal characteristics were found that indicated the possibility of reproducible negative resistance, photoemissive and photoconductive effects were observed and measured, and various materials were investigated to determine their suitability. While silicon proved to be superior for microwave converters, the properties of a great many materials were investigated—some of these, notably germanium, showed promise for use in other applications.

Then, in 1948, the crystal amplifier (christened transistor) was announced at the Bell Telephone Laboratories. John Bardeen, a theoretical physicist, and W. H. Brattain, a lab genius, produced the first working unit while engaged in a research program under the direction of William Shockley.

In the last few years, the theory of solids has been revised and advanced to a point where it can now be used to predict quantitative behavior of certain kinds of transistors. This ability is the final test of any theory.

While much is known about transistor action (enough to produce workable commercial units) a great deal more research must be done and is being done. However, development is proceeding at a rapid rate, and major advances in the art have been established. The state of the transistor art will not be covered here because it will be the subject of a comprehensive survey later in this series.

CONDUCTION

Very early in the investigation of the phenomenon of electric-current flow it was decided that the flow consisted of a movement of very small particles. Unfortunately, it was assumed that these particles were positively charged and that they tended to flow from a higher (positive) potential to a lower (negative) potential by virtue of seeking a condition of equilibrium. A current source, then, is merely required to produce an unbalance of particles—the circuit will then conduct in an attempt to restore balance. It is interesting to note that the conceptual error in this theory did not prevent the formulation of laws regarding the behavior of electricity, and great advances were made in utilizing devices that obeyed these laws. The advent of the vacuum tube made it necessary to revise some of these misconceptions, and discoveries in solid-state electronics have furnished more than ample validation of earlier theories about the behavior and nature of electric-current flow as well as the theory of solids.

It was soon discovered that the particle-flow concept was partly correct but that the particles were charged negatively—reversing some of the early concepts was all that was needed to account for some of the observed characteristics. In general, it could be said that while the concepts of quantitative behavior did not change, their qualitative character needed considerable revision. Electron flow, while showing some of the characteristics of a flow of small particles (which have been measured and shown to exist), also displays many of the characteristics of a wave motion. The billiard-ball analogy shows this action very neatly; if a single ball is driven straight into a row of balls, the impact force is transmitted from one ball to the next until it reaches the last ball in the row. The last ball will then move away from the line. It is obvious

that the ejected ball is not the one that was inserted—yet one ball enters the row and one ball leaves the other end of the row. The applied force can be considered to have moved through the line as an energy wave. If two balls are injected simultaneously, two will leave at the other end—indicating that a wave of double magnitude has been propagated down the row. Free electrons in a conductor behave in much the same manner. It has been pointed out that if the pressure wave were not transmitted freely along the conducting path, a pileup would occur and the resulting electrical stresses would be of fantastic magnitude because of the small distances involved. By way of illustration, assume a one-volt potential impressed across an insulator 10^{-8} cm. thick. A one-volt potential is not much but the stress would be equivalent to 100,000,000 volts per centimeter! (Furthermore, 10^{-8} cm. is a very great distance as seen from the electron's viewpoint.) Thus, the effect of localized stresses tends to prevent the flow from piling up at any point in the conduction path. The action of a potential upon free electrons in a conductor can be considered to be similar to a force acting upon an incompressible gas.

HALL EFFECT

The discovery of the Hall effect resulted in the greatest validation of the electron theory that has been obtained by physical means. In figure 1, a current-carrying slab of conducting (or semiconducting) material is subjected to a magnetic field which is oriented perpendicularly to the largest surface. Classical experiments show us that the combined action of the magnetic field and the electric current will tend to exert a downward force on the conductor—if the force is strong enough, the conductor will move downward. This action can easily be explained in terms of electrons flowing from left to

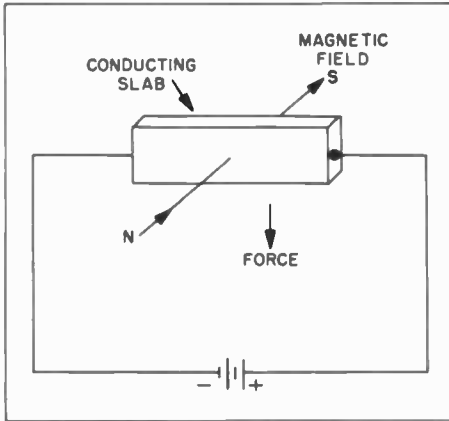

Figure 1. Circuit Setup for Illustrating Hall Effect

right or a flow of positive charges from right to left. However, let us assume that the slab is rigidly held so that it cannot move—it follows that there must be a tendency for the flow of current (whether positive or negative particles) to traverse the lower portion of the conducting slab. Thus, the resultant force will cause the conduction path to alter even if the conductor itself does not move.

If an electric current is a flow of positive particles, the bottom edge of the slab would become electrically positive in respect to the top edge. But, metallic conductors produce a negative voltage at the bottom of the slab for the conditions shown. Thus it must be concluded that the electric current is truly a flow of negative particles.

Of course, there are a few important exceptions to the general rule. Certain semiconductors show the presence of positive carriers—in fact, a certain amount of positive-carrier conduction occurs in all semiconductors, even if negative carriers predominate. These positive carriers were responsible for transistor action in the early units, as will be shown shortly. Positive carriers are now known to be the hole (or space where an electron should be)—when a hole moves, it moves only as a

result of being displaced by an electron, and the hole is considered to have moved to the point of origin of the displacing electron. Even though the hole acts as a physical carrier, it is made by the ejection of an electron. This concept must be used carefully to avoid confusion. For example, if the positive carriers were physical particles, injecting holes would tend to make the substance heavier at the point of injection, but the substance is actually made lighter because hole injection is really electron removal. A second peculiar concept exists in connection with the momentum of hole flow. In the case of a flow of holes, the momentum of the flow must be considered to be opposite to the direction of motion. In spite of objections, the concept of hole conduction is still useful because it simplifies many of the theoretical discussions and is easier to correlate with experimental data than the concept of electron flow.

ATOMIC STRUCTURE

The atomic theory seeks to describe the structure of matter, and, with all of its complexities, does a good job. This theory has done much to unite the fields of chemistry, physics, and electronics. It could be said that knowledge of all three of these fields is essential for the modern investigator of electronic phenomena.

The atom is considered to have a central mass called the nucleus which contains a number of neutrons and protons. Thus, almost all of the mass and all of the positive electrical charge is contained in the nucleus itself. The remainder of the atom is made up of electrons in orbits around the nucleus (much in the same manner that planets are arranged about a sun). Quantum mechanics shows that the orbital electrons are arranged in a series of shells—these shells are further subdivided into layers where each layer corresponds to an energy level. The first layer

out from the nucleus represents the lowest energy level, and it can contain at most two electrons (one for each direction of spin). At progressively higher levels, more electrons can be accommodated in each shell—the second shell contains at most eight electrons, the third shell 18 electrons, etc. The periodic atomic table illustrates the number found in each shell. Thus we find a number of shells of planetary electrons with the outer shells representing greater numbers of more energetic electrons.

We are interested in the outermost shell of electrons because it is here that the properties of the material become manifest. It is found that if the outermost layer contains eight electrons, the substance is very stable and the shell (or subshell as the case may be) is considered complete. The periodic atomic table groups elements into eight groups as determined by the number of electrons in the outer shell. For example, group I elements have a single electron in the outer shell. If this electron were removed by an external force, the element would exhibit a unit positive charge—thus the normal valence is said to be +1. Elements in group VIII (or as it is sometimes called, group 0) have a completed outer shell and are in general very stable, as characterized by the inert gases. Elements that display negative valences are those whose atoms have nearly filled outer shells—for example, if the outer shell contained seven electrons, the atom would be most likely to acquire an electron to complete the shell. Such atoms are said to have a valence of -1, and are found in group VII.

BAND THEORY

To visualize energy states in various materials, the diagram shown in figure 2 is often used. The shells of electrons are shown in terms of energy levels. Each shell is represented by a band. The intermediate regions, where electrons

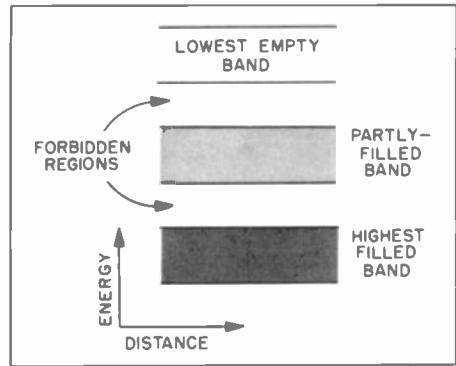

Figure 2. Band Structure of a Conductor

cannot exist, are called *forbidden regions*, while possible energy states are called *permitted regions*. Since only the outermost shells determine the behavior of the material, they are the only ones shown (the nucleus might be many bands below the lowest one on the diagram). For an atom to acquire energy, the planetary electrons must be moved into a higher band. Since the inner bands are filled, this action must take place at the upper level (or the exposed shell of electrons). The upper level is divided into a series of sublevels equal in number to the number of permitted electrons. These sublevels are very close together and in some cases overlapping, thus producing an almost continuous range of possible energies. Therefore, within a particular level, it is relatively easy for an electron to acquire energy, provided that the band is not completely filled. In the case of metals, this is the mechanism of conduction. The current source excites electrons in the upper band into the higher adjacent levels within the band. As the electron in the first atom falls back to its previous level, it releases the acquired energy, which excites an electron in an adjacent atom. At room temperature, this energy transfer between atoms is going on all the time, but the energy transfer is purely random, resulting in a net electron drift of zero. A current source has the effect of giving the random

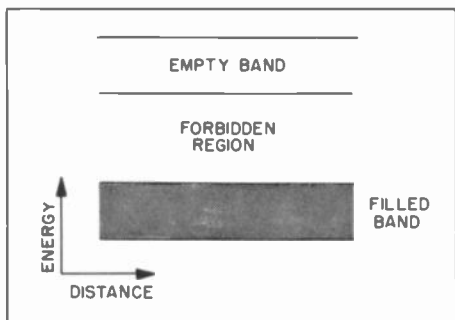

Figure 3. Band Structure of an Insulator

exchange a definite drift direction, and conduction takes place as described previously.

The positive temperature coefficient of resistance found in metals is accounted for by the crystalline structure of metals. The atoms are bound together in a definite pattern (a crystal) by valence bonds which are produced by inter-atomic sharing of outer-shell electrons. Increasing temperature will cause the structure to vibrate—the vibrating structure tends to interfere with the passage of conduction electrons and results in increased resistance. (It is interesting to note that as the temperature is increased still further, the vibration force exceeds the holding power of the valence bonds and the metal becomes a liquid.)

Figure 3 shows the band structure of an insulator. The upper band is filled and separated from the next permitted level by a large forbidden region. The energy jump required to move an electron out of the filled band into the empty band (thus producing a partly-filled band) is quite large. The separation between these two bands determines the rupture voltage of an insulator and is well demonstrated by the starting-voltage characteristic of a neon lamp. Neon is an insulator until disrupted by the action of a strong electric field.

This action also shows why insulation properties decrease with increased temperature. At room temperature, the

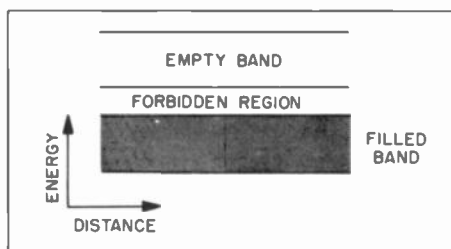

Figure 4. Band Structure of an Intrinsic Semiconductor

average thermal energy per atom is about 0.05 electron volt. A substance with a wide forbidden region will prevent thermal excitation from producing the required jump. For example, diamond, with a 7-electron-volt forbidden region, is a good insulator at room temperature. But at higher temperatures some of the high-energy electrons will have sufficient energy to jump the gap, thus producing a partly-filled band which allows conduction. This is true of all known insulators (except the vacuum).

SEMICONDUCTION

Figure 4 shows the band structure found in semiconductors. This case is similar to that of an insulator except that the forbidden region is smaller. At room temperature, thermal energies are sufficient to excite enough electrons into the empty band to allow some conduction. Here, the mechanism of semi-conduction makes use of two effects. It is obvious that when thermal excitation causes an electron to jump from the filled band into the adjacent permitted region, the previously empty band is now a partly filled band and the previously filled band is also now only partly filled. The electrons in the partly filled upper band can conduct in the previously described manner and the holes left in the previously filled band can behave as positive carriers of electric current. In practice, both electrons and holes contribute to conduction, but it has been demonstrated that electrons are more free to move than holes even

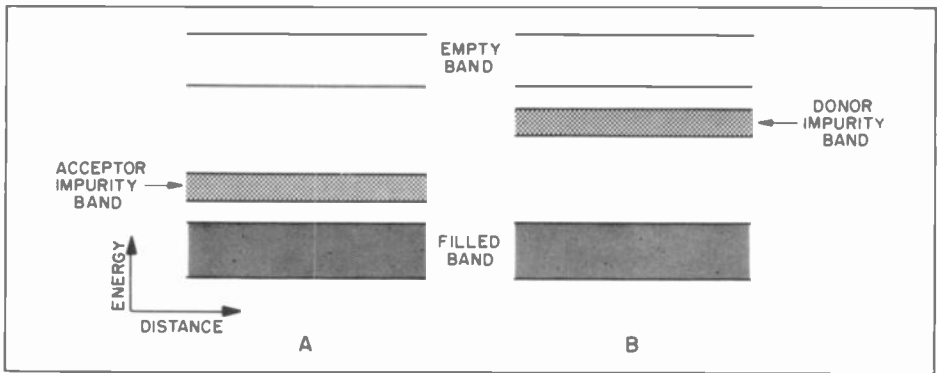

Figure 5. Band Structure of an Extrinsic Semiconductor
A. P-Type B. N-Type

though they each carry a charge of equal magnitude. This can be understood when it is considered that the conduction holes are farther from the outer surface of the atom than are the conduction electrons. The facility of motion is called *mobility*, which will be discussed in greater detail later.

Semiconduction which makes use of carriers produced by the internal action of the semiconducting material itself is called *intrinsic* semiconduction, while semiconduction resulting from externally introduced carriers or carriers produced with the aid of some other agency is called *extrinsic* semiconduction. Intrinsic semiconduction, therefore, implies an absolutely pure material, but even if the material is *not* pure, so long as the majority of the carriers come from the semiconductor atoms alone, then conduction is still said to be intrinsic.

The effect of impurities on the band structure is shown in figure 5. Two general classes of impurities are shown. In one case (figure 5A), the impurity has a band that lies just above the highest filled band. Its structure is such that it can accept thermally excited electrons from the filled band—the filled band thereby becomes partly filled, and conduction can occur. This class of impurity is called the acceptor-type impurity. The electrons removed from the filled band are held by the impurity atoms—this means that the holes left in

the partly filled band act as the carriers. This results in what is called *p-type* semiconduction (p because of the positive sign of the carriers). The second class of impurity has a band that lies just below the empty band, as shown in figure 5B. Thermal excitation causes electrons to be injected from the impurity into the empty (permitted) band which thereby becomes partly filled, thus allowing conduction. This class of impurity is called the donor-type impurity and results in what is called *n-type* semiconduction (n for negative carriers).

The percentage of impurity necessary to determine the type of conduction is extremely small, and small concentrations of impurities have radical effects upon the nature and magnitude of semiconduction. For example, adding one atom of boron for each million atoms of pure silicon can change the conductivity by a factor of 100,000 to 1. This impurity concentration would have been undetectable by methods used only a few years ago. Spectroscopically pure semiconductors still can have relatively vast numbers of impurity atoms. Pure germanium at room temperature would have a resistivity of about 60 ohm cm. (intrinsic conductivity), but it is extremely difficult to produce consistently germanium of sufficient purity to produce a resistivity as high as 10 ohm cm. (even though 55-ohm-cm. samples have been produced). In practice it has

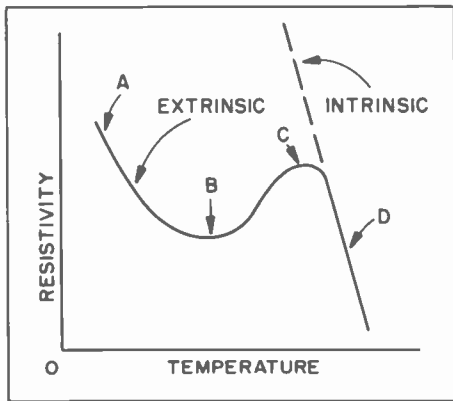

Figure 6. Plot of Resistivity Versus Temperature for a Typical Sample of Germanium

been found that conventional resistivity measurements are the best indication of purity values. The process of adding specific impurities is called “doping.”

It has been noted that n-type material can be converted to p-type material by heating and quenching. The resulting p-type material can be restored to its original type by heating again and cooling very slowly. These characteristics are more readily explained in terms of crystal structure than in terms of impurities.

Figure 6 shows an exaggerated plot of the resistivity against temperature for a typical sample of germanium. At absolute zero, semiconductors would be good insulators because there would be no thermal energy to excite electrons out of the filled band or into the empty band. As the temperature is increased, impurity atoms contribute either electrons or holes by thermal excitation, and resistivity drops—here we find the negative temperature coefficient of resistance found in insulators and semiconductors. At still higher temperatures, the curve levels off (point B) because the impurity atoms have produced as many carriers as possible. Between points B and C, the material behaves as a conducting metal—resistivity increases because vibration of the crystal lattice tends to interfere with the free passage

of carriers (it could be viewed as greater friction due to more frequent impacts between the crystal lattice and the carriers). At point C, a second transition occurs because more carriers are produced by excitation of electrons from the filled band into the adjacent permitted band. Since this is not determined by the impurity atoms, the action above point C is intrinsic. Extrapolating this portion of the curve (dotted line) shows how an absolutely pure sample would behave. Thus, impurity estimates can be made by comparing the actual conductivity of a sample against what the intrinsic value would be at the same temperature. Point C is important because transistors operate on the basis of carriers injected into extrinsic germanium. Since germanium becomes intrinsic in the neighborhood of 100° C. (point C), operation as a transistor above this temperature is not expected.

Silicon and germanium fall in group IV of the atomic periodic table. In general, semiconduction can be made extrinsic by adding group-III materials (which act as acceptors), or by adding group-V materials (which act as donors).

This can be viewed physically by considering valence, or outer-shell, electrons. The impurity atoms replace germanium atoms in the crystal, and therefore do not greatly upset the structure. It can be seen that if the impurity were in group III, an atom with three valence electrons would be replacing an atom that should have four. This lack of one electron is, in effect, a hole. A group-V impurity results in the substitution of an atom with five valence electrons into a lattice location where an atom with four valence electrons should be—thus, one relatively free electron is present for each impurity atom.

MATERIALS

At this time, germanium and silicon



Figure 7. Germanium Reduction Furnace

are the only substances that appear to have characteristics suitable for transistor action. Only germanium has been used with any great success, but, since germanium transistors are limited to temperatures below about 100°C ., silicon is under examination as a possible substitute because it could (theoretically) function at much higher temperatures. Of course, many materials have been investigated, including the metallic oxides and sulphides, but all have proven unsuitable except the two mentioned.

PRODUCTION OF GERMANIUM

Germanium is most readily obtained from its oxide, which exists as a white powder. The germanium dioxide is processed to obtain the desired degree of purity and is then converted to germanium by removing the oxygen. This reduction is accomplished by heating the germanium dioxide in a dry hydrogen atmosphere in what is called a reduction furnace (see figure 7).

The furnace consists of a glass tube in which is placed a small container filled with germanium dioxide. Hydrogen enters one end of the glass tube by

way of a silica-gel desiccator. The oxide is radiant-heated by means of electrically operated coils which are slowly pulled along the glass tube by a motor-pulley arrangement. Reduction occurs at about 650°C ., at which temperature the hydrogen and oxygen combine to form water vapor, thus leaving the relatively pure germanium. The water vapor is carried off through the exhaust—since the exhaust also contains uncombined hydrogen, a flame can be used to show the rate of flow (and incidentally to prevent explosive hydrogen concentrations in the room).

After reduction, the temperature of the germanium is raised to complete melting, after which the material is allowed to cool, thereby forming a solid germanium billet. It is noted that if cooling is not the same along the entire billet, the residual impurities tend to concentrate at the hot end. For example, the resistivity of a typical sample can vary from less than 0.01 ohm cm. at the hot end to over 2 ohms cm. at the cold end. This is thought to be due to a tendency for any material to crystallize in its pure state—the impurities are therefore pushed away from the cooler portions of the material. Thus, further effective purification of the germanium (over the oxide purity) can be accomplished by using only the end of the billet that is cooled first.

CRYSTAL GROWTH

Germanium produced by the reduction process is crystalline, but the crystals are very small and irregular. In transistor production, the aim is to produce the largest possible, uniform, single-crystal samples. Single crystals are grown by two widely used methods. In one method, the germanium is heated, seeded, and carefully cooled—as cooling progresses the melt crystallizes around the seed. The second method consists of dipping the seed into germanium which is just above the melting point. The seed



Figure 8. Crystal Pulling Furnace Setup (The equipment on the right is an induction heater used to energize the coil around the quartz tube. Monitoring equipment is contained in the rack at the left. The inset shows a pulled ingot just prior to removal from the furnace.)

is then slowly pulled up out of the melt—the crystal grows onto the seed and continues to grow as long as the pulling continues. These operations are performed in either a vacuum or an inert-gas atmosphere, and temperature conditions must be carefully observed and controlled.

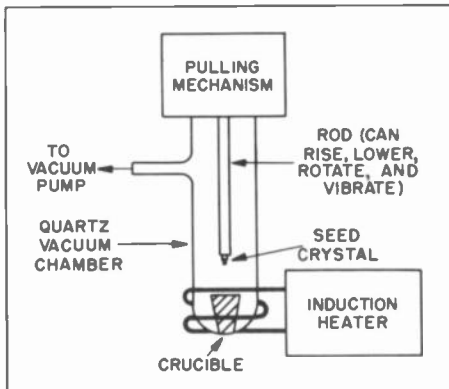

Figure 9. Diagram of Crystal-Pulling Furnace

Figure 8 shows a typical pulling furnace, a diagram of which is shown in figure 9. The crucible is either made of, or surrounded by, graphite which will absorb power from the induction heater, and is located near the bottom of the quartz tube. The volume inside the quartz tube is maintained at a pressure of about 10^{-5} mm. of mercury by means of continuous pumping.

The induction heater (rated at 22 kw.) is used to maintain the temperature at the desired point—regulation of this factor is indicated because of its critical nature.

The seed crystal is mounted on the bottom end of the vertical shaft. The seed must be monocrystalline because each crystal present in the seed will grow a corresponding extension. Furthermore, the seed must be oriented in the plane desired for the final crystal.

The purified, polycrystalline, metallic germanium, along with the desired doping agent (if used), is melted in the crucible, and, at the proper temperature, the seed crystal is lowered into the melt. The seed-crystal face is allowed to melt slightly and then the pulling is commenced. Pulling rate and melt temperature are very carefully controlled, and these two factors largely determine the diameter of the resulting "ingot". As the seed is withdrawn from the melt, it draws some of the melt with it—the upper portion cools and the crystal structure forms, using the seed as a pattern. If pulling occurs at a rate equal to the formation of the crystal, a uniform sample is obtained.

Vibration does not appear unfavorable, and in some cases, is desirable. In fact, some pulling schedules deliberately call for vertical vibration and/or rotation to be superimposed upon the pulling motion. It is thought that this action stirs the melt, and thus enhances uniformity.

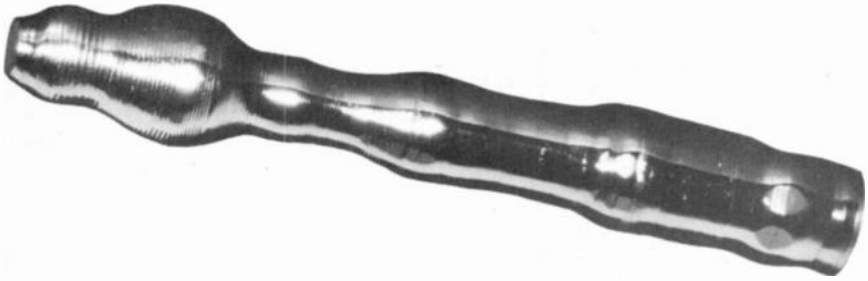

Figure 10. Germanium Twin Crystal (Pulled Ingot)

In spite of elaborate precautions, multiple-crystal formations sometimes occur. Figure 10 shows a six-inch twin formation. The structure of this ingot is almost perfect, and the twin faces are easily visible. Figure 11 shows a cross-sectional view of the same ingot—the grain boundary is clearly seen because of the altered light-reflecting characteristics. Figure 12 shows the seed-end view of a single-crystal ingot.

The foregoing method of growing crystals is most readily adaptable to high-purity materials. As was the case with the freshly reduced metal, the impurity content is lowest at the cold (seed) end of the ingot and the impurity content increases toward the other end.

When it is desired to grow crystals

with large impurity concentrations for the production of low-resistivity germanium, the pulling method is unsuitable and the temperature-lowering method is used. In this case, the setup shown in figure 13 is used. The germanium and doping agents (desired impurities) are heated in a crucible as before, and at the proper temperature, the seed crystal is lowered into the melt. As soon as the seed-crystal face has started to melt, the temperature is carefully lowered and the formation of the crystal is observed on the surface of the melt. If the crystal is not growing properly, the temperature is again raised and the seeding operation repeated until the desired pattern is observed. The melt

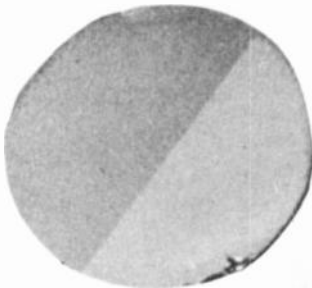

Figure 11. Cross-Sectional View of Twin Crystal



Figure 12. Seed-End View of Pulled Single Crystal

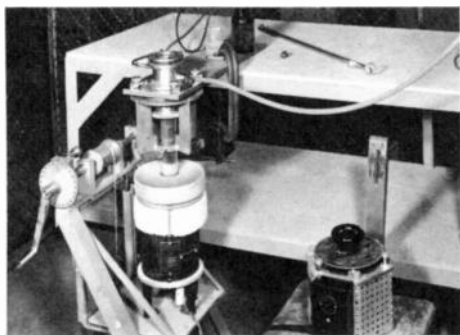

Figure 13. Crystal-Growing Furnace

is then slowly cooled until it has entirely crystallized. The cooling process can be accomplished in two ways: (1) the heat source can be slowly deactivated, or (2) the position of the heat source can be gradually lowered toward the bottom of the crucible, thereby causing the cooling to progress downward. This second method appears to give the greatest degree of control. Unfortunately, the solidified melt often breaks the crucible and, if not, the crucible must be broken to recover the crystal ingot.

MEASUREMENTS

After an ingot has been grown, it is sawed across the vertical (pull) axis at several points, and measurements are made of several characteristics. The sawing operation is performed with a diamond saw such as the one shown in figure 14. The ingot is firmly mounted upon a glass plate to facilitate holding for the sawing operation. The measurements are useful in determining which parts of the ingot can be used in making transistors—they will also aid in predicting transistor characteristics. The basic measurements include: resistivity, conduction type, minority-carrier mo-

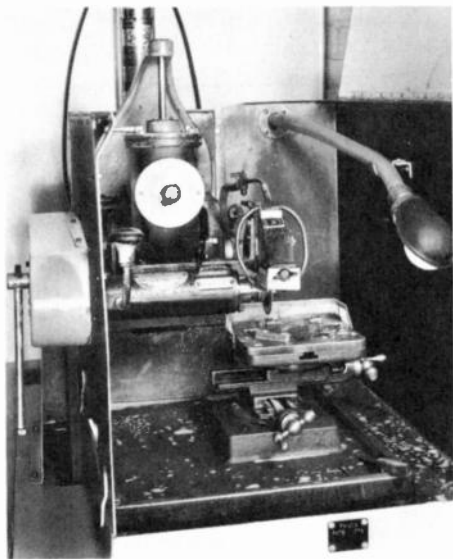

Figure 14. Diamond Saw for Cutting Germanium

bility, and minority-carrier lifetime.

Conduction Type

It is very important to know whether the transistor material is n-type or p-type and even more important to know if and where any p-n junctions occur. (The p-n junction is the boundary at which the conductivity type changes.) Point-contact transistors must not have any junctions in the vicinity of the points.

The Hall effect can be used but the most versatile method of determining type involves use of what is called a "hot" point, as shown in figure 15. The "cold" connection is merely a good ohmic* contact to the sample. The "hot" point is used to probe various points on the surface of the sample—type is indicated by the galvanometer.

* An ohmic contact is one that does not display rectification characteristics—it conducts equally well in both directions. Therefore, a good ohmic contact represents a low-resistance path to the flow of an electric current.

An ohmic contact can be secured by soldering a wire directly to the germanium crystal. This means that the soldering temperature must be high enough to cause the

solder to "wet" the germanium in order to provide a good connection. Since such temperatures are dangerously near the region in which changes in crystal structure occur, it has become standard practice to electroplate the germanium, in the area of the desired contact, with a metal that is readily wetted by solder at lower temperatures. The contact wire can then be soldered to the plated area with little danger of altering the characteristics of the semiconductor.

The point is heated to about 75° to 100° C. (extrinsic region) and applied to the germanium. The hot point will cause the generation of electron-hole combinations by thermal activity, thereby increasing carrier density in the vicinity of the point. The result is the production of a greater proportion of minority carriers—the hot point will become positive for n-type germanium and negative for p-type germanium. This action can be readily understood by assuming a material with 10,000 electrons and 10 holes (n-type). Suppose that thermal activity produced an additional 10 electrons and 10 holes. There will now be 10010 electrons and 20 holes—the increase in electrons is only 0.1% whereas the increase in the number of holes is 100%. Obviously a meter would record the increase in hole production.

Resistivity

Resistivity measurements consist of cutting a test bar of uniform cross section out of the part of the ingot where the resistivity data is required. The ends of the bar are rhodium- or palladium-plated to provide a means for soldering connecting wires. The bar is then connected into a circuit as shown in figure 16. Two exploration probes show the potential gradient at various points on the bar. The first check is to determine uniformity—this is done by maintaining a constant point separation and checking the potential difference at various points along the bar. If the bar is reasonably uniform, the following measurements are carefully noted:

1. Point separation
2. Voltage between points
3. Cross-sectional dimensions of the bar

Resistivity is then found by solving the equation:

$$\rho = \frac{VA}{IL}$$

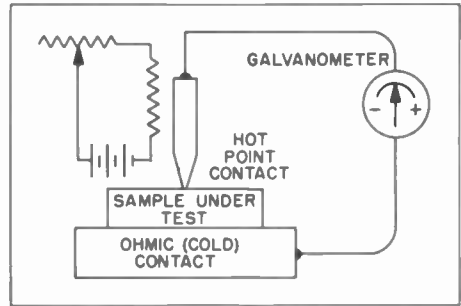

Figure 15. Hot Point Conductivity Test Setup

where:

- V = the voltage between the points
- I = the current flowing through the bar
- A = the cross-sectional area of the bar in cm.²
- L = the separation between points in cm.
- ρ = the resistivity in ohm cm.

The current is kept low enough (less than 0.5 ma. for a typical sample) to obviate the need for correcting for temperature increase.

Mobility

Since transistor action depends upon the presence of minority carriers (holes in n-type germanium, and electrons in p-type germanium) the facility of mo-

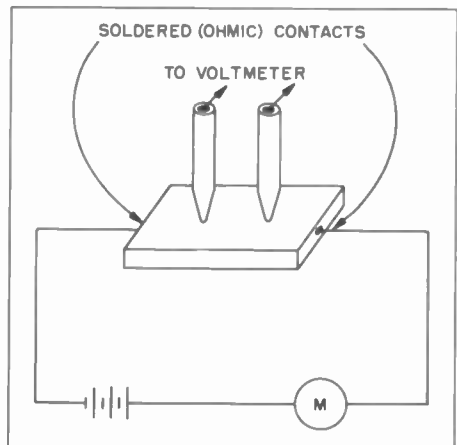

Figure 16. Resistivity Test Setup

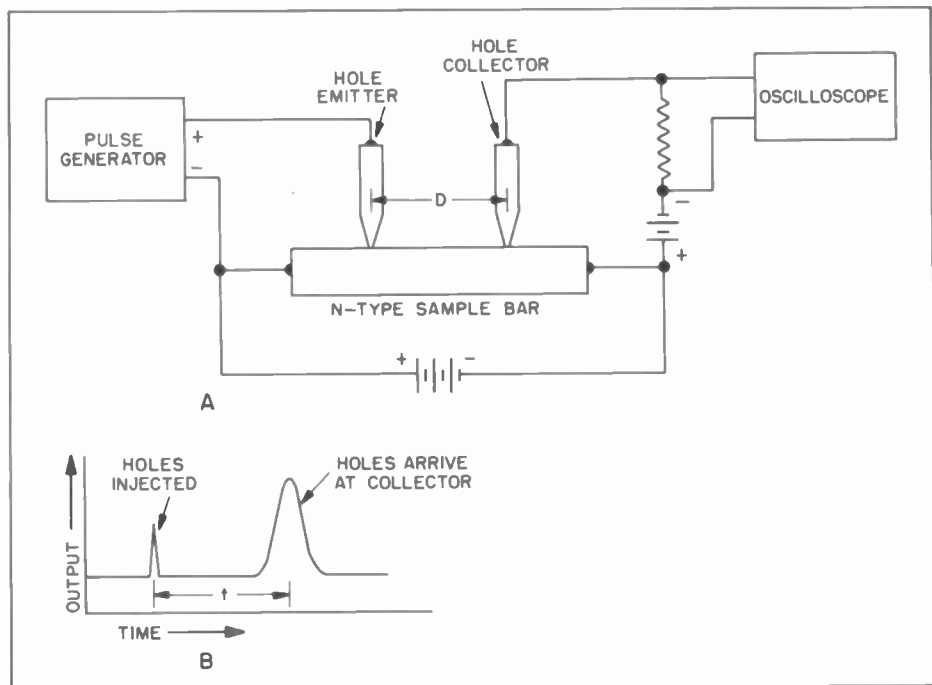

Figure 17. Mobility Test Setup, with Electronic Injection
A. Circuit B. Oscilloscope Display

tion of these carriers is important in determining maximum rate of response of transistors. Mobility is defined as the velocity of the carrier in respect to an applied electric field. The term used is often expressed in units of square centimeters per volt second ($\text{cm}^2/\text{volt}\cdot\text{sec.}$)—a very unlikely looking term which is more understandable when expressed as centimeters per second per volt per centimeter, or $(\text{cm.}/\text{sec.})/(\text{volt}/\text{cm.})$. The first term represents velocity and the second term represents voltage gradient. It can be seen that small mobilities indicate low velocities for a given electric field.

Figure 17A shows a mobility-measuring setup. A sample n-type germanium bar, similar to the one described under *Resistivity*, above, is connected across a battery that produces what is called a sweeping voltage (because it will cause holes to move from left to right in the sample)—if the sweeping voltage were reversed, no holes would arrive at the collector.

The pulse generator produces narrow positive pulses, thereby causing holes to be injected at the emitter. The holes are swept down the bar by voltage E, and they are collected by means of a negative electrode after moving through distance D. Arrival of the holes at the collector will result in a positive current pulse which is displayed upon the oscilloscope as shown in figure 17B. Fortunately, the injection pulse also appears upon the oscilloscope (practically instantaneously) because of the inherent ohmic nature of the circuit—the bar also acts like a conventional resistor, thus providing a voltage divider for transmitting the initial pulse directly to the oscilloscope. Measurement of time T is therefore a measure of the hole transit time. Mobility is found by:

$$\mu = \frac{D}{Et}$$

where:

D = the distance between points in cm.

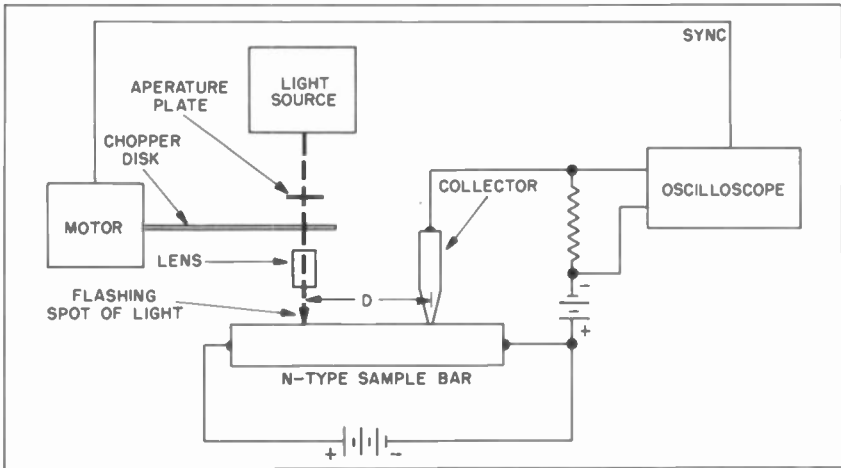

Figure 18. Mobility Test Setup, with Light Injection

E = the voltage gradient in volts per cm. of the sweeping field (divide the applied voltage by the length of the bar)

t = the transit time

μ = the mobility in cm. per sec. per volt per cm.

The mobility of electrons in p-type germanium can be measured using the same setup provided that all potentials are reversed.

Mobility measurement can be obtained by using the setup shown in figure 18: Here, the pulse generator and hole emitter are replaced by a flashing light source. A small spot of light focused upon the germanium bar will excite electrons into higher energy states (one photon will produce an electron-hole combination). The minority carriers will be swept to the collector as before and displayed upon the oscilloscope.

Hole mobility in germanium has been measured at 1700 cm.²/volt sec., and electron mobility at 3600 cm.²/volt sec.

Lifetime

As the minority carriers are swept down the bar, they are continuously recombining with majority carriers be-

cause of electrostatic attraction. Thus, lifetime as compared with mobility will show how far a minority carrier can be expected to travel for a given set of conditions. Furthermore, recombination is enhanced by, and is therefore an indication of, the presence of impurities and crystal-lattice imperfections.

To determine lifetime, the mobility setup is used, but instead of measuring time, a plot is made of the collector-pulse amplitude versus the spacing between the two points. The slope of the curve allows an estimate to be made of the average lifetime of the carriers.

The accuracy of lifetime measurements is dependent upon a constant-current emitter condition. This difficulty is overcome by the use of the photon source as previously described.

INGOT HANDLING

When it has been determined that a particular part of an ingot is suitable for transistor production (the desired material is ordinarily n-type with a resistivity of from 1 to 5 ohm cm.), a number of thin wafers are cut from the ingot in the same manner that the samples were obtained. Each wafer is palladium-plated on one side, mounted upon a glass plate, and cut into small pieces,

Figure 19. Germanium Wafer which Has Been Cut into Transistor Blanks

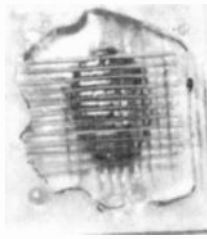

as shown in figure 19. Each of these tiny pieces (0.04" x 0.04" x 0.025") is destined to become the heart of a transistor. Fortunately, they are so small that thousands can often be cut from a single ingot—thus, the painstaking work of producing a large single crystal is amply rewarded.

The methods of fabricating transistors from the single-crystal germanium are many—therefore only the basic types will be discussed here.

POINT-CONTACT-TRANSISTOR FABRICATION

The first successful crystal amplifier was of the point-contact type, later called the type-A transistor. Some modern

units are quite similar to the earlier units but many advances in fabrication techniques have appeared.

Figure 20 shows the various parts used in the assembly of a transistor. The tiny germanium slab is soldered with the plated face toward the brass stud. (The plating facilitates low-temperature soldering and provides a good ohmic contact to the germanium.) The soldering operation is performed in the jig shown in figure 21. A loop of resistance wire coiled around the base stud is heated to a specific temperature by means of a controlled current. This action heats the stud upon which has been placed a tiny piece of solder, an even smaller drop of flux, and the plated germanium—the solder melts and secures the germanium to the stud in a few seconds. The soldered studs are cleaned to remove any traces of soldering flux and are then mounted in a holder, as shown in figure 22, for grinding. After being ground to a smooth flat surface, the crystal face is subjected to an etching and washing schedule to remove foreign particles and to provide a uniform clean surface.

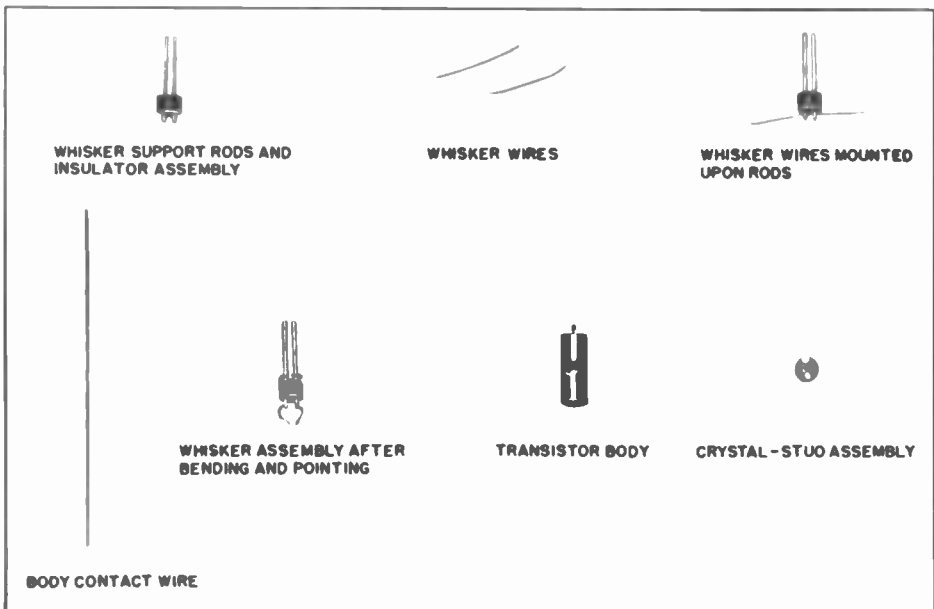

Figure 20. Various Component Parts of a Transistor

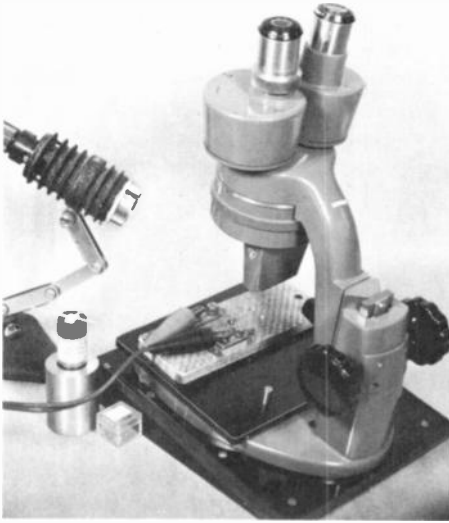

Figure 21. Jig Used for Soldering Germanium Blank to Base Stud

The whisker assembly is made up of an insulator which mounts two whisker-support rods (see figure 23). The whiskers are 3-mil phosphor-bronze wires swaged into the support rods. The whiskers are first bent into shape so that they overlap slightly, then pointing is accomplished by an electrolytic process. A current is passed through the whisker which is dipped into an acid solution. Electrolytic action eats away the point in a few seconds, with the action being controlled so that the whiskers are pointed. The electrolytic action is continued, while being observed under a microscope, until the proper point

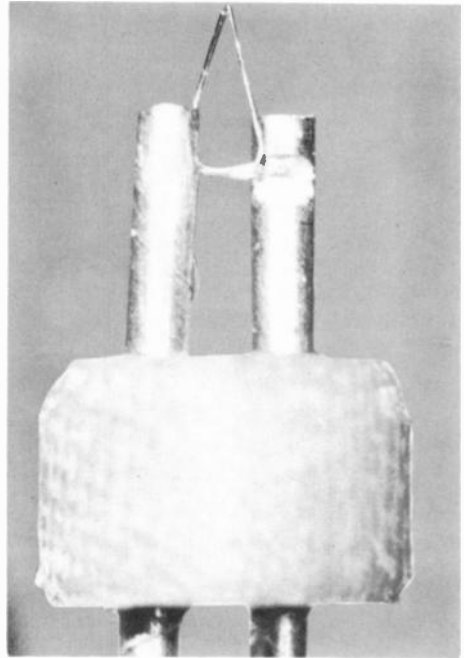

Figure 23. Whisker Assembly, Showing Initial Whisker Formation

spacing (about 2 mils) is obtained. Figure 24 shows the final product, and a closeup of the points is shown in figure 25. The oblique whisker angle is very helpful in preventing short circuits.

The whisker assembly is crimped into one end of the metal body, and the crystal stud, after being properly tapered, is forced into the other end. The assembly is mounted in a calibrated press which forces the stud into the

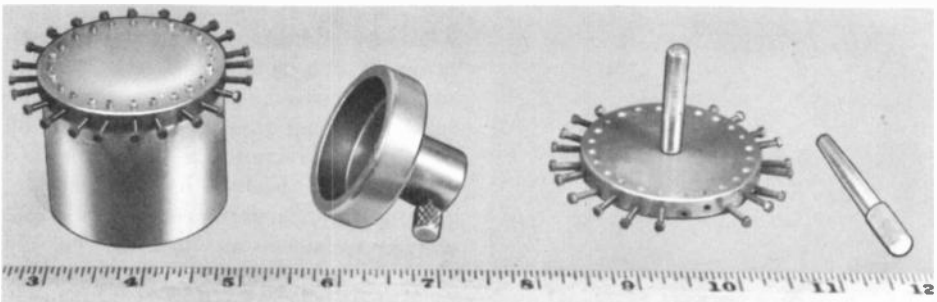

Figure 22. Holder Assembly For Grinding Crystal Face (Assembly at left shows 24 studs secured in Holder for grinding; left center shows weight used to apply proper pressure for grinding operation; right center shows empty holder, and object at right is wrench for operating locking screws.)

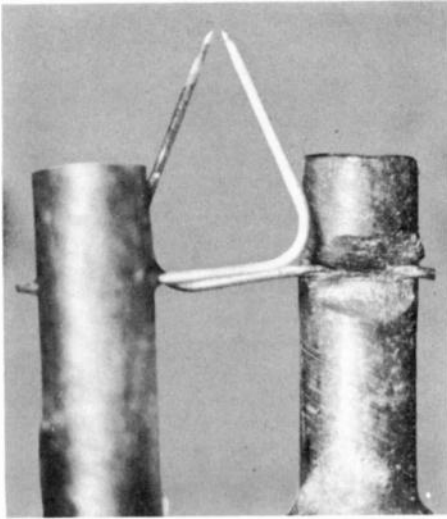

Figure 24. Completed Whisker Points

body until the crystal just touches the whiskers. Then the stud is advanced sufficiently to provide a prescribed deflection of the whiskers—thus, spring action provides the necessary point pressure. The foregoing operation is observed with the assistance of a low-power microscope which “looks” through a small inspection hole in the transistor body. Next, the unit is sealed for protection against moisture and vibration by means of a special wax or cement, and the inspection hole is cov-

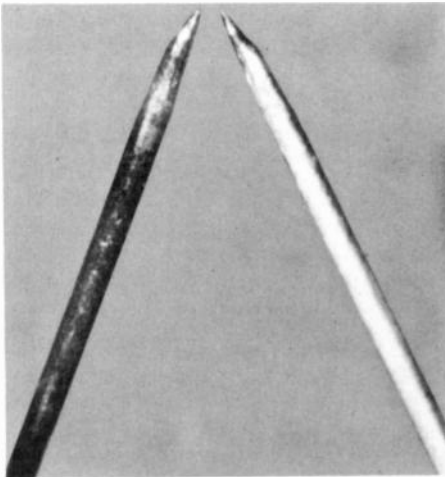

Figure 25. Closeup of Completed Whisker Points



Figure 26. Completed Transistor

ered by an identification label.

The transistor shown in figure 26 is now ready for a series of electrical tests. A wire is spot-welded to the metal body to facilitate soldering into a circuit, but the wire can be removed and the transistor plugged into a special socket. The body material is chosen with two main functions in view. It should have a coefficient of expansion roughly equal to that of the rest of the assembly so that thermal changes will not alter the contact characteristics, and the body should be opaque to light to eliminate photoelectric effects. An incidental feature is found in the shielding action of the body in circuits in which that element is grounded.

After the structure is completed, it is subjected to a “forming” process. Forming consists of passing a relatively large current through the collector whisker for a short period of time. This results in heating of the germanium (and the point) in the vicinity of the contact. In some cases, the whisker is actually welded to the germanium, thus improving mechanical characteristics a great deal. In addition, the electrical properties of the point as a collector are much improved. Forming has been used for some time in the production of diodes. The result is better forward conductivity, higher back resistance, greater stability, greater uniformity, and greater resistance to burnout. Forming does not have too great an effect upon an emitter, but it has been found that if both points are formed, either one works equally well as a collector; such transistors are called *reversible* transistors.

PHILCO TECHREP DIVISION BULLETIN

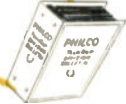

BULLETIN BINDERS NOW AVAILABLE WITHOUT RESERVATION

Since the first wave of orders for binders for the Philco TechRep Division BULLETIN was filled several months ago, we have received many comments regarding the richness and beauty of the materials used in the binders, and their generally pleasing design and construction. Therefore, we are pleased to announce that the number available at Headquarters is now such that we can offer them to all readers without requiring submittal of a reservation card prior to an order, as in the past.

The sketches on this page illustrate the use of the binders, which are of heavy-board construction, and covered with the finest-available, grained, Dupont Fabrikoid, gold-stamped as shown. The method of insertion is of the "wire-through-the centerfold" type, so that no holes need be punched in the magazines prior to insertion, and each binder holds twelve issues.

If you desire one or more of these binders, you may obtain them (postage prepaid) at a cost of \$1.50 each. This price represents the actual cost of the binder to Philco, so its quality is substantially higher than could ordinarily be obtained for this price. Make your check or money order payable to Philco Corporation, and send it to:

Philco Technical Publications Dept.
18th and Courtland Streets
Philadelphia 40, Pennsylvania

Be sure that your name and address are typed or printed clearly on your order, and that you indicate that your request is for the BULLETIN binder. (This is very important, because the above office also handles the sale of Philco Training Manuals and other technical publications.)

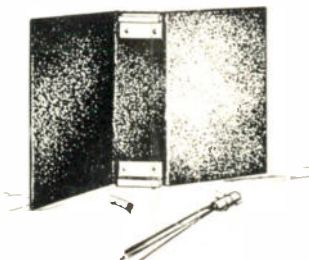
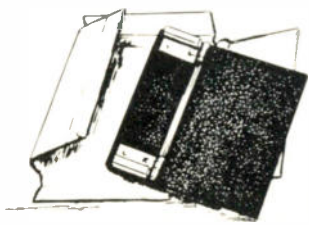
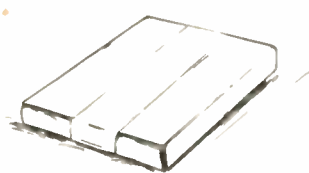

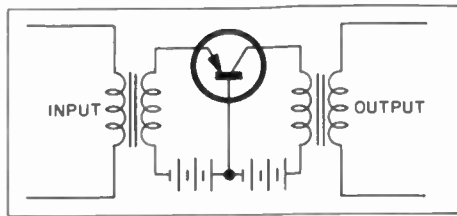

Figure 29. Schematic Diagram of a Transistor Amplifier. Showing Symbol

Figure 29 shows the schematic diagram of a transistor connected as an amplifier. In schematic form, the emitter is identified by an arrow. Transformers are shown, but resistance-capacitance coupling can be used. In general, emitter bias is very low (in the order of tenths of a volt) and collector bias is in the order of volts or tens of volts.

The emitter can modify the flow of collector current by emitting all of the holes directly to the collector—if this were true, the current gain (called alpha, or α) of the unit would be unity. Current gain is defined as the ratio of change in output current to change in input current. In practice, it is found that the emitter can modify the barrier to the extent of producing current gains of much greater than unity. If a current gain of unity is achieved, the voltage gain will correspond to the ratio of output to input impedance. Since the input point is biased in the forward direction (low impedance), and the output point in the reverse direction (high impedance), large voltage gains are readily obtained. The remaining problem is one of impedance matching. (Note that the relative input and output impedance values are in reverse of those found in vacuum-tube amplifiers.)

If p-type germanium were used instead of the pictured n-type, a reversal of conditions would be encountered. The emitter would have to emit electrons (minority carriers) and the collector would have to be biased positively to form a barrier to the positive carriers. To convert the schematic shown in figure

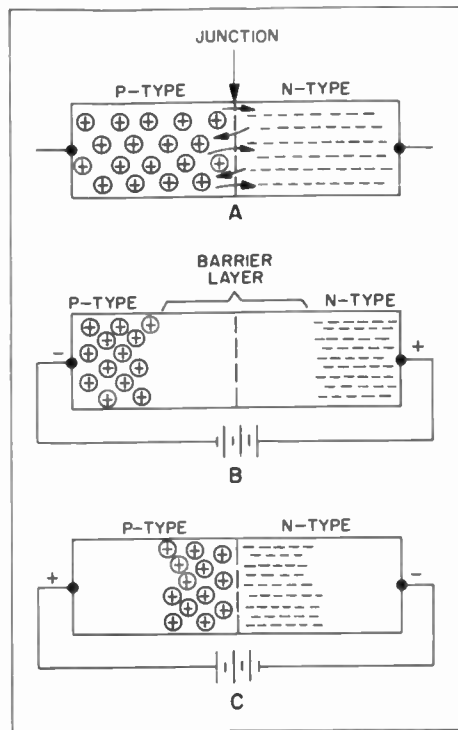

Figure 30. P-N Junction Action
A. Equilibrium
B. Biased to Produce a Barrier
C. Biased to Produce Conduction

29) to one for use with a p-type transistor, merely reverse the two batteries. The two types behave circuit-wise in a generally similar manner, but it is much easier to produce good n-type germanium.

THE P-N JUNCTION

One of the most significant developments in the transistor art has been the application of the p-n junction. As was pointed out in connection with the point-contact transistor, p-n junctions sometimes occur in spite of careful control, and, in that type of unit, are quite undesirable.

Assume a single-crystal germanium bar in which one half has donor impurities and the other half has acceptor impurities. Good ohmic contacts have been secured to each end of the bar. Figure 30A shows the bar in a state of

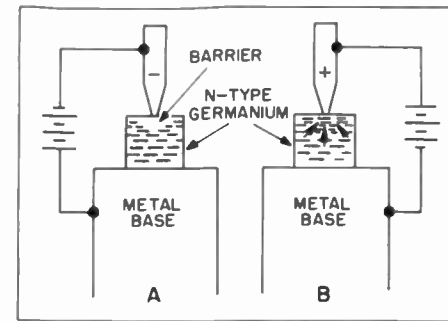

Figure 27. Bias Action of Point Contact
A. Bias Action Resulting in a Barrier
B. Bias Action Resulting in Conduction

A number of theories have been advanced to explain forming but it appears that the electrical properties are due to conversion, by thermal means, of some of the n-type material near the contact to p-type material. The result is a small p-n junction (junctions will be described in a later section).

Forming is accomplished in a variety of specific methods. One surge of current is often used, or a series of pulses can be used. In some cases, alternating current is used. Each method has its own peculiar advantages and faults, but, since most forming schedules are part of an assembly program, they will not be covered in detail here.

THEORY OF POINT-CONTACT OPERATION

Before launching into transistor operation, the action of a rectifying contact will be examined. Figure 27 shows a closeup of a point contact resting upon a sample of n-type germanium. In figure 27A, the contact is biased negatively and the negative carriers are repelled away from the contact, leaving the germanium without carriers. This carrier-free space is called the barrier because it is a very poor conductor. As the negative voltage is made larger, a point is reached where the electrostatic force disrupts the barrier. Transistor

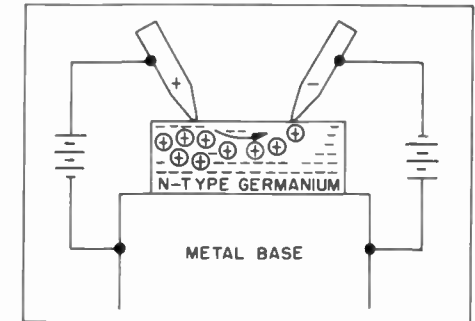

Figure 28. Action of Two Points Contacts Biased in Opposite Directions
operation is kept below the point of barrier breakdown.

Figure 27B shows the effect of a positive voltage on the point. The negative carriers are attracted to the point and the barrier vanishes. Conduction in this direction is limited only by the ohmic qualities of the circuit. Thus, the fact that better conduction occurs in one direction is easily seen, and the reason for rectification becomes obvious. However, there is an important point to be made. The positive point could be considered to be injecting holes into the germanium—the negative carriers then rush up to fill these holes which surround the positive point. In other words, the holes are injected by the point, after which they diffuse in the direction of the base (negative) terminal.

Now consider the action of both points together as shown in figure 28. It can be seen that some of the holes from the positive point diffuse into the barrier layer around the negative point. In fact, the negative point will attract the holes which then act as carriers in the barrier layer. This action then modifies the current flowing to the negative point. Since the positive point emits the holes, it is called the emitter, while the negative point is called the collector. It can be seen that since holes in n-type germanium are the minority carriers, element nomenclature is based upon the minority carriers.

(Continued on page 24)

equilibrium. The carriers migrate across the junction and neutralize each other in exact proportion to the number of electron-hole combinations produced by thermal activity. Of course no net flow takes place.

Figure 30B shows the bar connected to a battery. The applied polarity is such that the majority carriers retreat away from the junction—a barrier is thus created and the only current flow would be that made possible by minority carriers. In figure 30C, the battery is reversed, the carriers crowd up to the junction, and the rate of electron-hole combinations is greatly increased. The barrier almost vanishes, and conduction in this direction is excellent.

The natural p-n junction is too unpredictable to be of use in production, so several methods of deliberately growing them have been developed. One method used for pulled crystals utilizes a multi-chamber crucible. Each chamber contains a different impurity (for a single p-n junction, only two chambers would be used). The crystal is started from one chamber, but after a suitable growth interval the crucible is rotated so that the crystal continues growing from the second chamber. A large number of junctions in a single crystal can be grown in this manner. The thickness of a layer can be controlled by the time of growth from a particular chamber.

A second way of making junctions consists of a fusion process. In one case, a small button of indium is fused to an n-type germanium slab. Some of the indium atoms enter the germanium lattice in the form of acceptor impurities. This means that the germanium adjacent to the indium has become p-type and a junction is formed. The fusion process results in a strong bond between the two metals. Terminals are soldered to the two metals, and a mechanically rugged p-n junction is produced.

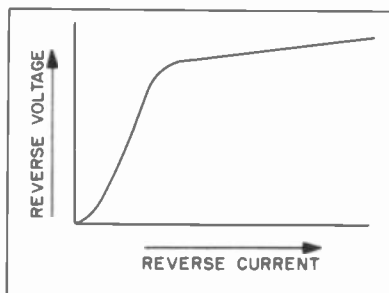

Figure 31. Plot of Reverse Current versus Reverse Voltage for a P-N Junction Diode, Showing Zenner Effect

JUNCTION DIODES

A number of commercial junction diodes have been produced, and they display very remarkable characteristics. For example, the BTL M-1754 (Bell Telephone Laboratories) junction diode has a forward resistance of less than 40 ohms at one volt, with a back resistance of more than 50 megohms at 25 volts. The maximum reverse voltage is 75 volts. The diameter is 0.09" and the length is only 0.175". A commercial power rectifier shows less than 0.4-ohm forward resistance, with a back resistance of over 400,000 ohms at 500 volts.

Since the back current is determined by the presence of minority carriers, temperature is rather critical for these diodes. The maximum temperature ratings are in the 50- to 80-degree C. region.

Another limiting factor is the junction capacitance. Even though the units have a small cross-sectional area, the barrier is so thin that relatively large capacitance is present. This limits these diodes to a maximum operating frequency of about 1 mc.

Some junction diodes display a very interesting characteristic called the Zenner effect. Figure 31 shows a plot of reverse voltage against reverse current. The curve rises in a regular fashion until the Zenner voltage is reached, whereupon the current rises abruptly.

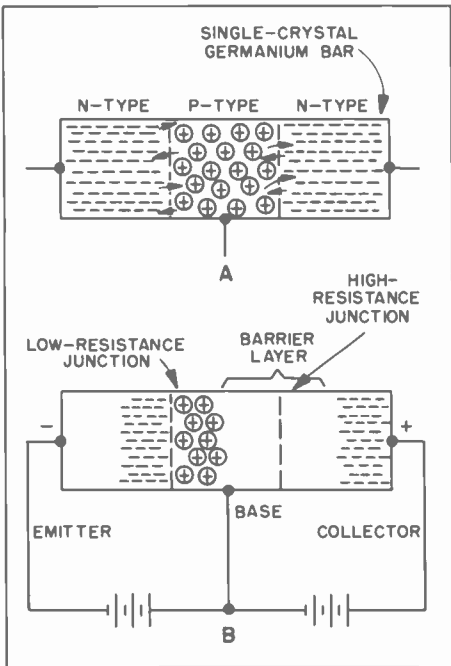

Figure 32. Junction Transistor, Showing Effect of Bias on Carriers

This is thought to be due to production of electron-hole combinations within the barrier by the action of the electrostatic stress forcing electrons into higher energy states. This appears reasonable because the Zenner voltage is not a function of temperature. This characteristic makes it possible to use a junction diode as a voltage regulator much in the same manner as a VR tube—in fact, the regulation is almost as good as that obtained with the VR-105. Zenner voltages have been found to range from a few volts up to many hundreds of volts. In germanium, the crystal orientation about the plane of the barrier has a decided effect on the Zenner voltage, but all of the determining factors are not yet known.

JUNCTION TRANSISTORS

Figure 32A shows a single-crystal germanium bar with two junctions. Good ohmic contact is made to each of the three sections. This device is known as the n-p-n type junction transistor. In

an actual unit, the middle (p-type) layer is extremely thin (in the order of mils). As in the diode case, there is a continual combination of carriers across the junctions, compensated for by the stabilizing effect of thermal carrier production. When batteries are connected as shown in figure 32B, the carriers are repelled away from the right-hand junction, thus forming a barrier, whereas the carriers are pushed into the left-hand junction and conduction results. It can be seen that electrons are being injected into the p-type layer from the left—these electrons diffuse through the thin center layer directly into the barrier layer. The presence of electrons in the barrier causes an increase of conduction in the right-hand junction. In effect, we can see that two diodes are present—one conducting and one biased in reverse. The current flowing in the conducting section modifies the current flowing in the other section in such a manner that voltage gain can result. The junction transistor operates in a manner somewhat similar to the point-contact transistor, with the center portion acting as the base material and the two junctions acting in place of the rectifying point contacts. However, unlike the point-contact transistor, this type has a maximum current gain of unity. This does not prove a limitation, because the diode action of the junction is greatly superior to that obtained with point contacts. (As was pointed out before, voltage gain is a function of the ratio of output impedance to input impedance—the efficient junction action makes this factor very large.) The unit shown is an n-p-n transistor but a p-n-p structure could be utilized provided that all battery connections were reversed.

The limiting factor of unity current gain has been overcome by using a junction structure as shown in figure 33. Here, three junctions are used, resulting in an n-p-n-p type of structure. The addition of the third junction has the effect

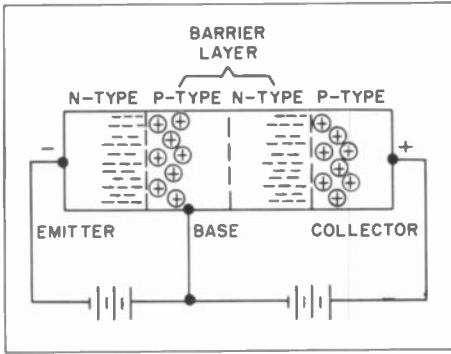

Figure 33. N-P-N Junction Transistor

of enhancing the flow of electrons that diffuse into the barrier; the diffusion of holes from the right-hand, p-type layer in the reverse direction attracts more electrons into the barrier region.

Figure 34 shows the structure of a fused-junction transistor. Two indium buttons are fused to the opposite faces of a single-crystal slab of n-type germanium; the indium alloys with the germanium, thus producing a strong mechanical bond. Some of the indium enters into the lattice structure of the germanium crystal where it becomes a p-type impurity. Thus, the structure acts as a p-n-p type junction transistor. A metal tab is soldered to the base of the assembly to act as a supporting contact, and two fine wires are soldered to the indium buttons. The assembly is then potted in a thermosetting plastic. Figure 35 shows a typical completed unit (the exterior is painted black to eliminate photoelectric effects). This structure gives great promise because it is mechanically rugged, small, and fairly easy to fabricate.

PHOTO TRANSISTORS

Germanium is an excellent photoelectric material because the energy required to produce electron-hole combinations within it is roughly equal to the energy contained in a photon of light in the visible portion of the spectrum. Both photovoltaic and photocon-

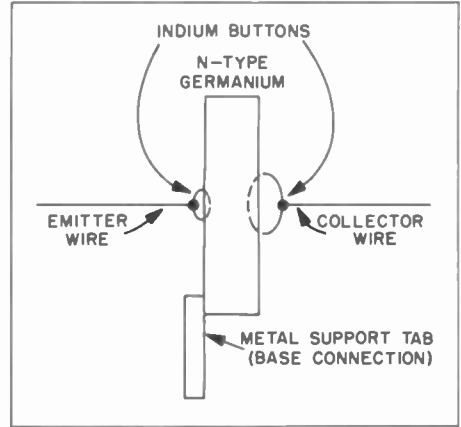

Figure 34. Fused-Junction Transistor

ductive effects can be obtained. The latter effect is utilized in many ways, one of which was discussed above, under the heading of *MEASUREMENTS (Carrier Mobility and Life)*. In amplifier-type transistors, the photoelectric effect is very undesirable, and the case must be made opaque to light to prevent changes in the operating point.

The best photoelectric response is obtained by biasing a germanium diode in the reverse direction, the light input then modifies the barrier layer, thereby varying the reverse conductivity. This effect is caused by the production of electrons and holes within the barrier as a result of photon absorption. The photoelectric efficiency can be made to approach 100% very closely because the electron-hole production is localized at the point of photon absorption rather than throughout the entire crystal.

Figure 36 shows a sketch of a devel-



Figure 35. Completely Assembled Fused-Junction Transistor

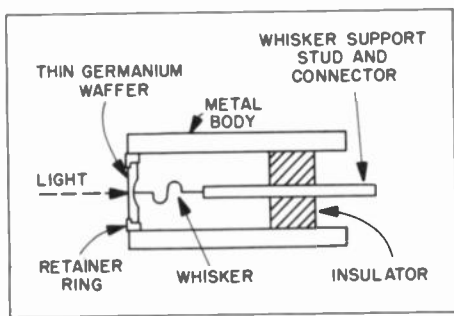

Figure 36. Point-Contact Photo Diode

perimental point-contact photo diode. Light shining on the outside of the thin germanium (single-crystal) wafer effectively modifies the barrier initially formed by imposing a reverse bias on the point contact. The width of the light-sensitive area is found to be less than 0.01 cm., resulting in very good resolution. Sensitivity is quite good, being about 0.07 ma. per millilumen. Response to fluctuating light values is also good—flat response to 200 kc. is common.

The p-n junction diode is also excellent in terms of photo response. Light shining upon the junction (barrier) of a reverse-biased diode will cause large changes in the back resistance. Because of its inherently large back resistance, this type of photo diode must work into a large load resistance. A typical example is the BTL M-1740. With a 135-volt supply and a one-megohm load, the dark current is less than 20 μ a. at 20° C. Five millilumens focused on the junction will result in about 135 μ a. of current (a ratio of almost seven to one). This photo diode measures 0.02" x 0.04" x 0.125" and provides a high degree of resolution. Of course, the dark current is a strong function of temperature—80° C. is the maximum permitted value. The maximum frequency of response to fluctuating light is only about 25 kc. because of the large value of load resistance and the relatively large value of shunt capacitance of junction diodes.

Even greater photo sensitivity can be

obtained by using the current-multiplying action of a second p-n junction (this action was shown in connection with the n-p-n-p transistor).

FREQUENCY RESPONSE

One of the most serious limitations encountered in transistor development has been the limited maximum frequencies obtained. In order to overcome this obstacle, a large number of studies have been instituted. The result was a ten-fold increase in maximum frequency over the period of September, 1949 to January, 1952.

The reasons for this poor frequency response is made up of two main factors—shunt capacitance and transit time. In the case of the point-contact transistor, shunt capacitance is so small that its effect can be ignored (typical point-contact capacitance values are often less than 1 μ f.). Since it takes a finite time for the minority carriers injected at the emitter to diffuse into the barrier layer, it follows that changes in emitter current must be slow enough to permit successive changes to act upon the barrier. Mobility measurements indicate how rapidly the carriers can move under certain conditions, and will establish the maximum theoretical frequency limits. Thus, it is necessary to work with controllable factors to improve frequency response. Obviously, the less the point separation the less the transit time, but here a limitation is imposed by the increasing likelihood of shorts. The present spacing values are about the best that can be obtained with available mechanical techniques, and not much improvement can be expected in this direction.

Since electrons have greater mobility than holes, it is reasonable to assume that p-type transistors would have a greater maximum frequency than n-type transistors because electrons are the minority carriers in p-type germanium.

Experimental evidence verifies this assumption.

In practice it has been found that predicted maximum frequency values are difficult to achieve. The actual carrier path is not always directly from emitter to collector but is somewhat greater because the carriers wander in a random manner during transit (typical of any diffusion process). This means that the actual average path is much greater than a straight line between the two elements.

Another cause of increased transit time is the presence of crystal lattice defects (sometimes called traps). Since the electron propagates as a wave, the crystal lattice can be considered to be a transmission line. Lattice imperfections act like discontinuities in the transmission medium and the wave is reflected. To the electron (or hole) this is equivalent to altered direction of motion. The greater the number of discontinuities (or imperfections) or the greater their magnitude, the greater will be the scattering action and the transit time becomes longer. The action is equivalent to hypothetical traps grabbing the carrier and holding it for a time, then releasing it. This concept can be verified by measuring mobility before and after bombarding the crystal with nuclear particles. Mobility can be decreased in this manner, apparently because of lattice disorders resulting from impacts. Growing and maintaining perfect crystals would be the answer to this problem.

Junction transistors display transit-time effects, but shunt capacitance is their limiting factor. In practice, it is the capacitance of the collector junction that becomes the limiting parameter. Unfortunately, this capacitance cannot be tuned out (as it is in a tuned vacuum-tube amplifier) because a series-resistance (the equivalent internal resistance of the transistor) prevents physical iso-

lation of the capacitance. The effect is something like that found in an electrolytic capacitor at high frequencies.

The value of any capacitor is determined by plate area, plate separation, and dielectric constant. In a junction, the area can be made small but the dielectric constant is inherently high (about 16), and the separation, as determined by the barrier thickness, is very small (in the order of 10^{-6} cm.). The net result is extremely large capacitance values, even for small areas. Furthermore, any conditions such as applied voltages and signals which alter the barrier will also alter this effective shunt capacitance.

POWER CAPABILITIES

Power-handling capabilities of point-contact transistors leave much to be desired. The delicate point can easily be damaged by the application of excessive currents. Improved heat-dissipation features can be applied but power ratings above about 600 mw. do not appear feasible. Junction transistors have been constructed with 2-watt ratings by using large blocks of germanium; however, this results in reduced frequency ratings, and is at best a compromise. Of course a 2-watt unit is adequate for the output stage of a home radio.

SPECIAL TYPES

All of the transistors described have been either diodes or triodes. Tetrode structures have been produced to take advantage of some of the special properties available. Point-contact tetrodes contain a second emitter point located near the two conventional points. If two signals of different frequencies are applied to the two emitters, the collector current will be modified by the heterodyne frequencies as well as the original frequencies. Thus, a very simple mixer structure is available. For this type of service, the two input frequencies can

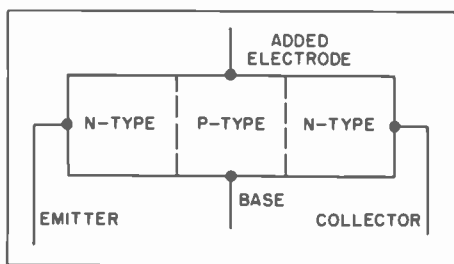

Figure 37. Junction-Tetrode Transistor

be well above the cutoff frequency of the transistor—provided that the difference frequency is within the response limit of the transistor, useful conversion gain is possible. This effect is understandable when it is considered that crystal rectifiers do not require a time interval for diffusion between two contact points. Each input point acts as a rectifier and the beat frequency thereby produced is amplified by the barrier-modification action as described. Converters, operating with input frequencies of hundreds of megacycles have shown conversion transconductances in the order of 500 μmhos .

A junction tetrode has been constructed as shown in figure 37. If the added electrode is connected to a negative voltage, the transistor action will be confined to the lower portion of the base (the minority carriers will be repelled away from the top). Thus, the effective junction area is reduced, and the diffusion path is made shorter. The

effect is extended frequency response—these units can operate at about 10 times the frequency of comparable triode structures.

The fieldistor is another crystal amplifier worthy of mention. In this device the emitter point (or junction) is replaced with an electrode held away from the semiconductor surface by a very thin dielectric. Amplifying action takes place by the effect of electrostatic stress (produced by the emitter) modifying a conventional barrier. (Consider the Zenner effect described under junction diodes.) This device has the advantage of very high input resistance as contrasted with the low transistor input resistance. However, the fieldistor has been more useful as a research tool than as a practical device.

CONCLUSION

The transistor has proved itself worthy of intensive development which has resulted in a considerable increase in our knowledge of the physics of solids. It has already found applications where size, ruggedness, low power consumption, and long life are desirable, and it is expected to displace the vacuum tube in a great many functions. The major problem at present is the mass production of units with consistent characteristics, but while this problem is a very complex one, it is well on the way to being solved.



CIRCUITRY "PACKAGES" FOR ELECTRONIC COMPUTERS

An improved "building block" for the rapid, trouble-free assembly of a wide variety of electronic computer systems.

(Editor's Note: The information contained in this article was obtained from the National Bureau of Standards, U. S. Dep't. of Commerce, and appears here through the courtesy of that agency.)

MODERN ELECTRONIC COMPUTERS, like other highly complex electronic equipment, must have provisions for rapid testing and replacement of components if a high percentage of satisfactory operating time is to be attained. An electronic computer generally contains tens of thousands of components—vacuum tubes, germanium diodes, and other parts—and hundreds of thousands of soldered connections. Even momentary failure of a single component or connection may cause misperformance, and tie up hundreds of thousands of dollars worth of equipment. However high the quality of components and workmanship, failures will occur at intervals, and the practical value of a complicated and costly computer may well depend in large measure on the speed with which troubles can be located and corrected.

The National Bureau of Standards has recently developed an improved system of standardized plug-in circuitry "packages" for use in the construction of electronic computers. These rapidly replaceable units, if adopted by manufacturers, promise to combine reduced manufacture and repair cost with improved computer reliability. By the proper interconnection of a sufficient number of the new NBS units, most of the circuitry of large and complex computers can be constructed. The NBS system is an extension of similar improvements under development by industry.

CONSTRUCTION DETAILS

Developed in the NBS electronic-computers laboratory, the new circuit packages are being incorporated in an advanced computer (designed for special experimental requirements of the Department of Defense) now under construction at the Bureau. Each unit has a large number of connections brought out to connector pins, making possible the utilization of the unit in many different ways. A test jack at the top of each package helps locate defective units, and as soon as a trouble-causing package is located, a trouble-free one can be inserted in its place.

A distinctive feature of NBS computer design, both past and present, is the general similarity of most of the circuit stages. Although many hundreds of stages are required, a single basic tube circuit, with minor modifications, is adapted to the great majority of requirements. Thus, in the Bureau's SEAC (National Bureau of Standards Eastern Automatic Computer, in successful productive operation since June, 1950) as well as in the new computer, the same basic circuit serves as a low-impedance pulse driver, as a flip-flop multivibrator, and for a number of gating functions. This general circuit uniformity invites the use of mass-produced circuit packages.

The basic NBS packages, shown in figures 1 and 2, consist of an amplifier



Figure 1. Plugging One of New NBS "Packages" into Electronic Computer Rack at National Bureau of Standards

tube, a pulse transformer, and a number of germanium diodes. The total number of diodes required per package may be as high as 38 (some are in parallel), most of them for signal input. For economy, since not all prospective applications will require so many diodes, four slightly altered versions of the NBS unit are provided, embodying different numbers of diodes. Differences between the four versions are so minor that they do not interfere with mass production. The NBS packages are already being produced for the Bureau by a private manufacturer.

A second type of package (not shown), identical in size to that containing the tube and diodes, houses delay lines for interconnection between stages. Both types are designed for ruggedness, mass production, and quick testing and servicing by easily trained personnel. Etched circuitry and dip-soldering help make construction simple and foolproof.

Sufficient heat is dissipated in each

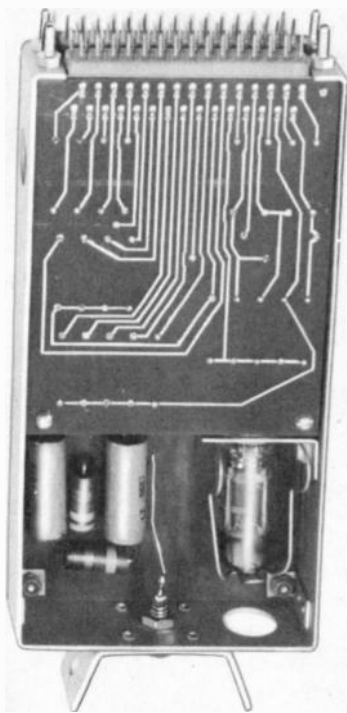

Figure 2. External View of Basic NBS Circuitry Package (Etched circuitry and dip-soldering facilitate economical and error-free mass production. Most of the components have separate connections brought out to the connector pins, thus providing easy checking of components and flexibility in external interconnection.)

of the compact packages to make forced-air cooling desirable, particularly since the packages are mounted close together in large numbers. In the new computer, air from suitably located ducts in the sides of the racks is forced into a hole in the side of each package. Entering air flows first over the temperature-sensitive germanium diodes, then over the heat-producing tube and resistors, and finally out through a hole in the end of the package.

APPLICATIONS AND TEST FEATURES

The packages measure approximately

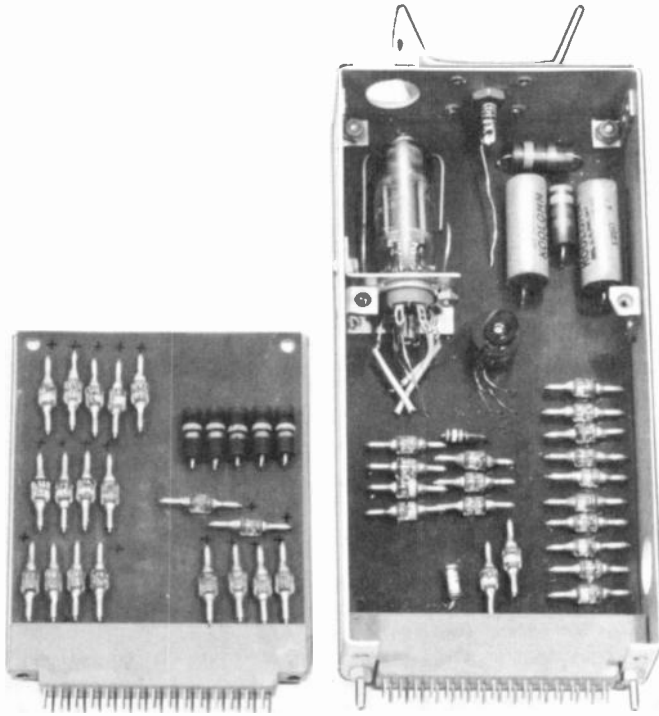

Figure 3. Partly Disassembled View of Unit in Figure 2, Showing Tube, Capacitors, Resistors, and Large Number of Germanium Diodes (For economy, several variations are provided, differing only in the number of diodes. A second type of plug-in package houses delay lines required for connection between certain computer stages.)

1 inch high by $3\frac{1}{2}$ inches wide by 7 inches deep. Plans for the new NBS computer call for some 800 packages, plugged into 10 chassis holding 80 packages each. The chassis will be mounted on racks measuring about 7 feet high by 3 feet wide (see figure 3). Each rack holds four chassis. A handle at the end of each package facilitates insertion and withdrawal, and heavy guide pins assure correct insertion and at the same time protect the 60 connector pins from accidental damage in handling. Many of the components in the package are connected to separate pins and have no connection with other components when the package is unplugged. This has two advantages: it permits flexibility in ex-

ternal connection, and also permits testing the unplugged package for faulty components without improvised circuit paths. The test jack at the top of each unit permits easy checking of output signals by means of an oscilloscope.

Defective components within individual packages are quickly located with a special test unit. The package is plugged into the test equipment and a selector switch is rotated to obtain quick checks on the condition of each component. Trouble-free packages are similarly tested periodically as a routine preventive-maintenance measure; components whose characteristics have drifted beyond acceptable tolerances are replaced.

These rapid test procedures, requiring specialized test equipment, are uniquely applicable to the standardized-package system.

A type-6AN5 miniature beam-power tetrode is used for the transformer-coupled pulse amplifier that is the heart of each of the NBS circuitry packages. The transformer has a 10-to-1 turns ratio, giving an extremely low output impedance—less than 100 ohms. This results in a high degree of freedom from

noise pickup and permits the use of long signal leads.

The standardized NBS plug-in packages will provide for about 90 percent of total circuitry requirements, exclusive of memory units, in the Bureau's new computer. The packaged-circuitry approach is expected to lead to computers that are less expensive in construction, more reliable in operation, and simpler in maintenance. This should result in lower total cost per useful computation.

TELEPHONE HANDSET INTERCOM SYSTEM

by David T. Armstrong

Construction details for a useful two-station intercom (with signalling provisions) which can be built from readily available components.

(Editor's Note: All rights to this article have been reserved by the author; therefore, no portion of it may be extracted, reprinted, or reproduced in any form, without written permission of the publisher.)

A VERY useful, private intercom system may be arranged quite simply by utilizing two TS-13 handsets; these are showing up in surplus again and are

likely to be available for some time. The handset circuit is shown in figure 1. A pair of these can be connected into a system wired as indicated in figure 2.

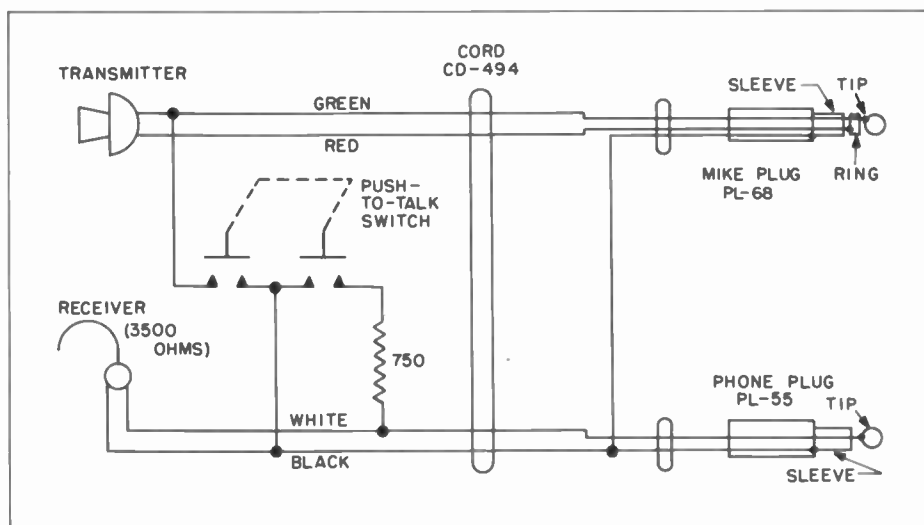

Figure 1. Schematic Diagram of Handset TS-13

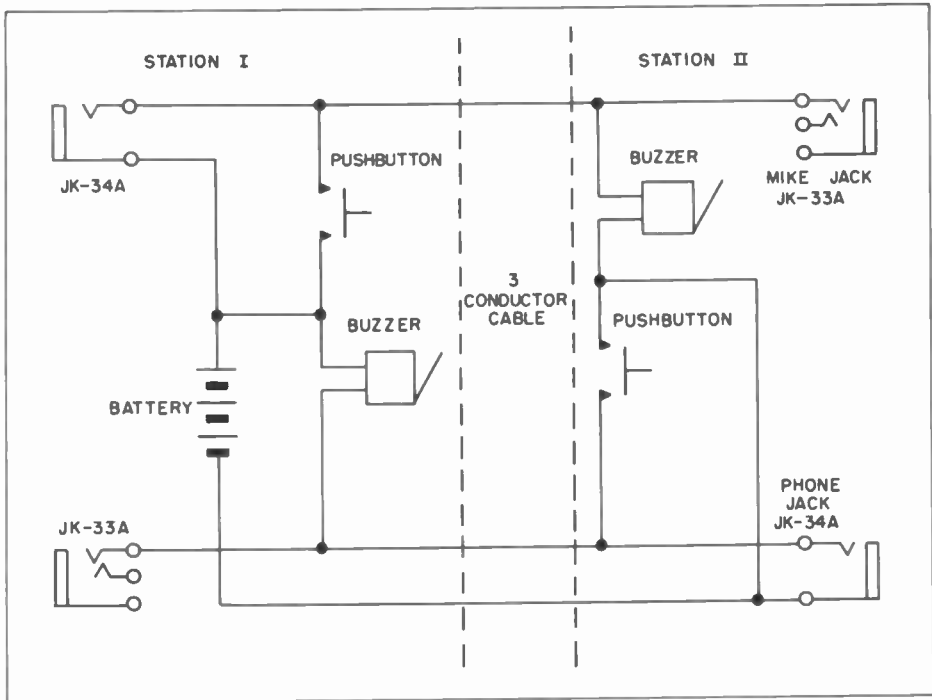

Figure 2. Schematic Diagram of Intercom Circuit for Use with TS-13

Other more complicated arrangements are possible, but, in the model developed, it was desired to utilize low-voltage three-wire cable of the type used to connect heating-system thermostats to the motor relay.

The handsets are equipped with PL-68 and PL-55 plugs, which require JK-33A and JK-34A jacks, respectively.

In this circuit, both tip and sleeve (to use telephone terminology) of the JK-34A jacks are used, with the battery in the sleeve ends. Only the ring connection is used on the JK-33A jacks. Figure 3 shows the complete schematic of the intercom circuit. The buzzer system is superimposed upon the basic telephone circuit in such a way that two stations are possible. The pushbutton in

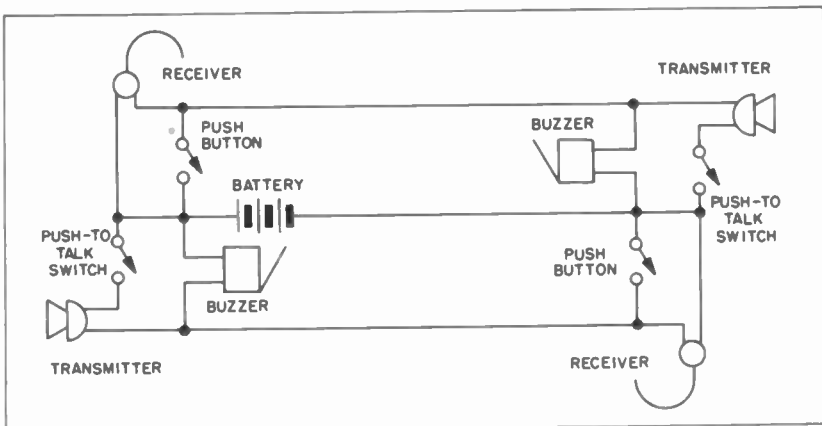

Figure 3. Complete Schematic Diagram of Intercom Circuit

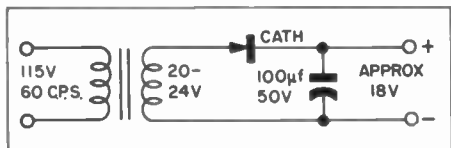

Figure 4. Alternate Power Supply for Intercom Circuit

station 1 operates the buzzer in station 2; similarly, the pushbutton in station 2 operates the buzzer of station 1. Sounding of the buzzer is the signal to the individual at the other end to operate the press-to-talk switch on his TS-13 handset.

The intercom system built by the author has been operating successfully for a year with two, number-six (1.5-volt) dry cells. For convenience, the entire assembly was enclosed in a metal, duplex-receptacle box and mounted permanently in the wall as an electrical outlet would be. The cover of the box was drilled for three holes: one for the pushbutton, and one each for the two jacks. The buzzer was fastened to the

base of the metal receptacle box. This was a permanent installation between kitchen and cellar, since with the workroom and play room in the cellar, much time is spent there. However, such a system has a great many other applications. For example, many military electronics installations require two-way communications between isolated points, such as between a control tower and a power shelter.

Talking volume may be increased by using more dry cells, or by use of the rectifier circuit shown in figure 4. This circuit utilizes a typical gas-heating-system (or door-chime) transformer which supplies 20 to 24 volts a.c. at the secondary. Feeding this through a selenium rectifier with an electrolytic capacitor, as shown, provides approximately 18 volts d.c. Normal telephone voltage is 24 volts d.c. A 22.5-volt radio battery will do very well and will last for quite a long time. Of course, when designing the system it is important that the buzzer be chosen for the voltage being used.

What's Your Answer?

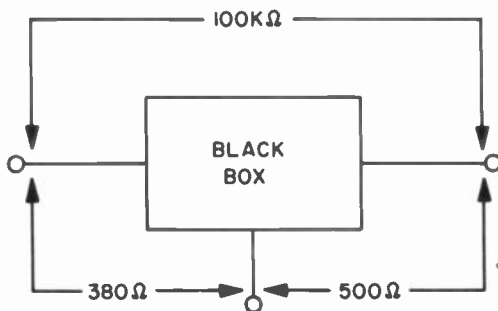

This month's problem involves the classical "black box." However, this black box has three leads connected to it. A conventional resistancal meter (in this case the Philco 7005) was used to measure the resistances involved, and the values obtained are shown in the drawing. We know that the box contains no voltage sources.

What is in the box?

(Solution next month)

LOW-VOLTAGE OPERATION OF THE PE-215A

By Warren Moser
Philco Field Engineer

Modification to carbon-stack voltage regulator of PE-215A to obtain regulation at 208 volts.

SINCE THE PE-215A ALTERNATOR is made for 240-volt operation, the voltage regulator which is supplied as part of the power panel has been designed to function at or about this setting. The range of voltage over which this regulator will operate is approximately from 220 to 260 volts, and this variation is possible through the use of the 0-40-

ohm variable rheostat (see figure) in the regulator-coil circuit and the sliding weight on the coil-armature horizontal-link bar. To obtain alternator potentials of lower values, the exciter field rheostat must be cut in; however, no automatic regulation is afforded when the unit is operated in this manner. The voltage requirement at all A. C. & W. sites is 208

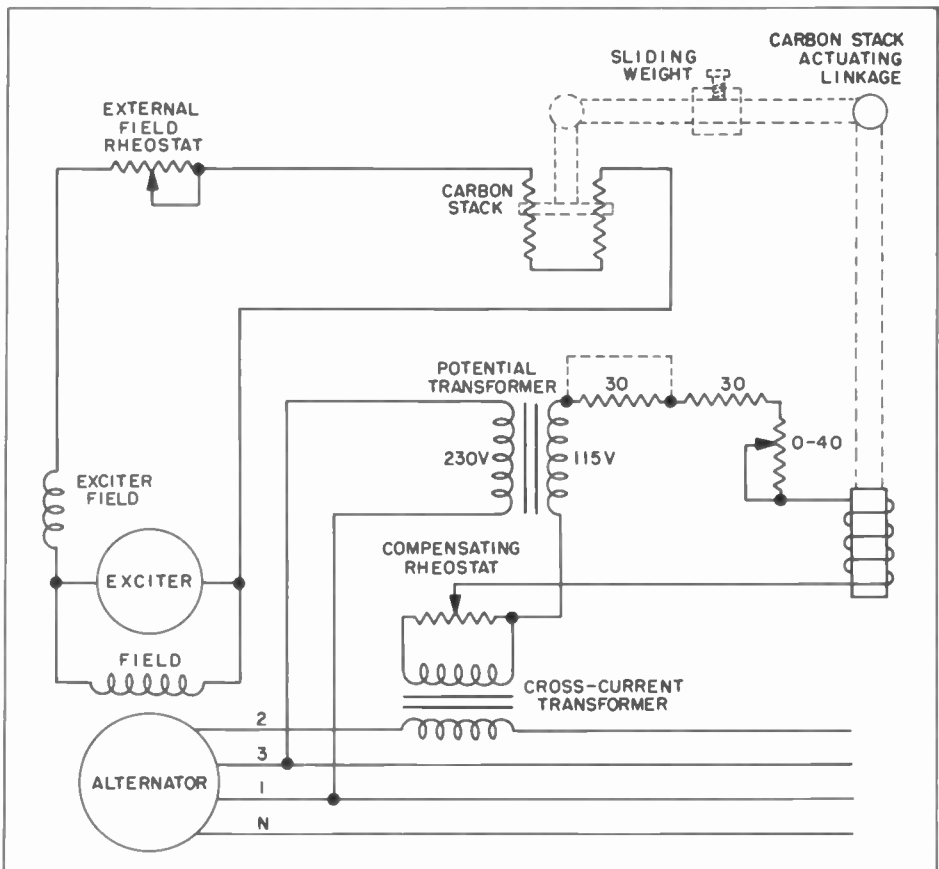

Schematic Diagram of Voltage-Regulator Circuit of PE-215A

volts, and since this is considerably lower than that made possible by the proper use of the voltage regulator, the sites having PE-215A power units are being handicapped by the lack of automatic voltage regulation. This is particularly disturbing where the radar and communications equipment obtain power from the same source as the station utilities. The starting and stopping of electric utility motors results in large fluctuations of generator voltage which is detrimental to both the operation and the condition of the aforementioned electronic devices.

In normal operation, the exciter field rheostat is maintained in the "all-out" position. This rheostat is connected in series with the variable-resistance carbon pile; thus, the exciter output is controlled solely by the field resistance interposed by the carbon-stack resistor. The resistance of the stack is determined by the position of the regulator-coil armature which operates a mechanical linkage. The power supply for the regulator coil is a 2-to-1 ratio potential transformer, whose primary winding is connected between phases 1 and 3 of the alternator. In series with the regulator coil are two 30-ohm fixed resistors and one 0—40-ohm variable rheostat. By changing the resistance in the regulator-coil circuit with the variable rheostat, and by adjusting the sliding weight on the coil-armature link bar, the alternator voltage for which the regulator will operate can be varied from 220 to 260 volts. To lower the alternator voltage, the resistance is decreased, and vice versa.

With the variable rheostat in the all-out position, the exciter field rheostat must be cut approximately half way in to lower the alternator voltage from 220

to 208 volts. Since the voltage in the regulator-coil circuit is thus reduced without the removal of additional resistance, the current in the coil is rendered incapable of producing enough flux to lift the armature, and the armature drops from the coil, thereby removing all resistance from the carbon stack. The only resistance remaining in the exciter field is that afforded by the hand-controlled field rheostat. Since the coil armature will no longer operate to vary the resistance of the carbon pile, the automatic-regulation feature is entirely lost.

To permit the voltage regulator to operate in a lower voltage range, additional resistance must be removed from the regulator-coil circuit. This is readily possible by removing one of the 30-ohm fixed resistors from the coil circuit. The resistors are normally connected together at the bottom, so it is only necessary to change the top lead from one resistor to the bottom terminal of the other resistor, or to place a jumper across one resistor. With the link-bar weight in a central position, the range of voltage thus made possible with the variable rheostat in the coil circuit is approximately 190 to 230 volts. Should it be necessary at a later date to use the alternator and power panel for the designated 240-volt output, the 30-ohm resistor can easily be put back into the circuit to make this possible.

In the event that the original settings of the vertical link rod, the regulator-coil armature, or the dash-pot stabilizer and spring have been tampered with, it will be necessary to readjust these components, as outlined in the technical manual, to obtain efficient operation of the regulator.

* * * * *

ARTIFICIAL TARGET GENERATOR

by Arthur G. Rakosnik

Philco Field Engineer

An easily constructed precision delay circuit that can be used as an artificial target generator for radar calibration.

IN ORDER TO CALIBRATE the radar-gun-sight system in fighter aircraft, it is necessary to use a real or artificial target of known range. The artificial target generator (ATG) described in this article will provide such a target near the minimum range of the radar being checked. It is intended to be used with Range Calibrator TS-102. To use the TS-102, it was formerly necessary to place an actual target (usually a triangular corner reflector) the desired distance from the airplane's radar antenna. Not only was the measuring of this distance tedious and time-consuming, but, in instances where the airplane was parked in the vicinity of hangars or hills, it was an almost impossible task. For a time, a TS-102, with its PHASE CONTROL bolted securely, was used for pre-flight checks. While this allowed the TS-102 markers to maintain their relative ranges, the tendency for the TS-102 to drift made this method unsatisfactory. New test equipment (now in production) will assure rapid, accurate calibration of airborne radar; however, there is a possibility of some months' delay before all organizations are equipped with this new test apparatus. Until such time, the small target generator shown in figure 1 can serve as interim equipment.

The ATG was developed as a result of a need for a device which, when triggered by a radar pulse, would produce a negative marker pulse at a range of about 1000 feet. Such a pulse is required to calibrate several airborne radar sets. The idea of installing the target generator within the TS-102 was

immediately discarded, because it would have been an unauthorized modification of Air Force equipment. Since the generator would, of necessity, be a separate unit, it was desirable to make it as compact as possible. A built-in power supply would have added bulkiness, so other sources of heater and B+ voltages were used. Connecting the heaters of the two 12AT7's in series across the airplane's 28-volt bus solved the low-voltage problem. When Gunsight A1CM is operating, B+ voltage for its amplifier is provided by Static Converter E-1, which is a well-regulated, 300-volt, d-c power supply. In most aircraft, these

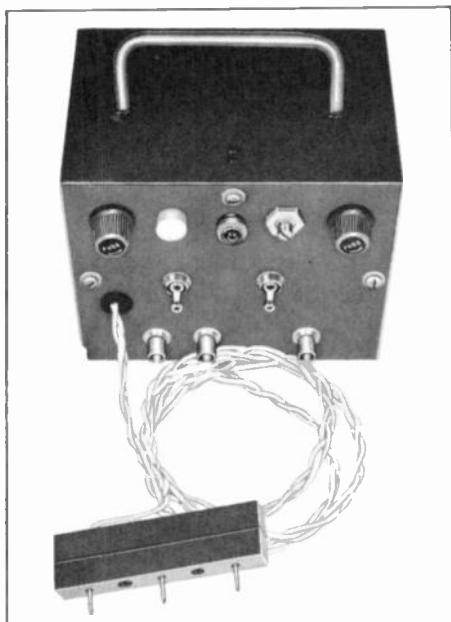

Figure 1. Front View of Artificial Target Generator. Showing Power Plug

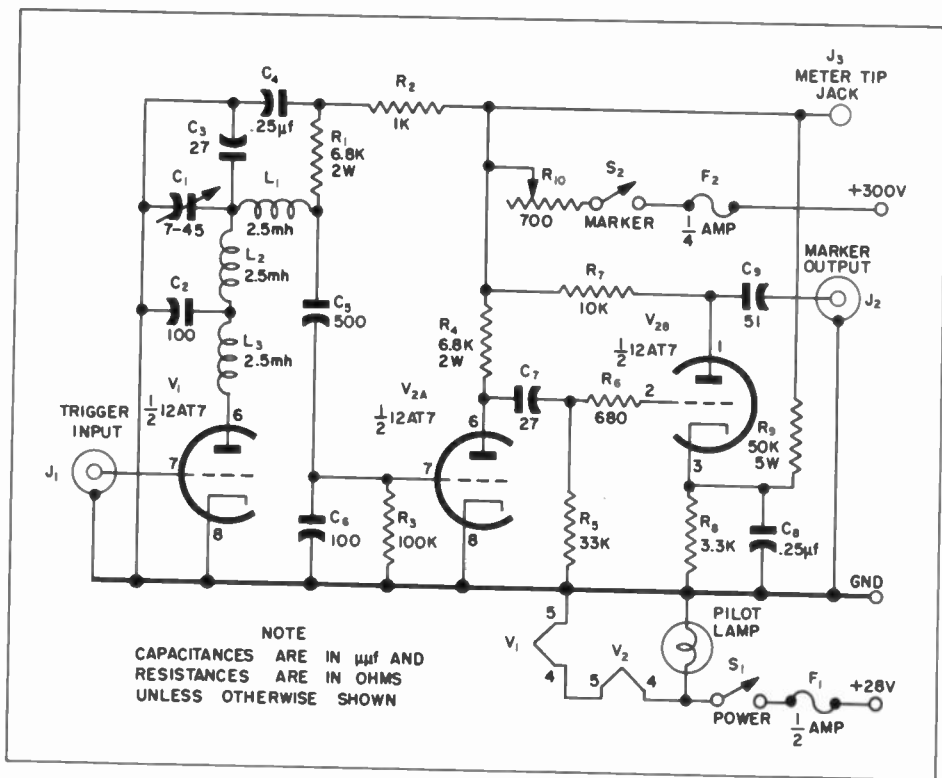

Figure 2. Schematic Diagram of ATG

two potentials are at the radar-gunsight voltage test panel. The power plug shown in figure 3 was fabricated to fit the tip jacks carrying the desired voltages (300 volts d.c. from the E-1, and 28 volts d.c. from the airplane primary bus). While this unit is designed to be used with the AN/APG-30 radar, it could be used with other radar installations. Since the cabinet housing the test set measures only 6" x 5" x 4 $\frac{1}{4}$ ", it is extremely compact and portable.

CIRCUIT THEORY

Figure 2 shows that the circuit of the ATG consists of three stages. V_1 is a delayed-pulse generator, V_2 is a pulse shaper, and V_3 is a pulse amplifier. A negative radar-trigger pulse is fed to the grid of the delayed-pulse generator, which normally conducts heavily unless cut off momentarily by the input pulse. In the plate of this stage there is a reso-

nant circuit composed of L_2 , C_1 , C_2 , and C_3 . This tuned tank will be shock-excited as V_1 is cut off. The delayed pulse is produced by the first negative half cycle of this oscillation. Since the oscillation will always start as a positive half cycle, a delay approximately equal to the time for half a sine wave is introduced. The delayed pulse is stretched into a broad negative pulse with a peak amplitude of 100 volts because of the long time constant of R_3 and C_6 . Since the pulse-shaper stage also normally conducts heavily, it is cut off for the duration of the wide negative pulse. This causes the plate voltage of V_2 to be at B+ from time d to about 50 $\mu\text{sec.}$ later. The tube then slowly resumes conduction, and waveform D in figure 4 is generated. This square wave is differentiated by C_7 and R_5 so that only a narrow positive pulse, occurring at time d , is passed to the grid of V_3 . V_3 is a simple amplifier

which is held well beyond cutoff by a 17-volt positive potential on its cathode. The input pip appearing at the grid overcomes this bias so that a negative pulse is produced at the plate. When the test set is connected so that its marker pulse is fed to the RANGE CALIBRATE VIDEO jack of PP-493/APG-30, the amplitude of this pulse at J_2 is 16 volts, which is sufficient to give a strong "lock-on" condition. Since it was found that the 300-volt potential was slightly different in each airplane, R_{10} was added. This front-panel adjustment is set for a B+ voltage of 290 volts when the ATG is first calibrated. Then, whenever the unit is used for checking radar, the voltage is measured at J_3 , and R_{10} is adjusted so that the voltage is exactly 290 volts. (A range error of four feet per volt is introduced if this voltage is incorrect.) Since variable capacitor C_1 tunes the resonant circuit, it causes the frequency to vary and consequently changes the delay time. This capacitor is intended as a calibrating adjustment.

OPERATION

Radar calibration can easily be performed with the ATG and Range Calibrator TS-102. The following procedure is used when adjusting the AN/APG-30 radar. It is assumed that the access hatch has been removed, that power has been applied to the airplane, and that necessary test equipment is at hand. It is further assumed that the ATG has previously been calibrated against a known target of 300-yards range.

1. Insert ATG power plug into proper tip jacks of gun-sight radar voltage test panel. Observe correct positioning of plug.
2. Disconnect trigger cable from RT-181/APG-30 and reconnect it to one of the trigger inputs of the ATG.
3. Connect cable CG-409/U (or

equivalent) from remaining ATG trigger jack to the TRIGGER jack of RT-181.

4. Connect cable CG-409/U (or equivalent) from ATG marker output to the RANGE CALIBRATE VIDEO jack of PP-493/APG-30.
5. Turn on ATG power switch and allow a 30-second warm-up period.
6. After warm-up, turn on MARKER switch.
7. Adjust R_{10} for a 290-volt reading at J_3 . (Measure with Multimeter TS-352/U.)

When the MARKER switch is turned on, the radar ON-TARGET indicator will light, and the range dial on Range Servo RS-105 should read 900 feet. If it doesn't, the radar RANGE ZERO potentiometer (R_{615}) is adjusted until the 900-foot mark is under the pointer. The radar is now accurately calibrated at minimum ranges.

The ATG is disconnected and set aside. The trigger cable is reconnected to RT-181, and Range Calibrator TS-102 is properly connected to the radar set. The initial marker of the TS-102 is placed at the 900-foot range in the following manner:

1. Advance the MARKER AMPLITUDE control until radar lock-on is produced.
2. Rotate the PHASE control until the RS-105 range dial reads 900.

The TS-102 is now calibrated for all ranges. Its first marker simulates a 900-foot target, and since each succeeding pulse is 500 yards farther out in range, targets at 2400 feet, 3900 feet, 5400 feet, etc., are readily available. In AN/APG-30 installations, adjustment of the SLOPE RANGE capacitor (C_{606}) is

carried out by causing the radar to lock on the 5400-foot marker and adjusting C_{606} until the RS-105 range dial reads 5400. The zero adjustment is again checked for a 900-foot reading on the initial marker. If the radar produces the correct range as it locks on each of the TS-102 markers within its range, the system is properly calibrated.

CALIBRATION

When it is desired to calibrate the ATG itself, it should be connected to the radar system of an aircraft, as previously explained. A suitable target is set up exactly 300 yards away from the radar antenna. If the radar locks on this actual target, the range dial on the RS-105 will read 900. (If not, the radar is not calibrated.) Even if this reading is not correct, the exact reading that appears should be noted. The radar is then made incapable of detecting actual targets (usually by disconnecting the waveguide to the antenna and substituting Dummy Load TS-108). The ATG MARKER switch is turned on, and the range-dial reading should be the same as was produced by the actual target lock-on. To correct any error, C_1 in the ATG is varied until the two readings are identical. The target-generator B+ voltage measured at J_3 must be 290 volts when the unit is calibrated, R_{10} being adjusted for the correct voltage.

CONSTRUCTION

The size of the ATG was kept small by installing the electronic components upon a chassis 5" x 4" x 1½". As was mentioned previously, a cabinet 6" x 5" x 4¼" was built to contain this chassis. No details of cabinet construction are discussed here because figure 1 shows the simplicity of the entire device. Furthermore, since the circuit is not especially critical, the unit can be made to any convenient dimensions and in many chassis layout variations.

The various components mounted on

the front panel are: The upper row from left to right—28-volt fuse holder, J_3 (the 290-volt test point), pilot light, R_{10} (the 290-volt adjustment), and the 300-volt fuse holder. The left-hand switch is the POWER switch, while the right-hand one is the MARKER control. The two coaxial connectors on the left are wired in parallel, and are the trigger inputs. The remaining connector carries the output marker pulse.

The photo of the unit fails to show two important features: the location of C_1 , and the location of the ventilation port. Variable capacitor C_1 , the ATG calibration adjustment, is mounted on the rear of the chassis, and can be varied by a screwdriver inserted through a hole in the back of the cabinet. A screened hole two inches in diameter in the center of the back of the cabinet provides adequate ventilation for normal use.

An assembly drawing of the power plug is shown in figure 3. The drawing illustrates its construction, so that no further comment is necessary. One inadequacy of the plug is readily apparent. Since it is not polarized, it can be plugged into the tip jacks two ways. If it is inserted incorrectly, 300 volts will be placed across the heaters. This would blow the 28-volt fuse. In order to prevent incorrect use, the plug was labeled so that if the plug is held in the proper position, the word "TOP" appears on the side of the plug. If it is incorrectly positioned, the label "DANGER, DO NOT INSERT" is seen. While it is still possible to blow fuses, such occurrences are rare.

The waveforms pictured in figure 4 were measured in the units constructed by the author. As can be seen, they have been somewhat exaggerated for clarity and continuity. If the construction of an artificial target generator is contemplated, these waveforms will be useful in the final testing of the finished circuit.

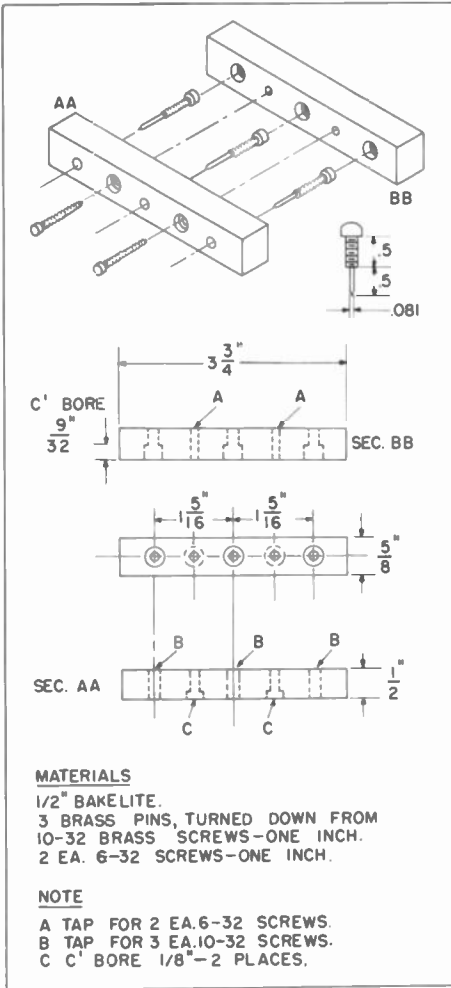

Figure 3. Assembly Drawing of Power Plug for ATG

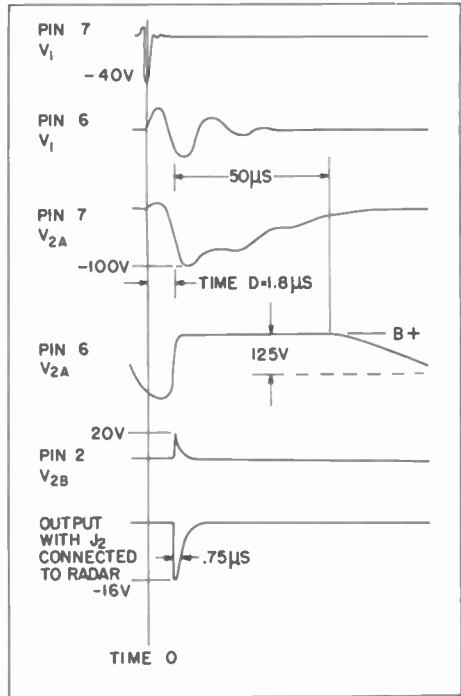

Figure 4. Waveforms Observed at Various Points in ATG

The parts needed to build the ATG are easily obtained through Air Force Supply. No stock numbers are listed in the table below for most of the parts shown in the schematic diagram, because they are common items and can readily be found in the appropriate stock catalogs. However, the numbers of the hard-to-get items are included.

TABLE I. PARTS LIST FOR ARTIFICIAL TARGET GENERATOR

QUANTITY	NOMENCLATURE	STOCK NUMBER
3 ea.	Coil, r-f	3300-310004995
1 ea.	Capacitor, variable	3300-313430120
1 ea.	Resistor, variable	3300-394344012
2 ea.	Holder, fuse	8800-619703-4
2 ea.	Connector, UG-604/U	8850-470507

* * * * *

Solution to . . .

Last Month's "What's Your Answer?"

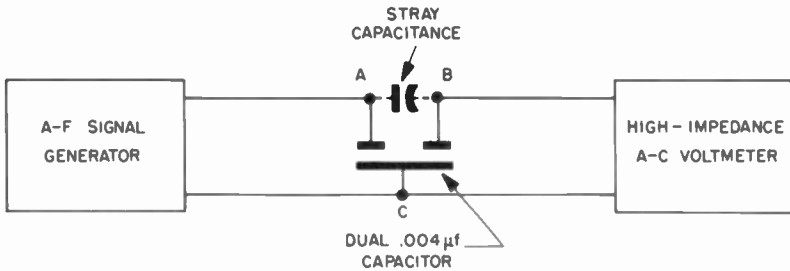

No!

The stray capacitance between sections is very real and quite important in some circuit applications. This capacitance is measured by means of the circuit shown in the illustration. In order to get accurate measurements, the input capacitance of the voltmeter should be much smaller than the nominal value of the capacitor (ordinarily this is no problem). The frequency of the a-f signal generator is adjusted so that the capacitive reactance of the B section is small compared to the voltmeter's input resistance. For a .004- μ f. capacitor, 400 c.p.s. will produce an X_c value of about 100K ohms—a 1-megohm (or better) meter would introduce negligible error.

First the a-f signal at A is adjusted for some convenient value—say 50 volts. Then the voltage at B is read. It can be seen that for the conditions stated, the

stray capacitance acts as a voltage divider in conjunction with the B section of the dual capacitor. Stray capacitance is related to output voltage by the equation:

$$C_{\text{stray}} = \frac{E_{\text{out}} C}{E_{\text{in}} - E_{\text{out}}}$$

Since C_{stray} is much smaller than C, and since C in this case is .004 μ f., a 50-volt input would reduce the equation to:

$$C_{\text{stray}} = 80 E_{\text{out}}$$

where C_{stray} is in μ f. and E_{out} is in volts.

The importance of this stray capacitance can be appreciated by examining a typical high-frequency amplifier. Suppose that the dual capacitor were used to by-pass the plate and cathode in a single stage. Excessive stray capacitance could easily cause oscillation in a high-gain stage. At best, regenerative action would be present.



