

NOVEMBER 1981

HEWLETT-PACKARD JOURNAL



Contents:

NOVEMBER 1981 Volume 32 • Number 11

- 3 Development of a Large Drafting Plotter**, by Marvin L. Patterson and George W. Lynch
This low-cost plotter extends HP's low-mass, low-inertia technology to the production of drafting-quality plots up to D- or A1-size in a minimum of floor space.
- 7 Aspects of Microprocessor and I/O Design for a Drafting Plotter**, by Lowell J. Stewart, Dale W. Schaper, Neal J. Martini, and Hatem E. Mostafa
The use of a powerful microprocessor allows the designer to provide desirable features without increasing the complexity of the hardware.
- 12 Motor Drive Mechanics and Control Electronics for a High-Performance Plotter**, by Terry L. Flower and Myungsae Son
HP's low-mass, low-inertia design greatly simplifies the mechanical drive and servo control electronics.
- 16 Firmware Determines Plotter Personality**, by Larry W. Hennessee, Andrea K. Frankel, Mark A. Overton, and Richard B. Smith
This firmware provides drafting-quality lettering, keeps track of pens and plotting parameters, and minimizes the need for operator adjustments.
- 24 New Language Tools Aid Plotter Firmware Development**, by Andrea K. Frankel
Using a high-level language for developing firmware code has both advantages and limitations.
- 25 Y-Axis Pen Handling System**, by Robert D. Haselby, David J. Perach, and Samuel R. Haugh
An adaptive pen-lift mechanism, automatic pen selection and storage, and a sturdy drive system are key elements of this design.
- 33 X-Axis Micro-Grip Drive and Platen Design**, by Ronald J. Kaplan and Robert S. Townsend
Moving paper accurately with grit-covered wheels requires careful attention to platen design and grit-wheel fabrication.

In this Issue:



This month we continue coverage of HP's new low-mass, low-inertia plotting technology. In our October issue were articles on the development of this technology, on an optical encoder that plays an important role in it, and on a cardiograph that uses the new type of plotter mechanism to record electrocardiograms on standard-size paper. This month's issue is devoted to the 7580A Drafting Plotter, a high-performance large-scale plotter that extends the new technology to the making of large drafting-quality plots. Operating under computer control, the 7580A accurately and rapidly produces engineering drawings, integrated circuit layouts, architectural drawings, and other large plots. It draws on standard drafting media—paper, vellum, or polyester sheets—using roller-ball, fiber-tip, or liquid-ink drafting pens. It stores up to eight pens at a time, keeping them capped so they won't dry out, and automatically selects the one it's told to plot with. The results it produces are comparable in quality to those of the best drafting plotters available, but thanks to the new plotting technology, the 7580A costs only about half as much as conventional plotters and takes up much less floor space. In fact, to someone familiar with conventional flatbed plotters, the 7580A is a strange-looking device. Instead of a pen moving over a stationary piece of paper lying on a flat surface, one sees a bar-shaped mechanism held up by two legs, with the paper draped over the bar and hanging out loose on both sides. In operation, the pen slides rapidly back and forth along the bar and the paper flies just as rapidly back and forth across the bar. That it works so well is a tribute to both the basic concept and the engineering that turned the concept into a product.

Marv Patterson and George Lynch introduce us to the new drafting plotter on page 3, and the other articles in the issue discuss various aspects of the design.

R. P. Dolan

Editor, Richard P. Dolan • Associate Editor, Kenneth A. Shaw • Art Director, Photographer, Arvid A. Danielson • Illustrator, Nancy S. Vanderbloom
Administrative Services, Typography, Anne S. LoPresti, Susan E. Wright • European Production Supervisor, Henk Van Lammeren

Development of a Large Drafting Plotter

Developing a large X-Y plotter that provides drafting-quality drawings, requires minimal floor space, and costs less than half comparable machines was not easy. This article outlines the history and performance features of HP's largest X-Y plotter.

by Marvin L. Patterson and George W. Lynch

WHAT DOES IT TAKE TO MAKE a drafting plotter? When the original investigation team for the HP Model 7580A Drafting Plotter (Fig. 1) was first presented with this question Hewlett-Packard's interest in plotters had only included small digital X-Y plotters for use with desktop computers or in the timeshare computer environment. An opportunity was perceived, however, for a low-cost machine that could efficiently produce drawings having the size and overall appearance of the work produced by drafting people. Just how this capability related to plotter specifications was not yet known.



Fig. 1. The HP Model 7580A Drafting Plotter uses a micro-grip paper-drive mechanism to produce high-quality drawings on a variety of commonly used drafting media. Liquid-ink, fiber-tip, or roller-ball pens can be easily used to meet different drafting requirements. The design reduces the cost of the instrument, its power consumption, and the floor space required.

Project activity began with the design of a large flatbed plotter for use as a test bed and with a study to determine just what was meant by "drafting quality." This study quickly revealed how incredibly precise human drafting can be. The use of a straightedge, compass and templates can produce work that appears perfect to the unaided eye. The only facet of human output that might be improved was found to be variations in linewidth and density. Liquid-ink pens leave a characteristic round blob at the end of each line as the pen comes to rest. More particular drafting people trim the end of each line with a razor blade to eliminate even this small problem—a truly tough act to duplicate by machine.

How Straight Is Straight?

Having given up on duplicating the smoothness and precision of a human using a compass and straightedge, we used the test-bed plotter to produce a series of progressively bad lines. A qualitative comparison of these lines with those drawn along a straightedge produced some insight into the plotter specifications required to produce acceptable line quality. The noticeability of line imperfections was found to be a function of both the amplitude of line perturbations and their spatial frequency. This relationship is shown in Fig. 2.

Fig. 2 shows that, while the mechanism doesn't have to be perfect, short-duration perturbation amplitudes caused by the control system and mechanical tolerances must be kept well below 0.025 mm. At spatial wavelengths approaching the maximum plotter dimensions the eye is much more tolerant of small perturbations. This means that the straightness of the pen carriage guides can be relaxed to something in excess of a millimetre before noticeable cosmetic effects occur. Of course drafting accuracy considerations constrain this specification to tighter values.

Industry Standard Pens and Media

Work performed by drafting personnel falls into two general categories: working drawings and finished-quality drawings. This leads to the use of a variety of writing instruments and drawing media. A pen using capillary action to feed liquid ink is usually used for the final drawing. The final drawing medium is usually vellum or polyester film. Working drawings are most often done with pencil on paper or vellum. Here speed and reproducibility are more important than the cosmetic appearance of the drawing.

This need for both working and finished-quality draw-

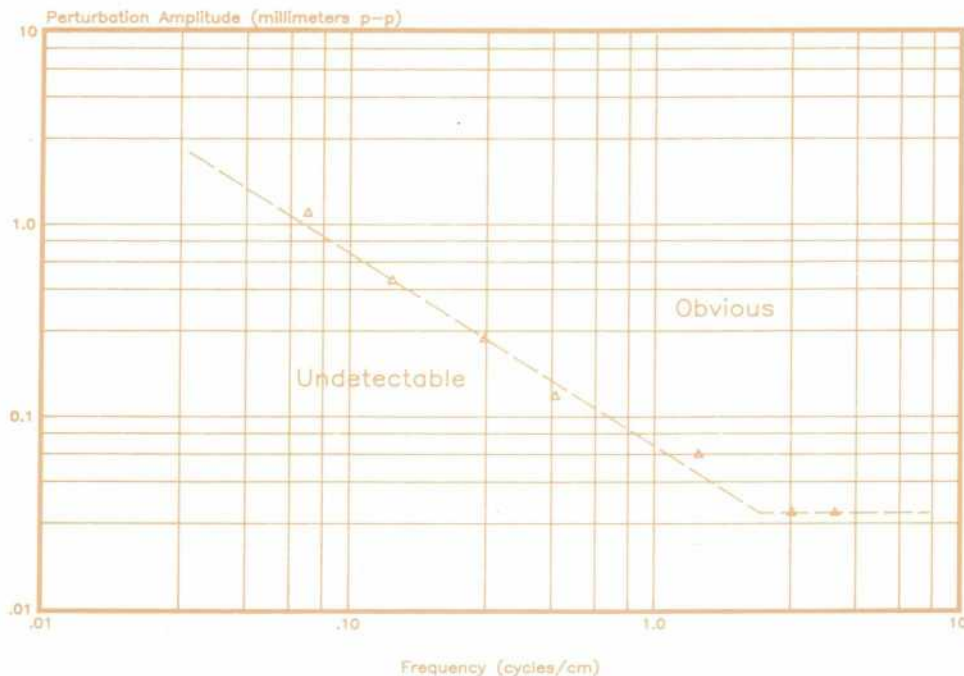

Fig. 2. The noticeability of perturbations from a straight line is a function of their amplitude and how widely they are separated along the line (spatial frequency) as shown by the above graph.

ings requires that the drafting plotter offer a high-speed writing system for low-cost media and a liquid-ink writing system for the more expensive media specified by various industry standards. Many customers use drafting media preprinted with boundaries, title blocks and other markings specified for their particular application. To be accepted widely, a drafting plotter should accept these preprinted forms in a straightforward manner. In general, a drafting plotter should be able to handle standard-size drafting sheets of paper, vellum and polyester film.

The ability to handle both a high-speed writing instrument and liquid-ink pens requires control of the speed of the pen and the force with which it is applied to the drafting media. Liquid-ink pens in particular dry out quickly if they are not capped when not in use. Since many pens are needed to provide variety in both linewidth and color, an automatic method of capping unused pens must be provided to ensure that pens operate reliably throughout the life of their ink supply.

Dynamic Performance and Cost

To a large degree the value of a drafting plotter is a function of how quickly it can produce a drawing. This depends upon the speed and acceleration provided by the control system. Inertial forces placed upon the motors and other moving elements in the mechanism increase as direct functions of the acceleration and the amount of mass in motion. Because the X and Y axes of the plotting mechanism are inherently different, these forces tend to cause the pen trajectory to deviate from the desired path, creating less than perfect line quality. The strength of the moving elements and their supporting structures must be increased to keep these deviations from being objectionable at higher accelerations. However, there is a design tradeoff, because when strength is increased, mass is increased and acceleration and speed are reduced. The useful acceleration of a plotter is thus determined by the size of the motors, the

amount of mass in motion, the amount of mismatch between the two axes, and the strength of moving parts and the surrounding structure.

The cost of a plotter is determined largely by the size of the mechanism, the X-Y drive motors and the corresponding motor drive amplifiers and power supplies. As higher acceleration forces the size and strength of the motors and mechanism upwards, the cost of the electronics tracks accordingly. If methods can be found that reduce the amount of mass in motion, the cost to produce acceptable line quality at a given acceleration is dramatically reduced.

Once these relationships are understood, the algorithm for designing a successful drafting plotter is clear. It must have very high acceleration and writing speed while the mass of moving parts and the size of the drive motors are kept to a minimum. One HP division manager stated this rather succinctly. "Simply design it light, straight, strong and cheap."

It is said that time and tide wait for no man. So it is with the drafting plotter market. When the 7580A project began, a large flatbed plotter with about 1g acceleration and a price of about \$10,000 (US) offered a significant contribution to the marketplace. After the project was temporarily suspended and later resumed, however, several new competitive products had been introduced that seriously affected the viability of the original 7580A approach. For several months the design team struggled with the problem of how to make a contribution in this new marketplace. Our old flatbed approach was clearly no longer the right answer but we were finding it difficult to come up with a new idea that would provide significantly better performance at a lower cost.

HP Labs to the Rescue

At this time the 7580A design team became aware of the Sweetheart project at Hewlett-Packard Laboratories (described in last month's issue).¹ A group of engineers there

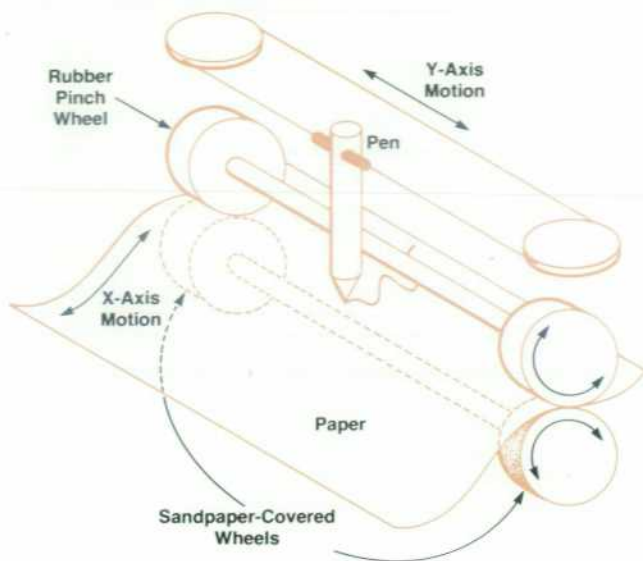

Fig. 3. The basic X-Y plotting mechanism used in the 7580A moves the paper along one axis by gripping its edge on two opposite sides between two rollers (one covered with grit). The impressions of the grit on the back side of the paper during the initial moves provide accurate registration for subsequent moves. The pen is moved along the other axis by a cable drive and fixed guide rail arrangement. The position and velocity of the paper and pen are sensed by digital encoders located on the shafts of the motors driving each axis.

had developed an unconventional X-Y plotting mechanism which moved a piece of paper along one axis by gripping its edges between pinch rollers and sandpaper-covered wheels as depicted in Fig. 3. The pen was moved along the other axis by a simple drive belt and fixed guide rail system. This is an innovative idea that minimizes the amount of mass in motion, thus allowing incredible accelerations with very small motors.

Two things were intuitively obvious to the 7580A design crew, however, that made us doubtful that this mechanism represented an answer to our dilemma. First of all, the paper would obviously slip and lose registration in the grit-wheel drive scheme. Because drafting plotters need impeccable repeatability, this would simply be intolerable. Second, while this plotter was nice for a sheet of notebook paper, it certainly did not represent a viable answer for handling the large-size media required for a drafting plotter.

Our skepticism was quickly squelched. The team at HP Laboratories convinced us that the sandpaper grit on the paper drive wheels acted like a microscopic sprocket drive. Impressions made in the paper by the grit particles on the first pass acted like sprocket holes. On each subsequent pass, the same grit particle that made the original impression would realign itself with its impression, thus forcing perfect registration and repeatability.

As for large-size media, the designers simply cut one of their small 21.5-cm wide plotters in two, welded in an extension, and within a week had a 61-cm wide breadboard design working perfectly. After this demonstration the San Diego Division crowd was convinced and the design of the 7580A laboratory prototype began.

The impact of the 7580A can be summarized in two

words: price and performance. This novel product offers line quality and dynamic performance comparable to the finest competitive plotters at about one-half the typical price. In addition, a number of innovative features are included that are not yet available on other products. This combination of price, performance and features represents a major contribution to low-cost, single-user, desktop-computer-based, CAD (computer-aided design) systems.

Performance

Maximum dynamic performance of the 7580A is specified as 60 cm/s slewing velocity at an acceleration of 4g or 3920 cm/s². When operating at these levels, the 7580A draws lines whose visual quality is essentially flawless. Repeatability, the ability to retrace a line or draw to the same point from different directions, is consistent to less than 0.05-mm error. Since the density of ink lines tends to be a function of line speed, the 7580A holds the pen velocity constant at all line slopes to provide more uniform lines. Most other plotters hold the axial velocity constant. This causes lines with a 45-degree slope to be drawn with over 40% greater velocity than either horizontal or vertical lines, thus producing undesirable line density variations.

As seen in the examples of Fig. 4, the precision and smoothness of lines drawn by the 7580A compares favorably with those drawn by a human. The addressable endpoint resolution of the plotter is 0.025 mm but the control system uses increments eight times smaller so that the graphical output appears to be essentially perfect to the unaided eye.

The plotter has internal firmware code that generates two separate character fonts. The first has a constant character spacing that is convenient when labels are generated by a computer program. Characters in this font are composed of straight line segments. The second font uses proportional character spacing for maximum readability. Characters in this font are created from straight line and arc segments to give the appearance of template-quality lettering. An internal algorithm in the plotter approximates the arc segments with a series of small straight lines. The smoothness of the arcs (length of the small straight lines) is programmable so that coarse approximations can be used when speed of lettering is important. For final high-quality copy the line lengths can be set to a fine value that causes the arcs to appear smooth and continuous.

Features

Probably the most significant new feature of the 7580A is its pen handling system (Fig. 2, page 9). Pens are held in a rotatable carousel until selected by the pen carriage. While in the carousel, pen tips are sealed by rubber caps and stay wet and ready to write—even liquid-ink drafting pens. Liquid-ink pens have been a traditional problem for drafting plotters since they frequently dry up and clog if left in the open air for more than five minutes. The pen carousel feature makes the 7580A the first drafting plotter capable of using multiple drafting pens without operator intervention.

There are three different carousels provided for liquid-ink, roller-ball and fiber-tip pens. Each carries a unique optical marking that identifies it to the 7580A's microprocessor. Default values for maximum pen speed and writing

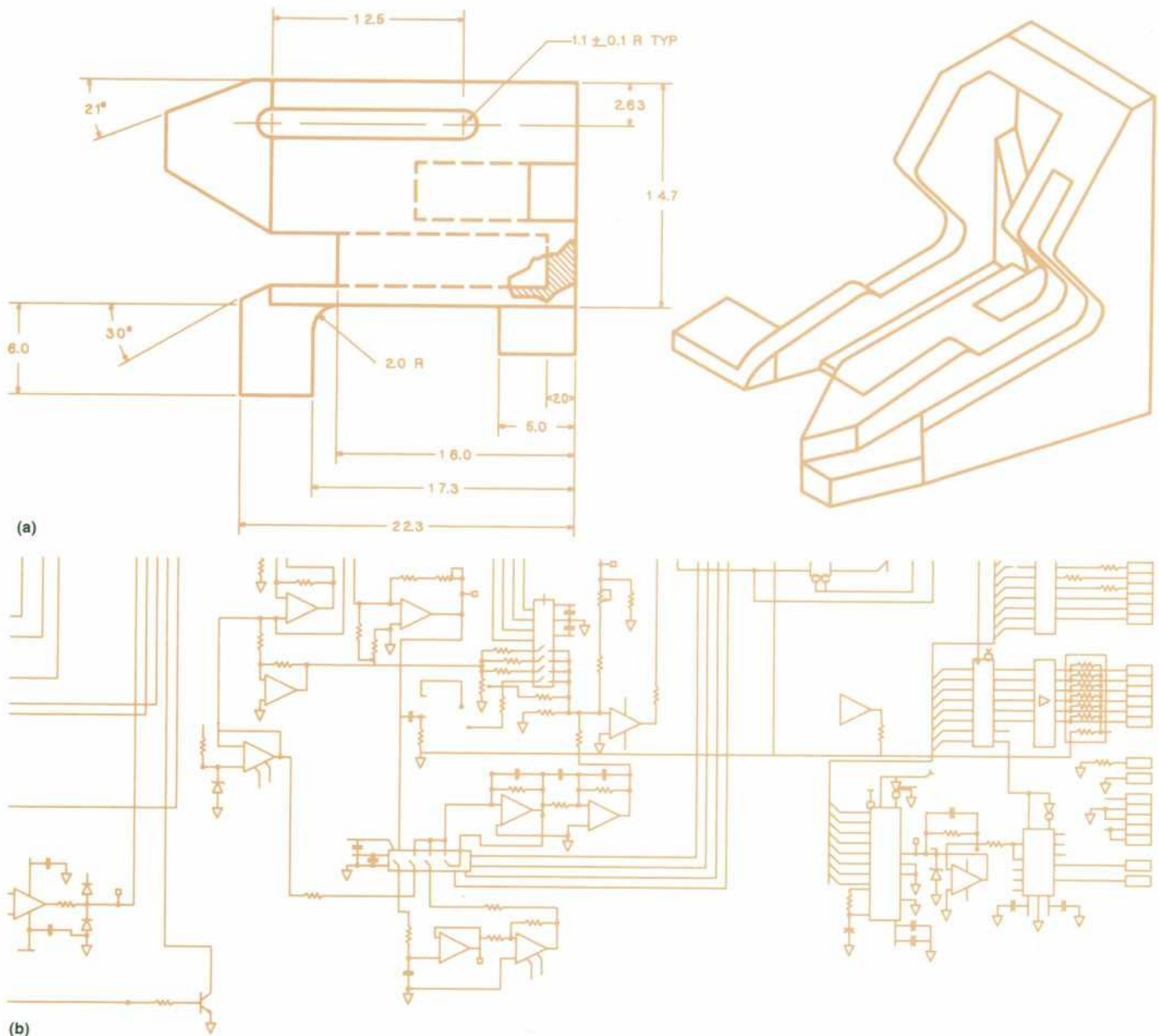

Fig. 4. Examples of the plotting capability of the 7580A shown actual size. (a) Mechanical part drawing. (b) Logic schematic.

force are automatically reset each time the carousel is changed. Thus an operator can go from a working drawing to a final liquid-ink copy by simply changing carousels and loading the desired final drawing medium.

The design of the 7580A allows it to accept industry standard drafting pen inks and capillary tips as well as commonly available sheets of drawing media up to D or A1 size (622 × 1190 mm). The need for expensive sprocket-holed media is avoided as is the need to adjust sprocket wheel spacing as humidity causes the media to shrink or expand. Drawing materials for the 7580A can usually be found at a local drafting supplies store.

Reducing the mass of moving parts not only affects the dynamic performance and cost but it also reduces the overall weight and power consumption of the product. Because of this, the 7580A is the first truly portable large drafting

plotter. Weighing less than 64 kilograms, it rolls smoothly on casters and can be moved easily between workstations. When not in use it can be moved out of the way; it occupies less floor space than the typical typing table. Power consumption is less than 170 watts, a factor of two to four times less than competitive products.

Acknowledgments

The overwhelming success of the 7580A since its introduction is a tribute to the excellence of the design team. Larry Hennessee, firmware project leader, Bob Haselby, electronics project leader, and the rest of the team took the 7580A from a laboratory concept to a thoroughly engineered and tested product.

The overwhelming customer acceptance of the 7580A is largely due to the product design created by Bart Davis. His

George W. Lynch



George Lynch was project manager for the 7580A Plotter and is now doing 7580A sales development. He's been with HP since 1973 and has also contributed to the mechanical design of the 9872A Plotter. He's the author of a paper on grit-wheel technology and is named as an inventor on a patent on the 9872A pen lift and several pending patents related to the 7580A platen technology. He received his BSME degree in 1971 from Oklahoma State University and his MS in aeronautical engineering in 1973 from California Institute of Technology. George was born in

Texas and grew up in Bartlesville, Oklahoma. He is married, has a daughter, and lives in Escondido, California in a house of his own design and construction. He's interested in home computers and is "anxiously awaiting ski season."

Marvin L. Patterson



Marv Patterson received his BSEE and MSEE degrees in 1963 and 1970 from the University of Washington. He joined HP in 1973 with several years of design and project management experience in telemetry systems, microwave antennas, and control systems. He has served as project manager for the 7221A Plotter and the motor drive system of the 9872A Plotter, and as project manager and now section manager for the 7580A Plotter. His work has resulted in three patents in diverse areas and in several articles and papers (including two in the HP Journal) on active filter

design, step motor control, plotter design, and computer graphics. He has taught computer graphics at San Diego State University. Marv was born in Ontario, Oregon and now lives in Ramona, California. He is married, has three children, and has a passion for long-distance cross-country, bad-weather flying.

design takes full advantage of the new technology and provides an attractive package with unprecedented portability and floor space efficiency for a D- and A1-size plotter. Ken Slavin designed the castings, framework and the legs for the 7580A.

The 7580A Drafting Plotter is an excellent example of the creative potential that can exist within the Hewlett-Packard environment. The market and product wisdom of a manufacturing division were combined with the creative resources of HP Laboratories to provide a remarkable new

capability in a corner of the industry that was thought to be mature and stable. This product represents the culmination of several years of thought and effort for some of us and will be a source of pride for all of those involved in its development for many years to come.

Reference

1. W.D. Baron, L. LaBarre, C.E. Tyler, and R.G. Younge, "Development of a High-Performance, Low-Mass, Low-Inertia Plotting Technology," Hewlett-Packard Journal, October 1981.

Aspects of Microprocessor and I/O Design for a Drafting Plotter

by Lowell J. Stewart, Dale W. Schaper, Neal J. Martini, and Hatem E. Mostafa

WHEN DESIGNING THE HP MODEL 7850A Drafting Plotter, we chose a more powerful 16-bit microprocessor instead of an 8-bit microprocessor. This helps minimize the hardware and has other advantages. Since part of the servo control is done in software, it is useful to be able to do 16-bit arithmetic rapidly so that plotting speed is not limited by computational time. Being able to address a lot of memory makes adding future software enhancements easier and allows writing some of the code in a high-level language. The faster processing speed and extra memory addressing enable the system to use firmware protection methods rather than limit switches and other methods that have to be readjusted manually.

The microprocessor is a Z8002 which has a time-

multiplexed address and data bus. Address data is written onto the bus when the address strobe (AS) is asserted. Data is written onto the bus or read from the bus during the data strobe (DS). The microprocessor is capable of addressing up to 64K bytes of memory. The address strobe is the master sync for the system. There is always an AS pulse for every machine cycle, but there may not be a DS pulse. Internal operations do not output a DS pulse.

Internally there are four circuit boards on the microprocessor bus (Fig. 1). The processor circuit board contains the microprocessor, the bus timing and control logic, the ROM, the RAM, the I/O control logic, and the vectored interrupt priority logic. Each of the four boards on the bus is selected by one of four address lines from the processor. Four other address lines go to each of the boards on the bus

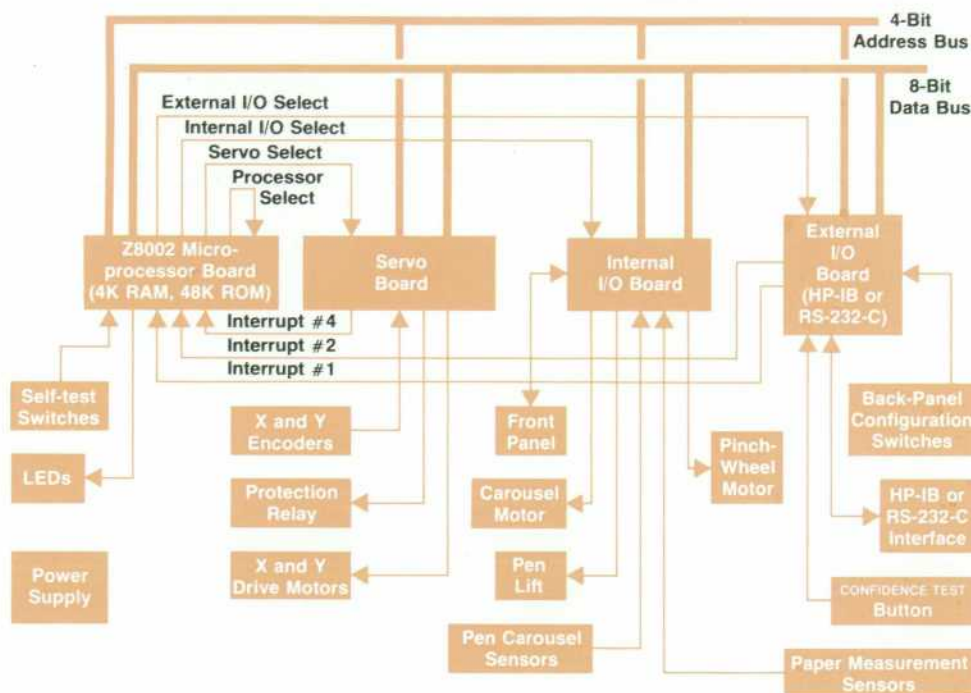

Fig. 1. Block diagram of the electronic system for the HP Model 7580A Drafting Plotter.

so each board may have up to 16 read/write registers. The 7580A uses 48K bytes of ROM (read-only memory) and 4K bytes of RAM (random-access memory) with most of the code written in ALGOL. Time-critical and I/O routines are written in assembly language. The microprocessor has a vectored interrupt capability which works with some of the hardware and software to give a four-level priority system. A servo board controls the drive motors (discussed in the article on page 12), and an internal I/O board is used to control the sensors, the pen lift, the front panel, and the other motors. The microprocessor has its own board, and there is a board to handle the RS-232-C or HP-IB* data interface.

One of the most challenging parts of building a plotter is accurately controlling the main drive motors. Substantial processor code and an entire circuit board are dedicated to moving the motors so that they draw straight vectors. The 7580A uses rate feedback to control the motors. This means that there are both position and velocity feedback loops. The position loop is handled by the microprocessor in firmware and it runs at a 1-kHz sample rate. The velocity loop runs faster and it is implemented in hardware on the servo board. Because the position loop is handled in software and the Z8002 is so powerful, the velocity-profiling algorithm in the 7580A is much more complicated than in any previous HP plotter.

Velocity Control

The velocity profile describes the speed of the pen tip on each axis so that it will make a straight line from a stationary starting point to a stationary resting point without exceeding the pen's maximum velocity or the drive mechanics' acceleration limit. In all previous HP plotters the speed of the pen tip when it was writing depended on the angle of the line being drawn. This was because an algorithm cal-

culating the position of the next point by assuming a constant linear velocity was too complicated for earlier processors, given the time allowed. The 7580A, however, uses this type of algorithm and also allows continuous user-selectable velocity and acceleration as measured along the drawn line. This ensures attractive, uniform lines at any angle using three different types of pens.

The plotting routine that generates the velocity profile accepts an X-Y position and immediately calculates the length of the line to be drawn. Because of the large size of the 7580A plotting surface and the fact that the servo-control algorithms use a resolution eight times finer than the user is allowed to address, all calculations are done in 32-bit arithmetic. The plotter uses the line length to calculate the time needed to accelerate to the desired velocity and the time needed at this velocity to be able to decelerate to a stop near the correct endpoint. Since the control system is digital, the plotter can only accelerate, decelerate, or travel at the same speed for an integer number of discrete time intervals. Given this requirement and the user-specified acceleration and speed, the line may not stop exactly at the endpoint. This would be unacceptable. This problem is solved by going back and using the accelerate, decelerate, and constant-speed times calculated previously to solve for an acceleration that will put the pen exactly at the desired endpoint when it stops. The reason that acceleration is modified and not speed is that the speed along the line after acceleration is derived by multiplying the acceleration time by the acceleration. Scaling the acceleration also scales the speed.

Position Control

It is of critical importance to get the error signal—position desired minus actual position attained—to the motors as quickly as possible after the position counter is read. If there is any delay between reading the current

*Hewlett-Packard's implementation of IEEE Standard 488 (1978).

position counter and producing the error signal the system will have moved and this will make it much more difficult to control. This delay is minimized by reading the X- and Y-position registers immediately after an interrupt has been called and getting the error numbers, using the desired position calculated in the last time interval, out to the motors as quickly as possible. The processor is now free to calculate the next desired position at its leisure for use in the next interrupt.

The plotter does not have to do any multiplying to get the next position because a difference equation approach is used to find the next desired position. While accelerating, the acceleration for each axis is added to the old speed to get the new speed. This speed is then added to the old position to get the new position for each axis. The constant-speed and deceleration parts of a move are handled in a similar way. The nice feature of this algorithm is that once the setup for a move is done, only add operations are required to generate the next position. Adding is much faster on a computer than multiplying or dividing.

System Protection

A common argument against using a microprocessor to control motors is that if the processor ever loses its little binary mind the drive motors might thrash around madly and damage people and equipment. To prevent this, the servo board constantly monitors the servo operation by checking its response to interrupts. If the microprocessor ever responds incorrectly for more than a specified period, the servo board opens a relay and shuts the motors down. For the same reason, the processor monitors the servo board by checking to be sure that reasonable error signals driving the motors cause reasonable displacements and that only believable motor speeds are reported by the servo board. If the processor ever thinks that the servo board is broken, it cancels the error signals to the motors and opens the motor relay to render the motors harmless. This means that if anything ever gets caught in the moving parts of the plotter the processor will detect it and shut everything down before anything breaks.

Pen Carousel Control

Pens are kept in a pen carousel when not in use. Up to eight pens may be kept capped and ready for plotting in each carousel. There are three types of carousels, one for each type of pen—fiber-tip, roller-ball, and liquid-ink. The plotter uses two reflective strips on the side of each carousel to identify the type of carousel in the system (see Fig. 2). There is a wide strip which gives the plotter a reference point and a narrow strip which indicates the carousel type. When a carousel is inserted into the plotter it breaks a light beam from an LED (light-emitting diode) to a phototransistor which signals to the processor that it must initialize the carousel at the first convenient time. The plotter completes whatever action it is doing and starts turning the step motor connected to the carousel. The processor actually controls the individual phases of the step motor and has the capability to reduce the phase current when the motor is just standing still and does not need full torque.

To initialize the pen carousel the processor applies full motor torque and accelerates the step motor up to speed and maintains this speed while it monitors the reflective sensor.

When a reflective strip is seen by the sensor the processor counts the number of motor steps during which the reflection persists to see if this is the wide or the narrow reflective strip. If it is the narrow strip the processor ignores it and continues rotating the carousel, looking for the wide strip. When the processor finds the wide reflective strip it has a reference to measure from. It rotates the carousel one more complete revolution. During this revolution the processor checks each of the pen stables via another LED and phototransistor pair to see if each is occupied and remembers which stables have pens in them and which do not. In addition it looks for the narrow reflective strip and uses its location to determine which type of carousel is in the machine. The carousel type determines which set of default pen speed, pen force, and acceleration numbers to use with the pens taken from the carousel.

When a user commands the plotter to pick a pen out of the carousel the plotter checks its memory to see if that pen is in the carousel. If the pen was there when the carousel was initialized and the carousel has not been removed, the plotter proceeds to try to pick it. First the processor tells the drive motor to move the pen carriage between an LED and a phototransistor pair to see if there is a pen in the holder. You can't pick a pen if you already have one, so if the holder does have one it must put the old pen away first. When this is completed the processor rotates the carousel so that the desired pen is in front of the pen holder. The processor does another check to be sure that the pen holder is still empty and that the pen carousel still has a pen in the appropriate position. If anything is wrong at this stage the machine has a real problem so it shuts itself down and flags an error on the front-panel displays because if these conditions are not met the pen holder or the carousel can be damaged attempting to do a pen pick. However, this will not happen unless somebody has been trying to trick the plotter, or there is a rare hardware failure. The plotter then executes the pen

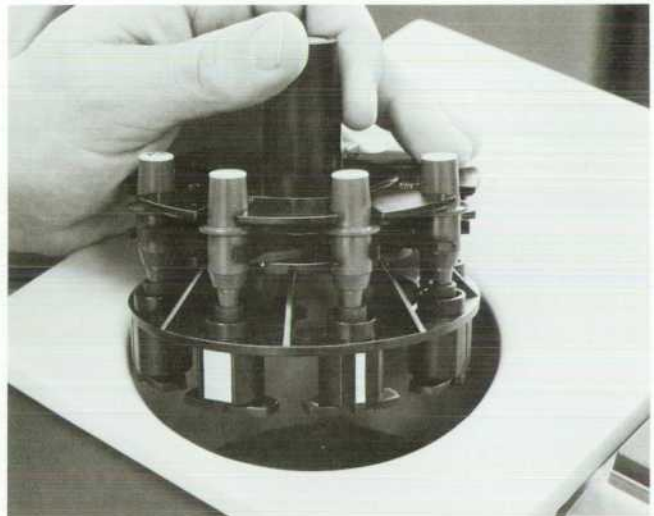

Fig. 2. The 7580A pen carousel can hold and cap up to eight fiber-tip, roller-ball, or liquid-ink pens. The carousel is initialized and the pen type is sensed by using two reflective strips mounted as shown. The wide strip is used for the initialization reference and the relative position of the narrow strip identifies the pen type (here, fiber-tip pens).

pick by moving the holder into the carousel until it engages the pen. The holder is then removed. Now the processor checks its sensors one last time to make sure that there is a pen in the holder and none in the carousel. If either of these conditions is not true, the pen pick has failed and there may be a loose pen jammed in the mechanism. The plotter must shut down and flag an error on its front-panel displays. By careful checking of the status of the pen holder and the carousel at each step of the pen pick, the possibility of unsuccessful pen picks and damage to expensive hardware is minimized.

Paper Control

To make the low-inertia, low-mass plotting system work it is important that the plotter be able to measure the size of the paper that is being used. If the grit wheels run the paper out too far, the 7580A will drop the paper on the floor. If the pen carriage writes over too far when a small piece of paper has been loaded the plotting surface will be damaged. The 7580A measures the paper in the X-axis, micro-grip paper-drive direction by using two paper sensors, and in the Y-axis, pen-carriage cable-drive direction by using its paper stops and a reed switch. The user loads paper by lining up one edge with a pair of paper alignment tabs, placing the movable pinch wheel so that it is above the opposite edge of the paper, and pressing the **CHART HOLD** key. When the plotter senses the pressed key, it lowers the pinch wheels to hold the paper to the grit wheels and checks the paper sensors to make sure paper is actually present. If both sensors are not covered by paper the paper has not been loaded correctly and cannot be measured, so the plotter raises the pinch wheels until the operator hits the key again. When the pinch wheels go down, the paper-alignment stops move out of the way of the paper so that they do not interfere with the paper motion during a plot. The paper sensor outputs require elaborate filtering to be useful, so the two outputs are multiplexed onto one filter to save hardware cost. To detect the front paper edge the microprocessor first switches in the front paper sensor and then starts moving

the paper edge up toward the front sensor. After the front edge is found the back sensor is switched on and the process is repeated for the back edge. To reduce initialization time the 7580A makes two passes at measuring each edge, a fast one to get an approximate edge position and a slower pass coming back the other way to get a more accurate edge position.

The paper width on the pen carriage axis is found by assuming that the movable pinch wheel is positioned over the paper edge and measuring where this pinch wheel is. The pinch wheel has a magnet glued to it and the pen carriage has a reed switch mounted on it. When the reed switch enters a strong magnetic field it closes. To eliminate position errors caused by variations in magnet strength, the switching point on the reed switch, and tolerance buildup between the pinch wheel and the pen carriage, the switch point is measured first coming from one direction and then coming from the other direction. Then the center of the magnet is assumed to be halfway between. Again the 7580A does both high and low-speed measurements to get accurate measurements in less time.

I/O Bus

The four major printed circuit board assemblies are connected through the I/O bus. The I/O bus consists of the timing and control logic, the four device address lines, sixteen bidirectional data lines, and the interrupt request logic. To prevent noise or loading of each printed circuit board from interfering with the bus operation, each circuit board is buffered so that only one low-power Schottky TTL load is presented to the bus.

The I/O timing and control logic is controlled by the microprocessor. The Z8002 microprocessor is capable of addressing 64K bytes of individual I/O ports. With this much addressing capability, each circuit board is assigned its own high-order address line to ease the hardware decoding logic. The I/O board address line is gated with an I/O control ($\overline{IO\overline{C}}$) pulse to form the individual board enable pulse. The low-order address lines, A1 through A4, are used to select any one of the sixteen I/O ports available to each circuit board.

The I/O bus direction is controlled by the read/write (R/\overline{W}) line. The selected I/O board bus drivers are enabled when the $\overline{IO\overline{C}}$ pulse is asserted. The individual I/O devices on the circuit boards are enabled by the I/O data strobe ($\overline{IO\overline{DS}}$) pulses. A general I/O device is shown in Fig. 3.

The I/O board consists of the I/O bidirectional bus drivers U1, the port decoder U2, and the I/O devices U3 and U4. These I/O devices may be an analog-to-digital converter as on the internal I/O board or the HP-IB bus controller as on the HP-IB I/O board. An I/O board is selected when its high-order address is true, as explained previously. This enables the bus drivers U1 in the direction specified by the R/\overline{W} line. The individual I/O device is enabled when the address decoder, determined by lines A1 through A4, selects it. The decoder sends out a pulse the width of $\overline{IO\overline{DS}}$ to the device. The device uses the trailing edge of the $\overline{IO\overline{DS}}$ pulse to store data for a write operation, or transfers the data onto the bus while the data strobe pulse is asserted on a read operation.

If the data strobe pulse had been used to enable the bus

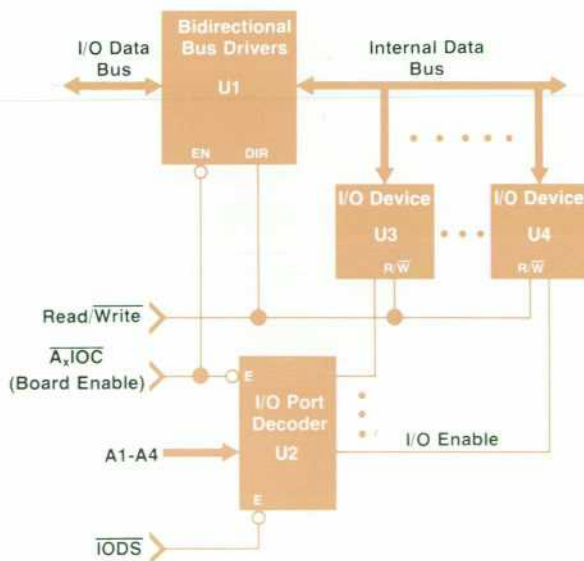

Fig. 3. Block diagram of a general I/O device for the 7580A.

drivers as well as the I/O device, it is possible that the bus drivers would be in their high-impedance state and the data lines would be floating before the I/O device had a chance to store the data. This could easily happen with the added gate delays in the decoder path. Also, to increase the access time available for the I/O devices, the bus drivers are enabled before the data strobe pulse begins. For the above reasons a new signal not generated by the microprocessor is used. The signal is the $\overline{I\!O\!C}$ pulse. Also, because of the long delay times of the data strobe pulse generated by the microprocessor, an additional $\overline{I\!O\!D\!S}$ pulse is created. The long delays create access time problems for some of the I/O devices; thus the $\overline{I\!O\!D\!S}$ pulse also guarantees that the data strobe pulse's trailing edge will end before the bus drivers' gating pulse.

All data transfers between I/O devices must first pass through the processor circuit board. The data is interpreted by the microprocessor and ROM (firmware) before being transferred to its final destination. An example is raising the pen when initiated from the front panel. The key press is sensed on the internal I/O circuit board, and sent to the processor PCA. The raise-pen command is interpreted in the firmware. The processor board then sends a command back to the internal I/O board to cause the pen-lift circuitry to drive the pen-lift mechanics to the up position.

Interrupts

The microprocessor has four methods of interrupt. The drafting plotter uses three of the methods available: reset,

nonvectored interrupt (NVI), and vectored interrupt (VI). Reset is a special case of interrupt, because it suspends all microprocessor operation, clears the program counter, and places the data and control lines in their high-impedance state. When reset returns to its high state, the microprocessor begins operation at location zero. A reset may be generated at turn-on time by a power-on signal received from the servo I/O board, or by a manual reset from the key on the processor board.

Nonvectored interrupt is connected to the microprocessor from the rear-panel **CONFIDENCE TEST** button. When enabled, NVI always causes a jump to the confidence test subroutine which executes a series of tests to verify the machine is operational.

Vectored interrupt means the microprocessor points to a specified location in memory, depending upon the data stored in the VI jump register. The jump register has the information indicating which I/O device is requesting an interrupt. The logic on the processor board is capable of handling up to four vectored interrupts. The 7580A uses three of these interrupts with the fourth being a spare. The three in order of priority are: servo I/O, I/O 1 (transmit ready or HP-IB controller), and I/O 2 (receive ready or IFC timer). Priority is determined by a lookup table in the firmware.

Acknowledgment

Bud White designed much of the internal I/O board for the 7580A.

Neal J. Martini



Neal Martini received his BSEE degree in 1969 from the University of Detroit and his MSEE degree in 1971 from the University of Missouri at Rolla. He joined HP in 1978, contributed to the 7580A Plotter electronic design, and is presently a San Diego Division lab project leader. He is married, has two children, plays piano, racquetball, and basketball, and likes to ski.

Hatem E. Mostafa



With HP's San Diego Division since 1979, Hatem Mostafa designed the power supply for the 7580A Plotter. Born in Cairo, Egypt, Hatem received his BSEE degree in 1979 from the University of Minnesota. He is married, lives in San Diego, and enjoys scuba diving, body surfing, science fiction, and backpacking.

Lowell J. Stewart



Lowell Stewart wrote control firmware and did firmware-hardware integration for the 7580A Plotter. Born in Dayton, Ohio, he attended Ohio State University, graduating with a BSEE degree in 1979. He joined HP's San Diego Division in 1979. Lowell enjoys scuba diving, boating, cycling, and less frequently, skiing and hiking. He's a resident of San Diego.

Dale W. Schaper



Dale Schaper received his BSEE degree in 1967 and his MSEE in 1972 from Long Beach (California) State University. He joined HP in 1972 after five years of electronic design in the defense industry. He has contributed to the design of the 7221A, 9872A, and 7580A Plotters. Dale is a runner and a cyclist. Born in Chicago, he is married, has two sons, and lives in Escondido, California.

Motor Drive Mechanics and Control Electronics for a High-Performance Plotter

by Terry L. Flower and Myungsae Son

THE MICRO-GRIP PLOTTING MECHANISM used in the HP Model 7580A Drafting Plotter is an unconventional design combining compact, simple motor-driven systems with digital control electronics (Fig. 1). Each axis of the plotter is driven by a separate motor mechanically coupled to the particular load for the axis (pen or paper). An optoelectronic encoder mounted on the motor's shaft senses position and velocity for the control electronics which then determines the appropriate output of the motor drive circuit for the next move along the axis.

Mechanical Design

Design considerations for the mechanical drive used in the 7580A are based on two key objectives: performance and reliability. The low-inertia approach of moving paper via grit-wheel-drive technology and pen changing via a carousel (which allows for the use of a single-pen pen carriage) means that performance and reliability can be achieved using parts smaller in size than one would normally expect in a D- and A1-size plotter. The drive motors (Fig. 2) are a good example of this. As a result, low cost is an added bonus.

Our performance goal is to achieve 4g acceleration and 60 cm/s slew speed while maintaining a high standard of line quality. A dc motor and shaft-mounted encoder combination is used because of its low-inertia/high-performance characteristic.

One of the early design decisions was how to couple the

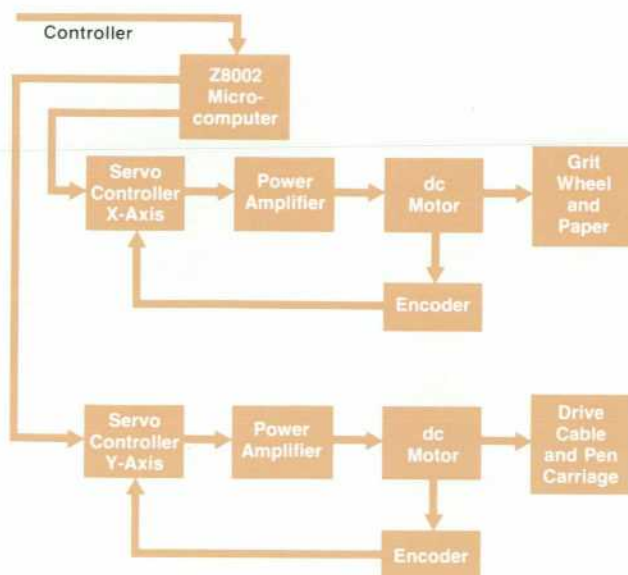

Fig. 1. Simplified block diagram of motor drive and servo system.

motors to the load. The pen-carriage axis uses a cable driven by a pulley to move the carriage back and forth along a straight guide rail. The cable-wound drive pulley is geared to the Y-axis drive motor. The X-axis grit wheels are geared directly to the drive motor. Some of the considerations that influenced the selection of a gear-driven approach are:

- Load inertia on the grit-wheel axis changes as a function of the medium being driven and its size. To keep this from disturbing the servomechanism and line quality it is desirable to make the motor and nonvariable portions of the total load inertia large with respect to the paper inertia.
- Physical size of the motor and thermal considerations indicate that geared reduction is beneficial.
- Mechanical stiffness and repeatability are necessary requirements.
- It is desirable to have the two axes driven in the same manner.
- A fine encoder resolution was needed to obtain velocity data.
- Maximum operating frequency of commercially available encoders is generally limited to 50 kHz.

Proper gear design is important to reach our goals of performance and reliability. A fine diametral pitch (DP) is desirable for several reasons. First, the finer the tooth the less the magnitude of sliding friction between mating teeth. The benefit is less wear. Second, noise is reduced with a fine pitch gear. Finally, high contact ratios can be achieved, that is, more than one tooth can share the load.

A 72-DP 20-tooth pinion is bonded to the motor shaft with an anaerobic adhesive. The pinion is hobbled from 303 stainless steel since it is subjected to much more wear than the driven gear due to the pinion's higher r/min. At 60 cm/s slew speed the motor turns at approximately 2900 r/min. The driven 72-DP gears are made of Teflon™-filled Delrin™. Plastic gears are desirable to keep inertia and gear noise at a minimum. Delrin was chosen because of its strength and low water absorption properties. Teflon filling means that additional lubrication is not necessary during the life of the plotter. The gears are hobbled to an AGMA quality number 10 specification. This includes a tolerance of 0.013 mm on tooth-to-tooth error and 0.025 mm on total composite error. Accuracy, repeatability, quietness, and wear are directly affected.

The gear used on the pen-carriage axis has 209 teeth while the gear used on the grit-wheel drive axis has 141 teeth. An odd number of teeth is chosen intentionally so that a particular tooth on the pinion will engage less frequently with a particular tooth on the driven gear than it would if an even number of teeth had been chosen. This also contributes to more even wear and quieter operation. A great deal of care is necessary during the fabrication and

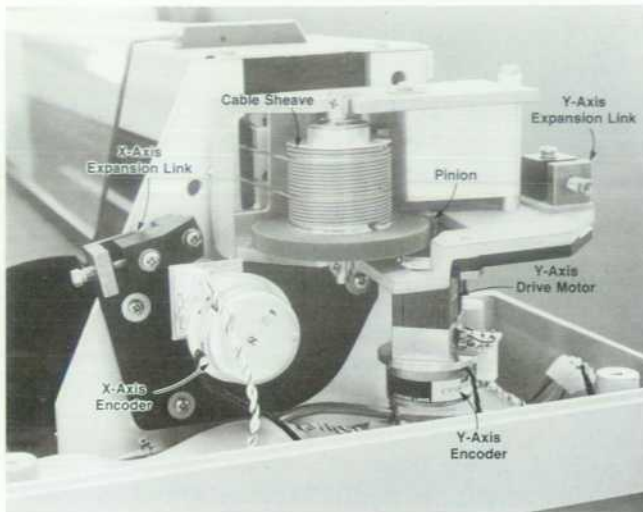

Fig. 2. Delrin™ expansion link assembly. This design, indicated by the arrows, compensates for the difference in thermal expansion rates between the aluminum and Delrin gears used in the drive motor systems. Note the small size of the drive motors.

assembly of the motor and gear-mounting parts to guarantee that the pinion and the gear are paralleled. This assures that the load is distributed over the entire 8-mm face width. Low tooth wear is the result.

The problem of thermal expansion of the Delrin gears was solved by a clever mounting scheme. An aluminum frame is used to mount the motor and gear on each axis. Since aluminum and Delrin have different coefficients of thermal expansion, there is a problem of gear backlash changing as a function of temperature. Backlash must be minimized since it affects line quality (line closure). The motor is mounted on a plate that is free to move with respect to the gear. This plate is restrained to the main aluminum frame by means of a Delrin expansion link (Fig. 2). The expansion link is located geometrically such that it moves the motor to and from the gear at the same rate the gear contracts and expands with temperature. As a result any component of backlash caused by temperature variations is eliminated. A repeatability specification of 0.05 mm is then attainable.

The 1000-line dual-channel optical encoder is the feedback element in the servo loop providing both positional and velocity information. Since the feedback element is right at the motor and not out at the pen tip or on the paper surface the pen is actually plotting outside of the servo loop. A stiff rigid system is necessary to couple the motors to pen and paper so that the position is not affected by resonances or loose tolerances outside of the servo loop. One potential problem is the drive cable acting as a spring in the pen carriage drive system. An initial concern was that the resonance of the cable would be so low that it would come close to the 100-Hz servo bandwidth. Waviness in the lines would have been the expected result. To stiffen the system and move the resonance higher a double-stringing technique is used. This is accomplished in the same amount of space that single stringing previously occupied. If everything were perfect the resonance should be higher by the square root of 2. The result is a resonance of approximately

230 Hz with the pen carriage all the way to the left-hand end of travel. As the carriage moves to the right one of the parallel springs is shortened and the resonance gets even higher.

The cable used to drive the pen carriage back and forth is composed of a combination of 303- and 304-stainless-steel strands wrapped in a 7×19 (7 bundles of 19 strands each) construction and covered with a nylon jacket. Fatigue life of the cable is an important consideration in selecting the drive pulley diameter. This leads to the drive pulley being larger in diameter than the grit wheel and thus the different number of teeth on the respective drive gears.

Servomechanism

The most frequently encountered requirements for a high-performance X-Y plotter are accuracy, speed and line quality. The achievement of the requirements here centers on the ability to control the movements of the pen and the paper. Servomechanisms are used to drive the plotting mechanism as desired under load and environmental variations. X-Y plotters need two axis-position control servos. The servos control the pen and paper so that they follow input vector profiles. The pen and paper must reach the target position while the drive motors for each of the two axes control velocity so that the pen follows the desired trajectory on the paper in real time. For accuracy, smoothness and the coordination of both axes, the servos should be insensitive to the parameter variations of the mechanical system, prime mover, and writing media. The servo bandwidth is frequently taken as a figure of merit for judging performance. Through the simulation and the analysis of the proposed mechanical system, the 7580A was modeled as a second-order system and the bandwidth was extended up to 100 Hz, which proved to be safe from mechanical resonance.

To control each state of an inertia-damping second-order system, information of two states is necessary. Position and velocity are the observation and control states in this system. The servo loop can be closed only with position feedback. But it is difficult to have loop gain high enough to get the required stiffness to desensitize the effect of load perturbations because of the stability problem caused by mechanical resonance. Many different styles of classical servo systems are available with a single feedback, but they have contradictory problems: if the stiffness at the stationary state is enhanced to reduce the error at the final position, the slew speed is sacrificed; if the slew speed is enhanced, a stability problem emerges or the stiffness is sacrificed. The 7580A obtains the position-feedback information from the optical shaft encoders which are easily interfaced to the microprocessor. Velocity information is estimated from the encoder counts.

Dual-Rate Sampled Data

The 7580A servo system (Fig. 3) is a dual-rate sampled data control system. In slow-rate mode, the position data from the optical encoders on each motor shaft is provided to the processor. Following the necessary calculations, the processor outputs position command signals corresponding to the difference between the desired and actual positions of the pen and paper. A fast-rate loop provides velocity data for damping the system.

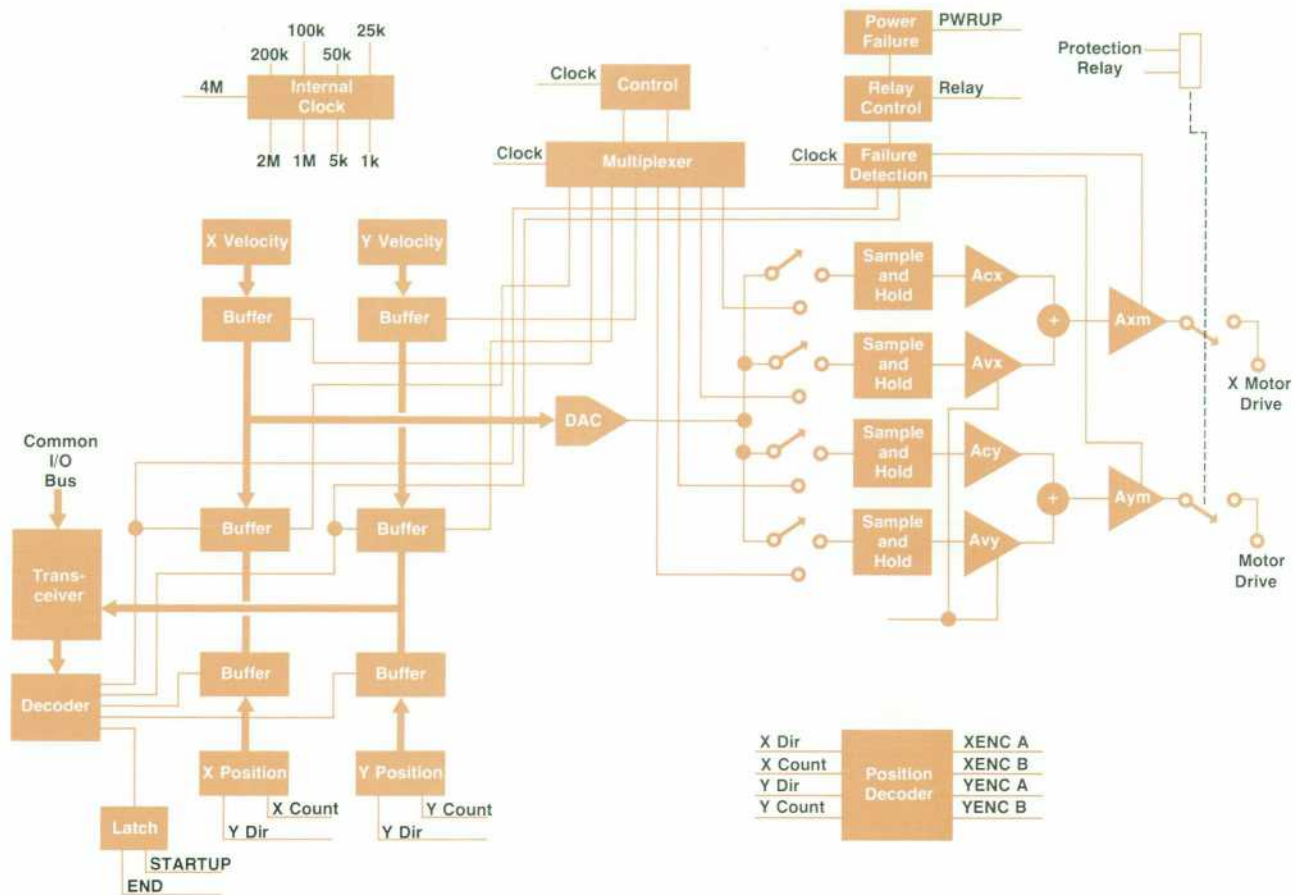

Fig. 3. Block diagram of the 7580A servo control system.

One method for obtaining velocity information would have been the use of a traditional tachometer. This would have allowed a continuous and accurate measurement that would have been easy to interface to the control electronics. However, the use of a tachometer was avoided because of troublesome motor-tachometer resonance and packaging difficulties. For digital plotters, estimating the velocity from an encoder signal is attractive because of hardware economy. To estimate the velocity, the time interval can be measured for a fixed count change or the count variation over a fixed time period can be determined. The velocity is a nonlinear function of time in the former case. This limits the implementation and performance. The 7580A uses the latter scheme. For better estimation, a large count and a small time interval are preferable, but they are conflicting requirements for physical realization. If the interval is small, the resolution may not be satisfactory because not enough counts may be registered during that time span. If the interval is large, there will be a delay in obtaining the velocity feedback. This has an adverse effect for damping the system. A large count requires a high-resolution encoder which is costly. A compromise is necessary in overall system design. The 7580A uses a 5-kHz velocity sampling rate which is five times faster than the main sampling rate. The fine resolution is obtained by detecting every edge of

the 1000 encoder pulses per revolution. This is equivalent to 4000 lines per revolution. In addition to this multiplicity of encoder pulses, the high gear reduction between the motor and the shaft makes the motor run faster and generates more counts per time interval. Thus, one position count amounts to $3.124 \mu\text{m}$ and at the maximum slew speed of 60 cm/s, 41 counts are registered for one velocity sampling period. To achieve the necessary speed in velocity estimation this is implemented in hardware.

By line quality, we mean the fidelity of the plot to the input. This is synonymous with dynamic accuracy. Traditionally, plotter accuracy means static accuracy, that is, how closely the actual pen position agrees with the desired endpoint. These performances are directly related to the servo characteristics of both axes. The dynamic matching of the two axes is the key to line quality in the 7580A. A large loop gain solves the accuracy problem and regulates the effect of load perturbation. The micro-grip drive and the high gear reduction reduce the effective load inertia, simplifying the matching. In most systems, the load inertia is dominant in the inertia term. In the 7580A, using gear reduction makes the load inertia equivalent to the motor inertia. The 4g acceleration, 60 cm/s slew speed and 0.025 mm resolution are achieved with a 100-Hz servo bandwidth.

Dual Bandwidth

There is an inherent limit cycle problem with the digital velocity estimator. This is because the velocity estimation is done discretely rather than continuously. The limit cycle causes physical dithering and audible noise. The dithering does not deteriorate the plotting quality because it is minute. But it can cause a wear problem, and the audible noise may be loud enough to bother the operator. When the pen and paper reach their target location in the 7580A, the processor changes the position command signal gain internally and sends an endpoint control signal to the servo board. Then the damping path gain is reduced to make the servo bandwidth 60 Hz. This proves to be tight enough at the stationary position to hold the motors still and minimizes the dithering.

To minimize the use of electronic hardware, a multiplexing scheme was chosen. Although this increases the complexity of the circuit, redundant hardware and data paths can be eliminated. There are two internal common buses on the servo board (Fig. 3). One is connected from the common I/O bus. The other is connected to the digital-to-analog converter (DAC). The buses are used to read the present position for the processor and to send the position command signal and the damping signal to the DAC. The 25-kHz multiplexer control signal sequentially enables the outputs of the X- and Y-velocity estimator and position error registers, applying their contents to the input of the servo DAC. These signals also enable the corresponding analog switches for the sample-and-hold circuits. The timing is such that the analog signal path to the sample-and-hold is completed 1.5 μ s after the digital input is available to the DAC. The path is opened 1.5 μ s before the input to the DAC is changed, keeping the DAC transient signals from reaching the sample-and-hold circuits. The four sample-and-hold circuits retain the signals, X-axis position command, X-axis damping, Y-axis position command and Y-axis damping. The outputs of the circuits go to the power amplifiers through the summing and gain control amplifier stages.

There are two safety features for plotter hardware protection. One is implemented in firmware as discussed in the article on page 7. The other is done in hardware. A drive-system protection relay is inserted between the axis drive motors and their respective drive amplifiers. This relay also has a set of contacts to protect the pen-lift voice coil against overcurrent conditions. This relay is closed by the processor at power-on and opens automatically upon loss of the +5V or \pm 12V supplies, loss of the system clock, pen-lift coil overcurrent, or failure to respond to a service request interrupt. This circuit completes the current path to the drive motors only when the detection circuit shows no failures. Thus, even with an initial failure, the mechanism can be protected.

Troubleshooting the multiplexed circuit and the servo system is inherently difficult. To ease the troubleshooting problem, there are three diagnostic LEDs (light-emitting diodes) on the servo board. One LED indicates the protection relay status, while the other two LEDs are used to indicate which path has trouble. By selecting the proper self-test switch on the processor board, the processor sends the signal to the corresponding path or reads the position

counts and calculates the velocity with the position count variation and feeds this into the position command path. With these operations and with LEDs and/or an oscilloscope, a troubled path can be identified easily. This capability reduces the troubleshooting time and painful effort.

The mechanical system, including the motors, was modeled on a computer and verified with an HP Model 5423A Structural Dynamics Analyzer.

Acknowledgments

Thanks to Al Kendig for the mechanical system simulation and estimation program which contributed to the speedy development of the servo system. Also, thanks to Bob Haselby for the helpful discussions during the 7580A project.

Terry L. Flower



Terry Flower received his BS degree in engineering from Harvey Mudd College in 1974 and his MSME degree from the University of California at Berkeley in 1976. With HP since 1976, he's done mechanical design for the 7245A and 7580A Plotters and is now a lab project leader with HP's San Diego Division. Born in Albany, New York, Terry lives in San Diego and enjoys cross-country skiing, backpacking, and bicycling.

Myungsae Son



Myron Son came to HP in 1973 with experience in the design of modems, disc drives, automatic test equipment, and telephone switching networks. He has contributed to the design of the 7450A and 9872A Plotters and the control system and motor driver of the 7580A Plotter. He is named inventor on a patent on a reverse channel receiver. Myron was born in Seoul, Korea. He received his BSEE degree from Seoul National University in 1964 and his MSEE degree from the University of California at Los Angeles in 1969. He is married, has a son, lives in Del Mar, California, and is interested in woodworking, painting, classical music, playing Go, reading, and church activities.

Firmware Determines Plotter Personality

by Larry W. Hennessee, Andrea K. Frankel,
Mark A. Overton, and Richard B. Smith

THE PERSONALITY OF THE HP MODEL 7580A Drafting Plotter is determined by 48K bytes of firmware as executed by a Z8002 microprocessor. The multilevel interrupt capability of the Z8002 allows the plotter to service the I/O, front panel, and axis-motor control algorithms upon time-driven and event-driven interrupts while processing commands from either the plotter's front panel or I/O in the background. The 64K-byte addressing space of the Z8002 lets the plotter firmware contain twelve character sets, six each of two different fonts, as well as a 1024-byte input buffer. Enough unused addressing space is available so that future enhancements to the plotter can be easily done by expanding the firmware.

Three levels of interrupt are used. The highest-priority interrupt services a 1-kHz sampled-data servo system to control the two drive motors. It also monitors any front-panel activity. The two lower-priority levels of interrupt service the I/O, which can be either the HP-IB* or RS-232-C at up to 9600 baud.

At power-on, the plotter initialization module determines which of the two I/O hardware modules is installed and activates the appropriate firmware module. Because both I/O configurations are buffered and data is sent to the 1024-byte input buffer or output from the output buffer upon demand, the I/O firmware module is independent of and entirely decoupled from the rest of the plotter's firmware. Because of the relatively small amount of code in each of the two I/O firmware modules, both are always resident so that the firmware and the processor/memory circuit board are the same in both I/O configurations.

The 7580A handles paper of various sizes. Paper loading and unloading is no more difficult than it is on a flatbed

*Hewlett-Packard's implementation of IEEE Standard 488 (1978).



Fig. 1. Front panel of the HP Model 7580A Drafting Plotter.

plotter. These features presented challenges to the firmware design team.

Unlike a flatbed device, which has a fixed platen with predetermined mechanical-travel limits for the axes, the effective platen size of the 7580A is a function of the size of the paper. The effects of this on the graphics setup parameters (character size, scaling, etc.) have to be minimized. A way to align the plotter had to be devised so that it can track lines on grid paper whose grid lines are not quite orthogonal to the paper's edges and therefore the platen edges. Because of the simultaneous motions of a pen along one axis and the paper along the other axis, a convenient method for permitting the operator to interrupt an in-progress plot asynchronously for observation is necessary. Another major design objective, underlying all other decisions, is that the HP 7580A be backward compatible to the rest of HP's HP-IB and RS-232-C plotters.

This last objective dictated that the Hewlett-Packard Graphics Language (HP-GL) be used as the interface communication language. Because of the many new and expanded features of the 7580A, new commands were added. The language syntax was made less stringent so that, compared to other HP-GL plotters, fewer bytes of data need to be sent to the 7580A for any given plot.

Backward compatibility introduced another problem. The standard vector endpoint resolution of HP's plotter family is 25 micrometres. This 25-micrometre distance is defined as one plotter unit. HP's other plotters are of a size such that any (vector) endpoint on their platens can be addressed in plotter units by a positive two's-complement integer number expressible in sixteen bits. Thus, HP's other plotters are first-quadrant devices. In the case of the 7580A, the lengths of D- and A1-size paper are on the order of 90 centimetres, or more than 36000 plotter units, a number too large to be represented as a positive two's-complement integer in sixteen bits. However, if the endpoint address in plotter units can be a positive or negative number, sixteen bits can represent numbers large enough to address every point on D- and A1-size, or even the larger E- and A0-size paper. Therefore, the 7580A's plotter unit origin is placed in the center of the platen (that is, the center of the loaded paper). Thus, the 7580A is a four-quadrant plotter. Existing software and controller firmware written to drive HP's other plotters can also communicate with the 7580A through a common sixteen-bit two's-complement integer format.

The front panel (Fig. 1) provides the operator with the means for locally controlling the 7580A. The front panel has twenty-two keys, eleven LED (light-emitting diode) indicators, a three-hexadecimal-digit matrix display, and a joystick. The joystick is used to position the pen locally on the paper. The LEDs indicate the current operating mode of the plotter, whether there has been an I/O or graphics error, whether ninety-degree rotation is in effect, whether the plotter was told to move outside the plotting limits, and

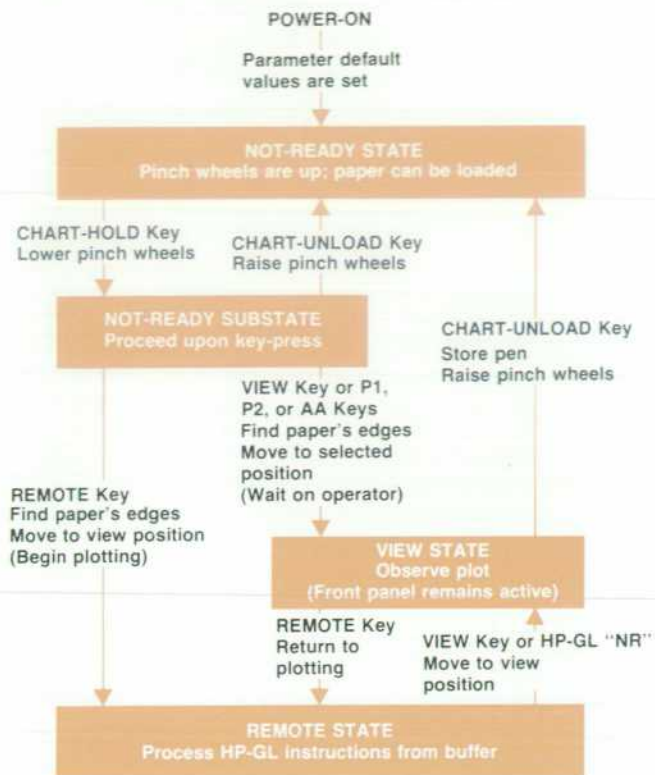

Fig. 2. Diagram of transitions between the 7580A's three operating states.

whether the plotter is expecting entry of a digitized point. Two LED indicators, in conjunction with the three-hexadecimal-digit matrix display, also prompt the operator when pen force and speed parameters are being entered from the front panel. The three digits in the display indicate the current pen number and its respective force and speed values in normal operation. Additionally, they indicate a hardware malfunction, should one occur during plotter operation.

The twenty-two keys let the operator enter pen force and speed values, select a pen, turn ninety-degree rotation on or off, enter scaling point positions on the paper (platen), align paper grid lines with the plotter axes after the paper has been loaded, and set the mode of the plotter to one of three operating states:

- Not-ready, for paper loading and unloading
- View, for asynchronous local interruption of an in-progress plot for operator inspection and/or optional modification of pen position or other parameters
- Remote, for fetching and processing HP-GL plotting commands from the input buffer.

The operating state of the plotter is controlled entirely by four of the twenty-two front-panel keys. Hence, an operator uses just these four keys in an environment where all plotting parameters are set via program control. The rest of the front-panel keys, and all of the indicators and the joystick, can be ignored in such an environment. This can help minimize the amount of operator training necessary.

A diagram of the plotter's operating states, and the front-panel key functions that invoke state transitions, is shown in Fig. 2. All state transitions are invoked solely from the

front panel with one exception: a program can issue an HP-GL command that causes the plotter to exit the remote state and enter the view state. Because it takes operator intervention to force the plotter back into the remote state, and because the remote state is the only state in which HP-GL commands are processed, the program can thus protect a just-finished plot from being drawn upon by a subsequent program before the operator changes the paper.

A function mentioned earlier is the alignment of the plotter's axes with the axes of grid paper. This is exclusively a local function in that it can be accomplished only via the front panel. The axis alignment function is necessary only if the paper's grid lines, when loaded, are not orthogonal to the plotter's axes. Whether or not axis alignment should be done, or has been done, is not known by the program driving the plotter. Good programming practice might require that the program send the operator a reminder to check for grid/plotter axis alignment when grid paper is in use. Should axis alignment be necessary, the logical axes of the 7580A can be rotated a few degrees away from its actual physical axes so that the plotter's effective axes are orthogonal to the grid's axes. This is done by using the front-panel joystick in conjunction with the **AXIS-ALIGN**, **P1**, **P2**, and **ENTER** keys.

Two other plotter functions are pen carousel initialization and confidence test invocation. Whenever a carousel is mounted, it is handled as though an "initialize carousel" key on the front panel were pressed. The carousel is automatically rotated so that its pen type (fiber-tip, roller-ball, or liquid-ink) and its occupancy state (actual number of pens in the carousel and where they are located) can be sensed and recorded. The 7580A then updates the occupancy state map every time there is any pen changing activity while the carousel remains mounted. Whenever a new carousel is mounted that differs in type from the previously

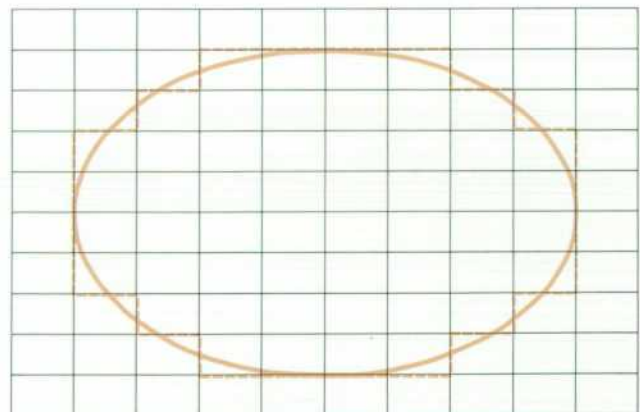

Fig. 3. When the user-specified units (black grid above) are much coarser than the internal plotter units the arc generator in the 7580A smooths curves by temporarily altering the transformation coefficients. Thus, instead of constraining curved lines to the user-grid intersections (colored dashed ellipse above), a more acceptable smooth plot (colored solid ellipse above) results.

mounted carousel, a set of default values for pen speeds and forces is invoked. These default values can then be changed, either by the program or via the front panel, for all pens of the carousel or for individual pens in the carousel.

A button on the back panel invokes the plotter's internal confidence test. To run the test, the plotter must have paper loaded such that it is in the not-ready state with the pinch wheels down on the paper. Otherwise, the **CONFIDENCE TEST** button has no effect. When the test is run, an exhaustive test plot is drawn on the loaded paper. The test plot can be inspected for line quality, retrace, pen concentricity, axis accuracy, and so forth to confirm satisfactory operation. No controller is required to run this test since the internal firmware contains the commands to make the test plot.

Firmware

When the plotter is turned on, it tests its ROM (read-only-memory) and RAM (random-access memory), checks an internal switch to see if some self-test is to be performed, initializes all the firmware modules, resets the hardware components, starts the one-millisecond processor interrupt, establishes the pen carriage position and enters the not-ready state. The plotter can then be set into its ordinary plotting mode, remote, via the front panel as discussed earlier and illustrated in Fig. 2. In remote, HP-GL commands in the form of a continuous stream of ASCII characters are taken from the plotter's buffer for processing.

When the I/O module is requested by the parser subroutine to get a command character from the buffer, it first checks to see if any front-panel activity has occurred. If so, it calls the front-panel handler to perform the appropriate action before examining the input buffer. Thus, continuous I/O activity does not lock out the front panel because the front panel has a higher priority.

The parser recognizes the HP-GL command set, which consists of two-letter mnemonic commands followed by optional parameters in the standard ASCII* character set. For example, AA 3000, 4000, 45, 1; is an arc-absolute command that directs the plotter to draw a 45 degree arc in one-degree increments centered about the point (3000, 4000), starting at the current logical pen position. The parser converts such an HP-GL command into a command number and a binary parameter list. An executive loop invokes the parser to get a command and gives it (and any accompanying parameter list) to the graphics module to dispatch the appropriate routine to do the command.

To keep the code design straightforward and modular, all coordinate transformation information is kept in matrices instead of distinct variables, allowing a single high-speed transformation routine to perform all translation, scaling and rotation. This structure also permits the rapid coordinate-system changes needed for drawing arcs, characters, and dashed lines.

Arc Generator

The 7580A contains a powerful arc generator. The arcs are composed of a series of connected straight chords. The length of a chord can be determined by either its subtended angle or a maximum allowable deviation from a true arc. Either of these methods can be selected through the HP-GL

command set. In addition, if a user-specified unit corresponds to many plotter units (coarse scaling) the arc generator automatically smooths the arc—the endpoints of each chord are not forced to lie on integer-valued user-unit grid points, but instead lie on the true arc (Fig. 3). This smoothing is accomplished by temporarily dividing the scaling coefficients in the transformation matrix by a power of two to make the largest one of them equal to about one plotter unit in one or both axes.

The arc generator accepts either a chord angle, or a maximum arc deviation from which it computes the corresponding chord angle. The resulting chord angle is decreased if necessary to fit an integral number of equal-length chords in an arc. To reduce processing time, all chord calculations are done using fixed-point integer arithmetic instead of floating point.

All angles are converted internally from degrees to binary-angular-measure format (BAM) by the formula $BAM = \text{degrees}/360$, and are stored as a 16-bit or 32-bit number. For example, 140° is represented by .0110001110001110.

The BAM format has the advantage that one does not need to use modulo 360 arithmetic when adding angles—only a binary add is needed. This format also simplifies the fixed-point sine and cosine calculations. The relationship $\sin(X) = \cos(X - 90)$ becomes $\sin(X) = \cos(X - 4000_{16})$, the input being 16 bits. The cosine calculation uses the first five terms of Taylor's series (with some coefficients adjusted to improve worst-case accuracy), which requires five 16-bit multiplies.

The arc algorithm is:

```
THETA := 0;
DO NUMBER_OF_CHORDS TIMES
BEGIN
  THETA := THETA + CHORD_ANGLE; (32-bit add)
  X := XCENTER + DX*COS(THETA) - DY*SIN(THETA)
    (16-bit multiplies)
  Y := YCENTER + DY*COS(THETA) + DX*SIN(THETA);
    (32-bit adds)
  DRAW(X, Y);
END;
```

This algorithm has the properties that:

- All chords are of equal length
- An arc does not drift, that is, the last chord ends at the true endpoint of the arc (iterative algorithms can drift)
- Chord endpoints are accurate to within one plotter unit for arcs of reasonable radii
- Chord calculations involve only fixed-point arithmetic, which reduces processing time.

Linetype Generation

A new feature of the 7580A is its ability to draw adaptive dashed lines. Adaptive dashed lines are drawn such that an integral number of dashes will fit in a line. Integer arithmetic is used to decrease processing time, and is assumed throughout the following discussion, i.e. all lengths are expressed as integral numbers of plotter units. The number of patterns drawn in a line is computed by

$$N = \frac{(\text{line length})}{(\text{nominal user-specified pattern length})} \quad (1)$$

* American Standard Code for Information Interchange

N is incremented by 1 if equation (1) has any remainder. The pattern length is then changed slightly by

$$\text{Pattern length} = \frac{(\text{line length})}{N} \quad (2)$$

This is rounded down if not an integer, assuring that the drawn pattern length will not exceed the nominal user-specified length. In general, N does not exactly divide the line length in equation (2). The gap $E = (\text{line length}) - N \times (\text{pattern length})$ is the amount the last dash-pattern would fall short of the line's endpoint (Fig. 4a).

Some of the few plotters that will do adaptive dashed lines simply leave a gap of E plotter units at the end of the line. The 7580's firmware avoids this annoyance by drawing the first E patterns (Fig. 4b) with an added length of one plotter unit, creating a small gap at the end of E patterns instead of a large gap of E plotter units at the end of the line. This assures that the last pattern will always end exactly at the line's endpoint, creating a uniform dashed appearance.

For example, given a nominal pattern length of 10 and a short line of 8, N is 1 and the pattern length becomes 8. For a line 76 units long, N is $76/10 = 7.6$ which rounds up to 8. The pattern length for this line then becomes $76/8 = 9.5$ which rounds down to 9. The gap $E = 76 - 8 \times 9 = 4$, thus the first four patterns are 10 units long and the last four patterns are 9 units long.

Smart Pen Module

The 7580A provides a variety of pen control features by means of the smart pen module (SPM) situated at the logical interface between the front-end graphics processing and the hardware-oriented vector generator. This module provides the ability to control pen movement parameters, automatic timeout features, and decision algorithms for pen selection and storing. A new feature allows the 7580A to do some buffering of pen actions to enhance performance.

The automatic pen (AP) instruction allows the user to specify combinations of three smart-pen functions:

1. Pick pen up if unused for x milliseconds

2. Put pen away if unused for x milliseconds
3. Buffer pen selects until pen is needed for draw.

The buffering of pen-select (SP) operations was motivated by observing a rather futile and embarrassing bit of behavior on another plotter. When a multicolor dashed-line pattern was defined in software and generated for a vector which was clipped, the pen selects for the portions of the line outside the window were not weeded out when the line segments were clipped. Watching pen after pen being selected, brought to the edge of the window, and returned to the stall without being used made us realize that a pen select is not necessary unless a line is to be drawn with that pen. Thus the smart pen module maintains a "logical pen" (last selected) and an "actual pen," and updates as needed. This feature can be defeated by sending the appropriate AP instruction, or by selecting a pen from the front panel. All front-panel operations are done immediately upon recognition of the pressed key. The SPM also remembers the last pen requested that was present in the carousel at the time. This follows the "principle of least astonishment" by preventing the plotter from stopping when given a command to select a pen that is not present in the carousel. In this case the plotter ignores the instruction and continues plotting with the last selected pen that was available.

In addition to the three functions listed above, a fourth function is used internally by the character generator and other graphics activities to request the SPM to buffer pen-up moves; the destination is saved and the move executed only when a pen-down move is needed. This enhances plotting speed by not wasting time moving the pen around when it is not drawing. The default case for the AP instruction is full user-selectable capabilities; for the occasional operation where the three SPM functions are not needed, they are easily defeated. The user is not allowed access to the buffering of pen-up moves because this would complicate the notion of current position. For example, if a move is buffered, what should the plotter output as the current actual pen position and the current commanded pen position? Should the plotter catch up on buffered moves upon receipt of the reset, or should they be forgotten? Upon initiation of front-panel action, such as joystick use, should the buffered moves be done? The code written for the joystick tries to create the illusion that the movement of the pen is directly related to the user's hand on the joystick. If the pen makes a sudden jump to a buffered position when the joystick is touched, that illusion is shattered, and manual operations such as digitizing points and aligning paper grids become more complicated. Acting on the "principle of least astonishment," the buffered-move feature is used internally to simplify processing elsewhere, but is defeated for user interaction.

When the automatic pen-lift or recap features are selected, the number of milliseconds used for the timeout depends on the type of pen carousel last mounted and initialized. If the carousel type is unknown (none present at power-up, or type not readable because the reflective coding strips on the carousel are damaged or not present), the plotter assumes that the most fragile type, drafting pens, type 3, are present. Liquid-ink drafting pens dry out rapidly, and so a 15-second timeout is set for them. Fiber-tip and roller-ball pen carousels (types 1 and 2) use a 65-second

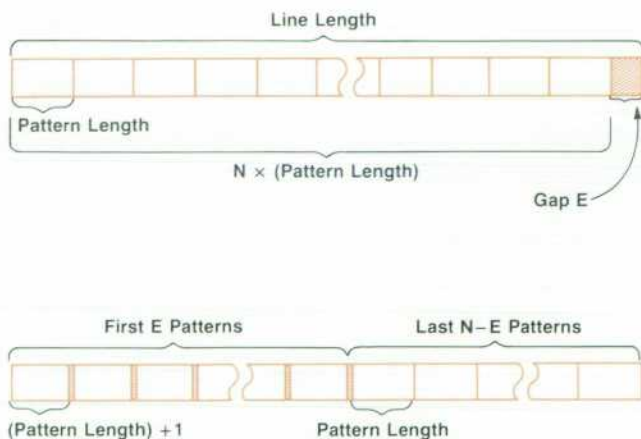

Fig. 4. (a) If the length of the dash pattern for a line does not evenly divide into the length of the line, the remainder causes a gap of length E at the end of the line as shown. (b) The 7580A avoids this by adding an equal part of the gap to a number of patterns at the start of the line.

timeout. This automatic feature is invisible to the user running remote programs. The plotter remembers the pen, logical position, and whether the pen was up or down, and executes a pen fetch and move to restore the state of the plotter upon receipt of the next command. Thus any command is executed properly regardless of whether an automatic timeout occurred or not. A pen which is inserted in the carriage penholder by the user (rather than being picked from the carousel by the plotter) does not activate these timeout features. The timeout is also defeated while the joystick is being used. These provisions are made to keep the automatic features from getting in the way of a manual digitizing operation. The digitizing sight does not need to be recapped and it would be disconcerting to have the pen holder suddenly race to the side of the plotter while ostensibly under joystick control!

Default values of force, speed, and acceleration are stored for each carousel type, along with maximum allowed values for each. After experimenting with many pens on a variety of plotting media, the following defaults were chosen:

DEFAULT	FORCE	SPEED	ACCELERATION
1	4(34 grams)	50 cm/s	4g
2	6(50 grams)	60 cm/s	4g
3	1(10 grams)	25 cm/s	4g
Max	8(66 grams)	60 cm/s	4g

The FORCE number is related to the force in grams by the formula $8 \times (\text{FORCE} - 1) + 10 = \text{force in grams}$.

When a carousel is initialized, its type is read and a pen occupancy map is made. If the carousel is of a different type from the previously initialized one (or if it is the first carousel initialization since power-up), the default values for all three parameters are placed in the parameter arrays for each pen. A group of new HP-GL commands is provided to allow the user to program new parameters for each pen or for all pens. For example, FS; sets the default force for all pens in the current carousel. FS 5; sets pen force 5 for all pens. FS 5,3; sets force 5 only for pen 3. VS (velocity select) and AS (acceleration select) work similarly. In all cases, parameters greater than the maximum allowable value are replaced with that value and pen numbers greater than the number physically possible (8) result in the instruction being ignored. If a carousel is replaced with a carousel of the same type, the parameters stored in these arrays are not

'Twas brillig, and the slithy toves
Did gyre and gimbel in the wabe;
All mimsy were the borogoves,
And the mome raths outgrabe.

'Twas brillig, and the slithy toves
Did gyre and gimbel in the wabe;
All mimsy were the borogoves,
And the mome raths outgrabe.

defaulted. This allows the user to pull the carousel, check or replace pens, and replace the carousel without having to respecify the parameters. The current pen number, force, and velocity (rounded to the nearest 10 cm/s) are displayed on the front panel.

The OT instruction returns the current (last initialized) carousel type and a bit map of pen stall occupancy. This allows a sophisticated program to tailor its pen choosing according to what is available at the time.

Character Generator

In designing the character generator, we began by investigating new and better character fonts to incorporate into the 7580A to upgrade from the fixed-cell stick font used in all of HP's other vector plotters. High on the design objectives list was the desire to include a set with variable-width characters and variable spacing, because a set with these features produces text with high aesthetic appeal. We also wanted to design a set based on arc segments as well as vectors so that the coarseness of the characters is not tied to their size. Balanced against these wants were the constraints—the space allocated for firmware fonts was not infinite, the enhanced characters could not be allowed to degrade character throughput, and any styles or features desired must be easily translated into some machine-storable/machine-executable format.

There was also the explicit concern that the 7580A remain backward compatible with the HP 9872/7220 family of plotters, that is, that the set of HP-GL commands pertaining to labeling be retained and have the same meaning regardless of font change. This requirement to "change but stay the same" had a major influence on the character generator development.

Variable Spacing

In a variable-spacing font, the spacing between any two characters depends on the characters on either side of the space. The combination LT, for instance, will have very little space added between the characters because the concavities of the two letters complement each other. That is, there is a visual open space between the characters. In contrast, the combination ME will have a large amount of space added between the letters, because the juxtaposition of the two parallel verticals creates a crowded appearance. The goal is to adjust the spacing for any likely combination of letters so that the text appears to be evenly spaced to the eye, produc-

Fig. 5. The HP Model 7580A Drafting Plotter has two character fonts. (a) Font with variable spacing and the use of arcs for curved characters (character set 10). (b) Font with fixed spacing and vector-drawn characters (character set 0). (The poem is from Lewis Carroll's "Through the Looking Glass.")

ing aesthetically pleasing and easy-to-read lettering. This is demonstrated in Fig. 5a.

The spacing table is a two-dimensional matrix indexed by the letter on the left and the letter on the right. Building on the work of HP's Corporate Industrial Design group on variable spacing, which was based on fixed character sizes and limited to alphanumeric characters only, we converted the space table to the same primitive grid units in which the strokes for a character are defined, and expanded the table to include the large variety of foreign language and special symbols in the plotter's character sets. Placement of a symbol in a row was based on analysis of what kind of right-hand edge it presented to its neighbors; similarly, column placement depended on analysis of the left-hand edge of the picture. We looked at solidness of fill, concavities and convexities, common subelements, and busyness when comparing characters, but mostly it was the artist's trained eye and intuition that made the selection.

It is highly desirable to have numbers line up in neat columns for applications such as the parts list on a mechanical drawing, regardless of the font or fonts selected for the drawing. Of course, this conflicts directly with the characterization of symbols based on their appearance, so the spacing table was modified especially for this purpose. The numbers were classified according to their width, so that they could be put into special categories. As a result the numbers relate to other numbers in a fixed-spacing manner while retaining aesthetically pleasing relationships with letters and punctuation marks.

Another problem was trying to keep the size of the spacing table reasonable while still accommodating the special cases of auto-backspace characters such as the tildes and umlauts in the foreign character sets. A negative space is required to center these characters properly over the preceding character. Ensuring that every conceivable combination would look centered presented a problem. The tilde is a good example. A lower case n and lower case m share the same row of the space table since they present identical right-hand edges to the character following them, but they are obviously different in width. To center the tilde over both of them is impossible unless we split the category, and that approach yields a table an order of magnitude larger than the one we wanted to use! We chose to compromise, and selected from each row in the space table the character over which the auto-backspace character was most likely to appear, and used that to determine the spacing entry in the table.

By working to reconcile the artist's point of view with that of the engineer, we were able to see the need for another enhancement to the character generator: adjustable spacing. In HP's previous plotters, the space between characters is scaled by the same transformation as the characters themselves; if there is a half-character-width of space between A and B with 1-mm-high letters, there will be the same ratio of space to letter with 15-cm-high letters. Aesthetically, this is wrong: the larger the characters, the less space that is needed for visually pleasing text. We could not adjust this internally and maintain backward compatibility with HP's previous plotters, so we added an extra spacing (ES) command which allows the user to specify the space to be added (or subtracted) from spaces between characters and lines.

The existence of variable-width characters or variable spacing means that operations such as centering a label are no longer as simple as counting the number of printing characters and doing a character plot command to position the pen half that number of spaces back. Internally, each character in a variable-spaced font has its width, centroid information, left spacetable index, and right spacetable index stored along with its picture. To implement the label origin (LO) command, the buffered label must be traced through, and the number of grid units for each character width and space looked up and accumulated so the exact string length can be determined.

To help sophisticated users who need to do label positioning beyond what is provided by the LO command, the instructions BL (buffer label), OL (output label information), and PB (print buffer) were added to the instruction set. The command `BLxxxxxxxx<etx>` stores a label of up to 150 characters in the plotter's label buffer but does not print it. The OL command can be used to obtain the actual length of the longest line in the label buffer, converted to the units that the character plot instruction uses. Also returned are the number of printing characters and spaces less backspaces in that line and the effective number of linefeeds (LF-VT) in the buffer. This provides the user with the information needed to position the label as desired.

In addition, the OL command, used in conjunction with the ES command, provides the means to stretch or shrink a line to fit a known space evenly without resorting to adding whole spaces between words or altering character size. For example, if it is known that the lines to be justified are approximately 65 spaces wide, one would turn extra spacing off (ES:), buffer the line to be justified (`BLxxxxx<etx>`), and request an OL to receive LEN, NUM_CHARS, NUM_



Fig. 6. Effect of chord angle on character quality. The letter B is drawn above for various selected chord angles. The smaller the chord angle the smoother the arcs and the longer it takes to write the character.

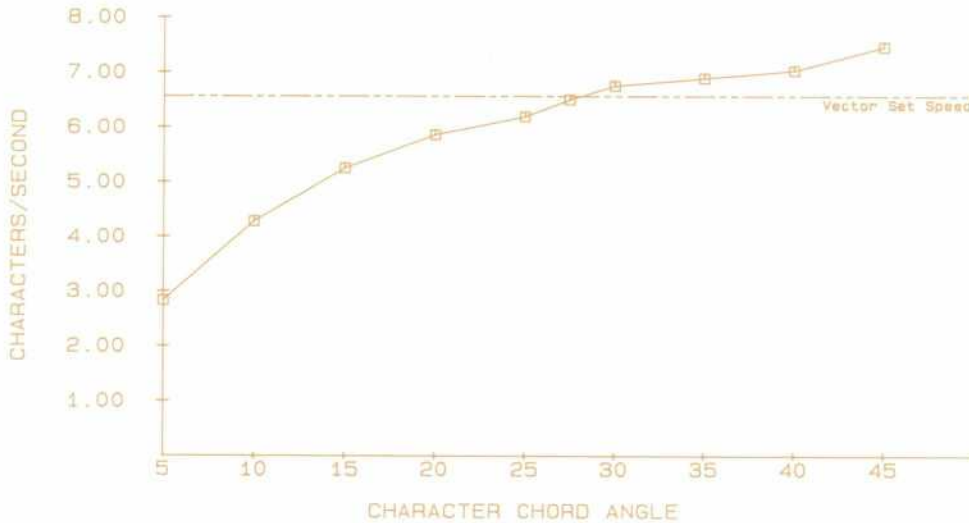

Fig. 7. Relationship between arc-generated character plotting speed and the selected arc chord angle.

LINES. The adjustment $A=(65-LEN)/(NUM_CHARS-1)$ is added to the spacing by using it as the first parameter to the ES command, and the label is printed with the PB instruction. This sequence can be placed easily in a loop or subroutine to facilitate easy use.

Compatibility Problems

Implementing the new character sets revealed a whole set of problems pertaining to spacing and the relationship of the sizing commands SI and SR to the units of spaces and lines used in the CP command. We had given free reign to the artists of HP Corporate Industrial Design (CID) in designing the characters and spacing of the several fonts being considered. It was not until one of the marketing support engineers tried running a prototype 7580A with an HP-85 Computer as controller that we realized that the ratios

$$\text{SPACE/CHARACTER WIDTH} = 1.5$$

$$\text{and LINEFEED/CHARACTER HEIGHT} = 2$$

which held for the 9872A Plotter character sets could not be changed because the HP-85 firmware did its LORG (label origin) calculations based on these ratios. When designing characters based on rounded shapes rather than oblongs, an interesting psychovisual phenomenon can be observed: for a letter such as uppercase S to appear to be the same height as uppercase T, the top curve of the S must actually extend somewhat above the level of the crossbar of the T. Our eyes seem to cue on area in preference to linear comparisons, in effect doing an integration. The IBM Selectric™-like character set we were trying out at that time was designed to produce visually correct characters, thus all of the curved capitals (S, O, C, etc.) were a shade taller than 1/2 the linefeed distance, and most of the letters filled more than 2/3 of their space. The unacceptable result on the HP-85 was letters overlapping lines or clipped off.

As ROM release deadlines drew near, we attempted to fix the problem in the code by scaling and translating the characters by a small amount to place them within the

2/3×1/2 box. Although the characters did not look quite as attractive with the new arrangement, which left much more space between the characters, they were still better than the stick set they were replacing, and quite acceptable to most of the engineers. The appearance of the output was, however, totally unsatisfactory to the artists at CID, who told us they could produce a much better result with a different character set designed specifically to the new constraints. In two weeks' time, they presented us with a modern Eurostyle-like set which we settled on as the default character set in the 7580A. The same set, slightly modified to use fewer vectors in the curved regions, was also selected for the 9872C/T plotter. Each character is based on a rounded square shape which fills up its box, lessening the visual impact of the larger amount of space between characters. Since the curves are more squared, they do not exhibit the visual phenomenon mentioned above; the curved and flat-topped letters both appear to be and are of equal size, and so can be confined to the 2/3×1/2 box. This set (Fig. 5b) has the additional advantage of looking good at very small sizes. Net result: a solution both the engineers and the artists could be happy with!

There was no way to reconcile the variable-width, variable-spacing set with the 2/3×1/2 requirement, so we decided to sidestep the issue by using the fixed set as the default set for those applications that needed the known spacing, and including the more complex set for new applications. However, this set opened up a new problem area: if letters vary in width and in spacing, what does the SI or SR command specify the size of? Compatibility considerations led us to decide that the SI/SR commands still specify the size of 2/3 of a space and 1/2 of a line as used in the character plot command, but should that box be the size of the largest letter or a representative letter, and if so, which one? As with many decisions, we let our eyes make the choice: fitting a capital A to the box and scaling accordingly resulted in capital letters being roughly the same size in both fonts. However, since most of the letters are not as wide as the A, text done in the variable-spacing font usually occupies less

space than text in the fixed font as shown in Fig. 5; hence the motivation for the OL command described above.

Although not immediately obvious to most, the design of a character set to be used with variable spacing is not simply a matter of adding a spacing table to a previously designed fixed font. Our original desire was to include a font with an optional spacing table, and have an HP-GL command to set fixed spacing or variable spacing at the user's option. The problem with this can be seen most easily by comparing an i or l in the two sets (Fig. 5). In the font with variable spacing, the letter has almost zero width, and is situated at the far left side of its box; in the fixed-cell font, the letter is widened with serifs and more nearly centered in its box to eliminate wide gaps within words.

Arc-Generated Characters

The first consideration in designing characters based on arcs as well as vectors was to use the powerful arc generator code already written for the 7580A without giving up the flexibility of the character generator with respect to parameters such as slant, size, and direction. This meant that, in addition to providing the arc generator with the center point, chord angle, and total angle for the arc, a way had to be found to apply the current character transforms to the individual chords of the arcs. The modularity to make this possible already existed: the arc generator works in current units, and the routine that takes vectors in current units transforms them to plotter units, clips them, and ships them out, looking in a global integer for the address of the active current-unit-to-plotter-unit (CUPU) transform matrix to use. The general transform is:

$$\begin{bmatrix} X & Y & 1 \end{bmatrix} \times \begin{bmatrix} A & D & 0 \\ B & E & 0 \\ C & F & 1 \end{bmatrix} = \begin{bmatrix} X' & Y' & 1 \end{bmatrix}$$

If, for example, we have character size (WIDTH, HEIGHT), slant SLANT, a direction specified by (RUN, RISE), and carriage return point (the origin of the character generator's grid system), the transform matrix will be set up as follows:

$$\begin{aligned} \text{HYP} &= \sqrt{\text{RUN}^2 + \text{RISE}^2} \\ \text{CHCOS} &= \text{RUN}/\text{HYP} \\ \text{CHSIN} &= \text{RISE}/\text{HYP} \end{aligned}$$

$$\text{XS} = \frac{\text{WIDTH (cm/character width)} \times 400 \text{ (plotter units/cm)}}{\text{number grid units per character width in current font definition}}$$

$$\text{YS} = \frac{\text{HEIGHT (cm/character height)} \times 400 \text{ (plotter units/cm)}}{\text{number grid units per character height in current font definition}}$$

$$\begin{aligned} A &= \text{XS} \times \text{CHCOS} \\ B &= \text{XS} \times (\text{SLANT} \times \text{CHCOS} - \text{CHSIN}) \\ C &= \text{CARRIAGE RETURN X COORD (plotter units)} \\ D &= \text{XS} \times \text{CHSIN} \\ E &= \text{YS} \times (\text{SLANT} \times \text{CHSIN} - \text{CHCOS}) \\ F &= \text{CARRIAGE RETURN Y COORD (plotter units)} \end{aligned}$$

Switching between plotter units, user units, and the character generator's coordinate system is then basically a matter

of transforming the set of variables representing the current logical and physical position from one system to the other, and setting the global pointers to the appropriate transform matrix and its inverse. The inverse must be available for reset applications to back out of the unit system into plotter unit coordinates. Although requiring a bit more coordination between parts of the code, the flexibility gained by treating the character generator's parameters as a general transform greatly simplified the integration of the new arc characters.

Since the vector font was stored as relative (incremental) vectors on a primitive grid, the arc font was designed to use relative vectors and relative arcs. The arcs are stored as center point (two signed bytes, relative to starting position), total angle (a 16-bit signed fixed-point number, radix after most significant bit), and endpoint (two signed bytes, relative to center point of arc). The endpoint information was needed to convert subsequent relative vectors into absolute vectors. Rather than constrain the font designers to use a set of six or eight predefined arcs as in some arc fonts we studied, we instead allowed them to specify any arc with a starting point, center point, and end point coinciding with grid intersection points. We ended up with a grid resolution corresponding to 42 units/space by 72 units/line, or 28 by 36 units over the area occupied by the uppercase letter A. This allowed for an almost infinite set of arcs, from the tight circles of the period and % to the shallow arc, almost a line, in the center of the S.

To make the arc characters more flexible, we added a user command to allow adjustment of the chord angle used to create the arcs. Chord angles greater than 45 degrees produce unrecognizable pictures, and angles essentially equal to zero are clearly useless; any angle in between is acceptable. Thus the tradeoff between character plotting speed and character quality is in the user's hands (Fig. 6). Larger chord angles can be selected for quick checkplots and small lettering where the chords are less noticeable, while the smaller chord angles can be selected when the need is for higher-quality letters (especially at larger sizes) and plotting speed is less important.

There was some concern in the early stages of development that using more intricate characters—and especially generating all those chords in each character's arc segments—would degrade character throughput. Since we were using a different processor, new hardware technology, and a different firmware development language from any of our plotter projects in the past, we really had no way to estimate ahead of time what our character throughput would be. Instead, we relied on a simple test: printing the 52 upper and lowercase letters, 2.5 mm high. At this size, the 9872A Plotter's character throughput was specified at 3 characters per second. We were pleased to see that the fixed-cell Eurostyle vector font plotted at over 6.6 characters per second even though it was defined on a 32-by-32 grid compared to the 9872A's 4-by-8 grid and thus used more vectors. The arc font's speed is plotted in Fig. 7. The coarse (45 degree) characters are done more than twice as fast as the fine (5 degree) characters. The chord angle at which both plotting speed and subjective fineness of the arc characters equal those of the vector font is approximately 27 degrees.

We noticed an interesting problem with respect to the period, exclamation point, question mark, and so forth. So that they would not disappear at large sizes, these were designed as circles of one grid-unit radius, rather than dots. At the default chord angle of 5 degrees, this results in 72 chords for each tiny circle! These circles take a noticeable amount of time to draw, and have both a functional impact on character throughput and a negative psychological impact on how the user sees the plotter. We did not want to fix these tiny circles at some arbitrary number of chords, however, as the mismatch in curve quality in, say, a question mark's large curve and small dot becomes noticeable at the character size range used for wall charts and large plot titles. The solution uses the arc generator's distance tolerance mode for one-grid-unit circles if the character's width or height is less than 0.5 cm. This means that circles less

than 1/64 cm in radius within characters are actually done as octagons. Subjectively, it is hard to discern greater curve quality at smaller sizes, and the octagon can be plotted fast enough to reduce the throughput problem.

Acknowledgments

Lowell Stewart did the servo and motor driver routines and internal I/O. Eric Zarakov created the font-digitizing software and did the initial research into alternate character fonts which launched the work on the new character generator. Al Kendig performed rigorous and ongoing QA testing of the code during the development phase, providing helpful insights into consistency problems.

We especially wish to thank Ted Renteria and Maria Vincze of HP's Corporate Industrial Design for their fine work in designing the new character fonts to our ever-

New Language Tools Aid Plotter Firmware Development

by Andrea K. Frankel

Before work started on the firmware for the 7580A, the decision was made to use a high-level language for the task. Several of the project engineers are computer-science-oriented, and it was felt the time had come to take advantage of high-level languages for reasons of improved code readability and ease of code modification and debugging. The question was, which language?

PASCAL was an obvious first choice. However, the versions available for microcomputers at that time were either interpretive, highly inefficient, or severely limited in features. The need was for a flexible but "ROMable" language, close enough to the underlying machine to allow bit and byte manipulation, but sophisticated enough to let the compiler shoulder the burden of routine detail. A language called Z8KL was chosen. It was devised in-house on the metacompiler TREE-META by Lynn Wheelwright, of HP's Signal Analysis Division. Debugging and custom tailoring of the language was a joint project, with both the designer and the users contributing bug reports, possible fixes, and suggestions for expanded features during the first six months of the language's use.

Z8KL is essentially an ALGOL-60 type of language with a useful set of extensions which were added when needed. Data types include byte, integer, double integer, real, complex, binary-coded decimal, alpha (string constants), and pointers, with full address arithmetic and indirection possible on pointers. A set of new intrinsics was added to the language which maps directly onto 1-5 assembly language instructions to allow operations usually available only at assembly level to be imbedded in more readable high-level code. For instance, the code

```
INTEGER PENMAP,ACPEN;  
WHILE TBIT(PENMAP,ACPEN) DO ACPEN:=ACPEN+1;
```

compiles as efficiently as writing it in assembly language directly, but is easy to incorporate into a complex algorithm without obscuring overall control flow. Bit set/clear/test, arithmetic and logical shifts of bytes and integers, access to condition codes ("If OVERFLOW or CARRY then ..."), and block move instructions are examples of Z8000 instructions which were included as intrinsics in Z8KL for ease of programming.

The addition of equivalencing, the address-of function, an assemble statement for imbedding in-line code, optional register allocation declarations, and a floating-point library to the usual ALGOL features such as imbedded assignments, case and if-

then-else expressions and statements, and a variety of looping constructs made Z8KL a handy tool that eased the task of writing large amounts of code. The parser, the command dispatcher, the bulk of the graphics (scaling, arcs and circles, dashed lines, etc.), the smart pen module and the character generator were all written in this language. The I/O and the servo driving routines as well as some mathematical routines in the graphics library were written in assembly language because of timing considerations and the personal preference of the engineers responsible.

The conclusions after using a high-level language for firmware development on the 7580A are generally favorable. Major changes in the firmware were made several times when the code was in the 95%-complete stage, and the readability of the code helped make change both easier to implement and less dangerous in its side effects. An emphasis on more generalized, parameterized routines resulted in a high fan-in for the low-level utility routines, which is desirable both from a space-saving viewpoint and also for minimizing the number of modules to debug. As expected, the high-level code did use a significant amount of memory space; however, this is no longer as important a factor as it once was. Modern 16-bit microprocessors allow for an address space of 64K even without extensions, and the cost of an extra ROM pair in the final product is not excessive. Since the processing speed and instruction power of microprocessors such as the Z8000 allow the use of the compiler's slightly less efficient code in all but a few critical paths, the main consideration is to plan for enough memory when the initial processor board layout is done.

A problem encountered with code written in a high-level language is the difficulty of RAM entry-pointing; there is no straightforward way to accomplish this in high-level languages as they exist now. This points out a gap in the current computer language field: other than the spotty offerings from the computer manufacturers themselves and a few isolated software houses providing special-purpose tools, there does not seem to be a visible effort to provide a good high-level language tool for writing microprocessor-based firmware—good in the sense of providing the language features, ease of use, and efficiency of object code we want, as well as easy conversion to ROM. After the experiences of the 7580A project, other San Diego Division projects have selected high-level languages for all or part of their firmware. However, more work on appropriate tools is needed before we can feel really confident recommending it for general use.

changing constraints. We are also greatly indebted to Lynn Wheelwright of the Signal Analysis Division for creating the compiler, assembler, and linker for the firmware development tools, and for taking the time from his own busy schedule to maintain and debug them for us. In addition, we

wish to thank the various designers of the firmware for plotters made previously by the San Diego Division, for their helpfulness in sharing algorithms, bringing potential problem areas to our attention, and in general giving us the benefit of their experience.

Richard B. Smith



Rick Smith developed the HP-IB and RS-232-C I/O systems for the 7580A Plotter. A graduate of Carnegie-Mellon University, he received his BS degree in electrical engineering in 1979 and joined HP the same year. He lives in San Diego, California and enjoys bicycling and ice hockey.

Mark A. Overton

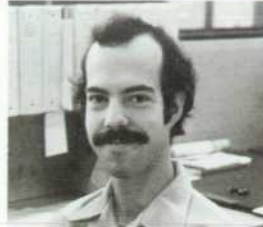

Mark Overton joined HP in 1979 after receiving his BA degree in computer science from the University of California at San Diego. He wrote the parser and some of the graphics firmware for the 7580A Plotter. He's a member of the ACM, a native of Hays, Kansas, and a resident of San Diego. He's active in his church and enjoys working on cars.

Larry W. Hennessee



Larry Hennessee has been involved with computers ever since he received his BSEE degree from Case Institute of Technology in 1963. With HP since 1968, he has written software for instrumentation and data acquisition systems, worked on the RTE operating system for HP 1000 Computers for several years, and helped develop the firmware for the 9872A, 7245A, and 7580A Plotters. A native of Barberton, Ohio, he is married, has two children, and lives in San Diego.

Andrea K. Frankel



Andrea Frankel worked on the character generator code, the smart pen module, new font development, and software tools for the 7580A Plotter. She serves on HP's interdivisional graphics peripheral interface standard group and is a member of the ACM and the IEEE Computer Society. She's been with HP since 1979. Andrea received her BA degree in computer science from the University of California at San Diego in 1980. New wave science fiction and organic gardening rank high on her list of interests, which also includes live jazz, cooking, jazz dance, batik and other crafts. She is married and lives in San Diego.

Y-Axis Pen Handling System

by Robert D. Haselby, David J. Perach, and Samuel R. Haugh

THE DESIGN OBJECTIVES for the Y-axis pen handling system (Fig. 1) of the HP Model 7580A Drafting Plotter are to provide excellent dynamic performance characteristics while paying close attention to reliability, serviceability, and manufacturability. A great number of design considerations are merged into the pen-lift, pen carriage, pen stable, pen capping, and Y-axis arm designs.

Pen-Lift System

The pen-lift system in a high-quality plotter becomes as important as the position servos if drafting-quality plots are to be obtained. The importance is obvious. The position servos can move the pen in a perfectly straight line, but if the pen is bouncing or has the incorrect force, then a drafting-quality line will not result. To obtain a quality line the pen must be lowered to the plotting medium with a controlled velocity so that pen-tip damage is eliminated and pen bounce is reduced. Once in contact with the plotting

medium, the pen must be kept there with the optimum force for the combination of pen and plotting medium in use. The force and speed should be adjustable to handle different pen and medium combinations.

The pen-lift mechanism and pen carriage should be rigid enough so that the pen won't bounce or chatter as it writes. It must have low mass to minimize the load on the drive motors and to keep the system resonance well out of range of the servo bandwidth. The supporting structure should withstand the inertial forces caused by a 4g acceleration along the Y-axis, and not respond to perturbations caused by the writing medium.

When the requirement of high throughput is included in the design goals, further characteristics are indicated. The first requirements are high acceleration and high slew speed. However, this is only part of the picture. The time required to lift and lower the pen must be reduced if high throughput is to be realized. This becomes especially important when plotting characters and dashed lines, which require a lot of pen-lift action. As stated above, the rate of impact of the pen with the plotting surface must also be controlled. This results in the following engineering tradeoffs.

First, for a fixed rate of descent, the time to drop the pen is directly proportional to the distance that the pen must drop. To reduce the pen drop time, the distance must be reduced. This reduced distance implies tighter control of manufacturing tolerances and precise adjustment of the height of the mechanism. Neither of these implications is desirable for a friendly (that is, no tedious user-performed pen-height adjustments), manufacturable plotter. The maximum rate of descent before pen damage occurs is related to the kinetic energy ($\frac{1}{2}mv^2$) of the pen and pen-lift mechanism. Reduc-

ing the mass of the pen and the associated moving portion of the pen-lift mechanism allows the impact velocity to increase without increasing the kinetic energy. This also decreases the time for pen-lift action.

Other requirements for a drafting-quality pen lift are:

- The pen-lift path of motion should be vertical. This eliminates plotter position errors that would result if the writing surface is not perfectly flat.
- The mass of the entire pen carriage should be reduced so that the drive requirements for the Y-axis drive motor are reduced.
- The pen carriage should be driven at its center of mass so that the high acceleration (4g) does not excite resonant modes of the pen carriage structure.

Pen-Lift Mechanism

The combination of light aluminum investment castings and close manufacturing tolerances with careful magnetic circuit and bobbin design to minimize mass provides a strong, lightweight, high-performance, versatile pen-lift mechanism.

The vertically moving mechanism (Fig. 2) consists of an intricate aluminum investment casting to which a plastic pen holder and voice coil bobbin are attached. Low-friction vertical motion is attained by use of a linear ball bearing fitted into this pen-lift arm casting. The mass of the pen-lift arm assembly without a pen is 20 grams, but with a full drafting pen the total vertically moving mass approaches 30 grams. The shaft upon which the arm rides is hardened 440C stainless steel, centerless ground to a diameter tolerance of ± 0.0025 mm to minimize mechanical play.

The shaft is housed in another investment casting into which is pressed a very small radial ball bearing. This

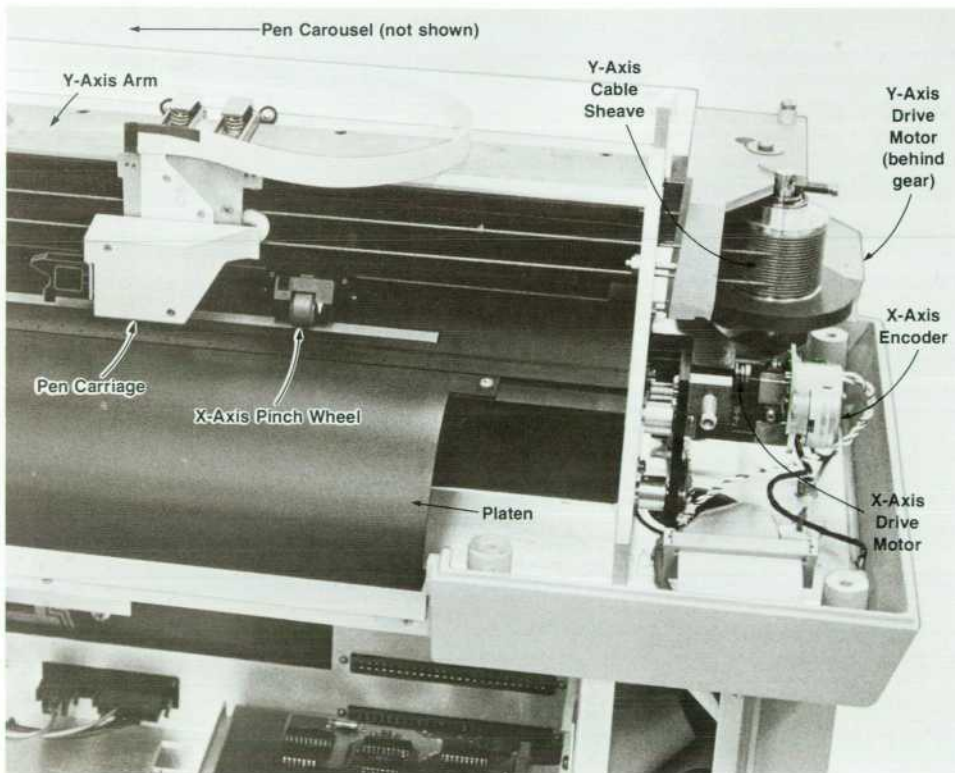

Fig. 1. The Y-axis pen handling mechanism used in the HP Model 7580A Drafting Plotter is a pen carriage driven by a cable and drive pulley arrangement. The carriage is guided by a straight arm and carries a pen holder that can pick and deposit pens in a carousel located at one end of the arm. The drive motor is digitally controlled with an optical shaft encoder providing position and velocity feedback information.

bearing restrains the pen-lift arm from rotating about its shaft. An extension spring loads the arm against this bearing and keeps the pen raised when the power is off. The linear actuator must overcome this spring force to apply pen-down force.

The magnetic circuit of the linear actuator consists of a magnetically soft 1018 cold-rolled steel voice-coil cup, magnet, and steel pole cap (Fig. 3). The cup and the pole cap, which has a conical depression to direct magnetic flux into the radial gap, are electroless nickel-plated to prevent corrosion of the mild steel. The samarium cobalt magnet material has an energy product of two million pascals. Rare-earth cobalt magnets possess the virtue of being extremely powerful; they are ideal for applications requiring minimum mass. The entire cup assembly weighs only 19 grams and develops over 100 grams of force per ampere of coil current. The voice-coil cup assembly fits into the pen-lift housing concentrically about the bobbin, which is precisely wound with six layers of 32 AWG self-bonding magnet wire. To achieve maximum efficiency from the voice coil the bobbin must fit into the magnetic air gap as closely as possible without contacting the cup. Therefore the machining tolerances on the two investment castings are as small as ± 0.03 mm.

To the front of the housing is screwed the injection-molded panel that holds the optical position sensors. One integral assembly carries power to the bobbin coils and position sensors. It is plugged into the left end of the plotter using a printed circuit board termination reflow-soldered to one end of the ten-conductor trailing cable. These two components are the same as those used in the HP Model 7225A Plotter.¹ The trailing cable, with a fatigue life of over five million cycles, is reflow-soldered at the other end to another printed circuit board which is attached to the pen carriage by two screws. This is a special flexible circuit board fabricated with Kapton™ insulation and fiberboard

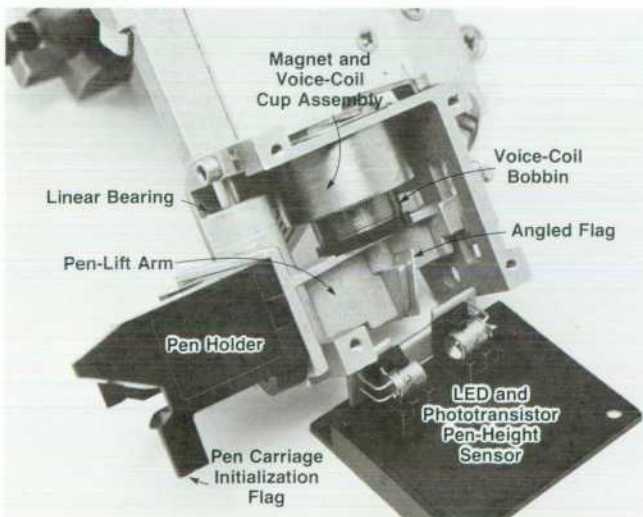

Fig. 2. The pen-lift mechanism moves the pen vertically on a linear ball bearing guided by a stainless steel shaft. The pen holder is made of plastic and is electromagnetically driven by a voice coil and magnet arrangement. The pen-height sensor consists of an angled flag and an LED-phototransistor pair (see Fig. 5).

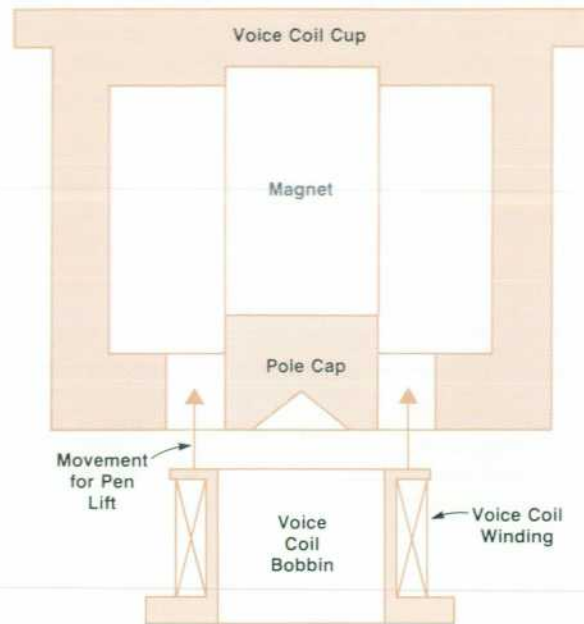

Fig. 3. Linear actuator magnet, voice-coil cup, pole cap assembly, and voice-coil bobbin for pen-lift mechanism.

backing. Where there is no stiff backing the Kapton insulation and copper conductors are able to bend or flex. The voice-coil bobbin is adhered to the end of one flexible segment and its wires are soldered to exposed tinned conductor pads. At the end of the other segment are soldered the optical position sensor components, snapped into their plastic panel, and two small pens on the sensor panel are captured by holes in the circuit board to attach the panel to the board. Lastly, a magnetic reed switch is soldered to the stiffened portion of the circuit board. This component is used to sense the position of the movable right-hand pinch wheel during initialization, thereby determining the width of the paper in the plotter. A magnet in the pinch-wheel housing causes the reed switch to close whenever the pen carriage passes over the pinch wheel. This information is sent to the 7580A system processor via the trailing cable (see page 10).

During assembly of the pen carriage, no electrical terminations need to be made. It is necessary only to screw the flexible circuit assembly and the pen-lift assembly to the pen carriage, the bobbin onto the pen-lift arm, and the sensor panel to the pen-lift housing. Next, the voice-coil cup is inserted into the housing and held in place by a beryllium-copper leaf spring. This ease of assembly and disassembly greatly enhances the serviceability of the unit. The pen lift has been tested to confirm that it meets the lifetime goal of fifty million up/down cycles. The test was stopped after seventy million cycles with little apparent reduction in performance.

Pen-Lift Control System

This system (Fig. 4) is best described as a closed-loop adaptive servo system. It uses an optical position sensor to sense the linear actuator position relative to the pen-lift carriage frame. The position sensor consists of a light-emitting-diode (LED) and a phototransistor fixed into the

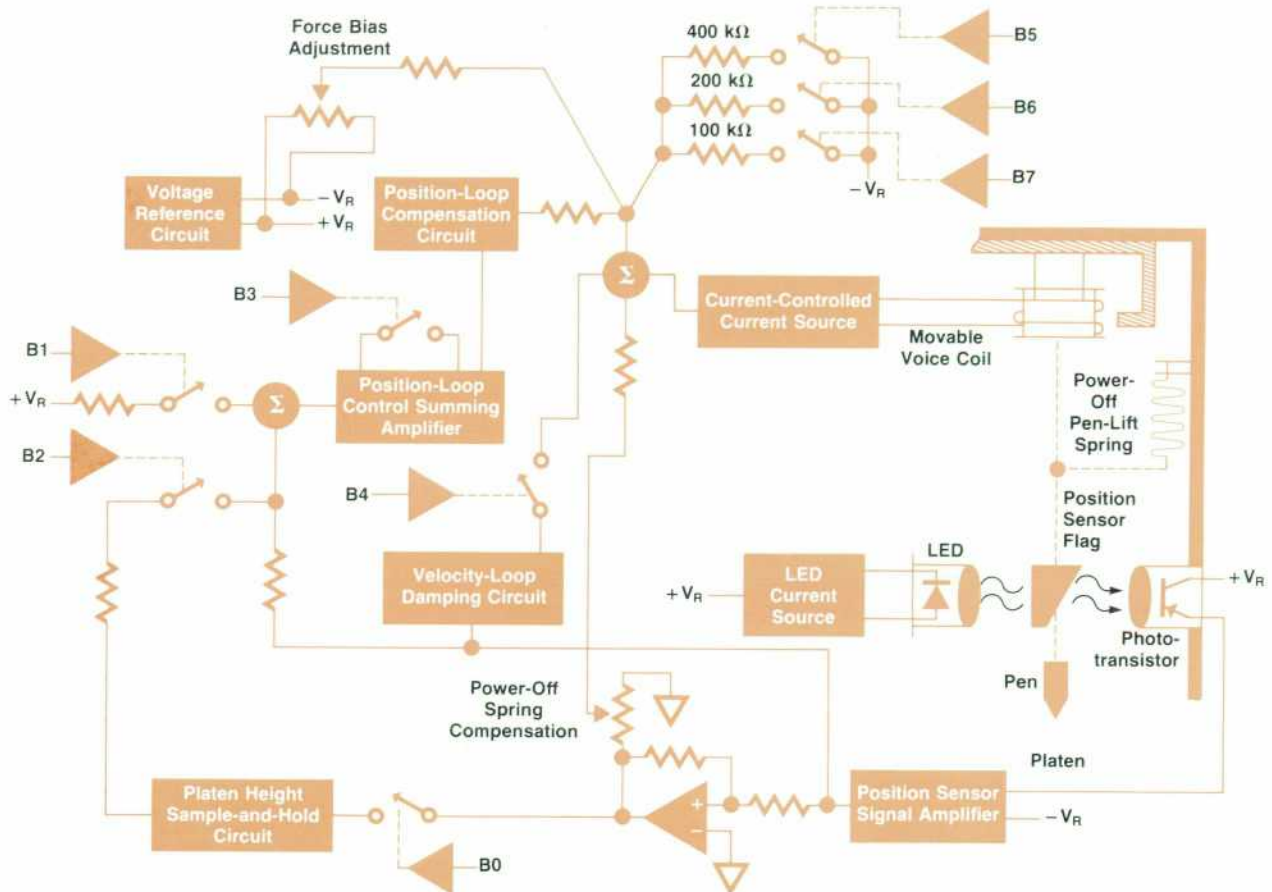

Fig. 4. Block diagram of pen-lift control system.

pen-lift housing such that the optical path between them can be partially occluded by a small flag attached to the pen actuator. The flag is angled by 30 degrees to increase the amount of actual travel relative to the LED-phototransistor pair as shown in Fig. 5. The optical sensor is temperature compensated so that the phototransistor output current is not sensitive to temperature changes that affect the optical output of the LED. The output of the position sensor is inverted and stored in an analog sample-and-hold circuit. This microprocessor-controlled circuit stores the pen position just prior to the last pen lift and thus represents the approximate height of the writing surface in a region close to the position of the last vector endpoint. How this is used will be discussed later when the pen-drop cycles are described.

The control system operates in four different microprocessor-controlled modes. The first mode is a cascade-compensated position control loop. This is used to raise the pen during pen-lift operations. The input signals for this loop are controlled by switches B1 and B2. When both switches are open the control system lifts the pen until the optical sensor output is approximately zero. The sensor offset control is adjusted so that this position is about 0.25 mm below the upper mechanical limit of travel. This is the full lift position of the pen-lift. To lower the pen a velocity control loop is implemented by closing switches B3, B4, B5, B6 and B7 while at the same time opening all others. Switch B3 disables the position control loop by setting the position

loop gain to zero. In the velocity control mode, switches B5, B6 and B7 apply a force input while switch B4 enables a velocity feedback signal. After 10 ms, switches B5 and B7

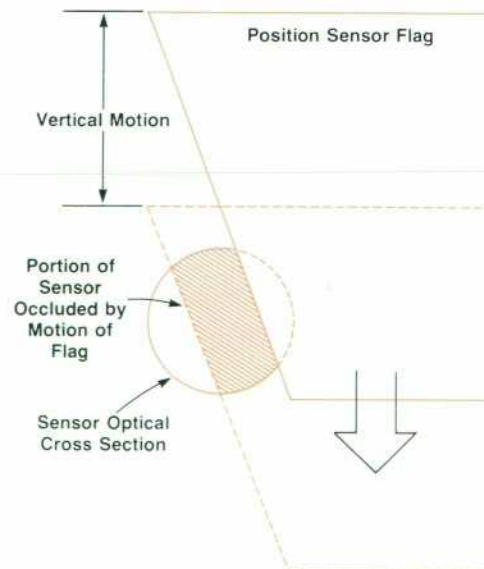

Fig. 5. A flag attached to the pen-lift arm is used to sense the vertical position of the pen (see Fig. 2). As the pen moves up and down the flag blocks varying portions of an infrared beam between an LED source and a phototransistor detector.

are opened. This results in a high initial velocity for the first 10 ms and a slower constant velocity until the pen contacts the platen (Fig. 6a). This time may be as short as 20 ms worst case if a long pen and a high spot in the writing surface occur at the same time. However, since this is not known *a priori*, a full 40-ms delay must elapse before applying the programmed writing force and commencing lateral pen motion.

Eight levels of writing force are set by microprocessor control of switches B5, B6, and B7. These switches are connected to binary-weighted current sources which are applied to the input of the current-controlled current-source output amplifier. This results in a constant pen force since the voice-coil force is independent of position. Other inputs to the output amplifier are the force bias adjustment and the power-off pen-up spring compensator. The spring compensator circuit feeds back a signal that is proportional to the actuator position and minimizes the effects of the power-off pen-up spring upon the command force. This adjustment and the force bias adjustment are required since tolerances of springs are generally not closely controlled. Once the commanded force is applied, an additional 5 ms is allowed for settling before lateral pen motion is started.

When the microprocessor sets the force, it also closes switch B3, which disables the position loop, and switch B0, which sets the platen height sample-and-hold circuit to the sample state. This circuit's output now follows the pen position as the pen moves in the lowered position.

When the end of a vector is reached and a pen-up command is encountered, the following state changes take place. First, the platen-height sample-and-hold circuit is placed in the hold state by opening switch B0. This stores a voltage that represents the present platen position. The force input switches (B5, B6, and B7) are also opened. Finally the position loop is enabled by opening B3 and closing B1 and B2. This causes the pen to lift about 0.64 mm above its last pen-down position (Fig. 6b). This lift requires only about a 3-ms delay before lateral movement with the pen up can begin. If the pen-up time caused by a long move or no further commands lasts longer than 100 ms, the pen position control loop is modified by opening B1 and B2. This modification results in the pen's being lifted to the full up position (Fig. 6c) and to the state at the beginning of this discussion. If the pen-up time is less than 100 ms, the pen

drops at the slower velocity, but this time the approximate distance is known and the combined drop and settling time is only 20 ms, which shows that plotting involving short pen-up moves saves about 25 ms per pen-lift cycle. One hundred milliseconds corresponds to a lateral pen-up move of about 6 cm and the assumption is that the platen irregularities are smooth enough that the pen height will not change significantly in less than that distance.

A safety shutdown circuit is included in the pen-lift drive circuitry to prevent damage to the voice coil by excessive power dissipation that could be caused by either a malfunction or misadjustment of the pen-lift control system.

In summary, time spent lifting or lowering the pen in a high-speed plotter is time not spent plotting. The adaptive features of the design reduce the time spent lifting and lowering the pen when the plotting task is pen-lift intensive. The actual pen-lift rates (just pen-up and pen-down commands) are 36 cycles per second for the short-lift cycle and about 17 cycles per second for the high-lift cycle.

Pen Stable Carousel

To provide writing speed, pen acceleration and line quality the writing system must be rigid and have minimum mass. Carrying more than one pen on the pen carriage would substantially increase the mass of the pen carriage and thus the response time of the plotter. Thus, to have a multiple-pen option some means of easily exchanging the pen on the pen carriage is required.

The pen carriage on the 7580A, unlike flatbed plotters, can move only along a single axis. The well-tested pen-changer mechanism used in HP's 9872A Plotter family could not be used in the 7580A because it requires motion of the pen carriage in both the X and Y axes. The new pen-changer mechanism uses the linear motion of a rigid pen holder attached to the pen carriage and the rotary motion of a round pen stable or carousel.

The pen holder supports the pen at three points, two of which are fixed points, and the third is a pivoted lever which exerts a force of 907 grams on the pen body. This configuration offers maximum stability of the pen and insures a vibration-free pen even under high acceleration and writing speed.

A 6-mm-wide flag on the bottom of the pen holder is designed to break a light beam when the pen holder is

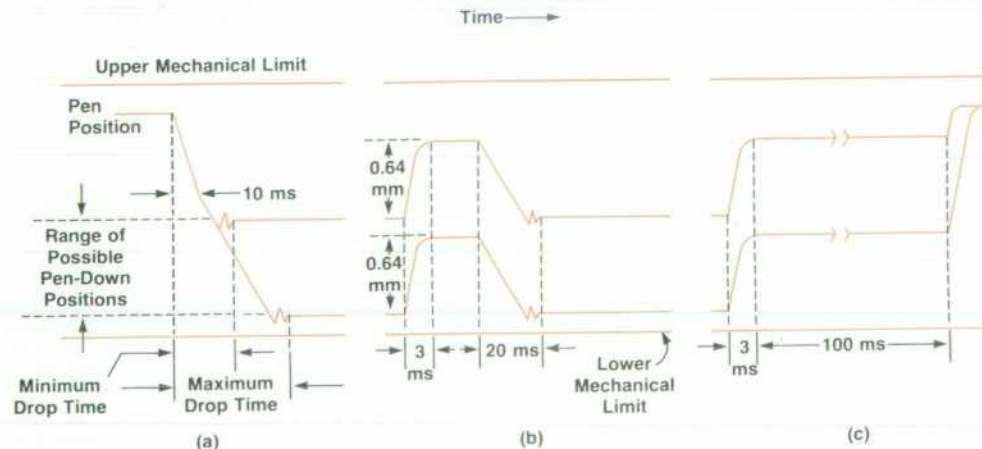

Fig. 6. Pen-lift sequences. (a) After a long move (greater than 100 ms) the pen is dropped until the surface of the platen is contacted. The position of the pen is then stored as the current platen height. (b) During short lateral moves the pen is lifted a smaller distance above the current platen height and then dropped after the move to the same platen height. (c) If a pen-up move takes longer than 100 ms, the pen is raised to its full up position and the sequence in (a) is used to drop the pen after the move and to determine an updated platen height.

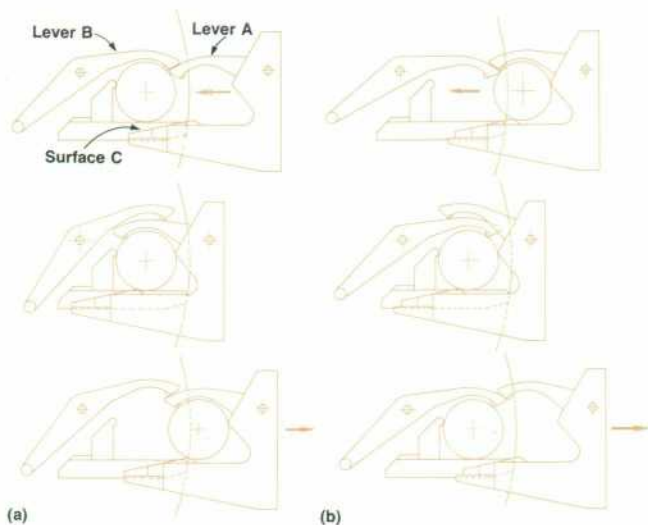

Fig. 7. Pen exchange cycles. (a) Picking a pen from the carousel. (b) Depositing a pen in the carousel. Note the interaction of levers A and B during each cycle.

positioned beyond the left edge of the writing area. The point where this light beam is broken is recognized by the plotter as the initialization position for the pen carriage. The ramps on the pen holder aid in aligning it with the carousel when picking and depositing pens.

The pen carousel is designed to hold up to eight pens and automatically cap the ones that are not in use. In the carousel the pens are held in a manner similar to that used by the pen holder. The carousel is placed outside of the platen area to reduce the length of the Y arm and the pen carriage drive cable. The pen holder reaches out through the side plate into the carousel to pick or deposit a pen.

The carousel is driven directly by a step motor, eliminating moving mechanical parts like belts and gears. To gain higher resolution for the angular position of the carousel, which is important to a smooth pen-picking operation, the step motor is operated in the half-step mode.

The carousel rotates in either direction to choose the shortest path to present the selected pen to the pen holder. When a pen is to be deposited back in the carousel it rotates in the same manner to present an empty stable space to the pen holder.

There are three different carousels, one for each type of pen: fiber-tip, roller-ball and liquid-ink drafting pens. Each carousel is coded by using reflective aluminum strips mounted on the lower part of the carousel. The 7580A's microprocessor uses reflective light sensors to read this code and differentiate between the three carousels. The pen force, acceleration and speed are set to the optimum values for each type of pen automatically.

The exchange of a pen between the pen holder and the pen carousel is done in the following way. When a pen is to be picked the empty pen holder travels toward the carousel. Before passing the left-hand side plate to get to the carousel area, the 7580A's microprocessor checks for the presence of a pen, both in the pen holder and the selected pen position in the carousel. If there is a pen in the pen holder, which can happen only if someone deposited a pen into the pen holder manually, or if there is no pen in the carousel in the selected position, the plotter will ignore the order to pick that pen. The same thing will happen if the operator orders the plotter to deposit a pen in the carousel when all eight pen stations are already occupied.

When the empty pen holder starts to penetrate into the carousel, lever A acts as a wedge between the pen body and lever B (Fig. 7a). At that time the pen holder body, surface C, comes in contact with the pen which supplies a reaction force to eliminate turning of the carousel. As the pen holder

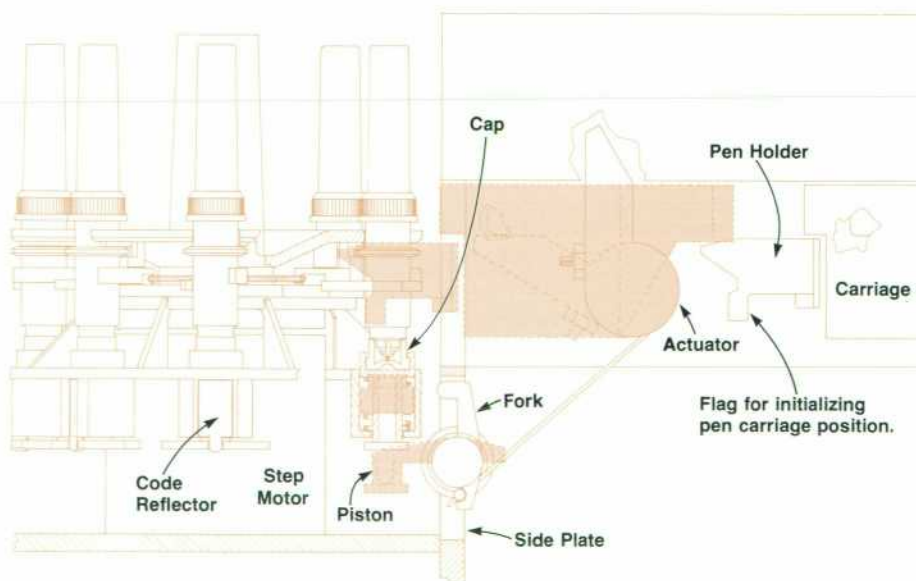

Fig. 8. Pen exchange and capping mechanism. The shaded dashed outline areas indicate the position of the actuator, fork, pen holder, carousel, piston and cap when a pen is being picked from or deposited into the carousel.

penetrates deeper into the carousel, lever B slides along the back of lever A. When the pen holder penetrates deeply enough the pen snaps into its new position in the pen holder. As the pen holder withdraws from the carousel with the pen, lever B assumes the empty position. When the pen is deposited back into the carousel the same process is reversed (Fig. 7b). Lever B acts as a wedge to peel lever A off the pen and grab the pen away from the pen holder.

Pen Capping

One area where a design contribution was necessary is the drafting-pen design and the pen capping and storing mechanism. Highly important was finding an attractive solution to the problem of rapidly drying liquid-ink drafting pens. These pens are known for superb line quality, lines very dense and constant in width, but at the same time were hard to use on a plotter because of the constant operator attention required just to keep the ink flowing when needed. The 7580A offers the customer a new drafting pen design and an automatic capping system that keeps the pens ready to use after not being used for 24 hours and more. The drafting pen and its cap are designed to prevent any air penetration to the pen tip or its air-vent channel when the pen is stored in the carousel. The roller-ball and fiber-tip pens are also stored capped in their carousels.

Pen caps are part of the carousel and as such continue to cap the pens when the carousel is pulled out of the plotter. This allows the operator to use any kind of pen available for the 7580A without the need to cap the pens manually when the carousel is stored out of the plotter.

The automatic pen capping mechanism of the 7580A does not use any active elements like motors or solenoids. The motion of the pen carriage operates it. When the pen carriage moves toward the carousel to deposit a pen it pushes and rotates the actuator lever (Fig. 8). A cable connects the actuator and the fork so that the fork moves as the actuator does. The fork then pushes the carousel's piston for the desired pen down, lowering the pen cap and clearing the way for the incoming pen. After the pen is deposited into the carousel the pen holder withdraws from the carousel area, the pen carriage releases the actuator lever, and the fork returns to its original position, releasing the piston and thus capping the pen.

When a pen is to be picked the actuator lever and fork behave the same way to push down the respective piston. The cap is lowered enough to allow the pen to be picked and carried away by the pen holder. At that time the actuator lever is released and the fork and the cap return to their original positions.

The fork is designed to perform two more functions: it aligns the carousel to the exact picking location and it locks the carousel in place during the pen exchange cycle. This way, even if the step motor misses a step, the fork will return the carousel to the desired position and thus cancel the motor's error.

Y-Axis Configuration

Because of the need for a massive support bar for the X-axis pinch wheels, the geometry of the micro-grip drive was not optimum for the pen carriage system design. Structurally and dynamically, the Y-axis arm should be directly

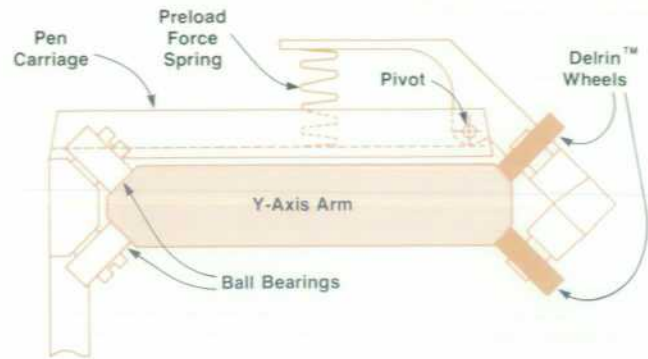

Fig. 9. The pen carriage is mounted on the Y-axis arm by four bearings on the front of the arm and two preloaded arms pressing four Delrin™ wheels on the back of the arm. Two of the front bearings and one of the arms with two Delrin wheels are shown in the end view above.

adjacent to the pen-lift housing to allow maximizing the stiffness and minimizing the mass of the pen carriage structure. But the bar that bears the 5.4-kg loads from the pinch wheels has to occupy that space. The Y-axis arm, which has to be separate from the pinch wheel bar to prevent cross-coupling of the axes, is located just above the pinch wheel support structure. Careful attention was given to laying out the geometry to allow for driving the pen carriage close to its center of mass. This minimizes inertial moments on the carriage arising from 4g acceleration along the Y-axis.

The Y-axis arm is fabricated from two machined 303-stainless-steel bars screwed together and then crush ground. The two bars are necessary to provide a cross-section stiff enough to resist transient vibration and bending from drive cable tension. The crush grinding process accurately forms bearing surfaces straight to within 0.08 mm over the 850-mm length.

The pen carriage is guided along the front of the Y-axis arm by four radially preloaded ball bearings oriented to constrain the carriage from rotation about both the X-axis and the Z-axis of the plotter. Two pivoted preloading arms (Fig. 9) carry four bearings pressed into Delrin™ wheels riding on the back side of the Y-arm bar and constraining the carriage against Y-axis rotation. Preload force is supplied by coil springs snapped into pockets in the carriage and the preloading arms.

The 952-gram radial preload force on the guide bearings, along with the small gravity bias and inertial reactions, produces a maximum shear stress of 4.7×10^8 N/m² at a distance of 0.0086 mm below the ground bearing surface of the Y-arm. The fatigue life of this surface is therefore well over an order of magnitude greater than the design goal of two million cycles. As for the bearings, calculations show that the B10 life is two orders of magnitude greater than the required 1100 kilometres of travel under worst-case assumptions. Extensive life testing has confirmed the reliability of the pen carriage guiding system.

The Y-axis motor, encoder, drive gear and drive cable sheave are mounted at the right end of the arm (Fig. 1). The drive cable, strung as two cables in parallel to double the effective spring constant, wraps around the drive sheave at the right, passes along the back of the arm, and continues

around the return pulleys at the left. The doubled-over ends meet in the front at the drive cable bracket, looping over two small sheaves which serve to equalize cable tension in the various segments.

The pen carriage is fastened to the drive cable bracket by two screws. The entire Y-axis system can be removed from the plotter as an integral unit without unstringing the drive cable and with or without the pen carriage. The pen carriage can be removed with the Y-axis arm in place. These options greatly enhance the overall serviceability of the 7580A.

The coefficient of thermal expansion of the stainless steel Y-axis arm is matched to that of the drive cable so that cable tension will not change over the 75°C operating temperature range. However, because the aluminum platen expands at a different rate, the Y-axis arm is pinned into a mounting plate screwed to the left side plate of the plotter. This arrangement compensates for the different thermal expansions as well as allowing for adjustment of the parallelism between the micro-grip drive shaft and the Y-axis arm to within 0.05 mm.

Pen Carriage Dynamics

As mentioned above, the geometry of the micro-grip drive forces the Y-axis arm to be located farther away from the pen-lift housing than desired. The die-cast pen carriage is the structural link between the guide bearings/Y-axis arm interface and the pen-lift assembly. As the distance between the two increases to accommodate the pinch wheel bar, the mass required to provide the necessary stiffness for vibration resistance also increases. Extensive use was made of the HP Model 5423A Structural Dynamics Analyzer during the development of the 7580A to investigate the nature of the dynamic load responses of the pen carriage system.

Accelerometer studies yielded transfer functions that show system resonances. The information was used to ensure that material was placed only where required to add stiffness to the casting. In particular, the height of the four ribs across the top of the carriage was increased by 2.0 mm, eliminating a complex torsional mode excited by Y-axis acceleration. Vertical (Z-axis) acceleration of the pen-lift arm had excited a bending resonance at 180 Hz which was reduced to an acceptable amplitude by this addition of material and by increasing the thickness of the front face of the carriage.

The configuration of the Y-axis radial guide bearings evolved as a result of an earlier similar investigation. By using the 5423A and a bench test fixture, several resonant modes were eliminated by changing to this configuration from a V-groove arrangement before the carriage ever drew a line on the plotter.

Acknowledgments

The authors would like to thank George Lynch for his leadership and help in conceptualizing solutions to difficult mechanical problems. Thanks to John Jensen of the HP Neely Sales office in Santa Clara for working his magic with the 5423A Analyzer, Bud White for handling details of the front panel, internal I/O and main interconnect boards, and the carousel sensor and motor-drive electronics. Rick Tverdoch designed the pinch wheel mechanism and the liquid-ink pens.

Reference:

1. P. Maiorca and N. MacNeil, "A Closed-Loop System for Smoothing and Matching Step Motor Responses," Hewlett-Packard Journal, February 1979, p. 23.



Samuel R. Haugh

Sam Haugh received his BSME degree from Stanford University and joined HP in 1978. He was responsible for the design of the 7580A Plotter's pen-lift mechanism, pen carriage, and Y-axis arm and for the final tolerance analyses. A patent application resulted from his work on the pen-lift mechanism. He later became fabrication process engineering supervisor and is currently taking a leave of absence to study for his MBA degree at Stanford. Sam was born in Pasadena, California and considers San Diego his home. He is married and enjoys skiing, fishing,

backpacking, most sports, photography, and San Diego Chargers football.



David J. Perach

Dave Perach developed the damped pen lift for the 9872A Plotter and the pen changing and capping mechanism for the 7580A Plotter. Both of those designs have qualified for patents. Dave graduated from California State Polytechnic Institute at Pomona with a BSME degree in 1974 and joined HP's San Diego Division the same year. Born in Jerusalem, he has served as a technician in the Israeli Air Force. Dave enjoys camping, skiing, world travel, woodworking, rebuilding cars, and photography. He designed and is still building the Perach home in Poway,

California while his wife cares for their avocado grove. The Perachs have two children.



Robert D. Haselby

Bob Haselby was the electronics project leader and designed the pen-lift electronics for the 7580A Plotter. With HP since 1973, he also designed drive electronics for the 7221A and 9872A Plotters and I/O hardware and firmware for the 7221A. He's co-author of a paper on the 9872A's drive system and co-inventor on a patent on that system. Born in Kokomo, Indiana, Bob served in the U.S. Navy for six years and then studied electrical engineering at Purdue University, receiving BSEE and MSEE degrees in 1972 and 1973. He's a sailor who likes to develop electronic

gadgets for navigation, and he enjoys woodworking and reading. He's married, has two children, and lives in Escondido, California.

X-Axis Micro-Grip Drive and Platen Design

by Ronald J. Kaplan and Robert S. Townsend

THE MICRO-GRIP DRIVE MECHANISM is the design foundation of HP's 7580A Drafting Plotter, enabling it to provide excellent performance at a low cost and be easy to use. Small grit-covered wheels move the drawing medium along the X-axis of the 7580A, thereby replacing the heavy, bulky components used in other plotters with a low-mass, low-inertia drive mechanism. This design permits the use of lighter parts and smaller, less expensive drive motors while retaining high reliability and plot quality.

Micro-Grip Drive

In the 7580A two opposite edges of the drawing medium are held between a pinch wheel and a cylindrical roller whose surface is coated with a layer of grit particles (Fig. 1). When the grit-covered roller is rotated the points of the particles make thousands of tiny impressions in the back surface of the drawing medium during its first pass through the plotter. These impressions are discernible, but not obvious to the naked eye. When the drawing medium makes additional passes through the plotter each impression realigns itself with the same grit particle that created it, in effect behaving like a miniature sprocket drive system. This phenomenon provides the accurate registration required of a drafting plotter.

There are many differences between a prototype machine that moves paper repetitively most of the time and a finished product that can move virtually any medium reliably with absolute repeatability. By absolute repeatability we mean that each grit particle will realign itself within the impression it made in a previous pass of the medium over the grit wheel. When the engineers at HP's San Diego Divi-

sion were first introduced to the grit-wheel drive concept it was in the form of wheels covered by thin strips of sandpaper. These wheels were pressed into the plotting medium by cast rubber rollers. The problems associated with sandpaper-covered wheels were generally inherent weaknesses in the backing material of the sandpaper. The problems ranged from the cracking of the resin adhesive when the sandpaper was bent around the aluminum wheel to variations in the backing thickness.

If you try to push a grit particle into a sheet of polyester film by pushing down on it with a piece of cardboard don't be surprised if you dent the cardboard instead. By adhering the grit directly to the wheel and eliminating the paper backing a much more reliable and consistent system is produced.

As the grit-wheel investigation continued certain parameters proved to be major difficulties in the manufacturing of grit-wheel systems. These were:

- Grit-wheel tracking (repeatability)
- Grit-wheel life
- Grit-wheel accuracy
- Pinch-wheel geometry and parameters.

The first decision made was what materials to make the grit wheel from. Our system model showed that for absolute repeatability a large proportion of the particles needed to have points with subtended angles that were less than a critical angle. This critical angle is a function of both the particle material and the plotting medium material. The particles also need to be made of a material hard and tough enough to deform the extremely durable polyester films permanently without excessive dulling. After looking at many different materials ranging from crushed walnut shells to diamonds and cubic boron nitride it was decided that aluminum oxide had the best combination of desirable

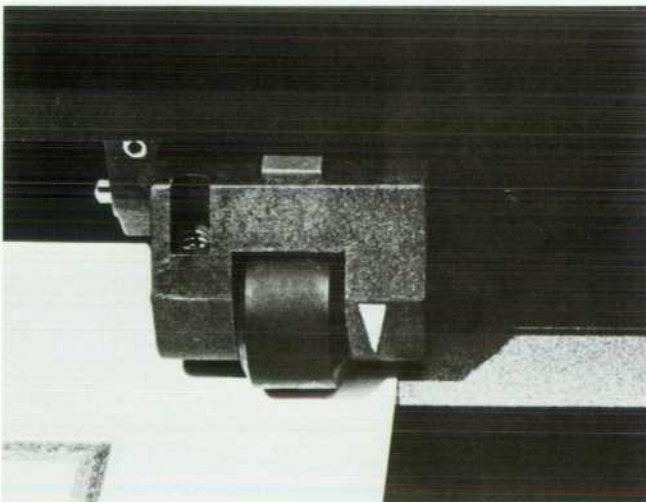

Fig. 1. The micro-grip drive used in the HP Model 7580A Drafting Plotter moves the plotting medium along the X-axis by pressing the medium against a grit-covered drive wheel with a pinch wheel.

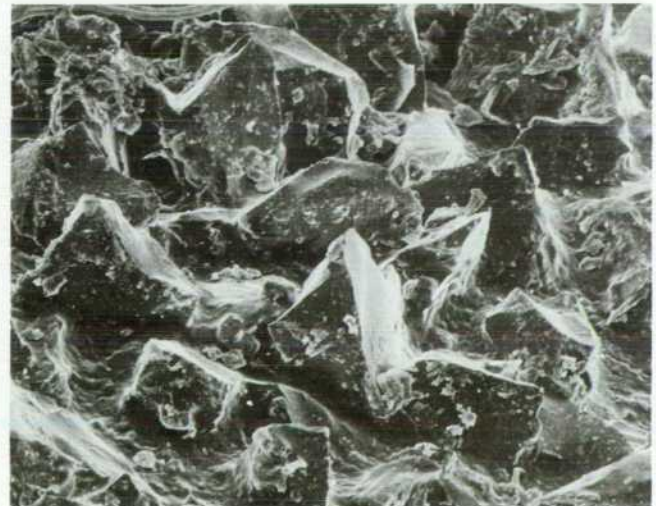

Fig. 2. Aluminum oxide grit shown at a magnification of 132x.



Fig. 3. Grit indentations in polyester film shown at a magnification of 80 \times .

properties. Aluminum oxide is one of the hardest materials known to man, trailing only silicon carbide and diamonds. It is also tougher than silicon carbide. Another feature of aluminum oxide is that it has a conchoidal fracture, that is, when it does fracture it leaves sharp points and edges (Fig. 2) which make suitable impressions in polyester film (Fig. 3).

Another factor in repeatability is the number of particles per unit area. If the number is low, not enough particles will be in contact with the plotting medium to transmit the required forces. If the particle density is too high, excessive force is needed to create the pressure required to deform polyester film.

Accuracy requirements for the 7580A are such that the grit-wheel pitch diameter needs to be held to an absolute tolerance of ± 0.025 mm. To achieve this tolerance many factors must be controlled. The grit particles are screened through sieves until a uniform particle size distribution is achieved. Adhesive thickness is controlled to assure that a consistent amount of grit is picked up. Particle density also plays an important role in pitch diameter tolerance. The grit is applied to the two wheels used in one 7580A at the same time to reduce the difference in pitch diameters between the two drive wheels.

The pinch wheels presented an entirely different problem. Material selection was to optimize characteristics of hardness, compression set, abrasion resistance, hysteresis energy losses and temperature effects. Material hardness and geometry determine the size of the contact area with the grit wheel. This contact patch has a large effect on some very critical parameters. Contact stress at the peaks of the grit particles affects not only repeatability but also grit particle wear and adhesive matrix fatigue. Since the effects of temperature on a polymeric elastomer are generally large, a material had to be selected that kept the particle stresses within a range that assured absolute repeatability from 0 $^{\circ}$ C to 65 $^{\circ}$ C.

A situation can sometimes exist where a pinch wheel does not move for an extended period while left in the loaded position. In this situation when the wheel again

begins to move a thumping can occur like the flat area on an automobile tire after a cold night. The compression set of the material was reduced so that after one rotation the flat area goes away. Another characteristic that was considered was the hysteresis of the material when rolling. This is one of the major sources of energy loss in the X-axis of the machine, and needed to be minimized.

Platen

The platen system is the heart of the X-axis of the plotter and is a major reason why the micro-grip drive works. The tracking of the grit wheel is dependent upon a number of important alignments. All of these basically accomplish one task—to keep the plotting medium from buckling. If the plotting medium buckles, the edge of the medium is constrained to rotate away from the normal to the drive axis. When this happens tracking fails and registration is lost. The platen of the 7580A works in many different ways to avoid paper buckling. One way is the contour of the platen. If you take a flat sheet and try to apply force to the outer edges while friction over the middle of the sheet resists the motion, you can virtually guarantee that the sheet will buckle. The system has no stiffness to resist buckling other than the stiffness of the plotting medium itself. By taking that same sheet and holding it down with a vacuum into a curvature, a cylindrical shape is created to resist the shear stresses without depending solely upon the stiffness of the sheet material.

The vacuum also serves to hold the medium down against the platen in the region of the pen. The vacuum level required depends on the type of paper and its width, length, and thickness. However, regardless of the vacuum level used, there is an area where the paper tends to lift off the writing surface (Fig. 4).

This lifting of the paper can cause a problem that is best described with the aid of Fig. 5. When the drive force is applied to the paper the paper begins to lift and the height above the platen increases to a maximum and then slowly decreases as the paper reaches maximum velocity. If the pen is not lifted high enough or the start of the paper drive is not delayed enough after the start of the pen-lift action, the surface of the paper in the problem area will hit the pen tip

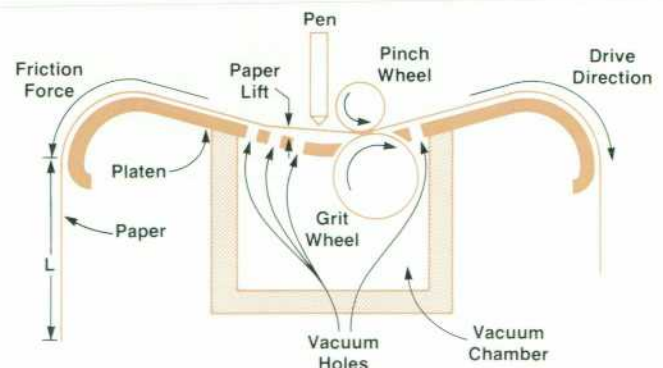

Fig. 4. When the plotting medium is driven in either direction (here to the right) it will lift up from the platen surface next to the grit-wheel drive as shown because of frictional forces opposing its movement. These forces, and thus the amount of lifting, are a direct function of the hang length L .

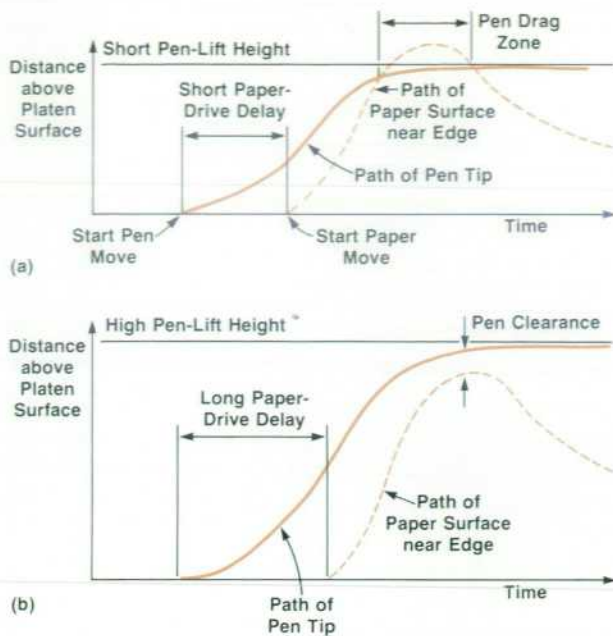

Fig. 5. (a) For a nonplotting pen and paper move the pen will drag on the paper in the lifted area if the pen is not raised high enough or the start of the paper drive is not delayed enough. (b) By increasing pen-lift height and/or paper drive start delay, pen drag is avoided.

as shown in Fig. 5a. If the pen-lift height and/or paper drive delay are increased as shown in Fig. 5b, the pen tip will always clear the paper.

For a given paper type, width, and vacuum level, the lift height is dependent on the hang length L (Fig. 4). If the lift height is defined for a given paper length, then the lift area can be determined. If a short pen lift is about to occur in this area, a higher pen lift with increased time delay for the paper drive can be executed.

The firmware in the 7580A quickly determines the presence of the pen in the lift area by defining the area as a function of paper size. The paper size approximates the manner in which the lift area changes with paper length and, if worst-case paper length, width, thickness, type, and vacuum level values are used in the function, the approximation will be conservative for all situations.

The considerations for selecting a vacuum level are:

- If the vacuum level is very high, the friction between the paper and the platen surface is very high and the drive forces on the edges will produce large buckling stresses near the pinchwheels.
- Too low a vacuum level produces pen drag over too large a lift area.
- Noise level
- Cost
- Vacuum level drop with decreasing paper size. This occurs because of the typical fan characteristic shown in Fig. 6. As the paper size gets smaller, more vacuum holes are uncovered, which increases the flow rate and consequently decreases the static pressure.

Vacuum levels high enough to produce the first problem were never achieved. Given a tubeaxial fan characteristic, where relatively large flow rate changes can occur without

large static pressure drops, the hole pattern machined in the platen of the 7580A maintains the vacuum at a sufficient level for all media sizes, so that vacuum drop problems are avoided. The problem then becomes one of obtaining a high enough vacuum level to prevent pen drag while remaining low in cost and noise and meeting VDE and UL approvals.

Tubeaxial fans are inherently low in cost due to simple design. The fan used in the 7580A can operate on ac line voltage and frequency while still passing the VDE high-potential test for safety. Line-voltage operation reduces the fan cost (no special low-voltage windings are required) and lowers the power supply cost (no special low-voltage taps on the transformer). Noise is kept to an acceptable level with proper packaging.

The platen contour is designed to approximate the shape that a sheet of plotting media wants to be in, given the system loads on the medium. By approximating this shape the medium tends to flow more smoothly over the platen, thus reducing normal loads on the platen surface. When the normal loads are reduced, friction is reduced and the medium has less internal stress to initiate buckling.

Another area largely responsible for increased friction between the platen and medium is the static electric charge that will build up whenever two nonconducting surfaces are in contact. Most of us as youngsters have seen a Van de Graff generator in an elementary school science class. The generator consists of a driven nonconducting belt that is rubbed against a hard rubber rod to accumulate static charge. This charge is transferred by a conductive brush to a metal sphere where millions of volts are easily developed. The 7580A platen acts like a Van de Graff generator with the plotting medium acting as the nonconducting belt. It is not surprising that tremendous static charges can be generated by the moving sheet. This is especially true if the plotting medium is polyester film which is one of the best dielectric materials. We have measured hundreds of thousands of volts on polyester film. When this happens the film literally glues itself to the platen surface. Friction forces of this nature guarantee medium buckling.

To combat static charge generation we need to keep the sheet out of intimate contact with the platen surface. Like two plates of a capacitor the greater the separation of the two plates the less the charge that will accumulate. One way is to lift the medium off the surface by putting a textured coating on the platen. This coating, besides being textured, is filled with carbon and Teflon™. Teflon reduces system friction, thus reducing triboelectric charge accumulation, and the carbon helps dissipate any charge on the platen surface. Another action to reduce the incidence of high

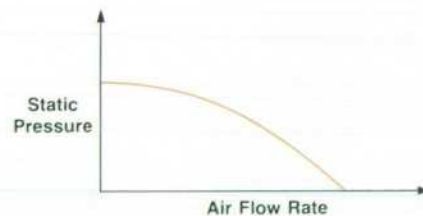

Fig. 6. Typical fan characteristic showing decrease in static pressure (vacuum level) as air flow rate increases.

static charge is to recommend that the customer use only double-matte polyester sheets as opposed to single-matte. The matte surface again helps prevent intimate contact between the polyester film and the platen surface.

The other major sources of buckling are concerned with the alignment of the system parts. The toe-in alignment of the grit wheels and the camber of the grit wheels are examples. The height of the grit wheels relative to the platen, also called the platen tangency of the grit wheels, can affect tracking of the micro-grip drive. These alignments are all

held by mounting the grit wheels very carefully to the platen on surfaces that are machined to very tight tolerances.

Acknowledgments

Many thanks to Bill Mills-Curran who created the model for the platen contour and Tom Camis of the Boise Division who aided in the understanding of electrostatic charge generation.

Robert S. Townsend



Bob Townsend received his BSME degree in 1979 from California State Polytechnic University at Pomona and joined the 7580A Plotter project the same year as a mechanical designer. A resident of San Diego, Bob was born in nearby Riverside. He plays piano and racquetball and enjoys running and radio-controlled airplanes. He recently left HP to become a student again, this time at the University of California at San Diego.

Ronald J. Kaplan



Ron Kaplan was responsible for the X-axis mechanism of the 7580A Plotter. A native of Los Angeles and a graduate of San Diego State University, he received his BSME degree and joined HP in 1978. He is married, has a daughter, and lives in San Diego. His interests include scuba diving, square dancing, and skiing.

PRODUCT INFORMATION



HP Model 7580A Drafting Plotter

MANUFACTURING DIVISION:

San Diego Division
16399 W. Bernardo Drive
San Diego, California 92127 U.S.A.

TECHNICAL DATA: HP Publication 5953-4073.

PRICE IN U.S.A.: \$15,450.

Hewlett-Packard Company, 3000 Hanover Street, Palo Alto, California 94304

HEWLETT-PACKARD JOURNAL

NOVEMBER 1981 Volume 32 • Number 11

Technical Information from the Laboratories of
Hewlett-Packard Company

Hewlett-Packard Company, 3000 Hanover Street
Palo Alto, California 94304 U.S.A.

Hewlett-Packard Central Mailing Department
Van Heuven Goedhartlaan 121

1181 KK Amstelveen, The Netherlands

Yokogawa-Hewlett-Packard Ltd., Suginami-Ku Tokyo 168 Japan
Hewlett-Packard (Canada) Ltd.

6877 Goreway Drive, Mississauga, Ontario L4V 1M8 Canada

Bulk Rate
U.S. Postage
Paid
Hewlett-Packard
Company

0400094035&&&HANS&QM00
MR Q M HANSEN
NASA AMES RESEARCH CENTER
FPD DIV
CODE BLDG N 244-7
MOFFETT FIELD CA 94035

CHANGE OF ADDRESS • To change your address, send this card to Hewlett-Packard Journal, 3000 Hanover Street, Palo Alto, California 94304 U.S.A. Allow 60 days.