



High-Directivity Coaxial Directional Couplers and Reflectometers

ABOUT a year ago *hp* announced a reflectometer system for wave guide use.* This was a system that, like a slotted line measurement, gave quantitative impedance mismatch information but would give the information for a whole wave guide range of frequencies in about the same time that a slotted line measurement could be made at only one frequency. The saving of time and effort offered by a system that automatically presents quantitative mismatch information on a meter will be appreciated by anyone who has plotted VSWR measurements over wide frequency ranges with a slotted line.

The speed of measurement of the reflectometer and the fact that it could be operated by non-technical personnel in production testing have resulted in considerable demand for a similar system for coaxial devices. To this end a series of new coaxial directional couplers

whose performance substantially surpasses any heretofore known to be available has recently been designed. The new couplers operate over 2.1:1 frequency bands in the 216-4,000 megacycle range, have coupling ratios of 20 db, and have directivities of at least 26 and 30 db, depending on their particular frequency range (see accompanying table).

Coaxial couplers with these characteristics are obviously suited to forming accurate reflectometers for coaxial systems, and the final design of the couplers has been carried out with a view toward reflectometer use. The couplers have thus been designed as dual couplers: one coupler provides a sample of both an incident and a reflected wave at separate terminals.

The schematic arrangement of the couplers is shown in Fig. 2. They consist basically of a main arm with two coupled auxiliary arms. All

*J. K. Hunton and N. L. Pappas, "The *hp* Microwave Reflectometers," *Hewlett-Packard Journal*, Vol. 6, No. 1-2, Sept.-Oct., 1954.



Fig. 1. New *hp* coaxial dual directional couplers can be used for reflectometer, power monitoring or load-adjusting applications. Model shown is for 2-4 kmc range.

Fig. 2. (At right) Schematic diagram of electrical operation of new coaxial dual directional couplers.

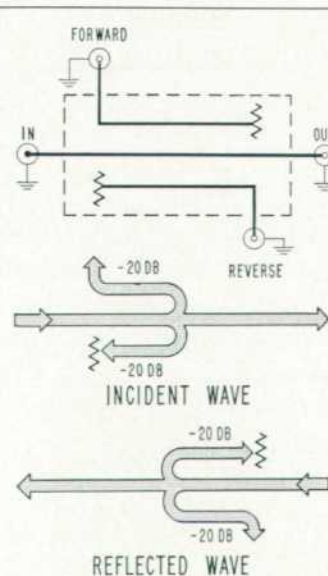

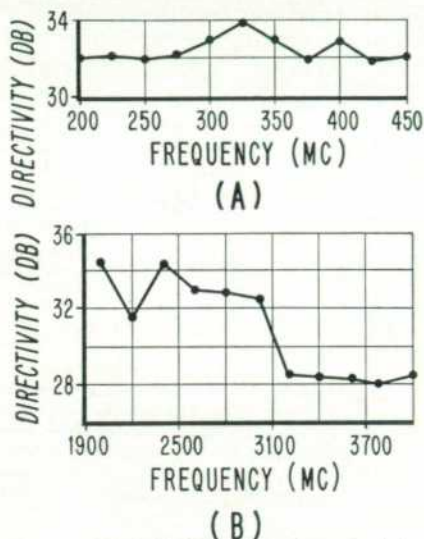

Fig. 3. Typical directivity characteristics of new couplers.

of the arms are constructed as strip transmission lines in which strip conductors are placed between two ground planes.

If an incident wave is applied at the left as shown in the diagram, the wave passes down the main arm. In the region where the lines are coupled, a wave 20 db below the incident wave will be coupled to the "Forward" terminal, while a second wave 20 db below the incident wave will be coupled to the resistive termination in the "Reverse" arm. Since the combined power in the two split-off waves amounts to only 2% of the power in the main wave, the main wave is essentially unaltered and continues to the right-hand terminal.

A wave applied at the right end of the coupler is coupled in an analogous manner. Waves 20 db below the left-traveling wave will be coupled to the "Reverse" terminal and to the resistive termination in the "Forward" arm, while the main part of the wave continues to the left-hand terminal.

The couplers thus provide equal

-hp- COAXIAL COUPLERS

-hp- No.	FREQ. RANGE	COUPLING RATIO	DIRECTIVITY
764D	216- 450 MC	20 DB	30 DB
765D	450- 945 MC	20 DB	30 DB
766D	940-1975 MC	20 DB	26 DB
767D	1900-4000 MC	20 DB	26 DB

fractions of right-traveling and left-traveling waves at separate terminals. The ratio of these waves will be equal to $|\rho|^*$, the magnitude of the reflection coefficient of any device connected to the output of the coupler. This ratio can be measured (Fig. 4) by applying the outputs of the "Forward" and "Reverse" terminals to the -hp- 416A Ratio Meter, using suitable detectors to demodulate the amplitude-modulated power which must be used with the system.

In an ideal directional coupler, no power from a forward wave would be received at the reverse terminal and no power from a reverse wave would be received at the forward terminal. In practice some undesired power is received at these terminals, although it has been possible to design the couplers so that this undesired power is at least 46 db below the parent wave, i.e., at least 26 db below the desired wave at the opposite terminal. In other words the directivity of the couplers is at least 26 db (30 db in the lower frequency couplers) over the complete frequency range [Fig. 3(a), (b)].

The coupling mechanism itself consists of quarter-wavelength sections of the conductors placed suitably near one another to achieve the desired degree of coupling. The combined effects of electrical and magnetic coupling impart directivity to the coupled wave. The unused terminal of each of the auxiliary arms is terminated in a special wide-range low-reflection resistor to absorb any power coupled to that terminal.

REFLECTOMETER SETUPS

Fig. 4(a) is a diagram of the -hp- coaxial reflectometer setup for the range from 216 to 945 megacycles and Fig. 4(b) is a similar diagram for the range from 940 to 4,000 megacycles. In each of these ranges the generator must be amplitude modulated at a 1,000-cps frequency to correspond to the acceptance frequency of the ratio meter.

For reflectometer purposes, it is

$$|\rho| = \frac{VSWR-1}{VSWR+1}$$

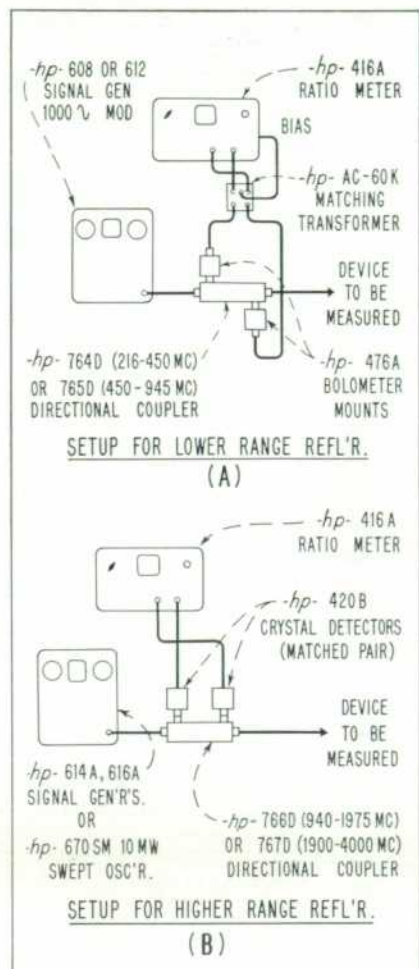

Fig. 4. Equipment arrangement to form reflectometer using new coaxial couplers.

convenient if the signal generator is capable of delivering at least 10 milliwatts to the reflectometer. If a generator with this order of power is not available, however, a source capable of 1 milliwatt output such as the -hp- 608, 612A, 614A, and 616A series can be used. Use of such a lower power source requires a special technique in reading the ratio meter and limits the lowest readable reflection coefficient to about 3%, but this is usually more than adequate for coaxial systems. It is further desirable that the generator have a low VSWR similar to that of the generators indicated in Fig. 4.

It is also convenient if the generator is a swept type such as the -hp- 670SM, since such a generator usually permits faster examination of a given frequency range. At the lower of the frequencies in question few generators are mechanically swept,

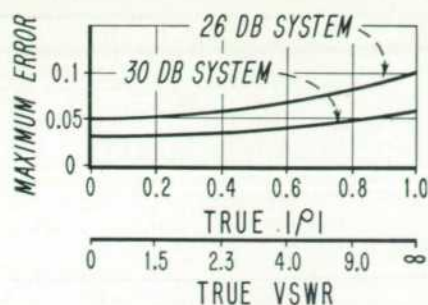

Fig. 5. Accuracy of reflection coefficient measurements after detector response has been applied (see text).

but it is entirely practical to use hand-tuned generators such as the *-bp-* 608, 612A, 614A, and 616A series indicated in the diagrams. If swept generators are used, their sweep rate should not exceed 2 to 3 sweeps per second to avoid obscuring fine structure.

When a swept generator which provides an external sweep voltage is used, the measured magnitude of reflection coefficient can be continuously displayed as a function of frequency on a d-c oscilloscope. The ratio meter is designed to provide a d-c voltage proportional to the measured reflection coefficient for oscilloscope presentation.

DETECTOR MOUNTS

It will be noted that the detector mounts indicated for the lower range (Fig. 4(a)) are different from those indicated for the upper range (Fig. 4(b)). The *-bp-* 476A Bolometer Mount indicated for the lower range consists of four bolometer elements arranged to appear as a resistance of 50 ohms to a coaxial line. To supply biasing power to the elements, the mounts should be used with the *-bp-* AC-60K Matching Transformer. This device is designed to match the mounts to the ratio meter and at the same time to apply d-c bias power from a supply in the ratio meter to the bolometer elements.

For frequencies above 940 megacycles, a matched pair of *-bp-* 420B crystal detector mounts is indicated. These mounts use type 1N26 silicon crystals which are selected and loaded to provide optimum square-law

and frequency responses. When supplied in matched pairs, the relative frequency response is maintained to within 1 db. The crystal mounts can also be used in the lower range, if desired, but bolometer mounts generally give superior performance and have thus been recommended for the lower range. In the higher range the performance of the bolometer mounts is inferior to that of the crystal mounts.

ACCURACY

A full analysis of reflectometer error is a lengthy matter, but the results as applied to the coaxial reflectometer are summarized in Fig. 5. From these curves it will be seen that the accuracy of the coaxial reflectometer is entirely commensurate with that needed for measuring typical 50-ohm coaxial devices. This becomes more apparent when it is recalled that the reflection coefficient of a type N connector is likely to be $|0.1|$ (VSWR = 1.22) in the range between 1,000 and 4,000 megacycles and $|0.05|$ (VSWR = 1.1) in the range between 200 and 1,000 megacycles. The reflection coefficient of a measured device which uses a type N connector cannot be expected, then, to be below these values on a wide-band basis.

In Fig. 5 it will be seen that the accuracy in the region between 200 and 945 megacycles is somewhat better than that in the region between 940 and 4,000 megacycles. This is principally due to the fact that the couplers have higher directivity in the lower range.

It should be noted that the curves of Fig. 5 apply only after a reflectometer frequency response curve has been applied to the meter reading. Since the detector elements will have some difference in their frequency response, it is desirable to determine and plot this frequency response when the reflectometer is first put into use. Detector frequency response is obtained by a point-by-point calibration of the reflectometer as described later.

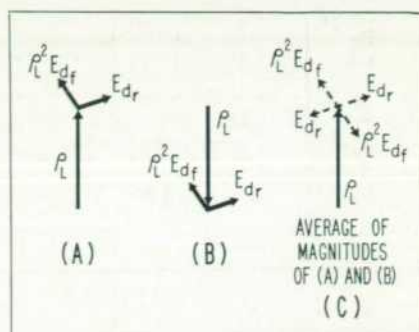

Fig. 6. Reversing phase of ρ_L (a, b) by open- and short-circuiting output of reflectometer permits influence of small errors to be avoided in calibration process. Dashed lines in (c) show how averaging causes small error terms to be mutually compensating in calibration process.

CALIBRATION PROCEDURE

The ratio meter is designed so that it will compensate for any differences in the mean coupling value of the directional couplers as well as for differences in the efficiency (as distinguished from frequency response) of the detectors used on the coupled arms. It is desirable to calibrate the reflectometer by suitably adjusting the gain of the ratio meter with the panel gain control each time the equipment is turned on.

Calibration consists merely of short-circuiting and open-circuiting the end of the reflectometer at a single frequency and then adjusting the gain control so that the average of the two readings is 100%. When this has been done, the accuracy indicated in Fig. 5 will be obtained at that frequency.*

To clarify what the calibration process does, it is necessary to consider the error signals that arrive at the reverse and forward terminals. These error signals result from the fact that the reverse and forward halves of the couplers have a finite directivity. When the ratio of the total signal at the reverse and forward terminal is formed, it is found to consist of the true reflection ρ_L from the load being measured plus two error terms E_{dr} and $E_{df}\rho_L^2$, where E_{dr} and E_{df} are the directivities of the reverse and forward halves, respectively, of the coupler.

These two error terms combine

*To facilitate shorting the reflectometer, a plug-in shorting device is furnished with each coupler.

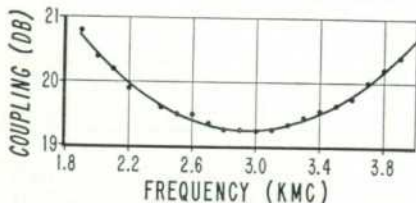
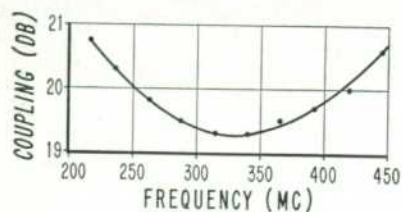

Fig. 7. Typical coupling characteristics of new couplers.

with the main signal ρ_L reflected from the load in a manner that can be represented by the vector diagram of Fig. 6(a). The relative phases of these three signals are unknown; but it is known that at any one frequency the phases will be fixed with regard to one another. Now, when the load is alternately short- and open-circuited, the phase of ρ_L will be alternately reversed, because the reflection coefficient of a short is $+1$ while that of an open is -1 . The relation of the signals in the two situations will then be as indicated in Fig. 6(a) and (b). It can be seen that the average of the magnitudes of these two vector sums is $|\rho_L|$, regardless of the phase of the two error signals (as long as that phase is fixed).

In other words the process of short-circuiting and open-circuiting the reflectometer and then setting the average of the two readings to 100% is a method of adjusting the calibration of the ratio meter with-

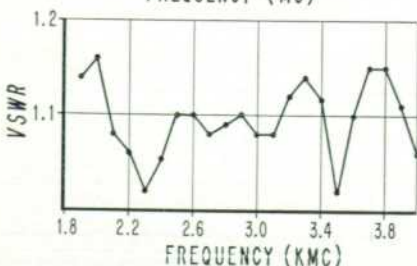
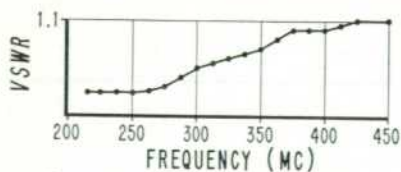

Fig. 8. Typical input VSWR of couplers.

out allowing error signals to influence the calibration. The error signals will still be present with other loads, however, and it is these that account for the error shown in Fig. 5(a).

DETECTOR FREQUENCY RESPONSE

The difference in the frequency response of the two detectors can be obtained by extending the calibration process to other frequencies. The only difference in the procedure is that the setting of the gain control on the ratio meter should not be changed from its initial calibration setting. After the ratio meter has been calibrated in the manner described above, the reflectometer should be short- and open-circuited at other frequencies. The difference between a 100% reading and the average of each of these short- and open-circuited readings will be the response of the system at that frequency. These differences should be plotted as part of a system response curve. The curve should be retained for future use and applied to the meter reading as a correction factor.

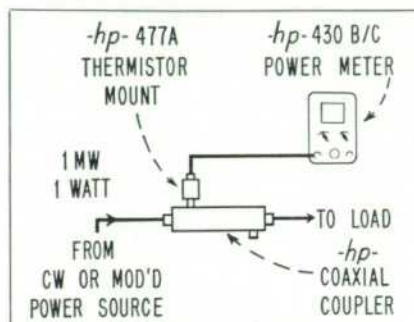

Fig. 9. Coupler can be used to extend power-measuring range of -hp- 430B or 430C Microwave Power Meter from 10 milliwatts to 1 watt.

POWER MONITORING AND LOAD ADJUSTING

The accuracy and constancy of coupling of the new couplers means that they can readily be used in power-monitoring and load-adjusting applications. One of the couplers can be used to extend the range of the -hp- Model 430B/C Microwave Power Meter, for example, from 10 milliwatts to 1 watt average (Fig. 9).

The couplers can also be used with medium-power transmitters (up to 50 watts average) to assist in antenna adjustments or to monitor the power fed to the antenna.

J. K. Hunton, H. C. Poulter, and C. S. Reis

SPECIFICATIONS

-hp- MODELS 764D, 765D, 766D, 767D COAXIAL DUAL DIRECTIONAL COUPLERS

	-hp- 764D	-hp- 765D	-hp- 766D	-hp- 767D
Frequency Range:	216 Mc to 450 Mc	450 Mc to 945 Mc	940 Mc to 1975 Mc	1900 Mc to 4000 Mc
Coupling Attenuation: (both secondary arms)	20 db	20 db	20 db	20 db
Accuracy of Coupling: (both secondary arms)	± 1 db	± 1 db	± 1 db	± 1 db
Max. Primary Line SWR: (50 ohm terminations)	1.10	1.15	1.20	1.25
Max. Secondary Line SWR: (50 ohm terminations)	1.10	1.20	1.30	1.35
Minimum Directivity: Primary Line	30 db	30 db	26 db	26 db
Insertion Loss: Detectors for Reflectometer:	Approx. 0.15 db	Approx. 0.20 db	Approx. 0.25 db	Approx. 0.35 db
Power Handling Capacity:	50 watts cw 10 kw peak	Primary Line Connectors:	Male, Female Type N	
Secondary Line Connectors:	Female, Type N	Accessory furnished:	1 -hp- 803A-76G shorting plug.	
Size:	9" x 2 1/2" x 1 3/8"	Weight:	Approx. 2 lbs.; 4 lbs. packed	
		Price: (each model)		\$125.00

Auxiliary Equipment:

-hp- Model 608C VHF Signal Generator, \$950.00	-hp- Model AC-60K Barretter Matching Transformer, \$45.00
-hp- Model 612A UHF Signal Generator, \$1200.00	-hp- Model 416A Ratio Meter, cabinet mount, \$450.00
-hp- Model 614A UHF Signal Generator, \$1950.00	-hp- Model 416AR Ratio Meter, rack mount, \$435.00
-hp- Model 616A UHF Signal Generator, \$1950.00	-hp- Model 430C Microwave Power Meter, cabinet mount, \$250.00
-hp- Model 476A Bolometer Mount, \$85.00	-hp- Model 430CR Microwave Power Meter, rack mount, \$255.00
-hp- 125-UG57B/U Male Type N to Male Type N Adapter, \$3.75	-hp- Model 477A Coaxial Thermistor Mount, \$75.00
-hp- Model 420B Coaxial Reflectometer Crystal Mount, \$75.00 each (Order in "matched pairs")	

* 2 -hp- 125-UG57B/U Male Type N to Male Type N Adapters and 1 -hp- AC-60K Barretter Matching Transformer are required with 476A's.

Prices f.o.b. Palo Alto, California

Data subject to change without notice.