

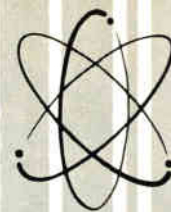

Techni-talk

COMPLETE ELECTRONIC SERVICING INFORMATION
radio • tv • hi-fi



Vol. 16. No. 3

Fall, 1964

The Oscilloscope — Calibrating — 4

The first two issues in this series contained construction information on a high impedance probe and square wave generator. Various distortions of square wave shapes and the interpretation of these distortions were given in the last issue. In this issue information on measuring wave shapes and the construction of a calibrating voltage source will be described.

Defects in certain receiver components can attenuate the desired pulse or waveform without seriously affecting its shape. It is therefore essential during troubleshooting to examine both the shape of the wave and its amplitude. As the oscilloscope reproduces both the positive and negative going excursions of a sine or complex wave, amplitude measurements are made of their peak-to-peak values and it is therefore necessary to make calibrations on the basis of peak-to-peak voltage. Figure 1A illustrates the peak-to-peak value of a sine wave in comparison to its rms value.

In order to make accurate measurements, the scope should be equipped with a graph or transparent ruled scale mounted over the face of the cathode ray tube. This graph may be divided into five or ten squares per inch in both the vertical and horizontal direction. The scope is then calibrated, for example by adjusting the vertical gain control to expand a 100-volt peak-to-peak voltage to 2 inches or 10 squares. Usually, the horizontal gain is reduced to a minimum during calibration.

This results in a single vertical line as shown in figure 1B. This is less confusing to view than an expanded waveform thus minimizing the possibility of making an error. An unknown signal producing 4 squares of signal using the same gain setting in the vertical direction would have a value of 40 volts pp. or, if 12 squares, would represent 120 volts pp.

Fixed Voltage Sources

Two sources of ready-made calibrating voltages are the filament voltage present in the television receiver and the AC line voltage. For

accuracy in either case, measure those voltages with a reliable AC meter. If the meter used is calibrated in peak-to-peak voltage, no conversion will be necessary.

If, however, the meter is calibrated in rms values, it will be necessary to convert the rms to peak-to-peak values by using the following formula: Peak-to-peak voltage = $2.828 \times \text{rms}$. 6.3 volts will then equal approximately 18 volts peak-to-peak, or the line voltage (if 115 volts,) will equal approximately 325 volts peak-to-peak. Assuming the scope is adjusted to display the 18-volt signal at an amplitude of 5 squares, then each square would represent 3.6 volts peak-to-peak. As the maximum usable area is about 4 inches on a 5-inch tube, this would allow for a measurement of 20 squares, or in the case of the above voltage and gain setting, a limit of 72 volts.

Variable Voltage Sources

Greater flexibility can be obtained by using a variable voltage source. Several types of calibration units are available or a simple inexpensive unit may be constructed. Details for two such units are illustrated in figures 2 and 3. These units offer isolation as well as a smooth variable control of the calibrating voltage source. Table I lists the range of the peak-to-peak voltages that may be required and their rms values.

Peak-to-peak voltages in excess of 300 volts can be measured by adjusting the scope gain to one-inch deflection with 106 volts rms applied. With this setting, the peak-to-peak value of an unknown voltage will be 300 volts times the number of inches deflection. Do not apply voltages to the scope or probe in excess of the limits suggested by the manufacturer. In order to insure error-free calibrations, always feed the calibrating voltages through the probe or any isolating resistor or capacitor which will be attached to the scope cable while troubleshooting or making measurements. Do not remove the voltmeter from the calibrating unit during scope calibration if the meter used tends to load down the circuit, such as a 20,000-ohm-per-volt type.

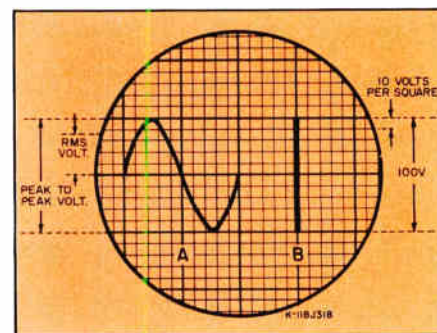

Fig. 1 (a) Comparison of Peak to Peak and R. M. S. Voltages
(b) Horizontal Gain Reduced to Minimum During Calibration

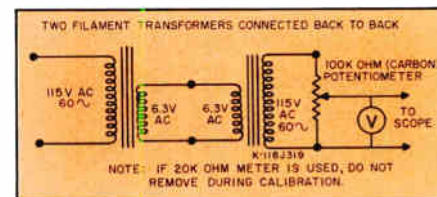

Fig. 2 Calibration Unit using two transformers

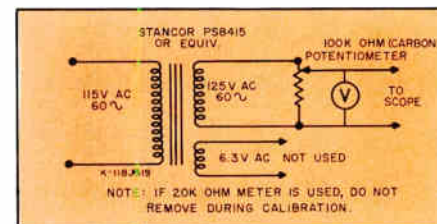
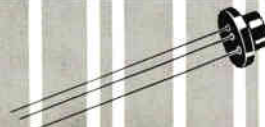
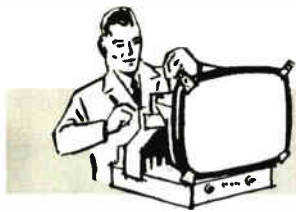

Fig. 3 Calibration Unit using one transformer

RMS	P. to P.
.53	1.5
1.06	3.0
5.3	15.
10.6	30.
53.	150.
106.	300.

The above peak-to-peak values are approximate and were rounded off for convenience.





BENCH NOTES

SOLDER REMOVING AID

When removing components from printed circuitry, it is desired to remove excess solder in order to facilitate the operation. A "solder-sucker" may be easily made, at virtually no expense from a small size plastic squeeze bottle.

Fit a two-inch piece of tubing to the top (the tubing from an old ball-point pen cartridge does nicely — aluminum preferred). A bit of epoxy type glue will secure the tubing to bottle top.

To operate, heat the joint until the solder flows, squeeze the bottle, and apply the tip to the heated joint. Release the bottle and excess solder will be easily removed, making component removal convenient.

*Edward Grey
3205 Keniston Lane
Jacksonville, Fla.*

YOKE REMOVAL

Here is a very simple solution to removing a yoke that has become "frozen" to the picture tube neck. Merely use a good tuner cleaner solution, and spray the liquid around the picture tube neck. This lubricates the neck and allows the yoke to be removed easily.

Any approved tuner cleaner will not affect the wiring on the yoke which can be wiped dry after its removal. This procedure has worked every time.

*Carlton C. Mills TV
20 Gordon Place
Scarsdale, N. Y.*

USE A BLANKET

When transporting receivers in a passenger stationwagon, place a blanket on the tailgate. Put the set on the blanket and slide both into the wagon. When unloading, just pull the blanket. Set will come out with out crawling inside or using an additional man.

*Alvin Krum
644 Lincoln Avenue
Maywood, N. J.*

CUTOUT IMPROVES EYE LOUPE

I find a jeweler's eye loupe very helpful in the study of tiny components, but it's a chore to be continually removing and replacing the loupe when doing fine work.

By cutting out a section of the housing, the loupe is improved so I can see objects in normal size with out removing it from the eye — sort of a bifocal effect.

Because light can enter through the cutout, I can also place the modified tool directly on small drawings and schematics for easier reading.

*Harry J. Miller
Advance Television-Radio
991 Forty-Second St.
Sarasota, Fla.*

CHECK SOLDERING GUN TIPS CLOSELY

When a soldering gun tip does not produce heat, the tip is cracked or open. An open soldering gun tip is the cause of the loss of high heat. When the trigger is depressed, the tip will only get slightly warm. This open tip can not be seen without the use of a magnifying glass. Yet, the tip will look perfect to the naked eye.

*A. von Zook
Corralitos Radio Shop
142 Hanes Road
Corralitos, Calif.*

SHADED SCREEN

A Magnavox 24" TV, Chassis V-21-06CB, came into the shop with the following symptom.

Set had complete raster, however, video appeared on $\frac{2}{3}$ of right side, with picture area rolling slowly and with fair sound.

Fault with a defective electrolytic filter capacitor C 1 which has four units in one can.

B+ voltage showed only a slight reduction. Apparent defect was common coupling between the various sections of the electrolytic capacitor. All symptoms disappeared when complete unit was replaced.

*A. Borgetti
A & B T.V. Service
6735 Baring Avenue
Hammond, Ind.*

SPRAY EXTENSION

The needle of an old hypodermic makes an excellent extension for pressurized spray cans. The small diameter makes it possible to spray through very small holes in control and other parts.

*William Schoeck
1133 Oak Street
W. Palm Beach, Fla.*

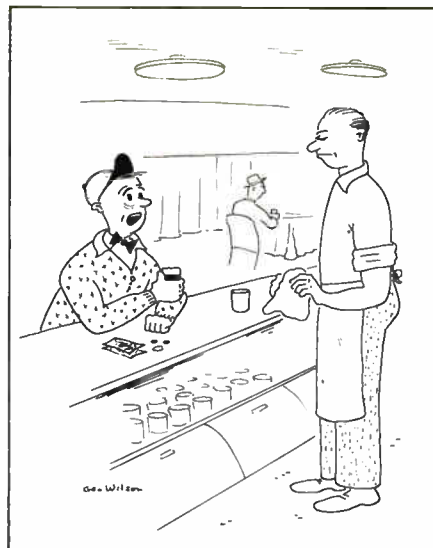

"I've had it two weeks — checked all the tubes, cleaned and straightened the pins, replaced the linearity coil, pulled every capacitor, changed the transformer and yoke . . ."

SOLDERING HINT

Wrapping a piece of aluminum foil around the element of a soldering iron speeds its heating action, and wrapping a few turns of asbestos tape around the shank will help prevent burning insulation or components when soldering in cramped spots.

*Stan Clark
Box 2162
East Bradenton, Fla.*

TOOTHPICKS ARE USEFUL

I have found that a box of toothpicks are useful in my shop. After removing transistors, condensers, and resistors from the P-C board, you can melt the solder and then insert the round toothpick in the hole where the old part was removed and solder will not stick to the toothpick, therefore leaving the hole open to install the new part with ease.

*Carlos Brownderville
Carlos Brownderville's
Radio & Television Service
Weiner, Arkansas*

NOTE:

Those desiring to have letters published in this column should write the Editor Techni-Talk, Electronic Components Division, General Electric Company, Owensboro, Kentucky. For each such letter selected for publication you will receive \$10.00 worth of General Electric tubes. In the event of duplicate or similar items, selection will be made by the Editor and his decision will be final. The Company shall have the unlimited right without obligation to publish or otherwise use any idea or suggestion sent to this column.

Caution: The ideas and suggestions expressed in this column are those of the individual writers. These ideas and suggestions have not been tried by the General Electric Company and therefore are not endorsed, sponsored or recommended.

What's new!

SEVENTH EDITION TRANSISTOR MANUAL, ETR-3296

Your distributor now has this new fact-filled G-E Transistor Manual containing 652 pages of theory, circuits, specifications and other valuable information needed by every engineer, hobbyist and experimenter.

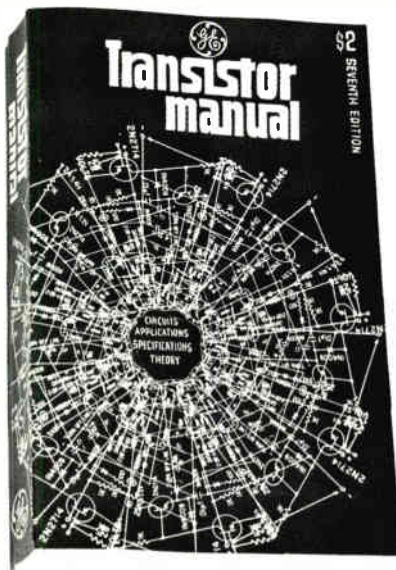

- 19 Fact-filled Chapters
- Emphasis on circuits and how-to-do-it information.
- The Experimenters Chapter is twice as big, compared to our Sixth Edition, with circuits to build receivers, transmitters and many more.
- There's a new chapter on Tunnel Diode Characteristics and also on Small Signal Characteristics.
- The audio and hi-fi sections have been updated, including circuits for complete stereo systems.
- Basic semiconductor theory section has been expanded and simplified.
- This Edition brings the production run on General Electric Transistor Manual up to one million copies.



Ask your G-E distributor for a copy of ETR-3296. If he is unable to supply you use order coupon on page 7. The price is only \$2.00.

SCR* MANUAL ETR-3875

Unquestionably, the most authoritative and well-received manual on SCR's from the originator of the Silicon Controlled Rectifier . . . General Electric

- Chapters on phase control, inverters and static switches have been completely rewritten to reflect refinements and new circuit developments to make this information more useful than heretofore.
- New chapters cover the exciting new "first cousins" of the SCR: the gate turn-off switch and light activated SCR's.
- Amply illustrated with schematics, outline drawings, design curves, and useful circuits.
- Written and edited by our experienced, professional staff of power semiconductor application and design engineers.
- Contains 409 pages . . . more than 50% is new unpublished material.
- Presented in easy-to-read straight-forward language.

* Silicon Controlled Rectifier

Ask your G-E distributor for a copy of ETR-3875. If he is unable to supply you use order coupon on page 7. The price is only \$2.00.

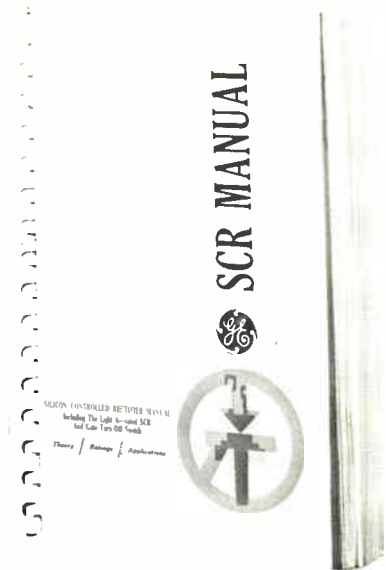

NEW GENERAL ELECTRIC TUBES AND COMPACTRONS LISTED BY RECEIVER

tubes



Here is a list of *NEW* General Electric receiving tubes and compactrons and the manufacturers using these types in their receivers. Be ready to service the new model re-

ceivers by having at least one of each type on hand. They are now available from your General Electric tube distributor. Asterisk indicates compactron types.

TYPE	SET MANUFACTURER	FUNCTION
2DV4	RCA — TV	RF Ampl.
2HA5	Admiral TV	RF Ampl.
4JC6	RCA TV	IF Amp.
4JD6	RCA TV	IF Amp.
5HA7*	Emerson TV	Syn, AGC
5LJ8	Sarkes tuner, TV (Use by Admiral, etc.)	Oscillator-Mixer
6BH11*	G-E	Hor. Osc., control & discharge
6HB7	St'd K Tuner, Motorola)	Osc.-Mixer
6HQ5	St'd K Tuner, Motorola)	RF Amp.
6J10*	Zenith TV	Sound Det. & Output
6JM6*	Zenith TV	Hor. Out
6JN6*	Zenith TV	Hor. Out
6JS6A*	GE & Zenith Color TV	Horizontal output
6JV8	Admiral TV	Vid. Amp. & Sound IF
6KR8	Philco	Video Amp. and Sync. Sep.
6KT8	Zenith	Chroma amplifiers, color killer and sound IF & Sync. Amp. Limiter
9GV8	Admiral TV	Vert. Osc. & Output
10KR8	Philco	Video Amp.
12GN7	Zenith Color TV	Video Amp.
12JN6*	Motorola TV	Horizontal output
12JN8	G-E-AM, FM	RF & Osc. mixer multiplex
13GF7	RCA TV	Ver. Osc.-Out
15LE8	Motorola	Color demodulator
16GY5*	Emerson TV	Hor. Output
17AY3	Zenith	Damper
17JB6	RCA TV	Hor. Out.
17JM6*	Zenith TV	Hor. Out.
17JN6*	Zenith TV	Hor. Out.
21HB5*	G-E TV	Hor. Output
23Z9*	G-E TV	Vert. Osc. -Out & Sync. Sep.
33GY7*	G-E TV	Hor. Damper & Output
33JV6*	Admiral TV	Horizontal output
38HE7*	Motorola TV Admiral	Hor. Output and Damper

*Compactron Type



doorknob hangers

...easy to use
...effective

Your service message goes straight to the customer's door, where it can't be missed. Carry a supply with you on service calls, and snap them on the doorknobs of adjoining houses and apartments. Doorknob Hangers are also effective for completely canvassing an entire neighborhood; have them distributed throughout the area you serve. Colors—red-orange and black. Imprinted

with your name, address and phone number. Actual size—3 7/8" x 6 3/4". Order by ETR number printed on each card. Minimum quantity—100. Minimum quantity any single card—100.

- No imprint—100.....\$1.50
- Imprinted For first 100.....\$4.25
- Each additional 100 imprinted.....\$1.75

Detach bottom section and snap onto line cord



complete home entertainment service in a

HURRY



TV RADIO PHONOGRAPH

EXPERT SERVICE ON ANY MAKE OR MODEL TV • RADIO • PHONOGRAPH

CALL ETR - 1067 YOUR IMPRINT

AUTHORIZED DEALER GENERAL ELECTRIC Electronic TUBES

Detach bottom section and snap onto line cord



TV RADIO PHONOGRAPH

we're service specialists



EXPERT SERVICE ON ANY MAKE OR MODEL TV • RADIO • PHONOGRAPH

CALL ETR - 1072 YOUR IMPRINT

AUTHORIZED DEALER GENERAL ELECTRIC Electronic TUBES

Detach bottom section and snap onto line cord



ELECTRONICS



WANT A PATTERN-PERFECT PICTURE?

Our professional TV Tune-Up corrects set troubles fast. For your assurance of complete satisfaction we use dependable G-E Service Designed covering tubes and Black Daylite picture tubes. All new parts in a fused glass envelope. ETR 3219

EXPERT SERVICE ON ANY MAKE OR MODEL TV • RADIO • PHONOGRAPH

CALL ETR-3219 YOUR IMPRINT

AUTHORIZED DEALER GENERAL ELECTRIC RADIO TV TUBES

Detach bottom section and snap onto line cord



WORTH \$1.00 TO YOU

Here's dependable TV Service, and a real value for you. One dollar will be deducted from your next TV Service Charge when you present this card to our technician. We install dependable G-E tubes and parts. CALL US FOR RELIABLE SERVICE



EXPERT SERVICE ON ANY MAKE OR MODEL TV • RADIO • PHONOGRAPH

CALL ETR - 1308 YOUR IMPRINT

AUTHORIZED DEALER GENERAL ELECTRIC Electronic TUBES

Detach bottom section and snap onto line cord



Professional TV service

Your set should be repaired only by a qualified technician



EXPERT SERVICE ON ANY MAKE OR MODEL TV • RADIO • PHONOGRAPH

CALL ETR-1745 YOUR IMPRINT

AUTHORIZED DEALER GENERAL ELECTRIC Electronic TUBES

Detach bottom section and snap onto line cord



don't miss the Big Games



safeguard your home entertainment, call us for expert TV Service. Our expert technicians will put your set in top operating condition.

EXPERT SERVICE ON ANY MAKE OR MODEL TV • RADIO • PHONOGRAPH

CALL ETR - 1746 YOUR IMPRINT

AUTHORIZED DEALER GENERAL ELECTRIC Electronic TUBES

Order items by Title and ETR Number through your AUTHORIZED G-E TUBE DISTRIBUTOR.

postage meter ads

do an extra selling job

A postage meter saves time, speeds your mail, stops stamp losses, does its own bookkeeping and adds prestige to your mail. Plus the fact that you can actually advertise your services on the envelope *as you stamp!* All of this with no capital investment. *You simply lease the machine . . . not buy it.* See your local Post Office for details about a postage meter. See your Distributor for the postage meter ads.

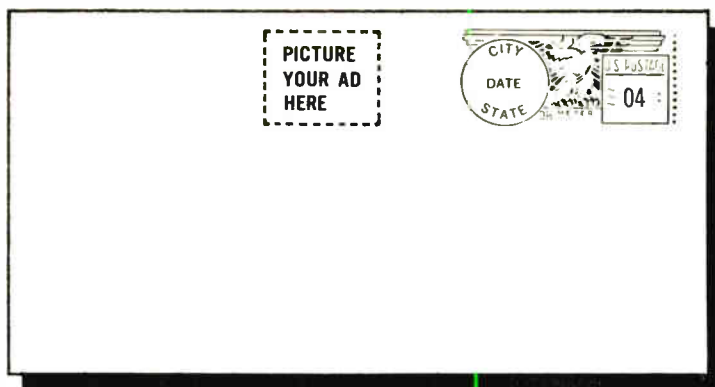

4 DESIGNS TO CHOOSE FROM

DEPENDABLE TV SERVICE

ETR-1587-1 (DM)
Cost \$17.50



ETR-1587-3 (DM)
Cost \$17.50

FAST TV SERVICE



ETR-1587-2 (DM)
Cost \$17.50
ETR-1587-4 (RT)
Cost \$20.00
ETR-2684—for
Model 5300 \$17.50

Best for any set



ETR-1587-5 (RT)
Cost \$20.00

BLACK-DAYLITE



compliments of:

AUTHORIZED GENERAL ELECTRIC TUBE DEALER

Stresses importance of calling professional TV-Radio technicians.

ETR-1462, "SET OWNER'S GUIDE"
Cost . . . No imprint . . . per 100 . . . \$2.00
Imprinted . . . first 100 . . . \$4.75
Each additional 100 . . . \$2.25

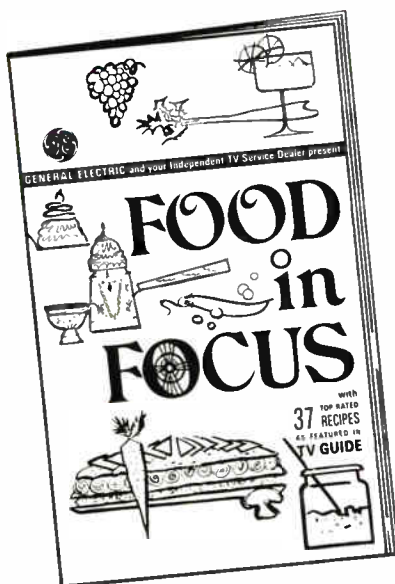

"FOOD IN FOCUS" RECIPE BOOK

Featuring favorite foods of famous stars in full color, this 40-page cookbook with 37 top-rated recipes has been designed for universal appeal. Includes four pages of customer tips for a better TV picture, hints on when to call a service technician and space for your imprint. Use it as a premium, as a giveaway or as a store traffic builder.

ETR-3353, "FOOD IN FOCUS" booklet
Cost \$0.20



Highlights the technical training and investment required of the TV Service Dealer.

ETZ-889, "TV SERVICE PROFESSION"
Cost . . . No imprint . . . per 100 . . . \$2.00
Imprinted . . . first 100 . . . \$4.75
Each additional 100 . . . \$2.25



BOOK MATCHES—YOUR BEST GIVE-AWAY

People never refuse a book of matches. And what better way than to have "20 lights" light up your store name and address. That's right, all book matches are imprinted. Leave a few here . . . a few there . . . everywhere. They will really pay!

ETR-3519
IMPRINTED MATCHES
2,500 BOOKS PER CASE

Cost . . . 1 case \$31.25
2-3 cases (per case) . . . \$27.50
4-9 cases (per case) . . . \$25.00
10-24 cases (per case) . . . \$22.50
25 or more (per case) . . . \$21.00



SERVICE-DESIGNED ENTERTAINMENT SEMICONDUCTORS

**A FEW
WILL DO**

UNIVERSAL REPLACEMENT TRANSISTORS

- Designed for General Replacement Use.
- Replaces Most Types of Transistors Used in Radios, TV Sets and Other Devices.

Highly dependable low cost transistors especially designed as general replacements for most types of transistors used in Radio and TV Sets and other home entertainment devices. The nine transistors listed below cover the vast majority of applications that a radio or TV serviceman will encounter. They permit a service shop to reduce to a minimum the number of different types of transistors that it must stock. Av. Wt.: 2 oz.

Catalog No.	Outline Drawing	Use	Application	List Price
GE-1	B	PNP	MIXER/OSCILLATOR CONVERTER * RF and IF AMPLIFIER	\$2.10
GE-2	B	PNP	AF AMPLIFIER	2.00
GE-3	C	PNP	AF POWER AMPLIFIER	3.75
GE-4	D	PNP	AF HIGH POWER AMPLIFIER	7.40
GE-5	B	NPN	MIXER/OSCILLATOR CONVERTER * RF and AF AMPLIFIER	2.75
GE-6	A	NPN	MIXER/OSCILLATOR CONVERTER * RF AMPLIFIER	2.90
GE-7	A	NPN	IF AMPLIFIER	2.65
GE-8	B	NPN	AF AMPLIFIER	2.00
GE-9	*B	PNP	MIXER/OSCILLATOR CONVERTER * RF and IF AMPLIFIER	2.00
GE-10	E	NPN	AF AMPLIFIER * DRIVER * OUTPUT	1.95

*GE-9 Smaller size than GE-1 (GE-9 .209 diameter — GE-1 .335 diameter.)

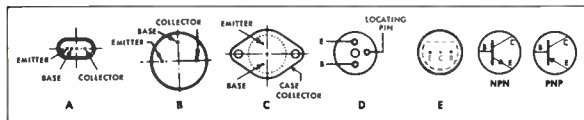

EACH TRANSISTOR IS SKIN PACKAGED WITH INTERCHANGEABILITY ON BACK OF CARD



FRONT

PNP TYPE		GE-1		INTERCHANGEABLE WITH THE FOLLOWING											
2N111	2N139	2N271	2N412	2N415A	2N485	2N1109	GT-761	2S45	2S452						
2N111A	2N140	2N271A	2N413	2N416	2N486	2N1110	GT-761R	2S52	SYL-1536						
2N112	2N218	2N273	2N413A	2N417	2N614	2N1111	GT-762R	2S53	SYL-1537						
2N112A	2N219	2N274	2N414	2N481	2N616	2N1266	GT-766	2S437	SYL-1583						
2N113	2N247	2N409	2N414A	2N482	2N617	GT-759R	CR-760	2S438	SYL-1608						
2N135	2N252	2N410	2N414B	2N483	2N1107	GT-760	CH-766	2S439	SYL-1621						
2N136	2N257	2N411	2N415	2N484	2N1108	GT-760R	2S30	2S449							

BACK

NEW G.E. GE-504 UNIVERSAL RECTIFIER

A silicon rectifier with a 45-amp surge rating. Recommended as a replacement for all selenium, germanium and silicon rectifiers used in TV receivers. The 45-amp surge rating eliminates the need for the surge limiting resistors normally required when silicon rectifiers are used.

PIV is 400 volts; max. Idc, 750 ma. Shpg. wt. 2 oz.

LIST \$2.00



G.E. CRYSTAL DIODES

Type	Description	Average Forward Current (ma)	Peak Reverse Voltage (volts)	List Price
1N34AS	General Purposes	50	75	\$.60
1N60	Video Detector	50	30	.85
1N82A	Silicon UHF Mixer	—	5	1.45
1N295	50 MC Detector	30	50	.55

G.E. VAC-U-SEL^A DOUBLE DIODES

Miniature double diodes for TV horizontal phase detector, replacement and other applications. $\frac{1}{16}$ x $\frac{9}{16}$ x $\frac{1}{16}$ ". Shpg. wt. 2 oz.



Type No.	Ifwd	Imr	Description	Max. Case Temp.	List
6GC1	1.1 @ 2.5V	4 @ 20V	Common cathode	85°C	\$.99
6GD1	1.1 @ 2.5V	4 @ 20V	Series connected	85°C	.99
6GX1	1.1 @ 2.5V	4 @ 20V	Common anode	85°C	.99

G.E. SILICON AND GERMANIUM RECTIFIERS

These top hat, hermetically sealed rectifiers are designed for general purpose applications requiring maximum economy.

TYPE	PIV	MAX IDC	LIST PRICE
1N91	100	150	\$1.20
1N1692	100	600	.75
1N1693	200	600	.80
1N1694	300	600	.95
1N1695	400	600	1.10
1N1696	500	600	1.20
1N1697	600	600	1.55



SELENIUM RECTIFIERS FOR USE IN COLOR TV SETS

The GE CR series are the replacement rectifiers for all color chassis made by RCA, Zenith, GE and others, giving a complete color rectifier line for electronic parts distributors.

CATALOG NUMBER	TYPE	LIST PRICE
GE CR — 1	Focus Rect.	\$4.85
GE CR — 2	Boosted Boost	2.25
GE CR — 3	Convergence	1.60

G.E. SEMICONDUCTOR REPLACEMENT KIT

Model K-915A convenient kit covers a majority of entertainment-type semiconductor replacement needs — an ideal aid for radio and TV servicemen. Contains 22 units of service-designed semiconductors including 7 universal transistors, 3 silicon rectifiers, 6 crystal diodes, 5 dual diodes, and 1 power transistor. Units are housed in a sturdy cabinet with 15 clearly labeled drawers. Every unit always within handy reach. Cabinet size, 8½ x 12½ x 9". Shpg. wt., 4 lbs.

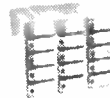

LIST \$38.83
NET \$19.57



SERVICE NOTES

COLOR TV SERVICE HINTS CY, CX, CW CHASSIS

The following service hints have been compiled from information supplied by distributors and from factory experience.

For easy reference, the information is presented in a "Symptom-Cure" form. The cause or cure are those which have been reported, though not verified by use. Also, they are not necessarily the only ones which will produce the symptoms listed.

CY CHASSIS	SYMPTOM	CAUSE — CURE
Video	Signal Overload Busy Background	AGC Control R-130, open Replace 6DS4
Audio	Hum or Buzz in background, volume at normal level.	Vertical pick-up on Vol. Control lead.
Chroma	Hue Control not in center of range. Loss of color on station but some color from generator. Lost color bar from Keyed Color Bar Generator, missing from display.	Adjust T-702 C-702 (.047 mfd.) defective. Slight overscan is intentional to permit best linearity and convergence at edges. (Will not be a customer complaint). Try another 6JE6.
Sync	No color Sync-Horizontal Hold unstable. Poor Sync	Defective 3.58 Crystal, C-520 leaky. Leaky Electrolytic Cap. C-118, 124, 136
CRT Display	Raster Bloom No Hor-Sweep or H. V. Poor-Focus Red and Green will not converge at center Poor Purity	R-150 open Replace 6JE6 Focus Rectifier CR102 shorted. Reverse Red static magnet. Degauss — Adjust yoke tilt.
CX CHASSIS		
CRT Display	Bright Hor. line 3 inches wide rolling up screen. Blooming Red and Green will not converge at center. Poor Purity	Poor ground on Electrolytic Cap. TSL 15-63). TSL 23-62) Reverse Red Static magnet. Degauss — Adjust yoke tilt.
CW CHASSIS		
Video	Weak or no video — Audio present.	L-112 open
CRT Display	Intermittent loss of brightness and contrast Red and Green will not converge at center Poor purity	Electrolytic Cap. C-119D intermittent Reverse Red static magnet. Degauss — Adjust yoke tilt.

RECORD CHANGER SERVICE HINTS

MODEL: G.E. RD100 Series

SYMPTOM: Unit will cycle to off position as if last record had completed playing, even though record balance arm is up on the record load position, or in automatic repeat position.

CAUSE: Quadrant lever is sticking (see Fig. 1) in shut-off position due to presence of oil, grease or foreign matter.

CORRECTION: Remove oil, grease, or foreign matter from quadrant lever. Quadrant lever should be dry and clear of any lubricant and move freely by gravity. The quadrant lever may be cleaned with a small brush and alcohol.

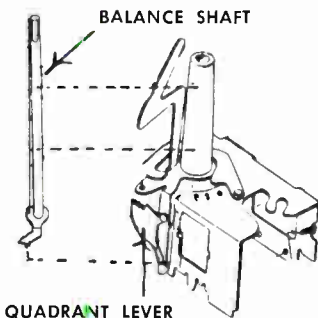

Fig. 1 Sticking Quadrant Lever

MODEL: G. E. RD100 Series

SYMPTOM: Unit does not shut off automatically after last record has finished playing. In some cases record support arm may be rotated much further than the normal 90° arc, causing damage to record indexing parts.

CAUSE: The foot on the lower end of record balance shaft (see Fig. 1) may be bent up, preventing the balance shaft from actuating the quadrant lever.

CORRECTION: Balance shaft can usually be straightened. If not, replace balance shaft.

NOTE: The balance shaft is usually bent up by the inadvertent application of excessive downward pressure exerted on the balance arm when in automatic repeat position. In later production, the balance shaft was beefed up to alleviate this problem.

99 SHUTOFF LEVER ASSEMBLY

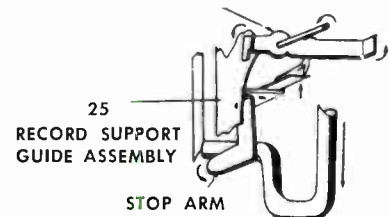

Fig. 2 Shutoff Mechanism Parts

MODEL: All V.M.

SYMPTOM: Tone arm returns to rest post and changer shuts off instead of playing record.

CAUSE: Stop arm (see Fig. 2) is binding in shut-off position. Binding may be due to burrs and/or gummy lubricant. Securing rivet can also cause binding.

CORRECTION: Remove burrs and/or gummy lubricant — free rivet.

ORDER COUPON

Available from your local G-E tube distributor or can be ordered direct.

General Electric Company
Department "B"
3800 N. Milwaukee Avenue
Chicago 41, Illinois

Enclosed is money order or check payable to General Electric Company for:

QUANTITY		PRICE
.....	ETR-3826 Door Clock Sign.....	\$.50 each \$.....
.....	ETR-3896 Cutting Tool for Printed Cir. Board	.25 each
.....	ETR-3910 Five-in-One Combination Tool.....	.98 each
.....	ETR-1067 Doorknob Hangers
.....	ETR-1072 Doorknob Hangers	See page 4
.....	ETR-1308 Doorknob Hangers	for price
.....	ETR-1745 Doorknob Hangers	information
.....	ETR-1746 Doorknob Hangers
.....	ETR-3219 Doorknob Hangers
.....	ETR-1587-1 Postage Meter Ads.....	17.50 each
.....	ETR-1587-2 Postage Meter Ads.....	17.50 each
.....	ETR-1587-3 Postage Meter Ads.....	17.50 each
.....	ETR-1587-4 Postage Meter Ads.....	20.00 each
.....	ETR-1587-5 Postage Meter Ads.....	20.00 each
.....	ETR-2684 Postage Meter Ads.....	17.50 each
.....	ETR-3353 Food in Focus Recipe Book.....	.20 each
.....	ETR-1462 Set Owners' Guide	See page 5
.....	ETZ-889 TV Service Profession	for price
.....	ETR-3519 Book Matches	information
.....	ETR-3296 Transistor Manual	2.00 each
.....	ETR-3875 SCR Manual	2.00 each
.....	(Include applicable state and local tax) \$.....	TOTAL \$.....

NAME

STREET ADDRESS

CITY, STATE and ZIP CODE

Printed Circuit Board Cutting Tool, ETR-3896

This new G-E Service Aid is a real time saver when servicing printed circuit boards. This versatile tool has many features:



- Makes Printed Circuit troubleshooting easy. Use tool to cut through conductor — make test — then flow solder across cut.
- Blade slides horizontally — adjusts to cut "paper thin." In this position tool cuts only the printed circuit and does not weaken board.
- Blade retracts — safe to carry in pocket or service case.
- Uses standard single-edge blade.
- Blade easily replaced or turned around. Retract blade into holder — then spring heavy part of blade toward larger open side of holder and slide blade out.
- Has many other uses for cutting, trimming and opening packages.

Ask your distributor for ETR-3896 or use the handy order coupon on page 7. The price is only \$.25.

Door Clock Sign ETR-3826

Let your customers know when — you are open, you are closed, you will be back.

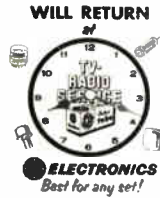

- Here are some ways it can be used:
- Hang on front door or in a visible location.
 - Move hands to time of return when leaving for lunch — for the day — for service calls — for emergencies.
 - Turn sign around so OPEN is visible when you return.
 - Build good will . . . your customers will appreciate knowing WHEN to stop.
 - Made of durable plastic to last indefinitely.

Ask your distributor for ETR-3826 or use handy order coupon on page 7. The price is only \$.50.

Five-in-One Combination Tool ETR-3910

Here is an new servicing tool that will save time either on the bench or on home service calls.



- Here are many of the useful features:
- Lightweight pocket tool for faster electronic servicing.
 - Five tools in one with pocket clip.
 - Contains No. 1 Phillips screwdriver and standard screwdriver; 1/4", 1/8" and 3/8" hex sockets.
 - Tool parts made of tempered, hardened tool steel, nickel plated.
 - Handy for use in shop, car or home.
 - Plastic shock-proof handle.

Ask your distributor for ETR-3910 or use the handy order coupon on page 7. The price is only \$.98.

GE Techni-talk

Vol. 16 No. 3 Fall, 1964

In this issue:	Page
The Oscilloscope — Calibrating — 4.....	1
Bench Notes	2
What's New!	3
Service Dealer Promotions.....	4
G-E Service-Designed Entertainment Semiconductors	6
Service Notes	7

Techni-talk on AM, FM, TV Servicing, published quarterly by ELECTRONIC COMPONENTS DIVISION, GENERAL ELECTRIC COMPANY, OWENSBORO, KY. In Canada: Conodion General Electric Co., Ltd., 189 Dufferin St., Toronto 3, Ontario. R. G. Kempton, Editor. Copyright 1964 by General Electric Company.

This copy of **Techni-talk** comes to you through the courtesy of your General Electric tube distributor.

NOTE: The disclosure of any information herein conveys no license under any General Electric patent and, in the absence of an express written agreement to the contrary, the General Electric Company assumes no liability for patent infringement (or any other liability) arising out of use of such information by others.