

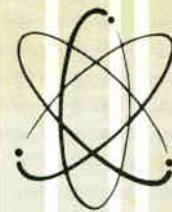

Techni-talk

COMPLETE ELECTRONIC SERVICING INFORMATION
radio • tv • hi-fi



VOL. 10 NO. 5

SEPT.—OCT. 1958

NOISE CANCELLER CIRCUITS

Several different noise canceller circuits have been used in General Electric TV receivers during the past several years. The original circuit was first used in the "Stratopower" chassis and was the type using two triodes feeding a common load. Essentially the same circuit was used in the "EE", "H", "J" and "O" chassis. The pentagrid type of canceller was first used in the "G" and "K" chassis. It has had improvements in control of G1 bias in later receivers and has appeared in the "S", "ST", "U" and "U2" receivers. The late version of the "U2" contained still another variation. The canceller control tube was eliminated and the d-c bias for G1 of the canceller tube was controlled from the first I-F amplifier tube. Each type of circuit used in the various model receivers will be described individually.

Basic Noise Canceller Circuit Used in "EE", "H", "J" and "O" Receivers

The noise canceller is a device designed to combat ignition and similar interference which often is a cause of sync instability.

Fig. 1 shows the type of noise canceller circuit used in "EE", "H", "J" and "O" receivers. The sync amplifier tube (V113A) receives the video signal derived from the video detector as shown in Fig. 1. V113A amplifies and inverts the signal, thereby making the sync pulses positive at its plate as shown.

The noise inverter or canceller, V113B, is tied across the output of the sync amplifier V113A. The cathode of the canceller has a fixed positive bias applied by virtue of R301, R302. Its grid is maintained at a negative bias level proportional to the peak voltage of the incoming signal. This negative grid bias is obtained from the crystal diode, Y151, and suitably filtered by R166 and C169. These two bias voltages combine to cut off the canceller tube, V113B, so that it will normally not conduct in the presence of a received television signal.

The cathode of the canceller, V113B, is fed a signal consisting of video and negative-going sync as well as impulse noise, if any (figure 2). Since the canceller is biased off and will not pass any signals less than the sync-tip level,

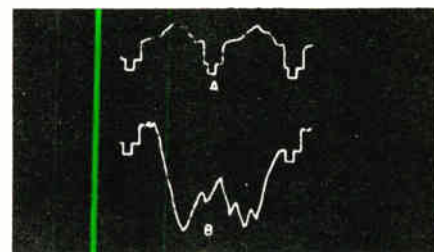
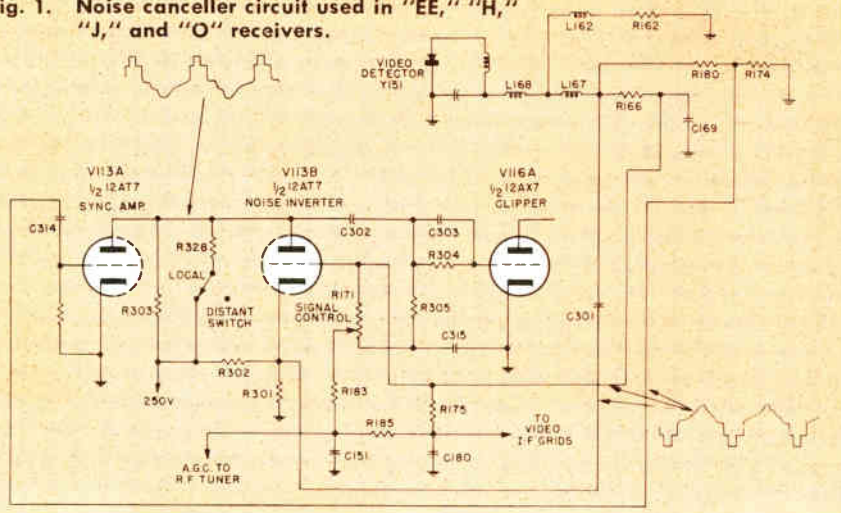

Fig. 2. Normal video signal in "A" and same signal with large bursts of noise "covering" practically two complete horizontal lines in "B."

nothing happens until a noise burst of greater-than-sync-tip level occurs. When this happens, the canceller tube, V113B, will conduct heavily, and virtually short-circuit the output of the sync amplifier. Of course, during the time interval of the noise burst, neither sync nor noise will be present in the output of the sync clipper (figure 3). At these times, the inertia of the sweep circuits or "fly-wheel" effect is relied upon to maintain proper frequency. After the noise burst ends the canceller tube, V113B, ceases to conduct and the circuits return to normal operation. (For maximum efficiency, however, the canceller is normally biased in such a manner as to slightly wipe sync. This is mentioned here instead of earlier, to prevent confusion.)

The composite video waveform from the plate of V113 A & B (depending on
(Continued on page two)

Fig. 1. Noise canceller circuit used in "EE", "H", "J" and "O" receivers.



Is your service bench equipped with a mirror? The G-E Bench Mirror is readily adjustable for easy viewing. This accessory will save valuable servicing time and make bench work easier. Ask your distributor for ETR-1275.



SERVICE NOTES

Excessive Width — U2 Receivers

For the past several years, our designs have not included a width control, and our design centers are such that under conditions of low line voltage, the raster will fill the mask. At higher line voltages, the width increases somewhat. There may be cases where a combination of high line voltage and unequal distribution of component tolerances could result in a customer complaint of excess width.

A complaint of this type may be described as poor horizontal linearity, or left side stretch, or just plain too wide. It is actually the extra width which causes the impression of poor linearity, and reduction of the width would return linearity and stretch to normal.

To decrease width, the following change may be made:

1. Increase the horizontal output tube screen resistor, R264 from 8200 ohms to 12000 ohms which reduces the horizontal output with resultant decrease in high voltage and width.
2. Decrease damper capacitor, C262 from 260 mmf. to 210 mmf., which brings the high voltage back up to its normal value and further reduces the width. This 210 mmf.

Have you had trouble removing safety glass? This G-E Service Aid will help you remove safety glass easily and safely. Saves time and prevents damage to glass or cabinet. Ask your distributor for ETR-1592 Safety Glass Puller.



Noise Canceller Circuits (con't)

SYNC PULSES MISSING FOR DURATION OF NOISE BURST



Fig. 3. Resultant sync output (hole punching).

noise conditions, if any) is next impressed upon the grid of the clipper tube, V116A, through capacitor C302 and the network consisting of C303 and R304. Since the sync information is of positive polarity at this point, it will cause the grid of the clipper to draw grid current and consequently charge

4KV capacitor is catalogued as RCW3356 or WT18X327.

Both components must be changed to preserve circuit relationships, and a reduction of width of approximately two inches will result. The change is recommended only in cases of actual complaint.

Repair of Ratio Detector Transformers

Some ratio detector transformers used in older receivers, such as U, MM, Q2, etc., developed leakage in the capacitor mounted in the base of the transformer. These transformers were formerly known as RTD024, RTD025, and RTD026. It has been the common practice to replace the entire transformer in case of failure.

We herewith present a procedure for repairing the defective transformer without removing it from the chassis. At your discretion, this procedure may be used rather than replacing the complete transformer. There is a possibility that this may be a shorter and easier operation with less likelihood of damage to associated circuits.

The procedure is as follows:

1. Remove the shield can from the assembly.
2. Unsolder 1 or 2 coil leads sufficient to remove the coil form from the plastic base. Identify the leads to insure replacement to the proper terminals.
3. Break the heat seal posts and remove the plastic cover.
4. Remove the top contact plate by bending. This will break loose near the terminal and open the capacitor.
5. Remove and discard silvered mica.

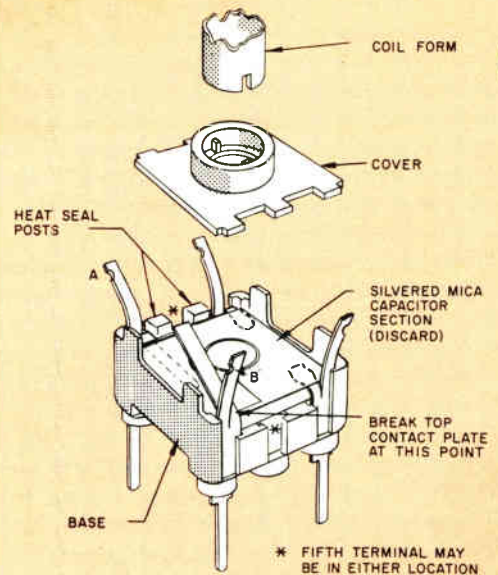

Fig. 1.

6. Replace the cover by softening the plastic base with heat or cement cover to base with Glyptal.
 7. Install a 120 mmf. capacitor, WT19X38, to the secondary terminals on the plastic base. Terminals A and B in Fig. 1.
 8. Replace the coil and reconnect the coil leads to the proper terminals. The leads must be connected to the correct terminals for proper operation.
 9. Replace the shield can making sure the added capacitor and the terminals do not short to the can.
 10. Align if necessary.
- An exploded view of the transformer assembly is shown in Fig. 1.

C302 and C303. This negative charge sets the operating bias for the clipper. This bias voltage is such that the tube is biased beyond cut-off and hence passes only the most positive portions of the driving signal, i.e., the sync information. The only signals to be found at the clipper plate, therefore, will be horizontal and vertical sync pulses which have been stripped free of video and blanking information (figure 4). The inclusion of the network consisting of C303 and R304 permits rapid recovery of sync after impulse noise inter-

VERTICAL SYNC PULSES EQUALIZING PULSES HORIZONTAL SYNC PULSES

Fig. 4. Composite sync at plate of clipper.

ference by the introduction of a "double" time constant. C303 discharges rapidly after a noise pulse, while the charging time constant of C303 and R304 is made quite long. The charge on capacitors C302 and C303 is permitted to slowly leak off through R305, R171 and R166 toward a minimum reference bias voltage developed by the crystal diode, Y151.

(Continued in next issue)

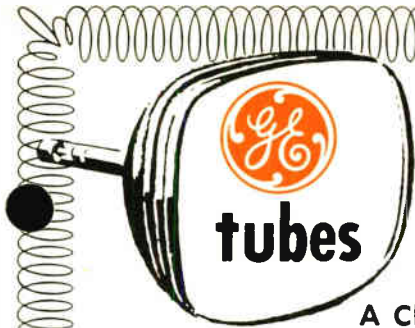

TV PICTURE TUBE WARRANTY AND ADJUSTMENT POLICY

A Clear-Cut and Well Defined Procedure to Protect You and Your Customers

WARRANTY — When used within its rating in a standard home television receiver, each General Electric Direct View Television Picture Tube (hereinafter referred to as a television picture tube) sold for replacement purposes is warranted against defects in workmanship and materials for a period of twelve (12) months from date of installation in a User's set. General Electric Company reserves the right, however, to limit its warranty to a total of eighteen (18) months from the date of shipment, as determined by the code date on such replacement tube.

The tube must, in the event of such defects appearing within the warranty period, be returned by the User for inspection and replacement to the source from which the User purchased the tube or to his Service Dealer, together with his Claim Card or Warranty Certificate.

The foregoing is in lieu of any other warranty or liability on replacement picture tubes, express, implied, or statutory, and General Electric Company neither assumes nor authorizes any person to assume for it any other obligation or liability in connection with said tube.

OPERATION OF REPLACEMENT TELEVISION PICTURE TUBE WARRANTY CARD PROCEDURE

Each warranty card provided with tubes shipped to Distributor after June 1, 1958 will be serially numbered corresponding with the serial number of the tube with which it is cartoned. The three parts

of this card will be designated as follows:

- (1) Dealer File Card (2) User Registration Post-card (3) User Warranty Certificate

PROTECT YOUR CUSTOMERS • FOLLOW THESE DIRECTIONS:

GENERAL ELECTRIC TUBE SERIAL NO 160074
REPLACEMENT TELEVISION PICTURE TUBE WARRANTY

PURCHASED FROM _____
DISTRIBUTORS NAME & ADDRESS _____

SOLD TO _____ DATE INSTALLED _____
USER'S NAME & ADDRESS _____ MONTH DAY YEAR

IN EVENT OF FAILURE WITHIN WARRANTY DATE OF ADJUSTMENT _____
NATURE OF FAILURE _____ MONTH DAY YEAR

DEALER FILE CARD

- 1 DEALER FILE CARD**
- A. When you sell the tube to the User, fill out the information required on each of the three warranty cards that came with the tube. Be sure the information on all three of the cards coincides.
 - B. File your Dealer File Card.

GENERAL ELECTRIC TUBE SERIAL NO 160074
REPLACEMENT TELEVISION PICTURE TUBE REGISTRATION

PLEASE DO NOT FOLD, SPINDLE, OR BUTILATE THIS CARD

PURCHASED FROM DEALERS NAME _____
ADDRESS _____ DATE PURCHASED _____
MONTH DAY YEAR

USERS NAME _____
STREET _____
CITY _____ STATE _____
MAKE TV SET _____ DATE SET PURCHASED _____

USER REGISTRATION POST CARD

- 2 USER REGISTRATION POSTCARD**
- Be very careful when removing cards from booklet, that postage tab remains intact on User Registration Postcard, as in illustration.
- Under new postal law, effective August 1, four (4) cents postage is required for this card.
- Give this card to the User and instruct him to mail it to General Electric immediately. This card must be on file at the General Electric Company for warranty to be considered valid.

GENERAL ELECTRIC TUBE SERIAL NO 160074
REPLACEMENT TELEVISION PICTURE TUBE USER WARRANTY CERTIFICATE

SOLD TO USER _____ DATE INSTALLED _____
NAME OF USER _____ MONTH DAY YEAR

ADDRESS _____
DEALERS NAME _____
ADDRESS _____
DISTRIBUTORS NAME _____
ADDRESS _____

IN EVENT OF FAILURE WITHIN WARRANTY DATE OF FAILURE _____
NATURE OF FAILURE _____ SIGNATURE OF USER _____ MONTH DAY YEAR

KEEP THIS CARD IN A SAFE PLACE. IT ASSURES YOU THE MAXIMUM WARRANTY TO WHICH YOU ARE ENTITLED.

- 3 USER WARRANTY CERTIFICATE**
- Give this card to the User with the suggestion that he keep it in a safe place.
- IF THE TUBE FAILS WITHIN THE WARRANTY PERIOD:**
- A. Inspect tube to see if it is defective.
 - B. Compare the *Dealer File Card* and the *User's Warranty Certificate* to determine if an adjustment is in order.
 - C. If adjustment is in order, replace the User's tube.
 - D. Return defective tube with User's Warranty Certificate to your General Electric Distributor.

HOW



TRANSISTORS ARE MADE

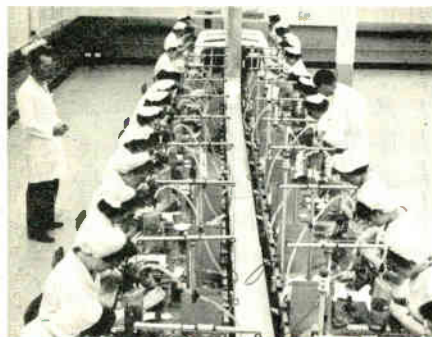

Ideal Manufacturing Conditions — At General Electric's Buffalo Plant, environmental conditions are very closely controlled. Slight pressurization controls dust concentration by making the air flow out of the transistor manufacturing area. Here highly skilled workers fuse base leads to the transistor bar in this immaculate "Snow White" operation.



Assemblies Closely Checked — This Kodak Contour Projector enlarges the transistor sub-assembly *fifty* times, enabling a thorough visual check to be made. From beginning to end, the delicate operations necessary to make a high quality, reliable transistor are performed under microscopic surveillance. Every precaution is taken to make the end results measure up to General Electric standard of quality.



Performance As Specified — Before the transistors are capped, their electrical performance is checked in these "dry boxes" which enable temperature and humidity conditions to be very closely controlled. Most tests are far more stringent than will be encountered by the transistor under normal operating conditions.

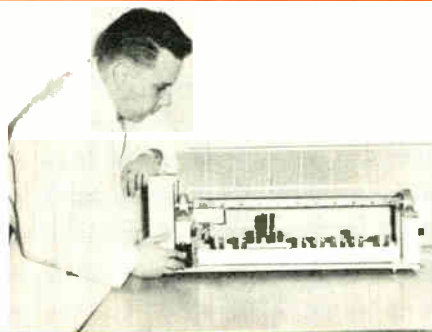

Will The Leads Take It? — Mechanical tests include vibration, leak detection, temperature cycling, centrifugal, and humidity. Here leads are tested for fatigue limits by attaching one pound weights in a special testing rack and bending the transistors back and forth three times.



Ruggedness A Byword — Have you wondered about possible damage incurred in dropping a G-E Transistor? This "Guillotine" subjects weighted transistors to a free fall resulting in a shock rated at 1500 G's, which in layman's terms, is equivalent to dropping them off the Empire State Building!

FROM A LUMP OF METAL TO AN ELECTRONIC MARVEL

At General Electric the production of transistors begins with the further refining of the basic raw material — either germanium or silicon. Through a zone refining furnace, an alternate melting and refreezing process produces an ingot of metal that is 99.99999% pure. Various processes are then used to produce either rate-grown, meltback, or alloy junction elements that are the heart and soul of the transistor.

The alloy-junction type, which was first developed in General Electric Laboratories, uses a thin wafer of metal mounted on a cradle (a sort of picture window). Small dots of indium are alloyed on each side producing the all-important PN junctions to which electrodes are fused. In the rate-grown type, also introduced by General Electric, a bar of metal is grown to produce alternate "P" and "N" type regions. This is then sliced to produce pieces about 10 mils by 10 mils by 100 mils with the thin "P" layer in the center and long "N" regions on each side. This tiny bar is then mounted onto a header and soldered to two electrodes, one being attached to each end of the bar. (See photo at left showing magnified assembly)

The meltback and double meltback processes are further refinements which makes possible good performance at higher frequencies, with higher alpha-cutoffs, high base to emitter breakdown voltages, and other increases in performance. The final assembly operation for all types is the welding of the metal cap to the header assembly in an atmosphere which protects the transistor from contamination.

Semiconductor products actually got to market earlier in the rectifier business than in the transistor business. Of particular interest today is a device recently introduced by General Electric comprising more than two rectifying junctions — called a SILICON CONTROLLED RECTIFIER. Basically it will perform the same function as a gas thyatron although only about 1/100 the size.

Future uses for transistors and other semiconductors seem to be limited only by the imagination. Automobiles, home appliances, machinery — both office and factory, will be making use of these electronic marvels, broadening the use of electronic circuits to an extent almost beyond comprehension. And one of the foremost suppliers of these extraordinary devices will be GENERAL ELECTRIC, backed by its unequalled research facilities and reputation for quality second to none.

What's new!



400 MA GERMANIUM TV RECTIFIERS

As of September 1, 1958, only two types of Germanium TV Rectifiers will be offered for selenium replacement, greatly simplifying the line and offering the serviceman 400ma units at a price lower than he formerly paid for 250ma units. These types are the 1N1008 Halfwave Type and the 1N1016 Doubler Type. Both units have a 400ma rating.

The 1N1008 will have a list price of \$2.50 and the 1N1016 \$5.00.

Complete information for proper selenium replacement selection is available in the GENERAL ELECTRIC Germanium TV Rectifier REPLACE-
MENT GUIDE.

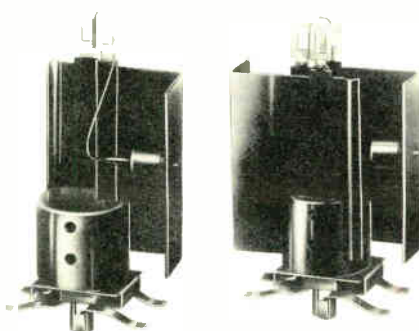

Type 1N1008
Halfwave

Type 1N1016
Doubler

JUST OUT! GENERAL ELECTRIC TRANSISTOR MANUAL

Latest applications, circuit diagrams and specifications

The greatly expanded new 3rd Edition of General Electric's Transistor Manual is just off the press. Throughout its more than 160 pages you'll find the very latest advances in the art of transistors and rectifiers.

The G-E Transistor Manual has become the most-used book in the transistor field. Get your copy from your G-E Tube Distributor.

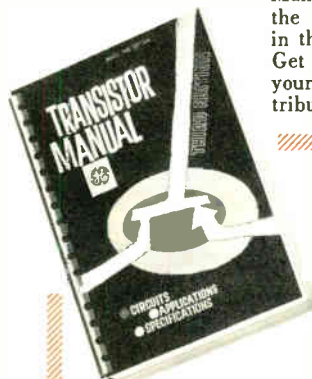

50DC4 DIODE FOR HALF-WAVE POWER RECTIFIER APPLICATIONS

The 50DC4 is a miniature half-wave rectifier designed for use in line-operated equipment having series-connected heaters. The heater is tapped to permit operation of a panel lamp.

It is expected that the 50DC4 tube will be used principally in two or three tube phonograph amplifiers. The 50DC4 could also be substituted for the 35W4 in "higher than normal" line voltage areas.



Heater Voltage, AC or DC $50 \pm 10\% V$
Heater-Tap Voltage 7.5 V
Heater Current 0.15 Amp.

CHARACTERISTICS AND TYPICAL OPERATION HALF-WAVE RECTIFIER WITH PANEL LAMP NUMBER 40 OR NUMBER 47

Heater Voltage (Pin 3 to 4)	45	45 V
Heater-Tap Voltage (Pin 4 to 6)	5.5	5.5 V
Heater Current (Pin 3 to 6)	150	150 ma
AC Plate-Supply Voltage, RMS	117	117 V
Filter Input Capacitor	40	40 μF
Total Eff. Plate-Supply Impedance	15	15 Ω
Panel-Lamp Shunting Resistor	100	75 Ω
DC Output Current	90	100 ma



NEW TV PICTURE TUBE REPLACEMENT GUIDE

Lists over 320 monochrome and color picture tubes.



Ask your distributor for ETR-702C.

GENERAL ELECTRIC "GOLDEN CLASSIC" AND "STEREO CLASSIC" STEREOGRAPHIC MAGNETIC VARIABLE RELUCTANCE HIGH FIDELITY CARTRIDGES

The new General Electric "Golden Classic" and "Stereo Classic" Stereophonic Magnetic Variable Reluctance High Fidelity Cartridges climax the G-E tradition of outstanding cartridge performance at moderate cost. This tradition began in 1946 with introduction of the initial monaural type, and reached new heights in 1957 with introduction of the world-famous VR-II Four-Gram Series.

The inherent high quality of reproduction resulting from magnetic variable reluctance design is even more pronounced in stereophonic cartridges. Stereophonic disc recordings require extremely high lateral and vertical compliance, low record and stylus wear, low intermodulation and harmonic distortion, and highly effective separation between the dual stereo signals. These qualities are offered by the "Golden Classic" and "Stereo Classic" Cartridges in full measure.

The "Golden Classic" type GC-7 and "Stereo Classic" type CL-7 cartridges are similar in all design respects except that type GC-7 has a .7 mil diamond stylus, and type CL-7 has a .7 mil synthetic sapphire stylus. Their applications are in stereo systems with either turntables or record-changers.

The "top audiophile performance" version of the "Golden Classic" cartridge is type GC-5 which uses a .5 mil diamond stylus. The .5 mil stylus version is designed for application only in turntables with high quality tone arms.

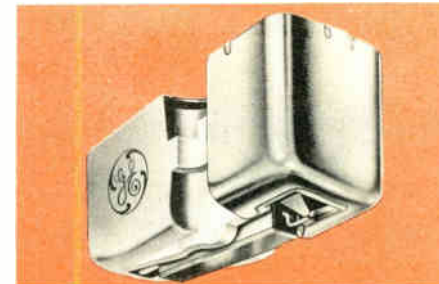

Although outwardly similar to the .7 mil stylus types, the GC-5 will have several performance ratings which are considerably higher. As an example the GC-5 will have a 20 through 20,000 cycle frequency response, at a tracking force of 2 to 4 grams. Both the "Golden Classic" Model GC-7, and the "Stereo Classic" CL-7 have a frequency response of 20 through 17,000 cycles at a tracking force of 3.5 to 7 grams.

BENCH NOTES

Those desiring to have letters published in this column should write the Editor, Techni-Talk, Electronic Components Division, General Electric Company, Schenectady 5, New York. For each such letter selected for publication you will receive \$10.00 worth of General Electric tubes. In the event of duplicate or similar items, selection will be made by the Editor and his decision will be final. The Company shall have the unlimited right without obligation to publish or otherwise use any idea or suggestion sent to this column.

Caution: The ideas and suggestions expressed in this column are those of the individual writers. These ideas and suggestions have not been tried by the General Electric Company and therefore are not endorsed, sponsored or recommended.

CONTROL EXTENSION

To work the controls on the back of a TV set while watching the front is quite a job. The screwdriver will slip off just about the time you are ready to adjust one. To remedy this I took a lead pencil and removed the eraser. As the metal cap fits snugly over the

controls, it is no job to put the pencil on a control and adjust it while watching the screen.

Robert E. Redd
Redds Radio & TV Service
P.O. Box 12
Union Furnace, Ohio

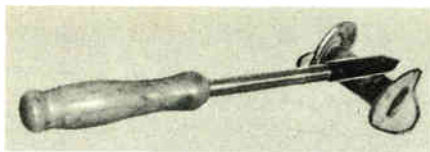

HOLDER FOR SOLDERING IRON

Instead of discarding empty spools that once held solder wire, bend over the edges of the spools and use them to rest the iron on.

Harry J. Miller
991 — 42nd Street
Sarasota, Florida

VERTICAL JITTERS

Admiral Model No. 21F1, replaced all tubes which might be involved but to no avail. After pulling set, vertical output transformer T402 developed an open winding during test. Replaced T402 three times with a new one, thinking the transformers were defective due to arcing between winding and core. On third try, studying schematic very carefully and noting length of this arc, decided the only source from which this high voltage could leak through would

be in the deflection yoke. Noted however C429, which is connected between the HV and the horizontal yoke windings, might be leaky and thus provide the shortest path to ground through deflection yoke's horizontal and vertical coils and through T402 (reason winding opened) to ground. Replacement of C429 (500 mmf, 20 KV) remedied the trouble.

Anthony F. Grossi
36 Smith Avenue
Haskell, New Jersey

CHECK FOR FLYBACK TRANSFORMERS

The simplest way I have found to verify a shorted flyback transformer winding is to connect a known good flyback (any type) in series with the primary winding of the unit in question. To do this, I remove the plate lead from the horizontal output tube in the set and connect the B plus and output plate leads of the substitute transformer between the plate cap and the original lead. If the output tube is being driven and is receiving screen and plate voltage, the substitute flyback will develop high voltage even though the questionable unit doesn't. I keep an inexpensive flyback on the bench just for such tests with test leads and clips permanently attached.

W. E. Smith
P.O. Box 24
Malad City, Idaho

New SERVICE-DESIGNED Tubes

General Electric has previously announced a number of "Service-Designed" television receiving tubes with design features to insure satisfactory performance as replacements in all television circuits.

High reliability techniques have been extended to the most-used television receiving tubes, thereby enlarging the line of "Service-Designed" types. TV viewers, dealers and distributors are now given additional measures of reliability.

The principal improvements that give you extra values in "Service-Designed" tubes are:

1. "Snow-White" manufacturing procedures — to minimize short circuits between tube elements caused by lint and dust.

2. Adoption of an accelerated heater cycling test to make sure tubes will

perform properly under wide variations in household line voltage.

3. Attaining greater uniformity by across-the-board use of a new G-E developed method of testing for shorts or opens.

4. Building receiving tubes to meet life tests twice as rigid as the Joint Army-Navy (JAN) specifications for tubes in the entertainment class.

5. A new method of controlling the insulation coating on heater wire to prevent "hot spots" that tend to cause tube failure.

6. Tapering the ends of pins on octal tube bases to save time for service technicians when inserting and removing tubes, and to prevent socket damage.

7. Extending stiff military-type glass strain specification tests to all "Service-Designed" tubes.

8. Development of new materials for use in tubes. New anode and grid wire materials permit greater heat dissipation, thus providing a built-in safety factor which allows tubes so constructed to run at higher levels of overload before failing, or conversely, lengthens life at normal ratings.

9. Use of a new hard-to-remove branding ink to prevent removing the warranty date code either by accident or by deliberate erasure by tube counterfeiter.

Many other improvements are being made on individual tube types.

"Service-Designed" reliability features are being built into the types listed below. Many are the high-volume movers of today's TV Service Business, the others are being "Service-Designed" for use in original equipment — tomorrow's TV Service Business.

1B3-GT	3CB6	5EU8	6AU6-A	6CD6-GA	6EU8	12AT7
1H2	3DT6	SU4-GB	6AX4-GT	6CG7	6EW6	12AU7-A
1J3	4BN6	5U8	6BK7-B	6CG8-A	6J6	12AX4-GTA
1K3	4BU8	5V3/SAU4	6BN6	6CL8-A	6SN7-GTB	12BY7-A
1X2-B	4BZ6	5Y3-GT	6BQ6-GA	6CX8	6T8-A	12BQ6-A
2AF4-A	SAQ5	6AF4	6BQ7-A	6CYS	6U8-A	12DQ6-A
2CYS	SBK7-A	6AF4-A	6BU8	6DN7	6V6-GT	12SN7-GTA
3BN6	5CG8	6AL5	6BZ6	6DQ6-A	7EY6	17AX4-GT
3BU8	5CL8-A	6AQ5-A	6BZ7	6DT6	8CG7	17DQ6-A
3BZ6	5EA8	6AU4-GTA	6CB6-A	6EA8	8CX8	19AU4-GTA

SUCCESSFUL SERVICE MANAGEMENT

"SWIM-OR SINK!"

by **GORDON E. BURNS**

DISTRIBUTOR SALES MANAGER

GENERAL ELECTRIC RECEIVING TUBE DEPARTMENT



Careful business management is the secret of success in small business as well as in big business — and is perhaps even more vital to a small business which usually has no "fat" to live on.

Careful management by the independent service dealer today can assure a rosy future as we look ahead to 2.2 billion receiving tube sockets in electronic equipment in the United States by 1962. Already we have 1.9 billion operating sockets in use, an average of 38 per family.

Sockets mean tube renewals, and tube renewals mean good business. Receiving tube replacements in 1957 totaled 185 million tubes. The market for 1958 promises to nearly match that figure. By 1962 the replacement market should increase by over 20%, to an annual total of 225 million tubes.

The recession of recent months has tended to cause some postponement of radio and television repairs. But such repairs will not be abandoned indefinitely.

Meanwhile, depending upon their local situation, many service dealers are finding remunerative "side lines" in

custom high fidelity installations and service, industrial electronic servicing, and in commercial radio communications service.

Over 190 million receiving tubes will be used for all replacements during 1959. This condition literally outlines the scope of the service industry for more than a year ahead. Coupled with tube replacements, of course, will be business in other renewal components, repairs and adjustments, and many installations of a variety of types.

In the next five years, rapid growth in population, increasing replacement demands for durable goods, innovations, and other favorable factors will contribute to economic expansion. During this period population should increase by 14 million and industrial production by 20%. Such growth insures a much larger market for industrial electronics, including controls, communications, instruments and data processing equipment.

In the face of such factors, careful business management by the independent service dealer becomes all-important. He must think out his position in

his community, and his community's position in this expanding economy. The service dealer first must assume that he, with his special knowledge and technical ability and facilities, will be an important factor in the shape of things to come. Having made this assumption, the service dealer then must carefully plan to manage his business according to the soundest forecasts he can muster. He should plan for flexibility — alternate ways to employ his labor and capital.

This advice may be somewhat akin to advising a man to learn how to swim after he has fallen into deep water. But businessmen, like swimmers, simply must learn to keep their heads above water. Some will learn the easy way, some will learn the hard way — and, unfortunately, some will never learn and eventually will go under.

The important point is to learn to swim before you get in deep water. Careful business management methods which prepare for all eventualities will be the salvation of those intelligent enough to recognize their value.

Announcing... 1958 ALL AMERICAN AWARDS

Again General Electric will launch a nationwide campaign to build public recognition for radio and television technicians

The pioneer 1957 All-American Awards, by which G.E. paid tribute to the many community services by TV

technicians, were solidly successful in capturing the imagination and fostering the goodwill of people from coast to coast.

A new awareness was created of service dealers' unselfish activities in behalf of others. In 1958, this public recognition will be further strengthened — by the All-American Awards for the current year.

Again, advertising in LIFE . . . dramatic window and other displays . . . national press publicity . . . all will spotlight the television technician and his important place in the community.

Last year's winners included a heroic Texan who swam raging flood waters to save lives, a Kentuckian cited for helping blind students, and several others who devoted much time to developing home town youth programs.

Candidates may be nominated by any individual or organization familiar with the community service rendered by an electronics technician. Letters addressed to the All-American Awards Committee, General Electric Company, Owensboro, Ky., must be postmarked not later than October 12.

Nominees will be judged by an impartial panel of public figures versed in community and public affairs. Each of the ten technicians whose public or community service is judged most outstanding will receive a trophy and \$500 at a presentation ceremony to be held in Washington, D. C., on November 24.

Ask your nearby General Electric tube distributor for complete details.



All American 1957 Award winners met December 10 at Washington, D.C. Each winner received a handsome trophy, and a check for \$500 for community-activity or charity use.

NEW



BUSINESS BUILDERS

Vol. 10

No. 5

IDENTIFY YOUR STORE TO ATTRACT NEW BUSINESS



Sign-A-Rama

ETR-1290A

Command attention for blocks! Advertise your service business with this new concept in illuminated signs — brightly lighted with six flashing lamps that give 6500 lumens output. Hardware included. Size — 24" x 48". Color — red-orange, black, grey and white.

Projecting Sign

ETR-1566

Attract attention to your store with this brightly-colored, double faced sign. Baked enamel on 18-gauge metal. All hanging hardware included. Size — 48" x 36". Color — red-orange, black, grey and white.

Projecting Sign Nameplate

ETR-1566-1

Your name individually processed on 18-gauge metal. Attaches to hanging hardware provided with ETR-1566.



Two-Way Light Set

ETR-1566-2

Bright illumination for your outdoor sign and store front. Attaches to hanging hardware provided with ETR-1566.



Illuminated Clock
ETR-1291A

Functional advertising for your service shop. Can be hung in display window or wall. Also, an easel is provided so that the clock can be used as a self-standing counter display piece. Long-life bulbs included. Size — 16" diameter. Colors — red-orange, black, grey and white.

Techni-talk

on AM, FM, TV Servicing

published bi-monthly by

ELECTRONIC COMPONENTS DIVISION

GENERAL ELECTRIC

SCHENECTADY 5, N. Y.

In Canada

CANADIAN GENERAL ELECTRIC CO., LTD.

187 Belfair St., Toronto 3, Ontario

B. G. KEMPTON, Editor

COPYRIGHT 1958

BY GENERAL ELECTRIC COMPANY

index

Noise Canceller Circuits.....pages 1 & 2
 Service Notes on G-E Receivers.....page 2
 Tele-Clues—"M-4" Schematic.....pages 3 & 4
 TV Picture Tube Warranty and Adjustment Policypage 5
 How Transistors are Made.....page 6
 What's Newpage 7
 Bench Notespage 8

New Service-designed Tubespage 8
 Announcing 1958 All American Awardspage 9
 Successful Business Management "Swim — or Sink"page 9
 New G-E Business Builderspage 10
 New G-E Service Aid—Magnetic Swing-Beam Service Lightpage 10

NOTE: The disclosure of any information herein conveys no license under any General Electric patent and, in the absence of an express written agreement to the contrary, the General Electric Company assumes no liability for patent infringement (or any other liability) arising out of use of such information by others.

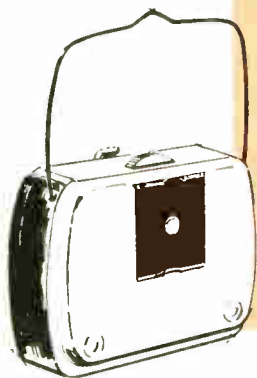

Magnetic Swing-Beam Service Light

- Magnet holds light securely to chassis
- Swing-beam puts light where you need it
- Uses standard batteries which are easily replaced

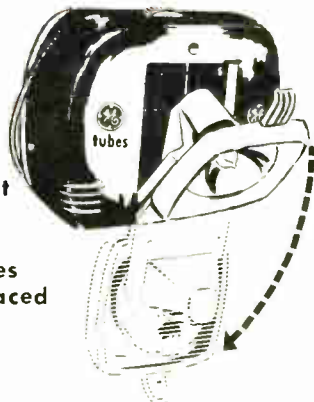

ETR-1593

This copy of Techni-talk comes to you through the courtesy of your local General Electric tube distributor.

ELECTRONIC COMPONENTS DIVISION

GENERAL ELECTRIC

Schenectady 5, N. Y.

BULK RATE

U.S. Postage

PAID

Schenectady, N. Y.

Permit No. 148

Mr. Thomas F. Boyd
415 Fredericksburg Rd.
San Antonio 1, Texas
E-250/HOU-23

5-18-54

NOW AVAILABLE THROUGH YOUR AUTHORIZED G-E TUBE DISTRIBUTOR