

Portafax



PERSONAL TELEVISION PRODUCT SERVICE, COLLEGE BLVD., PORTSMOUTH, VA.

JULY, 1967

VOL. 1, NO. 1

AUDIO ALIGNMENT PROCEDURE

The following procedure is suggested as a quick, accurate method for aligning the audio section in receivers which contain SB, SC, or S-1 Chassis and VB, VC, or V-1 Chassis. Do not attempt to use this procedure on other chassis types.

- (1) Connect a VTVM between C309/R309 junction and chassis ground. This point is the low end of the Quadrature Coil (L302).
- (2) Set the VTVM on the 0-5 Volts Negative DC range.
- (3) Properly tune in a strong local signal and set the volume control to a low audible level.
- (4) Adjust L302 Quad. Coil for maximum meter indication. There are two possible peak indications when tuning this coil. Starting with the core at the top of the coil form (away from the circuit board) tune down through the coil for the second peak indication.
- (5) Reduce the signal level by tuning in a weak station, or fine tuning away from audio until the picture "smears".
- (6) Adjust L301 Audio Interstage Transformer for maximum indication.
- (7) Tune L157 Sound Take-Off Coil for maximum meter indication.
- (8) Disconnect the VTVM leads from the receiver. The audio section is now aligned for optimum operation.

CHANGE IN MODEL & CHASSIS DESIGNATORS

Beginning January 1, 1967, a new model designator system was put into effect for all portable television receivers produced by the Personal Television Department.

The model year designator was replaced with a letter indicating chassis family type, according to the following examples:

12" Monochrome Receivers	-- S Chassis	-- M151CEB	became	M151SEB
15" Monochrome Receivers	-- S Chassis	-- M503CWH	became	M503SWH
12" Transistor Receivers	-- T Chassis	-- TR812CVY	"	TR812TVY
10" Monochrome Receivers	-- V Chassis	-- M138CVY	"	M138VVY
Porta Color Receivers	-- H Chassis	-- M213CWD	"	M213HWD

(2)

To provide chassis identification for service information, the following changes were made:

HC Chassis became H-1 Chassis
SC Chassis became S-1 Chassis

TC Chassis became T-1 Chassis
VC Chassis became V-1 Chassis

The chassis are identical. For instance, the VC Chassis is the same as the V-1 Chassis.

The model number stamped on the cabinet back changed to incorporate this information as shown in the following examples:

M151CEB became M151SEB-1
Thus indicating the S -1 Chassis is utilized in the receiver.

M213CWD became M213HWD-1
Thus indicating the H -1 Chassis is utilized in the receiver.

C Line Service Manual sections are presently being revised to include this new designation system.

SERVICE MANUAL PAGES

File the following pages in the indicated section of the "C" Line Service Manual. Destroy the old pages which have been superseded.

SC CHASSIS: Pages SC1-5, SC3-1, SC3-3, SC3-5.
TC CHASSIS: Pages TC4-5.
VC CHASSIS: Pages VC1-3, VC1-5, VC3-1.

The following pages are the first Personal Television Department pages for the Volume D Service Manual.

S-2 CHASSIS: S Chassis Index Tab, Pages S1-1, S2-1, S2-3, S3-1, S3-3, S3-5, S3-7.

Portafax



PERSONAL TELEVISION PRODUCT SERVICE, COLLEGE BLVD., PORTSMOUTH, VA.

AUGUST-SEPTEMBER, 1967

VOL. 1, NO. 2

TC CHASSIS -- POWER SUPPLY PRE-REGULATOR TRANSISTOR (Q21) FAILURE

Some cases of Q21 failure in the TC Chassis power supply may be traced to a broken solder connection at the point where the Series Regulator (Q20) collector heat sink is fastened through the circuit board. This point is located behind the VHF tuner, next to the large electrolytic capacitor C401.

If this solder point breaks loose, the collector of Q20 becomes disconnected from the circuit, forcing Q21 to carry the full output load, and causing it to fail.

The remedy is to completely fill the slot hole where the heat sink passes through the board with solder. A fairly high wattage soldering iron must be used in order to make a good solder bond to the heat sink material, thus insuring a good electrical connection between the series regulator collector and the board circuitry.

It is recommended that you re-solder this point on all TC Chassis which come into the shop for service in order to prevent future Q21 failure.

SERVICE MANUAL PAGES

File the following pages in the VOL. D Service Manual. Destroy old pages which have been superseded.

S CHASSIS: Pages S1-3, S1-5, S3-1, S3-4



Portafax



PERSONAL TELEVISION PRODUCT SERVICE, COLLEGE BLVD., PORTSMOUTH, VA.

OCTOBER-NOVEMBER, 1967

VOL. 1, NO. 3

S-2 CHASSIS MODELS

Personal Television Department is now producing their familiar vertical design 12-inch M150 Model series and 15-inch M500 Model series monochrome receivers with a new and improved chassis. A 12-inch Designer M160 Model series has also been added featuring compact horizontal styling and improved serviceability.

The new S-2 Chassis is similar to the previous SB, SC and S-1 Chassis. Several circuit changes and general mechanical layout improvements have been incorporated.

1. Horizontal blanking -- accomplished through a special pulse winding on the horizontal output transformer.
2. Broad Banded Sound -- through a new type double-tuned sound take-off coil - provides less critical ST0 adjustment for good sound.
3. More reliable horizontal sweep and high voltage circuitry:
 - a) Layer wound sweep transformer primary.
 - b) Improved mounting for the high voltage rectifier tube to reduce possible corona problems.
 - c) Air sealed high voltage rectifier tube socket and socket pins to reduce possible corona problems.
4. Less possibility of circuit board breakage and cracking:
 - a) Stronger circuit board base material.
 - b) Better weight distribution -- vertical transformer moved from middle to the left side of the board.
 - c) Filter electrolytic capacitor moved from the middle to the rear corner and supported with a clamp bracket. Helps prevent Mount Tabs from cracking loose at copper circuit connection points.
5. Better serviceability -- The main circuit board in the Designer models can be serviced without removing any front control knobs.

SERVICE MANUAL PAGES

File the following pages in the indicated section of the C Line Service Manual. Destroy the old pages which have been superseded.

TC CHASSIS: TC1-1, TC1-3

File the following pages in the Vol. D Service Manual. Destroy old pages which have been superseded.

S CHASSIS: Pages S1-1, S1-7, S1-9, S2-1, S2-3



Portafax



PERSONAL TELEVISION PRODUCT SERVICE, COLLEGE BLVD., PORTSMOUTH, VA.

DECEMBER, 1967

VOL. 1, NO. 4

NEW HIGH VOLTAGE TRANSFORMER FOR PORTA COLOR

A high voltage transformer which has the tertiary "donut" encased in RTV silicone rubber is now being used in Porta Color (H-1 Chassis) receivers.

The new transformer will provide greater reliability and increased resistance to high temperature and humidity. It can be readily recognized by the white plastic cup around the tertiary winding.

ES77X2 is the replacement part catalog number and will supersede ES77X89 transformer.

The value of damper capacitor C269 used with this new type transformer must be 105pf, 4KV. This capacitor (Cat. No. ES18X17) will be supplied with all ES77X2 replacement transformers.

When changing the capacitor, place it close to the circuit board, and dress it away from the damper tube shield. Be sure there are no sharp solder points or pigtailed left under the board near damper choke L252.

SERVICE MANUAL PAGES

This issue of Plan E includes the complete new H-1 Chassis service manual.

File the following pages in the Vol. D Service Manual in alphabetical and numerical order.

H-1 CHASSIS: H Chassis Index Tab, Pages H1-1, H1-3, H1-5, H2-1, H2-3, H3-1, H3-3, H3-5, H3-7, H3-9, H3-11, H3-13, H4-1.

The people in Personal Television Product Service wish you all a Merry Christmas and a Happy, Prosperous New Year.

Vince Patton

V. W. Patton
Manager-Product Service



Portafax



PERSONAL TELEVISION PRODUCT SERVICE, COLLEGE BLVD., PORTSMOUTH, VA.

JANUARY - FEBRUARY, 1968

VOL. 2, NO. 1

NEW PERSONAL COLOR RECEIVER

The Personal Television Department has recently released to the field their M235GWD-1 color television featuring the new G-1 CHASSIS, designed with the service technician in mind.

Several features are incorporated into these sets to provide for ease in servicing. The 15MP22 color picture tube contains in-line electron gun configuration, with the red gun in the middle, blue on one side, and green on the other. Simplified purity and convergence adjustments are used similar to those on the familiar General Electric 10-Inch Porta Color receivers.

When the cabinet back is removed, the main circuit boards are readily accessible from both top and bottom sides. Circuit components are arranged for ease in locating, trouble-shooting, and replacement. Copper pattern layout and circuitry symbol numbers are plainly indicated with paint on the component side of the circuit board.

The cabinet front separates from the bottom to make picture tube replacement less difficult. This feature also provides clear access to the tuner and control package mounted on a detachable plastic bracket at one side of the cabinet bottom.

High voltage compartment and power supply components are mounted separately at the left rear corner of the cabinet bottom, and all fuses are easily accessible.

Distinctive cabinet styling, slide rule channel number indication, automatic degaussing circuitry, and Insta-Color operation combine to make the M235GWD-1 a feature-packed personal color television receiver.

NEW SERVICE MANUAL PAGES

File the following pages in the indicated section of the C Line Service Manual. Destroy the old pages which have been superseded.

VC CHASSIS: VC1-1, VC3-7

File the following pages in the Vol. D Service Manual. Destroy the old pages which have been superseded.

S CHASSIS: S1-3, S1-5, S1-7, S1-11, S1-13, S1-15, S3-1, S3-3, S3-5, S3-7.

A SUBSCRIPTION PLAN PUBLICATION

29-1700-68A



Portafax



PERSONAL TELEVISION PRODUCT SERVICE, COLLEGE BLVD., PORTSMOUTH, VA.

MARCH, 1968

VOL. 2., NO. 2

15MP22 COLOR PICTURE TUBE

During early production of Model M235GWD-1 portable color receivers, a 15MP22 picture tube was used which requires a potential of +640 Volts on the red, blue, and green screen grids.

Later, a 15MP22 with a modified gun assembly was introduced. This newer type tube requires a +450 Volt potential on the screen grids.

Both types of CRT's are presently being used in production, but the early type is gradually being phased out.

When servicing a G-1 Chassis receiver, it is important to apply the proper screen grid potential for the type of picture tube in the set. Early and Late CRT's are both designated 15MP22, but may be identified in the following manner.

Look at the neck of the picture tube near the socket base. There are colored glass rods supporting the electron guns inside the neck of the tube.

Early 15MP22 tubes have Blue support rods - proper screen voltage setting is +640 Volts.

Later 15MP22 tubes have Green support rods - proper screen voltage setting is +450 Volts.

Field replacement CRT's will be the later type 15MP22 with green support rods.

SERVICE MANUAL PAGES

This issue of PLAN E includes the complete new G-1 Chassis Service Manual.

File the following pages in the VOL. E Service Manual Binder in alphabetical and numerical order.

G-1 CHASSIS: G Chassis Index Tab, Pages G1-1, G1-3, G2-1, G2-3, G3-1, G3-3, G3-5, G3-7, G3-9, G3-11, G3-13, G3-15, G3-17.



Portafax



PERSONAL TELEVISION PRODUCT SERVICE, COLLEGE BLVD., PORTSMOUTH, VA.

APRIL, 1968

VOL. 2, NO. 3

G-1 COLOR CHASSIS CRT SOCKET WITH BUILT-IN SPARK GAP

The picture tube socket used in the G-1 Chassis color receiver contains a special built-in spark gap consisting of a grounded brass plate placed close to the socket terminals (see sketch below). An unusually high voltage on a socket terminal will arc to the brass plate rather than to an adjacent terminal, thus protecting the picture tube and its associated components. This is normal, and does not necessarily mean the socket is defective, but usually indicates a problem in associated circuitry.

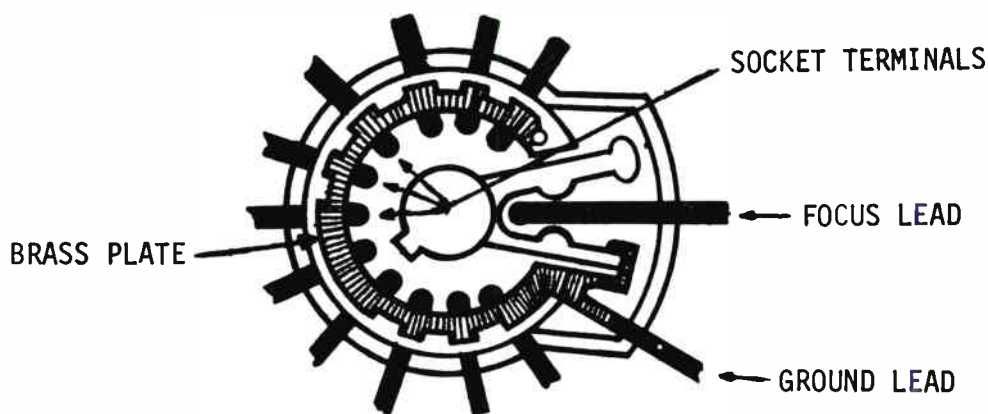

REAR VIEW OF SOCKET (COVER REMOVED)

(over)

For example, we have had cases of a continuous arcing condition in the CRT socket caused by an open 47 Meg. resistor (R284) in the focus voltage divider circuit. To obtain best focus, this resistor is connected through a wire jumper to one of three points — B+ boost, +280V, or chassis ground. A bad solder connection at the jumper or an open R284 could cause the voltage on the focus anode terminal (Pin 9) to rise, causing an arc inside the CRT socket.

Should you be called upon to service a G-1 Chassis receiver which has a continuously arcing CRT socket, compare the socket pin voltages to the voltages shown on the schematic diagram. The focus voltage (Pin 9) should be between +3000 volts and +5000 volts with respect to chassis ground. If it is more than 5000 volts, check for an open circuit somewhere between the focus control (R283) and the low potential end of the focus voltage divider circuit.

SERVICE MANUAL PAGES

File the following pages in indicated section of the 'C' Line Service Manual. Destroy old pages which have been superseded.

SC CHASSIS: Pages SC1-1, SC1-3, SC1-5, SC1-7.

HC CHASSIS: Page HC1-1.

Portafax



PERSONAL TELEVISION PRODUCT SERVICE, COLLEGE BLVD., PORTSMOUTH, VA.

MAY, 1968

VOL. 2, NO. 4

G-1 CHASSIS - HIGH VOLTAGE ARCING

We have had a few reports of G-1 Chassis receivers arcing from the high voltage rectifier plate cap to the metal shield can. This could be the result of drawing an arc from the plate cap with a screwdriver when checking for presence of high voltage. The arc sometimes carbonizes the plate cap and reduces its insulating qualities.

The high voltage at the plate cap can be checked with a neon bulb taped to an insulated non-metallic rod or a similar device. Under no circumstances should an arc be drawn from the cap.

Caps which have already been carbonized can be repaired by covering them completely with corona seal. To accomplish this, first remove the cap from the high voltage rectifier tube and then pull it out of the high voltage compartment through the opening by the transformer terminals. Apply the corona seal and then replace the cap on the HV rectifier tube. CAUTION: Do not exert undue strain on the cap lead or you may loosen the connection at the transformer tertiary winding.

* * * * *

NEW DAMPER TUBE - H-1 CHASSIS

Late production H-1 Chassis portable color receivers use a 17BW3 damper tube instead of a 12AX3. The 17BW3 is directly interchangeable with, and is a recommended replacement for, the 12AX3.

This will increase the total filament string voltage drop from 117.5 Volts to 121.5 Volts and should help improve reliability. If a damper tube fails in an HC or H-1 Chassis, use a 17BW3 tube as a replacement.

* * * * *

SERVICE MANUAL PAGES

File the following pages in the proper section of the Service Manual binder as indicated. Destroy old pages which have been superseded.

VOL. E BINDER:

G CHASSIS: Pages G1-1, G1-5, G2-1, G2-3, G3-11, G3-13, G3-17

VOL. D BINDER:

S CHASSIS: Pages S1-9, S1-15

"C" LINE BINDER:

SC CHASSIS: Pages SC1-9, SC2-5, SC2-7, SC3-3, SC3-5, SC3-7

VC CHASSIS: Pages VC1-3, VC1-5, VC2-1, VC2-3, VC2-5, VC2-7



Portafax



PERSONAL TELEVISION PRODUCT SERVICE, COLLEGE BLVD., PORTSMOUTH, VA.

JUNE, 1968

VOL. 2, NO. 5

H-1 CHASSIS - HIGH VOLTAGE COMPARTMENT DOORS

Late production H-1 Chassis receivers contain a high voltage transformer which has the tertiary encased in RTV silicone rubber (ES77X2). These transformers, which are easily recognized by the white, plastic cup around the tertiary, offer increased resistance to high temperature and humidity. To allow better air circulation around the transformer, the door on the high voltage can has been eliminated. This was made possible by the special properties of the new type transformer construction.

Receivers which are equipped with the older type, wax impregnated transformers (ES77X89) must have a door on the high voltage compartment. When servicing these receivers be sure that this door is securely fastened before reassembling the cabinet back.

Do not install the old wax type transformer (ES77X89) in an H-1 receiver which does not have a door on the HV compartment.

H-1 CHASSIS - INTERMITTENT HUM BAR

We have had some field reports of an intermittent hum bar in the 10-inch, H-1 Chassis, color receivers. This condition may be caused by a poor ground connection at the black lead from the vertical output transformer.

On some sets, this lead is grounded at the same terminal board as the AC line choke. Poor contact with chassis ground because of a loose or stripped screw can cause AC to modulate the vertical sweep, producing intermittent hum in the picture.

Move and solder this black ground lead to the lance located on the top right side of the high voltage transformer compartment. The black lead from the convergence assembly is also connected to this point. Check the terminal board screw for tightness. If stripped, replace with a larger diameter screw or solder the lug and screw to the high voltage cage. Be careful not to change the lead dress or damage any wire insulation in this area while soldering.

SERVICE MANUAL PAGES

File the following pages in the proper section of the Service Manual binder indicated. Destroy old pages which have been superseded.

VOL. D BINDER:

H CHASSIS: Pages H1-1, H1-3, H1-5, H3-1, H3-9, H3-13

C LINE BINDER:

TC CHASSIS: Pages TC1-1, TC2-1, TC2-3, TC2-5, TC3-1, TC3-3, TC3-5, TC3-7, TC3-9
TC3-11, TC4-1, TC4-3



Portafax



PORTABLE TELEVISION PRODUCT SERVICE, COLLEGE BLVD., PORTSMOUTH, VA.

JULY-AUGUST, 1968

VOL. 2, NO. 6

NEW 10-INCH PORTABLE COLOR RECEIVER

The Portable Color Television Department has recently released for sales our Model WM226HWD-2 receiver containing the new H-2 color chassis.

In addition to the excellent serviceability and reliability proven in the field by past versions of H Chassis receivers, some new features have been incorporated.

H-2 Chassis receivers use the new 11WP22 picture tube which has the same basic in-line gun features as the original 11SP22 Porta Color* CRT, but contains definite design improvements over the earlier type picture tube.

The same fine rare earth red phosphor and brilliant blue phosphor are utilized along with a new type of brighter green phosphor which provides truer yellows----all combining to produce one of the brightest pictures in the industry. 11SP22 picture tubes have proven to be more reliable than most other picture tubes. The 11WP22 CRT is expected to equal, and possibly improve upon, this record.

Smaller phosphor dot size, 60% more dots and aperture mask holes, sharper electron gun beams, and the use of tinted faceplate glass combine to give finer picture detail, less dot blooming at high brightness levels, and greater picture contrast.

In the main chassis, a new design high voltage transformer, encapsulated in RTV silicone rubber for high reliability, is capable of providing more power for the sweep and high voltage circuits.

Varactor tint control circuitry of the type used on more expensive larger screen color receivers has been added. Now the customer has a wider flesh tone range for easy tint control adjustment.

To top it all off, improved cabinet styling with woodgrained control panels and bar-type secondary control knobs provide the ultimate in customer eye appeal.

* * * * *

SERVICE MANUAL PAGES

This mailing of PLAN E includes the new P-1 Chassis service manual. File the following pages in the proper section of the service manual binder indicated. Destroy old pages which have been superseded.

VOL. E BINDER

G CHASSIS: Pages G3-1, G3-3, G3-5, G3-11, G3-13, G3-17, G3-19

P CHASSIS: P Chassis Index Tab, Pages P1-1, P3-1, P3-3, P3-5, P3-7

C LINE BINDER

TC CHASSIS: Page TC 3-11

* Trademark, General Electric Company



Portafax



PORTABLE TELEVISION PRODUCT SERVICE, COLLEGE BLVD., PORTSMOUTH, VA.

SEPTEMBER-OCTOBER, 1968

VOL. 2, NO. 7

QUADRATURE COIL TUNING CAPACITOR

The quadrature coil tuning capacitor used in all current General Electric portable television receivers, has a negative temperature coefficient to compensate for temperature produced drift in associated components. The schematic designations, by chassis, for this capacitor are:

S-2 Chassis - C308
P-2 Chassis - C308
V-2 Chassis - C308

H-2 Chassis - C307
G-1 Chassis - C307

Should this capacitor not track properly with temperature, the audio may distort with temperature changes.

The audio may be good initially and become distorted in a few hours or it could be poor initially and gradually get better as the receiver reached normal operating temperature.

When making repairs to any receiver using a quadrature grid audio detection system, it is good practice to check the audio quality at two temperature extremes; when the receiver is cold, and after it has reached normal operating temperature. If the audio is distorted at either of these points, it is possible that the capacitor is not tracking correctly and it should be replaced.

Replacement capacitors must have the proper temperature coefficient to insure reliable receiver operation. In the case of the chassis listed above, the capacitor should be 18pf, 10%, N470 (Cat. No. ET18X399).

After replacing the capacitor, the quad coil should be realigned and the receiver rechecked at both temperature extremes.

SERVICE MANUAL PAGES

This mailing of PLAN E includes the new H-2 Chassis service manual. File the following pages in the service manual binder as indicated.

VOL. E BINDER:

H CHASSIS: H Chassis Index Tab, Pages H1-1, H2-1, H2-3, H3-1, H3-3, H3-5, H3-7
H3-9, H3-11, H3-13, H3-15, H3-17



Portafax



PORTABLE TELEVISION PRODUCT SERVICE, COLLEGE BLVD., PORTSMOUTH, VA.

NOVEMBER, 1968

VOL. 2, NO. 8

CUSTOMER SAFETY

General Electric has made it a policy to specify check point areas within a television chassis which should be inspected each time a receiver is serviced to provide maximum reliability and customer safety.

Test procedures are developed and printed in service manual publications for each portable model receiver. You, as a good technician, realize the importance of proper lead dress, solder icicles, wire clippings, and wire lead lengths.

But how about the guy who serviced that receiver before you worked on it? Take a good overall look at that chassis before you reassemble it into the cabinet. Not just the section you worked on, but all of it.

After you have the set "ready to go" perform that final safety test as specified in your service manual.

When you really think about it, it makes good sense---both professionally and from a business viewpoint. Doesn't it?

* * * * *

M014P CHASSIS - SOLDER CHECK POINTS

M014P nine-inch monochrome tube receivers (all cabinet colors) require a visual safety inspection of the copper side of the circuit board whenever a set is serviced.

When looking at the bottom of the receiver with the back removed, the rear portion of the circuit board extends out beyond the plastic cabinet bottom.

Always inspect this section to determine if there are any wire leads or solder icicles that may protrude from the bottom of the circuit board far enough to bind on the bottom section of the plastic cabinet back or possibly protrude into the ventilating slots in the bottom of the cabinet back.

If this situation can exist, clip off excess lead lengths or solder, especially in the vertical triple control and the contrast control areas before replacing the cabinet back.

Be sure to perform the safety test specified in the P Chassis Service Manual after completely reassembling the receiver.

(Over)

SERVICE INFORMATION CORRECTION

The replacement transistor listing on Page TC3-10 in the TC CHASSIS section of C LINE Service Manual information describes Q23 as a PNP transistor. Please change this to read NPN.

* * * * *

SERVICE MANUAL PAGES

File the following pages in the proper section of the VOL. E Service Manual binder. Destroy old pages which have been superseded.

VOL. E Service Manuals:

G CHASSIS: Pages G1-1, G1-3, G1-5, G1-7, G3-7, G4-1, G4-3

H CHASSIS: Pages H1-3, H1-5, H4-1

P CHASSIS: Pages P1-1, P1-3, P3-1, P3-5, P3-7, P3-9, P3-11

NOTE: Do not throw away Page P3-3 when filing P CHASSIS sheets.

Portafax



PORTABLE TELEVISION PRODUCT SERVICE, COLLEGE BLVD., PORTSMOUTH, VA.

DECEMBER, 1968

VOL. 2, NO. 9

SC/S-1 CHASSIS - LOW SENSITIVITY ON WEAK SIGNALS

Occasional complaints of poor sensitivity on the SC/S-1 Chassis line of receivers have been reported in the field.

In most cases, this is caused by an excessive AGC keying pulse being applied to the plate of AGC Keyer V4B (14BR11).

The pulse is obtained across a capacitive voltage divider consisting of C262 and C263 in the damper circuit. If the pulse exceeds 360 volts P-P, a negative IF AGC voltage can be developed on weak signals. Negative AGC applied to the grid of the 1st IF amplifier V3A (11BQ11) will result in a loss of sensitivity, especially if the IF circuits are slightly out of alignment.

Changing the value of capacitor C263 from 1500 pf to 1800 pf, 500V (G. E. Catalog No. ET22X195) will usually correct the problem.

This modification should not be made on all SC/S-1 Chassis receivers. Use only as required to correct individual low sensitivity complaints.

* * * * *

NEW HIGH VOLTAGE RECTIFIER TUBE

Current production G-1 chassis 14-inch color receivers use a 3DA3 high voltage rectifier tube. This new type is a direct replacement for the 3CX3 tube used previously. CAUTION - The 3CX3 cannot be used to replace the 3DA3.

Beginning with chassis stamped EN 326, the tube socket wiring was revised to accommodate only the 3DA3 tube. Filament leads are now connected to Pins 5 and 8 of the tube socket, instead of Pins 3 and 8. In the 3DA3 tube, Pins 3 and 5 are connected together enabling this tube to function in sockets wired for either a 3DA3 or a 3CX3.

When your present stock of 3CX3 tubes is depleted, we recommend using the 3DA3 tube as a replacement in G-1 chassis receivers.

(OVER)

H CHASSIS RECEIVERS - HIGH VOLTAGE CHECK POINTS

Certain areas in the high voltage and horizontal sweep section of the H Chassis 10-inch color receiver should be inspected each time a set is serviced to reduce the possibility of corona and arcing problems.

1. Remove all pigtails and sharp solder points from the bottom of the horizontal output and damper tube sockets.
2. Check to be sure there are no sharp solder points on the bottom of the circuit board in the area near the damper choke. Make sure the special insulating sleeve completely covers damper choke L252.
3. Inspect the damper choke wire lead where it passes through the opening in the circuit board. If the insulation appears nicked, deteriorated, or damaged in any way, replace the lead with high voltage anode lead wire. Be certain you make a smooth solder connection to the damper choke. Cover the solder joint with heat shrinkable tubing (EP50X1) or at least four layers of black plastic insulating electrical tape.
4. Dress all wire leads connected to the high voltage transformer away from adjacent transformer terminals. Be sure the damper capacitor connected to Terminal 3 is dressed away from the metal chassis.

* * * * *

NEW SERVICE MANUAL PAGES

File the following pages in the proper section of the Service Manual binder indicated. Destroy old pages which have been superseded:

VOL. E SERVICE MANUAL

G CHASSIS: Page G1-9

VOL. D SERVICE MANUAL

S CHASSIS: Pages S1-1, S1-5, S1-7, S1-9, S1-15, S3-1, S3-5, S3-7



SEASON'S GREETINGS

Best wishes for a Merry Christmas and a Happy, Prosperous New Year from all of us in Portable Television Product Service.

A. A. Thiemens

A. A. THIEMENS
Manager - Product Service

Portafax



PORTABLE TELEVISION PRODUCT SERVICE, COLLEGE BLVD., PORTSMOUTH, VA.

JANUARY, 1969

VOL 3, NO. 1

INTERMITTENT HORIZONTAL OSCILLATOR START-UP

Occasional field reports have been received indicating horizontal oscillator start-up problems on monochrome "S" Chassis and "V" Chassis receivers. These chassis both use an 8LT8 tube in the same basic oscillator circuit.

The problem appears as a "no raster" symptom when the receiver is turned on. Sometimes switching the set off and on will cause the oscillator to start. Then the receiver may operate normally for some period of time, only to have the problem occur again a few days or weeks later. Because the problem is random and intermittent in nature, it is very difficult to pin down. Normal troubleshooting procedures do not seem to provide any answers.

First, the receiver should be checked out thoroughly. Change the 8LT8 tube and check all associated circuitry to determine that components are the proper value and not defective. Reduce the AC line voltage by means of a variac to 100 Volts and check for oscillator operation. Sometimes a borderline no-start will show up under reduced line voltage.

If a chronic start-up problem exists, R254 should be increased in value to 10 megohms. Original values found in "S" and "V" Chassis receivers will be 4.7, 5.6 and 6.8 megohms.

Increasing R254 resistance will reduce grid current under startup conditions raising the grid input impedance. With the circuit noise working into the higher impedance, lower energy noise is sufficient to start the oscillator.

An increase in the value of C254 from 390pf to 470pf will also aid oscillator start-up. However, changing this capacitor value can be extremely touchy, because C254 controls part of the temperature compensation of the horizontal oscillator. The replacement part used must be a ceramic 470pf, N750, 5%, 500V unit (G. E. Catalog No. EU18X542 or equivalent).

After changing capacitors, check the receiver for horizontal drift and hold in range. Using a strong channel signal (preferably Channel 6) set the fine tuning for best picture, and all other controls in their normal operating position.

Turn the horizontal hold control two full turns counterclockwise. Switch to the next highest channel and then return to the original channel. Now slowly turn the horizontal hold control clockwise until the picture just barely "hangs on" out of sync. You should count three or four bars just before the picture snaps into sync. Repeat this same procedure in the opposite direction.

After completing this test, the control has to be returned to its proper setting. This can be approximated by fine tuning into audio and adjusting the horizontal hold for a floating picture. Exact horizontal frequency adjustment procedure can be found in the specific chassis service manual.

(OVER)

These field fixes are applicable only to individual chronic horizontal oscillator start-up problems which will not respond to normal troubleshooting and repair procedures and should not be indiscriminately applied.

The change in R254 value is very much preferred over the capacitance change when dealing with this "no start" condition

* * * * *

HEAT SHRINKABLE TUBING AVAILABLE

Many occasions arise in the shop when a connector, component, or wire splice must be adequately covered with electrical insulation.

Heat shrinkable insulating tubing is now available in a package containing two 24-Inch lengths--one small diameter and one large diameter. This new stock item may be obtained by ordering G. E. Catalog Number EP90X1 through your local General Electric Replacement Parts Distributor.

The tubing shrinks quickly to approximately one-half the original diameter at temperatures above 125°C. Shrinkage in length is not more than 10%.

A preferred method of heating the tubing is with a hot air device such as a hair dryer, although heat from a high wattage soldering iron tip or light bulb held close to the tubing will work well.

This material is the same type as that used in the production of G. E. portable television receivers at the factory.

Cut the tubing to any desired length with a pair of scissors or wire cutters slide it over the connection, and heat shrink it down for a tight fit.

You will quickly find many uses for this handy material in your shop.

* * * * *

SERVICE MANUAL PAGES

File the following pages in the proper section of the Service Manual binder indicated. Destroy old pages which have been superseded.

VOL E BINDER

P CHASSIS: Pages P2-1, P2-3, P2-5

VOL D BINDER

H CHASSIS: Pages H1-1, H3-9

Portafax



PORTABLE TELEVISION PRODUCT SERVICE, COLLEGE BLVD., PORTSMOUTH, VA.

February - March, 1969

VOL. 3, No.2

"P" CHASSIS 10V DC LINE - IMPROPER FILTERING

Troubles that seem to have no source can be difficult to pinpoint. An interesting case is the effective series resistance (ESR) of an electrolytic. All electrolytics have this characteristic, which is usually of little consequence to the normal operation of a television receiver. But, we will examine a P Chassis circuit in which this characteristic is quite critical.

ESR is related to the dissipation factor of electrolytics and should not be confused with leakage resistance. ESR is the sum of the resistances encountered in the electrolyte, leads and foils of the capacitor. This can be visualized as a resistor in series with the capacitor. In 200 ufd capacitors ESR figures of 2 ohms are not uncommon and generally present no problem at power line frequencies (60 Hertz).

Filtering of the 10V DC source in the P Chassis is accomplished by C402C, a 200 ufd 70V electrolytic. In some sets where the ESR goes above 2 ohms some strange symptoms develop: picture contrast may vary from left to right (left being washed out, right being high contrast). Horizontal tearing, vertical jitter, and singing horizontal output transformers may also occur.

Troubleshooting procedure can be either waveform analysis using an oscilloscope or bridging of the 10V line with a known good 200 ufd electrolytic. The VHF tuner 10V input terminal is a convenient test point. The oscilloscope pattern of a good electrolytic will show a 0.5V neg spike with a repetition rate of 15.75KH. A defective unit will show something resembling a distorted 15.75KH sine wave. As little as 0.3V pp of this 15.75KH sine wave component can cause problems in the picture. It is a good practice to bridge the replacement capacitor (ES31X7) into the circuit before removing the original unit to make sure the new unit will function satisfactorily.

Replacement with a new electrolytic capacitor (G.E. Cat. No. ES31X7) will normally cure the problem.

SERVICE MANUAL PAGES

This mailing includes the new C-1 Chassis service manual. File the following pages in the proper section of the service manual binder indicated. Destroy old pages which have been superseded.

VOL. 1969 BINDER

C-1 CHASSIS: C Chassis Index Tab, Pages C-1, C1-3, C2-1, C2-3, C3-1, C3-3, C3-5, C3-7, C3-9, C3-11, C3-13, C3-15, C3-17, C3-19, C3-21

VOL. D BINDER

H CHASSIS: Page H1-1

A SUBSCRIPTION PLAN PUBLICATION

29-1700-69B



Portafax



PORTABLE TELEVISION PRODUCT SERVICE, COLLEGE BLVD., PORTSMOUTH, VA.

JUNE/JULY, 1969

VOL 3, NO. 3

HIGH VOLTAGE TRANSFORMER SQUEAL - 14 INCH COLOR G-1 CHASSIS

There have been some complaints of High Voltage Transformer fundamental frequency squeal in G-1 Chassis Receivers. Current production receivers (EN433 and higher) are being manufactured with an increased HVT core air gap.

The air gap is controlled by special paper tape between the core halves. Originally, one thickness of tape was used to create this air gap. Now, two thicknesses of tape are used to create a 15 mil gap. The proper tape is Scotch Brand No. 280, which is available from your General Electric Parts Distributor under Catalog Number EP60X9.

To modify an early production receiver, dismantle the HVT and remove the original air gap tape from the core halves. There may be some versions with black plastic electrical tape used as pads between the core and high Voltage Cage. Remove these pieces of tape also. Use four pieces of new tape approximately 1 1/2 inches long. Attach tape to both ends of both core halves as shown in the drawing. Be careful that the tape does not wrinkle or have foreign material stuck to it, as this air gap dimension is critical.

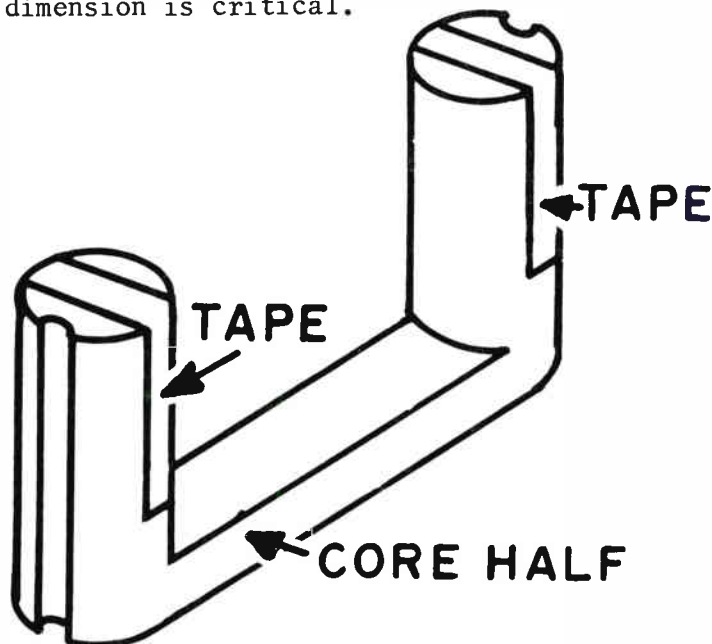

The second part of the modification is the elimination of the pincushion correction circuit. Remove the brass screws securing the pincushion transformer assembly to the HVT cage and clip the transformer winding leads close to the terminal board. Discard the pincushion transformer, but salvage the terminal board

(OVER)

and insulating strip. Securely mount the terminal board and the fish paper insulator in the space formerly occupied by the transformer, using the same brass screws. Cut off any excess length of the screws. To restore continuity in the vertical yoke circuit, the green lead on the pincushion transformer terminal strip has to be moved one terminal to the rear which is a common ground point. This procedure leaves C275 (3 uf) and R275 (22Ω) out of the circuit on the power supply board. They can be left on the board or removed at your discretion.

To insure proper performance of the set, it is essential that both steps of this procedure are performed. Eliminating the pincushion transformer will not adversely affect receiver performance, but will decrease the load on the horizontal output tube resulting in cooler operation and increased reliability.

Apply power to the receiver and reset the High Voltage to 21KV at Zero beam current (minimum brightness) with a line voltage of 120V AC.

Be sure to perform the Safety Check as specified in your G CHASSIS Service Manual after reassembling the receiver.

* * * * *

C-1 CHASSIS - 18 INCH COLOR IMPROVED DEGAUSSING ACTION

Some early production C-1 Chassis receivers were subject to complaints of repeated purity problems. Manual degaussing would correct the impurity but the problem recurred after a short period of time. This has been attributed to the charge remaining in electrolytic capacitor 2C405 after the receiver is turned off.

Degaussing action has been improved in current production receivers by the addition of a 100K, 1/2 watt resistor connected in parallel with 2C405. The resistor is physically located adjacent to 404 on the power supply board. Receivers bearing serial numbers 5D4-----and higher are equipped with this resistor. To improve performance, we recommend that the resistor be added to any early production C-1 Chassis which comes in for service.

* * * * *

SERVICE MANUAL PAGES

This mailing includes the new H-3 Chassis and T-5 Chassis Service Manuals to be filed in VOL 1969 BINDER as indicated.

File update pages in the section of the service manual binder indicated. Destroy old pages which have been superseded.

VOL 1969 BINDER

H-3 CHASSIS: H-3 Chassis Index Tab, Pages H1-1, H1-3, H1-5, H2-1, H2-3, H3-1, H3-3, H3-5, H3-7, H3-9, H3-11, H3-13, H3-15, H3-17, H4-1
T-5 CHASSIS: T-5 Chassis Index Tab, Pages T1-1, T3-1, T3-3, T3-5, T3-7, T3-9, T3-11, T3-13

VOL E BINDER

G CHASSIS: Page G1-1

Portafax



PORTABLE TELEVISION PRODUCT SERVICE, COLLEGE BLVD., PORTSMOUTH, VA.

AUGUST, 1969

VOL 3, NO. 4

C-1 CHASSIS - CHROMA NOISE

A change has been incorporated in late production C-1 chassis receivers to reduce chroma noise in weak signal locations. The value of the matrix resistor, 4R544, has been changed from 2.7K to 1.2K to improve the signal to noise ratio in the G-Y color difference amplifier. If needed, this improvement can be incorporated in early production receivers by paralleling the 2.7K resistor with a 2.2K, 1/2 watt resistor. The 2.2K resistor can be placed on the bottom of the circuit board. (See Illustration).

BOARD NO. 4--VIDEO-AUDIO-CHROMA CIRCUIT BOARD

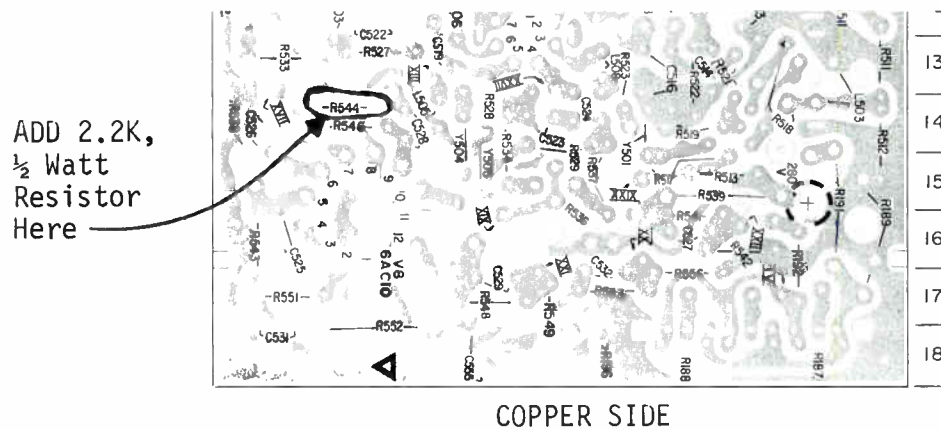

INTERMITTENT AUDIO IN S-2, P-1, AND P-2 CHASSIS

The small, green, .047 ufd. capacitors used in the audio circuits of S-2, P-1, and P-2 chassis receivers could be responsible for complaints of intermittent audio. In S-2 chassis receivers, these capacitors are designated C309, and in P-1 and P-2 chassis receivers, they are designated C304 and C310.

If C309 (S-2 chassis) or C310 (P-1, P-2 chassis) opens, audio is lost, sync buzz becomes pronounced and off channel white noise is normal. There is very little effect on the audio quality when these capacitors are shorted.

(OVER)

In P-1 and P-2 chassis receivers, an open C304 causes reduced audio, sync buzz and no white noise when the tuner is switched to an unused channel. A shorted C304 upsets the bias of Q301 and causes loss of audio. There is usually no damage to Q301 when this happens.

SERVICE MANUAL PAGES

This mailing includes the complete V-2 chassis service manual to be filed in the VOL E Binder.

File update pages as indicated. Destroy old pages which have been superseded.

VOL E Binder - G Chassis - Page G1-3. V-2 Chassis-Index Tab, Pages V1-1, V1-3, V2-1 V2-3, V3-1, V3-3, V3-5, V3-7, V3-9, V3-11.

Portafax



PORTABLE TELEVISION PRODUCT SERVICE, COLLEGE BLVD., PORTSMOUTH, VA.

SEPTEMBER, 1969

VOL 3, NO. 5

HIGH VOLTAGE REGULATION IN H-3 CHASSIS

In the H-3 Chassis series of color television receivers, the high voltage is regulated by controlling the power delivered to the High Voltage Transformer. This power is controlled by the Horizontal Output Tube plate current, which, in turn, is controlled by the Horizontal Output Tube control grid bias voltage.

The high voltage regulation circuit monitors a voltage pulse from the High Voltage Transformer and automatically adjusts the control grid bias voltage according to the amplitude of this pulse.

A Voltage Dependent Resistor, R272, and capacitor C275 are the principal components of the regulation circuit. The VDR acts as a diode in series with a resistor. When the voltage across the VDR is high (700-1000 volts), its internal resistance is about 700Kohms. At lower voltages this resistance increases to about 5 meg ohms.

From Pin 6 of the High Voltage Transformer, a positive going pulse is supplied to the regulation circuit. The amplitude of this pulse varies with the high voltage--that is, as high voltage increases, pulse amplitude increases, and vice versa. This pulse, applied to the VDR thru C275 and R274, causes the VDR to conduct and C275 becomes charged. Between pulses, C275 discharges thru R274 and a parallel network made up of R265, R270 and R272, R273. The negative voltage developed by this discharge is coupled to the Horizontal Output Tube control grid via R264.

The charge developed across C275 can be increased by either raising the pulse amplitude or reducing the resistance of the VDR. Because of the VDR's characteristics, both of these changes occur at the same time. The result is that larger voltage changes are developed from small pulse amplitude changes than would be the case if the VDR was a simple diode.

Should the pulse amplitude increase (indicating a rise in high voltage), C275 will receive a greater charge, and a more negative bias voltage will be developed and coupled to the control grid. Plate current thru the Horizontal Output Tube and the High Voltage Transformer will be reduced, and the high voltage will return to normal.

The High Voltage Set control, R273, limits the current flow thru the regulation components and thus limits the charge impressed on C275. The control (shown in diagram below) should be adjusted to produce 17.2KV at the CRT second anode when the brightness is at minimum and the receiver is operating with 120 VAC line input. Increasing the line voltage to 130V AC should not cause the second anode voltage to exceed 17.8KV.

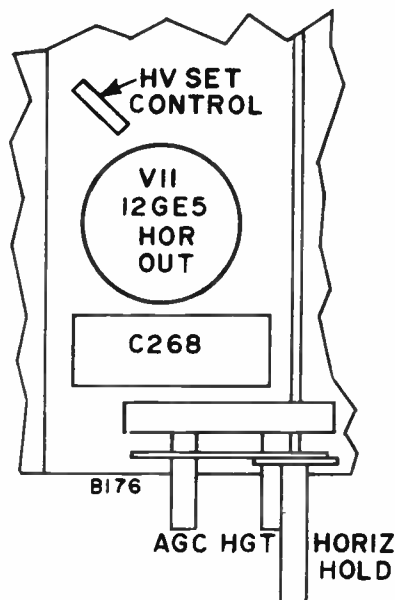

29-1700-69E

(OVER)

DIFFERENCES IN UHF TUNERS

GE is currently using several UHF tuners that look very much alike, but have several differences worth noting. Essentially, all the tuners were designed to one set of specifications, but two Engineering groups were involved. The result was several subtle differences which prevent indiscriminate substitutions. These differences encompass the mounting brackets, antenna isolation, B+ dropping resistors, and tracking characteristics. To insure proper performance and safe operation of the equipment, it is best to use the exact replacement for the original: i.e. EP85X2, ES85X1, ET85X53, etc.

Most of you are already aware of the antenna isolation differences, but because of the significance of this point, it is repeated here. In some sets that are transformer powered, the antenna circuit was not d-c isolated from the receiver ground or common. Obviously, tuners designed for this application should not be used in transformerless television sets since the chassis ground or common point is, in reality, one side of the AC power line.

A further consideration is the possibility of installing a different VHF tuner than the original. Some VHF tuners have UHF B+ circuit dropping resistors inside the tuner, while others do not. The best way to determine if the proper total dropping resistance is correct is to simply measure the UHF B+ voltage at the UHF Tuner itself. The voltage should be 22 volts on all recent models. For this check it is necessary to place the VHF Channel Selector in the UHF position.

The UHF tuner will function over a wide range of B+ voltages, but to insure that the tuner will meet FCC radiation specifications it is suggested that the tuner have 22 volts at the B+ terminal. Should the voltage be something other than 22 volts, the resistor which connects the VHF tuner to the UHF tuner B+ point should be changed in value to produce 22 volts at the UHF tuner. This resistor's value should be between 10,000 ohms and 20,000 ohms on models that use a 150 volt B+ source.

After getting the replacement tuner installed and working properly, tracking of the channels should be checked, Channel 27 being received somewhere near 27 on the indicator and Channel 75 being received somewhere near 75 on the indicator. The different tuner designs require different indicators.

The best way to avoid all the problems pointed out above is to use an exact replacement tuner when possible.

* * * * *

SERVICE MANUAL PAGES

This mailing includes three new model pages and two page revisions.

File updated pages as indicated. Destroy old pages which have been superseded.

VOL E BINDER

P Chassis: Pages P1-5, P1-7

VOL 1969 BINDER

H-3 Chassis: Page H1-7

C-1 Chassis: Pages C3-17, C3-21

Portafax



PORTABLE TELEVISION PRODUCT SERVICE, COLLEGE BLVD., PORTSMOUTH, VA.

OCTOBER, 1969

VOL 3, NO. 6

VDR's (VOLTAGE DEPENDENT RESISTORS - VARISTORS) and TDR's (TEMPERATURE DEPENDENT RESISTORS - THERMISTORS)

In modern television design, devices are being used in critical circuits to automatically adjust circuit parameters to maintain constant performance regardless of variables such as line voltage changes, component aging, and thermal effects.

Two of these devices which are quite popular today are the VDR and TDR. Both are non-linear resistors. This means, for instance, that doubling the voltage across them does not double the current through them. These non-linear resistors can be manufactured with either a positive or negative coefficient. A negative coefficient device is one whose resistance will decrease with an increase of the electrical or environmental conditions to which it is sensitive.

Checking a non-linear resistor requires some knowledge of how it functions. A simple ohmmeter check will not provide an accurate test. Most non-linear resistors can be checked in operational circuits using simple voltage measurements and observing circuit performance. The absolute ohmic value is not the important measurement -- the device's reaction to environmental change is what must be determined.

TESTING THE VDR

The VDR is a non-linear resistor whose resistance is a function of voltage. VDR's currently used in General Electric portable TV's have a negative coefficient.

VDR's are used in high voltage regulator and boost voltage circuits and in de-gaussing circuits.

Most VDR's will read open when checked with a simple ohmmeter. Therefore, the VDR must be tested by applying a voltage to it and measuring the current through it. Such a test may be done with the VDR in the TV circuit or in a special bench test circuit. In either case, a milliammeter is placed in series with the VDR, and the voltage applied to it is varied. (See Figure 1.)

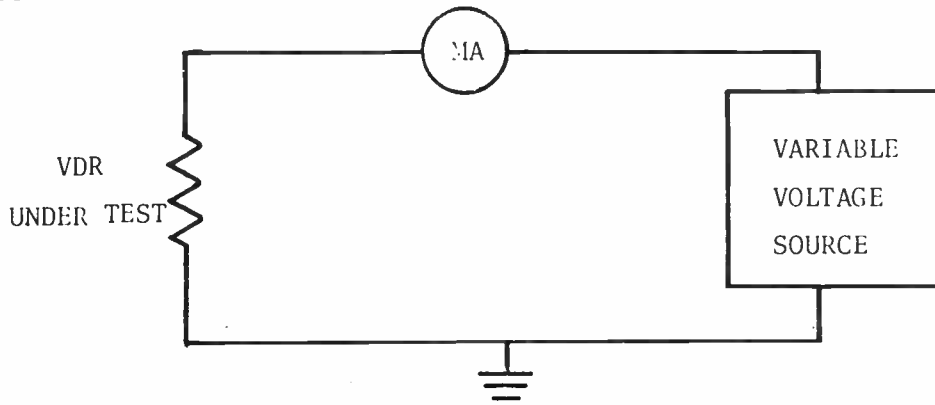

Figure 1 - VDR Test Circuit

Plotting a graph of voltage vs. current for the VDR shows its performance characteristics. Such a graph might look like that in Figure 2.

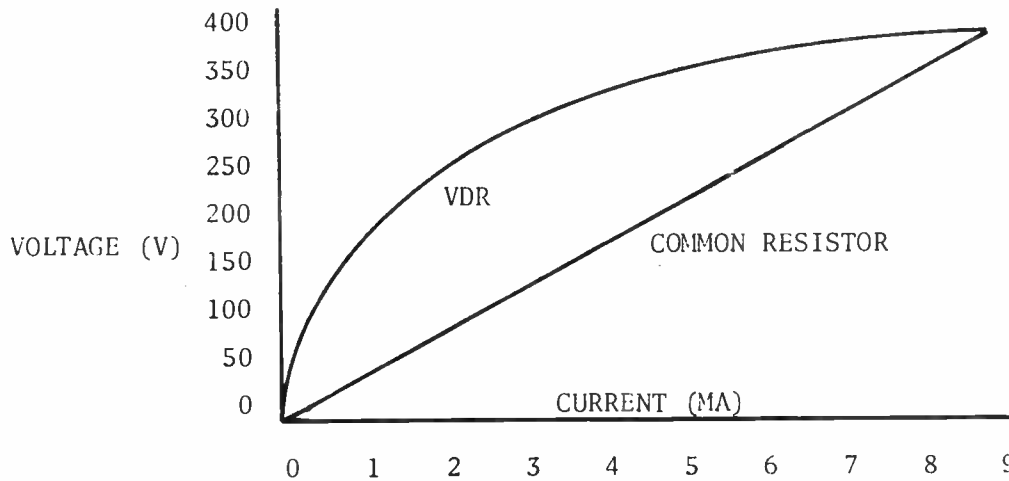

Figure 2 - Voltage vs. Current for a negative coefficient VDR

VDR's come with many voltage and current ratings, so don't expect the values in Figure 2 to exactly agree with the numbers on your graph. The important thing is for the non-linearity of current change with voltage variations to be evident.

In most instances, suspected defective units can be verified by checking the current at the voltage specified in the parts list.

VDR's (VOLTAGE DEPENDENT RESISTORS - VARISTORS) and
 TDR's (TEMPERATURE DEPENDENT RESISTORS - THERMISTORS)
 (CONTINUED)

Some of the VDR's currently being used include:

EU14X196	65MA @ 20V ±20%	(C CHASSIS)
EP13X1	65MA @ 20V ±20%	(G CHASSIS)
EP13X2	1MA @ 850V ±15%	(G CHASSIS)
ES14X212	1MA @ 17V ±15%	(TC/T-1 CHASSIS)

One precaution must be observed with this test procedure: DON'T EXCEED THE POWER RATING OF THE VDR. Power ratings are similar to carbon resistors; that is, physical sizes are approximately the same. Also, note that VDR's have a negative thermal coefficient, so the readings should be taken quickly.

TESTING THE TDR

The TDR is a non-linear resistor whose resistance is a function of temperature. The heat that influences the TDR can be externally applied or developed by the current passing through the device. Characteristics of a typical negative coefficient TDR are compared with an ordinary resistor in Figure 3.

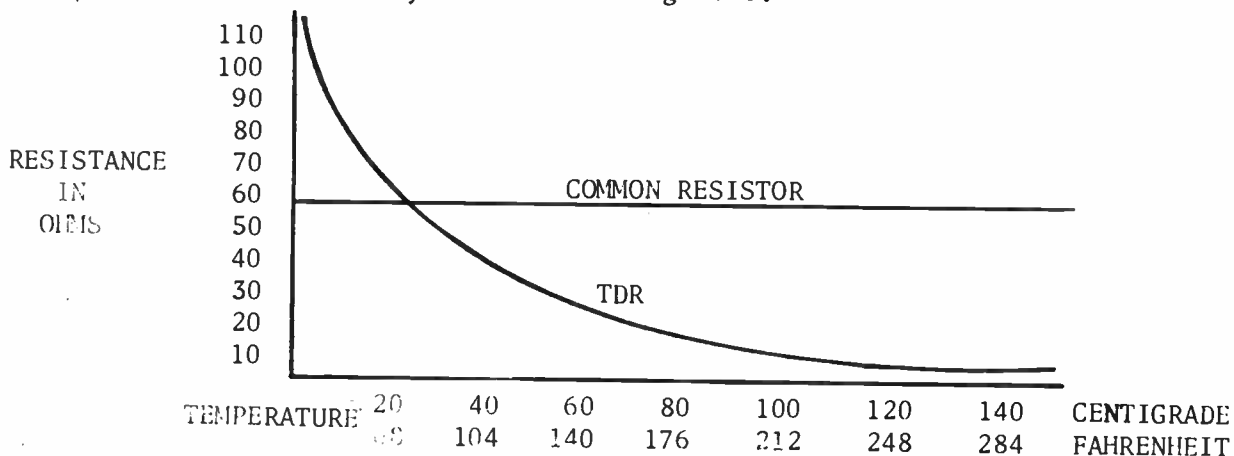

Figure 3 - Resistance vs. Temperature for a TDR and a common resistor.

TDR's were used initially in filament systems for controlling warm-up or limiting surges. They were commonly referred to in the past as "glow bars". Currently they are being used extensively in automatic degaussing circuits and deflection yoke circuits. In degaussing circuits they provide a fading effect which results in a gradually decreasing magnetic field that eliminates undesired magnetism. In deflection circuits they correct for the increased resistance of the windings as they heat up.

TDR's can usually be checked with an ohmmeter. To test a TDR, connect an ohmmeter to the device and apply a source of heat (such as a soldering iron or heat lamp). The resistance of the TDR will change as the temperature changes. For low ohmic values, the heating effects of the meter current will have to be allowed for.

Some of the TDR's currently being used include:

EP14X10	100Ω @ 25°C	(C CHASSIS)
EU14X147	3.8Ω @ 25°C	(C CHASSIS)
EP14X206	1.052 meg @ 25°C	(G CHASSIS) (H CHASSIS)
EP14X5	120Ω @ 25°C	(G CHASSIS)
ES14X213	3000Ω @ 25°C	(TC/T-1 CHASSIS)

NOTE: 25°C is assumed to be normal room temperature. All resistance figures are ±25%.

* * * * *

SPECIAL I.F. ALIGNMENT TOOL FOR THE T-5 CHASSIS

The following item may be used for i.f. alignment of the T-5 Chassis:

Transistor I.F. Core Alignment Tool
GC No. 9440
Walsco 2501

(This special tool is needed for the square adjustment hole.)

* * * * *

SERVICE MANUAL PAGES

This mailing includes seven new and revised pages for Vol. D and three pages for the 1969 Vol.

File updated pages as indicated. Destroy old pages which have been superseded.

VOL D BINDER

S-2 Chassis: Pages S1-1, S1-17, S1-19, S2-1, S2-3, S2-5, S3-7

1969 VOL BINDER

C-1 Chassis: Pages C1-5, C1-7.

Portafax



PORTABLE TELEVISION PRODUCT SERVICE, COLLEGE BLVD., PORTSMOUTH, VA.

NOVEMBER/DECEMBER, 1969

VOL 3, NO. 7

TROUBLESHOOTING "NO HIGH VOLTAGE" PROBLEMS (C-1 CHASSIS)

"No High Voltage" problems in C-1 chassis receivers can be easily solved if a systematic troubleshooting procedure is used and one important point is remembered.

The point to remember is that the drive signal to the horizontal output tube grid cannot be measured with a DC voltmeter. The DC grid voltage is a combination of the voltage produced by grid rectification of the drive signal, and the feedback voltage developed by the high voltage regulation system. A fault in the horizontal output stage may result in less feedback voltage, and consequently, less DC voltage on the grid. Therefore, using this DC voltage as a measure of drive signal can lead to false conclusions.

The easiest troubleshooting method is to systematically isolate the horizontal output stage from its various load circuits, making use of the plugs and sockets incorporated in the design of the receiver. During this procedure, permanently connect a high voltage meter to the CRT second anode so as to continuously monitor the high voltage. If disconnecting a component restores the high voltage, the trouble is obviously in that component or its associated circuitry.

Troubleshooting Procedure

1. Change the tubes; V10, horizontal output; V11, damper; V13, HV rectifier.
2. Disconnect the CRT socket. This checks the possibility of a shorted CRT. Leave the CRT socket disconnected while performing step 3. Otherwise, should the high voltage be restored with the yoke disconnected, the undeflected beams may permanently damage the CRT screen.
3. Disconnect the yoke plug. With the yoke and CRT disconnected, the normal high voltage is 10-12KV. Boost voltage will remain normal at 750 - 860 volts. If the trouble is not in the yoke, reconnect the yoke and CRT.
4. Disconnect the convergence plug. If the problem is in the convergence assembly, all voltages will return to normal.
5. Check the drive voltage to the horizontal output tube with a scope. Use the junction of 5C264 and 5R268 on board #5. The peak to peak voltage should be 200 volts or more.

6. Check the screen voltage of the horizontal output tube. Use a socket adaptor or measure at the terminal board adjacent to the socket. (The third terminal from the side of the receiver is the screen connection. It is accessible from the top of the chassis.) The voltage is normally 150 - 200 volts. It will drop to 70 - 90 volts if the yoke is disconnected or if the high voltage regulation system is not operating.
7. Unsolder the focus coil and the focus rectifier. If the problem is in this circuit, all voltages will return to normal, except that there will be no focus voltage.

The above procedure has checked all of the major components in the horizontal output circuit except for the high voltage transformer. Before concluding that the transformer is defective, check the miscellaneous small components in the circuit; capacitors, resistors, choke coils, etc.

The voltages in the following chart were taken at the points indicated, using a normal receiver, with faults introduced as noted. It illustrates the effect that output circuit faults have upon horizontal output tube screen and control grid voltages, and may be an additional aid in troubleshooting C-1 receivers.

CONDITION	HORIZ.OUT. SIG.GRID P-P VOLTS	HORIZ.OUT. SIG.GRID DC VOLTS	HORIZ.OUT. SCREEN GRD. DC VOLTS	B+ BOOST VOLTS	HV,CRT 2nd ANODE	FOCUS VOLTS	JCT.5C268 T252A, P-P VOLTS
Normal receiver	270	-70	150-200	740	22KV	4KV	560
Convergence plug disconnected	280	-82	155-200	680	20KV	4KV	560
Yoke plug disconnected	250	-54	70-75	860	10-12 KV	3KV	380
Focus coil and rectifier disconnected	270	-76	160-200	725	25KV	68 volts	580
Jct. 5C268, T252A shorted to chassis	220	-44	90	625	20KV	5KV	0
5C268 open	240	-46	90	720	26KV	4.5KV	600
5C268 shorted	240	-46	90	700	26KV	4KV	600
7C280 shorted	270	-88	160-200	750	22KV	4KV	560
7C276 shorted	270	-74	155-200	700	22KV	4KV	520

CORRECTION FOR PICTURE TUBE TILT

Chassis: TC12" transistor

Problem: Picture tube tilts clockwise, caused by inadequate support at the picture tube right bottom corner.

Correction: Loosen picture tube sling, level picture tube, and wedge an EP3X21 rubber wedge between the right bottom corner of the picture tube and the picture tube sling mounting boss. Tighten picture tube sling.

PERFORMANCE CHECK AND "TOUCH-UP" ALIGNMENT WITH VECTORSCOPE

A vectorscope display of the R-Y and B-Y chroma signals provides a means of checking the overall operating condition of a receiver's chroma section and "touching-up" the demodulator transformer alignment.

A scope with a 500 khz bandwidth is satisfactory for this check. The most important criteria are that the scope not load the signal source excessively, and that the gain of the vertical and horizontal amplifiers be equal.

A suitable input cable network is shown below. Construct two identical cables, placing the resistors and capacitors near the clip, as shown.

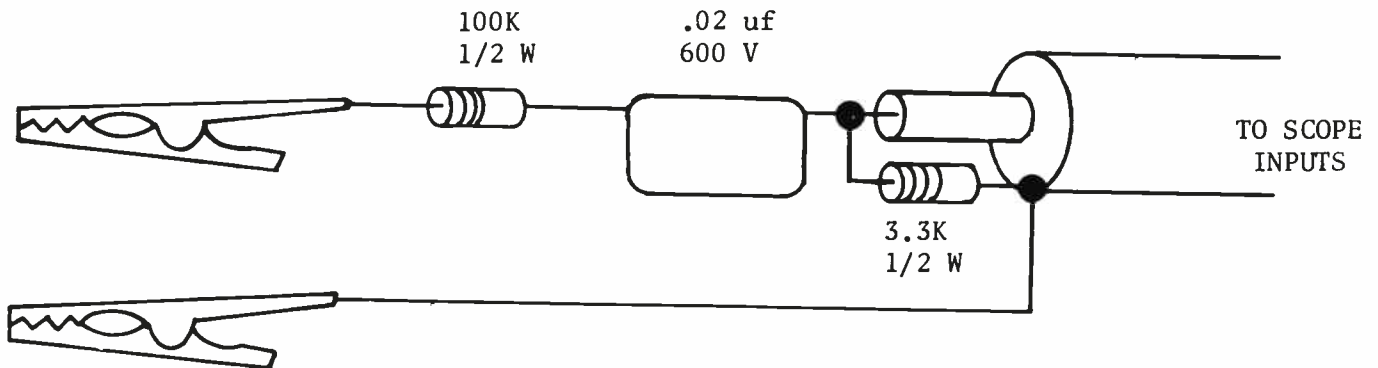

To calibrate the scope, connect the cables to the scope input terminals. Apply a 30 volt RMS signal to the vertical input cable, and adjust the scope vertical gain controls for a 2-inch vertical line. Disconnect the vertical cable. Then apply the 30 volt RMS signal to the horizontal input cable, and adjust the scope horizontal gain controls for a 2-inch horizontal line. Disconnect the 30 volt RMS source. Do not readjust the gain controls after this calibration.

Overall Chroma Section Performance Check

Connect the horizontal input cable to the grid of the CRT blue gun (B-Y signal). Connect the vertical input cable to the grid of the CRT red gun (R-Y signal).

Connect a keyed rainbow generator to the receiver, and adjust the receiver for a normal color bar pattern.

Normal scope displays for various chassis are shown below. Adjust the receiver's COLOR control to vary the size of the scope display. DO NOT ADJUST THE SCOPE GAIN CONTROLS.

Vector display for C-1 chassis:
1st. vector is burst signal.
Angle between R-Y and B-Y
vectors is about 135 degrees.

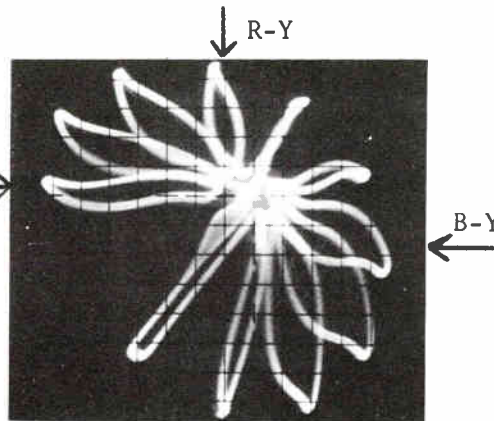

Vector display for G-1 chassis:
1st. vector is burst signal.
Angle between R-Y and B-Y
is about 150 degrees.

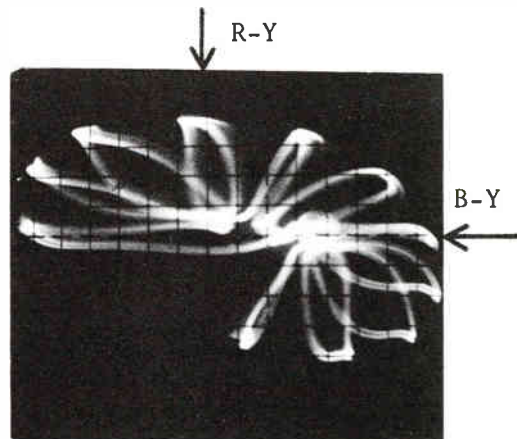

Vector display for H-2 chassis:
Burst signal and retrace
blanking signal are combined
in vector at lower left of display.
Angle between R-Y and B-Y is
about 150 degrees.

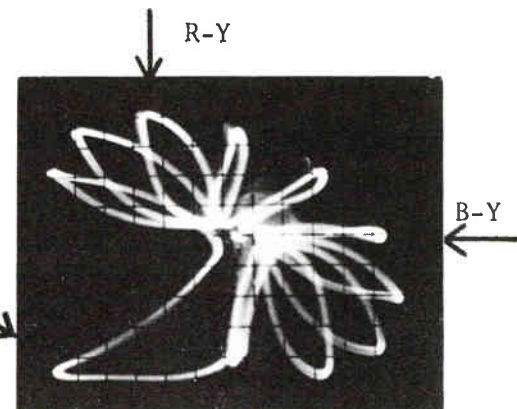

If the vector display appears to be inverted, check the Vertical Polarity Switch on the scope (positive voltage should cause upward deflection) and the input cable connections (R-Y signal to vertical input and B-Y signal to horizontal input).

The vectors should be properly positioned when the TINT control is at, or near, the center of its range. Rotating the TINT control through its range should cause the vectors to shift at least 40 degrees each way.

Touch-up Alignment of Demodulator Transformer

Set the TINT control to its center position. Adjust the Demodulator Transformer bottom core to place the B-Y vector properly. Adjust the top core to place the R-Y vector properly.

There is some interaction between the two adjustments. Repeat the above steps as necessary, to position the vectors properly.

NOTE: If extensive adjustment is necessary, align the subcarrier system using the service manual instructions, then recheck the vector placement.

If the vector display looks good but the color bar pattern on the picture tube does not, check the balance control adjustments, the G-Y amplifier circuit, and the picture circuit and adjustments.

PLASTIC WIRE TIE (NEW PART)

A wire tie, to be used as required, is now available for use in wire dressing, etc., for television receivers.

It can be ordered in multiples of 100 from New Concord.

N-EP90X3 WIRE TIE - Plastic bead type, 4" long, std. pkg. of 100

(The "N" in the part number identifies this part as a new item, not previously stocked.)

HELP!

A reader of an electronics magazine recently sought help by writing the following letter to the magazine*:

"Would you tell me how to take the back off of my GE Porta-Color TV set? I took all the knobs off and the screws, it says to, but I couldn't seem to make it."

The magazine's reply:

"Have you tried a crowbar or beer bottle opener? Best bet is to call the GE service department in Boston and ask. Unless you know what you're doing, don't mess around with the innards of a color TV set. Frankly, if you can't get the back off, what the heck you plan to do once it's off - electrocute yourself?"

* Reprinted with permission of: *SCIENCE AND ELECTRONICS*
229 Park Avenue South
New York, New York 10003

PORTAFAX INDEX

Too often, helpful items get buried in dusty files. As a tool for locating past PORTAFAX articles, an index, subdivided by chassis and subject, is included with this edition.

* * * * *

SERVICE MANUAL PAGES

File the following pages in the proper section of the Service Manual binder indicated. Destroy old pages which have been superseded.

VOL D BINDER

S-2 CHASSIS: Pages S1-1, S1-3, S1-5, S1-7, S1-9, S1-11, S1-13, S1-15, S1-21, S1-23, S3-5

H-1 CHASSIS: Pages H1-1, H1-3, H1-5, H2-1, H2-3, H3-1, H3-9, H3-13, H4-1

UHF Tuners: Page "D" Line UHF-7

VOL E BINDER

G-1 CHASSIS: Page G3-1

VOL 1969 BINDER

C-1 CHASSIS: Pages C1-9, C3-1

H-3 CHASSIS: Pages H1-9, H3-1

Portafax



PORTABLE TELEVISION PRODUCT SERVICE, COLLEGE BLVD., PORTSMOUTH, VA.

JANUARY/FEBRUARY, 1970

VOL 4, NO. 1

INTERMITTENT HIGH VOLTAGE: P-2 AND S-2 CHASSIS

To cure this high voltage problem, the high voltage rectifier tube quite often is replaced. However, the real source of trouble may be a poor solder connection at the high voltage rectifier socket. When the tube is replaced, the solder connections are re-soldered; thus, it is not known for sure if the tube was really at fault! Always check the solder connections before replacing the high voltage rectifier tube.

ARCING IN CORONA SEAL ON HIGH VOLTAGE RECTIFIER SOCKET: C-1 CHASSIS

Some problems associated with the high voltage rectifier socket in C-1 chassis receivers have been traced to the corona seal around the socket terminals.

Excessive leakage currents in some corona seal has caused any or all of the following failures:

1. Arcing in the corona seal.
2. Deterioration of the rectifier socket.
3. Deterioration of the 2-ohm filament series resistor.

The cure is to remove all the old corona seal, replace all damaged components, and install new corona seal (Cat. No. ET90X24) in any receiver which has a failure in this area.

INTERMITTENT NO AUDIO

CHASSIS: All chassis using printed circuit board mounted audio output transformers.

SYMPTOM: Audio intermits at intervals during warm-up.

CAUSE : Intermittent solder connections at circuit board where transformer leads pass through board.

CURE : De-solder leads, one at a time, and use a knife to scrape the transformer lead clean to insure a good solder flow when the lead is resoldered to the board. Resolder.

CAUTION: Visual inspection of the solder connection can be misleading. The solder fillet may look perfectly good and still be making a poor electrical connection to the lead.

ANYONE LOST A TV SET?

Recently received at General Electric's Portsmouth facility was a television set -- with no address or identification! None other, that is, except a newspaper used for packing material. To locate the owner, the following letter was sent to the newspaper in Chestertown, Maryland:

"To The Editor:

Perhaps you can help us locate someone who:

1. Reads the KENT COUNTY NEWS;
2. Is minus one small General Electric television set;
3. May drink Ron Bacardi Superior (silver label) Rum in copious quantities.

Reason: Recently, the local post office received a General Electric television set with no delivery address, packed in a cardboard Rum carton(12 bottles) and using your newspaper (Wed., June 18, 1969) as packing material.

Since this TV set was originally built here, the post office sent the set to us.

Now we are faced with the problem of locating the customer. We have been waiting for some word from the owner, but there has been none.

Can you help?

We will be glad to return the set (packed properly) to the owner if said owner provides proper identification.

(signed) Art Thiemens
Product Service"

The owner was located, and his set has been returned, properly packaged and addressed.