



**Electronic
TUBES**

G-E HAM NEWS

Copyright 1955, by General Electric Company

MAY-JUNE, 1955

VOL. 10-NO. 3

TUBE DEPARTMENT
GENERAL ELECTRIC
Schenectady 3, N. Y.

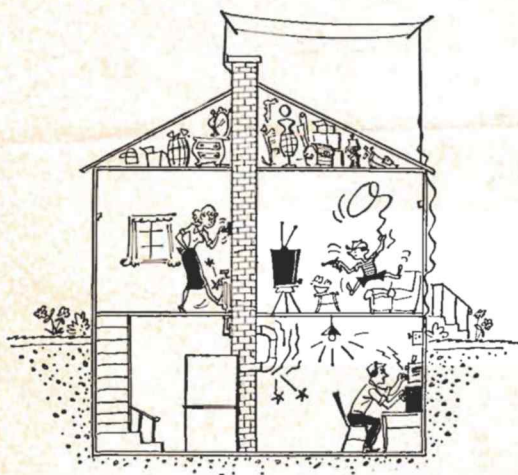

Did you know that pipe-pounding and light-flicking intercom systems are obsolete? Try this efficient, all-electronic model and promote peace with the family.

—*Lighthouse Larry*

HAM SHACK INTERCOM

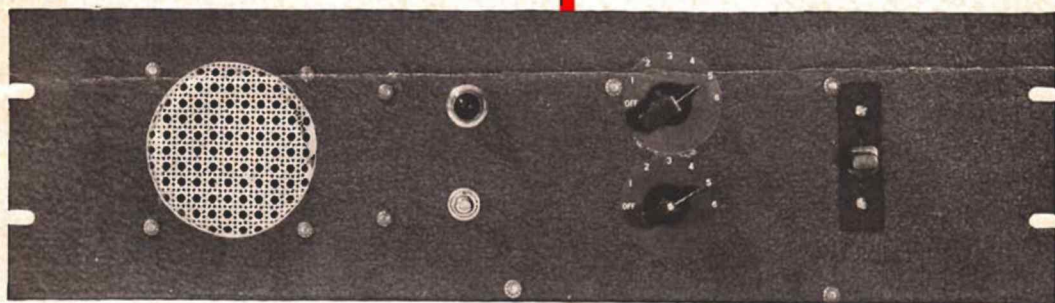
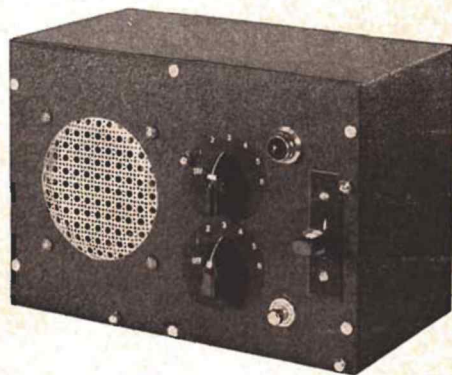

CONTENTS

"Operation Crystal"	page 2
Ham Shack Intercom	page 3
Edison Radio Amateur Award Winner	page 6
Sweeping the Spectrum	page 7
Essential Characteristics Handbook	page 8

OPERATION CRYSTAL



Checking the operation of this "earphone chassis" model sent me digging into my old junk box to find the necessary material. Out came a plastic-cased earphone instead of the metal one shown in the original model built by Edgar M. Weed, K2BO, of Morris Plains 22, N. J.

A pi from a mangled 2.5 mh RF choke was connected as a self-resonant coil in the illustrated circuit to receive the local broadcast station operating on the 1240 KC *Conelrad* frequency. Another pi may be connected in series with the first for improved results if your local station operates below 1000 KC. For the "last ounce" in volume, a Miller type 70A slug-tuned antenna coil could be used in a large headphone case with the slug adjusted by a screwdriver through a hole in the case.

A "field" test was made by running around the neighborhood clipping the antenna lead onto fences, fire hydrants, unoccupied automobiles, and the like. A weighted length of antenna wire was even tossed over some tree branches with good results. (These tests are best made at night unless you want to convince your already skeptical neighbors that their favorite radio amateur has gone completely crazy!)

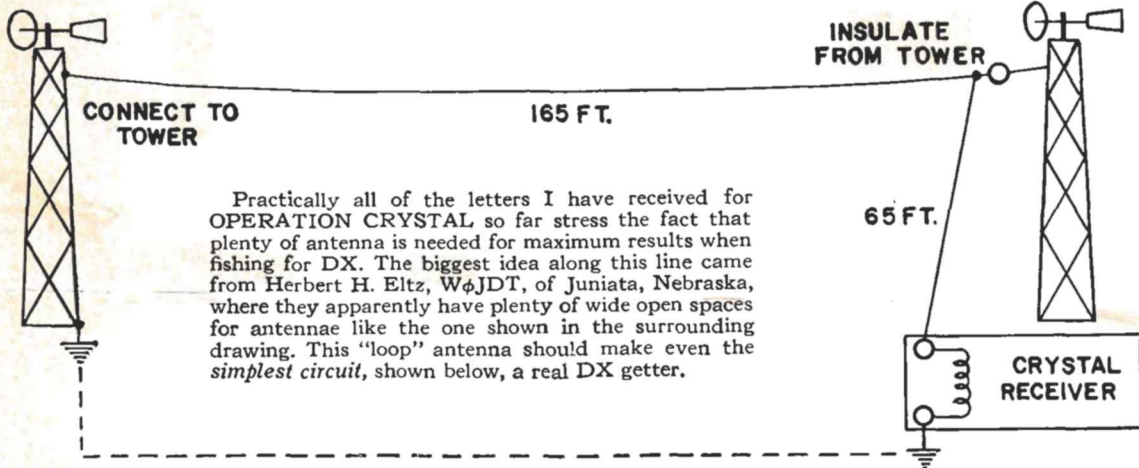
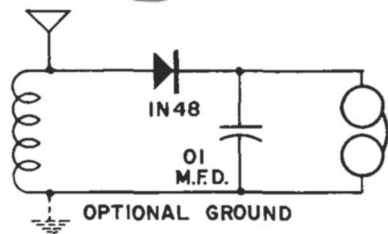
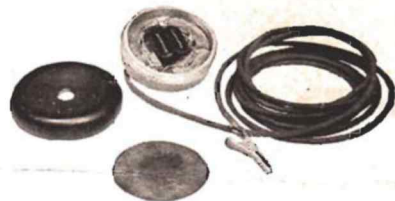

This set makes up in volume and simplicity what it lacks in selectivity, according to tests run at my shack. The strongest local station will be the one that wins at the earphones. In some locations a mixture of stations will result, but that should be no problem when receiving *Conelrad*. Polarity of the crystal seems to be unimportant. Although several persons submitted this idea, Jerry Lucha, of Wilmington, Delaware, sent the first such entry to be received at my office.

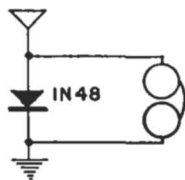

All ideas submitted before December 1, 1955, will be eligible for publication in the OPERATION CRYSTAL column. (See G-E HAM NEWS, Volume 10, No. 1.) Do not send in your model Construction and antenna hints of an outstanding nature are also eligible. All material submitted must be free of patent restrictions and becomes the property of G-E HAM NEWS.

—Danny Diode

HAM SHACK INTERCOM

What's so unusual about an inter-com system? The control circuits of this G-E HAM NEWS model are designed specifically with the "hermit" type of radio shack in mind—a good nickname for most home stations located in attics, upstairs rooms, cellars, or even an actual shack in the yard. When installed in the radio shack, rapid temper-saving communication is available to the front and rear doors, kitchen, nursery, or what-have-you. It will replace, at nominal cost, the more conventional systems of signalling the "chief op'." Banging on the floor, ceiling and plumbing, or flicking the cellar or attic light on and off would no longer be in vogue. It is also a handy gadget to have for communication between tents at the radio club's annual Field Day station.

For the "occasional" 'phone man, it could be used as a speech amplifier to drive the grid of a "clamp" tube on the screen of that tetrode final amplifier even while it is also on duty in its intended role. One position of the master station selector switch could be reserved for this application.

As a general-purpose audio amplifier, it is even handy for checking the output of the Jr. op's crystal receiver. When the XYL sees how much fun you are having with it, she is sure to want a master station for the kitchen. Keep that in mind when scrounging for the parts.

Two types of construction, rack panel and table cabinet, are described to show how the master station could fit into most styles of ham shack arrangement.

CONTROL CIRCUITS

As shown in Fig. 1, the 3PDT relay and the station selector switch, S_2 , form the heart of a control system that allows the master station amplifier to be activated from any remote station simply by pressing switch S_1 , to the "talk" position. This grounds one side of the heater winding and energizes the relay. A ground path provided by one relay contact then acts as a "holding" switch for the relay coil current. Heater and plate power are applied through the other two normally open contacts. The amplifier is turned off by pressing S_2 , on the master station, to remove the relay coil power. The heater current must be isolated from the relay-closing circuit, otherwise the extra voltage drop through the external cable would affect the relay operation.

Up to four remote stations can be selected by S_2 , the fifth position connecting all stations at once. Any remote station can call into the master station, regardless of the setting of S_2 , when S_1 is in the "talk" position. The remote station signal then goes directly to the input of the amplifier whenever S_1 is in the "listen" position.

If only the master and one remote station are needed, S_2 and its associated wiring and terminal strips enclosed in the dotted lines on the diagram will not be necessary. Further simplification is possible by eliminating the control relay, if the amplifier runs continuously.

Inexpensive four-wire TV antenna rotator control cable is used to connect the master and remote stations when the complete control system is desired. The rotator cable is flat in cross-section and can easily be run around door and window casings, behind moldings and base-boards, under rugs or even fished through walls, if you are the ambitious type of person. Two or three-wire cable may be used with the simplified circuit.

AMPLIFIER CIRCUIT

A three-stage audio amplifier circuit is used, with the input signal from the speaker-microphones fed into one cathode of a 12AX7 twin-triode. This grounded-

grid input circuit has less gain than conventional types, but eliminates the input matching transformer which would otherwise be necessary. Sufficient output at only 110 plate volts is possible with the new 6CA5 beam-pentode tube in the power output stage. (See G-E HAM NEWS, Volume 10, No. 1, for ratings and description.) The coupling, cathode by-pass and shunting condensers are tailored to attenuate frequencies outside the normal speech range, reducing any stray hum pickup by the remote station cables. (See G-E HAM NEWS, Volume 4, No. 4, for details.)

Expensive instant-heating type tubes were deemed unnecessary because the amplifier was found to be capable of passing a signal about 8 seconds after the relay was energized.

A transformer-powered, half-wave, selenium-rectifier plate supply with an RC filter is used to minimize the shock hazard always possible with transformerless type supplies. This also simplifies the tube heater and relay power problem. The power transformer, T_1 , runs all the time that the power switch, S_3 , on the volume control shaft is "on." After running several hours in the stand-by position, the transformer was barely warm. The built-in power supply can be eliminated if a similar source is available in the shack.

Standard 3.2-ohm voice-coil PM speakers could be used in place of the 45-ohm types designed especially for inter-com service if each remote station does not require over 25 feet of connecting cable. Savings in original cost would be about fifty cents per speaker.

CONSTRUCTION

All new parts were used in the model stations, but either one could be built around a "defunct" table radio chassis and cabinet. The amplifier and power supply is built on a Bud CB-1620 miniature open-end aluminum chassis drilled according to Fig. 2. All parts are arranged so that the same chassis can be mounted vertically in either a 6 x 9 x 5-inch metal utility box, or on a 5 $\frac{1}{4}$ -inch wide relay rack panel. Station selector switch, S_2 , and the volume control, R_5 , mount with the shafts projecting through the underside of the chassis. Five 3-terminal tie-points are fastened under the chassis at the places shown in the bottom view, Fig. 3, when the transformers and sockets are assembled with 6-32 x $\frac{1}{4}$ -inch and 4-40 x $\frac{1}{4}$ -inch machine screws. Soldering lugs are also placed on these screws for ground tie-points. Rubber grommets are used in the six $\frac{3}{8}$ -inch diameter holes marked "D" where leads from the transformers, switches and volume control pass through the chassis.

All wiring is done with conventional colored hook-up wire, as no shielded leads were found necessary. The wires to the speaker, S_1 , S_2 and the pilot-light bracket are left a few inches longer than necessary. These parts are then fastened to the panel, drilled as shown in Fig. 4, before the chassis is assembled with $\frac{3}{4}$ -inch long tubular metal spacers between the bottom lip of the chassis and the panel. Note that blank spaces are left under the chassis where the panel-mounted parts are located. As the power relay mounts on the bottom of the box next to the chassis, connections made to it were left slightly long and then laced together. Small rubber feet, $\frac{3}{8}$ -inches in diameter, fastened on the bottom of the cabinet, provide clearance for the relay mounting screw-heads. The terminal strips for connecting to the remote stations were mounted directly on the back of the cabinet. Leads from the strips to S_2 and the relay are made long enough to allow the back to be opened with the chassis in place.

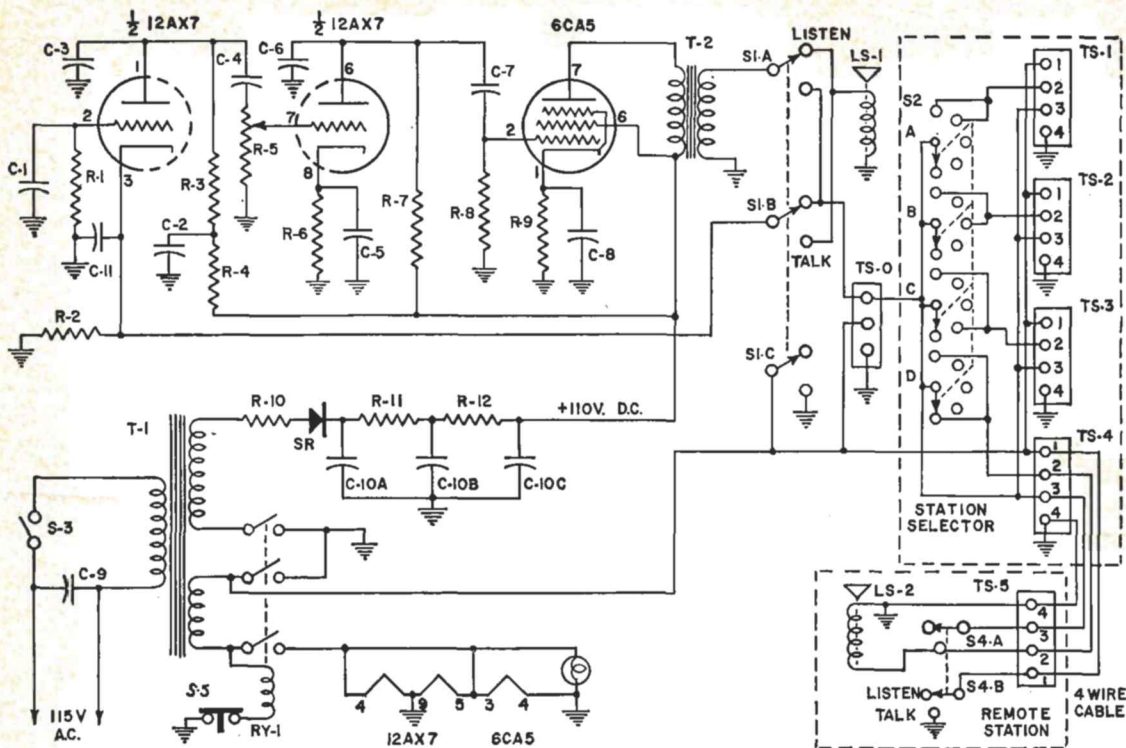

Fig. 1 Schematic diagram

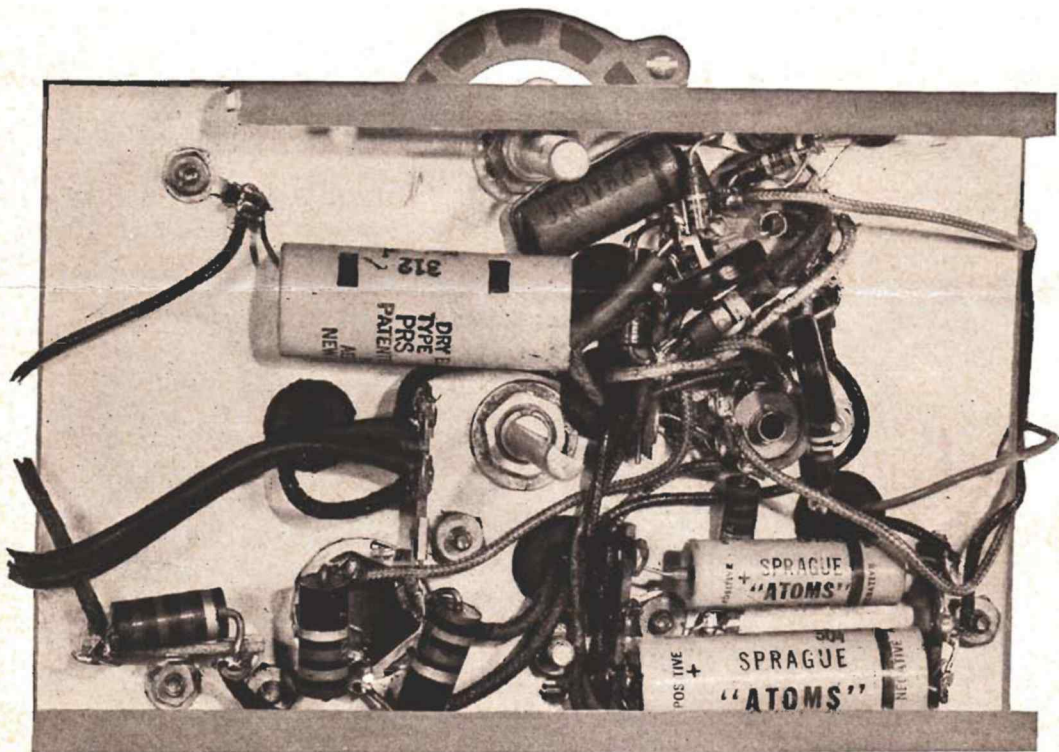
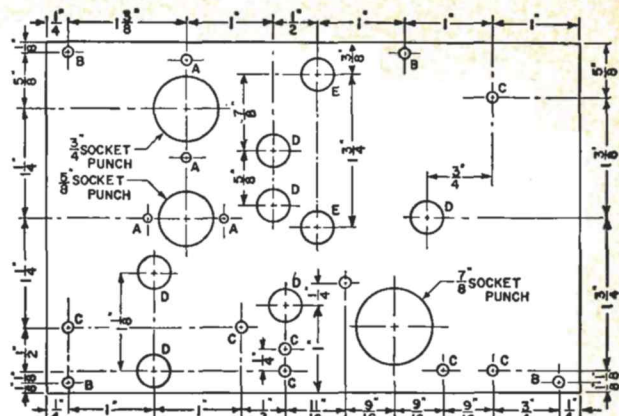

Fig. 3 Chassis bottom view

- "A" drill—No. 32 spaced to suit tube sockets.
- "B" drill—No. 26 through both chassis and bottom lip.
- "C" drill—No. 26 for T₂ at left, T₁ at right, C₁₀ at 1/8-inch hole and rectifier at bottom center.
- "D" drill—3/8-in. dia for rubber grommets.
- "E" drill—1/4-in. dia for R₅ and S₂.

Fig. 2 Chassis drilling layout (top view)



PARTS LIST

- C₁—0.1-mfd, 200-volt paper.
- C₂—10-mfd, 150-volt miniature electrolytic.
- C₃, C₆—500-mmf, 500-volt disc ceramic.
- C₄, C₇—2000-mmf, 500-volt disc ceramic.
- C₅—10-mfd, 50-volt miniature electrolytic.
- C₈—50-mfd, 50-volt miniature electrolytic.
- C₉—0.05-mfd, 600-volt paper.
- C_{10a,b,c}—Three-section, 40-mfd, 150-volt electrolytic, "twist-lock" type not over 3 inches high.
- C₁₁—5000-mmf, 500-volt disc ceramic.
- I₁—1/2-inch jeweled pilot light and bracket.
- LS₁, LS₂—4-inch PM speakers, 45-ohm voice coils (QUAM 4AO7Z45 or similar).
- R₁—10-megohm, 1/2-watt.
- R₂—470-ohm, 1/2-watt.
- R₃, R₇—0.1-megohm, 1/2-watt.
- R₄, R₆—2200-ohm, 1-watt.
- R₅—0.25-megohm potentiometer with SPST switch.
- R₈—0.24-megohm, 1/2-watt.
- R₉—120-ohm, 1-watt.
- R₁₀—100-ohm, 2-watt.

- R₁₁, R₁₂—180-ohm, 2-watt.
- RY₁—3PDT, 6-volt AC coil relay (Potter & Brumfield KR-14A 6-volt AC coil).
- S₁—4-pole, 2-position, non-shorting, spring return lever switch.
- S₂—4-pole, 5-position, shorting rotary switch.
- S₃—SPST switch on back of potentiometer R₅.
- S₄—2-pole, 2-position, non-shorting, spring return lever switch.
- S₅—SPST, normally closed push-button switch.
- SR—130-volt, 75 ma, half-wave selenium rectifier.
- T₁—Half-wave power transformer, 125 volts @ 50 ma, 6.3 volts @ 2 amp. secondaries.
- T₂—4-watt universal output transformer, connected to match speakers used.
- TS₁₋₅—4-terminal and lug phenolic strips.
- TS₀—optional strip when S₂ is not needed.
- Dial plates: (1) 5-position tap switch plate (Mallory No. 375).
- (1) OFF and 10-position volume control plate (Mallory No. 390).
- (2) Single gang lever-switch plates (Centralab P-1755).

The above description also applies if the chassis will be housed in a small table radio cabinet, except that small blocks of 3/4-inch thick white-pine are glued to the inside of the panel and 1 1/2-inch long wood screws fasten the chassis to the blocks from the rear. A back cover of 1/8-inch thick tempered hard-board with the terminal strips mounted on it is then fashioned.

RELAY RACK MODEL

The amplifier chassis bolts directly to the rear of the relay rack panel, with the control shafts located about 2 inches off-center. The lower edge of the chassis comes flush with the same edge of the panel. The speaker, S₁, S₆, power relay and pilot-light bracket are fastened to

unused portions of the panel either side of the chassis. The speaker is centered about 4 inches from one end of the panel and the relay positioned next to it. The pilot-light bracket and S₁ are located in line with the control shafts between the chassis and relay. Talk-listen switch, S₁, mounts about 1 inch from the other end of the chassis. Ornamental-head screws are used wherever the heads show on the front of the panel.

A decorative pattern of holes drilled through the panel can be used as a speaker grille, or a small piece of "do-it-yourself" perforated aluminum sheet can be used between the speaker and a 3 1/4-inch diameter hole bored through the panel. A "dished" effect was obtained by gently tapping the sheet with an object slightly smaller than the hole. Standard lever and rotary switch plates identify the various controls.

The terminal strips were mounted on a small piece of hard-board and fastened to a pair of small angle brackets assembled under the chassis mounting screws.

REMOTE STATIONS

A Bud CS-1948 4-inch metal speaker cabinet houses each remote speaker and the call-in switch, S₄. A Cinch-Jones No. 17-4 terminal strip for the external cable is mounted on the back of the box with 6-32 x 1/4-inch machine screws. Note that the cabinet is grounded to the terminal strip.

Many other possible uses will probably occur that have not been mentioned in this description, although our few examples show that an inter-com system is a necessity in many amateur radio installations.

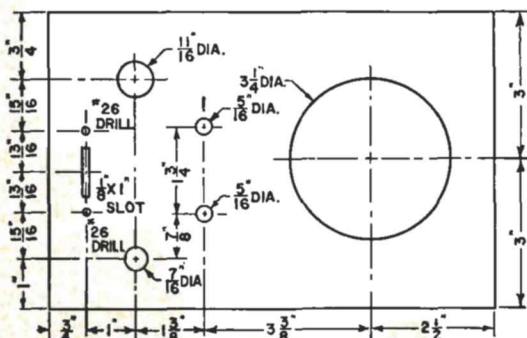
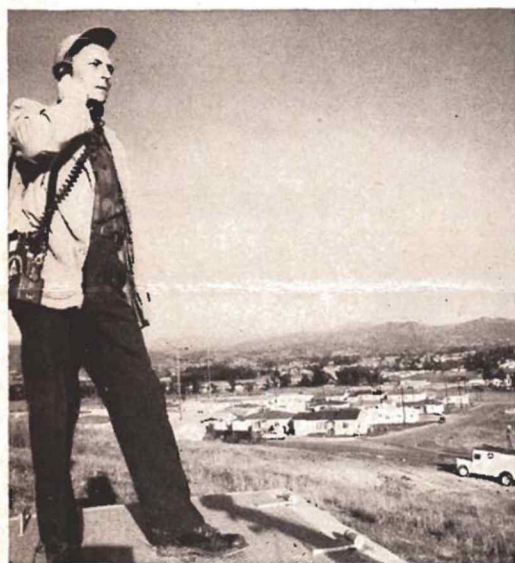
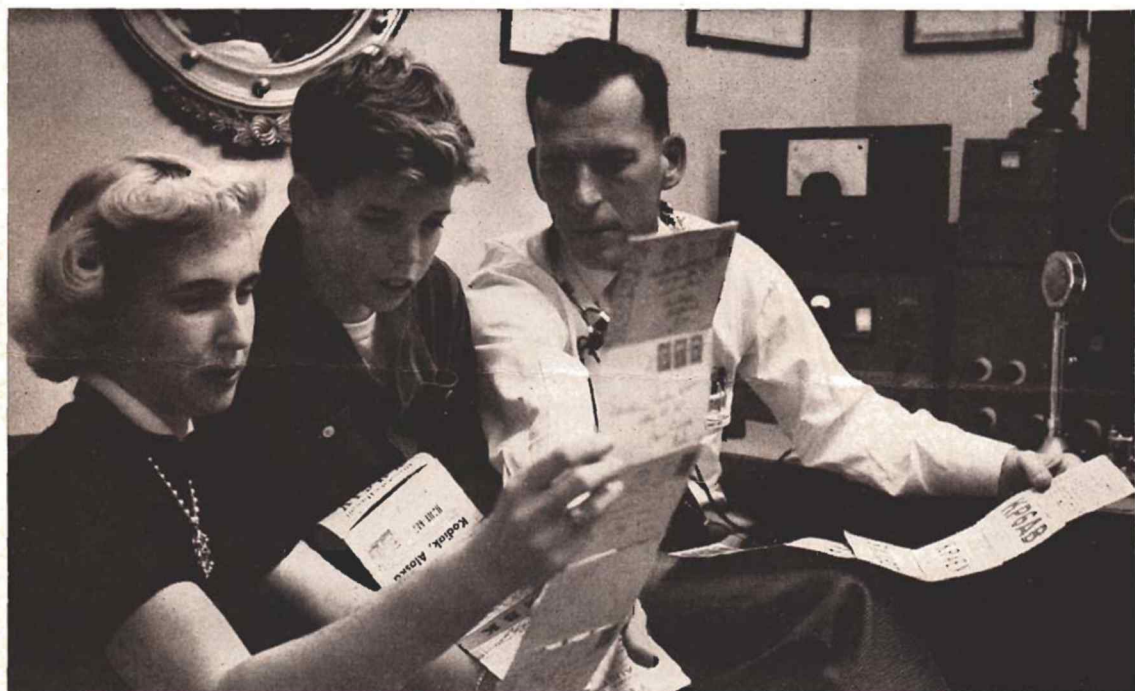

Fig. 4 Panel drilling layout for cabinet model

1954 EDISON AMATEUR RADIO AWARD WINNER

Judges:

Val Peterson, Administrator, FCDA
E. Roland Harriman, President, Red Cross
Edward M. Webster, Commissioner, FCC
Goodwin L. Dosland, President, ARRL



Ben Hamilton, W6VFT, shown with XYL Flora Mae and son Richard at his La Mesa, Calif., home station (top), catches a moment's relaxation from activities which consume more than 20 hours weekly in addition to his career as industrial electronics instructor at San Diego Junior College and Vocational School. The Civil Defense control center (upper right) co-ordinates operation of nets for CD, Zone Warden, Red Cross disaster service, county road service, and AREC in 36 of 44 communities in 60 by 70-

mile San Diego County. Four bands are used to insure adequate coverage of rugged mountains, coastal, and desert terrain (bottom left). His program of network planning; specifying, installing and maintaining equipment; personnel alerting system, and classwork training of operators (lower right) has given his 750,000 neighbors one of the best such services in the nation.

Ben is communications chairman for the Red Cross chapter, SCM for ARRL, communications officer in the 40th Division of the California National Guard, and is a veteran of World War II and the Korean War.

SWEEPING *the* SPECTRUM



All the recent activity in the transistor field has touched off a couple of interesting programs on that subject at one of the local radio clubs, remarks our editor . . . who is keeping an eye out for some good transistor ham gear ideas. Most good-sized cities must have either a manufacturer or user of transistors who might supply someone well-versed in the subject to act as a club program speaker. The subject is probably too extensive to cover in one program—fundamentals could be handled in one session, and applications in another. Primary amateur interest would naturally be in the portable and miniature equipment field.



I caught our editor taking a peek at the scene of the first live closed-circuit telecast ever made to an I.R.E. Convention on March 22nd here at the Power Tube Plant of General Electric in Schenectady, even though it took place after normal working hours. He also dug up the information that the show was the first inter-city live closed-circuit telecast participated in by General Electric.

Manufacturing techniques on a new line of metal-ceramic UHF Special Purpose and Transmitting tubes were shown to a private audience in the West Ballroom of the Waldorf-Astoria Hotel in New York City, 170 miles away. Particularly impressive was a demonstration showing a ceramic tube envelope withstanding heat from a gas-torch that reduced a similar glass envelope to a shapeless molten mass. "Star" of the show was the new GL-6442 UHF Lighthouse triode, utilizing 61 component parts assembled in 164 precision mechanically controlled operations which factor out heavy reliance on operator skill. Power inputs of 12 watts at 350 plate volts in a class C CW amplifier or oscillator at frequencies up to 2500 MC are possible in grounded-grid cavity circuits. As a plate-pulsed oscillator, it may be used up to 4000 MC at 3000 positive peak plate volts. Short electron transit time, low lead inductance and interelectrode capacities and excellent isolation of the anode from the cathode allow efficient operation at these frequencies.



From a recent issue of the Suburban Radio Club, Ferguson, Missouri, bulletin comes word of this novel use of a grid-dip oscillator.

A general contractor directed scathing imprecations at the carpenters, electricians and others of the construction crew whom he condemned individually and collectively for the delays and troubles which, he roared, were ruining him. If he could only get a little money ahead he would quit this losing game, etc. No more custom home construction jobs for him!

"How in blue blazes are we going to find the electric outlets that those plasterers buried so thoroughly

and now have been tiled over in the kitchen? Who is going to pay for chopping up these walls?"

An electrician, also a radio ham, then advanced, "I'll bet coffee against your coffee and doughnuts that a good radio man could spot them within two inches without even scratching the paint."

"All right, it's a deal," said the contractor. "I will give you five minutes a plug, but heaven help you if you are giving me a wrong steer."

It was a curious group that gathered around as *you know who* coupled his grid-dip meter to one of the lines in an exposed socket and picked up the signal on his little wave-meter which in turn was plugged into a large volt-ohm meter. With the aid of the swinging needle, he followed the invisible wires up the wall, across the ceiling and down the outer wall. The carpenter drove his chisel through at the indicated spot, right in the middle of an outlet box, of course. The others were uncovered in rapid succession, and once again pure genius brought home the coffee and doughnuts.

The frequency? This, our hero refused to divulge, but the real mystery seems to be: How did that grid-dip meter, wavemeter and multi-meter just happen to be so handy?



Although operation of a mobile radio station by the driver of a motor vehicle is illegal in many states, the Egyptian Radio Club of Granite City, Illinois, has established a class to teach members how to drive an automobile while talking into a microphone.

The club has set up an obstacle course on "the south ten acres" of their club grounds which duplicates the conditions encountered in city driving—rough streets, traffic snarls, baby buggies and police patrol cars. Several members have "donated" the use of their cars to simulate heavy traffic similar to that encountered while mobiling.

A beginner in the course is equipped with a chest microphone, which is used for the first three lessons, or until he shows aptitude for further learning. After the student becomes accustomed to the feel of the "mike" at his nose, a regular hand-held microphone is substituted. The instruction committee guarantees that an ERC-trained ham can talk on the mobile wirelessly and drive anywhere! Yes, anywhere!

In spite of such educational efforts, undoubtedly the safest and best course of action is to refrain from operating a mobile rig while actually moving, or in stop-and-go traffic. This is particularly important where a hand-held microphone is used or while attempting to tune the mobile installation. Even a minor accident, which involves no injuries, resulting from these distractions would be bad public relations for amateur radio. Also, the outcome of any civil action could be influenced by the fact that one of the parties involved did not give driving his undivided attention.

—Lighthouse Larry

essential characteristics handbook

Look for the cover pictured at the right on the counter of your local G-E Tube Distributor, who should now have his copies of the new, completely revised, G-E Receiving Tube Essential Characteristics Handbook. Latest information on over 100 new miniature, sub-miniature, series-string, special purpose and television picture tubes, plus a separate section on germanium diodes, is packed into a compact 6 x 8½-inch size. A multi-ring binder allows the book to stay open and lie flat at any page. The type style used shows at a glance whether a tube is miniature, glass or metal. A bonus feature is the printing of the base diagram on the same page as the tube listing—no tedious thumbing back and forth for this information.

Function, maximum ratings, and typical operating conditions of over 1700 tube types are listed clearly. Outline drawings with dimensions allow you to determine whether or not that 5-tube receiver will fit into your favorite-brand coffee can. A section with circuit diagrams for most typical receiving tube applications brings up the rear.

Do not write to Lighthouse Larry for your copy! They are available only through authorized G-E Tube Distributors.

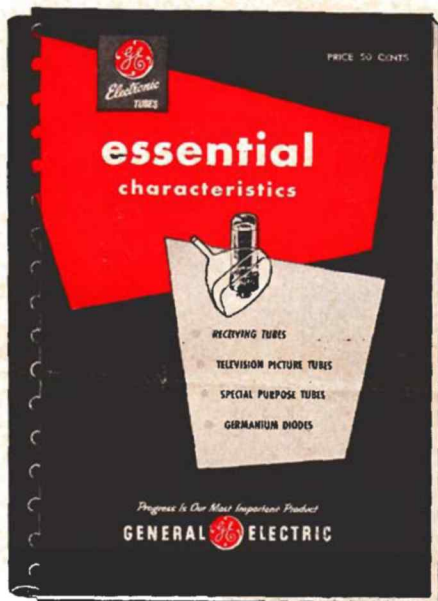

G-E HAM NEWS

Available FREE from

G-E Electronic Tube Distributors

published bi-monthly by

TUBE DEPARTMENT

GENERAL  ELECTRIC

Schenectady 5, N. Y.

In Canada
Canadian General Electric Co., Ltd.
Toronto, Ontario

E. A. NEAL, W2JZK—EDITOR

MAY-JUNE, 1955

Printed in U.S.A.

VOL. 10—NO. 3