



Electronic
TUBE

Ham News

Copyright 1951, by General Electric Company



JANUARY—FEBRUARY, 1951

VOL. 6—NO. 1

ELECTROPHONE

*An Inexpensive Condenser Microphone
for the Home Experimenter*

..... ARTICLE ON ELECTROPHONE STARTS ON PAGE 2

Announcing the New UHF Miniature MAGNETRON

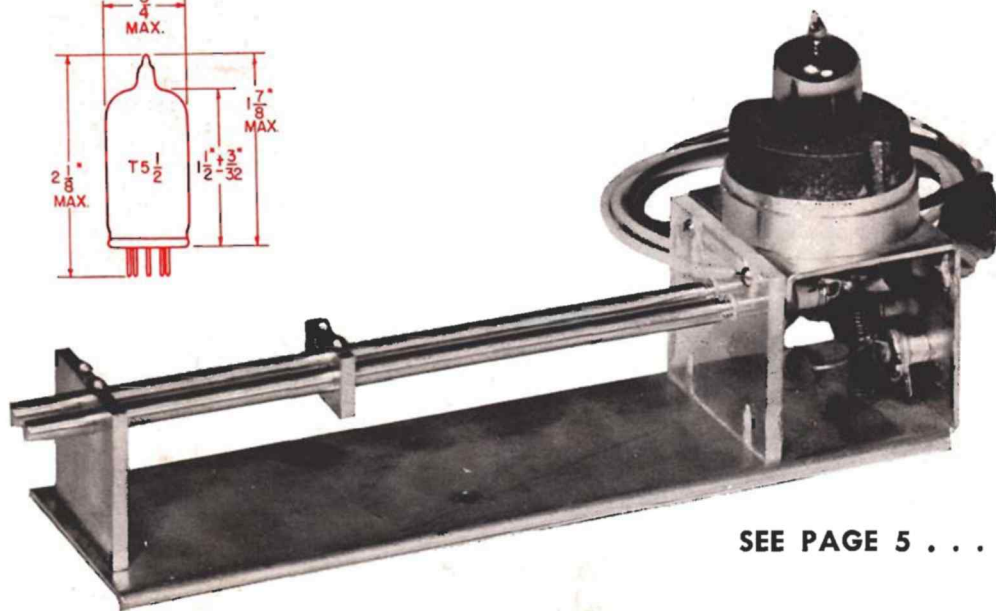
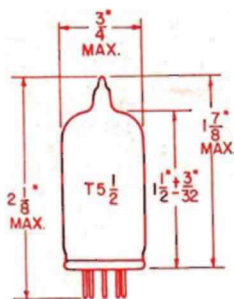

SEE PAGE 5

Contents

Electrophone (Inexpensive condenser microphone)	pages 2-4
Technical Information (Z-2061)	page 3
Technical Tidbits (Using resistors as R-F loads)	pages 6-8

ELECTROPHONE

Many items around almost any ham shack are home-made. Some amateurs make their own transmitters, some their own receivers, but very few amateurs have ever made their own microphone. This has been due primarily to the fact that it is difficult and expensive to make a microphone of good quality. The microphone about to be described is the exception to the rule, as it is easy to make and is a good quality microphone.

The Electrophone is a condenser microphone of novel construction which requires no external source of polarizing voltage. Very few parts are required to make the Electrophone, and almost any amateur can put one together in an evening. The output is higher than can be obtained from a regular condenser microphone, and if the Electrophone is carefully made, the output will almost be equal to that from a crystal microphone.



Fig. 1. View of Electrophone showing aluminum foil diaphragm

the two plates forming the condenser microphone. The electric lines of force may be thought to travel from one electric pole to the other just as we have been accustomed to thinking of the magnetic lines of force in a permanent magnet with a north and a south pole.

Electrets themselves are not new, nor are condenser microphones employing electrets new, that is, it has always been theoretically possible to make a microphone in this manner. The Electrophone is a practical example of this sort of thing. The word electret was coined by Oliver Heaviside in the latter

part of the nineteenth century to denote a permanently charged material, but the first electret was not made until 1925.

CONDENSER MICROPHONES

The regular type of condenser microphone consists of a small capacitance which may be varied by the pressure of sound waves impinging on one of the condenser plates. If a source of direct current is placed in series with this condenser the current will vary as the capacitance changes. If this current is passed through a relatively high resistance a varying voltage drop will exist across this resistance. The variation in voltage drop will take place at an audio rate, and if the high resistance is placed in the grid circuit of a tube amplifier, the audio frequency voltage may be amplified in a normal manner.

The fixed voltage source which provides the direct current is called a polarizing voltage. This voltage serves, in a condenser microphone, in the same way as the voltage in a carbon microphone, although the action of the two types of microphones is quite different.

No external polarizing voltage is necessary with the Electrophone, because it supplies its own internal source of voltage. This voltage is supplied with an electret.

ELECTROPHONE ELECTRET

An electret may be compared to a permanent magnet. That is, a permanent magnet is a continuous source of electromagnetic lines of force, whereas an electret is a continuous source of electrostatic lines of force. It is usually made in the form of a disk of insulating material which has permanently residing on its two flat surfaces electrical charges equal but opposite in sign.

Fig. 2 shows the manner in which the electret, having a positive charge on its upper surface and a negative charge on the lower, induces charges on

MAKING THE ELECTRET

The electret is the heart of the Electrophone, and should be made as carefully as possible. The general procedure is to take a piece of suitable insulating material and apply heat to it while a d-c voltage is applied across the two faces. Both the heat and the voltage necessary are critical, although not sufficiently critical to cause the constructor any trouble.

It is absolutely necessary to use the proper insulating material in preparing the electret. Those materials recommended are Lucite, Plexiglas or Kel-F. One material which will not work is polystyrene. If you are in doubt as to whether the material you have is polystyrene, Plexiglas or Lucite, a simple flame test may be made. Polystyrene burns with a smoky flame, while Lucite and Plexiglas burn with a clear blue flame.

Once you have the proper material, select a piece about one-sixteenth inch thick and cut it in the shape of a circle. The exact diameter of the circle will depend upon the microphone case you use. These details will be discussed later. Next, procure a heavy pan or thick piece of metal (see Fig. 3). The purpose of the large mass of metal is to maintain as uniform a temperature as possible on the electret.

The next item necessary is a power supply which will give a voltage of anything from 1000 volts up to approximately 10,000 volts. The higher the voltage that is used, the better a microphone you will have, from the standpoint of sensitivity. Ideally, use as high a voltage as possible without causing arc-over between the two polarizing voltage electrodes.

A satisfactory microphone may be made with 1000 volts, but for best results use at least 2500 or 3000 volts, and if you want to do a superior job, use 10,000 volts. The job of providing a power supply is not as difficult as it may sound, because only a few *microamperes* of current are required.

In case you haven't already guessed it, the best place to obtain a high voltage which is capable of only a small amount of current is a television receiver.

An r-f power supply of this type is ideally suited, not only because the voltage runs quite high, but also because there is much less danger involved in using such a power supply. However, regardless of the type of voltage supply used, remember that high voltages are dangerous and extreme caution must be exercised so as to avoid contact with the high voltage.

If you are unable to obtain a high voltage supply, one may be put together for the purpose. Fig. 5 shows a suggested circuit for a high-voltage power supply.

Once everything is ready, we may proceed to make the electret. Place the large pan or piece of metal on a source of heat. A burner in a gas or electric stove is quite suitable. Arrange the insulating material on top of the pan as shown in Fig. 3. Procure a top electrode (you may use the top of the microphone case as explained later) and place it on top of the insulating material, making sure that it is centered so as to prevent arc-over.

Next, connect the negative voltage supply to the bottom electrode, and also to the stove, then connect the positive lead from the power supply to the top electrode. Now, leaving the voltage supply turned off, turn on the heat and bring the insulating material up to temperature. Plexiglas and Lucite should be brought to a temperature of 140 degrees Centigrade (285 degrees Fahrenheit) and Kel-F should be heated to 205 degrees Centigrade (400 degrees Fahrenheit).

These temperatures are not too critical and one may use the softening point of the plastic as a convenient guide instead of using a thermometer. Each of the temperatures listed is the point at which the insulating material begins to soften. If desired, a small piece of the material may be placed in the pan and used as a test piece. Examine it with a fork periodically and when it becomes soft the larger piece will be at about the proper temperature.

At the moment when the plastic has reached the proper temperature, turn on the high voltage supply and leave it on for two hours. During this two-hour period the temperature of the plastic should be maintained at the temperatures previously mentioned. In general the heat will have to be turned down a bit in order that the temperature is not increased. Keeping an even temperature is not difficult if a large body of metal is used as indicated. After two hours, turn off the heat, but keep the high-voltage supply on. When the insulating material has cooled down to room temperature, disconnect the high voltage.

If you wish to check the actual temperature of the electret to ascertain if it is cool, remember to turn off the high voltage. Also, do not touch the face of the electret, either at this time or at any later time, as continuous handling of the electret will eventually ruin it. When you have finished with the electret, wrap it in metal foil until you are ready to mount it in the Electrophone. Any spare electrets you may have made should also be stored in this manner.

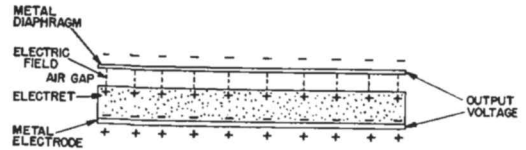

Fig. 2. Cross section of Electrophone

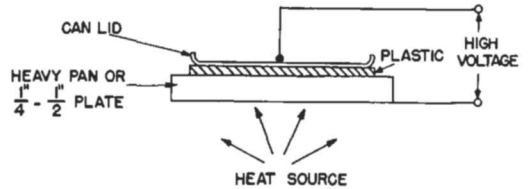

Fig. 3. Arrangement for charging the electret

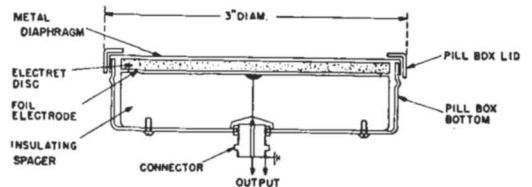

Fig. 4. Cross section of Electrophone showing constructional details

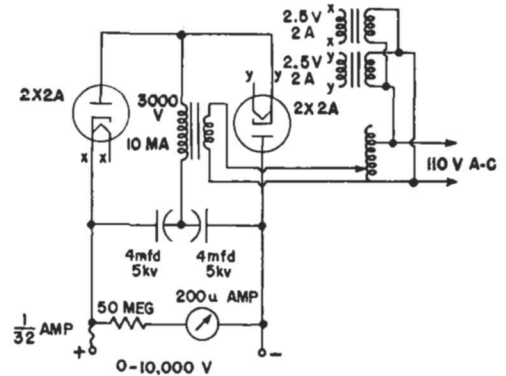

Fig. 5. High voltage power supply suitable for making electret

COMPLETING THE MICROPHONE

Amateurs with machine shop facilities will no doubt be able to make a very fancy housing for the microphone, but metal pill boxes or salve cans, three inches in diameter and one inch thick are available at most drug stores or drug supply houses, and these make an ideal case for the Electrophone. The photo-

graphs show quite clearly how these salve cans are employed. The top of the salve can can be used as the top electrode when making the electret, as it has a rounded and curved-up edge which helps prevent voltage flashover.

After the can top has been used in this manner, the center of it may be cut out as shown in Fig. 1. The hole should have a diameter of approximately $2\frac{3}{4}$ inches. A standard meter punch may be used, or the area may be chiseled out neatly.

The next step is to provide the main body of the salve can with a connector of some sort. The type shown in Fig. 6 is a standard microphone connector

of the sort that you might normally put on the chassis of your speech amplifier. Mount this connector in any convenient manner.

Referring to the cross-section view of the Electrophone, Fig. 4, you will note that an insulating spacer is required. This can be almost any substance, although the regular plastics will probably work the best. Its diameter should be such as to clear the inside of the can (in our case $2\frac{7}{8}$ inches) and its thickness should be adjusted to locate the outer surface of the electret just flush with the edge of the can, as shown in the sketch. Two holes may be drilled and tapped in the bottom of the insulating material to hold it to the bottom of the can.

A clearance hole for the output connector must be placed in this plastic, and also a hole must be drilled through the piece, in the center, in order to make contact with the foil on the bottom of the electret. To mount the insulating spacer, first solder a piece of bare wire to the output connector, then slip the insulating spacer into the can while feeding the wire through the center hole in the spacer. Next, fasten the spacer down with the machine screws and cut off the wire that protrudes above the spacer.

With a hot soldering iron a little depression about $\frac{1}{4}$ inch in diameter is melted out around the wire and a ball of solder formed in this depression. The solder should protrude slightly above the surface of the spacer so that it may serve as a blunt contact point.

It is now time to take the electret out of its protective foil wrapping and mount it in the can. Before this is done, however, you must prepare a piece of metal foil—preferably aluminum foil of the sort that is sold in grocery stores—to use as the back electrode on the electret. Cut a circle of foil with a diameter one-fourth inch less than that of the electret. Place this piece of foil on one side of the electret, and press it firmly in place. Make sure that you get it in the right position to start with, as you will not be able to slide the foil once it touches the surface of the electret. A suggested way to do this is to place the electret face down on a large piece of foil, then carefully place one edge of the circular piece about one-eighth of an inch from the side of the top face of the electret, and slowly lower the piece of foil, keeping hold of it until you are sure that it is centered. Once it is on, carefully, but firmly, press the foil against the electret.



Fig. 6. Rear view of Electrophone showing microphone connector

Finally, cut a larger piece of foil to use as a diaphragm, and place it over the top of the can (before the electret is put in) and fold it around the sides, trimming the edges to make a neat job. Now, remove the large piece of foil, place the electret in position, place the large piece of foil over the electret, and put the top of the can in place. The microphone should now look as shown in Fig. 1.

Ideally the top piece of foil should remain suspended above the surface of the electret with as close spacing as possible, but in the practical sense it does not matter if the foil touches the electret in a few spots. However, do not press the outer foil against the surface of the electret, as the more contact area that exists, the less output you will get from the microphone.

Many modifications of this construction will undoubtedly suggest themselves to the experimenter. The important thing to remember is that dimensions are not critical and an experimenter need not be hesitant to construct a working microphone of this type.

PERFORMANCE

Several Electrophones have been in use at W2UKL for over a year and no decrease in the output voltage of 0.02 to 0.03 volts has been observed. Some experimenters have observed electrets for twelve years without noticing any substantial decrease in charge. No attempt was made to protect them from humidity other than keeping them in their mounting cans.

No feedback troubles have been experienced and the Electrophone was merely plugged in to an existing crystal microphone input jack on the speech amplifier. The quality is good and on-the-air tests showed the Electrophone to compare favorably with a crystal microphone.

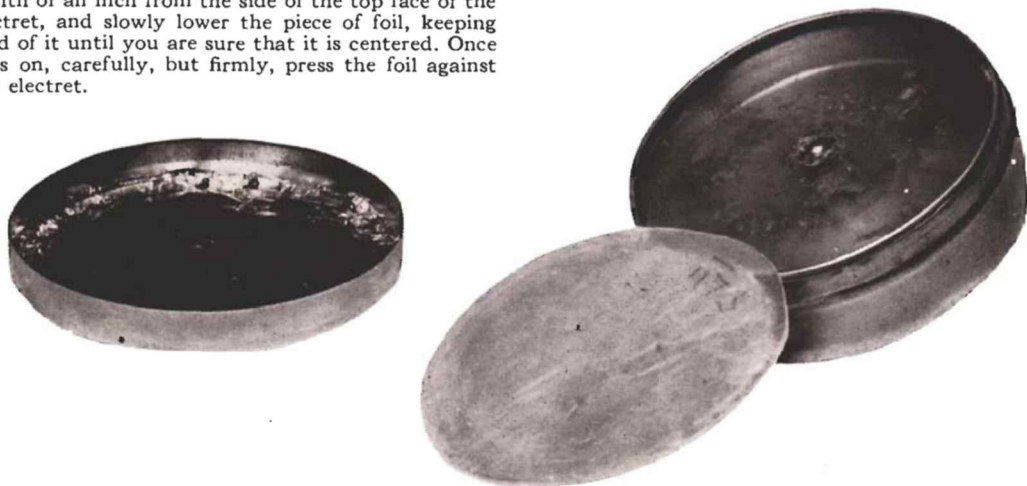

Fig. 7. Disassembled view of Electrophone

The New UHF Miniature Magnetron

The new miniature magnetron tube recently announced by the General Electric Tube Divisions will undoubtedly find itself in many ham shacks in the near future. This tube is capable of operating continuously from 30 to 900 megacycles at a quarter-watt output.

Although designed primarily for television receivers operating in the proposed ultra-high-frequency television band, the Z-2061 will find wide use wherever a low power oscillator at these frequencies is required. The price of the Z-2061 will be comparable with other television receiver tube prices, which means that the amateur finally will be able to procure a low cost tube for operation on the ultra-highs.

Up to this time, magnetrons have been used to generate the high power required for radar equipment and counter-radar equipment used extensively during World War II. During this time the magnetron was not generally thought of as a practical device for TV home receivers, but through the combined efforts of the G.E. Laboratories and the Tube Divisions, the magnetron principal has now been successfully applied to make it a useful tube for the proposed UHF television band.

Generally speaking, a magnetron is a diode which, when operated in a magnetic field, can be made to generate radio frequency oscillations. In the case of the Z-2061, the magnetic field is supplied by a doughnut-shaped magnet, which fits over the tube. The magnetic field strength required is approximately 600 gauss. When the tube circuit is initially adjusted, it is necessary to rotate the magnet until the

magnetic poles are in the proper position for operation.

A typical test oscillator for the miniature magnetron is pictured in Figs. 8 and 9. This oscillator in appearance is not unlike others with which the amateur is familiar. The circuit of the test oscillator is given in Fig. 10. It is not particularly intended to be duplicated by amateurs or experimenters but it does indicate how simple a circuit may be used.

Tuning, in the test oscillator pictured, is accomplished by changing the position of the shorting bar on the two anode lines. The oscillator pictured may be tuned over the range from 300 to 900 megacycles. Output may be obtained by coupling to the anode lines in a manner similar to the method used with other parallel line oscillators.

Internally, the Z-2061 consists of eight vanes arranged in a circle around the cathode. Alternate vanes are connected together, so that each anode consists of four vanes. The entire tube is therefore seen to consist of 8 vanes, a cathode and a filament. Dimensions internally are large enough so that no critical spacing is involved.

Tests indicate that the tube has good frequency stability, both for voltage changes and magnetic field variations. Further, the hum and noise level is down more than 60 db below carrier level.

An early issue of the *Ham News* will give constructional data on equipment designed for amateur services and employing the Z-2061.

—Lighthouse Larry

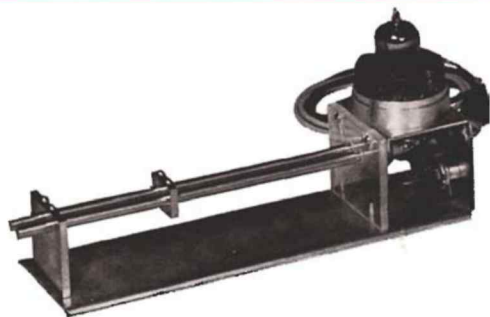

Fig. 8. Experimental test arrangement for Z-2061 magnetron

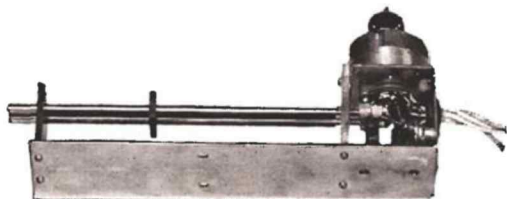

Fig. 9. Underside view of Z-2061 test setup

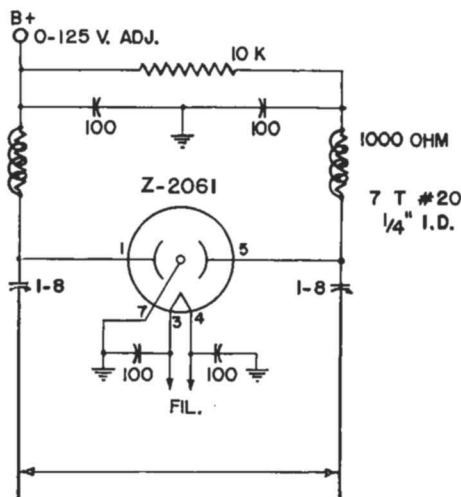

Fig. 10. Circuit diagram of Z-2061 test set

USING RESISTORS AS R-F LOADS

The practice of testing an amateur transmitter while it is coupled to an antenna is quite common, despite the fact that the F.C.C. frowns on such doings. While testing an antenna system, of course, it is necessary to be on the air, but for most transmitter tests a dummy load is desirable. Use of a dummy antenna not only obviates unnecessary QRM but, if a known dummy load is employed, quantitative measurements of actual power output can be obtained.

The purpose of this article is to explain how to procure a good dummy load, and how to use it.

TYPES OF DUMMY LOADS

Anything which will absorb power and not act as an efficient r-f radiator may serve as a dummy load. As we know, an electric light bulb can be used. As a matter of fact, it is possible to use a tub of salty water as a dummy load. In actual practice most amateurs use either a light bulb or non-inductive resistors.

Electric light bulbs have one big disadvantage, and that is, their resistance varies with the amount of current passing through them. If the resistance of a dummy load is not known accurately, then it is impossible to make any accurate output measurements. However, in the case of the light bulb, most amateurs judge output by the amount of brilliance in the lamp. Unfortunately this can be most misleading, because a large change in the amount of power dissipated may be indicated by an imperceptible change in brilliance.

Non-inductive resistors are perhaps the logical choice for use as dummy loads, if only because they have fewer disadvantages than other types of loads. The cost of these units is surprisingly low, and properly handled, they will be a permanent investment. For this reason all further discussion will be restricted to the use of resistors as dummy loads.

RESISTORS IN GENERAL

Many different types of resistors are currently manufactured, but those in widespread use fall into two general categories: the composition type and the wire-wound type. Composition resistors are seldom used for dissipation of more than 2 watts, although they are available in 5 watt sizes. Wire-wound resistors are available with dissipation ratings up to 200 watts.

Composition types of $\frac{1}{4}$, $\frac{1}{2}$, 1 and 2 watt ratings

are made in resistance values from 10 ohms to 20 megohms. For lower resistance values, these same wattage ratings can be obtained in wire-wound units only. For example, one manufacturer makes $\frac{1}{2}$ watt wire-wound units in the resistance range from 0.47 ohms to 820 ohms.

Wire-wound units can be obtained in resistance ranges from a few tenths of an ohm up to 250,000 ohms, but not all wattage ratings and styles are available over this complete resistance range.

All resistors will not serve as usable dummy loads. Those which are usable are the composition type and the non-inductive wire-wound type. The criteria here is lack of inductance.

A wire-wound *inductive* resistor will not serve as a dummy load at radio frequencies because its relatively high inductance will not permit a current flow unless a tremendous voltage is available.

For example, assume that a regular inductive resistor has an inductance of 100 millihenrys, and a resistance of 100 ohms. An inductance of 100 millihenrys at 14 megacycles is an inductive reactance of 9,000,000 ohms! One ampere of current, representing a real power of 100 watts into this resistor, would require that 9,000,000 volts be applied to the resistor. This example assumes that the inductive resistor had zero capacitive reactance, which is not possible, but

the example does serve to illustrate why it is difficult to get power into an inductive resistor at these frequencies—unless a difficult tuning job is attempted.

COMPOSITION RESISTORS

A simple equivalent circuit of a composition resistor is shown in Fig. 12-A, where R is the d-c resistance and C the total capacitance across the resistor. The equivalent circuit will not hold strictly true for all frequencies but it suffices for most generalizations.

At frequencies up to approximately 100 megacycles the inductance may be neglected (except for very low values of resistance). The total capacitance is also low, being less than one mmf (when considering composition resistors in the resistance range below 1000 ohms). The effective capacitive reactance is high enough that it presents no problem.

In other words, composition resistors are good for use at radio frequencies. They will act as though they are a pure resistance—within limits. The main disadvantage of these units is that they are available only in low-wattage styles. This need not be too serious a drawback, as will be explained later.

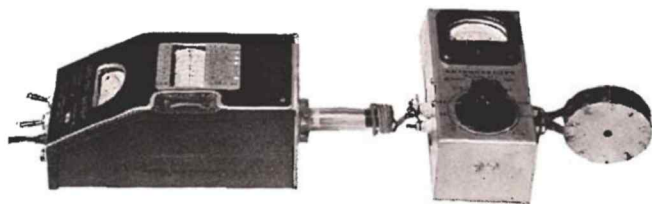

Fig. 11. Arrangement used for testing resistors

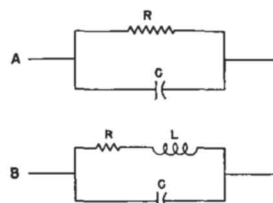

Fig. 12. Equivalent circuits

WIRE-WOUND RESISTORS

Fig. 12B shows the simple equivalent circuit of a wire-wound resistor. This will hold true in a general way for both inductive and non-inductive units, where R is the d-c resistance, C the total capacitance, and L the total inductance. In the case of non-inductive units, L is the residual inductance. However, because of such factors as skin effect and dielectric loss there will be some limiting frequency where this circuit is no longer valid.

As frequency is increased the inductive reactance increases proportionately and the capacitive reactance decreases proportionately. Both of these effects are undesirable. Regular wire-wound resistors cease to be resistors in the true sense of the word at frequencies slightly above the audio range.

For radio-frequency uses it is necessary to go to the so-called non-inductive resistors. These are manufactured in such a way that the inductance is kept at a minimum. One popular scheme is the Ayrton-Perry winding in which two layers of wire are wound in opposite directions. As an example of what may be accomplished, one manufacturer states the inductance of a wire-wound unit at 66 microhenrys and the inductance of an identical value non-inductive unit at 0.6 microhenrys.

Generally speaking, non-inductive wire-wound resistors are not as good for use at radio frequencies as composition resistors, but the wire-wound units are capable of dissipating a great deal more power, and by the proper choice of unit satisfactory operation may be obtained.

POWER CONSIDERATIONS

Before discussing which resistor to use where, it might be well to consider power ratings. If you have a kilowatt transmitter, with an output of 750 watts, it might seem necessary to have a dummy load capable of dissipating this amount of power. However, this is not true, because it is possible to use resistors (both the composition type and wire-wound type) at several times their rating.

Tests have been made to determine the amount of overload which may be placed on resistors, and the following conclusions may be drawn. A resistor, or resistors of the composition or wire-wound type, may be used at 300% overload if the overload is applied for not longer than one minute, and if a fifteen minute cooling-off period is allowed between successive on periods.

Inasmuch as most tests can be conducted in a sixty-second on period, there is no need to use resistors which are capable of dissipating the full amount of power. As a matter of fact, if it is desirable to use resistors for long test periods, it may be necessary to have a safety factor involved unless adequate ventilation is provided for the resistors. That is, for long test

periods, you should use resistors capable of dissipating twice the power you apply to them.

CHOOSING A RESISTOR

Now that we have a general idea of the power rating we may need, let's see what resistors we can use for various power levels.

For measurement or antenna matching work, where you usually use your VFO or a grid-dip meter for a power source, half-watt composition resistors are adequate, power-wise. For impedance values of 50, 75 or 100 ohms, single unit $\frac{1}{2}$ watt resistors are good up through 150 megacycles. For 300 ohm work, a single 300 ohm resistor is not satisfactory, as the effective capacitive reactance starts to show up at 100 megacycles. However, two 150 ohm $\frac{1}{2}$ watt resistors in series are satisfactory up to 150 megacycles.

No tests were made on resistors of more than 300 ohms resistance, but it is obvious that the capacitive reactance will be a factor to be considered, so that higher and higher values of resistance will be "pure resistance" only for lower and lower frequencies.

Dummy loads capable of handling sixty watts (the output of a 100 watt input transmitter) can be made by employing 2 watt composition resistors. Ten 2 watt resistors will dissipate twenty watts, which, with our factor of three employed, allow their use as 60 watt loads. Obviously, these resistors can be placed either in series or in parallel, but tests indicate that it is desirable to make these loads as follows.

For a 50 ohm load use ten 500 ohm resistors in parallel. For a 75 ohm load, use ten 750 ohm resistors in parallel. For a 300 ohm load, use ten 30 ohm resistors in series. All of these combinations give good results as dummy loads up to 150 megacycles.

The proper way to parallel resistors is indicated in Fig. 13. Make two circular disks of copper or brass, and drill ten holes, equally spaced, around the edge of each disk. Mount the resistors between the disks and solder each lead to the disk. If desired, a coaxial fitting may be mounted, as shown, or broad straps may be soldered to the two disks.

If you use a 300 ohm load, the resistors should be in series. The best way to do this is to make two sets of



Fig. 13. Examples of parallel-connected resistors



Fig. 14. Examples of high-power resistors



Fig. 15. Low-power resistor examples

five resistors, each set in a straight line, then connect one end of the two sets together. This brings the two leads of the composite resistor adjacent to each other. All leads in the series string should be as short as possible.

Dummy loads capable of handling 300 watts can be made from ten 10 watt non-inductive resistors. For a 50 ohm load, use ten 500 ohm resistors in parallel. For a 75 ohm load use ten 750 ohm resistors in parallel. For a 300 ohm load, use ten 3000 ohm resistors in parallel. All three combinations are usable to 150 megacycles if the units are paralleled as described before.

Dummy loads for powers above 300 watts can be made in a variety of ways. The best load, as indicated by a series of tests, is a series-parallel combination of 10 watt non-inductive wire-wound units. For example, ten 1500 ohm 10 watt resistors in parallel, connected in series with a similar unit, gives a 300 ohm load capable of handling 600 watts.

Higher wattage resistors can also be used, and tests have been run on all the resistors shown in the photographs. In general, it becomes increasingly difficult to make good dummy loads as the power requirements are raised. Non-inductive resistors with power ratings of 50, 100, 120 and 160 watt ratings have too much residual inductance to be used, singly, at frequencies higher than approximately ten megacycles, unless compensating capacitance is used in series with the resistors.

For example, a typical resistor with a residual inductance of two microhenrys requires a series capacitance of approximately 100 mmf at ten megacycles in order to be a "pure resistance."

Placing these larger-wattage resistors in parallel will decrease the effective inductance, but not suffi-

ciently, unless a large number of them are so connected. They can be used singly, or in pairs, if you wish to "tune out" the series inductance by means of a series capacitance.

USING A DUMMY LOAD

There are a few precautions to be observed when connecting a dummy load to a source of power. One, make as direct a connection as possible, and use low inductance leads, such as copper straps.

Two, keep the dummy load away from metallic objects, in order to avoid an unbalance to ground. Three, keep the dummy load well in the clear so that adequate air circulation is assured.

FINAL NOTES

The information just given on non-inductive resistors is intended as a general guide to the selection of such resistors. Rigorous and complete tests are quite difficult to make, especially when a large variety of resistors is considered. Most of the data given was determined by the test arrangement shown in Fig. 11, which consists of a Millen grid-dip meter and an Eldico Antennascope. This sort of test permits a practical answer to be obtained quite easily.

The wire-wound resistors tested were made by Ward-Leonard, Sprague and Ohmite. These three companies have standard lines of non-inductive resistors which are readily available.

—*Lighthouse Larry*



Ham News

Available FREE from

G-E Electronic Tube Distributors

Printed in U.S.A.

FROM:

A Bi-monthly Publication

TUBE DIVISIONS, ELECTRONICS DEPARTMENT

GENERAL  ELECTRIC

SCHENECTADY 5, N. Y.

(In Canada, Canadian General Electric Company, Ltd., Toronto, Ont.)

GEO. H. FLOYD, W2RYT—EDITOR