

THE CROSLEY BROADCASTER

VOLUME 14

MAY 15, 1935

NUMBER 6

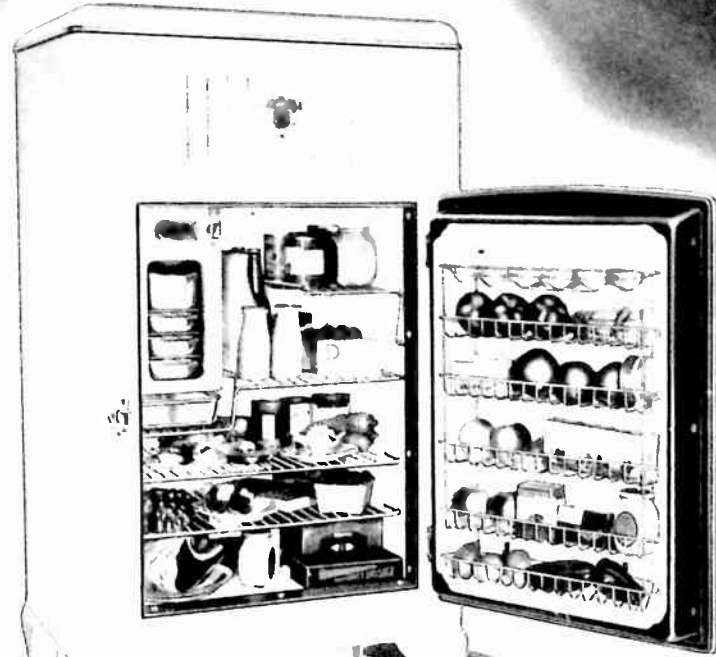

BREAKING SALES

RECORDS EVERYWHERE



TALKS TO THE

TRADE

P O W E L C R O S L E Y , J R . S A Y S :

THE backbone of any business is reputation and certainly nothing can build a better reputation for a dealer than to sell merchandise of the finest quality. It is hardly necessary to point out the excellent reputation enjoyed by dealers everywhere who are linked with the Crosley Shelvador. As a Shelvador dealer, you are of course impressed with the intense enthusiasm expressed by housewives who are daily enjoying the Shelvador. These same housewives are so completely satisfied with their purchase that they are proud to tell others of the Shelvador and of you. When you sell a Shelvador, you are creating additional good will and building the sort of reputation to which all dealers aspire—you are known to handle the very finest.

For that is exactly the Shelvador—the very finest! Its outward quality is instantly apparent—it has unparalleled beauty, matchless conveniences and advantages. Its inherent quality is equally outstanding—as attested to by the thousands of users who have praised the long, trouble-free, economical, dependable service. Although Shelvador refrigerators incorporate everything that could be desired and more, they are priced most attractively.

That's why the Shelvador is found in the finest homes in the land—where quality is of utmost importance and price doesn't matter. That's why the Shelvador is enjoying such sweeping popularity everywhere. That's why "no dealer can afford **not** to handle Shelvador."

NO DEALER CAN AFFORD NOT TO HANDLE CROSLLEY



T H E C R O S L E Y B R O A D C A S T E R

THE CROSLLEY BROADCASTER. EARL DITTMAR, EDITOR. PUBLISHED BY THE CROSLLEY RADIO CORPORATION, CINCINNATI, OHIO. COPYRIGHT 1935. ALL PRICES QUOTED HEREIN ARE EASTERN PRICES. ALL PRICES SUBJECT TO CHANGE WITHOUT NOTICE.

Shelvador Sales Records Shattered . . .

"Sitting on top of the world" is literally true when you stop to consider the sales records that are being shattered everywhere by Shelvador this year. Sales by distributors to dealers for the first three months of 1935 are approximately 400 per cent ahead of the same period of last year. Orders for trainload after trainload are being received at the factory from distributors. 125 carloads! 140 carloads! 80 carloads! 45 carloads! These and many others are *single orders!*

The factory is being pressed by the distributors and dealers to rush shipments to meet the demands of their customers. The factory production has been exceeding the estimated daily capacity of 2,000 and has run as high as 2,600 Shelvador refrigerators in a single day.

These unprecedented records are proof-sufficient of the immense popularity of Shelvador—and every Crosley distributor, dealer and salesman is to be heartily congratulated on the important part he is playing in this sweeping Shelvador sales and profit victory.

Icyball Going Big . . .

Wherever people work, live or play without the aid of electricity—that is where Crosley dealers are finding a ready market for the new Crosley Icyball. This marvelous refrigerator requires neither gas nor electricity and provides all the advantages and conveniences of mechanical refrigeration for rural homes, summer camps, roadside stands, dairies, boats and other unwired places.

Everywhere, dealers are finding unlimited enthusiasm, for these un-

wired places are now being supplied with ideal refrigeration and at a price within reach of all.

Many reports from dealers indicate surprising results. Several distributors have ordered Icyball refrigerators by the carload. Some have placed their sales quota for the year at 1000 Icyball refrigerators.

The new Icyball is going over in a big way and is bringing extra sales and profits to dealers who are getting behind it. Are you taking full advantage of this *plus* business to be had in your community?

June Brides . . .

In but a few days the month of weddings will be here. This is a splendid opportunity for every Crosley dealer to make additional sales and profits by equipping the June bride's home with a Crosley Radio or Shelvador refrigerator or both.

Notices of engagements, showers, and similar affairs as well as marriage licenses will appear in your local paper. These notices are your guide to June bride prospects. Our suggestion is that you follow them up with sales literature and sales calls. Your efforts will undoubtedly be well rewarded.

Sales Sense . . .

Contrast these two incidents: In a certain town in the Middle West a salesman of electric refrigerators has called on a prospect. His entire sales presentation is devoted to a semi-technical explanation of the mechanics of the refrigeration unit and the construction of the cabinet.

A competitor salesman calls on the same prospect, shortly thereafter. His talk is centered around the theme

of convenience, economy and advantages of electric refrigeration.

Which man is going to get the order? You'll agree, of course, that, under similar conditions, the second man wins. For common sales sense tells us that after all, the average prospect is chiefly interested in the things that the electric refrigerator is going to do for him. Of course, it is wise for a salesman to be well versed in the technical and mechanical construction of his refrigerator so that he can intelligently answer any questions that might arise. But, after all, any user is mostly concerned in the degree of service he can expect from his purchase.

And this is where the Shelvador electric refrigerator gives salesmen a keen edge over all competition. It serves better by providing more usable space, greater conveniences, more advantages. In fact, the Shelvador has definite advantages that can be obtained nowhere else in the world. On top of this, the Shelvador refrigerator is a great value and experience in thousands of kitchens proves that it provides dependable, economical, trouble-free refrigeration. Those are the reasons why it has gained such tremendous popularity with housewives everywhere—why it has become the fastest selling electric refrigerator line in America.

Yes, it is good sales sense to sell Shelvador!

Shelvador Price Card . . .

Every Shelvador dealer and salesman should always carry in his pocket one of the Shelvador price cards now available. Showing the capacity, dimensions and prices of all Crosley electric refrigerator models, this card is just the thing for ready reference. Ask your Crosley distributor to provide the number you need.



Beautiful Display Attracts Widespread Attention . . .

"One of the most beautiful window displays ever seen," is the favorable comment accorded this gorgeous Shelvador display recently arranged by the Hadley Furniture Company of Worcester, Mass. In fact, it created such favorable attention that stores from other cities sent their window trimmers to see it.

Being on a prominent corner in Worcester and visible from three sides, this window display had a most excellent location.

The background was a maroon and the background striping was chromium, which created an extremely beautiful setting for the Shelvador models on display.

Effective use of display cards included cards for various features with ribbons tying them up with the actual features on the refrigerator.

Such aggressive use of window space is deserving of highest applause and will undoubtedly merit well-rewarded Shelvador sales.

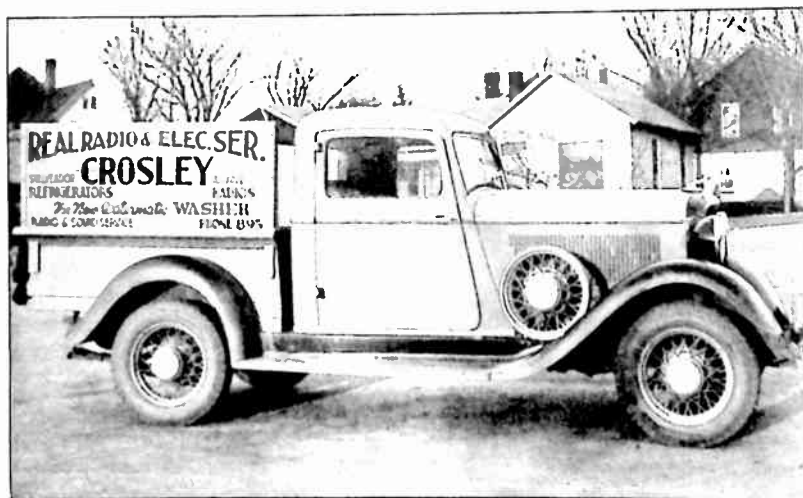

Dealer Features Crosley On Truck Sign . . .

Appreciative of the power of advertising, the Real Radio and Electric Service of Wisconsin Rapids, Wisconsin, has not overlooked the opportunity of utilizing their attractive truck as an advertising medium. The accompanying photograph shows how effectively this truck helps to keep the name "Crosley" before the people of this community. This is but one example of the aggressive methods employed by this firm to promote Crosley sales.

According to W. A. Roosevelt

Company, Crosley distributor of La Crosse, Wisconsin, this dealer is one of the most active in the territory.

Dealers Study Service At Factory . . .

G. L. Williams, Crosley dealer at Carbondale, O., and Roy Martin, service man for General Stores, Concho, W. Va., have just completed a week's training in the service department at the Crosley factory in Cincinnati.

New Dealer Orders Two Carloads . . .

The Standard Tire Co., Cedar Rapids, Iowa, has been appointed a dealer for Crosley Shelvador electric refrigerators by Herbert Hieb, president, Hieb Distributing Company, Crosley distributor of Des Moines, Iowa. Orders for two carloads of Shelvadors were placed by Ed Owens, manager, Standard Tire Co. Mr. Hieb reports that the Standard Tire Company is meeting with great success in selling refrigerators.

Famous English Actress Praises Crosley Shelvador . . .

Gracie Fields, famous English actress and noted movie, broadcasting and stage star, is an ardent admirer of Crosley Shelvador electric refrigerators.

Miss Fields is one of the most sensational successes in stage history. She achieved instant acclaim on the stage and has played the leading roles in many of the most outstanding stage successes in England. She had the lead in "It's a Bargain," which ran for two years. She played Sally Perkins in "Mr. Tower of London" that was so popular that it ran from 1918 to 1925. Her career is one outstanding triumph after another. She has recently signed movie contracts at fabulous figures.

She is equally noted for her charitable work. She maintains the Gracie Fields Orphanage at Peacehaven, near Brighton, Sussex, England, for orphans of actors.

"I chose Crosley Shelvador refrigerators for my home and for use in the Gracie Fields Orphanage at Peacehaven because the Crosley obviously holds much more than any other refrigerator of the same size I have seen," wrote Miss Fields to A. J. Balcombe, Ltd., London, Crosley distributor for Great Britain and the Irish Free State.

"The Shelvador is a really brainy idea—you can tell what a wonderful difference it makes because it has made an ordinary domestic model quite big enough for use in a big institute. What a blessing—apart from the economy—to be able to keep food fresh in such quantities and for such a time.

"And how the kiddies will love the ice cream and iced drinks which can be made so easily, and so quickly!"

Crosley Dealer Has Baseball Club To Sell Crosley Products . . .

With a championship baseball team that won the pennant in the Three Falls Cities baseball league, and furnished four players for the Louisville baseball club in 1934, Clifford Bensinger, of the Clifford Bensinger Furniture Co., Crosley dealer of New Albany and Jeffersonville, Ind., has entered the 1935 baseball season with a new four-acre baseball park at New Albany, which is situated just across the Ohio from Louisville.

The Bensinger-Crosley baseball team played 32 games in 1934 and won 28. "We have an even stronger team this year," Mr. Bensinger stated. By a coincidence he started with four new players as did Powel Crosley, Jr., president of the Crosley Radio Corporation, with his Cincinnati Reds.

So popular was the Bensinger-Crosley team that the average attendance at each Sunday game was 3500 for the entire season. In addition to the good playing of the team which was featured prominently in the sports news of southern Indiana, and northern Kentucky newspapers, the Clifford Bensinger Furniture Co. gave away a Crosley Radio or Shelvador electric refrigerator each month to the party holding the lucky ticket. This year either a Crosley radio or Shelvador will be awarded the lucky ticket holder each week. In addition all persons purchasing merchandise at the Clifford Bensinger stores at either New Albany or Jeffersonville, or paying on account, will be given one chance to win one of the prizes for each dollar so paid. Local merchants will also award various prizes this season. Advertisements in the local newspapers will announce the games to be played and the prizes to be given away at each game.

One of the features at the Bensinger-Crosley Baseball Park is an enclosed outdoor display, in which permanent showing of Crosley radios and Shelvadors will be installed. All the concessions on the grounds are equipped with Crosley Koldrink bottle coolers to insure the fans of cool, refreshing drinks.

Mr. Bensinger who began as a Crosley dealer three years ago now

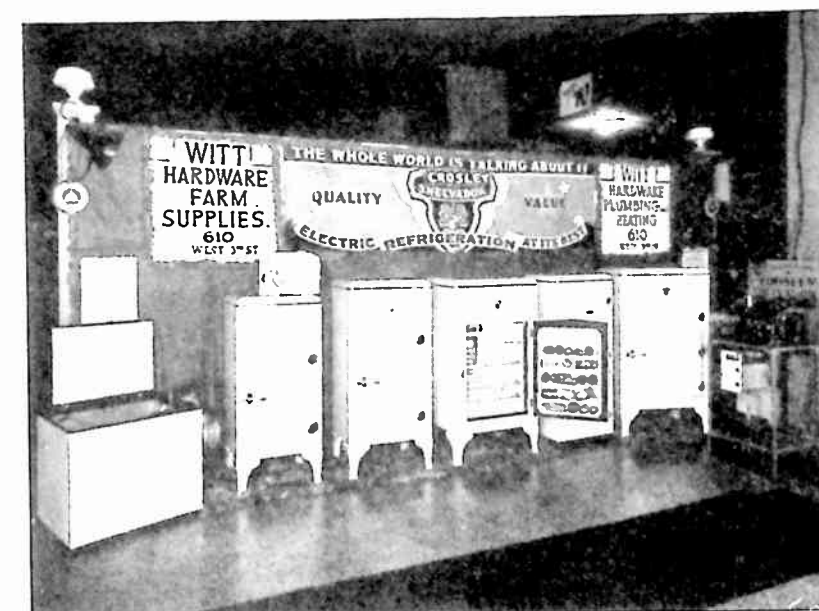

At Davenport Better Homes Exposition . . .

This attractive Shelvador display was recently arranged by the Witt Hardware Company of Davenport, Iowa, during that city's Better Homes Exposition. L. C. Wheeler, vice-president of Hardware Products

Company of Sterling, Illinois, Crosley distributor serving this territory, says, "Mr. Witt senses the market and is going after the business in an aggressive way. He will do big things this year with Shelvador."



Attractive Interior Display . . .

The Mullen Appliance Sales, Lafayette, Indiana, has an attractive store interior as can be seen from this photograph. Shelvador refrigerators

are displayed on one side and Crosley radios on the other. Kiefer-Stewart Company, Indianapolis, Indiana, is the distributor serving this territory.

sells only Crosley radios and Shelvador electric refrigerators. He developed the baseball club himself; but this season, J. E. Johnson, president, and S. J. Rapier, vice president,

Cooper-Louisville Co., Crosley Distributor, Louisville, are associated financially in the project with Mr. Bensinger.



Novel Display At Amarillo . . .

This display of Shelvador refrigerators at a show in Amarillo, Texas, contained a rather novel and very effective feature. A show case of eleven cubic foot capacity was refrigerated by a unit taken from a 6 cubic foot Shelvador. Also the show case con-

tained food items that were taken from the door of a Shelvador to prove the large amount of food that the door holds.

Ray Noblitt, manager of the Cal Farley Tire Company, Amarillo dealer who sponsored the display, stated

Distributors Visit Crosley Factory . . .

J. E. Johnson, president, Cooper Louisville Co., Crosley distributor at Louisville; Clarence S. Tay, manager Crosley Distributing Corporation, Chicago; and Fielding H. Robinson, manager, Crosley Distributing Corporation, New York, were recent visitors at the Crosley factory. All have reported large gains and sales of Crosley Shelvador electric refrigerators in their territories and state that with the warm season now at hand they anticipate greatly increased sales.

that this Shelvador exhibit attracted more attention than any other line at the show. Good results are anticipated as several hundred people a day visited the booth.

The Shield Company, Crosley distributor at Forth Worth, Texas, states that this dealer is doing a wonderful job and expects to sell at least 200 Shelvadors this season.

Powerful WLW Broadcasts Feature Crosley Products

500,000-watt WLW — the world's most powerful broadcasting station is carrying these programs, devoted to Crosley radios and refrigerators, into the homes of America to keep the nation ever-conscious of Crosley products and to win prospects and sales for Crosley dealers.

(Tune in to 700 Kc.—Eastern Standard Time Listed)

MONDAY	WEDNESDAY	SATURDAY
A. M. 6:30—Top o' the Morning with McCormick Fiddlers (Crosley Battery Radios). 7:30—Cheerio (Shelvador Refrigerators). 8:15—Music by Divano (Crosley Radios). 11:30—Morning Housewarmers (Shelvador Refrigerators).	A. M. 6:30—Top o' the Morning with McCormick Fiddlers (Crosley Battery Radios). 7:30—Cheerio (Shelvador Refrigerators). 8:15—Music by Divano (Shelvador Refrigerators). P. M. 3:30—Crosley Business News (Crosley Radios for office use). 3:45—Dorothea Ponce, blues singer (Shelvador Refrigerators). 6:15—Bob Nolan (Crosley Radios).	A. M. 6:30—Top o' the Morning with McCormick Fiddlers (Crosley Battery Radios). 7:30—Cheerio (Shelvador Refrigerators). 8:15—Rhythm Jesters (Crosley Radios). 10:30—Rex Griffith, vocalist (Shelvador Refrigerators). 11:15—Nora Beck Thuman, soprano (Crosley Radios). P. M. 1:30—Crosley Business News (Crosley Radios for office use). 5:30—R. F. D. Hour—Boss Johnston, McCormick Fiddlers, Larry Greuter, accordionist (Crosley Battery Radios).
P. M. 3:30—Crosley Business News (Crosley Radios for office use). 6:15—Bob Nolan (Shelvador Refrigerators). 7:00—Virginio Marucci Orchestra (Shelvador Refrigerators).	THURSDAY A. M. 6:30—Top o' the Morning with McCormick Fiddlers (Crosley Battery Radios). 7:30—Cheerio (Shelvador Refrigerators). 8:15—Rhythm Jesters (Crosley Radios). P. M. 3:30—Crosley Business News (Crosley Radios for office use). 11:05—Zero Hour (Shelvador Refrigerators).	SATURDAY A. M. 6:30—Top o' the Morning with McCormick Fiddlers (Crosley Battery Radios). 7:30—Cheerio (Shelvador Refrigerators). 8:15—Rhythm Jesters (Crosley Radios). 10:30—Rex Griffith, vocalist (Shelvador Refrigerators). 11:15—Nora Beck Thuman, soprano (Crosley Radios). P. M. 1:30—Crosley Business News (Crosley Radios for office use). 5:30—R. F. D. Hour—Boss Johnston, McCormick Fiddlers, Larry Greuter, accordionist (Crosley Battery Radios).
TUESDAY A. M. 6:30—Top o' the Morning with McCormick Fiddlers (Crosley Battery Radios). 7:30—Cheerio (Shelvador Refrigerators). 11:00—Chandler Chats, with Organ (Crosley Radios). P. M. 3:30—Crosley Business News (Crosley Radios for office use). 5:00—Mary Alcott, blues singer (Crosley A. F. Radios). 8:30—Crosley Follies — orchestra — vocalists — dramatic skit — (Shelvador Refrigerators). 11:30—Los Amigos—Spanish Music (Crosley Radios and Refrigerators).	FRIDAY A. M. 6:30—Top o' the Morning with McCormick Fiddlers (Crosley Battery Radios).	In addition to these programs, many spot announcements boosting Crosley products are broadcast each day.

THE GREATEST SALES HELP YOU HAVE EVER HAD!

CROSLY PRESENTS NEW BEAUTY AND WORLD-WIDE RECEPTION IN THE NEW 1935 CROSLY RADIOS

● THE NEW 1935 Crosley Radios presented on this and the two following pages, have reached a new pinnacle in beauty and smartness. New, rare, and costly woods, modern and pleasing design, have set a pace for the entire radio world to follow. Likewise, these Crosley models include the latest improvements and features in radio—each giving outstanding performance for its price class. The sensational values maintain Crosley's world leadership in offering "the most for the radio dollar". Several models have the Dual Range feature—providing police, amateur and aviation in addition to standard broadcasts. The new American-Foreign and All-Wave Receivers bring a new thrill to all those interested in distant, foreign reception.

*Use code word for telegraphic orders to distributors.

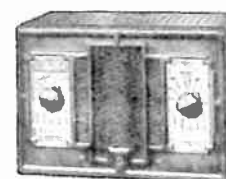

*WRCIK

\$19.99

Complete With Tubes and Fabric Carrying Case

Dimensions:
6 $\frac{3}{4}$ " high,
9 $\frac{5}{8}$ " wide,
4 $\frac{1}{2}$ " deep.

FORTY-ONE
4 TUBES . AC DC
SUPERHETERODYNE

● OPERATES on any 110 volt circuit. Has two Double Purpose Tubes, Full Floating Moving Coil Electro-Dynamic Speaker, Pilot Light, Attached Antenna. No ground required.

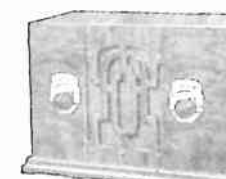

*WRCIH

\$22.50

Complete With Tubes

Dimensions:
7 $\frac{3}{4}$ " high,
10 $\frac{3}{4}$ " wide,
5" deep.

FORTY-ONE DELUXE
4 TUBES . AC DC
SUPERHETERODYNE

● OPERATES on any 110 volt circuit. Has two Double Purpose Tubes, Full Floating Moving Coil Electro-Dynamic Speaker, Pilot Light, Attached Antenna. No ground required.



*SLMII

\$19.99

Complete With Tubes

Dimensions:
11 $\frac{5}{8}$ " high,
10" wide,
7 $\frac{3}{4}$ " deep.

FIVER
5 TUBES
SUPERHETERODYNE

● RECEIVES all standard broadcasts and some police calls. One Double Purpose Tube—Illuminated Dial—Combined Volume Control and On-Off Switch. Full Floating Moving Coil Electro-Dynamic Speaker.



*SLMIR

\$32.50

Complete With Tubes

Dimensions:
17" high,
13 $\frac{1}{2}$ " wide,
8 $\frac{3}{4}$ " deep.

534 CC A. F.
5 TUBES . American-Foreign
SUPERHETERODYNE

● AMERICAN broadcasts—535 to 1730 Kc. and Foreign broadcasts 5300 to 15,700 Kc.—Automatic Volume Control—Two Double Purpose Tubes—Two Position Tone Control—Full Floating Moving Coil Electro-Dynamic Speaker.

534 QE A. F. LOWBOY

\$47.50

Complete With Tubes

Dimensions:
36" high,
22 $\frac{1}{4}$ " wide,
11 $\frac{3}{4}$ " deep.



*SLMIR

PRICES SLIGHTLY HIGHER IN FLORIDA, TEXAS, ROCKY MOUNTAIN STATES AND WEST

May 15, 1935

SIXTY-ONE A.F.



*SXHWL

\$39.95

Complete With Tubes

Dimensions:
16 1/8" high,
13 7/8" wide,
8 5/16" deep.

6 TUBES . American-Foreign SUPERHETERODYNE

• AMERICAN broadcasts—550 to 1700 Kc. and Foreign broadcasts 5,800 to 15,300 Kc.—Illuminated Airplane Type Dial—Automatic Volume Control—Three Gang Tuning Condenser—Full Floating Moving Coil Electro-Dynamic Speaker.

SIXTY-FOUR MD LOWBOY

\$54.50

Complete With Tubes

Dimensions:
36" high,
22 1/4" wide,
11 3/4" deep.

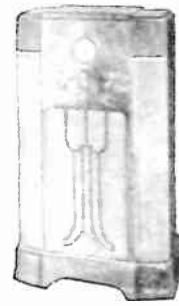

*SXHWL

614EH THREE BAND ALL-WAVE



*SXIRM

\$49.95

Complete With Tubes

Dimensions:
16 1/8" high,
13 7/8" wide,
8 5/16" deep.

6 TUBES . Three Band All-Wave Superheterodyne

• AMERICAN broadcasts—(540 to 1650 Kc.)—Police, amateur, aviation broadcasts (1650-5000 Kc.)—Foreign broadcasts (5800-15,350 Kc.)—Illuminated Airplane Type Dial—Automatic Volume Control—Three Gang Tuning Condenser—Full Floating Moving Coil Electro-Dynamic Speaker.

614PG THREE BAND ALL-WAVE LOWBOY

\$65.00

Complete With Tubes

Dimensions:
36 1/2" high,
22 5/8" wide,
12 1/16" deep.

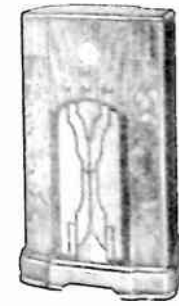

*SXIRL

714GA THREE BAND ALL-WAVE

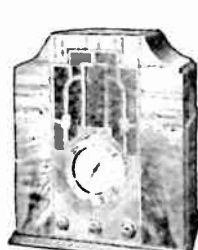

*SSIRM

\$65.00

Complete With Tubes

Dimensions:
18 5/8" high,
16 1/4" wide,
10 1/4" deep.

7 TUBES . Three Band All-Wave Superheterodyne

• AMERICAN broadcasts (540-1700 Kc.)—Police, amateur, aviation broadcasts (1700-5000 Kc.)—Foreign broadcasts (5800-15,350 Kc.)—Dual Ratio Tuning Control—Illuminated Airplane Type Dial—Automatic Volume Control—Continuous Tone Control—Full Floating Moving Coil Electro-Dynamic Speaker.

714NA THREE BAND ALL-WAVE LOWBOY

\$85.00

Complete With Tubes

Dimensions:
38" high,
23" wide,
11 1/4" deep.

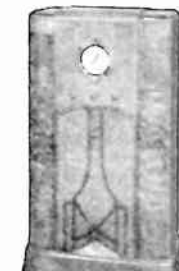

*SSIRL



*SQIRM

\$79.50

Complete With Tubes

Dimensions:
19 1/4" high,
16 1/2" wide,
10" deep.

CENTURION

10 TUBES . All-Wave SUPERHETERODYNE

• Five Tuning Bands, 150 to 22,000 Kc.—Two Double Purpose Tubes—New Illuminated Airplane Type Dial—Band Spread Pointer—Automatic Volume Control—Dual Ratio Tuning Control—Continuous Tone Control—Push-Pull Output—Full Floating Moving Coil Electro-Dynamic Speaker.



*SQIRL

\$100.00

Complete With Tubes

Dimensions:
40 1/2" high,
25 1/4" wide,
12 1/2" deep.

CENTURION LOWBOY

10 TUBES . All-Wave SUPERHETERODYNE

• Five Tuning Bands, 150 to 22,000 Kc.—Two Double Purpose Tubes—New Illuminated Airplane Type Dial—Band Spread Pointer—Automatic Volume Control—Dual Ratio Tuning Control—Continuous Tone Control—Push-Pull Output—Full Floating Moving Coil Electro-Dynamic Speaker.



*RRBI

\$19.99

Complete Less Batteries

Dimensions:
8" high,
10 1/2" wide,
5" deep.

BATTERY FORTY

4 TUBES . Superheterodyne BATTERY RECEIVER

• SUPERHETERODYNE chassis. Designed for use with the 2-volt air

cell "A" battery or regular 6-volt battery connected for 2 volts. Low battery drain. Two Double Purpose Tubes increase the efficiency to that of an ordinary six tube set. Pentode Output. Permanent Magnet Speaker.



*RLBMM

\$29.95

Complete Less Batteries

Dimensions:
13 3/8" high,
10" wide,
8 1/2" deep.

BATTERY FIVER

5 TUBES . Superheterodyne BATTERY RECEIVER

• GENUINE superheterodyne chassis. Designed for use with 2-volt air-cell "A" battery. Has Pentode Output, Airplane Type Dial, Permanent Magnet Speaker.

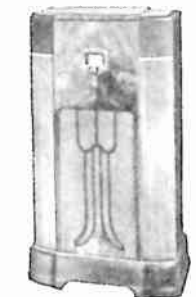

*RLBML

\$49.95

Complete Less Batteries

Dimensions:
36" high,
22 1/4" wide,
11 3/4" deep.

BATTERY FIVER LOWBOY

5 TUBES . Superheterodyne BATTERY RECEIVER

• GENUINE superheterodyne chassis. Designed for use with 2-volt air-cell "A" battery. Has Pentode Output, Airplane Type Dial, Permanent Magnet Speaker.



*RXBBI

\$69.50

Complete Less 6-Volt Battery

Dimensions:
19" high,
15 3/4" wide,
9 5/8" deep.

BATTERY SIX

6 TUBES . Three Band All-Wave Battery Receiver

• SIX-TUBE Superheterodyne—Operates from 6-Volt Storage Battery—No "B" Batteries Required—Three

Tuning Bands (Standard Broadcasts 540-1700 Kc.—Police, Amateur, Aviation Broadcasts 1700-5000 Kc.—Foreign Broadcasts 5800-15,350 Kc.)—Automatic Volume Control—Airplane Type Dial—Continuous Tone Control—Moving Coil Permanent Magnet Speaker.

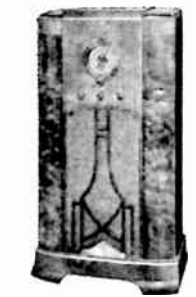

*RXBIL

\$84.50

Complete Less 6-Volt Battery

Dimensions:
38" high,
23" wide,
11 1/4" deep.

BATTERY SIX LOWBOY

6 TUBES . Three Band All-Wave Battery Receiver

• SIX-TUBE Superheterodyne—Operates from 6-Volt Storage Battery—

No "B" Batteries Required—Three Tuning Bands (Standard Broadcasts 540-1700 Kc.—Police, Amateur, Aviation Broadcasts 1700-5000 Kc.—Foreign Broadcasts 5800-15,350 Kc.)—Automatic Volume Control—Airplane Type Dial—Continuous Tone Control—Moving Coil Permanent Magnet Speaker.

PRICES SLIGHTLY HIGHER IN FLORIDA, TEXAS, ROCKY MOUNTAIN STATES AND WEST

PRICES SLIGHTLY HIGHER IN FLORIDA, TEXAS, ROCKY MOUNTAIN STATES AND WEST



This Much More in A SHELVADOR

Nowhere else in all the world can anyone find such appealing features as are a part of the new 1935 Crosley Shelvador Electric Refrigerators. Here are features that provide housewives with everything they could desire—that carry with them such an irresistible sales appeal that the Crosley Shelvador has become the fastest growing line of electric refrigerators in America. And these features—this sales appeal is exclusive with Crosley dealers.

"This Much More In A Shelvador" is a phrase that immediately tells everyone here is greatly increased usable capacity and with this feature things are twice as easy to find. The Shelvador and the other exclusive Crosley features are **extra** features—in addition to the outstanding value, dependability, high quality, trouble-free service that characterize every Crosley model—that bring such tremendous pride and satisfaction to every Crosley Shelvador owner.

FEATURES THAT HOUSEWIVES PREFER



Automatic Interior Light illuminates interior whenever door is opened.

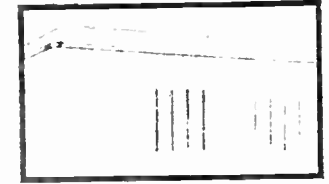

Ventilated Frost. Maintains proper circulation of air around unit.

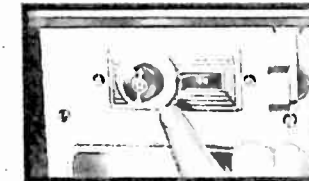

Temperature Control enables user to speed up freezing of ice cubes and frozen dishes.

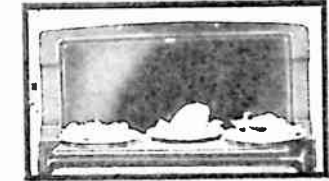

Shelvatrav. Handy auxiliary shelf and serving tray.

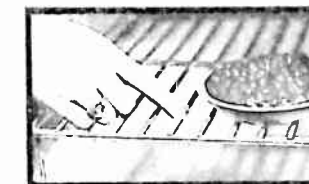

Flat Bar Shelves make it easy to slide dishes in or out.

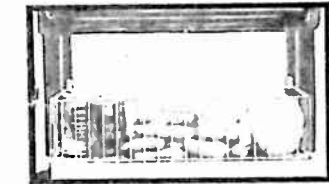

Shelvbasket. Ideal for greens, carrots, canned goods and the like.

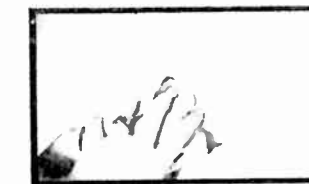

Porcelain Interior of rounded corners and stainless bottom.

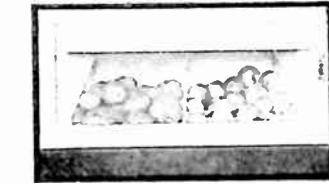

Storabin. For potatoes, onions and other bulk items.

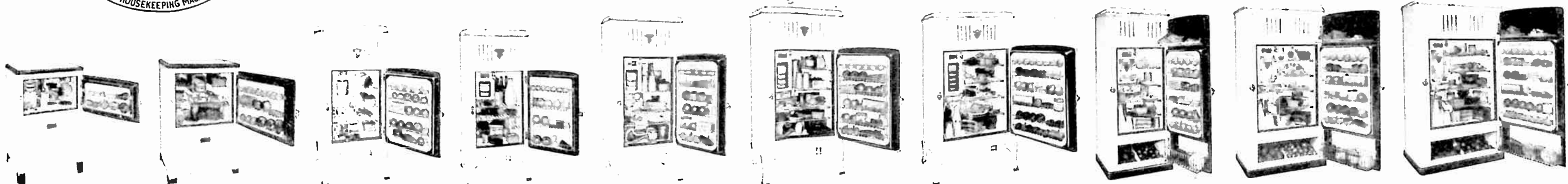

FR-20 Table Shelvador has two cubic feet NET capacity; 5.2 square feet shelf space. Two ice trays; uses Rotary compressor. Dimensions: 36" high, 23 1/2" wide, 25" deep. **\$79.50**

FR-30 Table Shelvador. 3.1 cubic feet NET capacity; 7 square feet shelf space. 2 ice trays. Uses Rotary compressor. Dimensions: 30" high, 23 1/2" wide, 25" deep. **\$94.50**

FA-35 Shelvador. 3.5 cubic feet NET capacity; 7.5 square feet shelf space. One ice tray and one double-depth tray. Dimensions: 49 11/16" high, 23 1/2" wide, 24 3/16" deep. **\$99.50**

FA-40 Shelvador. 4.09 cubic feet NET capacity; 8.6 square feet of shelf space. One ice tray and one double-depth tray. Dimensions: 52 3/4" high, 23 1/2" wide, 25 1/2" deep. **\$112.50**

FA-50 Shelvador. 5 cu. ft. NET capacity; 11.3 square feet shelf space. Dimensions: 56 1/4" high, 25 1/2" wide, 24 1/2" deep. **\$129.50**
Porcelain Exterior (PFA-50) **\$132.00**

FA-60 Shelvador. 6 cu. ft. NET capacity; 13.5 sq. ft. shelf space. Dimensions: 56 1/2" high, 30 3/4" wide, 25 1/2" deep. **\$149.50**
Porcelain Exterior (PFA-60) **\$174.50**

FA-70 Shelvador. 7.08 cu. ft. NET capacity; 14.9 sq. ft. shelf space. Dimensions: 57 1/2" high, 32 3/4" wide, 25 1/2" deep. **\$169.50**
Porcelain Exterior (PFA-70) **\$194.50**

F-43 Tri-Shelvador. 4.3 cu. ft. NET capacity; 9.15 sq. ft. shelf space. Dimensions: 56 9/16" high, 23 1/2" wide, 23 1/2" deep. **\$139.50**
Porcelain Exterior (PF-43) **\$139.50**

F-55 Tri-Shelvador. 5.51 cu. ft. NET capacity; 11.6 sq. ft. shelf space. Dimensions: 57 1/2" high, 29" wide, 25 1/2" deep. **\$164.50**
Porcelain Exterior (PF-55) **\$187.00**

F-70 Tri-Shelvador. 7.08 cu. ft. NET capacity; 14.9 sq. ft. shelf space. Dimensions: 58 1/2" high, 32 3/4" wide, 25 1/2" deep. **\$189.50**
Porcelain Exterior (PF-70) **\$219.50**

ALL PRICES INCLUDE DELIVERY, INSTALLATION, ONE YEAR FREE SERVICE ● PRICES SLIGHTLY HIGHER IN FLORIDA, TEXAS, ROCKY MOUNTAIN STATES AND WEST



Beautiful Display At London . . .

No photograph could begin to do justice to this most beautiful display of Shelvador refrigerators. It was a recent exhibit at the Home Exhibition, Olympic, London, England and was sponsored by A. J. Balcombe Ltd., London, Crosley distributor for Great Britain and the Irish Free State.

Local Testimonial Campaign Proves Effective . . .

Utilizing the pride of ownership that comes to every user of a Crosley Shelvador, the Endicott Furniture Company of Endicott, N. Y., have developed a local testimonial campaign that is both unique and effectively executed. The initial weapon of this promotional plan is to secure testimonials, which this aggressive firm is accomplishing through sending a letter to every Shelvador owner and user. The appeal of this testimonial-seeking plan is that in exchange for a short letter on the subject "Why I like my Crosley", the Shelvador user is presented with a valuable gift from the Endicott Company.

The best letters received each week are being used as the basis of this firm's local newspaper advertising campaign. The heading of one recent ad read, "Kitchen Tested! Kitchen Tried! By your Friends and Neighbors!"

Undoubtedly anyone in Endicott who needs electric refrigeration and reads a published testimonial of a

friend or neighbor will be stimulated to the point of investigating Shelvador.

Endicott and Company are to be congratulated on the creation and adoption of so effective a plan for going after Shelvador sales.

The Crosley distributor serving this territory is the Wehle Electric Company of Binghamton, N. Y.

Sells Five In Two Days . . .

A record of five Shelvador electric refrigerators being sold in the first two days of handling the line is that achieved by Letourneau Furniture Company of East Jaffrey, New Hampshire. Mr. Letourneau writes, "I am certainly glad to have taken the Crosley for my line of refrigerators. I went out and sold five (5) in two days which is more than I've ever averaged with a competitive line."

This new Crosley dealer is in the territory of Coghlin Electric Company, Crosley distributor at Worcester, Mass.

Unbeatable . . .

G. G. Kendall of Kendall's Radio Service, Keene, N. H., says that the Crosley Sixty-One AF is unbeatable. Having sold quite a few of these sets, he has experienced some remarkable feats of performance. His letter follows:

"At the present time I have one

New Massachusetts Dealer . . .

The Thompson Tire Co., Inc., with headquarters in Brockton and operating nine stores in Massachusetts, has been designated an authorized dealer for the complete line of Crosley Shelvador electric refrigerators and Crosley radios in all its stores, David Rockman, general manager, George Collins Co., Crosley distributor, Boston, announces. The Thompson stores are located in Brockton, headquarters for the company, Taunton, North Attleboro, Randolph, Stoughton and Quincy.



Display Helps Sell Shelvadors . . .

The Fair Store of Sturgeon Bay, Wisconsin, recently featured the Shelvador in this attractive window display executed by George McCormick of that company. According to W. J. Grall of the Fair Store, this display created favorable comment and was of material assistance in selling several Shelvador refrigerators.

customer that is running a Model 61 with a stove poker for an antenna and he has received Moscow, Russia. I very often demonstrate these sets by using a small screw driver and even my finger as an antenna. Why I have even had Paris, using a dime as an antenna.

"In my shop I have a fine antenna for world wide reception and have logged stations all around the world with the Crosley 61. I defy any competitive make to beat the 61 for performance or price or any way you want to take it."

Ott-Heiskell Puts On Shelvador Program . . .

Twice a week the Shelvadorians bring an interesting program of radio entertainment over WWVA, Wheeling, W. Va. The programs are sponsored by the Ott-Heiskell Company, Crosley distributor of this city, and ten Crosley Shelvador electric refrigerator dealers, who share the cost mutually. This is the third season the Shelvadorians have been heard over this station. They continue through the active refrigerator selling season. One of the features of the program is the cleverly dramatized announcements advertising Shelvadors. Station WWVA reaches a large number of listeners and the program has always proved very productive, states Henry G. Roth of the Ott-Heiskell Company.

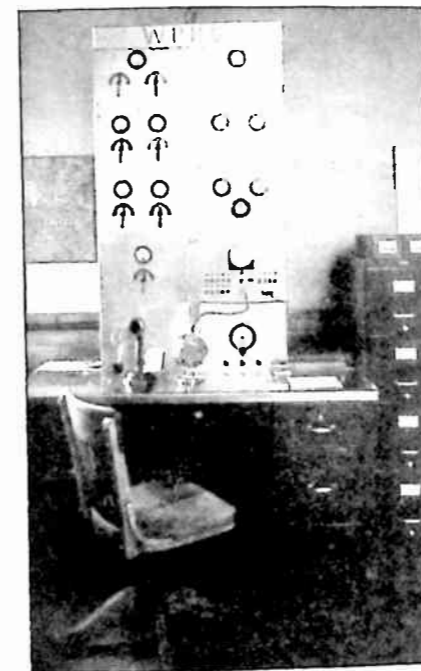

Centurion Used As Police Equipment . . .

Built into the instrument panel of the new Bristol, Virginia-Tennessee Police Transmitter which has recently been completed, is a Crosley Centurion chassis. Mounted on the lower right hand panel, this radio is used for receiving purposes. "The boys say it is doing the job in fine style," says J. I. Cecil of the Interstate Hardware Company, local Crosley distributor. "In addition to using the Crosley set in the Police Station, their Police cars are also equipped with Crosley Roamios," he adds.



Carload Of Shelvadors . . .

The trucks of the Clifford Bensing Company, New Albany and Jeffersonville, Indiana, are lined up ready

Sells 14 In One Day . . .

The sale of fourteen Crosley Shelvador electric refrigerators on a single Saturday by Cal Farley, Crosley dealer at Amarillo, Texas, is reported by C. B. Savage, of the Shield Company, Inc., Crosley distributor at Fort Worth. In reporting this record sale, Mr. Savage says, "This is very good work, particularly when the plight of the Panhandle territory is considered."

An interesting sidelight reminiscent of the early Southwest, is given to the story by Mr. Savage. "In the sale of three of the fourteen Shelvadors, three families had journeyed into Amarillo from their homes five miles north of Tascosa, located in Oldham County. Tascosa was the capital of this part of the country in the buffalo and early cattle days, and was a town of considerable repute in gambling, shooting and other roughness incident to early settlements.

"These three families live on what is known as Boot Hill. It was the cemetery for Tascosa in the old days and derived its name from the fact that the dead men shot in Tascosa were buried with their boots on in that cemetery. The three families stated that they had looked over all the makes of refrigerators on display in Amarillo and had come to the conclusion the Shelvador was what they wanted. A slight argument arose be-

to start delivering a carload of Shelvador refrigerators—a convincing example of the rewards that come to aggressive Crosley dealers.

Anchor Lite Names Eighteen Shelvador Dealers In Week . . .

Harold Goldstein, president, Anchor Lite Appliance Company, Crosley distributors, Pittsburgh, Pa., reports that Crosley Shelvador electric refrigerators are making tremendous gains in popularity in Western Pennsylvania. In one week recently, Mr. Goldstein reported eighteen new dealers in his territory. They are Spear & Company, Frank & Seder, Wurlitzer's, all of Pittsburgh; Hart's, Inc., East End, Pittsburgh; R. E. Kaplan, McKeesport; Hanley's, New Castle; Frank Levin, Jeanette; R. E. Canon, Franklin; Milleman Music Co., Ambridge; Milheim Music Co., Butler; Miller & Bigg, Latrobe; Swank Hardware, Johnstown; Dubois Furniture, Dubois; Adelman & Ratowsky, Philipsburg; Schmitt Battery & Electric Co., Homestead; W. H. Fisher, Verona; Hill & Leresch, Wilkinsburg; and Winter Music Co., Altoona.

tween them as to when they were going to make their purchases. They decided to settle the issue by tossing a coin. So a nickel was tossed with 'heads up' for the immediate purchase. And 'heads up' it was and the sale was made immediately, giving three sales in a bunch to make up the fourteen."



At "Newark On Parade" Electric Show . . .

When thousands of people recently visited the "Newark On Parade" electric show, they were greeted by this attractive exhibit of Shelvador refrigerators. According to Tod Harrison of the E. A. Kirch Company, Newark, N. J., one of the dealers who sponsored the display, the results secured through this effort have

been very favorable.

Other dealers in the territory of Apollo Distributing Company, local Crosley distributors, took turns in sponsoring the display. These were Kresge Department Store and Goerke and Son, who report the receipt of numerous prospects through this effort.

Real Merchandising Program Sells Shelvadors For Apollo . . .

A merchandising program not only to sell Crosley Shelvador electric refrigerators to dealers, but to help the dealers sell them to users, is aiding the Apollo Distributing Company of Newark, N. J., to dispose of its million-dollar order of Shelvadors as fast as the factory can ship them.

Fred Goldberg, treasurer of Apollo, says, "We have lined up every large department store in Newark—L. Bamberger & Company, Kresge Department Store, Hahne & Company and Goerke & Son. Several days ago Kresge Department installed a refrigerator window and they informed us that they obtained 24 leads through the display in a few days and that they felt sure 75 per cent would result in sales.

"Recently we appointed Goldberg, Inc., one of the leading department stores in Trenton, who are carrying Crosley Shelvadors exclusively. The Block Boys and Harry Brody, proprietors of General Supply Company, Hackensack, N. J., have to date sold 87 Shelvadors."

Assisting the efforts of a highly skilled field sales force, is direct-mail coaching of dealers in taking the fullest advantage of the Shelvador exclusive features which make them appeal to housewives. Dealers are not only urged but shown how to make the best use of the many Crosley promotional items and direct consumer sales helps.

In order that a new high sales record may be hung up, Apollo has given all dealers in its territory a carefully worked out quota.

Spear Service Manager Sees How Shelvadors Are Made . . .

Arthur A. Hinchcliff, manager of the service department of Spear & Co., large Crosley dealer of Pittsburgh, made a tour of inspection of the Crosley factory here recently. This store, which is the largest furniture house in Western Pennsylvania, has handled Crosley Shelvadors since they were introduced.

Mr. Hinchcliff stated that their store has been completely modernized, and that the electric appliance

FCC Authorizes Full Time 500KW Power For WLW . . .

WLW resumed full time operation at 500,000 watts power at sundown May 9th on authority of the Federal Communications Commission.

For the past three months WLW has been operating after local sundown with a power reduced to 50,000 watts pending completion of new antenna equipment designed to reduce WLW's signal in the Toronto (Canada) area. Steps to reduce the Crosley station's signal in this territory were taken following the Canadian government's complaint that Cincinnati's super-powered station—the most powerful in the world—interfered with local night time reception of station CFRB, Toronto.

The FCC action followed exhaustive tests by government engineers of WLW's new antenna equipment. Satisfactory reduction of the station's signal in the Toronto area was reported to the commission.

The new equipment—first of its type ever used in commercial broadcasting—differs, according to J. A. Chambers, WLW Technical Supervisor, from the usual directional antenna in that it achieves both horizontal and vertical radio directivity. The Crosley antenna system, in other words, reduces WLW signal strength in a specific spot location without a similar reduction in intervening territory and without jeopardizing the station's service in other directions by high angle interfering radiations. Because of its unique function, Engineer Chambers has named the new antenna a "suppressor" antenna. More than \$30,000 was spent in its design and construction.

Uninterrupted broadcasting at full 500,000 watts power was resumed on May 9th.

department is housed in an annex to the main building. Both the store exterior and interior are strikingly beautiful in their modernistic design, settings and furnishings, and have attracted widespread attention. A. J. Buzzard is manager of the Electrical Appliance Department.

Mr. Hinchcliff said that business has been slow in starting in Pittsburgh, but that it has now shown a decided turn for the better and that Spear & Co. expects to have the largest business in the history of the store this year.

Shelvadors Show Steel-Body Autos They Can Take It, Too . . .

All kinds of stunts have been improvised to show the durability of steel-body automobiles; but it remained for an accident that Marvin C. Moody, Crosley dealer of Louisville, Miss., had with a Crosley Shelvador electric refrigerator to prove that none of these automobiles have anything on a Crosley Shelvador's ability to "take it."

Mr. Moody had sold an FA-50 Shelvador to a lady in town, and not having a delivery truck himself asked a local grocery man by the name of Richardson to make delivery for him. Mr. Richardson happens to be a disciple of Sir Isaac Walton, and being in a hurry to get to a spot where the fish were waiting with eager appetites, he picked up a colored boy to hold the box on the truck. Speeding around a corner at the post office in the center of the town at the rate of about 30 miles an hour, the boy and the refrigerator both were shot out from the rear of the truck, falling from a height of seven feet to the brick pavement. Mr. Moody was driving behind the truck in his car and had to pull to one side quickly to avoid running into the refrigerator.

"I was heartbroken," says Mr. Moody, "for it was the only box of this size I had and I couldn't afford to lose a refrigerator. We picked up the top which had sailed through the air, and found it was not damaged in the least, nor even scratched. Then we loaded the Shelvador back onto the truck and took it back to the store, taking another Crosley to the lady so that she would have refrigeration until we could get another Shelvador for her like the one she had ordered.

"We taped the cord in three places where it had been cut by broken glass from the glass tray which fits beneath the ice compartment—which proved to be the only thing broken in the fall. Even the electric light in the cabinet was not injured and burned brightly when the current was turned on. We took out the plate on which the motor and compressor are mounted, straightened it out and put it back in place, plugged the cord into a light socket, and the refrigerator ran as if nothing had

(Continued on Page 16)



Rosenfield's Gets Solid Carload Of Shelvadors . . .

Rosenfield's, for more than 81 years a leading house furnishing store in Baton Rouge, La., recently received a carload of Crosley Shelvador electric refrigerators. The picture shows the car as it was placed on the siding with the men who comprise the Rosenfield refrigerator sales personnel. From left to right, they are: R. E. Berkey, department head and sales manager; Leo Higginbotham and Cecil Boring, salesmen; and Albert J. Weilbaeher, representative for Louisiana and Southern Mississippi. L. S. Melton, another salesman for Rosenfield's, was not present at the time the picture was taken.

Attention is also called to the beautiful new delivery truck which was especially purchased for the delivery of Shelvadors and Crosley radios exclusively. Snow white with apple green fenders and gold lettering, this vehicle makes a striking appearance and advertises Rosenfield's and Crosley products.

"While the Crosley refrigerator department at Rosenfield's is but a few weeks old, the demand for Shelvadors has been so great and sales so much better than anticipated, that the management decided to purchase them in carload lots, thus enabling us to show the complete line at all times in our sales rooms on the mezzanine floor," stated R. E. Berkey. "Then, too, we are anticipating a tremendous business this summer and due to the great factory demand, we found it necessary to contract a carload so that we may give prompt delivery on any model our customers may choose." J. B. Caradine, general manager of Rosenfield's, stated that he is well pleased with the progress made by the Crosley Shelvador refrigerator department since its formal opening. Saturday, March

16, and looks forward with great expectations to the greatest refrigeration year in the history of the city, O. G. H. Rasch, secretary-treasurer, Interstate Electric Co., Crosley distributor, New Orleans, states.

"It Takes The Cake" . . .

Henry Wright of Cleveland, Ohio, is so enthused over his Crosley Sixty-One AF that he has written the following complimentary letter:

"I have owned a good many receivers, both long and short wave, but this Crosley 'takes the cake'! For stepping out and really getting to the other parts of the world, it certainly makes a fellow feel good—especially when he can show his friends the kingpin of the lot. It is one of the very few and far between sets that really performs like it is advertised. The Crosley does this and then some.

"I live on a street with a car line on it; also there is a factory across the way and high power lines of the Cleveland Electric Company. So again I say that is why this set has certainly made me a Crosley booster.

"As I write I am listening to music from Zeesen, Germany. I have had programs from Monte Carlo; Tokyo, Japan; Madrid, Spain; Santa Domingo; Barraquilla, Colombia, S. A.; Daventry, England, and over fifty more that I have logged.

"Certainly wish to congratulate you on the efficiency and performance of your receiver and you can put me down as a satisfied customer."

New Boston Dealer . . .

C. E. Osgood & Co., with stores in Boston and Roxbury, Mass., has been appointed dealer for Crosley Shelvador electric refrigerators, David C. Rockman, general manager, George Collins Co., Crosley distributor. Boston, announces.

(Continued from Page 15)
 ever happened to it. It has been running more than 72 hours and operating perfectly.

"About fifty people were on the corner when the accident happened. A woman passing in her car happened to hear the crash and saw so many people come out to see the wreck that she watched us pick it up and put it back in the truck. A little later she came into the store and expressed her sorrow that such a nice refrigerator should have been ruined, especially when she needed one just like it. She asked me what I was going to do with it. I showed it to her. When she saw that it was running she was hardly able to believe it. I took her order for a Shelvador to be delivered in two weeks.

"Everybody is talking about the accident and large numbers of people are coming into the store to see the refrigerator for themselves. They elbow each other out of the way to get a close look at it, so as to be convinced. We have placed this sign on the box which we display in the front of the store."

"THEY CAN TAKE IT"

This Crosley Shelvador Refrigerator was thrown from a delivery truck while traveling at a rate of speed of 30 miles per hour. A 7-foot fall on brick pavement.

Examine it—It has one new part—the glass tray under the ice compartment, and it is running nice—no service man has been called—see this Shelvador on demonstration at our store.

"This is going to sell lots of refrigerators for me," Mr. Moody states, and I am not going to lose by the accident. They ask me what I will take for the box that was in the accident. I tell them I am going to keep it for my own use as it is an unusual refrigerator just like all Shelvadors.

"I attribute the good luck of the accident to the motor mounting in the top of the box, to the good box, the rubber cushion mounting, the spring suspensions, all of which caused the shock to be less severe than would have been possible perhaps in any other box. It is truly a remarkable box. It landed on its top. The motor, compressor, etc., received quite a jar and I was sure the pipes would be broken, turning the gas loose, but they remained intact. The box then fell over on its back, a very hard fall in itself."

Your Opportunity for Extra Profits

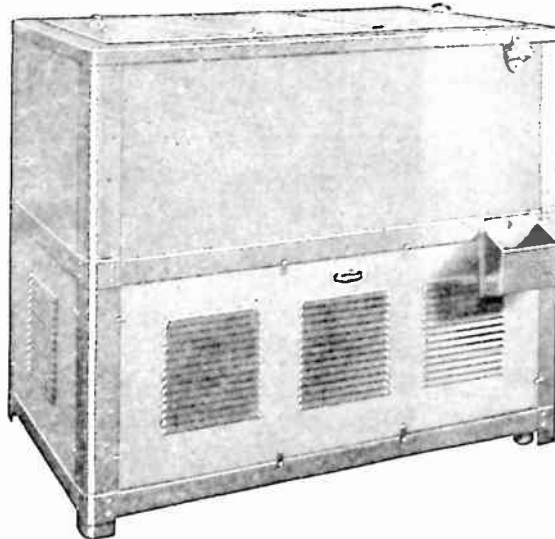

\$99.50

**DELIVERED,
 INSTALLED,
 ONE YEAR
 FREE SERVICE**

Price Slightly Higher In Florida, Texas, Rocky Mountain States and West.

MANY stores and other places in your neighborhood are in need of efficient, dependable economical beverage dispensing equipment. Crosley dealers everywhere are finding the road to extra profits by supplying this need with the new Crosley Koldrink Electric Bottle Cooler. It is ideal in every way for restaurants, druggists, hotels, roadside stands, summer camps, grocers and other retailers of bottled beverages. Also of particular value to the small dairyman. Get behind the Koldrink now—you will be surprised at the extra profits awaiting you.

The new Koldrink uses the Crosley Shelvador refrigeration unit with 1/4 H. P. motor—60 cycles A. C. It is ample in size—holds about 125 12-oz. bottles or 152 6-oz. bottles. It is also sufficiently high to hold 24- to 32-oz. bottles upright. Equipped with cold control —is easily cleaned. Cabinet is finished in an attractive dark green. Outside dimensions: 44 1/2" long, 25 1/2" wide, 37" high. Shipping weight 350 pounds. Ample insulation throughout. Sides 2", bottom 2 1/2".

**CROSLY KOLDRINK
 Electric Bottle Cooler**

Satisfied Owner . . .

"I recently bought one of your Crosley Fivers from Paul Ross of Washington, Missouri," writes Mike Wilkinson of Boles, Missouri. "I

wish to congratulate you as well as Mr. Ross as I think your radio as fine as any could wish for. With my congratulations, I remain a satisfied Crosley owner."

CROSLY SERVICE SUPPLEMENT

MODEL 5V2

Type	Where Used	TUBE VOLTAGES—MODEL 5V2							
		Ef	Ep	Eg	Esg	Ek	Esup	Eg-osc	Ep-osc
6A7	Osc-Mod.	6.5	240	0	90	3	0	-15	125
6D6	I. F.	6.5	240	-3.5	125	0	0	—	—
6B7	Diode-AF	6.5	30	-3.5	40	0	—	—	—
42	Output	6.5	230	-18	240	0	—	—	—
80	Rectifier	5.1	—	—	—	240	—	—	—

ALL VOLTAGES ARE PLUS OR MINUS 10%. ALL DC VOLTAGES ARE MEASURED TO CHASSIS AT 117.5 LINE WITH 1000 OHMS PER VOLT 250-VOLT VOLTMETER. POWER DEMAND IS 50 WATTS AT 110 VOLTS 60 CYCLES. ALIGNMENT AND SERVICING PROCEDURE SAME AS ON MODEL 5V1.

PARTS LIST—MODEL 5V2

Figures in first column refer to parts shown in diagrams.

Item No.	Part No.	Description	Item No.	Part No.	Description	
1	G24—32000	Preselector Coil	26	G10—26719	Ant.-Gnd. Terminal	
2	G15—32002	Oscillator Coil	27	B—33906A	A. C. Cord and Plug	
	W—25025B	Coil Shield 1"	28	W—33556	A. C. Switch	
3	W—25200	Coil Socket	29	W—25937	Level Control	
	W—26891	Insulating Washer	30	W—25937	275 Ohm Resistor	
	W—21451C	Retaining Ring	31	—21237A	60,000 Ohm Resistor	
	G2—32003	1st. I. F. Transformer	32	—21876	10,000 Ohm Resistor	
	W—25024B	Coil Shield	33	—26577	3 Megohm Resistor	
	W—25200	Coil Socket	34	—23785	500,000 Ohm Resistor	
	W—26891	Insulating Washer	35	—21455	300,000 Ohm Resistor	
	W—21451C	Retaining Ring	36	—23785	500,000 Ohm Resistor	
	W—32003	2nd. I. F. Transformer	37	—21875	100,000 Ohm Resistor	
	W—25024B	Coil Shield	38	—23785	500,000 Ohm Resistor	
4	W—25200	Coil Socket	39	W—31883	8,500 Ohm Resistor	
	W—26891	Insulating Washer	40	—24990	25,000 Ohm Resistor	
	W—21451C	Retaining Ring	41	—21875	25,000 Ohm Resistor	
	G21—33002	Tuning Condenser Gang	42	—23785	100,000 Ohm Resistor	
	G21—25050	Dial Assembly	43	—23785	500,000 Ohm Resistor	
	G8—32075	Drive Wheel Assembly	44	—418C	Speaker	
	G4—33005	1st. I. F. Primary Trimmer Condenser	45	W—31007A	Speaker Cable	
	W—25008A	1st. I. F. Secondary Trimmer Condenser Adj. Blade only	46	G6—30745	Power Transformer, 110 Volt, 60 Cy.	
	5	G3—33005	2nd. I. F. Primary Trimmer Cond.	47	G7—30745	Power Transformer, 110 Volt, 25 Cy.
		G3—33005	2nd. I. F. Secondary Trimmer Cond.	48	G8—30745	Power Transformer, 220 Volt, 25 Cy.
6	W—27668	0.0001 Mfd. Condenser	49	W—33557	D. P. D. T. Switch	
7	W—28621	0.02 Mfd. 200 Volt Condenser	50	G14—27812	Dial Light Bracket Assembly	
8	W—26571	0.0005 Mfd. 400 Volt Condenser		G47—27456	6-A-7 Socket	
9	W—30321A	1.0 Mfd. 160 Volt Condenser		W—27981A	Tube Shield Base	
10	W—30321A	1.0 Mfd. 160 Volt Condenser		W—28632A	Tube Shield	
11	W—28621	0.02 Mfd. 200 Volt Condenser	51	G75—27456	6-D-6 Socket	
12	W—30323	0.01 Mfd. 200 Volt Condenser		W—27981A	Tube Shield Base	
13	W—25537A	0.001 Mfd. 400 Volt Condenser	52	B—26009D	Tube Shield	
14	W—30322A	0.03 Mfd. 400 Volt Condenser		G48—27456	6-B-7 Socket	
15	W—29271A	0.00017 Mfd. 200 Volt Condenser		W—27981A	Tube Shield Base	
16	W—30059C	0.006 Mfd. 200 Volt Condenser	53	W—28632A	Tube Shield	
17		0.02 Mfd. 400 Volt Condenser	54	G25—27456	—42 Socket	
18		0.02 Mfd. 400 Volt Condenser	55	G6—27456	—80 Socket	
19		8.0 Mfd. 250 Volt (Yellow) Cond.	56	W—30805	0.01 Mfd. 400 Volt Condenser	
20		8.0 Mfd. 450 Volt (Red) Condenser	57	W—21455	300,000 Ohm Resistor	
21		8.0 Mfd. 450 Volt (+Red, —No Code) Condenser		W—23013	2,000 Ohm Resistor	
22				W—32352	Knob (Black)	
23				W—31585B	Knob (Brown)	
24				W—31463	Escutcheon	
25						

New "Scotch Girl" Display

Attention is drawn to your Shelvador display by the cleverly-illustrated Scotch girl and Scotch Terriers when you utilize these attractive display cards. The white background of the cards creates a refreshing atmosphere that is most pleasing. Ask your Crosley distributor to supply you.



Visits Crosley Factory ...

T. W. Cook, president, Advance Electric Company, Crosley distributor, Terre Haute, Ind., was a recent visitor at the Crosley factory. Mr. Cook sounded an optimistic note on the coal mining situation, on which much depends in his territory.

"Business is beginning to pick up in our territory now," said Mr. Cook. "We have suffered from the mining trouble and the recent anticipated strike, with the result that buying was delayed. The strike was put off and it is now believed that there will be no further trouble and that all differences will be settled satisfactorily. As a consequence buying is now becoming active and business is much better than it was a year ago. We anticipate a good season with Crosley Shelvador electric refrigerators."

New Shelvador Display Cards ...

Emphasizing the pride of ownership that comes to every Shelvador user, this new display is very attractive and colorful. The five small cards are adaptable for use with a display of several Shelvador models. Your Crosley distributor can supply you.



New Shelvador Billboard Poster ...

Extremely colorful is this new distinctive billboard poster that is now available to help Crosley dealers in their local Shelvador promotion activities. It exemplifies the high quality that characterizes every Crosley Shelvador and makes them the pride of the finest homes everywhere. See your Crosley distributor now for your billboard poster requirements.

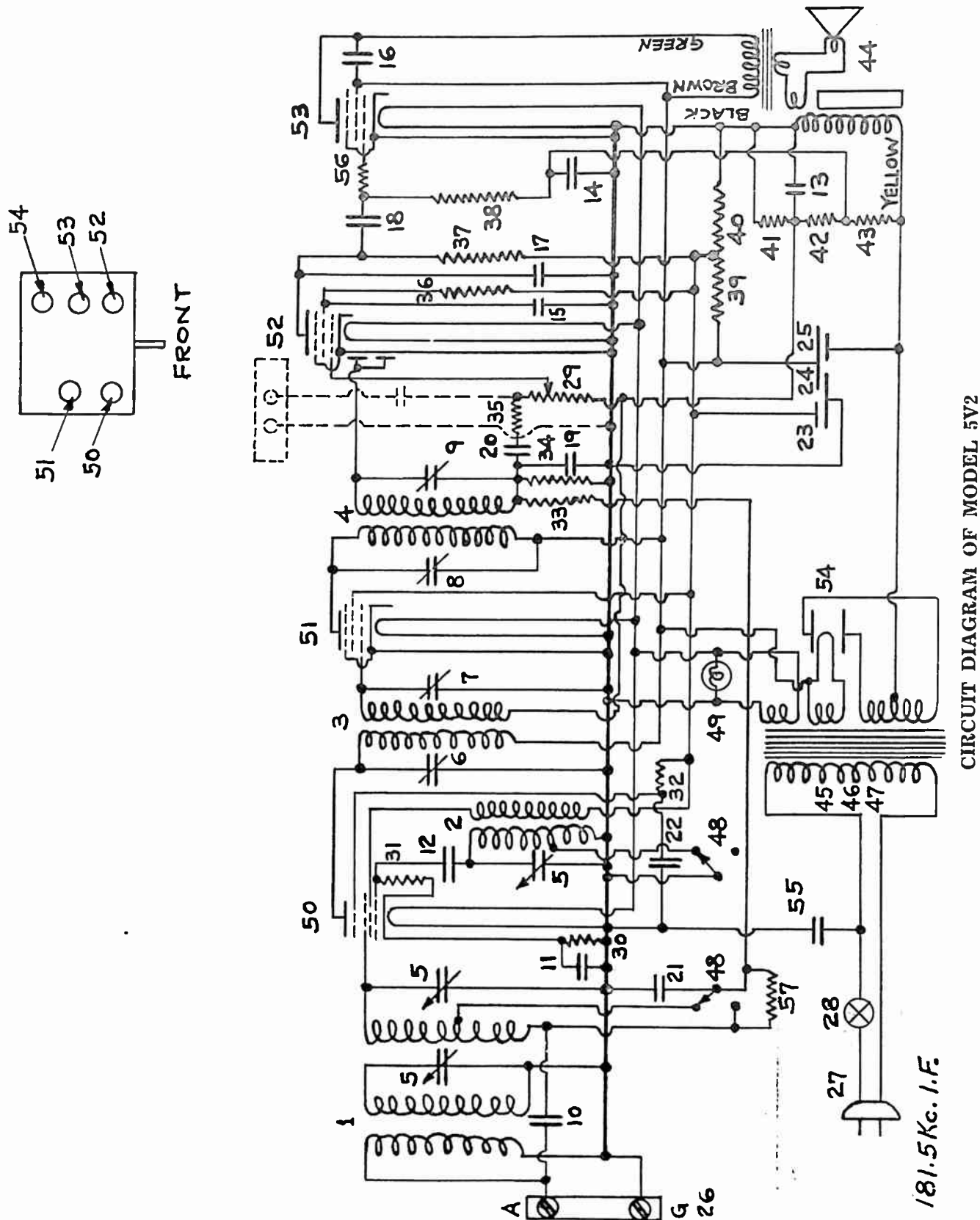

CIRCUIT DIAGRAM OF MODEL 5V2



RURAL HOMES

This is your Plus Market



PLACES WITHOUT
ELECTRICITY



SUMMER CAMPS

FOR EXTRA SALES AND PROFITS

Now is the time for Crosley dealers to "cash in" on this golden opportunity for extra sales and profits. There is a big market in every community for the amazing Crosley Icyball—the ideal refrigerator for rural or small town homes, summer camps, roadside stands, dairies, boats, or any other place without electricity.

The Icyball provides the advantages and conveniences of mechanical refrigeration, without using gas or electricity. Has no moving parts, requires no oiling, has no odor and is absolutely noiseless. Upkeep cost is only a few cents a day.

Gross capacity is 4.3 cubic feet. Freezing tray makes 14 ice cubes. Interior of 24 gauge galvanized iron. Gleaming white lacquer exterior with black trimmings. Insulated with Balsam Wool—3½" on bottom, ¾" on sides, 2" on top.

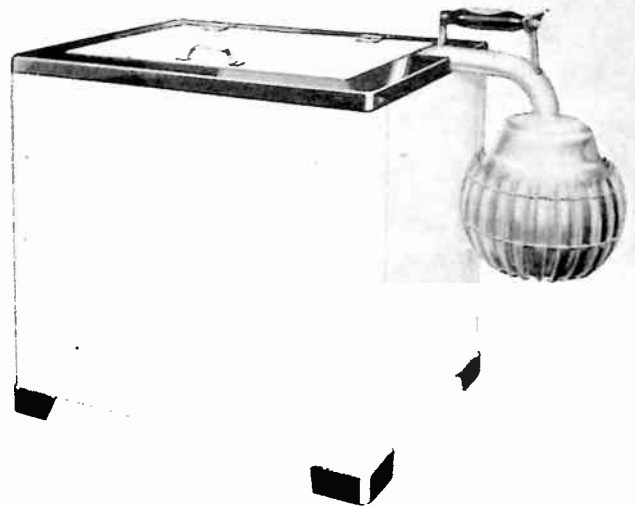

Rubber gasket under lid. Outside dimensions: 28 1/16" high (including hardware), 41½" wide (including ball), 24 5/16" deep.

\$59.95

Priced so low that it is within reach of practically everyone.....

F. O. B. Factory
Price includes Cabinet, Stove,
Icyball Unit, Stabilizer, Tub.



DAIRIES



BOATS



ROADSIDE STANDS

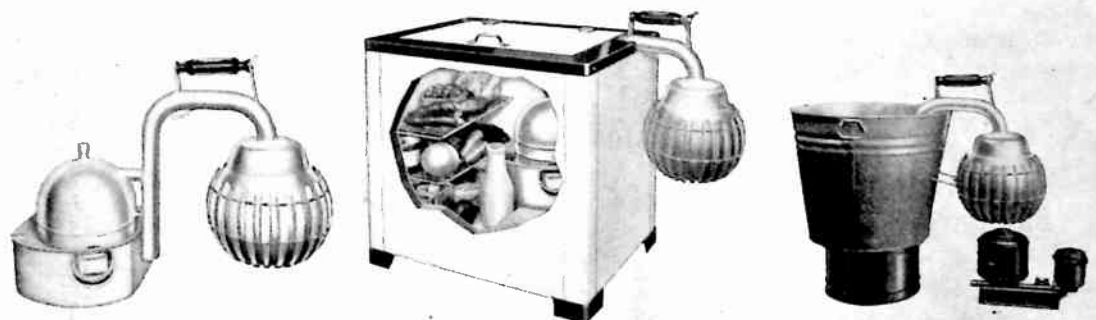

Here is the Crosley Icyball freezing unit and stabilizer. The unit consists of two special metal balls joined together by a strong metal tube.

In the Crosley Icyball, there is generous space to facilitate the arrangement of all food items. Ample room is provided for storing bottled goods.

No attention is necessary while the hot ball is being heated about an hour and a half each day to force the refrigerant into the cold ball.

The new

CROSLEY

ICYBALL

REFRIGERATOR