

THE ~~CROSLLEY~~ BROADCASTER

VOLUME 14

MAY 1, 1935

NUMBER 5

1935 — MAY — 1935

SUN. MON. TUES. WED. THUR. FRI. SAT.



Every day is a
Selling day for **SHELVADOR**



TALKS TO THE

TRADE

POWELL CROSLLEY, JR. SAYS:

THAT the 1935 Crosley Shelvador Electric Refrigerators are immensely popular is substantially proven in the unprecedented sales records being established. During the first three months of this year, sales by distributors to dealers increased approximately 400 per cent as compared with the same period of last year.

An average of from 1800 to 2000 Shelvador refrigerators are being produced each day to satisfy the tremendous public demand. Carload after carload are being shipped to distributors. The all-time high for a single refrigerator order was for 125 carloads from Newark, N. J. Other distributors are shattering previous records with orders for 45 carloads from Chicago, 40 carloads from Nashville, 80 carloads from Detroit, and many others.

With the company payroll the largest in its history and the number of employees totalling over 4200,

production is being increased as fast as possible to take care of the insistent demands from the field for more and more Shelvador refrigerators.

Such popularity is well deserved, for nowhere else except in the Shelvador can anyone find such greatly increased usable space, such extra advantages, conveniences, beauty, and value. Coupled with this is the dependable, economical, trouble-free refrigeration for which Crosley refrigerators are noted. More and more housewives throughout the country are learning these reasons for the Shelvador popularity—that's why this popularity is so steadily increasing—why the Shelvador is the fastest growing line of electric refrigerators in America.

Every Crosley dealer can take part in this tremendous popularity, in this sweeping public acceptance, in these unprecedented sales records—by pushing Shelvador NOW!

NO DEALER CAN AFFORD NOT TO HANDLE CROSLLEY



THE CROSLLEY BROADCASTER

THE CROSLLEY BROADCASTER. EARL DITTMAR, EDITOR. PUBLISHED BY THE CROSLLEY RADIO CORPORATION, CINCINNATI, OHIO. COPYRIGHT 1935. ALL PRICES QUOTED HEREIN ARE EASTERN PRICES. ALL PRICES SUBJECT TO CHANGE WITHOUT NOTICE.

Your Best Salesman . . .

Without a doubt, the best salesman for the Shelvador is the Shelvador itself. It takes but a glance for anyone to see the extra usable space, the extra advantages and conveniences made possible by this feature that is exclusive with Crosley dealers. Therefore, it naturally follows, that one of the best ways to sell the Shelvador is to display the Shelvador—to get the Shelvador before as many people as possible.

And when you display it—whether it be in the window, in the store, at a show, exhibit or whatnot—*always keep it filled with food.* Artificial food displays are available for this purpose from your Crosley distributor.

There are several strong reasons, that experience has taught us, why it is necessary to have every Shelvador on display filled with food. First of all, the food makes it look alive and adds interest, thereby enhancing the attraction of the Shelvador itself. The food on the door shelves also helps to show, at a glance, the use and purpose of these shelves. Moreover, the food on the shelves is necessary to help convince the onlookers as to how much the Shelvador holds.

These are definite facts that have been proven by actual demonstrations in the field. It is to your advantage to display the Shelvador wherever possible, to keep the door open, and to keep it filled with food. Then, as P. W. Bialkowski, Crosley West Coast District Manager, says: "With the Shelvador open and full of food, a salesman can gag himself and just point and still make the sale."

Home-News Pictorial . . .

A new four-page newspaper that is abundant in pictures is now avail-

able to help every Crosley dealer promote Shelvador sales. Containing photographs of news interest, yet dramatically illustrating strong Shelvador selling points, each of the four pages is almost certain to grasp attention and help impress the reader that the Shelvador is the one to buy.

This sheet is just the thing to pass out from house to house, from the store, at shows, exhibits and similar occasions.

It is made up in tabloid size and has generous space for dealer's imprint. Order a quantity of Home News Pictorials from your Crosley distributor and start passing them out now.

Radio Industry Keeps Climbing . . .

In a recent issue of *Radio Retailing*, this magazine's annual statistical sales survey of the radio industry revealed that more radio receivers were manufactured last year than any previous year in radio history. A total of 4,696,000 radio sets were sold in 1934, which figure includes 612,000 for export, thereby reducing the domestic sales volume to 4,084,000. This is the best year for domestic sales since 1929 and 278,000 sets ahead of 1933.

These facts should mean a lot to everyone engaged in the radio industry. They undeniably prove that the radio market represents a vast opportunity—that there is a sales volume of vast proportions to be had—that consumer demand for radio is not losing its foothold, but rather is steadily climbing.

According to *Radio Retailing*, 19 out of every 30 homes already own a set—yet last year, 2,250,500 set owners were persuaded to buy a more modern receiver. Congratulations are in order to the radio retailers for

such a splendid selling job. The same calibre of salesmanship—of going after those people without radio, but also concentrating on the replacement market—will bring equal if not superior results in 1935.

Mother's Day . . .

May 12th is the day that has been set aside to pay tribute to every mother. And as sons and daughters make plans to gladden mother's heart, what could be more appropriate a gift to consider than a Shelvador or Crosley Radio.

A Shelvador will bring endless joy as it lightens mother's daily tasks and helps to make housekeeping a pleasure. The added conveniences and advantages of the Shelvador will bring her a new deal that she could not secure in any other way.

Perhaps a portable AC-DC Crosley Forty-One will be just the thing that will delight mother. Then she can have radio entertainment in her bedroom, in the kitchen or wherever she may be.

Crosley dealers can take advantage of this opportunity by telling everyone in their territory to make this a Mother's Day that She will long remember by giving Her a Crosley Shelvador or Radio.

New Shelvador Game . . .

Just the thing for the kiddies—yes, and some grown-ups, too—is the new game of Shelvador Food Marketing. It is played somewhat like the Parcheesi game. It is instructive, entertaining and will help to keep the name Shelvador before the families who play it.

Ask your Crosley distributor to show you a sample and then start distributing it at shows and similar affairs.



Minot Dealer Meeting ...

Here is the crowd of dealers that assembled at the recent meeting held by Minot Supply Company, Minot, N. Dak. According to H. F. Jaax,

Crosley representative, an excellent meeting was held with tremendous optimism indicated over the new Crosley lines.

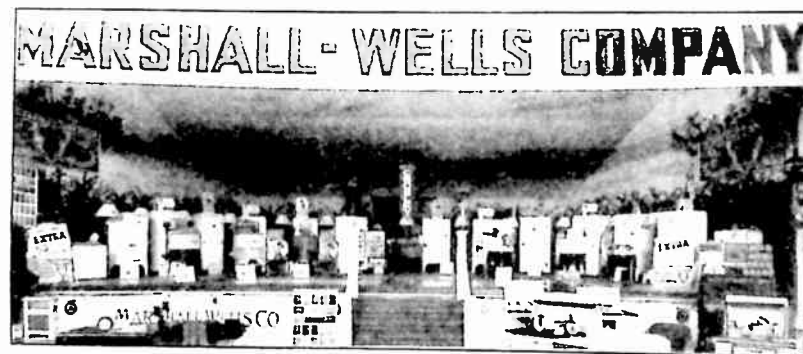

Stealing The Show In Billings ...

Those who attended the Home Modernization Exposition recently held in Billings, Montana were greatly impressed with the Shelvador display there under the sponsorship of Marshall Wells Company, local Crosley distributor. Occupying the entire stage of the auditorium of the Midland Empire Fairgrounds, thirteen Crosley refrigerators were exhibited. Without a doubt, this was the most impressive exhibition of the entire exposition.

In addition to this display, two local dealers—Nelson Music House and Associated Stores had individual booths showing Crosley Shelvadors.

O. L. Griggs of Marshall Wells says, "Judging from reports which we chanced to overhear and which were also directed to us, we without a doubt, stole the show."

Tenk Hardware Holds Crosley Group Meetings ...

Two dealer group meetings have been held by Tenk Hardware Company, Crosley distributor, Quincy, Ill. The first took place at Macomb, Ill., Thursday night, March 21, and the second at Keokuk, Ia., Tuesday night, April 2.

The first meeting was conducted by Mr. Windsor, service man for Tenk Hardware. The complete details of the workings of Crosley Shelvador electric refrigerators, features and sales points were covered in detail.

N. B. Getty, secretary of the Tenk Company, reported enthusiastic meetings and stated that the company contemplated holding similar meetings at other points in its territory.

Utah Stores Take On Crosley Shelvadors ...

L. R. Holden, assistant Manager, Western Supply Co., Crosley distributor, Salt Lake City, announces the appointment of three prominent dealers in Utah for Crosley Shelvador electric refrigerators: Z. C. M. I., Salt Lake City, with I. F. Christensen in charge of the refrigerator department; Southwest Furniture Co., Provo, with Arch White in charge of the department; and Sterling Furniture Co., Ogden, with F. A. Madsen in charge.

"The outlook is extremely good—sales are over 100 per cent above last year," states Mr. Holden. "All dealers are showing much enthusiasm."

Crosley Dealer Goes Through 4 Dust Storms ...

Living through four dust storms in five days, one of which chased him out of the state and followed him more than 1000 miles, was the experience of Lee E. Putney, Crosley dealer of Irving, N. Y., described in the Buffalo Evening News on his return from a trip to McCook, Nebraska, to visit relatives there.

Describing one of the storms at Denver, Mr. Putney said, "In less than ten minutes it was upon us. The air was filled with clouds of fine powder, finer than flour, and the brightly shining sun was completely blotted out. When we first saw it rolling toward us, the natives thought it was a cyclone except for the great size of its front.

"We retreated into the house and closed all the doors and windows tightly, but the dust sifted in through almost impossible places. That evening we ate a supper finely sifted over with the top soil of Kansas. It got in our eyes, ears and hair. It gritted out teeth. Even inside the house the air was hazy.

"When we went to bed that night, the sheets were gritty. And when we woke up in the morning, the outline of our heads showed in a quarter-inch-deep layer of dust. The rug on the floor was completely overlaid with a thick coating, so thick that you couldn't see the colors."

Mr. Putney said that "sand, whipped by a gale, filled the air with clouds of sharp, stinging particles that almost suffocated everything in its path, and etched deep pits in his windshield."

Nashville Orders 40 Carloads ...

Wheless Gambill, Jr., of the Gambill Distributing Co., Crosley distributor at Nashville, Tenn., recently visited the Crosley factory with eight leading Crosley dealers from Tennessee. Mr. Gambill placed an order for 40 carloads of Crosley Shelvador electric refrigerators to be shipped at the rate of a carload a day commencing at once.

Dealers accompanying Mr. Gambill were: R. A. Coleman, Sterchi Bros., Nashville; James Brown, Sterchi Bros., Chattanooga; Ben Bourne, Castner Knott Co., Nashville; Erle Hyde, Erle Hyde, Inc., Nashville; Frank O. Harper, Shelbyville Harness Co., Shelbyville, Tenn.; J. R. Riley, Paris Radio Co., Paris, Tenn.; Chas. Q. Townsend, Terrell Electric Co., Chattanooga, and O. L. Smith, Chapman Drug Co., Knoxville, Tenn.

Two Promotions Staged By Lappin ...

The Lappin Electric Company, Crosley distributor at Milwaukee, Wisconsin, has entered into two recent promotional activities that should reap material returns in the way of Shelvador sales.

The first of these was the distribution of prize drawing cards to everyone that attended the recent Milwaukee Home Show. A Shelvador was given to the lucky person the last day of the show. The retained side of the card requested certain information about refrigeration interest and listed the individual's name and address. All in all, about 10,000 prospects were served through this source. The prospects were proportioned to the various dealers of the territory and considerable sales are anticipated.

The other promotional activity is in the nature of a prize contest for all Shelvador dealers and salesmen. Two thousand dollars (\$2,000.00) in cash prizes are being given to Shelvador salesmen in a contest for the month of April and a season contest for the salesman who sells the most Shelvadors before August 1st.

D. C. Lappin, president of Lappin Electric Company, says, "Salesmen and dealers are very much enthused over this contest and we believe it will stimulate considerable activity on Crosley Shelvadors in this territory."

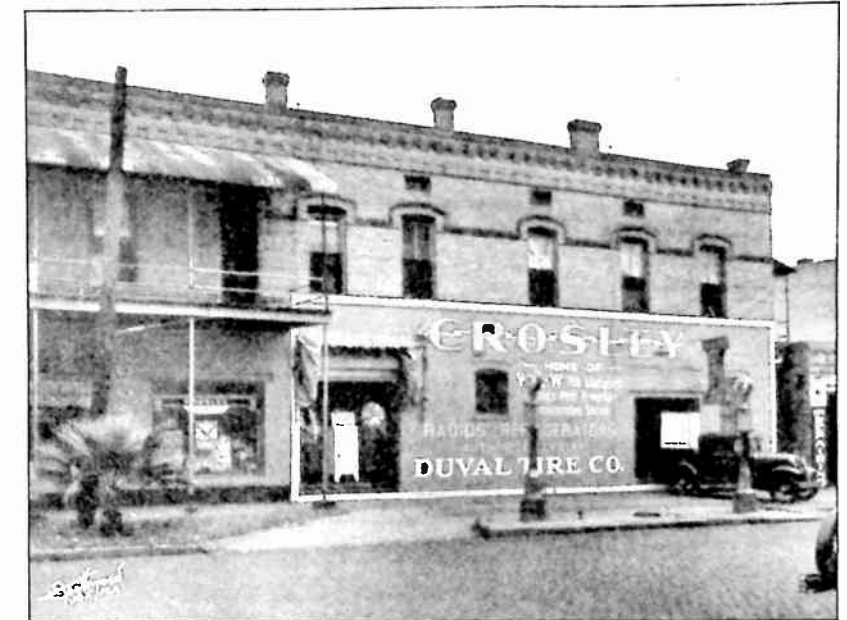

Excellent Use Of Side Wall ...

Crosley dealer Duval Tire Company of Jacksonville, Florida, has made excellent use of the side wall of their building. As shown in the

accompanying picture, the painted sign makes an effective tie-up with WLW and Crosley radios and refrigerators.

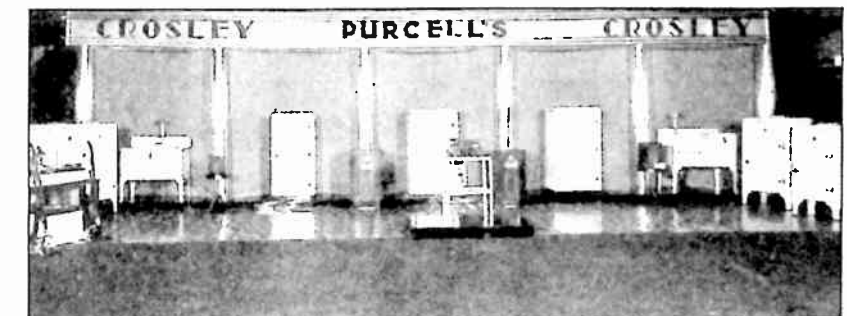

Most Attractive Display At Show ...

This display of Crosley Shelvadors and Radios was adjudged the most attractive at the recent Home Appliance and Trade Show held in Lexington, Kentucky. Sponsored by the J. D. Purcell Company of that city, this exhibit received considerable favorable comment from the more than 7,000 persons in attendance. The display was in silver and red and was designed and constructed by I. L. Vonderheide, advertising manager of Purcell's.

New Location For Baltimore Distributor ...

Lincoln Sales Corporation, Crosley distributor at Baltimore, Maryland, moved into new spacious quarters on April 1st. Their show room, offices and service departments are now located at 1307 St. Paul St., Baltimore.

"12-Year-Old Crosley As Good As New" ...

That is the substance of this interesting letter recently received from Miss E. Sanford, Athens, Georgia.

"Just a line to thank you for all the wonderful things my tiny one-tube Crosley radio has brought into my lonely life—installed March 4th, 1923. I have celebrated each of the years as birthdays, giving a new tube and batteries (if needed), shining up all connections, etc., and I feel sure it is as good as when first installed.

"I just wanted you to know I am still thoroughly satisfied and would not exchange for any loud speaker set I have ever seen, if it meant my set would be taken away.

"Thank you truly for what you have done for this big old world of ours."



Impressive Sales Meeting . . .

The refrigerator salesmen of J. W. Green, Inc., Newark, N. J., recently attended a sales meeting conducted for them by H. M. Bergman, Sales Manager of Apollo Distributing Company of that city.

One of the program features was

the showing of the moving picture talkie, "A Glorious Fourth", which deeply impressed all of the men.

George Fralick, refrigerator buyer for J. W. Greene, has stated that their 1935 quota is from 500 to 700 Crosley Shelvador refrigerators.

T. C. Jones Opens Third Store . . .

The third store of the T. C. Jones Company in Ft. Worth, Texas, has been opened. It is located in the center of the city and will be the company's number one store. The T. C. Jones Company is one of the leading Crosley dealers in the Southwest. Mr. Jones reports that his Shelvador sales are running more than 300 per cent ahead of those of 1934. In March alone he sold 15 more refrigerators than he did in the first three months a year ago. He stated that he believed that Crosley is likely to end up this year as the largest seller in the electric refrigeration business.

More Than Pleased . . .

"I am more than pleased with my new Crosley Radio", writes Rev. M. J. Durkop of Toledo, Ohio. "I thought my old radio of another make could not be beat, but now I know 'You're THERE With a Crosley'. I am highly elated that it brings in so many stations with remarkable clarity."

Powerful WLW Broadcasts Feature Crosley Products

500,000-watt WLW — the world's most powerful broadcasting station is carrying these programs, devoted to Crosley radios and refrigerators, into the homes of America to keep the nation ever-conscious of Crosley products and to win prospects and sales for Crosley dealers.

(Tune in to 700 Kc.—Eastern Standard Time Listed)

MONDAY	TUESDAY	WEDNESDAY	THURSDAY	FRIDAY	SATURDAY
A. M. 6:30—Top o' the Morning with McCormick Fiddlers (Crosley Battery Radios). 7:30—Cheerio (Shelvador Refrigerators). 8:15—Music by Divano (Crosley Radios). 11:30—Morning Housewarmers (Shelvador Refrigerators).	A. M. 6:30—Top o' the Morning with McCormick Fiddlers (Crosley Battery Radios). 7:30—Cheerio (Shelvador Refrigerators). 11:00—Chandler Chats, with Organ (Crosley Radios). P. M. 3:30—Crosley Business News (Crosley Radios for office use). 6:15—Bob Nolan (Shelvador Refrigerators). 7:00—Virginio Marucci Orchestra (Shelvador Refrigerators).	A. M. 6:30—Top o' the Morning with McCormick Fiddlers (Crosley Battery Radios). 7:30—Cheerio (Shelvador Refrigerators). 8:15—Music by Divano (Shelvador Refrigerators). P. M. 3:30—Crosley Business News (Crosley Radios for office use). 3:45—Dorothea Ponce, blues singer (Shelvador Refrigerators). 6:15—Bob Nolan (Crosley Radios).	A. M. 6:30—Top o' the Morning with McCormick Fiddlers (Crosley Battery Radios). 7:30—Cheerio (Shelvador Refrigerators). 8:15—Rhythm Jesters (Crosley Radios). P. M. 3:30—Crosley Business News (Crosley Radios for office use). 11:05—Zero Hour (Shelvador Refrigerators).	A. M. 6:30—Top o' the Morning with McCormick Fiddlers (Crosley Battery Radios). FRIDAY 6:30—Top o' the Morning with McCormick Fiddlers (Crosley Battery Radios).	A. M. 7:30—Cheerio (Shelvador Refrigerators). 8:15—Divano Trio (Crosley Radios). P. M. 3:30—Crosley Business News (Crosley Radios for office use). 7:00—Virginio Marucci and Orchestra (Shelvador Refrigerators). SATURDAY A. M. 6:30—Top o' the Morning with McCormick Fiddlers (Crosley Battery Radios). 7:30—Cheerio (Shelvador Refrigerators). 8:15—Rhythm Jesters (Crosley Radios). 10:30—Rex Griffith, vocalist (Shelvador Refrigerators). 11:15—Nora Beck Thuman, soprano (Crosley Radios). P. M. 1:30—Crosley Business News (Crosley Radios for office use). 5:30—R. F. D. Hour—Boss Johnston, McCormick Fiddlers, Larry Greuter, accordionist (Crosley Battery Radios).

THE GREATEST SALES HELP YOU HAVE EVER HAD!

In addition to these programs, many spot announcements boosting Crosley products are broadcast each day.

CROSLEY PRESENTS

NEW BEAUTY AND WORLD-WIDE RECEPTION
IN THE NEW 1935

CROSLEY RADIOS

THE NEW 1935 Crosley Radios presented on this and the two following pages, have reached a new pinnacle in beauty and smartness. New, rare, and costly woods, modern and pleasing design, have set a pace for the entire radio world to follow. Likewise, these Crosley models include the latest improvements and features in radio—each giving outstanding performance for its price class. The sensational values maintain Crosley's world leadership in offering "the most for the radio dollar". Several models have the Dual Range feature—providing police, amateur and aviation in addition to standard broadcasts. The new American-Foreign and All-Wave Receivers bring a new thrill to all those interested in distant, foreign reception.

*Use code word for telegraphic orders to distributors.



*WRCIK

\$19.99

Complete With Tubes and Fabric Carrying Case

Dimensions:
6 $\frac{3}{4}$ " high,
9 $\frac{5}{8}$ " wide,
4 $\frac{1}{2}$ " deep.

FORTY-ONE

4 TUBES . AC DC
SUPERHETERODYNE

OPERATES on any 110 volt circuit. Has two Double Purpose Tubes, Full Floating Moving Coil Electro-Dynamic Speaker, Pilot Light, Attached Antenna. No ground required.



*WRCIIH

\$22.50

Complete With Tubes

Dimensions:
7 $\frac{3}{4}$ " high,
10 $\frac{3}{4}$ " wide,
5" deep.

FORTY-ONE DELUXE

4 TUBES . AC DC
SUPERHETERODYNE

OPERATES on any 110 volt circuit. Has two Double Purpose Tubes, Full Floating Moving Coil Electro-Dynamic Speaker, Pilot Light, Attached Antenna. No ground required.



*SLMIX

\$19.99

Complete With Tubes

Dimensions:
11 $\frac{5}{8}$ " high,
10" wide,
7 $\frac{3}{4}$ " deep.

FIVER

5 TUBES
SUPERHETERODYNE

RECEIVES all standard broadcasts and some police calls. One Double Purpose Tube—Illuminated Dial—Combined Volume Control and On-Off Switch. Full Floating Moving Coil Electro-Dynamic Speaker.

534 CC A. F.



*SLMRL

\$32.50

Complete With Tubes

Dimensions:
17" high,
13 $\frac{1}{2}$ " wide,
8 $\frac{3}{4}$ " deep.

5 TUBES . American-Foreign
SUPERHETERODYNE

AMERICAN broadcasts—535 to 1730 Kc. and Foreign broadcasts 5300 to 15,700 Kc.—Automatic Volume Control—Two Double Purpose Tubes—Two Position Tone Control—Full Floating Moving Coil Electro-Dynamic Speaker.

534 QE A. F. LOWBOY

\$47.50

Complete With Tubes

Dimensions:
36" high,
22 $\frac{1}{4}$ " wide,
11 $\frac{3}{4}$ " deep.



*SLMRL

PRICES SLIGHTLY HIGHER IN FLORIDA, TEXAS, ROCKY MOUNTAIN STATES AND WEST

May 1, 1935

The Crosley Broadcaster

SIXTY-ONE A.F.



*SXILWM

\$39.95

Complete With Tubes

Dimensions: 16 1/8" high, 13 7/8" wide, 8 5/16" deep.

6 TUBES . American-Foreign SUPERHETERODYNE

• AMERICAN broadcasts—550 to 1700 Kc. and Foreign broadcasts 5,800 to 15,300 Kc.—Illuminated Airplane Type Dial—Automatic Volume Control—Three Gang Tuning Condenser—Full Floating Moving Coil Electro-Dynamic Speaker.

SIXTY-FOUR MD LOWBOY

\$54.50

Complete With Tubes

Dimensions: 36" high, 22 1/4" wide, 11 3/4" deep.

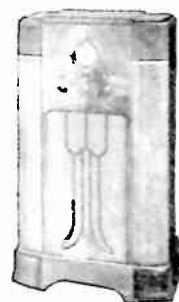

*SXHWL

614EH THREE BAND ALL-WAVE



*SXIRM

\$49.95

Complete With Tubes

Dimensions: 16 1/8" high, 13 7/8" wide, 8 5/16" deep.

6 TUBES . Three Band All-Wave Superheterodyne

• AMERICAN broadcasts—(540 to 1650 Kc.)—Police, amateur, aviation broadcasts (1650-5000 Kc.)—Foreign broadcasts (5800-15,350 Kc.)—Illuminated Airplane Type Dial—Automatic Volume Control—Three Gang Tuning Condenser—Full Floating Moving Coil Electro-Dynamic Speaker.

614PG THREE BAND ALL-WAVE LOWBOY

\$65.00

Complete With Tubes

Dimensions: 36 1/2" high, 22 5/8" wide, 12 1/16" deep.



*SXIRL

714GA THREE BAND ALL-WAVE

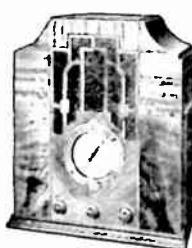

*SSIRM

\$65.00

Complete With Tubes

Dimensions: 18 3/8" high, 16 1/4" wide, 10 1/4" deep.

7 TUBES . Three Band All-Wave Superheterodyne

• AMERICAN broadcasts (540-1700 Kc.)—Police, amateur, aviation broadcasts (1700-5000 Kc.)—Foreign broadcasts (5800-15,350 Kc.)—Dual Ratio Tuning Control—Illuminated Airplane Type Dial—Automatic Volume Control—Continuous Tone Control—Full Floating Moving Coil Electro-Dynamic Speaker.

714NA THREE BAND ALL-WAVE LOWBOY

\$85.00

Complete With Tubes

Dimensions: 38" high, 23" wide, 11 1/4" deep.

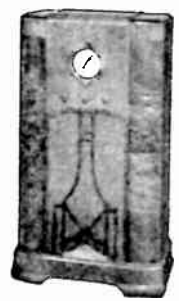

*SSIRL



*SQIRM

\$79.50

Complete With Tubes

Dimensions: 19 1/4" high, 16 1/2" wide, 10" deep.

CENTURION

10 TUBES . All-Wave SUPERHETERODYNE

• Five Tuning Bands, 150 to 22,000 Kc.—Two Double Purpose Tubes—New Illuminated Airplane Type Dial—Band Spread Pointer—Automatic Volume Control—Dual Ratio Tuning Control—Continuous Tone Control—Push-Pull Output—Full Floating Moving Coil Electro-Dynamic Speaker.



*SQIRL

\$100.00

Complete With Tubes

Dimensions: 40 1/2" high, 25 1/4" wide, 12 1/2" deep.

CENTURION LOWBOY

10 TUBES . All-Wave SUPERHETERODYNE

• Five Tuning Bands, 150 to 22,000 Kc.—Two Double Purpose Tubes—New Illuminated Airplane Type Dial—Band Spread Pointer—Automatic Volume Control—Dual Ratio Tuning Control—Continuous Tone Control—Push-Pull Output—Full Floating Moving Coil Electro-Dynamic Speaker.



*RRBI

\$19.99

Complete Less Batteries

Dimensions: 8" high, 10 1/2" wide, 5" deep.

BATTERY FORTY

4 TUBES . Superheterodyne BATTERY RECEIVER

• SUPERHETERODYNE chassis. Designed for use with the 2-volt air

cell "A" battery or regular 6-volt battery connected for 2 volts. Low battery drain. Two Double Purpose Tubes increase the efficiency to that of an ordinary six tube set. Pentode Output. Permanent Magnet Speaker.



*RLBMM

\$29.95

Complete Less Batteries

Dimensions: 13 1/8" high, 10" wide, 8 1/2" deep.

BATTERY FIVER

5 TUBES . Superheterodyne BATTERY RECEIVER

• GENUINE superheterodyne chassis. Designed for use with 2-volt air-cell "A" battery. Has Pentode Output, Airplane Type Dial, Permanent Magnet Speaker.

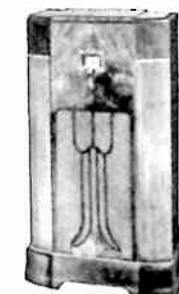

*RLBML

\$49.95

Complete Less Batteries

Dimensions: 36" high, 22 1/4" wide, 11 3/4" deep.

BATTERY FIVER LOWBOY

5 TUBES . Superheterodyne BATTERY RECEIVER

• GENUINE superheterodyne chassis. Designed for use with 2-volt air-cell "A" battery. Has Pentode Output. Airplane Type Dial, Permanent Magnet Speaker.



*RXBIM

\$69.50

Complete Less 6-Volt Battery

Dimensions: 19" high, 15 3/4" wide, 9 5/8" deep.

BATTERY SIX

6 TUBES . Three Band All-Wave Battery Receiver

• SIX-TUBE Superheterodyne—Operates from 6-Volt Storage Battery—No "B" Batteries Required—Three

Tuning Bands (Standard Broadcasts 540-1700 Kc.—Police, Amateur, Aviation Broadcasts 1700-5000 Kc.—Foreign Broadcasts 5800-15,350 Kc.)—Automatic Volume Control—Airplane Type Dial—Continuous Tone Control—Moving Coil Permanent Magnet Speaker.



*RXBIL

\$84.50

Complete Less 6-Volt Battery

Dimensions: 38" high, 23" wide, 11 1/4" deep.

BATTERY SIX LOWBOY

6 TUBES . Three Band All-Wave Battery Receiver

• SIX-TUBE Superheterodyne—Operates from 6-Volt Storage Battery—

No "B" Batteries Required—Three Tuning Bands (Standard Broadcasts 540-1700 Kc.—Police, Amateur, Aviation Broadcasts 1700-5000 Kc.—Foreign Broadcasts 5800-15,350 Kc.)—Automatic Volume Control—Airplane Type Dial—Continuous Tone Control—Moving Coil Permanent Magnet Speaker.

PRICES SLIGHTLY HIGHER IN FLORIDA, TEXAS, ROCKY MOUNTAIN STATES AND WEST

PRICES SLIGHTLY HIGHER IN FLORIDA, TEXAS, ROCKY MOUNTAIN STATES AND WEST

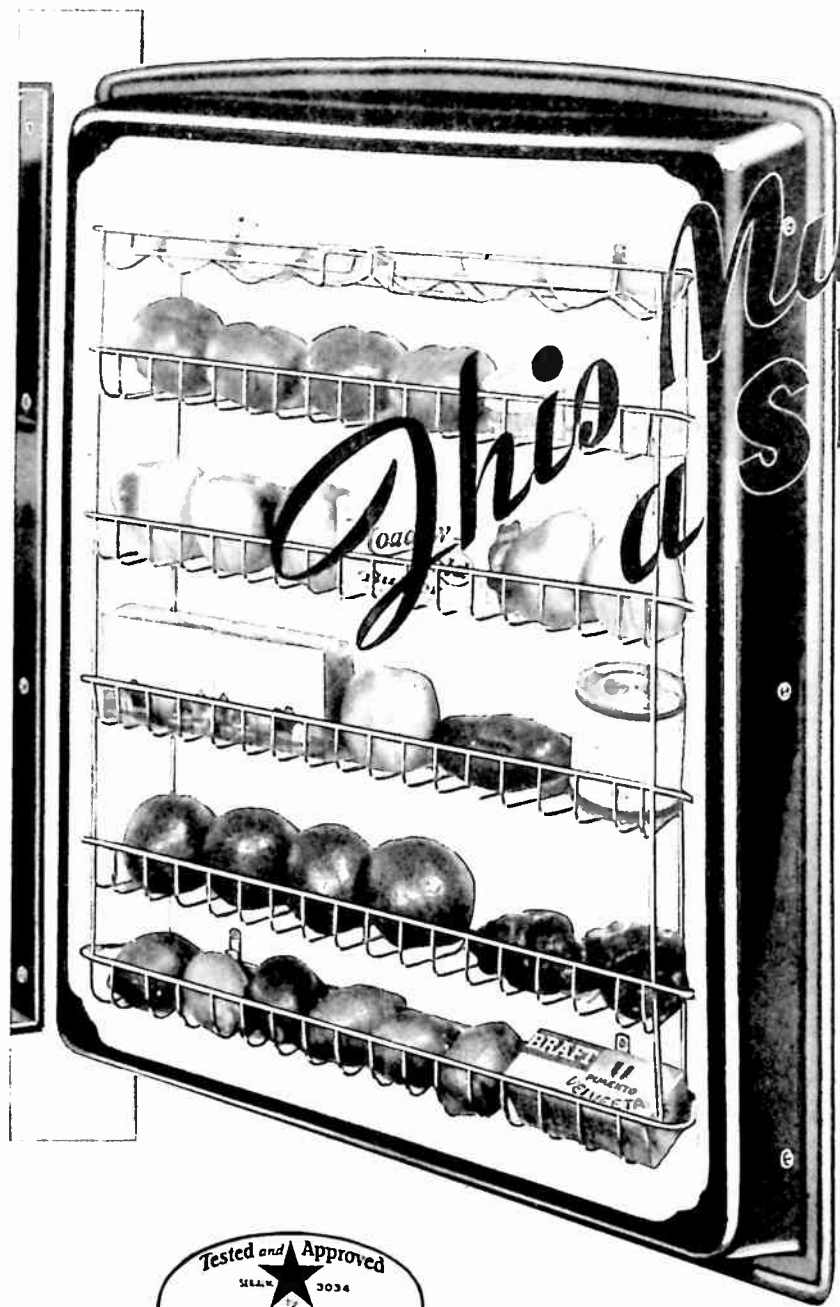

Much More in SHELVADOR

Nowhere else in all the world can anyone find such appealing features as are a part of the new 1935 Crosley Shelvador Electric Refrigerators. Here are features that provide housewives with everything they could desire—that carry with them such an irresistible sales appeal that the Crosley Shelvador has become the fastest growing line of electric refrigerators in America. And these features—this sales appeal is exclusive with Crosley dealers.

"This Much More In A Shelvador" is a phrase that immediately tells everyone here is greatly increased usable capacity and with this feature things are twice as easy to find. The Shelvador and the other exclusive Crosley features are **extra** features—in addition to the outstanding value, dependability, high quality, trouble-free service that characterize every Crosley model—that bring such tremendous pride and satisfaction to every Crosley Shelvador owner.

FEATURES THAT HOUSEWIVES PREFER



Automatic Interior Light illuminates interior whenever door is opened.

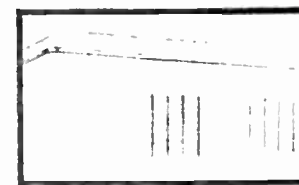

Vented Front. Maintains proper circulation of air around unit.

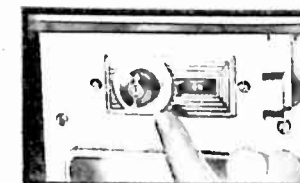

Temperature Control enables user to speed up freezing of ice cubes and frozen dishes.

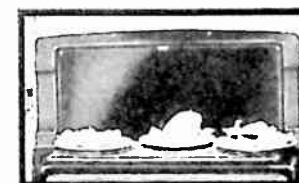

Shelvotray. Handy auxiliary shelf and serving tray.

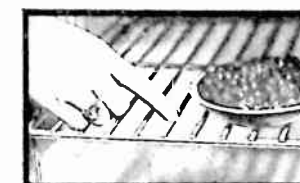

Flat Bar Shelves makes it easy to slide dishes in or out.



Shelvabasket. Ideal for greens, carrots, canned goods and the like.



Porcelain Interior of rounded corners and stainless bottom.

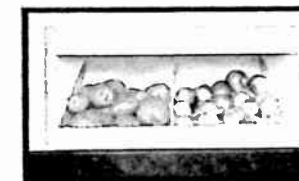

Storage bin. For potatoes, onions and other bulk items.

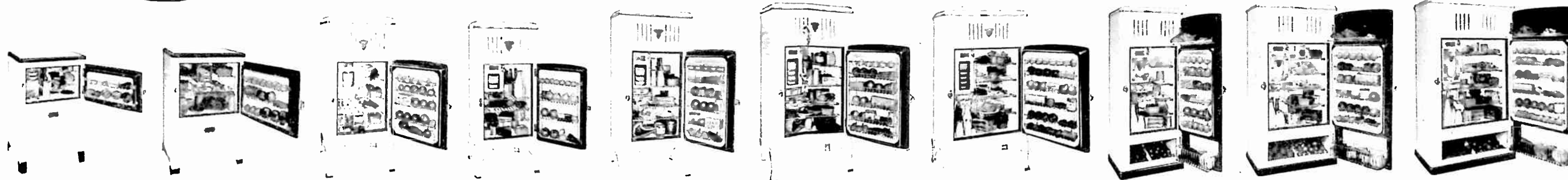

FB-20 Table Shelvador has two cubic feet NET capacity; 5.2 square feet shelf space. Two ice trays; uses Rotary compressor. Dimensions: 36" high, 25 1/2" wide, 25" deep. **\$79.50**

FR-30 Table Shelvador. 3.1 cubic feet NET capacity; 7 square feet shelf space. 2 ice trays. Uses Rotary Compressor. Dimensions: 30" high, 23 1/2" wide, 25" deep. **\$94.50**

FA-35 Shelvador. 3.5 cubic feet NET capacity; 7.5 square feet shelf space. One ice tray and one double-depth tray. Dimensions: 49 11/16" high, 23 1/2" wide, 24 3/16" deep. **\$99.50**

FA-40 Shelvador. 4.09 cubic feet NET capacity; 8.6 square feet of shelf space. One ice tray and one double-depth tray. Dimensions: 52 3/4" high, 23 1/2" wide, 25 1/2" deep. **\$112.50**

FA-50 Shelvador. 5 cu. ft. NET capacity; 11.3 square feet shelf space. Dimensions: 56 1/4" high, 25 1/2" wide, 24 1/2" deep. **\$129.50**
Porcelain Exterior (PFA-50) **\$132.00**

FA-60 Shelvador. 6 cu. ft. NET capacity; 13.5 sq. ft. shelf space. Dimensions: 59 1/4" high, 30 3/4" wide, 25 1/2" deep. **\$149.50**
Porcelain Exterior (PFA-60) **\$171.50**

FA-70 Shelvador. 7.08 cu. ft. NET capacity; 14.9 sq. ft. shelf space. Dimensions: 57 1/2" high, 32 3/4" wide, 25 1/2" deep. **\$169.50**
Porcelain Exterior (PFA-70) **\$194.50**

F-43 Tri-Shelvador. 4.3 cu. ft. NET capacity; 9.15 sq. ft. shelf space. Dimensions: 56 9/16" high, 23 1/2" wide, 23 1/2" deep. **\$139.50**
Porcelain Exterior (PF-43) **\$159.50**

F-55 Tri-Shelvador. 5.51 cu. ft. NET capacity; 11.6 sq. ft. shelf space. Dimensions: 57 1/2" high, 29" wide, 25 1/2" deep. **\$164.50**
Porcelain Exterior (PF-55) **\$187.00**

F-70 Tri-Shelvador. 7.08 cu. ft. NET capacity; 14.9 sq. ft. shelf space. Dimensions: 58 3/4" high, 32 3/4" wide, 25 1/2" deep. **\$189.50**
Porcelain Exterior (PF-70) **\$219.50**

ALL PRICES INCLUDE DELIVERY, INSTALLATION, ONE YEAR FREE SERVICE ● PRICES SLIGHTLY HIGHER IN FLORIDA, TEXAS, ROCKY MOUNTAIN STATES AND WEST

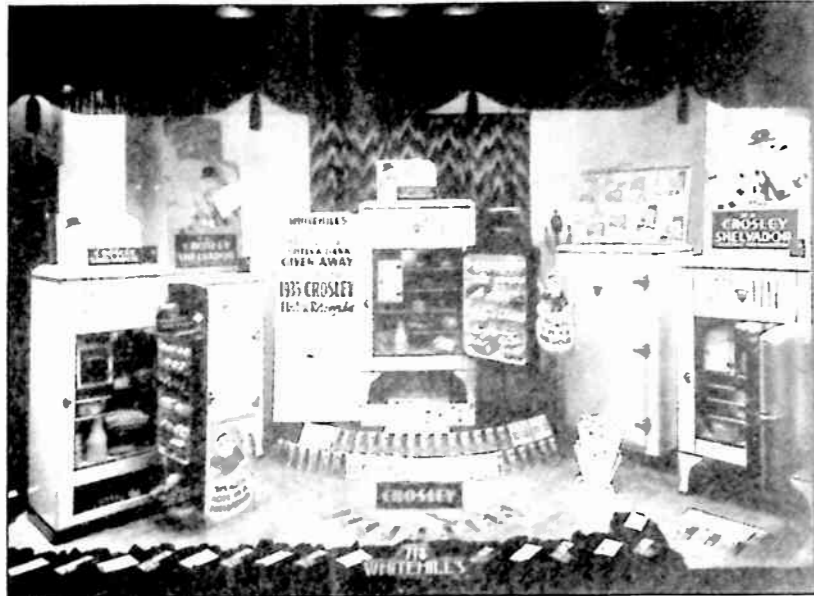

Philadelphia Display Sells 50 . . .

The window of Whitehill's, Crosley dealer at Philadelphia, recently contained this effective Shelvador display. Excellent use was made of the 20-page Shelvador circular as a display aid.

That this display was productive of real results is evidenced in the statement of Albert L. Rothman, Whitehill's general manager, that it was responsible for the sale of fifty Shelvadors within a very short time.



Shelvador At Vienna Fair . . .

Natives of Austria learned that there is nothing like a Shelvador when they recently viewed this exhibit at the Vienna Fair. Firmaing Hans Finsterle is the local Crosley distributor.

Dallas Shelvador Sales 125 Percent Ahead of '34 . . .

Sales of Crosley Shelvador electric refrigerators in Dallas are more than 125 per cent ahead of those for the same period in 1934. J. C. Mirus,

vice president, Dallas Electric Supply Co., Inc., Crosley distributor in this city, states.

"Since January 18, we have appointed in the city of Dallas eleven Crosley dealers who are all now active in the sale of Crosley Shelvador refrigerators," said Mr. Mirus. "It is the largest number of dealers that we have ever had in the city of Dallas on Shelvadors. Due to their unusually low prices, well known quality and exclusive features, Crosley Shelvadors are the most sought after

Aitken Places 80-Car Order For Shelvadors . . .

James E. Aitken, of the Aitken Radio Corporation, Crosley distributor in Detroit, Michigan, has placed an order for 80 carloads of Crosley Shelvador electric refrigerators to be shipped in April and May. Mr. Aitken reports general business conditions much better in Detroit and that some of the leading stores there are making a feature of Shelvadors this season.

Crosley Sales In N. Y. Area Exceed 1935 . . .

Sales of Crosley Shelvador electric refrigerators in the New York area are far ahead of last year's figures, Grant Layng, sales manager, Retail Division, The Crosley Distributing Corporation of New York, states. "New dealers are continually being added," said Mr. Layng.

"Howard Radio, operating four stores in the metropolitan area, have taken over a group of experienced electric refrigerator salesmen, and are developing an outside organization from their Yonkers store," Mr. Layng reports. "With Crosley representation in a brand new showroom just constructed they have ten men covering the lower Westchester field.

"Fennel Furniture Company, one of the biggest furniture dealers in the Bronx, recently added Crosley to their refrigerator department, and the salesmen had a get-together meeting at which Crosley sales points were outlined to them.

"J. Michaels, operating nine stores under the name of Michaels & Company and the Long Island Furniture Company, have put a large display of Crosley Shelvadors in all of their outlets. Mr. J. Weiss, the buyer, is actively behind Shelvador, and their sales figures with the Crosley line actually increased 200 per cent over their same figures last year when they handled one line.

"John Mullins & Sons, one of Brooklyn's oldest furniture stores, have just received the new line of Crosley Shelvadors. This is their third successive season with Crosley refrigerators, and they expect to surpass all previous seasons' business."

line in north-eastern Texas and we look forward to further increases during the 1935 season."

New Dealer Appointments . . .

Again and again, from every section of the country come reports from distributors of new dealer appointments. Everywhere, alert retailers are learning the truth of that slogan, "No dealer can afford *not* to handle Crosley." A few announcements of recent appointments follow:

The P. B. Margrove Co., Lynn, Mass., the largest department store on the North Shore has been appointed a dealer for Crosley Shelvador electric refrigerators by the George Collins Co., Crosley distributor, Boston, David C. Rockman, general manager of that company, announces. The Margrove company is preparing a large merchandising campaign and expect to sell 900 Shelvadors this season.

The appointment of several new Crosley dealers in northern Indiana is announced by J. E. Davidson, president, Davidson Sales Co., Crosley distributor of South Bend. They are: Radio Bargain Store, Radio Mart and Ries Furniture Co., all of South Bend; Templin Music Stores of Elkhart and Mishawaka and Berman's of Elkhart. All are outstanding dealers in northern Indiana and a number of them will handle Crosley Shelvador electric refrigerators exclusively.

Announcement is made by H. W. Eskuche, president, Western Supply Co., Crosley distributor, of Salt Lake City, that the Axelrad Furniture Company of Salt Lake, one of the largest in the state, has been designated a dealer for Crosley Shelvador electric refrigerators. This store has been an outstanding dealer in electric refrigerators and will conduct an aggressive campaign on Shelvadors in 1935, Mr. Eskuche states.

Jacob Lowenstine & Sons, the well known department store at Valparaiso, Indiana, has taken on Crosley Shelvador electric refrigerators and Crosley radios, J. E. Davidson, president, Davidson Sales Co., Crosley distributor, at South Bend, announces.

The Albert Hess Furniture Co., one of the largest furniture houses in Louisville, Ky., has become a dealer for Crosley Shelvador electric refrigerators, J. E. Johnson, president, the Cooper-Louisville Co., Crosley distributor, announces.

Announcement has just been made

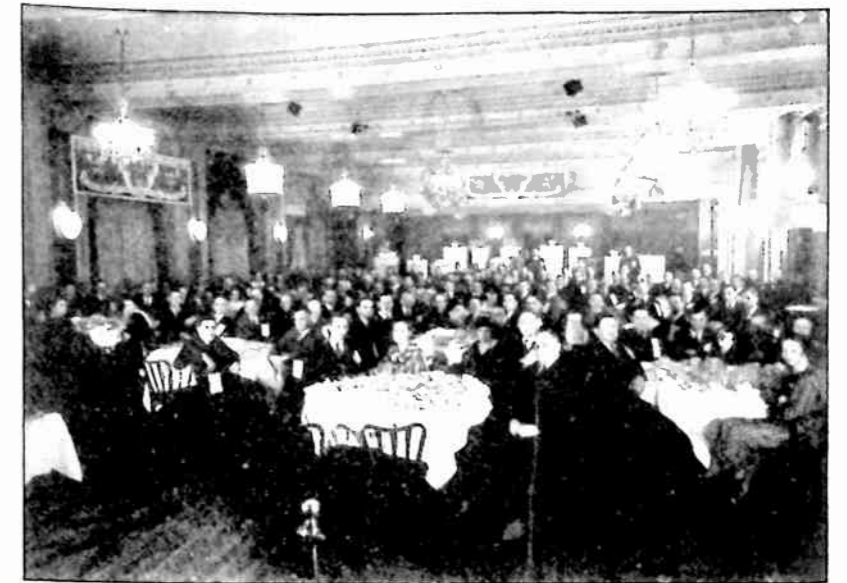

Dealer Meeting At Troy . . .

Judging from the expressions in this photograph, the recent dealer

meeting held by H. A. McRae and Company, Inc., Troy, N. Y., went over with a bang.

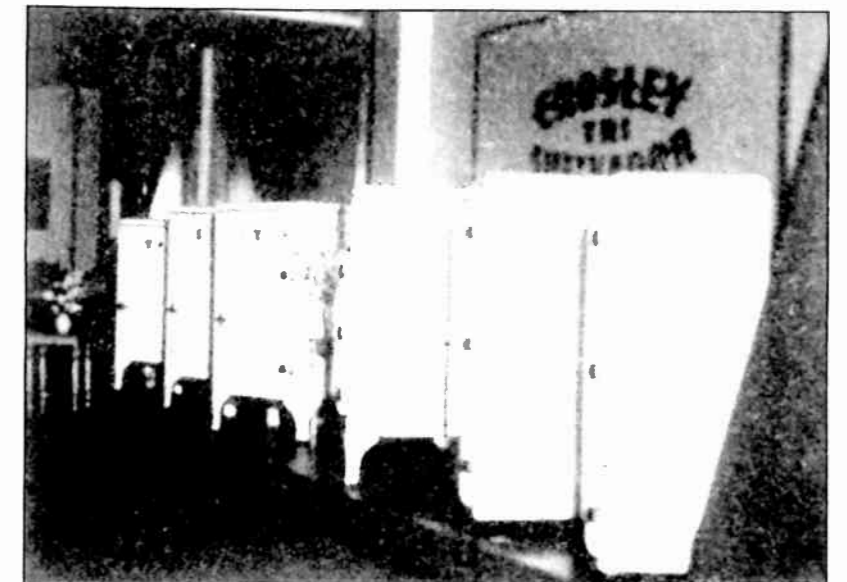

Section Of Sterling's Display Room . . .

It is said that one of the finest radio and refrigerator display rooms between Chicago and the coast is that of the Hardware Products Company,

Crosley distributor at Sterling, Illinois. The photograph shows a section of the Shelvador display.

50 Carloads For St. Louis . . .

of six prominent stores in different parts of the country who have been designated dealers for Crosley Shelvador electric refrigerators. They are, the Max Barnett Furniture Company, New Orleans, La.; Good Housekeeping Shop, Providence, R. I.; Stern & Company, Philadelphia, Penn.; Commercial Trading Company, Norfolk, Va.; Feld Furniture Company, Vicksburg, Miss.; and the St. Paul Furniture Company, St. Paul, Minn.

An order for 50 carloads of Crosley Shelvador electric refrigerators was placed by Ben Cohen, president, Glasco Electric Co., Crosley distributor, St. Louis, on his recent visit to the Crosley factory. The refrigerators are to be shipped as rapidly as possible after present orders are filled. Mr. Cohen reported that business on Shelvadors in his territory is exceptionally good.



Crowds Gather To See Shelvador . . .

Here is a sample of the vast crowds that stopped to view the Shelvador at

the Electric Progress Exposition recently held in Cincinnati.

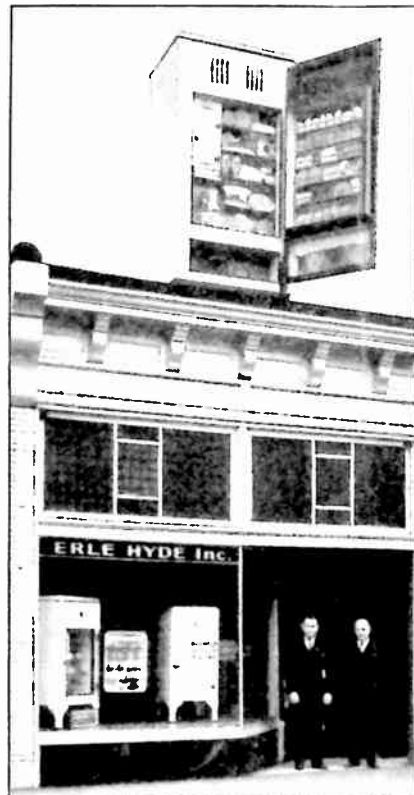

In Nashville, It's Shelvador . . .

In Nashville, they have a word for it. It's Shelvador. Wheelless Gambill, Jr., and his dealers have made it that. Recently Erle Hyde, who was formerly sales manager for the distributor of a competitive line, was attracted to the Crosley proposition be-

cause of the sensational value of the 1935 Shelvador.

Mr. Hyde opened up for business March 5 under the name of Erle Hyde, Inc., and with one salesman sold 35 Shelvadors the first two weeks he was open. The Gambill Distributing Company, Crosley distributor at Nashville, placed the big 16-foot Shelvador display on the top of the building in which Mr. Hyde is located. It is illuminated every evening by 40-watt colored bulbs on the inside of the box.

"Thrill Of Our Lives" . . .

That Frank J. Heimbaugh of Akron, Ohio, is completely satisfied with his new Crosley Radio is putting it mildly, if one is to judge from this enthusiastic letter received from him:

"Yes, I was there last night. I just can't help letting you know. I just purchased a new 6-tube all-wave Crosley radio for my son. We had the thrill of our lives, stayed up late last night and got up early this morning to find out what stations we could get. Well, we were not disappointed. It surely was a revelation. I have four radios in my house, car, and shop, of very popular makes and thought they were good, but when I got this Crosley, well that's different. It is also nice to look at, which doesn't help reception, but is a satisfaction. I am going to have a Cros-

Christman Crosley Cooking School Is Great Success . . .

A cooking school that had an attendance of 3500 and secured several hundred prospects in addition to making a good number of sales for Crosley Shelvador electric refrigerators was recently held by the Christman Dry Goods Co., leading department store of Joplin, Mo. A unique guessing contest was staged in connection with the school to secure names of persons who did not have an electric refrigerator. Those attending were asked to fill in and sign a blank, giving name, address and stating whether person owned an electric refrigerator. Space was provided at the top in which to enter the guess of the person as to the number of articles in the Crosley Shelvador.

Describing the cooking school and contest, J. E. Swindler, sales manager, Rogers & Baldwin Hardware Co., Crosley distributor, Springfield, Mo., said: "We had two F-55's on display; one closed and the other open and filled with articles of food, but not overflowing. Each person was required to guess the number of articles of food in the refrigerator. To do so every one had to look very carefully. As a result a number of complimentary remarks were passed as to its capacity and what a lot of articles could be placed in the door. Six prizes, all different sized baskets of groceries, fruits and Coca-Cola constituted the prizes. There were 237 articles of food in the F-55 and nine persons guessed the exact amount, and all received a first-prize basket. Out of the 3500 in the contest only 40 guessed over the 200 mark."

Walter T. Noss, special representative, Rogers & Baldwin Hardware Co., cooperated with the school, and he reports that L. F. Campbell, manager of the Christman furniture and refrigerator department was highly pleased with the results, and has inaugurated an aggressive "direct-by-mail" campaign, using cards to follow up the prospects secured. Strong newspaper copy was also used to call the attention of housewives to the school. Securing an attendance of 3500 in a city with a population of 33,500 was regarded as exceptional by those sponsoring the school.

ley for my shop as soon as I can see my way clear, instead of the one I got".

Big Chicago Stores Having Large Sales Of Shelvadors . . .

Sales of Crosley Shelvador electric refrigerators in the Chicago market are eclipsing the 1934 record by a wide margin, C. E. Tay, manager, The Crosley Distributing Corporation, Chicago, reports. "All of our dealers in the Chicago area are enjoying greatly increased business this season," he said. "The big stores carrying Crosley Shelvadors are featuring them in their sales and advertising programs. Among them are Wieboldt Stores, Inc., Marshall Field & Company, Fish Furniture Company, and the General Furniture Company.

"Wieboldt's operate four department stores in the outlying business sections of Chicago and one in Evanston, prominent suburb of Chicago. They are concentrating their efforts on two nationally advertised lines of refrigerators, one of which is the Crosley Shelvador. The appliance departments of these stores are in charge of able managers who work under the direction of James Parker, who it will be recalled addressed the National Dry Goods Association convention on the subject of electric refrigerators last winter.

"Marshall Field & Company opened their seasonal advertising on Crosley Shelvadors with an advertisement in the Chicago Daily News, March 15. The theme of the advertising was stressed in the headlines, "Quality Through and Through." A reflection of the sustained radio market was an advertisement by Marshall Field's in the Chicago Evening American the same day.

"Operating eight furniture stores in the Chicago territory, the Fish Furniture Company is one of the largest retail refrigerator outlets in the country. Seven of their stores are located in Chicago and the eighth is in Gary, Indiana. This chain confines its efforts to two standard brands of refrigerators. Their advertising campaign on Crosley Shelvadors started in January and has been one of the most comprehensive and consistent refrigerator advertising campaigns ever conducted by a retail outlet, with copy appearing semi-weekly in the leading Chicago papers. The appliance division is in charge of Wm. M. Egan who has a national reputation as a shrewd and successful operator.



Dealer Stages Electric Show . . .

Staging a three-day electric show in the store was the successful idea of Rudner and Jacobs, Wellsburg, W. Va.

This aggressive Crosley dealer recently held a show to further the sale of the Crosley Shelvador. Every model was on display and as a special feature the firm gave away, during the show, a four-piece stainless steel refrigerator set with each purchase of a Shelvador.

In preparation for the event, the store was rearranged and beautifully decorated. Newspaper advertising with the offer of free prizes every night, served to promote the show which attracted considerable atten-

tion. Large crowds were in attendance and, in every way, the show was a huge success.

Although this is the fourth year that this firm has been handling Crosley electric refrigerators, they have never made a charge for service. According to Harry Jacobs, the manager, the required servicing has been of such a minor nature that he has never found it necessary to make any charges.

This live-wire dealer is in the territory of Ott-Heiskell Company, Wheeling, W. Va.

Civil War Veteran Chooses Shelvador . . .

Lippincott Electrical Company, Bellefontaine, Ohio, reported a Shelvador sale to one of the three surviving Civil War Veterans of that county. According to Mr. Lippincott, a Shelvador FA-70 was recently sold to Mr. Jerry Overholser for his daughter, Mrs. W. W. Barton, with whom he makes his home.

"Mr. Overholser was 90 years old on January 15th, 1935," writes Mr. Lippincott. "He is very active, takes long walks every day and attends to his own business affairs. Before retiring he was a commission agent in this city for a number of years. Mr. Overholser selected the largest size Crosley for its capacity to hold watermelons."

The Lippincott Electrical Company is in the territory of Aitken Radio Corporation, Crosley distributor at Toledo.

dising problems, Mr. Coyne has been highly successful in his refrigerator operations."

**Erskine-Healy, Inc.,
Holding Sales Schools
On Shelvadors . . .**

Sales schools for a period of six weeks or more are being conducted by Erskine-Healy, Inc., Crosley distributor, Rochester, N. Y., on Crosley Shelvador electric refrigerators, Ray F. Healy announces.

Describing the method of conducting these schools, Mr. Healy said, "Our plan for this season is to have the first part of the session conducted by a dealer or a dealer's salesman who has done an outstanding job selling Crosley Shelvadors. We opened on March 22 in the Rochester Gas & Electric auditorium with our city sales manager, Harry V. Barrow, in charge of the session. He first introduced Charles Howe, manager of Howe & Rogers Co., the largest Crosley dealer in this territory and probably the largest electric refrigeration dealer in this territory. Mr. Howe told of the success Howe & Rogers have had for three years with Crosley refrigerators, the possibilities in the business for the dealer and the salesman and the very satisfactory cooperation they had received from Erskine-Healy.

"Following Mr. Howe was Joseph Thompson, known as "Tommy" to the entire trade. Mr. Thompson sold 125 Crosley Shelvadors in 1934 for Howe & Rogers and expects to double this record in 1935. He gave a complete presentation on how he sells a refrigerator to a prospect. The session was concluded by Jack Knabb, Rochester sales counselor who has been engaged to assist us in sales promotion work with our dealers. He brought out many points that every dealer and salesman can use to advantage in his daily work."

**Television? Sees
WLW On Thermometer . . .**

Harold E. Senf, of Middletown, Ohio, was mystified one morning recently when he thought that a case of television had been discovered in his thermometer.

Looking out the window at the thermometer on the outside, his little daughter Phyllis, who is just under four years old, called to her parents and said, "I can see WLW on the thermometer." So much in earnest was she that her father had to go and see to satisfy her. When he got there she confi-

**NOW IS THE TIME
TO CASH IN!**

This is an opportunity that should be taken advantage of by every Crosley dealer. Restaurants, bar-b-que stands, clubs and other retailers of draught beer are finding other kinds of refrigeration inadequate during the warm weather. Undoubtedly a number of these stores are your neighbors—your friends. Tell them now of the Crosley Kool-Draft—the ideal electric draught beer cooler and dispenser.

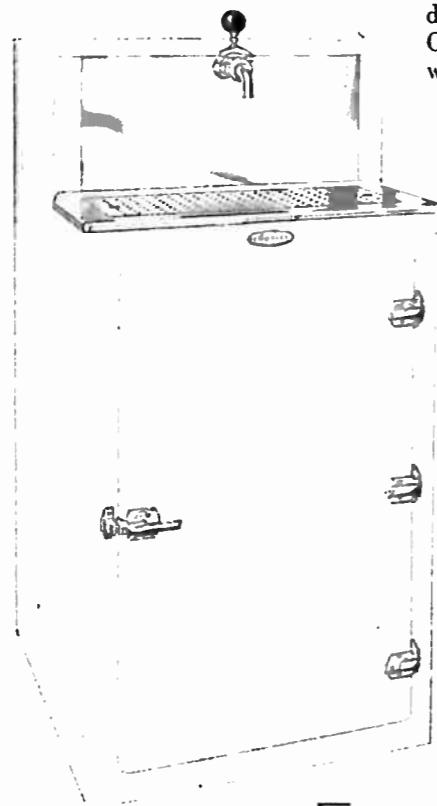

The Crosley Kool-Draft is built upon the same high standards that characterize all Crosley products. Equipped with full opening faucet of brass, chromium plated. Thermostatically controlled cooling coil.

Cold control permits regulation of temperature of drawn beer above or below 40 degrees as the user desires.

Cabinet is sturdily constructed with steel and wood frame. Built to withstand hard usage when changing half-barrels of beer. Refrigeration unit operates on any 110-volt, 60 cycle A.C. light socket. It is removable without disconnecting any tubes. Casters available at slight additional cost.

Dimensions: 52 3/4" high, 26 1/4" wide, 29" deep. Drain board is 4 1/2" from bottom.

**SEE YOUR CROSLY
DISTRIBUTOR
FOR SPECIAL PRICE**

**CROSLY KOOL-DRAFT
THE ELECTRIC DRAUGHT BEER COOLER**

dently pointed to the figure 70 on the thermometer. "Without being told," said Mr. Senf, "she obviously had learned to associate the figure 70 with the letters WLW which appear beside it on the dial of our Crosley radio. She has never been taught to read,

and apparently this is her first attempt to correct the deficiency—although her interpretation is figuratively rather than literally correct. It is evident that radio has an important educational influence on a very immature mind."

CROSLY SERVICE SUPPLEMENT

MODEL 5A3—ROAMIO

Type	Where Used	TUBE VOLTAGES—MODEL 5A3						
		Ef	Ep	Eg	Ec	Esg	Eosc	E Sup-G
78	R. A. Amp	6.0	230	0-30	5.0	100	—	5.0
6F7	Osc.-Mod.	6.0	230	0-30	8.0	100	55	—
6B7	I. F. Amp. Diode Det. A. V. C.	6.0	230	0	3.0	100	—	—
78	Audio Amp.	6.0	60	0-30	3.0	25	—	3.0
42	Output	6.0	220	0	16.0	230	—	—

VOLTAGES MEASURED TO CHASSIS WITH A 500 VOLT 1000 OHMS PER VOLT VOLTMETER. 6 VOLT BATTERY USED.

VOLTAGE LIMITS PLUS OR MINUS 10%.

PARTS LIST—MODEL 5A3

Figures in first column refer to parts shown in diagrams.

Item No.	Part No.	Description	Item No.	Part No.	Description
1	G19-32000	Antenna Coil	48	W-31102	Fuse Carrier
	W-30802A	Coil Shield		-33B	Speaker
	W-30026A	Retaining Shield	49	1B-32037	6 SA 4 Syncrotube
2	G11-32001	R. F. Coil	50	G1-32769	Power Transformer
	W-30802A	Coil Shield	51	G11-24628	"B" Filter Choke
	W-30877	Insulating Washer	52	W-32759	8. Mfd. 300 Volt Condenser
	W-30026A	Retaining Ring	53	G1-32755	R. F. "B" Choke
3	G14-32002	Osc. Coil	54	G6-28067	R. F. "A" Choke
	W-25025B	Coil Shield	55	W-30366	0.5 Mfd. 160 Volt Condenser
	W-26891	Insulating Washer	56	W-30366	0.5 Mfd. 160 Volt Condenser
	W-21541C	Retaining Ring	57	W-32762	0.005 Mfd. 1,000 Volt Condenser
4			58	G81-27975	6 SA 4 Socket
5	G2-33002	Tuning Cond. Gang	59	W-21452	1,100 Ohm Resistor
6			60	W-30741	0.00025 Mfd. (Mica) Condenser
7			61		
8	G6-32003	1st. I. F. Prim. Tuning Cond.	62	W-21454	1 Megohm Resistor
9			63	W-21237A	60,000 Ohm 1/4 Watt Resistor
10			64	W-32780B	0.05 Mfd. 400 Volt Condenser
11	G7-32003	2nd. I. F. Sec. Tuning Cond.	65	W-32780B	0.05 Mfd. 400 Volt Condenser
12			66	W-32782B	0.01 Mfd. 400 Volt Condenser
13			67	W-26156A	S. P. S. T. Switch (Tone Control)
14	W-32711A	0.1 Mfd. 200 Volt	68		Dial Light
15		0.1 Mfd. 200 Volt	69	W-32757	12 Amp. Fuse
16		0.05 Mfd. 400 Volt	70	W-32741A	0.0005 Mfd. (Mica) Condenser
17	Deleted		71	W-32741A	0.0005 Mfd. (Mica) Condenser
18	W-32779B	0.02 Mfd. 200 Volt Condenser	72	Deleted See 74	
19	W-32781B	0.1 Mfd. 200 Volt Condenser	73	W-24784	0.25 Mfd. 200 Volt Condenser
20	W-32780B	0.05 Mfd. 400 Volt Condenser	74		"A" Choke
21	W-32779B	0.02 Mfd. 200 Volt Condenser	75	G8-31701	0.0025 Mfd. Condenser
22	W-32780B	0.05 Mfd. 400 Volt Condenser	76		0.0025 Mfd. Condenser
23	W-23635	0.006 Mfd. 400 Volt Condenser	77		"A" Lead
24	W-32741A	0.0005 Mfd. (Mica) Condenser	78	W-30741	0.0025 Mfd. (Mica) Condenser
25	Deleted See 78			B-32783	Antenna Cable
26	W-32802	8. Mfd. 300 Volt Condenser		W-29754C	0.5 Mfd. Condenser (Eliminator)
27	W-21452	8. Mfd. 20 Volt Condenser		L-32810	Remote Control Assembly Complete
28	W-28589	1,100 Ohms Resistor		B-30372B	Housing
29	W-21454	350 Ohms Resistor		G2-31538	Cover Assm.
30	W-21875	1 Megohm 1/4 Watt Resistor		W-30370	Dial Glass only
31	W-23403	100,000 Ohms Resistor		B-32812	Dial
32	W-21454	150,000 Ohms Resistor		W-30371A	Dial Hand
33	W-23875	1 Megohm Resistor		G1-30295	Gear Assm.
34	W-25521	500,000 Ohm Resistor		G5-23472	Knob (Tuning)
35	W-32331	450 Ohm Resistor		G1-28036	Knob (Key)
36	W-26525B	55,000 Ohm 1/2 Watt Resistor		G7-25868	Drive Shaft 15" (V. C.)
37		15,000 Ohm Resistor		G21-25868	Drive Shaft 15" (Tuner)
38	G4-28067	25,000 Ohm Resistor		G8-25868	Drive Shaft 30" (V. C.)
39		R. F. "A" Choke		G20-25868	Drive Shaft 30" (Tuner)
40	W-30436A	Level Control		W-26315	1/4 x 1/4 Dog Pt. S. P. Set Screw (4 used)
41	G49-27975	Switch		W-28029B	Sterring Column Bracket
42	G48-27975	6-F-7 Socket		G1-28035	Strap Assm.
	W-27981A	6-B-7 Socket		R-186	1/4 x 3/4 R. H. Machine Screw (black) (1 used)
	W-30964	Tube Shield Base		W-20802	No. 10 Shakeproof Washer (black) (4 used)
	W-30964	Tube Shield		R-181	No. 10 x 1/4 R.H. Machine Screw (black) (3 used)
43	G25-27975	42 Socket		C-141	1/4 x 1 1/2 Fr. Hd. Machine Screw (2 used)
44	G39-27975	78 Socket		W-31539	No. 2-56 x 1/4 R.H. Machine Screw (1 used)
45	L-35108	Antenna Body and Sleeve Assm.		G17-26317	Dial Light Bracket Assm.
46	G1-32750	Antenna Lead Assm.		G8-32750	Dial Light Lead Assm.
47	Deleted See 77				
	G5-31701	"A" Cable Assm.			

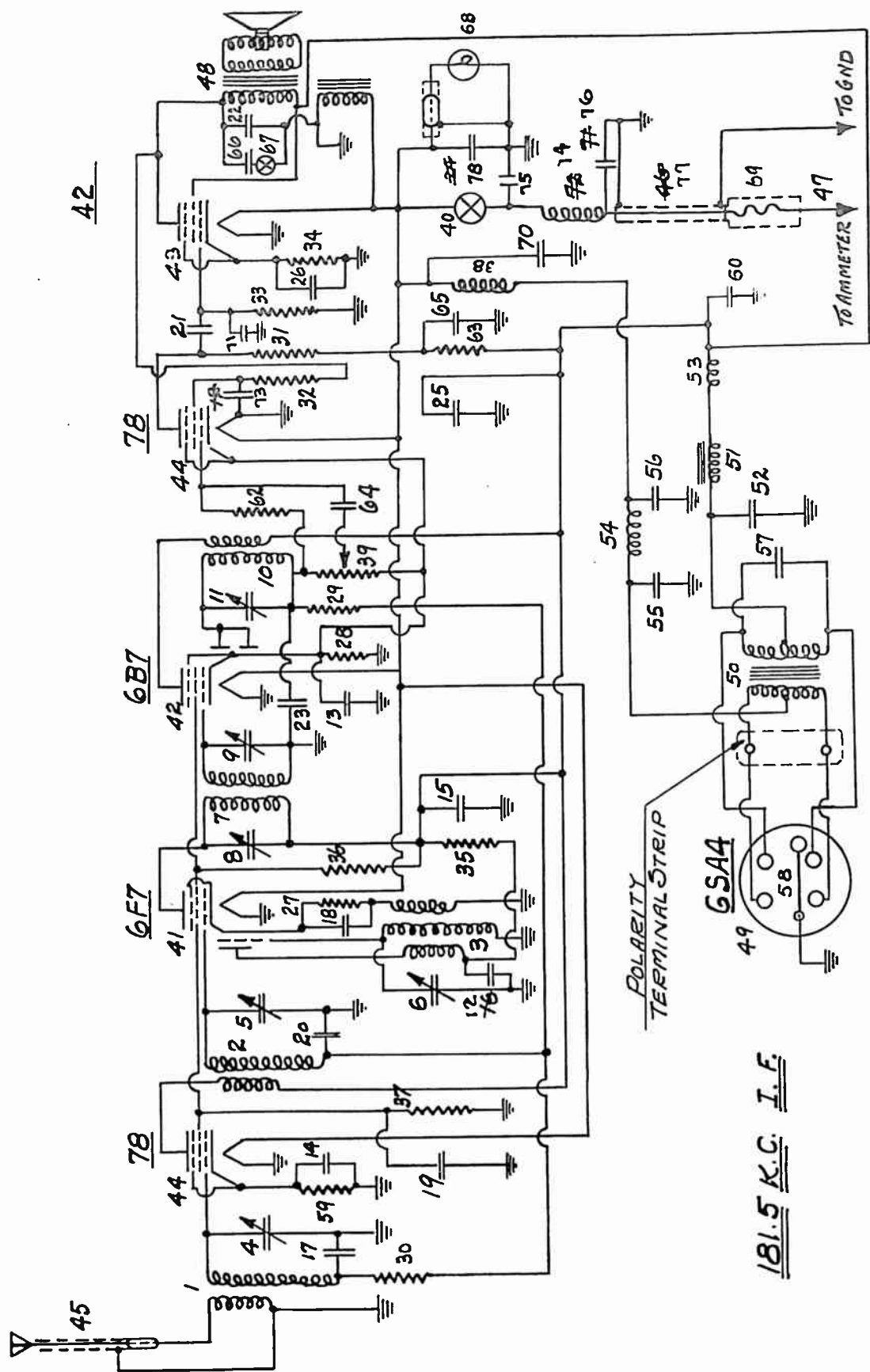

CIRCUIT DIAGRAM—MODEL 5A3

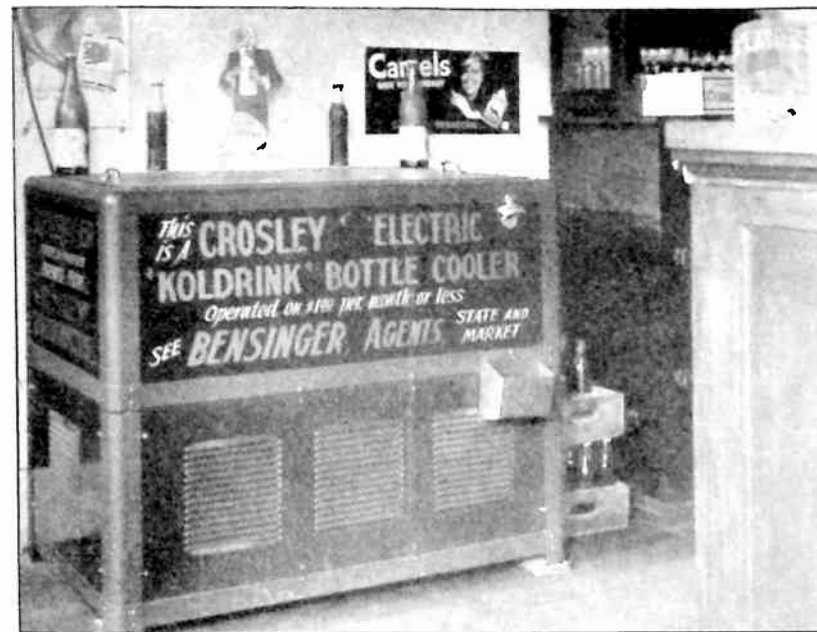

Aggressive Sales Methods Bring Koldrink Sales . . .

With an aggressive promotion campaign that is centered around the demonstration of the Crosley Koldrink Electric Bottle Cooler itself, the Clifford Bensinger Furniture Company of New Albany and Jeffersonville, Indiana, is winning well-merited sales. At the time of writing, when the season had barely started, this energetic firm had sold over twenty Koldrink coolers. They anticipate selling one hundred Koldrinks before the season is over!

You, of course, know that the Crosley Koldrink is an electric bottle cooler that is a necessity for restaurants, druggists, hotels, roadside stands, summer camps, grocers and any other retailer who wants to dispense bottled drinks in the most economical, practical and palatable manner.

It seems that the Koldrink itself is its best advertisement, according to the successful experiences of the Clifford Bensinger Furniture Company. As can be seen in the accompanying photograph, this firm gets permission from the owner to place advertising on the Koldrink.

This advertising sign reads, "This is a Crosley Koldrink Electric Bottle Cooler—operated on \$1.00 per month or less—see Bensinger." They attempt to position the Koldrink in a prominent place so that the advertising will show to best advantage.

At the new Bensinger baseball park in New Albany, Indiana, two Koldrinks are installed in the concession stand. Mr. Bensinger be-

lieves that this demonstration alone will sell lots of Koldrinks. Certainly it will be placing the Koldrink before vast crowds of people.

A fundamental selling doctrine is that if you want to sell something—go out and do it. Certainly, Mr. Bensinger is a firm believer in that principle. He has laid the foundation by getting the Koldrink with his advertising sign before as many people as possible—a splendid advertising plan. His selling plan is equally as easily understood. He goes out after the business!

"As to the selling of the Koldrink," says Mr. Bensinger, "We have a new Ford truck which makes trips daily in the city and in the country, which we figure is the only way to sell them to people living out of the city. People become interested immediately and before very long we have an order for the Koldrink."

"Any confectionery, grocery or soft drink stand that has been paying out from twenty-five to fifty cents a day for ice can be sold a Koldrink. As the electric current to operate a Koldrink averages about \$1.00 a month, the balance saved on the ice can be paid on the cooler and the owner has then paid for his Koldrink in one year without any extra cash outlay."

This is obviously a convincing argument that should impress any prospective Koldrink user. The added fact that the Koldrink makes it possible to serve drinks at the right temperature, thereby possibly increasing the retailer's sales of

bottled drinks, should prove doubly convincing.

In speaking of service, Mr. Bensinger remarks, "Of all the Crosley Koldrinks we have sold, we have not had a service call on any of them. They certainly perform well and every customer is a booster. We secure lots of prospects from satisfied users and we lose no time in closing the deal."

Here is an example of how one Crosley dealer is winning extra profits through the sale of the Crosley Koldrink. It is an example that can be followed with surprising results by every Crosley dealer.

Crosley Bottle Cooler Doubles Sales For Grocer . . .

One example of the gratification evidenced by retailers of bottled beverages over the Crosley electric bottle cooler is found in a recent letter from a Kentucky grocery store.

United Market of Mayfield, Kentucky writes: "We are glad to tell you that last July we installed a Crosley electric bottle cooler and our bottled drinks have since doubled in sales. Our only complaint is that we didn't get it soon enough. Many thanks for making a cooler like this."

So thoroughly convinced is the United Market that the Crosley bottle cooler is an extremely valuable asset that they recently ran a newspaper advertisement featuring it. The ad read, "We sold nearly 24,000 bottles of Coca Cola last year because we keep it cold. We use a Crosley Electric Bottle Cooler. If you like it cold come and see us."

Obviously, any beverage retailer who materially increases his sales through the installation of the Crosley Bottle Cooler will be a firm believer in it. That's why it has become so tremendously popular and why Crosley dealers are enjoying such amazing sales success with it.

A Proud Owner . . .

"Almost four years ago, my brother, Guy R. Brumage, a dealer of Oshkosh, Wisc., presented me with a seven-tube Crosley radio," writes Mrs. Harry Bort of St. Joseph, Mich. "In all this time I have never had to do a single thing to the radio, no repairs of any kind and we certainly enjoy it very much."

TEN TUBES...FIVE BANDS

*Bring thrilling world reception
plus weather reports...*

**THAT MEANS
PROFITS FOR
YOU!**

The radio achievement of 1935—the Crosley Centurion—is bringing untold thrills as it receives world-wide broadcasts plus the new weather band. It gets and gives more than any other radio. That's why it is bringing unprecedented sales and profits to Crosley dealers everywhere.

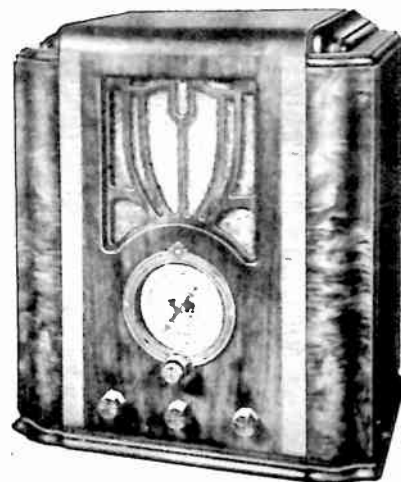

THE CROSLY CENTURION

The ultimate in beauty, performance, quality and value! You'll like the design, the lines, the harmonious blending of choice woods. Pin stripe and figured walnut veneer adorn the front panel. Pilasters are of stump walnut veneer. Sides are of walnut veneer.
\$79.50
 Complete With Tubes

57 FEATURES INCLUDING:

Ten-tube all wave superheterodyne . . . Five tuning bands, 150 to 22,000 Kc. . . . Two double purpose tubes . . . New, illuminated airplane type dial . . . Band spread pointer . . . Automatic volume control . . . Dual ratio tuning control . . . Continuous tone control . . . Push-pull output . . . Full floating moving coil electro-dynamic speaker.

CENTURION (Lov)

It puts new beauty in the living room . . . the weather at your fingertips. The cabinet front panel of center matched figured walnut veneer is effectively framed with California Claro walnut veneer on the pilasters, arch and top.
\$100.00
 Complete With Tubes

Prices Slightly Higher In Florida, Texas, Rocky Mountain States and West.

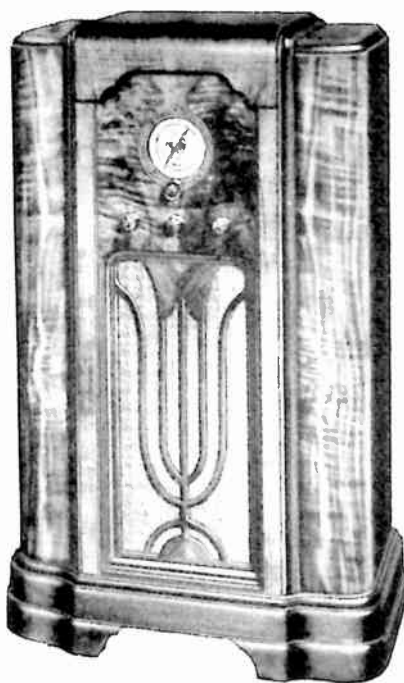

Whatever Happens....You're *There* With A Crosley
CROSLY RADIO