

THE GENERAL RADIO

# EXPERIMENTER

SR

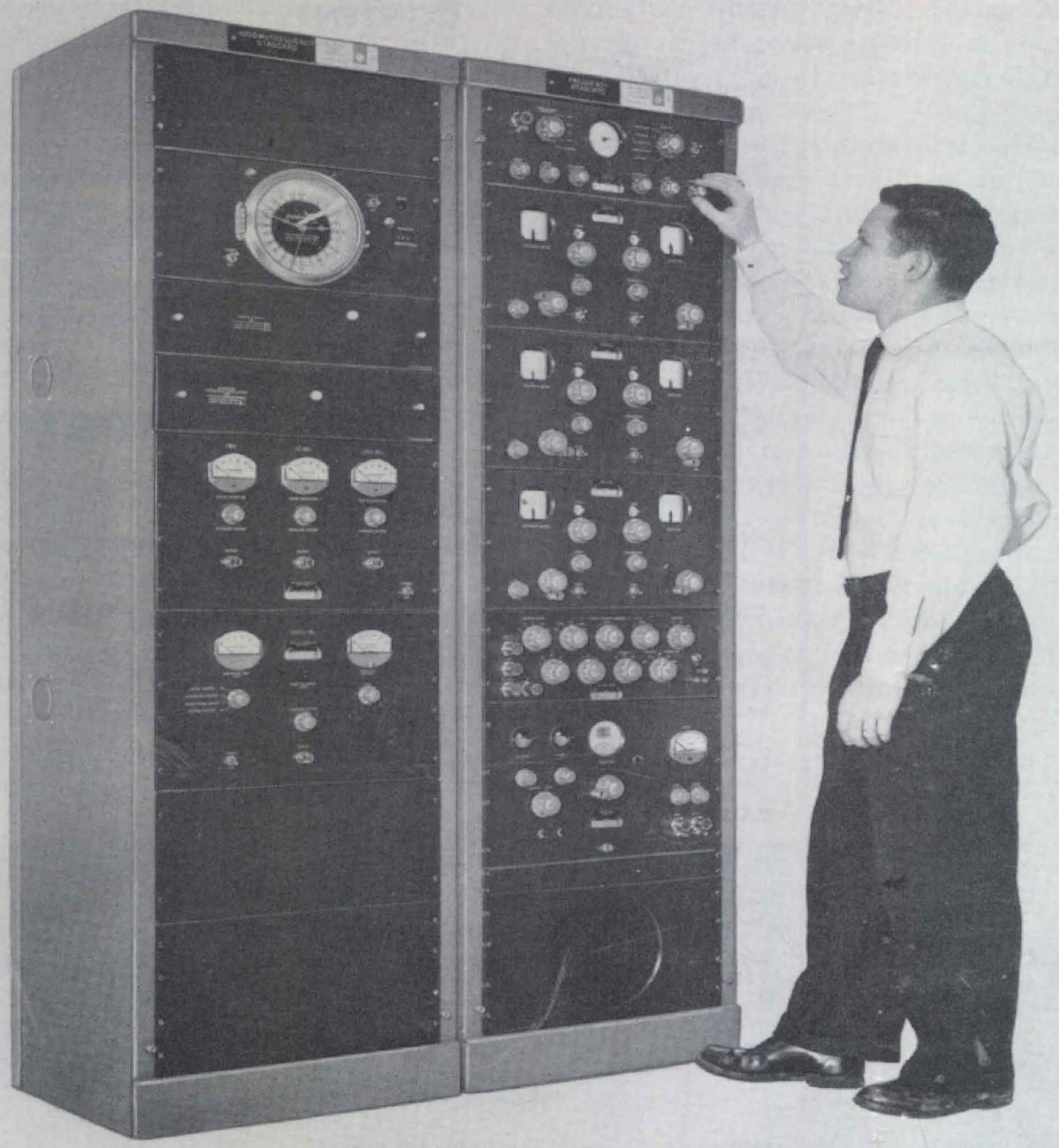

VOLUME 35 No. 4

APRIL, 1961

IN THIS ISSUE



**New Frequency Standard  
Representative for New Zealand**

# EXPERIMENTER



©1961—GENERAL RADIO COMPANY, WEST CONCORD, MASS., U.S.A.

Published Monthly by the General Radio Company

VOLUME 35 · NUMBER 4

APRIL, 1961

## CONTENTS

	Page
The New General Radio Frequency Standard . . . . .	3
Representative Appointed for New Zealand . . . . .	16
Precision Conductance Bridge . . . . .	16

The General Radio EXPERIMENTER is mailed without charge each month to engineers, scientists, technicians, and others interested in electronic techniques in measurement. When sending requests for subscriptions and address-change notices, please supply the following information: name, company address, type of business company is engaged in, and title or position of individual.

## GENERAL RADIO COMPANY

West Concord, Massachusetts

Telephone: (Concord) EMerson 9-4400; (Boston) MISSION 6-7400

- NEW YORK:** Broad Avenue at Linden, Ridgefield, New Jersey  
Telephone — N. Y., WOrth 4-2722  
N. J., WHitney 3-3140
- CHICAGO:** 6605 West North Avenue, Oak Park, Illinois  
Telephone — VillAge 8-9400
- PHILADELPHIA:** 1150 York Road, Abington, Pennsylvania  
Telephone — HANcock 4-7419
- WASHINGTON:** 8055 13th St., Silver Spring, Maryland  
Telephone — JUniper 5-1088
- LOS ANGELES:** 1000 North Seward St., Los Angeles 38, Calif.  
Telephone — HOLlywood 9-6201
- SAN FRANCISCO:** 1186 Los Altos Ave., Los Altos, Calif.  
Telephone — WHitecliff 8-8233
- CANADA:** 99 Floral Parkway, Toronto 15, Ontario  
Telephone — CHerry 6-2171

### REPAIR SERVICES

- EAST COAST:** General Radio Co., Service Dept., 22 Baker Avenue,  
West Concord, Mass.  
Telephone — Concord, EMerson 9-4400  
Boston, MISSION 6-7400
- NEW YORK:** General Radio Co., Service Dept., Broad Ave. at  
Linden, Ridgefield, New Jersey  
Telephone — N. Y., WOrth 4-2722  
N. J., WHitney 3-3140
- MIDWEST:** General Radio Co., Service Dept., 6605 West North  
Ave., Oak Park, Illinois  
Telephone — VillAge 8-9400
- WEST COAST:** General Radio Co., Service Dept., 1000 North  
Seward Street, Los Angeles 38, Calif.  
Telephone — HOLlywood 9-6201
- CANADA:** Bayly Engineering, Ltd., First St., Ajax, Ontario  
Telephone — Toronto EMpire 2-3741

### COVER

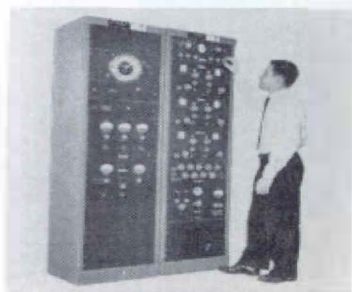

View of the new Type 1120-AH 1000-Mc Frequency Standard (left-hand rack) with the Type 1105-B Frequency Measuring Equipment (right).



# THE NEW GR FREQUENCY STANDARD

Like voltage, current, and impedance, frequency is a factor in most electrical measurements. It enters directly into ac measurements, and indirectly into dc measurements, appearing most often as its reciprocal, time. Since time is reciprocally related to frequency, a good frequency standard can become a good time standard for time measurements. In view of the necessity for some sort of frequency standard for even a 1000-cycle impedance measurement, it has become almost routine for an electrical measurement laboratory to possess a stable frequency standard which can be checked against standard-frequency or standard-time signals from appropriate sources.

It would be a mistake to consider that a "frequency standard" consisted solely of an extremely stable oscillator. Frequency dividers and multipliers are necessary to make the frequency standard useful over the range of frequencies covered by electrical measurement techniques, and to permit calibration of the frequency in terms of recognized international standards. The provision of

standard output signals over the range from low audio to microwave frequencies insures maximum usefulness for applications ranging from heterodyne-system frequency measurements to service as time-base reference in digital counters for frequency and time-interval measurements.

The frequency standard described in this article makes available, in various combinations, equipment to produce fundamental frequencies from 60 cps to 1000 Mc. It includes completely new instruments for generating the standard frequency, for deriving the desired low-frequency sub-multiples, and for developing harmonic-rich outputs. An improved Synchronometer\* integrates the 1000-cycle output to permit time comparisons with standard-time transmissions, and the TYPE 1112-A and TYPE 1112-B Standard-Frequency Multipliers<sup>1</sup> provide high-frequency output up to thousands of megacycles. These several instruments can be used individ-

\*Trademark pending.

<sup>1</sup>Frank D. Lewis, "New Standard-Frequency Multipliers," *General Radio Experimenter*, Vol. 32, No. 14, July, 1958.

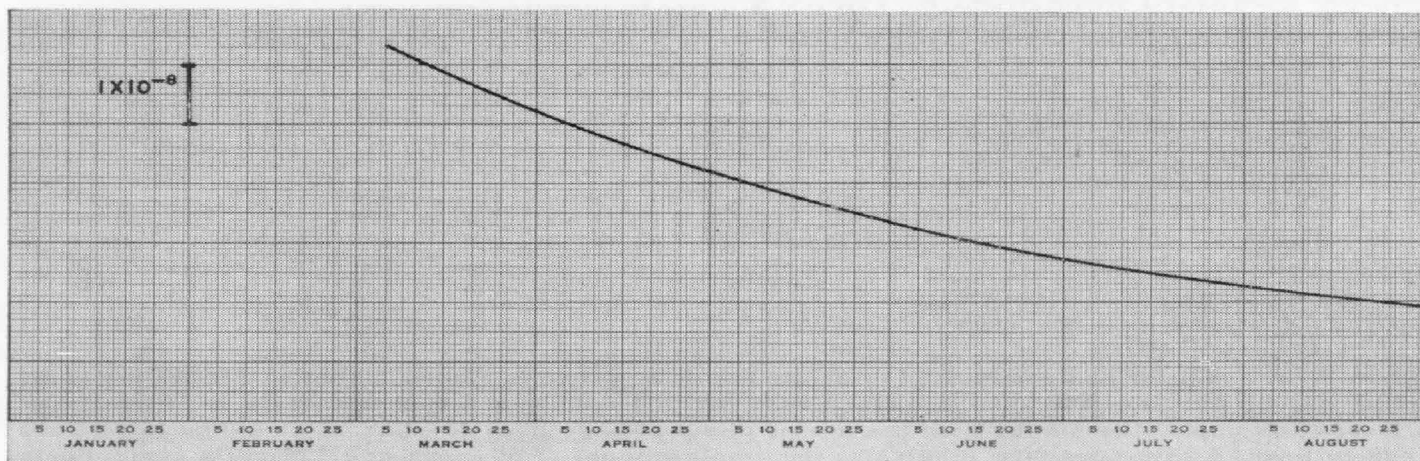

Figure 1. Frequency of Type 1113-A Standard-Frequency Oscillator compared with 18.0-kc standard-frequency transmissions of NBA over a six-month period. The average daily drift at the end of this period is  $1.2 \times 10^{-10}$ . The NBA transmitter is maintained on frequency by comparison with a cesium beam.

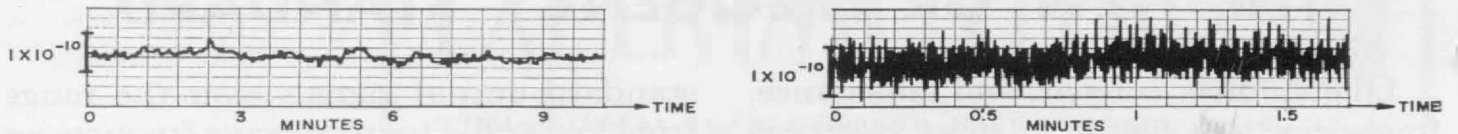

Figure 2. Intercomparison of frequencies of two Type 1113-A Standard-Frequency Oscillators. The short-term frequency instability of one oscillator alone is less than this combined instability by  $1:\sqrt{2}$ . The left-hand plot shows frequency variations averaged over 1-second sampling periods; the right-hand plot shows frequency variations averaged over 0.1-second periods.

ually or in various combinations to meet specific needs. They are designed to cooperate with the General Radio TYPE 1105-B Frequency Measuring Equipment as well as with counter-type frequency-measuring systems.

New techniques, circuits, and components have been used wherever applicable, consistent with conservative design. Practical compromises have been sought throughout to provide performance commensurate with the present state of the art at prices in keeping with equipment for everyday use. Thus, in accord with General Radio practice, the instruments are designed to be rugged, accurate, and dependable for ordinary environments but not (with the considerable added cost necessary) to cope with the stringent requirements of the military services for extreme environmental conditions.

The TYPE 1120-AH 1000-Mc Frequency Standard illustrated in Figure 1 comprises the TYPE 1113-A Standard-

Frequency Oscillator, the TYPE 1114-A Frequency Divider, the TYPE 1103-B Synchronometer, and the TYPES 1112-A and 1112-B Standard-Frequency Multipliers. Used in conjunction with the TYPE 1105-B Frequency Measuring Equipment and the new TYPE 1130-A Digital Time and Frequency Meter<sup>2</sup> this yields a comprehensive line of integrated frequency-measuring equipment.

### THE TYPE 1113-A STANDARD-FREQUENCY OSCILLATOR

The heart of the assembly is, of course, the standard-frequency generator. The General Radio TYPE 1101-B Piezo-Electric Oscillator, last of a long line<sup>3</sup> of distinguished predecessors, added its own contribution to the excellent reputation of General Radio frequency standards for dependability in the field. Today's requirements, however, demand considerably better stability.

<sup>2</sup>To be announced next month.

<sup>3</sup>James K. Clapp, "A New Frequency Standard," *General Radio Experimenter*, Vol. 3, No. 11, April, 1929.

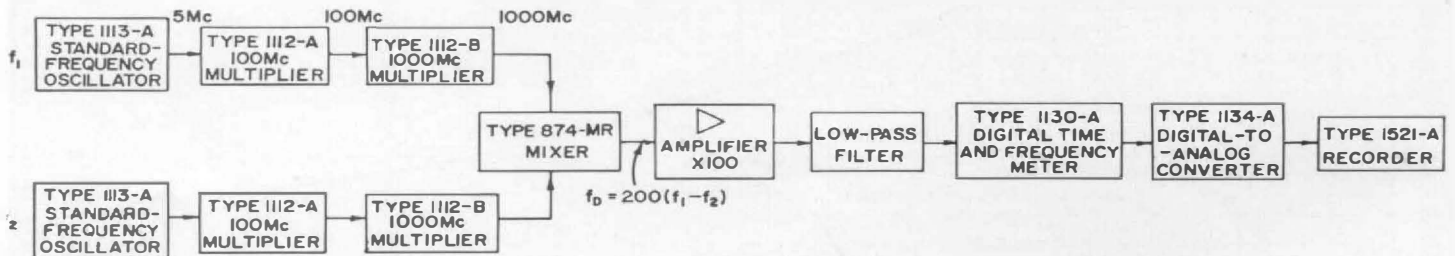

Figure 3. Schematic of equipment used to obtain the data plotted in Figure 2. Two oscillators are compared at 1000 Mc. The difference frequency  $f_D$  is made 1 cps for a 1-second sample or 10 cps for a 0.1-second sample. The output from the mixer, about 500-mv peak-to-peak, is amplified to 50 volts peak-to-peak. A low-pass filter eliminates the small amount of 60-cycle and 120-cycle components introduced by the multipliers. Its cut-off frequency is 15 cps, with better than 40 db attenuation at 60 cps. The period of the difference frequency  $f_D$  is measured with the Type 1130-A Digital Time and Frequency Meter and its output converted into analog form by the Type 1134-A Digital-to-Analog Converter. The output is plotted by a Type 1521-A Recorder. This recorder has a bandwidth of 10 cps which permits the measurement of stability for 0.1-second samples.



The new TYPE 1113-A Standard-Frequency Oscillator, which replaces it, uses the Gouriet-Clapp circuit<sup>4</sup>, instead of a modified Meacham bridge, and replaces the second-harmonic extensional-mode quartz bar,<sup>5</sup> operating at 100 kc, with a contoured AT-cut quartz plate, operating at 5 Mc. This plate, developed by a group at the Bell Telephone Laboratories<sup>6</sup> under a Signal Corps contract, has a storage factor,  $Q$ , in the range of 2 to  $3 \times 10^6$ , which makes possible a high degree of decoupling between the frequency-control element and its maintaining circuit. This, in turn, minimizes short-term frequency variations. Care in processing, with particular attention to avoiding contamination,<sup>7</sup> minimizes long-term drift. Overall stability is therefore excellent, as shown in Figures 1 and 2.

Figure 4 is a schematic of the oscillator, showing the frequency-control system and the delayed AGC, which maintains the drive power to the crystal at approximately  $0.5 \times 10^{-6}$  watts, a level carefully chosen to be large enough to be

<sup>4</sup>James K. Clapp, "A Broadcast Frequency Monitor for the 20 Cycle Rule," *General Radio Experimenter*, Vol. 14, No. 8, January 1940.

<sup>5</sup>E. P. Felch and J. O. Israel, "A Simple Circuit for Frequency Standards Employing Overtone Crystals," *Proc. IRE*, Vol. 43, No. 5, pp. 596-603, May, 1955.

<sup>6</sup>F. D. Lewis, "Frequency and Time Standards," *Proc. IRE*, Vol. 43, No. 9, p. 1055 and Appendix pp. 1065-1068, September, 1955.

<sup>7</sup>James K. Clapp, "On the Equivalent Circuit and Performance of Plated Quartz Bars," *General Radio Experimenter*, No. 10-11, Vol. 22, March-April, 1948.

<sup>8</sup>A. W. Warner, "High-Frequency Crystal Units for Primary Frequency Standards," *Proc. IRE*, Vol. 40, No. 9, pp. 1030-1033, September, 1952.

<sup>9</sup>A. W. Warner, "Frequency Aging of High-Frequency Plated Crystal Units," *Proc. IRE*, Vol. 43, No. 7, pp. 790-792, July, 1955.

"out of the noise" for short-term fluctuations but small enough so that aging and variations of frequency with drive level, which become significant at high powers, are minimal. Premium quality, long-life tubes are used for oscillator and amplifiers to assure reliability and to increase the time between tube replacements. To minimize effects of cathode-interface impedance<sup>8</sup> the oscillator tube is operated at relatively low transconductance and at reduced heater temperature. Filtered dc heater voltage minimizes 60-cycle frequency modulation, and well-regulated heater and plate supplies make the operation of the instrument substantially independent of line voltage. Ac and dc feedback in the AGC amplifier system keeps the crystal drive level within 10% for 2:1 change in transconductance of the tubes.

The temperature-control for the quartz plate is a two-stage system based upon the vacuum-bottle oven that has given excellent reliability over the years in the TYPE 1184-A-A Television Transmitter Monitor.<sup>9</sup> The temperature of this oven is determined by a mercury thermostat, which provides an on-off signal to the grid of a thyatron that controls directly the low-power oven heater. Cyclical temperature changes arising from this on-off heating system have

<sup>8</sup>C. T. Kohn, "The Effect of a Cathode Impedance on the Frequency Stability of Linear Oscillators," *Proc. IRE*, Vol. 48, pp. 80-88, January, 1960.

<sup>9</sup>C. A. Cady, "New Television Transmitter Monitor," *General Radio Experimenter*, Vol. 31, No. 4, September, 1956.

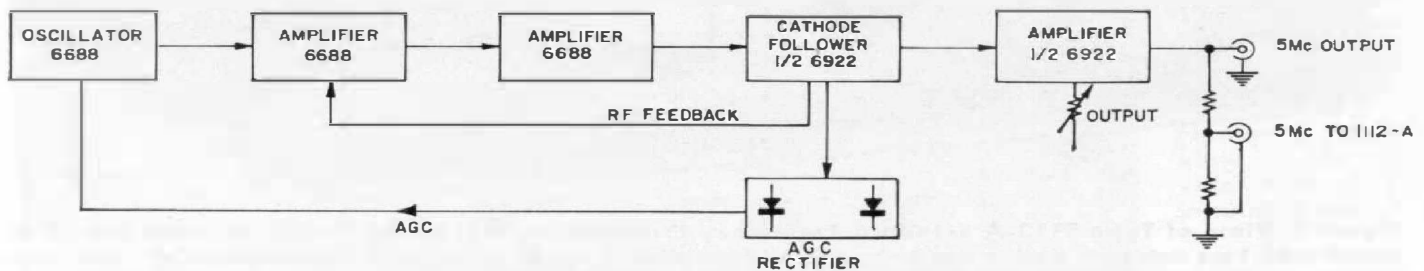
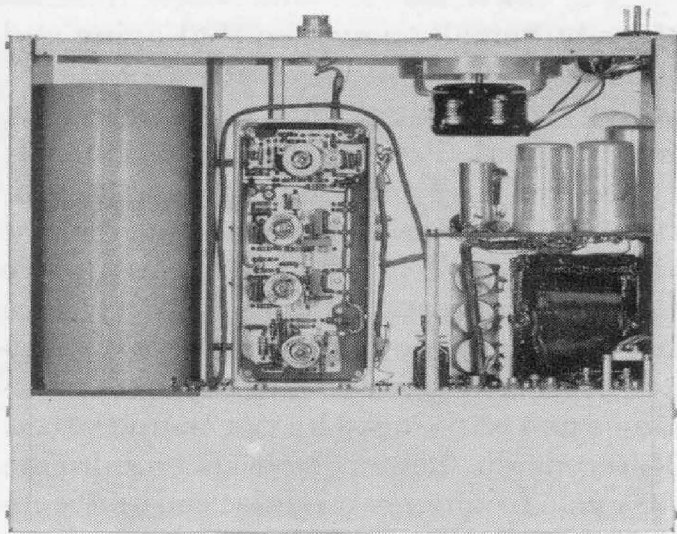

Figure 4. Block schematic of the Type 1113-A Standard-Frequency Oscillator.



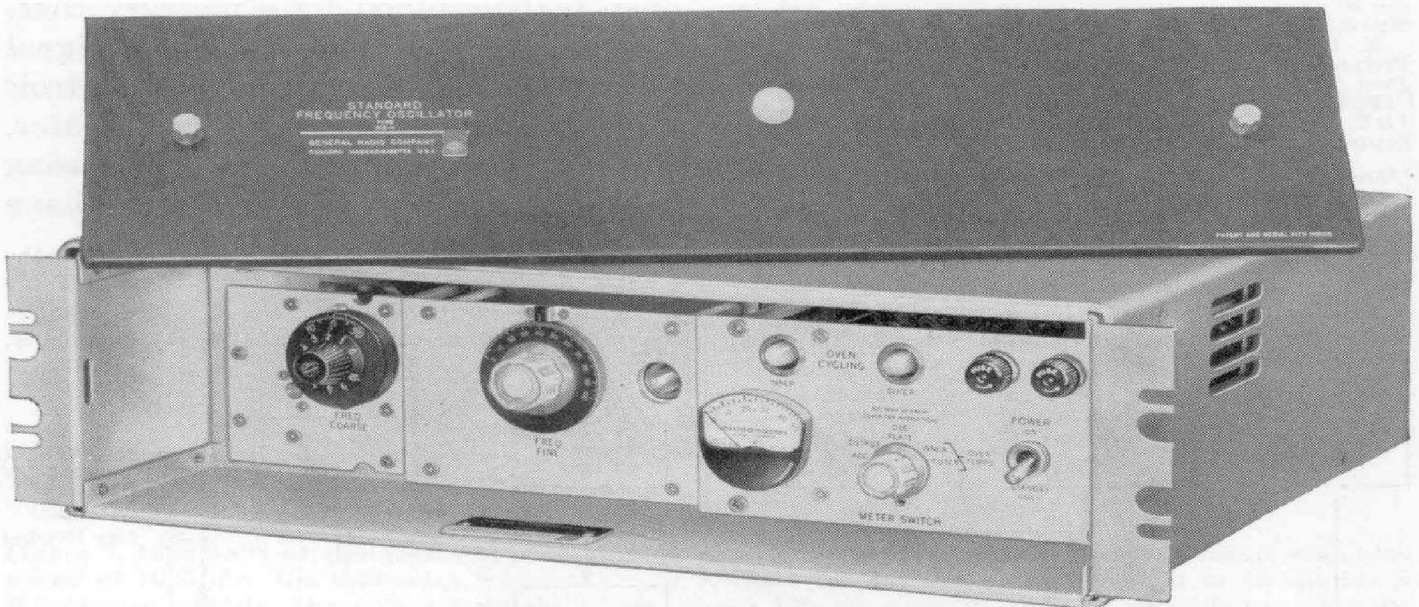

**Figure 6.** Interior view of the standard-frequency oscillator. Note that all parts are easily accessible. The crystal oven is at the left. The amplifier tubes and other circuit elements are mounted on a Fiberglas etched board in a cast frame. At the rear is a cooling fan with thermal cut-off, which turns off the power if the fan fails.

been reduced to the order of  $0.001^{\circ}\text{C}$  at the quartz plate, and a resultant frequency cycling of less than  $10^{-10}$ . A fan is used to equalize the temperature in the cabinet in order to keep the instrument components cool and to provide a

suitable ambient for the outer stage of the temperature-control system. The outer stage, itself, makes it necessary for the inner stage to cope with only a small temperature range. The combination maintains at least a 1500:1 control ratio over an ambient temperature range of  $0^{\circ}$  to  $50^{\circ}\text{C}$ .

To provide maximum protection against changes in ambient temperature, the oscillator-circuit components that enter into the establishment of frequency are all mounted in the oven with the quartz plate. The coarse frequency adjustment, which covers a range of adjustment of about  $5 \times 10^{-7}$ , is included among these components, and is provided with an ingenious drive mechanism that minimizes heat-leakage problems while assuring precise settability. The fine frequency adjustment, however, covers an adjustment range of only  $\pm 5 \times 10^{-9}$  and is not sensitive enough to ambient changes to warrant temperature control. It is individually calibrated to be direct reading, with divisions provided at inter-



**Figure 5.** View of Type 1113-A Standard-Frequency Oscillator control panel. The front panel is held in place with two catches, and is easily removed for adjustment of controls or observation of oven performance. The meter can be switched to perform any one of several functions, as a diagnostic device. The coarse and fine frequency controls cover a total range of adjustment of  $5 \times 10^{-7}$  yet permit setting to  $10^{-10}$ . The fine control is direct-reading, with divisions spaced at intervals of  $5 \times 10^{-10}$ .



Figure 7. Front view of the Frequency Divider with panel removed.

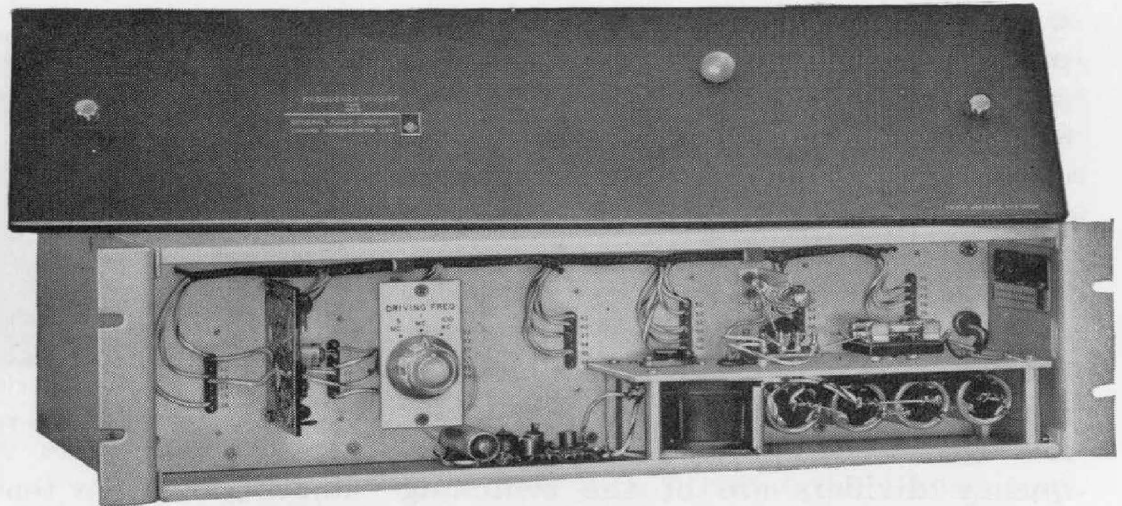

vals of  $5 \times 10^{-10}$  and is settable to  $10^{-10}$ .

For operational checks, a five-point meter circuit is included. The meter checks oscillator bias, rf output, plate current, inner-oven temperature, and outer-oven temperature.

#### TYPE 1114-A FREQUENCY DIVIDER

The Frequency Divider produces from the 5-Mc standard signal a series of output frequencies with fundamentals of 1 Mc, 100 kc, 10 kc, 1 kc, and 100 cps. Additional plug-in units are available to furnish outputs at 400 cps and 60 cps. These output frequencies are essentially sine waves. For those applications where harmonic series are needed, the TYPE 1108-B Coupling Panel<sup>10</sup> provides a harmonic-rich output. One of the important considerations in the design

<sup>10</sup>See Type 1105-B Frequency-Measuring Equipment, page 12.

of a frequency standard is that it "fail safe," that is, that there be no possibility that either the output frequencies or the indicated time be in error as a result of failure of the standard-frequency signal. There are two fail-safe conditions in the TYPE 1120-Frequency Standards. First, the synchronous clock will fall out of synchronism and not restart if the driving signal fails or changes frequency momentarily; and, second, the frequency dividers have no output in the absence of an input signal.

The dividers, however, are designed to restart when the input signal reappears. Thus no valuable data are lost in such applications as automatic frequency-comparison systems in the event of temporary power failure, while the clock stoppage indicates that the timing sequence has been interrupted.

Figures 7 and 8 show the mechanical



Figure 8. Rear view of the divider with plug-in units installed.

construction of the divider. The front panel can be removed to make test points easily accessible from the front of the relay rack. Plug-in units for the desired output frequencies are inserted from the rear (Figure 8). A typical plug-in unit is shown in Figure 9. Transistors are used throughout for reliability, small size, and low-power consumption. Figure 10 is a block diagram of the divider. The 5:1-Mc divider is regenerative, while the lower-frequency dividers are of the switching type.

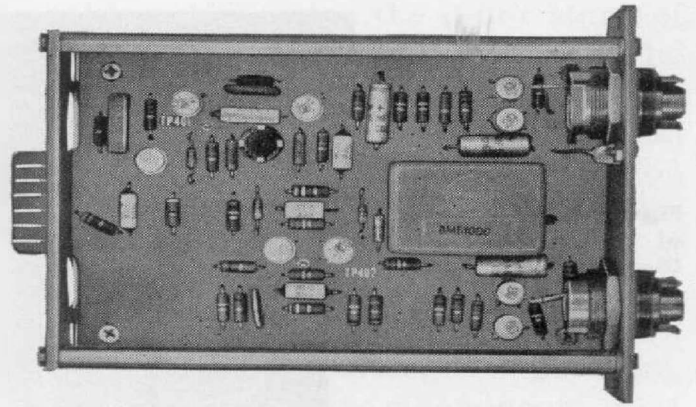

Figure 9. View of a typical plug-in unit.

The regenerative P1-unit divides the original 5-Mc frequency (or, optionally, 2.5 Mc) to 1 Mc. Each of the following units (P2 to P5) divides by 10. The optional 400-cycle unit selects the second harmonic of a 200-cycle signal, and the optional 60-cycle unit divides 200 by 10 and selects the third harmonic of the 20-cycle signal.

The 5:1-Mc regenerative divider is shown in elementary form in Figure 11. To explain its operation, let us assume the presence of a small 1-Mc voltage in the 1-Mc circuit. This is multiplied to 4-Mc, which is fed back to the mixer and heterodyned with the 5-Mc input, increasing the 1-Mc output.

This regenerative process produces a 1-Mc sine wave. The operating conditions of the circuit are set to obtain

limiting on a few tenths of a volt input, and the output is essentially constant over 5:1 drive range. For 2.5-Mc input the mixer generates the 5 Mc second harmonic and works as described above, dividing effectively by 2/5.

The lower frequency dividers are of the "switching" type. Figure 12 is a block diagram. The input signal, a square wave, is differentiated. The trigger generator is an amplifier generating short, positive trigger pulses. They are used to drive a monostable multivibrator (one-shot). The time constant of this circuit is chosen to reset at every fifth trigger pulse. Hence, one output pulse is generated for every 5 input pulses. The next stage is a bistable multivibrator (flip-flop). The square wave from this flip-flop is one tenth of the input frequency. A narrow-band filter selects the fundamental component

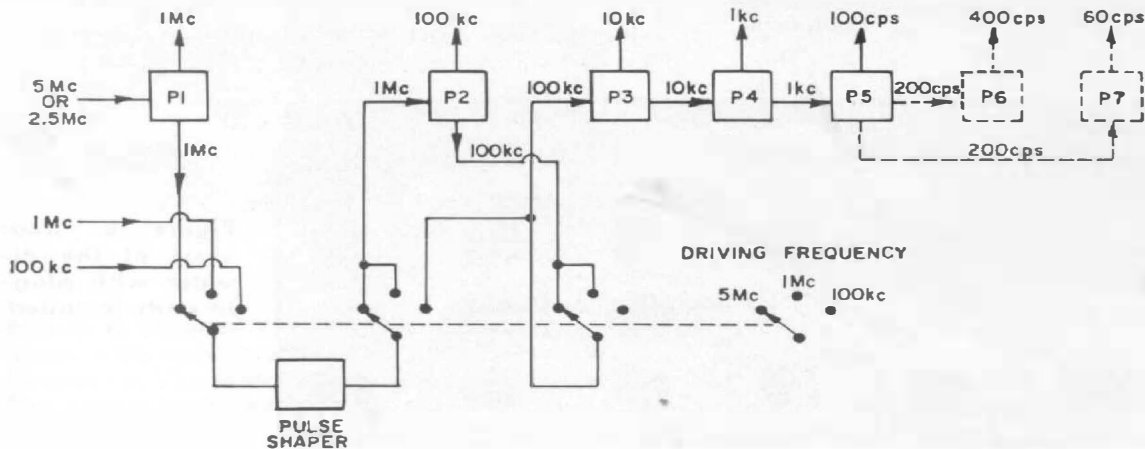

Figure 10. Block diagram of the Frequency Divider.



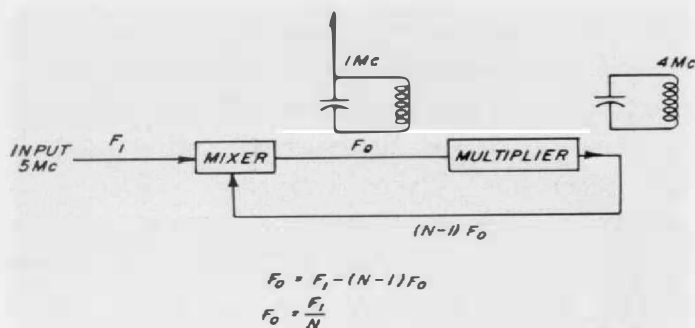

Figure 11. Elementary schematic of the 5:1 regenerative divider.

which is available at the output terminal.

The choice of a regenerative divider from 5 Mc to 1 Mc and switching dividers for the lower frequencies was dictated by two considerations: The use of a regenerative divider above 1 Mc is more economical, while below 1 Mc switching dividers have better phase stability. An important objective of this design has been to obtain high-phase stability so that the output signals can be used for the generation of high-order harmonic spectra with a minimum of phase modulation. For such applications, square-wave outputs are provided at 100 kc and 10 kc in addition to the sine-wave outputs.

The phase stability of a divider may be expressed in two ways: either in degrees phase angle of the output, or in terms of absolute time variation (jitter). In a regenerative divider, the slope of the signal voltage decreases by an order of magnitude for each division by 10. Assuming constant circuit-noise level, the phase-angle jitter will be invariant. This means that the time jitter in absolute units increases by one order of

magnitude for each decade of division. Switching dividers on the other hand may be assumed to have constant rise time regardless of fundamental frequency so that the time jitter remains invariant. This means that the phase noise is reduced by an order of magnitude for each 10:1 division. Given an over-all division ratio of 1000, say from 1 Mc to 1 kc, and assuming that for each stage a switching divider contributed 1 nsec, then we will have a total of 3 nsec time jitter at the 1-kc output. If a regenerative divider operating over the same range starts with a 1-Mc slope equal to that of the switching divider, then the 1-Mc to 100-kc stage will contribute 1 nsec as in the pulse system described above. From 100 kc to 10 kc the slope of the sinusoidal waveform has decreased by 10:1, hence, the jitter will be 11 nsec, and at 1-kc output, the jitter will be 111 nsec. This is 30 times more than the switching divider.

While this hypothetical example is for illustrative purposes only, measurements have shown similar relationship between the jitter of such circuits. A typical figure for the circuits of the TYPE 1114-A is an average of .05 nsec of jitter per decade. The measurement was made with a sampling oscilloscope measuring the total jitter of the 100-c output with respect to the 5-Mc input.

### THE TYPE 1103-B SYNCHRONOMETER

The reciprocal relationship between frequency and time has been of prime importance from the earliest days of

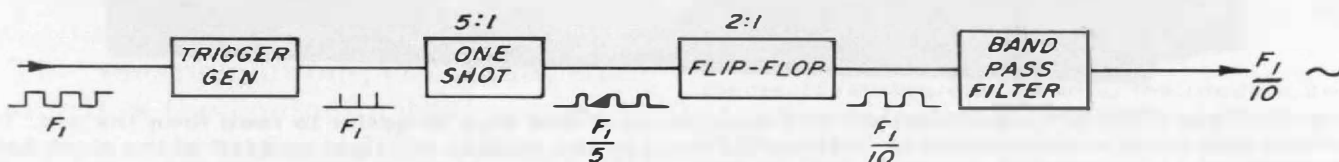

Figure 12. Block diagram of the switching divider.

frequency standards. Time is a fundamental dimension in our physical descriptions of things, and the need for more and more accurate measurements of time has steadily increased over the years. A frequency standard, which generates a series of events at a very constant rate, can be considered as a linear interpolator between measured times that mark the beginning and end of time intervals. To perform this function it is necessary that the events be counted over the interval, and this counting can be nicely done by a synchronous clock.

The events counted are ultimately displayed by the clock as turns of a shaft, or, in finer detail, by the angle of the shaft. A clock designed to run from a frequency standard should therefore run smoothly, at a very constant angular velocity, so that its shaft angle bears a constant relationship to the electrical angle of the sinusoidal driving signal, and it should be provided with a mechanism for accurately determining the shaft angle at any desired point in time.

The General Radio Synchronometers<sup>11</sup> have, over the years, met these requirements admirably, as attested by their

use throughout the world. They are based, primarily, upon a 1000-cycle synchronous motor having a 100-tooth rotor fabricated from high-grade silicon-steel laminations. Two driving coils, oppositely disposed with respect to the rotor shaft, carry the 1000-cycle driving signal superimposed upon a dc biasing current. Pulses of torque are therefore exerted upon the teeth at a 1000-cycle rate as they pass the pole pieces, and the rotor shaft turns at 10 revolutions per second. The rotor itself carries a circular well, coaxial with the shaft, which contains radial baffles and which is partially filled with mercury. The mercury, in this configuration, does double duty in serving as a heavy mass to produce flywheel action and as a damping agent to minimize hunting.

The rotor shaft, which is vertical when the instrument is in its normal operating position, drives a horizontal shaft at 1 revolution per second through the combination of a worm and gear. This shaft, in turn, drives the clock mechanism through another right-angle worm-

<sup>11</sup>"The Type 411 Synchronous Motor." *General Radio Experimenter*, Vol. 1, No. 11, May, 1927.

H. S. Wilkins, "Synchronous Motor-Driven Clocks." *General Radio Experimenter*, Vol. 5, No. 5, October, 1930.

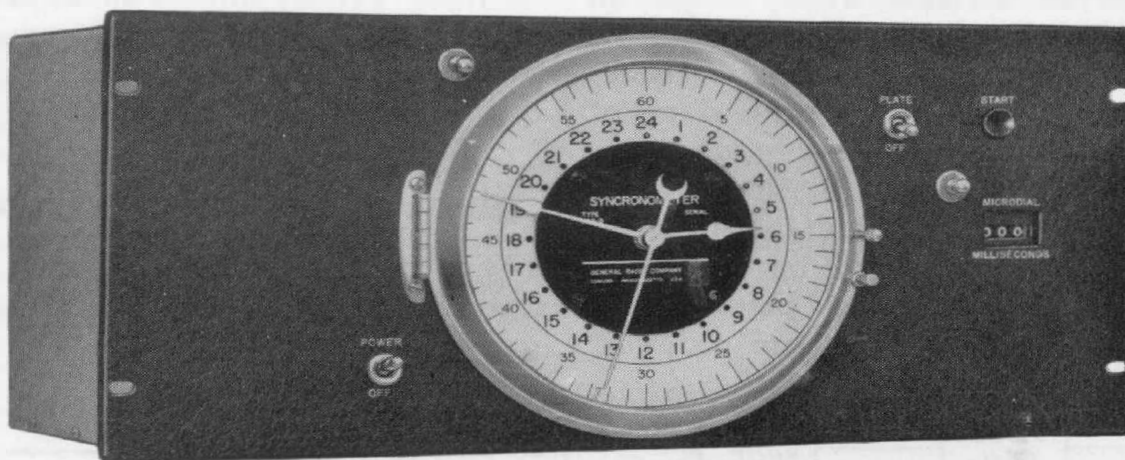

**Figure 13. Type 1103-B Synchronometer.** The new 24-hour dial face is easier to read than the old. The microdial and second-hand shafts are accessible through the ports to the right and left of the clock face, respectively, and can be set with a crank. The Type 1103-B is completely self-contained, with its own power supply, and can be driven from any one-volt 1000-cycle source.

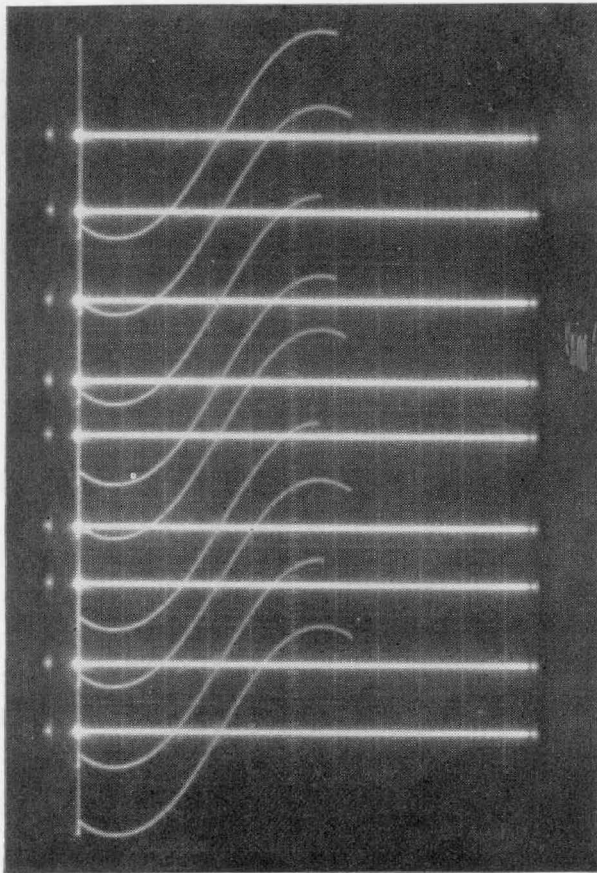

**Figure 14. Successive traces, at 2-second intervals, of 1000-cycle signals terminated by closure of the contactor in the Type 1103-B Synchronometer. For comparisons with standard-time signals the Type 1109-B Comparison Oscilloscope is recommended.**

and-gear combination, which reduces the speed to 2 revolutions per minute. The second hand of the clock is driven from this shaft through a 2:1 differential gear, which makes possible continuous adjustment of the second-hand position without affecting the operation of the clock motor in any way. The minute-hand and hour-hand shafts are positively driven by the second-hand shaft, so that their relative positions remain correct when adjustments are made. The hands themselves, however, are driven through slip clutches so that they can be individually set, when desired.

The one-revolution-per-second shaft also drives the contactor that is used to determine the value of the shaft angle at a given moment in time. The con-

tactor is mounted on a disc, whose plane is normal to the shaft, on a bearing that is accurately coaxial with the shaft. The contactor is actuated by a cam on the shaft, and the angular position of the disc is adjustable from the front panel through a worm-and-wheel drive. A mechanical counter, driven from the adjusting shaft, provides an in-line digital readout that is direct reading in milliseconds and that can be read to 0.1 millisecond on an interpolating scale having marks at 0.2-millisecond intervals. This choice of scale makes the resolution compatible with the uncertainty in pulse-starting time that arises from propagation anomalies for time signals received over radio paths. This uncertainty, which may be as little as 2 microseconds for ground-wave reception, is generally about 0.1 millisecond for sky-wave reception.<sup>12</sup>

<sup>12</sup>H. F. Hastings, "Precision Frequency Control and Millisecond Timing," Report of NRL Progress, p. 18, August, 1960.

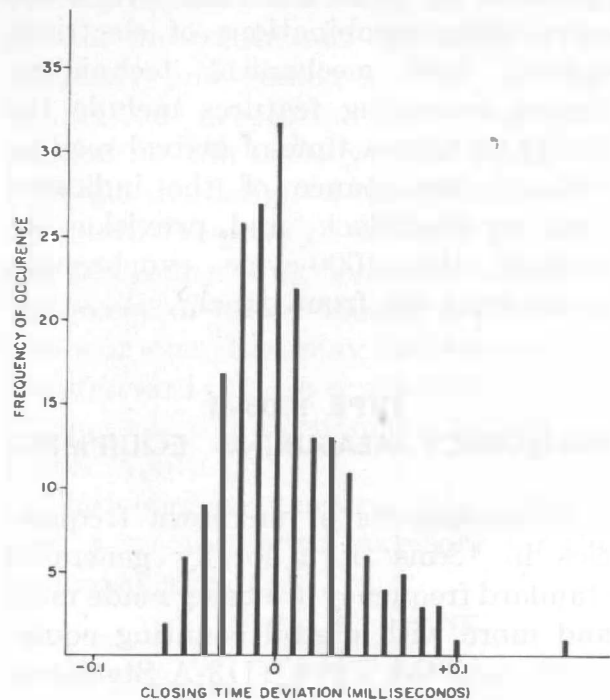

**Figure 15. Histogram showing the random nature of variations in closure time of the contactor in the Type 1103-B Synchronometer. The average deviation is less than the average uncertainty in sky-wave reception of time signals.**



The TYPE 1103-B Synchronometer, shown in Figure 13, is improved over its predecessor in several respects. From an operating standpoint, however, the most important are, undoubtedly, the mechanical features discussed above, which make possible more convenient use with an improvement in accuracy of 10:1. An important ingredient in the mechanical system is the contactor, which follows the general design of a contactor worked out by H. F. Hastings of the Naval Research Laboratory. This contactor-mechanism has a very long service life because wear is distributed over a large area, and an accuracy of closure of approximately  $\pm 50$  to  $\pm 80$   $\mu\text{sec}$ , without "bounce." Figure 14 shows typical performance for signal display and Figure 15 is a histogram of closing times.<sup>13</sup> The ruggedness of a simple mechanism, refined by improvements based on experience, provides a reliability of operation and ease of maintenance seldom approached by more complex systems incorporating combinations of electrical, optical, and mechanical techniques. Proven operating features include the ability to take a time-of-arrival reading without disturbance of the indicated time on the clock, and provision for starting the 1000-cycle synchronous motor from the front panel.

### TYPE 1105-B FREQUENCY-MEASURING EQUIPMENT

Measurements of unknown frequencies in terms of a locally generated standard frequency are being made more and more with digital counting equipment, and the TYPE 1113-A Standard-

Frequency Oscillator and the TYPE 1130-A Digital Time and Frequency Meter have been designed to combine the high accuracy and stability of a frequency standard with the high resolution and convenience of a counter.

There are, however, limitations to counters that make imperative the use of other types of measuring instrument. In particular, the counter is inherently a broad-band device, wide open to noise and unable to distinguish between a wanted zero-crossing and an unwanted spike. When measurements of frequency must be made in the presence of noise there is therefore a need for devices that make this discrimination. The human ear is excellent for this purpose, and the radio receiver, with human operator, has found considerable use over the years.

The TYPE 1105-B Frequency-Measuring Equipment comprises, basically, three regenerative radio receivers, or tuned detectors, covering the frequency range from 100 kc to 100 Mc, combined with three high-stability heterodyne-frequency-meter oscillators covering the fundamental frequency ranges 100-200 kc, 1-2 Mc, and 10-20 Mc. The tuned detectors can be operated either oscillating, for initial pickup of the unknown signal, or non-oscillating for detection of the difference frequency between the unknown signal and a standard-frequency signal. This standard-frequency signal can be either a harmonic of the heterodyne-frequency meter, used to locate the frequency within  $\pm 0.1\%$ , or a 10-kc harmonic of the TYPE 1114-A Frequency Divider, used to make the final precise measurement. The final measurement can be made by comparison of the difference frequency with that of the TYPE 1107-A Interpolation Oscillator. The resolution and stability of this instru-

<sup>13</sup>The closing time is used for reference because of its inherently greater reliability. For a description of use of the Synchronometer see: F. D. Lewis, "Standard Time Signals," *General Radio Experimenter*, Vol. 32, No. 13, June, 1958.



ment are adequate to provide a precision of comparison of  $\pm 0.5$  cps, and accuracy corresponding can be assured by comparison of the output of the Interpolation Oscillator with the 100-cps output of the TYPE 1114-A Frequency Divider to locate high-accuracy points on the dial. By adjusting the zero of the beat-frequency oscillator used in the Interpolation Oscillator, one can set the dial to read exactly at such points, thereby making the accuracy equal to the resolution. The fractional accuracy then becomes  $\pm 5$  parts in  $10^6$  for a frequency of 100 kc, increasing to  $\pm 5$  parts in  $10^9$  for a frequency of 100 Mc.

The performance of the TYPE 1105-B Frequency-Measuring Equipment greatly exceeds that of its predecessor at the high-frequency end of its measuring range because the 10-kc and 100-kc harmonics are much stronger. The TYPE 1114-A Frequency Divider does not, in itself, produce a wide range of harmonic frequencies. Avalanche-transistor harmonic generators have therefore been incorporated in the TYPE 1108-B Coupling Panel to perform this specialized function. This approach produces strong, solid harmonic "picket fences" through and beyond the range of the TYPE 1105-B.

The signal produced by the difference frequency between one of these pickets and the unknown frequency is entirely adequate to drive a counter if the unknown signal is greater than about  $100\mu\text{v}$  and "out of the noise." For measurements of this kind a counter can therefore be substituted for the TYPE 1107-A Interpolation Oscillator. For general "off-the-air" measurements, however, the discrimination that can be provided by the oscilloscope comparison with the Interpolation Oscillator is in many cases vital.

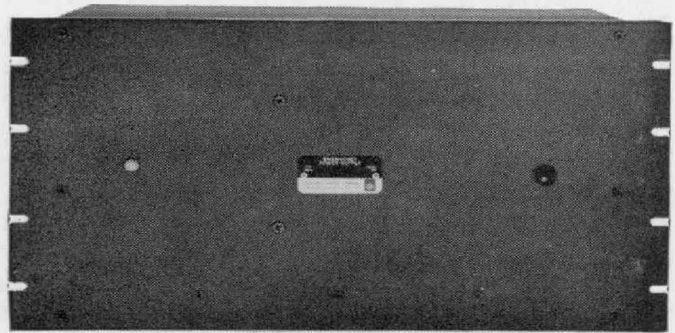

Figure 16. Panel view of the Type 1116-A Emergency Power Supply.

### TYPE 1116-A EMERGENCY POWER SUPPLY

An emergency power supply unit is available to maintain continuous operation of a frequency standard comprising an oscillator, frequency-divider, and clock unit. The TYPE 1116-A Emergency Power Supply furnishes ac power from storage batteries, the switch-over being accomplished automatically upon failure of the main ac supply. The transition to battery supply occurs without interruption of the continuous operation of the oscillator and timing system, so that calibration procedure involving time integration can be fully relied upon.

While the design of the TYPE 1113-A Standard-Frequency Oscillator prevents the possibility of permanent damage in the event of power failure, a period of hours or even days may be necessary for the standard to recover equilibrium after a temporary unsettlement caused by power failure.

The emergency power supply is, therefore, a recommended accessory for the frequency standard.

— R. W. FRANK

— F. D. LEWIS

— H. P. STRATEMEYER

#### Note

The design of the various instruments making up the complete frequency standard and measuring equipment has



called upon the talents of many General Radio engineers. The early concept and construction of the TYPE 1113-A Standard-Frequency Oscillator was worked out by C. A. Cady; the final engineering development was the responsibility of H. P. Stratemeyer, who was also completely responsible for the development and design of the TYPE 1114-A Frequency Divider. The development of the TYPE 1112 Frequency Multipliers, which

was started by J. K. Clapp, was completed by F. D. Lewis, who, with R. A. Mortenson, was also responsible for the modifications to the TYPE 1103-B Synchronometer. The avalanche transistor harmonic generators for the TYPE 1108-B Coupling Panel were designed by J. K. Skilling. The over-all program was under the supervision of R. W. Frank.

— EDITOR

## SPECIFICATIONS

### TYPE 1120 FREQUENCY STANDARDS

Each frequency standard assembly is supplied in a floor-type relay rack. The panels and relay rack are finished in General Radio gray crackle lacquer. Space is available in the rack for addition of such auxiliary items as line-voltage regulators, emergency power supply units, radio receiving equipment, and loud speakers.

The performance specifications of these frequency standards are listed under the descriptions of the component units described in the following pages. Two models are available, TYPE 1120-A and TYPE 1120-AH.

#### TYPE 1120-A FREQUENCY STANDARD

##### Components:

TYPE 1113-A Standard-Frequency Oscillator  
TYPE 1114-A Frequency Divider  
TYPE 1103-B Synchronometer  
Floor-type relay rack  
Blank panels to fill rack  
Connection cables

**Output Frequencies:** 5 Mc, 1 Mc, 100 kc, 10 kc, 1 kc, 100 cps. Plug-in units for 400 cps and 60 cps are also available. See TYPE 1114-A Frequency Divider.

**Power Input:** 130 watts, maximum, at 105 to 125 (or 210 to 250) volts, 50 to 60 cps.

**Dimensions:** Height 76½", width 22", depth 18½ inches (1950 by 560 by 470 mm), over-all.

**Net Weight:** 82 pounds (37.5 kg).

#### TYPE 1120-AH

#### 1000-MEGACYCLE FREQUENCY STANDARD

##### Components:

TYPE 1113-A Standard-Frequency Oscillator  
TYPE 1114-A Frequency Divider  
TYPE 1103-B Synchronometer  
TYPE 1112-A Frequency Multiplier  
TYPE 1112-B Frequency Multiplier

**Output Frequencies:** 1000 Mc, 100 Mc, 10 Mc, 5 Mc, 1 Mc, 100 kc, 10 kc, 1 kc, 100 cps; optionally 60 cps and 400 cps.

**Power Input:** 330 watts, maximum at 105 to 125 (or 210 to 250) volts, 50 to 60 cps.

**Dimensions:** Height 76½", width 22", depth 18½ inches (1950 by 560 by 470 mm), over-all.

**Net Weight:** 142 pounds (65 kg).

#### TYPE 1116-A EMERGENCY POWER SUPPLY

**Input:** 115 or 230 volts, 50 to 60 cps from power line. 28–32 volts, 7.5–6.5 amp from battery (when operating frequency standard).

**Output:** 115 volts, nominal, 60 cps, 180 watts continuous. Frequency standard requires 130 watts, max.

**Accessories Required:** 28-, 30-, or 32-volt battery; battery charging equipment.

**Dimensions:** Length 19", height 10½ inches (485 by 270 mm), depth behind panel 13 inches (330 mm).

**Net Weight:** 58½ pounds (26.6 kg).

#### TYPE 1113-A

#### STANDARD-FREQUENCY OSCILLATOR

##### Frequency Stability:

**Aging:** Less than  $5 \times 10^{-10}$  per day, averaged over 10 days, after 60 days of operation. After 1 year of operation typical drift is less than  $2 \times 10^{-10}$  per day.

**Short-Term:** Better than  $1 \times 10^{-10}$  per minute, as measured with 1-second samples.

**Oven Cycling:** Less than  $1 \times 10^{-10}$  peak to peak.

**Ambient:** Less than  $1 \times 10^{-10}/^{\circ}\text{C}$  ( $5 \times 10^{-9}$  for 0–50°C).

**Line:** Less than  $1 \times 10^{-10}$  for 105 to 130 volts.

**Loading:** Less than  $\pm 2 \times 10^{-10}$  for 50 ohms  $\pm 20\%$ .

##### Frequency Adjustments:

**Coarse:** Approximately  $500 \times 10^{-9}$ .

**Fine:**  $\pm 5 \times 10^{-9}$  in divisions of  $5 \times 10^{-10}$ .  
**Stability:** To  $1 \times 10^{-10}$ .

**Output:** 1 volt rms into 50 ohms at 5 Mc. .4 volt rms for General Radio TYPE 1112-A Frequency Multiplier.





**Power Input:** 105 to 125 (or 210 to 250) volts, 50 to 60 cps, 100 watts.

**Tube Complement:** One each 6AN8, 5AV5GA, 5965, 5727, 5651, 6922/E88CC; three 6688/E180F.

**Transistor Complement:** One each 2N1138, 2N1372, two 2N445A.

**Dimensions:** Panel, 19 by 5¼ inches (485 by 135 mm); depth behind panel, 16 inches (410 mm).

**Net Weight:** 30 pounds (13.6 kg).

#### TYPE 1114-A FREQUENCY DIVIDER

**Transistor Complement:** One each 2N645 and 2N1218, two 2N1396, three 2N1372, four 2N520, seven each 2N169A and 2N582, fifteen 2N404, and sixteen 2N1374.

**Input:** 5 Mc, 1 Mc, 100 kc, 50 ohms. 1 volt  $\pm 50\%$ .

**Output:** (with 5-Mc input): 5 Mc

Sine Waves:

1 Mc	} 1 v {	+50%	}	into 50 ohms
100 kc				
10 kc	} 1 v {	+50%	}	into 600 ohms
1 kc				
100 c	} 1 v {	+50%	}	into 600 ohms
*400 c				
*60 c				

\*Optional accessories

Square Waves: 100 kc } Approximately 7  
10 kc } volts pp open circuit

**Spurious Signals:** Better than 34 db down.

**Jitter:** Less than .5 nsec for 100 c output with respect to 5 Mc input.

**Power Input:** 105 to 130 (or 210 to 260) volts, 50 to 400 cps, approximately 7 watts.

#### TYPE 1103-B SYNCHRONOMETER

**Input:** 1000-cycle sine wave, one volt into 50,000 ohms.

**Microdial:**

Contact stability: Maximum contact closing time deviation at any microdial setting is  $\pm 0.1$  msec.

**Calibration Errors:** The maximum deviation between the indicated microdial setting and the actual contact closing time varies sinusoidally from 0 to  $\pm 1$  msec over the 1000-msec range.

**Accuracy of Time Increments:** The maximum error over a time interval of 25 msec is  $\pm 2\%$   $\pm 0.1$  msec.

**Power Input:** 105 to 125 (or 210 to 250) volts, 50 to 60 cps; 22 watts, continuous; 10 watts for starting motor.

**Dimensions:** Panel 19 by 8¾ inches (485 by 225 mm); depth behind panel, 11 inches (280 mm).

**Net Weight:** 35 pounds 16.0(kg).

#### TYPE 1112-A STANDARD-FREQUENCY MULTIPLIER

**Spurious Signals:** Unwanted harmonics of the input frequency are at least 100 db below the desired output frequency.

**Frequency-Modulation Noise:** Less than  $\pm 1 \times 10^{-9}$  residual noise.

**Locking Range:** The input signal can drift  $\pm 15$  parts in  $10^6$  before the locked oscillator goes out of control.

**Bandwidth:** (Expressed as allowable frequency-deviation rate)

**Input:** 1 volt, 100-kc sine wave from standard-frequency oscillator. Can also be driven at input frequencies of 1, 2.5, and 5 Mc; required input is approximately 5 volts.

Will run free with no input signal, but absolute frequency may be in error by several parts per million.

**Output:** Four channels; one each of 1 Mc and 10 Mc, and two of 100 Mc; all sine wave; all 50 ohms; 20 milliwatts, max., into 50 ohms.

**Open-Circuit Output Voltage:** Approximately 2 volts.

**Terminals:** TYPE 874 Coaxial Connectors; adaptors are available to fit all commonly used connector types.

**Tube Complement:** Two each 6AU6, 6C4, 6BC5, 6CY5, 6X8; three 6AN8; one each 6080, 12AX7, 5651.

**Power Supply:** 105 to 125 (or 210 to 250) volts, 50 to 60 cycles, 110 watts.

**Accessories Supplied:** TYPE CAP-22 Power Cord, TYPE 874-R22 Patch Cord, two TYPE 874-C58 Cable Connectors, spare fuses.

**Dimensions:** Relay-rack panel, 19 by 12¼ inches (480 by 330 mm); depth, 11½ inches (310 mm).

**Net Weight:** 25 pounds (11.5 kg).

#### TYPE 1112-B STANDARD-FREQUENCY MULTIPLIER

**Input:** 20 milliwatts, 100 Mc, sine wave from TYPE 1112-A Standard-Frequency Multiplier; 50-ohm input impedance.

**Output:** 1000-Mc sine wave; 50 mw into 50-ohm load; 50-ohm output impedance.

**Locking Range:**  $\pm 100$  kc at the input frequency.

**Bandwidth:** Allowable frequency deviation rate is 100,000 cycles at the input frequency.

**Tube Complement:** Three each 6AG5, 6AU5GT, 12AX7, 5651; two 6AK5; one each 6U6, 6AU6, 6BM6, 5876.

**Power Input:** 125 watts.

**Accessories Supplied:** TYPE CAP-22 Power Cord, TYPE 874-C58 Cable Connector, two TYPE 874-R22 Patch Cords, spare fuses.

**Net Weight:** 35 pounds (16.0 kg).



Other specifications are identical with those for TYPE 1112-A, above.

For a complete description of these instruments, see the *General Radio Experimenter*, 32, 10, July, 1958.

**TYPE 1105-B  
FREQUENCY-MEASURING EQUIPMENT**

**Dimensions:** Height 76 1/8, width 22, depth 20 1/2 inches (1950 by 550 by 500 mm), over-all.  
**Net Weight:** 370 pounds (168 kg).

Type		Code Word	Price
1120-A	Frequency Standard.....	ENDOW	\$3640.00
1120-AH	1000-Megacycle Frequency Standard.....	ENJOY	6450.00
1116-A	Emergency Power Supply.....	MUMMY	540.00
1113-A	Standard-Frequency Oscillator.....	ALLOT	1550.00
1114-A	Frequency Divider.....	ADOWN	950.00
1114-P6	400-cycle Plug-in Unit.....	CAMEL	85.00
1114-P7	60-cycle Plug-in Unit.....	CALIF	115.00
1103-B	Synchrometer.....	AUDIT	900.00
1112-A	Frequency Multiplier.....	EPOCH	1450.00
1112-B	Frequency Multiplier.....	EPODE	1360.00
1105-B	Frequency-Measuring Equipment.....	MITER	5900.00

U.S. Patent No. 2,548,457  
Patent Pending

## PRECISION CONDUCTANCE BRIDGE

A precision conductance bridge employing a General Radio TYPE 1605-A Impedance Comparator is described in the March issue of *Journal of the Electrochemical Society*.<sup>1</sup> Designed for use in the electrochemical laboratory, the bridge has been used for studies of the electrical

conductances of high-temperature matter, inorganic salt systems (240-1000°C) and solutions of electrolytes in aqueous and organic solvents at temperatures of 0-45°C.

<sup>1</sup>George J. Janz and James D. E. McIntyre, "A Precision Conductance Bridge of New Design," *Journal of the Electrochemical Society*, March, 1961.

## REPRESENTATIVE APPOINTED FOR NEW ZEALAND

The firm of W. and K. McLean, Limited has been appointed General Radio sales representative for New Zealand. All technical and commercial

inquiries regarding General Radio products should now be directed to that firm, P. O. Box 3097, Auckland.

**General Radio Company**