

# THE GENERAL RADIO EXPERIMENTER



VOLUME 34 No. 5

MAY, 1960

IN THIS ISSUE

▶ VSWR Measurements  
Tools for Type 874 Coaxial Con-  
nectors





©1960—GENERAL RADIO COMPANY, WEST CONCORD, MASS., U.S.A.

Published Monthly by the General Radio Company

VOLUME 34 • NUMBER 5

MAY, 1960

CONTENTS

|                                                       | Page |
|-------------------------------------------------------|------|
| Rapid VSWR Measurements with the Admittance Meter     | 3    |
| Assembly Tools for Type 874 Coaxial Connectors . . .  | 7    |
| Unit Oscillator Used as Pump in Parametric Amplifier. | 8    |

The General Radio EXPERIMENTER is mailed without charge each month to engineers, scientists, technicians, and others interested in electronic techniques in measurement. When sending requests for subscriptions and address-change notices, please supply the following information: name, company address, type of business company is engaged in, and title or position of individual.

GENERAL RADIO COMPANY

West Concord, Massachusetts

Telephone: (Concord) EMerson 9-4400; (Boston) CLearwater 9-8900

- NEW YORK:** Broad Avenue at Linden, Ridgefield, New Jersey  
Telephone — N. Y., WOrth 4-2722  
N. J., WHitney 3-3140
- CHICAGO:** 6605 West North Avenue, Oak Park, Illinois  
Telephone — VIlIage 8-9400
- PHILADELPHIA:** 1150 York Road, Abington, Pennsylvania  
Telephone — HANcock 4-7419
- WASHINGTON:** 8055 13th St., Silver Spring, Maryland  
Telephone — JUniper 5-1088
- LOS ANGELES:** 1000 North Seward St., Los Angeles 38, Calif.  
Telephone — HOLlywood 9-6201
- SAN FRANCISCO:** 1186 Los Altos Ave., Los Altos, Calif.  
Telephone — WHitecliff 8-8233
- CANADA:** 99 Floral Parkway, Toronto 15, Ontario  
Telephone — CHerry 6-2171

REPAIR SERVICES

- EAST COAST:** General Radio Co., Service Dept., 22 Baker Avenue,  
West Concord, Mass.  
Telephone — Concord, EMerson 9-4400  
Boston, CLearwater 9-8900
- NEW YORK:** General Radio Co., Service Dept., Broad Ave. at  
Linden, Ridgefield, New Jersey  
Telephone — N. Y., WOrth 4-2722  
N. J., WHitney 3-3140
- MIDWEST:** General Radio Co., Service Dept., 6605 West North  
Ave., Oak Park, Illinois  
Telephone — VIlIage 8-9400
- WEST COAST:** General Radio Co., Service Dept., 1000 North Seward  
Street, Los Angeles 38, Calif.  
Telephone — HOLlywood 9-6201
- CANADA:** Bayly Engineering, Ltd., First St., Ajax, Ontario  
Telephone — Toronto EMpire 2-3741

COVER



Richard L. Brereton, of Canada Wire and Cable Co., Ltd., Leaside, Ontario, well-known authority on cable testing, is shown operating his convenient, rack-mounted assembly of General Radio equipment for the measurement of attenuation and other characteristics of high-frequency cable.



# RAPID VSWR MEASUREMENTS WITH THE ADMITTANCE METER

Although the TYPE 1602-B UHF Admittance Meter is widely used for high-frequency impedance and admittance measurements, its possibilities for the rapid measurement of standing-wave ratio are not so well recognized. With this instrument, VSWR can be calculated from the values of conductance and susceptance which are measured directly, but the measurement can be greatly simplified when VSWR alone is required, without phase information. Two approximately direct-reading methods have been developed, one of which requires a mechanical movement of one of the controls on the instrument while the other uses only the meter reading on the detector as an indication of the VSWR. The former method is exact for all values of VSWR, while the latter method is approximate and is limited to a VSWR range up to approximately 1.2. Both methods require a detector capable of giving an accurate measure of the relative output level, as, for instance, one of the Type DNT Detectors.

## The Admittance Meter

In normal use the TYPE 1602-B Admittance Meter measures admittance or impedance in the frequency range between 40 and 1500 Mc with a nominal accuracy of  $\pm 3\%$ . It is direct reading in conductance and susceptance (or resistance and reactance). Figure 1 shows the scales and controls, Figure 2 the rear; Figure 3 is a schematic. Admittance measurements are made by a null method in which voltages derived from the currents in the standard conductance arm and the standard susceptance arm are balanced against a voltage derived from the current in the unknown arm.

The coupling of each of the loops shown in Figure 3 can be varied by rotation of the loop. One of the coaxial lines is terminated in a conductance standard, which is a pure resistance equal to the characteristic impedance of the line; one in a susceptance standard, which is a short-circuited length of coaxial line; and one in the unknown circuit. The outputs of the three loops are com-

Figure 1. Close-up view of the scales and controls of the Admittance Meter.

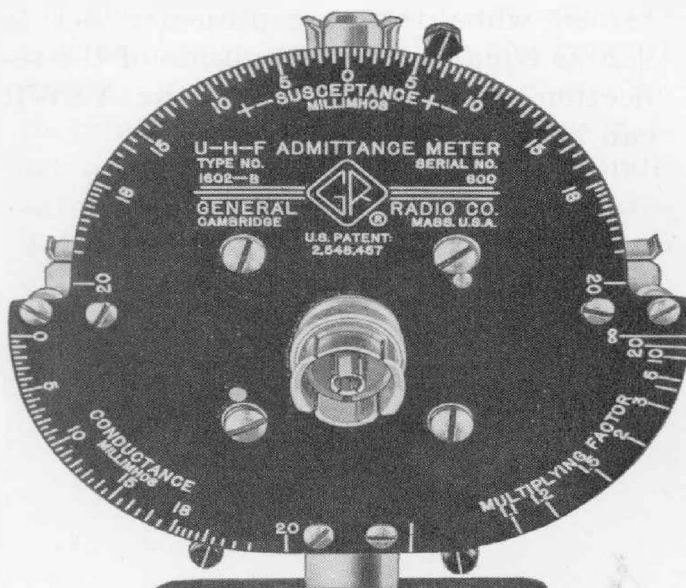
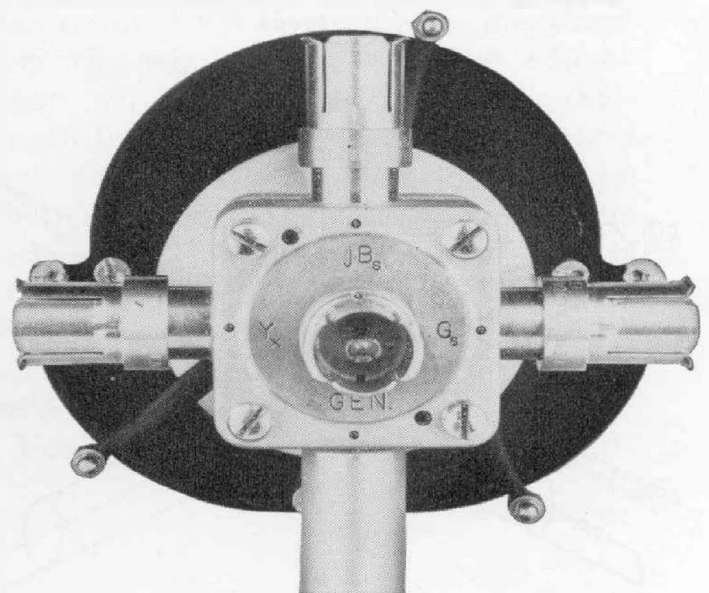

Figure 2. Rear view, showing identification of the coaxial lines.



bined in parallel and, when the loops are properly oriented, the net output is zero. The device therefore balances in the same manner as a bridge.

At balance the voltage induced in each of the three loops is proportional to the mutual inductance between each line and loop and to the current flowing in the corresponding line. Since all three lines are fed from a common source, the input voltage is the same for each line, and the current flowing in each line is proportional to the input admittance.

The loops associated with the unknown admittance and the standard conductance can each be rotated through an angle of 90°, but the loop associated with the standard susceptance is arranged to be rotatable through an angle of 180°, thus allowing the measurement of positive as well as negative values of unknown susceptance with a single susceptance standard.

The conductance scale is inherently independent of frequency. The susceptance standard is always adjusted to produce the same magnitude of susceptance at each frequency.

**Admittance and Impedance Measurements**

The three loops are adjustable by the

**Figure 3. Schematic diagram of the Admittance Meter, showing the functional arrangement of lines and loops.**

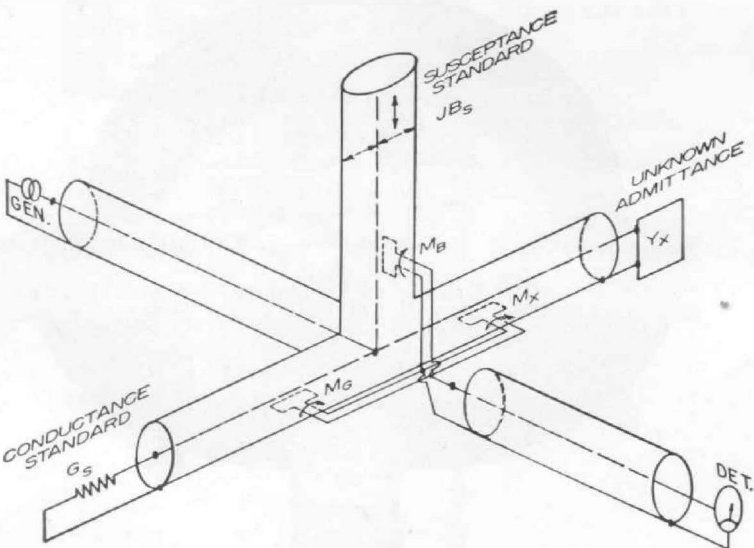

arms shown in Figure 2 and carry indicators as shown in Figure 1. Thus the admittance parameters,  $G$  and  $B$ , can be read directly from the scales. The scale for the loop in the unknown line indicates the multiplying factor. If a quarter-wave line is inserted between the instrument and the unknown, the admittance is inverted. The millimho scale readings are then proportional to impedance and, when multiplied by 2.5, they indicate the series resistance and reactance in ohms.

**VSWR Measurements by the Voltage-Ratio Method**

For VSWR measurements, one simple method is based on a measurement of the ratio of the output voltages obtained at two settings of an indicator arm. This method is particularly attractive for measurements of the VSWR of antenna systems and components in which the VSWR is not greater than about 10 to 1.

In this method the 50-ohm termination is inserted in place of the susceptance standard in the  $B_s$  line; the  $G_s$  line remains open-circuited; the unknown is connected to the  $Y_x$  line. The conductance indicator is set to zero, and the multiplying factor indicator is set to 1. The ratio of the output voltage,  $V_1$ , obtained when the susceptance indicator is set to  $-20$ , to the output,  $V_2$ , obtained when the susceptance is set to  $+20$  is equal to the magnitude of the reflection coefficient,  $\Gamma$ , and the VSWR can be determined as follows:

$$|\Gamma| = \left| \frac{V_1}{V_2} \right|$$

$$VSWR = \frac{1 + |\Gamma|}{1 - |\Gamma|} = \frac{1 + \left| \frac{V_1}{V_2} \right|}{1 - \left| \frac{V_1}{V_2} \right|}$$



TABLE 1

| $V_1/V_2$<br>db | $\Gamma$ | VSWR  | $V_1/V_2$<br>db | $\Gamma$ | VSWR  |
|-----------------|----------|-------|-----------------|----------|-------|
| 1               | .8913    | 17.41 | 17              | .1413    | 1.33  |
| 1.2             | .8710    | 14.50 | 18              | .1259    | 1.29  |
| 1.4             | .8511    | 12.43 | 19              | .1122    | 1.24  |
| 1.6             | .8318    | 10.90 | 20              | .1000    | 1.22  |
| 1.8             | .8128    | 9.66  | 21              | .0891    | 1.194 |
| 2               | .7943    | 8.73  | 22              | .0794    | 1.170 |
| 2.2             | .7762    | 7.94  | 23              | .0708    | 1.153 |
| 2.4             | .7586    | 7.29  | 24              | .0631    | 1.136 |
| 2.6             | .7413    | 6.73  | 25              | .0562    | 1.120 |
| 2.8             | .7244    | 6.26  | 26              | .0501    | 1.105 |
| 3               | .7079    | 5.85  | 27              | .0447    | 1.093 |
| 3.5             | .6683    | 5.03  | 28              | .0398    | 1.083 |
| 4               | .6310    | 4.42  | 29              | .0355    | 1.074 |
| 4.5             | .5957    | 3.95  | 30              | .0316    | 1.066 |
| 5               | .5623    | 3.57  | 31              | .0282    | 1.058 |
| 5.5             | .5309    | 3.26  | 32              | .0251    | 1.051 |
| 6               | .5012    | 3.01  | 33              | .0224    | 1.046 |
| 6.5             | .4732    | 2.80  | 34              | .0200    | 1.041 |
| 7               | .4467    | 2.62  | 35              | .0178    | 1.036 |
| 7.5             | .4217    | 2.46  | 36              | .0158    | 1.032 |
| 8               | .3981    | 2.32  | 37              | .0141    | 1.029 |
| 8.5             | .3758    | 2.20  | 38              | .0126    | 1.027 |
| 9               | .3548    | 2.10  | 39              | .0112    | 1.023 |
| 9.5             | .3350    | 2.01  | 40              | .0100    | 1.020 |
| 10              | .3162    | 1.92  | 42              | .0079    | 1.016 |
| 11              | .2818    | 1.79  | 44              | .0063    | 1.013 |
| 12              | .2512    | 1.67  | 46              | .0051    | 1.010 |
| 13              | .2239    | 1.58  | 48              | .0040    | 1.008 |
| 14              | .1995    | 1.50  | 50              | .0032    | 1.006 |
| 15              | .1778    | 1.43  | 55              | .0018    | 1.004 |
| 16              | .1585    | 1.37  | 60              | .0010    | 1.002 |

If the VSWR is less than 1.2, the following approximation is valid:

$$\text{VSWR} = 1 + 2 |\Gamma| = 1 + 2 \left| \frac{V_1}{V_2} \right|$$

The calculations can be eliminated through the use of Table 1, which indicates the value of  $\Gamma$  and VSWR for various values of  $\frac{V_1}{V_2}$  expressed in decibels.

The voltage induced in the susceptance loop is proportional to the current flowing in the terminated line and is, therefore,  $-KY_o$  when the indicator is set at  $-20$  and  $+KY_o$  when the indicator is set at  $+20$ . The voltage induced in the multiplying factor loop when the indicator is set at unity is  $KY_x$ . Therefore, the total voltage,  $V_1$ , at the detector when the susceptance indicator is set at  $-20$  is

$$V_1 = KY_x - KY_o$$

and when the susceptance indicator is set at  $+20$ ,

$$V_2 = KY_x + KY_o$$

or

$$\frac{V_1}{V_2} = \frac{Y_x - Y_o}{Y_x + Y_o} = \Gamma$$

and therefore in terms of the magnitudes alone,

$$|\Gamma| = \left| \frac{V_1}{V_2} \right|$$

For this measurement a detector with a wide linear range (at least 50 db) and a calibrated attenuator, such as one of the Type DNT Detectors, is required. With the Type DNT Detectors, the value of  $\frac{V_1}{V_2}$  is obtained as the difference between two decibel readings.

For maximum accuracy the VSWR of the 50-ohm termination unit should be as close to unity as possible. If the termination is perfect, the resulting VSWR error is less than about 0.01 up to 500 Mc and 0.02 up to 1000 Mc for low VSWR magnitudes. The performance can be checked by substitution of another low-VSWR, 50-ohm termination for the unknown.

### Rapid VSWR Measurements by a Direct Method

For VSWR measurements on a large number of components at a single frequency, or on a single component whose maximum VSWR must be measured over the whole range of some adjustment, as, for example, an adjustable-length line, an even more rapid method than that previously described can be used. This method is valid as long as the VSWR is less than about 1.2 and is particularly useful for the determination of small standing-wave ratios. Its high resolution permits the measurement of VSWR's as low as 1.002.

For this measurement the Admit-



tance Meter is set up as for admittance measurements, with one of the Type DNT Detectors, with the standard conductance in the *G* arm, and with the standard susceptance stub set for the operating frequency in the *B* arm. A low-VSWR, 50-ohm termination is plugged into the unknown arm, and the meter is balanced for a null with the multiplier set exactly at 1.2.

The multiplier arm is then set at 1.0. This unbalance is equivalent to that produced by a VSWR of 1.22 in the unknown. The generator output is then adjusted to produce a detector reading

equal to one of the calibration levels on the chart in Figure 4 (ave off). The multiplier is then returned to its 1.2 reading, and adjusted to produce a null balance. The unknown is then plugged into the unknown arm in place of the 50-ohm termination and the meter reading noted. The corresponding VSWR is then read from the chart of Figure 4.

Since no adjustments are required after the instrument has been calibrated, VSWR measurements can be made on a large number of elements very rapidly merely by plugging them into the instrument and observing the meter indi-

Figure 4. Chart for determining VSWR from detector output readings.

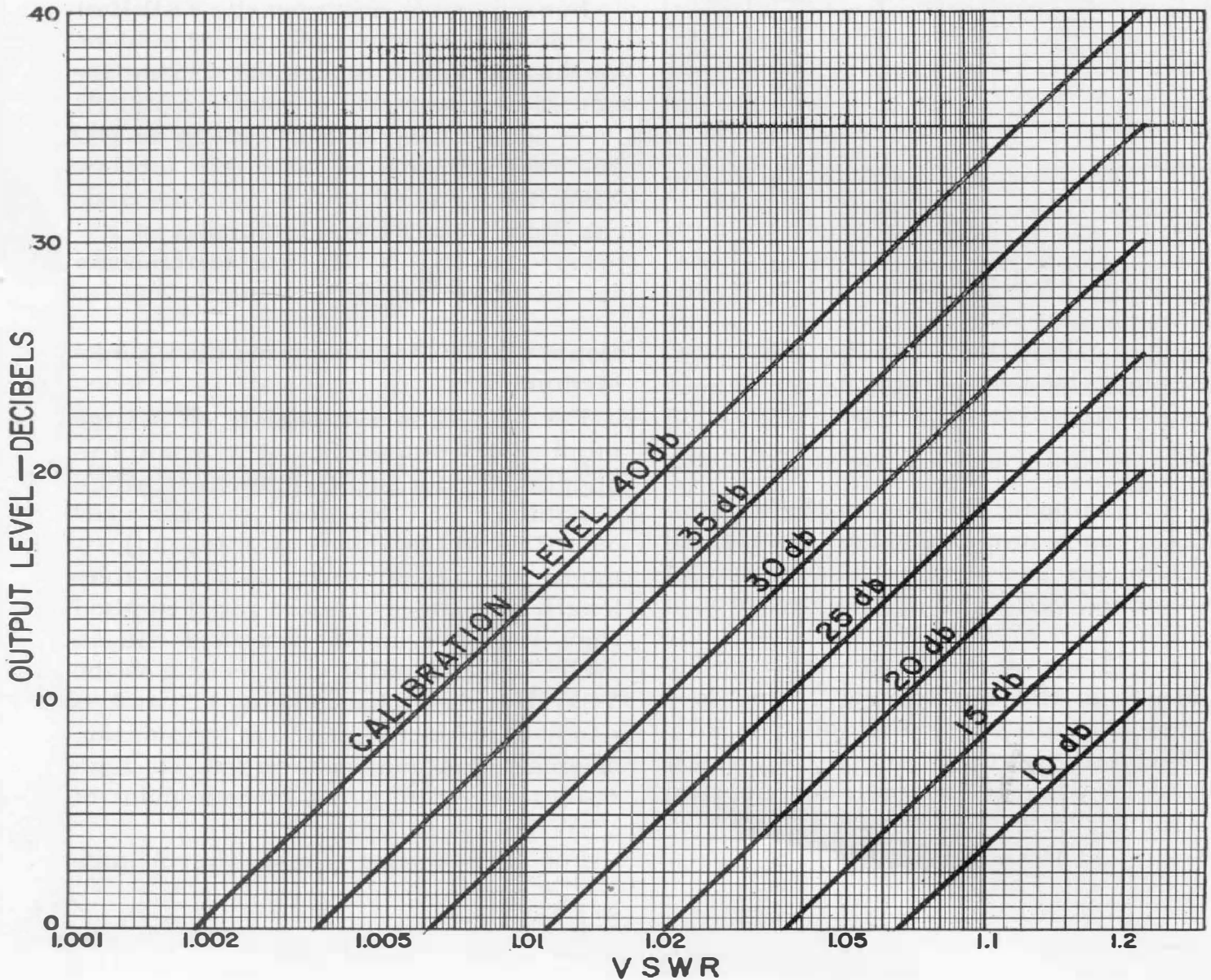



ation. Continuous measurements can also be made of the VSWR of components as they are adjusted.

The accuracy of the method at very low values of VSWR is primarily determined by the VSWR of the 50-ohm termination unit used to set up the instrument. The residual VSWR can be as large as twice the VSWR of this termination. The accuracy of the method also decreases at large values of VSWR, reaching  $\pm 0.006$  at a VSWR of 1.1 and  $\pm 0.03$  at a VSWR of 1.22.

— R. A. SODERMAN

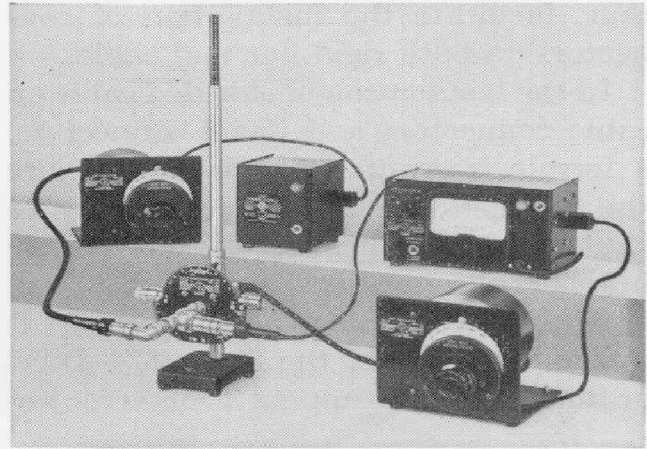

Figure 5. The Admittance Meter as set up for admittance or VSWR measurements, with a Type 1209-B Unit Oscillator and a Type DNT-3 Detector.

## ASSEMBLY TOOLS FOR TYPE 874 COAXIAL CONNECTORS

To facilitate the assembly of our TYPE 874 Coaxial Connectors on cables or rigid line, we are making available a set of tools, illustrated in Figure 1. The TYPE 874-TOK Assembly Tool Kit consists of an outer-connector wrench, an inner-connector wrench, and a coupling-nut wrench, as shown in Figure 1. The inner-connector wrenches are used for holding and installing both the insulat-

ing bead and the inner connectors. They also prevent possible damage to the keyway in the bead during installation which can result in misalignment of the inner and outer connectors. The outer-connector wrench and the coupling-nut wrench are used to install the outer connector and to tighten the coupling nut properly without marring the surface. These three wrenches, which are sold as a

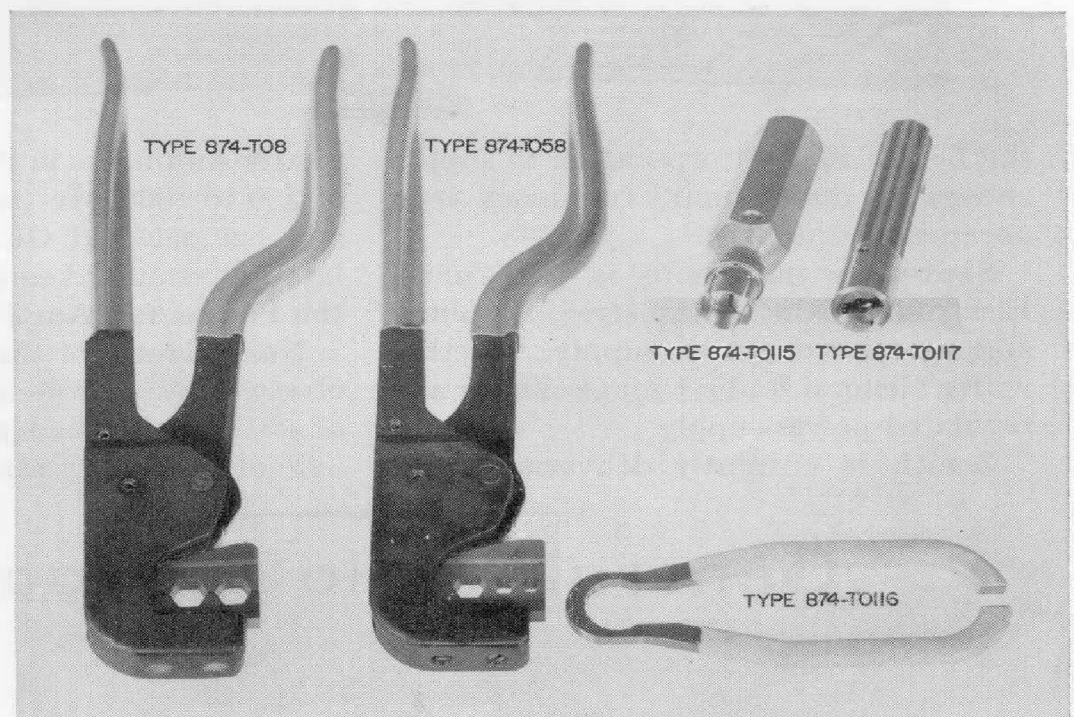

Figure 1. View of the assembly tools for assembly of Type 874 Coaxial Connectors. The three tools at the right, Types 874-T0115, 116, and 117, comprise the Type 874-TOK Tool Kit. The crimping tools are shown at the left.



unit, facilitate the installation of connectors on both rigid line and cable.

In the installation of shielded cable on cable connectors and panel connectors, a ferrule is crimped in place to secure the braid of the cable shield firmly to the shell of the connector. When large numbers of connectors are to be installed, or where the neatest possible crimp is wanted, the use of the TYPE 874-T058 or the 874-T08 Crimping Tools is recom-

mended. These tools use hexagonal dies to produce a hexagonally shaped crimp. The appropriate tools for each 874-type cable or panel connector are indicated below.

| <i>Connector Type</i> | <i>Crimping Tool Type</i> |
|-----------------------|---------------------------|
| 874-C58, -P58, -PB58  | } 874-T058                |
| 874-C62, -P62, -PB62  |                           |
| 874-C, -P, -PB        |                           |
| 874-C8, -P8, -PB8     | } 874-T08                 |
| 874-C9, -P9, -PB9     |                           |

| <i>Type</i> | <i>Code Word</i> | <i>Price</i> |
|-------------|------------------|--------------|
| 874-TOK     | COAXBITTEN       | \$20.00      |
| 874-T058    | COAXCRIMPO       | 75.00        |
| 874-T08     | COAXCRIMBA       | 85.00        |

## UNIT OSCILLATOR USED AS PUMP IN PARAMETRIC AMPLIFIER

An interesting application of General Radio equipment is the use of the TYPE 1218-A Unit Oscillator (900-2000 Mc) by

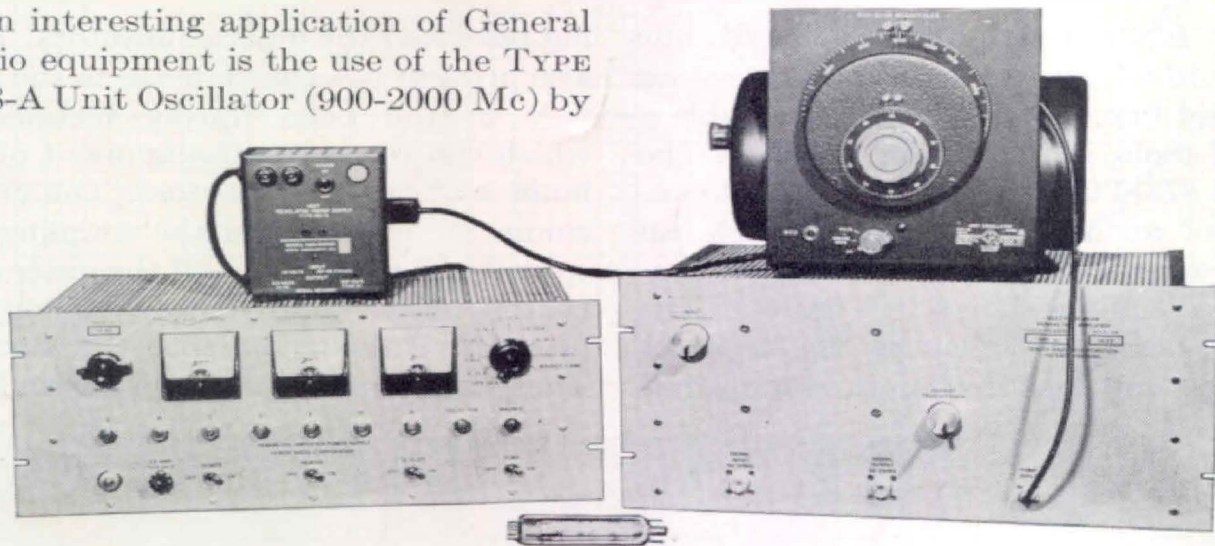

the Zenith Radio Corporation to supply energy at the "pump" frequency in a parametric amplifier.

Shown in the photo is the Zenith Electron Beam Parametric Amplifier and associated power supply, together with a General Radio Unit Oscillator and regulated power supply.

Zenith is currently delivering Para-

metric Amplifiers in the frequency range of 350 to 1000 Mc (and soon 1300 Mc) and has selected General Radio Oscillators as standard equipment to "pump" the Parametric Amplifier.

Noise figures of the order of 1 db are observed over a wide band. Unconditional stability and high gain are characteristic of electron tube parametric devices.

# General Radio Company