

the GENERAL RADIO Experimenter



© 1958 - GENERAL RADIO Company, Cambridge, Mass., U.S.A.

Since 1915 - Manufacturers of Electronic Apparatus for Science and Industry

VOLUME 32 No. 13

JUNE, 1958

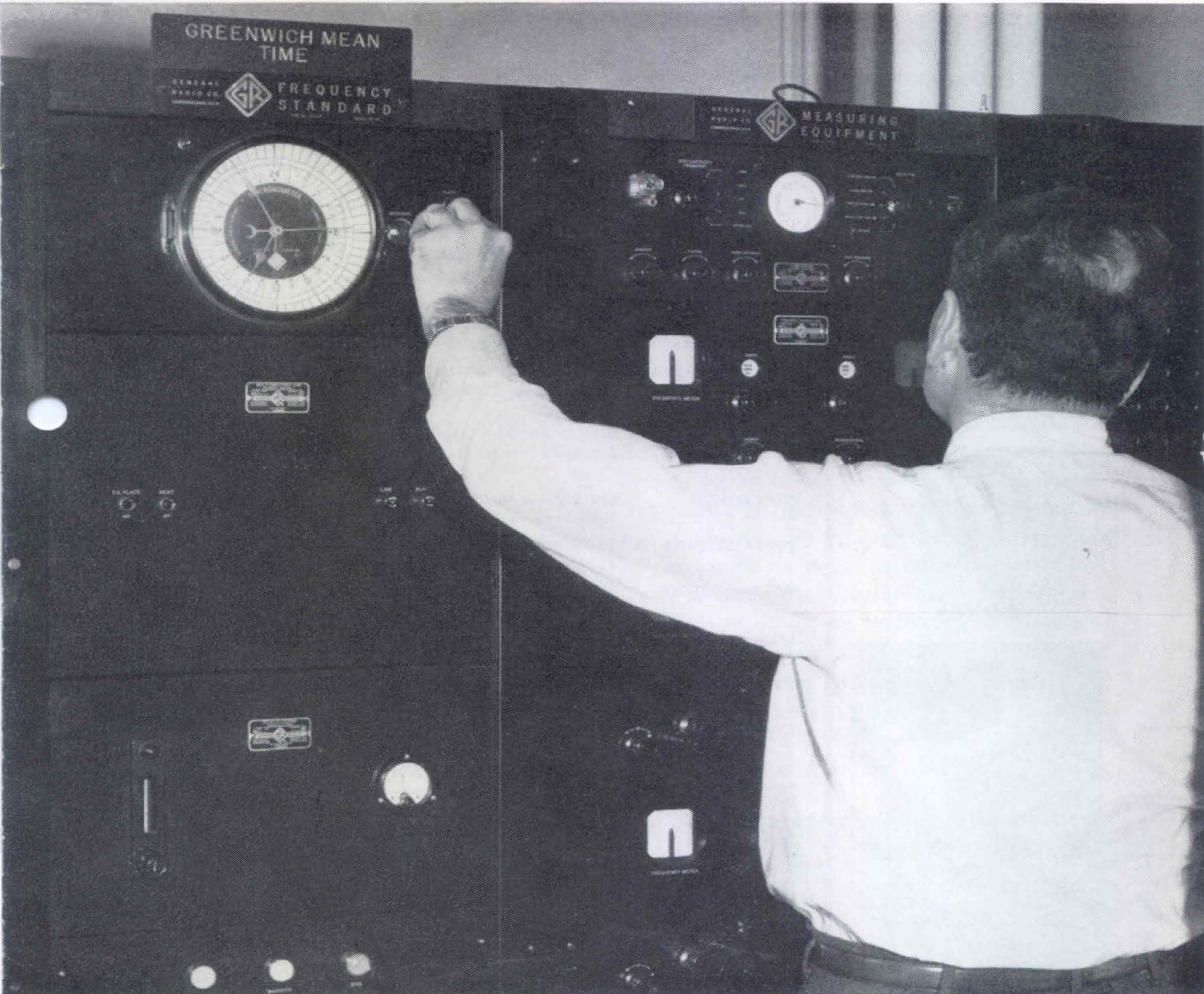

In This Issue

Improving the Accuracy
of Time Comparisons

the GENERAL RADIO Experimenter



Published Monthly by the General Radio Company
VOLUME 32 • NUMBER 13 **JUNE, 1958**

CONTENTS

	Page
Standard Time Signals.....	3

The General Radio EXPERIMENTER is mailed without charge each month to engineers, scientists, technicians, and others interested in electronic techniques in measurement. When sending requests for subscriptions and address-change notices, please supply the following information: name, company address, type of business company is engaged in, and title or position of individual.

GENERAL RADIO COMPANY

275 Massachusetts Avenue, Cambridge 39, Mass.
 Telephone: TRowbridge 6-4400

- NEW YORK:** Broad Avenue at Linden, Ridgefield, New Jersey
 Telephone — N. Y., WOrth 4-2722
 N. J., WHitney 3-3140
- CHICAGO:** 6605 West North Avenue, Oak Park, Illinois
 Telephone — VillAge 8-9400
- PHILADELPHIA:** 1150 York Road, Abington, Pennsylvania
 Telephone — HAncock 4-7419
- WASHINGTON:** 8055 13th St., Silver Spring, Maryland
 Telephone — JUniper 5-1088
- LOS ANGELES:** 1000 North Seward St., Los Angeles 38, Calif.
 Telephone — HOllwood 9-6201
- SAN FRANCISCO:** 1182 Los Altos Ave., Los Altos, Calif.
 Telephone — WHitecliff 8-8233
- CANADA:** 99 Floral Parkway, Toronto 15, Ontario
 Telephone — CHerry 6-2171

REPAIR SERVICES

- EAST COAST:** General Radio Co., Service Dept., 22 Baker Avenue,
 West Concord, Mass.
 Telephone — ConCord, EMerson 9-4400
 LinCln, CLearwater 9-8900
- MIDWEST:** General Radio Co., Service Dept., 6605 West North
 Ave., Oak Park, Illinois
 Telephone — VillAge 8-9400
- WEST COAST:** Western Instrument Co., 826 North Victory Boule-
 vard, Burbank, Calif.
 Telephone — VICToria 9-3013
- CANADA:** Bayly Engineering, Ltd., First St., Ajax, Ontario
 Telephone — Toronto EMpire 8-6866

COVER



Comparing time signals with the Type 1100-AP Primary Frequency Standard in the General Radio laboratories. The Comparison Oscilloscope is at the top of the rack directly in front of the observer, who adjusts the Microdial as he watches the oscilloscope pattern.



STANDARD TIME SIGNALS

Improving the Accuracy of Comparison Between Radio and Local Time Standards

Many of the activities associated with the International Geophysical Year require accurate time and frequency standardization. It is frequently desirable to have a local time-and-frequency standard, for use when radio reception is poor or when local timing equipment is to be operated. Standardization can be accomplished by a comparison of the time indicated by the local standard, such as the TYPE 1100-AP Primary Frequency Standard, with the standard radio time signals transmitted by national agencies in the United States and in other countries. These signals consist, in part, of pulses, dots, or dashes at intervals of one second. This article describes a method of measurement of the time of arrival of time signals with a precision of ± 1 millisecond.

The Local Standard

The TYPE 1100-AP Primary Frequency Standard comprises a quartz crystal oscillator operating at 100 kc and a frequency divider chain with output frequencies at 100 kc, 10 kc, 1 kc, and 100 cycles per second. The 1-kc output drives a precision clock (the TYPE 1103-A Synchronometer), in which is incorporated a contactor that opens and

closes once per second. This contactor is adjustable in phase, or time of operation with respect to the clock shaft, in such a way that the closing time can be set at any value with respect to an arbitrary zero, from 0 to 999 milliseconds and on around, through zero, into the next second. A calibrated control, called the Microdial, is provided, which is graduated in 10-millisecond increments from 0 to 100 in 360° , or 0 to 1000 milliseconds.

Calibration

The calibration of a time or frequency standard by reference to radio time signals requires a series of measurements of the time of arrival of standard time signal pulses over an extended period of days or weeks in order to reduce the errors in time-signal reception times to negligible proportions. In the measurement the audio frequency dash or tick in the radio receiver output is compared with a timed reference signal from the local source to be calibrated. For example, let us assume that the standard time signals are received at a setting of 26.3 on the first day, 26.4 on the second — to 27.3 on the eleventh day. This represents an increase of the Microdial

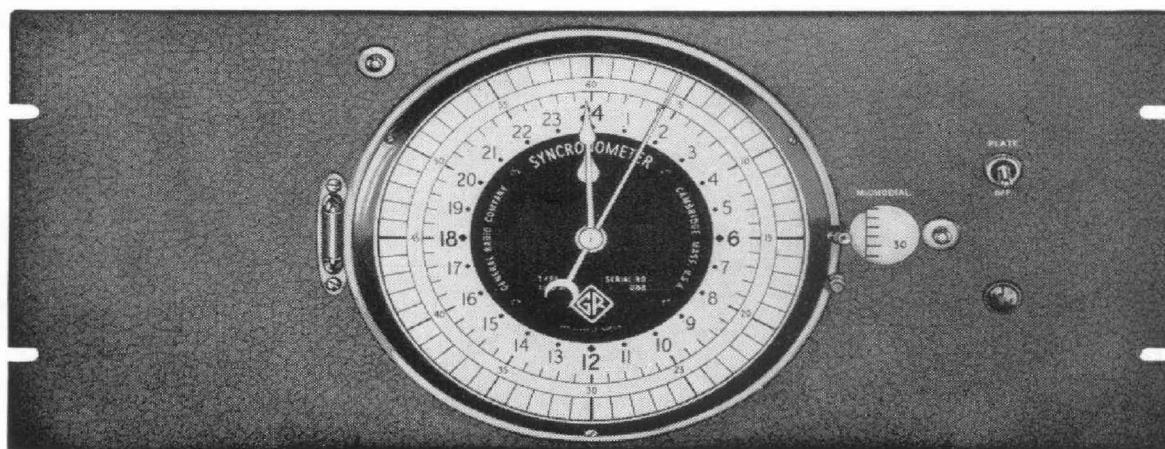

Figure 1. Panel view of the Synchronometer. The Microdial is at the right of the clock face.

reading of 1 division in 10 days or 10 milliseconds, which is 1 millisecond per day gain. Each day consists of a total of 86,400 seconds (mean solar time). This figure is approximately 10^5 seconds, or 10^8 milliseconds, per day. Since the frequency-standard clock is gaining at the rate of 1 millisecond per day, the clock-oscillator frequency (local frequency standard) is running approximately 1×10^{-8} too high in frequency, and is constant in frequency. If the Microdial setting had gained, or lost, time at a rate proportional to the square of the elapsed time, the frequency of the clock oscillator would have been changing at a constant rate of increase per day. Thus it is possible to compare local frequency standards with standard time signals for calibration of both frequency and time indications. In order to achieve the desired precision in the use of this method to calibrate the TYPE 1100-AP Primary Frequency Standard, it is necessary to use the Microdial contactor with an oscilloscopic indication of the time signal.

Use of the Microdial

As originally contemplated, the Microdial contactor was used as a phase-able gate, which let a time signal through when it was open and shorted it out when closed. The operator determined the time of arrival of the time signal by finding the setting of the Microdial for which the "nose" of the time signal was just barely perceptible, in head telephones or a loudspeaker. The precision

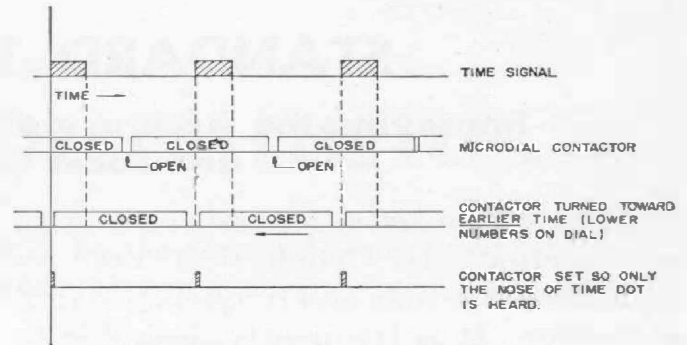

Figure 2. Diagram of time comparison using the Microdial.

of setting by this method is approximately ± 5 milliseconds. A time diagram of this operation is shown in Figure 2. For greater precision in this comparison method, a detector, or display device, is needed for indicating more precisely the relationship between the Microdial setting and the time of arrival of the signal. The aural method is subject to confusion from interfering noises and signals, and it depends upon the hearing of the operator for establishing a constant interval in milliseconds between the start of the time pulse and the closing of the Microdial contactor.

The Comparison Oscilloscope

A precision time-interval indicator is readily available in the TYPE 1105-A Frequency Measuring Equipment in the form of the TYPE 1109-A Comparison Oscilloscope, shown in Figure 3. The circular sweep of this cathode-ray indicator can be driven by the frequency standard at a sweep rate of 100 cycles per second, which gives a time scale of 10 milliseconds per revolution, with no

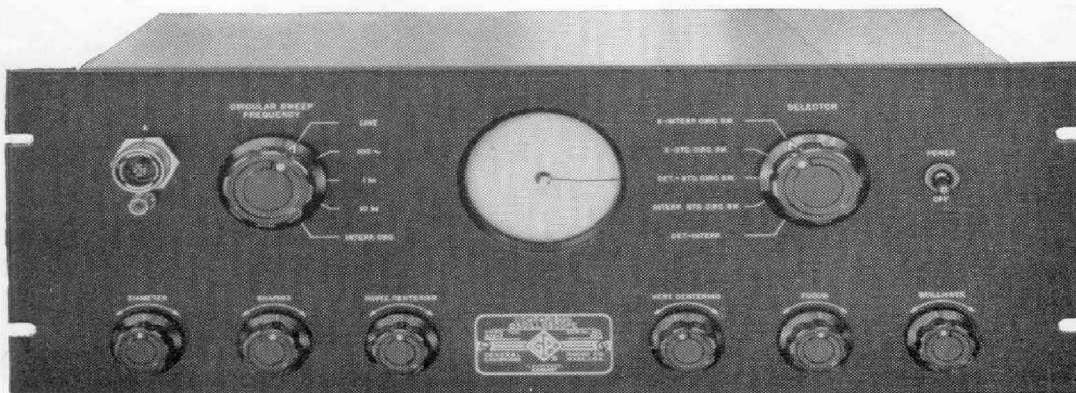

Figure 3. Panel view of the Type 1109-A Comparison Oscilloscope.



starting transient since it runs continuously. This oscilloscope thus provides the precision time scale required for accurate determination of the time of arrival of the time signals. All that is required is a knowledge of the characteristics of the time signals and of their appearance as seen on the oscilloscope, so that a suitable method may be chosen for using the display to calibrate the time of arrival of the time pulses.

Such a method has been in use here at the General Radio Company for several months with entirely satisfactory results. This method requires the following settings of the selector switches of the TYPE 1109-A Comparison Oscilloscope:

(CIRCULAR SWEEP FREQUENCY) to 100 cycles, and SELECTOR to DET.-STD. CIRC. SW. The radio-frequency time signal must then be received by a detector unit, which may be a TYPE 1106-A, -B, or -C Frequency Transfer Unit or a radio receiver. The resulting audio signal is supplied to the oscilloscope. In the TYPE 1105-A Frequency Measuring Equipment Assembly, this is accomplished by setting the switch on the TYPE 1108-A Coupling Panel to select the DETECTOR at L(ow), M(edium), or H(igh) frequency, as required, or EXT. (external) for a separate receiver. The audio signal will produce a radial deflection of the scope pattern. Adjustment of the Microdial setting will then vary the closing time of the gate so that, with the MICRODIAL switched ON (on the Coupling Panel),

the start of the time signal can be seen, and the closing time of the contactor can be set to a selected constant time delay after the start of the time signal. Although time signals from different sources have slightly differing characteristics, it is interesting to note that it is possible to reduce many of them to a completely standardized display, as shown in Figure 4.

In this diagram, the constant time-delay is 3 milliseconds and the audio signal is 1000 cycles per second. These are convenient values and are used in the examples that follow. The choice of 1000 cycles for the audio tone is convenient because (1) it is the modulation tone on the time signals from WWV, and (2) it bears an integral relationship to the 100-cycle circular sweep frequency, thus assuring a stationary pattern. The 3-millisecond delay interval is chosen because (1) the Microdial contactor must short out at least a portion of the time-signal pulse or there will be no way to tell when it is set correctly, and (2) the 3-cycle (or 3 millisecond) tick which remains is long enough to give an audible pulse, which can be distinguished aurally from most impulse noise, and (3) it provides a long enough period for the signal to build up if filters are added to reduce noise.

THE CALIBRATION METHOD IN USE

NSS Time Signals (U. S. Naval Observatory)

The time signals controlled by the U. S. Naval Observatory are transmitted from stations NSS, NBA, and NPG on a variety of frequencies (see current listing of frequencies and transmission schedules in U. S. Naval

Figure 4. Diagram of time-signal display on Type 1109-A Comparison Oscilloscope with Microdial contactor set to close 3 milliseconds after start of time signal.

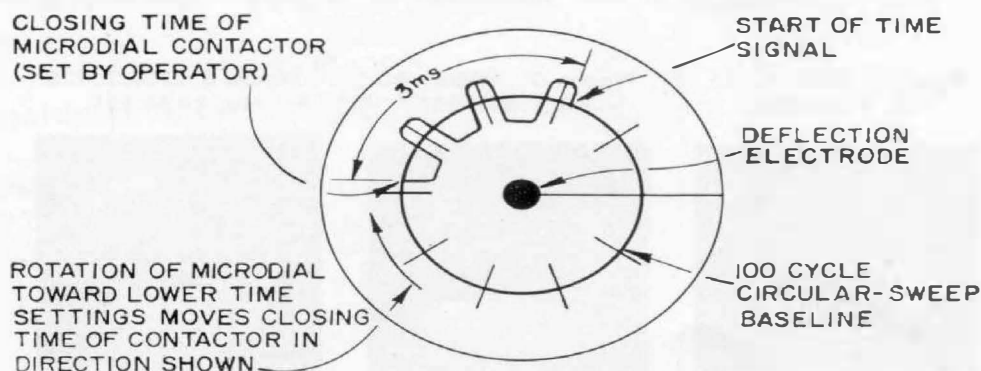

Observatory bulletins). These transmissions consist of a series of dashes at one-second intervals, each dash being a keyed continuous-wave signal, unmodulated. These time signals are radiated during the five minutes preceding the hour at the scheduled time.

For the display of this type of time signal on the circular-sweep scope, a heterodyning frequency must be added to provide an audio-frequency beat tone. For ease of calibration, this beat should be set as near to 1 kc as possible by reference to the pattern on the circular-sweep scope with the Microdial contactor not operating. Each cycle of the beat frequency is then equal to one millisecond, but the exact phasing of the various cycles is usually not steady enough to be used as a direct time calibration. The display presented by this method appears identical to that of the modulated signal from WWV (see next section) when the Microdial contactor is operating with a 3-millisecond interval between "nose" and closing time of the contactor. A photograph of the oscilloscope display of the time signal from NSS is shown in Figure 6. Note the apparently exact duplication of the display of Figure 7 with the notable exception that the signal-to-noise ratio is considerably better in the case shown in Figure 6. The heterodyning frequency was provided by the heterodyne frequency-meter oscillator in the Type 1106-B Frequency Transfer Unit. A Hammarlund SP-600-JX receiver was used as an external detector.

WWV Time Signals (National Bureau of Standards)

The time pulses from WWV comprise five complete cycles of 1-kc modulation on the carrier of the standard-frequency transmission, as shown in Figure 5. During the last two minutes of most of the five-minute intervals in any given hour (except for the various interruptions scheduled — see the current bulletin of National Bureau of Standards), the carrier frequency and the time ticks are the only signals transmitted. The Microdial contactor remains open for approximately 50 milliseconds, or 5 revolutions of the circular sweep. Therefore, the baseline of the sweep is visible throughout the entire circle even though the deflection leaves no baseline during the pulse. If the contactor is not set to short out part of the time signal pulse, the display is similar with the Microdial contactor in or out of operation, except that there is more noise and a brighter baseline display when the contactor is not in use.

When the phasing of the contactor is adjusted close to the desired value, the counter-clockwise end of the 5-cycle pulse will be shorted out first if the Microdial is rotated

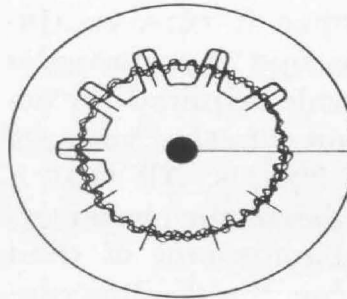

Figure 5. Diagram of time signal from WWV with Microdial contactor not operating.

from the higher numbers toward the lower numbers on the dial, as shown in Figure 2. If the Microdial is set to an improper setting, the contactor will always be closed when a time pulse is received and no deflection will be displayed.

One of the advantages of the use of this method of time-signal reception-time calibration is that relatively accurate results can be obtained in the presence of interference strong enough to prevent use of the carrier frequency of WWV as a standard frequency. A photograph of the Type 1109-A Comparison Oscilloscope display taken under such conditions is shown in Figure 7. The interference was a combination of several signals, at least one of which was an experimental pulse-train generator in an adjoining laboratory. The receiver was the detector in the Type 1106-B Frequency Transfer Unit.

CHU Time Signals (Dominion Observatory, Ottawa, Canada)

Time signals are transmitted by the Dominion Observatory, Ottawa, Canada, by the keying of a 1000-cycle tone on the carrier of station CHU. The signals are long dashes of 1000-cycle signals once each second, the time being announced in voice after the fiftieth second of each minute. The 1000-cycle modulating frequency is a standard frequency, and the keying device selects a constant starting phase for the modulating pulse. Hence each modulation cycle represents one millisecond. The display of this signal is again practically identical with the preceding two examples, as shown by the oscilloscope photograph of Figure 8. Some interference is apparent in this photograph, the beat note shown arising from a commercial communications transmitter on an adjacent channel. This signal was received on the Type 1106-B Frequency Transfer Unit, a regenerative detector. A sketch of the oscilloscope display during the "on" period of the CHU time signal is shown in Figure 9, the Microdial contactor being switched off. Familiarity with this display enables easy recognition and tuning-in of the time signal.

Figure 6. NSS, 9.425 Mc, 1456 EST.

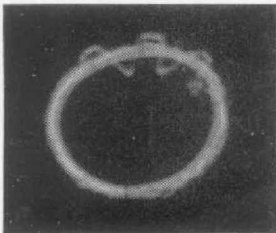

Figure 7. WWV, 10 Mc, 1437 EST.

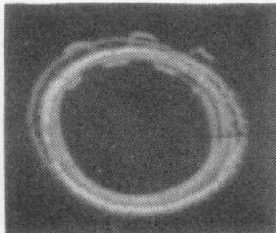
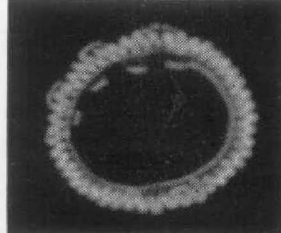

Figure 8. CHU, 7.335 Mc, 1424 EST.



Photographs of time-signal displays on Type 1109-A Comparison Oscilloscope, at Cambridge, Mass., December 19, 1957. Receiver was the Type 1106-B Frequency Transfer Unit except for Figure 6 where Frequency Transfer Unit supplied heterodyning frequency for SP-600-JX receiver.



Figure 9. Diagram of display during "on" period of time signal from CHU (Dominion Observatory, Ottawa, Canada), showing 10 equally spaced intervals of 1 millisecond each, corresponding to the modulation frequency of $1000 \sim$ ($100 \sim$ scope sweep frequency). Microdial switched OFF. The phasing shown here is arbitrary.

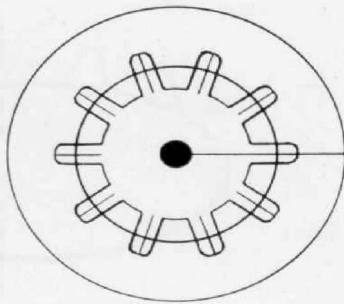

Calibrated Scale on Oscilloscope

A useful addition to the TYPE 1109-A Comparison Oscilloscope is a calibrated scale engraved on a sheet of transparent plastic material, which is placed next to the face of the oscilloscope tube. This scale, shown in Figure 10, has 10 equiangular divisions and a complete circle, which is used as a target on which to align the circular sweep.

Each tenth of the circular sweep circle represents one actual millisecond of time as counted off by the frequency standard, so that this scale can be used directly as a millisecond vernier scale to read between the 10-millisecond calibration points on the Microdial. Since the sweep voltage is not adjustable in phase for synchronism with the calibrated divisions of the Microdial, an arbitrary zero point must be established.

Use of Selective Filters

When electrical noise and interference are heavy, the use of selective filters may improve the signal-to-noise ratio. Filters can also be used to select the time-signal component of the WWV transmission during transmission of the standard audio tone signals. In each case, it is essential to determine the time-delay introduced by the use of the filter in order to be able to remove the additional error from this source. This problem is important mainly in the establishment

Figure 10. Diagram of transparent scale used on Type 1109-A Comparison Oscilloscope.

of accurate time for time-of-occurrence measurements, since the time-delay of a given filter would subtract out in a time-interval measurement such as is used in frequency standardization.

The circular-sweep oscilloscope display provides a simple means for checking the filter time-delay. If the time signals can be received without the filter, then a quick check of the display time with and without the filter switched into the circuit gives the desired delay-time calibration directly.

For example, the crystal filter of the SP-600-JX receiver in use in our frequency standard room appears to introduce approximately 0.5 millisecond delay when the selectivity is switched from 3 kc (xtal out) to 1.5 kc (xtal in). This crystal filter can be used to suppress the single-sideband tone transmission of WWV, leaving the time signals in the clear during the entire five-minute period.

The use of a selective audio filter ahead of the Microdial contactor may result in some noise-pulse-induced ringing of the filter. This condition is improved slightly by placement of the audio filter in the circuit following the Microdial contactor, since the number of large noise pulses coming through the open "gate" is less than the total number of noise pulses ahead of the "gate."

Discussion of Results of Use of This Method of Calibration

The dial readings of the Microdial can be estimated to 0.1 division of the dial. The accuracy of the estimate de-

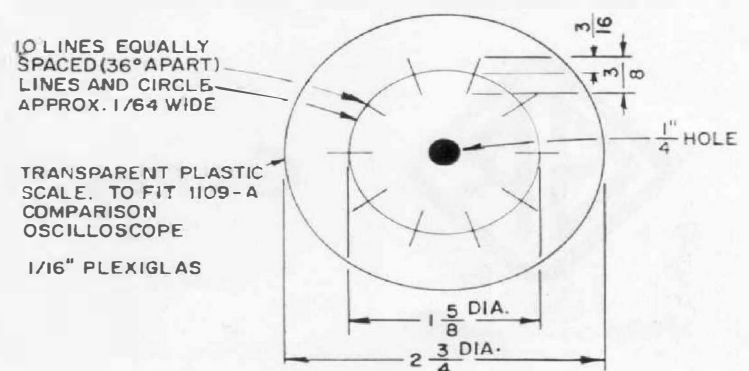

depends upon the use of a standard direction of approach to the setting point and the use of the vernier scale provided by the oscilloscope as described above. In general, the dial readings made by this method have exhibited a consistency of better than ± 1 millisecond. This degree of reliability is adequate, since the time signals show a propagation-caused variation sometimes as great as ± 1 millisecond. In general, the stability of the arrival time of the time signals is better than ± 0.3 millisecond.

Over the past few months, calibration of the General Radio working frequency standard has been carried out by this method with a precision entirely adequate for precise frequency measurement of $\pm 1 \times 10^{-8}$ without correction for the variations in the transmission time of the time signals. By taking account of the corrections provided by the U. S. Naval Observatory, Washington, D. C., it is possible to improve this figure. In any case, this calibration method provides a local time standard, independent of radio propagation conditions, with a simple, accurate, checking method for use when radio propagation conditions are favorable, to allow direct calibration by comparison with externally available standard time signals.

An "Emergency" Method

The display method described above assumes possession of a complete TYPE 1100-AP Primary Frequency Standard with TYPE 1105-A Frequency Measuring Equipment Assembly. When only the TYPE 1100-AP Primary Frequency Standard is available, an oscillographic

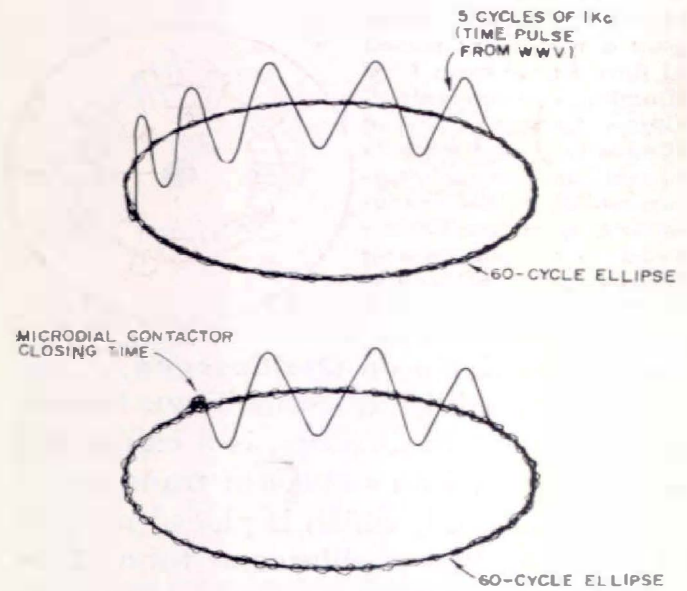

Figure 11. Diagram of oscilloscope display on conventional oscilloscope, showing 3-millisecond interval of modulated pulse between "nose" of pulse and closing of contactor.

display can be made, independent of the circular sweep, by a setting of the Microdial to chop off the required part of the time signals as shown on a conventional oscilloscope with, for example, a 60-cycle sine-wave sweep on the horizontal plates and a small amount of 60-cycle sine wave added to the vertical deflection signal along with the time-signal input. The "nose" of the time pulse will then be visible, as it is on the circular sweep display with standard sweep rate, the difference being that there is no accurate vernier "gain-or-loss of time" scale on the scope. The modulated time signals from WWV and CHU permit easier use of this display than do the c-w pulse type of signals. A sketch of an oscilloscope display of this "emergency" display method is shown in Figure 11.

— FRANK D. LEWIS



General Radio Company