

THE

General Radio EXPERIMENTER

VOLUME XXVII No. 5

OCTOBER, 1952

Copyright, 1952, General Radio Company, Cambridge, Mass., U. S. A.

ELECTRICAL MEASUREMENTS AND THEIR INDUSTRIAL APPLICATIONS

NEW COAXIAL ACCESSORIES — ADAPTORS, LINE STRETCHER, COMPONENT MOUNT, BALUN, TERMINATIONS, AND INSERTION UNIT

●EARLY IN THE DEVELOPMENT OF RADAR, the importance of smooth coaxial connections became evident, and coaxial measuring equipment was found necessary to achieve them. The virtues of completely shielded structures with uniformly distributed parameters and simple geometric configurations were quickly recognized, and a tremendous effort was put forward to bring coaxial measurement techniques up to a level adequate for accurate measurement. Out of this work came widespread use of the slotted line, the directional coupler, the "line stretcher," the wave-guide-below-cutoff attenuator, the matching section, the balun, the "magic T," and all the other items of

Figure 1. View of the Type 874-M Component Mount as set up for measuring a resistor at 500 megacycles with the Type 874-LK Constant-Impedance Adjustable Line and the Type 1602-A Admittance Meter.

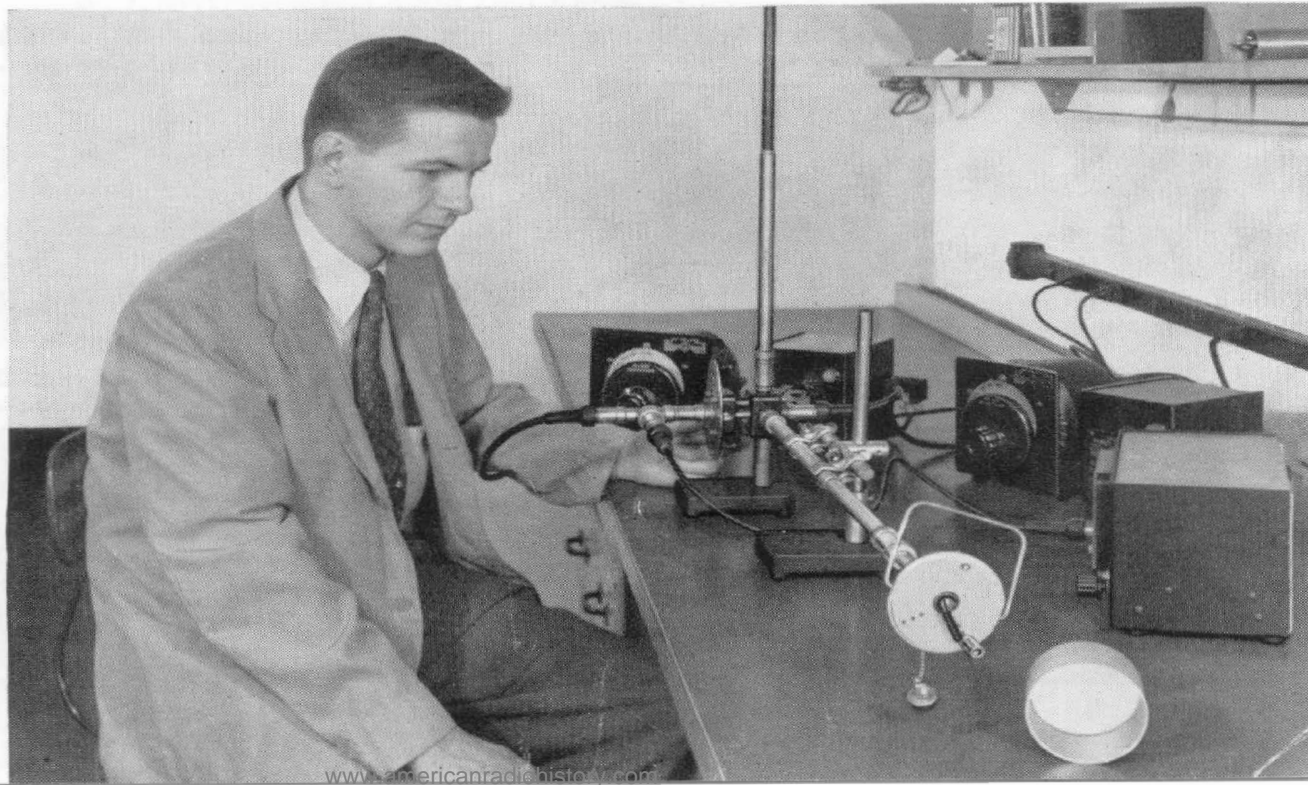

microwave "plumbing." However, most of these devices were developed for relatively narrow frequency ranges. Accuracy was important. Flexibility and versatility in use were secondary.

At the end of the war it became clear that commercial use of the entire portion of the spectrum sampled by radar was inevitable. Therefore, the manufacturer of measuring equipment was faced with the problem of synthesizing the devices and methods that had been devised for specific frequencies into a universal system that would cover a wide frequency range extending downward to the lower frequencies where lumped-parameter devices are satisfactory and upward to the high frequencies where wave guide and cavity devices become desirable.

Out of a study of this problem grew the General Radio TYPE 874 line of coaxial elements. The element of flexibility is achieved by making various component parts plug into one another readily, and the element of versatility is obtained by making a sufficient variety of component parts.

The common element in this integrated line of parts is the TYPE 874

Coaxial Connector.¹ It was considered essential from the beginning that a connector be used that would plug into another identical connector. Experience had shown that combinations of elements not originally anticipated would be found useful and that male and female connectors would complicate this added usefulness.

The various connectors that had been developed during the war were reviewed, and it was found that nothing was available that would meet this need. The TYPE N Connector had been established as standard, and a continuing program of development had brought its mechanical design and electrical performance to a high degree of perfection as a general system connector. As a connector for an integrated line, however, it failed to meet the requirement that any connector plug into any other connector since it was basically a male-female design. It was, therefore, decided that a new connector, designed specifically for measurements, was needed.

Ideal specifications for this new connector were agreed upon as follows:

¹W. R. Thurston, "A Radically New Coaxial Connector for the Laboratory," *General Radio Experimenter*, Volume XXIII, No. 5, October, 1948.

Figure 2a. Type 874-QNP and -QNJ Adaptors to Type N Connector.

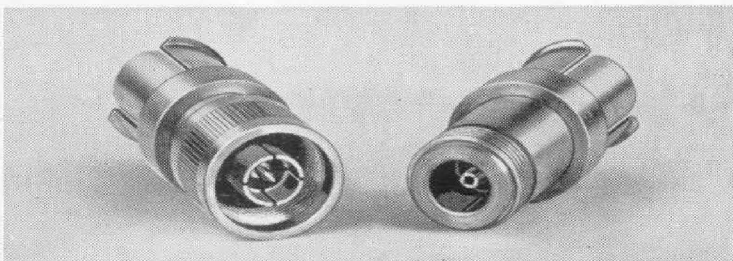

Figure 2b. Type 874-QCJ and -QCP Adaptors to Type C Connector.

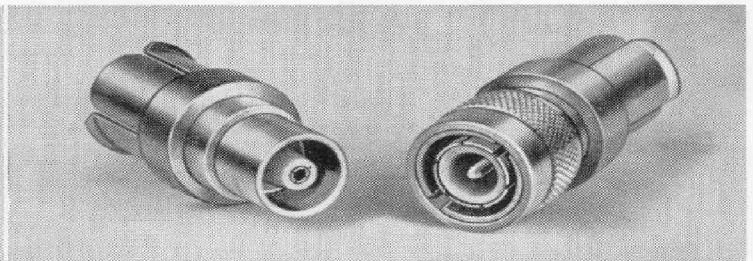

Figure 2c. Type 874-QBJ and -QBP Adaptors to Type BNC Connector.

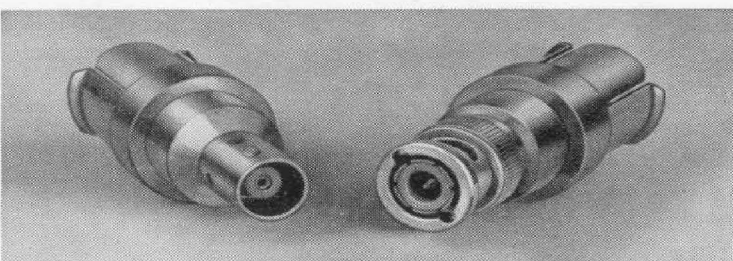
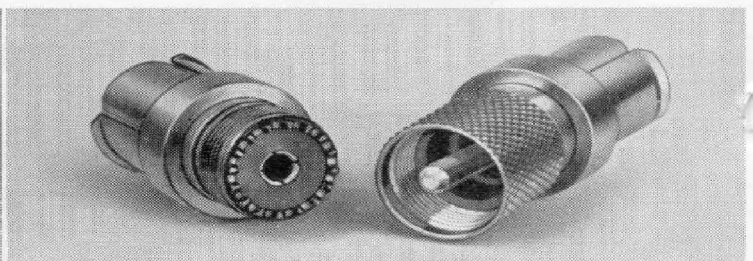

Figure 2d. Type 874-QUJ and -QUP Adaptors to Type UHF Connector.





1. Each connector should plug into any other connector.

2. Electrical characteristics should be at least as good as those of the TYPE N Connector.

3. The connector should be adaptable to mounting on panels, solid-outer-conductor coaxial lines, or flexible cables without basic change.

4. The connector should accept not only other connectors of the same type but also TYPE 274 Banana Plugs.

5. The connector should be designed as a quick-connect-and-disconnect instrument connector rather than as a system connector with provision for locking junctions together,² pressurizing, etc.

6. The characteristic impedance should be 50 ohms to simplify calculations and to approximate the characteristic impedance of TYPE RG Cables in widespread use.

These objectives were ultimately achieved and the success of the TYPE 874 Connector in meeting general laboratory requirements has been amply demonstrated. In General Radio equipment, its advantages have been so apparent that it has been adopted throughout as a universal connector, not only for v-h-f and u-h-f devices, but also for lower-frequency equipment where the shielding and small ground inductance of a coaxial connector are essential.

A virtually complete line of high-frequency coaxial measuring equipment has been designed around the TYPE 874

²An external spring-type lock is available.

Connector. Most of these pieces have been previously announced and are now widely used throughout industry and in educational institutions. They include a slotted line, admittance meter, bolometer bridge, and a variety of accessory equipment.

To make the features of this line of coaxial equipment as universally available as possible, the General Radio Company now offers (1) a line of adaptors which will permit interconnection of TYPE 874 equipment with other commonly used coaxial systems, (2) a constant-impedance line stretcher, (3) a component mount to facilitate the measurement of resistors, capacitors, inductors, and other circuit elements, (4) a balun for converting balanced to unbalanced impedances, (5) short and open circuit terminations to aid in setting up measuring equipment, and (6) an insertion unit for mounting arbitrary coaxial networks.

ADAPTORS

The new TYPE 874 Coaxial Adaptors are designed to connect measuring equipment using TYPE 874 Coaxial Connectors to other pieces utilizing any of the common high-frequency coaxial connectors — TYPE N, TYPE C, TYPE

Figure 3. VSWR as a function of frequency for typical adaptors. Measurements were made on pairs of adaptor units, as shown in the sketch, and, hence, the standing-wave ratios shown are the totals produced by two pairs of Type 874 Connectors plus a pair of UG-type (i.e., N, C, or BNC) connectors.

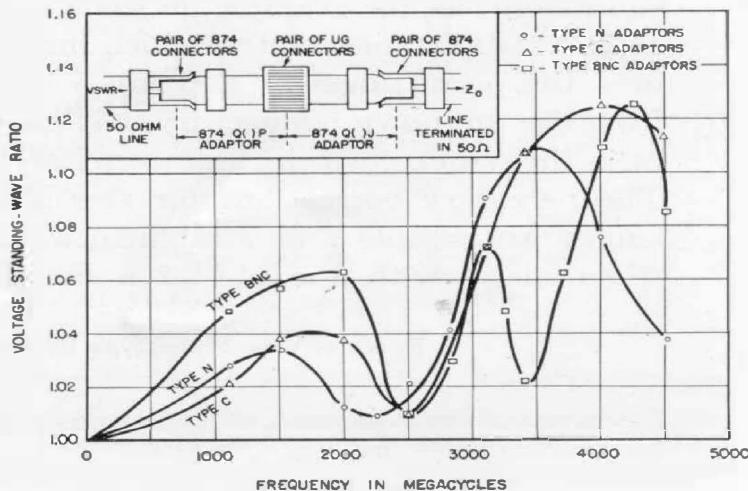

BNC, and TYPE UHF.³ These adaptors are shown in Figure 2. Their excellent electrical characteristics⁴ are illustrated in the plots of VSWR versus frequency, shown in Figure 3. The use of these adaptors makes it possible to utilize the advantages of the TYPE 874 line when measurements are made on equipment

fitted with military-type connectors. The availability of both male and female adaptors makes possible the conversion to TYPE 874 Connectors with a minimum of interconnecting elements.

³Drawings 874-QHP and 874-QHJ are available for manufacturing adaptors to TYPE HN Connectors.

⁴UHF connectors do not have a constant impedance and introduce an appreciable reflection in the line at the higher frequencies.

TYPE 874 ADAPTORS

<i>Type No.</i>	<i>Elements Used in Adaptor</i>	<i>Code Word</i>	<i>Price</i>
874-QNP	Type 874 Connector and Type N Plug Connector . . .	COAXNUTTER	\$4.50
874-QNJ	Type 874 Connector and Type N Jack Connector . . .	COAXNAGGER	3.75
874-QBP	Type 874 Connector and Type BNC Plug Connector .	COAXBUNNER	6.00
874-QBJ	Type 874 Connector and Type BNC Jack Connector .	COAXBOGGER	5.75
874-QCP	Type 874 Connector and Type C Plug Connector . . .	COAXCUFFER	6.50
874-QCJ	Type 874 Connector and Type C Jack Connector . . .	COAXCOGGER	4.75
874-QUP	Type 874 Connector and Type UHF Plug Connector .	COAXYUPPER	4.25
874-QUJ	Type 874 Connector and Type UHF Jack Connector .	COAXYUNDER	4.00

TYPE 874-LK CONSTANT-IMPEDANCE ADJUSTABLE LINE

Measurements on 50-ohm coaxial systems can be greatly facilitated if the lengths of transmission lines in the system can be adjusted without introducing appreciable discontinuities.

It is usually not possible to measure impedance directly at the location of an unknown, because some length of line exists between the point at which the measurement is made and the point at which it is desired. This line length may be a piece of coaxial cable necessary to connect the measuring instrument to an inaccessible unknown, as, for instance, an antenna; it may be in the measuring equipment, as, for example, in the TYPE 1602-A Admittance Meter, which measures the admittance at a point 5 cm. from the unknown connector; or it may be in the structure of the unknown itself. The necessary corrections for this line length are simple and straightforward when made with the aid of a Smith

chart, but become tedious when a long series of measurements is to be made.

The need for these corrections can be eliminated if the electrical distance between the measuring point and the desired point can be made equal to an integral number of half-wavelengths. This can be easily accomplished by the use of a line of adjustable length (line stretcher) inserted between the unknown and the measuring device, provided the line has a uniform characteristic impedance. Conventional adjustable lines, however, do not have a constant characteristic impedance as the length is varied and are, therefore, not satisfactory for this purpose. This disadvantage is eliminated in the TYPE 874-LK Constant-Impedance Adjustable Line shown in Figure 4.

This air-dielectric coaxial line has a maximum length of 80 cm. and a minimum length of 58 cm. with an adjust-

Figure 4. View of the Type 874-LK Constant-Impedance Adjustable Line.

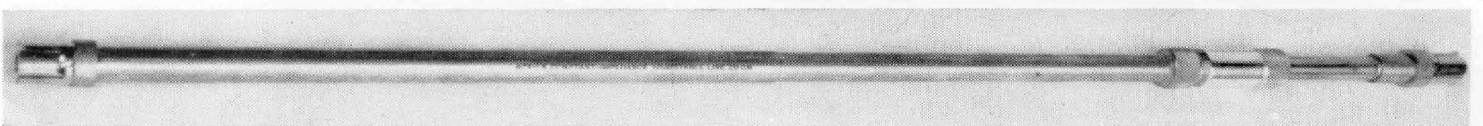



ment range of 22 cm. The line is fitted with TYPE 874 Coaxial Connectors at each end and a locking mechanism for maintaining the adjustment.

The ratio of the diameters of the inner and outer conductors, and hence the characteristic impedance, is held constant at all points along the line. This is accomplished by having the inner and outer conductors slide at different points as shown in Figure 5. No significant electrical discontinuities are introduced by the steps because the stray capacitance resulting from the abrupt changes in diameters are compensated by slightly offsetting the steps in the inner and outer conductors. Because the characteristic impedance is constant, this line is aperiodic and thus can be used over a wide frequency range. The VSWR of a typical line as a function of frequency is shown in Figure 6.

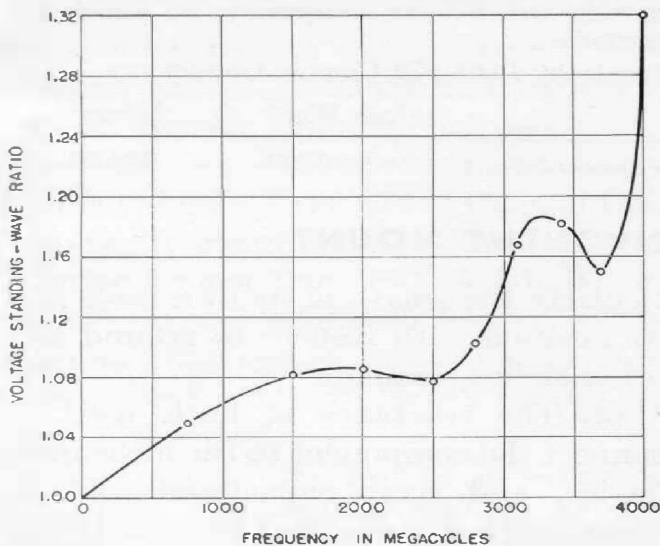

Figure 6. Voltage-standing-wave ratio as a function of frequency for a typical Type 874-LK Constant-Impedance Adjustable Line. These values include the VSWR of two pairs of Type 874 Connectors, and the magnitude plotted at each frequency is the maximum of several measurements made with different settings of the line.

In impedance measurement, the error introduced by the adjustable line is a function of the frequency and the unknown impedance. The maximum error

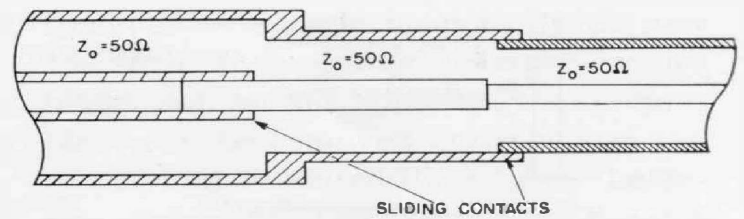

Figure 5. Simplified cross section of the adjustable line, showing how the sliding contacts are arranged to hold the characteristic impedance constant as the length is varied.

is proportional to the VSWR of the adjustable line itself when terminated in 50Ω .

A line of this type has many uses. In addition to using it as a half-wave line to eliminate line corrections, one can adjust the measuring-point-to-desired-point distance to be an odd number of quarter wavelengths and thereby convert an admittance reading device into an impedance reading device and vice versa. This line can, for instance, be used in this way to increase the accuracy and range of measuring instruments, particularly the TYPE 1602-A Admittance Meter, as a converter of low impedance (high admittance) to low admittance, which can be measured with greater accuracy than high admittance; it can also be used to make the admittance meter direct reading in impedance. In a matched system, on the other hand, no admittance variation occurs, but the line can be used to obtain a constant-magnitude, variable-phase output voltage. It has been used to provide differently phased voltages for elements of an antenna array.

One of the common uses for the adjustable line is in a matching section for converting a load impedance to the characteristic impedance of a line system. Proper matching is often necessary. It minimizes standing-wave ratio and the accompanying line loss; or enables one to draw maximum power from a source.

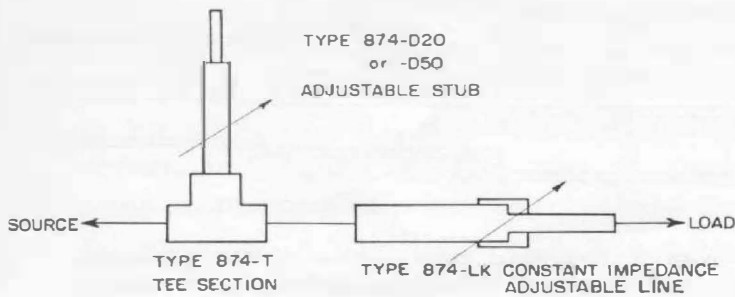

Figure 7. Functional diagram of an impedance-matching transformer made up of coaxial elements.

In matching for unity standing-wave ratio, a point on the line is found at which the real part of the effective admittance is equal to the characteristic admittance, and a shunt susceptance, usually in the form of an adjustable-length short-circuited line, is inserted to cancel out the imaginary part. Thus the

line will appear matched on the generator side of the shunt susceptance. The matched condition can be determined by measurement with the admittance meter or the slotted line.⁵ A matching section utilizing this principle is shown in diagrammatic form in Figure 7. It consists of a TYPE 874-LK Adjustable Line, a TYPE 874-T Tee, and a TYPE 874-D20 or D50 Adjustable Stub.

When it is desired to draw maximum power from a generator, the generator must face the conjugate of its internal impedance. Experimentally this condition can be achieved by adjusting the transformer elements until the power dissipated in the load is a maximum.

⁵R. A. Soderman and W. M. Hague, "U-H-F Measurements with the TYPE 874-LB Slotted Line," *General Radio Experimenter*, November, 1950.

SPECIFICATIONS

Impedance: 50.0 ohms.

Length: Maximum, 80 cm.; minimum, 58 cm.; adjustment range, 22 cm.

VSWR: Less than 1.10 at 2000 Mc; approximately linear with frequency at lower frequencies.

Terminals: TYPE 874 Coaxial Connectors.

Type	Code Word	Price
874-LK	Constant-Impedance Adjustable Line.....	COAXKEEPER \$36.00

THE TYPE 874-M COMPONENT MOUNT

The measurement of the admittance or impedance of components at high frequencies is complicated by many factors, the most important of which generally are:

(1) The component's arrangement in the circuit in which it is to be used, par-

ticularly the length of its own leads and its position with respect to ground and other circuit elements.

(2) The reactance of leads used to connect the component to the measuring device, and stray capacitance of the measuring terminals to which the leads are connected.

The complications resulting from (1) can be minimized by approximating as closely as possible the contemplated environment; those from (2) by using a coaxial connecting system whose effect

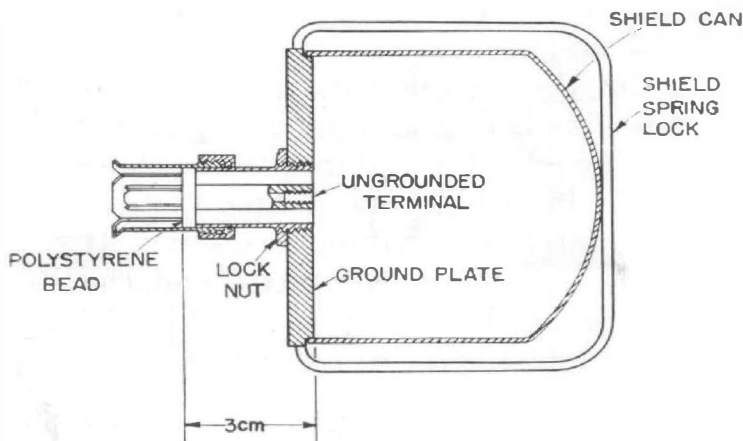

Figure 8. Cross section of the component mount.

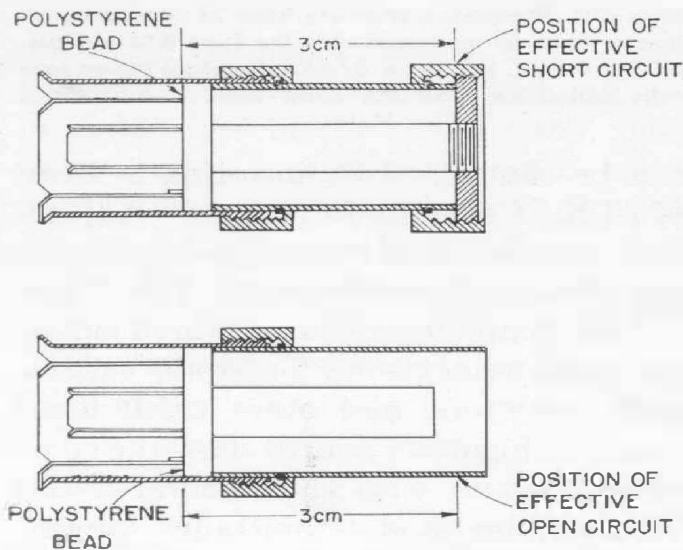

Figure 9. Cross-section diagrams of the Type 874-WN3 Short-Circuit Termination and the Type 874-WO3 Open-Circuit Termination.

can be readily computed or compensated.

The TYPE 874-M Component Mount has been designed with these objectives in mind. It provides a shielded enclosure of convenient size within which a component can be mounted in a variety of ways, thereby enabling the user to approximate a circuit environment closely. Mounted on a TYPE 874-B Coaxial Connector, it connects to a TYPE 874-LB Slotted Line or TYPE 1602-A Admittance Meter through a smooth 50-ohm coaxial system that makes correction or compensation for "lead" length simple and straightforward.

A sketch of the mount is shown in Figure 8. The end of the center conductor of a section of 50-ohm air line is used as the ungrounded terminal and the outer conductor is extended in the form of a disc for a ground plane. The unknown is connected between the center conductor and the ground plate. It is connected by screws or binding posts, which are provided. Several mounting holes are arranged on the ground plate to provide a variety of

spacings — $\frac{1}{2}$ inch, $\frac{3}{4}$ inch, 1 inch, and $1\frac{1}{4}$ inch. If necessary, a larger ground plate can be installed or the ground plate can be removed entirely and the center unit mounted directly on the device under test. The shield cover isolates the unknown from external electrostatic or electromagnetic interference.

To correct for the effect of the coaxial line connecting the measuring point and the component to be measured, one must know the line length accurately. The line length can be determined most readily by an impedance measurement with the line terminated in a short or open circuit at the terminals to which the component is to be connected. A low-inductance disc, supplied with the unit, can be screwed into the center terminal in place of the unknown to short-circuit the system at the ground plane.

Alternatively, to avoid the need for disconnecting the component to be measured from its mounting, the entire component mount can be unplugged and a TYPE 874-WN3 Short-Circuit Termination or a TYPE 874-WO3 Open-Circuit Termination can be substituted. These terminations, supplied as accessories, place a short or open circuit at a distance of 3 cm. from the bead in the coaxial connector, a distance equal to that between the bead and the ground plane in

Figure 10. View of the component mount plugged into a General Radio slotted line for the measurement of a resistor.

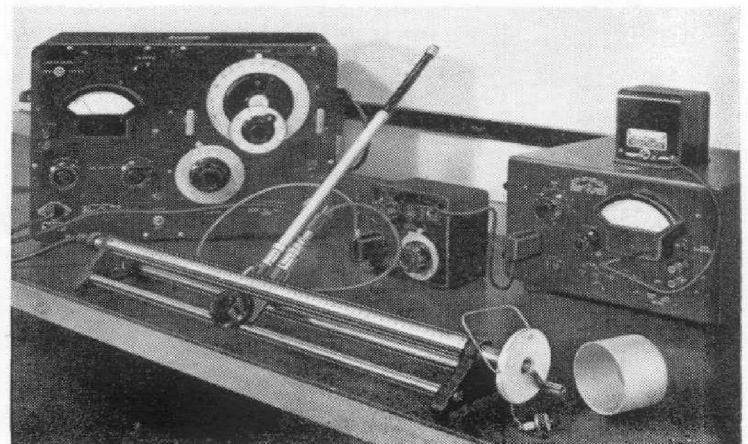

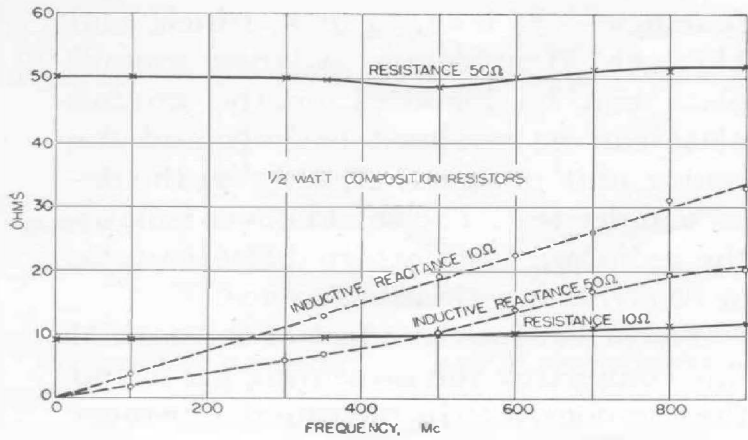

Figure 11. Frequency characteristics of two composition resistors as measured with the Type 874-M Component Mount, the Type 874-LK Constant-Impedance Adjustable Line, and the Type 1602-A Admittance Meter.

the component mount. These units are shown in Figure 9.

The effect of the coaxial line can be calculated from transmission-line equations or read from a Smith chart; or it

can be eliminated by inserting a TYPE 874-LK Constant-Impedance Adjustable Line between the measuring device and the component mount. The TYPE 874-M Component Mount is well suited for measurements on resistors, capacitors, inductors, and other small components. Figures 1 and 10 show the component mount with the General Radio Slotted Line and Admittance Meter. Figure 11 shows the results of a set of measurements made with the TYPE 874-M Component Mount and the TYPE 1602-A Admittance Meter.

SPECIFICATIONS

Frequency Range: d-c to 5000 Mc.

Accessories Supplied: One TYPE 874-WN3 Short-Circuit Termination, one TYPE 874-WO3 Open-Circuit Termination.

Other Accessories Recommended: One TYPE 874-LK Constant-Impedance Adjustable Line.

Dimensions: Diameter of ground plate, 3 inches. Height of shield can, 2 5/8 inches.

Terminal: TYPE 874 Coaxial Connector.

Type	Code Word	Price
874-M Component Mount.....	COAXYMOUNT	\$25.00

THE TYPE 874-UB BALUN

The TYPE 874-UB Balun brings to the measurement of balanced impedances the simple, accurate techniques already highly developed for coaxial systems. The need for measurements of this kind is growing rapidly with the use of balanced systems in television and communications, and satisfactory equipment has not previously been available.

For accurate impedance measurements, it has generally been found impractical to use conventional transformers to effect the conversion from balanced to unbalanced impedance because of losses and limited frequency range. The TYPE 874-UB Balun has, therefore, been designed to use an artificial half-

Figure 12. View of the Type 874-UB Balun with two Type 874-D20 Adjustable Stubs and two Type 874-L10 Air Lines as tuning elements. The 300-ohm connector is shown in the foreground. The balun is shown mounted on a Type 874-Z Stand.

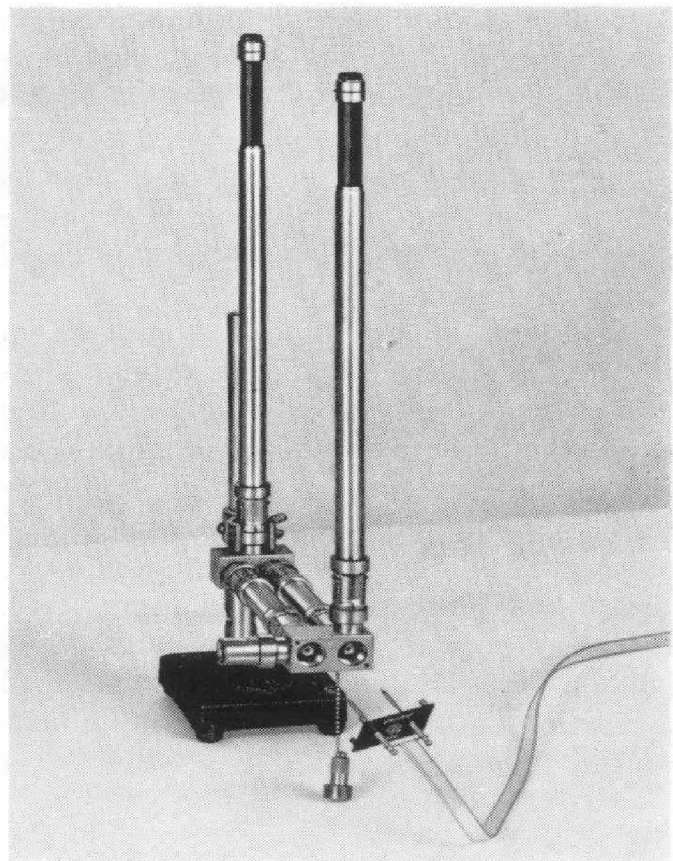



wave line, which, when tuned to the operating frequency, makes the desired conversion accurately and without appreciable loss in the balun itself. The balun, shown in Figure 12, can be used over a frequency range from 50 to 1000 megacycles. It is made tunable so that the best possible accuracy can be obtained at any frequency within its range.

The basic theory underlying the operation of the balun is as follows:

The voltage appearing at one end of a section of transmission line, an integral number of half-wavelengths long, is equal in magnitude and 180 degrees out of phase with the voltage at the other end, independent of impedance. In addition, the impedance appearing at one end is equal to that at the other end. If a half-wavelength line is connected as shown in Figure 13, it provides a balanced output from an unbalanced input, and vice versa. The unbalanced voltage is equal to the voltage from either balanced terminal to ground, that is, one half the voltage between the balanced terminals. The impedance seen at the unbalanced terminals will be one quarter the impedance at the balanced terminals.

The use of an actual half-wavelength section of line restricts the frequency range greatly unless many different lengths of line are used. A much wider

frequency range can be obtained by using a semi-artificial or loaded half-wave line as shown in Figure 14. The principle of operation of the artificial half-wave line has been described previously.⁶

The TYPE 874-UB Balun consists of two connector blocks with terminals for connecting various lengths of line and shunt tuning elements to cover a wide frequency range. The balun is adjusted for proper operation at a particular frequency by means of the shunt tuning elements. The necessary measurements to indicate correctness of tuning adjustments are conveniently made with the TYPE 1602-A Admittance Meter. A TYPE 874-WN3 Short-Circuit Termination and a TYPE 874-WO3 Open-Circuit Termination are supplied with the balun to facilitate tuning adjustments. At the higher frequencies, TYPE 874-D20 Stubs are used as tuning elements, and at the lower frequencies TYPE 874-VC Variable Capacitors are used. Figure 15 shows the frequency ranges obtainable with various combinations of elements.

The unbalanced end of the balun is a TYPE 874 Coaxial Connector, and thus the balun can be used with any General Radio measuring equipment and, by

⁶D. B. Sinclair, "Measuring Balanced Impedances with the R-F Bridge," *General Radio Experimenter*, Volume XVII, No. 4, September, 1942.

Figure 13. Diagram showing how a half-wave line operates as a balanced-to-unbalanced transformer.

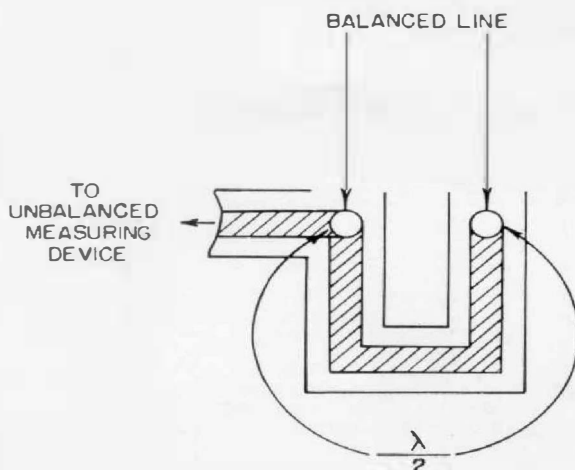
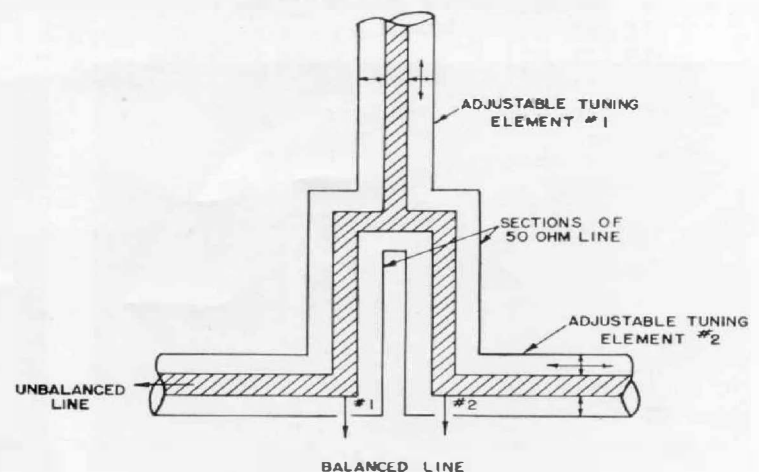

Figure 14. Diagram of a loaded, or semi-artificial half-wave line, which can be tuned over a wide frequency range.



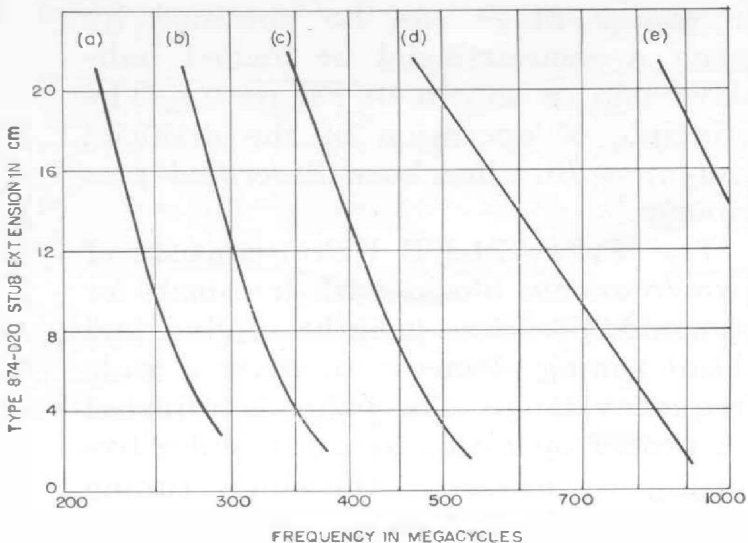

Figure 15. Tuning ranges of the balun for various combinations of tuning elements as listed in the specifications (next page). Note that the complete UHF-TV range is covered by a single combination.

means of the previously described adaptors, with equipment of almost any other manufacture.

When the balun is used with the TYPE 1602-A Admittance Meter and the TYPE 874-LK Adjustable Line, the adjustable line can be set so that the effective distance between the unbalanced terminals of the balun and the measuring point in the admittance meter is an odd number of quarter wavelengths. Under these conditions the admittance meter readings multiplied by ten give the actual balanced impedance in ohms. Figures 16 and 17 show the balun in operation.

In order to minimize errors, the balanced line under measurement should

have its characteristic impedance remain constant right up to the terminals of the balun. The line impedance may be appreciably affected by the proximity of the grounded balun block; and, hence, for the most accurate results, a terminal unit designed for the line to be tested should be used for connection to the balun. The TYPE 874-UB-P1, a terminal unit designed for 300-ohm twin lead, is supplied with the balun. This is shown in Figure 12. This terminal unit is equivalent to a short length of 300-ohm line and compensates for the presence of the balun block. When it is used for measurements on 300-ohm twin lead, it insures a constant 300-ohm characteristic impedance directly to the balun terminals. If desired, balanced lines having other characteristic impedances can be measured using the 300-ohm terminals if corrections are made for the equivalent length of 300-ohm line in the terminal unit. Data for this correction are supplied in the operating instructions that accompany the instrument.

Figures 18 and 19 show typical measurements made with the TYPE 874-UB Balun.

Figure 16. The Type 874-UB Balun in use with a slotted line to measure 300-ohm twin lead.

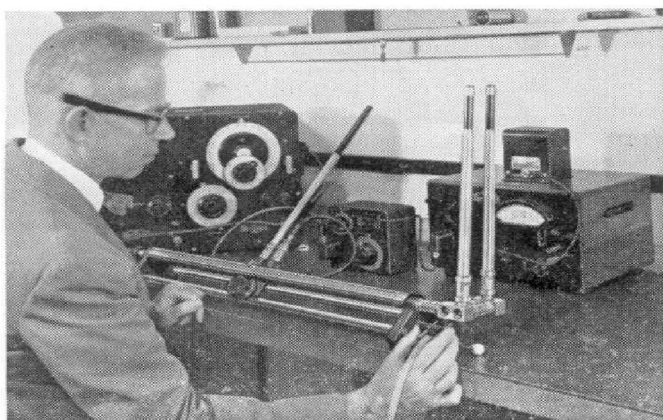
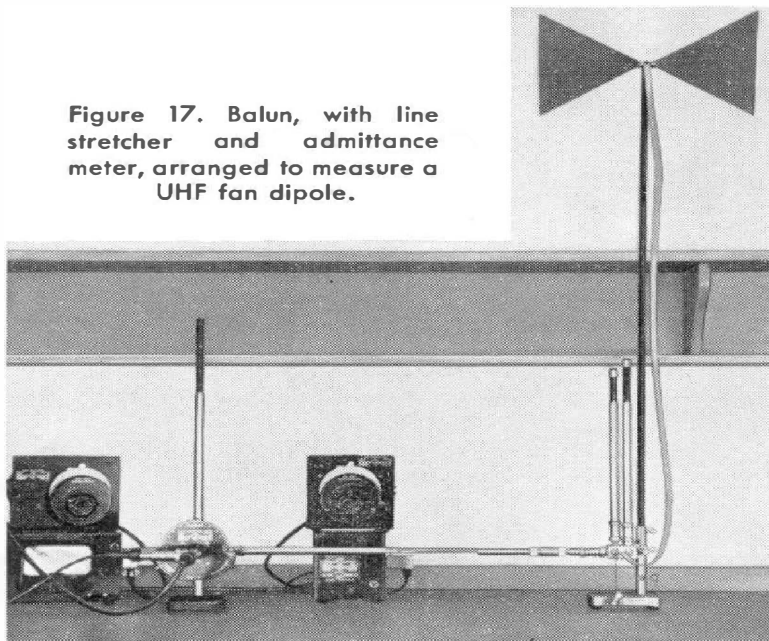

Figure 17. Balun, with line stretcher and admittance meter, arranged to measure a UHF fan dipole.



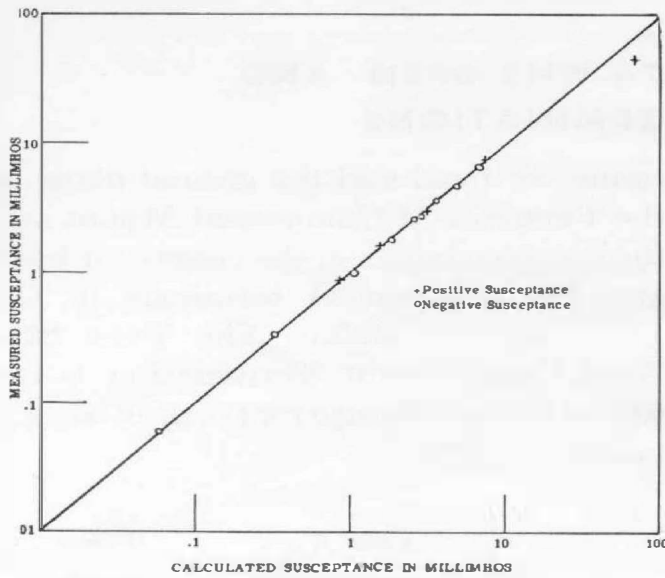

Figure 18. Measured vs. calculated values of susceptance for various short-circuited lengths of 300-ohm balanced line at 400 megacycles. Measurements were made with the Type 874-UB Balun and the Type 1602-A U-H-F Admittance Meter.

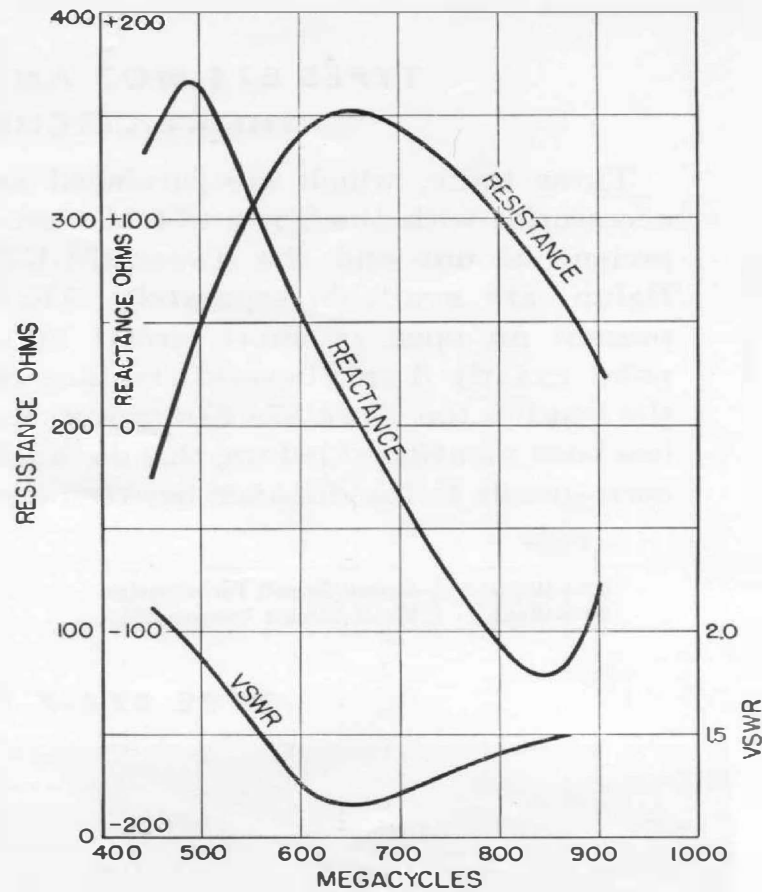

Figure 19. Measured values of resistance, reactance, and VSWR of the fan dipole shown in Figure 17.

SPECIFICATIONS

Frequency Range: 50 to 1000 Mc with proper accessories (see Figure 15).

Accessories Supplied: One TYPE 874-UB-P1 300-ohm Terminal, one TYPE 874-WN3 Short Circuit Termination, one TYPE 874-W03 Open-

Circuit Termination.

Other Accessories Recommended: One TYPE 874-LK Constant-Impedance Adjustable Line (when used with the TYPE 1602-A Admittance Meter), and one TYPE 874-Z Stand.

Accessories Required for Various Frequency Ranges:

Figure 15 Curve	Accessory Equipment	Frequency Range
(d), (e)	2-Type 874-D20 Adjustable Stubs.....	470-1000 Mc
(c)	2-Type 874-D20 Adjustable Stubs and 2-Type 874-L10 Air Lines....	350-525 Mc
(b)	2-Type 874-D20 Adjustable Stubs and 2-Type 874-L20 Air Lines....	275-380 Mc
(a)	2-Type 874-D20 Adjustable Stubs and 2-Type 874-L30 Air Lines....	225-280 Mc
	2-Type 874-D50 Adjustable Stubs and 2-Type 874-L30 Air Lines....	170-280 Mc
	2-Type 874-VC Variable Capacitors + Lengths of Line ⁷	50-300 Mc

⁷Actual lengths required for operation in this frequency range will be available in the near future. Write for information.

Type		Code Word	Price
874-UB	Balun.....	COAXYBALUN	\$70.00
874-D20	Adjustable Stub (20 cm.).....	COAXTUBBER	10.50
874-D50	Adjustable Stub (50 cm.).....	COAXBIGGER	12.00
874-L10	50-Ω Air Line (10 cm.).....	COAXDECKER	6.50
874-L20	50-Ω Air Line (20 cm.).....	COAXVENTER	6.50
874-L30	50-Ω Air Line (30 cm.).....	COAXTRIPLY	7.50



TYPES 874-WO3 AND 874-WN3 OPEN- AND SHORT-CIRCUIT TERMINATIONS

These units, which are furnished as accessories with the TYPE 874-M Component Mount and the TYPE 874-UB Balun, are available separately. They present an open or short circuit at a point exactly 3 cm. beyond the face of the bead in the TYPE 874 Connector. As has been mentioned before, this distance corresponds to the distance between the

connector bead and the ground plane in the TYPE 874-M Component Mount and the distance between the connector bead and the unbalanced terminals in the TYPE 874-UB Balun. The TYPE 874-WO3 Open-Circuit Termination is designed to compensate for fringing capacitance.

Type		Code Word	Price
874-WO3	Open-Circuit Termination.....	COAXYTRIPU	\$2.50
874-WN3	Short-Circuit Termination.....	COAXYTRINU	3.75

TYPE 874-X INSERTION UNIT

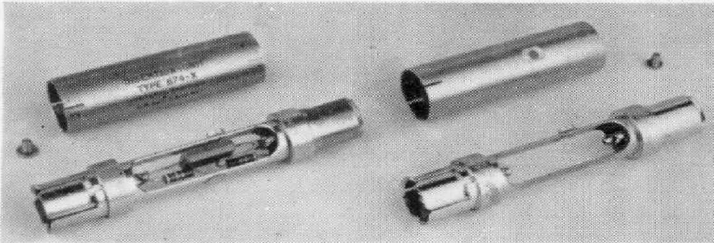

Figure 20. Two views of the Type 874-X Insertion Unit. The left-hand view shows how circuit elements can be conveniently mounted in the structure.

This unit is a hollow cylinder fitted with TYPE 874 Connectors at each end. Its cover sleeve slides back to allow ac-

cess to a region inside of about 2 inches in length and 1/16 inch in diameter. In this region between the TYPE 874 Connectors, almost any arbitrary arrangement of small components, such as resistors, capacitors, or inductors, can be mounted. The insertion unit, shown in Figure 20, has been used as a shielded housing for impedance matching networks, attenuator pads, VHF transformers, filters, and a variety of other networks.

Type		Code Word	Price
874-X	Insertion Unit.....	COAXHOPPER	\$10.00

All TYPE 874 Connectors are covered by U. S. Patents Nos. 2,125,816 and 2,545,847.

GENERAL RADIO COMPANY

275 MASSACHUSETTS AVENUE

CAMBRIDGE 39

MASSACHUSETTS

TELEPHONE: TRowbridge 6-4400

BRANCH ENGINEERING OFFICES

NEW YORK 6, NEW YORK
90 WEST STREET
TEL.—WOrth 2-5837

LOS ANGELES 38, CALIFORNIA
1000 NORTH SEWARD STREET
TEL.—HOLlywood 9-6201

CHICAGO 5, ILLINOIS
920 SOUTH MICHIGAN AVENUE
TEL.—WAbash 2-3820