

# General Radio EXPERIMENTER

VOLUME XXII No. 7

DECEMBER, 1947

Copyright, 1947, General Radio Company, Cambridge, Mass., U. S. A.

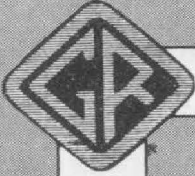

ELECTRICAL MEASUREMENTS AND THEIR INDUSTRIAL APPLICATIONS

## V-20 SERIES VARIACS — NEW, STANDARD MODELS REPLACE 100 SERIES — RATINGS INCREASED

<i>Also</i>	
<b>IN THIS ISSUE</b>	
	<i>Page</i>
AUDIO-FREQUENCY DISTORTION AND NOISE MEASUREMENTS . . . .	5
MISCELLANY . . . . .	8

● **THE TREND** towards increased watts per pound already noticed in the previously announced V-5 and V-10 Series Variacs\* is even more pronounced in the V-20 Series. Where the V-10MT delivers 112 per cent more power per pound than the 100-Q, the V-20M (a cased model) delivers 143 per cent more power per pound than the 100-Q. Once again the use of new materials and design formulae have made possible a marked improvement.

Ratings of V-20 Series Variacs double those of the V-10 Series, just as the latter doubled V-5 ratings. V-20 is rated at 20 amperes, with a 30-ampere maximum. V-20H rates at 8 amperes; 10 amperes maximum. These ratings necessitate a departure from the terminal practice of the previously announced V-5's and V-10's. Heavier, barriered terminals are provided in a box designed for BX or conduit attachment, since V-20 capacities exceed those of ordinary plugs, cords, and outlets (Figure 2).

V-20's, nevertheless, bear a marked resemblance to V-5's and V-10's, being designed on the same general principles. The two brushes are of the new unit con-

\*Gilbert Smiley, "V-5 Series Variacs — New, Improved Models Replace 200-C Series," *General Radio Experimenter*, May, 1946; "V-10 Series Variacs — New, Standard Models, Intermediate Between 200-C and 100 Series," *General Radio Experimenter*, July-August, 1946.

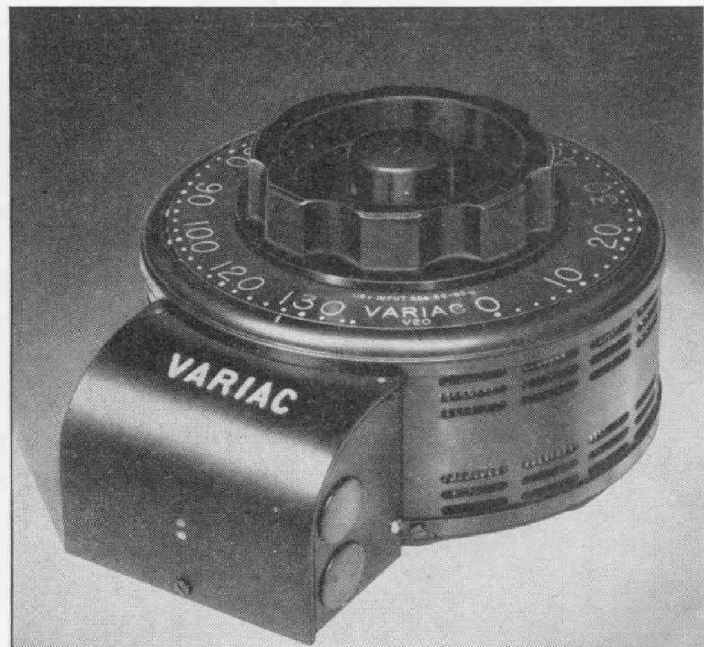

Figure 1. View of the Type V-20M Variac.

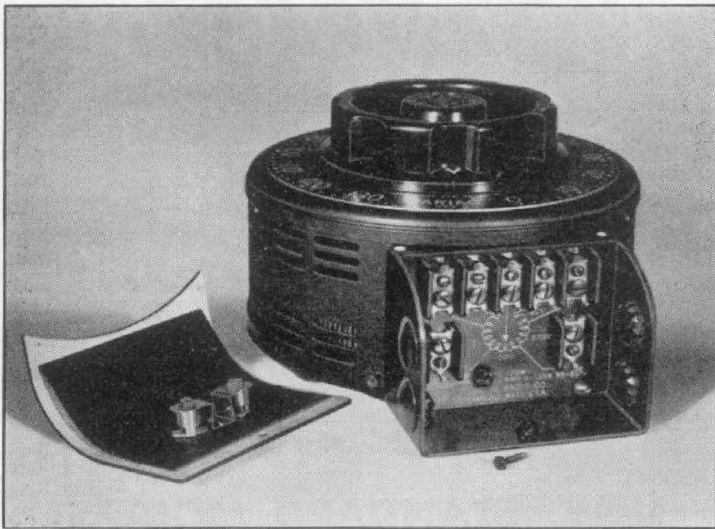

Figure 2. View of the V-20M with terminal box cover removed. Note the spare set of brushes attached to the cover.

struction, and, in addition, spare brushes are mounted in the terminal box. The case may be removed by loosening two screws; the terminal cover by one. Low-loss scroll core construction is standard. Aluminum base, dial, and enclosing parts contribute strength with light weight.

The control knob is a newly designed combination knob and hand-wheel, which is greatly improved in both appearance and utility over the earlier handwheel.

Rounded contours and compressible rubber feet minimize damage to adjacent objects. Corrosion-resistant materials with a durable baked finish preserve appearance. Every effort has been made to incorporate in V-20 Series Variacs all possible convenience, reliability, and efficiency.

Like the V-10's, V-20's are wound on a new concentric toroidal winding machine with great gains in both winding speed and accuracy. The V-20 winder, like the V-10 winding machine, was produced from our own designs in our own

tool room. Figure 3 shows a winding in process.

Since the outstanding feature of the V-20 is its truly remarkable output per pound of weight, some further expansion of this subject seems warranted. Thirty amperes at 115 volts is 3.45 KVA, the V-20 rating. Completely cased, the V-20 weighs but 20<sup>3</sup>/<sub>4</sub> pounds. One V-20 in single-phase service will deliver .166 KVA per pound. Contrast this figure with a tabulation of older models:

Variac	KVA/lb.	V-20 Gain
200-CM	.0908	83%
100-Q	.0684	143%

When standard Variacs, V-20's included, are operated in a three-phase wye connection, the power output is still further increased because the over-voltage portion of the winding allows the units to be operated at double their normal single-phase line voltage. Three V-20M units in a three-phase wye deliver 12 KVA, corresponding to 0.192 KVA per pound.

Open delta (Figure 5) and overvoltage circuits (Figure 6) do not increase KVA per pound but do extend usefulness. Figure 6 is especially interesting in

Figure 3. A V-20 winding in process.

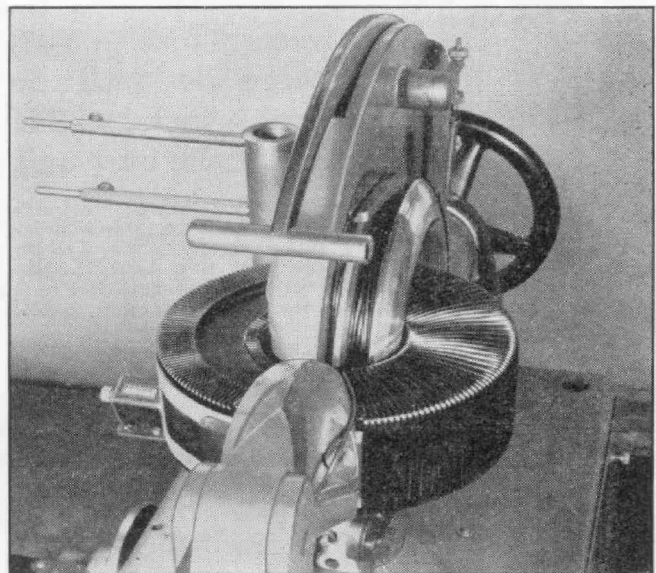



that two V-20's so connected will deliver 0-270 volts from a 230-volt line at 20 amperes rated, whereas two V-20H's in parallel would cover the same range at but 16 amperes rated. Two V-20H's connected according to Figure 6 will cover 0-540 volts from a 460-volt line at 8 amperes rated.

Figure 9 shows a V-20 used with a supplementary transformer to cover a limited voltage range. Suppose, for example, that a range of 0-10 volts is required. The ratio of the supplementary transformer is  $115/10 = 11.5$ . Since current is in inverse ratio to voltage, the current step-up is  $11.5/1$ . Thus, with the supplementary transformer, the V-20 will supply  $20 \times 11.5 = 230$  amperes over the 0-10-volt range. Furthermore, the entire Variac range will be used in going from zero to ten volts, finer adjustment of load is possible, and wear is distributed evenly over the Variac winding.

Figure 10 shows a V-20 and supplementary transformer operated to secure line-voltage regulation. As shown, the range is from 105 to 125 volts, with 115 volts out. The transformer ratio is  $5.75/1$ . The available current is

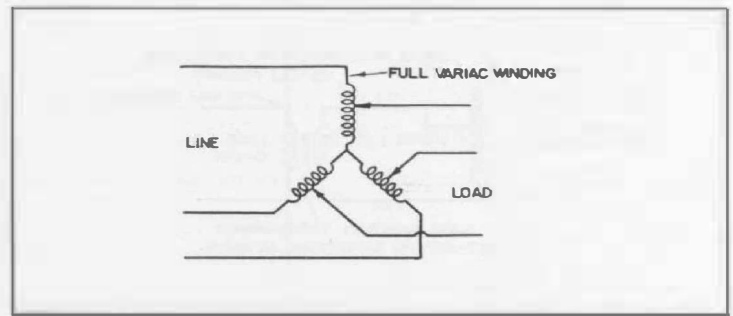

Figure 4. Three-ganged Variacs in a wye connection. Line voltage can be double the normal single-phase line voltage of the Variac.

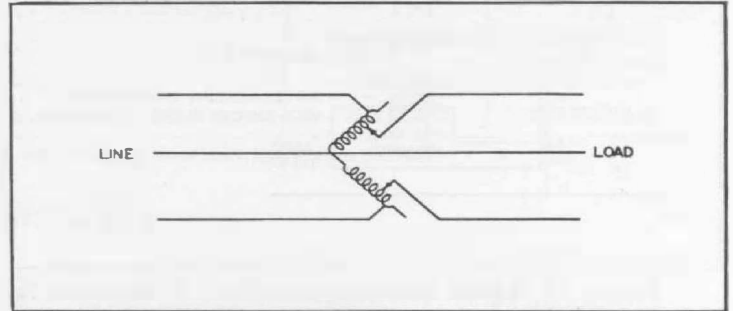

Figure 5. The open delta, a convenient three-phase connection using only two Variacs.

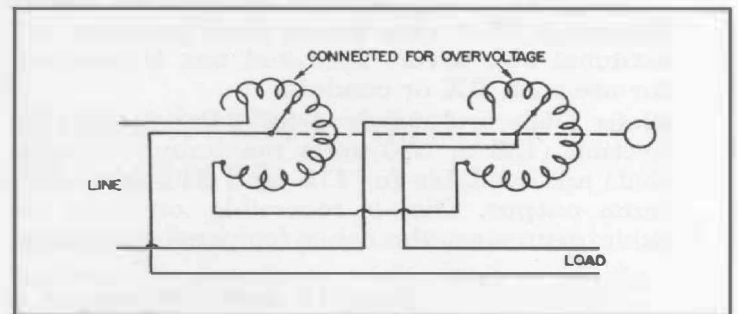
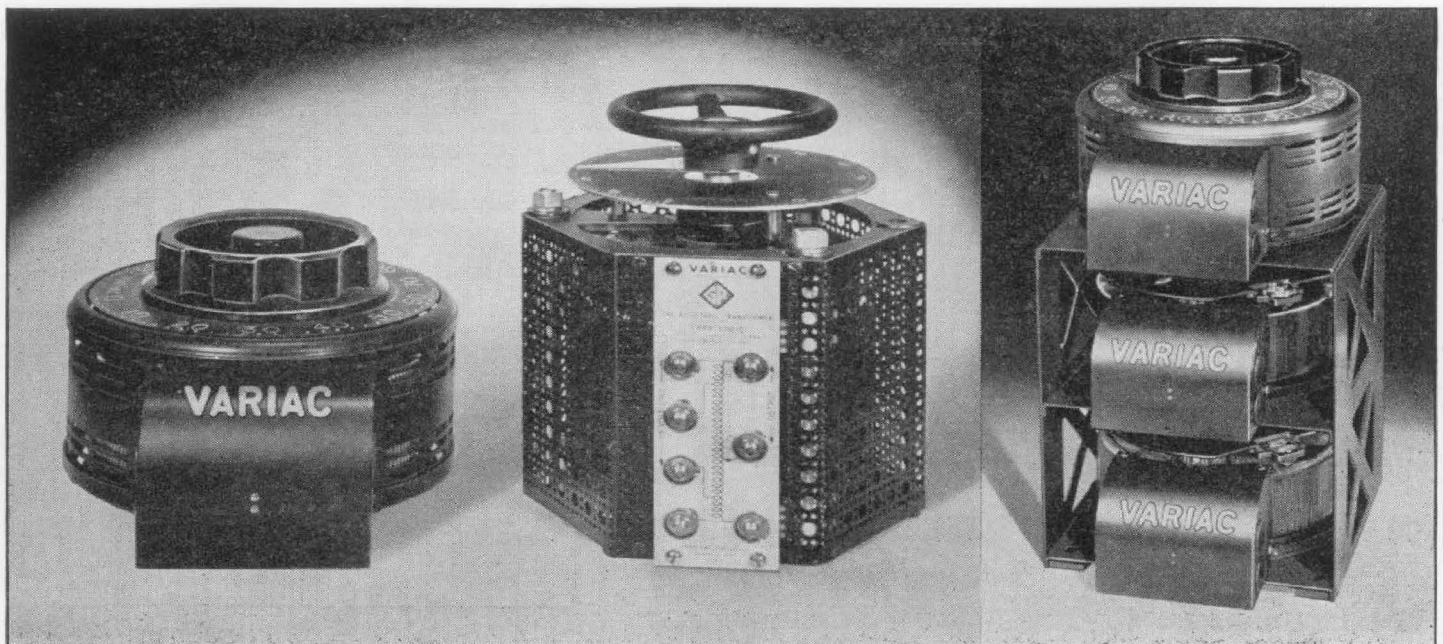

Figure 6. Two Variacs in series with single control can be operated at double the voltage of a single unit.

Figure 7. The new Type V-20M shown beside its predecessor, Type 100-Q. Delivering 66% more power, the V-20 is much smaller.

Figure 8. A three-gang assembly of V-20 Variacs.



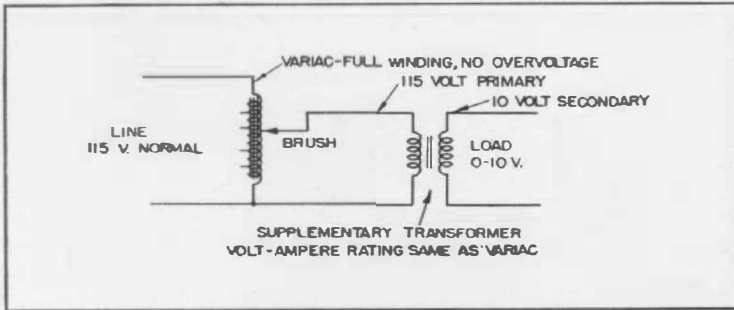

Figure 9. Connections of Variac and supplementary step-down transformer.

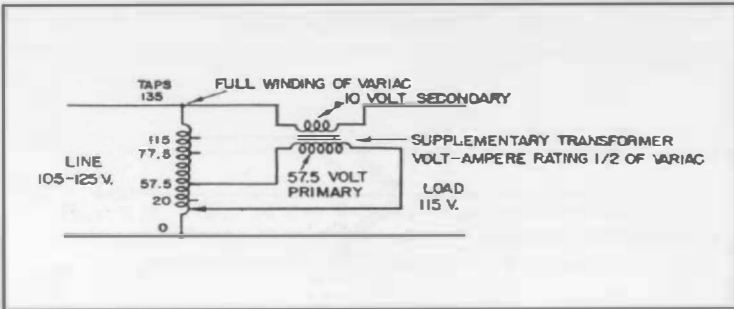

Figure 10. Variac and supplementary transformer for line voltage correction.

115 amperes ( $5.75 \times 20$ ), yielding a KVA capacity of 13.2 over the entire regulation range. Note again that regulation is close and that wear is reduced by working the whole Variac winding. When the brush is below the tap, voltage is subtracted from the line voltage; when above, added to it.

Thus in Figures 9 and 10 are shown ways of still further increasing the effectiveness of the V-20's high output. These supplementary transformer circuits are equally effective with all new Variacs having taps 6 and 7 to permit the use of the circuit of Figure 10.

—GILBERT SMILEY

SPECIFICATIONS

**Mounting:** All models are supplied with case and terminal box cover. Terminal box is designed for use with BX or conduit.

**Dials:** Dials are engraved for overvoltage connection (135 or 270 volts maximum). Special dials are available for 115- and 230-volt maximum output. Dial is reversible, one side for table mounting, the other for panel mounting.

**Current Ratings:** In the following table, *Rated Current* is the current that can be safely drawn at any dial position and is determined by the loss in the winding; maximum current can be safely drawn at voltages close to input line voltage or at low output voltages and is determined by brush loss. A load drawing maximum current at line voltage will not overload the Variac at lower voltages.

Figure 11. Outline dimensions of Types V-20M and V-20HM Variacs.

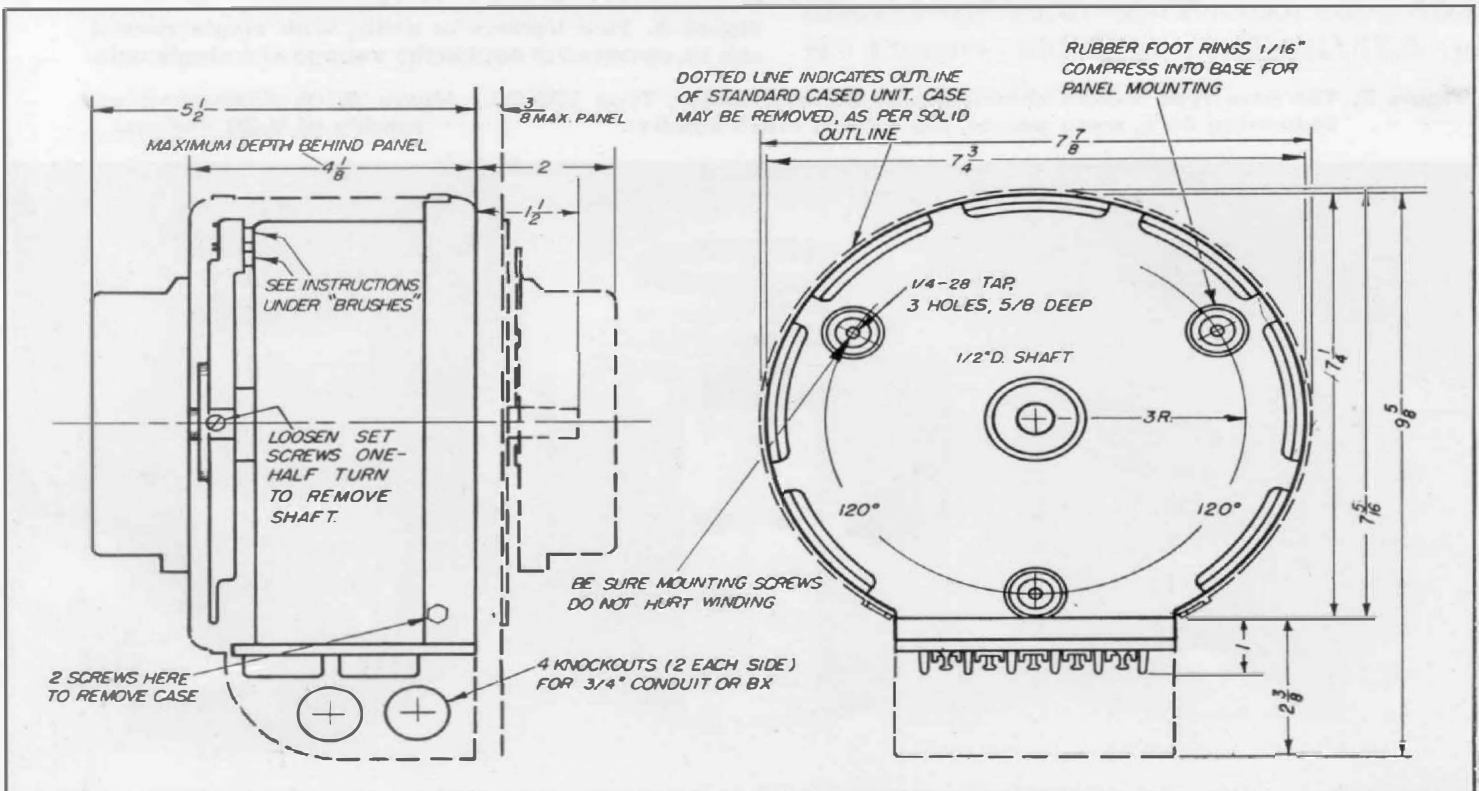



<i>Type</i>	<i>V-20M</i>	<i>V-20HM</i>
Load Rating (KVA) .....	3.45	2.3*
Input Voltage .....	115	230 or 115
Output Voltage (Zero to ) .....	115 or 135	270 or 230
Rated Current (Amperes) .....	20	8*
Maximum Current (Amperes) .....	30	10
No-Load Loss ~ 60 (Watts) .....	27	27
Over-all Height for Table Mounting (Inches) .....	5½	5½
Maximum Panel Thickness (Inches) .....	¾	¾
Depth behind Panel (Inches) .....	4½	4½
Diameter of Variac Cylinder (Inches) .....	7⅞	7⅞
Add for Terminal Box (Inches) .....	1¾	1¾
Net Weight (Pounds) .....	22¾	21½
Code Word .....	JEWEL	JIMMY
Price .....	<b>\$55.00</b>	<b>\$55.00</b>

\*With 115-volt input applied across half the winding, rating is reduced to one-half the value shown.

### GANGED MODELS

<i>Type</i>	<i>Description</i>	<i>Code Word</i>	<i>Price</i>
<b>V-20-G2</b>	<b>2-Gang Type V-20</b> .....	JEWELGANDU	<b>\$126.00</b>
<b>V-20-G3</b>	<b>3-Gang Type V-20</b> .....	JEWELGANTY	<b>182.00</b>
<b>V-20H-G2</b>	<b>2-Gang Type V-20H</b> .....	JIMMYGANDU	<b>126.00</b>
<b>V-20H-G3</b>	<b>3-Gang Type V-20H</b> .....	JIMMYGANTY	<b>182.00</b>

## AUDIO-FREQUENCY DISTORTION AND NOISE MEASUREMENTS

Just before the war, when the requirements of national defense began to take up more and more of our facilities, it became necessary to discontinue the manufacture of some instruments because they were used primarily for civilian purposes. Among these was the TYPE 732-B Distortion and Noise Meter and the TYPE 732-P1 Range Extension Filter. These very popular instruments had found wide use throughout the broadcast industry, both here and abroad, and in a great number of sound recording and motion picture studios.

Particularly for the broadcast and communications laboratory applications, a new type of distortion and noise meter\* was developed just after the war and introduced in 1946. It

makes possible the measurement of harmonic content of any fundamental frequency in the band from 15 to 15,000 cycles with harmonics up to 45,000 cycles.

There are some applications, however, where a sharply selective tuning element is not desirable. This is particularly true when making distortion measurements of sound on film or on disk recordings where the fundamental frequency is not constant. Variations in the fundamental frequency, such as "wows" and other irregularities, will cause detuning of the highly selective single-frequency R-C filter used in the TYPE 1932-A Distortion and Noise Meter. This difficulty is completely overcome with the TYPE 732-B Distortion and Noise Meter. It is equipped with a 400-cycle high-pass

\*TYPE 1932-A Distortion and Noise Meter.

L-C filter, so that measurements of the harmonic content of a 400-cycle signal can be rapidly made. If the 400-cycle signal is somewhat unsteady, the accuracy of the measurement is not affected, because of the width of the pass band. As an auxiliary unit for use with the distortion meter, the TYPE 732-P1 Range Extension Filters are available, so that distortion measurements at additional fundamental frequencies of 50, 100, 1000, 5000, and 7500 cycles can be made.

The simplicity of this distortion meter and its speed of operation make it a most useful instrument for production tests on radio transmitters and receivers. Among the measurements that can be made with this instrument are: (1) Signal-to-noise ratio; (2) distortion vs. power, r-f level, frequency, and percentage modulation; (3) audio frequency response; (4) noise vs. carrier level; and (5) hum modulation and hum level. Other measurements that can be

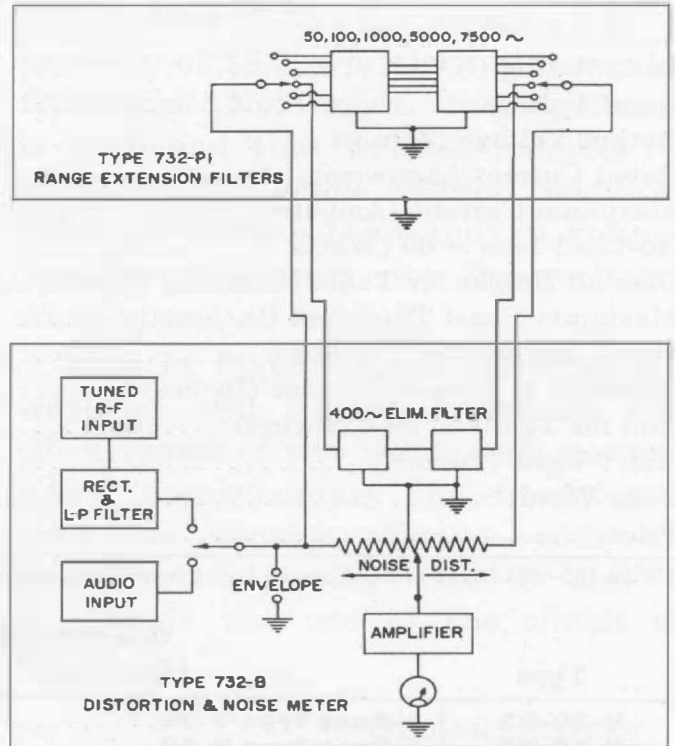
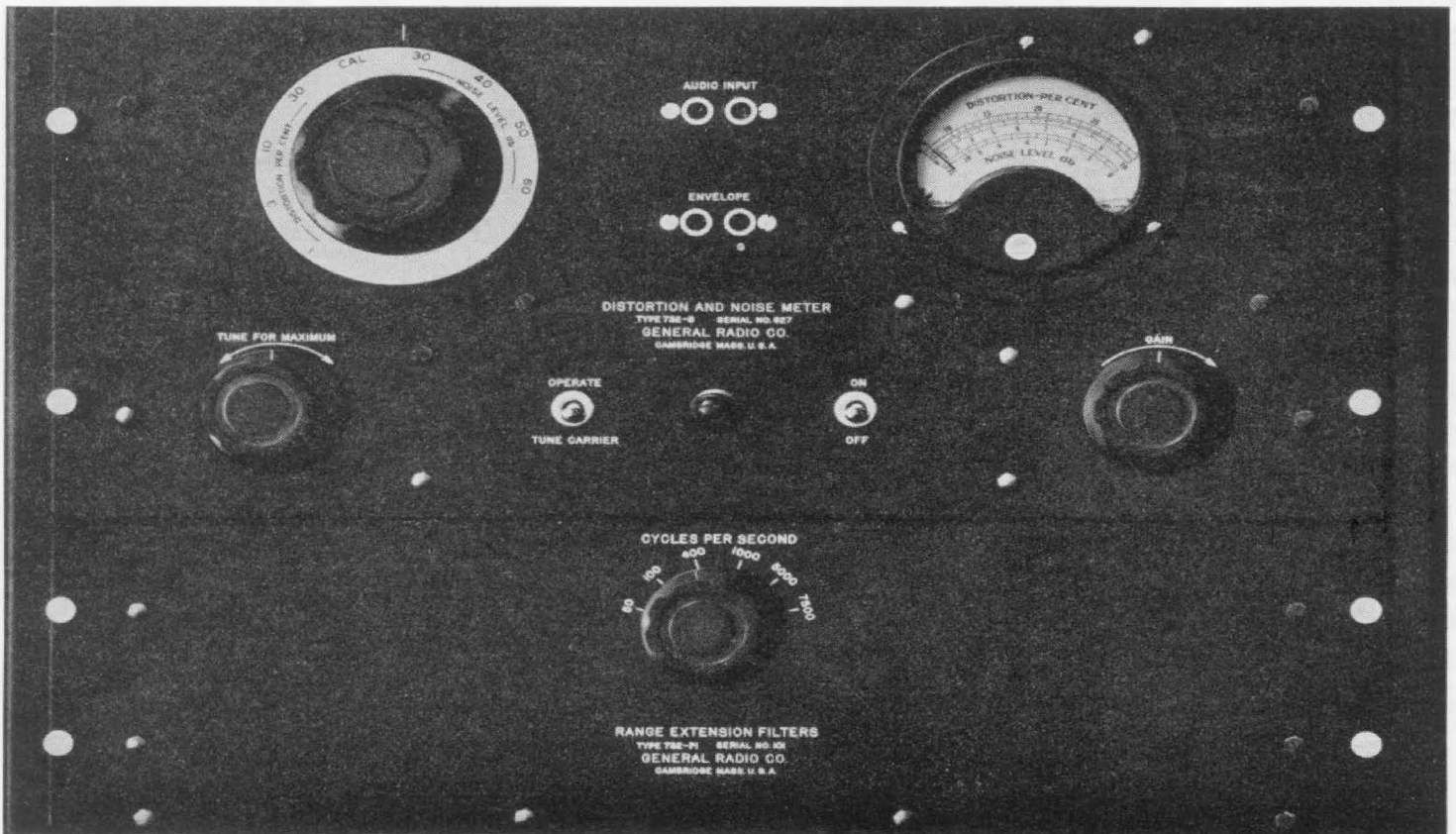

Figure 2. Functional block diagram showing connections between the distortion and noise meter and the range-extension filters.

made on receivers include (1) distortion and noise as a function of audio output; (2) whistle output at 2nd and 3rd har-

Figure 1. Panel view of the Type 732-B Distortion and Noise Meter with Type 732-P1 Range-Extension Filters.





monics of the intermediate frequency; and (3) two-signal cross talk.

There has been a steady and continuing demand for the TYPE 732-B Distortion and Noise Meter with the Range

Extension Filter, and we have been glad to meet it by the resumption of production at this time. *Deliveries can be made promptly.* Detailed specifications are given below. — A. E. THIESSEN

## SPECIFICATIONS FOR TYPE 732-B DISTORTION AND NOISE METER

**Distortion Range:** Distortion is read directly from a large meter. Full-scale values of 30%, 10%, 3%, and 1% are provided, and are selected by a multiplier switch. The range for carrier-noise measurement is from 30 to 70 db below 100% modulation or 65 db below an audio-frequency signal of zero level.

**Input:** A tunable r-f input circuit and a 500-ohm audio-frequency input circuit are provided.

**Audio-Frequency Range:** 380 to 420 cycles for distortion measurements; 30 to 24,000 cycles for noise or hum measurements. For extending the distortion measurements range, see TYPE 732-P1 Range-Extension Filters.

**Carrier Frequency Range:** The TYPE 732-B Distortion and Noise Meter is designed to operate at any carrier frequency between 0.5 and 60 megacycles. This range is covered by two coils. A single coil (either for the 0.5- to 8-Mc range or for the 3- to 60-Mc range) is supplied with the instrument unless both coils are specifically ordered. The coils are readily interchanged. (See price list.)

**Accuracy:** The over-all accuracy of measurement of each distortion range is better than  $\pm 5\%$  of full scale  $\pm 0.1\%$  distortion.

**Meter:** A Weston Model 643 Meter, calibrated directly in per cent distortion and decibels noise level, is provided. Zero adjustment of the

meter is made by a knob projecting from the meter face.

**Controls:** A carrier control is provided for tuning the input circuit of the instrument to resonance with the carrier. A switch is provided for selecting the proper distortion or noise range. An amplifier gain control and an ON-OFF switch with pilot lamp are also provided.

**Vacuum Tubes:** One 37, two 6C6, one 1-V, and one 84 are supplied.

**Other Accessories Supplied:** Spare fuses and pilot lamps. Two dummy plugs to be used if the TYPE 732-P1 Range-Extension Filters are not connected. One carrier input coil.

**Terminals:** In addition to the radio-frequency input binding posts at the rear, two normal-through Western Electric output double jacks are provided on the panel, one at high impedance for the modulated envelope from the rectifier, and one at 500 ohms for use in audio-frequency testing.

**Power Supply:** 115 or 230 volts, 40 to 60 cycles.

**Mounting:** The instrument is relay-rack mounted. The panel is aluminum with the standard General Radio black-crackle lacquer finish.

**Dimensions:** Panel, 19 x 8 $\frac{3}{4}$  inches; depth behind panel, 12 inches.

**Net Weight:** 40 pounds.

Type	Description	Code Word	Price
732-B	Equipped for 0.5- to 8-Mc Carrier Range . . .	EXPEL	\$374.00
732-B	Equipped for 3- to 60-Mc Carrier Range . . .	EQUAL	374.00
732-P6	Extra Coils for 3- to 60-Mc Carrier Range . . .	CYNIC	16.50
732-P5	Extra Coils for 0.5- to 8-Mc Carrier Range . . .	CULER	16.50

Figure 4. Functional schematic diagram of the Type 732-B Distortion and Noise Meter.

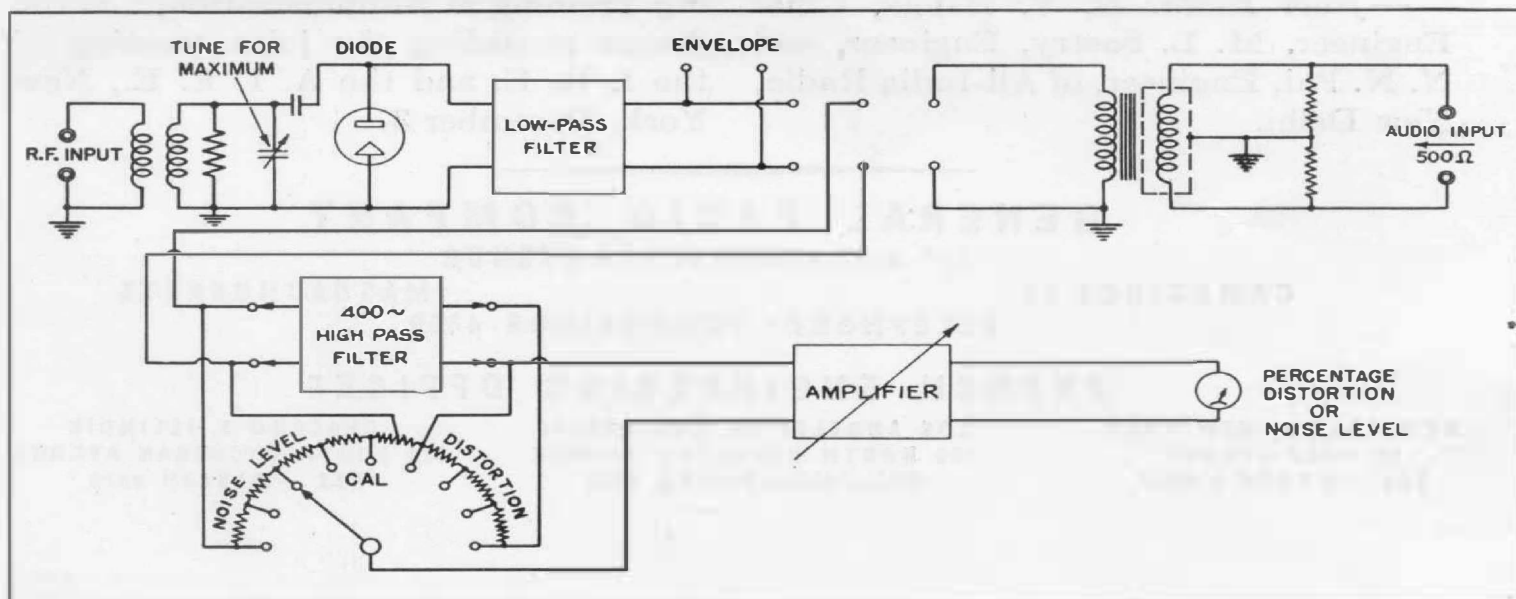



SPECIFICATIONS FOR TYPE 732-PI RANGE-EXTENSION FILTERS

Audio-Frequency Range: 50, 100, 1000, 5000, and 7500 cycles. Flat band width ±5%.

Accuracy: At distortions greater than 0.5%, the error is less than 10% of the true value ±0.15% distortion.

Accessories: Two shielded cables are supplied for connecting the TYPE 732-P1 Range Extension Filters to a TYPE 732-B Distortion and Noise Meter.

Test Voltage: The TYPE 1301-A Low-Distortion Oscillator is recommended as the source of test voltage.

Controls: A single control is provided for selecting the proper filter.

Mounting: The instrument is relay-rack mounted. The panel is aluminum with the standard General Radio black-crackle lacquer finish.

Dimensions: Panel, 19 x 5 1/4 inches; depth behind panel, 12 inches.

Net Weight: 25 pounds.

Type	Description	Code Word	Price
732-P1	Range-Extension Filters.....	ESSAY	\$209.00

MISCELLANY

Recent Visitors to General Radio

— from Holland: Dr. C. E. Maitland, General Board of Management, and Dr. R. M. M. Obermann, Chief Engineer, Instrument Laboratory, State Board of Post and Telegraph Service; Willem A. Van Waasdijk, Chief Engineer, Radio Division, Van Der Heem, N.V., The Hague; F. C. L. Van Vugt, E. Wieringa, M. Vader, and H. Landeweer, of N. V. De Bataafsche Petroleum Mij., The Hague.

— from Switzerland: Dr. Karl Berger, Lecturer of High Voltage Engineering, Swiss Federal Institute of Technology, Zurich.

— from Norway: Erik Julsrud, Engineer, Broadcasting Dept., Norwegian Telegraph Administration, Oslo.

— from India: B. V. Baliga, Chief Engineer, M. L. Sastry, Engineer, and N. N. Pai, Engineer, of All-India Radio, New Delhi.

— from England: Dr. A. J. Biggs, of the Research Laboratories of General Electric Company, Ltd., Wembley, and C. H. Crocker, Development Laboratories, General Electric Company, Ltd., Coventry.

Papers Presented

— by W. N. Tuttle, Development Engineering, "Thyratron Control of A-C Motors," at the National Electronics Conference, November 5.

— by R. A. Soderman, Development Engineering, "A V-H-F Bridge for Impedance Measurements at Frequencies between 20 and 140 Mc," at the Rochester Fall Meeting, November 19.

— by H. B. Richmond, Chairman of the Board, "The Value of an Engineering Training in Administration," at the dinner preceding the joint meeting of the I. R. E. and the A. I. E. E., New York, December 3.

GENERAL RADIO COMPANY

275 MASSACHUSETTS AVENUE

CAMBRIDGE 39

MASSACHUSETTS

TELEPHONE: TROWBRIDGE 4400

BRANCH ENGINEERING OFFICES

NEW YORK 6, NEW YORK
88 WEST STREET
TEL.—WORTH 2-5837

LOS ANGELES 38, CALIFORNIA
950 NORTH HIGHLAND AVENUE
TEL.—HOLLYWOOD 6201

CHICAGO 5, ILLINOIS
920 SOUTH MICHIGAN AVENUE
TEL.—WABASH 3820