

EUROPEAN  
SALES DIRECTOR

SYLVAN GINSBURY

86, rue du Péllican  
ANTWERP, BELGIUM

# AEROVOX

1932

## CONDENSER and RESISTOR MANUAL and CATALOG



AEROVOX WIRELESS CORPORATION  
70-82 WASHINGTON ST.  
BROOKLYN, N. Y.  
U. S. A.

# AEROVOX

## *A Name That Stands for Quality*

**S**INCE 1922 the name AEROVOX on a condenser or resistor has marked a product of outstanding quality and has been the user's assurance of dependable service and long-lasting satisfaction.

Whether you are a radio experimenter, buying a single part from a dealer, or a radio or electrical manufacturer buying thousands of parts direct from the factory, you are assured of the same high quality of material and workmanship.

By specializing exclusively in the manufacture of condensers and resistors, the Aerovox Wireless Corporation has built up an organization of condenser and resistor specialists that leads these twin fields in quality and quantity production of such units for the radio and electrical industries.

## CONSULTING SERVICE

Special studies are continually being made by Aerovox engineers of the peculiarities of various types of radio circuits and industrial applications where condensers and resistors are employed.

As a result of these special studies, Aerovox engineers are in a position to recommend the types of condensers and resistors best suited to any given application.

Large economies can often be effected in condenser and resistor manufacture by proper selection of dimensions and characteristics that lend themselves to economical manufacture. The importance of early consultation with Aerovox engineers, while the design of the radio receiver or other electrical machinery is in its formative stage is evident. By making proper allowance for the most efficient and economical assembly, costs can be reduced and assembly facilitated.

Radio, Electrical and Industrial Engineers may avail themselves of this consulting service with Aerovox Engineers without charge or obligation.

## GUARANTEE

We guarantee that all Aerovox Products are designed and built to meet the most exacting electrical and mechanical requirements and are thoroughly tested before shipment. They will give long and satisfactory service under the operating conditions for which they are designed.



# AEROVOX

## 1932 CONDENSER and RESISTOR MANUAL and CATALOG



### AEROVOX WIRELESS CORPORATION

#### *General Offices and Factory*

Cable Address      70-82 WASHINGTON ST.  
Radiwac, New York      BROOKLYN, N. Y.      Code:  
Bentley's

#### *Domestic Sales Offices*

112 Canal Street BOSTON, MASS.	565 W. Washington Boulevard CHICAGO, ILL.	3429 Mines Ave. LOS ANGELES, CAL.
618 Dayton Industries Bldg. DAYTON, OHIO	2043 East 77th Street CLEVELAND, OHIO	302 Smith Tower Bldg. SEATTLE, WASH.
5551 Vancouver Ave. DETROIT, MICH.	490 Sexton Bldg. MINNEAPOLIS, MINN.	391 Arcade Bldg. ST. LOUIS, MO.
401 N. Broad Street PHILADELPHIA, PA.	533 Dwight Building KANSAS CITY, MO.	1214 St. Charles Ave. NEW ORLEANS, LA.
107 South St. Paul Street DALLAS, TEX.		

#### *Foreign Sales Offices*

Pasaje Barolo 359 BUENOS AIRES ARGENTINA	90 Maitland Street TORONTO, ONT. CANADA	49 Obrapia Ave. HAVANA CUBA
35-43 Clarence Street SYDNEY AUSTRALIA		86 Rue Pelican ANTWERP BELGIUM





# CUSTOMERS GENERAL INFORMATION

## PLEASE READ CAREFULLY

### Prices

The list prices given in this catalog are the retail prices to consumers in packaged single unit quantities and apply in the United States and Canada. These consumer list prices, of course, are subject to regular jobber and dealer quantity discounts.

Quantity prices to manufacturers will be quoted on application on all standard items listed in this catalog and on orders for special items.

All prices are F.O.B. Brooklyn, New York and subject to change without notice.

### Suggestions for Ordering

Orders will be expedited and confusion and misunderstanding will be avoided if the quantity, Type Number and Code Word of the item ordered is given on the order. Where the item is not a standard item and is not listed in the catalogue it will be helpful if complete details and specifications are given together with information regarding the manner in which the part is to be used and some circuit data.

When ordering by telegraph please specify quantity and code word. We suggest that foreign customers use Bentley's Code. Our Cable Address is Radiwac, New York.

Shipping instructions should accompany all orders.

### Shipments

In instances where the complete order cannot be filled at once, all available items will be shipped and the balance will be shipped as soon as possible thereafter.

All shipments are made in accordance with instructions received with orders. Where such instructions are not given we will use our best judgment in the selection of freight, express or parcel post in accordance with the method which we believe will accomplish the desired result at minimum cost.

Shipments are made promptly subject to the usual limitations

imposed by influences beyond our control.

### Shipping Quantities of Units

All parts listed in this catalog are packed singly or in standard quantities per unit package as listed. Parts for manufacturers are packed in bulk and shipped in accordance with instructions received with order.

### Insurance of Shipments

Unless instructed to the contrary, we will insure all steamer and parcel post shipments against non-delivery if we deem it advisable. A nominal additional charge will be made on such shipments to cover the cost of the service.

### Adjustment of Claims

All shipments are carefully checked and packed by experienced packers. Receipts from the transportation company indicate that goods were received with full count and in good condition.

Claims for non-delivery, loss or damage in transit should be made promptly against the transportation company or post office department.

We shall be glad to do whatever lies in our power to expedite such adjustments when we are notified in such cases.

Claims for shortage or clerical errors should be made promptly on receipt of goods. In such cases please give complete details and refer to our invoice number and packing slip.

### Return of Goods

No goods should be returned for credit or exchange without our consent. Before returning goods please send us complete details regarding the reasons for your desire to return them, refer to numbers of invoices covering such items and then wait for permission from us to return them.

Much delay, transportation expense and misunderstandings will be avoided by following this procedure. We are ready to cooperate in every way possible in rectifying any errors for which we are responsible and to make

good any defects in our products but we cannot allow goods to be returned without our permission and shipping instructions.

### Statement of Policy

The policy of the Aerovox Wireless Corporation will always be to provide the best possible merchandise at the lowest possible price. To this end, we reserve the right to change, without notice, specifications and prices on our standard items whenever improved processes, better raw materials or manufacturing requirements make such changes advisable.

On parts made to manufacturers' specifications, however, no changes will ever be made except with due notice to and authorization from the customer.

### Guarantee

We guarantee that all Aerovox Products are designed and built to meet the most exacting electrical and mechanical requirements and are thoroughly tested before shipment. They will give long and satisfactory service under the operating conditions for which they are designed.

### Cancellation of Orders

Cancellation of orders cannot be made without our consent. We shall be glad to cancel orders wherever possible without charge or obligation to our customers but where such cancellations involve a loss on our part due to expenses incurred in fabricating the necessary material for the order we must insist that we be indemnified for such losses.

### Terms of Payment

Terms of payment are net 30 days or 1% discount for payment within 10 days from date of shipment. When cash accompanies the order, we will pay transportation charges anywhere in the United States or Canada in place of allowing the usual cash discount.

Shipments will be made C.O.D. if credit has not been established.

COOPERATION IS OUR SLOGAN OF SERVICE TO CUSTOMERS



## GENERAL FEATURES AND INSULATION SPECIFICATIONS OF ALL AEROVOX PAPER DIELECTRIC CONDENSERS

### Capacity Tolerance

Aerovox paper condensers can be made to any standard tolerance in accordance with manufacturers' specifications.

### Special Capacities

Smaller, larger or intermediate sizes, as well as combinations of various units into blocks or special units can be made to manufacturers' specifications in standard or special cans or containers.

### Impregnation

All Aerovox paper condensers are impregnated scientifically by means of a special process improved by the Aerovox organization. The special impregnating compound used in Aerovox condensers whose insulation specifications are given on this page, has a high melting point of 195 degrees Fahrenheit, which protects the condenser against the heat developed in modern amplifier and power units.

The average melting point of the paraffins still used in many condensers is approximately 130 degrees Fahrenheit.

### How To Use Insul. Spec. Chart

All capacities of any given voltage series have the same insulation specifications. Run down the first column at the left of the chart till the desired D.C. voltage rating is found. All characteristics of the series of condensers listed on the line above will be found to the right of the D.C. voltage rating. Two different types of insulation are used in the 1000 volt class, as indicated.

All Aerovox Paper Condensers  
Manufactured Under  
U.S. Pat. No. 1,736,764

### Winding Characteristics

All standard Aerovox paper condensers listed in this catalog are non-inductively wound. Inductively wound condensers can be furnished to manufacturers in any capacity or voltage rating, on special order.

### Safety Factor

All Aerovox paper condensers are scientifically designed, built and rated to operate safely at their rated working voltages. The safety factor is in excess of that required to withstand both R. M. A. and N. E. M. A. retest requirements (twice the rated voltages for 15 seconds after which the condenser is to be discharged through a resistance of 50 ohms or more).

### Standard Packages

All paper and electrolytic condensers listed in this catalog are packed one in a box. A standard package contains ten boxes.

### Insulation Resistance

The insulation resistance of all Aerovox condensers is in excess of R. M. A. and N. E. M. A. standard requirements.

### Dielectric Material

The condenser tissue used in Aerovox paper condensers is a special grade dielectric paper, free from acid, alkali, bleaching material and impurities.

### Dependability

Aerovox condensers are being used in large quantities by receiver manufacturers who realize the importance of sending out receivers which they can be sure will not be returned for service and repairs due to condenser breakdowns. They have been selected by the largest manufacturers only after exhaustive, competitive tests have proved conclusively the ability of Aerovox condensers to perform safely and efficiently under all conditions of operation.

### INSULATION AND VOLTAGE SPECIFICATIONS of Aerovox Paper Dielectric Condensers

Maximum D.C. Working Voltage	Maximum A.C. Working Voltage	D.C. Retest Voltage (15 sec.)	Total Number of Papers	No. of Papers Between Plates	Thickness of Each Paper in Inches	Total Thickness of Insul. Bet. Plates
200-Volt Series—Types 200-S, 200-SU & LU, 202, 207, 250, 260, 261, 262, 270, 281, 1120						
200	125	400	4	2	.0005	.001
300-Volt Series—Types 300-S, 302, 307, 350, 360, 361, 381						
300	175	600	6	3	.0004	.0012
400-Volt Series—Types 400-S, 400-SU & LU, 402, 407, 450, 460, 461, 462, 470, 481						
400	250	800	6	3	.0005	.0015
500-Volt Series—Type 502						
500	300	1000	8	4	.0004	.0016
600-Volt Series—Types 600-SU & LU, 602, 650, 670, 681						
600	350	1200	8	4	.0005	.002
800-Volt Series—Type 802						
800	440	1600	10	5	.0005	.0025
1000-Volt Series—Types 1000-SU & LU, 1002, 1051						
1000	600	2000	12	6	.0005	.003
1000-Volt Series—Types 1070, 1081						
1000	600	2000	6	3	.001	.003

For detailed specifications and prices of the items listed above consult the detailed descriptions of those units in the other pages of this catalog. See index on page 48.

### A Word About Voltage Ratings

All Aerovox Paper Dielectric Condensers are conservatively rated for safety. Because of the comparative lack of standardization of some condenser manufacturers on voltage ratings, condensers should be compared on the basis of their insulation specifications for any given capacity and price. Aerovox makes no secret of the insulation specifications of its condensers.

APPROVED AND USED BY THE BEST-KNOWN SET MANUFACTURERS





# SUGGESTIONS ON ORDERING AND USING PAPER CONDENSERS

**T**HE general constructional characteristics of Aerovox paper condensers are given on page 3. A careful reading of the data contained on that page will be helpful.

To provide long life and freedom from breakdown troubles it is important that a condenser be conservatively rated to withstand the voltages met with under all conditions of operation in the field.

The high quality insulation, non-inductive winding characteristics, heat resisting impregnating and sealing compounds, high insulation resistance, low leakage, low power factor, low equivalent series resistance and high safety factor of Aerovox condensers make them the ideal condensers for all radio and electrical applications. They will outlast the other parts in an electrical installation provided they are not abused in service by the application of excessive voltages and extremely high temperatures.

## Advantages of the Non-Inductive Winding

All Aerovox standard condenser sections are non-inductively wound, with all of the adjacent layers of each plate connected together.

This type of winding has been found the most satisfactory for all electrical and radio applications and manufacturers are urged to use this type of condenser in preference to the inductive or non-inductive windings in which connections to each plate are made at only one or at most a few places on each foil.

Our type of non-inductive winding, with all adjacent layers of each winding connected together provides a section of negligible inductance and absolute minimum plate resistance. This type of construction results in maximum efficiency, minimum power loss, reduced heating of the dielectric, low power factor and the elimination of troublesome inductance effects in neighboring circuits.

Where cost considerations make it necessary, we are in a position to furnish the other types of windings. These units may be used in certain low frequency applications but are not as satisfactory as our standard adjacent-layers-connected non-inductive units for the higher audio and radio frequency applications.

## Capacities

Aerovox paper condensers are available in units of from .0001 mfd. to 10 mfd. and higher. The standard capacities which can be furnished in the various types of standard cans and containers are listed in the following pages. Production facilities are geared to furnish the capacities listed or multiples of such capacities most economically and it is suggested that

the types listed be used wherever possible. Special capacities can be furnished on order.

## Capacity Requirements

The capacity required to give efficient operation in any circuit can be determined theoretically and experimentally by the designer of the circuit through the use of well-established engineering principles which cannot be discussed in detail here. However, it will be well to mention certain factors which should be kept in mind in determining the proper capacities for efficient operation and economical manufacture.

The cost of condenser capacity for any given voltage characteristics increases, within certain limits, practically in direct proportion to the increase in capacity.

In certain circuits, for filtering and bypass use, the increase in results (reduction of hum or coupling) is not directly proportional to the increase in capacity used.

Such cases follow a law of diminishing returns such that increase in capacity beyond a certain point does not produce sufficient betterment of circuit operation to warrant the extra cost, space and weight of additional capacity.

The designer of a circuit should therefore strive to determine the minimum value of capacity which will give satisfactory, practical results at a reasonable cost, under actual operating conditions.

## Capacity Tolerances

In practically all radio filtering and bypassing applications, the capacity required is not critical. Receiver and amplifier manufacturers will do well in such cases to allow us the practical capacity tolerances of 20% plus, 10% minus, which make for economical manufacture.

Where closer tolerances are required, for use in tuned filter circuits for instance, we can manufacture condensers to rigid capacity tolerances but prices are somewhat higher than for units where more liberal capacity tolerances are permitted, because of the careful time-consuming control which must be exercised to keep such units within the required limits.

## Voltage Ratings

The voltage ratings of paper condensers listed in this catalogue are in accordance with the safety standards of the R.M.A. (Radio Manufacturers Ass'n) and N.E.M.A. (National Electrical Manufacturers Ass'n). They are also based on the experience we have gained from the testing of thousands of condensers under various conditions of operation for varying periods of time (life tests).

The D.C. working voltage ratings are based on the maximum D.C. potentials which the condensers will withstand in continuous operation. The D.C. test voltage ratings should be used only for acceptance testing and not for continuous operation. The A.C. ratings are the r.m.s. 60-cycle A.C. voltages which they will withstand in continuous operation.

When used on pulsating D.C. circuits, such as the filter circuits of power supply units, it is important to find out the maximum or peak voltage attained across the circuit in which the condenser is to be used.

Ordinary D.C. voltmeter readings are not reliable indicators of the maximum voltages present in such circuits, since D.C. voltmeters give only the effective voltage readings. The actual peak voltages in such circuits may be considerably higher and the D.C. working voltage rating of the condenser used should be based on the peak voltages present in the circuit and not on the D.C. voltmeter readings.

## Measuring Peak Voltages

The actual peak voltages which are applied across any given condenser can be determined exactly only by making peak voltmeter or oscillograph tests with the circuits operating under normal conditions and also under the abnormal conditions often met with in actual operation in the field.

The theory and construction of a simple peak voltmeter has been described in the Vol. I, No. 4 issue of The Aerovox Research Worker. A copy of this issue containing complete instructions for the construction and use of this instrument will be mailed on receipt of 10 cents to cover cost of reprint and postage.

It is recommended that wherever possible, manufacturers use an oscillograph to determine the voltage and frequency characteristics of the circuits across which the condensers are to be connected and that this data be supplied to us when ordering condensers for such use.

## Abnormal Conditions

Abnormal conditions of operation which are likely to occur at any time during the life of the set should be taken into consideration. Such conditions should be produced artificially and the voltage conditions noted in making the tests to determine the proper voltage ratings of condensers to be used in such circuits.

The reduction of load on the power unit by the removal of tubes (especially power tubes) of the receiver while the power supply is turned on, the temporary no-load conditions which occur when the set is first turned on and before the tubes heat up and draw plate current, the normal and abnormal

COMPLETE SPECIFICATIONS ELIMINATE NEEDLESS DELAYS



line voltage conditions in various parts of the country and their resultant effect in increasing the voltage across the output of the rectifier and across the filter and bypass condensers should all be taken into account in determining the maximum or peak voltages which will be applied across condensers in various circuits.

The Aerovox Wireless Corporation, through its specially equipped laboratory and specially trained laboratory men is in a position to assist manufacturers in determining the peak voltages and any peculiar operating conditions which might effect the life of condensers used in such circuits. We are always ready to cooperate with manufacturers by making tests on their chassis and suggesting recommendations regarding the characteristics of suitable condensers for such circuits. This service is rendered without charge or obligation.

When used in high frequency circuits, it is also necessary to take into consideration the effects of high frequency pulsations and the additional strain which they impose on the dielectric of the condenser. It is necessary to allow a more conservative voltage rating for any given condenser when used on high frequency circuits.

### Condenser Testing

The production acceptance voltage test for condensers recommended by the R.M.A. and N.E.M.A. is the application of a steady D.C. voltage, equal to twice the rated working voltage of the condenser, for 15 seconds, after which the condenser should be discharged through a resistor of 50 ohms or more connected across the condenser terminals. The use of the resistor in discharging the condenser is to prevent damage to the condenser by too rapid discharge. Condensers should never be left in a charged condition after testing.

### Measuring Capacity

The capacity of a condenser will vary somewhat when measured with different types of measuring instruments, and under different voltages, frequency and waveform conditions.

In specifying condensers which must be kept to very close tolerances therefore, it is advisable to state the measuring instruments that will be used in checking capacities and the voltage, frequency and waveform used in testing. The capacity readings of any given condenser increase slightly with decrease in frequency and are highest when tested with direct current.

### Effects of Temperature

Best results will be obtained with any condenser, regardless of make, when it is used in a cool, well-ventilated portion of the receiver, amplifier or power supply assembly.

The application of excessive heat, resulting from the placement of the condenser close to apparatus which generates considerable heat, such as amplifier and rectifier tubes, transformers, resistors carrying heavy currents, choke coils etc. is detrimental

to the efficiency and long life of the condenser. When condensers are placed in catacombs containing such units, the high temperature and poor ventilation will adversely affect the life of the condenser and constitute abuse of the condenser. When ordering condensers, the temperature which may be expected at the condenser under actual operating conditions should be given, if possible.

The special compounds used for impregnating and sealing Aerovox condensers have a high melting point of 195 degrees Fahrenheit. Because of this fact Aerovox condensers will withstand higher temperatures than other condensers using lower melting point impregnating and sealing compounds but the importance of using them in cool portions of any assembly cannot be minimized, if long life and uninterrupted, efficient operation are to be obtained.

### Information Required

In ordering condensers and condenser blocks or samples with quotations, delay and misunderstanding will be avoided if the following points are covered in the request for samples or quotations:

A schematic wiring diagram, similar to the ones given in this catalog for condenser blocks should be sent to us, and the capacities and peak voltages which they must withstand under normal and abnormal conditions should be given for each section.

A diagram of the circuit in which the condensers are to be used is helpful to us in checking the voltage requirements necessary because of peculiarities of circuit conditions. Circuit diagrams should give constants of the circuit, such as capacities of condensers, resistance values of resistors, inductance, resistance and current carrying capacity of chokes, transformer voltage characteristics, types of tubes used as rectifier and amplifiers, characteristics of voltage divider, loudspeaker field coil etc.

Information furnished to us will be kept strictly confidential.

### Shape and Size of Container

During the course of the many years that we have been manufacturing condensers of every description, we have accumulated a large number of tools and dies for making cans of a wide variety of shapes, sizes and materials.

By using these available tools, dies and stock material it is often possible to eliminate costly tooling up and its attendant delay and we are glad to pass on the savings to our customers. It is suggested that manufacturers consult with us on their requirements while the development of their assembly is in its formative stages and layouts can be designed to accommodate standard condenser cans.

On condensers for power supply filtering and bypassing, it is recommended that one dimension be five inches, another dimension either two or four inches and the third dimension, whatever is necessary to hold the re-

quired capacity and voltage ratings of the necessary sections. These recommendations permit the use of standard condenser sections with resultant savings in cost and elimination of delays caused by the necessity of winding special sections to fit odd size cans.

A sketch showing the maximum allowable dimensions, the desired arrangement of mounting feet or flanges, and the location of leads and terminals is helpful to us and enables us to submit samples which fit in best with your assembly.

Standard Aerovox cans are made of standard tinplate or sheet cold rolled steel and it is recommended that manufacturers use one or the other of these materials for their cans. We are prepared however to furnish any type of can, made of any type of material to specifications. Cans can be furnished in any desired finish.

### Leads and Terminals

The sketch of the can desired should include the location of terminals. Wherever necessary, it is possible to bring out terminals or leads on one or more sides, top and bottom of the can. The most economical construction however is obtained when all the terminals are brought out through a single terminal strip located on one of the sides, top or bottom of the can.

We can use high grade fibre, Bakelite or any other desired insulating material for terminal strips. If there is any preference for any particular type or color of insulating material, this fact should be mentioned. Unless instructed to the contrary we shall use standard insulating material for terminal strips.

The standard soldering terminals used on Aerovox condensers are an improved type. The wire lead from the condenser section inside the can is threaded to the outside of the terminal strip, through an eyelet which fastens the terminal to the terminal strip. The wire is then soldered to the outside of the terminal, providing visual indication that the lead from the condenser section is securely connected to the terminal. This construction eliminates any uncertainty of poor connection or the possibility of loosening of the connection when heat is applied to the terminal as is the case with terminals where the lead is soldered on the inside of the condenser.

### Color Codes for Leads

The leads used in Aerovox wire lead condensers are high grade colored rubber-covered and cotton-braided wire, capable of providing efficient insulation under all the conditions met with in practice. The length of leads required for each section should be specified.

Manufacturers who desire us to use special color codes to identify the leads from various sections should indicate the colors which they desire in their specifications.

If the suggestions for ordering given above are followed, delay and confusion resulting from misunderstandings will be avoided.



## OIL IMPREGNATED CONDENSERS FOR INDUSTRIAL USES

**A**EROVOX Oil Impregnated Condensers are mounted in hermetically sealed containers filled with the same highly refined oil especially developed for impregnating them. The method of sealing these condensers precludes the introduction of air and moisture into the can, thus preventing oxidation of the oil.

One of the greatest difficulties encountered in the design of oil condensers is to properly construct a terminal which will prevent the leakage of oil and be correct electrically. Aerovox has accomplished this by an original riveted construction (patent applied for) which overcomes the objection of depending upon a tightened screw to prevent the leakage of oil.

The condenser sections are held firmly in a steel clamp, which maintains the constant capacity of the unit. The sections are non-inductively wound and are thoroughly insulated from the clamp and the can by a special treated insulating paper.

The condenser sections are wound and processed with utmost care by the most modern methods and equipment. The condenser tissue and foil used are thoroughly tested to meet the most stringent specifications.

Every operation and every part which enters in the manufacture of these condensers is subject to the strictest inspection in order to insure the highest type of product for the user. The results are condensers of high insulation resistance, dielectric strength and low power factor, all of which contribute to the long life of the condenser.

Aerovox Oil Impregnated Condensers are designed for a.c.\* use in connection with industrial equipment such as motors, transformers, electric furnaces, welders, and other apparatus for the correction of low power factor or for other purposes where a constant capacity is required when the condensers must operate at high temperatures. In comparison

\*These condensers can also be used on d.c.

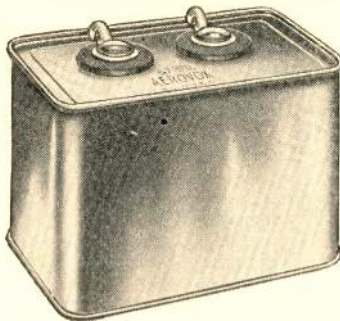

Oil Impregnated  
Condenser

with paper condensers these oil impregnated condensers have lower power factors, are capable of operating continuously at higher temperatures and have extremely long life under these conditions.

Aerovox Oil Impregnated Condensers have found wide use in conjunction with split phase motors in which the capacitor is used to supply two phase power to give the motor high starting torque. After the motor reaches running speed a centrifugal switch arranges the circuit so that the condenser acts as a power factor correction unit and causes the motor to operate at nearly unity power factor under running condition. With other types of motors they are used for starting only, after which the condenser is automatically cut out of the circuit by means of a centrifugal switch. In this manner it is possible to design split-phase motors of high starting torque and good power factor.

Oil impregnated condensers can also be used in industrial plants for the correction of low power factor. Whenever a plant is operating at low power factor excessive costs are paid for power. The distribution system is required to handle unnecessarily large currents, and maximum efficiency is not obtained from the motors connected to the circuit. By the use of power factor correcting condensers these serious sources of inefficiency are eliminated and the plant owner pays only for the power actually used to produce his product.

When considering the installation of capacitors for power factor correction an intelligent survey of conditions should be made by an engineer or contractor to determine just what the troubles are and to what extent they can be remedied by improving the power factor. It is recommended however that each motor or other piece of equipment be individually corrected for power factor, rather than to provide a corrective capacitor for a large group of equipment. By installing the corrective condensers directly after units operating at low power factor maximum savings are obtained.

The corrective effect produced by a condenser of a given number of microfarads capacity is not a constant factor but depends upon voltage and frequency. The following table gives the number of microfarads of capacity per Kv-a. when employed across a source of 60 cycle current for various voltages.

Line Voltage	Mfds. per Kv-a.
110	219.00
220	54.80
440	13.70
550	8.80
1100	2.20
2200	.55
2300	.50

It will be noted that as the voltage increases, the capacity in microfarads required to provide one Kv-a. of corrective capacity decreases. Thus, for 220 volts, the capacity required for one Kv-a. correction becomes  $\frac{1}{4}$  of the amount required at 110 volts. At 440 volts, the capacity required is  $\frac{1}{16}$  of that required at 110 volts.

These condensers are not carried in stock but are made only to special order in any desired capacities and operating voltages. They are recommended for use wherever exceptionally long life is required.

Further information concerning oil impregnated condensers to meet individual specifications will be gladly furnished on request.





## COMPACT, CARTRIDGE CONDENSERS



Types 281, 381, 481, 681 and 1081

THE condensers shown here have been designed to meet an extensive demand for high grade units at low cost. They are especially suited for manufacturing requirements and radio service work as replacement condensers in all radio and audio frequency bypassing circuits, as coupling and isolating condensers in resistance and impedance coupled amplifiers and other circuits where compact, non-inductive, high insulation resistance condensers are required.

All condensers employ high grade sections thoroughly impregnated and hermetically sealed in specially treated insulated tubes with a compound which will withstand high temperatures and humidity.

The ends of the bare wire leads in these condensers are helically wound and soldered to the ends of each section insuring dependable contact both mechanically and electrically.

Units may be mounted by soldering the wire leads directly to terminals of the apparatus, on insulating strips underneath the chassis, or in any other way that suggests itself to the user.

Condensers of special capacities made for manufacturers are usually available from stock. Jobbers kindly write for particulars regarding units on hand.

WORKING VOLTAGES		
Type No.	Working Voltages	
	D.C.	A.C.
281	200	125
381	300	175
481	400	250
681	600	350
1081	1000	600

STOCK CAPACITIES			
Cap. Mfds.	List Price	Code Word	Tube Symbol
<b>TYPE 281</b>			
.006	\$.20	REIGN	T1
.01	.20	REINS	T2
.015	.20	RELAX	T2
.02	.20	RELOY	T2
.03	.20	RELIC	T3
.05	.23	REMIT	T3
.1	.27	RENEW	T4
.25	.35	REPAY	T7
.5	.55	REPEL	T10
<b>DUAL SECTION TYPE</b>			
.1-1	.50	REPRE	T11
<b>TYPE 381</b>			
.006	\$.22	REPLY	T1
.01	.22	REPUT	T2
.015	.22	RERED	T2
.02	.22	RESET	T2
.03	.22	RESID	T4
.05	.25	RETCH	T4
.1	.30	RETIN	T5
.25	.42	RETUR	T9
<b>DUAL SECTION TYPE</b>			
.1-1	.65	REVEL	T12
<b>TYPE 481</b>			
.006	\$.24	WHALE	T1
.01	.24	WHACK	T2
.015	.24	WHARF	T3
.02	.24	WHEAT	T3
.03	.24	WHEEL	T4
.05	.27	WHELP	T5
.1	.32	WHIFF	T6
.25	.50	WHIMP	T10
<b>DUAL SECTION TYPE</b>			
.1-1	.72	WHINE	T13
<b>TYPE 681</b>			
.006	\$.27	WHIRL	T2
.01	.27	WHISK	T3
.015	.27	WHIPS	T4
.02	.27	WHIST	T4
.03	.27	WHITE	T5
.05	.30	WHITH	T6
.1	.40	WHOLE	T9
<b>TYPE 1081</b>			
.006	\$.35	WIDTH	T4
.01	.35	WIDOW	T5
.015	.35	WHOOP	T6
.02	.35	WIELD	T7
.03	.35	WINCE	T8
.05	.45	WISHY	T10
<b>SPECIAL UNITS</b>			
Higher, lower or intermediate capacity and voltage units, including dual section types, may be had on special order for manufacturers only.			
Packed ten in a box Standard Package—10 Boxes			



Types 281, 381 and 481 Dual Section Units

Dual section condensers in Types 281, 381 and 481 are provided with a common terminal lug which may also be employed to mount the condensers in the chassis assembly.

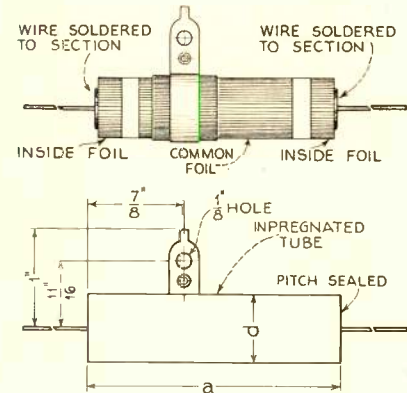
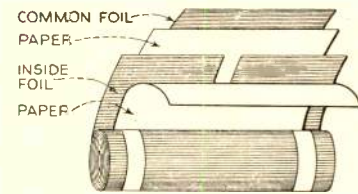

Above shows the construction of the Type 281 dual section condenser and the approximate location of the common terminal in the tube.

TUBE DIMENSIONS		
Tube Symbol	Length of Tube (a)	Diameter of Tube (d)
T1	1 3/4"	5/8"
T2	1 3/4"	7/16"
T3	1 3/4"	1/2"
T4	2 1/8"	1/2"
T5	2 1/8"	9/16"
T6	2 1/8"	5/8"
T7	2 1/8"	11/16"
T8	2 1/8"	3/4"
T9	2 1/8"	15/16"
T10	2 1/8"	7/8"
T11	2 1/16"	5/8"
T12	2 1/16"	3/4"
T13	2 1/16"	7/8"

Tube diameter subject to tolerance of 1/32" plus or minus.

## STAMPED METAL CASE CONDENSERS



Types 260, 360 and 460



Types 261, 361 and 461



Types 262 and 462

THESE condensers are very popular among manufacturers, service men and experimenters for use in practically all radio and audio frequency bypass circuits, coupling and isolating circuits, or any other desired combination in meeting various circuit requirements.

Particular attention is directed to the fact that these units are available in capacities and voltage ratings used in most all standard radio circuits and therefore adapted for replacement purposes in service work.

The sections are hermetically sealed in stamped metal cases with terminals brought out through insulating strips centered in large holes in the sides as shown in the accompanying photos.

The X and XD-type cans are used for the 260, 360 and 460 units, the XX- and XY- type cans used for the 261, 361 and 461 units, and the ZB- and ZC- type cans for the 262 and 462 units.

All units listed on this and the following page are standard condensers which are available from stock for manufacturers and the general retail trade. Special variations in capacities and working voltages of these units can be furnished to manufacturers on special order as described on page 10

WORKING VOLTAGES			
Type No.	Working D.C.	Voltages A.C.	
260, 261 & 262	200	125	
360 & 361	300	175	
460, 461 & 462	400	250	

STOCK CAPACITIES			
Cap. Mfds.	List Price	Code Word	Can Symbol
<b>TYPE 260</b>			
.05	\$.42	TOKAY	X
.1	.42	TOUSE	X
.25	.48	TREAT	X
.5	.58	TROUT	XD
<b>TYPE 261</b>			
1.0	\$.85	TWAIN	XX
<b>TYPE 262</b>			
2.0	\$1.45	URNS	ZC
<b>TYPE 360</b>			
.05	\$.46	TOPAZ	X
.1	.46	TRACE	X
.25	.60	TRIAD	X
<b>TYPE 361</b>			
.5	\$.80	TUBER	XX
1.0	1.20	TWEED	XY
<b>TYPE 460</b>			
.05	\$.50	TORCH	X
.1	.50	FRASH	X
.25	.65	TURKE	XD
<b>TYPE 461</b>			
.5	\$.85	TUNNY	XX
<b>TYPE 462</b>			
1.0	\$1.25	TUFTE	ZB

**SPECIAL CAPACITIES:** Larger or intermediate sizes, as well as combinations of various sizes into blocks or special units may be had on special order for manufacturers only.

All units packed one in a box. Standard Package — 10 Boxes. For insulation specifications of all Aerovox Paper Condensers, see page 3.

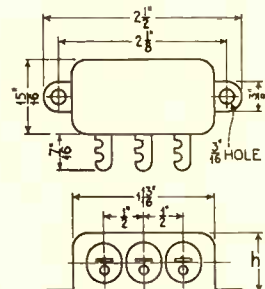

Dimensions of X-, XA- and XB- and XD-type Cans used in Types 260, 360, 460 Condensers and special units for manufacturers.

Dimension "h" is 1/2" for XA cans, 5/8" for XB cans, 13/16" for X, and 7/8" for XD cans.

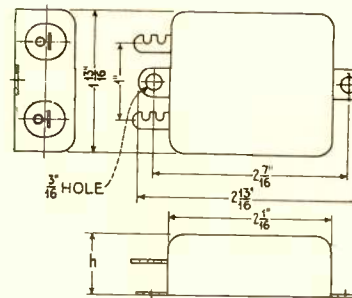

Dimensions of XX-type and XY-type Cans used in Types 261, 361, 461 Condensers and special units for manufacturers.

Dimension "h" is 13/16" for XX cans and 1" for XY cans.

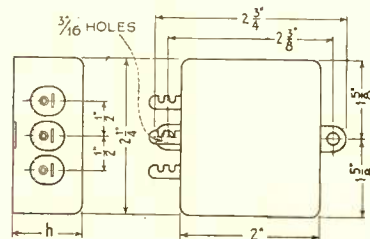

Dimensions of ZA-, ZB-, ZC- and ZD-type Cans used in Types 262, 462 and special units for manufacturers.

Dimension "h" is 1/8" for ZA cans, 1" for ZB cans, 1 1/4" for ZC cans and 1 1/4" for ZD cans.

STAMPED METAL CASE CONDENSERS MAKE NEAT ASSEMBLIES



## STAMPED METAL CASE CONDENSERS

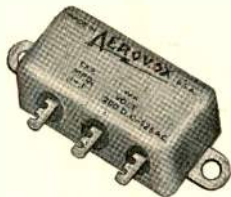

Types 260-21, 260-225, 260-31,  
360-21 and 460-21

### Type 260-21

List Price—\$.65

Code Word—WITTY

Can Symbol—X

Cap. Mfd.	Sect. No.	Working D.C.	Working Volt. A.C.
0	0	—	—
.1	1	200	125
.1	2	200	125

### Type 260-225

List Price—\$.80

Code Word—WOOER

Can Symbol—XD

Cap. Mfd.	Sect. No.	Working D.C.	Working Volt. A.C.
0	0	—	—
.25	1	200	125
.25	2	200	125

### Type 260-31

List Price—\$.90

Code Word—WREAK

Can Symbol—X

Cap. Mfd.	Sect. No.	Working D.C.	Working Volt. A.C.
Common grounded to can			
.1	1	200	125
.1	2	200	125
.1	3	200	125

### Type 360-21

List Price—\$.70

Code Word—WORLD

Can Symbol—X

Cap. Mfd.	Sect. No.	Working D.C.	Working Volt. A.C.
0	0	—	—
.1	1	300	175
.1	2	300	175

THE double and triple section condensers in stamped metal cases listed here are standard bypass units designed for practically all radio circuit requirements. They are compact and easily adapted into any chassis assembly making a neat appearance in the completed apparatus.

Double section units are provided with three terminals as shown in the photos, one terminal being common. Type 260-31 three section condensers have three terminals with the common connection grounded to the can. Type 461-31 three section condensers are provided with four terminals, two at each short side of the can, one terminal being common.

Can dimensions are given on page 8. For special capacity combinations which can be furnished to manufacturers in this type of can, see page 10.

### Type 460-21

List Price—\$.75

Code Word—WORTH

Can Symbol—X

Cap. Mfd.	Sect. No.	Working D.C.	Working Volt. A.C.
0	0	—	—
.1	1	400	250
.1	2	400	250

### Type 261-25

List Price—\$1.05

Code Word—WREST

Can Symbol—XX

Cap. Mfd.	Sect. No.	Working D.C.	Working Volt. A.C.
0	0	—	—
.5	1	200	125
.5	2	200	125

### Type 361-225

List Price—\$1.00

Code Word—WORRY

Can Symbol—XX

Cap. Mfd.	Sect. No.	Working D.C.	Working Volt. A.C.
0	0	—	—
.25	1	300	175
.25	2	300	175

### Type 361-25

List Price—\$1.35

Code Word—WOUND

Can Symbol—XY

Cap. Mfd.	Sect. No.	Working D.C.	Working Volt. A.C.
0	0	—	—
.5	1	300	175
.5	2	300	175



Types 261-25, 361-225,  
361-25 and 461-225

### Type 461-31

List Price—\$1.20

Code Word—SCULL

Can Symbol—XX

Cap. Mfd.	Sect. No.	Working D.C.	Working Volt. A.C.
0	0	—	—
.1	1	400	250
.1	2	400	250
.1	3	400	250

### Type 461-225

List Price—\$1.10

Code Word—SCURF

Can Symbol—XX

Cap. Mfd.	Sect. No.	Working D.C.	Working Volt. A.C.
0	0	—	—
.25	1	400	250
.25	2	400	250

### Type 262-11

List Price—\$1.60

Code Word—WICKE

Can Symbol—ZC

Cap. Mfd.	Sect. No.	Working D.C.	Working Volt. A.C.
1.0	1	200	125
0	0	—	—
1.0	2	200	125

### Type 462-25

List Price—\$1.50

Code Word—WRATH

Can Symbol—ZC

Cap. Mfd.	Sect. No.	Working D.C.	Working Volt. A.C.
0	0	—	—
.5	1	400	250
.5	2	400	250



## STAMPED METAL CASE CONDENSERS SPECIAL UNITS FOR MANUFACTURERS



ZA, ZB, ZC and ZD cans

BECAUSE of their compactness, high quality, efficiency and ease with which they can be adapted for easy assembly into any chassis layout, the condensers in the series shown on this and the preceding pages are very popular with radio manufacturers.



WA, WB, WC and WD Cans

Type of Can	D.C. Wk. Volt. of Sects.	Number of Sects.	Capacities Mfd.
X	200	2	.25-.1
	200	4	.1-.1-.1-.1
	200	2	.25-.25
	300	3	.1-.1-.1
XX	200	2	.5-.5
	200	3	.25-.1-.1
	200	3	.5-.1-.1
	200	3	.25-.25-.25
	300	3	.25-.1-.1
	300	2	.25-.25
XY	400	4	.1-.1-.1-.1
	400	3	.25-.1-.1
	200	4	.25-.25-.25-.25
	200	4	.5-.5-.1-.1
	200	3	.5-.5-.5
	300	3	.5-.1-.1
ZA	300	3	.25-.25-.25
	300	3	.25-.25-.25
	400	2	.5-.1
	200	4	.25-.25-.25-.25
	300	5	.25-.25-.25-.1-.1
	400	2	.5-.5
ZB	300	4	.25-.25-.25-.25
	300	4	.25-.25-.25-.25
	400	2	.5-.5
	400	5	.25-.25-.25-.1-.1
ZC	200	5	.5-.5-.5-.1-.1
	200	4	.5-.5-.5-.5
	300	4	.5-.5-.1-.1
	400	4	.25-.25-.25-.25
ZD	200	3	1.0-1.0-.5
	200	4	1.0-1.0-.25-.25
	300	3	.5-.5-.5
	400	3	.5-.5-.25

For dimensions of cans see page 8.

A table showing the maximum total capacities at various working voltages which can be fitted into the various sized cans of this series is given at the right.

The table at the left gives some specimen capacity combinations which can be furnished in multiple section units. Numerous other combinations, including sections of different working voltages, can also be fitted into these stamped metal cases.

Condensers in the XX, XY, ZA, ZB, ZC and ZD cans can be made in a wide variety of single capacities and combinations. From one to six terminals can be provided, one for each section terminal.

Insulated wire leads through a rubber grommet or fibre bushing can also be furnished instead of soldering lug terminals.

The terminals can be brought out on any side or can be distributed as desired, some on one side and the others on the other sides or top. Any terminal or number of terminals can be grounded to the case.

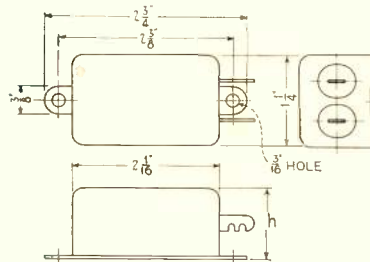

Dimensions of WA, WB, WC and WD cans used for special manufacturers' type condensers.

Dimension "h" is 1/2" for WA cans, 3/4" for WB cans, 1" for WC cans and 1 1/4" for WD cans.

Type of Can	D.C. Wk. Volt. of Sect.	Single Section Units Total Mfds.	Double Section Units Total Mfds.	Three or More Sects. Total Mfds.
WA	200	.3	.3	.3
	300	.2	.2	.2
	400	.15	.15	.15
WB	200	.6	.6	.6
	300	.4	.4	.4
	400	.25	.25	.25
WC	200	.75	.75	.75
	300	.5	.5	.5
	400	.4	.4	.4
WD	200	1.	1.	1.
	300	.75	.75	.75
	400	.5	.5	.5
X	200	.5	.4	.3
	300	.3	.25	.2
	400	.2	.2	.2
XA	200	.2	.15	—
	300	.15	.1	—
	400	.1	.05	—
XB	200	.25	.2	—
	300	.2	.15	—
	400	.125	.1	—
XD	200	.5	.5	.4
	300	.3	.3	.3
	400	.25	.2	.2
XX	200	1.0	1.0	.75
	300	.75	.6	.5
	400	.5	.4	.3
XY	200	1.25	1.1	1.0
	300	1.0	1.0	.75
	400	.75	.6	.5
ZA	200	1.25	1.1	1.0
	300	1.0	.9	.75
	400	.75	.6	.5
ZB	200	1.5	1.25	1.2
	300	1.2	1.0	.9
	400	1.0	.8	.6
ZC	200	2.0	2.0	1.8
	300	1.4	1.25	1.1
	400	1.1	1.0	.8
ZD	200	2.5	2.5	2.0
	300	1.75	1.7	1.5
	400	1.25	1.2	1.0

For dimensions of cans see page 8.





## GENERAL PURPOSE NON-INDUCTIVE CONDENSERS



Types 207, 307 and 407



Types 200-S, 300-S and 400-S

WORKING VOLTAGES			
Type No.	Working Voltages		Can Symbol
	D.C.	A.C.	
207	200	125	
307	300	175	
407	400	250	

For Insulation Specifications see page 3.

STOCK CAPACITIES			
Cap. Mfds.	List Price	Code Word	Can Symbol
TYPE 207			
.05	\$.55	TOPSY	AA
.1	.55	TITLE	AA
.25	.60	TOADY	AA
.5	.70	TOAST	AA
1.0	.90	TOKEN	A
2.0	1.50	TONGS	B
4.0	2.70	UNMAN	BD
TYPE 307			
.05	\$.60	TONIC	AA
.1	.60	TOXIN	AA
.25	.70	TRESS	AA
.5	.90	TRYST	A
1.0	1.30	TWEAK	B
2.0	2.15	ULTRA	BC
TYPE 407			
.05	\$.65	TOUQUE	AA
.1	.65	TRAIT	AA
.25	.75	TRITE	AA
.5	.95	TUMOR	B
1.0	1.35	TWINE	BB
2.0	2.25	UNIFY	BD

Special capacities and working voltages or combinations with or without mounting lugs can be supplied on special order to manufacturers only.

Packed one in a box.  
Standard Package—10 Boxes.

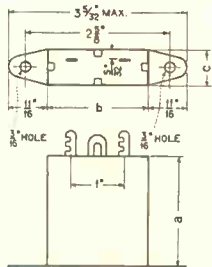

Can Dimensions  
AA, A, B, BB, BC and BD  
Types 207, 307 and 407

ALL of these condensers are non-inductively wound and the elements are of the same high grade construction as all other Aerovox paper condensers. They are designed for use in all radio and audio frequency bypass circuits, for resistance and impedance coupled amplification, for power amplifier output circuits and for all other purposes where capacities of from .05 to 4 mfds. in working voltages of 200, 300 and 400 volts D.C. are required.

The 300 and 400-volt units are ideal for bypassing the 90, 135 and 180-volt taps of voltage divider circuits, where the voltages are usually much higher than the nominal voltages at the taps, before the heater tubes warm up and plate current is drawn.

The only difference between the two series of units is in the case mountings. The body dimensions of both types, for equal capacities and working voltages are the same.

For General Characteristics of all Aerovox Paper Condensers see page 3.

CAN DIMENSIONS					
Can Symbol	Can Symbol	Height a	Width b	Depth c	
AA	AAH	1 3/8"	1 13/16"	5/8"	
A	AH	2 1/16"	1 13/16"	5/8"	
B	BH	2 1/16"	1 13/16"	1 5/8"	
BB	BBH	2 1/16"	1 13/16"	1 5/8"	
BC	BCH	2 1/16"	1 13/16"	2"	
BD	BDH	2 1/16"	1 13/16"	2 1/2"	

Types BC and BD cans are provided with two mounting holes on each end instead of one, as shown in the sketch to the left. Dimension "d" is 1" for BC and 1 1/2" for BD can.

WORKING VOLTAGES			
Type No.	Working Voltages		Can Symbol
	D.C.	A.C.	
200-S	200	125	
300-S	300	175	
400-S	400	250	

For Insulation Specifications see page 3.

STOCK CAPACITIES			
Cap. Mfds.	List Price	Code Word	Can Symbol
TYPE 200-S			
.05	\$.55	ICING	AAH
.1	.55	IDEAL	AAH
.25	.60	IDIOM	AAH
.5	.70	IMAGE	AAH
1.0	.90	IMPEL	AH
2.0	1.50	IMPLY	BH
4.0	2.70	UNITY	BDH
TYPE 300-S			
.05	\$.60	TOMIN	AAH
.1	.60	TOWEL	AAH
.25	.70	TREND	AAH
.5	.90	TRUTH	AH
1.0	1.30	TWANG	BH
2.0	2.15	ULCER	BCH
TYPE 400-S			
.05	\$.65	TOPIC	AAH
.1	.65	TRAIN	AAH
.25	.75	TRIBE	AAH
.5	.95	TUMID	BH
1.0	1.35	TWILL	BBH
2.0	2.25	UNCLE	BDH

Special capacities and working voltages or combinations with or without mounting lugs can be supplied on special order to manufacturers only.

Packed one in a box.  
Standard Packages—10 Boxes.

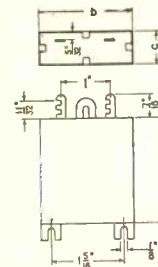

Can Dimensions  
AAH, AH, BH, BBH, BCH  
and BDH  
Types 200-S, 300-S and 400-S

AEROVOX CONDENSERS FILL EVERY CIRCUIT REQUIREMENT

## NON-INDUCTIVE CONDENSERS IN BAKELITE CASES



Types  
250, 350, 450, 650 and 1051

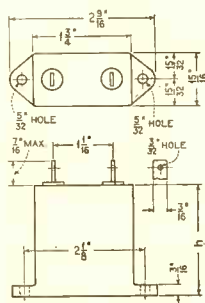

Height dimension "h" is 1 1/16" for the "Y" case types and 1 3/4" for the "Z" case types.

**M**OUNTED in attractive bakelite cases, these condensers are exclusive in design by Aerovox and adapted for radio and radio frequency bypassing, resistance or impedance coupled amplification parallel feed amplifiers, coupling condensers in photo-electric cell amplifiers, or for any purpose where compact, high insulation resistance, non-inductive condensers are required. The bakelite case prevents leakage between terminals and eliminates all possibilities of grounding the terminals through the case.

### WORKING VCLTAGE

Type No.	Working Voltages	
	D.C.	A.C.
250	200	125
350	300	175
450	400	250
650	600	350
1051	1000	600

For Insulation Specifications of all Aerovox Paper Condensers, see page 3.

### STOCK CAPACITIES

Cap. Mfds.	List Price	Code Word	Case Symbol
<b>TYPE 250</b>			
.05	\$ .55	THIGH	Y
.1	.55	THINE	Y
.25	.60	THING	Y
.5	.70	THINK	Y
1.0	.90	THIRD	Z
<b>TYPE 350</b>			
.05	\$ .60	TOPER	Y
.1	.60	TRAIL	Y
.25	.70	TRIAL	Y
.5	.90	TULLE	Z
<b>TYPE 450</b>			
.05	\$ .65	TOTAL	Y
.1	.65	THONG	Y
.25	.75	THORN	Y
.5	.95	TUTOR	Z
<b>TYPE 650</b>			
.05	\$ .70	TOUGH	Y
.1	.85	THROB	Y
<b>TYPE 1051</b>			
.05	\$ .85	TOUGH	Y
.1	1.15	THROW	Z

Special Capacities: Larger or intermediate sizes, as well as combinations of various sizes into blocks or special units may be had on special order for manufacturers only.  
Packed one in a box.  
Standard Package—10 Boxes.

## HEAT RESISTING CONDENSERS FOR AUTOMOBILE RADIOS

**T**HESE condensers are impregnated with a high melting point compound and enclosed in leakproof metal cylinders filled with the same high melting point compound. They are ideal for use in automobile radios, ignition systems, interference and spark suppressors on electrical machinery and other applications where temperatures up to 160 degrees Fahrenheit are encountered.

Type 1120 condensers may be used up to 200 volts d.c. under temperatures up to 115 degrees F. At temperatures up to 160 degrees F. they should be used at voltages no higher than 150 volts d.c.

Higher capacities can be furnished in somewhat longer cylinders. In standard units one terminal is grounded to the can, but they can be furnished with two insulated wire leads.

The drawn shell container in which these condensers are



Type 1120

mounted is completely encircled by a rugged steel band. This type of mounting insures the unit against injury from the severest vibration.

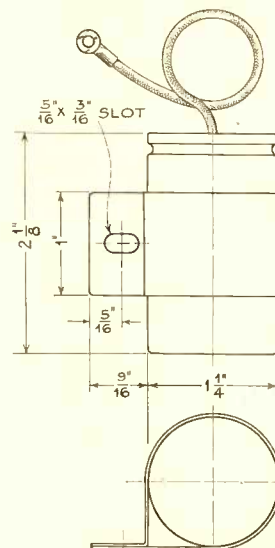

Dimensions of Type 1120 Condensers

### TYPE 1120—STANDARD CAPACITIES

Cap. Mfd.	Working Voltage		List Price	Code Word	Will withstand Temperature of
	D.C.	A.C.			
.5	150		\$1.10	ROUTE	160 degrees F.
.75	150		1.25	ROWDY	160 degrees F.
1.0	150		1.40	RUCHE	160 degrees F.



## COMPACT, TUBULAR CONDENSERS



Types  
270, 470, 670 and 1070

THESE compact, tubular condensers may be used in all radio and audio frequency bypassing circuits, as coupling and isolating condensers in resistance and impedance coupled amplifiers and for any other purpose where low-cost compact, non-inductive, high insulation resistance condensers in capacities of from .0001 to .5 mfd. are required.

TUBE DIMENSIONS		
Tube Symbol	Length of Tube	Diameter of Tube
	a	d
U1	1 3/8"	7/8"
U2	1 3/8"	1 1/2"
U3	1 3/8"	9/16"
U4	1 3/8"	5/8"
U5	1 3/8"	11/16"
U6	1 3/8"	3/4"
U7	1 3/8"	1 1/4"
U8	1 15/16"	1 3/4"
U9	1 3/8"	7/8"

Types 270, 470, 670 and 1070 tubular condensers are non-inductively wound, thoroughly impregnated and sealed in round fibre tubes. The terminals provide a convenient means for mounting the condensers on subpanels or directly to binding post terminals.

Units of special design for manufacturers can be provided with soldering lugs or wire leads to meet specifications.

WORKING VOLTAGES		
Type No.	Working Voltages	
	D.C.	A.C.
270	200	125
470	400	250
670	600	350
1070	1000	600

For Insulation Specifications of all Aerovox Paper Condensers, see page 3.

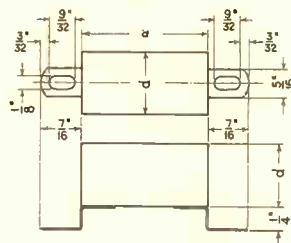

Dimensions of Types 270, 470, 670 and 1070 Condensers. See table for dimensions "a" and "d".

STOCK CAPACITIES			
Cap. Mfds.	List Price	Code Word	Tube Symbol
<b>TYPE 270</b>			
.01	\$.45	TABID	U1
.015	.45	TANSY	U1
.02	.50	TAUBE	U1
.03	.50	TAWNY	U1
.05	.55	THRUM	U2
.1	.60	THUMB	U4
.25	.75	THUND	U8
<b>TYPE 470</b>			
.01	\$.50	THUMP	U1
.015	.50	THYME	U1
.02	.55	TIDAL	U2
.03	.55	TIDIN	U3
.05	.60	TIGHT	U5
.1	.70	TIMID	U9
<b>TYPE 670</b>			
.01	\$.55	TACIT	U1
.015	.55	TASTY	U2
.02	.60	TAUNT	U3
.03	.60	TAXID	U7
.05	.65	TOTEM	U7
.1	.80	TRAWL	U8
<b>TYPE 1070</b>			
.01	\$.60	TINGE	U4
.015	.60	TIPSY	U5
.02	.70	TIRED	U6
<b>SPECIAL UNITS</b>			
Higher, lower or intermediate capacity and voltage units may be had on special order for manufacturers only.			
Packed one in a box. Standard Package—10 Boxes.			

## REPLACEMENT UNITS FOR STANDARD RECEIVERS

In order to meet the demand by radio jobbers, mail order houses and service men for Aerovox replacement blocks and condensers, we have introduced a number of units designed for standard radio receivers and power units, a few of which are shown in the accompanying photos.



Atwater Kent 37 and 38 Unit



R.F. Bypass Unit and Speaker Filter Unit for Atwater Kent Receivers

All units are identical in size and mounting arrangements to those originally employed by the manufacturers. In many cases the working voltages of condenser sections have been increased even beyond the manufacturers' original specifications. The necessary choke coils are also included in various units.

These units are the finest replacement condensers obtainable, embodying Aerovox high quality construction throughout. They are carefully engineered and built to give long lasting service in the sets for which they are designed.

Among the units available are filter and bypass blocks for Majestic, Atwater Kent, Crosley and other standard sets.

Information and list prices on this special line of replacement units will be gladly sent on request.



Majestic Model 9P6 Unit



## UNCASED REPLACEMENT CONDENSERS FOR FILTER AND BYPASS USE

THESE uncased sections are in every respect the same as the sections used in our standard type filter condensers. They are all non-inductively wound using a high grade special dielectric paper, free from acid, alkali, bleaching material and impurities.

They are thoroughly impregnated with the same high melting point compound to protect them against heat and provided with insulated wire leads for connections.

All sections are carefully dipped in a special wax compound which forms an extra heavy coating to prevent them from absorbing moisture and accidental damage in handling.

In keeping with modern methods of packing, each unit is securely wrapped in moisture-proof cellophane which not only

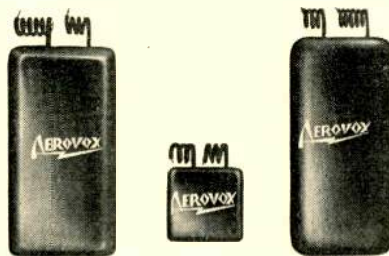

Type LU Long Unit    Type SU Short Unit    Type LU Long Unit

### Wax Dipped and Wrapped in Cellophane

Aerovox Unmounted Replacement Condensers come to you in perfect condition. The special wax compound dipping and cellophane wrapping protects them against dust, moisture and injury.

insures the user of receiving these condensers in clean and perfect condition, but also prevents them

from sticking together in bulk shipments.

As for construction and rating characteristics, these units are scientifically designed, carefully built and conservatively rated to operate safely at their rated voltages. The insulation resistance and safety factor is in excess of both R.M.A. and N.E.M.A. standard requirements.

The extremely low cost of these unmounted condenser sections make them especially attractive to service men.

They are particularly suited for use as replacements for punctured sections in existing filter blocks of power supply units. When existing punctured sections are removed from filter units and replaced by Aerovox replacement units of the proper capacity and voltage rating no more trouble will be experienced from broken down condenser sections.

### STOCK CAPACITIES, WORKING VOLTAGES, CODE WORDS, SIZES AND PRICES

Type No.	Type of Section	Cap Mfds.	Working Voltage		List Price	Code Word	Dimensions			Type No.
			D.C.	A.C.			Length	Width	Depth	
200-SU	Short	.1	200	125	\$.25	INSUL	1 1/16"	5/8"	1/4"	200-SU
200-SU	Short	.25	200	125	.35	INTER	1 1/16"	3/4"	3/8"	200-SU
200-SU	Short	.5	200	125	.40	CHUCK	1 1/16"	1 1/2"	3/8"	200-SU
200-SU	Short	1.0	200	125	.60	CHUMP	1 1/16"	1 5/8"	5/8"	200-SU
200-SU	Short	2.0	200	125	1.00	CHURL	1 1/16"	1 5/8"	1 1/8"	200-SU
200-LU	Long	1.0	200	125	.60	CHURN	4 1/2"	1 1/4"	3/8"	200-LU
200-LU	Long	2.0	200	125	1.00	INVES	4 1/2"	1 3/4"	1/2"	200-LU
400-SU	Short	.1	400	250	.30	INVID	1 1/16"	5/8"	3/8"	400-SU
400-SU	Short	.25	400	250	.40	INWAR	1 1/16"	1 1/16"	7/16"	400-SU
400-SU	Short	.5	400	250	.60	IONIC	1 1/16"	1 5/8"	5/8"	400-SU
400-SU	Short	1.0	400	250	.95	CHUTE	1 1/16"	2 1/8"	7/8"	400-SU
400-SU	Short	2.0	400	250	1.65	INCIP	1 1/16"	2 1/8"	1 3/4"	400-SU
400-LU	Long	1.0	400	250	.95	CHYLE	4 1/2"	1 7/8"	1/2"	400-LU
400-LU	Long	2.0	400	250	1.65	INCEN	4 1/2"	1 7/8"	1"	400-LU
600-SU	Short	.1	600	350	.35	IRONY	1 1/16"	7/8"	5/8"	600-SU
600-SU	Short	.25	600	350	.65	IRRAD	1 1/16"	1 5/8"	5/8"	600-SU
600-LU	Long	.5	600	350	.85	CHYME	4 1/2"	1 3/2"	1/2"	600-LU
600-LU	Long	1.0	600	350	1.30	ISSUE	4 1/2"	1 7/8"	5/8"	600-LU
1000-SU	Short	.1	1000	600	.55	ISLAN	1 1/16"	1 5/8"	1 3/16"	1000-SU
1000-LU	Long	.5	1000	600	1.50	ISOTH	4 1/2"	3 7/8"	1/2"	1000-LU
1000-LU	Long	1.0	1000	600	2.65	CIDER	4 1/2"	3 7/8"	7/8"	1000-LU

Insulation specifications of these condensers will be found on page 3.

## REPLACEMENT CONDENSERS FIT ALL SERVICE REQUIREMENTS



## MANUFACTURERS' BYPASS CONDENSER BLOCKS

IN addition to the many types of standard condensers and bypass blocks listed in this general catalog, the Aerovox Wireless Corporation has made and is prepared to make other units in cans of various sizes and shapes to suit individual requirements of manufacturers.

In the course of the many years during which the Aerovox Wireless Corporation has been manufacturing standard and special units for manufacturers, it has accumulated a vast number of tools and dies which can be used to make up condenser units and blocks which may exactly fit your requirements.

In such cases therefore, the elimination of tooling costs permits worthwhile savings to the manufacturer whose requirements



Type 1130

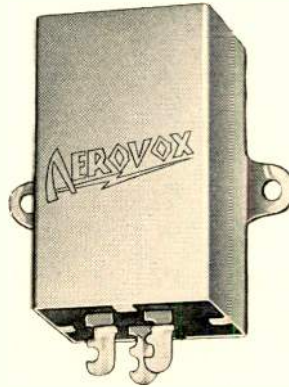

Type 1140

as to can sizes and shapes can be filled with the tools and dies available.

The cans of various sizes which are available and the combinations of capacities which can be fitted into them are too numerous to permit detailed description in this general catalog.

A number of them however are shown on this page to give an idea of the wide selection of types and sizes which are available.

We shall be glad, on receipt of specifications or a statement of requirements, to submit blueprints of cans and containers which can be supplied to meet such specifications or requirements without tooling costs by the use of stock dies and materials available in our can manufacturing department.

## MANUFACTURERS' CONDENSER BLOCKS

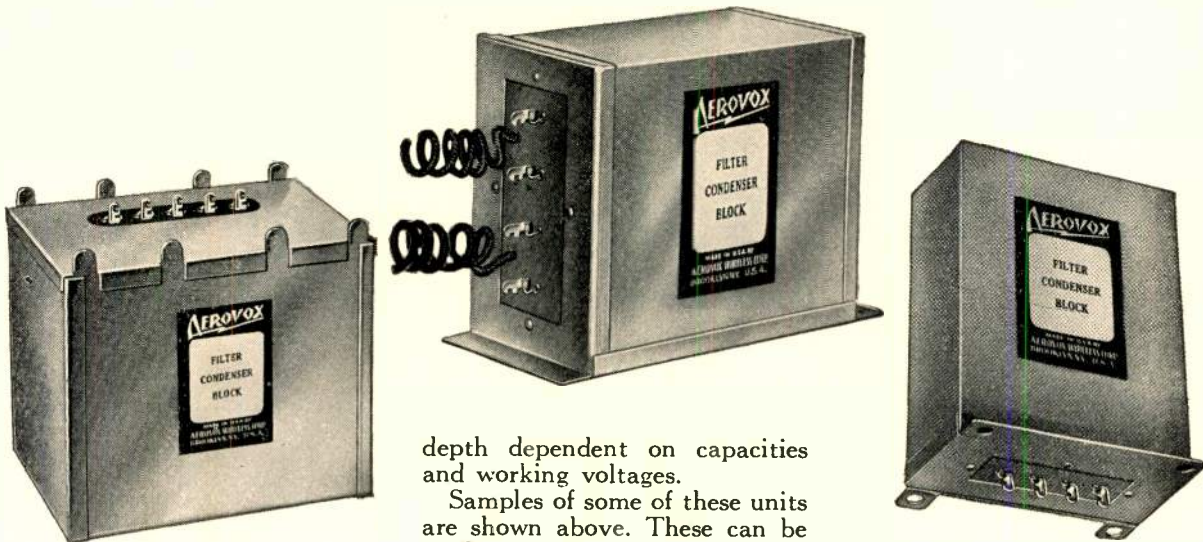

depth dependent on capacities and working voltages.

Samples of some of these units are shown above. These can be made with or without mounting lugs or flanges and with terminals or flexible wire leads, arranged as desired for ease in assembly.

In some instances a receiver manufacturer may desire to have a condenser unit or block mounted in a can similar to other units in the receiver to preserve uniformity of appearance in the chassis. The Aerovox Wireless Corporation is in a position to build such units in cans furnished

by the receiver manufacturer, or to furnish complete units, including cans designed to match the other units of the chassis. To all appearances the unit becomes a part of the receiver manufacturer's own output.

The Aerovox Wireless Corporation is serving as the main source of supply for the leading set manufacturers.

THE Aerovox Wireless Corporation is tooled to make any size can and to assemble any condenser combinations in accordance with specifications. In drawing up specifications, manufacturers might keep in mind that R.M.A. and N.E.M.A. recommend a standard height of five inches and standard widths of two inches or four inches, with

SPECIAL FILTER BLOCKS MADE TO ORDER AT SHORT NOTICE

## DIMENSIONS OF CANS FOR FILTER CONDENSERS AND FILTER CONDENSER BLOCKS

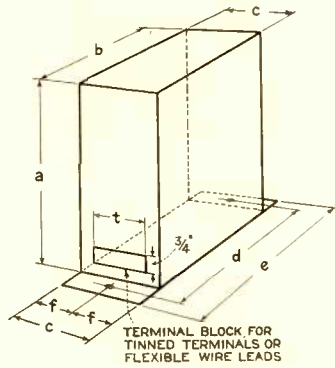

### 2-Hole Mounting Cans

Can Symbol	a	b	c	d	e	f	t
E	5"	2"	$\frac{5}{8}$ "	$2\frac{5}{8}$ "	$3\frac{5}{32}$ "	$\frac{5}{16}$ "	$\frac{3}{8}$ "
F	5"	2"	$1\frac{1}{16}$ "	$2\frac{5}{8}$ "	$3\frac{5}{32}$ "	$1\frac{7}{32}$ "	$1\frac{1}{16}$ "
G	5"	2"	$1\frac{7}{16}$ "	$2\frac{5}{8}$ "	$3\frac{5}{32}$ "	$2\frac{3}{32}$ "	$\frac{7}{8}$ "
FF	5"	4"	$\frac{3}{4}$ "	$4\frac{5}{8}$ "	$5\frac{5}{32}$ "	$\frac{3}{8}$ "	$\frac{3}{8}$ "
GG	5"	4"	1"	$4\frac{5}{8}$ "	$5\frac{5}{32}$ "	$\frac{1}{2}$ "	$\frac{5}{8}$ "
HH	5"	4"	$1\frac{1}{4}$ "	$4\frac{5}{8}$ "	$5\frac{5}{32}$ "	$\frac{5}{8}$ "	$\frac{3}{4}$ "
II	5"	4"	$1\frac{1}{2}$ "	$4\frac{5}{8}$ "	$5\frac{5}{32}$ "	$\frac{3}{4}$ "	$\frac{7}{8}$ "

### 4-Hole Mounting Cans

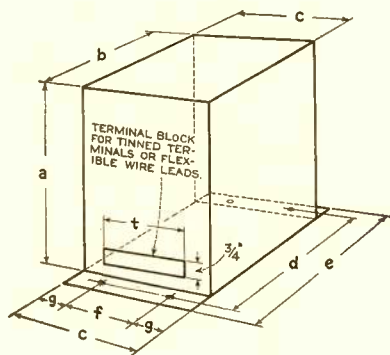

Can Symbol	a	b	c	d	e	f	g	t
H	5"	2"	$1\frac{13}{16}$ "	$2\frac{5}{8}$ "	$3\frac{5}{32}$ "	$\frac{13}{16}$ "	$\frac{1}{2}$ "	$1\frac{1}{8}$ "
I	5"	2"	$2\frac{9}{16}$ "	$2\frac{5}{8}$ "	$3\frac{5}{32}$ "	$1\frac{9}{16}$ "	$\frac{1}{2}$ "	$1\frac{3}{4}$ "
J	5"	2"	$3\frac{7}{16}$ "	$2\frac{5}{8}$ "	$3\frac{5}{32}$ "	$2\frac{7}{16}$ "	$\frac{1}{2}$ "	$2\frac{9}{16}$ "
JJ	5"	4"	$1\frac{3}{4}$ "	$4\frac{5}{8}$ "	$5\frac{5}{32}$ "	$\frac{3}{4}$ "	$\frac{1}{2}$ "	1"
KK	5"	4"	2"	$4\frac{5}{8}$ "	$5\frac{5}{32}$ "	1"	$\frac{1}{2}$ "	$1\frac{1}{4}$ "
LL	5"	4"	$2\frac{1}{2}$ "	$4\frac{5}{8}$ "	$5\frac{5}{32}$ "	$1\frac{1}{2}$ "	$\frac{1}{2}$ "	$1\frac{5}{8}$ "
M	5"	4"	3"	$4\frac{5}{8}$ "	$5\frac{5}{32}$ "	2"	$\frac{1}{2}$ "	$2\frac{1}{4}$ "
MM	5"	4"	$3\frac{1}{2}$ "	$4\frac{5}{8}$ "	$5\frac{5}{32}$ "	$2\frac{1}{2}$ "	$\frac{1}{2}$ "	$2\frac{1}{2}$ "

### 6-Hole Mounting Cans

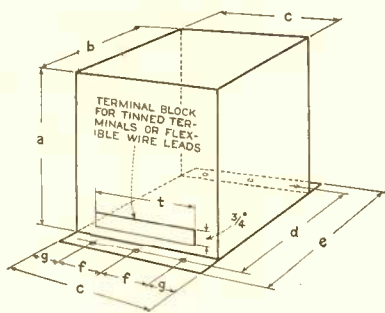

Can Symbol	a	b	c	d	e	f	g	t
K	5"	2"	4"	$2\frac{5}{8}$ "	$3\frac{5}{32}$ "	$1\frac{1}{2}$ "	$\frac{1}{2}$ "	$3\frac{1}{8}$ "
L	5"	2"	5"	$2\frac{5}{8}$ "	$3\frac{5}{32}$ "	2"	$\frac{1}{2}$ "	4"
N	5"	4"	4"	$4\frac{5}{8}$ "	$5\frac{5}{32}$ "	$1\frac{1}{2}$ "	$\frac{1}{2}$ "	3"
O	5"	4"	5"	$4\frac{5}{8}$ "	$5\frac{5}{32}$ "	2"	$\frac{1}{2}$ "	4"
P	5"	4"	$6\frac{3}{8}$ "	$4\frac{5}{8}$ "	$5\frac{5}{32}$ "	$2\frac{11}{16}$ "	$\frac{1}{2}$ "	$5\frac{1}{4}$ "
Q	5"	4"	$7\frac{5}{8}$ "	$4\frac{5}{8}$ "	$5\frac{5}{32}$ "	$3\frac{5}{16}$ "	$\frac{1}{2}$ "	$6\frac{1}{2}$ "

*Overall dimensions of Cans are plus or minus 1/16"*

The Aerovox Wireless Corporation is tooled to make up cans of any type, size or mounting at short notice.

**CAN SIZES ARE IN ACCORD WITH STANDARDIZED PRACTICE**



## SOCKET POWER FILTER CONDENSERS



Type 202



Type 1002



Type 402

THIS series of socket power filter condensers is available in seven groups to meet the requirements of all types of modern socket power units or power packs for receiving equipment. For use in higher power units employing higher voltages, the use of the transmitting paper condensers described on page 41 is recommended.

The socket power filter condensers listed on this page are all non-inductively wound. The dielectric material employed is a special dielectric paper, free from acid, alkali, bleaching material and impurities.

They are thoroughly impregnated with a high melting point compound to protect them against the heat developed in high power units.

These condensers are scientifically designed, carefully built and conservatively rated to operate safely at their rated voltages.

The insulation resistance and safety factor is in excess of both R. M. A. and N. E. M. A. standard requirements so that

once installed they can be depended upon to give long, satisfactory and trouble-free service.

The condenser sections employed in the construction of these units are the same as those that are used in the special blocks and units furnished to the largest set manufacturers.

The metal cases of these condensers are of uniform height and provided with convenient mounting feet. Any number of units can be mounted side by side, making a pleasing and compact assembly, in the construction of standard power supply units.

An assortment of these single units of various capacities and working voltages will enable the experimenter to build up a large variety of filter condenser block combinations by grouping the required units together.

From the experimenter's viewpoint an assortment of single units is preferable to an assortment of blocks, since the cost of replacing single units, made necessary by breakdown due to accidental application of excessive voltage, is much less than in the case of blocks.

STOCK CAPACITIES			
Cap. Mfda.	List Price	Code Word	Can Symbol
<b>TYPE 202</b>			
1	\$1.15	OMENS	E
2	1.65	OLIVE	F
4	2.60	ONION	G
<b>TYPE 302</b>			
1	\$1.35	MELEE	E
2	2.00	MERGE	F
4	3.40	MERIT	GG
<b>TYPE 402</b>			
1	\$1.60	PEWIT	F
2	2.40	PHASE	G
4	4.20	PHIAL	HH
<b>TYPE 502</b>			
1	\$1.90	UHLAN	F
2	2.85	UNION	G
4	5.00	UPSET	HH
<b>TYPE 602</b>			
1	\$2.20	QUIRK	G
2	3.30	QUIET	HH
4	5.75	QUOTE	KK
<b>TYPE 802</b>			
1	\$2.75	RIGHT	GG
2	4.75	RIGID	II
4	8.75	RIGOR	LL
<b>TYPE 1002</b>			
1	\$3.50	RAVEL	HH
2	6.50	RAVEN	KK
4	12.00	READY	N
<p style="font-size: small;">Special capacities: Larger or intermediate sizes, as well as combinations of various sizes into blocks or special units may be had on special order for manufacturers only.</p> <p style="font-size: small; text-align: center;">Packed one in a box. Standard package—10 boxes.</p>			

WORKING VOLTAGES		
Type No.	Working Voltages	
	D.C.	A.C.
202	200	125
302	300	175
402	400	250
502	500	300
602	600	350
802	800	440
1002	1000	600
For Insulation Specifications, see page 3.		

**CAN DIMENSIONS**

For detailed Can Dimensions of all Aerovox Paper Dielectric Condensers listed on this page, refer to the corresponding Can Symbol Code Letters on page 16.

For General Characteristics of all Aerovox Paper Dielectric Condensers, see page 3.

**ALL OUR STOCK CONDENSERS ARE NON-INDUCTIVELY WOUND**

## STANDARD FILTER CONDENSER BLOCKS

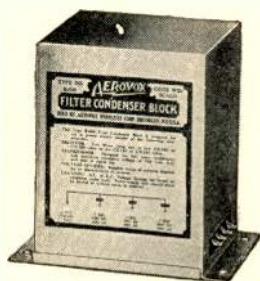

Type B-600

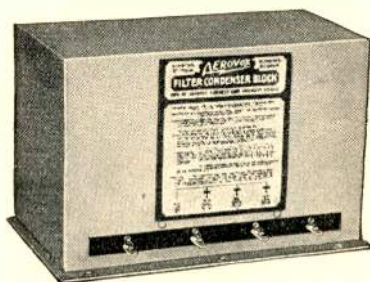

Type B-1000



Type B-800

### Type B-400

List Price—\$11.25

Code Word—SALVO

Can Symbol—LL

Cap. Mfd.	Working Volt. D.C.	A.C.
0	—	—
2	400	250
4	300	175
4	300	175

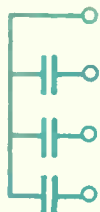

The B-400 Block is for use in power supply circuits employing an -80 type full-wave rectifier tube and designed to supply "B" and "C" voltages to receivers employing one or two -71-A type tubes in the power stage. It can be used with any power transformer designed to supply a secondary voltage of not more than 300 volts AC per anode to the rectifier.

### Type B-800

List Price—\$21.00

Code Word—SCALY

Can Symbol—O

Cap. Mfd.	Working Volt. D.C.	A.C.
0	—	—
2	800	440
4	600	350
4	600	350

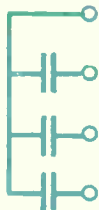

The B-800 Block is for use in power supply circuits employing either one -81 type rectifier for half-wave rectification, or two -81 tubes for full wave rectification, to supply "B" and "C" voltages to receivers employing one or two -10 or -50 type tubes in the power stage. It can be used with any power transformer designed to supply a secondary voltage of not more than 600 volts AC per anode to the rectifier.

TO meet the demands of all types of filter circuits for use with different types of rectifiers and amplifiers, the Aerovox Wireless Corporation has developed the line of filter condenser blocks described on this page, and the series of bypass condenser blocks described on the opposite page.

By using a suitable combination of filter and bypass condenser blocks, the filtering requirements of any standard filter and voltage divider circuit can be met at minimum cost.

The condenser sections used in these blocks are non-inductively wound and thoroughly impregnated using the highest grade materials obtainable.

Each unit is provided with strong mounting strips which are an integral part of the can. The terminals are located near the base to provide convenience in wiring, short leads and safety.

The units can be depended upon to give long and satisfactory service without danger of breakdown troubles when used under the conditions for which they are designed and recommended.

For insulation specifications of the condenser sections used in these blocks, see the table on page 3. The insulation specifications of the sections are the same as those of other standard units of the same voltage ratings.

All blocks are packed one in a box. Standard Package—10 boxes.

For can dimensions refer to corresponding can symbols on page 16.

Special Blocks: On quantity orders, special blocks can be furnished to meet manufacturers' specifications regarding capacities, voltage ratings and types of cans etc. See Page 15.

### Type B-600

List Price—\$15.50

Code Word—SCALD

Can Symbol—M

Cap. Mfd.	Working Volt. D.C.	A.C.
0	—	—
2	600	350
4	500	300
4	400	250



The B-600 Block is for use in power supply circuits employing either one or two -80 type full wave rectifiers or two type -81 rectifiers connected to give full wave rectification, to supply "B" and "C" voltages to receivers employing one or two -45 or two -71-A or one or two pentode type tubes in the power stage. It can be used with any power transformer designed to supply a secondary voltage of not more than 400 volts AC per anode to the rectifier.

### Type B-1000

List Price—\$27.00

Code Word—SCANT

Can Symbol—Q

Cap. Mfd.	Working Volt. D.C.	A.C.
0	—	—
2	1000	600
4	800	440
4	800	440

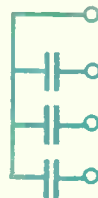

The B-1000 Block is for use in power supply units employing one or two -81 rectifiers for half or full-wave rectification, to supply "B" and "C" voltages to receivers employing one or two -50 type tubes in the power stage. It can be used with any power transformer designed to supply a secondary voltage of not more than 750 volts AC per anode to the rectifier.



## STANDARD FILTER BYPASS CONDENSER BLOCKS

### Type B-1

List Price—\$3.00  
Code Word—SCATH  
Can Symbol—FF

Cap. Mfd.	Working Volt. D.C.	Working Volt. A.C.
0	—	—
1	300	175
1	200	125

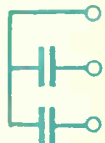

The Type B-1 unit can be used where a 90 to 135-volt tap and a 45-volt tap must be bypassed. It is also ideal for use in bypassing two grid bias resistors, across one of which the voltage drop may be comparatively high such as the 51 volts required for -45 type power tubes and the 84 volts required for -50 type power tubes.



Type B-2

### Type B-2

List Price—\$4.75  
Code Word—SCOBS  
Can Symbol—HH

Cap. Mfd.	Working Volt. D.C.	Working Volt. A.C.
0	—	—
1	400	250
1	300	175
1	300	175

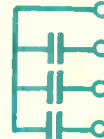

The Type B-2 unit is designed for bypass service in connection with voltage dividers which furnish one 180-volt tap and two lower voltage taps. It may also be used as a filter block in connection with a low voltage transformer (not over 250 volts a.c. per plate) and an -80 type rectifier circuit, where cost is a very important factor and some hum due to somewhat imperfect filtering is not objectionable.

### Type B-3

List Price—\$7.50  
Code Word—SCREW  
Can Symbol—JJ

Cap. Mfd.	Working Volt. D.C.	Working Volt. A.C.
0	—	—
1	400	250
4	300	175
1	300	175

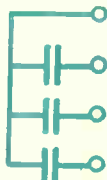

The Type B-3 unit is similar to the B-2 unit except that a 4-mfd. section has been substituted for one of the 1-mfd. sections. The use of the 4 mfd. section across the 90-volt tap improves filtering and reduces hum, usually due to coupling, to a minimum. This unit can also be used as a filter unit for the use recommended in connection with B-2 with better filtering action provided by the 4-mfd. section.

All Bypass Blocks packed one in a box. Standard Package—5 Boxes  
For dimensions of cans see page 11.

### BUFFER AND HIGH VOLTAGE BYPASS CONDENSER BLOCKS

Types 646, 1046 and 1546 Buffer Condensers are ideal for use across the sections of the secondary of power transformers designed for use with gaseous type rectifiers.

These units consist of two non-inductively wound .1 mfd. sections connected in series and provided with a centertap as shown in the diagrams at the bottom of this page.



Type 646, 1046 and 1546

### Type B-4

List Price—\$10.00  
Code Word—SEEDY  
Can Symbol—KK

Cap. Mfd.	Working Volt. D.C.	Working Volt. A.C.
0	—	—
1	400	250
4	300	175
1	300	175
1	300	175
1	200	125
1	200	125



The Type B-4 unit is similar to the Type B-3 unit except that three additional 1-mfd. sections have been added to take care of an extra tap at the divider and to provide two low voltage sections for bypassing grid bias resistors.

This unit can also be used as an inexpensive filter and bypass block for an -80 type rectifier, using the 1-4-1 sections as the filter unit and the others as bypass units.

### Type 646

List Price—\$1.60  
Code Word—SAGAS  
Can Symbol—E

Cap. Mfd.	Working Volt. D.C.	Working Volt. A.C.
.1	600	350
0	—	—
.1	600	350



### Type 1046

List Price—\$2.25  
Code Word—SALVE  
Can Symbol—F

Cap. Mfd.	Working Volt. D.C.	Working Volt. A.C.
.1	1000	600
0	—	—
.1	1000	600

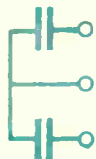

### Type 1546

List Price—\$3.75  
Code Word—SAVOY  
Can Symbol—H

Cap. Mfd.	Working Volt. D.C.	Working Volt. A.C.
.1	1500	800
0	—	—
.1	1500	800



All units packed one in a box—Standard Package—10 Boxes.

For lower voltage bypass blocks, see index on page 48.

## HI-FARAD DRY ELECTROLYTIC CONDENSERS

Manufactured Under  
U.S. Patent Nos. 1,789,949, and 1,815,768  
Other Patents pending



**Type G Condensers**  
Grounded Mounting

**A**EROVOX Hi-Farad Dry Electrolytic Condensers are of superior mechanical and electrical design. The DRY characteristics of these units make it possible to mount them in any position—upright, inverted, horizontal or at any other desired angle, without danger of spilling or leakage. For all practical purposes they can be handled and mounted in the same manner as wax paper condensers.

The cost per microfarad as compared with paper condensers of the same voltage rating is very low. This permits the use of higher capacity units at an actual savings in cost.

The high voltage characteristics (500 volts D.C. peak without series connections) permits their practical use in most of the standard comparatively high voltage power supply filter circuits.



**Type E Condensers**  
Universal Mounting

### Uses of Hi-Farad Condensers

- Filter Condensers in Power Supply Units.
- Filter Condensers in "A" Eliminators.
- Filter Condensers in Audio Amplifiers.
- Bypass Condensers in Audio Amplifiers.
- Filter Condensers Across Dynamic Speaker Field Windings.
- Filter and Bypass Condensers for Short Wave Transmitters and Receivers.
- Filter and Bypass Condensers for Amateur Transmitters and Receivers.
- Filter and Bypass Condensers for Amplifiers and Power Supply Units for Television Transmitters and Receivers.
- Spark Suppressors, and Noise Filters on D.C. Contactors, Circuit Breakers, Commutators, Motors, or other D.C. Apparatus.

Higher voltage units for transmitting and other high voltage circuits may be obtained by connecting two or more of the 500 volt units in series or by using the high voltage transmitting electrolytic condensers described on page 41.

The filtering action of this type of condenser is equivalent, per microfarad, to that of wax paper condensers of equivalent capacity so that they can be used to replace paper condensers in filter and audio bypass circuits.

Their self-healing and surge proof characteristics prevent damage to the condenser from high voltage surges, thereby increasing their life indefinitely and making them very safe for use in filter circuits.



**Type S Condenser**  
Screw Mounting



**Type I Condensers**  
Insulated Mounting

They are much more compact and lighter in weight than wax paper condensers of equivalent capacity and voltage rating.

They are unaffected by extremely low temperatures.

The leakage current of these units is very low. They retain this low leakage current characteristic even after long periods of idleness.

The 100- and 200-volt units are ideally suited for use as bypass units in audio amplifier plate and high voltage grid bias circuits. The connection of such units across the field windings of high voltage dynamic speakers will eliminate all hum due to imperfect filtering.

The lower voltage condensers are well adapted for use in lower voltage grid bias circuits.

The very high capacity, 12-volt units were developed for use in the filter circuits of "A" eliminators.

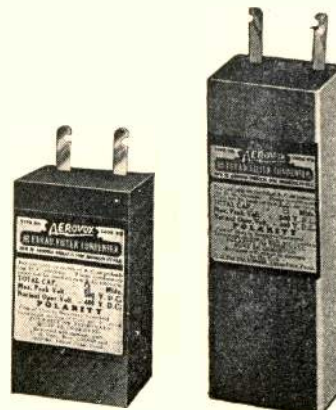

**Type P Condensers**  
In Cardboard Boxes

**HI-FARAD CONDENSERS CAN BE MOUNTED IN ANY POSITION**





## HI-FARAD DRY ELECTROLYTIC CONDENSERS IN CARDBOARD BOX CONTAINERS TYPE P5—500 VOLTS D.C. PEAK



**Type P5**  
Single Section Unit

**H**I-FARAD Dry Electrolytic Condensers in cardboard box containers shown in the photos herewith possess exactly the same electrical characteristics as other Hi-Farad condensers, but have been designed primarily to reduce cost to a minimum.

The units are sturdily constructed, the terminals being securely riveted to re-enforced tabs which connect directly to the anode and cathode foils. The lugs are tin-dipped to permit ready soldering to the terminals.

These condensers operate efficiently over wide ranges in temperature—even at very low temperatures the electrolyte will not freeze. It is recommended, however, that the units be so located in the radio receiver or assembly or other devices in which they are used so that the operating temperature of the condenser will not exceed 130 degrees F. If these temperatures are not exceeded, and the units are not subjected to voltages in excess of their rating, the condensers will operate efficiently for long periods of time without deterioration.

A point of importance in the construction is the fact that the condenser is so wound that the negative foil is the outer layer and therefore affords a considerable degree of electrostatic shielding. These units can therefore be

mounted close to each other without danger of any electrostatic coupling between the units.

The application of these units in many radio and electrical assemblies may often be an advantage over the can type units. In cases such as making up a compact block of several units where no common ground is required, or concealing them beneath chassis, these units are especially desirable.

They are especially suited for service work in repairing broken down sections of condenser blocks used in radio receivers and power supply units. Quick replacements can easily be made without even removing the inoperative condenser from the set. All that is necessary is to clip the connection of the particular section and attach the leads to the terminal lugs of the new Hi-Farad condenser. When connections are made, however, care should be taken to observe the polarity of the leads.

Under no condition should these condensers be used on raw a.c. current.



**Type P5**  
Double Section Unit

The high voltage characteristic (500 volts d.c. peak) of these condensers permits their use in most all standard filter and bypass circuits of modern receivers, amplifiers and power supply units. They are by far more compact, lighter in weight and economical than wax paper condensers of equivalent capacity and voltage rating, and all-around in keeping with the requirements of present day radio design.

### STANDARD CAPACITIES, PRICES AND SIZES

#### TYPE P5—500 Volts D.C. Peak\*

Type No.	Cap. of Sections Mfds.	Total Cap. Mfds.	List Price	Code Word	Box Dimensions		
					Length	Width	Depth
P5-1	1	1	\$ .80	WANDA	2 3/8"	1 3/8"	1 3/8"
P5-2	2	2	.95	WARTY	2 3/8"	1 3/8"	1 3/8"
P5-4	4	4	1.10	WASHY	4 1/8"	1 3/8"	1 3/8"
P5-5	5	5	1.20	WATOT	4 1/8"	1 3/8"	1 3/8"
P5-6	6	6	1.30	WASTE	4 1/8"	1 3/8"	1 3/8"
P5-8	8	8	1.45	WATCH	4 1/8"	1 3/8"	1 3/8"
P5-22	2-2	4	1.50‡	WATEL	2 3/8"	1 3/8"	1 3/8"
P5-24	2-4	6	1.65‡	WAVER	4 1/8"	1 3/8"	1 3/8"
P5-26	2-6	8	1.80‡	WAXEN	4 1/8"	1 3/8"	1 3/8"
P5-28	2-8	10	1.95‡	WEARY	4 1/8"	1 3/8"	1 3/8"
P5-44	4-4	8	1.80‡	WEAVE	4 1/8"	1 3/8"	1 3/8"
P5-46	4-6	10	1.95‡	WEDGE	4 1/8"	1 3/8"	1 3/8"
P5-48	4-8	12	2.10‡	WEEDY	4 1/8"	1 3/8"	1 3/8"
P5-66	6-6	12	2.10‡	WEIGH	4 1/8"	1 3/8"	1 3/8"
P5-68	6-8	14	2.25‡	WEIRD	4 1/8"	1 3/8"	1 3/8"
P5-88	8-8	16	2.45‡	WENCH	4 1/8"	1 3/8"	1 3/8"

Note \*: The D.C. working voltage rating of condensers is 10% less than the peak voltage rating and usually varies with circuit and load conditions. Peak voltage rating should never be exceeded (surges excepted).

The negative terminal of double section units is common.

Note †: These are not standard units but can be made, in substantial quantities, for manufacturers, jobbers and large users.

FOR MANUFACTURERS: The above are representative standard units carried in stock. Special units of any desired capacity, voltage ratings above 500 volts peak, or combinations can be made to manufacturers' specifications.

All units packed one in a box. Standard Package—10 Boxes.

## HI-FARAD DRY ELECTROLYTIC CONDENSERS CAN DIMENSIONS AND MOUNTING DETAILS

Can Symbol	TA	TB	TC	TD	TE	TF	TG	TH	TI	TJ
Diameter "D"	1 3/8"	2 1/2"	3"	1 3/8"	2 1/2"	3"	2"	2"	1 3/8"	1 3/8"
Length, "L"	4 1/8"	4 1/8"	4 1/8"	2 5/8"	2 5/8"	2 5/8"	4 1/8"	2 5/8"	1 3/4"	1 1/8"

### SCREW MOUNTING UNITS

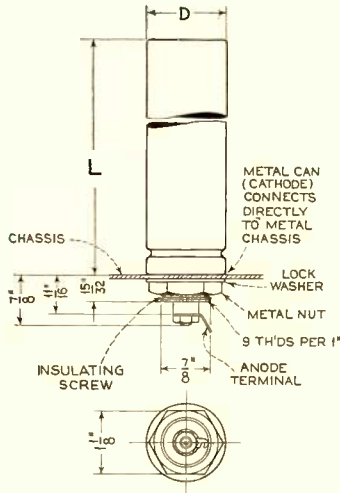

**Type G Condenser**  
CAN (NEGATIVE) GROUNDED TO CHASSIS  
Furnished in TA, TD, TG, TH, TI and TJ Cans.

Type I Condensers, as shown at the right, have an insulating boss, integral with the cover, which keeps the can clear of the metal chassis when mounted. In the Type G condensers, shown at the left, the edge of the can comes in contact with the chassis. Type G condensers can also be furnished with 3/4"-16 thread.

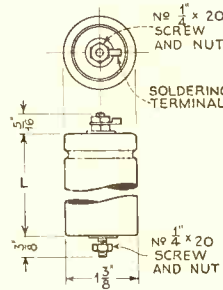

**Type S Condenser**  
SCREW MOUNTING CAN (NEGATIVE) GROUNDED  
Furnished in TD, TI and TJ Cans.

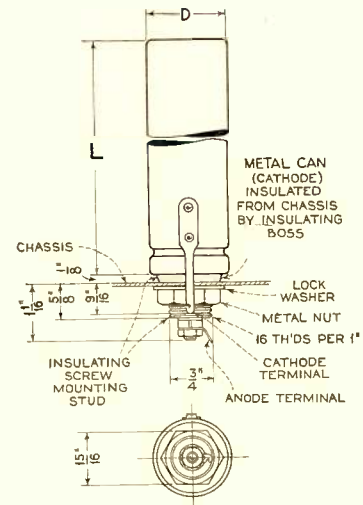

**Type I Condenser**  
CAN (NEGATIVE) INSULATED FROM CHASSIS  
Furnished in TA, TD, TI and TJ Cans.

### UNIVERSAL MOUNTING UNITS

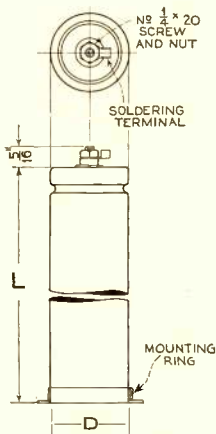

**Type E Condenser**  
UNIVERSAL MOUNTING CAN (NEGATIVE) GROUNDED  
Furnished in TA, TB, TC, TD, TE, TF, TI and TJ Cans.  
Supplied with mounting ring shown below.

Type E Condensers are furnished with mounting rings which enable them to be mounted in any position. They are available in a wide variety of sizes, capacities and voltage ratings for every condenser requirement in filter and bypass circuits, and may be had in single, double, triple and quadruple section units in the following size cans:

Can Symbol	TA	TB	TC	TD	TE	TF	TI	TJ
Max. Number of Terminals	1	3	4	1	3	4	1	1

The standard dimensions of Aerovox Hi-Farad Condenser units make it possible to replace standard electrolytic units of other makes with Hi-Farad units without chassis changes.



Mounting Ring for Type E Condenser

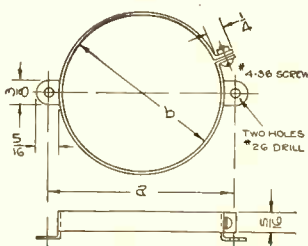

Mounting Ring Dimensions		
Type No.	Dimensions	
	a	b
TAR	1 11/16"	1 3/8"
TBR	2 13/16"	2 1/2"
TCR	3 3/16"	3"

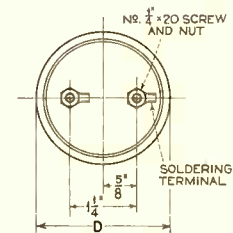

Two Terminal Condensers

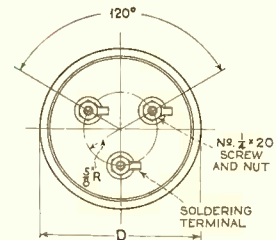

Three Terminal Condensers

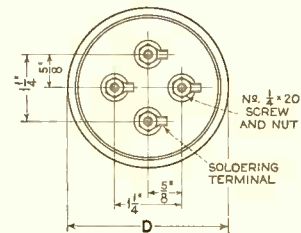

Four Terminal Condensers

CAN SIZES OF HI-FARAD CONDENSERS ARE STANDARD





## HI-FARAD DRY ELECTROLYTIC CONDENSERS 500 VOLTS PEAK

### CHARACTERISTICS, STANDARD CAPACITIES, PRICES AND CODE WORDS

TYPE G5—500 Volts D.C. Peak*				
Type No.	Cap. Mfds.	List Price	Code Word	Can Symbol
G5D-1	1	\$1.00	DRUNK	TD
G5D-2	2	1.20	DUCAL	TD
G5-2	2	1.20‡	FUDGE	TA
G5D-4	4	1.40	DUMMY	TD
G5-4	4	1.40‡	FUGUE	TA
G5-5	5	1.50	DUMPS	TA
G5-6	6	1.60	DWELL	TA
G5-8	8	1.70	ENNUI	TA
G5-10	10	2.10	FAKIR	TA
G5-12	12	2.25	FEIGN	TA
G5-14	14	2.40	FELLY	TG
G5-16	16	2.60	FEOFF	TG

TYPE S5—500 Volts D.C. Peak*				
Type No.	Cap. Mfds.	List Price	Code Word	Can Symbol
S5-1	1	\$1.00	VIXEN	TD
S5-2	2	1.20	VOCAL	TD
S5-4	4	1.40	VOGUE	TD

Note\*: The D.C. working voltage rating of condensers is 10% less than peak voltage rating and usually varies with circuit conditions. Peak voltage rating should never be exceeded (surges excepted).  
 List prices of Type E condensers include units complete with mounting rings.  
 List price of all mountings rings—15 cents each.  
 Note †: These are not standard units but can be made, in substantial quantities, for manufacturers, jobbers and large users.  
 FOR MANUFACTURERS: The above are representative standard units carried in stock. Special units of any desired capacity, voltage ratings above 500 volts peak, or combinations can be made to manufacturers' specifications.  
 All units packed one in a box—Standard Package—10 Boxes

TYPE I5—500 Volts D.C. Peak*				
Type No.	Can. Mfds.	List Price	Code Word	Can Symbol
I5D-1	1	1.00	DRYLY	TD
I5D-2	2	1.20	DUCHY	TD
I5-2	2	1.20‡	FULLY	TA
I5D-4	4	1.40	DUMPY	TD
I5-4	4	1.40‡	FUSEE	TA
I5-5	5	1.50	DUNCE	TA
I5-6	6	1.60	DYING	TA
I5-8	8	1.70	ENSUE	TA
I5-10	10	2.10	FATTY	TA
I5-12	12	2.25	FEIGN	TA

TYPE E5—500 Volts D.C. Peak*					
Type No.	Cap. of Sections Mfds.	Total Cap. Mfds.	List Price	Code Word	Can Symbol
E5D-1	1	1	\$1.00	CHECK	TD
E5D-2	2	2	1.20	CHEEK	TD
E5-2	2	2	1.20‡	CHEIR	TA
E5E-22	2-2	4	2.40‡	CHREV	TE
E5-22	2-2	4	2.40	CHESS	TB
E5F-222	2-2-2	6	3.25‡	DRAFT	TF
E5-222	2-2-2	6	3.25	CHIDE	TC
E5-2222	2-2-2-2	8	4.65	CHIEF	TC
E5D-4	4	4	1.40	CHILD	TD
E5-4	4	4	1.40‡	CHRIS	TA
E5-44	4-4	8	2.65	CHILL	TB
E5E-44	4-4	8	2.65‡	DRAMA	TE
E5-444	4-4-4	12	3.75	CHINA	TC
E5F-444	4-4-4	12	3.75‡	DRAPE	TF
E5-4444	4-4-4-4	16	4.75	CHINE	TC
E5-5	5	5	1.50	CHINK	TA
E5-55	5-5	10	2.75	DOCKE	TB
E5-555	5-5-5	15	3.90	DOMES	TC
E5-5555	5-5-5-5	20	5.25	DIMES	TC
E5-6	6	6	1.60	CHIRP	TA
E5-66	6-6	12	3.00	DINER	TB
E5-666	6-6-6	18	4.15	DOGER	TC
E5-6666	6-6-6-6	24	5.50	DIVES	TC
E5-8	8	8	1.70	CHOIR	TA
E5-88	8-8	16	3.25	CHORD	TB
E5-888	8-8-8	24	4.50	CIGAR	TC
E5-8888	8-8-8-8	32	6.00	CIVIL	TC
E5-248	2-4-8	14	4.00	CLAIM	TC
E5-288	2-8-8	18	4.75	CLAMP	TC
E5-2816	2-8-16	26	5.00	CLANG	TC
E5-812	8-12	20	4.00‡	DOWAG	TB
E5-816	8-16	24	3.80	DORMA	TB
E5-8816	8-8-16	32	6.00	DOOMS	TC
E5-10	10	10	2.10	DRESS	TA
E5-12	12	12	2.25	DRIFT	TA
E5-16	16	16	2.60	DRIVE	TB
E5-20	20	20	3.50	CLASH	TB
E5-30	30	30	5.00	CLASP	TC

#### Type E Multiple Section Units



Two Section Unit  
In a TB Can



Three Section Unit  
In a TC Can



Four Section Unit  
In a TC Can



Three Section Unit  
In a TF Can

For can dimensions and mounting details of electrolytic condensers, see Page 22.

HIGH CAPACITY, LOW COST, LONG LIFE, 500 VOLTS PEAK



## HI-FARAD DRY ELECTROLYTIC CONDENSERS

FOR OPERATION AT 200, 100, 50, 25, 24, and 12 VOLTS D.C.

TYPE E200—200 Volts D.C. Peak*					TYPE E25—25 Volts D.C. Peak*				
Type No.	Cap. Mfds.	List Price	Code Word	Can Symbol	Type No.	Cap. Mfds.	List Price	Code Word	Can Symbol
E200-5	5	\$1.35	FLUSH	TD	E25-5	5	\$.95	FRESH	TJ
E200-10	10	1.55	CLASS	TA	E25-10	10	1.00	CLERK	TI
E200-15	15	1.75	FLUTE	TA	E25-15	15	1.05	FRIAR	TI
E200-20	20	2.00	FOCUS	TA	E25-20	20	1.05	FRILL	TI
E200-25	25	2.50	DROIT	TB	E25-25	25	1.05	CLIFF	TI
E200-50	50	3.75	DROLL	TB	E25-50	50	1.15	CLIMB	TI
E200-75	75	5.25	FOGGY	TC	E25-75	75	1.25	FRITH	TD
E25-100	100	1.40	DROOP	TD	TYPE E24—24 Volts D.C. Peak*				
TYPE E100—100 Volts D.C. Peak*					E24-500	500	\$3.00	FROCK	TB
E100-5	5	\$1.05	FOIST	TI	E24-1000	1000	4.00	FRONT	TB
E100-10	10	1.15	CLEAN	TI	E24-1500	1500	6.00	FROST	TC
E100-15	15	1.20	FOLIO	TD	E24-2000	2000	7.00	FROTH	TC
E100-20	20	1.25	FOLLY	TD	TYPE E12—12 Volts D.C. Peak*				
E100-25	25	1.35	FONDA	TD	E12-500	500	\$2.00	DROWN	TA
E100-50	50	1.85	CLEAR	TA	E12-1000	1000	3.00	FRUSH	TB
E100-75	75	2.50	CLEAT	TB	E12-1500	1500	3.50	CLIME	TB
E100-100	100	2.80	CLEFT	TB	E12-2000	2000	4.00	CLING	TB
TYPE E50—50 Volts D.C. Peak*					E12-4000	4000	7.00	CLOAK	TC
E50-5	5	\$1.00	FORAY	TI	TYPE 6A—12 Volts D.C. Peak*				
E50-10	10	1.05	FORCE	TI	6A-1500	1500	\$3.50	CONCH	Note 1
E50-15	15	1.10	FORTE	TI	6A-2000	2000	4.00	CONGE	Note 1
E50-20	20	1.10	FORUM	TI	6A-4000	4000	7.50	CONOY	Note 2
E50-25	25	1.15	FOYER	TI	Note 1. Can size 1 1/4" x 4 1/2" x 5 1/2" fitted with mounting lugs. Note 2. Can size 2 1/2" x 4 1/2" x 5 1/2" fitted with mounting lugs.				
E50-50	50	1.35	FRAIL	TD					
E50-75	75	1.75	FRANK	TA					
E50-100	100	1.85	FREAK	TA					

### TYPE S FOR OPERATION AT 200, 100, 50, and 25 VOLTS D.C.

TYPE S200—200 Volts D.C. Peak*					TYPE S25—25 Volts D.C. Peak*				
Type No.	Cap. Mfds.	List Price	Code Word	Can Symbol	Type No.	Cap. Mfds.	List Price	Code Word	Can Symbol
S200-5	5	1.35	VIAND	TD	S25-5	5	\$.95	VADEL	TJ
TYPE S100—100 Volts D.C. Peak*					S25-10	10	1.00	VAING	TI
S100-5	5	1.05	VENGE	TI	S25-15	15	1.05	VALAN	TI
S100-10	10	1.15	VENUS	TI	S25-20	20	1.05	VALET	TI
S100-15	15	1.20	VERGE	TD	S25-25	25	1.05	VALID	TI
S100-20	20	1.25	VERSE	TD	S25-50	50	1.15	VALOR	TI
S100-25	25	1.35	VESTA	TD	S25-75	75	1.25	VALUE	TD
TYPE S50—50 Volts D.C. Peak*					S25-100	100	1.40	VAIVE	TD
S50-5	5	1.00	VAPID	TI	CAN DIMENSIONS				
S50-10	10	1.05	VAPOR	TI	For detailed can dimensions and mounting details of all electrolytic condensers listed on this page, refer to the corresponding Can Symbol Code Letters on Page 22.				
S50-15	15	1.10	VAULT	TI					
S50-20	20	1.10	VAUNT	TI					
S50-25	25	1.15	VENAL	TI					
S50-50	50	1.35	VENDI	TD					

Note \*: The D.C. working voltage rating of condensers is 10% less than the peak voltage rating and usually varies with circuit and load conditions. Peak voltage rating should never be exceeded (surges excepted).

FOR MANUFACTURERS: The above are representative standard units carried in stock. Special units of any desired capacity and voltage rating or combinations can be made to manufacturers' specifications.

USE HI-FARAD LOW VOLTAGE UNITS IN BYPASS CIRCUITS





## HI-FARAD DRY ELECTROLYTIC CONDENSERS

LOW VOLTAGE UNITS IN CARDBOARD CONTAINERS FOR MANUFACTURERS



**Type P Condenser**  
In Cardboard Box  
For Manufacturers Only

HI-FARAD low voltage electrolytic condensers will be found very useful in the construction of radio receivers, amplifiers and similar equipment where comparatively high capacities are required in circuits where the peak voltages are comparatively low. The listings on this page indicate the capacities and voltages for which these condensers are designed. The voltages indicated are the peak operating voltages and it is essential that they be used in circuits where peak voltages do not exceed the voltage ratings of the condensers.

High capacity low voltage electrolytic condensers are used to a considerable extent for the bypassing of C-bias resistors in audio frequency circuits. For example, a 25 mfd. condenser connected across the C-bias resistance of a pentode circuit will eliminate common coupling in the C-bias circuit; common cou-

pling in this circuit has the effect of reducing the gain especially at low frequencies with the result that the high frequencies are unduly emphasized. Connecting a high capacity electrolytic condenser across the bias resistance eliminates the common coupling and greatly improves the tone quality.

These condensers can also be used for bypassing other circuits in audio amplifiers across which there are comparatively low peak voltages. The advantages of complete bypassing in audio frequency circuits has always been realized but the cost in using paper condensers has been high. These low voltage, high capacity electrolytic condensers make it possible to use complete bypassing at reasonable cost.

They can also be used to bypass the C-bias circuit of the second detector in superheterodyne circuits and will serve the dual purpose of bypassing the audio frequencies and also the high intermediate frequency. Although the capacity increases with increasing frequency, it remains sufficiently high to afford satisfactory bypassing at the intermediate frequency. These condensers have been used for this purpose by many radio set manufacturers.

Hi-Farad condensers maintain their characteristics over wide ranges in temperature and are not affected by extreme cold such as they might be subjected to during transportation. It is recommended however that the maximum operating temperature be not in excess of about 130 degrees F. It is also essential that the peak voltages in the circuit are not in excess of the rated voltage of the condenser. Although the condenser will withstand momentary surges which produce voltages in excess of the rated voltage, this characteristic should only be considered a safety factor and care should be taken that the normal voltages are not above the rating of the condenser.



**Type PR Condenser**  
In Cardboard Tube  
For Manufacturers Only

The larger condensers, Type P, are assembled in rectangular boxes with lugs for terminals. The smaller units, Type PR, are completely sealed in round tube containers with a special pitch compound and provided with bare wire leads for terminals as shown in the illustration above. The unit can be mounted in any desired position either upright, inverted or horizontal. They may be fastened to the chassis by means of a metal clamp around the section or may be placed with other units inside a metal container.

Type P50—50 Volts				
Type No.	Cap. Mfds.	Box Dimensions		
		Length	Width	Depth
P50-75	75	4 1/16"	2"	1 3/8"
P50-100	100	4 1/16"	2"	1 3/8"
Type P100—100 Volts				
P100-50	50	4 1/16"	2"	1 3/8"
P100-75	75	4 1/16"	4"	1"
P100-100	100	4 1/16"	4"	1"
Type P200—200 Volts				
P200-10	10	4 1/16"	1"	1 5/8"
P200-15	15	4 1/16"	1"	1 5/8"
P200-20	20	4 1/16"	1 1/2"	1 5/8"
P200-25	25	4 1/16"	2"	1 3/8"
P200-50	50	4 1/16"	4"	1 3/8"
P200-75	75	4 1/16"	4"	2"
P200-100	100	4 1/16"	4"	2 1/4"

Type PR25—25 Volts			
Type No.	Cap. Mfds.	Tube Length	Dimensions Diameter
PR25-5	5	2 3/4"	5/8"
PR25-10	10	2 3/4"	5/8"
PR25-15	15	2 3/4"	7/8"
PR25-20	20	2 3/4"	7/8"
PR25-25	25	2 3/4"	7/8"
PR25-50	50	2 3/4"	1 1/8"
PR25-75	75	2 3/4"	1 1/4"
PR25-100	100	2 3/4"	1 1/4"
Type PR50—50 Volts			
PR50-5	5	2 3/4"	5/8"
PR50-10	10	2 3/4"	7/8"
PR50-15	15	2 3/4"	1 1/8"
PR50-20	20	2 3/4"	1 1/8"
PR50-25	25	2 3/4"	1 1/8"
PR50-50	50	2 3/4"	1 3/4"
Type PR100—100 Volts			
PR100-5	5	2 3/4"	7/8"
PR100-10	10	2 3/4"	1 1/8"
PR100-15	15	2 3/4"	1 1/8"
PR100-20	20	2 3/4"	1 1/4"
PR100-25	25	2 3/4"	1 1/4"
Type PR200—200 Volt Condensers			
PR200-5	5	2 3/4"	1 1/4"

HIGH CAPACITY UNITS OF SMALL PHYSICAL DIMENSIONS

## MICA CONDENSERS MOULDED IN BAKELITE

THESE condensers are moulded in bakelite. The capacity of the condenser element is predetermined by a patented process. The bakelite seals and protects the condenser against extreme temperature, moisture and chemical action.

Manufactured Under  
U.S. Pat. No. 1,650,395

The dielectric is of the finest grade India Ruby Mica, the plates are tinfoil, and the condenser elements are thoroughly impregnated. They are compact in size with special lugs and mounting features which allow for screw, eyelet or soldering assembly on insulating or metal subpanels and apparatus terminals.

The Type 1450, 1455 and 1475 units are designed for general use where comparatively high capacity and high voltage ratings are required.

The "Midget" Type mica condensers 1460, 1461, 1462, 1463, 1465 and 1467 are designed

for use in small spaces where lower capacities and voltage ratings are desirable. Their small physical dimensions make them ideally suited for use in midget receivers and other compact assemblies.



**Type 1450**

Capacities  
00004 to .02 Mfd. Inclusive

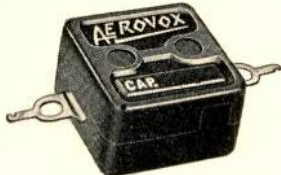
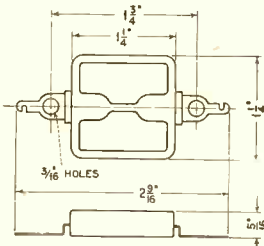

**Type 1450**

Capacities  
025 to .04 Mfd. Inclusive

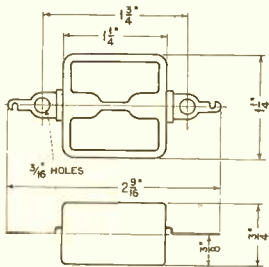

**Type 1455**

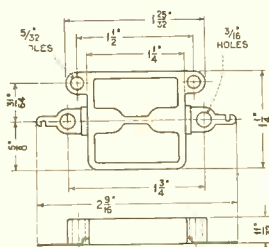

**Type 1475**

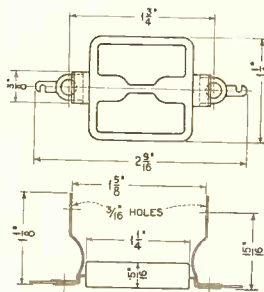

**Type 1460**

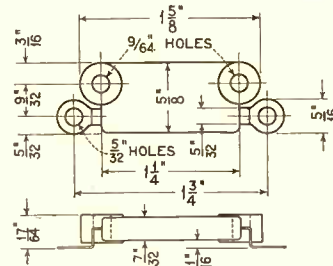

**Type 1461**

The same as Type 1460 in every respect except that it is provided with soldering terminals instead of screw hole terminals.



**Type 1462**

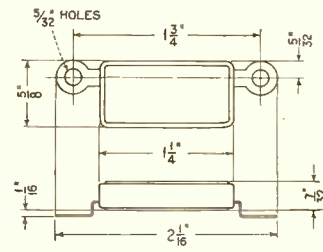

**Type 1463**

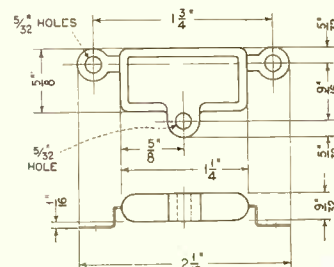

Voltage Characteristics					
Type No.	Cap. Mfd.	Work Volt.		Retest Volt.	
		D.C.	A.C.	D.C.	A.C.
1450	up to .04	500	350	1000	700
1455	up to .03	500	350	1000	700
1475	up to .02	500	350	1000	700
1460	up to .003	450	300	900	600
1461	up to .003	450	300	900	600
1462	up to .003	450	300	900	600
1463	up to .003	450	300	900	600
1465	up to .0005	250	175	500	350
1467	up to .0005	250	175	500	350

SAFE AGAINST DAMAGE, MOISTURE AND CHEMICAL ACTION





## MICA CONDENSERS MOULDED IN BAKELITE



Type 1465

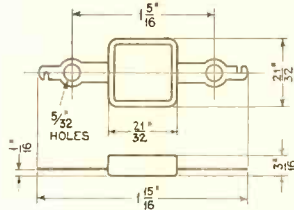

Type 1465 condensers are the smallest size units in the mica condenser series and are provided with convenient lug terminals for screw mounting or soldering. They are available in capacities up to .0005 mfd.

Type 1467 condensers are slightly larger in size than the Type 1465 units and are furnished with bare copper wire leads for connections. These units are available in all capacities up to .002 mfd.

For Voltage Characteristics of Mica Condensers, see Page 26.



Type 1467

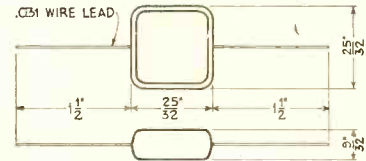

### STOCK CAPACITIES, PRICES AND CODE WORDS

Cap Mfds.	TYPE 1450		TYPE 1455		TYPE 1460		TYPE 1461		TYPE 1462	
	List Price	Code Word	List Price	Code Word	List Price	Code Word	List Price	Code Word	List Price	Code Word
.00004	\$.30	SERGE	\$.35	SHUTE	.20	TEENS	\$.20*	WRING	\$.20*	ARIAN
.00005	.30	SERVE	.35	SHYLY	.20	TEETH	.20*	WRIST	.20*	ASPIC
.00007	.30	SETON	.35	SIBYL	.20	TEMPT	.20*	WRITE	.20*	AUDIT
.000075	.30	SKULK	.35	SILLY	.20	URBAN	.20*	WROTH	.20*	AULIC
.0001	.30	SEPOY	.35	SINUS	.20	TENET	.20*	WRUNG	.20*	AWFUL
.00015	.30	SEPIA	.35	SKIFF	.20	TEPID	.20*	XANTH	.20*	COPAL
.0002	.30	SENNA	.35	SLACK	.20	TERSE	.20*	XEBEC	.20*	COPSE
.00025	.30	SEDGE	.35	SLAKE	.20	TESTY	.20*	XYLOG	.20*	CRATE
.00037	.30	SEDAN	.35	SLANG	.25	THANE	.25*	XYLAT	.25*	CRAVE
.0005	.30	SECCO	.35	SLASH	.25	THANK	.25*	XYPE	.25*	CRAZE
.001	.30	SCULK	.35	SLEEK	.25	THEIR	.25*	YACHT	.25*	CREAM
.0015	.35	SKULL	.35	SLEET	.35	USAGE	.35*	YEIAL	.35*	CREED
.002	.35	SENSE	.40	SLICE	.35	THEME	.35*	YEARN	.35*	CREEP
.0025	.35	SHOOT	.40	SLICK	.35	THERE	.35*	YEAST	.35*	CRESS
.003	.45	SHORE	.50	SLIDE	.40	THICK	.40*	YEALD	.40*	DEBAR
.004	.45	SHORT	.50	SLIME						
.005	.45	SHOTE	.50	SLIMY						
.006	.55	SHOUT	.60	SLING						
.0075	.65	SHOVE	.70	SLINK						
.01	.75	SHOWY	.80	SLOOP						
.015	.90	SHREW	.95	SLOPE						
.02	1.05	SHRED	1.10	SLOSH						
.025	1.65	SMACK	1.35	SLOTH						
.03	2.00	SMART	1.50	SLOYD						
.035	2.35	SMASH								
.04	2.70	SMEAR								
Cap Mfds.	TYPE 1463		TYPE 1465		TYPE 1467		TYPE 1475			
	List Price	Code Word	List Price	Code Word	List Price	Code Word	List Price	Code Word	List Price	Code Word
.00004	\$.20*	CUPID	\$.20	CROAK	\$.20*	SYNOD				
.00005	.20*	CURIO	.20	CRONE	.20*	SYNIP				
.00007	.20*	CURRY	.20	CRONY	.20*	SYRIN				
.000075	.20*	CURSE	.20	CROON	.20*	SYSY				
.0001	.20*	CURST	.20	CROSS	.20*	SWOOP	.40	SHRUB		
.00015	.20*	CURVE	.20	CROUP	.20*	SWIFT	.40	SHRUG		
.0002	.20*	CYCLE	.20	CROWD	.20*	SWOLL				
.00025	.20*	CYNIC	.20	CROWN	.20*	SWIND	.40	SHUCK		
.00037	.25*	CZECH	.25	CRUDE	.25*	SYLLY				
.0005	.25*	DAIRY	.25	CRUEL	.25*	SYCAM	.40	SHUNT		
.001	.25*	DAISY			.25*	SKILY				
.0015	.35*	DALLY			.35*	SLAVE				
.002	.35*	DANDY			.35*	SLUGG				
.0025	.35*	DEATH								
.003	.40*	DEBAR								

\*Asterisk used with prices of items listed indicate units made regularly for manufacturers and usually available from stock.  
SPECIAL CAPACITIES: The capacities listed in the above

table are stock capacities. Intermediate capacities may be obtained to order at the price of next higher stock capacity for manufacturers only.  
All Units Packed 10 in a Box. Standard Package—10 Boxes.

For High Voltage Mica Condensers suitable for transmitting purposes, see Pages 42 and 43.

THE BAKELITE CASING PROTECTS THE CONDENSER ELEMENTS

## INTERFERENCE FILTERS



Type IN-25

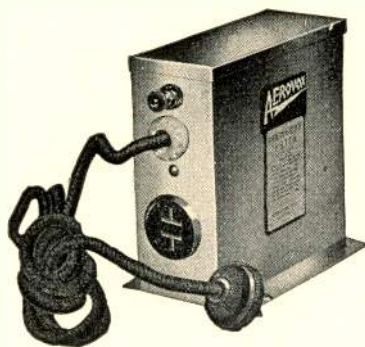

Types IN-24 and IN-44

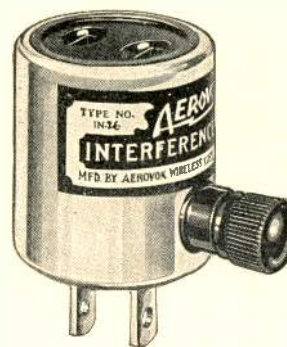

Type IN-26

PREVENT  
RADIATION  
INTERFERENCE

Type No.	List Price	Code Word	For Use On		Can Symbol
			D.C.	A.C.	
IN-24	\$5.00	INDUE	200	110	I
IN-25	1.75	INFER	200	110	—
IN-26	2.25	INGOT	200	110	—
IN-44	6.50	INERT	400	220	J

Packed one in a box. Standard Package—10 Boxes  
For dimensions of cans I and J, see page 16.

ELIMINATE  
NOISY  
RECEPTION

### ELIMINATION OF "MAN-MADE STATIC"

**A**EROVOX Interference Filters are made in four types. They are designed to meet the requirements of most installations for the elimination of radio interference. They may be installed between apparatus which causes interference and the line, to prevent interference from being transmitted over the line, or they may be installed between the line and a radio receiver to prevent interference in the line from affecting the operation of the receiver.

Interference which comes in over the antenna and ground system cannot be eliminated by using any type of filter arrangement. Interference caused by electrical appliances, however, must be eliminated at its source by connecting an AeroVox Interference Filter between the source of the interference and the line.

Where the interference is very bad, as is the case with heavy-duty machinery, the use of the Type IN-24 for A.C. lines not exceeding 110 volts and D.C. lines not exceeding 200 volts and the Type IN-44 for A.C. lines not exceeding 220 volts and D.C. lines not exceeding 400 volts, are recommended.

Connections are made by connecting the binding post of the

interference filter to the frame of the machine which is causing the interference and plugging the interference filter between the line and the machine.

For lighter duty units such as small electric fans, motors and other interference creating devices, used on A.C. lines not exceeding 110 volts or on D.C. lines not exceeding 200 volts, the Types IN-25 and IN-26 Interference Filters will be ample.

The scheme of connections used with these units is the same as that used with the Types IN-24 and IN-44 units but due to their smaller size and lower cost they are much more convenient to use for lighter duty work.

The Type IN-25 Interference Filter can be installed at any wall outlet, the screw which mounts it on the wall plate serving as the ground connection to the grounded conduit box. It is recommended for use with stationary equipment such as fans, radio receivers etc. which do not require long extension leads.

The Type IN-26 Interference Filter is designed for insertion in extension leads. It is ideally suited for portable equipment requiring long extension leads such as vacuum cleaners, etc.

Stopping the interference at

its source prevents the line from acting as a transmitting antenna and ground system.

When the interference is coming in over the line to which a receiver is connected, and not over the antenna and ground system, it can be eliminated by connecting an AeroVox Interference Filter between the receiver and the line and grounding the binding post terminal of the filter to a good ground (preferably a ground other than that used as a ground for the receiver). When a wall outlet is used with the receiver, a Type IN-25 unit will be found convenient. When a lighting socket is used, the Type IN-26 used in connection with a standard plug will prove very satisfactory.

Since the AeroVox Interference Filters are pure capacity filters, there is no danger of burnouts, no matter how much current is drawn by the devices with which they are connected.

It is suggested that wherever possible, the units be disconnected from the line when not in use. The energy consumed by the connection of these units across a line is negligible being of the order of two cents or less per month even when connected continuously across the line.

INTERFERENCE FILTERS ELIMINATE "MAN MADE" STATIC



**PYROHM HEAVY DUTY  
VITREOUS ENAMEL RESISTORS**

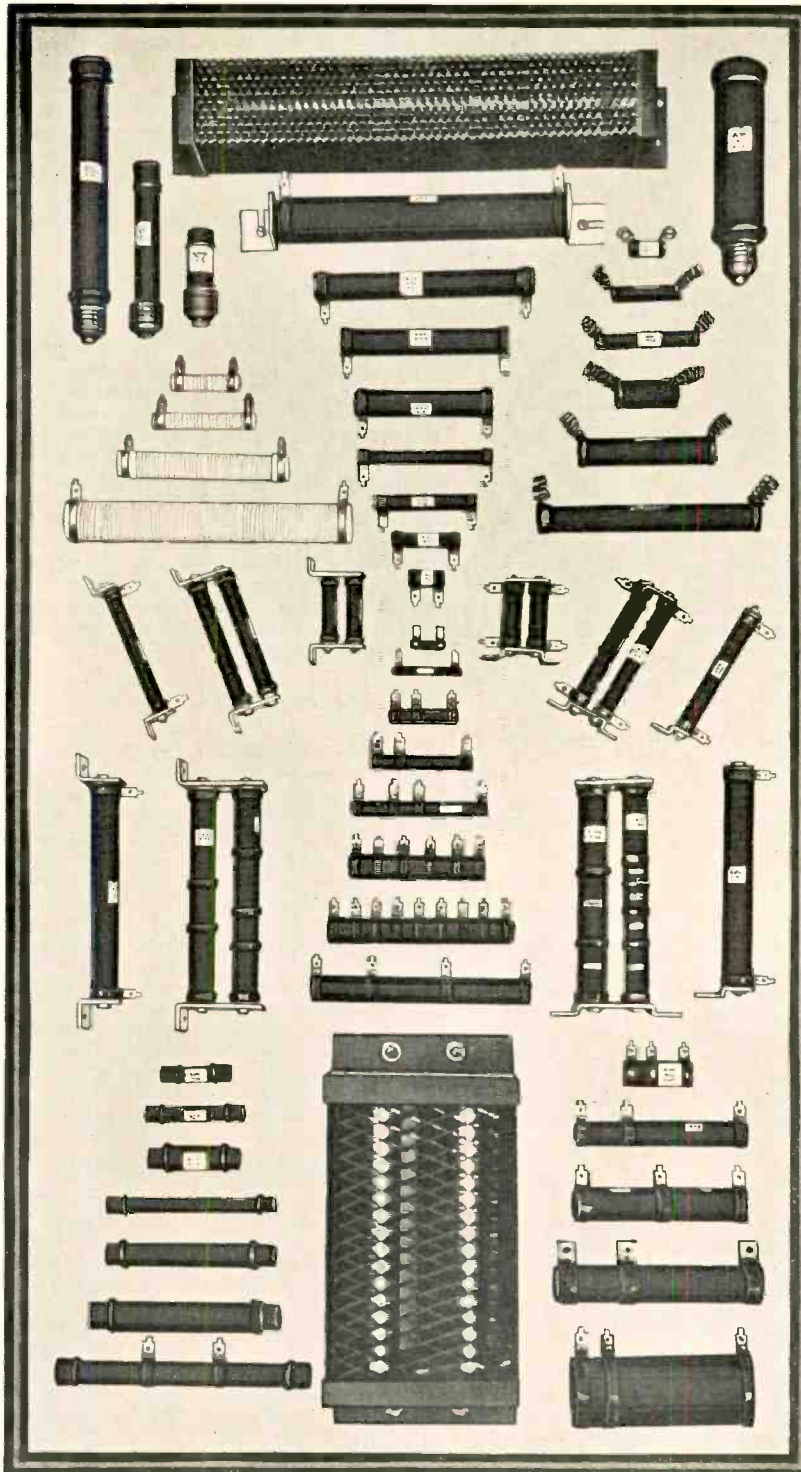

Representative Types of Aerovox Resistors

The above assembly shows various types of Aerovox Pyrohm resistors provided with different style terminals and mountings. These units are designed in all resistance values and current ratings for practically every radio, electrical and industrial use.

**AEROVOX** Pyrohm Resistances are made of the best grade of resistance wire, wound on a refractory tube and coated with a porcelain enamel which is fired on and thoroughly covers and protects the wire against moisture, oxidation and mechanical injury.

Pyrohm Resistors can be used under heavy loads without injury to the wire windings as the coefficients of expansion of the wire, tube and enamel are practically the same.

One of the most important features of Aerovox Pyrohm Resistors is the method used to obtain positive contact between the ends of the wire of the resistance element and the terminals of the units.

In the Aerovox Pyrohm resistors, a few turns of the end of the resistance wire are wound around a lip raised from the terminal as shown in the cutout view herewith.



While other resistor manufacturers merely coat this junction with a cement which protects the joint from the entry of enamel when the unit is fired, Aerovox goes one important step forward by using a special silver soldering process which joins the resistance wire and terminal electrically, and effectively prevents the entry of the enamel or the formation of any oxide films which would tend to reduce the electrical efficiency of the joint.

**PROTECTIVE CAGE  
PYROHMS**



**AEROVOX** Protective Cage Pyrohms are ideally suited for use wherever protection against mechanical injury must be afforded to Pyrohm resistors without interfering with necessary ventilation. The cages serve the double purpose of protection and mounting. They can be made for any size Pyrohm and can be designed to mount a single resistor or a group of resistors. Quotations will be furnished gladly on receipt of specifications or a statement of the requirements.

**THERE IS A PYROHM RESISTOR FOR EVERY REQUIREMENT**



## IMPORTANT INFORMATION ON PYROHM RESISTORS

### Resistance Values

In ordering a resistor of a given resistance value, it is advisable to give the load and ventilation conditions under which the resistor is to be used. No matter what type of resistor is used, a slight variation in the measured resistance value is possible between the cold and hot resistance value if the current flowing through the resistance is sufficient to raise it to a comparatively high temperature.

To be sure of efficient operation, a resistor should be selected which has the required resistance value under actual operating conditions.

In ordering tapped resistors, the resistance of each section should be indicated clearly.

### Accuracy Required

Pyrohm resistors are made regularly to a tolerance of 10% plus or minus, but can be made to closer tolerances on special order, at somewhat higher prices. Unless otherwise specified the standard tolerance of 10% will be used.

### Production Testing

While it is desirable to test resistors with operating current flowing through them, the difficulties in the way of time required to bring them up to temperature make it advisable to test them cold in production or acceptance testing. In such cases however, allowance should be made for the slight difference in resistance of a unit when tested cold and when tested with operating current flowing through it.

### Standard Tubes and Terminals

Unless otherwise specified, our standard tubes and terminals, listed in this catalogue, will be furnished. Special tubes and terminals can be furnished to manufacturers' specifications.

### Type of Service

For industrial uses the time cycle of service or average conditions of continuous or intermittent service should be given.

### Watts Dissipation

To enable us to determine correctly the size of wire and tube required to provide the necessary watts dissipation without excessive heating, it is necessary to indicate the total current in amperes or milliamperes flowing through each section.

### Load Limitations

The maximum loads which may be applied safely to these resistors, as well as to any similar resistor, as long as the maximum rating is not exceeded, is governed by the use to which the resistor is put and by the heat tolerances of apparatus placed in close proximity to the resistor.

## NOTE

Much delay, confusion and expense will be avoided and the efficiency of the units in operation will be improved if complete information regarding the characteristics desired in the finished unit are given.

In ordering resistors for any given application, it is well to keep in mind the facts mentioned on this page regarding the characteristics of vitreous enamel resistors under different operating conditions.

### Heat Dissipation

Aerovox Pyrohm Vitreous Enamel Resistors are made by winding a special high grade resistance wire of low resistance temperature co-efficient on a porcelain tube. The entire unit is completely coated with a liquid enamel and then fired to a red heat. The result is a resistor unit with a glassy enamel coating which is fused tightly to the wire, terminals and tube.

The vitreous enamel coating is especially designed for its heat conducting qualities. This construction greatly increases the watt capacity of the resistor due to its heat dissipating characteristics.

### Application of Resistor

A circuit diagram, showing the application of the resistor, with constants of the circuit elements, especially as regards voltages and currents, is desirable, since the more information is given regarding the manner in which the resistor is used, the better position we are in to recommend the best resistor for the purpose.

### Method of Rating

The standard method of arriving at the maximum rating of resistors of the Pyrohm vitreous enamel type, is the input in watts required to produce a temperature rise of 250 degrees Centigrade (482 degrees Fahrenheit) at the hottest point of the resistor, when the resistor is surrounded by at least one foot of free air, the surrounding air being at a temperature not exceeding 40 degrees C. (104 degrees F.).

This is a standard of the N. E. M. A. and the R. M. A.

The maximum rating in watts and the maximum current carrying capacity of the Pyrohm resistors listed in this catalogue is based on the above standard, although these resistors will carry heavier loads safely, with corresponding increase in temperature.

### Ventilation Conditions

A drawing or plan showing the location of the resistor in reference to other parts is desirable. Under conditions of good ventilation a resistance of lower watt rating and lower price may be suitable. Under poor conditions of ventilation or when the resistor is close to parts which may be adversely affected by heat, a unit of higher watt rating must be recommended for safety.

### Effect of Ventilation on Rating

When used in poorly ventilated places, or close to other pieces of apparatus, such as condensers, which might be damaged by excessive heat, it is necessary to reduce the rating of the resistor. It is difficult to tell to just what extent poor ventilation or close proximity of other apparatus, which limits circulation of air, will increase the temperature of the resistor with any given current flowing through it. However, in the current capacity ratings given with the various units, three different ratings are given with each resistor and will serve as a guide in using them.

### Maximum, Normal and Cool Ratings

The "Maximum" watt rating or "Maximum" current capacity rating is based on the input which will cause a temperature rise of 250 degrees C. (482 degrees F.) at the hottest point of the unit when suspended in at least one foot of free air. The "Normal" watt rating or "Normal" current capacity rating is based on the input which will cause a temperature rise of approximately 175 degrees C. (347 degrees F.) under the same conditions of ventilation. The "Cool" watt rating or "Cool" current capacity rating is based on the input which will cause a temperature rise of approximately 100 degrees C. (212 degrees F.) under the same conditions of ventilation.

### Recommendations on Use

A safe rule to follow in using resistors of this type is to use them at the "Cool" rating. This rating is 50% of the maximum current capacity rating and 25% of the maximum watt rating. Such use makes plenty of allowance for poor ventilating conditions such as are found in the usual installation.

Where there is no danger of damage to other parts from the heat developed by the resistors, or where the ventilation is very good, it is permissible to use them at the higher "Normal" and even "Maximum" ratings.

### Consulting Service

Aerovox Resistor Specialists will be glad to give resistor users the benefit of their wide experience in the resistor field, in the solution of resistor problems or in the selection of the proper resistor for any given purpose.

**PYROHM RESISTORS ARE CONSERVATIVELY RATED FOR SAFETY**





## CHARACTERISTICS AND PRICES OF PYROHM RESISTORS



Pyrohms with Wire Leads



Type 992



Tapped Pyrohms

AEROVOX Pyrohm Standard single section and tapped resistors are furnished regularly with the standard terminals

shown directly above and at the right. On quantity orders they can also be furnished with wire leads, as shown above at the left,

with ferrule terminals as described on page 34, or with any special terminals in accordance with specifications.

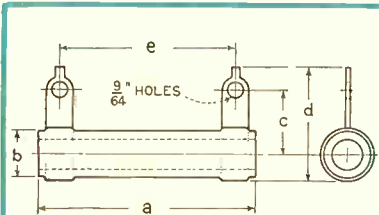

Dimensions of Types 991, 992, 993, 994, 996-4, 996-5, 996 and 998 Pyrohm Resistors.

Type No.	Rating in watts			Limits in ohms		Dia. of Tube	Finished Dimensions				
	Max.	Normal	Cool	Min.	Max.		a	b	c	d	e
991	7.0	3.5	1.75	.1	1,000	1/16"	1"	1/2"	9/16"	1 1/8"	5/8"
992	15.0	7.5	3.75	.1	5,000	1/16"	2"	1/2"	9/16"	1 3/8"	1 5/8"
993	24.0	12.0	6.0	.1	8,000	1/16"	3"	1/2"	9/16"	1 3/8"	2 3/8"
994	32.0	16.0	8.0	.2	12,000	1/16"	4"	1/2"	9/16"	1 3/8"	3 5/8"
996-4	60.0	30.0	15.0	.2	17,500	3/4"	4"	1 3/16"	3/4"	1 1/2"	3 5/8"
996-5	75.0	37.5	18.75	.25	25,000	3/4"	5"	1 3/16"	3/4"	1 1/2"	4 5/8"
996	100.0	50.0	25.0	.3	35,000	3/4"	6 1/2"	1 3/16"	3/4"	1 1/2"	6 3/8"
998	200.0	100.0	50.0	.3	60,000	1 1/8"	8 1/2"	1 3/16"	1"	1 13/16"	8 3/8"

Dimensions given in the above table are approximate. Any resistance value within the limits given can be furnished to manufacturers only on special order.

The maximum resistance limit given for each type is the highest resistance which is it possible to furnish in that type, without taps, using resistance wire not smaller than .002" in diameter. Higher resistance values can be obtained by using finer wire. While we do not recommend the use of wire finer than .002", we can fill manufacturers' specifications requiring the use of wire as fine as .00175", where space considerations make this necessary.

The use of taps on these units will reduce the available winding space for the resistance element and consequently the maximum total resistance it is possible to furnish in each type. Type 991 cannot be furnished with taps. On Types 992, 993 and 994; deduct 2,200 ohms from the maximum limit for each tap. On Types 996-4, 996-5 and 996, deduct 3,400 ohms from the maximum limit for each tap. On Type 998 deduct 4,500 ohms from the maximum limit for each tap. The maximum limit, less deductions for taps gives the maximum total resistance which can be obtained on a given type of tube using wire not finer than .002".

TYPE 991			Rating in Watts		
			Max.	Normal	Cool
			7	3.5	1.75
Resist. Ohms	List Price	Code Word	Current Cap. in ma.		
			Max.	Normal	Cool
10	\$.65*	ACME	837	591	418
20	.65*	ACUTE	591	418	295
25	.65*	ABAF	529	374	264
50	.65*	ABASE	374	264	187
75	.65*	ABASH	305	216	152
100	.65*	ABATE	264	187	132
150	.65*	ABBEY	216	152	108
200	.65*	ABBOT	187	132	93
250	.75*	ABHOR	167	118	83
300	.75*	ABIDE	152	108	76
400	.75*	ABODE	132	93	66
500	.75*	ABUSE	118	83	59
750	.75*	ABYSS	96	68	48
1,000	.75*	ACRID	83	59	41

\*Asterisk used with prices of items listed indicates units made regularly for manufacturers and usually available from stock.

### TYPE 992

Resist. Ohms	List Price	Code Word	Rating in Watts		
			Max.	Normal	Cool
			15	7.5	3.75
3	\$.75*	ADULT	2,236	1,581	1,118
4	.75*	AEGIS	1,936	1,369	968
5	.75*	AGAVE	1,732	1,225	866
50	.75*	AMEND	548	387	274
75	.75*	ACTOR	447	316	223
100	.75	ADAGE	387	274	193
150	.75	ADAPT	316	223	158
200	.75	ADDER	274	193	137
250	.80	ADDLE	245	173	122
300	.80	ADEPT	223	158	111
350	.80	ADIEU	207	146	103
400	.80	ADOBE	193	137	96
500	.80	ADOPT	173	122	86
650	.80	ANISE	152	107	74
700	.80	AFFIX	146	103	73
750	.80	AFOUL	141	100	70
800	.80	AGAPE	137	96	68
1,000	.80	AGENT	122	86	61
1,100	.80	ANKER	116	82	58
1,200	.80	AGILE	112	78	56
1,250	.80	AORTA	109	77	54
1,500	.80	AGONY	100	70	50
1,750	.80	AISLE	92	65	46
1,800	.80	APPLY	91	64	45
2,000	.80	ALARM	86	61	43
2,250	.90	ALDER	81	57	40
2,400	.90	ALERT	78	56	39
2,500	.90	ALIAS	77	54	38
2,750	.90	ARGIL	73	52	36
3,000	.90	ALIBI	71	50	35
3,250	.90	ARIES	70	50	35
3,500	.90	ALIEN	65	46	27
3,750	.90	ARRET	63	45	31
4,000	.90	ALIGN	61	43	30
4,500	.90	ALIKE	57	40	28
5,000	.90	ALLAY	54	38	27

Items not marked with asterisk are stock sizes. All units packed one in a box. Standard Package—10 Boxes.

With reference to Maximum, Normal and Cool Current Ratings, see page 30.

SPECIAL RESISTORS CAN BE FURNISHED ON SHORT NOTICE



## CHARACTERISTICS AND PRICES OF PYROHM RESISTORS

TYPE 993 For Manufacturers Only			Rating in Watts		
Resist. Ohms	List Price	Code Word	Max.	Normal	Cool
			24	12	6
			Current Cap. in ma.		
			Max.	Normal	Cool
100	\$.90*	ASSET	490	346	245
600	.90*	AMASS	200	141	100
1,000	.90*	AMITY	155	110	78
2,000	.90*	AMUCK	110	78	55
2,500	.95*	ANNEX	98	69	49
3,000	.95*	ANNUL	89	63	44
3,500	.95*	ANODE	82	58	41
4,500	1.00*	ANTIC	78	55	39
5,000	1.00*	ANVIL	69	49	34
8,000	1.00*	APART	55	39	27

TYPE 994			Rating in Watts		
Resist. Ohms	List Price	Code Word	Max.	Normal	Cool
			32	16	8
			Current Cap. in ma.		
			Max.	Normal	Cool
10	\$.90*	ARGUE	1,789	1,264	894
20	.95*	ARGUS	1,264	894	632
100	.95*	AROMA	566	400	283
250	.95*	ARROW	357	253	179
500	.95*	ARRAS	253	179	126
700	.95*	ARRAY	214	151	107
750	.95*	ARSON	207	146	103
1,000	.95	ASSAY	179	126	89
1,500	.95	ASTER	146	103	73
2,000	.95	ATOLL	126	89	63
2,500	1.00	ATTAR	112	79	56
3,000	1.00	ATTIC	103	73	51
4,000	1.00	AUGHT	89	63	49
5,000	1.00	AVERT	79	56	39
6,000	1.10	AWAIT	73	51	36
8,000	1.10	AWARD	63	49	31
10,000	1.10	AWARE	56	39	28
12,000	1.10	AXIOM	51	36	25

TYPE 996-4			Rating in Watts		
Resist. Ohms	List Price	Code Word	Max.	Normal	Cool
			60	30	15
			Current Cap. in ma.		
			Max.	Normal	Cool
100	\$1.25*	BACON	775	548	387
500	1.25*	BARON	346	245	173
700	1.25*	BASIL	293	207	146
1,000	1.25*	BASTE	245	173	122
1,500	1.25*	BATCH	200	141	100
2,000	1.25*	BATHE	173	122	86
2,500	1.25*	BAYOU	155	109	77
4,500	1.25*	BAIRN	115	81	57
10,000	1.50*	BELCH	77	55	38
17,500	1.50*	BERRY	58	41	29

TYPE 996-5			Rating in Watts		
Resist. Ohms	List Price	Code Word	Max.	Normal	Cool
			75.0	37.5	18.7
			Current Cap. in ma.		
			Max.	Normal	Cool
100	\$1.40*	BAIZE	866	616	433
500	1.40*	BANNS	387	274	193
1,000	1.40*	BASAL	274	193	137
1,500	1.40*	BEAMY	224	158	112
2,000	1.40*	BEAST	193	137	96
5,000	1.40*	BEDEW	122	86	61
10,000	1.50*	BEDIM	86	61	43
20,000	1.75*	BYLAW	61	43	30
25,000	1.75*	BEDYE	54	38	27

TYPE 996			Rating in Watts		
Resist. Ohms	List Price	Code Word	Max.	Normal	Cool
			100	50	25
			Current Cap. in ma.		
			Max.	Normal	Cool
50	\$1.50	BEGUM	1,414	1,000	707
100	1.50*	BELIE	1,000	707	500
150	1.50	BELOW	812	574	406
250	1.50	BENET	632	447	316
500	1.50	BILGE	447	316	223
750	1.50	BILLY	365	258	182
1,000	1.50	BIPED	316	223	158
1,200	1.50	BERYL	289	204	144
1,500	1.50	BISON	258	182	129
2,000	1.50	BLADE	223	158	111
2,500	1.50	BLAME	200	141	100
3,000	1.50	BLANK	182	129	91
3,500	1.50	BLARE	169	119	84
4,000	1.50	BLAST	158	111	79
5,000	1.50	BLAZE	141	100	70
6,000	1.60*	BLEAK	129	91	64
7,500	1.60*	BLEAR	115	81	57
8,000	1.60*	BLEED	111	79	55
10,000	1.60*	BLEND	100	70	50
12,000	1.60*	BLESS	91	64	45
15,000	1.60*	BLIND	81	57	40
20,000	1.85	ENDOW	70	50	35
25,000	1.85	BLOCK	63	44	31
30,000	1.85	BLOOM	57	40	28
35,000	1.85	BLUFF	53	37	26

TYPE 998			Rating in Watts		
Resist. Ohms	List Price	Code Word	Max.	Normal	Cool
			200	100	50
			Current Cap. in ma.		
			Max.	Normal	Cool
10	\$2.00*	BIFED	4,472	3,162	2,236
50	2.00*	BIGHT	2,000	1,414	1,000
100	2.00*	BLAND	1,414	1,000	707
250	2.00*	BLOAT	894	632	447
500	2.00*	BLOOD	632	447	316
1,000	2.00*	BOGUS	447	316	223
2,500	2.00*	BOLUS	283	200	141
5,000	2.25*	BOOSE	200	141	100
10,000	2.25*	BOOZE	141	100	71
20,000	2.25*	ENDUE	100	71	50
25,000	2.25*	BOSKY	89	63	44
50,000	2.25*	BOURN	63	44	31
60,000	2.25*	BRAID	57	40	28

\* Asterisk used with prices of items listed indicates units made regularly for manufacturers and usually available from stock.

Items not marked with asterisk are stock sizes. All units packed one in a box. Standard Package—10 Boxes.

With reference to Maximum, Normal and Cool Current Ratings, see page 30.

PYROHM RESISTANCE VALUES STAY CONSTANT IN SERVICE





## EDISON BASE PYROHM RESISTORS



Types 997 and 999



Type 999-A

**T**HE Types 997, 999-A and 999 Edison Base Pyrohm Resistors are ideal for use wherever high-grade interchangeable resistors of fairly high current carrying capacity are required.

The use of the Edison Base mounting permits easy insertion into or removal from a circuit for quick changes of resistances to compensate for different conditions of line voltage or load.

The Edison Base is standard in size and will fit any standard screw type receptacle, lamp socket or series tap.

The various stock values are suitable for use in cutting down excessive line voltages for operating a receiver at its rated voltage, as regulating resistors in battery charging, as elements in the resistance banks of D.C. battery eliminators operating from standard D.C. and farm lighting lines, as units in testing load resistance banks for laboratory and experimental work or for any other purpose where a resistor with this type of mounting is required to effect quick changes of resistance values or current carrying capacity.

Resistance values and current carrying capacities other than those listed may be obtained by series and parallel connections of the units in suitable resistance banks.

A simple scheme of connections for a resistance bank or mixing panel which permits a wide variety of series and parallel combinations of such units is shown at the right. Individual sockets can be used for mounting the Edison Base resistors although more compact assembly is possible by using cluster receptacles for the parallel units. Additional units can be added if required. Switches across each parallel group short out the sections when not required in the system.

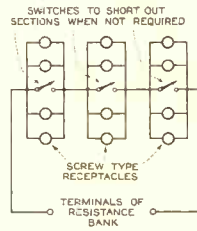

Dimensions of Type 997 Edison Base Pyrohm Resistors



Dimensions of Type 999-A Edison Base Pyrohm Resistors

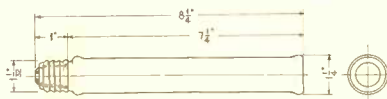

Dimensions of Type 999 Edison Base Pyrohm Resistors

TYPE 997			Rating in Watts		
Can be made in resistance values of from .5 ohms to 20,000 ohms.			Max.	Normal	Cool
Resist. Ohms	List Price	Code Word	Current Cap. in ma.		
			Max.	Normal	Cool
3	\$1.50	BORAX	4,472	3,162	2,236
4	1.50	BOSSY	3,873	2,739	1,936
5	1.50	BOTCH	3,464	2,449	1,732
6	1.50	BOUGH	3,162	2,236	1,581
7	1.50	BOUND	2,927	2,069	1,463
10	1.50	BOWER	2,449	1,732	1,224
15	1.50	BOXER	2,000	1,414	1,000
20	1.50	BRACE	1,732	1,224	866
25	1.50	BRAIN	1,549	1,095	774
30	1.50	BRAKE	1,414	1,000	707
50	1.50	BRASS	1,095	774	547
60	1.50	BRUNT	1,000	707	500
75	1.50	BRUSH	894	632	447
90	1.50	BRUSK	812	574	406
110	1.50	BRUTE	737	521	368
220	1.50	BUDDY	521	368	260
250	1.50	BRUIN	490	346	245
330	1.50	BUDGE	426	301	213
350	1.50	BRAZE	413	292	206
440	1.50	BUFFO	368	260	184
600	1.50	BUGLE	316	223	158
1,000	1.50	BREAK	245	173	122

TYPE 999-A			Rating in Watts		
Can be made in resistance values of from 1.25 ohms to 45,000 ohms.			Max.	Normal	Cool
Resist. Ohms	List Price	Code Word	Current Cap. in ma.		
			Max.	Normal	Cool
62	\$2.75	BROOD	1,391	974	695
75	2.75	BRUIT	1,264	894	632
90	2.75	BUSHY	1,148	812	574
110	2.75	BUTTE	1,042	737	521
220	2.75	BUXOM	737	521	368
330	2.75	BYWAY	602	426	301

TYPE 999			Rating in Watts		
Can be made in resistance values of from 1.5 ohms to 60,000 ohms.			Max.	Normal	Cool
Resist. Ohms	List Price	Code Word	Current Cap. in ma.		
			Max.	Normal	Cool
62	\$2.75	BUILD	1,560	1,102	780
75	2.75	BULKY	1,414	1,000	707
90	2.75	BUNCH	1,290	913	645
110	2.75	BURGH	1,167	825	583
220	2.75	BURIN	825	583	412
330	2.75	BURLY	693	490	346

All units packed one in a box. Standard Package—10 boxes.

For manufacturers only, Pyrohm resistors can be furnished in any resistance values, within the limits specified, on special order.

All above units are made regularly for manufacturers and are usually available from stock.

With reference to maximum, normal and cool current ratings, see page 30.

EDISON BASE PYROHMS ARE IDEAL FOR RESISTANCE BANKS



## FERRULE TYPE PYROHM RESISTORS

For Manufacturers Only



**A**EROVOX Ferrule Type Pyrohm Resistors are ideal for use in experimental layouts, telephone, telegraph, switchboard, signal work or any other application where quick changes of resistance values or replacements are required.

These units are made in exactly the same manner and have the same mechanical and electrical characteristics as the Pyrohm units described in the preceding pages. Instead of being supplied with the usual soldering terminals however, the resistor unit proper is made with wire leads and assembled between two brass ferrules as shown in the illustrations above.

The ferrules are standard in size to fit the standard fuse clips available from all electrical supply houses. The dimensions and distances between

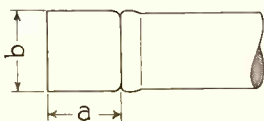

Types A, B and C  
Ferrules

### DIMENSIONS OF FERRULES

Ferrule	a	b
Type A	1/2"	9/16"
Type B	1/2"	11/16"
Type C	1/2"	13/16"

ferrules of all resistors in each watt rating group is the same to provide interchangeable features.

In ordering ferrule type Pyrohms it is important to give both the resistor type which forms the foundation unit of the assembly and also the type of ferrules required, by adding the code letter of the ferrule to the Type Number of the resistor. Thus a Type 946 Resistor with 11/16" (Type B) Ferrules would be specified as a Type 946-B Ferrule Type Pyrohm Resistor. Special size ferrules can be supplied on special quantity orders.

In specifying ferrule type resistors, the points mentioned on page 30 should be taken into consideration.

Ferrule Type Pyrohm Resistors are supplied only to manufacturers. Prices will be quoted gladly on receipt of specifications.

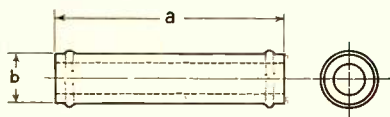

Dimensions of Resistor Section  
Types 941, 942, 943, 944, 946-4, 946-5,  
946 and 948

Dimensions of ferrules should be added for overall dimensions of Ferrule Resistors.

Type No.	Rating in watts			Limits in ohms		Dia. of Tube	Finished Dim.	
	Max.	Normal	Cool	Min.	Max.		a	b
941	7.0	3.5	1.75	.1	1,000	1/16"	1"	1/2"
942	15.0	7.5	3.75	.1	5,000	1/16"	2"	1/2"
943	24.0	12.0	6.0	.1	8,000	1/16"	3"	1/2"
944	32.0	16.0	8.0	.2	12,000	1/16"	4"	1/2"
946-4	60.0	30.0	15.0	.2	17,500	3/4"	4"	13/16"
946-5	75.0	37.5	18.75	.25	25,000	3/4"	5"	13/16"
946	100.0	50.0	25.0	.3	35,000	3/4"	6 1/2"	13/16"
948	200.0	100.0	50.0	.3	60,000	1 1/8"	8 1/2"	13/16"

Dimensions given in the above table are approximate. Any resistance value within the Minimum and Maximum values given under the heading "Limits in Ohms" can be furnished to manufacturers.

The maximum resistance limit given for each type is the highest resistance which it is possible to furnish in that

type, using resistance wire not smaller than .002" in diameter. Higher resistance values can be obtained by using finer wire. While we do not recommend the use of wire finer than .002", we can fill manufacturers' specifications requiring the use of wire as fine as .00175", where space considerations make this necessary.

Types 941, 942, 943 and 944 units can be supplied regularly only with Type A ferrules. The other units can be supplied with any of the three ferrule types listed on this page. On special orders, any type or size of ferrule can be furnished to meet manufacturers' specifications.

## BRACKET MOUNTED PYROHM RESISTORS

For Manufacturers Only

Bracket Mounted Pyrohm Resistor units as illustrated in the accompanying photo are adapted for use in railway signal, telephone, telegraph systems, and many other applications where interchangeable resistance values are required.

These units employ standard Pyrohm resistor elements at each end of which a mounting bracket is firmly fitted. The wire leads of the resistor are soldered to the brackets which serve both as terminals and means of mounting the units on binding post terminal blocks.

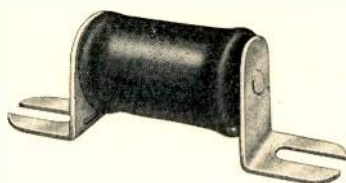

Resistors of various diameters can also be supplied to manufacturers' specifications. Prices will be quoted gladly on request.

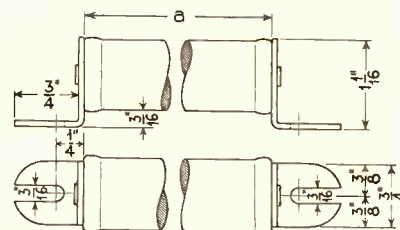

Dimensions of Bracket Mounted Pyrohm Resistors. Dimension "a" varies with the length of the resistor unit.

FERRULE RESISTORS PROVIDE INTERCHANGABLE FEATURES



## PYROHM VOLTAGE DIVIDER TAPPED RESISTORS

FOR STANDARD POWER UNITS



Type CC



Type 996-171



Type 996-245

**A**EROVOX Tapped Pyrohm Voltage Divider Resistors are made to meet the require-

ments of practically all the popular receiver and power pack circuits, and give the user a substantial saving in price, labor and space.

individual Pyrohm Resistors in the various sections to get the exact values.

TYPE CC				
List Price—\$5.50 Code Word—SKATE Total Resistance—41,000 ohms				
Section Taps	Resist. Ohms	Current Cap. in ma.		
		Max.	Normal	Cool
Resistor No. 1				
1 to 2	6,000	63	44	31
2 to 3	2,700	63	44	31
3 to 4	2,300	63	44	31
4 to 5	2,000	63	44	31
5 to 6	8,000	63	44	31
Resistor No. 2				
7 to 8	5,000	75	52	37
8 to 9	7,000	75	52	37
9 to 10	8,000	75	52	37

This voltage divider is designed for use in power supply units for operation with receivers and amplifiers employing one or two 310 or 350 tubes in the power stage. It consists of two Type 996 Tapped Pyrohm Resistors, with a Type VV-2 double vertical mounting. It can be had with Type HH-2 horizontal mounting on request.

In use, Tap No. 6 of Resistor No. 1 is connected with Tap No. 7 of Resistor No. 2, thus connecting the two units in series. Tap No. 1 is connected to "B—" and Tap No. 10 is connected to "B+ Max."

The taps to use for various voltages depends on the tubes used in the receiver and amplifier. The proper taps to use can be found by calculation or by trial.

When the resistance values required by special circuits cannot be obtained with these units, the special voltage dividers required can be provided by using

TYPE 996-171				
List Price—\$2.10 Code Word—SIGHT Total Resistance—13,000 ohms				
Section Taps	Resist. Ohms	Current Cap. in ma.		
		Max.	Normal	Cool
1 to 2	2,000	70	49	35
2 to 3	3,000	70	49	35
3 to 4	3,000	70	49	35
4 to 5	3,000	70	49	35
5 to 6	2,000	70	49	35

This voltage divider is designed for use in power supply units for operation with receivers and amplifiers employing one or two 371-A power tubes in the power stage. It consists of a Type 996-5 Tapped Pyrohm Resistor. No mounting is furnished with this resistor but Type VV-1 vertical mounting or Type HH-1 horizontal mounting are available as separate units.

In use, Tap No. 1 is connected to "B—", Tap No. 6 to "B+ Max."

The taps to use for various voltages depends on the tubes used in the receiver. The proper taps may be found by calculation or by trial.

TYPE 996-245				
List Price—\$4.75 Code Word—SKEIN Total Resistance—11,325 ohms				
Section Taps	Resist. Ohms	Current Cap. in ma.		
		Max.	Normal	Cool
Resistor No. 1				
1 to 2	2,000	150	105	75
2 to 3	1,350	150	105	75
3 to 4	200	249	174	124
4 to 5	775	150	105	75
Resistor No. 2				
6 to 7	1,000	90	63	45
7 to 8	800	150	105	75
8 to 9	700	150	105	75
9 to 10	3,000	90	63	45
10 to 11	750	150	105	75
11 to 12	750	150	105	75

This voltage divider is designed for use in power supply units for operation with receivers and amplifiers employing one or two 345 power tubes in the power stage. It consists of two Type 996 Tapped Pyrohm Resistors, with a Type VV-2 vertical double mounting. It can be had with Type HH-2 horizontal mounting on request.

In use, Tap No. 1 is connected to "B—" and Tap No. 12 to "B+ Max." Tap No. 5 of Resistor No. 1 is connected with Tap No. 6 of Resistor No. 2 to connect the two units in series.

The taps to use for various voltages depends on the tubes used in the receiver and amplifier. The proper taps may be found by calculation or by trial.

## ADJUSTABLE PYROHM RESISTORS

TYPE UR-10				
List Price—\$1.50 Code Word—SHADE Total Resistance—750 ohms Wound on a Type 994 Tube Possible Resistance Values 50, 100, 150, 200, 250, 300, 350, 400, 450, 500, 550, 600, 650, 600 and 750 ohms.				
Section Taps	Resist. Ohms	Current Cap. in ma.		
		Max.	Normal	Cool
1 to 2	50	249	174	124
2 to 3	100	249	174	124
3 to 4	200	127	89	63
4 to 5	400	127	89	63



**A**NY resistance value within the maximum of each resistor can be obtained by connecting the various sections in series and shunting out the undesired sections. They are ideal for experimental use as grid bias resistors and for voltage divider sections

TYPE UR-13				
List Price—\$1.50 Code Word—SKIMP Total Resistance—2,250 Wound on a Type 994 Tube Possible Resistance Value 150, 300, 450, 600, 750, 900, 1,050, 1,200, 1,350, 1,500, 1,650, 1,800, 1,950, 2,100 and 2,250 ohms.				
Section Taps	Resist. Ohms	Current Cap. in ma.		
		Max.	Normal	Cool
1 to 2	150	249	174	124
2 to 3	300	127	89	63
3 to 4	600	90	63	45
4 to 5	1200	90	63	45

## PYROHM RESISTOR MOUNTINGS

**T**HE Pyrohm Resistor Mountings listed on this page are designed to simplify the assembly of resistors.

Each type is available in two sizes, one for mounting small-size Pyrohm resistors such as the Types 991, 992, 993 and 994 resistors and the other for mounting the larger sizes such as the 996-4, 996-5, 996, and 998 resistors.

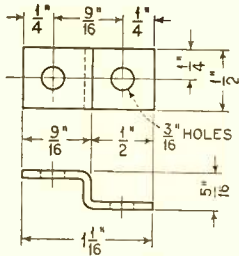

Dimensions of  
Type V-1 Single Mounting

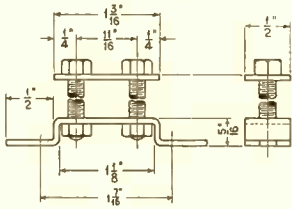
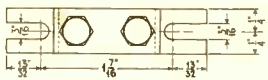

Dimensions of  
Type V-2 Double Mounting

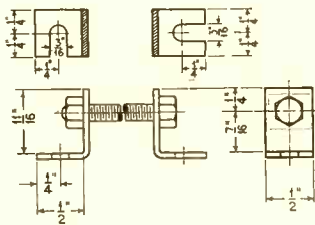

Dimensions of  
Type H-1 Single Mounting

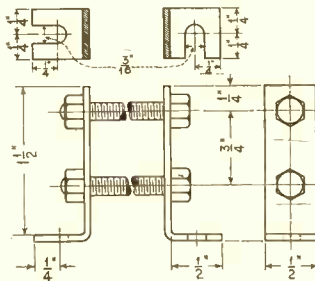

Dimensions of  
Type H-2 Double Mounting

### VERTICAL MOUNTINGS

Type No.	List Price	Code Word
V-1	\$.15	SCORN
V-2	.25	SCOUR
VV-1	.25	SCRAP
VV-2	.35	SCRIP

Packed one in a box.  
Standard Package—10 Boxes.

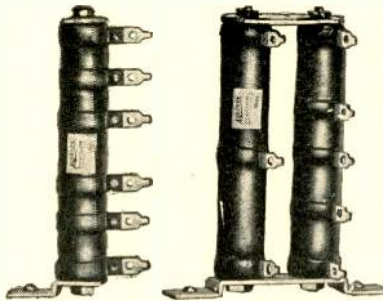

Types  
V-1 and VV-1      Types  
V-2 and VV-2

### For Mounting Pyrohm Resistors

H-1	One 991, 992, 993 or 994
H-2	Two 991, 992, 993 or 994
V-1	One 991, 992, 993 or 994
V-2	Two 991, 992, 993 or 994
HH-1	One 996, 996-4 or 996-5
HHH-1	One 998
HH-2	Two 996, 996-4 or 996-5
VV-1	One 996, 996-4 or 996-5
VV-2	Two 996, 996-4 or 996-5

All units are furnished complete with  
threaded rods, nuts and washers.



Types H-1, HH-1 and HHH-1



Types H-2 and HH-2

### HORIZONTAL MOUNTINGS

Type No.	List Price	Code Word
H-1	\$.15	SCOPE
H-2	.25	SCORE
HH-1	.35	SCOUT
HHH-1	.35	SCHOT
HH-2	.35	SCOWL

Packed one in a box  
Standard Package—10 Boxes

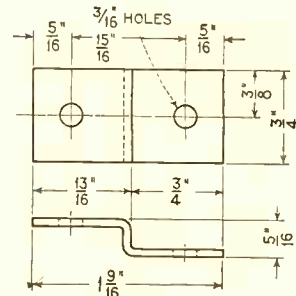

Dimensions of  
Type VV-1 Single Mounting

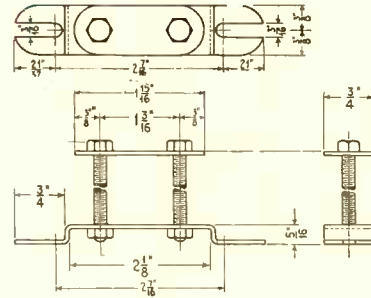

Dimensions of  
Type VV-2 Double Mounting

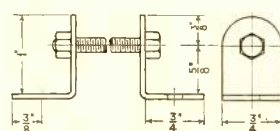

Dimensions of  
Type HH-1 Single Mounting

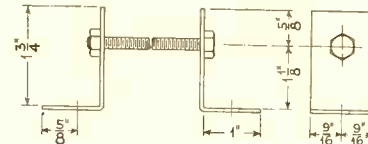
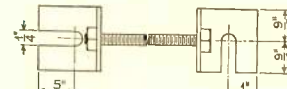

Dimensions of  
Type HHH-1 Single Mounting

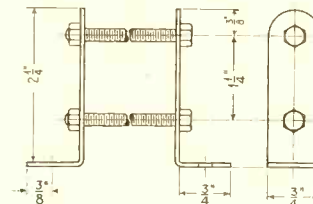

Dimensions of  
Type HH-2 Double Mounting

Special mounting brackets or modifications of the above brackets can be furnished on special order.

**RESISTORS ARE EASILY MOUNTED WITH AEROVOX MOUNTINGS**



## WIRE WOUND RESISTORS



Type 981

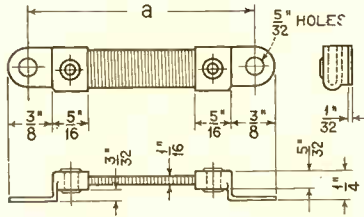

Dimension of Type 981. Dimension "a" varies with resistance and current carrying capacity of element.

### STOCK SIZES

Resist. Ohms	List Price	Max. Current Ma.	Code Word
8	\$.20	200	PANIC
16	.20	200	PYGMY
31	.20	200	PUTTY
66	.20	120	PURSE
100	.20	120	PROVE
250	.20	120	PRUDE
500	.20	85	PULSE
750	.20	85	PUNCH
1000	.20	70	PUNIC
1250	.30	70	PUPIL
1500	.30	70	PUPPY
2000	.30	70	PUISM

Packed one in an envelope. Standard Package—100.

THE Type 981 resistor units are wire wound on flat fibre strips. The extremely low inductance and distributed capacity of these units make them ideally suited for use as grid suppressors.

Terminal connections are firmly made by fastening the terminal lug to the strip with eyelets. They are provided with lugs which serve the double purpose of terminals and mountings.

### CENTER-TAPPED RESISTORS

THE Type 986 resistor units are specially designed for use in A.C. filament circuits. They are available in a wide variety of sizes to suit all conditions of operation with different types of tubes. All terminals are solidly anchored, the units are center-tapped and the terminal lugs are designed to simplify mounting and connections.

#### SPECIAL VALUES

Resistance values other than those listed may be obtained on special order by manufacturers.

#### ACCURACY

Type 981 and 986 resistor units are accurate to within 10% but may be obtained to closer tolerance on special order.

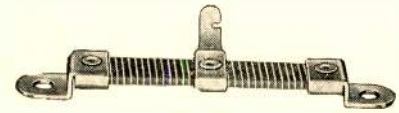

Type 986

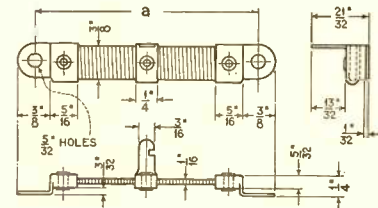

Dimension of Type 986. Dimension "a" varies with resistance and current carrying capacity of element.

### STOCK SIZES

Resist. Ohms	List Price	Max. Current Ma.	Code Word
10	\$0.25	447	RAZOR
20	.25	321	REACH
30	.25	231	REALM
40	.25	231	REBUS
50	.25	196	RECUR
60	.25	196	REDAN
100	.25	101	REFER
200	.25	70	REGAL

Packed one in an envelope. Standard Package—100.

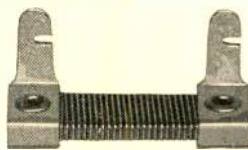

Type 982

For Manufacturers only

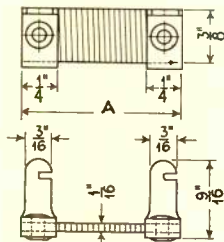

Dimensions of Type 982 resistors for manufacturers only. Dimension "a" varies with the current carrying capacity of the element.

## WIRE WOUND RESISTORS FOR MANUFACTURERS

WIRE wound resistors Types 982 and 987 are especially designed for manufacturers use on special order. These units are easily connected by means of soldering lug terminals which also serve as mounting supports.

Types 982 resistor units differ from the standard Type 981 only in the design of the terminal end piece and are suited for use in small spaces such as in midget radio set assemblies.

Type 987 center-tapped resistors are practically the same as the standard Type 986 units only that soldering lug terminals are so arranged as to permit connections and mounting in more compact assemblies.

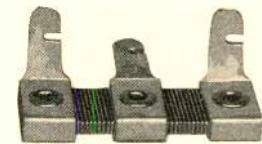

Type 987

For Manufacturers only

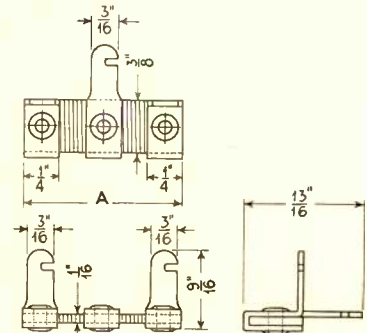

Dimension of Type 987 resistor for manufacturers only. Dimension "a" varies with the current carrying capacity of the element.



## CARBON RESISTORS



Type 1094

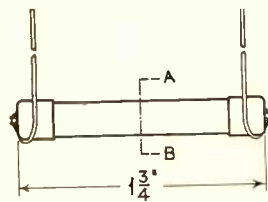

Dimensions of Type 1094

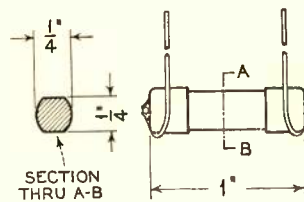

Dimensions of Type 1095



Type 1095

**A**EROVOX solid moulded carbon resistors are designed for fairly heavy loads and have many varied applications, such as, in resistance coupled amplifiers, plate voltage reducers, grid bias circuits, grid suppressors, and ignition suppressors in automotive radios. They are especially adapted for use in circuits where non-inductive resistors of high current carrying capacity are required.

The element, of special composition, is non-hygroscopic, and therefore, unaffected by humidity changes. Its slight positive temperature coefficient is just sufficient to compensate a minute potential coefficient, and also protects the unit against heavy, short period overloads.

These resistors are absolutely noiseless and permanent on and off full load. They are ruggedly constructed and have great mechanical strength. This together with their exceptional electrical properties make them ideal resistors for many uses.

The power rating of these resistors is exceptionally conservative being based on the permanency of the resistor, operating under normal atmospheric conditions at 100 per cent overload; thereby allowing for extremely limited radiating area while operating under full rated load.

Resistance Ohms	Type 1094		Type 1095	
	List Price	Code Word	List Price	Code Word
100	\$.25	ENTRY	\$.25	CLOSE
250	.25	ENVOY	.25	CLOUD
500	.25	EPACT	.25	CLOUT
750	.25	EPHOD	.25	CLOVE
1,000	.25	EPOCH	.25	CLOWN
2,500	.25	EQUIP	.25	CLUCK
5,000	.25	ERASE	.25	CLUMP
7,500	.25	ERECT	.25	COACH
10,000	.25	ERGOT	.25	COAST
25,000	.25	ERODE	.25	COCOA
50,000	.25	ERROR	.25	COLIC
75,000	.25	ESSAY	.25	COLON
100,000	.25	ETHER	.25	COLOR
150,000	.25	ETHOS	.25	COMET
200,000	.25	EVUS	.25	COMMA
240,000	.25	EVADE	.25	COOKY
Megohms				
.25	.25	EVENT	.25	CORAL
5	.25	EVICT	.25	CORPS
.75	.25	EVOKE	.25	CORSE
1.0	.25	EXACT	.25	COUCH
1.5	.25	EXALT	.25	COUGH
2.0	.25	EXCEL	.25	COUNT
2.5	.25	EXERT	.25	COUPE
3.0	.25	EXILE	.25	COURT
4.0	.25	EXIST	.25	COVET
5.0	.25	EXODE	.25	COVEY
6.0	.25	EXPEL	.25	COZEN
7.0	.25	EXTOL	.25	CRACK
8.0	.25	EXTRA	.25	CRAFT
9.0	.25	EXUDE	.25	CRAMP
10.0	.25	EARTH	.25	CRANE
15.0	.25	ELECT	.25	CRANK
20.0	.25	EMEND	.25	CRAPE
25.0	.25	EMPTY	.25	CRASH

Resistance values of carbon resistors vary somewhat under different conditions of load. In specifying resistances, manufacturers should state the normal working voltage across the resistor or the current it is called upon to carry. Resistance measurements should be made under actual load conditions if accuracy is important.

Packed 10 in a box. Standard Package—10 Boxes

Each unit is carefully measured on precision instruments and inspected electrically and mechanically before being packed for shipment. Facilities are maintained for testing resistors in accordance with manufacturers' specifications where extreme accuracy is required.

Type 1094 resistors are rated at one watt and Type 1095 rated at one half watt. They will, however, stand overloads of 100 per cent above rated wattage for an appreciable time without injury.

The accompanying table gives standard values carried in stock. Units of intermediate values, however, are usually available for manufacturers, jobbers and large users.

### R.M.A. STANDARD COLOR CODE

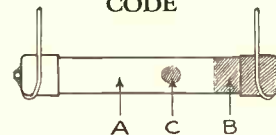

- A—Body color represents first significant figure.
- B—End color represents second significant figure.
- C—Dot color represents the number of ciphers following the first two figures.

A Body Color	B End Color	C Dot Color
0 Black	0 Black	.0 Black
1 Brown	1 Brown	0. Brown
2 Red	2 Red	00. Red
3 Orange	3 Orange	000. Orange
4 Yellow	4 Yellow	0,000. Yellow
5 Green	5 Green	00,000. Green
6 Blue	6 Blue	000,000. Blue
7 Violet	7 Violet	0,000,000. Violet
8 Gray	8 Gray	00,000,000. Gray
9 White	9 White	000,000,000. White

**MOULDED CARBON RESISTORS FOR A WIDE VARIETY OF USES**





## LAVITE NON-INDUCTIVE RESISTORS



Type 1098

**A**EROVOX Lavite Resistors should be used wherever non-inductive resistors capable of carrying comparatively heavy currents are required. The resistance element consists of a heavy special deposit on a large corrugated insulating rod.

These units are particularly suited for use in resistance and impedance coupled amplifiers and

STOCK SIZES			
List Price	All Values	\$1 00	
Resist.	Max. Current Ma.	Recom. Current Ma.	Code Word
1,000	54.8	38.3	ELDER
2,000	38.7	27.1	ELITE
5,000	24.5	17.1	ELOPE
10,000	17.3	12.1	EAGER
15,000	14.1	9.8	EARLY
20,000	12.2	8.5	EASEL
25,000	10.9	7.6	ELUDE
30,000	10.0	7.0	EBONY
50,000	7.7	5.4	EMERY
75,000	6.3	4.4	ECLAT
100,000	5.5	3.8	EDIFY
200,000	3.8	2.6	EDICT
250,000	3.5	2.4	EDUCE
500,000	2.4	1.7	EJECT

Packed one in a box.  
Standard Package—10 boxes.

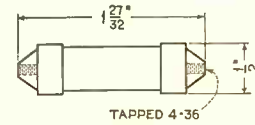

are the ideal resistors for television amplifiers.

Lavite resistors are standard in size to fit any grid leak mounting. The ends of the resistors are tapped to take a 4/36 screw for screw mounting assembly.

The maximum rating of these resistors is three watts.

Special values can be supplied on order to manufacturers.

## GRID LEAK RESISTORS



**T**HE Type 1092 Metalohm grid leak type resistors are built around a resistance element which consists of a metallic deposit on a glass rod, sealed in a glass tube.

The Type 1090 resistors employ a special impregnated paper resistance element and are excellent for use where low price is a main consideration.

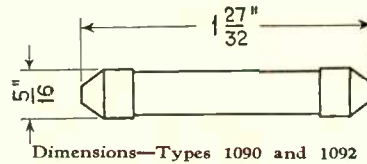

Resistance Ohms	Type 1090		Type 1092	
	List Price	Code Word	List Price	Code Word
10,000	\$.15	FAUGH	\$.20	NORTH
25,000	.15	FIRST	.20	NERVE
50,000	.15	FIRTH	.20	NERVE
75,000	.15	FLAKE	.20	NICHE
100,000	.15	FLAIL	.20	NIECE
150,000	.15	FLANK	.20	NINNY
200,000	.15	FINIS	.20	NINTH
240,000	.15	FAULT	.20	NOISE

Packed 10 in a box. Standard Package—10 Boxes

Resistance Meg-ohms	Type 1090		Type 1092	
	List Price	Code Word	List Price	Code Word
.25	\$.15	FACET	\$.20	NABOB
.5	.15	FAGOT	.20	NADIR
.75	.15	FARCE	.20	NITRE
1.0	.15	FAINT	.20	NAIAD
1.5	.15	FANCY	.20	NAIVE
2.0	.15	FAVOR	.20	NAPPY
2.5	.15	FEAST	.20	NASAL
3.0	.15	FEMUR	.20	NASTY
4.0	.15	FENCE	.20	NATAL
5.0	.15	FENNY	.20	NATTY
6.0	.15	FERRY	.20	NAVAL
7.0	.15	FETCH	.20	NEEDY
8.0	.15	FIBRE	.20	NAVVY
9.0	.15	FIELD	.20	NEGRO
10.0	.15	FILLY	.20	NEIGH

## GRID LEAK AND RESISTOR MOUNTINGS

**T**YPE 1049 single mounting and Type 1050 double mounting will take any standard grid leak or resistor and make good contact. A space is provided for mounting a con-

denser in the base of Type 1050 when used as a resistance coupler unit.



Type 1049

Type No.	Mounting	List Price	Code Word
1049	Single	\$.25	TABBY
1050	Double	.50	TABLE

Packed one in a box.  
Standard Package—10 boxes.

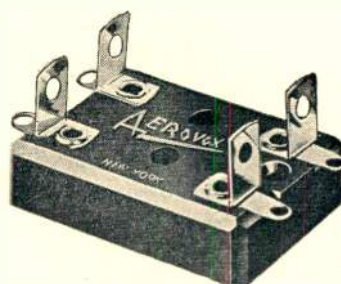
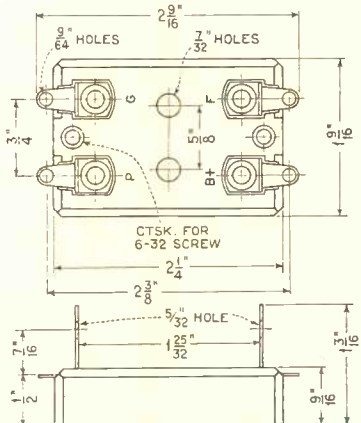

Type 1050

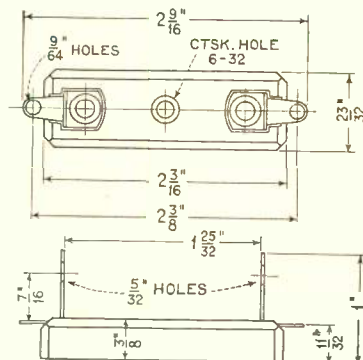

**AEROVOX GRID LEAK UNITS ARE NOISELESS IN OPERATION**

## REACTANCES OF STANDARD CAPACITIES AT COMMONLY USED FREQUENCIES

THE reactance of a condenser in ohms for any given frequency is obtained by dividing 1 by the product of 6.28 times the frequency in cycles times the capacity of the condenser in farads. In the chart shown below, the capacitive reactance of a number of standard capacities of from .00005 to 15 mfd. is given for the lowest and highest frequencies of the frequency bands most commonly used in practice.

CAP. IN MFDS	FREQUENCY IN CYCLES PER SECOND						
	Broadcast Radio Frequencies		Audio Frequencies		Power Supply Frequencies		
	500,000	1,500,000	50	10,000	25*	60	120
	CAPACITIVE REACTANCE IN OHMS						
.00005	6,369.4	2,123.1	63,694,267	318,471	127,388,534	53,078,503	26,539,252
.0001	3,184.7	1,061.6	31,847,133	159,235	63,694,267	26,539,252	13,269,626
.00025	1,273.8	424.6	12,738,853	63,694	25,477,706	10,615,600	5,307,850
.0005	636.9	212.3	6,369,426	31,847	12,738,853	5,307,850	2,653,925
.001	318.5	106.2	3,184,713	15,924	6,369,427	2,653,925	1,326,963
.005	63.7	21.2	636,943	3,185	1,273,885	530,785	265,393
.01	31.8	10.6	318,471	1,592	636,943	265,393	132,696
.015	21.2	7.1	212,314	1,061	424,629	176,929	88,464
.02	15.9	5.3	159,235	796	318,471	132,697	66,348
.05	6.4	2.1	63,694	318	127,389	53,078	26,539
.1	3.2	1.1	31,847	159	63,694	26,539	13,270
.25	1.28	.42	12,739	64	25,478	10,616	5,308
.5	.64	.21	6,369	32	12,739	5,308	2,654
1.0	.32	.11	3,184	15.9	6,369	2,654	1,327
2.0	.16	.05	1,592	7.9	3,184	1,327	663
4.0	.08	.03	796	3.9	1,592	664	332
6.0	.05	.02	531	2.6	1,062	442	221
8.0	.04	.01	398	2.0	796	332	166
10.0	.03	.01	318	1.6	637	265	133
15.0	.02	.01	212	1.1	425	177	88

\*Full wave rectification of 25-cycle current is equivalent to 50-cycle column under "Audio Frequencies."  
Half wave rectification of 25-cycle should never be used because of hum.

Radio Editor  
zines and  
are hereby  
mir

**FREE**

of the  
research  
orker.

# The AEROVOX



## Research Worker

The Aerovox Research Worker is a monthly house organ of the Aerovox Wireless Corporation. It is published to bring to the Radio Experimenter and Engineer authoritative, first hand information on condensers and resistances for radio work.

No. 1
No. 7

### WRITE FOR THIS HELPFUL PUBLICATION

THE Aerovox Worker is a free publication, issued by the Aerovox Wireless Corporation to keep radio experimenters, engineers and manufacturers abreast of the latest developments in radio.

Useful information on the design

problems of radio receivers and amplifiers with special attention to the proper use of condensers and resistors is given in each issue.

A request to be placed on the mailing list for the Research Worker will bring you this interesting and helpful peri-

odical regularly without charge or obligation.

Flexible morocco finished loose-leaf binders containing back numbers of the Research Worker are available at \$2.50 each prepaid. Binder without back numbers, \$1.00 each prepaid.

**READ THE RESEARCH WORKER FOR VALUABLE INFORMATION**



## TRANSMITTING APPARATUS SECTION HIGH VOLTAGE TRANSMITTING FILTER CONDENSERS



Types 1003, 1503, 2003,  
2503, 3003 and 3503  
Paper Condensers

THESE transmitting condensers are designed to fill the filter circuit requirements of heavy duty power supply units. They are ideal for use in all D.C. generators or rectified A.C. output circuits used to feed the filter circuits of transmitters and heavy duty amplifiers, and are being used in large quantities by amateur and commercial transmitting stations where high quality, compact units, constant capacity and high safety factor are required.

The paper condenser sections used in these units are non-inductively wound to provide good power factor and low equivalent series resistance characteristics. They are thoroughly impregnated with high grade impregnating oil instead of the wax com-

pounds used in lower voltage units and are carefully sealed in the metal cans with a high melting point wax to protect them against the high temperatures met with in high power units.

These units are conservatively rated to afford maximum safety under the no-load and keying conditions met with in transmitting circuits. The A.C. ratings are less than .7 times the D.C. ratings to allow for the heating effects of A.C. and pulsating D.C. operation.

THE high voltage dry electrolytic condensers listed here represent a distinct advance in design of high voltage transmitting condensers for use in broadcast transmitters, amateur transmitters, high voltage amplifiers and other purposes where high voltage filter condensers are required.

These condensers will withstand the voltages indicated in the table for long periods of time without deterioration. Voltage surges do not have any permanent effect on the condenser but merely cause a temporary breakdown which is automatically re-healed as soon as the voltage drops to its normal value.

They can be used in filter circuits in exactly the same manner as paper condensers of equivalent voltage rating. Care should be taken however that the polarity indicated on the condenser is observed. It is essential that the positive terminal of the condenser be



Types 1004, 1504, 2004,  
2504, 3004 and 3504  
Electrolytic Condensers

connected to the positive side of the circuit.

Where voltages are used in excess of those for which these condensers are designed, a series connection of two or more of these high voltage condensers will permit their use on higher voltages. Unlike paper condensers these electrolytic high voltage condensers can be connected in series without the use of any shunting resistors or other devices to give uniform voltage distribution.

Where cost is an important factor these electrolytic high voltage condensers will prove desirable as their cost is much lower than paper condensers of equivalent capacity and voltage rating.

PAPER TRANSMITTING CONDENSERS						ELECTROLYTIC TRANSMITTING CONDENSERS					
Type No.	Cap. Mfds.	List Price	Code Word	D.C. Work. Volt.	Can Sym. ol	Type No.	Cap. Mfds.	List Price	Code Word	D.C. Work. Volt.	Can Symbol
1003	1	\$3.75	RANGE	1000	HH*	1004	1	\$3.50	VICAR	1000	G *
1003	2	6.50	RAPID	1000	KK*	1004	2	4.25	VICIN	1000	HH *
1503	1	6.25	RIVET	1500	LL *	1004	4	5.00	VIGIL	1000	II *
1503	2	10.75	ROXEY	1500	O *	1504	1	5.50	VIGOR	1500	II *
2003	1	10.50	ROAST	2000	M *	1504	2	6.50	VILLA	1500	JJ *
2003	2	19.50	RATAT	2000	P *	1504	4	12.00	VIMIN	1500	MM*
2503	1	12.50	ROBIN	2500	O *	2004	1	7.25	VINAC	2000	LL *
3003	1	16.00	ROCKY	3000	P *	2004	2	8.75	VINCI	2000	M *
3503	1	18.50	ROMAN	3500	P *	2004	4	16.00	VIOLA	2000	P *
						2504	1	9.50	VIPER	2500	MM*
						2504	2	17.25	VIRGO	2500	P *
						2504	4	33.50	VIRTU	2500	Note 1
						3004	1	11.50	VIRUS	3000	MM*
						3004	2	21.50	VISIT	3000	Q *
						3004	4	41.50	VISOR	3000	Note 2
						3504	1	13.75	VISTA	3500	P *
						3504	2	26.00	VITAL	3500	Note 3
						3504	4	51.00	VIVID	3500	Note 4

Note \*: Supplied with glazed porcelain terminals at top of can as shown in photo instead of terminal strip shown in dimension drawings of cans on page 16.

Special Units: Higher or lower capacities, as well as combinations of various units into blocks can be furnished on special order to manufacturers. Prices on application.

Note 1. Can size 4"x12 1/4"x5"      Note 3. Can size 4"x 9 1/2"x5"  
 Note 2. Can size 4"x13 1/2"x5"      Note 4. Can size 4"x 19" x5"



## TRANSMITTING MICA CONDENSERS



Types 1455, 1456 and 1457

For dimensions see page 26.



Type 1450

For dimensions see page 26.



Type 1661

AEROVOX Mica Transmitting Condensers are available in a wide variety of capacities, working voltages and mechanical constructions to suit all the requirements of the average low and high power amateur transmitter.

The dielectric used in all Aerovox Mica Condensers is the finest grade India Ruby Mica, the plates are made of special foil and the condenser element is thoroughly impregnated to protect the unit against moisture, and to insure long life.

The capacity of the condenser element is predetermined by a patented process.

All standard units are made to a tolerance of 10% plus or minus but can be made to closer tolerances on special order at a slight additional cost.

The types 1450 and 1455 condensers are the standard mica condensers used for receivers and for all low-current, low voltage applications in transmitters. They are rated 1,000 volts D.C. test

voltage and 500 volts D.C. working voltage.

Prices and code words of the units of this type which are most commonly used in transmitting circuits are given on this page. More detailed information on them will be found on pages 26 and 27.

The Type 1456 and 1457 condensers are similar in mechanical construction to the Type 1455 condensers but are designed especially for use in higher voltage applications such as are required in the comparatively higher power amateur transmitting circuits. The insulated mounting holes are a feature of Type 1455, 1456 and 1457 Mica Condensers.

All type 1450, 1455, 1456 and 1457 condensers are moulded in genuine bakelite cases which seal and protect the condenser elements against extreme temperature, moisture and chemical action.

The Types 1661, 1771, 1772, and 1773 units are thoroughly impregnated,

insulated and encased in sheet metal cases as shown. They are provided with insulated wire leads.

The Types 1881, 1882 and 1883 units are also thoroughly impregnated and insulated but are enclosed in cast aluminum cases and provided with Isolantite insulated terminals.

The difference between Aerovox Mica condensers of the same voltage rating lies in the currents which they will carry without excessive heating.

The Types 1450, 1455 and 1661 are designed for the currents and voltages normally met with in the low voltage,

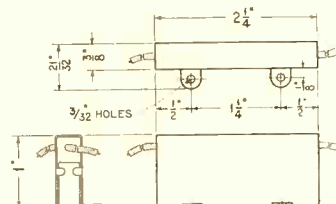

Dimensions of Type 1661 condenser.

### Code Words and Prices—Transmitting Mica Condensers

TYPE NO.	1450†		1455†		1456		1457		1661	
D.C. Test Voltage	1000 Volts		1000 Volts		2500 Volts		5000 Volts		1400 Volts	
CAP. MFD.	List Price	Code Word	List Price	Code Word	List Price	Code Word	List Price	Code Word	List Price	Code Word
.00005	\$.30	SERVE	\$.35	SHYLY	\$.50	SHAKE	\$.65	SHEET	\$1.50	SHOCK
.00007	.30	SETON	.35	SIBYL	.50*	SHRIE	.65*	SILIC	1.50*	SINCE
.000075	.30	SKULK	.35	SILLY	.50*	SICKE	.65*	SIMIL	1.50*	SKILL
.0001	.30	SEPOY	.35	SINUS	.50	SHAKY	.65	SHELF	1.50	SHORN
.00015	.30	SEPIA	.35	SKIFF	.50*	SHALE	.65*	SHELL	1.50*	SMELT
.0002	.30	SENNA	.35	SLACK	.50	SHANK	.75	SHIFT	1.50	SMERK
.00025	.30	SEDGE	.35	SLAKE	.50	SHAPE	.75	SHINY	1.50	SMITE
.00037	.30	SEDAN	.35	SLANG	.50*	SIDER	.90*	SIMON	1.50*	SKITT
.0005	.30	SECCO	.35	SLASH	.50	SHARE	.90	SHIRE	1.50	SMITH
.001	.30	SCULK	.35	SLEEK	.65	SHARK	1.20	SHIRK	1.50	SMOCK
.0015	.35	SKULL	.35	SLEET	.80	SHARP	1.40	SHIRR	2.00	SNEER
.002	.35	SENSE	.40	SLICE	.95	SHAWL	1.60	SHOAL	2.00	SMOKY
.0025	.35	SHOOT	.40	SLICK	1.00*	SHILL			2.00	SNACK
.003	.45	SHORE	.50	SLIDE	1.10*	SHAWN			2.00	SHEET
.004	.45	SHORT	.50	SLIME	1.10*	SHEAF			2.00	SHOAT
.005	.45	SHOTE	.50	SLIMY	1.25	SHEAR			2.00	SNARE
.006	.55	SHOUT	.60	SLING	1.25	SHEEN			2.00*	SNICK
.0075	.65	SHOVE	.70	SLINK	1.60*	SHOUL			2.25	SNARL
.01	.75	SHOWY	.80	SLOOP	2.00	SHEER			2.35	SNATH
.015	.90	SHREW	.95	SLOPE						
.02	1.05	SHRED	1.10	SLOSH						
.025	1.65	SMACK	1.35	SLOTH						
.03	2.00	SMART	1.50	SLOYD						
.04	2.70	SMEAR								

Types 1661 units packed one in a box. Standard Package—10 Boxes.

Types 1450, 1455, 1456 and 1457 units packed 10 in a box. Standard Package—10 Boxes.

Note †: For complete information on Types 1450 and 1455 mica condensers, suitable for low voltage applications in transmitters, see pages 26 and 27.

Note \*: These are not standard capacities but are usually available from stock.

TRANSMITTING MICA CONDENSERS THAT "STAND THE GAFF"



## TRANSMITTING MICA CONDENSERS



Types 1771, 1772 and 1773  
Condensers

low current circuits of low power transmitters using 7.5 watt tubes of the UX-210 and CX-310 types.

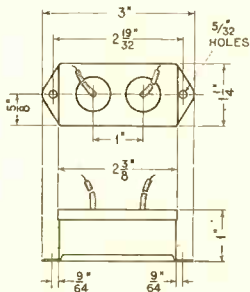

Dimensions of Types 1771, 1772 and 1773 condensers.

### Voltage Characteristics

Type No.	Test Volt.		Work Volt.	
	D.C.	A.C.	D.C.	A.C.
1450 ‡	1000	700	500	350
1455 ‡	1000	700	500	350
1456	2500	1750	1250	875
1457	5000	3500	2500	1750
1661	1400	1000	700	500
1771	1400	1000	700	500
1772	3500	2500	1750	1250
1773	7000	5000	3500	2500
1881	1400	1000	700	500
1882	3500	2500	1750	1250
1883	7000	5000	3500	2500

A.C. voltage ratings at 60 cycles. Note: For details of Types 1450 and 1455 condensers see pages 26 and 27.

Types 1456 and 1457 condensers are designed for use in comparatively higher voltage circuits using 50 to 100 watt tubes of the UX-203-A and UX-852 types.

The Types 1771 and 1881 are designed for use in low voltage applications of high power circuits where high current carrying capacity is required.

The Types 1772, 1773, 1882 and 1883 are designed for use in higher voltage higher power circuits employing UX-204-A type tubes where high current carrying capacity without excessive heating is required.



Types 1881, 1882 and 1883  
Condensers

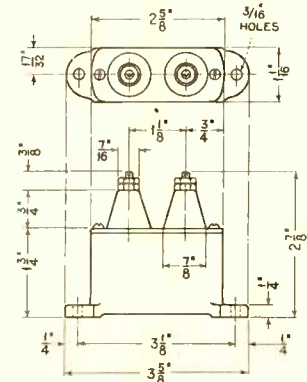

Dimensions of Types 1881, 1882 and 1883 condensers.

### Code Words and Prices—Transmitting Mica Condensers

TYPE NO.	1771		1772		1773		1881		1882		1883	
	D.C. Test Voltage	1400 Volts	3500 Volts	7000 Volts	1400 Volts	3500 Volts	7000 Volts	1400 Volts	3500 Volts	7000 Volts		
CAP. MFD.	List Price	Code Word	List Price	Code Word	List Price	Code Word	List Price	Code Word	List Price	Code Word	List Price	Code Word
.00005	\$3.25	SPADE	\$3.60	SPUNK	\$4.50	STALE	\$7.75	STATE	\$8.25	STOUP	\$8.50	SULKY
.00007	3.25*	SANCT	3.60*	SATIS	4.50*	SCATT	7.75*	SCHIS	8.25*	SENAT	8.50*	SEQUE
.000075	3.25*	SANHE	3.60*	SAUNT	4.50*	SCEPT	7.75*	SCIEN	8.25*	SENES	8.50*	SERAP
.0001	3.25	SPARK	3.60	SPURN	4.50	STALK	7.75	STAVE	8.25	STOUT	8.50	SULLY
.0002	3.25	SPIKY	3.60	SPURT	4.50	STALL	7.75	STAYS	8.25	STRAW	8.50	SUNNY
.00025	3.25	SPINE	3.60	SQUAB	4.50	STAMP	7.75	STEAD	8.25	STREW	8.50	SURAH
.00037	3.25	SANIT	3.60	SAVAN	4.50	SCHEM	7.75	SCIOL	8.25	SENTE	8.50	SERIC
.0005	3.25	SPIRE	3.60	SQUAD	4.50	STAND	7.75	STEAK	8.25	STRIP	9.00	SURGE
.001	3.25	SPIRY	3.85	SQUAT	4.75	STARE	7.75	STEAL	8.25	STRUM	9.25	SURLY
.0015	3.50	SPIRE	3.85	SQUAW	5.25	STARK	8.00	STEAM	8.50	STUCK	9.75	SWAIN
.002	3.50	SPLAY	4.00	SQUIB	5.75	START	8.00	STEED	8.50	STUDY	10.50	SWALE
.0025	3.50	SPOIL	4.00	STACK	6.75	STARC	8.00	STEEL	8.50	STUFF	11.25	SWAMP
.003	3.50	SPOKE	4.25	STAFF			8.00	STEEP	9.00	STUNG		
.004	3.50	SPOOL	4.50	STAGE			8.00	STEER	9.00	STUNT		
.005	3.50	SPOON	4.75	STAIR			8.00	STERN	9.25	STUPE		
.006	3.50*	SAPIE	5.25*	SCAFF			8.25*	SCIRR	9.75*	SEPAR		
.0075	3.75	SPORT	5.25	STAIN			8.25	STICK	9.75	SUAVE		
.01	3.75	SPOUT	6.50	STAIR			8.25	STINT	11.00	SUGAR		
.015	4.00	SATAN	6.75	SCAND			8.50	SCISS	11.25	SEPTE		
.02	4.00	SPRAT	7.00	STAKE			8.50	STOAT	11.75	SUITE		
.025	4.75	SATIR					9.00	SCONE				
.03	4.75	SPRAY					9.00	STOLE				
.04	4.75	SPREE					9.50	STONE				
.05	5.50	SPRIG					9.50	STONY				
.075	6.00	SPRIT					11.00	STOOK				
.1	7.00	SPUME					11.00	STOOP				

All units packed one in a box. Standard Package—10 Boxes

Note \*: These are not standard capacities but are usually available from stock.

DESIGNED TO FILL EVERY TRANSMITTING REQUIREMENT

## PYROHM TRANSMITTING GRID LEAKS



Pyrohm Transmitting Grid Leak

**A**EROVOX Pyrohm Transmitting Grid Leaks are widely used in all amateur and commercial transmitting apparatus employing standard tubes.

The grid leak resistance values which have been found to give best all around results and the types of Aerovox Pyrohm Resistors suitable for such use with different types of tubes are given in

Type Tube	Type No.	Resist. Ohms	Rating Watts	List Price	Code Word
UX-210	994-CT	10,000	32	\$1.50	WAFER
UX-852	996-CT	20,000	100	2.75	WAITE
UV-211	996-CT	10,000	100	2.50	WAGER
UV-203A	996-CT	10,000	100	2.50	WAGER
UV-204A	998-CT	10,000	200	3.25	WAIST
UV-845	998-CT	50,000	200	3.50	WAIST

NOTE \*: Prices include horizontal type mounting brackets. All units are furnished with center tap.

the accompanying table. The values apply to the R.C.A. tubes listed or their Cunningham and De Forest equivalents.

## PYROHM BLEEDER RESISTORS

**A**EROVOX Pyrohm Bleeder Resistors are generally used across the output of the plate supply of transmitting circuits to protect filter condensers from high peak voltages, discharge condensers when the key is open, eliminate "chirps" and steady the note.

The required number of resistor units are furnished for series connection in order to give the total resistance required under each output voltage condition.

Output Voltage	Type No.	Number of Units in Series	Total Resist. Ohms	Current Ma.	List Price†	Code Word
500	996-5	1	25,000	20	\$1.75	BEDYE
1000	996-52	2	50,000	20	3.50	VOLTE
1500	996-53	3	75,000	20	5.25	VOUCH
2000	996-54	4	100,000	20	7.00	VOWEL

† Prices are for the number of units required to give total resistance value under each condition. Mounting brackets extra. See page 36.

## PYROHM CENTER-TAPPED FILAMENT RESISTORS

**A**EROVOX Pyrohm Center-Tapped Filament Resistors are suited for use across the filaments of transmitting tubes to obtain the electrical center of the filament. They will carry safely, without heating, the plate and grid current of the tube.

Tube Volt.	Type No.	Resist. Ohms	List Price	Code Word
2.5	992-CT	20	\$1.00	WAKEN
7.5	992-CT	100	1.00	WALTZ
10.0	992-CT	100	1.00	WALTZ

Mounting brackets extra. See page 36.

Complete details of size, watts rating and current carrying capacity of other Pyrohm Vitreous Enamel Resistors suitable for use as grid leaks and other uses in transmitting circuits will be found on pages 31 and 32.

## A PRACTICAL REACTANCE-FREQUENCY CHART AND HOW TO USE IT

**T**HE chart on the opposite page makes it a simple matter to determine the reactance of any condenser or choke coil between the limits of .1 mmfd. and 10 mfd. and .01 micro-henries and 1000 henries. The frequency range covered is from 10 cycles to 5000 kilocycles and the reactance range is from .01 ohms to one million ohms.

The lines slanting upwards from the left to the right are associated with the inductances indicated along the upper and right hand edges. The lines slanting downward from the left to the right are associated with the capacities listed along the upper and right hand edges. The frequency is given along the lower edge and the reactance in ohms along the left hand edge.

To determine, for example, the reactance of a condenser at a certain frequency, it is necessary simply to follow along the vertical line corresponding to the proper frequency until it intersects the line corresponding to the capacity. The reactance indicated at this point of intersection is

the reactance of the condenser at the frequency referred to. For example, a 1 mfd. has a reactance of 1600 ohms at a frequency of 100 cycles. This value is found by referring to the vertical line corresponding to the 100 cycles until it intersects the 1 mfd. slanting line. This point of intersection corresponds to a reactance of 1600 ohms. The main divisions are divided into ten parts by the light lines, each light line representing double the value of the preceding line. For example, between 100 and 1000 cycles, there are ten light lines. Beginning at the 100 cycle line and moving towards the right, the first light line is 200 cycles, the next light line 300 cycles, and so on up to 1000 cycles. The capacity and inductance lines are sub-divided in the same manner.

The advantage of this chart over other types of reactance charts is that very wide ranges of values can be covered in a small space, and the percentage accuracy is constant throughout the range. It is hoped that the chart may be useful to users of Aerovox products.



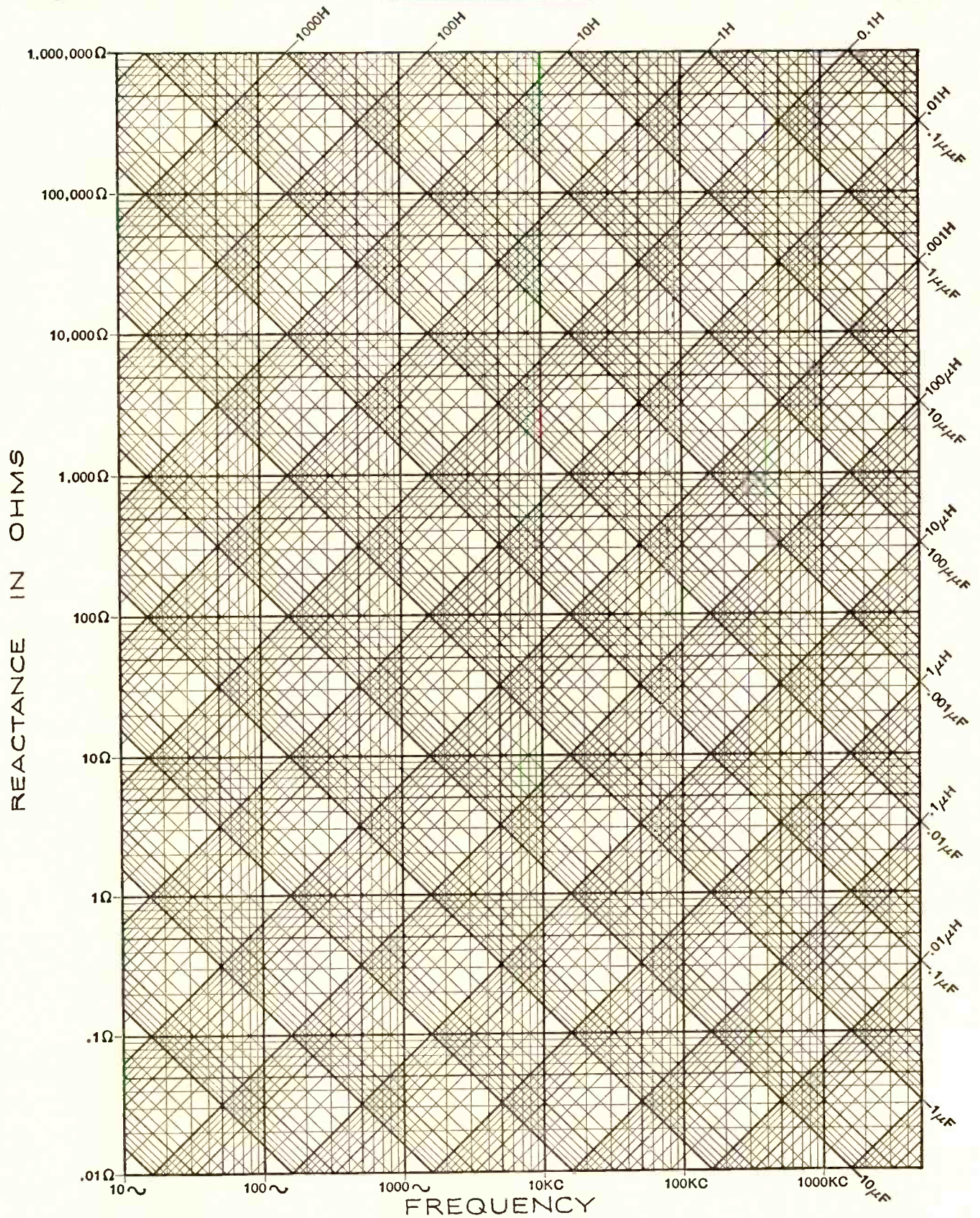

KC = kilocycles  
 $\Omega$  = ohms

$\mu$ F = microfarads  
 $\mu\mu$ F = micromicrofarads

H = henries  
 $\mu$ H = microhenries

For use of this chart, see page 44. By courtesy Bell Laboratories. Additional copies of this chart available from Keuffel & Esser Co., N. Y.

**AEROVOX CONDENSERS AND RESISTORS ARE DEPENDABLE**



# HELPFUL DATA FREQUENTLY USED IN

## Ohm's Law

Ohm's Law expresses the relationship which exists between the electromotive force (E) in volts, the current (I) in amperes and the resistance (R) in ohms in any electrical circuit and is the basis of most electrical calculations and relationships.

It may be expressed in various forms, depending on the quantity for which one may be solving the equation. It is most easily remembered as:

$$E = I \times R$$

in which the symbols appear in alphabetical order, (E, I, R,) with the equal sign after the first symbol. The equation may be solved for any of the elements by simple transposition.

## Ohm's Law for A.C. Circuits

For alternating current circuits, Ohm's Law becomes:

$$E = I \times Z$$

where Z is the resultant effect, in ohms, of the ohmic resistance, capacitive reactance and inductive reactance of the circuit.

## Impedance of A.C. Circuits

$$Z = \sqrt{R^2 + (Xl - Xc)^2}$$

## Reactance of a Condenser

$$Xc = \frac{1}{6.28 \times f \times C}$$

See page 32 for chart showing reactances of condensers of various standard capacities at frequently used frequencies.

## Reactance of an Inductance

$$Xl = 6.28 \times f \times L$$

## Resonance in an A.C. Circuit

In an A.C. circuit, resonance takes place when the capacitive reactance (Xc) equals the inductive reactance (Xl), thereby reducing the total reactance of the circuit to zero.

## Frequency of Resonance

$$f = \frac{1}{6.28 \sqrt{L \times C}}$$

## Peak Value A.C. Voltage

The peak or crest value of voltage of an alternating current sine wave is represented approximately by:

$$Ep = 1.4 \times E$$

## Power in a Circuit

$$P = E \times I = I^2 \times R$$

## Meter Multipliers

A series of articles on the use of resistances to increase the range of voltmeters and milliammeters appeared in the Aerovox Research Worker, Vol. 3, Nos. 1 and 2. Copies of these back issues will be sent on receipt of 20 cents to cover cost of reprints and postage.

## Explanation of Symbols Used in Formulae in This Article

- C — Capacity in FARADS.
- Ct — Total or resultant capacity in FARADS of a number of condensers connected in series, parallel or series-parallel.
- E — Effective voltage in VOLTS.
- Ep — PEAK VALUES OF VOLTAGE in alternating and fluctuating voltage circuits.
- f — Frequency in CYCLES PER SECOND.
- I — Effective current in AMPERES.
- L — Inductance in HENRIES.
- P — Power in WATTS.
- Q — Quantity of electricity in COULOMBS.
- R — Resistance in OHMS.
- Rt — Total or resultant resistance in OHMS of a number of resistors connected in series, parallel or series-parallel.
- r — Shunt or leakage resistance in OHMS of a condenser or of a resistance connected across a condenser.
- W — Work in JOULES or WATT-SECONDS.
- WL — Wavelength in METERS.
- Xc — Capacitive reactance in OHMS.
- Xl — Inductive reactance in OHMS.
- Z — Impedance in OHMS.

## Metric Prefixes Commonly Used with Electrical Quantities

- Meg- or Mega- = 1,000,000 = 10<sup>6</sup>
  - Myria- = 10,000 = 10<sup>4</sup>
  - Kilo- = 1,000 = 10<sup>3</sup>
  - Hecto- = 100 = 10<sup>2</sup>
  - Deka- = 10 = 10<sup>1</sup>
  - Deci- = .1 = 10<sup>-1</sup>
  - Centi- = .01 = 10<sup>-2</sup>
  - Milli- = .001 = 10<sup>-3</sup>
  - Micro- = .000,001 = 10<sup>-6</sup>
  - Milli-micro- = .000,000,001 = 10<sup>-9</sup>
  - Micro-micro- = .000,000,000,001 = 10<sup>-12</sup>
- The prefix "pico-" is sometimes used in place of "micro-micro-"

## Resistance Conversion Factors

To change ohms to megohms, divide ohms by 1,000,000.  
Example: 25,000 ohms = .025 megohms.  
To change megohms to ohms, multiply megohms by 1,000,000.  
Example: .025 megohms = 25,000 ohms.

## Frequency-Wavelength Conversion

$$WL = \frac{300,000,000}{f}$$

## Resistances in Series

$$Rt = R1 + R2 + R3 \text{ etc.}$$

If the resistances are all of the same value, the total resistance will be equal to the resistance of one multiplied by the number connected in series.

## Resistances in Parallel

$$Rt = \frac{1}{\frac{1}{R1} + \frac{1}{R2} + \frac{1}{R3} \text{ etc.}}$$

If the resistances are all of the same value, the total resistance will be equal to the resistance of one divided by the number connected in parallel.

The total resistance of resistors connected in series parallel is found by separating them into groups, finding the resultant resistance of each group and reducing the network into a series of resultant resistances, after which the total resistance of the network can be determined.

## Total Watts Rating of Resistors of Equal Resistance and Rating

The total watts rating of resistors of equal resistance and watts rating connected in series or parallel is equal to the watt rating of one multiplied by the number connected in series or parallel.

## Resistance Required to Produce a Desired Voltage Drop

The resistance required to produce a voltage drop sufficient to reduce an available voltage to a desired voltage, when the current taken by the device at its rated voltage is known, may be found by using the equation for Ohm's Law when solving for resistance:

$$R = \frac{E}{I}$$

in which E is the voltage drop required and I is the current taken by the device at its rated voltage. This form is used when it is desired to reduce the line voltage from 110 to 6 volts for instance, in which case the voltage drop is 110-6=104; when it is desired to reduce the voltage of a battery to that required by the filament of a vacuum tube, etc.

## Resistance Measurements

A complete description of a very simple and efficient Ohmmeter for Resistance Measurements appeared in the Aerovox Research Worker, Vol. 3, Nos. 3 and 4. Copies of these back issues will be sent on receipt of 20 cents to cover cost of reprints and postage.

## Voltage Divider Design

A series of articles on Voltage Divider Design and the Selection of Resistors for Power Supply Units appeared in the Research Worker, Vol. 1, Nos. 8, 9, 10, 11 and 12 and Vol. 2, No. 5. Copies of these issues will be mailed on receipt of 60 cents to cover cost of reprints and postage.



# SOLVING CONDENSER & RESISTOR PROBLEMS

## Specific Inductive Capacity

The specific inductive capacity or dielectric constant (k) of any dielectric is the ratio of the capacity of a condenser using that dielectric to that of an identical condenser (same plates and separation) using air as the dielectric.

$$\text{--- } 0 \text{ ---}$$

## Charge on a Condenser

$$Q = C \times E$$

$$\text{--- } 0 \text{ ---}$$

## Current Through and A.C. Voltage Across a Condenser

$$I = 6.28 \times f \times E \times C$$

$$\text{--- } 0 \text{ ---}$$

## Potential Energy Stored in a Condenser

$$W = \frac{C \times E^2}{2} = \frac{E \times Q}{2} = \frac{Q^2}{2C}$$

$$\text{--- } 0 \text{ ---}$$

## Capacity of Condensers in Parallel

$$C_t = C_1 + C_2 + C_3 + C_4 \text{ etc.}$$

When the capacities of the condensers are equal, the total capacity is equal to the capacity of one condenser multiplied by the number of condensers connected in parallel.

$$\text{--- } 0 \text{ ---}$$

## Capacity of Condensers in Series

$$C_t = \frac{1}{\frac{1}{C_1} + \frac{1}{C_2} + \frac{1}{C_3} + \frac{1}{C_4}} \text{ etc}$$

The total capacity of a number of condensers of equal capacities when connected in series is equal to the capacity of one condenser divided by the number of condensers connected in series.

The total capacity of a series combination of any number of condensers is always less than the capacity of the lowest capacity condenser of the combination.

$$\text{--- } 0 \text{ ---}$$

## Capacities Required for Bypassing and Filtering

Complete data on the capacities required for efficient filtering in power supply units is contained in a series of articles on "Filter Circuit Design" which appeared in the Aerovox Research Worker, Vol. 1, Nos. 6 and 7. Copies of these back issues will be mailed on receipt of 20 cents to cover cost of reprints and postage.

Complete data on the capacities required for efficient bypassing and filtering in R.F. and A.F. circuits is contained in a series of articles entitled "How to Increase Efficiency of Circuits by Proper Bypassing and Filtering" which appeared in the Aerovox Research Worker, Vol. 2, Nos. 7, 8 and 9. Copies of these issues will be supplied on receipt of 30 cents to cover cost of reprints and postage.

## Frequently Used Electrical Units

**VOLT** — The unit of electromotive force, is the force required to send one ampere of current through one ohm of resistance.

**AMPERE** — The unit of current, is the current flow which one volt will send through a resistance of one ohm.

**OHM** — The unit of resistance, is the resistance offered to the passage of one ampere when impelled by one volt.

**COULOMB** — The unit of quantity, is the quantity of current which passes through one ohm in one second when impelled by one volt, or the flow of one ampere through one ohm for one second.

**WATT** — The unit of power, is the power to do work represented by the flow of one ampere through a resistance of one ohm under a pressure of one volt.

**JOULE** — The unit of work, is the work done by one watt in one second (watt-second) or the energy expended by one ampere flowing through one ohm under a pressure of one volt for one second.

**FARAD** — The unit of capacity is the capacity of a condenser which is charged to a potential of one volt by one coulomb or which takes a charge of one coulomb under a pressure of one volt.

$$\text{--- } 0 \text{ ---}$$

## Capacity Conversion Factors

To change farads to microfarads, multiply farads by 1,000,000.

To change farads to micro-micro-farads multiply farads by 1,000,000,000,000.

To change microfarads to micro-microfarads, multiply microfarads by 1,000,000.

To change micro-microfarads to microfarads, divide micro-microfarads by 1,000,000.

To change micro-microfarads to farads, divide micro-microfarads by 1,000,000,000,000.

## Capacity Measurements

A complete description of a number of simple ways to measure capacities of condensers, appeared in the Aerovox Research Worker, Vol. 2, Nos. 2 and 3. Copies of these back issues will be sent on receipt of 20 cents to cover cost of reprints and postage.

$$\text{--- } 0 \text{ ---}$$

## Caution in Measuring Capacity

The capacity reading of a condenser will vary somewhat when measured with different types of measuring instruments, and under different voltages, frequency and waveform conditions.

$$\text{--- } 0 \text{ ---}$$

## Voltage Ratings of Condensers in Parallel

With condensers connected in parallel, the voltage rating of the combination is limited by the voltage rating of the lowest voltage condenser, and the voltage applied across the combination should never exceed that of the condenser having the lowest voltage rating.

$$\text{--- } 0 \text{ ---}$$

## Voltage Ratings of Condensers in Series

The calculation of the resultant voltage rating of condensers connected in series is rather complicated unless the condensers connected in series are of the same capacity, voltage rating and power factor.

When condensers of equal capacity are connected in series, any voltage applied across the combination will distribute itself equally across each condenser and the voltage across each condenser will be equal to the voltage across the combination divided by the number of condensers connected in series, provided the insulation resistances or power factors of the condensers are equal. When the insulation resistances are not the same for each condenser, the voltage distribution across the condenser will be affected to a greater or lesser extent depending on the waveform of the applied voltage. The effect of unequal voltage distribution can be minimized by the use of resistor balances (high value resistors across the condensers).

Because of their inherent equalizing characteristics, Aerovox Hi-Farad DRY Electrolytic Condensers are ideally suited for series connections to obtain high voltage units of high capacity.

$$\text{--- } 0 \text{ ---}$$

## Equivalent Series Resistance of Shunt Resistance Across a Condenser

The effect of a high value of resistance connected across a condenser may be resolved into the effect of a resistance connected in series with the condenser by means of the following equation in which "r" is the shunt resistance and "R" is the equivalent series resistance. The equation holds true only for condensers of very low power factor.

$$R = \frac{1}{(6.28f)^2 \times C^2 \times r}$$



# INDEX



## PAPER CONDENSERS

	Page		Page
Auto Generator Condensers.....	12	Oil Impregnated Condensers.....	6
Bakelite Cased Condensers.....	12	Replacement Condensers for Standard Sets.....	13
Buffer Blocks, High Voltage.....	19	Replacement Condensers, Unmounted.....	14
Can Dimensions of Filter Condensers.....	16	Socket Power Filter Condensers.....	17
Cartridge Condensers.....	7, 13	Special Manufacturers' Blocks.....	15
Filter Blocks.....	18	Suggestions on Ordering and Using.....	4
Filter Bypass Blocks.....	19	Stamped Metal Case Condensers.....	8
General Characteristics.....	3	Stamped Metal Case Condensers, Multi-Section..	9
General Purpose Condensers.....	11	Stamped Metal Case Condensers, Mfgs' Type....	10
Heat Resisting Automobile Condensers.....	12	Tubular Condensers.....	7, 13
Insulation Specifications.....	3	Transmitting Condensers.....	41
Interference Filters.....	28	Uncased Replacement Condensers.....	14

## HI-FARAD DRY ELECTROLYTIC CONDENSERS

"A" Condensers (High Capacity, Low Voltage)..	24	Cardboard Container Type, Low Voltage.....	25
Can Dimensions.....	22	General Characteristics.....	20
Can Type, 500 Volt.....	23	Mounting Details.....	22
Can Type, Low Voltage.....	24	Transmitting Condensers.....	41
Cardboard Container Type, 500 Volt.....	21	Uses of Hi-Farad Condensers.....	20

## MICA CONDENSERS

Moulded Bakelite Condensers.....	26, 27	Transmitting Condensers.....	42, 43
----------------------------------	--------	------------------------------	--------

## PYROHM VITREOUS ENAMEL RESISTORS

Adjustable Resistors.....	35	General Information on Pyrohms.....	30
Bracket Mounted Resistors.....	34	Mounting for Pyrohm Resistors.....	36
Characteristics and Prices.....	31, 32	Protective Cage Units.....	29
Edison Base Resistors.....	33	Transmitting Resistors.....	44
Ferrule Type Resistors.....	34	Voltage Divider Tapped Resistors.....	35

## CARBON AND WIRE WOUND RESISTORS

Carbon Resistors.....	38	Lavite Resistors.....	39
Grid Leak Resistors.....	39	R.M.A. Standard Color Code.....	38
Grid Leak Mountings.....	39	Wire Wound Resistors.....	37

## TRANSMITTING APPARATUS

Bleeder Resistors.....	44	Filter Condensers, Electrolytic Type.....	41
Grid Leak Resistors.....	44	Filter Condensers, Paper Type.....	41
Filament Resistors.....	44	Mica Condensers.....	42, 43

## INFORMATION AND USEFUL DATA

Aerovox Research Worker.....	40	Information on Paper Condensers.....	4
Customers General Information.....	2	Reactance-Frequency Chart.....	45
Helpful Data on Condensers.....	47	Reactance of Standard Capacities.....	40
Helpful Data on Resistors.....	46	Sales Offices and Addresses.....	1

**THE MOST COMPLETE LINE OF CONDENSERS AND RESISTORS**



# RAPID GROWTH

## A SIGN OF PROGRESSIVE POLICIES AND QUALITY PRODUCTS

**T**HAT the policies inaugurated in 1922, when the Aerovox Wireless Corporation came into being, and since steadfastly maintained are sound, is best attested to by the rapid growth of the organization.

From the small beginnings for which a working area of 1,000 square feet was ample, the Aerovox plant has increased steadily until now a working area of over 80,000 square feet is necessary to meet the demand for Aerovox products. The layout of this modern plant, devoted exclusively to the manufacture of condensers and resistors, is efficiently planned to eliminate waste space, lost motion and excessive overhead expense.

This sound, rapid growth has been attained by strict adherence to a policy which has kept uppermost, the idea and ideal that to successfully produce radio and electrical products requires a high degree of specialization.

## SPECIALIZATION PRODUCES HIGH QUALITY AT MINIMUM COST

The concentration of engineering, production and sales facilities and efforts on related products has resulted in the attainment of maximum efficiency and quality at minimum cost.

That this policy and the low-cost, high quality products which it makes possible to produce are appreciated by radio and electrical manufacturers, and consumers is evidenced by the fact that Aerovox condensers and resistors are used in the leading radio receivers and electrical appliances.

Because of its concentration of effort on specialized products, the Aerovox Wireless Corporation has kept abreast of the latest developments in its chosen fields.

By constant attention to the problems in this field its engineers have been able to make many important contributions to the art that has brought condensers and resistors to their present high state of development.

It has been gratifying to the men who have bent their efforts to produce high quality products at minimum cost, to see their labors bearing fruit in the form of steadily increasing business and prestige.

The Aerovox Wireless Corporation takes this opportunity of thanking its many friends whose confidence and patronage have made its rapid progress possible.



# Fully Equipped to Render Service

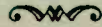

**T**HIS booklet was prepared to give complete, detailed information on Aerovox products.

The electrical specifications, details of construction, and general data on both condensers and resistors are given in such form that all who have use for these products can determine very easily the units which are best suited for their requirements.

To insure the uniformity and high quality of Aerovox products, a completely equipped laboratory, manned by competent engineers, tests the raw material and carefully follows the manufacturing processes.

A modern tool and machine shop is maintained to rush tools and dies required to manufacture units for special needs.

A staff of trained men stands ready at all times to assist in the selection of standard parts, or in the design of parts for special uses.

Aerovox prompt service is directly due to the complete manufacture of each product in its entirety from the raw materials within our own plant under one roof. Because of this complete supervision and control, Aerovox products are

## "Built Better"

AEROVOX PRODUCTS ARE FOR SALE BY

If you do not know where to buy Aerovox products in your locality, the Aerovox Sales office nearest to you (see page one) will be glad to tell you where to buy them, or you may write direct to the Aerovox Wireless Corporation, 70 Washington St., Brooklyn, N. Y., for information regarding your nearest dealer.