

Radio Editors of magazines and newspapers will be given permission to reprint in whole or in part, with proper credit to the Aerovox Corporation, the contents of this issue of the Aerovox Research Worker, upon written request.

The AEROVOX Research Worker

The Aerovox Research Worker is edited and published by the Aerovox Corporation to bring to the Radio Experimenter and Engineer, authoritative, first hand information on capacitors and resistors for electrical and electronic application.

VOL. 27, NO. 10 and 11

OCT. - NOV., 1957

Subscription By Application Only

Understanding the New Microwave Tubes Part 2: The Back-Wave Oscillator

By the Engineering Department, Aerovox Corporation

THROUGHOUT the history of the development of radio, the problem of frequency tunability has been a persistent one. For early communication and broadcast radio, the major problem was that of *tuning range*. The frequency coverage normally achieved by circuits which were mechanically tuned by varying the capacitance of a capacitor was supplemented through the use of plug-in coils, and later by "band switching". Probably the first requirement for *speed of tuning* came with the development during the late thirties of the "panoramic" type of receiver. This receiver, shown in block diagram form in Fig. 1, is used to visually monitor segments of the radio frequency spectrum by sweeping the local oscillator rapidly over a broad range and presenting the output of the receiver on an oscilloscope so that the time base represents frequency and the vertical axis represents signal strength. During World War II, this type of receiver became very important as "search receivers" for detecting enemy radio and radar activity. It was probably this application which lent the most impetus to the development of the backward-wave oscillators to be discussed in this issue. These *voltage tuned* oscillators have found ready acceptance since they represent the first wide range, *electronically tuned* generators available anywhere in the radio-frequency spectrum. Aside from their important military uses, they are appear-

ing in commercial signal generators where wide frequency sweeping is required to study the broadband characteristics of duplexing devices, antennas, amplifiers, and delay line structures. For this reason, a general understanding of the principles involved is important to anyone engaged in the electronics field.

Part 1 of this series contained a discussion of the traveling-wave amplifier and showed how this device differed from its predecessor, the klystron amplifier, in that the electrons interacted with a *traveling* electromagnetic wave on a special transmission line rather than with a *standing* wave in a high "Q" cavity resonator. In this way, broadband amplification is accomplished since the degree of interaction between

the wave on the delay line and the electron stream is essentially the same over wide frequency ranges. Since any amplifier will oscillate if regeneration is provided, it was only natural that researchers would seek means to use the principle of distributed interaction to provide a broadband oscillator.

In the klystron and traveling-wave amplifiers discussed in Part 1, sustained oscillations would result if a portion of the output signal were introduced as "feed-back" into the input terminals of the tube. For the case of the klystron, the frequency of oscillation would be determined by the resonant frequencies of the cavities, and would be variable only by mechanically altering the L-C constants of them. In the travelling-

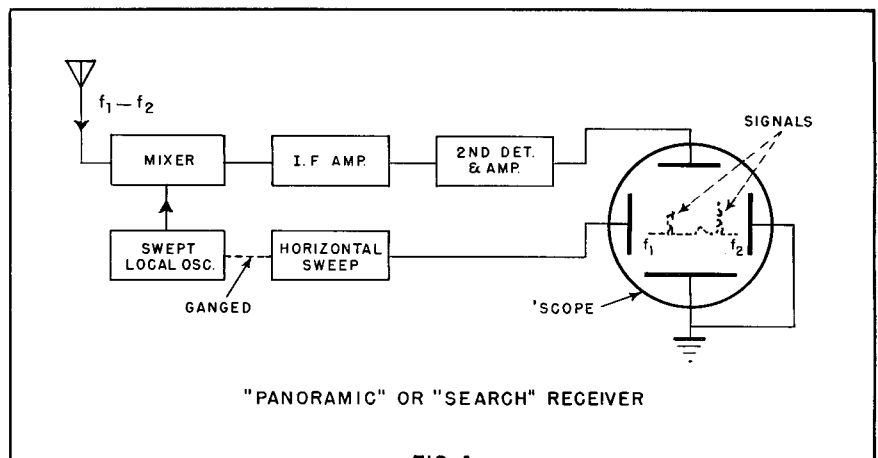

FIG. 1

AEROVOX - - The Finest In Electronic Components

wave amplifier used as an oscillator, as in Fig. 2, the frequency of oscillation could be varied considerably by altering the length of the feed-back path. This is due to the fact that only an integral number of wavelengths can exist around the feed-back loop, and in the absence of any other frequency determining element, the wavelength would automatically adjust to match boundary conditions as the path length were altered. Of course, since the helix is a broadband circuit, more than one frequency might exist for which the helix plus feed-back path is an integral number of wavelengths long. In this case, the only mechanism available for selecting which frequency the tube would operate at would be adjustment of the beam velocity, since it will be remembered from Part 1 that synchronism between the beam and the wave on the helix must exist for gain, and oscillation, to occur. Therefore, if the undesired frequency had a velocity of propagation which differed markedly from that of the desired one, the beam velocity could be varied to favor oscillation at the desired frequency. This concept of frequency selection by the coincidence of beam velocity with wave velocity is an important one in understanding the backward-wave oscillator.

Another concept which it is important to establish here is that of *electronic feed-back*. In both the two cavity klystron oscillator and the traveling-wave oscillator discussed above, the feed-back was *electromagnetic*; a portion of the output r. f. energy was fed back into the input of the tube to cause regeneration. However, in the reflex klystron oscillator (See AEROVOX RESEARCH WORKER, April, 1952), the feed-back can be said to be *electronic*. In this tube, shown in Fig. 3, the electrons are sent from a conventional electron gun through a single cavity which acts as both buncher and catcher. On the first trip through, velocity modulation, which really constitutes a radio frequency signal, is impressed on the beam. This "signal bearing" beam is then turned around by a negatively charged "reflector" or "repeller" electrode and sent back through the same cavity in such a phase as to sustain the oscillation. Thus, it is the arrival of the properly phased bunches of electrons at the input portion of the tube which cause further bunching of the beam and regeneration. Thus, we see that an r. f. signal can exist on an electron stream, as well as on a metallic conductor.

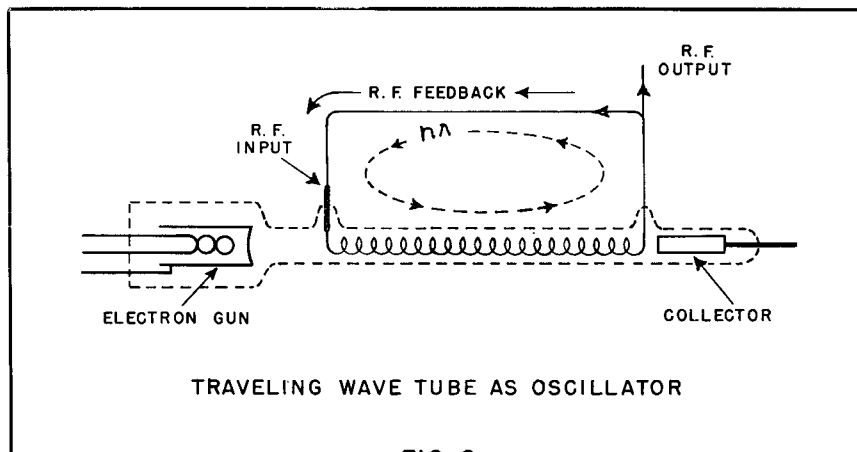

FIG. 2

Another point of similarity between the reflex klystron and the backward-wave oscillator is the fact that a small amount of electronic tuning is achieved in the former by varying the repeller voltage, so that the electrons are returned to the cavity differently phased. Such electronic tuning is limited by the bandwidth of the resonant circuit, however, to usually less than 1% of the operating frequency. Typically, a 10,000 megacycle reflex klystron might be capable of rapid electronic frequency sweeping over a range of 30-40 megacycles and mechanical tuning over a range of 1000 megacycles. (Tubes of this kind have been made use of in commercial swept-

signal generators where the outputs of two such klystrons are heterodyned and the difference signal is used as the signal output. When the frequency of one of them is electronically swept by a saw-tooth or sine-wave voltage, the low frequency output signal is swept by the same amount. Thus, electronically swept signal generators having to 40 megacycles at center frequencies from a few kilocycles to 1000 megacycles are provided.)

Backward Wave Oscillation

Let us see now how the properties of distributed interaction, as possessed by the traveling-wave amplifier, and electronic feed-back, as employed in the reflex klystron, can be com-

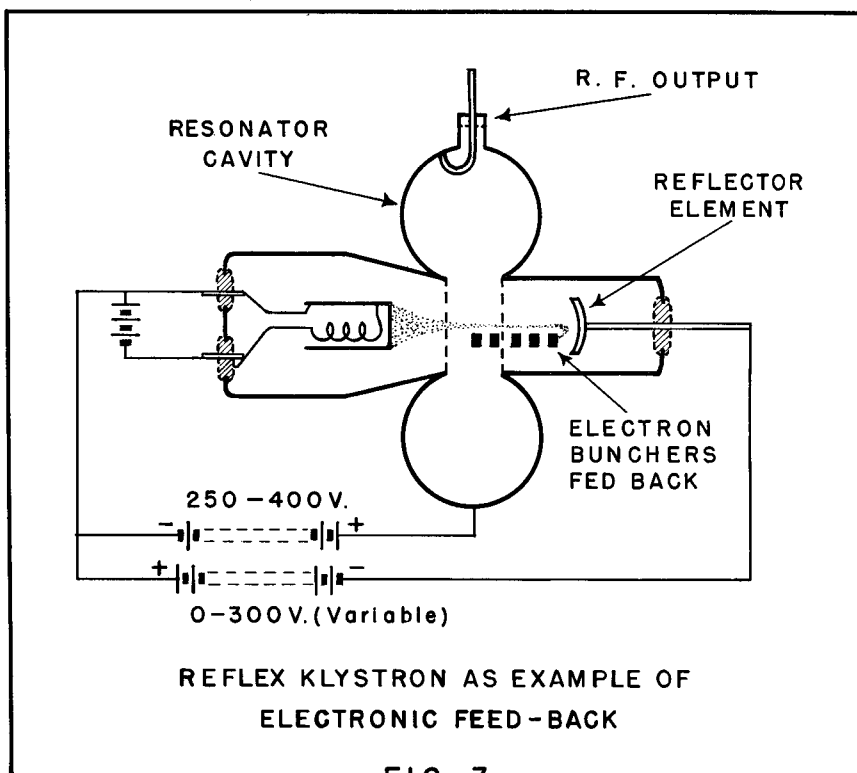

FIG. 3

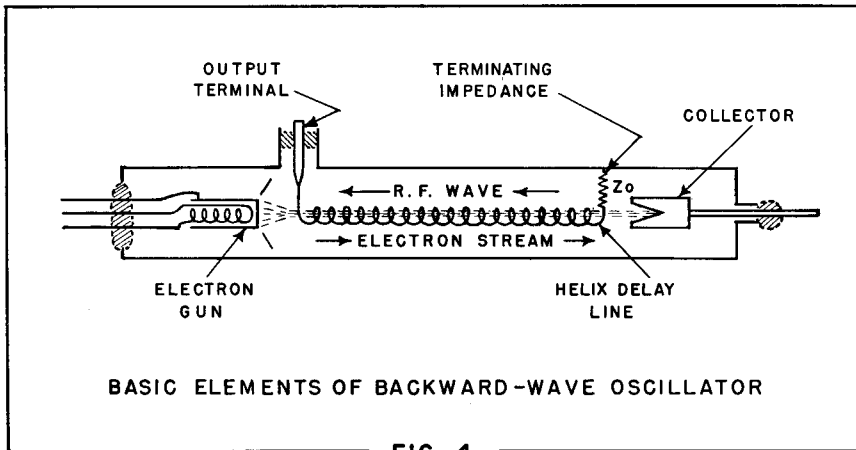

FIG. 4

bined to make voltage tunable oscillations possible. The basic elements of a backward-wave oscillator are shown in Fig. 4. An electron beam is sent along a delay line somewhat similar to that used in the traveling-wave tube and collected at the far end by a "collector". The output terminal, however, is at the end of the tube nearest the electron gun, while the far end of the delay line is terminated in an impedance equal to that of the line. In other words, the electron stream interacts with a wave on the delay line which is traveling in the *opposite* direction. Hence the name, *backward-wave* oscillator, sometimes abbreviated b. w. o.

As the electron stream travels along the delay line, the electrons are bunched by the fields associated with the wave and, in turn, impart energy to the growing wave on the line. Since the bunched electrons represent a radio-frequency signal, they also provide feed-back to the input end of the tube which starts a new wave traveling toward the gun end which, in turn, is amplified, rebunches the incoming beam, etc. The termination absorbs any energy associated with waves traveling in the forward direction. As in the traveling-wave oscillator with electromagnetic feed-back discussed above, the

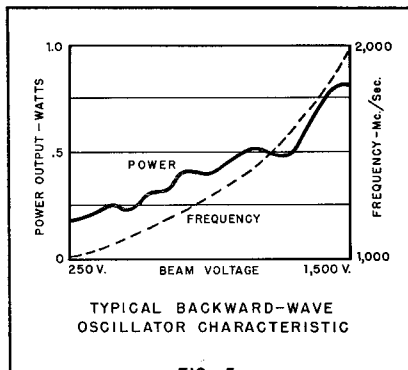

FIG. 5

phase shift around the feed-back loop must be equal to an integral number of wavelengths for oscillation to occur. The frequency of the oscillation so produced is controlled solely by the velocity of the electron beam which, of course, is controlled by the beam voltage. Frequency ranges as large as 2:1 are achieved by tubes of this type. Fig. 5 shows how the frequency and power output vary with voltage for a typical b. w. o. Note that the frequency does not vary linearly with voltage for this type of voltage tuning.

To understand how the velocity of the electron stream determines the frequency of oscillation, it is necessary to understand something about the *dispersion characteristic* of delay lines. This consists of a plot of the angular frequency (ω) versus the phase constant (β) as shown in Fig. 6 for a given delay line, and shows how the velocity of propagation varies with frequency. The phase velocity of a wave on the line is given by:

$$V_p = \frac{\omega}{\beta}$$

ω is the angular frequency $2\pi f$

β is the phase constant $\frac{2\pi}{\lambda}$.

Therefore, on this characteristic, constant phase velocities are represented by lines of constant slope passing through the origin such as dotted line O-A (since on such lines the ratio of ω to β is constant.) Electron beam velocities are also represented by such lines. Lines having the greatest slopes represent the highest velocities. Backward waves are represented by portions of the dispersion characteristic having negative slopes.

For a traveling-wave amplifier, a segment of the dispersion curve such as X-Y would be utilized for the operating range since a single beam

velocity, such as represented by line O-A, would match the velocity of propagation of the wave over an appreciable frequency range, f_1 to f_2 . Thus, any signal frequency within this range entering the tube would be amplified without changing the beam velocity. This portion is called the "non-dispersive" part of the delay line characteristic.

On the other hand, the portion of the dispersion curve between Y and Z is *highly dispersive*, since the velocity of propagation is changing rapidly with frequency. Since the slope is negative (representing a negative group velocity), this segment represents a backward wave and would be used for a backward-wave oscillator. Here a single beam velocity, as represented by line O-B for instance, intersects the wave velocity curve at only one point. This indicates that synchronism between the two, and therefore gain and oscillation, occur at only a single frequency, f_3 . Then, if the beam voltage is varied so as to cause the electron velocities to vary through the range O-B to O-C, the output frequency is swept continuously from f_3 to f_4 . Since the tuning is purely electronic, sweeping can be accomplished at much greater rates than with mechanical tuning. Another advantage of the b. w. o. is that the *pulling-figure*, i. e., the change in output frequency with variations in load impedance, is smaller than in conventional oscillators.

As with the traveling-wave amplifier, the backward-wave oscillator electron beam must be made to travel along a confined path close to the delay line. Longitudinal magnetic focussing fields are provided by solenoid electromagnets or by permanent magnets. Generally, the structure for a backward-wave oscillator is shorter than that required for forward-wave amplification, so that the focussing problem is simpler in the oscillator and the form factor more adaptable to equipment use.

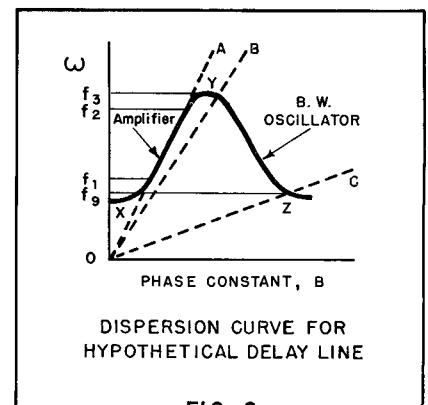

FIG. 6

CINEMA INSTRUMENT COMPONENTS

PRECISION WIRE WOUND RESISTORS

Military and Industrial precision resistor specification requirements have been met by Cinema Resistors for over two decades.

In accuracies of 1% to 1/40%, Cinema Resistors represent a "High Reliability Component" at its best. Let us service your next precision resistor inquiry.

CERAMIC BOBBIN
& ENCAPSULATED
TYPES

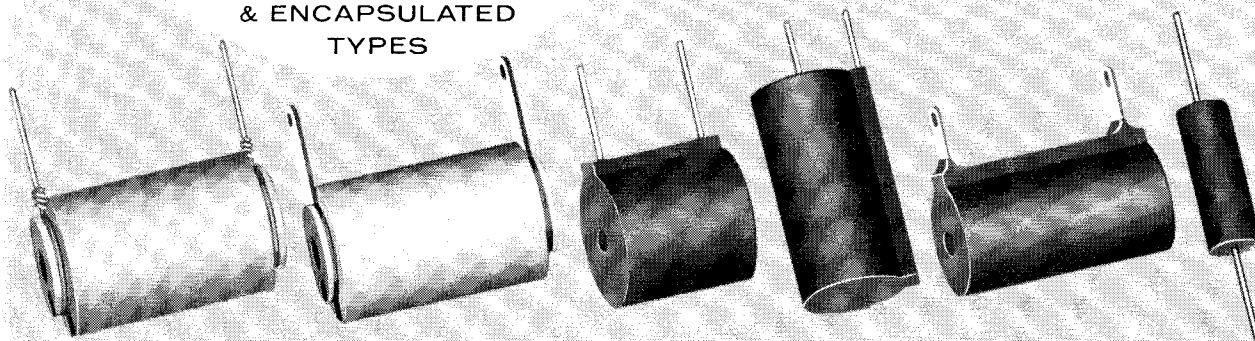

INSTRUMENT SWITCHES

Maximum flexibility is given an electronics circuit, with a minimum of electronic components, by the use of Instrument Switches.

Built for dependable service, low resistance, they meet each specific problem. Rapid delivery is our policy. Let us service your next instrument switch inquiry.

ROTARY TAP
TYPES

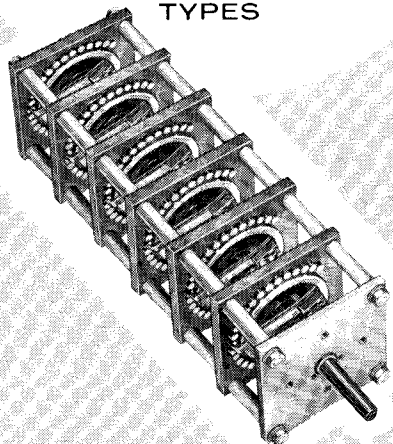

CINEMA ENGINEERING

DIVISION AEROVOX CORPORATION

1100 CHESTNUT STREET
BURBANK, CALIFORNIA