

# AEROVOX RESEARCH WORKER

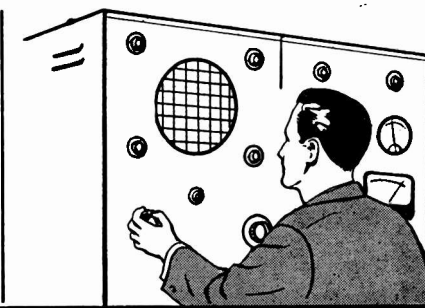

Radio Editors of magazines and newspapers will be given permission to reprint in whole or in part, with proper credit to the Aerovox Corporation, the contents of this issue of the Aerovox Research Worker, upon written request.

The Aerovox Research Worker is edited and published by the Aerovox Corporation to bring to the Radio Experimenter and Engineer, authoritative, first hand information on capacitors and resistors for electrical and electronic application.

VOL. 29, NOS. 9 - 12

SEPTEMBER - DECEMBER, 1959

Subscription By  
Application Only

## Dielectric Absorption

By the Engineering Department, Aerovox Corporation

**T**HIS phenomenon of dielectric absorption is not often mentioned among the characteristics of capacitors. It is the physical manifestation of the polarization of a dielectric in an electric field. Some students and technicians, may be unacquainted with it. This property is important, however, since it is a loss source in capacitor operation. The efficient application of capacitors to electronic circuitry requires an understanding of dielectric absorption, as well as capacitance, power factor,  $Q$ , inductance, resonant frequency, and leakage resistance. This article describes the phenomenon and its principal manifestations.

### Qualitative Description

When a steady d-c voltage ( $E$ ) is applied through a charging resistor ( $I$ ) flows into a capacitor. The current is initially high but decreases exponentially with time. After a certain interval, the capacitor theoretically should become fully charged and the current should have fallen to zero. The voltage at this time will equal the supply voltage,  $E$ . If there is any current flow after the instant at which the capacitor becomes fully charged, it theoretically should be a steady value determined by the supply voltage and the parallel (leakage or dielectric resistivity) resistance of the capacitor.

In practice, these conditions are not always obtained. Actually, current continues to flow into the capacitor for a short time after the instant at which calculations show the capacitor should have been fully

charged, and eventually this particular current flow ceases. This additional electrical energy is envisioned as being absorbed by the dielectric, hence the term dielectric absorption. Conversely, if a fully-charged capacitor is suddenly discharged (e. g., by placing a short circuit across its

capacitor several times before handling its terminals. High voltage capacitors should have short circuit straps across their terminals at all times except in use.

Dielectric absorption is more pronounced in some dielectrics than in others. Dielectric absorption is dependent on the polarization of the molecule or the crystal and should not be confused with a current flow due to low ion mobility.

### Importance in A-C Operation

From the foregoing discussion, it is clear that the capacitor dielectric may absorb energy beyond that required to charge the capacitance, and significant time is required to drain all of the energy (the total of that energy which charged the capacitance and that which was absorbed in the dielectric) out of the capacitor.

Many capacitor applications are of the a-c type, i. e., coupling, bypassing, filtering, etc. If a sinusoidal voltage stress is applied to a dielectric the residual charge left in the capacitor, when the voltage reverses half-cycle for a complete discharge of the capacitor, constitutes a loss of energy. For this reason, dielectric loss is a function of frequency and, among other effects is related to the change of dielectric constant with frequency.

An analogy is quickly seen between absorption in dielectrics and hysteresis in magnetic materials. Whereas in magnetic materials a small amount of residual magnetism remains in the material after the magnetizing force is removed, a small

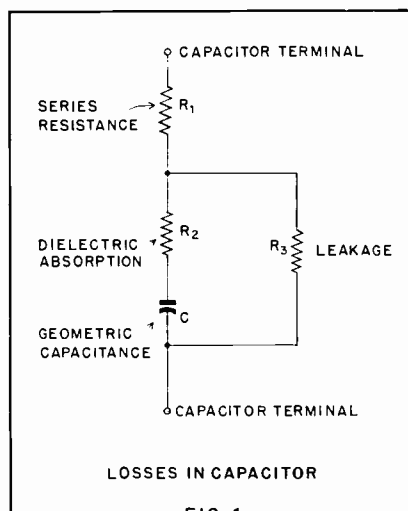

terminals), it does not give up all of its charge instantaneously. Instead, current drains out of the capacitor after the instant at which calculations would indicate the geometric capacitance to be fully discharged. This latter effect is well known to anyone who has tried to discharge a capacitor with a screwdriver; sparks can be drawn on a number of successive short circuits, and a prime rule of safety against electric shock consequently is to discharge

**AEROVOX - - The Finest In Electronic Components**

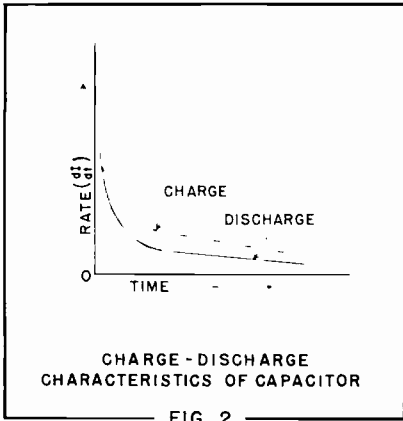

amount of residual electrification is left in the dielectric after the charging voltage is removed. In practical magnetic devices (such as chokes, inductors, and transformers), hysteresis contributes to core losses. And in capacitors, dielectric absorption similarly is responsible for part of the dielectric losses. The losses in each instance are heat. Because of these similarities, dielectric absorption often is called dielectric hysteresis.

#### Nature of Loss

Dielectric absorption appears as a series resistance component of the capacitor. Thus, in the equivalent circuit given in Figure 1 (which neglects capacitor inductance),  $R_2$  represents the dielectric absorption portion of Resistance  $R_1$  is the remainder of the losses which are part of the equivalent series resistance of the capacitor as a unit. It is the total of all in-phase ohmic factors, including the resistance of leads, terminals, and foils or plates, skin effect, corona losses, etc. Resistance  $R_3$  represents the dielectric leakage. The latter resistance is very high in all good-grade nonelectrolytic capacitors, ranging from 500 megohm mfd to megohms or more in paper types to over a million megohms mfd in polystyrene capacitors. The geometric capacitance,  $C$ , may be determined in the conventional manner from charge or discharge time constant measurements made with a constant d-c voltage and accurately-known external series resistor for "non polar" dielectrics. ( $C = t/R$ , where  $t$  is the time in seconds for the charging current to reach 67% of its final value or for the discharge current to fall to 33% of its initial value).

After charging of the capacitor is completed, a steady current flows through  $R_3$ , due to leaking through the dielectric between the plates. But this current is not present during discharge in the external circuit, hence cannot be mistakenly attributed to dielectric absorption. That cur-

rent which is due to absorption flows for an the capacitance is being charged and then falls to zero, but the leakage current continues.

Figure 2 illustrates the relationship to time of the rate ( $dI/dt$ ) of charge (upper curve) and of discharge (lower curve). If there were no hysteresis effect (dielectric absorption), these two curves would coincide at all points. Since the dielectric is not perfect, however, this ideal condition does not result, and

the amount of dielectric absorption is proportional to the separation between the curves.

#### Aspects and Concepts

Attention often is called to Maxwell's theory that nonhomogeneity in dielectrics is the causation of dielectric absorption. In double-layer dielectrics in which the layers are of different materials for example, it appears from this theory that the charges entering and leaving the dielectric "couple" are proportional to

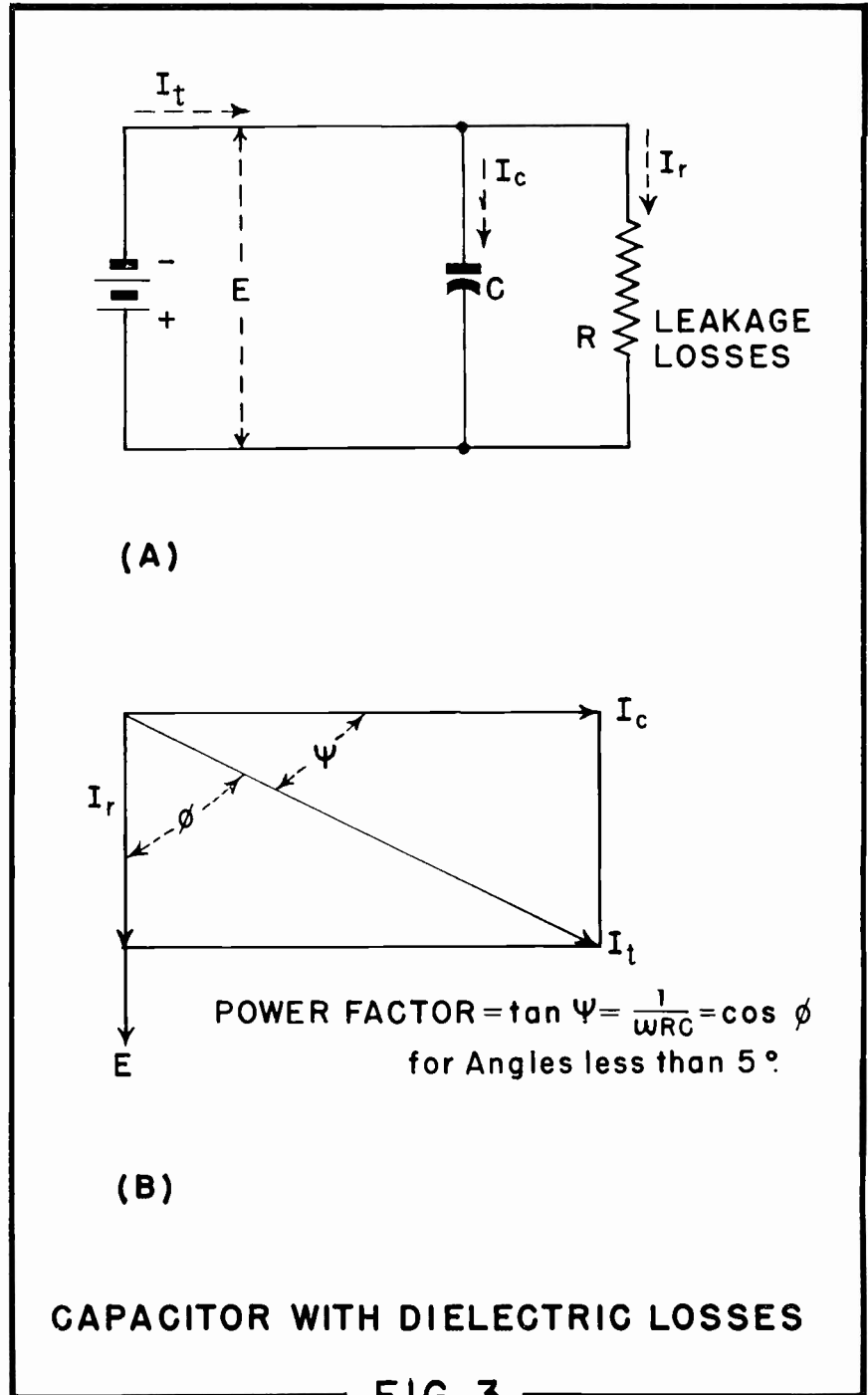

the conductivities of the two dielectrics, and this would account for the separation between the curves in Figure 2. Waxed or oiled paper might furnish an example of a double dielectric. But this theory does not account for the fact that dielectric absorption also appears in single, homogeneous dielectrics, both amorphous and crystalline. This may be due to impurities within the material.

Because the dielectric is under electrical stress while the capacitor is charged, the residual charge due to dielectric absorption to denote a relatively slow recovery from the stress. In the charged dielectric, the atoms become polarized electric doublets which are envisioned physically as being stretched under the electrical stress. They are thought to bind the charges on the capacitor plates, and during the existence of these doublets these charges cannot escape from the plates. But also, because the dielectric is not perfect, it contains a few conduction electrons which can migrate from one side of the dielectric to the other under the influence of the electrostatic field. The charges represented by these electrons join with the doublets in binding the charges on the plates. During discharge, the initial current flowing out of the capacitor (the free discharge) is due to recovery of the doublets from the stress and to the movement of charges due to the difference of potential between the plates. But the charge due to the binding action of the separated conduction electrons mentioned above cannot contribute to the discharge current immediately but only after the relatively lengthy recombination of these electrons in the dielectric. Thus, the charge bound by the conduction electrons seems to have been absorbed in the dielectric.

This would indicate that dielectric materials having the highest values of leakage resistance, having fewer migratory electrons, would exhibit the least absorption, and vice versa, which is generally the case. Thus, ordinary bakelite has high absorption (and is not used between capacitor plates) whereas absorption in such dielectrics as mica and Mylar is negligible.

There is little doubt that the various manifestations, demonstrable experimentally, which commonly are ascribed exclusively to dielectric absorption are due to a combination of factors which include the effects of equivalent series and shunt resistance of a capacitor and which are evaluated by measurements of Q and power factor. This is evident on inspection of the equivalent circuits

and vector diagrams in Figures 3 and 4. Both conditions apply in every case, since the practical capacitor has both series and shunt losses, however small.

### Practical Manifestations

In a-c circuits, dielectric absorption results in inefficiency and power loss at high frequencies. Heating of the capacitor is a common evidence. It can give rise to puzzling situations by causing an apparent change of capacitance. Capacitors designed for

radio-frequency use have low dielectric absorption.

In d-c applications, such as timing circuits and energy storage, dielectric absorption can prolong charge and discharge time beyond the interval calculated and expected in terms of the geometric capacitance. A capacitor having high absorption cannot be discharged immediately and, for safety, must be given a number of successive discharges to empty it completely.

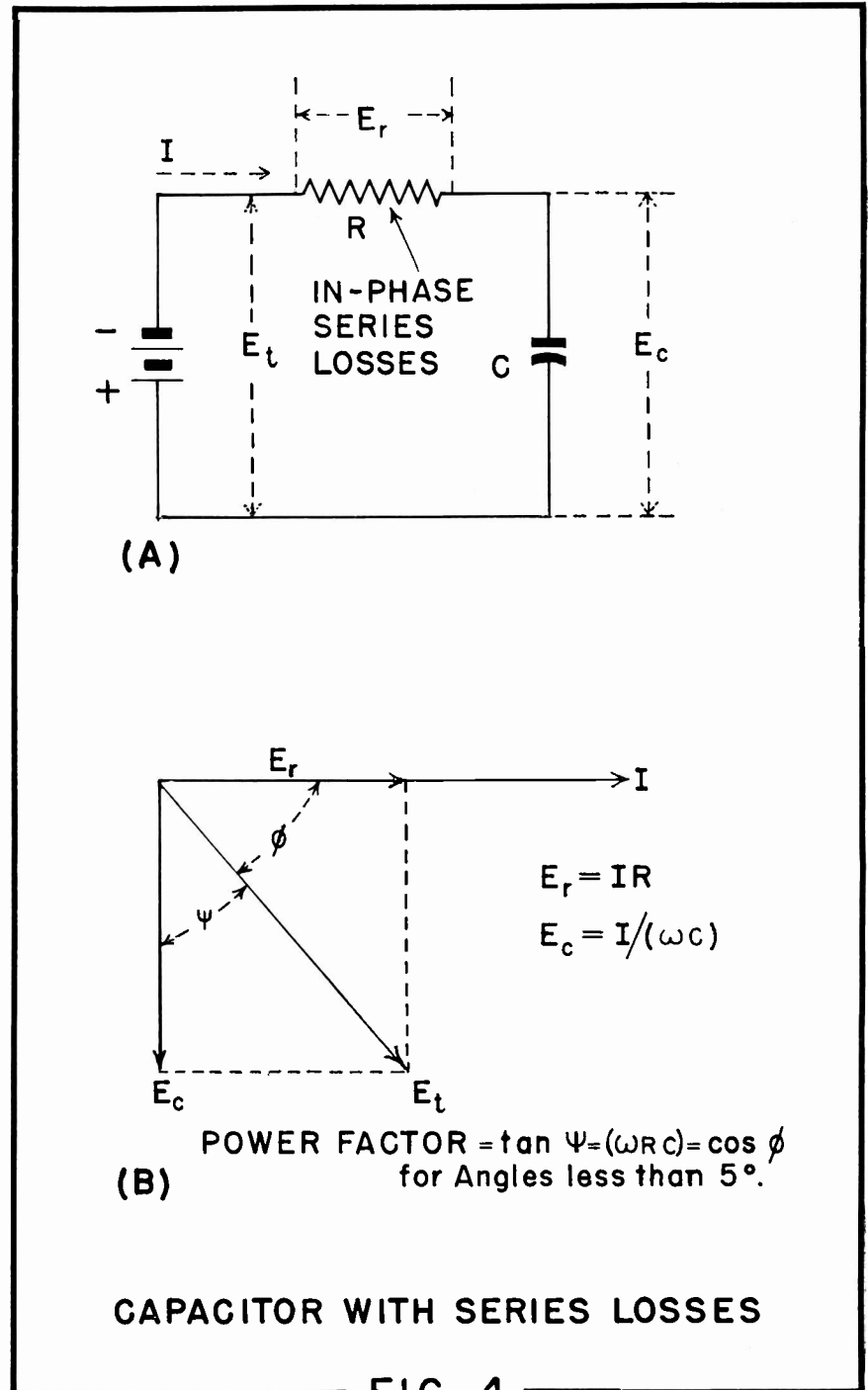
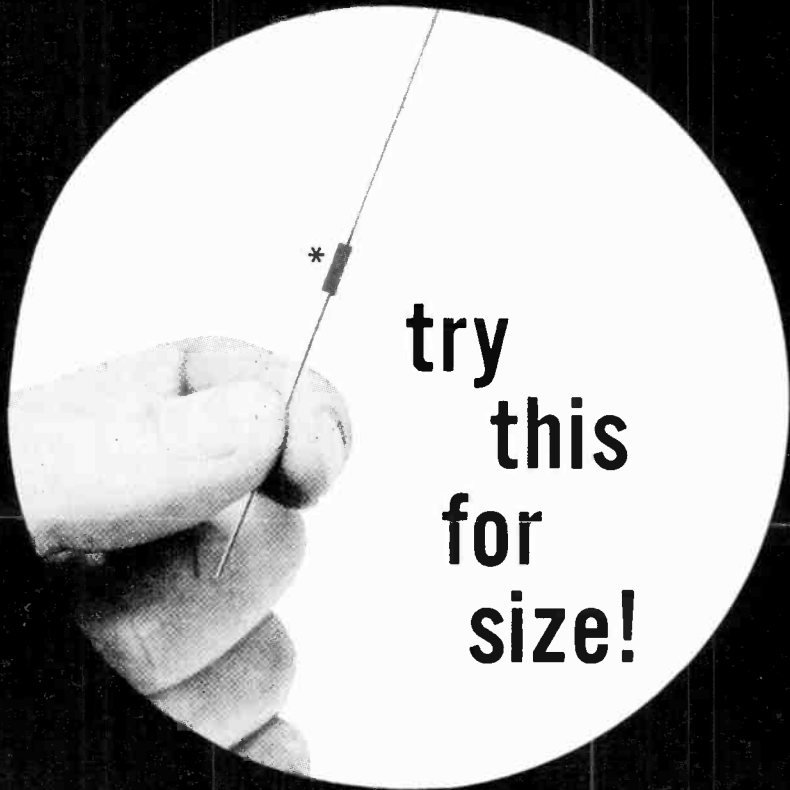

FIG. 4



\* Actual size of a 1000 mmf. unit @ 100 vdc.

# Aerovox CERAFIL<sup>®</sup> Capacitors

**CERAFIL... positively the smallest ceramic capacitors available anywhere.** These remarkably ultra-miniature units are designed primarily for airborne and spaceborne equipment, transistorized circuit applications in hearing-aids and other critical applications where space and weight are at an absolute premium

**CERAFIL... provides completely new design and construction features in a ceramic capacitor.** This unique construction makes it possible to obtain extremely high capacities per unit volume.

**CERAFIL... units are rugged ceramic capacitors of proven reliability for operation at temperatures from -55°C to +85°C and to 125°C when derated to 50 volts.** Available in capacities from 10 mmf. to 100,000 mmf. in working voltages of 30 and 100 vdc. in axial or radial lead construction. They will meet or surpass all the requirements of MIL-C-11015A.

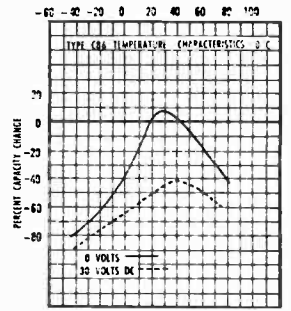

TYPICAL TEMPERATURE COEFFICIENT CURVES - TYPE C80 AND C8A

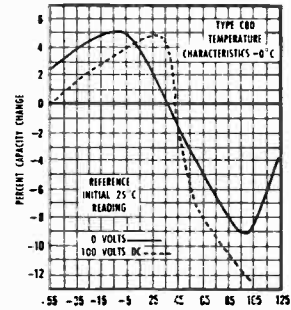

**DISTRIBUTOR  
DIVISION**

Write today for complete technical information on these ultra-miniature Cerafil Capacitors to...

**AEROVOX  
CORPORATION**

NEW BEDFORD, MASSACHUSETTS, U.S.A.