

COMMUNICATIONS

INCLUDING "RADIO ENGINEERING" AND "TELEVISION ENGINEERING"

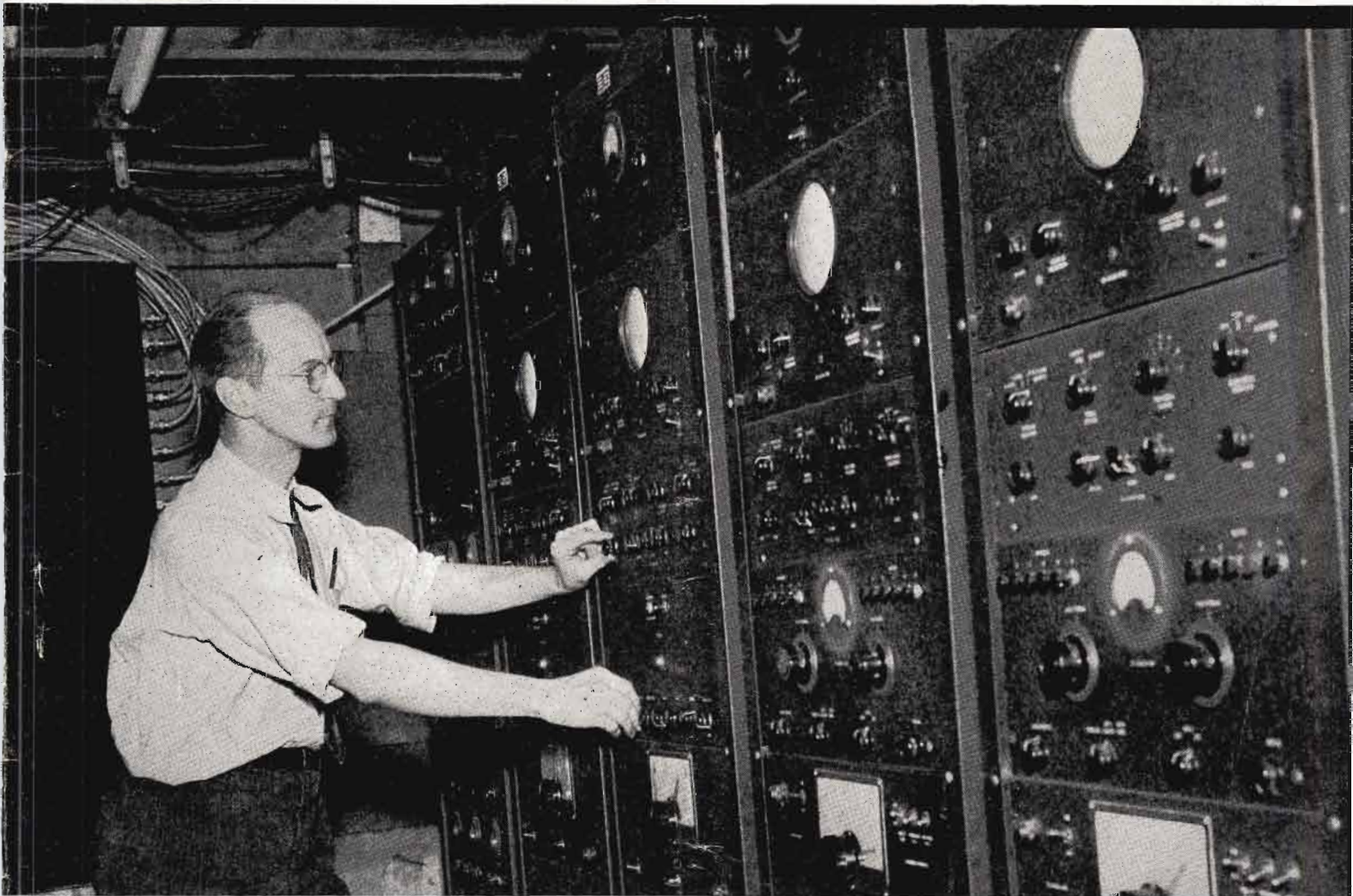

SEPTEMBER

* SELECTING BROADCAST STATION EQUIPMENT * TELEVISION ANTENNAS
* SHORT TELEPHONE LINES IN BROADCASTING

1947

Just roll it open!

SIMPSON Model 260 Volt-Ohm Milliammeter

...with Roll Top Safety Case*

• The world's finest high sensitivity set tester certainly deserves the best in carrying cases. So we decided to give it just that by *building* the tester into the case to make an integral unit of case and instrument. Here's how we do it: we take the standard Model 260, place it inside a housing of heavily molded bakelite, and permanently fasten it there. Instrument and case become one unit. Beneath the instrument is a compartment for test leads. Over the face of the instrument a roll top (of molded bakelite, too) slides up to open, down to close, the case. With a flick of the

finger you roll it up and out of sight and the instrument is ready to carry, and fully protected. With the Roll Top Safety Case you cannot leave your carrying case behind. It is never in the way. And you have *constant, important protection to your 260 from damage, whether in use or not.*

Just remember this fact, always: You cannot touch the precision, the useful range, or the sensitivity of Simpson Model 260 in any other instrument of equal price or in some selling for substantially more.

*The regular Model 260, without Roll Top Safety Case, is always available, of course.



Simpson 260, High Sensitivity Set Tester for Television and Radio Servicing

At 20,000 Ohms per volt, this instrument is far more sensitive than any other instrument even approaching its price and quality. The practically negligible current consumption assures remarkably accurate full scale voltage readings. D.C. current readings as low as 1 microampere and up to 10 amperes are available.

Resistance readings are equally dependable. Tests up to 20 megohms and as low as 1/2 ohm can be made. With this super sensitive instrument you can measure a wide range of unusual conditions which cannot be checked by ordinary servicing instruments.

Model 260—Size 5 1/4" x 7" x 3 1/8" \$38.95
 Model 260, in Roll Top Safety Case—Size 5 3/8" x 9" x 4 3/4" \$43.75
 Both complete with test leads

Volts D. C. (at 20,000 ohms per volt)	Volts A. C. (at 1,000 ohms per volt)	Output	Milliamperes D. C.	Microamperes D. C.	Ohms
2.5	2.5	2.5 V.	10	100	0-2000 (12 ohms center)
10	10	10 V.	100		0-200,000 (1200 ohms center)
50	50	50 V.	500		0-20 megohms (120,000 center)
250	250	250 V.		Amperes	
1000	1000	1000 V.		D. C. (5 Decibel ranges: -10 to +52DB)	
5000	5000	5000 V.		10	

SIMPSON ELECTRIC COMPANY
 5200-5218 West Kinzie Street, Chicago 44, Illinois
 In Canada, Bach-Simpson Ltd., London, Ont.

Simpson
 INSTRUMENTS THAT STAY ACCURATE

ASK
 YOUR
 JOBBER

10-7-47 14 #3

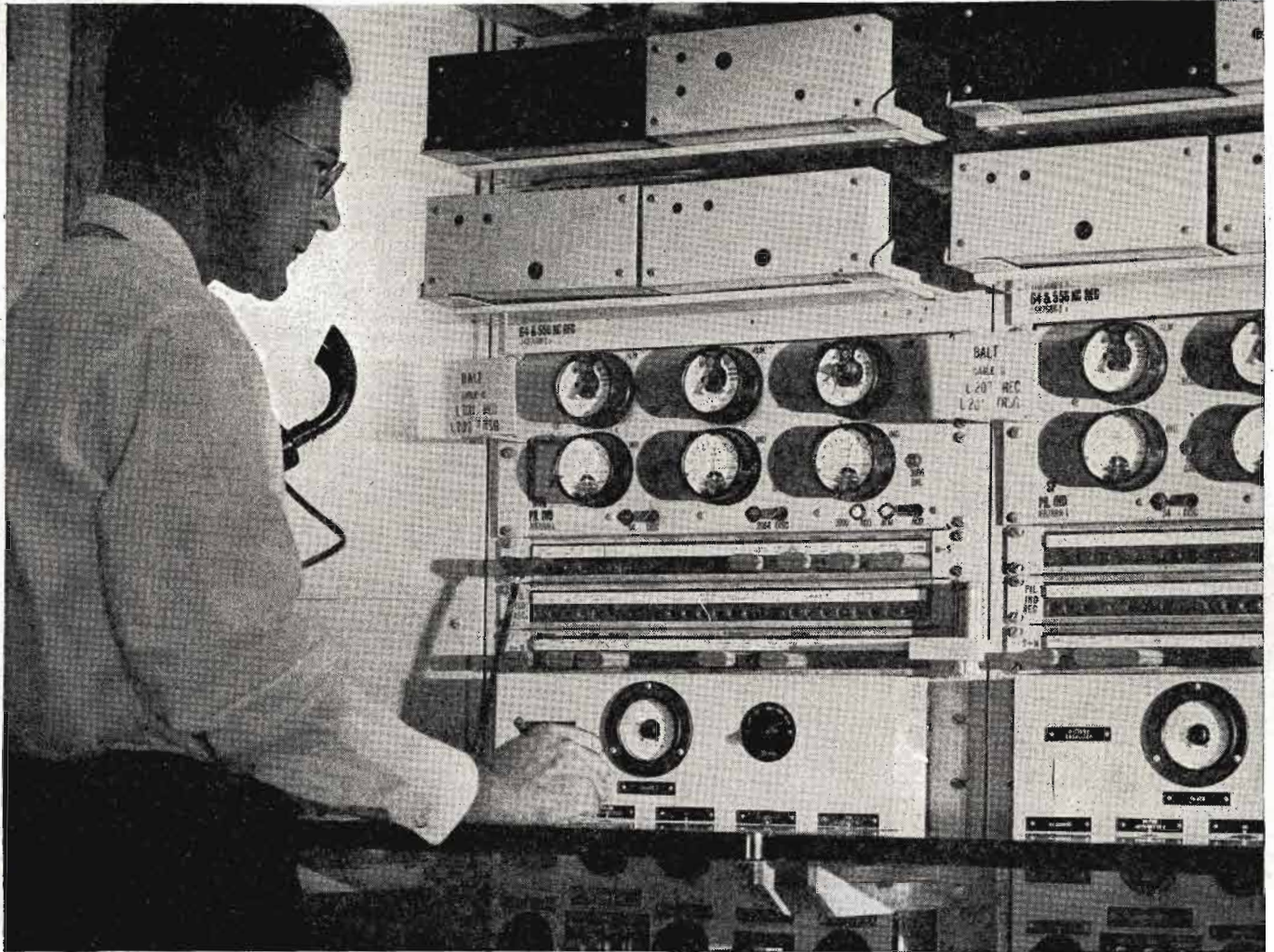

At Philadelphia, a testboard man answers as an electronic watchman calls attention to conditions on one of the coaxial systems to Baltimore and Washington.

“Send Help to Manhole 83”

Strung out along every Bell System coaxial cable, electronic watchmen constantly mount guard over your voice. Some are in manholes under city streets; some are in little huts on the desert. Most situations they can deal with; if things threaten to get out of hand, they signal the nearest testboard.

Principal care of the electronic watchman is the transmission level. Sun-warmed cables use up more energy than cold ones, so a transcontinental call may take a millionfold more energy to carry it by day than by night.

Each watchman — an electronic regulator — checks the transmission level and adjusts the amplification which sends your voice along to the next point. Many hundreds of regulators may be at work on a single long distance call.

Without automatic regulation, the precise control of energy in the Bell System's long distance circuits would be a superhuman task. So Bell Laboratories, which in 1913 developed the first high vacuum electronic amplifier, went on to devise the means to make them

self-regulating in telephone systems. This is one reason why your long distance call goes through clearly, summer or winter.

BELL TELEPHONE LABORATORIES

Exploring and inventing, devising and perfecting for continued improvements and economies in telephone service.



COMMUNICATIONS

Including Television Engineering, Radio Engineering, Communication & Broadcast Engineering, The Broadcast Engineer. Registered U. S. Patent Office.

LEWIS WINNER

Editor

F. WALEN

Assistant Editor

Bryan S. Davis, President

Paul S. Weil, Vice Pres.-Gen. Mgr.

F. Walen, Secretary

A. Goebel, Circulation Manager

Cleveland Representative:

James C. Munn
2253 Delaware Dr., Cleveland 6, Ohio
Telephone: Erieview 1726

Pacific Coast Representative:

Brand & Brand
1052 W. Sixth St., Los Angeles 14, Calif.
Telephone Michigan 1732
1085 Monadnock Bldg., San Francisco 5, Calif.
Telephone Douglas 4475

Wellington, New Zealand: Te Aro Book Depot.
Melbourne, Australia: McGill's Agency.

Entered as second-class matter Oct. 1, 1937 at the Post Office at New York, N. Y., under the Act of March 3, 1879. Subscription price: \$2.00 per year in the United States of America and Canada; 25 cents per copy. \$3.00 per year in foreign countries; 35 cents per copy.

COVER ILLUSTRATION

Operating the television sound f-m i-f sweep unit in the RCA tv-receiver production setup at Camden, N. J. See page 8 of this issue for further details.

TELEVISION ENGINEERING

- Television Receiver Production Test Equipment.....John A. Bauer 8
RCA System Set Up at Camden, N. J., Plant Provides 13-Channel Video and Sound Transmission for Testing Up to 500 TV Receivers Per Day.
- WTTG TV Antennas.....G. Edward Hamilton and R. K. Olsen 14
Photographic Study of the Plumbing and Mechanical Features of Washington, D. C., Antenna System.

A-M BROADCASTING

- Selecting A-M Broadcasting Equipment.....Hobart A. Stephenson 12
Features Considered in Choosing Transmitter, Antenna, Audio Units and General Accessories.
- Broadcast Station Engineering Bookkeeping System.....F. J. Sheehan 22
Forms Used at WTOL for Tube Inventories, Transmitter Operation Control, Network Schedules, Remotes, Recording, etc.

SOUND ENGINEERING

- Short Telephone Lines in Broadcast Operation.....Alan Sobel 16
Methods Which Can Be Used to Improve Frequency Response of Lines As Short As 3,000 Feet.
- An Audition-Amplifier Volume Indicator.....F. E. Bartlett 38
Modification of Commercial Unit Provides Vu to Check Balance, Gain Riding and Pre-Airing Levels.

F-M BROADCASTING

- H-F F-M Quadriline R-F Amplifier.....Ralph G. Peters 36
Highlights of Design and Application Features.

MONTHLY FEATURES

- News and Views.....Lewis Winner 7
- The Industry Offers..... 24
- Veteran Wireless Operators' Association News..... 26
- News Briefs of the Month..... 31
- Advertising Index 40

Entire contents Copyright 1947, Bryan Davis Publishing Co., Inc.



Published monthly by Bryan Davis Publishing Co., Inc.
52 Vanderbilt Avenue, New York 17, N. Y. Telephone Murray Hill 4-0170



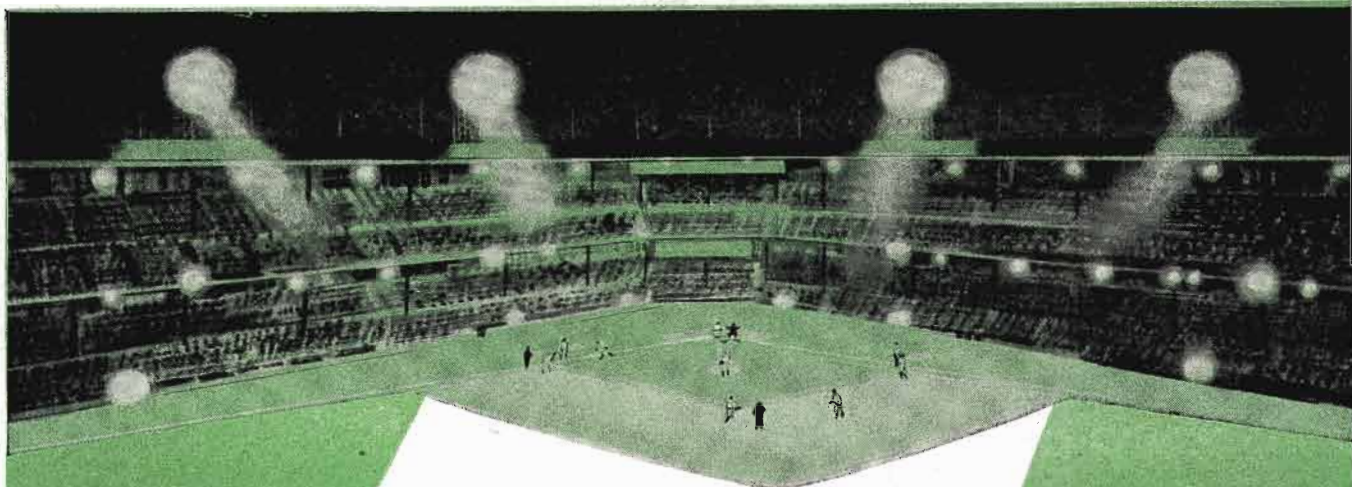

Why the *Lock-In* tube is at home

IN TELEVISION!

ULTRA-HIGH FREQUENCIES... HANDLED WITH EASE

Sylvania Lock-In is *the* tube specifically engineered to more than satisfy the requirements of television equipment—handles ultra-high frequencies with ease! Electrical features include: short, direct connections... fewer welded joints—less loss; getter located at top... shorts eliminated by separation of getter material from leads.

STAYS PUT IN SOCKET... MECHANICALLY RUGGED

Specially designed "lock-in" locating lug on each tube keeps it in place—assuring firm socket contact. Improved tube mount keeps elements ruggedly supported on all sides. There are few welded joints and *no* soldered joints—the elements can't warp or weave.

COMPACT... MADE TO FIT SMALL SPACES

This famous Sylvania product is ideal for use in modern sets, where the tendency has been toward more compact units—has reduced overall height and weight. Has no top cap connection... overhead wires are eliminated! See *Sylvania Distributors* or write *Radio Tube Division, Emporium, Pa.*



SYLVANIA'S LOCK-IN TUBE...

...the radio tube whose electrical and mechanical superiority makes it the ideal choice for marine radar, equipment in the air, on the road, FM and television.

SYLVANIA ELECTRIC

MAKERS OF RADIO TUBES; CATHODE RAY TUBES; ELECTRONIC DEVICES; FLUORESCENT LAMPS; FIXTURES; WIRING DEVICES; ELECTRIC LIGHT BULBS

ELECTRONIC

EQUIPMENT

BARGAINS

JOBBERS

WHOLESALEERS

MANUFACTURERS

Large inventories of valuable electronic tubes, devices and equipment are being offered by the WAA Approved Distributors listed herewith for your convenience. Alert commercial buyers are taking advantage of this big bargain opportunity. Why not fill *your* present and future requirements from these available stocks. Act now—while inventories still permit wide selection.

Purchase of this surplus equipment has been greatly simplified. The Approved Distributors appointed by WAA were selected on a basis of their technical background and their ability to serve you intelligently and efficiently. Write, phone or visit your nearest Approved Distributor for information concerning inventories, prices and delivery arrangements. You'll find you can "Save with Surplus."

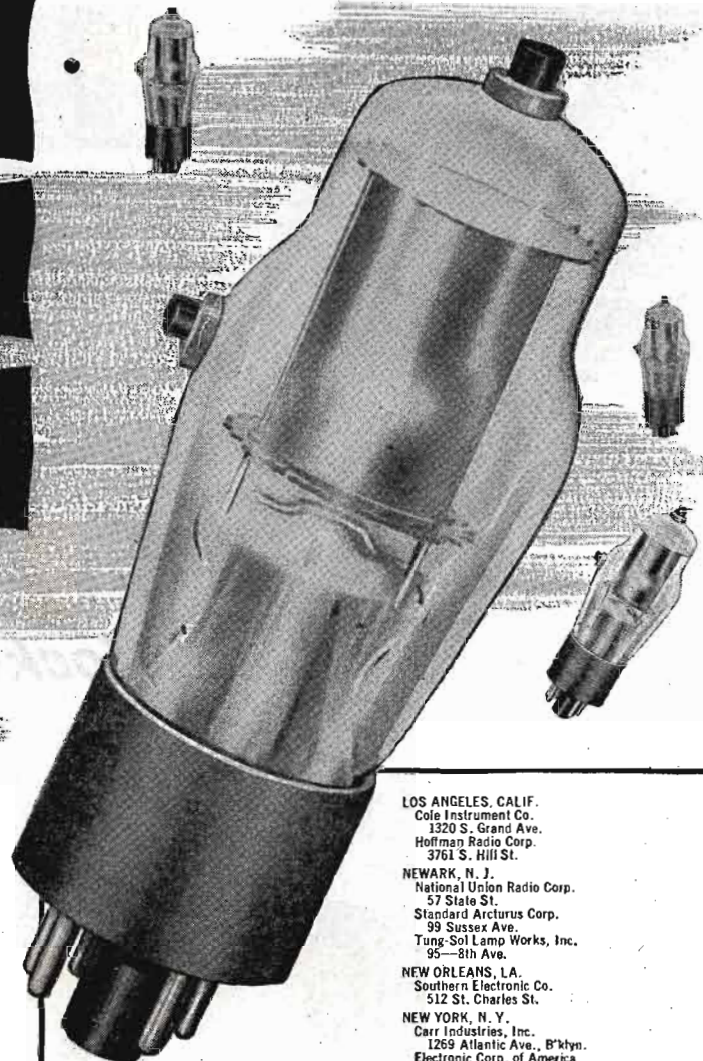

LOS ANGELES, CALIF.
Cole Instrument Co.
1320 S. Grand Ave.
Hoffman Radio Corp.
3761 S. Hill St.

NEWARK, N. J.
National Union Radio Corp.
57 State St.
Standard Arcturus Corp.
99 Sussex Ave.
Tung-Sol Lamp Works, Inc.
95—8th Ave.

NEW ORLEANS, LA.
Southern Electronic Co.
512 St. Charles St.

NEW YORK, N. Y.
Carr Industries, Inc.
1269 Atlantic Ave., B'klyn.
Electronic Corp. of America
353 W. 48th St.
Emerson Radio & Phonograph Corp.
76—9th Ave.

General Electronics, Inc.
1819 Broadway
Hammarlund Mfg. Co., Inc.
460 W. 34th St.
Johanns & Keegan Co., Inc.
62 Pearl St.
Newark Electric Co., Inc.
242 W. 55th St.
Smith-Moecker Engineering Co.
125 Barclay St.

NORFOLK, VA.
Radio Parts Distributing Co.
128 W. Olney Road

ROCHESTER, N. Y.
W. & H. Aviation Corp.
Municipal Airport

SALEM, MASS.
Hytron Radio & Electronics Corp.
76 LaFayette St.

SCHENECTADY, N. Y.
General Electric Co.
Bldg. 267, 1 River Road

WASECA, MINN.
E. F. Johnson Co.
206 2nd Ave., S. W.

BOSTON, MASS.
Automatic Radio Mfg. Co., Inc.
122 Brookline Ave.
Technical Apparatus Co.
185 Washington St.

BUCHANAN, MICH.
Electro-Voice, Inc.
Carroll & Cecil Sts.

CANTON, MASS.
Tobe Deuschmann Corp.
863 Washington St.

CHICAGO, ILL.
American Condenser Co.
4410 N. Ravenswood Ave.
Belmont Radio Corp.
3633 S. Racine Ave.

EMPORIUM, PENNA.
Sylvania Electric Products, Inc.

FORT WAYNE, IND.
Essex Wire Corp.
1601 Wall St.

HOUSTON, TEXAS
Navigation Instrument Co., Inc.
P. O. Box 7001, Heights Station

OFFICE OF AIRCRAFT AND ELECTRONICS DISPOSAL

WAR ASSETS ADMINISTRATION



Offices located at: Atlanta • Birmingham • Boston • Charlotte • Chicago • Cincinnati • Cleveland
Dallas • Denver • Detroit • Fort Worth • Helena • Houston • Jacksonville • Kansas City, Mo. • Little Rock
Los Angeles • Louisville • Minneapolis • Nashville • New Orleans • New York • Omaha • Philadelphia
Portland, Ore. • Richmond • St. Louis • Salt Lake City • San Antonio • San Francisco • Seattle • Spokane • Tulsa

10-7-47

NEW! A complete portable recording console THE PRESTO 90-A

Here in one easily portable unit is complete amplifier equipment to produce recordings on remote assignments that equal the best recordings in permanent installations.

Presto 90-A has 3 low-level input channels with mixers, master gain control and variable high and low frequency equalizers.

It has four fixed characteristics: flat between 30 and 15,000 CPS...NAB recording...78 r. p. m. recording...playback complimenting NAB recording.

Other features include: line input and output, V. U. meter, switching for one or two recorders, over-all gain—115 db, power—10 watts undistorted.

In quality of parts and workmanship and in flexibility of operation, the Presto 90-A is the equal of the finest studio equipment.

Presto engineers are proud to present this new recording console as a forward step in recording equipment.

Immediate delivery can be made from stock.

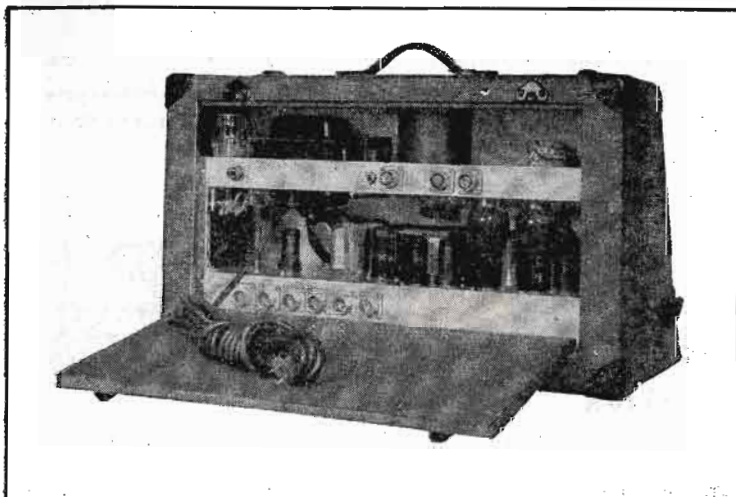
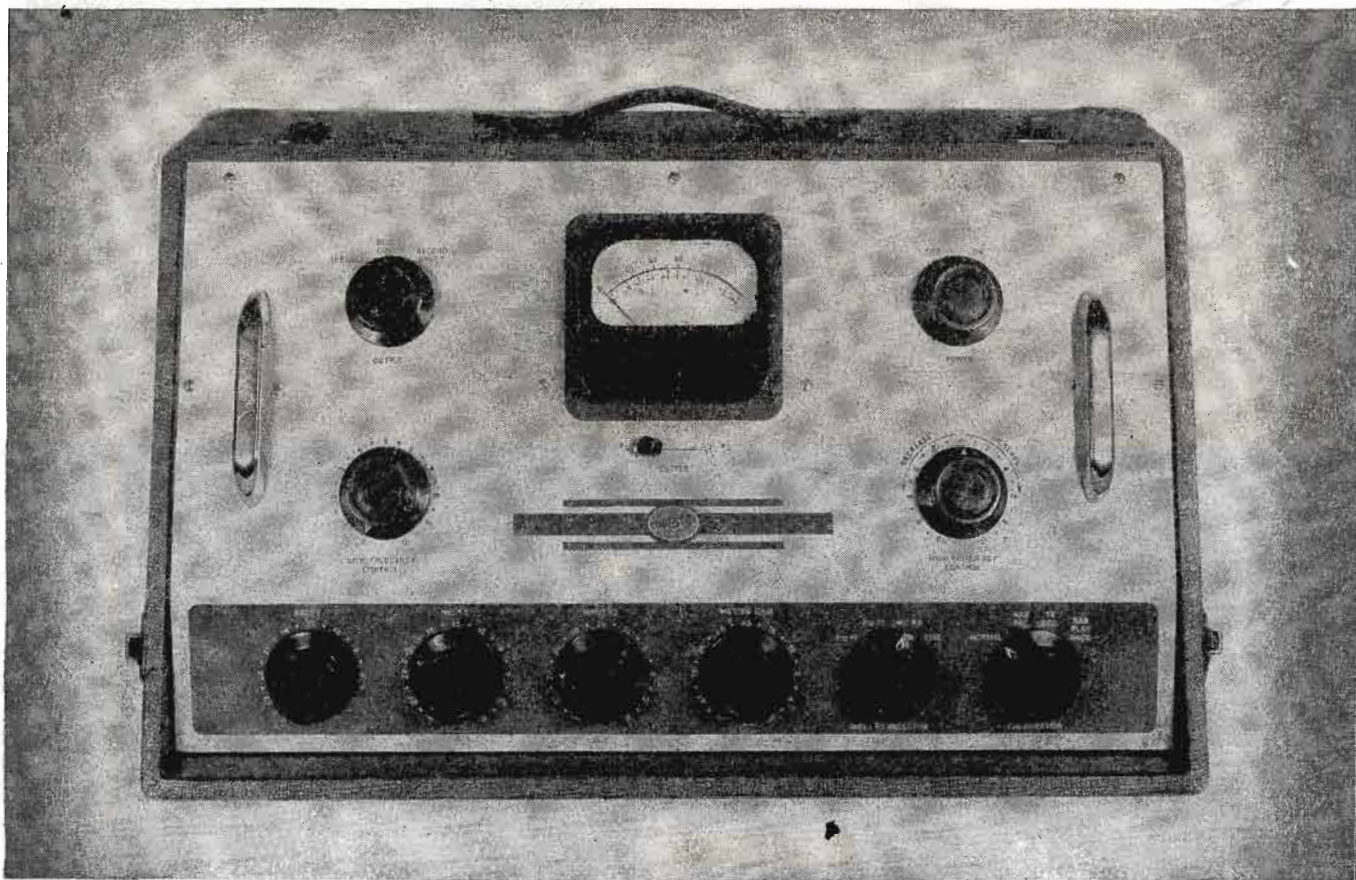

PRESTO

RECORDING CORPORATION
246 WEST 55TH STREET, NEW YORK 19, N. Y.
Walter P. Downs, Ltd., in Canada

FREE! Presto will send you free of charge a complete bibliography and digest of all technical and engineering articles on disc recording published since 1921. Send us a post card today.

New! **UNITIZED** amplifier systems for recording



Flexibility is the outstanding advantage of the new Fairchild Unitized Amplifier System. It includes 13 basic components which can be assembled in an endless number of combinations to meet the standard, special and changing recording requirements of schools, broadcasting and the professional recording industry. Related units are simply plugged in or cabled together. It's that easy . . . that quick!

Fairchild's Unitized Amplifier System now makes it practical and economical to build highly individualized audio systems to satisfy all of the varied and changing requirements of the individual recording engineer. Further, the flexibility of the Fairchild system permits the units to be rearranged or the system to be expanded at will without obsoleting a single component.

Fairchild's 13 basic components have been especially designed by recording engineers to meet the specific requirements of the various types of recording systems.

- | | |
|--|-----------------------------------|
| Unit 620 — Power Amplifier | Unit 626 — NAB Equalizer |
| Unit 621 — Microphone Preamplifier | Unit 627 — Variable Equalizer |
| Unit 622 — Pickup Preamplifier Equalizer | Unit 628 — Diameter Equalizer |
| Unit 623 — Line Amplifier | Unit 629 — Mixer |
| Unit 624 — Output Switch Panel | Unit 630 — VI Panel |
| Unit 625 — Input Switch Panel | Unit 631 — Bridging Device |
| | Unit 632 — Auxiliary Power Supply |

Study the typical setups shown on this page. Then set down your own requirements . . . select the basic units you'll need . . . assemble them for convenient panel board operation . . . or let us do it for you. How will your specific amplifier system perform? Professionally! Like all Fairchild Sound Equipment—it keeps the original sound alive. Precisionized mechanical and electronic skill is the precise reason.

Want more details? Address: 88-06 Van Wyck Boulevard, Jamaica 1, New York.

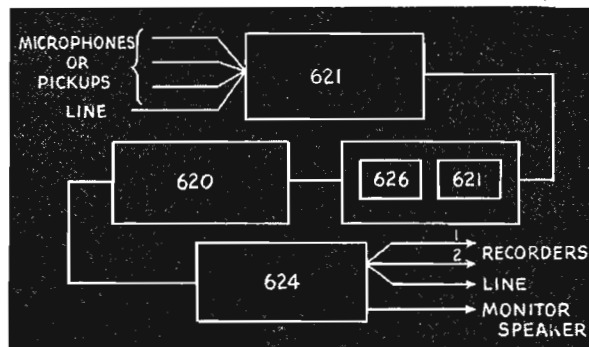

Single Channel Systems: for recording from a microphone or record or playing back from a pickup.

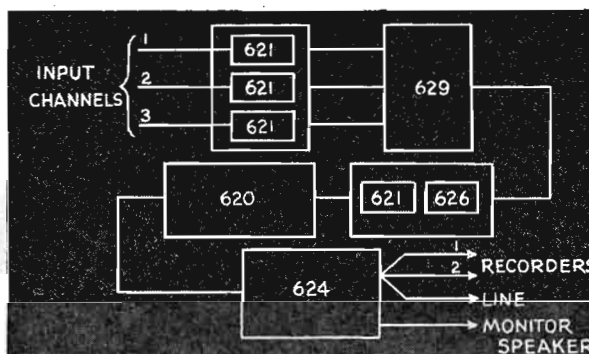

Multiple Channel Systems: for recording simultaneously through multiple input channels in conjunction with a mixer.

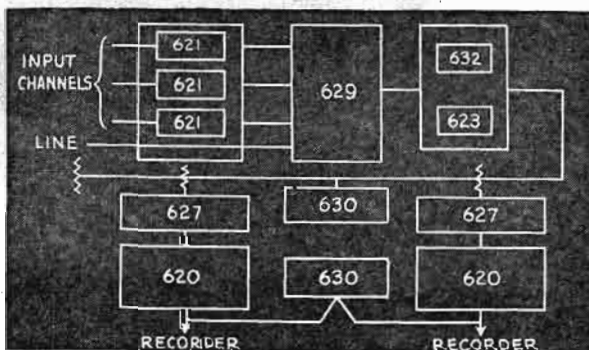

Dual Recording Channels: for recording simultaneously on two machines through dual channels with separate variable equalizers.



MAKERS OF: TRANSCRIPTION TURNTABLES, STUDIO RECORDERS, MAGNETIC CUTTERHEADS, PORTABLE RECORDERS AND LATERAL DYNAMIC PICKUPS

COMMUNICATIONS

LEWIS WINNER, Editor

SEPTEMBER, 1947

AT THE NAB BROADCAST ENGINEERING CONFERENCE

Television Engineering

WITH TELEVISION TRANSMISSION becoming a permanent service in the key areas of the nation, tv receiver production increasing daily and the viewing audience growing rapidly, the problem of program syndication has become quite a factor. While some intercity network facilities have been made available and the construction of further links are underway, there will be a large section of the United States that, for several years, will not have available intercity connections for tv programs. The use of film transcriptions provides an effective solution to this problem. Two procedures can be followed. In one, we have the standard technique of directly filming the scene or production. However, this method is quite expensive and syndication requires many stations to defray the cost. The second method involves direct photographing of the television image from a kinescope, while a tv production is being produced for the air at the studio of the key station. Discussing this procedure at the NAB engineering clinic, O. B. Hanson, vice president and chief engineer of NBC, said that this is a preferable method, since it permits the camera and sound recorder to run continuously, while the show is in production without the usual stop and start and later assembly into a finished film, with a corresponding waste of film. These films can be developed by rapid processes and the negative can be re-transmitted by tv for repeat performances.

The NBC system uses an 8-mc wide band to provide a very high resolution for the picture. Thus far, 16-mm film has been used, to reduce the cost of film stock.

Recording is done at 24 frames so that the films can be used on standard equipment, and the sound is recorded at 36 feet per minute. To record at 24 frames, the camera is driven by a synchronous motor and the shutter designed so that it is opened for exactly 1/30 of a second in each 1/24 of a second rotation time.

NBC has found that the most effective screen is composed of a blue flu-

orescent zinc sulphide, and the film stock a blue sensitive type. This combination has been found to be 20 times more actinically effective than the white phosphor screen P-4 used in home-type receivers.

O. B. Hanson reported that kinescope photographs are helpful for critical analysis of production techniques and will find wide use for audition purposes.

Audio Facilities

IN AN INTERESTING TALK on audio considerations for broadcasting stations, the development of a new method for suppression of record needle noise and hiss was disclosed by John Colvin, audio facilities engineer of ABC. The new suppressor, designed by Dr. Olson of the Princeton Labs of RCA, employs germanium diodes.

Two sets of series diodes are connected back-to-back to form a full-wave rectifier, essentially linear, except for very small voltages. Identical filters are used, before and after the diodes, to eliminate distortion due to clipping and bending of the load line. The input filter admits a band of frequencies one octave wide and output filter passes only this octave and rejects other frequencies by at least 30 db. Mr. Colvin stated that the frequency range of the system has been arbitrarily divided into four channels: 0 to 1,500 cycles, 1,500 to 3,000 cycles, 3,000 to 6,000 cycles, 6,000 to 12,000 cycles. It was pointed out that very little noise occurs below 1,500 cycles and thus the foregoing division and octave relationship was applied. For the low pass filter an *m* derived section is used. A value of .6 was selected since input and output terminals are in resistive networks. Mr. Colvin said that with the low-pass section adjusted for satisfactory operation, rejection at the notch is 38 db, least rejection 21 db, and rejection at three octaves is 25 db.

Discussing other applications of the suppressor, Mr. Colvin pointed out that it showed considerably promise when used with magnetic tape recorders.

Maintenance

THE ALL-IMPORTANT SUBJECT OF MAINTENANCE received quite a thorough analysis by three experts: G. Porter Houston, chief engineer, WCBM; A. E. Towne, director of engineering, Associated Broadcasters; and Dixie B. McKey, consulting radio engineer.

Mr. Houston covered maintenance of the small station, Mr. Towne maintenance procedures for the medium-sized station, and Mr. McKey analyzed the care and maintenance of directional antennas.

The multi-element directional antenna was stressed as a particularly important item in the maintenance calendar by Dixie McKey. He pointed out that the failure of individual components in such an array can produce serious trouble, by either removing the station from the air due to the transmitter or transmission line protective circuits, or a shifting in the radiation pattern so as to cause severe objectionable interference to other stations on the channel.

Each and every directional antenna is a custom-built job, designed and constructed to meet certain specific requirements.

The preparation of a station maintenance routine should be based on the proof of performance report as prepared and filed by the engineer in charge of the installation. This report, said Mr. McKey, which is filed with the FCC, is extremely important since it provides a day-to-day source of information and is thus invaluable in establishing a maintenance schedule.

Analyzing transmitter maintenance, Mr. Houston defined the term as any duty, operation or task that is necessary or aids in keeping the equipment functioning at optimum performance.

Mr. Houston emphasized that maintenance is an extremely important factor in broadcasting. Applying a routine inspection and correction schedule will afford a quick and accurate analysis of trouble and allow maximum service with no, or minimum of failure, and with a minimum of trouble to the engineer.—L. W.

TELEVISION RECEIVER Production Test Equipment

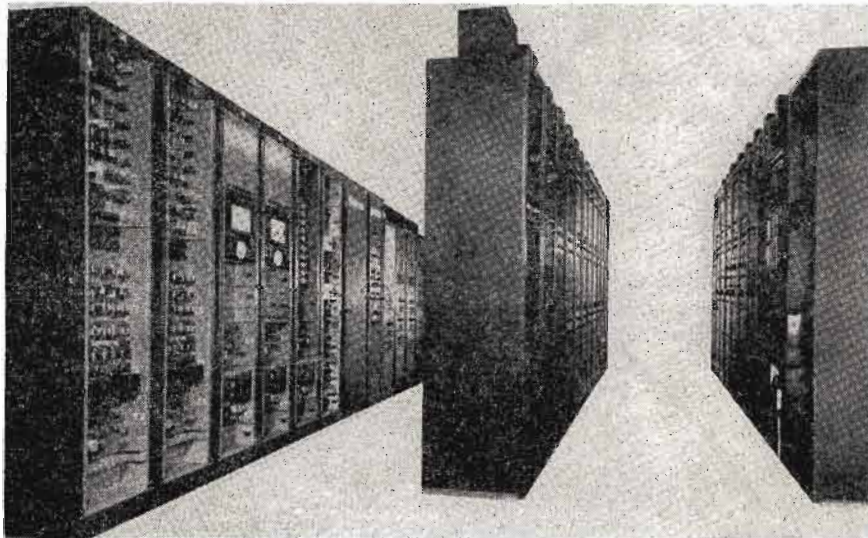

Figure 1

The central signal cage setup. All of the left-hand line and two-thirds of the center line of equipment are devoted to television testing. The remainder of the equipment is provided for testing of a-m and f-m sections of combination receivers.

Figure 2

Composite video rack assembly. In *a* appears a TX-6425 unit; *b*, TX-6418-501; *c*, TX-6418-502; *d*, TX-6424. The unit in *1* is a MI-26100; 2, MI-26110; 3, MI-21523-B1; 4, MI-26270; 5, M-441578; 6, MI-26030; 7, MI-26135; 8, K-259310; 9, T-618794; 10, MI-26085; 11, K-399951; 12, TX-6328; 13, MI-26155, and 14, K-259311. B' is a T-268768 unit.

SYNC. GEN. RACK 1	SYNC. GEN. RACK 2	CAMERA AND MONITOR RACK	CAMERA AND MONITOR RACK	DISTRIBUTION RACK
A	A	B	C	D
TIMING UNIT ¹	TIMING UNIT ¹	MONOSCOPE CAMERA ⁶	MONOSCOPE CAMERA ⁶	DIST AMPLIFIER ¹³
		MONITOR ⁷	MONITOR ⁷	DIST AMPLIFIER ¹³
SHAPING UNIT ²	SHAPING UNIT ²	MONITOR SW. PANEL ⁸	MONITOR SW. PANEL ⁸	DIST AMPLIFIER ¹³
		SYNC SW. PANEL ⁹	GRATING GEN ¹²	DIST & MONITOR SW PANEL ¹⁴
		B' ¹		
REG. PLATE SUPPLY ³	REG. PLATE SUPPLY ³	REG. PLATE SUPPLY ³	REG. PLATE SUPPLY ³	REG. PLATE SUPPLY ³
FILTER ⁴	FILTER ⁴	REG. PLATE SUPPLY ¹⁰	REG. PLATE SUPPLY ¹⁰	REG. PLATE SUPPLY ¹⁰
TERMINAL PANEL ⁵	TERMINAL PANEL ⁵	RACK SW. PANEL ¹¹	RACK SW. PANEL ¹¹	RACK SW. PANEL ¹¹
N° 1	N° 2	N° 3	N° 4	N° 5

TELEVISION has now been launched as an industry. Increased production has become a factor, and in view of the rather involved structure of the television receiver it has become necessary to develop new procedures and test equipment.

One of the major problems in television receiver production is alignment. To provide accuracy of alignment, we developed a transmitter center or *central signal cage* where all but the r-f sweep signals originate.

Factors which had an influence on this choice were: First, the flexibility of such a system allows for ready expansion of production test facilities at minimum further expenses. For example, signals from the central cage were first fed to two test lines which initiated production. Within two months this was increased to four lines and later to six. The only changes required were the extension of signal lines and the addition of attenuator panels. Second, test duties may be suitably divided for available personnel by allowing any number of signals to be fed wherever required. Thus highly trained personnel are not required to do the work of bench testing. Also, complete sets of specially designed bench-type equipment are not required.

In Figure 1 appears a view of the central signal cage at our Camden plant.

Composite Video Generator Equipment

The *composite video generator equipment* is set up in a rack and panel arrangement, Figure 2. The first two racks, 1 and 2, each contain a *synchronizing generator*¹ of standard design. These are employed alternately from day to day, a spare being thus constantly available in the event of trouble. Racks 3 and 4 each contain a *monoscope camera*² and *master monitor*³. Also used is a *grating generator*⁴ of special design, which is in rack 4. Rack 5 contains three *distribution amplifiers*⁵ which allows a spare unit in case of trouble. When all five racks

¹RCA TG-1A.

²RCA TK-1A.

³RCA TM-5A.

⁴RCA WA-3A.

⁵RCA TA-1A.

are suitably interconnected two main types of composite video signals are available. The first is a monoscope modulated signal which is used for resolution and other general tests. The second is the bar or grating generator signal which is used for linearity checks.

These signals are fed to the production floor over a video distribution system and are employed for all tests following the second detector in the receiver. The amount of testing at this point is considerable and consumes approximately half of the total chassis test time. It is at the *video test positions* that the ion trap is aligned. This is followed by horizontal and vertical centering, size and linearity adjustments and focussing. Several other controls are now operated also for the first time. These are the contrast, brightness, vertical and automatic horizontal hold controls. The complete video system finally affords a means of checking the sensitivity of the receiver video system and any other characteristics of interest.

Central Cage Video Switching Provisions

It will be noted that the synchronizing switch panel in rack 3 allows the choice of either synchronizing generator, 1 or 2, to supply signal for the whole floor at any one time. Either monoscope camera, rack 3 or 4, may be selected for use by a switching panel in rack 5 or both cameras may be made active for maintenance. This same switching panel allows the choice of either master monitor in rack 3 or 4 for use in viewing directly the picture produced by one of the monoscope cameras or on-the-line output of the distribution amplifiers. Any one of the distribution amplifiers may be selected and the picture output viewed for monitoring.

In addition to a 10" monitoring kinescope, these master monitors also contain a 5" oscilloscope so that the com-

System, Involving 22 Racks of Equipment, and Providing 13-Channel Video and Sound Transmission, Set Up at Camden, N. J. Plant to Test Up to 500 TV Receivers a Day, Such as Types 630-T and 621-T. Equipment Includes Composite Video Generator Unit with Synchronizing Generator, Monoscope Camera, Master Monitor, Grating Generator and Distributing Amplifiers. Also Used Are Video and Sound I-F Alignment Equipment, F-M Sound Transmitters, a 13-Channel TV R-F Sweep, Music Modulation Sources, Etc.

by **JOHN A. BAUER**

Supervisor, Test and Measuring Equipment Engineering
RCA Victor Division, RCA

posite video wave form may be seen in the system by direct selection or external connection while the picture is in sight.

Grating Generator

This unit provides the only absolute method of checking linearity through a television system. It serves to *double check* the sweep linearity of the monoscope camera. This is important since the camera is the only source of video test signal which would otherwise be available to the factory floor. If either the horizontal or vertical sweep voltages in the camera should become nonlinear it is possible that the receivers might become misaligned, due to compensation in test for this nonlinearity. Should this occur, a perfect circle would be observed in the

receiver with monoscope modulation while a nonlinear bar distribution would be observed in either horizontal or vertical direction or both.

In Figure 3 appears a view of the grating generator. When connected with the synchronizing generator from 9 to 35 horizontal bars may be generated while locked in with the field frequency. Similarly, 7 to 49 bars may be generated locked in with the line frequency. A small percentage of bars (16 to 18% of the horizontal, and 7 to 8% of the vertical) are lost during respective blanking intervals. The number of bars is independently adjustable and so is the bar width. The combined output of horizontal, vertical and blanking pulses is designed for a 75-ohm load and is adjustable from 0 to 2 volts, peak to peak. The contrast control allows the bar pulse level to

Figure 3
The grating generator.

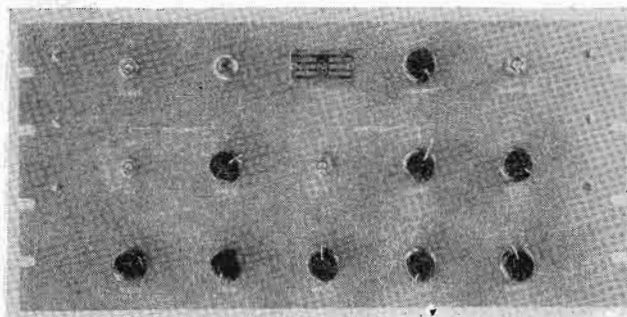
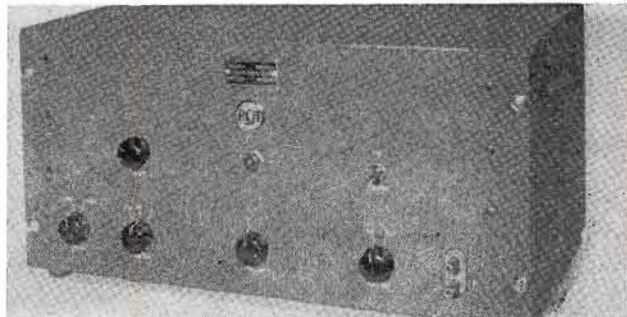

Figure 4
Video amplifier.



be adjusted independently of the blanking level. A polarity switch allows for a black picture with white bars where required for special purposes.

Video monoscope and grating (or bar) composite video signals are transmitted to all video test positions over single-ended 50-ohm coaxial lines. These are then run in and out of as many video amplifiers in series as are required, thence to a termination; *video amplifier*⁶ is shown in Figure 4. The circuit detail which allows ten or more video amplifiers to be fed from the same line appears in Figure 5. This will be recognized as a high-impedance capacity-compensated attenuation section. The 5 to 20-mmf trimmers (34) across 1-megohm resistors (83) compensate for the total capacity appearing across the 470,000-

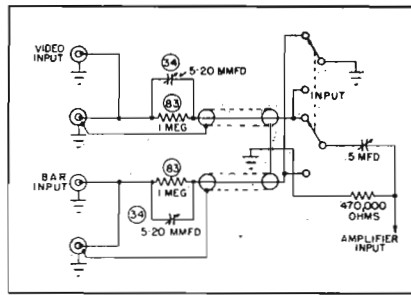

Figure 5
Circuit detail of the video amplifier input for the TX-6440 unit.

ohm resistor. Switching from bar to video input automatically grounds the

⁶RCA TX 6440.
⁷RCA TX 6319.

undesired signal without loading the line unduly.

The video amplifier will deliver approximately 100 volts, peak-to-peak signal, across 2,000 ohms which is more than sufficient to drive the 10BP4 kinescope grid directly. This is possible since the sync separator circuits in the receivers follow the kinescope grid. Coarse and fine-attenuator controls, together with a polarity switch, allow signal to be impressed stage by stage farther back into the chassis to the second detector. A lower output impedance of 500 ohms may also be selected. Frequency response is within 1 db from 30 cycles to 5 mc. The gain is 40 db with distortion below 5%.

Sound I-F Alignment

Sound i-f alignment of the receiver is accomplished with the aid of an i-f

Figure 6

Front view of the television sound i-f i-f sweep unit.

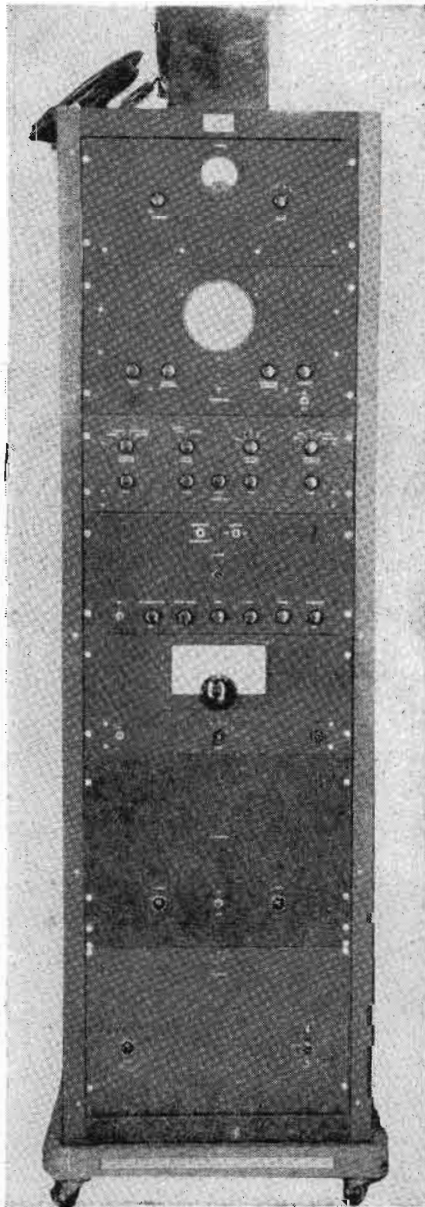

Figure 7

Front view of the three frequency a-m signal generator.

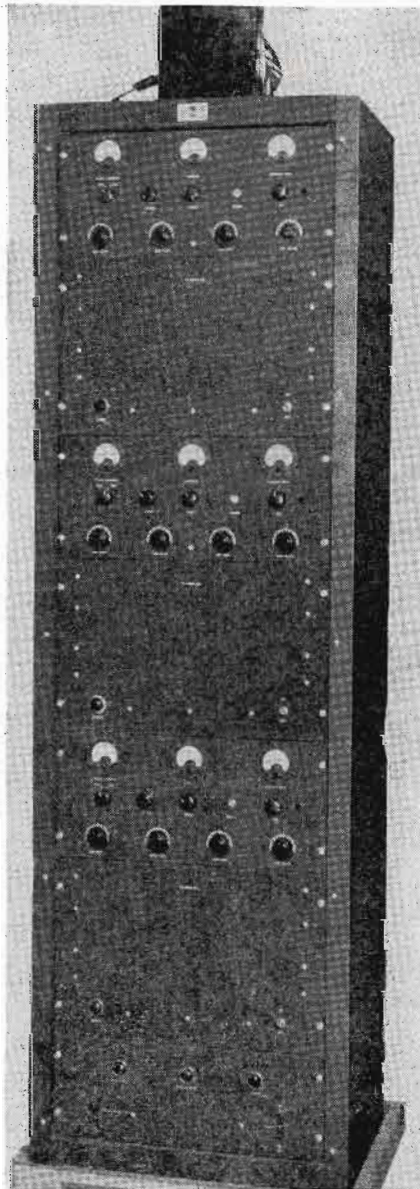
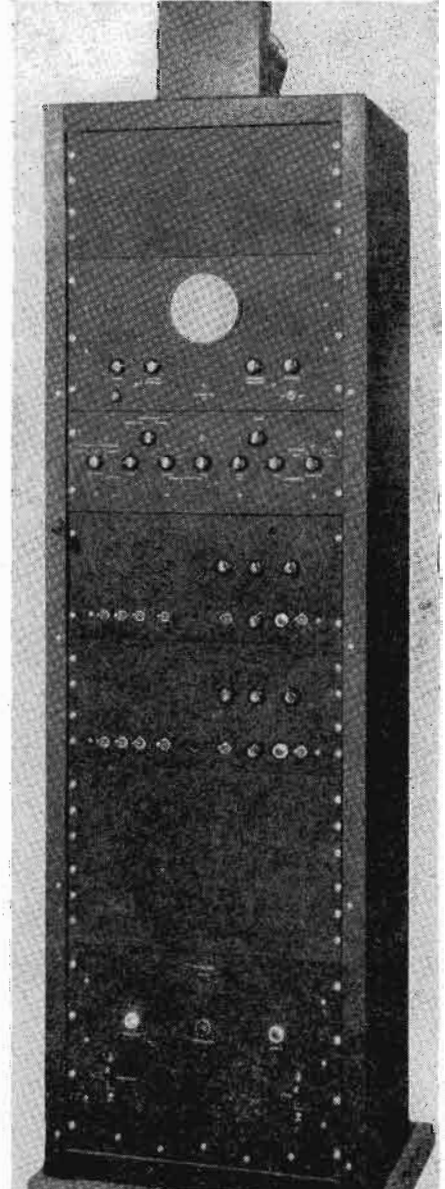

Figure 8

The television video i-f sweep unit.



sweep generator,⁷ shown in Figure 6. This rack, located in the central signal cage, furnishes a signal at the sound i-f carrier of 21.25 mc swinging ± 400 kc at a 60-cycle rate. Preliminary and some final adjustments of the discriminator, second and first i-f stages are made with this signal fed through an attenuator.

Three marker signals are generated in this rack and are superimposed on the sweep signal. They show up on the oscilloscope used in alignment. The center marker represents the sound carrier frequency of 21.25 mc and is crystal controlled. The two remaining markers are equidistant above and below this center marker and set to about 200 kc. They are generated as sidebands by modulating the sound carrier marker frequency with an oscillator adjustable from 100 to 500 kc. This allows them to be set at fixed frequencies within which the discriminator must be linear, or the overall sound i-f response must be flat as required by the specifications of the receiver.

Following these adjustments a crystal controlled 21.25-mc signal is selected from the signal selector and attenuator panel. With this the discriminator secondary and sound trap circuits are finally aligned.

An additional sound i-f sweep generator is used to align the i-f portion of the f-m receiver chassis included in combination console models.

Video I-F Alignment

Due to the fact that a stagger tuned system was employed in our line of television receivers a number of fixed-frequency generators were required. These were in addition to those normally required to align the trap circuits necessary to eliminate interference in the video from own sound, adjacent picture and adjacent sound carriers. A typical fixed frequency generator is shown in Figure 7. This

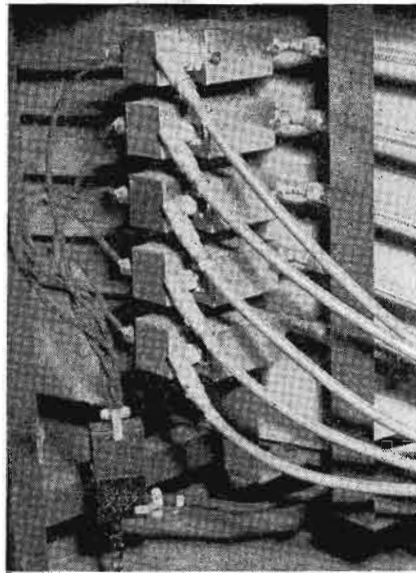

Figure 9
The line coupler.

will supply three crystal-controlled carriers, and they may be modulated.

I-F Signals and Alignment Function in 630TS Receiver

Signal No.	Frequency	Align Function
1	23.4 mc	4th picture i-f
2	25.2 mc	3rd picture i-f
3	22.3 mc	2nd picture i-f
4	25.3 mc	1st picture i-f
5	21.8 mc	Converter
6	21.25 mc	Own sound i-f and traps
7	27.25 mc	Adjacent sound trap
8	19.75 mc	Adjacent picture trap
9	Sound i-f sweep	Sound i-f system
10	Video i-f sweep	Video i-f system

Three racks of equipment, similar to Figure 7, supply the first eight signals. This leaves one generator as a spare. The generators may be operated self-excited if required in an emergency or

⁷RCA TX-6322.
⁸RCA TX-6414.
⁹RCA TX-6303.

slight changes are to be made in crystal frequency.

Use of these signals is straightforward. Briefly, they are obtained from selector and attenuator panels and used to appropriately trim circuits for maxima or minima in the output of the receivers as required.

After all individual circuits in the video i-f system are adjusted to their proper frequencies, a sweep signal swinging from 20 to 28 mc at a 60-cycle rate is applied to the receiver. The overall video i-f response curve is then displayed on an oscilloscope.

Figure 8 is a photo of the video i-f sweep.⁸ This unit contains two sweep chassis panels, providing a spare, and a monitoring oscilloscope. Constant check on the flatness of the output and presence of three superimposed marker signals is thus assured. These markers are crystal controlled and located at 25.75 mc, the video i-f carrier; 23 mc, marking the limit of the lower edge of the pass band for 7" receivers; and 22 mc which marks the lower pass band limit for the 10" receivers. A vibrating capacitor assembly of proven design provides the frequency modulation.

Low-Frequency Distribution System

Since all of the ten signals listed in the foregoing are fairly close to each other in the spectrum each is fed to the factory over a separate single-ended 50-ohm coaxial line. This was felt necessary to avoid the possibility of misalignment by relatively inexperienced personnel should more than one signal be applied to the line.

Signals are taken off the lines at the factory i-f test positions by means of coupling boxes,⁹ Figure 9. Each coupling box contains a miniature tube whose grid is lightly coupled to the line by means of a variable capacitor. The output of each coupling box is run

(Continued on page 21)

Figure 10
Low-frequency selector and attenuator panel.

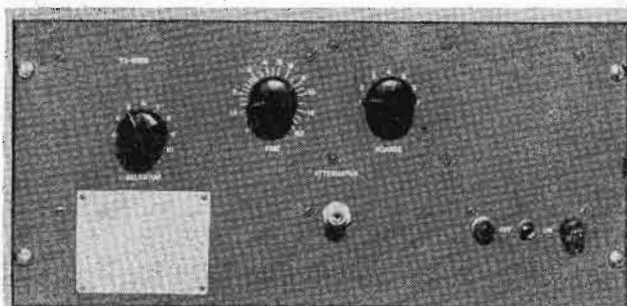
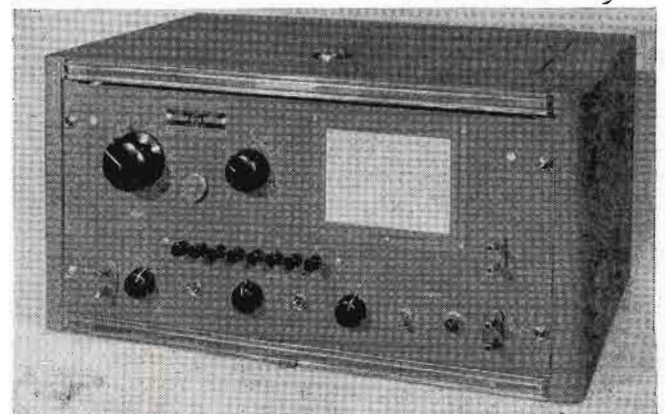
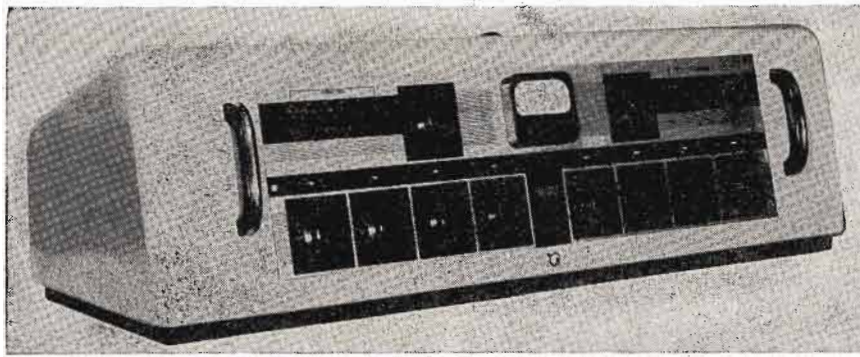

Figure 11
Thirteen channel television r-f sweep.





SELECTING

Speech-input control console used by WCNT.
(Courtesy Gates)

THE SELECTION OF BROADCAST-STATION equipment is, in the main, determined by personal preference for particular physical, mechanical and electrical features. In general, equipment approved by the FCC will operate in a satisfactory manner.

In arranging for our a-m installation, the transmitter was the first item of equipment considered, since we felt it was more or less, the focal unit with which all other items must work.

In selecting a transmitter, the handling and maintenance factor must be considered too, for there are certain desirable qualities in the matter of control, timing and wiring which can facilitate handling and maintenance. Incidentally, we have been frequently asked about the use of composite equipment. Experience has shown that on a long range basis, composite equipment is no less expensive than factory-built equipment and will often prove far more expensive. Factory equipment guarantees cover workmanship and component parts. While any competent engineer can build suitable equipment, he is not so likely to thoroughly engineer his work, and thus more difficult and generally more frequent maintenance are required.

Transmitter Features

In choosing the transmitter, it was felt desirable to find a unit which was compact, in view of our desire to hold our building and control room size to a minimum. It was felt desirable to have all controls adjustable during normal operation on the front panel. Other features considered necessary were an output that would load to a wide range to give greatest flexibility and range in choice of transmission line, and coupling that should be easily adjustable over a reasonable range. We selected a transmitter¹ (about 42" x 34" x 78") with exciter, buffer, driver, final amplifier and load-tuning

controls located on the front panel. The unit, thoroughly metered, provides readings of oscillator plate current, buffer grid and plate current, driver grid and plate current, final plate and filament voltage, and transmission line input current. It is also possible to measure either modulator plate current or the combined reading, and first audio stage or second audio stage plate current.

Other front-panel controls include modulator grid bias and neutralization.

Output load range, from 50 to 300 ohms, is ample for virtually any commonly used broadcasting transmission line. Incidentally output is capacity coupled and loading variable.

The Antenna

After selecting a transmitter the next consideration was the antenna. With our operating frequency of 1210 kc, a height of 210' was the minimum for our class of operation.

Again checking relative merit, price and availability; desiring to use series feed due to its obvious merit for broadcast service, particularly in coupling and power measurement, and preferring in general uniform cross-section towers, we selected a guyed, uniform cross-section tower.² While self-supporting, tapered towers are quite adequate, a better current distribution is obtainable with a uniform cross section. The effect of the guy wires is negligible. While it is preferable to have a uniform cross section, self-supporting structure, the increased cost of this tower appeared, in our view, to outweigh this advantage. The guyed tower also has greater structural strength, an important con-

sideration in areas in which high winds are prevalent.

The Ground System

A companion consideration was the ground system. Here a great many factors may be involved in addition to what may be most desirable. In our case the ground system is composed of 120 radials, 315' long, buried an average of 6". It may be desirable to erode the radials into the ground by merely staking them out on freshly plowed earth; however, in our case it was necessary to place the studio structure on the same land, and it was desired to keep the land under some form of cultivation to keep down vegetation. This necessitated burial. As to the change in signal strength, due to variation of radial depth, figures of an accurate nature seem to be lacking. We have received very excellent results with our installation.

For an antenna tuning unit we desired a very simple circuit, and se-

Front view of WCNT 1-kw transmitter.
(Courtesy Gates)

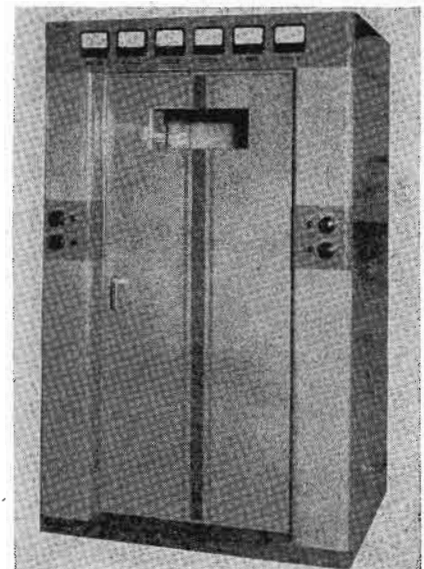

¹Gates Radio BC-1E.

²Wincharger.

³Gates.

⁴Gates Radio 31-A.

A-M Broadcasting Equipment

Features Considered in Choosing a 1-Kw Transmitter, Antenna, Ground System, Studio Console, Turntables and Microphones.

by **HOBART STEPHENSON, Jr.**

Chief Engineer
WCNT, Centralia, Ill.

lected a tuning unit³ built to work with the transmitter.

Studio Consoles

Studio console selection is also predicated on personal electrical and mechanical preferences, with particular emphasis on flexibility and ease of operation and, of course, the requisite number of channels. We desired provisions for handling two studios and a control room microphone, two turntables, and sufficient remote channel circuits, plus talk back and monitor provisions. Two microphones in each studio were considered sufficient. This meant five microphone channels without tone amplifiers, and some system for handling remote lines. It was felt that eight channels were sufficient, as it is difficult for an operator to cover more than eight settings at a glance. This meant only one remote

gain control and channel, but provisions for selecting one of several remote lines.

Monitor Provisions

Monitor provisions had to be adequate to handle at least five speakers, and preferably more, and it was necessary that at least three speakers interlock to microphone channels, cutting speaker when microphone is open.

In the talk-back circuit, no amplifier was necessary, but it was necessary to have provisions for connection of at least two microphones to an external talk back amplifier to provide inter-communication.

Other required features were provisions for cueing on any remote line circuit and connection of any channel to either program or monitor amplifier with means of connecting

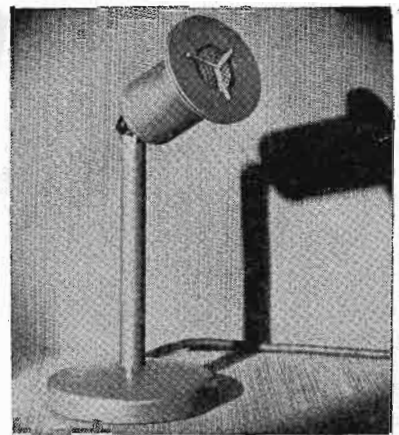

Salt-shaker dynamic microphone used at WCNT. Mike employs a disc-shaped baffle that provides directivity to the microphone; non-directivity is achieved by removing disc baffle and placing mike in vertical position.

(Courtesy W.E.)

monitor speakers to either output; this makes auditioning possible while *on the air*, without requiring additional facilities.

Separate network input was considered desirable but not necessary.

The console we selected⁴ has five microphone inputs, two turntable inputs, one remote channel with provisions for the selection or cueing of six lines by key switches. These eight channel controls are arranged in line across the bottom portion of the console front panel. Above these are the channel switches, and program and monitor master gain controls. Any channel may be connected to either the program or monitor amplifier, and the monitor system fed with either out-

(Continued on page 37)

Typical field response for salt-shaker microphone.
(Courtesy W.E.)

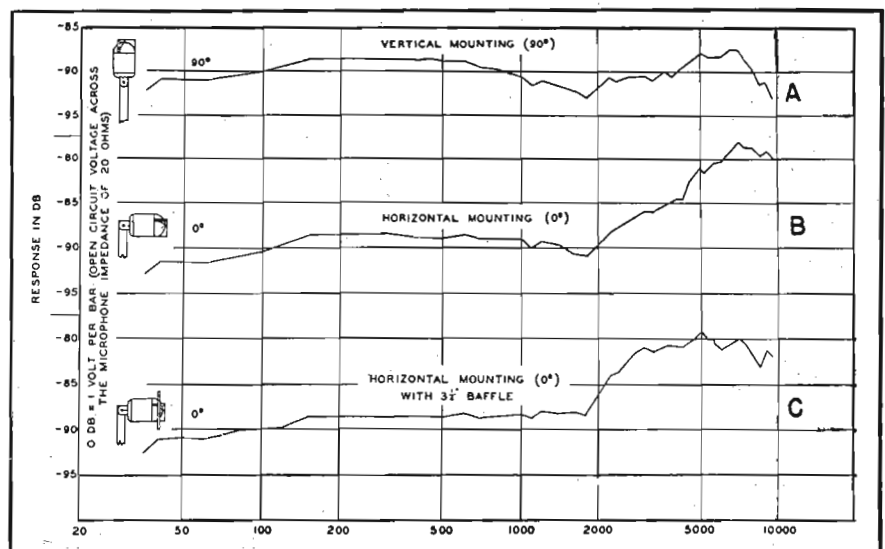

Rear view of 1-kw transmitter.
(Courtesy Gates)

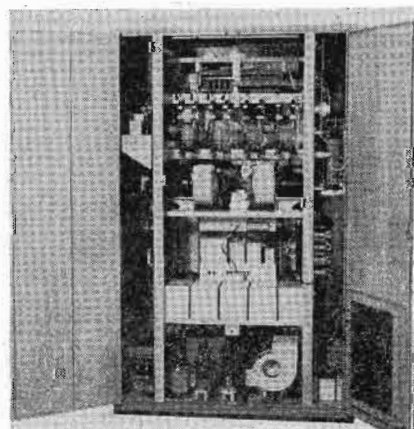

WTTG TV Antennas

A Series of Articles Detailing the Theoretical and Practical Aspects of Television-Antenna Design and Measurement Appeared in the January, February and March, 1947, Issues of **COMMUNICATIONS**. Certain Aspects of the Plumbing and Mechanical Features of a TV-Antenna System, Employing Designs Outlined in the Articles, and Now in Use at WTTG, Harrington Hotel, Washington, D. C., Appear in the Views on This Page. Photos and Data by G. E. Hamilton and R. K. Olsen of Allen B. DuMont Labs.

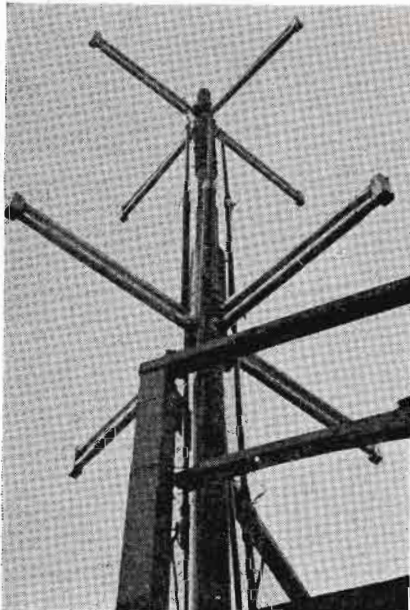

Above: Experimental step used for two-bay turnstile system. It will be noted that the antenna elements are stud mounted to sections of spur pole whose diameter are the same as the final pole on which the system was mounted. To determine the correct length of each element, a trombone system was employed allowing for minor length variations. When the correct position had been determined, it was welded. Below the platform is a measurement laboratory allowing investigation to proceed during inclement weather. *Below:* Mounting of antenna elements to the main spur pole. The two top doughnuts serve as the sound radiating system. A balanced feed system is employed with the transmission lines passing through the inside of the pole. Short horizontal projections on the pole are steps for convenience in making necessary adjustments.



Above: Phasing, matching and feed lines required to produce a circular radiation field pattern. Rings into which the end seals fit are required to maintain a balance between the two transmission lines. *Below:* Closeup of overall antenna supporting structure. Front of the system is driven, while back acts as a parasitic reflector.

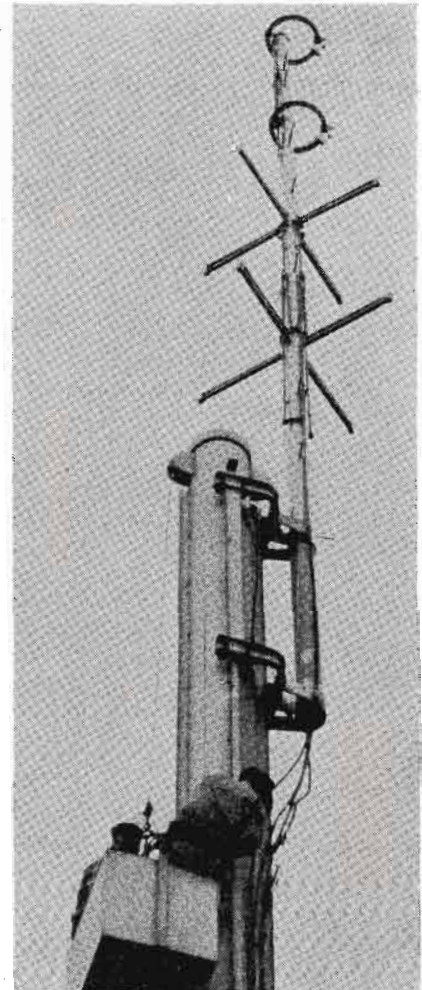

Above: Complete antenna in position. *Below:* Method of spur pole mounting and transmission-line junction points. At these junction boxes, all matching transformers and feed lines are terminated.

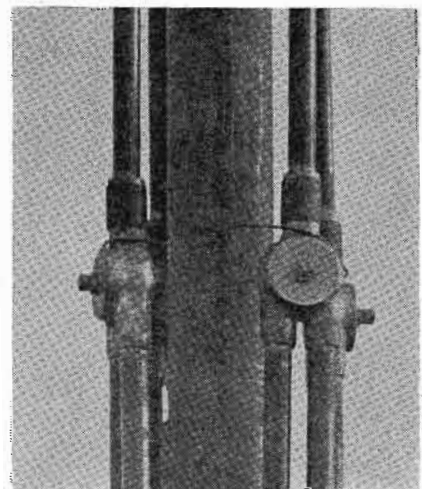
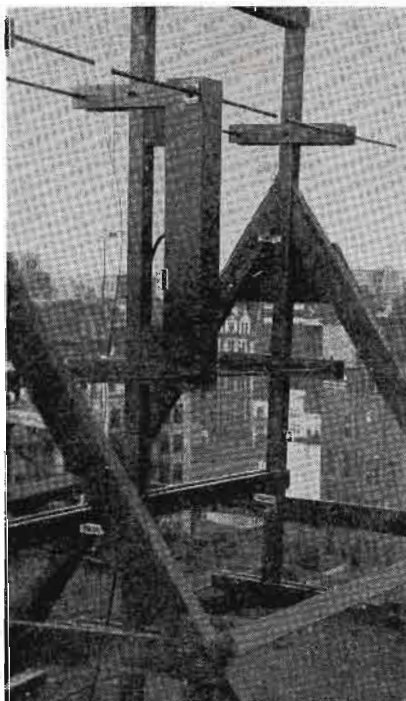
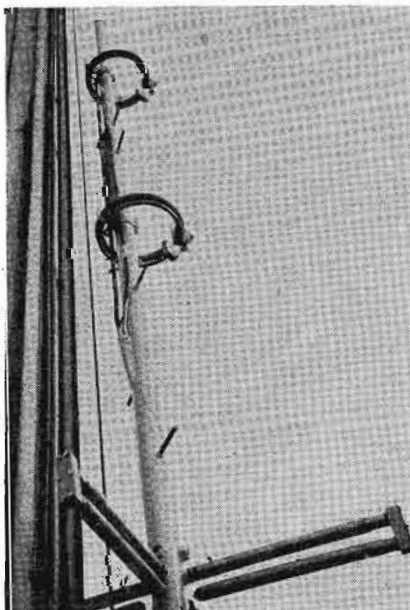

★ ANSONIA ★ **Ankoseal**

will not support Combustion

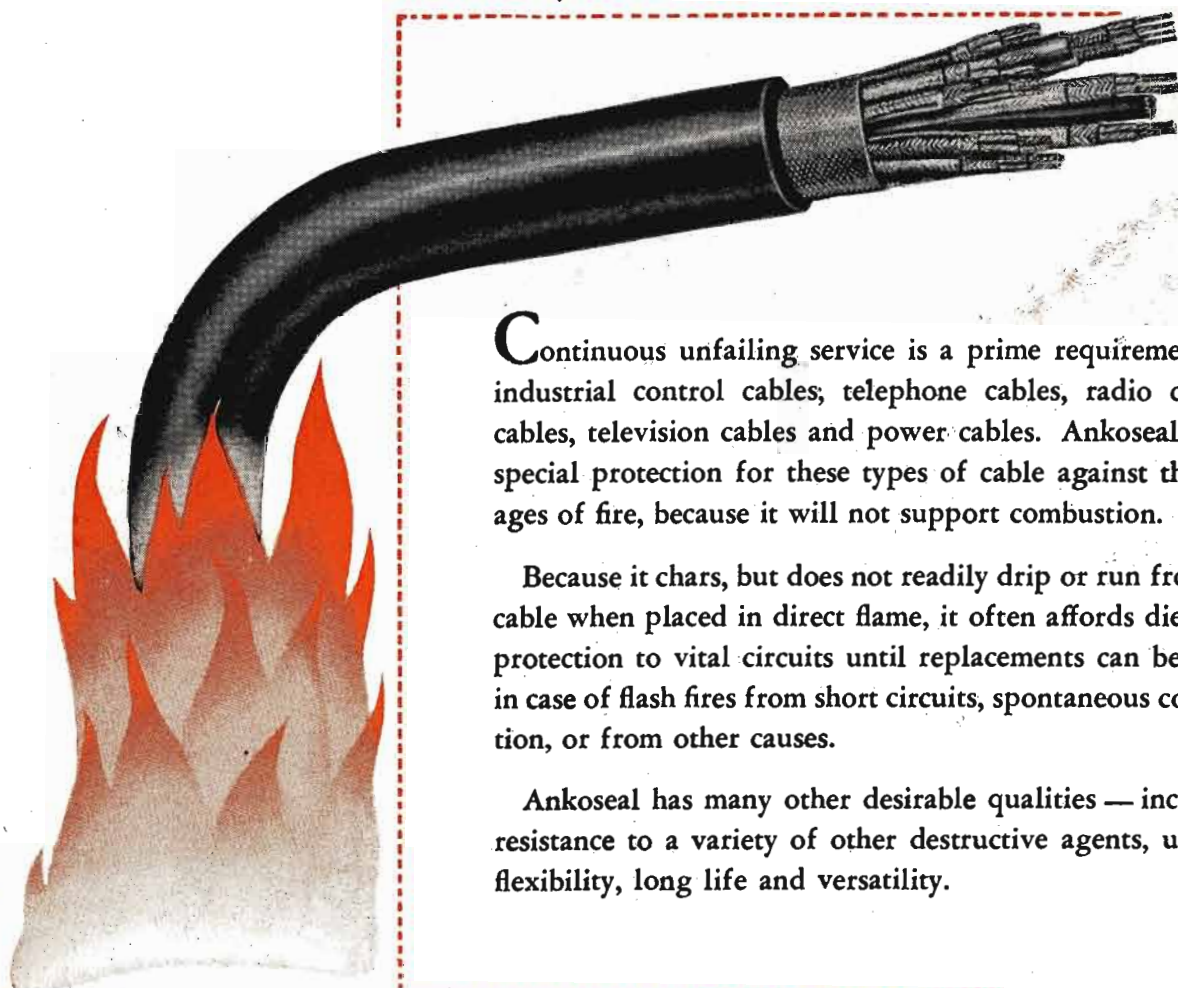

Continuous unfailing service is a prime requirement for industrial control cables, telephone cables, radio control cables, television cables and power cables. Ankoseal offers special protection for these types of cable against the ravages of fire, because it will not support combustion.

Because it chars, but does not readily drip or run from the cable when placed in direct flame, it often affords dielectric protection to vital circuits until replacements can be made in case of flash fires from short circuits, spontaneous combustion, or from other causes.

Ankoseal has many other desirable qualities — including resistance to a variety of other destructive agents, unusual flexibility, long life and versatility.

THE ANSONIA ELECTRICAL DIVISION

ANSONIA, CONNECTICUT *of*

NOMA ELECTRIC CORPORATION



Author at the WKCR control board.
(Photo by Ann Terry)

Figure 1
Remote lines of WKCR.

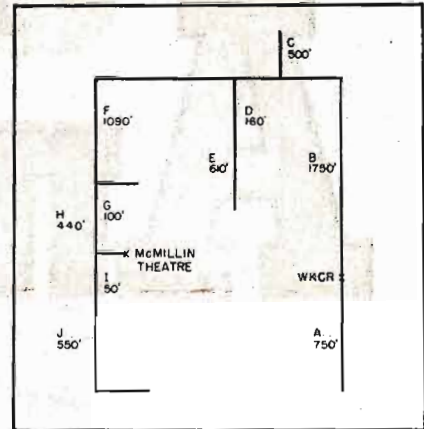

SHORT TELEPHONE LINES In Broadcast Operation

AUDIO LINES used by broadcast stations may be divided into two classifications; long lines and short lines. Long lines, or lines of intercity length, are almost invariably rented from the telephone company. Such lines are rented as a service with certain definite characteristics. It is the responsibility of the telephone company to have their lines perform as agreed upon, and the only responsibility of the broadcaster is to feed such a line at a prescribed level and to receive the signal from the line. Once the class of service desired has been agreed upon, the broadcaster has no further concern with the operation of the telephone lines as transmission lines. He has purchased a service.

Short lines, on the other hand, which may be from a few hundred feet to several miles in length, may be leased from the local telephone company or operated by the broadcaster. The latter, for example, is the case at WKCR, where station-owned-and-operated lines extend through the steam tunnels which link most buildings on the Columbia University campus. Where such lines are privately owned, all responsibility, including installation and maintenance, is in the hands of the broadcaster. Where the lines are rented from the telephone company, the latter is responsible for maintenance. Considerable leeway in the operation

Discussion of Methods for Improving Frequency Response of Telephone Lines as Short as 3000 Feet, by Lowering Terminating Impedance, at Expense of Higher Attenuation. Presented is an Approximate Analysis of a Typical Privately-Operated Line for Two Standard Operating Impedances, 600 and 150 Ohms.

by **ALAN SOBEL**

Engineering Director
WKCR, Columbia University

of such short lines is often granted by the telephone company. By treating them as transmission lines rather than as services, considerable advantages may accrue.

WKCR Remote Lines

Since program lines are normally operated in conjunction with adjustable equalizers to compensate for their non-uniform response, an exhaustively correct analysis of the situation is not absolutely essential. In the case of the

WKCR system, with its numerous spurs (Figure 1), there are too many operating combinations to make such an analysis feasible. Accordingly several simplifying assumptions have been made in this paper, providing an approximate solution which is sufficiently accurate to provide several important conclusions.

Parameters of the Line

The material used in the lines is 22 stranded twisted pair, rubber in-

Figure 2
T section.

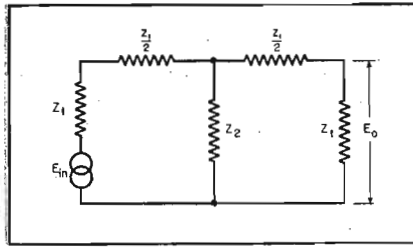
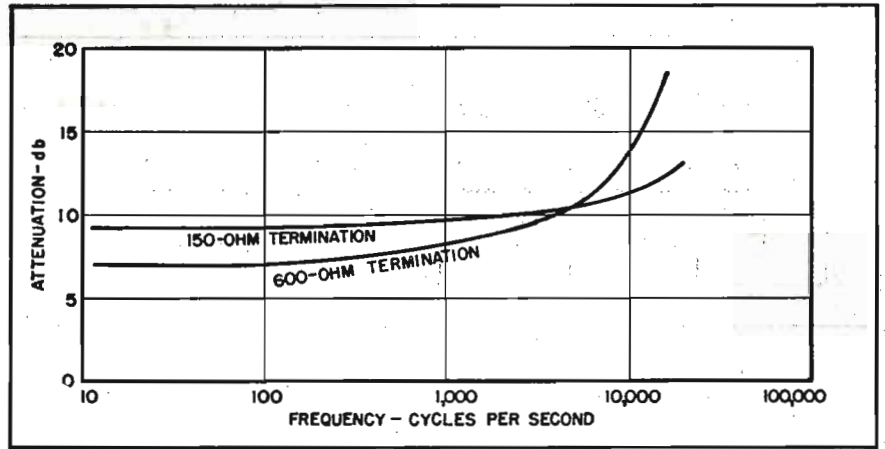

Figure 3
Transmission line performance.



sulated, with impregnated cotton braid overall. This is not particularly suitable for use in steam tunnels, since the rubber deteriorates quite markedly in the high temperature and humidity. However, its low first cost and availability during the war were sufficient justification for its selection when it was first installed, while the deterioration is not so bad as to preclude use of the line. The parameters of this line are

$$\begin{aligned} R &= 0.038 \text{ ohms/loop foot} \\ C &= 29 \times 10^{-12} \text{ farad/foot} \\ L &= 0.24 \times 10^{-6} \text{ henry/foot} \\ G &= 0 \end{aligned}$$

The resistance of the wire has been corrected to a temperature of 40° C. This is higher than the temperature in the steam tunnels, but the additional resistance will help to compensate for our neglect of inductive reactance. The capacitance was prorated from manufacturer's values for a similar wire.¹ Inductance was calculated as for parallel wires, and multiplied by an arbitrary factor of 1.1 to account for the additional length due to the twisting of the two conductors. Conductance has been assumed zero. In the hot, moist steam tunnels, this assumption is probably in error. However, it will suffice.

Additional assumptions made are standard in studies of cables.² They are that the inductive reactance and the conductance are both negligible with respect to the resistance and the shunt capacitive reactance, respectively. For twisted pair such as this, the first assumption is correct except at the higher frequencies, while the lines under consideration are short

enough so that the conductance will not make an important contribution to the results. Under these conditions, the expressions for series impedance, z , and shunt admittance, y , per unit length become

$$z = R \quad (1)$$

$$y = j\omega C \quad (2)$$

In an additional assumption R and C have been considered constant over the audio range.

Analysis of Line Performance

In analyzing the performance of the line the equivalent T -section method will be used. For a short line, the expressions for the components of a T section (Figure 2) are³

$$Z_1 = z l \quad (3)$$

$$Z_2 = 1/y l \quad (4)$$

where l is the length of the line. For our analysis we shall disregard the spurs on the line and treat it as a simple line 3,440' long, the length from McMillin Theater to the WKCR control room.

Normally the lines at WKCR are arbitrarily assigned an impedance of 600 ohms, the standard impedance for telephone line work. This means that the lines are terminated at each end in a resistance of 600 ohms. Under these conditions, the performance is as shown in Figure 3. In Table 1 appear tabulated values for frequencies in the

audio range at either extreme of the transmission band required by the FCC for standard and f-m broadcast operations.

It will be noted that the loss is quite high, and varies greatly with frequency, showing a spread of more than 10 db between 30 and 15,000 cycles. That 600 ohms is a purely arbitrary impedance is shown by the wide variation of the characteristic impedance, Z_0 , with frequency. In any event, the loss cannot be less than 6 db. This is at once apparent if, in Figure 2, we let Z_1 be zero and Z_2 be infinite. In this case we have the two terminating impedances, Z_L , in series. The voltage developed across the load impedance is half of the impressed voltage, by Ohm's law. This means that $E_1/E_2 = 2$, which in terms of decibels is 6 db, using the equation

$$\text{No. of db} = 20 \log_{10} E_1/E_2 \quad (5)$$

where E_1 and E_2 are, in general, any voltages.

Varying the Terminating Impedance

On *local loops*, or short lines, telephone company practice is to operate the lines at an assigned impedance of 150 ohms. Transformers are used to match the line to the usual amplifier input and output impedances of 600 ohms. Examining the advantages of this practice by the same method, we find that there is a decided advantage from the point of view of frequency response, although the attenuation at

¹Belden Manufacturing Company, catalog 843; (1943). The wire used is similar to Belden type 8205.

²L. A. Ware and H. R. Reed, *Communication Circuits*, p. 63; John Wiley and Sons.

³Ware and Reed, p. 100.

f	$z l$	$y l$	Z_0	db loss $Z_L = 600$	db loss $Z_L = 150$
30	$0.038/0^\circ$	$5.5 \times 10^{-9}/90^\circ$	$2,600/45^\circ$	6.9	9.2
100	$0.038/0^\circ$	$18. \times 10^{-9}/90^\circ$	$1,400/45^\circ$	6.9	9.2
5,000	$0.038/0^\circ$	$0.91 \times 10^{-6}/90^\circ$	$200/45^\circ$	10.0	10.0
15,000	$0.038/0^\circ$	$2.7 \times 10^{-6}/90^\circ$	$120/45^\circ$	17.0	12.0

Table 1.

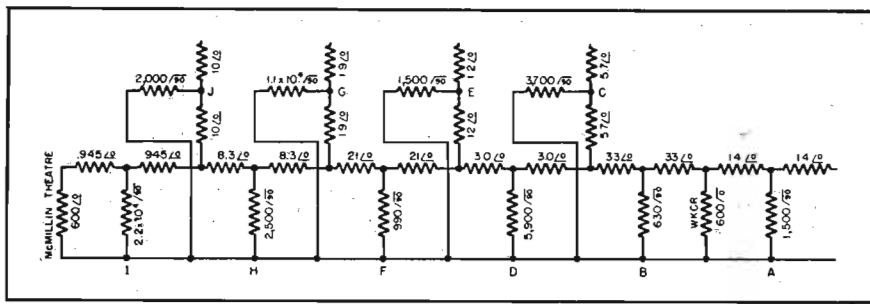
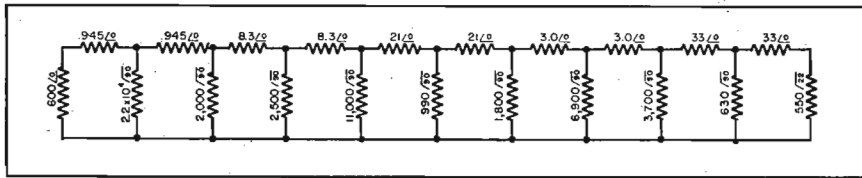

Figure 4 (above)
WKCR lines as a system of T sections, at 5 kc.

Figure 5
Simplified version of Figure 4.



the lower frequencies is higher; Table 1 and Figure 3.

We have limited ourselves to these two impedances because they are standard. On privately-operated lines there need be no such restriction on impedance values, and any convenient value might be used. For any one line there will be an optimum terminating impedance determined by the frequency response desired, the increasing attenuation as Z_t is decreased, and the matter of inductive pickup. To minimize the latter, it is desirable that the signal voltage be high, so that the signal-to-noise ratio will be large. For a given power, the higher the impedance, the higher will be the voltage.

Most line amplifiers and remote amplifiers are designed to work with 600-ohm lines. Where transformers are available, there is an advantage in using a low impedance, as we have seen. If, however, resistive matching is employed, the situation is not quite so favorable. This is because of the loss involved in resistive matching,

which in the case in question would be 11.4 db at each end of the line.⁴ Whether such a loss is tolerable will depend upon the individual transmission line and associated equipment.

The Effect of Spurs

Thus far we have treated only the simple line. However, the actual WKCR lines contain several spurs, which modify the line performance. To get an idea of how the results we have just obtained are modified by the spurs, we can treat the complete system as a series of T sections, using a frequency of 5,000 cycles. Figure 4 shows the configuration obtained, while Figure 5 shows the hanging T sections reduced to shunt impedances. For our purposes, it is unnecessary to solve the complex ladder thus obtained, and we can make a very rough approximation by lumping all series elements and all shunt elements, to produce a simple T. This is shown in Figure 6a, while Figure 6b shows the T obtained for the line neglecting spurs. The loss of the new section is 13 db, as against 10 db for the old. It will be seen that the effect of the spurs is (in this simplified analysis) to add to the shunt capaci-

Figure 6a (left) and b (right)

In this figure appear 5,000-cycle T sections. In a we have a simplified version of Figure 5, and in b we have the equivalent T of the McMillin-WKCR line, neglecting spurs.

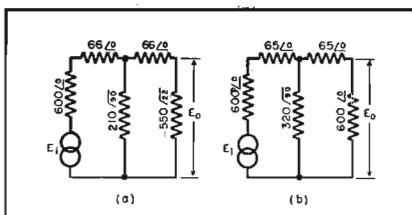

⁴Daven Company 1940 catalog; p. K13.

⁵S. P. Mead, *Phase Distortion and Phase Distortion Correction*, Bell System Technical Journal, pp. 195-224; April, 1928.

Figure 7 (right)
Equalizer circuit.

tance of the line. The high frequency response is thus further impaired.

Equalizers

It can be seen, by this analysis, that transmission lines such as the one under discussion have very poor frequency response even though they are quite short electrically. Where such lines are to be used for program transmission, some means of compensating for this distortion must be employed. A method often used in broadcast work is to connect a parallel resonant circuit across the line, in series with a variable resistor; Figure 7. The circuit is resonated at a frequency in the higher ranges of the band to be transmitted, while the amount that the circuit affects the transmission characteristics of the line is determined by the series resistor. Adjustment is made experimentally by transmitting tones of various frequencies at constant amplitude and adjusting the equalizer for best results. Sometimes a series circuit resonant at a low frequency is used.

Although no mention has been made of phase distortion, it should not be assumed that this is a subject which may be completely neglected.⁵ Fortunately, phase distortion must be quite large before it is noticeable to the ear, and large amounts of phase distortion are seldom met with on short lines.

Conclusions

There are decided advantages in operating short lines with cable-type characteristics at low impedances. Desirable conditions of operation can be arrived at by approximate methods. These are adequate since a final figure for assigned impedance, at which the line will be operated, will in most cases be a standard figure readily available in commercial equipment.

The methods outlined are as applicable to lines carrying audio power, such as loudspeaker feed lines, as they are to lines carrying only low-level signal. A rapid analysis of this sort will determine whether a distant loudspeaker is most advantageously fed by

(Continued on page 21)

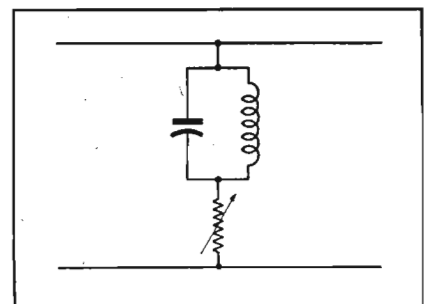

4-750A



INTER-OFFICE MEMO

TO: Adv. Dept.

RE: The attached ad.

Because of our conservative outlook this copy missed one of the hottest stories of the year, the 4-750A for FM...Reports from the field indicate we have the standout answer to 3 kw on the FM band...One station is delivering 3 kw of power to the antenna from a pair of 4-750A's driven by two 4-125A's. From the story I got the equipment was just coasting.

Typ. Oper. { Freq 40 Mc.
 Power Output 3 kw
 Plate Voltage 3.97 kv
 Plate curr. 1.1 amp.
 Screen curr. 240 amp.
 Screen Voltage 250 v.

EIMAC 4-750A POWER TETRODE Electrical Characteristics	
Filament: Thoriated tungsten	
Voltage	7.5 volt
Current	20 amp
Direct Interelectrode capacitances (av.)	
Grid-plate	.24 μuf
Input	26.85 μuf
Output	7.78 μuf
Maximum Ratings	
D-C Plate Voltage	6000 max. volts
D-C Plate Current	700 max. ma.
Plate Dissipation	750 max. watts

mac tetrode—the power step-up you have added to the Eimac line.

output at 4000 plate volts, with less than the 4-750A opens a new field of possibilities in electronic equipment. A pair of these tetrodes, low-power tubes, will supply more than

A potential workhorse for communications and industrial use, the 4-750A has the ability to deliver its maximum power over a wide range of frequencies. Inherent characteristics include the familiar attributes of Eimac tetrodes—stability, economy, and dependability

Complete technical data and performance characteristics will soon be available. Write now for your copy.

**EITEL-McCULLOUGH, INC., 1744 San Bruno Avenue
 San Bruno, California**

Follow the Leaders to



EXPORT AGENTS: FRAZAR AND HANSEN, 301 CLAY STREET
 SAN FRANCISCO 11 CALIFORNIA U.S.A.

A HABIT TO JOE...

"NEW IDEA" TO HIS NEPHEW



**...YET BOTH WANT THE SECURITY
your P.S. Plan Provides**

HAVE YOU told all your new or recently hired employees about the benefits of the Payroll Savings Plan for the regular purchase of U. S. Savings Bonds? Wage earners, according to a recent nation-wide survey, want security more than anything else. They prefer security to big pay, soft jobs, authority, "success."

There is no surer way to this peace of mind than systematic savings. And what surer, safer, better means can your employees find than payroll allotments for U. S. Savings Bonds? Bonds that return \$4 at maturity for every \$3 they invest!

Your active support of the Payroll Savings Plan is an investment in employee contentment, in the citizenship of your community, and in the security of America's future. This is practical "employee relations" of the highest type and pays dividends of satisfaction to everyone.

Start a drive today for larger participation in the plan. Many employees may be unfamiliar with its advantages. If you want literature for distribution, contact your State Director of the Treasury Department's Savings Bonds Division.

*New
Savings Bonds Plan
won't affect the
P. S. P.*

THE Treasury Department and the banks of America are making it possible for farmers, doctors, and other self-employed people to participate in "automatic" Bond buying by special arrangement with their banks. This extension of the Savings Bonds program is not a partial payment plan and is intended *only* for people who are not in a position to take advantage of the Payroll Savings Plan.

The Treasury Department acknowledges with appreciation the publication of this message by

COMMUNICATIONS



This is an official U.S. Treasury advertisement prepared under the auspices of the Treasury Department and The Advertising Council.

Short Telephone Lines

(Continued from page 18)

a 500-ohm line and a matching transformer, or directly at voice coil impedance, if the attenuation at this termination is not prohibitive.

Bibliography

Albin, F., et al. *Motion Picture Sound Engineering*; D. Van Nostrand Company, 1938.*

Nilson, A. R., and J. L. Hornung. *Practical Radio Communication*; McGraw-Hill Book Company, 1943.*

Norris, F. W., and L. A. Bingham. *Introductory Study of Electrical Characteristics of Power and Telephone Transmission Lines*; International Textbook Company, 1936.

Reference Data for Radio Engineers, 2nd ed.; Federal Telephone and Radio Corporation, 1946.

Shea, T. E. *Transmission Networks and Wave Filters*; D. Van Nostrand Company, 1929.*

Sterling, G. E. *The Radio Manual*; D. Van Nostrand Company, 1929.*

Terman, F. E. *Radio Engineers' Handbook*; McGraw-Hill Book Company, 1943.*

*Sources of equalizer information.

TV Receiver Tests

(Continued from page 11)

through a coaxial drop line to a selector and attenuator panel,²⁰ which is located near the test personnel.

Advantages accruing from the use of the coupling boxes are that line loading is minimized to the extent where any reasonable number of i-f test positions may be set up; main signal lines may be extended at will without reducing the signal level except due to line attenuation; discontinuities due to resistor isolation at signal take off points are minimized. Reflections which would seriously hinder test results with the 20 to 28-mc video sweep signal are thus effectively reduced.

The attenuator panel furnishes filament voltages to the tubes in the coupling boxes. Plate voltage is applied only to the tube handling the desired frequency by means of the selector control which also switches the drop lines. The ratio of desired-to-undesired signal is thus kept high. The coarse-attenuator control provides for 120-db attenuation in 10 times steps while the fine control allows for an additional 25 or 26 db.

This basic distribution system will handle up to eleven different frequencies or sets of frequencies below 32 mc and is in use for domestic and ex-

(Continued on page 35)

10-7-47

CURRENTLY

SORENSEN & COMPANY, INC.

Manufacturers of

VOLTAGE REGULATORS, NOBATRONS & ELECTRONIC APPARATUS

FROM
SORENSEN
AT
STAMFORD

SORENSEN
5
& COMPANY

**RUNAWAY
VOLTAGES
STOPPED AT 1/10 OF 1%**

Rated performance of Model 1750-S guarantees delivery of output line voltages at a regulation accuracy of 0.2% under varying load. However, in actual tests of this unit voltage stabilization was held to within 0.1% under full operating conditions. This conservative safety rating of 0.2% is typical of all Sorensen performance factors.

Input voltage range.....95-125
Adjustable output between.....110-120
Load range.....200-2000 VA
Regulation accuracy.....0.2%
Harmonic distortion.....2% max.
Recovery time.....6 cycles
Input frequency range.....55-65 cycles

IT IS "A NATURAL"
FOR CONTROLLING
VOLTAGES IN LAB-
ORATORIES, ASSEMBLY
LINE TESTING AND AS
A COMPONENT OF
YOUR ELECTRICAL
UNIT.





Send me the Electronics Journal "Currently" regularly in addition to the resume on "Electronic Batteries."

NAME _____ TITLE _____

COMPANY _____

ADDRESS _____

SORENSEN & COMPANY, INC.

375 FAIRFIELD AVE. • STAMFORD, CONN.

Write

**for the latest
in electronic
developments**

Series of Forms Covering Transmitter Operation, Tube Inventory, Network Schedules, Recordings, Antenna Air Pumps, and Remotes Used to Follow Through on Operation of Station Engineering Department.

by **F. J. SHEEHAN**

Chief Engineer
WTOL, Toledo, Ohio

to further assist our engineers in quick tracing and servicing.

Network Form

Network interruptions are quite a problem to the operating engineer. Each interruption must be recorded. The reason, location and duration of the interruptions must be kept on a form convenient for reference and reporting to the network office. The form we use is shown in Figure 2.

Schedule of Hours Form

The schedule of hours on the air is another important report which must be kept. Our schedule (Figure 3) provides for Sunday to Saturday data, and includes information on remotes and maintenance.

Tube Data

A running record of tube operation is essential to every station. In the form we use (Figure 4) are data on the date and place the tube was installed, plus the condition of the tube when it was installed. A tube inventory sheet is also a part of this form.

Teletype Records

The engineering department of some stations use a teletype machine. It is necessary to keep a record of the calls. This record (Figure 5) should contain the date, time, station to and

from, and whether the message was collect or not.

Records and Transcriptions

The transcription-record department of most medium-sized stations is a part of the engineering setup with recording activities usually conducted in the main control room.

It is thus an engineering responsibility to keep a record of the sides, size, date, type and program recorded; Figure 6.

Type information includes data on aluminum, glass, steel, or fabric base; size details, sixteen, twelve or ten and eight-inch sides.

Antenna Line Information

Most antennas are fed with a concentric line that requires a dry gas or air. With either type a record (Figure 7) of the condition or number of strokes should be kept. At WTOL a dry air pump is used. The engineers are assigned a certain number of strokes per week and they keep a record on the chart illustrated. The number of strokes will vary with the diameter and length of the transmission line in various installations.

The Payroll Sheet

The payroll sheet is another important form requiring daily attention. Our form (Figures 8 and 9) has a line for each day and a column for time, on and off, and the total time. It can be compared against the work-

Figures 4a, 5, 6 and 7

In Figure 4a appears a tube-report form. In Figure 5 we have an engineering department teletype report. Figure 6 shows a typical recording sheet. The antenna air-pump sobedule is shown in Figure 7.

schedule set sheet, Figure 3. The operating log is also a part of the payroll sheet.

The payroll schedule also includes a form covering transportation, a necessity to a station with many remotes requiring the use of taxicabs or other transportation.

Figures 8 and 9

In Figure 8 appears the transportation sheet used by the WTOL engineering department, and in Figure 9 we have payroll portion of form.

The Industry Offers

B & W LIGHTWEIGHT DISTORTION METER

A distortion meter, model 400, has been announced by Barker & Williamson, Inc., 237 Fairfield Avenue, Upper Darby, Pa.

The circuit of the distortion meter consists essentially of a Wien bridge null balance included in a feedback amplifier in combination with vacuum-tube voltmeter and accurately calibrated attenuator. The amplifier is capable of complete fundamental frequency suppression, but produces no attenuation of frequencies removed one octave or more.

Frequency range of unit as distortion meter, for fundamentals from 50 to 15,000 cycles, measuring harmonics up to 45,000 cycles; as voltmeter and db meter, from 30 to 30,000 cycles.

Sensitivity for noise and distortion measurements, minimum input .3 volt; as a voltmeter, full scale readings of .3, .1, .03, .01, and .003 volts.

Calibration for distortion measurements $\pm 10\%$; for noise measurements ± 1 db; for voltage measurements $\pm 5\%$.

Controls include calibration control and on-off switch combined; frequency range switch; coarse frequency control; fine frequency control; coarse amplitude control; fine amplitude control; noise and distortion range switch; vacuum-tube voltmeter zero adjust; input terminal, impedance 100,000 ohms; and output terminals, 100,000 ohms impedance.



DAYTON AIRCRAFT ANTENNA TENSION UNITS

Antenna tension units and insulators which were developed by Air Material Command during the war for the protection of aircraft radio equipment from precipitation static are now being made available for commercial and private aviation by Dayton Aircraft Products, Inc., of Dayton, Ohio. Pictured on the right next to the antenna post is a tension unit and on the left is an insulator.

Units shield the antenna from corona discharge (St. Elmo's Fire).



DU MONT IMAGE-ORTHICON CAMERA

Image-orthicon camera chains incorporating a newly designed image-orthicon camera have been announced by Allen B. Du Mont Laboratories, Inc.

Camera features a lens turret that takes up to four lenses of various focal lengths. The turret is operated by a rotatable handle at the rear of the camera, locking any one of the indicated lenses in position. Diaphragm setting is also controlled from the rear of the camera, while focusing is controlled by the concentric handle at the rear of the camera, which moves the image-orthicon tube back and forth.

To avoid parallax difficulties, the camera retains the Du Mont-originated electronic viewfinder. Mounted on top of the camera proper, this assembly slips down in place, at the same time establishing plug-in connections. The electronic viewfinder chassis is included in the camera housing. The televised image as shown on the viewfinder screen is viewed through a shadowbox at the rear of the camera. The camera can be operated with or without the electronic viewfinder, an optical viewfinder being provided when necessary.

Voltage control is provided for variation in pickup tubes. Video preamplifier is essentially non-microphonic so that image pickup is virtually unaffected by variation or jarring of the camera in operation. Controls at the rear of the camera, made available by opening panel doors, regulate heater or blower for the operation of the image-orthicon tube at the proper temperature; centering of electronic image; adjustment of preamplifier gain and alignment coil current.

Pilot light at the rear of the camera indicates "On the Air." If the cameraman is following the pickup through the electronic viewfinder, a second pilot light inside the shadow box is used for the cue.

The camera takes a plug-in headset and microphone for use with the inter-communicating system of the studio or outside crew. A 2P23 image-orthicon is used in camera.

The image-orthicon camera chain includes the pickup auxiliary, low-voltage supplies, synchronizing pulse generator, camera control and monitor, distribution amplifier and low-voltage supply, and the mixer amplifier and monitor, adapted to two, three or four camera operation.

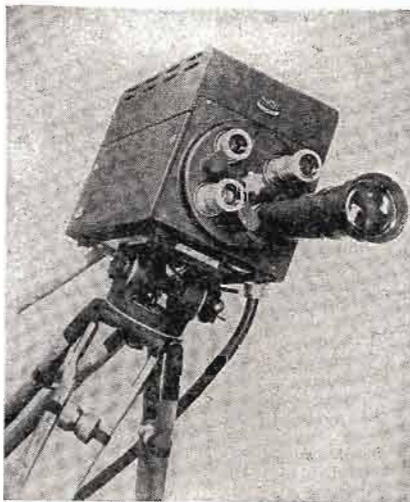

FREED VACUUM-TUBE VOLTMETER

A vacuum-tube voltmeter, No. 1060, which can be used at audio and supersonic frequencies, and as a null detector in a-c bridge measurements, has been developed by the Freed Transformer Company, Inc., 72 Spring Street, New York 12, New York.

Input impedance is 50 megohms shunted by 15 mmfd. Voltmeter has a frequency range from 10 cycles to 1.6 mc, with a .5-db variation from 10 cycles to 1.6 mc, and a .1 db variation from 20 to 500,000 cycles.

SIMPSON ROLL TOP INSTRUMENT CARRYING CASE

The roll top safety case, engineered for the model 260 volt-ohm milliammeter, has been announced by the Simpson Electric Company, Chicago. Instrument is permanently fastened into the roll top case which is of heavily molded bakelite, and large enough to provide a compartment for leads beneath the instrument. The front is covered by a roll top panel, a sliding cover of narrow bakelite segments on a backing of cloth.

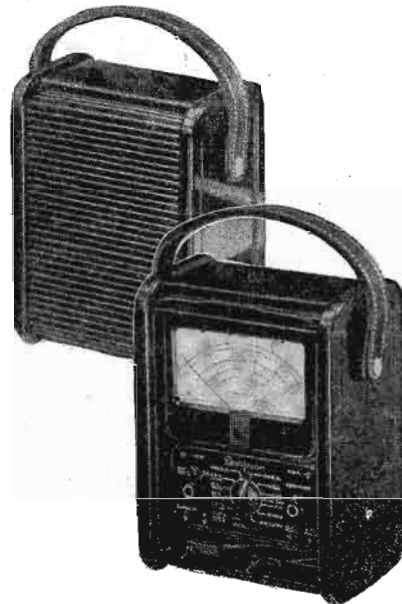

ELECTRO-VOICE BROADCAST DYNAMIC MICROPHONE

A moving-coil dynamic microphone, E-V635, designed for broadcasting and recording, has been announced by Electro-Voice, Inc., Buchanan, Michigan.

Microphone is omni-directional below 2000 cps, becoming directional at higher frequencies. It is effective for group as well as individual pickup. Range said to be 60-13,000 cps ± 2.5 db. Output said to be -53 db.

Recessed impedance-selector switch in the microphone stud permits choice of 50 or 250 ohms impedance in the one microphone.

Swivel head permits 90° vertical tilt for aiming at sound source. Cable connector of the Cannon XL-3 type is built into the microphone stud. Stand coupler has standard $\frac{5}{8}$ "-27 thread.

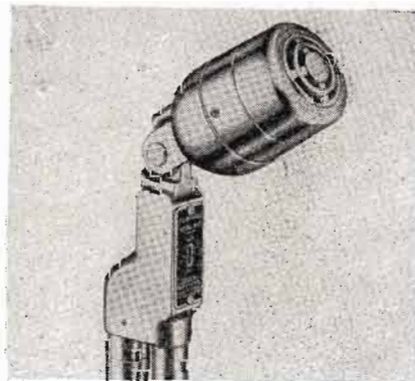

SYLVANIA 7-INCH SCOPE

A seven-inch scope has been announced by the radio tube division of Sylvania Electric Products Inc., 500 Fifth Avenue, New York 18, N. Y.

Uses a push-pull amplifier with four 7C7s. Provision is made for Z axis input with impedance to ground approximating 1/2 megohm, with 30-mmfd shunt capacitance.

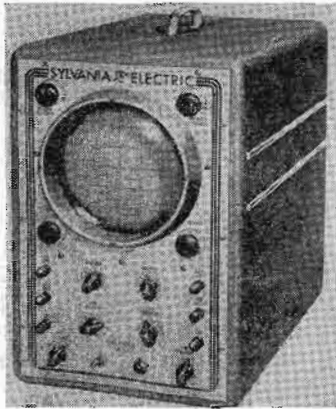

MILLEN U-H-F TRANSMITTER

A u-h-f crystal-controlled transmitter with outputs on the 10-11, 6- and 2-meter amateur bands, has been developed by the James Millen Manufacturing Company Inc., of Malden, Mass.

Transmitter uses an 829B in the final power amplifier stage, with plate input up to 100 watts. Crystal control is by means of the newly developed Biiley overtone crystal-oscillator unit.



SORENSEN VOLTAGE REGULATOR

A voltage regulator, model E-3006, especially applicable for testing of instruments, has been announced by Sorensen & Company, Inc., Stamford, Connecticut.

Physically the unit is divided in half. Upper half is a modified Nobatron with an output voltage of 6 d-c; load range, 7 1/2 to 15 amps; regulation accuracy, 0.1%; ripple voltage rms (max.), 1/4%; recovery time, 0.2 seconds; input frequency range, 50 to 60 cycles; and ambient temperature range, -50°C to +50°C.

Lower half contains a regulated d-c power supply with an output voltage of 0 to 300 volts d-c continuously adjustable; load capacity, 100 milliamperes; regulation accuracy, 1/10 of 1%; and input-frequency range, 50 to 60 cycles.

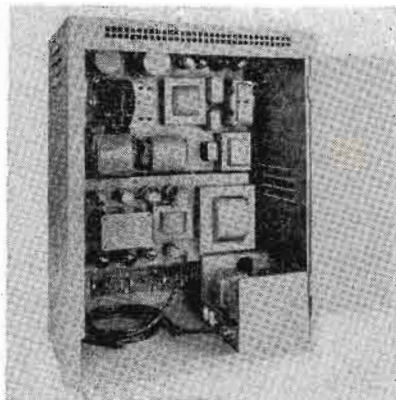

(Continued on page 28)

Whether RADIO AMPLIFIER or QUANTOMETER



PHOTO COURTESY RADIO STATION WOR & WESTERN ELECTRIC

Cannon Electric Type DPB Connector using gold-plated contacts in Studio Control Booth Console, Type 120 Amplifier in the low level side. Plug-in connector greatly increases ease of servicing and maintenance.

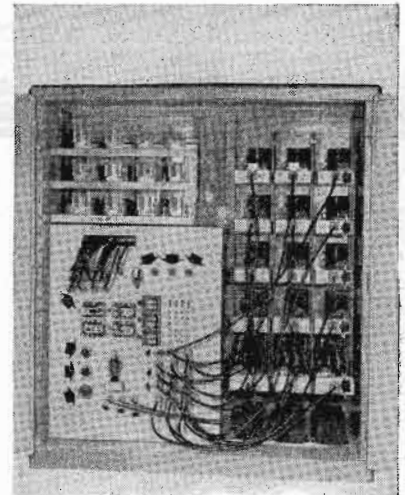

PHOTO COURTESY APPLIED RESEARCH LAB., GLENDALE, CALIF.

Arrows point to Cannon Electric Type "K" fittings connecting a maze of circuits on the Quantometer, a direct-reading spectrometer which determines chemical analysis of metals in 45 seconds. Rear view shown.

Plug-in with CANNON PLUGS



K-21 Plug



RK-24C Plug

TYPE "K"—made in 3 general shell types with nearly 190 insert arrangements available for a wide variety of wire sizes, including coaxials.



TYPE DPB—rack type pin and socket assemblies (both for fixed mounting) carry standard, coaxial and twinax contacts. Six basic layouts available in DPB, many more in the larger DPD shell size.



NEW EDITION C-46-A CATALOG—For a complete survey of the majority of Cannon Electric products, send for this C-46-A Catalog, containing prices on many items. Also included are the names and addresses of our distributors. Write Department I-121.



CANNON ELECTRIC DEVELOPMENT COMPANY

3209 Humboldt Street, Los Angeles 31, California
Canada & British Empire—Cannon Electric Co., Ltd., Toronto, Ontario • World Export
Agents (excepting British Empire) Frazar & Hansen, 301 Clay St., San Francisco 11, Calif.



VETERAN WIRELESS OPERATORS ASSOCIATION NEWS

W. J. McGONIGLE, President

RCA BUILDING, 30 Rockefeller Plaza, New York, N. Y.

GEORGE H. CLARK, Secretary

Personals

TELEVISION has become the favorite subject of VWOA life member John R. Poppele, who is vice-president and chief engineer of WOR and president of the TBA. JRP, who is also a member of the board of directors of the VWOA, predicted in a speech before a television society in Philadelphia that within the next few years we will see television becoming a billion-dollar industry. The television audience, said JRP, will be many times larger than the present broadcast audience.

In view of the possibilities of television, WOR has placed orders for two transmitters, for a station in New York and in the nation's capital. It is expected that these stations will begin operation during the summer of 1948. Both stations will be linked so that New York and Washington stations will be able to exchange programs.

The Washington transmitter will be located at the highest point in the city, 40th and Brandywine Streets, N.W., 412 feet above sea level. The height of the television tower will be 300 feet, thus providing an overall antenna height of over 700 feet. The New York television transmitter may be located at 444 Madison Avenue.

Both transmitters will operate on channel 9; 186 to 192 mc.

JRP revealed that construction on the antenna in Washington began over a month ago and should be completed very shortly.

The call letters of the New York station will be WOR-TV and the Washington station, WOIC.

Good luck, JRP, on these enterprises.

EVERYONE WAS GRIEVED to learn of the death of VWOA honorary member Lt. Gen. James G. Harbord, former chairman of the board of RCA.

The General had joined RCA on January 1, 1923, after a brilliant career in the Army. He served as the president of RCA until 1930 and from then



Life member J. R. Poppele (rear) discussing the television plans of WOR with T. C. Streibert (left), president of WOR, and A. Josephsen of RCA. WOR recently purchased a 5-kw RCA television transmitter for use in their new station WOIC, Washington, D. C.

until July 11, 1947, had been chairman of the board of directors, when he retired under the RCA pension plan.

General Harbord entered the Army as an enlisted man in 1889 and had seen service in Cuba, the Philippines and on the Mexican Border. In 1917, General John J. Pershing selected him as chief of staff of the first AEF in France.

During his war years, promotion came rapidly for General Harbord. He was but a Major attending the United States Army War College when he was named chief of staff and promoted to Lt. Colonel. Less than a year later he was elevated to Brigadier General and after his celebrated success in the offensive at Soissons in France, he was promoted to Major General. On July 9, 1942, he became a Lieutenant General. The General had also seen active duty during the Spanish American War when he was a Major in the Second U. S. Volunteer Cavalry (the Torrey Rough Riders). In 1902 he was sent to the Philippines and in the following year he was appointed Colonel and Assistant Chief of the Philippine Constabulary by Governor

Taft. He remained in that post for ten years.

Many distinguished honors were conferred on General Harbord. These included the Distinguished Service Medal, U. S. Army; Distinguished Service Medal, U. S. Navy; Knight Commander, St. Michael and St. George, Great Britain; Commander, Legion of Honor, France; Croix de Guerre, France, with two palms; Grand Officer, Order of the Crown of Belgium; Commander, Order of St. Maurice and St. Lazarus, Italy. Other honors included Grand Officer, Prince Danilo, Montenegro; La Solidaridad, Panama; Grand Officer, Polonia Restituta; and the Ordnance Medal of Merit for 1937, Army Ordnance Association.

He was also honored by many universities, receiving a Bachelor of Science degree from the Kansas State Agricultural College; Master of Science, Kansas State Agricultural College; Doctor of Laws, Trinity College; Doctor of Laws, Colgate University; Doctor of Laws, Marietta College; Doctor of Laws, Yale College; and Doctor of Laws, Washington and Jefferson College.

His leadership in the military and industrial affairs of the nation will be missed.

VETERAN MEMBER JOHN V. L. HOGAN has been petitioned to run for the IRE Regional Director post for the North Central Atlantic Region. JVLH, who is now president of the Interstate Broadcasting Co. (WQXR and WQXQ), and also president of Radio Inventions, Inc., and Faximile, Inc., has been very active with the IRE. In 1920 he was president and from 1916 to 1919 he served as vice president. He has been on a number of important committees, including awards, facsimile, nominations, papers, papers procurement, papers review, professional recognition and standards.

Here's our vote, JVLH.

10-7-47

Here's Why Your Antenna Installations Will Give

LONGER-LASTING PERFORMANCE

with Federal's



H-F Transmission Lines

1. Their unusually low attenuation losses assure the most efficient transfer of energy between antenna and receiver or transmitter.
2. Their uniformity and permanence of characteristics permit peak receiver performance, without annoying distortion from locally-induced interference.
3. Their flexibility and outstanding resistance to weathering, moisture and abrasion contribute to years of trouble-free service.

IN THE FIVE ITEMS listed here, there's a high-frequency cable for practically every antenna application. The K-1128 75-ohm line, for transmitter use—the K-1079 and K-1046 lines for general FM and Television service. The smooth oval cross-section of these 75, 100, and 300-ohm lines prevents the accumulation of foreign matter, thereby maintaining stable capacity characteristics. The K-32 and KT-51 coaxial cables offer peak performance for applications where locally-induced interference is severe.

For complete information and prices on these cables, see your local distributor. For other high-frequency cables—write to Federal, Dept. D110.

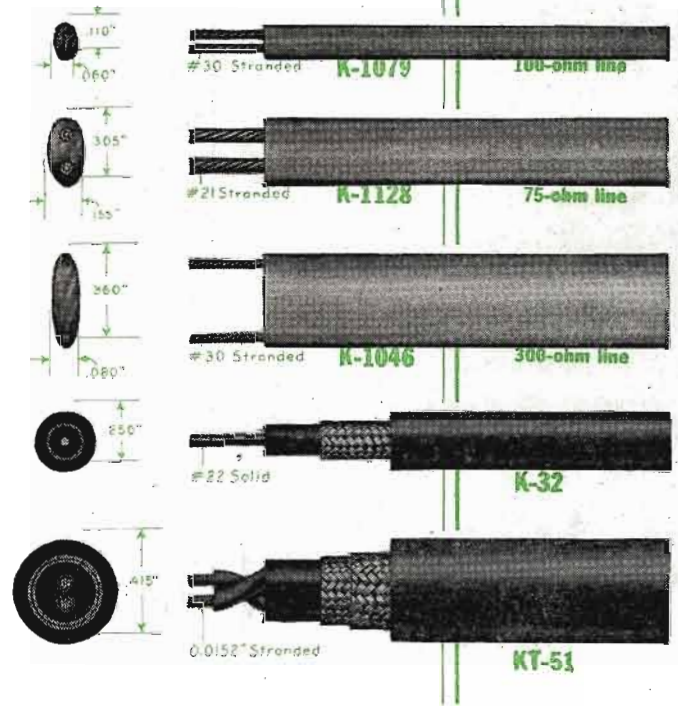

Type Number	Characteristic Impedance Ohms	Velocity of Propagation (in percent)	Capacitance Per Ft. mmf	Attenuation, Db per 100 Ft. Frequency in Megacycles				
				1.0	1.7	30	100	300
K-1079	100	71	15.5	.6	.75	2.8	5.2	8.8
K-1128	75	71	19.5	.3	.4	2.0	4.0	7.3
K-1046	300	81	4.0	.38	.57	.85	2.0	—
K-32	73	66	22	—	—	2.0	3.8	7.0
KT-51	95	56	16	—	—	1.8	3.8	7.5

•Reg. U. S. Pat. Off



KEEPING FEDERAL YEARS AHEAD... is IT&T's world-wide research and engineering organization, of which the Federal Telecommunication Laboratories, Nutley, N. J., is a unit.

Federal Telephone and Radio Corporation

100 KINGSLAND ROAD, CLIFTON, NEW JERSEY

In Canada: — Federal Electric Manufacturing Company, Ltd., Montreal.
Export-Distributors: — International Standard Electric Corp., 67 Broad St., N. Y. C.

Designed for



Application



90810

90810 HIGH FREQUENCY TRANSMITTER

The No. 90810 crystal control transmitter provides 75 watt output (higher output may be obtained by the use of forced cooling) on the 10-11, 6 and 2 meter amateur bands. Provisions are made for quick band shift by means of the new 48000 series high frequency plug-in coils.

Crystal and circuit development on "third overtone frequency output crystals" has made possible this highly efficient unit, providing high output and crystal control with a minimum of tubes.

The No. 90810 consists of a Bliley CCO-2A crystal oscillator unit, using a 6AC7 crystal oscillator, a 2E26 tripler and an 829B power amplifier stage. For 10 meter operation, a conventional crystal is used, the crystal unit driving the 829 direct. For 6 meter operation, an overtone crystal is used in the crystal stage and drives the 829 directly as a power amplifier. For 2 meter operation, the overtone crystal is likewise used, but the output from the crystal unit is fed through the 2E26 tripler.

JAMES MILLEN MFG. CO., INC.

MAIN OFFICE AND FACTORY
MALDEN
MASSACHUSETTS



The Industry Offers

(Continued from page 25)

ADVANCE ELECTRIC RELAY

A relay designed for spdt switching of 50-ohm coaxial lines, 7200 AC or 8200 DC, has been announced by the Advance Electric & Relay Co., 1260 West 2nd Street, Los Angeles, California.

Has internal 1/4" silver contacts, and 3/16" silver external contacts for simultaneous control of indicator lights and other associated circuits.

Connectors are Amphenol 83-IR for RG-8U coax cable. Standing wave ratio is said to be 1.02 with the coax cable.

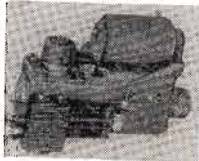

SIGMA 3-POSITION RELAY

A 3-position or null indicating polarized relay has been announced by Sigma Instruments, Inc., 70 Ceylon St., Boston 21, Mass. Contact structure of up to a maximum of four normally open circuits for each polarity (total of eight).

When the coil is provided with two opposed windings for use in a push-pull output circuit, minimum differential power requirements are approximately .005 watt per contact pole. With a single-wound coil, about .0025 watt is needed per contact pole.

The armature, which is almost exactly balanced, has snap-action centering or detent, and does not move gradually with increasing coil current. About 25 grams of force at the contacts are available from an input of .005 watt, and a similar amount for holding the central or null position, with input balanced or zero.

TEKTRONIX SCOPE

An oscilloscope featuring a vertical amplifier bandwidth of 3 cps to 10 mc with one stage and 3 cps to 8 mc with two stages has been announced by Tektronix, 1516 S. E. Seventh Avenue, Portland 14, Oregon.

Other features of the scope include a horizontal deflection sensitivity of 4 volts per inch d-c or peak to peak a-c; continuously variable sweep speed from 1/40 second per inch to 1/4 microsecond per inch; trigger selector; illuminated graticule and sweep magnifier.

ELECTRICAL REACTANCE COMPENSATING CERAMIC CAPACITORS

To compensate for the drift in the isolating circuit of f-m receivers where 6SB7 or similar tubes are used, the Electrical Reactance Corporation, Franklinville, New York, have designed a drift stabilizer that can be produced with any temperature coefficient or capacity. Unit may consist of a steatite capacitor rating of 5 mmfd combining a resistor element of 15 ohms as an inherent part of the unit. Manufacturer claims that the curve of compensation can be controlled by the amount of resistance wire or heating element placed around the steatite base tube.

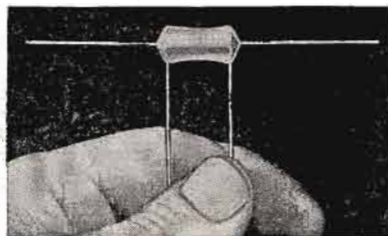

KENMORE METALS DUAL METAL WIRE

Electroplated and drawn wire, Fernicklon, that can be bent, swaged, hammered, woven or twisted without flaking has been announced by Kenmore Metals Corporation, Warren,

TRIG TOWER

is self-supporting
no guys needed

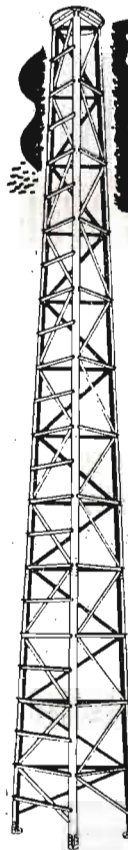

Trig Tower is Rugged

Holds top load of 200 pounds in 90 mile wind. Precision-built of aluminum alloy; triangular, tapered design. Self-supporting, no guys needed. Ladder, integral with Tower.

Trig Tower is Economical

Light weight cuts cost of shipping, assembly, footing, erection. 30 ft., 20 ft., in 10 ft. sections, and complete 10 ft. unit at low net prices.

Trig Tower is Easy-To-Set-Up

Delivered knocked-down with full instructions, mechanical drawings, marked parts. One man can assemble with wrenches alone; two men "walk" Tower into position. TRIG: trim, trusty, sound, firm... Webster

Dept. C

See your local dealer today or write
ROSTAN CORPORATION
202 East 44th Street, New York 17, N. Y.

ZOPHAR

WAXES COMPOUNDS and EMULSIONS

FOR INSULATING and WATERPROOFING of ELECTRICAL and RADIO COMPONENTS

Also for CONTAINERS and PAPER IMPREGNATION

FUNGUS RESISTANT WAXES

ZOPHAR WAXES and COMPOUNDS Meet all army and navy specifications if required

Inquiries Invited

ZOPHAR MILLS, INC.

FOUNDED 1846
122-26th ST., BROOKLYN, N. Y.

Pennsylvania: offices at 80 Broad Street, New York City.

In processing wire, metal rods of $\frac{1}{4}$ " diameter are first electroplated continually, then cold-drawn down to diameters as fine as 0.0038". One inch of $\frac{1}{4}$ " plated rod may produce up to 100,000 feet of plated wire.

Initial production at the Warren plant includes steel wire with nickel and copper wire with nickel or silver.

Kenmore Metals Corporation was formed in June, 1946, for the purpose of expanding pilot plant production of the wire into quantities for commercial use. Principals include Herbert Kenmore, president and co-inventor of the process and Conda P. Boggs, vice president of Sylvania Electric Products Inc.

STANWYCK MINIATURE I-F TRANSFORMERS

A line of midget i-f transformers with molded powdered iron cores has been announced by The Stanwyck Winding Company, 102 South Landers Street, Newburgh, New York.

Units use treated mica compression trimmers.

Correct coupling co-efficient said to be maintained with iron cores inserted into a specially stamped platform.

Pre-aligned to 455 kc.

Mounted in a $\frac{3}{4}$ " square can x $1\frac{1}{8}$ ".

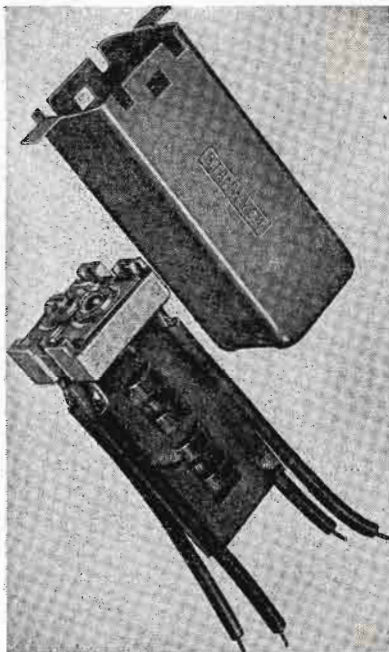

G.E. HIGH-VOLTAGE IGNITRON

An ignition, type GL-5630, for transmitter and power rectification applications, has been developed by the tube division of G. E. Tube rectifies and regulates current, and provides a one-cycle circuit breaker action simultaneously.

Suitable for applications which require up to 3000 kilowatts of d-c power.

A feature of the tube is a control grid which times current to a micro-second and gives the tube its voltage-regulating and circuit-breaker qualities. Handling of high voltages is achieved by a special potential-dividing grid which lowers the voltage gradient between the anode and cathode.

Has a peak voltage, forward or inverse, of 20,000. Its peak current is 200 amperes and its average current is 50 amperes.

ACA DIRECT-COUPLED AMPLIFIER

A direct-coupled amplifier, model 100 GE, to accommodate the G. E. variable reluctance magnetic pickup has been developed by the Amplifier Corp. of America, 398-31 Broadway, N. Y. 13, N. Y.

Equipped with preamplifier and fixed pre-equalizer. Contains, in addition, a variable high-frequency equalizer for compensation of preemphasized recorded and radio programs, as well as a low-frequency equalizer for compensation of constant-amplitude recordings.

Utilizes a signal self-balancing and current drift-correcting direct-coupled output circuit. Response is said to be 20 to 20,000 cycles ± 1 db;

(Continued on page 30)



We're Not Snake Charmers

We can't wind coils without wire . . . and of the right size. Magnet wire shortages, existing for many months, have prevented us from accepting orders for coil windings using sizes not obtainable.

For your convenience we list wire sizes which we have in stock. If these sizes meet your specifications we can make prompt delivery.

- PLAIN ENAMEL MAGNET WIRE**
 #21 - #22 - #23 - #24 - #25
 #29 - #30 - #34 - #35 - #42

COTO-COIL CO., INC.
 COIL SPECIALISTS SINCE 1917
 65 Pavilion Ave., Providence 5, R. I.



LEACH RELAYS

BETTER CONTROLS
THROUGH
BETTER RELAYS

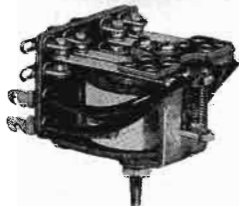

LEACH MIDGET SERIES
for SPACE ECONOMY in
MODERN DESIGN

Leach Midget Relays meet today's demand for compact design—and assure positive, dependable control. The Midget Series offers a wide choice of types, each so tiny it weighs less than two ounces and all measure less than two inches.

When you hold a Leach Midget Relay, between just two fingers, you can readily see the evidence of manufacturing skill and Electrical-Engineering design that's typically *Leach*. Here, quality materials and careful workmanship challenge comparison. The term "Mighty Midgets" is aptly suited to Leach Midget Relays.

LEACH RELAY CO.

5915 AVALON BOULEVARD, LOS ANGELES 3, CALIF.

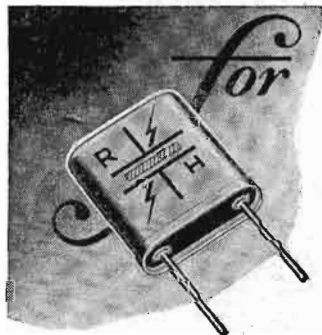

RH-7M

RADIO MANUFACTURERS... A LOW COST CRYSTAL

RH-7M is a new hermetically sealed crystal unit which combines wide frequency range and increased performance with low cost. RH-7M is provided with wire leads to specified length. On fixed frequencies of transmitters or receivers this unit can be soldered in directly with other components of the set thus eliminating plug in sockets and possibility of contact failure. RH-7M with prongs to fit standard sockets can be supplied on special order.

Any fundamental frequencies from 3 mc. to 20 mc. can be supplied with tolerances from 0.01% down to plus or minus 0.003% over a temperature range of minus 55° to plus 90°C.

For series resonance application frequencies of mechanical overtone (mode) from 15 mc. to 75 mc. can be supplied.

This unit is also very adaptable for low frequency filter circuits. CT cut, center mounted, plated crystals have a frequency range from 300 kc. to 600 kc. DT cut, center mounted crystals range from 200 kc. to 400 kc.

Patent Pending

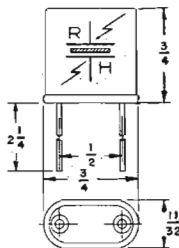

RH-7M Dimensions



**REEVES-HOFFMAN
CORPORATION**

SALES OFFICE: 215 EAST 91 STREET, NEW YORK 28, N. Y.
PLANT: 321 CHERRY STREET, CARLISLE, PA.

The Industry Offers

(Continued from page 29)

develops 23 watts with less than 1% total distortion.

Features include a non-frequency discriminating scratch suppressor which is said to reduce scratch by 10 db.



AEROVOX HIGH-VOLTAGE MIDGET-CAN ELECTROLYTICS

Midget-can Aerovox electrolytics heretofore available in voltage ratings up to 450 d-c-w. are now available also in higher voltage ratings of 500, 600, and 700 d-c-w, or 650, 750, and 850 surge volts, respectively. Capacitance values are 8, 10, 12, and 16 mfd.



C-D TV CAPACITORS

Capacitors, RC-108, with ratings of .05 mfd, 3500 v-d-c, have been announced by Cornell-Dubilier Electric Corporation, South Plainfield, New Jersey.

Built in a cylindrical metal container 1 1/4" in diameter, 3" long with screw-type terminals mounted on ceramic insulators protruding 3/4" from each end of the case.

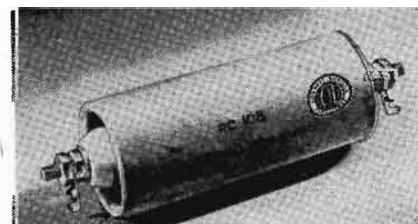

News Briefs

INDUSTRY ACTIVITIES

The 1947 Rochester Fall Meeting of members of the IRE and RMA engineering department will be held at the Sheraton Hotel, Rochester, New York, November 17, 18 and 19.

Virgil M. Graham is chairman of the Rochester Fall Meeting Committee. Other officers are: Howard A. Brown, vice chairman; H. J. Klumb, treasurer; and O. L. Angevine, secretary.

Technical Session Program

Monday, Nov. 17

V-H-F Direction Finder for Airport Use; A. G. Richardson, Federal Telecommunication Labs.

Design and Layout of Radio Receivers and the Maintenance Man; A. C. W. Saunders, Saunders Radio & Electronics School.

R-F Inductance Meter with Direct Reading Linear Scale; Harold A. Wheeler, Wheeler Labs.

Use of Miniature Tubes in A-C/D-C Receivers for A-M and F-M; R. F. Dunn, RCA.

Two Signal Performance of Some F-M Receiver Systems; B. D. Loughlin, Hazeltine Electronics Corp.

Tuesday, Nov. 18

Avenues of Improvement in Present Day Television; Donald G. Fink, McGraw-Hill.

Standardization of Transient Response of Television Transmitters and Receivers; R. D. Kell and G. L. Fredendall, RCA Labs.

Psychoacoustic Factors in Radio Receiver Loudspeaker Selection; Hugh S. Knowles, Jensen Manufacturing Company.

Spectral Energy Distribution of Cathode-Ray Phosphors; R. M. Bowie and A. E. Martin, Sylvania Electric.

Quality Control in Receiving Tube Manufacture; J. A. Davies, G. E.

Wednesday, Nov. 19

V-H-F Bridge for Impedance Measurements Between 20 and 140 Megacycles; Robert A. Soderman, General Radio.

Metallized Film Coaxial Attenuators; John W. E. Griemsmann, Polytechnic Institute of Brooklyn.

I-F Selectivity Considerations in F-M Receivers; R. B. Dome, G. E.

The Organization of the Work of the I. R. E. Technical Committees; L. G. Cumming, IRE.

A New Television Projection System; William E. Bradley, Philco Corporation.

B. E. Shakelford, manager of the license department of R.C.A. International Division, New York, N. Y., has been nominated for presidency of IRE.

G. E. two-way f-m equipment is being installed on the tugs of the New York Central.

Transmitting and receiving antenna have been set up on top of a 218-foot grain elevator at Weehawken, N. J.

Minnesota and Ontario Paper Company, Minneapolis, employed a G. E. f-m system among logging units engaged in the summer movement of cords of pulpwood.

Five 60-watt portable stations housed in trunk units were at strategic points near the Minnesota border in Ontario.

The five-man RCA Victor television crew which televised Pope Pius XII, at Vatican City and the La Scala Opera returned to U. S. recently.

The group, headed by Richard H. Hooper, company promotion manager, included Joseph A. Jenkins, executive producer for the unit, Chester E. Davis, chief engineer, Edward K. Price and John H. Roe.

A special adaptation of the W. E. 238 type mobile radiotelephone system is being used by

(Continued on page 32)



LOW-RESISTANCE TEST SET #670C
1,000 to 500,000 micro-ohms
(Other ranges from 200 micro-ohms to 100 ohms)



KILOVOLT METER #785P
AC-DC 5-10-20 KV
(Other ranges from 1.5 to 200 KV)

Shallcross



KELVIN-WHEATSTONE BRIDGE #638-2
0.0001 ohm to 33.11 megohms
(7 additional designs and 15 types of percent limit bridges)



DECADE BOX #825
11,110-ohms in 1 ohm steps
(Other designs, 1 to 7 dials, from 0.1 to 11,111,110 ohms)

... for electrical measurements

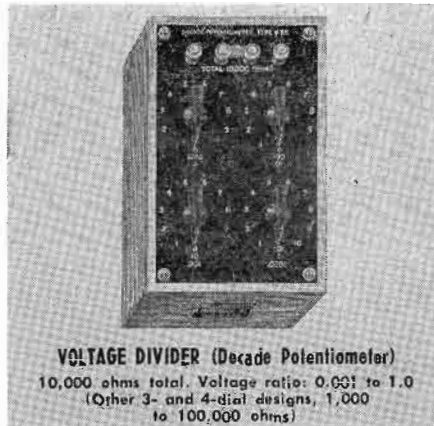

VOLTAGE DIVIDER (Decade Potentiometer)
10,000 ohms total. Voltage ratio: 0.001 to 1.0
(Other 3- and 4-dial designs, 1,000 to 100,000 ohms)

Shallcross Electrical Measuring Instruments are made in many types — from sturdy, inexpensive bridges for school and production use, to fault location bridges, high-voltage test equipment, low-resistance test sets and numerous others.

Write for Bulletin on any type.

AKRA-OHM PRECISION RESISTORS
14 Standard Types.
50 available special designs.

PRECISION SWITCHES
350 designs for instruments and high-grade electrical apparatus.

ATTENUATORS & CONTROLS FOR COMMUNICATION EQUIPMENT

Shallcross Manufacturing Co.

Electrical Measurement Specialists
Dept. 0-97 Collingdale, Pa.

COMMUNICATIONS FOR SEPTEMBER 1947 • 31

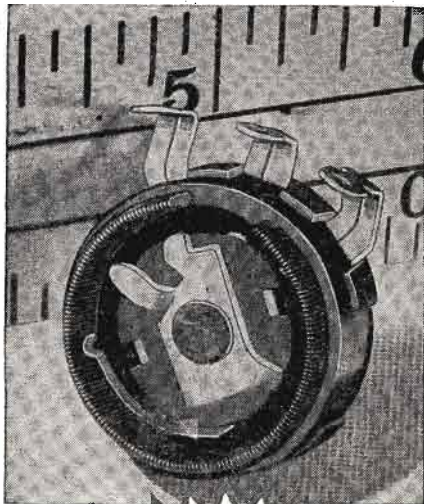

**Midget
WIRE-WOUND
Controls**

★ Clarostat Series 43 wire-wound potentiometers and rheostats are interchangeable mechanically (dimensions, mountings, shafts, terminals, etc.) with composition-element Series 37 Clarostat controls. Space-savers. Dependable. Long life. Often preferred to larger controls for resistance values up to 10,000 ohms linear.

Bakelite body with protective metal cover (shown removed in illustration).
1 to 10,000 ohms. Standard tolerance, within 10% plus or minus.
Power rating: 2 watts average.
Single tap at center can be provided. Tapers not practical.
300° mechanical rotation, 280° electrical, without switch; 260° with switch.

★ For engineering data on this handy midget wire-wound control, write for Bulletin No. 116.



CLAROSTAT MFG. CO., Inc. • 285-7 N. 6th St., Brooklyn, N. Y.

NEWS BRIEFS

(Continued from page 31)

the Pennsylvania and B. & O. for service between Washington and New York. Service will permit passengers to make telephone calls from the train to their homes or offices or to be called from any subscriber's number.

Featuring phase modulation and direct crystal control, the equipment was designed by Bell Telephone Lab for mobile service in the 152-162 mc band. System consists of transmitter, receiver, and a control unit.

The New York Central System will, in October, begin experimental operation of radiotelephone service on the Twentieth Century Limited between New York and Buffalo.

Calls to and from the Century will be routed through the nearest of the nine Bell System general highway mobile band fixed stations now being erected at New York; on a hill near Peekskill; Kingston; Guiderland, south of Albany; Fonda; Utica; Syracuse; Rochester and at Buffalo. Transmissions from the Century, using i-m, will be on 43.66 mc. and transmissions from the Bell System stations to the speeding train will be on 35.66 mc.

An auto, equipped with a mobile radiotelephone system, operating in the 152-162 mc range, and covering the route between Atlantic City and Philadelphia, was used by FTR to demonstrate mobile operations to delegates from many of the 71 countries attending the International Telecommunications Conference at Atlantic City.

PERSONALS

Wm. M. Maguire has been transferred from the Salem, Mass., plant to the distributor sales department of the radio tube division of Sylvania Electric Products, Inc. He will serve as products specialty salesman in cooperation with Sylvania sales division managers and distributors in the eastern half of the United States.



Dr. A. C. Krueger, formerly development engineer, guided missiles project, Republic Aviation Corp., and with the Manhattan Project at the U. of Chicago during the war, has joined the staff of Airborne Instruments Laboratory, Mineola, N. Y., in the capacity of supervising engineer, antenna design section.

Edward A. Miller is now vice president, in charge of engineering, of the Acme Electric Corp., Cuba, N. Y.



John K. Hillard, chief engineer of Altec Lansing Corporation, is now on a tour of Alaska as a consultant on motion picture theatre and military electronic problems.

Robert G. Herzog has been appointed vice president in charge of engineering of Universal General Corp., 365 Canal St., New York 13, N. Y.

Ralph J. Hugh has been appointed sales director of industrial control division of The

JUST PUBLISHED

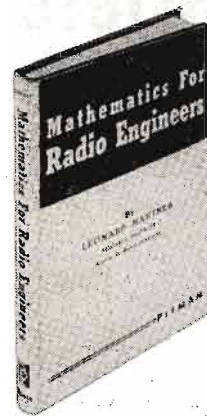

For

- Practicing Engineers
- Radio Technicians
- Radio Service Men
- Radio School and College Students

327pp. \$5.00

Illustrated Graded Problems and Answers

Here is an outstanding new book that covers practically all the mathematics needed to solve everyday design problems in radio, electronics, radar, and allied fields. Relates fundamental concepts to physical applications. Deals with the solution of typical problems and gives applications that represent most recent advances in radio engineering.

MATHEMATICS FOR RADIO ENGINEERS

By Leonard Mautner, Research Engineer, Allen B. Du Mont Laboratories

This practical, easy-to-read text includes mathematical analysis of frequency, amplitude and phase modulation—spectrum analysis of television sawtooth and synchronizing pulses—Wien bridge circuit analysis—determinant solution of networks for phase-shift oscillators—differentiation, integration and sawtooth generation circuits for television.

Send for a Copy on Approval

Pitman Publishing Corporation
2 West 45th St., New York 19, N. Y.

JONES 300 SERIES PLUGS and SOCKETS



P-306-CCT

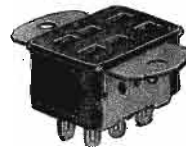

S-306-AB

A high quality line of small Plugs and Sockets adaptable to a thousand uses.

All Plugs and Sockets are Polarized. "Knife-switch" Socket contacts

are of phosphor bronze, cadmium plated. Bar type Plug contacts are of brass, silver plated.

Insulation is of BM 120 molded Bakelite. Caps are of metal with formed fibre linings. Made in 2 to 33 contacts. Although designed for 45 volts at 5 amperes, these Plugs and Sockets can be used at higher ratings where circuit characteristics permit. 2 contact round, others rectangular. For additional information write today for catalog No. 14 showing complete line of Electrical Connecting Devices.

HOWARD B. JONES DIVISION
CINCH MFG. CORP.
2460 W. GEORGE ST. CHICAGO 18

Langevin Mfg. Corp. **Stephen J. Deitz** has also joined Langevin as head of sales engineering.



R. J. Hugh

S. J. Deitz

* * *

James L. Highsmith, Box 1367, Durham, N. C., has been appointed C. P. Clare sales representative in North Carolina and South Carolina.

Willy Dumke has been elected vice president in charge of production of speakers, transformers and hearing aids of the Zenith Radio Corporation.

Everett B. Boise has been appointed Hytron sales engineer for the New York and Mid-Atlantic area.

Mr. Boise was formerly with National Union as chief commercial engineer.

Rodolfo M. Soria is now with the American Phenolic Corporation, Chicago, Illinois, as project engineer, in charge of special development work on antennas and transmission lines. He was formerly instructor in electrical engineering at Illinois Institute of Technology.

Donald A. Quarles, director of apparatus development of Bell Telephone Labs., has been elected a vice president.

Mr. Quarles has been with the Bell System since 1919 and has previously served as outside plant development director and transmission development director.

W. J. Brown, P. O. Box 5106, Cleveland, Ohio, former vice president of Brush Development Co., and now a professional consulting engineer, sailed recently to England to conduct a survey of European communications development activities.

Mr. Brown, who was also formerly chief engineer of Electric and Musical Industries, is now American consultant for EMI.

Grote Reber has been appointed to the staff of the National Bureau of Standards.

Mr. Reber is supervising the erection of a German Giant Wurzburg, a large and powerful radar device, that will be used to detect the solar and cosmic radiation which penetrates the earth's atmosphere.

Herbert F. Harris, comptroller for Jensen Manufacturing Company, died recently.

Arthur Koehler has been appointed production manager of Sorensen & Company, Inc., Stamford, Connecticut.

Mr. Koehler was formerly with Arma Corporation in Brooklyn, New York and with Langevin Company, New York.

William J. Doyle has become general sales manager. The Astatic Corporation, Conneaut, Ohio. Mr. Doyle will coordinate all sales activities, including original equipment for radio manufacturers, jobber and export sales, service, and government contracts. **Ray T. Schottenberg** will head the jobber sales division, and **C. O. Brandes** will continue in his export capacity.

A. A. Ward, vice president of Altec Lansing, has been elected vice president in charge of manufacturing, of the parent company, Altec Service.

G. L. Carrington has been reelected president; H. M. Bessey, vice president and secretary; P. F. Thomas, treasurer; and R. J. Belmont, assistant secretary-treasurer.

* * *

LITERATURE

Electro-Voice, Inc., Buchanan, Michigan, have released a bulletin, No. 134 illustrating and describing the new model 430 button-control floor stand.

United States Television Mfg. Corp. have published a 16-page booklet, "How to Sell Television Sets Profitably."

Booklet includes an analysis of the television industry, opportunity to dealers, how to

(Continued on page 34)

Metallic Rectifiers Since 1923

Selenium

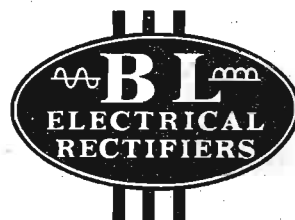

Copper
Sulphide

A modern plant plus a resourceful engineering staff and a quarter century of experience

provide the "know-how" and facilities to serve YOUR AC to DC power conversion requirements.

Manufacturers of selenium and copper sulphide rectifiers, rectifier-transformer assemblies and AC-DC power supply units for every requirement.

Consulting service available without obligation

THE BENWOOD - LINZE CO.

Division of the Sperry Corporation

1815 Locust St.

St. Louis, 3, Mo.

Long Distance Telephone Central 5830



STANDARDIZED READY-TO-USE METAL EQUIPMENT

ADAPTABLE FOR EVERY REQUIREMENT

Par-Metal Equipment offers many features, including functional streamlined design, rugged construction, beautiful finish . . . plus ADAPTABILITY. Eliminate need for special made-to-order units on many jobs.

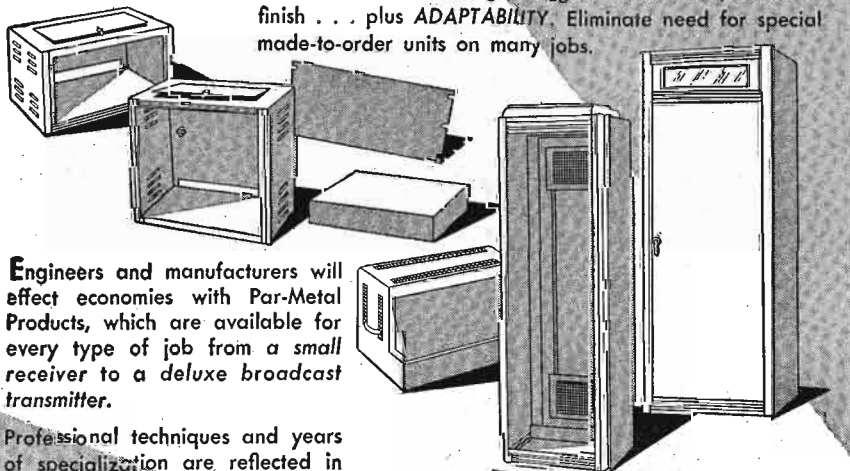

Engineers and manufacturers will effect economies with Par-Metal Products, which are available for every type of job from a small receiver to a deluxe broadcast transmitter.

Professional techniques and years of specialization are reflected in the high quality of Par-Metal.

CABINETS • CHASSIS PANELS • RACKS

Write for Catalog





RMC TRANSCRIPTION PLAYER

(Patents Applied for)

**Model TP-16C Turntable
and Case only**

In Carrying Position:
23" w., 17½" h., 8" d.

**Two-Speed . . . 16-inch . . . Low
Price . . . Portable . . . Compact
Lightweight . . . Easy to Carry**

Designed and built to meet the quantity production demand for a fine tone, dependable, and very low price transcription player. Advanced design, expertly engineered, and sturdily-built for trouble-free performance. Meets the demands of radio stations, transcription services, advertising agencies, and schools for realistic reproduction of transcription records up to 16 inches, 78 or 33 1/3 r.p.m. Free of wow and rumble. Switch output impedance: 30, 250, and 500/600 ohms.

Constant speed heavy duty motor, silent, smooth operation. 16" TURN-TABLE embodies special re-enforced construction (patent pending).
Descriptive Bulletin TP5, Upon Request.

RADIO-MUSIC CORPORATION

PORT CHESTER, NEW YORK

Value Ful RIDER BOOKS FOR THE ENGINEER

UNDERSTANDING MICROWAVES

by Victor J. Young

Provides a foundation for understanding the various microwave developments of past five years \$6.00

AC CALCULATION CHARTS by Lorenzen

For student engineers or practising engineers for whom it provides answer five times faster than slide rule \$7.50

CATHODE RAY TUBE AT WORK

The underlying theory and practical application of commercial oscilloscopes, profusely illustrated. \$4.00

Send for Latest Catalog

JOHN F. RIDER Publisher, Inc.

404 FOURTH AVENUE, NEW YORK 16, N. Y.
Export Division: Rocke-International Corp.
13 E. 40th Street, New York 16, N. Y.

News

(Continued from page 33)

get prospects, how to demonstrate television, and has a list of question-and-answers that invariably come up for discussion.

Thomas & Skinner Steel Products Co., 1128 East 23rd Street, Indianapolis, Indiana, have published a 12-page electrical laminations handbook and catalog, No. 47.

Booklet contains data on stock lamination dies, weights, characteristics and suggested applications of electrical steels. A section is also devoted to oriented steels and thin steels, with a table of data on core loss for very thin steels.

Permoflux Corporation, 4900 West Grand Avenue, Chicago 39, Illinois, and 236 South Verdugo Road, Glendale 5, California, have published a four-page bulletin with data on 52 types of p-m speakers, 54 types of e-m speakers, and 20 types of replacement transformers.

Data supplied includes characteristic specifications for all types; sizes, flux density, voice coil diameters and impedance, watts, dimensions and recommended transformer sizes.

Rubicon Company, 3669 Ridge Ave., Philadelphia 32, Pa., have released a 12-page bulletin, No. 100, describing resistance standards and resistance bridges. Operation, application, construction, and other pertinent data are furnished on Wheatstone, Kelvin, Mueller and limit bridges.

Standard resistors of the Bureau of Standards and Reichsanstalt types, standard shunts and decade resistance boxes are described.

John F. Rider Publisher, Inc., 404 Fourth Ave., New York 16, N. Y., will publish a series of 99 cent 5¼"x7" technical radio text books this fall.

The "99ers," as they are to be called, will contain from 128 to 160 pages.

Among the Rider titles to be released are: "Installation and Servicing of Low Power Pub-

lic Address Systems," "Signal Generator at Work," "Understanding Vectors and Phase in Radio Work," "Understanding Transmitters," "Adjusting Transmitters with the Oscilloscope," and "R-F and I-F Selectivity."

Cleveland Institute of Radio Electronics, S-9 Terminal Tower, Cleveland 13, Ohio, have prepared a 40-page booklet entitled "How to Pass FCC License Examinations."

Booklet gives an explanation of license requirements; extracts from various government pamphlets, amended Communications Act of 1934 and "Rules Governing Commercial Radio Operators"; information about examining offices; list of FCC publications; and suggestions about preparation for the examinations with a formal study course and pre-examination tests.

O'Neil-Irwin Manufacturing Company, Lake City, Minnesota, have prepared a 40-page Di-Acro catalog, No. 47-12, with data on die-less duplicating.

Catalog contains illustrations and specifications on benders, brakes, shears, and rod parters.

Carter Motor Company, 2664 N. Maplewood Ave., Chicago, Illinois, have released a bulletin No. 447-J covering dynamotors, converters, multi-output dynamotors, genemotors, and the magmotors.

Additional data includes graphic presentation of voltage input and output.

Eitel-McCullough, Inc., San Bruno, California, have prepared data sheets on Eimac mercury vapor rectifiers, 872A/872 and 866A/866.

The Hammarlund Mfg. Co. Inc., 460 W. 34th St., N. Y. 4, N. Y., have prepared a 4-page bulletin on the NZ-10 neutralizing capacitor, which replaces the type N-10.

Planet Radio Mfg. Corp., 6508 Euclid Avenue, Cleveland 3, Ohio, have published data sheets on 10- and 15-watt amplifiers.

Technology Instrument Corp., 1058 Main Street, Waltham 54, Mass., have prepared a supplement sheet covering price and special requirement data on variable resistors.

Federal Tool and Manufacturing Co., 3212 North Washington Avenue, Minneapolis 12, Minn., have prepared a 4-page bulletin covering short-run stampings.

Harvey Radio Laboratories, Inc., 449 Concord Avenue, Cambridge, Mass., have released a leaflet describing the Harvey visual alignment signal generator.

International Nickel Company have prepared a sixteen-page booklet on the materials required for the metal-arc, oxy-acetylene and submerged melt welding of nickel and the high nickel alloys. Offered too is general information as the type of welding rods to use, recommended amperages for electric-arc welding, and the proper flux to select for gas welding and brazing.

Aerovox Corp., New Bedford, Mass., have released data sheets on the 1690 and 1780 mica capacitors.

The 1690 capacitor is for use in ultra-high-frequency circuits where it is essential to keep the minimum inductance of the circuit as low as possible. The 1780 is a water-cooled mica capacitor, and handles up to 2,000 kva.

The Westinghouse Electric Corp., P. O. Box 868, Pittsburgh 30, Pa., have released a 44-page bulletin (B-3610) describing tubes, instruments, transformers, switches, relays, capacitors, etc. Provided are application data, performance curves and quick selection charts.

Kurz-Kasch, Inc., Dayton, Ohio, have released a 16-page booklet describing plastic knobs for receivers and instruments. Presented are illustrations and blueprints of a wide variety of available types.

TV Receiver Tests

(Continued from page 21)

port a-m receiver testing, in addition to the television application.

Head-End Alignment

Because of anticipated technical difficulties in suitably transmitting frequency-modulated signals swinging over bands as wide as 10 to 12 mc in the 40- to 220-mc portion of the spectrum it was decided to generate them locally. This was the only exception to the generation and transmission of signals from the central signal cage. A *thirteen-channel television r-f sweep*,¹¹ shown in Figure 11, was therefore designed as a piece of bench test equipment. It was primarily intended for alignment of the thirteen channel head end tuner unit as a sub-assembly but has since been adopted also for final tuner unit checks after installation in receivers and for trouble shooting. Approximately thirty-five of these generators are located at appropriate positions on the test floor.

An r-f sweep of approximately 10-mc width is available for visual alignment of each of the assigned television channels. Output is flat within $\pm 10\%$ with no sharp dips or rises apparent. Marker signals for the picture and sound carrier points are superimposed for each channel. These appear as sharp distinctive vertical bars which are controllable in amplitude.

Crystal-Controlled Oscillators

These markers are produced by two crystal-controlled oscillators producing a series of appropriate harmonics. The harmonics are in turn mixed with a single frequency for each channel which is produced by a self-excited oscillator.

Sound and picture carrier frequencies spaced 4.5 mc apart are thus produced for marker purposes with minimum spurious effects. When the marker frequencies beat with the sweep signal in a mixer the resulting low difference frequency is amplified, rectified and caused to fire a small thyratron discharging in the grid circuit of the sweep oscillator. The markers may be turned off if desired. Their stability is within 25 kc at operating temperature. This appears to be adequate for checking pass bands from 4.5 to 6 mc wide.

¹¹RCA WE-94A.

[To Be Concluded in October]

10-7-47

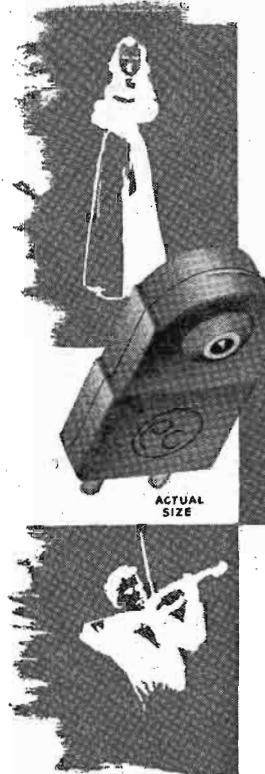

Frankly
**THE MOST
 EXPENSIVE...**

INDISPUTABLY
the finest

The Pickering Cartridge provides the cleanest reproduction ever achieved, with linear response to the limits of audibility. It tracks with only 15 grams pressure and fits practically any arm. It is acknowledged to be the finest record reproducer.

PICKERING & CO., INC., 29 WEST 57TH STREET, N. Y. C.

NEW...IMPROVED

PRECISION ATTENUATORS

by TECH LABS

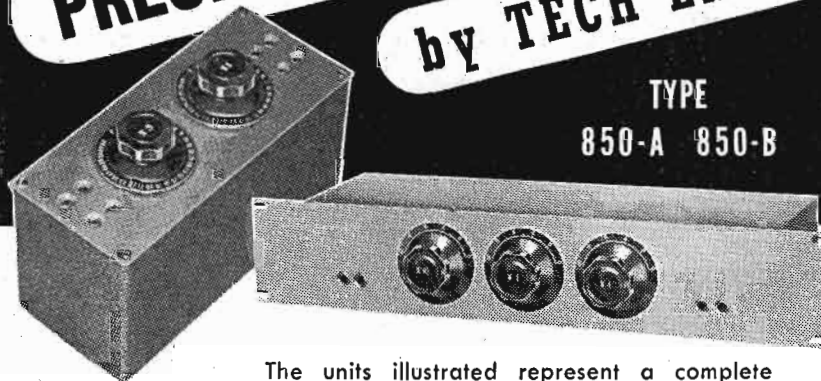

TYPE
 850-A 850-B

The units illustrated represent a complete redesign of our older precision attenuators for laboratory standards. Flat for all frequencies in the audio range. Reasonably flat to 200 k.c. up to 70 db.

Bulletin sent on request.



Manufacturers of Precision Electrical Resistance Instruments
 337 CENTRAL AVE. • JERSEY CITY 7, N. J.

ENGINEERED FOR EFFICIENT FM AND TELEVISION RECEPTION

Magic Wand Aerials for FM and television offer electrical efficiency possible only through the enthusiastic teamwork of Ward's top-drawer experimental laboratory, and production facilities.

As the world's largest producer of aerials for car and home, Ward also is pioneering in educating 33 million present, and prospective, FM and television receiver owners that a good outdoor dipole antenna is necessary if quality reception is to be enjoyed. Watch for our hard-hitting ads in the Saturday Evening Post and leading newspapers.

In addition to developing outstanding FM, television and automotive aerials, Ward also has design and production capacity available to take care of special aerial needs. Submit your aerial problems to us now for an efficient, and economical, solution.



WARD
Magic Wand
FM AND TELEVISION
AERIALS

THE WARD PRODUCTS CORP.
1523 E. 45th Street, Cleveland 3, O.
Division of The Gabriel Company
EXPORT DEPT., C. W. Brandes, Mgr.,
4900 Euclid Ave., Cleveland 3, O.
IN CANADA: Atlas Radio Corp.,
560 King St., W., Toronto, Ont.

WORLD'S LARGEST MAKER OF AERIALS FOR CAR AND HOME

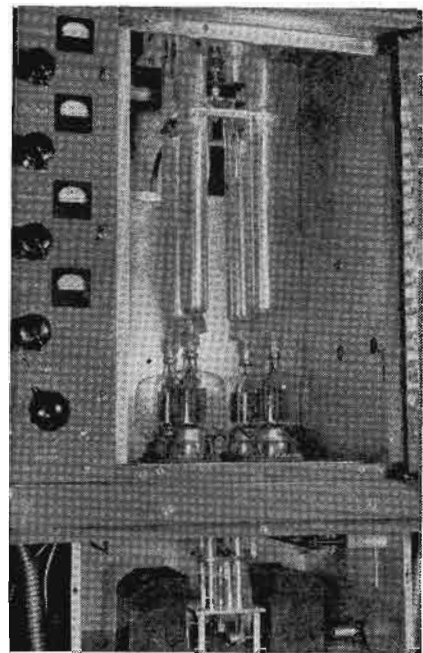

Figure 1
View of the quadriline amplifier as used in an f-m transmitter. Note the variable shorting plates which tune plate circuit to resonance. Neutralizer capacitors are in lower compartment. Overall screen-voltage control with individual balancing controls are on front panel. Individual meters are used for each of the tubes.

Amplifier, with its four-wire transmission-line resonant circuit, features a confined field characteristic. The field, as in the case of the coaxial circuit, is confined to the area within the transmission lines, with little stray field existing. By eliminating the stray field, the lines are lengthened and tendency towards parasitic oscillations is eliminated.

At 10-kw output, at an efficiency of not less than 80% and with an r-f driving power of 750 watts, the following meter readings have been recorded:

- Plate voltage 4.95 kv
- Plate current 2.48 amperes
- Grid voltage -400
- Grid current 400 ma
- Screen-grid current 130 ma each
- Screen-grid voltage 300

Figure 2
A simplified circuit diagram of the quadriline amplifier.

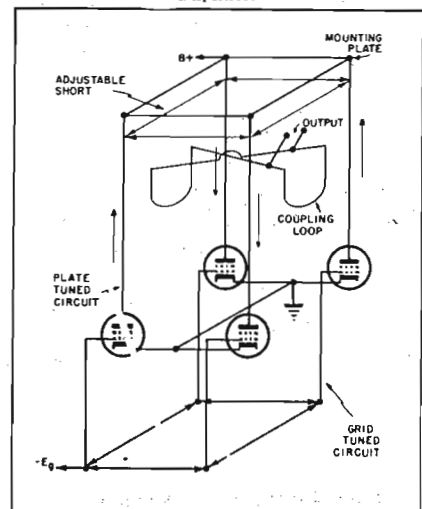

H-F F-M Quadriline R-F Amplifier

by RALPH G. PETERS

RECENTLY the development of a 10-kw r-f power amplifier employing four 4-1000A¹ tetrodes in a low-driving power quadriline circuit² was announced.

A view of the quadriline amplifier as used in an f-m transmitter appears in Figure 1, and in Figure 2 appears a simplified circuit diagram of the amplifier. Four tubes placed at the corners of a square are employed with vertical mounting of the tuned circuits. These tuned circuits consist of resonant lengths of line in a four-wire transmission-line arrangement.

The amplifier is similar to two push-pull amplifiers in a parallel circuit where the phase of one pair is reversed. The instantaneous phase relationships are indicated in the diagram

by the arrows on the plate tuned lines. The d-c voltages are common to all four tubes.

A variable shorting plate, used to tune the plate circuit to resonance, consists of a plate with four holes in it, each hole consisting of a series of fingers which make sliding contact with the tuned line. The lines themselves are mounted solidly by means of a conducting mounting plate. The output coupling loops are also mounted on a sliding support and are let down through the shorting plate so that they are always at the maximum current points of the lines. Two output loops, cross-connected to take care of the phase reversal, are employed.

A similar circuit is employed for the grid input tank circuit. Here screen-grid neutralization is used.

¹Eimac.
²Radio Engineering Laboratories.



JK STABILIZED OVEN
 Range 80 to 7500 kc. Standard five prong base. Octal on special order. Approved by the FCC for BC stations. Can be supplied in hermetically sealed, pressure mounted, plated and wire mounted crystals. Also with variable micrometer air gap mounting to give exact frequency adjustment. Plus or minus 1 degree C maintained. 6.3 v. heater unit; others on special order. Current is approx. 1 ampere at 6.3 v. Molded phenolic body. Also available without thermometer or without side terminal.

Write for Illustrated Folder

The JAMES KNIGHTS CO.
 SANDWICH, ILLINOIS

RESISTORS

IS OUR BUSINESS

Complete RMA Range
 1/2 - 1 - 2 Watt
 5%, 10%, 20% Tolerances
 IN STOCK AT ALL TIMES

LEGRI S COMPANY, Inc.
 846-850 Amsterdam Avenue
 New York 25, N. Y.

Ask For Our New Price List

dpdt switch to the output of the monitoring amplifier, the volume indicator could then be switched at any time needed, from one circuit to the other.

Further examination of the diagram revealed that the most convenient place for making these connections was at the terminals of K8, the regular emergency switch. In the console the meter was connected to this switch and the monitor output also was connected through this switch for emergency operation.

Reasoning that an arrangement for switching the volume indicator from the present terminals to the monitor out terminals was all that was required, we searched through our component boxes for a suitable dpdt switch. We found a key-type line switch from an old amplifier, which seemed to fit the bill. This switch, fastened to a mounting plate, had a number of leaves in addition to those needed for dpdt operation. Removal of the mounting plate revealed that the switch was similar, in design and appearance, to the channel keys on the console. Examination revealed that there was ample room on the panel of the console directly above K7 and on a horizontal line with the channel keys and K8, the line-out switch, as shown in Figure 2. Since we wished to make our connections at K8 we decided to mount the switch at this position.

Using the mounting plate as a template, holes were drilled and the switch mounted. We didn't even bother waiting till the console was out of operation. A small U-magnet was placed just beside the position-to-be to collect all steel shavings resulting from the drilling. Short pieces of push-back had been previously soldered to the proper terminals of the switch so that a minimum number of solder connections would be required in the somewhat cramped space within the console.

The total cost for this installation was:

1 key-type switch.....	\$1.20
15" push-back wire.....	.05
Time (2 hours maintenance man)	4.00
Total cost	\$5.25

There is a slight additional operation which may be included. With the master volume control of the monitoring amplifier set in the same position as the master volume control on the program amplifier, you will find that there is a slight difference in the readings of the meter when switched from one circuit to the other. This can be remedied by using a compensating circuit and employing the extra leaves on the reclaimed switch for the extra connections.

*RCA 40C.



Great, New, Complete CONCORD Radio Catalog

160 value-packed pages of RADIO PARTS • RADIO SETS HAM GEAR • AMPLIFIERS TESTERS • Electronic Equipment MAIL COUPON FOR FREE COPY

Ready now—the greatest, most complete presentation of radio, electronic and television equipment and supplies in Concord history! Packed from cover to cover with thousands of items—Radio Parts, Radio Sets, Amplifiers, Sound Systems, Test Equipment for every purpose, Record Players, Record Changers, Television Equipment, Ham Gear, Receivers, Transmitters—160 pages of everything and anything in Radio and Electronics, and featuring a special bargain section of hundreds of money-saving values in top quality, standard-make parts, including scores of new items from nationally-famous makers. Immediate shipment from CHICAGO OR ATLANTA. Write for your FREE copy at once.

WANTED—TRADE-INS ON COMMUNICATIONS EQUIPMENT—Always highest trade-in values on communications receivers. Write, phone or call to tell what you have, or send it for free appraisal.
TIME-PAYMENT PLAN—Buy your Radio and Electronic Equipment from Concord on EASY PAYMENTS—Communications Receivers, Transmitters, Radios, Radio-Phonos, Sound Equipment, Test Equipment. Write us your needs.



Concord Radio Corporation, Dept. R-97
 901 W. Jackson Blvd., Chicago 7, Ill.
 Yes, rush FREE COPY of the comprehensive new Concord Radio Catalog.

Name.....
 Address.....
 City.....State.....

FOR THE BEST IN FM

- ✓ Andrew Coaxial Transmission Line
- ✓ Andrew Installation of Line and Antenna

At FM frequencies, transmission lines are tricky. That's why broadcasters who value reliability buy ANDREW transmission lines. Having bought the best, they find it good business to have Andrew engineers install it. ANDREW field crews are supervised by radio engineers of long experience, because we believe that steeplejacks alone cannot properly install transmission lines, antennas, and lighting equipment. If you prefer to employ your own workmen, we'll gladly furnish a supervisory engineer. ANDREW coaxial transmission line, and installation service, may be purchased directly from the factory; or through any FM transmitter manufacturer. If you buy an FM package, be sure to specify ANDREW.

J. M. Troesch of WSTV is one of many satisfied ANDREW customers.

WSTV
Serving the In-State Area

THE VALLEY BROADCASTING COMPANY
EXCHANGE REALTY BUILDING
STEUENVILLE, OHIO.

June 30, 1947

The Andrew Company
363 East 75th Street
Chicago 19, Illinois

Attention: Mr. C. Russell Cox, Sales Manager

Dear Mr. Cox:

I have just approved the payment of your bills for installing our transmission line and modifying our tower. I wish to take this opportunity to compliment your company on sending a man as competent and as conscientious as Carl Meyer to supervise and work at this job.

For your information, an FCC inspector arrived the day we went on the air and remarked that it was the best FM installation he has seen thus far. He also wired the Commission to the effect that conditions were good at our installation.

Yours very truly,
THE VALLEY BROADCASTING COMPANY
J. M. Troesch
J. M. TROESCH
Technical Director

JMT/39

COAXIAL BROADCASTING SYSTEM

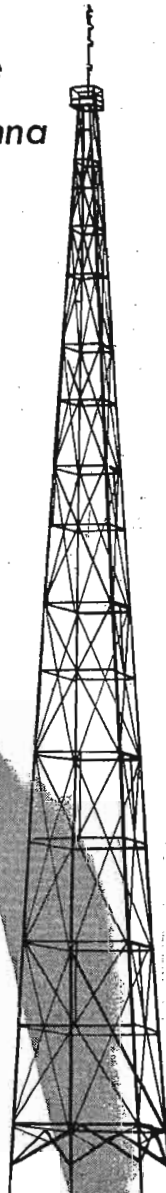

ADVERTISERS IN THIS ISSUE

COMMUNICATIONS INDEX

SEPTEMBER, 1947

ANDREW COMPANY	40
Agency: Burton Browne, Advertising	
THE ANSONIA ELECTRICAL DIV. NOMA ELECTRIC CORP.	15
Agency: Albert Frank-Guenther Law, Inc.	
BELL TELEPHONE LABORATORIES.....	1
Agency: N. W. Ayer & Son, Inc.	
THE BENWOOD-LINZE CO.....	33
Agency: Major Adv. Agency	
CANNON ELECTRIC DEVELOPMENT CO.....	25
Agency: Dana Jones Co.	
CLAROSTAT MFG. CO., INC.....	32
Agency: Austin C. Lescarboura & Staff	
THE CLEVELAND CONTAINER CO.....	37
Agency: The Nesbitt Service Co.	
CONCORD RADIO CORP.....	39
Agency: E. H. Brown Adv. Agency	
COTO-COIL CO., INC.....	29
Agency: Frank E. Dodge & Co., Inc.	
EITEL-McCULLOUGH, INC.....	19
Agency: L. C. Cole, Advertising	
ELECTRONIC RESEARCH & MFG. CORP.....	38
FAIRCHILD CAMERA & INSTRUMENT CORP.	6
Agency: G. M. Basford Co.	
FEDERAL TELEPHONE & RADIO CORP.....	27
Agency: Rickard & Co.	
GENERAL RADIO CO.....	Inside Back Cover
HEWLETT-PACKARD CO.....	Back Cover
Agency: L. C. Cole, Advertising	
HOWARD B. JONES DIV. CINCH MFG. CORP.	32
Agency: Merrill Symonds, Advertising	
THE JAMES KNIGHTS CO.....	39
Agency: Rudolph Bartz, Advertising	
LEACH RELAY CO.....	30
Agency: The McCarty Co.	
LEGRI S. CO., INC.....	39
Agency: Bergman-Jarrett Co.	
JAMES MILLEN MFG. CO., INC.....	28
PAR-METAL PRODUCTS, INC.....	33
Agency: H. J. Gold Co.	
PETERSEN RADIO CO., INC.....	38
Agency: Bozell & Jacobs	
PICKERING CO.....	35
Agency: Benton & Bowles	
PILOT MARINE CORP.....	38
PITMAN PUBLISHING CORP.....	32
PRESTO RECORDING CORP.....	5
Agency: Roy S. Durstine, Inc.	
RADIO-MUSIC CORP.....	34
Agency: A. J. Slomanson Co.	
REEVES-HOFFMAN CORP.....	30
JOHN F. RIDER PUBLISHER, INC.....	34
Agency: Lansford F. King, Advertising	
ROSTON CORP.....	28
Agency: Mel Miller Associates	
SHALLCROSS MFG. CO.....	31
Agency: The Harry P. Bridge Co.	
SIMPSON ELECTRIC CO.....	Inside Front Cover
Agency: Kreicker & Melan, Inc.	
SORENSEN & CO., INC.....	21
Agency: Henry A. Stephens, Inc.	
SYLVANIA ELECTRIC PRODUCTS, INC.....	3
Agency: Newell-Emmett Co.	
TECH LABORATORIES	35
Agency: Lewis Adv. Agency	
TRIPLETT ELECTRICAL INSTRUMENT CO.....	37
Agency: Western Adv. Agency, Inc.	
U. S. TREASURY DEPT.....	20
WAR ASSETS ADMINISTRATION	4
Agency: Fuller & Smith & Ross, Inc.	
WARD PRODUCTS CORP.....	36
Agency: Burton Browne, Advertising	
ZOPHAR MILLS, INC.....	28
Agency: Gunn-Mears Adv. Agency	

ANDREW CO. 

363 EAST 75th STREET • CHICAGO 19

Pioneer Specialists in the Manufacture of a Complete Line of Antenna Equipment

WRITE FOR COMPLETE CATALOG

Selecting A-M Units

(Continued from page 13)

put. Talk back provisions are provided from one studio and the control room by using an external amplifier. In addition, the transmitter may be fed from either the program amplifier or monitor amplifier providing provision for emergency operation in the event of program amplifier failure.

The monitor amplifier will feed five or six 12" speakers at reasonable level, and each studio and control room speaker is interlocked through the respective microphone channel switches. These same interlocking switches also control the studio warning lights.

Turntables

We desired units suited to an in-line arrangement which meant all control must, for easy operation, be at one point on the equipment. Units were found,⁵ in which the speed selection and on-off control were combined in one lever switch. The speed selection is obtained by throwing the lever switch the correct direction. This left but one actual operational device, the limiter. Inasmuch as the rest of the equipment selected was produced by one company, we also purchased our limiter from the same source.

Frequency and modulation monitors were unobtainable, hence none have been purchased as yet.

The final selection was that of microphones and transcription and phono pickups.

Microphones are also a matter of personal preference. Excellent results have been obtained with dynamic microphones⁶ if their use is restricted to voice. This particular microphone is very gentle with female voices. It further lends itself well to remote use.

For general purpose use we have found the cardioid to be very effective, particularly for wide-angle pickups.

For work requiring intricate balance in small spaces, the directional velocity microphone⁸ has been excellent.

⁵Gates Radio.

⁶Western Electric 738 A Salt Shaker.

⁷Shure Brothers 556A.

⁸RCA Jr. or Sr. velocity.



These spirally laminated paper base, Phenolic Tubes are delivered already punched and notched to meet the exact requirements of the customer.

Ask also about...

#96 COSMALITE for coil forms in all Standard Broadcast Receiving sets. SLF COSMALITE for Permeability Tuners.

Spirally wound kraft and fish paper Coil Forms and Condenser Tubes.

There is a definite saving to you in specifying and using Cosmalite.

*Trade Mark Registered

The CLEVELAND CONTAINER Co.
6201 BARBERTON AVE. CLEVELAND 2, OHIO

- All-Fibre Cans • Combination Metal and Paper Cans
- Spirally Wound Tubes and Cores for all Purposes
- Plastic and Combination Paper and Plastic Items

★ ★ ★

PRODUCTION PLANTS also at Plymouth, Wisc., Ogdenburg, N. Y., Chicago, Ill., Detroit, Mich., Jamestown, N. H.
PLASTICS DIVISION at Plymouth, Wisc., Ogdenburg, N. Y. • ABRASIVE DIVISION at Cleveland, Ohio. • N. Y. SALES OFFICE - 1186 Broadway, Room 223 • IN CANADA - The Cleveland Container Canada Ltd., Prescott, Ontario.

NEW "HAND-SIZE LABORATORY"

MODEL 666HH VOLT-OHM-MILLIAMMETER

Packs a laboratory of versatile service into a size that fits your hand and weighs only 1½ lbs. Features: Greater scale readability, low contact resistance jack achieved by new banana-type plug-in leads, greater stability evolved through special new type resistors—and others. Delivers better results than many larger, costlier testers. See, try, compare the performance of this thoroughgoing example of dependable Triplet engineering.

RANGES

D.C. VOLTS: 0-10-50-250-1000-5000, at 1000 ohms/Volt.

A.C. VOLTS: 0-10-50-250-1000-5000, at 1000 ohms/Volt.

D.C. MILLIAMPERES: 0-10-100-500, at 250 millivolts.

OHMS: 0-2000-400,000.

Write Dept. A97
for descriptive
material



Triplet

ELECTRICAL INSTRUMENT CO.

Bluffton Ohio ★ ★ ★

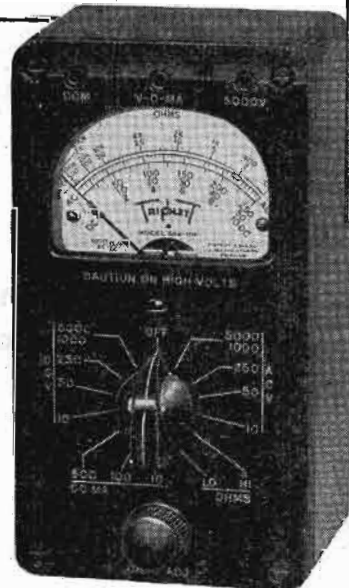

An Audition-Amplifier VOLUME INDICATOR

Modification of Commercial Unit Provides Audition Volume Indicator to Check Balance, Gain Riding on Auditions, Pre-Airing Levels, Etc.

by F. E. BARTLETT.

Chief Engineer
KSO, Des Moines, Iowa

A FEW MONTHS ago we installed a console¹ which provides two-channel switching in all fader inputs, and thus a microphone, network, or remote line input may be switched to the program amplifier or to the input of the monitoring amplifier for audition purposes. While applying the unit for audition work, we found a need for a level indicator on the output of the audition-

monitor amplifier. It was required for a number of operations . . . proper gain riding on auditions, checking for balance, feeding auditions to the recording machines, measuring pre-airing level checks of studios, remote pickups, etc.

First we considered the installation of a second meter, but this was im-

¹RCA 76-B-2.

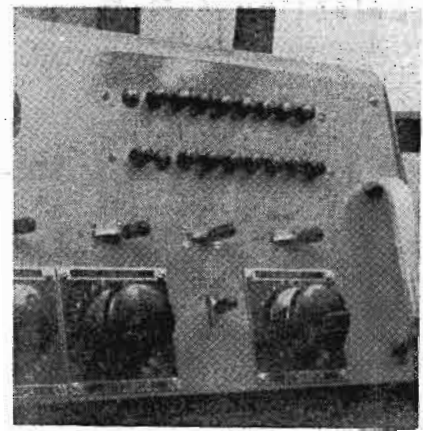

Figure 3
View of switching section on console.

practical from a number of viewpoints. A temporary portable meter was hooked up externally, but, while this confirmed the need for a measuring instrument, its use was not entirely satisfactory.

Examination of the circuit diagram, showing the connections of the instrument's *vu* meter to the program amplifier output, revealed that the entire meter assembly could be removed from the output connection without affecting its operation in any way. If this meter connection could then be lifted and connection made by means of a

Figure 1
Schematic of the switch-hookup system in console.

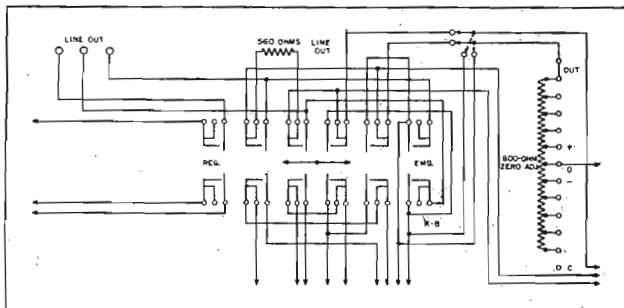
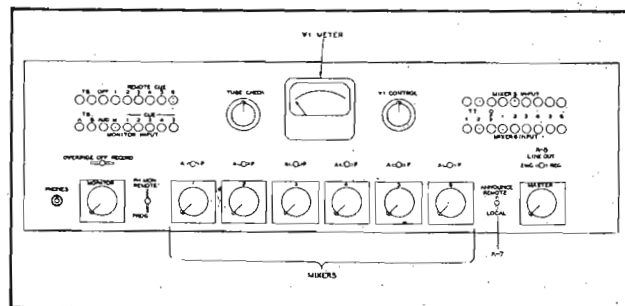

Figure 2
Front panel view of console showing positions of switches.



For Dependable Commercial Service

Designed for the rigors of commercial service in all types of radio communication . . . broadcast, mobile, aircraft, police. Precision made for utmost in stability, dependability, trouble-free operation. Calibrated within .005 per cent of specified frequency . . . range 1.5 to 10.5 MC. Temp. coefficient less than 2 cycles per megacycle per degree centigrade. Weighs less than 3/4 ounce. Gasket sealed against contamination and moisture. Meets FCC requirements for all above services. See your jobber—Petersen Radio Company, Inc., 2800 W. Broadway, Council Bluffs, Iowa. (Telephone 2760.)



PR Precision CRYSTALS

Electronic Research & Mfg. Corp.

A Service to INDUSTRY
Development and Construction of
Electronic Equipment for Any Application

1420 E. 25th St., Cleveland 14, O. - Ph.: SU. 1958

ROTARY CONVERTERS

D.C. TO A.C.

INPUT: 115 Volt D.C., 2.7 Amperes, 3600 R.P.M.
OUTPUT: 110 Volt A.C., 1.14 Amperes, 60 Cycle, Single Phase, 125 V.A.
Filter Equipped, Manufactured by ELECTRIC SPECIALTY CO.
TYPE R-182—NEW EQUIPMENT—Surplus—In Stock

PILOT MARINE CORP., 29 Broadway, N. Y. 6, N. Y.
Whitehall 3-3734

TO MEASURE

- RESISTANCE
- INDUCTANCE
- CAPACITANCE
- STORAGE FACTOR
- DISSIPATION FACTOR

IN

ANY LABORATORY

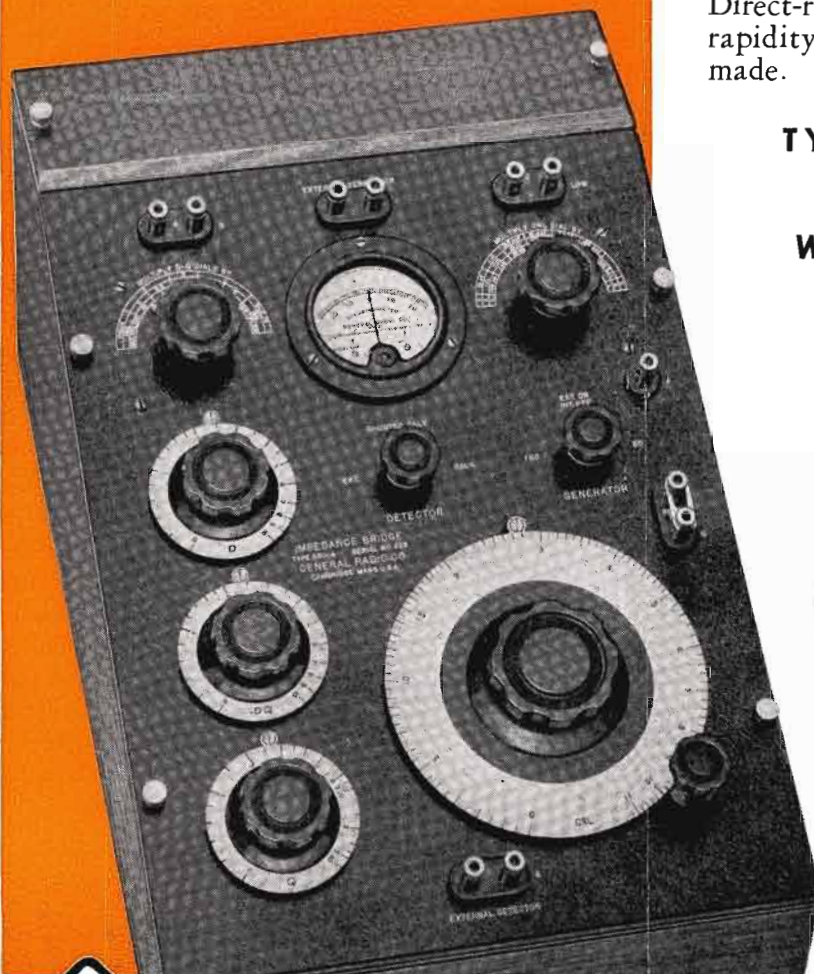

IN ANY laboratory where electrical equipment is used this self-contained, portable, direct-reading bridge is indispensable. It is always set up and ready for immediate use. Its accuracy is sufficient for the majority of routine measurements over these very wide ranges:

RESISTANCE: 1 milliohm to 1 megohm

INDUCTANCE: 1 microhenry to 100 henrys

CAPACITANCE: 1 micromicrofarad to 100 microfarads

STORAGE FACTOR (X/R): .02 to 1000

DISSIPATION FACTOR (R/X): .002 to 1

The bridge includes built-in standards, batteries, a 1000-cycle tone source for a-c measurements, a zero-center galvanometer d-c null detector and terminals for a headset for 1000-cycle null detection. Provision is made for use of an external generator for measurements over a wide range from a few cycles to 10 kilocycles. Direct-reading dials add greatly to the ease and rapidity with which measurements can be made.

**TYPE 650-A IMPEDANCE
BRIDGE.....\$240.00**

Write for complete information



This useful accessory converts the Type 650-A bridge to a-c operation. It includes a vacuum-tube oscillator, amplifier, and rectifier for providing dc for the bridge. All are mounted in a metal cabinet with top control panel which replaces the wooden cover used on the battery compartment. The sensitivity of the bridge is increased greatly with this oscillator-amplifier for both a-c and d-c measurements. TYPE 650-P1 OSCILLATOR-AMPLIFIER — \$150.00.



GENERAL RADIO COMPANY Cambridge 39,
Massachusetts

90 West St., New York 6

920 S. Michigan Ave., Chicago 5

950 N. Highland Ave., Los Angeles 38

HERE'S FLAT RESPONSE UP TO 700 MC



410A VACUUM TUBE VOLTMETER

with its new *-hp-* low-capacity diode probe, measures all the important radio voltages without disturbing circuits under test.



CHECK THESE FACTS ABOUT THE NEW *-hp-* PROBE*:

- Small size for ease in contacting hard-to-get-at components.
- Ultra-short leads, direct grounding assure high frequency response.
- Rugged, mechanical construction, dural shell, polystyrene insulation.
- Specially-designed diode has short transit time, low input capacity, high resonant frequency of 2000 mc.
- Detachable tip lowers input capacity, shortens diode lead, utilizes maximum capabilities of diode.

*Reproduced actual size

The specially-designed diode, in combination with the *-hp-* probe design, makes possible the exceedingly flat frequency response shown graphically in Figure 1.

With this flat frequency response are combined the factors of low input capacity and high input resistance. The variation of these factors with

frequency is shown in Figure 2. The input resistance and reactance are high throughout the entire range of the instrument, and thus measurements are made without appreciable detuning or loading of circuit. Maximum measuring accuracy is assured.

In addition to swiftly, easily, accurately making uhf radio measure-

ments, this *-hp-* 410A is a convenient voltage indicator up to 3000 mc. And it serves equally well as an audio or d-c voltmeter, or an ohmmeter. A-c measurements are made in 6 ranges ... full scale readings 1 to 300 v. D-c full scale readings from 1 to 1000 v in 7 ranges. Input resistance all ranges - 100 megohms. As an ohmmeter, the *-hp-* 410A measures resistances from 0.2 ohms to 500 megohms in 7 ranges.

In short, this *-hp-* 410A Vacuum Tube Voltmeter is ideal for obtaining most important parameters in radio design, manufacture, or servicing. Write today for full details. Hewlett-Packard Company, 1407E Page Mill Road, Palo Alto, California.

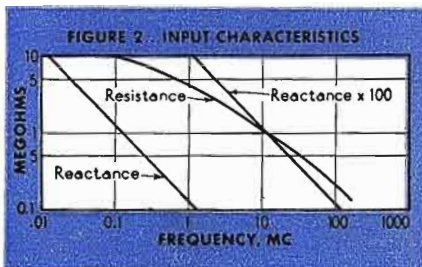
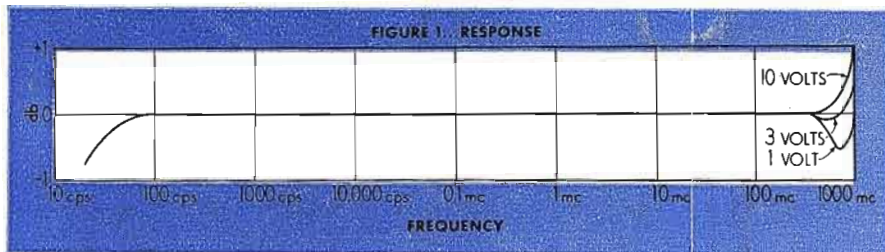

- | | | |
|--------------------------------|-------------------------|------------------------|
| Noise and Distortion Analyzers | Wave Analyzers | Frequency Meters |
| Audio Frequency Oscillators | Audio Signal Generators | Vacuum Tube Voltmeters |
| Amplifiers | Power Supplies | UHF Signal Generators |
| Square Wave Generators | Frequency Standards | Attenuators |
| | | Electronic Tachometers |