

# COMMUNICATIONS

INCLUDING "RADIO ENGINEERING" AND "TELEVISION ENGINEERING"

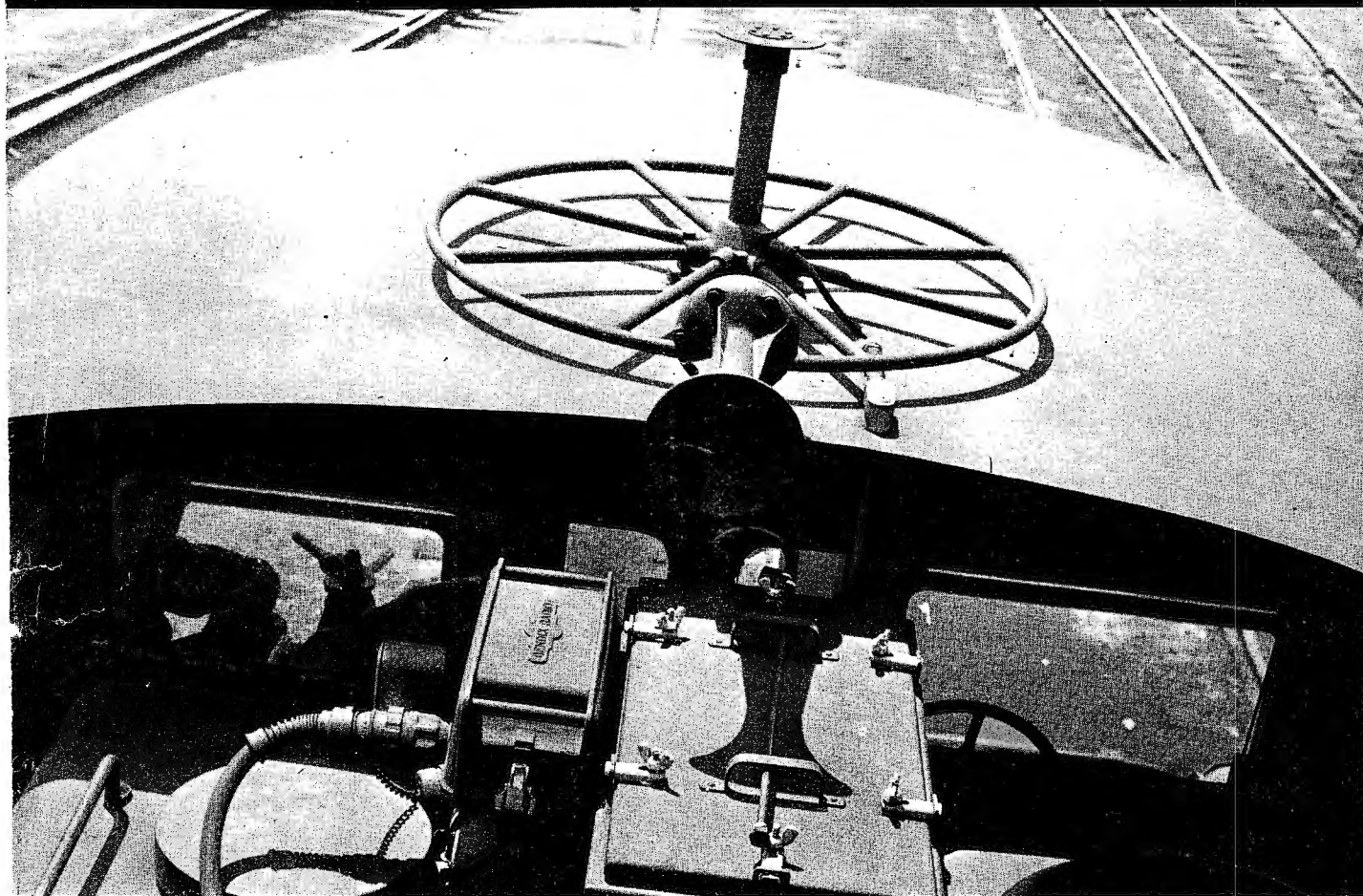

AUGUST

★ V-H-F IMPEDANCE-BRIDGE DESIGN ★ F-M TRAIN-RADIO FACILITIES  
★ POWER-LINE CARRIER COMMUNICATIONS

1947

# CLARE New Type "J" Relay Provides Sure, Positive Action with Exclusive Twin-Contact Design

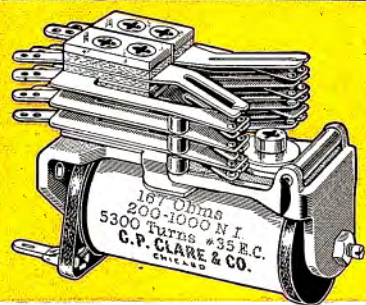
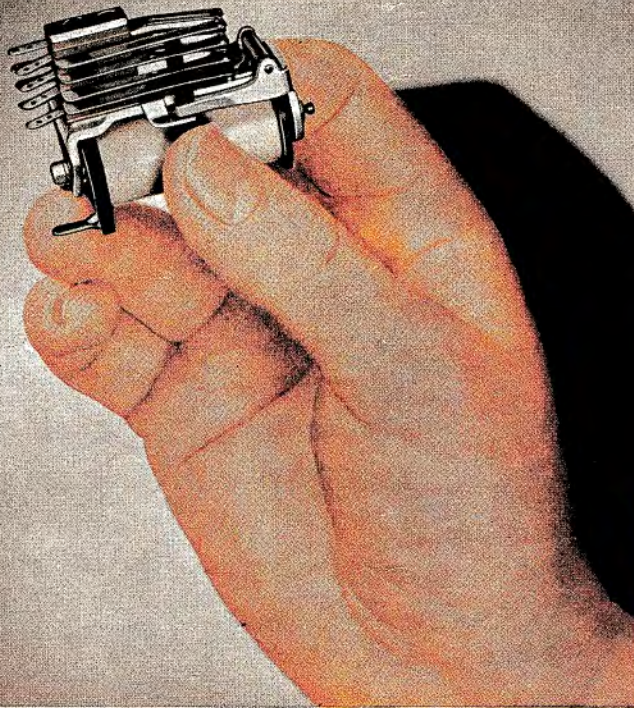

● Here, at last, is a twin-contact design in which the chance of contact failure is actually reduced to the practical limit.

Exclusive design of the CLARE Type "J" d.c. Relay allows the twin contacts to operate independently of each other so that one contact is sure to close even when the other may be blocked by presence of dirt or grit.

This sensational new relay combines the best features of the conventional telephone-type relay with the small size and light weight developed during the war for military aircraft use.

Weighing little more than two ounces, slightly over two inches in length, it has the sturdy construction, large contact spring capacity, extreme sensitivity, and adaptability to a wide range

of specifications for which CLARE Relays are noted.

Modern designers, working to develop close-coupled, compact equipment to meet today's streamlined standards, welcome this highly efficient combination of capacity and small size.

CLARE Relays are especially designed for jobs where ordinary relays won't do. If you have such a relay problem, Clare Sales Engineers are located in principal cities to help you work out a Clare "Custom-Built" Relay that will just fit your needs. Write: C. P. Clare & Co., 4719 West Sunnyside Avenue, Chicago 30, Illinois. Cable Address: CLARELAY. In Canada: Canadian Line Materials, Ltd., Toronto 13, Ontario.

## All These Features . . . and More . . . Provided By CLARE Type "J" Relay

**Independent Spring Contacts.** Dome shaped contacts on movable springs; flat discs on fixed springs.

**High Current-Carrying Capacity.** Twin contact points of palladium. Rated current-carrying capacity: 4 amperes, 150 watts.

**New Design Large Armature Bearing Area.** Hinge type armature has new design bearing providing largest possible bearing surface. Pivot pin turns in cylinder of different metal which is full width of heelpiece.

**Sensitive, Efficient Magnetic Structure.** Heelpiece and other magnetic iron parts are exceptionally heavy for size of relay . . . provide highly sensitive and efficient magnetic path.

**High Operating Speed.** Designed for extremely fast operation . . . a minimum of one to two milliseconds.

**Permits Handling Large Spring Loads.** Power and sensitivity permit handling of large spring loads. Both single and double-arm relays available. Maximum of 10 springs on single-arm relay . . . 20 springs (10 in each pileup) on double-arm relay.

# CLARE RELAYS

"Custom-Built" Multiple Contact Relays for Electrical and Industrial Use

Now - 3

FERRANTI DIVISIONS OFFER  
**LOW COST PRODUCTS**

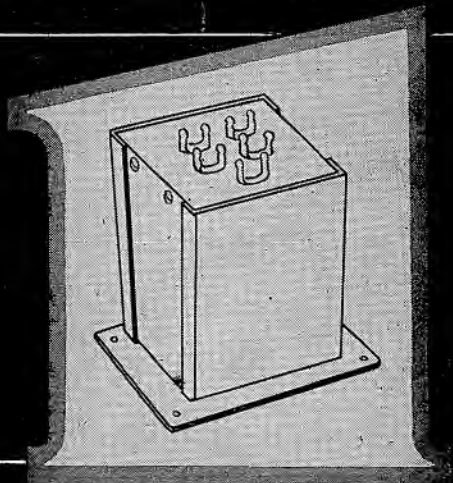

FERRANTI HIGH QUALITY

## TRANSFORMERS

AUDIO AND POWER TRANSFORMERS  
CHOKES · FILTERS · COILS · ETC. ETC.

STOCK UNITS

HERMETICALLY SEALED—CUSTOM BUILT

LARGE OR SMALL QUANTITIES

FERRANTI HIGH QUALITY

## WIRING & ASSEMBLIES

ELECTRONIC AND MECHANICAL ASSEMBLIES  
SUB-ASSEMBLIES · COMPONENT PARTS

FERRANTI NOW OFFERS  
THE BENEFITS OF WAR-GAINED EXPERIENCE  
ON ALL TYPES OF  
ASSEMBLY JOBS—LARGE OR SMALL

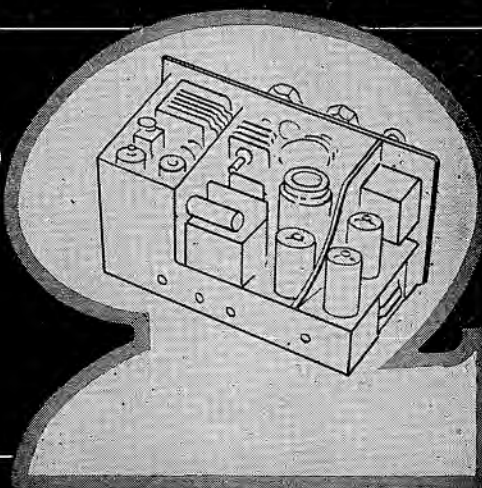

FERRANTI HIGH QUALITY

## SHEET METAL & BAKELITE FABRICATION

FROM SHEETS, RODS AND TUBES—PANELS  
CASES, TERMINAL BOARDS, RACKS, CHASSIS, ETC.  
CUT — PUNCHED — DRILLED — ENGRAVED  
FINISHED TO SUIT YOUR NEEDS

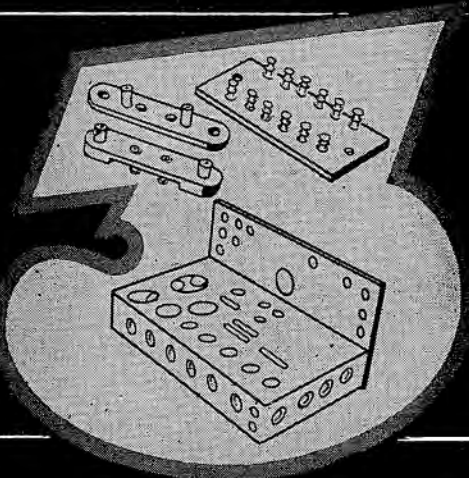

QUALITY—AT LOW COST . . . PROMPT DELIVERY

**FERRANTI ELECTRIC, INC. • RCA BUILDING**

NEW YORK 20, NEW YORK

SEND US YOUR SPECIFICATIONS FOR IMMEDIATE ATTENTION

# COMMUNICATIONS

Including Television Engineering, Radio Engineering, Communication & Broadcast Engineering, The Broadcast Engineer. Registered U. S. Patent Office.

## LEWIS WINNER

Editor

## F. WALEN

Assistant Editor

Bryan S. Davis, President  
Paul S. Weil, Vice Pres.-Gen. Mgr.  
F. Walen, Secretary  
A. Goebel, Circulation Manager

### Cleveland Representative:

James C. Munn  
2656 E. 128th St., Cleveland 20, Ohio  
Telephone CEdar 7783

### Pacific Coast Representative:

Brand & Brand  
1052 W. Sixth St., Los Angeles 14, Calif.  
Telephone MIchigan 1732  
1085 Monadnock Bldg., San Francisco 5, Calif.  
Telephone Douglas 4475

Wellington, New Zealand: Te Aro Book Depot.  
Melbourne, Australia: McGill's Agency.

Entered as second-class matter Oct. 1, 1937 at the Post Office at New York, N. Y., under the Act of March 3, 1879. Subscription price: \$2.00 per year in the United States of America and Canada; 25 cents per copy. \$3.00 per year in foreign countries; 35 cents per copy.

## COVER ILLUSTRATION

Two-way v-h-f f-m transmitter-receiver and wagon wheel antennas atop one of the Western Maryland diesel switch engines at Port Covington terminal in Baltimore. The Port Covington communications system operates on two-channels, 158.67 and 158.43 mc, for yardmaster to all-locomotives transmission on the first channel, and locomotive to yardmaster transmission on the second channel. See page 14 of this issue for further details.

(Courtesy Bendix Radio)

## ENGINEERING MEETING

The NAB Engineering Clinic Session at Atlantic City..... 13

## RAILROAD COMMUNICATIONS

F-M Receiver Design for Railroad Service.....David W. Martin 14  
*F-M 152 to 162-mc Modified Single Super Developed for Steam Locomotive Service.*

## AUDIO FACILITIES CONTROL

An Automatic Gain Control and Limiting Amplifier for Broadcast Stations 18  
*System Utilizes a Guardian Limiter and Amplifier Setup for Regulated Audio Output.*

## CARRIER COMMUNICATIONS

Power Line Carrier Communications.....R. C. Cheek 20  
*Analysis of Systems Operating in 50 to 150-kc Band, Including Data on Coupling Methods, Trap Circuits, Transmitters with Beam-type Oscillators, Special Receivers, etc.*

## COMPONENT DESIGN

Significance of Watt-Second Ratings of D-C Capacitors.....J. D. Stacy 24  
*Watt-Second (Joule) Ratings, Introduced in Wartime Standards, Now Being Adopted Commercially to Aid in Selection of Life Test and Permissible Operating Voltages at Higher Temperatures.*

## INSTRUMENT DESIGN

A V-H-F Bridge for Impedance Measurement Between 20 and 140 MC.....Robert A. Soderman 26  
*Bridge for Impedance Measurements on Distributed Parameter Circuits Using Coaxial Transmission Lines, as Well as on Lumped Parameter Circuits.*

## MOBILE COMMUNICATIONS

Mobile F-M Communications Equipment for 30 to 44 MC.....R. B. Hoffman and E. W. Markow 34  
*Transmitter and Fixed Station Equipment Data.*

## MONTHLY FEATURES

News and Views.....Lewis Winner 13  
News Briefs of the Month..... 29  
The Industry Offers..... 30  
Veteran Wireless Operators' Association News..... 32  
Advertising Index ..... 48

Entire contents Copyright 1947, Bryan Davis Publishing Co., Inc.



Published monthly by Bryan Davis Publishing Co., Inc.  
52 Vanderbilt Avenue, New York 17, N. Y. Telephone MUrray Hill 4-0170





Why  
the *Lock-In* tube is at home  
**ON THE ROAD!**

**STAYS PUT IN SOCKET...THROUGH LOCK-IN FEATURE**

No matter how rough the road, the tubes in an automobile's radio will stay in their sockets—if those tubes are Sylvania *Lock-Ins*. Specially designed "lock-in" locating lug on each tube keeps them in place—assuring firm socket contact.

**COMPACT...MADE TO FIT SMALL SPACES**

This famous Sylvania product is ideal for use in space-seeking modern vehicles—it's so compact . . . has reduced overall height and weight. Further, it has no top cap connection . . . overhead wires are eliminated!

**MECHANICALLY RUGGED...ELECTRICALLY SUPERIOR**

Improved tube mount keeps elements ruggedly supported on all sides. There are few welded joints and *no* soldered joints—the elements can't warp or weave. Electrical features include: short, direct connections . . . less loss; getter located on top . . . shorts eliminated by separation of getter material from leads. See *Sylvania Distributors or write Radio Division, Emporium, Pa.*



**SYLVANIA'S LOCK-IN TUBE . . .**

. . . the radio tube whose electrical and mechanical superiority makes it the ideal choice for equipment on the road, in the air, marine radar, FM and Television.

**SYLVANIA  
ELECTRIC**

MAKERS OF RADIO TUBES; CATHODE RAY TUBES; ELECTRONIC DEVICES; FLUORESCENT LAMPS, FIXTURES, WIRING DEVICES; ELECTRIC LIGHT BULBS

# SPRAGUE

PIONEERS OF ELECTRIC & ELECTRONIC PROGRESS

\* **MIDGET**

**CAPACITORS**



**... that operate at high temperature**  
**... that are really moisture resistant**

Sprague Types 68P and 69P MIDGET Paper Dielectric Capacitors are the first small-size tubulars to operate at 85°C, and to have adequate humidity protection. They are moderately priced to meet the needs of small radio receivers, "personal" radios and other electronic instruments where high component quality in minimum space is essential.

The usual practice in producing small capacitors is simply to "whittle down" conventional types. Dielectrics are made thinner. End seals are reduced in depth. Protective wrappers are eliminated—and troubles have invariably cropped up in direct relation to this sacrifice of normal safety factors.

Sprague Types 68P and 69P Midgets, however, prove that really small capacitors can be fully dependable. Made by new processes and with new materials, they are a direct adaptation of Sprague experience in engineering reliable, humidity resistant capacitors for the proximity fuse and other small electronic assemblies for war equipment. They operate satisfactorily at high temperatures. They meet the proposed RMA humidity specifications. So eminently satisfactory have these little capacitors proved that they are already replacing the larger-size Sprague Type AG Paper Tubular Capacitors in many applications.

*Write for Sprague Engineering Data Bulletin 202*

**SPRAGUE ELECTRIC COMPANY, NORTH ADAMS, MASS.**

\*Trademark Reg. U. S. Pat. Office

**PROFESSIONAL PERFORMANCE—that keeps the original sound alive!**

**Stop  
'Wow'!**



**—with a positive drive at 33.3 and 78 rpm**

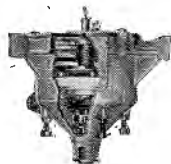

Remember this: When a listener becomes dissatisfied with the quality of your programs, he simply twists a dial. And in doing so, he also tunes out his pocketbook. So why jeopardize what is probably your best source of revenue—*your recorded programs!*

Professional recording and playback should be, and can be, 'WOW'-free. How? With the time-tested Fairchild direct-from-the-center turntable drive, shown above. It eliminates all variations in turntable speed. Evenness of speed is obtained by a carefully calculated loading of the drive mechanism to keep the motor pulling constantly; by careful precision control of all drive alignments that might cause intermittent grab and release; by carefully maintained .0002" tolerances in all critical moving parts.

Further aid to 'WOW'-free performance is provided by a perfectly balanced turntable with extra weight in the rim and a turntable clutch that permits smooth starting, stopping and shifting from 33.3 to 78 rpm in operation.

Fairchild's 'WOW'-free performance is available on professional Transcription Turntables, Studio Recorders and Portable Recorders. For complete information—and prompt delivery—address: 88-06 Van Wyck Blvd., Jamaica 1, New York.



- Transcription Turntables**
- Studio Recorders**
- Magnetic Cutterheads**
- Portable Recorders**
- Lateral Dynamic Pickups**
- Unitized Amplifier Systems**

 **Fairchild** CAMERA  
AND INSTRUMENT CORPORATION



# Why this team can bring

**A**CTIVE DEVELOPMENT of loudspeakers moved forward after World War I, when Western Electric produced the 196W, employing a non-magnetic diaphragm driven by an armature. First used in the Victory Loan campaign of 1919, the 196W took part in the national political conventions of 1920, the presidential inauguration of 1921, and the burial of the Unknown Soldier later the same year. Success of these pioneer public address systems rested not only on loudspeakers but also on high quality microphones and amplifiers—all Western Electric developments.

Continual progress in the intervening years has kept pace with the development in Bell Telephone Laboratories of telephone transmitters and receivers for the Bell System. Fundamental to both loudspeakers and telephones have been the Laboratories' pioneering studies in sound, speech, hearing and the theory of vibrating systems.

Sound distribution systems, sound motion pictures and radio broadcasting—all have benefited from the teamwork which has done so much to make possible today's efficient, powerful, wide-range loudspeakers.



**1919.** New York's Victory Loan celebration pioneered the art of reaching tremendous audiences. 113 Western Electric speakers made possible this mass demonstration of the new art.



**1924.** Non-directional, small in size, yet extremely wide-range for its day, the 540 cone speaker designed for broadcasting was so popular for home receivers that it became a symbol of early radio.



**1926.** The 555 Receiver, with its large wooden horn, contributed to the success of sound motion pictures. From this single-unit loudspeaker grew the high quality wide-range theatre speaker systems of today.

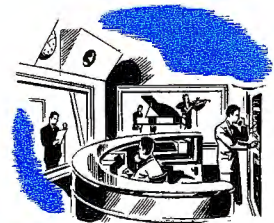

**1937.** The introduction of the 750 series of loudspeakers provided the first really wide-range direct radiator. With the proper mounting, this speaker covers a frequency band from 80 to 10,000 cycles. Still a popular speaker.



# you loudspeakers like these



**728B** 12" direct radiator, 30 watts continuous capacity. Frequency response 60 to 10,000 cps.

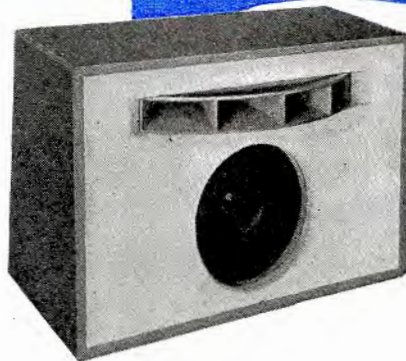

**757A** two unit system, using 728B plus separate high frequency speaker. Frequency response 60 to 15,000 cps.



**756A** 10" direct radiator, power handling capacity 20 watts, response 65 to 10,000 cps.

**755A** 8" direct radiator, 8 watts capacity. Response 70 to 13,000 cps.

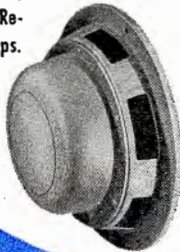

**TODAY** Western Electric offers a complete line of wide-range direct radiators, high frequency speakers, horns and multi-unit systems all designed by Bell Telephone Laboratories. There's one to meet your requirements for highest quality sound whether you want an eight inch, eight watt speaker, or a giant theatre-type system with 120 watts capacity.

No matter which you select, you get the benefit of a brand experience which long antedates the public address art.

— QUALITY COUNTS —



**1943.** Battle announce speaker designed for the United States Navy hit a new high in intelligibility and power. Used on all types of Navy ships, they passed commands to fighting men over the noise of battle.



**BELL TELEPHONE LABORATORIES**  
World's largest organization devoted exclusively to research and development in all phases of electrical communications.

**Western Electric**

Manufacturing unit of the Bell System and the nation's largest producer of communications equipment.

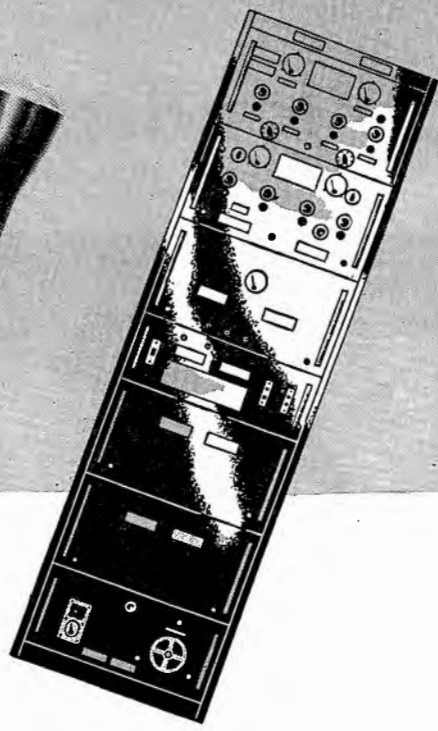
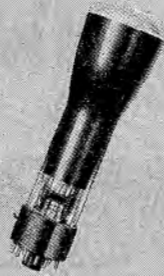
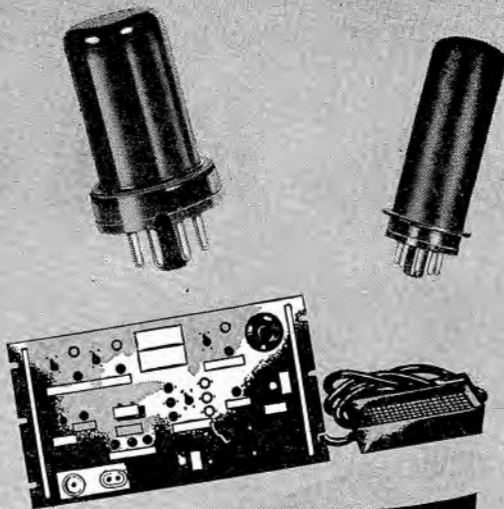

**SURPLUS  
ELECTRONIC  
EQUIPMENT**

**MANUFACTURERS  
JOBBERS  
WHOLESALEERS**

The War Assets Administration, through its network of Approved Distributors, is offering electronic tubes, devices and equipment which were declared surplus by the Armed Forces. Take advantage of this great opportunity to fill your present and future needs at fraction-of-cost prices. Most inventories still permit wide selection.

Purchasing of this equipment has been simplified to a high degree. The WAA Approved Distributors listed at right were appointed on a basis of their ability to serve you intelligently and efficiently. Write, phone or visit your nearest Approved Distributor for information concerning inventories, prices and delivery arrangements. You'll find you can "Save with Surplus."

OFFICE OF AIRCRAFT AND ELECTRONICS DISPOSAL



Offices located at: Atlanta • Birmingham • Boston • Charlotte • Chicago • Cincinnati • Cleveland • Dallas • Denver • Detroit • Fort Worth • Helena • Houston • Jacksonville • Kansas City, Mo. • Little Rock • Los Angeles • Louisville • Minneapolis • Nashville • New Orleans • New York • Omaha • Philadelphia • Portland, Ore. • Richmond • St. Louis • Salt Lake City • San Antonio • San Francisco • Seattle • Spokane • Tulsa

1282

- BOSTON, MASS.**  
Automatic Radio Mfg. Co., Inc.  
122 Brookline Ave.  
Technical Apparatus Co.  
165 Washington St.
- BUCHANAN, MICH.**  
Electro-Voice, Inc.  
Carroll & Cecil Sts.
- CANTON, MASS.**  
Tobe Deutschmann Corp.  
863 Washington St.
- CHICAGO, ILL.**  
American Condenser Co.  
4410 N. Ravenswood Ave.  
Belmont Radio Corp.  
3633 S. Racine Ave.
- EMPORIUM, PENNA.**  
Sylvania Electric Products, Inc.
- FORT WAYNE, IND.**  
Essex Wire Corp.  
1601 Wall St.
- HOUSTON, TEXAS**  
Navigation Instrument Co., Inc.  
P.O. Box 7001,  
Heights Station
- LOS ANGELES, CALIF.**  
Cole Instrument Co.  
1320 S. Grand Ave.  
Hoffman Radio Corp.  
3761 S. Hill St.
- NEWARK, N. J.**  
National Union Radio Corp.  
57 State St.  
Standard Arcturus Corp.  
99 Sussex Ave.  
Tung-Sol Lamp Works, Inc.  
95—8th Ave.
- NEW ORLEANS, LA.**  
Southern Electronic Co.  
512 St. Charles St.
- NEW YORK, N. Y.**  
Carr Industries, Inc.  
1269 Atlantic Ave.,  
B'klyn.  
Electronic Corp. of America  
353 W. 48th St.  
Emerson Radio & Phonograph Corp.  
76—9th Ave.  
General Electronics, Inc.  
1819 Broadway  
Hammarlund Mfg. Co., Inc.  
460 W. 34th St.  
Johanns & Keegan Co., Inc.  
62 Pearl St.  
Newark Electric Co., Inc.  
242 W. 55th St.  
Smith-Meeker Engineering Co.  
125 Barclay St.
- NORFOLK, VA.**  
Radio Parts Distributing Co.  
128 W. Olney Road
- ROCHESTER, N. Y.**  
W. & H. Aviation Corp.  
Municipal Airport
- SALEM, MASS.**  
Hytron Radio & Electronics Corp.  
76 LaFayette St.
- SCHENECTADY, N. Y.**  
General Electric Co.  
Bldg. 267, 1 River Road
- WASECA, MINN.**  
E. F. Johnson Co.  
206—2nd Ave., S. W.

# Farnsworth

## RADIOTELEPHONE SYSTEMS BUILT *specifically* TO MEET RAILROAD SERVICE REQUIREMENTS

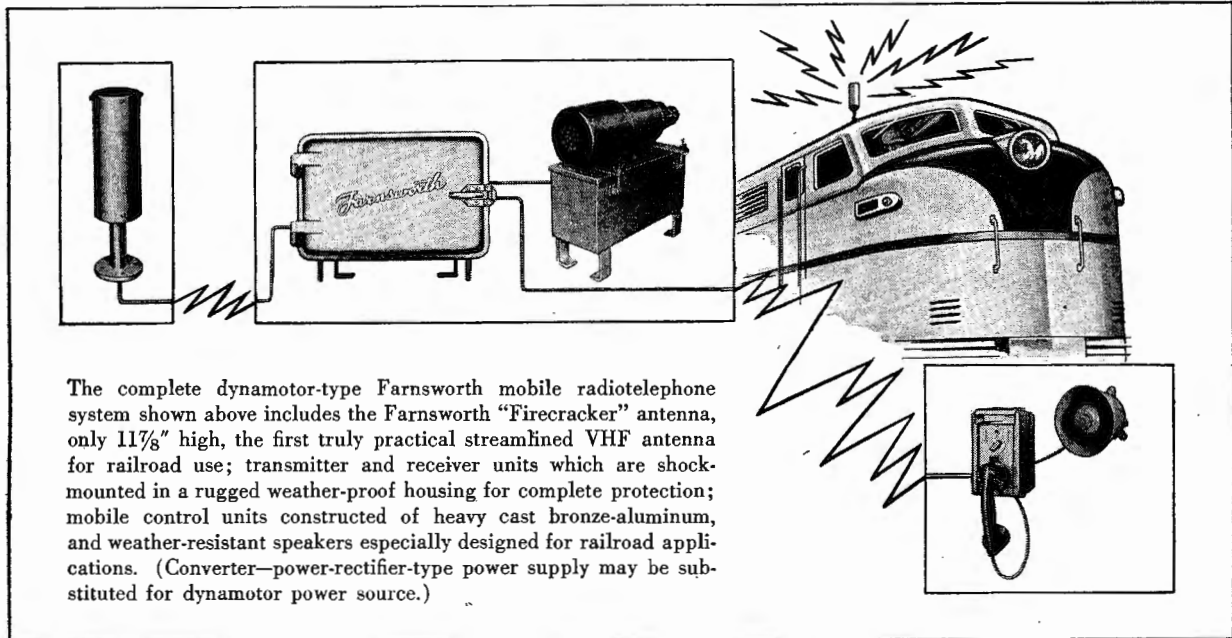

**R**ADIO has already demonstrated its usefulness in railway operations. The design of proper specialized equipment for the practical application of this dependable communications tool in railway service is, however, dependent upon a thorough knowledge of the unique and exacting requirements of railway operation.

Because Farnsworth engineers have secured this knowledge through their pioneering accomplishments in adapting radio to railroad operations, Farnsworth is today producing VHF communications systems that have been *specifically designed and precisely developed for railway service.*

Standardized design and unitized construction are only two of many important engineering results of Farnsworth's pioneering, long-term development and field-testing program in railway radio communications.

They give Farnsworth equipment these practical features:

- The same receiver, transmitter, and in some cases, power supply and remote control unit, is usable for mobile, wayside or relay installations, thus providing complete interchangeability of basic equipment.
- Because all connections are made by a single, break-away plug, transmitters, receivers and power converters can be instantly disassociated for purposes of maintenance or relocation without manually disconnecting a single wire.
- Personnel unlicensed by the FCC and without technical training can replace all units of Farnsworth systems.

Only Farnsworth radiotelephone systems offer all these vital service and maintenance advantages. For complete information write Farnsworth Television & Radio Corporation, Dept. C-8, Fort Wayne 1, Indiana.

## Farnsworth

*Television · Radio · Phonograph-Radio*

Farnsworth Radio and Television Receivers and Transmitters • Aircraft Radio Equipment • Farnsworth Television Tubes • Mobile Communications and Traffic Control Systems for Rail and Highway • The Farnsworth Phonograph-Radio • The Capehart • The Panamuse by Capehart

COMMUNICATIONS FOR AUGUST 1947 • 9



When and where  
*Split-Second Action*  
 spells successful telecasts...

**DU MONT Type 5098A**  
**IMAGE ORTHONIC PICKUP HEAD**

▶ Vital functions at very fingertips...electronic viewfinder showing precisely what is being telecast... every component and circuit instantly accessible—yes indeed, the cameraman with the new Du Mont Image Orthicon Pickup Head is ready for *anything* and *everything* that comes along. And that means still better television programs.

Operated as part of the Du Mont Type TA-124-B Image Or-

thicon Chain, this latest television camera is truly ideal for reporting news, sports and other field operations. It is also suitable for small-scale studio operations because of its inherent sensitivity and flexibility.

Now in regular production, the Du Mont Image Orthicon Pickup Chain, equipped with this new Type 5098A Head or improved camera, is available for prompt delivery.

START AS SMALL AS YOU  
 WISH, WITH THE DU MONT

*Acorn Package*

▶ Call, 'phone or write for detailed information on Du Mont television equipment fitted to your plan—and budget.

©ALLEN B. DU MONT LABORATORIES, INC.

**FEATURING...**

Essential controls concentrated at rear of camera.

Hinged chassis and removable "Snap-on" panels permit immediate adjustments and replacements.

Super-sensitive Image Orthicon tube.

Lens turret takes up to four lenses of various focal lengths.

Rotatable handle at rear positions, locks and indicates any lens. Iris control setting adjustable from rear. Focusing by rotatable pan handle.

Electronic viewfinder removable. Mounts and plugs in on camera frame.

Video pre-amplifier essentially non-microphonic.

Pilot light indicates "On the Air." Second pilot light in shadow box cues cameraman while televiewing.

Plug-in headset and microphone harness for intercommunications.

Du Mont "one-operation" connecting plugs make all connections with orthicon chain units, saving minutes of precious time.

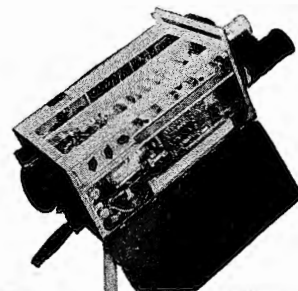

**DUMONT**

*First with the Finest in Television*

ALLEN B. DU MONT LABORATORIES, INC. • GENERAL TELEVISION SALES OFFICES AND STATION WABD, 515 MADISON AVE., NEW YORK 22, N. Y. • DU MONT'S JOHN WANAMAKER TELEVISION STUDIOS, WANAMAKER PLACE, NEW YORK 3, N. Y. • HOME OFFICES AND PLANTS, PASSAIC, NEW JERSEY



*Listen*  
...IT'S A  
**Jensen**

**MODEL VH-91**  
*Hypex*\* **SPEECHMASTER**

Delivering good quality, intelligible speech with maximum "punch" to override high noise levels, the Model VH-91 Speechmaster is recommended for paging and intercommunication applications. Hypex horn formula gives useful output over a 100° angle.

Especially efficient for voice, the VH-91 has a frequency range of 400-5,000 cycles. Power handling capacity: 15 watts maximum speech signal input. Designed for both inside and out-of-door use, VH-91 will withstand extreme weather conditions, including exposure to salt spray. Nominal voice coil impedance 8 ohms. Transformer number Z-3345, with 5/8" x 5/8" core available for 45-ohm use. Bell diameter, 8 7/8 inches; height, 9-1/16 inches; weight, 4 1/4 pounds.

Universal mounting bracket adjusts projector to any direction, locks securely in position by a single wing nut, has facilities for mounting transformer.

**Jensen VH-91 Speechmaster Projector (ST-171).....\$32.50**  
\*Trade mark registered

**JENSEN MANUFACTURING COMPANY**  
6603 S. LARAMIE AVE., CHICAGO 38, U. S. A.  
In Canada: Copper Wire Products, Ltd., 11 King St., W. Toronto 1



*Designers and Manufacturers  
of Fine Acoustic Equipment*

DEFLECTION COIL  
SHELL CYLINDER

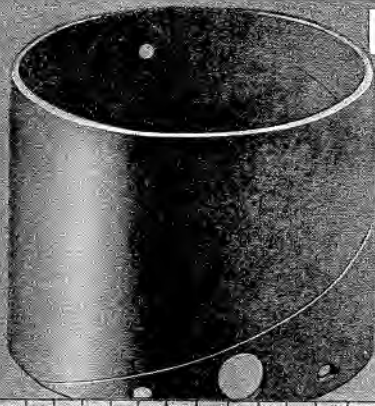

DEFLECTION  
COIL CORE



SHELL

DEFLECTION COIL  
TERMINAL RING

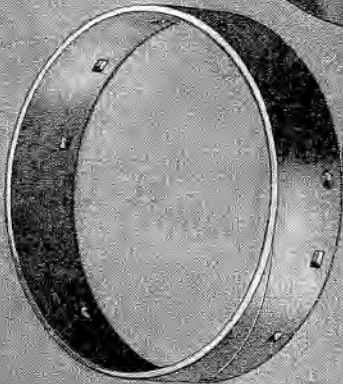

RETAINING RING

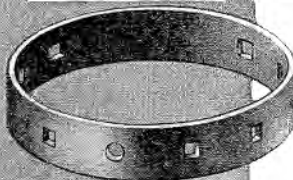

HALF SHELL



**PUNCHING AND  
NOTCHING AS MAY BE  
DESIRED.**

\*Trade Mark Registered

**The CLEVELAND CONTAINER Co.**  
6201 BARBERTON AVENUE  
CLEVELAND 2, OHIO

PRODUCTION PLANTS also at Plymouth, Wisc., Ogdensburg, N. Y., Chicago, Ill., Detroit, Mich., Jamesburg, N. J.  
PLASTICS DIVISIONS at Plymouth, Wisc., Ogdensburg, N. Y. • ABRASIVE DIVISION at Cleveland, Ohio  
New York Sales Office—1186 Broadway, Room 223

IN CANADA—The Cleveland Container Canada Ltd., Prescott, Ontario

PUNCHED COSMALITE<sup>\*</sup>  
COIL FORMS FOR..

# Television RECEIVERS

A new and further step in the ever increasing use of these spirally laminated paper base, Phenolic Tubes. Performance based upon approximately seven years of research.

Other Cosmalite Types—  
#96 COSMALITE for coil forms in all standard broadcast receiving sets.

SLF COSMALITE for Permeability Tuners.

Spirally wound kraft and fish paper Coil Forms and Condenser Tubes.

Attractive prices.  
Fast deliveries.

Inquiries given  
specialized  
attention.



# COMMUNICATIONS

LEWIS WINNER, Editor

AUGUST, 1947

## THE ENGINEERING SESSION AT THE NAB ATLANTIC CITY CONFERENCE

BROADCASTING facilities will receive an extensive analysis during a one-day clinic session at the NAB Conference in the Ambassador Hotel, Atlantic City, on Monday, September 15. The meeting, which will open at 9:45 A.M., will be addressed by NAB president, Justin Miller.

Orrin Towner, chairman of the NAB engineering executive committee, will preside over the morning session during which four papers will be presented:

(1) *Recent Television Developments, with Particular Emphasis on Photography of Kinescope Images*; O. B. Hanson, vice president and chief engineer, NBC.

*Talk, to be illustrated with motion pictures, will also provide a description of the Washington and New York NBC television stations.*

(2) *F-M Transmitter Facilities Construction Problems*; Paul A. DeMars, consulting radio engineer, Washington, D. C.

*A discussion of the technical and economic problems encountered in the construction of broadcast transmitters.*

(3) *Recent Audio Developments*; John Colvin, audio facilities engineer, ABC.

*Mr. Colvin will discuss practical audio-facilities layouts for low and medium power a-m and f-m stations and will also analyze methods of turntable operation and new audio-facilities developments, such as record surface noise suppressors, etc.*

(4) *Transmitter Maintenance for the Small and Medium-Sized Stations*; G. Porter Houston, chief engineer, WCBM, Baltimore, Maryland, and Alfred E. Towne, director of engineering, KSFO, San Francisco, Calif.

*Mr. Houston will cover the small station problems and Mr. Towne the medium-sized station setups.*

### Afternoon Session

Royal V. Howard, NAB director of engineering, will preside over the afternoon session, during which three groups of papers will be offered:

(5) *Directional Antennas, Their Care and Maintenance*; Dixie B. McKey, consulting radio engineer, Washington, D. C.

(6) *Technical Regulation of Radio*; George P. Adair, former FCC chief engineer, and now radio-engineering consultant, Washington, D. C.

*Mr. Adair will elaborate on technical regulations, both past and future, and the responsibilities of the FCC, the broadcaster and the engineer. He'll also discuss operator-licensing requirements.*

(7) *FCC Industry Roundtable*; Royal V. Howard, moderator.

*In this, the final meeting of the afternoon, which will last about 1 hour and 20 minutes, five members of the FCC will appear in a question and answer panel: George E. Sterling, chief engineer; John A. Willoughby, assistant chief engineer*



Royal V. Howard

*in charge of the broadcast branch; James E. Barr, chief, standard broadcast division; Cyril M. Braum, chief, f-m broadcast division, and Curtis B. Plummer, chief television broadcast division.*

On September 16th, the NAB recording and reproducing standards committee will meet to study recording and reproducing standards. One of the problems that will be discussed will be high frequency pre-emphasis for transcriptions. Present standards show a high-frequency boost of 100 milliseconds. Some feel that this should be reduced to about 75 milliseconds for f-m. Other standards that will be discussed include recorded level, signal-to-noise ratio, concentricity of center hole, turntable diameter (this was tentatively standardized with a minimum diameter of

(Continued on page 41)



Orrin W. Towner



O. B. Hanson



Paul A. deMars



John D. Colvin

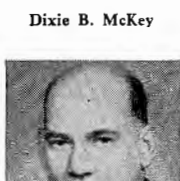

Dixie B. McKey

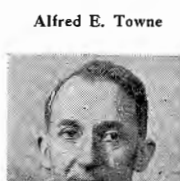

Alfred E. Towne

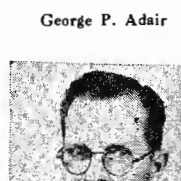

George P. Adair



George E. Sterling

# F-M Receiver Design For RAIL RADIO SERVICE

OVER THE PERIOD of the last ten years, the design of receivers for use in the emergency services has followed a definite trend. The change from the low-frequency band (in the neighborhood of 40 mc) to the 152-162 mc band has seen a tendency to carry these older design procedures over into the higher frequency equipment. While there is some justification for this, the designer of equipment for use in the new band must realize he is facing a new set of problems which differ considerably from those of the old band. First, the more than threefold increase in frequency greatly increases the effects of input circuit loading. Tubes which are entirely satisfactory for use at 40 mc, appear at 160 mc, as very low resistances because of the greatly increased transit-time loading. Almost the only acceptable pentodes are the 955, 6AK5 and AG5 and even these exhibit quite a bit of loading. The best tube, 6AK5, looks like 2,000 ohms. This limits the amount of gain that can be realized in the antenna circuit to 6.3, which may be calculated quite easily from the ratio of impedance levels assuming the input to match a 50-ohm transmission line.

Loading is also of importance in the mixer stage but here the choice of tubes is greater since the problem of achieving a good mixer noise figure is of primary importance and it is necessary to resort to triode mixing.

In any event, the loading introduced by transit-time effects in the grid circuits of the r-f and mixer, and to some lesser degree the plate circuit of the r-f, broaden the band-pass characteristics of the front and so a relatively high i-f frequency must be used. This necessarily high i-f frequency, coupled with the desire to attain as great an overall stable gain as can be tolerated, has led to the wide useage of the double super. In this type system, the first i-f may be high in frequency and may contribute quite a bit of gain. It is followed by a second mixer feeding a lower i-f in which the remaining gain is realized. Output to input feedback is thus effectively prevented since the output frequency differs widely from the input frequency. The necessity for having quite high overall gain in emergency services receivers is well

---

**F-M 152-162 Mc Band Modified Single Super, Developed for Steam-Locomotive Service, Features Half-Frequency Mixing to Reduce Receiver Reradiation and Spread Oscillator Harmonics Which Reduces Spurious Response Problem. Crystal Switching Included for Dual-Frequency Operation. Set Can Be Used in 120-Kc Spacing System.**

---

by **DAVID W. MARTIN**

**Project Engineer  
Bendix Radio Division, Bendix Aviation  
Corp.**

established. Often it is the rule, rather than the exception, that the receiver operate consistently in the *fringe area* where the signal delivered to the antenna coil is on the order of 1 microvolt or less. This situation occurs because of the relatively low power of emergency transmitters, especially in the mobile equipment, which, in the new band, usually run about 15 watts to 50 watts maximum. In addition, at 160 mc, it does not require a very large object to create quite a *shadow* region in which signal levels may be far below those existing in regions around this area. Fortunately, complete absence of signal seldom occurs in the 152-162 mc band in areas in the service range since stray reflections from buildings, water towers and other prominences reinforce the field. Continuous monitoring of receiver avc voltage on an especially-designed a-m receiver carried in the head end of a mile-long freight train with a continuously operating 15-watt transmitter in the caboose, using a cathode-ray indicator and very rapid avc, showed many dips of field strength to the one-microvolt region as the train sped through cuts around blind curves and in classification yards. In this severe service, the only evidence of complete loss of signal occurred when the head end or caboose were well inside a tun-

nel. Similar conditions have been experienced when one unit was traveling hilly roads in an automobile.

When the level is down to 1 microvolt, the signal is still useable so it is desirable that an f-m set be limited at or below this level or that an a-m set have its avc knee at or about 1 microvolt. Most limiters require from 0.5 to 1 volt at their inputs for saturation. Therefore the overall gain is on the order of a million to the limiter. The limiter itself contributes an additional gain, below the limiting threshold, of five or ten. This additional gain causes a single super to be extremely *hot* insofar as regeneration is concerned, and while sufficient overall gain can be realized in an a-m receiver without trouble using a single superhet, this does not hold true in the f-m version. Another advantage claimed for the double super is that, since the second i-f may be low in frequency, the bandwidth may be made less than in the instance of the single super. This is true, but it is not a contributing factor in 152-162 mc equipment. Here the 6-db bandwidth is set primarily by crystal and i-f drifts, and the resultant drift with the best available present-day equipment is greater than the minimum bandwidth which may be achieved using a single superhet with an i-f frequency sufficiently



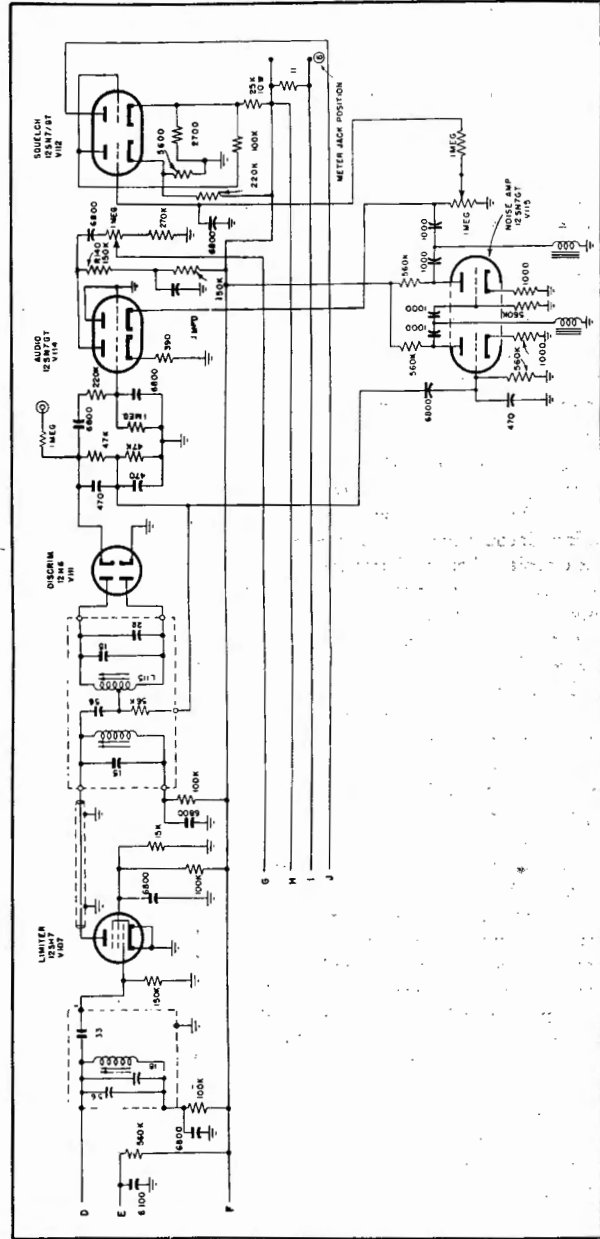
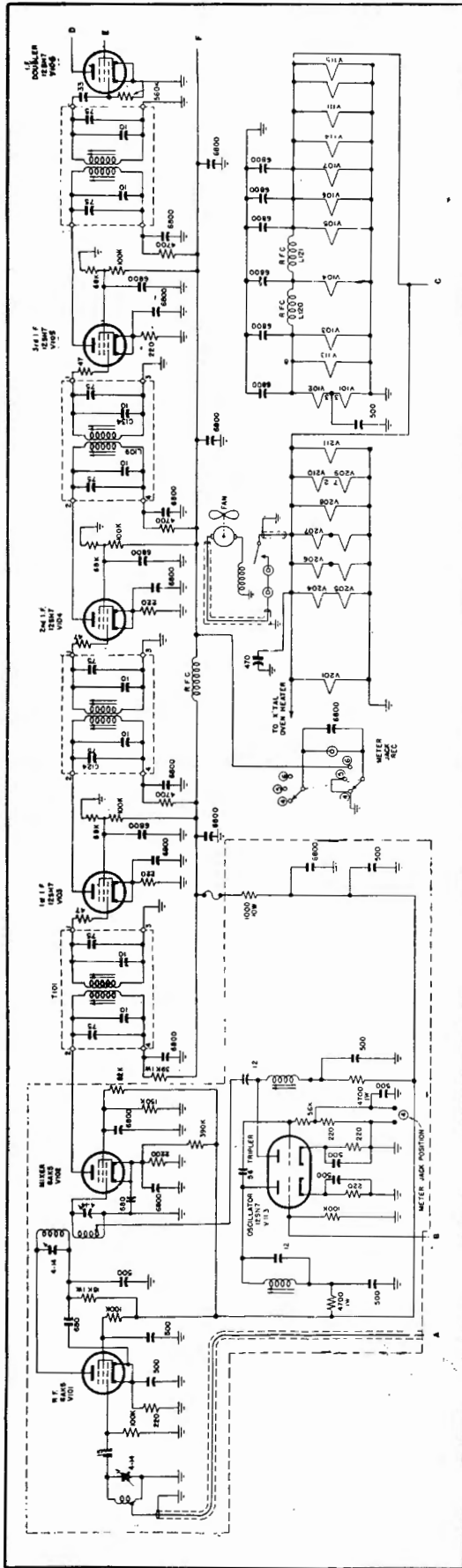

Figure 1 (above) and 1a (right)

In Figure 1 appears the r-f, mixer, i-f, doubler and tripler stages of the receiver of the transmitter-receiver designed for locomotive installation. The limiter, discriminator, audio, squelch and noise-amplifier circuit section is shown in Figure 1a. The receiver features a 9.5 mc i-f, operating at 9.5 mc wave and temperature compensated and wave-around permeability-tuned coils.

high to obtain adequate i-f rejections.

One great advantage in the use of single supers is the extremely simple undesired response pattern. In a double super, the pattern is infinitely more complex since each i-f and oscillator produces its own group of responses. A single super using crystal generation of the oscillator frequency has responses associated with the crystal unwanted harmonics as well as the normal image frequency. This is, of course, also true of a double super.

In Figure 1 appears a circuit of an f-m receiver-transmitter,<sup>1</sup> the receiver employing a modified single-super circuit.

The front end embodies the design features previously mentioned. Injection of the oscillator voltage (at  $\frac{1}{2}$  mixing frequency) is in the mixer grid circuit. This half frequency mixing achieves two purposes. First, it reduces receiver reradiation greatly since the oscillator frequency is well removed from the resonant frequency of the circuits tuned to signal frequency. Second, it spreads oscillator harmonics and thus reduces the spurious response problem. In addition, the circuit of the harmonic generator is greatly simplified. This simplification is increased by the use of crystals oscillating at their third harmonic mode. These mode oscillators also greatly reduce spurious responses from crystal harmonics by spreading these harmonics widely frequencywise. Because of the wide frequency separation of harmonics it is possible to restrict the tuning of the adjustments in the harmonic generator circuit so that mistuning to the wrong frequency harmonic is impossible. Tuning is facilitated by metering circuits which allow measuring harmonic generator grid current.

Crystal switching is included for dual-frequency operations and is quite simple since the oscillator itself is all that need be switched. This is another advantage over the double super, in which the first i-f frequency must be changed when changing operating frequency, if only one crystal is used.

The i-f uses three gain stages operating at 9.5 mc and four transformers (Figure 2) which are temperature compensated and use special cone-wound permeability-tuned coils in large copper cans to realize the  $Q$ 's necessary to attain the desired bandwidth. The overall antenna-to-doubler-grid gain is sufficient to cause sensible saturation of the doubler-lim-

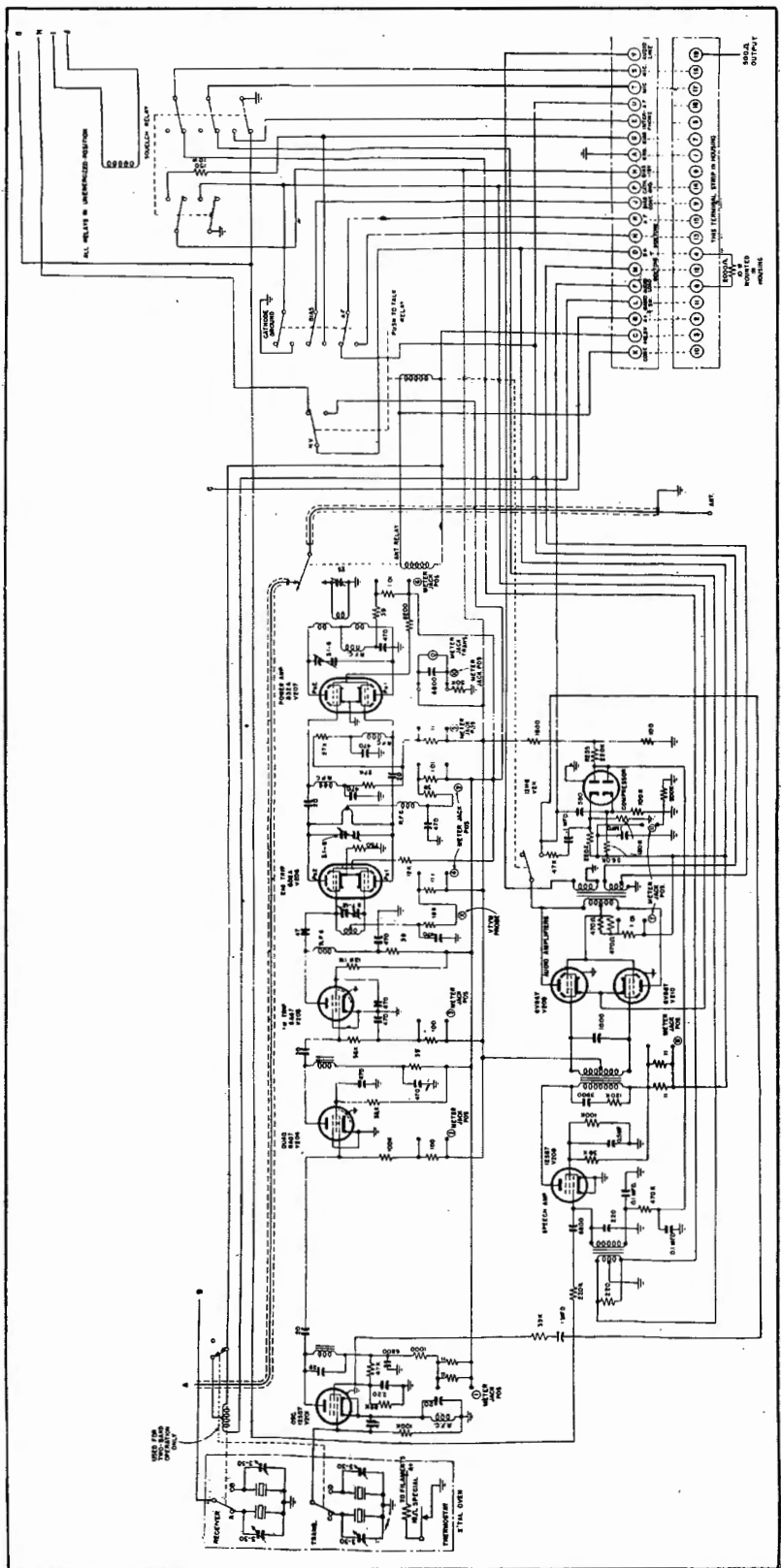

Figure 1b

Transmitter portion of the railroad transmitter-receiver. Note the relay system and the crystal oven used in the receiver and transmitter portions of the system.

<sup>1</sup>Bendix MRT-1E. Features circuit designs developed by the authors of this paper, R. K. Frazier, R. B. Edwards and C. M. Sanford.

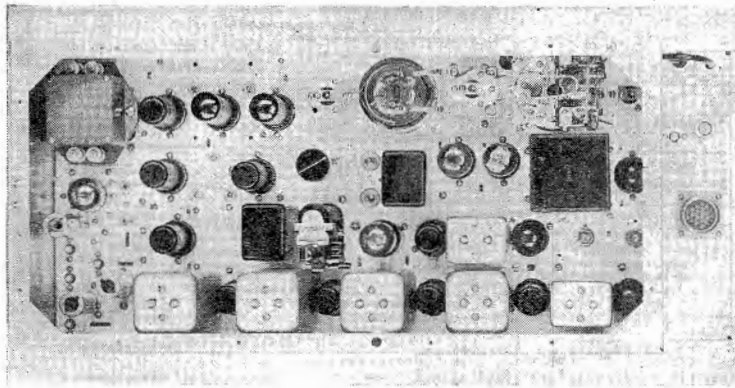

Figure 4  
Top view of the chassis of the receiver.

iter from front-end and antenna noise. The doubler makes the use of the single super in this application practical. This tube is a limiter with circuit constants so chosen as to make it an efficient frequency multiplier. The plate load resonates at twice the i-f frequency or 19 mc so that the gain from doubler input to discriminator is all at 19 mc which does not feed back into the input of the 9.5 mc i-f. The discriminator is no more difficult to design than a 9.5-mc discriminator since the band-width is doubled when the frequency is doubled.

The discriminator is conventional and drives an audio amplifier and a noise amplifier. The latter amplifier amplifies that band of noise above 15 kc closing a squelch relay only when the noise is below a predetermined value. Therefore noise bursts do not tend to open the squelch circuit. Relay squelch was used to allow desired circuit switching in addition to audio operation. Such circuit switching allows the receiver to draw less current in the absence of signal by effectively removing  $B+$  from the audio output stage. This is quite a reduction since the audio stage is a pair of 6V6s chosen to provide adequate speaker volume for installations in steam locomotives.

Incidentally in designing this equipment the stringent requirements of steam locomotive service were followed.

Although a locomotive is quite a large device, it is amazing to see how much of the space is in use and how little indoor space remains for equipment installations. Tunnel clearances determine headroom and it often happens that installations must be made on the engine cover in a diesel switcher (*cover illustration*) or on the tender of a steam locomotive. The exposed installations naturally result in equipment temperatures on the order of 70° or more, when, for instance, the engine remains in direct sunlight. Hence the

Figure 2  
A view of the i-f transformer, using the conical coil, removed from the can.

need for a fan in the system. This also makes the problem of i-f temperature-frequency compensation severe and the use of *BT*-cut crystals with a high temperature turnover point mandatory. The tender mounting means the equipment will very often be subjected to heavy baths when the tender overflows or the filler hose slips while filling. Thus water-tight construction is absolutely essential.

#### A-M Systems

It is also possible to use a-m equipment for this service; tests have shown it will give excellent service if attention is given certain requirements. First, the signal range encountered varies from well under a microvolt to several hundred-thousand microvolts. These changes may be rapid. Extreme signal strength modulation may be caused by passing a string of freight cars, for example. Therefore, the receiver must have amplified avc flat within  $\pm 2$  db from 1 microvolt to 1 volt and the time constant of the avc string must be made very short.

The use of f-m does offer some advantages in that the time constant of the limiters can be made so short as to eliminate *any* possibility of flutter. There is a limit on avc time constant in an a-m receiver which is set by the point at which feedback occurs and the point of excessive demodulation. F-m receiver design does not suffer from these limitations. It must be remembered that since flutter is quite a problem, ratio-detectors with their long time constants cannot be used in this service.

The results obtained from this equipment have been quite encouraging. Sensitivity, defined by 20-db quieting, using a signal generator<sup>2</sup> with 6-db pad



runs around 0.8 microvolt. The squelch system may be set to operate on noise reduction of 10 to 30 db and hence it may be set to close at, above or below, the receiver sensitivity defined by 20-db quieting.

#### Receiver Selectivity

In Figure 3 appears an i-f curve. Plot was found to hold from  $-50^{\circ}$  C to  $+70^{\circ}$  C with a total maximum drift of not over 4 kc.

All spurious responses, including image, run, in production units, have been found to be 80 db below the signal. This includes all spurious re-

(Continued on page 37)

<sup>2</sup>Measurements Corp. model 80.

Figure 3  
The i-f selectivity curve for the receiver. The straight side portion of the curve below 60 db is due to the action of the doubler.

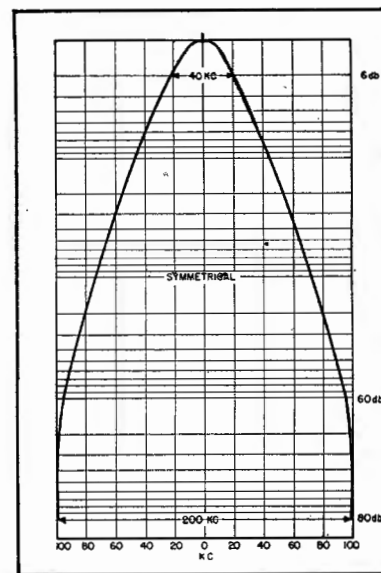

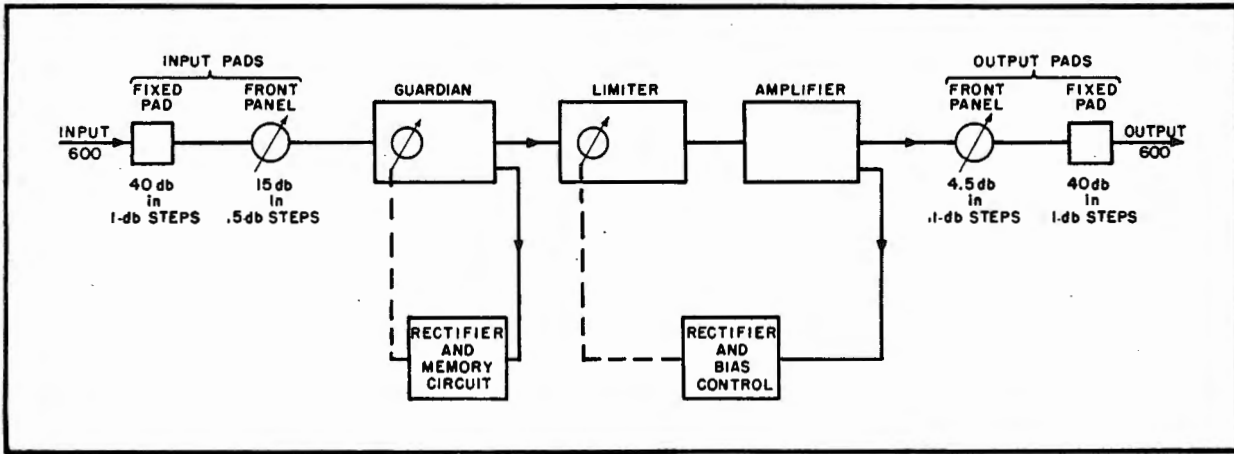

# An Automatic Gain Control and Limiting Amplifier FOR BROADCAST STATIONS<sup>1</sup>

IN NORMAL BROADCASTING procedure, control operators reduce the dynamic range by as much as 20 db. This dynamic range is still further reduced by the desire to maintain a high percentage of modulation at all times, and it is extremely difficult to constantly maintain this close regulation. Early attempts to alleviate this situation were made by the use of the peak limiting, or compressor amplifiers at the transmitter. The object of this limiter was to reduce any peak values above the pre-determined danger point by providing a ceiling for the signal going into the transmitter. Unfortunately, this has led to the relaxing of critical monitoring by giving the operator a false security of proper operation. By depending upon this limiter, no provisions are made to restore the signal in case the program level drops during the program or, at the switching of a program. If

this drop in level is restored manually, it leaves the transmitter in a hazardous position, and is asking the limiter to do a larger percentage of the correction when the proper level is restored.

That is, no provisions are made for the automatic reduction of the signal, the control correction depending upon the operator. Thus an automatic-gain-control amplifier is necessary before the peak limiter to maintain constant audio flow into the transmitter at all times.

Over a long period of peak value recording of conventionally monitored programs, it has been found that the average peak level varies  $\pm 6$  db by careful operators, and as much as

$\pm 10$  db by operators who have a tendency to rely on the peak-limiting amplifiers. Referring to Figure 1, it will be noted that if the average peak value of the signal is allowed to be fed in 10 db below the knee of the curve, the modulation level will be seriously affected. If the average peak value is allowed to ride as high as 10 db above the knee of the curve, a large portion of the body of the program will be compressed and the instantaneous peaks of program will produce serious and undesirable over-modulation.

To overcome the problem an automatic gain control-limiting amplifier<sup>2</sup> has been designed for installation between the studio audio facilities and the transmitter. Figure 2 shows the sections into which the unit is divided; an automatic gain control or guardian

(Continued on page 36)

<sup>1</sup>From a paper presented by W. M. Jurek and J. H. Guenther of the Langevin Co. before the IRE-RMA Spring Meeting in Syracuse, N. Y.  
<sup>2</sup>Langevin 119-A Progar; units were originally built by Royal V. Howard and further developed by Langevin.

Figure 2 (Above)  
 Functional block diagram of the Progar system.

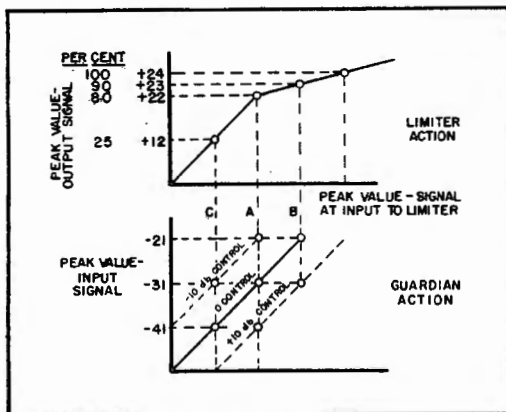
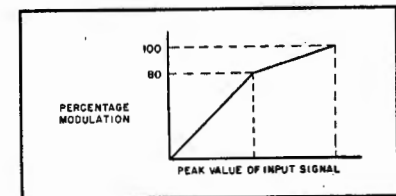

Figure 3  
 Plots illustrating the combined action of the two units of the Progar system. Vertical axis of the lower graph represents the peak value of the signal at the output of the guardian system which is also the input to the peak limiter.

Figure 1  
 This plot illustrates a practical application of the peak limiter type of action. The peak values of the input signal are plotted in the bottom of the chart, and at the left appear the modulation percentage values of an a-m signal. By proper adjustment of the peak-limiter amplifier, the knee of the curve is placed to correspond to the 80% modulation point of the transmitter.





**WILCOX**  
*First Choice of The  
Great Silver Fleet*

**Eastern Air Lines Chooses WILCOX VHF  
For Their Fleet of New-Type Constellations**

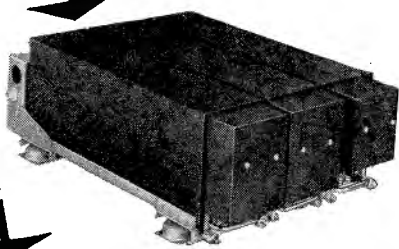

**Write Today FOR COMPLETE  
INFORMATION AND SPECIFICATIONS**

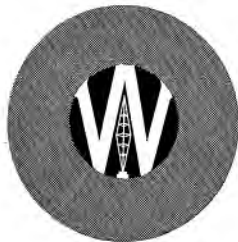

**WILCOX**  
**ELECTRIC**  
**COMPANY, INC.**

14th AND CHESTNUT STS. • KANSAS CITY 1, MO.

**New Features Offered in the  
118-132 Mc. Band by the Wilcox  
Type 361A Communications System**

**• UNIT CONSTRUCTION FOR EASE  
IN HANDLING**

The 50 watt transmitter, high sensitivity receiver, and compact power supply are each contained in a separate 1/2 ATR Chassis. Any unit may be readily removed from the common mount for inspection. Individual units are light in weight, small in size, and easily handled.

**• 70 CHANNELS COVER PRESENT  
AND FUTURE NEEDS**

Both the receiver and transmitter contain a frequency selector mechanism with provisions for 70 small hermetically sealed crystals. Selection of the crystals automatically adjusts the radio frequency amplifiers and harmonic generator circuits to operate at their maximum performance for each selected frequency. Either simplex or cross-band operation may be obtained.

**• SIMPLICITY OF CIRCUIT DESIGN  
MEANS EASY MAINTENANCE**

Simple, conventional circuits minimize the number and types of tubes, and require no special training or techniques for adjustment. All components are accessible for routine inspection and service.

# Power-Line CARRIER

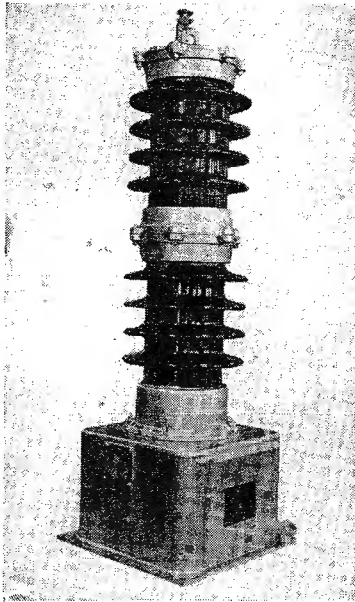

Figure 1  
A typical power-line carrier coupling capacitor used for 115-kv service.

POWER-LINE CARRIER equipment is used today by nearly every major electrical utility system in the country for many diverse applications such as protective relaying, remote metering and control, and telephone communications, the latter being the earliest application, introduced in 1923.

The primary reasons for using carrier communications equipment are the reliability, the rapidity, and the economy with which carrier communication can be established between points on a power system. On many large systems, power-line carrier is the primary means of communication between dispatchers' offices and important stations, and carrier channels are often used as trunk lines linking PBX

boards at important stations and division offices. Carrier channels are an integral part of the overall communication systems of many utilities.

## The Power-Line Carrier Frequency Spectrum

The frequencies normally used for power-line carrier communication lie in the band from 50 to 150 kc. Use of this band of frequencies is dictated by the characteristics of the power lines employed as a carrier transmission medium. Power transmission lines and power systems are usually designed without regard to their suitability as channels for the transmission of high frequencies. Power lines are generally adequately transposed for power frequencies, but such transposition is ineffective at carrier frequencies. Surge impedances are seldom matched over an entire carrier circuit, and taps and branch lines along the channel may cause severe reflection losses at carrier frequencies. As a result, the upper limit of the useful power-line carrier band is set by transmission losses, largely due to radiation, which increase rapidly as the carrier frequency is increased much above 150 kilocycles.

## Coupling Methods

It is universal practice to couple carrier currents to transmission lines through coupling capacitors (Figure 1) specifically designed for such service. Such capacitors are series tuned

to allow the carrier frequency to pass freely onto the line, but they offer high impedances to power frequencies. Where circuit breakers or other switching equipment may interrupt the carrier channel, or where the carrier channel must be transferred from one power line to another, assemblies consisting of two or more coupling capacitors and series tuning units are used to bypass the gap.

A single conductor of a three-phase power line is often used as a carrier channel, with ground return. This arrangement offers maximum economy in coupling and bypassing equipment, but for the lowest possible attenuation and noise level, a second conductor of the three-phase line is often used as a return circuit.

Short branch or spur lines along the carrier channel may approximate an odd quarter wavelength and as a result present a very low impedance at the carrier frequency. Losses due to such spur lines can be eliminated by inserting line traps (Figure 2) in series with the offending circuit at the tap point. Line traps consist of a coil of heavy cable, capable of carrying the full power current of the line, tuned to parallel resonance at the carrier frequency by means of a shunt capacitor.

## Typical Power-Line Carrier Units

The variety of power-line carrier applications and the many specific requirements of individual users make it impractical to manufacture complete power-line carrier assemblies as single

Figure 2  
Power-line carrier-line trap. This device, inserted in series with a tap line on a power circuit, prevents loss of carrier energy in the tap line.

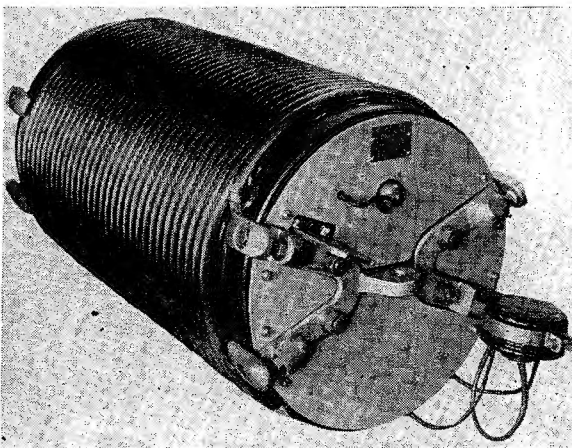
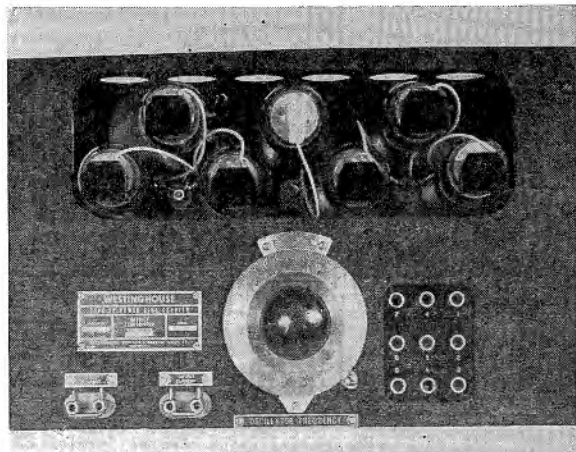

Figure 3  
Power-line carrier-communications transmitter. In this system seven 807's are used in an oscillator power-amplifier circuit, which is grid-bias modulated and provides a carrier output of 25 watts.



# COMMUNICATIONS

An Analysis of Systems Operating in the 50 to 150-Kc Band. Presented Are Data on Coupling Methods, Trap Circuits, Transmitters Using Beam-Type Oscillators and Grid-Bias Modulation, Two-Stage I-F Superhet Receivers, Manual and Automatic Simplex Systems, Two-Frequency and Multi-Station Duplex Systems, Calling Systems, etc.

by **R. C. CHEEK**

Central Station Engineer  
Westinghouse Electric Corp.

units. Instead, individual assemblies are made up from a wide line of unitized components. These component units are built for standard 19" rack mounting and are combined to form an assembly capable of performing the required functions.

A typical power-line carrier transmitter is shown in Figure 3. A beam-type oscillator tube in a Colpitts circuit is used to excite six similar tubes in push-pull-parallel. Grid-bias modulation is employed. This transmitter has a carrier output of 25 watts, which is adequate for all the usual power-line carrier applications. Lower-powered transmitters, designed to operate directly from the 125-volt or 250-volt batteries, usually provided in power stations, are also available.

A superheterodyne power-line carrier receiver, often used for communication work, is shown in Figure 4. An adjustable band pass filter is used in the input stage. A two-stage i-f amplifier includes a power-output stage to supply i-f power to operate electronic switching circuits where the latter are used. Power rectifiers are used for detection and avc rectification. An avc system is required in power-line carrier work to minimize variations in signal strength caused by changes in channel attenuation as a result of system switching and the formation of sleet on lines. Such a system also

compensates for the different distances separating stations on a channel.

#### Communication Systems

Many different combinations of carrier units can be used to make up a power-line carrier communication assembly. The combinations may differ in the method of calling, power supply, modulation system, and in numerous other details, but any given assembly can be classified as either a simplex assembly or a duplex assembly, depending upon the method of operation of the carrier system in which it is used.

A *simplex* system is one in which transmission can proceed from one station only at any given instant. In simplex power-line carrier systems, all stations on a given channel operate on a single frequency. Transmission and reception cannot take place simultaneously on the same frequency at a given station, because the transmitter will block the local receiver and may even damage it permanently unless the receiver is de-energized during transmission. The simplex system therefore requires means for turning off the receiver during periods when the transmitter is energized for transmission. If the system is one in which this switching operation is performed manually, it is called a manual or "push-

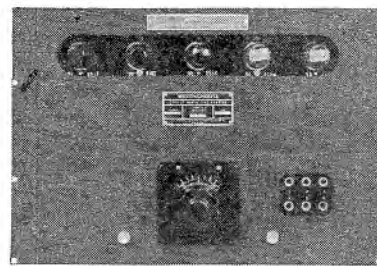

Figure 4  
Power-line superheterodyne receiver. In this unit are a converter, two i-f amplifiers and two full-wave rectifiers for detection and avc.

to-talk" simplex system. If the system is one in which the transfer is performed automatically by equipment within the carrier assembly, it is called an automatic simplex system.

A *duplex* system is one in which transmission can take place simultaneously from both stations involved in the conversation. In the usual duplex system, two frequencies are used. At one station the first frequency is used for transmission, the second for reception. At the other station, the first frequency is used for reception, the second for transmission. Since the transmitter and the receiver at a given station operate on different frequencies, both can be energized continuously during the conversation, and simultaneous two-way transmission can be obtained. It is usual practice to limit the difference between the transmitting and receiving frequencies in this system to not less than 20 per cent of the higher of the two frequencies, to prevent the local transmitter from interfering with the local receiver.

#### Comparison of Simplex and Duplex Systems

The simplex system, because it requires only a single carrier frequency, lends itself more readily to application in extensive carrier communication setups, involving more than two terminals, than does the duplex system. In the latter system, unless communication is desired between a central office and several other stations that do not require communication with each other, each station must be able to transmit and receive on both of the two frequencies used. Even with this arrangement, however, only two terminals can be operated at a time, and full party-line communication as provided by the simplex system cannot be obtained.

The duplex system requires two frequencies per channel and is limited in general to two terminals per channel. For these reasons the duplex system is

(Continued on page 38)

# 50 kw. FM..

## High Band FM Comes Of Age..

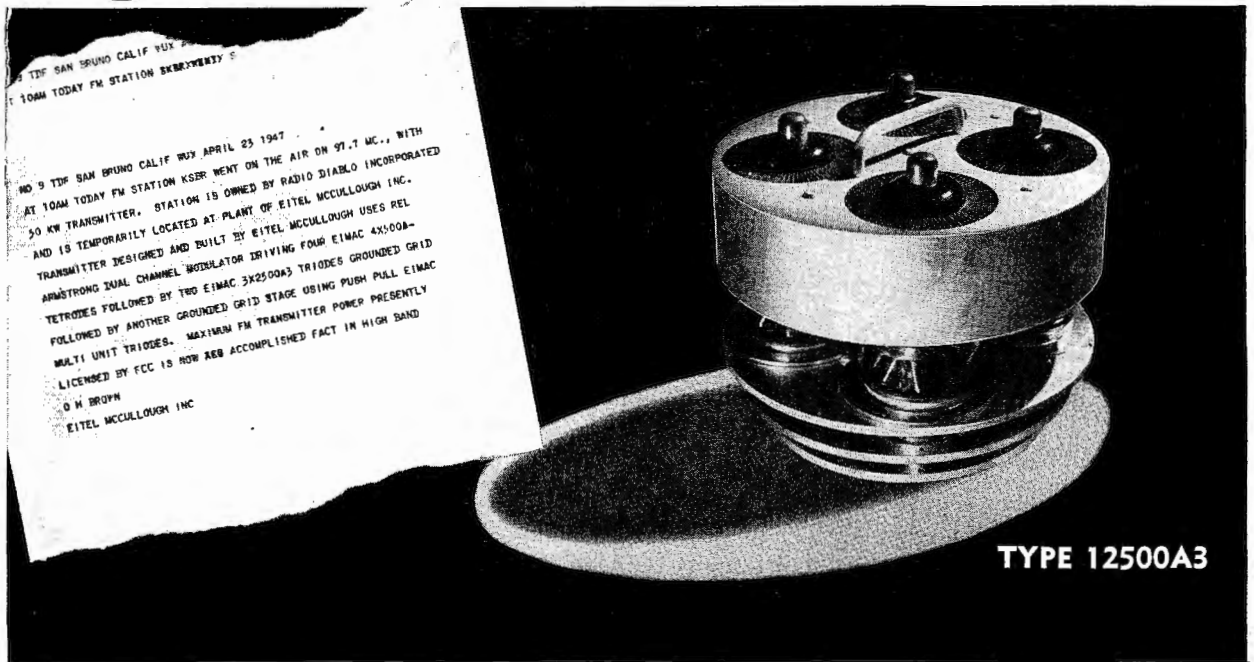

### Here's How It Is Done . . .

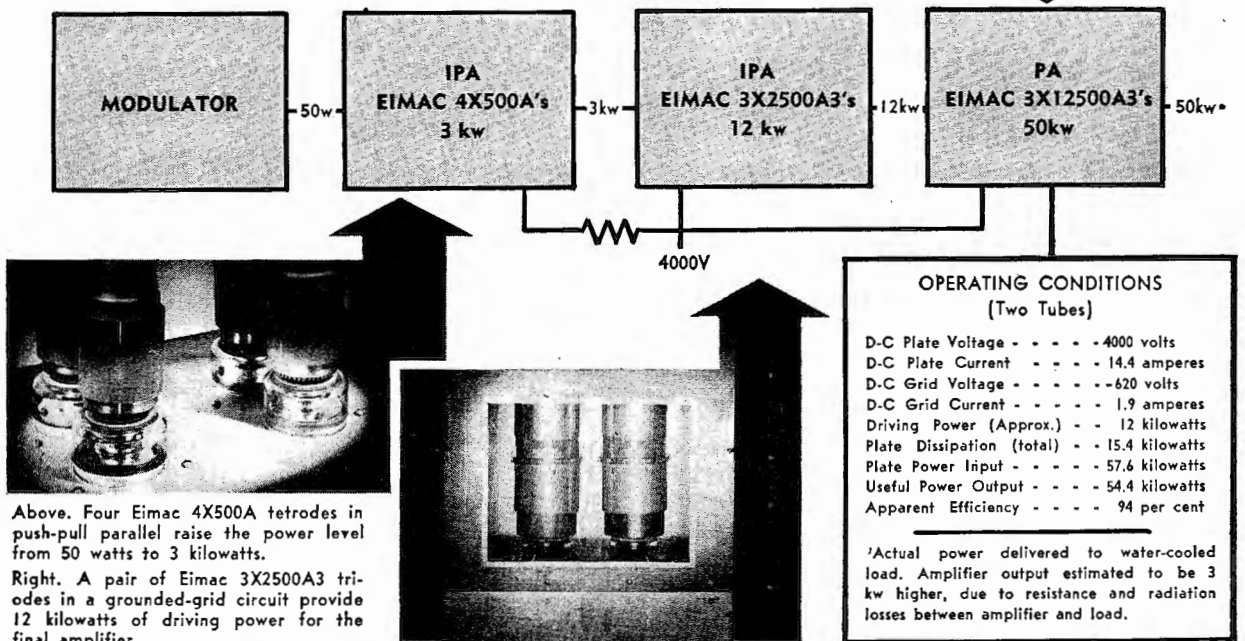

Above. Four Eimac 4X500A tetrodes in push-pull parallel raise the power level from 50 watts to 3 kilowatts.

Right. A pair of Eimac 3X2500A3 triodes in a grounded-grid circuit provide 12 kilowatts of driving power for the final amplifier.



# ON THE AIR

## ...with Eimac Tubes, Of Course...

When KSBP put the first 50-KW high-band FM transmitter on the air Eimac tubes were in every important socket. This was only natural, as Eimac tubes have been associated with every FM transmitter development, including the original historic 1935 demonstration before the IRE.

KSBP's 50-KW amplifier was designed and built by Eimac to demonstrate the capabilities of the new Eimac 3X12500A3 multi-unit air cooled triode. A pair of these new triodes in a grounded-grid circuit easily delivers 50-KW at high-band FM frequencies, with power to spare. Performance of this sort is made possible by sound vacuum-tube engineering. Because of its unique multi-unit design, the 3X12500A3 combines high power capability with close electrode spacing and low lead inductance, thus making it possible to produce high power at VHF with low plate voltage and high over-all efficiency. These same features make the 3X12500A3 an outstanding performer at low frequencies.

Data on the 3X12500A3 and the 50-KW amplifier are available. Write to

**EITEL-McCULLOUGH, INC.**  
176 San Mateo Ave., San Bruno, California

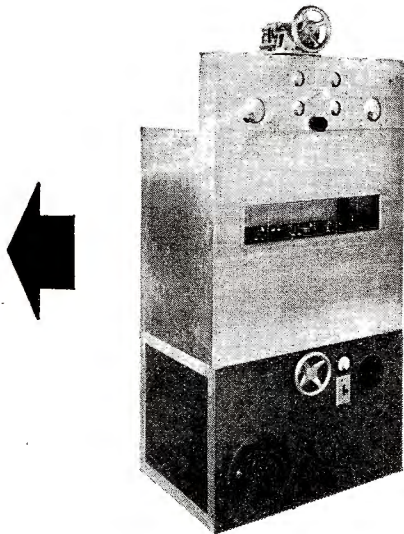

The final amplifier at KSBP—the amplifier that made FM history—consists of little more than two Eimac 3X12500A3 triodes and a pair of shielded, low-loss tank circuits.

The unit is extremely compact considering its power capabilities. Width 36"; Height 70"; Depth 25".

### TYPE 3X12500A3 ELECTRICAL CHARACTERISTICS

Filament: Thoriated tungsten	
Voltage	7.5 v
Current	192 amp.
Amplification Factor (Aver.)	20
Direct Interelectrode Capacitances (Av.)	
Grid-Plate	95 $\mu$ fd.
Grid-Filament	240 $\mu$ fd.
Plate-Filament	5 $\mu$ fd.
Transconductance ( $e_b=3000$ v, $i_b=4a$ )	80,000 $\mu$ mhos

PRICE \$700

### TYPE 3X2500A3 ELECTRICAL CHARACTERISTICS

Filament: Thoriated tungsten	
Voltage	7.5 v
Current	48 amp.
Amplification Factor (Av.)	20
Direct Interelectrode Capacitances (Av.)	
Grid-Plate	20 $\mu$ fd.
Grid-Filament	48 $\mu$ fd.
Plate-Filament	1.2 $\mu$ fd.
Transconductance ( $i_b=830$ ma, $E_b=3000$ v)	20,000 $\mu$ mhos

PRICE \$165

### TYPE 4X500A ELECTRICAL CHARACTERISTICS

Filament: Thoriated tungsten	
Voltage	5.0 v
Current	13.5 amp.
Screen-grid amplification (Av.)	6.2
Direct Interelectrode Capacitances (Av.)	
Grid-Plate	0.05 $\mu$ fd.
Input	12.8 $\mu$ fd.
Output	5.6 $\mu$ fd.
Transconductance ( $i_b=200$ ma, $E_b=2500$ v, $E_{c2}=500$ v)	5200 $\mu$ mhos

PRICE \$85

Follow the Leaders to

**Eimac**  
REG. U. S. PAT. OFF.  
**TUBES**

The Power of FM

Export Agents: Frazer & Hansen, 301 Clay St., San Francisco 11, Calif

# Significance of Watt-Second

IT HAS BEEN THE PRACTICE in the past to consider capacitance and voltage as the only necessary components for a rating of d-c capacitors. While this may suffice in the case of small tubular paper units used in receivers, it is not adequate for the wide range of sizes found in high-power equipment application. Neither of the above components of rating taken separately give any indication of relative physical size. The truth of this assertion may become evident if one considers that capacitance, dimensionally, is linear as is shown by the basic equation for capacitance:

$$C \text{ (mfd)} = \frac{k \text{ (conversion factor)} \times K \text{ (dielectric constant)} \times A \text{ (dielectric area)}}{d \text{ (dielectric thickness)}} \quad (1)$$

$$\text{Dimensionally } C : \frac{L_2}{L} : L$$

Likewise the voltage rating which can be applied to a dielectric is obviously a function of thickness and for a limited range of thickness one may, without appreciable error, assume that it has the form:

$$E \text{ (rated volts)} = k_1 \text{ (conversion factor)} \times d \text{ (dielectric thickness)} \quad (2)$$

By squaring equation (2) and multiplication of equation (1), we arrive at:

$$CE^2 = k K k_1^2 (Ad) \quad (3)$$

Where:  $(Ad)$  represents physical volume  $(V)$  of the active dielectric.

The basic derivation of the energy stored in a capacitance shows that  $W$

$$\text{(Watt-sec. or Joule)} = \frac{C \text{ (farads)}}{2}$$

$\times E^2$  (volts), and if  $E$  represents the rated voltage of the capacitor, *rated* energy storage is:

$$W = \frac{k k_1^2 K V}{2}$$

Thus, for any given dielectric material and over a limited thickness range, physical volume is proportional to the energy storage capacity. This rating may be most conveniently calculated from capacitance and voltage ratings if the equation is memorized as:

$$\text{watt-sec.} = \frac{(\text{microfarads}) \times (\text{rated kilovolts})^2}{2}$$

Watt-second ratings of d-c capacitors are quite comparable to the long

## Watt-Second (Joule) Rating, Introduced in Wartime Standards, Now Being Adopted Commercially as an Important Factor in Selection of Life Test and Permissible Operating Voltages at Higher Temperatures.

by J. D. STACY

Capacitor Engineering Section  
General Electric Company

established kva (reactive) ratings of a-c capacitors which are derived from the basic equation of a-c current in a capacitance:

$$I \text{ (amperes)} = \frac{E \text{ (volts)}}{x_c \text{ (reactance ohms)}}$$

where:

$$x_c \text{ (ohms)}$$

$$= \frac{1}{2 \pi f \text{ (frequency)} \times C \text{ (microfarads)} \times 10^{-6}}$$

Therefore,  $I = 2 \pi f C E \times 10^{-6}$ , and  $kvar = EI \times 10^{-3} = 2 \pi f C E^2 \times 10^{-9}$ . It will be noted that this equation contains a  $CE^2$  factor indicating proportionality to volume over a limited thickness range, as above.

### The War Standard

With the issue in 1944 of *American War Standard C-75.16-1944*, many engineers saw, for the first time, a watt-second (Joule) rating of d-c paper capacitors introduced as an important factor in the selection of life test and permissible operating voltages at higher temperatures. This consideration of watt-second rating has been carried into the superseding *PRO JAN-C-25* specification and may be expected to become a part of any d-c paper capacitor standards established in the future.

For the *war standards*, four arbitrary groups of watt-second ratings were selected to cover the field, since it was the opinion of the manufactur-

ers that this would provide an adjustment of test and working voltages adequate to compensate for the factors in capacitor life expectancy which require such adjustment.

The groups are:

Group	Watt-second range
1	0 to 0.5 <sup>(1)</sup>
2	0.5+ to 5.0 <sup>(2)</sup>
3	5.0+ to 50.0
4	50.0+ up

### Factors Which Require This Adjustment

(1) It has become the fairly general practice of the capacitor designer to use the same dielectric thickness for any given voltage rating regardless of the area of dielectric involved. Right or wrong, this practice must be recognized. For any specified voltage, a large watt-second rating involves a large area of dielectric and will result in a greater percentage of rejections by the making of short-time dielectric tests in the factory than the smaller area of dielectric in the small watt-second rating tested at the same voltage. The practice of testing at a definite per cent overvoltage is considered adequate only for conditions where normal room ambient temperatures are encountered.

(2) When it is desired to test or operate a capacitor at elevated temperature, it may be expected that a small unit will dissipate its losses to the surrounding medium with less internal temperature rise than would be encountered by a large unit. This follows because the larger the unit, the lower the ratio of outer surface (dissipating area) to volume, and there is

(Continued on page 40)

<sup>(1)</sup>Limited to capacitors rated 1,000 volts or less except for metal-cased tubular designs for which ratings of 1,500 volts are allowed.

<sup>(2)</sup>Includes capacitors with ratings between 0 and 0.5 watt-second when excluded by voltage rating from group 1.

# RATINGS OF D-C CAPACITORS

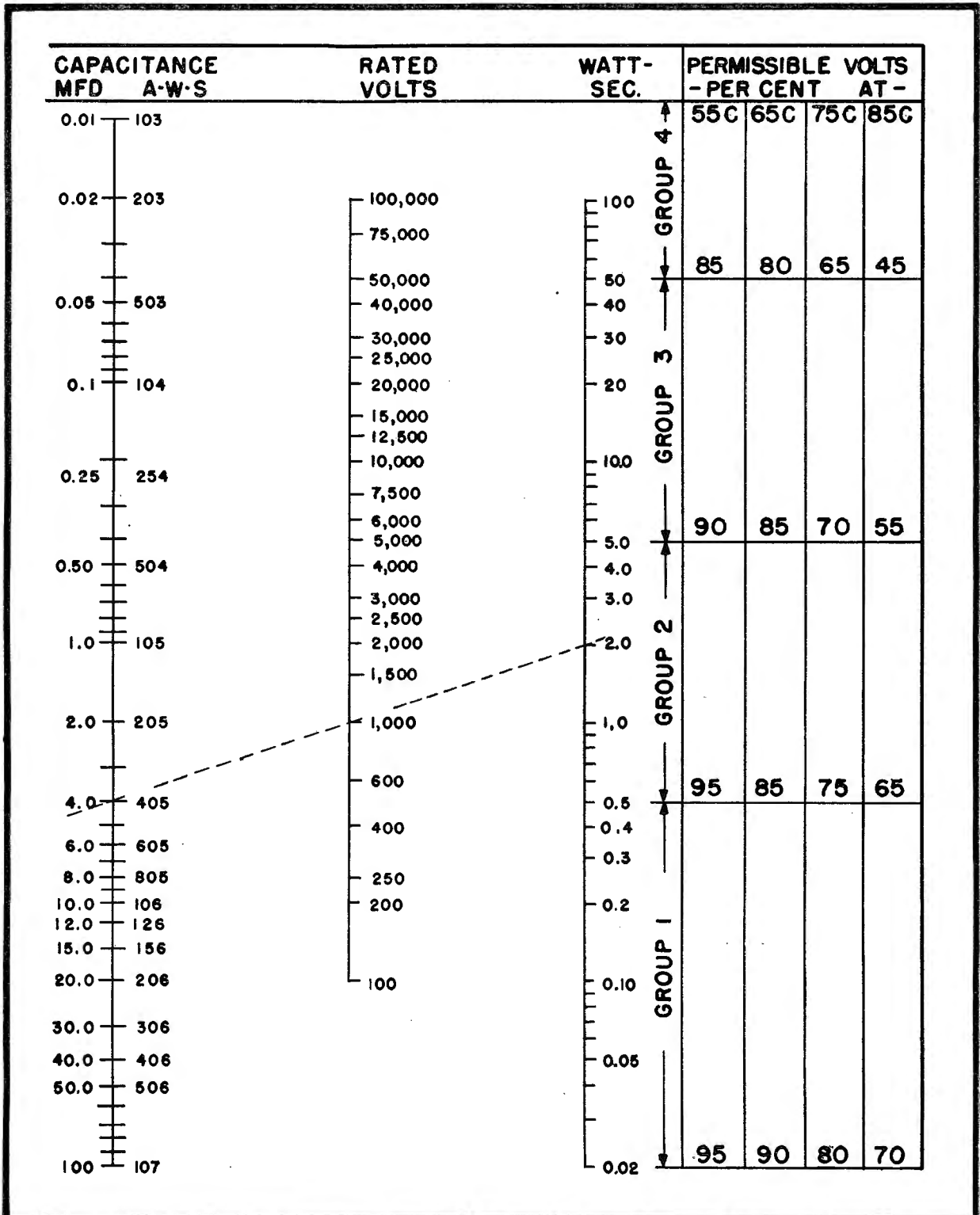

Figure 1. Nomograph providing watt-second rating of usual range of standard d-c paper capacitors and characteristic *D*, *E* and *F* temperature-operating factors of PRO-JAN-C 25, to be applied to voltage ratings in each watt-second group for the most frequently encountered temperatures of surrounding media.

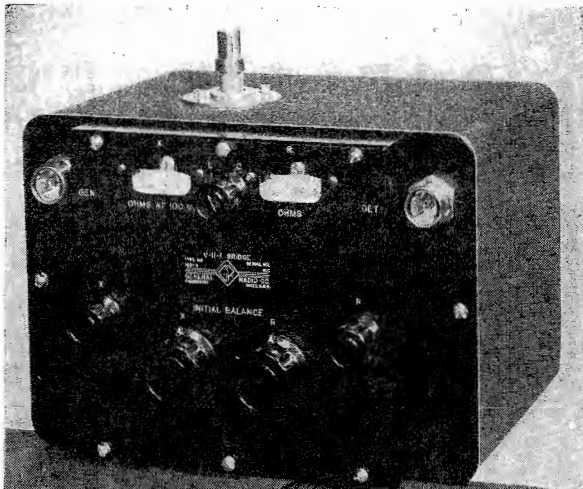
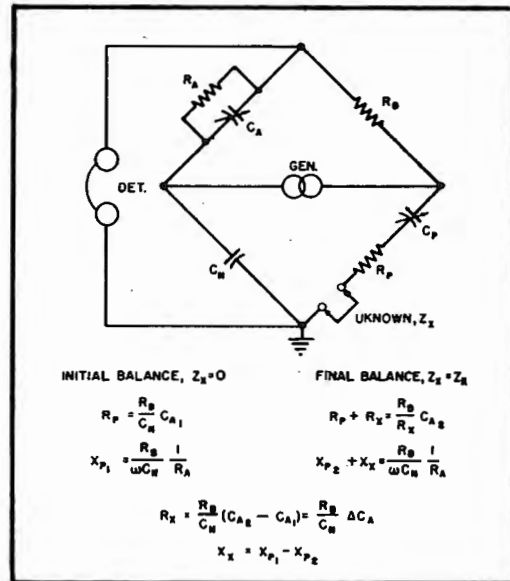

Figure 1 (Right)  
Basic bridge circuit and equations for balancing.

Figure 3 (Above)  
A view of the v-h-f bridge.



# A V-H-F BRIDGE

## For Impedance Measurements Between 20-140 Mc<sup>1</sup>

THE MEASUREMENT of the impedance of both lumped and distributed parameter circuits in the vicinity of 100 mc is complicated by two factors: (1) most impedance-measuring instruments designed for use at lower frequencies are unusable in this range as a result of the errors introduced by stray inductances and stray capacitances, and (2) slotted transmission lines, which are generally used for impedance measurements at higher frequencies, are large and awkward to use.

### Solution to Problem

To solve the problem, a new type of impedance bridge has been developed, which affords measurement of relatively low impedances over the frequency range from about 20 to 140 mc, and is adaptable to measurements on

Bridge for Impedance Measurements on Distributed Parameter Circuits Using Coaxial Transmission Lines, as Well as on Lumped Parameter Circuits, Utilizes a Modified Schering Bridge Circuit in which Both Resistive and Reactive Components of the Unknown Impedance Are Measured in Terms of Incremental Capacitances.

by **ROBERT A. SODERMAN**

Development Engineer  
General Radio Company

<sup>1</sup>From a paper presented at the New England Radio Engineering meeting at Cambridge, Mass.

<sup>2</sup>Sinclair, D. B., *A Radio-Frequency Bridge for Impedance Measurements from 400 kc to 60 mc*, Proc. IRE, pp. 497-503; November 1940.

coaxial-line as well as lumped-constant circuits. This bridge is composed of lumped-constant elements, arranged in a circuit in such manner that errors due to stray inductances and capacitances are kept small. The basic bridge

circuit, the modified Schering type shown in Figure 1, is similar to that used in the r-f bridge developed by D. B. Sinclair<sup>2</sup> in 1940, which is useful up to about 60 mc. In the new bridge, the resistive and reactive components

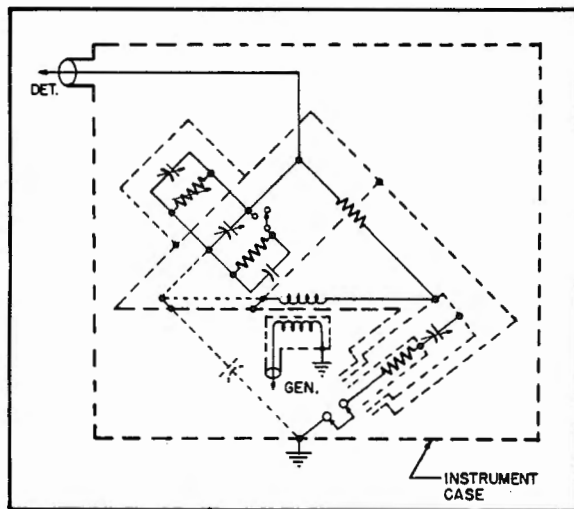

Figure 2  
Complete bridge circuit showing shielding.

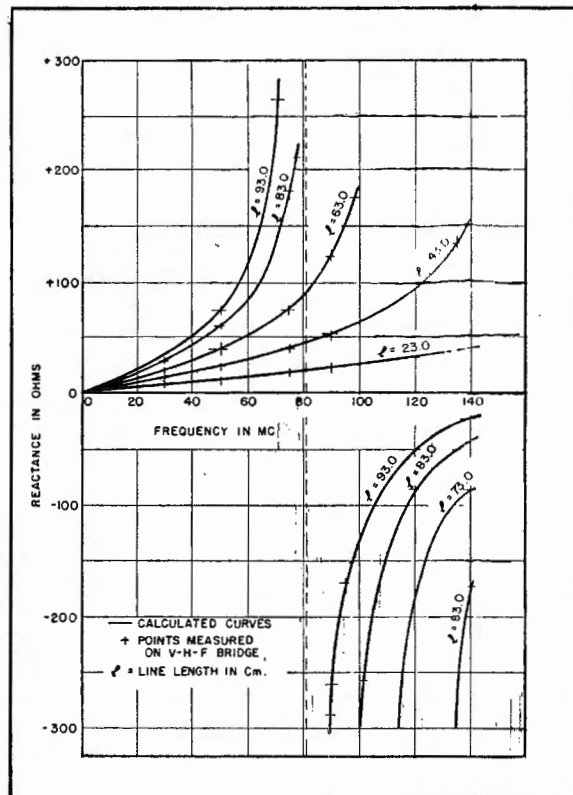

Figure 4  
Measured and calculated reactance of short-circuited 50-ohm coaxial lines as a function of frequency.

of the unknown impedance are measured in terms of incremental capacitances and are indicated on separate dials. The direct-reading resistance range is from 0 to 200 ohms and is independent of frequency except for small corrections. The direct-reading reactance range is from 0 to  $\pm 200$  ohms at 100 mc and is inversely proportional to frequency.

#### Stray Coupling Control

As previously mentioned, common impedances, stray inductances, and stray capacitances in the bridge are serious sources of error in the frequency range under consideration. In some cases, common inductances of the order of 0.5 cm [ $(0.5 \times 10^{-9})$  henries] and stray capacitances of the order of 0.05 mmfd could cause appreciable errors. Fortunately, many of the most serious errors are caused by stray couplings between two or more circuit elements. Stray reactances associated with a single element in most cases affect only the initial balance conditions and have no effect on the accuracy. Therefore, it was found possible to keep the undesired stray couplings, and hence the errors, relatively small by individually shielding most of the

components and by minimizing common inductances.

#### Shielding

Figure 2 shows the complete circuit with the shielding indicated by heavy dotted lines. The additional components indicated over those shown in the basic circuit are used to set up the initial balance.

#### Accuracy

Using the technique outlined for the reduction of errors due to residual parameters, it was possible to obtain an over-all accuracy of better than  $\pm (2\% + 1 \text{ ohm})$  in the resistive component and better than  $\pm (5\% + 2 \text{ ohms})$  in the reactive component. The ohmic uncertainty indicated in the accuracy statement for the resistive component is roughly proportional to the magnitude of the reactive component, and the opposite is true for the reactive component.

#### Coaxial Adapter

The unknown terminal is a very important part of an instrument of this

type, as it must be designed to permit connection of both lumped components and coaxial-line circuits to the bridge with a minimum of transformation of the unknown impedance by stray reactances. With this bridge measurements on coaxial-line circuits can be made relatively accurately, since a coaxial connector can be mounted directly on the bridge, thus eliminating errors due to stray inductance and capacitance of a connecting lead between the terminals on the bridge and the line. In Figure 3, the coaxial adapter is shown mounted on the top surface of the bridge. For measurements on components and many other types of circuits, a pair of terminals or a single terminal and a ground plane are provided.

#### Instrument Uses

This bridge is well adapted to measurements on various types of elements such as resistors, capacitors, inductors, transmission line networks, antennas, etc., over the previously mentioned frequency range. Typical measurements made on various lengths of short-circuited coaxial line over a fairly wide frequency range are compared with the theoretical values in Figure 4.

**A HABIT TO JOE...**

**"NEW IDEA" TO HIS NEPHEW**



**...YET BOTH WANT THE SECURITY  
your P.S. Plan Provides**

HAVE YOU told all your new or recently hired employees about the benefits of the Payroll Savings Plan for the regular purchase of U. S. Savings Bonds? Wage earners, according to a recent nation-wide survey, want security more than anything else. They prefer security to big pay, soft jobs, authority, "success."

There is no surer way to this peace of mind than systematic savings. And what surer, safer, better means can your employees find than payroll allotments for U. S. Savings Bonds? Bonds that return \$4 at maturity for every \$3 they invest!

Your active support of the Payroll Savings Plan is an investment in employee contentment, in the citizenship of your community, and in the security of America's future. This is practical "employee relations" of the highest type and pays dividends of satisfaction to everyone.

Start a drive today for larger participation in the plan. Many employees may be unfamiliar with its advantages. If you want literature for distribution, contact your State Director of the Treasury Department's Savings Bonds Division.

*New  
Savings Bonds Plan  
won't affect the  
P. S. P.*

THE Treasury Department and the banks of America are making it possible for farmers, doctors, and other self-employed people to participate in "automatic" Bond buying by special arrangement with their banks. This extension of the Savings Bonds program is not a partial payment plan and is intended *only* for people who are not in a position to take advantage of the Payroll Savings Plan.

*The Treasury Department acknowledges with appreciation the publication of this message by*

**COMMUNICATIONS**



*This is an official U.S. Treasury advertisement prepared under the auspices of the Treasury Department and The Advertising Council.*

# News Briefs

## INDUSTRY ACTIVITIES

A reorganization of the FCC engineering department was announced recently by George E. Sterling, FCC chief engineer. Chief changes were the promotion of George S. Turner to assistant chief engineer and assistant chief engineer George K. Rollins' transfer to head up a new radio operator and amateur division. Assistant chief engineer John A. Willoughby will be responsible for engineering contacts relating to new broadcast stations, engineering status of applications, and, in part, providing engineering liaison with the CAA in clearance and marking of radio towers.

Branch chief positions in the engineering department was abolished by the directive, and assistant chief engineer Marion H. Woodward has been assigned to common carrier. Marine Radio and Safety will be assigned to William H. Krebs. Mr. Turner, who filled the vacancy created by Mr. Sterling's appointment, was assigned additionally the field engineering and monitor division.

The change abolished the international division, which will now come under the jurisdiction of the radio section of the common carrier division.

Dr. George D. Stoddard, new president of the University of Illinois, will deliver the keynote address at the National Electronics Conference which will be held at the Edgewater Beach Hotel, Chicago, on November 3, 4, and 5. Walter Evans, vice president of Westinghouse Electric Corp., will speak at the Monday luncheon.

The RCA Victor Division of RCA and Warner Bros. Pictures, Inc., have signed a contract for a joint program of research on large-screen television.

The program provides for the shipment of new types of black-and-white large-screen television equipment, developed by the RCA engineering products department, to the Burbank studio for study. RCA will also provide technical and research information and the assistance of engineering personnel and field engineers.

Jack L. Warner has assigned Colonel Nathan Levinson, head of the studio's engineering and technical research staff, to direct the experimental program for Warner's.

Electronic Sound Engineering Co., 4344 W. Armitage Ave., Chicago 39, has granted a license for the manufacture of its high-fidelity amplifier circuit to the Universal Broadcast Equipment Corporation, Chicago, of which Roy T. Rogers is president.

Harry W. Becker, chief engineer of Electronic Sound, is the inventor of the circuit.

Salescrafters, Inc., 510 N. Dearborn Street, Chicago 10, Ill., headed by Bob Karet and Ray Huttmacher, have been appointed national sales representatives for the Amo miniature tube puller made by the Oliveri Tool Co., Chicago.

The third annual electronics trade show of WCEMA will be held from Sept. 26 to 28 in San Francisco. Exhibits will be open to conference attendees on the first two days and the public will be admitted on the third day.

Exhibits are under the direction of W. Noel Eldred, WCEMA secretary, 395 Page Mill Road, Palo Alto, Calif.

The IRE, in San Francisco, will hold a three-day technical conference, Sept. 23 to 25.

Dr. Frederick Terman and William Hewlett are on the papers committee.

The instrument and tube sales division of Allen B. Du Mont Laboratories, Inc., is now located in the building 16, at 1000 Main Avenue, Clifton, N. J. Telephone number is Sherwood 2-7440.

Reeves Sound Studios are now located at 304 East 44 Street, N. Y. City.

Engineers at the Cook Research Laboratories, Chicago, recently discovered a method for locating faults or grounds between inner and outer screens of a screen setup. One standard laboratory oscilloscope, solenoid exploring coil, and a 1-kva, 60-cycle/sec, step-down transformer were used.

In the test method used, similar to a landmine detecting technique, the low-voltage secondary of the transformer was connected with one terminal to the outer screen and one terminal to the inner screen. With its primary energized from the laboratory power circuit, approximately 100 amperes flowed from one screen to the other through the one or more faults. With this fault current flowing, the solenoid exploring coil (having its terminals connected to the vertical deflecting circuit of the oscilloscope) was moved along the inside wall of the room, and particularly along the wall-ceiling and wall-floor junctions.

By observing the oscilloscope screen while moving the coil, the operator could observe the increase or decrease of signal produced by the magnetic field of the fault current flowing in the inner screen. As a fault was approached, the signal amplitude would build up and when going directly over the fault, the amplitude would go to zero and reappear with reversed polarity. In every case, the faults were found to be at the exact points where the polarity reversal took place. To prevent getting false indications of polarity reversal the operator had to take care not to rotate the exploring coil about any of its own axes as he moved it along.

The City of Dayton, Ohio, recently installed a 152.162-mc FTR emergency system for its police department.

A beacon-type transmitting antenna with a power gain of 3 is being used by the mobile transmitters, with a 25-watt output.

Central station 250-watt transmitter is arranged with two exciters. One of these, on a frequency of 156.33 mc is used to drive the final power amplifier at its resonant point. This circuit is employed to transmit all messages for the City of Dayton to its police cruisers. The other exciter, on a frequency of 155.73 mc can be substituted for the first one by operating a switch on the police control console which, in turn, causes the appropriate relays to function in the transmitter cabinet, connecting the second exciter to the final stage.

The receiver is a double conversion super-heterodyne employing two crystals for oscillator control. The first i-f is 10.7 mc and the second i-f is 1.7 mc. Double limiters are used and the audio circuit is de-emphasized to correspond to the transmitter modulation characteristics.

## PERSONALS

John H. Canzenhuber, manager broadcast sales, radio division, Western Electric Company, recently returned from trip to broadcast stations in the west and mid-west.

He reported intense activity in modernizing and enlarging facilities.



Sam Norris, associated with Ampere Electronic Corporation, Brooklyn, N. Y., since 1929 in various sales capacities, has been elected executive vice president.



Charles J. Pannill has retired as president and director of Radiomarine Corporation of America, having reached retirement age under the RCA retirement plan. Mr. Pannill joined RCA on January 1, 1928.

Howard C. Deckard has joined the Federal Telephone and Radio Corporation to become general plant manager of the Clifton plant.

E. N. Wendell, vice president in charge of Federal Telephone and Radio Corporation, Clifton, N. J., has been elected a director of RMA for a three-year term.

Antony Wright, former manager of the television receiver engineering section of RCA, has been named chief engineer of United States Television Mfg. Corp., 3 W. 61 Street, New York 23, N. Y.



Edwin B. Hinck has been named sales manager of Industrial Television, Inc., 36 Franklin Avenue, Nutley 10, N. J. Mr. Hinck was formerly connected with the transmitter sales department of Allen B. Du Mont Laboratories, Inc.

John I. Crockett, Jr., is now sales manager of Merit Coil and Transformer Corp., Chicago.

Herb Becker, 1406 S. Grand Ave., Los Angeles 15, Calif., has been appointed Merit Coil representative for Southern California and Arizona.

General A. W. Marriner, formerly director of the aviation department, International Telecommunication Laboratories, has been named assistant technical director for the International Telephone and Telegraph Corporation.

James R. Donahue, formerly sales manager of Standard Arcturus, has been elected president of Arcturus Radio & Television Corporation, 19 Nesbitt Street, Newark, N. J. Arcturus Radio, subsidiary of Standard Arcturus Corp., will build tv sets.

John V. Rice, formerly associated with National Union Radio Corporation, is now sales manager of the tube division of Standard Arcturus.

David Sarnoff has been elected to serve RCA as its chairman as well as its president.

Maj. Gen. Harry C. Ingles (ret.), president of RCA Institutes, has been elected a director of RCA and its subsidiaries.

(Continued on page 47)

# The Industry Offers

## RCA STUDIO-TYPE IMAGE ORTHICON

A studio-type image orthicon television camera has been developed by the RCA engineering products department.

Camera functions at light levels down to 25 foot candles.

Slightly larger than the portable image orthicon television field camera, the studio camera is designed for use on a dolly or pedestal. It has a battery of four lenses mounted in a rotary turret, the necessary circuits for deflecting the scanning beam, and a video amplifier. Camera also has a self-locking screw focusing mechanism and a built-in electronic view finder and hood.

Lens turret is rotated by turning a handle located on the rear of the camera. A trigger switch is incorporated into the turret control handle to cut off the picture signals while the turret is being turned. The lenses used in the turret are of the Ektar type, and are available in sizes from 35 mm F:2.8 to 135 mm F:3.8.

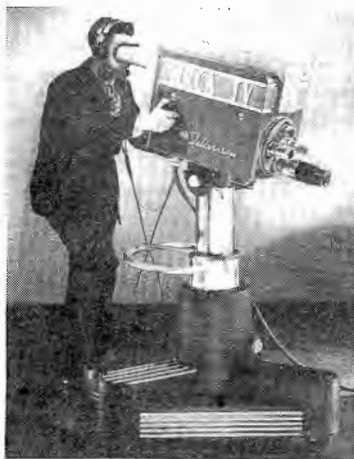

\*\*\*

## RADIO SPECIALTY COAXIAL ANTENNA

A coaxial antenna, RSMC, for use on frequencies between 30 and 200 mc, and with powers up to 250 watts has been announced by Radio Specialty Manufacturing Co., Portland 14, Ore. Antenna is made of aluminum and steel tubing. Maximum antenna weight is 12 pounds.

A standing-wave ratio no greater than 1:1.25 is claimed, with antenna connected to a source of properly tuned r-f through a 75-ohm concentric line.

\*\*\*

## B & W BUTTERFLY TYPE VARIABLE CAPACITORS

A line of variable capacitors, type JCX, featuring butterfly rotor construction has been announced by Barker & Williamson, Inc., 237 Fairfield Avenue, Upper Darby, Pa.

Capacitors are said to have 25% of the frontal area of the heavier CX type capacitors. Units can be used in medium-powered triode or tetrode stage plate circuits where modulated plate voltage does not exceed 1,250 and unmodulated plate voltage is not more than 1,500 volts. The airgap is .125".

Three standard types are available: JCX100E, mounting length of 5 1/2" and a capacity of 100 mmfd per section; JCX50E, 3 3/4" and a capacity of 50 mmfd per section; and JCX25E, 2 3/4" and a capacity of 25 mmfd per section.

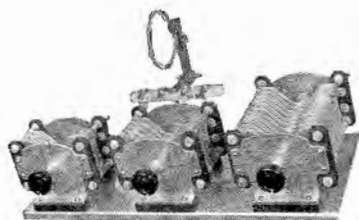

## FAIRCHILD CONSOLE TYPE STUDIO RECORDER

A studio recorder of console type, unit 523 recorder, has been announced by the Fairchild Camera & Instrument Corp., 88-06 Van Wyck Boulevard, Jamaica 1, N. Y. The table accommodates all sizes of acetates as well as 18" flamed wax masters. Features a 33 1/3 rpm Fairchild drive, 541 type magnetic cutterhead, microscope, and lead screw mechanism. Cutting pitch is continuously variable from 80 to 160.

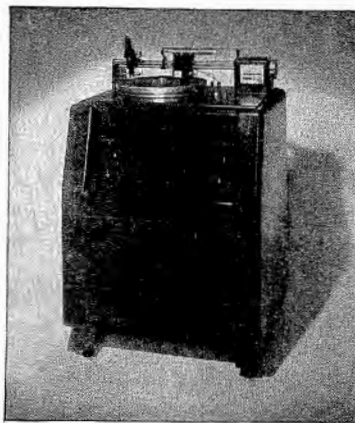

\*\*\*

## PRECISION TEST SET

A 20,000 ohms-per-volt, wide range test set, series 858 multi-master, has been announced by Precision Apparatus Co., Inc., 92-27 Horace Harding Boulevard, Elmhurst, L. I., N. Y. Features automatic push-button range and function selection system.

One row of five buttons selects all functions such as volts, ohms, mills, decibels, amperes and microamperes. Another row of six buttons selects all ranges. There are 54 ranges to 6,000 volts, 600 megohms, 12 amperes, 70 db and 60 microamperes, 20,000 and 1,000 ohms-per-volt d-c, and 1,000 ohms-per-volt a-c.

Incorporates a 50-microampere, 4 1/2" rectangular meter. A 600-megohm insulation resistance test range is provided in addition to five self-contained ohmmeter ranges to 60 megohms.

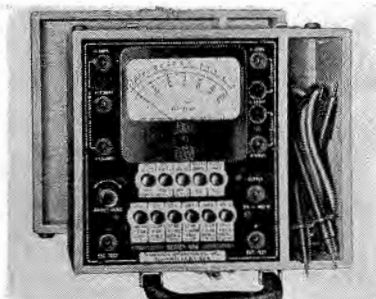

\*\*\*

## ALLIED LAB VTVM

A vtvm, model 730, incorporating miniature tubes, has been announced by Allied Laboratory Instrument, Inc., 355 West 26 Street, New York 1, N. Y.

Instrument has an r-f probe which is said to have a flat response to 120 mc.

Power consumption said to be less than 1 watt. Meter is a 1-milliamperer type. Size 8 1/2" x 5 1/2" x 3".

## EIMAC 65-WATT TETRODE

A 65-watt tetrode, type 4-65A, has been announced by Eitel-McCullough, Inc., 178 San Mateo Avenue, San Bruno, Cal. Tube is radiation cooled, and features an instant-heating 6-volt thoriated tungsten filament, non-emitting grids, and a processed metal plate, all enclosed in a hard glass envelope.

Plate voltage range, 400 to 3,000 volts. In typical operation (class C telegraphy or f-m telephony) at a plate voltage of 400 volts and .1 ampere of plate current, a power-output of 28 watts is obtained with less than 2 watts of grid driving power. In the same type of application a single tube operating at 2,000 plate volts will provide 200 watts of power-output. Performance is said to be maintained well into the v-h-f bands, above 200 mc.

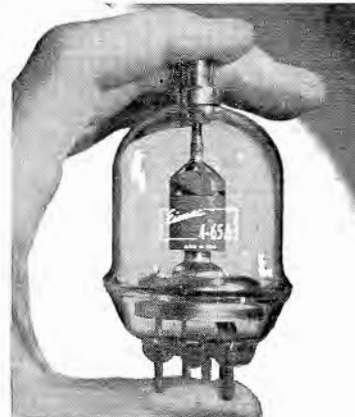

\*\*\*

## UNIVERSAL FREQUENCY RECORD

A constant velocity frequency record, D61A, with a double-faced duplicate recording, has been announced by the Universal Microphone Company, Inglewood 2, California.

It is a 12" recording at 78 rpm, pressed from vinylite, and recorded in three parts. The first section gives a continuously rising tone of 50 to 10,000 cps. Frequencies are voice announced in 15 breaks. The range of frequencies is composed of three consecutive steps recorded at constant velocity: 50-200 cps at +7 db; 200-500 cps at +14 db; and 500-10,000 cps at +21 db. The second section consists of a 1,000-cycle tone recorded in steps of 2 db from +8 to +18. The final section provides a 400-cycle tone recorded at +18 db, with zero reference established at an arbitrary level.

\*\*\*

## LANGEVIN 20-WATT AMPLIFIERS FOR WIRED MUSIC

Amplifiers providing approximately 20 watts (+43 dbm) with less than 2% rms total harmonic distortion from 100 to 7,500 cycles, or less than 5% rms total harmonic distortion from 50 to 15,000 cycles have been announced by the Langevin Co., 37 W. 65 Street, New York 23, N. Y.

Four types are available: wired music input (type 610-A), low-level microphone input (type

(Continued on page 42)

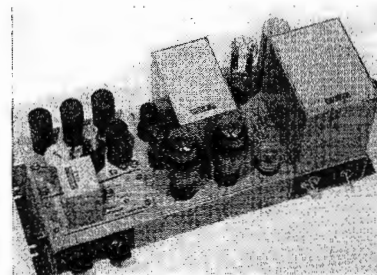



**P**icture  
of **YOUR**  
cable  
requirements  
being  
protected  
by

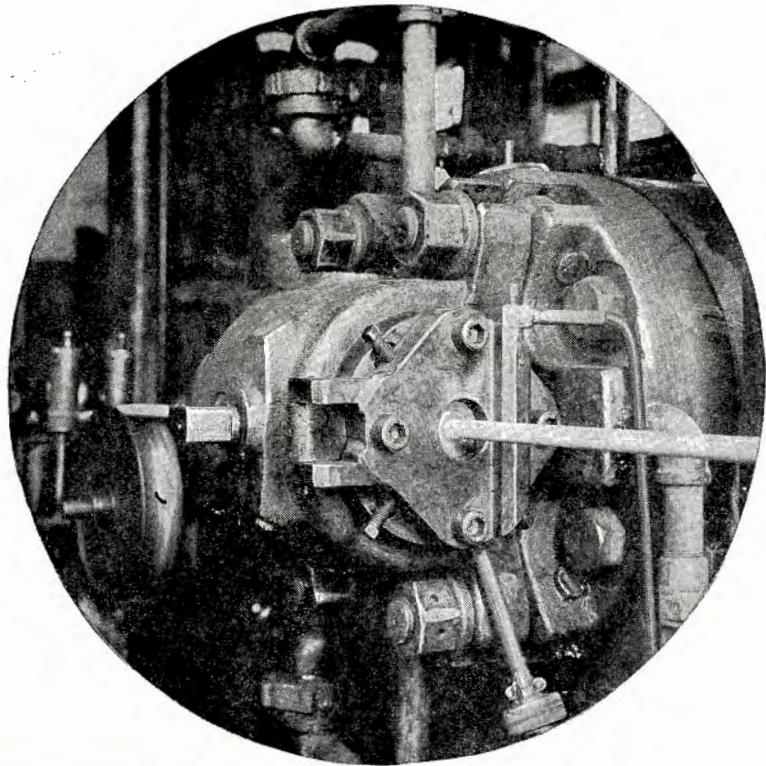

★ **ANSONIA** ★  
**Ankoseal**



Complicated control cables or relatively simple communications wiring, your cables will last longer and give better service when coated with Ankoseal. Equally as important, you will secure a cable that is precisely engineered for your job.

**THE ANSONIA ELECTRICAL DIVISION**  
ANSONIA, CONNECTICUT *of*  
**NOMA ELECTRIC CORPORATION**



## U. N. Communications

THE GIANT U. N. communications system, now under the direction of VWOA honorary member Major General Frank E. Stoner will provide for the most extensive coverage of the world ever scheduled.

The system, involving an expenditure of about eight million dollars, includes an European station, originating and relay; Pacific area relay station, and a Latin American originating and relay point.

Describing the system, General Stoner said that each originating center will have complete equipment for transmission and reception, connected by wire, low-power radio or microwave channels, permitting re-broadcasting on standard or local existing networks.

Gen. Stoner also revealed that a study of the listening habits indicated that approximately three-hundred million people throughout the world daily listen to some form of broadcasting and that most are in the habit of listening to their own local networks. It was decided therefore that the maximum listening audience could be obtained only by feeding the existing standard and low-frequency networks and that only a small portion of the world's population could be reached by direct high-frequency international broadcasting.

Provision of international broadcasting frequencies which will not dislodge or interfere with existing services is being sought by the U. N. A conservative initial estimation of the needs for the United Nations is twelve frequencies in the international broadcasting band. This problem is now being considered by the Atlantic City Telecommunications Conference.

Gen. Stoner pointed out that in the plan for use of international broadcasting and press distribution for the United Nations, programs in one country may be supplied by wire or radio point-to-point transmission for rebroadcasting over standard frequency stations in other countries. The plan provides for the export of recordings and script material for use



VWOA honorary member Brigadier General Frank E. Stoner (right), who is now United Nations chief communications engineer, congratulating Capt. G. H. Finch on the recent use of Finch facsimile apparatus at U. N. headquarters.

by stations in other countries. It is felt that all methods of distribution of actual programs and program material must be used in an effort to reduce the international frequency requirements of the United Nations to the minimum.

The United Nations' own facilities will not be employed for handling any official business to member nations and will refrain from entering the point-to-point general service field in competition with member nations' commercial systems, said Gen. Stoner. He pointed out that it is neither possible nor desirable for the United Nations to establish a world-wide point-to-point system for handling its own official message business.

### System Uses

Discussing the communications system applications, Gen. Stoner said that it is assumed that all of the specialized agencies will use the United Nations network facilities for mass communications in an effort to effect the widest dissemination of material rapidly and economically.

He said: "Broadcasts of United Nations press material and releases will be handled expeditiously by super-imposing a radio-printer on active voice broadcast channels, permitting the handling of voice and printed

record simultaneously without harm to the quality of the voice transmissions. The large number of field offices to be established throughout the world will be able to receive both voice and U. N. press releases for rapid dissemination in their own area. This type of service will create for the newspapers and broadcasting stations of the world a reserve of United Nations material always available and timely.

"The U. N. communications network will serve as a feeder to all national and international networks from its one primary and three secondary stations. It should service all the networks of the world. Its size should not cause the dislodgment of any high-frequency station operating in the national or international public interest.

### Value of Communications

"The war revealed in a spectacular way the vital significance of communications. Armies of the Allied nations, separated by oceans and continents, were connected together and controlled by integrated national systems—national systems through combined procedures and methods operated efficiently as a single integrated system. Messages jumped from cable to radio to land line and between national networks with speed and accuracy. Leaders were able to communicate orally around the world. Written messages were sent from hemisphere to hemisphere in seconds. Soldiers were separated from their homeland only by the distance to the nearest telephone.

"Dissemination of mass material by electrical means was essential to the defeat of the common enemy. The maintenance of a firm peace requires comparable, if not better, world-wide service to defeat the enemies of mankind—ignorance, fear, misunderstanding, selfishness and mistrust. Our plan calls for the expenditure of only a minute portion of the amount we spent during the war—small insurance for the preservation of peace!"

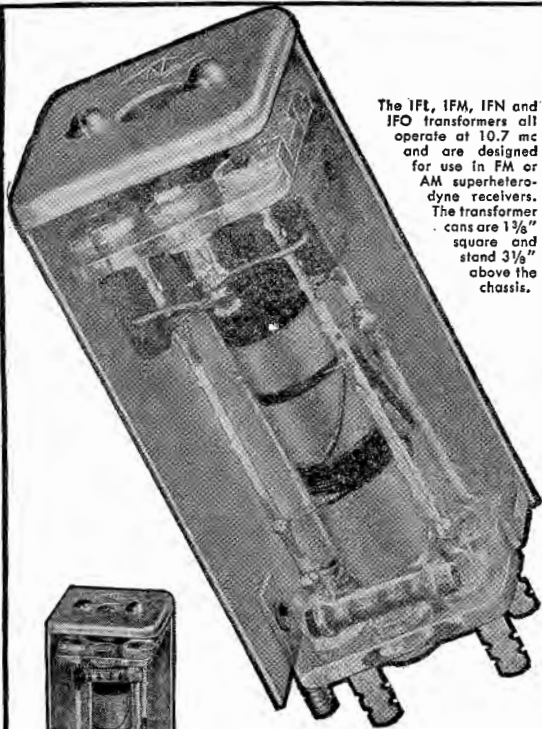

The IFT, IFM, IFN and IFO transformers all operate at 10.7 mc and are designed for use in FM or AM superheterodyne receivers. The transformer cans are 1 3/8" square and stand 3 1/8" above the chassis.



The IFM is an IF transformer with a 150 KC bandwidth at 1.5 db attenuation. Approximate stage gain of 30 is obtained when used with 6SG7 tube. Net Price.....\$6.45



The IFL discriminator transformer is suitable for use in conventional FM receiver discriminator circuits and is linear over a band of  $\pm 100$  KC. Net price.....\$6.90

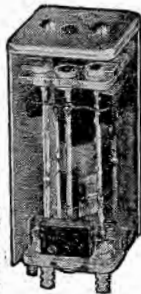

The IFN is an IF transformer with a 100 KC bandwidth at 1.5 db attenuation. Approximate stage gain of 30 is obtained when used with 6SG7 tube. Net Price.....\$6.45

The IFO is an FM discriminator transformer of the ratio type and is linear over a band of  $\pm 100$  KC. Net Price.....\$6.98

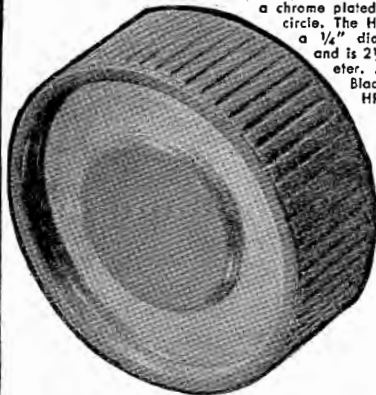

The HRT is a new plastic tuning knob with a chrome plated appearance circle. The HRT knob fits a 1/4" diameter shaft and is 2 1/8" in diameter. Available in Black or Gray. HRT Knob. Net Price \$ .75

The HRS Knobs are a new series of plastic knobs with a chrome-plated skirt. They all fit 1/4" diameter shafts. Three types are available in Black or Gray.



HRS-3 Knob.....0-10 through 300° rotation. Net price.....\$ .51



HRS-1 Knob....ON-OFF through 30° rotation. Net price.....\$ .51



HRS-2 Knob.....5-0-5 through 180° rotation. Net price.....\$ .51



## THE NATIONAL EMBLEM ON PARTS IS YOUR GUARANTEE OF QUALITY

For over 25 years, hams, engineers and radio technicians have agreed that National parts were thoroughly reliable in manufacture and performance.

That reputation is your guarantee of quality when ordering National parts for new equipment.

If you need parts that will fit as they're supposed to, that will give you long hard service, then National's your best bet — as any radio veteran can tell you.

Send today for your copy of the new 1947 National catalog, containing over 600 parts.

**National Company, Inc.**  
Dept. No. 11  
Malden, Mass.

MAKERS OF LIFETIME RADIO EQUIPMENT

# MOBILE F-M COMMUNICATIONS Equipment For 30 to 44 mc

---

Part II' . . . Data on Transmitter and Fixed-Station Equipment. Transmitter Uses Crystal-Controlled Master Oscillator, Phase-Shift Variable Transconductance Type Modulation and Four Frequency-Multiplying and Amplifying Stages. Discussed Also Are the Receiving Selective-Calling System Which Employs a Two-Tube Wien-Bridge Oscillator Circuit.

---

by R. B. HOFFMAN and E. W. MARKOW

Radio Equipment Division  
Federal Telephone and Radio Corp.

IN THE INITIAL installment, which appeared in the June, 1947, issue of COMMUNICATIONS, circuit and operating data on the f-m receiver were presented. In this, the concluding installment, the transmitter and fixed-station equipment are analyzed.

## Transmitter

The mobile transmitter, Fig. 5, consists essentially of a crystal-controlled master oscillator; a phase shift, variable transconductance-type modulator; and four frequency-multiplying and amplifying stages driving the power amplifier stage. The power-amplifier stage consists of either one 5516 or two in parallel, providing respectively 25 or 50 watts of r-f power.

The 6AK5s are used in the oscillator, modulator, first doubler, quadrupler, second doubler, and doubler-driver stages.

The oscillator is conventional, crystal-controlled; crystal exhibits a frequency shift of less than  $\pm 0.1\%$  over a temperature range of  $-30^{\circ}\text{C}$  to  $70^{\circ}\text{C}$ . The r-f signal is then modulated by the 6AK5 modulator applied to the grid of the first doubler, and further multiplied and amplified by succeeding quadrupler, second doubler,

and doubler-driver stages. Each of these stages operates as a saturated class C amplifier. The output of the power-amplifier stage, also operating class C, is coupled to the antenna through a tuned-pi network.

## Variable Transconductance Phase-Shift Modulator

In this system the value of the cathode resistor is very high so that the grid bias of the remote cut-off tube is high and the tube transconductance is low. The master oscillator voltage is fed to the tuned plate circuit of the modulator through two paths: (1) grid-to-plate capacitance of the tube, and (2) tube conduction. Thus, the voltage developed across the tuned plate circuit consists of two components, nearly opposite in phase with respect to each other. With no modulating signal being applied, these two components are equal in magnitude. When an audio signal is applied from the microphone to the grid the instantaneous value of tube transconductance and the amount of r-f plate current is changed in accordance with the

<sup>1</sup>Part I appeared in June, 1947, COMMUNICATIONS.

instantaneous magnitude of the audio voltage. As the audio signal increases and decreases through its cycle the r-f component of voltage across the tuned circuit changes accordingly in magnitude. Since, however, the component due to grid-to-plate capacity conduction remains constant, the resultant r-f voltage across the tuned plate circuit shifts in phase through an angle  $\alpha$ . Thus, changes in the instantaneous magnitude of the audio signal express themselves as corresponding excursions of the phase angle and phase deviations of the r-f voltage from the phase at zero modulating signal condition. The frequency of the audio signal expresses itself as the *rate* with which the phase of the resultant r-f voltage changes. The usable a-f modulation band extends up to about 3 kc. The maximum equivalent frequency deviation does not exceed 15 kc in accordance with FCC requirements. Any amplitude modulation introduced by the modulator is eliminated by the succeeding saturated r-f stages.

Plate and screen potentials required for the transmitter operation are obtained from a built-in dynamotor which derives its power from the car battery. For fixed installations the dynamotor is replaced by a separate 117-volt 50/60-cycle-operated power pack.

## Fixed Station Equipment

A fixed station console is also available. This includes a 50-watt transmitter, receiver, transmitter power supply, speech amplifier, and a carrier monitor (optional).

The receiver power supply is operated from 117 volts a-c, and employs a 5Y3-GT in place of the 6X5-GT. The receiver is not operated with the *selective-calling* feature and can therefore hear all mobile units in the system.

Transmitter plate, heater and relay power is derived from an external a-c operated power supply. For the 6-volt d-c relay, power is obtained from a selenium rectifier circuit using a bridge-type circuit and filter. Plate power is obtained from a conventional full-wave rectifier circuit using a 5R4-GY.

The speech amplifier includes four selective-calling signal oscillators, an

800-cycle attention-tone oscillator, 7,000-cycle sub-carrier oscillator, modulator, two-stage pre-amplifier, and a modulation-level limiter. The selective-calling oscillators are used only to generate the low-frequency signal to which the receiver decoders are responsive and operate only during the one-second interval when the *select* tone is being transmitted. The 7,000-cycle oscillator provides the carrier for the low frequency signal and is modulated in the modulator stage. A one-second *select* tone transmission period is obtained by using a relay connected in series with a large capacitor; the relay opening and breaking the *select* oscillator circuits after an interval of about one second. The preamplifier provides gain for the low level microphone used at the fixed station.

### Preamplifier

The preamplifier consists of one stage of audio amplification, one limiter stage, and one power output stage, employing a 6SL7-GT, 6AL5, and a 6V6-GT respectively. The amplifier circuit is a conventional resistance-coupled circuit. The function of the limiter is to provide constant amplifier output so that the transmitter frequency deviations are kept within the required limits of  $\pm 15$  kc. The limiter circuit is arranged so that one-half of the 6AL5 limits the positive peaks of modulating voltage and the other half of the tube the negative peaks of the signal. The limiter is capable of maintaining amplifier output variations within 10 db of a constant level for a 40-db variation of amplifier input signals. For all practical purposes, this provides constant output for all normal microphone users. The level limiting is adjustable by means of a potentiometer at the rear of the console, as is the output of the amplifier. The output impedances of the preamplifier are 3.2 ohms (used in other applications to drive a loudspeaker) and 600 ohms which feeds the transmitter through a matching pad.

### Selective-Calling Oscillator

Each of the selective-calling oscillators is a two-tube Wien-bridge-type oscillator consisting of one-half of each a 6SL7-GT and 6SN7-GT, both

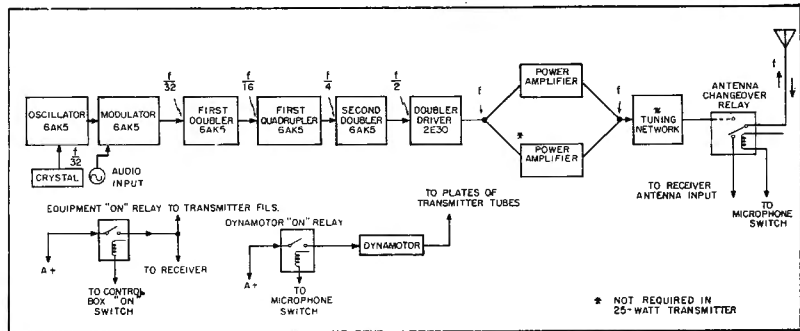

Figure 5  
Block diagram of the 25/50-watt i-m mobile transmitter.

dual triodes. The oscillators do not operate until the push button associated with the particular channel desired is pressed and the *plate-on* lever switch depressed. The sub-carrier and attention-tone oscillators are also of the Wien-bridge type and are similar to those used for *select* tone signals.

The 7,000-cycle sub-carrier is modulated by the low-frequency *select* tone signal in the modulator stage which consists of a dual triode 6SN7-GT connected as a conventional Heising amplitude modulator. The modulator, Figure 6, produces essentially 100% modulation with very little distortion. The low-frequency signal is applied to the grid of  $V_1$  and the 7,000-cycle tone is applied to the grid of  $V_2$ . The d-c plate voltage of  $V_2$  is adjusted to be

equal to  $\frac{1}{2}$  the signal voltage swing across  $R_{L1}$ . The output of  $V_1$  is superimposed on the d-c plate voltage of  $V_2$ , thereby causing the instantaneous plate voltage to vary from zero to twice the d-c value in accordance with the low-frequency signal impressed on the grid of  $V_1$ . This results in a variation in amplitude of the 7,000-cycle signal in accordance with the low-frequency signal. A high pass R-C filter is provided in the output of  $V_2$  to pass the modulated 7,000-cycle tone, but to block the low-frequency signal.

The design features described in this article are applicable to 152-162 mc equipment, with selective-calling and squelch circuits virtually identical. The r-f stages require major changes at the higher frequencies.

Figure 6  
Diagrammatic analysis of the 7000 cycle sub-carrier modulator.

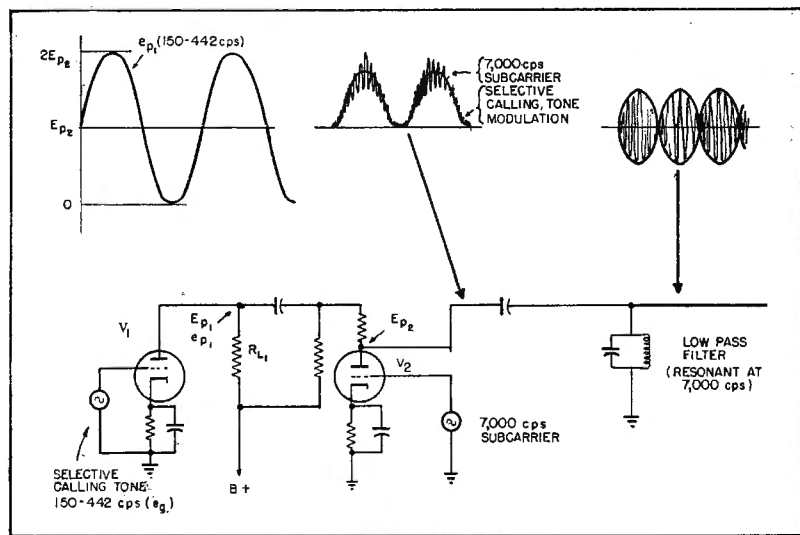

Designed for



Application



**The No. 92101—Antenna Matching Preamplifier**

The Millen 92101 is an electronic impedance matching device and a broad-band preamplifier combined into a single unit, designed primarily for operation on 6 and 10 meters. Coils for 20 meter band also available. This unit is the result of combined engineering efforts on the part of General Electric Company and the James Millen Manufacturing Company. The original model was described in C.E. Ham News, November-December, 1946. The No. 92101 is extremely compact, the case measuring only 6 1/4" x 5 1/4" x 3". The band changing inductor unit plugs into the opening in the front of the panel. Plug is provided for securing power requirements for the 6AK5 tube from the receiver. Coaxial connectors are furnished for the antenna and receiver connections.

**JAMES MILLEN MFG. CO., INC.**

MAIN OFFICE AND FACTORY  
MALDEN  
MASSACHUSETTS



**Gain Control**

(Continued from page 18)

amplifier that provides a regulated audio flow, and an improved type of peak limiter amplifier.

**Operation of Unit**

The input signal is first fed into the guardian amplifier and from there, branches into two circuits, part going into the rectifying and memory and part going to the peak limiter. The output of the rectifying and memory circuit controls the gain of the guardian amplifier. The output of the limiter also branches into two circuits, part going to the output load and part to the rectifier and bias control circuits which provides fast gain reduction action of the peak limiter amplifier.

The input controls of the guardian amplifier are adjusted so that the average peak input signal is -31 db. The average peak into the limiter then occurs at A (Figure 3) which is at the knee of the curve and the average peak output is +22 db; this value being made equivalent to 80% modulation. As the body of the program material falls below the average peak, the full dynamic range of the material is reproduced due to the linear action of both amplifiers. Any transient peaks above the average peaks are compressed in the limiter section by the peak limiter action.

If the average peak value of the input should increase and remain there for any reason, as from -31 db to -21 db, the input to the limiter will increase to B (Figure 3) and the average peak output will +23 db, or 90% modulation. Under this condition, part of the body of the program below the average peaks will be compressed in the limiter. The gain of the guardian amplifier is then reduced to the -10 db control line so that the increased input produces an output from the guardian back at A, and the output from the limiter is again back at +22 db. The time for the guardian section to decrease its gain is much slower than the limiter attack time but is still too fast to be detected by the ear.

**RC Time Constant Circuit**

To make the automatic gain control action possible, without destroying the dynamic range, a special circuit has been devised using RC time constants where the charging of the circuit is fast and the discharge of the

It's

• *Legri S*

for

• **RESISTORS**

HALF - ONE - TWO WATT

- INSULATED
- ANY TOLERANCE  
(Resistors calibrated within 1 and 2%)
- ANY QUANTITY
- ANY MAKE
- ALL SELECTED AND SORTED

*Immediate Delivery!*

**FROM STOCK**

**WE SHIP THE SAME DAY YOUR ORDER IS RECEIVED**

*Inquire Today!*

**LEGRI S COMPANY, INC.**

*Electronic Parts and Components*

846-850 AMSTERDAM AVENUE

NEW YORK 25, N. Y.

AC 2-0018

*Crystals for the Critical*



**"STABILIZED"**

**H11 FOR MARINE AND AIRPLANE APPLICATION**

The H11 is known the world over as the old standby for airplane and marine application. Frequency tolerance held to .004% over a wide temperature range. 3-pin base with pin diameter .156" and spaced .500 and .812". Can be supplied with two crystals or one crystal and a heater unit for maintaining constant temperature.

*Write for Illustrated Folder*

**The JAMES KNIGHTS CO.**  
SANDWICH, ILLINOIS

circuit is slow, with the added feature of a delay before the discharge of the circuit takes place. This delay provides that if the signal level drops, the gain is not changed in the amplifier until the pre-determined time has elapsed. The fast charging of the circuit goes into action whenever the signal level is increased above its normal level thereby reducing the gain of the amplifier in proportion to the signal increase. Both of the amplifier sections operate on the servo-mechanism principles where the control of the circuit is determined by the permissible error in the control circuit. By this, the automatic gain control section allows a 1-db increase in the output for every 10-db increase of the input. The gain control of this section, therefore, must provide a gain reduction of 9 db for the permissible 1-db increase of the output. This same reference control action takes place in the limiting section above the knee of the curve.

If it is desired, the limiter may be operated as a compressor amplifier. There is a gain control between the guardian and limiter sections which allows the point *A* of Figure 3 to be moved from the knee of the limiter curve to any point up to 16 db above the knee. The limiter itself will take care of peaks as high as 30 db above the knee.

## Railroad Receiver Design

(Continued from page 17)

sponses further than 120 kc from the carrier.

The receiver crystal drift is well within .005%, being temperature compensated.

The receiver is satisfactory for use in any 120-kc channel spacing system without regard to physical spacing of equipment. Tuning of the receiver is quite simple since metering of the harmonic generator grid circuit allows accurate setting of the oscillator-plate coil, while metering of the squelch current allows setting the harmonic generator plate load as well as all r-f and i-f circuits. Because of the heavy utilization of the emergency band, it is necessary to set crystal and i-f frequencies with extreme care on this or any other equipment.

**NEW**  
TECH-LAB  
DEVELOPMENT

For **RAPID**  
**MEASUREMENT**  
OF  
**AUDIO FREQUENCY**  
**GAIN or LOSS**

**TYPE 1A**  
**TRANSMISSION**  
**MEASURING SET**

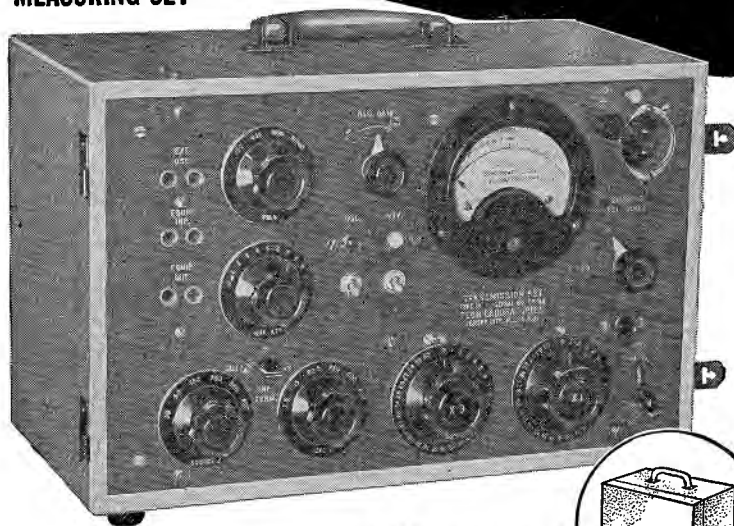

*Completely Self-Contained*

PORTABLE • AC OPERATED

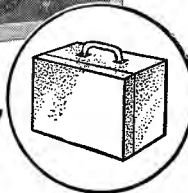

With this instrument it is possible to quickly and accurately analyze and service equipment in different locations without fuss in time consuming demounting and transportation of apparatus. It will thus pay for itself in a short time and no modern radio station can afford to be without it. It can also be used to good advantage in factory checking and inspection of audio equipment.

The set combines in a modern efficient manner an accurate vacuum tube voltmeter, an audio oscillator with four fixed frequencies and a precision attenuator all mounted in a handy cabinet easily carried by the operator.

### SPECIFICATIONS

- GAIN: Up to 80 db.
- LOSS: 60 db. maximum.
- VACUUM TUBE VOLTMETER:  
Range—40 to +40 db.  
(1 mv. ref. level)
- AUDIO OSCILLATOR:  
Freq. Range; 100 to  
10,000.
- PRECISION ATTENUATOR:  
Flat to 20 KC; 93 db.  
in .1 db. steps.
- DIMENSIONS:  
10 1/4" x 16 1/4" x 8 3/4"
- WEIGHT: 30 lbs.
- INPUT: 115 Volts.  
60 cycles, 70 watts.

**TECH**  
LABORATORIES, INC.

Manufacturers of Precision Electrical Resistance Instruments  
337 CENTRAL AVE. • JERSEY CITY 7, N. J.

# RH-7B

RH-7B can be supplied with 3-15 mc fundamental output frequencies, or 15-75 mc harmonic mode output frequencies.

By doubling or tripling in the plate circuit of the crystal stage, sufficient output can be obtained to excite the following stage in a transmitter to frequencies as high as 200 mc.

This versatile crystal unit can also be used as a local oscillator in a receiver at frequencies up to 200 mc.

Capacity between pins in the harmonic mode unit is less than 4 mmfd. As low as  $\pm 0.005\%$  maximum frequency drift over a temperature range of  $-55^{\circ}\text{C}$  to  $+90^{\circ}\text{C}$ .

Write for Bulletin RHC-3

## REEVES-HOFFMAN CORPORATION

SALES OFFICE: 215 EAST 91 STREET, NEW YORK 28, N. Y.  
PLANT: 321, CHERRY STREET, CARLISLE, PA.

## Carrier Communications

(Continued from page 21)

much less economical of space in the carrier-frequency spectrum than is the simplex system. Since crowding of the carrier spectrum is a serious problem on many power systems today, this factor alone is often sufficient to rule out the use of the duplex system.

The major advantage of the duplex system, an advantage which in the minds of some users outweighs any disadvantages it may have, is its ability to provide two-way conversation without the switching operations required by the simplex system. Modern automatic simplex equipment, however, practically eliminates the basis for any objections that may exist in regard to switching because the switching function is so rapid and quiet that the user of the equipment usually is unable to detect the fact that it is taking place. In up-to-date automatic simplex equipment, the transfer from sending to receiving conditions can be made so rapid that a party speaking can be interrupted during a sentence. The inability of the listener to interrupt the speaker in this manner has been an objection to the automatic simplex system in the past.

### Single-Frequency Manual-Simplex System

In the manual-simplex system, the switching operations necessary to transfer the equipment from the receiving to the transmitting condition and back again are performed manually by the speaker, usually by means of a push-button on the telephone handset. Although it is sometimes possible to provide for complete operation of the equipment over a two-wire extension, a control circuit separate from the speech circuits is usually necessary. This is one of the most important disadvantages of the manual simplex system, aside from the fact that users must become accustomed to performing the necessary switching

Figure 5  
Basic units of a manual simplex carrier-communications assembly.

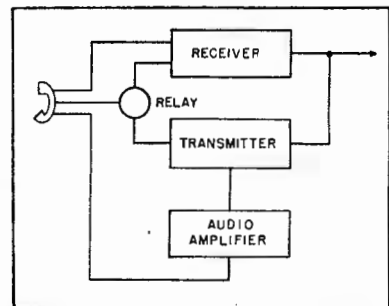

### JONES TERMINAL PANELS

Our large variety of Terminals plus special equipment enable us to give unusual service on special Terminal Panels. Send us a print or description of your requirements and we will promptly submit prices and deliveries. Hundreds of standard Terminal Strips listed in Catalog No. 14. Send for your copy today.

HOWARD B. JONES DIV.  
CINCH MFG. CORP.  
2460 W. GEORGE STREET  
CHICAGO 18, ILLINOIS

# new

## CONCORD Radio Catalog

### free

Featuring Outstanding Values in:

#### INDUSTRIAL ELECTRONIC AND TEST EQUIPMENT

#### RADIO PARTS • SETS • AMPLIFIERS

This is it—the new 1947 Concord Catalog—a vast, complete selection of everything in Radio and Electronics—thousands of items available for IMMEDIATE SHIPMENT from CHICAGO or ATLANTA—hundreds now available for the first time—featuring new, latest 1947 prices. See new LOWER prices on RADIO SETS, PHONO-RADIOS, RECORD CHANGERS, RECORD PLAYERS, PORTABLES, AMPLIFIERS, COMPLETE SOUND SYSTEMS, TESTERS. See latest listings of standard, dependable lines of radio parts and equipment—tubes, condensers, transformers, relays, etc. Write for FREE COPY—NOW! Address Dept. R-87.

TIME PAYMENTS: Write us for details of time payment plan on Communications Receivers, Amplifiers, Test Equipment, Radios, Phono-Radios, etc.

# CONCORD

RADIO CORPORATION  
LAFAYETTE RADIO CORPORATION  
CHICAGO 7, ILL.      ATLANTA 3, GA.  
501 W. Jackson Blvd.      255 Peachtree St.



operation. The requirement that d-c control circuits be provided, plus the fact that a special telephone instrument with a *push-to-talk* button is necessary, precludes any simple method of extending a manual simplex telephone channel through a conventional PBX board. The system is therefore generally used where a simple point-to-point communication channel is required and telephone extensions from the carrier set are short and relatively few in number. For such applications as routine or emergency communication between system operators who are accustomed to handling the equipment, the manual simplex system is often entirely adequate.

The block diagram of Figure 5 shows the basic units required for a manual simplex assembly. The relay removes power from the receiver and applies it to the transmitter when the control button on the handset is operated. The audio amplifier is sometimes omitted.

#### Two-Frequency Duplex System

The basic units of a two-frequency duplex assembly are shown in Fig. 6. Aside from the fact that the transmitter and receiver operate on different frequencies, the most important difference between this assembly and that of Figure 5 is the addition of the audio hybrid unit. It is this unit which makes it possible for the transmitter and the receiver to operate continuously during the conversation, without switching operations, with a conventional two-wire telephone extension.

Figure 7 shows a complete two-frequency duplex assembly. From top to bottom, the units are the transmitter, audio amplifier, panel for test meter unit, superheterodyne receiver, audio hybrid unit, power distribution unit, 640-volt rectifier unit, and 120-volt rectifier unit.

The assembly shown in Figure 7 is used with telephone extensions that  
(Continued on page 46)

Figure 6  
The basic units of a two-frequency duplex-communication assembly.

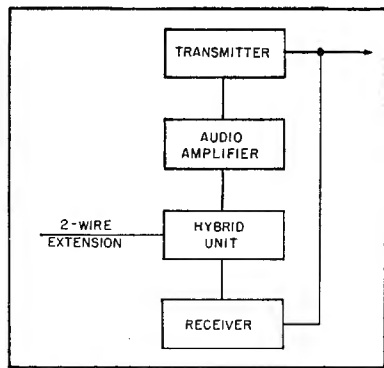

## Andrew "KNOW-HOW" in FM makes W-E-L-D technically outstanding

- Andrew Co. congratulates LESTER H. NAFZGER, chief engineer of Ohio's first FM station, WELD in Columbus, on a technically outstanding installation.

The entire transmission line system was supplied by Andrew Co. and installed by WELD with the assistance of skilled Andrew Engineers.

The Andrew reputation for supplying quality components, and for engineering skill, already is well established in the FM field. Call on Andrew for assistance in solving *your* FM problems!

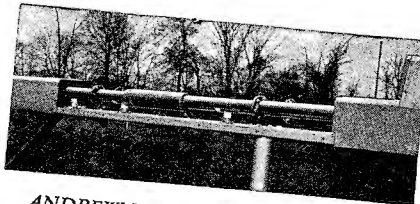

ANDREW FM-AM isolation section with cover removed, revealing two 3/8" FM transmission lines and expansion joints.

#### ANDREW CO. EQUIPMENT AT WELD

- Duplicate 3/8" FM transmission lines, expansion joints, elbows, tower brackets, and all fittings.
- Horizontal "bazooka" sections for isolating WELD (FM) from WBNS (AM).
- Auxiliary antenna for standby service.
- Assistance to WELD personnel in installation of transmission line and "bazooka."

# ANDREW CO.

363 EAST 75th STREET • CHICAGO 19



WRITE FOR  
COMPLETE CATALOG

Pioneer Specialists in the Manufacture of a Complete Line of Antenna Equipment



# STANDARDIZED READY-TO-USE METAL EQUIPMENT

ADAPTABLE FOR EVERY REQUIREMENT

Par-Metal Equipment offers many features, including functional streamlined design, rugged construction, beautiful finish . . . plus ADAPTABILITY. Eliminate need for special made-to-order units on many jobs.

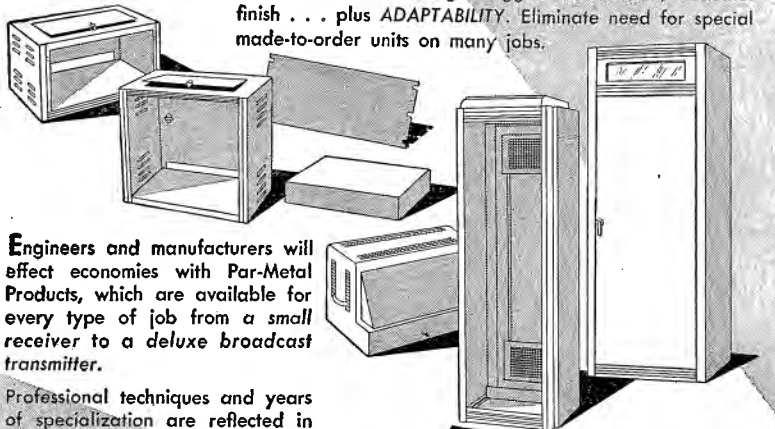

Engineers and manufacturers will effect economies with Par-Metal Products, which are available for every type of job from a small receiver to a deluxe broadcast transmitter.

Professional techniques and years of specialization are reflected in the high quality of Par-Metal. . .

**CABINETS • CHASSIS  
PANELS • RACKS**

*Write for Catalog*



## D-C Capacitors

(Continued from page 24)

an increase in length of the heat flow path from interior to dissipating surface in capacitors which have the desired case proportions. This causes the large unit to operate in a more unfavorable condition because increasing temperature of interior is accompanied by an increase of leakage current and the power loss, incident thereto, which increases the equilibrium temperature. Dielectric life is very sensitive to temperature. It is also sensitive to voltage, and an adjustment of voltage downward can be made to compensate for the increase of temperature over a considerable temperature range. Therefore, the capacitor which will have the higher internal temperature must be operated or life tested at a lower voltage to maintain a desired life expectancy.

The life test and operating voltage adjustments which are tabulated in PRO-JAN-C-25 are compromises arrived at by discussion between the Armed Services and the capacitor industry and by considering the prominently available materials used for dielectric impregnation.

For any specific combination of manufacturer and material a somewhat different adjustment of voltages would be true. This results from the fact that the processes used to dry and impregnate the capacitors as well as the processes of conditioning the impregnant to secure uniformity and stability vary widely among manufacturers. It was, therefore, necessary to reach a compromise in the standards which would allow availability of a large amount of product and a life expectancy well above that of the lowest grade of product which had previously been accepted.

It is probable that the accumulation of knowledge will indicate that the same watt-second group adjustment of test voltage and operating voltage and the ratio required between these for a constant life expectancy, which has been quite well established for voltage ratings of 1,000 volts and less, will not hold for voltage ratings above these and that additional volt-rating groups, each in turn separated into watt-second groups, will be required to more accurately cover the problem of capacitor rating selection for electrical equipment.

Since the watt-second rating is of so much importance to the application of capacitors, a means of rapid calculation is desirable. Such a means is found in the nomograph (Figure 1)

### Metallic Rectifiers Since 1923

Selenium



Copper  
Sulphide

**A modern plant plus a resourceful engineering staff and a quarter century of experience**

provide the "know-how" and facilities to serve YOUR AC to DC power conversion requirements.

**Manufacturers of selenium and copper sulphide rectifiers, rectifier-transformer assemblies and AC-DC power supply units for every requirement.**

Consulting service available  
without obligation

**THE BENWOOD - LINZE CO.**

Division of the Sperry Corporation

1815 Locust St.

St. Louis, 3, Mo.

Long Distance Telephone CEntral 5830

which not only indicates the watt-second rating of the usual range of standard d-c paper capacitor ratings but also shows the characteristic *D*, *E*, and *F* temperature derating factors of PRO-JAN-C-25 to be applied to voltage rating in each watt-second group for the most frequently encountered temperatures of surrounding media.

Another convenient means of calculation is a table of watt-sec. per microfarad for each of the standard voltage ratings. Such a table is shown in Figure 2.

Rated Volts	Watt-sec. per mfd
100	.0050
200	.0200
250	.03125
400	.0800
600	.1800
1,000	.5000
1,500	1.125
2,000	2.000
2,500	3.125
3,000	4.500
4,000	8.000
5,000	12.500
6,000	18.100
7,500	28.125
10,000	50.000
12,500	78.125

Figure 2

## NAB Session

(Continued from page 13)

the reproducing turntable, 15 $\frac{1}{2}$ ""); minimum turntable torque; output level of the pickup equalizer combination, tracking error, groove contour, etc. Provision for international standards will also be covered during the meeting.

The NAB recording and reproducing standards committee was first organized in June 1941. The present standards were officially adopted by NAB in March 1942. Wide representation among broadcasters and industry is expected at this interesting session.

### RCA 50-KW F-M

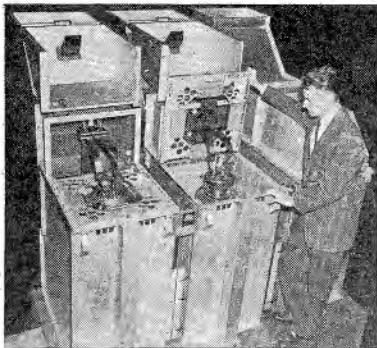

Danna Pratt, manager of RCA broadcast equipment sales, examining one of the grounded-grid tank circuits and the RCA 5592 h-1 tubes used in the amplifier circuits of the 50 kw f-m transmitter, type BTF 50-A.

**CURRENTLY**  
**FROM SORENSEN AT STAMFORD**  
**SORENSEN & COMPANY, INC.**  
*Manufacturers of*  
**VOLTAGE REGULATORS, NOBATRONS & ELECTRONIC APPARATUS**  
**SORENSEN & COMPANY**

## POWERFUL NEWS! SORENSEN SYSTEM NOW APPLIED TO DC VOLTAGE REGULATION

The Sorensen system of AC electronic voltage regulation provides quick, accurate response to even the smallest voltage change with a minimum wave distortion and a regulation accuracy of  $\frac{1}{2}$  of 1%.

Arrange now to receive your personal copy of the Sorensen electronics journal "Currently", published bi-monthly.

This same electronic regulation system has been incorporated into the Nobatron, providing a source of regulated DC voltage at currents and stabilities that, in the

past, was available only with batteries.

This new source of stabilized DC voltage is obtainable in six standard models operating on a 95-125 AC source of 50 to 60 cycles.

Among the more important uses for Nobatrons are DC ammeter calibration in experimental and quality control laboratories, testing of components in the automotive and aircraft industries in battery-operated relays and in other applications where it is desirable to replace a battery to guarantee continuous regulated power supply.

### GENERAL AC REGULATOR SPECIFICATIONS

Input Voltage Range (-1 model) .. 95-125  
 (-2 model) .. 190-250  
 Output Voltage Range (-1 model) .. 110-120  
 (-2 model) .. 220-240  
 Load Range ..... 25-30,000 V. A.  
 Regulation Accuracy .....  $\frac{1}{2}$  of 1%  
 Harmonic Distortion ..... 5% Max. (2% in "S" Models)  
 Input Frequency Range ..... 50-70 cycles  
 Inductive Power Factor Range ..... Down to 0.7 P.F.

For standard voltage regulation, Sorensen Model 500 is a proven leader in its field—compact, accurate and dependable. This model typifies the Sorensen line of AC and Nobatron all-purpose voltage regulators. Let a Sorensen engineer help you with your next voltage regulation problem.

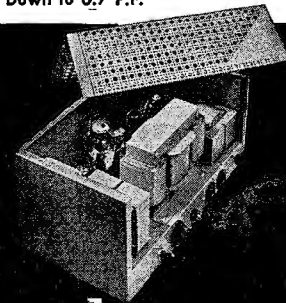

**SORENSEN & COMPANY, INC.**  
**375 FAIRFIELD AVENUE • STAMFORD, CONNECTICUT**

# Norman B. Neely Enterprises

INVITES YOU

TO ATTEND THE  
WEST COAST ELECTRONIC MANUFACTURERS  
ASSOCIATION TRADE SHOW

HOTEL WHITCOMB  
SAN FRANCISCO

OUR COMPLETE TECHNICAL STAFF WILL BE IN  
ATTENDANCE AT BOOTHS 3, 4, and 5  
SEPTEMBER 26, 27, and 28

OFFICES IN  
SAN FRANCISCO      HOLLYWOOD      PORTLAND

## The Industry Offers

(Continued from page 30)

610-B), wired music input and low-level microphone input (type 610-C), and two microphone inputs (type 610-D).

Gain is approximately 61 db matching 150 or 600 ohms; approximately 45 db bridging 600 ohms.

Tube complement: one 6SJ7; one 6V6GT; two 6L6G; and one 5U4G.

\*\*\*

### VITAMITE RECHARGEABLE BATTERIES

A one-ounce non-spill 2-volt rechargeable battery has been developed by the Vitamite Company, 227 West 64 Street, New York City. Battery is enclosed in a one-piece molded plastic case.

\*\*\*

### SPERTI HAND-HELD TWO WAY UNIT

A transmitter-receiver operating in the 144-148-mc band, weighing 3½ pounds with batteries, has been developed by the electronic division of Sperti, Inc., Norwood Station, Cincinnati 12, Ohio.

Has adjustable tuning on both transmitter and receiver.

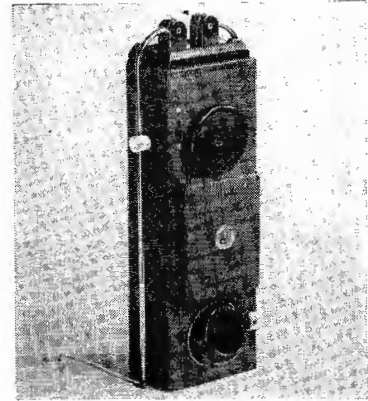

\*\*\*

### DRAKE SOCKET ASSEMBLIES

A series of double contact candelabra bayonet-type socket assemblies for housing 115v household type lamps have been announced by the Drake Mfg. Co., Chicago. Installed lead-in wires of any length from 2½" to 60". Choice of 10 stock brackets.

Catalog, incorporating these new assemblies and a line of bayonet and screw dial and jewel miniature socket assemblies, is available.

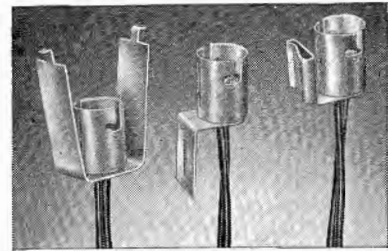

\*\*\*

### RCA AIRCRAFT ANTENNA

An aluminum aircraft slot antenna which may be fitted into the wing or fuselage surface, eliminating antenna aerodynamic drag, is now in production by the aviation section of the RCA engineering products department.

Antenna, type MI-19727, is a cavity resonating device suitable for transmission and reception in the 420 to 460-mc band. It is designed for operation in high-speed planes and replaces the protruding half-wave dipole antenna now in use.

The exposed face of the antenna is covered by a plexiglass plate.

Two slot antennas are used in an altimeter installation. These are mounted about 20' apart on the under side of the wings or fuselage, and

## HOPP Plastic RADIO DIALS

DIAL WINDOWS, NAME PLATES, GAUGES,  
CALCULATORS, SCALES, CHARTS, ETC.

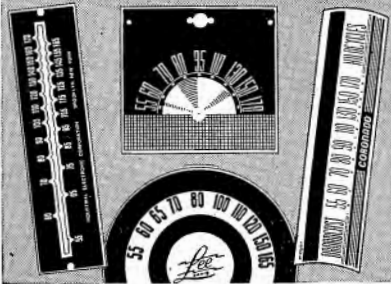

PLASTIC RADIO DIALS have endless possibilities in design, size, shape and color combination. Attractive and durable, our radio dials, windows and scales are preferred by many leading Radio manufacturers.

Not only for dials, but for numerous other electronic and electrical applications, Laminated Plastics are preferable.

Consult with our artists and engineers regarding applications for your particular purpose. Or . . . send us your blue prints or samples for quotation.

**THE HOPP PRESS, INC.**  
460 W. 34th STREET, NEW YORK 1, N. Y.  
ESTABLISHED 1893

## BROWNING INSTRUMENTS

For Precise Communications

### S-4 FREQUENCY METER

Designed especially for mobile transmitters. Reading accuracy to one part in one thousand. Tests frequencies from 1.5 to 100 mc. Telescoping antenna forms convenient handle.

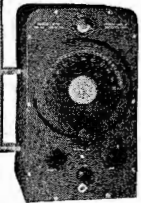

### RJ-12 FM-AM TUNER

Hi-sensitivity tuner for FM-AM reception. Separate RF and IF systems on both bands. Armstrong FM circuit. One antenna serves both FM and AM. Tuning eye shows correct tuning.

### OTHER BROWNING INSTRUMENTS

MJ-9 Frequency Meter and ECO for Hams. RH-10 Frequency Calibrator for full, accurate use of WWV signals. Model OL-15 Oscilloscope for laboratory work, production testing or research.

WRITE FOR DESCRIPTIVE LITERATURE



are connected to the altimeter in the cockpit by 52-ohm concentric transmission line.

\*\*\*

### OHMITE 2-WATT MOLDED COMPOSITION POTENTIOMETER

A 2-watt molded composition potentiometer, type AB, has been announced by Ohmite Manufacturing Co., 4974 West Flournoy Street, Chicago 44, Ill.

Resistance element is a thick, solid-molded ring, heat treated under pressure. Terminals are embedded in the resistance element.

Available in sixteen stock resistance values from 50 ohms to 5 megohms with a linear taper. Five stock values from 0.1 megohm to 2.5 megohms are available in a clockwise logarithmic taper. Three stock values, 10,000, 25,000, and 50,000 ohms are available in a counter-clockwise logarithmic taper. The unit is 1 1/16" in diameter and extends 9/16" behind the panel. An on-off switch is also available for mounting on the potentiometer. For complete information, write for bulletin 131.

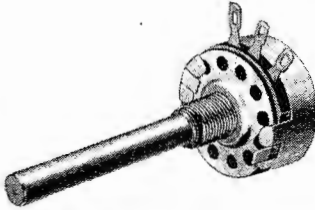

\*\*\*

### C-D CAPACITORS

A dual 20-mfd 150-wv capacitor, type BRL-2215SS, has been announced by the Cornell-Dubilier Electric Corporation, Department R, South Plainfield, New Jersey. Unit contains two leads for each 20-mfd section. It is 15/16" in diameter and 2 7/8" long.

Television high-voltage capacitors, type TMC, have also been announced by C-D.

Housed in tubular, hermetically-sealed containers of seamless drawn metal tubing and are impregnated and filled with Dykanol. Capacitors are self-supporting as one lead is brought out from each end.

Available capacities range from .005 to .05 mfd.; d-c voltage ratings from 2,000 to 5,000.

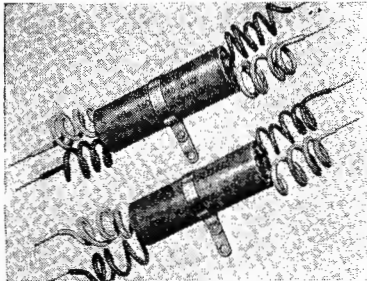

Type BRL-2215SS

\*\*\*

### DU MONT POLAR CO-ORDINATE INDICATOR

A polar co-ordinate cathode-ray indicator, type 275-A, for plotting phenomena on a circular time base has been announced by Allen B. Du Mont Laboratories, Inc., Clifton, N. J.

A Du Mont 5CP-A cathode-ray tube used as the indicator, operates at a total accelerating potential of 3,000 volts.

Radial deflection is obtained by modulation of two 90° out-of-phase sine-wave signals which produce the circle. The circle signals are applied to the control grids of pentode tubes. By applying the modulating signal to the screen grids of these tubes, their transconductance is varied according to the instantaneous signal amplitude. Push-pull (or balanced) deflection is used.

\*\*\*

### TRICRAFT F-M/TV ANTENNA

An f-m/tv antenna, model 300, developed by the antenna development group of Belmont Radio Corp., has been announced by the Tricraft Products Company, 1535 North Ashland Avenue, Chicago 22, Ill.

Antenna consists of a relatively thin, long dipole which is a half-wave long at 70 mc placed  
(Continued on page 44)

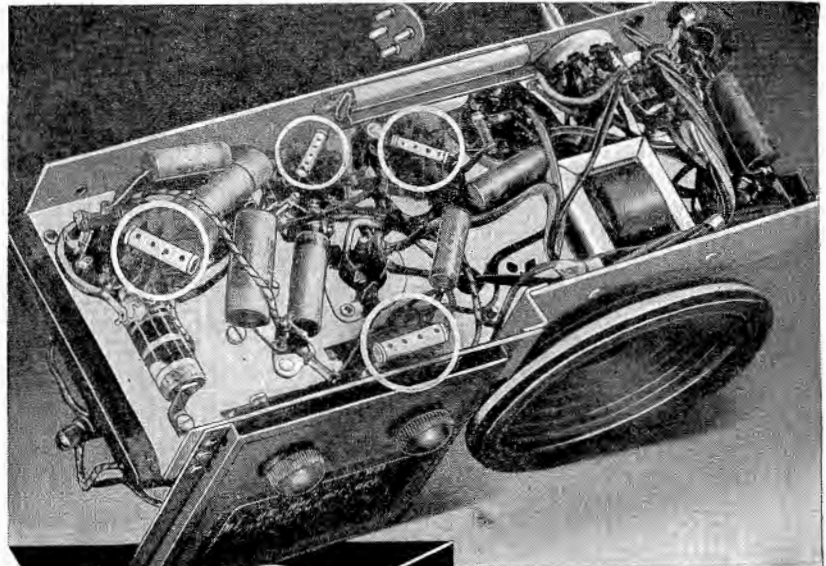

# Hi-Q

# CERAMIC CAPACITORS

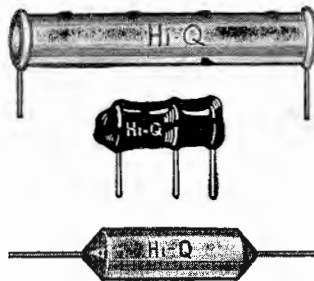

General purpose capacitors adequately meet the requirements of small AC-DC sets. Their reliable performance and long life make them especially desirable in applications where other types of more expensive units must be replaced. In addition HI-Q general purpose capacitors avoid aging and comparable reduced performance.

We shall be glad to submit samples for your examination.

OTHER



COMPONENTS

WIRE WOUND RESISTORS



FEED-THRU & STAND-OFF CAPACITORS

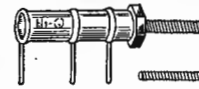
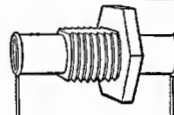

CHOKE COILS

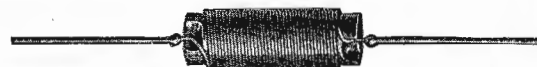

# Hi-Q

# ELECTRICAL REACTANCE

C O R P O R A T I O N

FRANKLINVILLE, N. Y.

# TOROIDAL COIL FILTERS

... are the answer to any network problem

- SHARP CUT-OFF
- LOW INSERTION LOSS
- HUM PROOF
- COMPACT
- HIGH STABILITY

Toroidal Coils

Inductance—1 MHY to 3 HYS  
 Frequency—300 cy. to 30,000 cy.  
 "Q"—55 at 1000 cy.; 150 at 3000 cy.

Ask to be put on mailing list for complete catalogue of coils and filters.

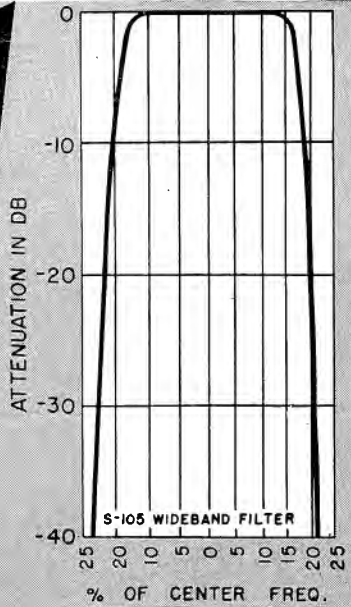

Actual measurements taken on Toroidal Coil Filter manufactured by Burnell & Co.

**Burnell & Co.**

Designers and Manufacturers of Electronic Products

45 WARBURTON AVENUE, YONKERS 2, N. Y.

**PREMAX**

## Antennas for Mobile Units

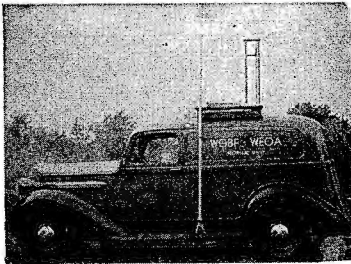

Collapsible Tubular Metal Antennas in varying heights from 6' to 35'—the type that will withstand weather conditions, corrosion and severe shock. Tested and proven in war—now standard equipment in fire, police and other municipal and federal services.

Ask your Radio Jobber for the new Premax Antenna Catalog.

**Premax Products**

Division Chisholm-Ryder Co., Inc.

4710 Highland Avenue, Niagara Falls, N. Y.

## MICO ENGRAVER

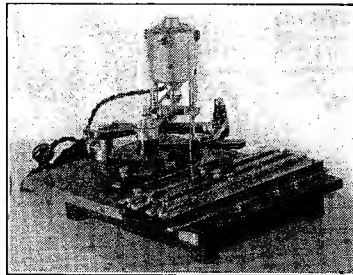

For lettering panels of steel, aluminum, brass, or bakelite, or for marking finished apparatus.

A sturdy machine for routine production as well as occasional engraving.

Attachments increase its versatility to include large work on flat or curved surfaces.

Excellent engraving can be produced by an inexperienced operator.

Prompt delivery. Catalogue on request.

**Mico Instrument Co.**  
 88 TROWBRIDGE STREET  
 CAMBRIDGE, MASS.

## The Industry Offers

(Continued from page 43)

near a short, relatively thicker dipole which is a half-wave long at 128 mc.

The short, thick dipole is connected at its end through inductive rings to the approximate mid points of the thin, long dipole section. These rings, besides end feeding the short dipole, give mechanical support to the thin dipole. In the lower tv band the antenna acts like a broad-band folded dipole resonant at approximately 65 mc, with the thin member resonant at approximately this frequency and the short, heavy-member end loaded by the inductive rings at its end. In the higher tv band the long, thin dipole is  $1\frac{1}{2}$  wavelengths in the center of the band. The short member is end fed by means of the inductive rings connecting it to the long member such that currents flow in the two dipoles approximately in phase, substantially raising the radiation resistance of the antenna above a  $1\frac{1}{2}$ -wavelength dipole.

\*\*\*

### MOTOROLA 25-44 MC HANDIE TALKIE

An 18-tube handie-talkie type crystal-controlled f-m transmitter and receiver with dry battery power supply, weighing 7 pounds, for the 25- to 44-mc band has been developed by Motorola, Inc., 4545 Augusta Boulevard, Chicago 51, Ill. Uses cellular construction, sub-miniature tubes and superheterodyne circuit. Less than one microvolt will produce 20 decibels quieting in the output. Power output of transmitter is .6 watt. The handset or earphones of the receiver will operate on 2.5 milliwatts.



Motorola f-m handie-talkie equipment in use during a recent fire department test in Chicago.

\*\*\*

### MICARTA PILOT LIGHT ASSEMBLY

Candelabra base 110 v, 75-watt pilot-light assemblies which may be secured by clip-on or snap-in brackets for panels up to .078" thick have been announced by Micarta Fabricators, Inc., 5324 N. Ravenswood Avenue, Chicago 40, Ill. Bakelite insulating shell. Furnished with leads already soldered in any length to meet manufacturers' specifications.

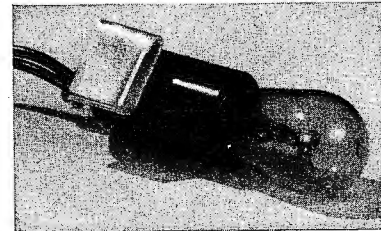

\*\*\*

### R-MC TRANSCRIPTION PLAYER

A transcription player, TP-16C, for transcription records up to 16", 78 or 33 1/3 rpm, is

available from the Radio-Music Corporation, East Port Chester, Connecticut.

Motor is constant-speed type. Drive wheel and idler have neoprene tires, precision ground for concentricity. Switch output impedance, 30,250, and 500/600 ohms.

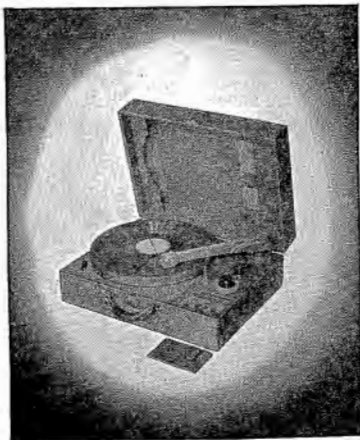

### E-Z TABS

Code wire markers of the E-Z tab design have been announced by the Western Lithograph Company, Los Angeles 54, Calif. Markers can be removed without disturbing remaining markers on the card.

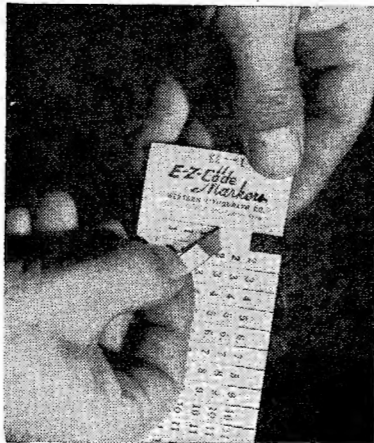

### RAYTHEON VACUUM CAPACITORS

A 100-mmfd vacuum capacitor has been announced by the Power Tube Division, Raytheon Manufacturing Co., Waltham, Mass.

Peak r-f voltage, 20,000 volts; d-c voltage, 16,000 volts; rms current, 60 amperes; frequency, at ratings up to 30 mc; ambient temperature, 50° C; length (overall), 7.25"; diameter, 2.5".

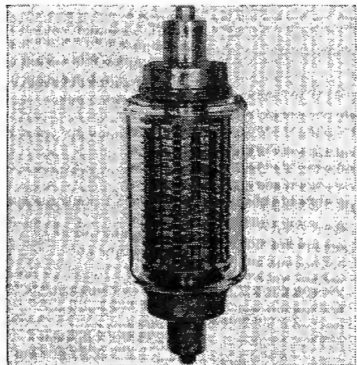

# Whether OSCILLOGRAPH RECORDER or ELECTRONIC TIMER

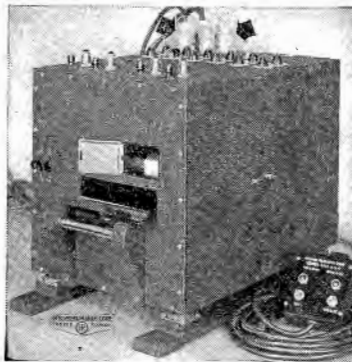
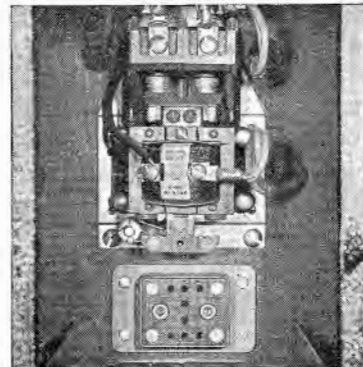

PHOTO COURTESY HEILAND RESEARCH CORP., DENVER, COL.

**AUTOMATIC RECORDER**, Type A301R, is equipped with Cannon Electric Type "K" Plugs and Receptacles. This instrument may be employed wherever multiple electric low-frequency phenomena, either periodic or transient, are to be recorded or studied.



UNRETouched CANNON ELECTRIC PHOTO

**ELECTRONIC UNIT** in timer for die-casting machines equipped with Cannon Electric DPD Plugs. Panel portion is shown above. Rack unit plugs into the panel and carries pin insert assembly. Timer regulates die-casting interval automatically.

## Plug-in with CANNON PLUGS



K-21 Plug



RK-24C Plug

**TYPE "K"**—made in 3 general shell types with nearly 190 insert arrangements available for a wide variety of wire sizes, including coaxials.



**TYPE DPB**—rack type pin and socket assemblies (both for rigid mounting) carry standard, coaxial and twinax contacts. Six basic layouts available in DPB, many more in the larger DPD size.



**NEW EDITION C-46-A CATALOG**—For a complete survey of the majority of Cannon Electric products, send for this C-46-A Catalog, containing prices on many items. Also included are the names and addresses of distributors. Write Department H-121 for a free copy.



## CANNON ELECTRIC DEVELOPMENT COMPANY

3209 Humboldt Street, Los Angeles 31, California

Canada & British Empire—Cannon Electric Co., Ltd., Toronto, Ontario • World Export Agents (excepting British Empire) Frazar & Hansen, 301 Clay St., San Francisco 11, Calif.

# Carrier Communications

(Continued from page 39)

provide complete d-c paths between the carrier set and the telephone instrument. The hook switch in the telephone instrument is used to energize the transmitter through a d-c control circuit when the instrument is picked up. If the telephone extension does

not provide a d-c path, the same assembly might be used with the transmitter energized continuously, whether conversation is taking place or not. This type of operation is often considered objectionable, however, because of the possibility of continuous interference with other carrier channels. Alternatively, the assembly might include an additional unit called an audio-relay unit. This unit functions

automatically to energize the transmitter as soon as an audio signal, either a voice signal or a ringing signal, reaches the assembly from the telephone line. Time delay circuits in the audio relay unit function to keep the transmitter energized continuously during the conversation, but they turn off the transmitter at some predetermined time after conversation ceases. **[To Be Concluded in October Issue]**

**Figure 7**  
A typical two-frequency duplex power-line carrier-communications assembly. Units, from top to bottom, are transmitter, audio amplifier, panel for test-meter unit, superheterodyne receiver, audio hybrid unit, power distribution unit, and 640-volt and 120-volt rectifiers.

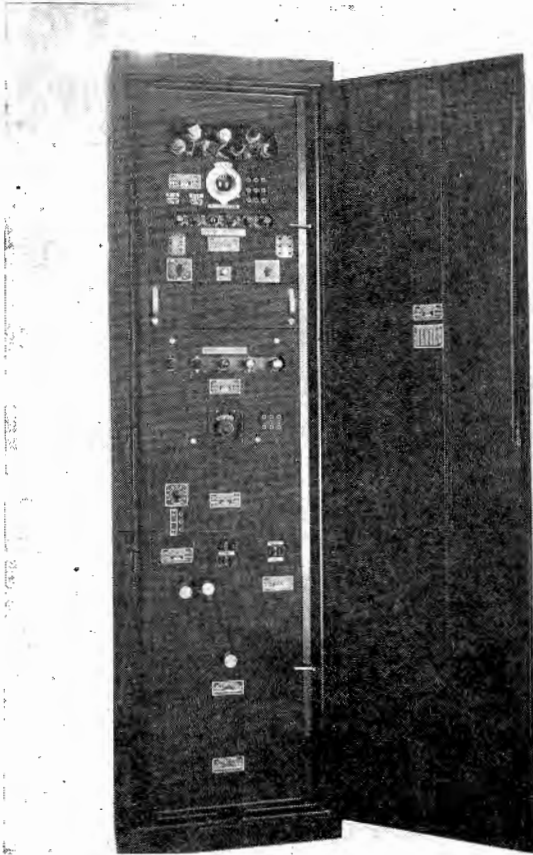

**Figure 8**  
Automatic simplex power-line carrier-communications assembly which permits single conversation among several stations on the channel.

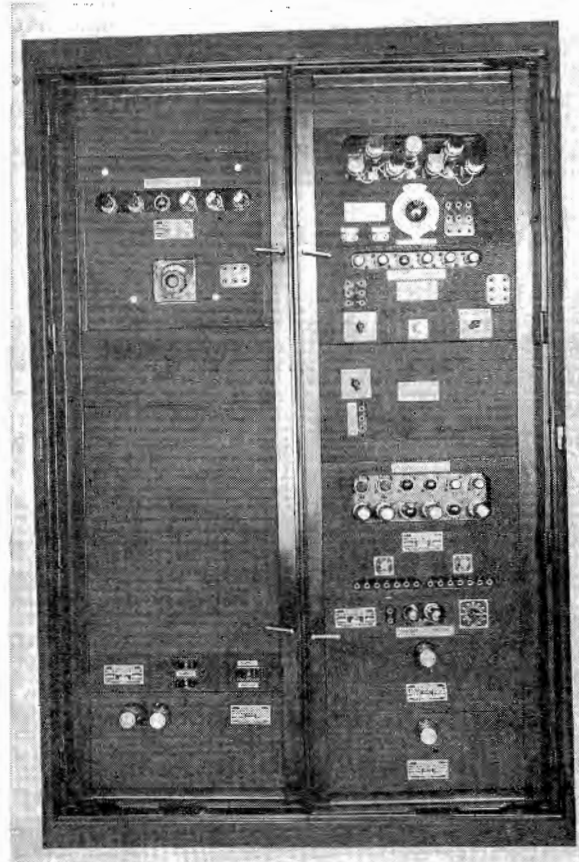

## ... For Dependable Commercial Service

Designed for the rigors of commercial service in all types of radio communication . . . broadcast, mobile, aircraft, police. Precision made for utmost in stability, dependability, trouble-free operation. Calibrated within .005 per cent of specified frequency . . . range 1.5 to 10.5 MC. Temp. coefficient less than 2 cycles per megacycle per degree centigrade. Weighs less than 3/4 ounce. Gasket sealed against contamination and moisture. Meets FCC requirements for all above services. See your jobber—Petersen Radio Company, Inc., 2800 W. Broadway, Council Bluffs, Iowa. (Telephone 2760.)

# PR Precision CRYSTALS

## Electronic Research & Mfg. Corp.

A Service to INDUSTRY

Development and Construction of Electronic Equipment for Any Application

1420 E. 25th St., Cleveland 14, O. - Ph.: SU. 1958

GEORGE P. ADAIR

Radio Engineering Consultants

1833 M STREET, N. W.  
WASHINGTON 6, D. C.

EXECUTIVE 1230



## NEWS BRIEFS

(Continued from page 29)

Stanley Bracken has been elected president of Western Electric Company to succeed Clarence G. Stoll on his retirement September 30.



Orrin E. Dunlap, Jr., has been elected vice president in charge of advertising and publicity for the Radio Corporation of America.

Mr. Dunlap became director of advertising and publicity of RCA on January 1, 1944, after serving four years as manager of the RCA department of information.

Clark C. Rodimon has joined National Company, Inc., Malden, Mass.

P. C. Sandretto has been named director of aviation for the International Telecommunication Laboratories. Mr. Sandretto was formerly superintendent of the United Air Lines communications laboratories. During the war he served as a Colonel, as chief of the electronics section for AAFPOA (later USSTAF).

George J. Maki has opened a radiotelegraph consultant office at Moraga, Calif.

He was formerly with Collins Radio Company as design engineer on frequency-shift radioteletype equipment.

Jack Totten has been named vice president in charge of sales of the Remler Company, San Francisco.

Mr. Totten was formerly with Gilfillan Bros., Inc.

\*\*\*

### LITERATURE

The Seletron Division of the Radio Receptor Company, Inc., 251 West 19 Street, New York 11, N. Y., has released an 8-page bulletin on the subject of selenium rectifiers for direct current requirements.

American Relay and Controls, Inc., 2555 Diversey Avenue, Chicago, have published a 4-page bulletin describing switches, relays and specialized controls.

The Superior Electric Company, 25 Church Street, Bristol, Conn., have released a 12-page bulletin, 547, on voltage control. Bulletin features the developments in Powerstat variable transformers and Stabiline automatic voltage regulators.

Data includes ratings, detail drawings, photographs, and performance and engineering data.

The Bendix Radio Division, Bendix Aviation Corp., Baltimore 4, Md., has prepared a booklet with a step-by-step explanation of the function of GCA (ground-controlled approach) radar.

Booklet contains a foreword written by J. W. Reeves, Jr., Rear Admiral U. S. Navy, Commander, Naval Air Transport Service.

Eitel-McCullough, Inc., San Bruno, Calif., have released data sheets on eight tubes: 4-125A, 4-250A, 4-65A, 4X150A, 4-1000A, 3X2500A3, 3X2500F3 and 3X12500A3; power tetrodes, external anode tetrodes, external anode triodes and high-power triodes respectively.

The transmitter division of G. E. has prepared a 12-page booklet, EBR-99, on the limiting amplifier (type BA-5-A).

Issue 8 of the Western Electric Oscillator contains articles on loudspeakers by Frank Nickel and R. S. Lanier. A description of the new acoustic test room at Bell Telephone Laboratories is also included in this issue.

In another article, H. W. Auguststadt of Bell Telephone Labs describes the application of a series of building block amplifiers to multiple channel speech and music distribution systems.

Sorensen and Company, Inc., Stamford, Conn., have published a four-page bulletin, *Currently*, describing Nobatrons, and other voltage regulating equipment.

# NEW, IMPROVED TONE ARM FOR PARA-FLUX REPRODUCERS

(Trade-Mark)

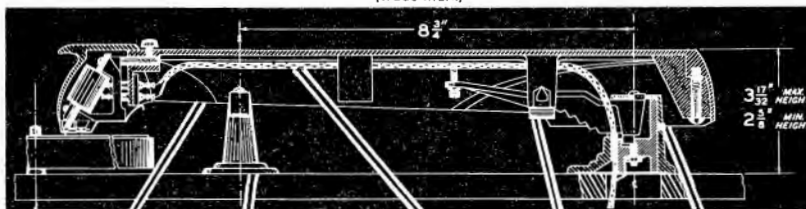

Flexible wire leads shielded throughout with special grounded bond between arm and swivel base.

Frictionless horizontal fulcrum floated on Neoprene for silent non-resonant movement.



Tone arm resting stand supplied with each arm matching design, equipped with durable, spring clip which prevents arm from being knocked on to turntable.

Simple, single locking set screw (in the swivel base above the turntable base) allows quick, convenient height adjustment of tone arm level.

All parts cast from aluminum by new, precision dies, under high pressure.

Here's a new, improved Tone ARM, model A-16, now available to users of PARA-FLUX REPRODUCERS. It's a clean-cut, highly engineered job that embodies unique features for finer, smoother operation. All parts are now die-cast. Embodies new Arm Stand for ease in handling.

Doing one thing well . . . specialized engineering in the design and manufacture of PARA-FLUX REPRODUCERS . . . has enabled us to achieve this most efficient TONE ARM and interchangeable REPRODUCERS for affording the most realistic reproduction of transcriptions.

Our old tone arm offered many advantages as evidenced by more than 1500 now in service at AM and FM stations. Users can now exchange these old arms for the new Model A-16 Arm at a cost of only \$15.00 . . . and can have the advantages of these latest refinements by returning the old arm either to us, or any jobber, listed below, and immediately obtain a new Arm, without delay.

### R-MC AUTHORIZED STOCKING JOBBERS:

ALBANY, N. Y.—E. E. TAYLOR CO.  
 ALLENTOWN, PENNA.—RADIO ELECTRIC SERVICE CO.  
 ASHEVILLE, N. C.—FRECK RADIO, REFRIGERATION & SUPPLY CO.  
 ATLANTA, GA.—SPECIALTY DIST. CO.  
 AUGUSTA, GA.—PRESTWOOD ELECTRONICS CO.  
 BINGHAMTON, N. Y.—FEDERAL RADIO SUPPLY  
 BOSTON, MASS.—DEMAMBRO RADIO CO.  
 BOSTON, MASS.—RADIO WIRE TELEVISION CO.  
 BUFFALO, N. Y.—DYMAC INC.  
 CHARLESTON, S. C.—RADIO LABORATORIES, INC.  
 CHATTANOOGA, TENN.—W. B. TAYLOR CO.  
 CHICAGO, ILL.—CONCORD RADIO CORP.  
 CHICAGO, ILL.—TRI-PAR SOUND SYSTEMS  
 CHICAGO, ILL.—WALKER-JIMIESON, INC.  
 CHICAGO, ILL.—NEWARK ELECTRIC CO.  
 LOS ANGELES, CALIF.—RADIO PRODUCTS SALES, INC.  
 LOS ANGELES, CALIF.—RADIO SPECIALTIES CO.  
 MADISON, WISC.—SATTERFIELD RADIO SUPPLY CO.  
 MILWAUKEE, WISC.—RADIO PARTS CO., INC.  
 PHILADELPHIA, PENNA.—ALGENE RADIO AND SOUND CO.  
 PORTLAND, ORE.—UNITED RADIO SUPPLY  
 QUINCY, ILL.—GATES RADIO CO.  
 ROANOKE, VA.—LEONARD ELECTRONICS  
 ROCHESTER, N. Y.—ROCHESTER RADIO SUPPLY  
 SAN DIEGO, CALIF.—COAST ELECTRIC CO.  
 SAN FRANCISCO, CALIF.—SAN FRANCISCO RADIO SUPPLY CO.  
 SCRANTON, PENNA.—FRED P. PURSELL  
 TOPEKA, KANSAS—JOHN A. COSTELOW CO.  
 TUCKAHOE, N. Y.—ELECTRONICRAFT  
 WASHINGTON, D. C.—UNITED STATES RECORDING CO.  
 WINSTON SALEM, N. C.—DALTON HEGE

Descriptive, Illustrated Bulletin PR5, upon request

# RADIO-MUSIC CORPORATION

EAST PORT CHESTER, CONN.



Universal Reproducer



Lateral Only Reproducer



Vertical Only Reproducer

# WHY IS ASTATIC'S MODEL "QT" Such a Popular Cartridge?

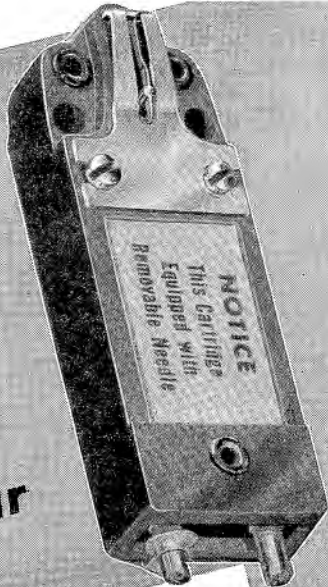

**The Answer Is**, of course, that Astatic's new model "QT" Pickup Cartridge provides exceptionally clear, clean, quiet reproduction and provides for the constancy of such quality reproduction during the life of the instrument. These are important things to every manufacturer of modern record players.

This new, Astatic "QT" Cartridge is equipped with a MATCHED Needle. This needle possesses all the qualities of a permanent Needle plus the advantage of being REPLACEABLE. This assures the manufacturer, and the ultimate user, that the quality of reproduction shall remain constant throughout the life of the Cartridge REGARDLESS of the number of times the Needle is replaced.

The unique design of the Needle employed exclusively in the "QT" Cartridge plus certain improved qualities of the Cartridge itself, have resulted in a quality of reproduction which is essentially free from objectionable noises radiating directly from the surface of the record. Special literature is available upon request.

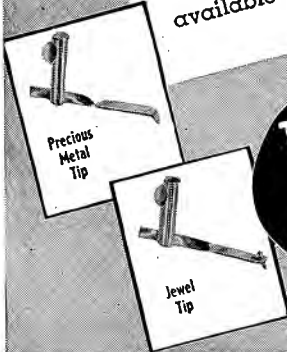

## ADVERTISERS IN THIS ISSUE

### COMMUNICATIONS INDEX AUGUST, 1947

GEO. P. ADAIR .....	46
ANDREW CO. ....	39
Agency: Burton Browne, Advertising	
THE ANSONIA ELECTRICAL DIV. NOMA ELECTRIC CORP. ....	31
Agency: Albert Frank-Guenther Law, Inc.	
THE ASTATIC CORPORATION.....	48
Agency: Wearstler Advertising, Inc.	
BELL TELEPHONE LABORATORIES.....	6, 7
Agency: Newell-Emmett Co	
THE BENWOOD LINZE CO.....	40
Agency: Major Adv. Agency	
BROWNING LABORATORIES, INC.....	42
Agency: The Charles Brunello Co.	
BURNELL & CO.....	44
Agency: Mitchell Adv. Agency	
CANNON ELECTRIC DEVELOPMENT CO.....	45
Agency: Dana Jones Co.	
C. P. CLARE AND CO.....	Back Cover
Agency: Hamilton Adv. Agency, Inc.	
THE CLEVELAND CONTAINER CO.....	12
Agency: The Nesbitt Service Co.	
CONCORD RADIO CORP.....	38
Agency: E. H. Brown Adv. Agency	
ALLEN B. DUMONT LABORATORIES, INC.....	10
Agency: Austin C. Lescarboursa & Staff	
EITEL-McGULLOUGH, INC.....	22, 23
Agency: L. C. Cole, Advertising	
ELECTRICAL REACTANCE CORP.....	43
Agency: Scheel Adv. Agency	
ELECTRONIC RESEARCH & MFG. CORP.....	46
FAIRCHILD CAMERA & INSTRUMENT CORP.	5
Agency: G. M. Basford Co.	
FARNSWORTH TELEVISION & RADIO CORP..	9
Agency: N. W. Ayer & Son, Inc.	
FERRANTI ELECTRIC, INC.....	1
GENERAL RADIO CO.....	Inside Back Cover
GUARDIAN ELECTRIC .....	Back Cover
Agency: Kennedy & Co.	
THE HOPP PRESS, INC.....	42
Agency: Gallard Adv. Agency	
JENSEN MFG. CO.....	11
Agency: Burton Browne, Advertising	
HOWARD B. JONES DIV. CING MFG. CORP.	38
Agency: Merrill Symonds, Advertising	
THE JAMES KNIGHTS CO.....	36
Agency: Rudolph Bartz, Advertising	
LEGGI S. COMPANY, INC.....	36
Agency: Shaw Associates	
MICO INSTRUMENT CO.....	44
JAMES MILLEN MFG. CO., INC.....	36
NATIONAL CO., INC.....	33
Agency: John A. Cairns & Co., Inc.	
NORMAN B. NEELY ENTERPRISES.....	42
PAR-METAL PRODUCTS CORP.....	40
Agency: H. J. Gold Co.	
PETERSEN RADIO CO.....	46
Agency: Bozell & Jacobs	
PREMAX PRODUCTS DIV. CHISHOLM-RYDER CO., INC. ....	44
Agency: Norton Adv. Service	
RADIO-MUSIC CORP. ....	47
Agency: A. J. Slomanson Co.	
REEVES-HOFFMAN CORP.....	38
SORENSEN & CO., INC.....	41
Agency: Henry A. Stephens, Inc.	
SPRAGUE ELECTRIC CO.....	4
Agency: The Harry P. Bridge Co.	
SYLVANIA ELECTRIC PRODUCTS, INC.....	3
Agency: Newell-Emmett Co.	
TECH LABORATORIES, INC.....	37
Agency: Lewis Adv. Agency	
U. S. TREASURY DEPT.....	28
WAR ASSETS ADMINISTRATIONS.....	8
Agency: Fuller & Smith & Ross, Inc.	
WESTERN ELECTRIC CO.....	6, 7
Agency: Newell-Emmett Co.	
WILCOX ELECTRIC CO., INC.....	19
Agency: Arthur C. Rippey & Co.	

## For SIMPLE CONVERSION to A-C OPERATION

**S**EVERAL G-R instruments, equipped with a battery block to secure the maximum portability for field use, are often operated continuously for many hours in the laboratory, in testing and in production. For such uses an a-c operated power supply to replace the battery is a great convenience.

The Type 1261-A Power Supply was designed for this use. Mechanically and electrically it is interchangeable with a BA48 battery, supplying the same voltages and current. It is interchangeable with the BA48 battery in the Type 759-A or -B Sound Level Meter, the Type 720-A Heterodyne Frequency Meter and the Type 1231-A Amplifier & Null Detector.

It also can be used as a general-purpose substitute for a BA48 battery. Its output is: FILAMENT SUPPLY: 1.5 or 3.0 volts up to 350 ma; PLATE SUPPLY, when used on a 115-volt 60-cycle-line with normal filament current of 300 ma: 133 volts, open circuit; 107 volts at 3 ma; 89 volts at 5 ma; 72 volts at 7 ma; maximum output current of 8 ma.

A selenium rectifier and L-C filter with two flashlight cells floating across the output provide a low-impedance, well-filtered and regulated d-c filament supply. A relay opens the circuit when the instrument is not in use so that the life of the batteries is equivalent to their shelf life.

A conventional vacuum-tube rectifier and R-C filter provide the plate supply. A 4-terminal output socket fits the plug on the battery cable of the instruments which use the BA48 battery; octal selector plugs inserted into a socket on the power supply make it possible to select filament and plate voltages for various needs.

**IMPORTANT** — When ordering be sure to specify type and serial number of any of the three G-R instruments with which the supply is to be used; otherwise we will ship a selector plug which the user can wire to meet his individual requirements.

**TYPE 1261-A POWER SUPPLY . . . . . \$95.00**

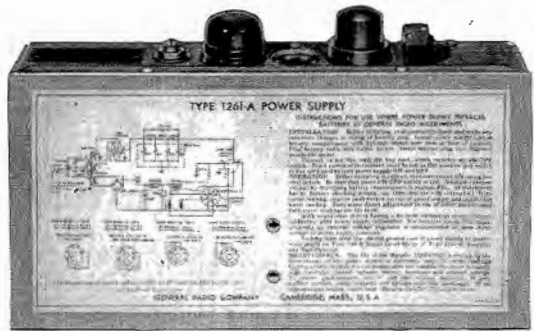

**TYPE 759-B  
SOUND-LEVEL  
METER**

*For all types of Noise Measurements, Accurate, very sensitive, anyone can operate.*

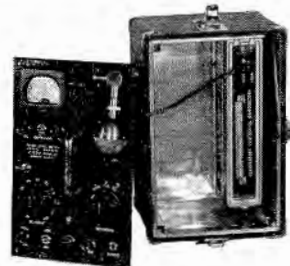

**TYPE 1231-A  
AMPLIFIER  
&  
NULL DETECTOR**

*A high gain general-purpose laboratory amplifier and a sensitive visual null detector for bridge measurements.*



**TYPE 720-A  
HETERODYNE  
FREQUENCY METER**

*For measurement of frequencies by harmonic methods between 10 and 3,000 megacycles.*

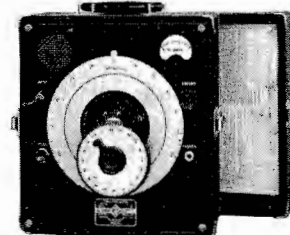

## A-C SUPPLY TO REPLACE STORAGE BATTERIES

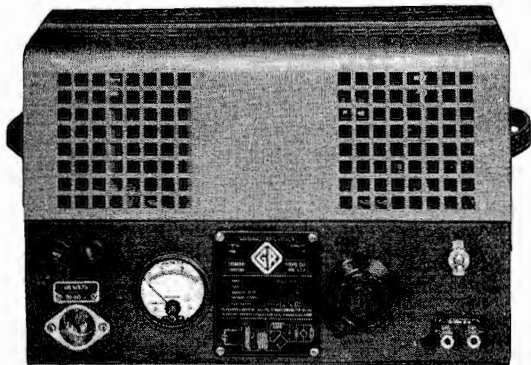

● The Type 1260-A VARIAC\*-RECTIFIER effectively replaces the usual storage battery for general laboratory use. It is a convenient variable d-c voltage source for use in many types of experimental circuits for operation from 115-volt, 60-cycle lines.

Essentially this supply consists of a transformer with VARIAC\*-controlled input, a selenium rectifier, an output filter and a d-c output meter.

The output voltage range is 0-10 volts at 4 amperes; maximum power of 40 watts; maximum current 4 amperes; no-load voltage 15. The power input at full 40-watt load is about 75 watts; the hum voltage at 10 volts, 4 amperes, is less than 100 millivolts or 1% of the output voltage, when the supply is operated on a 60-cycle line.

This supply is a very convenient unit for operating battery-driven equipment at voltages up to 10 volts. The ability to set the d-c voltage at any desired value between 0 and 10 is an added advantage in many cases.

**TYPE 1260-A VARIAC\*-RECTIFIER . . . . . \$125.00**

\*Reg. U.S. Pat. Off.

**ORDER NOW — Delivery of BOTH Probably from STOCK**



**GENERAL RADIO COMPANY** Cambridge 39, Massachusetts

90 West St., New York 6

920 S. Michigan Ave., Chicago 5

950 N. Highland Ave., Los Angeles 38

# GUARDIAN

presents...

a new **MIDGET**  
CONTACT ASSEMBLY  
*Interchangeable*  
with the **GUARDIAN Series 200**  
STANDARD CONTACT ASSEMBLY  
AND COIL ASSEMBLY

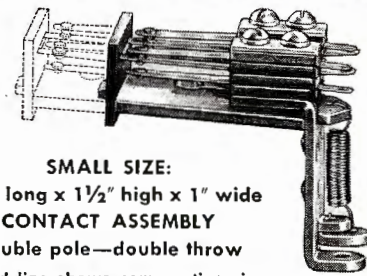

**SMALL SIZE:**  
1 5/8" long x 1 1/2" high x 1" wide  
CONTACT ASSEMBLY  
double pole—double throw  
Dotted line shows comparative size

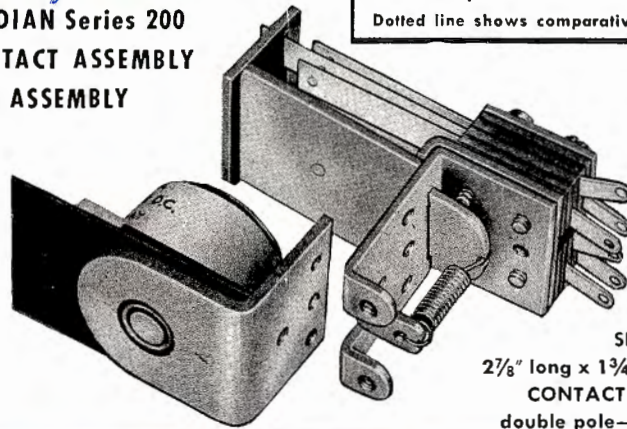

**SIZE**  
2 7/8" long x 1 3/4" high x 1" wide  
CONTACT ASSEMBLY  
double pole—double throw

## Popular RADIO RELAYS in the GUARDIAN line:

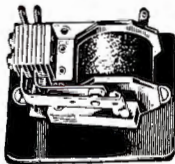

**K-100 Keying Relay** For low voltage control of high voltage transmission. Guardian Series K-100 Relay will follow key or bug at highest WPM rate attainable. High speed response, strong magnet and return spring give clean make and break, produce best CW note. Coils: 5 to 16 v., A.C.; coils for other voltages on specifications.

**B-100 Break-in Relay** For break-in operation on amateur transmitters. The Guardian B-100 Relay has laminated field piece and armature. Fine 1/4" silver DPDT contacts, capacity to 1500 watts, 60 c., non-inductive A.C., and in A.C. primary circuit of any inductive power supply delivering up to 1 KW, inclusively.

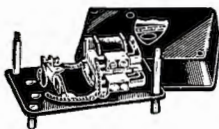
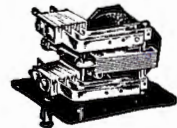

**T-100 Time Delay Relay** In radio transmitter circuits, Guardian's T-100 Time Delay Relay prevents damage of rectifiers and tube filaments by preventing plate current before filaments are sufficiently heated. Laminated field piece and armature. Mounted in dust-proof metal box.

**L-250 Overload Relay** Provides accurate, fixed overload protection against current surges and continuous overloads. Guardian's L-250 Relay replaces expensive, time-wasting fuses. Attracts armature on 250 mils. Max. drop across coil—10 v. Guardian's L-500 Relay attracts armature at 500 mils. Max. drop across coil—5 volts. Ideal for experimenters on new circuits.

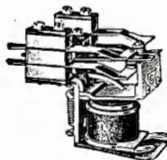
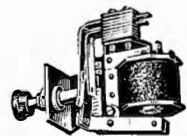

**A-100 Antenna Relay** A low loss AISiMag insulated relay. For single wire fed installations specify the A-100-C, SPDT unit. Two A-100-C in place of one A-100 in open wire line systems will avoid possible impedance mismatch. A very popular relay with radio amateurs.

SEE THESE AND OTHER GUARDIAN RELAYS AT YOUR JOBBER — OR WRITE FOR BULLETIN R-6.

Ask your jobber for the new midget contact switch assembly which is interchangeable with the Guardian Series 200 coil assembly. Your jobber carries a complete line of Guardian radio relays.

# GUARDIAN

1610-J W. WALNUT STREET

# ELECTRIC

CHICAGO 12, ILLINOIS

A COMPLETE LINE OF RELAYS SERVING AMERICAN INDUSTRY