

# COMMUNICATIONS

\$1.00

INCLUDING "RADIO ENGINEERING" AND "TELEVISION ENGINEERING"



NOVEMBER

\* POSTWAR BROADCAST ANTENNAS

\* 40-WATT DISC-RECORDING AMPLIFIER

\* NICKEL PLATE ROAD RADIOTELEPHONE TESTS

1946



INVESTIGATE ...

*Airloop*

... THE BUILT-IN LOOP ANTENNA AND CABINET BACK

one of a battery  
of presses die  
stamping AIRLOOPS  
out of flat  
sheet copper  
at 1400 per hour

PRODUCING PRECISION  
MADE AIRLOOPS WHICH  
PROVIDE BETTER  
PERFORMANCE  
AT LOWER COSTS

patent #2,401,472

FRANKLIN



CORPORATION

43-20 34th ST. LONG ISLAND CITY 1, N. Y

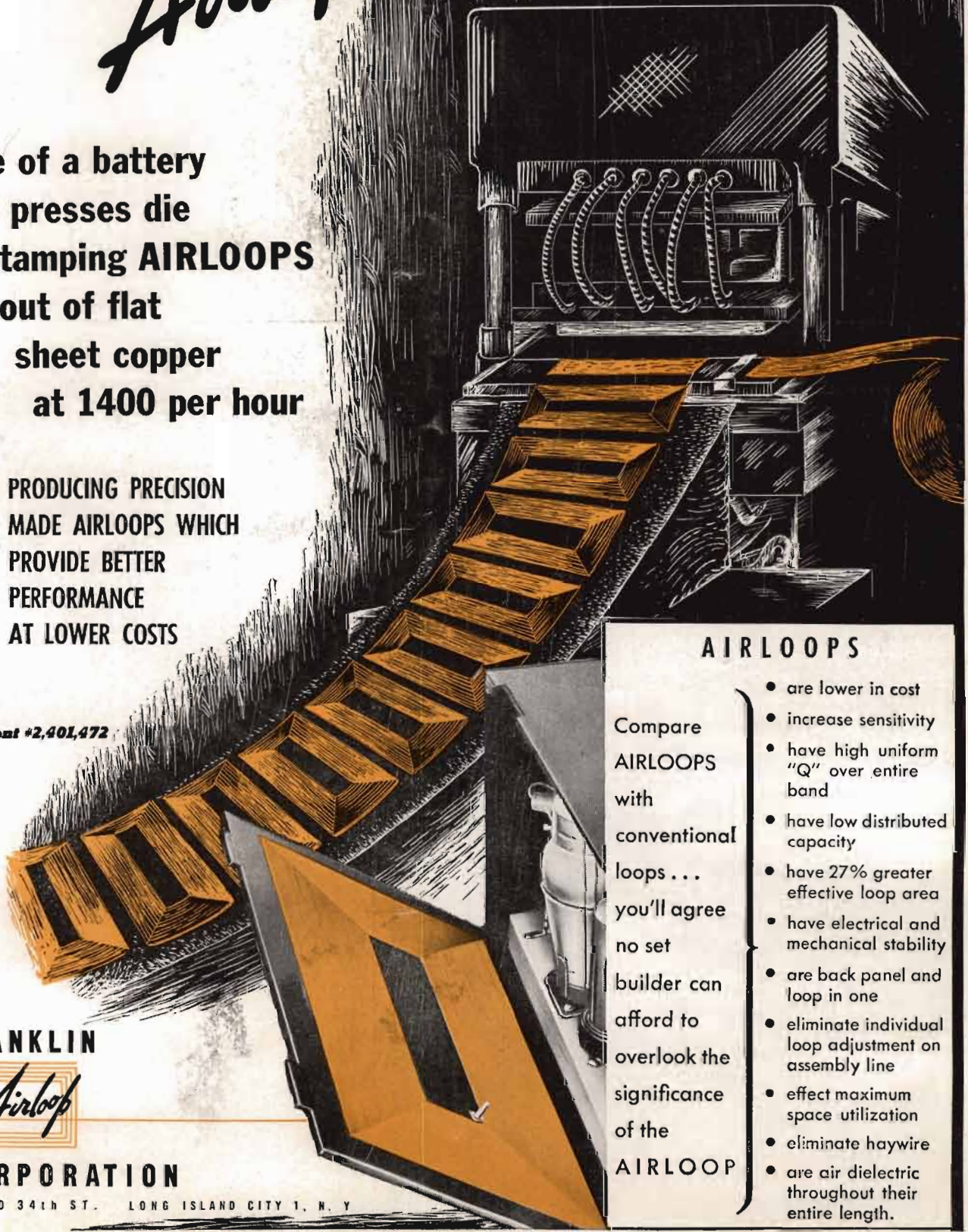

### AIRLOOPS

Compare  
AIRLOOPS  
with  
conventional  
loops ...  
you'll agree  
no set  
builder can  
afford to  
overlook the  
significance  
of the  
AIRLOOP

- are lower in cost
- increase sensitivity
- have high uniform "Q" over entire band
- have low distributed capacity
- have 27% greater effective loop area
- have electrical and mechanical stability
- are back panel and loop in one
- eliminate individual loop adjustment on assembly line
- effect maximum space utilization
- eliminate haywire
- are air dielectric throughout their entire length.



# RAYTHEON

## Announces a New High-G<sub>m</sub> Miniature Pentode

Announcement of Raytheon type 6AH6 makes available a miniature cathode-type high-G<sub>m</sub> pentode specifically designed for application in wide-band amplifiers. The availability of this tube makes possible space and weight reduction of television cameras, television receivers, radar amplifiers, and other multi-tube equipment.

The excellence of Raytheon design for type 6AH6 contributes several desirable performance features, including a plate family characterized by a sharp "knee" at very low plate voltages. Thus increased voltage output and reduced distortion are obtained compared to other tubes of equal transconductance. The low input and output capacitances also allow greater stage gain for a given band-width, and greater band-width for a given stage gain.

### DESCRIPTIVE DATA

TYPE 6AH6  
BULB: GLASS T-5½  
CHARACTERISTICS

Heater Voltage . . . . .	6.3 volts
Heater Current . . . . .	0.45 amp
Plate Voltage . . . . .	300 volts
Grid No. 2 Voltage . . . . .	150 volts
Cathode Resistor . . . . .	160 ohms
Plate Current . . . . .	10 ma
Grid No. 2 Current . . . . .	2.5 ma
Plate Resistance . . . . .	0.5 megohm
Transconductance . . . . .	9000 umhos
Grid No. 1 Bias for 10 ua plate current . . . . .	-7 volts

TYPE 6AH6  
BASE: MINIATURE BUTTON 7-PIN  
CAPACITANCES (μμf)

	WITHOUT SHIELD	SHIELDED
Grid No. 1 to Plate . . . . .	0.030 max.	0.020 max.
Input . . . . .	10.3	10.5
Output . . . . .	2.0	4.0



# G<sub>m</sub>-9000

## Type 6AH6



*Excellence in Electronics*

RAYTHEON MANUFACTURING COMPANY  
RADIO RECEIVING TUBE DIVISION  
Newton, Mass. • Chicago • Los Angeles

© 1946

# We See...

FREQUENCY ALLOCATIONS for a-m, f-m and television still appear to be quite a knotty problem for industry and government.

In a-m, it is the clear-channel project that is still not solved. In the discussion and analysis stages for nearly a year, the study will continue for many more months and *may* be concluded at the final-stage hearings in Washington during the early part of 1947. The provision for 750-kw stations, suggested during the early hearings, has now been included in an extensive proposal by the Clear-Channel Broadcasting Service group. In this allocation plan, twenty stations would be allowed to operate on 750-kw, with the four major networks receiving five of these outlets. The stations would appear in a five-region arrangement to supply national skywave service; Northeastern, Southern, Great Lakes, Western and Pacific. The plan would also provide 50-kw power for groups of stations now operating on 10-kw to expand daytime groundwave service.

In the f-m broadcasting picture, the virtues of 45-50 against 88-108 mc are still being argued. Although the FCC has definitely stated that the higher frequency channels will be the *band* on which f-m will operate for quite awhile, many feel that tests now being conducted will prove that the low bands are essential to certain types of areas and should be reinstated. One manufacturer has already issued a report that supports the superiority of the 45 to 50-mc band for rural areas revealing, too, that BBC tests have confirmed these findings.

The commercial users of f-m have also been quite active in studying the usefulness of the various low and high frequencies allocated to them. The study has been particularly extensive in the police and emergency fields. At the recent APCO Conference in Buffalo, police communications supervisors emphasized that frequency coverage was continually being analyzed in an effort to improve service. Thus far, it appears as if the 152 to 160-mc bands have been most effective in urban and suburban areas. Commenting on this coverage, representatives from Los Angeles stated that the high frequencies provided a better signal in both the hilly areas and in the downtown skyscraper areas, thanks to reflections. The 32 to 40-mc signals faded out during these tests, the experts revealed. In a large city like New York, the 160-mc band has also proved superior, the only problem being sufficient mounting areas for high antennas. In view of the problem—the lack of very tall city-owned or controlled buildings—the New York City police plan to use, in the main, the lower bands.

The low and high frequencies used in television will also be up for discussion during the December color standard hearings in Washington, with the discussions centering on the permanency status of the present black and white 44 to 88 and 174 to 216-mc bands versus the 490-mc bands for color. In presenting the proposed standards, the virtues of both simultaneous and sequential methods of transmission and their current and future application possibilities on the higher bands will be major points of debate, and quite a debate is in the offing.

Looks like quite a program for government and industry during the next few months!—L. W.



## NOVEMBER, 1946 VOLUME 26 NUMBER 11

### COVER ILLUSTRATION

An 8-element square-loop transmitting antenna operating at 930 mc, used in a p-t-m multiplex broadcasting system.  
 (Courtesy Federal Telephone and Radio Corporation)

### A-M BROADCAST ANTENNAS

Postwar Broadcast Antenna Installation.....David W. Jefferies 11  
*Quarter-Wave Self-Supporting Steel Radiator, Recently Installed, Typical of Type Soon to be Installed By Many Local-Channel Outlets.*

### RAILROAD RADIO COMMUNICATIONS

Railroad Radiotelephone Tests on the Nickel Plate Road..Ralph G. Peters 14  
*Highlights of Test Results Prepared from Report Compiled for Association of American Railroads.*

### EMERGENCY COMMUNICATION ANTENNAS

A Folded Unipole Antenna for Emergency Communications...J. S. Brown 18  
*Quarter-Wave Ground-Plane Antenna Combines Radiating and Matching Functions.*

### RECORDING AMPLIFIERS

40-Watt Beam-Power Amplifier for Disc Recording...John K. Hilliard 22  
*Amplifier Designed to Maintain Rated Output Over Wide-Frequency Range.*

### LOGS

A-M Transmitter 5-Kw Log..... 25

### DRY-DISC RECTIFIERS

Selenium Rectifiers.....Julian Loebenstein 26  
*Discussion of Construction and Application of Selenium Rectifier Discs.*

### MONTHLY FEATURES

Editorial (We See).....Lewis Winner 2  
 Veteran Wireless Operators' Association News..... 32  
 Book Talk ..... 35  
 News Briefs of the Month..... 36  
 The Industry Offers..... 44  
 Advertising Index ..... 52

Published Monthly by the Bryan Davis Publishing Co., Inc.

BRYAN S. DAVIS, President

F. WALEN, Secretary

PAUL S. WEIL, Vice Pres.-Gen. Mgr.

A. GOEBEL, Circulation Mgr.

Advertising and Editorial offices, 52 Vanderbilt Ave., New York 17, N. Y. Telephone, MUrray Hill 4-0170. Cleveland Representative: James C. Munn, 2656 E. 126th St., Cleveland 20, Ohio; Telephone CEdar 7783. Chicago Representative: Lawrence Wehrheim, 5510 W. Lemoyne Ave., Chicago 51, Ill.; Telephone MERrimac 7919. Pacific Coast Representative: Brand & Brand, 1052 W. Sixth St., Los Angeles 14, Calif.; Telephone, Michigan 1732. Brand & Brand, 1085 Monadnock Building, San Francisco 5, Calif.; Telephone, Douglas 4475. Wellington, New Zealand: Te Aro Book Depot. Melbourne, Australia: McGill's Agency. Entire contents Copyright 1946, Bryan Davis Publishing Co., Inc. Entered as second class matter Oct. 1, 1937, at the Post Office at New York, N. Y., under the act of March 3, 1879. Yearly subscription rate: \$2.00 in the U. S. and Canada; \$3.00 in foreign countries. Single copies, twenty-five cents in United States and Canada; thirty-five cents in foreign countries.





# EVERY DE MORNAY-BUDD WAVE GUIDE is Electrically Tested, Calibrated and Tagged



Crystal Mount DB-453



Rotating Joint DB-446



90° Elbow (H Plane) DB-433



Pressurizing Unit DB-452



Mitered Elbow (H Plane) DB-439



Uni-directional Broad Band Coupler DB-442

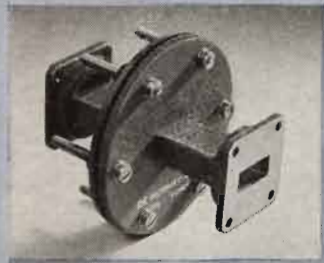

Bulkhead Flange DB-451



Uni-directional Narrow Band Coupler DB-440



90° Twist DB-435

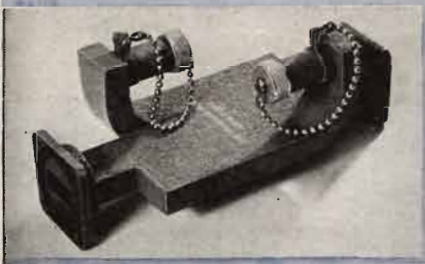

Bi-directional Narrow Band Coupler DB-441

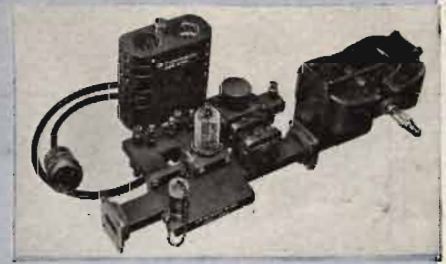
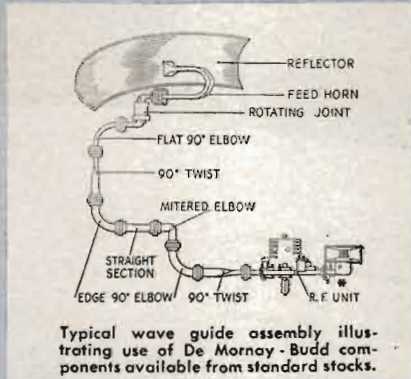

RF Radar Assembly DB-412

When you use any De Mornay-Budd wave guide assembly, you know exactly how each component will function electrically. You avoid possible losses in operating efficiency through impedance mismatches, or breakdown and arcing caused by a high standing wave ratio. (See chart below.)

De Mornay-Budd wave guides are manufactured from special precision tubing, and to the

most stringent mechanical specifications. Rigid inspection and quality control insure optimum performance.

**NOTE: Write for complete catalog of De Mornay-Budd Standard Components and Standard Bench Test Equipment. Be sure to have a copy in your reference files. Write for it today.**

The curve shows the manner in which the reflected power increases with an increase in the voltage standing wave ratio. The curve is calculated from the following equation:

$$\% \text{ Power Reflected} = \left( \frac{\left( \frac{V_{\max}}{V_{\min}} \right) - 1}{\left( \frac{V_{\max}}{V_{\min}} \right) + 1} \right)^2$$

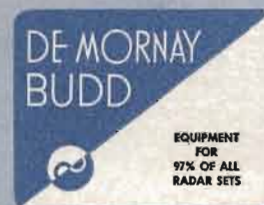
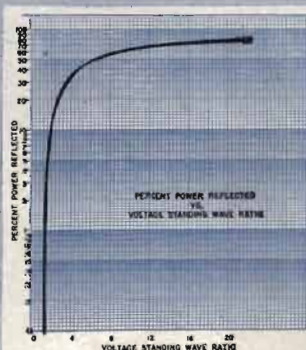

De Mornay-Budd, Inc., 475 Grand Concourse, New York 51, N. Y.





# FOR HIPERM ALLOY TRANSFORMERS

The UTC Hiperm alloy audio transformers are specifically designed for portable and compact service. While light in weight and small in dimensions, neither dependability nor fidelity has been sacrificed. The frequency characteristic of the Hiperm alloy audio units is uniform from 30 to 20,000 cycles. These units are similar in general design and characteristics to the famous Linear Standard audio Series.

## UTC Hiperm Alloy Transformers Feature

- True Hum Balancing Coil Structure... maximum neutralization of stray fields.
- Balanced Variable Impedance Line... permits highest fidelity on every tap of a universal unit... no line reflections or transverse couplings.
- Reversible Mounting... permits above chassis or sub-chassis wiring.
- Alloy Shields... maximum shielding from induction pick-up.
- Multiple Coil, Semi-Toroidal Coil Structure... minimum distributed capacity and leakage reactance.
- High Fidelity... UTC Hiperm Alloy Transformers have a guaranteed uniform response of  $\pm 1.5\text{DB}$  from 20-20,000 cycles.



FOR IMMEDIATE DELIVERY  
From Your Distributor

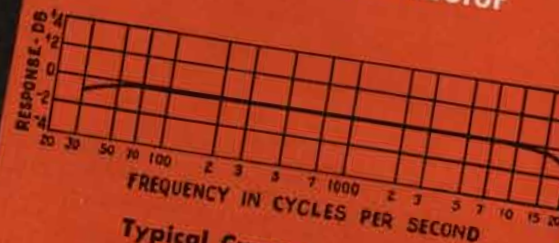

Typical Curve for HA Series

Type No.	Application	Primary Impedance	Secondary Impedance	$\pm 1$ db from	Max. Level	Max Unbal. DC in primary	List Price
HA-100	Low impedance mike, pickup, or multiple line to grid.	50, 125, 200, 250, 333, 500 ohms	60,000 ohms in two sections	30-20,000	+22 DB	5 MA	18.60
HA-100X	Same as above but with tri-alloy internal shield to effect very low hum pickup.						23.95
HA-101	Low impedance mike, pickup, or multiple line to push-pull grids.	50, 125, 200, 250, 333, 500 ohms	120,000 ohms overall, in two sections	30-20,000	+22 DB	5 MA	21.25
HA-101X	Same as above but with tri-alloy internal shield to effect very low hum pickup.						26.60
HA-108	Mixing, low impedance mike, pickup or multiple line.	50, 125, 200, 250, 333, 500 ohms	50, 125, 200, 250, 333, 500 ohms	30-20,000	+22 DB	5 MA	18.60
HA-106	Single plate to push-pull grids	8,000 to 15,000 ohms	135,000 ohms 1.5:1 ratio, each side	30-20,000	+22 DB	0	15.95
HA-113	Single plate to multiple line.	8,000 to 15,000 ohms	50, 125, 200, 250, 333, 500 ohms	30-20,000	+22 DB	1 MA	17.95
HA-134	Push-pull 89's or 2A3's to line.	5,000 to 10,000 ohms	50, 125, 200, 250, 300, 500 ohms	30-20,000	+32 DB	5 MA	19.95
HA-135	Push-pull 2A3's to voice coil.	3,000 to 5,000 ohms	30, 20, 15, 10, 7.5, 5, 2.5, 1.2	30-20,000	+32 DB	5 MA	18.60

The above listing includes only a few of the many Hiperm Alloy Transformers available... write for catalog.

*United Transformer Corp.*

150 VARICK STREET NEW YORK 13, N. Y.  
EXPORT DIVISION: 13 EAST 40th STREET, NEW YORK 16, N. Y., CABLES: "ARLAB"



# KAAR

*INSTANT*  
**HEATING**

# MOBILE FM

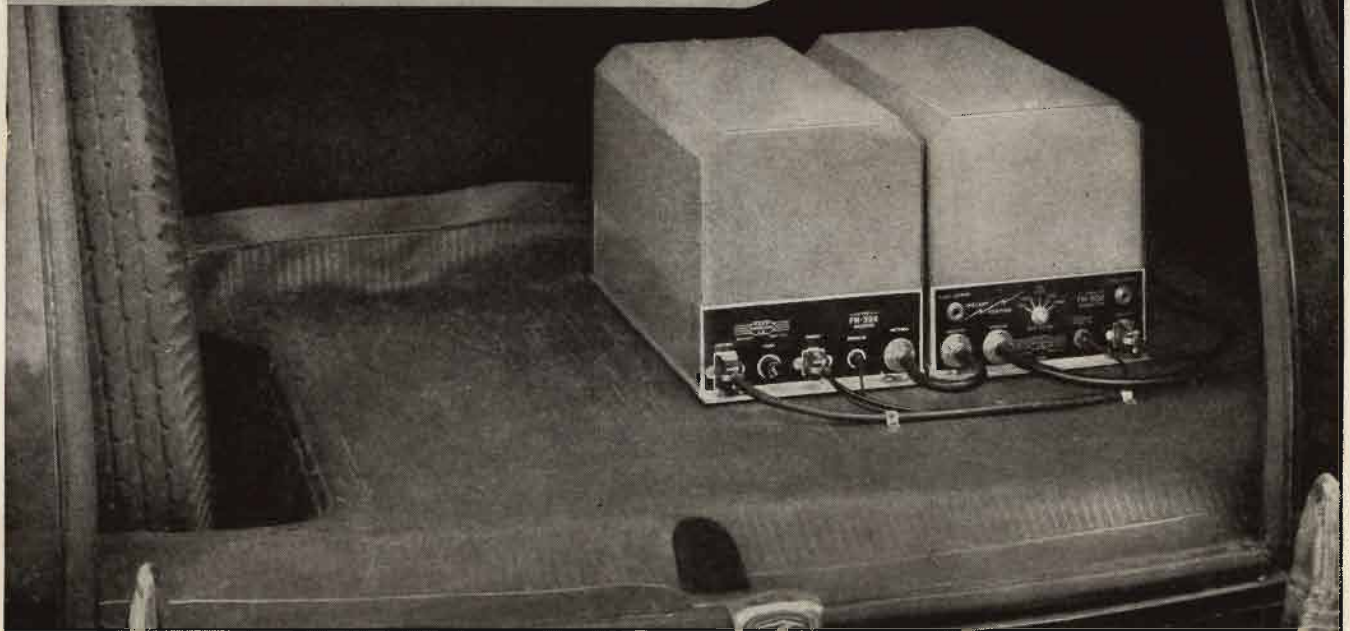

## *Now available!* An FM Radiotelephone with a truly **NATURAL** voice quality!

New KAAR FM radiotelephones offer an improvement in tone quality which is surprising to anyone who has had previous experience with mobile FM equipment. The over-all audio frequency response through the KAAR transmitter and receiver is actually within plus or minus 5 decibels from 200 to 3500 cycles! (See graph below.) This results in vastly better voice quality, and greatly improved intelligibility. In fact, there is appreciable improvement even when the FM-39X receiver or one of the KAAR FM transmitters is employed in a composite installation.

KAAR FM transmitters are equipped with instant-heating tubes, thus making it practical to operate these 50 and 100 watt units from the standard 6 volt ignition battery without changing the generator. Inasmuch as standby current is zero, in typical emergency service the KAAR FM-50X (50 watts) uses only 4% of the battery current required for conventional 30 watt transmitters. Battery drain for the KAAR FM-100 X (100 watts) is comparably low.

For full information on new KAAR FM radiotelephones, write today for Bulletin No. 24A-46.

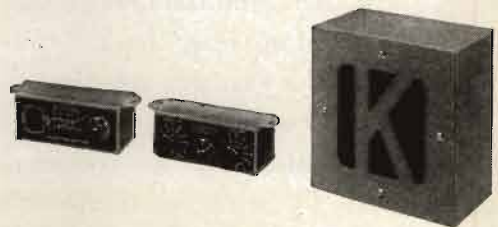

KAAR LOUD SPEAKER, remote controls for transmitter and receiver (illustrated above) and the famous Type 4-C push-to-talk microphone are among the accessories furnished with the equipment.

### IMPROVED OVER-ALL FREQUENCY RESPONSE THROUGH KAAR FM TRANSMITTER AND RECEIVER

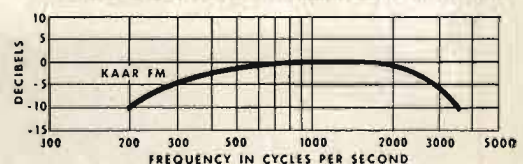

**KAAR ENGINEERING CO.**  
PALO ALTO • CALIFORNIA





# Why

# this team stands



**1914.** World's first vacuum tube repeater amplifier; designed by Bell Telephone scientists and made by Western Electric for transcontinental telephony, was the start of modern electronic communications.

**1919.** These Western Electric amplifiers powered the mightiest sound system of its day, used at New York's "Victory Way" Celebration after World War I. There were 113 loudspeakers in the system.

**W**HEN Bell Telephone scientists designed and Western Electric manufactured the first vacuum tube repeater amplifier back in 1914, they opened a vast new frontier of communications and sound distribution. Up to that time, telephone communications—both by wire and radio—could cover only limited distances and produce relatively low volumes.

For more than 30 years, this team has produced ever better amplifiers for

almost every use—long distance wire and radio telephony, radio broadcasting, sound distribution systems, mobile radio, sound motion pictures, disc recording, acoustic instruments and radar.

Equipped with unexcelled tools of research, experience, skill and manufacturing facilities, the Bell Laboratories-Western Electric team will continue to design and build amplifiers outstanding in quality, efficiency and dependable performance.

— QUALITY COUNTS —



## BELL TELEPHONE LABORATORIES

*World's largest organization devoted exclusively to research and development in all phases of electrical communications.*

# Western Electric

*Manufacturing unit of the Bell System and the nation's largest producer of communications equipment.*



# for *Quality* in Amplifiers



**1922.** The Western Electric 8A was the first commercial broadcasting amplifier. Today, 24 years later, some of these 8A's are still in use. This long life speaks volumes for the quality built into them.



**1928.** This ac operated amplifier, one of the first made, reduced maintenance costs and did away with cumbersome batteries and charging equipment. It was used to record some of the earliest sound motion pictures.



**1934.** Western Electric was an early leader in making compression type amplifiers to enable higher speech intensity between noise level and overload point. This equipment was used in overseas radiotelephony.



**1946.** The brand new 124H and J amplifiers for wired music and public address systems are small and light weight, yet deliver 20 watts. They are setting new standards of quality for music reproduction.



**1942.** This compact and powerful unit for battle announce systems is typical of Western Electric amplifiers designed during the war. It operated dependably when mounted a few feet from the largest guns.



**1938.** Negative feedback is another of Bell Laboratories' many contributions to amplifier design—now in general use. This amplifier for disc recording was able to supply as much as 50 db of feedback.

**1946.** The 1126C is the latest design of Western Electric's popular level governing amplifiers. In operation it acts as a program-operated gain control to prevent overmodulation in AM or FM broadcasting. It immediately reduces gain when an instantaneous peak exceeds a predetermined level, slowly restores it when the peak is passed.

GraybaR  
 Distributed by  
**GraybaR**  
 OFFICES IN 95 PRINCIPAL CITIES





# How to give a Bigger Bonus

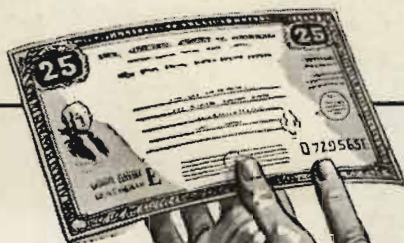

...without  
budgeting your  
budget a bit!

**S**UPPOSE Bill S., one of your employees, is due for a \$75 bonus this year. If you give the bonus in U. S. Savings Bonds, Bill will receive—not \$75, nor a \$75 Bond—but a \$100 Bond.

Yes, the bonus in Bonds looks like a lot more—and it is more. (Every \$3 put into U. S. Savings Bonds pay \$4 at maturity.) With the same size appropriation, you're actually giving a bigger bonus.

Consider, too, that Savings Bonds mean individual security for each Bond-holder—and collective security for all of us, because they help to control inflationary

tendencies. You can easily see that you're doing yourself, your employees, and your country a favor by deciding to...

## Give the BONUS in BONDS

...and keep up your Payroll Savings Plan!  
**IMPORTANT:** If you have not already received your copy of "How You Can Help Give Free Enterprise a Boost," write on your letterhead to: Room 750, Washington Building, U. S. Savings Bonds Division, Washington 25, D. C. Limited supply. Please write today.

*The Treasury Department acknowledges with appreciation the publication of this message by*

## COMMUNICATIONS

*This is an official U. S. Treasury advertisement prepared under the auspices of the Treasury Department and The Advertising Council.*





**Your Cable Problems**

*stated here*



★ **ANSONIA** ★  
**Ankoseal**

*answers here*

We have designed many cables which have solved a multitude of problems. When you come to Ansonia for something original in cables, our engineers will turn out a product to meet your specific requirements.

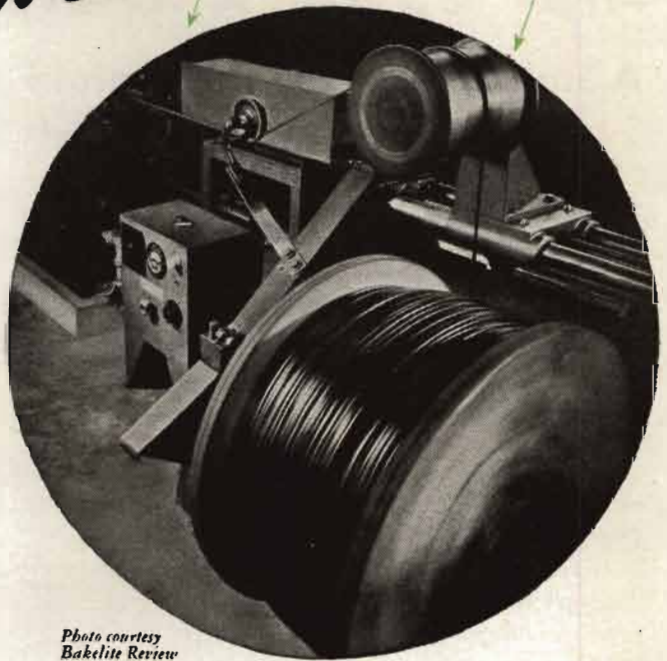

*Photo courtesy  
Bakelite Review*

**THE ANSONIA ELECTRICAL DIVISION**  
ANSONIA, CONNECTICUT *of*

**NOMA ELECTRIC CORPORATION**





LABORATORY INSTRUMENTS FOR SPEED AND ACCURACY

# +40 db



*New*

## **-hp- 450A AMPLIFIER**

### **A Stable, Wide-band, General Purpose Laboratory Instrument**

This versatile *-hp-* Amplifier is ideal for general laboratory use. It provides unusual stability at 40 or 20 db gain, and new freedom from spurious responses. Low phase shift is assured by a straightforward, resistance-coupled amplifier design, together with inverse feedback. Frequency response is flat within  $\frac{1}{2}$  db between 10 and 1,000,000 cycles. Varying tube voltages or aging tubes have no appreciable effect on the gain or other characteristics. The amplifier is fully operated from a 115 volt 60 cycle power supply.

When used in conjunction with the *-hp-* 400A Vacuum Tube Voltmeter, this amplifier increases the voltmeter's sensitivity by 100 times (300 microvolts full scale) at 40 db. At 20 db gain, sensitivity is multiplied 10 times (3 millivolts full scale). And since the 450A is designed for use with the 400A, both have identical base sizes to permit stacking and short-leads.

This rugged, compact amplifier is ready now for early shipment. Your inquiry or order will be given prompt attention.

#### **SPECIFICATIONS**

**GAIN:**

40 db (100X) or 20 db (10X)  
(Panel Selector Switch)

**FREQUENCY RESPONSE:**

at 40 db gain:  
within  $\pm \frac{1}{2}$  db between 10 and 1,000,000 cps  
within  $\pm 1$  db between 5 and 2,000,000 cps  
at 20 db gain:  
within  $\pm \frac{1}{2}$  db between 5 and 1,000,000 cps  
within  $\pm 1$  db between 2 and 1,200,000 cps

**INPUT IMPEDANCE:** 1 megohm shunted by approximately 15  $\mu$ ufd

**OUTPUT:** 10 Volts maximum to 3,000 ohms or higher resistive load

**INTERNAL IMPEDANCE:** Less than 150 ohms over entire range

**POWER SUPPLY:** 115 volts 50/60 cycles 40 watts

**MOUNTING:** Metal Case, leather carrying handle

**SIZE:** 7 $\frac{1}{2}$ " wide, 5 $\frac{1}{4}$ " high, 9 $\frac{1}{2}$ " deep  
Net weight 10 lbs.  
Shipping weight 18 lbs.

**PRICE:** \$125.00 FOB Palo Alto, California



**INCREASES SENSITIVITY OF -hp- 400A 100 TIMES!**



## **HEWLETT-PACKARD COMPANY**

1278E Page Mill Road, Palo Alto, Calif., U. S. A.



# COMMUNICATIONS

LEWIS WINNER, Editor

\* \* NOVEMBER, 1946 \* \*

## POSTWAR BROADCAST ANTENNA Installation

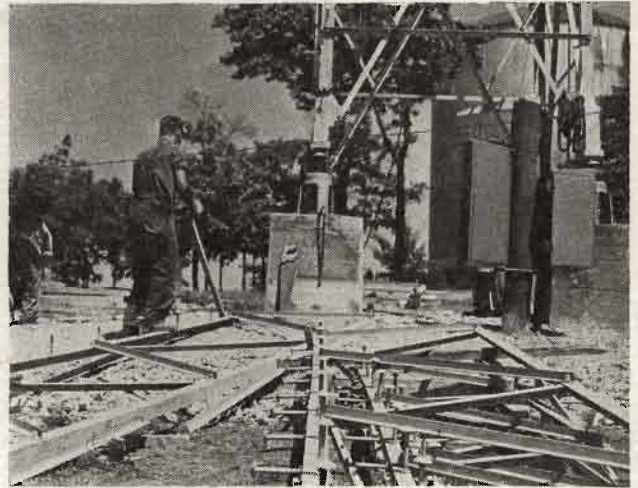
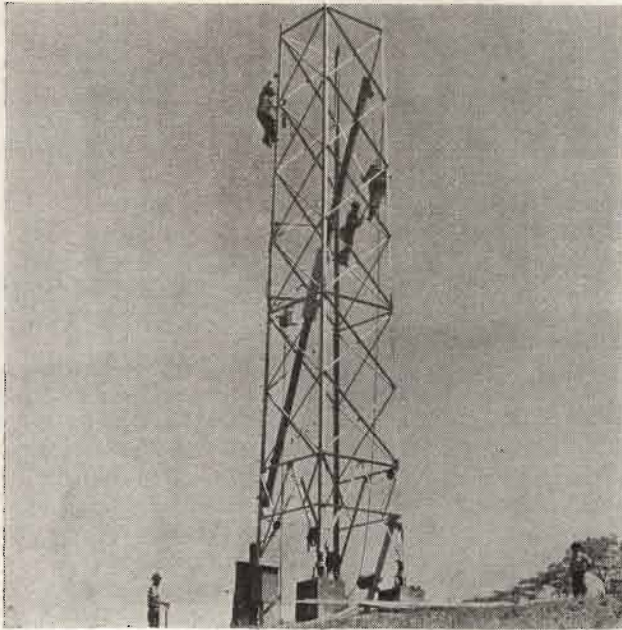

by **DAVID W. JEFFERIES**

**Chief Engineer  
WTBO, Cumberland, Maryland**

WHEN OUR STATION shifted from 820 to 1,450 kc on full-time operation we found that it would be necessary to replace our inverted *L* type of antenna with counterpoise. This had performed satisfactorily for a great many years on the old frequency but offered only disappointment when the station shifted to the higher frequency. The replacement decided upon was a quarter-wave self-supported vertical steel radiator with an extended copper mesh ground screen, in addition to radials spaced at  $4^\circ$  intervals. Signal strength from the new tower was found to exceed that of the inverted *L* by an average of 4 db.

The radiator itself, fabricated of steel, was supplied in 25' lengths and assembled on the site. The contractor, a New York erecting firm, furnished the tower steel, lighting equipment, paint and labor as a *package* proposi-

**Installation of Quarter-Wave Self-Supporting Steel Radiator, Recently Completed, Uses Extended Ground Screen System. Antenna is Typical of Type Soon To Be Installed by Many Local-Channel Outlets. New Installation Also Includes Audio-Sampling Setup Using Germanium Crystal Diodes.**

tion. The company's construction superintendent used local union labor exclusively. If the efficiency of the Cumberland crew is any criterion, it would appear that many tower installa-

tions could be made without resorting to the importation of an erecting gang.

Installation of the complete radiating system, including digging of foundation holes in an extremely difficult shale formation, laying of the ground elements, erection and painting of the tower, required a little more than three weeks, even though work was hindered by frequent spring rains. Actual erection of steel, once the four porcelain insulators were set in proper alignment, involved two-days' work by

(Above)

Figures 1 (left) and 2 (right)

Figure 1 shows workmen bolting second 25' section of postwar quarter-wave antenna in place. Assembling of tower sections on ground is shown in Figure 2.



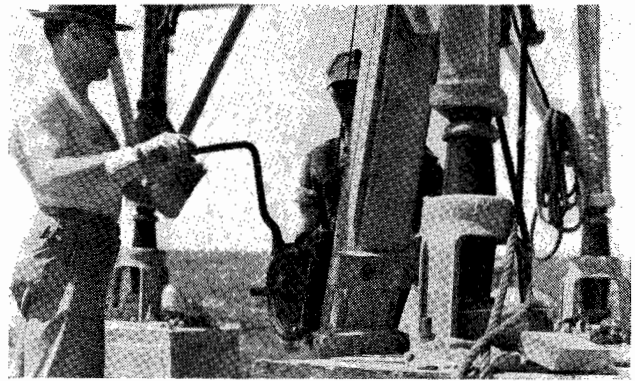
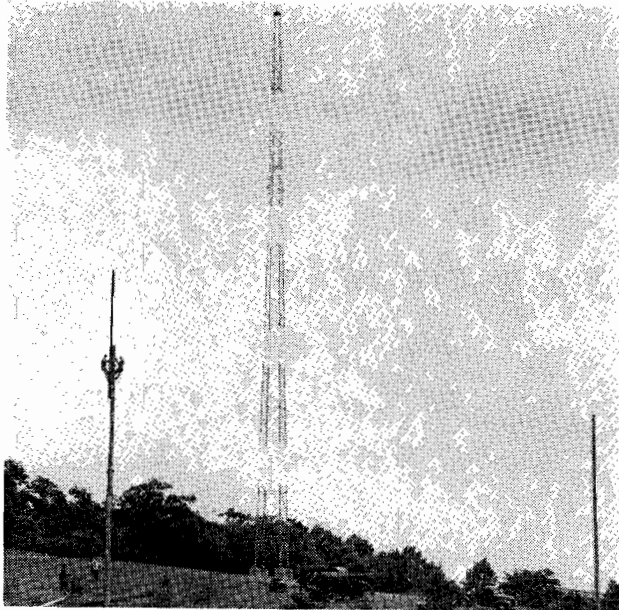

Figure 4 (above)  
Two-man winch for hoisting steel tower sections.

Figure 3  
Completed quarter-wave tower. At left we see workmen dismantling old 100' masts which supported inverted L antenna for many years.

a crew of four. Tower site chosen was 120' from the transmitter house, necessitating installation of coaxial cables for r-f transmission and several pairs of electric-power wires and shielded communication circuits. Because the broadcasting plant adjoins a city park, it was necessary to make the antenna installation attractive without, of course, hindering radiation effectiveness.

To avoid unsightly overhead wiring, the two coaxial cables and associated wire circuits were placed in a 2½" pipe conduit and buried to a depth of approximately 18". The pipe joints were sealed with white lead to exclude moisture. As the terrain slopes upward to the tower, no difficulty is expected in maintaining adequate drainage should leakage occur. Since the conduit turns upward to the transmitter after entering the cellar, numerous half-inch holes were drilled at the pipe's lowest point in a further effort to aid drainage. The necessity for preventing water collection within the conduit was not discounted, remembering particularly a somewhat similar installation in New York State, when freezing of water within a conduit pinched a coaxial cable together, throwing the station off the air until emergency repairs could be effected.

The half-inch coaxial cables, one for daily use, the other an auxiliary line, are nitrogen filled under a pressure of fifteen pounds to exclude moisture and to maintain a continued high breakdown voltage rating.

Scarcity of lumber and other materials, plus the more than usual requirement for attractiveness, led to the decision to forego construction of a tuning house beneath the tower. Two weatherproof housings were provided, securely bolted to a short length of

erect chestnut pole. These contain a tuning network,<sup>1</sup> audio sampling diode circuit, remote antenna current metering equipment, r-f lighting chokes and necessary capacitors.

It is of interest to note that the tuning unit housing and feeder conduit were installed before work commenced on the tower and ground system. This simplifies the laying of ground screen and radials and the procedure is recommended.

Concrete piers for the tower are 8' high, reaching below the ground surface some 6' into almost solid rock. Numerous reinforcing rods were criss-crossed and wired into place within the forms before the coarse concrete mixture was poured. The piers were allowed to season for six days before steel erection commenced.

To facilitate hoisting the steel into place, a gin pole was constructed by butting two 18' six by sixes and securely cleating them together. While a borrowed telephone pole of similar length might have offered a simpler and cheaper solution, it was found that only creosoted poles were available. These are so much heavier than untreated poles, as to be both unwieldy and dangerous.

A two-man winch was employed to lift the 25' steel sections into place. As stated, two men on the ground and two workmen aloft completed the steel work in two days. Electric conduit was next fitted and painting followed during the first spell of dry weather.

#### The Ground System

In view of a somewhat rocky soil condition in the immediate vicinity of

<sup>1</sup> RCA type.

the transmitter property, it appeared highly desirable to install a large copper mesh ground screen directly beneath the tower. In addition, ninety radials, each a quarter-wave in length, were deemed advantageous in securing an effective low-resistance contact with ground.

The mesh, 48' x 48' in size, manufactured for the purpose, was supplied in rolled-up sheets, each 6' x 8'. These were laced together with bare copper wire and securely soldered, this work being done after the tower erection was completed, to minimize wear and tear on the mesh.

The radials, of No. 8 gauge soft-drawn bare copper wire and uniformly spaced 4° apart, were laid out to a distance of 175', a quarter-wave length at the operating frequency of 1,450 kc. After this layout was finished, trenches were dug and the wires buried to a depth of about 4".

A simple way to determine the spacing between radials is to drive a circle of stakes a quarter-wavelength from the tower center. At this circumference the distance between stakes can be found by the simple formula,  $2 \pi R/90$ , the result being 12' 3". This, of course, automatically spaces the radials 4° apart. A pole, cut to the proper length, facilitates locating the spot for driving each stake.

Most of the radials were terminated at the edge of the ground screen, being securely wrapped around the mesh and soldered. Every tenth radial was continued on into the tower base, soldered every few inches to the mesh, and finally grouped into a cable of nine wires. This cable was continued on up the pole supporting the antenna tuning unit and terminated at a large ground stud.

After completion of the ground sys-



tem, some 4" of washed gravel was leveled onto the copper mesh, offering effective protection from tramping feet and limiting weed growth as well. An attractive rustic picket fence was erected around the edge of the mesh. This type of barrier, constructed of a durable peeled Michigan evergreen timber, is surmounted by a single strand of barbed wire, meeting FCC requirements for security. Several high voltage signs, procured from the local power company, warn passersby of the hazard within the enclosure. The rustic fence blends well with park surroundings and the landscaping of the area.

### Obstruction Lighting

Specified lighting for the tower called for a 300 m/m electric code beacon, flashing aviation red forty times a minute. Two 500-watt PS-40 mogul pre-focus lamps were used. They burn simultaneously, operating from sunset to sunrise, being controlled by a photoelectric device. The light-sensitive instrument turns the beacon on whenever illumination from the north sky falls to a predetermined minimum. The method is recommended over manual control, as positive operation is insured and a current saving is effected in summer when the device shuts off illumination long before an operator arrives for the morning shift.

When hazard to air traffic is likely during construction of a tower, red warning lights are required after the structure reaches a height of 150'. At least one 100-watt lamp should be displayed from sunset to sunrise, visible in all directions of possible aircraft approach. The nearest CAA office should be notified when temporary lights are placed in operation. With the completion of specified lighting, CAA should be contacted for an air-navigation certificate. This is issued upon submission of data covering the tower and the type of obstruction marker in use. In case of a light failure of more than thirty minutes' duration, a report should be telephoned to the nearest CAA office.

### Improved Coverage

As indicated previously, tests over a wide area indicated a gain of approximately 4 db over the discarded inverted L-type antenna. Measurements were made with mobile equipment at a distance of six to eight miles from the transmission point, comparing signal strength of both antennas at each point a stop was made. In several instances a substantially greater gain was noted, this doubtless being due to the somewhat directive proper-

ties of the old radiator. One of these signal nulls covered most of a town some nine miles from the station.

Extensive series of listening tests indicated that the service area is very good in view of the power and frequency employed and more particularly the extremely irregular mountainous terrain in the vicinity of Cumberland.

### Galvanized Surface Treatment

An effective tower-surface etching treatment<sup>2</sup> was applied, preparatory to painting the galvanized surfaces on towers.

In the treatment the following procedure was used:<sup>3</sup>

Into one gallon of soft water two ounces each of copper chloride, copper nitrate and sal ammoniac were dissolved. Then two ounces of commercial muriatic acid were added; this should be done in an earthen or glass vessel, never in tin or other metal receptacle. The solution was applied with a wide, flat brush. The galvanized iron assumed a dark, almost black, color. On drying, this became a greyish film, effectively preventing paint from peeling when applied to galvanized surfaces.

As the suggested formula is highly corrosive to clothing, due care must be exercised during application of the solution.

### Audio Sampling

In another transmitter improvement we applied the stable germanium crystal diodes to our audio sampling system. Vacuum tube diodes had been employed, but none proved satisfactory. In the tube systems, distortion and hum appeared to be necessary by-products, to a greater or lesser degree, and the ever-present filament transformer was an inconvenient adjunct to the monitoring method.

The crystal diode (1N34) seemed to have the necessary power capabilities, was distortionless and hum-free, and required no filament supply. After consultation with the diode engineers<sup>4</sup> two circuits were suggested, one for direct-driving of push-pull grids. The latter design, permitting sampling right at the antenna lead, was adopted. The rectified signal is coupled through

(Continued on page 34)

<sup>2</sup> Used by Hartenshine-Zane Company, N. Y.;  
<sup>3</sup> based on Department of Commerce air-navigation specification 743.  
<sup>4</sup> Sylvania.

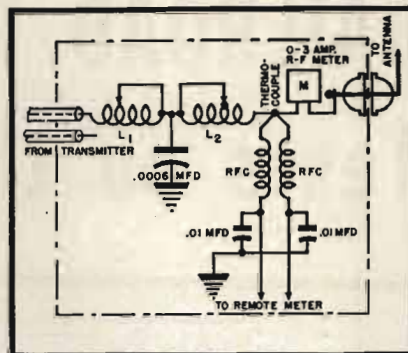

Figure 5  
RCA  $\pi$ -network tuning unit used with postwar antenna system.

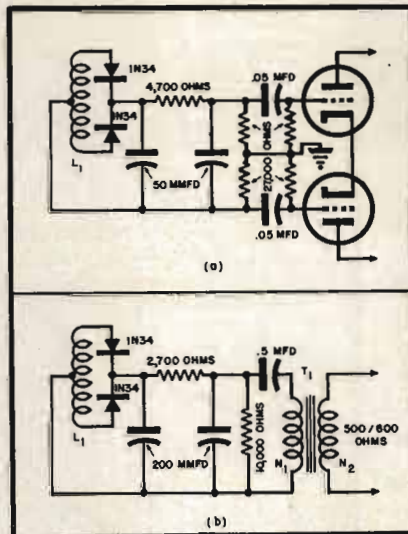
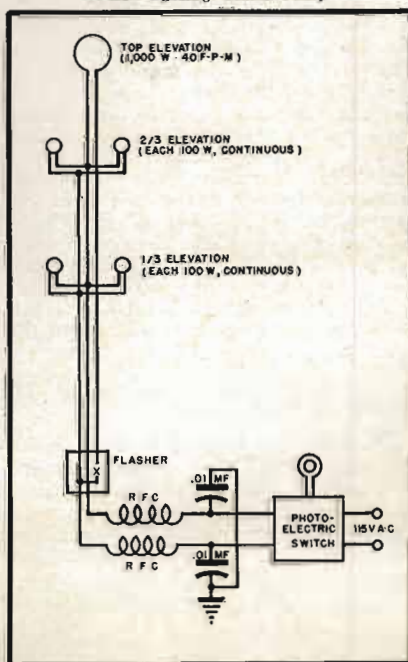

Figure 6  
In (a) appears sampling circuit for direct feeding of monitor-amplifier grids using crystal diodes. A crystal-diode sampling circuit for monitoring remotely from amplifier is shown in (b). The transformer ratio  $N_1/N_2$  should be greater than 10:1. Dimensions of  $L_1$  are not critical; 25 turns on a 1" form, center-tapped, will do.

(Circuit data courtesy Sylvania)

Figure 7  
Tower lighting circuit setup.





# RAILROAD RADIOTELEPHONE

## Tests on the Nickel Plate Road

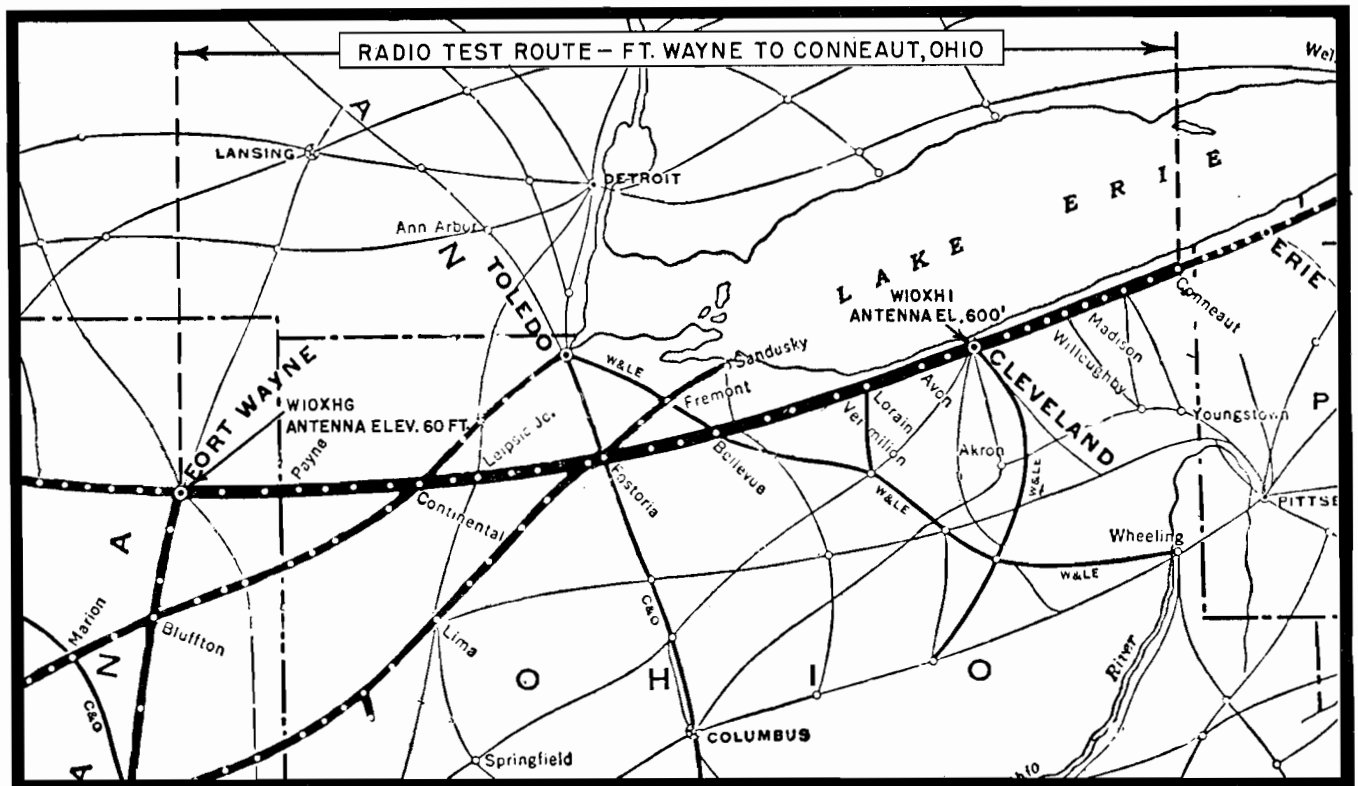

by RALPH G. PETERS

### Highlights of Test Results Prepared from Report Compiled by Farnsworth Radio and Nickel Plate Road for Association of American Railroads.

DURING THE EARLY part of July a series of two-way v-h-f (161.775 mc) railroad radiotelephone communications tests<sup>1</sup> were held on the NKP main line between Fort Wayne, Indiana, and Conneaut, Ohio, and in yard and terminal areas in Fort Wayne, Bellevue (Ohio), Cleveland, and Conneaut. The two-way system was operated between locomotive and caboose of a freight train of the maximum length normally employed (about 80 cars); between a train and fixed 10-watt station at the West Wayne Yards, (antenna elevation 60'); between a train and a fixed 10-watt station at Cleveland, Ohio, (antenna elevation 600'); and between a locomotive and caboose, when the locomotive was detached from the train.

#### Purpose of Tests

The tests were conducted to study the performance of v-h-f f-m equipment operating on high-speed freight trains; to determine distances over which reliable two-way point-to-train communications might be maintained with fixed

stations and on mobile units; and to observe performance of equipment in point-to-train and end-to-end service in various parts of large cities.

#### Fixed Station at West Wayne Yards

At the West Wayne Yards the equipment consisted of: a 10-watt v-h-f f-m transmitter<sup>2</sup>; receiver having a sensitivity of approximately 0.5 microvolt; power supply unit; three-unit fixed station rack for wall-mounting of units; local control unit including a loudspeaker and microphone; voltage-regulation transformer<sup>3</sup>; and a fixed station antenna.

The antenna, of colinear-array type, having a gain of approximately 3 db over a standard dipole, was installed on a wood pole at a height of approximately 60' above ground. A coaxial cable<sup>4</sup>, employing flexible polyethylene insulation,

was used between the antenna and the equipment in the yard office.

#### Locomotive Equipment

Mobile radiotelephone equipment was installed on a steam engine. A 10-watt transmitter similar to and interchangeable with that used at the fixed station, was shock-mounted with the receiver in a weatherproof metal housing on the tender of the locomotive. A firecracker low-clearance transmitter-receiver antenna, having an over-all height of 11 $\frac{3}{4}$ " above its mounting flange, was located on the top of the equipment housing. A 32-volt operated motor generator of self-

<sup>1</sup> Conducted by the New York, Chicago and St. Louis R.R. Co. (Nickel Plate Road) in association with Farnsworth Television and Radio Corp.

<sup>2</sup> Pre-production model of Farnsworth 15-watt production model, type M-100-2.

<sup>3</sup> Sola.

<sup>4</sup> Amphenol AN type RG17/U.





Figure 1 (left)  
Transmitting from demonstration coach. At microphone, Ralph DeLany, chief engineer of WHK, Cleveland. Looking on are H. C. Land, assistant superintendent of communications of Chesapeake and Ohio Railroad and L. E. Kearney, AAR communications engineer.

Figure 2  
Twin speaker installation in coach.

regulating type was used for power supply. This unit was operated from a 32-volt turbo-generator on the locomotive and supplied 6.3 volts a-c for the filaments as well as 350 volts d-c for plate power. An automatic voltage-regulator held the filament-voltage variation within 5%, from one-half load to full load in the filament circuit, over a primary-voltage range of 30-40. The plate-voltage variation was held within 10% over the same range. The microphone was a military-type with noise-discriminating construction. A weatherproof reentrant loudspeaker was also employed in the cab for reproduction of received voice signals.

The total power consumption of the transmitter and receiver, exclusive of conversion losses in the motor generator, was approximately 150 watts when receiving, (including standby operation of transmitting-tube heaters), and 250 watts when transmitting.

#### Caboose Equipment

Equipment in the caboose was similar to that employed on the locomotive, except that an experimental *cartwheel* antenna of ground-plane type, was employed in lieu of the low-clearance antenna. Power supply consisted of a gasoline driven generator<sup>5</sup> and a 115-volt a-c supply unit.

A remote control unit was located near the center of the caboose, and was accessible whether a person was standing on the floor or sitting in the cupola.

A second remote control unit was located in a coach coupled to the caboose

and was interconnected with the local control unit of the caboose to permit remote control of the caboose transmitter from the coach. The two remote control units, one in the caboose, and the second in the office car, were equipped with an *intercom* circuit, which, by means of a push-button selector switch, made it possible for the remote control units to be used in direct-line audio communication between the office car and the caboose, as well as in radio communications service.

#### Cleveland Terminal Tower Fixed Station Equipment

A fixed station at the Terminal Tower Building, Cleveland, used two colinear-array antennas, mounted on the forty-fourth floor balcony, about 600' above ground. One antenna was located on the east side of the building, and the second antenna was mounted on the west side. A coaxial cable connected antenna con-

nection terminal box and the transmitter and receiver units.

While from a propagation viewpoint, it would have been desirable to locate a single antenna at the top of the building, more than 200' above the point where the equipment was installed, such an arrangement would have involved considerable installation expense and other complications which were not believed to be justified for test purposes.

Two antennas were used since preliminary tests with a single antenna on the south side of the building had shown that a pronounced radiation lobe existed toward the south, with appreciably less radiation to the east and west, where good radio coverage was most necessary.

#### Fixed Station Performance Characteristics

The fixed station transmitter used a crystal-controlled phase-shift to produce a maximum frequency swing of  $\pm 15$  kc with respect to the mean carrier frequency. A limiting circuit, incorporated in the speech amplifier of the transmitter, was utilized to prevent excessive frequency deviation with abnormally high acoustic speech levels at the microphone. Two crystals were provided in the transmitter to permit operation on either of two designated frequencies as determined by a selector switch at a remote control point. However, in these tests only one crystal was employed since all communications were on a single frequency.

The transmitter was operated on a press-to-talk simplex basis, with plate power being applied by means of a press-

<sup>5</sup> Onan.

Figure 4  
Main station antenna on the 44th floor balcony of the Terminal Tower Building, Cleveland. This is one of two antennas used by remote-control unit.

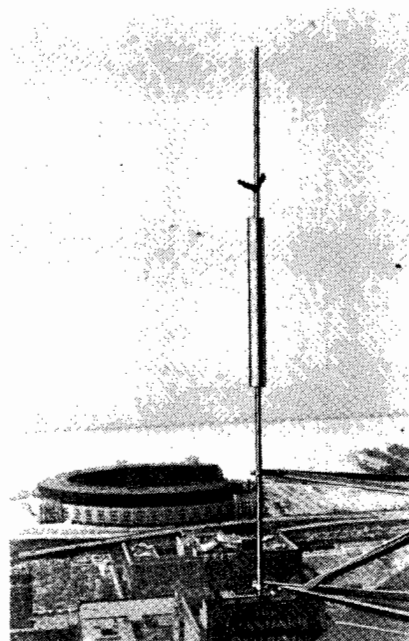

Figure 3  
Cartwheel-type antenna atop caboose.

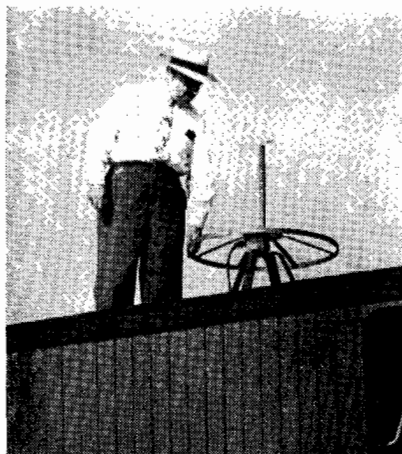
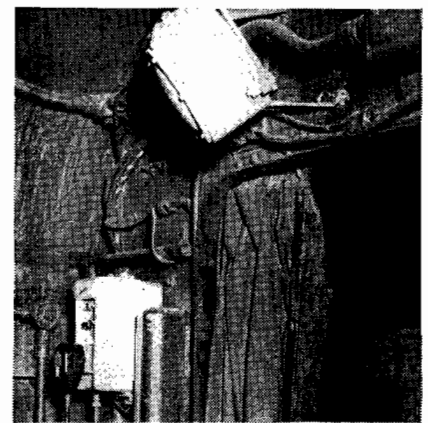

Figure 5  
Inside cab of the Nickel Plate locomotive.





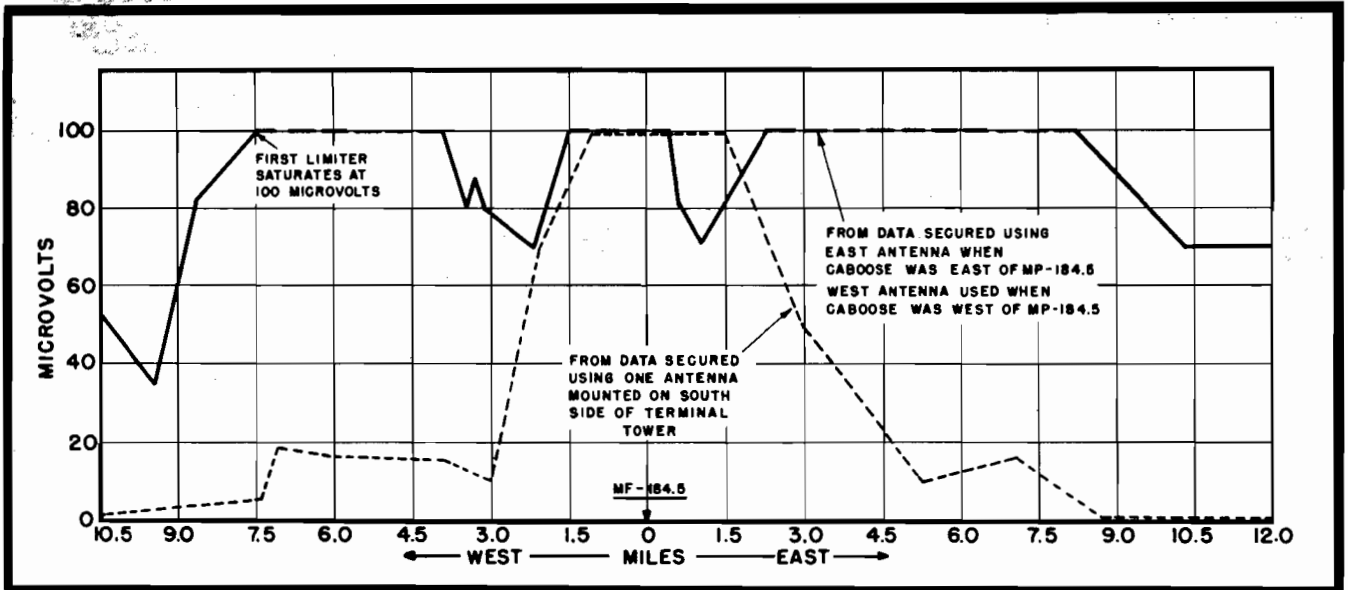

Figure 6

Radio-frequency signal strengths versus distance, from east and west antennas, at fixed stations in Terminal Tower Building, Cleveland. In the tests the second limiter saturated at less than 1 microvolt, producing full audio output at this signal input level.

to-talk control circuit associated with a push-button switch on a handset.

The fixed station receiver was of a crystal-controlled superheterodyne type, with a normal output rating of 5 watts. Sensitivity of the receiver was sufficient to produce full audio output with a received carrier signal strength of approximately 1 microvolt.

An electronic squelch circuit was utilized to render the audio output circuit effective with a minimum r-f signal input of approximately 0.5 microvolt, or at a higher level as determined by the squelch-control adjustment. Two limiters were used in cascade in the i-f portion to produce full saturation of the second limiter at an r-f signal input level of approximately 1 microvolt.

Selectivity of the receiver was such as to produce a response at least 75 db down at 120 kc off resonance (alternate channel separation).

The audio-frequency response was

within  $\pm 2$ db over a 200 to 3000-cycle range, as referred to the standard de-emphasis characteristic of an f-m receiver, which produces a response decreasing with increase in audio frequency at a rate of 6 db per octave.

The automatic volume control (limiter) circuits of the receiver, held the audio output constant within limits of 4 db when the r-f signal input was increased from 1 microvolt to 1 volt, with no overloading being produced at 1-volt r-f signal input.

#### Mobile Equipment

The transmitters employed on the locomotive and caboose were identical to and interchangeable with those installed at the fixed stations, except that the units were shock-mounted in a weather-proof metal case designed for mobile railroad service.

The receivers were similar to and in-

terchangeable with those employed at the fixed station.

#### Test Procedure and Results

On the first day of the tests local communications were carried on between the West Wayne radio station and train equipment, as well as between the radio-equipped caboose and locomotive, as the caboose, coach and office cars for the accommodation of observers was being moved from West Wayne to Fort Wayne, where 80 freight cars were picked up. The train then proceeded east toward Cleveland. Completely solid two-way communications, in which no flutter or electrical noise was discernible, was maintained between the caboose and engine, and between both these units and the West Wayne fixed station until Dawkins, Indiana, was reached, a dis-

(Continued on page 30)

Figure 7

Variations of r-f signal strength versus distance in tests made in vicinity of fixed station (184.5 mile post) in Terminal Tower Building. Antenna elevation at this station was 600'.

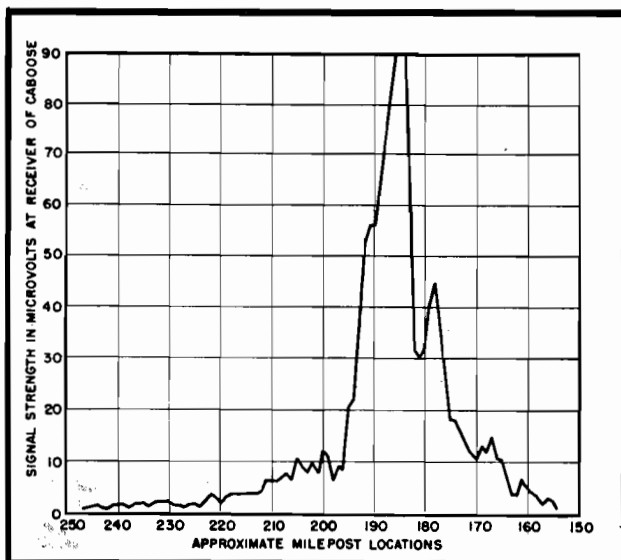
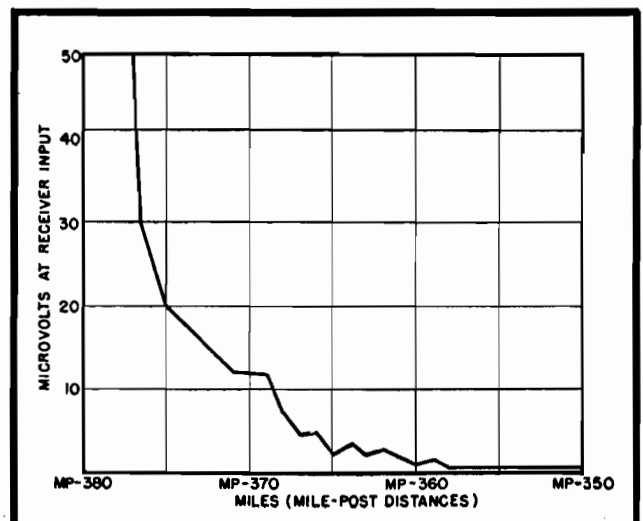

Figure 8

Variation of r-f signal with distance in tests made in vicinity of fixed station at West Wayne Yards. Here the antenna elevation was 60'.







**Now! Farnsworth brings top-quality music and radio entertainment to modern passenger trains!**

**NOW!** Progressive railroads can offer the traveling public the same high quality of music and entertainment enjoyed in their passengers' own homes. With this new service, railroads can pave the way to greatly increased passenger train luxury and revenue.

In offering the first practical electronic program distribution system, Farnsworth has met the three basic requirements which railroad-conducted studies have shown necessary to high-quality rail-borne entertainment: (1) uniform, low-level sound distribution; (2) automatic compensation for varying ambient noise levels; (3) programs that passengers want to hear.

In the de luxe Farnsworth systems four channels are available for individual selection: popular or luncheon music; semi-classical or dinner music; radio programs; train announcements and travel talks. Also available are more simplified single- or dual-channel systems.

All Farnsworth systems are simple to install; operate automatically and unattended. Unitized construction permits instantaneous replacement of units without manual disconnection of a single wire. Other noteworthy features are: push-button precision crystal radio tuning and self-rewinding wire reproducing mechanisms.

Farnsworth Passenger Program Distribution Systems have been engineered by the same laboratories that gave the world its finest instrument for musical reproduction — The Capehart.

Farnsworth Television & Radio Corp., Dept. C-11, Fort Wayne 1, Indiana.

---

*Farnsworth*  
*Television · Radio · Phonograph-Radio*

Farnsworth Radio and Television Receivers and Transmitters • Aircraft Radio Equipment • Farnsworth Television Tubes • Halstead Mobile Communications and Traffic Control Systems for Rail and Highway • The Farnsworth Phonograph-Radio • The Capehart • The Panamuse by Capehart



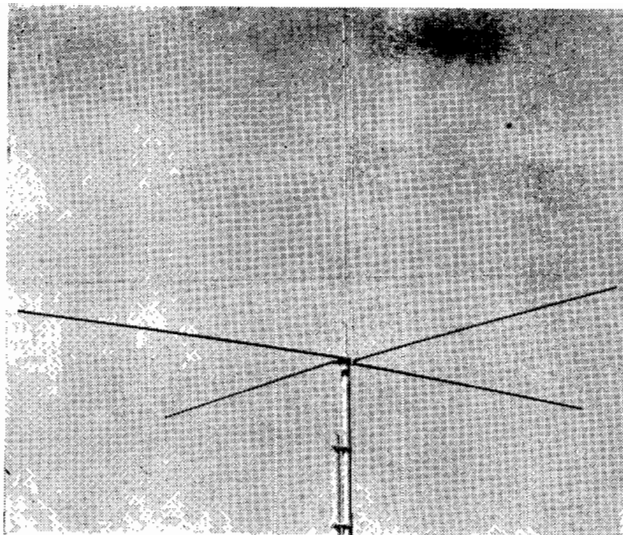

Figure 2  
A 30- to 44-mc type of folded unipole.

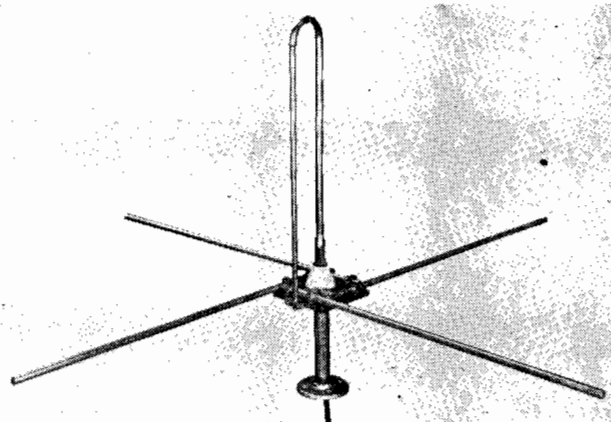

Figure 3 (below)  
Another version of the unipole for 152 to 162 mc.

# A FOLDED UNIPOLE ANTENNA For Emergency Communications

by J. S. BROWN

Assistant Chief Engineer  
Andrew Company

WITH THE INCREASING USE of communications systems by the police and other emergency services on the higher frequencies has come many new design requirements. In antennas, for instance, it has been found that there are five design features that should be included at the higher frequencies to provide maximum efficiency: (1)—vertical polarization; (2)—input impedance that matches the transmission line, allowing for an easier tune-up in the field; (3)—fairly broad-band im-

pedance characteristic to minimize field installation and adjustment; (4)—provision for lightning protection; and (5)—omnidirectional radiation pattern in the horizontal plane.

To meet these specifications, the unipole type of antenna was developed.

## Derivation of Unipole

In the case of a conventional half-wave folded dipole antenna, an electrical neutral or ground plane is known to exist at the center of the antenna and perpendicular to its axis. If the antenna is oriented vertically, we have a mechanical ground plane where the electrical one exists, and the lower dipole can be removed. Thus, only one of the dipoles remains.

## Electrical Components

Electrically the antenna consists of a conventional quarter-wave ground plane antenna with a matching stub projecting below the antenna.<sup>1</sup> The radiating and matching functions are combined into the same elements.

## Input Resistance

The input resistance of a quarter-wave ground plane antenna, theoretic-

ally 36.6 ohms, in practice is found to be in the neighborhood of 25 to 35 ohms, which is not a satisfactory match to a 70-ohm transmission line. Folding the quarter-wave radiator will transform this upwards, and if the diameters of the two elements are equal the resistance will be multiplied by a factor of *four*.<sup>2</sup> If the diameters of the folded members are not equal, however, factors other than four are obtainable. This provides a very convenient and flexible method of providing a proper impedance match over a wide range of impedances, and can be applied to numerous antenna configurations.

## Diameter Ratios

Several sets of data giving the resistance multiplying factor as a function of the diameter ratio of the two members have been studied and found to vary widely. In general, if the fed member is larger than the grounded member, the resistance will be multiplied by a factor less than *four*; if the grounded member is larger than the driven element a multiplication of greater than *four* will result. In practice it is necessary to make actual impedance measurements on models to

Figure 1

Schematic of the folded unipole antenna.

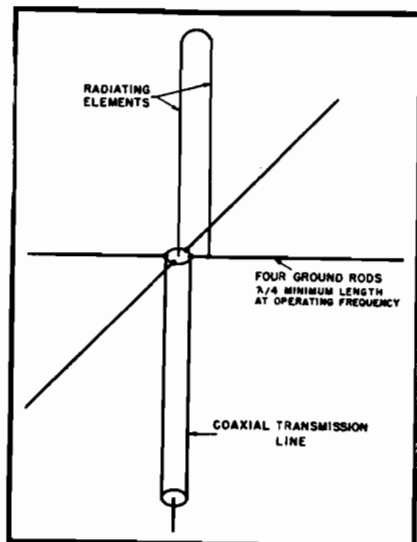



# Discussion of Quarter-Wave Ground-Plane Antenna That Combines Radiating and Matching Functions, Providing Vertical Polarization, Input Impedance That Matches Transmission Line, Fairly Broad-Band Impedance and Omnidirectional Radiation Pattern in Horizontal Plane.

arrive at the desired result, since such effects as the insulator capacity have considerable influence on the final result.

### D-C Path to Ground

A very important feature of the folded member is that a d-c path to ground is provided within the antenna system itself. While it will not eliminate all possibility of damage to antenna or line from lightning, there is a path to ground that will allow induced surges and static charges to leak off, thus helping to minimize the chances of damage to the line and other equipment from these causes. Operating experience with grounded antennas of various types also indicates a decrease

in rain and snow static over ungrounded antennas.

### Ground Rods

Studies were made to determine the number and length of ground rods required for best efficiency. The importance of a low-loss ground system has been recognized in the standard broadcast industry,<sup>3</sup> and the same principles apply at higher frequencies.

### Radiation Current Flow

A ground plane that does not provide a low-resistance return path introduces a loss resistance in series with the radiation resistance of the antenna. Since the radiation currents flow through both resistances the efficiency

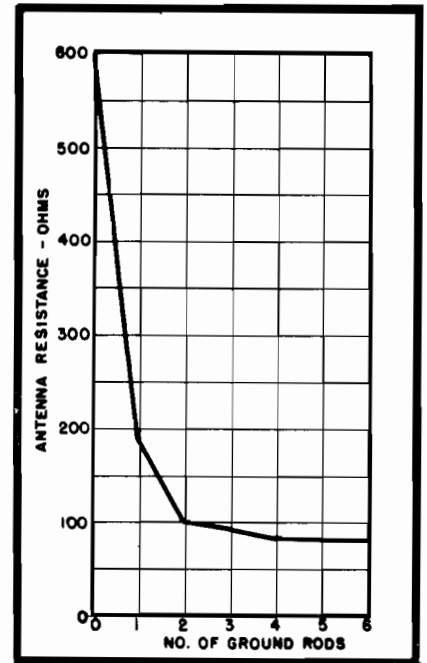

Figure 4

Plot showing how varying the number of ground rods affects the antenna resistance; ground rods are  $\frac{\lambda}{4}$  long.

of the antenna is reduced, as the power dissipated in the ground return resistance is not radiated, but lost power.

### Ideal Ground Plane

The ideal ground plane is, of course, a large metallic sheet. Mechanical limitations indicate an approximation to this, which is accomplished by using several ground rods.

Tests were made on a model on which the number of ground rods was varied from one to six. The input resistance versus number of rods is plotted in Figure 4. From this it is apparent that very little increase in efficiency

Figure 6

Resistance and standing-wave ratio curves for a 30 to 44-mc model.

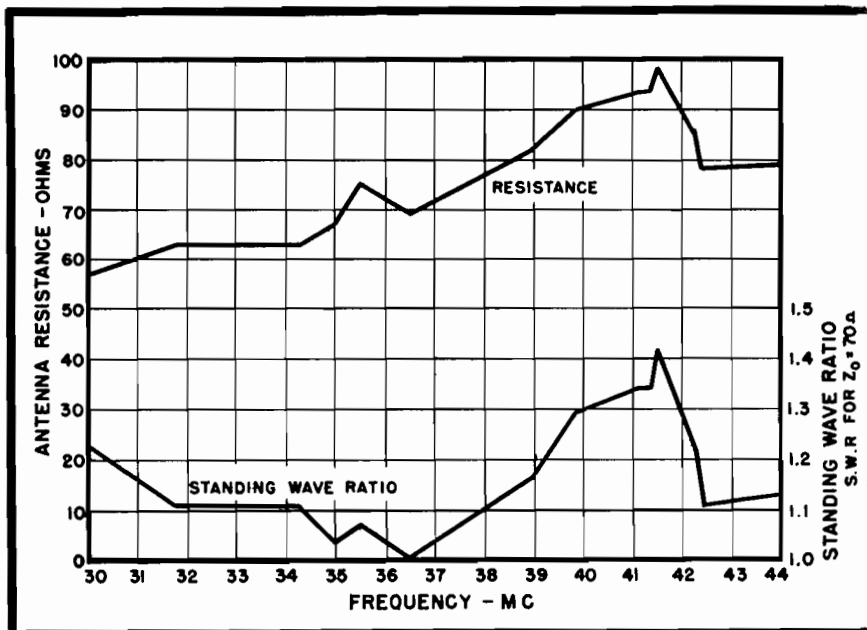
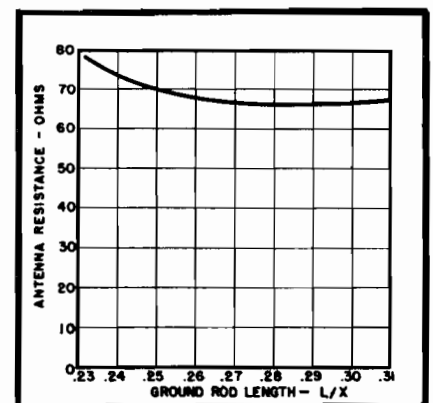
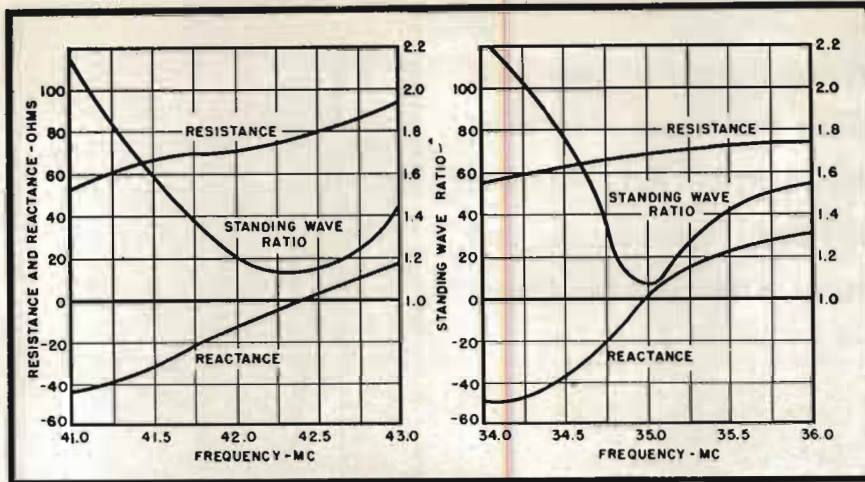

Figure 5

Effect of ground rod length on antenna resistance; length of ground rods not changed over band, vertical members being cut to length for operating frequency.





Figures 7 and 8

Resistance, reactance and standing-wave ratios for two different frequency applications. In Figure 7 (left) we have the plots for a 42.4-mc whip and in Figure 8 appears the plot for a 35-mc whip.

is effected if more than four rods are used.

In another test, using a model with four ground rods, the lengths of the rods were varied, giving the results plotted in Figure 5. Quarter-wave rods appear to be the shortest that should be used for best efficiency.

It might be thought that, with only four ground rods, directional effects due to currents in the rods would upset the desired non-directional pattern. Horizontal patterns were taken on a 160-mc model of the antenna, and we observed no deviation whatever from a non-directional pattern.

#### The 30 to 44-mc Antenna

In the 30-44 mc version of the antenna, the vertical members are seamless aluminum tubes, of corrosion-resisting 61ST alloy. Ground rods are 8' tapered steel tubes,  $\frac{3}{4}$ " diameter

at the large end and tapering to  $\frac{3}{8}$ " at the small end. The rods are plugged at both ends and plated. The support tube is a  $2\frac{1}{2}$ " diameter aluminum tube with the top end spun out to form a support for the antenna. The coaxial line is fed up through the support tube, and anchored to the tube by a clamp inside the bottom end of the tube.

#### Performance Curves

From the resistance and standing wave ratio curves, Figure 6, it can be seen that the resistance varies between 57 and 99 ohms, which gives a standing-wave ratio of 1.41 at the worst point. This value of standing-wave ratio is low enough to make the length of the transmission line from antenna to transmitter non-critical, permitting a discontinuation of the time-honored practice of installing a line that is a quarter wave or so too

long and then trimming it a foot at a time until a point on the line is reached where the impedance will allow the transmitter to load. A lower standing wave also means lower losses in the line, and is a factor to be considered in low-power installations.

#### Resistance-Reactance-Standing-Wave Ratios

Figures 7 and 8 show resistance, reactance, and standing-wave ratios for two different frequencies in the 30-44 mc spectrum. It can be seen that not only is the bandwidth more than ample for emergency f-m requirements, but it is wide enough to make the whip lengths not critical, thus simplifying the task of adjustment to the desired frequency in the field.

Standing-wave ratio curves for two whip lengths for an antenna designed for use with 52-ohm cable appear in Figure 9 and similar curves for a 75-ohm antenna are shown in Figure 10. It is seen that the 152 to 162-mc band can be covered with only two whip lengths. This makes it possible for the antennas to be completely fabricated in the factory, eliminating field adjustments.

#### Credits

Acknowledgement is made to Dr. R. E. Beam of Northwestern University, under whose direction much of the preliminary experimental work was done.

#### References

- <sup>1</sup>G. H. Brown and J. Epstein, *An Ultra-High-Frequency Antenna of Simple Construction*, COMMUNICATIONS; July, 1940.
- <sup>2</sup>King, Mimno, and Wing, *Transmission Lines, Antennas, and Wave Guides*, p. 226.
- <sup>3</sup>G. H. Brown, R. F. Lewis, J. Epstein, *Ground Systems as a Factor in Antenna Efficiency*, Proceedings, IRE; June, 1937.

Figure 9

Standing-wave ratios for two whip lengths in the 152 to 162-mc band, with the antenna designed for a 52-ohm cable.

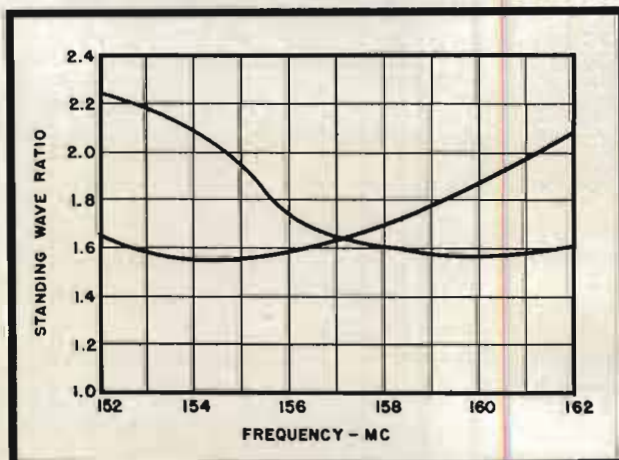
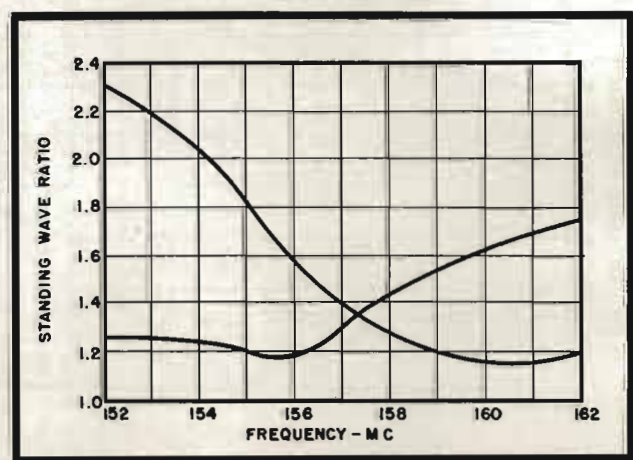

Figure 10

Standing-wave ratios for two whip lengths in the 152 to 162-mc band, using a 75-ohm line.





# Eimac Tetrodes lead the way to simplified CRYSTAL FREQUENCY CONTROL FOR DIATHERMY and ELECTRONIC HEATING

Crystal control of frequency now becomes the practical answer to the new frequency stability requirements. Eimac tetrodes make crystal frequency control feasible and simple. *Crystal control through Eimac tetrodes means maximum frequency stability, end of objectionable radiation, and handy portability for electronic heating units of the future.*



Eimac 4-250A Tetrode

## Here's How an Eimac Tube Makes This Practical

The way just one Eimac 4-250A tetrode makes crystal frequency control practical is shown in this *operative*, experimental circuit assembled by Eimac engineers. The circuit is also applicable to other forms of electronic heating.

## Greater Stability... Longer Life

Both tetrodes have specially treated elements that insure longer life. Both have non-emitting grids which give great operating stability.

Because of their low grid-plate capacitance (0.12  $\mu\text{ufd}$  in the 4-250A and 0.05  $\mu\text{ufd}$  in the 4-125A), these tubes normally require no neutralization at diathermy or heating frequencies. (In fact, the 4-250A normally requires no neutralization up to 70 Mc; 4-125A ordinarily needs none even at 120 Mc.)

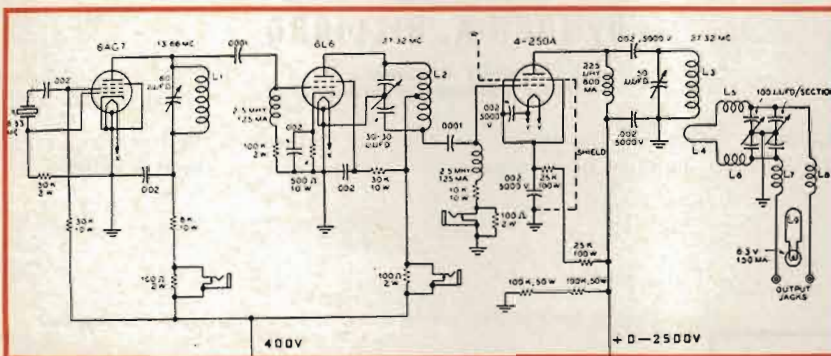

## Eimac Tetrodes for Power Amplification Throughout the Useful Frequencies

Dependable, durable Eimac tetrodes are admirably suited for diathermy or electronic heating work, or for almost any power amplification assignment at any frequency, including

VHF. Write today to Eimac's local representatives or factory engineers for complete data on these tubes.



Eimac 4-125 Tetrode

## Here's Why Eimac Tubes Make Crystal Frequency Control Practical

Because of their unique characteristics, Eimac power tetrodes such as the 4-250A and 4-125A are ideal for use in circuits like the one above.

These tubes have an unusually high power-gain for efficient performance at medium, high, or the very high frequencies used in diathermy and heating. For example, the 4-250A (at frequencies up to 70 Mc.) develops power output of 750 watts with a driving power of less than 5 watts. The 4-125A tetrode delivers 375 watts output with less than 3 watts drive.

Follow the Leaders to

**Eimac**  
TUBES

**EITEL-McCULLOUGH, INC.**

1290F San Mateo Avenue • San Bruno, Calif.   
Export Agents: Frazer and Hansen, 301 Clay St., San Francisco 11, California, U. S. A.

Figure 1  
Approximate response with preequalization

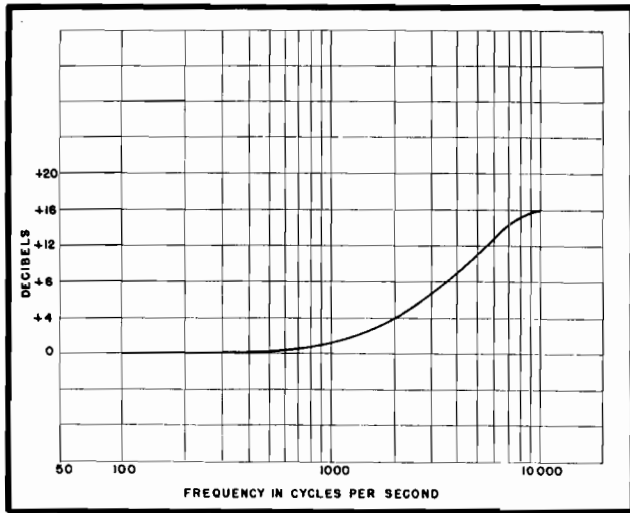
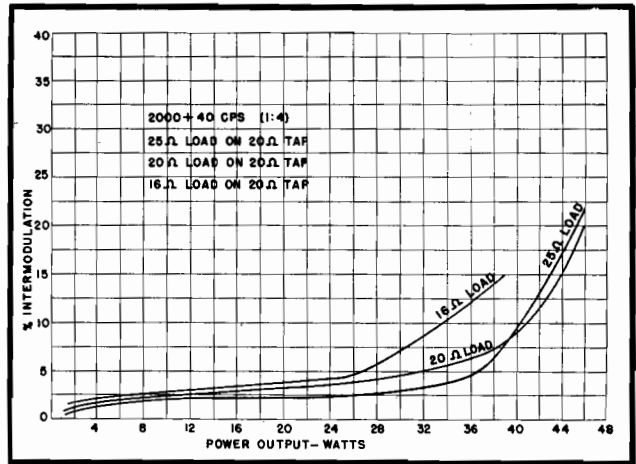

Figure 2  
Intermodulation curves as a function of power output and load impedance.



# 40-Watt Beam-Power Amplifier FOR DISC RECORDING

DURING THE PAST FEW years disc-recording use has increased considerably, with a corresponding improvement in standards of service, particularly with 33 $\frac{1}{3}$  rpm transcriptions required to reproduce the original quite faithfully.

## Importance of Preequalization

In providing these improved standards of service preequalization has been

## Amplifier Designed to Maintain Rated Output Over Wide Frequency Range.

by **JOHN K. HILLIARD**

Chief Engineer  
Altec Lansing Corporation

an important factor. It has been the general accepted practice to preequal-

ize the response of the input to the recorder so that the highest frequencies

Figure 4  
Curve of intermodulation and power for 12,000 and 100 cycles with a 20-ohm load on the 20-ohm tap.

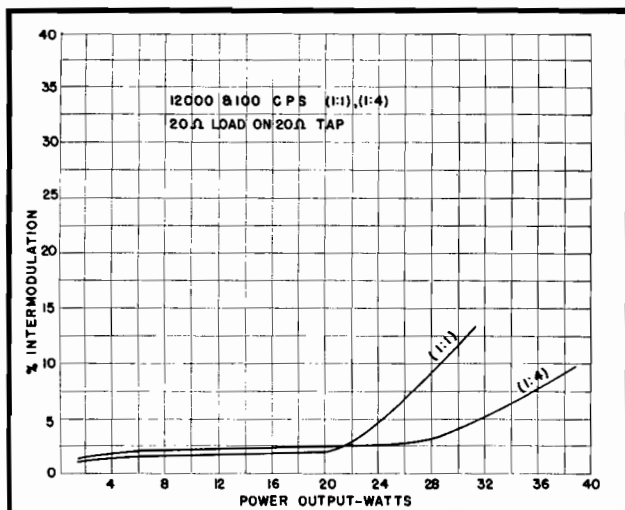

Figure 3  
A curve of 2000 and 60 cycles on a 1:4 ratio using a 20-ohm load on a 20-ohm tap.

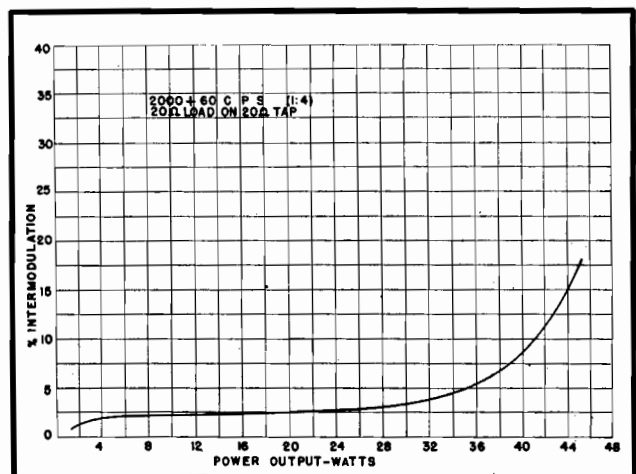
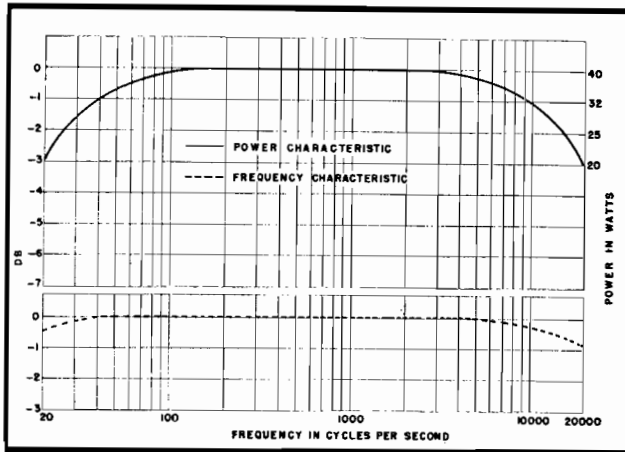



Figure 5  
Power and frequency characteristics of the amplifier.



recorded are emphasized greatly. The approximate rate of this equalization varies from zero at 300 cycles to 16 db at 10,000 cycles; Figure 1.

#### Peak Instantaneous Control

The Figure 1 curve is predicated on data indicating that the average maximum power in music and speech occurs in the 300- to 500-cycle region. It has been found that the amplifier and recorder must be designed to handle the peak instantaneous power which may occur at all frequencies throughout the entire frequency range. For this reason, with the high frequencies emphasized to the degree shown in Figure 1, it is to be expected that under certain conditions it will be possible to have a considerably higher amplitude transmitted to the recorder at these high frequencies as compared to the band below 500 cycles.

#### High Peak Energy Problem

A detailed study over a period of several years has shown that frequencies in 2,000 to 6,000-cycle range contribute to overload a very large percentage of the time. The high peak energy in this frequency band is particularly associated with speech where the artist is working close to the microphone. This is undoubtedly due to the rise in response usually associated with the various types of microphones generally

used, and to the manner in which the artist is speaking.

#### Variable Equalization

To compensate for the loss of high frequencies on the inside of the disc variable equalization has been provided by several designers. This is usually from 6 to 10 db at 10,000 cycles. As a consequence, it has been found necessary to use a power amplifier to operate the disc recorder which has a very high overload point compared with the so-called *operating level*. It has been found that a power of at least 15 watts is required and it is preferable to have 40-50 watts available.

#### Amplifier Designs

To a large extent, designers of amplifiers in the past have rated their amplifiers on the basis of the distortion at 400 cycles. It was then the practice to maintain this rated power up to approximately 2,000 cycles and beyond this point, due to capacity in the circuit and high leakage inductance and distributed capacity in the output transformer, the output power was therefore reduced. It is now recognized

Figure 6  
Equalizer system that may be used at input or amplifier for preemphasized recording.

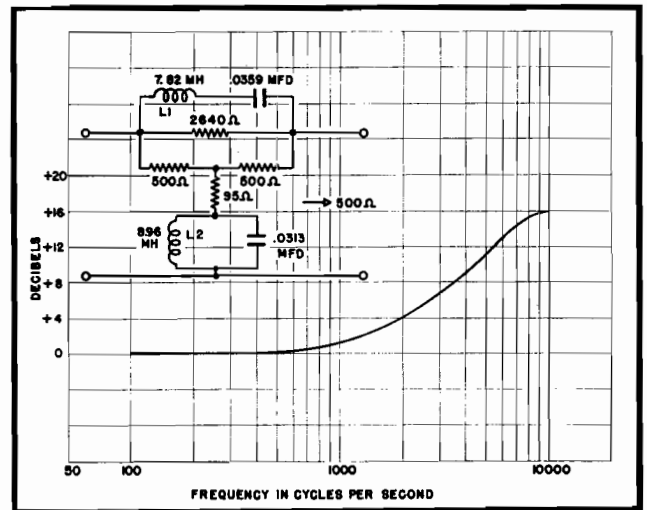

that it is necessary to maintain rated power output up to the highest frequencies that are to be recorded. This is particularly necessary to provide the necessary carrying capacity for sound effects which may have very high transmitted amplitudes at high frequencies.

#### 40-Watt Amplifier

To meet these fidelity and power requirements, a 40-watt amplifier<sup>1</sup> was recently designed.

#### Test Plots

In Figure 2 appears an intermodulation curve for the amplifier, with the curve as a function of power output and load impedance. The test signals consisted of 2,000+ 40 cps (1:4). The 2,000-cycle signal was 12 db lower or  $\frac{1}{4}$  the amplitude of the 40-cycle signal. Curves are plotted for 16-, 20- and 25-ohm loads on the nominal 20-ohm tap. The lower test frequency of 40 cycles was adjusted to be 12 db higher than the 2,000-cycle value so that the test would be primarily a measurement of distortion at low frequencies.

#### Response Curves

Figure 3 shows a curve of 2,000 and 60 cycles for the amplifier on the 1:4 ratio using a 20-ohm load on the 20-

<sup>1</sup> Altec Lansing A255

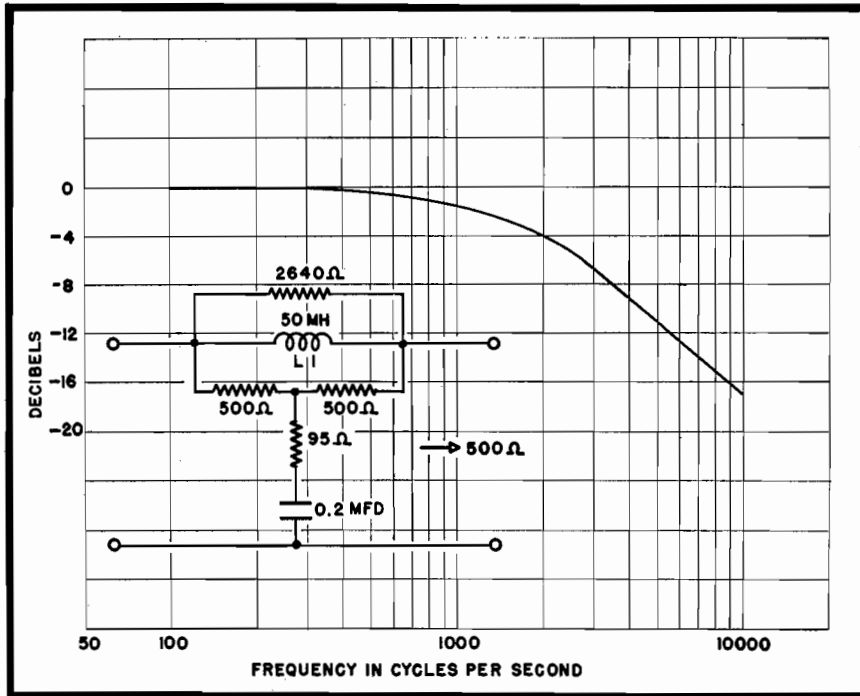

Figure 7

Schematic circuit and curve of post equalizer used for monitor and playback to compensate for recording rise.

ohm tap. In Figure 4 we have the curve of intermodulation and power for 12,000 and 100 cycles with a 20-ohm load on the 20-ohm tap. The 1:4 curve was obtained with the 12,000-

cycle amplitude,  $\frac{1}{4}$  that of the 100-cycle amplitude. This ratio was used so that the intermodulation would be generated mainly by 100 cycles. The 1:1 curve was obtained with the 100-

Figure 8  
Schematic of 40-watt beam-power amplifier.

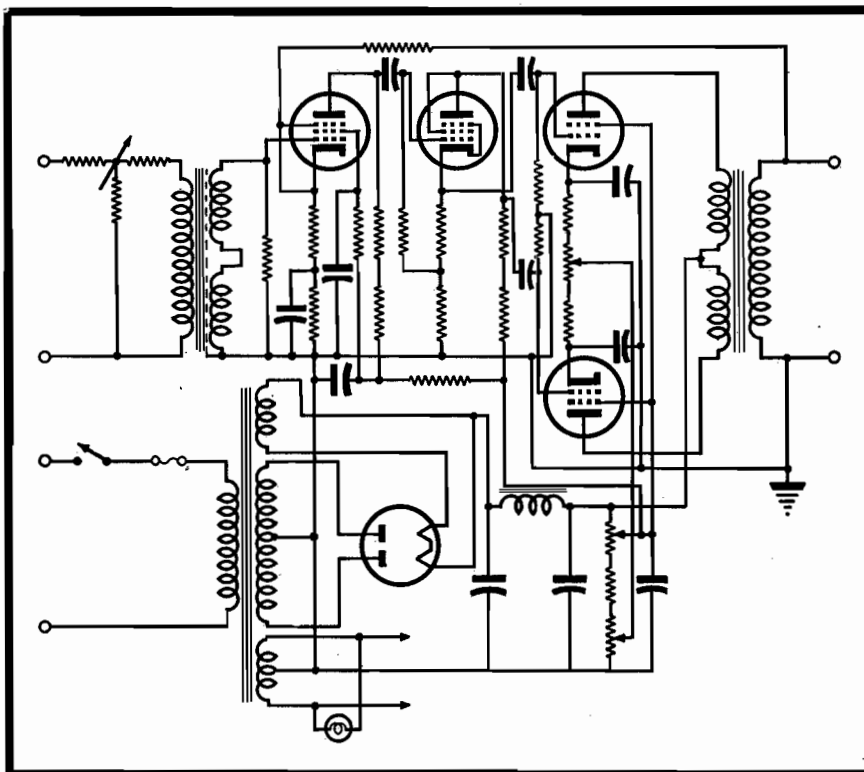

and 12,000-cycle signal of equal amplitude. This curve indicates the intermodulation as generated principally by 12,000 cycles since it is higher than with 1:4 ratio.

### Power Characteristics

Figure 5 shows the power characteristics of the amplifier from 20-20,000 cycles. This is the undistorted output as observed on an oscilloscope. This method was used as a rapid check for distortion throughout the entire range. It indicated that response runs could be made over the 20- to 20,000-cycle range at 3 db below rated power without distortion interfering with the measurements.

### Preemphasized Recording

Where the amplifier is to be used for preemphasized recording, an equalizer, as shown in Figure 6, may be used at the input of the amplifier. The insertion loss of the equalizer for frequencies below 300 cycles is 16 db. Where it is desirable to use a post equalizer for monitor or playback purposes to compensate for the recording rise, the system shown in Figure 7 can be used. This provides the approximate reciprocal of the recording characteristic. The input transformer is particularly designed for levels below -12 dbm and as a result the inductance of the windings will not appreciably change although the current through them will vary over a range of 60 db. As a result the frequency response of the amplifier will not vary over a 60-db range in level.

### Amplifier Features

The amplifier has a 6SJ7 pentode in the first stage, followed by a 6V6 phase inverter which drives the final push-pull stage using two 807s. The rectifier is a 5R4GY type.

A schematic of the amplifier is shown in Figure 8. The plate transformer is tapped so that the amplifier can be set for 40 watts output or may be operated at reduced voltage so as to deliver 30 watts. The output noise level is approximately -30 dbm. The output transformer is tapped so that it will deliver its rated power into load impedances of 10 and 20 ohms. A mismatch of 25% from the rated impedance is permissible with less than 1 db reduction in power. Feedback voltage is obtained from a tertiary winding, so that ungrounded loads may be used.



# A-M TRANSMITTER 5-Kw Log

250-A-46

Month \_\_\_\_\_

Year \_\_\_\_\_

W O R

BAMBERGER BROADCASTING SERVICE, Inc.

CARTERET, N. J.

5 KW TRANSMITTER — 710 KC. — W. E. D-87691 Ser. # 106

Checked By \_\_\_\_\_

Sig. of Person in Charge \_\_\_\_\_

## MASTER OPERATING LOG

NO.	ITEM	II OPTI- MUM	III LOWER LIMIT	IV TOLERANCE	V UPPER LIMIT	VI UNIT	VII ENTRIES TO BE MADE IMMEDIATELY AFTER GOING ON THE AIR								
							MON.	TUES.	MON.	TUES.	MON.	TUES.			
1	LOCAL STANDARD TIME	( )	( )	( )	( )	( EST-EDST )									
2	LOG STARTING TIME	( )	( )	( )	( )	( HR-MIN )									
3	TEMPERATURE OUTSIDE	( )	( )	( )	( )	( °F )									
4	WEATHER CONDITIONS	( )	( )	( )	( )	( SYMBOL )									
5	TOWER AND BEACON LIGHTS	( )	( )	( OPR.COND. )	( )	( ON-OFF )									
6	A. C. POWER PANEL—PWR. SUP. SW. D4A	( )	( )	( )	( )	( ON-OFF )									
7	LINE VOLTAGE—PHASE A	( )	( 200 )	( 230-240 )	( 250 )	( VOLTS )									
8	LINE VOLTAGE—PHASE B	( )	( 200 )	( 230-240 )	( 250 )	( VOLTS )									
9	LINE VOLTAGE—PHASE C	( )	( 200 )	( 230-240 )	( 250 )	( VOLTS )									
10	LINE VOLTAGE FREQUENCY	( )	( 54 )	( 59-61 )	( 66 )	( CYCLES )									
11	RECTIFIER UNIT—DIST. WATER PRESSURE	( )	( 28 )	( 40-50 )	( 60 )	( LBS. )									
12	P. A. UNIT—DIST. WATER TEMPERATURE	( )	( 40 )	( 85-150 )	( 180 )	( °F )									
13	OSC. UNIT—14 V. FIL. GEN. VOLTAGE	( 14 )	( 12 )	( 14 )	( 15 )	( VOLTS )									
14	22 V. FIL. GENERATOR VOLTAGE	( 22 )	( 20 )	( 22 )	( 23 )	( VOLTS )									
15	250 V. BIAS GENERATOR VOLTAGE	( 250 )	( 240 )	( 250 )	( 260 )	( VOLTS )									
16	1600 V. PLATE GENERATOR VOLTAGE	( 1600 )	( 1400 )	( 1600 )	( 1700 )	( VOLTS )									
17	RECTIFIER UNIT—RECT. NO. 1 FIL. VOLT.	( 200 )	( 190 )	( 200 )	( 210 )	( VOLTS )									
18	RECTIFIER NO. 2 FIL. VOLTAGE	( 200 )	( 190 )	( 200 )	( 210 )	( VOLTS )									
19	RECTIFIER NO. 3 FIL. VOLTAGE	( 200 )	( 190 )	( 200 )	( 210 )	( VOLTS )									
20	RECTIFIED VOLTAGE	( )	( 10 )	( 11-12 )	( 12.5 )	( KVS )									
21	OSCILLATOR UNIT—XTAL. SEL. SW. POS'N.	( )	( )	( )	( )	( 1-2 )									
22	XTAL. NO. 1 TEMPERATURE	( )	( 55 )	( 58.8-57.2 )	( 59 )	( °C )									
23	XTAL. NO. 2 TEMPERATURE	( )	( 57 )	( 58.8-59.2 )	( 61 )	( °C )									
24	OSC. GRID. CURRENT ADJUSTMENT	( )	( 0 )	( 45-70 )	( 100 )	( DIVS )									
25	OSCILLATOR GRID CURRENT	( )	( .5 )	( 1.50-2.25 )	( 3 )	( MILS )									
26	OSCILLATOR PLATE CURRENT	( )	( 40 )	( 48-55 )	( 65 )	( MILS )									
27	1-C FREQ. METER OSC. PLATE VOLT.	( 130 )	( )	( 128-132 )	( )	( VOLTS )									
28	1-C FREQ. METER OSC. GRID CURRENT	( )	( .05 )	( 25-45 )	( 8 )	( MILS )									
29	FREQUENCY DEVIATION	( )	( -20 )	( +3 )	( +20 )	( CYCLES )									
30	1ST AMPLIFIER GRID CURRENT	( )	( 1 )	( 2.5-5 )	( 8 )	( MILS )									
31	1ST AMPLIFIER PLATE CURRENT	( )	( 75 )	( 90-105 )	( 115 )	( MILS )									
32	1ST AMPLIFIER OUTPUT CURRENT	( 230 )	( 200 )	( 230 )	( 300 )	( MILS )									
33	2ND AMPLIFIER GRID CURRENT	( )	( 5 )	( 10-14 )	( 20 )	( MILS )									
34	2ND AMPLIFIER PLATE CURRENT	( )	( 70 )	( 75-85 )	( 90 )	( MILS )									
35	2ND AMPLIFIER OUTPUT CURRENT	( )	( .9 )	( 1.0-1.25 )	( 1.5 )	( AMPS )									
36	FEEDBACK CURRENT	( )	( )	( )	( )	( MILS )									
37	MODULATION UNIT—MOD. PLATE CURRENT	( )	( 65 )	( 80-100 )	( 125 )	( MILS )									
38	3RD AMPLIFIER GRID CURRENT	( )	( )	( 0 )	( )	( MILS )									
39	3RD AMPLIFIER PLATE CURRENT	( )	( 300 )	( 450-600 )	( 700 )	( MILS )									
40	3RD AMPLIFIER OUTPUT CURRENT	( )	( 4.5 )	( 5.0-5.5 )	( 6.0 )	( AMPS )									
41	POWER AMPLIFIER UNIT—P. A. GRID. CUR.	( )	( 0 )	( 0-10 )	( 20 )	( MILS )									
42	RECTIFIER UNIT—RECT NO. 1 PLATE CUR.	( )	( .35 )	( .38-50 )	( .55 )	( AMPS )									
43	RECTIFIER NO. 2 PLATE CURRENT	( )	( .35 )	( .38-50 )	( .55 )	( AMPS )									
44	RECTIFIER NO. 3 PLATE CURRENT	( )	( .35 )	( .38-50 )	( .55 )	( AMPS )									
45	POWER AMPLIFIER UNIT—P. A. PLATE CUR.	( )	( 1.05 )	( 1.15-1.50 )	( 1.65 )	( AMPS )									
46	L.P.D. CURRENT	( )	( )	( )	( )	( MILS )									
47	LEAKAGE CURRENT	( )	( 0 )	( 0-10 )	( 15 )	( MILS )									
48	TUNING UNIT—CLOSED CIR. CURRENT	( )	( 18 )	( 21-25 )	( 27 )	( AMPS )									
49	ANTENNA CURRENT	( 8.25 )	( 7.82 )	( 8.25 )	( 8.38 )	( AMPS )									
50	3RD P. A. UNIT—50 KW—WEST ANT. CUR.	( )	( 5.7 )	( 5.8-6.1 )	( 6.2 )	( AMPS )									
51	CENTER ANTENNA CURRENT	( )	( 5.0 )	( 5.1-5.4 )	( 5.5 )	( AMPS )									
52	EAST ANTENNA CURRENT	( )	( 5.3 )	( 5.7-6.0 )	( 6.3 )	( AMPS )									
53	AUDIO FACILITIES ROOM—BLDG. TEMP.	( )	( 65 )	( 75-100 )	( 105 )	( °F )									
54	AUDIO FACILITIES	( )	( )	( OPR.COND. )	( )	( OK-N* )									
55	M. E. ROOM—AV. % MOD. ON 731A MOD. METER	( )	( 50 )	( 85-100 )	( 105 )	( % )									
56	C.T.M. ALARM UNIT	( )	( )	( OPR.COND. )	( )	( OK-N* )									
57	5 KW DIST. WATER EXP. TANK LEVEL	( )	( 0.5 )	( 1-3 )	( 5 )	( INCHES )									
58	BASEMENT—SWITCH ROOM INSPECTION	( )	( )	( OPR.COND. )	( )	( OK-N* )									
59	230 V. DISTRIBUTION PANEL SW. NO. 1	( )	( )	( )	( )	( ON-OFF )									
60	5 KW TRANSMITTER SWITCH NO. 7	( )	( )	( )	( )	( ON-OFF )									
61	5 KW-230V. POWER SUPPLY SEL. SW. NO. 8	( )	( )	( OPR.COND. )	( )	( P5-EDG )									
62	14 V. FIL. MOTOR GENERATOR TEMP.	( )	( )	( OPR.COND. )	( )	( OK-N* )									
63	22 V. FIL. MOTOR GENERATOR TEMP.	( )	( )	( OPR.COND. )	( )	( OK-N* )									
64	250 V. BIAS MOTOR GENERATOR TEMP.	( )	( )	( OPR.COND. )	( )	( OK-N* )									
65	1600 V. PLATE MOTOR GEN. TEMP.	( )	( )	( OPR.COND. )	( )	( OK-N* )									
66	CONDITION—MOTORS—GEN.—PUMPS—GLANDS	( )	( )	( OPR.COND. )	( )	( OK-N* )									
67	CIRCULATE VENTILATOR MOTOR NO. 1	( )	( 30 )	( 35-60 )	( 65 )	( °C )									
68	EXHAUST VENTILATOR MOTOR NO. 2	( )	( 30 )	( 35-60 )	( 65 )	( °C )									
69	E. D. G.—RPM.—FULL LOAD	( )	( 1150 )	( 1190 )	( 1230 )	( R.P.M. )									
70	GENERATOR OUTPUT VOLTAGE	( )	( 180 )	( 200 )	( 210 )	( VOLTS )									
71	GENERATOR OUTPUT CURRENT	( )	( 80 )	( 90-100 )	( 110 )	( AMPS )									
72	E.D.G. GOVERNOR OIL LEVEL	( )	( )	( FULL )	( )	( OK-N* )									
73	MOTOR OIL PRESSURE	( )	( 15 )	( 30-50 )	( 75 )	( LBS. )									
74	MOTOR TEMPERATURE	( )	( 100 )	( 160-180 )	( 205 )	( °F )									
75	E.D.G. WATER COOLING VALVES—OPEN	( )	( )	( OPR.COND. )	( )	( OK-N* )									
76	GENERATOR CHARGING RATE	( )	( 0 )	( 5-15 )	( 30 )	( AMPS )									
77	LOG FINISHING TIME	( )	( )	( )	( )	( HR-MIN )									
78	ENTRIES TO BE MADE BEFORE GOING ON THE AIR						MON.	TUE.	MON.	TUE.	MON.	TUE.	MON.	TUE.	
79	DATE OF ENTRY														
80	XTAL HEATER SEL. SW. D18C	( )	( R )	( L-R )	( )	( )									
81	XTAL HEATER 230 V. SW. D11C	( )	( ON )	( ON-OFF )	( )	( )									
82	RELAY CUR. ADJ. XTAL NO. 1	( )	( 81 )	( DIVS )	( )	( )									
83	RELAY CUR. ADJ. XTAL NO. 2	( )	( 71 )	( DIVS )	( )	( )									
84	EMG. ANT. SW.—110 V. SW. D19C	( )	( OFF )	( ON-OFF )	( )	( )									
85	1ST AMPLIFIER INPUT	( )	( 25 )	( DIVS )	( )	( )									
86	1ST AMPLIFIER TUNING	( )	( 51 )	( DIVS )	( )	( )									
87	2ND AMPLIFIER BAL. COND.	( )	( 66 )	( DIVS )	( )	( )									
88	2ND AMPLIFIER TUNING	( )	( 47 )	( DIVS )	( )	( )									
89	3RD AMPLIFIER INPUT	( )	( 63 )	( DIVS )	( )	( )									
90	3RD AMPLIFIER BAL. COND.	( )	( 40 )	( DIVS )	( )	( )									
91	3RD AMPLIFIER TUNING	( )	( 31.5 )	( DIVS )	( )	( )									
92	P. A. BALANCING COND.	( )	( 75 )	( DIVS )	( )	( )									
93	P. A. CLOSED CIRCUIT TUNING	( )	( 65 )	( DIVS )	( )	( )									
94	ANT. COUPLING CIRCUIT	( )	( 6 )	( DIVS )	( )	( )									
95	1126A PRGM. AMP. "B" VOLT %	( )	( 110 )	( % )	( )	( )									
96	A.F.C.R. FADER & KEY POS'N'S	( )	( )	( OK-N* )	( )	( )									
97	WAVE FORM—OSCILLOGRAPH	( )	( )	( OK-N* )	( )	( )									
98	WATER LEVEL D. W. STG. TNK	( )	( )	( INCHES )	( )	( )									
99	480 V.A.C. POWER PILOT LIGHTS	( )	( )	( OK-N* )	( )	( )									
100	INSP.—ANT.—TOWERS—EMG. ANT.	( )	( )	( OK-N* )	( )	( )									
101	COND. EMG. ANT. COUP. HOUSE	( )	( )	( OK-N* )	( )	( )									
102	E.D.G. GASOLINE GAUGE	( )	( )	( GALS )	( )	( )									
103	EMG. ANT.—OUTSIDE ANT. CUR.	( )	( )	( AMPS )	( )	( )									
104	SIGNATURE OF TECHNICIAN			ON	OFF	DATE	109								
105							110								
106							111								
107							112								
108							113								

MAKE ENTRIES IN INK, PLACE AN ASTERISK (\*) AFTER AN ABNORMAL ENTRY, CORRECT SAME WHERE POSSIBLE

114 SHEET NO.

[Courtesy Charles H. Singer, Assistant Chief Engineer, WOR-WBAM, author of the series of papers on "Preventive Maintenance", which has been appearing in COMMUNICATIONS; next installment to appear in December.]



# SELENIUM RECTIFIERS

## Discussion of Construction and Application of Selenium Rectifier Discs.

by JULIAN LOEBENSTEIN

Electrical Engineer  
Seletron Division, Radio Receptor Company

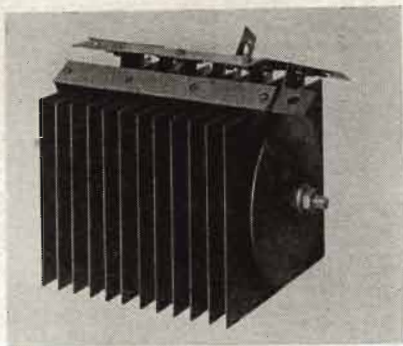

Views of typical selenium rectifiers.

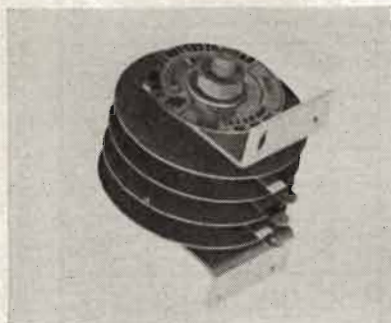

(Below)

Miniature 5-plate selenium rectifier with 1"x1" plates recently designed to replace such rectifier tubes as 25Z5, 35Z5, 0Y4, etc., in a-c/d-c receivers.

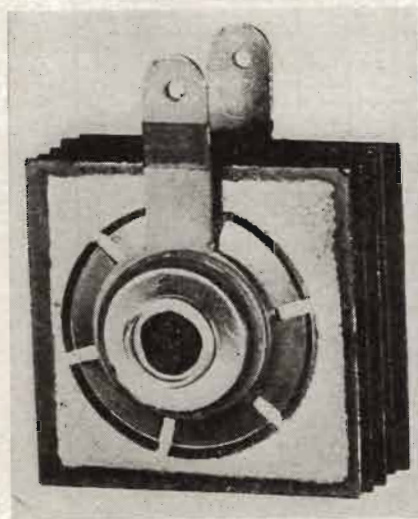

UNDER WAR STIMULUS many improvements have been made in the selenium rectifier and its range of application has been widened.

Whereas a few years ago the dimension of the selenium plates was limited to relatively small sizes, with a correspondingly large bulk for high current capacities, the plate sizes now have been increased to approximately thirty square inches. Also, in past years, the maximum a-c voltage applicable to individual plates was 18. Now plates capable of sustaining much higher voltage have been developed.

Thus, for a given applied a-c voltage fewer plates need be used than was formerly the case, making it both convenient and economical to handle applications such as theatre arc projection, electroplating and other electrochemical uses as well as battery charging, welding, business machines, cathodic protection, motor speed control, and the replacement of vacuum tubes in home receivers.

### Plate Preparation

Although the rectifier plate as an end product incorporated in a rectifier stack seems like the simplest possible device, its manufacture involves a number of stages. A rectifier base plate is prepared so that a layer of selenium and a counter-electrode layer of alloy may be placed over the selenium. The base plate serves as one electrode and the metal alloy as the other. In addition, the plate is treated in such a manner that it presents a high resistance to the flow of current from its alloy front electrode to the aluminum back electrode and a low resistance to the current flow from the aluminum to the alloy electrode. The high resistance from front to back electrode is called the reverse resistance (or leakage), while the low re-

sistance from the back to front electrode is known as the forward resistance. Theoretically, the greatest degree of rectification would be obtained if the rectifier had an infinite reverse resistance and zero forward resistance. Naturally, this condition is impossible to achieve in production, but the more nearly it can be approached, the more efficient the rectifier. These characteristics are shown in Figure 1 in connection with which it should be noted that the reverse current and voltage are plotted to a different scale from the forward resistance.

### Aluminum Base

Some selenium rectifiers use a base plate of aluminum, providing an exceedingly light stack which is easy to handle in assembly and in addition reducing the weight of the product in which it is used. The use of aluminum also eliminates the possibility of base-plate rusting.

### Selection of Stack

The selection of the proper stack depends upon a number of factors. For instance, for a given d-c output, different stack designs are required if the d-c circuit feeds into a resistive load, a capacitive load or load with a counter-electromotive force such as is encountered in battery charging or motor speed control. The size and spacing of the plates will also depend upon the ambient temperature and the time cycle of operation.

### Design Factors

In general, for design purposes, a stack is considered as under continuous use if it is in operation for fifteen minutes or more continuously, because during this time the stack will reach



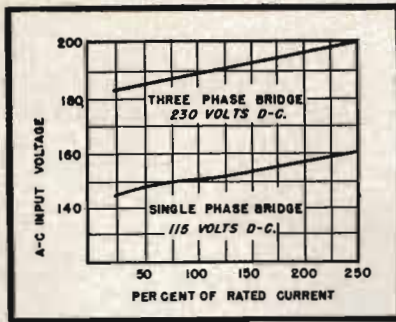

Figure 2  
The a-c input voltage for typical rectifiers.

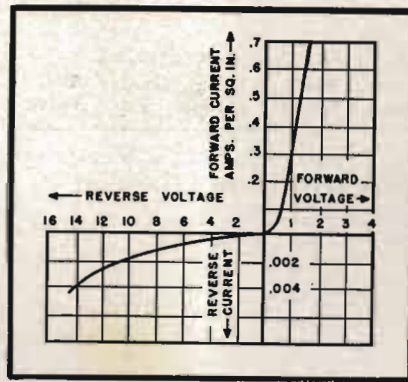

Figure 1  
Forward and reverse characteristics for d-c.

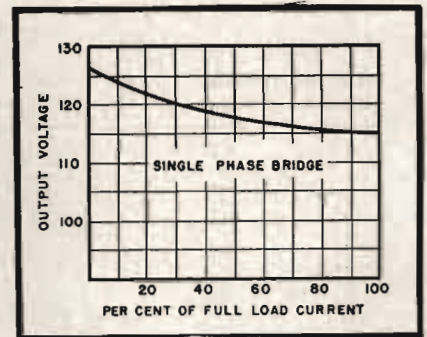

Figure 3  
Output voltage variation with load.

its maximum temperature. However, if it is on and off during a period of less than fifteen minutes, smaller plates may be used. Thus the timing cycle is an important design factor.

Other factors which affect stack design are the number of plates per stack. Where, in a stack, cooled by natural convection, only a few plates are assembled, as for instance two or four, the plates may be rated at a higher current capacity than when assembled in larger stacks, of say twenty plates, because in the smaller stacks air circulates more freely around the plates. Under forced cooling, plates may be conservatively rated at two and a half times normal rating.

**Ventilation**

When stacks are used with forced ventilation the circuit should be so designed that the supply of current to

the rectifier will be interrupted if the circulation of air should be stopped for any reason. If this is not done the stack will quickly overheat and be ruined.

As in all types of rectification stacks may be supplied for half-wave center tap and bridge circuits and each in turn for single or three-phase rectification. Where considerable power is involved three-phase rectification is to be desired because, besides balancing the circuit, it operates at a higher efficiency. In single-phase circuits, with resistive load, it is not unusual to obtain an efficiency of 62%, whereas for battery charging the efficiency may be as high as 75%. Three-phase circuits, on the other hand, regardless of application may approach 85%.

as efficient as the full-wave circuit. The stack, for half wave, will probably be less expensive than for full wave. While the transformer will be more expensive, the total overall cost will have to be considered. In designing equipment for sizable power applications the difference in sales price of the equipment for half wave as against full wave should be balanced against possible differences in the purchaser's power bills. This may result in the sale of a more expensive piece of equipment initially, but result in an overall saving to the purchaser. Individual cases must be considered with these points in mind.

**Variety of Stack Arrangements**

The demand for rectifier stacks is so varied as to currents, voltages, temperatures and circuit applications that in general it is not practical to carry stacks in stock. However, individual plates are usually available for ready assembly into a great variety of series

**Three-Phase Application**

In considering three-phase application, however, it should be remembered that the half-wave circuit is not

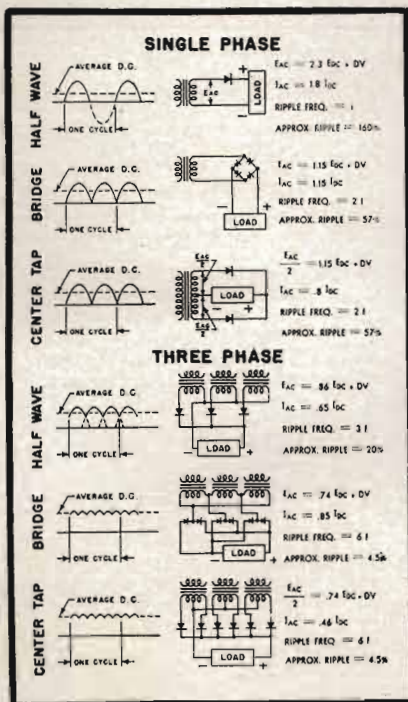

Figure 4

Six common circuits in which selenium rectifiers are used, with approximate wave shapes under resistive load, ripple frequency, ripple percentage and approximate a-c/d-c ratio.

- $E_{AC}$  = Approximate a-c input voltage (rms)
- $E_{DC}$  = Average d-c output voltage
- DV = Voltage drop in rectifier (rms)
- $I_{DC}$  = Average d-c output
- $I_{AO}$  = rms a-c
- $f$  = Input frequency
- % Ripple = rms a-c ripple component/average d-c voltage

Figure 5 (right)

A 12-volt 3,000-ampere selenium rectifier unit. (Courtesy Richardson Allen Corp.)

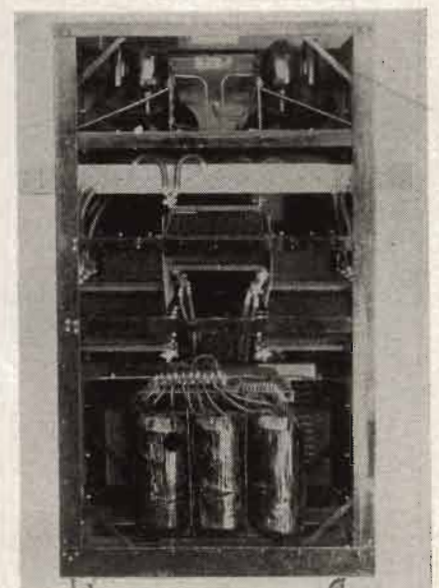

Diameter Inches	Basic Plate	1Max Plates Per Stack	2SINGLE PHASE		—THREE PHASE—			D-C Valve
			Half Wave	Center Tap	Half Wave	Bridge	Center Tap	
1	A	36	.075	.15	.20	.225	.27	.12
1	A	28	.11	.22	.29	.33	.4	.17
1 3/8	B	36	.15	.30	.40	.45	.55	.23
1 3/8	B	28	.23	.45	.60	.67	.82	.34
1 3/4	C	40	.30	.60	.80	.90	1.1	.45
1 3/4	C	28	.39	.78	1.0	1.1	1.4	.58
2 1/2	D	40	.60	1.2	1.6	1.8	2.2	.90
2 1/2	D	28	.78	1.6	2.1	2.4	2.8	1.2
3 3/8	E	40	1.2	2.4	3.2	3.6	4.5	1.3
3 3/8	E	28	1.5	3.1	4.1	4.6	5.8	2.4
+ 4 3/8	E	28	1.8	3.5	4.6	5.2	6.5	2.7
+ 6" sq.	E	28	2.7	5.4	7.2	8.1	10.0	4.1
4 3/8	F	40	2.0	4.0	5.3	6.0	7.5	3.1
4 3/8	F	28	2.6	5.2	6.9	7.8	9.7	4.0
+ 6" sq.	F	28	3.7	7.4	9.8	11.1	13.3	5.7
+ 8" sq.	F	28	5.0	10.0	13.0	15.0	18.0	7.5

The maximum reverse rms volts per plate is 18. Maximum blocking voltage for d-c valve is 15.  
+ Cooling fin dimension.  
1Maximum plates per stack is 16 for all sizes where vibration is present.  
2Single plate, current ratings are for resistive or inductive loads.  
Ratings for battery charging or capacitive loads are 80% of the values shown.

Figure 6  
Selenium dry-disc ratings. Continuous d-c amperes 35° C ambient are indicated.

and parallel plate arrangements as needs may dictate.

During the first 10,000 hours of operation rectifiers age to a certain degree. During this period the forward and reverse resistances increase gradually after which time they become stabilized. In some applications, this increase in resistance, with a corresponding drop in d-c output voltage, may be ignored while in other cases it may be necessary to compensate for it by a

5% to 10% increase in the a-c input voltage.

Voltage regulation varies from approximately 15% with new stacks to 20% when aged. The use of cooling fins or forced air cooling may increase the regulation to 25%. Figure 3 shows the variation of output voltage with current changes for a typical single-phase bridge rectifier.

The a-c input voltage to be applied to selenium rectifiers for a given d-c

output voltage is governed by the circuit arrangement, the type of load and the voltage drop. Various rectifier circuit arrangements, approximate wave shape, and circuit factors involved for resistive or inductive loads are shown in Figure 4.

#### Selenium-Disc Features

In analyzing weight and size factors of dry-disc rectifiers, it has been found that selenium, magnesium copper sulphide and copper oxide had relative weights of 1, 1.4 and 3.4, respectively, at one ampere output. In addition, sulphide cells appeared to have shorter life than selenium cells and definitely limited to low voltage use.

Selenium has been found to have a much higher reverse voltage than magnesium copper sulphide and copper oxide cells. The oxide runs about one-quarter that of selenium. This means that where voltages over six volts are involved the selenium, by virtue of this higher reverse voltage, will require fewer plates. The forward drop is approximately the same in both oxide and selenium types.

#### Aluminum Plate Features

Selenium rectifiers using aluminum plates are also instantly ready for use at any time, requiring no warming up period. Also their efficiency is uniformly high over a wide load range and they involve no standby losses when not under load. In addition, they have the favorable feature of almost 100% power factor.

Type of Rectifier	Power Rating	Operation	Maintenance	Notes
Dry-disc rectifiers	From milliwatts to 20 kw	Rectifying action takes place at metallic junction to provide current flow in one direction only.	Very little.	No moving parts. Quiet in operation. No warm-up time necessary. Wide range of currents and voltages possible by series or parallel groups of stacks.
Hot-cathode	to 40 kw	Uni-directional current flows from heated filament to plate only.	Tube replacements from time to time.	Current output ranges from 0.125 to 20 amp. Warm-up times vary from 10 sec. to 5 min. Operation quiet. No moving parts. Vertical mounting often necessary.
Igniter tube rectifiers	to 120 kw	Uni-directional current flows from graphite anode to mercury pool through controlled ionization of mercury vapor.	Maintenance of cooling water supply essential to safeguard tubes. Replacement of electrodes or tubes from time to time.	For heavy surge current applications as control of spot and seam welders. Auxiliary starting apparatus necessary.
Motor-generator sets	20 watts to 150 kw	Direct-current generator driven by single-phase or three-phase motor.	Same as for other rotating equipment.	Voltage regulation good. Output voltage easily controlled.

Figure 7  
General characteristics of rectifying equipment.



change pitch and direction almost  
instantaneously with the improved  
Presto 8-D Recorder

The Improved Presto 8-D Recorder is equipped with a reversing device for the feed screw. Result: Six feed pitches, inside-out and outside-in, using only one feed screw. This feed screw need never be removed from the recorder. Thus, changes in pitch and direction are accomplished within a matter of seconds.

The Presto 8-D Recorder is the easiest and most convenient machine to operate because of the arrangement of its controls and the cantilever overhead which saves lost motion in operation. Its unusually heavy construction assures high fidelity masters and instantaneous recordings.

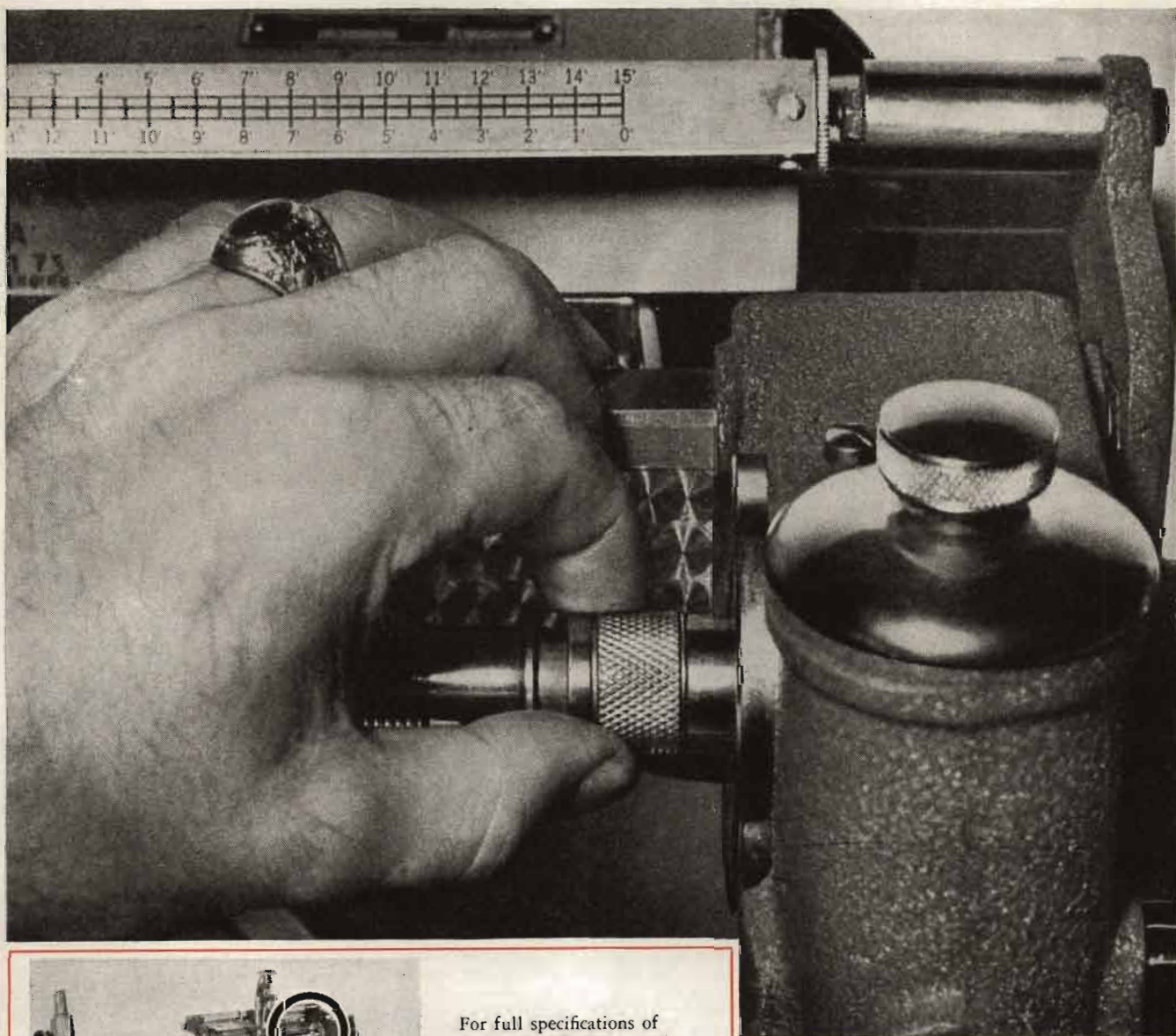

For full specifications of the Presto 8-D please write Presto Recording Corporation, 242 West 55th Street, New York 19, N. Y. To insure future delivery within a reasonable time, we suggest you place your order now for immediate listing.

**PRESTO**

RECORDING CORPORATION  
242 West 55th Street, New York 19, N. Y.  
Walter P. Downs, Ltd., in Canada

*World's Largest Manufacturer of Instantaneous Sound Recording Equipment*



ESTABLISHED 1906

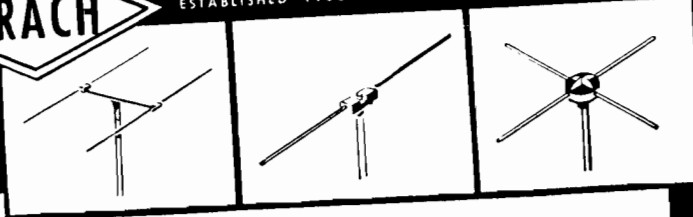

# ANTENNA SYSTEMS for USERS of PRIVATE BRANDS

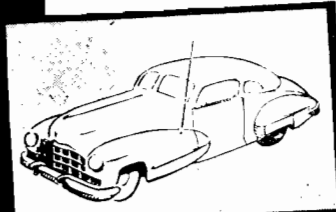

We manufacture the following, under private labels and trademarks:

**AUTOMOBILE ANTENNAS** . . . every variety, including types that can be raised and lowered from inside the car.

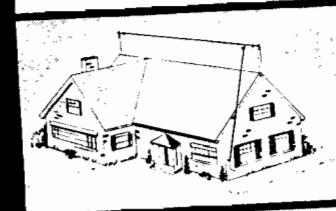

**RESIDENTIAL ANTENNAS** . . . AM and FM, for homes, stores and multi-family buildings. Complete lines of noise-reducing systems incorporating latest patented developments of coupling transformers.

**FM, AM and TELEVISION** . . . Dipoles with or without reflectors, folded dipoles, turnstile, radiating types and other combinations for roof, sidewall and other mountings.

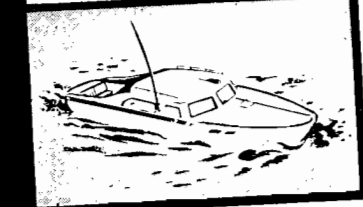

**MARINE ANTENNAS** . . . Collapsible and transmitting types for every purpose.

**For POLICE and other mobile units** . . . roof-top antennas for ultra-high frequencies.

WE INVITE INQUIRIES AND CONSULTATIONS.

## L. S. BRACH MFG. CORP.

200 CENTRAL AVENUE NEWARK, 4 N. J.



WORLD'S OLDEST AND LARGEST MANUFACTURERS OF RADIO ANTENNAS AND ACCESSORIES

## RAILROAD RADIO

(Continued from page 16)

tance of 14.2 miles. East of Dawkins, flutter and other signal variations first became noticeable in the contacts between the train and the West Wayne station, and point-to-train communication ceased in an area slightly west of Edgerton, Indiana, 16.9 miles to the east of the West Wayne station. End-to-end communications remained unaffected.

During the trip a stop was made at Continental, Ohio, with the head end of the train positioned west of the Clover Leaf District crossing. The engine was detached and moved southwest for a distance of about 3 miles to the west end of the Clover Leaf District passing siding. Good radio contact was maintained between the caboose and engine while this

move was being made, except for some flutter which was noted when the engine was passing through wooded territory and along the sides of buildings located between the locomotive and caboose. However, the degree of flutter was not sufficient to interfere with the intelligibility of the voice signals being exchanged in each direction.

Throughout the trip from Fort Wayne to Bellevue, solid end-to-end connections were maintained, with no flutter nor electrical noise being noted in any area along the route. Signal strengths at the input of the caboose receiver were measured on occasions during these contacts by means of a vacuum-tube voltmeter, connected in the first limiter circuit of the caboose receiver. The average signal strength observed in end-to-end communications during the run from Fort

Wayne to Bellevue was between 45 and 50 microvolts.

In another test run between Bellevue and Cleveland at a point 37 miles west of Cleveland, good signals were received in the caboose from the Tower station, and at a point 36 miles west of Cleveland good signals were received in the locomotive from the Tower building. At an overhead bridge east of Vermilion, Ohio, about 35 miles from Cleveland, solid two-way contact was established between the caboose and the tower station. At this point the station located in the Tower building advised that signals were first received from the caboose at a time when the train was approximately 57 miles west of Cleveland, but that the signals did not remain strong enough for reliable copying until the train was about 35 miles west of Cleveland. Solid, reliable two-way contact between the caboose and the Cleveland station was maintained thereafter.

When the train was passing Lorain, Ohio, approximately 26 miles west of Cleveland, the operator at the tower stated that the voice signals exchanged between the engine and caboose were very strong and clear.

The train was stopped at Sheffield, Ohio, approximately 21 miles west of Cleveland, and the engine was detached and operated over the South Lorain Branch to South Lorain, Ohio, and return. Solid contact was maintained between the caboose and engine while the engine was moving in both directions, except for a short period when flutter was noticed as the engine moved through a wooded area.

This did not interfere with the intelligibility of the voice signals.

Following the test run to South Lorain, the train proceeded to Cleveland. At Avon, Ohio, the tracks passed under a high-tension line, but no effect on the communications circuit was noted. Solid communications were maintained between the tower and train as the train approached Cleveland, with no audible flutter or electrical noise except for a brief interval when the caboose passed under an overhead bridge west of West 110th Street, Cleveland, and when the caboose passed West 38th Street, Cleveland, at which point the trolley lines of the Cleveland Union Terminal run parallel to the Nickel Plate tracks. At the latter location, the squelch circuit of the receiver was opened for short intervals by electrical noise from the trolley line in the immediate vicinity of the caboose antenna. When signals from the tower building were being received, this noise did not interfere with communications due to saturation of the limiter circuit in the receiver.

As the train proceeded through the center of Cleveland, solid contact was provided at all times between the engine and caboose, and with the tower station, with no evidence of flutter or electrical noise except for short intervals at several points when the locomotive passed under bridge structures.

Throughout the trip, from Bellevue to Conneaut, and through the Cleveland industrial area, no difficulty was experienced in maintaining solid contact between the ends of the train, and no flutter nor electrical noise was observed during any of the end-to-end communications.

During a portion of the return run from Conneaut to Cleveland, when the train was within the effective two-way



communications range of the Tower station, measurements of signal strength at the caboose receiver were made at various mile-post locations to indicate the extent to which the signal intensity increased as the communications distance decreased.

From 30 miles east to the East 55th Street yard, Cleveland, the field strength at the caboose receiver built up rapidly and at all times produced a strong audio signal. It was noted that until the average signal strength built up to approximately 5 microvolts or more, occasional dips in r-i signal intensity occurred so that extraneous noise was observed on occasion at some of these points of reduced signal intensity. This did not, however, interfere with signal intelligibility. Above 5 microvolts, no dip in signal strength affected the complete quieting action of the receiver.

On another run the equipment was operated westbound from Cleveland Coach Yard to Bellevue, Ohio, about 63 miles from Cleveland. On this trip measurements of received signal strength at the caboose receiver were made at mile-post intervals to provide an indication of the decay of signal strength with distance. At a point 25 miles west of Cleveland, flutter was reported at the station on the locomotive. From that point west to Bellevue, the station on the locomotive could be heard by the Cleveland operator, but the signals were not clearly intelligible. On the caboose, two-way communications with the Cleveland station was maintained to Bellevue, a distance of about 63 miles, with flutter first being evidenced in the audio signal 39 miles west of Cleveland. At this location, the signal strength at the caboose receiver was in the range from 0.8-4.4 microvolts, with an occasional word being dropped out between this point and a point opposite the Bellevue Yard Office. At this location, the local noise level was high and words were dropped out more frequently.

During the Cleveland-to-Bellevue run, measurements of received signal intensity showed that the decay in signal strength was extremely rapid for about 13 miles, with the signal strength dropping to less than 10 microvolts at this distance. Beyond this point, several abrupt peaks in signal strength were noted; aside from this, decay was gradual for about 28 additional miles, after which the decay with distance was relatively small, dropping only from 3 microvolts to 1 microvolt in the remaining 23 miles to Bellevue.

Solid communications were maintained at all times between the engine and caboose, over a total train length of 82 cars, during the run from Bellevue to Fort Wayne. At Continental, 47 miles east of Fort Wayne, the train passed through an electrical storm area, with lightning being observed on both sides of the track; at Goodwin, 10 miles west of Continental, the train ran through a severe rain storm, with considerable lightning, for approximately 3 miles. No static was heard at any time in these storm areas, and no electrical noise was experienced in communications between the engine and caboose.

#### Conclusions

One of the principal conclusions drawn from the tests, and from a consideration of signal strength data compiled was that

(Continued on page 34)

## Standardizing the "POP" in Toasters 24 Hours a Day *Without Burning a Slice...*

SORENSEN Regulators straighten out weaving input voltages. It's done the electronic way... without moving a muscle. No moving parts assure you of quick response, low maintenance and longer life.

Protecting costly laboratory apparatus from over-voltages, speeding up assembly line testing or applied to any of your regulation problems, the SORENSEN Regulator can be counted on to do the job with precision and accuracy.

Write for more information.

Arrange for a demonstration today.

A LINE OF STANDARD REGULATORS FOR LOAD RANGES UP TO 5000 V.A.  
SPECIAL UNITS DESIGNED TO FIT YOUR UNUSUAL APPLICATIONS.



**SORENSEN & COMPANY, INC.**  
STAMFORD, CONN.



# VETERAN WIRELESS OPERATORS ASSOCIATION NEWS

W. J. McGONIGLE, President

RCA BUILDING, 30 Rockefeller Plaza, New York, N. Y.

GEORGE H. CLARK, Secretary

## Personals

MANY VETERAN VWOA members attended the recent conference and exhibition of the Television Broadcasters Association at the Waldorf-Astoria in New York City.

VWOA life members at the conference included Raymond F. Guy, radio facilities engineer, NBC; O. B. Hanson, vice president and chief engineer, NBC; Brigadier General David Sarnoff, president, RCA; E. A. Nicholas, president, Farnsworth Television and Radio Corp.; E. H. Rietzke, president, Capitol Radio Engineering Institute; G. W. Johnstone, director of radio activities of the National Manufacturers Association and Lewis Winner, editor of *COMMUNICATIONS*. . . . Life member Jack Poppele, vice president and chief engineer of WOR, as president of the TBA, delivered an enlightening address on television and its future during the sessions. . . . VWOA honorary member Alfred N. Goldsmith presented an interesting talk on twenty years of television progress. . . . VWOA honorary members Major General Harry C. Ingles, Chief Signal Officer of the Army, and Mark Woods, president of the American Broadcasting Company, were also at the TBA conference. . . . Dr. Lee DeForest paid a surprise visit to the conference and appeared during a panel on television receiver servicing conducted by Lewis Winner.

VETERAN MEMBER ROSCOE KENT returned from Florida recently, quite recuperated. He is now associated with Radio Inventions, Inc., of which our good friend John V. L. Hogan is president, as consultant and patent advisor. Good luck RK. . . . A. F. "Steve" Wallis remains in New York doing promotional work. Winter is approaching though and time for his annual Florida trip. . . . More than happy to announce the complete recovery of the VWOA *work-horse* "Bill" Simon, treasurer and executive secretary. Bill is back in the saddle again and going stronger than ever. . . . Captain Fred Muller, former



VWOA life member Ray F. Guy, radio facilities engineer, NBC, who at present is supervising installation of the NBC television transmitter in the Wardman Park Hotel, Washington, D. C.

VWOA president, continues to serve as Electronics Officer of the Sixteenth Fleet, U. S. Navy. From apprentice seaman to a four-striper in the Naval Reserve is quite a proud accomplishment. . . . George H. Clark, VWOA secretary and historian spent much of the summer at his country place in northern New Jersey. . . . J. H. Appel, Jr., is Examining Officer with the FCC in the New York office. . . . It has been a long time since we have had word from year book editor C. S. Anderson, formerly with RCA Institutes, now retired. . . . Geo. W. Ahrens is now stationed at Galveston, Texas.

## Books by VWOA Veterans

OUR GOOD FRIEND GEORGE H. CLARK is the author of a book on the life of John Stone Stone. George presents an authentic study of Mr. Stone with whom he worked very closely in the early days. . . . Only a limited quantity of books have been produced in a special edition form. Another printing, for wider distribution, may be completed at a later date. . . . VWOA life member Donald McNicol has also written a book covering "Radio's Conquest of Space." DM presents a personalized story of the men whose skill and imagination produced the inventions and

refinements that have made radio communications so vital a part of life today. . . . Although the book is written in a non-technical form, it includes invaluable data on communications developments from the days of Hertz to the present. DM reveals some of the accidental discoveries that played so important a part in communications development. . . . VWOA men will find in this book quite a fascinating collection of anecdotes on many builders of the radio industry. . . . We are quite sure that everyone will enjoy reading this new volume by DM. It has been published by Murray Hill Books, Inc., New York City.

## Tintype

A REVIEW OF THE ACTIVITIES of Capt. Charles William Horn, life member VWOA reveals that C.W.H. is probably "the oldest man in broadcasting." He planned and set up KDKA in Pittsburgh, the pioneer broadcaster.

C. W. H.'s radio career goes back many years. He was 16 when he went to sea as an operator. In 1917, he entered the Naval Reserve and served in the third Naval District.

During World War II, he was assigned to Headquarters as a Special Assistant to the Director of Naval Communications.

C.W.H.'s broadcast activities also included the first synchronization procedure, the link between WBZA in Springfield and WBZ in Boston. Today that synchronized method is still being used. He also has been very active in television, having conducted developments for the very-high frequency video station of NBC atop the Empire State Building in New York City. The first relay station for television was also set up under his direction at Mt. Arny, New Jersey in 1931.

Currently, he is a fellow of the Institute of Radio Engineers and honorary member of the Princeton Engineering Society. He has been president of the Radio Club of America and president of the New York Electrical Society. He is also a past director of VWOA.





The Collins 32V-1 Ham-band Transmitter

You **CAN** take it with you!

The Collins 32V is the last word in compact, efficient, and versatile transmitters for amateur radio. It is small enough to set right on your operating desk. It is light enough to take anywhere—all you need to put it on the air are a 115 volt a-c power source, key or microphone, and an antenna. The 32V has more desirable features per cubic inch than any previous equipment.

For instance, compare these features with your desires: 150 watts input on CW, 120 watts on phone, v.f.o. control, band switching, direct frequency reading dial, push to talk, clean keying, 6 bands. A pi network is in-

cluded for output coupling—and it's easy to use. One control tunes the final and another control loads it into the antenna.

The v.f.o. is so accurate you'll be using it to calibrate your receiver. It's permeability tuned, and can be set to within 500 cycles on the 80 meter band. The overall accuracy and stability are within one dial division.

Be one of the first to own this brand new job. You'll be proud of its excellent performance and attractive appearance. \$475.00 with tubes. Let us send you an illustrated bulletin with complete details.

FOR RESULTS IN AMATEUR RADIO, IT'S . . .

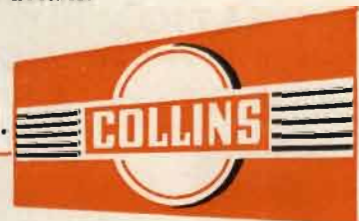

**COLLINS RADIO COMPANY, CEDAR RAPIDS, IOWA**

11 West 42nd Street, New York 18, N. Y.

• 458 South Spring Street, Los Angeles 13, California

*Laboratory Standards*

By  
**MEASUREMENTS CORPORATION**

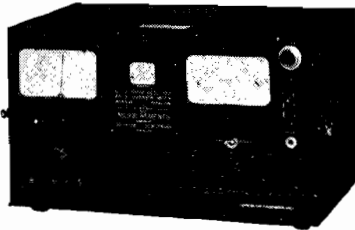

**U. H. F. RADIO NOISE and FIELD STRENGTH METER**

*Model 58*

**FREQUENCY RANGE:** 15 to 150 mc. Push-button switching for rapid, accurate measurement of noise levels or field strength.

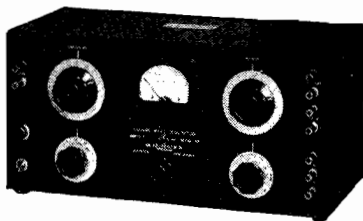

**SQUARE WAVE GENERATOR *Model 71***

**FREQUENCY RANGE:** 5 to 100,000 cycles.  
**WAVE SHAPE:** Rise time less than 0.2 microseconds.  
**OUTPUT VOLTAGE:** 75, 50, 25, 15, 10, 5 peak volts fixed; 0-2.5 volts continuously variable.

**MANUFACTURERS OF**  
Standard Signal Generators  
Pulse Generators  
FM Signal Generators  
Square Wave Generators  
Vacuum Tube Voltmeters  
UHF Radio Noise & Field Strength Meters  
Capacity Bridges  
Megohm Meters  
Phase Sequence Indicators  
Television and FM Test Equipment

Catalog on request

**MEASUREMENTS CORPORATION**  
BOONTON NEW JERSEY



**RAILROAD RADIO**

*(Continued from page 31)*

with f-m radiotelephone equipment of the specified power output and sensitivity ratings, reliable two-way point-to-train communications may be expected over air-line distances up to 14 to 16 miles, in flat terrain, when the fixed-station antenna is situated at a height of approximately 60' above ground; and over air-line distances of 30 to 38 miles when the fixed-station antenna is at an elevation of approximately 600' above ground.

**Average Signal Intensities**

It was also learned that average signal intensities of 3 microvolts or better at the train receiver may be expected to provide good communications along railroad right-of-way, and that if receiver sensitivity is held at this value or better throughout each maintenance period, satisfactory communications of a *solid* nature should be provided in both urban and rural areas where these minimum levels are existent. If some electrical noise can be tolerated in urban areas, and more frequent maintenance can be permitted, the system may be expected to function satisfactorily with signal strengths of 1 microvolt or less, and to provide useful communications over somewhat greater distances than indicated previously.

The test also clearly demonstrated that a satisfactory end-to-end radio communications link can be maintained at all times between a caboose and engine of an 80-car freight train, involving a 3 to 4-mile distance.

**POSTWAR ANTENNA**

*(Continued from page 13)*

a high-fidelity transformer to a lead-shielded pair placed in the underground conduit connecting tower and transmitting house. Output of the crystal diodes equals in amplitude that supplied by conventional vacuum-tube diodes and is sufficient for transmission over the low-impedance line to monitor amplifier equipment, within the station proper.

Signal level on the 500/600-ohm line is on the order of -16 db, with total crystal current approximately two-tenths of a milliamperere. Operating so far below maximum ratings, the life span of the 1N34 diodes can be said to be practically infinite.

A dual unit (1N35) consisting of two matched germanium crystal diodes, offers an improved mounting and might well be substituted for the type described.

**ZOPHAR WAXES COMPOUNDS and EMULSIONS**



FOR  
INSULATING and WATERPROOFING  
of ELECTRICAL and  
RADIO COMPONENTS

Also for  
CONTAINERS and PAPER  
IMPREGNATION

FUNGUS RESISTANT WAXES

ZOPHAR WAXES and COMPOUNDS

Meet all army and navy  
specifications if required

*Inquiries Invited*

**ZOPHAR MILLS, INC.**  
FOUNDED 1846  
122-26th ST., BROOKLYN, N. Y.

- SPEAKERS
- AMPLIFIERS
- RECORDING MACHINES
- PUBLIC ADDRESS SYSTEMS
- MICROPHONES (GUITAR)
- VOLUME CONTROL (FOOT PEDAL)

Complete facilities for manufacturing all types of Radio, Sound, Recording, Directional Finding and associated equipment. Our public address systems and theatre speakers are known all over the world. Write for literature on the above mentioned lines.

Many products formerly manufactured under the trade names of Fox and De Armond are now combined with Rowe Industries.

15 years' experience at your command.

Submit your problems. Address Dept. 35.

**ELECTRONICS DIVISION**

**ROWE Industries**

3120 MONROE ST., TOLEDO 6, OHIO



## STRIPS FAST— CLEAN!

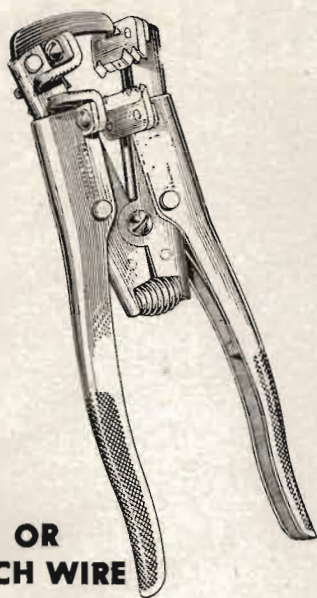

**WON'T  
CRUSH OR  
SCRATCH WIRE**

### IDEAL "E-Z" WIRE STRIPPER

Here is a Triple Action Wire Stripper that cuts and strips insulation—all in one simple operation. A lever stops return of the arms of the Stripper until wire is removed, then the arms snap back quickly to normal position—doing a speedy, clean job. Eliminates waste, otherwise caused by crushing or nicking the wires.

A safe, handy, pocket size tool (7½" long; weight 24 oz.) with cutting blades shielded to guard user's hand. "Universal" Model strips wires from No. 22 to 10 gauge A.W.G., solid or stranded.

Distributed Through  
**IDEAL** AMERICA'S LEADING WHOLESALERS  
**IDEAL INDUSTRIES, Inc.**  
(Successor to Ideal Commutator Dresser Co.)

4025 PARK AVE. SYCAMORE, ILL.

PROTECT YOUR HOME FROM  
TUBERCULOSIS

**BUY  
CHRISTMAS SEALS**

## BOOK TALK . . .

### APPLIED MATHEMATICS FOR RADIO AND COMMUNICA- TION ENGINEERS

By Carl E. Smith, Director of Engineering, United Broadcasting Company, Cleveland; President, Cleveland Institute of Radio Electronics . . . 336 pp . . . New York: McGraw-Hill Book Co. . . . \$3.50

This textbook, the outgrowth of courses begun in 1934 to meet the needs of broadcast operators and engineers, is lucid enough for students with a simple high-school education and complete enough to serve as a reference and refresher for the technical man.

Mr. Smith begins with a review of the fundamental operations in arithmetic, logarithmic, and algebraic computations and a discussion of the slide rule as a means of adding logarithms graphically. Several subsequent chapters discuss vectors as applied to alternating currents and cover both graphical and analytical methods of analysis. This secondary-school level of the text concludes with a review of determinants and quadratic equations.

The latter portion of Mr. Smith's book is an abbreviated treatment of the outlines of calculus. After an introduction into hyperbolic concepts, Mr. Smith covers differentiation of algebraic and transcendental functions and includes a chapter on elementary integration. The final chapter on infinite series and on wave forms of periodic functions is, of course, particularly valuable in the study of alternating currents. A comprehensive appendix that contains tables, formulas, and a collection of curves showing square, sawtooth, and other waves together with their equations and the relative amplitude of their harmonics, concludes the text.

Mr. Smith has incorporated a number of exercises in each chapter to illustrate the material covered. Relating these exercises a little more closely to actual radio problems might have helped stimulate the radio-student's interest more effectively. Nevertheless, Mr. Smith has produced a useful text that will help satisfy a real need.

#### MARCHAND AND SINGER PAPERS TO APPEAR IN DECEMBER

The next installments of the papers by N. Marchand on *F-M Mobile Communications* and Charles Singer on *Preventive Maintenance* will appear in the December issue of COMMUNICATIONS.

## Here's the Finest in Amplifier Systems



This complete recording amplifier channel develops full power from 40 to 10,000 cycles without the usual dirty highs or intermodulation distortion. No other amplifier system can produce such performance. Another Altec Lansing first . . . it is ideal for studio recording. Available complete or in separate units.

A-420 PRE-AMPLIFIER  
P-409 REGULATED POWER SUPPLY  
A-322 LIMITER AMPLIFIER  
M-500-4 MIXER PANEL  
A-255 POWER AMPLIFIER  
A-127 MONITOR AMPLIFIER

Complete details of gain frequency and power can be obtained from your dealer or

**ALTEC**  
LANSING CORPORATION  
1161 NORTH VINE ST.  
HOLLYWOOD 38, CALIF.  
250 W. 57th ST., N. Y. 19, N. Y.  
"KEEP ADVANCING WITH ALTEC LANSING"



*At Last...*

THE  
MOTOR  
THAT  
OPENS  
NEW  
HORIZONS  
IN  
RADIO  
AND  
ELECTRONIC  
FIELDS

- the *Minimotor*.
- the Alni Corporation is pleased to announce the availability of the lowest practical current consumption D.C. motor in the world.
- the motor of an entirely new principle! No rotating windings.
- the motor that can operate on as little as thirty milliwatts power.
- the motor that is ideal for saving current where power supply is an important factor.
- the motor that has countless applications in the miniature horsepower field.
- the motor that may well be the answer to your problem.
- the *Minimotor*.

Outline your specific applications and requirements to our Special Projects Division.



**ALNI CORPORATION**  
Reeves International Building  
10 EAST 52nd STREET  
NEW YORK 22, N. Y.

## NEWS BRIEFS

### RAYTHEON RECEIVES MICROWAVE STATION PERMITS

The Raytheon Manufacturing Company have been granted construction permits for two experimental class I microwave stations for de- within the continental limits of the country veloping vehicle equipment. One portable and mobile station with one unit is to be located and one mobile station in the general vicinity of Boston, Mass.

Frequencies, assigned on a temporary basis, are: 1750-1825, 3500-3700, 6350-6500, 11,500-12,000, 16,000-18,000 and 26,000-30,000 megacycles. Power will be 100 watts. Emission will be pulse and f-m.

### D. A. DAVIS NOW CANNON ELECTRIC S-M

Don A. Davis, for several years chief engineering representative for the Cannon Electric Development Company, Los Angeles, has been appointed sales manager. He replaces William V. Brainard who resigned to form his own sales promotion service.

### FTR OPENS MONTREAL PLANT

The newly organized Canadian subsidiary of Federal Telephone and Radio Corporation, the Federal Electric Manufacturing Co., has moved into a new plant on St. Lawrence Boulevard in the St. Laurent Parish of Montreal about five miles from the center of Montreal.

### BENNETT NOW ST. LOUIS MICROPHONE CHIEF ENGINEER

Robert M. Bennett, Jr., has been appointed chief engineer of the St. Louis Microphone Co., St. Louis, Mo.

### STOLL AND BUCKLEY RECEIVE MEDAL FOR MERIT

Clarence G. Stoll, president of Western Electric, and Oliver E. Buckley, president of Bell Telephone Laboratories have been awarded the Medal for Merit.



C. G. Stoll and Major Gen. H. C. Ingles, Chief Signal Officer of the Army

### CLEVELAND TO HAVE DuMONT TELEVISION STATION

Scripps-Howard Radio, Inc., has awarded to Allen B. Du Mont Laboratories, Inc., a contract for the installation of a 5000-watt television station in Cleveland.

Colonel James C. Hanrahan, vice president of Scripps-Howard Radio, Inc., will be manager of the station. J. B. Epperson will be chief engineer.

### A. B. CHAMBERLAIN CITED BY ASA FOR WAR WORK

A. B. Chamberlain, CBS chief engineer, has received a Certificate of Award from the American Standards Association, for his work from June 1942 to November 1943 as the U. S. Navy Bureau of Ships' representative on the association's War Committee for Electronics Standardization.

### KELLOGG SWITCHBOARD RECEIVES EXPERIMENTAL V-H-F PERMIT

Kellogg Switchboard and Supply Company, Chicago, has been granted a construction per-

## CORWICO WIRES



made by engineers  
for engineers.....

**CORNISH WIRE CO., INC.**  
15 Park Row • New York City, 7

## PERMANENT MAGNETS

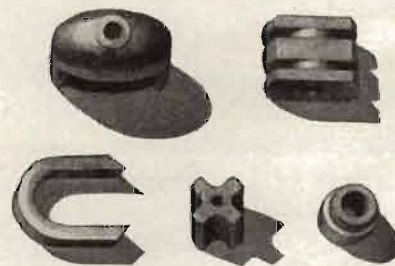

ALLOYS:

**Cobalt • Chrome • Alnico**

The making of permanent magnets is an alloy, too . . . of experience, engineering, facilities. We'll be glad to tell you more. Write for bulletin.

**THOMAS & SKINNER STEEL PRODUCTS CO.**  
1113 E. 23rd St., Indianapolis 5, Ind.

# Thomas & Skinner



mit for a class 1 experimental 30 to 40 mc/152-158 mc station for portable and portable-mobile study. Power will be 30 watts, and for emission, AO, A1 and f-m and tone.

#### SHURE CATALOGS

Two catalogs, 155 and 156, covering microphones and pickups and cartridges have been released by Shure Brothers, Inc., 225 West Huron Street, Chicago 10, Ill.

Catalog 155, discussing microphones, features an article, "How to Select the Proper Microphone," covering requirements, types, polar response, characteristics, and frequency response.

Catalog 156 describes crystal pickups and lever-type cartridges, and features an article, "Facts You Should Know About Pickups," discussing needle-point compliance, tracking angle, tone arm mass, voltage sensitivity, type of needle, amplifier input circuits and surface noise.

#### DR. R. A. GALBRAITH NOW E. E. DEPT. HEAD AT SYRACUSE UNIVERSITY

Dr. Ralph A. Galbraith has been appointed professor of electrical engineering and chairman of the department, Syracuse University, N. Y.

Dr. Galbraith is a contributing author to the recently published book "Principles of Radar" by the staff of the M. I. T. Radar School.

#### FRANK LESTER NOW WITH RADIO WIRE TELEVISION

Frank Lester has been named head of the amateur division by Radio Wire Television, Inc., 100 Avenue of the Americas, N. Y. C.

Mr. Lester was with R.W.T. from 1928 to 1941. He was chief engineer for the Electronic Corporation of America from 1941 to 1946.



#### PARTS SHOW SCHEDULED FOR MAY, 1947

A four-day parts-equipment show, conducted by Radio Parts and Electronic Equipment Shows, Inc., 111 W. Washington Street, Chicago, Illinois, will be held at the Stevens Hotel in Chicago during the week of May 11, 1947. The show is jointly sponsored by the National Electronic Distributors Assn., Association of Electronic Parts and Equipment Manufacturers, Sales Managers Club Eastern Division, and Radio Manufacturers Assn.

Kenneth C. Prince is show manager. Board members include: Jack Berman, Shure Brothers; Charles Golenpaul, Aerovox Corp.; Jerome J. Kahn, Standard Transformer Corp.; Sam Poncher, Newark Electric; Walter W. Jablon, Hammarlund Manufacturing Company; Robert C. Sprague, Sprague Products; R. J. Sherwood, The Hallierafters Company; and William L. Schoning, of Lukko Sales Corp.

Features of the show will include an "NEDA Day" and an "Open House" day, at which time Service Men, amateurs, engineers and the general public will be admitted.

#### WNBT AND WPTZ TO EXCHANGE PROGRAMS

An agreement providing for the exchange of both commercial and sustaining television programs between WNBT in New York and WPTZ in Philadelphia has been signed by NBC and Philco.

#### GENERAL STONER HEADS UN COMMUNICATIONS PANEL

Brigadier General Frank E. Stoner, Assistant Chief Signal Officer, has been loaned by the War Department to serve as chairman of a panel of communications experts who will establish communications practices and policies for the dissemination of information from the United Nations General Assembly.

#### TRIODE DATA

A 72-page book discussing gas filled triodes, prepared by G. Windred, has been published by

(Continued on page 38)

# A Little Thing

## Which Means a Lot

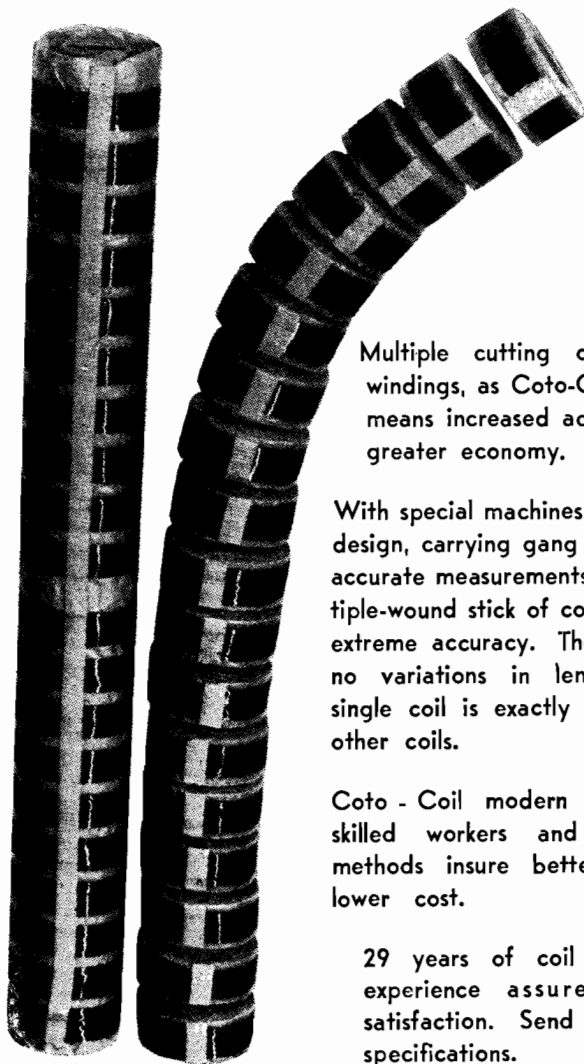

Multiple cutting of multiple windings, as Coto-Coil does it, means increased accuracy . . . greater economy.

With special machines of our own design, carrying gang saws set to accurate measurements, each multiple-wound stick of coils is cut to extreme accuracy. There can be no variations in length. Each single coil is exactly like all the other coils.

Coto-Coil modern equipment, skilled workers and advanced methods insure better coils at lower cost.

29 years of coil winding experience assures your satisfaction. Send us your specifications.

## COTO-COIL CO., INC.

COIL SPECIALISTS

SINCE 1917

65 Pavilion Ave.

Providence 5, R. I.

## NEWS BRIEFS

(Continued from page 37)

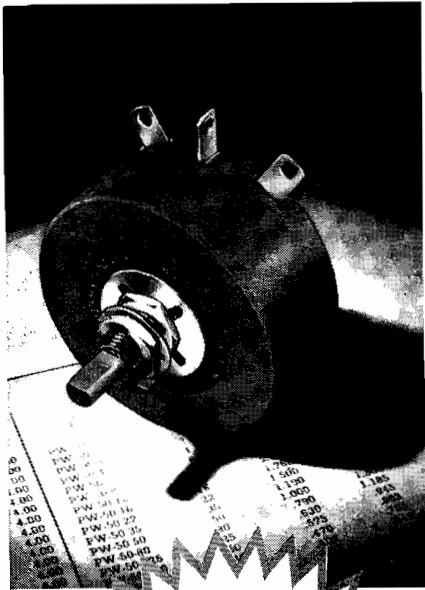

**HEAVY-DUTY  
Rheostats**

Several hundred thousand of these Clarostat power rheostats in daily use are proving that "they can take it" — and then some. No tougher controls are made.



Insulated metal core supporting resistance winding imbedded in famous "Greenohm" cold-setting inorganic cement, readily dissipates heat of full load and even overloads.



25-watt: 1 to 3500 ohms. 50-watt: 1/2 to 5000 ohms. Similar in design and construction.

### ★ New CATALOG . . .

Just one of the many items listed in the new Clarostat postwar catalog. Ask your local Clarostat jobber for your copy — or write us direct.



CLAROSTAT MFG. CO., Inc. • 285-7 N. 6th St., Brooklyn, N. Y.

the Hulton Press, Ltd., 43 Shoe Lane, London E.C. 4, England.

Discussed are general principles of the art, construction and physical properties of tubes, ratings, methods of control, cathode protection, methods of testing and general applications. A variety of circuits, charts and curves appear in this interesting book.

### AMP TERMINAL BOOKLET

A loose-leaf booklet, illustrating and describing a variety of solderless terminals, has been published by Aircraft Marine Products, Inc., 1523 N. 4th Street, Harrisburg, Pa.

Samples of the various types of terminals are included in the booklet.

### EDISON THERMAL RELAY DATA

An 8-page leaflet discussing thermal relays has been published by the Instruments Division of Thomas A. Edison, Inc., West Orange, N. J.

Basic circuits and operating curves are supplied.

### MALLORY MYE ENCYCLOPEDIA

The 5th edition of the MYE servicing encyclopedia, containing over 4,000 replacement listings, has been published by P. R. Mallory, Inc. Replacement data covers controls, capacitors and vibrators.

### ANDERSON NOW AT WHEELCO

John E. Anderson has been appointed manager of the Indianapolis sales and service office of Wheelco Instruments Co., Chicago, Ill. The office is located at 107 S. Capitol Avenue, Indianapolis 4.

### WALTER WIDLAR OPENS TEXAS SALES OFFICE

Walter Widlar has opened a sales representative office at 701 N. 10th Street, McAllen, Texas.

### TECHNOLOGY INSTRUMENT BOOKLETS

Data describing the dynamic noise suppressor and precision type variable resistors appear in booklets prepared by the Technology Instrument Corporation, Waltham 54, Mass.

Both booklets contain electrical and mechanical operating data.

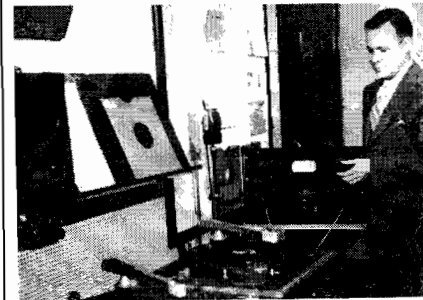

H. H. Scott, president of Technology Instrument Corp. with the dynamic noise suppressor at WEEI, Boston.

### GENERAL RADIO V-T-V-M DATA

The current issue of the "General Radio Experimenter" contains a discussion of the 1800-A vacuum-tube voltmeter.

Presented are operating curves and a schematic diagram of the instrument.

### L. W. HOWARD AND O. D. PERRY OPEN TRANSFORMER PLANT

L. W. Howard has taken over the inventory and equipment of the Electronic Components Co., and with O. D. Perry has formed the Triad Transformer Mfg. Co., with offices and plant at 423 N. Western Avenue, Los Angeles 4, Calif.

### GALVIN RECEIVES WAR DEPARTMENT AWARD

Brigadier General Calvert H. Arnold, Chief, Signal Corps Procurement and Distribution

## JONES 500 SERIES PLUGS and SOCKETS

(Heavy Duty)

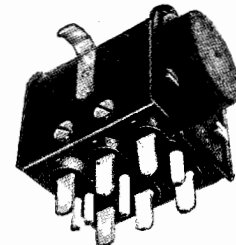

P-506-CE

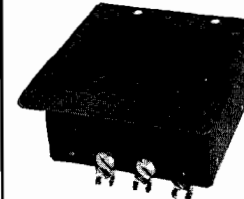

S-506-DB

Designed for 5000 Volts and 25 amperes per contact. Socket Contacts of phosphor bronze, knife-switch type, silver plated. Plug Contacts are of hard brass, silver plated. Made in 2, 4, 6, 8, 10 and 12 Contacts.

All Plugs and Sockets are Polarized. Long leakage path from Terminal to Terminal and Terminal to ground. Caps and Brackets

are of steel, parkerized. Plug and Socket blocks interchangeable in Caps and Brackets. This series is designed for heavy duty electrical work and will withstand severest type of service.

Write for Bulletin No. 500 describing this line of Heavy Duty Plugs and Sockets.

**HOWARD B. JONES DIVISION**  
CINCH MFG. CORP.  
2460 W. GEORGE ST. CHICAGO 18

### ATTENTION! ENGINEERS, TECHNICIANS! Save on Electronic & Communication Supplies. Plate Transformer



Wilcox CW3 Receiver

(used for aircraft monitoring) a fixed frequency receiver (1100 KC. to 16,500 KC) xtal controlled superhet with BFO and AC power supply; 110 V. 60 Cy.; makes a beautiful ham receiver with a converter. Coils can be furnished in any of the following groups: 1100-2100 KC; 3500-8100 KC; 5600-10,000 KC; 9400-16,500 KC; complete with add. set of tubes and one set of coils. \$32.50 less xtal.



Full Wave Selenium Rectifier  
Perfect for bias application. Use your DC relays from an AC source. Unit is very small and compact. Only requires 3" x 1/2" mounting space. Rectifier for input up to 300 Volts at 40 ma. output. Made by G.E. \$0.89 or 5 for \$4.00

Johnson type 803 ceramic socket suitable for both 803 & RK 28 etc. tubes—comes complete with rubber and aluminum 5" diameter shock mount. Very special \$1.99

Socket for 204A, 849.....\$1.95  
Cramer hour counter, counts up to 9999.9 hours.  
110 Volts AC, 60 Cy.....\$4.95  
Coax chassis conductors, silver plated.....\$0.40  
Coax right angle connectors, silver plated.....\$0.90  
Chassis feed thru female on both sides.....\$0.79  
6B4 perfect speech tube same as 2A3 but 6 Volt fil.....\$1.39  
G.E. 872A JAN tube.....\$3.50  
G.E. 866 JAN. tube.....\$1.39  
9 conductor cable shielded with rubber outside covering. Per foot.....\$0.12  
Coax cable, RG8U or RG11U. Per 100 ft.....\$7.50  
Coax couplings for standard .405 cable, silver plated. Chassis or cable.....\$0.40

All tubes new and guaranteed. All our prices F.O.B. our warehouse New York City, New York. Write for our latest bulletin 12C.

IMMEDIATE DELIVERY

**NIAGARA RADIO SUPPLY**  
160 Greenwich St., New York 6, N. Y.  
Bowling Green 9-7993



Service, representing the Secretary of War, and Major General H. C. Ingles, Chief Signal Officer, presented a Certificate of Appreciation to P. V. Galvin for services rendered by the Galvin Mfg. Corporation to the Signal Corps during World War II.

**ROY S. LAIRD AND HERBERT E. LENSE OF OHMITE RECEIVE ASA APPRECIATION CERTIFICATES**

For contributing time and experience to the war committee work of the American Standards Association, Roy S. Laird, vice president in charge of sales, and Herbert E. Lense, laboratory director of Ohmite Manufacturing Company, were recently presented with an ASA appreciation award.

**PACENT NOW ON AIEE BOARD OF EXAMINERS**

Louis Gerard Pacent, president of Pacent Engineering Corporation, has been appointed a member of the board of examiners of the American Institute of Electrical Engineers to represent the radio engineering profession.

**ELECTRO-VOICE CARDYNE MICROPHONE BULLETIN**

A bulletin (No. 131) describing the Cardyne cardioid dynamic microphone has been issued by Electro-Voice, Inc., Buchanan, Mich.

**MACMILLEN NOW ASA INFORMATION HEAD**

Frank MacMillen has joined the staff of the American Standards Association as director of information.

**OLSON NAMED DuMONT TELESET SALES MANAGER**

Victor E. Olson has been appointed sales manager of the receiver sales department of Allen B. DuMont Laboratories, Inc.

**PRESS WIRELESS ENGINEERING DIV. TO MOVE TO HICKSVILLE**

The engineering division of Press Wireless Manufacturing Corporation, is being moved from 38-01 35th Avenue, Long Island City, to the company's factory on Cantiague Road, Hicksville, Long Island.

**HUGHES TO MANAGE MASCO**

Sherman K. Hughes has been appointed general manager of the Mark Simpson Manufacturing Co., Inc., Long Island City, New York.



**ABC TWIN CITIES AFFILIATE RECEIVES TELEVISION CP**

A television construction permit has been issued to WTCN, affiliate of the American Broadcasting Company in the twin cities, Minneapolis-St. Paul. The antenna will be erected atop the Foshay Tower. Joseph Beck is television director of WTCN.

**RALPH WEST NOW SUN RADIO SOUND DEPT. HEAD**

Ralph West has been named manager of the sound department of Sun Radio & Electronics Co., Inc., 122-124 Duane St., N. Y. C.

**PAUL H. KLEIN BECOMES JFD AD MAN**

Paul H. Klein has been appointed advertising manager of the JFD Manufacturing Company, Brooklyn, N. Y.

**DE MORNAY-BUDD CATALOG**

An 18-page loose-leaf booklet describing microwave components and test equipment has been prepared by the electronic sales division of DeMornay-Budd, 475 Grand Concourse, N. Y. 51, N. Y.

Among the items described are straight sections, narrow band couplers, 90° elbows, 90°

(Continued on page 40)

Insuline began to design, develop and produce quality radio parts for the industry a quarter of a century ago.

Today, Insuline produces one of the biggest lines of standard parts—everything from a small stamping to a giant transmitter cabinet—and occupies an enviable position as a to-your-specifications manufacturer.

You'll find quantity and quality, speed and precision, at Insuline. You'll find more complete details in Insuline's hot-off-the-press catalog. Write Dept. A-13 for your copy—now!

Designed for



Application

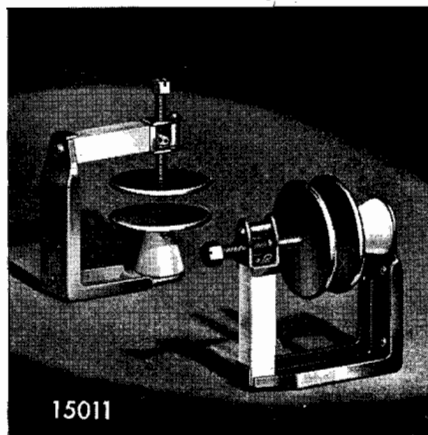

15011

**Disc Type  
Neutralizing Capacitor**

Designed originally for use in our own No. 90881 Power Amplifier, the No. 15011 disc neutralizing capacitor has such unique features as rigid channel frame, horizontal or vertical mounting, fine thread over-size lead screw with stop to prevent shattering and rotor lock. Heavy rounded-edged polished aluminum plates are 2" diameter. Glazed Steatite insulation.

**JAMES MILLEN  
MFG. CO., INC.**

MAIN OFFICE AND FACTORY  
**MALDEN  
MASSACHUSETTS**



**NEWS BRIEFS**

(Continued from page 39)

mitered elbows, bulkhead flanges, crystal mounts and broad-band couplers.

**HALLICRAFTERS RECEIVER-  
ANTENNA FOLDER**

An 8-page folder describing communications receivers and antennas has been released by the Hallicrafters Co., Chicago, Illinois.

Discussed are 6, 9 and 15-tube models, loud-speakers and roof-top, indoor and window mounting antennas.

**RALPH HAINES NOW AERO  
NEEDLE S-M**

E. Ralph Haines has been appointed sales manager of the Aero Needle Company, Chicago.

Mr. Haines was formerly with Raytheon Manufacturing Co., as a distributor sales executive.

**BEN ADLER JOINS TEMCO**

Ben Adler has been elected vice president in charge of engineering of the Transmitter Equipment Mfg. Co., Inc., N. Y. City.

Mr. Adler was formerly chief facilities engineer at the American Broadcasting Company.

**DuMONT C-R OSCILLOGRAPH  
MANUAL**

A 39-page operating and maintenance manual on the 274 oscillograph has been issued by Allen B. Du Mont Laboratories, Inc., Passaic, N. J. The manual also contains a discussion of the theory of operation of the cathode-ray tube and oscillograph circuits, with illustrations and diagrams.

Available at 50c per copy.

**HEACOCK APPOINTED TELEX S-M**

W. J. Heacock has been appointed sales manager of Telex, Inc., Minneapolis.



**DALMO VICTOR RADAR  
ANTENNA DATA**

A colorful 4-page leaflet discussing airborne radar antennas has been released by Dalmo Victor, San Carlos, California.

**ETTCO TOOL CO.**

A 16-page booklet describing drilling and tapping equipment has been released by Ettco Tool Co., Inc., 594 Johnson Avenue, Brooklyn 6, N. Y.

**WARD LEONARD CONTROL BULLETIN**

An 8-page folder (No. 1000) describing and illustrating resistors, rheostats, motor starters and switches has been released by Ward Leonard Electric Co., Mt. Vernon, N. Y.

**L. B. KEIM JOINS DAVEN**

L'ewellyn Bates Keim has been appointed field electronics engineer of the Daven Company, 191 Central Avenue, Newark, N. J.

Mr. Keim was formerly chief engineer and operating head of the Muzak station, WGYN



**WESTINGHOUSE HANDBOOK ON  
ELECTRONIC EQUIPMENT  
MAINTENANCE**

Preventive maintenance techniques are outlined in a new 6 3/4"x3 3/4" handbook "Maintenance of Industrial Electronic Equipment" announced by Westinghouse.

Six basic maintenance operations—cleaning, inspecting, feeling, tightening, adjusting and lubricating—are discussed and applied to vacuum and ignitron tubes, capacitors, resistors, fuses, bushings and insulators, relays, switches, transformers, filter chokes, terminal blocks, meters and other components.

A copy of the booklet, B-3658, may be secured from the Westinghouse Electric Corporation, P. O. Box 868, Pittsburgh 30, Pennsylvania.

**ROSEBRAUGH NOW PHILCO  
INDUSTRIAL DIV. S-M**

A. J. Rosebraugh has been appointed sales manager of the industrial radio division of

**STATEMENT OF THE OWNERSHIP, MAN-  
AGEMENT, CIRCULATION, ETC., REQUIRED  
BY THE ACTS OF CONGRESS OF AUGUST  
24, 1912, AND MARCH 3, 1933, OF COMMUNI-  
CATIONS**

Published monthly at New York, N. Y., for October 1, 1946.

State of New York } ss.:  
County of New York }

Before me, an attorney and counselor-at-law, in and for the State and county aforesaid, personally appeared B. S. Davis, who, having been duly sworn according to law, deposes and says that he is the Business Manager of COMMUNICATIONS, and that the following is, to the best of his knowledge and belief, a true statement of the ownership, management, etc., of the aforesaid publication for the date shown in the above caption, required by the Act of August 24, 1912, as amended by the Act of March 3, 1933, embodied in section 537, Postal Laws and Regulations, to wit: 1. That the names and addresses of the publisher, editor, managing editor, and business manager are: Publisher, Bryan Davis Publishing Co., Inc., 52 Vanderbilt Avenue, New York 17, N. Y.; Editor, Lewis Winner, New York, N. Y.; Managing Editor, None; Business Manager, B. S. Davis, Ghent, N. Y.; 2. That the owners are: Bryan Davis Publishing Co., Inc., 52 Vanderbilt Avenue, New York 17, N. Y.; B. S. Davis, Ghent, N. Y.; J. C. Munn, Union City, Pa.; A. B. Goodenough, Port Chester, N. Y.; P. S. Weil, Great Neck, N. Y.; F. Walen, Union City, N. J.; G. Weil, Great Neck, N. Y.; L. Winner, New York, N. Y. 3. That the known bondholders, mortgagees, and other security holders owning or holding 1 per cent or more of total amount of bonds, mortgages, or other securities, are: None. 4. That the two paragraphs next above, giving the names of the owners, stockholders and security holders, if any, contain not only the list of stockholders and security holders as they appear upon the books of the company, but also, in cases where the stockholder or security holder appears upon the books of the company as trustee or in any other fiduciary relation, the name of the person or corporation for whom such trustee is acting is given; also that the said two paragraphs contain statements embracing affiant's full knowledge and belief as to the circumstances and conditions under which stockholders and security holders who do not appear upon the books of the company as trustees, hold stock, and securities in a capacity other than that of a bona fide owner; and this affiant has no reason to believe that any other person, association, or corporation has any interest direct or indirect in the said stock, bonds, or other securities than as so stated by him.

(Signed) B. S. DAVIS, Business Manager.  
Sworn to and subscribed before me, this 27th day of September, 1946.

(Seal) BERNARD M. KOMMEL,  
Attorney and Counselor-at-Law.  
Commission expires March, 1948.



Philco Corporation with headquarters in Detroit. He will be in charge of receiver sales to the automobile industry.

**BURGENBAUCH AND BRAY  
JOIN ELLINWOOD INDUSTRIES**

Theodore K. Burgenbauch has been appointed electronics division production manager of Ellinwood Industries, Los Angeles.

Burgenbach formerly was with General Electric Co. in Schenectady, New York.

Bernard L. Bray has been named sales manager of the marine equipment division of Ellinwood Industries.



T. K. Burgenbauch

B. L. Bray

**WARD NOW SPRAGUE ELECTRIC V-P**

Ernest L. Ward has been elected vice president of the Sprague Electric Company, North Adams, Mass.

**CALL LETTER CHANGE FOR ZENITH  
F-M STATION**

The call letters of Zenith Radio Corporation's 50-kw f-m station have been changed from WWZR to WEFM.

**TIMMINGS BECOMES  
MANUFACTURER'S AGENT**

George H. Timmins, 149 W. Ohio Street, Chicago 10, has resigned as sales manager of the DX Radio Products Co., 2310 Armitage, Chicago, and will devote his time to serving the industry in and around Chicago as a manufacturer's agent.

**MAINTENANCE SERVICE  
INAUGURATED BY AVIOMETER**

A maintenance service supplying standard replacement parts for microphones, headsets, handsets and aircraft intercommunication equipment, has been announced by the Aviometer Corporation, 370 W. 35th St., New York City.

**ALLOY METAL WIRE, ROD AND  
STRIP CATALOG**

A 28-page catalog covering engineering data on nickel-alloy strip, wire or rod has been released by the Alloy Metal Wire Co., Inc., Prospect Park, Penna.

Engineering information covers strength, electrical resistivity, modulus of elasticity, heat treatment, temperature limits, and magnetic properties.

**EIMAC PRICE SHEETS**

Price listings of Eimac tubes, rectifiers, vacuum capacitors, vacuum switches and diffusion pumps, have been prepared by Eitel-McCullough, Inc., San Bruno, California.

**IRC TECHNICAL DATA BULLETIN**

An engineering bulletin covering the type H IRC control has been prepared by the International Resistance Company, 401 North Broad Street, Philadelphia, Pa. Resistance value and taper data are offered.

**MEASUREMENTS CATALOG**

A 28-page catalog describing signal generators, radio noise and field strength meters, vacuum-tube voltmeters, accessories, etc., has been published by Measurements Corporation, Boonton, New Jersey. Complete specifications are offered.

**ELECTRICAL REACTANCE CORP.  
CAPACITOR BULLETIN**

A 4-page bulletin describing HiQ silver electrode ceramic axial-lead capacitors has been

(Continued on page 42)



**MODEL  
No. 4031**

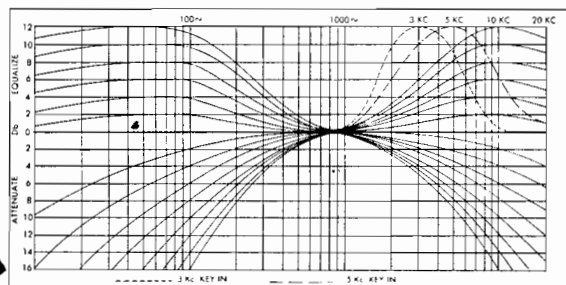

Curve showing the characteristics at each point of attenuation and equalization in 2 db steps.

**Complete Selectivity on ONE Panel!**

Capable of providing variable regulation over a range of 16 db attenuation and 12 db equalization in 2 db steps at both ends of the sound spectrum without wave distortion, the CINEMA Program Equalizer is one of the most advanced units on the market today.

Designed to fit the rapidly expanding needs of motion picture, recording and radio broadcast industry for recording, re-recording and high fidelity sound reproduction, this new equalizer can be cut in or out of the line without changing the overall signal level. Variable peak positions are available at 3, 5, and 10 Kilocycles, selected at will by a key on the panel. Designed with a constant "K" circuit, the impedance remains constant over the entire range.

The illustrated Program Equalizer shown above is an arrangement for a single channel. Multiple channel panels can be supplied to fit your studio requirement.

**SEND FOR LITERATURE  
ON TYPE 4031 EQUALIZER**



**CINEMA  
ENGINEERING COMPANY**

ESTABLISHED, 1935

1510 W. VERDUGO AVE., BURBANK, CALIFORNIA

**BUILT for  
ACCURACY and SERVICE**

by  
*Doolittle*

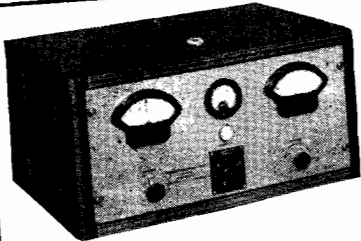

## FM and AM FREQUENCY MONITORS

Direct reading. No charts or complicated calculations necessary. Available for all the frequencies used by the Emergency Services, including the new 152-162 mc. band. Designed for operation on 110 V. AC 60 cycles.

Also available for the New  
88-108 mc. FM Broadcast Band.

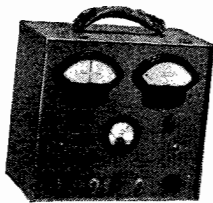

## PORTABLE FM MONITOR

Model FD-10A is similar to the FD-9A except operates on 6 Volts D.C. Designed for checking FM Mobile Transmitting Equipment at point of operation. Supplied for operating on one or two frequencies between 30-44 mc.

Other DOOLITTLE equipment includes Station and Mobile Antennae, Station Control Units, Mobile Receivers and Transmitters, Station Receivers and Transmitters for the Emergency Services.

SEND FOR FULL DETAILS

*Doolittle*  
**RADIO, INC.**

7421 S. LOOMIS BOULEVARD  
CHICAGO 36, ILLINOIS

BUILDERS OF PRECISION RADIO EQUIPMENT

## NEWS BRIEFS

(Continued from page 41)

published by Electrical Reactance Corporation, Franklinville, N. Y. Specifications and capacitance values and type designations are presented.

### LEACH RELAY CATALOG

A 48-page catalog listing relays for aircraft, light and heavy duty circuit control, sensitive, telephone, make-before-break, latch, time delay, impulse, radio, high-frequency and keying, has been released by Leach Relay Company, 5915 Avalon Boulevard, Los Angeles 3, California.

Engineering details, showing types numbers, contact arrangement, coil voltages available, dimensions and weights are tabulated for each type of relay.

### CONCORD RADIO PARTS BULLETIN

An 8-page parts bulletin has been released by the Concord Radio Corporation, 901 West Jackson Boulevard, Chicago 7, Illinois.

### NATIONAL UNION TO SELL RECEIVERS

Five receiver models will be available from the National Union Radio Corporation, Newark, New Jersey.

First model announced is a 6-tube a-c/d-c table model.

### BIRD ELECTRONIC BULLETINS

Bulletins describing coaxial switches for v-h-f/u-h-f, and a wattmeter and wide-band line termination unit for 10 to 1500-mc output measurements have been prepared by Bird Electronic Corporation, 1800 East 38 Street, Cleveland, Ohio.

### C-D CATALOG

A 24-page catalog, 195A, covering electrolytic, paper and mica capacitors, and capacitor test instruments and interference filters, has been released by Cornell-Dubilier Electric Corporation, South Plainfield, N. J. Design and engineering information, dimensional sketches, physical properties and installation instructions for these capacitors appear in the catalog.

### REEVES SOUNDRAFT FORMED

Reeves Soundcraft Corporation was recently formed to produce recording discs. Hazard E. Reeves is president.

A. C. Travis, Jr., has been named vice president in charge of sales; Ray S. Dech is vice president in charge of manufacturing, and R. C. Marshall 3d, secretary and treasurer.

Sales offices will be in the Reeves International Building, 10 East 52nd Street, New York. Plant is in Allentown, Pa.



A. C. Travis, Jr.

### LEAR ENGINEERING APPOINTMENTS

Harry S. Jones, former chief engineer, instrument division, of Thomas A. Edison, Incorporated, has been appointed assistant chief engineer in charge of research and development for Lear, Incorporated, Grand Rapids, Michigan.

Harry E. Rice has become chief engineer of the Lear home and aircraft radio division. William J. Perfield will head engineering activities of the Lear electro-mechanical division.

Niels Eklund has been appointed chief physicist.

### ACME ELECTRIC BECOMES CORPORATION

The Acme Electric Corporation, Cuba, N. Y., has been incorporated under the laws of the State of New York.

## tone - color - design

with HIGH FIDELITY Performance

in  
The  
NEW  
St. Louis

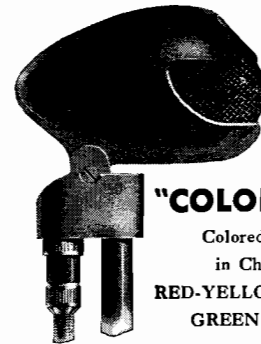

### "COLORMIKE"

Colored Plastic  
in Choice of  
RED-YELLOW-ORANGE  
GREEN or BLUE

NEW! St. Louis is ready with the outstanding unit in a plastic dynamic microphone, explicitly designed to permit free passage of sound from the outside to inside of the mike. Ideal for color television, night clubs, home communications.

Range: 40-10,000 Cycles. High impact, rugged plastic case. Variable impedance output, adjustable to low, 200, 500 or high. Alnico-V Magnet.

Write today for further information on the complete St. Louis line of "Finer Modern Dynamic Microphones."

Licensed under Patents of the American Tel. & Tel. Co. and Western Electric Company, Inc.

### ST. LOUIS MICROPHONE CO.

2726-28 Brentwood Blvd.  
St. Louis 17, Missouri

### ELECTRONIC STOP WATCH

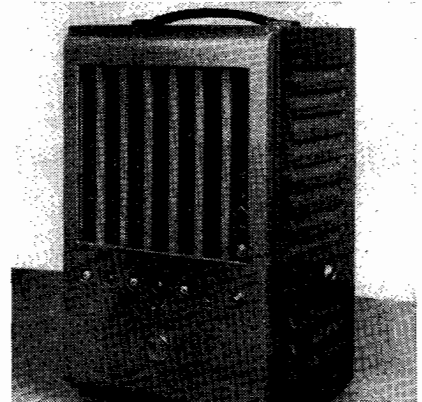

A time interval counter, that can clock pulses in steps of one millionth of a second, recently developed by RCA.

### PRESS WIRELESS 20,000 WATT CHINA TRANSMITTER



Allen R. Richter (right) foreign sales manager of Press Wireless and S. L. Chang, radio engineer of the Central News Agency of China, with one of the 20,000-watt radiotelegraph transmitters to be sent to China soon.



**MINIATURE V-H-F TRANSMITTER**

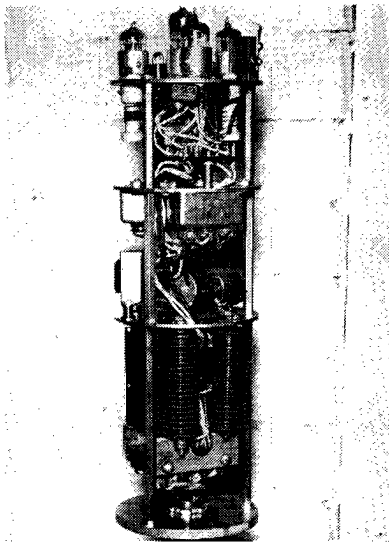

A 1/4 watt v-h-f transmitter for ship-to-ground communications recently developed by the Capital Airlines, National Airport, Washington, D. C.

**WBKB TELEVISION PICKUP EQUIPMENT**



Captain W. C. Eddy, director of television for Balaban and Katz, with RCA image orthicon camera recently flown to WBKB in Chicago.

**HEARING AID AUDIOMETER**

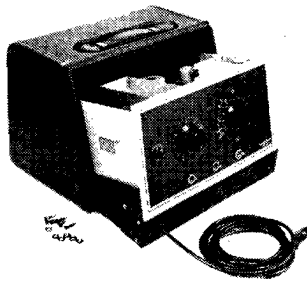

Portable audiometer recently developed by the Bell Telephone Labs.

**TELERAN BLIND-FLYING UNIT**



Dr. D. H. Ewing, of RCA Victor, demonstrating television camera pickup system used in teleran blind-flying system.

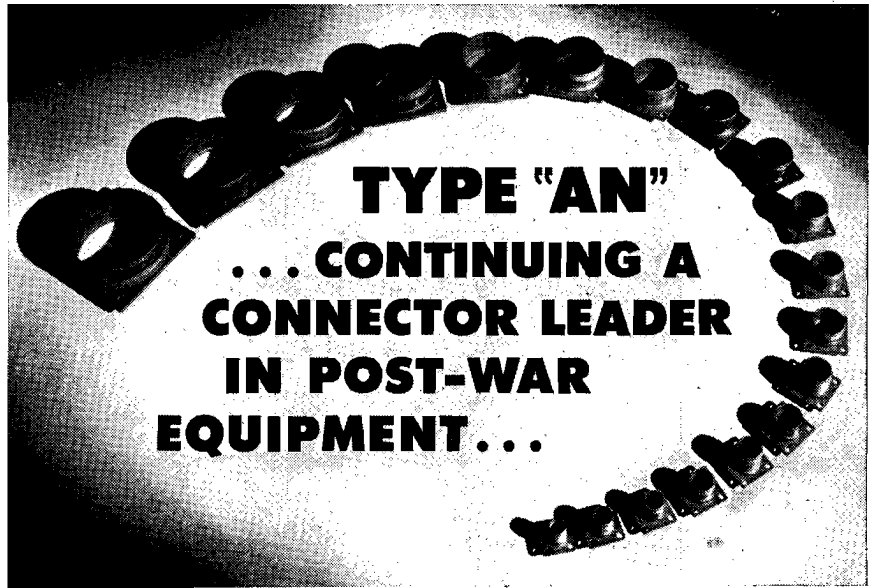

Type AN3102 Receptacle Shells, sizes 8S to 48

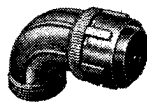

AN3108 Plug

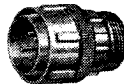

AN3106 Plug



AN3100 Recep.



AN3101 Recep.

Developed prior to World War II for standardization purposes, the AN (Army-Navy Specifications) Connector type series remains as one of the most versatile and widely known lines of electric multi-contact fittings. The large range of shell sizes, insert arrangements, interchangeable parts and accessory fittings make the Cannon Electric "AN" a desirable, all-purpose connector. Cannon Electric's "Quality Control" from diecasting to assembled fitting produces a dependable product used extensively not only in aircraft but also in radio, radar, instruments and countless general electrical applications.

Thousands of aircraft and radio technicians worked with these "Cannon Plugs" during the war; the same thousands are still demanding Cannon quality in peacetime because they know it served them well when the perfect operation of every electrical part of the war machine meant the protection of lives and more efficient prosecution of the offensives.

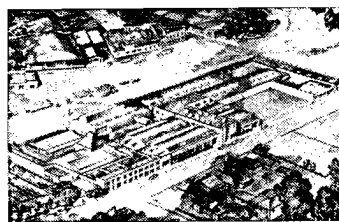

The 6th Revised Edition of the "AN" Bulletin will be mailed free upon request. Write Dept. K-121, Cannon Electric Development Co., 3209 Humboldt Street, Los Angeles 31, Calif. Prices on specific "AN" Connectors must be obtained from Cannon representatives located in principal cities or directly from factory. For those living outside the U. S. A. and in countries other than the British Empire, write Frazar & Hansen, 301 Clay Street, San Francisco 11, Calif.

**CANNON ELECTRIC DEVELOPMENT COMPANY**

3209 Humboldt St., Los Angeles 31, Calif.

IN CANADA (and British Empire export)  
CANNON ELECTRIC COMPANY, Ltd., TORONTO



**SINCE 1915**

THIS NOT THIS



## Man, Here's Comfort for EARS!

That's right, mister. The Telex MONOSET replaces hot, headache-y, old-style headphones wherever comfortable hearing is needed. Worn under the chin, the MONOSET eliminates head and ear fatigue. So for *comfort* for ears (your own or your customers) specify Telex MONOSET. *Immediate delivery.*

Weighs only 1.3 oz. Fully adjustable to all head sizes. Rugged Tenite construction. Removable plastic ear tips. Frequency response: 50 to 3,000 c.p.s. Maximum sound pressure output: 300 to 400 dyns per sq. cent. Available in two impedances: 128 and 2,000 ohms.

Write to Department H for information and quotations.

"Hearing At Its Best"



Complete with light plastic cord and standard phone plug.

**USERS:** Electrical transcribing machines. Program distribution systems. Commercial aircraft operations. RR inter-communication systems. Laboratory testing equipment. Wired music systems. Radio station operations. Radio "hams" and engineers.

# TELEX INC.

ELECTRO-ACOUSTIC DIVISION  
Minneapolis, Minn.

Canadian Distributors: Addison Industries, Ltd., Toronto

# THE INDUSTRY OFFERS . . .

## NATIONAL CHOKES

A line of 430 types of chokes ranging from the midget R-33 to the giant R-500, suitable for use in the supersonic region, has been announced by the National Company of Malden, Mass. Thirty-two standard values, from one microhenry to 10 millihenries, are available.

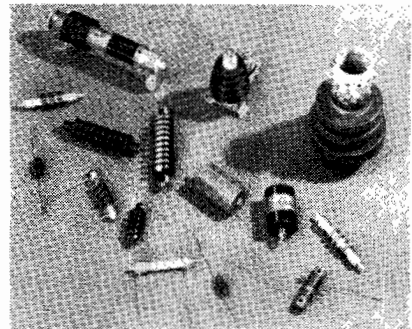

## DAVEN ATTENUATORS

Attenuators with built-in cueing controls have been developed by the Daven Company, 191 Central Avenue, Newark 4, N. J.

Provision is made at the extreme attenuation position for connecting the incoming signal to a cue circuit before fading in the signal. A lug on the terminal board is provided for connection to the cueing system.

The cueing feature may be supplied on any type of Daven attenuator. However, it is primarily recommended on those controls used for mixing purposes, which are provided with a taper to infinity.

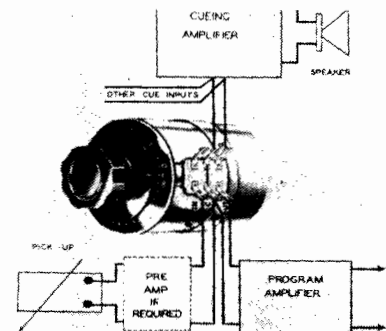

## CANNON ELECTRIC TERMINAL BLOCK

Terminal blocks (Y6) with basic-unit design have been announced by Cannon Electric Development Company, 3209 Humboldt St., Los Angeles 31, California. Additional units may be added to basic units, both vertically and horizontally, with side brackets and extra top interlocking strips.

Both sides of the block are identical and may be plugged in on either side with the six-contact plug, or a single contact. A crimp-type single contact is available as well as the standard solder-pot type, although the six-contact plug carries solder-pot contacts only.

The contacts are brass, silver-plated and accommodate No. 16 AWG wire for 5-ampere circuits.

## BLILEY CRYSTAL-CONTROLLED OSCILLATOR

A crystal-controlled oscillator for alignment and other test applications has been developed by the Bliley Electric Company, Erie, Pennsylvania. Known as the CCO, the unit employs low-temperature coefficient quartz crystals that are said to be stable to within  $\pm 0.1\%$ .

Provides selection of five most commonly used intermediate frequencies: 175, 262, 370, 455 and 465 kc. Crystal control is also provided

# The FINEST MICROPHONES

for P.A. and RECORDING!

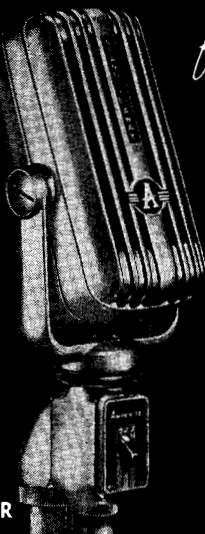

**AMPERITE VELOCITY MICROPHONE WITH PATENTED ACOUSTIC COMPENSATOR**

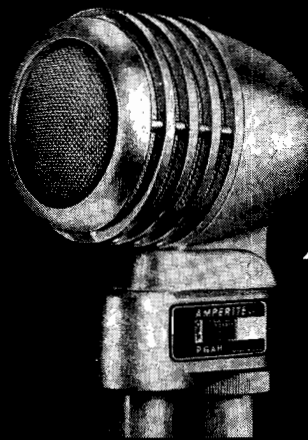

**New P.G. DYNAMIC WITH NEW SUPERIOR ELIPSOID PICK UP PATTERN!**

**AMPERITE KONTAK MIKES IDEAL FOR AMPLIFYING STRINGED INSTRUMENTS**

USED WITH ANY AMPLIFIER AND WITH RADIO SETS.

ASK YOUR JOBBER . . . WRITE FOR FOLDER

# AMPERITE

561 BROADWAY NEW YORK





at 200 kc for r-f alignment and at 1000 kc for short-wave alignment. An external socket is provided to accommodate special frequencies that may be required. Unit also has a three-position modulation selector and a five-step attenuator with vernier output control from 0 to 15 volts.

No warm-up period is said to be necessary.



### ST. LOUIS MICROPHONE COLORED MIKES

Plastic *Colormike* microphones in five colors—red, blue, green, yellow and orange—have been announced by St. Louis Microphone Co., 2726-28 Brentwood Blvd., St. Louis 17, Mo.

Variable impedance output permits a choice of 50, 200, 500 or 50,000 ohms for balanced-line output.

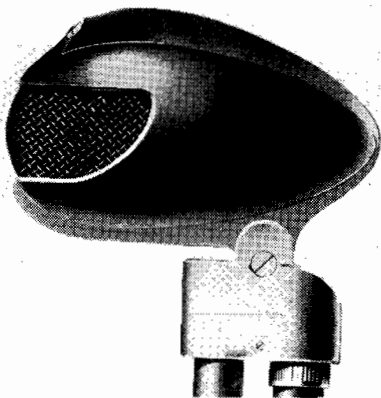

### G.C. WIRE-STRIPPER KIT

A wire-stripper kit, 733-K, for stripping insulation of 8 to 30 wire has been announced by the General Cement Manufacturing Co., 919 Taylor Avenue, Rockford, Illinois.

Available with seven interchangeable blades.



### UNIVERSITY SUBMERGENCE LOUDSPEAKERS

Submergence and explosion-proof speakers have been announced by University Loudspeakers, Inc., 225 Varick Street, New York 14, N. Y.

One model, MSR, uses a reflex air-column horn radial deflector for 360° dispersion and an hermetically-sealed housing. Power is 15 watts; frequency coverage, 250 to 6000 cycles. Height, 10½"; depth, 8½"; width, 7½".

Another model, MM-2TC, is directional, consisting of a reflex air column horn and an hermetically-sealed housing. Power is also 15 watts; frequency coverage, 300 to 6000 cycles; and dispersion is 120°. Height, 10"; depth, 5¾"; width, 7½".

Impedance of both types, 16-ohms direct.

### BRUSH MINIATURE EARPHONE

A miniature crystal-type (13/16" x 5/16") insert earphone for use with personal vestpocket receivers has been announced by the Brush

(Continued on page 46)

## For FM and TV

NEW ANDREW COAXIAL CABLE WITH  
**51.5 OHMS IMPEDANCE!**

### Meets Rigid FM-TV Standards

A new coaxial cable, especially designed for FM and TV use, is now a reality at the Andrew Co. Scheduled for mid-June delivery to the first orders received, these new cables, in 4 sizes, introduce the following important engineering features:

1. Characteristic impedance of 51.5 ohms. (The regular Andrew cables for AM applications have a nominal impedance of 70 ohms.)
2. Connectors and associated fittings have been engineered with special care to avoid reflections and discontinuities. Being completely solderless, these fittings simplify installation and eliminate problems of flux corrosion and pressure leaks.
3. Insulators are spaced 12 inches apart in the 3 large size cables, and 6 inches in the 7/8-inch cable.
4. Improved low loss insulation material is used, having a dielectric constant of 6.0 and a maximum loss factor of .004 at 100 mc.
5. Close tolerances have been established on conductor and insulator dimensions, in order to maintain a constant characteristic impedance.
6. Inner and outer conductors are made of copper having a minimum conductivity of 95% IACS at 25° centigrade.

Your order now is the best assurance of early delivery on this new coaxial cable for your FM or TV installation.

Write or wire the Andrew Co., 363 East 75th Street, Chicago 19, Illinois, for complete information or engineering advice on your particular application.

#### ATTENUATION CURVE

Attenuation is calculated to provide for conductor and insulator loss, including a 10% derating factor to allow for resistance of fittings and for deterioration with time.

- The new 51.5 ohm air insulated coaxial cable for FM and TV comes in 4 sizes, priced tentatively as follows: 7/8", 42c per ft.; 1 1/8", 90c per ft.; 3 1/8", \$2.15 per ft.; 6 1/8", \$5.20 per ft. Andrew Co. also manufactures a complete line of accessories for coaxial cables.

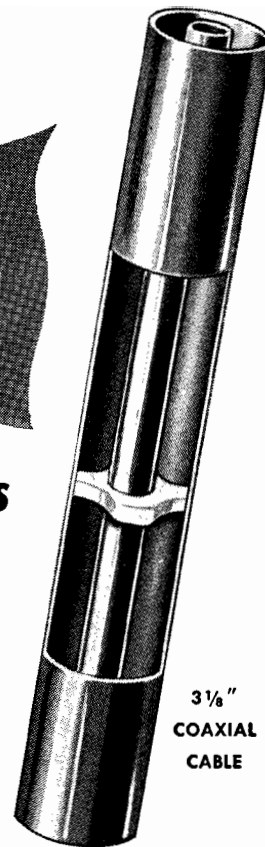
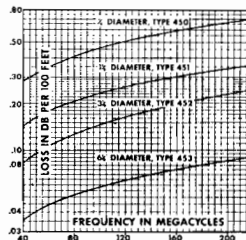

3/8"  
COAXIAL  
CABLE



6 1/8"  
COAXIAL  
CABLE



**ANDREW CO.**  
363 EAST 75th STREET  
CHICAGO 19, ILLINOIS

# VACUUM TUBE VOLTMETER

MODEL 62

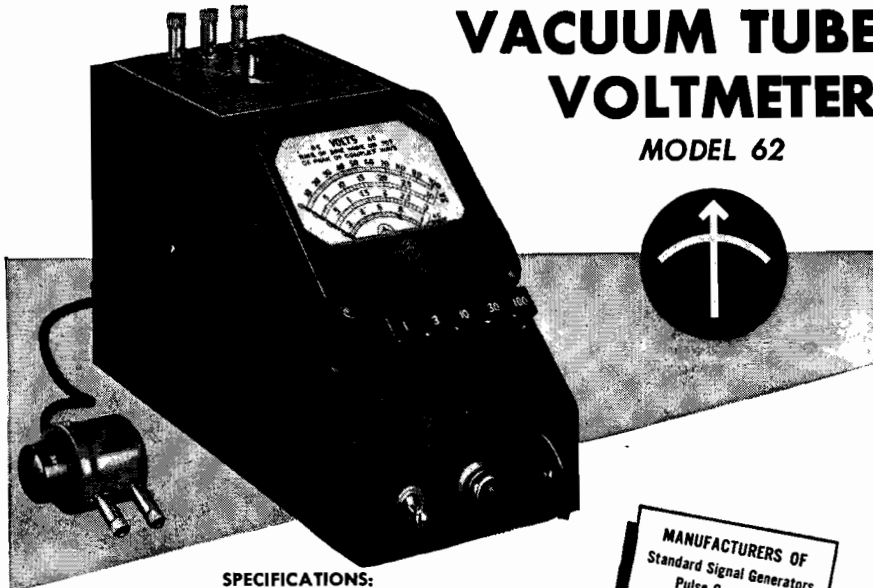

### SPECIFICATIONS:

**RANGE:** Push button selection of five ranges—1, 3, 10, 30 and 100 volts a.c. or d.c.

**ACCURACY:** 2% of full scale. Useable from 50 cycles to 150 megacycles.

**INDICATION:** Linear for d.c. and calibrated to indicate r.m.s. values of a sine-wave or 71% of the peak value of a complex wave on a.c.

**POWER SUPPLY:** 115 volts, 40-60 cycles—no batteries.

**DIMENSIONS:** 4 3/4" wide, 6" high, and 8 1/2" deep.

**WEIGHT:** Approximately six pounds. *Immediate Delivery*

**MANUFACTURERS OF**  
Standard Signal Generators  
Pulse Generators  
FM Signal Generators  
Square Wave Generators  
Vacuum Tube Voltmeters  
UHF Radio Noise & Field  
Strength Meters  
Capacity Bridges  
Megohm Meters  
Phase Sequence Indicators  
Television and FM Test  
Equipment

**MEASUREMENTS CORPORATION**  
BOONTON NEW JERSEY

repetition frequency may be determined by internal or external trigger.

Internal trigger output characteristics provide a repetition frequency of 500, 1000, 2000 and 5000 pps; positive pulse reaching 200 volts minimum in 0.3 microsecond, adjustable in time from 75 microseconds before to 25 microseconds after start of sweep.

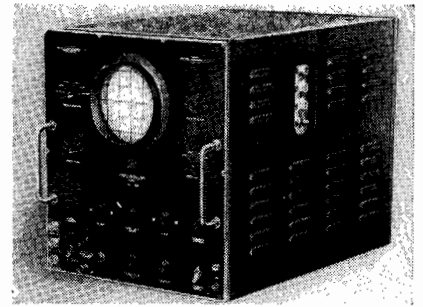

### SORENSEN VOLTAGE REGULATOR

A 400-cycle aircraft line-voltage regulator has been announced by Sorensen and Company, Inc., Stamford, Connecticut.

Will supply loads totaling 500 volt-amperes with voltage said to be regulated to an accuracy of 0.2%. Shock mounted. Transformer and reactor components Fosterite impregnated. Adjustable output voltage, from 110 to 120. Input voltage may vary from 95 to 125. Weighs 12 1/2 pounds.

### RAYTHEON MINIATURE R-F AMPLIFIER TUBES

Two miniature cathode type r-f amplifier tubes, 6BD6 and 12BD6, electrically equivalent to 6SK7 and 12SK7, are now being produced by Raytheon Manufacturing Co., Newton, Mass. Designed to replace such tubes as the 6D6, 6U7G, 6K7, 6SK7, 12SK7GT, etc.

Both tubes are of the heater type; heater voltage for the 6BD6 being 6.3 (current, .3 ampere), heater voltage for the 12BD6 is 12.6 (current, .15 ampere). Plate voltage is 300. Overall length, 2 3/4"; maximum seated height, 1 1/8"; maximum diameter, 3/4".

## THE INDUSTRY OFFERS . . .

(Continued from page 45)

Development Co., 3405 Perkins Avenue, Cleveland 14, Ohio.

Frequency range is said to be 40 to 6000 cps. Normal loudness available when earpiece is driven with 1 volt, power requirement being 10 microwatts.

Weighs 1/4 ounce. Impedance is 120,000 ohms at 1000 cps. No transformer is necessary.

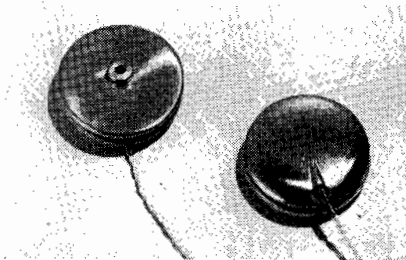

### EVEREADY B BATTERIES

Miniature-type B batteries, 5 3/8" x 2 1/6" x 7 3/4", have been announced by the National Carbon Company.

Batteries, built on the mini-mar principle, weigh 4 pounds, 4 ounces.

### CORNELL-DUBILIER MIDGET CAPACITORS

Midget capacitors, types ZY and ZZ, impregnated with halowax and non-inductively wound with Kraft paper, have been developed by the Cornell-Dubilier Electric Corporation, South Plainfield, New Jersey.

ZY units are 3/4" in length and from 5/32" to 9/32" in diameter. Values range from .0001

to .03 mfd.; d-c rated voltages from 150 to 600 volts. ZZ units are 1/2" in length and from 5/32" to 1/4" in diameter. Values range from .0001 to .01 mfd.; 150 volts d-c.

Capacitors have 2" leads anchored in a heat resisting compound.

### RCA VOLTOHMYST FOR F-M AND TELEVISION

A voltohmyst for use up to 250 mc has been announced by the test and measuring equipment section of the RCA engineering products department.

The new unit, designated as WV-75A, is said to operate as a v-h-f voltmeter, audio voltmeter, a-c voltmeter, d-c voltmeter, ohmmeter, and f-m indicator. Permits reading of both a-c and d-c voltages up to 1000. Also has a polarity reversing switch.

A full-wave rectifier is built into a-c probe. Diode probe contains a standard AN (Army-Navy) integral female fitting for direct connection to a coaxial line. Measurements at high frequencies are made by direct contact with central pin and ground ring at the end of diode probe, while an alligator clip for central pin and short ground lead serve as adaptors for voltage measurements at the lower frequencies.

When used as an ohmmeter, one scale works for all ranges with no zero resetting necessary. His six scales for d-c resistance readings, covering the 0-to-1,000 ohm to 0-to-1,000 megohm ranges.

### SYLVANIA SYNCHROSCOPE

A synchroscope, with a 5" cathode-ray oscilloscope; trigger generator for synchronization; adjustable time delay phasing circuits; and seven input connectors and selector switch, has been announced by the electronics division, Sylvania Electric Products, Inc., 500 Fifth Avenue, New York 18, N. Y.

Sweep speeds of .01"; .05"; .2"; 1"; 2"; and 5" per microsecond with a minimum sweep amplitude of 4" on a 5" c-r tube are provided. Sweep may be started with external positive or negative signal; delayed up to 90 microseconds from internal trigger; or the sweep



### TINNERMAN SPEED NUTS

Heat-treated spring-steel speed nuts (C7000) have been announced by Tinnerman Products, Inc., 2012 Fulton Road, Cleveland 13, Ohio. Line is said to comprise all sizes required to fit ten most popular sizes of machine screws and sheet metal screws.

### COMMUNICATIONS CO. TAXICAB MOBILE EQUIPMENT

Mobile 152-162 mc f-m transmitter-receiver units for taxicabs, police, and other similar services, model 210, have been announced by the Communications Company, Inc., 300 Greco Avenue, Coral Gables 34, Florida.

Transmitter circuit uses indirect f-m of the narrow swing type, crystal controlled. Receiver is a dual conversion, crystal controlled, superheterodyne. Bandwidth said to be 32.5 kc for 2 x down (6 db) and 106 kc for 100 x down (60 db).

Transmitter tubes include one 3A5 oscillator-audio amplifier, two 2E25 balanced modulators, three 2E25 frequency multipliers, one 3D23 driver and doubler, and one 3D23 power amplifier. Receiver tubes include one 9001 r-f amplifier, two 6AK5 first and second mixers, three 1T4 i-f amplifiers, two 1T4 limiters, two 1S5 for discriminator and first audio stage, two 3Q5 a-f amplifiers, one 1S5 squelch, one 1T4



oscillator and doubler and three 1T4 frequency multipliers.

The power supply contains a 600 volt dynamotor providing high voltage supply for transmitter, and a vibrator power pack with cold cathode rectifier tubes furnishing 130 volts *B* to the remainder of the set.

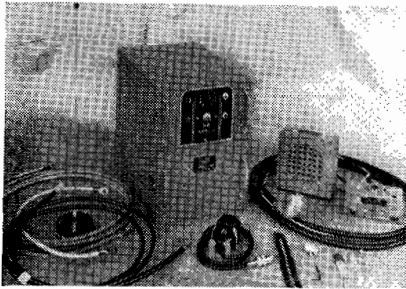

**MILLES 2" OSCILLOSCOPE**

A 2" rack type oscilloscope, 90902, has been developed by James Milles Manufacturing Company, Inc., 150 Exchange St., Malden, Mass.

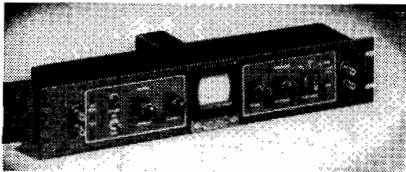

**HEWLETT-PACKARD WIDE-BAND AMPLIFIER**

A wide-band amplifier that is said to provide unusual stability at 40 db or 20 db gain has been announced by Hewlett-Packard Co., Palo Alto, Calif. Low phase shift is said to be assured by a resistance-coupled amplifier, together with inverse feedback.

Frequency response is said to be flat within 1/2 db between 10 and 1,000,000 cycles. Input impedance is 1 megohm shunted by 15 mmfd. Internal impedance is less than 150 ohms over the entire range.

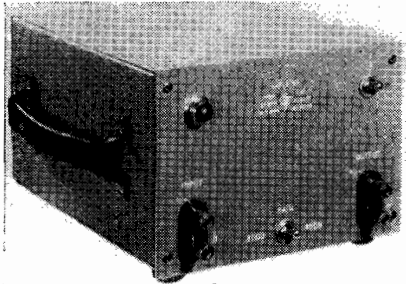

**SOUND APPARATUS TWIN RECORDER**

A twin-recorder for making simultaneously two records of the same or different phenomena, has been developed by Sound Apparatus Company, 233 Broadway, New York 7, N. Y.

Unit provides graphic recordings of noise and vibration, current and voltage, linear and logarithmic, db and phon, average and rms value, peak and average value, amplitude and velocity, and velocity and acceleration.

**G.R. V-T-V-M**

A vacuum-tube voltmeter (1800A) superseding the 726-A has been announced by General Radio Company, 275 Massachusetts Avenue, Cambridge 39, Mass.

Range of a-c voltage measurement is 0.1 to 150 volts. Frequency correction curves for both resonance and transit-time effects for frequencies up to 500 mc are supplied. Where absolute voltage readings are not required, the instrument can be used as a voltage indicator up to 2500 mc. Single zero setting serves for all ranges. D-c voltages between 0.01 and 150 can be measured.

The rated accuracy for both a-c and d-c measurements is said to be ±2%.

Probe is furnished with a variety of fittings, including both coaxial and banana-plug terminals and a 50-ohm disk resistor for coaxial

(Continued on page 48)



CBS Photo

**TELEVISION - IT'S HERE!**

(Quoting—Television Broadcasters Association)

Here's Your Opportunity to "get in on the ground floor" and prepare for great opportunities ahead

**NOW—for the First Time, CREI Offers  
A Complete, Streamlined Home Study Course in  
PRACTICAL**

**TELEVISION**

**ENGINEERING**

**FOR THE PROFESSIONAL RADIOMAN**

Here is the basic, practical type of engineering training that will qualify you for a "key" job in the expanding Television industry. Sooner or later you must face Television—as a problem, or as an opportunity. You can't rest on your past radio experience. But, you can use it as a firm foundation, upon which you can add greater knowledge and ability with the help of this new CREI home study course. It costs you nothing but a few minutes' time to get complete details. Write at once for FREE DETAILS of the Television Engineering Course.

**CAPITOL RADIO ENGINEERING INSTITUTE**

Dept. CO-11, 16th and Park Road, N. W., Washington 10, D. C.



**Just Off the Press!  
Mail Coupon for  
Complete Free  
Details and  
Outline of Course**

If you have had professional or amateur radio experience and want to prepare for opportunities in TELEVISION, let us prove to you we have the training you need to qualify. To help us intelligently answer your inquiry—PLEASE STATE BRIEFLY YOUR BACKGROUND OF EXPERIENCE, EDUCATION AND PRESENT POSITION.

Member Natl. Home Study Council—Natl. Council of Technical Schools—Television Broadcasters Assn.

CO-11  
GENTLEMEN: Please send me your free booklet, "Your Opportunity in the New World of Electronics", together with full details of your home study training. I am attaching a brief résumé of my experience, education and present position.

Name .....  
Street .....  
City ..... Zone ..... State .....

CHECK  PRACTICAL RADIO ENGINEERING COURSE  PRACTICAL TELEVISION ENGINEERING  I am entitled to training under the G. I. Bill.

# ATTENUATORS by TECH LABS

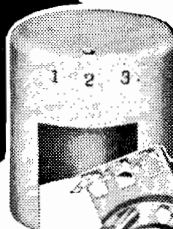

MIDGET  
TYPE  
600

"Midget" model is especially designed for crowded apparatus or portable equipment.

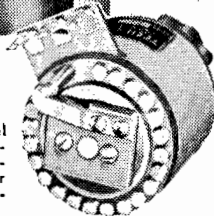

STANDARD  
TYPE  
700

- Solid silver contacts and stainless silver alloy wiper arms.
- Rotor hub pinned to shaft prevents unauthorized tampering and keeps wiper arms in perfect adjustment.
- Can be furnished in any practical impedance and db. loss per step upon request.
- TECH LABS can furnish a unit for every purpose.
- Write for bulletin No. 431.



Manufacturers of Precision Electrical Resistance Instruments  
337 CENTRAL AVE. • JERSEY CITY 7, N. J.

## THE INDUSTRY OFFERS . . . —

(Continued from page 47)

line measurements. Probe cap is removable to give a minimum input capacitance of 3.1 mmfd. Input resistance at low frequencies is 25 megohms, decreasing at higher frequencies owing to loss in the shunt capacitance. Two input resistances are available for d-c measurements—10 megohms and open grid.

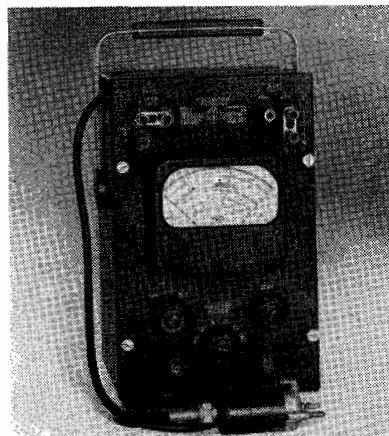

### KAY-LAB MICRO-MIKER

A Micro-Miker (model 401A) to measure small capacities appearing in vacuum-tube amplifiers, input and output capacities of vacuum tubes and stray capacity between wiring and chassis has been developed by the Kalbiell Laboratories, 1076 Morena Blvd., San Diego 10, Calif. Range is from 0 to 230 mmfd on a semi-logarithmic scale. Measurement is made by direct substitution in a parallel resonant circuit between 2.5 and 3.5 megacycles.

Measures shunt capacity and a resistor as small as 2000 ohms may be connected across the unknown capacity.

Instrument consists of a radio frequency oscillator loosely coupled to a tuned detector. The detector output is rectified and applied to a tuning eye to indicate resonance. The tuned circuit of the oscillator has three capacitors effectively across it: (a) a semi-logarithmic variable air capacitor, (b) the fixed capacity of an 18" shielded lead which may be connected to the unknown capacity; and (c) unknown capacity which may or may not be connected to the oscillating circuit.

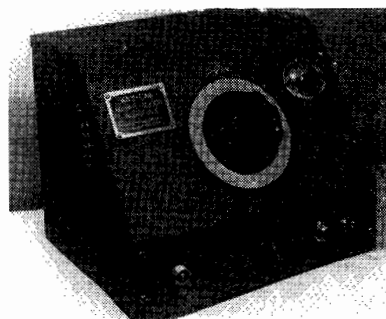

### RCA ALL-CHANNEL TELEVISION TRANSMITTERS

A 5-kw television transmitter (TT-5A) for use on any one of twelve frequency channels has been placed in production by the RCA Engineering Products Department.

Heart of the transmitter is output tube, dual-tetrode 8D2L.

Transmitter uses high-level modulation, requiring only one broad band r-f stage.

Visual and aural units of transmitter are incorporated in one unit, 17" by 3" by 7".

Built-in reflectometer provides measurement of standing-wave ratio in the transmission line.

### EIMAC HEAT DISSIPATING CONNECTORS

Heat-dissipating connectors, type H-R, for connections to plate and grid terminals, to provide heat transfer from tube element and

## "POWER TO BURN"



Littelfuse precision-built fuses are so inexpensive that every manufacturer can effectively protect his product and reputation at relatively small cost. Complete range of types and sizes for instruments, small motors, radio and electronic circuits, automobile, aircraft and marine instruments, and all types of electrical equipment. For complete information on these and other Littelfuse quality products, send for Catalog No. 9 . . . just off the press.



**FUSE EXTRACTOR POST** for 8AG fuses. Finger operated. Also available with screw-driver slot knob. A quicker, safer, simpler method for mounting and changing fuses.

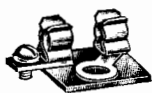

**METER-BACK MOUNTING** for 8AG fuses. Mounts direct on one meter binding post and wire connects to screw terminal of mounting. Overall length only 1 1/2".

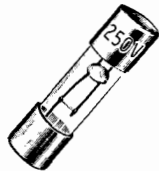

**8AG FUSE.** "Quicker than a short circuit." Precision designed and built. Note bridge-type construction which protects the delicate filaments in fuses of very low fractional amperage.

**LITTELFUSE**

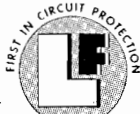

*Incorporated*

4767 N. RAVENSWOOD AVE.

CHICAGO 40, U.S.A.

NITE-T-LITE • SWITCH-LITE • IGNITION-FRITZ • NEON INDICATORS • SWITCHES • CIRCUIT BREAKERS • FUSES, MOUNTINGS AND ACCESSORIES



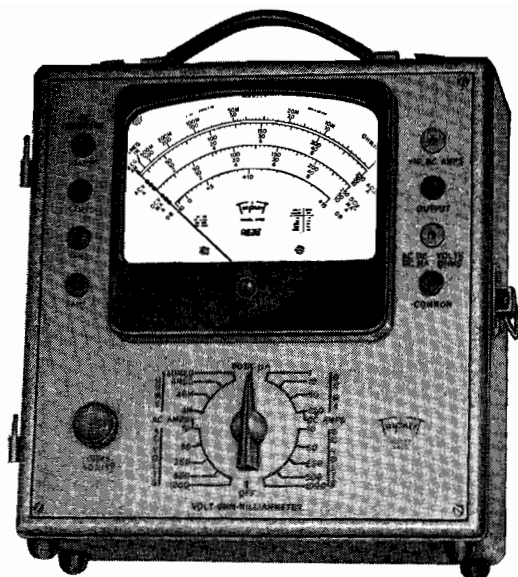

MODEL 2405

# Volt-Ohm-Milliammeter

25,000 OHMS PER VOLT D.C.



## SPECIFICATIONS

NEW "SQUARE LINE" metal case, attractive tan "hammered" baked-on enamel, brown trim.

- **PLUG-IN RECTIFIER**—replacement in case of overloading is as simple as changing radio tube.
- **READABILITY**—the most readable of all Volt-Ohm-Milliammeter scales—5.6 inches long at top arc.
- **RED-DOT LIFETIME GUARANTEE** on 6" instrument protects against defects in workmanship and material.

### NEW ENGINEERING • NEW DESIGN • NEW RANGES 30 RANGES

- Voltage: 5 D.C. 0-10-50-250-500-1000 at 25000 ohms per volt.  
 5 A.C. 0-10-50-250-500-1000 at 1000 ohms per volt.
- Current: 4 A.C. 0-.5-1-5-10 amp.  
 6 D.C. 0-50 microamperes—0-1-10-50-250 milliamperes—0-10 amperes.
- 4 Resistance 0-4000-40,000 ohms—4-40 megohms.  
 6 Decibel -10 to +15, +29, +43, +49, +55  
 Output Condenser in series with A.C. volt ranges.

Model 2400 is similar but has D.C. volts Ranges at 5000 ohms per volt.

Write for complete description

# Triplet

## ELECTRICAL INSTRUMENT CO.

BLUFFTON, OHIO.

glass seal to air have been announced by Eitel-McCullough, Inc., San Bruno, Cal.

Connectors are machined from solid dural rod.

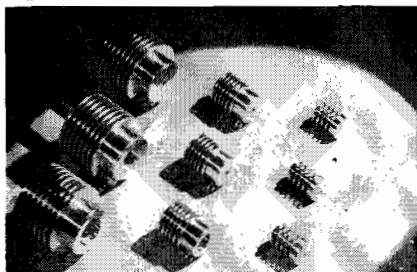

### VERTROD LEADIN

A 300-ohm leading line (300-D) for use in f-m and television has been announced by Veretro Company, N. Y. City.

Leadin uses polyethylene insulation supporting two conductors.

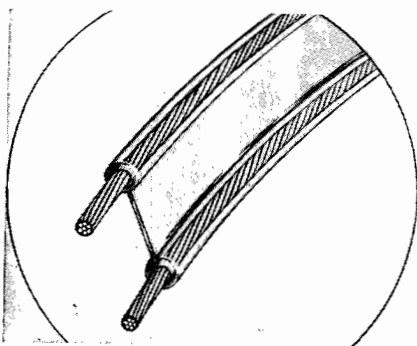

### FAIRCHILD STUDIO RECORDER

A studio recorder, 523, that accommodates 18" flowed wax masters, acetate, or thicker wax

masters, has been announced by the Fairchild Camera and Instrument Corporation, Jamaica, N. Y. For 33 1/4 and 78 rpm.

Drive is direct through worm and gear at 33 1/4-rpm speed.

The 78-rpm speed is secured through a ball race mechanism which operates in light oil in a dustproof housing. Change of speed is accomplished by pulling up or pushing down a shift pin protruding slightly above the record, from hollow turntable shaft.

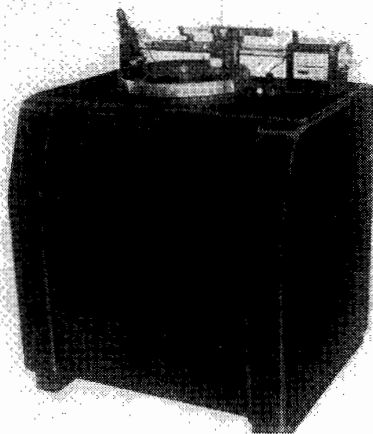

### TELEVISIO VIBROMETER

An electronic vibrometer, 11-B, for detecting sources of wear, strain and noise has been announced by Televiso Products Co., 7466 Irving Park Road, Chicago 34. Vibrometer is an amplified vacuum-tube voltmeter with a cable-attached search prod. It registers all three types of vibration: displacement, velocity and acceleration on a calibrated meter scale.

With prod attached, the frequency response is 5-2500 cps. Five ranges of rms displacement measured are: 0-.01", 0-.03", 0-.1", 0-.3",

0-1". The five velocity ranges covered are (in inches per second): 0-1, 0-3, 0-10, 0-30, 0-100. The five acceleration ranges are (in inches per second): 0-100, 0-300, 0-1000, 0-3000, 0-10,000.



### G.E. POTENTIOMETER

A 5" x 10" x 7 1/4" self-balancing potentiometer has been developed by the G. E. meter and instrument division.

Said to permit measurement of d-c voltages from 10 microvolts to 1 volt.

Self-contained case houses bridge elements, power supply, light source, and light-beam galvanometer. Assembled on a welded metal chassis, the unit weighs 5 pounds.

At balance, the current drawn by the input circuit is 0.01 microampere. Output is 5 milliamperes full-scale for any input range and any output-instrument circuit resistance up to 1,500 ohms.

The potentiometer is said to balance to ±1 microvolt; response time, 1 second on the 200-

(Continued on page 50)

microvolt range, and less than 1 second on higher ranges. . . .

**KINGS ELECTRONICS TUNABLE DIPOLE**

An adjustable type of dipole for television and f-m has been announced by Kings Electronics, 372 Classon Avenue, Brooklyn 5, N. Y. Adjustable feature of dipole consists of an u-h-f element calibrated from 1.0 to 21.5 in half-steps. After facing antenna in direction of greatest signal strength, should any weak stations develop, this element can be moved in or out, according to a carefully calculated table, and then locked into position.

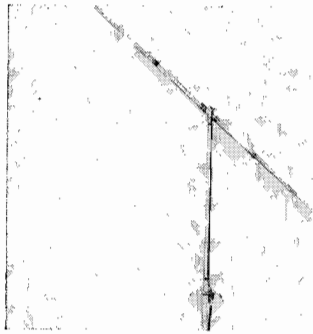

**HOLUB WIRE STRIPPERS**

An automatic wire stripper, A-02, that strips from No. 10 to 22 solid or stranded wires, has been developed by Holub Industries, Inc., Sycamore, Illinois. Clamps wire, cuts the insulation and strips in one operation. Blades are renewable.

**STANDARD ELECTRICAL VARIABLE TRANSFORMERS**

A variable transformer with an isolated primary, types LR-5, 10, 22 and 24, has been an-

**THE INDUSTRY OFFERS . . . —**

(Continued from page 49)

nounced by the Standard Electrical Products Company, Dayton 3, Ohio. Types LR-5 and 10, for 115-volt input, provide output voltage of 70 to 140; maximum ratings (va), 500 and 1000, respectively. Types LR-22 and 24, for 230-volt input, provide output voltage of 70-140; maximum ratings (va), 500 and 1000, respectively.

**G.E. 5-KW MAGNETRON**

A magnetron, furnishing 5 kw of continuous power output and designed for use as a c-w oscillator, has been announced by the tube division of G. E.

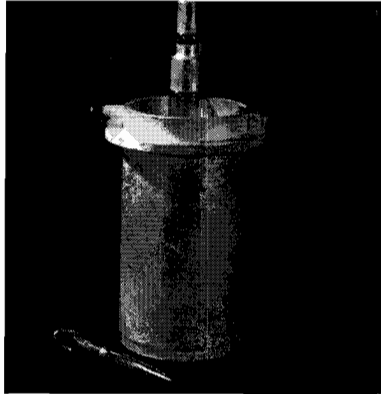

**SOUND EQUIPMENT CORP. SOLDER DISPENSER**

A solder dispenser, Kwik-feed, operated by thumb or finger pressure of the hand holding the iron, has been announced by Sound Equip-

ment Corporation, 3903 San Fernando Road, Glendale 4, California. Can be attached to conventional electric soldering iron by means of an adjustable adapter leaf. Has positive ratchet feed. Tube which feeds the solder is adjustable.

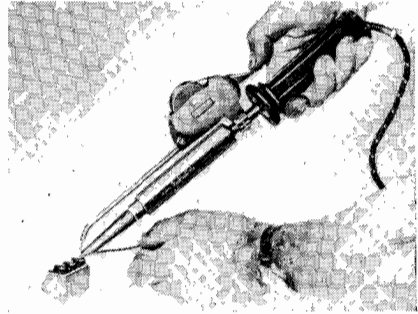

**AEROVOX UNIVERSAL CLEAT-MOUNTING ELECTROLYTICS**

General-purpose cleat-mounting electrolytic capacitors, type PRVC, in aluminum cans have been announced by Aerovox Corporation, New Bedford, Mass. Can be used as a substitute for metal-can electrolytics requiring a mounting hole in the chassis or using twist-prong mounting washer. Have insulated positive and negative wire leads, color-coded for polarity. Multiple-section units have concentric-wound sections with common negative lead. Available in popular ratings and capacitances. . . .

**FTR HEAVY-DUTY SELENIUM RECTIFIER STACK**

A selenium rectifier stack with double studs, center contact construction and 26-volt plates, has been developed by Federal Telephone and Radio Corporation, Newark, N. J. Employing rectangular, square-cornered plates instead of round type, the stack is designed to mount



**PR Precision CRYSTALS**

**. . . For Dependable Commercial Service**

Designed for the rigors of commercial service in all types of radio communication . . . broadcast, mobile, aircraft, police. Precision made for utmost in stability, dependability, trouble-free operation. Calibrated within .005 per cent of specified frequency . . . range 1.5 to 10.5 MC. Temp. coefficient less than 2 cycles per megacycle per degree centigrade. Weighs less than 3/4 ounce. Gasket sealed against contamination and moisture. Meets FCC requirements for all above services. See your jobber—Petersen Radio Company, Inc., 2800 W. Broadway, Council Bluffs, Iowa. (Telephone 2760.)

*Electronic Research & Mfg. Corp.*

**A Service to INDUSTRY DEVELOPMENT AND CONSTRUCTION OF ELECTRONIC EQUIPMENT FOR ANY APPLICATION**

Write or telephone for a discussion of your problem—without obligation.

1420 East 25th Street, Cleveland 14, Ohio SU. 1958

**WILLARD 2 VOLT COMPACT RECHARGEABLE Spill-Proof STORAGE BATTERY**

In an attractive Clear Plastic Case. Only 2 3/4" square and 6" overall height. About the size of the ordinary #6 Dry Cell. Rating 24 AH. Gains nicely for other voltages in multiples of 2 volts. Ideal for many applications. Shipped dry with electrolyte for each in separate container. (Cannot be shipped Parcel Post.)

CLOSE OUT PRICE While Our Stock Lasts. Every One BRAND NEW! Stock No. 5A133, ONLY \$2.95 In Case Lots of 42. Each. \$2.50

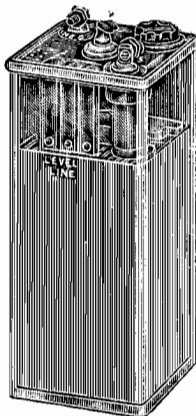

**BA BURSTEIN-APPLEBEE CO.** 1012-14 McGee, Kansas City 6, Mo.

**REMLER APPOINTED Agent for**

**WAR ASSETS ADMINISTRATION (Under Contract No. 59A-3-48)**

. . . to handle and sell a wide variety of **ELECTRONIC EQUIPMENT**

released for civilian use Write for Bulletin Z-1A

Remler Company, Ltd., 2115 Bryant St., San Francisco 10, Cal.

**REMLER SINCE 1918**

Pioneers in Electronics and Plastics



either in a vertical position or in a horizontal position.

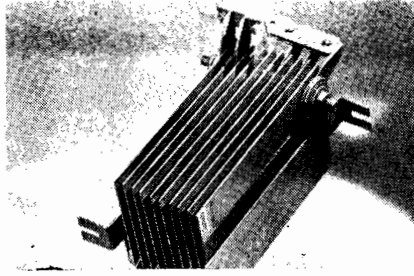

### COLLINS AMATEUR RECEIVER

An amateur receiver for the 80, 40, 20, 15, 11 and 10-meter bands has been announced by the Collins Radio Company, Cedar Rapids, Iowa.

Receiver features include straight-line tuning, dial calibrated directly in frequency, 50-db image rejection on all bands, crystal filter-variable selectivity, automatic noise limiter, double conversion, signal-strength meter, amplified avc, 10:1 signal-to-noise ratio, etc.



### TECHNO-CRAFT RECORDER

An instantaneous recording mechanism of the

over-head type has been announced by Techno-Craft Products, (Techno Machine and Tool Co.) 200 Hudson Street, New York 13, N. Y.

Features are said to include cutting needle angle adjustment, single lever for engaging feed screw and lowering cutting head. Thumb-screw allows for adjustment of cutting depth. Cutting pitch is 110 lines per inch, outside-in. Two models available for recording up to 16" diameter.

Four types of Astatic cutting heads are furnished: X-26, X-29-A, M-41-8 and M-41-500.

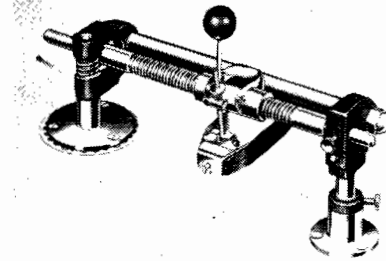

### KIRKLAND INDICATING LIGHT

Indicating lights, type ML, have been announced by the H. R. Kirkland Company, Morristown, N. J.

Basic lampholder housing (bakelite) can be furnished for use with one, two, three or four S6-120 v bulbs (3/4" o. d.) or smaller diameter bulbs.

Units have black-faced plate with engraved markings shown in white, with translucent inner core.

Also available are plates with bulls-eyes, with and without marking, used when full side-visibility is desirable.

Plate dimensions are 3 3/4" x 1 1/2", with 3" x 1 1/16" allotted for actual light area.

### RCP DYNOPTIMUM TUBE TESTER

A tube tester, model 322, using a dynoptimum circuit, has been announced by Radio City

Products Company, Inc., 127 West 26th Street, New York City 1.

Comes in two types, open-faced and portable. Open-faced model is housed in a new style crackle-finish steel sloping cabinet, 12"x6"x8". Portable carrying case is 13"x7"x9".

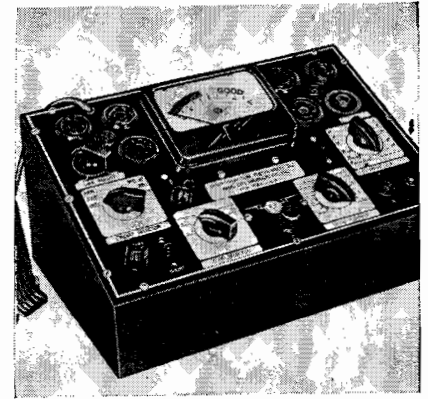

### RAYTHEON 1-KW A-M TRANSMITTERS

A 1-kw a-m transmitter, the RA-1000, has been announced by Raytheon Manufacturing Company's broadcast equipment division of Chicago.

Modulation is said to be 100% high level; audio input (500-600 ohm source) for 100% modulation, zero level db for 1-milliwatt reference level; average program level, -5 db (1 milliwatt reference level); audio distortion (50-7500 cycles), less than 2 1/4% rms for 95% modulation; noise level, more than 60 db below 100% modulation.

Output circuit designed to feed 70-250 ohm transmission lines.

Crystal oscillator, 6J5; buffer, class A 807; r-f driver, push-pull 813's; r-f power amplifier, push-pull 833A's; first audio, push-pull class A 6J7's; second audio, push-pull class A 6J5's; audio driver, push-pull class A 845's; modulator, push-pull class B 833A's.

FOR RADIO AND ELECTRONICS

ask **NEWARK**  
They'll have it!

**PARTS**  
**EQUIPMENT**  
**SETS**

IF YOUR NEEDS in radio or electronics parts, sets or equipment are available ANYWHERE, save time by phoning or wiring Newark Electric. Our tremendous stocks are complete and up-to-the-minute in all three stores.

**COMPETENT TECHNICAL MEN** handle your inquiries and orders at Newark. They know what you are talking about and can handle all requests intelligently and promptly. They know the stock — they know industry's problems and needs. They can give you prices and delivery dates on specific merchandise.

IN NEW YORK AND CHICAGO you get speedy door-to-door delivery. Out-of-town orders are shipped the day they are received.



N. Y. C. Stores: 115 W. 45th St. & 212 Fulton St.  
Office & Warehouse: 242 W. 55th St., N. Y. 19



Uncertain, industry-wide conditions have delayed our complete catalog, but we'll gladly send you literature on ANY manufacturers' products. Send your inquiries by mail, telegraph or phone. They will be answered completely and promptly. When writing, address Dept. L3.

- ★ In New York or Chicago you'll enjoy our big bargain counters, loaded down with unusual surplus radio and electronics items, fascinating to those with inquiring minds.
- ★ The Public Address departments in all stores are full of interesting merchandise. Industrial buyers are invited to take advantage of Newark's set and appliance departments in both New York stores.

NEWARK ELECTRIC COMPANY, INC.: Dept. L3.  
Please send informative literature on the following:

NAME: \_\_\_\_\_  
ADDRESS: \_\_\_\_\_  
CITY: \_\_\_\_\_ STATE: \_\_\_\_\_





# RADIO PARTS

## ELECTRONIC NEEDS!

### Check These CONCORD VALUES!

Concord has them! Radio and Electronic Parts, Supplies and Equipment of every kind, for every need... long awaited, hard-to-get items... new merchandise, just received... Hundreds of bargains... in stock NOW for IMMEDIATE SHIPMENT from CHICAGO or ATLANTA.



**WELLS-GARDNER BC-348-N Communications Receiver.** 6 Bands—200-500 KC. and 115 MC. to 18 MC. in 5 Bands. 2 stages RF, 3 stages IF. Beat Frequency Oscillator, Crystal IF, Filter, Manual or Automatic A.V.C. Complete with tubes and 24 V.D.C. input dynamotor power supply, but supplied with complete instructions and diagrams for converting to 110 V.A.C. 60 cycle operation. **BC-348-N \$53.95**



**ALNICO V 5" P. M. SPEAKER**  
New Alnico V magnet provides maximum performance with minimum weight. Normal wattage 3, peak wattage 4 1/2. V.C. impedance 3.2 ohms, depth 2 7/16". **SB7009 \$1.98**



#### CARBON THROAT MICROPHONE

Will work into any 200 ohm impedance input circuit. Has adjustable strap to fit any neck. Ideal for ultra high frequency mobile work for hams. Supplied with strap, 10' cord and plug. **SB7060 \$49**

#### 9003 VHF Midget Super Control RF Pentode Tube \$95

**HEAVY DUTY LINE FILTER Solar Elim-O-Stat.** Completely shielded. Type EN106. **SB3218 Each \$1.79**

**WIRE STRIPPER** Strips wire instantly! Fastens to bench or other support. Wire stripped to any length. Strips wire up to 12 MM diam. Each **C15268 \$98**

**TUNER UNIT TU-10-B** Continuous frequency range from 10 MC. to 12.5 MC. VFO oscillator tuning section, buffer, coupling, capacitors and choke & buffer output matching tapped coil & condenser. Size 16 3/8" lg. x 7 3/8" h. 5 1/2" deep. **A54132 \$2.95**

**T-17-B 200 Ohm Carbon Mike.** Lightweight, with press-to-talk button. Built-in filter to suppress carbon hiss. 5' rubber covered cable and PL-48 3-circuit plug supplied. **SB7062 \$2.49**

**Midget Volume Control**—1 Meg. ohm Standard 3/8" Bushing, 1/4" dia. Shaft, 3/4" long, with split spline for push-on knob. **C3154 \$35**

**STANCOR Universal Output Transformer Type A3856.** Primary for all single or push-pull plates. Secondary adjustable from 1 to 30 ohms. Two-inch mounting centers. 4 watts at 35 mils. **C1675-SPECIAL \$1.32**

Write for catalog of Radio Parts and Electronic Equipment. Packed with Radio Needs—new and scarce items—Bargains. Write Dept. R-116.

**CONCORD RADIO CORPORATION**  
LAFAYETTE RADIO CORPORATION  
CHICAGO 7 ATLANTA 3  
901 W. Jackson Blvd. 265 Peachtree Street

# ADVERTISERS IN THIS ISSUE

COMMUNICATIONS—NOVEMBER, 1946

ALNI CORPORATION ..... 36 Agency: Henry A. Stephens, Inc.	HEWLETT-PACKARD CO. .... 10 Agency: L. C. Cole, Advertising
ALTEC-LANSING CORPORATION ..... 35 Agency: Reiss Advertising	IDEAL INDUSTRIES, INC. .... 35 Agency: Van Auken & Ragland
AMPERITE CO. .... 44 Agency: H. J. Gold Co.	INSULINE CORPORATION OF AMERICA ..... 39 Agency: S. R. Leon & Co.
ANDREW CO. .... 45 Agency: Burton Browne, Advertising	HOWARD B. JONES DIV. CINCH MFG. CORP. 38 Agency: Merrill Symonds, Advertising
THE ANSONIA ELECTRICAL DIV. NOMA ELECTRIC CORPORATION ..... 9	KAAR ENGINEERING CO. .... 5 Agency: The Conner Co.
BELL TELEPHONE LABORATORIES ..... 6, 7 Agency: Newell-Emmett Co., Inc.	LITTELFUSE, INC.* ..... 48 Agency: Burton Browne, Advertising
L. S. BRACH MFG. CORP. .... 30 Agency: United Adv. Agency	MEASUREMENTS CORPORATION ..... 34, 46 Agency: Frederick Smith
BURSTEIN-APPLEBEE CO. .... 50 Agency: Frank E. Whalen Adv. Co.	JAMES MILLEN MFG. CO., INC. .... 40
CANNON ELECTRIC DEVELOPMENT CO. .... 43 Agency: Dana Jones Co.	NEWARK ELECTRIC CO., INC. .... 51 Agency: The Charles Brunelle Co.
CAPITOL RADIO ENGINEERING INSTITUTE. 47 Agency: Henry J. Kaufman & Associates	NIAGARA RADIO SUPPLY ..... 38 Agency: Burke & Wayburn Adv. Co.
CINEMA ENGINEERING COMPANY ..... 41 Agency: The McCarty Co.	PETERSEN RADIO CO., INC. .... 50 Agency: Bozell & Jacobs
C. P. CLARE AND CO. .... Back Cover Agency: Hamilton Adv. Agency, Inc.	PRESTO RECORDING CORPORATION ..... 29 Agency: Roy S. Durstine, Inc.
CLAROSTAT MFG. CO., INC. .... 38 Agency: Austin C. Lescarboura & Staff	RAYTHEON MFG. CO. .... 1 Agency: Burton Browne, Advertising
COLLINS RADIO COMPANY ..... 33 Agency: McCann-Erickson, Inc.	REMLER CO., LTD. .... 50 Agency: Albert A. Dreiman
CONCORD RADIO CORP. .... 52 Agency: E. H. Brown Adv. Agency	ROWE INDUSTRIES ..... 34 Agency: The Miller Agency Co.
CORNISH WIRE CO., INC. .... 36 Agency: Hart Lehman, Advertising	SORENSEN & CO., INC. .... 81 Agency: Henry A. Stephens, Inc.
COTO-COIL CO., INC. .... 37 Agency: Frank E. Dodge & Co., Inc.	ST. LOUIS MICROPHONE CO. .... 42 Agency: Altman-Gilbert Adv. Agency
DeMORNAY-BUDD, INC. .... 3 Agency: Federal Adv. Agency	TECH LABORATORIES ..... 48 Agency: Lewis Adv. Agency
DOOLITTLE RADIO, INC. .... 42 Agency: Henry H. Teplitz, Advertising	TELEX, INC. .... 44 Agency: Campbell-Mithun, Inc.
EITEL-McCULLOUGH, INC. .... 21 Agency: L. C. Cole, Advertising	THOMAS & SKINNER STEEL PRODUCTS CO.. 38 Agency: The Caldwell-Baker Co.
ELECTRONIC RESEARCH & MFG. CORP. .... 50	TRIPLETT ELECTRICAL INSTRUMENT CO... 49 Agency: Western Adv. Agency, Inc.
FARNSWORTH TELEVISION & RADIO CORP. 17 Agency: N. W. Ayer & Son, Inc.	U. S. TREASURY DEPT. .... 8
FRANKLIN AIRLOOP CORP. .... Inside Front Cover Agency: Sam J. Gallay	UNITED TRANSFORMER CORP. .... 4 Agency: Shappe-Wilkes, Inc.
GENERAL RADIO CO. .... Inside Back Cover	WESTERN ELECTRIC ..... 6, 7 Agency: Newell-Emmett Co., Inc.
	ZOPHAR MILLS, INC. .... 34 Agency: Copp Adv. Agency



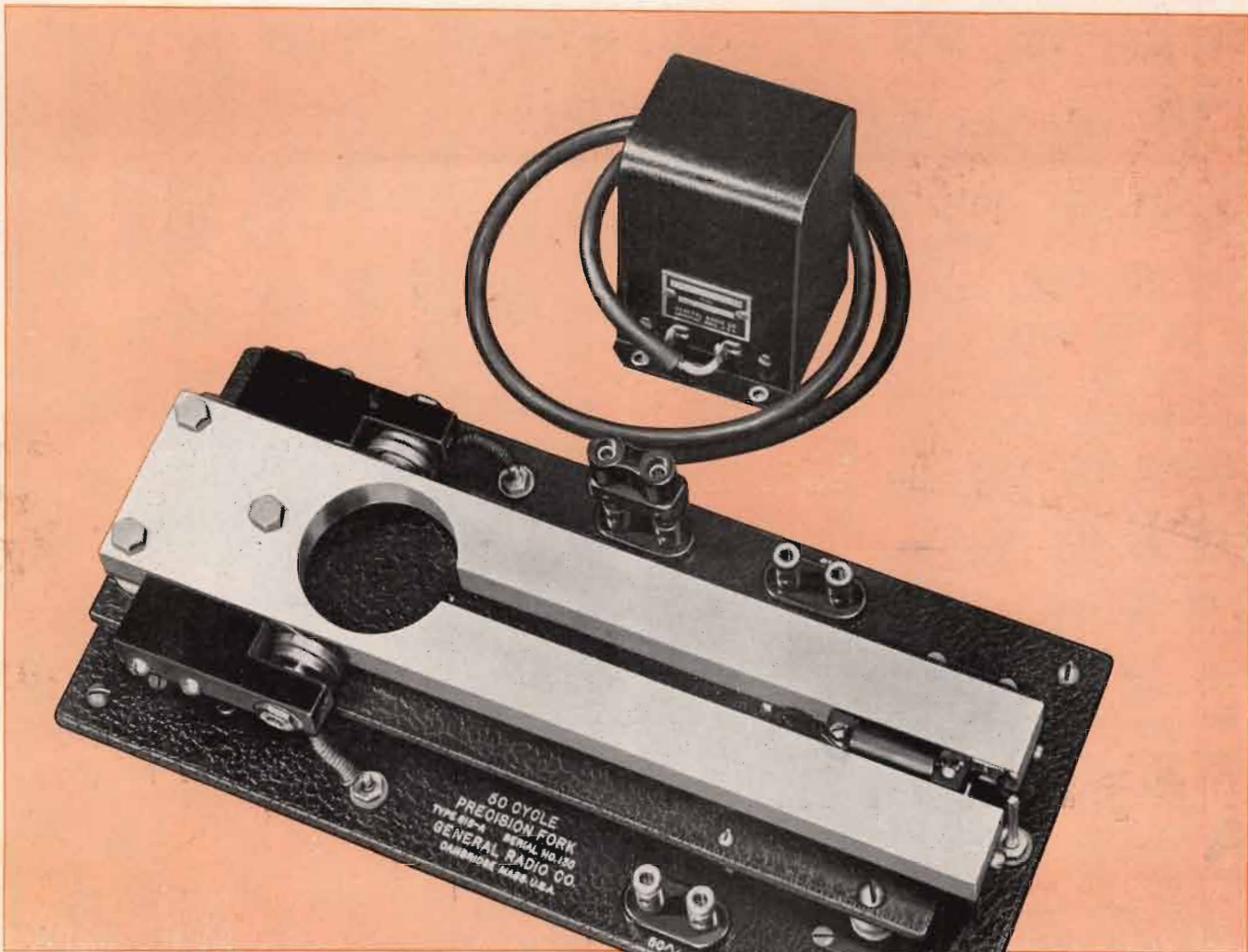

## TEN PARTS PER MILLION ... and a few in stock!

Where the ultra refinement of temperature control is not required, the G-R Type 815 Precision Forks have more than sufficient accuracy for use both in the laboratory and in the field. They are supplied in frequencies of 50, 60 and 100 cycles with a calibration accuracy of ten parts per million. They make excellent low-frequency standards.

Stock for the forks is low-temperature-coefficient stainless steel, received by us in bars. A sample fork is made from each bar and the coefficient of the stock is obtained after a protracted temperature run.

The forks are then machined in our shops. When measured to one millicycle, the unmounted fork is about 2 cycles below its nominal frequency. After this initial measurement, the excess material is milled from the end of the tines and a second frequency check is made. Occasionally the forks must be milled a second time.

Two adjustable loading screws are placed in holes drilled and tapped in the end of each tine. The fork is

then assembled and the temperature coefficient of the outer tine screw is obtained. If necessary, excess material is removed from the outer tine screw. The screws are adjusted so that the frequency is within  $\pm 0.001\%$  of its nominal value. The voltage coefficient of frequency is obtained; it averages about 0.005%. Output voltage and harmonic content are then measured.

When orders are received the forks are returned to the standardizing laboratory, given a half-hour run and the frequency is measured at a driving voltage of exactly four volts. With each fork a calibration certificate is supplied to show: the frequency to within  $\pm 0.001\%$  at a stated temperature between 70 and 80 deg. F.; the temperature and voltage coefficients of frequency.

TYPE 815-A	50-CYCLE FORK	.....	\$175.00
TYPE 815-B	60-CYCLE FORK	.....	185.00
TYPE 815-C	100-CYCLE FORK	.....	185.00
TYPE 815-P1	Transformer (for use between the fork and relatively high-impedance loads)	.....	6.95

AT THE MOMENT WE HAVE A SMALL STOCK OF THESE FORKS



# GENERAL RADIO COMPANY

Cambridge 39,  
Massachusetts

90 West St., New York 6

920 S. Michigan Ave., Chicago 5

950 N. Highland Ave., Los Angeles 38





## More Than Relays... It's CLARE Reputation They Hold In Their Hands!

● Relays are no side line with Clare. Precise, "custom-built" relays are our stock in trade.

Through these trained fingers in Clare's modern test laboratory pass every Clare "Custom-Built" Relay to make sure that each fulfills the customer's requirements exactly. Operate and release current . . . contact sequence . . . contact pressure . . . coil resistance . . . high-voltage insulation . . . every detail must check.

This painstaking testing of the manufacture and precise adjustment of each relay is one reason why thousands of users of Clare "Custom-Built" Relays count on them for applications where ordinary relays won't do.

Clare "custom-building" means that the proper combination of various Clare features may be built into a

standard frame so as to provide a relay ideal for the specific requirement. This makes possible a flexibility of design and construction which gives unusual operating reliability even under severe conditions of temperature, humidity, atmospheric pressure or vibration.

See your nearest Clare sales engineer. They are located in principal cities to work with you in the development of "custom-built" relays to meet your most unusual relay requirements. Let them show what Clare "custom-building" can mean to you. Do you have the new Clare Engineering Data Book? If not, send for your copy today. Address: C. P. Clare & Company, 4719 West Sunnyside Ave., Chicago 30, Ill. Cable Address: CLARELAY.

*In Canada: Canadian Line Material Ltd., Toronto 13*

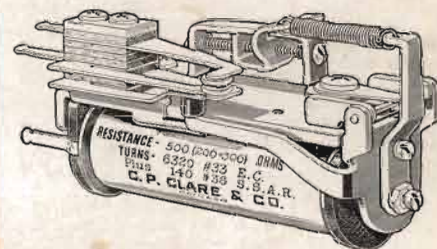

**Clare Micro-Adjustment Relay**—This Clare Micro-Adjustment Relay is capable of unusually precise adjustments for marginal, close differential operation. It is for use in applications where extremely accurate adjustment is required.

The armature tension is adjusted by tightening or loosening the spring which is attached to a post at the armature end of the relay.

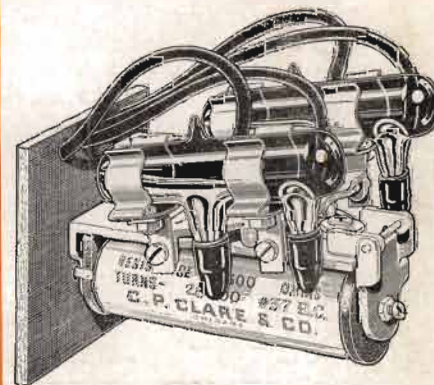

**Clare Mercury Contact Relay**—Shown above is a Clare Type "M2" Mercury contact relay with glass enclosed contacts. The mercury contact is mounted on a tilt table attached to the heelpiece of the relay. These relays must be mounted horizontally. Clare also provides Mercury contact relays with Bakelite enclosed contacts and with metal contacts.

# CLARE RELAYS

"Custom-Built" Multiple Contact Relays for Electrical and Industrial Use