

# COMMUNICATIONS

INCLUDING "RADIO ENGINEERING" AND "TELEVISION ENGINEERING"

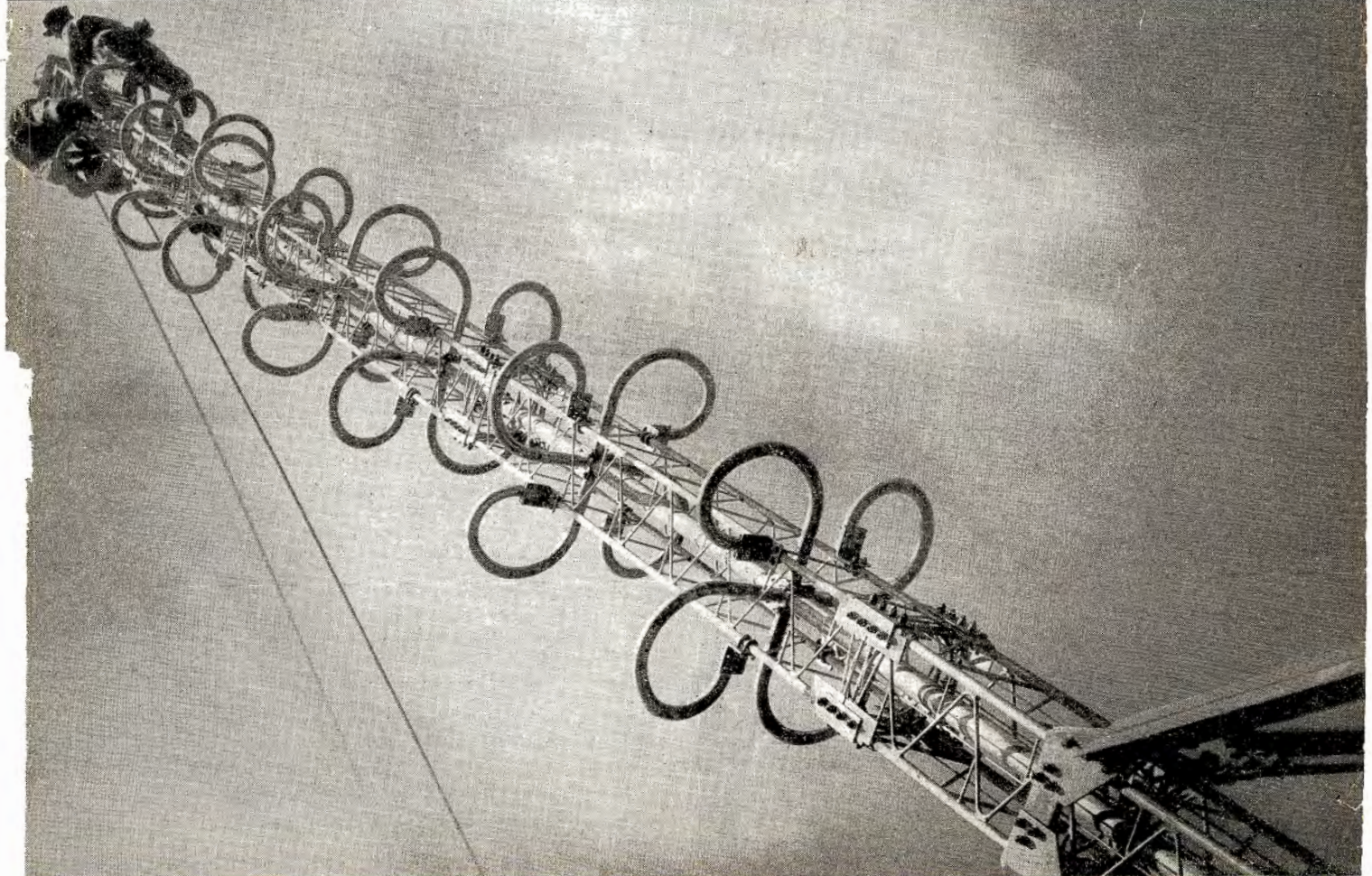

AUGUST

★ LINK-COUPLED COIL DESIGN

★ CARRIER-PROGRAM FAILURE ALARM SYSTEM

★ USE OF MARKET SURVEY DATA FOR TRANSMITTER DESIGNS

1946

# Largest MYCALEX

## Part Ever Molded

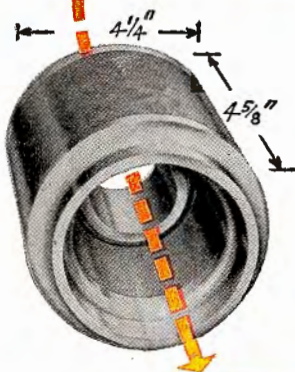
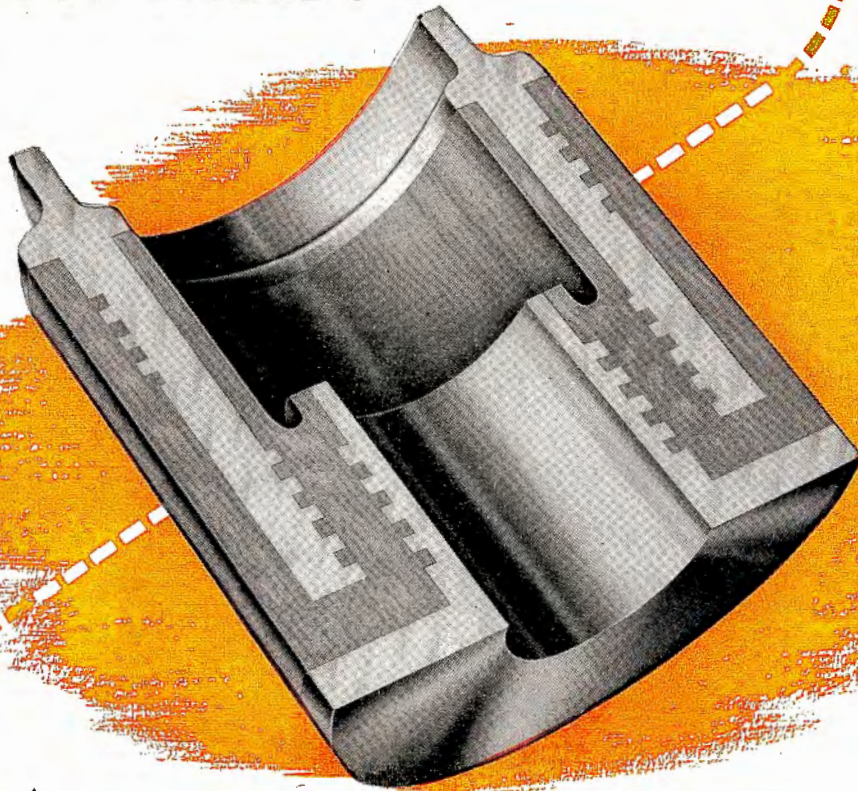

This cross section of a MYCALEX-to-metal molded component part was made for one of the country's leading manufacturers, and is the result of close cooperation between the customer's and our own engineering staffs. It exemplifies a new development in the molding of MYCALEX 410 with metal to form a hermetic seal.

The objective was to take advantage of the low loss factor and other desirable properties of MYCALEX 410 to produce a rugged bushing assembly in a single molding operation.

A difficulty was presented by the extremely long and branched path which the MYCALEX 410 had to follow. Total charge of MYCALEX 410 was 7 pounds, while the metal weighed 6 pounds to make a total weight of 13 pounds.

The MYCALEX and metal were sealed into one closely-bonded integral part, held to extremely close dimensional tolerances.

For more than 27 years MYCALEX has met and surpassed the most exacting needs engineers have been able to devise from year to year. MYCALEX 410, together with our highly perfected methods of molding it, is the greatest advancement in this high frequency low loss insulation to date.

Our technical staff is at your service. What is your problem in low loss insulation?

### MYCALEX CORPORATION OF AMERICA

"Owners of 'MYCALEX' Patents"

Plant and General Offices, CLIFTON, N. J.

Executive Offices, 30 ROCKEFELLER PLAZA, NEW YORK 20, N. Y.

# ELECTROSTATIC VOLTMETER

*For  
Accurate  
Measurement  
In High Impedance  
Circuits*

**PORTABLE  
PROJECTING  
FLUSH**

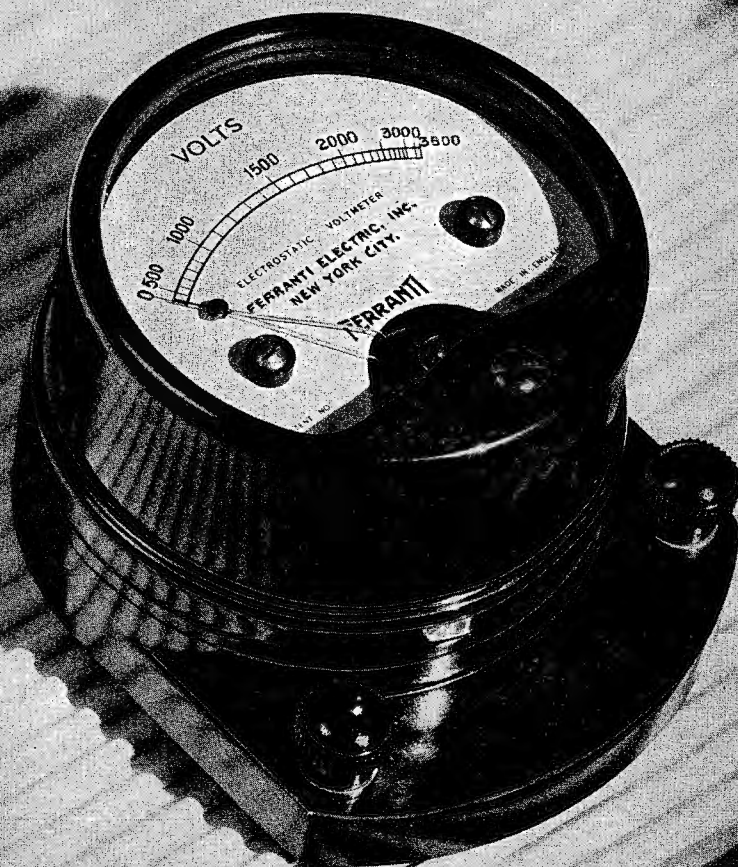

#### RANGES

- 0- 150 Volts
- 0- 300 Volts
- 0- 450 Volts
- 0- 600 Volts
- 0- 750 Volts
- 0-1000 Volts
- 0-1500 Volts
- 0-2000 Volts
- 0-2500 Volts
- 0-3000 Volts
- 0-3500 Volts

**FERRANTI ELECTRIC, INC.**

30 ROCKEFELLER PLAZA  
NEW YORK, N. Y.

Ferranti Electric, Ltd., Toronto, Canada • Ferranti, Ltd., Hollinwood, England

# We See...

A-M BROADCASTERS may soon have a new set of engineering standards to follow. For as a result of a series of meetings during the clear-channel hearings in Washington, a revision of Part 1 of the *Standards of Good Engineering Practice* has been prepared and submitted to the FCC. Prompted by broadcast engineering progress, substantial increases in the number and powers of stations, population shifts and corresponding economic changes, and the coming preparation of the North American Regional Broadcast agreement, the proposal offers many modifications of the old standards and many entirely new procedures.

In the new category of the standards, we find data on atmospheric noise, listeners' opinions on the ratio of signal to interference, interference ratios and frequency separation, and several new approaches to the calculation of groundwave and skywave signals.

In discussing atmospheric noise, the proposal shows what signal level (called the 50% atmospheric-noise-free signal) is required for standard acceptable service, plots being offered to determine field intensities required to offset noise interference. The proposal also points out that as a result of listener polls in 1945 and the beginning of this year, the 20:1 ratio, heretofore used for the minimum desired-to-undesired signal ratio for groundwave interfering with groundwave, was still satisfactory. Approximately two-thirds of the listeners polled for the average types of programs, involving speech and music, supported this ratio. Incidentally, it was learned that the required ratio was nearly doubled for speech-to-speech interference.

The new proposal also calls for a 30-kc separation of stations in the same area, as against the current 40-kc requirement. A 1:2 ratio of desired-to-undesired groundwave at 10 kc is also proposed; at 20 kc the ratio is 1:30. A ratio of 1:5 for the desired groundwave to undesired 10% skywave at 10 kc also appears in the proposal. Some have indicated that this ratio should be similar to that of the groundwave ratio.

Analyzing skywave interference to skywave service, the revised standards state that for stations on the same channel the reference contour should be based on a minimum 20:1 ratio of the 50% skywave value of the desired to the 10% skywave value of the undesired signal.

To assist in the calculation of skywave signals, the FCC is preparing sets of skywave curves peculiar to transmission by one, two, three or more hops, where the vertical field intensity pattern departs radically from that of a .311 antenna or where the transmission path has seawater deflection points.

Every effort has been made to include provisions that will not only accommodate present allocation problems but those that might arise in the future.

Congratulations to the government and industry specialists who spent endless hours preparing this proposal, which will undoubtedly become one of the most important reference standards in the industry.—L. W.

# COMMUNICATIONS

Including Television Engineering, Radio Engineering, Communication & Broadcast Engineering, The Broadcast Engineer. Registered U. S. Patent Office.  
 Member of Audit Bureau of Circulations.

**AUGUST, 1946 VOLUME 26 NUMBER 8**

## COVER ILLUSTRATION

Installing the recently-developed clover leaf f-m antenna at the f-m laboratories of the Bell Labs at Whippany, N. J.  
 (Courtesy Western Electric)

## A-M AND F-M TRANSMITTER DESIGN

Broadcasting Transmitter Design as Determined by a Market Survey.....M. R. Briggs 11  
*Survey Among Present and Future Managers and Operators of F-M Stations to Obtain Cost, Service and Design Data.*

## COIL DESIGN

Link-Coupled Coil Design.....Samuel Sabaroff 16  
*Procedure Used to Determine Design Requirements of Link-Coupled Coils.*

## STATION CONTROL

Broadcast Station Alarm System for Carrier and Program Failures.....Russell R. Taylor 20  
*Alarm System That Provides Aural and Visual Indication at Transmitter and Studio.*

## F-M BROADCASTING

Direct F-M Transmitters.....N. Marchand 24  
*Analysis of Reactance-Tube Modulated Oscillators and R-F Amplifiers Using Grounded-Grid Circuits.*

## MARINE COMMUNICATIONS

The Electronic Navigator.....Thomas Grover and E. C. Kluender 30  
*Details of 10-cm Surface Search and Navigational Radar.*

## BROADCAST STATION MAINTENANCE

Preventive Maintenance for Broadcast Stations.....Chas. H. Singer 33  
*Discussion of Maintenance Facilities, Preventive Maintenance Procedures and Precautions.*

## MONTHLY FEATURES

Editorial (We See).....Lewis Winner 2  
 Veteran Wireless Operators' Association News..... 34  
 News Briefs of the Month..... 40  
 The Industry Offers..... 46  
 Book Talk ..... 50  
 Advertising Index..... 56

Published Monthly by the Bryan Davis Publishing Co., Inc.

**BRYAN S. DAVIS, President**

**F. WALEN, Secretary**

**PAUL S. WEIL, Vice Pres.-Gen. Mgr.**

**A. GOEBEL, Circulation Mgr.**

Advertising and Editorial offices, 52 Vanderbilt Ave., New York 17, N. Y. Telephone, MUrray Hill 4-0170. Cleveland Representative: James C. Munn, 10515 Wilbur Ave., Cleveland 6, Ohio; Telephone, SWEetbriar 0052. Chicago Representative: Lawrence Wehrheim, 5510 W. Lemoyne Ave., Chicago, Ill.; Telephone MERrimac 7919. Pacific Coast Representative: Brand & Brand, 1052 W. 1085 Monadnock Building, San Francisco 5, Calif.; Telephone, Douglas 4475. Wellington, New Zealand: Te Aro Book Depot, Melbourne, Australia: McGill's Agency. Entire Contents Copyright 1946, Bryan Davis Publishing Co., Inc. Entered as second-class matter Oct. 1, 1937, at the Post at New York, N. Y., under the act of March 3, 1879. Yearly subscription rate: \$2.00 in the U. S. and Canada; \$3.00 in foreign countries. Single copies, twenty-five cents in United States and Canada; thirty-five cents in foreign countries.

# pace in Microphone Development



1931: Bell Telephone Laboratories developed the Western Electric moving coil or dynamic microphone. The first of its kind, it was rugged, noiseless, compact, and needed no polarizing energy. Many are still in use.



1935: The first non-directional mike — the famous Western Electric 8-Ball, designed by Bell Laboratories. Small, spherical, it provided top quality single mike pick-up of speech or music from every direction.



1936: Directional with slide-on baffle, non-directional without it, the Western Electric Salt Shaker gave highest quality pick-up at new low cost. Widely used in studios and remotes as well as in high quality sound distribution.



1946: No larger in diameter than a quarter, the 640 Double A condenser mike (shown with associated amplifier) is ideal for single mike high fidelity pick-ups. It was originally designed as a laboratory test instrument.

What is a microphone? Fundamentally it's a device which converts sound into electrical energy—just what Bell's original telephone did for the first time away back in the seventies.

Today's Western Electric mikes—the Salt Shaker, Cardioid and 640 Double A—are a far cry from the first crude, close-talking telephone transmitter. But they're its direct descendants.

Year after year, Bell Telephone scientists—through continuing research—have developed finer and finer telephones and microphones.

Year after year, Western Electric has manufactured these instruments, building quality into each one.

Together these teammates have been responsible for almost every important advance in microphone development.

Whether you want a single mike, a complete broadcasting station, or radio telephone equipment for use on land, at sea or in the air, here's the point to remember:

If Bell Telephone Laboratories designed it and Western Electric made it, you can be sure there's nothing finer.



BELL TELEPHONE LABORATORIES

*World's largest independent branch enterprise in research and development in all phases of technical communications.*

**Western Electric**

*Manufacturing arm of the Bell System and the world's largest producer of communications equipment.*

**BOOST KVA RATING BY FIVE OR MORE . . .**

**CUT PRESENT SIZES OF POWER CAPACITORS . . .**

**AEROVOX SERIES 1780**

*Water-cooled*

## **MICA CAPACITORS**

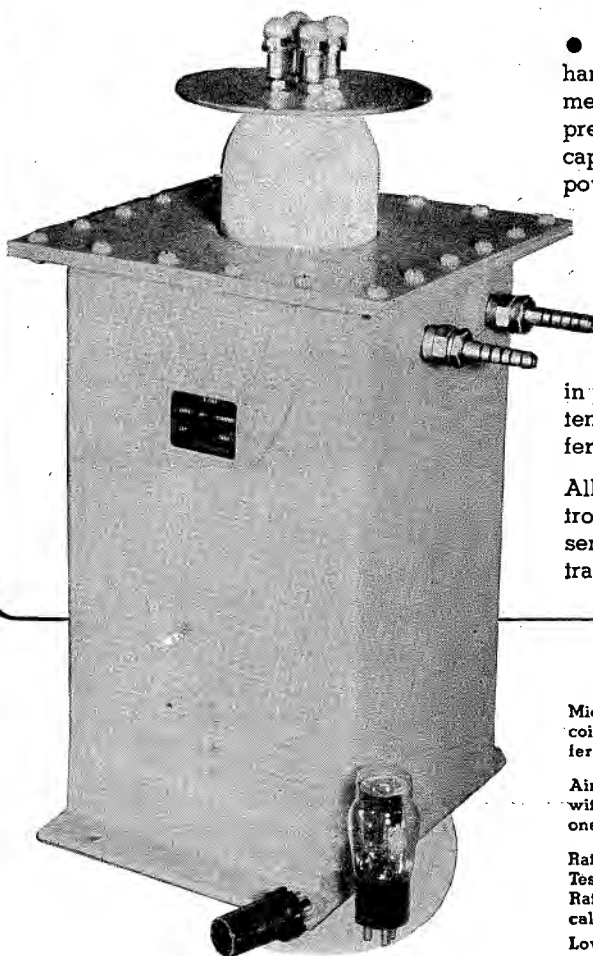

● This new water-cooled oil-filled mica capacitor handles exceptional KVA loads for its size. This means that more power can be handled than with previous capacitors of similar size or, conversely, capacitor size can be greatly reduced for given power ratings.

Series 1780 capacitors attain their higher KVA ratings in two ways: (1) By exceptional design such as critical arrangement and location of sections; choice of materials; specially-plated parts; large cross-section of conductors; careful attention to details and true craftsmanship in production. (2) By the use of a water-cooling system so designed as to provide maximum heat transfer from capacitor section to cooling coils.

All in all, here is a sturdy, compact, hard-working, trouble-free mica capacitor for extra-heavy-duty service, such as induction furnaces and high-power transmitters.

### *Featuring...*

Mica stacks in oil bath. Cooling coils in oil bath for efficient transfer of heat.

Air-cooled operation, 200 KVA; with water-cooling, 1000 KVA—a one-to-five ratio.

Ratings up to 25,000 volts A.C. Test. Capacitances up to .01 mfd. Rated loads up to 1000 KVA. Typical unit: 20,000 V. at .01 mfd.

Lower power factor (.01%). Long life and large factor of safety.

Provisions for making connections with high-current-capacity conduc-

tors. Four-stud terminal. Grounded case.

Heavy welded metal case, hermetically sealed. Exceptionally sturdy construction.

Series-parallel mica stack designed for uniform current distribution throughout.

Silver-plated hardware for minimum skin resistance. To minimize or eliminate corona, terminals are finished with large radii of curvature. Steatite insulator shaped to hold gradients below corona limits.

**TECHNICAL DATA ON REQUEST**



**FOR RADIO-ELECTRONIC AND INDUSTRIAL APPLICATIONS**

**AEROVOX CORPORATION, NEW BEDFORD, MASS., U.S.A.**

SALES OFFICES IN ALL PRINCIPAL CITIES • Export: 13 E. 40th St., NEW YORK 16, N. Y.

Cable: 'ARLAB' • In Canada: AEROVOX CANADA LTD., HAMILTON, ONT.

# SYLVANIA NEWS

## CIRCUIT ENGINEERING EDITION

AUG. Prepared by SYLVANIA ELECTRIC PRODUCTS INC., Emporium, Pa. 1946

### MODERN SET DESIGN SEEN GREATLY INFLUENCED BY NEW SYLVANIA ELECTRIC T-3 TUBE

*Commercial Version of Proximity Fuze Tube  
Is Tiny, Rugged, Has Long Life*

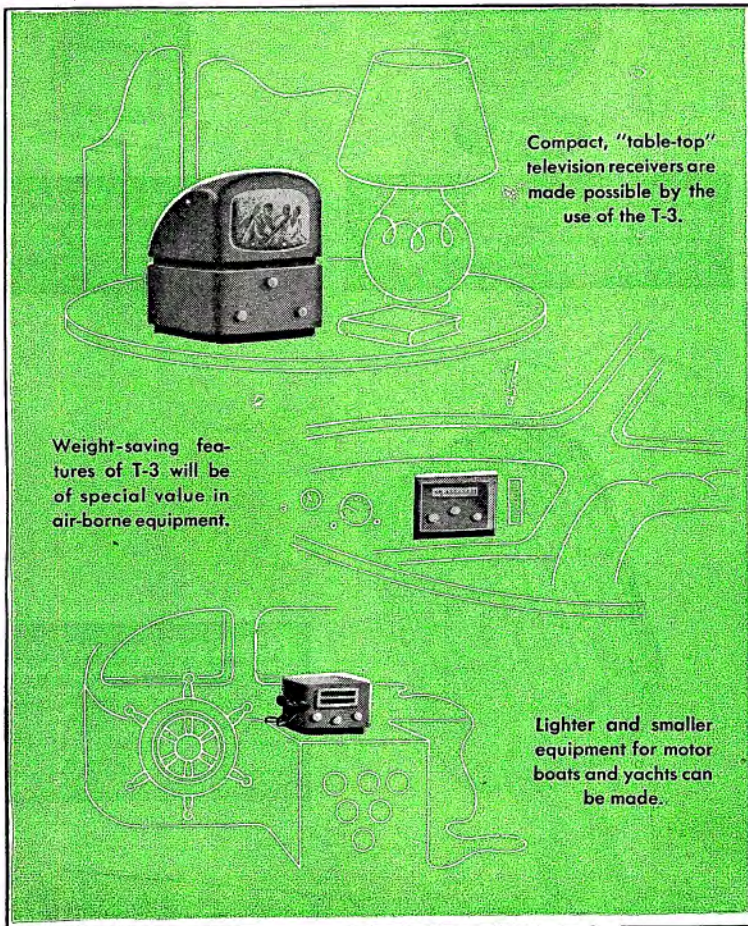

Radio equipment manufacturers are viewing with marked interest the radical reductions in size and weight now made possible in many types of electronic equipment through the use of the sensationally small Sylvania vacuum tube, T-3.

The commercial version of the former proximity fuze transceiver tube is noted for exceptional ruggedness... long life... ideal suitability for high frequency operation.

Some of the design possibilities opened by the T-3 are shown here. Of course, its potentialities are not limited to these fields.

Write Sylvania Electric Products Inc., Emporium, Pa.

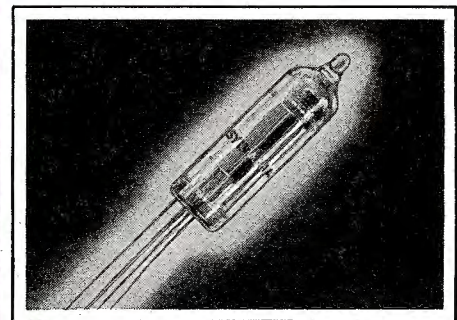

The T-3 tube is shown here in its actual size.

# SYLVANIA ELECTRIC

Emporium, Pa.

MAKERS OF RADIO TUBES; CATHODE RAY TUBES; ELECTRONIC DEVICES; FLUORESCENT LAMPS, FIXTURES, WIRING DEVICES; ELECTRIC LIGHT BULBS

# Why

## this team sets the

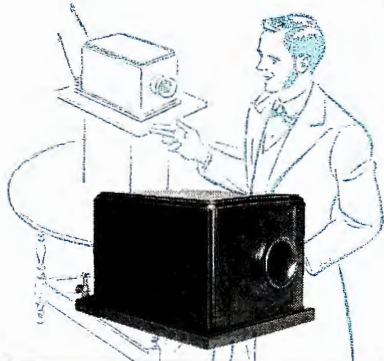

1877: Grand-daddy of all microphones was Alexander Graham Bell's box telephone, into which Thomas A. Watson shouted and sang in the first intercity demonstrations of the infant art of telephony.



1920: Telephone scientists developed the first successful commercial mike—the double carbon button air-damped type. Used first in public address systems, it later became the early symbol of broadcasting.

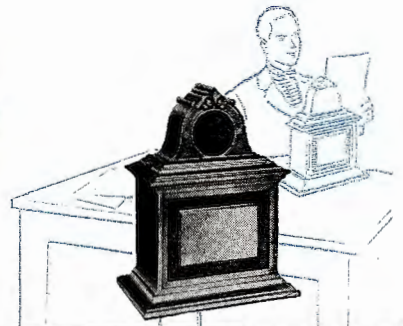

1921: The condenser microphone, designed by Bell Laboratories for sound measurement in 1916, entered the public address and broadcasting fields. It provided a wide frequency range and reduced distortion.

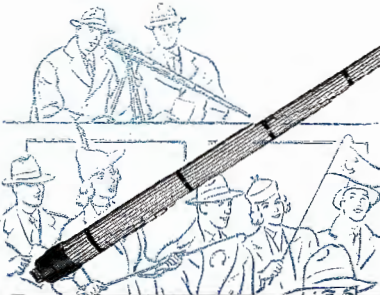

1937: The Western Electric "Machine Gun" mike does for sound pick-up what the telephoto lens does for photography. Sharply directional, this microphone makes sound "close-ups" of unusually long range.



1938: Cardioid directional microphone, with ribbon and dynamic elements, was the first mike ever to combine 3 pick-up patterns in one instrument. The later 639B, with 6 patterns, is also one of the finest all-purpose mikes ever made.

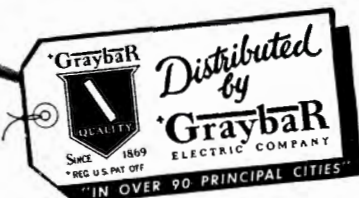



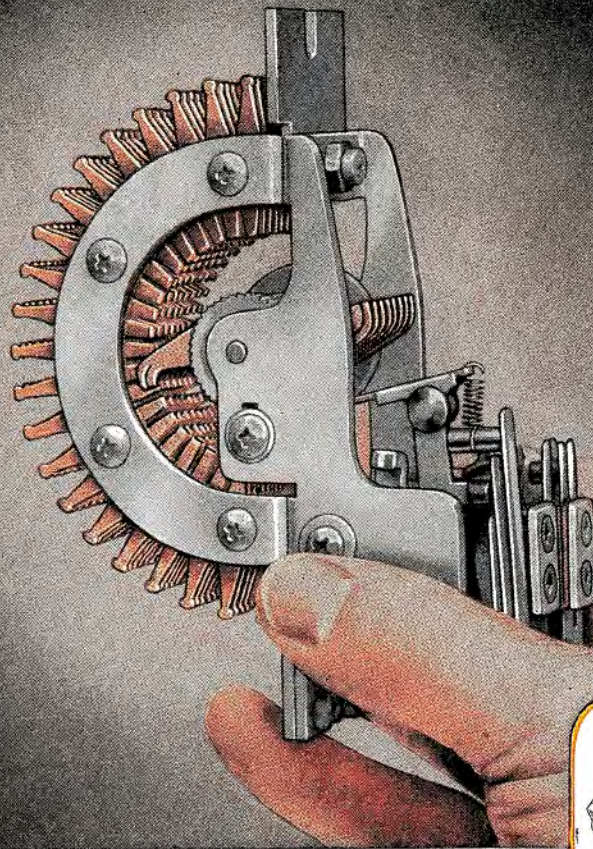

## A New CLARE Stepping Switch for Your Most Exacting Control Demands

● Here's a new Clare Spring-Driven Stepping Switch that will select any channel or circuit path out of twenty ... or forty. It will give automatic control of a series of operations ... provide an accurate counter with initiation of impulses supplied by the objects to be counted. Combined with one or more switches as counters, it is a dependable totalizing switch.

Like all Clare Relays and electrical control apparatus, this Clare Spring-Driven Stepping Switch is built for the tough job ... for applications that must have dependable, precise performance.

If your requirements are top notch ... if just an ordinary relay or stepping switch won't do ... Clare sales engineers are located in principal cities to show you how Clare products can provide just the performance you must have.

Ability of Clare products to meet

your most exacting control demands stems from Clare's up-to-the-minute engineering, careful selection of highest quality materials and manufacture that adheres closely to precise standards.

That is why users of Clare "Custom-Built" Relays represent the top names in American industry ... concerns who stake their good name on Clare performance.

Join the thousands of designers who have learned to count on Clare Relays and Clare "custom-building." Contact your nearest Clare sales engineer for information and advice. He is listed in your telephone book. Let us send you the new Clare Engineering Data Book, packed with information you can use. Address: C. P. Clare & Co., 4719 West Sunnyside Avenue, Chicago 30, Illinois. Cable address: CLARE-LAY. In Canada: Line Materials Ltd., Toronto 13.

# CLARE RELAYS

"Custom-Built" Multiple Contact Relays for Electrical and Industrial Use

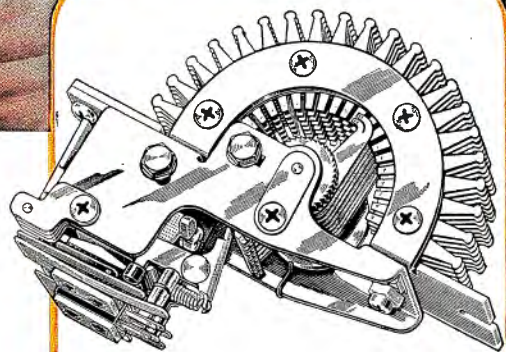

### SPECIFICATIONS

#### OPERATION

Automatic, or remote-controlled.

#### WIPERS

One to eight, traversing individual contact levels.

#### INTERRUPTER SPRINGS

Usually Form 1B, to open operating current at the end of each step. As many as eight contact springs may be provided. Contacts: single.

#### OPERATE SPEED

Remote-controlled operation—30 steps per second maximum; Self cycling operation—60 steps per second average.

#### FINISH

Framework and armature—cadmium; Bank contacts and wipers—phosphor bronze.

#### SIZE

Overall length—5 5/16"; width—2"; height—4 3/16".

# Highlights in THE 1946 Jensen LINE

★ *Hypex*  
PROJECTORS

★ **COAXIAL**  
SPEAKERS

★ *Speech Master*  
REPRODUCERS

★ *Bass Reflex*  
REPRODUCERS

★ **HYPEX Projectors** better than ever—more efficient. They have the famous Hypex "flare formula"—not exponential—developed by Jensen acoustical research. Driver units employ the Jensen "Annular" diaphragm, clamped at periphery and center—another exclusive feature!

★ **COAXIAL Speakers.** Now four improved 15" and 12" designs for high-fidelity, extended-range reproduction. High-frequency Control provides instant fidelity adjustment to suit program quality and listener preference. Available in complete Reproducers.

★ **SPEECH MASTER Reproducers.** Designed especially for crisp highly-effective speech reproduction. Desk-, panel-, wall-mounting types in power ratings for low-level and high-level applications.

★ **BASS REFLEX\* Reproducers.** A complete line of reproducers with speaker installed, or enclosures only, in fine furniture or utility styles—all with the smoothly extended low-frequency range for which Jensen Bass Reflex is justly famous.

\*Trade Mark Registered

These are only a few of the many distinguished products in the complete Jensen line. Write for catalogs and data sheets for further information.

JENSEN MANUFACTURING COMPANY

6603 S. LARAMIE AVE., CHICAGO 38, ILLINOIS  
In Canada—Copper Wire Products, Ltd. 11 King Street West, Toronto

**Jensen**  
SPEAKERS  
WITH  
**ALNICO 5**

*Specialists in Design and Manufacture of Acoustic Equipment*



THE COUNTERSIGN OF DEPENDABILITY IN ANY ELECTRONIC EQUIPMENT

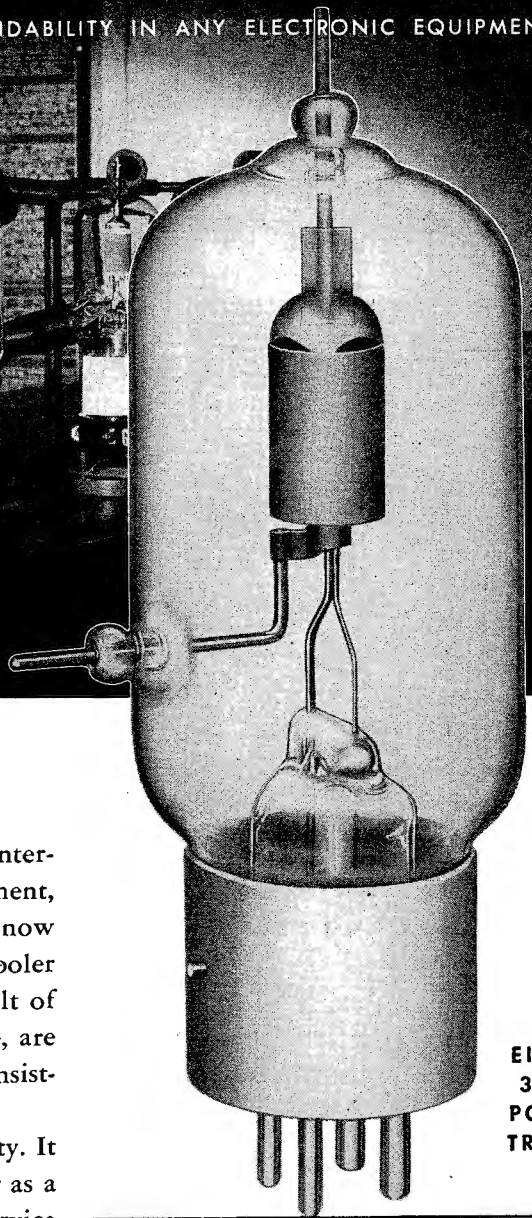
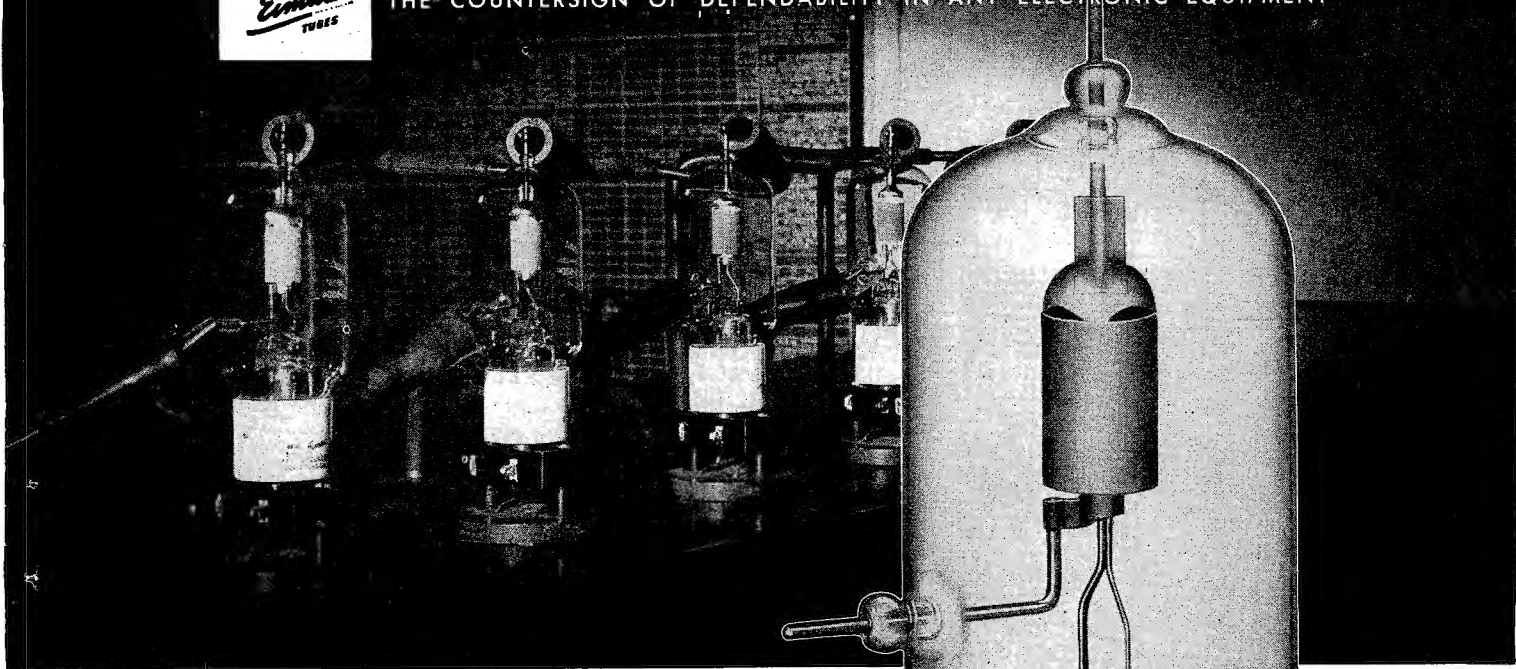

## A BETTER 35TG

The famous Eimac 35TG VHF tube, with its low inter-electrode capacitances, its logical terminal arrangement, its lack of internal hardware, *is further improved*. It now has a non-emitting grid, an improved filament, and a cooler operating plate. These improved elements, the result of wartime developments in manufacturing technique, are being incorporated in many Eimac tubes and are consistently resulting in vastly increased life.

The 35TG is a power triode of wide applicability. It will function as a Class-C oscillator or amplifier, or as a Class-B audio or supersonic amplifier, and in such service will give excellent performance, due to its stability and low driving-power requirements.

Longer operating life is but one of the many advantages afforded by Eimac tubes. It will pay you to keep informed... see your nearest Eimac representative today, or write direct.

Follow the leaders to



**EITEL-McCULLOUGH, INC.**  
1229-F San Mateo Ave., San Bruno, Calif.  
Plant located at: San Bruno, California

Export Agents: Frazar and Hansen, 301 Clay Street, San Francisco 11, California, U. S. A.

**EIMAC  
35TG  
POWER  
TRIODE**

### ELECTRICAL CHARACTERISTICS

Filament: Thoriated tungsten		
Voltage . . . . .	5.0 volts	
Current . . . . .	4.0 amperes	
Amplification Factor (Average) . . . . .	39	
Direct Interelectrode Capacitances (Average)		
Grid-Plate . . . . .	1.8 uuf	
Grid-Filament . . . . .	2.5 uuf	
Plate-Filament . . . . .	0.4 uuf	
Transconductance ( $i_b = 100$ ma., $E_b = 2000$ V., $E_c = -30$ V.) . . . . .		2850 umhos
Frequency for Maximum Ratings . . . . .	100 mc	

### CALL IN AN EIMAC REPRESENTATIVE FOR INFORMATION

ROYAL J. HIGGINS (W9A10), 600 S. Michigan Ave., Room 818, Chicago 5, Illinois. Phone: Harrison 5948.

VERNER O. JENSEN, CO., 2616 Second Ave., Seattle 1, Washington. Phone: Elliott 6871.

M. B. PATTERSON (W5CI), 1124 Irwin-Keasler Bldg., Dallas 1, Texas. Phone: Central 5764.

ADOLPH SCHWARTZ (W2CN), 220 Broadway, Room 2210, New York 7, N. Y. Phone: Cortland 7-0011.

HERB BECKER (W6QD), 1406 S. Grand Ave., Los Angeles 15, California. Phone: Richmond 6191.

TIM COAKLEY (W1KKP), 11 Beacon Street, Boston 8, Massachusetts. Phone: Capital 0050.



LABORATORY INSTRUMENTS FOR SPEED AND ACCURACY

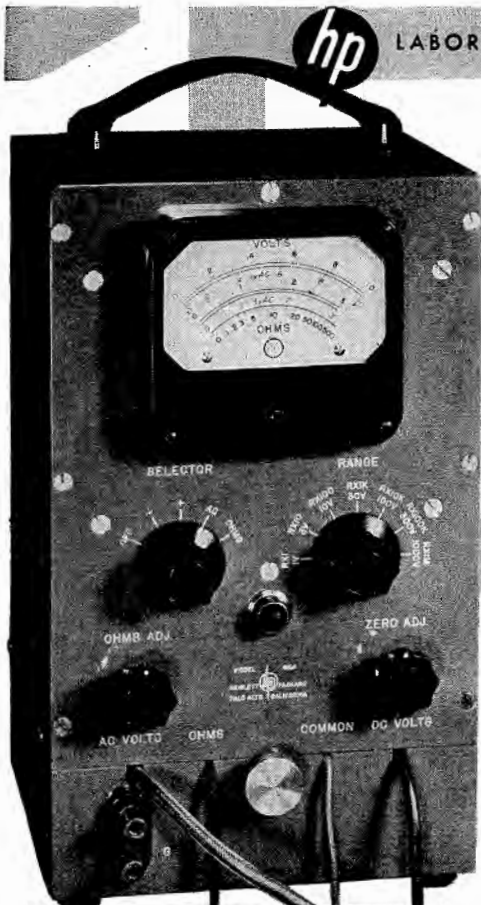

# Sensational New VACUUM TUBE VOLTMETER

20 cps to 700 Mc  
1.3 mmfd input capacity

...the instrument you have been waiting for!

-hp- Model 410A

Far surpassing any comparable instrument, this new *hp*- Model 410A High Frequency Vacuum Tube Voltmeter measures voltage over a wider frequency range, and at a higher input impedance than any previously available instrument.

The extremely high input impedance for ac measurements makes possible the testing of video and VHF amplifier circuits without disturbing the circuit under test. The 410A for the first time provides an instrument which will give accurate voltage measurement from audio frequency up through the micro wave regions.

The *hp*- Model 410A is the instrument the whole electronic industry has been looking for. Your early inquiry will be best assurance of prompt delivery. Write today for more complete information — prices — delivery dates.

## SPECIFICATIONS

### ac Measurements

Six ranges, full scale readings 1, 3, 10, 30, 100, and 300 volts.

Input impedance, 6 megohms in parallel with 1.3 uuf.

Frequency response, 20 cps to 700 mc  $\pm 1$  db.

### dc Measurements

Seven ranges, full scale readings 1, 3, 10, 30, 100, 300, and 1000 volts.

Input impedance, 100 megohms, all ranges.

### Resistance Measurements

Seven ranges, mid scale readings 10, 100, 1000, 10,000, 100,000 ohms, 1 megohm and 10 megohms. Accuracy:  $\pm 3\%$

The wide range of 410A is made possible by a special probe employing a diode developed by Eimac specifically for Hewlett-Packard. The probe has an input capacity of 1.3 micro-microfarads, and the input resistance is 6 megohms.

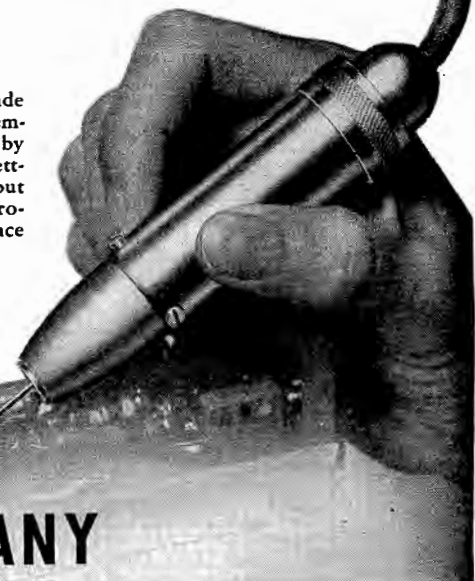

...another *hp* achievement!  
**HEWLETT-PACKARD COMPANY**

1159E PAGE MILL ROAD, PALO ALTO, CALIFORNIA, U. S. A.

# COMMUNICATIONS

LEWIS WINNER, Editor

AUGUST, 1946

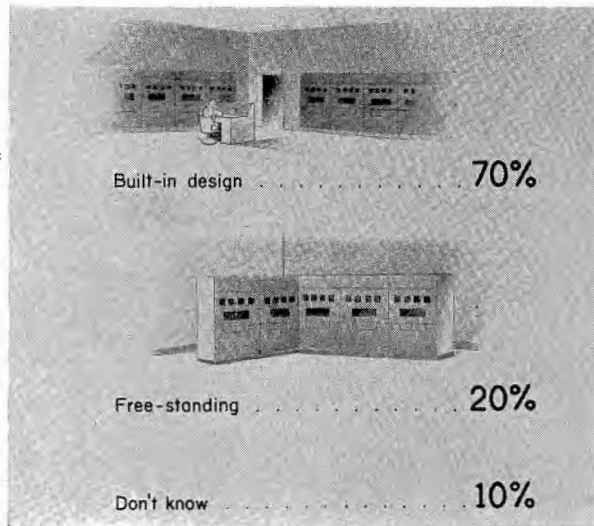
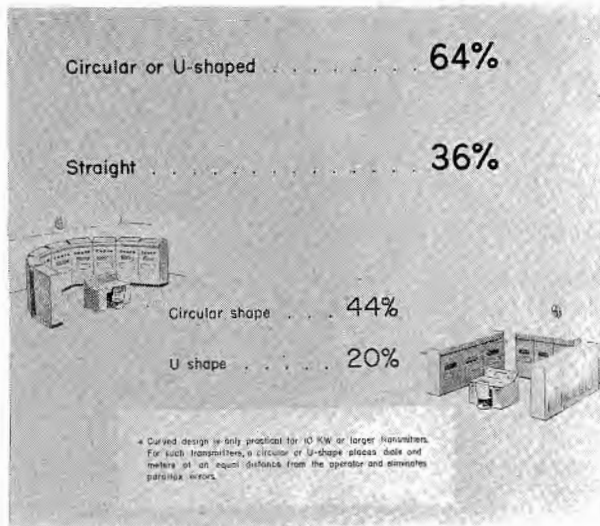

## BROADCAST TRANSMITTER DESIGNS As Determined by a Market Survey

by M. R. BRIGGS

Manager Broadcast Engineering, Industrial Electronics Division  
Westinghouse Electric Corporation

THE DESIGN OF A-M BROADCAST TRANSMITTERS has been, up until a few years ago, a matter of evolution. As many of you probably remember, the first transmitters were bread-board affairs, following amateur practice. Later, pipe framing was used to mount the equipment, with the location of control determined by the mounting of the particular piece. Meters were located wherever convenient. Further development brought forth the individual frame type of construction, with each major unit in a separate frame, the whole transmitter being

**Impartial Survey of Present and Future Managers and Operators of 24 F-M Stations on Air and 67 Soon to Go on Air Reveals Vital Equipment Cost, Service and Design Data.**

composed of the individual frames bolted together.

The latest a-m designs utilize cube type of construction with emphasis placed on accessibility, ease of operation and maintenance. These designs represent mostly the thoughts and ideas of the radio *design* engineer. If the engineer has had practical experience in the operation of a broadcast

transmitter, it is usually found reflected in the transmitter design.

With the advent of f-m, the design of f-m transmitters appeared not to follow the evolved standard practices of a-m transmitter construction. Circuits were complicated, equipment was reduced in size, and servicing became a major problem.

It was felt that a comprehensive

Above, left.  
Illustrating reply to inquiry regarding transmitter design inquiry.

Above, right.  
Illustrating reply to inquiry regarding preferences for a built-in or free-standing transmitter.

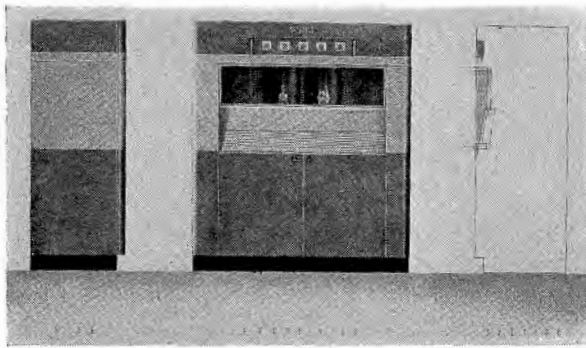

Proposed design for a 1-kw f-m transmitter, based on survey data.

survey conducted among managers and operators who had extensive f-m experience as well as those who, because of a broad broadcasting background, were familiar with the art, would indicate preferences and requirements directly affecting the design and construction of future f-m equipment. While the survey plans were particularly pointed towards f-m transmitter design, it was believed that many of the comments, preferences and suggestions would be applicable to a-m transmitter designs. The survey results proved that many of the design requirements had dual applications.

The survey, conducted by Cushing and Nevell under our auspices, covered 91 f-m stations and license applicants located in 56 cities and 22 states. Of the stations visited, 24 are presently operating f-m; 67 are prospective f-m operators. Personnel interviewed totalled 162, including 21 present managers, 51 future managers, 28 present operators and 62 future operators. (The term operators includes chief engineers as well as transmitter operators.)

Separate questionnaires, prepared for each of the four classifications of persons interviewed, solicited information and opinions concerning all phases of installations, management, operation and maintenance of f-m equipment. Questions were phrased either to obtain a direct *yes* or *no* response, or to invite opinions and suggestions which would indicate definite reactions and trends.

All persons interviewed showed keen interest in the survey, cooperated fully, and offered further assistance if desired. The majority of those interviewed wanted to be informed as to what manufacturer would eventually make use of the findings for the design of equipment. In no case, however, were we disclosed as the sponsor; as a matter of fact, in many cases the agents making the survey did not know for whom it was being done.

The survey contained three main

sections . . . *equipment, services, and general comments.* Questions, answers and suggestions within these sections were classified by subject matter.

#### Equipment

##### 1. Transmitter

Interviewed: *Future managers and operators.*

Question: *Will the transmitter station be open to visitors?*

Yes ..... 71%  
No ..... 18%  
Don't Know ..... 11%

Of the present operators interviewed on this subject, 55% stated that their f-m stations were open to visitors. Chief items of interest to visitors include general appearance, oscillograph, tubes, meters, antenna, and operational procedure.

Interviewed: *Future managers.*

Question: *What do you expect to pay for your complete installations?*

Price Estimate	Size of transmitter station					
	1 kw	3 kw	5 kw	10 kw	25 kw	50 kw
Don't know ...	3	3	1	6	1	4
\$ 15,000- 25,000	1	1	..	..	..	..
\$ 25,000- 30,000	..	2	..	..	..	..
\$ 30,000- 50,000	1	..	..	4	..	..
\$ 50,000- 75,000	1	..	..	7	..	..
\$ 75,000-100,000	1	2*	1	1	..	..
\$100,000-150,000	..	..	..	..	..	..
\$150,000-175,000	..	..	..	..	..	3
\$175,000-300,000	..	..	..	1	..	2

Interviewed: *Future operators.*

Question: *What power will be available at your transmitter?*

220 volts, 60 cycles, 3 phase ..... 65%  
230 volts, 60 cycles, 3 phase ..... 8%  
440 volts, 60 cycles, 3 phase ..... 6%  
Don't know ..... 21%

Interviewed: *Future operators.*

Question: *Will there be an alternate supply?*

No ..... 46%  
Own generator ..... 21%  
Two lines ..... 21%  
Don't know ..... 12%

\*This estimate includes cost of complete building.

Interviewed: *Future managers.*

Question: *What do you expect to pay for your transmitter?*

Price Estimate	Size of transmitter station					
	1 kw	3 kw	5 kw	10 kw	25 kw	50 kw
Don't know ...	4	4	2	8	1	5
\$ 5,000- 10,000	1	..	..	..	..	..
\$ 10,000- 15,000	2	4	..	..	..	..
\$ 15,000- 20,000	..	..	..	5	..	..
\$ 20,000- 25,000	..	..	..	6	..	..
\$ 25,000- 50,000	..	..	..	..	..	..
\$ 75,000-100,000	..	..	..	..	..	2
\$100,000-125,000	..	..	..	..	..	1
\$125,000-150,000	..	..	..	..	..	1

Interviewed: *Present managers and operators.*

Question: *When do you plan to buy new f-m equipment?*

Do not know ..... 28%  
5 years ..... 34%  
10 years ..... 8%  
10-15 years ..... 6%  
Not at all ..... 8%  
When more power is desired ..... 16%

Many of those planning to remodel intend to add more power to their station.

Interviewed: *Present and future managers and operators.*

Question: *Do you consider the appearance of the transmitter important?*

Yes ..... 89%  
No ..... 11%

The morale building feature of neat appearing equipment was greatly stressed by chief engineers and by managers. Appearance was also considered an important factor in stations open to visitors. Many managers and operators felt that the prestige of the station is enhanced by its appearance, and an impressive appearance helps convince an advertiser that a good job will be done for his product. However, others emphasized that looks help, but performance counts, and that appearance must not interfere with engineering.

Interviewed: *Future managers*

Question: *Do you favor a conventional or modern treatment in the design and layout of your station?*

Modern ..... 84%  
Conventional ..... 16%

Typical f-m transmitter designed in accordance with suggestions proposed during survey.



Interviewed: *Future managers and operators.*

Question: *Do you favor a built-in or free standing design and layout in your transmitter room?*

- Built-in ..... 70%
- Free standing..... 20%
- Don't know ..... 10%

Interviewed: *Future operators.*

Question: *Do you favor a straight, circular or a U-shaped design for your transmitter?*

- Circular ..... 44%
- Straight ..... 36%
- U-shaped ..... 20%

It was determined that circular or U-shaped design was only practical for transmitter larger than 10 kw. For such transmitters, a circular or U-shaped design places dials and meters at an equal distance from the operator and eliminates parallax errors.

Interviewed: *Future managers and operators.*

Question: *Do you have any preference about the use of color on your f-m equipment?*

- Yes ..... 96%
- Immaterial ..... 4%
- \*Grey ..... 32%
- Blue-grey ..... 30%
- Umber-grey ..... 13%
- Blue ..... 10%
- Green ..... 6%
- Brown ..... 3%
- Others ..... 6%

Other characteristics were: non-reflecting surface (8<sup>1</sup>); colors standardized for chain (4); non-reflecting glass (3); and no chrome (2).

\*Grey was used by many people in expressing a preference for blue-grey or umber grey.

Interviewed: *Future operators.*

Question: *Do you prefer a compact or roomy transmitter?*

- Roomy ..... 96%
- Compact ..... 4%

Storage space for spare parts and tools was requested by fourteen, space around hot equipment by three.

Roomy transmitters were preferred especially because they afford easy access to parts, and also permit better ventilating and more thorough cleaning. Engineers, operators and even managers of broadcasting stations were painfully aware of the lack of accessibility in their equipment and were definite in their opinion that future transmitters must be roomier.

Interviewed: *Present operators.*

Question: *Do you think that dust protection is important?*

- Yes ..... 71%
- No ..... 29%

More space to facilitate cleaning was requested by fifteen; use of the precipitron as standard equipment by nine; more efficient screens on blowers by four; and cleaning equipment as part of ventilating system by three.

Operators stressed dust protection, stating that a large percentage of repair and overhaul was due to dust and dirt.

Interviewed: *Present and future managers and operators.*

Question: *What features and special features would you like to have incorporated in your transmitter?*

Voluntary comments . . .

- Controlled tube cooling after shutdown (2).
- Point-to-point wiring (2).
- Better quality insulation (3).
- Sliding or rolling doors (3).
- Wireless link from studio (3).
- Legends for controls printed directly on panel (4).
- Manufacturer's name on nameplate (4).
- Diagrams on transmitter doors (5).
- Nameplate legends should be more legible (5).
- Standardized design for chain stations (5).
- Standardized tube sockets (5).
- Trough conduits instead of pipe conduits (5).
- Thermostatic control of ventilation (5)
- Provision for using tube heat-to-heat building (6).
- Greater accessibility to mounting nuts and bolts (7).
- Overload alarms (7).
- Sturdier and more accessible terminal connections (7).
- Diagrams on rollers or door panels (8).
- Micro-switch cut-off on doors (8).
- Thermometers as standard equipment in cubicle interior (8).
- Circuit breakers to replace fuses (10).
- Parts not in open vertical arrangement mounted on sliding shelves (11).
- Oscillograph (12).
- Trough lights on front of transmitter (14).
- Inside lights and outlets (15).
- Quieter operation of blower system (16).
- More adequate ventilation (19).

The general feeling was that circuit breakers give lower maintenance and less trouble than fuses. They also give a visual indication of trouble, and hence a quicker return to normal operation. Some operators suggested circuit breakers for all main circuits and fuses with neon lights for others. A total of 258 out of 274 operators and managers, however, preferred cir-

<sup>1</sup>Number of persons offering information.

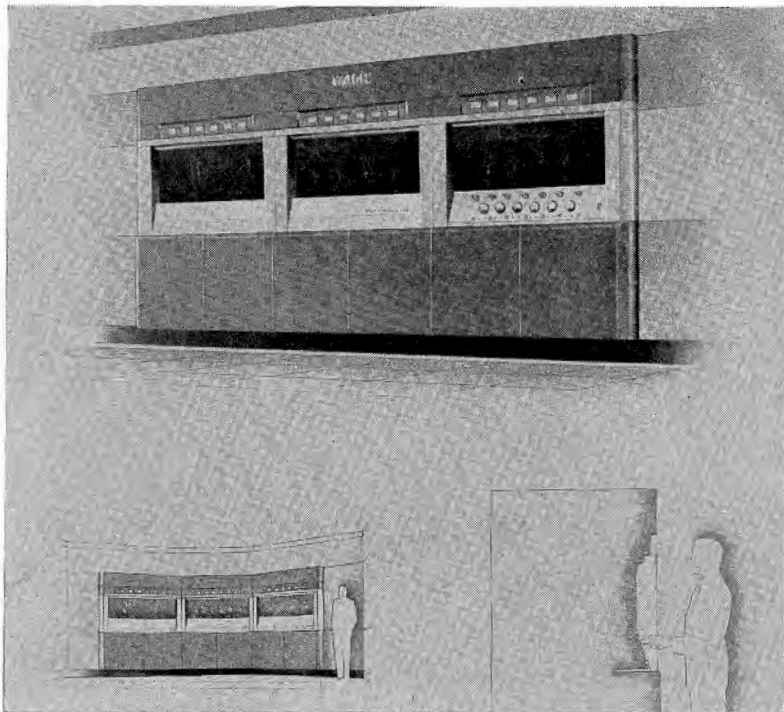

Proposed design for a 10-kw f-m transmitter, based on survey replies.

cuit breakers for overload protection.

## 2. Consoles

Interviewed: *Future operators.*

Question: *What shape console do you prefer?*

Curved ..... 48%  
 Flared sides ..... 40%  
 Straight ..... 12%

Approximately 50% of those interviewed stressed that operator's comfort should be taken into consideration.

Interviewed: *Present and future operators.*

Question: *What special features would you like to see on your console?*

Voluntary comments . . .

- Built-in clock (6).
- File drawer for FCC reports (7).
- Antenna light signal at console (8).
- Circuit indicator lights on console (9).
- Power light indicator (9).
- Provision for microphone on console (11).
- Adequate drawer space (16).
- Space for long-carriage typewriter (18).
- Swivel chair designed for console (20).
- Turntable on console (20).
- Space for log book (21).
- Built-in telephones (24).
- Adequate knee and leg room (40)

## 3. Controls

Interviewed: *Present and future operators.*

Question: *Where would you prefer to have your power controls?*

Console ..... 60%  
 Transmitter ..... 20%  
 Both ..... 20%

Question: *Where would you like to have your r-f controls?*

Transmitter ..... 60%  
 Console ..... 34%  
 Both ..... 6%

Other featured included . . . guarded controls (8); controls requiring vernier adjustment to be at transmitter, locked (7); concealed transmitter controls (5); console controls grouped according to functions (3).

Interviewed: *Future operators.*

Question: *Do you prefer manual or automatic controls?*

Manual ..... 43%  
 Automatic ..... 39%  
 Both ..... 18%

## 4. Meters

Interviewed: *Present and future operators.*

*Voluntary comments:*

- Black faces (4).
- Monitor meters visible from console (5).
- Non-reflecting glass on meters (6).
- More meters (7).
- Sloped meters (7).
- Duplicate meters on console (8).
- Every important circuit to be individually metered (10).
- Meters at eye level (16).

- Illuminated faces (19).
- Stainless faces (20).
- Larger faces on meters (25).

## 5. Tubes

Interviewed: *Future managers and operators.*

Question: *Do you think the tubes should be visible?*

Yes ..... 96%  
 No ..... 4%

Operators stressed the importance of visible tubes for operational procedure while the managers stated that station visitors would be interested in seeing the tubes.

Interviewed: *Present and future operators.*

Question: *Do you prefer air-cooled or water-cooled tubes?*

Air-cooled ..... 94%  
 Water-cooled ..... 6%

Others wanted . . . Stand-by (spare) tubes wired to switch into circuit (12); easier tube replacement (8); life of tube guaranteed (5); provide means for using tube heat to heat building (5); standardized tube socket (4); tubes individually metered (3).

Air cooled tubes were preferred because they are less messy and do away with complicated water system plumbing, electrolysis, and sweating. They give less mechanical difficulty, are clean, economical, easy to maintain and compact. Those who spoke out for water-cooled tubes, however, felt that over 5 kw the necessary blowers and fans cost as much to maintain as a water system.

## 6. Monitors

Interviewed: *Future operators.*

Question: *Should the frequency and modulation monitors be incorporated in the transmitter or furnished as a separate unit?*

Separate ..... 57%  
 Incorporated ..... 43%

Separate units were preferred because they eliminate shielding difficulties. Of those favoring separate units, approximately 25% suggested that the monitors be incorporated in the console. Five said that monitor meters should be visible from console.

## 7. Antenna

Interviewed: *Future operators.*

Question: *Do you require any special type of f-m antenna?*

No ..... 71%  
 Yes ..... 22%  
 Don't know ..... 7%

Others wanted . . . directional an-  
 (Continued on page 44)



# COIL DESIGN

by **SAMUEL SABAROFF**

Transmitter Engineer, WCAU  
Consultant, Barker and Williamson

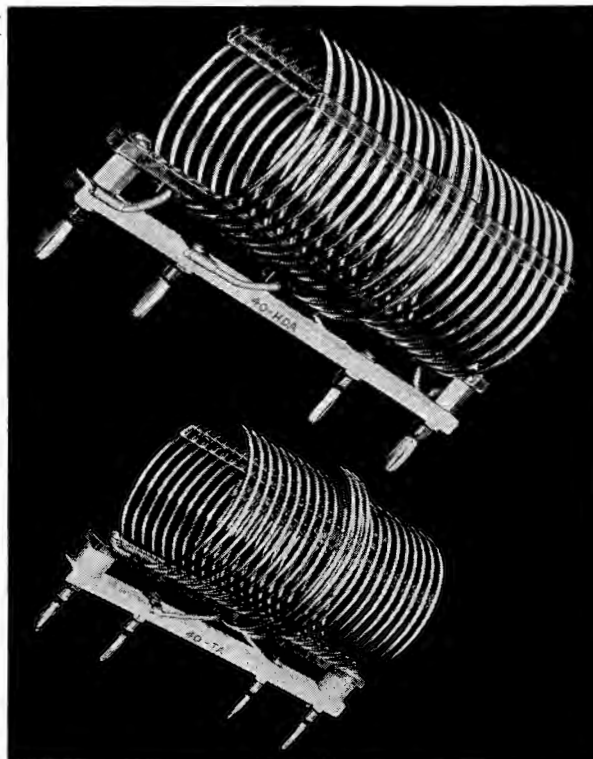

$$X_P = \frac{ZQ}{(1+Q^2)} = 200 \text{ ohms} \quad (a)$$

$$X_{P0} = X_P \frac{(Q_P + Q_S)}{Q_P} = 201.3 \text{ ohms} \quad (b)$$

$$Q_{S2} = \frac{Q_S Q_{S1}}{Q_{S1} - Q_S} = 0.202$$

$$X_S = R_{S2} Q_{S2} = 101.5 \text{ ohms} \quad (c)$$

$$E_P = \frac{Q}{Q_P} = 0.94$$

$$W_P = (1 - E_P) W = 60 \text{ watts} \quad (d)$$

$$E_S = \frac{Q_S}{Q_{S2}} \rightarrow 1.0$$

$$W_S = (1 - E_S) E_P W \rightarrow 0 \quad (e)$$

$$E = E_P E_S = 0.94 \quad (f)$$

$$e_P = \sqrt{Z W} = 2450 \text{ volts} \quad (g)$$

$$e_S = \sqrt{R_{S2} (W - W_S - W_P)} = 685.6 \text{ volts} \quad (h)$$

$$I_P = \frac{e_P}{X_P \sqrt{Q^2 + 1}} = 12.25 \text{ amperes} \quad (i)$$

$$I_S = \frac{e_S}{R_{S2}} = 1.37 \text{ amperes} \quad (j)$$

$$X_C = \frac{Z}{Q} = 200 \text{ ohms} \quad (k)$$

The necessary design requirements for a link-coupled coil have now been determined. The next step is a consideration of the practical attainment of such a coil. Such consideration may

## An Analysis of a Procedure Used to Determine the Design Requirements of Link-Coupled Coils with Resistance Loads.

show the necessity of a re-estimate of the original assumptions for  $Q_{P0}$ ,  $K$  and  $Q_{S1}$ . Repeated application of the foregoing design procedure will then be necessary until a more practical set of values has been derived.

An important practical factor of a link-coil assembly is its efficiency. The efficiency is the ratio of the power output to the power input. For best efficiency then, the power lost in transfer should be a minimum. Any material in the field of the coil tends to absorb power and thus reduce the amount available. A type of construction with a minimum of material in the coil field is therefore desirable for maximum efficiency.

The source of heat in a coil assembly can be separated into two distinct parts; that due to the ohmic losses of the coil itself, and that due to the power absorption by the coil supports. In a properly designed coil,

the supporting framework is a minimum consistent with the required mechanical strength.

Losses in the coil supports can become serious at the higher frequencies. At these frequencies, self-supporting coils must be used, or else the coil field is so oriented that it encloses a minimum of supporting material. Generally, the amount of power absorbed by the coil supports is a small fraction of the total power handled and has a minor effect on the overall efficiency.

Heat in a well designed coil is due to the ohmic loss in the wire itself. When this is true, the coil dissipation for a safe temperature rise may be determined by measurements made with a 60-cycle exciting current.

### Appendix I

A theoretical justification for the foregoing design procedure is presented in this appendix.

In an inductively-coupled arrange-

See appendix 2 for a nomogram (Figure 4) for these expressions.

ment with resistance load, the effective primary reactance is

$$X_P = X_{P0} - \frac{X_M^2 X_S}{X_S^2 + (R_{S1} + R_{S2})^2} \quad (1)$$

and the increase in primary resistance is

$$R_P = \frac{X_M^2 (R_{S1} + R_{S2})}{X_S^2 + (R_{S1} + R_{S2})^2} \quad (2)$$

The expression for the unloaded primary reactance in terms of the loaded primary reactance may be found by eliminating  $X_M$  from equations (1) and (2), obtaining

$$X_{P0} = X_P \left( \frac{Q_P + Q_S}{Q_P} \right) \quad (3)$$

The loaded primary  $Q$  is defined as

$$Q = \frac{X_P}{R_{P0} + R_P} \quad (4)$$

This may be written as

$$\frac{1}{Q} = \frac{1}{Q_{P0}} + \frac{1}{Q_P} \quad (5)$$

Substituting equation (3) in (5) and solving for  $Q_P$ , we have

$$Q_P = \frac{Q (Q_{P0} + Q_S)}{Q_{P0} - Q} \quad (6)$$

The value for  $Q_{P0}$  is usually more than 300, while  $Q_S$  is generally less than unity. Thus when  $Q_S \ll Q_{P0}$ , equation (6) is finally

$$Q_P = \frac{Q Q_{P0}}{Q_{P0} - Q} \quad (7)$$

The coefficient of coupling is defined as

$$K^2 = \frac{X_M^2}{X_{P0} X_S} \quad (8)$$

Since  $Q_P = X_P/R_P$  and  $Q_S = X_S/(R_{S1} + R_{S2})$ , equations (1), (2) and (8) may be combined into

$$Q_P = \frac{1 + Q_S^2 (1 - K^2)}{Q_S K^2} \quad (9)$$

Solving equation (9) for  $Q_S$  we have

$$Q_S = \frac{2}{Q_P K^2 \pm \sqrt{Q_P^2 K^4 - 4(1 - K^2)}} \quad (10)$$

$Q_P$  can be considered to be an auxiliary variable, useful for calculating purposes.

An expression for  $Q_S$  in which  $Q_P$  is not used, can be obtained from equations (1), (2) and (8). This is

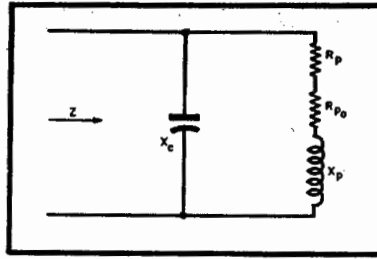

Figure 3  
Equivalent primary circuit.

$$Q_S = \frac{2 \left( \frac{Q_{P0} - Q}{Q_{P0}} \right)}{Q K^2 \pm \sqrt{Q^2 K^4 - 4 \left( \frac{Q_{P0} - Q}{Q_{P0}} \right) \left[ \left( \frac{Q_{P0} - Q}{Q_{P0}} \right) - K^2 \right]}} \quad (11)$$

There is little practical difference between equations (10) and (11).

Analyzing equation (10) we find that  $Q_S$  is double valued. This confirms the fact that there are two values of secondary reactance which will give the required value of  $Q_P$  when the coefficient of coupling is fixed. It may also be noticed that  $Q_S$  becomes imaginary when the quantity in the radical of equation (10) becomes negative.

Practically, this means that a desired loading will not always be obtained by increasing the number of turns in the secondary. In fact, loading will increase and then decrease as the secondary inductance is increased. The criterion for the possibility of a solution is found by determining the condition necessary to keep the quantity in the radical of (10) always positive.

This is found to be

$$Q_P \geq \frac{2}{K^2} \sqrt{1 - K^2} \quad (12)$$

It is practical to keep the secondary reactance at a minimum, so that the smaller of the two values of  $Q_S$  should be taken as a solution. Thus

$$Q_S = \frac{2}{Q_P K^2 + \sqrt{Q_P^2 K^4 - 4(1 - K^2)}} \quad (13)$$

The primary efficiency is

$$E_P = \frac{R_P}{R_{P0} + R_P} \quad (14)$$

By means of equations (4) and (14), the primary efficiency becomes

$$E_P = \frac{Q}{Q_P} \quad (15)$$

The power dissipated in the primary is then

$$W_P = (1 - E_P) W \quad (16)$$

The effective secondary  $Q$  is defined as

$$Q_S = \frac{X_S}{R_{S1} + R_{S2}} \quad (17)$$

Remembering that  $Q_{S1} = X_S/R_{S1}$ , and  $Q_{S2} = X_S/R_{S2}$ , equation (17) becomes, after solving for  $Q_{S2}$ ,

$$Q_{S2} = \frac{Q_S Q_{S1}}{Q_{S1} - Q_S} \quad (18)$$

The secondary reactance is then

$$X_S = R_{S2} Q_{S2} \quad (19)$$

The secondary efficiency is

$$E_S = \frac{R_{S2}}{R_{S1} + R_{S2}} \quad (20)$$

Dividing the right hand side of equation (20) through by  $X_S$ , we have

$$E_S = \frac{Q_S}{Q_{S2}} \quad (21)$$

The power dissipated in the secondary is

$$W_S = (1 - E_S) E_P W \quad (22)$$

The overall efficiency is the product of the primary and secondary efficiencies

$$E = E_P E_S \quad (23)$$

The equivalent primary circuit is shown in Figure 3. For unity power factor, it can be shown by ordinary circuit theory that

$$Z = X_P \frac{(1 + Q^2)}{Q} \quad (24)$$

so that

$$X_P = Z \frac{Q}{(1 + Q^2)} \quad (25)$$

and

$$X_C = \frac{Z}{Q} \quad (26)$$

From power considerations, the primary voltage is

$$E_P = \sqrt{Z W} \quad (27)$$

The primary current is determined by finding the primary impedance and

(Continued on page 45)

# FAST, ACCURATE, FIELD-STRENGTH MEASUREMENTS

FOR STANDARD AM BROADCAST FREQUENCIES



## with FEDERAL'S FIELD INTENSITY METER

For radio broadcast station engineering consultants, service or field men—

- for measuring radiation patterns of directional antennas
- for checking power characteristics of transmitters by radiation measurement
- for locating the best area for installation of radio stations or antennas

Federal's compact, light-weight, field intensity meter, Type FTR-101C, is a sturdy and highly accurate instrument—readily portable and quickly set up for operation. It permits precision measurements of field strengths from 20 microvolts to 10 volts per meter, over a frequency range of 200 to 400 and 530 to 7000 kc. Built-in coils, changed by a single control switch, cover the entire range—no plug-in coils are used. To assure more rapid and accurate indications, a vacuum-tube voltmeter is used instead of a thermocouple instrument.

The antenna loop for the broadcast band is built into the cover, and is electrostatically shielded to prevent interference from body capacity. A single control tunes the loop and two oscillators in one operation.

Measurements may be taken from an automobile while it is in motion, by connecting the set to a rod antenna by means of a transmission-line adapter, available on order.

Write Department B110 for complete descriptive and performance data.



### Easy to Carry!

Complete set weighs only 29 pounds, including power pack or light weight batteries. Ready for carrying, set is only 15 inches long, 11 inches high and 9 inches deep.



### Easy to Set Up!

Meter can be unpacked, set up, and in service in a matter of seconds. The case is light enough to be mounted on a tripod for easier field operation, and includes a tripod socket for this purpose. It also has rubber feet and can be set on any level surface.



## Federal Telephone and Radio Corporation

Newark 1, New Jersey



In Canada:—Federal Electric Manufacturing Company, Ltd., Montreal  
Export Distributor:—International Standard Electric Corporation

# LINK-COUPLED

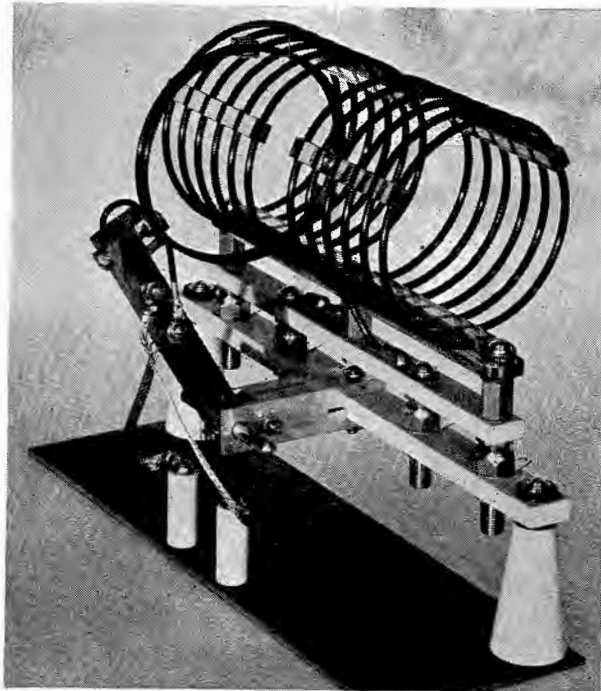
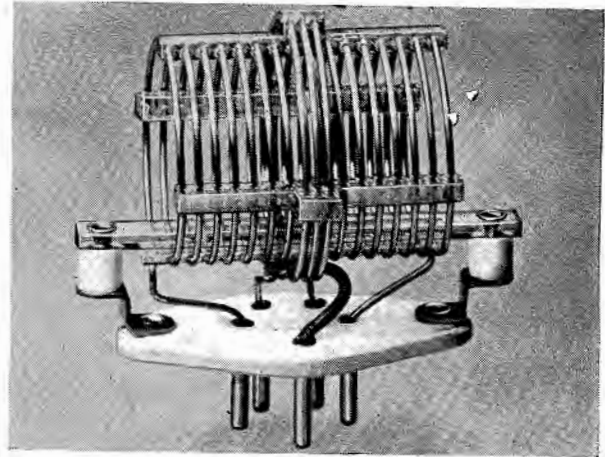

Figure 2 (left, below, extreme right)  
Examples of link-coupled coils.



LINK-COUPLED COILS with resistance loads are extensively used for transferring power from one circuit to another. In designing such coils, information gathered from past experiences and practice will prove very helpful. With these data as a base we can proceed to determine many pertinent coil-design factors.

The initial information that should be available includes a mental picture of the possible physical construction, probable primary and secondary  $Q$ , coefficient of coupling, input impedance, operating  $Q$ , input power and load resistance. With these factors known, we can determine such quantities as: effective and actual primary reactance, secondary reactance, power dissipation, overall efficiency, primary and secondary current and voltage; capacitive tuning reactance, etc.

In Figure 1 appears a typical link-coupled arrangement, in which:

- $Z$  = input impedance
- $X_c$  = capacitive tuning reactance
- $R_{P0}$  = intrinsic primary resistance
- $X_{P0}$  = intrinsic primary reactance
- $X_M$  = mutual reactance
- $R_{S1}$  = intrinsic secondary resistance
- $X_{S1}$  = intrinsic secondary reactance
- $X_S$  = secondary reactance
- $R_{S2}$  = resistive secondary load

Design conditions which must be known are:

- $Z$  = input impedance
- $R_{S2}$  = load resistance
- $Q$  = effective operating  $Q$
- $W$  = input power

Factors that must be estimated are:

- $Q_{P0}$  = intrinsic primary  $Q$
- $Q_{S1}$  = intrinsic secondary  $Q$
- $K$  = coefficient of coupling

Quantities that must be determined are:

- (a)  $X_P$  = effective primary reactance
- (b)  $X_{P0}$  = actual primary reactance
- (c)  $X_S$  = secondary reactance
- (d)  $W_P$  = power dissipated in primary
- (e)  $W_S$  = power dissipated in the secondary
- (f)  $E$  = overall efficiency
- (g)  $e_P$  = voltage across primary
- (h)  $e_S$  = voltage across secondary
- (i)  $I_P$  = primary current
- (j)  $I_S$  = secondary current
- (k)  $X_C$  = capacitive tuning reactance

Definitions and additional symbols used in the design procedure include:

- $R_P$  = resistance reflected into primary due to load on secondary
- $Q_P = X_P/R_P$  = loaded primary  $Q$  with primary losses neglected
- $Q_{P0} = X_{P0}/R_{P0}$  = intrinsic primary  $Q$

Figure 1  
Link-coupled coil arrangement.

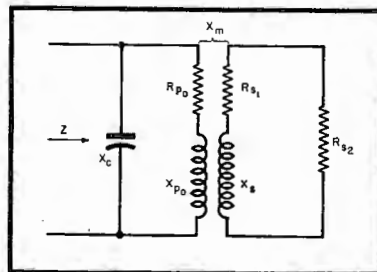

- $Q = X_P/(R_P+R_{P0})$  = loaded primary  $Q$
- $E_P$  = primary efficiency
- $Q_S = X_S/(R_{S1} + R_{S2})$  = effective secondary loaded  $Q$
- $Q_{S1} = X_S/R_{S1}$  = intrinsic secondary  $Q$
- $Q_{S2} = X_S/R_{S2}$  = loaded secondary  $Q$  with secondary losses neglected
- $E_S$  = secondary efficiency

## Example

Let us assume that

- $Q = 30$
- $Z = 6000$  ohms
- $R_{S2} = 500$  ohms
- $W = 1000$  watts

And it is estimated that

- $Q_{S1} = 300$
- $K = 0.4$
- $Q_{P0} = 500$

Now let us follow through with the design procedure:

$$Q_P' = \frac{Q Q_{P0}}{Q_{P0} - Q} = 31.9^*$$

In the above expression, it is assumed that  $Q_S \ll Q_{P0}$ , which is practically true.

$$Q_S = \frac{2}{Q_P K^2 + \sqrt{Q_P^2 K^4 - 4(1-K^2)}} = 0.202^*$$

A requirement for the possibility of a solution is that the value for  $Q_S$  is real. That is, the quantity in the radical must be positive.

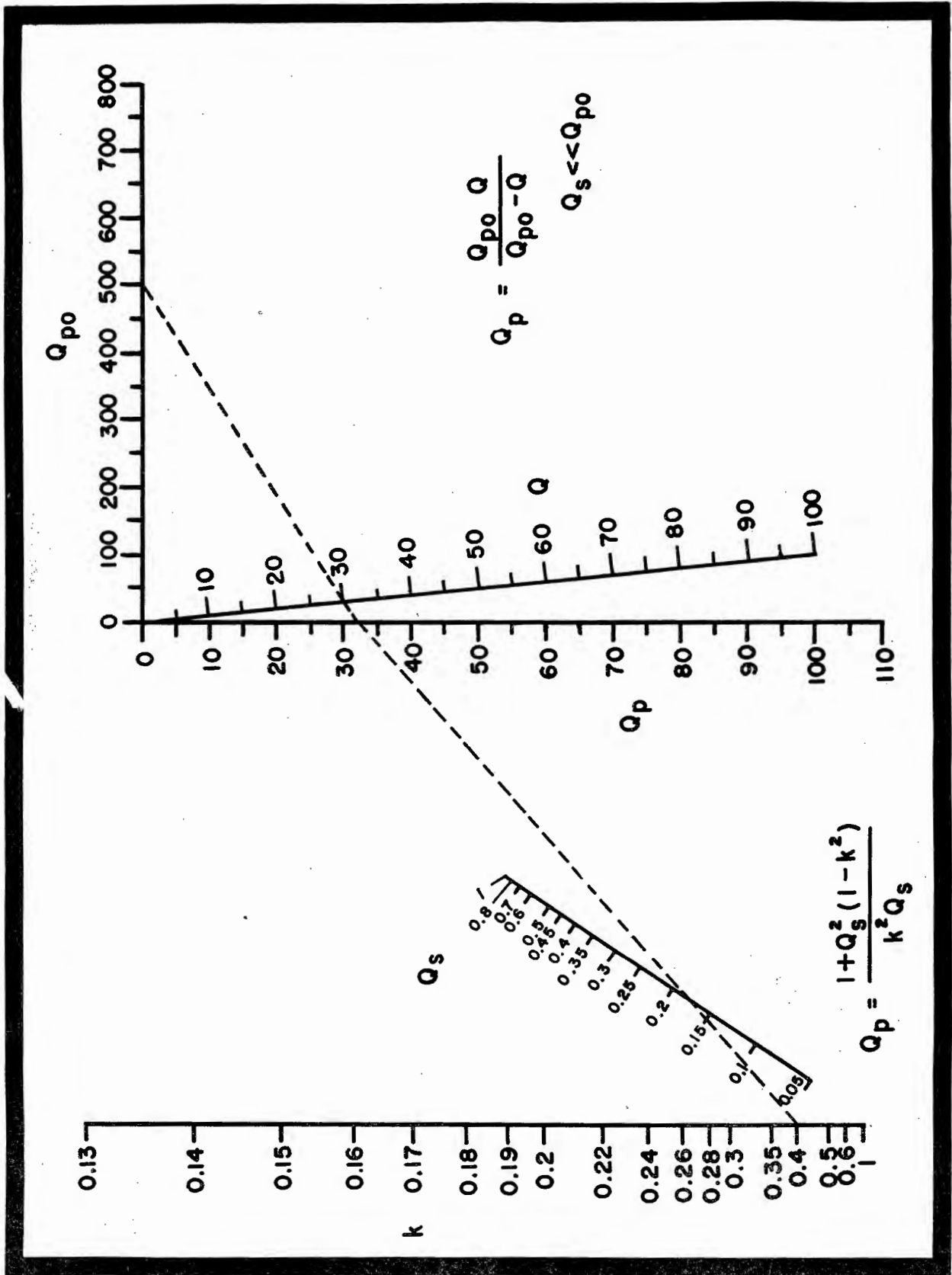

Figure 4

Nomogram for link-coupled coil design, with resistance load. Line on which  $Q$  is plotted can be considered as an auxiliary tuning line. Dotted line represents problem considered in paper.

# BROADCAST STATION ALARM

## System for Carrier and Program Failures

TO REDUCE OUTS, or time off the air, to a minimum, carrier or program-failure alarms<sup>1</sup> have been found quite effective. They are particularly useful at the smaller station, permitting the operator to perform many extra duties around the transmitter room, such as servicing and maintaining auxiliary equipment.

These alarms usually provide aural notice at the transmitter, and a visual signal at the studio control room. In a system developed for use at WSAN, the alarm bell circuit was arranged so that the bell at the transmitter continues to ring until released. This notifies the operator to investigate the failure, even though normal operation may have been resumed. To alert announcers at the studio a light remains lit, even though the program continues normal, until the bell is released at the transmitter.

### The Circuit

A 1V is used to rectify the modu-

**Alarm System, to Minimize Time off Air, Provides Aural Signal at Transmitter and Visual Indication at Studio Control Room When Carrier or Program Fails, Alerting Operator and Announcer.**

by **RUSSELL R. TAYLOR**  
Chief Operator, WSAN

lated carrier. After the r-f is filtered out, the a-f component passes through a 6J7 limiting stage to be rectified again by a 6H6. This supplies a control voltage for a 6C5 relay tube across an RC circuit, composed of a 4-mfd capacitor and three separate resistors, selected by a three-point switch (SW<sub>3</sub>, Figure 1). Capacitor discharge across these three resistors determines the

<sup>1</sup>E. J. O'Brien, COMMUNICATIONS; August, 1942.

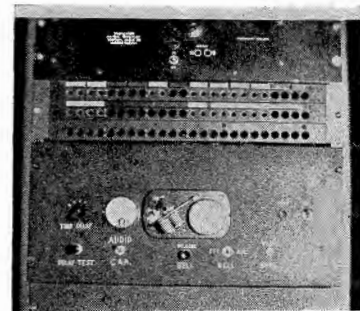

Figure 2  
Alarm unit in rack with alarm bell cover removed.



Figure 3  
Rear view of alarm unit.

Figure 4  
Rear view of unit with cover of timing assembly removed.

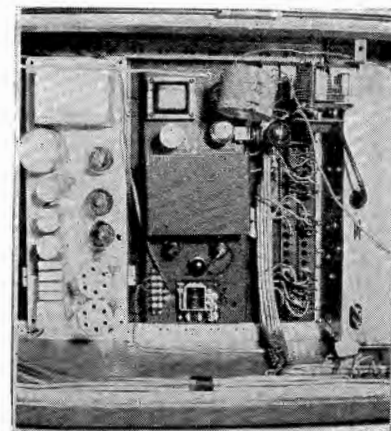
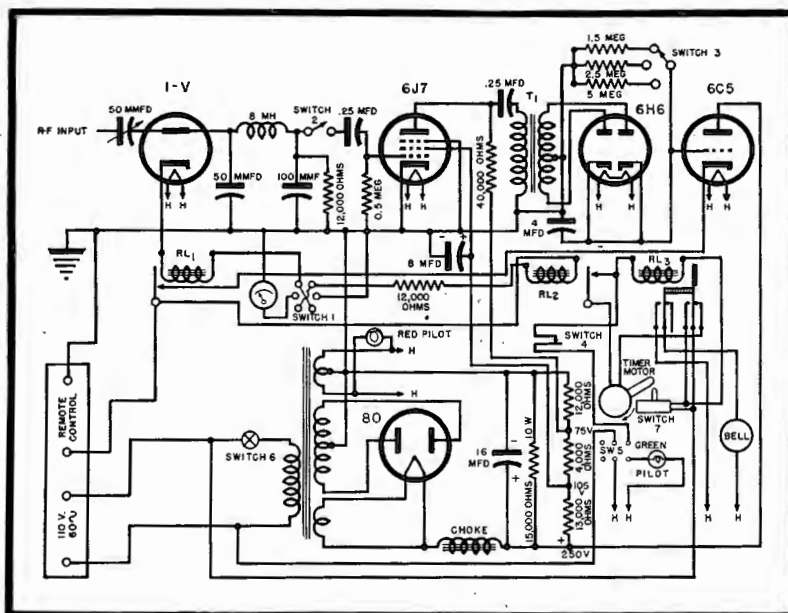
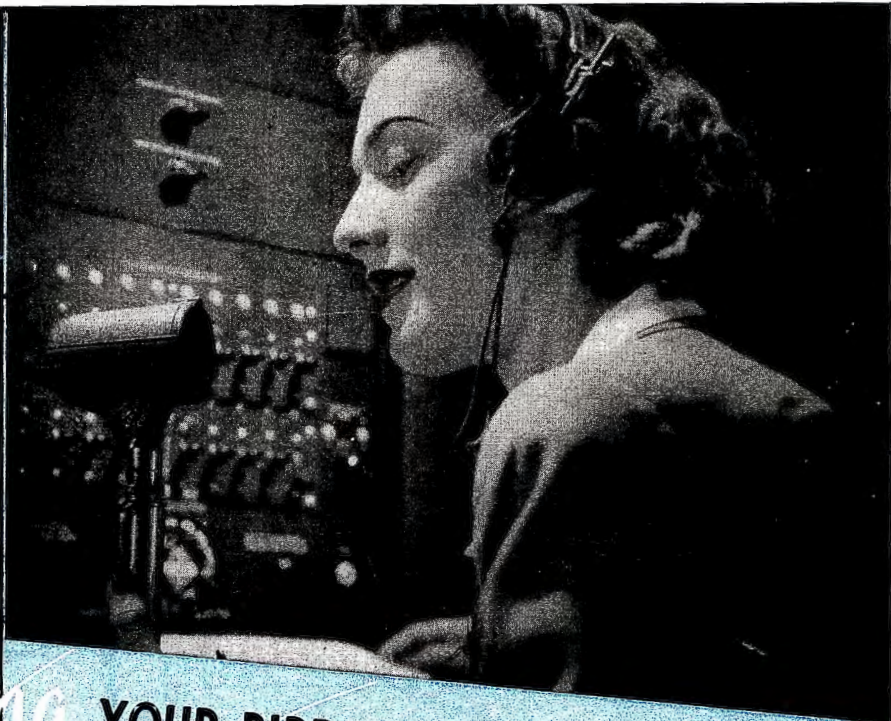
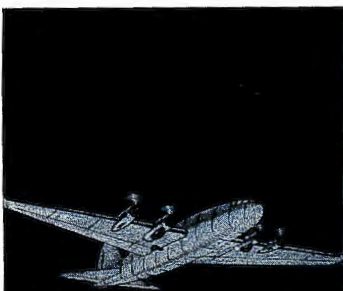

Figure 1

Circuit of the carrier and program-failure alarm system used at WSAN. SW<sub>2</sub> and SW<sub>4</sub> are push-button switches; SW<sub>1</sub> and SW<sub>5</sub>, d-p-d-t toggle switches; SW<sub>3</sub>, 3 point rotary switch; SW<sub>6</sub>, s-p-s-t toggle switch; SW<sub>7</sub>, microswitch; T<sub>1</sub>, push-pull input transformer; RL<sub>1</sub> and RL<sub>2</sub>, sensitive relays; RL<sub>3</sub>, 110 volt a-c d-p-d-t relay.





Bringing

## YOUR BIRDS HOME TO ROOST

Dependable communication between planes and airports is yours with Wilcox radio equipment. Its high performance is but one of many virtues. Economy, convenience, easy maintenance, and protection against frequency obsolescence are provided through extensive research, careful assembly, and thorough testing. Check the features of the Wilcox Type 99A Transmitter and see what they mean to you.



**★ Four transmitting channels, in the following frequency ranges:**

- 125-525 Kc. Low Frequency
- 2-20 Mc. High Frequency
- 100-160 Mc. Very High Frequency
- Other frequencies by special order

**★ Simultaneous channel operation, in following maximum combinations:**

- 3 Channels telegraph
- 2 Channels telephone
- 1 Channel telephone, 2 Channels telegraph

**★ Complete remote control by a single telephone pair per operator**

**★ 400 Watts plus carrier power**

**★ REMOVABLE R.F. HEADS** are protection against frequency obsolescence. All connections to the transmitter are by means of plugs and receptacles. Instant removability means quick and easy maintenance.

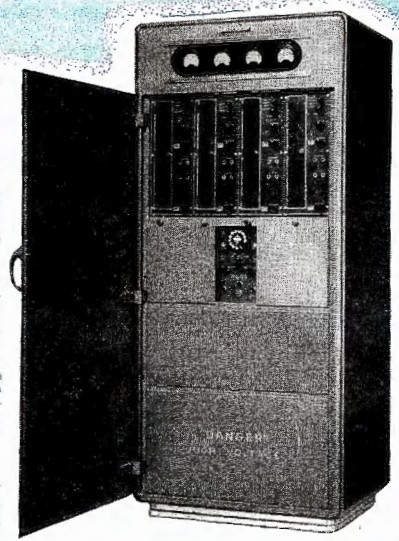

WRITE FOR COMPLETE INFORMATION

**WILCOX ELECTRIC COMPANY, INC.**  
KANSAS CITY, MISSOURI

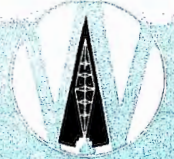

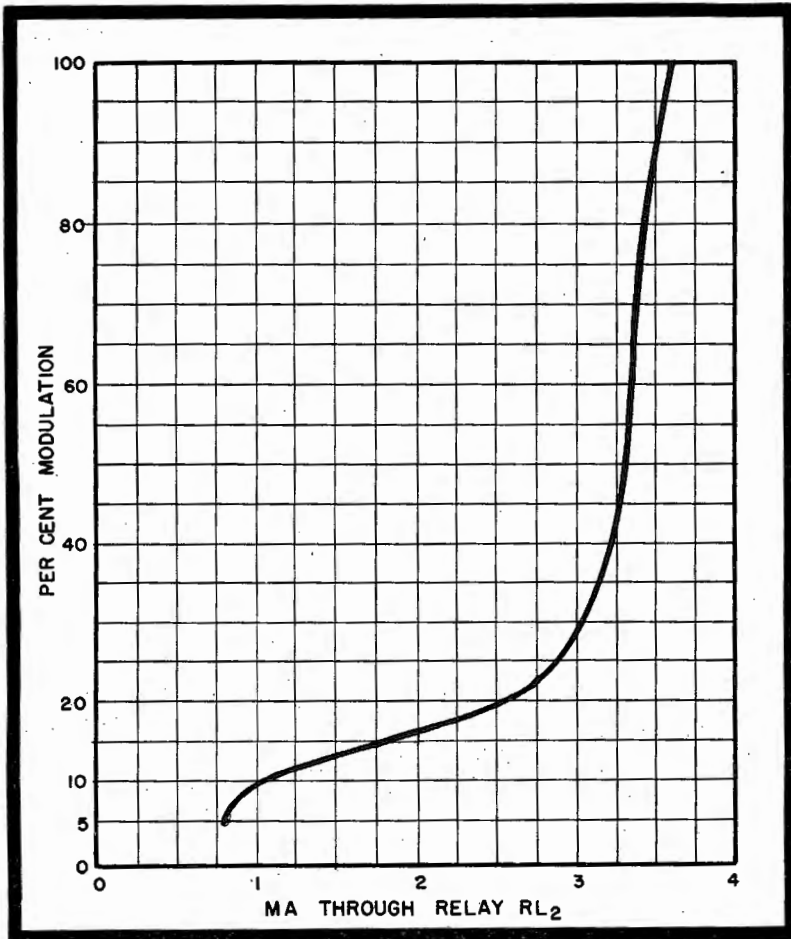

Figures 6 (above) and 7 (below)

Figure 6, current through RL<sub>2</sub> plotted against modulation percentage, with a rectifier current of 5 ma flowing through the IV. Figure 7, rate of decay of current through RL<sub>2</sub> plotted against time for various switch positions.

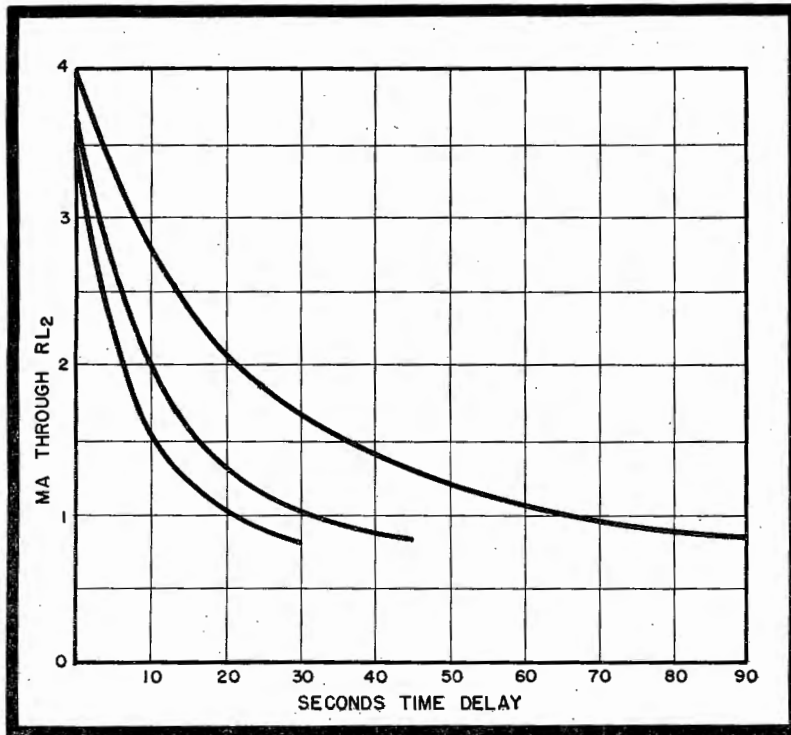

time for a 6C5-cathode relay, RL<sub>2</sub>, to drop out, thereby causing the alarm to sound. Since the relay directly controls the operation of the alarm, the current through RL<sub>2</sub> passes through the contacts of a carrier relay, RL<sub>1</sub>. Therefore if the carrier fails, it has control over RL<sub>2</sub>, operating the alarm on either carrier or program failure. When there is no modulation, the grid of the 6C5 is at zero potential, thus allowing, after proper adjustment, the relay, RL<sub>2</sub>, to drop out at .8 milliamperes. When modulation is applied, a positive potential is built up across the RC-timing circuit, thereby causing the 6C5-cathode current to increase and pull up the RL<sub>2</sub> armature. When a release button, SW<sub>4</sub>, is depressed, the alarm circuit can be then shut off.

This alarm also features an alarm-bell silencer, using a switch, SW<sub>5</sub>, and timing motor and relay, RL<sub>3</sub>. This permits the bell to be silenced, while searching for troubles.

#### Remote Relay

A 6C5-relay system, Figure 2, was developed for studio use. In this system the control voltage is obtained from the 6C5 in the transmitter. This is applied to the center tap of the transmitter 111-C repeat coil through a 250,000-ohm resistor. This resistor was found necessary to prevent overloading of the 6C5 at the transmitter should either line be accidentally grounded. The resistor does not interfere with the operation of the studio relay nor affect the release time.

Quite often the carrier is momentarily interrupted, due to line surge conditions, but recycling of the transmitter relays applies the carrier in a short time. To prevent the alarm from sounding under the above conditions, the timing motor is adjusted to delay

(Continued on page 55)

Figure 5  
Remote relay circuit for studio use.

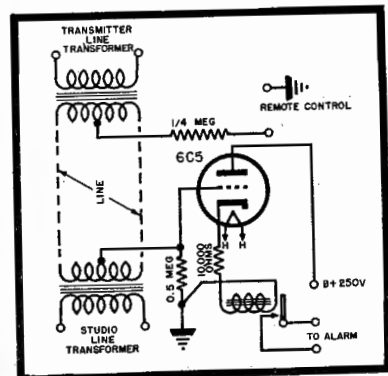





## *Aircraft communication at its best*

**THE COLLINS 18S-1** transmitter-receiver is engineered for high performance in aviation communications. It is specifically designed for commercial airlines and executive aircraft. Reflecting years of experience and proved dependability in the field of aircraft radio, the 18S-1 is new in every respect, and has performed superbly under flight tests.

Ten channels, with twenty crystal controlled frequencies are available for transmission between 2.5—10.0 mc. Power output from the transmitter is more than 100 watts. The receiver is controlled by a separate group of 20 crystals, and does not necessarily operate on the transmitting frequency. Quick, automatic frequency selection is provided, with all circuits tuned and ready to operate. Remote control encourages locating the unit with respect to proper weight distribution within the plane. The 18S-1 works into a 50 ohm transmission line.

A single 1½ ATR unit cabinet contains transmitter, receiver, and dynamotor power supply for the transmitter. The receiver operates directly from the 26.5 volt d-c source. The entire weight, including shock mount, is 60 lbs.

The first group of these equipments is scheduled for delivery to airlines in September of this year. Write today for further information.

**Collins Radio Company, Cedar Rapids, Iowa**

11 West 42nd Street  
New York 18, N.Y.

458 South Spring Street  
Los Angeles 13, California

— IN RADIO COMMUNICATIONS, IT'S ...

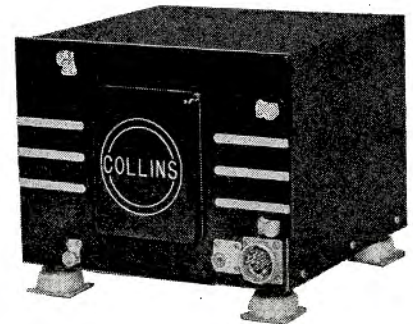

**THE 180K-1** antenna loading unit efficiently transfers the power output from the 18S-1 to any standard commercial fixed antenna. Remote controlled, pretuned operation for ten channels is provided. The nominal input impedance is 50 ohms. Weight, 10 lbs. Size, 7½" h, 10½" d, 12" l.



# DIRECT F-M TRANSMITTERS

THE DIRECT F-M BROADCAST transmitter has the same basic divisions as the f-m transmitter using a phase modulator. It also consists of an exciter unit followed by the necessary stages of multiplication to obtain the desired final frequency. After the final frequency is reached there are sufficient power amplifier stages for obtaining the desired power output. The power amplifier stages are class C. To increase the power output of a transmitter, even after installation, all that usually has to be done is to add one or more stages of r-f amplification.

The major difference in the direct f-m transmitter lies in the exciter unit. It employs a modulated oscillator and a control system which keeps the center frequency of the modulated oscillator at the assigned carrier frequency within the limits set by the FCC. It is done by comparing the center frequency with the output of a crystal oscillator and using the result to adjust the modulated oscillator.<sup>1</sup> The number of combinations of the different modulated oscillators and the different control methods is very large. Actually, of course, each manufacturer has his favorite method of modulation and control.

## Reactance Tube with Motor Control<sup>2</sup>

In Figure 1 appears a block diagram of an exciter unit using a reactance tube for frequency modulation of the f-m oscillator and a two-phase motor to control the center frequency. The oscillator operates at a center frequency between 4.5 and 6 mc. This frequency is noted as  $f$ . The output from the modulated oscillator is divided by 240 and fed into the balanced modulators of the control system. The frequency therefore of the input signal to the modulators will be between 18.75 and 25 kc; crystal oscillator operates be-

<sup>1</sup>Instructor in Graduate Electrical Engineering courses, Columbia University.

<sup>2</sup>N. Marchand, *Direct F-M Modulators*, COMMUNICATIONS; April, 1946. N. Marchand, *Direct F-M Frequency Control Methods*, COMMUNICATIONS; July, 1946

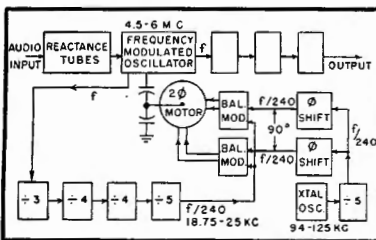
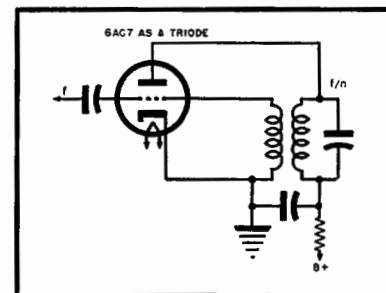

Figure 1 (left)

Block diagram of an exciter unit employing a reactance tube modulator and a two-phase motor control for frequency stabilization.

Figure 2

A locked-in oscillator frequency divider using a 6AC7 as a triode oscillator.



Part Eight of a Series of Papers on F-M Transmitters Discussing Exciters, Consisting of Reactance-Tube Modulated Oscillators, and R-F Amplifiers Using Grounded-Grid Circuits. Because of the Many Ramifications of Transmitters Using These Type Circuits the Analysis Has Been Prepared in Two Installments, Part Two to Appear Next Month.

by N. MARCHAND\*

Consulting Engineer  
Lowentherz Development Company

tween 94 and 125 kc. Dividing the crystal frequency by five should yield the same frequency of  $f$  divided by 240. A difference between the two frequencies causes the control motor to turn and vary the center frequency of the modulated oscillator until the difference is zero.

Figure 2 shows the locked-in frequency divider circuit used in the exciter unit. It uses a 6AC7 connected as a triode with the tuned circuit in the plate circuit. This circuit permits division ratios of as much as five-to-one with stable operation. The wave shape of the output is sufficiently good for its use in the control circuit. It covers the required tuning range by an adjustable iron slug in the tuned circuit. The lock-in range is as high as  $\pm 5\%$ .

A circuit diagram of the complete exciter is shown in Figure 3. The output frequency of the exciter will fall in the 40.5 to 54-mc range. With a fre-

quency multiplication of two in the amplifier stages it will provide a frequency range in the output of 81 to 108 mc. The second crystal shown in the diagram is a spare, and only one crystal is used at a time. The crystal oscillator may operate at any frequency between 94 and 125 kc without the use of any tuning adjustments.

In Figure 4 is shown a front and rear view of the two-phase motor used for the frequency-control system. It was found advisable to mount the tuning capacitor on an insulator at one end of the motor shaft. The fixed plates of the capacitor are split in half, one half grounded and the other half connected to the master oscillator circuit. By using this type of construction all backlash and lost motion as well as friction, other than that of the motor bearings themselves, is eliminated. The full range of control only requires the motor to turn  $\pm 45^\circ$ . The rate of frequency correction is limited by one requirement: it must not cause

\*N. J. Oman, *A New Exciter Unit*, RCA Broadcast News; January, 1946.

All illustrations courtesy RCA.

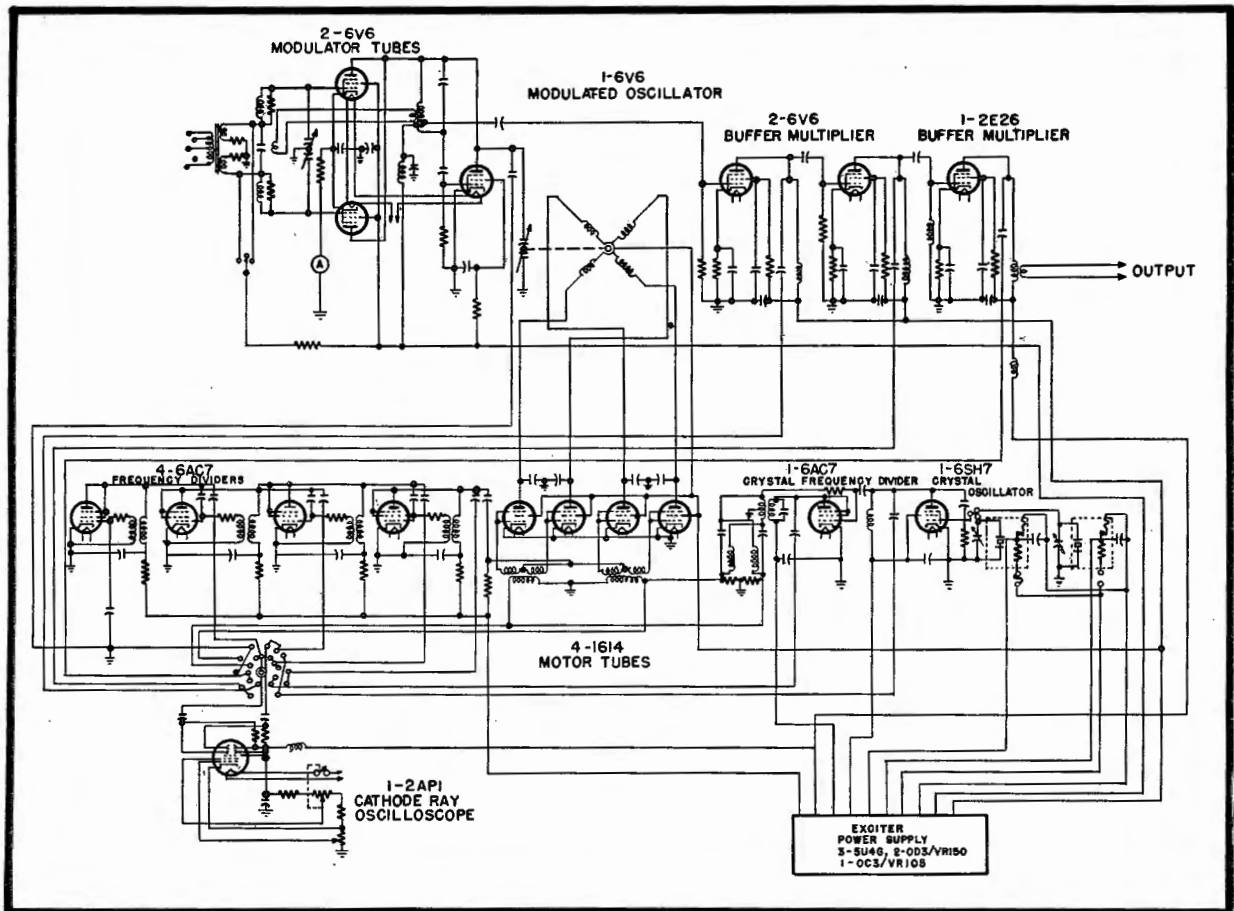

Figure 3  
The circuit diagram of a reactance tube, two-phase motor control exciter unit. Note that only one crystal is in actual use, the other being a spare.

frequency demodulation at the lowest signal frequency. The motor itself is an induction motor with viscous damping to prevent overshooting. The damping unit can be seen in Figure 4. It is enclosed in the lucite case on the front end of the shaft.

#### Built-in Checking Device

To allow for rapid checking of the circuits a test equipment unit has been built into the exciter. A cathode-ray oscilloscope, with a selector switch, is provided to permit checking of the operation of each divider and each multiplier by means of lissagous figures. A three-position selector switch enables the operator to apply a d-c potential to either reactance tube grid, causing the frequency of the modulated oscillator to shift high or low over a considerable range. The behavior of the frequency-control motor and the relative rotation of the shaft required to correct the artificial frequency shift may be observed on a dial on the motor shaft. This operation gives a rapid check of the performance of the reactance tubes

and the frequency-control mechanism. A meter is provided to read the plate current of the reactance tubes and the modulated oscillator. A buzzer, operated by a cam on the frequency-control capacitor shaft, provides warning if for any reason the frequency control is about to fail because of passing through maximum or minimum of oscillator tuning-control capacity.

In Figure 5 appears a front view of the complete exciter unit. In the center of the unit can be seen the built-in cathode-ray oscilloscope and its accompanying selector switch. The distortion in the output of the exciter is of the order of 0.5% for modulating frequencies from 30 to 15,000 cycles. The noise level in the output is 74 db below 100% modulation.

#### The Grounded-Grid Amplifier<sup>3</sup>

Used in conjunction with the above exciter unit is the grounded-grid am-

<sup>3</sup>C. J. Starnier, *The Grounded Grid Amplifier*, Broadcast News; January, 1946.

plifier. In the grounded-grid amplifier the grid is at a-c ground potential and the drive is applied between cathode and ground. The d-c and a-c potentials and currents used are the same as in the conventional circuits so far as the tube itself is concerned. This means that ratings that apply to one will apply equally to the other.

The advantages claimed for this type of circuit are:

- (1) The circuits are simpler and require fewer components than the conventional circuits.
- (2) Neutralizing, when necessary, is very simple and is not required at all for low powers.
- (3) The circuits are stable and do not need critical adjustments, even at 100 mc.
- (4) The output is greater from an amplifier using a tube of a given size.
- (5) It is possible to use the same tubes in drivers and power am-

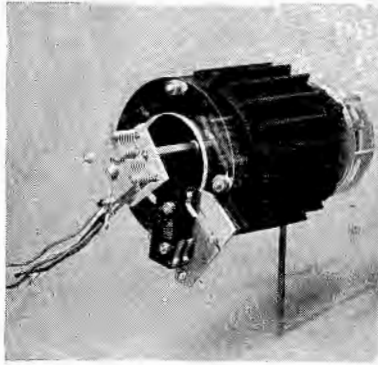
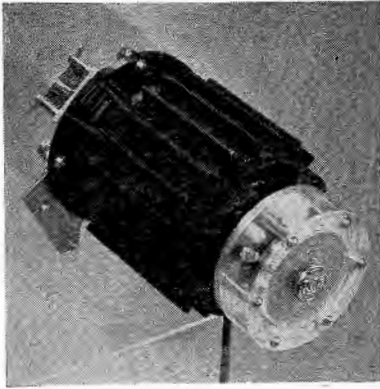

Figure 4

Front and rear views of the two-phase motor with the frequency determining capacitor mounted directly on the shaft.

plifiers reducing the number of different types required.

**Theory of Operation**

In Figure 6 we have a simplified circuit diagram of a grounded-grid amplifier. No neutralizing circuits are shown for this preliminary discussion. It will be noticed that the input is applied between cathode and ground (grid potential) so that it appears across grid to ground as in the con-

ventional circuit. However the output is taken across plate to grid instead of plate to ground.

In Figure 7 is shown the load and grid swings in voltage. Here it will be noticed that the grid is constant at zero potential while the cathode voltage varies. When the cathode swings negative it produces the same effect as the grid voltage swing positive in the conventional circuit. In other words, the cathode voltage, noted as  $E_g$ , is in phase with the plate voltage,  $E_p$ , and

Figure 5

Front view of the reactance tube, motor-controlled exciter unit showing the built in cathode-ray oscillograph and selector switch.

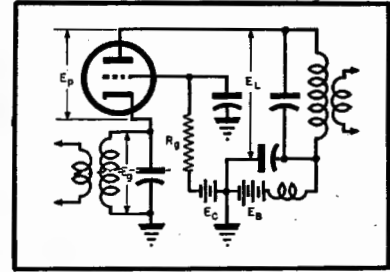
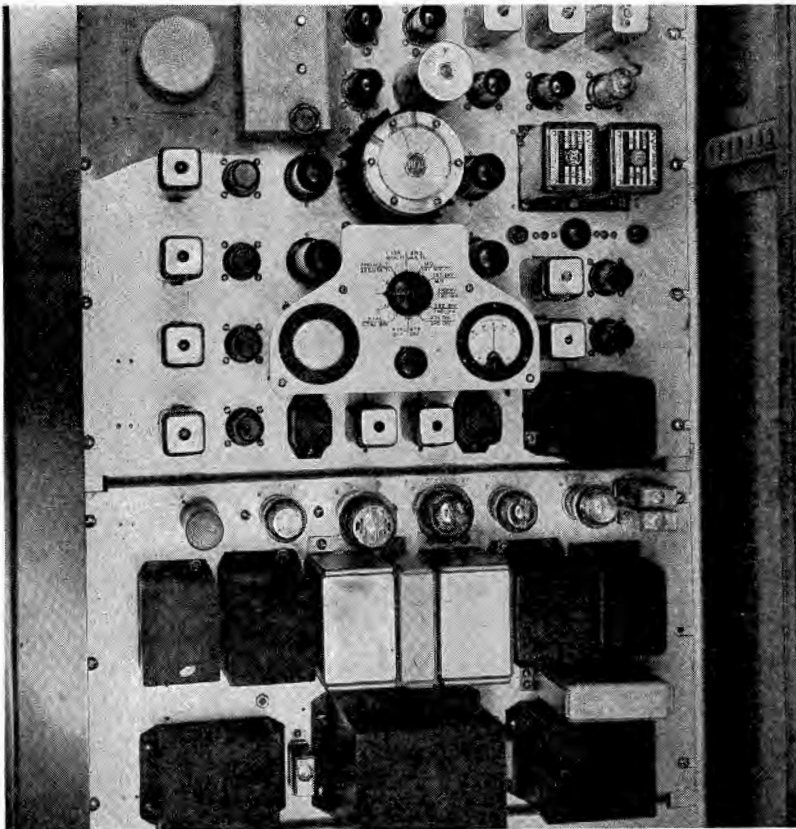

Figure 6

Circuit of a grounded grid amplifier showing  $E_L$ , the a-c voltage across the load,  $E_p$ , the a-c voltage across the plate to grid, and  $E_g$  the a-c input voltage.

the limit of downward swing is now  $-E_c$  instead of the positive grid swing. Referring now to Figure 6 it can be seen that the output voltage,  $E_L$ , is equal to the plate a-c voltage,  $E_p$ , plus the driving voltage  $E_g$ . Inasmuch as they are both in phase the output voltage is given by

$$E_L = E_p + E_g \quad (1)$$

Denoting the rated peak a-c plate current as  $I_p$ , the power output,  $P_o$ , would be given by

$$P_o = \frac{I_p \times E_L}{2} \quad (2)$$

Calling the power output of a conventional circuit  $P'$ , and since the tube

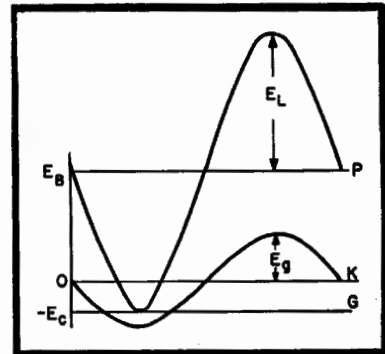
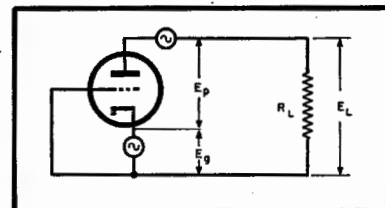

Figure 7

The load and grid voltage swings for the grounded grid amplifier.  $P$  is the plate d-c voltage,  $K$  the cathode d-c voltage, and  $G$  the grid d-c voltage.

Figure 8

Equivalent circuit of a grounded-grid amplifier. Note how both  $E_g$  and  $E_p$  contribute to the output voltage.





# LS SERIES

## The Ultimate in Quality

UTC Linear Standard Audio Transformers represent the closest approach to the ideal component from the standpoint of uniform frequency response, low wave form distortion, high efficiency, thorough shielding and utmost dependability. Wartime restrictions having been lifted, and UTC production running at full capacity, we now offer these transformers for immediate delivery.



### UTC Linear Standard Transformers feature...

- **True Hum Balancing Coil Structure** . . . maximum neutralization of stray fields.
- **Balanced Variable Impedance Line** . . . permits highest fidelity on every tap of a universal unit . . . no line reflections or transverse couplings.
- **Reversible Mounting** . . . permits above chassis or sub-chassis wiring.
- **Alloy Shields** . . . maximum shielding from induction pickup.
- **Multiple Coil, Semi-Toroidal Coil Structure** . . . minimum distributed capacity and leakage reactance.
- **Precision Winding** . . . accuracy of winding .1%, perfect balance of inductance and capacity; exact impedance reflection.
- **Hiper-Alloy** . . . a stable, high permeability nickel-iron core material.
- **High Fidelity** . . . UTC Linear Standard Transformers are the only audio units with a guaranteed uniform response of  $\pm 1.5$ DB from 20-20,000 cycles.

*For Immediate Delivery*

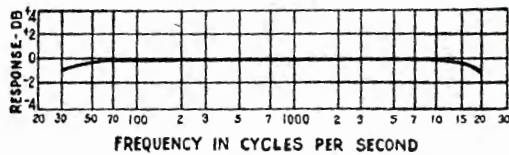

Typical Curve for LS Series

Type No.	Application	Primary Impedance	Secondary Impedance	Max. Level	Relative hum-pickup reduction	Max. unbalanced DC in primary	List Price
LS-10	Low impedance mike, pick-up, or multiple line to grid.	50, 125, 200, 250, 333,500 ohms	60,000 ohms in two sections	+15 DB	-74 DB.	5 MA	\$22.50
LS-10X	As above	As above	50,000 ohms	+14 DB	-92 DB	5 MA	\$28.10
LS-21	Single plate to push pull grids	8,000 to 15,000 ohms	135,000 ohms; turn ratio 1.5:1 each side. Split Pri. and Sec.	+14 DB	-74 DB	0 MA	\$21.25
LS-30	Mixing, low impedance mike, pickup, or multiple line to multiple line	50, 125, 200, 250, 333, 500 ohms	50, 125, 200, 250, 333, 500 ohms	+17 DB	-74 DB	5 MA	\$22.50
LS-30X	As above	As above	As above	+15 DB	-92 DB	3 MA	\$28.10
LS-50	Single plate to multiple line	8,000 to 15,000 ohms	50, 125, 200, 250, 333, 500 ohms	+17 DB	-74 DB	1 MA	\$21.25
LS-55	Push pull 2A3's, 6A5G's, 300A's, 275A's, 6A3's	5,000 ohms plate to plate and 3,000 ohms plate to plate	500, 333, 250, 200, 125, 50, 30, 20, 15, 10, 7.5, 5, 2.5, 1.2	+36 DB			\$25.00
LS-57	Same as above	5,000 ohms plate to plate and 3,000 ohms plate to plate	30, 20, 15, 10, 7.5, 5, 2.5, 1.2	+36 DB			\$17.50

The above listing includes only a few of the many units of the LS Series. For complete listing — write for catalogue.



*United Transformer Corp.*

150 VARICK STREET NEW YORK 13, N. Y.  
EXPORT DIVISION: 13 EAST 40TH STREET, NEW YORK 16, N. Y., CABLES: "ARLAB"

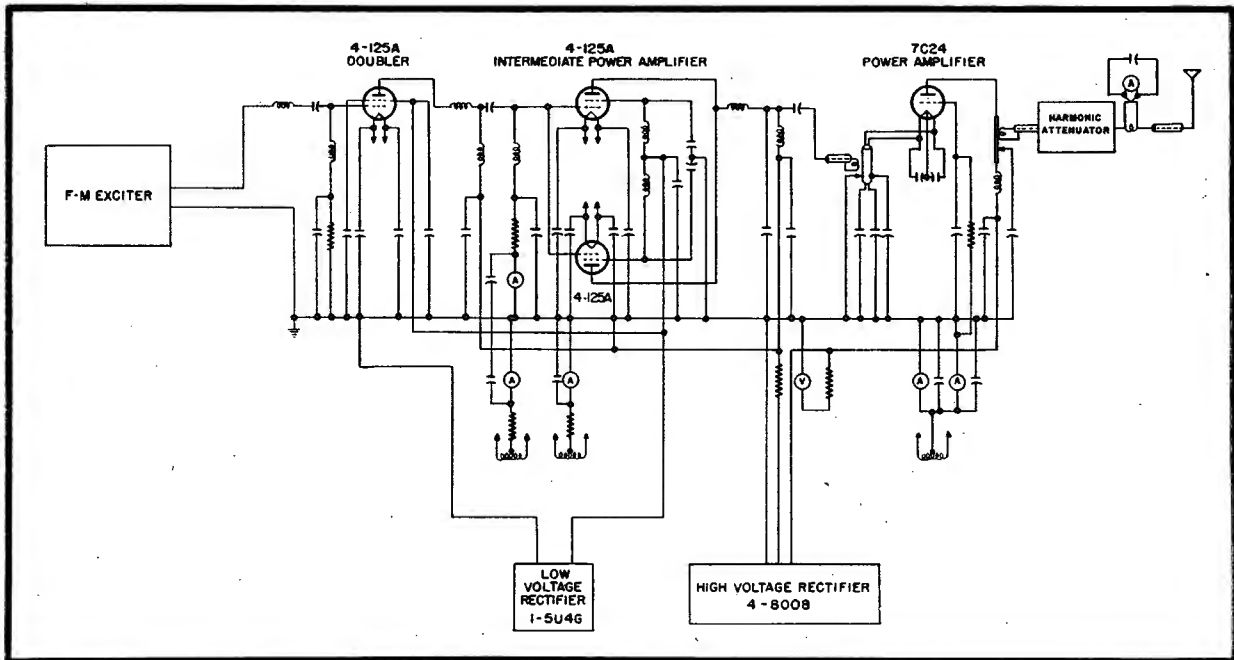

Figure 9  
Circuit of a 250 to 1,000 watt f-m transmitter using a 7C24 grounded-grid power amplifier.

potentials and currents are the same in both cases, we have

$$P'_o = \frac{I_p \times E_p}{2} \quad (3)$$

Comparing (2) and (3) it can be seen that using a tube with the same ratings in first a conventional circuit and then in the grounded-grid amplifier circuit the power output has increased by

$$\Delta P_o = \frac{I_p \times E_g}{2} \quad (4)$$

This power does not come from the tube itself but must come from the driver. It means that the driver power must increase by that amount. However it will be noted that even though the power required from the driver increases, the amount of power fed into the grid of the tube remains the same and the extra power appears as useful power in the output circuit.

In Figure 8 appears the equivalent circuit of a grounded-grid amplifier.  $E_g$  now appears between cathode and ground;  $E_L$  is made up of both  $E_g$  and  $E_p$ . This agrees with (2) for the

power output of this type of circuit. To obtain the same a-c plate current, the load resistor  $R_L$  is larger than would be encountered in a conventional circuit because of the higher output voltage available.

Neutralization, when required, may be accomplished by inserting an inductance in series with the grid. For values of plate-to-cathode capacity normally encountered in tubes adaptable to grounded-grid use, the inductance in the grid-to-ground circuit is sufficient and in some cases even series capacitance may be required. At frequencies where the physical size of the tube becomes an appreciable part of  $\frac{1}{4}$  wavelength, it may become necessary to use a tuneable bias blocking capacity to reduce the tube element inductance to a value low enough for neutralization.

#### A 250-to-1,000 Watt Transmitter

It is now possible to combine the exciter unit shown in Figure 3 with a series of amplifiers to obtain a complete transmitter. A circuit diagram of such a transmitter is shown in Figure 9. The output of the exciter unit is fed into a 4-125A doubler. The doubler is followed by two 4-125A, in parallel as an intermediate r-f stage. If the transmitter output were taken from these tubes a 50-to-250-watt transmitter would be obtained. For a

250 to 1,000 watts of output power the intermediate r-f amplifier is followed by a grounded-grid amplifier using a 7C24.

This tube, shown in Figure 10 with a 6AC7 metal tube for size comparison, was designed for use as a stable amplifier tube at 100 mc in a grounded-grid circuit. It resembles in size and appearance the 827-R but differs inasmuch as it is a triode whereas the former was a tetrode. Moreover the construction is quite different. The 7C24 is provided with a grid structure specifically designed to offer a maximum of shielding between the plate and filament electrodes, resulting in a very low plate-to-filament capacity. The grid connection is a disc seal brought out through the glass all the way around the tube. When this is utilized in connection with an external shield, the input and output circuits of the amplifier can be well isolated.

In the output circuit of the transmitter is a harmonic attenuator to reduce the harmonic content of the output. All of the components of the transmitter are mounted in two standard transmitter cabinets. In the right-hand cabinet are mounted the high-voltage rectifier and the exciter unit, and in the left-hand cabinet are the r-f amplifiers. There is additional space in this cabinet permitting addition of units to increase the power above 1,000 watts.

The transmitter will operate on any specified frequency between 88 and 108 mc. It has an r-f output impedance of

(Continued on page 54)

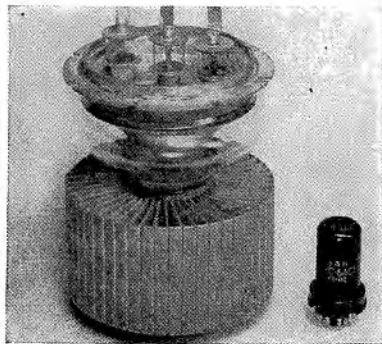
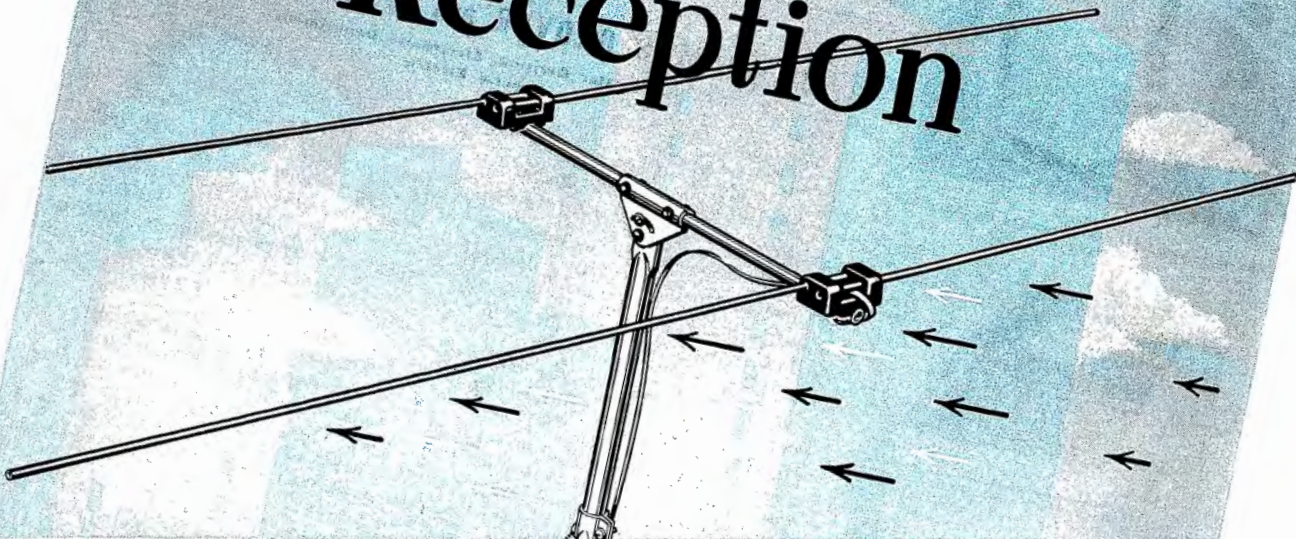

Figure 10  
The 7C24, especially designed for 100-mc transmitters, shown with a 6AC7 metal tube for size comparison.

BETTER

# FM Reception





## AMPHENOL DIPOLE ANTENNAS

Amphenol Dipole Antennas and Dipole Antennas with Reflectors are engineered to provide excellent reception of FM even in zones of low signal strength.

The directional array virtually eliminates reflected signals, while building up required signal strength. The swivel feature on the mounting bracket and the mast head of the reflector types allows for tilting of the antenna plane to the optimum angle. An exclusive feature of all Amphenol FM Antennas is the Amphenol Twin-Lead low-loss transmission line from antenna to receiver.

## TWIN-LEAD TRANSMISSION LINE

A recent Amphenol innovation—a perfect parallel-line lead-in wire extruded with polyethylene dielectric. This low-loss transmission line is highly efficient, inexpensive and completely moisture-proof, and remains flexible at temperatures well below zero. Twin-Lead is manufactured in three impedances that cover requirements for all Broadcast, FM and Television reception.

-  300 OHM provides best impedance match for FM and Television.
-  150 OHM is for experimental work and other special applications.
-  75 OHM is best suited to match a 1/2 wave element and should be used where receiver input impedance is 75 ohms.



**AMERICAN PHENOLIC CORPORATION**  
 CHICAGO 50, ILLINOIS  
 In Canada • Amphenol Limited • Toronto

COAXIAL CABLES AND CONNECTORS • INDUSTRIAL CONNECTORS, FITTINGS AND  
 CORDS • ANTENNAS • RADIO COMPONENTS • PLASTICS FOR ELECTRONICS

# The ELECTRONIC NAVIGATOR

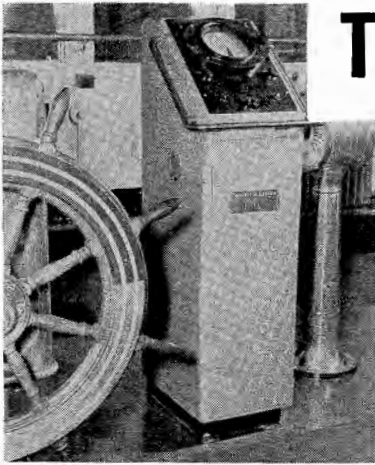

Figure 1  
Electronic navigator console aboard the American Mariner.

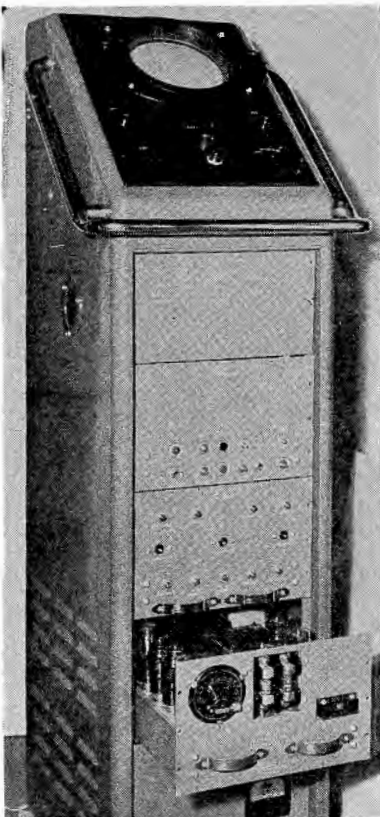
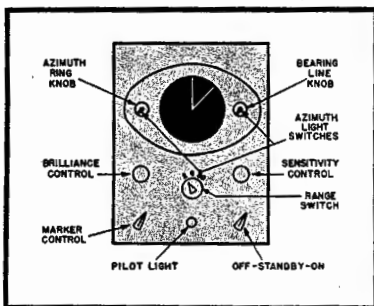

Figure 2  
Console with one of the removable chassis pulled forward.

Figure 2a  
Operating control panel (below).



Data on 10-CM Merchant Ship Surface-Search and Navigational Radar, with Range of 200 Yards or Less to 30 Miles Maximum.

by THOMAS GROVER and E. C. KLUENDER

Transmitter Division, Electronics Department  
General Electric

THE NEED OF EQUIPMENT to enable the mariner to plot a safe course through fog, storm and darkness has been vitally demonstrated in the long lists of strandings and collisions in maritime history. The solution has finally been found in radar.

Radar for peacetime use must, of course, differ from military radar. Most of the military radars were required to determine enemy presence at great distances. This was important because it gave our armed forces more time to take appropriate action. Peacetime radar is more concerned about near objects. Danger lies not in coming within range of the enemy's guns or bombs, but in coming into bodily contact with another vessel or in running aground. The lower the minimum range, the more narrow the channel that may be navigated in fog and darkness. Minimum range is a function of target size and location, antenna lo-

cation, and operator's ability. Because of these variables, it is difficult to state a number and call it the minimum range. With the *electronic navigator* the minimum range is 200 yards; this is a conservative figure, however, since distances less than 100 yards may be measured under many circumstances.

Military requirements permitted the use of radar operators and a crew of radar technicians to operate and interpret data. Peacetime radar must be simple to operate, requiring no extensive training on the part of bridge personnel.

In the summer of 1943 the first experimental *electronic navigator* model was installed on the Great Lakes ore boat, *J. A. Farrell*. This installation proved quite successful. Based on the experience obtained in prototype in-

Figure 3  
Block diagram of system.

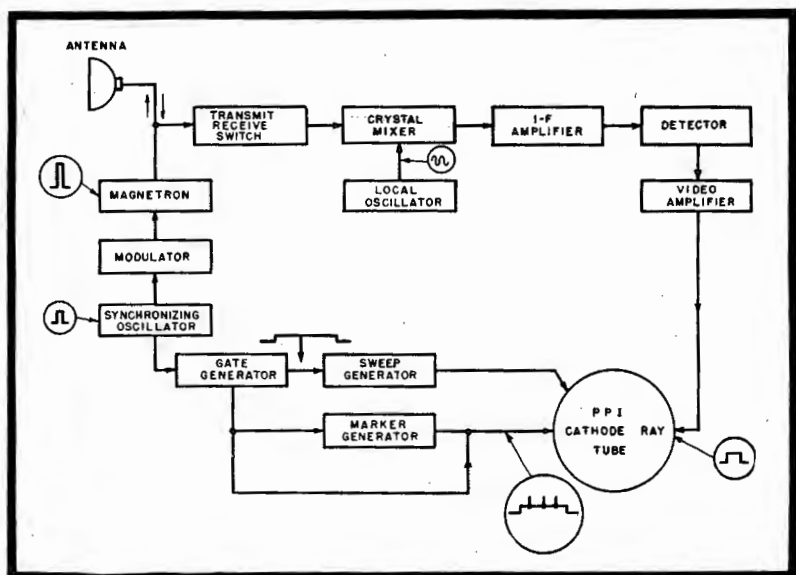





Cardioid (heart-shaped) Polar Pattern. Wide-angle front pick-up horizontally and vertically, diminishes sharply to dead zone at rear. Sound at rear dead zone cancels out and is not reproduced. Solves everyday sound problems—in a great many applications.

**Only the Cardyne Gives You All This!**

- New E-V Mechanophase\* Principle
- True Cardioid Unidirectional Performance
- Reduces Background Noise, Reverberation
- Stops Feedback—Permits Greater Volume
- Relatively High Output
- New E-V Acoustalloy Diaphragm
- Substantially Flat, Wide-Range Response
- And other E-V Features

\*Patents Pending

*Announcing*

**NEW  
Electro-Voice  
CARDYNE**

Now you get More Features...  
More Advantages than ever... in a Single Head

**Cardioid Dynamic  
Microphone**

New E-V developments bring you true cardioid unidirectivity... smooth, wide-range response... high output... and other desirable advantages in a rugged single-head dynamic.

Through the exclusive new E-V *Mechanophase\** principle, the CARDYNE virtually eliminates unwanted sounds... gives you only the sound you want, with greater definition and fidelity. Substantially reduces background noise and reverberation. Increases effective working distance from microphone. Stops feedback. Permits increased loud-speaker volume. Gives extremely accurate pick-up and reproduction of music and speech... indoors and outdoors. Highly suitable for the most exacting sound pick-up work... in studio and remote broadcasting, disc and film recording, public address and communications.

Trim, modern, functional design, finished in rich satin chromium. Smooth, firm tilting action. "On-Off" switch. Ruggedly built to withstand severe operating conditions. Available in 50, 250, 500 ohms impedance, or Hi-Z (direct-to-grid, 25,000 ohms). Low impedances balanced to ground. Also available without "On-Off" switch. Send now for *Cardyne Bulletin No. 131*.

**CARDYNE II. Model 731.** List Price ..... \$75.00  
Frequency response, substantially flat, 30-12,000 c.p.s.

**CARDYNE I. Model 726.** List Price ..... \$55.00  
Frequency response, substantially flat, 40-10,000 c.p.s.

No finer choice than

**Electro-Voice**

ELECTRO-VOICE, INC., 1232 South Bend Ave., South Bend 24, Indiana  
Export Division: 13 East 40th St., New York 16, N. Y., Cables: Arlab

# ANOTHER NEW VARIAC



FOR some time there has been a steady demand for an intermediate size VARIAC . . . something between the new Type V-5 (old Type 200-C) with a 5 ampere rated output, and the Type 100 with an 18 ampere rating. The new Type V-10 has been designed to supply this need. Its rated output is 10 amperes, with a maximum of 15. This maximum rating coincides with the capacity of outlets, plugs, cords and No. 14 circuits ordinarily found in the laboratory and in the home.

The electrical and mechanical features . . . many of them exclusively found in the VARIAC and all of them entirely new in the "V" types of VARIAC . . . are similar to those in the Type V-5, and include:

1. New Unit Brush—brush, holder, pressure spring and current lead in one unit; removable in a second without any tools; when brush wears away, holder cannot short-circuit winding.
2. Improved terminal plate with molded barriers between terminals to prevent short-circuits from strands of wire; both screw- and solder-type terminals; wiring diagram on terminal plate shows normal voltage between terminals.
3. New strip-wound, silicon-steel core contributes to weight reduction of 25% below normal.
4. Entirely new mechanical design of structural parts, mostly in aluminum.
5. Double-pole line switch breaks both sides of the line.
6. New, large, output-voltage dial with additional calibration points and larger figures.
7. A single screw, readily accessible under dial, loosens shaft for reversing dial and knob to change from table to panel mounting without affecting brush or stop settings.

The Type V-10 VARIAC will be in production soon; deliveries are scheduled to start in November. Prices of the six models of the Type V-10 range between \$27.50 and \$35.50.

Write for a copy of the new VARIAC BULLETIN. It describes the Type V-10 and all other VARIACS.

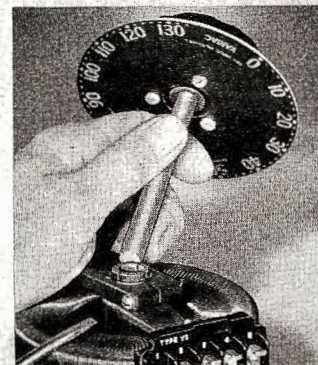

## GENERAL RADIO COMPANY

Cambridge 39,  
Massachusetts

90 West St., New York 6

920 S. Michigan Ave., Chicago 5

950 Highland Ave., Los Angeles 38

Designed for



Application

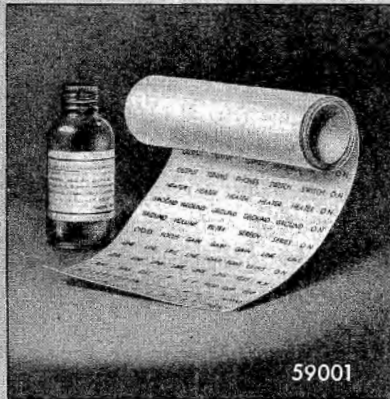

59001

**The No. 59001  
PANEL MARKING  
TRANSFERS**

The panel marking transfers have  $\frac{1}{8}$ " white block letters. Special solution furnished. Must not be used with water. Equally satisfactory on smooth or wrinkle finished panels or chassis. Ample supply of every conceivable word or marking required for amateur or commercial equipment.

**JAMES MILLEN  
MFG. CO., INC.**

MAIN OFFICE AND FACTORY  
MALDEN  
MASSACHUSETTS



## ADVERTISERS IN THIS ISSUE

COMMUNICATIONS—AUGUST, 1946

AEROVOX CORP. .... 6	HEWLETT-PACKARD CO. .... 10
Agency: Austin C. Lescarboursa & Staff	Agency: L. C. Cole, Advertising
ALLIED RADIO CORP. .... 52	THE HOPP PRESS, INC. .... 48
Agency: George Brodsky, Advertising	Agency: Gallard Adv. Agency
AMERICAN PHENOLIC CORP. .... 29	
Agency: Burton Browne, Advertising	
AMPEREX ELECTRONIC CORP. .... 51	JENSEN RADIO MFG. CO. .... 8
Agency: Frank H. Kaufman & Co.	Agency: Burton Browne, Advertising
AMPERITE CO. .... 42	HOWARD B. JONES, DIV. CINCH MFG. CORP. 46
Agency: H. J. Gold Co.	Agency: Merrill Symonds, Advertising
ANDREW COMPANY .... 47	
Agency: Burton Browne, Advertising	
THE ASTATIC CORP. .... 39	MEASUREMENTS CORP. .... 46
Agency: Wearstler Advertising, Inc.	Agency: Frederick Smith
	MICO INSTRUMENT CO. .... 52
BARKER & WILLIAMSON. .... 45	JAMES MILLEN MFG. CO., INC. .... 51
Agency: The Harry P. Bridge Co.	MYCALEX CORPORATION OF AMERICA
BELL TELEPHONE LABORATORIES. .... 4, 5	Agency: Rose-Martin, Inc. Inside Front Cover
Agency: Newell-Emmett Co., Inc.	
BENWOOD-LINZE COMPANY .... 51	NATIONAL CO., INC. .... 35
Agency: Major Adv. Agency	Agency: Graydon Smith, Advertising
L. S. BRACH MFG. CORP. .... 36	NEW YORK TECHNICAL INSTITUTE OF NEW JERSEY .... 54
Agency: United Adv. Agency	NIAGARA RADIO SUPPLY. .... 40
BURSTEIN-APPLEBEE COMPANY .... 51	Agency: Burke & Wayburn Adv. Co.
Agency: Frank E. Whalen Adv. Co.	
	PAR-METAL PRODUCTS CORP. .... 36
CANNON ELECTRIC DEVELOPMENT CO. .... 43	Agency: H. J. Gold Co.
Agency: Dana Jones Co.	PERMOFLUX CORP. .... 37
CAPITOL RADIO ENGINEERING INSTITUTE. 53	Agency: Turner Adv. Agency
Agency: Henry J. Kaufman & Associates	PETERSEN RADIO CO. .... 54
CINEMA ENGINEERING CO. .... 55	PREMAX PRODUCTS DIV. CHISHOLM-RYDER CO., INC. .... 48
Agency: The McCarty Co.	Agency: Norton Adv. Service
C. P. CLARE AND CO. .... 7	
Agency: Hamilton Adv. Agency, Inc.	
CLAROSTAT MFG. CO., INC. .... 40	REMLER COMPANY, LTD. .... 54
Agency: Austin C. Lescarboursa & Staff	Agency: Albert A. Drennan
COLLINS RADIO CO. .... 23	JOHN F. RIDER PUBLISHER, INC. .... 40
Agency: McCann-Erickson, Inc.	Agency: Lansford F. King
CONCORD RADIO CORP. .... 44	ROWE INDUSTRIES .... 52
Agency: E. H. Brown Adv. Agency	Agency: The Miller Agency Co.
COTO-COIL CORP. .... 41	
Agency: Frank E. Dodge Co., Inc.	
	SOLAR MFG. CORP. .... 38
DOOLITTLE RADIO, INC. ....	Agency: O. S. Tyson & Co., Inc.
Agency: Henry H. Teplitz, Advertising	STANDARD PIEZO CO. .... 48
	Agency: T. L. Dartnell Adv. Agency
EITEL-McCULLOUGH, INC. .... 9	SYLVANIA ELECTRIC PRODUCTS INC. .... 3
Agency: L. C. Cole, Advertising	Agency: Newell-Emmett Co., Inc.
ELECTRONIC RESEARCH & MFG. CORP. .... 54	SYRACUSE UNIVERSITY .... 51
ELECTRO-VOICE, INC. .... Back Cover	
Agency: Henry H. Teplitz, Advertising	TECH LABORATORIES .... 49
	Agency: Lewis Adv. Agency
FEDERAL TELEPHONE & RADIO CORP. .... 13	THOMAS & SKINNER STEEL PRODUCTS CO. 46
Agency: Rickard & Co.	Agency: The Caldwell-Baker Co.
FERRANTI ELECTRIC, INC. .... 1	UNITED TRANSFORMER CORP. .... 27
	Agency: Shappe-Wilkes Inc.
GENERAL RADIO CO. .... Inside Back Cover	
GUARDIAN ELECTRIC CO. .... 31	WILCOX ELECTRIC CO. .... 21
Agency: Kennedy & Co.	Agency: Arthur G. Rippey & Co.
	WESTERN ELECTRIC .... 4, 5
	Agency: Newell-Emmett Co., Inc.

## STATION ALARM

(Continued from page 22)

operation by three seconds or more as required.

### Installation

The alarm unit r-f input terminals are connected in parallel with the r-f input of a G. R. noise and distortion meter. The r-f control on the noise meter was used to adjust the carrier current to 5 milliamperes. It was also noted that the noise meter could be turned on or off without disturbing the calibration of the meter.

### The Timing Circuit

When relay RL<sub>3</sub> drops out, it energizes the timing motor. After a delay of three seconds the arm of the timing motor operates a microswitch, SW<sub>7</sub>, thereby energizing the a-c relay, RL<sub>5</sub>. When RL<sub>5</sub> operates, one of the contacts opens the timing motor circuit, thereby returning its arm to the original position by means of a spring. The a-c relay remains energized, and the bell will continue to sound even though the armature of relay RL<sub>2</sub> is pulled up by the program, until button-switch SW<sub>4</sub> is operated.

### Construction

The alarm was built in a discarded Gates air-raid alarm unit. All wiring was removed, a 1V and 6H6 tube added, and rewired.

Since the power unit supplied about 300 volts it was decided to use choke input and load down the filter with a 15,000-ohm 10-watt resistor, in addition to the voltage dividing networks. This then supplied the necessary 250 volts.

A resistor could have been substituted for the choke, with capacitor input. By properly selecting the series resistor a positive voltage of 250 could also be obtained without extra bleeder load.

## COLLINS BROADCAST TRANSMITTERS

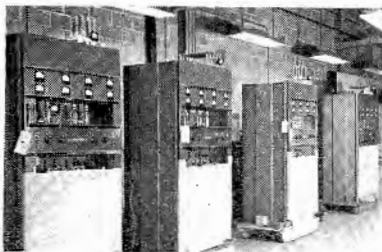

Model 300G, 250-watt, Collins broadcast transmitters coming off the production line.

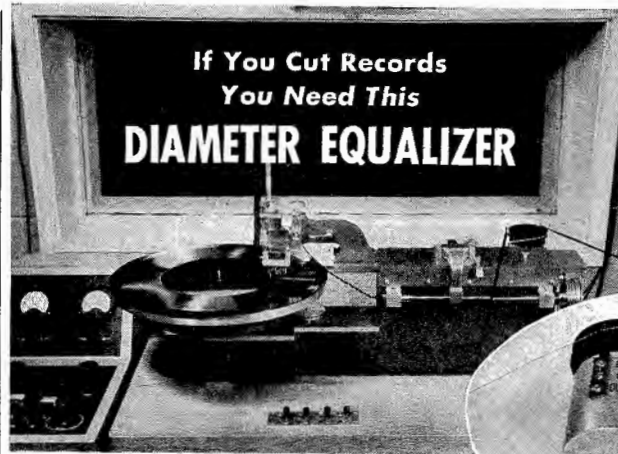

Cinema Diameter Equalizer installation in the new recording studio at Radio Center, 6000 Sunset Blvd., Hollywood, California.

## Automatic Equalization at ANY Cutting Head Position

Type No. 3991

Simplified—light—adaptable to all types of disc cutting lathes, this new member of the Cinema Variaten equalizer line can be installed without making any mechanical alterations of recording lathe.

As groove speed decreases, this Variaten unit automatically equalizes the high frequencies over a pre-determined curve. The unit gives an 8 db rise at 5" diameter, decreasing to zero db at 12" diameter at 10,000 cycles. Insertion loss is 10 db.

A spring return regulates the equalizer setting, and is cord-connected to the moving bed or cutting head carriage of the recording lathe. Tension is adjusted to impose a very light drag on the lead screw mechanism.

Built for long wear from standard Cinema components, this unit can be expected to deliver many years of dependable, precision equalization. It is easy to install by bracket mounting to any flat surface. It is available now in limited quantities. Place your order today to insure early delivery.

Write for descriptive literature showing installation methods.

**NEW! CONSOLES BUILT to your specification are now available at Cinema Engineering. Adaptable for either studio or network mixing or full speech input system control. Write for details.**

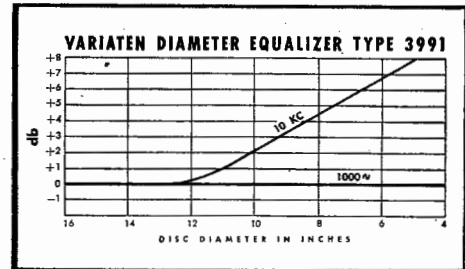

### SPECIFICATIONS

**Equalization:** From 8 db at 5" diameter to 0 db at 12" diameter—10,000 cycles.

**Impedance:** 500 ohms.

**Insertion loss:** 10 db.

**Mounting:** Bracket adaptable to any flat surface. Flexible cord connection to cutter carriage.

**Dimensions:** 3 3/8" Diameter

3 3/4" High

2 1/8" Bracket Extension



# CINEMA ENGINEERING COMPANY

ESTABLISHED, 1935

1510 W. VERDUGO AVE., BURBANK, CALIFORNIA

## F-M TRANSMITTERS

(Continued from page 28)

35 to 75 ohms. Its stability is better than  $\pm 2,000$  cycles as required by the FCC, and is capable of being modulated with a frequency deviation of up to  $\pm 100$  kilocycles.

### Higher Power Transmitters

To obtain a higher power output it is only necessary to continue to add r-f power amplifier stages. For instance, to increase the power output of the above transmitter to as high as 3 kw only another cabinet containing another power amplifier need be added. The power amplifier actually used is another 7C24 tube in a grounded-grid circuit. The 1,000-watt transmitter merely acts as a driver stage for the higher power amplifier. This makes a complete 3-kw transmitter in three cabinets.

Similarly to increase the power still more it is only necessary to continue to add amplifier stages. All of these stages are class C amplifiers and even though they are amplifying a modulated wave they are operating at their maximum efficiency. This, as pointed out before, is one of the advantages of using f-m.

observed before and during maintenance procedures.

Every effort must be made to avoid personnel injury during maintenance work. Familiarity with equipment may cause the *know-it-all* maintenance technician to become careless. In turn, carelessness results in accidents for which there is no excuse. Aside from possible injury to personnel, damage to equipment may result. It is necessary to pay strict attention to every safety measure.

Numerous voltages used during the operation of the radio plant are high and dangerous. *Death* by electrocution is an almost certain penalty for the maintenance man who takes chances with high-voltage circuits. The careful maintenance man makes certain that every precaution is taken. He never trusts others to take precautions for him.

### Equipment Damage

Numerous parts such as tube envelopes and resistor bodies, particularly when they are located in the high-power components, remain very hot

## PREVENTIVE MAINTENANCE

(Continued from page 33)

for several minutes after the power-supply switches have been turned off. In fact, some units have a temperature so high that very painful burns will result if the bare skin touches them. A burn is bad enough; but it may lead to other serious consequences. Involuntary movements of an arm or the body, following a burn, may damage the equipment, and especially the tubes. If work is started immediately after the power switches have been turned off, extreme care must be exercised.

The careful handling of equipment should become a regular habit. Space for working on parts should not be made by pushing, tugging or moving other parts out of the way. Everything should be done to avoid placing unnecessary strain on wires, cables, connections, and couplings.

Tools that are used inside the components must be held firmly. Special care must be taken to prevent the dropping of pliers, screwdrivers, or other repair tools on breakable parts. A heavy tool, if dropped, may readily fall on a tube or other fragile part and cause much damage.

[To Be Continued]

### Electronic Research & Mfg. Corp.

**A Service to INDUSTRY**  
DEVELOPMENT AND CONSTRUCTION  
OF ELECTRONIC EQUIPMENT FOR ANY  
APPLICATION

Write or telephone for a discussion of your problem—  
without obligation.

1420 East 25th Street, Cleveland 14, Ohio  
SU. 1958

### REMLER APPOINTED

Agent for

## WAR ASSETS ADMINISTRATION

(Under Contract No. 59A-3-48)

... to handle and sell a wide variety of  
**ELECTRONIC EQUIPMENT**

released for civilian use

Write for Bulletin Z-1A

Remler Company, Ltd., 2115 Bryant St., San Francisco 10, Cal.

# REMLER SINCE 1918

Radio • Communications • Electronics

## RADIO INSTRUCTORS

Receiver Servicing Experience. College Degree Preferred. \$3600 a year to start. \$4200 after four months. Work in the heart of the Radio Industry. We will teach you how to handle practical television. Write Raleigh G. Dougherty, 158 Market Street, Newark 2, New Jersey, c/o New York Technical Institute of New Jersey, America's foremost television school.

**CRYSTALS**  
EXCLUSIVELY



**SINCE**  
1934

PETERSEN RADIO CO. Council Bluffs, Iowa

## WANTED! Radio-Service Engineer WHO CAN WRITE! . . .

A permanent, interesting and good-paying position for the right man who can write on MODERN POST-WAR EQUIPMENT AND SERVICE METHODS. This may be "the very thing you've been looking for." Write, giving full qualifications and experience. Box 846, COMMUNICATIONS, 52 Vanderbilt Avenue, New York 17, N. Y.

## WHEN YOU CHANGE YOUR ADDRESS

Be sure to notify the Subscription Department of COMMUNICATIONS, 52 Vanderbilt Avenue, New York 17, N. Y., giving the old as well as the new address, and do this at least four weeks in advance. The Post Office Department does not forward magazines unless you pay additional postage, and we cannot duplicate copies mailed to the old address. We ask your cooperation.

The normal antenna sensitivity is five microvolts and the loop sensitivity is 25 microvolts per meter.

### COLLINS AIRCRAFT COMMUNICATIONS UNITS

An aircraft transmitter (100 watts)-receiver for 2 to 10 mc, type 18S-1, has been announced by the Collins Radio Company, Cedar Rapids, Iowa. Has ten operating channels with two frequencies per channel. Designed to operate into a 50-ohm transmission line. Remote control is provided.

The receiver features avc, automatic noise limiter, optional dual output, one stage of tuned r-f amplification, and an output of 100 milliwatts. It operates directly from a 26.5-volt d-c source.

An aircraft antenna loading unit, 180K-1, has also been announced by Collins. Designed primarily as a companion unit for the 18S-1 transmitter-receiver. Has a nominal input impedance of 50 ohms and will handle input power of up to 125 watts.

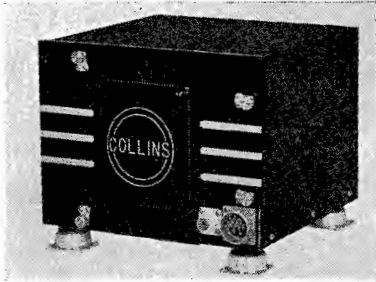

Collins 180K-1

### MILES PORTABLE TAPE RECORDER

A continuous tape recorder, designed for continuous recording and play-back up to 3 hours, type FR, has been announced by the Miles Reproducing Co., Inc., 812 Broadway, New York, N. Y.

Recorder employs an endless loop of film which is placed in the magazine; recording time depends upon the length of the loop used. Loops can be supplied for 15 minutes, one hour, two hours and up to three hours. Provides 300 tracks of recording.

Sound track is formed by indenting a groove into film, 5/8" wide and .003" thick.

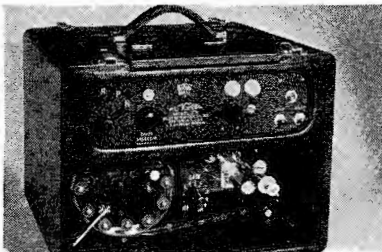

### MILLEN TRANSMITTING CAPACITORS

Variable air capacitors, 04000 series, with peak voltage ratings of 3,000, 6,000 and 9,000 volts, have been announced by the James Millen Manufacturing Company, Inc., 150 Exchange St., Malden, Mass.

Right angle drive, 1/1 ratio. Adjustable drive shaft angle for either vertical or sloping panels. Polished aluminum plates with 13/4" radius. Multiple finger rotor contactor.

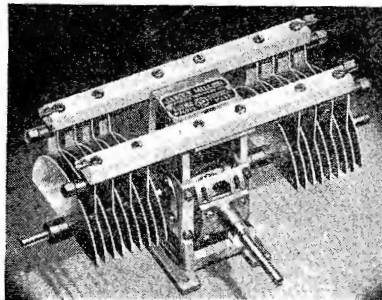

CAPITOL RADIO ENGINEERING INSTITUTE — Where Professional Radiomen Study

## FCC PREDICTS HUGE COMMUNICATIONS EXPANSION WITHIN NEXT FEW YEARS

... 400 new AM stations  
 ... 2950 FM stations ...  
 5000 more radio-equipped  
 planes ... 1800 aviation  
 ground stations ... radio  
 equipped autos, trains,  
 railroads ... facsimile,  
 ship-to-shore, multi-pur-  
 pose micro-wave relay link  
 systems and many other  
 new services will be  
 readied and operative  
 within the next few  
 years ...  
 —from BROADCASTING, 6/14

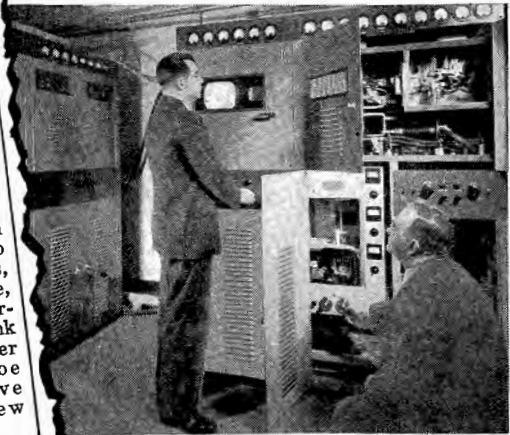

—R.C.A. PHOTO

## You Can Qualify for One of These New, Good Paying Jobs . .

CREI Technical Training NOW Will Enable You to Gain the Ability to Choose Your Job Tomorrow—Right in Your Own Home Town

Never before have men like you had the chance to step into brand new jobs in brand new fields. FM, Television, Facsimile and other electronic communications systems for both government and industry will require thousands of highly trained, expert radio communications engineers and technicians.

NOW is the time to take the time to prepare yourself for these important career jobs. CREI home study training can show you the way by providing you with the "tools" with which to build a firm foundation of ability based on a planned program of modern technical training.

This is real, honest-to-goodness practical radio engineering training that leads to better jobs and more rapid promotions . . . the type of training for which many thousands of professional radiomen have enrolled during the past 19 years.

Mail coupon for free booklet today. (Veterans! CREI training is available under the "G.I." Bill.)

### INDUCTANCE

Funny how many men are like an electrical conductor that becomes electrified when near a charged body. Expose them to the right training, thinking and study and they turn out "first rate". Men who are looking ahead, place themselves in positions where they are continuously preparing for a better job, tomorrow.

*E. H. Rietzke*  
 President of CREI

# Capitol Radio Engineering Institute

E. H. RIETZKE, President

Dept. CO-8, 16th and Park Road, N. W., Washington 10, D. C.

Branch Offices:

New York (7): 170 Broadway Chicago (2): 30 N. LaSalle St. San Francisco (2): 760 Market St.



If you have had professional or amateur radio experience and want to make more money, let us prove to you we have the training you need to qualify for a better radio job. To help us intelligently answer your inquiry—PLEASE STATE BRIEFLY YOUR BACKGROUND OF EXPERIENCE, EDUCATION AND PRESENT POSITION.

CO-8

Capitol Radio Engineering Institute  
 16th and Park Road, N. W., Washington 10, D. C.  
 Gentlemen: Please send me your free booklet, "Your Opportunity in the New World of Electronics", together with full details of your home study training. I am attaching a brief résumé of my experience, education and present position.

Name .....

Street .....

City..... Zone..... State.....

Occupation .....

I am entitled to training under the G.I. Bill.

# ALLIED

## for everything in Electronics and Sound

Equipment for Research  
Development • Maintenance

1946 Catalog **FREE**

### Largest Stocks • Complete Service From one Central Supply Service

Leading industrial and engineering firms depend on the ALLIED Catalog as their Buying Guide for everything in radio, electronics and sound. Lists more than 10,000 quality items . . . radio and electronic parts, vacuum tubes, tools, test instruments, audio amplifiers, accessories . . . complete lines stocked by a single reliable source. Try ALLIED'S expert, specialized industrial service. Send for FREE Catalog now!

*Everything in Radio and Electronics*

**ALLIED RADIO CORP.**

833 W. Jackson Blvd., Dept. 31-H-6, Chicago 7, Illinois



#### Sound Equipment

See ALLIED'S wide selection of Intercom, Paging and Public Address systems. Models for every industrial purpose.

Send for  
*Your*  
**ALLIED  
CATALOG**

## YOU GET MANY *Extras!*

Rowe No. 7  
Permanent  
Magnetic  
Driver Unit

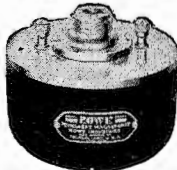

**E**XTRA power, extra long life, extra freedom from break-downs, extra ease of replacement . . . these are but a few of the many extras you get in the ROWE No. 7 PERMANENT MAGNET . . . first choice of sound engineers who investigate thoroughly and analyze carefully.

The 3 lb., 4 oz. ALNICO Magnet gives power and permanency, combined voice coil and diaphragm assembly heads off trouble, provides for quick replacement if necessary. Write for circular giving complete details. Address, Dept. 32.

**ELECTRONICS DIVISION**

# Rowe Industries

3120 MONROE ST., TOLEDO 6, OHIO

## —MICO— ENGRAVER

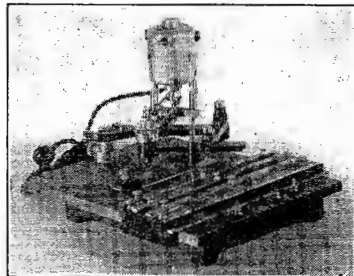

*For lettering panels of steel, aluminum, brass, or bakelite, or for marking finished apparatus.*

A sturdy machine for routine production as well as occasional engraving.

Attachments increase its versatility to include large work on flat or curved surfaces.

Excellent engraving can be produced by an inexperienced operator.

*Prompt delivery. Catalogue on request.*

**Priced from \$115 with Type**

**Mico Instrument Co.**  
88 TROWBRIDGE STREET  
CAMBRIDGE, MASS.

## THE INDUSTRY OFFERS . . . —

*(Continued from page 47)*

olms, 0.2 megohms, and 0.20 megohms); and 6 db ranges from -12 to +70 db.

#### CORNELL-DUBILIER VEHICULAR FILTERS

Type MC vehicular filter capacitors for spark suppression, noise elimination and arc quenching, have been announced by the Cornell-Dubilier Electric Corporation; South Plainfield, N. J.

Capacitor is hermetically sealed, oil impregnated and oil filled.

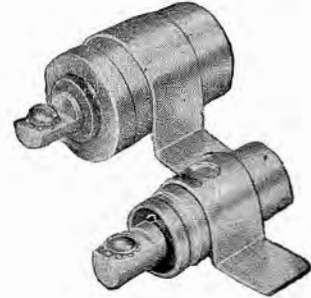

#### MARION ELAPSED-TIME INDICATOR

An elapsed-time indicator, type HM3, indicating elapsed time from zero to 9,999.9 hours has been produced by the Marion Electrical Instrument Company, Manchester, New Hampshire.

Features glass-to-metal hermetic seal construction. Unit conforms with standard JAN 1-6 mounting dimensions.

#### SOUND APPARATUS WARBLE TONE OSCILLATOR

An electronic warble tone oscillator, loudspeaker and microphone, with a preamplifier, has been produced by Sound Apparatus Company, 233 Broadway, New York 7, N. Y.

Designed primarily for use with model PL automatic high-speed power level recorder and model FR automatic frequency response recorder.

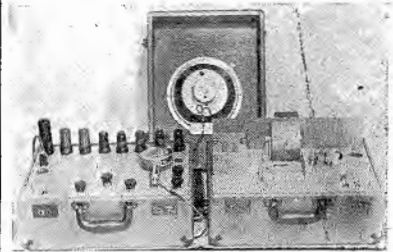

#### FAIRCHILD AUTOMATIC D-F

A dual-remote control automatic radio-direction finder for aircraft, the AN/ARN-6, has been announced by Fairchild Camera & Instrument Corp., Jamaica, N. Y.

For four-band operation, including those of European and Asiatic stations and marine beacons in the 100-1750-kc range.

Radio compass 16-tube receiver operates from standard 28-volt aircraft power supply.

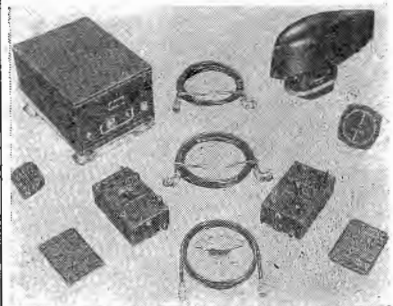

**TUBE INFORMATION  
FOR THE  
RADIO INDUSTRY**

**Call On  
APPLICATION  
ENGINEERING  
DEPARTMENT**  
No Obligation

FOR ANSWERS TO SPECIFIC PROBLEMS

**AMPEREX  
ELECTRONIC CORPORATION**  
25 Washington St. B'lyn 1, N. Y. Cable: AmpereX  
In Canada: Rogers Majestic Ltd. Toronto 28

**POWER  
TUBES**



**SINCE 1925**



S O N E D

**SYRACUSE UNIVERSITY**

**Openings in the Department of Electrical Engineering**

The College of Applied Science, Syracuse University, is seeking candidates for two positions in its Department of Electrical Engineering, one of which will include the Chairmanship of the Department.

It is desired that each applicant have the following qualifications, although it is not expected that all will be fully met:

1. Have Ph.D. or D.Sc. degree.
2. Have had considerable experience as a teacher in the field of Radio Engineering, including broad experience in the use of radio equipment and apparatus.
3. Possess considerable formal training in, and ability to use higher mathematics.
4. Have had considerable background and training in Electro-magnetic theory.
5. Have had a few years' experience with commercial organizations as design or development engineer on radio equipment.
6. Age range preferred, 35 to 45 years.

Address correspondence to:

*Louis Mitchell, Dean  
College of Applied Science  
Syracuse University  
Syracuse 10, New York*

**18 YEARS IN RADIO**



Latest developments in radio and electronic parts and devices, newest "Ham" gear, "Gadgets" to delight the experimenter, bargains in war surplus goods, all in new catalog for you.

**BURSTEIN-APPLEBEE CO.,**  
1012 McGee, Kansas City 6, Mo.

Send me FREE new B-A Catalog. **COM**

**BIG  
CATALOG  
FREE**

I AM \_\_\_\_\_ **COM**

STATE CONNECTION IN INDUSTRY \_\_\_\_\_

NAME \_\_\_\_\_

ADDRESS \_\_\_\_\_

TOWN \_\_\_\_\_ STATE \_\_\_\_\_

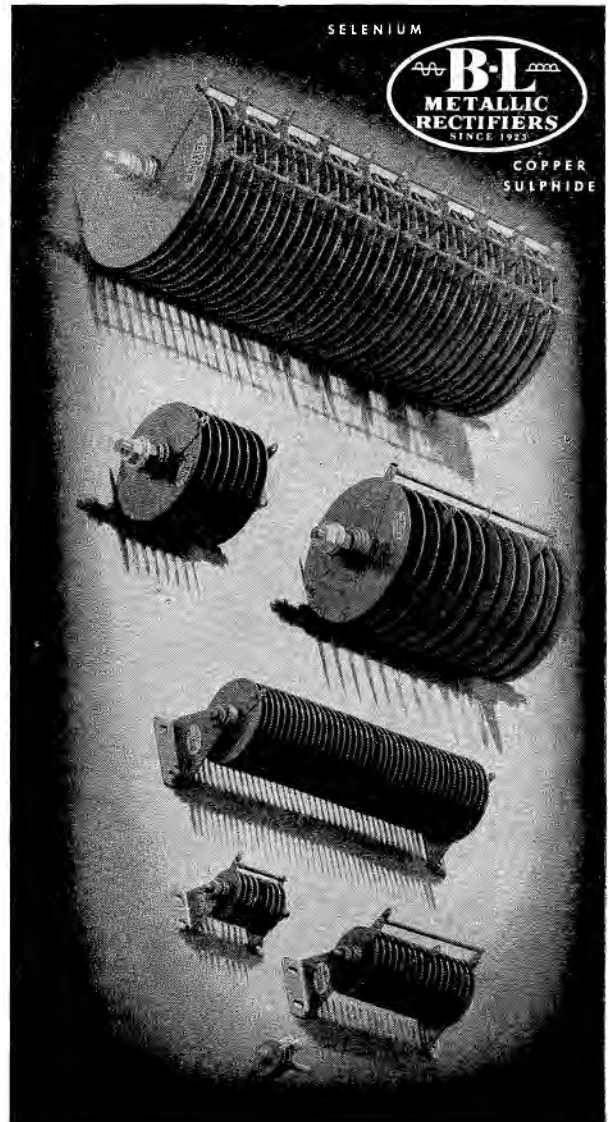

**B-L METALLIC RECTIFIERS**  
from Milliwatts to Kilowatts

If you have an A.C.-D.C. conversion problem, let B-L engineers help you. We have successfully produced many appliances formerly thought impractical.

B-L Metallic Rectifiers have been favorably known to the electrical industry for many years. They are reliable, efficient, designed to get *your* job done right!

No matter what rectifier applications you are considering, B-L will be glad to work with you. Selenium and Copper Sulphide Rectifiers for all needs are available.

Write today for Bulletin R-41

**THE BENWOOD-LINZE COMPANY**

1815 LOCUST STREET ST. LOUIS 3, MO.

Long Distance Telephone Central 5830

Designers and Manufacturers of Selenium and Copper Sulphide Metallic Rectifiers, Battery Chargers and DC Power Supplies



# BOOK TALK . . . .

## PRINCIPLES OF RADIO FOR OPERATORS

By **Ralph Atherton**, Assistant Professor of Physics, Miami University . . . 344 pp. . . . New York: The Macmillan Company . . . \$3.75

An interesting little volume developed for a sixteen-week Navy radio operator's course. Designed for the student with no background beyond a high-school education, the book provides a lucid and well-organized elementary text in the major concepts of electricity and radio. Judging from the demonstrations, films, and review tests described at the end of each chapter, Mr. Atherton has devoted considerable attention to the teachability of his course.

Mr. Atherton introduces his work by describing present-day theories regarding the nature of electricity and current-flow and shows how a battery may be used to build up an electromotive force. The natural transition into magnetism and its application in motors, generators and meters completes his description of elementary electrical concepts. After a short digression into waves of the sound, electrical, and radio-frequency variety, Mr. Atherton discusses inductance, capacitance, vacuum tubes, and power supplies as applied to radio. The last section of his text is devoted to receivers, transmitters, and antennas. In each case, Mr. Atherton first explains elementary equipment before going on to the relatively complex type representative of modern practice. An appendix that includes safety measures, a mathematics review, and tables of tube characteristics and radio symbols concludes the book.

Mr. Atherton does not cover any new material. However, he has succeeded in organizing his course well, providing a text that is excellently tailored to the needs of the student with little or no radio background.

## THE DECIBEL NOTATION AND ITS APPLICATIONS TO RADIO ENGINEERING AND ACOUSTICS

By **V. V. L. Rao**, Radio Engineer, Gov't of Madras . . . 179 pp . . . Madras: Addison & Co., Ltd. . . . \$3.00

This volume offers a compilation of

data covering the development, meaning, and use of the decibel notation ordinarily available only in fragmentary form from scattered sources.

Mr. Rao begins by pointing out that physiological sensations — loudness, pitch, brightness—increase in intensity much more slowly than the stimuli creating them. Approximately, the sensation varies as the logarithm of the applied stimulus, making a logarithmic unit necessary as an index of the relative stimulus; the reason for the development of the decibel and neper units, both being fundamentally logarithms of power ratios, to the base ten and the base  $e$  respectively. Mr. Rao incorporates table for conversion from one unit to the other, discusses applications to current and voltage ratios, and describes the various energy levels that have been used as zero references. This section of the text concludes with a number of illustrative examples as applied to typical amplifiers.

Measurement of the sensation of loudness is more difficult than measurement of sound stimulus because the ear's response is not uniform at all frequencies and the shape of the response curve is not constant at all intensities. Nevertheless, *phon* logarithmic units have been developed to evaluate loudness. Mr. Rao discusses *phon* definitions used in a number of countries and tabulates relationships between them and other types of units.

The last section of the text covers a large number of practical applications of the decibel notation. These include detailed discussions of radio receivers, transformers, pickups, and attenuators, among others. Logarithmic tables and a bibliography conclude the book.

Mr. Rao's brochure is quite a useful work of reference.

## TWO-WAY RADIO

By **Samuel Freedman**, Commander U.S.N.R. . . . 506 pp . . . Chicago and New York: Ziff-Davis Publishing Co. . . . \$5.00

Commander Freedman's book surveys the entire field of two-way radiophone

voice communication in a descriptive style. He is mainly concerned with describing what equipment is available and what its performance capabilities are. To a lesser extent, he touches on the how and the why of its operation. Numerous photographs enliven the text.

An introductory chapter discusses wavelength, frequency, and skip-distance in elementary language. The book continues with a discussion of planning for two-way radio installations, including geographic, economic, and legal considerations.

A second section describes mobile and headquarters stations together with their associated equipment as used in communicating with automobiles. Considerable attention is devoted to problems of noise and vibration. An elementary discussion of guided carrier systems using wayside wires and power lines follows and then the manner in which this means of communication has been applied to traffic and power-net control is touched on. The section concludes with a description of microwaves and frequency modulation.

A third portion of the book covers two-way radio applications to transport by railway, highway, sea and air. The comparison between the advantages of radio and signalling on railroads appear quite new. Radio patrol for police, fire, and forestry services is well-known, of course, but highway radio is just at the beginning of its development. Marine and aeronautical equipment descriptions serve to summarize data.

Next, the book describes the possibilities of two way radio for personal applications to doctors, farmers, and the general public. The text concludes with a discussion of maintenance problems, licensing regulations, and a brief description of some existing two-way systems.

Commander Freedman has been successful in compiling a large amount of material from diverse sources. He is enthusiastic about the possibilities of two-way radio-voice communication, justifiably, for the most part. However, he overlooks one objection that merits consideration. That is the fact that voice communication leaves no permanent record to fix responsibility in applications involving safety of life or equipment. Although this objection can be answered by the use of recording or facsimile devices, Commander Freedman might well have devoted some space to it.

ing members are of plated steel.

Available with mounting brackets for chimney or roof.

**ELECTRO-VOICE CARDIOID DYNAMIC MICROPHONES**

Single-head cardioid dynamic microphones, Cardyne type, have been developed by Electro-Voice, Inc., 1239 South Bend Ave., South Bend 24, Indiana.

Utilizing the new mechanophase principle, the Cardyne is said to provide cardioid unidirectionality, high output, wide-angle pick-up at front of microphone, but is dead at rear. Sound at rear dead zone cancels out and is not reproduced.

Output level (Hi-Z, 25,000 ohms), 53 db below 1 volt/dyne/cm<sup>2</sup>, open circuit. Stand coupler thread, 5/8"-27. Equipped with 20' shielded cable. Available in 50, 250, 500 ohms, or Hi-Z (direct-to-grid, 25,000 ohms) impedance. Low impedances balanced to ground.

Made in two models: Cardyne II, model 731, 30-12,000 cps; Cardyne I, model 726, 40-10,000 cps.

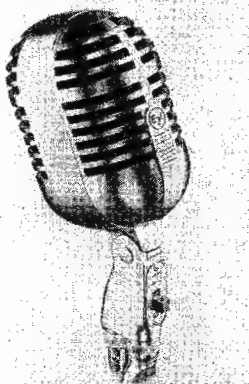

**GUARDIAN RELAY INTERCHANGEABLE COILS AND CONTACT ASSEMBLIES**

Relays, type 200, which feature an interchangeable coil and operates on any standard voltage or current, have been developed by the Guardian Electric Manufacturing Company, 1623 West Walnut Street, Chicago 12, Illinois.

Relay consists of two basic parts, a coil assembly and a contact assembly. Held rigidly together with two screws and lockwashers.

Separate relay combinations are possible by making different connections on the switch blade terminals and putting together any of nine standard a-c or d-c coils with either of two switch assemblies, single-throw double-pole or double-pole double-throw. An extra kit containing contact switch parts permits making contact combinations up to four-pole double-throw.

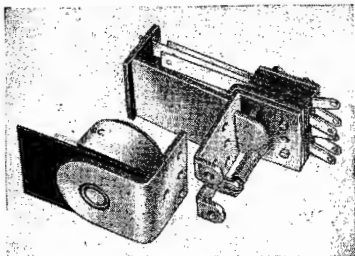

**PRECISION APPARATUS CIRCUIT TESTER**

A 41-range, panel mount, a-c/d-c laboratory circuit tester, series 864, incorporating a 9" rectangular, 5000 ohms-per-volt meter, has been developed by the Precision Apparatus Co., Inc., 92-27 Horace Harding Blvd., Elmhurst, N. Y.

Has 6 d-c voltage ranges at 5000 ohms per volt (0-12, 0-60, 0-300, 0-600, 0-1200 and 0-6000 volts); 6 d-c voltage ranges at 1000 ohms per volt (0-12, 0-60, 0-300, 0-600, 0-1200 and 0-6000 volts); 6 a-c voltage ranges at 1000 ohms per volt (0-12, 0-60, 0-300, 0-600, 0-1200 and 0-6000 volts); 7 d-c current ranges (0-300 microamperes, 0-1.2, 0-12, 0-60, 0-300 and 0-1200 milliamperes and 0-12 amperes); 4 resistance ranges (0-2000 ohms, (15 ohms at center scale), 0-200,000

(Continued on page 52)

*Unusual and Vital*  
**ELECTRONIC EQUIPMENT**

PRODUCED BY

**TECH LAB**  
SUBCONTRACTING DEPT.

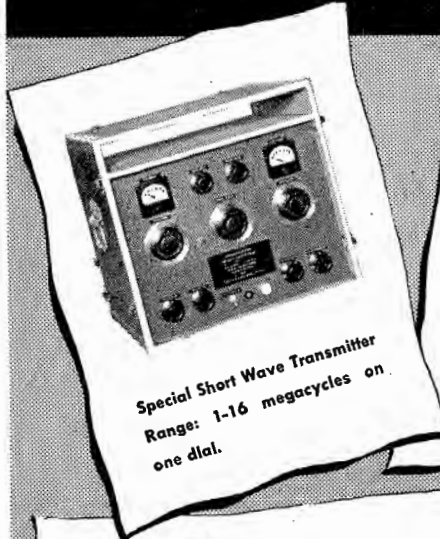

Special Short Wave Transmitter  
Range: 1-16 megacycles on one dial.

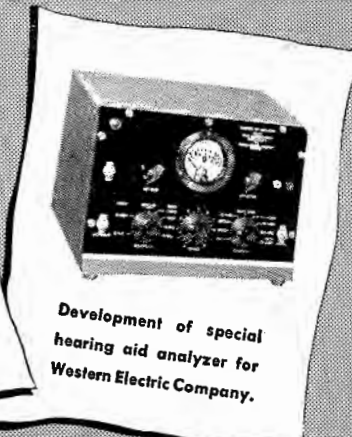

Development of special hearing aid analyzer for Western Electric Company.

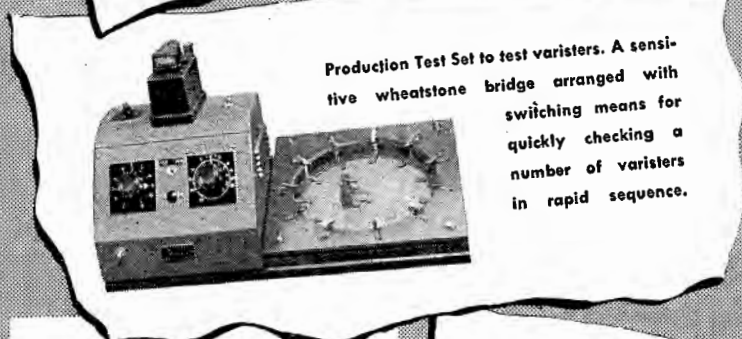

Production Test Set to test varistors. A sensitive wheatstone bridge arranged with switching means for quickly checking a number of varistors in rapid sequence.

Manufacturers have continually called upon the modern facilities of Tech Lab Subcontracting Department to assist them in the production of unusual and vital electronic equipment. Our Engineering Department is ready to assist you with your production problems.



Carbon filling machines for precision filling of carbon microphones.



MANUFACTURERS OF PRECISION ELECTRICAL RESISTANCE INSTRUMENTS

15 LINCOLN STREET, JERSEY CITY 7, N. J.

# STANDARD CRYSTALS

For commercial airline, civilian aircraft, marine, police, railway, automotive, and other communication equipment.

Complete line for the amateur bands.

Custom units for laboratory, experimental, and specialized applications.

Let us engineer your frequency control problems.

Write for free catalog and other information.

## STANDARD PIEZO COMPANY

Established 1936

Quartz Crystals and Frequency Control Equipment

Office and Development Laboratory

SCRANTON, PA.

CARLISLE, PA., P. O. Box 164

CARLISLE, PA.

**PREMAX**

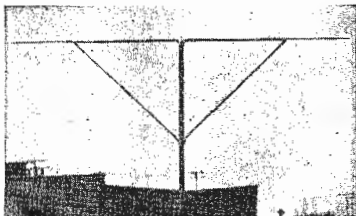

### One Antenna For Both FM and Television

Antennas effective in the 44 to 88 mc. range and in the 174 to 216 mc. range as well as those satisfactory in the 44 to 216 mc. range are now available. This covers, with one antenna, both FM and Television bands. Send for Bulletin No. 4610.

**Premax Products**

Division Chisholm-Ryder Co., Inc.

4610 Highland Avenue, Niagara Falls, N. Y.

### HOPP Plastic RADIO DIALS

DIAL WINDOWS, NAME PLATES, GAUGES,  
CALCULATORS, SCALES, CHARTS, ETC.

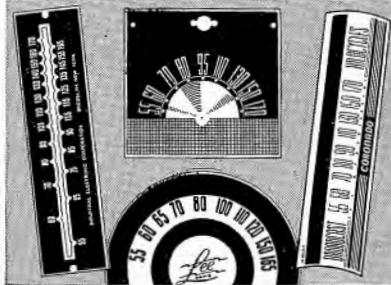

PLASTIC RADIO DIALS have endless possibilities in design, size, shape and color combination. Attractive and durable, our radio dials, windows and scales are preferred by many leading Radio manufacturers.

Not only for dials, but for numerous other electronic and electrical applications, Laminated Plastics are preferable.

Consult with our artists and engineers regarding applications for your particular purpose. Or . . . send us your blue prints or samples for quotation.

**THE HOPP PRESS, INC.**  
460 W. 34th STREET, NEW YORK 1, N. Y.

ESTABLISHED 1893

## THE INDUSTRY OFFERS . . .

(Continued from page 47)

tivity and balance controls, and the power switch.

The high-voltage tester has two indicating instruments on the front panel, one measuring the applied field, from which the induced volts per turn may be determined, and the other indicating faulty coils.

### N. A. PHILIPS HI-Q TRIMMERS

Hi-Q 3 to 30-mmf air capacitors developed in the Philips Laboratories at Eindhoven, Holland, have been announced by North American Philips Co., Inc., 100 E. 42nd St., N. Y. C.

Capacitor consists of two sets of concentric aluminum cylinders which are moved together or apart along a common longitudinal axis by means of a screw. Rotor and stator are one-piece assemblies and have a low value of inductance.

Less than 1/8" in diameter and 1-7/16" in length. Linear relationship covers 27 mmfd over three full rotations.

### BROWNING 5" OSCILLOSCOPE

A 5" oscilloscope, model OL-15, has been announced by Browning Laboratories, Inc., Winchester, Massachusetts.

Response curve of the vertical amplifier is said to be linear and without positive slope from 10 cycles to over 4 mc. Horizontal amplifier response said to extend linearly from 10 cycles to over 1 mc. Sawtooth sweep range is from 5 cycles to 500 kc.

Triggered sweeps of 1, 4, 20, and 200 microseconds per inch provided by the internal trigger generator or by external pulses.

Dimensions: 15 3/4" x 12 3/4" x 19 3/4".

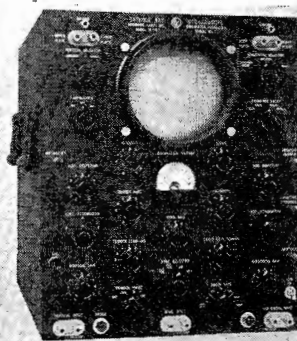

### GULOW POWER TRANSFORMERS

Single-phase and three-phase power transformers are now manufactured by the Gulow Corporation, 62 William Street, New York City. The single phase units are of both the isolated and auto-transformer type. Capacities range in the standard voltages from .050 kva up to 5 kva and the auto transformer from .250 kva to 50 kva. These are for 60 cycles continuous duty with 55° C maximum rise. The three phase power transformers are for all standard voltages from .50 kva to 15 kva.

### ANDREW F-M/TELEVISION ANTENNA

A dual 5-element fan-type antenna for television and f-m use, the Di-Fan, has been announced by the Andrew Co., Chicago 19, Ill. Unit uses aluminum alloy elements. Support-

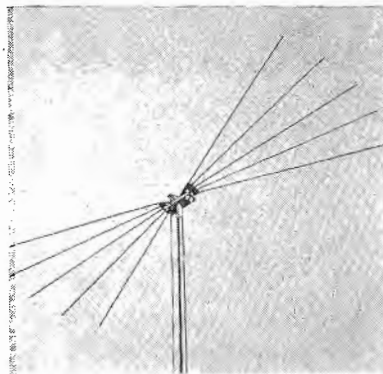

constant to within 1% for loads from 0 to 75 ma.

Either positive or negative output terminal may be grounded. Total noise and hum is said to be less than 0.005 volt for any condition of operation. The unit also provides 6.3 volts a-c center-tapped for heating filaments.

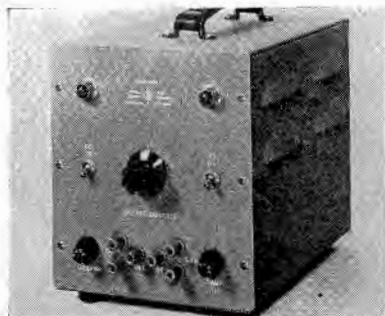

#### BLILEY CRYSTAL

A 3105-kc crystal unit, type VX2, featuring a gasket sealed assembly and solder lug connections to replace the usual pin contacts has been announced by the Bliley Company, of Erie, Pennsylvania. Available at any specified frequency between 3,000 kc and 11,000 kc.

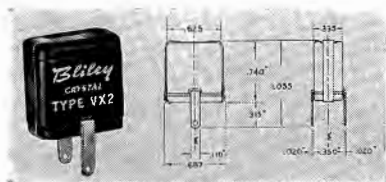

#### CLARE STEPPING SWITCH

A spring-driven stepping switch has been produced by the C. P. Clare Company, 4719 West Sunnyside Avenue, Chicago 30, Illinois.

Under the control of a telephone dial, or other impinging device, the switch will select desired channel, or circuit path, out of 20 or 40. Automatic control of a series of operations in a predetermined manner.

Maximum number of contacts for a 20-point switch is 8; for a 40-point switch, 4. Maximum operating speed with remote control is 30 steps per second. Average operating speed with self cycling operation is 60 steps per second.

The switch consists essentially of one or more wiper springs, fixed on a shaft rotated by a pawl and ratchet mechanism. This mechanism is actuated by an electromagnet which responds to momentary current impulses.

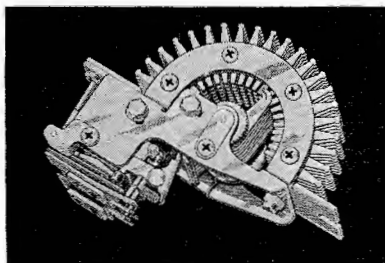

#### G.E. COIL TESTERS

Coil tester designed to detect short circuits and defective insulation in high-speed production testing of electric coils have been announced by G. E. Testers are available for high-voltage or low-voltage applications.

The low-voltage tester shows the presence of short-circuited turns in a coil. The high-voltage tester is used when an overvoltage test is required for the insulation between turns and layers of coils. The turn-to-turn voltage in the high-voltage tester is said to be high enough to stress the insulation beyond service requirements.

On front of the low-voltage tester are mounted a short-indicating milliammeter, sensi-

(Continued on page 48)

# ANDREW *Semi-Flexible* COAXIAL CABLE

BETTER ON 3 COUNTS

✓ LOWER loss than plastic 30% to 50% less loss than in plastic cables of same diameter.

✓ GREATER power capacity Insulation does not melt or soften . . . develops less heat than plastic cables.

✓ LONGER lasting Andrew cables are made entirely of copper and stone, two materials which have unlimited life and which impart the greatest resistance to crushing, corrosion and weathering.

**ANDREW "FIRSTS"** Here's proof of Andrew Leadership in the development of semi-flexible coaxial cables: 1) First to produce  $\frac{3}{8}$  and  $\frac{7}{8}$  inch soft temper cables in 100 foot lengths . . . 2) First to offer continuous coils of unlimited length with factory splicing . . . 3) First to offer lines shipped under pressure with all fittings attached.

Such continued leadership enables Andrew to offer better semi-flexible coaxial cables; cables that are better than those made from any other materials.

A complete line of coaxial cables, accessories, and other antenna equipment is produced by Andrew.

**ANDREW CO.**

363 E. 75th ST. • CHICAGO 19, ILL.

Pioneer Specialists in the Manufacture of a Complete Line of Antenna Equipment

These are the famous Andrew semi-flexible coaxial cables in  $\frac{3}{8}$  and  $\frac{7}{8}$  inch diameters (shown in actual size). Because of their better construction and design they are used throughout the world by thousands of broadcast, police, government, and military radio stations as the most efficient device for connecting antenna to transmitter or receiver.

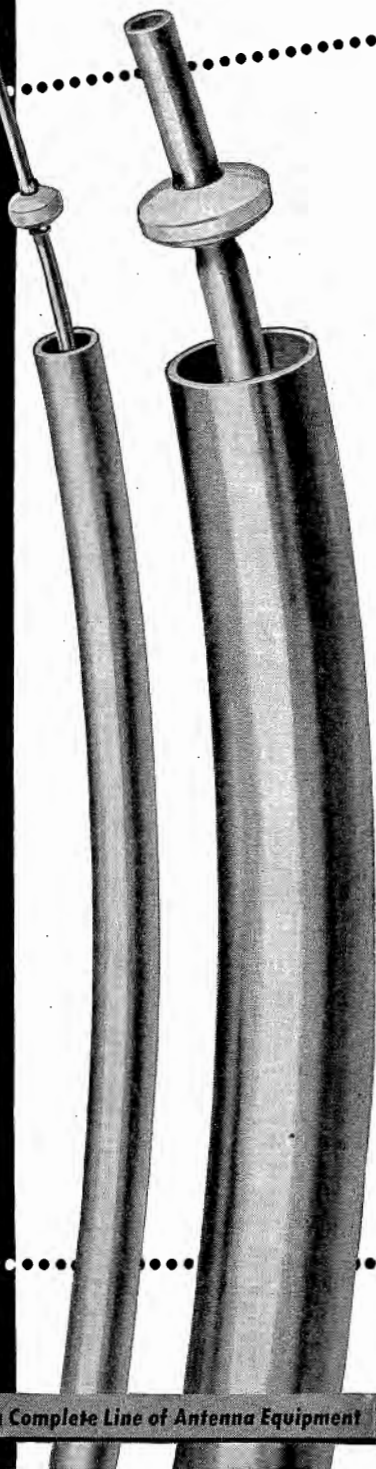

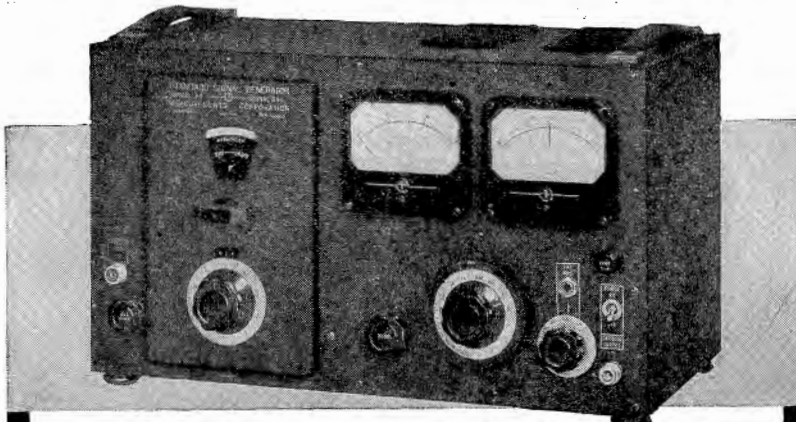

## STANDARD SIGNAL GENERATOR Model 80

**CARRIER FREQUENCY RANGE:** 2 to 400 megacycles.

**OUTPUT:** 0.1 to 100,000 microvolts.  
50 ohms output impedance.

**MODULATION:** A M 0 to 30% at 400 or 1000 cycles internal.  
Jack for external audio modulation.  
Video modulation jack for connection of external pulse generator.

**POWER SUPPLY:** 117 volts, 50-60 cycles.

**DIMENSIONS:** Width 19", Height 10 1/4", Depth 9 1/2".

**WEIGHT:** Approximately 35 lbs.  
Suitable connection cables and matching pads can be supplied on order.

**MANUFACTURERS OF**  
Standard Signal Generators  
Pulse Generators  
FM Signal Generators  
Square Wave Generators  
Vacuum Tube Voltmeters  
UHF Radio Noise & Field Strength Meters  
Capacity Bridges  
Megohm Meters  
Phase Sequence Indicators  
Television and FM Test Equipment

**MEASUREMENTS CORPORATION**  
BOONTON NEW JERSEY

## JONES 300 SERIES PLUGS and SOCKETS

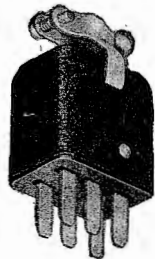

P-306-CCT

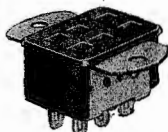

S-306-AB

A high quality line of small Plugs and Sockets adaptable to a thousand uses. All Plugs and Sockets are Polarized. "Knife-switch" Socket contacts are of phosphor bronze, cadmium plated. Bar type Plug contacts are of brass, silver plated.

Insulation is of BM 120 molded Bakelite. Caps are of metal with formed fibre linings. Made in 2 to 33 contacts. Although designed for 45 volts at 5 amperes, these Plugs and Sockets can be used at higher ratings where circuit characteristics permit. 2 contact round, others rectangular. For additional information write today for catalog No. 14 showing complete line of Electrical Connecting Devices.

**HOWARD B. JONES DIVISION**  
CINCH MFG. CORP.  
2460 W. GEORGE ST. CHICAGO 18

## PERMANENT MAGNETS

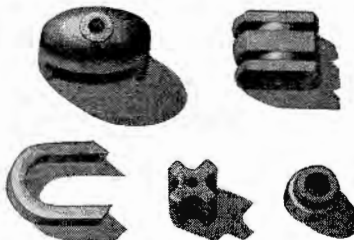

**ALLOYS:**

**Cobalt • Chrome • Alnico**

The making of permanent magnets is an alloy, too . . . of experience, engineering, facilities. We'll be glad to tell you more. Write for bulletin.

**THOMAS & SKINNER STEEL PRODUCTS CO.**  
1113 E. 23rd St., Indianapolis 5, Ind.

**Thomas & Skinner**

# THE INDUSTRY OFFERS . . .

## RAYTHEON F-M PHASE SHIFTER

A new type of f-m frequency modulator, cascade phase shifter, has been developed by S. G. Jones, chief engineer, and Myer Marks, development engineer, of the broadcast equipment division of Raytheon Manufacturing Company, Chicago, Ill.

By means of single low-frequency crystal, direct crystal control of the carrier frequency is said to be obtained.

## FTR HOOK-UP WIRE

A thermoplastic insulated radio hook-up wire, tested to underwriters standards, has been announced by Federal Telephone and Radio Corporation, Newark, N. J.

FTR engineers say that oxidation and changes in temperature do not affect the wire and that it will not crack or become brittle. Wire is also said to be abrasion resistant.

The wire is said to be high in dielectric and tensile strength. Short time tests said to show a dielectric strength of 800 volts per mill with a 0.020" wall thickness; thirty day test at 90°C, a tensile strength of 2100-2250 pounds per square inch.

Available in solid or stranded types ranging in size from 24 to 14 for high or low voltage needs. Comes in 14 brilliant colors.

## ELECTRONIC LABS VIBRATOR INVERTER

A vibrator inverter, designed to permit operation of a-c phonographs with d-c, has been announced by Electronic Laboratories, Inc., Indianapolis, Ind.

Unit measures 4 1/4" x 4" x 2 1/4" and weighs 14 ounces. With an input of 115 volts d-c the inverter's output is 110 volts, 60-cycle a-c providing a maximum load capacity of 25 watts.

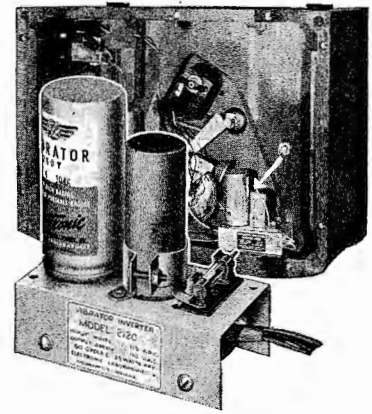

## CLARK P-A AMPLIFIERS

Ten, twenty and thirty-watt amplifiers, using simplified terminal-strip component-mounting methods have been produced by Clark Radio Equipment Corporation, 4313 Lincoln Avenue, Chicago 18, Ill.

Amplifier response is said to be from 30 to 15,000 cycles.

## BRADLEY RECTIFIERS

Copper-oxide battery-charger rectifiers rated for 2, 3, and 4 1/2 volts d-c output, with d-c current up to 1 1/2 amperes, have been announced by Bradley Laboratories, Inc., 82 Meadow Street, New Haven, Connecticut.

Lead wires are presoldered.

## HEWLETT-PACKARD REGULATED POWER SUPPLY

A regulated power supply, model 710A, (7 1/4" x 8" x 11 1/4"), for line-voltage variations of ± 10%, has been announced by Hewlett-Packard Co., Palo Alto, Calif. Output is said to be continuously variable from 180 to 360 volts, remaining

## LINK-COUPLED COILS

(Continued from page 18)

dividing into the primary voltage. Thus

$$I_p = \frac{e_p}{\sqrt{X_p^2 + (R_p + R_{p0})^2}} \quad (28)$$

In terms of  $Q$ , equation (28) becomes

$$I_p = \frac{e_p Q}{X_p \sqrt{Q^2 + 1}} \quad (29)$$

The secondary voltage, from power considerations, is

$$e_s = \sqrt{R_{s2} (W - W_p - W_s)} \quad (30)$$

The secondary current is then

$$I_s = \frac{e_s}{R_{s2}} \quad (31)$$

### Appendix II

A nomogram for equations (7) and (13) is shown in Figure 4. This affords a means of making a rapid preliminary investigation as to the practicability of a particular problem. The line on which  $Q_p$  is plotted can be considered as an auxiliary turning line.

The dotted line is the problem that has been considered as an illustration. The estimated value of  $Q_{p0} = 500$  has been connected to intersect the  $Q$  line at the required value of  $Q = 30$ , and continued to intersect the  $Q_p$  line at 32. This value of  $Q_p$  is then connected to the assumed value of  $K = 0.4$ , intersecting the  $Q_s$  line at  $Q_s = 0.19$ .

It will be noticed that values of  $Q_s < 1$  have only been shown, and that it is taken as single valued. This is in accordance with the fact that it is more practical to take the smaller value of  $Q_s$ , this being generally less than unity. Actually the curve for  $Q_s$  turns back almost on itself in the region near  $Q_s = 1$ , and the larger values are practically equal to the reciprocal of the values shown. A set of conditions which do not allow an intersection with the  $Q_s$  line indicates an impossible solution in which the condition of equation (12) is not satisfied.

### Reference

F. E. Terman, *Radio Engineer's Handbook*, pp. 148-150, McGraw-Hill Book Company, Inc.

# INDUCTORS



... BIG or LITTLE ...  
STANDARD or SPECIAL

Here you see a large B&W low-frequency variometer-type inductor, tailor-made for a war equipment application, compared in size to the B&W 75-watt "Junior" of amateur radio fame. If a 25-watt "Baby" were put in the picture you'd hardly see it—and some of the new coils just coming off B&W production lines are many times smaller than that!

The point is that B&W offers inductors in the broadest assortment of shapes, sizes, and types on the market today. Whatever your requirement, write for recommendations and suggestions.

### NOTE THESE ADVANTAGES OF B&W "AIR WOUND" CONSTRUCTION

- Weigh less
- Mount easier
- Less susceptible to damage
- Offer greater design adaptability
- Wound to uniform pitch
- Exceptionally low dielectric loss



**BARKER & WILLIAMSON**  
235 FAIRFIELD AVENUE UPPER DARBY, PA.

Export: Royal National Co., 75 West St., New York 6, N. Y.

# SURVEY TRANSMITTER DESIGN

(Continued from page 14)

tenna for local requirements (8); de-icers on antenna (4); and electrical storm protection (4).

Interviewed: *Future operators.*

Question: *What type of transmission line do you expect to use?*

Coaxial ..... 83%  
Other ..... 17%

Interviewed: *Future operators.*

Question: *What will be the impedance of your transmission line?*

70 ohms ..... 48%  
72 ohms ..... 15%  
Don't know ..... 19%  
Assorted answers ..... 18%

Interviewed: *Future operators.*

Question: *Will the transmission line be pressurized?*

Yes ..... 67%  
No ..... 9%  
Don't know ..... 24%

Others wanted leak-proof insulation (3); and open-line transmission (2).

## Services

### 1. Planning

Interviewed: *Future managers and operators.*

Question: *Would you like assistance in planning your complete f-m installation?*

Yes ..... 54%  
No ..... 46%

Two asked that stations submit design for approval by manufacturer.

Interviewed: *Future managers and operators.*

Question: *Would you like assistance in installing your equipment?*

Yes ..... 75%  
No ..... 25%

Supervisory assistance was asked for by eighteen; sixteen wanted a final check of installation, while twelve asked that the manufacturer handle complete installation.

Interviewed: *Future managers and operators.*

Question: *Would you like assistance in the layout of your transmitter station?*

Yes ..... 87%  
No ..... 13%

Interviewed: *Future managers and operators.*

Question: *Would you like assistance in studio design?*

Yes ..... 60%  
No ..... 40%

Three asked for printed precautions and suggestions for studio designers.

Interviewed: *Future managers and operators.*

Question: *Would you like continued servicing from manufacturer's engineers?*

Yes ..... 88%  
No ..... 12%

Engineer-trained representatives were requested by five; four wanted servicing calls not included in original over-all expense; three wanted repair service and two asked for periodic calls.

A very common complaint was that the average local distributor was not thoroughly familiar with answers to broadcasting problems. Requests were made for factory representatives, talking the broadcasting engineer's language, to make periodic service calls, and always be available in case of trouble.

## General Comments

Interviewed: *Present and future managers and operators.*

Question: *What do you think of f-m?*

Good opinion ..... 64%  
Poor opinion ..... 36%

### Favorable comments:

Local service better than a-m.  
Break for small stations.  
Noise-free reception.  
Low power consumption.  
Better quality reception.  
Very good for poor channel a-m stations.

### Unfavorable comments:

Over-rated.  
Bad for rural areas.  
Over-publicized.  
Splits audiences with a-m.  
Too many technical difficulties.

Interviewed: *Present managers.*

Question: *What is the public reaction to f-m?*

Good ..... 75%  
Poor ..... 5%  
Don't know ..... 20%

### Comments:

Noise free feature should receive stronger stress than quality in f-m ads.  
With cheap receivers, f-m will not surpass a-m.

**READY NOW!** 8 giant-size pages packed with long-awaited Radio and Electronic Parts, Supplies and Equipment—new merchandise, just received—now in stock for IMMEDIATE SHIPMENT! See hundreds of items for every Radio and Electronic need—for building, repair, maintenance—for engineer, manufacturer, service man, amateur—top-quality, standard-made parts—including Condensers, Resistors, Meters, Controls, Switches, Relays, Transformers, Test Equipment, Tools, Amplifiers, Record Players, Record Changers, and many other new and scarce items—scores of them at money-saving bargain prices—all ready for shipment at once from CHICAGO or

ATLANTA. Mail coupon below TODAY for your FREE copy of new CONCORD Bulletin.

### Did You Get CONCORD'S NEW COMPLETE CATALOG?

Showing the latest and greatest selection of guaranteed quality Radio Sets, Phono-Radios, Radio Parts, Supplies, Equipment, Amateur Gear, Kits—plus the new Multi-amp Add-A-Unit Amplifiers—exclusive with CONCORD. If you do not have the new COMPLETE CONCORD Catalog, check coupon below.



**CONCORD**  
**RADIO CORPORATION**  
LAFAYETTE RADIO CORPORATION  
CHICAGO 7 ATLANTA 3  
901 W. Jackson Blvd. 265 Peachtree Street

CONCORD RADIO CORPORATION  
901 W. Jackson Blvd. Dept. R-86 Chicago 7, Ill.  
Please rush my FREE COPY of the new Concord Bulletin of Radio Parts.  
 (Check if you also want new Complete Concord Radio Catalog)  
Name.....  
Address.....  
City..... State.....

pany, is now chairman of the board and John B. Turner is executive vice president.



**WESTON TO HAVE NEW BUILDING**

The Weston Electrical Instrument Corporation is constructing a new engineering and administration building on the plant grounds at Newark, N. J.

**PHILCO LICENSES RCA**

Philco Corporation has licensed RCA to use its "advanced i-m system" and approximately 600 other Philco patents.

**DR. B. S. ELLEFSON APPOINTED DIRECTOR OF SYLVANIA CENTRAL ENGINEERING LABS**

Dr. Bennett S. Ellefson has been named director of the central engineering laboratories of Sylvania Electric Products, Inc. Dr. Ellefson will direct planning, organization and coordination of fundamental and applied research and development.



**GUARDIAN RELAY-KIT BULLETIN**

A 4-page bulletin describing series-200 relays with interchangeable coil and contact assemblies, and kits of switch parts, has been released by the Guardian Electric Mfg. Co., 1623 West Walnut Street, Chicago 12, Ill.

**G.E. VACUUM-CAPACITOR BOOKLET**

A 16-page booklet discussing high-voltage vacuum capacitors has been prepared by the tube division of the G. E. electronics department.

Presented are schematic drawings, circuit diagrams, rating and installation photographs, design and operating features, and application data.

**HERLEC CORP. FORMED BY CRL ENGINEERS**

Thomas B. Hunter, Milton Ehlers and Harry W. Rubinstein, former Chicago sales representative, chief ceramic engineer and chief engineer, respectively, of Centralab, have formed a ceramic-capacitor manufacturing company, Herlec Corporation, 422 North 5th Street, Milwaukee 2, Wis.

**TECHNOLOGY INSTRUMENT Z-ANGLE METER BULLETIN**

A 4-page bulletin describing a Z-angle meter, type 310A, for impedance measurements, has been published by the Technology Instrument Corporation, Waltham, Mass.

The meter has an impedance range of from .5 to 100,000 ohms. Direct reading is provided. Meter uses direct-comparison method.

**UNIVERSITY SPEAKER CATALOG**

A 24-page catalog describing super-power speakers, driver units, reflex trumpets, radial reflex projectors, etc., has been released by University Loudspeakers, Inc., 225 Varick Street, New York 14, N. Y.

**GENERAL CERAMICS AND STEATITE DATA**

A 48-page catalog, No. 2000, describing steatite pillar insulators, bushings, coaxial cable insulators, lead-in insulators, coil forms, etc., has been prepared by the General Ceramics and Steatite Corporation, Keasbey, New Jersey.



Photo courtesy Pacific Division Bendix Aviation Corp., North Hollywood, Calif. Transmitter-Receiver Unit for mobile communication equipment. Model LTR-1



K-23C Plug

Integral Clamp

**QUALITY ELECTRICAL CONNECTORS IMPROVE OPERATION AND SELLING FEATURES OF ANY EQUIPMENT...**

An axiom of the electrical equipment industry receiving greater and greater acceptance is "No equipment is better than its electrical connections." Cannon Electric has long taken pride in furnishing connectors for quality equipment. These vital parts are recognized by manufacturers as "musts"—such as the Collins and Bendix new equipment shown here. Many other prominent firms specify Cannon Plugs because "Equipped with Cannon Plugs" means quality connections.

Two-channel Transmitter, 17E-2. Specially designed for executive planes.

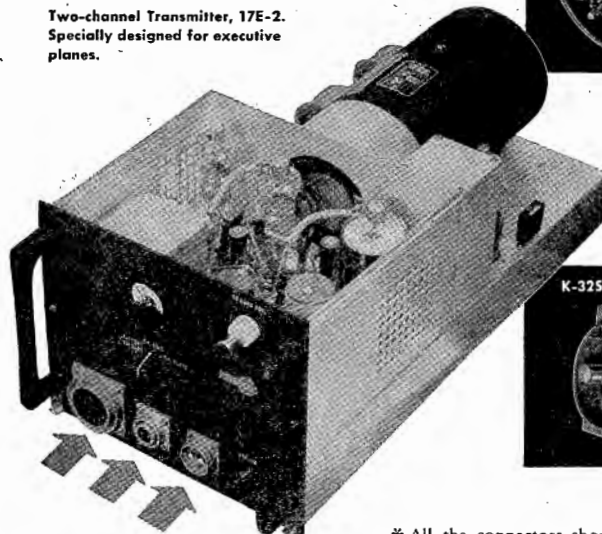

RK-22 Plug

Photo courtesy Collins Radio, Cedar Rapids, Iowa.



K-325L Receptacle

**CANNON ELECTRIC DEVELOPMENT COMPANY**  
 LOS ANGELES 31, CALIF.  
 In Canada — Toronto, Ont.

\* All the connectors shown in the transmitters are type "K." If you wish a bulletin covering these fittings, write Cannon Electric Development Co., Dept. H-121, 3209 Humboldt Street, Los Angeles 31, Calif. for Type "K" Bulletin, or contact our representatives located in principal cities of the U.S.A.



**SINCE 1915**



The **FINEST MICROPHONES**  
for P.A. and RECORDING!



**AMPERITE VELOCITY MICROPHONE WITH PATENTED ACOUSTIC COMPENSATOR**

**New P. G. DYNAMIC WITH NEW SUPERIOR ELIPSOID PICK UP PATTERN!**

**AMPERITE KONTAK MIKES IDEAL FOR AMPLIFYING STRINGED INSTRUMENTS USED WITH ANY AMPLIFIER AND WITH RADIO SETS.**

ASK YOUR JOBBER . . . WRITE FOR FOLDER

# AMPERITE

561 BROADWAY NEW YORK



## AVAILABLE NOW —

**Excellent Chicago space for radio or television station, recording or audition studios, ad or art agency, any firm needing unusual 2-fl. space**

Unusual circumstances make immediately available 8,664 sq. ft. on top two floors of nationally known, modern Chicago office building. Space now laid out with private offices and studio workrooms. One 2-story acoustically treated studio is 38'x46'. Exceptionally attractive opportunity for radio or television station, recording or audition studios, advertising or art agency, commercial photographer—any firm requiring unusual space. Rare chance to acquire prestige downtown location, close to all city and suburban transportation, at a rental which invites immediate attention.

Principals or Agents Address, Box 1864, COMMUNICATIONS,  
52 Vanderbilt Ave., New York 17, N. Y.

## NEWS BRIEFS

(Continued from page 41)

named director of communications for Trans World Airline.

Captain Goldsborough will supervise TWA communications and air navigation policies for both transcontinental and international divisions. He will serve as coordinator and do liaison work between TWA and various aviation groups, including PICAQ, CAA, FCC, RTCA, ATA and the AITA.



### COMMANDER ALLEN NOW WITH TELEPHONICS CORP.

Commander Hugh E. Allen has joined Telephonics Corporation, New York City, as manager of electronics engineering and sales.



### ARMY SIGNAL ASSOCIATION FORMED

The Army Signal Association, a national organization of wartime military communications personnel and members of the radio, telephone, movie and allied industries, was established recently with the selection of Major General Harry C. Ingeles, Army Chief Signal Officer, as honorary president. Brig. Gen. David Sarnoff of RCA, was chosen interim president. With headquarters in Washington, 631 Pennsylvania Ave., N.W., chapters are being established in all principal cities. Brig. Gen. Stephen H. Sherrill (ret.) of Washington is executive secretary.

Darryl F. Zanuck, Twentieth Century-Fox; William J. Halligan, Hallicrafters; and Fred Friendly, former Signal Corps sergeant, were named interim vice presidents.

Interim directors include: Carroll O. Bickelhaupt, American Telephone & Telegraph; George P. Dixon, International Telephone and Telegraph Corp.; Paul V. Galvin, Galvin Manufacturing Corp.; Dr. Harold Z. Zahl, Signal Corps Engineering Labs., and Fred R. Lack, Western Electric Co.

### JFD EXPANDS

A new plant site, located on 16th Avenue, 61st to 62nd Street, Brooklyn, N. Y., has been purchased by the JFD Manufacturing Co., 4111 Fort Hamilton Parkway, Brooklyn 19, New York.

### DR. YERZLEY NOW MYCALEX DIRECTOR OF RESEARCH AND ENGINEERING

Dr. Felix L. Yertzley has been named director of research and engineering of the Mycalex Corporation of America.

### TOBE CATALOG

A 40-page catalog describing capacitors and noise-suppression filterettes has been published by the Tobe Deutschmann Corporation, Canton, Massachusetts.

Offered are dimension drawings, type designations, ratings, and specification data.

### R. P. EVANS ELECTED TURNER PRESIDENT

Renald P. Evans has been elected president of The Turner Company, Cedar Rapids, Iowa. Mr. Evans was Turner's general manager for the past three years.

David Turner, founder of The Turner Com-

Shallcross Manufacturing Company, Collingdale, Penn.

Presented are dimension data, mounting specifications, minimum and maximum resistance values, tolerance, temperature charts, and temperature coefficient data.

A copy of the chart is available free of charge; ask for Shallcross Akra-Ohm resistor engineering data chart.

**M. W. BURRELL NOW COLLINS G-S-M**

Max W. Burrell has been appointed general sales manager for the Collins Radio Company, Cedar Rapids, Iowa. He will be in charge of Collins marketing activities, including the New York and Los Angeles offices.



**V-H-F DATA IN AEROVOX RESEARCH WORKER**

A series of articles entitled "V. H. F. Primer" is appearing in the "Aerovox Research Worker." Copies of the bulletins are available free from any Aerovox jobber or direct from Aerovox Corporation, New Bedford, Mass.

**HERMAN SMITH TO MANUFACTURE PARTS**

Herman H. Smith has resigned as president of Radio Essentials, Inc., Mount Vernon, N. Y., and formed his own organization, Herman H. Smith, Inc.

The new company will manufacture components and hardware.

**WENDELL BECOMES V-P IN CHARGE OF FTR**

Edward N. Wendell, who has been associated with I. T. & T. since 1925, has been appointed vice president in charge of the Federal Telephone and Radio Corporation.



**WESTINGHOUSE METAL AND ALLOY BOOKLET**

A 48-page illustrated booklet describing the physical and electrical characteristics of magnetic metals and alloys, including Hipernik, Conpernik, Hiperco, Hipersil and Puron, has been published by the Westinghouse Electric Corporation, Box 868, Pittsburgh 30, Pa.

In one section of the book appears data on electrode, filament and contact metals, properties and applications of tungsten, molybdenum and Cupaloy. Two glass sealing alloys, Kovar "A" and Dumet, are outlined in another section. Other sections discuss brazing and soldering alloys, including Phos-Copper, 35-alloy and tin-lead and pure tin solders, and physical and mechanical properties of K-42-B, a high temperature alloy.

Sketches, diagrams, curves and tables are presented throughout the booklet.

**ZUCKERMAN JOINS SUN RADIO**

Walt Zuckerman has been named manager of the amateur sales and technical department of Sun Radio & Electronics Co., Inc., 122-124 Duane St., New York 7, N. Y.

He was formerly with the U. S. Army Signal Corps overseas as Communications Engineer.

**CAPT. GOLDSBOROUGH NOW TWA DIRECTOR OF COMMUNICATIONS**

Capt. Paul Goldsborough, U. S. N. R., former president of Aeronautical Radio, Inc., has been  
(Continued on page 42)

1917

1946

MODERN  
COIL WINDINGS

**General Grant  
Was Right**

He had one idea . . . to win a war. He had one plan . . . and he stuck to that plan until the war was won.

We wind coils for those who need them. That's our business and we're going to stick to it. We're specialists and do not make apparatus requiring coils, thus avoiding competition with those we hope to serve.

So far, we have been able to do a rather remarkable job as winders of coils, in spite of postwar limitations. If you require coil windings, we should be pleased to show you how well we can serve you.

**COTO-COIL CO., INC.**

COIL SPECIALISTS SINCE 1917

65 PAVILION AVE.

PROVIDENCE 5, R. I.

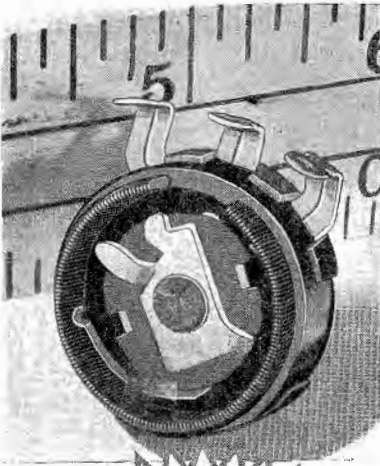

**Midget  
WIRE-WOUND  
Controls**

★ Clarostat Series 43 wire-wound potentiometers and rheostats are interchangeable mechanically (dimensions, mountings, shafts, terminals, etc.) with composition-element Series 37 Clarostat controls. Space-savers. Dependable. Long life. Often preferred to larger controls for resistance values up to 10,000 ohms linear.

Bakelite body with protective metal cover (shown removed in illustration).

1 to 10,000 ohms. Standard tolerance, within 10% plus or minus.

Power rating: 2 watts average.

Single tap at center can be provided. Tapers not practical.

300° mechanical rotation; 280° electrical, without switch, 260° with switch.

★ For engineering data on this handy midget wire-wound control, write for Bulletin No. 116.



CLAROSTAT MFG. CO., Inc. • 285-7 N. 6th St., Brooklyn, N. Y.

## NEWS BRIEFS

### GOVERNMENT REPORTS ON GERMAN WAR DEVELOPMENTS

A 32-page report on German ceramic materials for high-frequency insulation developed during the war has been prepared by the Office of Technical Services, Department of Commerce.

The report discusses German automatic dry pressing methods.

For automatic dry pressing of steatite, granules of various sizes were mixed and moistened until the mixture held together if squeezed by hand. No pressing oil or other lubricant was added to the steatite body.

Pressure was controlled at the press by weighing the pressed parts and measuring their length. Values and tolerances for these quantities were set at the beginning of a run by firing samples. Dry pressed parts were made in sizes up to 100 millimeters in diameter.

The report reveals that Germany's lack of high-grade mica and the demand for mechanical rigidity in the design of vacuum tubes led to the wartime development of a new method for making ceramic tube spacers. To make the spacers, prisms cut from a special kind of talc, mined at Goeppersgruen, Bavaria, were used.

Talc nuggets from the Bavarian deposit have a densely grained crystalline structure and do not show cleavage in any preferred direction. The report states that an almost identical type of talc, probably suitable for the German method, exists in Montana.

The new method of making the spacers involved cutting the prisms into thin plates and punching the complete plates, outside contour and holes, on a hand-operated punching press. Under the old, normally used procedure, the plates were milled to the appropriate outside contours, and then the holes were drilled by using a jig. With this new process one operator can punch 8,000 plates a day.

Another report describes a German-developed "Photophone" captured by Allied troops in North Africa, which provides for short distance voice communication over a beam of light.

The instrument, which resembles an oversized pair of binoculars mounted on a tripod, will transmit voices over a diffused light beam, or over an extremely narrow beam of white, red, or invisible infra-red light, according to the report.

The receiving component of the speech amplifier consists of a photoelectric cell followed by three resistance coupled stages of amplification. The sending component uses a single stage of amplification between the microphone and a mechanical modulator which transmits the message over the light beam. Optical units to send and receive the light, a telescopic sight for focussing the beam, batteries, amplifier, earphones, and microphones are component parts of the equipment. Completely assembled, the equipment weighs about 50 pounds and may be carried by one man.

The report describes the construction and operating details of the equipment, and includes circuit diagrams.

Manufacturers interested in examining a "Photophone" should communicate with Edwin Y. Webb, Chief, Communications Unit, Technical Industrial Intelligence Branch, Department of Commerce.

### COL. HALE NOW JEFFERSON-TRAVIS V-P

Colonel George C. Hale has been appointed vice president in charge of operations of the Jefferson-Travis Corporation, N. Y. C., N. Y.

Colonel Hale spent three years as world-wide Communication Equipment Officer on the staff of General Arnold, Army Air Forces Chief.



### SHALLCROSS RESISTOR WALL CHART

A wall chart illustrating and describing 54 precision resistor types has been released by the

## BOOKS FOR THE ENGINEER

### UNDERSTANDING MICROWAVES

(Chapter Heads)

The Ultra High Frequency Concept Stationary Charge and its Field • Magnetostatics • Alternating Current and Lumped Constants • Transmission Lines Poynting's Vector and Maxwell's Equations • Waveguides • Resonant Cavities • Antennas • Microwave Oscillators • Radar and Communication • Section Two is devoted to descriptions of Microwave Terms, Ideas and Theorems. Index.

400 PAGES

PRICE \$6.00

### A-C CALCULATION CHARTS

Student engineers will find this book invaluable. Simplifies and speeds work. Covers all AC calculations from 10 cycles to 1000 megacycles.

160 PAGES

PRICE \$7.50

### JOHN F. RIDER, Publisher, Inc.

404 FOURTH AVENUE, NEW YORK 16, N. Y.  
EXPORT DIV.: ROCKE-INTERNATIONAL ELEC. CORP.  
13 E. 40TH STREET, NEW YORK CITY, CABLE ARLAB

### OUTSTANDING VALUES IN COMMUNICATION AND ELECTRONICS SUPPLIES

Order Today — Immediate Delivery  
HEWLETT-PACKARD AUDIO OSCILLATOR



Model 200B, frequency range 20 cycles to 20,000 cycles in 3 ranges. A Precision Laboratory Instrument. Complete with tubes and power supply, reconditioned and guaranteed by Niagara. Special...\$75.00

### PLATE TRANSFORMER

6200 Volt CT — 700 Mils. 110 Volts, 80 Cycles—tapped primary 2 KVA Amertran. Limited quantity...\$39.95

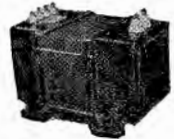

### HAND SET

200 ohms carbon mike—magnetic phone 600 ohms—complete with rubber cord 6'—Terminates in standard mike and phone plugs. Only .....\$6.95



Quantity orders on any of above items invited. All prices FOB our warehouse, New York City, N. Y.

Write for our latest Bulletin 8C

NIAGARA RADIO SUPPLY  
160 Greenwich St., New York 6, N. Y.  
Bowling Green 9-7993

6-mile range and 10-mile markers on the 30-mile range.

#### Selsyn-Positioning System

To complete the chart presentations, bearing information must be added to range information. This is accomplished by means of a selsyn-positioning system, Figure 4. A 1/6-hp motor located in the antenna pedestal (Figure 6) drives a 201:1 gear reduction which is an integral part of the motor. The output shaft of the gear motor rotates the antenna at a speed of approximately 10 rpm.

Antenna position information is obtained from a selsyn which is driven from the gear motor at the same speed as the antenna. The rotating rotor of the selsyn establishes a rotating field in the three stator windings. Voltages developed in these three windings are fed to three similar windings in another selsyn located in the console unit and mechanically connected to the sweep coil around the cathode-ray tube. The sweep coil is rotated by the coil-driving motor through a gear reduction at a rate dependent upon the voltage generated in the rotor of the selsyn in the console. If the sweep coil and antenna are kept in correspondence, no voltage will be developed in the console selsyn rotor. If the sweep coil either leads or lags the antenna, however, the selsyn rotor sends a voltage to an amplifier system called the servo amplifier.

The voltage is amplified and used to drive the sweep coil either forward or backward in whatever direction may be necessary to bring the system to correspondence. In this fashion a constant correction is applied to the coil-driving motor to assure that any instantaneous position of the antenna is accurately portrayed on the face of the cathode-ray tube.

Figure 7

Selsyn electrical-positioning device, type 5CT.

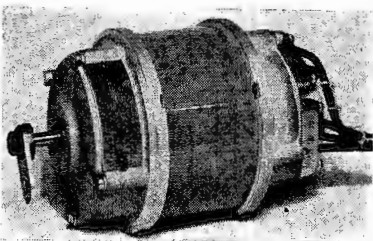

## For GRAND PERFORMANCE

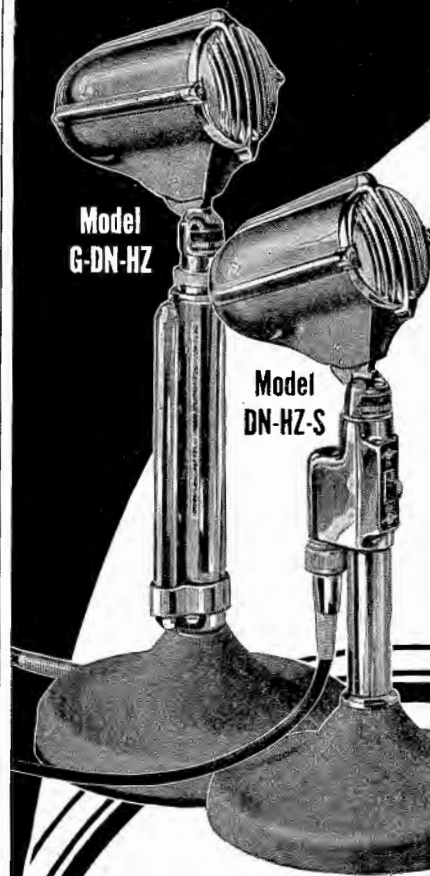

### Astatic

#### DYNAMIC MICROPHONES NEWLY DESIGNED AND ENGINEERED

● Incorporating advanced ideas in operation and design, Astatic DN-Series Dynamic Microphones are highly recommended for a wide variety of communications and public address applications, especially where temperatures vary and high relative humidity is encountered.

*Four Models*  
of different output  
impedances, are  
available: DN-50,  
DN-200, DN-500  
and DN-HZ.

*Any one* of these models is available with the Type G, Grip-to-Talk Desk Stand. Only one model, however, DN-HZ-S, high impedance, is available with the Type S On-Off Switch. Astatic Dynamic Microphones are semi-directional in character, incorporate a unitary moving coil system and carefully proportioned acoustic circuit to highly damp the natural resonance of the moving parts and provide a response substantially flat from 50 to 7,000 cycles. All DN-Series Microphones are sturdy and dependable, relatively low in cost, smartly streamlined, attractively finished in opalescent gray with bright chrome grille, and sure to give long, satisfactory service.

THE *Astatic* CORPORATION  
CONNEAUT, OHIO  
IN CANADA: CANADIAN ASTATIC LTD., TORONTO, ONTARIO

**SPECIALIZED Skill in METAL**

**CABINETS**

**PANELS • CHASSIS • RACKS**  
with Beautiful Chrome Trim

**PAR-METAL PRODUCTS CORPORATION**  
32-62 - 49th STREET  
LONG ISLAND CITY 3, NEW YORK  
Export Dept.: Roche International Corp.  
13 East 40 Street, New York 16

The time-tested Par-Metal line presents superior features of styling, design, and construction. True to policy, Par-Metal continues to specialize in Electronic Housings exclusively...and is therefore able to offer leadership in value. Compare! Write for Catalogue.



★  
**Have You Seen  
The Solar System?**

It's a bi-monthly magazine of authoritative information on new developments in the capacitor field. Simply fill in the coupon below if you'd like to receive this easy-to-read

**FREE**

technical publication regularly at your home or at your office.



1689

Solar Manufacturing Corporation  
285 Madison Avenue, New York 17, N. Y.

Gentlemen: Please send me the SOLAR SYSTEM regularly, starting with the current issue.

Name.....

Address.....

City..... Zone No..... State.....

**NAVIGATOR**

(Continued from page 37)

range selected, i.e., the time required for a radar wave to travel 2 miles and back, 6 miles and back, or 30 miles and back. By applying this block signal to a sweep-generator stage, a sawtooth wave of the same duration as the block is generated. This sawtooth is applied to a coil encircling the neck of the cathode-ray tube and causing the spot to be deflected radially from the center of the tube to its outer perimeter. The result is a displacement along the face of the tube proportional to the time required to send a wave to the target and have it return. The distance to the target can therefore be learned by noting where on the face of the tube the intensity modulation occurs.

**Use of Markers**

Distance can be judged more accurately by noting the target position in relation to simulated targets whose position is accurately controlled. These targets are known as markers and are the product of the marker generator. On the 2-mile range, markers appear at 1-mile intervals. Since radio waves travel at a speed of 327 yds per microsecond, the time elapsed in traveling a distance of one nautical mile and returning is.

$$t = \frac{(2,026.7 \text{ yds}) (2)}{327 \text{ yds/microsecond}}$$

or 12.4 microseconds. Thus to simulate 1-mile signals, the marker generator produces sharp impulses every 12.4 microseconds. In a similar fashion, 2-mile markers are generated for the

Figure 6

Antenna pedestal including parabolic reflector and polystyrene doublet housing.

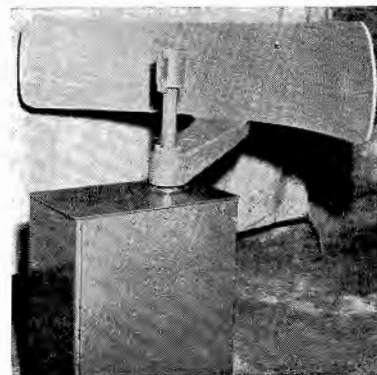

to provide a low-impedance path to the heterodyne receiver.

#### Receiver

The first element of the receiver is a silicon crystal mixer to which is fed a c-w signal from the local oscillator in addition to the 3,200-mc signal from the antenna. The local oscillator frequency is adjusted to either 30 mc above or below the incoming signal frequency. The output of the mixer will contain sum and difference components in addition to the fundamentals. It is the 30-mc difference frequency which is amplified and put to use. The other components are bypassed in the mixer output section and i-f amplifier input.

The i-f amplifier employs six stagger-tuned stages of amplification at 30 mc. Stagger tuning provides the necessary wide bandwidth necessary to pass the high-frequency video components resulting from the relatively sharp-cornered and steep wave-front signals. Gain is maintained by the use of high- $\mu$  miniature tubes.

A single section of a miniature diode is used as a conventional heterodyne second detector. Detector output is amplified by two video stages before being fed to the cathode-ray tube. Presence of a target is indicated by an intensity modulation on the face of the cathode-ray tube.

Simultaneous with the above sequence of events, the synchronizing oscillator sends a one-half micro-second wave to a gate generator. This stage consists of a multi-vibrator whose output is also a square wave, but this square wave is of longer duration. The time of duration is dependent upon the

Figure 5

Antenna pedestal with cover removed.

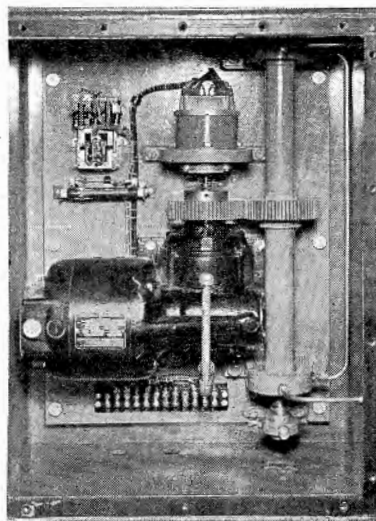

# Permoflux Speakers

with Powerful  
**ALNICO 5**  
Magnets!

## The Right Speaker for Every Purpose

Perfectly matched to your circuit and cabinet requirements, Permoflux Speakers will faithfully translate the tone excellence of your design. They combine high sensitivity with wide frequency response and rugged mechanical construction. Manufactured in a wide range of sizes and power handling requirements under methods assuring unusual quality control, Permoflux PM and Electrodynamic Speakers provide the finest sound reproduction for every application.

**PERMOFLUX**  
PERMOFLUX CORPORATION  
4900 WEST GRAND AVE., CHICAGO 39, ILL.

CABLE ADDRESS: "PERMO" CHICAGO, ILL.  
West Coast Plant: 236 So. Verdugo Rd., Glendale, Calif.  
Eastern Office: 108 Central Ave., Westfield, N. J.

PIONEER MANUFACTURERS OF PERMANENT MAGNET DYNAMIC TRANSDUCERS

*A Buy-word for Excellence*

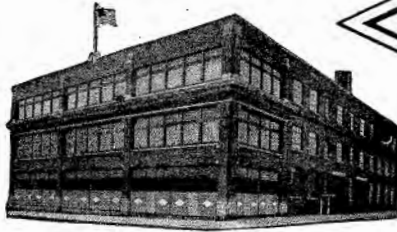
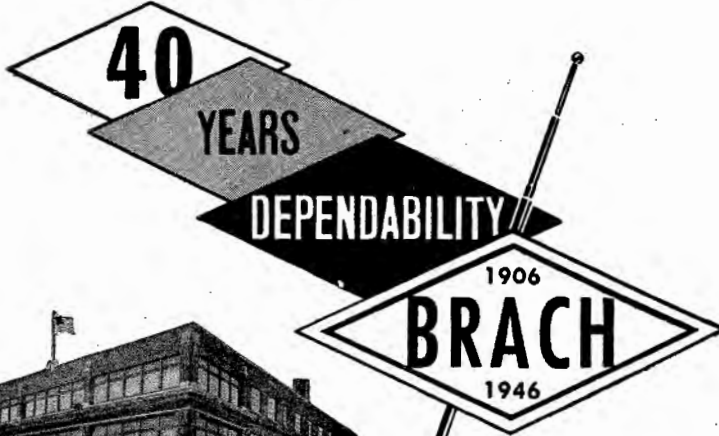

**PUR-A-TONE**  
Reg. Trade Mark

**ANTENNAS**

ALL TYPES FOR  
 • AUTOS  
 • HOMES  
 • MARINE  
 A.M. — F.M. — TELEVISION

Make pleased customers and bigger profits . . . ask your distributor for BRACH Puratone ANTENNAS.

Special-purpose transmitting antennas designed for volume production to your own specifications. Collapsible—sectional—direction finding—radar and coaxial type. All sizes, lengths and materials. Consult us on your needs.

**L. S. BRACH MFG. CORP.**  
 200 CENTRAL AVENUE NEWARK, N. J.



WORLD'S OLDEST AND LARGEST MANUFACTURERS OF RADIO ANTENNAS AND ACCESSORIES.

**NAVIGATOR**

(Continued from page 30)

stallations, the first commercial model was installed aboard United States

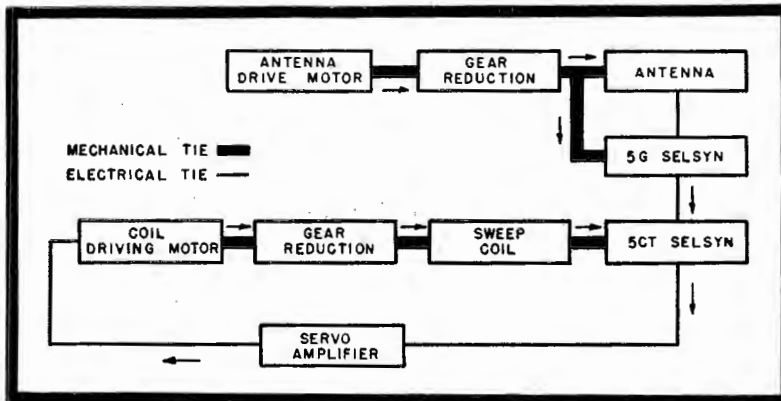

Maritime Service training ship *American Mariner*.

**Use of PPI**

Conforming with the requirements for ease of interpretation, the *plan position indicator* presentation was employed because of the similarity between it and the navigational charts. In Figure 2a appears the operating control panel with the PPI: Range scales of 2, 6, or 30 miles are provided so that the operator may have before him the best presentation for his needs.

Figure 1 shows the sloping front panel of the binnacle containing the operator controls and the indicator face.

**Basic Operation**

The essential components of the *electronic navigator* appear in Figure 3. The sequence of operations begins with the synchronizing oscillator, which generates a square-shaped wave. This square wave is of one-half micro-second duration and is repeated 1,500 times a second.

The square wave is greatly amplified in the modulator stage by a pliatron. The resultant output furnishes plate power for the magnetron. This tube oscillates at 3,200 mc whenever the modulator supplies a pulse of power. These high-frequency pulsed oscillations are fed to the antenna through an r-f transmission line and then directed into space. The pulses are of high enough magnitude to cause an arc in the transmit-receiver switch. The arc causes the impedance to the crystal mixer to be greatly increased, thus preventing energy from being fed to the crystal mixer and i-f amplifier.

**Horizontal Beam**

Once the r-f power leaves the antenna it travels in a 5° horizontal beam in the direction the antenna is pointing at the time. If the beam is directed toward land, or a ship, or any solid material, a small part of the energy will be reflected back to the antenna. By the time this small signal reaches the antenna, the transmitted pulse will have been finished so the antenna is free to act as a receiving antenna. It collects this feeble received energy and sends it to the transmit-receive switch

Figure 4  
 Block diagram of antenna-positioning system.

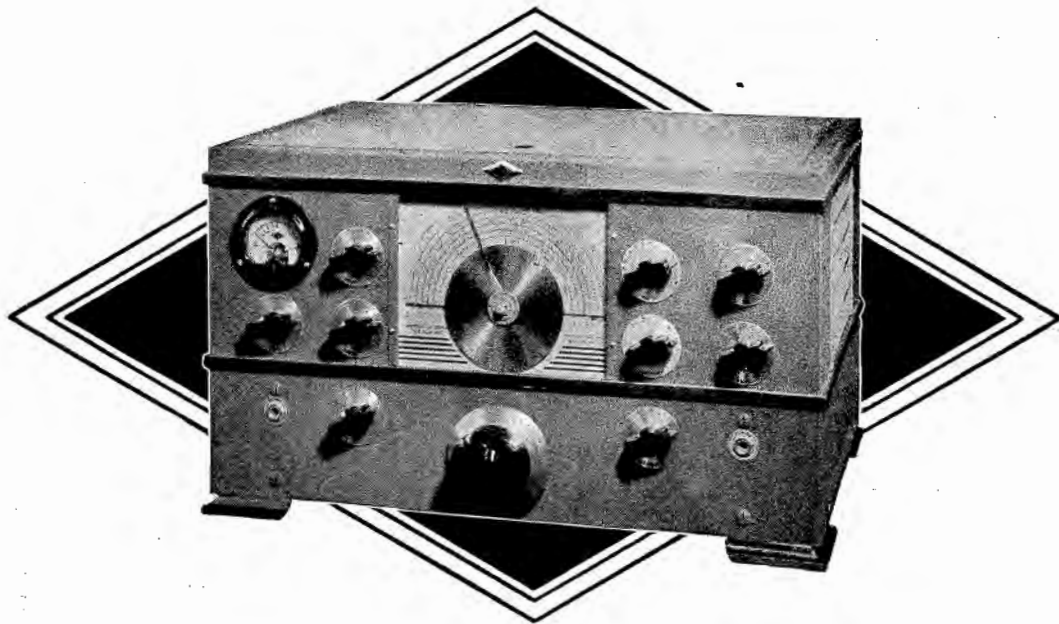

## THE NC-2-40C RECEIVER

Back of the superb NC-2-40C receiver stand National's twenty-five years of experience in building to the highest quality. In the NC-2-40C as in other products, National has excellence for sale. Stability and sensitivity are outstanding. Controls are convenient to the hand and smooth in operation. All important auxiliary circuits — wide range crystal filter, noise limiter, S-meter, beat oscillator, AVC — are present in advanced design. You will find the operation of the NC-2-40C a gratifying pleasure and its ownership a source of pride. See it at your dealer's.

NATIONAL COMPANY, INC.



MALDEN, MASSACHUSETTS







### Personals

R. L. WILLITS HAS BEEN brass pounding since 1929. He started with RMCA and Mackay. At present he is attached to the Ambrose E. Burnside. . . J. R. Arkinstall is now with the New York State Maritime Academy at Fort Schuyler, in charge of the radio school, as a Lieutenant Commander. His keying days started in 1927. He has sailed on many ships such as the Santa Teresa, Coamo, George Washington and the Ft. St. George. . . Judson Vanderhoof was a first Lieutenant in the U. S. Marine Corps at San Francisco in 1927. He is back with the Marines at Quantico, Va., at NFV. He saw service on the USS Henderson and also did some key pounding at NPP, Peiping, China and NAA and NSS in Washington. . . E. C. Page, recently named vice president in charge of engineering at the Mutual Broadcasting System, has been an operator since 1920. During his first years of brass pounding he served on the Great Lakes vessels. Broadcasting activities followed with operations at KFAF, Denver, Colorado; WBBM, Chicago and others in the Chicago area. He served as a consulting engineer for over a decade and in 1942 joined the U. S. Army. . . We were shocked to hear of the death of Commander S. Friedman's son, Robert, at the U. S. Naval Hospital in San Diego. Our deepest regrets, S. F.

FEW CAREERS HAVE BEEN as colorful as that of Capt. Pierre Henri Boucheron, U.S.N.R., life member of the VWOA, who is now in charge of WGL, the Farnsworth station at Ft. Wayne, Indiana. Back in 1917, Capt. Boucheron entered the Naval Reserve as a Warrant (Radio) Gunner, serving throughout World War I in many radio posts. At the conclusion of the war, he joined RCA and served as director of public relations for many years. He was called back to duty in July, 1941, and commissioned Lt. Commander. His initial assignment took him to Greenland where he established

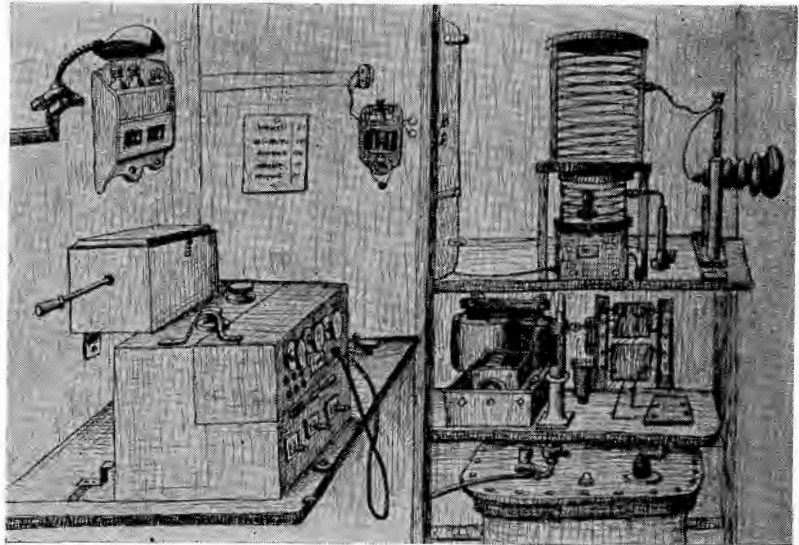

George Clark sketch of Stone equipment installed by George on U. S. R. C. Manning at San Francisco, 1907.

(Courtesy G. H. Clark)

communication bases. After a fourteen month stay in Greenland, he returned to Washington and became Assistant to the Director of Naval Communications. In July, 1943, Capt. Boucheron was sent to Casablanca as a Communications Officer for the Moroccan Sea Frontier. In September, 1944, he was transferred to the staff of the Commander of Naval Forces in France. Here he served as a Communications Officer under Vice Admiral Allan G. Kurk. On June 30, the command was dissolved and Capt. Boucheron returned to this country to resume his business activities with Farnsworth.

Capt. Boucheron has received many decorations for his outstanding services: Navy Commendation Ribbon, for his work in Greenland; the World War I Medal; American Defense Ribbon; European Theatre Ribbon; World War II Ribbon; 20-year Naval Reserve; Order of Ouissam Alaouite Cherifien, grade of Commander, awarded by the Sultan of Morocco; and the degree of Chevalier, Legion d'Honneur, by the French Government.

He is a member of the Institute of Radio Engineers, Explorers Club,

Army and Navy Club of Washington, and Radio Club of America.

In the citation for "La Croix de Chevalier de la Legion d'Honneur," Capt. Boucheron was cited "for perfection of the difficult communication setup required for the Naval operation on the German-held pockets of the Gironde and Ile d'Oleron which permitted excellent results during the period of combat."

WE ARE INDEBTED TO GEORGE H. CLARK for the interesting sketch appearing this month. The sketch made by George H. Clark in 1907 at San Francisco, is that of the Stone equipment installed by George on the R. C. Manning. This equipment was designed by John Stone who was head of the Stone Telephone and Telegraph Co., Boston, Mass. Incidentally, George's work during the early days also included design of many Navy receivers such as the types A, B and C and later SE 143. George also developed the Navy pack CN 241, several crystal detector designs, etc.

George, who retired a short while ago, appears to be more active than ever. He just likes work, he says.

# PREVENTIVE MAINTENANCE for Broadcast Stations

by **CHARLES H. SINGER**

Assistant Chief Engineer  
WOR-WBAM

ALTHOUGH WORK BENCHES are useful for all transmitter plants a large bench is essential in the high-powered stations. The work bench must be carefully planned and laid out so that there is a place for everything. Various maintenance aids should also be provided. These include handy maintenance kits which can be picked up and carried to the job, a test wagon fully equipped for more elaborate on the spot maintenance, and a portable test bench equipped with power outlets and selected test instruments for emergency and routine operations.

The well-planned transmitter plant should have an elaborate measuring equipment room. In this room, test apparatus should be set up in racks so that typical tests and measurements can be made simply by establishing the correct cross-connections. In addition, special apparatus set-ups should be provided to solve specific problems as they arrive. At WOR, for instance, we have a tube reconditioner unit to extend tube life.

## Studio Plant

Too often one unit in a combination is permitted to assume a greater importance than any of its supporting units. Typical of this is the ball carrier on the gridiron who is glorified for the touchdown feat, an accomplishment attributable in equal measure to all eleven members of the team. For instance, without the studio plant the transmitter could not exist; indeed, there would be no need for its existence.

Since the programs originate in the studios, the maintenance facilities should be of the best to give the transmitter group a dependable, high quality program feed. A typical studio plant should have a test bench with all of the commonly used test instruments conveniently laid out and accessible. The test bench should include adequate work space, storage facilities, and perhaps a bench for receiving work to be done. A completely equipped machine shop with facilities for storage should

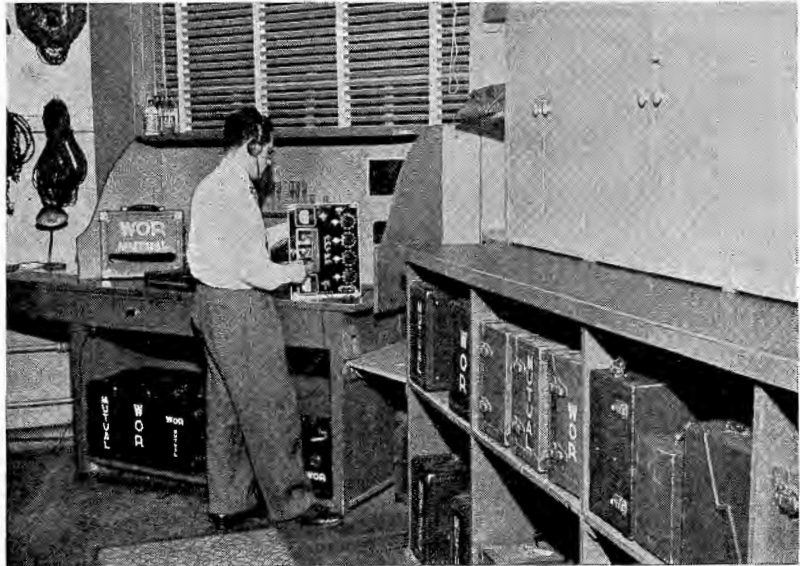

WOR field engineering division test bench.

---

## Third of a Series of Papers Offers a Discussion of Maintenance Facilities, Preventive Maintenance Procedures and Precautions.

---

also be provided. Very often the commercial equipment available on the open market must be modified to meet special studio or program requirements. A wire room for wire supplies, and providing work space for routine wiring jobs should be available for this purpose.

### Field Engineering

In larger stations the *field engineering division* maintains a large store of apparatus. A small test bench for routine maintenance and adequate storage facilities should be provided for this group, and the bulk of the major maintenance jobs should be routed through the studio maintenance group.

### Preventive Maintenance Procedures

Preventive maintenance procedures

are designed to: (a) combat the ravages of weather on the equipment; (b) prevent the detrimental effects of dirt, dust, and moisture on the operation of the equipment; (c) keep the equipment in such condition as to insure uninterrupted operation; (d) keep the equipment in condition, so that it will always operate at maximum efficiency; and (e) prolong the useful life and assure the dependability of the equipment.

In following through with preventive maintenance it is necessary to consider things to be done to the equipment while it is on the air, and things to be done to the equipment during normal periods of non-operation, i.e., while the set is *off the air*.

### Precautions During Maintenance Work

Special safety precautions must be

(Continued on page 54)



# COMMUNICATIONS will cost

**you only \$1.00**

**for the next 12 issues**

To the Publisher of

## COMMUNICATIONS

52 Vanderbilt Ave., New York 17, N. Y.

Please enter annual subscriptions (12 issues) for each of the undersigned for which payment is enclosed at the rate of \$1.00 each. (This rate applies only on 4 or more subscriptions when classifications are given.)

Name .....

Address .....

City-State .....

Occupation .....

Employed by .....

Nature of Business .....

(State if Manufacturer, Broadcast Station, etc.)

Product .....

Name .....

Address .....

City-State .....

Occupation .....

Employed by .....

Nature of Business .....

(State if Manufacturer, Broadcast Station, etc.)

Product .....

Name .....

Address .....

City-State .....

Occupation .....

Employed by .....

Nature of Business .....

(State if Manufacturer, Broadcast Station, etc.)

Product .....

Name .....

Address .....

City-State .....

Occupation .....

Employed by .....

Nature of Business .....

(State if Manufacturer, Broadcast Station, etc.)

Product .....

● A subscription to COMMUNICATIONS will provide timely and authoritative articles of decided importance to every engineer and executive in radio, broadcasting, television, facsimile, sound recording and projection, aeronautical, police, railroad, marine and emergency communications.

Leading design, manufacturing and operations engineers keep posted on all new developments in this fast-moving industry by reading COMMUNICATIONS every month. It has helped them. It can help you.

You and your associates can obtain a year's subscription to COMMUNICATIONS (12 issues) for only \$1.00 each by using the Group Subscription Plan. Here's how:

A regular yearly subscription to COMMUNICATIONS costs \$2.00—but, when four or more men sign up at one time, each one is entitled to the half-price rate. (Foreign subscribers only pay \$2.00 each.)

It is easy to get three or more of your associates to subscribe with you. Thousands of leading engineers and executives have subscribed year after year on that basis. Use the convenient form on this page. Fill in the names, tear out and mail today with your check or money-order. Renewals and extensions are acceptable also.

**COMMUNICATIONS** • 52 Vanderbilt Ave., New York 17, N. Y.

for every control need...

# RELAYS *by* GUARDIAN



Whether the principle is electronic or magnetic . . . here are some of the latest, greatest basic design Guardian Relays, Solenoids and Stepping Switches we are privileged to present to design engineers.

Each unit offers an unlimited number of variations . . . often making a *standard* Guardian Relay a "special," effecting big savings in time and money. Highly efficient, compact, low-priced, long life, you can depend on it—they'll increase the dependability and quality of your product.

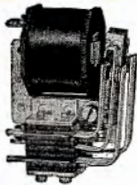

### Series 40 A. C. Laminated Relay

This laminated relay is designed to produce maximum output with minimum current input. Typical uses include control of call system bells; auxiliary for automatic radio tuning; remote control of fractional motors; safety devices; instruments; sound movie auxiliaries.

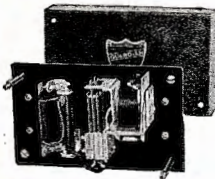

### Series T-110 Time Delay Relay

This relay employs a resistance wound bimetal strip to achieve a delayed operation from 10 to 60 seconds. Current flows through the windings generating heat, causing the bimetal strip to bend, closing a contact after the required time delay.

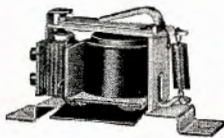

### Series 120

The Series 120 is a small, compact relay. It is an economical unit designed for control needs which do not exceed single pole, double throw combination. Economy and simplicity of construction make it possible to offer the Series 120 at a low price compared with its high quality performance.



### Series 1-A Solenoid

The series 1-A Solenoid by Guardian is one of numerous types for intermittent and continuous duty. Applications include valve control and operation; electrical locking; clutch and brake operation; material ejector; spray gun operation among others.

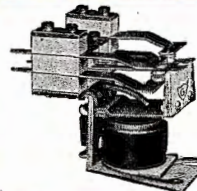

### Series A-100 High Frequency

This A151Mag insulated relay is compact, convenient, low in cost. In radio applications it is used for antenna change-over, break-in, high voltage keying, grid controlled rectifier keying, remote control of receiver and transmitter, and other high frequency applications.

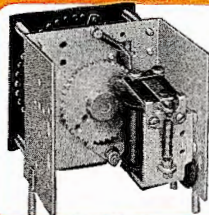

### Series R Stepper

This Relay is built in three basic types for A.C. and D.C. operation: (1) Continuous rotation, (2) Electrical reset, (3) Add and subtract. Its principle application is automatic circuit selection including automatic sequence, automatic wave changing on short wave transmitters, automatic business machines, totalizing units, conveyor control.

# GUARDIAN ELECTRIC

1610-J W. WALNUT STREET

CHICAGO 12, ILLINOIS

A COMPLETE LINE OF RELAYS SERVING AMERICAN INDUSTRY