

# COMMUNICATIONS

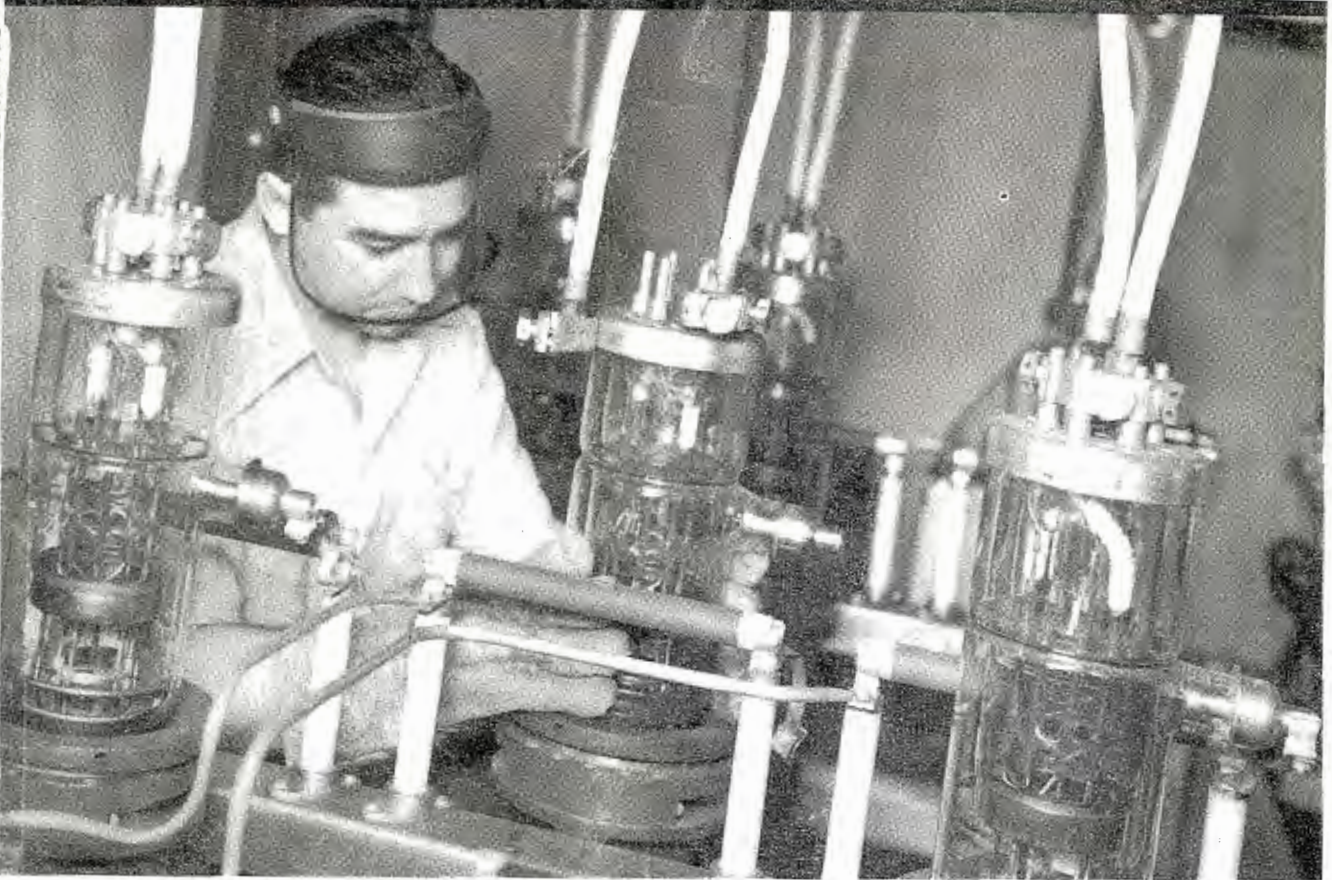

DECEMBER

- ★ RADIO ENGINEERING
- ★ REPORT ON IRE FALL MEETING
- ★ TRANSMISSION LINE DIELECTRICS
- ★ AERONAUTICAL COMMUNICATIONS
- ★ H-F HIGH-POWER TRANSMITTER DESIGN
- ★ TELEVISION ENGINEERING

1944



# *HYTRON has made them all!*



The march of Hytron receiving tube progress down through the years is fascinating. One looks back on tubes, tubes, and more tubes: battery, AC, AC/DC, diodes, triodes, pentodes, beam tetrodes, multiple purpose types, G's, MG's, BANTAM GT's—and now the miniatures. Price and size have been drastically cut; quality and performance, amazingly improved.

Hytron has made them all. Its long and varied experience is priceless in a complex industry where probably never will all the answers be known. In making radio tubes, painfully acquired practical

experience must supplement the formulae of science.

With an eye to present and future, Hytron is concentrating its production of receiving tubes on preferred BANTAM GT types needed for war—for today's civilian replacements—and ultimately for post-war. Its wartime activities are teaching Hytron new techniques of miniature production. Many potentially popular Hytron miniatures are in development. Typical American dissatisfaction with anything but perfection continues; the parade of Hytron receiving tubes marches on.

OLDEST EXCLUSIVE MANUFACTURER OF RADIO RECEIVING TUBES

**HYTRON**  
CORPORATION

ELECTRONIC AND RADIO TUBES

SALEM AND NEWBURYPORT, MASS.

**BUY ANOTHER WAR BOND**





AIRPORT LOUNGE at the TACA HEADQUARTERS at TEGUCIGALPA HONDURAS

*Comfort at the Airport...*  
**SAFETY IN THE AIR**

One of RADIO RECEPTOR'S most valuable contributions to safety in the air is its

**3 KW MULTIPLE UNIT GROUND STATION TRANSMITTER**

This equipment, Type CT-3000—"THE GLOBE GIRDLER," is used at airports for communication with planes and with other airports—for long distance as well as local communication. It is ruggedly designed for continuous use under adverse and rigorous conditions. Transformer and coils are impregnated for operation in a tropical climate.

**OPERATING CHARACTERISTICS**

The transmitter assembly is composed of individual units, one for each RF channel, one for each modulator, and one for the rectifier power supply unit. The RF and modulator units are interwired and connected to operate from the common rectifier power supply unit.

**FREQUENCY RANGE**—2 to 20 mc. RF units are supplied with coils and capacitors to operate at a single specified frequency and output load. Components are available for operation on any other frequency and output load impedance within the limits specified.

**POWER OUTPUT**—2.5 KW continuous, 3 KW intermittent service.

**FREQUENCY CONTROL**—Low temperature coefficient crystal control at a sub-multiple of output frequency.

**RF LOAD IMPEDANCES**—Grounded or balanced transmission line loads—50-700 ohms. Loading inductor or series condenser available on special order for working directly into reactive antenna.

**TYPE OF TRANSMISSION**—A-1 (CW Unmodulated telegraph), up to four simultaneous channels; or A-3 (telephone Modulated carrier), up to two simultaneous channels.

**MODULATION**—High level modulation of RF power amplifier by means of Class B audio modulator.

**NOISE LEVEL**—Carrier noise 40 db. below 100% modulation.

**KEYING**—High speed (200 words per minute) electronic keying standard. Slow speed keying of oscillator available on special order.

**POWER SUPPLY REQUIREMENTS**—230 volts 50/60 cycles, 3 phase.

*Also available in output powers of 1 and 5 KW. Circular on request.*



**RADIO RECEPTOR COMPANY, INC.**

251 WEST 19th STREET

NEW YORK 11, N. Y.

SINCE 1922 IN RADIO AND ELECTRONICS

# COMMUNICATIONS

Including Television Engineering, Radio Engineering, Communication & Broadcast Engineering, The Broadcast Engineer. Registered U. S. Patent Office.  
 Member of Audit Bureau of Circulations.

*We See...*

LONG, SWIFT AND DECISIVE were the strides made by *radio communications* during 1944 . . . a year that can be recorded as one of the most significant in *communications* history. While rigid military secrecy precluded a complete discussion of the dominant developments completed, reports from all war theatres gave proof to the salient contributions provided by *communications*. D-Day, June 6, offered strong evidence of that fact . . . with a brilliant test of the worthiness of United States equipment.

And on the home front substantial progress was chronicled too. Hearings that will affect the complete frequency allocation program for the next five to ten years were held by IRAC and the FCC. The importance of *broadcast communications* was stressed by IRAC in allotting 61% of the spectrum between 42 and 1,000 megacycles for i-m, television and relays. At the FCC hearings, experts testified that *radio communications* have become increasingly important to many industries. Aircraft, railroads and emergency services, to cite a few, will demand a variety of equipment. For instance, fire fighting units will probably need equipment for 130,000 units. Over a quarter of a million airplanes will need communications equipment; over 6,000 airports are scheduled for new communications installations. And most of the major railroad lines have made plans for radio communication services. The use of u-h-f and v-h-f for radio and wire relay links was also stressed at the hearings, with A. T. & T. announcing their \$2,000,000 coaxial-cable link covering some 7,000 miles, and RCA, G.E. and others disclosing their coast-to-coast satellite station plans.

Yes, 1944 was an epic year in *communications* . . . and 1945 will probably offer lively competition.

THE TWENTY-FIFTH ANNIVERSARY of broadcasting will be celebrated in 1945. Throughout the year broadcast stations will observe this anniversary with appropriate programs. And the featured slogan on all programs will be . . . "Radio's Twenty-Fifth Anniversary . . . Pledged to Victory!"—L. W.

DECEMBER, 1944

VOLUME 24 NUMBER 12

COVER ILLUSTRATION

Installing water-cooled power tubes in modulator unit of 200-kw transmitter.  
 (Courtesy Federal Telephone & Radio Corp.)

U-H-F TRANSMISSION DESIGN

Dielectrics in U-H-F Flexible Coaxial Cables . . . . . A. J. Warner 33

TELEVISION ENGINEERING

Signal Intensity Tests On A Mountain Top . . . . . Donald Phillips 36

ENGINEERING CONFERENCE REVIEW

A Report On The 1944 Rochester Fall Meeting . . . . . Lewis Winner 40  
*Filament Design (H. J. Dailey)* . . . . . 40  
*Video Amplifiers (Dr. M. J. Larsen)* . . . . . 41  
*Resonators (W. R. MacLean)* . . . . . 42  
*Pulse Time Modulation (E. Labin)* . . . . . 42  
*U-H-F Measurements (Dr. W. T. Dakin)* . . . . . 46  
*Silicones (Dr. S. L. Bass)* . . . . . 48

AERONAUTICAL COMMUNICATIONS

Graphical Solution For CAA Course Alignment  
 (Part II, Charts) . . . . . G. L. Brewer 52

BROADCAST TRANSMITTER DESIGN

Bethany 200-kw H-F Transmitters  
 (Part II) . . . . . R. J. Rockwell 58

U H-F LABORATORY RESEARCH

Power Supply For U-H-F Velocity-Modulated Tubes . . . . . Iredell Eachus, Jr. 62

TRANSMITTER DEVELOPMENT

Transmitter Design Yesterday and Today . . . . . Donald McNicol 64

MONTHLY FEATURES

Editorial (We See) . . . . . 2  
 Veteran Wireless Operators' Association News . . . . . 68  
 News Briefs of the Month . . . . . 77  
 The Industry Offers . . . . . 92  
 Advertising Index . . . . . 100

Published Monthly by the Bryan Davis Publishing Co., Inc.

BRYAN S. DAVIS, President  
 F. WALEN, Secretary

PAUL S. WEIL, General Manager  
 A. GOEBEL, Circulation Manager

Advertising and Editorial offices, 19 East 47th St., New York 17, N. Y. Telephone PLaza 3-0483. Cleveland 6, Ohio; James C. Munn, 10515 Wilbur Avenue. Pacific Coast Representative: Brand & Brand, 816 W. Fifth St., Los Angeles 13, Calif.; Telephone, Michigan 1732. Wellington, New Zealand: Te Aro Book Depot. Melbourne, Australia: McGill's Agency. Entire Contents Copyright 1944, Bryan Davis Publishing Co., Inc. Entered as second-class matter October 1, 1937, at the Post Office at New York, N. Y., under the act of March 3, 1879. Yearly subscription rate: \$2.00 in the United States and Canada; \$3.00 in foreign countries. Single copies, twenty-five cents in United States and Canada; thirty-five cents in foreign countries.







*... and never the twain shall meet*

"East is east and west is west," wrote the poet, "and never the twain shall meet."

But he was wrong.

The twain *shall* meet. The peoples of the earth shall begin to know each other — and work together — for peace and plenty for all.

And the miracle will be due in great part to the coming Age of Flight. . . .

Communications will help make Air Transport safer — more economical — faster. Harvey-Wells Electronics produces communications equipment designed for complete dependability, engineered for maximum efficiency . . . selected for War, perfected for Peace.

In the Age of Flight, look to Harvey-Wells for ideas, skill, imagination — setting the pace for progress in communications!

*Know the company that wants your business! Our CASE BOOK tells the story of Harvey-Wells and its place in Electronics. Send for it today. Your name on your letter-head is sufficient.*



**Harvey** - **WELLS**  
E L E C T R O N I C S

SETTING THE PACE FOR PROGRESS IN COMMUNICATIONS

HARVEY-WELLS ELECTRONICS, INC. SOUTHBRIDGE, MASSACHUSETTS

COMMUNICATIONS FOR DECEMBER 1944 • 3





# CRYSTALS

The recognized quality and dependability of AAC quartz crystals is the result of AAC's wide experience as one of America's largest producers of transmitters and other precision radio equipment. AAC quartz crystals and crystal units have proved so outstanding in meeting intricate specifications and exacting requirements that they are today demanded by many of the world's greatest airlines, radio manufacturers, various branches of the armed services and other government agencies.

This practical achievement background—plus AAC's staff of skilled engineers and modern-to-the-minute manufacturing facilities is ready to meet your crystal needs advantageously. Rapid delivery of standard types—also special types, ground and mounted to your specifications.

**ELECTRONICS DIVISION**  
Kansas City, Kansas



WRITE now for your free copy of the new AAC crystal catalog giving detailed facts about AAC quartz crystals and crystal units.

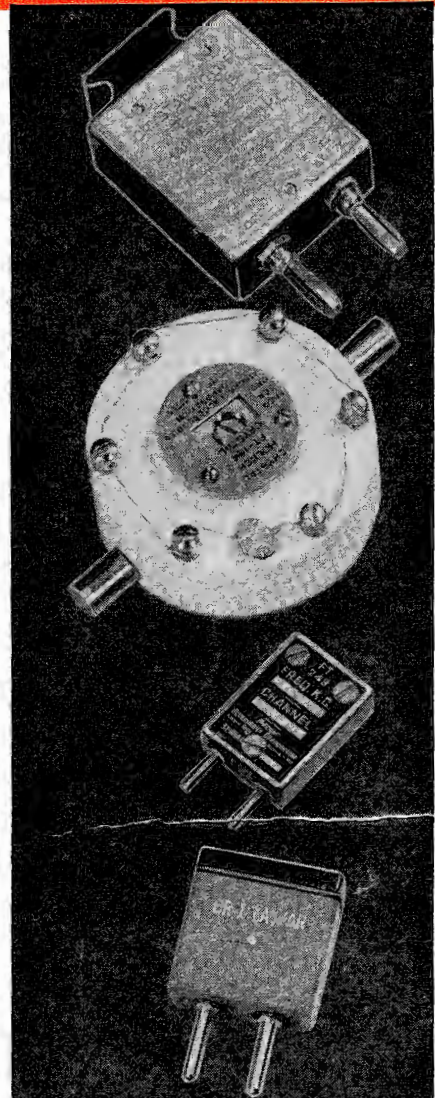
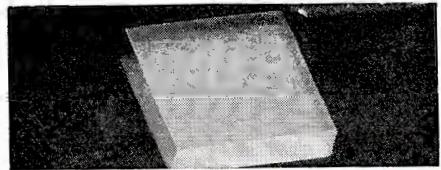

**AIRCRAFT**  
RADIO and  
Kansas City, Kans.



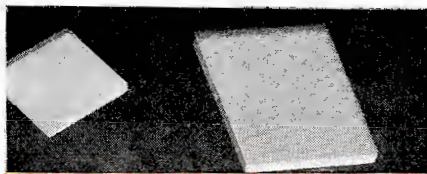

# PRECISION MADE FOR PRECISE PERFORMANCE

*and*

## PROVED IN USE!



There is no question about AAC crystals meeting the most exacting requirements under severe operating conditions. Their reliability has been tested and proved a thousand times over . . . in battlefront service to the armed forces . . . in helping to keep the communication systems of many leading airlines working efficiently . . . in meeting the quality demands of radio manufacturers. The list of users of AAC crystals shown below is a tribute to the engineering skill and fine manufacturing facilities behind AAC crystals.

Braniff Airways, Inc.  
Chicago & Southern Air Lines, Inc.  
National Airlines, Inc.  
Northwest Airlines, Inc.  
Pan American Airways System  
Pan American-Grace Airways, Inc.  
Pennsylvania-Central Airlines Corp.  
Transcontinental & Western Air, Inc.

Colonial Radio Corp.  
Columbia Broadcasting System, Inc.  
Stewart-Warner Corporation  
Western Electric Company, Inc.  
Zenith Radio Corporation

Remember, crystal production is only one of AAC's services to the aviation and electronics industries. The production of airborne and ground radio equipment at the rate of more than 30 million dollars yearly for U. S. government and leading airlines demonstrates the wide scope and high rating of AAC manufacturing ability.

E-134

**A**CCESSORIES **C**ORPORATION  
ELECTRONICS • ENGINEERED POWER CONTROLS  
New York, N. Y. Burbank, Calif. Cable Address: AACPRO



# Would You Pay A WHOLE DOLLAR for your daily paper?



**T**HAT man is here again! The guy who used to say "I can get it for you wholesale" now whispers: "I can get it for you **WITHOUT RATION COUPONS . . .**" The sad thing is that—he **CAN**. But, oh, what a price you pay!

You can't beat arithmetic. If there are ten refrigerators for sale and a hundred eager bidders for them, the seller is going to nick those ten buyers for *all the traffic will bear!* Then prices soar . . . the dollars that buy those refrigerators drop in value. Too few goods, too much money on the loose, connive to breed the worst of all national dangers: **INFLATION**. A 100-cent dollar sinks to 5c—or less—in buying power! Uncontrolled prices . . . *less* for your hard-earned money! A drop in the value of your savings account, of your insurance, of everything

you own. Would you like to pay a whole dollar for your daily paper?

"Ration coupons?" Oh, nuts! "Ceiling prices?" "Listen, fella, I can get you what you want—for only a few dollars more . . ." Don't you believe him. He can't, *really!* You may not give up ration coupons **THIS** time, but you may have to give up **MUCH** more in the long run. The unhappy spiral of inflation can put every thing you want and need 'way beyond your price-reach! Don't let this happen to *you*—your neighbors, your entire nation. Instead, for a **FAIR** share at a **FAIR** price, take the Consumers' Pledge of Fair Play, and **LIVE UP TO IT:** "I will pay no more than ceiling prices; I will take no rationed goods without giving up ration coupons." **DEFEAT** the scourge of Inflation!



THE MARK OF

EXCELLENCE

Here at Kenyon, we're proud to play our small role on the stage of a **BIG** war. That's why **EVERY** Kenyon transformer used by our fighting forces throughout the world reflects only the highest precision craftsmanship. Kenyon workers are doing their share—bringing Victory closer by turning out top quality transformers *uninterruptedly*—and as fast as possible!

**KENYON TRANSFORMER CO., Inc.** 840 BARRY STREET  
NEW YORK, U. S. A.

# COMIN' AT YOU!



Buy War Bonds

... and some for all!

Here comes aluminum . . . rolling out to meet the highest *record* demand in its history . . . and back to do a bigger and better job in PRESTO RECORDING DISCS!

PRESTO ALUMINUM RECORDING DISCS are now available in all sizes from 6½ inch to 17¼ inch. That's *good news* for broadcasting stations, recording studios and schools all over the nation . . . who know through valued experience that PRESTO is

simpler to handle—doesn't require fussy adjustments . . . and, in fact, is the smoothest cutting disc they've ever used!

Order PRESTO ALUMINUM DISCS from your regular electronics distributor. May we suggest that you split your order—50% aluminum and 50% glass base for the time being, so that we can fairly distribute PRESTO ALUMINUM DISCS over the first big demand?

## PRESTO RECORDING CORPORATION

242 West 55th Street

New York 19, N. Y., U. S. A.

*Walter P. Downs Ltd., in Canada*

COMMUNICATIONS FOR DECEMBER 1944 • 7







700  
SERIES

900  
SERIES

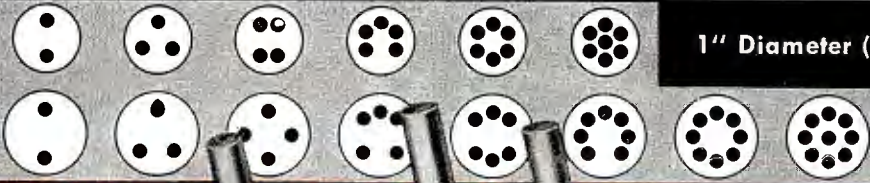

1" Diameter (.952)

1 1/4" Diameter  
(1.235)

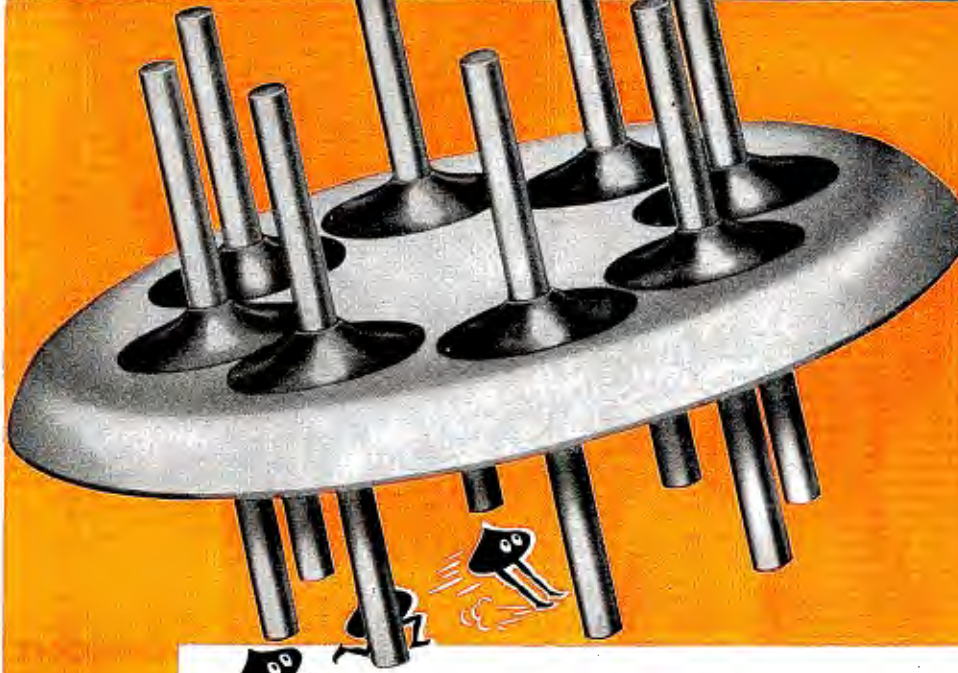

Fusite terminal panel used as cover for container. A single sealing operation.



Hole punched and adapter socket formed to receive Fusite terminal panel.



**WARNING:** . . . the illustration to the left is not drawn from real life. But getting down to the real facts of life, Fusite multi-terminal panels make your fondest dreams come true regarding hermetic sealing. Fusites can and do stand production handling. They pass the tough thermal shock test of dry ice to boiling water. They are made of cold-rolled steel, tin plated. But this is only part of the story. The glass insulation is joined by interfusion with metal. And it works! Fusite is the only (so far as we know) multi-terminal panel interfused within a reinforced metal shape, all in one piece. One and only one sealing operation is required to hermetically seal electronic component parts—such as transformers, relays, coils and the like. Write on your business letterhead for samples and descriptive literature (we may have it ready). And don't send us an order now . . . but please remember to do so when Uncle Sam says, "Okay, boys, you can produce for others." We want your business, but we no-can-do, now! We'll need it then. So let's be friends now and customer-friends then. Thanks for readin' and writin' and rememberin'.

**WITH  
FUSITE  
SEALS**



I'M JUST AN AMP,  
A' CIRCUIT SCAMP,  
AND DAMPNES SETS ME REELING;  
SO KEEP ME DRY,  
INTENSELY SPRY,  
WITH **FUSITE ATMO-SEALING**.

GLASS TO METAL

**CINCINNATI ELECTRIC  
PRODUCTS COMPANY**

**FUSITE**

CARTHAGE AT HANNAFORD, NORWOOD,  
CINCINNATI 12, OHIO

© 1944 C. E. P. C.

**NO DAMP AMPS**



**THAT ALL MAY HEAR...**



**THE BRUSH BR2S MICROPHONE**

has a floating, shock-proof "Sound-Cell" assembly. This crystal microphone satisfies the most rigid requirements for—

- INSTITUTIONAL APPLICATIONS
- INDUSTRIAL INSTALLATIONS
- PUBLIC ADDRESS SYSTEMS
- DISC RECORDING
- MONITORING
- RADIO

Its high quality performance, coupled with its low cost, recommend it for practically all applications where fidelity of reproduction is important.

*Write for descriptive literature and price*



**THE BRUSH DEVELOPMENT COMPANY**

3503 PERKINS AVENUE

CLEVELAND 14, OHIO

*New*  
**INTERNAL-PIVOT**  
**PANEL INSTRUMENTS**  
 2½ - inch - 1 inch deep



For radio and other communications service: Type DW-51 d-c voltmeters, ammeters, milliammeters, and microammeters; Type DW-52 radio-frequency ammeters (a-c thermocouple-type). Cases are brass or molded Textolite.

**A New Design That Puts  
 More Instrument into Less Space**

These new, internal-pivot instruments were developed to fill a vital need—particularly in the radio and aircraft fields—the need for compactness. They are *thin*—in most ratings, less than 1 inch deep.

More important is the way their thinness was achieved. In the sketch below, see how the pivots are solidly anchored to the *inside* of the armature shell so they cannot work loose. The moving parts are permanently aligned with stationary parts by bolting the core assembly to a one-piece cast-comol magnet.

Other features are: large-radius pivots, high torque and good damping, lightweight moving element, and ample clearances. Added up, they give you an instrument well able to withstand vibration and hold its rated accuracy, one that is fast on response and easy to read accurately—a design that packs all-round fine performance in a small space.

For ratings, price, and dimensions, ask our nearest office for Bulletin GEA-4064, which covers instruments for radio and other communications equipment; or Bulletin GEA-4117, which describes those suitable for naval aircraft. *General Electric Company, Schenectady, N. Y.*



Type DW-53 d-c voltmeters, ammeters, and volt-ammeters that are specially designed to measure voltage and current in battery and battery-charging circuits on naval aircraft. They meet applicable Navy specifications.

*Invest in  
 your future*  
**BUY WAR BONDS**



**HEADQUARTERS  
 FOR  
 ELECTRICAL  
 MEASUREMENT**

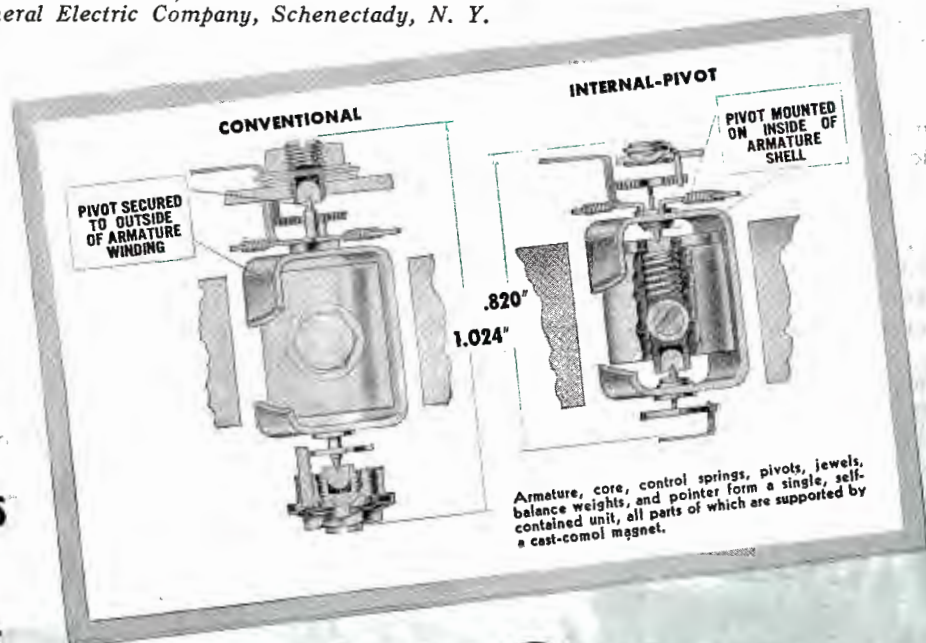

**GENERAL  ELECTRIC**  
672-26-4300



In ratings from 1000 volts to 10,000 volts test . . .

*Molded-in-Bakelite*  
**MICA CAPACITORS**

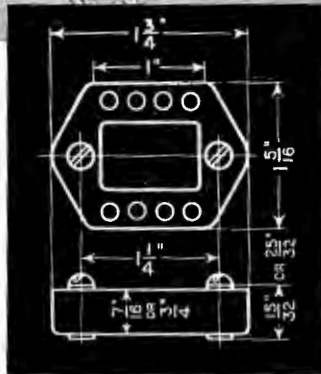

● The 1650 Series is the most rugged of the heavy-duty molded-in-bakelite mica capacitors of the extensive Aerovox line. These high-voltage units are intended for the most critical service of low-powered transmitting circuits, buffer stages, power amplifiers, laboratory equipment, etc. Also recommended for use in ultra-high-frequency circuits, and accordingly their r.f. current ratings are given in the Aerovox Capacitor Catalog.

The extra-generous use of high-grade dielectric material provides that greater factor of safety for longer service under severest operating conditions.

Standard units with tapped holes take 6/32 screws which serve for terminals. Also available with clearance holes through which screws or rods may be slipped, so that two or more units can be stack-mounted. Low-loss ceramic mounting insulators are available for mounting on metal surfaces. Standard units molded in brown bakelite. Also available in low-loss (yellow) XM bakelite.

In 1000, 2500, 5000, 7500 and 10,000 volts D.C. test. Capacitance ratings from .00005 mfd. to .06 mfd. in Type 1650 at 1000 v. D.C. test; .00005 mfd. to .001 mfd. in Type 1654L at 10,000 v. D.C. test.

● Literature on request . . .



*Capacitors*

**INDIVIDUALLY TESTED**

AEROVOX CORPORATION, NEW BEDFORD, MASS., U. S. A.

SALES OFFICES IN ALL PRINCIPAL CITIES

Export: 13 E. 40 ST., NEW YORK 16, N. Y. • Cable: 'ARLAB' • In Canada: AEROVOX CANADA LTD., HAMILTON, ONT.

The Best  
Show  
On the Air  
Saturday  
Night!

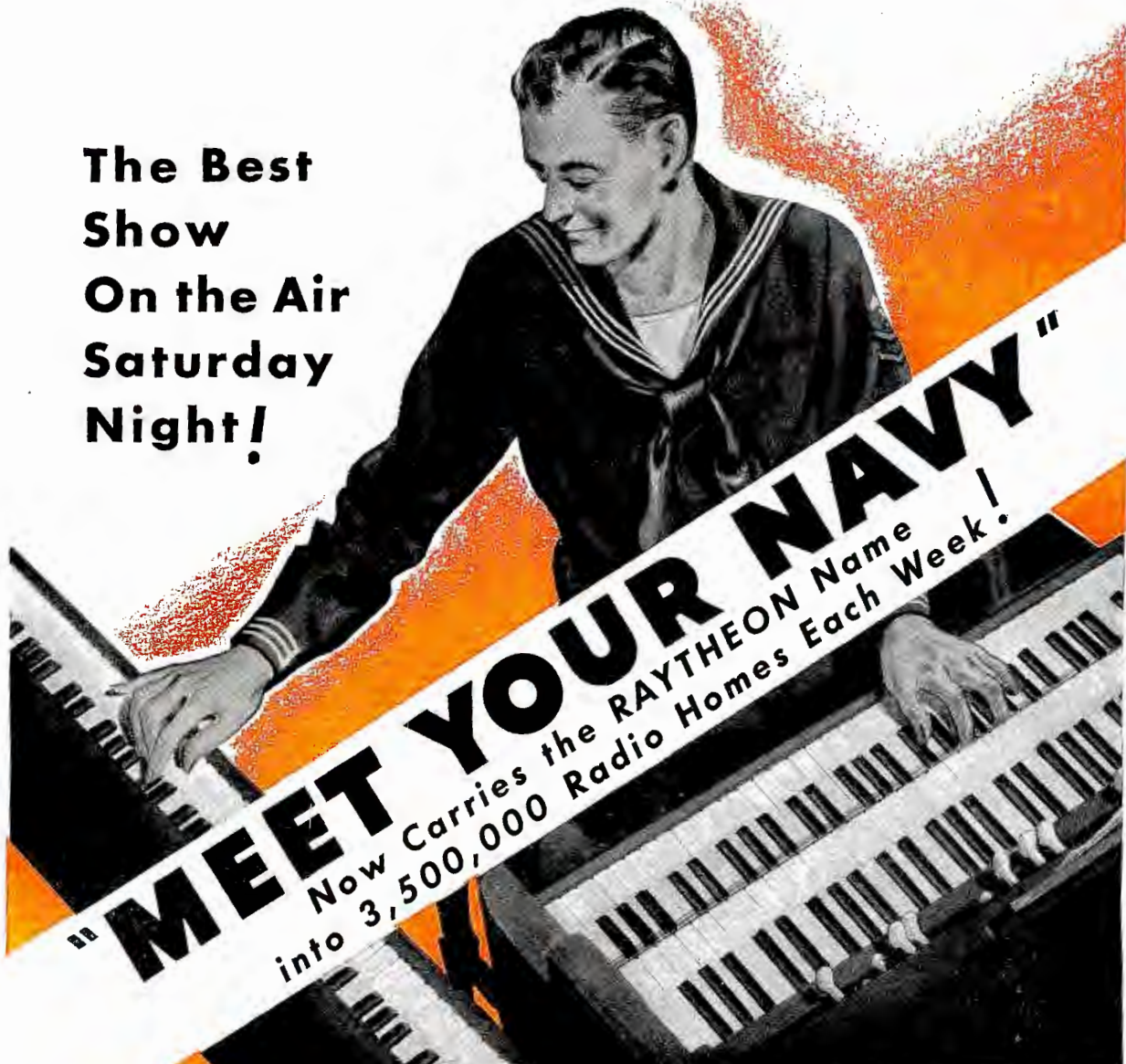

**"MEET YOUR NAVY"**  
Now Carries the RAYTHEON Name  
into 3,500,000 Radio Homes Each Week!

**Free!**

Ask your Raytheon distributor  
for colorful, attention-getting  
"Meet Your Navy" display to  
tie in with this great program.  
Easel-mounted, 17 1/2 x 20 1/2"



*Every Saturday Night*

**ENTIRE BLUE NETWORK**

*Coast to Coast 181 Stations*



**RAYTHEON MANUFACTURING COMPANY**

Waltham and Newton, Massachusetts



All Four Raytheon Divisions  
Have Been Awarded Army-  
Navy "E" with Three Stars

**RAYTHEON**

*High Fidelity*



**ELECTRONIC AND RADIO TUBES**

DEVOTED TO RESEARCH AND THE MANUFACTURE OF TUBES AND EQUIPMENT FOR THE NEW ERA OF ELECTRONICS

COMMUNICATIONS FOR DECEMBER 1944 • 13



# FROM ONE SMALL TOWN TO THE EARTH'S FAR CORNERS



**O**UT to the Far East, to ports on the seven seas identified only in code on the packing cases, goes war material so vital that it is needed on every beachhead and before the beachhead is created—poured out of *one* shipping room in just *one* factory in just *one* small Connecticut town!

Incredible? Not when Yankee ingenuity is taken into consideration—the same Yankee

ingenuity that stems from many lifetimes of meeting difficult situations.

That's the case here at Ansonia—typical of our approach to the problems which any form of electrical cables can solve. However difficult the requirements of peace may be, we feel that we can be of assistance in meeting them in new ways, as we have met the changing problems of war *and* peace before.

**ANKOSEAL** multi-conductor insulated cables are among the most promising of Ansonia war-proven developments. If you have, or expect to have, a use for electrical cables—

**CHECK ANKOSEAL!**

## THE ANSONIA ELECTRICAL COMPANY



Specializing in "Ankoseal" a Thermoplastic Insulation  
ANSONIA • CONNECTICUT



A Wholly-Owned Subsidiary of

## NOMA ELECTRIC CORPORATION

GENERAL OFFICES • NEW YORK, N. Y.

—In peacetime makers of the famous Noma Lights—the greatest name in decorative lighting. Now, manufacturers of fixed mica dielectric capacitors and other radio, radar and electronic equipment.





EASTERN AIR LINES

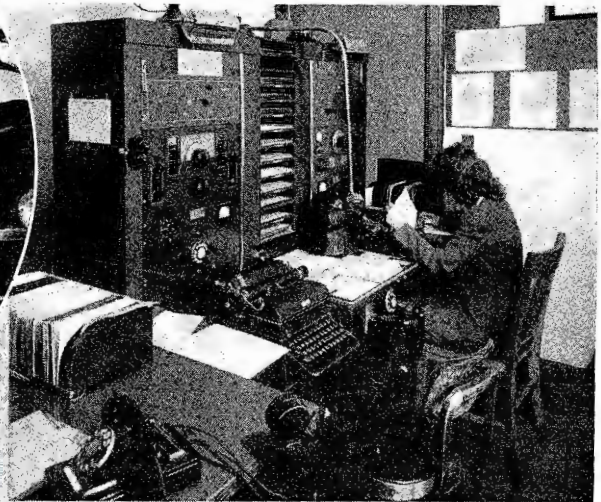

MID-CONTINENT AIRLINES

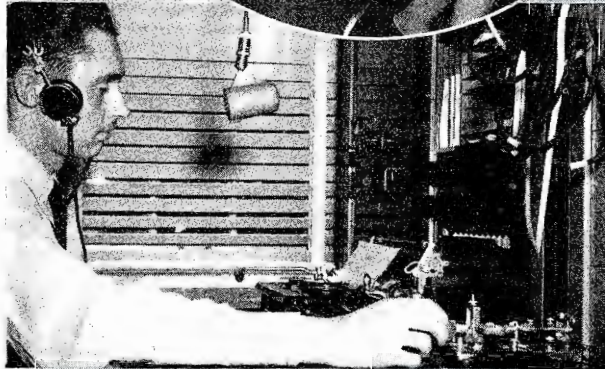

BRANIFF AIRWAYS



(ABOVE) PENNSYLVANIA-CENTRAL AIRLINES  
(BELOW) AMERICAN AIRLINES



## *Wilcox Installations with the Airlines*

### *for Dependable Radio Communications*

For many years the major commercial airlines of the United States have relied upon Wilcox dependability in their daily operations. In the postwar era of electronics and aviation, look to Wilcox for continued leadership in the development of radio communication.

**WILCOX  
ELECTRIC  
COMPANY**



Fourteenth and Chestnut Kansas City, Mo.  
*Manufacturers of Radio Equipment*



**Variable Tuning Condensers, Push Button Tuning**

**Mechanisms and Actuators, Phonograph Record Changers**



**A NEW DIVISION  
UNDER THE DIRECTION OF  
LEE GOLDER**

identified for more than 20 years with  
the manufacture of radio speakers.

Millions of radio components on the far flung battle areas of the world bear the G.I. insignia. What they have accomplished is already in the archives.

Behind General Instrument's record of achievement in the quantity production of electronic equipment for military use, stands nearly a quarter century of highly specialized production and experience in the field of radio components for home receiving sets.

**GENERAL ELECTRONIC APPARATUS CORP.**

A SUBSIDIARY OF

**GENERAL INSTRUMENT CORP.**

829 NEWARK AVE., ELIZABETH 3, N. J.



... and now  
**speakers**  
**by G.I.**

The addition of a complete line of speakers is, therefore, not a venture into a new field, but the logical outgrowth of our expanded facilities, developed by wartime activities and increased resources in the radio equipment industry.

The resourcefulness and ingenuity—the expanded and perfected facilities that made this mammoth production possible will be put, without stint, behind our new speakers. Set manufacturers will know what this will mean.

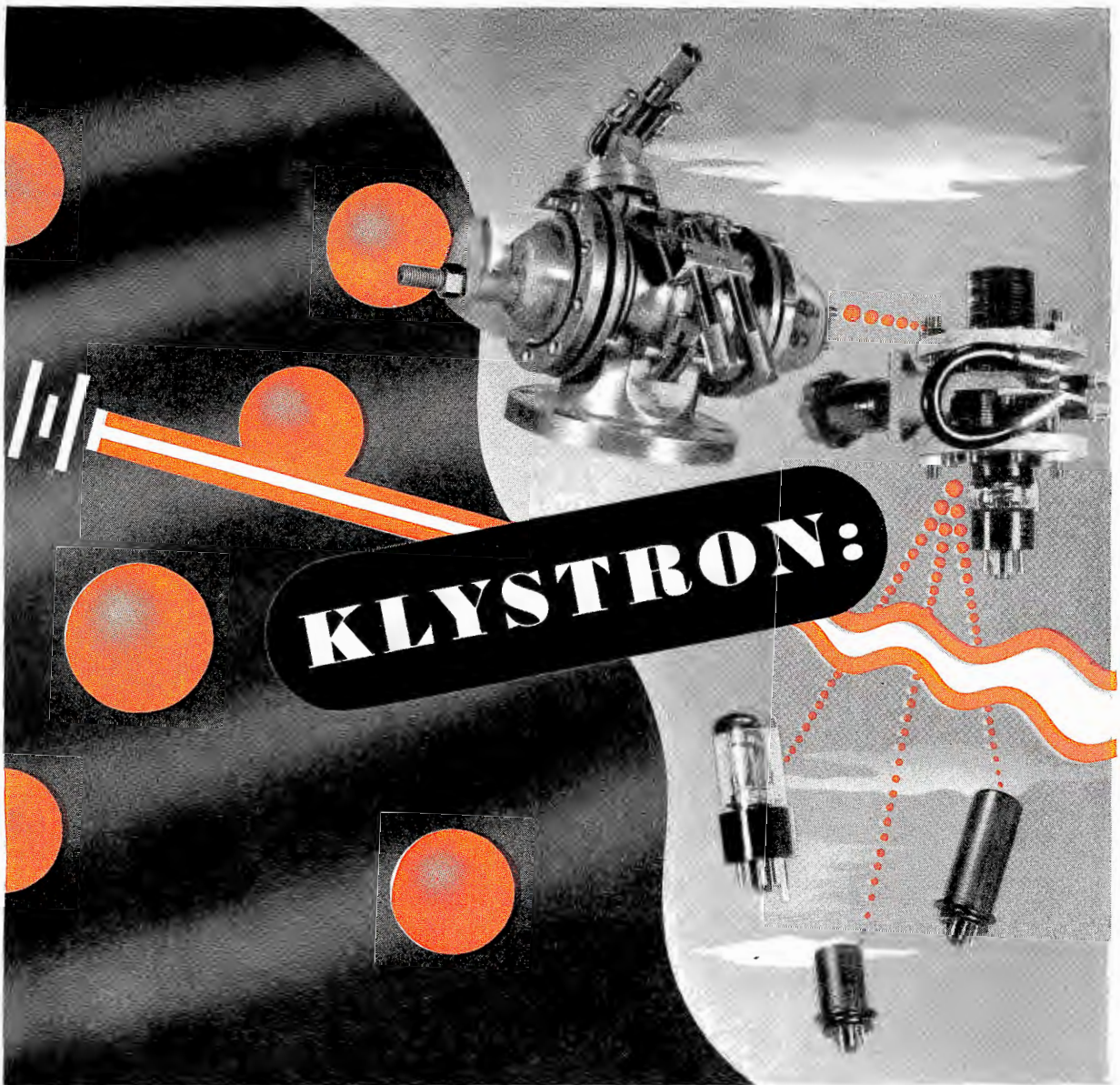

# KLYSTRON:

## How many Klystrons *are* there?

COMPARED with the early Klystrons which Sperry first developed some years ago, the more recent forms represent dramatic improvements in both size and performance.

And this is only the beginning!

Information on the newer types is presently restricted to those qualified under Military regulations.

But Sperry Klystrons are in use on many battle fronts, and in many applications . . .

There are small Klystrons, and large ones . . . low-powered ones and high-powered ones. There are Klystrons which generate, amplify, and multiply. Where required, frequency stability (better than that required for

broadcast purposes) is readily applied by conventional means.

Klystrons are easily modulated for new and all conventional purposes. And, by means of a single knob, they can be tuned continuously over a wide band, or the operator can snap-tune them to previously selected bands.

Write us for further information.

## Sperry Gyroscope Company

GREAT NECK, N. Y. • DIVISION OF THE SPERRY CORPORATION

GYROSCOPICS • ELECTRONICS • RADAR • AUTOMATIC COMPUTATION • SERVO-MECHANISMS

COMMUNICATIONS FOR DECEMBER 1944 • 17



*Gates Brings You New Turntable Improvements that  
assure Noiseless Positive Operation*



**THE GATES CB-7  
Transcription  
Turntable**

**Engineered for Exceptional Performance  
Designed for those who Demand the Best**

Developed after months of experimentation with various synthetic rubbers that are impervious to oil and temperature, to provide an inside rim drive that is positive and "wow" free. The result is an efficient, yet handsomely designed, turntable that is proving its sturdiness throughout the world under the most rigid wartime conditions—and here at home to the complete satisfaction of those who demand a trouble-free turntable for all recording and playback purposes.

*Available Now On Proper Priority*

(Wartime restrictions do not allow the sale of new broadcasting equipment without priority; therefore, this equipment is presented merely to acquaint you with Gates' developments. Our post-war priority delivery system may be of interest. Write at once for details.)

**Planning for New Equipment?  
Consider These Gates Advantages:**

1. Heavy rugged construction combined with precision in its highest form . . .
2. Uses 1/50 HP of inside rim drive. Proved choice of discriminating engineers . . .
3. Inbuilt long life, for years of continuous service with minimum attention . . .
4. Instantaneous speed change combined with "wow" free accuracy and regulation . . .
5. Electrical reproducing set supplied for all popular playback requirements, with accentuating and high fidelity response characteristics . . .
6. Designed for the hardest, most exacting professional usage . . .
7. Ball bearing motor.

*Gates*

**RADIO COMPANY**  
QUINCY, ILLINOIS, U. S. A.

*Manufacturers of Radio Broadcast Transmitters, Speech Equipment, Recording Apparatus and Allied Equipment in the Electronics Field.*

# This SOLA CONSTANT VOLTAGE TRANSFORMER has an important postwar future in

# YOUR



HEATING CONTROLS •  
REFRIGERATION CONTROLS • TELEVISION SETS • F-M RADIO • VACUUM TUBE VOLTMETERS • ELECTRONIC GAUGING AND INSPECTION EQUIPMENT • PHOTO-METRIC INSTRUMENTS...there are other applications of course

Here is a SOLA Constant Voltage Transformer that should be a built-in part of your equipment—

**First:** because it will stabilize output voltage at your rated requirements regardless of line voltage fluctuations as great as  $\pm 12$  to 15 %.

**Second:** because its small, compact size is ideal for chassis mounting.

**Third:** because of its low, economical cost.

**Fourth:** because of the saving that can be made through the elimination of other components.

**Fifth:** because a majority of anticipated service calls can be eliminated from your cost calculations.

**Sixth:** because the users of your product will get greater satisfaction from trouble-free service.

This particular transformer is rated at 6.3 volts, 17VA output and is designed primarily for the stabilization of vacuum tube filament and heater voltages. Other voltages and capacities for chassis mounting can be supplied on the same low cost, economical basis to meet your exact requirements.

## Constant Voltage Transformers

### To Manufacturers:

Complete specification details covering this new Constant Voltage Transformer will be furnished at your request.

Ask for Spec. No. ECV-103

Transformers for: Constant Voltage • Cold Cathode Lighting • Mercury Lamps • Series Lighting • Fluorescent Lighting • X-Ray Equipment • Luminous Tube Signs • Oil Burner Ignition • Radio • Power • Controls • Signal Systems • Door Bells and Chimes • etc. SOLA ELECTRIC CO., 2525 Clybourn Ave., Chicago 14, Ill.



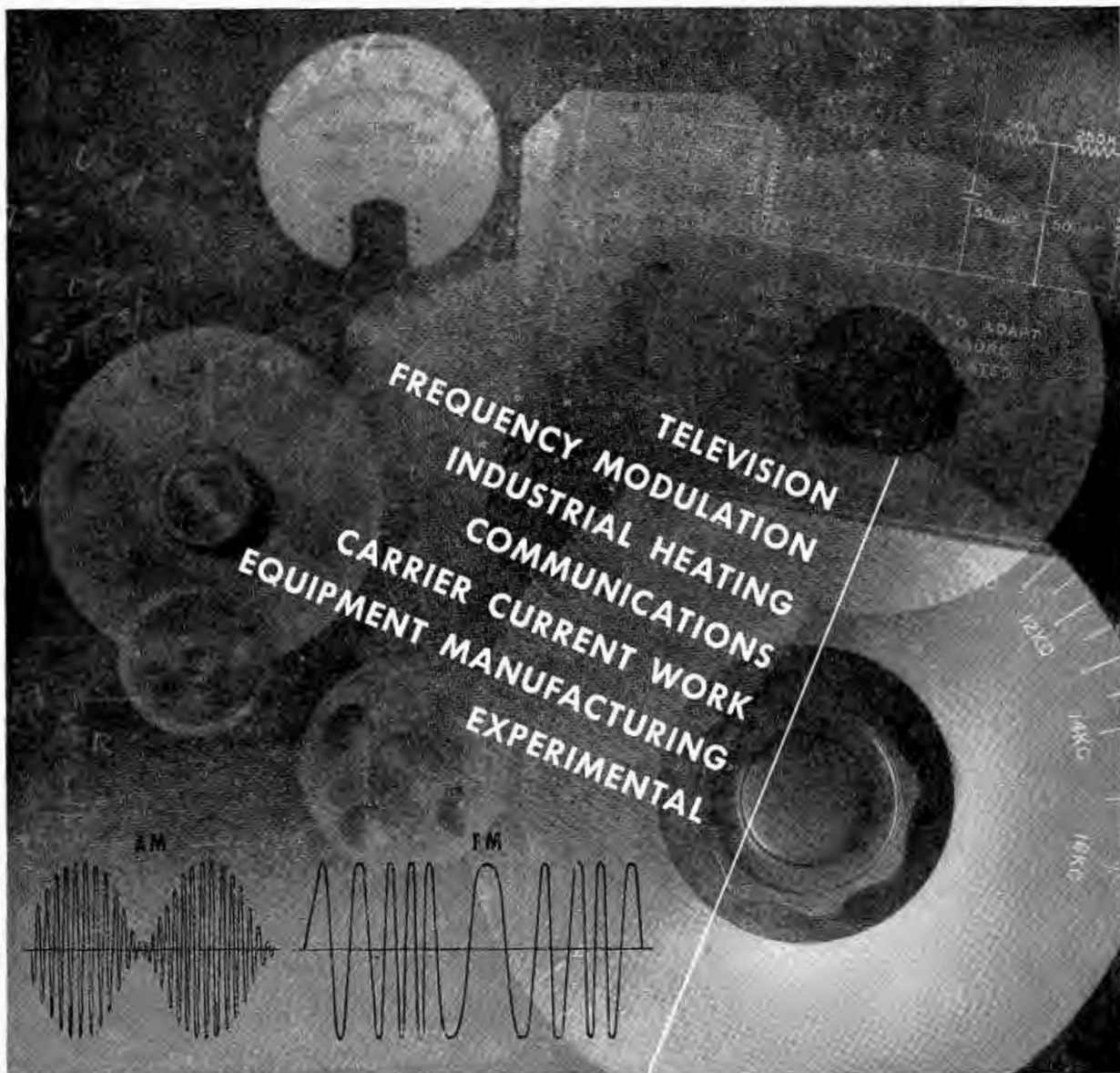

TELEVISION  
 FREQUENCY MODULATION  
 INDUSTRIAL HEATING  
 COMMUNICATIONS  
 CARRIER CURRENT WORK  
 EQUIPMENT MANUFACTURING  
 EXPERIMENTAL

## Post-war electronics demands new instruments

 As the "era of electronics" approaches, it is increasingly evident that the need for more accurate, highly specialized instruments becomes greater. Many of the fore-runners of such instruments are already perfected and in use today, but they are still under cover of strict military censorship. When these new developments and others now in the process of development are released — not all, but certainly a good many of the commonly known instruments will instantly become obsolete. In your plans for post-war activity you should make careful note of this fact, for it may save you valuable time in future plant or product conversion.

*-hp-* instruments are in the vanguard of these new developments. New *-hp-* oscillators, signal generators and vacuum tube voltmeters are setting new standards for rugged construction and split-hair accuracy. Technical data on these and others not yet perfected are, of course, not available today, but the time is not far off when they can be released.



In contemplating the improvement of your laboratory or the alteration of your production with post-war activities in mind, it will pay you to consult *-hp-* engineers. These new instruments may be the answer to your problem. Please give us full details so we can be of maximum assistance.

**HEWLETT-PACKARD COMPANY**

**BOX 931 E STATION A • PALO ALTO, CALIFORNIA**

CANADIAN OFFICE: 560 KING STREET WEST, TORONTO 2

931

20 • COMMUNICATIONS FOR DECEMBER 1944

*Casting the International Meter Rods in Paris 1874. The degree of accuracy attained 1/10,000,000 of a quadrant of a terrestrial meridian.*



WHO SETS THE

*Quality Standard*

FOR TRANSMITTING TUBES



371-B



BW II



KU-23



813



949-A



CV-II



967



905



972-A

UNITED



TRANSMITTING  
TUBES



**I**N every art or craft, the work of some acknowledged master sets the standard.

Since 1934 UNITED has won recognition by specializing exclusively in the engineering, design and building of transmitting tubes which are unchallenged for excellence. UNITED tubes excel in every electronic application . . . including radio communication, physiotherapy, industrial control and electronic heating. In these and other applications, tubes by UNITED continue to win top honors for uniformly dependable performance.

In communication equipment for airlines, commercial broadcasting, police radio stations and other vital civilian services, UNITED transmitting tubes set the standard. Accept nothing less than UNITED quality tubes for your requirements.

*Order direct or from your electronic parts jobber.*

**UNITED ELECTRONICS COMPANY**

NEWARK, 2

New Jersey

Transmitting Tubes EXCLUSIVELY Since 1934

COMMUNICATIONS FOR DECEMBER 1944 • 21



# *A matter of inconvenience—nothing more!*

OUR stranded friend is the victim of a faulty measuring device. The gauge said "quarter-full" when the tank was empty. The result—a little profanity and an hour's inconvenience.

But not all instruments can be excused so lightly. At work in this war, and in readiness for the years to follow, are thousands of instruments whose accuracy may mean the difference between success and failure, be-

tween safety and danger, between life and death. These instruments *must not lie!* Too much depends upon them.

Boes is building instruments of this character. To date, we have not been asked to create instruments in which an element of error could be tolerated. Quite on the contrary, we've been expected to produce instruments of greatest accuracy and, most important, instruments of *sustained accu-*

*racy.*\* The methods and facilities that are available for this work may be useful to you now, and will certainly be available to you in the years ahead.

\* **SUSTAINED ACCURACY** is not an easy quality to achieve. It must take into account all factors of use—must then employ the design, the alloys, the construction that infallibly protect an instrument against all threats to its reliable performance. Such instruments, obviously, must be built with performance—not price—in mind. We invite the inquiries of those who are interested in such standards.



# *Boes* instruments

*for Measuring, Metering & Testing Equipment* ☆ *The W. W. Boes Co. Dayton, Ohio*

# ANOTHER HARWOOD FEATURE . . .

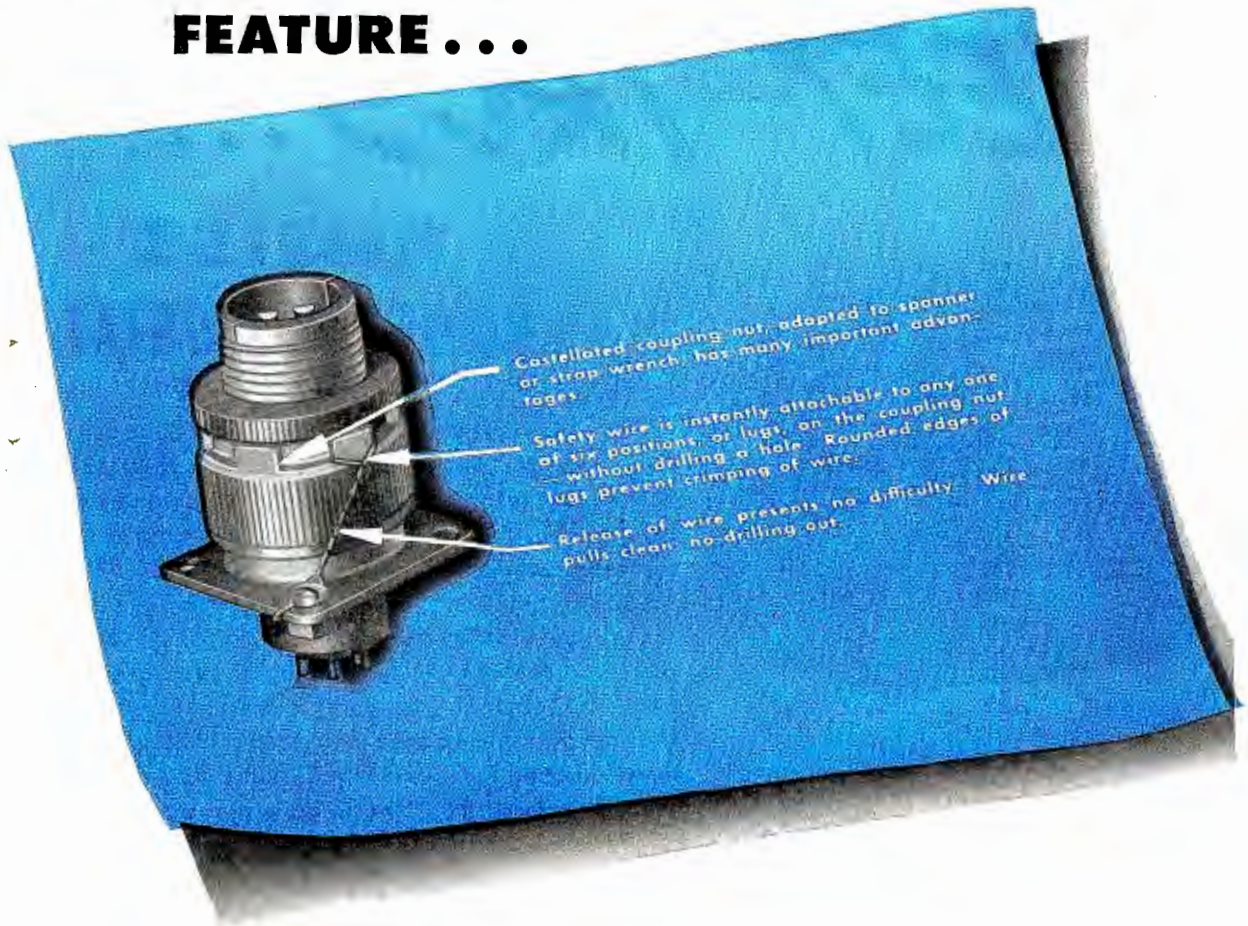

Castellated coupling nut, adapted to spanner or strap wrench, has many important advantages.

Safety wire is instantly attachable to any one of six positions of lugs on the coupling nut—without drilling a hole. Rounded edges of lugs prevent crimping of wire.

Release of wire presents no difficulty. Wire pulls clean, no drilling out.

**Safety wiring** always a problem—in assembly, field service, and maintenance. Harwood's specially designed coupling nut for AN Type Electrical Connectors overcomes this. Simply loop the wire as shown in any one of six positions after installation. Safety wire will not chafe, cut, or break, due to all surfaces being smooth and rounded. It is a decided advantage in assembly, too. Write for details today.

## THE HARWOOD Co.

Division of Los Angeles Corporation

540 NORTH LA BREA AVE., LOS ANGELES 36, CALIF.

WEbster 7184





# MEET IRC'S...

## AN3155 POWER RHEOSTAT



AN3155  
50-watt

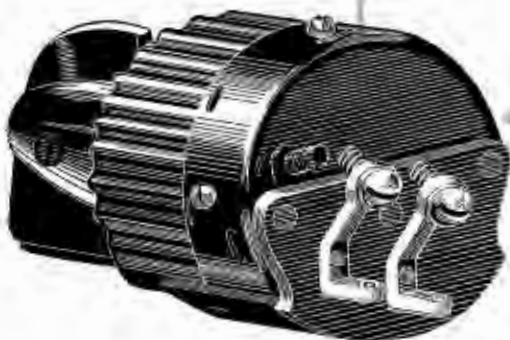

AN3155  
25-watt;  
showing terminal  
positions

Here's a power rheostat with a short past but a long future. Rugged in construction, light in weight and neat in appearance, it conforms in every respect to Army-Navy AN3155 specifications. It embraces all the features of IRC's well-known PR25 and PR50 rheostats.

Both the winding core and housing, of this completely sealed unit, are of aluminum to effect greater heat dissipation. To still further aid this important characteristic the housing is coated with a special heat-radiating finish developed by the IRC Research Staff. As a result the AN3155 generates a maximum temperature rise of only 170° as against an allowable 300°. Another feature of interest is the fact that the AN3155 can be operated at full power load in as low as 25% rotation.

Available in 25 or 50 watt models with either linear or tapered windings, the IRC AN3155 should find many useful post-war applications in the aviation industry.

Technical data and further information will be sent on request.



# INTERNATIONAL RESISTANCE CO.

401 N. Broad St., Philadelphia 8, Pa.

*IRC makes more types of resistance units, in more shapes, for more applications than any other manufacturer in the world.*



# How much does

# an ARC- -BACK\*

# cost you?

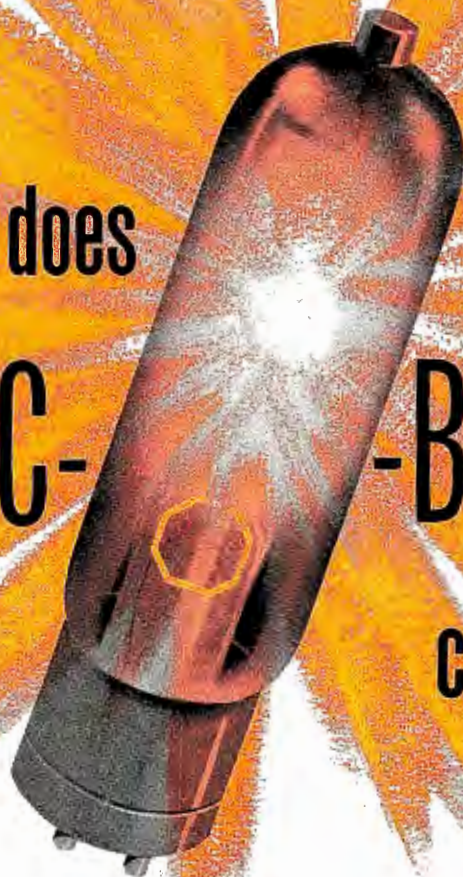

#### IT ALL DEPENDS.

If it happens during a sustaining program, your listeners will tune in another station.

If it happens during a sponsored program, the immediate cost may run high.

But whatever the real cost is, RCA engineers know it is important. They constantly guard against the danger of outage-producing arc-backs when developing rectifiers.

RCA research pays dividends...to you. Take, for example, the new RCA 872A/872. This heavy-duty rectifier, which supersedes the earlier 872 and 872A, will do the job of either of the former tubes...for a longer period of time.

Why? Because of important improvements in design.

These new design features mean *freedom from arc-backs*. They also mean longer, more dependable performance...a fact that has already been well attested in reports from broadcasters using the new rectifier.

The RCA 872A/872...an improved tube, offering

freedom from arc-backs and longer service...is just one more reason why RCA transmitting tubes are the standard of comparison in the broadcasting industry.

*The Magic Brain of all electronic equipment is a Tube...and the fountain-head of modern Tube development is RCA.*



\* An "arc-back" is a reversal of the current flow in a rectifier tube. In transmitting equipment, it may interrupt broadcasting.



62-6R1.7

## RADIO CORPORATION OF AMERICA

RCA VICTOR DIVISION • CAMDEN, N. J.

LEADS THE WAY... In Radio... Television... Tubes  
Phonographs... Records... Electronics

**BUY MORE WAR BONDS**

COMMUNICATIONS FOR DECEMBER 1944 • 25





*History of Communications. Number Twelve of a Series*

## COMMUNICATION BY THE BLINKER



The Blinker, an adaptation of the Heliograph with its own source of light, has been found invaluable for night and day Naval Communications. While limited by "line-of-sight" transmission and the elements of weather, it has been an aid to our cautious convoys during "radio silence."

When Victory is ours and the days of "radio silences" are gone forever, private citizens again will have electronic voice communication equipment for their yachts and other pleasure craft. With the release of civilian radio bands Universal will again offer the many electronic voice components for use in marine craft.

◀ *FREE—History of Communications Picture Portfolio. Contains over a dozen pictures suitable for office, den, or hobby room. Write for your "Portfolio" today.*



**UNIVERSAL MICROPHONE COMPANY**  
INGLEWOOD, CALIFORNIA



FOREIGN DIVISION: 301 CLAY STREET, SAN FRANCISCO 11, CALIFORNIA • CANADIAN DIVISION: 560 KING STREET WEST, TORONTO 1, ONTARIO, CANADA

26 • COMMUNICATIONS FOR DECEMBER 1944



You have to *know* to design for quality . . . efficiency . . . reliability.

In FM equipment these factors are vitally important and can only result from proved ability.

You will find this ability at Federal — whose engineer-specialists *know* FM.

Federal's broadcast equipment has earned an enviable reputation . . . the end result of a long list of impressive achievements. It was Federal's engineers who contributed their knowledge to the development of the "Micro-ray", the forerunner of modern high-frequency technique.

This pool of research and development experience, working in the same tradition of perfection, is now responsible for Federal's FM equipment — the ultimate in modern engineering design.

Look to Federal for complete FM installations . . . antennas, cables, transmitters, transformers, vacuum tubes . . . all backed by Federal's name . . . the name that stands for the best in broadcast equipment.



*Federal Telephone and Radio Corporation*



Newark 1, N. J.





This is the **APPROVED**  
**MINIATURE**  
**TUBE SOCKET**  
 THAT MEETS  
**ARMY-NAVY SPECIFICATION**  
**JAN-S-28**



**TWO TYPES OF SOCKET**

Navy Grade G Steatite  
 and General Purpose Type  
 with Mica Filled Plastic

**WRITE TODAY**  
**FOR SAMPLES AND PRICES**



Photographs  
 Twice Size

**HUGH H.**  
**EBY**  
 INCORPORATED  
 18 W. CHELTEN AVE.  
 PHILADELPHIA 44, PA.

**MINIATURE TUBE SHIELDS**  
**QUICK REFERENCE CHART**

Tube Type No.	Description	EBY Tube Catalog No.	Shield Height
1A3	H-F Diode	7797	1 3/4"
1L4	R-F Amplifier Pentode	7797	1 3/4"
1R5	Pentagrid Converter	7797	1 3/4"
1S4	Power Amplifier Pentode	7797	1 3/4"
1S5	Diode-Pentode	7797	1 3/4"
1T4	Super-Control R-F Amplifier Pentode	7797	1 3/4"
2D21	Thyratron (Gas-Tetrode)	7797	1 3/4"
3A4	Power Amplifier Pentode	7797	1 3/4"
3A5	H-F Twin Triode	7797	1 3/4"
3Q4	Power Amplifier Pentode	7797	1 3/4"
3S4	Power Amplifier Pentode	7797	1 3/4"
6AG5	R-F Amplifier Pentode	7797	1 3/4"
6AK6	Power Amplifier Pentode	7797	1 3/4"
6AL5	Twin Diode	7798	1 3/8"
6AQ6	Duplex-Diode High-Mu Triode	7797	1 3/4"
6C4	H-F Power Triode	7797	1 3/4"
6J4	U-H-F Amplifier Triode	7797	1 3/4"
6J6	Twin Triode	7797	1 3/4"
9001	Detector Amplifier Pentode	7798	1 3/8"
9002	Detector Amplifier Triode	7798	1 3/8"
9003	Super-Control R-F Amplifier Pentode	7798	1 3/8"
9006	U-H-F Diode	7798	1 3/8"

# How's this for POWER FACTOR and DIELECTRIC CONSTANT

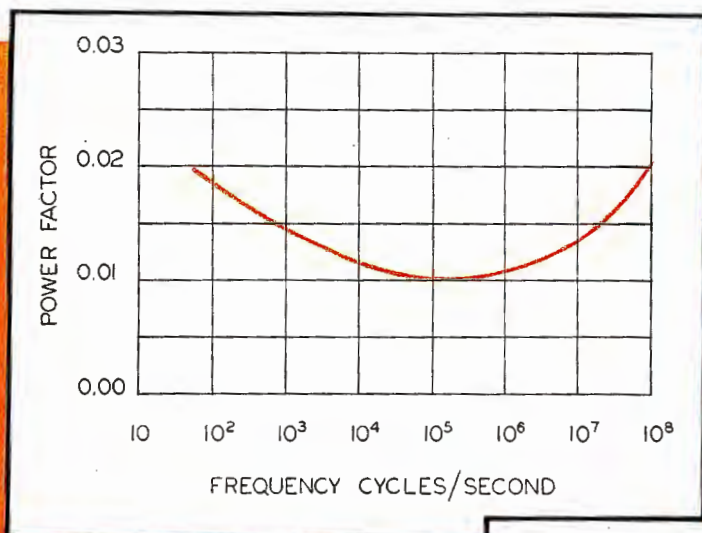

*In a  
Machinable,  
Easily Worked  
Material?*

**T**HESE curves show how closely Formica MF-66, glass mat base laminated phenolic insulating material, approaches ceramics and other high quality insulators at high frequencies. It can perform many of the functions for which these materials were once thought necessary.

At the same time it has the mechanical strength to withstand sharp blows and the vibration that is so often present where airborne, ship, and ground installations must be used. Dimensions are stable under changes in temperature and humidity. MF-66 resists the growth of fungi and may be used in the tropics.

It has the usual Formica characteristics of machinability and workability—speeding production and reducing labor costs.

This combination of qualities opens a wide field for the application of the material which as yet has scarcely been scratched.

Test samples are available on request.

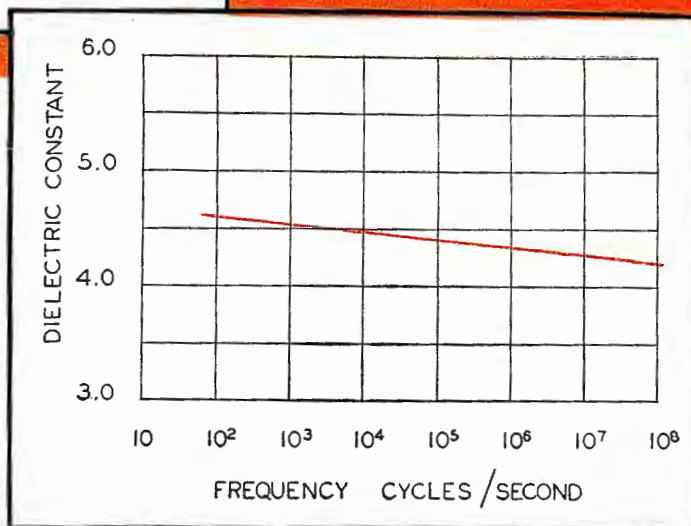

● These data represent average values measured at normal laboratory conditions of temperature and humidity on specimens not previously conditioned.



**THE FORMICA INSULATION COMPANY**  
4635 Spring Grove Avenue, Cincinnati 32, Ohio



# Continuous Supplies...

## CALL FOR MOUNTING DOLLARS



Official U. S. Coast Guard photo

.... **STEP UP**

### **YOUR PAY ROLL PLAN!**



Official U. S. Marine Corps photo

War is a continuous job.

Ever-widening, ever-advancing fighting fronts call for a never-ending flow of manpower and materiel—*financed by a continuous flow of money.*

Your responsibility as top management increases with the mounting tide of battle. You've been entrusted with two major responsibilities—steadily maintained production, and steadily maintained War Bond Sales through your Pay Roll Savings Plan.

So keep this one salient fact before you at all times: *The backbone of our vital war financing operation is your Pay Roll Savings Plan.*

Your job is to keep it constantly revitalized. See to it that not a single new or old employee is left unchecked. See to it that your Team Captains solicit everyone for regular week-in and week-out subscriptions. And raise all percentage figures wherever possible.

Don't underestimate the importance of this task. This marginal group represents a potential total sales increase of 25% to 30% on all Pay Roll Plans.

Constant vigilance, in a quiet way, is necessary to keep your Pay Roll Savings at an all-time high. Don't ease up—*until the War is won!*

*The Treasury Department acknowledges with appreciation the publication of this message by:*



### **Back the Attack!**

### **SELL MORE THAN BEFORE!**

### **COMMUNICATIONS**

*This is an official U. S. Treasury advertisement prepared under the auspices of Treasury Department and War Advertising Council*

*Made in Japan\**



A recent UTC analysis of Japanese components substantiates the conclusive superiority of products of American design and construction... for example, on transformer components...

\*  
Japanese components illustrated obtained from the Pacific war theatre for the UTC Research Laboratory



JAPANESE unit weighs **8 oz.**  
...failed on 15 minute submersion test  
...very narrow frequency range.



UTC hermetic capacitor weighs **1 oz.**  
...takes full hermetic sealing tests  
...has twice the frequency range.



MAY WE COOPERATE WITH YOU ON DESIGN SAVINGS FOR YOUR APPLICATION... WAR OR POSTWAR

*United Transformer Co.*  
150 VARICK STREET NEW YORK 13, N. Y.  
EXPORT DIVISION; 13 EAST 40th STREET, NEW YORK 16, N. Y.. CABLES: "ARLAB"



# RESEARCH



Continual research in chemistry, metallurgy and effects of various atmospheres on different plating finishes assures you that your Hammarlund variable capacitor will stay on the job.

THE SIGN OF QUALITY



ESTABLISHED 1900

# HAMMARLUND

THE HAMMARLUND MFG. CO., INC., 460 W. 34<sup>TH</sup> ST., N. Y. C.  
MANUFACTURERS OF PRECISION COMMUNICATIONS EQUIPMENT

# COMMUNICATIONS

LEWIS WINNER, Editor

\* \* DECEMBER, 1944 \* \*

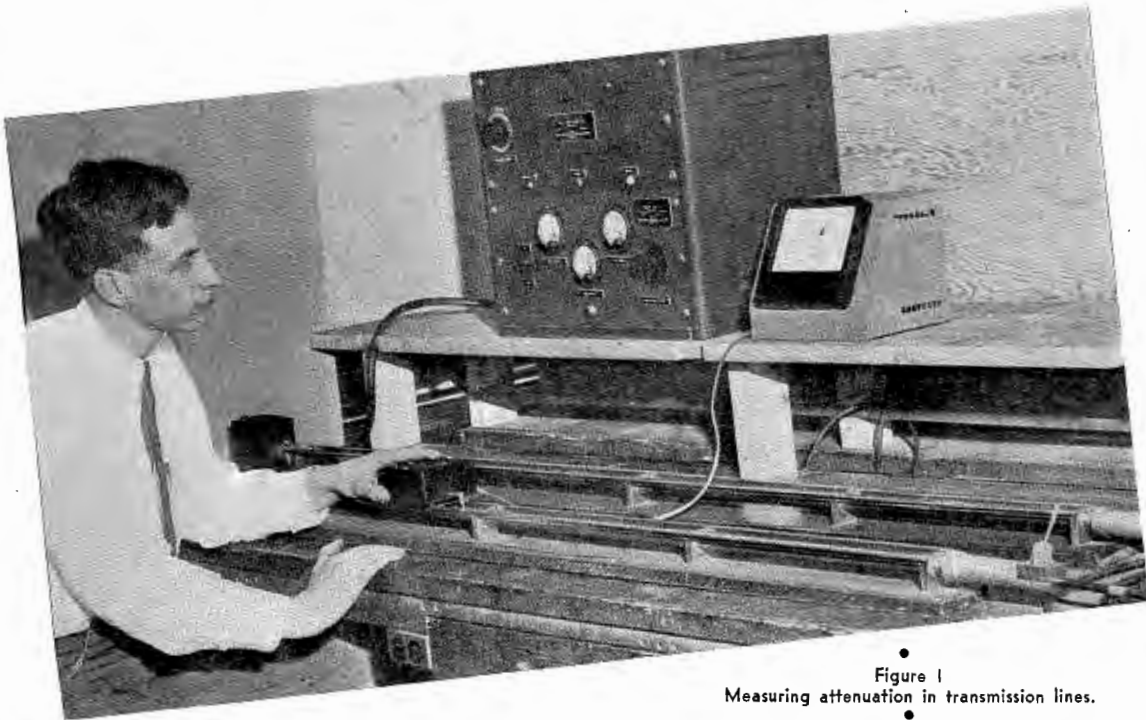

Figure 1  
Measuring attenuation in transmission lines.

## DIELECTRICS IN U-H-F FLEXIBLE COAXIAL CABLES

by **A. J. WARNER**

Technical Director  
Intelin Division  
Federal Telephone & Radio Corp.

**M**UCH of the communications equipment playing such a large part in the successes of the armed forces of the United Nations could never have been built but for the development of the flexible coaxial cable for ultrahigh frequency transmission and the dielectrics and

insulators that made it possible. Although these synthetic materials are the result of years of research by chemists, the nature of them, their enormous possibilities, and their present limitations are vitally important to the communications engineer in order that he may utilize them to the utmost of their capacities.

In essence, such a high-frequency transmission line consists of a central metallic conductor, insulated with a low-loss dielectric material, and outer conductor made by braiding metal wires over the dielectric, and an outer protective sheath. One of the most

important electrical properties of a line of this type is its attenuation. This attenuation, or loss, is not a constant value, but varies with frequency, becoming larger as the frequency increases; nor is the rate of increase of attenuation constant with frequency, since the two factors coming into play, namely the copper losses and the losses in the dielectric, vary differently with frequency.

The loss due to the dielectric is given by a very simple formula

$$\alpha_d = 2.78 \cdot p \cdot \sqrt{K} \cdot F$$

where

COMMUNICATIONS FOR DECEMBER 1944 • 33

TRANSMISSION DESIGN



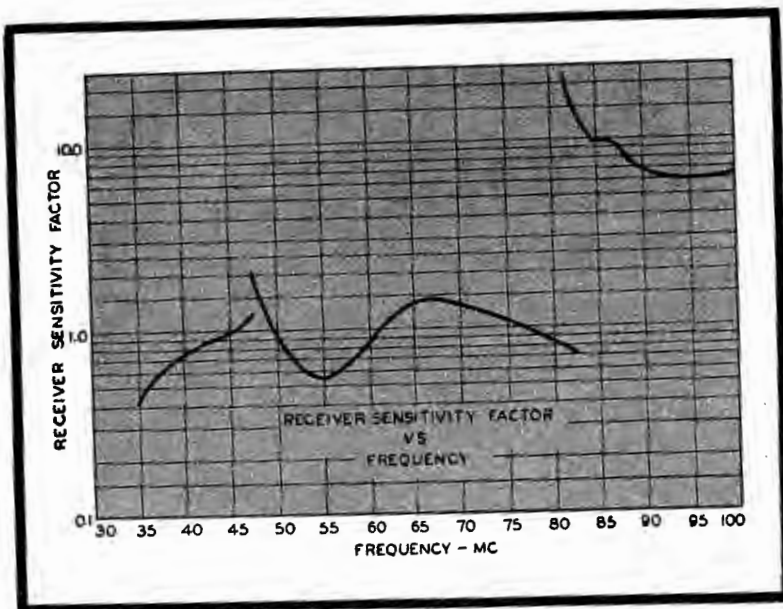

Figure 2  
Second set of curves derived from receiver calibrations. Here we have frequency versus receiver sensitivity with respect to sensitivity at 50 mc, as unity.

special attention. The report states that this was set so that the antenna bearing was S 18° W on a horizontal level. At the far end the rhombic was approximately 35' above ground, and at the receiving end (at the flag pole) it was 14' above ground. Readings taken outdoors, required the use of an 8' coaxial lead-in to the receiver.

Readings were also taken in the house. Here a 125' coaxial cable was required. Under the latter setup input voltage signal strengths decreased about 20% to 25%, according to the report.

To obtain input signal strengths, the engineers determined which one of the four arbitrary r-f gain settings would be used to give about mid-range deflection for each station. Thus the

maximum ma reading was obtained.

A table, showing signal strengths of stations received at Mt. Greylock, disclosed that WRGB of Schenectady gave best reception. In this instance, the sound input was 15,360  $\mu$ v with a dipole; the video input was 1,400  $\mu$ v.

Commenting on the antennas, the report says:

"More precise readings could have been taken had the antenna used been more flexible. An antenna mounted on a 30' pole which could be swung in the direction of selected station, would be more suitable. A variable wavelength antenna would as well be more de-

Figure 3  
Signal strength of television stations received at Mt. Greylock, Massachusetts.

sirable than the fixed frequency one used. On the dipole antenna when a station was tuned in at several megacycles above or below the frequency of the antenna, a standing wave or off-resonance condition occurred, and the lead-in cable become very touchy. Reversing the lead-in to the receiver terminals gave a different output reading on the recording instrument. On the rhombic antenna it was noted that if a station was only a few degrees off the direct bearing, reversing the lead-in cable did not seem to have much effect on it. However, if the station was in a direction at right angles to the antenna, reversing the lead-in cable made it very touchy."

In addition to the tabulated readings, filmed recordings were also made. These included stills of the antenna setups, and motion pictures of stations WNBT, WCBW and WABD during broadcasts.

The second test, conducted by O. Y. Brandt, featured graphic recording, using an Esterline Angus graphic recorder.

Two types of antennas were also used in this test; a half-wave dipole and a rhombic, both being horizontally polarized. The dipole was cut to channel 3, or 66-72 mc with a reflector spaced  $\frac{1}{4}$  wavelength. The lead-in was 25' of the copelene coaxial type. An 8-wavelength antenna was used for the rhombic; also for channel 3. A  $\frac{1}{4}$ -wavelength matching stub, (Continued on page 88)

Station	Freq. in Mc		Station Location	Approx. Airline Distance to Receiver	Date	Time	$\mu$ v Receiver		Signal Setup	Measured	
	Sound	Video					on Rhombic	on Dipole		Sound	Video
WNBT	55.75	51.25	New York, N. Y.	134 mi.	8-2	3-5 PM			f	55.5	20.8
						noon			f	62.5	48.0
						evening	623	576	o		
WCBW	65.75	61.25	New York, N. Y.	134	8-2	3-5 PM			f	14.0	4.4
						evening			f	63.0	19.4
						evening			f	179.0	164.0
						evening	364	283	e		
WABD	83.75	79.25	New York, N. Y.	134	8-2	3-5 PM			f	20.3	12.0
						evening			f	47.0	51.4
						evening	69.3	25.4	c		
						evening	73.6	34.6	b		
WRGB	71.75	67.25	Schenectady, N. Y.	40	8-3	evening			g	15360	1400
						evening	6656	156	e		
						evening	739	183	a		
WPTZ	71.75	67.25	Philadelphia, Pa.	210	8-4	evening			f	6.2	5.0

Setup a: Readings taken at flagpole, with 125' copelene lead-in.  
 Setup b: Readings taken at flagpole, with 125' copelene disconnected.  
 Setup c: Readings taken in lodge, with 125' copelene lead-in.  
 Setup d: Readings taken in lodge, with 125' copelene disconnected.  
 Setup e: Readings taken at flagpole, with 8' copelene lead-in.  
 Setup f: Readings taken in lodge, dipole directed to N. Y. C.  
 Setup g: Readings taken in lodge, dipole directed to Schenectady.  
 Note: Low  $\mu$ v signals should be corrected for noise.



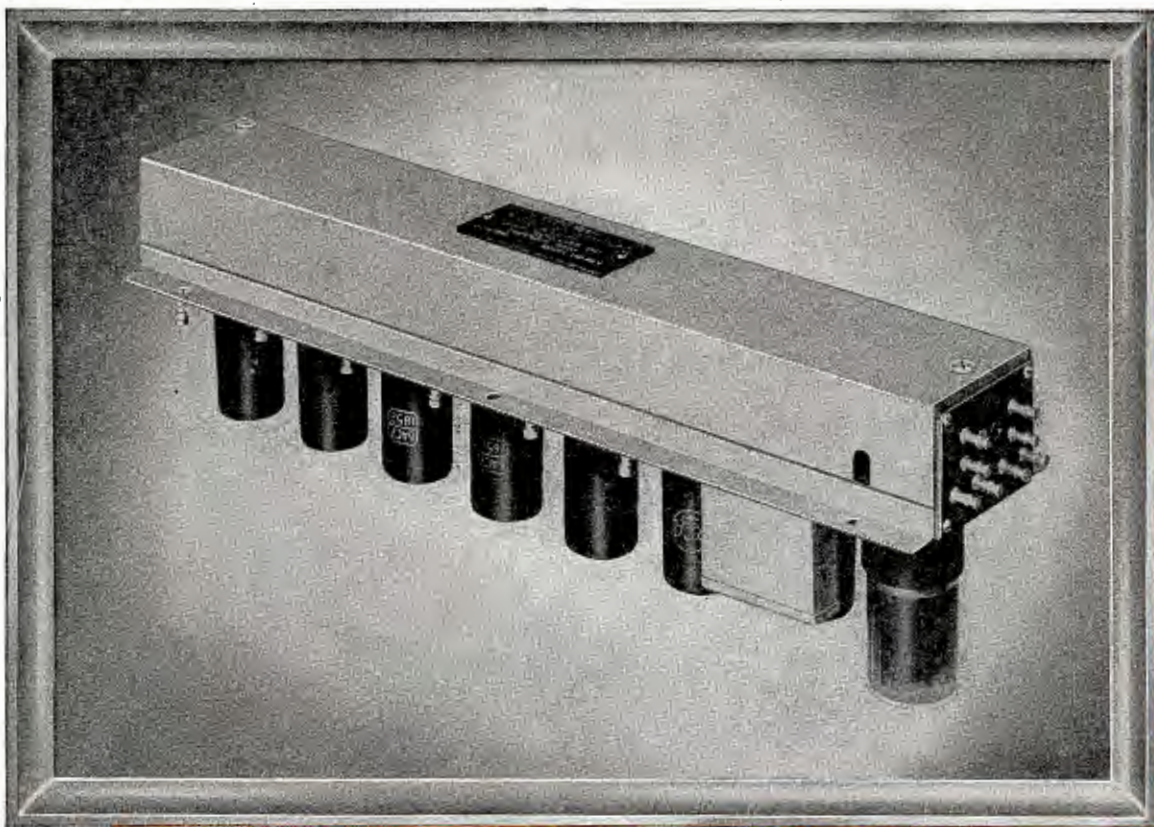

DOES THIS **HARVEY "AMPLI-STRIP"**  
*Fit Into Your Picture?*

It does if you need thoroughly dependable I-F and AUDIO Amplification. The HARVEY "AMPLI-STRIP" was designed and developed to provide a compact, convenient and practical Audio and I-F Amplifier. Custom-made to meet *your* electrical characteristics. This tested and proved "AMPLI-STRIP" will meet your most exacting performance standards.

The "AMPLI-STRIP" provides an excel-

lent example of how the knowledge and experience gained by HARVEY through years of specialization in the radio-electronic field results in practical, efficient, reliable apparatus.

Why not let HARVEY of Cambridge help you to bring to a successful solution any of the present or projected radio-electronic problems that may be troubling you? Just get in touch with



**HARVEY RADIO LABORATORIES, INC.**  
**442 CONCORD AVENUE • CAMBRIDGE 38, MASS.**



**HARVEY  
 UHX-25**

A 25-Watt  
 General Purpose  
 Radio Telephone  
 Transmitter

Available for operation between 1.5 M.C. and 30 M.C.

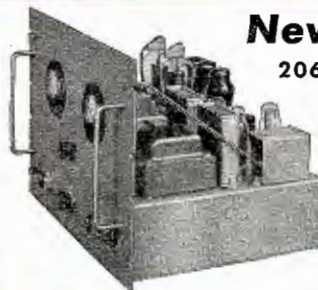

**New HARVEY**

**206 PA REGULATED  
 POWER SUPPLY**

for Laboratory  
 D. C. Source—  
**RANGE 500  
 to 1000 VOLTS**

500 to 700 at 1/4 ampere  
 700 to 1000 at .2 ampere



# A REPORT ON THE 1944

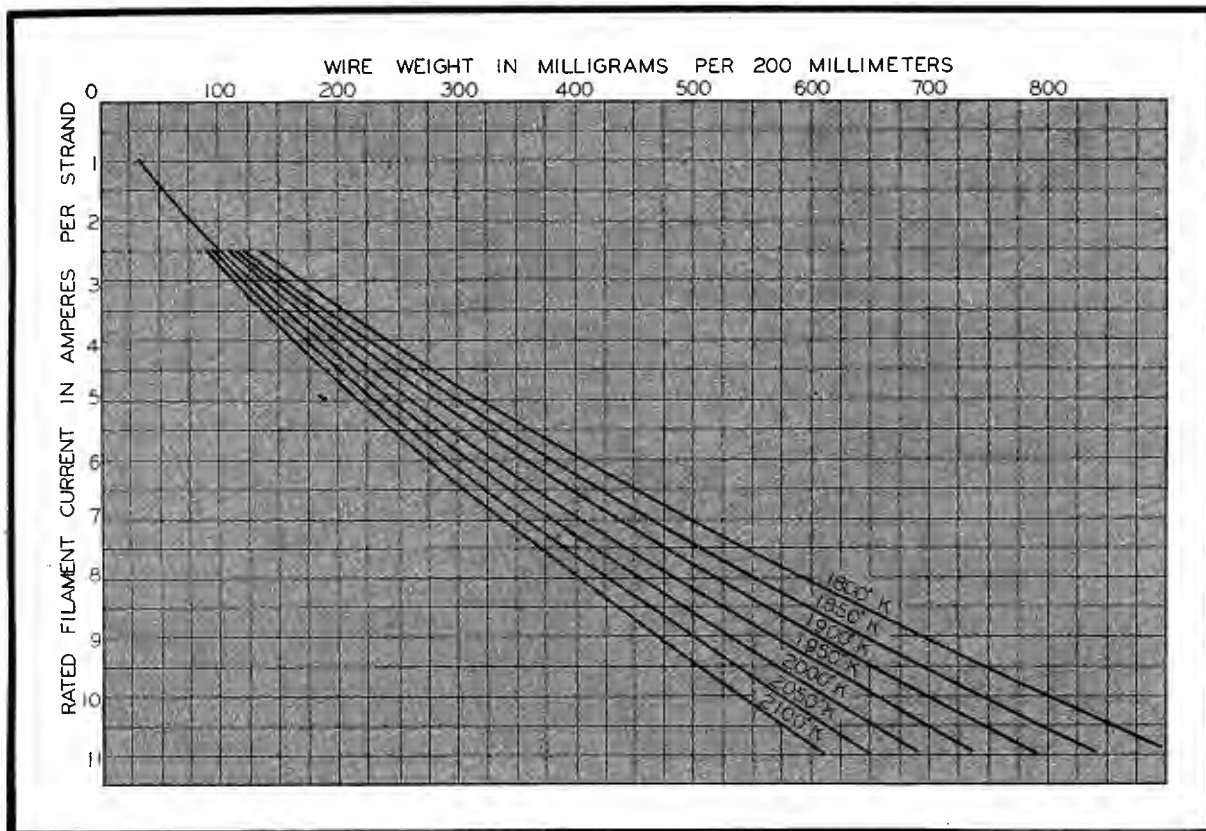

Figure 1

A family of curves for various filament temperatures versus wire weights.

**A**N intriguing analysis of carbonized thoriated tungsten filaments, disclosing how precalculations may be made, was offered by H. J. Dailey, section engineer, electronics engineering department at Westinghouse, at the Fall meeting. How the same basic calculations may be used on pure tungsten filaments, was also revealed.

Calculations and curves presented covered thoriated tungsten filaments between 1800° and 2200°K and pure tungsten between 2200° and 2800°K.

Discussing why the data developed is applicable to the calculation of carbonized (or carburized) thoriated tungsten filaments, Mr. Dailey said that we know that as a tungsten filament is carbonized its resistance increases and its thermal or power emissivity also increases. This holds true, particularly in the region where thoriated tungsten filaments are useful, explained Mr. Dailey. Accordingly, he said, the increase in resistance increases the watts dissipated per unit of length of the filament, and therefore if the thermal emissivity were unchanged the temperature of the filament would have to increase to radiate the increased wattage.

## Thermal Emissivity

It was then pointed out that as the thermal emissivity of the carbonized surface increases by the same percentage as the increase in resistance due to carbonization, it becomes evident that for the

same current the temperature of the pure tungsten filament and for the carbonized tungsten filament must be the same at some point in the carbonizing cycle, Mr. Dailey said that this holds true at the point where the resistance has been increased by 20%.

When we carbonize a tungsten filament, said Mr. Dailey, the resistance is usually allowed to increase from 1.15 to 1.25 times the original resistance obtained when passing the rated current for which the filament is being designed; viz., the current at which the filament is to be operated is passed through the filament. Then we measure this initial voltage. And after carbonization, according to Mr. Dailey, we find that the final voltage is from 1.15 to 1.25 the initial voltage or an average increase of 1.2 times the original voltage when measured at the same current.

Since we have found that the power emissivity of a carbonized filament is apparently independent of the degree of carbonization (providing the wire does not develop surface cracks, as such cracks act as black body radiating surfaces), explained Mr. Dailey, we may make a calculation of the expected variation in temperature due to variations in the percentage of carbonization.

Explaining the error factor, Mr. Dailey said that we may expect an error in temperature of approximately  $\pm 1\%$ , for a range in carbonization between a voltage increment of 1.15 and 1.25. These calculations, he said, hold for a filament operated at fixed filament current.

While it is possible to calculate the variation in temperature with variation in filament current due to variation in percentages of carbonization when measured at constant voltage, Mr. Dailey showed that it is more convenient to plot a family of curves for various temperatures in the range being explored and pick off the temperatures from the curves, Figure 1. Explaining these curves, Mr. Dailey said that the variation of temperature due to variations in wire diameter may be seen by studying the abscissa in the range in question. The ordinates reveal the variation in temperature with filament current. If we analyze the variation in filament wire weight and variation in filament current, we will note that these two define a rectangle which has at its center the point provided by a calculation of the wire size (mean dimension) and the mean of the filament current design center, pointed out Mr. Dailey.

Explaining the ratio of two adjacent sides of the rectangle Mr. Dailey said that it is more important to hold filament current within close limits than it is wire weight.

Mr. Dailey also pointed out that it is useful to know the percentage of carbonization in the ratio of the cross-section of the filament composed of  $W_2C$  to the

# ROCHESTER FALL MEETING

Highlights of Papers Presented By

H. J. Dailey, M. J. Larsen, W. R. MacLean,

E. Labin, T. W. Dakin and S. L. Bass

by LEWIS WINNER

Editor

total cross-section of  $W + W_2C$ . These are readily calculable, he said, since we know the resistivities of the two materials.

Analyzing this, he stated, that the resistivity of pure tungsten at  $2000^\circ K = 59.4 \times 10^{-6}$  ohm cm. Thus, he said, the resistivity of  $W_2C$  at  $2000^\circ K = 121 \times 10^{-6}$  ohm cm.

And for operation at  $2000^\circ K$  we have:

Resistance increase (at operating current)	% of total area composed of $W_2C$	Total resistivity in ohm cm
1.057	10	$62.7 \times 10^{-6}$
1.115	20	$66.2 \times 10^{-6}$
1.18	30	$70.0 \times 10^{-6}$
1.255	40	$74.7 \times 10^{-6}$

Accordingly by determining the voltage increase at the design center filament current it is possible to predict what percentage of the cross sectional of the filament will be tungsten carbide, according to Mr. Dailey.

In a discussion of the helical filament, Mr. Dailey said that the calculations given do not theoretically hold for these filaments practically. However, he said, they are quite useful. For, he pointed out, if the ratio of the distance between the center of one filament turn and the center of the adjacent turn to the diameter of the wire is greater than 5, the calculations may be used with a negligible error. If this ratio is less than 5 the following relation can be applied:

$$A = B - \left( \frac{r}{d} \right)^2 B, \text{ where}$$

- A = current required for helical filament.
- B = calculated current for straight filament of same wire size.
- r = radius of wire
- d = center to center distance

Mr. Dailey explained that while this relation will not apply to a rigorous mathematical analysis, for most practical purposes it is quite sufficient.

## VIDEO AMPLIFIERS

In a paper on L-F Compensation of Multi-Stage Video Frequency Amplifiers, Dr. M. J. Larsen of the Stromberg-Carlson research department discussed the contribution of the impedance elements in control grid, screen

ENGINEERING CONFERENCE REVIEW

grid and plate circuits to distortion of a transmitted square wave, which appears as a rounding of the flat top.

## Multiple Stages

In introducing his analysis, Dr. Larsen said that the problem of holding phase shift and amplitude characteristics in a multi-stage video amplifier within prescribed limits becomes increasingly difficult as the number of stages is increased. When we depart from the optimum phase and amplitude characteristics in such an amplifier, we find that the amplifier is not able to pass 1-f square waves without either rounding or tilting, or both, of the wave, explained Dr. Larsen.

When an amplifier is adjusted experimentally to pass 1-f square waves, it is common to vary the grid resistance following the stage involved until the output waveform is symmetrical, pointed out Dr. Larsen. A fundamental component somewhat enlarged causes the waveform rounding, he said, but in proper phase. When we square the waveform, we generally try to eliminate tilt, or obtain zero phase shift of the fundamental component, he explained. Such a procedure, he said, leaves an augmented fundamental, as it is impossible in conventional circuits to compensate for phase shift and amplitude change simultaneously. Since the third, fifth and higher-odd components of the square wave have negligible change from their normal amplitude or phase, Dr. Larsen said that the effect of the fundamental only need be considered.

Probing the rounding of the square

wave problem, Dr. Larsen pointed out that this rounding may be conveniently expressed as the increase over the normal amplitude of the fundamental component divided by the normal amplitude, or

$$\frac{\Delta E}{E_{g2ht}} = \frac{E_{g21f} - E_{g2ht}}{E_{g2ht}} \quad (1)$$

$$\approx \frac{X_r^2}{R_L R_f} + \frac{X_r X_d}{R_L r_{sc}}$$

where  $E_{g2ht}$  is the peak value of the a-c wave:

Or

$$\frac{\Delta E}{E} \approx \frac{2}{\pi} \left( \frac{X_r^2}{R_L R_f} + \frac{X_r X_d}{R_L r_{sc}} \right) \quad (2)$$

where E is the peak to-peak value of the square wave.

Dr. Larsen explained that the first term in expression (2) is the rounding contributed by the plate circuit, while the second term is that contributed by the screen. He offered a comparison of the relative contributions of the plate and the screen using the values:  $C_f = 20$  mfd,  $R_f = 10,000$  ohms,  $C_d = 10$  mfd,  $R_d = 56,000$  ohms,  $R_L = 1,000$  ohms,  $f = 20$  cycles.

Thus, he said, the rounding contributed by the plate is

$$2X_r^2/\pi R_L R_f = 1\%$$

and that by the screen is

Figure 2

A square wave showing rounding by an augmented fundamental component. Upper curves show amplitude changes with and without screen compensation, analyzed by Dr. Larsen.

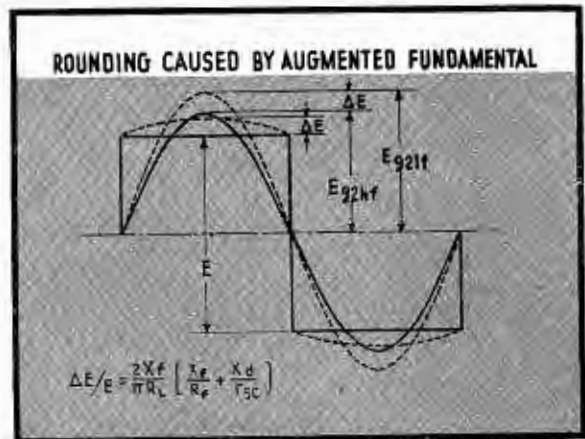



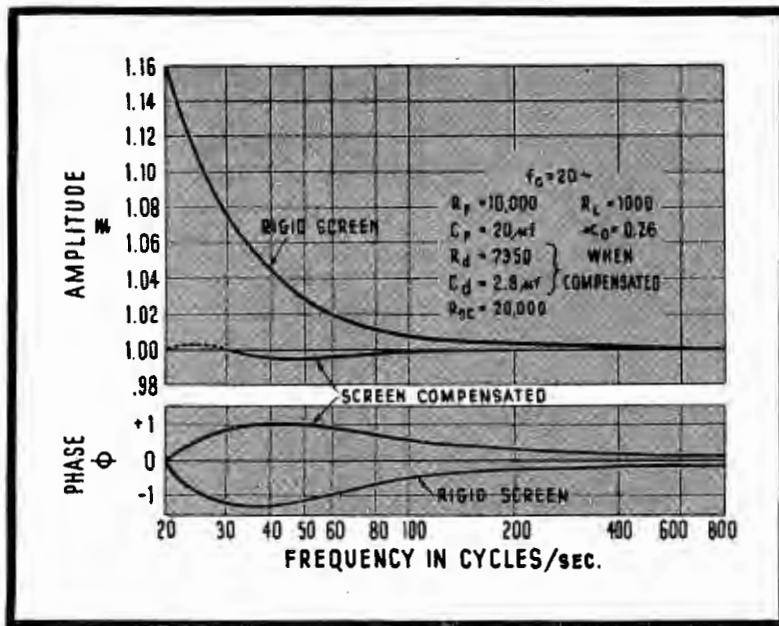

Figure 3  
Comparison of amplitude and phase distortion with and without screen compensation.

$$2X_r X_a / \pi R_L r_{se} = 1\%$$

In view of this finding, the total rounding is 2%, of which 1% is contributed by the plate and 1% by the screen. Obviously, he said, a larger screen filter capacitance should be used and possibly a larger plate filter capacitance.

To complete a design, explained Dr. Larsen, it is necessary to evaluate the grid-coupling resistance and the coupling capacitance. Thus under balanced conditions, or when a symmetrical square wave is obtained, we find that the grid resistance and coupling reactance are proportional respectively to the real and imaginary components of the plate voltage, he said.

For most practical applications where final adjustment usually would be made experimentally, Dr. Larsen offered the approximate design ratio

$$R_g / X = R_L / X_r \quad (3)$$

which is often written as

$$R_g C = R_L C_r$$

With the circuit values cited previously, at a frequency of 20 cycles, expression (3) provides

$$R_g / X = 2.5$$

We thus find that the correct value of  $R_g$  is about 15% larger on the basis of the approximate expression, he said. This, however, he explained, corresponds with what is observable experimentally.

In discussing practical considerations, Dr. Larsen stated that where the screen reactance is high enough to cause con-

siderable rounding, the dynamic screen resistance enters into the calculations. Therefore, he said, because of the wide variation in the screen resistance among different samples of tubes of a given type, replacements of tubes is likely to cause a tilt of the previously balanced wave. It is wise therefore, he explained, to bypass the screen with a sizeable capacitance and thereby minimize the effect of variations in screen resistance.

Rounding, according to Dr. Larsen, is directly proportional to the number of stages. He pointed out that 1% rounding in one stage, for example, would be hardly noticeable, but this would lead to 10% in ten stages which may be altogether excessive.

An interesting calculated comparison of screen compensation versus a rigid screen was presented by Dr. Larsen, Figure 3, in which 10 stages of amplification were assumed. The plot reveals that the amplitude distortion is relatively negligible while using screen compensation. Dr. Larsen said that both curves start with zero phase shift, as balanced adjustment was assumed, and vary about the same amount with frequency. He stated that a comparatively small screen filter capacitance was required.

Covering the practical limitations of screen compensation, Dr. Larsen said that were it not for the fact that the dynamic screen resistance influences the performance of a screen compensated stage, this type of compensation would be most excellent. He said that in some cases the filter resistance used in the screen for compensation becomes quite low and un-

less special power supplies are used, additional filtering may be necessary to minimize overall regeneration. In addition, he said, too large voltage swings on the screen may result in distortion in stages having a large output voltage. Where however the screen resistance can be maintained relatively constant, this type of compensation is very practical, he pointed out.

An interesting series of experimental tests were also described by Dr. Larsen. He said that the tests were run on a nine-stage amplifier, with the gain reduced every third stage so as to prevent excessive grid swing. Dynamic screen resistances were measured for the individual tubes, explained Dr. Larsen, and under controlled conditions, screen compensation showed a marked advantage over the case when the screens were maintained rigid. Random interchange of tubes, however, he said, usually disturbed the wave form seriously, as the tubes varied considerably with regard to their screen resistances.

Dr. Larsen explained that slight changes in waveform occurring between the reference frequency (20 cycles) and the higher frequencies indicated that the experimental results followed the trends predicted by the calculated curves, as shown in Figure 3, for instance.

## RESONATORS

THE reactance theorem for a resonator received an effective analysis by W. R. MacLean of the graduate electrical engineering department of the Polytechnic Institute of Brooklyn. His paper took as its point of departure the well-known Foster theorem of network theory which states that in any non-dissipative two-terminal linear passive network (i.e., one made up of coils and condensers only and without iron saturation), the slope of the reactance curve as a function of frequency is always positive.

Mr. MacLean undertook to prove this same theorem for the case of a *lossless electromagnetic enclosure*: any sort of disposition of perfect conductors within an enclosing shield which is fed through a shielded transmission line. The proof was based upon certain very general energy relationships. Interesting was the fact that instead of using a variable frequency source, the frequency variation was obtained by moving a plug in the transmission line, while the cavity is oscillating. (This is similar to tightening a violin string while it is vibrating). In the proof, use was made of an old heat theorem of Helmholtz.

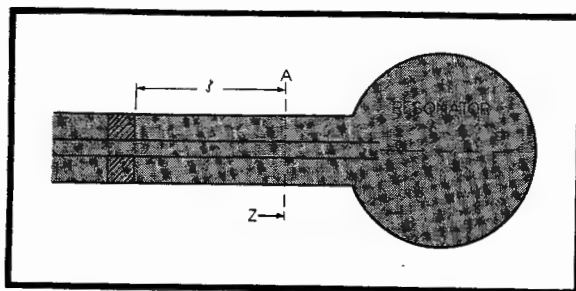

Figure 4  
Impedance into general resonator measured at section A (MacLean paper). As  $s$  is varied, frequency changes.

## PULSE TIME MODULATION

THE development of a system of pulse time modulation, was revealed by E. Labin of the Federal Tele-

(Continued on page 46)

ENGINEERING CONFERENCE REVIEW

# ELECTRONIC RESEARCH FOR INDUSTRY

**FOR A SINGLE PROJECT OR A COMPLETE SERVICE . . . THE NATIONAL UNION LABORATORIES ARE AVAILABLE TO YOU**



The *idea* that electronics may work to advantage in your peacetime products or processes—is only the start. Making it *work* by developing efficient, up-to-the-minute applications is where this task really begins.

Here, highly specialized experience and proved resourcefulness of National Union can save you time and money. How extensive or

limited your electronic research requirements may be is no problem. National Union has the top-flight scientists, the costly laboratory equipment and high-priority materials to take all or any part of the assignment.

May we discuss electronic research with you? Without obligation, of course. Please address Department C.

## NATIONAL UNION RESEARCH LABORATORIES

National Union Radio Corporation

Newark 2, New Jersey



# OHMITE

*Close Control* RHEOSTATS

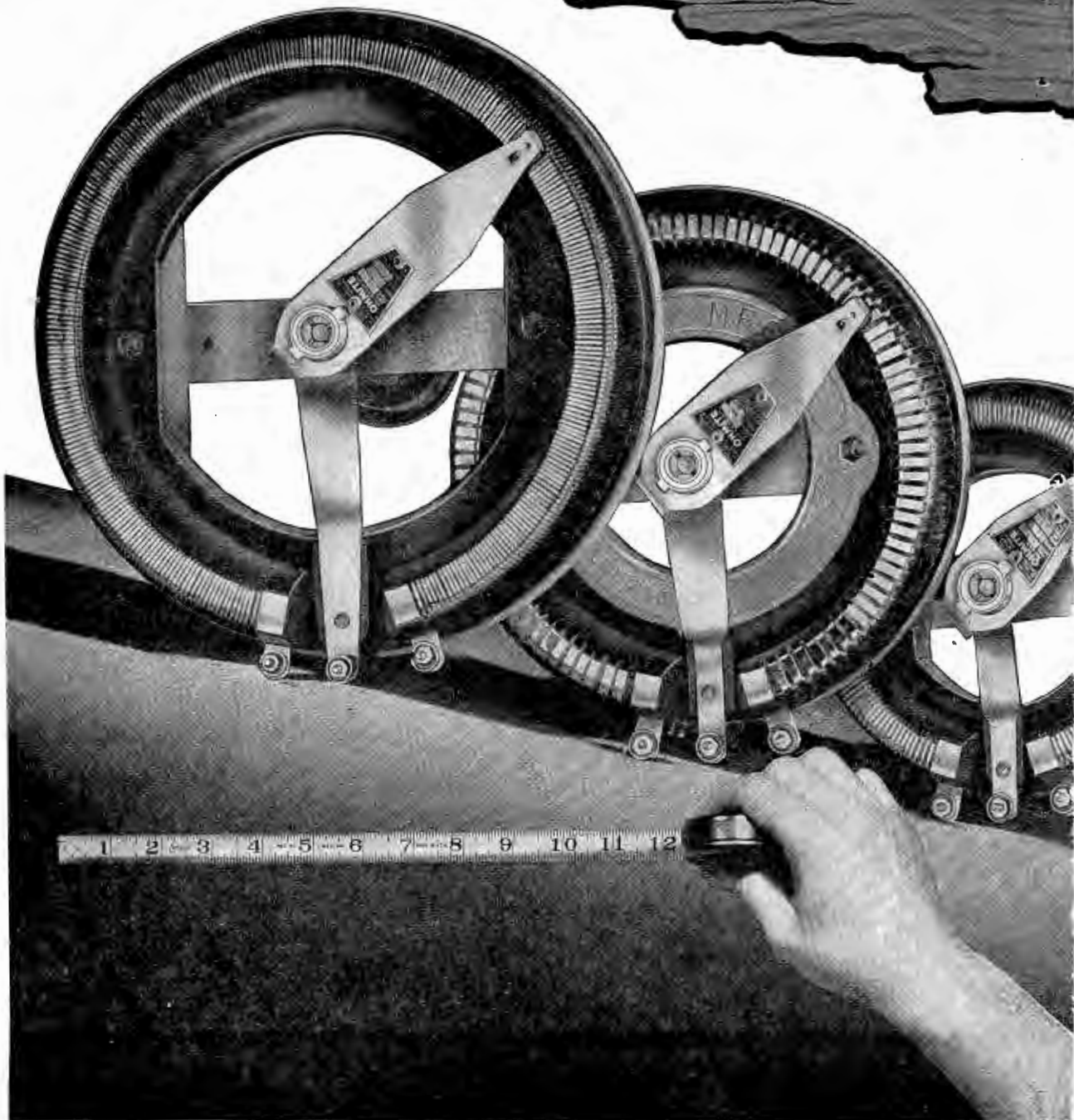

*First in Quality*

*First in Range*

*First in Quantity*

10 WATTAGE SIZES  
FOR EVERY  
RHEOSTAT NEED  
Stock or  
Special Units

The constant and exacting test of experience has proved the high quality of Ohmite Rheostats. Special Ohmite design features assure permanently smooth, gradual, close control under varying conditions of shock, vibration, temperature, humidity and altitude. The Ohmite series of 10 wattage sizes illustrated here is the most extensive made today—ranging from 25 to 1000 watts, from 1 $\frac{9}{16}$ " to 12" diameter, in a wide range of resistance values. This assures the best unit for each application. As a result—Ohmite has produced more close-control power rheostats for war equipment and war industries than any other manufacturer.

Consult Ohmite Engineers on your war or postwar rheostat-control problem. Get the benefit of Ohmite experience.

**OHMITE MANUFACTURING COMPANY**  
4870 FLOURNOY STREET • CHICAGO 44, U. S. A.

*Write on company letterhead for Industrial Catalog and Engineering Manual No. 40. Gives helpful data on Rheostats, Resistors, Tap Switches and Chokes.*

*Be Right with* **OHMITE**  
RHEOSTATS • RESISTORS • TAP SWITCHES



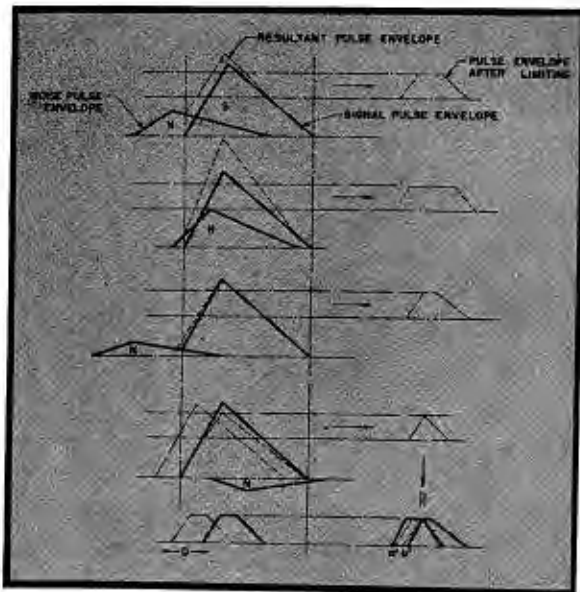

Figure 5

An idealized pulse, discussed by E. Labin, represented by a triangle, with noise represented by a similar triangle of lower amplitude and same duration. Representation of noise and pulses by triangles is justifiable because the shape is actually determined by the frequency band of receiver. Distortion introduced in the desired pulses by different noise pulses is also indicated here.

Figure 6 (below)  
Arrangement of resonant-cavity apparatus for measurement of dielectric properties by wavemeter method.

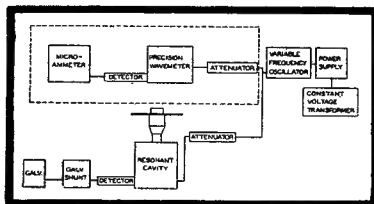

Figure 7 (below)  
Interior views of cavities used at 200 megacycles.

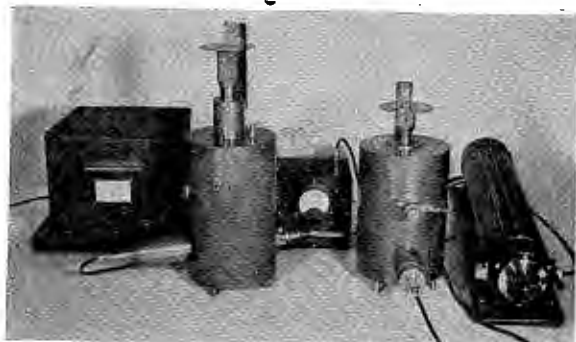
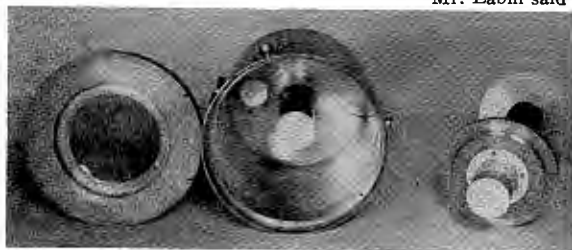

Figure 8  
(Left, below)

Measuring equipment for 200 megacycles. Left to right: galvanometer, measuring cavity, microammeter, oscillator and constant voltage control.

(Continued from page 42)

phone and Radio Laboratories, at one of the Fall meeting sessions.

Describing this form of modulation, Mr. Labin said that it consists essentially in transmitting intelligence by pulses of constant amplitude and duration. The instantaneous amplitude of the voice is translated into a variation of time intervals of successive pulses, the rate of this variation corresponding to the instantaneous frequency of the signal. The bandwidth is determined by the steepness of the pulses which can be adjusted according to the type of operation desired.

Some of the advantages disclosed were simplification derived from use of more rugged repeaters, capable of operating on trigger action, thereby materially reducing the usual requirements for stability, distortion and noise.

Mr. Labin said that research and devel-

opment work on this project began in the Paris Laboratories of I. T. & T. in 1937.

Mr. Labin stated that pulse modulation improves the signal-to-noise ratio, offering some theoretical results to show quantitatively how this improvement depends upon the frequency band used.

He pointed out that a receiver for any type of modulation can be divided into: (a) A linear amplifier followed by a linear detector; (b) A series of limiters introducing a fixed or adjustable amplitude gate; (c) A converter or demodulator restoring the audio characteristics of the original signal; and (d) A series of audio filters eliminating all frequencies not used in the desired signal, followed by audio amplifiers which bring the signal to the desired level.

In an a-m system, (b) does not exist, said Mr. Labin, and (c) is identical with a linear detector which we have supposed to be included in (a). In other words, in this a-m system, the whole receiver can be considered as a linear system insofar as the relationship between the output audio signal and the original audio signal at the transmitter and the output and input signals are concerned.

In an f-m system, said Mr. Labin, (b) generally precedes the linear detector of (a), and (c) is represented by a discriminator of more or less conventional type.

In pulse modulation, (b) may precede or follow the linear detector and (c) is some type of demodulator circuit, explained Mr. Labin.

The essential difference of t-m (time modulation) and f-m as compared to a-m is that the receiver is no longer a linear system, according to Mr. Labin. Continuing this analysis, he said: "The relation between the audio output signal of the receiver and the audio input signal at the transmitter obviously must be linear but, in the receiver itself, non-linear devices considerably distort the signal-noise relationship. This difference, in an f-m or t-m receiver, necessitates the introduction of the concept of output signal-to-noise ratio as opposed to input signal-to-noise ratio. The input signal-to-noise ratio is the ratio which exists at the input of (a) or at the input of (b). This ratio is simply the ratio of the amplitude of the incoming wave to the amplitude of the noise (or, if preferred, the ratio of the corresponding powers).

"Such a ratio depends essentially on the field strength at the receiver or, for identical propagation conditions, on the transmitted power and on the frequency band of the receiver.

"The relation between the frequency band and the amplitude of the noise is well known. It signifies that the equivalent power generated by the noise is proportional to the frequency band of the receiver.

"The output signal-to-noise ratio is actually the important factor, and represents the ratio of the audio output signal to the audio output noise."

#### U-H-F MEASUREMENTS

A RESONANT cavity method for measuring dielectric properties at u-h-f, described by Dr. T. W. Dakin, of the insulation department at Westinghouse, revealed how a reentrant cylindrical cavity was adapted to measure the dielectric constant and power factor of small disc samples of insulating materials. Several different sized cavities were used

ENGINEERING CONFERENCE REVIEW

# wherever a tube is used . . .



## COMBUSTION CONTROL

*for example:*

An abnormal increase in the density of smoke passing through a boiler breeching means a reduction of heat, loss of efficiency, increase in fuel consumption, and probably violation of smoke control ordinances. The electronically operated Warner Combustion Supervisor detects such conditions, turns in an audible or visible alarm, and sets in motion the mechanism that will bring about efficient combustion.



Control Unit

## THERE'S A JOB FOR *Relays* BY GUARDIAN

The "Combustion Control Supervisor," made by Warner Electronic Devices of Chicago, is a photo-cell system that responds to any predetermined degree of smoke density. To avoid "false alarms" resulting from momentary puffs of smoke, it is equipped with a time delay feature.

Warner's specified that the three relays used in this system must be sensitive but not delicate; that they require no adjustment; and that they meet Underwriter's requirements.

Guardian engineers developed the Series 155 D.C. relay as the answer to these specifications. This is a compact, sturdy, easily mounted unit with constant spring tension on the contacts. It is widely used on remote selection devices and other low voltage applications. Copper slug time delays up to .05 seconds on attract and 0.15 seconds on release are available. Coils for operation on any voltage up to 230 volts D.C. For further information write for Series 155 bulletin.



Series 155 D.C. Relay

Consult Guardian whenever a tube is used —however—Relays by Guardian are NOT limited to tube applications, but are used wherever automatic control is desired for making, breaking, or changing the characteristics of electrical circuits.

# GUARDIAN ELECTRIC

1623-P W. WALNUT STREET CHICAGO 12, ILLINOIS

A COMPLETE LINE OF RELAYS SERVING AMERICAN WAR INDUSTRY

COMMUNICATIONS FOR DECEMBER 1944 • 47



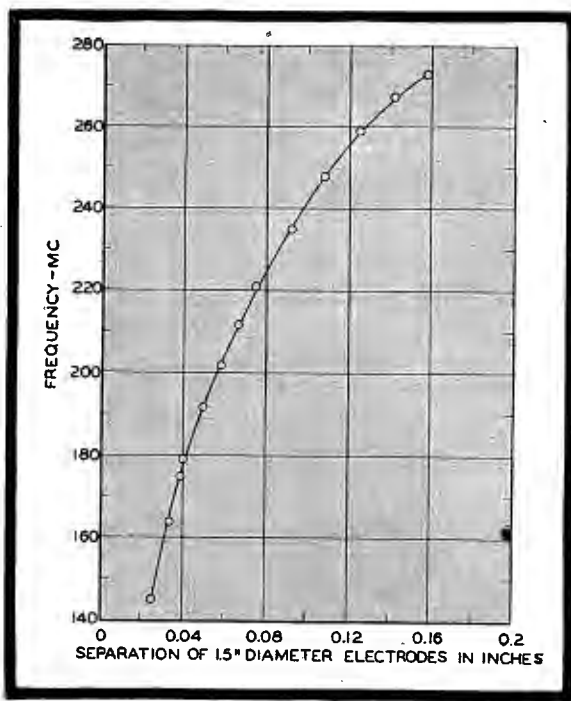

to cover a range of frequency from 50 to 1000 megacycles. An accuracy of  $\pm 0.0005$  in  $\tan \delta$  and  $\pm 1\%$  in dielectric constant was available according to Dr. Dakin. The cavity's high  $Q$  ( $> 2000$ ), affords greater sensitivity to low power factor dielectric samples than any conventional coil and capacitor resonant circuit, explained Dr. Dakin.

Typical results of measurements of dielectric properties at about 200 megacycles

Material	Thick-ness of sample inches	Dielec-tric Constant	Dissi-pation Factor
Micarta #254 (Cresol-Formaldehyde; resin paper filled)	0.150	3.72	0.047
Columbia Resin CR-39	0.149	2.96	0.027
Pure fused quartz	0.206	3.79	0.0001
Polystyrene sample A	0.150	2.55	0.0003
Polystyrene sample A	0.100	2.565	0.0003
Polystyrene sample A	0.250	2.56	0.0003
Polystyrene sample B	0.151	2.56	0.0005
Polyvinyl Carbazole	0.115	3.06	0.0009
Special Styrene Copolymer	0.183	2.64	0.008
High Tension Porcelain	0.186	5.90	0.010
Zircon Porcelain	0.178	9.5	0.0008
Ultra Steatite	0.215	5.23	0.0007
Steatite	0.247	5.45	0.0034

### SILICONES

**S**ILICONES, the new dielectric that is characterized by its high order of heat stability, were discussed by Dr. Shailer L. Bass, director of research at Dow Corning Corporation, at the meeting. Dr. Bass explained that communications equipment has depended upon two broad classes of dielectrics; organic and inorganic. He said that the organic insulations, which are essentially compounds of carbon, are used in a variety of physical

forms varying from molded plastics and wire coatings to potting compounds, cements, and liquid or wax impregnants. They fill the need for average temperature requirements. However, he said,

Arrangement of cavity equipment for measuring dielectric properties of material by frequency modulation method.

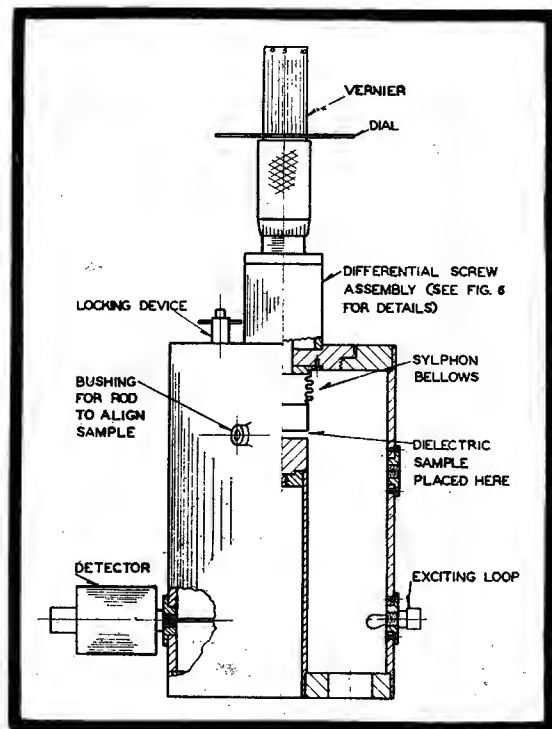

Figures 9 (above left) and 10 (above) Figure 9, relation between resonant frequency and separation of electrodes of 200-mc cavity. Figure 10, reentrant cavity used for measuring dielectric properties.

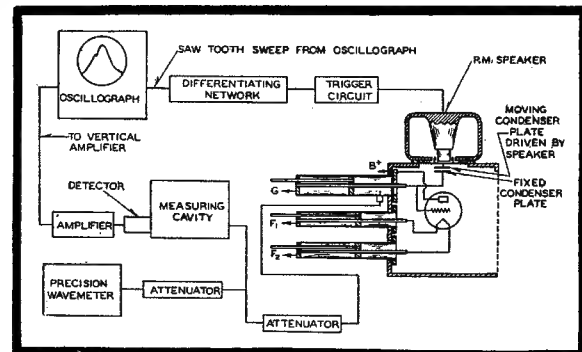

when the service requires stability at elevated temperatures, the organic dielectrics soon reach a temperature limit of effectiveness. One reason for this, he explained, is the inherent instability of the carbon-

to-carbon linkage. That is, he said, the rate of aging, determined by the time for the insulation to fail the test for a given

(Continued on page 50)

Effect of temperature on dielectric constant of liquid silicones, discussed by Dr. Bass, as compared to typical transformer oil of petroleum origin.

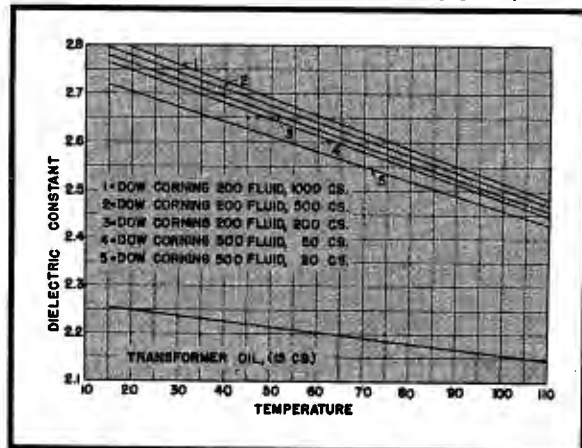



*"In times like the present, men  
should utter nothing for which they  
would not willingly be responsible  
through time and in eternity."*

*Abraham Lincoln, 1861*

*a Merry Christmas  
and Happy New Year*

**Jensen**

Jensen Radio Manufacturing Company  
6601 S. Laramie Ave., Chicago, Ill.

COMMUNICATIONS FOR DECEMBER 1944 • 49



# LOOK TO CANNON 'DP' CONNECTORS IN 1945

HERE ARE A FEW OF  
THE 'DP' CONNECTORS  
AVAILABLE NOW—  
AND MANY NEW  
DESIGNS ARE COMING

NEW applications of the exclusive Cannon Electric "DP" series of connectors have recently been extended from rack equipment in radio assembly to such uses as special centralized aircraft control on through to signal relay equipment.

Several new "DP" connectors of strikingly new design will be released in 1945—testimony to the progressive engineering Cannon Electric incorporates into its products. Since Cannon Electric pioneered the aircraft electrical connector in 1932, this development process has gone steadily onward. Cannon is prepared to meet the demands of postwar electrical equipment.

Cannon Type DP Connectors cover a variety of rack, panel and bail-type fittings, carrying from eight to 135 circuits with amperage range from 10, 15, 30 and 40 in many varied arrangements, including coaxial contacts.

All these and many other high quality electrical connectors are Cannon designed and manufactured.

For detailed engineering data on Type DP Connectors refer to the Cannon DP Bulletin. Write to Department A-121, Cannon Electric Development Company, 3209 Humboldt Street, Los Angeles 31, California.



## CANNON ELECTRIC

Cannon Electric Development Co., Los Angeles 31, Calif.

Canadian Factory and Engineering Office:  
Cannon Electric Company, Limited, Toronto

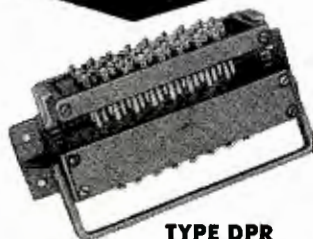

TYPE DPR



TYPE DP-30



TYPE DP-D



TYPE DP-P10

## IRE REPORT

(Continued from page 48)

physical property, such as flexibility, follows pretty closely the rule of half the life for every rise of ten degrees centigrade in temperature. And the eventual thermal decomposition product of organic dielectrics is carbon. Accordingly, explained Dr. Bass, the end result of exposure of organic insulating materials to elevated temperatures is to change a dielectric to a conductor.

In the inorganic spacing materials we have a framework of silicon and oxygen atoms, the two most abundant elements in the earth's crust. In this group we find quartz, vitreous silica, glass, asbestos, mica and ceramics. These materials are all high polymers, large molecules, explained Dr. Bass. And their molecular framework is essentially a structure of silicon atoms bound to each other through oxygen atoms, with a heat stability due to the inherent stability of this silicon-oxygen-silicon bonding. Unfortunately, said Dr. Bass, these materials are limited in physical forms to comparatively hard, brittle solids.

Explaining silicones, Dr. Bass said that they are a new class of semi-inorganic high polymers based upon silicon and oxygen instead of carbon, bridging the gap between the completely organic products and completely inorganic materials. Dr. Bass said that silicone products include liquid dielectrics, lubricants, greases, resins and varnishes, etc.

There are two groups of liquid silicones, based on the range of viscosity and service temperature to be covered: (a)—for use down to  $-55^{\circ}\text{C}$  and below; and (b)—for use down to  $-40^{\circ}\text{C}$  and up to  $200^{\circ}\text{C}$ . Dr. Bass said that all viscosity grades in this type are non-volatile liquid dielectrics with an even lower rate of viscosity change with temperature than the lighter viscosity fluids of (a).

Liquid silicones are noncorrosive to metals and are nonsolvents for rubber, synthetics and other organic plastics, said Dr. Bass. He said that their flash points are considerably higher than petroleum oils of equivalent viscosity and they will burn, when once ignited, to form silica, carbon dioxide and water. Discussing surface tension, he said it is low, about 20 dynes per cm, and they readily wet clean, dry surfaces of glass, ceramics and metals, making them water repellent; they are insoluble in water and are unaffected by water, dilute acids or salt solutions. They are soluble in most organic solvents including carbon tetrachloride and aromatic naphthas, but are insoluble in alcohol and acetone, pointed out Dr. Bass.

The power factors of the fluids are unusually low, said Dr. Bass, being less than .0001 at ordinary frequencies, and they do not increase appreciably with increased frequency up to  $10^7$  and  $10^8$  cycles. At higher frequencies, however, explained Dr. Bass, there is evidence of a more rapid rise in power factor. Their dielectric strength is 250-300 volts per mil at 100 mils; volume resistivity is in the order of  $10^{14}$  and does not drop below  $10^{12}$  at  $200^{\circ}\text{C}$ , he said. In view of these dissipation factors at elevated temperatures or at high frequencies and their inertness to moisture, they are useful in liquid filled condensers, said Dr. Bass.

The introduction of silicone varnishes with their greater thermal stability has

REPRESENTATIVES IN PRINCIPAL CITIES—CONSULT YOUR LOCAL TELEPHONE BOOK

provided a very effective insulation, said Dr. Bass. He said that silicone resins are useful for filling voids and excluding moisture from equipment insulated with fiberglass, mica or asbestos.

One varnish developed is used to bond fiberglass or asbestos served magnet wire, to varnish fiberglass or asbestos tapes, cloths and sleeving, and as an adhesive for bonding mica sheets to silicone varnished fiberglass cloth in the production of a flexible ground insulation.

This new silicone insulating varnish is applied and handled in a manner exactly similar to conventional organic varnishes except that higher baking temperatures are required, explained Dr. Bass. He pointed out that after drying off the solvent, the equipment is usually given an intermediate bake for 2 to 4 hours at 150° C after which it is cured for 1 to 3 hours at 250° C until the varnish becomes tack-free. This baking, he said, converts the silicone to a hard but flexible resin which effectively seals the equipment against moisture; it is not deteriorated by oil and is unusually resistant to chemicals.

The higher operating temperatures possible with silicones, also make possible higher output by simply adding more load on an existing design, said Dr. Bass. In one instance, a 10 h-p motor built with silicon insulation was one-half the size and weight of a standard type unit, according to Dr. Bass. He said that the silicone motor will probably outlast the conventionally insulated motor because it does not carbonize when overloaded and the moisture proofness is retained on long aging at elevated temperatures.

Thermosetting silicone resins were also discussed by Dr. Bass. He said that many types of electrical insulation constructions require thermosetting resins for use in their fabrication: laminated board, coil forms, tubes, slot sticks, and laminated mica. There are several types of silicone under development for bonding Fibreglas and asbestos textiles to each other or to mica, he explained. These resins are supplied in solution, he said, and used to coat or impregnate the product to be laminated. The resulting coated cloth or sheet can be laminated in the conventional press at temperatures of 230° to 250° C, according to Dr. Bass.

Figure 13

Glass coil forms treated with liquid silicones, showing highly water repellent surface. When exposed to high humidities under condensing conditions, silicone film prevents moisture from forming continuous liquid film.



**There's a Lot in a Transformer  
That You Can't See . . .**

Of course we are proud of the appearance of ADC Transformers. One of our greatest satisfactions however, is in the way they are designed and built—for it is upon these qualities that ADC performance has been achieved and maintained.

It might be easier to make transformers some other way, but we enjoy doing our work the right way—and that means a lot to all of us here at ADC.

**SEND FOR LATEST CATALOG!**



**Audio Development Co.**  
2833 13th Ave. S., Minneapolis, Minn.



# GRAPHICAL SOLUTION FOR CAA COURSE ALIGNMENT

[PART TWO OF A TWO-PART PAPER]

by G. L. BREWER

Chief, High Frequency Unit  
Signals Division, CAA

## GRAPHICAL METHOD FOR COURSE ALIGNMENT.

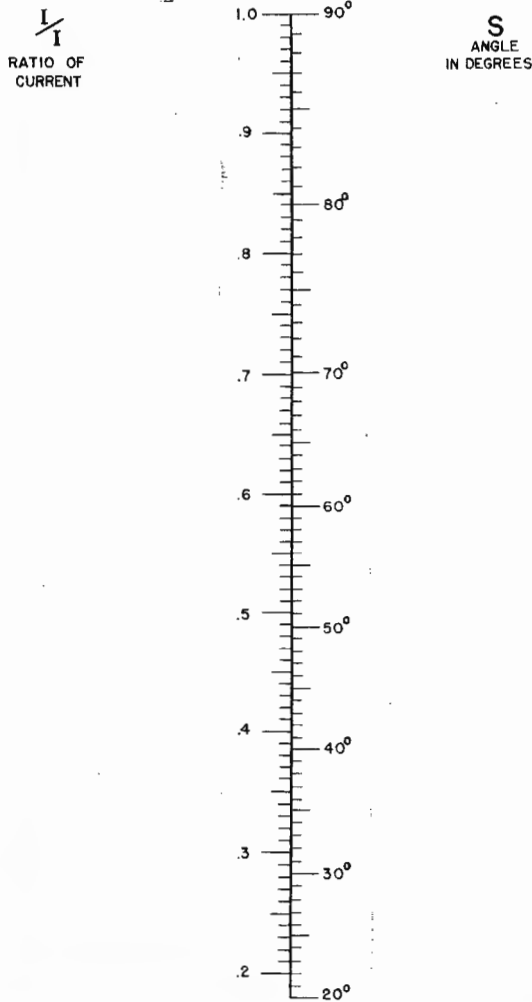

Chart 1

A graphical method employed by the CAA for determining the adjustments necessary for properly orienting the four courses of a CAA radio-range station employing the modified Adcock antenna system is described in this paper. The method was introduced by the writer in 1938 to provide a simple and direct procedure whereby CAA personnel, especially those in the field, could pre-determine the correct adjustments of the radio equipment for producing the required courses. The extensive simultaneous equations necessary to secure these data in the past were presented in the initial installment.

Charts presented in this installment were referred to last month, under the *Course Squeezing* heading. A condensation of these data are offered in this installment to facilitate the use of the charts.

The smaller angle subtended by the bisecting lines is referred to chart 1 and the ratio of primary currents determined. The smaller current is for the goniometer primary having the same signal identification letter as the smaller quadrants.

The angle of bend for a pair of courses is the angle between either course and the corresponding bisecting line. The angle of bend for one pair of courses is referred to chart 2 and the bending effect, *L*, thus determined.

To adjust the relative output of the carrier and sidebands so that 30% modulation exists on the strongest course or courses, the power output of the carrier channel is first adjusted to the level designated for the desired coverage of the station. Then the sideband power is adjusted by setting the r-f current in the sideband tower  $T_1$ , when the goniometer is set on zero, in accordance with the ratio of currents obtained from chart 3 (identified as chart 4 in previous installment), after the values of  $L_0$  and angle *A* are determined by use of a graphical method as described and illustrated in Figure 4 (November, COMMUNICATIONS).

Chart 3 is used by drawing a line from the value of angle *A* on the right-hand scale through the frequency to the left-hand scale. At this intersection the value of  $L_0$  is added using the  $L_0$  scale. The ratio of current values opposite this point is the ratio to be used for adjusting the current in the sideband tower  $T_1$  (when the goniometer is set on zero) with respect to the current in the center tower for 30% modulation of the range signals. (See pages 53 and 56 for charts 2 and 3)

AERONAUTICAL COMMUNICATIONS

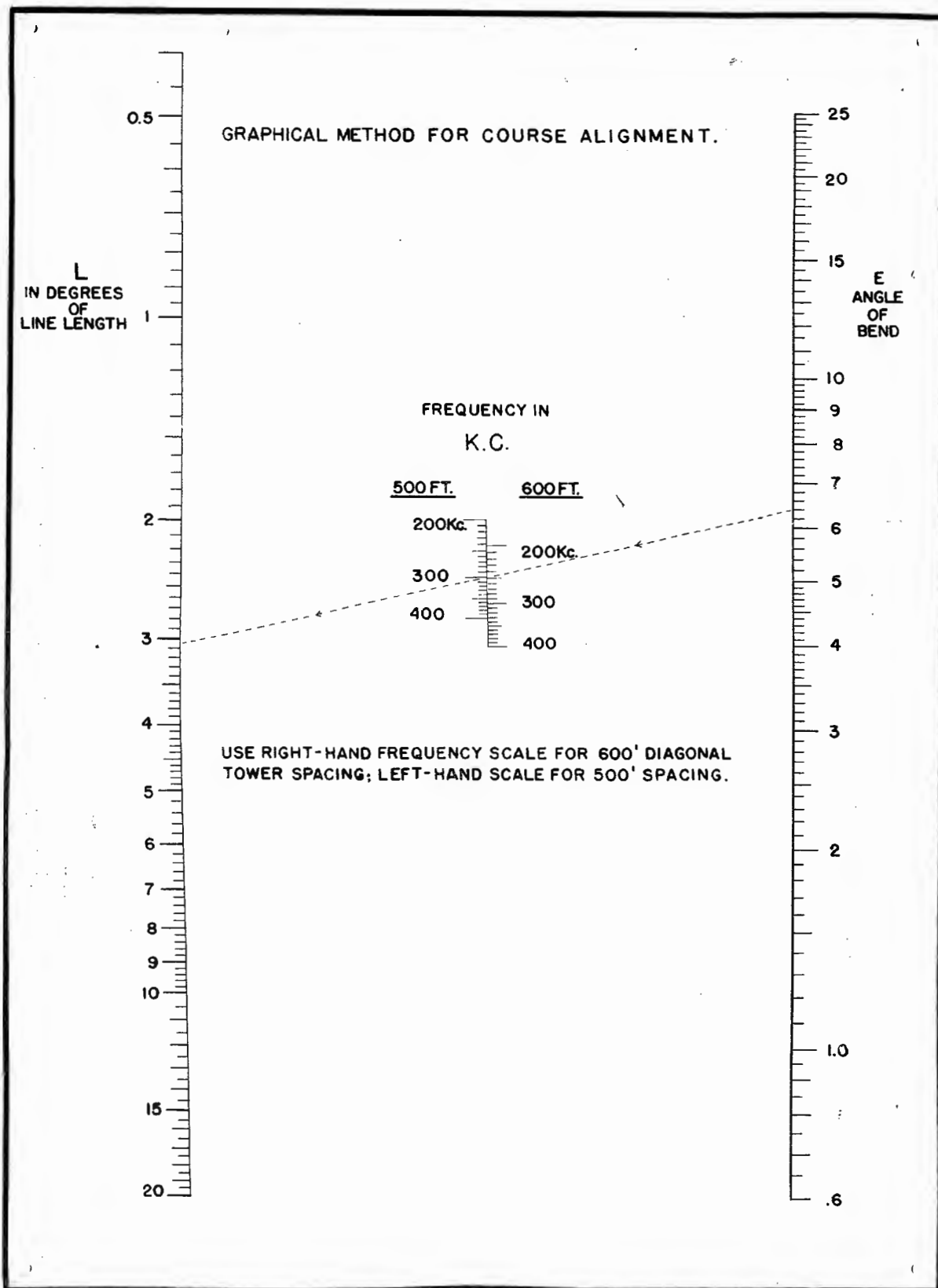

●  
Chart 2 (Chart 3 appears on page 56)  
●



# 1 Two-Way Speaker

## READY FOR INSTALLATION!

• The Altec Lansing multicellular two-way speaker is ready for installations. It provides broadcasters, manufacturers and audiences with quality sound in a frequency range up to 15,000 cycles plus. One of the exclusive reasons why the Duplex speaker revolutionizes the methods of sound reproduction.

SEND FOR BULLETINS

# ALTEC

LANSING CORPORATION

1210 TAFT BLDG., HOLLYWOOD 28, CALIF.

## COAXIAL CABLES

(Continued from page 35)

trical requirements, therefore, is seen to be no mean figure. Intensive studies on the structure of high polymers in relation to their physical properties, and the knowledge of what is required for electrical characteristics, have provided clues to the final answer.

It is now well established that high polymers, such as cellulose, polystyrene, lucite, polyethylene, polyvinyl chloride, nylon, etc., consist of long chains of atoms of different length and which are bound to each other by van der Waal's or secondary forces, or by what is known as the hydrogen bond. It is in the molecular configuration of these long chains that we find the explanation of why one plastic differs from another in physical properties. While the information in this field is still somewhat fragmentary, it is possible to make broad generalizations which have proven to be of inestimable value not only in understanding the basic physical reasons for the behavior of these materials, but in determining which way to proceed in the synthesis of new compounds.

The relationship between mechanical properties and average chain length of the molecule is such that there exists a critical minimum value of chain length before any mechanical strength is reached. This minimum value ranges between 40 to 80 units and is smallest in the case of nylon and longest in the case of hydrocarbons such as polyethylene and polystyrene. Once this minimum chain length has been reached, the material shows mechanical strength, and its ultimate properties are roughly in proportion to the average chain length, until an upper limit of chain units of about 250 is reached beyond which there is no appreciable change.

Summarizing the results of much work in this field the following would appear to be a reasonable explanation of the facts:

(1)—A typical plastic is characterized by a molecular structure wherein the forces between chains are moderate and the geometry of the chains such that crystallization (as deduced from x-ray examination) can generally occur. The exact nature of the material will be greatly influenced by external conditions such as temperature and pressure.

(2)—Fibres are found where the

forces between the chains are strong and the structure of the chains such that they fit easily into a crystal lattice. This gives rise to high external crystallinity and the typical fibrous structure.

(3)—Rubbers are formed when the molecular attraction between chains is very small and the chains are so constructed that they fit badly into a crystal lattice. Under these conditions the material under stress always has a tendency to return to its original state.

It is, of course, obvious that these three groupings are not absolute, since they grade into one another, and by suitable mechanical treatment it is often possible to make a material from one of the groups fall into another category. A few typical examples of high polymers will demonstrate how this conception works out in practice.

Natural rubber is a polymeric isoprene. In its unstretched state it has an amorphous structure as shown by x-ray analysis, but if it is stretched to 200% or more it exhibits characteristic crystallinity. The presence of the methyl groups on the chain, situated as they are, prevent the close packing of the chains, and this coupled with the low molar cohesion gives this material its characteristic rubbery properties.

Polyethylene is an example of a very simple molecule, with a marked absence of side groupings. The molecules pack tightly together and the material exhibits a typical x-ray pattern. Thus polyethylene tends toward the fibre like structure and this is borne out by the ease with which filaments of this material can be made and the *cold-drawing* effect that is observed on stretching, coupled with the relatively sharp melting point exhibited by this material.

The synthetic rubber, *GR-S* or *Buna-S* is a good example of how these concepts or physical properties have been put to practical advantage. *GR-S* as is well known, is a copolymer of butadiene and styrene. Butadiene by itself has been polymerized, but the products obtained are not very well explored or identified. However, it would be expected that in a pure polybutadiene the chains would pack tightly together and that marked crystallinity would be observed. We would, therefore, expect the material to be somewhat similar to polyethylene only if anything, a little more of a true

(Continued on page 90)



## unlimited frequency selection

— over two critical ranges: 20 to 100 cycles; 4,000 to 10,000 cycles with an available boost of 0 to 20 db.

Unlimited frequency selection — an unusual operational advantage offered by the equalizer unit of the Fairchild Amplifier-Equalizer — compensates for brilliance-loss at the slower 33.3 speed and for response-deficiencies of cutterhead, disc material, pickup, or speaker by electronically boosting the higher frequencies from 4,000 on up to 10,000 cycles — with a negligible effect on volume and without loss in the bass.

With a Fairchild Amplifier-Equalizer and two No. 539 Fairchild Recorders, it is possible to record or play back continuously; to make duplicate records; or to "dub" from



**No. 540 AMPLIFIER  
EQUALIZER**

one table to the other. Wherever extreme flexibility, low noise level, low distortion content and fine frequency response are professional requirements, the one answer is the Fairchild Amplifier-Equalizer.

All Fairchild sound instruments are built to meet the exacting professional requirements of the radio and communications fields. To electronic skill Fairchild has added the plus of exceptional mechanical skill — skill long practised in .0002" tolerance production of aerial and gun cameras, and aircraft computing gunsights.

Descriptive and priority data are available.



*Fairchild* **CAMERA**  
AND INSTRUMENT CORPORATION

**SOUND  
EQUIPMENT**



88-06 VAN WYCK BOULEVARD, JAMAICA 1, N. Y. • New York Office: 475 TENTH AVENUE, NEW YORK 18, N. Y.

**SOUND EQUIPMENT—PRECISIONIZED—mechanically and electronically—FOR FINER PERFORMANCE**

COMMUNICATIONS FOR DECEMBER 1944 • 55



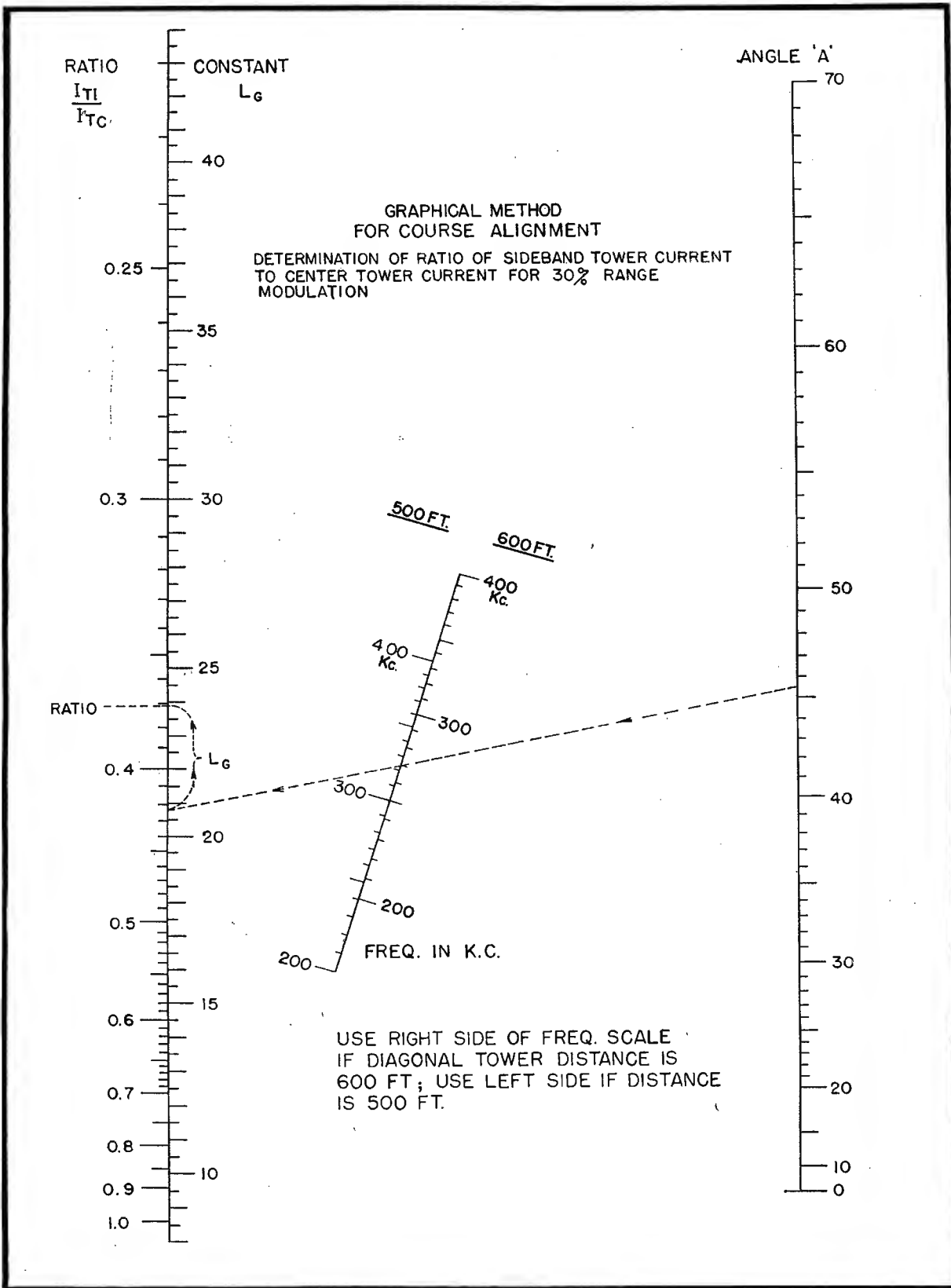

Chart 3 (Charts 1 and 2 appear on pages 52 and 53)



# Something to Remember about having your CAPACITOR SPECIFICATIONS MATCHED

## SPRAGUE CAPACITOR TYPES

Dry Electrolytic  
Paper Dielectric  
Mica Dielectric  
Power Factor Correction  
Motor Starting  
High Voltage Networks  
Radio Noise Suppression  
Filters, etc., etc.

In designing or producing a radio or electrical product, there are plenty of things to think of besides capacitors. Moreover, unless you've specialized, it's difficult to keep fully abreast of modern capacitor developments. That's why we make this suggestion:

Write today for a supply of Sprague Sample Request Forms. Then, as capacitor applications arise, use these forms to send full details to Sprague engineers. Let them make suggestions. Benefit from their broad experience, as well as from the fact that Sprague regularly produces dozens of standard

Capacitor types, plus hundreds of adaptations and special units.

Such a request places you under no obligation to buy the recommended type. It simply assures you of specialized attention in the selection of an important component on which there are many factors to consider—angles which cannot always be cataloged completely or promptly, or which cannot be uncovered in any other way than through this personalized engineering service.

Write today for a supply of Capacitor Sample Request Forms.

**SPRAGUE ELECTRIC COMPANY, North Adams, Mass.**  
(Formerly Sprague Specialties Co.)

A typical group of Sprague Dry Electrolytic Capacitors designed to match special specifications.



**CAPACITORS • KOOLOHM RESISTORS**  
T. M. REG. U. S. PAT. OFF.



# BETHANY 200-KW H-F TRANSMITTERS

by R. J. ROCKWELL

Director of Broadcast Eng.  
The Crosley Corporation

[The initial installment of this paper, which appeared in November **COMMUNICATIONS**, covered the basic purposes of the transmitters, and pioneering steps in solving problems including selection of suitable sites, buildings and necessary materials. Many of the transmitting features were also analyzed. These included transmission and antenna systems, r-f generators, r-f drivers, final amplifier, plate tank circuit, audio and control room equipment, modulation, power supply substation and transformer vault. In this, the concluding installment, Mr. Rockwell discusses the high voltage supply filter, rectifier cabinet, carrier alarm, antenna switching, matching and operation.]

tacts. The bias-power supply consists of a 7.5-kva transformer, with 2-10 henry 2.5-ampere chokes in the full-tap circuit, and a .5-ampere 10-henry choke in the half-tap circuit. With only the low voltage and bias supplies operating, the a-c power for the latter is fed through the 240-v breaker panel; but when the high voltage power supply is energized, the power is fed through a 7.5-kva step-down transformer from the secondary of the 750-kva plate transformer, which causes the bias voltage to vary directly in proportion to the changes in the high voltage supply. The low voltage supply uses a 5-kva transformer, and the same size filter chokes as the bias supply. The d-c power from the low voltage and bias supplies also incorporates a set of surge resistors and standard three-pole isolation switches.

All of the condensers used in the power supplies are equipped with a special fuse mechanism, which automatically disconnects a faulty condenser from the bank, and places a short across it.

## Rectifier Cabinet

The rectifier cabinet (Figure 17) contains three rectifiers, two of which are low voltage bridge circuits, one providing bias voltages of 2000 and 4000 v, and the other providing plate voltages of 1000 and 2000 v. The third rectifier is the high voltage six-phase single Y circuit.

(Continued on page 60)

THE high-voltage supply filter consists of a .5/2 henry reactor, and 20 mfd. of 20,000-v condensers. Power from filter is distributed to other components in the vault on copper buses. All d-c power circuits to the r-f section have series surge-limiting resistors, and magnetically operated isolation switches, which are mounted on the vault walls. The 24-ohm surge-limiting resistor for the final amplifier is a bank of edgewise-wound resistors, mounted in a rack. For the lower voltage circuits, standard open-wound resistors are used. The isolation switches are standard 25,000-v 3-ampere single pole switches with arcing horns added to minimize burning of the con-

Figure 17  
The rectifier cabinet.



Figure 18  
Tube switching panel

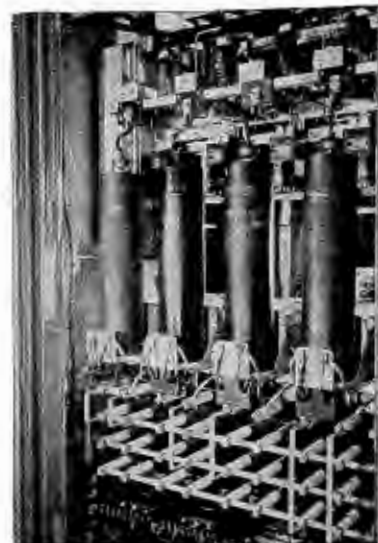

R. F.  
CONTACTORS  
and  
M. P.  
SWITCHES

Johnson R. F. Contactors were designed for switching high voltage antenna circuits in Phasing Equipment and for similar applications. Made in two sizes, these Contactors provide long creepage paths, high current carrying capacity, high voltage rating and no holding current is required. They can be operated on either 110 or 220 volt power circuits. Either size is available with a variety of contact arrangements including auxiliary contacts for signal or pilot light indicators. Contacts are sectionalized to provide large contact area and their wiping action makes them self-cleaning. Write today for more information and quotation giving contact arrangement desired.

Johnson Make - Before - Break Switches were designed for inserting and removing meters from antenna circuits without opening the circuit. Features include R. F. insulation, high voltage breakdown rating, high current, carrying capacity, and wiping contacts insuring low resistance.

Ask for Catalog 968 (E)



E. F. Johnson Co. Waseca, Minn.

# Centralab

## CERAMIC CAPACITORS for HIGH VOLTAGE

Three new double cup style ceramic capacitors engineered by Centralab for transmitter applications where high working voltages and loads are required.

Type 850 currently available with two terminal styles — axial screw type and lug style . . . or one of each. Capacities ranging from 25MMF NPO to 100MMF N750. Working voltage to 10,000 D.C. Type 851 available with two terminal styles as illustrated. Capacities ranging from 25MMF NPO to 200 MMF N750. Working voltage to 20,000 D.C.

Type 852 designed to withstand shock of 100 to 200 G. Axial screw style terminal. Capacities range from 10MMF NPO to 25MMF N750. Working voltages to 10,000 D.C. Ask for Bulletin 721 and 814.

Producers of Variable Resistors • Selector Switches  
• Ceramic Capacitors,  
Fixed and Variable •  
Steatite Insulators.

# Centralab

Division of GLOBE-UNION INC., Milwaukee





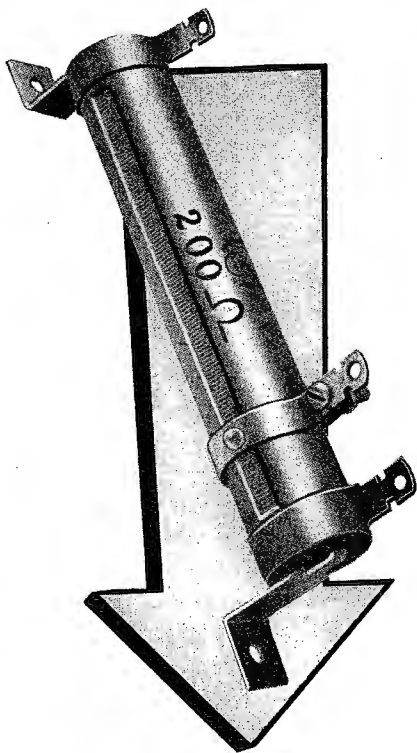

## For the TOUGHEST RESISTORS, ask for GREENOHMS

★ Greenohms — those green-colored cement-coated Clarostat power resistors—definitely “stay put”. You find them today in the finest electrical, electronic and radio assemblies. They are TOUGH. Resistance is *right* to start with — and stays *right* after years of use and abuse. Yet they cost no more.

Standard 10 and 20 watt fixed. 1-50,000 and 1-100,000 ohms. Standard adjustable 25 to 200 watts. 1-100,000 ohms. Brackets. Additional sliders available. Also available in special windings, taps, terminals, mountings, etc.



★ Write for Literature . . .

Descriptive bulletin sent on request. Also sample for your test. Let us quote on your resistor needs.



CLAROSTAT MFG. CO., Inc. • 285-7 N. 6th St., Brooklyn, N. Y.

(Continued from page 58)

cuit, employing six 870A tubes, and provides plate voltage for the modulator and final amplifier. Two spare 870 tubes are kept continuously heated, making a total of eight tubes, all of which are mounted on a thermostatically-controlled air duct, with nozzles blowing on their individual mercury radiators. This duct is supplied from a vertical duct in which are mounted strip heaters and their control switches, and which connects with the overhead cold air supply.

Below the tubes, at the rear of the cabinet, (Figure 18) is a tube switching panel, so arranged as to make switching of spare tubes into the circuit an error-proof procedure. Six of the eight tubes are always connected into the circuit by means of six jumper straps, in pairs of three different lengths, no two of which are identical due to the left or right twist of the top end of each strap. The upper switch jaws just below the tubes are mounted at corresponding angles, slanting alternately left and right, and connecting alternately to cathodes and anodes of all eight tubes.

When a fault occurs, the annunciator light on the front meter panel indicates which tube is defective, and it is necessary only to remove the corresponding jumper strap and insert it into the only vacant position into which it will fit. This arrangement provides one spare tube each for the parallel cathode side and the parallel anode side of the circuit. Below this switching panel are mounted the high-leakage reactance-type filament transformers for the 870 tubes, which automatically limit starting filament current.

### Tube Cooling

The heat dissipation system consists of a separate blown-air and water cooling system for each transmitter. The fan and pumping equipment for each unit is housed in the fan room directly behind the unit. Each system is designed to dissipate 350 kw of electrical power, and provide for removal of waste heat in the transmitter cabinets and high velocity air for cooling the mercury radiators on the high voltage rectifier tubes, as well as cooling water to the ignitron units. The system is also arranged to furnish by-product ventilation of the building in summer, and heating of the building in winter. Auxiliary steam coils are installed in connection with the air units, to operate automatically when there is insufficient waste electrical heat for adequate building heating.

Each fan room is equipped with two double-inlet, double-width centrifugal fans, individually motor driven. The fan suction plenum is connected through dampers to a filtered outdoor air plenum, to the building concourse, and to a recirculated warm air bypass. The fans discharge the air through four, finned copper, distilled water cooling coils, from where the heated air is wasted to atmosphere or delivered to the building for recirculation. Forced air ventilation for the transmitter cabinets and ignitron cooling system is taken directly from the fan discharge plenum, which is maintained at constant pressure. An evaporative cooling section is provided for the ignitron unit, to supply water at lower temperature for this unit. The remainder of the system utilizes dry air cooling, to obvi-

ate maintenance of coil surfaces and attendant spray water nuisances.

Each transmitter is equipped with a separate distilled-water circulating system. The pump is of the horizontally split case type, direct connected to a 1750-rpm motor. The pump takes its suction from an open surge tank and discharges the water through the finned cooling coils previously mentioned. From here it goes to a distributing supply header below the transmitter cabinets, where it is fed through individual circuits to the various tube jackets and coils. The heated water is then collected in a similar supply header which carries it back to the surge tank, which serves as an air release and automatic make-up chamber. A similar system of much smaller capacity is used for the ignitron system.

Water is distilled in a 50-gallon-per-hour capacity still in the boiler room, and is pumped from there to a gravity tank in the tower, then to the various surge tanks. The still is operated by steam from the heating boilers.

A complete pneumatic control system operates the various dampers in the blown-air system, from a master panel housed in the main control center at the rear of each transmitter unit. Flow meters, pressure gauges and thermometers are conveniently located on the slanting front edge of the transmitter catwalk, so the operator can instantly determine the water flow and air and water temperature at critical points in each circuit.

### Control Circuits

Since the complete transmitter unit is composed of two r-f sections, one power supply and one modulator, the control circuit had to be arranged to provide for individual or simultaneous operation of these sections. As it is set up, either r-f section can be operated as an individual transmitter, or both can be operated from the common power supply and modulator. In case of a fault or tube overload while both units are in operation, automatic isolation of the units is provided, to minimize loss of air time of the unit in operating condition.

The heart of the control system is located in the rectifier cabinet, and each function in the operation is initiated from the push button on the front control panel. The relay panel contains the primary-control relays plus the annunciator relays. On the meter panel at the top of the rectifier cabinet, a set of 50 annunciator lights indicate open transmitter or vault doors, and the operation of overload relays, each of which has an associated annunciator relay, which locks up after a fault occurs, lighting the corresponding annunciator light until a reset button is pushed. Another button closes all annunciator relays to test for burned out lights.

For checking faults in the control system, a series of 40 small 1/25-watt neon lights are provided on the annunciator relay chassis, each of which is connected across a particular set of overload relay contacts, door interlocks, or control relay contacts, so that in normal operation none of the lights would be lit; but, if a fault occurs, the neon light number, in conjunction with a chart, tells which circuit is open. In turn, each overload relay has a neon light across its contacts,

(Continued on page 66)

# welding with a paint brush?



*Alloy flows easily and weld is quickly completed under arc.*

To solve a difficult welding problem, Eimac laboratory technicians compounded a welding alloy that could be applied with a paint brush. The alloy flows easily under an arc to complete the weld, yet subsequent heating to temperatures as high as 2900 degrees Centigrade will not destroy the weld.

Such is but an example of the application of the Science of metallurgy in the "science behind the science of electronics." The extent to which Eimac Engineers went to solve this relatively small problem reveals two important facts:—(1.) The thoroughness of Eimac Engineering, and (2.) The completeness of their engineering facilities. The leadership which Eimac tubes enjoy throughout the world in all phases of electronics is attributable to the soundness of this engineering.

Performance of any electronic equipment is a direct reflection of the performance of its vacuum tubes. Hence it is advisable for users and prospective users of electronics to look first to the vacuum tube requirements. Because Eimac makes electron vacuum tubes exclusively their advice to you is unbiased and can be of great value. A note outlining your problem will bring such assistance without cost or obligation.

**EITEL-McCULLOUGH, INC.**, 870 San Mateo Ave., San Bruno, Calif.  
Plants located at: San Bruno, California and Salt Lake City, Utah  
Export Agents: **FRAZAR & HANSEN**,  
301 Clay St., San Francisco 11, California, U. S. A.



Write for your copy of *Electronic Tubes*—a 64 page booklet fully illustrated—covering fundamentals of electronics and many of its important applications. Written in layman's language.



Follow the leaders to

**Eimac**  
REG. U. S. PAT. OFF.  
**TUBES**

## The Science Behind the Science of Electronics

*is the focusing of all branches of science upon the development and improvement of electron vacuum tubes.*



**SPECTROGRAPH**... Analysis determines exact characteristics of metals to be joined.

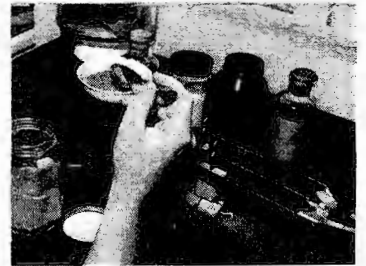

**METALLURGY**... Compounding special alloys of metals.



**OPTICS**... For studying the effects of processing.



**ELECTRONICS**... Welded elements in electron vacuum tubes withstand tremendous heat.

870



# POWER SUPPLY FOR U-H-F VELOCITY-MODULATED TUBES

Power supply circuit for the klystron.  $R_{AA}$  are four selected resistors permitting the 0 to 1.5 ma meter to read 3000 volts d-c.

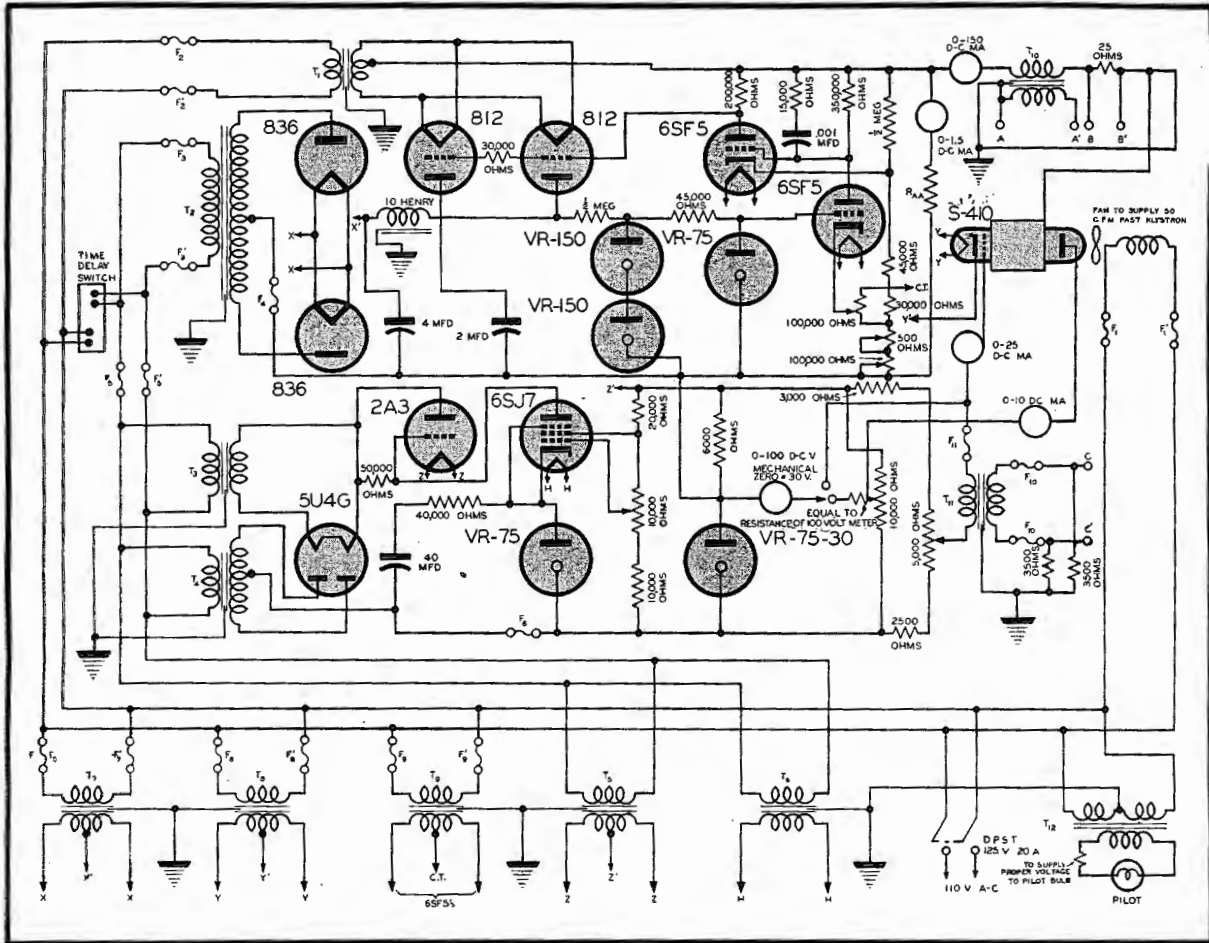

Transformer characteristics:  $T_1$ , 110-v to 6.3 at 10 amp, 5,000 volts insulation;  $T_2$ , 110-v to 1,500, each side of center at 250 ma;  $T_3$ , 110-v to 5.0 at 3 amp, 3,000 volts insulation;  $T_4$ , 110-v to 2.5 at each side of center at 90 ma, 3,000 volts insulation;  $T_5$ , 110-v to 2.5 at each side of center at 1.0 amp, 3,000 volts insulation;  $T_6$ , 110-v to 2.5 at 10 amp, 3,000 volts insulation;  $T_7$ , 110-v to 2.5 at 10 amp, 3,000 volts insulation;  $T_8$ , 110-v to 6.3 at 2 amp, 3,000 volts insulation;  $T_9$ , 110-v to 6.3 at 2 amp, 3,000 volts insulation;  $T_{10}$ , modulation transformer (1:3), at 2 amp, 3,000 volts insulation;  $T_{11}$ , modulation transformer (1:1), 2,000 volts insulating;  $T_{12}$ , 60-80 ma, 600 to 800 v c.t. (small power transformer); and  $T_{12}$ , 60-80 ma, 600 to 800 v c.t. (small power transformer; h-v secondary connected to lines).

**T**O analyze critically the characteristics of the klystron, serving as a general purpose r-f source of approximately 3,000 mc in our laboratory, it was necessary to develop a special power supply. This unit had to be capable of operation with a minimum amount of instruction and operate continuously for a period of 4 to 6 hours, with reasonable stability as regards to frequency and amplitude for one-half hour or more.

## by IREDELL EACHUS, JR.

Formerly ESMT Communications Instructor, Moore School of Electrical Engineering, University of Pennsylvania; now on leave.

This paper is based on work carried on by the author at the Moore School

To obtain the long range stability required it was necessary to regulate

the fluctuations of line voltage and to prevent excessive heating of any part of the apparatus. The effect of temperature on resistors and on the dielectric in condensers is well known. There is in this case another place where the operating temperature is important. The primary frequency determining elements are the rhumbatrons. These are essentially small metal containers in which the electromagnetic waves oscillate in a natural mode of oscillation. The resonant frequency at which the natural oscillations occur is directly dependent upon the interior dimensions of the rhumbatrons. The rhumbatrons also serve

(Continued on page 97)

U-H-F LABORATORY RESEARCH

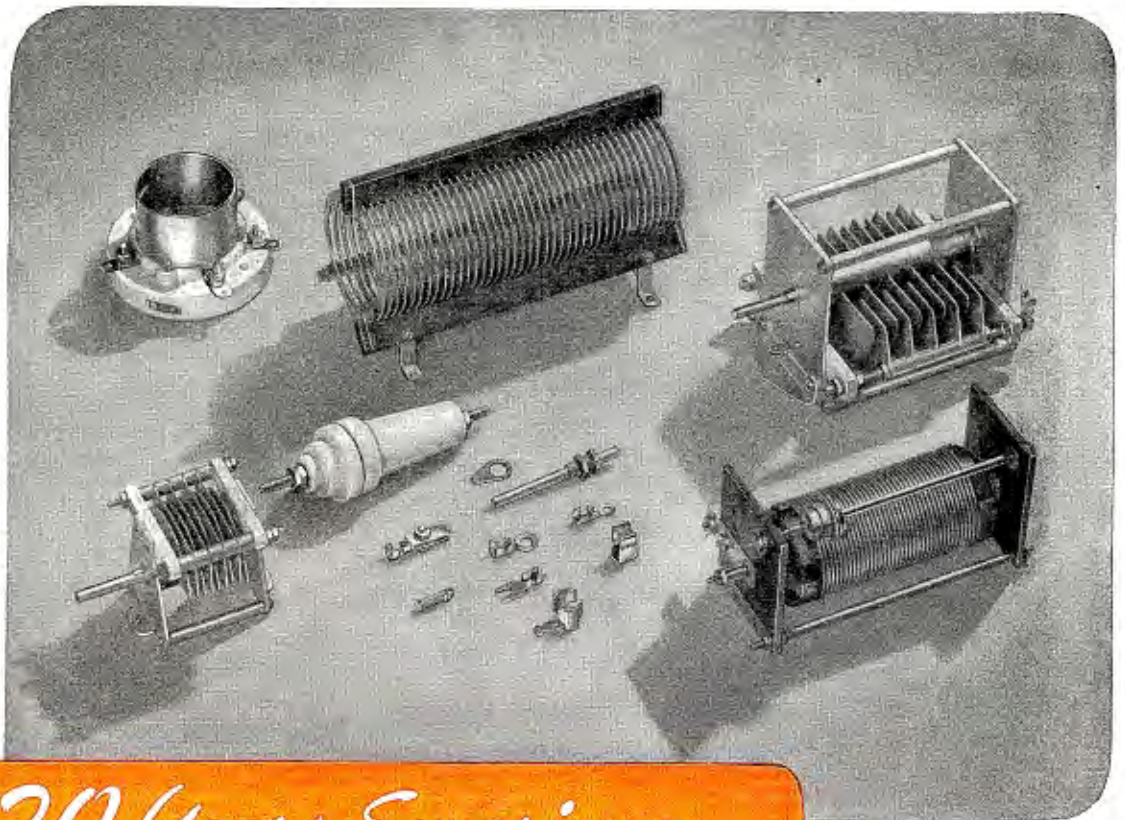

*20 Years Experience*  
**In Parts Manufacture**

- CONDENSERS—Variable, Fixed, Gas Filled Pressure, Neutralizing—a type for every transmitter need.
- INDUCTORS—Wire-wound, edgewise wound copper strip, copper tubing—fixed, tapped, or continuously variable—50 watt to 100 KW.
- INSULATORS—Stand-off, Thru-Panel, Cones, Bushings, Antenna Strain or Compression—a type for every requirement.
- TUBE SOCKETS—Steatite or Porcelain—Wafer, Bayonet, Miniature, Acorn or Special Types—a socket for almost any transmitting tube.
- HARDWARE—Tube Caps, Inductor Clips, Solder Terminals, Fuse Clips, Panel Bearings, Flexible Shafts—those hard-to-find constructional parts.

**OTHER  
 FAMOUS  
 JOHNSON  
 PRODUCTS**

- Plugs and Jacks
- Couplings
- Concentric Line
- Chokes
- Antennas
- Antenna Phasing Equipment
- Antenna Coupling Units
- Heavy Duty R. F. Relays
- Make Before Break Switches
- Sampling Transformers

Ask for Catalog 968E



**JOHNSON**  
*a famous name in Radio*

**E. F. JOHNSON COMPANY • WASECA • MINNESOTA**

COMMUNICATIONS FOR DECEMBER 1944 • 63



# TRANSMITTER DESIGN YESTERDAY AND TODAY

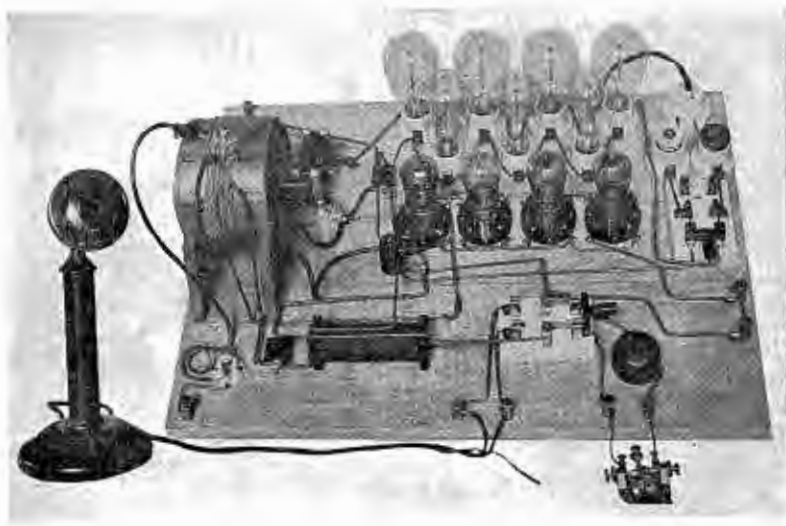

by DONALD McNICOL

**I**NSPECTING the extensive electrical and mechanical equipment of a modern high-power radio broadcasting station, and giving the once-over to a 1944-vintage mobile radio station of the armed forces presents food for thought, particularly to radio engineers with memories. Young men, who prior to the war were not even remotely associated with radio are providing us with glowing accounts of what the radio communication men are accomplishing with present-day equipment, on the battlefields, where they fought. To the non-radio man the accomplishments border on the miraculous. Indeed, many of the young radio men at the front who learned all they know about radio

Figure 1  
Phone transmitter of late 1920, assembled by New York experimenters. The dpdt switch provided for buzzer operation by Morse key for test or for telegraph.

within the past three or four years, are accomplishing miracles in the field. They view the equipment as something that has come out of the intense war effort in production of recent months, and in some degree this is true. To the host of radio engineers, however, still active, who can recall the steps in development of the equipment which have been taken in the course of the years, occurs a sobering thought. In sober thinking there is the impulse to contemplate what another

quarter of a century of engineering development will do to the equipment of today. The inventive, the constructive engineer, the engineer with vision is not given to gloating over past or present accomplishments. Rather, in the main his thinking is along the line of what can be done, what must be done to provide extensions and betterments, above and beyond what is available today.

Engineers who ponder over the possibilities of advancement of an art, have the benefit of a yardstick, a measure, in what has been accomplished in a given period of time. Viewed in short periods of time, the curve of improvement progress may flatten occasionally before resuming the climb to the upper right-hand corner of the sheet. But when the base line covers a period of twenty to twenty-five years, what has taken place through the years stands out in bold relief.

It is the purpose in this paper to mark only one of the milestones in the progress of radiophone development. However for the sake of perspective it might be recorded that in association with the late Charles V. Logwood, in 1908, in the West, we constructed for demonstration purposes a model of Collins' radiophone transmitter, the type exhibited by Collins at Madison Square Garden, New York, in that year. It was necessary to make up an arc generator patterned after  
(Continued on page 89)

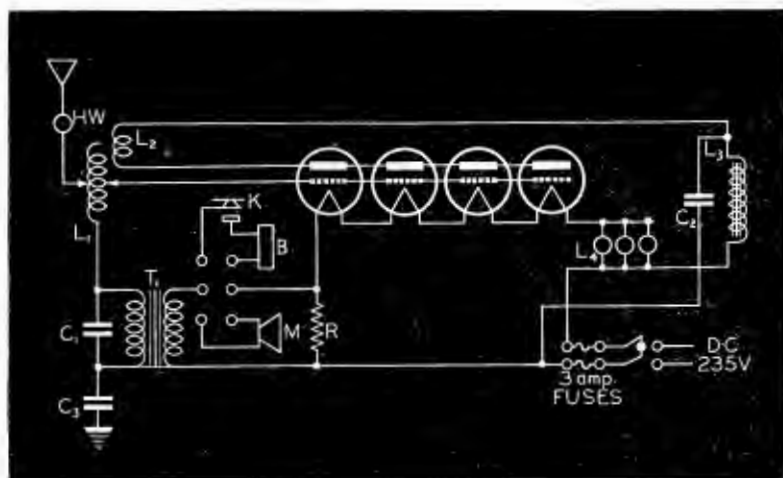
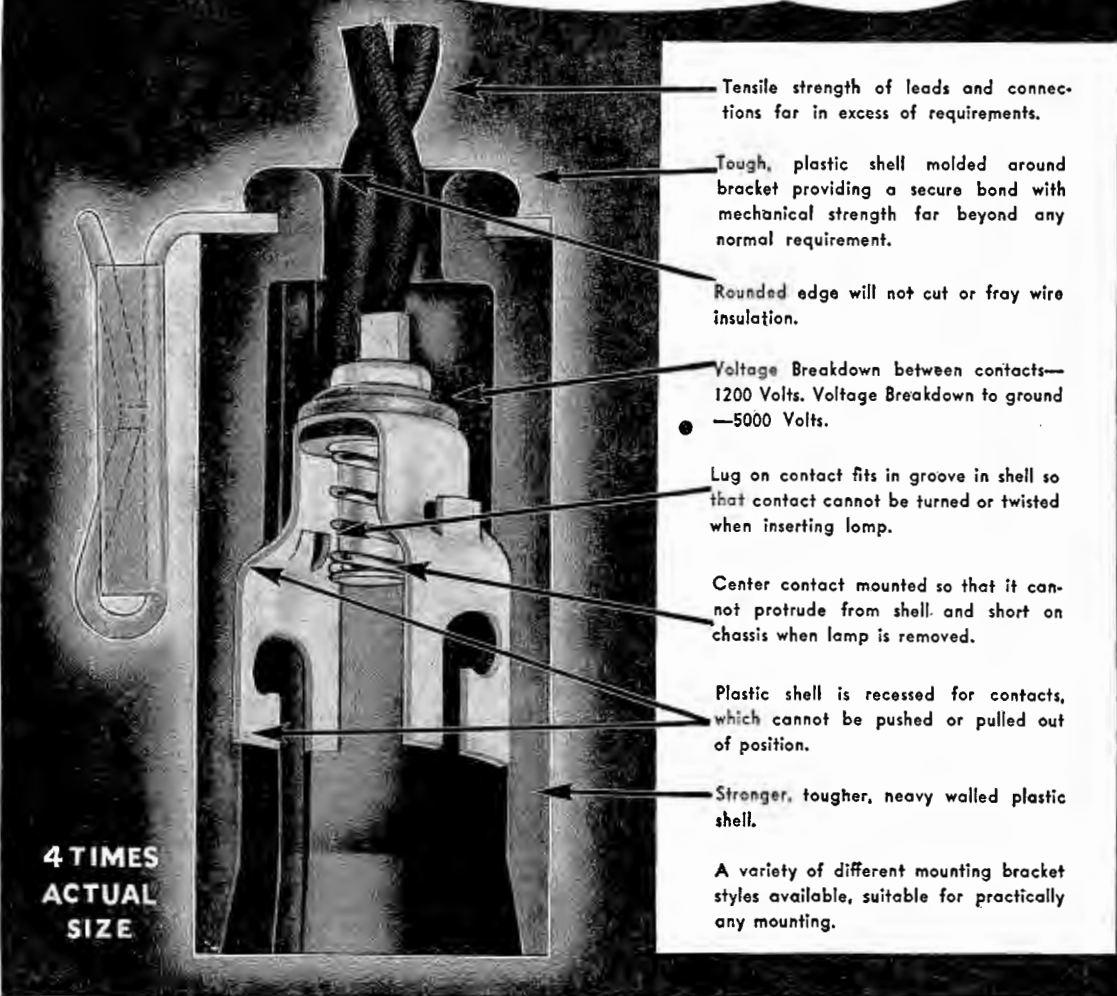

Figure 2

Circuit of transmitter shown in Figure 1.  
L<sub>1</sub>: antenna grid inductance (5½" tube, with 13 turns of No. 18 dcc or annunciator wire, tapped each turn). L<sub>2</sub>: plate inductance (5" tube, with 14 turns of No. 18 wire, tapped each alternate turn). L<sub>3</sub>: iron core, 1-henry choke coil. C<sub>1</sub> and C<sub>2</sub>: r-f bypass .003-mfd condensers, mica insulated, to carry the power voltage applied. C<sub>3</sub>: 2-mfd condenser to ground. T<sub>1</sub>: Telephone transformer (one employed was a W.E. 5A). K: Morse key. B: buzzer. M: microphone (one type used was W.E. 284W). R: n-i resistance .60 ohm, to carry 2.5 amperes. L<sub>4</sub>: Incandescent lamps, in bank, to permit flow of 2.4 amperes through the four UV 202 filaments in series.  
HW: hot-wire ammeter.

# *a New and Superior* DIAL LIGHT SOCKET



**4 TIMES  
ACTUAL  
SIZE**

- ← Tensile strength of leads and connections far in excess of requirements.
  - ← Tough, plastic shell molded around bracket providing a secure bond with mechanical strength far beyond any normal requirement.
  - ← Rounded edge will not cut or fray wire insulation.
  - ← Voltage Breakdown between contacts—1200 Volts. Voltage Breakdown to ground—5000 Volts.
  - ← Lug on contact fits in groove in shell so that contact cannot be turned or twisted when inserting lamp.
  - ← Center contact mounted so that it cannot protrude from shell and short on chassis when lamp is removed.
  - ← Plastic shell is recessed for contacts, which cannot be pushed or pulled out of position.
  - ← Stronger, tougher, heavy walled plastic shell.
- A variety of different mounting bracket styles available, suitable for practically any mounting.

## ***For Your Present and Post-War Production***

**40TH ANNIVERSARY  
1904-1944**

This year Lenz celebrates its 40th year of service to the communications industry.

Lenz Dial Light Sockets have always been known for their superior mechanical qualities and electrical characteristics.

Now these sockets are still further improved, with even greater mechanical strength. A stronger, tougher plastic shell is attached to the bracket with a new type of construction that provides a virtually unbreakable bond between shell and bracket. Its excellent electrical characteristics are maintained.

Consider these Lenz Dial Sockets for your present and post war production. Write for sample today.



**LENZ ELECTRIC  
MANUFACTURING CO.**

1751 N. WESTERN AVE.

CHICAGO 47, ILLINOIS

**ELECTRIC CORDS, WIRES AND CABLES**



## 200-KW TRANSMITTERS

(Continued from page 60)

so the exact location of the trouble can be determined quickly.

This same equipment is duplicated in a dummy rectifier cabinet in the companion transmitter on the opposite side of the concourse, both operating with a common power supply and modulator.

All overload and arc-back relays, with the exception of the high-current delayed a-c overloads, are d-c telephone type relays, with special coil and contact insulation. The coil of the relay is in series with a current adjusting rheostat, and this combination is shunted by another resistance of the proper value for the protected circuit. This is a very flexible and satisfactory means of overload protection. Because of high operating speed, this type of relay gives better protection than the standard overload device. In cases where the coil must be at a high potential to ground, such as for arc-back protection of the rectifier tubes, the contacts are removed from the frame, and operated by an insulating rod.

All 240-v power is fed through a breaker panel in the wall cabinet behind the transmitters, and then through contactors which are operated by relays of the control circuit.

### Filament Control

Conventional water flow and water temperature protection are provided in the filament circuits. Distilled water pumps, fans and filaments are controlled by the first pair of push buttons on the panel. A time delay provision is incorporated, to continue operation of pumps and fans until 15 minutes after filament shutdown. In addition, filament switches are provided for individual water-cooled tubes or banks of tubes, (depending on number of tubes in series on one water circuit), which permit changing of tubes without turning off all tube filaments. These switches control the primary power contactor, and short out the water flow interlocks associated with each particular tube or bank of tubes. The circuit is so arranged that turning on the filaments of the separate r-f section also turns on the filaments of the main transmitter, since the modulator and rectifier are needed for its operation. Conversely, turning off the filaments of the main transmitter turns off the filaments of both units.

### Low Voltage and Bias Control

The second pair of push buttons provide control for the low voltage and bias systems. The interlock system is divided into three sections, one of which contains the door interlock switches of the rectifier, modulator, catwalk and transformer vault, and the overload relays contacts associated with these units. In series with this are the interlocks and overload relay contacts for each of the r-f sections. An emergency *off* push button is located in the center of the control panel of each cabinet. These are also in series with the interlocks. Magnetically controlled isolation switches are used to remove the d-c voltage from an r-f section when not in use, or if a failure in one should occur while both are on the air. These switches are designed to break circuits with the power on. The a-c power for the

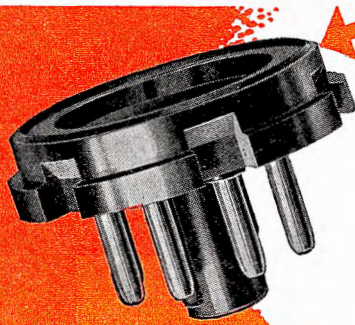

## MOISTURE "Sealed Out"

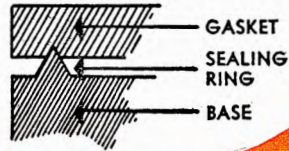

## Moisture Proof OCTAL-TYPE BASE

HOWARD'S Octal-type base keeps out all moisture and dirt, in spite of contraction and expansion caused by heat and cold, by means of a gasket seated on a sealing ring. Designed for radio tubes, crystal holders, transformers, electrolytic condensers, and practically all types of plug-in equipment, this base is made in natural or black Bakelite and has molded-in pins. Write today to HOWARD for prices!

★ BUY WAR BONDS ★

# HOWARD MANUFACTURING CORP.

COUNCIL BLUFFS, IOWA



## THERMOSTATIC METAL TYPE DELAY RELAYS PROVIDE DELAYS RANGING FROM 1 TO 120 SECONDS

### Other important features include:—

1. Compensated for ambient temperature changes from  $-40^{\circ}$  to  $110^{\circ}$ F.
2. Contact ratings up to 115V-10a AC.
3. Hermetically sealed — not affected by altitude, moisture or other climate changes . . . Explosion-proof.
4. Octal radio base for easy replacement.
5. Compact, light, rugged, inexpensive.
6. Circuits available: SPST Normally Open; SPST Normally Closed.

WHAT'S YOUR PROBLEM? Send for "Special Problem Sheet" and Descriptive Bulletin.

**AMPERITE CO.** 561 BROADWAY  
NEW YORK 12, N. Y.

In Canada: Atlas Radio Corp., Ltd.  
560 King St. W., Toronto



bias supply is fed through the same contactor that supplies the low voltage power, when the low and bias voltage supplies are first turned on. However, when high voltage is turned on, the bias power is obtained as described in the discussion of the transformer vault.

Bias switching is accomplished with a fast-operating reversing contactor, mechanically interlocked to prevent an interconnection of the power sources.

### High Voltage Controls

An unusual feature of this system is the anti-pumping circuit. Should a fault occur while the *on* push button is held down, the power supply interrupter has only one closure, and will not reclose until the button is released and pushed again.

D-c voltage to both the r-f driver and final amplifier is fed through individual magnetically operated high-voltage isolation switches. The control of these switches is arranged to operate only when the d-c voltage is off. Thus, if one r-f section is turned on while the other is operating, the power supply shuts down long enough for switching to take place, then automatically comes on again. The same occurs if one of the units is turned off, or if an overload occurs in either section. To facilitate neutralizing of the final amplifier, a switch is provided on the relay panel of this cabinet for individual control of the isolation switch, thus removing high voltage from the unit, and permitting it to be applied to all other units.

### The Ignitron

Another novel feature of this installation is the use of the ignitron as the 2300-v high-speed circuit breaker. The overload-relays protecting equipment connected with the high voltage supply have one set of contacts in a conventional interlock circuit, which serves to remove power supplying the thyratrons which ignite the ignitrons. A second set serves to bias the thyratrons in advance of removing power, so that if an overload occurs, there is an almost instantaneous interruption of power; many times faster than with conventional a-c relays. The control system is, of course, tripped by the first set of contacts when a fault occurs, and interrupts the control voltage for the ignitron. Thus, two means have been included to insure shutdown of the high voltage supply, making a high-speed circuit that operates in 3 to 10 milliseconds after the overload relay operates, depending on the portion of the cycle the ignitron is passing at the time. The average time of the telephone-type overload relays used is about 5 milliseconds. Thus the overall time for interruption of power is only a fraction of that required for the conventional overload relay and air-oil-circuit breaker.

The high-voltage tap changer remote rheostat, with its associated torque switch and front panel control, as previously explained, is duplicated in the dummy cabinet on the opposite side of the course. Associated with this control on both main and dummy rectifier cabinets is a push-button to switch the tap changer

(Continued on page 70)

## PORTABLE POWER PROBLEMS

THIS MONTH—EASTERN AIR LINES' RADIO COMPASS TEST UNIT



ACCURATE PRE-FLIGHT tests of vital automatic radio compasses on all planes operated by Eastern Air Lines are quickly made with a portable, *battery-operated* oscillator unit. The time-saving, dependable instrument was developed by Eastern radio engineers, who selected Burgess Batteries to provide the necessary voltage for test readings.



THE OSCILLATOR UNIT is not influenced by external conditions, permitting service technicians to check for dangerous radio compass defects while aircraft are inside hangars or close to metal objects, long before plane departure time. Burgess Industrial Batteries are designed to meet the requirements of exacting special applications. Let Burgess engineers help you solve your portable power problems. Write us today about your specific needs, or send coupon for free *Engineering Manual*. Burgess Battery Company, Freeport, Illinois.



### FREE . . . 80-PAGE ENGINEERING MANUAL!

31 descriptive pages, 25 charts and 36 data tables on dry battery characteristics for electronic applications. Tabbed for ready reference. Write Dept. 6 for your free copy. Burgess Battery Company, Freeport, Ill.

Name .....

Company .....

Address .....

City ..... State .....



## BURGESS BATTERIES





W. J. McGONIGLE, President

RCA BUILDING, 30 Rockefeller Plaza, New York, N. Y.

GEORGE H. CLARK, Secretary

**Personals**

FROM the Pacific area, we've received a letter from a VWOA member that bristles with news. It's from Lt. Commander V. H. C. Eberlin, Air Communications officer for Admiral Sample. Commander Eberlin says:

"It matters not where you are in the restless Pacific, sooner or later COMMUNICATIONS catches up with you. It is certainly a pleasure to have this medium of learning where and what some of the other members are doing. . . . Especially so since we have during the past few months been covering the waterfront from Tokyo's front door to the Phillipines, lending a helping hand to setting the rising sun.

"Our last endeavor was in the battle of Samar Island, off the mouth of the Gulf of Leyte. We had just finished supporting the Leyte Island landing a few days previous, when ole man Nip slipped an end run on our gallant group. They came in running with everything blazing and for hours it appeared like they might make a touchdown. Our team took everything they had, and it was plenty, but the old forward pass finally turned the tide and those that were left limped home through a blaze of fire.

"Tokyo Rose can now brag about having the largest underwater fleet of all time. The figures may seem fantastic, but they're true.

"You can issue a charter for the Philippines chapter of the VWOA; we've just finished the groundwork and laid the cornerstone.

"Hello to the gang from your Far Eastern representative."

LIEUTENANT George Bonadio of the United States Navy reported some interesting experiences in the present war as 44th Division Radio Officer, Amphibious Force Pacific Fleet Radio Officer (including the Japanese code) and as Fifth Army Headquarters Radio Officer (Army-Navy Communication Liaison Officer). . . . From Hugo L. Estberg we learn that he started as a ship radio officer during the last war with RCA



Brigadier-General David Sarnoff, who has just returned from overseas duty.

and served for some time at WNY in New York. From 1923 until the present he has been identified with merchandising and servicing. . . . It was grand to see Charles G. Cooke at the recent Fall meeting. Mr. Cooke was one of the earliest radiomen in the United States Navy starting in November 1903. He served aboard the USS Prairie, USS Illinois, and operated at the Portsmouth Navy Yard in 1907. At present he is with Du Mont.

**Merit**

BRIG. GENERAL David Sarnoff, number 1 life member of VWOA, recently returned to the Office of Chief Signal Officer in Washington, after almost a year's service as special consultant on communications matters in the office of the Allied Supreme Command in London. In recognition of his outstanding accomplishments Gen. Sarnoff was awarded the Legion of Merit.

Our sincere congratulations, General Sarnoff on your splendid achievements. General Sarnoff received our Association's Marconi Memorial Medal of Achievement, a few years ago.

**In Memoriam**

ON March 4, 1942, Louis Crowley, received a telegram disclosing the urgent need for seagoing operators. He was then at RCA Communications. He flew from New York to Texas and sailed on

March 5th (the next day) aboard the SS Swiftsure. The boat dropped anchor at South Africa, Iran, Iraq, Arabia, India, Australia and back to the middle East. On the night of October 8, 1942, enroute back to the U. S., the Swiftsure was torpedoed off the East coast of Africa. The vessel was lost, but most of the men managed to get into lifeboats and three days later landed at Capetown.

A few weeks later Radio Officer Crowley, together with some two hundred other repatriates, sailed aboard the MV Zandam.

On November 2, 1942, the Zandam was torpedoed and sunk about five hundred miles off the coast of Brazil. Only three lifeboats reached land. Radio Officer Crowley was reported seen aboard a life raft. But eighty-three days later only three crewmen of the Zandam were picked up off a liferaft. They were unable to give information as to any other survivors . . . two hundred had been lost.

The VWOA and members of the industry mourn the loss of a brave man . . . Louis Crowley. The United States Maritime Commission has notified Mrs. Crowley that she will be presented the Mariner's Medal. This to be added to Radio Officer Crowley's three area ribbons and one combat ribbon with two stars.

**20th Anniversary**

THE Veteran Wireless Operators Association will celebrate its twentieth anniversary with a Victory Dinner-Cruise on the Belvedere Roof of the Hotel Astor, New York City on Saturday evening, February 17, 1945. Be sure to send in your reservation at the earliest possible moment!

**Boston**

THE Navy Radio Training personnel of the Massachusetts Radio and Telegraph School recently tendered a testimonial dinner to the founder of our Boston chapter, Guy Entwistle. Guy was presented with a suitably inscribed scroll. Congratulations, Guy. You have always done a grand job for VWOA, too!

NATIONAL RECEIVERS ARE THE EARS OF THE FLEET



OFFICIAL U. S. NAVY PHOTOGRAPH  
FROM FREDERICK LEWIS

EACH LST  
HAS TWO  
NATIONAL  
RECEIVERS



**NATIONAL COMPANY**

MALDEN  MASS, U. S. A.

NATIONAL RECEIVERS ARE IN SERVICE THROUGHOUT THE WORLD



# HARVEY

has for  
*Immediate Delivery*

- American War Standard Meters in all different ranges — microammeters, milliammeters, ammeters, voltmeters, db. meters, portable instruments, etc.

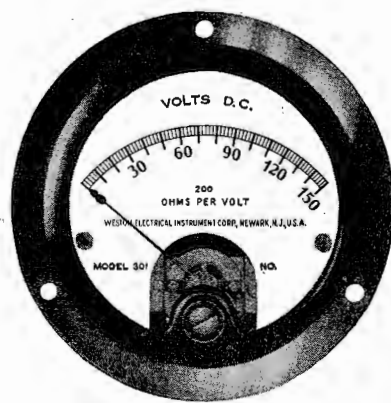

Illustrated is the Weston Model 301, just one example of the wide variety of famous make meters available at HARVEY'S.

- Mica Capacitors with 2%, 5%, 10%, or 20% tolerance to American War Standards. Also in stock are oil and electrolytic condensers.
- Precision carbon or wire wound resistors.
- 10 and 50-watt ceramic sockets.

... and hundreds of other critical radio and electronic components.

**HARVEY** is the complete radio and electronic supplier. Locating hard-to-find parts is but one of our many plus-services. We are prepared to answer your technical questions . . . to advise you about priorities. Fast deliveries to any point in the United States.

*Don't forget . . .*

**HARVEY** also carries distinguished **AUDAK** equipment . . . cutters, jewel points, and pick-ups preferred by broadcasting stations and recording studios.



This merchandise available with suitable priority. Write, phone: LOnacre 3-1800

## HARVEY RADIO COMPANY

# HARVEY

103 WEST 43rd ST., NEW YORK 18, N. Y.

## 200-KW TRANSMITTERS

(Continued from page 67)

control circuits from one rheostat to the other.

### Automatic Reset

The fourth pair of push buttons on the control panel operate the automatic recloser circuit. When *on*, this circuit automatically reenergizes the power supply after an overload occurs. Should a second overload occur, or the first fault still exist, within fifteen seconds, that particular r-f section in which the fault took place is isolated and the remainder of the transmitter turned on again. If no further trouble develops within that fifteen-second period, the system resets itself and is ready to operate again.

### Carrier Alarm

A relay in the cathode circuit of one of the final power amplifier tubes oper-

Figure 19

Elements composing the antenna switch. They are the same diameter and spacing as pipe conductors connected to switch.



ates the carrier-alarm system. This relay is set so that it will pull in under normal operating conditions, but drop out if excitation or plate voltage should fail. And in conjunction with another relay, it operates the alarm, a warning light above each transmitter, and a horn common to all six final amplifiers. If a transmitter goes off the air, the carrier alarm can be switched off temporarily, but becomes effective each time the transmitter is turned on.

### Personnel Protection

For the safety of personnel, all equip-

A STEADY SOURCE OF ALL ELECTRONIC EQUIPMENT

**TERMINAL RADIO CORP.**  
Telephone: WOR 2-4416  
85 CORTLANDT ST., NEW YORK, N. Y.

*Your Plant*

FOR ACTION PHONE! WIRE! WRITE BULLETINS AND CATALOGS ON REQUEST

We need a **RADIO COST ESTIMATOR:**

A shrewd analyst to derive cost from blueprints and assemblies of home radios. Postwar program in offing. Must know modern fabrication and operation throughout machine shop and assembly, and be familiar with writing operation and process sheets.

**MAGUIRE INDUSTRIES, Inc.**  
Electronic Division  
342 W. Putnam Ave., Greenwich, Conn.

## JONES 500 SERIES PLUGS AND SOCKETS

Designed for 5,000 volts and 25 amperes. All sizes polarized to prevent incorrect connections, no matter how many sizes used on a single installation. Fulfill every electrical and mechanical requirement. Easy to wire and instantly accessible for inspection. Sizes: 2, 4, 6, 8, 10, and 12 contacts. Send for a copy of Bulletin 500 for complete information. Write today.

**HOWARD B. JONES CO.**  
2460 W. GEORGE STREET  
CHICAGO 18, ILL.



ment operating at high voltage is completely enclosed and interlocked. Each transmitter cabinet has a solenoid-operated shorting mechanism which grounds all high voltage terminals in the cabinet when any cabinet door is opened. This is located in the upper part of the cabinet where it is easily visible from both front and rear. Catwalk grills and doors are interlocked to operate the shorting mechanism in the rectifier cabinet.

The high voltage components in the transformer vault are enclosed with wire fencing. Before this section of the vault can be entered, a lever must be thrown which operates disconnect and grounding switches, and a mechanical interlock on the cage and ignitron doors.

#### Transmission Lines

The transmission lines from the transmitters to the main antenna switching station are all of 300-ohm surge impedance. The section leading out of the building is of 2" copper pipe, in order to be self-supporting across 18' driveway clearance, and to present good corona conditions through the glass entrance pane. These pipes are spaced 13". From this point to the main switching station, the line consists of a 4-wire construction, using two pairs of 1/0 copper weld (each pair as one conductor), spaced 2 1/8" one above the other, and 7" between pairs, which is the same spacing as used in the 300-ohm switch structure, where two 1" copper pipes are used for each line. To maintain spacing between wires on each side of the line, cast clamps are used at intervals of about 10'.

#### Antenna Switching Station

To meet the requirements of multiple switching of antennas and transmitters at 200-kw powers, the following specifications had to be met in the design of the main antenna switching station:

- (1)—Provision for connecting any transmitter transmission line to any antenna transmission line.
- (2)—Provision for unlimited expansion of number of transmitter and antenna transmission lines.
- (3)—Maintenance of 300-ohm im-

(Continued on page 72)

Figure 20

A view of one of the transmitter vaults.

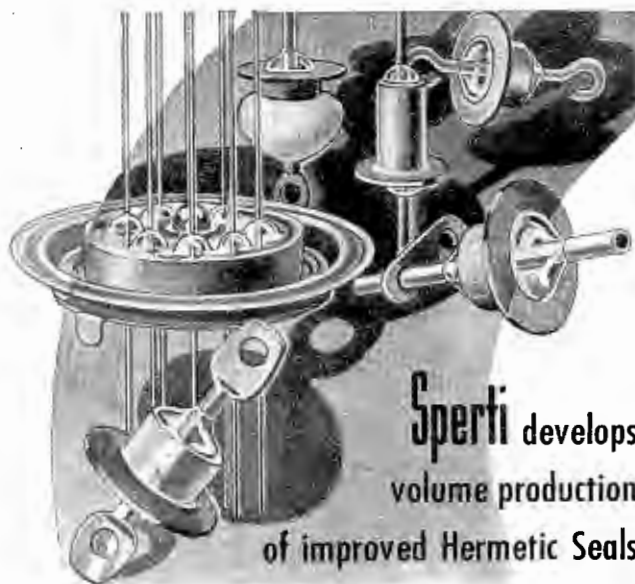

**Sperti** develops  
volume production  
of improved Hermetic Seals

**Conforming to Army-Navy requirements  
for critical field conditions**

Transformers, condensers, relays, vibrators and various component parts can now be protected against heat and tropical humidity, salt spray, sand infiltration, fumes, fungus attack and other varied conditions that cause sensitive equipment to fail under critical conditions.

In the laboratories beyond Sperti, Inc., techniques have been discovered which permit volume production of improved Hermetic Seals at low cost, safeguarded by unique inspection methods.

#### Principal features of the improved Sperti Hermetic Seal are:

1. Small, occupies little space, one piece, no other hardware needed, simple and easy to attach. (Soldering temperature not critical.)
2. Vacuum tight hermetic bond, hydrogen pressure tested for leaks.
3. Resistant to corrosion.
4. High flash-over voltage. Does not carbonize.
5. Insulation resistance, 30,000 megohms, minimum, after Navy immersion test.
6. Thermal operating range—70° C. to 200° C. Will withstand sudden temperature changes as great as 140° C.

Wire or phone for information, today. Give as complete details as possible so that samples and recommendations may be sent promptly.



RESEARCH, DEVELOPMENT, MANUFACTURING, CINCINNATI, OHIO  
COMMUNICATIONS FOR DECEMBER 1944 • 71



Designed for



Application



No. 33991

**Voltage Regulator  
Tube Socket**

Sturdy, compact with dependable contacts. Another in the series of Millen "Designed for Application" components for modern circuits. For use with miniature neon type dual contact bayonet base voltage regulator tubes such as Radiotron No. 991.

**JAMES MILLEN  
MFG. CO., INC.**

MAIN OFFICE AND FACTORY  
MALDEN  
MASSACHUSETTS



(Continued from page 71)

- pedance throughout, regardless of switching operations.
- (4)—Elimination of all dead-end effects.
  - (5)—Provision for breaking up all unused lines to prevent possibility of resonance.
  - (6)—Simplicity of operation and identification for scheduled switching.

These requirements were met by designing a structure carrying incoming transmitter transmission lines on a lower level, and outgoing antenna transmission lines on a higher level, at right angles with the incoming lines. Between these two levels are vertical spiral riser lines, terminating top and bottom with double-pole, double-throw switches. On short posts near the ground are operating cranks, which operate the switches through mechanical linkage.

Electrically, all lines continue through the structure as long as all switches are in horizontal position. Operation of a lower switch breaks the line at that point, and connects the transmitter with its vertical riser. Operation of the associated upper switch breaks the antenna line at this point and connects the antenna to the riser, thus completing the circuit from transmitter to antenna. No unused lines remain connected to the system to cause dead end effects. The unused lines which have been disconnected may be further broken up into shorter sections, if desired, by operating other switches beyond the point where the connection was made, in order to prevent any possible resonant effect.

As seen in Figure 19, the elements composing the switch are of the same diameter and spacing as the pipe conductors connected to the switch, providing constant impedance throughout the structure.

No limitations are imposed on possible future expansion, since it is necessary only to add more lines and switches as transmitters or antennas are added.

**Matching Sections**

Immediately upon leaving the main antenna-switching station, impedance matching sections are inserted between the 300-ohm gear and the 500-ohm antenna transmission lines. These sections comprise 3 lines, each one-quarter wave long in tandem, varied in spacing and

Figure 21

An interior view of the antenna service car. Equipment in this car includes two-way f-m communications equipment, affording constant contact with the control room.



**ARPIN**  
RECTIFIERS  
MERCURY  
VAPOR  
HALF WAVE  
**575-A**  
FOR HIGH  
VOLTAGE

- HIGH POWER TRANSMITTERS
- INDUCTION HEATING EQUIPMENT
- SPECIAL INDUSTRIAL APPLICATIONS

**IMMEDIATE DELIVERY**

575-A is a heavy-duty half-wave rectifier tube of exceptional performance. Filament of edge-wise wound ribbon of a new alloy, giving greater thermionic emission reserve. No arc-back at full rating. Used by Signal Corps and many large manufacturers. Two tubes for full-wave rectification in single phase circuits deliver 5000 volts DC at 3 amps, with good regulation. Filament 5 volts, 10 amps. Peak Plate Current 6 amps. Peak Inverse Voltage 15,000 volts.

**WRITE FOR NEW CATALOG**

illustrating and describing the ARPIN 575-A and other tubes in the ARPIN line.

**ARPIN MANUFACTURING CO.**  
422 Alden St. Orange, N. J.

**AT 100 MC**

POWER FACTOR 0.0033  
DIELECTRIC CONSTANT 3.57

**DILECTENE**

A CONTINENTAL-DIAMOND  
ENGINEERED U-H-F  
INSULATING PLASTIC

**STABLE UNDER**

- ◆ High Humidity
- ◆ Temperature Extremes
- ◆ Mechanical Stress
- ◆ Chemical Conditions

READILY MACHINED  
For complete technical  
data, send for Bulletin DN

**CONTINENTAL-DIAMOND  
FIBRE COMPANY**

NEWARK 51 DELAWARE  
DC

conductor size to accomplish the transition. Two types are used: type *A* sections have a design frequency of 12.3 mc, and are connected to lines serving both large and small antennas requiring maximum frequency range of 6 to 18 mc; type *B* sections are designed at 13 mc, and are used in connection with lines serving antennas operated between 7.5 and 15.5 mc.

Transmission lines of 500 ohms from these impedance matching sections to the antennas are, in some cases, as long as 3750'. To keep loss at a minimum consistent with cost and use of critical materials, 4-wire construction was used, consisting of two pairs of number 2 copper weld wire, each pair spaced  $\frac{3}{4}$ " as one conductor, with 20" spacing between pairs, and with all four wires in the same horizontal plane. As in the case of the lines leading from the transmitter building, clamps maintain the  $\frac{3}{4}$ " spacing.

Lines run at about 15' above ground in most places. Turns are accomplished by vertical spiralled jumpers to maintain equal conductor length and spacing. Where more than one transmission line is carried by the same pole line, a spacing of better than four times the 20" conductor spacing is maintained, to keep coupling at a reasonable minimum.

#### Line Switches

The 24 antennas are arranged in 9 groups, 6 of these containing 3 antennas each, the other 3 containing only 2 each. Each group is fed by a pair of transmission lines. In the case of the two-antenna groups, lines run directly from the switching station to the antennas; but in each of the 6 triple-antenna groups, one transmission line runs from the switching station to the middle antenna, while the other is arranged to be switched between the small and the large antennas, since these two are never used simultaneously. A special double-pole, double-throw switch is located along the transmission line near the antennas, so constructed as to have 500-ohm surge impedance. Thus no disturbance is introduced into the transmission system. The switch itself is located at transmission line level, and is operated through a mechanical linkage system, by a lever at waist height.

#### Reentrant Rhombic Antennas

Because of relative ease and low cost of construction, amount of critical material required, and satisfactory performance over a rather wide frequency range, rhombic type antennas are used for the 24 radiators. Three sizes cover the frequency range of 6 to 18 mc, with adja-

(Continued on page 74)

Figure 22

Water controls on front ledge of transmitter catwalk.



# Telex Receivers are tiny . . . but tough!



Photograph Signal Corps, U. S. Army

During the daring invasion of Attu Island Telex tiny Receivers proved they were tough. In this Aleutian campaign our men and equipment mastered the severest weather and the most rugged terrain ever encountered.

In this atmospheric graveyard of fog and dampness the Division Command Post was established on Attu. Vital messages were delivered with exceptional clarity by dependable Telex Receivers—the product of masterful engineering.

In solving your present and near future electronic development problems, the experience of Telex engineers in creating the first wearable Electronic Hearing Aid and in serving the U. S. Army Signal Corps should be of great help to you. Write us today.

#### Telex Experience Offers:

##### Magnetic Receivers:

**Cu. Vol.**—Approx. 0.3 cu. in.  
**Impedance**—Up to 5000 ohms.  
**Sensitivity**—18 dynes/sq. cm. for 10 microwatt input.  
**Construction**—Rugged and stable, using only finest materials, precisely machined—no diaphragm spacing washers in Telex receivers.

##### Transformers and Chokes:

**Cu. Vol.**—Down to .15 cu. in.  
**Core Material**—High permeability steel alloys.  
**Windings**—To your specs. (Limit of six outside leads on smallest cores.)

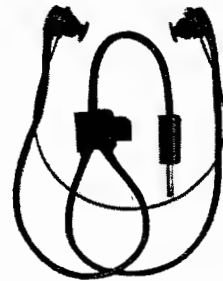

ELECTRONIC PRODUCTS DIVISION

# TELEX

PRODUCTS COMPANY

Telex Park • Minneapolis • Minnesota



# STANDARD



*Air Tuned I.F. Transformer*

## INGENUITY

When a really difficult coil problem confronts you, let us demonstrate how our specialized research, engineering and production skill can solve it — just as it has so many other complex assignments. Our engineering staff is available for consultation without obligation.



WE INVITE YOUR INQUIRIES

# STANDARD WINDING CO.

44-62 Johnes Street  
NEWBURGH, NEW YORK  
NEW YORK OFFICE: 53 PARK PLACE  
REctor 2-5334

(Continued from page 73)

cent size pairs being used simultaneously.

These three sizes are designed at mid-frequencies of 16.33 mc, 11.67 mc, and 9.33 mc, with a low vertical angle of approximately 10° and a beam width of 20° at these frequencies. Antennas are four wavelengths long on each side, with a tilt angle of 70°, and an average elevation of 1.4 wavelengths above ground. They are constructed of three number 6 copper weld wires on each side, spaced at the side poles, and converging to a point at each end. Due to low inherent coupling between adjacent rhombic antennas, common support poles were used between antennas. Each pole is actually two poles, spliced butt-to-butt with a steel sleeve. Poles rest in a 6" recess in a concrete base, and are guyed at three points.

In order to avoid wasting up to 50% of the power delivered to the antenna, by the conventional dissipative rhombic termination method, reentrant transmission lines have been incorporated, whereby the normally dissipated power is returned to the input line, properly phased and adjusted as to voltage magnitude, through the use of stub lines of the proper values and spacings along the return line. Impedance of the input line is corrected in a like manner, and in some cases combined with one of the reentrant stub lines. All stubs of the shorted variety are grounded at the midpoint of the short, to provide static drain, and lightning protection.

### Operation

Transmitters are scheduled in pairs, so that, as one frequency is becoming less effective in a chosen coverage area, the other is already in operation on the frequency next coming into maximum effectiveness.

To change frequency, two men are required to make the necessary technical adjustments in the short period allowed (usually 15 minutes). One man retunes the transmitter, and the other makes the necessary antenna changes and adjustments. The control operator shuts down the transmitter after the scheduled sign-off, and disconnects the frequency generator which had been driving the transmitter, connecting it to the proper generator to supply the new frequency. This change is made on the r-f generator

# NO SHORTS

when you use

## Gothard

### PILOT LIGHTS and DIAL LIGHT

#### Bracket Assemblies

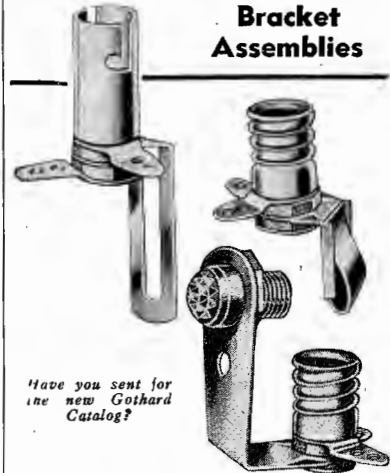

*Have you sent for the new Gothard Catalog?*

Gothard has developed and standardized an important terminal improvement in all Gothard Lights. Specially embossed octagon washers, blanked from linen base laminated bakelite 3/32" in thickness, permanently lock the terminals in position—no turning—no shorting—above average insulation. This and other Gothard pioneered features will greatly aid you in establishing a higher standard of performance in your precision products. Ask for complete information.

## Gothard

MANUFACTURING COMPANY

1335 North Ninth Street, Springfield, Ill.

Export Division:

25 Warren Street, New York 7, N. Y.

CABLES: SIMONTRICE, NEW YORK



# OUTSTANDING QUALITY!

## CETRON

in Electronic Tubes  
... Phototubes  
Rectifiers and  
Special Tubes

PROMPT DELIVERIES on most types  
Send for Catalog

### CONTINENTAL ELECTRIC COMPANY

CHICAGO OFFICE  
100 N. WABASH STREET

GENEVA, ILL.

NEW YORK OFFICE  
237 W. 14th ST.

patching panel. Then he moves the dials on the transmitter unit to pre-determined settings, or changes pre-tuned coil condenser circuits as required for each stage of the transmitter, beginning with the lower power stages, and ending with the high power final stage and the adjustable antenna coupling loop.

While these adjustments are being made at the transmitter, the second man proceeds, in an antenna-service car, to the main switching station, where he connects the proper transmitter transmission line with the proper antenna transmission line. Then he proceeds to the antenna group, and connects the transmission line to the desired antennas through the line switches previously described. Finally, the proper stubs are inserted by use of switches, to adjust the antenna for its assigned operating frequency.

Upon completion of the necessary adjustments, he advises the transmitter operator, who is then ready to put the transmitter on the air on its new frequency.

#### Antenna Service Car

The car which is used for these operations is especially designed and equipped for antenna work. Its equipment includes a complete two-way f-m communications set, with which the technician is in constant communication with the control room.

The f-m receiver is just one part of the complete *intercom* system, which also includes telephones and public address systems. The combination of the three affords a complete and flexible means of communication between personnel anywhere on the property.

The public address system employs permanent-magnet speakers which serve both as speakers and microphones. These are located throughout the building and at the main antenna switching station at the rear of the building. On the concourse, speakers are concealed above the transmitter units, with a switch key on the hand rail. At each of these positions, a key is also provided to mute the monitor to prevent interference with the public address speakers. When one of the concourse speakers is used as a microphone, the other five are silenced automatically by a relay, to avoid feed-back. The same system is used at the switching station, where there are six speakers.

The f-m system is tied into the public address system in such a way that any calls picked up on the receiver are fed directly into the public address line. Through relay control, the f-m transmitter may be operated from the public address station at the control desk. The f-m system is used to maintain contact with the operator of the antenna service car, and with maintenance crews in the field.

#### Acknowledgments

The inception and realization of this project was made possible largely through the confidence, cooperation and active assistance of J. D. Shouse, vice president in charge of broadcasting, The Crosley Corporation; J. O. Weldon, chief of the Communication Facilities Bureau, OWI; and E. J. Boos, business manager, broadcast division, The Crosley Corporation.

It would also not have been possible to complete an undertaking of this size without the untiring efforts and close co-

*(Continued on page 76)*

**RADIO SPEAKERS**  
*for all applications*

Recently expanded production facilities combined with complete engineering "know-how" enable Consolidated Radio Products Co. to supply the finest radio speakers available. Speakers can be furnished in the following ranges:

*Dynamic Speakers from 2 inches to 18 inches*  
*Permanent Magnet Speakers from 2 inches to 18 inches*  
*Headsets*

*Electronic and Magnetic Devices*  
**CONSOLIDATED RADIO**  
*Products Company*  
350 W. ERIE ST., CHICAGO 10, ILL.

*Small and Medium*  
**TRANSFORMERS**

Consolidated Radio is also a nationally known manufacturer of small and medium transformers including Pulse Transformers, Solenoid and Search Coils.

Engineering service is available to design transformers and speakers for special applications, or to your specifications.



## EASTERN PUMPS FOR VACUUM TUBE COOLING SYSTEMS

Five different models, of small centrifugal pumps designed for circulating water through the cooling systems of communication and X-ray tubes have been successfully designed by Eastern Engineering Company, long a leading manufacturer of small pumps for big jobs. These pumps may be had for either land, sea or airborne installations.

### AIRBORNE MODELS

(Designated as the AR Series)

These are designed in conformance with Army and Navy standards. They have the following outstanding features:

EXTREMELY LIGHT WEIGHT • COMPACT • INTEGRAL PUMP AND MOTOR UNIT • EXPLOSION PROOF • VARIED PERFORMANCES AVAILABLE • OPTIONAL VOLTAGES • LONG LIFE - CONTINUOUS DUTY • DEPENDABLE OPERATION • UNIVERSAL MOUNTING



The pump and motor are one integral unit weighing but two and one-third pounds and measuring over-all  $5\frac{1}{2}'' \times 4\frac{1}{2}'' \times 2\frac{1}{2}''$ .

Performance up to 11 P. S. I. and up to 5 gallons per minute. Models are available in standard 12 and 24 volt D. C. ratings. Shown are performance curves for the AR2, 3 and 4. All models have long life and are rated for continuous duty with the exception of model AR4, which under 8 P. S. I. is rated for intermittent duty. While the curves shown are those for which production is now standard, it is readily possible to obtain other characteristics where quantity is involved.

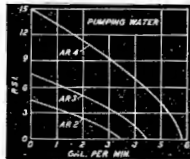

The pump is equipped with a mechanical rotary seal which positively seals against any leakage. This seal is adjusted at the factory and tested under excessive pressure. Once the pump has been released from the test room no further attention or maintenance is necessary for either motor or pump during the life of the unit.

### LAND AND SEA MODELS

(Designated as E-1 and E-7)

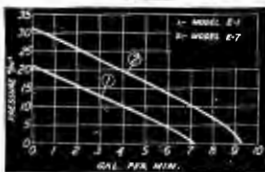

Both are centrifugal pumps, powered by General Electric Universal Motors. Model E-1 is  $7'' \times 3\frac{3}{4}'' \times 3\frac{3}{4}''$ ,  $\frac{1}{16}''$  H. P., weighs 6 lbs. and has a Maximum Pressure of 20 lbs. P. S. I. with a Maximum Capacity of 7 G. P. M. Model E-7 is  $9'' \times 4'' \times 4''$ ,  $\frac{1}{8}''$  H. P., weighs 8 lbs. and has a Maximum Pressure of 30 lbs. P. S. I. and a Maximum Capacity of 9 G. P. M. Performance curves for both models are shown above. Both of these models are designed for long life. They are equipped with mechanical rotary seals which completely seal the pumps against leakage. While the curves shown are those for which production is now standard, it is readily possible to obtain other characteristics where quantity is involved. They can be obtained with motors to meet Navy Specifications.

**EASTERN ENGINEERING COMPANY**  
1 FOX STREET - NEW HAVEN 6, CONN.

(Continued from page 75)

operation of the entire broadcast engineering staff, as well as outside engineering organizations, who contributed materially to the project, in spite of facilities already overloaded with war contracts.

Acknowledgment is hereby gratefully extended to the engineering staff, particularly:

- W. S. Alberts, chief propagation engineer  
J. A. Baysore, supervisor, antenna construction  
L. G. Bertenshaw, purchaser and expeditor  
C. C. Bopp, design and development engineer  
D. H. Ehlman, supervisor, machine shop  
J. L. Hollis, chief design engineer  
E. F. Jenkins, equipment test engineer  
P. J. Konkle, chief management engineer  
F. N. Lantzer, chief transmitter engineer  
H. Lepple, design and development engineer  
J. M. McDonald, assistant engineering director  
W. A. Moore, chief design draftsman  
W. B. Nester, design draftsman  
C. A. Robson, design draftsman  
R. L. Schenck, design and development engineer  
C. B. Sloan, design and development engineer  
R. H. Uphaus, design and development engineer  
P. A. Young, propagation engineer

The outside engineering organizations participating in the project included:

- Federal Telephone and Radio Corporation; high-power vacuum tube developments  
General Electric Company; ignitron equipment  
The Cincinnati Gas and Electric Company; substation and primary power design, antenna mechanical design  
The E. A. Gast Engineering Company; civil engineering and surveying  
O. W. Mote, consulting engineer; vacuum tube cooling, building heating and ventilating design  
C. W. Sinnege; building design and architectural engineering.

Figure 23

Rhombic antenna, showing reentrant feature and stub-tuning arrangement.

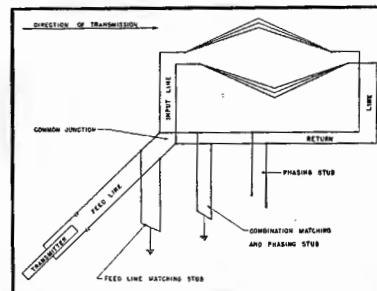

## Permanent MAGNETS

By

Thomas & Skinner

ALL SHAPES... ALL SIZES  
Cobalt • Chrome • Tungsten  
Stamped, Formed or Cast.

ALNICO

(Cast or sintered, under G. E. license)

Also: LAMINATIONS for output transformers of highest permeability. Standard stocks in a wide range of sizes for Audio, Choke, Output and Power Transformers. Write for dimension sheet. . . . TOOLS . . . . DIES . . . . STAMPINGS . . . . HEAT TREATING. 44 YEARS' SPECIALIZED EXPERIENCE

**Thomas & Skinner**

STEEL PRODUCTS CO.

1113 E. 23rd St., Indianapolis 5, Ind.

## Wanted ENGINEERS

Radio

- \* Electrical
- \* Electronic
- \* Mechanical
- \* Metallurgical
- \* Factory Planning
- \* Materials Handling
- \* Manufacturing Planning

Work in connection with the manufacture of a wide variety of new and advanced types of communications equipment and special electronic products.

Apply (or write), giving full qualifications, to:

R.L.D., EMPLOYMENT DEPT.,

**Western Electric Co.**

100 CENTRAL AV., KEARNY, N. J.

\*Also: C. A. L.

Locust St.,

Haverhill, Mass.

Applicants must comply with WMC regulations

# NEWS BRIEFS

## CIVILIAN-MILITARY NEEDS WILL KEEP TUBE QUOTAS HIGH AFTER V-E DAY

Combined military and civilian requirements for receiving tubes will be about 60 to 70 per cent above present maximum production rates after Germany's defeat, Government officials told the Radio Receiver Vacuum Tube Industry Advisory Committee recently.

Committee members said their ability to meet these requirements will be almost wholly dependent upon an increase of manpower in the industry. Cutbacks occurring in other industries should substantially increase the supply of labor available for radio tube production, they said.

Military requirements for receiving tubes now average approximately 10,000,000 tubes a month. The end of the European war will reduce military requirements slightly, but not until one year after Germany's defeat is a 45 per cent cut in such requirements expected, WPB officials said.

At present, approximately 13 per cent of total radio receiver tube production is available to civilians for replacement purposes only.

A report issued by the WPB recently stated that scarcely half enough radio receiving tubes have been available during the last two years to replace those worn out in civilian sets.

The civilian replacement tube shortage was due to increased military demand from 16 per cent of the total production in 1941 to 65 per cent the next year, 82 per cent in 1943, and 86 per cent in 1944. Labor is in short supply, but sufficient facilities and materials are available so that if 6,000 more female workers could be obtained, production of receiving tubes both for military and civilian programs could be stepped up, allowing an increase in civilian replacement tubes up to 4,000,000 a month, according to WPB.

During 1944, replacement tubes available to civilians cannot exceed 19,000,000, as against demands exceeding 36,000,000, the division said. The 19,000,000 tubes should enable home owners to maintain at least one radio receiver in operation, WPB said.

The present schedule for the production of civilian receiving tubes in the first quarter of 1945 is set tentatively at about 2,000,000 a month, an increase of about 500,000 tubes a month over past WPB authorization. However, the estimated monthly production can be attained only if increased labor is obtained and military demands do not increase, WPB said. If conditions are anticipated correctly, it is hoped that civilian tubes may be produced at the rate of 4,000,000 a month within about four months after V-E day.

Total employment in radio receiving tube plants was only 15,000 in 1941, but has increased to 39,000 today.

Under the conditions imposed by military demands, receiving tubes available for the public's use dropped gradually from 30,000,000 in 1941 to present renewal shipments of 19,000,000 tubes a year.

Army and Navy tubes that are not actually

(Continued on page 78)

## TELEVISION RELAY

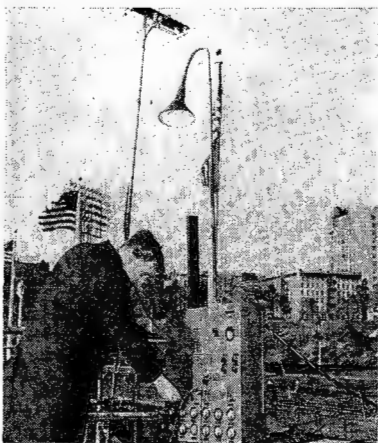

A v-h-f transmitter and antenna on roof of Polo Grounds relaying television pickup of Army-Duke game to WNBT atop Empire State tower.

# SHEET METAL FABRICATION

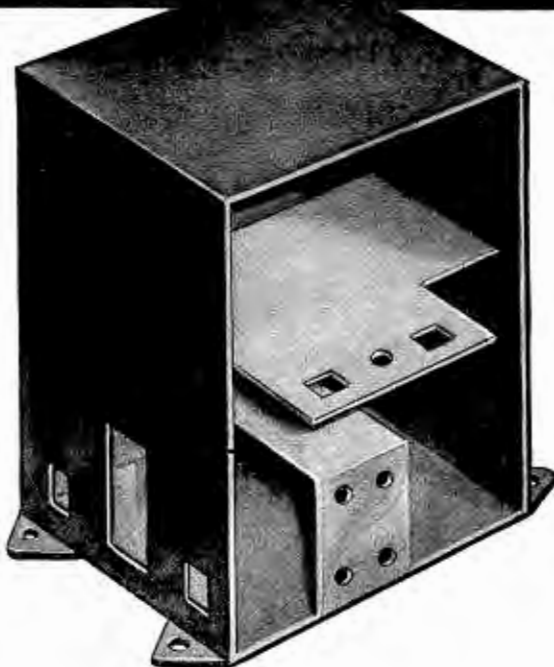

"Cole Steel Equipment" specializes in tough sheet metal assignments as well as boxes, chassis, and instrument housings. Whether your blueprints call for extreme precision or gauge limits, we're geared to design, fabricate and finish exactly to specifications. Whatever your problem, let us help you.

## COLE STEEL OFFICE EQUIPMENT

will again be available  
after the war

# COLE

STEEL EQUIPMENT COMPANY

349 Broadway, New York 13, New York • Factory: Brooklyn, New York



**PREMAX**

**Tested  
In War**

New designs, for mobile land and marine installations will be available when V-E Day comes.

**READY  
For Peace**

**RADIO  
ANTENNA**

*Premax Products*

Division Chisholm-Ryder Co., Inc.  
4501 Highland Avenue, Niagara Falls, N. Y.

**PLASTIC  
NAME  
PLATES**

**SCALES, GAUGES,  
CALCULATORS,  
CHARTS,  
DIALS,  
ETC.**

- Impervious to moisture, grease, oils, acids, alkalis.
- Printing guaranteed not to wash or rub off.
- Non-inflammable, non-corrosive plastic.
- Printed and laminated vinylite and cellulose acetate.

SAMPLES AND ESTIMATES GLADLY SUPPLIED ON REQUEST  
WRITE DEPARTMENT C.

**THE HOPP PRESS, INC.**

PRINTING — FABRICATING — FORMING

**460 W. 34th STREET, N. Y. C.**

ESTABLISHED 1893

## NEWS BRIEFS

(Continued from page 77)

needed are being channeled back to the original manufacturers through the Defense Supplies Corporation for redistribution, first for other war requirements as they may occur and then to civilians. \* \* \*

### RCA HOLDS 25TH ANNIVERSARY DINNER

A twenty-fifth anniversary dinner of the Radio Corporation of America was held recently at the Waldorf-Astoria, in N. Y. City. A highlight of the dinner was a message from President Roosevelt. Speakers included Major General H. C. Ingles, Chief Signal Officer, United States Army; Rear Admiral Joseph R. Redman, Director of Naval Communications, and Brig. Gen. David Sarnoff, president of RCA. Among guests at the speakers' table were Owen D. Young, founder and first chairman of the board of RCA; Edward J. Nally, the first president of RCA; Will Hays, president of the Motion Picture Producers and Distributors of America, Inc.; Major General James A. Code, Assistant Chief Signal Officer, and Brig. Gen. Frank E. Stoner, Chief of the Army Communications Service.

Participating in special program were Arturo Toscanini, Dr. Frank Black, Gladys Warthout, Lauritz Melchior, Hildegard, the Bernard Brothers and members of the NBC Summer Symphony. Dr. James Rowland Angell, public service counsellor of the National Broadcasting Company, served as toastmaster, and Lowell Thomas was master of ceremonies.

Gen. Sarnoff, who returned recently after eight months of military service overseas, as special consultant on communications to SHAEF, declared that America's entire radio industry deserved high praise for record-breaking achievements in supplying the fighting forces of the United Nations with the finest radio-electronic instruments of war.

Gen. Sarnoff announced that the board of director approved a retirement plan providing pensions for life, for service prior to December 1, 1944, and life annuities for RCA employees based on equal contributions from the employees and the company after that date. \* \* \*

### MOTOROLA APPOINTS WAVERING AND STELLNER VICE PRESIDENTS

Elmer H. Wavering has been named vice-president in charge of the new automotive division of Motorola radio, and Walter H. Stellner is now vice-president in charge of the new Motorola home products division.

Mr. Wavering joined Motorola as an engineer in 1930, and pioneered the design and engineering development of the first commercial car radio receiver during that year. \* \* \*

### PACENT, JR., JOINS EMERSON RADIO

Louis G. Pacent, Jr., has been named head of the industrial engineering department of the Emerson Radio and Phonograph Corporation. Mr. Pacent holds degrees in industrial management from Columbia. He is the son of Louis G. Pacent, president of the Pacent Engineering Corporation. \* \* \*

### RECHARGEABLE BATTERY FOLDER

A six-page bulletin on the recently introduced rechargeable wet-storage battery for flashlights has just been published by The B. F. Goodrich Company, Industrial Products Division, Akron, Ohio.

The catalog section outlines the development of the rechargeable wet storage battery built on the same principle as the automobile storage battery.

Featured are data on charging units sold with

### WALKIE-TALKIE INTERVIEW



Carole Landis being interviewed via a walkie-talkie by Chicago *Daily News* editors who are at their office. Jerry Thorp, reporter, carried the equipment. John Payne and George Jessel are at right.

the battery. These range from a single unit to 12-unit gang chargers. Testers are also described and testing methods outlined. \* \* \*

### A. T. & T. PROMOTES WILSON

Leroy A. Wilson has been elected vice president of the American Telephone and Telegraph Company, in charge of business research and Bell System revenue requirements studies.

Mr. Wilson was previously assistant vice president of A. T. & T. in charge of the commercial division. \* \* \*

### METAL HOSE BULLETIN

A 12-page pamphlet, "Flexible Metal Hose for Every Industrial Use," has been released by the Chicago Metal Hose Corporation, Maywood, Ill.

The basic types of flexible metal hose available and some of their specifications, are presented. \* \* \*

### U. S. AND INDIA NOW HAVE DIRECT RADIO-TELEGRAPH SERVICE

Direct radio-telegraph service between New York and Bombay, India, 8,000 miles around the globe, was introduced recently by R.C.A. Communications, Inc., 66 Broad Street, New York City. \* \* \*

### SHERMAN WAR MATERIAL PACKAGING MANUAL

A revised manual on the protection of war materials has been issued by Sherman Paper Products Corporation, Newton Upper Falls, Massachusetts. In it are included digests of government specifications, with an expanded section on the protection of metal products. Included, too, is a cushion-wrapping method, also illustrated photographically in step-by-step sequence; 25 new photographs have been added. \* \* \*

### THOMPSON, BELOUNGY AND BOWMAN PROMOTED BY CBS

Robert G. Thompson, CBS, New York, James J. Beloungy, CBS, Chicago, and Lester H. Bowman, CBS, Los Angeles, who supervise network technical operations in their areas, have been designated as managers of technical operations, Eastern, Central, and Western Divisions, respectively.

Thompson has been with the network since

### PART III OF WRIGHT PAPER ON RESISTIVE NETWORKS TO APPEAR IN JANUARY

The third part of the Paul B. Wright paper on *Resistive Attenuator, Pad, and Network Theory and Design*, scheduled to appear in this issue, will appear in the January issue.

### ELECTRICAL OR RADIO ENGINEER WANTED

Should have general experience in Electrical or Radio Measurements. Graduate engineer (radio or electrical) from recognized engineering school, desirable. Long-established radio-electrical components manufacturer in New England, doing war work at present. Postwar future for right man. Give detailed outline of experience, etc., salary requirements. Box 1244 COMMUNICATIONS, 19 E. 47 St., New York 17, N. Y.

September, 1929, when he joined as a field operator in the technical department.

Beloungy joined CBS in January, 1934, as chief engineer of WPG, Atlantic City, N. J.

Bowman came to the network in March, 1929, as a supervisor in technical operations at WABC.

Dr. Peter C. Goldmark, and William B. Lodge have also won CBS promotions. Dr. Goldmark is now director of engineering research and development.

William B. Lodge has been named director of general engineering.

Technical operations in the fields of standard broadcasting, f-m and short-wave broadcasting will continue under the direction of Henry Grossman, director of technical operations, and under the general supervision of James M. Seward, the network's director of operations.

**LEWYT POSTWAR PLANS**

Lewyt Corporation of Brooklyn, N. Y., will enter the consumer field after the war, Alex M. Lewyt, president, announced recently.

Lewyt Corporation will make office communication equipment; electronic equipment, and products used by industry in their manufacturing processes.

**GAROD EXPANDS**

The Garod Radio Corporation, 70 Washington Street, Brooklyn 1, N. Y., has taken on an additional floor.

**RMA SUBSCRIBES TO 6TH WAR LOAN**

An RMA subscription of \$50,000 to the 6th War Loan was authorized by the association's board of directors recently.

**ELECTRONICS NOT IN SPOT AUTHORIZATION PLAN**

Increased military electronic production, vital to the war effort, has made it impossible to issue spot authorizations, according to the WPB.

The WPB statement was issued "to remove any ambiguity" about the application of the "spot" plan to electronic equipment. It said WPB Limitation Order L-265 was amended to provide that no producer shall manufacture any electronic equipment except "to fill preferred orders or to fulfill, under Controlled Materials Plan, any authorized production schedule or authorized program as defined in CMP Regulation I, except a schedule or program authorized under Priorities Regulation 25 ('Spot' authorization plan)."

**PAYNE BECOMES V-P OF FINCH**

George Henry Payne, of the board of directors of the Finch Telecommunications, Inc., of Passaic, N. J., has been elected vice-president of the company and chairman of the advisory board for those newspapers desiring to inaugurate facsimile in connection with their regular publications.

Mr. Payne was formerly FCC Commissioner.

**CROWLEY H-F IRON CORE DATA**

A 36-page catalog describing Crollite Magicore h-f iron cores has been released by Henry L. Crowley & Company, Inc., 1 Central Ave., West Orange, N. J.

The catalog covers the uses and functions of powdered iron cores; permeability and "Q" of various materials at different frequencies; effects of the addition of adjusting screws; copper cores; mechanical considerations, stand-

(Continued on page 80)

**WABC-FM ANTENNA**



New two-bay G.E. f-m circular antenna recently installed by CBS atop 700-foot building at 500 Fifth Avenue, New York City.

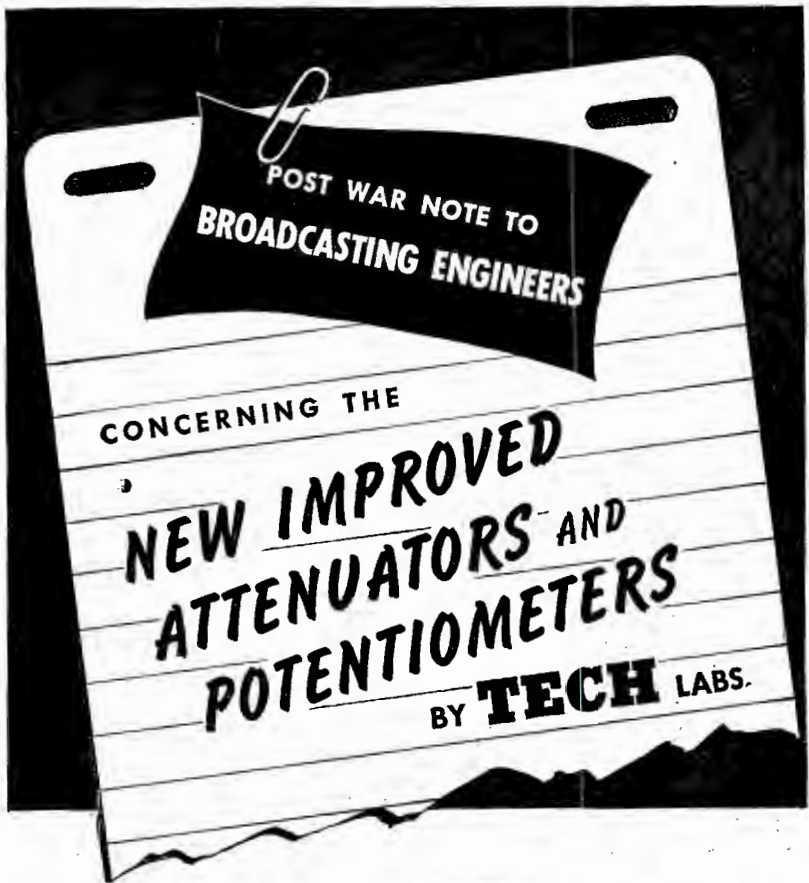

All our modern production facilities, manpower and materials are engaged in supplying our armed forces with quality electrical resistance instruments. Once the Victory has been won, Broadcast Engineers everywhere can rely on Tech. Labs. for prompt shipment on precision attenuators and potentiometers.



**TYPE 600**

- Stainless silver contacts and wiper arms eliminate the necessity of frequent cleaning and result in less noise.
- Better insulation and moisture proofing result in superior performance.
- Improved mechanical construction — pinned rotor hubs and detent gears—results in longer trouble free operation.



**TYPE 700**



MANUFACTURERS OF PRECISION ELECTRICAL RESISTANCE INSTRUMENTS

15 LINCOLN STREET, JERSEY CITY 7, N. J.



## NEWS BRIEFS

(Continued from page 79)

ard pieces and sizes; and special cores especially of large dimensions.

A copy is available to any designer, engineer, purchasing agent or production man writing on his business stationery.

### CLAROSTAT INTERIM LINE CATALOG

To span a gap between the wartime and post-war era, the Clarostat Mfg. Co., Inc., 285-7 N. 6th St., Brooklyn, N. Y., have published an "Interim Line" catalog. It lists such items as composition-element and wire-wound controls, switches, constant-impedance attenuators, universal metal-tube plug-in resistors, power rheostats, power resistors, voltage regulators, and glass-insulated flexible resistors.

### WIRE RECORDER LEAFLET

A new model of the General Electric magnetic wire recorder has been described in a 4-page bulletin. The new recorder is now available to radio stations. Features include new recording head, new belt drive, new level-winding wire guides, aluminum case.

The G. E. magnetic wire recorder has been used experimentally by a number of stations including WGN, Chicago; WGY, Schenectady; WFIL, Philadelphia; WFBL, Syracuse; and WHIO, Dayton.

G. E. engineers say that while speech can be recorded and reproduced with excellent fidelity, in its present stage of development the unit is not recommended for recording music for broadcast purposes. A unit especially designed for broadcast use and having audio characteristics comparable to electrical transcriptions is planned, but the development may not come until after the war.

### G.E. VISIT DAY PROGRAM

Effective December 1, Wednesday and Friday have become "open-house" visiting days to the G. E. stations in Schenectady.

To make arrangements for a visit, write or wire W. R. David (f-m/a-m) or J. D. McLean (television), Electronics Department, General Electric Company, Schenectady 5, N. Y., a few days in advance of your visit, stating your time of arrival and your requirements for hotel and return train reservation, if any.

### PETERSON NOW WITH UNITED ELECTRONICS

Arnold Peterson has been named application engineer at the United Electronics Company, Newark, New Jersey.

### ROYAL HEADS NEW NBC TELEVISION DEPT.

John F. Royal has been designated vice presi-

### F-M RECORDING ANTENNA



U-h-f doublet receiving antenna picking up signals from four Chicago f-m stations for observation.

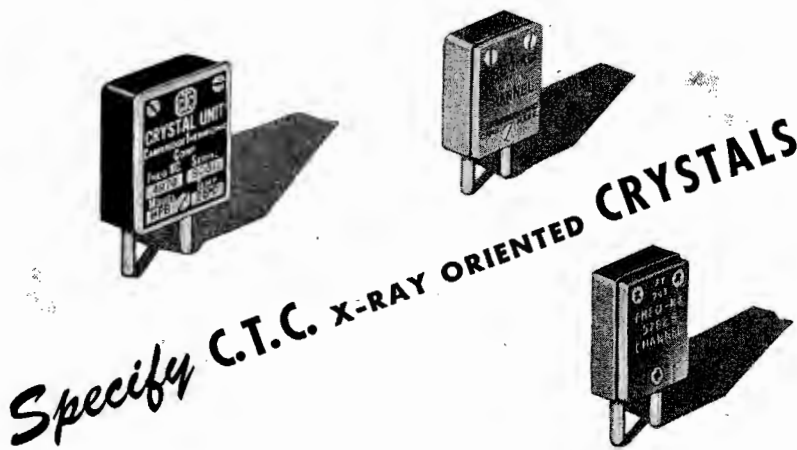

Specify **C.T.C. X-RAY ORIENTED CRYSTALS**

You'll find that X-RAY ORIENTATION — predetermination of the crystallographic axes of the Crystals to permit accurate cutting — insures constant frequency over a wide temperature range in every C.T.C. Crystal.

Multiple mechanical lapping operations; dimensioning by edge lapping; finishing to final frequency by etching, are among the other important operations that guarantee high activity and constant frequency throughout the long life of C.T.C. Crystals.

For prices, delivery dates etc., get in touch with

## CAMBRIDGE Thermionic CORPORATION

442 CONCORD AVENUE

CAMBRIDGE 38, MASSACHUSETTS

Products  
of  
**"MERIT"**

**MERIT COIL AND TRANSFORMER CORP.**

ENGINEERS AND MANUFACTURERS OF TRANSFORMERS FOR ELECTRICAL APPLIANCES  
INVESTING IN THE NEWEST AND BEST METHODS OF MANUFACTURE  
Chicago 40, Illinois

*Announcing!*  
Our new plant is now in full production, greatly increasing our capacity. We believe it to be the most modern and efficient unit now engaged in the production of transformers, coils and allied electronic equipment.

Please take note of our new address where you will always receive a cordial welcome.

Sincerely yours,  
*[Signature]*  
President.

**OUTPUT TRANSFORMER**  
Hermetic-Sealed  
Glass Terminals

**MERIT COIL & TRANSFORMER CORP.**  
4427 North Clark St. CHICAGO 40, ILL.

dent in charge of a newly established department of television.

Under the new order, Ray Kelly, manager, program production facilities; John T. Williams, business manager, television department; production directors Edward Sobol, Paul Alley, Ernest S. Colling and their staffs will report to Mr. Royal.

#### ZIMMERMAN WITH FTR

Frank O. Zimmerman has been named assistant manager of the Chicago sales branch of Federal Telephone and Radio Corporation. Mr. Zimmerman formerly was with Westinghouse Electric Elevator Company at Chicago and Indianapolis. R. A. Vogeler is manager of the Chicago office.

#### W.E. CELEBRATES 75TH YEAR

Western Electric observed its 75th anniversary in November. As part of the anniversary observance, employees in key cities from Coast to Coast previewed a feature length motion picture entitled "Heritage for Victory," dramatizing the growth of the organization.

#### R. J. HIGGINS APPOINTED TURNER REP.

Royal J. Higgins, 600 South Michigan Avenue, Chicago, Illinois, has been appointed Chicago area representative by The Turner Company of Cedar Rapids, Iowa.

Mr. Higgins was formerly advertising manager of the Hallicrafters Company.



#### RCA F-M COVERAGE CALCULATOR

An f-m coverage calculator to assist in planning an f-m station, has been developed by the RCA engineering department. Copies of the rule are available at one dollar each from Radio Corporation of America, RCA Victor Division, Camden, New Jersey.

#### D. H. MILLER OF SPEER CARBON DEAD

Dudley H. Miller, president of the Speer Carbon Company, died recently.

#### MACHINE SCREW THREAD CARD

A pocket-size card form table of machine screw thread dimensions is being issued free by Manufacturers Screw Products, 222 W. Hubbard Street, Chicago 10, Illinois.

The table shows the nominal diameter and threads per inch (National coarse and National fine) for all standard machine screws and the maximum and minimum major, minor and pitch diameters for each size. In addition, tap drill sizes and diameters for each screw are

(Continued on page 82)

#### F-M RECORDER STATION



Recording response of f-m on special ink recorders. Charts are sent to Washington for evaluation.

# CONCORD Service!

## NONE BETTER IN AMERICA FOR RADIO AND ELECTRONIC PARTS AND EQUIPMENT



*Sure! Swift! Satisfactory!* That's the story of Concord Radio Corporation's service. Twenty-two years of "delivering the goods" have made us a top supplier of radio and electronic merchandise to industry, government and the trade. Two strategically located "supply bases"—CHICAGO and ATLANTA—are as close to you as a letter, a telephone call, a telegram, or a message on the teletype. Here is what Concord can offer you:

- The finest merchandise from the best manufacturers
- Large and complete stocks of components and equipment
- A seasoned selling staff of radio and electronic experts
- Consultant radio technicians and engineers
- Same-day shipment, wherever humanly possible
- Super-speed "special service" for military and industrial needs
- Special radio training kits for radio schools



Wetron  
2 1/2" Model  
106 Williamson  
D.C. 6-100

Wetron  
2 1/4" Model  
106 Williamson  
D.C. 6-300

Your Cost, either type, \$4.95



IRC Dual  
Potentiometer  
1 1/2" diameter  
1/2" deep  
3/4" shaft—1 1/2" long  
Your Cost, 89c

Micro-Switch, Type  
Z, S.P.S.T. Normally  
closed. Auto-switch,  
similar to above but  
normally open.

Your Cost,  
either type, 79c



25 WFD, 25 WFD  
condenser in 40-  
micro-ohm case.  
Your Cost, 28c

### FREE! Special Supplement! "Hard-to-Find Radio and Electronic Parts and Equipment"

Sixteen pages, jammed to the margins with such items as condensers, wire, switches, volume controls, relays, resistors, test accessories, speakers, etc. *There's not another listing like it anywhere else in the country today!* All items are on the "high requirement" list . . . all first quality . . . all exceptional values and all available for immediate shipment!

#### MAIL THIS COUPON FOR RUSH SERVICE

CONCORD RADIO CORPORATION  
901 W. Jackson Blvd., Chicago 7, Ill., Dept. No. R-124

Please rush me the new 16-page "Special Supplement" by Concord Radio Corporation.

NAME \_\_\_\_\_  
ADDRESS \_\_\_\_\_  
CITY \_\_\_\_\_ STATE \_\_\_\_\_



# CONCORD RADIO CORPORATION

## Lafayette Radio Corporation

901 W. Jackson Blvd., CHICAGO 7, ILL. ★ 265 Peachtree St., ATLANTA 3, GA.





## STEPPING UP PRODUCTION TEMPO

● At its large, new, modernly equipped plant at Conneaut, Ohio, The Astatic Corporation is today supplying Microphones, Pickups, Cartridges and wartime unmentionables to the armed forces, essential industries and accredited government agencies. With all operations and departments now under one roof, Astatic looks optimistically forward into the new year with greatly increased production facilities and customer accommodations. These advantages will enable Astatic to make a quick transition to meet commercial demands when the reconversion time arrives.

**THE Astatic CORPORATION**  
**ASTATIC** CORPORATION  
 CONNEAUT, OHIO  
IN CANADA CANADIAN ASTATIC LTD., TORONTO ONTARIO

NOTE:  
 Please change Astatic address in your files to CONNEAUT, OHIO.

## NEWS BRIEFS

(Continued from page 81)

also given, as well as a handy printed rule. Requests for the cards are to be directed to the engineering department.

### "E" AWARDS

The Hoffman Radio Corp., Los Angeles, has received the Army-Navy "E" production award. Two white stars have been added to the "E" flags of Clarostat Manufacturing Company, Inc., and the Amperex Electronic Corporation.

The Solar Manufacturing Corporation's number two plant in West New York, New Jersey, the Sharon works of Westinghouse and the Galvin Manufacturing Corporation have won the fourth white star for their "E" flags.

### CANNON WINS APPROVED RATING

Cannon Electric Development Company has received an "Approved" inspection rating from Major E. P. Higbee, Army Air Forces, Air Technical Service Command, for a period of six months.

### AIRCRAFT TOOLS CATALOG

A 178-page reference manual, containing photographs, blueprint drawings, and full construction details of small hand tools for aircraft production and maintenance has been released by Aircraft Tools, Inc., 750 E. Gage Avenue, Los Angeles 1, California.

There are sections on riveting tools, dimpling tools, angle drills, cutting tools, and bucking bars. One section is devoted to miscellaneous tools, such as strap duplicators, rivet squeezers, pliers, cable spicers, torque wrenches, chip chasers, and other precision-made products. Useful engineering data may be found in a 9-page appendix.

### HERCULES ELECTRIC MOVES TO NEW PLANT

The Hercules Electric and Manufacturing Corporation, manufacturers of d-c/a-c welders, transformers, coils, magnetic clamps, solenoids, rivet heaters, spot welders, fluorescent ballasts and special controls, are now located at 2500 Atlantic Avenue, Brooklyn 7, New York.

### CAIRO COMPANY TO DISTRIBUTE RECEIVERS

The Intercontinental Commercial and Industrial Company, 83 Azhar St., Cairo, have opened a distributing unit, and plan to sell American receivers and sound equipment.

Wide coverage is planned. Mansour & El Hamawy Sons operate the company.

### LEWYT OPENS CHICAGO OFFICE

Lewyt Corporation, Brooklyn, N. Y., has opened

### ACTION TESTS

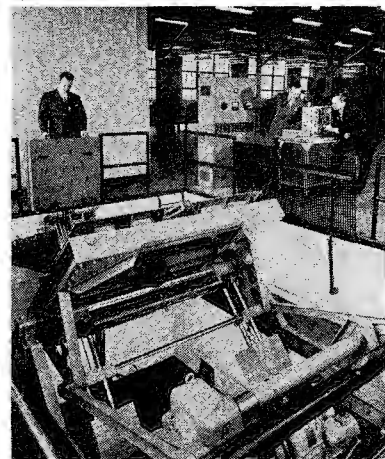

Type-test laboratory in Western Electric's Hawthorne works in Chicago to check performance of ship-borne equipment under the same conditions that will be encountered at sea. Bolted to the heavy steel table top, the equipment is rocked back and forth for hours, or days.

## Look! a production standard

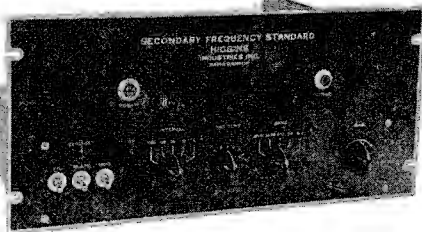

● ● ●  
 A Complete Secondary Frequency Standard Specifically Designed for routine production line operations.

**MODEL FS-10:** 1. 1000; 100; 25 and 10 kilocycle intervals • 2. Ample RF output • 3. Built in modulator, 1000 cycle tone • 4. A crystal stability of at least 1 cycle per megacycle per degree centigrade • 5. 105 to 120 v., 50 to 60 cycle, A.C. operation. Output unaffected by line variations • 6. Standard relay rack mounting • 7. Multivibrators stable under extreme line voltage variations

**MODEL FS-11:** 1. Same as the Model FS-10 except for an additional interval as required by YOUR type of work!

Prices and literature upon request

**Higgins**

INDUSTRIES INCORPORATED

2221 Warwick Avenue

Santa Monica, California

a Chicago sales office at 32 North State Street. B. H. Havens, a member of the New York sales staff, has been appointed manager of the Chicago office.

**WGN EXTENDS DEADLINE IN STUDIO DESIGN CONTEST**

Because of the interest in WGN's \$10,000 cash prize competition for the design of a studio theater seating 2,000 persons in its proposed Chicago Theater of the Air building to be erected after the war, the deadline for entries was extended fifteen days to December 1.

**WORNER ELECTRONIC EXPANDS**

Worner Electronic Devices are now located at larger quarters at 609 West Lake Street, Chicago 6, Illinois.

**GOLDER HEADS GENERAL INSTRUMENT SPEAKER UNIT**

Leon Golder, former secretary and sales manager of Rola, has become manager of the new speaker division at General Instrument Corporation, Elizabeth, N. J.

The speaker business will be conducted by the General Electronic Apparatus Corporation, a subsidiary of General Instrument Corporation.



**WESTINGHOUSE APPOINTS FAURIE, ECKSTEIN, AND HERRON**

Georges Faurie, formerly with the Delco appliance division of General Motors, has been named advertising and sales promotion manager for the newly created radio receiver division of Westinghouse.

Paul H. Eckstein has been appointed assistant sales manager of the receiver division.

A. L. Herron will manage the receiver cabinet division at Westinghouse. Mr. Herron was cabinet engineer for Stewart-Warner Corporation from 1935 to 1940.

**D. MARTIN JOINS WILCOX-GAY**

D. Martin has been appointed chief engineer of the Wilcox-Gay Corporation.

Prior associations include Westinghouse Aircraft Division, de Forest Radio Company, Federal Telephone and Radio Manufacturing Company, Radio Receptor Company and the J. H. Bunnell Company.

**BENDIX PRODUCES OVER 75,000 RADIO COMPASSES**

A total of 75,430 radio compasses are said to (Continued on page 84)

**H-F HEAT SEALING**



(Courtesy North American Philips Co., Inc.) Sealing anode and grid caps to bulb of an 833A with a h-f coil. Metal is heated by means of induction. Bell jar is filled with nitrogen to reduce oxidation.

*Greetings*

To the many friends of Stancor, our sincere thanks for your generous cooperation throughout the past year. It is a genuine pleasure to assure you that the future not only will bring greater fulfillment of your needs, but electronic refinements of which you and we both shall be proud. Won't you kindly accept our wishes for your good health and prosperity.

STANDARD TRANSFORMER CORPORATION, 1500 NORTH HALSTED ST., CHICAGO 22, ILLINOIS



*Transformers*



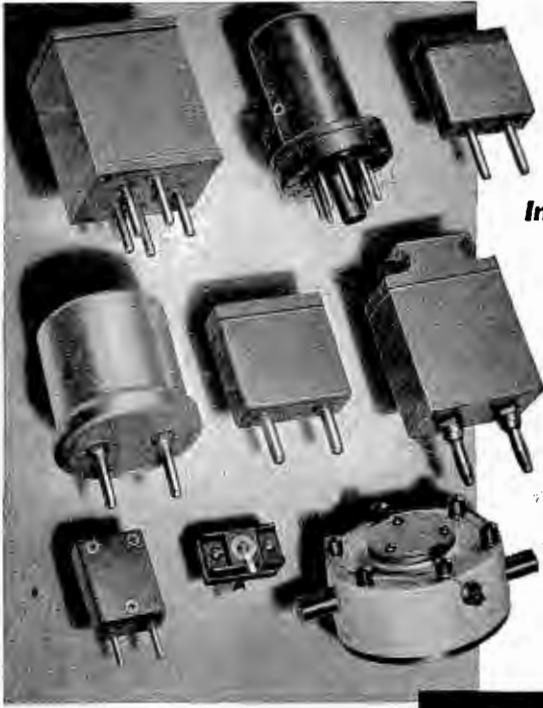

**In QUARTZ  
CRYSTALS**  
*the most significant  
advancements have  
been introduced by*  
**BLILEY**

Do more than before . . .  
buy extra War Bonds



**BLILEY ELECTRIC COMPANY • UNION STATION BUILDING • ERIE, PENNSYLVANIA**

*Laboratory  
Standards*

**MODEL 62**

**VACUUM TUBE VOLTMETER**

**SPECIFICATIONS:**  
**RANGE:** Push button selection of five ranges—1, 3, 10, 30 and 100 volts a. c. or d. c.  
**ACCURACY:** 2% of full scale. Useable from 50 cycles to 150 megacycles.  
**INDICATION:** Linear for d. c. and calibrated to indicate r.m.s. values of a sine-wave or 71% of the peak value of a complex wave on a. c.  
**POWER SUPPLY:** 115 volts, 40-60 cycles—no batteries.  
**DIMENSIONS:** 4 1/4" wide, 6" high, and 8 1/2" deep.  
**WEIGHT:** Approximately six pounds. **PRICE:** \$135.00 f.o.b. Boonton, N. J.

**MEASUREMENTS CORPORATION**  
**BOONTON, NEW JERSEY**

**NEWS BRIEFS**

(Continued from page 83)

have been delivered to allied forces since Pearl Harbor by the Bendix radio division of Bendix Aviation Corporation.

**B-C MILLING CUTTER DATA**

A milling cutting data book has been published by the Barber-Colman Company, Machine and Small Tool Divisions, 19 Loomis Street, Rockford, Ill.

This book is based on performance data taken directly from the field. It will be issued without charge upon receipt of a request on company letterhead, and signed by one in a key post.

**RAYTHEON TUBE DATA BOOK**

A tube data and substitution chart booklet with complete information on electrical characteristics, and outline drawings and diagrams of all receiving, hearing aid, and special purpose tubes, as well as radio panel lamps has been published by radio receiving tube division, Raytheon Manufacturing Company, Chapel Street, Newton 58, Mass.

A large portion of this book is also devoted to a chart of simplified interchange information, including over 1600 substitutions.

**CARLIN, SWEZEY, JOIN MBS**

Phillips Carlin has been named vice president in charge of programs of the Mutual Broadcasting System. Robert D. Swezey has been appointed vice president and assistant general manager at Mutual.

Mr. Carlin and Mr. Swezey were formerly with the Blue network.

**SOWARD GOES TO SUPREME INSTRUMENTS**

Raymond Soward has become chief engineer of Supreme Instruments Corporation, Greenwood, Mississippi.

From 1936 to 1938, Mr. Soward was employed as design engineer for Supreme. He was recently a radio engineer in the Signal Corps in Atlanta, Georgia.

Mr. Robert H. Streeter has become a design engineer at Supreme, and will assist Mr. Soward.



Raymond Soward



Robert H. Streeter

**BLACK INDUSTRIES DRILL-TOOL MANUAL**

A 24-page hardsteel operator's manual has been issued by the Black Drill Company, division of Black Industries, Cleveland, Ohio.

It contains revised tables on drilling speeds recommended for drilling hardened steels, amplified instructions on the correct procedure for wet and dry drilling and information on the

**SMITH OF GALVIN HONORED**



Donald Henry Smith, left, chief engineer of the Galvin Manufacturing Corporation, Chicago, before WGN microphone acknowledging Chicago Tribune War Workers Award, for his walkie-talkie contribution.

application of hardsteel in tool bits, and tool tips used in machining the hard, tough steels and abrasive copper and aluminum alloys.

**MALLORY WELDING BROCHURE**

A 32-page catalog on "Resistance Welding Electrodes and Alloys," has been published by P. R. Mallory & Co., Inc., Indianapolis, Indiana. The catalog lists the company's complete line of standard spot welding electrodes and water-cooled holders.

A complete listing of "Do's and Don'ts" for improved resistance welding is featured. Stock sizes of Mallory alloys, their various applications and typical physical properties are also included.

**SIGNAL CORPS STANDARDIZATION BOOKLET**

A 12-page booklet on Signal Corps standardization, describing the program for the standardization of component parts and materials used in Signal Corps equipment, has been released by the Army Service Forces, Signal Corps Standards Agency, 12 Broad Street, Red Bank, N. J.

Hereafter, the Signal Corps will require the use of only approved component parts and materials wherever possible in the equipment supplied to it. Signal Corps tentative specifications 71-4902 is the medium by which this will be effected.

The booklet has been sent to all prime contractors of Signal Corps equipment and will be sent to all component parts manufacturers and materials suppliers.

An insert in the booklet lists the standard specifications completed under this program as well as those still being processed.

**PEEK JOINS ELECTRONIC LABORATORIES AS S-M**

Walter E. Peek has been appointed sales manager of Electronic Laboratories, Inc., Indianapolis. Mr. Peek has been a member of the engineering staff for the past four years, serving in both a design and sales engineering capacity, with particular attention to the vibrator field.

Mr. Peek was chief radio engineer of Noblitt-Sparks Industries, Columbus, Indiana, for several years.



**UNITED ELECTRONICS' RETIREMENT PLAN**

A pension trust plan for employees of the United Electronics Company, Newark, was announced recently.

The pension plan provides for participation by the employees but the employees do not contribute to the fund. All contributions are made by the company.

Coverage includes all employees who have been at the plant for 18 months or more and are over 21 years of age and under 55½ years. Eligibility will be determined each year on November 1 and any employee not eligible this year may apply next year.

The rate of pension is approximately 21¼ per cent of the participating employee's base pay. A minimum of \$20 monthly has been established. An employee receiving an annual salary of \$2,000 would receive \$35 monthly.

Payments will begin at the retirement age of 65 and will continue for the life of that employee. In the event of death before 10 years' payments have been made, the beneficiaries will receive the remainder of the payments up to ten years. In the event of death before retirement, the beneficiaries, however, may settle for a cash settlement in a lump sum equal to 100 times the monthly payment.

**G. E. PROMOTES SHATTUCK, NELSON, BURNS AND LEEDS**

Donald Shattuck has been appointed manager of the contract receiver section, specialty division of the electronics department, General Electric.

In this capacity, Mr. Shattuck will have charge of a newly organized section of the division with headquarters at the Thompson Road Plant, Syracuse.

J. E. Nelson is now sales manager of industrial tubes. He will be responsible for the sale of all the industrial tubes made by the division. His headquarters will be at Schenectady.

Gordon E. Burns has been named supervisor

(Continued on page 86)



*Plugs*

**FOR VICTORY**

**PLUGS & CONNECTORS**

Signal Corps and Navy Specifications

Types :		P L		
50-A	61	74	114	150
54	62	76	119	159
55	63	77	120	160
56	64	104	124	291-A
58	65	108	125	354
59	67	109	127	
60	68	112	149	

PLP		PLQ		PLS	
56	65	56	65	56	64
59	67	59	67	59	65
60	74	60	74	60	74
61	76	61	76	61	76
62	77	62	77	62	77
63	104	63	104	63	104
64		64			

N A F  
1136-1 No. 212938-1

Other Designs to Order

Remler is equipped for the mass production of many types of radio and electronic devices from humble plugs and connectors to complete sound amplifying and transmitting systems. Ingenious production techniques contribute to Remler precision, reduce costs and speed up deliveries. • The Axis is on the run...Victory is in sight. Let us help you finish the job.

Wire or telephone if we can be of assistance

**REMLER COMPANY, LTD.**

2101 Bryant St. • San Francisco, 10, California

**REMLER**  
SINCE 1918  
*Announcing & Communication Equipment*



Take a **TURRET TERMINAL LUG**  
LIKE THIS...



Swage it to the Board  
LIKE THIS...



And in a jiffy you have  
a good, firm Turret Terminal



It's as simple as that with these heavily silver plated C. T. C. Turret Terminal Lugs. Quick soldering, too. Sufficient metal is used to give them strength but there's no surplus metal to draw heat and increase soldering time.

C. T. C. Turret Terminal Lugs are stocked to meet a wide range of board thicknesses. Order them from

## CAMBRIDGE *Thermionic* CORPORATION

442 CONCORD AVENUE

CAMBRIDGE 38, MASSACHUSETTS

## FROM THE HOUSE OF JACKS

... and other radio and electronic components!

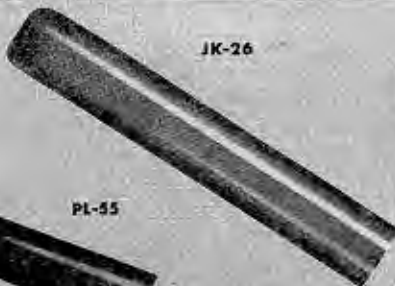

JK-26

PL-55

PL-54

America's largest producer of JK-26 jacks. All models built to strict Signal Corps specifications.

### Experience for Sale!

Amalgamated Radio, pioneers in the field, maintain experimental and development laboratories for post-war radio and television equipment. Our components are completely engineered in a self-contained factory equipped with tools of our own design. Years of specialized experience assure high quality products at low cost. Inquiries are invited.

ADDITIONAL JACKS & PLUGS FOR IMMEDIATE DELIVERY

JK-55 JK-48 PL-291 PL-291A PL-204

## AMALGAMATED RADIO TELEVISION CORP.

476 BROADWAY • NEW YORK 13, N. Y.

## NEWS BRIEFS

(Continued from page 85)

of personnel in the electronics department at Schenectady, N. Y. Mr. Burns formerly was in charge of personnel work for the department's tube division.

L. M. Leeds has been appointed manager of the electronics laboratory. W. C. White, formerly in charge of this laboratory, has been appointed the electronics engineer of the G.E. research laboratory.

Mr. Leeds is stationed in Schenectady and will have charge of electronic research and advanced development for the electronics department.

\*\*\*

### SHAKEPROOF FOLDERS

Four folders covering application data on thread-cutting, screws and lock washers, have been released by Shakeproof, Inc., 2501 N. Keeler Avenue, Chicago, 39, Illinois.

\*\*\*

### AEROVOX ENGINEERING BULLETINS

Latest releases of the "Aerovox Research Worker" contain data on capacity quality factors and a dictionary of capacitor applications and recommended types.

\*\*\*

### WESTINGHOUSE INSTALLS

#### R.R. RADIO AT PLANT

Six f-m transmitters, linking a central railroad dispatcher's office and five diesel-electric locomotives in two-way communication, is expected to be in operation on terminal railroad lines of the Westinghouse Electric and Manufacturing Company, East Pittsburgh, Pa., within three months.

The main station will use a 50-watt unit. The mobile transmitters will be of 40-watt power. All six stations will broadcast in the 10-meter band.

Authorization for construction of the unique radio system has been granted by the FCC, and WPB priorities for the necessary equipment accompany the authorization.

A class 1 engineer will be on duty in the central station, and class 3 operators will be on duty elsewhere.

\*\*\*

### DOC POWER CELEBRATES

#### 23D YEAR IN RADIO

Dr. Ralph L. Power, Los Angeles radio counselor, celebrated his 23d year in radio in October. He began in 1922 when he left a professorship at USC to become a radio announcer and newspaper radio editor locally.

\*\*\*

### BENDIX NAMES ROCHESTER AND

#### VILAS AS DISTRICT MANAGERS

Samuel Rochester, formerly buyer for Bendix Radio, has been appointed district manager of the home radio unit in the Middle Atlantic territory, with headquarters in Baltimore.

Royal Vilas, former WPB official, has become home radio district manager with headquarters in Atlanta.



Samuel Rochester

Royal Vilas

\*\*\*

### MINNESOTA MINING, GRINDING AND FINISHING BOOKLETS

Four publications illustrating and describing the 3-M method of grinding and finishing have been released by Minnesota Mining and Manufacturing Company, Saint Paul, Minnesota.

One booklet in the new series entitled "Step Up Production with the 3-M Method of Grinding and Finishing," is for purchasing agents, work managers, production managers, chief engineers and plant superintendents.

Included are photographs of production jobs, a formula for determining abrasive belt sizes and placement of backstand idlers, complete data on 3-M abrasive belt sizes and grits and segment face contact wheels.

The other booklets describe grinding and

finishing of small parts and tools, heavy duty grinding and finishing of flat or curved surfaces.

**M. H. COOK PROMOTED BY BELL LABS**

Morris H. Cook has been appointed director of specialty products development of Bell Telephone Laboratories. He comes from the Hawthorne works of Western Electric where he was superintendent of manufacturing engineering.



**PIANO MAKERS USE  
OPERADIO PAGING SYSTEM**

Steinway and Sons, piano manufacturers, have installed an Operadio industrial music and voice-paging system in their N. Y. plant.

**GERMAIN RETURNS AS  
STROMBERG-CARLSON S-M**

E. S. Germain, prewar radio sales manager of Stromberg-Carlson Company's Pacific Coast division, has resumed that position.

Mr. Germain, in early 1942, was drafted from his sales post in the San Francisco office to become manager of the company's Government sub-contract sales division in Rochester.

**TELECHRON BOOKLET**

A 20-page booklet discussing synchronous motors, instrument movements, gear trains and industrial clock equipment has been prepared by the Warren Telechron Company, Ashland, Massachusetts.

**PHILCO APPOINTS GILLIGAN  
AD MANAGER**

John F. Gilligan has been appointed advertising manager of Philco Corporation. Mr. Gilligan joined Philco in 1922.

**GUBB TO SERVE ON  
CORNELL BOARD OF TRUSTEES**

Larry E. Gubb, chairman of the board of directors of Philco Corporation, has been elected to the board of trustees of Cornell University, at Ithaca, N. Y. Mr. Gubb was graduated in 1916 from Cornell, and is president of the Cornell Alumni Association.

**MOTOROLA DEALER BULLETIN**

A 24-page, four-color book, entitled "When Motorola Radio Comes Home from War," has been issued by the Galvin Manufacturing Corporation, Chicago.

Several action photos of the handie talkie are included as well as views of the walkie talkie, guidon set and other Motorola radio war equipment.

**PRICE BROTHERS COMPANY  
EXPANDS POSTWAR PROGRAM**

Six manufacturer's agents have been added to the sales unit of Price Brothers Company, Frederick, Md., as part of a new postwar selling program. J. J. Schmidt was recently appointed general sales manager.

Manufacturers' agents appointed include Gerald G. Ryan Co., Chicago, Ill.; Bert A. Hansen, Buffalo, N. Y.; E. J. Wall, Lakewood, Ohio; L. R. Ward Company, Dallas, Texas; Fry & Roberts, Hollywood, California; and Gail Halliday, Denver, Col.

**FLUXMETER DATA**

An 8-page catalog describing a multirange fluxmeter, model F, has been published by Sensitive Research Instrument Company, 9-11 Elm Avenue, Mount Vernon, N. Y. Data presented includes methods of use and search coil design.

**CONCORD RADIO EXPANDS**

Concord Radio Corp., 901 W. Jackson Blvd., Chicago, has taken additional space for the kit and cable department, and warehousing facilities.

*Where  
Dependability Counts*

**Permoflux Acoustical Devices  
Are Proving their Superiority!**

Much of today's communication equipment is but remotely related to that in use when the war began. New Permoflux developments have meant increased efficiency for our fighting forces. The wide frequency response, extreme sensitivity and rugged mechanical design of Permoflux products have helped to achieve a standard of intelligibility heretofore unknown. Permoflux products will be available for many new post war applications.



TRADE MARK  
**PERMO-FLUX**

PERMOFLUX CORPORATION

4916-22 W. Grand Ave., Chicago 39, Ill.

PIONEER MANUFACTURERS OF PERMANENT MAGNET DYNAMIC TRANSDUCERS



BACK THE INVASION — BUY MORE BONDS NOW!

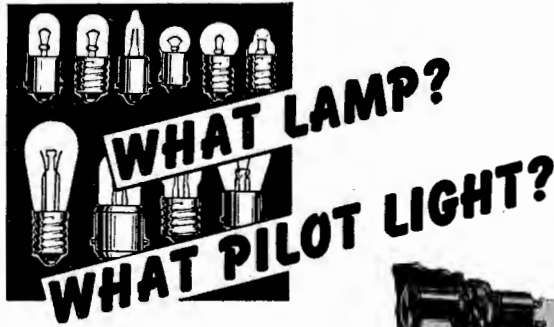

**ANSWERS TO BOTH QUESTIONS WAITING FOR YOU AT DIALCO**

Let us solve your problem with a complete unit — fitted with the proper G.E. or Westinghouse Lamp. We manufacture the most extensive line of Pilot Lights . . . Special emphasis on Neon applications. Write for Catalog today.

**YOU CAN DEPEND ON DELIVERIES WHEN YOU DEAL WITH THE**

*World's Largest Manufacturer of Pilot Lights*

**DIAL LIGHT CO.** of America, Inc.  
900 BROADWAY • NEW YORK 3, N. Y.  
Telephone: ALgonquin 4-5180-1-2-3

BACK THE INVASION — BUY MORE BONDS NOW!

**TELEVISION**

(Continued from page 38)

and a 240' copelene coaxial leadin were used. Two setups were employed. In one, the dipole was placed on the porch bannister facing S 18° W and about 18' above ground level. In the second instance, the rhombic was erected on a bearing of S 18° W at a horizontal level. At the far end the antenna was approximately 35' above ground, while at the receiving end, 14' above ground.

All readings were made in a room facing southwest directly below the dipole antenna.

Discussing the method of recording, the report states that the receiver was calibrated in two ways. First,  $\mu$ v versus ma at 50 mc, and r-f gains of 1.0, .1, .01, .001; and second, frequency versus set sensitivity with respect to sensitivity at 50 mc as unity. These calibrations provided two sets of curves.

In deriving the input signal strengths, the Du Mont engineers determined which one of the four r-f gain settings would be used to give about mid-range deflection for each station. To obtain the maximum ma reading for this setting, the curve shown in Figure 1, was used. Then, according to the report . . . "the signal for this ma reading at 50 mc was noted. This  $\mu$ v signal multiplied by the sensitivity factor obtained from the curve in Figure 2, gave the actual signal-strength voltage at the receiver terminals from the observed station at the observed frequency. In addition to tabulated readings, a permanent record was made by the use of an Enterline Angus graphic recorder, which over a period of time showed the variation of signal strength from the stations received.

Further recordings of signals received were made by film and movie camera."

**IRE WINTER MEETING**

THE 1945 winter technical meeting of the Institute of Radio Engineers will take place during a four-day interval beginning January 24, 1945 at the Hotel Commodore in New York City.

Technical sessions will begin on Thursday, January 25, at 2:00 P.M., in the grand ballroom. Speakers will include Jerry P. Minter, K. A. Norton, Harold A. Wheeler, Murray G. Crosby, Coleman Dodd, John D. Reid, R. L. Kelly, N. H. Green, E. D. McArthur, D. R. Hamilton, J. R. Pierce, Clayton E. Murdock, Major H. A. Zahl, Karl Van Dyke, Major Edward W. Johnson, I. E. Fair, C. W. Harrison, Clifford Frondel, Charles Roddy, Virgil E. Bottom, W. D. Cockrell, G. W. Klingaman, Paul D. Zottu, Wallace C. Rudd, Eugene Mittelman, George H. Brown, Captain E. M. Webster, Alfred N. Goldsmith, Allen Easton, R. F. Wild, R. L. Freeman, W. A. Hayes and Ralph Brown.

Subjects to be covered will include quartz crystals, vacuum tubes, industrial electronics, radio links and relays, v-h-f and u-h-f signal ranges, carrier amplitude and p-m reception, klystron characteristics, disk-seal tubes, reflex oscillators, broad-band aircraft antenna systems, solid dielectric lines, etc.

**ENGINEERS . . . .**  
**Are You Concerned With ?**  
**YOUR POST WAR FUTURE ?**

The Federal Telephone & Radio Corporation, the manufacturing unit of the International Telephone & Telegraph Corporation with its multiple business activities extending to all parts of the civilized world, will accept applications from experienced men for immediate employment with almost limitless post war possibilities. These positions should interest those with an eye to the future and whose interest lies in forging ahead with this internationally known organization whose expansion plans for post war are of great magnitude covering all types of radio and telephone communications. Advancement as rapid as ability warrants. Majority of positions are located in the New York area!

We need the following personnel! Men with long experience or recent graduates considered.

- ENGINEERS
- ELECTRONICS
- ELECTRICAL
- RADIO
- MECHANICAL
- CHEMICAL
- TRANSFORMER DESIGN
- SALES AND APPLICATION
- ENGINEERS
- PHYSICISTS
- DESIGNERS
- DRAFTSMEN
- TOOL DESIGNERS
- TECHNICAL WRITERS

**Look Ahead With Federal!**

If inconvenient to apply in person, write letter in full, detailing about yourself, education, experience, age, etc., to Personnel Manager.

**FEDERAL TELEPHONE & RADIO CORP.**  
39 Central Avenue  
**EAST NEWARK** **NEW JERSEY**

## TRANSMITTERS

(Continued from page 64)

Poulsen's design before even limited success was attained, but the problem of modulation was recognized as not soluble with the microphones at hand, or procurable.

It was with what had been learned during the latter years of World War I, about radio telephony, that radiophone broadcasting was given a start in 1920. The needs of war seemed to invite attempts at long distance operation, and for this purpose a large amount of equipment, and a bottomless source of replacement tubes were demanded—an undertaking possible only to the Navy Department, and to the telephone company. Radio amateurs and experimenters in this country had for years been making telling strides in developing radiotelegraph devices and services. Radiotelephony for a little time did not particularly intrigue the interest of the amateurs. For given equipment at cost its range was small compared to radiotelegraph. And tubes were priced at six dollars each!

The American experimenter, however, is a rugged and a determined soul. It was not long after the large companies had demonstrated the practicability of radiotelephony, that others entered the scene to simplify, modernize and project improvements.

At de Forest's laboratory were R. F. Gowen and C. V. Logwood; at City College, A. N. Goldsmith, Carl Dreher and Julius Weinberger. Here and there were others who undertook to utilize radiotelegraph parts as far as possible in making up radiophone outfits, satisfied at first with limited ranges. It was a time when no one regarded any *hook-up* as likely to suit him for longer than a few days, or a few hours.

Persons having receivers with detectors and two-step amplifiers (as they were then called) could pick up transmission from these sets at 15 to 20 miles, provided interference was not unreasonable. One of these transmitters at City College, New York, operating on 300 meters, was picked up at Princeton, N. J., 50 miles away, and at Poughkeepsie, N. Y., 75 miles away. For the experimenter the problem of available power was difficult in comparison with the power required for radiotelegraph operation. Some sets were operated on 110 or on 220 volts, which worked well enough but over shorter distances. The lucky fellows were those who could afford motor-generators having 350 to 500 volt output for the plate circuit. With the 235-volt input the antenna current danced around 0.8 to 1.2 amperes.

ONE CENTRAL SOURCE FOR

*All Types of Industrial*

# ELECTRONIC TUBES



STOCKS ON HAND FOR

*Immediate Delivery*

RECTIFIER  
POWER  
CONTROL  
PHOTO-ELECTRIC  
TRANSMITTING  
RECEIVING

Helpful  
**BUYING  
GUIDE**  
Available  
on Request  
Write for it!

Here you have the advantage of a *complete, centralized service* on all types of industrial electronic tubes. Many are "on-hand" for *rush delivery!* This enables you to obtain the exact type you require, in the shortest possible time. Rectifier, power, control, photo-electric, cathode ray, transmitting, or receiving . . . in RCA, G.E., Raytheon, Amperex, Eimac, Taylor, and other well known makes.

*Save time and work—Call Allied First!  
Write, Wire or Phone Haymarket 6800*

Engineering Service Available

EVERYTHING IN  
ELECTRONICS & RADIO

It's faster, simpler to get all your electronic and radio supplies from this one central source. We carry the largest and most complete stocks of parts and equipment under one roof . . . ready for immediate shipment. Besides, our procurement experts are in constant contact with all leading manufacturers. This complete service simplifies and speeds supply of diversified needs.

# ALLIED RADIO

C O R P O R A T I O N

833 W. Jackson Blvd. Dept. 31-M-4 Chicago 7, Illinois

SUPPLIERS OF ELECTRONIC PARTS AND EQUIPMENT TO INDUSTRIAL AMERICA

Electronic Tubes, Rectifiers, Power Supplies, Intercommunicating Systems, Sound Systems, Photo-Cell Equipment, Batteries, Chargers, Converters, Generators, Supplies for Resistance Welders, Fuses, Test Instruments, Meters, Broadcast Station Equipment, Relays, Condensers, Capacitors, Resistors, Rheostats, Transformers, Switches, Coaxial Cable, Wire, Soldering Irons, Microphones, Speakers, Technical Books, etc.



# IT'S DRY!

— and so is your equipment when it's been pressurized with an **ANDREW DRY AIR PUMP**



Type 876-A

• Dry Air Pumps provide simple, inexpensive source of dehydrated air for your pressurized electronic products. You can avoid component failure due to humidity by enclosing the entire apparatus in an air tight chamber and maintaining dry air pressure.

FOR DETAILED INFORMATION  
WRITE FOR BULLETIN No. 30

For air-borne equipment, too! Condenser plates will not spark over at high altitudes if the apparatus is pressurized with dry air, because then moisture condensation is no longer a problem.

## ANDREW CO.

363 East 75th Street  
Chicago 19, Illinois

NEED AN  
ULTRA-HIGH FREQUENCY  
I-F TRANSFORMER?



Here it is. It's C.T.C.'s LS-1, a tiny, slug tuned I-F Transformer that will meet your every requirement for efficient, dependable performance, just as it is doing for many manufacturers of high priority radio and electronic equipment.

Recently released for more general use, the LS-1 will bear looking into whether or not you have an immediate application for it. We'll be glad to send you the complete story.

## CAMBRIDGE Thermionic CORPORATION

442 CONCORD AVENUE

CAMBRIDGE 38, MASSACHUSETTS

## COAXIAL CABLES

(Continued from page 54)

plastic. By introducing styrene units into the chain, the bulky phenyl groups prevent the close packing of the chains and decrease the molecular attraction. Thus, instead of getting a hard rigid material like polystyrene, a typical rubbery product is the result.

Getting back to the problem of preparing a suitable dielectric for high-frequency transmission lines, it is apparently necessary to have a material that is intermediate between a plastic and a rubber, and yet which has satisfactory electrical properties.

The optimum electrical properties are found in the substantially non-polar materials such as hydrocarbons; for example, polybutene, polystyrene and polyethylene.

In the early days of the development, in this country, of high-frequency transmission lines having semi-flexible solid insulations, no satisfactory material was available. The familiar *marshmallow* type of insulation made by stiffening polybutene with various resins was not at all satisfactory for the severe service requirements. Because of the lack of a suitable dielectric, we undertook the development of such a material in January, 1942. Our method of attack on this problem was to take advantage of the dielectric properties of polystyrene and combine these with the rubbery properties of polybutene. This investigation involved the preparation of 332 different compositions before a satisfactory material was developed. The final composition was rubbery, had a power factor of 0.0006 and a dielectric constant of 2.42 at frequencies in the range of 10-400 megacycles.

Transmission lines manufactured with this dielectric, were suitable for use over a temperature range of  $-40^{\circ}\text{C}$  to  $+85^{\circ}\text{C}$ . It must be admitted, however, that the processing difficulties encountered in the use of this material were large and the utmost skill and care was necessary, particularly during the extrusion operation, to hold the size tolerances to the degree required for impedance uniformity.

In the spring of 1943, polyethylene became available for use in this country, and because of its properties, has now been selected as the preferred dielectric for all high-frequency transmission lines.

With polyethylene, a temperature range of  $-40^{\circ}\text{C}$  to  $+100^{\circ}\text{C}$  can be attained, while the power factor and dielectric constant of the material over

a very wide range of frequencies is 0.0003 and 2.3 respectively.

Further search and development will undoubtedly produce new materials having even more desirable properties, but the further improvements to be expected now are minor in character.

The outer protective jacket of a high-frequency transmission line is most usually a thermoplastic type of material. It must possess:

- (a)—Toughness.
- (b)—Resistance to abrasion.
- (c)—Low temperature flexibility.
- (d)—High temperature stability.
- (e)—Resistance to sunlight and ozone.
- (f)—Resistance to gasoline and oil.
- (g)—Resistance to water.
- (h)—Flame resistance.

It is well known that the pure hydrocarbons are readily combustible and that they are attacked by gasoline and oil, and therefore, they cannot, in general, be used as jacketing materials.

The best flame resistant materials are those which contain in their molecules halogen atoms such as chlorine, bromine or fluorine. Resistance to gasoline and oils is also encountered in such molecules. It is apparent that the arrangement of the atoms and the molecules in the material determines its physical behavior, and in order to get flexibility the chains must not be allowed to pack too tightly together or have too strong a molar cohesion. In a material like polyvinyl chloride the large bulky chlorine atoms tend to prevent close packing of the chains, while the forces between the chlorine atoms on one chain and the hydrogen atoms on the other chain are reasonably strong. The material is, therefore, a rather tough plastic, and in order to make it rubbery it is necessary to still further weaken the intermolecular forces and keep the chains further apart. This is done by the addition of suitable plasticizers. By copolymerizing vinyl chloride with a small amount of vinyl acetate, the chains are kept further apart than in the case of pure polyvinyl chloride by virtue of the bulky acetyl groups and in this way less plasticizer is required to bring this copolymer to an equivalent state of rubberiness. The development of suitable plasticizers for this purpose which will impart the optimum properties to the plastic has been another contribution of the chemist. And some of the more recent developments in this field with particular reference to the changes in properties of a high-frequency transmission line with heat ageing have been of para-

**NOW AVAILABLE —**

**NEW CATALOG, DESCRIBING THE COMPLETE LINE OF**

# Electro-Voice

## COMMUNICATIONS MICROPHONES

**Electro-Voice Differential Microphone, Lip-Type Model 245** for applications where background noise elimination, free use of hands and high articulation are required.

**Electro-Voice Differential Carbon Microphone, Hand-Held Model 205-S**, an ideal microphone for aircraft, industrial, rail-road, police and emergency services.

**Electro-Voice Carbon Microphone, Model 210-S**, a single button microphone which embodies all of the latest developments required for military use.

**Electro-Voice Dynamic Microphone, Hand-Held Model 600-D**, designed for high fidelity speech pick-up in those locations where the ambient noise does not exceed 100 db.

**ELECTRO-VOICE CORPORATION**  
1239 South Bend Ave., South Bend 24, Ind., Dept. C-12  
Please send us your new "Electro-Voice Communications Microphones Catalog."  
NAME OF COMPANY \_\_\_\_\_  
ADDRESS \_\_\_\_\_ STATE \_\_\_\_\_  
CITY \_\_\_\_\_  
ATTENTION OF \_\_\_\_\_

**Electro-Voice MICROPHONES**

ELECTRO-VOICE CORPORATION • 1239 SOUTH BEND AVENUE • SOUTH BEND 24, INDIANA  
Branch Division: 19 East 80th Street, New York 17, N. Y. • U. S. A. • Cable: AVICOM

mount assistance to designers and users of precision testing equipment.

This paper has covered very generally the subject of the influence of molecular configuration on the electrical and physical properties of plastic materials particularly applicable to a rather specialized field, namely, high-frequency transmission lines. However, the same general considerations hold for all types of insulating materials and plastics, and the next few years are bound to be ones in which the basic theoretical concepts discussed here will receive a very thorough trial and a more adequate investigation.

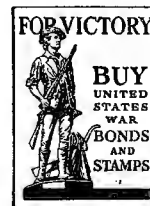



# AMPEREX



**WATER and  
AIR COOLED  
TRANSMITTING  
AND  
RECTIFYING TUBES**

**AMPEREX ELECTRONIC CORPORATION**  
79 WASHINGTON STREET • BROOKLYN 1, N. Y.

## G. E. 2,000,000 X-RAY

A 2,000,000-volt mobile x-ray unit has been developed in the research laboratory of G. E. at Schenectady. G. E. engineers state that the unit can x-ray foot-thick steel.

In radiographing an eight-inch steel casting the two million-volt outfit is said to be 78 times as fast as the million-volt.

William F. Westendorf and Dr. Ernest E. Charlton collaborated in the development of the machine.

## CARTER MULTI-GAUGE COMMUTATOR CHECK

To test the eccentricity of three or more commutators simultaneously to within .0001", a multi-gauge check has been developed by Carter Motor Company, 1608 Milwaukee Avenue, Chicago.

With this tolerance gauge, the armature is set into the jig and rotated. Indicating gauges applied to the commutators, read the deviation from true in thousands of an inch. The sections which do not meet specifications can then be trued-up. Since the armature is tested complete with bearings, a comprehensive check of the entire assembly is said to be possible.

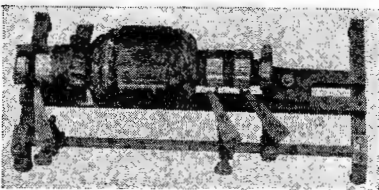

## G. E. HIGH-VOLTAGE D-C SUPPLY

High-voltage d-c power supply units, available in ratings up to 50,000 volts d-c, have been announced by G. E.

Each unit consists of a full-wave kenotron rectifier, a filter that is said to limit voltage ripple to 1% or less, and complete control equipment. The d-c output voltage can be controlled, from zero to maximum, with a motor-operated, dry-type, variable autotransformer.

Dust filters are also included. Portable units

# THE INDUSTRY OFFERS . . .

are also available; cabinet furnished on a four-wheel dolly truck.

A safety feature incorporated in the unit consists of an automatic solenoid-operated discharge switch.

## SPRAGUE HUMIDITY PROTECTION KOOLOHMS

Humidity protection is now included on all standard Sprague koolohm wire wound resistors.

This construction includes a glazed ceramic outer shell and a new type of end seal.

Type numbers of the resistors remain the

2



JAN. 14-31



Variable Attenuators • Mixers  
Potentiometers • Tap Switches  
Meter Shunts and Other  
Precision Resistance Devices

Engineering and Production of  
These Components Our Speciality

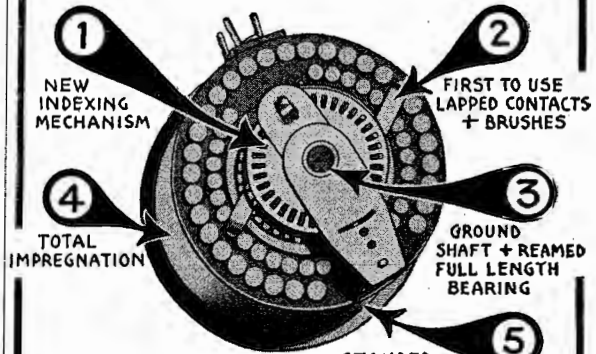

**5 MAJOR POINTS  
WIN FOR VARIATEN  
IN THE VARIABLE ATTENUATOR FIELD**

Point No. 2: Stone-lapped brush and contact surfaces insure long life and quiet operation. Final lapping operation is performed after soldering and impregnation, eliminating warpage due to heat.

## CINEMA ENGINEERING CO.

1508 W. VERDUGO AVE. • BURBANK, CALIF.

ESTABLISHED 1935

same except for the fact that the letter "T" has been added to the old designation.

## GREEN ELECTRIC MAGNETIC TESTING MOBILE RECTIFIER

A d-c rectifier with a fan-cooled selenium unit for magnetic particle inspection process that is said to reveal flaws in propeller shafts has been developed by W. Green Electric Company, 130 Cedar Street, New York 6, N. Y.

The unit is said to have a continuous capacity of 1500 amperes d-c, with proportionately higher rating for intermittent operation. The output voltage is adjustable in eight steps from one to six volts. Rectifier uses a three-phase, 440-volt, 25-cycle power supply.

## G. C. FOOT SWITCH

A flat foot test switch MF, for actuating one to eight circuits has been produced by General Control Company, 1200 Soldiers Field Road, Boston 34, Mass. The foot rest is 1/2" above the floor, and requires 1/16th" throw. This is said to allow the operator to support his whole foot nearly at floor level.

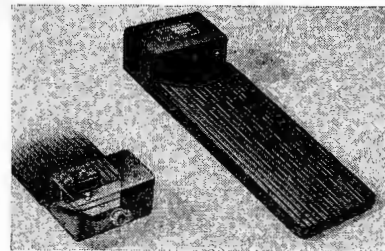

## C. E. P. HERMETIC TERMINALS

Hermetic terminals, fusite type, which are said to withstand a five-cycle thermal shock test and do not crack or fail at temperatures ranging from -50° C to +90° C have been announced by Cincinnati Electric Products Company, Carthage at Hannaford Avenue, Cincinnati 12, Ohio.

The terminals are also said to maintain insulation properties at approximately 2,500 volts.

Two standard types of terminals, one approxi-

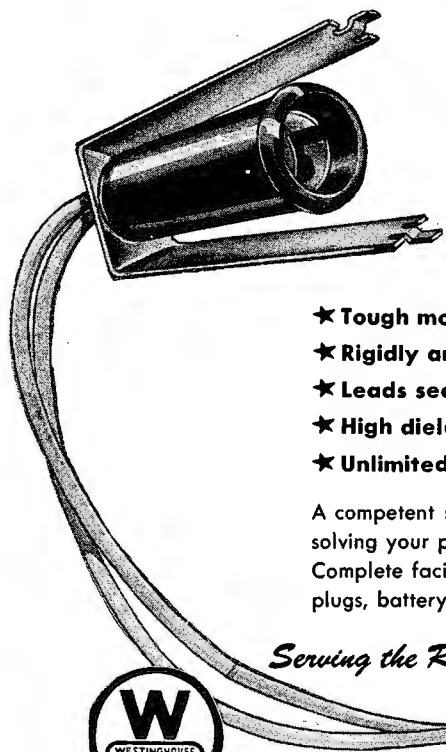

# DIALITE

*by Micarta*

- ★ Tough molded shell; high impact strength
- ★ Rigidly anchored to bracket to assure permanent position
- ★ Leads securely soldered, will not short inside shell
- ★ High dielectric strength
- ★ Unlimited mounting bracket possibilities for any requirement

A competent staff of engineers and designers is at your service to aid in solving your present and postwar problems and in developing new ideas. Complete facilities for the manufacture of terminal strips, coil forms, jack plugs, battery plug assemblies and resistor boards.

*Serving the Radio and Electronic Industry for Over 20 Years*



Fabricators of  
Laminated Material

## MICARTA FABRICATORS, INC.

5324 RAVENSWOOD AVENUE • CHICAGO 40, ILLINOIS • TELEPHONE LONGBEACH 9700

mately 1 1/4" in diameter, which has a capacity of from two to nine terminals, the other slightly under an inch in diameter, carrying from two to seven terminals, are made. Another feature of the terminals is said to be the complete interfusion of the glass and cold-rolled steel.



### ACME POWER TRANSFORMERS

Pressed steel end covers are used in an air-cooled transformer design announced by Acme Electric and Mfg. Co., Cuba, N. Y. Temperature rise is said to remain at 55° C. continuous. The pressed steel design covers all Acme air cooled transformers, auto and insulated types from 1 kva to 15 kva with primaries up to 2400 volts.

### STACKPOLE CARBON PILE RHEOSTATS

Continuously adjustable carbon rheostats formed on carbon disc piles, are now being made by Stackpole Carbon Company, St. Marys, Pa. By changing the pressure applied to these piles, different resistance values within their range is made available without opening the electrical circuits in which they are connected. The pressure to vary the resistance may be applied electrically, mechanically, centrifugally or hydraulically. Uses range from both generator and line voltage regulator applications to speed control through governed field current on motors.

Carbon piles are said to be supplied in practically any length pile and diameter required. Typically, a carbon disc pile 1 1/2" long

composed of discs .432" in diameter is said to permit a resistance range of from 60 ohms with 1 ounce pressure to .7 ohm at 32 pounds pressure.



### LANGEVIN SPEAKERS

A cast-aluminum loudspeaker, 26-8, designed to operate through high noise levels and with

uniform distribution over horizontal angles of 120° and vertical of 40°, has been announced by the Langevin Company, 37 W. 65th St., New York 23, N. Y. It can be used for voice reproduction by itself or as a high-frequency component to a wide-range system.

Said to handle power input of 40 watts when equipped with 2 Jenson U-20 drive units: 22" wide, 14 1/2" deep, 20" high.

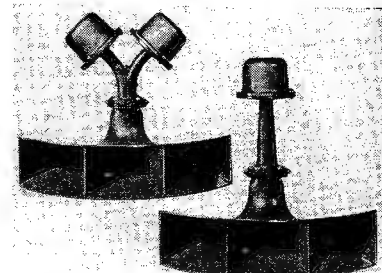

### AMCO PLASTIC CONDENSERS

A new assortment of plastic condensers have been announced by American Condenser Company, 4410 Ravenswood Ave., Chicago.

### DU MONT FERROGRAPH

Comparisons of ferrous materials as to analysis and heat-treatment are provided by the Ferrograph, a metal-testing instrument announced by Allen B. Du Mont Laboratories, Inc., Passaic, N. J. This instrument said to be available on outright sale, can be used to obtain information about iron and steel.

The Ferrograph utilizes the transformer principle of operation. A 23-cycle exciting current is fed into the primary coil while the output of the secondary is controlled by the magnetic characteristics of a metal sample introduced into the coil. The voltage from the secondary is filtered and the fundamental 23-cycle wave is impressed on the horizontal axis of the cathode-ray tube. The third harmonic is viewed on the vertical axis of the instrument.

The first and third harmonics will vary in phase and amplitude with variations in the

*(Continued on page 94)*

### Professional Services

Rates on Request

### ELECTRONIC DESIGN SERVICE

- Electronic Devices
- Transmitters
- Receivers

COMMUNICATIONS BOX DE  
19 E. 47th St., New York 17, N. Y.

WANTED — A Good Line of Equipment to Represent in Canada. Have 28 years of experience. Can sell, service, install any type of electrical communications equipment. 4 1/2 years active service Royal Canadian Air Force. Wholesale and retail connections. Full particulars, please. Urgent. C. FERGUSON, P. O. Box 544, Winnipeg, Canada.



# CRYSTALS

HOLLISTER  CRYSTAL CO.  
Boulder Colorado

QUARTZ OSCILLATORS SINCE 1927

SINCE 1922

## SUN RADIO

HAS BEEN  
*America's*

MOST COMPLETE

★ *Source of Supply* ★

for

**RADIO PARTS • TUBES**  
**INDUSTRIAL ELECTRONIC EQUIPMENT**  
**AMPLIFIERS and SOUND SYSTEMS**  
**BROADCAST and COMMUNICATIONS APPARATUS**  
**F/M—television—A/M**



**IMMEDIATE DELIVERY FROM STOCK**  
**ON OVER 10,000 ITEMS!**

Write on your company letterhead for FREE 800 page catalog

**SUN RADIO** 212 FULTON STREET  
**& ELECTRONICS CO.** NEW YORK 7, N. Y.  
Tel. BARclay 7-1840

## THE INDUSTRY OFFERS . . . —

(Continued from page 93)

analysis and heat-treatment of steel or iron. Sorting of commonly used SAE steels is quite practical although in some cases the difference obtained is very small and may not be sufficient for sorting production lots of parts. It is said that about 80% of the mixtures of two types of iron or steel that can occur, can be sorted by the Ferrograph.

Du Mont engineers say that the low-frequency exciting current has an advantage over the use of 60-cycle in that the reversals of magnetizing flux are slow enough to give some appreciable effect from residual magnetism. A long-persistence screen is used in the cathode-ray tube to avoid flicker from the low frequency used. A relay turns the cathode-ray beam off automatically unless there is a sample in the test coil. The flux in the test coil can be varied widely. It is possible to correlate with different variables by using different flux densities in the Ferrograph coil.

Calibrated scale provides ten divisions per inch, with the 10th division accentuated. Instrument operates on 115 volts, 40-60 cycles. Dimensions: 12½" w, 17¼" h, 23¾" d; weight, 100 pounds.



### AMP SOLDERLESS REPAIR KIT

An electrical wiring kit for general solderless wiring is now being manufactured by Aircraft-Marine Products, Inc., 1591F North Fourth Street, Harrisburg, Pa.

The kit comprises a 6-purpose installation tool which cuts and strips the wire, indicates stud sizes, and crimps terminals to the wire. Also included in the kit is an assortment of 100 AMP solderless terminals of the most commonly used types.



### G. E. PHOTOMETER

A transmission photometer for measuring the amount of light transmitted through very small areas of spectrographic plates, has been announced by G. E.

Requires a constant power supply of 6 volts, a-c or d-c, with an approximate capacity of 30 amperes. Consists essentially of a light source, an optical system, a galvanometer, a light-sensitive cell, and a mechanical stage for accommodating the plate. This stage, which has a three-point, ball-bearing suspension, is moveable in three directions.

When measuring the light transmitted through a plate, the latter is mounted on the mechanical stage and light from a 6-volt, 18-ampere projection lamp in the optical system



## R. F. CHOKES

Illustrated are standard stock chokes designed to cover a band of frequencies. Uniformly flat in response, Johnson R. F. chokes are equally effective over the entire range for which they were designed. Wire is enameled, silk covered, impregnated with low loss R. F. lacquer, and wound on steatite cores. Available in several current ratings.

Also available on special order are high current chokes for large transmitter applications. These special chokes are individually designed to operate on a specific frequency in such applications as tower lighting circuits and in power supply circuits. Send your specifications to Johnson for recommendations and quotations.

Ask for Catalog 968 (E)



E. F. Johnson Co. Waseca, Minn.

is collected by a condenser lens and focused on a wide-aperture lens, thus producing an image of the condenser lens on the plate. Magnified by an objective lens, this image is then cast upon a rectangular-shaped diaphragm located in front of the light-sensitive cell. The current output of the cell, which is the degree of light transmitted through the field of the plate, is shown on the galvanometer scale.

### BMP TUBE EXTRACTOR

For extraction of standard size metal tubes, the BMP Company, Boonton, N. J., have designed a metal tube extractor. Constructed of one-piece steel, plain, zinc or cadmium plated.

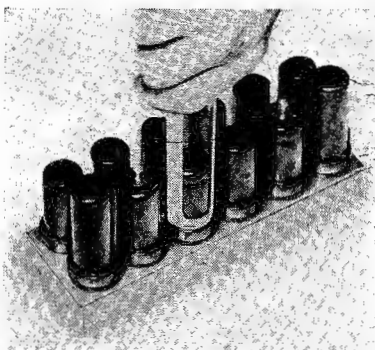

### TUBULAR PLYWOOD MASTS

A portable, telescopic, tubular plywood antenna mast has been announced by the Plymold Corporation, Lawrence, Mass. Heights up to 90' are available on order, with standard heights of 50', 55', and 75' carried in stock for immediate shipment. All masts are designed in sections not exceeding 12' in length. In shipment, these sections nest into one another forming one or two packages of small dimensions. Fittings, stays, and erection equipment are packed in a reusable case.

Masts are furnished with accessories so that they will be suitable for use either as an end

support for horizontal antennas, or as a complete support for u-h-f antennas. For horizontal antennas, masts have been designed and tested for a maximum antenna pull of 10,000 pounds.

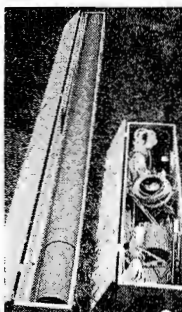

Left, mast and accessories packed for shipment. The 55' mast illustrated has a shipping weight of approximately 200 pounds. Below, method of erection. Mast is assembled horizontally on the ground and then raised by means of a boom and tackle.



### BETTS & BETTS CORROSEALD RELAYS

A midget type relay, hermetically sealed (corro-sealed) in a metal shell has been produced by Betts and Betts Corp., 551 W. 52d St., N. Y., 19, N. Y.

Units are normally sealed with content of pre-filtered dry air but can be furnished with inert gas or pressurized content when desired. Incorporates a standard octal plug base to facilitate testing. Unit is 1-11/16" long, 2 7/8" including prongs; weight 4 ounces.

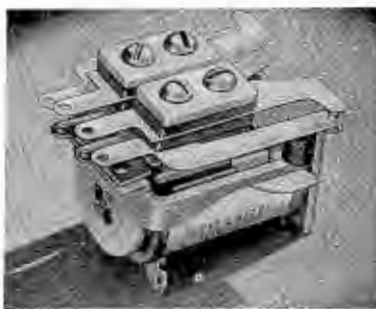

### STACK PLASTIC CLAMPS

Harness clamps of fabric-based phenolic are now being manufactured by Stack Plastics, 5835 West Washington Blvd., Culver City, California.

Clamps can be bolted or riveted directly to any bulkhead, wall or chassis.



### U. M. PORTABLE MICROPHONES

Type CU-1 and CU-2 microphones for mobile and marine and aircraft installations will be reissued early in 1945 by Universal Microphone Co., Inglewood, Cal.

Button impedance is 200 ohms and output approximately 30 volts rms across the microphone transformer secondary. Double-pole single-throw, press-to-talk switch connects microphone and relay circuits.

Motor noises, on mobile installations, are said

(Continued on page 96)

for **ACCURATE** yet **INSTANTANEOUS** READINGS . . .

Megohm Bridge



• In four models for various resistance ranges from 100,000 ohms to 100,000 megohms and with 250 or 500 v. D.C. bridge source voltage.

• Accurate to within 5% from 1 to 15 on scale, and as close as readable on remainder of scale.

• Operating entirely from A.C. power line. Self-contained D.C. supply for electron tube and bridge circuit. Unaffected by line-voltage fluctuations.

• Automatically charges condensers and high-voltage cables for rapid testing.

• Hardwood case. Slide-hinge removable cover. 8" l. x 7" h. x 5 3/4" d. 6 1/4 lbs.

• Type MB Megohm Bridge is a rapid, accurate instrument for routine insulation tests. Compact. Portable. Simple operation: non-laboratory workers can secure accurate, instantaneous results. Electron-ray null indicator replaces usual delicate galvanometer. Invaluable for testing electrical and electronic equipment insulation, leakage in cables and wiring, moisture content, etc. Typically an "Industrial Instrument."

• Write for bulletin . . .

	<b>Industrial</b>
	PLANT and OFFICES:
	17 POLLOCK AVENUE
	JERSEY CITY 5, N. J.
<b>Industrial Instruments</b>	





*Craftsmanship by*

# PAR-METAL

CABINETS

CHASSIS

PANELS

RACKS

When skill of a high degree becomes habitual, and shows up in the smallest detail — that's *Craftsmanship!*

Having specialized for many years, Par-Metal has this *habit of Craftsmanship* — expressed throughout the entire line, which ranges from small chassis to housings for huge transmitters.

To get a picture of what Par-Metal can do now (and the post-war possibilities) write for a copy of Catalogue No. 41-A.

PAR-METAL PRODUCTS CORPORATION

32-62—49th STREET, LONG ISLAND CITY, N. Y.

Export Dept.

100 Varick St., N. Y. C.

## Engineers & Draftsmen Wanted

*for Television and  
Automobile radio work*

Large, long-established Eastern manufacturer of electronic products requires a number of experienced engineers for the development and design of television and automobile radio sets. Applicants should give a detailed outline of their training experience and salary expectations. Applications and interviews (which may be granted in your locality) will be given the utmost confidence.

Hiring in accordance with WMC regulations. If you are looking to the future — this may be your opportunity to work with a reputable organization. Reply Box 132, Suite 617, 1457 Broadway, New York City.

## THE INDUSTRY OFFERS . . . —

(Continued from page 95)

to be damped out by anti-noise design. Both models are single buttons with plastic cases.

The CU-1 has a three-way plug, while the CU-2 has the PL-68 telephone type of plug.

Universal will also resume production soon with its KD and 15 mm's, both dynamic; 800 series, handi-type; 800 velocity series; and the X-1 and XX, both carbons, as postwar microphone releases.

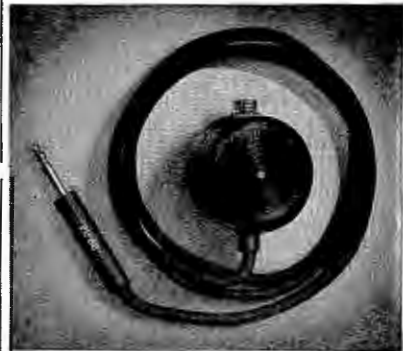

### VACUUM IMPREGNATION

Methods of impregnation of coils, armatures, transformers, etc., under pressure have been developed by Vacuum Impregnating Works, 638 Federal St., Chicago, Ill.

The methods are said to provide higher sustained voltages without overload, elimination of wear due to creeping of coils, prevention of insulation charring, etc.



### SLIDE-RULE DECIMAL POINT LOCATOR

A decimal point locator and slide rule that is said to determine the decimal point mechanically in involved expressions with results up to 19 places, has been announced by Pickett & Eckel, 53 W. Jackson Blvd., Chicago 4, Illinois.

Scale arrangements are said to afford 30-inch scale accuracy for cube root; 20-inch scale accuracy for square root; synchronized scales to permit result, square root, cube root, and log readings to be taken off the same one setting of the hairline.

An illustrated instruction manual has been written by M. L. Hartung, associate professor of the teaching of mathematics, The University of Chicago.

The decimal point locator and slide rule is 11" long, 2" wide,  $\frac{1}{8}$ " thick.

### G-M OVERLOAD CIRCUIT BREAKERS

Circuit breakers designed for the protection of either a-c or d-c circuits, that may be equipped with as many as three separate coil windings, providing a single unit for operation on different voltages has been announced by G-M Laboratories, 4300 N. Knox Avenue, Chicago, 41, Ill. They are said to have no appreciable time lag, and thus can be used with power vibrators or other electronic equipment where it is desired to open the circuit instantly when a predetermined overload occurs.

Respective windings may have a different number of turns and be of different size wire so proportioned that tripping may occur on overloads of three widely separated values from a fraction of an ampere up to 70 amperes. Each winding has an independent terminal connection so that the current value at which the circuit breaker operates is dependent upon the terminal to which the load is connected. For applications having only 1 tripping current value, single coil windings can be supplied.

The energy loss occurring in the series circuit is said to be low. Contacts are of  $\frac{1}{8}$ " diameter silver. Series coils are wound with heavy gage wire in relation to the normal current they carry. The double contacts are brazed to heavy silver plated copper bars. A guide prevents the contact assembly from shifting its position. These circuit breakers are usually factory adjusted to trip at twice the normal current value with a tolerance of plus or minus 25%. They

**IN New Jersey**

**IT'S WINCHARGER TOWERS**  
**FOR STATE POLICE RADIO AND F. M. SYSTEMS**

For their outstanding Radio Communication System, the New Jersey State Police use Wincharger Towers exclusively as supports for F.M. Antennas. They and hundreds of other stations in all types of broadcasting know that they depend on Wincharger for...

- ★ Strong, Clear Signals
- ★ Low Initial Cost
- ★ Pleasing Appearance
- ★ Low Maintenance

Immediate deliveries on suitable priorities. Write or wire for full information.

**BONDS FOR VICTORY**

**WINCHARGER**  
**ANTENNA TOWERS and VERTICAL RADIATORS**  
 WINCHARGER CORPORATION BLOOMINGTON, MISSISSIPPI

are not designed for operation on smaller overloads or on closer current tolerances.



**HICKOK MAGNETIC FLUXMETER**

A fluxmeter, 256, utilizing an electronic circuit so connected to an indicating meter that when the exploring inductor is placed in a magnetic field the indication of the meter will be in proportion to that field, has been developed by the Hickok Electrical Instrument Co., 10529 Dupont Avenue, Cleveland, Ohio. Model is designed to operate from 105-120 volts a-c, 50-cycle circuit.

Magnetic flux measurements can be compared within plus or minus 3%. Higher accuracy can be obtained by calibrating the instrument with a known gauss standard and using it shortly afterwards.

Has one sensitivity control, a four-position control, that serves the dual-purpose of turning the instrument off and selecting the three sensitivity positions. The balance control is used to pre-set the meter at zero.

Supplied with one standard exploring inductor that can be used to measure air gaps 1/2" or larger, or bar or disc type magnets.

Meter is a Hickok 4" rectangular size. Width, 9 1/2"; height, 10 1/2"; depth, 5"; net weight, 10 ounces.



**U-H-F POWER SUPPLY**

(Continued from page 62)

to conduct away or radiate the heat generated by losses in the klystron. It is therefore necessary to cool the rhumbatrons and for this purpose the manufacturer\* recommends an air stream of 50 cfm. This air stream must be directed past the tube in a way to effectively cool the klystron.

**Power Supply**

To prevent injury to certain parts of the apparatus it was necessary that

(Continued on page 99)

**FOR SPEEDY ACCURATE ALIGNMENT**

**Test Oscillator**

**SUPREME MODEL 571**

- Simple Operation— all ranges read on two basic scales.
- Dual Tuning Ratio. One for speed—one for vernier adjustments.
- Electron coupled circuit giving greatest stability. Iron core coils.
- Ladder Attenuator.
- Double shielding minimizes leakage.
- Golden Oak carrying case.

**SPECIFICATIONS**

**R.F. RANGES:**  
 65-205 KC.; 205-450 KC.;  
 450-2050 KC.; 2050-6500 KC.;  
 6.5-20.5 MC. Harmonics to  
 82 Megacycles.

**AUDIO FREQUENCY:**  
 400 cycles available for external testing.

**INTERNAL MODULATION:**  
 R.F. Carrier modulated at approximately 30% and 70% at 400 cycles. Modulation level selected by toggle switch.

**EXTERNAL MODULATION:**  
 Jack provided for external audio modulation.

**ACCURACY:**  
 1/2 of 1% on first three bands. 1% on last two bands.



**SIZE:**  
 9-1/2"x8-11/16"x7-3/8"

**POWER SUPPLY:**  
 115 volts 60 cycles—Special voltage and frequency on request.

**SUPREME**  
 SUPREME INSTRUMENTS CORP.  
 Greenwood, Miss., U. S. A.



## PERFORMANCE PERFECTIONISTS

Circuit engineers, by never-ending tests of Sylvania Radio Tubes, perfect their performance and compile data that leads to new electronic tube developments.



(Army-Navy E) Radio Division

# SYLVANIA

**ELECTRIC PRODUCTS INC.**  
EMPORIUM, PA.

Receiving Tubes Regular Style      Sylvania Lock-In Receiving Tube

## SENIOR ELECTRONIC ENGINEERS

Preferably graduates of communication engineering courses are required for designing receiving-type electronic equipment covering all frequency ranges, and other specialized electronic apparatus.

Design experience necessary, and knowledge of production is desirable. Excellent post-war opportunities. Salary open. Requirements urgent. Proof of citizenship and certificate of availability are necessary.

*Write giving detailed qualifications, and if satisfactory, interview will be arranged at our expense.*

### SUBMARINE SIGNAL CO.

175 State St., Dept. 420, Boston, Mass.

**Continuously Since 1930**

PRECISION GROUND

# Crystals

BY

# HIPOWER

AIRCRAFT MARINE • BROADCAST  
POLICE • COMMERCIAL • AMATEUR

## HIPOWER CRYSTAL COMPANY

Sales Division — 205 W. Wacker Drive, Chicago 6  
Factory — 2033 Charleston St., Chicago 47, Ill.

## "THE LAST WORD"

in **LOW LOSS INSULATION**

# MYCALEX

**1 MYCALEX 400**  
... highly perfected, approved by U. S. Army and Navy as L-4 insulation.

**2 MYCALEX K**  
... an advanced capacitor dielectric with a dielectric constant of 10 to 15.

**3 MOLDED MYCALEX**  
... available to specifications in irregular shapes and into which metal inserts may be incorporated.

*Write us about your high frequency insulating problems.*

### MYCALEX CORPORATION OF AMERICA

*"Owners of 'MYCALEX' Patents"*

Plant and General Offices  
CLIFTON, N. J.



Executive Offices  
30 ROCKEFELLER CENTER  
NEW YORK 20, N. Y.

NATION-WIDE MAIL ORDER DISTRIBUTORS SINCE 1928



## RADIO AND ELECTRONIC

DEVICES For Trade... Industry... Vocational  
... Communication... Public Utility and Experimental Applications

## BURSTEIN-APPLEBEE CO.

1012-14 McGee St.      Kansas City 6, Missouri



**CRYSTALS**

## CRYSTALS FOR THE CRITICAL

For years, The James Knights Company has specialized in quantity production of an exceptionally wide variety of Quartz Crystals. James Knights patents on precision cuts and improved mechanical processes are in general use throughout the crystal industry. We make samples nearly every day for some new customer so that he can design his equipment to fit a crystal that is now a standard of comparison. Why not let us help you?

**The JAMES KNIGHTS Co.**  
SANDWICH, ILLINOIS

**CRYSTALS**            **SINCE 1934**

**EXCLUSIVELY**

ORDERS SUBJECT TO PRIORITY

PETERSEN RADIO CO., Council Bluffs, Iowa

*Ted McElroy*

World's Largest Manufacturer of  
Wireless Telegraphic Apparatus

COMPLETE CENTRAL OFFICE EQUIPMENT

### McElroy Manufacturing Corp.

82 Brookline Avenue • Boston, Massachusetts

## Lister Electronic Products

CO.      CLEVELAND 3, OHIO

1814 E. 40TH ST.

*Development and Manufacture of*

TRANSMITTERS AND RECEIVERS, AM AND FM  
INDUCTION HEATING FURNACES  
ELECTRONIC GAUGING EQUIPMENT  
INDUSTRIAL ELECTRONIC EQUIPMENT

NATIONAL WAR FUND



FOR OUR OWN — FOR OUR ALLIES

(Continued from page 97)

the power be applied successively to different tubes or tube elements. The required delays were timed automatically and started by turning on the line switch. If the power line was momentarily disconnected, the klystron returned to normal operation with the minimum required delay by virtue of the thermal actuated delays used.

With the line switch thrown to the *on* position, voltage is applied to the large rectifier heaters, the klystron heater, the large regulator heaters (812's) and to the heaters of the 6SF5's. The time delay switch was set for a preheating period of 40 to 50 seconds. The 6SF5's do not require preheating but by preheating them the entire regulator works when the delay switch closes, thereby applying the accelerating voltage to the klystron at the instant the switch closes. Closing also applies the line voltage to the control grid supply in which the tubes are cold. The control grid voltage is applied later, dependent upon the tubes' warm-up time. The length of the second time delay is not critical providing there is a finite delay time. The second delay prevents the positive voltage being applied to the control grid before the accelerating voltage is applied. The high control grid current which would result might possibly burn out the control grid or cause the tube to become gaseous.

#### High Voltage Protection

The potential differences of some parts of the power supply are as high as 4,000 volts. Higher potentials would have been encountered in a power supply designed to deliver the full 3,000 volts to the klystron which is the rated maximum accelerating voltage. The insulation requirements for some components in such a supply would require specially designed or over-rated and bulky parts. However we found that a maximum accelerating voltage of about 1,800 volts did not reduce the overall flexibility for performing laboratory experiments, was sufficient for the klystron to deliver a reasonable amount of output power, and reduced the possibility of injury to the operator. For these reasons and because it was felt that standard parts should be used when possible, the lower voltage supply was thought preferable for this application.

To prevent injury by electric shock, due to a high potential, outside the case, all inputs were fused in both sides of the line and all transformer

\*Sperry Gyroscope Company.  
\*\*Brainerd, Khoeler, Reich, Woodruff, *Ultra High Frequency Techniques.*

cases and cores grounded to the chassis. Transformer  $T_{23}$ , connected across the line with the center tap, line side, was grounded to form a d-c path from both sides of the line to ground. The fusing was broken up in such a way that it also supplied the usual overload protection. To prevent a high voltage appearing on the signal input terminals, terminals *A* and *B'* were connected directly to ground.

For some applications it was found desirable that the terminals *C*, *C'* be balanced with respect to ground. To protect this circuit and to keep *C*, *C'* above ground, we made a high voltage trap of  $F_{10}'$  and  $R_{23}$  and  $F_{10}$  and  $R_{24}$ . If the input side of the transformer rises to more than 500 volts above ground, the fuses will blow, thus preventing the terminals from becoming hot.

For further protection the leads to the klystron were enclosed in an armored metal cable with the outside metal shield grounded. Packard cable or an equivalent must be used for the individual wires in the cables.

#### Voltage Regulation

Two voltage regulated d-c supplies are used to provide power for the klystron. The larger supply provides energy for the beam current, and the other supplies the control grid and collector anode voltages. Both supplies must be well regulated and must also be variable over a wide range of voltages.

The accelerating voltage is one of the primary determining factors in whether or not the tube will oscillate, and it also has a very appreciable effect on the frequency of the output. Thus for both operating and frequency stability the voltage must be very well regulated. The variation of frequency with accelerating voltage may be as high as 10-kc per volt for a klystron having a resonant frequency of about 3,000 mc. The greatest need foreseen for constant frequency, and therefore constant voltage, will be encountered when the tube is being frequency modulated. For an f-m bandwidth of 100 kc (100 kc for maximum signal modulation) a stability of 1 kc and an even smaller hum modulation are desirable and are provided by this power supply. The circuit used appears in the RCA tube manual; its operation is analyzed in several texts.\*\* The ripple voltage is about 0.01 volt peak. The power supply may be slightly simplified at the cost of increased maintenance by substituting a *B* battery as the reference voltage between the grid of 6SF5 and the negative side of the accelerating voltage supply.

[To be continued]

## TECHNICAL NOTES

Excerpts from New Home Study Lessons Being Prepared under the Direction of the CREI Director of Engineering Texts

## Circuit Equivalents

CREI has just published a new article on Circuit Equivalents. This particular section deals with another practical example of two circuits equivalent to one another. The example is that of the low frequency compensation for a video amplifier stage.

These articles on Circuit Equivalents are published in the CREI NEWS for the purpose of acquainting engineers with methods of analyzing and utilizing networks that occur in the communication art. It is hoped that this series of articles dealing with a subject that is not specifically covered in the ordinary text book will be of interest and value to all radio engineers. Further examples of equivalent circuits will appear in forthcoming issues of the CREI NEWS.

This publication is issued monthly by the Capital Radio Engineering Institute, and is free for the asking. Merely write and ask for the January issue of the CREI NEWS and your name will be placed on the mailing list to receive it regularly. In doing so you will incur no obligation whatsoever.

The subject of "Circuit Equivalents" is but one of many that are being constantly revised and added to CREI lessons by A. Preisman, Director of Engineering Texts, under the personal supervision of CREI President, E. H. Rietzke. CREI home study courses are of college calibre for the professional engineer and technician who recognizes CREI training as a proven program for personal advancement in the field of Radio-Electronics. Complete details of the home study courses sent on request . . . Ask for 36-page booklet.

## CAPITOL RADIO ENGINEERING INSTITUTE

E. H. RIETZKE, President

Home Study Courses in Practical Radio-Electronics Engineering for Professional Self-Improvement

Dept. CO-12, 3224-16th St., N.W.  
WASHINGTON 10, D. C.

Contractors to the U. S. Navy—U. S. Coast Guard—Canadian Broadcasting Corp.—Producers of Well-Trained Technical Radiomen for Industry



# AUDAX

RELAYED-FLUX

Microdyne

## The Importance of SPECIALIZATION

Aside from outstanding and long-acknowledged technical skill — our "Specialization Formula" — is probably as fully responsible for the world-renowned AUDAX quality as any other single factor.

We proudly concentrate all our energies and resources upon producing the BEST pick-ups and cutters. Because we are specialists in this field, much more is expected of us. Because the production of fine instruments like MICRODYNE is a full time job, it stands to reason that we could not afford to jeopardize our reputation—EVER—by making pick-ups a side-line.

After Victory, you may expect AUDAX improvements, refinements . . . master-touches to heighten the marvelous *fac simile* realism of AUDAX reproduction.

**AUDAX COMPANY**  
500-C Fifth Ave., New York 18, N. Y.

Creators of High Grade Electrical and Acoustical Apparatus Since 1915

Send for your copy of our informative "PICK-UP FACTS"

★ BUY WAR BONDS

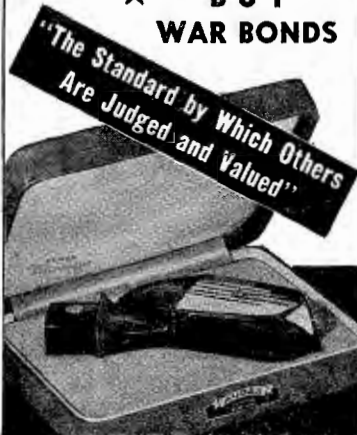

## ADVERTISERS IN THIS ISSUE

COMMUNICATIONS—DECEMBER, 1944\*

AEROVOX CORPORATION.....	12	HOLLISTER CRYSTAL CO.....	94
Agency: Austin C. Lescarboursa Staff		Agency: Meritt Owens Adv. Agency	
AIRCRAFT ACCESSORIES CORP.....	4, 5	THE HOPP PRESS, INC.....	78
Agency: Potts-Turnbull Adv. Co., Inc.		Agency: Gallard Adv. Agency	
ALLIED RADIO CORP.....	89	HOWARD MFG. CORP.....	66
Agency: Henry H. Teplitz, Advertising		Agency: Bozell & Jacobs	
ALTEC-LANSING CORP.....	54	HYTRON CORP.....	Inside Front Cover
Agency: Ervib, Wasay & Co. of the Pacific Coast		Agency: Henry A. Loudon—Advertising	
AMALGAMATED RADIO TELEVISION CORP.....	86	INDUSTRIAL INSTRUMENTS, INC.....	95
Agency: Shappe-Wilkes, Inc.		Agency: Austin C. Lescarboursa & Staff	
AMPREX ELECTRONIC CORP.....	92	INTERNATIONAL RESISTANCE CO.....	24
Agency: Shappe-Wilkes, Inc.		Agency: The Lavenson Bureau	
AMPERITE CO.....	66	JENSEN RADIO MFG. CO.....	49
Agency: H. J. Gold Co.		Agency: Burton Browne, Advertising	
ANDREW CO.....	90	E. F. JOHNSON CO.....	58, 63, 95
Agency: Burton Browne, Advertising		Agency: Davitt, Inc.	
THE ANSONIA ELECTRIC CO.....	14	HOWARD B. JONES	70
Agency: Albert Frank-Guenther Law, Inc.		Agency: Merrill Symonds, Advertising	
ARPIN MFG. CO.....	72	KENYON TRANSFORMER CO., INC.....	6
Agency: Gallard Adv. Agency		Agency: Jasper, Lynch & Fishel, Inc.	
THE ASTAC CORPORATION.....	82	THE JAMES KNIGHTS CO.....	98
Agency: Wearstler Advertising, Inc.		Agency: Turner Adv. Agency	
THE AUDAX CO.....	109	LENZ ELECTRIC MFG. CO.....	65
Agency: Hart Lehman, Advertising		Agency: Triangle Adv. Agency, Inc.	
AUDIO DEVELOPMENT CO.....	51	LISTER ELECTRONIC PRODUCTS CO.....	98
Agency: Turner Adv. Agency		McELROY MFG. CORP.....	98
BLILEY ELECTRIC CO.....	84	Agency: Shappe-Wilkes, Inc.	
Agency: Hardy Advertising		MAGUIRE INDUSTRIES, INC.....	70
THE W. W. BOES CO.....	22	Agency: Park City Adv. Agency, Inc.	
Agency: Kircher, Lytle, Helton & Collett		MEASUREMENTS CORPORATION.....	84
THE BRUSH DEVELOPMENT CO.....	10	Agency: Frederick Smith	
Agency: Gregory Adv. Agency		MERIT COIL & TRANSFORMER CORP.....	80
BURGESS BATTERY CO.....	67	Agency: Ross Llewellyn, Inc.	
Agency: Howard H. Monk & Associates		MICARTA FABRICATORS, INC.....	93
BURSTEIN-APPLEBEE CO.....	98	Agency: Sander Rodkin Adv. Agency	
Agency: Frank E. Whalen Adv. Co.		JAMES MILLEN MFG. CO., INC.....	72
CAMBRIDGE THERMIONIC CORP.....	80, 86, 90	MYCALEX CORPORATION OF AMERICA.....	98
Agency: Walter B. Snow & Staff		Agency: Rose-Martin, Inc.	
CANNON ELECTRIC DEVELOPMENT CO.....	50	NATIONAL COMPANY.....	69
Agency: Dana Jones Co.		Agency: Graydon Smith, Advertising	
CAPITOL RADIO ENGINEERING INSTITUTE.....	95	NATIONAL UNION RADIO CORPORATION.....	43
Agency: Henry J. Kamau, Advertising		Agency: Hutchins Adv. Co., Inc.	
CENTRALAB.....	63	OHMITE MFG. CO.....	44, 45
Agency: Gustav Marx Adv. Agency		Agency: Henry H. Teplitz, Advertising	
CINCINNATI ELECTRIC PRODUCTS CO.....	8, 9	PAR-METAL PRODUCTS CORP.....	96
Agency: Perry Brown, Inc.		Agency: H. J. Gold Co.	
CINEMA ENGINEERING CO.....	92	PERMOFLUX CORPORATION.....	87
Agency: John H. Riordan Co.		Agency: Turner Adv. Agency	
CLAROSTAT MFG. CO., INC.....	60	PETERSEN RADIO CO.....	98
Agency: Austin C. Lescarboursa & Staff		PREMAX PRODUCTS DIV. CHISHOLM-RYDER	
COLE STEEL EQUIPMENT CO.....	77	CO., INC.....	78
Agency: Ebnth & Kneuth		Agency: Norton Adv. Service	
CONCORD RADIO CORP.....	81	PRESTO RECORDING CORP.....	7
Agency: Shappe-Wilkes, Inc.		Agency: Fuller & Smith & Ross, Inc.	
CONSOLIDATED RADIO PRODUCTS CO.....	75	RADIO CORPORATION OF AMERICA.....	25
Agency: Burton Browne, Advertising		Agency: Kenyon & Eckhardt, Inc.	
CONTINENTAL DIAMOND FIBRE CO.....	72	RADIO RECEPTOR CO., INC.....	1
Agency: The Harry P. Bridge Co.		Agency: Shappe-Wilkes, Inc.	
CONTINENTAL ELECTRIC CO.....	74	RAYTHON MFG. CO.....	13
Agency: Duane Wansamaker, Advertising		Agency: Burton Browne, Advertising	
DIAL LIGHT COMPANY OF AMERICA, INC.....	88	REMLER CO., LTD.....	85
Agency: H. J. Gold Co.		Agency: Albert A. Drennan	
EASTERN ENGINEERING CO.....	76	SOLA ELECTRIC CO.....	19
Agency: Wilson & Haight, Inc.		Agency: Hardy Advertising	
HUGH H. EBY, INC.....	28	SPERRY GYROSCOPE CO., INC.....	17
Agency: Renne, Advertisers		Agency: Young & Rubicam	
EITEL-WOULLOUGH, INC.....	61	SPERTI, INC.....	71
Agency: L. C. Cole, Advertising		Agency: Stockton-West-Burkhardt, Inc.	
ELECTRO-VOICE MFG. CO., INC.....	91	SPRAGUE ELECTRIC CO.....	57
Agency: Shappe-Wilkes, Inc.		Agency: The Harry P. Bridge Co.	
FAIRCHILD CAMERA & INSTRUMENT CORP.....	55	STANDARD TRANSFORMER CORP.....	9
Agency: G. M. Basford Co.		Agency: Burnet-Kuhn Adv. Co.	
FEDERAL TELEPHONE & RADIO CORP.....	27	STANDARD WINDING CO.....	74
Agency: Marschalk & Pratt		Agency: Sternfeld-Godley, Inc.	
FEDERAL TELEPHONE & RADIO CORP.....	88	SUBMARINE SIGNAL CO.....	98
Agency: Commerce Agency, Inc.		Agency: The H. L. Moore Co.	
C. FERGUSON.....	93	SUN RADIO & ELECTRONICS CO.....	94
THE FORMICA INSULATION CO.....	29	Agency: Mitchell Adv. Agency	
Agency: The Chester C. Moreland Co.		SUPREME INSTRUMENTS CORP.....	97
GATES RADIO CO.....	18	Agency: O'Callaghan Adv. Agency, Inc.	
Agency: Henry J. Kaufman, Advertising		SYLVANIA ELECTRIC PRODUCTS, INC.....	98
GENERAL ELECTRIC.....	11	Agency: Arthur Kudner, Inc.	
Agency: G. M. Basford Co.		TECH LABORATORIES.....	79
GENERAL INSTRUMENT CORP.....	16	Agency: Lewis Adv. Agency	
Agency: H. W. Fairfax Agency, Inc.		THE TELEX PRODUCTS CO.....	73
GENERAL RADIO CO.....	Inside Back Cover	Agency: Ervib, Wasay & Co. of Minnesota	
GOTHARD MFG. CO.....	74	TERMINAL RADIO CORP.....	70
Agency: Merchandising Advertisers		Agency: Charles Brunelle	
GUARDIAN ELECTRIC.....	47	THOMAS & SKINNER STEEL PRODUCTS CO.....	76
Agency: Kennedy & Co.		Agency: The Caldwell-Baker Co.	
HALLICRAFTERS CO.....	37	U. S. TREASURY DEPT.....	30
Agency: Burton Browne, Advertising		UNITED ELECTRONICS CO.....	21
HAMMARLUND MFG. CO., INC.....	32	Agency: A. W. Lutz, Inc.	
Agency: Hooding & Arnold, Inc.		UNITED TRANSFORMER CO.....	31
HARVEY RADIO CO.....	70	Agency: Shappe-Wilkes, Inc.	
Agency: Shappe-Wilkes, Inc.		UNIVERSAL MICROPHONE CO.....	26
HARVEY RADIO LABORATORIES, INC.....	39	Agency: Ralph L. Power Agency	
Agency: Walter B. Snow & Staff		WESTERN ELECTRIC CO.....	76
HARVEY-WELLS ELECTRONICS, INC.....	3	Agency: Deutsch & Shea Adv. Agency, Inc.	
Agency: Franklin Adv. Service		WESTINGHOUSE ELECTRIC & MFG. CO., Back Cover	
THE HARWOOD CO.....	23	Agency: Fuller & Smith & Ross, Inc.	
Agency: John H. Riordan Co.		WILCOX ELECTRIC CO.....	15
HEWLETT-PACKARD CO.....	20	Agency: R. J. Totts-Galkins & Holden	
Agency: L. C. Cole, Advertising		WINCHARGER CORP.....	97
HIGGINS INDUSTRIES, INC.....	82	Agency: Critchfield & Co.	
HIPOWER CRYSTAL CO.....	98		
Agency: Turner Adv. Agency			

**NEW**  
**FREQUENCY**  
**METER**  
 and  
**MONITOR**

for **HIGH FREQUENCY**  
**SERVICES—1500 kc**  
 to **200 Mc**



For measuring and monitoring the carrier frequency of a-m transmitters, these two new G-R instruments offer many operating advantages over equipment formerly available.

With the Frequency Meter, readings are substantially independent of amplitude of modulation, input waveform and input voltage. Over very wide ranges, changes in any of these do not affect the meter indications. The instrument requires no direct connection to the transmitter . . . a foot or two of wire provides ample coupling. The indicating meter has six ranges with full-scale values of 200 cycles, 600 cycles, 2 kc, 6 kc, 20 kc and 60 kc.

One of the most useful features of the Frequency Monitor is its great sensitivity. It can be used to monitor mobile stations. The numerous operating conveniences include: a panel switch to select any one of four temperature-controlled quartz plates; a "stand-by" control to maintain operating temperature continuously with the tube circuits disconnected; positive indication of the direction of frequency deviation; panel terminals for the audio output and for the output of the crystal buffer stage for calibrating or adjusting transmitters or receivers.

You'll find that this combination of instruments is one of the best G-R has developed for high-frequency communications monitoring.

Because we are in full-time production of war orders, none of these instruments are available for shipment, and probably will not be until after the war. We ARE accepting reservation orders, however, and will fill them in rotation as soon as production starts.

**FREQUENCY METER**

**RANGE:** 0 to 60,000 cycles in six ranges  
**ACCURACY:**  $\pm 2\%$  of full scale  
**INPUT VOLTAGE:** Any between 0.25 and 150 volts  
**MOUNTING:** Relay-rack panel; walnut end-frames (illustrated) for table mounting, extra

**TYPE 1176-A FREQUENCY METER**  
 \$185.00

**FREQUENCY MONITOR**

**CARRIER RANGE:** 1500 kc to 200 Mc  
**ACCURACY:** 0.003% with our quartz plates  
**QUARTZ PLATES:** Up to four, not included in price; ground to channel frequency  
**MOUNTING:** Same as Frequency Meter

**TYPE 1175-A FREQUENCY MONITOR** . . . . . \$250.00

**GENERAL RADIO COMPANY**

**CAMBRIDGE 39, MASSACHUSETTS**  
 New York 6  
 Chicago 5  
 Los Angeles 38





**CONSIDER**

*Simplicity of Control*

**WHEN YOU SELECT A NEW TRANSMITTER**

Easy to put on the air, easy to keep on the air . . . that's what you want in a transmitter, and that's what Westinghouse equipment assures.

Specifically, here are some of the features that make for operating simplicity in Westinghouse Transmitters:

1. One Master Control puts the transmitter on the air and cuts the power off at the end of the broadcast period. It is impossible for power to be applied in the wrong sequence.
2. Individual Tuning and Adjustment Controls are mounted on the front panel, easily accessible.
3. Indicator Lights Flash Circuit Conditions to Operator, indicating instantly which circuit requires attention.
4. Simplified Circuits—require a minimum of tubes . . . no tricky wiring.

5. "De-ion" Breakers Show Outage Location, providing fuseless protection for the low-voltage power circuits.

Simplicity of Control is only one feature of Westinghouse Transmitters. Others equally important are: *Low Operating Cost, Continuity of Operation, High Fidelity Signals, Ease of Maintenance.*

**PLACE YOUR ORDER NOW  
FOR YOUR POSTWAR TRANSMITTER**

By placing your order today for a Westinghouse transmitter, you assure yourself of the fastest possible delivery following the lifting of wartime manufacturing restrictions. We are scheduling deliveries in the sequence in which orders are received. For details, write Westinghouse Electric & Mfg. Company, Dept. 1NB, P. O. Box 868, Pittsburgh 30, Pa.

J-08080

**Westinghouse RADIO DIVISION**  
PLANTS IN 25 CITIES . . . OFFICES EVERYWHERE



**A M • E L E C T R O N I C S • F M**