

COMMUNICATIONS

- ★ RADIO ENGINEERING
- ★ MEASUREMENT DESIGNS
- ★ MICROPHONE DEVELOPMENTS
- ★ PACK COMMUNICATIONS
- ★ TUBE APPLICATIONS
- ★ AIRCRAFT COMMUNICATIONS
- ★ TELEVISION ENGINEERING

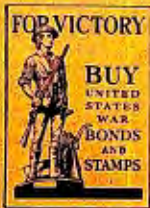

JANUARY
1943

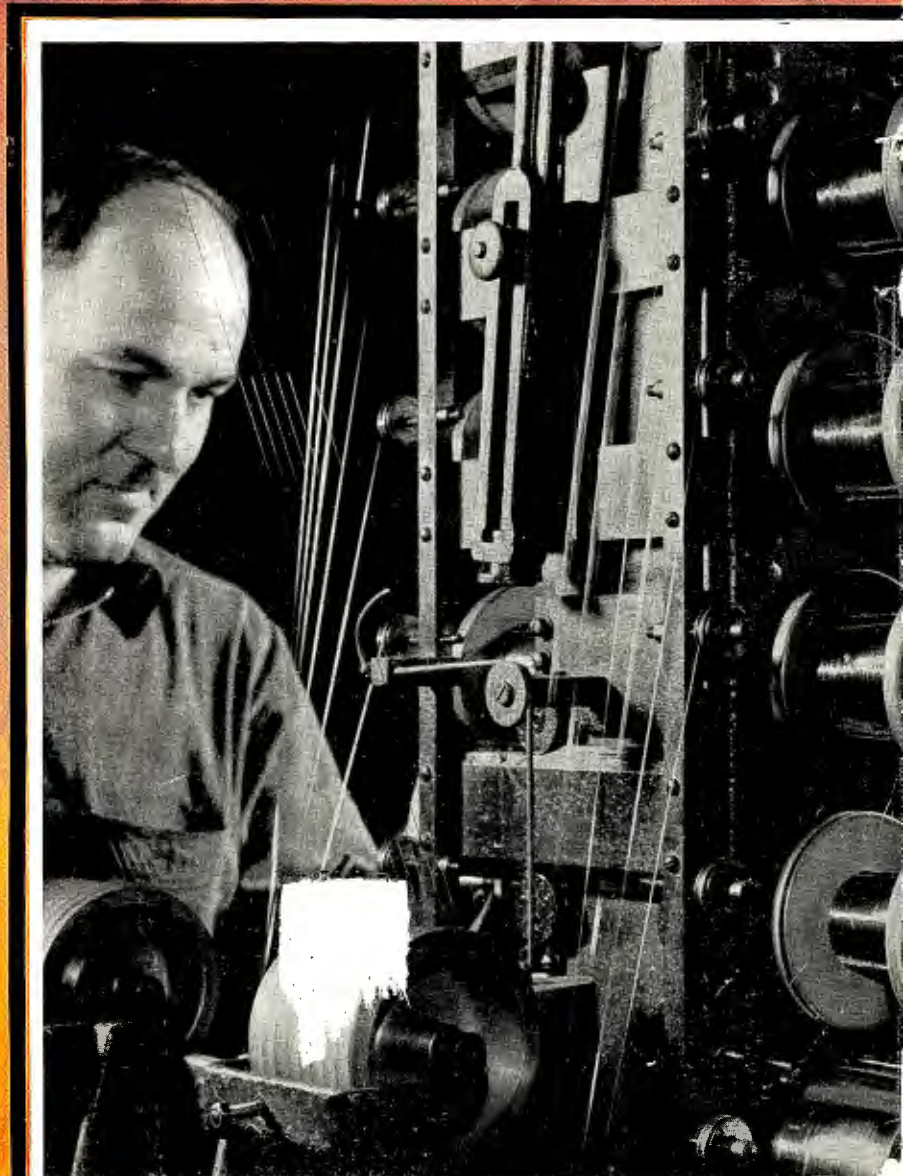

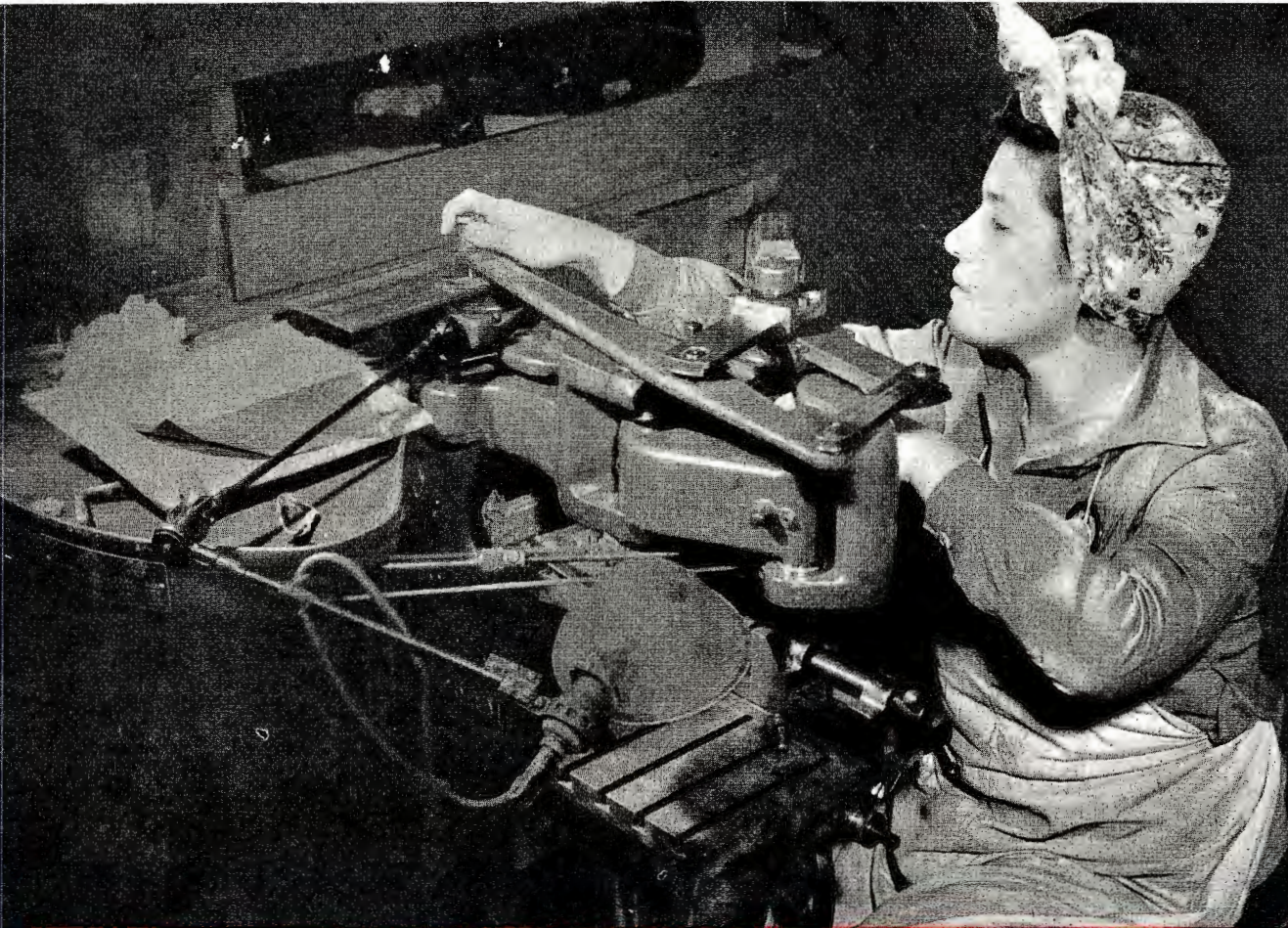

*To Build the Machines
to Build the Tools
to Beat the Axis*

U.S. Navy Official Photo



Tubes for INDUSTRIAL electronic devices that help to increase production are regarded as no less important than the use of such tubes in some military communications needs. Consequently, they are available to manufacturers of essential INDUSTRIAL electronic equipment.

AMPEREX power and rectifier tubes are incorporated in many of these new machines that make the tools . . . and forge the weapons . . . to defeat the Axis.

If you have a problem in which electronic tubes are required for machines that will help to speed war production, consult our engineering department.

AMPEREX ELECTRONIC PRODUCTS
79 WASHINGTON STREET • BROOKLYN, NEW YORK

2333 FOR 1918

2333 for the 325 employees and the 2008 products of the American Radio Hardware Co. 1918 for the new symbol of Victory...fateful date reminding the enemy of what was and what is to be.

Partner in the pattern for Victory are American Radio Multi-Contact Plugs and Sockets of which only a few are illustrated. The total line covers almost every known type of plug and socket... and if the need arises for special jobs, our flexibility in manufacture and experience permits us to produce practically overnight. These plugs and socket board assemblies are characterized by their ability to withstand tough punishment over the entire range of the thermometer... from extreme heat to extreme cold. Write for further information.

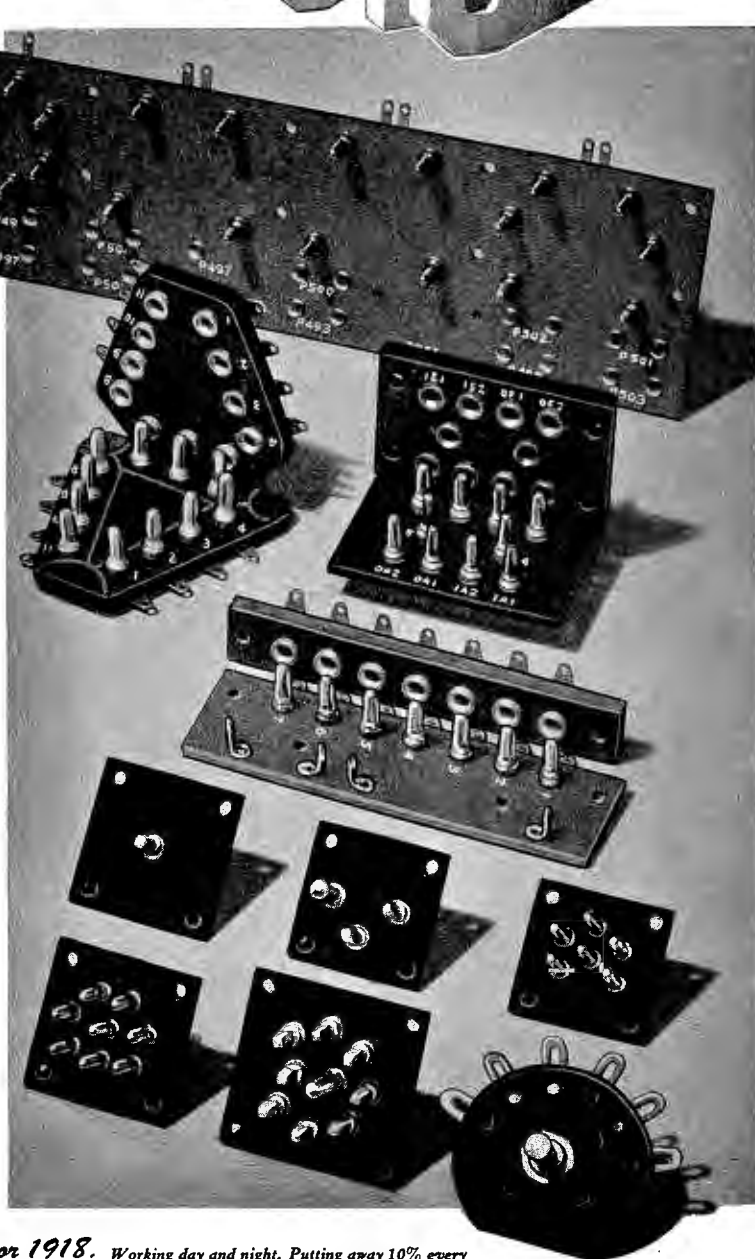

2333 for 1918. Working day and night. Putting away 10% every week for War Bonds and Stamps. Being good citizens by buying only the things we need. Welcoming rationing. Discouraging hoarding of any kind. Participating in civilian defense activities.



American Radio Hardware Co., Inc.

476 BROADWAY, NEW YORK, N. Y.

MANUFACTURERS OF SHORT WAVE • TELEVISION • RADIO • SOUND EQUIPMENT

We See...

ALTHOUGH DURING THE PAST YEAR, the *Communications* industry was besieged by hordes of barbed-wire war problems, typical American resourcefulness routed most of them. With shorts of curtailment orders, materiel shortages and manpower difficulties to contend with, the loss of time-on-the air and manpower hours, was amazingly low. Now, with the recent improvements in materiel production and priority grants, an even more outstanding exhibit of proficiency will result!

INTEREST IN THAT "1,000 Cycle Alarm Receiver" paper by C. H. Topmiller of WCKY (December, *COMMUNICATIONS*), has been keen. NAB, in their official bulletin of January 8, expounded the value of the Topmiller contribution. In addition, they sent reprints to all member stations. We are indeed proud to have been able to publish such an outstanding paper!

TO PUT EVERY USEABLE MOTOR in the country to work producing war materials, the WPB is now appealing to manufacturers who have idle motors to make them, available for sale. Motors, that have been left idle and forgotten about, motors that are being hoarded . . . all these are needed. Those who want new motors will have to declare what all motors are doing. If any idle motors are reported or if there are indications that there are idle motors, permission to buy a new one will not be granted. So, check up now, and keep those motors on the job!

BACK TO HIS DESK in Chicago has gone James S. Knowlson. After 15 months with the WPB, first as deputy director of priorities and later as director of industry operations, Mr. Knowlson has returned to his post as president of Stewart-Warner. Both industry and the WPB regretted his leaving his Washington post for his work was incomparable. Fortunately, he will still serve as a consultant to Donald Nelson. Thus, industry will still have the benefit of his wisdom.—L. W.



JANUARY, 1943

VOLUME 23 NUMBER 1

COVER ILLUSTRATION

Enameled-wire production under the supervision of a veteran wiremaker. (Courtesy, Westinghouse)

MEASUREMENT DESIGN AND APPLICATION

Accuracy Considerations in Standard Signal Generators... J. B. Minter 7

MICROPHONE DEVELOPMENT

Application of The Throat Microphone..... Jay Shawn 11

PACK COMMUNICATIONS SYSTEMS

Pack Communication Equipment for Fire Fighting (Part II)
 Art H. Meyerson 14

VACUUM TUBES

Water-Cooled Transmitting Tubes.. F. C. Dewalt and W. J. Walker 20

TELEVISION ENGINEERING

High Frequency Response of Video Amplifiers (Part II)
 Albert Preisman 29

AIRCRAFT COMMUNICATIONS

An Analysis of the Bellini-Tosi Direction Finder... Harvey Pollack 33
 Control Systems in Aircraft Communications.... Charles W. McKee 52

BIOGRAPHY

Nikola Tesla 36

GENERAL DEVELOPMENT PROGRESS

Developments of 1942..... Guy Bartlett 51

CIRCUIT ANALYSES

Nomogram for the Inductance of a Circular Ring.. T. S. E. Thomas 55

MONTHLY FEATURES

Editorial (We See)..... Lewis Winner 2
 News Briefs of the Month..... 35
 Veteran Wireless Operators' Association News..... 36
 The Industry Offers..... 42
 Book Talk 48
 Advertising Index..... 60

Published Monthly by the Bryan Davis Publishing Co., Inc.

BRYAN S. DAVIS, President

PAUL S. WEIL, General Manager

F. WALEN, Secretary

A. GOEBEL, Circulation Manager

Advertising and Editorial offices, 19 East 47th Street, New York City. Telephone PLaza 3-0483. Wellington, New Zealand, Te Aro Book Depot. Melbourne, Australia, McGill's Agency. Entire Contents Copyright 1943, Bryan Davis Publishing Co., Inc. Entered as second-class matter October 1, 1937, at the Post Office at New York, N. Y., under the act of March 3, 1879. Yearly subscription rate: \$2.00 in the United States and Canada; \$3.00 in foreign countries. Single copies, twenty-five cents in United States and Canada; thirty-five cents in foreign countries.

FROM SIGNAL LIGHTS TO SIGNAL CORPS

RELAYS BY GUARDIAN

★ Where formerly "Relays by Guardian" were used in such peacetime applications as signal lights . . . all "Relays by Guardian" have now gone to war. For example, the BK-10 relay handles two-way radio communication in several types of "Walkie Talkie" units.

It facilitates switching over from "send" to "receive." Built for operation at 12 volts, the BK-10 relay makes and breaks contacts firmly when the potential is reduced to 9 volts. Contact combination is made up of two stacks, one being single pole, double throw—the other 1 make, 1 break. Contact points are highly tarnish resistant sixteenth-inch palladium. The compact, light weight BK-10 relay weighs four ounces and measures $3\frac{1}{8}$ " x $1\frac{1}{2}$ " x $1\frac{3}{8}$ ". It is built to U. S. Army Signal Corps specifications.

Planning for today or post-war? Send for Bulletin 195 describing this and other "Relays by Guardian" used in aircraft, ground and mobile communications.

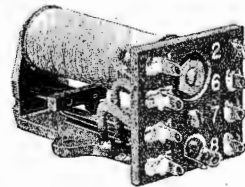

Series BK-10 Relay

GUARDIAN ELECTRIC

1623 WEST WALNUT STREET

CHICAGO, ILLINOIS

A COMPLETE LINE OF RELAYS SERVING AMERICAN WAR INDUSTRY

FOR VICTORY TODAY AND SOUND BUSINESS TOMORROW

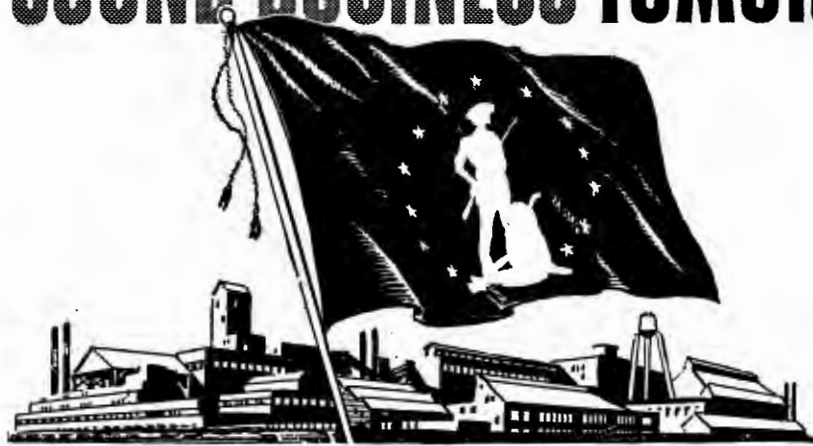

Get This Flag Flying Now!

This War Savings Flag which flies today over companies, large and small, all across the land means *business*. It means, first, that 10% of the company's gross pay roll is being invested in War Bonds by the workers voluntarily.

It also means that the employees of all these companies are doing their part for Victory . . . by helping to buy the guns, tanks, and planes that America and her allies *must* have to win.

It means that billions of dollars are being diverted from "bidding" for the constantly shrinking stock of goods available, thus putting a brake on inflation. And it means that billions of dollars will be held in readiness for post-war readjustment.

Think what 10% of the national income, saved in War Bonds now, month after month, can buy when the war ends!

For Victory today . . . and prosperity *tomorrow*, keep the War Bond Pay-roll Savings Plan rolling in *your* firm. Get that flag flying now! Your State War Savings Staff Administrator will gladly explain how you may do so.

If your firm has not already installed the Pay-roll Savings Plan, *now is the time to do so*. For full details, plus samples of result-getting literature and promotional helps, write or wire: War Savings Staff, Section F, Treasury Department, 709 Twelfth Street NW., Washington, D. C.



Save With

War Savings Bonds

This Space Is a Contribution to America's All-Out War Program by

COMMUNICATIONS



Wheezes, Wows, Squeaks, Noises,

are out because there are

NO GREMLINS

in GOULD-MOODY'S sensational

"Black Seal" GLASS BASE

Instantaneous

RECORDING BLANKS

Gremlins are those pesky little pixies who annoy pilots of the RAF and the U. S. Air Force. They're also present in many recording blanks, causing wows and rumbles, squeaks and noises. But, there are no Gremlins in "Black Seal" Glass Base Instantaneous Recording Blanks. They're the talk of the industry...giving a wide frequency range, true and beautiful reproductive qualities, and absolute freedom from noises—you hear only the performance itself! Try these Gremlin-free "Black Seal" blanks at our expense—if they don't come up to your expectations, send them back and we'll stand the entire tariff.

Old Aluminum Blanks Recoated with the "Black Seal" Formula in 24 fast hours.

Ship and Protect your Records with the new Gould-Moody PacKARTON lightweight, corrugated container. Saves time, saves records and reduces shipping costs.*

THERE ARE HUMAN GREMLINS, TOO!

They're well-meaning, but kind of careless, people who buy things they don't need, who spread rumors, who throw away scrap and rags, who waste fuel, who drive their cars too fast, who aim to but don't invest in War Bonds.

Help win the war, help spread the word

— DON'T BE A GREMLIN!



IMMEDIATE DELIVERY! Styli and shipping cartons supplied at cost.

*Reg. U. S. Pat. Off.

the **GOULD-MOODY** *company*

RECORDING BLANK DIVISION

395 BROADWAY

NEW YORK, N. Y.

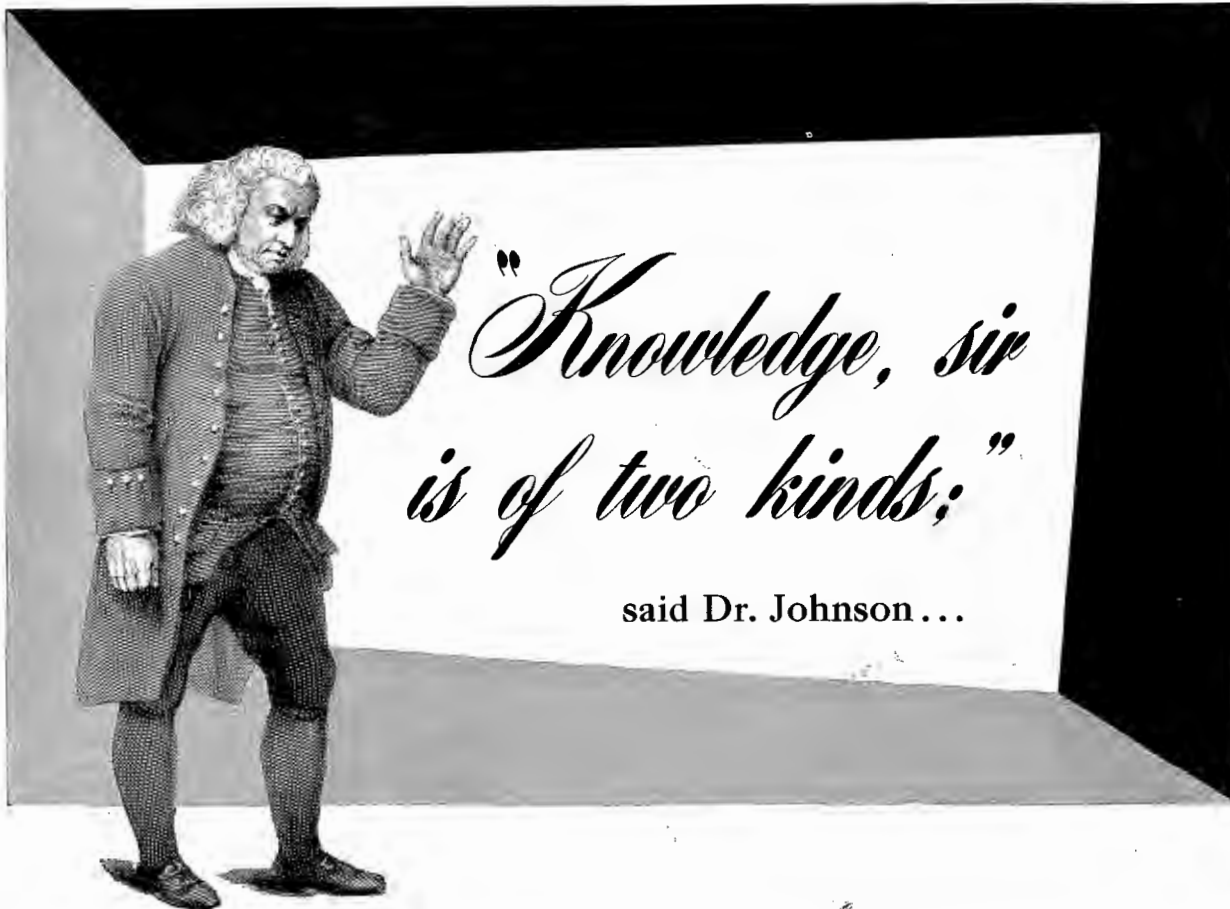

*"Knowledge, sir
is of two kinds:"*

said Dr. Johnson...

**"We Know a Subject Ourselves or
We Know Where We Can Find Information About It"**

Wise old Samuel Johnson was not, we suspect, talking about the electronics industries . . . But his statement, like most basic truths, applies directly to the increasing search for knowledge among executives and engineers in this field.

Here at IRC you will find a Service and Information Center staffed by electronic engineers of outstanding ability.

Their work has two main purposes:— to design, perfect and maintain the quality of IRC Resistors; to cooperate with you on Resistor applications of every nature. Their counsel is scientifically sound and scientifically impartial whether they recommend IRC units or some other make.

If there is a Resistor problem puzzling you, you can "find information about it" here.

Preferred for Performance **IRC** *Fixed & Variable Resistors*

INTERNATIONAL RESISTANCE COMPANY

415 N. BROAD STREET • PHILADELPHIA

Accuracy Considerations In STANDARD SIGNAL GENERATORS

by J. B. MINTER

Chief Engineer, Measurements Corporation

SINCE standard signal generators are primarily standards of r-f voltage, their output-voltage accuracy is therefore of foremost importance. From the chart in Figure 1 it is apparent that several factors contribute to output accuracy.

If the audio output from the receiver under test is to be measured, this being the usual case, it is necessary to consider the accuracy of per cent modulation calibration of the signal generator, as well as the carrier level. This is done by first measuring the output at a relatively high level (approximately 1 volt) with a diode voltmeter; then the signal is reduced by fixed steps to the desired level. In addition to the errors which may be present in the high level calibration and fixed steps, there is also the possibility of error due to neglect of the output impedance. The ideal voltage source would, of course, have zero impedance, but in order to minimize the power output requirements and permit supplying a maximum of several volts output, it is necessary to use output impedances of the order of 30 ohms.

Measurement of Modulation Percentage

Perhaps the most accurate method for measuring 100% modulation employs a reverse connected diode which rectifies all negative modulation peaks over 100%. This system makes use of the difference of two large quantities, namely the d-c plate voltage and the peaks of the modulating voltage as per Figure 2. Some systems in use on commercial signal generators use two meters, one of which reads the d-c plate voltage and the other the applied a-c modulation voltage. The system is calibrated at 100% and proportionate parts are tapped down on a divider network for lower percentages of modulation. This particular system involves the combination of two meter errors, as well as assuming that the modulation characteristic is linear.

Non-Linearity Errors

Modulation characteristics are far

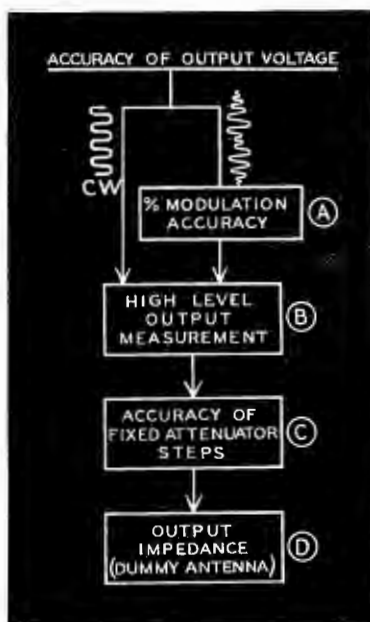

Figures 1 (left) and 2 (bottom)

In Figure 1 (A), dependent on method of calibration and measurement, we may have errors due to non-linearity, or IR drop in modulation choke. Percentage of accuracy is plus or minus 2 parts out of 30 at 30% modulation—plus or minus 5 parts out of 95 at 95% modulation. At (B), output is 1 volt at plus or minus 4%. Dependent on methods of measurement and calibration, errors may be due to carrier harmonic content and presence of modulation because of (a) asymmetry and (b) output VTVM limitations in linearity. At (C), accuracy is plus or minus 5%; total cumulative is plus or minus 10%. Overall accuracy—cw, plus or minus 15% maximum; and modulation, plus or minus 20% maximum.

Figure 2 illustrates an accurate 100% or over-modulation indicator.

from being linear. This is evident from the curve family of Figure 3. In the shaded area appears the linearity characteristics for all carrier ranges from 75 to 30,000 kc of a laboratory type signal generator.* It will be noted that the greatest departure from linearity occurs at the higher percentages of modulation. If the modulation is limited to 30%, only slight deviations from a straight line are evident. In this instrument the modulation measuring system shown in Figure 4 has been used with good accuracy. The modulation meter is calibrated at 30% initially by measurement of the actual modulation envelope on a cathode-ray oscilloscope

*Type 65-B.

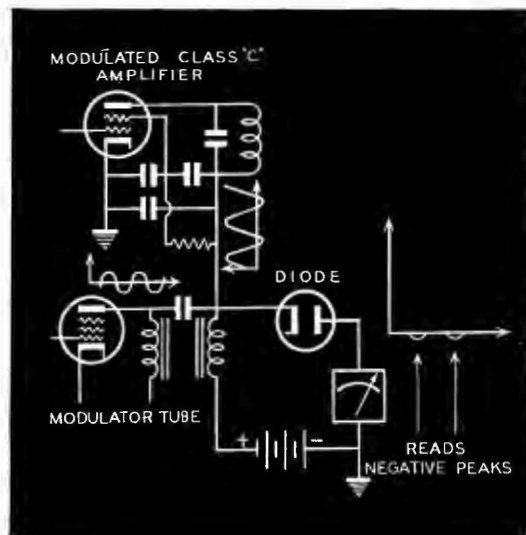

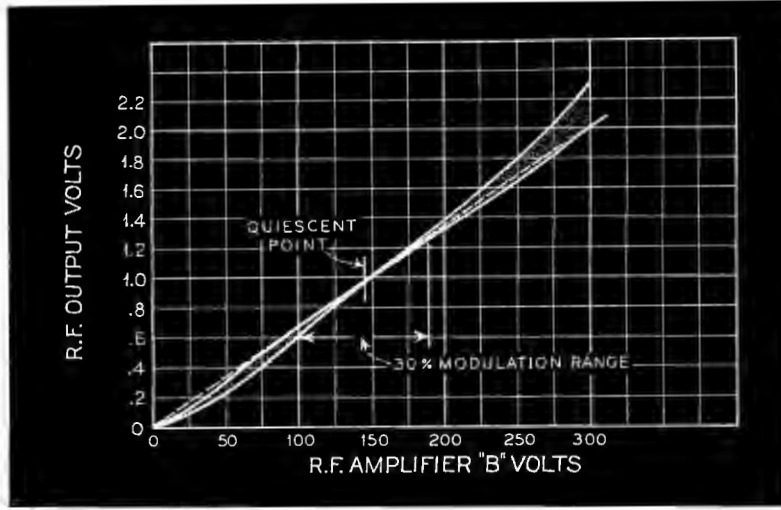

Figure 3
The r-f amplifier modulation linearity characteristics of the 65-B. The shaded area contains curves of all carrier frequency bands for a normal production model.

using a tuned circuit to step up the 2 volts to 100 volts directly on the plates of the 'scope as shown schematically in Figure 5. This initial calibration is much more easily done at 100% modulation where the oscilloscope pattern can be more easily checked, *but* because of the non-linearity of the modulation characteristic, the measured modulation at $.3 \times$ (the a-c necessary for 100% modulation) may be as high as 35% or as low as 25%, thus creating a serious error in modulation measurement. The modulation meter in this generator has a slightly distorted scale to better fit the average modulation characteristic; however, the accuracy of modulation indication is greater at 30% (where it is most used anyway), since it is correctly adjusted at this point.

Plate Voltage Errors

In some signal generators there is a considerable d-c drop in the modulation choke and r-f filter chokes which reduces the actual applied d-c voltage to the plate and screen of the r-f amplifier tube. Since the plate and screen current of the r-f amplifier vary somewhat over the tuning range and from one range to the other, more or less d-c drop occurs in the choke, depending on what carrier frequency and which end of the tuning range is being used. This variable drop causes an additional error in measuring the percent modulation and is especially noticeable when comparing the modulated outputs from the same signal generator in the overlap frequency region of two tuning ranges. This variation can be reduced to less than 3 volts out of 150 by minimizing the resistance introduced in the modulation choke and r-f filters. The use of ordinary components would introduce a variation of 12 or more volts or an error of 8% instead of 2%.

Harmonic Distortion

It is interesting to note that the audio harmonic distortion of the modulated carrier envelope is less than 1% at 30% modulation and rises slowly to 3 or 4%

distortion at 100% modulation except at very high frequencies, where the distortion at 100% may be as high as 7%. In general the distortion up to 90% is less than 2 or 3%. The use of some overall negative feedback would reduce this modulation distortion, but it is difficult to maintain stable operation over the wide carrier frequency range from 75 to 30,000 kilocycles when using enough overall feedback to afford appreciable improvement.

"Side-band cutting" limits the upper modulation frequency, because a single tuned circuit is employed in the final tank. At 1 megacycle this effect can be disregarded for modulation frequencies up to 5 kilocycles. As the frequency is decreased, and as the L/C ratio varies over the tuning range, attention must be paid to the limitations imposed by this tuned circuit. If measurements are confined to modulation frequencies of less than 1 kilocycle, no difficulty should be experienced down to the lower carrier limit of 75 kilocycles. As the carrier frequency is increased above 1 or 2 megacycles, the upper limit in modulation frequency is determined by the characteristics of the r-f filters in the modulated B+ lead entering the r-f generating compartment. These filters cut off at approximately 20 kilocycles.

Effects of Incidental F-M

The frequency modulation can be made less than .01% for 30% amplitude modulation. This is due to the modulated class "C" amplifier that affords considerable isolation from the oscillator circuit. In addition some neutralization can be employed to further reduce the residual frequency modulation to a negligible value. Therefore, if the bandwidth receiver under test is not comparable to .01%, very little error will be present because of the frequency modulation. If appreciable f-m is present, as is common in modulated oscillator types of signal generators, the apparent selectivity curve taken on a very selective set at higher

carrier frequencies will not be symmetrical with respect to mid-band frequency. We have this asymmetry because of the vector addition of the amplitude modulation with the frequency modulation on the two sides of the receiver selectivity curve which have opposite slopes; that is, positive and negative slopes (Figure 6). The exact location of the vector component M_{fm} of a-m, resulting from the f-m of the signal generator is only an approximately linear function of frequency swing for very small deviations.

The vector M_{fm} is a complicated function. It can only be said in general, therefore, that on the low frequency side of resonance the vector addition will always result in somewhat greater audio output, depending upon how steep the slope happens to be. Conversely, on the upper side of resonance the vector addition will always result in somewhat less audio output. The foregoing statements are based on the assumption that an increase in amplitude of the carrier produces an increase in frequency.

It has been general practice in the past to take selectivity curves on extremely sharp filters—such as crystal filters—without the use of any modulation, for all commercial signal generators with which the writer has had personal contact, have some degree of

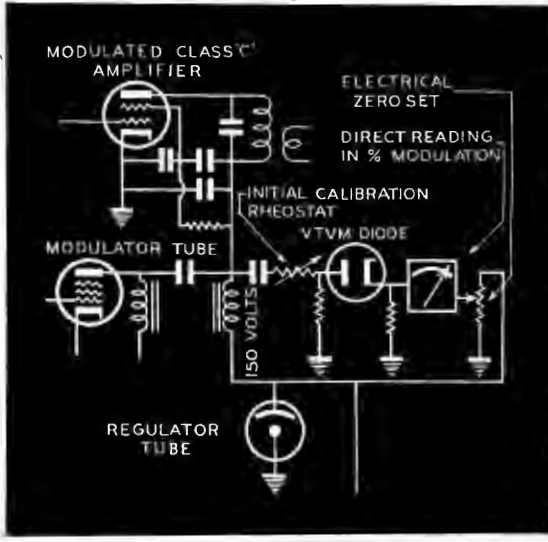

Figure 4
Modulation metering system used in the 65-B. The meter has a slightly distorted scale to better fit the modulation characteristic.

frequency modulation along with their amplitude modulation. In order to eliminate the need for modulation, it is merely necessary to insert some sort of carrier indicator, such as a microammeter in the diode leak, etc. In order to increase the usefulness of this arrangement, it is advisable to remove all avc from the receiver. In general, greater accuracy of measurement will always result if the carrier level can be read instead of the demodulated output. This statement holds true regardless of what type of signal generator is being used, since there is always some error present in the measurement of modulation. Chief objection to measuring the carrier is the necessity for opening up the receiver to insert a carrier level indicator and destroy the avc. Another objection appears in those measurements where the signal-to-noise ratio and audio output must be checked simultaneously with selectivity.

Measurement of High Level Output

Of the many methods of measuring the output from standard signal generators the "variable input type" (wherein the high level is metered directly by a vacuum tube voltmeter) offers a simple solution and reduces to a minimum the number of output control knobs, etc. This "variable input type" permits the use of a standard design of potentiometer, thus eliminating the short-lived calibrated slide-wire, which was the cause of much grief in earlier signal generators. Outputs between 0.2 and 2.2 volts are read directly on the meter in the 65-B generator. This meter is connected to a 6H6 diode used as an average type rectifier. The time

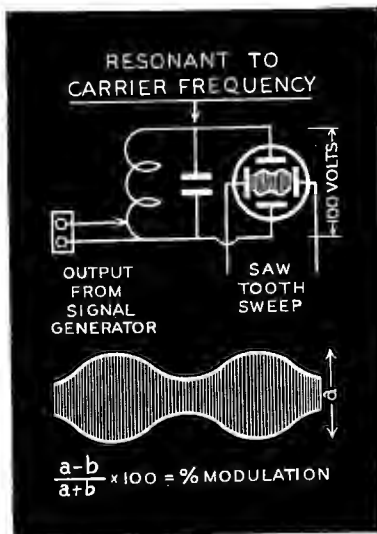

Figure 5
The method used to calibrate the modulation meter.

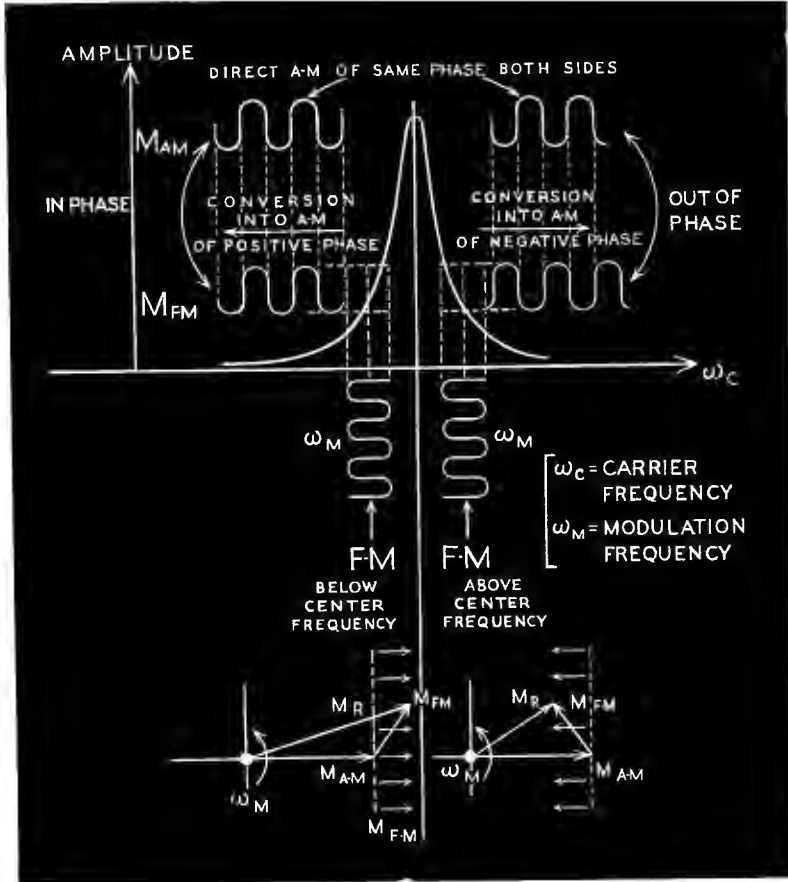

Figure 6

The effect of undesired f-m in the presence of a-m. Note, at lower left, that below resonance M_{F-M} lies to the right side of the dotted line, thus increasing the resultant audio output M_R ; never decreasing it. At lower right, above resonance M_{F-M} lies to the left of dotted line, thus decreasing the resultant audio output M_R ; never increasing it.

The above relation assumes an increase in amplitude is accompanied by an increase in carrier frequency. If the reverse is true, the phases must be reversed.

constants of this diode circuit are only "average" for audio frequencies. Actually at radio frequencies the time constants are such that the diode becomes a peak type voltmeter, but remains an average type as far as audio modulation is concerned. The average type has the advantage of yielding a reading of output independent of modulation depth (within limits of linearity at over 90% previously mentioned). The rms type and the peak type do not remain constant with varying depth of modulation; therefore these methods necessitate a correction factor if maximum accuracy is desired. It is well known that the rms type would read approximately 30% higher at 100% modulation, while the peak type would read twice or 100% greater at 100% modulation.

The accuracy of the 65-B diode output metering system is better than $\pm 4\%$ at 1 volt. The accuracy is somewhat less at .2 volt and slightly greater at 2.2 volt.

Microammeter Limitations

In order to assure the maximum of accuracy between the "low end" of one output step and the "high end" of the next lower step, (the overlap region), a specially shaped pole piece construction is used in the microammeter. In addition a unique jig for individual meter calibration provides an accuracy limited by the width of the pointer (about .030"). The mechanical friction and torque of the meter must be carefully controlled to permit prac-

tical realization of this high degree of accuracy. Under the present wartime conditions this latter task is at all times difficult, but strides have been made and are continuing to be made in further reducing mechanical "sticky action" to a vanishing point—that is small compared to .030".

Carrier Harmonics

Since the diode is actually a peak voltmeter as far as r-f is concerned, there remains an additional source of error due to the rather high harmonic content of the carrier. At the low carrier frequencies the final tuned circuit must be loaded down sufficiently to permit modulation up to several kilocycles, but this decrease in selectivity leads to higher r-f harmonics because the final amplifier is operating "class C" and generating r-f harmonics which are not entirely filtered out by the reduced selectivity of the final tank. It is possible to design

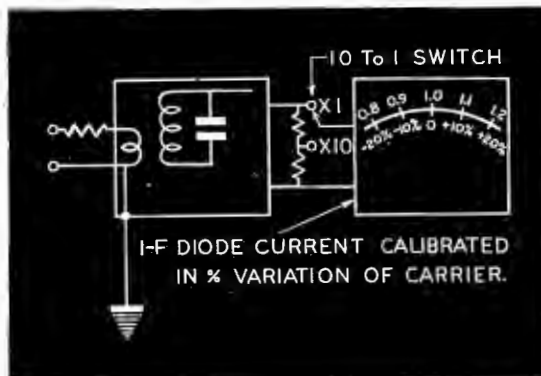
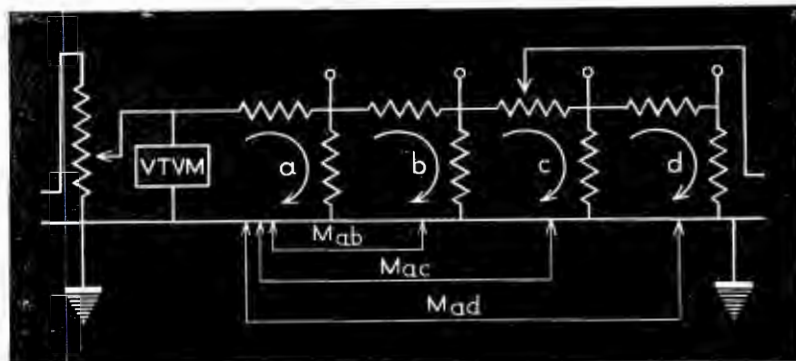

Figures 7 (left) and 8 (above)

In Figure 7, several mutual impedances are shown between the various meshes of a fixed step ladder network. Figure 8, a sensitive superheterodyne used without avc, provided with separate r-f and i-f manual gain controls to prevent overloading on strong signals.

theoretical circuits which will not generate excessive harmonics, as for example, either double tuned circuits, or class "A" operation of the final. Most measurements on receivers do not justify the expense, complication, and compromise necessary to reduce the r-f harmonics at the lower frequencies.

The r-f harmonics may be as high as 10% at 150 kc. As the frequency increases, the r-f harmonic content drops rapidly to something less than 2% in the broadcast band. Since the harmonic content is a function of L/C ratio in the final tank, the harmonics are greater near the high frequency ends of each tuning range.

Zero Set

Adjustment of zero on the output meter has always been a delicate procedure. And thus extreme care must be exercised if maximum accuracy is to be obtained at the lower end of the meter scale. In the 65-B output meter, for instance, there are two adjustments of zero; mechanical and electrical.

Mechanical zero must be made *first* with the instrument turned off for several minutes to permit the diode cathode to cool completely. Then the screw on the face of the meter must be adjusted until the meter reads exactly "o" on the calibration scale. Slight finger tapping is advisable to eliminate any "stickiness."

Next the instrument must be turned on for at least five minutes to permit the diode cathode to heat sufficiently. Then the output from the r-f generating unit must be reduced to zero by pushing range change buttons slightly until they all snap out, leaving none of the coils in position. The set screw on the panel just below the meter is then adjusted until the meter again reads exactly "o" on the calibration scale. Slight tapping with the fingers again is recommended to eliminate any "stickiness."

This last adjustment is the electrical zero adjustment of the diode circuit. It is sometimes likely, especially at high carrier frequencies, that a small residual impedance in the output knob

zero will not permit reducing the output to exactly zero; hence the reason for disconnecting all coils from the circuit to positively reduce the output to zero before attempting the electrical zero adjustment. Because of the special shaping of the pole pieces in the output microammeter serious errors will result if compensation of mechanical zero set by electrical zero set is permitted.

The residual impedance in the output knob is due to the commercial design of the potentiometer. To reduce the output of the signal generator to zero, therefore, several fixed decades have to be switched into place. If zero output is obtained at some particular spot on the output control, yielding what might better be termed a *null*, this condition is due to some leakage or stray field combining out of phase with the usual output through the attenuator. This type of leakage is termed "line leakage," since it occurs because there is a carrier potential difference between the a-c line cord and the outer metallic shield of the instrument, sometimes called "ground."

In most diode voltmeter circuits operating at levels as low as 1 or 2 volts the diode characteristics are not quite linear and must be carefully checked to secure maximum accuracy when using them with a carefully calibrated microammeter. We have developed a circuit which is remarkably free from errors of this sort. However the necessary components are a bit too bulky to permit installation in the generator now under discussion.

Selection of Diodes

The best solution is to group all usable diodes into several classes and calibrate meters to fit these various classes. A careful record is kept of each instrument so that replacement diodes of the correct type can be supplied when necessary. At present we have many instruments in service that have had over 10,000 hours of operation in the field, but there have been very few diode failures to date. This is so, because the diode is operated so far below its

normal rating that it is likely to outlast several sets of the other tubes in the instrument.

Fixed Attenuator Steps

There are some rather interesting effects which must be understood in order to design and build accurate fixed steps of attenuation, particularly as signal generators go to higher and higher carrier frequencies. In some of our standard signal generators we use the resistance type of fixed-step attenuation as high as 400 megacycles. However, in this region the mutual inductance type appears to be more convenient. Up to 200 or 300 megacycles we have had little difficulty in using fixed-step attenuators of the resistance type; while from 10 megacycles up to many thousands of megacycles, the mutual inductance type can be more easily constructed and produced in quantities.

In Figure 7 several mutual impedances are shown between the various meshes of a fixed step ladder network. These mutuals, either stray or otherwise are important and must be reduced to negligible values, if proper operation of the attenuator is to be obtained at higher frequencies. Self-inductance can easily be reduced to negligible proportions by suitable resistor design and arrangement, but mutual effects can give rise to errors that are otherwise difficult to eliminate. For example, the mutual effects can make the lower output ratios check either high or low in attenuation depending on where the input control is setting.

If the input potentiometer is set high so that considerable current flows in the "a" mesh, a larger magnitude of mutual "error" will be present in the "d" mesh, than if the pot were set to a lower value. The magnitude and phase of this induced error may be such as to either increase or decrease the ratio between "c" and "d" mesh. Errors of this type will be present to some extent in all attenuators, if the frequency is carried high enough and other errors do not swamp it. These errors will lead to inconsistent

(Continued on page 43)

Applications of

THE THROAT MICROPHONE

**In High Noise Levels This Tiny
Unit Finds Itself of Vital Import**

by JAY SHAWN

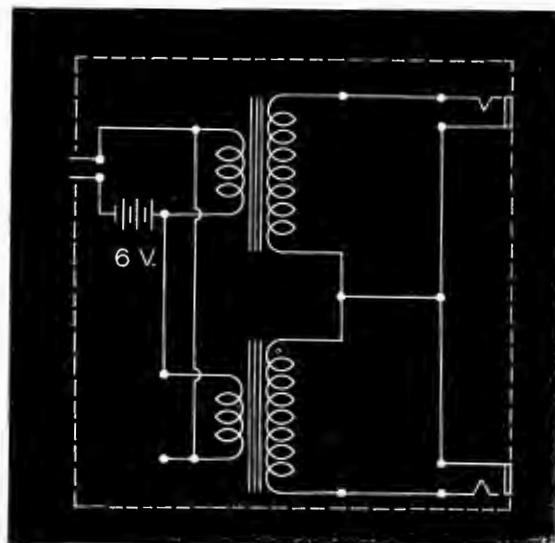
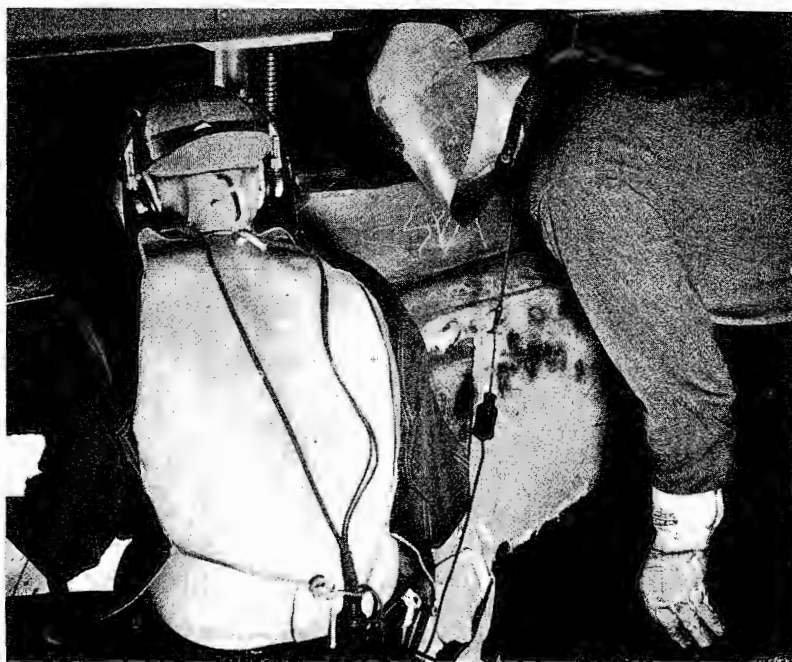

Figures 1 (left) and 2 (top)
Welding instructor and microphone with
throat microphone equipment (Figure 1). At
top (Figure 2), the portable carbon micro-
phone equipment for two-student instruction.

THERE once was an unsolved problem . . . has been the starting point of happy-ending stories of most present day technical advances.

One such story is that of the throat microphone, and the problem of transducing speech in surroundings where the noise level was of a very high order.

This very problem was one facet of the general problem of communication in aircraft, both for intracomunication between members of the ship's crew and for intercommunication from ship to ship and from ship to ground. The noise levels existing aboard high powered fighting aircraft, which for reasons of flying efficiency cannot be adequately soundproofed, are of the order of from

100 to 130 db during most flight conditions.

Early Applications

Early attempts at a solution involved concealing a standard microphone in the chin piece of the pilots' helmets and surrounding it as much as possible with sound absorbent material. It soon became apparent, however, that any pressure operated device would always be modulated, if not by the higher noise frequencies, by the subsonic frequencies due to low-order engine vibrations and to cabin resonances excited by these low-order frequencies. This low-frequency modulation, while bad enough in single engined airplanes, was even more noticeable in multi-engined craft

in which beats existed between engines.

Industrial plants, too, have this difficulty in many forms, but it was not until the present emergency with its many concurrent problems that the situation became acute enough to demand an active attempt at solution.

The foremost of the present-day war time problems in industry is the education of thousands of untrained men and women in new and complex arts. Sometimes this is complicated even more by the presence of noise levels so high that it is extremely difficult to convey information from instructor to student.

Inertia Operated Devices

The development of inertia operated devices designed for the measurement of mechanical vibration amplitudes provided the communications field with a practical approach to the problem. Several types of sensitive pickups were perfected, some of which had an output which was proportional to velocity; others had an output proportional to acceleration. Reducing these units to a conveniently small size and mounting

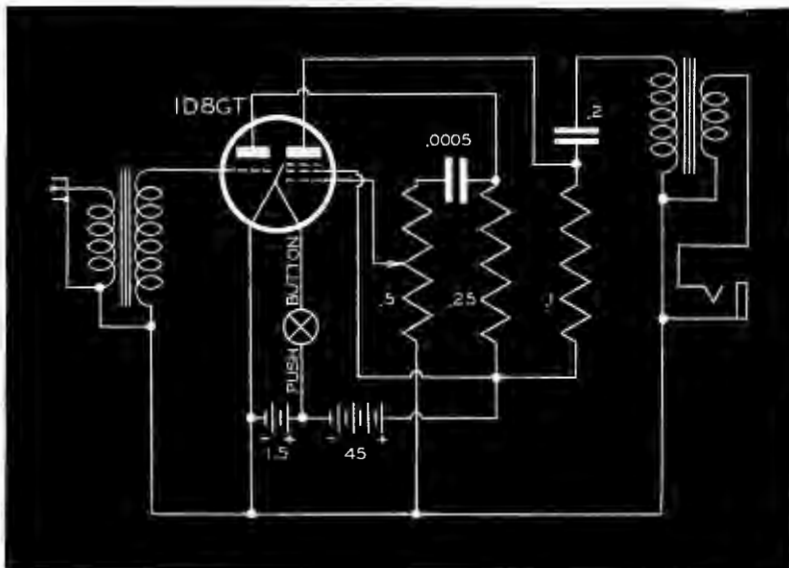

Figure 3
Dynamic type throat microphone portable amplifier unit, with ouncer transformers for input and output coupling.

since the men had to have freedom of movement the apparatus had to be portable.

Dynamic Microphone Unit

The communication equipment in this installation consists of a dynamic type throat mike which operates into a portable battery type amplifier; jacks are provided to handle two headsets if necessary. In Figure 3 is shown the circuit arrangement, which is of the simplest order. A type 1D8GT diode-pentode is used with a 45 volt "B" battery and a single flashlight filament supply. Ouncer transformers are used for input and output coupling, and a midget rheostat for a gain control. A push button turns the filaments on when the equipment is to be used.

Filter Mask Problems

Due to the fact that the filter masks are worn, distortion is encountered due to two effects. The first is that the high frequencies ordinarily present in the sibilant tones are considerably attenuated because of the decrease of the rate of air flow through the mouth, lips, and filter. Another cause of distortion is cavity resonance in the mouth due to the closing effect of the mask. Both of these factors tend to attenuate highs in

(Continued on page 26)

two of them on an elastic strap, gave to the industry the throat microphone as it is today.

Two basic types, motor and variable resistance, are being produced today in large quantities in the familiar form of dynamic and carbon microphones. Rochelle salt crystal units, while they have not come into as wide use as the others because of their sensitivity to temperature and to atmospherics, also have many applications in fields other than in aircraft.

Industrial Applications

This type of equipment is now making its appearance in industry. Recently, in one of the plants of the Curtiss Wright Corporation large numbers of men had to be trained in the intricacies of atomic-hydrogen and heliarc welding. The noise level resulting from the banks of welding equipment in use is such that conversation is practically impossible and instructions could be given to a welding student only with considerable difficulty. A further obstacle is that special masks are used as protection against the arcs so that conversation would be awkward even if there were no surrounding noise. In order to provide adequate communication, a system employing throat microphones was installed.

Mobile Design

In this particular case it was desired that the communication equipment be readily mobile, though not necessarily portable, and of as high level as possible because of the electrical interference having its source in the arcs. These two factors indicated the use of carbon microphone equipment with battery and coupling transformer mounted on a small wheeled dolly with components hooked up as shown in Figure 2. Each instructor's microphone is connected to two pairs of headsets as the activities of two students are supervised simultaneously. Audibility and intelligibility are excellent. An aiding factor is that

the masks, which extend back over the ears, attenuate by about ten db the noise of the arc being operated by the instructor and student.

140 DB Project

In another application the requirements were quite a bit more difficult to meet. In this case men were using high speed grinders in rough grinding and in finishing the surfaces of metal parts. The noise level is really terrific, being of the order of 140 db as measured with a GR sound level meter, and conversation is totally impossible. Furthermore, the men all wear respirators and dust filters so that speech even without surrounding noise level, is difficult to understand. Under these conditions, higher signal levels were required than could be attained without amplifiers, and

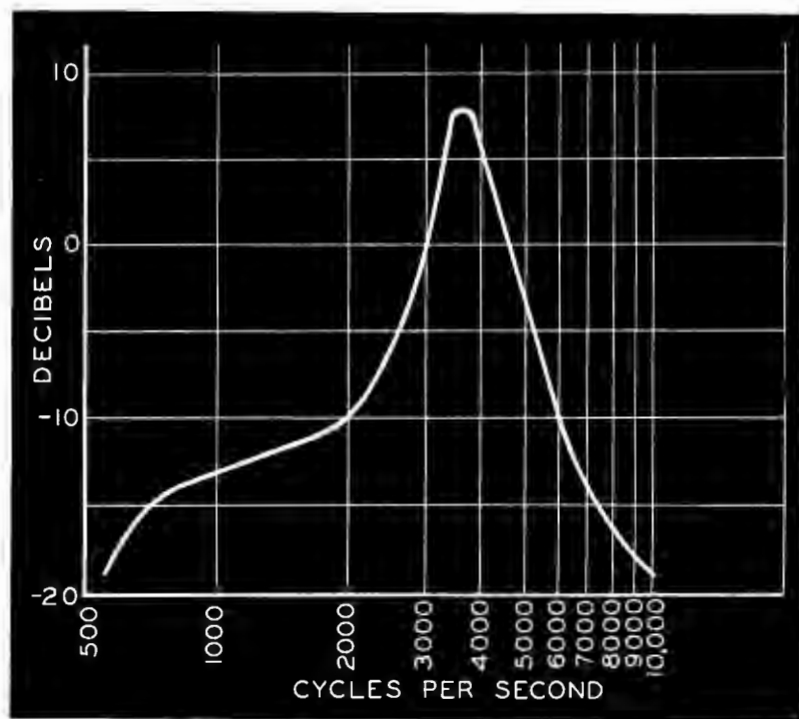
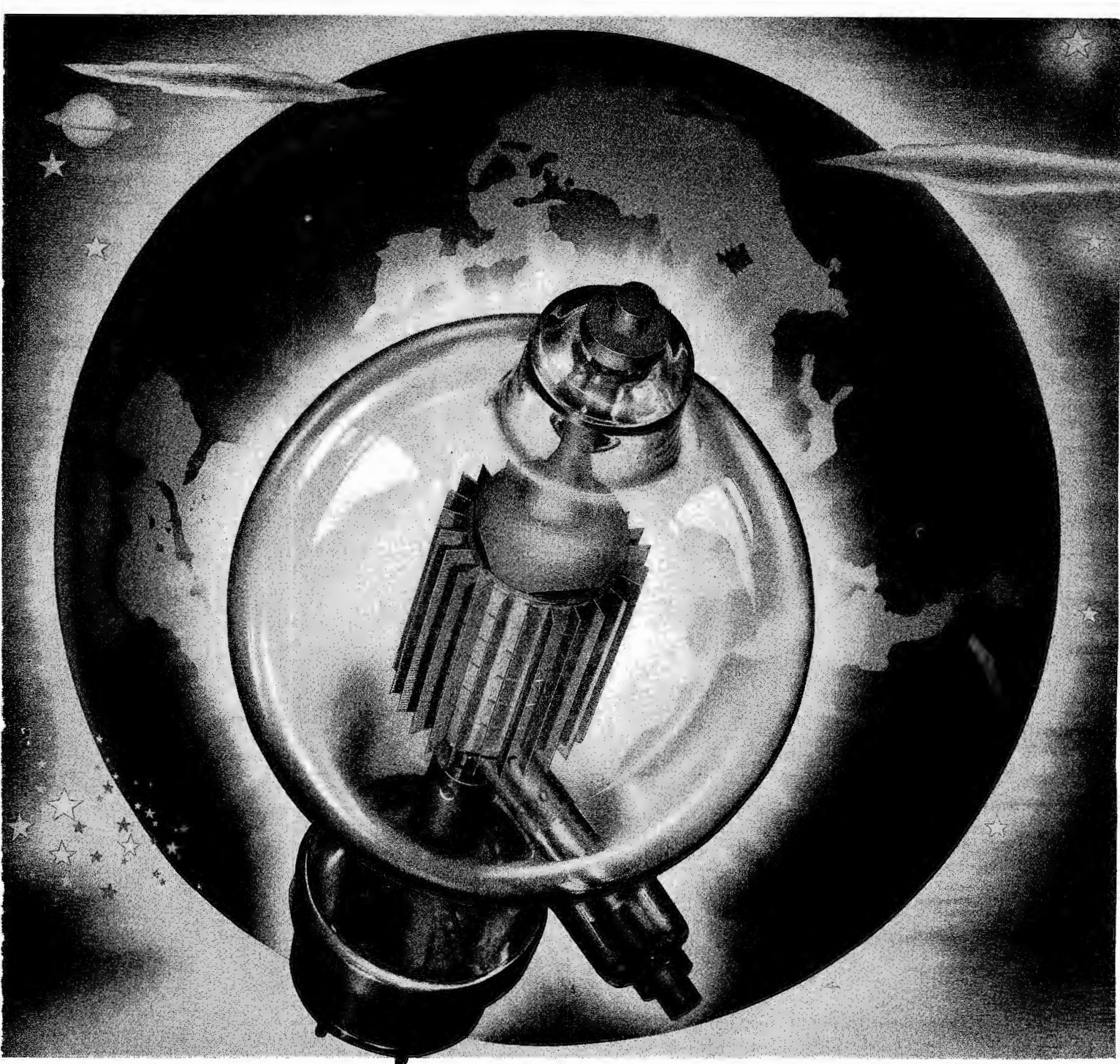

Figure 4
Response of carbon microphone.



This is a "GLOBAL" war... A man-made globe
—the electronic tube—is today one of the key weapons of battle. Eimac
tubes have assumed a rank of "high command" in this "global" war.
Again they are "first choice in the important new developments in radio"



THE JOINT ARMY-NAVY "E" awarded September 4, 1942 ...
first award of this kind to a manufacturer of electronic tubes.

EITEL-McCULLOUGH, INC.

SAN BRUNO, CALIFORNIA

Export Agents: Frazar & Company, Ltd., 301 Clay St., San Francisco, Calif.

Eimac
TUBES

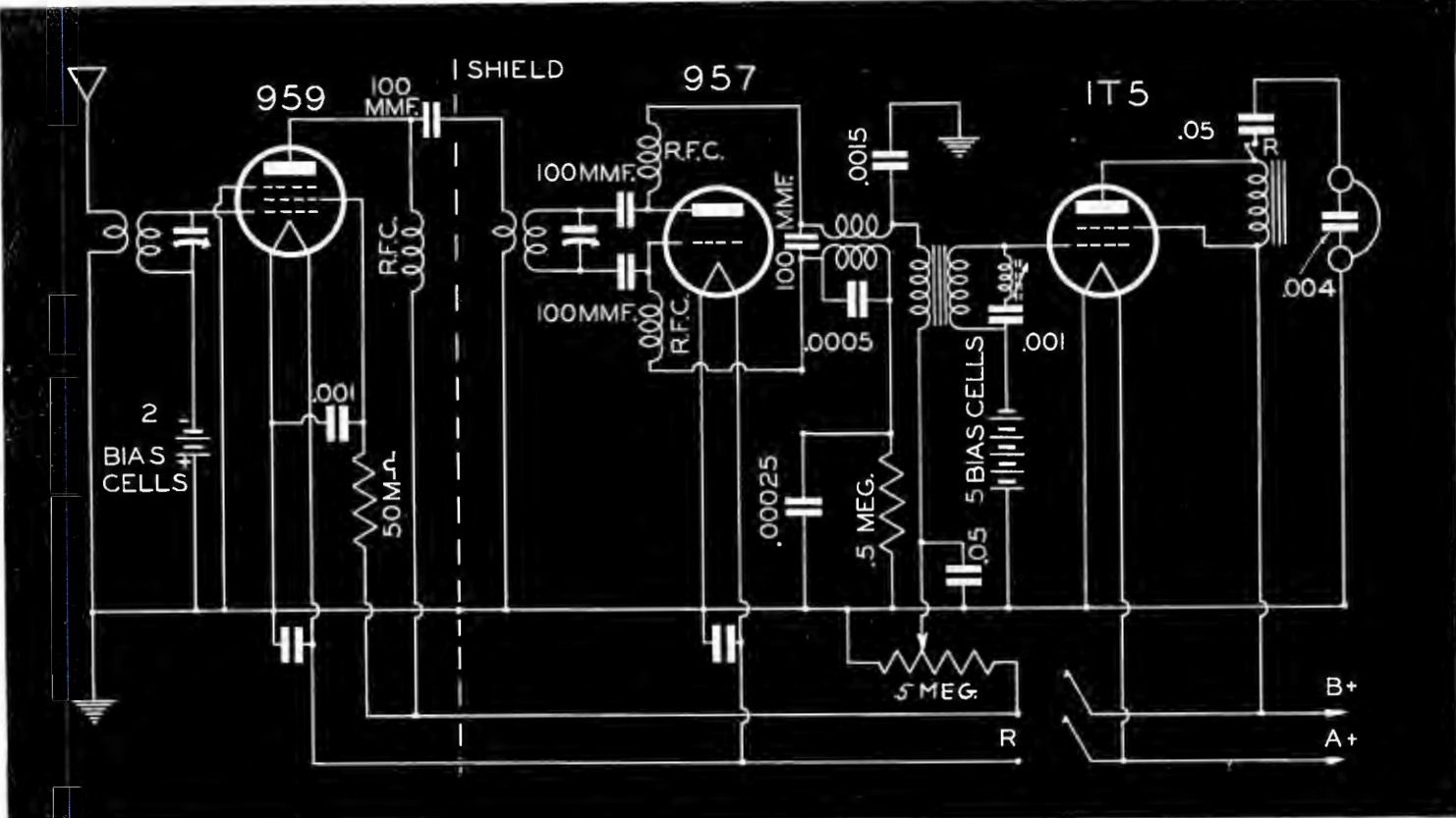

Figure 15

The receiver portion of the pack unit with a newly added r-f stage. It will be noted that in making the r-f addition, a coil has been substituted for the resonant line in the super-regenerative detector. Note s-r filter across grid of 1T5.

Pack Communications Equipment

FOR FIRE FIGHTING

**Conclusion of Two-Part Paper Describes
Transmitter and Receiver Improvements;
U-H-F Test Instrument and Antenna Data**

by **ART H. MEYERSON**

New York Fire Department Radio Laboratory

CONTINUING with the discussion of antennas, we found that with a resonant antenna, representing a pure resistive load, maximum frequency deviation was upward. Apparently most foreign bodies approaching the antenna have a capacitive reactance. To overcome this, the antenna was made inductively reactive by lengthening it from 64 cm to 74 cm. This reduced frequency deviation from ± 250 kc to ± 40 kc.

Another trouble with pack radio antennas is the lack of sufficient ground plane to make up the other one-quarter wave for a full one-half wave. Using a separate antenna for the receiver

helps, since it acts as a counterpoise, but the directional effects are very marked. All methods tried in making up the reflected one-quarter wave resulted in diminished field strength. The only method that was fairly successful was the lengthening of the transmitting antenna beyond its resonant length, so that it performed a dual service; cutting down the effect of foreign bodies, while making up the lack of sufficient ground plane.

Incidentally, it was found that removing the upper stand-off on the transmitting antenna increased the field strength about 10%. Our new type of stand-off with a new type of construction that

reduces its capacity to the case, corrects this condition.

The antenna for the receiver is less than a one-half wave, the overall length to ground being about 125 cm. Here again we compromised. A resonant one-half wave antenna was too long and seriously affected the transmitter with its directional effects. A one-quarter wave antenna also made the transmitter highly directional. It was therefore decided to use an intermediate length since results were comparable to those obtained with resonant lengths.

Inductive coupling to the antenna is used in both the transmitter and receiver. The coupling loop for the receiver was made fairly large, about 4" long, to help increase the length of the antenna to ground. In the transmitter since a coaxial feeder is used, the length of the coupling loop affects the oscillator circuit more than it does the antenna length. The size of the coupling loop is determined by the following factors.

Since the losses in the coupled circuit increase with the size of the coupling

element, and since the greatest transfer of energy takes place at the point of optimum coupling, the smallest size loop which will give maximum energy transfer at optimum coupling will cause the least loss.

A one-quarter wave antenna represents a resistance of 35 ohms, and a 2-volt 60 ma. pilot light also represents a resistance of approximately 35 ohms. Thus a pilot light shunted across loops of various sizes and coupled into the oscillator will afford a degree of brilliance, which is measured on a calibrated light meter. With this method, the loop which gave maximum brilliance for optimum coupling was selected, since it was the best value of coupling inductance.

Since loading the oscillator with the loaded inductance increased the frequency of oscillation, the oscillator was returned to the assigned frequency, and this was established as the operating point. The pilot light was then removed and the antenna attached through the coaxial feeder. The length of the antenna was then adjusted until the frequency of the oscillator returned to the operating point. This length was found to be 74 cm. By experimentation, a resonant one-quarter wave antenna has been found to approach its theoretical length of 64 cm very closely. However, due to capacitive effects between the antenna and the case, and the fact that the case does not make up the reflected one-quarter wave, the antenna for our particular set of conditions had to be the longer length or 74 cm.

Experiments are now being completed on r-f stages for both transmitter and receiver, using one antenna. The need

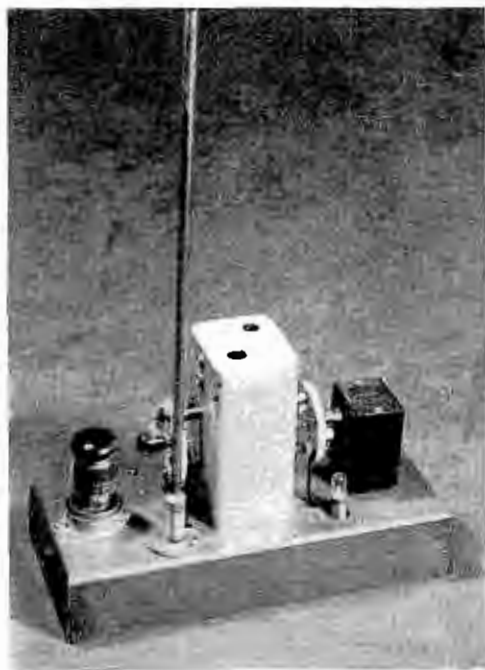

PACK COMMUNICATIONS SYSTEMS

Figures 16 (below) and 17 (right)

Diagram and view of the device used to determine the coupling required for the best value of coupling inductance, when selecting a coupling loop. See page 16 for operational and constructional data.

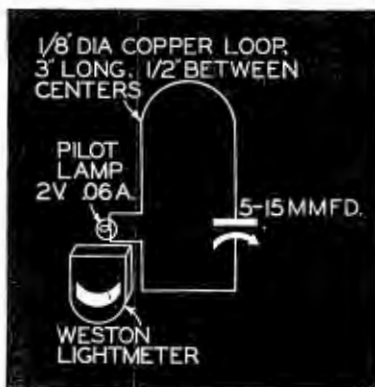

for an r-f stage for the receiver is acute. Because of re-radiation, no more than two pack sets may be used at the scene of a fire, except in the hands of highly experienced operators. We have rebuilt two packs, using a r-f stage in the receiver. The addition of this stage does not increase the gain or selectivity materially. However, the radiation is so materially reduced that it is possible to operate two packs within 30 feet of each other without any interference. Shunt feed is used in the plate circuit of the r-f amplifier to keep the coupling inductance at ground potential and to reduce the loading effect of this inductance on the super-regenerative detector. Tuning the plate circuit of the r-f stage increases the gain and selectivity slightly but does not warrant its use.

Since the r-f stage takes up quite a bit of space, it was necessary to reduce the size of the super-regenerative detector. Reducing the length of the resonant lines reduced its efficiency to such an extent that it was found necessary to use a coil. The gain of the new detector is slightly less, but is more than made up in the r-f stage. It was also found necessary to use the 959 in the r-f stage because of the poor input admittance of other type tubes. A further

Figure 17

Frequency deviation mixer, crystal controlled. See page 11, December, COMMUNICATIONS, for circuit diagram.

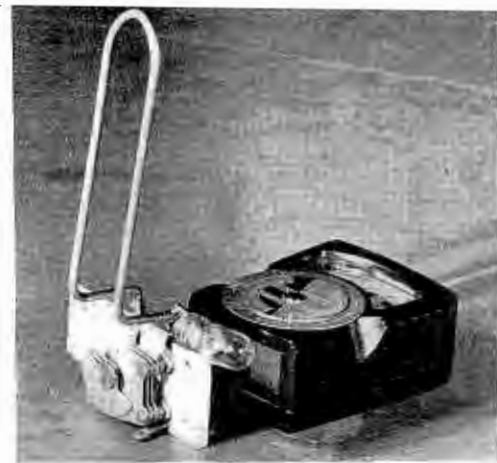

improvement was made in the audio section by replacing the grid bypass condenser of the 1T5 with a series resonant circuit tuned to the squelch frequency. This consists of a fixed .001 mfd. condenser and a variable iron core coil.

Further experimental work is being continued on the application of a r-f stage for the transmitter. Although the power output direct from the oscillator has been sufficient for our present purposes, increased performance demands require greater field strength. An r-f stage will increase both the field strength and the stability. The circuit shown has been tried and found good. A 957 may be substituted for the 958 in the oscillator portion and will deliver sufficient power to drive the 1291. The r-f amplifier, however, is too complicated for portable work and efforts are being directed towards simplification. Shielding between grid and plate elements right at the socket of the 1291 is necessary to prevent feedback.

With the addition of the r-f amplifiers to both receiver and transmitter, a single antenna switched from transmit to receive is feasible. To increase the efficiency of the battery supply, the use of two 4TA60 batteries instead of one will increase the battery life to 150 hours. This would increase the weight to 20 lbs, and the size to 5"x9"x16". A further increase of power could be gained by the use of a 1299 as a modulator and an increase in B voltage to 135 volts.

Tuning Problems

Another problem is a satisfactory method of tuning. Although the small trimmers are adequate, a sensitive touch is required to tune both the transmitter and receiver. These trimmers can be made shock-proof by the application of a drop of liquid polystyrene on the movable trimmer plate. However, a vernier adjustment of some kind would be ideal, provided it is shock-proof and accessible. We have been experimenting with a polystyrene rod so constructed that it changes the dielectric constant between the lines

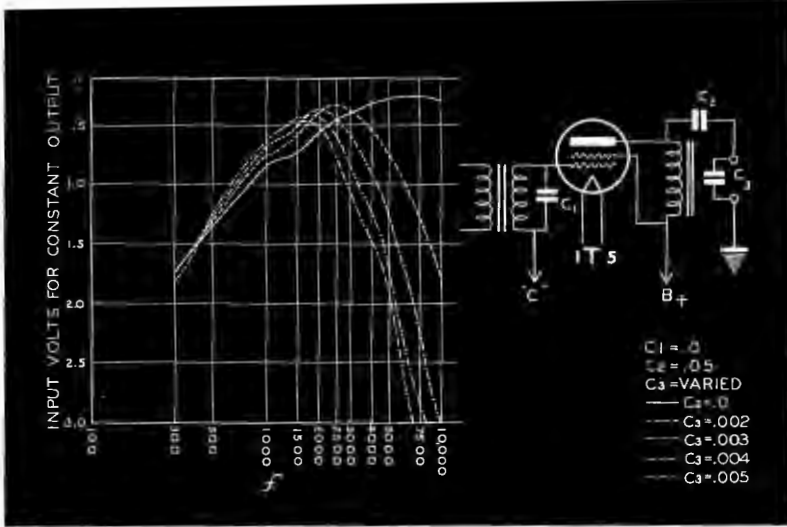

Figure 18

This graph shows variations in frequency response for various values of C_3 . Note increase in attenuation at 10,000 cycles.

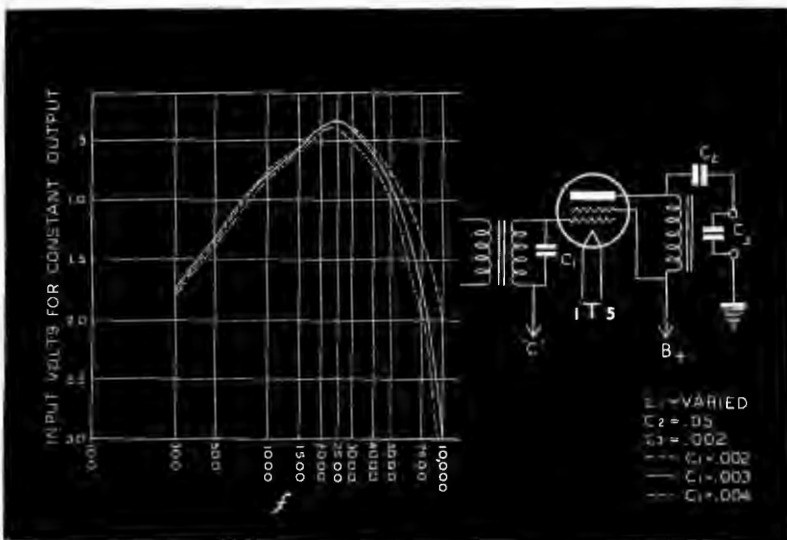

Figure 19

This graph shows variation in frequency response for various values of C_1 . Note that there is no improvement with this additional capacitor.

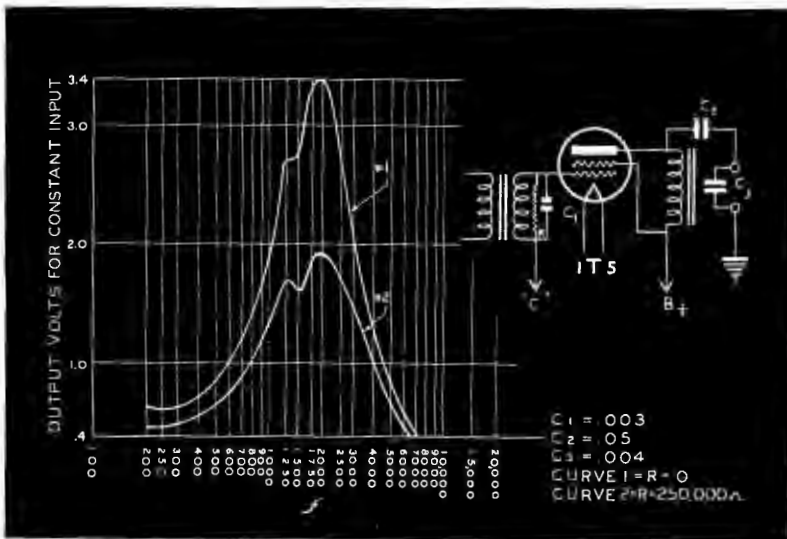

Figure 20

This graph shows effect of addition of R . Note how the attenuation is increased over the middle range.

and decreases in effective capacity with expansion due to heat.

Among other experiments still being conducted are those on antennas for pack sets.

Test Equipment

Three pieces of test equipment were designed and built especially for our work. The first problem was a satisfactory means of measuring field strength. Since our output power was in the order of milliwatts, standard field strength meters were useless. After trying a half dozen different circuits, we met with success. In our final field strength meter, we now can measure power output of the order of 50 milliwatts at a distance of 10 feet. The case was adapted to use discarded 4TA60 batteries; the ones used in our pack sets.

The next unit was developed to measure our frequency quickly with a fair degree of accuracy. This unit (see Figure 17) is a crystal mixed and amplifier. The crystal taken from one of the Fire Department car pickup receivers, operates at a frequency of 10583.33 kc. The tank is tuned to the fundamental frequency, but the crystal oscillator is very rich in harmonics.

The antenna in the cathode circuit of the 2nd 955 picks up our pack frequency, 117550 kc. The difference between this signal and the 11th harmonic of the crystal, 116416 kc, or 1134 kc, is then fed into the 7A7 amplifier. This signal is then fed into a standard receiver and the frequency checked. A frequency deviation of 1 kc can thus be easily detected.

The third unit was an output meter used to check the maximum power output available from the transmitter. This was constructed from a five plate midget tuning condenser, a 3-in. loop, a 2-volt 60 ma. pilot light and a Weston light meter (Figures 16-17). The light meter was mechanically attached to the pilot light, which was completely shielded from any external source of light. The light meter was calibrated in terms of milliwatts by means of a battery and rheostat. The method used was to couple the loop to the transmitter and then tune it for least frequency deviation of the transmitter for maximum coupling to the output meter. This was done by picking up the signal from the transmitter on a receiver and after coupling the output meter, bringing the signal back to the same point on the receiver. This loaded the transmitter with a pure resistance and gave an exact maximum power reading at resonance. This is derived from the for-

(Continued on page 19)

A NEW *Motorola* BUILDING



DEVOTED EXCLUSIVELY TO ELECTRONIC

Research and Engineering

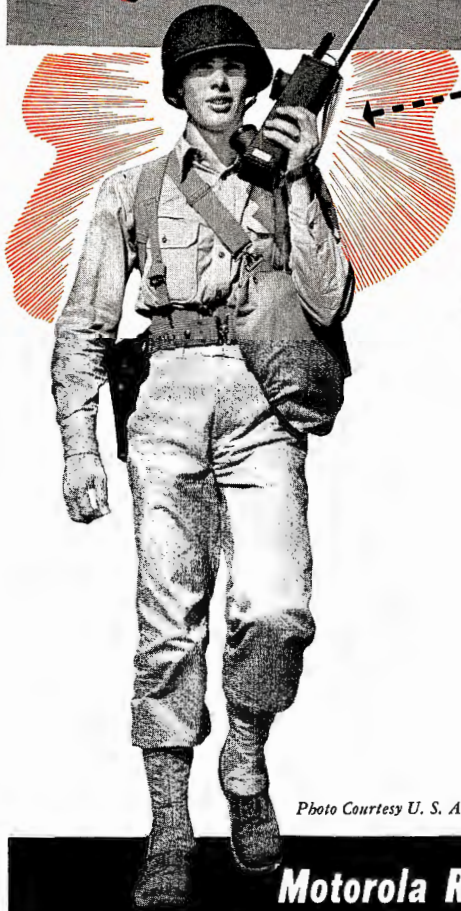

When war came, Motorola research and engineering was already at work around the clock on special assignments for our Armed Forces. Now in its new home, the Motorola staff of engineers and technicians is by specific government assignments at work on problems which embrace many important phases of electronic knowledge. This new Motorola engineering building increases many times our capacity for service of the highest order.

THE ARMY-NAVY "E"
Awarded for excellence in the production of Communications Equipment for America's Armed Forces



Photo Courtesy U. S. Army Signal Corps

**Motorola Radio Communication Systems
Designed and Engineered to Fit Special Needs**

GALVIN MFG. CORPORATION • CHICAGO



L A C E D W I R I N G H A R N E S S

F O R C O M M U N I C A T I O N S E Q U I P M E N T

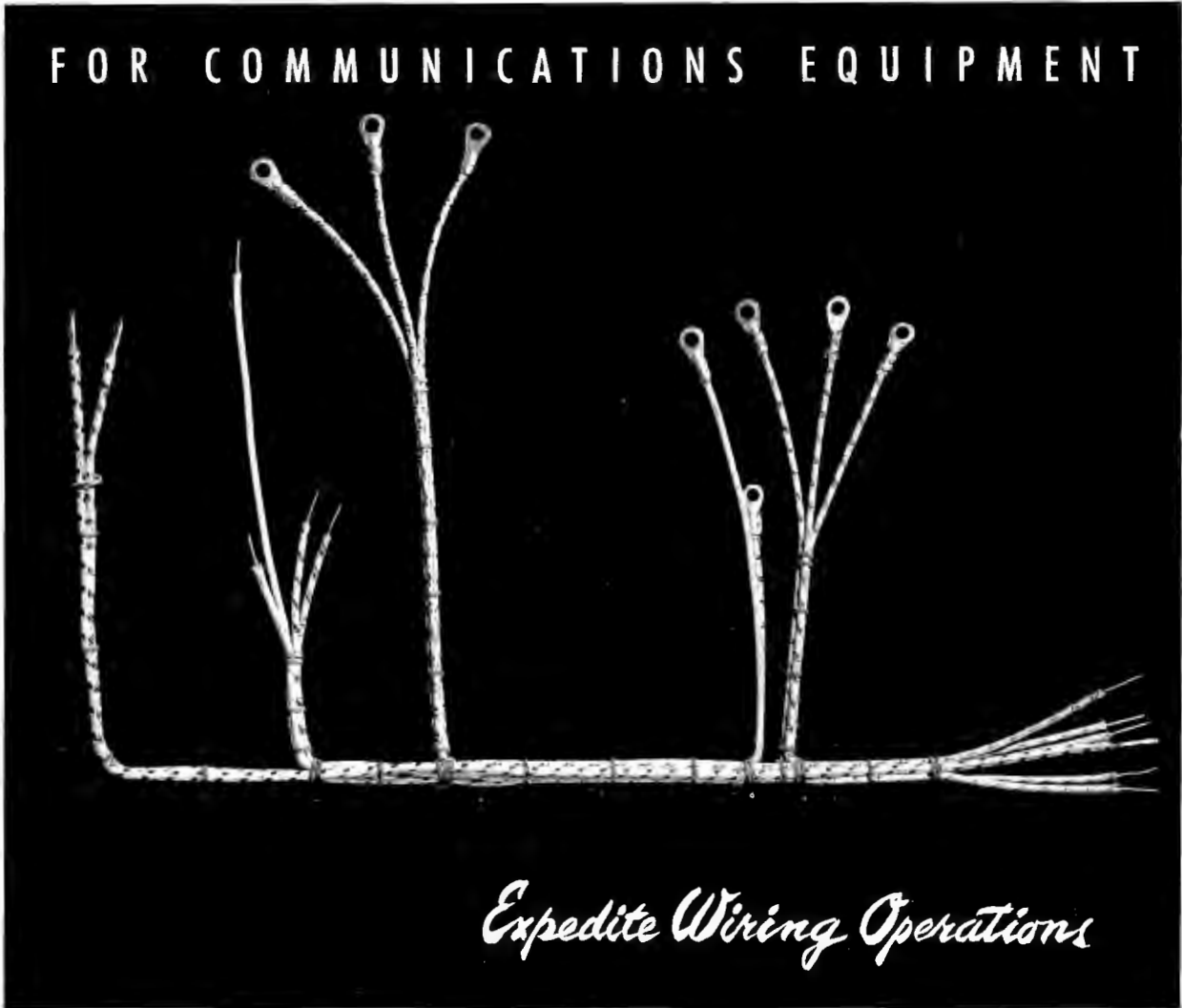

Expedite Wiring Operations

A sure cure for wiring "headaches." Constructed entirely of wires with approved types of color coded insulation, assembled exactly in accordance with your specifications, Lenz Laced Wiring Harnesses will speed up your wiring operations and permit the release of

some of your labor to other assembly tasks.

Make the Lenz organization a part of your factory. A Lenz Wire engineer will be glad to consult with you on your requirements. Quotations will be gladly furnished on receipt of specifications and sketch.



I N B U S I N E S S

S I N C E 1 9 0 4

L E N Z E L E C T R I C M A N U F A C T U R I N G C O .

1 7 5 1 N O R T H W E S T E R N A V E N U E • C H I C A G O , I L L I N O I S

PACK COMMUNICATION UNIT

(Continued from page 16)

mula for LCR in series. $Z \text{ (total)} = \frac{1}{\sqrt{R^2 + X^2}}$ where $X = \omega L - \frac{1}{\omega C}$. At resonance $\omega L = \frac{1}{\omega C}$; $Z \text{ (total)} = R$

Operation

It is important that operators be thoroughly instructed in the use of the pack sets. Operation by the inexperienced usually results in air-jamming. A definite procedure for message delivery has thus been established. Messages are identified and terse.

Primary Message

A sample of message exchange follows:

"Pack 3 to pack 4, pack 3 to pack 4—come in."

"Pack 4 to pack 3—what is your message?"

"Pack 3 to 4—notify Chief Smith that Engine Co. 31 has a line operating on the third floor rear.—Pack 3 by."

Concluding Reply

"Pack 4 to 3—your message received

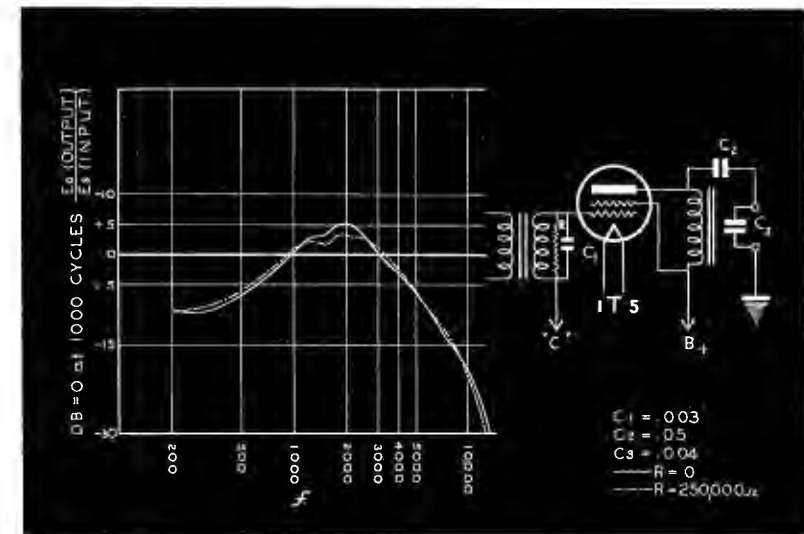

Figure 21

This graph shows db response of final audio-amplifier, with and without R.

—pack 4 by."

"Pack 4 to pack 3, pack 4 to pack 3—come in."

"Pack 3 to pack 4—what is your message?"

"Pack 4 to 3—Chief Smith has been notified. Tell Engine Co. 3 to stretch an additional line to the fourth floor—

orders of Chief Smith—pack 4 by."

"Pack 3 to 4—your message received—pack 3 by."

Although the above seems quite simple, it is not so easy under fire conditions. The operators must be thoroughly acquainted with fire fighting ter-

(Continued on page 47)

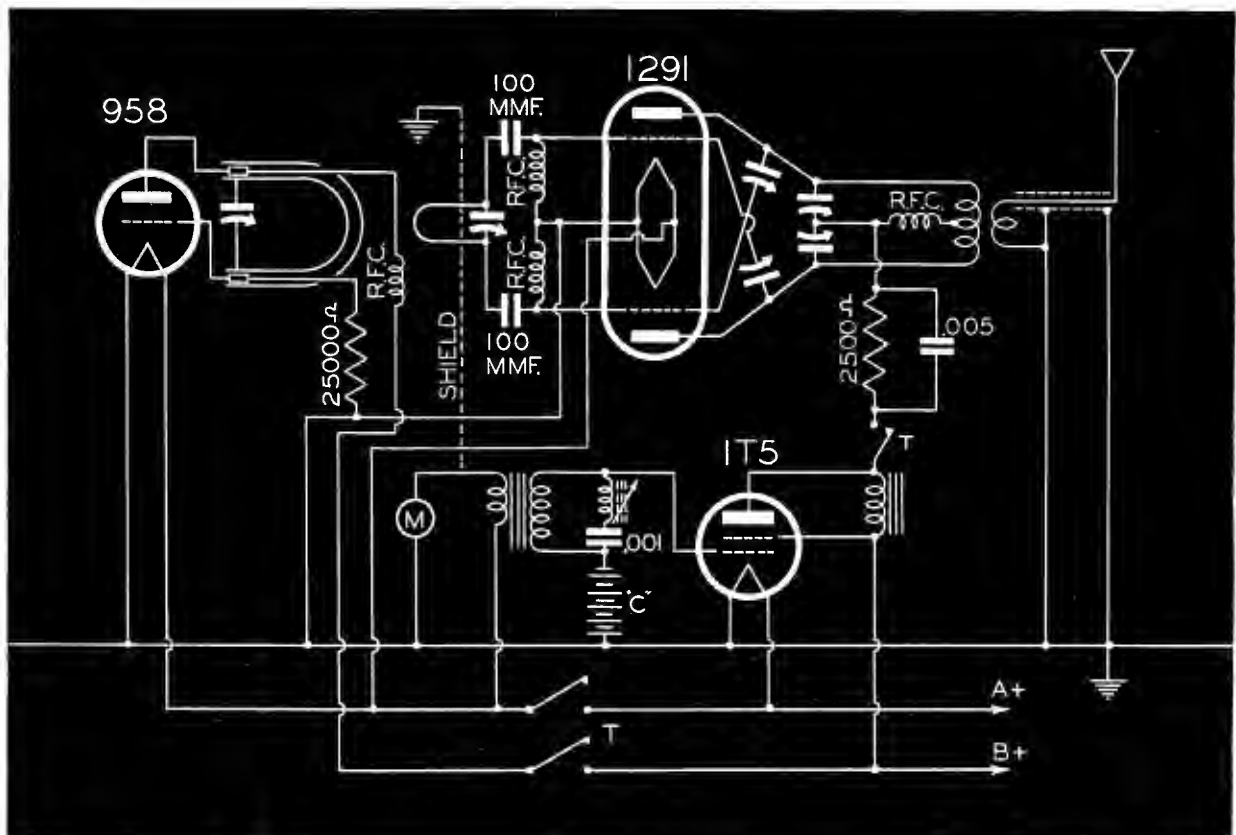

Figure 22

The transmitter with a newly added r-f stage. In the original, the oscillator was modulated and fed directly into the antenna.



WATER-COOLED TRANSMITTING TUBES

Their Installation and Operation

by K. C. DEWALT AND W. J. WALKER

General Electric Radio, Television and Electronics Department

Figure 1
A water-cooled transmitting tube that is used in ultra-high-frequency broadcast service.

WHILE transmitting tube longevity was always an important factor, today it has become the factor. Accordingly an abnormal degree of patience, care and resourcefulness is essential, particularly in installation and operation. This can be best exercised, if broadcast technicians and engineers are thoroughly familiar with the many variable factors of design and application. In water-cooled transmitting tubes, many such interesting characteristics appear.

Water Cooling System

Let us take the water-cooling system as an initial example. This system for the anode, consists, in general, of a source of cooling water, a water jacket, and a feed-pipe system which carries the water to and from the jacket. When the anode is at a high potential above ground, the feed-pipe system should have good insulation qualities and proper design to reduce the leakage current to a negligible value.

An outlet water thermometer and a water flowmeter are advisable since water flow and temperature are important. *The water must not be allowed to boil and the flow must be great enough to prevent steam bubbles form-*

ing on the plate surface. The temperature of the water at the outlet must not exceed 70° C. Proper functioning of the water-cooling system is of the utmost importance. Even a momentary failure of the water flow will damage the tube. It is, therefore, necessary to provide a method for preventing operation of the tube during such a condition. This may be accomplished by the use of water-flow circuit breakers, or interlocks, which open the filament and plate power supplies whenever the flow is insufficient or ceases.

Necessity for Upward Water Flow

The cooling water should flow upward along the anode and the piping must be arranged to avoid air traps in the jacket. Excessive water hammer may develop peak water pressures sufficient to deform the anode. Therefore, the piping system must be installed and operated properly so that water hammer does not occur. The pressure in the jacket must not exceed 80 pounds per square inch. If necessary, relief valves should be installed to prevent excessive pressure. The rate of water flow, usually sufficient for all types of service, is generally included with the tube descriptive data. Under abnormal conditions an increased rate of flow may be necessary to prevent overheating. The formation of steam may be detected by the use of an improvised stethoscope which may consist of six feet of insulating tubing with proper safety precautions. The stethoscope is pressed against the jacket at various points while suitable listening observations are made.

The Need for Distilled Water

Distilled water is recommended for cooling because it greatly reduces the probability of scale formation on the anode during life. Scale hinders proper

transfer of heat from the anode to the water. The mineral content, flow, heat dissipation, temperature, etc., of undistilled water are so varied that no specific recommendations to prevent scale can be made. A sample of the cooling water should be analyzed before plans are made for the water system. In general, water which shows a hardness greater than 10 grains per gallon should not be used. Regardless of the kind of water used, the system should be kept free from accumulation of foreign material. A 10 per cent solution of hydrochloric acid will ordinarily dissolve scale in emergency cases. After such treatment, the anode should be rinsed carefully. The tube must be removed from its jacket for this treatment and, since frequent removals are objectionable, because of danger from accidental breakage, it is desirable to prevent the formation of scale.

Forced Air Cooling

When *forced-air cooling* is required, a system should be used which consists of a blower with air ducts of proper cross-sectional area which supply air to suitable air nozzles. In certain of the larger tubes (such as the GL-862 and the GL-898) both the bulb and the stem must be air cooled. In these tubes the nozzle which supplies air to the filament stem is incorporated in the base, and the nozzle which supplies air to the bulb is part of the water jacket and acts as a combination air nozzle and electrostatic shield.

Tubes which require forced air cooling on the stem only have an air nozzle incorporated in the cathode base.

Where the air nozzle is not part of the base or water jacket and the grid and filament terminals and the bulb require air cooling, a nozzle should be

(Continued on page 22)

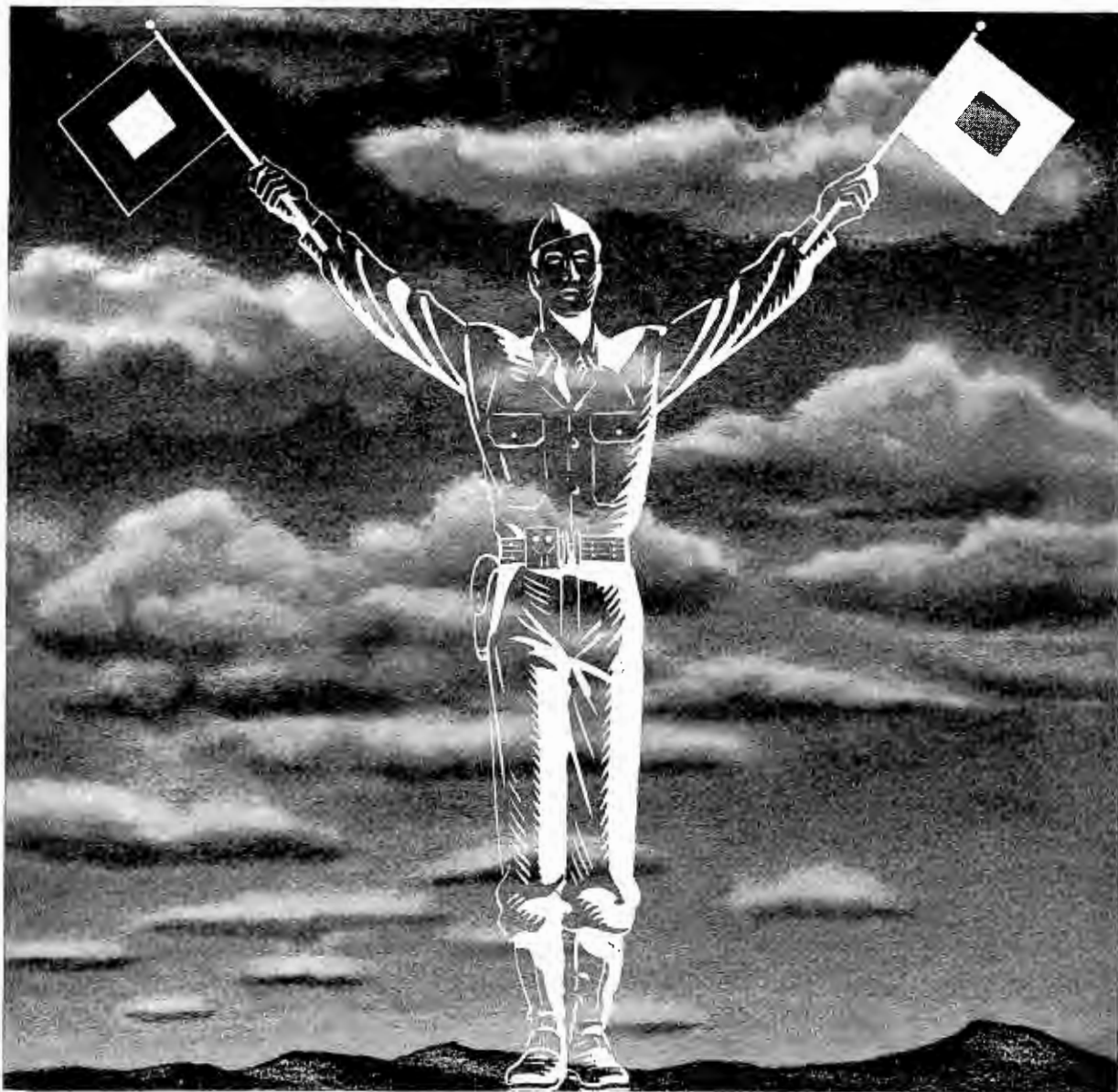

U. S. SIGNAL CORPS! When the smoke of battle fades and historians record the heroic deeds of men and armies —only then will we fully appreciate the important role of the U. S. Signal Corps in this world conflict! Our victories on the field and in the air can be attributed in a great measure to the sacrifice, skill and courage of the men in this branch of the armed services. They are in fact the nerve-center of our fighting forces.

COURTESY OF
JEFFERSON-TRAVIS RADIO MFG. CORP.

NEW YORK, N. Y.



WASHINGTON, D. C.



Figure 2
A triode transmitting tube, the 889, that uses a water jacket for cooling. This tube is used in the r-f power amplifier or as a class B modulator for high frequency broadcast service. Its plate dissipation is 5000 watts.

nectors particularly should be large and should make good contact.

In the case of the GL-8002 tube, three filament leads are brought out to terminals. These may be paralleled by capacitors to reduce the inductance of the filament circuit for the r-f returns. *The filament sections must be operated in series from the filament supply.* The center tap is to be used only for r-f or power supply returns.

Filament Starters

The high initial rush of current through the filament when the switch is first closed should be limited by the use of some form of filament starter. This may be a system of time-delay relays cutting resistance out of the circuit or a high-reactance filament transformer or a manual control. In any case, the starting current must never, even momentarily, exceed $1\frac{1}{2}$ times the normal value. Provision must be made also for accurate adjustment and maintenance of the filament voltage. The filament voltmeter should be connected to indicate the voltage at the filament terminals. The filament base should not be connected to ground or to any part of the circuit. Filament power may be alternating current or direct current. When alternating current is used, the plate and grid circuit returns should be made to the center point of the filament supply. When direct current is used, these returns should be made to the negative terminal.

Multiple Filament Tubes

For multiphase filament tubes it is essential that the connections for each type of filament voltage supply be made correctly in order to prevent distortion and possible failure of the filament.

The plate circuit should be provided with a time-delay relay to delay the application of plate voltage until the filament has reached at least 80 per cent of the normal voltage. It must be provided also with protective devices to prevent the tube from drawing a heavy overload. The coil of an instantaneous overload relay (set for slightly higher than normal plate current) placed in the ground lead of the plate return and operating to remove the plate voltage may be used for this purpose. The total time required for the operation of the relay and breaker should be in the order of one-tenth second and not more than one-sixth second. Plate series protective resistors should also be provided to protect the tube from excessive energy dissipation during instantaneous failure of insulation, within the tube or within the transmitter. The minimum value of this resistor which will give

WATER-COOLED TRANSMITTING TUBES

(Continued from page 20)

provided as part of the air-cooling system to direct the cooling air toward the top portion of the bulb.

Forced Air Circulation

The system should be arranged so that the temperature of the glass is not more than 150° C. at the hottest point. Even when forced air cooling is not specified, free circulation of air must be provided to limit the temperature of the glass to this value. When there is inadequate ventilation or where a tube is used at the higher frequencies, forced air cooling may be required. In such cases a small blower may be used with suitable nozzles directing the air to the areas where cooling is necessary.

The cooling air must not contain any foreign matter. The air-cooling system should be electrically interconnected with the filament and plate supplies to prevent the application of voltage to the tube without suitable cooling. Precautions should be taken to insulate the air-cooling system from the anode and grid.

Air and water cooling of such tubes as the GL-862 and -898 must be continued for ten minutes after power has been removed. For all other types water cooling only must be continued for two minutes after shutdown.

Electrical Problems

Suitable meters should be provided for reading filament voltage, plate voltage, and current, and d-c grid current. A tube life recording meter (to read hours of operation) should also be provided.

The installation of all wires and connections must be made so that they do not lie on or close to the glass of the tube. Otherwise, severe trouble may arise from corona discharge or increased dielectric loss which will result in almost certain puncture.

The filament circuit carries a high current at low voltage. Therefore, the usual precautions should be taken against loss of voltage and heating due to poor connections. The filament con-

adequate protection with minimum power loss is included in the tube descriptive data. Precautions must be taken so that no high capacitance is connected directly across the tube in such a manner that a disturbance within the tube will discharge appreciable energy from the capacitor.

Grid Circuit Conductors

The *grid circuit* should be provided with heavy conductors, carefully connected, in order to prevent overheating of the grid terminal due to r-f currents.

In the GL-8002 tube, three grid leads are brought out to terminals. These may be used in parallel to reduce the inductance of the grid circuit. If desired, to reduce coupling, one lead may be used for the neutralizing circuit and the other two for the grid-excitation circuit. When the tube is used in an oscillator circuit at the higher frequencies, it may be necessary partially to neutralize the feedback in order to prevent excess grid excitation caused by the normal grid-plate capacitance.

If two or more tubes are used in the circuit, controls should be provided so that adjustment may be made to balance properly the plate current taken by each tube.

Grid Bias Voltages

In *Class B service*, grid bias of excellent regulation is usually required.

In *Class C service*, the bias voltage may be supplied by a grid leak, or by a combination of grid leak and generator, grid leak and rectifier, or grid leak and cathode-bias resistor suitably by-passed. The combination method is particularly suitable to reduce distortion, especially in plate-modulated operation. Since the grid-bias voltage for Class C service is not particularly critical, correct circuit adjustment may be obtained with values differing widely from those indicated for this service.

Preventing Parasitics

The *circuits* should be arranged to prevent parasitic oscillations so that the tube will not be subjected to excessive voltages and currents.

Operation

When a new tube is first placed in operation, it should be operated without plate voltage for fifteen minutes at rated filament voltage. After this initial preheating schedule, plate voltage can be applied. For fifteen minutes the tube should then be operated at approximately one-half the usual plate voltage. Full voltage may then be applied and the tube operated under the normal load conditions for a period of one hour or more. Every three months spare tubes should be given the preheating and



Figure 3
The 893 tube, with a unique filament construction that permits operation from single-phase, three-phase, or six-phase a-c, or from d-c for all classes of service.

initial operation schedule discussed above.

Constant Voltage Filament Operation

The filament should be operated at constant voltage rather than constant current and must be allowed to reach at least 80 per cent normal voltage before plate voltage is applied. Intermittent power supply interruptions may be allowed provided the time off does not exceed one second. If the tube is to be used at relatively low output, the plate current will be less than normal, requiring less than normal emission of the filament. The filament, therefore, may be operated at a voltage slightly lower than rated voltage, giving longer life. The permissible reduction in filament voltage may be checked by reducing the filament voltage with the transmitter under normal operation to a value where reduction in output or increase in dis-

tortion can just be detected. The filament voltage must then be increased by an amount equivalent to the maximum percentage regulation of the filament supply voltage. Care must be taken that sufficient emission is provided. Otherwise, instability of operation or excessive distortion may be experienced, or the rated plate dissipation of the tube may be exceeded. From the viewpoint of tube life, it is usually economically advantageous to provide good regulation of the filament voltage. For example, if the filament is operated continuously at 6 per cent above normal voltage, the evaporation life will be reduced to approximately one-half.

Phase-Voltage Control

When a three-phase or six-phase alternating filament-supply voltage is used, the phase voltages must all balance within 15 per cent during the filament starting period. During normal operation the phase voltages must never, even momentarily, exceed 10 per cent unbalance.

Filament Operation During Idling

If the apparatus in which the tube is used is to be idle for periods not exceeding two hours, voltage should be maintained on the filament. However, if desired, provision may be made to reduce the filament voltage to approximately 80 per cent of the rated value during the stand-by. Where stand-by periods exceed two hours the filament voltage may be removed.¹

D-C Filament Excitation

When direct-current filament excitation is used, the filament leads should be reversed every 500 hours of operation.

Recommended Services

Data for transmitting tubes show the maximum ratings and typical operating conditions for each recommended class of service. The amplifier classifications used are those given in the Report of the Standards Committee of the Institute of Radio Engineers.

The output values given are approximate tube outputs under certain typical operating conditions. These must not be used as output ratings; circuit losses must be subtracted from the tube output in calculating the useful output.

Anode Dissipation

The approximate anode dissipation may be calculated from the following expression:

$$P = n \frac{(T_2 - T_1)}{(4)}$$

(kilowatts)

in which (T_1) is the known initial temperature of the cooling water in degrees centigrade, (T_2) the temperature of the

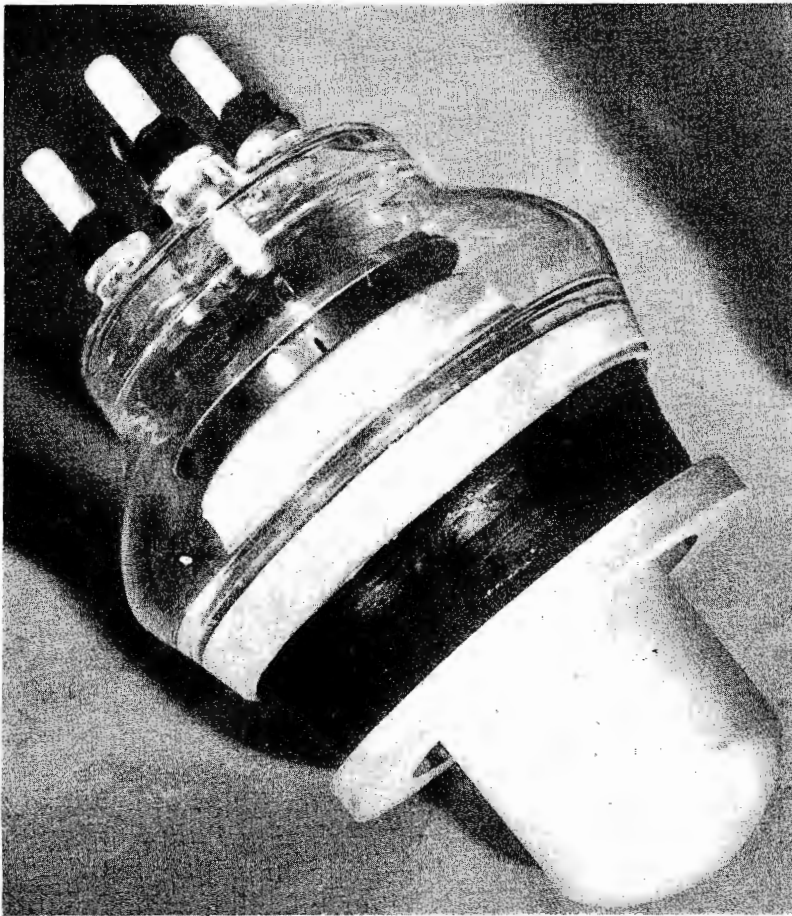

Figure 4

The 880 type tube, designed for ultra-high-frequency operation. This tube may be used either for water cooled or air-cooled service.

The tube should be tested upon receipt in the equipment in which it is to be used. The glass bulb, and particularly the glass area around the terminals, should be free from foreign matter. The leads become hot during operation so that any foreign material may become charred and cause puncture of the bulb.

The standard jacket supports the tube in the correct vertical position with the filament end up.

Placing Tube in Jacket

The tube should be placed in its water jacket carefully, centered accurately, and then firmly fastened. The tube should be secured in its jacket before making the electrical connections. When the jacket-clamping device is tightened, the contacts must seat properly on the tube flange. Proper seating in the jacket will be obtained by use of the standard gasket which is supplied with each tube. *A new gasket must be used whenever a tube is placed in the jacket.* It is recommended that the gasket be coated with a thin film of prodag to prevent sticking. The clamping device should first be tightened gently to prevent possible strain at the anode seal caused by improper seating of the flange. When this preliminary adjustment indicates the tube is seated properly, the jacket can be tightened securely. It is important that you do not tighten more than required to seat the anode flange properly on the gasket. *If these precautions are not taken, the tube may be ruined by a glass crack caused by the uneven pressure on the flange.* The grid and filament leads should not be taut, but should allow for some movement without placing a strain on the glass bulb. When electrical connections are made to the tube, care should be taken to exert as little bending movement as possible to the terminal pins. Before a readjustment of either the tube or its jacket is made, the leads should be disconnected. The retaining lugs, threads, and moving parts of the jacket may be kept free from rusting and sticking by coating them with a thin film of oil or oil-dag. No adhesive should be used to seal the jacket against leaks because any sticking of the anode in the jacket may cause the tube to be damaged during its removal.

¹See "Filament Control and Its Tube Life Affect," D. W. Jenks; pp. 12, 13, 14, 44, December, 1942, COMMUNICATIONS.

water at the water jacket outlet in degrees centigrade, and (n) the water flow in gallons per minute.

In determining the value of plate voltage for normal operation, the line voltage fluctuation, load variation, and manufacturing variations must be estimated so that the maximum rated values will not be exceeded.

New Circuits and Plate Voltages

When a new circuit is tried or when adjustments are made, the plate voltage should be reduced to approximately one-half the rated value to prevent damage to the tube or associated apparatus. After correct adjustment has been made with the tube operating smoothly and without excessive heating of the cooling water or the glass bulb, the plate voltage may be raised in several steps to the desired value. Adjustments should be made at each step for optimum operation.

Overload Problems

In case of overload and resultant overheating of the tube, the vacuum may be impaired. When the quantity of gas is not too great, the tube may be operated to bring about an electrical cleanup

of the gas. The first step in the process should be a short period of operation at a plate voltage of one-half the normal value. The plate voltage should then be increased to the normal value and the tube allowed to operate for a period of one hour or more. In severe cases it may be possible to age the tube by operating with a series resistor in the plate supply. Short periods of operation may be conducted at each step as the resistor is reduced until stable operation at the normal plate voltage is obtained.

Turning on Water

Before turning off the water preparatory to removing the tube, be sure that the inner electrodes are below red heat. Do not force the tube when removing it from the jacket. Release the securing device so that it will not stick, then manipulate the tube carefully to avoid putting strains on the glass. If sticking does occur, rotate the tube gently back and forth, at the same time raising it carefully.

Handling of Tubes

The handling of a transmitting tube requires care since a tube may be damaged if subjected to shock or vibration.



IN the manufacture of precision instruments for the Armed Forces we strive for short cuts in production—but not in *quality*. There can be no expediency, no compromise, no half-way measures. The success of the bomber's mission depends as much upon the efficiency of the instruments as it does upon the skill of the officers and men.

Meeting the specifications of the United States Armed Forces

is in itself an eloquent testimonial to the *quality* of DeJur meters, potentiometers and rheostats. However, we do not rest upon these laurels alone. Behind DeJur workers is the stern tradition of New England . . . honesty of craftsmanship, pride of skill, the deep, personal delight in doing a job and doing it better than anyone else—anywhere.

in war as in peace . . . nothing takes the place of quality. *Your inquiries are invited.*



DeJur AmSCO CORPORATION

SHELTON, CONNECTICUT

Manufacturers of DeJur Meters, Potentiometers, Rheostats and other Precision, Quality Electrical Instruments

Figure 6

Output characteristics of carbon (curve "a") and dynamic (curve "b") microphones. Curves "c," "d" and "e" represent open and semi-open throat response and whistling effects.

THROAT MICROPHONES

(Continued from page 12)

relation to lows so that provision must be made in the amplifier to attenuate lows. Enough gain is available in the unit as shown to allow for low attenuation merely through the use of a small enough interstage coupling condenser, although in some cases it was found more satisfactory to tune the primary of the output transformer to about three kilocycles.

The question of interdepartmental intercommunicators soon came in for its share of attention as a number of these units were in use in noisy locations. As ordinarily used, the communicators, while they had sufficient power to overcome ambient noise, could not be turned up to anywhere near full gain since the input noise level was too high. A relatively simple change was made in these units in which the interphone transducer was permanently disconnected from the input circuit while a single unit dynamic throat mike mounted as a lorgnette was hung from a hook. In use the lorgnette was held to one side of the larynx while the press-to-talk switch was operated with the free hand. It was found that highs had to be brought up considerably for adequate intelligibility, but once this was done communication was much more satisfactory than before, since higher gain could be used to overcome the noise levels at the receiving unit, without interference from the noise levels at the transmitting end.

Microphone characteristics play an important part in this phase of the com-

munication field as it does in others. However, the usual criteria are absent; that is flatness of response and desired field shape, to be replaced by the desirability of a frequency response which complements the vibratory output at the larynx. In general it may be considered that the reference output level is that produced by the guttural tones developed in the larynx itself, while the sibilants formed at the front of the mouth are attenuated as much as 20 db by two factors. The first is that in pressure developing speech which we consider normal, the lower frequency components from the larynx are considerably attenuated before reaching the air, while the throat microphone picks them up in full intensity, and the second point is that the high frequencies formed at the front of the mouth are attenuated because of the distance they have to go before reaching the throat mike and by the absorptive effect of the mouth and throat structures.

Peak Compensation

To compensate for this, some of the carbon microphones are peaked between 3500 and 4500 cycles as shown in Fig. 4. In the case of the dynamic microphones which are substantially flatter, the frequency response desired must be

obtained by adjusting the characteristics of the associated amplifying equipment.

Microphone Limitations

In general, the use of the throat microphone for communication in noisy surroundings seems an adequate solution in a great many difficult applications. Its use, however, seems limited to cases such as those mentioned in the foregoing; namely, for instruction purposes, for communication between members of working crews whose relative positions do not change very much, and for restricted interphone operation under conditions where the noise level at any station is so high that operation with pressure sensitive transducers is unsatisfactory.

Frequency Response

Curves on the frequency response of throat microphones are not in themselves conclusive. The only adequate method of testing the absolute frequency response of a throat microphone, whether dynamic or carbon, is to mount it on a vibrator and to shake it at a constant amplitude over the entire frequency range and measure the voltage output. A system of this type is diagrammatically indicated in Figure 5. The output of one type of carbon microphone is shown as curve "a" in Figure 6. It is to be noted that the output is practically constant until resonance is reached after the peak of which the response drops off exponentially. A dynamic microphone tested, as shown in "b", responds as a linear function of frequency up to resonance, peaks, and then drops off in the same manner as does the carbon.

Voice Amplitude Peculiarities

However curves of this sort while interesting of themselves do not have very much value in interpreting the response which will be obtained in actual use. The reason of course is that the voice amplitudes at the outside of the throat depend on the location of the

(Continued on page 46)

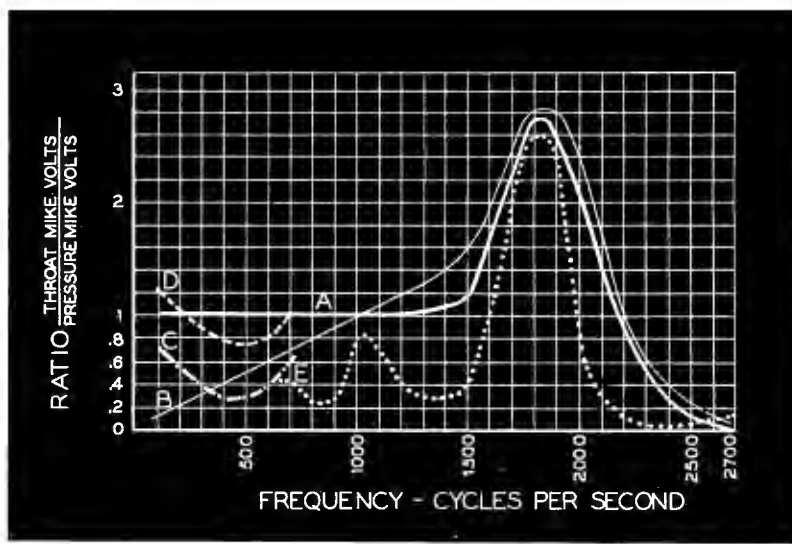
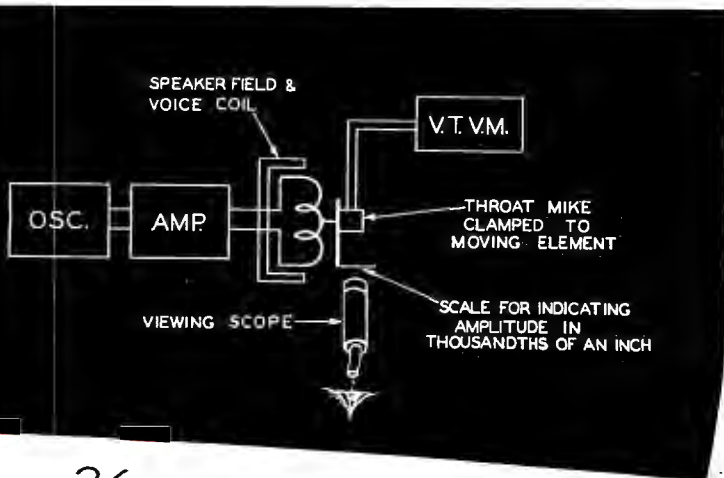

Figure 5

A system developed to test the absolute frequency response of a throat microphone. With this device, the microphone is shaken over the entire frequency range.



Preview

OF TRIPLE CHECKED ACCURACY

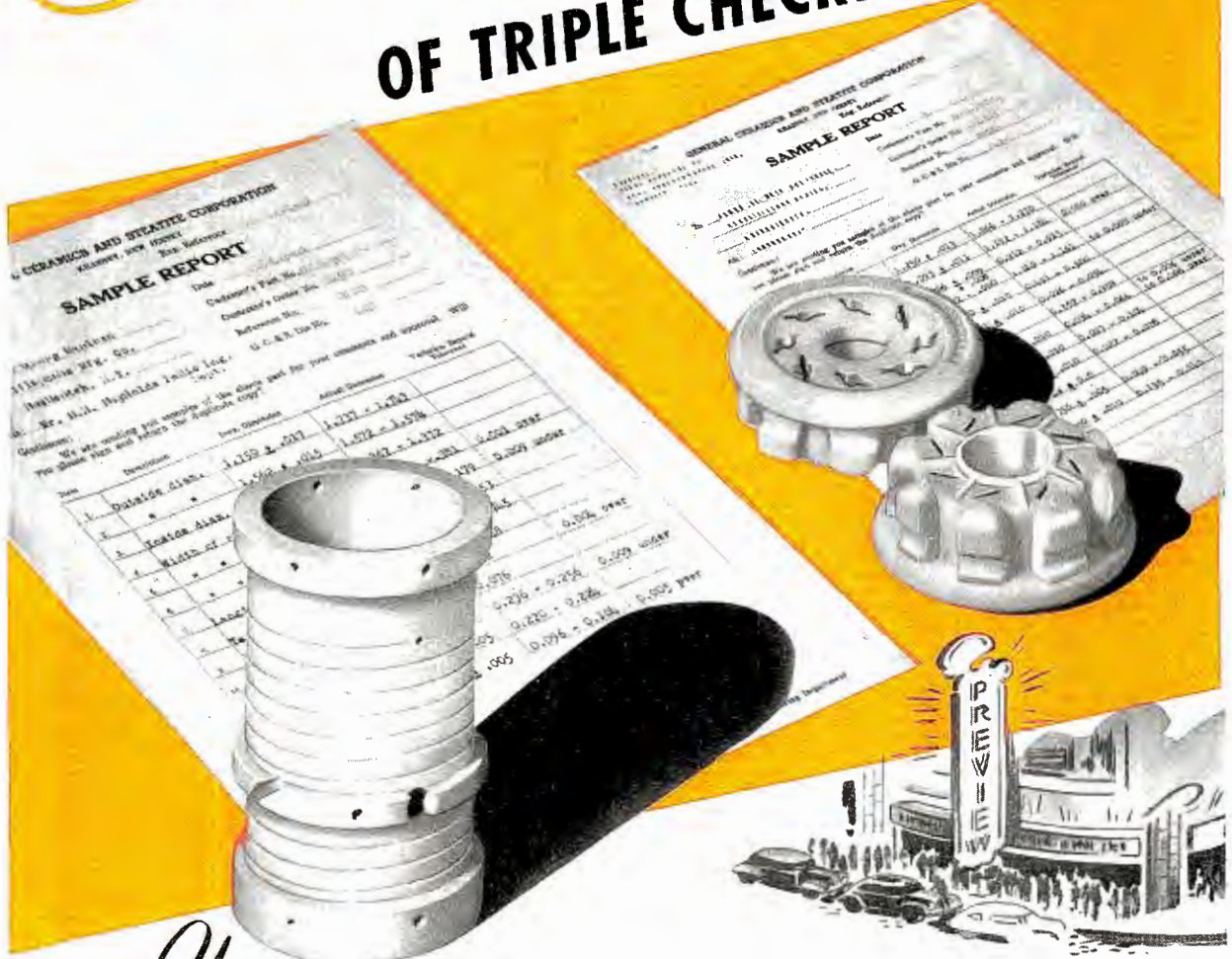

YOU get a preview of your special steatite insulators when we make them — and a *triple check* on the accurate compliance with your blueprints and specifications.

We make and check the tools for fabricating your order. *Check number one.*

Samples produced for you with these tools get a complete inspection of every detail. *Check number two.*

Inspectors make a "Sample Report" which you

receive with the samples. The report states drawing dimensions, actual dimensions and variations beyond tolerance, if any. Your *check number three* — after a preview of the product.

After your O.K., you can be sure that the rest of the order will conform to your specifications.

To the best of our knowledge, this service is unique in our field. It is one of the factors of our controlled manufacturing technique which assures quality and uniformity of product.

General Ceramics

AND STEATITE CORP.
KEASBEY NEW JERSEY



ST 2548

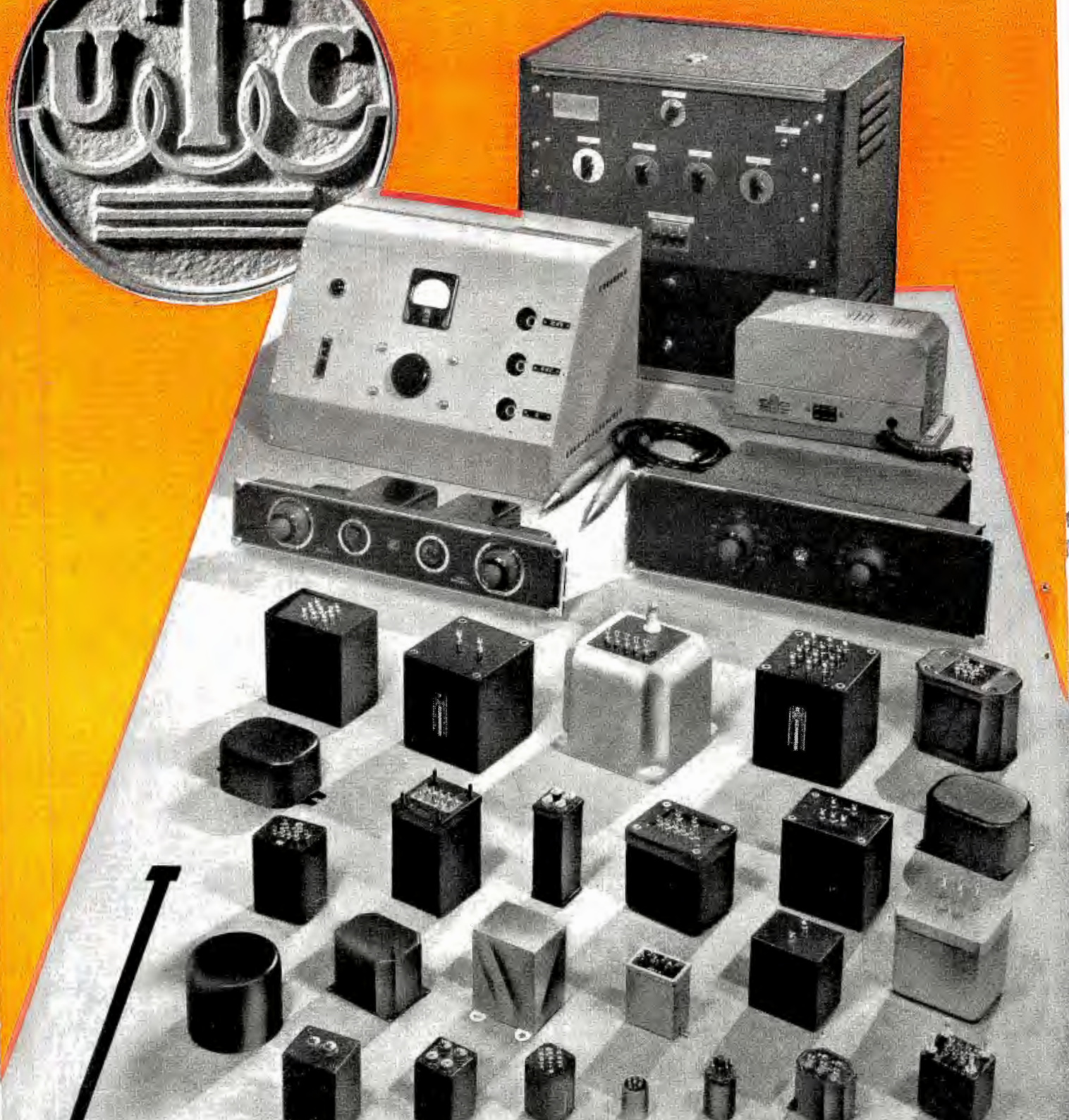

Leads the field

UNITED TRANSFORMER CO.

150 VARICK STREET



NEW YORK, N. Y.

EXPORT DIVISION: 100 VARICK STREET NEW YORK, N. Y. CABLES: "ARLAB"

High Frequency

RESPONSE OF VIDEO AMPLIFIERS*

[PART TWO OF A TWO-PART PAPER]

by ALBERT PREISMAN

Development Engineer, Federal Telegraph and Radio Corp.

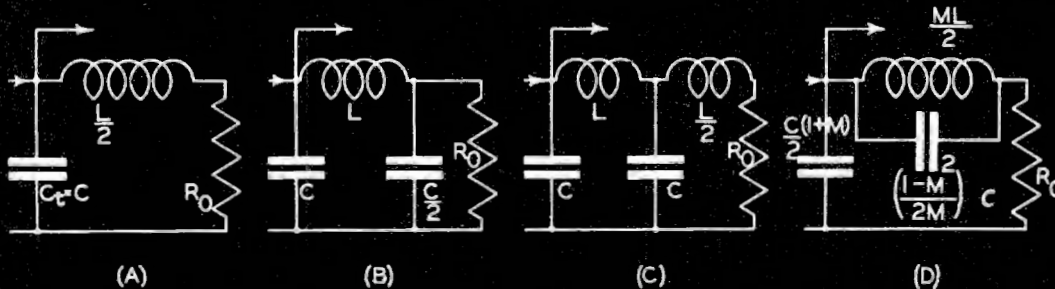

Figure 12
Shunt peaking
circuits.

(In the first portion of this paper, Mr. Preisman presented an analysis of the voltage amplifier and the resistance coupled amplifier. He then discussed the use of the filter theory and the controversial Percival method. The use of *M*-derived terminations and suggested configurations concluded this initial presentation. In this concluding section, Mr. Preisman offers further data on configurations and describes the Tellegen-Verbeck method. This method is of great import in determining the value of circuit constants necessary to achieve flatness of response or linearity of phase shift for a given circuit configuration.)

HOWEVER, in actual practice, the ratio of two capacities may not be 2-to-1 (or whatever optimum value should be as indicated by method described later). Thus, suppose the two capacities are C_1 and C_2 and are very nearly equal. In this case the transfer ratio of output to input voltages of the four terminal network may indicate a dip in the center of the band width. At the low frequency end, it is evident that the response is determined practically entirely by the value of R_0 .

*This paper, specially prepared for COMMUNICATIONS, is based on a talk presented by the author before the Communications group of the New York AIEE on October 26 on Video Amplifiers.

alone. If R_0 be reduced until the low frequency response is no greater than this dip at the center of the band, then it will be found that near the high end of the band an even greater peak in the response will be obtained. This results from a series resonant effect in the circuit. This peak at the high end of the band may be damped out in one of two ways . . . (1)—by shunting L with a resistance R_D (Figure 13C), or (2)—by shunting the capacity normally not shunted, by a suitable resistance R_D as shown in Figure 13D. In this way flatness of response may be obtained for all values of C_1 and C_2 but if their ratio depart too widely from the optimum value, then the gain for a given band width will not be much greater than that for some of the two terminal networks such as shown in Figure 12D. For this reason the two terminal configurations are generally preferred because they are simpler and easier to adjust. Indeed, the four terminal network, or in general, the multi-terminal network is employed where several outputs must be obtained from a common input. Such may be the case for example, in a television receiver where the output of the second detector feeds not only the kinescope video amplifier but a "synch" separator circuit as well. If all three were tied together to

one pair of terminals, the resulting capacity might be so great as to reduce the gain for a given band width to an unfavorably low value. By tapping these outputs from successive π sections in cascade, effective separation of these capacitive loads is obtained and the gain for a given band width is maintained at a higher value.

Tellegen-Verbeck Method

When a multi-stage amplifier is to be built, such as in the case of television terminal equipment, or where very accurate amplification at all frequencies must be had, such as in the case of cathode-ray oscillography, more accurate adjustment of the circuit parameters must be had than that indicated by the Percival method. It will be found in general, that the value of the circuit parameters which gives the highest gain over a given band width, does not necessarily give the greatest constancy in time delay, so that both requirements cannot simultaneously be met. The circuit parameters which give the best compromise between these two requisities are rather difficult to establish, since it is fundamentally based upon the analyst's opinion as to which is the best replica in the output circuit of the wave shape impressed upon

(Continued on page 32)



**We're experimenting
so you won't have to**

General Electric is operating today one of the world's most complete television stations, WRGB, at Schenectady. There, within the limitations of full-scale war production, G. E. is gaining practical knowledge on which to build a new industry.

For a clear television picture on a fluorescent screen is only the beginning of television. From there on out, problems still loom. What will television offer that movies, theater, concert hall,

M. J. ...



To help you plan for television, visit General Electric's proving-ground station WRGB, shown above

school, and radio cannot offer? Will the television screen make a good teaching platform? Will it further the fine arts, science, industry? What can it offer uniquely to the church?

How, in short, will television best serve the public welfare? How best improve our lives?

General Electric electronic engineers are studying and improving transmission and reception. And studio manager and program staff are urged to give fullest expression to creative

talents and ideas. For the General Electric vision is to make television stand on its own feet as a new cultural and entertainment medium.

In the future, when you are planning your television station, General Electric will be ready with a wealth of experience in television programming and techniques. General Electric today is scanning tomorrow. . . . Radio, Television, and Electronics Department, General Electric Company, Schenectady, New York.

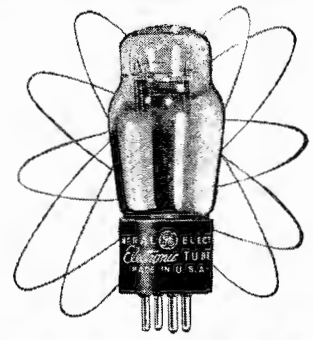

LEADER IN RADIO, TELEVISION, AND ELECTRONIC RESEARCH
GENERAL ELECTRIC
160-A1-6918

TELEVISION

VIDEO HIGH FREQUENCY RESPONSE

(Continued from page 29)

the input terminals. If such an opinion is reached then possibly the best method of establishing the proper circuit values for some given wave shape, is by the method of transient analysis, but unfortunately such an analysis does not lend itself readily to the determination of the circuit required for a given input and output wave shape.

However, generally speaking, the circuits previously presented are such that if the amplitude response is flat over the desired band width and then drops off gradually, then the phase shift over the flat region will be substantially linear and the response of the amplifier satisfactory for most ordinary purposes. Hence, the following method due to Tellegen and Verbeck⁵ is of great service in determining the value of the circuit constants necessary to achieve flatness of response or linearity of phase shift for a given circuit configuration. To exhibit the method, consider the ordinary shunt peaking circuit shown in Figure 14. As mentioned previously, the response is in direct proportion to the impedance Z across the input terminals. This evidently consists of C_1 paralleled by L and R in series, and has the value

$$Z = \frac{R + j\omega L}{1 - \omega^2 C_1 L + j\omega C_1 R} \quad (12)$$

Let $\omega_0^2 = 1/LC_1$, and $R = k\sqrt{L/C_1}$, then

$$Z = \frac{(k/\omega_0 C_1) [1 + j(1/k)(\omega/\omega_0)]}{1 - (\omega/\omega_0)^2 + jk(\omega/\omega_0)} \quad (13)$$

Now let $\omega/\omega_0 = \gamma$ for convenience. Then

$$Z = \frac{k}{\omega_0 C_1} \sqrt{\frac{1 + (1/k)^2 \gamma^2}{1 + \gamma^2 (k^2 - 2) + \gamma^4}} \left| \tan^{-1}(\gamma/k) - \tan^{-1} \left(\frac{k\gamma}{1 - \gamma^2} \right) \right| \quad (14)$$

Eq. (14) gives the value of the impedance in magnitude and angle form. As may be expected for a lumped network of finite number of meshes, the impedance is expressed as the square root of the ratio of two rational algebraic polynomials, in terms of the frequency variable, or in this case, in terms of the frequency ratio as a variable. It is this ability to express the impedance in the above form that permits of application of the Tellegen-Verbeck method. An examination of the physical circuit indicates obviously that it must have zero impedance at infinite frequency because of the initial capacity C_1 . Consequently, the impedance expression given by Eq. (14) will involve

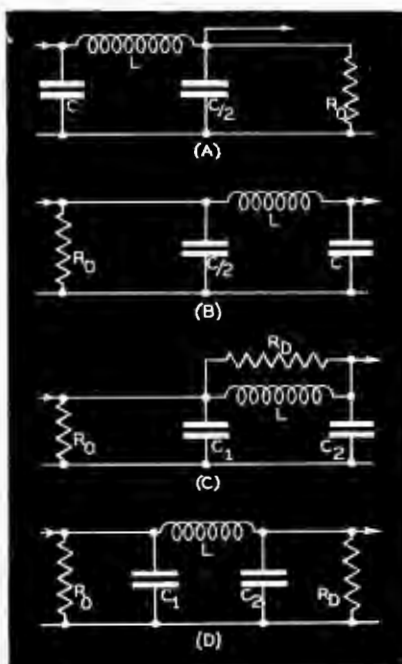

Figure 13
Series peaking circuits.

the frequency ratio γ to a higher power in the denominator than in the numerator, for then obviously, as γ approaches infinity, Z approaches zero. This indicates that for the particular circuit, Z cannot remain constant in amplitude as γ is increased indefinitely. However, for small values of γ , which means for values of frequency below the cut-off (in which case γ is fractional), higher powers of γ may be neglected for the frequency range to be considered. For the remaining terms of the denominator, if the coefficients of the powers of γ were equal to the coefficients of the powers of γ in the numerator, then the expression under the radical would become identically equal to unity, which means that Z would be constant. Of course, for values of γ greater than unity beyond the cut off frequency, the denominator would increase more rapidly than the numerator due to the presence of γ^4 and Z would therefore ultimately decrease to zero as stated pre-

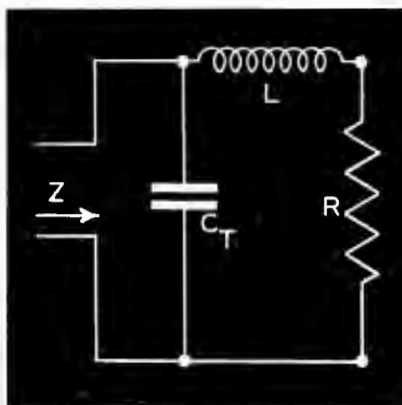

Figure 14
An ordinary shunt peaking circuit.

viously. The first pair of coefficients of the numerator and denominator, namely unity, are equal without any further argument. If we set the coefficients of the γ^2 terms equal, we obtain

$$k^2 - 2 = 1/k^2$$

from which

$$k = \sqrt{1 + \sqrt{2}} = 1.55 \quad (15)$$

This is the value of k (which is the number of times that R is greater than the $\sqrt{L/C_1}$), which gives the flattest response over the greatest possible band width for the configuration shown in Figure 14. This compares with the value of 1.14 for k if the Percival method were employed.

It might, therefore, indicate that this method provides a higher value of resistance than that of Percival. However, the bandwidth over which the response is flat to some predetermined degree, will be found to be less than that indicated by the method of Percival, so that actually the Tellegen-Verbeck method gives rise to a video amplifier stage which has less gain over a desired band width than the Percival method. To find over what band width the gain is flat to any desired degree, we substitute the value of k from Eq. (15) into Eq. (14) and then substitute various fractional values of γ and solve for each of these values of γ the corresponding values of Z . Z can then be plotted against γ and a curve (Figure 15) obtained.

Suppose we wish to find the value of γ at which Z , and hence the response, drops 2% below its value in the flat portion of the spectrum. Figure 15 indicates that this occurs at a value of γ equal to 0.46. If we were willing to consider a 10% drop-off in response as satisfactory, the corresponding value of γ would be larger. The value for 2% drop-off, namely, 0.46, indicates that the highest frequency f_H , over which the response is considered flat is 46% of the cut-off frequency. In practice, f_H is known from other considerations. Hence, the cut-off frequency f_0 can be found, and also

$\omega_0 = 2\pi f_0$. Since $\omega_0^2 = \frac{1}{LC_1}$ we have that

$$L = \frac{1}{\omega_0^2 C_1} \quad (16)$$

and R therefore equals

$$R = \frac{1.55}{\omega_0 C_1} \quad (17)$$

The capacity C_1 is also predetermined by the choice of tubes and physical circuit stray wiring capacities, so that R and L are completely determined by Eqs. (16 and 17).

In review, it will be noted that the

(Continued on page 49)

An Analysis of The BELLINI-TOSI FIXED DIRECTION FINDER

by HARVEY POLLACK

Chairman Technical Department, Melville Aeronautical Radio School

ONE of the most interesting types of direction-finder systems is the Bellini-Tosi. For years this fixed-loop direction finding method has been a favorite in Continental ship and fixed radio installations, but unfortunately, it has not found such great favor in this country. It does have effective properties, many of which are, however, quite critical.

In this system the main directional antenna consists of two fixed loops at right angles to each other (Figure 1) the plane of one running fore and aft on shipboard, the plane of the other place parallel to the beam of the vessel. Loop A is joined to a goniometer coil, A', and loop B to B', both goniometers being located in the control room and as is evident from the diagram, A' and B' are at right angles to each other. C is a rotatable search coil magnetically coupled to the goniometers.

Single Loop Action

For a single loop, the maximum induction which takes place due to the action of a passing wave occurs when the plane of the loop is parallel to the plane of propagation of the wave. If θ equals the angle between the plane of the loop and the direction of the wave, then writing E_1 for the maximum effective value of the e-m-f in the loop and E_θ for the e-m-f in the loop at the angle θ , we have . . .

$E_\theta = E_1$ when θ equals 0, and E_θ equals 0 when θ equals 90° (Figure 4). Thus, E_θ varies as the cosine θ , and we may write:

$$(1) \quad E_\theta = E_1 \cos \theta$$

The numerical value of E_1 is proportional to . . . (a) the height of the vertical sides of the loop, h , and the width of the loop, d , which controls the phase angle between the e-m-f's induced in the vertical sides of the loop. Since the resultant, or active e-m-f is that voltage available to the receiver, we are interested in the vectorial difference between the two e-m-f's induced in the sides of the loop. This gives a maximum value when d equals half a wave length, since the phase angle under these

conditions will be 180° . And (b), the intensity of the electric field, X . When d is small in comparison with the wave length, it follows that the area of the loop, A , should be made as large as possible. These factors may all be related in the following equation . . .

$$(2) \quad E_1 = \frac{2\pi X A}{\lambda} \text{ which equals } \frac{2\pi X A f}{v}$$

where $v = f\lambda$ and v is the velocity of electromagnetic waves, f is the frequency.

Fixed Loop Reception

Let us now consider the general case of fixed loop reception. The two loops of Figure 1 may be set up in any two vertical planes at right angles to each other. In order that each of them, treated as a separate antenna may have the same voltage induced in it by a passing wave in its own plane, both loops, theoretically, should have the same area since the e-m-f is a direct function of A . Suppose that a wave whose electric field is $E_m \sin \omega t$ is incident on the system at an angle θ with the plane of the loop B, and therefore at an angle $(90^\circ - \theta)$ with the plane of the loop A (Figure 2). Remembering that ω equals $2\pi f$, and substituting equation (2) in equation (1), we obtain . . .

$$\text{The e-m-f developed in Loop B} = \frac{\omega E_m A}{v} \cos \theta \cos \omega t$$

$$\text{The e-m-f developed in Loop A} = \frac{\omega E_m A}{v} \cos (90^\circ - \theta) \cos \omega t =$$

$$\frac{\omega E_m A}{v} \sin \theta \cos \omega t$$

These equations are valid only if the widths of A and B are small compared with the wavelength.

The currents in the goniometers produced by these e-m-f's depend upon the impedances of the former plus the impedance of the connecting leads and the remainder of the circuit. Since untuned antennas are used in practice, their resistance is negligible compared with their inductive reactance. If both circuits have the same inductance, L ,

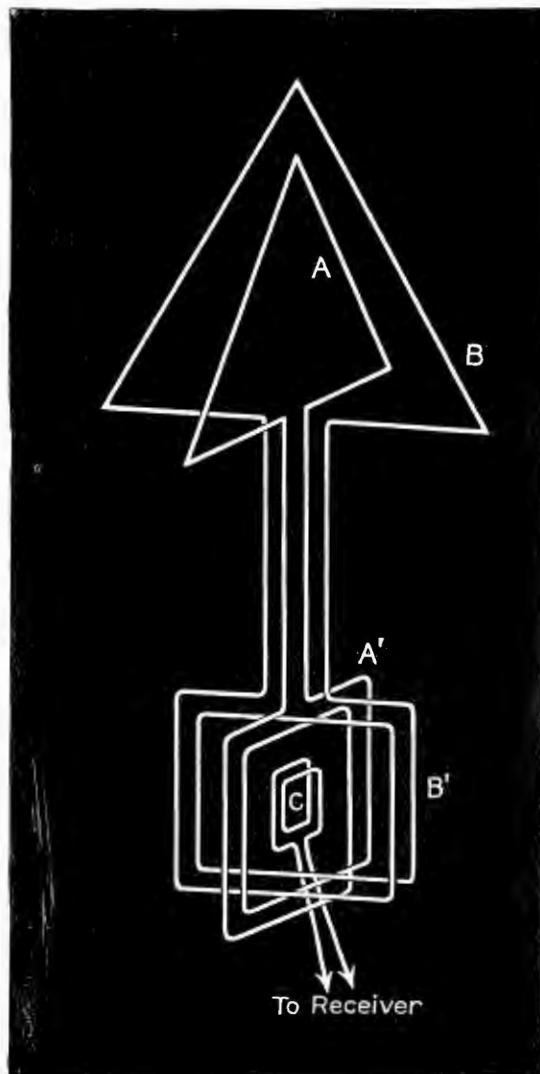

Figure 1
Two fixed loops that constitute the main directional antenna.

currents proportional to the e-m-f's and lagging 90° in phase with the former flow in the two goniometer windings, the currents being given by . . .

$$\text{The current in B}' = \frac{E_m A}{v L} \cos \theta \sin \omega t$$

$$\text{The current in A}' = \frac{E_m A}{v L} \sin \theta \sin \omega t$$

If the coils B' and A' are identical, except that they are at right angles to

each other, the fluxes produced by the currents bear the same proportion to the currents, and may be written as (Figure 3) . . .

$$\text{Flux through } B' = \phi \cos \theta \sin \omega t$$

$$\text{Flux through } A' = \phi \sin \theta \sin \omega t$$

They are therefore equivalent to a resultant flux $\phi \sin \omega t$ at right angles to a plane making an angle θ with the plane of B' (Figure 3). If, then, the plane of the search coil is set at right angles to this plane, that is in the direction of the resultant flux, C will have no flux linkage and no e-m-f will be produced. Thus zero signals are obtained when the plane of coil C makes the same angle with the plane of coil A , as the direction of the incident wave makes with the plane of the loop B . Hence, the Bellini-Tosi system enables the direction of a transmitter to be determined. It still requires, however, the use of a sense antenna for the determination of the compass direction from which the emission is taking place.

In passing, it is interesting to note that the maximum e-m-f in the search coil C (when C is at right angles to the direction of the resultant flux), is independent of the direction of the incident wave, since the maximum flux is always $\phi \sin \omega t$.

Equivalent Systems

The rotating loop and Bellini-Tosi system are electrically equivalent. In shore installations both systems acquit themselves admirably and one cannot say which is superior. The advantage of the Bellini-Tosi system on shipboard may usually be found in the larger loops possible with this system and in the elimination of the mechanical difficulties concomitant with exterior rotatory mechanisms. If the rotating coil can be fitted in a suitable position, it has the merit of simplicity from an electrical point of view. Where, in this case, the full resonant e-m-f from the loop is available for the receiver because the loop may be directly tuned with a condenser, in the Bellini-Tosi d-f there is a considerable loss in signal strength for which compensation must be made in the form of larger cross sectional loop areas. To correspond with a rotating coil of circular cross section and of a diameter of 4 feet it is necessary to have crossed Bellini-Tosi frames of about 7 feet square in order to have signals of equal strength. Where large frames are not particularly disadvantageous as on the ultra-high frequencies using small fixed crossed frames, the Bellini-Tosi system is definitely better since the only element to be rotated is a light search coil. The greatest disadvantage of the Bellini-Tosi d-f is the necessity for perfect electrical

(Continued on page 51)

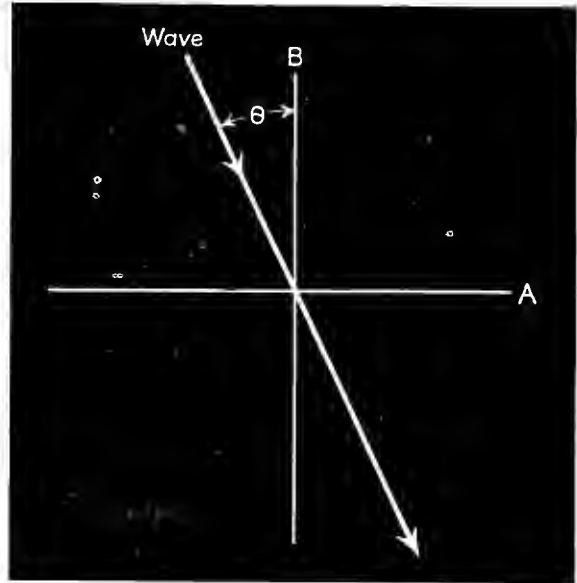

Figure 2
A wave with an electrical field incident on the loop system at an angle θ with the plane of the loop B and therefore at an angle $(90^\circ \text{ minus } \theta)$ with the plane of the loop A appears thusly.

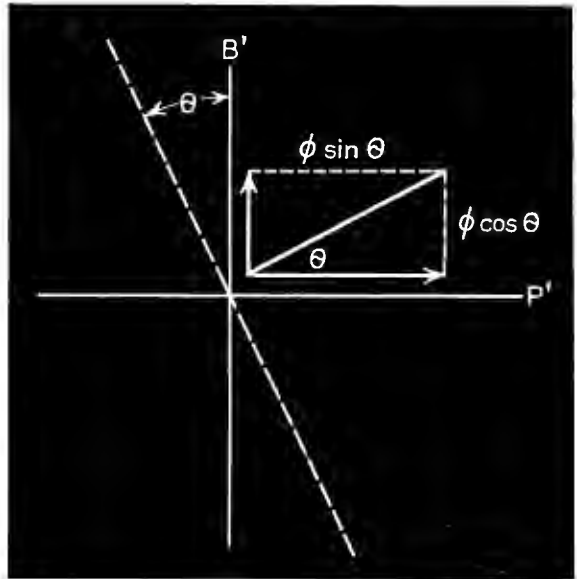

Figure 3
If the coils B' and A' are identical, except that they are at right angles to each other, the fluxes produced between currents bear the same proportion to the currents and may be shown this way.

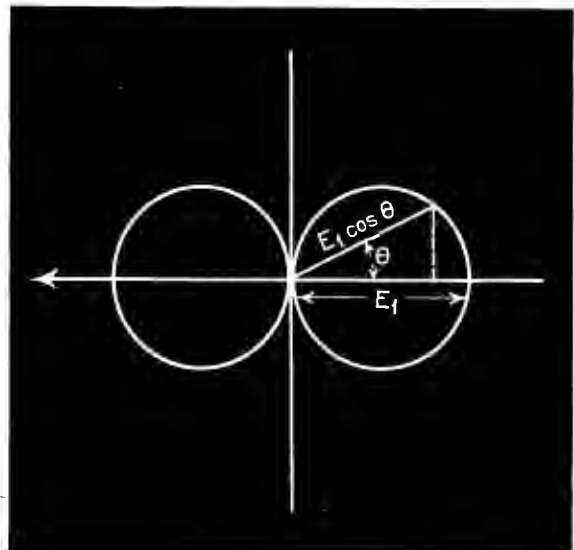

Figure 4
Determining the maximum induction taking place due to the action of a passing wave that occurs when the plane of the loop is parallel to the plane of propagation of the wave.

NEWS BRIEFS OF THE MONTH... —

SOLAR ANNOUNCES SALES SUBSIDIARY

To assist their jobbers, the Solar Manufacturing Corporation, Bayonne, New Jersey, has transferred all jobber sales activities to a new subsidiary organization, which will be known as the Solar Capacitor Sales Corporation.

Solar Capacitor Sales Corporation, like its parent company, will be located at Bayonne, New Jersey, and will operate under the guidance of the same management, including W. C. Harter as general sales manager, Syl Wolin as sales manager, and A. Prosdocimi as manager of the Export Division.

* * *

LANGEVIN'S NEW PLANT

The Langevin Company has just completed their new transformer plant at 37 West 65th Street, New York City. This plant will specialize in the manufacture of electrical transformers of all types for use in radio and Radar communication work.

* * *

ARMSTRONG WINS EDISON MEDAL

The Edison Medal for 1942 has been awarded by the American Institute of Electrical Engineers to Doctor Edwin Howard Armstrong, professor of electrical engineering, Columbia University, "for distinguished contributions to the art of electric communication, notably the regenerative circuit, the superheterodyne, and frequency modulation."

The Edison Medal was founded by associates and friends of Thomas A. Edison, and is awarded annually for "meritorious achievement in electrical science, electrical engineering, or the electrical arts" by a committee consisting of twenty-four members of the American Institute of Electrical Engineers.

* * *

MOTOROLA OPENS ENGINEERING BUILDING

A new Motorola engineering building devoted exclusively to research and development was recently opened. It is immediately adjacent to the main plant.



Top, the streamlined Motorola Engineering Building. Below, a research production line in this new building.

IRE ANNUAL MEETING, JAN. 28

The Institute of Radio Engineers, cooperating in the program to reduce rail passenger traffic, has designated January 28, as a nationwide Winter Conference Day. This will replace the usual three-day convention and exhibition held in January in New York City.

In New York City, the Institute of Radio Engineers has accepted the invitation of the American Institute of Electrical Engineers, which during the week of January 25-29 is holding its national technical meetings there, to join in activities with that society on January 28.

Institute sections, scattered in some 27 sections of the country and Canada, will hold separate technical meetings simultaneous with the conferences in New York City, and are having made available to them the papers and other materials contributed for use in New York City.

The day's activities at New York, to be held in the Engineering Societies Building at 33 West 39th Street, will open with a technical session beginning at 10:00 A. M. and concluding at 12:30 P. M. Papers by H. W. Leverenz, H. F. Olson, and O. H. Schade, all of Radio Corporation of America, and by R. S. Julian, of Bell Telephone Laboratories, Inc., will be presented.

At the annual meeting of the Institute, to begin at 2:30 P. M., retiring president Van Dyck will speak, following which president Wheeler will address the meeting. Talks by Mr. Van Dyck and Mr. Wheeler will be broadcast in the evening over CBS. An address by James Lawrence Fly, FCC and BWC chairman will also be broadcast at this time, from the IRE banquet in Washington.

The Institute Medal of Honor will be presented to William Wilson for his achievements in the development of modern electronics, including its application to radiotelephony.

Fellowships of the Institute will be conferred on Andrew Alford, Ivan S. Coggeshall, Captain Jennings B. Dow, Lee A. DuBridg, Peter C. Goldmark, Daniel E. Harnett, Dorman D. Israel, Axel G. Jensen, Lieutenant Colonel George F. Metcalf, and Irving Wolff.

A special-papers symposium, to conclude the annual meeting will feature Lloyd Espenschied who will set the stage with a brief summary of radio in two World Wars. Rear-Admiral S. C. Hooper of the United States Navy will speak on "The Production of Radio Facilities for Armed Services." Ray Ellis, Director of the Radio-Radar Division of the War Production Board, will address the group on "The Function of the War Production Board in Radio." F. R. Lack, of the Army-Navy Electronics Production Agency, will describe the work of that agency. H. P. Westman, of the War Committee on Radio, American Standards Association, will speak on "Radio Standards Go to War." Kirk Miles, of the National Roster, War Manpower Commission, will define the status of the engineer in Selective Service and the manpower program.

The day's events will culminate in a joint AIEE-IRE technical meeting at 8:30 P. M., on the subject of ultra-high frequencies, the address being given by Dr. George C. Southworth, of Bell Telephone Laboratories, Inc.

U-H-F COURSES AT BROOKLYN POLY

A group of seven graduate war training courses in u-h-f and cathode-ray circuits has been inaugurated at the Polytechnic Institute of Brooklyn, 85 Livingston Street. The courses, to be given by the graduate electrical engineering department as a part of the War Training Program of the United States Office of Education, will cover theory of cathode-ray circuits (10 sessions); experiments in cathode-ray circuits (9 weeks); introduction to microwave theory (10 sessions); introductory experiments in microwaves (9 weeks); theory of u-h-f generators and receivers (10 sessions); experiments in u-h-f generators and receivers (9 weeks), and measurements at u-h-f.

* * *

WEARSTLER MOVES

Wearstler Advertising, Inc., is now located in the Trinity Office Building, 20 West Front Street, Youngstown, Ohio.

* * *

UNIVERSITY LAB APPOINTS NEW REP

University Laboratories, 225 Varick Street, N. Y. City, has appointed Fred Somers of 2015 Grand Avenue, Kansas City, Missouri, as district representative for the following territory . . . Nebraska, Kansas, Iowa and Northwestern Missouri.

* * *

MONEL ENGINEERING BULLETIN

A 16-page Bulletin on the engineering properties of "K" Monel has been released by the International Nickel Company, Inc., 67 Wall Street, N. Y. City.

Data in the bulletin covers composition, physical constants, properties, working instructions, thermal treatment, corrosion resistance, applications, etc.

* * *

WESTMAN JOINS ASA

Harold P. Westman, who for fourteen years was with the Institute of Radio Engineers as assistant secretary, and then as secretary, is now with the War Committee on Radio of the American Standards Association.

During his IRE association Mr. Westman was very actively engaged in all of the IRE standardization activities. Mr. Westman was loaned to the ASA last March to serve as secretary of the committee. Increased committee work made it necessary to devote all his efforts to the ASA.

* * *

"E" TO MEISSNER

The Meissner Manufacturing Company, Mt. Carmel, Illinois, has been awarded the Army and Navy "E" for excellence in production.

Among those who participated in the award were Major W. G. Mee and Major

(Continued on page 37)





VETERAN WIRELESS OPERATORS ASSOCIATION NEWS

W. J. McGONIGLE, President

RCA BUILDING, 30 Rockefeller Plaza, New York, N. Y.

GEORGE H. CLARK, Secretary

Tesla

NIKOLA TESLA, one of the great leaders of electrical development, died on Thursday, January 7, 1943, at 85. He was found by a maid in his suite at the Hotel New Yorker, New York City, having apparently passed away peacefully.

Tesla's greatest achievements were in the realm of alternating currents for power work, and his development of the rotating magnetic field which made possible distribution of power to great distances, as exemplified in the Niagara Falls network.

His dream, however, lay in the realm of higher frequencies, and even before he harnessed himself to more material problems, he dreamed and talked and experimented along the lines of much higher frequencies, those later used in wireless communication. Although one of his earliest statements on this subject put communication first, and transmission of power second on the list of possibilities for high frequencies, later the greater aspect of power occupied his mind almost exclusively, for, as he said some time after, "communication was obvious, whereas power transmission was the more distant goal." It was for this reason that he experimented for years at Colorado Springs on power transmission without wires, and later built a station, with a mushroom-capped tower, at Warendencliff, Long Island, for further experiments of a like nature. But after experimenting for over ten years at this latter site, his results were slight only. The first World War put an end to this work, for his tower, so long a picturesque wireless relic, was blown up by the United States Government, due to reports that it might be used for signalling to enemy submarines.

However, his early and clear envisionment of the principles of communication without wires by means of high frequencies, and his even more startling statements of what such "world communication" would bring, makes him indeed a member of the wireless fraternity. In 1904 he described the flashing of news to all points, to be received by a device that might be carried in



Nikola Tesla, at the Age of 30

one's pocket, and even went so far as to describe "impressing American time on the earth," by means of clocks driven by this radiant energy. Said he: "When this occurs, humanity will be like an ant-heap stirred up with a stick."

In clear expression of the regret of the VWOA at the passing of one who was a veteran when our Association was first formed, our president sent the following message of condolence:

In Memory of Nikola Tesla

"The Veteran Wireless Operators Association regretfully sends a final message of farewell to that veteran of all veterans, Nikola Tesla. A1-

DINNER-CRUISE

*VWOA Eighteenth Anniversary
Dinner-Cruise, Hotel Astor,
Times Square, N. Y. C.
Thursday Evening,
February 11, 1943*

Tickets are available from the Association at Radio City. There will be the usual highlights with much reminiscing and camaraderie. Subscription . . . same as last year. **SEE YOU THEN!**—MC.

though he did not attain the practical demonstration of his ideas, in the realm of wireless communication, yet he had a clear understanding of the subject and of the broad way in which it could be brought to use.

"As early as February, 1893, he described a wireless transmitter, in general but nevertheless correct terms, and further stated that 'a properly adjusted self-induction and capacity device could be set in action by resonance at any point within a certain radius of the source.' This, he said, would lead to 'transmitting intelligence, or perhaps power, to any distance through the earth.'

"Here was wireless telegraphy clearly envisioned, and with it tuning . . . the first great essential in the art. Thus it is but fitting to place Nikola Tesla's name and his memory in the forefront of the list of those pioneers who foresaw many years ago the inherent principles of the art in which we, in a later time, were likewise pioneers."

Personals

To my VWOA friends . . . "This is Pierre Boucheron broadcasting a greeting to my many old friends of this glorious fraternity. Recently returned from a year's duty on Greenland's 'icy mountains,' and I mean they were ICY, but a very worthwhile and never-to-be-forgotten experience, with no regrets. I'll be glad to tell you about it sometime, individually or otherwise, and I will not have to mention the Military or reveal secrets either. Being back in the Naval Service is like old times, meeting many now great and near-great 'Brass-Pounders' of the vintage of 1910 and on, from Fracas Number 1 to the present day. And let us not forget the 1914 Vera Cruz occupation prelude in which I played a very minor role. While we are all older now, some balder, grayer, stouter and possibly a little disillusioned and frustrated after 50 winters or so, I've yet to meet one of the 'Wireless Clan' who does not still possess the sparkle and glitter of adven-

(Continued on page 40)

NEWS BRIEFS

(Continued from page 35)

Robert Orr representing the United States Army; Captain Robert Henderson and Lt. Crabtree representing the United States Navy. The award was made to James Watson, president of Meissner. Among the other Meissner officials present were Vincent Rocky.

* * *

R. M. ELLIS WITH PARTS DEVELOPMENT

R. M. Ellis has joined Aircraft Parts Development Corp., Summit, N. J., as Chief Mechanical Engineer. Mr. Ellis was formerly with Brewer Tichenor Corporation, Remington-Rand, Inc.

* * *

ADMIRAL HOOPER VISITS HALLICRAFTERS

The Hallicrafters, Inc., 2611 Indiana Ave., Chicago, Ill., were honored recently with a surprise visit and inspection by Rear Admiral Stanford C. Hooper. He was accompanied by Lt. Commander Karl Miles, former chief engineer of the company and now in charge of inspection of aircraft radio and electrical goods for the Navy. The Admiral was conducted through Hallicrafters plants by Ray Durst.

* * *

ELLERY W. STONE, POSTAL TELEGRAPH PRESIDENT

Ellery W. Stone, for the past three years executive vice-president of Postal Telegraph, Inc., was recently elected president.

Mr. Stone has been associated with the field of communications since he became a licensed radio operator in 1911 while still a high school student in Oakland, Calif. He subsequently attended the University of California, where he specialized in electrical and radio engineering.

In World War I, Mr. Stone served in the Navy as a lieutenant, being assigned to the Eleventh Naval District as District Communication Officer. Following that war he continued in the Naval Reserve. He is a commander, and has served on temporary duty in the present war. He is a member of various committees of the Board of War Communications.

* * *

ELECTRONIC LAB PUBLISHES DATA CHART VOLUME

An 86-page loose leaf book with 34 full-scale charts covering practically every major phase of radio design work, has been published by Electronic Laboratories, Inc., Indianapolis, Ind.

* * *

DETROLA SOLD

Ownership of Detrola Corporation changed hands recently when the entire stock holdings of John J. Ross and family were acquired by Strong, Carlisle & Hammond Company, of Cleveland, Ohio. Ill health of Mr. Ross prompted the sale.

The new president of Detrola Corporation is Joseph J. Stephens, of Cleveland, who is vice president and general manager of Strong, Carlisle & Hammond Company. Other officers of the company are . . . Roger M. Daugherty, vice president in charge of engineering; W. Keene Jackson, vice president in charge of sales.

The change will not affect the location or the manufacturing activities of the company.

Strong, Carlisle & Hammond Company, in addition to serving as industrial distributors for many nationally known manu-

(Continued on page 38)



The best of equipment is no better than the worst if the connections are not dependable. A "cheap" connector may prove to be the most expensive in the long run.

The makers of fine aircraft instruments use Cannon Connectors extensively because they know they can rely upon them to give dependable service under the most severe conditions.

Building quality electrical connectors takes "know-how" . . . and Cannon Connectors are the result of years of experience in their development and manufacture. That's why you can be *sure* the connector is as good as the equipment it connects when you standardize on standard Cannon Connectors for *your* instruments.

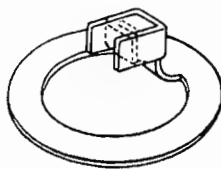

CANNON BONDING RING

For use wherever there is a need for bonding between the plug shell and wire shielding. Can be used with either cable clamp or flexible conduit coupling nut. Write for Bonding Ring Bulletin.

If you would like a copy of our 76-page illustrated manual, "Cannon Plugs for Aircraft Electrical Circuits," drop us a line on your business letterhead and we'll be glad to send you one.

REPRESENTATIVES IN PRINCIPAL CITIES—CONSULT YOUR LOCAL TELEPHONE BOOK

CANNON ELECTRIC



Cannon Electric Development Company, Los Angeles, California

Canadian Factory and Engineering Office: Cannon Electric Co., Ltd., Toronto, Canada

A NEW AND VITAL SERVICE



OUR sample department is now delivering highly specialized transformers in a matter of days only. This is a direct result of the increased demands by our customers for greater speed in the development of new designs for military equipment. The establishment of this entirely independent organization was effected for the sole purpose of delivering engineering service and sample components in the shortest possible time.

The significance of this N-Y-T Service can be stressed when case histories in our files (confidential for the present) show that performance was not merely fulfilled—but surpassed.

That's what we mean by a 'new and vital service' . . . a service which has been personalized to meet your requirements.



One of the thousands of designs made in the N-Y-T Service Department is illustrated here; a custom-designed unit suited perfectly to the circuit and the application. Inquiries invited.

NEW YORK TRANSFORMER COMPANY



28 WAVERLY PLACE NEW YORK, N. Y.

NEWS BRIEFS

(Continued from page 37)

facturers, is a distributor for Philco Corporation.

* * *

H. A. JONES NOW LIEUT.-COL.

Dr. H. A. Jones, manager of sales of G. E. electronic tubes for nonradio applications, has been commissioned a Lieutenant-Colonel in the U. S. Army Signal Corps, and has reported for duty with the Research and Development division of the Signal Corps, with an office in the new Pentagon Building, Arlington, Va.

* * *

STROMBERG-CARLSON WINS "E"

The Stromberg-Carlson Tel. Mfg. Company of Rochester, N. Y., has been awarded the Army-Navy "E."

* * *

GENERAL MAC ARTHUR WIRES GREETINGS TO HALLICRAFTERS

General Douglas MacArthur wired a Christmas message to the Hallicrafters employees commending them for their war effort and asking for their continued support. The message was read over the public address system to all the employees.

* * *

WESTINGHOUSE ORDERS TOP BILLION DOLLARS

The Westinghouse Electric and Manufacturing Company received orders for well over a billion dollars worth of war needed equipment in 1942, according to a report of A. W. Robertson.

The importance of radio equipment in modern war is illustrated by the fact that the Radio Division booked more orders than any other division in the company.

* * *

HENRI BOHLE PROMOTED

Henri C. Bohle, formerly assistant vice president, was elected a vice president of International Standard Electric Corporation, subsidiary of the International Telephone and Telegraph Corporation.

Mr. Bohle has served the International Standard Electric Corporation and its predecessors for thirty-one years. He was appointed director general of Le Matériel Telephonique, the Company's French manufacturing subsidiary, in 1927, and held this post for eight years.

In 1935 Mr. Bohle spent a year in Italy in charge of the corporation's subsidiary there. Since 1936 he has been in New York in the executive branch of the organization, and for the past five years he has been an assistant vice president.

* * *

RCA MANUFACTURING COMPANY CONSOLIDATED WITH PARENT COM'Y

The RCA Manufacturing Company, wholly-owned subsidiary of Radio Corporation of America, has been consolidated with the parent company.

The RCA Manufacturing Company's principal plants are located in Camden and Harrison, N. J.; Indianapolis and Bloomington, Indiana; Lancaster, Pa., and Hollywood, Cal. The RCA Laboratories are located at Princeton, N. J. The manufacturing organization will be known as the RCA Victor Division of Radio Corporation of America. The management, personnel, operations and sales policies will continue as heretofore.

* * *

LESLIE WOODS N. U. GENERAL MANAGER

Leslie J. Woods has been named vice-

president and general manager of the National Union Radio Corporation.

Born in England, Mr. Woods studied at the London Telegraph Training College. From 1919 to 1923, Mr. Woods served first in military and then in civilian capacities in the Middle East, helping to develop a world-wide communications system with the construction of wireless stations in Hamadan, Teheran, and Baghdad.

In 1923, he joined Philco. Upon the outbreak of war, because of his engineering knowledge and experience, Mr. Woods was transferred to Washington to assist in carrying through the very large commitments for communications equipment.

* * *

MAC LENNAN NOW ASS'T V-P OF I.T.&T.

A. M. MacLennan has been appointed assistant vice president of International Telephone and Telegraph Corporation. Mr. MacLennan, who continues as advertising manager, has been with I. T. & T. fourteen years.

* * *

W-L FIELD RHEOSTAT BULLETIN

Bulletin 60A, describing vitrohm and ribohm field rheostats, has been released by Ward-Leonard Electric Co., Mount Vernon, N. Y.

* * *

RECORDING STANDARDS DATA

The Gould-Moody Company, 395 Broadway, New York City, have prepared an effective circular, "Technical Standards and Good Engineering Practices", with 14 pertinent standards as established by the National Association of Broadcasters.

This interesting brochure may be obtained free of charge by writing to Gould-Moody Company.

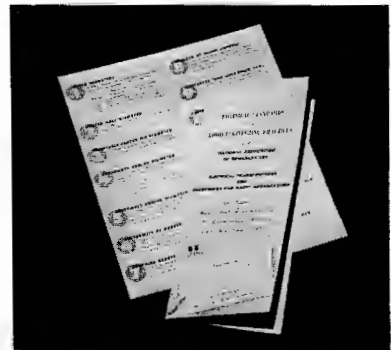

* * *

STONE NOW G. E. TELEVISION STATION PROGRAM MANAGER

Robert B. Stone has become the new program manager of WRGB, General Electric television station in Schenectady.

Mr. Stone, who has been working on program production at the station since November, 1941, succeeds John G. T. Gilmore, who has been commissioned a first lieutenant in the Signal Corps and is now in Army motion picture work at Astoria, L. I.

* * *

MARSHALL ELECTED V-P AT POSTAL

Walter P. Marshall, comptroller of Postal Telegraph, Inc., was in addition recently elected a vice-president and director of that Company. Mr. Marshall has been Comptroller of Postal Telegraph since 1939.

SLY NOW UNIVERSAL MICROPHONE TREASURER

Cecil Sly, has become secretary-treasurer of the Universal Microphone Co., Inglewood, Cal. For the past two years he had been comptroller of the firm and previously conducted his own office in Los Angeles as a business consultant. He succeeds I. I. Sevey, who remains in the firm on the administrative staff.

* * *

YOUNG AND SPENCER WIN STROMBERG-CARLSON PROMOTIONS

Frederic C. Young, chief engineer, was recently elected vice-president in charge of engineering and Lloyd L. Spencer, general sales manager was elected vice-president in charge of sales, of Stromberg-Carlson.

Mr. Young joined the Stromberg-Carlson organization in 1918. In 1926, Mr. Young was placed in charge of capacitor development. He was appointed in 1927 chief of the telephone laboratory in charge of sound system and telephone development. This was followed in 1937 by appointment as manager of engineering under Dr. R. H. Manson, at that time vice-president in charge of engineering. In 1940, Mr. Young was made chief engineer.

Mr. Spencer came to Stromberg-Carlson in October, 1937, as general sales manager. He is also president of the Stromberg-Carlson Telephone Manufacturing Company, Ltd., of Toronto, Canada.

* * *

G. E. ISSUES ELECTRONICS BOOKLET

"Electronics—A New Science for a New World" is the name of an interesting booklet just issued by General Electric. Presenting the general story of electronics, it tells of its past, its present, and its great possibilities for the future.

In the booklet, colorful accounts by word and illustration are told of how the electron is working today in war combat, in research, industry, radio and television, agriculture, and in medicine to reveal more and more of the structure and behavior of the human body.

A copy of the new booklet may be obtained by writing to the General Electric Company, Schenectady, N. Y.

* * *

NATIONAL UNION'S HUBER BROTHERS IN SERVICE

Ed Huber, USMC, former assistant office manager at National Union, Newark, N. J., and brother Sergeant George, formerly manager of the contract department, are now several thousand miles apart. Ed is engaged in communications work somewhere on a California desert, while George sports a Red Cross armband, with the Medical Corps on the African front.

* * *

SHAW JOINS AIRCRAFT PARTS

J. D. Shaw, formerly research and production engineer with Metals Disintegrating Company, has joined Aircraft Parts Development Corporation, Summit, New Jersey, as chief powder metallurgist.

* * *

G.E. PLASTIC PART DESIGN BOOKLET

A new 16-page booklet entitled "Designing Molded Plastics Parts," has been announced by G. E. It is an enlarged edition of a similar eight-page booklet issued last year. Subjects covered include: inserts, shrinkage, tolerances, wall thickness, holes, undercuts, ribs, bosses, fillets, threads, etc.

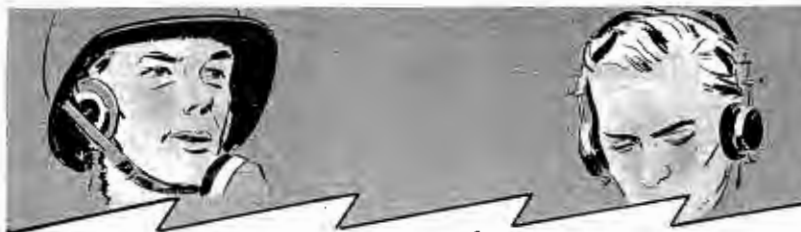

Everybody in Radio Knows Murdock!



BEHIND today's war production at Murdock is 39 years of "know how"!

In 1904 William J. Murdock saw clearly that sensitive Radio Phones could be made only by precision methods. He manufactured each part with scientific exactness.

In each year since, requirements for Radio Phone sensitivity and durability have become increasingly strict. Murdock has kept pace.

Today the U. S. Army Signal Corps and Air Corps take most of our production. Murdock Radio Phones must be right to meet their specifications.

Ask anybody in Radio—they know Murdock! Catalogue on request—write to Dept. 50.



Murdock
RADIO PHONES

MURDOCK MANUFACTURING CO.
CHELSEA, MASSACHUSETTS

NATIONAL UNION IS READY TO GREET ELECTRONIC SERVICE MEN

FROM THE SMOKE AND TRIAL OF BATTLE SHALL ARISE
A GREATER, STRONGER SERVICE INDUSTRY

Every ounce of National Union energy is thrown into the battle for victory. Our engineering, our production, our manpower and machinery are in the fight. As we battle on the research and production front we see the dawn of great new horizons as new products, new and better methods develop; we see the Radio Service man to whom we have devoted ourselves through the years standing on the threshold of a greater opportunity than he has ever known. National Union is deeply grateful for the loyalty of the service profession to National Union products. National Union is learning, watching every advancement in the electronic art, so when the day of Victory comes, the many thousands of service men who have grown with us in the past shall benefit in the future.

NATIONAL UNION RADIO Corp. 57 STATE STREET, NEWARK, NEW JERSEY

VWOA NEWS

(Continued from page 36)

ture and romance in his hypermetropic eye when the tropics or the arctic lands are mentioned. I salute you Veteran Wirelesmen all, and why don't I get a yearly reminder to pay my dues and get back on the Roster?"

Okeh, PB just send along a check for the amount shown on the statement being sent you by George Clark. Brother Boucheron was recently promoted to the rank of Commander, USNR. Congratulations and best wishes. He is on leave from Farnsworth Television and Radio Corporation where he occupied the position of general sales manager.

A. F. "Steve" Wallis, life member and former secretary and director of VWOA is back in New York after an absence of four years serving as Superintendent, Gulf Div. of Mackay Radio in New Orleans. At present he has the stupendous job of commissioning the U. S. Maritime Radio School at Huntington, L. I. With the rank of Lt. Comdr. he is Commanding Officer of the School. There are some vacancies for instructors in theory and code at this writing. Communicate with Commander Wallis at Huntington. . . . Congratulations to Fred Muller upon his recent promotion to Commander, USNR on active duty at the Brooklyn Navy Yard. . . . V. H. C. Eberlin, life member and former treasurer is back in Miami as District Radio Materiel officer with the rank of Lt. Comdr. Congratulations "Ebb". . . . Lieut. Karl Baarslag continues on active duty in Washington at the Navy Department. . . . "Bill" Freeland, former Mackay Marine inspector at New Orleans, has organized a new business, reclaiming transmitting tubes which have 'passed out' and we learn that business is booming, which we can readily understand with new tubes almost impossible to obtain. . . . We understand that E. E. "Bob" Rockle, supt. of communications for Waterman Steamship and Waterman Airways, still dreams of that super-airway-radio communication system, delayed for the duration. . . . "Flying Bill" Ehmer, past testimonial recipient, transport pilot, former pink ticket holder, licensed airplane mechanic, etc., etc., is now an instructor at the American Export Aeronautical School in Flushing, L. I. . . . Bennie Miessner, life member, spending the winter at his Chateau in New Jersey. . . . R. V. Howley, vice-prexy of Tropical Radio, now Lt. Comdr, USNR, has been on active duty locally we hear. . . . Our sincere thanks for Christmas greetings from . . . Robert T. Pollock, formerly president

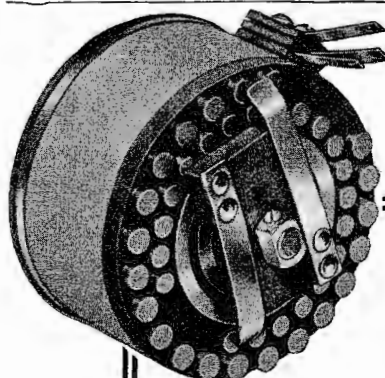

T-PADS! by TECH!

FOR SPEECH INPUT EQUIPMENT

A complete line of speech input controls, Time tested—second to none—at Competitive prices.

Embody years of engineering and production experience. Hundreds of satisfied customers. No exaggerated claims . . . but what we make will give you lasting and trouble-free service.

Also light and heavy duty tap switches—special controls to your specs.

Write for Bulletin 403.
Complete Catalog on request.

TECH LABORATORIES

7 Lincoln St.

Jersey City, N. J.

VWOA NEWS

(Continued from page 40)

of the American Institute of the City of New York, through which we have awarded our Marconi Memorial Scholarships these past years. Mr. Pollock is a prominent Consulting Engineer with offices in New York City. . . . Peter Podell, a charter member of our organization. . . . Victor Ladaveze and the gang at RCA Communications at Rocky Point, N. Y. . . . 'Bill' Fitzpatrick, also a charter member of VWOA. . . . J. R. Poppele, chairman of our scholarship committee. . . . George H. Clark, our very energetic secretary. . . . Henry Hayden, chairman of our membership committee . . . and many others.

We had an extremely pleasant telephone conversation with Frank Orth, one of our charter members, a mainstay of the Columbia Broadcasting System, inquiring about the next meeting. He even threatened to pay his dues if we have a meeting soon. We will have had a meeting before this reaches you, so there is no need to indicate the date thereof. . . . Congratulations to Hall Styles, chairman of our Los Angeles-Hollywood chapter upon his recent marriage to his secretary, nee Miss Lenore Cordia! Hal interviewed his new bride on the wedding day on his program, "Face the Facts," over KFVB, Los Angeles (or maybe it's Hollywood). . . . We learn that George Duvall, a real oldtimer, holder of several issues of that coveted "Pink Ticket," the Commercial Operator Extra First License, is now doing a real job as Technical Advisor to the Signal Corps in their immense job of training radiomen for the Army Signal Corps. George served for several years as president of the Radio Servicemen of America and is now president of the Television Technicians. . . . And, by the way, our prexy this month celebrates twenty years in radio and proudly retains Telegraph First, Telephone First and Class "A" Amateur radio licenses expiring in 1947. . . . Congratulations to Josef Israels II, veteran member, on his splendid biography of Justice Samuel Rosenman, one of President Roosevelt's most intimate advisors appearing in a current issue of the *Saturday Evening Post*. . . . Ted McElroy, champion key swinger and progressive key and allied equipment manufacturer, has been commuting between his Boston office and Washington and Chicago. McElroy has quite a plant in Chicago now. . . . We hoped we'd have the election results for you, but it will have to wait for the next issue. . . . As a final reminder, don't forget the eighteenth annual cruise at the Astor Hotel, New York City, on February 11, 1943.

"FROM that high resolve was born the Army-Navy Production Award which stands today as our fighting forces' joint recognition of exceptional performance on the production front . . . of the determined persevering, unbeatable spirit which can be satisfied only by achieving today what yesterday seemed impossible!"

We're sincerely proud of our award - its significance will always be our goal.

BLILEY ELECTRIC COMPANY · · · ERIE, PA.

Bliley Crystals

THE INDUSTRY OFFERS

GUARDIAN AIRCRAFT RELAYS

Five types of approved solenoid contactor units built to U. S. Army Air Force specifications for remote control of electrically actuated aircraft armaments, instruments and devices, have been announced by Guardian Electric, 1623 West Walnut Street, Chicago, Ill. Among these, the B-4 type, originally designed for airplane starting motors, may be used for other applications of heavy current control.

This relay operates on 24 volts producing a coil current of 300 milliamperes. Contacts are rated at 200 amperes at 24 volts d-c. The unit has a double pole, single throw, with normally open contacts. It is claimed that unit resists acceleration and vibration over 10 times gravity and operates in any position, and may be disassembled with pliers and screwdriver. Metal parts are plated to withstand 200 hour salt spray test. Weight of unit is 31 ounces. Descriptive circular and full details available gratis.

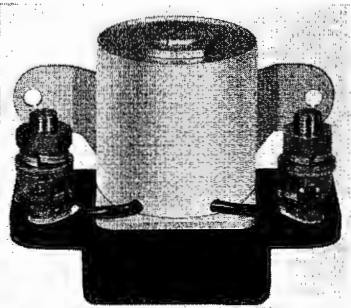

* * *

ISOLATING TRANSFORMERS

To eliminate interference that affects the testing of equipment The Acme Electric & Mfg. Co., Cuba, New York, have designed the type T-4173 isolating transformer. This transformer makes use of a secondary completely enclosed in a copper shield. Secondary terminal connections are provided by means of a lead shielded cable, the sheath of which is integrally joined to the copper enclosing shield of the secondary winding.

The manufacturer claims that the transformer, normally rated at 2 kva is capable of handling an over-load of 50% or a total load of 3 kva. The regulation of the transformer is 1% at 1 kva. The lighting in the shielded test-room, the use of soldering irons, instruments and various types of test equipment may all be operated from the shielded secondary of the isolating transformer without causing objectionable voltage drop. The use of instruments or equipment may be used as the need requires, the load being switched on and off without affecting the relatively constant voltage necessary for accurate testing.



DECADE RESISTANCE BOXES AND WHEATSTONE BRIDGE

Wheatstone bridge and decade resistance box units are now being made by Industrial Instruments, Inc., 156 Culver Ave., Jersey City, N. J.

Type DR d-c resistance decades are available in standard models with resistance ranges of .9 to 999,999 ohms total and with guaranteed accuracy of plus/minus 1% and 1.0% respectively. All coils are of manganin wire excepting the 100,000 ohm coils of Nichrome. All coils are bifilar-wound on ceramic tubes, oven-baked and protectively-coated. Switches have self-cleaning multi-blade phosphor-bronze spring wipers.

Wheatstone bridge type RN-1 contains four resistance dials with nine positions each, covering 9x1, 9x10, 9x100, and 9x1000 ohms, with decade multiplying dials. The ratio resistances have a guaranteed accuracy of plus/minus .05%, while the resistance coils in the decades of the bridge are guaranteed to plus/minus .1% tolerance. Specifications for switches and cabinet are the same as for the decade boxes already described. The galvanometer is of the moving-coil type with sensitivity of 1 microampere per division.



* * *

SURFACE-COATED ABRASIVE BELTS

Equipment incorporating the use of surface coated abrasive belts for producing faster and improved finishes is described in the booklet recently released by Minnesota Mining and Manufacturing Company of Saint Paul, Minnesota.

The method consists of the use of a backstand idler unit, utilizing a newly perfected segment face contact wheel and surface coated abrasive belts. One's present lathe or setup equipment can be used or a complete backstand idler unit acquired for this work.

There are three types of segment face contact wheels that increase the range of work with surface coated abrasive belts by providing a hard, flat surface for driving the belt, but with a soft center so that irregular shaped pieces can be finished.

The segment face wheel using surface coated abrasive belts is also incorporated into a swing grinder for sanding billets, bars and tubes. Pedestal mounted or suspended from overhead rail, it is effective for repair grinding, beveling and surface grinding and is described and illustrated in this booklet.

R.C.P. CATHODE-RAY OSCILLOSCOPE

A cathode-ray oscilloscope, model 555, has been announced by Radio City Products Company, Inc., 127 W. 26th St., N. Y. City. The oscilloscope uses a 5" cathode-ray tube operating on 2,000 volts. Maximum d-c voltage at input terminals of amplifier is 600, and direct to deflection plates 500 volts, rms. Input resistance is 3 megohms. Frequency response is ± 3 db from 20 cycles to 2 megacycles. Voltage gain is approximately 275 times. Ultra wide frequency range of sweep signal generator from 30 cycles to 350 kc; linear from 50 cycles. Unknown peak input voltage can be read on a direct indicating multi-range voltmeter. Instrument operates from standard 115 to 230 volt, 50 to 60 cycle a-c power supply.

Details on the oscilloscope may be obtained from the manufacturer.



* * *

G. R. BEAT-FREQUENCY OSCILLATOR AND STANDARD-SIGNAL GENERATOR

A general-purpose beat-frequency oscillator, type 913-A, has been developed by General Radio Company, 30 State Street, Cambridge, Mass., that is particularly useful as a power source for tests on audio-frequency lines and associated networks. It is also a suitable voltage source for bridge measurements and for modulating signal generators and test oscillators. The oscillator can be used on either balanced or unbalanced systems.

Constant output, low distortion, and a high degree of frequency stability are a few of the features. The output is 0.3 watt maximum. Output impedance is 550 ohms, so that the oscillator can be used with either 500- or 600-ohm lines. Open-circuit output voltage is 25 volts. For a matched resistive load, the output voltage varies by less than 0.25 db between 20 and 20,000 cycles.

With a matched load, total distortion is 0.2% between 150 and 7000 cycles; at 50 cycles it is about 2%. Power line hum

(Continued on page 57)

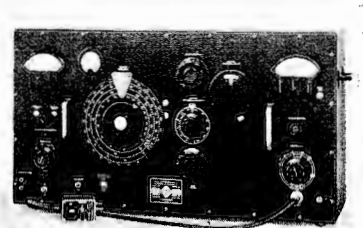

G. R. Standard Signal Generator.

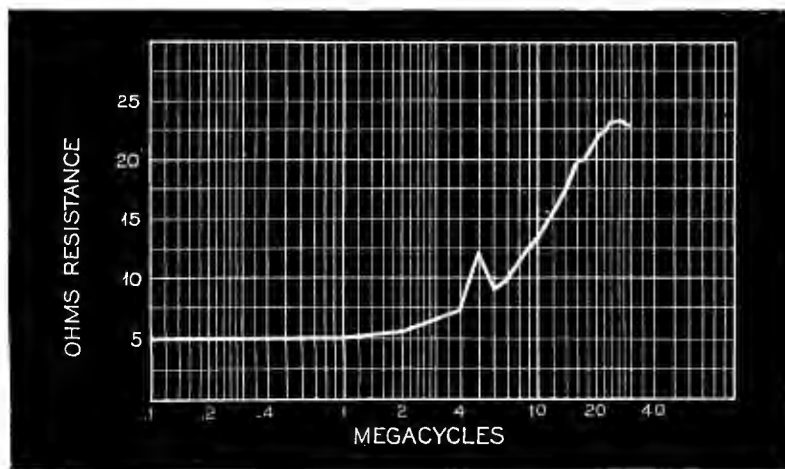

Figure 9
Measurement of output impedance against frequency of the 65-B at a one-thousand microvolt level.

ACCURACY IN STANDARD SIGNAL GENERATORS

(Continued from page 10)

readings in the overlap region between two fixed steps in addition to errors which may be due to initial calibration and lack of proper zero adjustment of the output voltmeter.

Shielding of the meshes frequently depends upon contact between two metals which may oxidize or corrode with time, thus increasing the ratio errors as well as "leakage" or stray field. For several years we have been using silver and silver-plating to assure permanent low-resistance contact at critical points.

Step Ratios

The attenuator ratios can be measured with a sensitive superheterodyne receiver arranged as shown in Figure 8. The output meter indicates carrier level and is calibrated in per cent variation of carrier at 456 kc where there is no difficulty with frequency effects in the attenuator. The independent manual adjustment of gain in the r-f and i-f amplifiers permit using the receiver over wide limits of input voltage without overloading or operating on a non-linear part of the tube characteristics, thus affecting the linear calibration of the i-f output meter.

To check for receiver linearity, a special output cable is available. This output cable provides an accurately determined 10 to 1 step of attenuation which is independent of amplitude and frequency. Actually if the frequency is carried high enough with the particular design in use, some error will result and a correction can be applied if necessary. A better u-h-f design is built right into the input of our high frequency test receivers which does not require this correction factor.

A fixed ratio of ten to one in the receiver i-f output meter circuit per-

mits not only a direct reading in per cent of the ratio error of a fixed step on the generator but a reading of the microammeter at the same point, thus obtaining maximum accuracy. By this method, 10 to 1 ratios can be read to an accuracy of 1% at any carrier frequency which the receiver is capable of converting down to the i-f channel.

Ratio errors in laboratory generators are usually less than 2%. At frequencies of 20 to 30 kc, these errors frequently rise as high as 3% to 4%, because of stray mutual couplings inherent in the generator design.

Overall Ratios

The ratios discussed above are termed the "step ratios" to distinguish them

from the "overall ratios." "Overall ratios" are encountered every time the overlap regions between two fixed steps are checked against each other; that is if $2 \times 1,000$ microvolts on one range gives the same output reading on a receiver as 20×100 microvolts, the "overall ratio" is perfect. Frequently, perhaps always, these ratios are checked under the worst possible conditions, and the results are correspondingly bad.

To obtain a truly accurate report on these ratios, mechanical and electrical zeros must be set in the proper sequence as previously explained, since compensation of mechanical shift by electrical zero set can give errors of 50% or more.

Then, it must always be remembered that the reading accuracy of any indicating instrument is usually specified in terms of full scale accuracy; therefore the *maximum per cent* of error will be present near the bottom of the scale. This means that the instrument has to be adjusted *first* to 20×100 and the receiver tuned for maximum. Next the output must be turned down to approximately 2, and the decade switch moved up to $\times 1,000$. Then the output knob must be adjusted for ex-

(Continued on page 44)

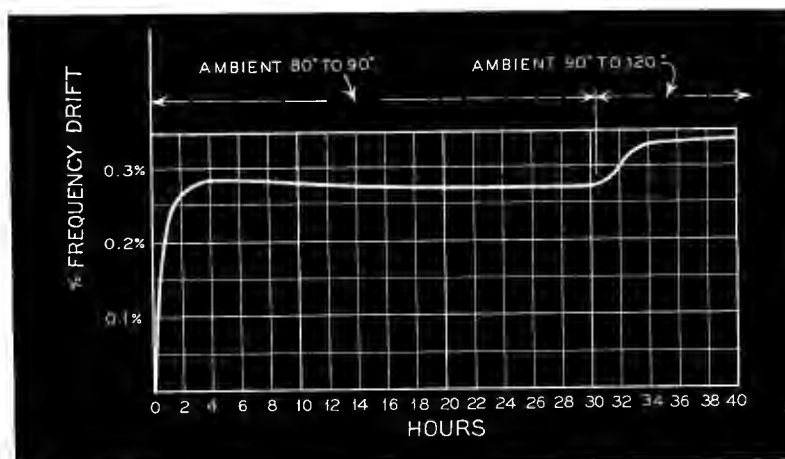

Figure 10
A drift run on a 65-B at eighteen megacycles.

2 important books
in the electronics field

COMMUNICATION CIRCUITS



by LAWRENCE A. WARE, Associate Professor of Electrical Engineering, and HENRY R. REED, Professor of Electrical Engineering, both at the State University of Iowa.

The theory and practice of communication are presented in this authoritative book which concentrates on the essentials of transmission. It offers a concise introduction to the principles behind communication transmission lines and their associated networks and a discussion of the use of Maxwell's equations and Bessel functions.

287 pages - 116 Illustrations - 6x9 - \$3.50

PRINCIPLES OF ELECTRONICS

by ROYCE G. KLOEFFLER, Head of the Department of Electrical Engineering, Kansas State College.



An up-to-date story of electron theory which begins with the discovery of the electron and carries the subject along to the most modern research in the field. A clearly written book which presents the important facts about electronics and forms a basis for more advanced study.

175 Pages - 177 Illustrations - 6x9 - \$2.50

JOHN WILEY & SONS, Inc.

ON APPROVAL COUPON

John Wiley & Sons, Inc.
440 Fourth Avenue, New York, N. Y.

Please send me a copy of:

- Ware & Reed's
 COMMUNICATION CIRCUITS — \$3.50
- Kloeffler's
 PRINCIPLES OF ELECTRONICS—\$2.50
- If at the end of ten days, I decide to keep the book (books), I will remit \$3.50, \$2.50, or \$6.00 for both, plus postage. Otherwise I will return book (books) postpaid.

Name

Address

City and State.....

Employed by.....C-1-43

SIGNAL GENERATOR ACCURACY

(Continued from page 43)

actly the same receiver output reading.

If these instructions are carried out, the "overall ratios" should check within the pointer width, which is approximately 5% of the 2.0 point on the meter but actually 0.2% of full scale current. And this is just ten times as good as most meter manufacturers would be willing to guarantee.

The important thing to remember is that the "overall ratio" errors are not necessarily cumulative, while fixed "step ratios" are generally cumulative. In other words "step ratio" errors add up, while the "overall ratios" do not.

In the 65-B the cumulation of "step ratio" error is held to less than $\pm 10\%$ over all six steps. Looking at this another way, the error is actually less than ± 1 db out of 120 db.

Output Impedance Considerations

The 65-B transmission line is terminated at its receiving or output end in its surge impedance (approximately 34 ohms), but the sending end is driven by an impedance of less than 34 ohms. On the output steps from " $\times 10K$ " or $\times 10,000$ down, the impedance is approximately 5 ohms, while on the " $\times 100 K$ " or top step, the impedance varies from almost zero to a higher value which is a function of the position of the output knob as well as frequency.

Since there is no reflection at the receiving or output end, the output voltage will not be affected by the lack of proper mismatch at the sending or signal generator end. A curve of the measured output impedance, versus



WAXES

AND

COMPOUNDS

FOR

INSULATION and WATERPROOFING

of ELECTRICAL and RADIO COMPONENTS

● such as transformers, coils, power packs, pot heads, sockets, wiring devices, wet and dry batteries, etc. Also WAX SATURATORS for braided wire and tape and WAXES for radio parts. The facilities of our laboratories are at your disposal to help solve your problems.

FOUNDED 1846

Zophar Mills, Inc.

120 - 26th ST., BROOKLYN, N. Y.

frequency is shown in Figure 9. The curve is not smooth, since the line is not electrically short in length at the higher frequencies.

The effect of this output impedance is to upset the antenna circuit selectivity and step up. The magnitude of the output impedance has been ignored by the writers of many receiver specifica-

(Continued on page 45)

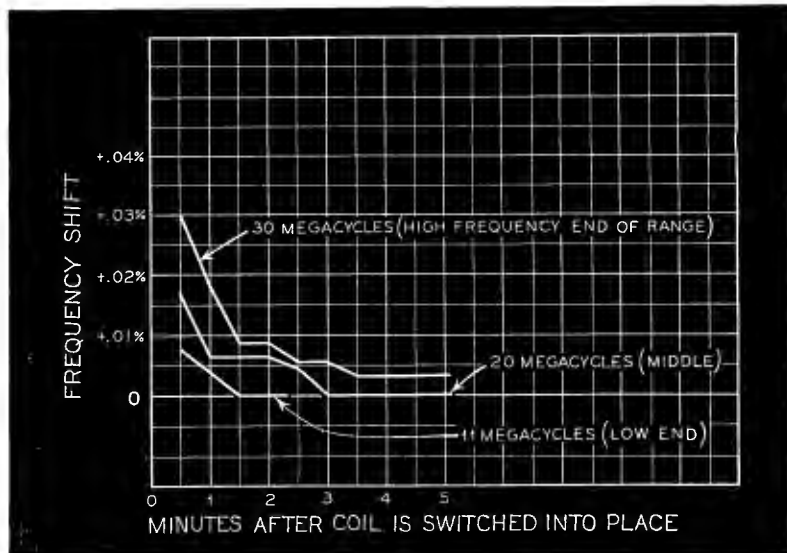

Figure 11
Short term drift due to coil heating. The worst condition is shown.

tions—both the commercial and military.

Summation of Output Errors

In general the maximum error of unmodulated carrier will not exceed $\pm 15\%$. The maximum error of modulated carrier will not exceed $\pm 20\%$ for 30% modulation. This means that the absolute value of the modulated microvolt should lie between 0.8 and 1.2 microvolts, which is ± 2 db out of a range of 126 db. The error will generally be less than the above figures.

Carrier Frequency Accuracy and Stability

Of secondary interest in standard signal generators is the accuracy of frequency calibration and their frequency stability and resetability. The 65-B is individually calibrated against crystal harmonics (which are accurate to within 1 or 2 parts per million) in a special jig, which prints the calibration directly on the scale with the instrument in operation. This saves considerable time and eliminates the laborious recording of much data usually necessary for later engraving of the dial. This direct printing method also eliminates questions of backlash in the usual engraving machine setup and the possibility of human error in recording and copying the tabulated data.

Calibration Accuracy

Actually the limitation is again one of width of the indicating line, which amounts to approximately .010" or about 0.1% at 1 megacycle. Most instruments which are warmed up for an hour or so will check within 0.2% at all carrier frequencies, although our guarantee is $\pm 0.5\%$.

Stability

The drift with respect to time is shown in Figure 10. This particular curve was taken at 18 megacycles and represents an average curve. The most important point is that after 45 minutes less than 0.1% of drift will occur if the ambient temperature stays within a range of 10° F. The effects of increasing the ambient are shown also.

No temperature compensation or tricks are used to attain this order of stability. It is predicted simply on a selection of stable components. We realize that this degree of stability could be improved somewhat by compensation, although the wide carrier frequency ranges complicate the problem. It is felt, however, that standard signal generators are standards of output, not frequency. Therefore the additional complications would not produce results in keeping with the effort.

There is a small additional drift which can be attributed to the heating of the



Listening Posts!

YOU will find Hallicrafters Communications Equipment working three shifts at our Country's "Listening Posts" . . . searching the airways for illegal programs and espionage messages.

Hallicrafters Communications Equipment is engineered to "take it" on this constant operating . . . there are no rest periods, no time out, it's constant performance!

The Hallicrafters Equipment you can buy—when communications equipment may again be sold for Civilian use—will incorporate all of the endurance and top quality performance you will ever demand.

Illustration—typical view of Hallicrafters Communications Equipment is a monitoring (listening in) station—somewhere in the U. S. A.

World's largest exclusive manufacturer of short wave radio communications equipment.



hallicrafters
CHICAGO, U.S.A.

oscillator coil by r-f current when the coil is switched into place. This short term effect is shown for the worst condition in Figure 11. It can be seen that it is less than .05%, even for the first few seconds after the coil is switched into position. After 1.5 minutes, it is practically unnoticeable.

Dial Spread

Frequency spread on the instrument and frequency-resetability are never as good as is desirable. However, very often an unreasonable demand is made which can be avoided. Some test specifications call for selectivity information on superheterodyne receivers at high

carrier frequencies. The i-f may have a pass-band of only 3 to 5 kc at 2X down. Such a sharp i-f channel demands very accurate carrier setting at frequencies as high as 30 megacycles.

A decidedly better measure of the selectivity of the r-f pre-selection circuits can be obtained by image ratio measurements which do not require such an unreasonable degree of frequency resetability.

Miscellaneous Noise in Signal Generator Output

The chart in Figure 12 indicates some of the various kinds of noise encoun-

(Continued on page 50)

ACCURATELY CHECK THE
FREQUENCY OF YOUR
ELECTRONIC EQUIPMENT

with a **MEISSNER**
SIGNAL
CALIBRATOR



INVALUABLE as a secondary frequency standard for **Crystal Manufacturers, Radio Laboratories, Government Inspectors.** Meissner Signal Calibrator delivers modulated or unmodulated signals every 100 kc., 50 kc., and 10 kc., over the entire range from 100 to 60,000 kc. Entire unit is mounted in 8" x 8" x 12" ventilated cabinet . . . net price . . . \$46.00

Write for Complete Catalog



Meissner
MT. CARMEL, ILLINOIS

"PRECISION-BUILT PRODUCTS"

ELECTRICAL ENGINEERS

College graduates for test and installation of precision electro-mechanical ordnance apparatus. Electronics, or communications experience desirable, but not required.

**ELECTRICAL TESTERS
FOR FACTORY TEST.
SOME ELECTRICAL
EXPERIENCE REQUIRED.
WOMEN CONSIDERED.
LOCATION JERSEY CITY
NEW JERSEY**

Replies should state age, experience and salary desired. If employed in a war industry do not apply. Box 538, Equity, 113 West 42nd St., N. Y.

THROAT MICROPHONES

(Continued from page 13)

source of the tones in the mouth or throat. Those breath tones formed at the lips, such as P are severely attenuated by the physical structure except for the shock excitation of the initial release of compressed air. The sound SSS almost never does come through (being attenuated about 30 db), while the tones generated in the throat, gutturals and vowels, are all of practically constant amplitude. In Figure 7, is shown a chart of the relative output of a carbon throat microphone in response to several characteristic tones.

Absolute Term Difficulties

As a result of this it is not advisable to indicate the response of a throat microphone in absolute terms, and so tests were made in which the output of the throat microphones were plotted as a function of frequency, but relative to the output of an ordinary pressure microphone whose response curve has been corrected to relative linearity over the frequency range desired.

Relative Outputs

In Figure 6 curve "c" is the relative output of the throat mike, as described above, over the frequency range reproducible by the average male throat with the mouth wide open. In curve "d" the mouth was only opened halfway during production of the tones, a factor which



Figure 7

Attenuation characteristics of various characters "spoken" via the throat microphone. The sound SSS almost never comes through, while the tones generated by the throat, gutturals and vowels, are all of practically constant amplitude.

-MICO- ENGRAVER

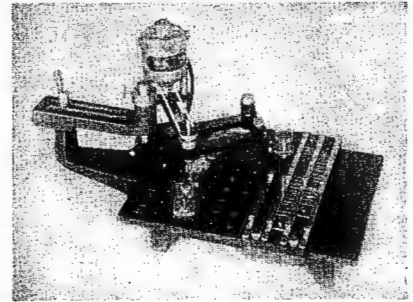

For lettering panels of steel, aluminum, brass, or bakelite, or for marking finished apparatus.

A sturdy machine for routine production as well as occasional engraving.

Attachments increase its versatility to include large work on flat or curved surfaces.

Excellent engraving can be produced by an inexperienced operator.

Prompt delivery. Catalogue on request.

Priced from \$115 with Type

Mico Instrument Co.

18 ARROW STREET
CAMBRIDGE, MASS.

changes somewhat the cavity resonance characteristics of the throat. Curve "e" is the output achieved by whistling, which, on the average, covers the range up to 2700 cycles per second. Higher frequency components were not analyzed at this time.

Incidentally in the case of the 140 db problem, fortunately the grinders are operated by air motors and so cause no electrical disturbances; also the rooms, in which the work is done all have metal walls which effectively act as shields for outside static.

Incidentally, it is interesting to note that throat microphones have been used with good success in Sweden not only in applications similar to those described here, but in many others. For instance, printing plants and smelting plants have adopted the microphone for interphone communications.

The tests indicated above were made with the assistance of several individuals who wore earphones and a throat mike, and reproduced as nearly as possible the frequency furnished to them by means of the earphones and supplied by a calibrated oscillator. A pressure type microphone was situated to the side at a distance of four inches, and, in conjunction with a response curve furnished by the manufacturer, served as the reference standard.

PACK COMMUNICATIONS UNIT

(Continued from page 19)

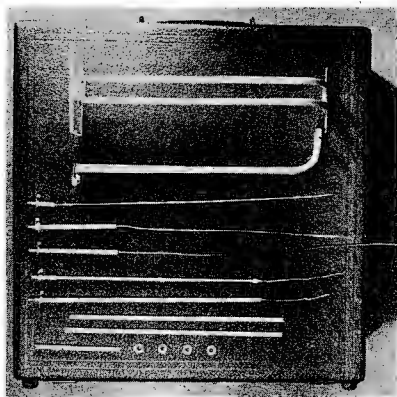

Figure 23

From top to bottom, assembled line and socket; line only; five types of slugs; polystyrene wrappers and insulation bushings. These are the components for a resonant line.

minology and procedure and must be able to extract the meat of a message so as to keep it short and to the point. It is also important that the operator have a good, clear voice with no defects such as lisps, etc.

Since the operation of the pack is simple, most operators have no trouble in mastering this end. However, there is a tendency on the operator's part to forget the switch from transmit to receive and vice versa. Thus this point of operation must be stressed during the training period, so that the action becomes automatic. It is a good idea to train operators in observation and report so that they lose their "mike" fright, and to conduct the training in public so that they also acquire stage presence.

With a well-trained crew, pack sets can be a real asset to any Fire Department.

Circuit Notes

On page 10, December COMMUNICATIONS, we discussed the squelch frequency. Although the best squelch frequency is 60 kc, which was obtained with a .00035 mfd. condenser across the s-r coil, a frequency of 42 kc which is obtained with a .0005 mfd. condenser is actually used. This was done to improve selectivity.

Reukema Formula Correction

The calculation shown in the December issue covered a value for a different length of line than used in this system. The correct formula is as follows:
 $D_{opt} = .01725 \lambda^{3/8}$

where D = distance between centers in cm.

λ = wave length in cm.

$D = 6.186 \frac{r}{Q}$ for maximum Q where $r =$ radius of conductor.
 For our assigned frequency 117.550 mc or 255.21 cm.

$r = .2826$ cm. or .11 inches.

$D = 1.7483$ cm. or .69 inches.

By increasing D and R to a maximum of 50%, the Q of the circuit can be increased. At the same time, the lines must be shorted gradually. This decreases the shorting resistance.

Squelch Filter

Originally C_1 referred to in the graphs (see pages 16 and 19) was in-

cluded in the first models because it helped attenuate the squelch frequency. In the later models, the squelch filter referred to in Figure 15 was substituted because it possessed a higher attenuation characteristic, than C_1 .

(All photos, courtesy Louis Pressman)

Bibliography

"Transmission Lines at Very High Radio Frequencies," Lester E. Reukema; Electrical Engineering, August 1937.
 "Radio Engineering" (a book), F. E. Terman; McGraw-Hill Book Co.
 "Radio Engineering Handbook" (a book), Keith Henney; McGraw-Hill Book Co.
 "Ultra-High-Frequency Techniques" (a book), Brainerd, Koehler, Reich, Woodruff; McGraw-Hill Book Co.
 "A Survey of U-H-F Measurements," L. S. Nergaard; RCA Review, October, 1938.

★ DEDICATED TO



BRACH Antennas and other radio and electrical products are now enlisted for the duration—serving, as in the First World War, to hasten the day of Victory. Their high peacetime standards, today applied to the needs of war, reflect our 36 years' experience in "QUANTITY-plus-QUALITY" manufacture.

L. S. BRACH MFG. CORP.

World's Oldest and Largest Manufacturers of Radio Aerial Systems

55-65 DICKERSON STREET • NEWARK, N. J.

BOOK TALK . . . —

1943 PLASTICS CATALOG

Compiled by Dr. Gordon M. Kline, Frederick B. Stanley, Raymond R. Dickey, Harriet B. Josephs, Florence E. Wall and Dorothy M. Martin. . . . 864 pp. . . . New York: **Plastics Catalogue Corporation**. . . . \$5.00.

This is a noteworthy book. It contains a most comprehensive presentation on the technical, practical and promotional aspects of plastics. Every conceivable subject is covered in an authoritative manner.

Applications of plastics in every arm, branch and bureau of the Government are discussed. The subject of synthetic rubbers is also covered effectively.

Charts showing plastics properties, plasticizers properties and solvents properties, chemical formulae of plastic resins and synthetic rubbers are also included.

Molding and fabricating are discussed in some 30 articles by plastic experts. Other topics covered include finishing, decorating and assembly, machinery and equipment, laminates, plywood and vulcanized fibre, coatings, and synthetic fibres.

For an up-to-the-minute story of plastics, you should have this book.—*O. R.*

FREQUENCY MODULATION

By August Hund, Member of the Navy Radio and Sound Laboratory, San Diego, Calif. . . . 375 pp. . . . New York: **McGraw-Hill Book Company, Inc.** . . . \$4.00.

This member of the McGraw-Hill radio communications series, provides the professional engineer with a superb analysis of one of the most popular subjects of the day. All phases of frequency modulation are discussed in a lucid and profound way.

There are five chapters, covering some seventy topics. The opening chapter covers the fundamental relations and features in frequency modulated, phase-modulated and amplitude-modulated systems. Succeeding chapters cover auxiliary apparatus used in f-m systems, transmitters for frequency modulation, receivers for frequency modulated currents, and transmitter and receiver antennas.

The appendix includes data that is invaluable in both the laboratory and study hall. For here the theory of the spectrum solution, effective input impedance and Q value of feeders and magnitude of important factors, are presented.

In the transmitter section appear discussions of commercial units of General

Electric, Westinghouse, and the Radio Corporation of America, in addition to an analysis of the Armstrong indirect f-m transmitter. Some very interesting notes on f-m signal generators are also presented.

Antennas are treated in an unusually complete form. Discussions cover input impedance and mutual impedance of dipoles, effect of the Q value of linear conductors on the self-impedance, formulas and computations for feeders and matching sections, dipole excitation, and quarter wave-length feeder sections.—*O. R.*

A PRACTICAL COURSE IN MAGNETISM, ELECTRICITY AND RADIO

By W. T. Charlesby and W. T. Perkins. . . . 312 pp. . . . Brooklyn, New York: **Chemical Publishing Company, Inc.** . . . \$4.00.

A fundamental text-book that will be helpful to students beginning the study of radio. Contents include discussions of magnetism, direct and alternating current, motors, radio and communications. Experiments that serve to effectively explain the various phases are presented at the conclusion of each chapter. Log tables, conversion charts and other essential tables are also included. Some 291 illustrations provide another helping hand in the defining of the theory and practice data provided in this volume.—*P. L.*

ELECTRICAL FUNDAMENTALS OF COMMUNICATION

By Arthur L. Alberf, Professor of Communication Engineering, Oregon State College. . . . 554 pp. . . . New York: **McGraw-Hill Book Company, Inc.** . . . \$3.50.

An outstanding text for students studying the fundamentals of telegraphy, telephony and radio.

Sixteen chapters cover the fundamentals of electronics, direct current, conductors, resistors and insulators, direct-current electric power and energy, alternating currents, the magnetic field and inductance, the electric field and capacitance, electric measuring instruments, alternating-current circuits, algebraic representation of alternating current quantities, electric networks, bridge circuits, the transmission of electromagnetic waves, fundamental principles of vacuum tubes and electroacoustics.

Helpful summaries and review questions follow each chapter. Problems are also presented, at these conclusions. These problems are unique in their con-

ception and will prove extremely valuable not only to the beginner, but even to the advanced student and reader.—*O. R.*

SHORT WAVE RADIO

By J. H. Reyner. . . . 186 pp. . . . London, England: **Sir Isaac Pitman & Sons, Ltd.** . . . \$3.25.

A compact, pocket-style book of fundamentals written in the English mode. Although non-mathematical, it does contain data that will prove interesting to engineers and technicians. Subjects covered include . . . wave propagation, antennas, transmitters, modulation, receivers, ultra short waves, frequency modulation and micro-waves.

In the chapter on micro-waves appears data on Barkhausen-Kurz, Gill-Morrell, and electronic and magnetron oscillations, and antennas. This is an exceptionally interesting discussion, even though it is quite basic in its interpretation.—*W. L.*

ELECTROMECHANICAL TRANSDUCERS AND WAVE FILTERS

By Warren P. Mason, Ph.D., Member of the Technical Staff of Bell Telephone Laboratories, Inc. . . . 333 pp. . . . New York: **D. Van Nostrand Company, Inc.** . . . \$5.00.

The study of the electrical and mechanical theories involved in filters, networks and similar allied projects has always been a keen subject of many. A variety of thoughts and equations have been prepared during the past century on this intriguing phase of engineering. In this volume, fundamental analogies and the distinct relationships between the electrical theory and mechanical theory are presented in a very effective manner.

Since the author is associated with a laboratory where much of this work is in progress, and where the development of the electrical wave filter and the first applications of network theory to mechanical systems took place, the data offered are complete and authoritative.

Among the topics analyzed are vibration of membranes and plates, electromechanical converting systems, acoustic equations and networks, the application of network theory to lumped mechanical systems, electrical theory, design of electromechanical systems, and the application of electromechanical impedance elements in electrical wave filters.

Some very interesting data are also presented in the appendix. We find, for instance, elastic and piezoelectric equations for crystals, general wave propagation taking account of viscosity effects and motion and impedance of a bar vibrating in flexure, taking account of rotary inertia.—*O. R.*

VIDEO HIGH FREQUENCY RESPONSE

(Continued from page 32)

Tellegen-Verbeck method consists of the processes of writing the desired circuit characteristic, such as, the driving point impedance in the case of a two terminal network, or the transfer characteristic in the case of a four terminal network, in the form of the quotient of two algebraic polynomials. The polynomials consist of terms in ascending powers of the frequency ratio or any other derived variable. Coefficients of like powers in the numerator and the denominator are then equated. This gives rise to equations or relations between the circuit parameters from which the optimum values of circuit parameters may be found, to achieve flatness of response. For some circuits more equations may result than there are circuit parameters to be determined. In such a case, only sufficient equations, starting with those obtained from the lowest power of the variable, are used to evaluate the circuit constants, and the remaining equations obtained from the higher powers of the variable are discarded. It may also happen that even if only sufficient equations are employed, the equations may give rise to negative or imaginary values of the circuit parameters. This indicates that the configuration is not physically realizable for the attaining of the desired objective, that is, flatness of response.

Often, however, in the latter case, a range of values for the circuit parameters may be found for which the configuration is physically realizable. That is, one of the equations is discarded and an arbitrary relation be-

tween two of the circuit parameters is established instead, such as for example, one capacity set equal to m times another capacity. The proper value of m which will avoid negative and imaginary circuit parameters can then be ascertained.

Additional Tellegen-Verbeck Example

We shall illustrate the Tellegen-Verbeck method with one more example. The circuit is shown in Figure (16.) From the filter theory viewpoint, this is a shunt m -derived half section terminated by a resistance and preceded by a capacity, which together with the capacity required for the half section, forms the total C_1 .

However, by the Tellegen-Verbeck method, we solve for Z . First, we let

$$LC_1 = \frac{1}{\omega_0^2}, \omega/\omega_0 = \gamma, C_2 = qC_1 \quad (18)$$

Then

$$|Z| = R \sqrt{\frac{1 - \gamma^2(1 - k^2 - 2q) + \gamma^4 q^2}{1 + \gamma^2(k^2 - 2 - 2q) + \gamma^4(1 + 2q + q^2 - 2qk^2) + \gamma^6 k^2 q^2}} \quad (19)$$

from which

$$q = \frac{1}{2(1 + \sqrt{2} - 1)} = 0.354 \quad (20)$$

and $k = 1.55$

Corresponding Values of q and k

For 2% drop of γ is 0.7. From this and the values for q and k given by Eq. (20), the proper values for L , C_2 and R may be found from C_1 and ω_0 , for the band width over which the variation in gain is less than 2%. It is interesting to note in passing, that the corresponding values for q and k when obtained by the Percival method are 0.666 and 1.633 respectively. This circuit has a band-width 75% greater than the shunt peaking circuit for the same gain, and is within 21% of the band-width which the best series peaked circuit can afford. The highest gain for a series peaked circuit occurs when $C_2 = 3C_1$ (Figure 13), in which case R_D equals infinity, that is, no damping resistance is required. This can be established very easily by the reader by means of the Tellegen-Verbeck method. (Note that if the Percival method were employed, then the optimum value for C_2 would be twice C_1 .) While such a value will afford a greater gain for a given band-width than the Tellegen-Verbeck method indicates, the

response will not be as flat and it will have a slight peak in the curve.

Lack of space precludes analysis of other circuits, such as those suggested in Figures 12 and 13, but their solutions are evident.

Notes

We further note that if linearity of phase shift is desired, then the derivative of phase angle furnished by the analysis, is taken and expanded in the form of a power series in terms of γ . Starting with the lowest power, coefficients are set equal to zero, and thus equations obtained to a number sufficient to evaluate the circuit parameters. It will be found in general that the values thus obtained will differ from those established by the requirement of flatness of response, which, as stated before, merely means that no circuit can simultaneously give maximum results for both requirements.

It must be remembered that a typical video amplifier may amplify voltages of frequencies extending from 30 up to 5 million cycles per second. An additional requirement for a satisfactory video amplifier is that the phase shift be as nearly linear with frequency as possible. The later phase requirement is something that is not stipulated for an audio amplifier.

Bibliography

- ¹"Low Frequency Square Wave Analysis," Albert Preisman, COMMUNICATIONS, March, 1942.
- ²Percival, U. S. Patent No. 215,656.
- ³"Wide-Band Amplifiers for Television," Wheeler, Proc. IRE, July, 1939.
- ⁴"A Wide-Range Video Amplifier for a Cathode Ray Oscilloscope," Albert Preisman, RCA Review, April, 1939.
- ⁵Tellegen-Verbeck, British Patent No. 469,791.
- Also "High Frequency Correction in Resistance-Coupled Amplifiers," E. W. Herold, COMMUNICATIONS, August, 1938.

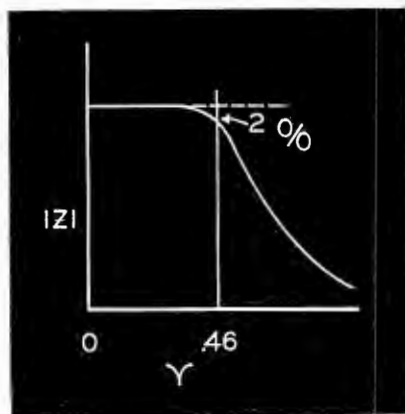

Figure 15

The results of a plot to determine the response drop in the flat portion of the spectrum.

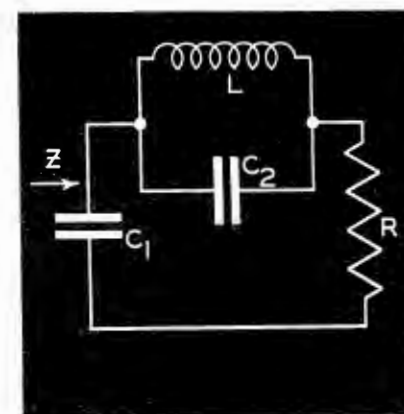

Figure 16

A shunt m -derived half section, according to the filter theory viewpoint.

ACCURACY IN STANDARD SIGNAL GENERATORS

(Continued from page 45)

tered in standard signal generators. The noises due to poor r-f contact can be solved at lower frequencies by suitable silver-to-silver contacts having pressures exceeding a critical value which depends somewhat upon the shape and arrangement of contacts, etc. As the frequency increases up beyond a few hundred megacycles, the difficulty of getting a low resistance moving contact increases, and such tricks as split-stator Colpitts oscillators are used to get around the necessity for moving contacts.

Hum

Hum of the 120-cycle variety can be eliminated by adequate filtering of the power supply. Sixty-cycle hum becomes more annoying as the frequency is increased and the only real solution at several hundred megacycles is to use d-c on the heater of the oscillator. The a-c field set up by the heater current causes mostly frequency modulation of the oscillator which is translated into amplitude modulation by the selectivity characteristic of the receiver. The lack of a "clean" beat note is familiar to all engineers working in the u-h-f field.

Ionization Noise

Under certain conditions it is possible to obtain an intermittent crackle from many standard signal generators. This usually occurs when selectivity curves are being taken very far out from center frequency and is the result of a small superimposed "ionization" ripple on the output of the standard signal generator cross-modulating the receiver.

The ionization occurs in various standard component parts used in the construction of the signal generator. The remedy is to obtain components which are free from ionization noise. This is easier said than done, particularly when there are severe space limitations and present overall dimensions are frozen by the war. This "ionization" noise has not been noticeable except by a few users, and a sort of "brute force" cure has been applied which does not require too much space. More work is being done on this matter at present to eliminate the noise at its source.

Hiss Noise

There is another type of noise peculiar to master oscillator tuned amplifier signal generators which sounds very much like hiss noise. This noise

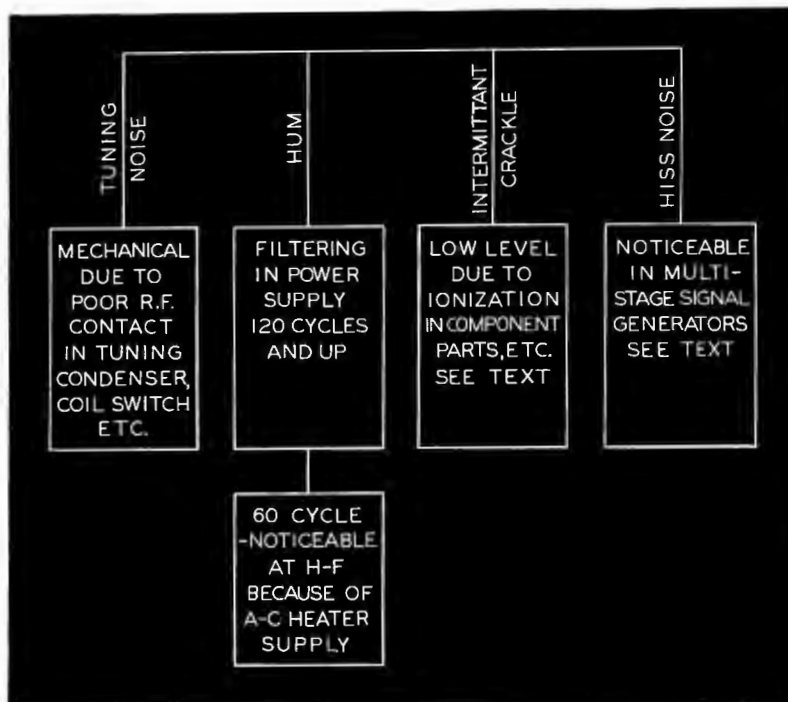

Figure 12

Characteristic noises in the output of standard signal generators and their causes.

is usually found when using the m-o-p-a, as the high level generator in the two signal generator method of measuring selectivity, and it is not noticeable much above 1 megacycle.

Examining the output of the m-o-p-a type signal generators reveal not only the carrier there but also a superimposed "shot noise" spectrum which may be as high as 100 microvolts at 100 kc and dwindle down to a few microvolts at 1,500 kilocycles. This is true only for carrier output of approximately one volt or more. This "shot noise" is generated in the plate circuit of the oscillator tube and amplified by the r-f amplifier along with the carrier.

It is interesting to note that the tuned-grid type of oscillator is free from this source of noise. However, tuned-grid type oscillators are not as desirable for operation at h-f. This type of noise is not noticeable above 1 megacycle because the values of resonant impedance are too low to build up very much "shot noise" in the plate circuit of the oscillator. Since the simple modulated oscillator type of signal generator does not have this noise in troublesome proportions, it seems wise to use this

type of generator as the high level generator and thus avoid any difficulty.

We thus find that there are many factors that control accuracy considerations in standard signal generators. For instance, ratio errors in laboratory generators are usually less than 2%. At frequencies of 20 to 30 kc, these errors however frequently rise as high as 3% to 4% because of stray mutual couplings inherent in generator design. We also learned that the r-f harmonics may be as high as 10% at 150 kc. As the frequency increases, the r-f harmonic content drops rapidly to something less than 2% in the broadcast band. Since the harmonic content is a function of the L/C ratio in the final tank, the harmonics are greater near the high frequency ends of each tuning range.

It was noted too that the greatest departure from linearity occurs at the higher percentages of modulation. If the modulation is limited to 30%, only slight deviations from a straight line are evident.

[Most of the remarks concern instruments of our own manufacture and do not necessarily apply to those of other origin.]



Premax Metal Antennas

Get the messages through! Premax Antennas and Mountings are available in many standard and special designs, for use of offensive and defensive agencies. Send for bulletin.

Premax Products

DIVISION OF

CHISHOLM-RYDER CO., INC.
4303 Highland Avenue, Niagara Falls, N. Y.

BELLINI-TOSI LOOP

(Continued from page 34)

balance between two separate antenna circuits. This balance is at once destroyed by a bad contact in one circuit and bearing errors up to 70 or 80 degrees are possible.

The action of the loop antenna in determining direction demands that all the energy reaching the receiver come from the loop system; for this reason, every portion of the d-f apparatus must be adequately shielded to the extent that the overall e-m-f developed on the grid of the first receiving amplifier tube will not exceed about 1/2% of the e-m-f delivered to this same grid by the loop system. Aside from the errors inherent in an imperfectly shielded set of equipment, others may sometime be produced by undesirable coupling between circuit elements and between the apparatus and elements within the room. With the Bellini-Tosi system, the two antennas should have identical electrical constants, except insofar as they are deliberately altered to allow for the effect of local disturbing factors. The goniometer must be completely shielded from all other instruments. To make certain that it itself is free from error, it is subjected to rigid tests before being used.

DEVELOPMENTS OF 1942

by GUY BARTLETT

General Electric Company

THE whole story cannot be told. All activities are now being directed to producing for the war at sea, for the war on land, and for the war in the air, both in direct production and in supplying essential tools to other war industries. Not until the victory has been won can the brilliant achievements of 1942 be revealed—achievements made possible by the combined all-out war production efforts of research, engineering, and manufacturing personnel.

Production lines which previously turned out many thousands of fractional-horsepower motors still produced small motors; a great many of them were of different kinds, frequently for direct-current use and with unusual characteristics requiring unique design and new material. Now they were needed for quite different applications in airplanes, tanks, ships, and the many other types of war equipment.

Manufacturers cut off whole production lines in certain instances and rushed into full production on new products, in some cases new even to the necessity of invention and development of the product in question. Production quotas went up—doubled, redoubled—and were met. The products were of great variety and the quantities tremendous by comparison with any known standard variety.

For instance, for thin, compact instruments there was produced a new element of the permanent-magnet, moving-coil type featuring "internal pivot" construction. Instead of being secured to the outside of the armature winding, the pivots are mounted inside the armature shell. The new miniature instruments are only 63 per cent as deep as previous models.

Glass vee jewels manufactured by a new process were put into mass production, breaking a bottleneck developed when importation of sapphire jewels from Switzerland was cut off. Used with steel pivots, the new jewels are in some respects superior to sapphires, are more uniform in shape and dimensions, and can be press-set, an easier operation than spun setting.

Among the year's new measuring instruments were a hook-on ammeter to measure direct current in a conductor without cutting the conductor; a high-sensitivity, self-contained frequency meter (for 60 cycles) with a precision of one part in 12,000; several modifica-

(Continued on page 56)

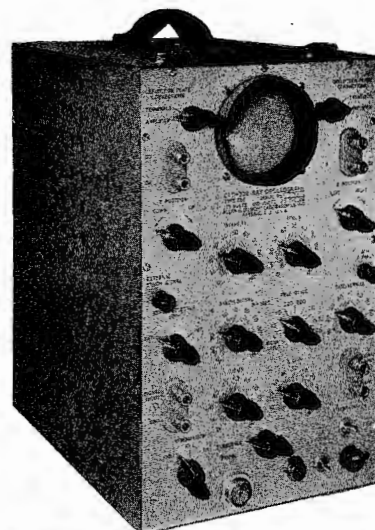

Uniform up to 2,000,000 cycles

★ Out of the flaming crucible of war which tries equipment as well as men's souls, comes this new DuMont Type 224 Oscillograph. And this is what it means to you:

First and foremost, its wide band Y-axis amplifier permits study of signals of frequencies far beyond the range of standard oscillographs. It has a faithful sinusoidal wave response — 20 to 2,000,000 cycles, and comparable square wave response to 100,000 cycles.

Second, it is a more versatile oscillograph, providing extreme variety in the application of signal to the cathode-ray tube. Handy connections on front panel. Also a test probe with shielded cable, reducing input capacitance and eliminating usual stray pickup.

Third, it is housed for severe service out in the field as well as in plant or laboratory. Protective removable cover safeguards panel and controls when not in use, especially in transit.

Other interesting innovations and advantages. Measures 14 1/2" h., 8 3/4" w., 15 1/2" d. Weighs 49 lbs.

★ Write for Literature . . .

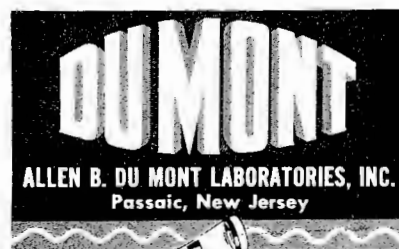

Cable Address: Wespexlin, New York



DYNAMOTORS

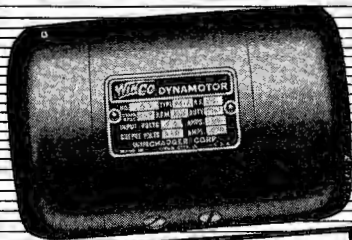

Where complete dependability is essential . . . where efficient electric power is important . . . specify WINCO DYNAMOTORS! WINCO DYNAMOTORS are built for all types of service . . . for operating temperatures ranging from -40° to $+65^{\circ}$ Centigrade.

- COMPACT
- LIGHT WEIGHT
- MINIMUM A.C. RIPPLE
- LOW VOLTAGE REGULATION

These are only a few of the quality features in WINCO DYNAMOTORS.

WINCO DYNAMOTORS are regularly available in standard outputs and sizes . . . special WINCO DYNAMOTORS can be designed to meet your exact need. Our complete free Advisory Engineering Service is yours without obligation — why not consult us?



The Dynamotor designed to insure maximum efficiency at all operating altitudes and temperatures.

WINCO DYNAMOTORS
WINCHARGER CORPORATION
 SIOUX CITY IOWA

CONTROL SYSTEMS IN AIRCRAFT COMMUNICATIONS

by CHARLES W. MCKEE

Supervisor of Aircraft Radio, Eastern Air Lines, Inc.

THE proper type of aircraft radio operating control system is a controversial subject. One fact that is well to consider as a design factor is that the radio controls are used methodically and the operator may not necessarily understand the radio function sequence that is set up in the circuit when a control is operated.

It must be also remembered that the pilot is engaged in flying the plane as well as being occupied by problems involving navigation, weather and power plant.

As a summation, the point is, to provide a control system that is fool-proof and, requires the minimum effort on the part of the pilots. This idea should also be carried through for use on the future large plane which will no doubt demand a radio-operator-technician.

Flexibility

One conventional radio control system trend is to make it very flexible by providing a separate and independent control for each operation. An opposite extreme is what might be called a "function control" where each unit is set up

for a pre-determined operating sequence. It is possible to set up each operating sequence by a single switch position.

The two mentioned extremes are short of the desired control system. While one is flexible to the highest degree, it is confusing to operate and also requires the operation of many switches and possibility of errors in the use of the equipment due to operating the wrong combination of controls. The "function control" limits the use of the equipment and involves complications.

Output Controls

Controls used to regulate the output of the aircraft receivers are usually referred to as volume controls. Technically, these controls are classified in accordance to the section of the receiver circuit that they are used. A sensitivity control is that control which determines the gain in the r-f section of the receiver. Volume or gain control is that which determines the a-f gain. Usually, the control across the headset is referred to as a level control.

Communications receivers in most cases use the manually operated sen-

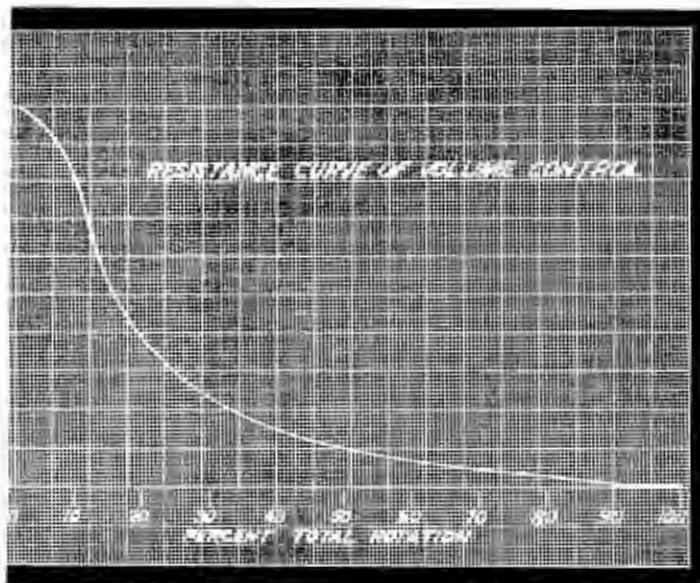

Figure 1

The per cent of maximum resistance, on the Y axis, plotted against percentage of total resistance, to determine the required volume control requirements.

sitivity control in conjunction with an automatic volume control. It is essential that good avc be provided for use on the communication type of receiver.

Sensitivity Control

The sensitivity control used with the beacon receiver for conventional beacon flying is more than a control for regulating the receiver output. Due to the fact that the beacon is operated on the principle of an equi-signal, conventional avc cannot be used. This also applies to the aural null type of radio direction finder. The reason is obvious; for example, when flying in the region of the twilight zone, avc would for example, increase the "A" and decrease the "N" character and result in an indication of an on-course signal. Another reason is the reduction of the "signal-surge," that is desirable as an indication just prior to "passing over the station."

The sensitivity control of the beacon receiver is used by the pilot to indicate the approach to the station. When near and flying to the station, the interval between the adjustment of this control due to rapid increase of signal provides the pilots with a valuable indication of his pending arrival over the range station.

Linear Characteristics

This discussion clearly indicates the necessity of a control that possesses a linear characteristic to the change in receiver output to the percent-rotation of the sensitivity control. Requirements are that the beacon receiver sensitivity control provides adequate signal level at a point miles from the station to a few hundred feet of the range station transmitter. As this control is rotated, the receiver output must be free of sudden or sharp changes in the signal level. It is essential that the control knob be of an indicating type and of a convenient size.

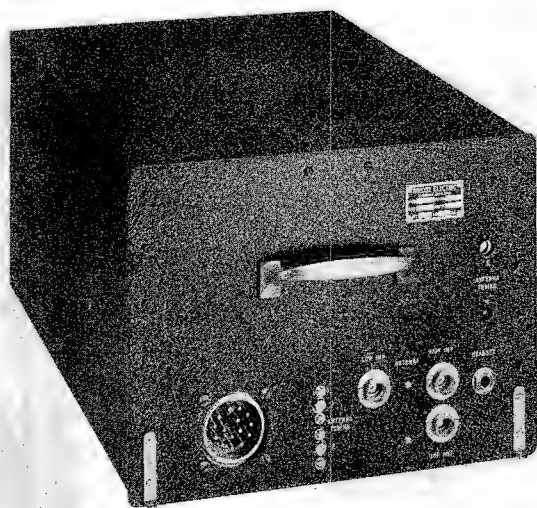

Figure 2

Panel view of a typical aircraft receiver, featuring characteristic simplification details. The cable connecting plug and antenna connections for l-f and u-h-f are readily accessible. Antenna adjustments for l-f and u-h-f are also available on this panel, instead of the rear.

Headset Level

It is mandatory that the beacon sensitivity control be adjusted for normal headset signal level at all times and avoid receiver overload. An overload condition will block one character and permit the other (weaker) character of the radio range signal to be received. This results in a reversal of the radio range course signals.

Anti-block AVC

To avoid operation of the receiver in an overloaded condition, a type of avc is used which is referred to as an anti-block type. During the time that the receiver is used at normal headset level, this type of avc is not in action. The anti-block avc eliminates the condition that would permit operation of the receiver in the region beyond the overload point at that which would appear to be normal head set level, but would result in a course reversal.

Further Simplification

As an example of further simplification and desirable characteristics of aircraft radio controls, let us take one type of automatic compass—in which, when functioning automatically the use of an audio gain control is required. When this equipment is in use as an aural null direction finder, a sensitivity control is required. The use of these controls operated in tandem mechanically solves the problem for the operator as to which control should be used.

[This is the fifth of a series of articles covering an analyses of aircraft communication equipment and components. Serving as an advisory editor for this series is Frank Melville, transatlantic aircraft communications expert, and president of the Melville Aeronautical Radio School.]

Till
VICTORY
and Beyond

You can count on Wincharger Antenna Towers. They combine strong efficient coverage with built to last qualities that insure you years of service.

Add to these advantages their strikingly attractive appearance plus a sensationally low initial cost and it's easy to see why an ever increasing number of Wincharger Antenna Towers are being used for:

**Commercial Broadcasting
Police Work
Signal Corps Air Lines
Ordnance Plants**

To be sure for years ahead—be sure to specify Wincharger Antenna Towers.

Makers of
WINCHARGER
FARM ELECTRIC
SYSTEMS
WINCO
DYNAMOTORS
WINCHARGER
VERTICAL
RADIATORS

WINCHARGER VERTICAL RADIATOR
WINCHARGER CORPORATION SIOUX CITY, IOWA



COMMUNICATIONS

19 E. 47th St., N. Y. C.

Please enter annual subscriptions (12 issues) for each of the undersigned for which payment is enclosed at the rate of \$1.00 each. (This rate applies only on 4 or more subscriptions when occupations are given.) Foreign Subscriptions are \$2.00 each.

Name

Street

City-State

Occupation or title

Employed by

Nature of business

(State if Manufacturer, Broadcast Station, etc.)

Product

Name

Street

City-State

Occupation or title

Employed by

Nature of business

(State if Manufacturer, Broadcast Station, etc.)

Product

Name

Street

City-State

Occupation or title

Employed by

Nature of business

(State if Manufacturer, Broadcast Station, etc.)

Product

Name

Street

City-State

Occupation or title

Employed by

Nature of business

(State if Manufacturer, Broadcast Station, etc.)

Product

Today, Mr. Engineer,
more than ever before
YOU MUST READ

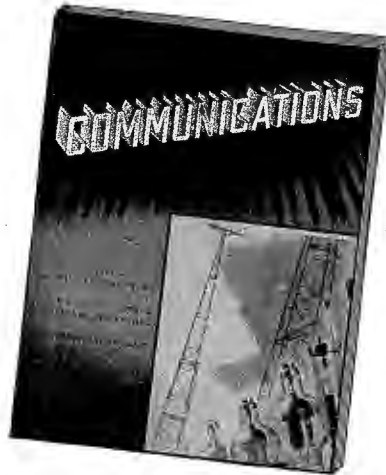

*to keep up with all the new
 developments in your in-
 dustry*

You and your associates can obtain a year's subscription to COMMUNICATIONS (12 issues) for only \$1.00 each by using the Group Subscription Plan.

A regular yearly subscription to COMMUNICATIONS costs \$2.00—but when four or more men sign up at one time, each one is entitled to the half-price rate. (Foreign subscribers on the Group plan pay \$2.00 each.)

NOMOGRAM for the INDUCTANCE OF A CIRCULAR RING

By T. S. E. Thomas
B.Sc., Ph.D.

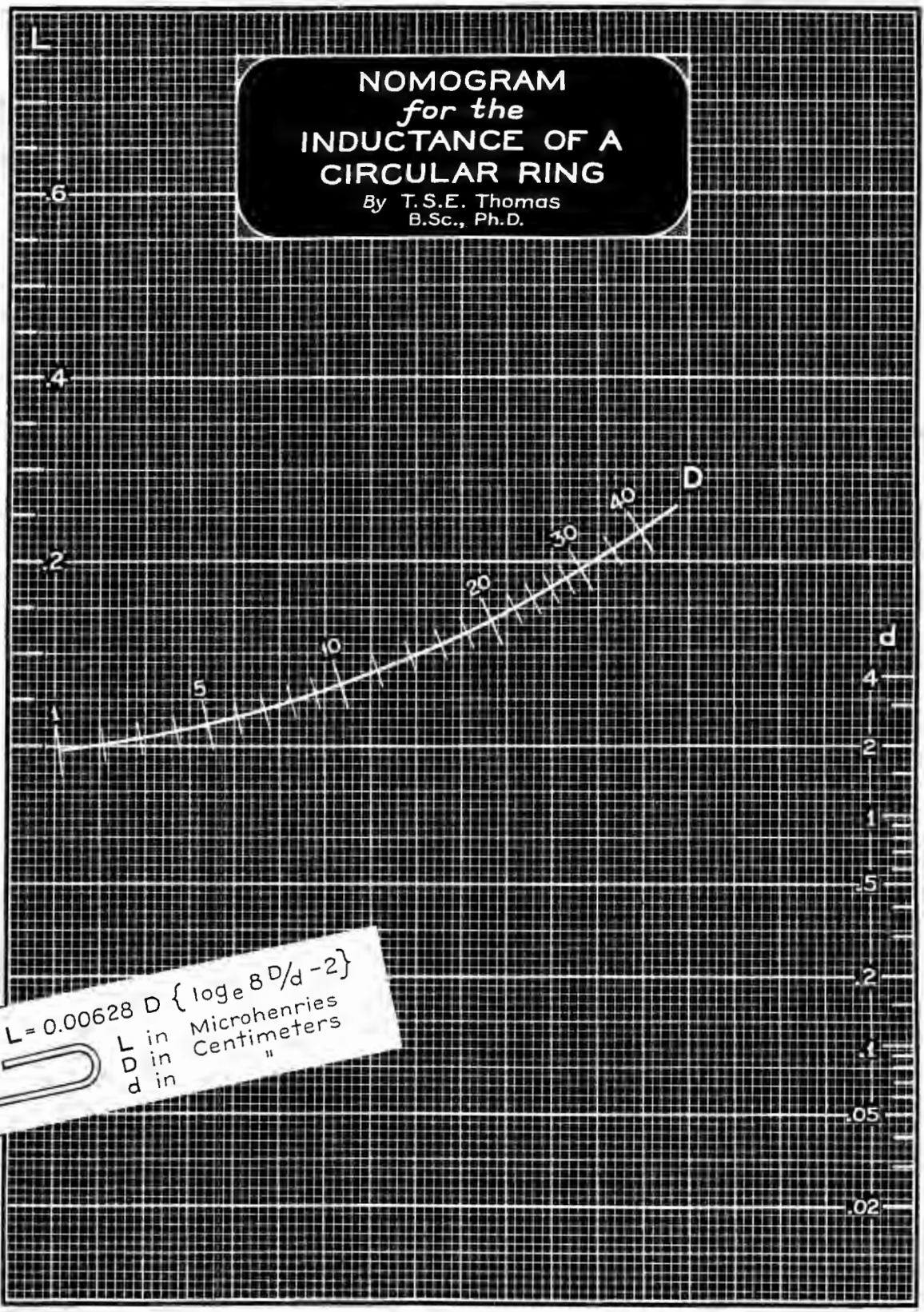

$$L = 0.00628 D \{ \log_e 8D/d - 2 \}$$
 L in Microhenries
 D in Centimeters
 d in "

[See page 56 for explanatory data]

TRIPLETT

Thin Line

INSTRUMENTS



**DEPENDABLE PRECISION
IN LIMITED SPACE**

Precision performance by new *thin* instrument with *standard* Triplett movement housed in either metal or molded case. No projecting base; wider shroud to strengthen face; simplified zero adjustment; balanced bridge support; metal bridges at both ends; doubly supported core. For "Precision in limited space" write for Triplett Thin Line Bulletin.

THE TRIPLETT ELECTRICAL INSTRUMENT CO.
Bluffton, Ohio

CRYSTALS  **SINCE**
EXCLUSIVELY **1934**

ORDERS SUBJECT TO PRIORITY
PETERSEN RADIO CO., Council Bluffs, Iowa

University

**REFLEX SPEAKERS are the
ACCEPTED STANDARD for Uncle Sam**

Only Reflex Speakers have the high efficiency vital for war use.
Only Reflex Speakers have the super acoustic output required for difficult war conditions. Send your special war problem direct to the engineering department.
University Labs., 225 Varick St., N. Y. C.



CRYSTALS by HIPOWER

Thousands of vital transmitting installations rely on the accuracy and dependability of Hipower Precision Crystal units. With recently enlarged facilities, Hipower is maintaining greatly increased production for all important services. When essential demand begins to return to normal, Hipower will be glad to help with your crystal needs.

HIPOWER CRYSTAL CO.
Sales Division—205 W. Wacker Drive, Chicago
Factory—2035 Charleston Street, Chicago, Ill.

NOMOGRAM FOR THE INDUCTANCE OF A CIRCULAR RING

Reprinted by Request

(See page 55)

IN experimental work with u-h-f circuits the inductance coils used may consist of a single turn coil in the form of a circular ring. The inductance of a circular ring may be obtained from a formula due to Kirchhoff.

$$L = 0.00628D \left\{ \log_e 8D/d - 2 \right\} \text{ microhenry}$$

where L is the inductance in microhenries, D the diameter of the coil and d the diameter of the wire (circular cross section). Both dimensions are in centimeters.

L, D and d Represented

The nomogram on page 55 represents the inter-relation of L, D and d for a certain range of values. Its range may be extended by making use of the rule that the inductances of geometrically similar circuits are directly proportional to their linear dimensions.

DEVELOPMENTS OF 1942

(Continued from page 51)

tions, for special applications, of the highspeed photoelectric recorder; an electronic crest-voltmeter; a light-beam a-c wattmeter to measure a small amount of power at low power factor, for testing very small motors; a sturdy galvanometer with higher sensitivity than previous self-contained units; a redesigned general-purpose oscillograph; and a three-tube cathode-ray oscillograph for simultaneously measuring three medium-high-speed transients.

For x-ray crystal-analysis equipments there were produced a quartz-crystal goniometer to measure accurately the orientation of pieces of quartz which are cut into oscillator plates for radios; a new crystal-analysis tube having two pure beryllium metal windows, having very low x-ray absorption and hence increasing tube output; and a portable x-ray diffraction unit for both diffraction and low-voltage microradiography.

A water-cooled transmitting tube for use in wide-band television amplifiers was designed to incorporate such features as inverted anode and short lead lengths with multiple terminal mount connections, reducing lead inductance and giving stable and efficient performance at high frequencies.

A most prolific source of evidence of continuing lightning discharges was found on several copper spheres mounted on radio towers. Analysis of the holes left by the discharges showed that 50 per cent of the holes result from strokes containing 17 coulombs or more. The largest hole found was the result of 240 coulombs.

Evidence of high-coulomb values in the lightning stroke also was found on roofs of ordinary dwellings, and from the burning down of conductors or distribution circuits. The evidence thus collected helps to explain numerous phenomena associated with lightning damage and permits proper measures for protection against such damage.

Carrier Current

The advantages of rack-and-panel construction were extended to additional carrier-current transmitter-receiver assemblies. In telemetering and control equipment there were important contributions to the war program of interconnecting electric power systems and of extending lines to vital war plants.

The practice of using one carrier channel for a number of services was expanded through the use of narrow-band frequency-shift arrangements.

These are but a few of the developments of 1942, an epic year in our history.

THE INDUSTRY OFFERS . . .

(Continued from page 42)

voltage is less than 0.05% on a 60-cycle line, and less than 0.1% on a 42-cycle line.

The voltage-regulated a-c power supply operates from a 115- or 230-volt power line, 40 to 60 cycles.

The oscillator can be used for either relay-rack or table mounting. Dimensions are $19\frac{3}{8} \times 14\frac{1}{2} \times 7\frac{1}{2}$ inches, and net weight is 35 pounds.

Another recent G. R. development is the type 805-A standard signal generator designed to meet the need for an all-purpose amplitude-modulated signal generator in the frequency range up to 60 megacycles. It is capable of testing both high-fidelity broadcast receivers and specialized military types.

The frequency range of 16 kilocycles to 50 megacycles is covered in seven ranges, direct-reading to an accuracy of 1%. A slow-motion drive is provided, with a dial which indicates frequency increments as small as 0.01%.

The output voltage at the end of a 75-ohm cable is continuously adjustable from 0.1 microvolt to 2 volts, and is indicated directly by a panel meter and a multiplier switch. The cable is terminated in its characteristic 75-ohm impedance, so that the generator impedance as seen by the device under test is 37.5 ohms. This impedance is constant for all output voltage settings.

Modulation is continuously variable from 0 to 100%, and is indicated by a panel meter. Internal modulation is available at 400 cycles and 1000 cycles. External modulation can also be used.

The envelope distortion is less than 5% at a modulation level of 80% and a carrier frequency of 1 megacycle. Carrier noise level is at least 40 db below 80% modulation.

Frequency modulation and stray fields are negligible. The generator operates from the a-c power line, 115 or 230 volts, 40 to 60 cycles. The internal power supply is voltage regulated. Power input is 180 watts, maximum.

The overall dimensions are $16 \times 33 \times 12$, and the net weight is approximately 120 pounds.

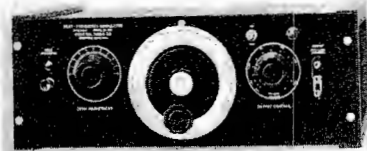

Beat-Frequency Oscillator

"CELL" RECEIVER CONSTRUCTION

A new method of assembling radio communication receivers from three basic cells and using only one type of tube in the entire circuit regardless of its complexity, has been introduced by the Electronics Division of the Harvey Machine Co., 6200 Avalon Blvd., Los Angeles, Calif. Three types of cells are produced in quantities; r-f units, i-f units and audio amplification units.

Flexibility in manufacturing is afforded, it is said, since practically any type of receiver can be assembled from previously constructed cells. For instance, if receivers for scout-cars are required, two r-f cells, one i-f cell and one audio cell are assembled by slipping the cells onto a group of bus-bars which connect the various cells

(Continued on page 58)



It provides continuous frequency response characteristics of any audio apparatus on a standard chart, in an absolutely automatic manner.

The Frequency Response Recorder, among its many other applications, measures voltage and current, sound intensity, actual loudness and vibration.

For complete technical information write for our bulletin, "Sound Advances."

SOUND APPARATUS COMPANY

150 WEST 46th STREET
NEW YORK, N. Y.

OUR
AUTOMATIC
FREQUENCY
RESPONSE
RECORDER
SAVES
VALUABLE
HOURS OF
SKILLED
MEN



IT'S
Performance
THAT COUNTS!

PILOT Light Assemblies may look alike, but it's performance that counts! Manufacturing these small parts in the large quantities now required calls for experience, high speed production, precision methods, and materials that always meet exacting specifications. DRAKE Assemblies have been developed to their high efficiency through years of specialization. Practically every leading radio and aircraft manufacturer uses them. Demand has grown enormously yet deliveries are keeping pace with requirements. When you specify DRAKE for the Pilot Light Assemblies you need, quality and dependable performance is assured.

Will a Copy of Our Catalog Help You?

DRAKE MANUFACTURING CO.
1713 W. HUBBARD ST. • CHICAGO, U.S.A.

A STEADY SOURCE OF ALL
ELECTRONIC
EQUIPMENT

TERMINAL RADIO CORP.
Telephone: WOrth 2-1111
85 CORTLAND ST., NEW YORK, N.Y.

TO: *Your Plant*

FOR ACTION:
PHONE! WIRE! WRITE!
BULLETINS AND CATALOGS ON REQUEST

THE INDUSTRY OFFERS . . . —
(Continued from page 57)

together and also are the structural members to hold the cells rigidly locked together. If on the other hand the orders being filled call for a highly sensitive and selective receiver, with provision for automatic direction finding equipment, and as many as four different frequency bands, nine or more of the cell-units together are assembled.

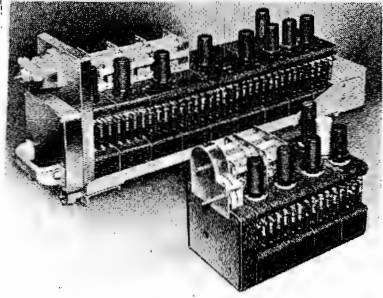

COMBINATION INSULATOR AND WIRE MARKER

Short lengths of extruded plastic tubing clearly marked with identification symbols are available from Irvington Varnish and Insulator Company, 6 Argyle Terrace, Irvington, N. J.

The tubing from which these new combination insulator-markers are made is said to have very high dielectric strength. Smooth inside surfaces permit quick application over wires and lugs. Legible numerals of the customer's choice are printed on the tubing with an ink that has resistance to chemicals, water and oils equal to that of the tubing itself. Available in colored tubing with either black or yellow

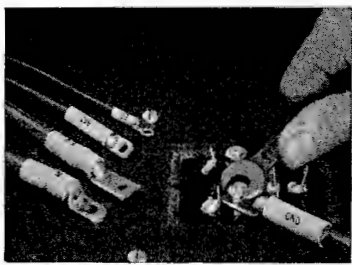

symbols, in ASTM sizes from No. 9 up to 3/8" I-D.

Other tubing made from much less critical plastic materials can be printed and utilized solely as wire markers.

INTER-COMMUNICATION SYSTEM

An inter-communication system featuring a "Conference Traffic Control" has been developed by Talk-A-Phone Mfg. Co., 1215 Van Buren Street, Chicago, Ill. This is said to afford any number of stations to hold a private conference without interruption or eavesdropping from other stations outside of the conference group. When one of the conference group is being called, he is signalled by a light so that he knows that the call is waiting.

Other new features include "Uni-Trans" or one way automatic transmission, especially effective for the dictation of letters and the complete recording of conferences. Units have an output of five watts.

An 8-page catalog describing this system and others is free for the asking.

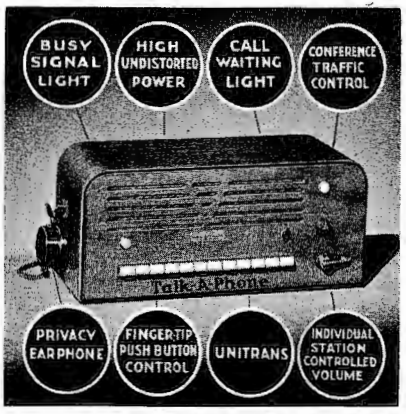

PHOTOSWITCH PHOTOELECTRIC CONTROLS

A new series of photoelectric controls type A15, are now available from Photoswitch, Inc., 19 Chestnut Street, Cambridge, Mass.

These controls include relay contacts conservatively rated at 10 amperes a-c at 115 volts. The output terminals are those of a single-pole double-throw switch, for either normally closed or normally open operation. This provides for action either when the light beam is broken or when it is made.

Operating range of type A15 is 20 feet with light source L30, and 40 feet with light source L60. Type A25 is supplied with light source L30 for 50 foot operation, and with light source L60 for 100 foot operation.



(Continued on page 59)

JONES 500 SERIES PLUGS AND SOCKETS

Designed for 5,000 volts and 25 amperes. All sizes polarized to prevent incorrect connections, no matter how many sizes used on a single installation. Fulfills every electrical and mechanical requirement. Easy to wire and instantly accessible for inspection. Sizes: 2, 4, 6, 8, 10, and 12 contacts. Send for a copy of Bulletin 500 for complete information. Write today.

HOWARD B. JONES
2300 WABANSIA AVENUE, CHICAGO

MOSSMAN LEVER-SWITCH

Donald P. Mossman, Inc., 6133 N. Northwest Highway, Chicago, announces a lever-switch, primarily designed for use in aircraft, communication, annunciator and fire alarm systems, testing apparatus, etc. It is available in an almost unlimited series of combinations of contact assemblies. Contacts, pile-ups and lever action is assembled to meet the specific requirement. It has locking and non-locking action (spring return to neutral position) and no throw stops.

Rating-maximum recommended is 5 amperes, 110 volt, a-c (non-inductive).

Diagram and complete details are given in the general data bulletin 82, which will be furnished by the manufacturer, upon request.

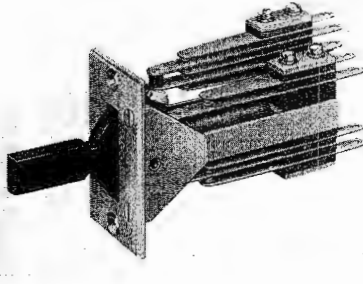

* * *

DISC CERAMICONS

Erie Resistor Corporation, Erie, Pennsylvania, announces new type disc ceramicons.

They are made in two sizes, basic type 1770 which is 3/4" in diameter and basic type 170 which is 15/16" in diameter. Height of the units vary in accordance with capacity. The maximum height, excluding mounting stud and terminal is 3/4".

Type 1770 is rated at 500 volts d-c working and is available in any standard temperature coefficient from ±120 (P120) to -750 parts per million per degree C (N750). Maximum capacity at zero temperature coefficient (NPO) is 1,000 mmf. and is approximately 7,000 mmf. in N750.

Type 170 is rated at 1500 volts d-c working. Maximum capacity in NPO is 400 mmf., and 1750 mmf. in N750.

The design of these condensers is said to be such that their resonant frequency is considerably higher than that of conventional condensers, an important characteristic for ultra-high frequency applications. The disc ceramicons are hermetically sealed to provide maximum protection against humidity.

Copies of a data sheet showing various

styles of available mounting studs and giving electrical characteristics of these ceramicons are available, gratis.

* * *

STACKPOLE SEALED VARIABLE RESISTORS

Two new closed-cover, sealed variable resistors have been recently announced by the Stackpole Carbon Company, St. Marys, Pennsylvania.

Known as the type MG variable resistor they are designed for use under conditions of extreme humidity or salt spray, and where internal and external leakage must be held to a minimum. A leakage resistance on the order of 300 megohms after 48 hours in 95% humidity at 40° C. is said to be obtained. Spacing of current-carrying parts is greater, and the surface insulation of the molded base is several times that of previous laminated-base units.

The Stackpole LP variable resistor is now also furnished with a dust-proof cover and is effectively sealed with a special compound to the point where resistivity from current-carrying parts after 48 hours of 95% humidity at 40° C. is five times that of the previous open construction units. The dust-proof cover is said to make the unit suitable for use in dusty or sandy localities.

Both of the new units have the Stackpole spiral connector, as well as a double-fingered element contacting member.

Stackpole engineering bulletin 6 describing these resistors in greater detail will be sent upon request to the manufacturer.

* * *

HALF-CYCLE ELECTRONIC SPOT WELDING CONTROL

An electronic half-cycle, synchronous control for the precise operation of resistance-welding machines has been announced by General Electric. Mounted in a protecting cabinet, the control is furnished in two types: the CR7503-A136, which also includes a welding transformer and is designed for bench mounting, and the CR7503-A133, which is without a transformer and is designed for wall mounting. Both types can be used either with tongs or with a suitable bench welder.

The control features of a new tube, the easily replaced GL-415; a new circuit which is said to make higher-speed welding possible; and a simplified initiating circuit. The new design also incorporates heat control by the phase-shift method. The heat adjustment is made by a dial mounted on the front of the cabinet.

The control facilitates the welding of tinned copper, steel, or alloy wires; of studs from 0.01 to 0.05 inch diameter to flat surfaces, with little or no indentation on the opposite surface of the metal, etc.

Putting 'em Thru the Mill!



Strip for Action! Strip made from Wilbur B. Driver Co. special alloys! Strip that has so many essential war uses! As it is rolled through our mills, day and night, we know it will do its part in flattening the Axis!

Consult us for your special alloy requirements in rod, wire, ribbon and strip — both hot and cold rolled.

WILBUR B. DRIVER CO.
NEWARK, NEW JERSEY

ELECTRICAL ENGINEER

with experience in the design and manufacture of electrical parts used in radio, telephone, and electronic industries. To work on post war as well as war-time development for a leading Philadelphia manufacturer.

Write giving full particulars

**BOX 143
COMMUNICATIONS**

19 E. 47th St. New York, N. Y.

DIE-LESS DUPLICATING

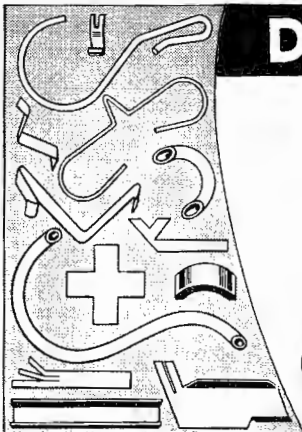

The parts shown are typical of the great variety of simple or intricate forms and shapes which can be quickly duplicated to a tolerance of .001 in. with DI-ACRO Precision Machines—Shears, Brakes, Benders. For experimental and research work or production runs, DI-ACRO Units form angle, channel, tube, rod, moulding, wire, strip stock; shear stock sheets, trim duplicated stampings. With DIE-LESS DUPLICATING, Man Hours and Critical Materials are frequently saved.



Send for 32-page catalog—"Metal Duplicating Without Dies."

O'NEIL-IRWIN MFG. CO., 322 - 8th Ave. S., Minneapolis, Minn.



BRAKE



BENDER



SHEAR

VELOCITY P.G. DYNAMIC

THE FINEST MICROPHONES

AMPERITE

FOR PUBLIC ADDRESS & RECORDING

MICROPHONES THAT SURPASS THE HIGHEST REQUIREMENTS OF BROADCASTING, PUBLIC ADDRESS, AND RECORDING

KONTAK MIKES

Write for Catalog

AMPERITE COMPANY
561 BROADWAY NEW YORK, N. Y.



Harvey may help to cure those headaches caused by scarcities of certain radio materials. We act as procurement agents for essential manufacturers and military services.

They find that our knowledge of the field and our intimate contact with sources of supply is invaluable in locating material and expediting deliveries. May we take a problem off your hands?

HARVEY RADIO CO.

103 W. 43 St.

New York, N. Y.

Index to Advertisers

| A | Page |
|--|--------------------|
| American Radio Hardware Co., Inc.... | 1 |
| Amperex Electronic Products | Inside Front Cover |
| Amperite Co. | 80 |
| B | |
| Bliley Electric Co. | 41 |
| Brach Mfg. Corp., L. S. | 47 |
| C | |
| Cannon Electric Development Co. | 37 |
| D | |
| De Jur-Amsco Corp. | 25 |
| Drake Mfg. Co. | 58 |
| Driver Co., Wilbur B. | 59 |
| Du Mont Labs., Allen B. | 51 |
| E | |
| Eitel-McCullough, Inc. | 13 |
| Equity | 46 |
| G | |
| Galvin Mfg. Corp. | 17 |
| General Ceramics and Steatite Corp. | 27 |
| General Electric | 30, 31 |
| General Radio Co. | Inside Back Cover |
| Gould-Moody Co. | 5 |
| Guardian Electric | 3 |
| H | |
| Hallcrafters Co. | 45 |
| Harvey Radio Co. | 60 |
| Hipower Crystal Co. | 56 |
| I | |
| International Resistance Co. | 6 |
| J | |
| Jefferson-Travis Radio Mfg. Co. | 21 |
| Jones, Howard B. | 58 |
| L | |
| Lenz Electric Mfg. Co. | 18 |
| M | |
| Meissner Mfg. Co. | 46 |
| Mico Instrument Co. | 46 |
| Murdock Mfg. Co. | 39 |
| N | |
| National Union Radio Corp. | 40 |
| New York Transformer Co. | 38 |
| O | |
| O'Neil-Irwin Mfg. Co. | 59 |
| P | |
| Petersen Radio Co. | 56 |
| Pioneer Gen-E-Motor | 57 |
| Premax Products | 51 |
| R | |
| RCA Mfg. Co., Inc. | Back Cover |
| S | |
| Sound Apparatus Co. | 57 |
| T | |
| Tech Laboratories | 40 |
| Terminal Radio Corp. | 60 |
| Thomas & Skinner Steel Prods. Co. | 38 |
| Triplett Electrical Instrument Co. | 56 |
| U | |
| United Transformer Co. | 28 |
| University Labs. | 56 |
| W | |
| Wiley & Sons, Inc., John | 44 |
| Wincharger Corp. | 52, 53 |
| Z | |
| Zophar Mills, Inc. | 44 |

LAMINATIONS

for Output TRANSFORMERS
of Highest Permeability

Standard stocks in a wide range of sizes for Audio, Choke, Output and Power Transformers. Write for dimension sheets.

permanent MAGNETS

ALNICO (Cast or Sintered)

COBALT-CHROME-TUNGSTEN

Cast, formed or stamped permanent magnets for all purposes. Engineering cooperation backed by 38 years experience in magnet making.

TOOLS » DIES » STAMPINGS
HEAT TREATING

Thomas & Skinner

Steel Products Co.

1113 E. 23rd St. Indianapolis, Ind.

NOTICE

Inductions into the armed forces and demands of war production industries have created shortages of labor necessary in the printing, handling and mailing of publications.

If your monthly copy of COMMUNICATIONS should be late in reaching you — remember that the delay is due to war conditions and the war effort must come first.

Please bear with us.

Thank You!

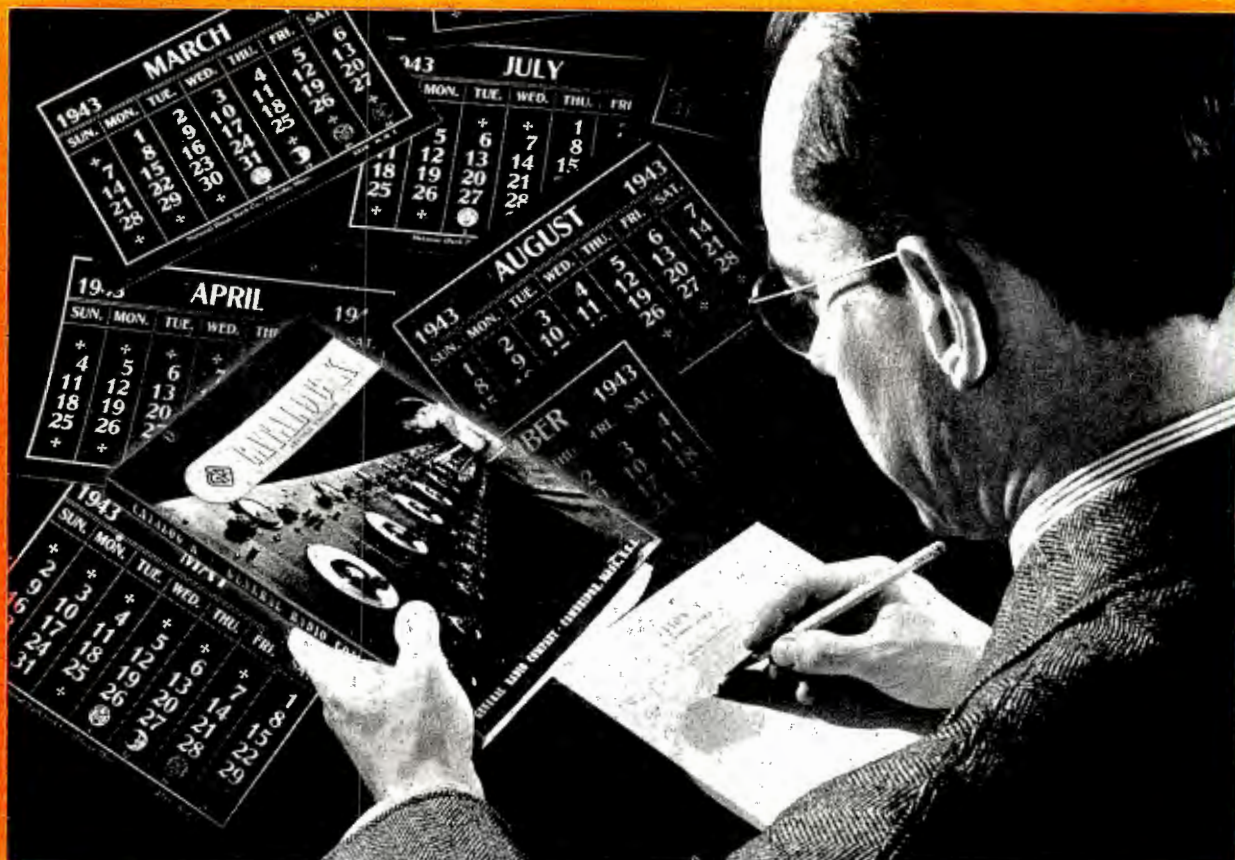

Forecasting Deliveries of Test Equipment for 1943

You can help us to schedule production for 1943 more efficiently so that you will be better assured of getting General Radio instruments when you need them. Estimate your test equipment requirements when you plan your own production and place your orders with us well in advance of the desired delivery dates.

Our present plant output is completely allocated, and current orders will be de-

livered early in 1943. If you will need instruments for use in late spring and summer, order them now, specifying the desired delivery dates. Ordering well in advance will help to assure on-time deliveries. On the other hand, please do not call for delivery ahead of actual needs, and thus prevent someone else from getting urgently needed equipment on time. Your co-operation will help us to deliver what you want, when you need it.



GENERAL RADIO COMPANY • Cambridge, Massachusetts



872-A/872

HALF-WAVE MERCURY-VAPOR

RECTIFIER

Price \$7.50



Designed for

LONGER LIFE-HIGHER PEAK EMISSION

WITH CORRESPONDINGLY LOWER TUBE DROP

RATINGS

- Filament Voltage, 5 volts
- Filament Current, 7.5 amperes
- Peak Inverse Voltage, 10,000 volts, max.*
- Peak Plate Current, 5 amperes, max.
- Average Plate Current, 1.25 amperes, max.

* For condensed-mercury temperature of 20-60° C.

While you've been busy making hard-to-replace transmitting tubes last longer on the job, RCA engineers have been losing no time in building longer potential life into the tubes that are produced. The RCA 872-A/872 Half-Wave Mercury-Vapor Rectifier offers a good example of achievements scored in this direction:

Adoption of a special alloy for the cathode base has yielded materially increased emission with correspondingly low tube drop which, in turn, has resulted in greatly improved shelf and operating life. Thermal efficiency has been greatly increased, and, therefore, the tube will withstand higher surge currents without sputtering of the cathode coating—an important factor in increasing life.

In brief, the RCA 872-A/872 of today is a stronger, sturdier tube than ever before—just as numerous other RCA Transmitting Tube types are delivering longer life and better performance as the result of progressive RCA engineering developments.

TIPS ON MAKING YOUR TRANSMITTING TUBES LAST LONGER

Many valuable operation hints on making Transmitting Tubes last longer that were incorporated in previous RCA advertising have now been compiled into a handy booklet. A copy will gladly be sent upon request to RCA Mfg. Co., Commercial Engineering Section, Harrison, N. J.



RCA TRANSMITTING TUBES

PROVED IN COMMUNICATION'S MOST EXACTING APPLICATIONS