

COMMUNICATIONS

**CATHODE-RAY
TUBES**

**FREQUENCY
MODULATION**

**NATIONAL
DEFENSE**

SEPTEMBER

1 9 4 1

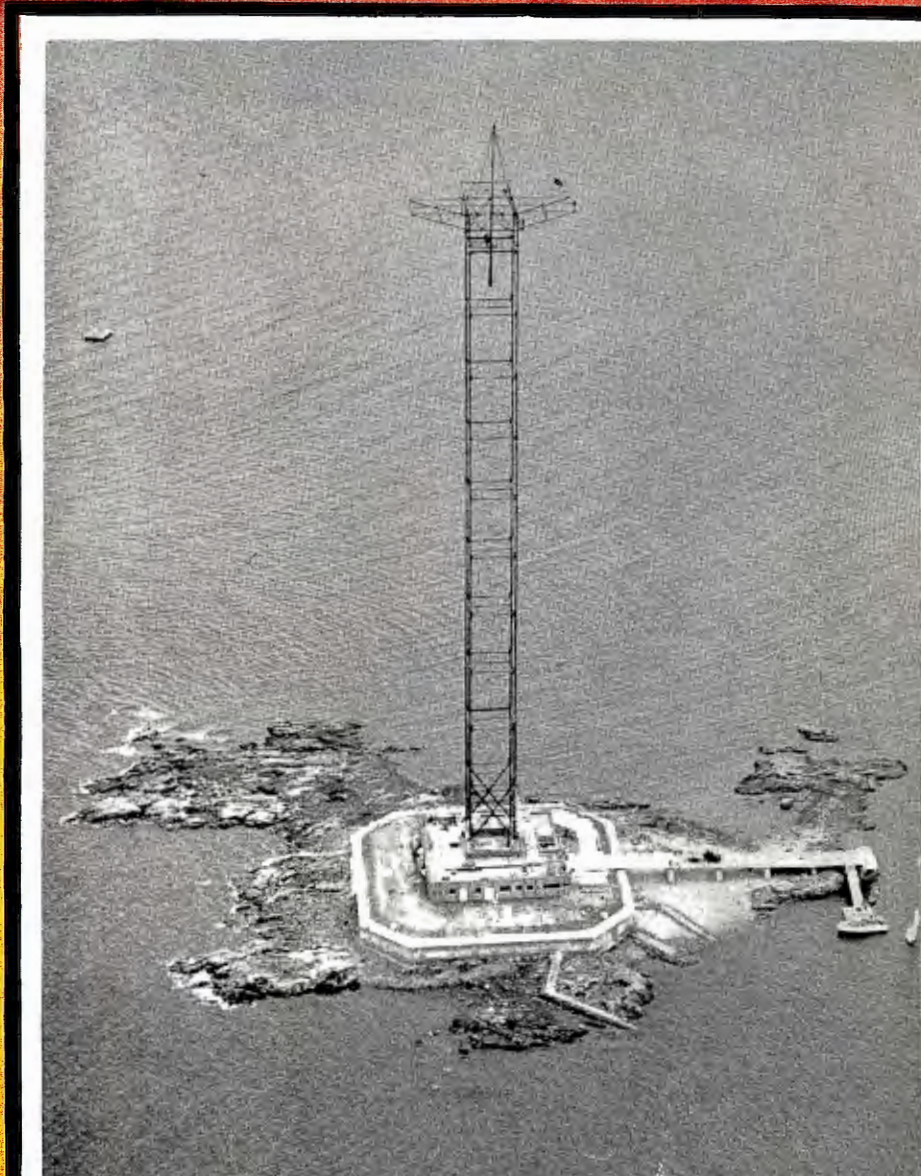

More than 100 types of tubes for use in Commercial Broadcasting, Point to Point Communication, Ultra High Frequency Transmission, Electro Medical Apparatus, High Voltage Rectification and many Industrial Applications.



We're in the Army* now

* U. S. Army, Navy, Civil, and Aeronautical Departments, etc.

. . . and faced with a continuous step-up in the demand for AMPEREX Transmitting and Rectifying Tubes for the armed services.

Despite the fact that your valued commercial orders for certain tube types must be subordinated to problems arising from the national emergency, the priorities situation, restrictions on certain rare refractory metals and materials, etc. . . . we are still able to fill all your orders.

However, in this period of unusual stress, we ask your consideration and cooperation in anticipating your requirements so that we may maintain our customary rapid delivery schedules.

AMPEREX ELECTRONIC PRODUCTS
79 WASHINGTON STREET • BROOKLYN, NEW YORK

**TRY A NEW
PRESTO GLASS
RECORDING
DISC AT
OUR EXPENSE**



Every recording engineer who has used the new Presto glass disc says it's the finest disc he has seen. Seeing is believing. We want you to see for yourself. So we're asking you to fill out the coupon below and mail it to us. The distributor you name will send you, free of charge, a sample Presto 12" glass disc.

When you get your disc, examine it under a strong light. Note the perfect smoothness of the recording surface, the complete absence of blemishes, streaks or swirls. Note the extra thickness of the Presto disc, the added rigidity and durability that makes it easier to handle, safer to use. Of the first 25,000 Presto glass discs shipped, 3 arrived broken. No breakage was reported in use.

Notice also the 2 holes in the Presto disc, a center hole that fits snugly over the turntable shaft, centering the disc accurately on the table, and a hole for the drive pin essential for positive operation of your

cutting mechanism. Both holes are protected with brass eyelets to prevent chipping.

Record a frequency run on your Presto disc. You'll find it reproduces the entire range from 50 to 8,000 c.p.s. without a suggestion of surface noise. The famous "Q" compound, originated and perfected by Presto, is now triple-filtered to remove impurities that cause noise and needle wear. You'll be amazed at the long life of your cutting needles used exclusively on Presto discs.

Every detail of disc manufacture has been perfected in the new \$250,000 Presto disc plant to give you better recordings. Now is your chance to try this new Presto disc at no cost.

MAIL THIS COUPON TODAY

PRESTO RECORDING CORPORATION
242 West 55th St., New York, N. Y.

Send us the free sample Presto glass disc (C-941).

Name of firm.....

Street and Number.....

City and State.....

We regularly buy our discs from:.....

Name of distributor.....

Street and Number.....

City and State.....

IMPORTANT

If you are using Presto glass discs as well as the thinner metal discs, ask your distributor for a thin rubber turntable mat. It compensates exactly for the difference in the thickness of the two discs and keeps the adjustment of your cutting mechanism and needle angle correct for both types. Thin mats are sent without charge to users of Presto discs.

PRESTO
RECORDING CORP.
242 WEST 55th ST. N.Y.

In Other Cities, Phone . . . ATLANTA, Jack. 4372 • BOSTON, Bel. 4510
CHICAGO, Har. 4240 • CLEVELAND, Me. 1565 • DALLAS, 37093 • DENVER,
Ch. 4277 • DETROIT, Univ. 1-0180 • HOLLYWOOD, Hil. 9133 • KANSAS
CITY, Vic. 4631 • MINNEAPOLIS, Atlantic 4216 • MONTREAL, Wel. 4218
PHILADELPHIA, Penny. 0542 • ROCHESTER, Cul. 5548 • SAN FRANCISCO,
CO, Yu. 0231 • SEATTLE, Sen. 2560 • WASHINGTON, D. C., Shep. 4003

World's Largest Manufacturers of Instantaneous Sound Recording Equipment and Discs

COMMUNICATIONS

SEPTEMBER
1941

including Television Engineering, Radio Engineering, Communication &
Broadcast Engineering, The Broadcast Engineer.
Registered U. S. Patent Office
Member of Audit Bureau of Circulations

VOLUME 21
NUMBER 9

RAY D. RETTENMEYER

Editor

• Contents •

COVER ILLUSTRATION

The 410-foot tower of radio station WABC. It is built on a man-made island in Long Island Sound, one mile off New Rochelle. The spot was chosen after exhaustive engineering studies, and is now named Columbia Island.

- 5 CATHODE-RAY DEMONSTRATION PANEL
By Squadron Leader R. K. Patrick
- 8 NEW SYSTEM OF FREQUENCY MODULATION
By Samuel Sabaroff
- 9 F-M NEWS
- 10 STANDARDS FOR ELECTRICAL TRANSCRIPTIONS
By Howard A. Chinn
- 12 BOOK REVIEWS
- 14 "ADD-A-UNIT" AMPLIFIERS WIDEN APPLICATION
SCOPE
By Harry Paro
- 18 VETERAN WIRELESS OPERATORS ASSOCIATION NEWS
- 20 CONSERVING MATERIALS AIDS NATIONAL DEFENSE
- 22 NEW PRODUCTS
- 26 IRON CORES
- 27 A PURCHASING GUIDE—Part I
By Lewis Winner
- 28 OVER THE TAPE
- 36 INDEX OF ADVERTISERS

• Comments •

THE Fiftieth Semi-Annual Convention of the Society of Motion Picture Engineers will be held at the Hotel Pennsylvania, New York City, from October 20-23. An interesting gathering is anticipated. There should be much in the technical sessions of interest to radio and television engineers.

The Annual Rochester Fall Meeting of the Institute of Radio Engineers will be held this year at the Sagamore Hotel in Rochester, N. Y., from November 10-12. While the program of the gathering has not been released, a lively meeting is expected. This should be particularly true in view of the priorities situation and the substitution program. All who can attend are urged to do so.

We believe the article in this issue by Mr. Patrick on the Cathode-Ray Demonstration Panel should be particularly interesting to our readers. It describes the special equipment used to teach radio fundamentals to the "WAGS", "WOGS" and "WEMS" of the Royal Canadian Air Force.

Another interesting paper appearing in this issue is devoted to Standards for Electrical Transcriptions. In it Mr. Chinn discusses the necessity for standards in this field and gives the results of a preliminary survey. COMMUNICATIONS is wholly in sympathy with this program, and urges the recording industry to cooperate and support it. Some fifty organizations are already members of the committee.

We should also like to call attention to the article on "Conserving Materials Aids National Defense." It tells how a saving of more than five million pounds of metal vital to national defense is being saved yearly through a materials substitution and conservation program.

As we go to press, the 1941 Conference of the Associated Police Communications Officers has just drawn to a close in Oakland, California. While Ye Editor did not attend, it is understood that the gathering was mainly concerned with National Defense, and that much good was accomplished.

Copyright 1941, Bryan Davis Publishing Co., Inc.

BRYAN S. DAVIS
President

JAMES A. WALKER
Secretary

Published Monthly by the
BRYAN DAVIS PUBLISHING CO., Inc.

19 East 47th Street
New York City

New York Telephone: PLaza 3-0483

PAUL S. WEIL
General Manager

A. GOEBEL
Circulation Manager

Chicago Office—608 S. Dearborn Street
Telephone: Wabash 1903



Wellington, New Zealand—Te Aro Book Depot
Melbourne, Australia—McGill's Agency

Entered as second-class matter October 1, 1937, at the Post Office at New York, N. Y., under the act of March 3, 1879. Yearly subscription rate: \$2.00 in the United States and Canada, \$3.00 in foreign countries. Single copies: twenty-five cents in United States and Canada, thirty-five cents in foreign countries.

Designed to Keep You Technically Up-to-the-Minute!

RCA TUBE PUBLICATIONS and ENGINEERING DATA

These RCA publications bring you the tube data and engineering help you need—when you need it—and in its most authentic and up-to-the-minute form. For years, RCA engineering has led the way, and these publications keep

you fully abreast of modern tube design and application. They are available through your RCA Tube and Equipment Distributor, or may be ordered direct from RCA, Commercial Engineering Section, Harrison, N. J.

RCA GUIDE FOR TRANSMITTING TUBES

Includes full details on RCA air-cooled transmitting tubes plus circuits and construction data on equipment of interest to experimenters, amateurs, and engineers. 50% larger. Fully illustrated. 72 pages. *Net price, 25¢ each.*

TT-100 TRANSMITTING TUBE BOOKLET

This attractively illustrated publication shows at a glance the maximum ratings and typical operation conditions of the entire line of RCA Transmitting and Special-Purpose Tubes. Contains 16 pages. *Single copies at no charge*

RCA HAM TIPS

RCA's newsy little publication devoted exclusively to the radio amateur. Jam-full of how-to-make-it articles, technical data, diagrams, transmitting tube advice, helpful hints. Fully illustrated. Issued seven or eight times a year. Your RCA Tube and Equipment distributor will be glad to supply you with it. *Available at no charge*

RCA PHOTOTUBE BOOKLET

Written by RCA engineers to give a clear understanding of phototube theory, construction, and operation. Complete with descriptive text, circuits, curves, and charted information. Booklet contains 16 pages. *Single copies at no charge*



HB-3 ALL TYPES TUBE HANDBOOK

Convenient, loose-leaf data, curves, etc., on all RCA transmitting, receiving, cathode ray, television and special-purpose tubes, complete with attractive, durable binders. Available on subscription basis. Write RCA Commercial Engineering Section, Harrison, N. J., for descriptive folder and order form.

RC-14 RECEIVING TUBE MANUAL

Now available with a 38-page supplement covering 99 additional receiving tube types and making the book a virtual encyclopedia, containing a total of 256 pages and covering 353 different receiving tube types. . . . *Net price, complete, 25¢*

1275-B RECEIVING TUBE BOOKLET

A handy guide for quick, easy reference. Includes the salient characteristics, socket connections, and a special classification index of the complete line of RCA Receiving Tube types. 16 pages. *Single copies at no charge*

INSTRUCTION BOOKLETS

These booklets contain complete, authorized information on Radio's finest line of Transmitting and Special-Purpose Tubes. They are included in the cartons with RCA Tubes, but bulletins on any tube type are available upon request. *Single copies at no charge*



Radio Tubes

PROVED IN COMMUNICATION'S MOST EXACTING APPLICATIONS

RCA MANUFACTURING CO., Inc., Camden, N. J. • A Service of The Radio Corporation of America
For Canadian prices write to RCA Victor Company Limited, Montreal



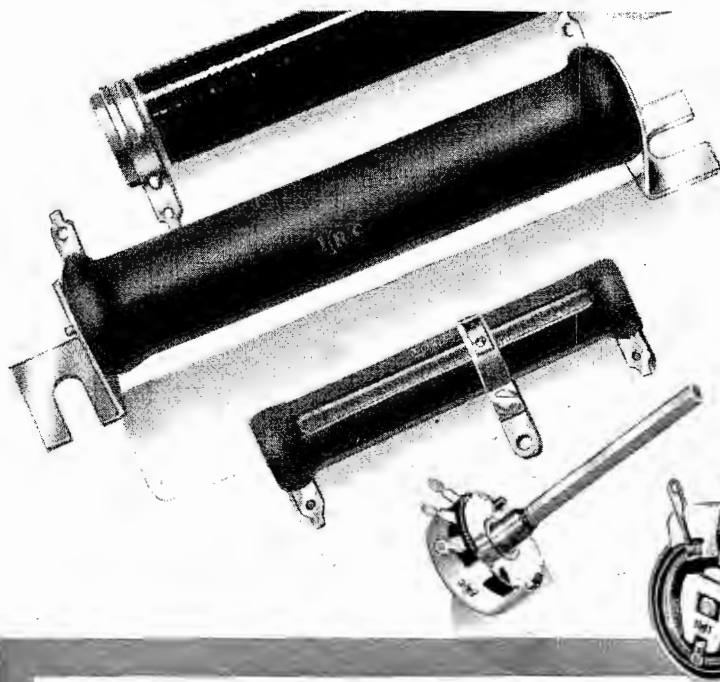

RESISTORS FOR DEFENSE

Resistors to satisfactorily meet the government's exacting and unusual requirements are an old story to IRC.

Many years of close collaboration with government agencies in the preparation of resistance specifications and in the development of special resistor types have been a natural result of IRC's acknowledged leadership in a highly-specialized technical field.

Today, with the tempo greatly accelerated in the face of national emergency, this background of specialized experience is proving of immeasurable benefit to defense manufacturers and their subcontractors.

It means informed engineering cooperation. It means the availability of tested and proven resistors of the many types required for the comprehensive defense program. It means elimination of guesswork and experimentation in obtaining with all possible speed the *right* resistor for any particular application.

Bring your fixed and variable resistance problems to IRC. Our engineers will be glad to cooperate.

INTERNATIONAL RESISTANCE COMPANY

415 North Broad Street, Philadelphia, Penna.



Makers of Resistance Units of More Types, in More Shapes, for More Applications Than Any Other Manufacturer in the World.

CATHODE-RAY DEMONSTRATION PANEL

• Description of a cathode-ray demonstration panel used for radio instruction at the wireless school of the Royal Canadian Air Force in Montreal

By SQUADRON LEADER R. K. PATRICK

*Chief Technical Officer
No. 1 Wireless School
Royal Canadian Air Force*

THE "Cathode-Ray Demonstration Panel" consists of a modern 14-tube superheterodyne radio receiver, a two-stage transmitter with modulator, amplifier and power supply. All this is mounted on a panel, approximately 8'x-4' in size. The components of the receiver are spread out across the face of the panel so as to correspond as closely as possible with a schematic diagram of the receiver which is drawn on the face of the panel. Two 9" oscillographs are embodied at the top of the panel and are used for visual demonstration. An ordinary dynamic speaker, also mounted on the panel, is driven by output of the receiver and all circuit functions can thus be both aurally and visually demonstrated. Either one or both of the oscillographs can be "tapped in," at a large number of points throughout the receiver circuit. Two signal generators, type 170, provide a source of signal. The two being required for demonstrating interfering signal cross modulation, etc. The b-f—A-f output of one signal generated is amplified and used to modulate the r-f output of the other so that variable frequency and percentage modulation is possible.

By the use of interchangeable components, which are readily plugged into the face of the panel, and by inter-switching, practically any radio phenomenon can be demonstrated. A few of these interchangeables are shown in the photograph on Fig. 1. The entire panel is mounted on wheels so that it can be shifted from one instructional room to another.

The panel was designed by Burlec Limited and the Royal Canadian Air Force for Radio instructional use in Wireless Schools of the Empire Air Training Scheme.

The panel is in use for the training

of Wireless Electrical Mechanics, Wireless Operators Ground and Wireless Air Gunners, and has its own particular uses in assisting the training of each of these tradesmen. It is estimated that with this panel, the time devoted to instruction in radio theory can be considerably reduced and the Student will obtain a clearer understanding of radio phenomena.

In the R. C. A. F. the Wireless Air Gunner ("Wag"), and the Wireless Operator Ground ("WOG") are required to know elementary radio theory, just enough to familiarize them with

the operation of radio transmitters and receivers, and in order for them to manipulate the equipment rationally. The only maintenance that they are likely to be called upon to carry out is of a routine nature. The Wireless Electrical Mechanical ("WEM") is the "radio serviceman" of the Air Force. He must understand advanced theory. The demonstration panel has its most important use in the training of the WEM as such things as alignment can be so simply demonstrated. However, elementary phenomena can, of course, be observed and demonstrated.

The receiver end of the demonstration panel can be a superheterodyne or

Fig. 1. Front view of cathode-ray demonstration panel.

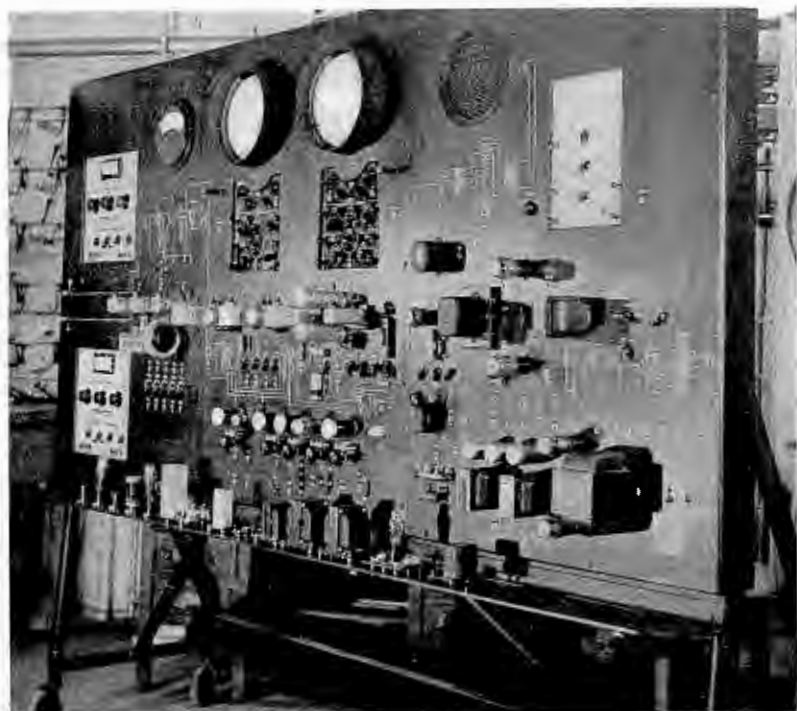

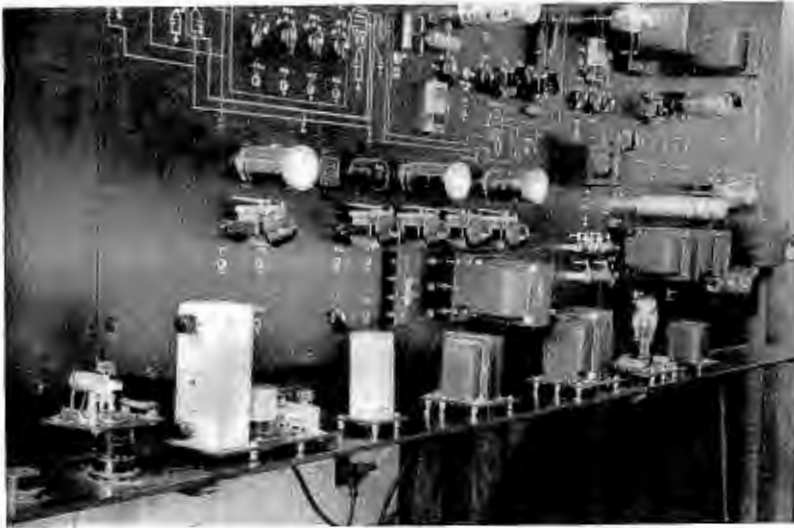

Fig. 6. (Above) Illustrating transmitter and some of interchangeable components.

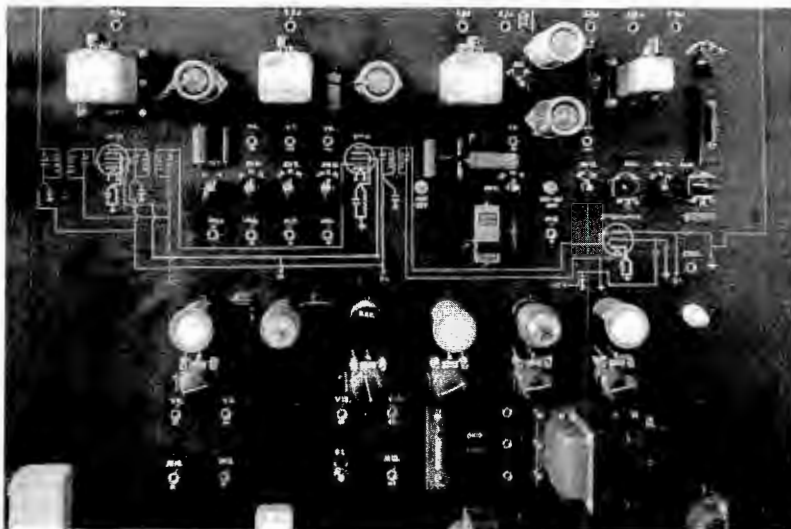

Fig. 2 (Left) The r-f section.

t-r-f receiver. It consists of a r-f amplifier tuning the broadcast band using a type 6L7G first detector and 6J5 oscillator a type 76 triode and 36 tetrode with a suitable adapter. The use of the 36 tetrode is for cross-modulation demonstrations. Fig. 2 illustrates the r-f section of the receiver.

The i-f amplifier is tuned to 100 kilocycles. This low frequency being used so that in modulated envelope demonstrations the sine wave of both the modulation and modulated frequencies may both be seen. The amplifier consists of two stages, air-tuned transformers being used. The first i-f transformer can be removed and a crystal filter unit plugged in. The second and third transformers have variable coupling so that variable band-width demonstra-

Fig. 3. (Below) The i-f and detector section.



tions are possible. The circuit possesses unusually high gain, necessary to produce overload when required. The i-f and detector section is illustrated by the photograph, Fig. 3.

In the r-f and i-f amplifier, as in the entire demonstration panel, all important resistors and condensers can be varied so that low, normal and high values of these components is obtained. This is accomplished with a three-point switch for each component. These are shown in Fig. 4, marked *Low*, *Normal*, *High*, above the switch.

The tuning condensers of the i-f amplifier are variable air type with extension shafts and a small knob provided. The tube line-up in the intermediate-frequency amplifier is a type 78 in each stage, in one of which a type 36 may be used to demonstrate overload. A type 6R7G is used as a diode or triode second detector. A switch is provided to utilize either section of this tube in the detector circuit.

The circuit is so arranged that a single switch changes operation from superheterodyne to tuned-radio-frequency receiver. Regenerative detection is similarly obtained. A 6J5G serves as a beat-frequency oscillator or quench-frequency oscillator. Superregenerative demonstration is possible by inserting the superregenerative panel in place of the second detector tube.

The demodulated output of the detector section is coupled to the first audio-frequency amplifier. The first audio-frequency amplifier may be choke-capacitance or resistance-capacitance coupled by using plug-in components. The value of the coupling condenser is varied by a three-point switch. Pro-

Fig. 7. (Below) Illustrating how cathode-ray tubes are connected into circuits.



vision is also made for feeding the output of a single-button carbon microphone into the audio channel by means of a jack marked "Mic," battery and microphone transformer being wired in the panel itself.

The driver audio tube is a 6F6, triode connected. This tube may be connected to either the a-f output stage or to the transmitter where it is used for grid or Heising modulation. Coupling to the push-pull stage is accomplished by either a conventional driver transformer or a phase inverter panel which may be plugged in, in place of the push-pull input transformer.

The push-pull output stage consists of 6F6 tubes which may be either triode or pentode connected by means of a toggle switch, and it is operated class "A" prime. The output transformer has secondary taps with variable output impedance which, together with a variable load resistor, provides adequate means of impedance matching. The output of the amplifier may be fed to either a resistance load or the 8" permanent-magnet dynamic speaker by means of a selector switch. This stage is also used for class "B" modulation of the transmitter, in which case, it is impedance coupled to the class "B" modulation transformer.

The power supply consists of large power transformer with two type 80 rectifiers. The anodes of each 80 tube are strapped to form a half-wave rectifier and the pair as full-wave. The anode circuit of one tube may be opened to demonstrate half-wave operation. The filter section consists of two chokes and three eight-microfarad filter condensers. Either or both chokes may be shorted, and any or all condensers cut out. (See Fig. 5.)

The demonstration transmitter consists of a master oscillator and amplifier. The master oscillator may be operated as either a "tuned-plate tuned-grid" or "Hartley" circuit, the coils for both being provided. Provision is also made for crystal operation. The oscillator tube is a 6J5G and the amplifier a 6F6G. Many demonstrations are possible in the transmitter circuit; insufficient neutralization, insufficient excitation, etc., being very easily demonstrated. The output of the transmitter is 7½ watts, a small 7-watt lamp serves as a dummy load. Grid, Heising, and Class "B" modulation of the r-f amplifier can be easily demonstrated. To change the method of modulation the operator merely inserts the panel in the circuit, switching being done automatically by the change. (See Fig. 6.)

The preceding is an outline of the circuit of the receiver, amplifier, transmitter and power supply of the cathode-ray demonstration panel. It is impos-

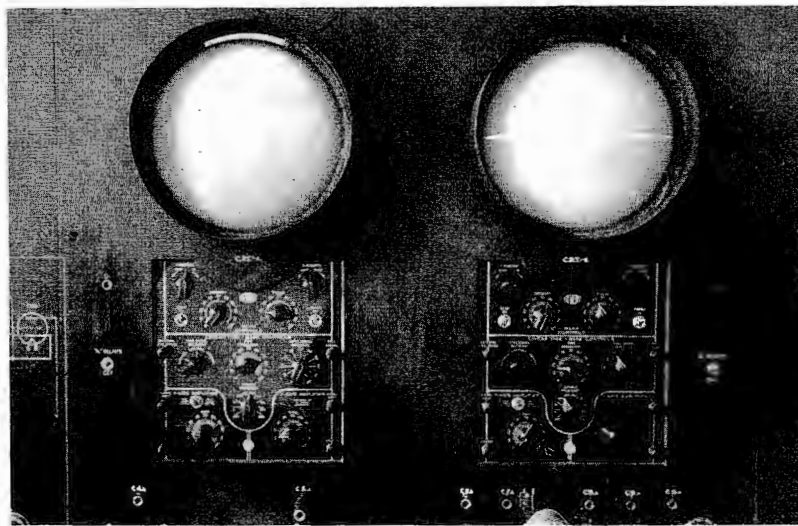

Above: Front view of cathode-ray oscillographs.

Fig. 5. (Right) A-f and power supply, showing loudspeaker and electronic switch.

sible to list all demonstrations possible with this equipment. Many elementary theory demonstrations are possible, i. e., hysteresis, tube characteristics, etc, these being demonstrated simply by inserting a small plug in the jack required, all switching being automatic. It is estimated that a total of 300 radio demonstrations are possible.

The radio-frequency signal is traced from its origin, at the signal generator, to the output at the loudspeaker. To observe the signal at any of the points intervening the demonstrator has simply to insert the plug in the jack marked "A" or "CRT "B" at the point at which the signal is to be observed. When the plug (C-R PANEL—continued on page 33)



Fig. 4. (Below) Taking a current reading.

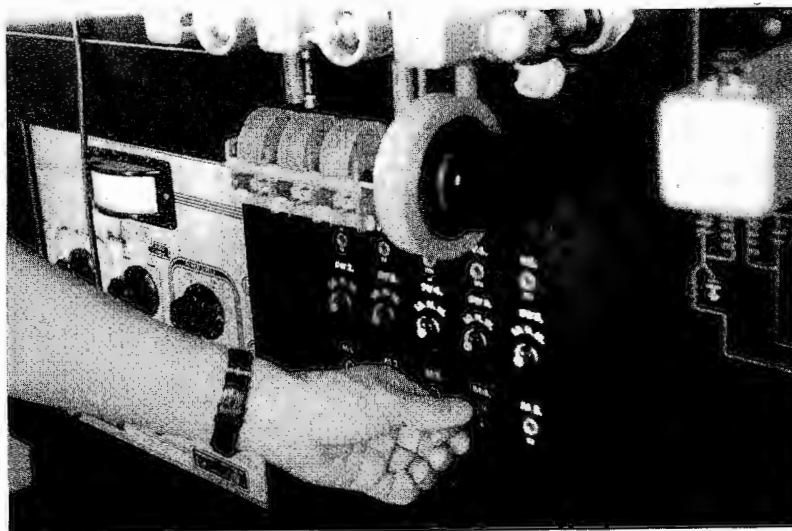

New System of Frequency-Modulation

● *In this article the author describes a method of frequency-modulation that will permit large phase shifts*

By SAMUEL SABAROFF
WCAU Broadcasting Co.

THERE are a number of methods available for the production of frequency-modulated signals. These may be divided into two main classifications: (1) in which the frequency of a stable oscillator is varied directly,^{1,2} and (2) in which the signal generated by a constant-frequency source is varied in phase in such a manner that its frequency variation is in accordance with a modulating signal.^{3,4,5}

The frequency variation obtainable by the methods of the first classification can be almost any required amount. However, the methods of the second classification have been limited to phase shifts ranging from 30 degrees in the Armstrong system to several hundred degrees in the Shelby system. The required frequency variation is usually obtained by means of a substantial amount of frequency multiplication.

A new method for the production of phase or frequency-modulated waves will now be described. It is essentially a system of modulation of the type included in the second classification. The possible phase shift, however, has been greatly extended. It is anticipated that with this system, phase shifts of 9,000 degrees or more are not at all unlikely.

It must be noted here that the practical application of this method is, as yet, in a rough preliminary laboratory stage. The material to be presented is of necessity therefore, of a somewhat tentative and theoretical nature. It is very possible that further work on it may be curtailed or stopped. The method is of interest, however, and its later resurrection may certainly be anticipated.

Let us consider the simple phase-modulated carrier

$$e = E \cos(\omega t - x) \dots\dots\dots (1)$$
 where $\omega =$ carrier frequency
 $x =$ phase modulation.

Equation (1) may be mathematically transformed in many ways without losing its identity. Each component of a particular form may then be separately generated and when combined in accordance with its mathematical derivation will result in the original form. It was by such an analysis that this scheme of generating a frequency-modulated carrier was developed.

Expand equation (1) into a trigonometric sum

$$e/E = \cos(\omega t) \cos(x) + \sin(\omega t) \sin(x) \dots\dots\dots (2)$$

It is evident that the right-hand portion of equation (2) is the sum of two components, each of which can be generated by a balanced modulator. It is necessary, of course, that the carrier and modulating voltages be of the proper phase and form. It can be seen that the required carrier voltage applied to each modulator differs in phase by 90 degrees. In order to secure a phase modulation described by x of equation (1), it is necessary that the modulating signal applied to one balanced modulator be a cosine function of x and the modulating signal applied to the other balanced modulator be a sine function of x . A block diagram of this arrangement is shown in Fig. 1.

There is no particular difficulty in fulfilling the necessary carrier requirements. Some difficulty was experienced, however, in evolving a method for predistorting the modulating signal in accordance with the sine and cosine.

A search was made for a purely electronic method for producing the required distortion of the modulating signal. It was found that available electronic methods invariably led to the undesired incorporation of a direct frequency-modulated oscillator somewhere in the system. After a consideration of several possible methods, it was felt that an electro-optical scheme for producing the required predistortion of the modulating signal was worthy of further study.

Consider the generic diagram in Fig. 2. The image of a sinusoidal mask is, by means of a mirror, allowed to impinge on a slit. The light passing through the slit energizes a photo-electric cell. Scanning theory⁶ shows that if the mirror could be allowed to sweep the image

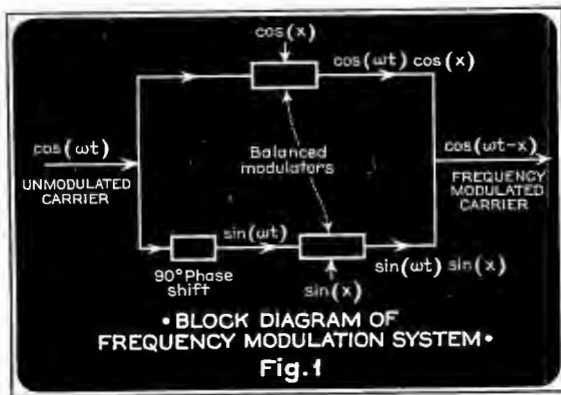

of the sinusoidal mask across the slit, the amount of light passing through the slit would vary in a sinusoidal fashion, thus similarly varying the output of the photoelectric cell. Vibrating the mirror on its axis in accordance with a modulating signal will cause to be delivered from the photo-electric cell a voltage which is a sinusoidal function of the modulating signal.

Disregarding amplitude, the photo-electric cell output variation is given by $\cos(\alpha + x)$, where α is a constant of mask position and x is expressed as an angular variation of the sinusoidal image on the slit. Positioning the resting point of the mirror so as to make α equal zero will make the photo-electric cell output proportional to $\cos(x)$. Making α equal to -90 degrees will make the photo-electric cell output proportional to $\sin(x)$. Since $\cos(x)$ and $\sin(x)$ are used simultaneously, it will be necessary to use the described arrangement in duplicate form. It is anticipated that it will be possible to obtain at least a 25-cycle displacement of the sinusoidal image thus allowing a phase shift of 9,000 degrees at the lowest modulating frequency.

Any inexact adherence to the requirements of equation (2) will become evident by the appearance of distortion in the modulation of the resulting carrier. In practice, variations of the component quantities do occur. It is of importance therefore to find criteria for determining the limits to which these variations should be controlled. In general, component variations will be indicated by either an inequality in the output voltages of the two balanced modulators or as an extraneous carrier component in the resultant modulated carrier or both.

These variational effects may be incorporated in equation (2) i.e.

$$e/E = \cos(\omega t) [\cos(x) - a] + (1 + A)\sin(\omega t) \sin(x) \dots \dots \dots (3)$$

where A is the inequality in the outputs of the balanced modulators and a is the amplitude of the extraneous carrier component. Mathematical analysis of equation (3) shows that for small values of A and a , the r-m-s distortion will in general not exceed $|A| + |a|$. This may be formulated

$$D < |A| + |a| \dots \dots \dots (4)$$

where D is the r-m-s distortion in the resulting frequency modulation. Equation (4) determines therefore, the limits of the necessary variational control in terms of the allowable distortion.

It may be of interest to mention a few variants of this

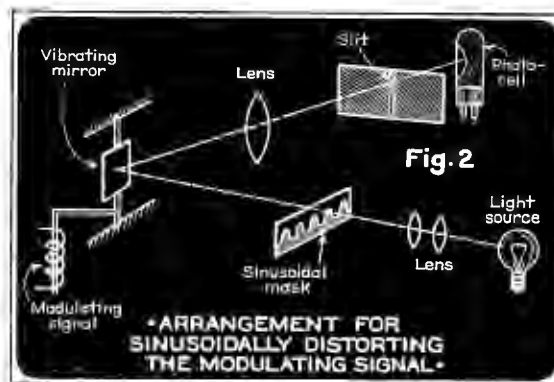

particular method for predistorting the modulating signal. The basic elements comprising this method are the slit, the mirror and the mask. Equivalent results may be obtained by fixing any two of these elements and moving the third in accordance with a modulating signal. It is possible also to distort the mask in such a manner as to compensate for any non-linearity in the system.

The sinusoidal mask may be constructed in a circular form, completely inclosing the light source. Rotating the mask in accordance with a modulating signal would then produce the desired predistortion. With the proper driving mechanism, the endless feature of the mask in this arrangement, admits of the possibility of producing very large phase shifts. The arrangement actually chosen, however, was determined by the available means at hand.

BIBLIOGRAPHY

- 1—"Synchronized Frequency Modulation," by W. H. Doherty, August, 1940, *Pickups*.
- 2—"A Transmitter for Frequency-Modulated Broadcast Service Using a New Ultra-High-Frequency Tetrode," by A. K. Wing and J. E. Young, p. 327, January, 1941, *RCA Review*.
- 3—"A Method of Reducing Disturbances in Radio Signalling by a System of Frequency Modulation," by Edwin A. Armstrong, p. 689, May, 1936, *PIRE*.
- 4—"System of Phase and Frequency Modulation," by Samuel Sabaroff, p. 11, October, 1940, *COMMUNICATIONS*.
- 5—"A Cathode-Ray Frequency-Modulation Generator," by R. E. Sheby, p. 615, September, 1939, *PIRE*.
- 6—"Scanning Theory," by Samuel Sabaroff, p. 497, May, 1941, *JSMPE*.

F-M NEWS

Washington Plans Hearing On New York F-M Applications

In an effort to unsnarl the present f-m tangle in New York City, where more applications for licenses have been received than there are f-m channels available, the Federal Communications Commission has announced its intention to hold a joint hearing on seven of the applications still ungranted.

Eleven commercial f-m licenses for New York City have already been approved. Most of the stations are now under construction.

The seven applications to be considered at the joint hearing will be those

of the New York Daily News; FM Radio Broadcasting Co.; Debs Memorial Radio Fund, Inc. (WEVD); Knickerbocker Broadcasting Co. (WMCA); WBNX Broadcasting Co.; Greater New York Broadcasting Corp. (WOV); and Wodaam Corp. (WNEW). In addition, the FCC will consider at the same time the application of the Mercer Broadcasting Co. (The Trenton Times) for a station at Ewing Township, N. J.

In announcing the hearing—which no definite date has been set—the FCC pointed out that only three Class B channels remain unassigned in the New York region. (A Class B type

f-m station is one intended to cover the basic trading area of a city over 25,000 population. It may be as large as 15,000 square miles. New York's established area is 8,500.)

New Commercial F-M Station In Ohio Goes On Air Soon

Another commercial f-m station will begin daily operation this month when W45CM of Columbus, Ohio, completes its program tests and inaugurates regular service on or about September 28.

This will be the sixteenth full-time commercial f-m station in the country to go on the air.

Standards for Electrical Transcriptions

By HOWARD A. CHINN

*Engineer-in-Charge
Audio Frequency Division
Columbia Broadcasting System*

THE widespread practice of television, a-m and f-m broadcasting stations to intersperse and supplement live-talent programs with recorded program material is well known. With the listener becoming increasingly fidelity-conscious, the success of such operation depends, to a large extent, upon the ability to effect the transition from one form of program material to the next without loss of fidelity. This, in turn, calls for the broadcasting of all types of programs not only with uniformly high quality, but also, in the case of musical numbers, with a consistent "balance" throughout the frequency spectrum. Furthermore, it is equally important that, for smooth continuity, each portion of the program be properly timed with respect to its predecessor.

In the case of disc recordings these requisites of good operation can only be realized if both the reproducing equipment and the recordings are in accordance with the best present-day engineering practices. In addition, these practices must be standardized in order to insure consistent reproduction when using the products of various manufacturers, and it is essential to standardize not only the electrical but also the mechanical features of the recordings.

The importance of these matters is exemplified by the following thumbnail sketch of the operations now undertaken day after day by some stations in the production of a fifteen-minute recorded program.

A minute of opening theme music is reproduced at 78 r-p-m, from an "outside-in" recording, using reproducing characteristic "Lateral A." This is followed by an opening announcement re-

produced at 33 1/3 r-p-m from an "inside-out" recording, requiring reproducing characteristic "Lateral B." Next there is the dramatic sequence of the program which, although also at 33 1/3 r-p-m entails a shift to "Vertical A" characteristic and is an outside-in record. Following this portion the closing announcement is made, again reverting to the 33 1/3 r-p-m, inside-out, "Lateral B" recording and, finally, the closing theme at 78 r-p-m, outside-in, "Lateral A" characteristic is used as background music for a station identification announcement by the local announcer.

Although entailing shifts, back and forth, from lateral to vertical, from 78 to 33 1/3 r-p-m, from inside to outside starting points, and from Lateral A to Lateral B to Vertical A recording characteristics, the typical operations outlined by no means runs the gamut of combinations which are currently in use in this country. Not only is it necessary to determine whether the recording is: (a) made at 78 or 33 1/3 r-p-m, (b) whether the start is at the outside or the inside, (c) whether it is laterally or vertically cut, but also (d) what recording characteristic was used, and (e) in some cases the reaction of the record material in the reproducer. To cope with (d) and (e) one lateral reproducer, currently in extensive use, provides a choice of 16 possible reproducing characteristics. Obviously, in broadcast station operations, where split second timing is the vogue, such complexity is undesirable, to say the least.

It is evident, therefore, in the interest of faithful reproduction, ease of operation, accurate "cueing" and faultless continuity, that comprehensive record-

In Favor of	Percentage
Vertical	43.1%
Lateral	35.6
No Preference	12.2
No Answer	9.1
	100%

RECORDING EQUIPMENT IN STATIONS
80.2% indicated they had recording equipment.

ing and manufacturing standards should be formulated and put into practice. Heretofore, no unified effort has been made towards this ambitious end by the industry in so far as "lateral" electrical transcriptions are concerned. In the case of "vertical" transcriptions, a standard recording characteristic (the response-frequency characteristic of the recorded amplitude or velocity) has been more or less unofficially maintained by the few that are in this field. However, even here, to the uninitiated there is considerable mystery as to just what the standard is.

In the case of 78 r-p-m "phonograph" records, a Radio Manufacturers Association committee was formed in the Fall of 1939 to consider standardization of the mechanical features of records, pickups, turntables, etc. To date, however, no consideration has been given to the all-important matter of standardizing on the recording characteristic or to the reconciliation of the differences between 78 r-p-m and 33 1/3 r-p-m "standards" where there are items common to both.

In passing, it is interesting to note a point where it would be expected, obviously, that the standards would agree and the possible consequences of the disagreement that exists. The center-pin diameter on transcription turntable is commonly made $0.280 \pm .001$ " whereas the center-hole of phonograph records is standardized by RMA as $0.286 \pm .001$ ". Furthermore, the maximum eccentricity of the center hole of phonograph records is given as 0.005".

If a phonograph record with a maximum size hole is placed on a transcription turntable with a minimum size pin and if, in addition, the center-hole ec-

	Average use per week per station	Percentage of total	Percentage of broadcast day*
Lateral Transcriptions	21.6 hours	56.3%	17.3%
Vertical Transcriptions	8.4	21.9	6.7
Phonograph Records	8.3	21.8	6.7
Totals	38.3 hours	100%	30.7%

*Assuming an 18-hour broadcasting day or 126-hour broadcasting week.

centricity is the maximum allowable, the resulting "wow" will be 0.96%. Since the average observer can detect a change in pitch of 0.3%, a wow of the above amount would be readily noticeable and, undoubtedly, be objectionable. In instances such as these, the phonograph record manufacturer is generally accused of poor recording whereas, in fact, it is simply a combination of factors, all of them within existing standards, that causes the difficulty.

The general situation is further complicated by the relatively large number of installations of "instantaneous" recording equipment in broadcasting stations, schools, advertising agencies, etc., where, more often than not, the recording characteristic is that which results from the particular combination of apparatus used and the ambient temperature prevailing at the moment. Mechanical standards, in such instances, are a function of the recording disc manufacturer and the whim of the recorder.

Reputable individual manufacturers have, of course, established and maintained their own standards, but these have not been officially collated or recognized. Moreover, such quasi-standards sometimes do not embrace all aspects of the matter, nor do they necessarily represent all the wishes of the operating companies. Furthermore, the standards being followed have not been afforded official recognition and, therefore, are not widely disseminated. As a result, even the conscientious manufacturer of recording and reproducing equipment is unable to build toward a universal standard. To an even greater extent the individual recorder, broadcast station or otherwise, is at loss as regards standards.

In order to correct this situation in so far as possible at the present state of the art and to provide a non-commercial common meeting ground for all concerned, a "Recording and Reproducing Standards Committee" has been formed with the National Association of Broadcasters functioning as a coordinating medium. For evident reasons, both the manufacturer and the user of transcriptions are vitally interested in the undertaking.

An organization meeting of the committee was held in Detroit on June 26, 1941, following the IRE Convention. Representatives were present from the NAB, four transcription companies, six broadcasting stations or networks, and seven equipment manufacturers. The following "Purposes and Rules of Procedures" was adopted:

(1) The task of the Committee is to formulate "Recording and Reproducing Standards" that will tend to bring about uniform quality of reproduction of transcriptions with a minimum number

TABLE —COMMITTEE MEMBERS	
Alliance Mfg. Co.	Mirror Record Corp.
Altec Service Corp.	C. P. MacGregor Transcription Co.
Associated Music Publishers	Memovox, Inc.
The Astatic Corp.	Miller Brothers Recording Studio
Audio Devices, Inc.	Muscraft Records, Inc.
Bell Telephone Labs., Inc.	National Association of Broadcasters
Blackett-Sample-Hummert, Inc.	National Broadcasting Co., Inc.
David Bogen Co., Inc.	Pacific Sound Equipment Co., Inc.
Broadcast Productions	Permo Products Corp.
The Brush Development Co.	Photo & Sound Inc.
C. K. Recorders	Poinsettia, Inc.
Central Broadcasting Co. (WHO)	Presto Recording Corp.
Christensen Recording Studios	B. A. Proctor Co., Inc.
Columbia Broadcasting System, Inc.	Radial Service
Columbia Recording Corporation	RCA Manufacturing Co., Inc.
Electrical Research Products	Radio Features of America
FM Broadcasters, Inc.	Reeves Sound Studios, Inc.
Federal Recorder Co., Inc.	Rek-O-Kut Corp.
Federal Transcribed Programs, Inc.	Robinson Recording Labs.
Film Associates	J. P. Seeburg Corp.
General Communication Products Co.	Shure Brothers
General Sound Corporation	Star Record Co.
Gray Mfg. Co.	Technisonic Recording Lab.
Lillian Gurdon Radio Productions	United Artists Bureau
Harvard University	Universal Microphone Co. Ltd.
Hollywood Recording Co.	Thomas J. Valentino, Inc.
Illinois Educational Sound Service	Western Sound & Electric Lab., Inc.
John D. Keating	WGAR
Kermit-Raymond Corp.	World Broadcasting System

of equipment adjustments on the reproducing system.

(2) All companies interested in the manufacturing of disc recordings, the manufacture of disc recording equipment, the manufacture of disc reproducing equipment, the use of disc recordings, and others properly interested in the subject are entitled to membership on the committee.

(3) No company shall have more than one vote in any of the proceedings of the Committee and this shall be cast by the regularly designated representative of that company. In the absence of the regularly designated member, a duly authorized alternate may participate and vote for the regular member.

(4) Technical advisors to members of the committee may participate fully in meeting discussions; however, they will have no vote in the proceedings.

(5) No individual broadcasters will be entitled to a vote in the proceedings of the committee. The broadcasters as a whole will be entitled to representation through three members duly appointed by Neville Miller, president of the National Association of Broadcasters.

(6) The chairman of the committee is not entitled to vote except in case of a tie.

(7) It is clearly understood that participation in the work of the committee does not bind any individual or company to the formulated recommended standards.

An agenda of the topics upon which standardization should be sought was also prepared at this initial meeting. This agenda, which applies to both lat-

eral and vertical recording, is divided into two main categories. Under the heading of mechanical features are included such items as groove shape, groove pitch, terminal grooves, minimum diameter of recording, radial direction of recording, record dimensions (diameter, thickness, center-hole diameter), mean speed, wow, warping, labeling, etc. Under the heading of electrical features are such matters as recording characteristics, harmonic distortion, noise, recorded amplitude; methods of measurement, etc.

To date, the 58 companies listed in Table I, which includes only three broadcasting companies in compliance with Rule (5), have signified their interest in the project and accordingly have become members of the committee.

The first step in the formation of industry standards is, of course, a survey to determine current practices and the degree to which standardization of a given item exists. In order to expedite this work, an executive committee was formed and charged with the responsibility of formulating a questionnaire for distribution to the industry after approval by the committee as a whole. Work on the questionnaire is currently in progress, and when available, the results will be tabulated and analyzed by the executive committee and submitted to the main committee for their consideration.

Preliminary to the first meeting of the standardization committee a questionnaire was sent to broadcasting stations and, among other facts, the inter-

(TRANSCRIPTIONS—continued on page 33)

BOOK REVIEWS

AERONAUTIC RADIO, by Myron F. Eddy, published by The Ronald Press Co., 15 E. 26th St., New York City, 502 pages, price \$4.50.

Radio has become part and parcel of aeronautics. Many pilots and members of the ground crews are required to hold radio operators' licenses. A general knowledge of aeronautical radio, its functions and applications, is necessary to these men, as well as to the designers of aeronautical radio equipment. Hence, the first eleven chapters cover the data necessary to prepare the average person to pass the theoretical part of the examination for an aviation operator's license. The next five chapters explain the application of radio to aeronautics.

This book covers its subject in a clear and elementary style. It is easy to read and the contents are presented in a logical sequence. The author begins with fundamental concepts before delving deeply into his subject. There are adequate illustrations to clearly impress the subject matter on the reader's mind. Much of the contents applies to radio in other applications as well.

This book is recommended to all those in the engineering profession who are interested in the subject. R. D. R.

POWER FACTOR PROBLEMS IN ELECTRICITY SUPPLY, by G. W. Shubbing, published by The Chemical Publishing Co., 234 King St., Brooklyn, N. Y., 174 pages, price \$3.50.

This book is intended to give a simple account of power factor, its meaning and the causes of its variation, its effect on cost of and the changes for electrical supply, and the ways in which it can be artificially changed. Power and lagging magnetism volt-amperes are considered to be objective quantities in an alternating-current supply, for both of which the consumer is required to pay under what are called power-factor tariffs; and the process of power factor correction is explained as one whereby the consumer generates part or all of his magnetizing volt-ampere supply instead of purchasing it from the supplier. The quantitative aspect of power factor is illustrated by examples. The important question of the economic units of power factor correction is fully discussed. Electrical measurements connected with power factor is discussed in elementary style.

The book is intended for practical engineers and students. However, barring the appendix which does require a familiarity with higher mathematics, anyone with a working knowledge of elementary algebra can readily read and understand the text. This book is recommended. R. D. R.

FLUORESCENT LIGHT AND ITS APPLICATIONS, by H. C. Dake and Jack DeMent, published by Chemical Publishing Co., 234 King St., Brooklyn, N. Y., 256 pages, cloth binding, price \$3.00.

This treatise is intended to cover the needs of practically all types of readers except advanced students of fluorescence. It contains enough of the elementary treatment of the subject to satisfy the beginner. Yet there is sufficient technical infor-

mation to make the book interesting to engineers. Of especial interest are Chapters 1 and 2. Chapter 1 delineates the historical aspects of luminescence in considerable detail. Chapter 2 discusses the fundamentals of radiation, color and perception. Subsequent chapters cover the theory of luminescence, methods of examination of luminescent materials, sources of ultra-violet radiation, fluorescent minerals, radioactive minerals, and luminescence of gems and uses of ultra-violet light. An excellent bibliography of several hundred references is included covering many phases of the art.

The material in this book is well prepared, logically arranged and the subject matter discussed in a most interesting fashion. It is highly recommended.

R. D. R.

MATHEMATICS FOR ENGINEERS, second edition, by Raymond W. Dull, published by McGraw-Hill Book Co., 330 W. 42nd St., New York, 780 pages, cloth binding, price \$5.00.

The author states in his preface that this treatise has been prepared primarily for engineers, who want a quick and convenient reference; who have grown rusty in their mathematics; and who feel the need for a text for the study of mathematics. The author points out that two sources to which the engineer ordinarily turns for mathematical aid are the engineers' handbook and the mathematical text book. This treatise is intended to remedy this situation.

The author has attempted to treat each subject completely, without depending on a complete knowledge of the preceding subject matter. Chapter I deals with numerical computation with algebraic aids. Such items as multiplication tables, multiplication short cuts, algebraic aids, methods of checking and extracting roots. Chapter 2 deals with approximation and absolute relative errors. It deals with errors in numbers, errors in addition, errors in multiplication, errors in division, errors in powers and approximation. Succeeding chapters treat algebraic notation, ratio and proportion, binomials, polynomials, linear and quadratic equations, polynomial functions, power functions, progressions, indeterminate forms, logarithms, exponential functions, determinants, permutation and combinations, differential and integral calculus, etc.

The short cuts, methods of checking, graphical solutions are particularly apt. Of particular interest to this reviewer was the chapter on empirical equations which is so seldom a part of the engineer's mathematical equipment, but so useful in analytical work. The subject is well treated and presented in a logical and easily understandable manner.

The author, being a practicing engineer, is familiar with the things an engineer may wish to know about a subject. The material was taken largely from his reference notes, which are much the sort of notes any engineer practicing his profession could be expected to keep, although too few of them do so.

This is an excellent reference book and well adapted for use in bringing out certain phases of mathematics. The treatment is clear and logical. It is highly recom-

mended to engineers for reference purposes. R. D. R.

PLASTICS IN INDUSTRY, by Plastes, published by Chemical Publishing Co., 234 King St., Brooklyn, N. Y., 241 pages, cloth binding, price \$5.00.

This book is intended to acquaint industrialists with the essential facts regarding plastics, their origin, manufacture and uses. Plastics have been so much discussed in the press recently that many confused ideas relative to the industry is inevitable. The usefulness of plastics lies first in the fact that they are readily molded into complicated shapes and second that the finished product presents certain advantages. An object built of metal may have to be built up of several separate pieces, which may result in considerable wastage of material. It may require crimping, soldering, welding, sand-blasting, plating, paruling, or polishing to finish. Many times the same item may be molded in plastics in the proper color and finish with little or no material wastage. In addition more pleasing appearance and better performance may sometimes be obtained in plastics than fabricated metal. Examples are the telephone subset and silent gears.

This treatise covers its subject in a thorough but elementary style. The material is presented in an easily readable form. It is this reviewer's opinion that most engineers would be better for having read this book, even though they are familiar with the subject. The book is well illustrated. It is highly recommended. R. D. R.

• • •

RADIO ENGINEERS ATTEND SHIRTSLEEVE CONCLAVE

A crowd of serious-minded, but light-hearted radio engineers converged on Emporium, Penna., recently from widely separated radio manufacturing centers for the Fifth Annual session of the Emporium Section, Institute of Radio Engineers, Summer Seminar. Theme of the conclave was high frequencies, in keeping with the current National Defense headlines, and shirtsleeves and slacks were the order of dress in keeping with the torrid temperature.

Extending the Range of "Q" Meter Measurements to Higher Frequencies was the subject of an erudite paper delivered by C. J. Franks of the Boonton Radio Corporation. Impedance Measurements over a Wide Frequency Range was explored by L. E. Packard of General Radio Company.

The Megacycle Meter was explained by Jerry Minter of the Measurements Corporation. Its operation as well as its construction was painstakingly described. High Frequency Tube Phenomena was revealed by M. A. Acheson of the Hygrade Sylvania Corporation.

The entire proceedings were arranged by G. Campbell, Hygrade Sylvania Corporation, and directed by Ross Gessford, Hygrade Sylvania Corporation, President of the Emporium Section of the Institute of Radio Engineers. By special arrangement, movies were shown of mining, refining, and preparing nickel for commercial use, and also, a celluloid was shown of the amazing feat of rapidly restoring communications in the hurricane devastated New England area at the time of the 1938 disaster.

They let their **CONFIDENCE** be their Guide

Sight Unseen . . . Sound Unheard . . . Broadcasters buy
entire factory order of New RCA 250 watt transmitter



IN THIS TROUBLED WORLD where troubles are scraps of paper...where discord, distrust, and discontent are everyday headlines...we believe you will find this report of good-will and confidence as refreshing as we did.

No broadcaster ever saw an RCA 250-K Transmitter. No broadcaster ever heard an RCA 250-K. Nevertheless, broadcasters had such confidence in RCA engineering that they purchased the entire factory order of this new 250 watt transmitter...sight unseen, sound unheard.

RCA tries to merit confidence of this nature through the application of sound fundamentals of good engineering practice. Ours is a constant and studied effort to design and build the best possible equipment at the right price...We would welcome an

opportunity to be of service to your station. We are confident that the engineering resources of RCA will find the correct solution to any problem you may have.

Use RCA Tubes in Your Station for Reliable Performance

Specifications of the RCA 250-K
Frequency Response: Flat within ± 1.5 DB from 30 to 10,000 cycles at any percentage of modulation from 0 to 95.
Operation: Three power outputs: 100, 250, 100/250 Watts.

Frequency Range: 650-1600 KC.
Fidelity: Skillful feedback reduces distortion to less than 2% RMS between 50-7500 cycles up to and including 95% modulation.
Carrier Noise Level: At least 60 DB below the level for 100% modulation—unweighted.
Utilizes power change switch and equipment where required.
High level class B modulation.
Uses RCA "V"-Cut Crystals.
All meters at eye level for convenience in reading.
Low Maintenance: Uses minimum number of incandescent tubes.



Broadcast Equipment

RCA Manufacturing Co., Inc., Camden, N. J. • A Service of the Radio Corporation of America
New York: 1770 Sixth Ave. • Chicago: 589 E. Illinois St. • Atlanta: 530 Citizens & Southern Bank Bldg. • Dallas: Santa Fe Bldg. • San Francisco: 170 Ninth St. • Hollywood: 1016 N. Sycamore Ave.

Only a little over a year ago, this advertisement announced that the RCA 250-K transmitter was a sellout sight unseen. Since that time, 60 American Broadcasters have chosen the 250-K . . . and nine have gone to foreign countries.

TRAVEL where you like throughout the length and breadth of America . . . you're seldom far from the service area of *someone's* 250-K transmitter! For the RCA 250-K has won an acceptance never before accorded to *any* transmitter by *any* manufacturer!

American stations, built or building, have purchased 60 of these high-efficiency, high fidelity, 250-watters. Foreign purchasers account for nine

more. Performance alone can make that kind of record possible . . . and *performance* is precisely what the 250-K offers! Flat within $1\frac{1}{2}$ db. from 30 to 10,000 cycles up to 95% modulation, with extremely low inherent distortion and noise-level, the 250-K puts out the quality that pleases audiences and advertisers alike.

Learn the advantages of the 250-K for yourself—write for the complete story.

...and today, more than ever,

**IT'S AMERICA'S
FIRST CHOICE!**



250-WATT TRANSMITTER MODEL 250-K

*These American Stations
Have Chosen the 250-K*

KANA	KBIX	KBUR	KFBC	KFMB
KFPW	KFXM	KHAS	KLUF	KRJF
KVFD	KVOE	KWIL	KYAN	KYCA
WAJR	WARM	WATN	WBIR	WBTA
WCED	WBML	WBOC	WDAS	WDEF
WCBI	WDAK	WHKY	WFIG	WGTC
WHBQ	WGOV	WJHP	WHUB	WFPG
WINX	WIZE	WHYN	WGAC	WLBJ
WKIP	WKMO	WKWK	WKPA	WLAV
WLOK	WMJM	WMRN	WMOB	WMOG
WGGA	WORD	WSAV	WSOO	WSLB
	WTHT	WSOC	WTJS	

Never has ANY broadcast transmitter seen such universal acceptance... IN A LITTLE OVER A YEAR!



Use RCA Radio Tubes in your station for finer performance

Broadcast Equipment

RCA Manufacturing Co., Inc., Camden, N. J. • A Service of Radio Corporation of America • In Canada, RCA Victor Co., Ltd., Montreal



New York: 411 Fifth Ave. Chicago: 589 E. Illinois St. Atlanta: 530 Citizens & Southern Bank Bldg. Dallas: Santa Fe Bldg. San Francisco: 170 Ninth St. Hollywood: 1016 N. Sycamore Ave.

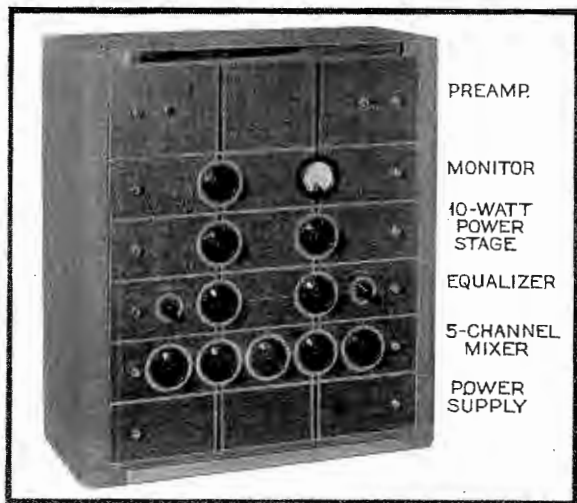

Fig. 1. Front view of equipment described in accompanying article.

"ADD-A-UNIT" AMPLIFIERS

Widen Application Scope

By HARRY PARO

Chief Sound Engineer
Lafayette Radio Corp.

THERE are many amplifier applications in recording and broadcast studios, theatres, schools and better grade sound-system installations where equipment of the "add-a-unit" type has much to recommend it.

In many such applications, for instance, there are certain requirements in mind at the time amplifier equipment is purchased, but no assurance that a week, a month, or six months later new requirements may not crop up which make the original equipment inadequate without expensive revamping, the addition of external accessory units, etc.

If the original equipment had in such cases been made up of coordinated panel units, with each function served by a separate unit and provision for patch-cord interconnections, desired alterations or additions could be made at any time by simply adding the newly required units to the rack and connecting them into the system.

In almost every studio that has been in existence for any length of time, there will be amplifiers that have been revamped so many times that they have almost lost their original identity; or have so many appendages that they offer a fair representation of a relief

map of a World War trench system. And in the shop are probably a half dozen others, the limitations in the original design of which have made them obsolete.

A properly designed "add-a-unit" system combines flexibility with compactness, and provides definite insurance of maximum utility and remote obsolescence. Moreover, the initial cost of such a system will likely be little more than that of a single amplifier to satisfy these same requirements.

An example of the type of equipment under discussion is shown in Fig. 1. The set-up shown is made up of "professional" type stock units assembled in an enclosed rack of matching finish. This particular assembly is for general sound and recording service, and consists of six units. With less comprehensive requirements, it might have

utilized as few as two units, the extra space being filled with blank panels, to be replaced with additional units as the requirement developed.

As it stands, it includes a 360-volt, 160-ma power supply, capable of providing ample power not only for the power amplifier, but for up to 12 preamplifiers and 10 electronic mixer channels; monitor panel with db meter; power amplifier consisting of three push-pull stages and providing 12 watts of high-fidelity output with harmonic distortion limited to 2½%; full range equalizer with highs and lows separately controlled by means of switch selected filters and noiseless "degree of equalization" controls; 5-channel electronic mixer; a group of three individually shielded preamplifier stages.

Where the requirements call for even more variety than represented in this

Fig. 2. Photo and circuit of the preamplifier unit. Note unit has both low and high impedance input.

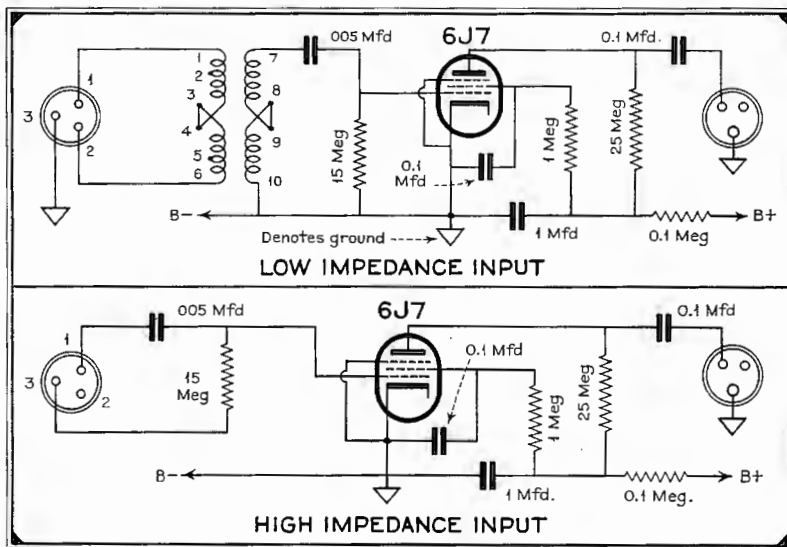
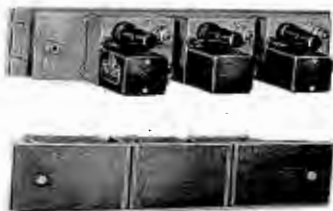

BRUSH

PRODUCTS

*Meet
Exacting
Requirements*

Brush crystal products, the results of Brush Research, are accepted the world over as standard for all applications in which the highest quality is required.



THE BRUSH DEVELOPMENT CO.
3316 PERKINS AVENUE CLEVELAND, OHIO

assembly, the entire equipment can be assembled on a larger standard rack, or it may in some cases be more convenient in operation to segregate the input equipment on a separate enclosed rack placed at the operating or monitoring position.

Each unit is limited in size to remain within the confines of a $3\frac{1}{2} \times 19$ -inch panel. The only exception is the heavy-duty power supply, which requires a panel $5\frac{1}{4} \times 19$ inches. In the case of the preamplifier stages, three of these chassis fit a single $3\frac{1}{2}$ -inch panel. All chassis are mounted directly on the rack in the conventional manner, but the panels attach to the unit chassis rather than the rack, thus permitting access to all underchassis wiring by loosening two knurled panel mounting screws and without the necessity for removing the chassis from the rack.

Something of the design considerations involved in the individual stock units is indicated in the unit illustrations of Figs. 2, 3 and 4.

Fig. 2, for instance, shows a preamplifier panel with three preamplifier stages. These may be either low or high-impedance units. Either type provides 35 db gain with frequency response flat within $\frac{1}{2}$ db from 50 to 10,000 cycles for the low-impedance type, or 30 to 15,000 cycles for the high-impedance type.

The input and output connections of each preamplifier terminate in three-prong shielded receptacles on the individual unit chassis. Power connections are made to busses inside the group chassis, which terminate in a power receptacle at one end of this chassis and into which a cable plug from the power-supply unit is inserted.

The low-impedance unit provides a choice of seven input values from 50 to 500 ohms. Output impedances of both units are suitable for direct connection to the grids of following voltage-amplifier tubes.

Fig. 3 shows views of the 5-channel mixer panel and its circuit. Here the individual input circuits terminate in shielded plug receptacles as does the

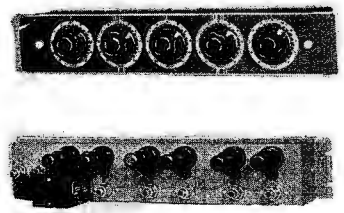
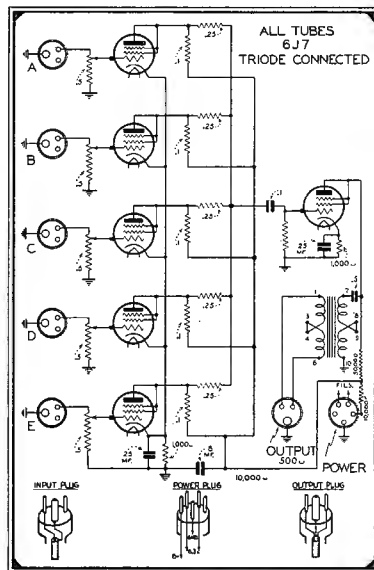

Fig. 3. Photo and circuit of the five-channel mixer.

and preamplifier panels are all to draw power from one source. A smaller one is available for use with assemblies which consist only of preamplifier and mixer combinations.

Two filament outputs provide 10 amperes at 6 volts. The high voltage is 360 volts at 160 ma. A 3-section filter results in entirely negligible ripple. Receptacles provide individual power-supply connections for a power-amplifier panel and for any desired combination of three mixer or preamplifier panels. If more than three are used, their supply cables can be paralleled to one plug.

Space does not permit detailed illustration of other available stock units, but all follow the general design principles outlined above, including convenient patch-cord and cable-plug interconnections, easy accessibility for inspection of wiring from the front, etc.

Further flexibility of add-a-unit equipment is contributed if due consideration is given in the circuit design, particularly that of the power amplifier to the matter of universal application. In the final amplifier unit of the equipment illustrated, for instance, a 3-posi-

common output. Any one of seven output impedance values is obtainable by internally connecting this latter receptacle to suitable taps on the self-contained output transformer. Power for all six tubes is provided through a power plug and cable, the opposite end of which plugs into the appropriate receptacle on the power supply chassis.

Each channel has its own triode-connected 6J7 tube which works through an isolating network into a common voltage amplifier. The isolating network eliminates any possibility of volume range compression or linear distortion. Attenuation is smooth and stepless. Gain is 37 db for each channel, and the frequency response flat within 0.8 db from 40 to 10,000 cycles.

Fig. 4 shows heavy-duty power supply used where a power amplifier, mixer

Fig. 4. Photo and circuit of the power supply unit.

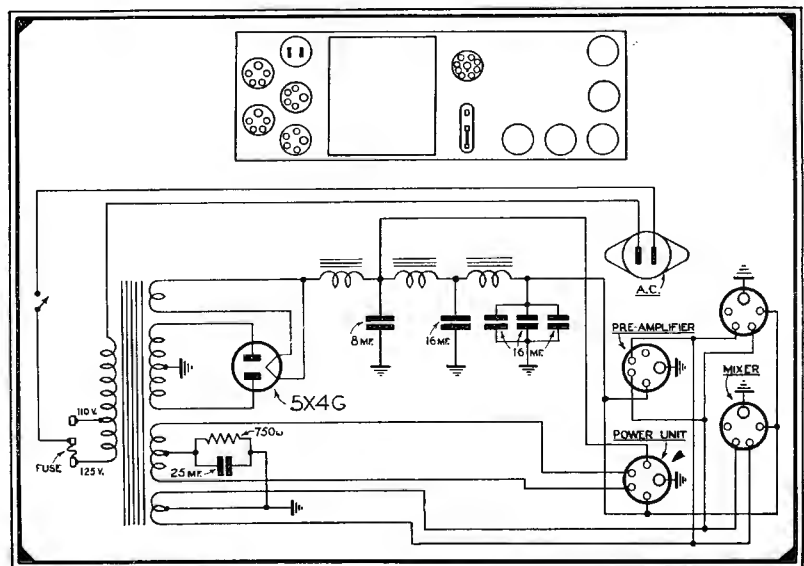
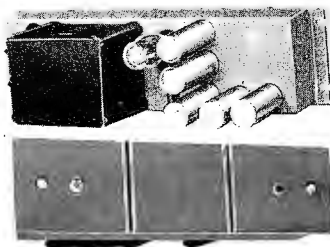

FEWER PARTS -- FEWER TUBES

when you choose G.E.'s
SIMPLIFIED CIRCUIT

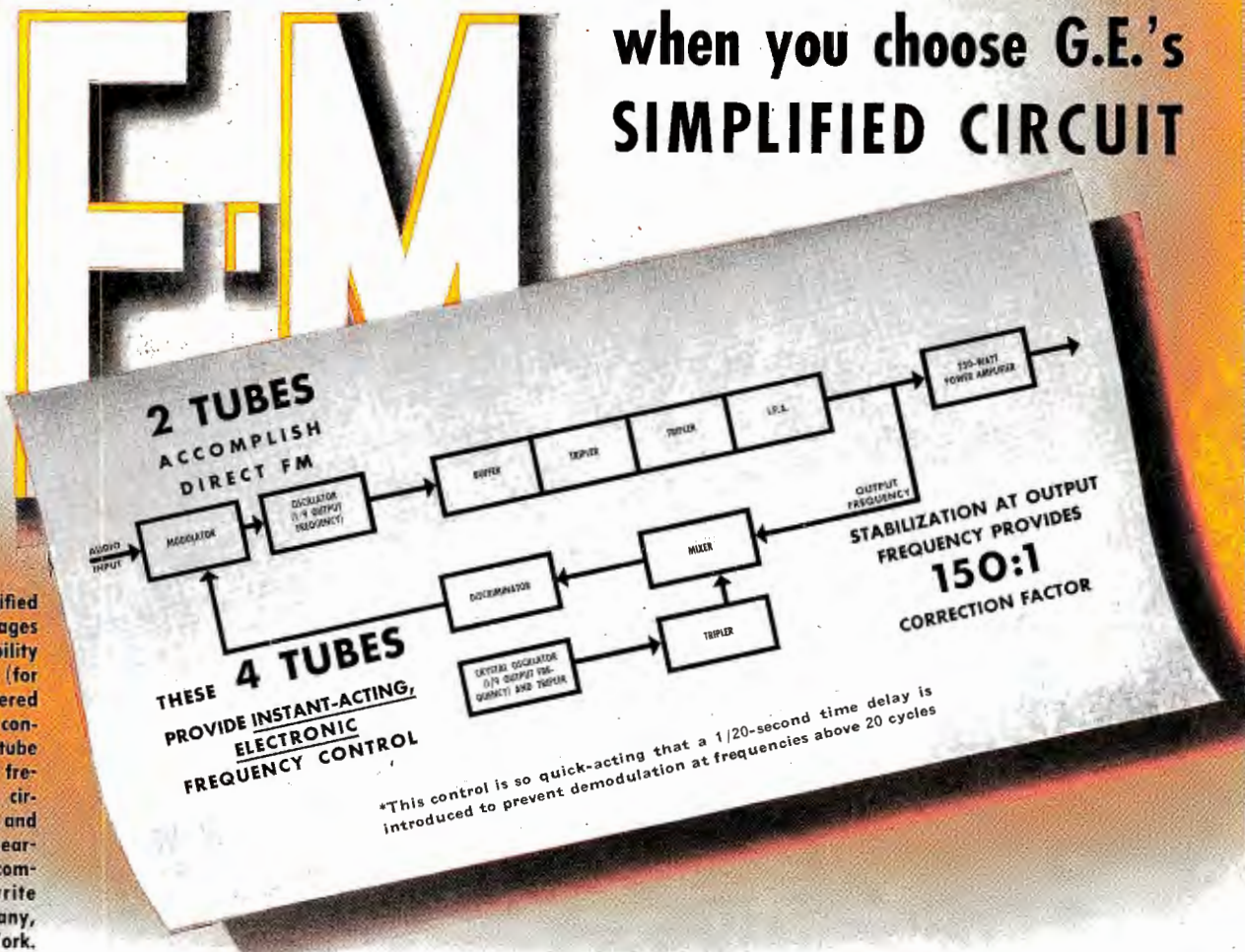

Inherent in this simplified circuit are the advantages of complete accessibility without disassembly (for every tube and soldered joint), low power consumption plus low tube replacement cost. The frequency stabilization circuit is simple, positive, and fast in action. Your nearby G-E man has the complete story. Or write General Electric Company, Schenectady, New York.

Engineers, look at this performance!

GUARANTEED PERFORMANCE CHARACTERISTICS

MEASUREMENTS ON TYPICAL PRODUCTION TRANSMITTERS

FREQUENCY STABILITY

± 1000 cycles over a normal room temperature.

For weeks Station W2XOY, General Electric's FM proving ground, has operated 10 hours a day within ± 200 cycles. Stability was measured every hour, using G.E.'s primary laboratory standard.

FM CARRIER NOISE LEVEL

Down 70 db at 100% modulation.

Production transmitters average 72 db down at 100% modulation.

HARMONIC DISTORTION

At 100% modulation less than 1% for modulating frequencies between 30 and 7500 cycles.

Actual performance based on units built to date indicates, at 100% modulation, less than 1% harmonic distortion for modulating frequencies between 30 and 16,000 cycles; less than 0.75% at 50% modulation; and less than 0.5% at 25% modulation.

AUDIO-FREQUENCY RESPONSE

The a-f characteristic from 30 to 16,000 cycles is within ± 1 db, with or without pre-emphasis.

Without pre-emphasis, about -0.3 db from 30 to 16,000 cycles; with pre-emphasis, about -0.8 db.

The performance values on the right are not to be construed as G-E guarantees. They represent typical measurements made on stock transmitters and, as such, reflect General Electric's conservative guarantee policy.

GENERAL ELECTRIC



VETERAN WIRELESS OPERATORS ASSOCIATION NEWS

W. J. MCGONIGLE, President

RCA BUILDING, 30 Rockefeller Plaza, New York, N. Y.

GEORGE H. CLARK, Secretary

OVER a coast-to-coast network of the Mutual Broadcasting System on Saturday, August 23rd, 1941, our Association presented the following program:

MR. MCGONIGLE: "Thank you, Mr. King."

"On July 20, 1937, Guglielmo Marconi, the founder of the wireless art, passed away. The Mutual Broadcasting System arranged a memorial program that day, on which it was my sad duty to participate, as president of our association of veteran wirelessmen.

"In conversation with J. R. Poppele, Chief Engineer of WOR, Mutual's New York Station, preliminary to the broadcast, the first plans for a perpetual memorial to the memory of Marconi were formulated.

"The original plan called for the erection of a suitable monument in New York. One of the first contributors to the Marconi Memorial Fund, subsequently established by the Veteran Wireless Operators Association with Mr. David Sarnoff as Chairman, was Mr. A. J. McCosker, President of WOR and Chairman of the Board of the Mutual Broadcasting System.

"This plan will culminate in the erection in Battery Park, New York, of a memorial which will incorporate the Wireless Operators Monument now located just outside the barge office in Battery Park and the bas-relief of the head of the father of wireless, together with the large black marble slabs, enclosing it, which formed a part of the Italian Building at the New York World's Fair.

"In further tribute to the memory of wireless pioneer, Marconi, our Association established Marconi Memorial Awards. During the year, just passed, it has been our privilege to present a Marconi Memorial Service Plaque to the Defense Communications Board through its chairman, Hon. James Lawrence Fly; a Marconi Memorial Medal of Service to Major General Joseph O. Mauborgne, Chief Signal Officer of the Army; a Marconi Memorial Medal of Service to Rear Admiral Leigh Noyes, Director of Naval Communications, and a Marconi Memorial Code Proficiency Award to the winner of the recent Army Amateur Code Proficiency contest.

"In 1939, our Association undertook the sponsorship of a Marconi Memorial Scholarship Award. Through the cooperation of Mr. C. J. Pannill, President of RCA Institutes and the Radiomarine Corporation of America, himself a wireless pioneer, arrangements were completed whereby our Association would, each year, place a worthy young man in RCA Institutes, for a two-year course of instruction in Radio and Electrical Communication as a living tribute to the memory of Marconi.

"When first confronted with the problem of selecting a worthy candidate for the

scholarship, Mr. J. R. Poppele, Chairman of our scholarship committee, found it a difficult one. We had the good fortune, however, to become acquainted with the fine accomplishments of the American Institute of the City of New York, an organization founded 114 years ago, which during the past ten years has devoted its efforts towards the scientific culture of American youth. One of its activities along this line is the organization of Science and Engineering clubs in high schools throughout the entire United States. The activities of the American Institute covers 42 states and includes 1,000 high schools in which 35,000 science-minded, ambitious American youths form the nucleus of American Science on the march.

"The American Institute, each year, conducts a nationwide contest to obtain a candidate for our Annual Marconi Memorial Scholarship.

"I now have the pleasure to present the President of the American Institute, Dr. H. C. Parmelee who will tell us about this year's contest."

DR. PARMELEE: "As President of the American Institute of the City of New York, I take great pride in the knowledge that our organization has been able to aid the Veteran Wireless Operators Association in their selection of an American youth to whom the Marconi Memorial Scholarship could be awarded. Educational experts on the staff of the American Institute developed a series of comprehensive tests to determine each contestant's aptitude for radio engineering, his knowledge of physics, mathematics and general science—his general intelligence and the suitability and adequacy of his present training. In conducting the test among high school seniors throughout the country we have the cooperation of the science instructors who act in the capacity of faculty advisors to the Science and Engineering clubs sponsored by the American Institute.

"The spirit and enthusiasm of the participants in this year's contest should make us all less apprehensive about the future of technical Americans. It is apparent that young America appreciates the situation confronting the world and is willing and anxious to acquire further education in order better to solve the many problems, to which it is the duty of science to provide solutions.

"This year's contest had a larger number of contestants than previous ones and the spirit of the participants was particularly high. Because of the increased interest in the scholarship and the closeness of the contest we of the American Institute should like to present two candidates for Marconi Memorial Scholarships. I feel certain that these two sterling young men possess the necessary scholastic qualifications for marked success in their chosen field of Radio Engineering."

"Will it be possible, Mr. McGonigle, for

your Association to accommodate these two aspiring young men?"

MR. MCGONIGLE: "Yes, Dr. Parmelee. Fortunately, Mr. C. J. Pannill, President of RCA Institutes, through whose good offices we have been able to offer this scholarship annually—fully aware of the present need and demand for more and better trained radiomen in furthering our National Defense, when apprised of the results of the contest conducted by your organization immediately agreed that we should place two students in the RCA Institutes under the Marconi Memorial Scholarship plan.

"Dr. Parmelee, I believe you should have the honor of presenting one of the scholars."

DR. PARMELEE: "In the contest conducted by the American Institute during the spring of this year, two high school students, members of our science clubs, proved outstanding. Stanley Goldfein, a graduate student of Erasmus Hall High School in Brooklyn was one of them. Stanley, will you please come forward and accept this Marconi Memorial Scholarship valued at \$1,000 under which you will obtain a comprehensive education in Radio and Electrical Communication at RCA Institutes? With the Scholarship I convey the best wishes of all of us for your successful completion of the prescribed course of study and your eventual success in this most important field of endeavor."

MR. GOLDFEIN: "Thank you, Dr. Parmelee. I fully appreciate the honor conferred upon me by this award and I express my sincere thanks for the part that you and the American Institute have played in making it all possible. I hope that my record of accomplishment under the scholarship may live up to the highest expectations of the Veterans of Wireless. I trust that some day I may be worthy of the name—Wireless Veteran."

MR. MCGONIGLE: "We take you now to the studios of WCLE Mutual station in Cleveland, Ohio. The Hon. W. B. Spagnola, Mayor of Youngstown, Ohio, will present the second Marconi Memorial Scholarship."

MAYOR SPAGNOLA: "I was, indeed, happy when Mr. McGonigle telegraphed me that John Marsey, a graduate student of East High School of our City of Youngstown, Ohio, had been awarded a Marconi Memorial Scholarship at RCA Institutes in New York. In Youngstown, we have a city which is contributing its all in industrial production towards the best possible National Defense. All branches of the government, and civilian organizations as well, are becoming ever more aware of the importance of the best possible communications. In order that this objective may be achieved we must, all of us, do our utmost towards seeing that those of the coming generations occupy their rightful place in the panorama which is developing. (VWOA—continued on page 35)

Variable Voltage

FOR YOUR LABORATORY, YOUR PRODUCT, OR YOUR PRODUCTION LINE



VARITRAN

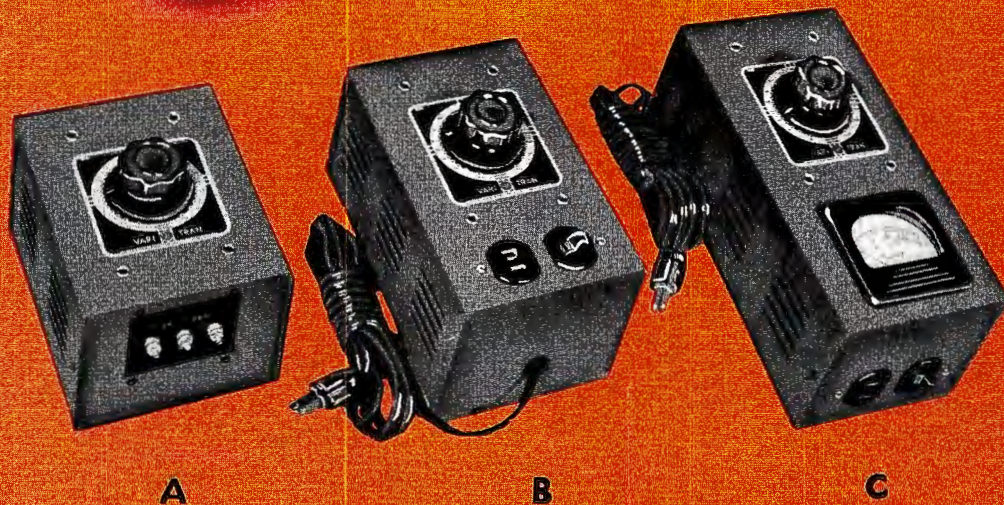

- ★ SMOOTH CONTROL
- ★ EXCELLENT REGULATION
- ★ HIGH EFFICIENCY
- ★ RUGGED CONSTRUCTION
- ★ WIDE RANGE (0-130 V.)
- ★ LOW TEMPERATURE RISE
- ★ ROLLER CONTACT
- ★ NO DISTORTION

VARITRAN CONTROL UNITS

For Controlling: Rectifier output, Motors, Heaters, Lights, Line voltage

METHOD OF OPERATION The UTC Varitran is a simple autotransformer with turns arranged on one layer so that every exposed turn may be used as a tap. A special non-fusing contact can be moved to any position on the winding, permitting the exact voltage desired to be obtained. The regulation and efficiency are excellent and no distortion of wave form occurs. The output voltage is independent of load.

Type	Input Voltage	Output Voltage	Watts	Max. Amps.	Figure	Net Price
V-0	115 volts	0-130	230	2	A	\$7.50
V-0-B	230 volts	0-260	230	1	A	9.50
V-1	115 volts	0-130	570	5	B	10.00
V-1-M	115 volts	0-130	570	5	C	15.00
V-2	115 volts	0-130	570	5	A	9.00
V-2-B	230 volts	0-260	570	2.5	A	11.50
V-3	115 volts	0-130	850	7.5	A	14.00
V-3-B	230 volts	0-260	850	3.75	A	18.00
V-4	115 volts	0-130	1250	11	A	20.00
V-4-B	230 volts	0-260	1250	5.5	A	25.00
V-5	115 volts	0-130	1950	17	A	32.00
V-5-B	230 volts	0-260	1950	8.5	A	37.00
V-6	115 volts	0-130	3500	30	A	60.00
V-6-B	230 volts	0-260	3500	15	A	70.00
V-7	115 volts	0-130	5000	44	A	87.00
V-7-B	230 volts	0-260	5000	22	A	95.00

VARITRAN RATINGS

Standard Varitrans are designed for 115 or 230 volt service. The respective output voltages are 0-130 and 0-260 volts. The Varitran autotransformer current and wattage rating is based at 115 volts. The maximum current can be taken at any point from 0 to 20 volts and from 95 to 130 volts, tapering off to 50% of maximum at the 65 volt point.

UNITED TRANSFORMER CORP.

150 VARICK STREET



NEW YORK, N. Y.

EXPORT DIVISION: 100 VARICK STREET, NEW YORK, N. Y. CABLES: "ARLAB"



Even sweepings are saved as the Nassau Smelting and Refining Company does its part to conserve defense materials.

pounds of nickel, well over three million pounds of zinc and 8,300 pounds of magnesium. Additional reductions are foreseen for 1942.

The Western Electric Company, manufacturing arm of the System, now saves 65 tons of aluminum annually by replacing aluminum with steel in the "finger wheel" on dial telephones. This is only one of many items of telephone equipment in which aluminum is being replaced by other materials. The total saving of aluminum is enough to build more than 275 military planes other than bombers, or half as many bombers, in accordance with the estimate of the

CONSERVING MATERIALS

MUCH has been heard concerning the substitution and conservation of metals necessary to our National Defense Program. Hence, it is interesting to note that a saving of more than five million pounds of metals vital to defense needs, including enough aluminum to build more than 275 fighter planes, is being effected by the Bell System this year through a materials substitution program.

Made possible through long-range

Below: Hot work. Well protected against the danger of molten metal, men at the Nassau Smelting and Refining Company plant cast an ingot in the composition furnace.



planning, research, and readjustments in manufacturing, the substituting of materials in 1941 will divert for use in defense work nearly 1,700,000 pounds of aluminum, almost a third of a million



Aeronautical Chamber of Commerce of America that the average non-bomber requires three tons of aluminum and the average bomber six tons.

The use of zinc is being substantially reduced by coating much of the hardware used on telephone pole lines with lead, instead of putting these products through a galvanizing process. Also, less zinc is being used in the production of new telephones.

Since 1925 the Bell System has been studying how to make the most effective use of materials. Immediately after

Left: Removing a condenser box from a retort after refuse has been drawn off.

Below: His protective clothing, reminiscent of a warrior's armor, an employee plays his role in the program of conserving metals. He's cleaning refuse from the neck of a condenser box during a galvanizing operation. Even the refuse has its uses.



An advance outpost here observes and transmits information concerning enemy activities to a command post behind the line. (Fox Dix, N. J.) All photos from Western Electric Co.

the outbreak of war in 1939, a survey was made of critical materials particularly used in the telephone system and efforts to determine suitable substitutes were initiated.

Because of the many factors involved in the introduction of substitutes—processing, engineering, materials and new procedures—the System will be faced with an inevitable rise in manufacturing costs as a direct result.

Efforts to conserve vital materials reach to all parts of the System. Telephone companies throughout the country are using much old equipment which



AIDS NATIONAL DEFENSE

might normally be replaced, so that new equipment may be used at other locations where the need is greater. Dial installations in some communities are being deferred, used switchboards are being reused, cables and are being re-sheathed and reused.

Supplementing the Bell System's substitution and conservation program are the reclamation activities it has been

Below: Streamlined production speeds defense effort. The infra-red ray baking tunnel in Western Electric's Specialty Products shop in the Kearny Works chops 75 per cent off the time it would otherwise take to bake the coating of wrinkle enamel on radio housings for the U. S. Army. Twenty feet in length, the tunnel is fitted with 64 lamps (totaling approximately 60,000 watts), which create a temperature of 425 degrees Fahrenheit in the metal of the housings, baking the enamel from the inside out.

carrying on since 1931, when the Nassau Smelting and Refining Company was acquired for the purpose of reclaiming junked material. Many of the materials used in telephone equipment are not expended, but can be reclaimed and reused.

The Nassau Smelting and Refining Company last year supplied the System with more than 42,000,000 pounds of metal. This was obtained chiefly from non-ferrous metals in outworn equipment, structures, and supplies junked by the operating telephone companies. Nassau supplied Western Electric with 12,000,000 pounds of copper wire bar,

more than 18,000,000 pounds of lead
(MATERIALS—continued on page 35)

Right: Defense assembly line scene. Workers in Western Electric's Specialty Products Division at the Kearny Works assemble frames for radio equipment that will go to the Signal Corps, U. S. Army
Below: Assembling and wiring apparatus for the U. S. Army.

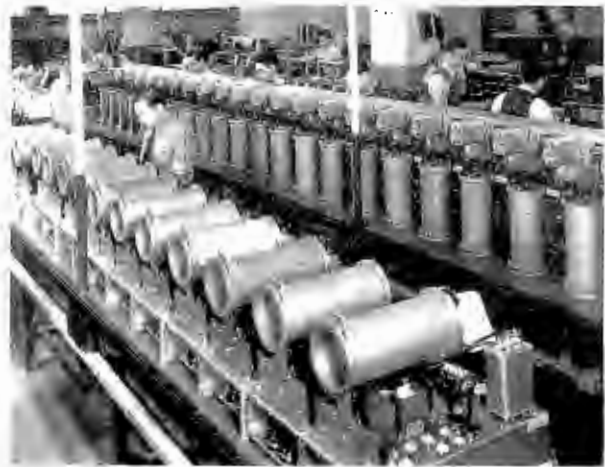
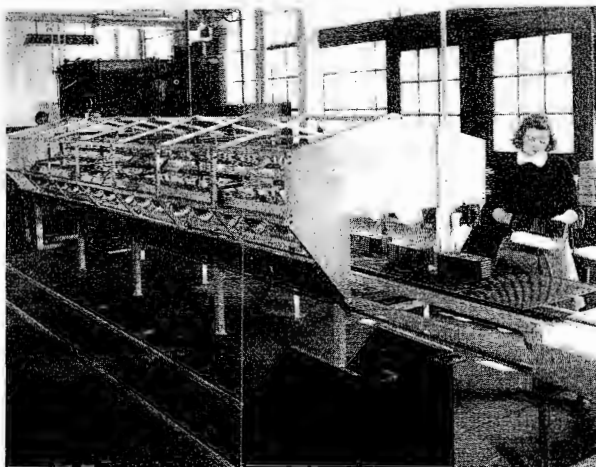

NEW PRODUCTS

PHONO AMPLIFIER

Webster-Rauland's new phono amplifier is shown in the accompanying illustration. Unit is designed with vertical front panel and within specified dimensions to permit rack mounting if so desired. Incorporates such features as: automatic volume expander up to 10 db; dual fader-phono unit (permitting mixing and fading of two phonos); two separate tone controls, each increases or decreases treble and bass re-

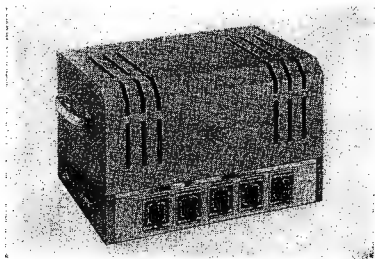

spectively; master volume control with a-c switch. Further information from Webster-Rauland, 3825 W. Armitage Ave., Chicago.

POWER RESISTORS

The Greenohm construction and materials employed for Clarostat power resistors are said to have passed the tests and now enjoy Navy Approved Class 1, Grade 2, rating. This means that such cement-coated power resistors have been found suitable in continuous operation at temperatures up to 275 deg. C., that such units can withstand severe heat shock without impairment, and that they can withstand long exposure to salt air and humidity. Greenohms are being made in accordance with Navy Specifications RE-13A-372J. Clarostat Mfg. Co., Inc., 285 N. Sixth St., Brooklyn, N. Y.

SMALL TRANSFORMERS

The United Transformer Corporation, 150 Varick Street, New York, N. Y., are now in quantity production on a new group of small transformer components. These output coupling units weigh only three-tenths of an ounce, and have dimensions $1\frac{1}{8}$ " x $1\frac{1}{8}$ " x $\frac{3}{4}$ ". Almost 10,000 turns are employed in the coil structure to effect an

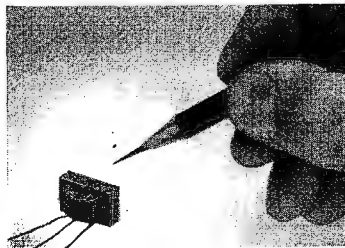

inductance of approximately 70 hys. These units are in use for hearing aid, aircraft, and similar applications.

DECADE INDUCTANCE

The New York Transformer Company, 480 Lexington Avenue, New York City, have just designed a new type decade inductance. This new NYT Co. Decade Inductance is said to be a precision laboratory unit valuable to the laboratory technician as an aid in setting up experimental filters, equalizers, tuned amplifiers, phasing networks, etc. The NYT Co. Decade Inductance is available in decades from .001 henries per step to 10 henries. It has an accuracy of plus or minus 5% with an operating level up to 30 db. These instruments may be had in either 2 or 3 decades in any of the inductance ranges desired.

WHITE TRACING CLOTH

Good, clear blueprints are said to be made from pencil tracings on The Frederick Post Co.'s new white tracing cloth, Whitex. Samples of Whitex can be obtained by writing The Frederick Post Company, Box 803, Chicago.

MICROPHONE

Shure Brothers announce that the Shure Unidyne dynamic cardioid microphone is now available in a series of "voice" models for police and commercial radio, as well as for public address, paging, broadcasting and recording. The new "Voice" Unidyne, employing the Shure patented Uniphase principle, is said to combine the advantages of true cardioid uni-directional per-



formance with emphasis on "voice" response. For further information, write to Shure Brothers, 225 West Huron Street, Chicago.

MICA CAPACITORS

A new midget molded-in-bakelite receiving circuit mica capacitor, Type 1478, is announced by Aerovox Corporation of New Bedford, Mass. This capacitor is an elongated version of the types heretofore offered in the "postage-stamp" series. Its body measurements are $1\frac{1}{16}$ " long by $\frac{7}{16}$ " wide by $\frac{3}{16}$ " thick. Hot-tinned brass wire leads provide the connections. The same molded casing is used for Type 1479 with silvered mica section. Both types, because of the longer casing, provide for higher capacity values at the given 1000 v d-c Test (500 v d-c-w) rating, it is said. The standard mica Type 1478 is available in from .0001 to .002 mfd, while the silvered mica Type 1479 comes in .0001 to .001 mfd capacity.



MULTICOUPLER ANTENNA SYSTEM

The inclusion of F-M reception along with the already well-known features of all-wave reception and minimized noise, marks the latest development in the multicoupler antenna system for apartment houses and other multi-radio buildings, according to Amy Aceves & King, Inc., 11 West 42nd St., New York City, its patentees and licensors. The new type system usually employs for its aerial a doublet of two wires, one 45 feet long and the other 15, supported by neat angle-iron masts mounted on coping or superstructure. Lightning arrestor and antenna transformer mount on mast, coping or wall, close to the aerial, so that no superfluous strain is placed on the wires. Where space is limited, vertical rod aeriels are used.

The transmission line from the aerial connects with the outlet couplers. Up to 20 couplers can be served with a single aerial and transmission line. The patented coupler unit is provided with a built-in polarized outlet, fitting a standard box with face plate, which in turn takes a special polarized attachment plug connecting with antenna and ground terminals of the radio set. No switching or other changes are required in making the outlet instantly available for satisfactory broadcast, short-wave or F-M reception.

DYNAMOTOR LINE

Pioneer Gen-E-Motor announces the issuance of its new Catalog No. D-EJD-41 featuring their line of dynamotors for all aircraft, sound and other power supply uses. This new line of Pincor dynamotors includes single output units ranging from the tiny Model DS, rated up to 15 watts, to the giant Model TS capable of 850 watts output, with all intervening ranges for every receiving and transmitting application, totally enclosed or ventilated. Featured also, is the new Pincor combination double input and double output dynamotor for both receiving and transmitting. These are designed not only to effect a



saving in cost but also to save space and weight in conformance with modern aircraft requirements. Address Pioneer Gen-E-Motor, 5841 Dickens Avenue, Chicago, Illinois, for copy of the new Pincor dynamotor catalog; export address, 25 Warren Street, New York City, N. Y.

KOOLOHMS

Type VD Koolohm resistors are said to provide a handy, economical answer to the problem of making up tapped resistors with any number of 10- or 15-watt sections of any required resistance values. The Koolohms are supplied in compact 10- or 15-watt sections equipped with ball and recess interlock feature. This prevents turning and automatically connects the units electrically in series when mounted on a threaded steel rod which is provided and which can be cut to desired length. Mounting feet and ceramic end-spacers are also supplied. Several resistor sections can be connected in series and be mounted on the same tie rod and mounting feet with a similar assembly insulated from it elec-



trically by means of the ceramic spacers. Overall length of the 10-watt Type VD Koolohm is $1\frac{1}{8}$ " and diameter is $\frac{5}{8}$ ". The 15-watt sections are $1\frac{9}{16}$ " long by $1\frac{1}{16}$ " diameter. The complete Koolohm catalog will gladly be sent you upon request to the Sprague Specialties Company, Resistor Division, North Adams, Mass.

TRANSCIEVER

A $2\frac{1}{2}$ meter transceiver has been announced by Abbott Instrument, Inc., 8 W. 18th St., New York City. Three 45-volt B batteries, self-contained for portable use, or 135-180 volts d-c from an a-c power supply are used in a circuit employing one



6G6G in the audio and modulator positions, and one 6J5GT as the super regenerative detector and r-f oscillator.

CACTUS NEEDLES AND SHARPENER

Much of the objection to cactus needles is said to be overcome by the new, simple sharpener just released by Duotone Co.,



Inc., 799 Broadway, New York City. This handy device utilizes the turntable of the phonograph like an emery wheel.



TYPE OP-182



TYPE OP-961

DAVEN OUTPUT POWER METERS

for Accurate Measurement of Power and Impedance

OP-182

Convenient meter reading is provided in this compact, space-saving OP-182 Output Power Meter. It is admirably suited for many power and impedance measurements, such as determining actual power delivered by an audio system to a given load, characteristic impedance or load variation effect on an A.C. source.

Terminal impedance remains essentially resistive over the audio frequency range of 30 to 10,000 cps. Impedances from 2.5 to 20,000 ohms in 40 convenient steps are available.

The indicating meter is calibrated from 0 to 50 mw., and from 0 to 17 db. Zero level at 1 mw. Four ranges of full scale readings from 5 mw. to 5 watts, and from -10 to +37 db. are provided by the meter multiplier. Accuracy within 5% at midscale.

The DAVEN catalog lists the most complete line of precision attenuators in the world: "Ladder", "T" type, "Balanced H" and Potentiometer networks—both variable and fixed types—employed extensively in control positions of high quality program distribution systems and as laboratory standards of attenuation.

Special heavy duty type switches, both for program switching and industrial applications are available.

SUPER-DAVOHM resistors are precision type, wire-wound units from 1% to 0.1% accuracy.

More than 80 laboratory test equipment models are incorporated in this catalog.

OP-961

A rugged, handy Output Power Meter for accurate measurements of audio signal systems having a maximum power output up to 50 watts. Highly recommended for measurements of characteristic impedance, load variation effects, transmission line equalization, insertion losses, filters, transformers, radio receiver outputs, and others.

Reliable readings of power and impedances from 2.5 to 20,000 ohms are guaranteed by a meter multiplier network of constant impedance, in combination with a carefully designed impedance changing network that remains essentially resistive throughout virtually the entire audio range.

Power ranges cover from 0.1 mw. to 50 watts in steps of 0.1 mw. Indicating meter is calibrated from 0 to 50 mw., and from 0 to 17 db., with a 1 mw. zero level. A 20-step multiplier extends the meter power reading from 0.1x to 1,000x scale value, and the db. reading in steps of 2 db., from -10 to +30 db., with full scale at +47 db. Accurate within 2% at midscale.

THE DAVEN COMPANY
158 SUMMIT STREET • NEWARK, NEW JERSEY

Now



G.A.W. CARBONYL IRON POWDER

We are now supplying numerous iron core manufacturers with **G.A.W. CARBONYL IRON POWDER.** ★ This remarkable iron product, with each individual particle a *true spheroid* averaging four microns, yields performance warranting your early investigation.

FOR INFORMATION
ADDRESS
THE MANUFACTURER

**GENERAL
ANILINE WORKS**

435 Hudson Street, N.Y.C.

OR THE DISTRIBUTOR

**ADVANCE SOLVENTS
& CHEMICAL
CORPORATION**

245 Fifth Avenue, N. Y. C.

RESISTOR POWER CORDS

A dependable and adequate supply of resistor power cords required as replacements for a-c d-c radio sets is claimed by Clarostat Mfg. Co., 285-7 N. 6th St., Brooklyn, N. Y., through its jobbing outlets. A choice of Clarostat power cords for



certain sets is offered, as well as several universal types serving a wide variety of sets. These Clarostat power cords have three conductors enclosed in heavy braided covering, with a tie cord at the chassis end and a molded rubber plug at the other. The three conductors furnish the necessary plate voltages for rectifier tube and the reduced voltages for the tube filaments.

TRANSMITTING TUBE

A new radio transmitting tube especially designed for high-frequency applications has been announced by the Vacuum Tube Department, General Electric Company, Schenectady, New York. Designated GL-8009, this water-cooled tube is similar to the GL-880, but has a six-pole terminal mount, and can be used as a Class B modulator, a radio-frequency amplifier, and an oscillator.

The design of the terminal mount connections and the introverted anode minimize lead inductance. While designed primarily for television service, the tube is suitable for any high-frequency broadcast application. It can be used up to 25 megacycles at maximum ratings, and up to 100 megacycles with reduced ratings. The tube has a plate voltage rating of 10,500 volts maximum at a plate current of six amperes, Class C telegraph service.

SPEAKER FIELD SUPPLY

Thordarson laboratories now have designed a speaker field supply for electrodynamic speakers. The flexibility of this field supply makes it adaptable to practically any loudspeaker that is equipped with a 2500-ohm field. The switching mechanism permits operation of two 2500-ohm fields requiring approximately 14 watts field excitation; four 2500-ohm fields re-

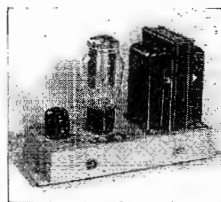

quiring approximately 8 watts field power; or, eight 2500-ohm fields requiring about 4 watts field power. Operates on 110-120 volts 50-60 cycle current, and measures approximately 9" long by 5" wide by 7" high. Information on the Thordarson speaker field supply and the entire Thordarson line of amplifiers is contained in Catalog No. 600-F available free from your distributor or direct from the factory. Thordarson Electric Mfg Company, 500 West Huron Street, Chicago.

LOW-FREQUENCY LINEAR TIME-BASE GENERATOR FOR OSCILLOGRAPHY

A low-frequency linear time-base generator, to be known as Type 215, has been developed by the engineers of Allen B. Du Mont Laboratories, Inc., Passaic, N. J., for release this fall. This instrument will be especially valuable in facilitating studies of low-frequency phenomena such as found in vibration studies, strain analyses, physiological applications and similar usages.

This generator has a frequency range from .2 to 125 cycles per second, with negligible deviation from absolute linearity. It offers both single and continuous sweeps controlled manually or by positive signal. The maximum undistorted output is 500 v d-c. Signal blanking facilities are provided. Type 215 generator is recommended for use with Du Mont Types 175 and 175A oscillographs which are provided with long-persistence screen teletrons operated at high accelerating potential. This instrument is housed in the standard Du Mont portable metal case, with leather carrying handle, and measures 14 x 8 x 17¼ inches. It weighs 35 lbs.

ELIM-O-STAT

Solar Manufacturing Corp., Bayonne, N. J., announces the latest addition to the line of "Elim-O-Stat" radio noise-suppress-



sors, the type AFL, designed to eliminate radio interference created by fluorescent lighting equipment. It is supplied in a small, narrow metal case for channel mounting.

TEST LIGHT

A new neon test light named "Ideal Test-Glo" for testing radio and electrical circuits, etc., has been placed on the market by the Ideal Commutator Dresser Co., 4025 Park Ave., Sycamore, Ill. Enclosed in a



transparent, plastic housing it is protected against high voltages by a special resistor. Rated capacity is 80 to 550 volts A.C. or D.C. Overall length, 8". Test leads are 4½" long and insulated for safety.

CARBON RESISTORS

In keeping with the trend towards still more compact radio components, Aerovox Corporation of New Bedford, Mass., has just announced smaller insulated molded carbon resistors to its trade. The new ½ and 1-watt units are considerably smaller than previous units bearing the same wattage ratings and type numbers. The size reduction is due to improvements in the resistance elements, and in no way reduces the load-handling properties of the units.

RCA SPEAKER BAFFLE

A loudspeaker baffle projecting sound uniformly over a 360° area through five evenly spaced apertures arranged in a horizontal plane has been announced by George Ewald, manager of the Commercial Sound Division of the RCA Manufacturing Co., Inc., Camden, N. J., for use in paging and announcing in industrial plants.

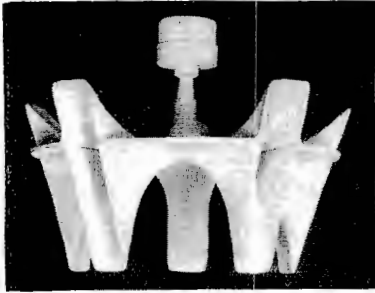

This new baffle, which operates from a single loudspeaker mechanism, is constructed of non-metallic non-vibratory acoustic material especially developed for this purpose. Its use releases a large quantity of aluminum, originally specified for the unit, for National Defense. The baffle is designed for operation with 5-, 10-, 12-, or 15-watt loudspeaker mechanisms, all of which are interchangeable. Special mounting brackets are provided for installation. It is 20" high, 20" deep and weighs 10 pounds.

MULTI-RANGE TESTER

Precision Apparatus Co., 647 Kent Ave., Brooklyn, N. Y., announce their Model 834, an all-purpose tester and troubleshooter meter which combines 31 ranges of a-c and d-c measurements in a minimum of space.

The instrument offers 18 a-c and d-c voltage ranges, at 1,000 ohms per volt; 4 current ranges, 3 resistance ranges to 5 meg and 6-db ranges.

All connections lead from only two pin-



jacks, with the exception of the 1,200 and 6,000 volt ranges. A 400 microampere rectangular indicating meter, and wire-wound multipliers are employed.

CINAUDAGRAPH SPEAKER WORKS UNDER WATER

An unusual feature of a recent National Defense sub-contract accepted by Cinaudagraph Speakers, Inc., 921 W. Van Buren St., Chicago, was the fact that the speaker had to be tested under water to meet stringent U. S. Navy requirements.

the **ONE** name for every Antenna Need

LINGO

"Proven by Service"

**TURNSTILE
RADIATORS**

FM

Constructed of full-weight copper-bearing seamless steel tubing. Lingo "Tube" Radiators are not to be confused with other light-weight tubular or structural steel towers. This extra assurance of stability is only one of the many plus advantages that have created for Lingo a reputation that has gained the respect of engineers everywhere.

AM

**VERTICAL
RADIATORS**

Lingo has set a new pace in the FM field! This new patented Turnstile Antenna is a distinct, new improvement over all previous designs. It is now offered with a background of experience and not EXPERIMENT . . . it is the result of a basically sound process of development and its excellent performance has already been proven.

★ ★ ★ ★ ★

WRITE FOR FACTS! Our engineering staff is ready and glad to provide complete technical data concerning your particular station. Write today and state frequency, power and location. (For FM—give height of building or supporting tower.)

JOHN E. LINGO & SON, Inc.
DEPT. B-9, CAMDEN, NEW JERSEY

This problem was solved by the use of entirely waterproof materials throughout. The cone and spider were made of components which were water-resistant, and non-soluble cement was used in putting them together. All metal parts of the unit were first plated and then treated with a water-repellant coating.

Normally, speakers are somewhat sensitive to moisture and heat conditions, but those built by Cinaudagraph under the sub-contract in question were to be used on one of Uncle Sam's new battleships under construction, and hence had to withstand all kinds of weather to insure continuous operation.

Of interest to engineers is the fact that the speakers actually seemed to work as well under water as in air except for the greater power required to activate the unit.

The cone action was the same in either medium, but the voice coil withstood 300% more wattage while completely immersed. This was due to the weight of the water pressing against the assembly, and the ability of the liquid to act as a coolant in dissipating any heat which might have resulted from the tremendous overload. It was found, for instance, that the wire safely carried the increased current under water; but burned through when the same power was applied and the speaker operated in air.

Having designed this waterproof speaker, Cinaudagraph Speakers, Inc., plans to offer similar units to the general public under the trade name of "The Mallard." All Mallards are of the permanent-magnet variety, and range in size from 3½ to 12 inches.

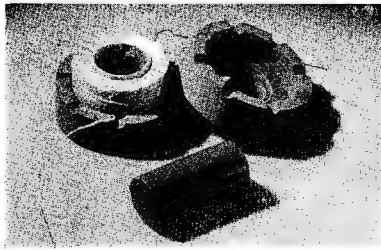

Crolite powdered iron core and shield, with coil inserted. The core at front slips into center of coil and shield. Slots in the shields accommodate the coil connections.

THE ALUMINUM shortage now troubling set designers and manufacturers of radio receivers is being partially offset by the substitution of high-frequency iron and permeability tuning to replace the aluminum variable tuning condenser and aluminum shield cans.

Inductive Tuning

Inductive tuning is not new; in fact it is the oldest type of tuning known and was described by Fleming in 1896 in his first book. Since then it has had many wild rides, but during the past few years it has become an important factor. Automobile manufacturers recognized its possibilities and have been taking advantage of the high gain possible and the small space requirements of this tuning method for some time.

Permeability tuning methods usually take the form of a high-frequency iron core moving in and out of the coil, altering its inductance after the fashion of

This three-gang permeability employs a preselector circuit. It is used by the Colonial Radio Corp. in the Pontiac auto set.

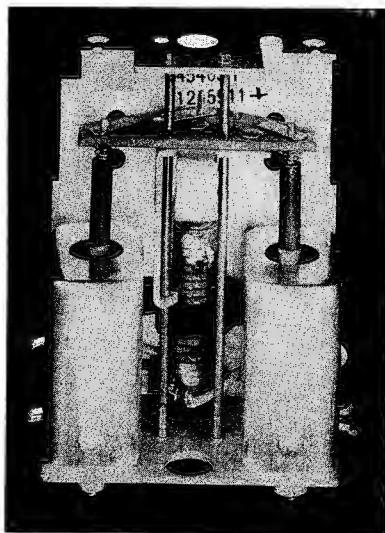

Powdered-Iron Cores and Tuning Units

the old time variometer used for tuning of the earlier receivers. The present tuners have a gang of coils and iron plungers that take the place of the more familiar gang condenser and coils. The iron plungers are moved back and forth in their respective solenoids by a suitable mechanical means, and are individually connected to the same through a screw stem or imbedded wire. The alignment of the different tuning circuits is achieved by adjusting the screw for each core.

Powdered Iron

American ingenuity again showed its force in connection with the powdered

Photo shows a typical three-gang permeability tuner with two of the coils shielded. Note the trimmer condensers at the front.

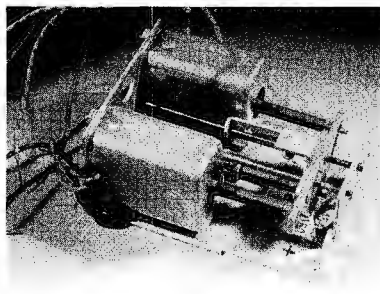

iron supply. With the coming of the war the source of supply became scarce. It was necessary to develop a material that would equal or exceed the imported types.

Such a domestic material is available today in abundance.

This powdered iron, in a variety of types, is used in i-f transformer housings and shields, too, in addition to inductive tuning units.

Shields

First, there is the closed-core type of coil in which the winding is held inside two halves of the powdered-iron shell which forms a complete electromagnetic shield. In the case of straight-core or open-core coils, a powdered-iron sleeve

This tuner has an r-f stage on all bands and covers the broadcast, 9, 11 and 15 mc spread bands. It is used by the Colonial Radio Corp. in one of their farm receivers.

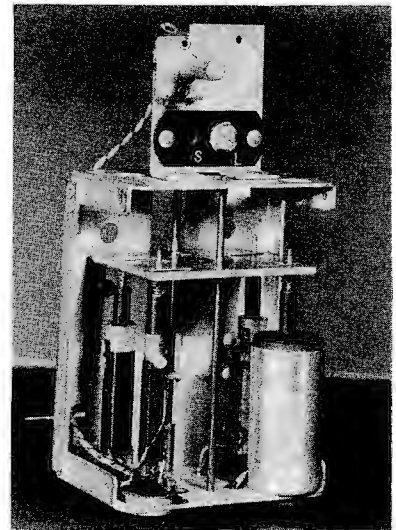

which fits around the windings and the center core acts as an electromagnetic and electrostatic shield. In some cases there is an additional or auxiliary shield such as a paper tube, the outside of which has been wrapped with a thin cylinder of copper foil. Sometimes other metals are used for the external shield.

Under test, the use of a powdered iron shield is said to increase the Q of a coil from say 150, with an aluminum shield, to 165. With an iron or "tin" can cover, the Q is reduced to 85. With zinc the Q would be 140.

Crolite high-frequency iron cores for permeability tuners are provided with screw insert for fixed insertion in coils.

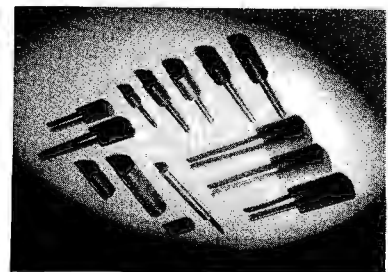

A PURCHASING GUIDE

Based On National Defense Program

PART I

By LEWIS WINNER

Market Research Engineer

MATERIAL	ORIGIN OF BASIC ORE	FULL PRIORITY	CRITICAL LIST	SUPPLY	HOW TO BUY
ALUMINUM (Bauxite)	New York Alabama Georgia Arkansas	Yes	...	Limited, though plants being built now may help. Improved rating already allowed for commercial equipment. Little hope for ordinary receivers.	Only where absolutely essential. Use other materials and methods wherever possible.
ANTIMONY	Arkansas South America China	...	Yes	Improving, with production increasing. Imports holding own.	With customary regularity. Overstock prohibited.
CADMIUM (recovered in process of zinc production)	New York New Jersey Oklahoma Kansas New Mexico Iowa Montana Idaho Utah Nevada Washington Missouri	...	Yes	Nominal now, as long as zinc production is maintained.	Cover operating needs, and hold small overstock.
CHROMIUM (Chromite ore)	Turkey Africa Philippines	Yes	...	Stockpile low. Domestic production not available yet.	Curtail and substitute.
COPPER	Tennessee Alabama Michigan New Mexico Colorado Oregon Montana Idaho Utah Arizona Nevada Washington Mexico Chile	Yes	...	Demand greater than production and import.	Hold as low as possible. Substitute methods will have to be used. Gov't will allow buying on essentials.
GRAPHITE	Alabama Mexico	...	Yes	Adequate stockpile for at least a year.	Proceed in usual fashion. No need to overstock.
LEAD	Alabama Iowa New Mexico Montana Nevada Washington Missouri Oklahoma Colorado Idaho Oregon Mexico	...	Yes	Excellent domestic production and good imports affording ample supply.	Purchase as needed, but do not build too high an inventory.
MAGNESIUM	Gulf of Mexico (Sea Water)	Yes	...	Good production, but defense demands require all available.	Eliminate from schedule now; has, however, excellent possibilities in latter part of '42.
MANGANESE (Ore)	Georgia Montana Nevada Cuba Africa	...	Yes	Adequate production and import, but requirements running high.	Hold to current requirements. Allow Gov't to build stockpiles.
MERCURY	Nevada California Mexico	...	Yes	Plentiful.	Buy as needed. No need to overstock.

*Copyright, 1941, by Lewis Winner.

Over the Tape

BARBLEY ENTERS NAVY

Bob Barbley, Sales Manager of the National Recording Supply Co., Hollywood, resigned in August to enter the naval reserve as a chief petty officer.

NEELY AT I. R. E. CONVENTION

Norman B. Neely, manufacturers representative, spent several days in the Northwest during the latter part of August, attending the IRE Convention in Seattle, Washington.

LEAFLET ON VOLTAGE RELAYS

Relays to protect 115 to 460-volt, 60-cycle circuits or apparatus against voltage changes of any predetermined value are described in a new 8-page bulletin announced by Westinghouse Electric and Manufacturing Company. Distinctive features, construction and operation are discussed. Voltage-time curves show per cent of maximum closing voltage at each setting of the relay time lever. Wiring diagrams show physical arrangement of coils and contacts as well as electrical connections. Outline drawings give overall dimensions and necessary mounting data. A tabulation lists styles and prices for 25 and 60-cycle relays for operation on 115 to 460-volt circuits. A copy of catalog section 41-291 may be secured from department 7-N-20, Westinghouse Electric and Manufacturing Company, East Pittsburgh, Pennsylvania.

TRANSMITTING CAPACITOR CATALOG

New types, revised listings and additional application data are covered in the 2nd edition of the transmitting capacitor catalog just issued by Aerovox Corporation of New Bedford, Mass. This handsome loose-leaf book, available to those engaged in designing, building and maintenance of commercial radio and electronic equipment, is kept up to date by the new pages issued from time to time, each copy being numbered and registered in the name of the holder for just such purpose. Registered recipients of the 1st edition will thus automatically receive the new sheets. Aerovox jobbers also have file copies which can be consulted by the trade interested in extra-heavy-duty types of capacitors.

GLASS DISC DISTRIBUTION

Presto Recording Corp., 242 W. 55th St., New York City, reports that neither domestic nor foreign distribution of their new glass base disc presents any problem in shipping or handling. Shipments were made to 14 foreign countries within a month after the disc was announced. Reports from tropical countries indicate that the glass base disc is unaffected by temperature or humidity.

TELEVISION STATION

Philadelphia's first television station, W3XE, owned and operated by Philco Radio and Television Corporation, has just been granted a commercial license for 60 days beginning September 1st, pending completion of installation of full power. Present power of the station is 3,000 watts, and it is expected that this will be increased

shortly to 10,000 watts, according to David Grimes, Chief Engineer of Philco. W3XE operates on channel 3, having a wave length of 66-72 megacycles.

PHILCO APPOINTMENTS

Election of Larry E. Cubb, former Executive Vice-President, to the office of Chairman of the Board of Philco Corporation, was announced today. Several other promotions were also made public at the same time. John Ballantyne, former Treasurer, was elected Vice-President in Charge of Operations; Thomas A. Kennally, formerly General Sales Manager, was named Vice-President in Charge of Sales; W. R. Wilson, Controller, succeeded Mr. Ballantyne as Treasurer; and James H. Carmine, former Assistant General Sales Manager, became General Sales Manager.

ALLIED RADIO CATALOG

Allied Radio Corporation has announced the release of a new 1942 catalog. A large publication comprising 212 pages, it represents months of preparation, research and market-combing in tabulating complete stocks of everything in radio. All merchan-



dise is carefully arranged in clearly defined sections and precisely indexed for speedy reference. It may be had free of charge from Allied Radio Corporation, 833 West Jackson Boulevard, Chicago.

ON ACTIVE DUTY

Pierre Boucheron, general sales manager of Farnsworth Television & Radio Corp. has been called to active duty as Lieutenant Commander in the U. S. Naval Reserve. Now stationed in Washington, he is preparing to leave shortly on a foreign assignment.

NEW BOOKLET

A new 8-page booklet for use in securing maximum protection on distribution circuits has just been announced by Westinghouse Electric and Manufacturing Co., East Pittsburgh, Pa. Several types of protective gaps are described as are insulated gaps designed to isolate the secondary neutral of a distribution transformer from the primary lightning arrester ground during normal conditions. Write to Westinghouse for your copy.

G.E. EXPANSION

Plans for a new building to be erected by the General Electric Company, for the manufacture here of industrial and radio tubes, have been announced by Dr. W. R. G. Baker, manager of the company's Radio and Television Department.

Construction will start within a few weeks. The building, to be located at the Westerly side of the Schenectady Works, is expected to be ready for operation by February. A single-story manufacturing section will contain 120,000 square feet of floor space while 15,000 square feet of floor space will be available in a two-story office section.

The new facilities will provide greater capacity for the manufacture of the company's lines of vacuum tubes which include air- and water-cooled radio transmitting tubes, ignitrons, hot-cathode mercury-vapor rectifiers, thyatron, high-vacuum rectifiers, phototubes, cathode-ray tubes, special receiver tubes, vacuum capacitors, measurement tubes, vacuum switches, vacuum and ionization gages, ballast tubes, vacuum flasks and similar products.

TEMCO MOVES

Transmitter Equipment Mfg. Co., Inc., have announced the removal of their executive offices, laboratory and factory to a modern plant at 3601 35th Ave., Long Island City, N. Y.

CONTINENTAL MUSIC DISTRIBUTOR

National Recording Supply Co., Hollywood, has been appointed west coast distributors for Continental Record Cabinets, made in Chicago by the Continental Music Co.

MICROPHONE SHIPMENTS

Frazar and Co., San Francisco, export agents for the Universal Microphone Co., Inglewood, Cal., in September shipped the last of a large monthly order of Universal aircraft microphones and earphones to the Union of South Africa.

NATIONAL RECORDING DISPLAY

In an effort to streamline its display of cutting needles, National Recording Supply Co., Hollywood, has issued a new dealer display board on which the firm has confined the line to three types. This, says Francis H. Brown, president, is in the interest of national defense movements which call for fewer models, thus releasing tools and manpower for other work. Effective on the release of the new display board, National's cutting line will hereafter be confined to the three types, in addition to its regular line of playback needles, lubricants and standard recording accessories.

UNIVERSAL MICROPHONE APPOINTMENT

Harry A. Turner has been appointed production supervisor at the Universal Microphone Co., Inglewood, Cal. An expert in time and motion study, he has a background of 40 years in die tool design at typewriter and automobile factories in the east.

CLOUGH-BRENGLE CATALOG

A new 24-page catalog covering their line of precision, laboratory and maintenance instruments for the radio and communications industry has just been announced by the Clough-Brengle Co., 5501 Broadway, Chicago, Ill. Copies are available on request.



MILITARY TYPE HANDI-MIKE

Unexcelled for use with mobile transmitters, sound trucks, call systems, sports arenas, carnivals, etc. Clear, crisp voice reproduction. Balanced grip, polished chrome plate, snap switch, 6 ft. flexible cord. Choice of circuits and switches, single or double button carbon, crystal or dynamic. All impedances. At your dealer or jobber.

UNIVERSAL MICROPHONE CO., LTD.

Inglewood Calif., U. S. A.



We manufacture a complete line of Electric Spot Welders, 1/2 to 250 KVA. Standard and Special Transformers. Incandescent lamp, radio tube, neon tube and fluorescent tube making equipment. Glass cutting, slicing and working equipment. College laboratory units. Vacuum pumps. Wire Butt Welders. A.C. Arc Welders from 100-400 Amps.

Write for Information.

Eisler Engineering Company

CHAS. EISLER, Pres.
741 S. 13th St. (Avon Ave.) Newark, N. J.



**AMATEUR
UNCON-
DITIONALLY
GUARANTEED**



COMMERCIAL

**WRITE US
FOR PRICES
Fast Service**

PETERSEN RADIO CO., Council Bluffs, Iowa

CANNON SOUND PLUGS AND RECEPTACLES

NOW STOCKED IN NEW YORK—The Cannon Electric Development Co. of Los Angeles has appointed us as distributors of their sound plugs and receptacles. Here is more evidence of Terminal's regular and reliable delivery of essential materials in the face of trying conditions.

TERMINAL RADIO CORP.
2 stores in New York City
Vanderbilt 6-5050

[68 West 45th Street
80 Cortlandt Street]

CRYSTALS by HIPOWER

The Hipower Crystal Company, one of America's oldest and largest manufacturers of precision crystal units, is able to offer the broadcaster and manufacturer attractive prices because of their large production and the exclusive Hipower grinding process. Whatever your crystal need may be, Hipower can supply it. Write today for full information.

HIPOWER CRYSTAL CO.

Sales Division—205 W. Wacker Drive, Chicago
Factory—2035 Charleston Street, Chicago, Ill.

When You Renew Your Subscription to

COMMUNICATIONS

Remember the Group Rate—\$1.00 a year for four or more subscriptions.

Regular Rate—\$2.00 a year in U. S. A.—\$3.00 in foreign countries



JOIN AMERICAN RED CROSS

FM/AM

In one General Coverage UHF RECEIVER



Incorporating both Frequency Modulation and Amplitude Modulation in one U.H.F. receiver. Covers three bands, 28 to 46 mc., 45 to 84 mc., 81 to 142 mc. Switch changing from FM to AM reception. Acorn tubes in RF and converter system. High gain 1852 tubes in iron core IF stages. Beam power tubes in AF amplifier. Controls are: RF gain control, band switch, antenna trimmer, IF selectivity control and power switch, volume control, pitch control, tone control, "S" meter adjustment, AVC control, off switch, send-receive switch, phone jack, amplitude of frequency modulation switch, 15 tubes. Operates on 110 volt 50-60 cycle AC. Model S-27 complete with tubes, \$195.00

the hallicrafters co.
CHICAGO, U. S. A.

*USED BY 33 GOVERNMENTS
SOLD IN 89 COUNTRIES*

**On land—
In the air—
On the sea—**

Wise Engineers are subscribing to

COMMUNICATIONS

COMMUNICATIONS
19 E. 47th St., N. Y. C.

Please enter annual subscriptions (12 issues) for each of the undersigned for which payment is enclosed at the rate of \$1.00 each. (This rate applies only on 4 or more subscriptions when occupations are given.) Foreign Subscriptions are \$2.00 each.

Name.....
Street.....
City-State.....
Occupation or title.....
Employed by.....
Nature of business.....
(State if Manufacturer, Broadcast Station, etc.)
Product.....

Name.....
Street.....
City-State.....
Occupation or title.....
Employed by.....
Nature of business.....
(State if Manufacturer, Broadcast Station, etc.)
Product.....

Name.....
Street.....
City-State.....
Occupation or title.....
Employed by.....
Nature of business.....
(State if Manufacturer, Broadcast Station, etc.)
Product.....

Name.....
Street.....
City-State.....
Occupation or title.....
Employed by.....
Nature of business.....
(State if Manufacturer, Broadcast Station, etc.)
Product.....

**ACT
NOW!**

Get three or more of your associates to join a Group with you. Hundreds of leading engineers and technicians have subscribed year after year on that basis. Use the convenient form on this page. Fill in the names, tear out and mail today with your check or money order. Renewals and extensions are acceptable also.

**at the low group
rate of only
\$1.00 per year.
12 big issues**

A regular yearly subscription to **COMMUNICATIONS** costs \$2.00—but when four or more men sign up at one time, each one is entitled to the half-price rate. (Foreign subscribers on the "G-S-P" only pay \$2 each).

RCA BULLETIN

The Aviation Radio Section, RCA Manufacturing Co., Inc., Camden, N. J., have just released a bulletin giving technical data on the AVT-110 and AVT-111 aircraft transmitters. The former unit has a dry battery power supply while the latter equipment is operated from a storage battery power supply. Copies available from the above organization.

INTERNATIONAL NICKEL BULLETIN

"Individualized Inco Nickel Alloys"—a twelve-page catalog giving individual characteristics, mechanical properties and application information on the Inco Nickel Alloys—Monel, "K" Monel, "KR" Monel, "S" Monel, "R" Monel, Nickel, "Z" Nickel and Inconel. Tables of physical constants and available forms are included. Copies are available upon request. The International Nickel Company, Inc., 67 Wall St., New York City.

**RELIEF SOUGHT
FOR**

RADIO PARTS MANUFACTURERS

Analyzing the problems confronting the radio parts industry, the Sales Managers' Club of Chicago appointed a Priorities Committee consisting of S. N. Shure, President of Shure Bros., Chicago; W. J. Halligan, President The Hallicrafters, Inc., Chicago; H. E. Osmun, Vice-President, Centralab Division, Globe-Union Inc., Milwaukee. The Committee retained Kenneth G. Prince as its counsel to prepare a brief on behalf of the radio parts industry and present it in Washington.

The Committee held frequent meetings to study the problems in the radio parts industry, and to evolve a means of obtaining consideration in Washington for a preference rating. Working in unison with the RMA Priorities Committee for the betterment of the entire radio industry the Committee and its counsel presented a brief to the office of Price Administration and Civilian Supply and to the Office of Production Management.

The brief asked for an allocation on sufficient raw materials to enable radio parts manufacturers to fabricate replacement parts for repair and maintenance of existing receivers. It is necessary that the industry furnish OPACS with figures showing the exact tonnage of each type of scarce material used by the industry annually, so that OPACS can know precisely how much of each raw material to allocate. OPACS realizes the difficulties which would be encountered in attempting to collect this information to allocate to the radio parts manufacturers approximately 60% of the raw material used by them in 1940 for the fabrication of repair and maintenance parts.

The 60% figure is predicated upon OPACS' belief that 40% of existing home receivers are what they term as "secondary sets" (the 2nd, 3rd, or 4th set in a home) which it is not essential to keep in repair.

The Committee were advised that manufacturers of radio parts might obtain an A-10 rating for that portion of the raw materials used to manufacture radio parts or accessories which found their way either directly or indirectly into Defense Supplies. It is estimated by the Committee that approximately 20% of all sales made by jobbers are now going into Defense Supplies and that if the jobber keeps accurate records, as the Committee will later recommend, a manufacturer can, in turn, receive an A-10 rating of 20% of his raw material requirements, which will put him in a position to re-stock the jobber.

A. T. & T. APPOINTMENT

L. G. Woodford, Assistant Vice-President of the American Telephone and Telegraph Company, has been appointed Chief Engineer of the company, effective immediately. Since July, 1940, Mr. Woodford has been in charge of the company's department of operation and engineering in the absence on leave of Vice-President W. H. Harrison, now in Washington as Director of the Production Division of the O.P.M. Mr. Woodford will report to Vice-President C. P. Cooper, pending Mr. Harrison's return.

ELECTROVOX EXPANDS

Increasing business has caused the Electrovox Company to increase all manufacturing facilities and move into larger quarters at 356 Glenwood Avenue, East Orange, N. J.

RCA APPOINTMENTS

Meade Brunet and Jay D. Cook have been elected Vice Presidents of the RCA Manufacturing Company by the Board of Directors, it has been announced by George K. Throckmorton, President.

Mr. Brunet, whose service with RCA and predecessor companies dates from 1919, will continue his present duties as Manager of the Engineering Products Division, including United States Government business. Mr. Cook, whose 14 years with RCA and a predecessor company began in the cost accounting department, will continue in charge of the International Division, which handles the company's export business and directs the activities of its foreign subsidiary companies.

G-E BOOKLET

The plastic department of the General Electric Company, Pittsfield, Mass., has prepared a 64-page illustrated booklet telling how Textolite plastics are made—covering each step from raw materials to the finished product—and indicating the variety of applications for which different types of Textolite are suited.

The booklet may be classed as an introductory encyclopedia on plastics manufacturing, since it covers the whole range of operations of the G-E plastics department.

In eight sections the booklet covers raw materials, development, designing and engineering, mold making, molding, laminating and fabricated parts, industrial design, and commercial policy. Two other sections present in chart form the properties of Textolite molded and Textolite laminated.

WEBSTER-RAULAND MOVES

Webster-Rauland, one of the largest manufacturers of sound equipment are now located in their new, modern, one-story plant at 4245 Knox Avenue, Chicago, Illinois. The Rauland Corporation was started twelve years ago by E. N. Rauland, a pioneer in the field of sound. Mr. Rauland's experience dates back to the first World War where he served actively in France as an officer in the U. S. Signal Corps.

HOWARD EXECUTIVE RETURNS TO PACIFIC COAST

Mr. Charles B. Shapiro, Executive Vice-President of the Howard Radio Company of Chicago, has returned to the Pacific Coast to resume his duties as chief of far-western sales. Mr. Shapiro had been temporarily re-called to Chicago to organize Howard's new Cabinet Plant.

A
V
I
A
T
I
O
N

Bliley Crystals



Positive, dependable frequency control for radio transmitters in marine-craft (ship harbor service) and in itinerant aircraft (3105kc. and 6210kc.) is economically obtained with the type MC5 Crystal Unit. This unit, low in cost yet precision-built, is made possible by the application of quantity production methods to an essentially custom manufactured product. WRITE FOR CATALOG 6-12

★
M
A
R
I
N
E
★

BLILEY ELECTRIC COMPANY

UNION STATION BUILDINGERIE, PA.

JONES 500 SERIES PLUGS AND SOCKETS

Designed for 5,000 volts and 25 amperes. All sizes polarized to prevent incorrect connections, no matter how many sizes used on a single installation. Fulfills every electrical and mechanical requirement. Easy to wire and instantly accessible for inspection. Sizes: 2, 4, 6, 8, 10, and 12 contacts. Send for a copy of Bulletin 500 for complete information. Write today.

HOWARD B. JONES

2300 WABANSIA AVENUE, CHICAGO





"Sylvaloy"

FILAMENT

Dependability... Uniformity

WILBUR B. DRIVER CO.
NEWARK, NEW JERSEY



STYLED FOR *Beauty*
ENGINEERED FOR *Silence*
NEW
FAIRCHILD
Cabinet Model
Transcription Turntable



- New-style mounting for lower noise level.
- All-metal cabinet; gun-metal finish, chrome trim.
- Famous Fairchild units perform better than ever in these new cabinets. 30" high.
- Roomy disc storage cabinets.

Write for Literature.

"...it had to satisfy Fairchild first"



AVIATION CORPORATION
 88-06 Van Wyck Boulevard, Jamaica, L. I., N. Y.

LAMINATIONS
 for Output TRANSFORMERS
 of Highest Permeability

Standard stocks in a wide range of sizes for Audio, Choke, Output and Power Transformers. Write for dimension sheets.

Permanent MAGNETS
 ALNICO (Cast or Sintered)
 COBALT-CHROME-TUNGSTEN

Cast, formed or stamped permanent magnets for all purposes. Engineering cooperation backed by 38 years experience in magnet making.

TOOLS • DIES • STAMPINGS
 HEAT TREATING

Thomas & Skinner
 Steel Products Co.
 1113 E. 23rd St. Indianapolis, Ind.

RMA RE-APPOINTS COOGAN

W. A. Coogan, Foreign Sales Manager, Hygrade Sylvania Corporation, has been re-appointed chairman of the R. M. A. export committee for the coming year. Four important meetings are held during the year, two in New York and two in Chicago, for discussion and cooperative action on radio export problems arising out of the fast changing economic structures of foreign countries, involving Foreign Exchange, Quotas, Licenses, etc.

Under Mr. Coogan's chairmanship, the policy of delegating to sub-committees the exploration of the more vital and pressing radio export subjects will be continued. Sub-committees active at present are, Ocean Freight Traffic Committee, Webb-Pomerene Act Committee, and the Priority Committee.

Overseas radio sales for 1940 were up \$1,439,118 over 1939 with receiving sets and transmitting apparatus showing the greatest increases. Total 1939 dollar volume for receiving sets, receiving tubes, components, loud speakers, other accessories, and transmitting apparatus, was \$22,179, 871; for 1940, \$23,618,989.

SYLVANIA TECHNICAL MANUAL SUPPLEMENT

Bringing the fifth edition, second printing, of the Sylvania Radio Tube Technical Manual up to date is a six-page, parallel fold supplement which lists all types announced in the interim. It is strip gummed on the back page permitting easy mounting to the inside back cover of the Technical Manual. These supplements are being offered free to all holders of the Sylvania Technical Manual. They can be secured either through Sylvania jobbers or by writing direct to Hygrade Sylvania Corporation, Emporium, Pa. The current Technical Manual is being shipped to purchasers with the new supplement fastened in place. The price remains unchanged, 35c.

BOOKLET ON MYCALEX

The plastics department of the General Electric Company, Pittsfield, Mass., has issued a 10-page booklet, illustrated with photographs and charts, explaining the nature, properties, advantages and applications of G-E Mycalex. It was announced recently that G-E had perfected a technique for the molding of Mycalex by the injection process, thereby broadening the field of its usefulness by permitting the production of more intricate shapes.

JENSEN LITERATURE

Condensed catalog No. 125 describes new Hypex Projectors, coaxial speakers and reproducers with high-frequency control. Form No. 126 is a treatise on "Hypex Horns" by Dr. Vincent Salmon. Form No. 127, "Loudspeakers for Speech and Music Reproduction," by Ralph P. Glover, analyses the requirements for speech and music reproduction. Data Sheet No. 123 completely describes Hypex Projectors employing the improved new formula non-exponential "Hypex" Horn and "Annular" driver unit. Jensen Radio Mfg. Co., 6601 South Laramie Ave., Chicago, Illinois.

HOWARD LITERATURE

A new folder, describing and illustrating the Howard Model 445 a-c—d-c universal communications receiver, is now available upon request from the Howard

radio Company, 1735 West Belmont Avenue, Chicago, Illinois, or through its distributors. Ask for Folder 108.

WESTINGHOUSE BULLETIN

Miniature a-c and d-c voltmeters and ammeters in the two-inch classification for general use are described in a new 12-page bulletin announced by Westinghouse. Full-scale readings on the d-c ammeter series are from 20 microamperes to 100 amperes and on the a-c units, from 5 milliamperes to 50 amperes. Voltmeter calibrations are from 5 millivolts to 1000 volts full scale on both a-c and d-c lines.

Permanent white dials, interchangeability of parts, and high overload capacity are among the features discussed. Operation and construction are described with a note on repulsion vane types for a-c circuits. Typical instruments are illustrated and cutaway views show construction details. A complete tabulation lists ratings, scale divisions, style numbers and list prices.

A copy of catalog section 43-330 may be secured from department 7-N-20, Westinghouse Electric and Manufacturing Company, East Pittsburgh, Pennsylvania.

SHURE & KAHN HEAD SALES MANAGERS CLUB, WESTERN GROUP

S. N. Shure of Shure Brothers and Jerome J. Kahn of Standard Transformer Corporation have been elected Chairman and Vice-Chairman respectively for the ensuing year by the Sales Managers Club, Western Group. They succeed John J. Robinson of Crowe Name Plate and Manufacturing Company and W. S. Hartford of Webster-Chicago.

CONSOLIDATED WIRE EXPANDS

Consolidated Wire & Associated Corporations announces that on September 1st all production and general office facilities had been moved to new and larger quarters at 1635 S. Clinton Street, Chicago, Ill. According to J. G. Mann, Treasurer, who released the announcement, the move is being made to facilitate the handling of orders for the numerous products of the company.

\$2,400,000 G-E EXPANSION

Construction of a new \$1,275,000 building for the assembly and testing of radio equipment for the Army and Navy has been started, according to an announcement by Charles E. Wilson, President of the General Electric Company.

The building, to be equipped at an additional cost of \$1,000,000, is part of a \$2,400,000 project of the Defense Plant Corporation for expansion of radio manufacturing facilities at the General Electric Plant here. The program includes purchase and renovation of the old Weber Electric Company plant. It will provide employment for approximately 2000 workers.

The new building, a single-story wooden structure 1000 feet long and 200 feet wide with 200,000 square feet of floor space, is expected to be finished by Oct. 1 and all equipment installed by next June. The Weber plant renovations, which will provide approximately 60,000 additional square feet of floor space, are expected to be completed by the first of next month. Production is already under way in part of this space.

The buildings and equipment, financed by the Defense Plant Corporation, will be operated by the General Electric Company, but title will remain with the government.

RESISTANCE TUNED AUDIO OSCILLATORS



LOW DISTORTION—less than 1% for distortion measurements on high quality audio equipment and broadcast transmitters.

EXCELLENT STABILITY—saves time because NO ZERO SETTING necessary.

WIDE FREQUENCY RANGE—models available from 5 cps. to 200,000 cps.

HIGH OUTPUT—models available with 1 to 5 watts output.

INEXPENSIVE—the Model 200B, 20-20,000 cps., 1 watt output—only \$85.80 net f.o.b. Palo Alto, California.

Write for complete information about these and other instruments

HEWLETT-PACKARD CO.

481 Page Mill Road • Palo Alto, California

YOUR ONE DEPENDABLE SOURCE OF SUPPLY . . .



VAST
COMPLETE
STOCKS

★
Immediate
Delivery
★

Your ALLIED Catalog!

EVERYTHING FOR THE FIELD OF ELECTRONICS

Today, more than ever, ALLIED is the name that means Everything in Radio. And more than ever, the new FREE 212-Page ALLIED Catalog is your Buying Guide to materials, parts, components and supplies for engineering, communications, laboratory and industrial applications of electronic equipment. You'll find more than 15,000 essential items in the new ALLIED Catalog—test equipment, communication sets, x-mitting gear—Everything in Radio—ready for delivery—all at the lowest prices. Reserve your copy of this Radio Buying Guide now!

Address Dept. 31-J-1 for
FREE copy.



ALLIED RADIO
833 W. JACKSON • CHICAGO

TRANSCRIPTIONS

(continued from page 11)

esting information shown in Tables II and III was obtained from the 197 stations reporting.

These figures explain the interest and enthusiasm that has been shown by the broadcasters in this project. The importance to them is evident when it is considered that almost one-third of their program material is obtained from disc recordings. Obviously, too much effort cannot be expended on this phase of the industry in order to provide the ultimate in performance.

The slightly greater preference for vertical over lateral recordings is interesting in the light of the fact that, including phonograph records, 78.7% of the recordings actually used are lateral-cut. Perhaps the lack of vertical reproducing equipment in some stations makes "distant fields more green," but then again it may be that the closer approach to standardization that has already been made in the vertical field results in more uniformly high quality and thereby accounts for the slight preference.

It is the aim of the Recording and Reproducing Standards Committee to formulate standards of good engineering practice covering all aspects of the recording and manufacture of electrical transcriptions upon which agreement can be reached. Furthermore, an effort will be made to reduce the number of variables to a minimum with the view to simplifying the users' problem of handling the record. Finally, an attempt will be made to correlate electrical transcriptions and phonograph record standards wherever possible.

The successful accomplishment of these aims will result in disc recordings that can be freely exchanged by all parties adhering to the standards with the assurance that the material will be faithfully reproduced and that the full advantage of modern, high-fidelity disc recordings is realized. This happy culmination of the project is contingent, of course, upon a continuance of the spirit of cooperation that has been manifested by those who have already taken an active part in the work and by those who have yet to be called upon. It is hoped that in spite of the many more urgent matters engaging the attention of practically everyone that enough time will be found to insure the success of this undertaking.

• • •

C-R PANEL

(continued from page 7)

nal is to be observed. When the plug or jack is inserted, automatic switching provides the proper sweep for the signal observed, and the operator has then



The Product of CATHODE-RAY HEADQUARTERS

★ Replete with features that make your work easier and more pleasant, DuMont Type 208 Cathode-Ray Oscillograph will extend your investigations into studies not previously feasible without much labor and expense. That is why it has already won the highest endorsements of users since its introduction a year ago.



This oscillograph is but one of a large line of instruments, cathode-ray tubes, and associated equipment developed, produced and marketed by the DuMont organization during a decade of intensive specialization. Such proven achievements have won for DuMont the enviable title of "Cathode-Ray Headquarters."



★ Write for DATA . . .

Technical bulletin on the Type 208 Oscillograph sent on request. Submit your cathode-ray oscillograph problem or application for our engineering aid.



POWER-
*When you need
it most!*



PINCOR
Motor-Generators

With PINCOR Motor-Generator sets there are no "emergencies." They are designed and built to furnish uninterrupted power through the years... an essential of power supply equipment.

These units are available in capacities to 10 kilowatts in a variety of types. PINCOR engineers are at your service. Write or wire for catalogue HMG 12 40!

PIONEER GEN-E-MOTOR
CHICAGO, ILLINOIS

Export Address: 25 Warren Street, N. Y., N. Y.
Cable: SIMONTRICE, New York



for
**production
testing**

the Model 14 is tried and proven

- **Maximum economy**
- **Maximum dependability**
- **10 frequencies as selected**
- **Variable air condenser for each frequency**
- **Range 100 k. c. thru F-M band**

Additional information on this and other Signal Generators on request.

Monarch MANUFACTURING CO.
3341 Belmont Ave. Chicago, Ill.
Cable Address: "MONMACO"

to adjust the amplitude of the signal only. The amplitude adjustment is unnecessary in most cases as resistance networks throughout the unit provide the approximate amplitude required. Fig. 7 illustrates how this is accomplished, and the marking on the jacks.

Voltage and current readings are taken at all points in the radio receiver or transmitter circuit. These being obtained on an 8" 50-microampere movement meter. To obtain a voltage and current reading the operator has simply to insert a small plug in the jack marked V or M. Directly under this V or M is a small number 10 or 50, etc. This number corresponds to the scale to be read that is 0 to 10 or 0 to 50 scale or whatever the case may be on the meter. The photograph in Fig. 4 shows the circuit and the jacks and how a reading is obtained.

Every effort has been made to eliminate the adjustment of controls or the wiring of leads during a demonstration. We feel that in doing this we have increased the efficiency of the unit tremendously. There is no confusion on the part of the class wondering what is going on when the instructor starts fiddling with a lot of controls, or patch cords, and further the instructor's time is utilized in lecturing and "setting up" equipment.

There were several problems to be overcome in the design of a panel such as this. A major problem was strays. The cathode-ray tube input leads are wired with one half-inch coaxial cable. Even with this low capacity cable, compensating condensers had to be used to prevent detuning effect in the r-f and i-f circuits. Another problem was providing the proper sweep for the signal to be observed. To do this properly we selected the 6 sweep frequencies most likely to be used in demonstrations. These frequencies are selected by means of relays which are operated by inserting the plug in the cathode-ray tubes throughout the panel. Another problem was providing the proper signal amplitude for visual observation. This was done by resistance and potentiometer networks, which reduced the signal to the level required.

There are only two places on the demonstration panel where patch cords are required. They are used to connect the output of each of the signal generators to the section of the receiver being demonstrated.

The use of completely wired circuits and automatic selectors have not limited the usefulness of the oscillograph. The oscillograph as an instrument has not been affected by these changes. The input to the oscillographs and controls are accessible and leads to other instruments are also possible.

The oscillographs themselves were originally 5-inch types. We use the sweep circuits and signal amplifiers of this unit to which we added a high-power amplifier using four 807's. There is sufficient voltage amplification to drive the 9" tubes used in the circuits. An external power supply for high voltage and for the 807's is provided in a separate unit for both the oscillographs. The advantages of using two oscillographs cannot be too strongly stressed. The simultaneous observation of the modulated envelope and the demodulated output of the detector is very impressive, and very illustrative for phase demonstrations. This is only one of many possible.

An electronic switch is also provided on the panel. This is connected automatically for observation of the input to the first a-f and the input to the second a-f or the out-of-phase input to the push-pull grid of the third a-f and the output of the third a-f. As in the rest of demonstration panel there are no patch cords, all sweep, synchronizing, and circuit connections being provided, simply by inserting the plug in the proper jack.

To prove the instructional value of the cathode ray demonstration panel a lecture was delivered to a class of 1,200 at No. 1 Wireless School, Montreal. This class represented groups in several phases of W.A.G., W.O.G., and W.E.M. training. After this lecture, several of the groups were interrogated to ascertain the success of the demonstration. The instructional staff of No. 1 Wireless School feel that as a result of this experiment the panel proved completely successful and that for theory instruction and maintenance instruction it surpassed the existing demonstration equipment and sound movies.

To ensure proper use of the demonstration panel a complete series of lectures and instructions have been written. These instructions will be improved from time to time and used as a standard with this panel.

It is interesting to note that the Navy and Army services of Canada are both interested in this panel to the extent of providing their schools with the instrument.

• • •

AMPLIFIER

(continued from page 16)

tion switch is incorporated on the panel, providing for instant choice of 78 r-p-m cutter, 33 1/3 r-p-m cutter, or playback. This switch not only selects the desired output device, but also introduces corresponding circuit changes which make for best performance of

each of these devices. Thus, in the 33 1/3 r-p-m cutter position a low-frequency attenuator is automatically introduced, properly proportioned to prevent the overcutting of "lows."

Another essential is the provision of wide impedance-matching latitude, making the system of use with any existing or planned lines, input or output equipment.

• • •

WVOA

(continued from page 18)

It is truly inspiring that such an organization as the Veteran Wireless Operators Association exists and in its activities includes scholarships in radio for aspiring and worthy young men. The American Institute deserves much credit for their fine cooperation with science students in high schools throughout the land. To these organizations I express my profound thanks for the honor accorded a young citizen of my city, John Marsey, during my public career, I have had many happy moments. This is one of the most enjoyable. The deep significance of the situation at present confronting our very existence makes it ever more important that you accredit yourself well. Mr. Marsey, as your Mayor, I dispatch you as a representative of the people of Youngstown, Ohio, to make the best possible use of the splendid training in Radio you will receive under this Marconi Memorial Scholarship."

MR. MARSEY: "Thank you, Mayor Spagnola. I feel deeply indebted to the Veteran Wireless Operators Association and the American Institute of the City of New York for the opportunity afforded me to secure a comprehensive education in Radio under the Marconi Memorial Scholarship. I deem it a signal honor that you, the Mayor of my home city of Youngstown, Ohio, made the presentation. And, then, too, Mayor, I certainly enjoyed the ride from Youngstown to Cleveland in your official car."

MR. McCONIGLE: "In the first contest conducted in 1939 for the Marconi Memorial Scholarship Robert Barkey, a graduate of Stuyvesant High School in New York City, was the winner. During the past two years Mr. Barkey has applied himself diligently and just last week received his diploma from RCA Institutes. Robert, I believe Mr. Poppele, Chief Engineer of WOR, has some interesting news for you."

"Jack" Poppele engaged Robert in an extemporaneous interview which concluded with an offer to Mr. Barkey to become a member of the engineering department of WOR. Mr. Barkey gratefully accepted the position and is now contributing his bit toward the further success of WOR.

• • •

MATERIALS

(continued from page 21)

alloy for cable sheathing, some 2,000,000 pounds of lead sleeving for cable splices, over 5,000,000 pounds of bronze wire bar, some 500,000 pounds of brass billets, over 3,000,000 pounds of solder in various forms, and more than 373,000 pounds of redistilled slab zinc. This year's totals are expected to mount considerably higher.

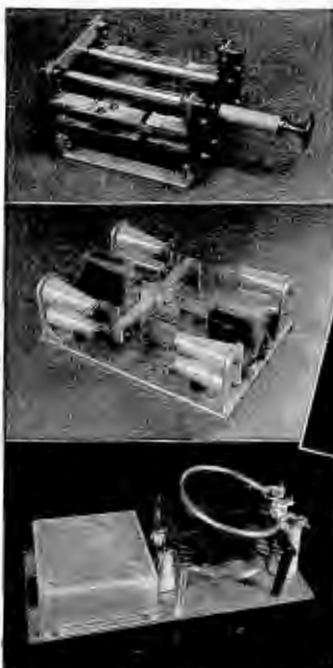

Hard to Get

COMPONENTS FOR BROADCASTING STATIONS

Illustrated are just a few of the many special items designed and built by Johnson. The R. F. Make-Before-Break switch permits the insertion or removal of a meter without breaking the circuit. The R. F. Contactor employs knife-type contacts and requires no holding current. Shown also is an Isolation Transformer for feeding a phase monitor or remote meter. The other illustration is a terminal fitting for a 2 3/8" concentric line on which an adjustable safety gap is provided.

Johnson Engineers design and build many pieces of apparatus for specific applications. If you have a problem, write to them for suggestions and recommendations.

ASK FOR THE NEW CATALOG 967E



E. F. JOHNSON CO

WASECA, MINNESOTA

EXPORT: 25 WARREN ST., NEW YORK, N. Y.

"MANUFACTURERS OF RADIO TRANSMITTING EQUIPMENT"

HUM BUCKING IN RECEIVERS WITH P-M SPEAKERS

IN RCA a-c, d-c receivers that use a p-m (permanent-magnet) speaker effective hum bucking is obtained through the use of an output transformer with tapped primary. The tap is established at a point where the "ampere turns" of ripple in the direction of the output plate balances the

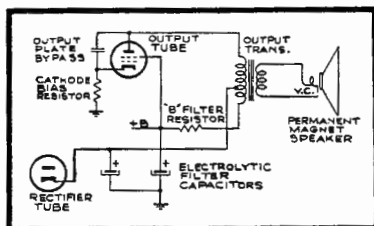

"ampere turns" of ripple in the direction of the screen and other plate circuits.

High residual hum (at zero volume setting) may be due to incorrect balance, and can usually be remedied by one of the following steps:

- Output tube with off-standard characteristics.
- Filter capacitor too low capacity, or too high internal resistance.
- B filter resistor not correct value. Measure resistance and change if necessary.
- Cathode bias resistor of output tube with incorrect value.
- If hum persists change the output-tube-plate by-pass to the rectifier cathode instead of to the output-tube cathode.
- If none of preceding steps reduces the hum to a satisfactory level, replace the output transformer.



WAXES AND COMPOUNDS

FOR INSULATION and WATERPROOFING of ELECTRICAL and RADIO COMPONENTS

● such as transformers, coils, power packs, pot heads, sockets, wiring devices, wet and dry batteries, etc. Also WAX SATURATORS for braided wire and tape and WAXES for radio parts. The facilities of our laboratories are at your disposal to help solve your problems.

FOUNDED 1846
Zophar MILLS, Inc.
120-26th ST., BROOKLYN, N. Y.

Radio's MASTER ENCYCLOPEDIA

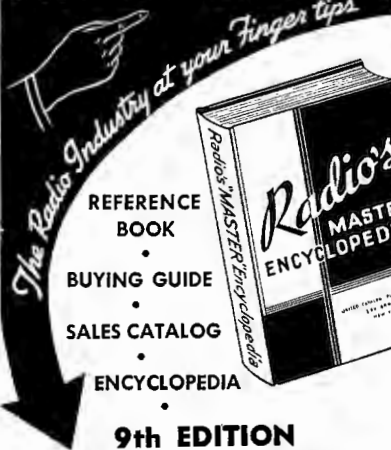

REFERENCE BOOK
BUYING GUIDE
SALES CATALOG
ENCYCLOPEDIA

**9th EDITION
OVER 800 PAGES**

THE ONLY OFFICIAL RADIO PARTS AND EQUIPMENT MANUAL

It took six years and thousands of dollars to develop this "MASTER CATALOG" of the radio industry to its present size—yet it costs you only \$2.50.

Compiled in co-operation with and approved by the Radio Manufacturers Group as the industry's official source book.

GIVES THIS IMPORTANT DATA

Contained within the hard covers of this 800 page MASTER BOOK are the listings of 90% of all Radio Parts and Equipment Manufacturers in the industry. In it you will find many thousands of items, such as electronic devices, transmitting and receiving sets, tubes, antennas, transformers, condensers, replacement parts, meters, laboratory test equipment, relays, plugs, coils, wire, and numerous other radio components. Thousands of clear illustrations with descriptions and specifications.—Yes, this is your "MUST HAVE BOOK".

•• WHO USES IT? ••

As the official source book of the radio industry it is constantly used by many American and Foreign governmental agencies, also industrial organizations, engineers, purchasing agents, laboratories, radio amateurs and service men, radio distributors, broadcast stations, schools, colleges, libraries, and by many others interested in Radio and allied fields.

SAVES TIME—SAVES MONEY

WHERE, WHAT AND HOW MUCH: Such information is instantly at your fingertips. This valuable RADIO MASTER eliminates the maintenance of bulky files. It is completely indexed for speedy reference.

If you buy, sell or specify you will find the RADIO MASTER an indispensable and handy book to have around at all times.

MONEY BACK GUARANTEE!

Order your copy today—look it over. You will find it to be an excellent investment; if not, return it to us in five days for full refund.

The price is only \$2.50 shipped anywhere in U.S.A. — \$3.00 elsewhere. We prepay transportation charges if remittance accompanies order.

UNITED CATALOG PUBLISHERS, Inc.
106A Lafayette St. New York, N. Y.

Index to Advertisers

A	
Advance Solvents and Chemicals Corp.	24
Allied Radio	33
Amperex Electronic Products, Inc. Inside Front Cover	
B	
Bliley Electric Co.	31
Brush Development Co.	15
D	
Daven Co., The.	23
Drake Mfg. Co.	36
Driver Co., Wilbur B.	31
DuMont Laboratories, Allen B.	33
E	
Eisler Engineering Co.	20
F	
Fairchild Aviation Corp.	32
G	
General Electric Co.	17
General Radio Co.	Inside Back Cover
H	
Hallcrafters Co., The.	20
Hewlett-Packard Co.	33
Hipower Crystal Co.	20
I	
International Resistance Co.	4
J	
Johnson Co., E. F.	35
Jones, Howard B.	31
L	
Lapp Insulator Co., Inc.	Back Cover
Lingo & Son, Inc., John E.	25
M	
Monarch Mfg. Co.	34
P	
Peterson Radio Co.	20
Pioneer Genemotor Corp.	34
Presto Recording Corp.	1
R	
Radio Amateur Call Book, Inc.	36
RCA Mfg. Co., Inc.	3, 13
T	
Terminal Radio Corp.	20
Thomas & Skinner Steel Prods. Co.	32
U	
United Catalog Publishers, Inc.	36
United Transformer Corp.	19
Universal Microphone Co., Ltd.	20
Z	
Zophar Mills, Inc.	35



PILOT LIGHT ASSEMBLIES

STANDARD TYPES IN LARGE VARIETY

Chances are you'll find it easy to get from us a standard type and size assembly to exactly suit your needs. For, we make stock units and parts in big variety. If a special design is required, our skillful engineers will gladly cooperate in creating a unit to exacting specifications.

Drake Assemblies are precision-built from finest materials. They are used by most leading electrical manufacturers. Will you write us about your needs?



SEND FOR CATALOG

DRAKE MANUFACTURING CO.
1713 W. HUBBARD ST. • CHICAGO, U. S. A.

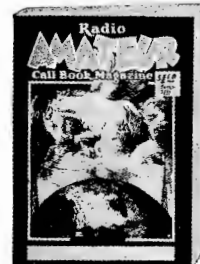

Radio Engineers

who are

RADIO AMATEURS

buy a fresh copy today of the

RADIO AMATEUR CALL BOOK

The CALLBOOK is the only publication that lists all licensed radio amateurs in the United States and foreign countries.

Complete . . . Accurate . . . Up-to-Date

Issued Quarterly

MARCH . . . JUNE . . . SEPTEMBER
and DECEMBER

Annual subscription \$4.00
Single copies \$1.25

Buy your copy now from your radio jobber
or direct from:

Radio Amateur Call Book, Inc.
608 S. Dearborn St., Chicago, Ill., U. S. A.



MAKING PRECISION CONDENSERS

ILLUSTRATIVE of the precision employed in the mechanical design of GENERAL RADIO products is the popular Type 722 Condenser series. In the manufacture of precision condensers the mechanical design has considerable bearing upon the ultimate accuracy obtainable.

The Type 722 Condensers can be reset to 1 part in 25,000, an accuracy comparable to that obtained only in the finest type of precision machine. To secure this accuracy of setting, exceedingly close mechanical tolerances are held.

A 50-to-1 worm drive, equipped with a $3\frac{1}{2}$ inch dial, is used for the fine setting adjustment. Backlash in the drive is kept very low (less than one-half worm division) by cutting the worm and worm shaft from an integral steel shaft, thus eliminating eccentricity due to setscrews and misfit.

The worm shaft is held to a tolerance of 0.0004 inch; the radial eccentricity of the worm gear is held to less than 0.002 inch. The main rotor shaft is held to a radial tolerance of 0.0005 inch and its bearing surfaces to 0.0002 inch. Ball bearings are used on the worm and main rotor shafts.

To take full advantage of the mechanical refine-

ments of the worm drive, correspondingly important electrical and mechanical design features are incorporated in the other parts of these condensers. The main shaft, rotor and stator plates, tie rods and heavy cast frame are all fabricated from aluminum alloy. A remarkably low temperature coefficient of capacitance of only 0.0022 per cent per degree C. (22 parts per million) results from this construction.

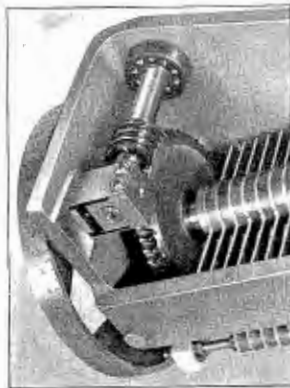

Small, properly placed waxed Isolantite bars insulate the rotor and stator plates. A figure of merit ($R\omega C^2$) of 0.04×10^{-12} , which is constant over the audio-frequency range and remains unchanged up to 75% relative humidity, is thus secured.

After assembly, the completed condensers pass through a number of aging cycles to relieve strains set up . . . strains which otherwise would not appear until years later. The condensers are then calibrated in our laboratories to an accuracy considerably better than that to which they are rated.

General Radio variable condensers have been used throughout the radio industry for years as the standard of variable capacitance. These condensers typify the care used in the electrical and mechanical design, production and testing of many General Radio instruments.

GENERAL RADIO COMPANY

CAMBRIDGE, MASSACHUSETTS

Branches in New York and Los Angeles

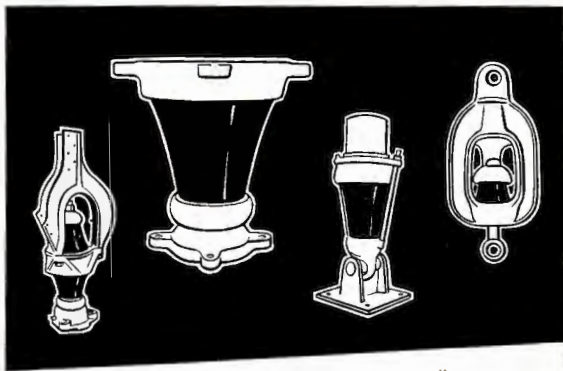

The largest and smallest. Lapp curved-side cones—for a low power pipe mast, and for the world's largest vertical radiator—1050 feet.



LAPP HAS MADE 142 DESIGNS

**IN ANTENNA
STRUCTURE INSULATORS**

**.. ALL ARE BASED ON THE
LAPP *CURVED-SIDE*
COMPRESSION CONE**

Each of the 142 Lapp units—for self-supporting towers, guyed masts and mast guys—is designed around the Lapp curved-side compression cone of electrical porcelain. More than 20 years of service records prove that this Lapp design meets every operating requirement. It affords double the strength of an ordinary straight-side cone, assuring the maximum in security and permanence. Finally, each insulator, before shipment, is tested by loading to 50% more than maximum design load. Most radio engineers know they've covered the insulator question adequately when they say to their tower manufacturer, "Use Lapp Insulators." Lapp Insulator Co., Inc., LeRoy, N. Y.

Specify **LAPP**
FOR SECURITY IN ANTENNA STRUCTURE INSULATORS