

From the Oldest to the Newest



ELECTRON POWER TUBES

Bulletin CDB-5

Catalog of Basic Types
and Index to Our
New Product Lines

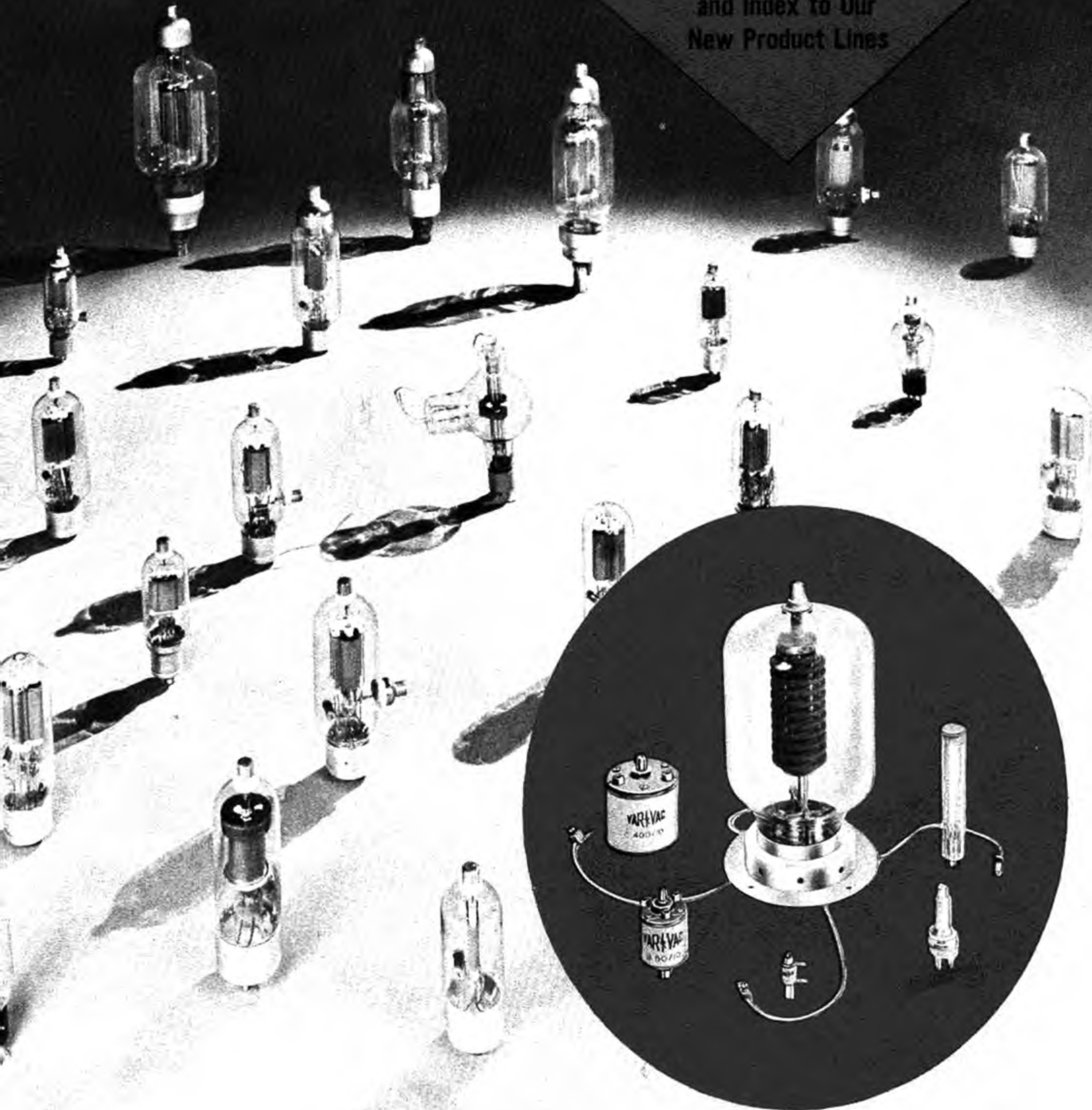

UNITED ELECTRONICS COMPANY

A DIVISION OF THE LING ELECTRONICS, INC. GROUP

42 SPRING STREET

SINCE 1934

NEWARK 4, NEW JERSEY

Foreword

At the time it became one of the LING ELECTRONICS, INC. group of industries in 1958, UNITED ELECTRONICS was one of the first six or seven companies longest engaged in the design and manufacture of transmitting power tubes for the general market. We believe it was then the only one of this group still in its original entity, remaining exclusively a producer of special purpose transmitting type tubes. Altogether, there are 24 or more companies who, among other activities, are now engaged in the production of this class of product.

The wide array of basic types you see displayed in this catalog have been continuously updated over the years in design and processing techniques. They, like our new era types, stand as industry criterions in quality and dependability. In detail, this catalog describes only our old basic types. It also indexes all of our contemporary product classes, and the special data bulletins describing them. Copies of these bulletins are available upon request.



NEWER PRODUCT GROUPS

EXTERNAL ANODE POWER DIODES AND TRIODES

Originally designed for oil immersed applications, many of the clipper diode rectifiers described herein are widely used in radiation cooled applications as well as in oil. Featuring low heater power and high inverse voltages the tubes are ideal for application under severe environmental conditions. Type 567, a metal-ceramic high mu triode, has recently been added to this group.



MAJOR SERIES, HIGH POWER INTERNAL ANODE, DIODES AND TRIODES

The wide application of types such as the X-80 and 561 in high power radar equipment attest to UNITED's position of superiority and leadership in this field. Featuring graphite anodes, bonded thoria filaments, and rugged construction, the tubes are well known to design engineers concerned with high power applications. A new triode being developed for SSB grounded grid linear operation has joined this group.



INTERMEDIATE POWER INTERNAL ANODE DIODES AND TRIODES

Fourteen clipper diode-rectifiers with peak inverse voltages between 2 and 40 kilovolts are described in this bulletin. Many feature the latest UNITED design improvements such as the large circumference kovar top seal, and have been recently designed to meet the critical size requirements, environmental conditions, and high power needs of modern electronic systems.

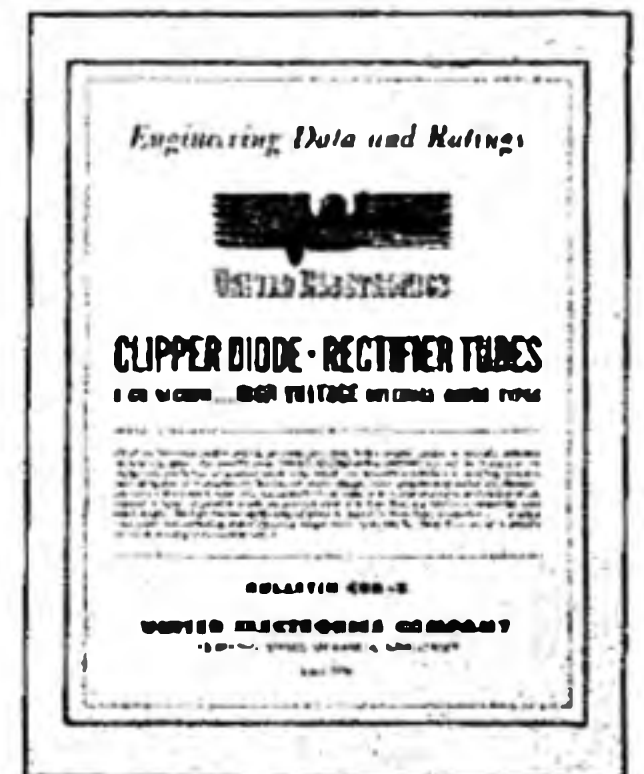

VARIABLE VACUUM CAPACITORS, CERAMIC ENVELOPE TYPE

This bulletin describes metal-ceramic variable vacuum capacitors capable of operating at temperatures up to 500° C under extremes of shock and vibration. These variable capacitors are unaffected by changes in atmospheric conditions such as pressure and humidity.

BASIC PRODUCT TYPES



TYPE 3B28
See Page 13**



TYPE 4B32
See Page 13**



TYPE CV-11
See Pages 6* and 13**



TYPE UXCv-11
See Pages 6* and 13**



TYPE HV-18
See Pages 6* and 13**



TYPE FV-20
See Pages 7* and 13**



TYPE KU-23
See Pages 7* and 13**



TYPE V70D
See Pages 8* and 13**



TYPE UE-100
See Pages 8* and 13**



TYPE 203 WA
See Pages 9* and 13**



TYPE 211W
See Pages 9* and 13**



TYPE 242C
See Pages 9* and 13**



TYPE 265
See Pages 10* and 14**



TYPE 311CH
See Pages 10* and 14**



TYPE 311CT
See Pages 10* and 13**



TYPE 311T
See Pages 9* and 13**



TYPE 468
See Pages 6* and 14**



TYPE 805
See Pages 11* and 14**



TYPE 810
See Pages 11* and 14**



TYPE 830B
See Pages 12* and 14**



TYPE 845W
See Pages 12* and 13**



TYPE 966
See Page 14**



TYPE 973
See Page 14**



TYPE UX973
See Page 14**



TYPE 8008XE
See Page 14**

VACUUM TRIODES

TYPE NO.	FILAMENT		Mu	MAX. ANODE RATINGS			TYPICAL OPERATION							INTERELECTRODE CAPACITANCE — mmf			MAX. FREQ. MC/SEC FULL INPUT
	Volts	Amps.		Volts	Amps.	Diss.	PLATE			GRID				G-P	G-F	P-F	
							Volts DC	Amps. DC	Output Watts	Volts DC	MA. DC	Driving Power Watts	Peak RF Grid Voltage				
CV-11	10	2.5	14	1500	.165	75	1250	.134	134	—200	5	1.5	300	9.0	5.0	2.3	30
UXCV-11	10	2.5	14	1500	.165	75	1250	.134	134	—200	5	1.5	300	9.0	5.0	2.3	30
HV-18	10	3.85	18	2500	.210	200	2000	.183	282	—240	21	8.4	400	6.5	5.0	1.5	50
FV-20	10	3.75	20	1750	.200	150	1500	.169	176	—200	10	2.0	380	6.8	5.1	3.5	50
KU-23	11	4.00	23	3000	.275	250	2500	.246	448	—250	18	7.6	435	6.5	6.0	1.4	30
V-70-D	7.5	3.25	28	1750	.170	85	1500	.148	182	—140	14	3.6	260	4.5	4.5	1.7	30
UE-100	10	2.5	23	1750	.150	75	1500	.148	183	—140	7	1.0	210	4.5	3.5	1.4	30
203-WA	10	3.25	25	1250	.175	100	1000	.165	113	—100	20	4.5	225	14.5	6.5	5.5	15
211-W	10	3.25	12	1250	.175	100	1000	.119	84	—180	12	2.5	210	14.5	6.0	5.5	15
242-C	10	3.25	12	1250	.175	100	1000	.119	84	—180	12	2.5	210	14.5	6.0	5.5	15
265	10	5.2	75	1800	.200	160	1500	.179	207	—80	18	1.4	180	11.0	7.8	3.8	15
311-CH	10	3.25	12	1750	.200	125	1500	.165	182	—300	12	5.7	470	8.0	5.5	4.5	30
311-CT	10	3.25	12	1500	.200	120	1500	.165	182	—300	12	5.7	470	8.0	5.5	4.0	20
311-T	10	3.25	12	1500	.200	100	1000	.119	84	—180	12	2.5	210	13.0	6.0	5.0	20
468	10	4.05	18	2500	.200	200	2000	.183	282	—240	21	8.4	400	7.0	8.8	1.25	30
805	10	3.25	100	1500	.210	125	1250	.182	158	—70	23	1.6	200	6.5	8.5	10.5	30
810	10	4.25	36	2500	.275	125	2000	.162	259	—150	22	5.8	265	4.8	8.7	12.0	30
830B	10	2.00	25	1000	.150	60	1000	.150	117	—160	33	10.1	310	11.0	5.0	1.8	15
845W	10	3.25	5	1250	.095	100	1000	.082	64	—400	2	0.6	500	13.5	6.0	6.5	15

GAS FILLED AND MERCURY VAPOR RECTIFIERS AND THYRATRONS

		Filament		Anode			Maximum Supply Frequency
		Vac	Aac	opx kv	ib a	lb Adc	
3B28	HALF-WAVE XENON* RECTIFIER	2.5	5.0	10	1.0	0.25	150**
4B32	HALF-WAVE XENON* RECTIFIER	5.0	7.25	10	5.0	1.25	150**
966	HALF-WAVE MERCURY VAPOR RECTIFIER	2.5	5.0	10	1.0	0.25	
973	MERCURY VAPOR GRID-CONTROLLED RECTIFIER	5.0	6.75	10	5.0	1.25	
UX-973	MERCURY VAPOR GRID-CONTROLLED RECTIFIER	5.0	6.75	10	5.0	1.25	
8008XE	HALF-WAVE XENON* RECTIFIER	5.0	7.25	10	5.0	1.25	150**

*Xenon-filled tubes operate over wide ambient temperature range without heating or cooling devices.

**For applications where the supply frequency exceeds 150 cps the use of a vacuum rectifier should be considered.

TABLE OF AVERAGE CHARACTERISTICS

CHARACTERISTICS CURVES

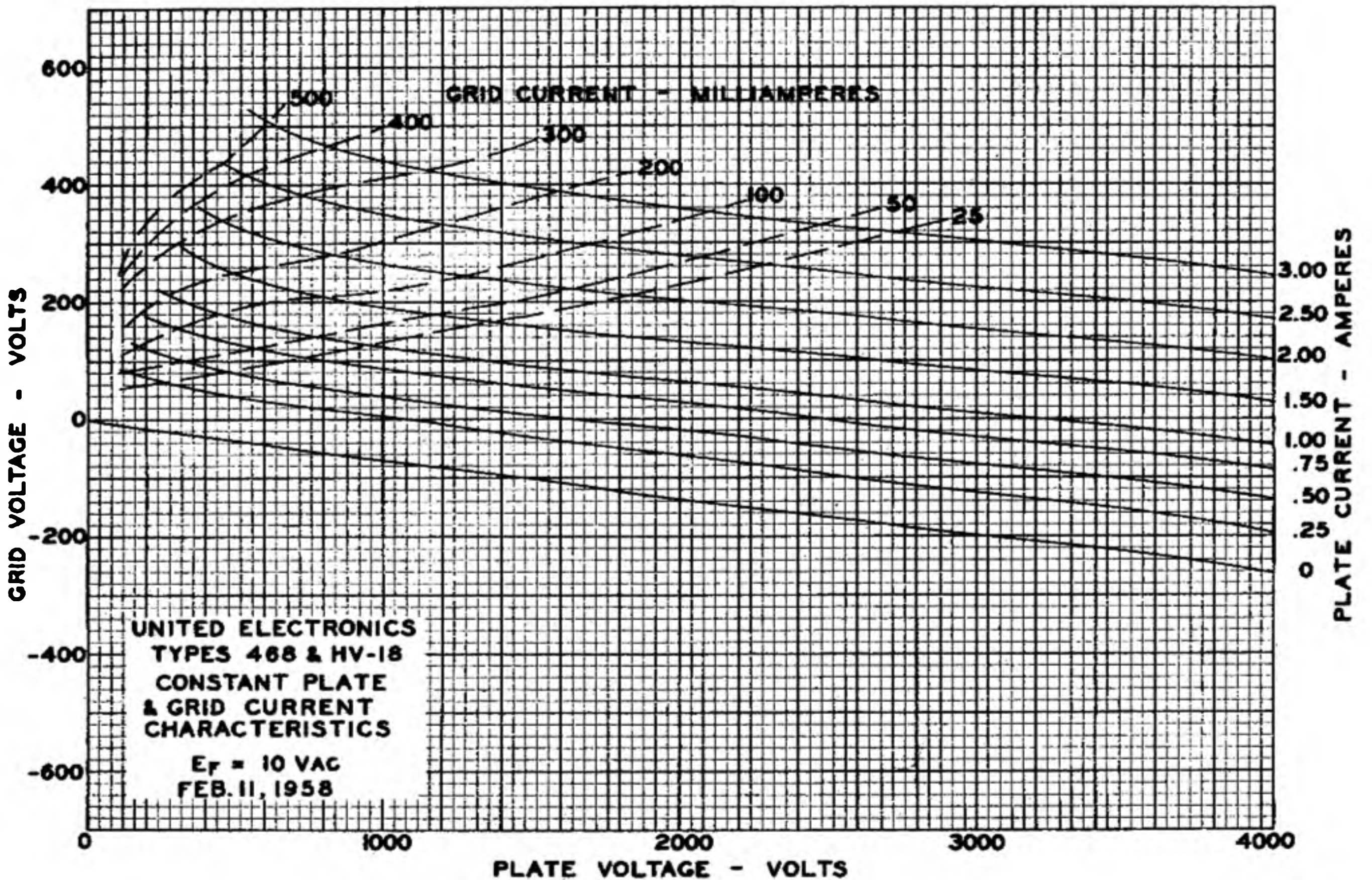
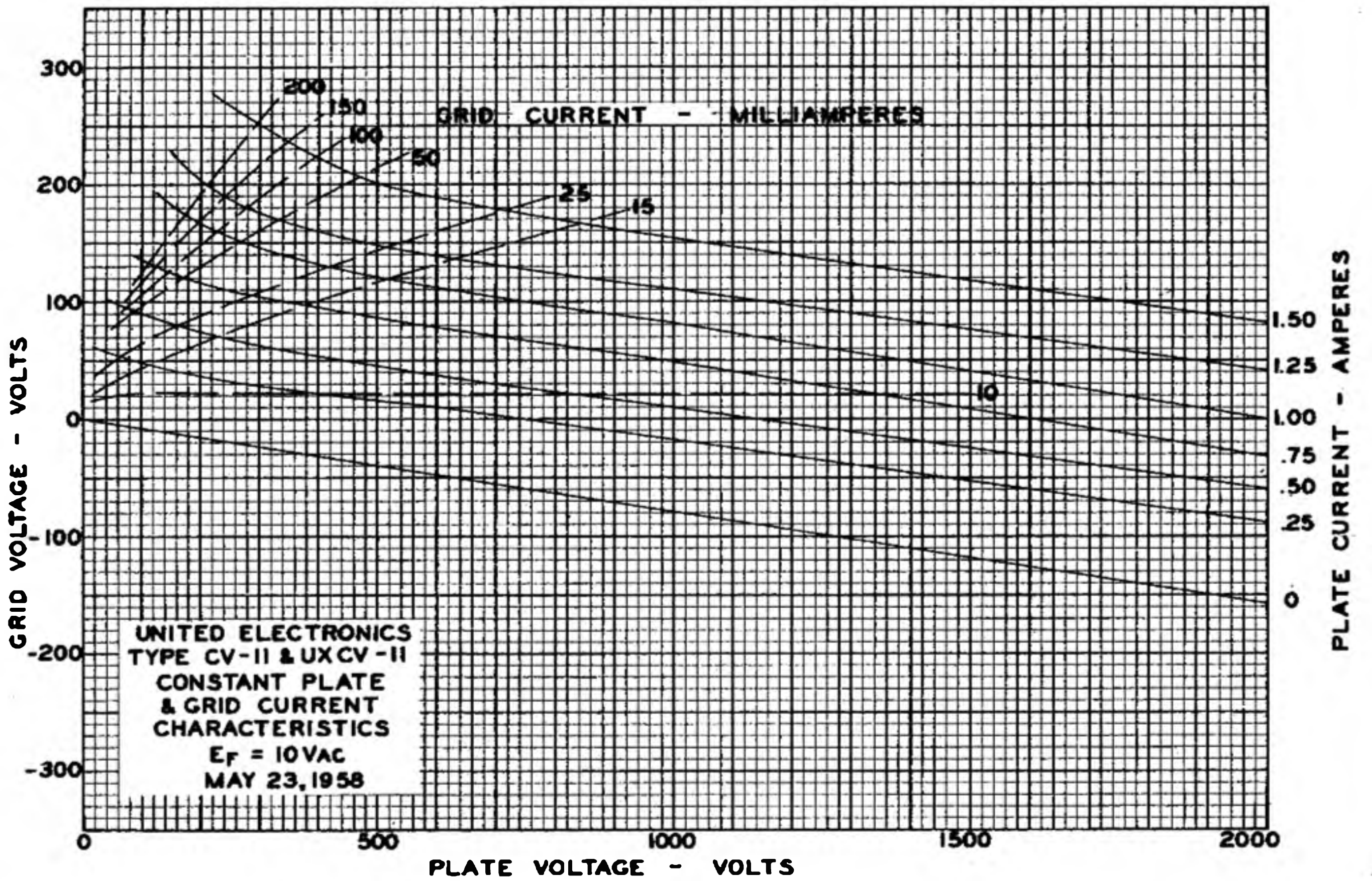

CHARACTERISTICS CURVES

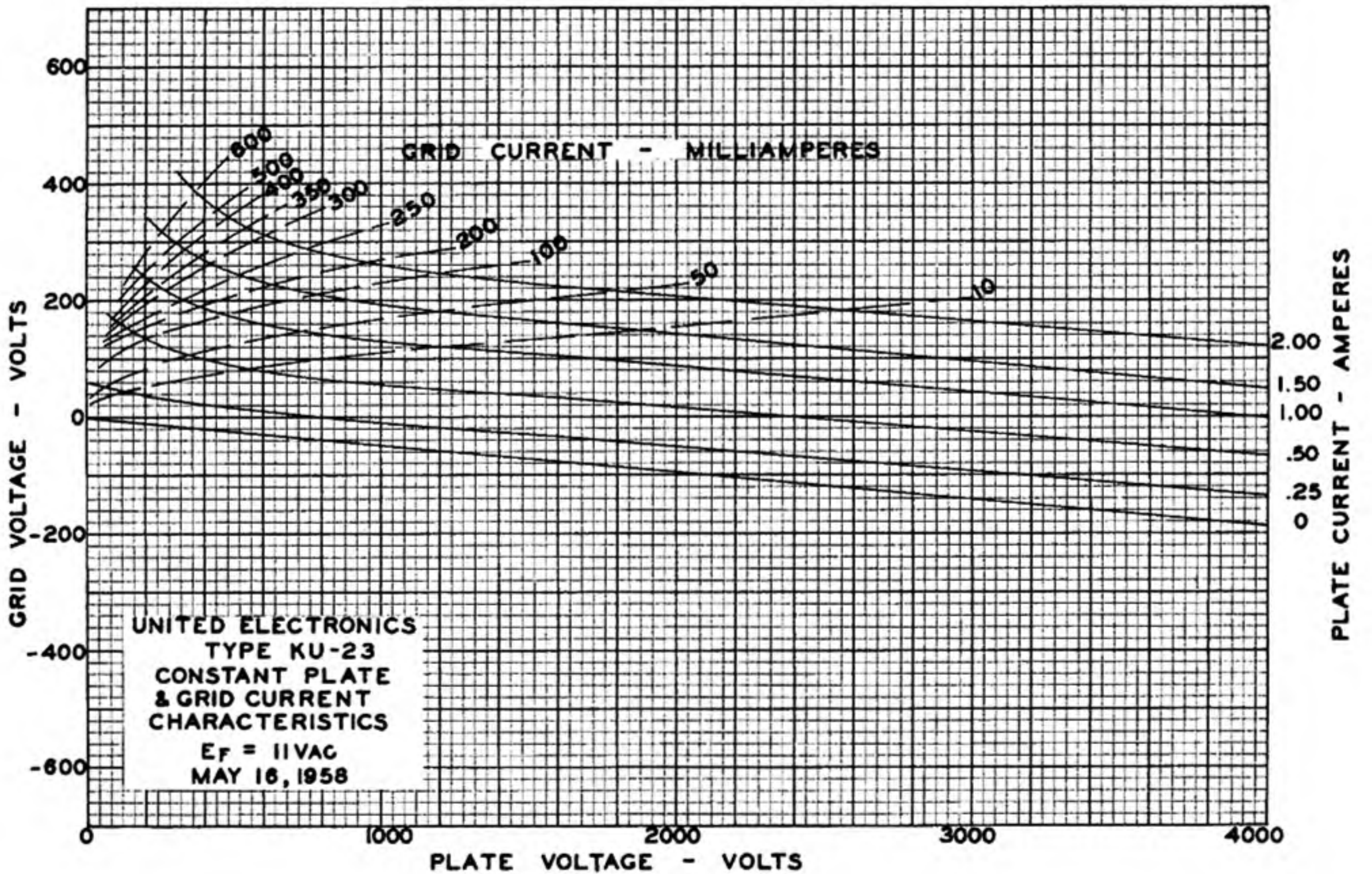
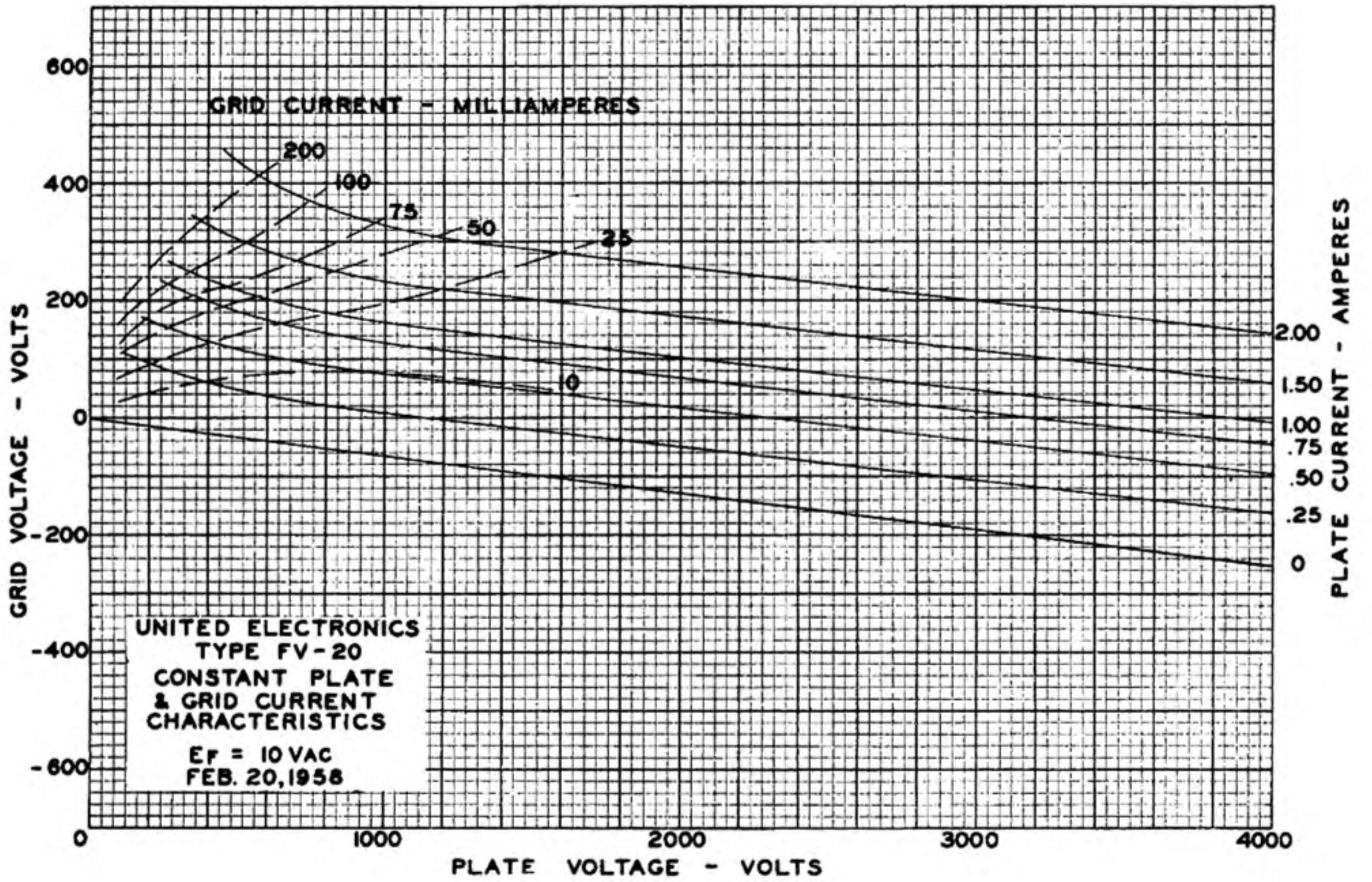

CHARACTERISTICS CURVES

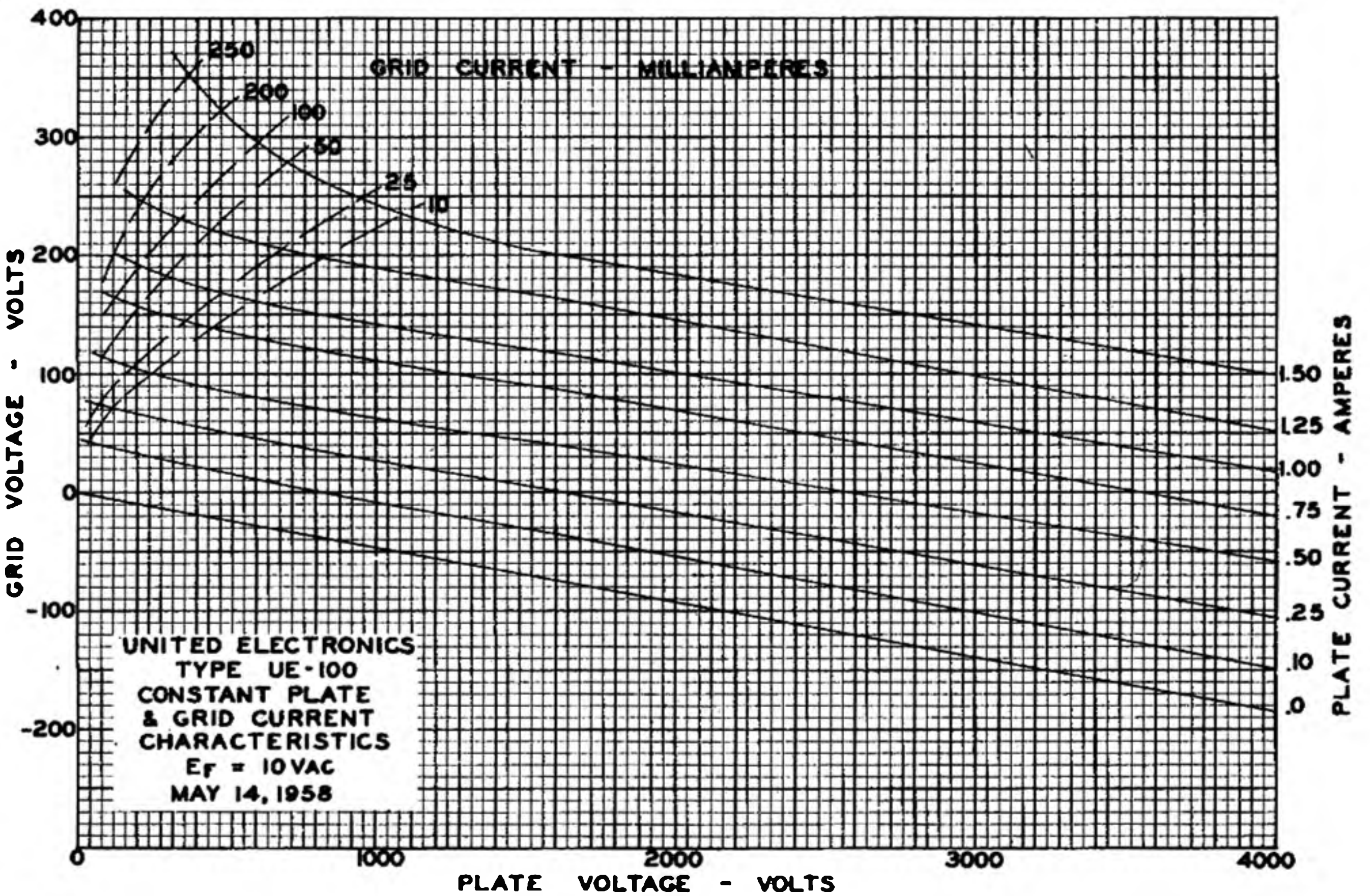
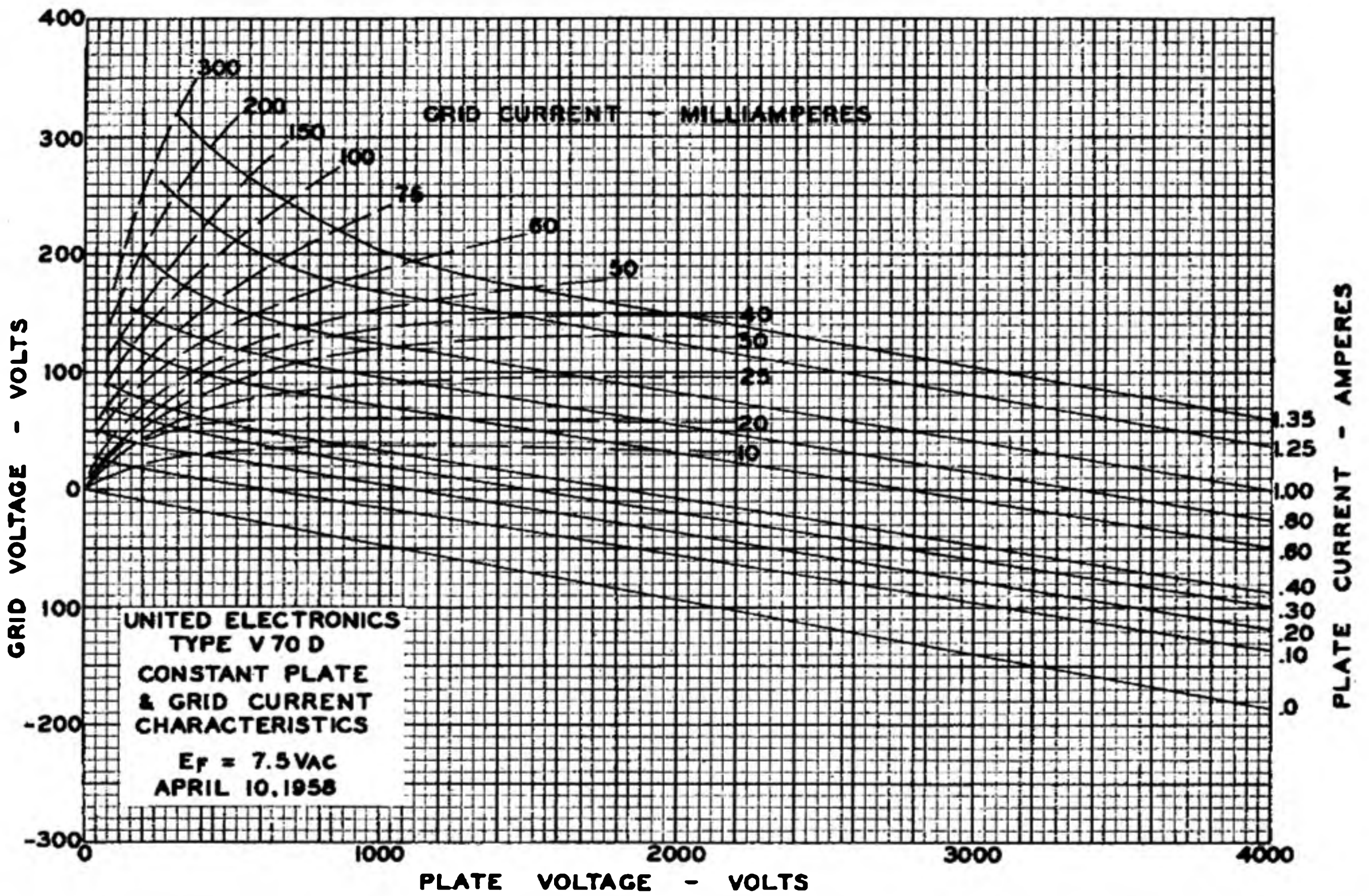

CHARACTERISTICS CURVES

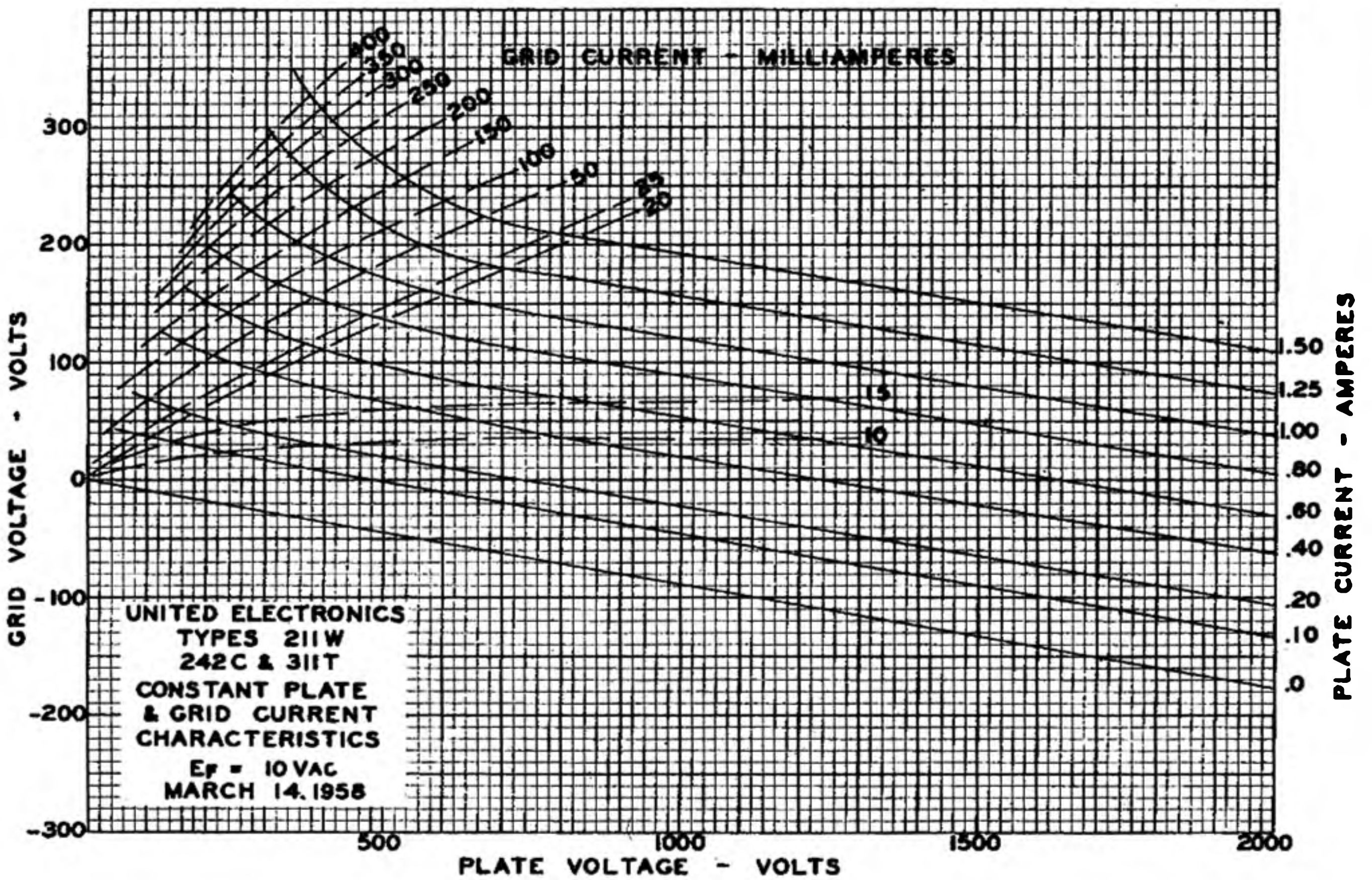
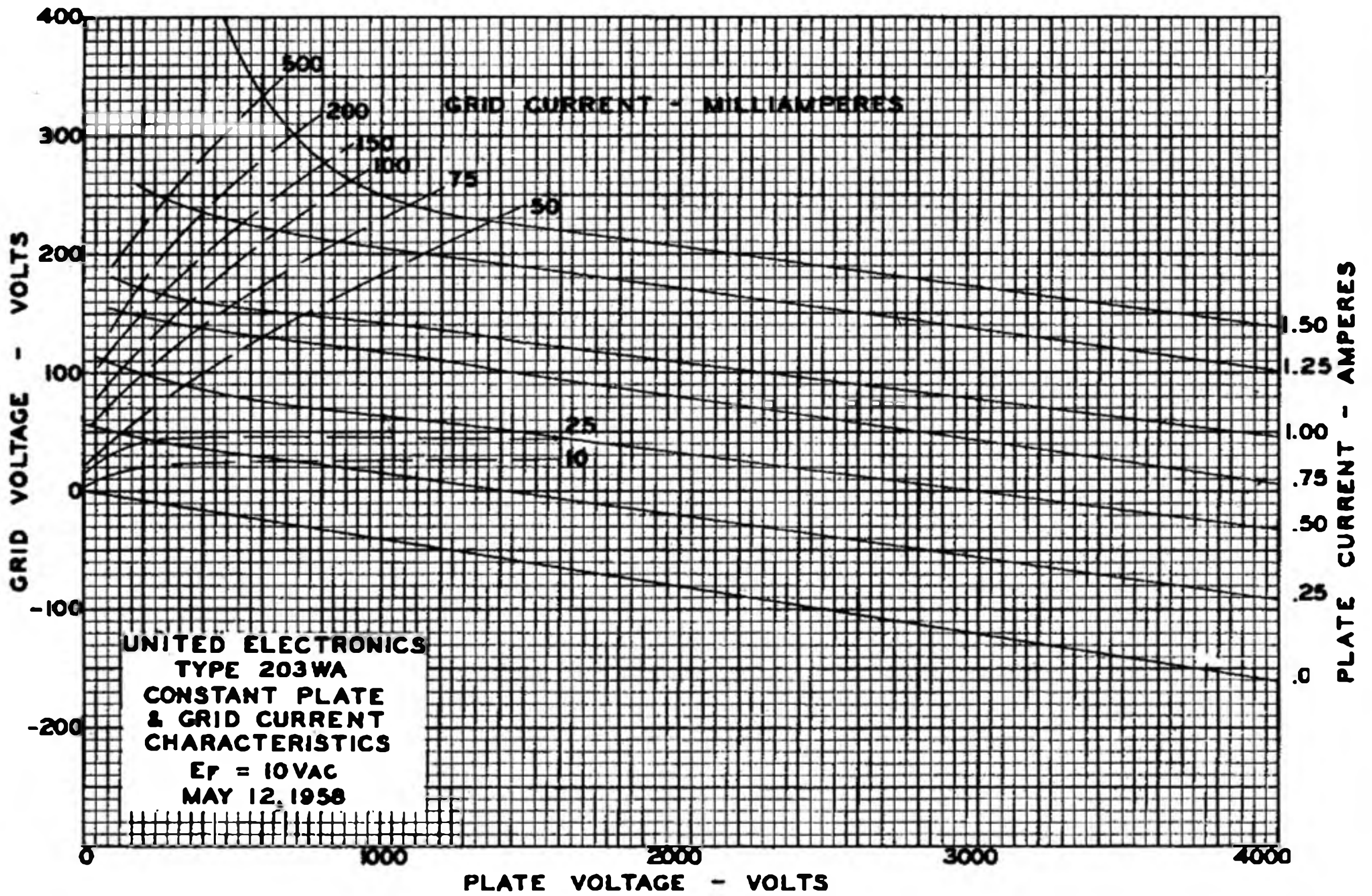

CHARACTERISTICS CURVES

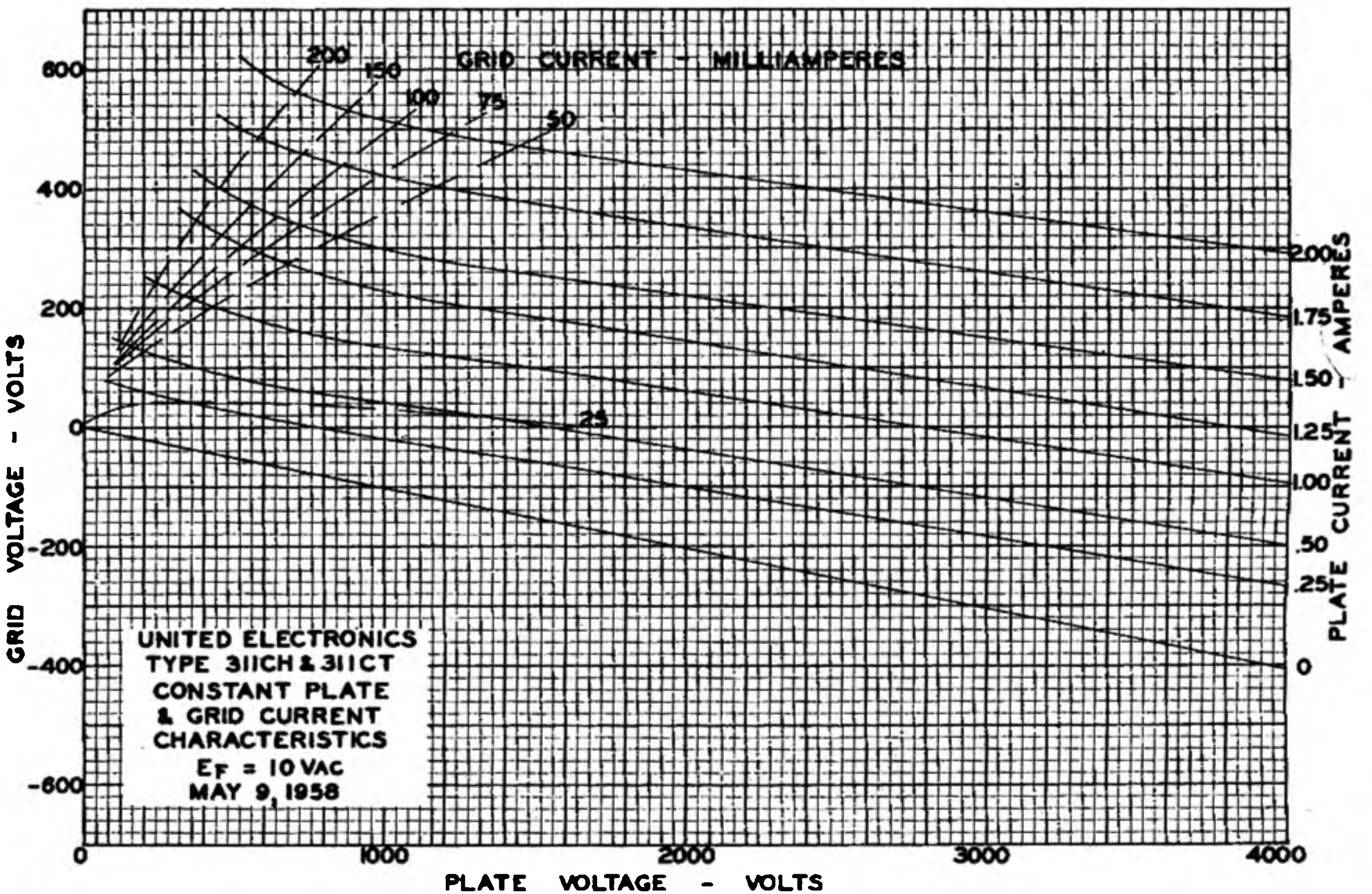
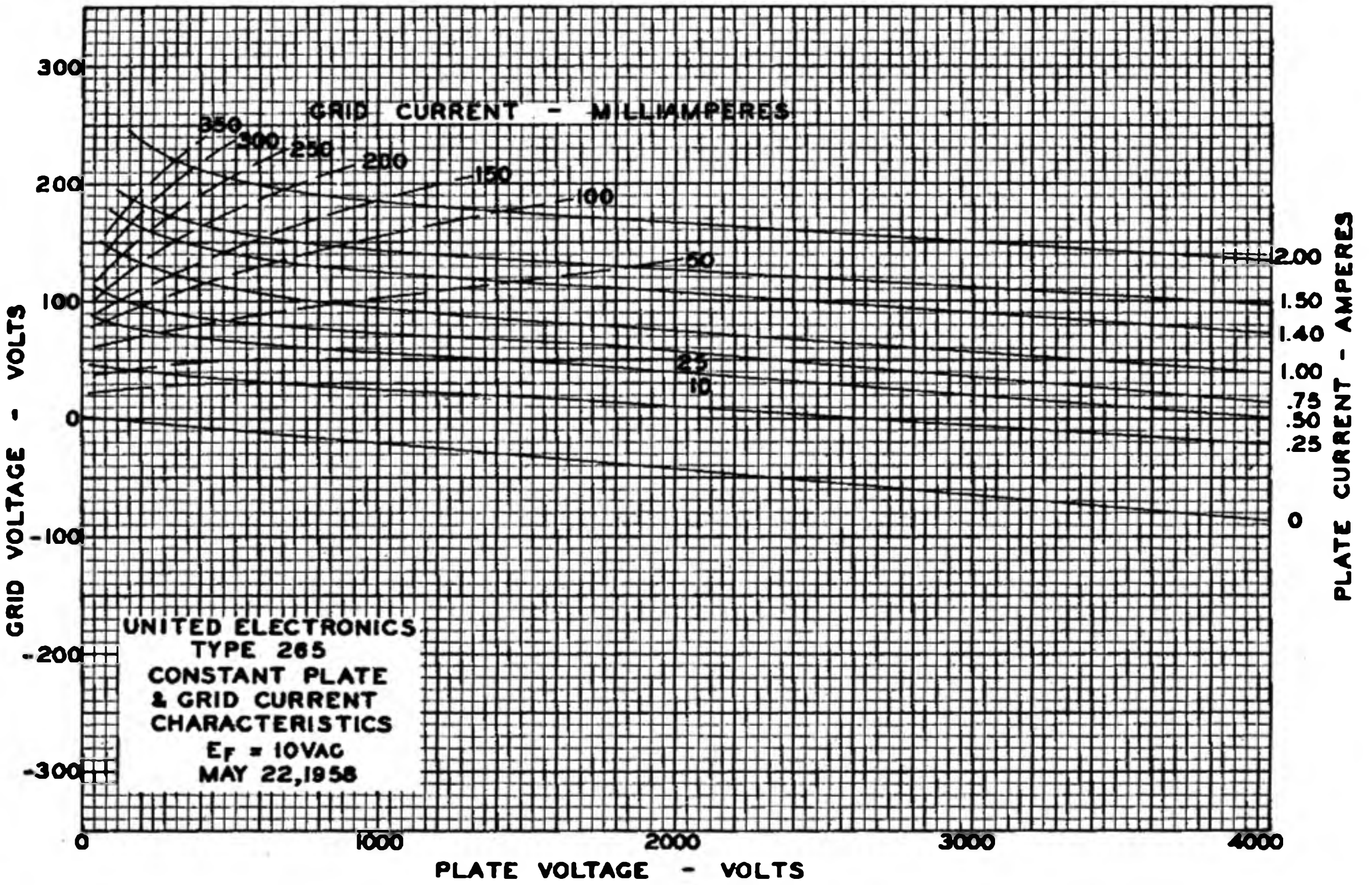

CHARACTERISTICS CURVES

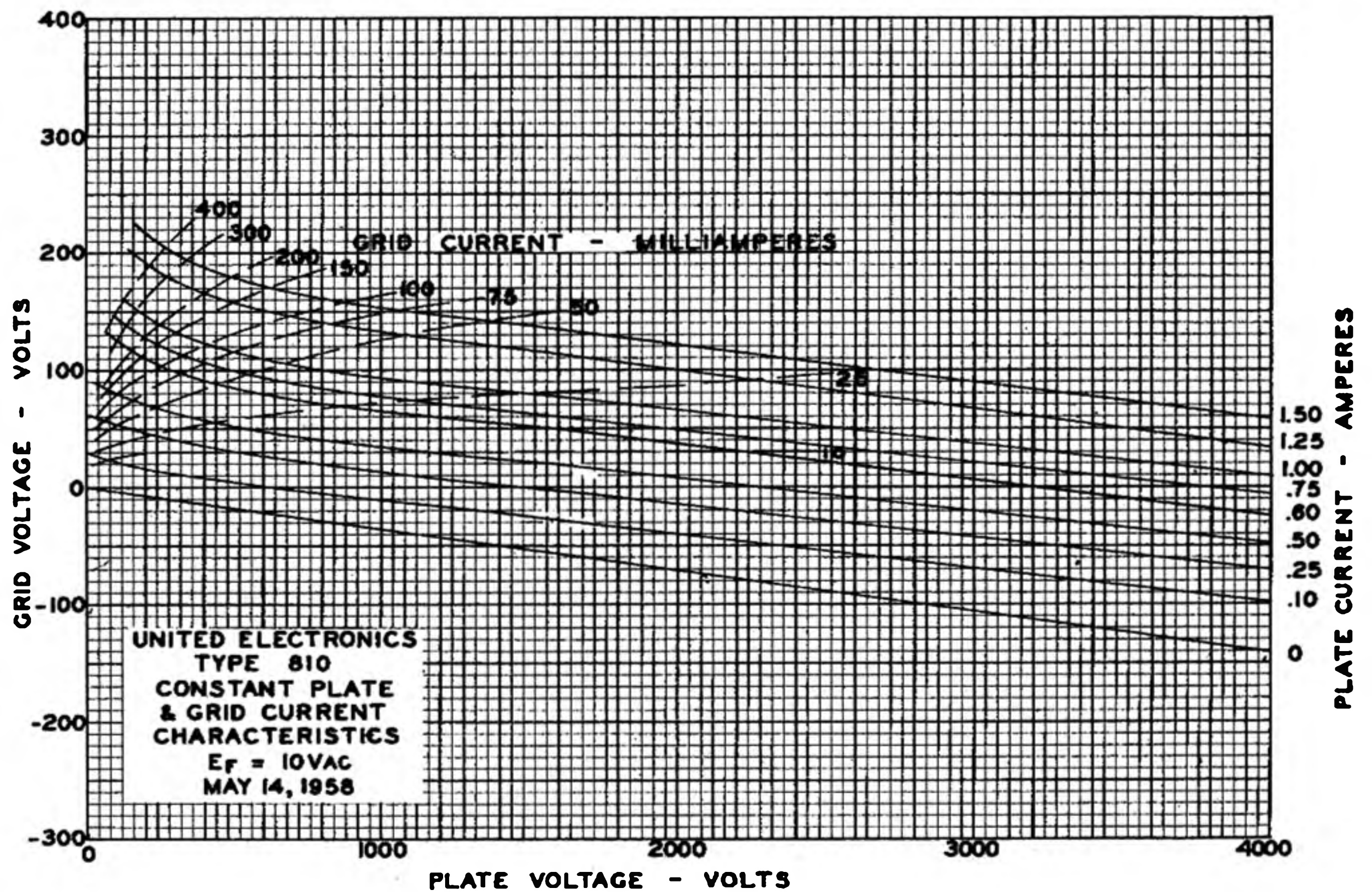
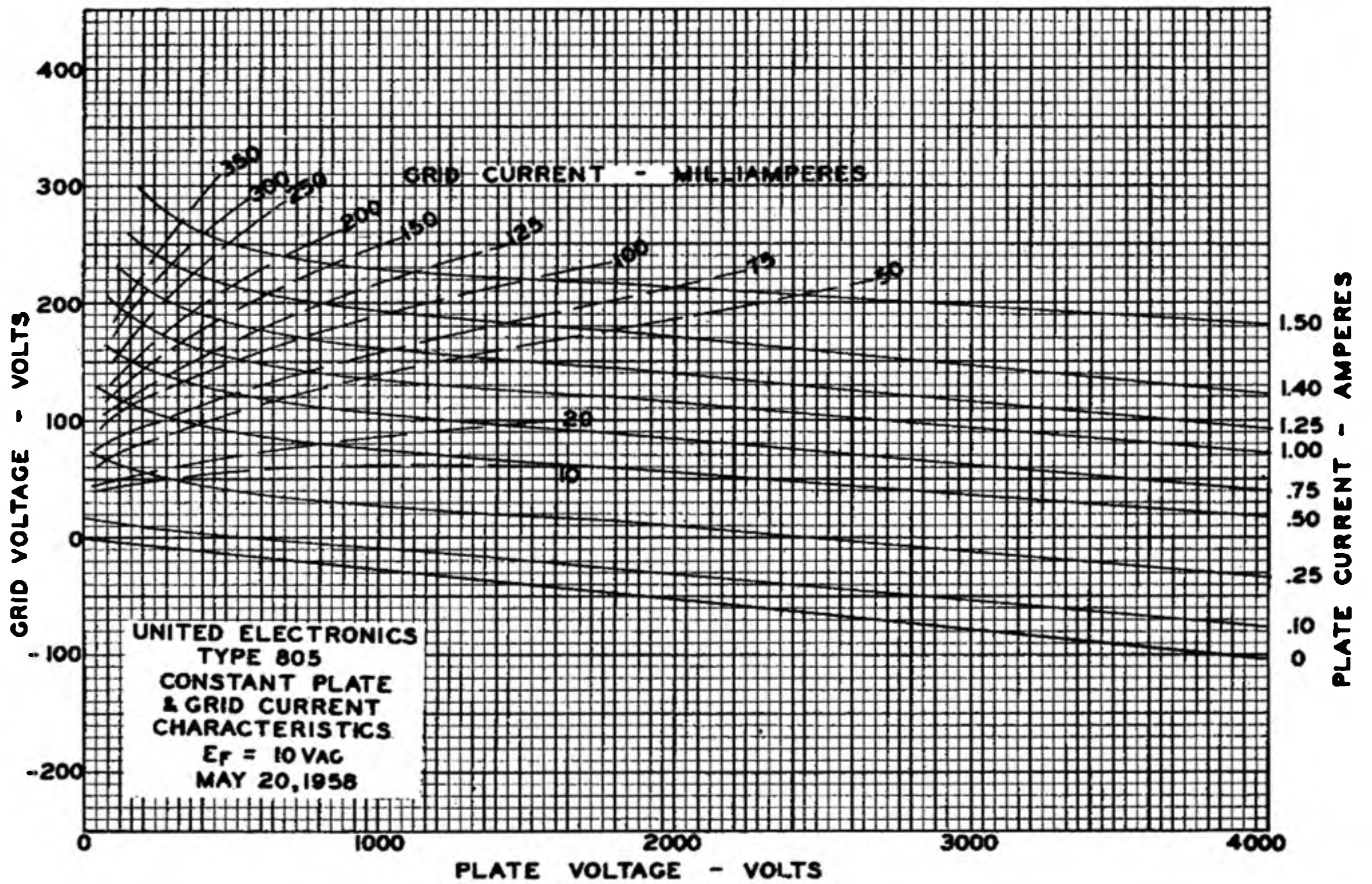

CHARACTERISTICS CURVES

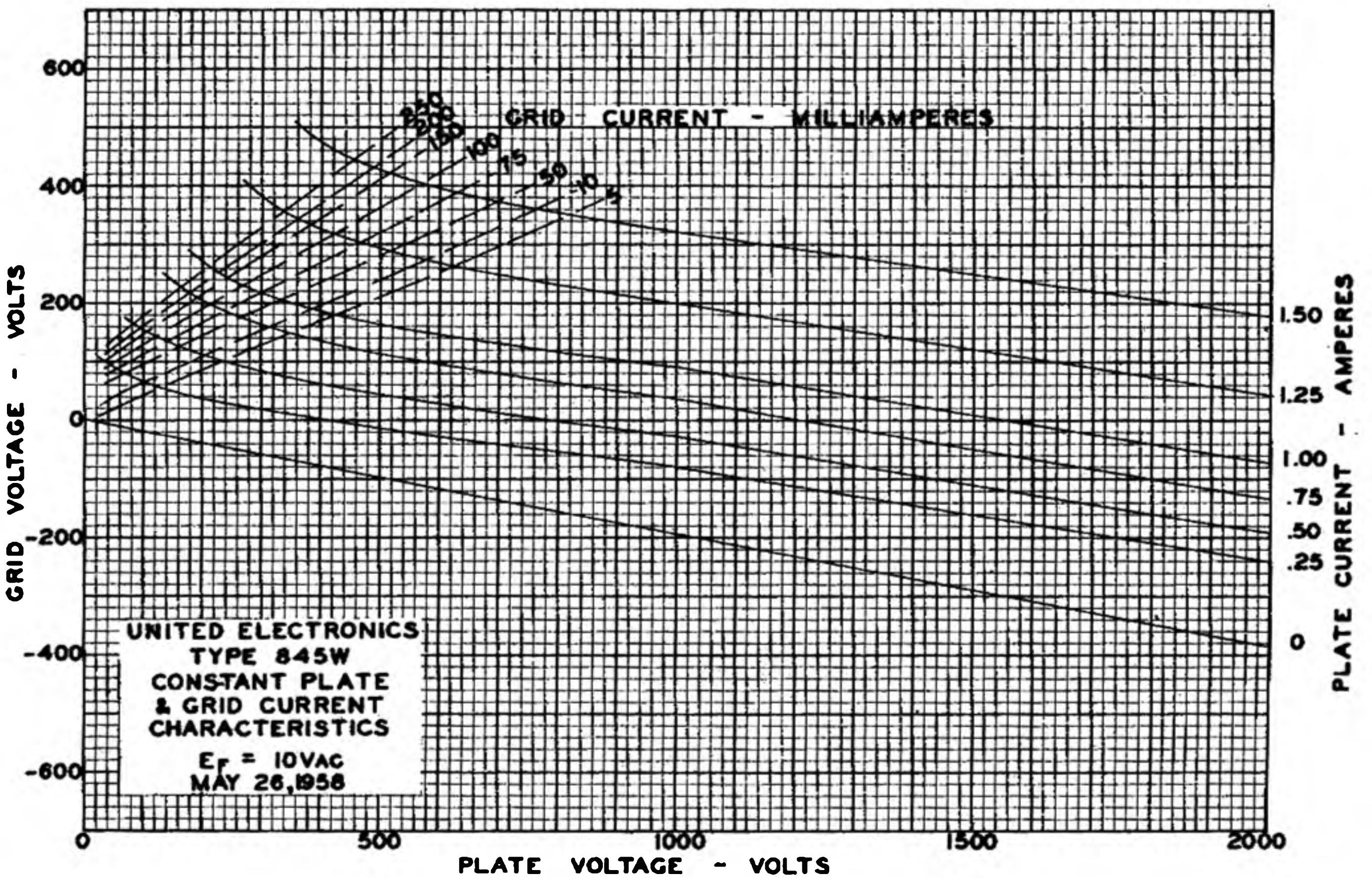
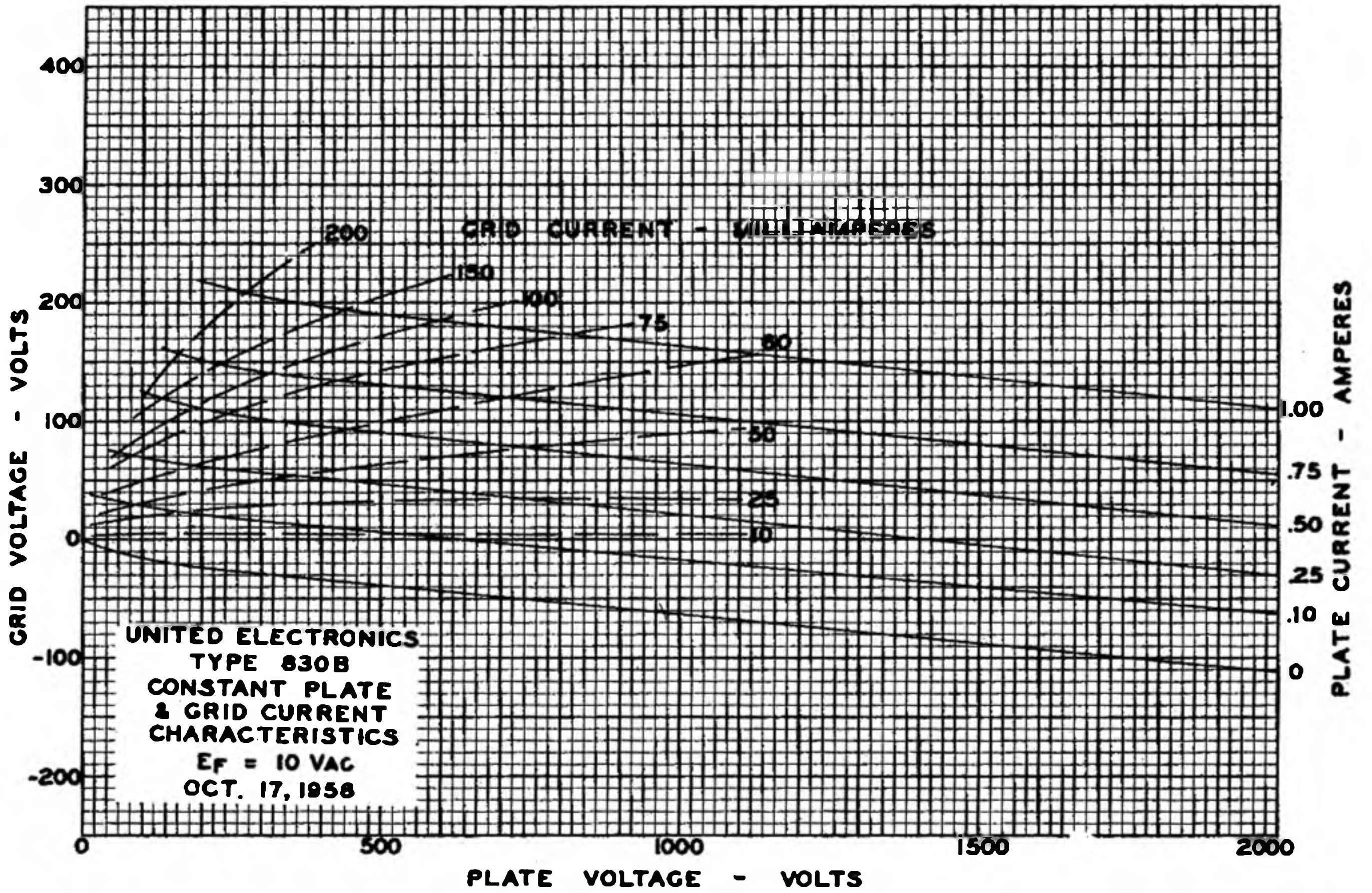

TYPE 3B28

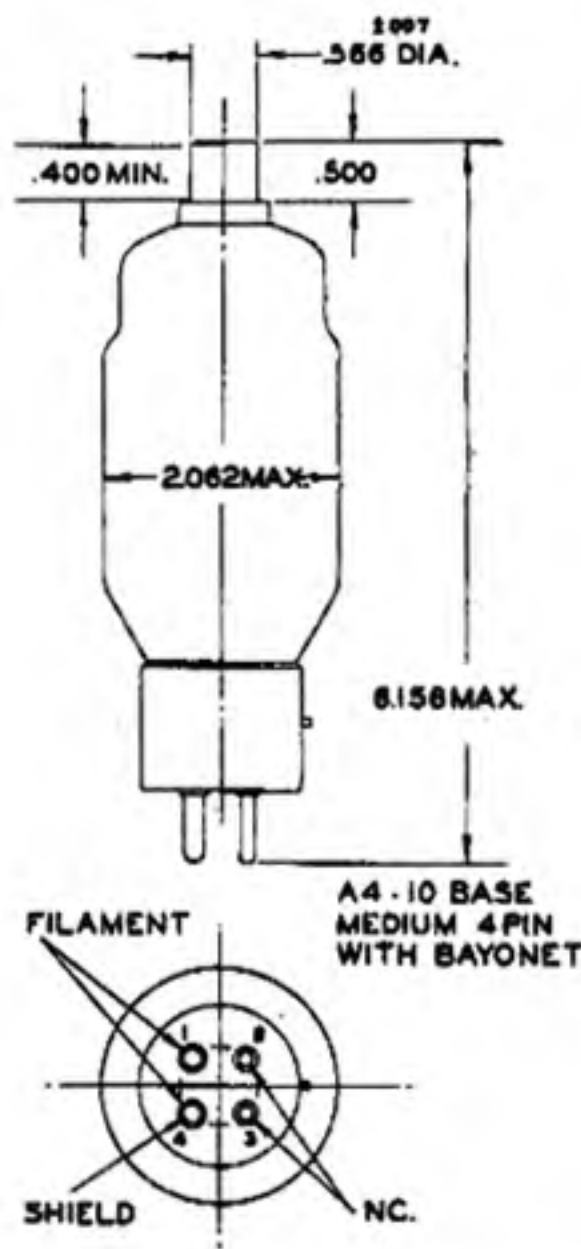

TYPE 4B32

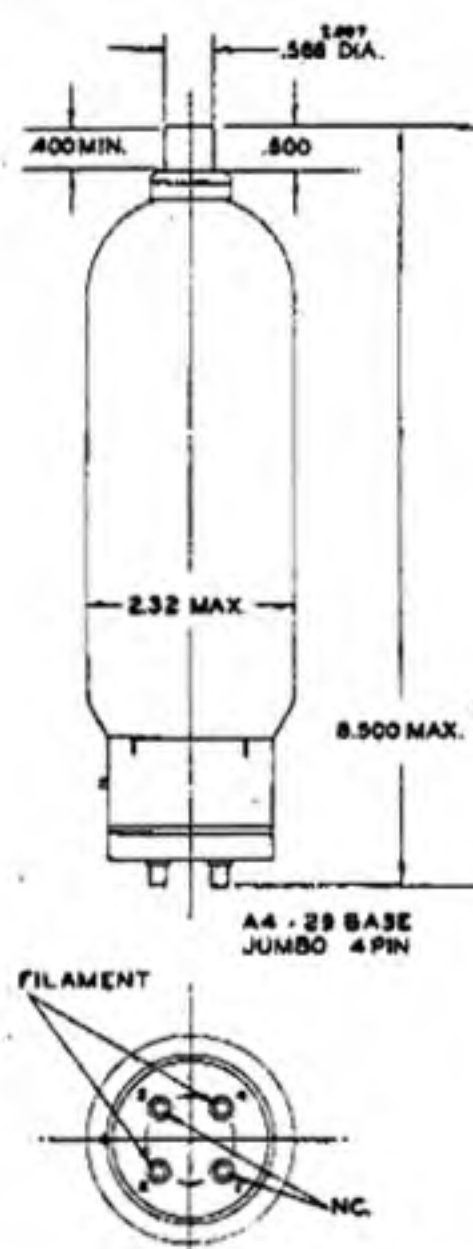

TYPE CV-11

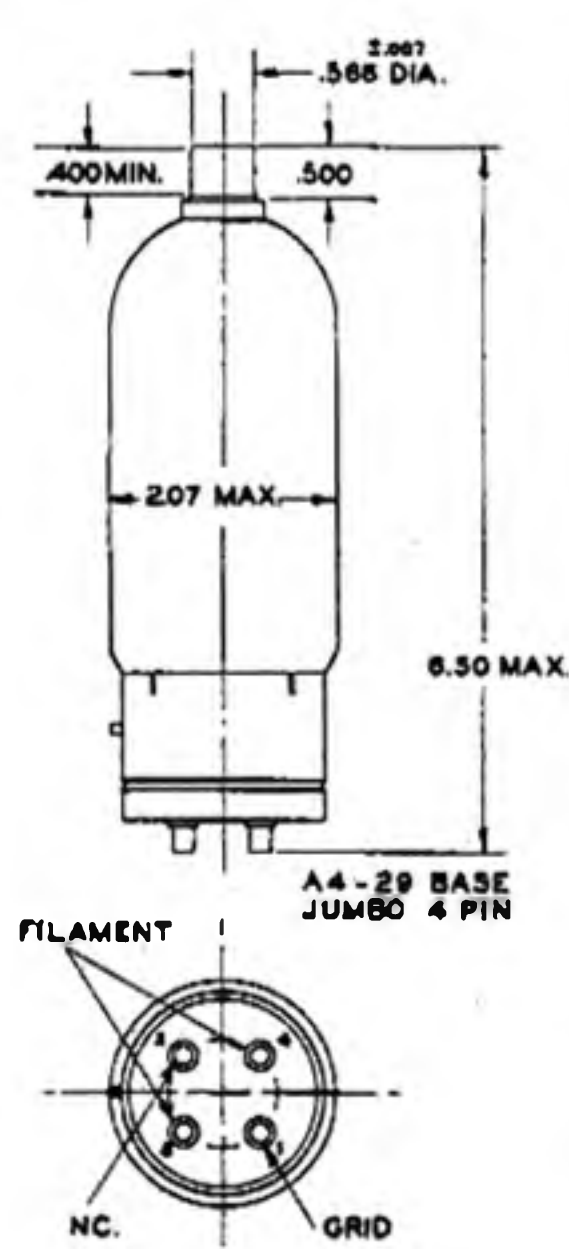

TYPES UXC-V11 & V70D

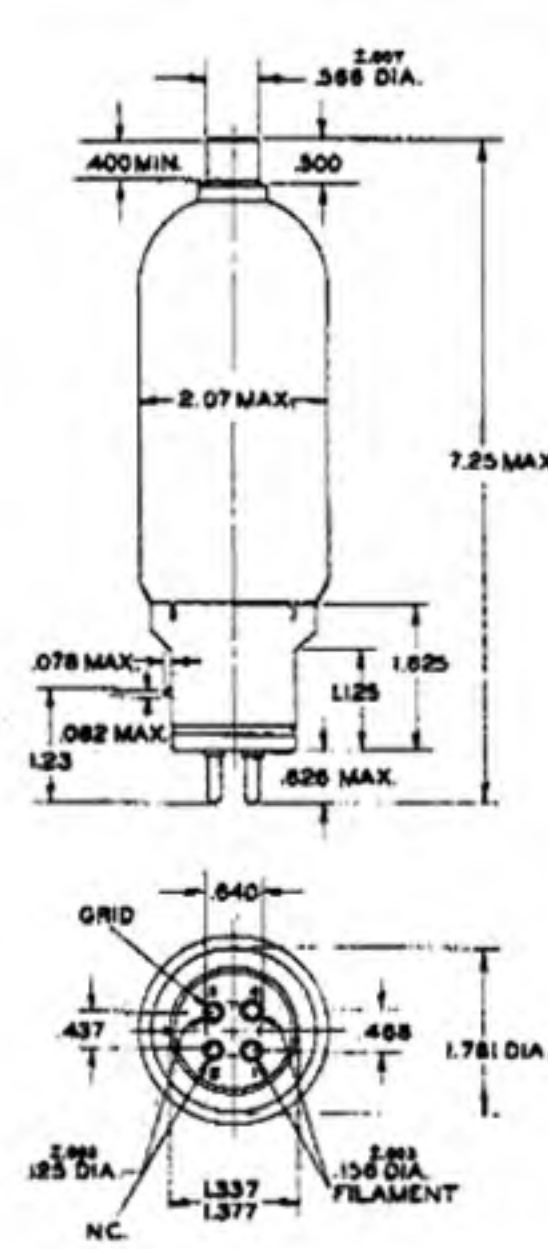

TYPE HV-18

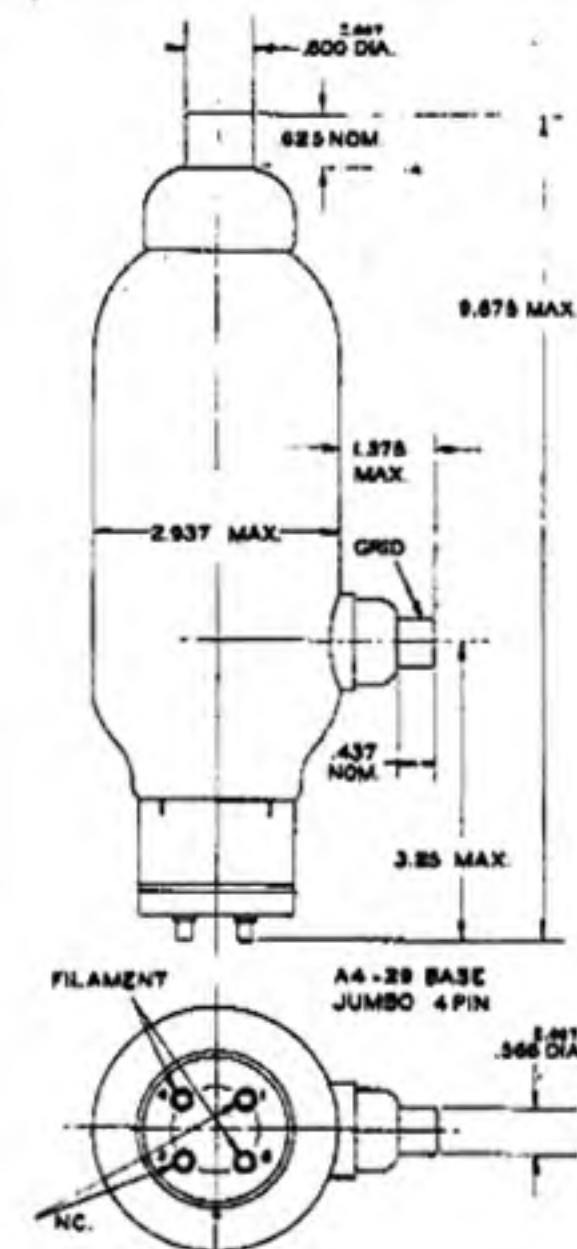

OUTLINE DRAWINGS

TYPE FV-20

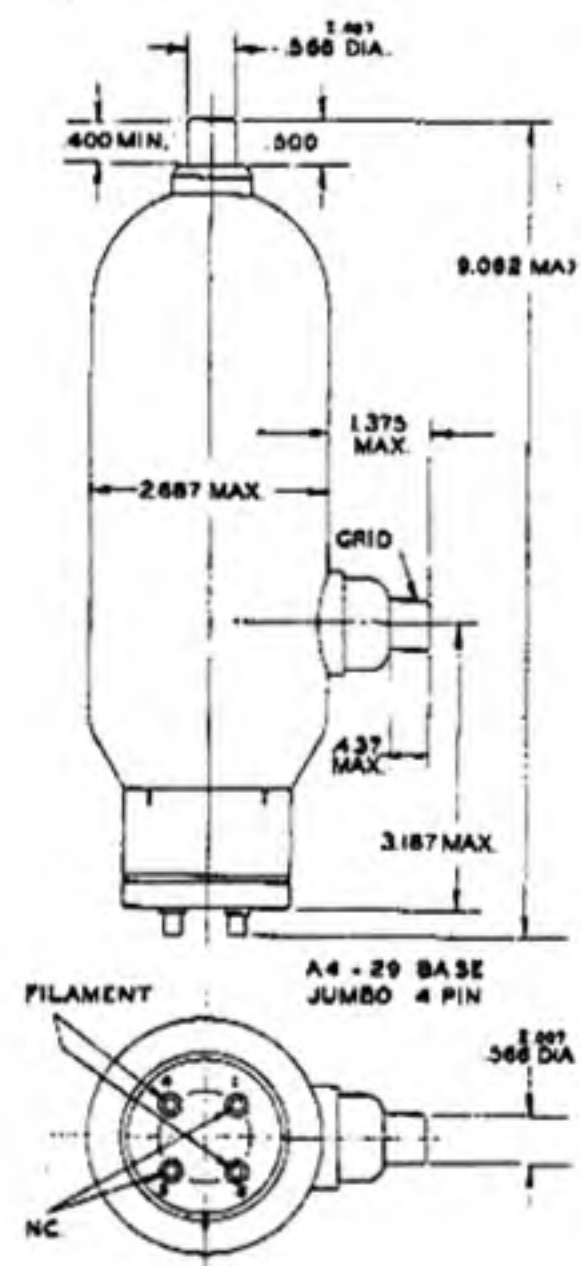

TYPE KU-23

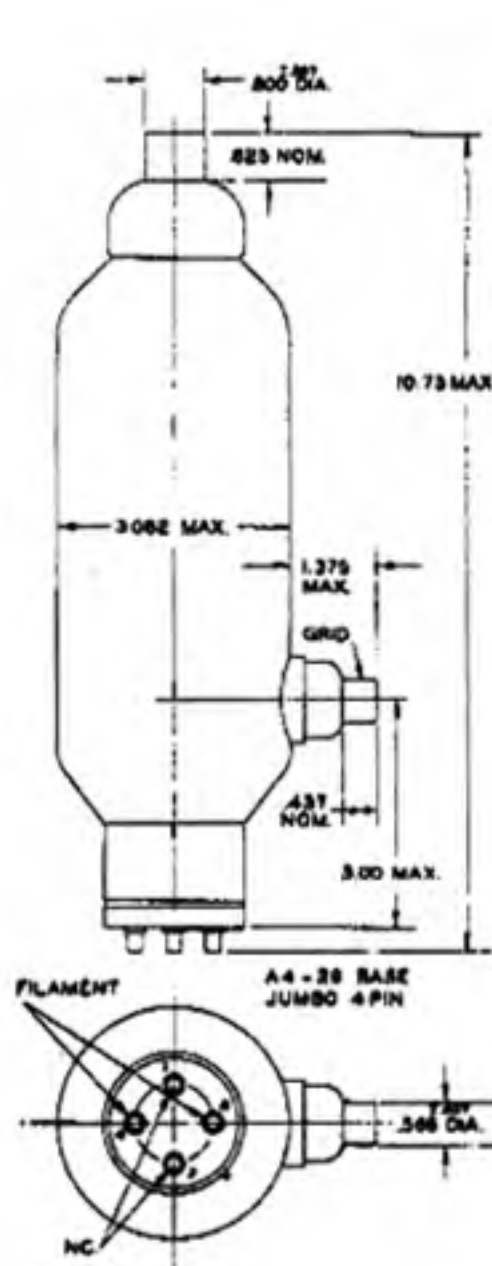

TYPE UE-100

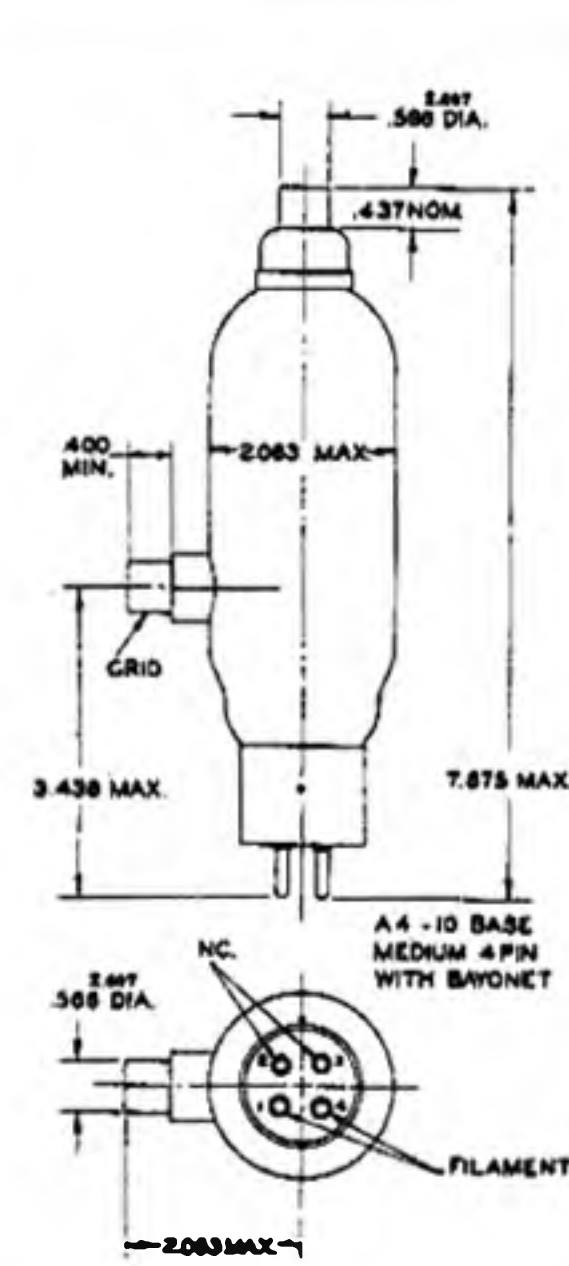

TYPES 203WA, 211W, 311CT, 311T, 845W

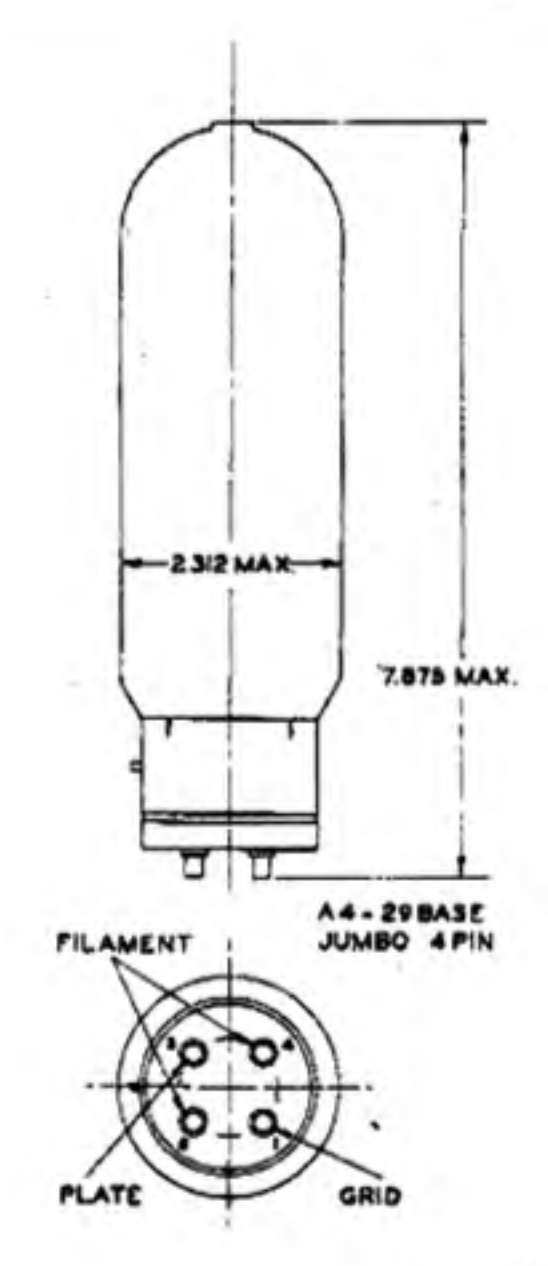

TYPE 242C

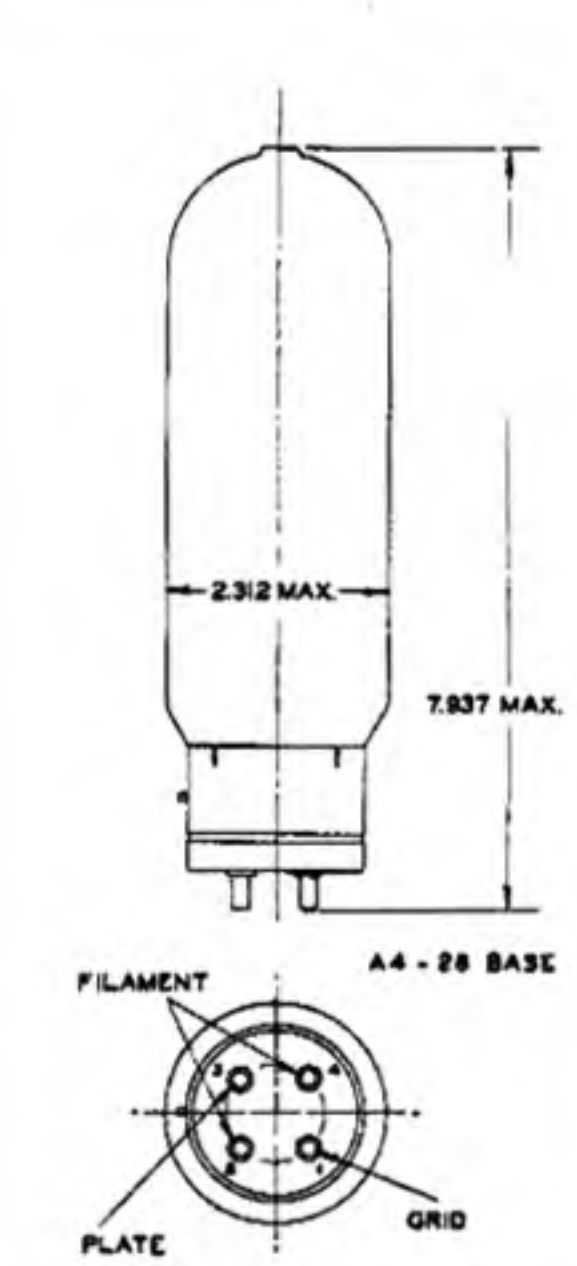

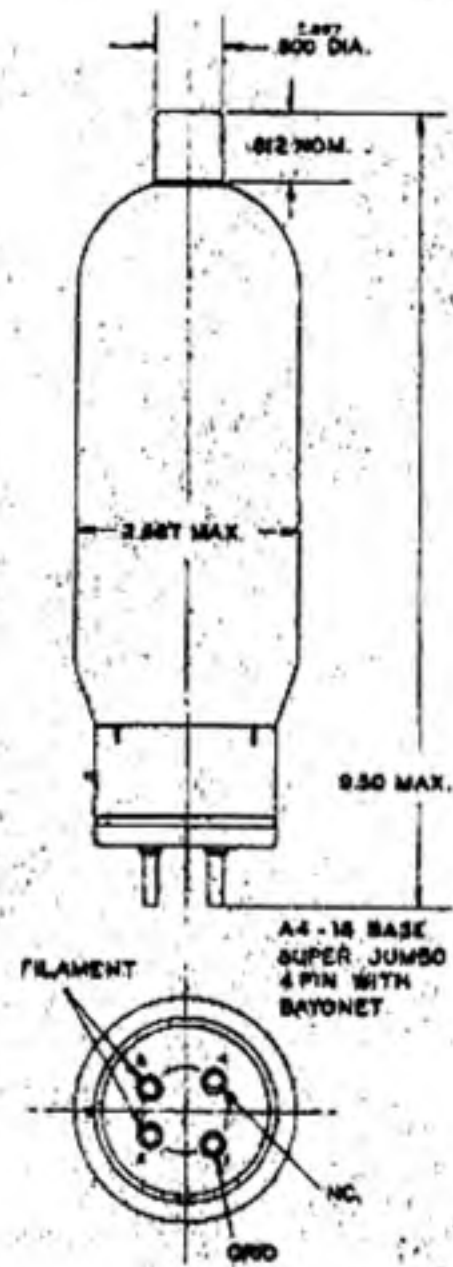
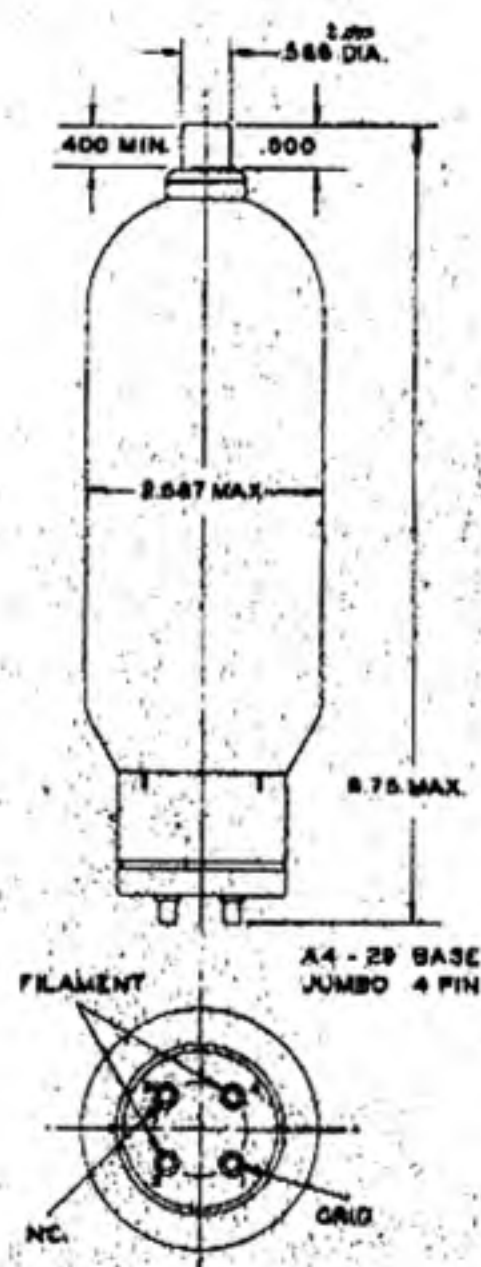
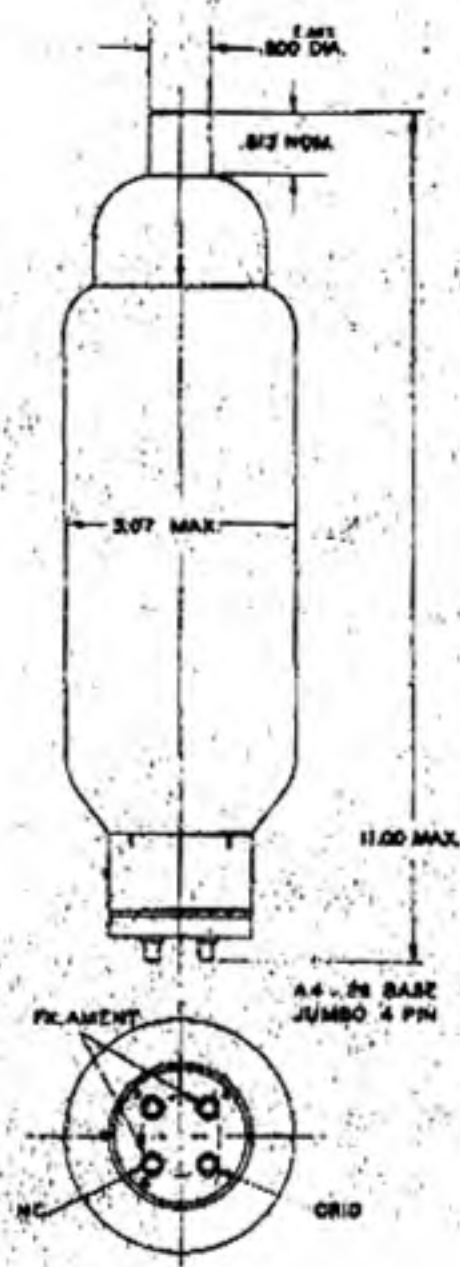
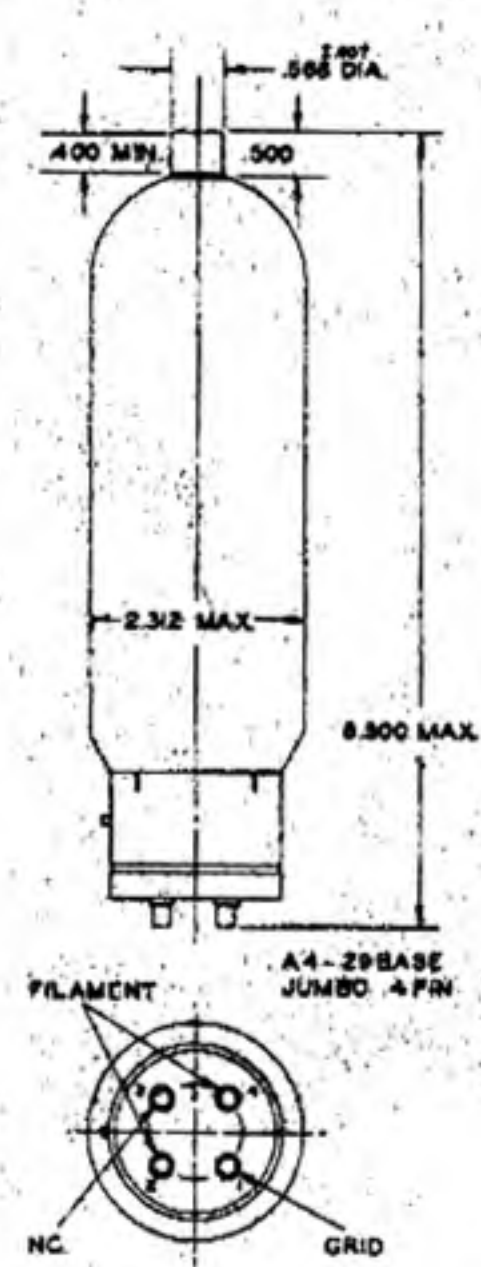
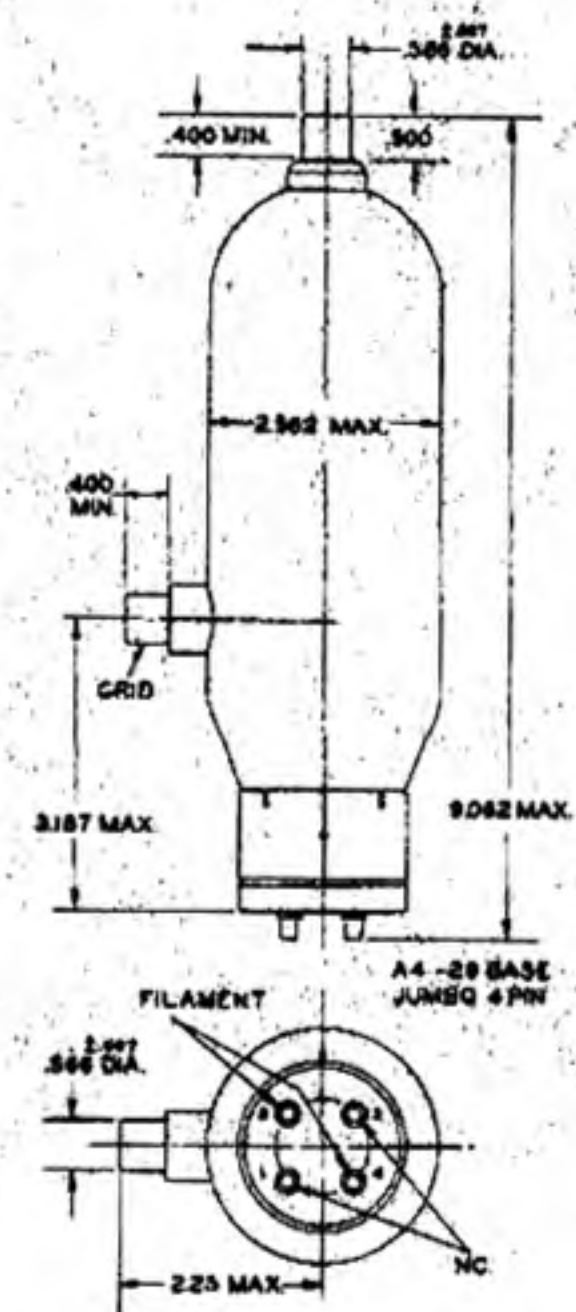
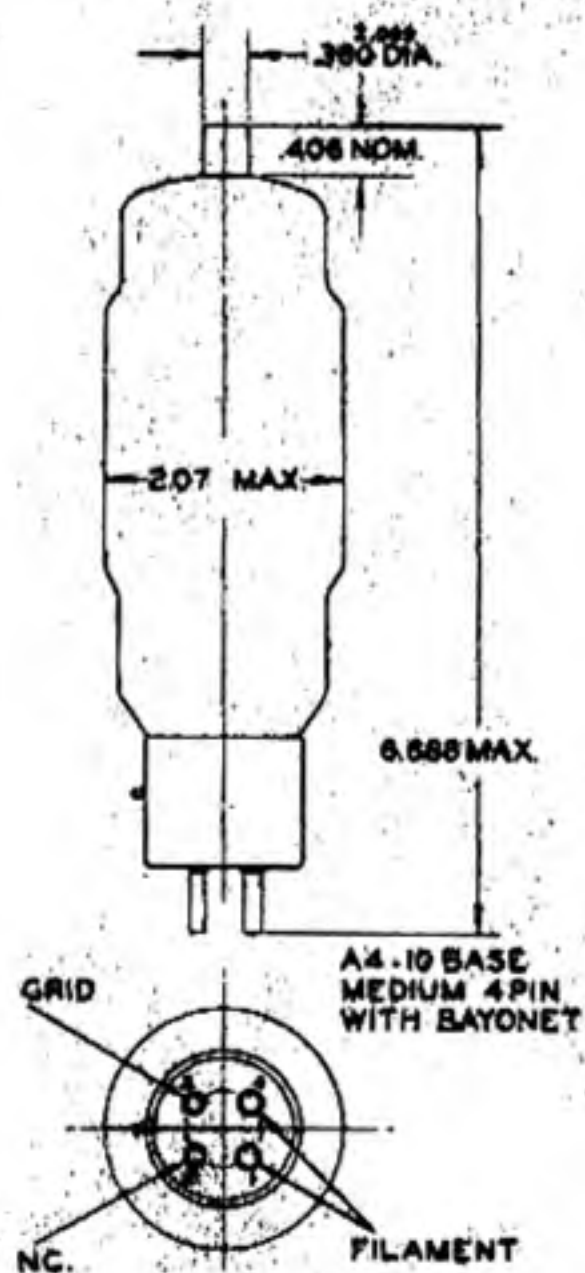
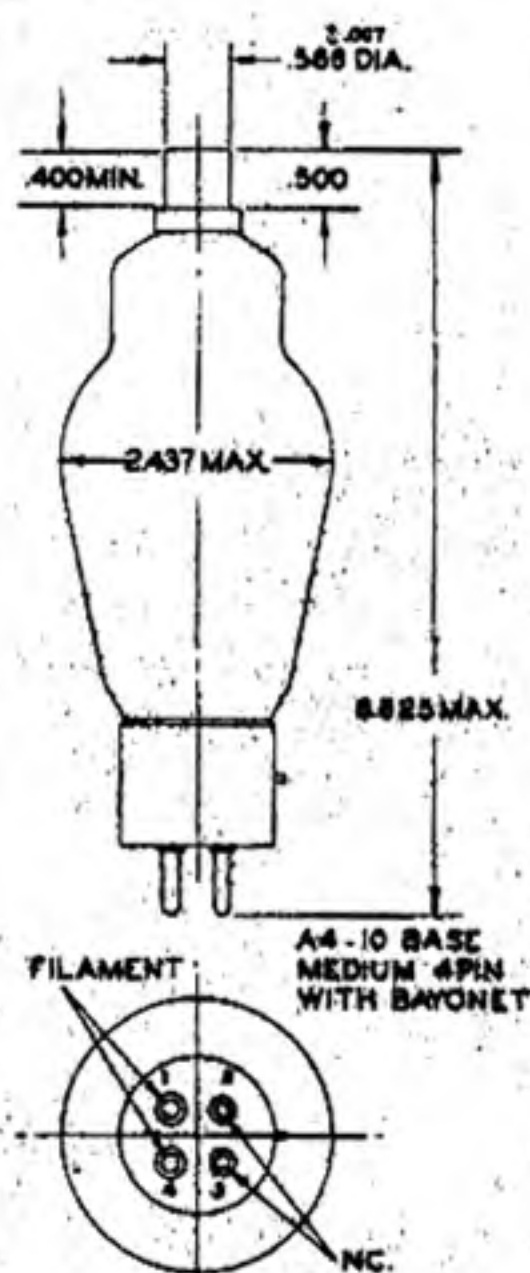
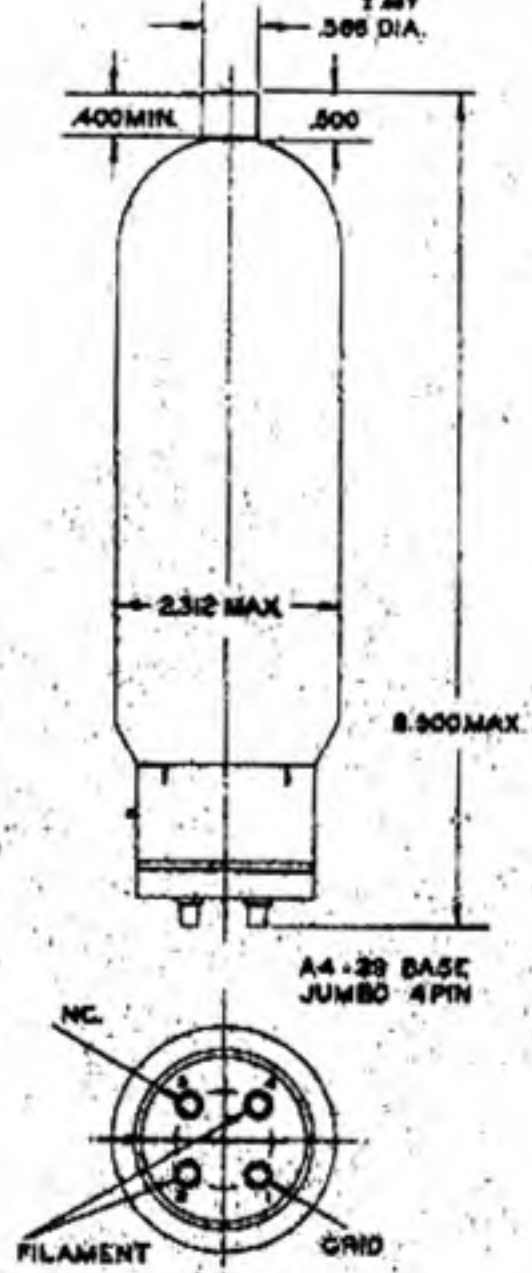
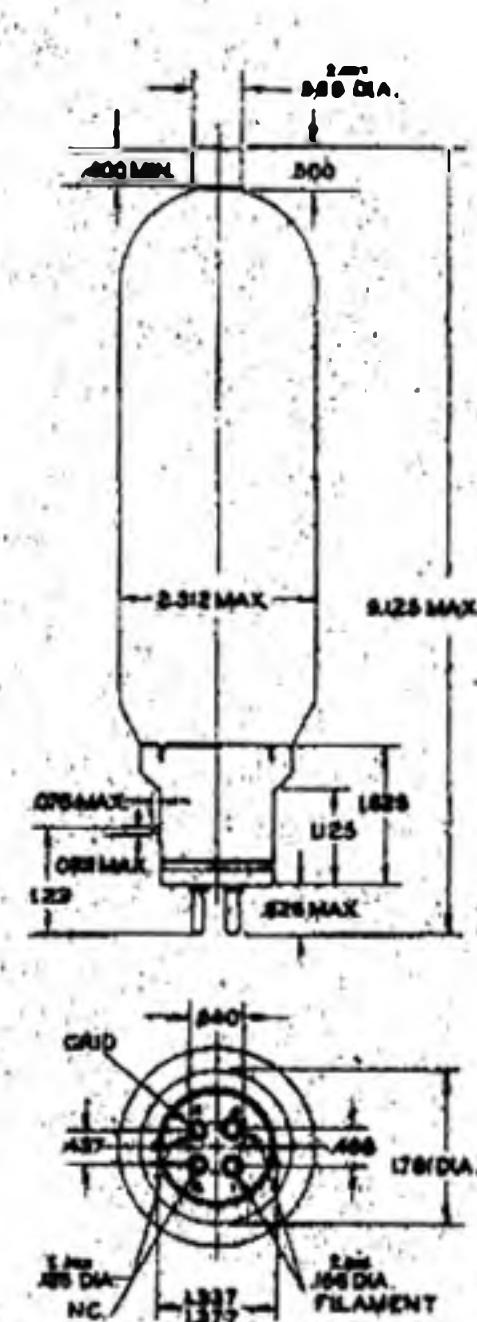
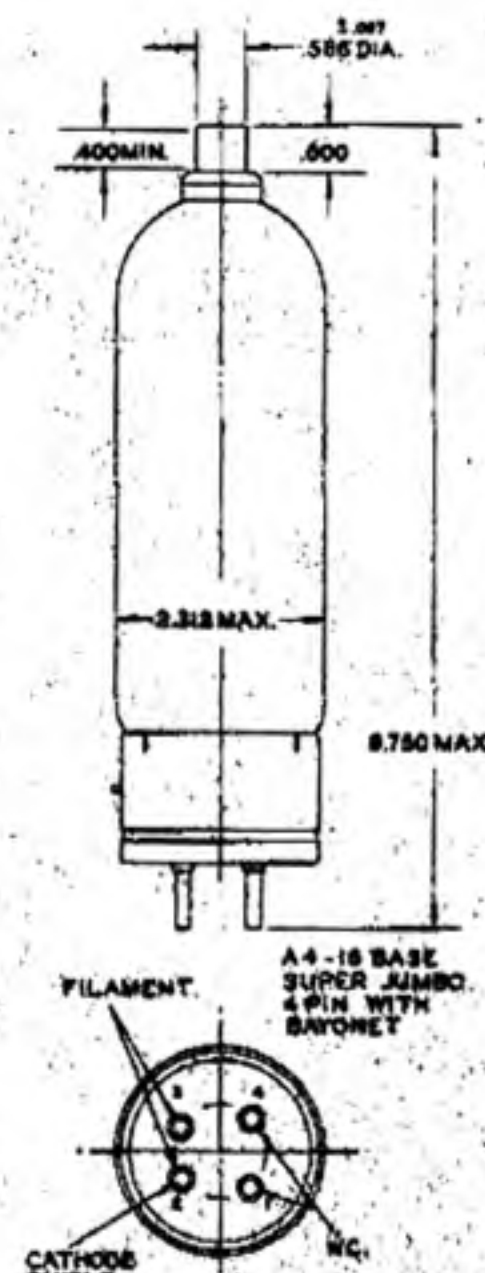
TYPE 265**TYPE 311CH****TYPE 468****TYPE 805****TYPE 810****OUTLINE DRAWINGS****TYPE 830B****TYPE 966****TYPE 973****TYPE UX973****TYPE 8008XE****TYPE 830B****TYPE 966****TYPE 973****TYPE UX973****TYPE 8008XE**

APPLICATIONS CHART

	CV-11	UXCV-11	HV-18	FV-20	KU-23	V-70-D	UE-100	203-WA	211W	242-C	265	311-CH	311-CT	311-T	468	805	810	830B	845W	3B28	4B32	966	973	UX-973	8008XE
DIATHERMY	X	X	X	X		X	X					X	X	X	X		X					X			
ULTRASONICS	X	X																				X			
R-F HEATING			X	X							X			X		X						X	X	X	
AMATEUR RADIO			X	X	X										X										
BROADCASTING			X	X		X	X	X			X				X	X		X							X
P. A. SYSTEMS									X								X	X							
MILITARY																	X		X	X	X				X
INDUSTRIAL			X							X				X								X	X	X	X

THE MARKS OF LONG RECOGNIZED QUALITY

A classic singularity of form has always enabled one to distinguish a tube made by UNITED ELECTRONICS from other makes of the same modular type. Almost all of our internal anode types, for instance, have employed anodes of electronic graphite rather than metal. For twenty years this company has continuously exploited the inherent merits of this material for internal anode vacuum types, so that today its use by this company has been advantageously extended to the production of VHF and very high voltage tubes with heavy plate dissipation ratings. Our old "50 watters" of the single end style embody a ruggedized mount top anchorage without the use of mica or dome pads. All of our higher power triodes such as those designed for use as heavy duty oscillators in diathermy and other RF and audio applications, have been kept free from metallic deposits on the inside of the bulb walls by the use of our patented isolated getter traps.

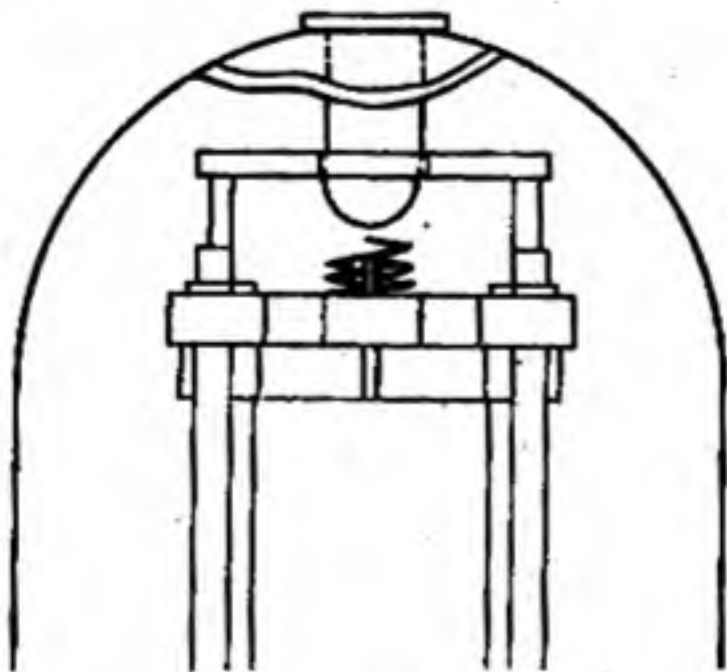

Ruggedized construction of "Single End" Types

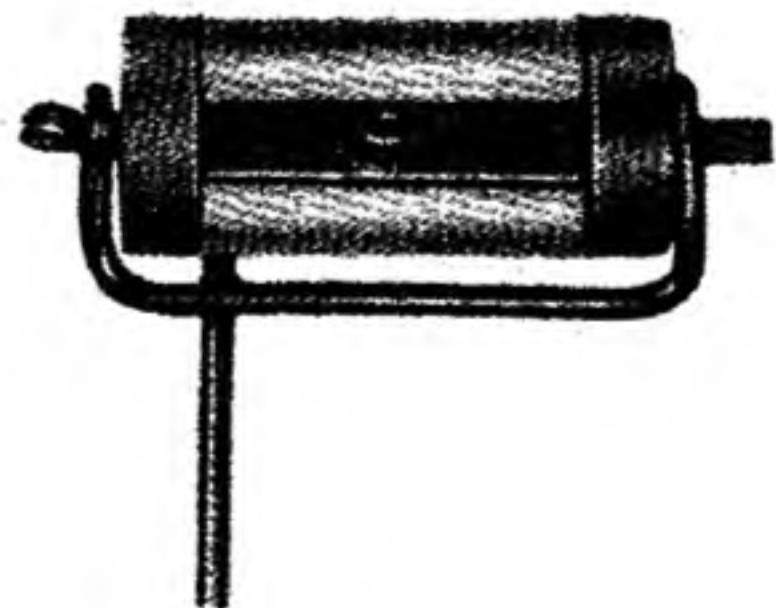

Isolated getter trap to prevent metallic deposits on tube parts and inner surface of bulb.

TUBE REPLACEMENT CHART FOR DIATHERMY

ALOE		BIRTCHER		BURDICK		LIEBEL-FLARSHEIM	
Model	United Tubes	Model	United Tubes	Model	United Tubes	Model	United Tubes
F7200	UXCV-11	505	UXCV-11	X-85	810 & 966	SW-227	468
F7300	966 & 311-CH	750	CV-11	MF-49	810		MOORADIAN
F7301	966 & 311-CH	753	CV-11	SU-4N	HV-18	R	HV-18 & 966
FB400	966 & UXCV-11	799-H	UXCV-11		FISCHER		SANITEX
FB410	UXCV-11	800	966 & 311-CH	1200	FV-20	300	UXCV-11
FB420	CV-11	850	966 & UXCV-11	1500	UE-100	400	UXCV-11
		2000	966 & 311-CH			500	UXCV-11 & 966

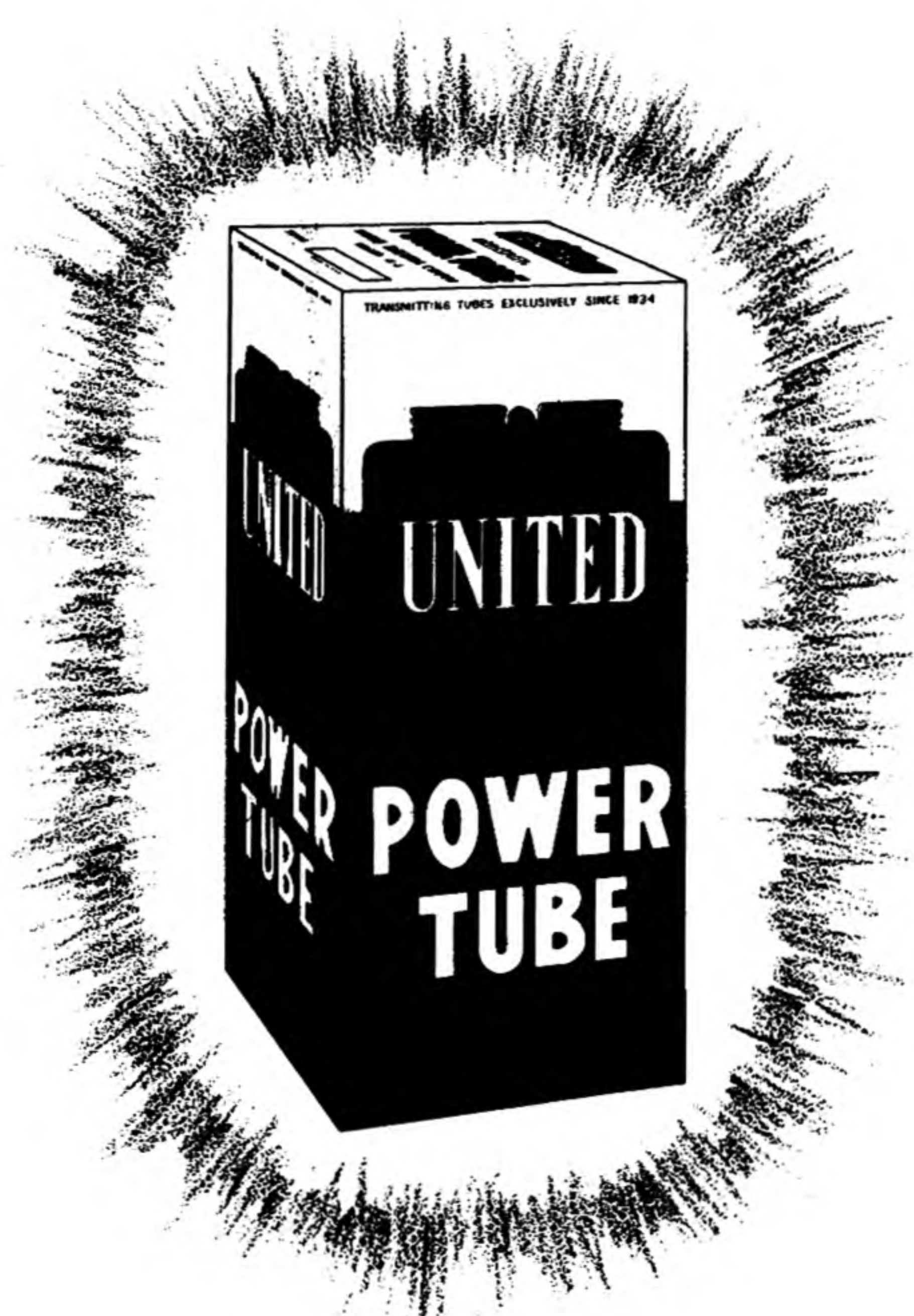

UNITED ELECTRONICS COMPANY

A Division of the LING ELECTRONICS, INC. Group

42 SPRING STREET

Since 1934

NEWARK 4, N. J.