

28211

LIBRARY STORE

ELECTRONIC TUBES XII
621.38/P534

TUBES FOR
COMPUTERS

THE SERIES OF BOOKS ON ELECTRONIC TUBES INCLUDES:

- Book I "Fundamentals of Radio-Valve Technique"
- Book II "Data and Circuits of Receiver and Amplifier Valves"
- Book III "Data and Circuits of Receiver and Amplifier Valves", 1st Suppl.
- Book IIIA "Data and Circuits of Receiver and Amplifier Valves", 2nd Suppl.
- Book IIIB "Data and Circuits of Receiver and Amplifier Valves", 3rd Suppl.
- Book IIIC "Data and Circuits of Television Receiving Valves"
- Book IV "Application of the Electronic Valve in Radio Receivers and Amplifiers",
Volume 1
- Book V Ditto, Volume 2
- Book VII "Transmitting Valves"
- Book VIIIA "Television Receiver Design" 1
- Book VIIIB "Television Receiver Design" 2
- Book IX "Electronic Valves in Pulse Technique"
- Book X "Analysis of bistable Multivibrator Operation"
- Book XI "U.H.F. tubes for communication and measuring equipment"
- Book XII "Tubes for computers"
- Book XIII "Industrial Rectifying Tubes"

Book IIIB and XIII are in preparation

BOOK XII

TUBES FOR COMPUTERS



TUBES FOR COMPUTERS

621.385.1 : 621.385.832 : 621.374.32

BY

MEMBERS OF
PHILIPS ELECTRON TUBE DIVISION

*

PHILIPS' TECHNICAL LIBRARY

All rights reserved by
N.V. Philips' Gloeilampenfabrieken, Eindhoven (Holland)
Printed in the Netherlands

Published 1956
All data in this book are given without prejudice
to patent rights of the above Company

PREFACE

During the last decennia the application of electronic tubes has made its way into fields that formerly were unexploited. This is both a consequence of the want of fundamentally new apparatus and of the technical progress that made it possible to comply with these wants.

An example of these applications is the electronic computer, which has proved to be a most valuable expedient on the different fields of society, such as science and engineering.

Several arithmetical operations, which normally take up much time, can be quickly and accurately carried out by the electronic computer. Special mention may be made of book-keeping and other administrative duties which can be established, according to a periodical programme, by means of punch-card machines.

Furthermore, the electronic computer proves its usefulness in collecting and working up statistical data on behalf of factories and industries, which enables rapid orientation and planning.

The solving of complex mathematical problems, which in the usual way was not or hardly possible, has rendered the computer almost indispensable for science.

In the mass production of mechanically formed products, an ever increasing use is made of computers for controlling the manufacturing process. Moreover, it is possible to keep a continuous check on this process, so that the necessary corrective measures can be taken automatically and without delay.

For counting-duties, where no intricate arithmetical operations appear, only a part of the computer need be used, viz. the counter. This electronic counter has the advantage of a higher operational speed than the mechanical counter, and is therefore very suitable for counting e.g. cycles of an alternating current, pulses, revolutions of machine parts rotating at a high speed, the number of ready products, etc.

The electronic tube, in its function of inertialess switch, is one of the essential component parts of an electronic computer. Though the fundamental operation and set-up of these tubes are the same as those for amplifying purposes, this particular application is rather unconventional.

The computer tubes described in this book are specially designed for this use and consequently answer the specific demands that are imposed on them.

CONTENTS

Preface	VII
INTRODUCTION	I
GENERAL NOTES ON COMPUTER CIRCUITS	2
The binary system	2
The bi-stable multivibrator	4
Cascade circuit of multivibrators	6
Decade counter with multivibrators	8
Free-running (a-stable) and one-shot (monostable) multivibrator	9
Gate circuit	10
REQUIREMENTS IMPOSED ON TUBES IN MULTIVIBRATOR AND GATE CIRCUITS	13
VACUUM TUBES FOR USE IN HIGH-SPEED COMPUTERS	16
THE E 90 CC AND E 92 CC	16
Technical data of the E 90 CC	17
Decade counter with four tubes E 90 CC with a maximum counting rate of 200 000 p/s	20
Decade counter with a maximum counting rate of 1 000 000 pulses per second	24
Technical data of the E 92 CC	28
Decade counter with four tubes E 92 CC with a maximum counting rate of 150 000 p/s	30
THE E 88 CC	33
Technical data of the E 88 CC (tentative)	34
THE E 91 H	36
Technical data of the E 91 H	36
Practical gate circuit with the E 91 H	39
THE E 1 T	40
TUBES FOR USE IN LOW-SPEED COMPUTERS	41
THE Z 50 T	41
Technical data of the Z 50 T	42
Ring counter with eight tubes Z 50 T	43
THE Z 70 U	45
Technical data of the Z 70 U (advance data)	46
Experimental decade counter with eight tubes Z 70 U	46
CONSTRUCTIONAL	50
	IX



INTRODUCTION

Two fundamentally different types of computer can be distinguished, viz. analogue and digital computers, the former dealing with the measuring of quantities, the latter with the counting of numbers.

The principle of an analogue computer is based on the analogy between arithmetic equations and corresponding physical laws. In analogue computers, numbers are first translated into physical quantities, such as lengths, masses, forces, voltages, etc.; subsequently, the required processes are carried out. The result appears as a physical quantity, which is re-translated into a corresponding number. Specially to high-order differential equations, which are extremely difficult to solve arithmetically, an analogue computer is a most useful expedient.

A simple example of an analogue computer is the slide rule, which enables multiplying, dividing, extraction of roots and involution.

In order to multiply two numbers with the aid of a slide rule, the logarithms of the numbers are converted into proportional lengths; then the lengths are so combined, that the total length is equal to the sum of the component lengths. The total length is therefore proportional to the sum of the logarithms of the numbers to be multiplied and thus proportional to the logarithm of the product of both numbers. The required product is obtained by converting the total length into the proportional number.

Other examples of analogue computers are the kWh-meter, which multiplies and integrates, and the familiar differential gear, which adds or subtracts.

In digital computers digits and numbers are represented by discrete stable positions. It is obvious that in these types of machines arithmetical processes have a discontinuous course; similar to the change from one number to another, the change from one stable position to another occurs by leaps and bounds.

Since the tubes described in this book are primarily intended for use in digital computers, the latter are treated in greater detail.

In principle, any device having two or more stable positions can be used as a digital computer, for

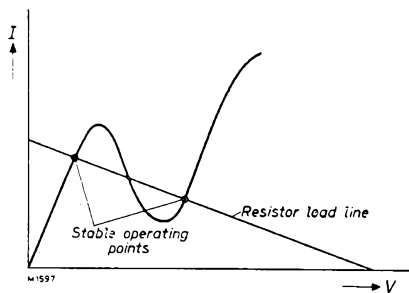

Fig. 1. Diagram showing the occurrence of two stable operating points when an electronic tube with a partly negative $I = f(V)$ characteristic is used in combination with a load resistor.

example a tumbler switch, a telephone relay of an electronic tube with a partly negative current-voltage characteristic, such as a transitron or a secondary-emission tube, which have more than one operation point (Fig. 1), and a gas- or glow-discharge tube.

Since in many applications the usefulness of a computer is determined by the time in which a calculation can be carried out, the operational speed of a computer is of paramount importance.

Mechanical computers, being relatively slow due to their inertia, are therefore inadequate when high speeds are required, so that fully electronical devices are frequently preferred.

One of the fundamental elements in the computing part of digital computers is the counter. The most common electronic counter is composed of bi-stable multivibrators (Eccles Jordan flip-flop circuits), which have two stable positions.

In high-speed multivibrator circuits, most tubes are of the double triode type. In this book three of these types are described, namely the E 90 CC, E 92 CC and E 88 CC¹⁾.

The beam deflection tube E 1 T is a decade counter tube with ten stable positions. It has a maximum counting rate of 100 000 pulses per second. In an experimental circuit a counting rate up to $2 \cdot 10^6$ pulses per second has been reached. A short description of the E 1 T is given in this book.

At present, increasing use is made of counters composed of cold-cathode glow-discharge tubes operating as bi-stable elements. In low-speed counters (up to about 1000-3000 pulses per second) the small trigger tubes Z 50 T and Z 70 U can be used advantageously. These tubes are also devices with two stable positions (the tube being either ignited or extinguished). A description of these tubes is also included.

In addition to the tubes mentioned above, other types, like dekatrons, thyratrons and transistors can be used as counter elements. Another unit, frequently used in digital computers, is the gate circuit, which has the purpose of passing or blocking pulses. The gate tube is the essential part of this circuit. In this book the dual-control gate tube E 91 H is described.

GENERAL NOTES ON COMPUTER CIRCUITS

THE BINARY SYSTEM

Since bi-stable multivibrators and cold-cathode tubes have two stable positions, counters equipped with these tubes, which are simply connected in cascade, naturally operate in the binary system. The principle of the binary system is outlined below.

¹⁾ The E 88 CC has, moreover, been designed as a low-noise amplifier in cascade circuits.

In the decimal system ten symbols are available (the digits 0 to 9), with the aid of which any rational number can be expressed. The notation of a decimal number consists in arranging series of digits so that they indicate subsequent powers of 10. The notation 723 in the decimal system denotes a quantity of units equal to

$$7 \times 10^2 + 2 \times 10^1 + 3 \times 10^0.$$

Decimal fractions, moreover, contain negative powers of 10; e.g. 864.39 denotes

$$8 \times 10^2 + 6 \times 10^1 + 4 \times 10^0 + 3 \times 10^{-1} + 9 \times 10^{-2}.$$

When two decimal numbers must be added, the coefficients of equal powers of 10 are added; if one of these additions exceeds the digit 9, a next higher power of 10 is obtained, the coefficient of the latter being augmented by 1 (the "carry").

Example:

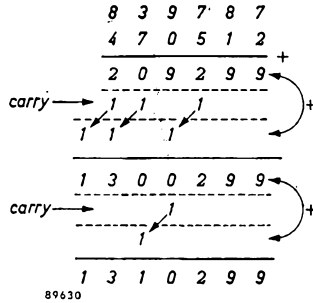

In analogy to the decimal system based on the number 10, any other arbitrary digit (or number) may be taken as the base of a digital system. In the binary system this base is 2, so that only two digits are considered, viz. 0 and 1. Arithmetical processes in the binary system are analogous to those in the decimal system.

In the binary system, numbers are represented as subsequent powers of 2, e.g.

$$a \times 2^n + b \times 2^{n-1} + c \times 2^{n-2} + \dots \text{ etc.},$$

the coefficient a, b, c , etc. representing one of the digits 0 or 1.

In order to convert a decimal number into a binary number, the former must be written in the highest possible powers of 2. Example:

$$\begin{aligned} 89 \text{ (decimal)} &= 1 \times 2^6 + 0 \times 2^5 + 1 \times 2^4 + \\ & 1 \times 2^3 + 0 \times 2^2 + 0 \times 2^1 + 1 \times 2^0. \end{aligned}$$

In the binary system the decimal number 89 is therefore written as 1011001.

Example of the addition of two binary numbers:

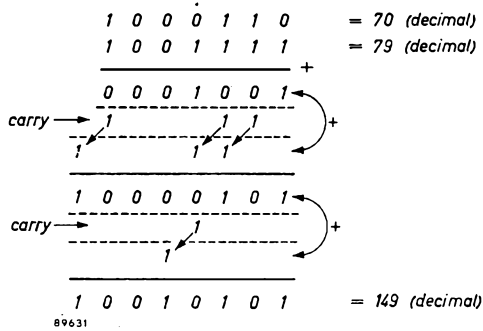

THE BI-STABLE MULTIVIBRATOR

The bi-stable multivibrator (flip-flop circuit) consists of two d.c. coupled amplifying stages with heavy negative feedback. In this circuit mostly twin triodes are used as amplifiers, and the cathodes of both sections are as a rule internally interconnected.

Fig. 2 shows the diagram of a conventional bi-stable multivibrator. The circuit elements are such that the circuit is symmetrical.

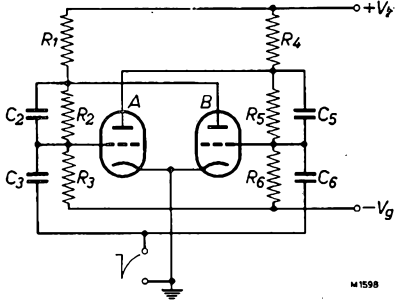

Fig. 2. Circuit diagram of a typical bi-stable multivibrator.

The grids of both triodes are cross-wise coupled to the anodes; the grid voltage of one tube section therefore depends both on the quiescent current through the voltage divider, connected between V_b and $-V_g$, and on the anode current of the other tube section. The capacitors C_2 and C_5 , which are shunted across the resistor R_2 and R_5 , form a low-impedance a.c. path between the anode of one section and the grid of the other section.

The grid supply voltage $-V_g$ is highly negative, so that it is below the cut-off voltages of the tubes. With suitable values of the circuit elements a stable condition is obtained at which one of the triode sections is conducting while the other is cut off. This can be explained by the following indirect demonstration.

Assuming that both triodes are conducting, a small decrease of the anode voltage of A will cause the grid voltage of B to decrease, which results in an increase of the anode voltage of B . This causes the grid voltage of A to rise, resulting in a

further decrease of the anode voltage of *A*. This cumulative process will continue until the decrease of the anode voltage of *A* has no longer any effect on the variation of the anode voltage of *B*; this occurs when *B* is completely cut off. The grid voltage of *A* is then about zero, due to the current flowing through the fairly large grid-leak resistor.

Owing to the symmetry of the circuit, an increase of the anode voltage of *A* will have an opposite effect. The condition at which both tubes are conducting is therefore unstable and non-consistent.

The performance of a bi-stable multivibrator is based on the subsequent conducting and non-conducting conditions of the triode sections. The turn-over is initiated by a negative voltage pulse simultaneously applied to both grids. To trigger the multivibrator, this pulse should satisfy certain requirements regarding its amplitude and slope. The turn-over of the multivibrator may be explained as follows.

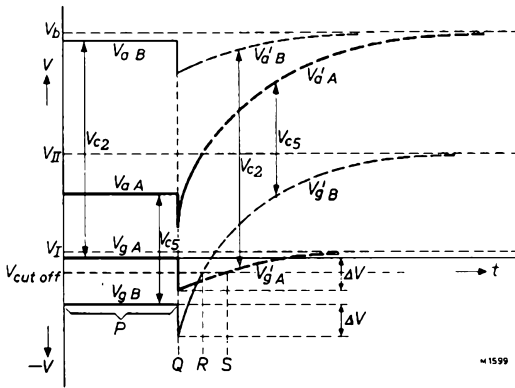

Fig. 3. Anode and grid voltages of a bi-stable multivibrator circuit before and after the trigger pulse has been applied.

Assume tube *A* to be conducting before the action, so that *B* is cut off. The grid and anode voltages of the tubes are then as indicated in Fig. 3, interval *P*. The voltages across the "memory"-capacitors C_2 and C_5 are indicated by V_{c2} and V_{c5} . The time constants of $C_2 \cdot R^2$ and $C_5 \cdot R_5$ are so large, that the voltages V_{c2} and V_{c5} may be assumed to remain constant during a relatively long time.

At the moment *Q* (Fig. 3) a negative-going voltage step ΔV is applied to both grids via the capacitors C_3 and C_6 ; this causes both the grid voltages and (due to the presence of the memory-capacitors) the anode voltages to drop by an amount ΔV . Tube *A* will then be cut off, because its grid voltage drops below the cut-off value.

Subsequently the grid anode voltages will tend to assume values corresponding to the static situation. This occurs exponentially, since C_3 and C_6 have to be charged via resistor networks. The final grid voltages are, however, different for both tubes, viz. $V_I (= V_b - V_{c2})$ and $V_{II} (= V_b - V_{c5})$, corresponding to V_{gA} and $V_{g'B}$ respectively (see Fig. 3). Although at the initial Q the initial grid voltage of B is lower than that of A , the grid voltage of B will reach the cut-off value sooner than the grid voltage of A (points R and S respectively). Point S will, however, not be reached, since the conducting of B causes its anode voltage to drop, decreasing in turn the grid voltage of A , thus preventing A from conducting. Finally, the static condition is obtained, at which B is conducting and A is cut off. The circuit is thus reversed with respect to its original condition.

Due to the symmetry of the circuit, the multivibrator will return to the opposite condition as soon as the next negative pulse is applied.

It may be desirable, and sometimes even necessary, to have an indication of the condition of the multivibrator. The most common indication is obtained by a neon pilot lamp, which is connected between the anode and the cathode of one of the triode sections of the multivibrator (Fig. 4). R is a current-limiting resistor.

When the triode A is cut off, its anode voltage exceeds the ignition voltage of the lamp, but when it is conducting, its anode voltage is too low to maintain a glow discharge.

The above-mentioned indication is only possible if the voltage excursions at the anode are sufficiently large to ensure that the lamp is ignited and extinguished. When this requirement is not fulfilled, a tuning indicator may be used instead.

The two resistors R_s , shown in the circuit of Fig. 4, which are directly connected to the grids of the triodes, prevent the circuit from oscillating; their influence on the performance of the multivibrator can be disregarded.

CASCADE CIRCUIT OF MULTIVIBRATORS

Fig. 5 shows two coupled multivibrator circuits I and II . The anode of the triode section A_I is connected to the grids of A_{II} and B_{II} via the capacitors C_c and C_c' . As soon as A_I starts conducting, its anode supplies a negative pulse to the grids of the multivibrator II , so that the latter is reversed. Since this occurs every time two pulses have been applied to multivibrator I , half the number of the pulses applied to I arrive at the input of II (scale-of-two).

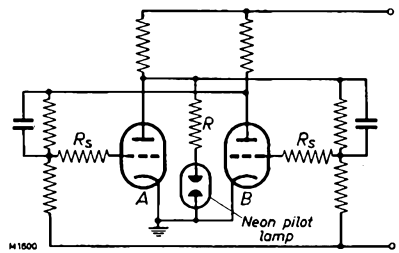

Fig. 4. Insertion of a neon pilot lamp in the multivibrator circuit to provide visual indication.

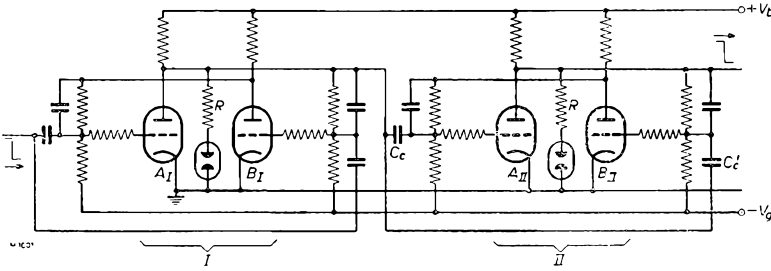

Fig. 5. Cascade circuit of two multivibrator circuits.

This chain can be extended to any arbitrary number of multivibrators. If each of these multivibrators is provided with an indication (e.g. a neon pilot lamp), the total number of pulses applied to the first multivibrator can be read (provided this number does not exceed $2^n - 1$, where n denotes the number of multivibrators). Assuming the extinguished and burning lamps to represent the values 0 and 1 respectively, the total number of pulses is read from right to left in the binary system as illustrated in Fig. 6. In this figure the multivibrators are indicated

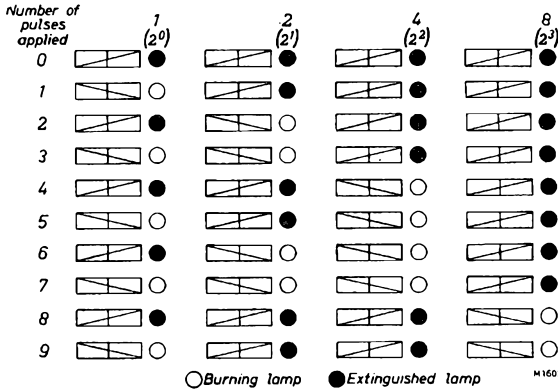

Fig. 6. Indication of the number of counted pulses by neon lamps, according to the position of the corresponding multivibrator circuits.

by (1) or by (2). The left and right halves of both symbols indicate the corresponding triode sections of the multivibrator. The position of the diagonal, which represents the level of the anode voltages of the triodes, indicates the condition of the multivibrator. Symbol (1) shows that the anode voltage of the left-hand section is low, whereas that of the right-hand section

is high, in other words, the left-hand section is conducting, and the right-hand section is cut off. Symbol (2) denotes the opposite case. By adding the values indicated by the burning and extinguished lamps, the total number of counted pulses can be ascertained.

The analogy of the cascade circuit of bi-stable multivibrators and the binary system can be seen as follows.

Similar to the binary system in which the coefficients of the powers of 2 can only be 0 or 1, a bi-stable multivibrator circuit has only two stable positions (left-hand section conducting, right-hand section cut off, or vice versa). When the figure 1, allotted to one of the positions of the multivibrator, is exceeded, the latter delivers an output pulse to the next multivibrator, which may be regarded as the augmentation of the coefficient of the next higher power of 2 by the carry 1.

In the preceding, the multivibrators were considered to be controlled by negative-going pulses only because in practice negative-going pulses are mostly preferred to positive pulses, for the following reasons.

1. When the multivibrator is controlled by positive-going pulses, the anode voltage drop of the initially non-conducting tube section is antagonized by the positive pulse at the grid of the conducting tube section. The triggering sensitivity is therefore smaller than when negative-going pulses are applied.
2. The leading edge of the negative-going pulses appearing at the anodes of the tubes is relatively steep because the internal resistance of the tube — being parallel to the output impedance — decreases the time constant of this impedance; this does not apply to positive-going pulses.
3. The driving power required for applying positive-going pulses to the cathodes largely exceeds the power necessary for controlling the grids by negative-going pulses. A further disadvantage of applying positive-going pulses to the cathode is that the cathode resistor cannot be by-passed. This results in negative feedback being applied, so that the amplitude of the pulses must be fairly large.

DECADE COUNTER WITH MULTIVIBRATORS

To avoid the necessity of coding and decoding (translation from the decimal system into the binary system and vice versa), multivibrators are frequently so combined that a decade counter is obtained. These decade counters consist of four multivibrators, which are so arranged that, after ten pulses have been applied to the input, one output pulse is produced and the counter is returned to its initial state¹).

There are several methods of realizing such circuits, all of them being based on the fact that a specific combination of multivibrator conditions corresponds to a certain number of pulses applied²). Such circuits will be discussed later.

¹) Four multivibrators normally connected in cascade supply one output pulse at every 16th incoming pulse.

²) It is generally possible to connect four multivibrators in such a way that any arbitrary pre-determined number between 0 and 16 causes the counter to supply one output pulse.

FREE-RUNNING (A-STABLE) AND ONE-SHOT (MONOSTABLE) MULTIVIBRATOR

In addition to being used in bi-stable multivibrators, double triodes are also employed in a-stable and monostable multivibrator circuits; the former are used as pulse generators and the latter as pulse shapers¹⁾ or pulse delay circuits.

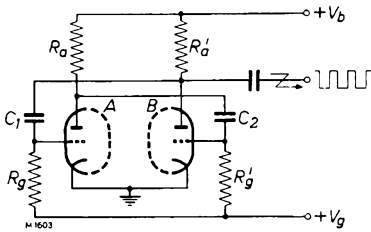

Fig. 7. Circuit diagram of a typical a-stable multivibrator.

A typical circuit of an a-stable multivibrator is shown in Fig. 7. The a-stable multivibrator differs from the bi-stable multivibrator in that:

- (a) the triode sections are only a.c. coupled;
- (b) the grids are positively biased.

During the heating-up period, one of the two triode sections will generally start to conduct first. Assume this is section A. The anode voltage of this section then assumes a lower value, and so does the grid voltage of section B due to the presence of the capacitor C₂. Since the grid voltage of section B drops temporarily below cut-off, this section is provisionally prevented from conducting. C₂ is subsequently charged via the resistors R_a and R_g' , causing the grid voltage of section B to rise. After a certain time, determined by the time constant of C₂ and R_a-R_g' , the negative grid voltage of section B decreases until the cut-off point is reached. Then section B starts to conduct, causing its anode voltage to decrease. Owing to the presence of C₁, the grid voltage of section A is decreased by the same amount, so that section A is now cut off. C₁ is then charged, and the grid voltage of section A rises until it reaches the cut-off value. Section A then becomes conducting again and the whole cycle is repeated. At the anodes of the tube sections square pulses are produced, the duration and repetition rate of which depend on the time constants of the RC-networks.

Another variant is the monostable (one-shot) multivibrator, which has only one stable position.

Fig. 8 shows the circuit diagram of such a monostable multivibrator. Its performance is based upon one of the couplings between the sec-

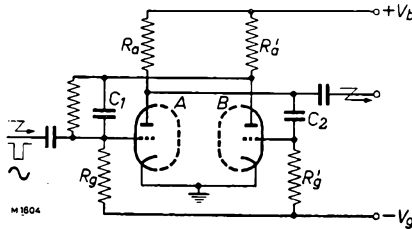

Fig. 8. Circuit diagram of a typical monostable multivibrator.

¹⁾ A pulse shaper is a device which modifies inadequate signals into signals the shape and amplitude of which are well suited for trigger purposes.

tions being similar to that of a bi-stable multivibrator, whereas the other coupling is similar to that of an a-stable multivibrator. Consequently, only one stable position is obtained which is turned over to the non-stable position during a short interval when a trigger pulse is applied.

During the quiescent state, triode section *A* is conducting, whereas section *B* is cut off. When a negative-going pulse is applied to the grid of section *A*, the latter is cut off, which causes section *B* to become temporarily conducting. After C_2 has been charged, section *B* is cut off and section *A* becomes conducting: the circuit has then returned to its initial state. The cycle is repeated only when another pulse is applied.

The negative voltage excursion that appears at the anode of section *A*, when this starts to conduct, is delayed with respect to the leading edge of the trigger pulse. This delay is equal to the interval during which section *B* is conducting, and this interval depends on the time constant $C_2 R_g'$.

Sinusoidal or other periodically varying voltages, the shape and amplitude of which are unfit to trigger a bi-stable multivibrator, can be applied to the input of a monostable multivibrator, which thus acts as a pulse shaper and supplies negative-going pulses. These have a sufficiently high slope to trigger a bi-stable multivibrator.

GATE CIRCUIT

In addition to the counter, the gate circuit is a unit frequently used in computers. This circuit consists of an electronic switch which passes or rejects pulses.

The gate tube is the most important element of a gate circuit. For this purpose multi-grid tubes (e.g. heptodes) may be used, circuited in such a way that passing the pulses depends on the voltage levels at one or more grids. Fig. 9 shows a simplified gate circuit¹⁾.

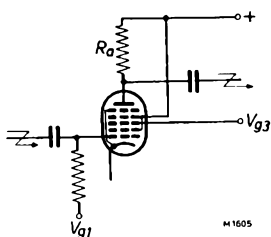

Fig. 9. The heptode as a gate tube.

The tube has five grids (g_1 to g_5); g_2 and g_4 are screen grids which have a fixed positive potential with respect to the cathode, and g_3 is the suppressor grid which is connected directly to the cathode.

Voltage pulses applied to the first control grid g_1 result in corresponding anode current pulses being produced when the tube is conducting. Since a resistor is incorporated in the anode circuit, voltage pulses will appear at the anode, which have the same shape and repetition rate as those at the grid, but the polarity of which is reversed.

¹⁾ To distinguish leads that serve for transportation of direct voltages and those used for the transport of pulses, the latter are marked $\overline{\rightarrow}$

According to whether the voltage of g_3 is above or below cut-off, the tube will be conducting or not, so that the pulses at the control grid g_1 are either passed or blocked. The voltage level at g_3 is determined by the anode voltage of one triode section of a bi-stable multivibrator; this level is high or low, depending on the number of pulses applied to the multivibrator being odd or even.

Fig. 10 represents a gate circuit consisting of a gate tube and a bi-stable multivibrator. In contrast to bi-stable multivibrators used as counters, the grids of both sections of the multivibrator shown in Fig. 10 are controlled separately. The anode voltage of the right section determines the voltage level of the third grid of the gate tube, the gate being opened when this section is cut off. When the multivibrator is reversed owing to a negative-going pulse being applied to the left (conducting) triode section, the gate is closed. A negative-going pulse applied to the right section of the multivibrator opens the gate.

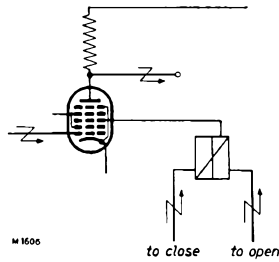

Fig. 10. Simplified diagram of a heptode gate tube, controlled by a multivibrator circuit.

As an example of the application of a gate tube, Fig. 11 shows a circuit diagram of a very simple computer, by means of which two digits x and y can be multiplied.

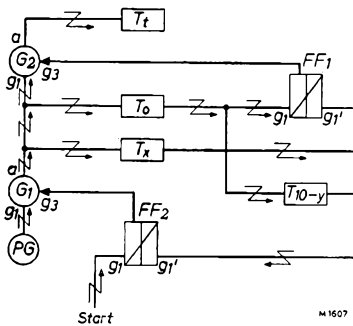

Fig. 11. Block diagram of a simple multiplication circuit.

Circles marked G represent gate tubes, whereas the rectangles marked T_x , T_0 and T_{10-y} represent decimal counters, which have been preset to the counting positions x , 0 and $10-y$ respectively, so that T_x , T_0 and T_{10-y} supply output pulses after $10-x$, 10 and y pulses respectively have been applied to their inputs. The circle marked PG is a pulse generator continuously supplying negative-going pulses. The bi-stable multivibrator FF_2 is provided with a device which enables a negative-going pulse being manually applied to g_1 ("start").

The initial positions of the multivibrators are as indicated in Fig. 11. The voltage level of g_3 of the main gate G_1 is low, so that the pulses supplied by PG are blocked. The process starts when a negative-going pulse is applied to g_1 of FF_2 . The latter is then reversed, and the level of g_3 of G_1 becomes high, which enables G_1 to pass pulses. These pulses are fed both to T_x , T_0 and to G_2 . However, G_2

is still closed, but after $10-x$ pulses, T_x delivers an output pulse which triggers FF_1 , so that G_2 is opened. G_2 then starts to pass pulses. This continues until 10 pulses have been passed by G_2 ; T_0 then supplies an output pulse that reverses FF_1 to its initial position, so that G_2 is closed. After 10 pulses the counter T_t has received $10 - (10 - x) = x$ pulses. At the same time T_{10-y} has received one pulse. At the next series of 10 pulses, x pulses are fed to T_x and one pulse to T_{10-y} . After y series of 10 pulses, T_{10-y} has received y pulses, so that it delivers an output pulse to FF_2 . This multivibrator is thus reversed and closes the gate G_1 , so that the pulses produced by PG are blocked. G_1 has thus passed $10 \cdot y$ pulses in total; from every series of 10 pulses T_t has received x pulses, the total number of pulses applied to T_t thus being y times x . The product yx can consequently be read out from T_t .

It is also possible to design circuits in which *two* conditions must be fulfilled to open the gate. In that case the control grid g_1 should have a negative bias, which normally keeps the tube cut off. The principle of such a method of operation is illustrated in Fig. 12, showing a 3-dimensional view of the relationship between the parameters I_a , $-V_{g1}$ and $-V_{g3}$.

At point O , both V_{g1} and V_{g3} are zero (high level); at point P , V_{g1} is below cut-off (low level) and V_{g3} is zero; at point Q , V_{g1} is zero and V_{g3} is below cut-off (low level); at point R , finally, both V_{g1} and V_{g3} are below cut-off.

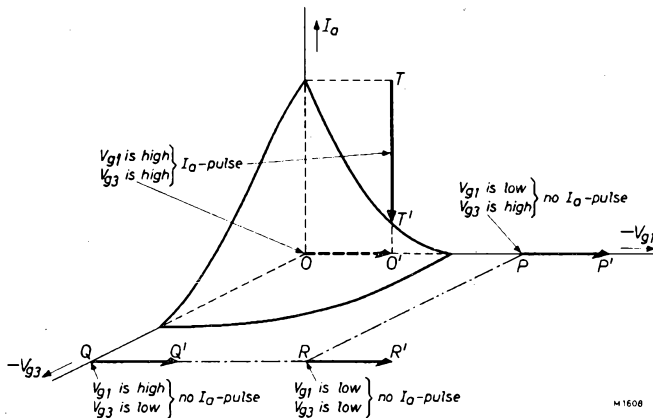

Fig. 12. Effect of biasing two grids of a gate tube.

When the tube is biased to point O , a negative-going pulse OO' at g_1 produces an anode current pulse TT' , whereas negative pulses at point P , Q and R have no influence on the anode current, so that no pulses are passed.

When the tube is initially biased to point R , it will therefore not pass pulses unless *both* V_{g1} and V_{g3} have attained their high level ("*and*" circuit).

When, on the other hand, the tube is biased to point O , only V_{g1} or V_{g3} need attain a low level to block the pulses ("or" circuit). Under these conditions the circuit is called a "buffer".

There are also circuits in which the passing or blocking depends on more than two conditions.

REQUIREMENTS IMPOSED ON TUBES IN MULTIVIBRATOR AND GATE CIRCUITS

For a reliable performance special demands must be fulfilled by multivibrator and gate circuit elements. Some of the most important requirements are mentioned below, together with the conditions the tubes in these circuits must satisfy.

The bi-stable multivibrator should come up to the following requirements:

- (1) It should be reversed when a well-defined pulse is applied to the input.
- (2) It should not be reversed by pulses of wrong polarity.
- (3) Shortly after the turn-over, the multivibrator should be reversed by the next pulse. This "dead time" should be as small as possible.
- (4) The negative-going pulse appearing at the anode of the triode sections should be able to trigger a following multivibrator (or an interstage pulse-shaper).

In computers the input pulses are applied to the multivibrator at regular intervals (random pulses are of no interest). Since the counting speed of a multivibrator, and therefore also the minimum interval between two pulses, are limited by the values of the circuit elements, the counting speed will also be affected by asymmetry of the tube. Symmetry of both tube halves is therefore essential.

Signals passing a C - R network are differentiated. The slope of the leading edge of a pulse, which always has a finite value, will therefore decrease, so that it is advisable to keep the time constants of the input and output impedances small. The following points are therefore of particular interest:

- (a) The anode-to-grid capacitance (C_{ag}) must be kept as small as possible in connection with the capacitive voltage dividing of the pulses at the anode. When C_{ag} is large, the amplitude of the input pulse will be decreased by capacitive voltage dividing due to the Miller effect, and the time constant of the input filter is increased. The C_{ag} mainly influences the trigger sensitivity (i.e. the amplitude of the minimum trigger pulse).
- (b) The internal d.c. resistance (R_i) of the triode sections should be low, so that the tube approximates an ideal switch ($R = 0$ or ∞). As follows from Fig. 13, the amplitude of the anode pulse is equal to $[R_a/(R_i + R_a)] V_b$. Therefore, the smaller the internal resistance, the larger the amplitude of the pulse will be. The time constant of $C_a R_i$, moreover, decreases with the value of R_i , so that the output pulse is less affected.

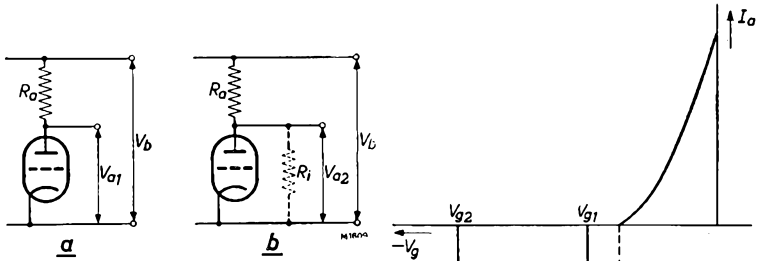

Fig. 13. Calculation of the amplitude of the negative pulse appearing at the anodes of a multivibrator.

(a) Tube non-conducting: $V_{a1} = V_b$.

(b) Tube conducting:

$$V_{a2} = [R_i / (R_i + R_a)] V_b;$$

pulse amplitude

$$V_{a1} - V_{a2} = [R_a / (R_i + R_a)] V_b.$$

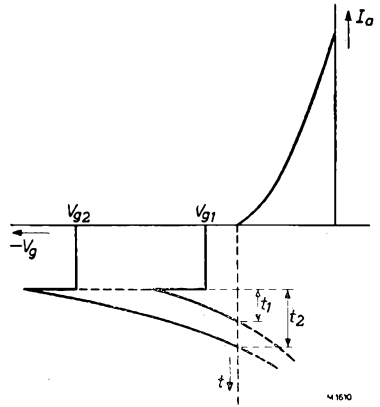

Fig. 14. Effect of the grid bias on the counting speed.

To obtain a high counting speed, the grid voltage of the non-conducting tube should not be far below the cut-off voltage. In Fig. 14 the grid voltage of the non-conducting tube has been plotted as a function of time for two different values of the initial voltage (V_{g1} and V_{g2}). It is seen that between the instant at which the negative pulse is applied and that at which the grid voltage reaches the cut-off value, the time interval decreases as the initial voltage approaches the cut-off voltage, in other words t_1 becomes smaller than t_2 .

Moreover, the time elapsing between the instant at which the non-conducting tube reaches the cut-off point and that at which this tube fully conducts, should be as short as possible. The anode voltage of the tube section that has just become conducting should drop very rapidly, so that the quiescent state is soon reached.

These conditions require the $I_a = f(V_g)$ characteristic of the tube to have a sharp intersection with the V_g -axis. Besides, the slope of this characteristic just above the cut-off point should have a fairly high value.

"Dual-control" gate tubes require sharp cut-off voltages at both control grids, and the cut-off voltages of both grids should, moreover, be almost equal.

The capacitance between the anode and all other electrodes should be small, to prevent excessive distortion of the output pulse; the capacitance between the two control grids should be small, to avoid the risk of cross-talk.

In view of the large number of tubes used in computers, the power dissipated is of great importance, so that the operating voltages and currents should have low values. The reliability and tube life are obviously also of great interest.

A phenomenon that may be experienced with tubes used in computers is the "interface", that is the occurrence of a poorly conducting layer between the cathode

Requirements imposed on tubes in multivibrator and gate circuits

body and its coating, which manifests itself as a network of resistances and capacitances. Such a layer may be formed after the tubes have been non-conducting for some length of time with their cathodes heated. This is due to the action of small portions of admixtures in the cathode material, such as silicon. Since multivibrator sections and gate tubes are either conducting or fully cut off, there is a risk of interface occurring in these tubes.

The interface, which may be regarded as an undesirable impedance in the cathode circuit of the tube, causes negative feedback and pulse deformation, and this may render the multivibrator inoperative. By taking special measures, the risk of interface may be reduced to such an extent that the influence of interface is negligible during the tube life.

VACUUM TUBES FOR USE IN HIGH-SPEED COMPUTERS

Data of the vacuum tube types E 90 CC, E 92 CC, E 88 CC and E 91 H are given below. These "special quality" tubes are generally intended for professional use. They are manufactured with special care to ensure high reliability, long life (minimum 10 000 hours) with little risk of failure, high stability and great uniformity.

Some of the measures taken during manufacture of the tubes to ensure the above-mentioned features, are the following:

- (a) The tube parts are meticulously cleaned before mounting.
- (b) Mounting of the parts is carried out in dust-free cabinets.
- (c) Welding of the parts and connecting leads is accomplished in an oxygen-free atmosphere, and the welding pressure, welding time and applied voltage are kept very constant.
- (d) The tubes are pumped during a fairly long period.
- (e) All tubes are tested on internal short-circuit or bad connections by means of vibrations.

The tubes mentioned above have a relatively low cathode temperature, which is beneficial to a good insulation between the electrodes. To prevent the occurrence of interface, the cathodes are made from passive nickel containing hardly any silicon.

The types E 90 CC, E 92 CC and E 88 CC are intended for use in multivibrator circuits, whereas the E 91 H is a dual-control gate tube.

Since the operating conditions of tubes used in multivibrators differ entirely from those used in amplification circuits, different requirements are imposed on their characteristic data, such as the mutual conductance, distortion, etc.

As mentioned before, two points of the $I_a = f(V_g)$ characteristics of tubes for multivibrator circuits are of prime importance, viz.

- (1) the cut-off voltage (in practice given at $I_a = 0.1$ mA);
- (2) the anode current at zero grid voltage. Therefore, these data are also quoted under the heading "Technical Data".

THE E 90 CC AND E 92 CC

The E 90 CC and E 92 CC are indirectly heated double triodes designed for use in multivibrator circuits. They are of the miniature type, which has been enabled by interconnecting both cathodes. The small dimensions of these tubes are of utmost importance with a view to their use in apparatus equipped with several hundreds of tubes.

The small internal resistance of the E 90 CC is of particular advantage for counters with high counting speeds.

The E 92 CC has a smaller anode-to-grid capacitance and a higher internal resistance than the E 90 CC. In applications where sensitivity rather than counting speed is important, the E 92 CC is preferred to the E 90 CC.

TECHNICAL DATA OF THE E 90 CC

Heating: indirect by a.c. or d.c.; series or parallel supply

Heater voltage $V_f = 6.3 \text{ V}^1)$

Heater current $I_f = 0.4 \text{ V}^1)$

CAPACITANCES

Anode to all other electrodes $C_{aa'}$ = $0.35 \pm 0.07 \text{ pF}$

$C_{a'a}$ = $0.4 \pm 0.07 \text{ pF}$

Grid to all other electrodes $C_{gg'}$ = $3.4 \pm 0.5 \text{ pF}$

$C_{g'g}$ = $3.4 \pm 0.5 \text{ pF}$

Anode to grid C_{ag} = $3.5 \pm 0.5 \text{ pF}$

$C_{a'g'}$ = $3.2 \pm 0.5 \text{ pF}$

Grid to heater C_{gf} < 0.15 pF

$C_{g'f}$ < 0.3 pF

Cathode to heater C_{kf} = 7.6 pF

Between both sections $C_{aa'}$ < 1.4 pF

$C_{gg'}$ < 0.22 pF

C_{ag} < 0.35 pF

$C_{a'g}$ < 0.15 pF



89517

Fig 15. Photograph of the E 90 CC (actual size).

BASE CONNECTIONS AND DIMENSIONS

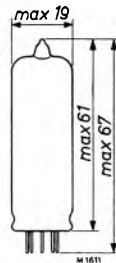
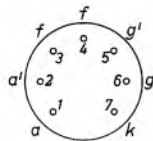
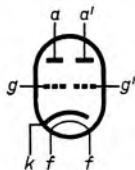

Fig. 16. Electrode arrangement, electrode connections and maximum dimensions in mm (miniature base).

¹⁾ The maximum deviation of I_f at $V_f = 6.3 \text{ V} \pm 0.02 \text{ A}$.

To obtain a useful tube life of 10 000 hours in the case of parallel supply, the maximum variation of V_f should be less than $\pm 5\%$ (absolute limits).

To obtain a useful tube life of 10 000 hours in the case of series supply, the maximum variation of I_f due to voltage fluctuations and tolerances in the parts should be less than $\pm 1.5\%$ (absolute limits).

TYPICAL CHARACTERISTICS (each section)

Anode voltage	$V_a = 100 \text{ V}$
Grid voltage	$V_g = -2.1 \text{ V}^2)$
Anode current	$I_a = 8.5 \pm 4 \text{ mA}$
Mutual conductance	$S = 6 \pm 1.5 \text{ mA/V}$
Amplification factor	$\mu = 27$
Starting point grid current	$-V_g (I_g = +0.3 \mu\text{A}) = 0.2 \text{ V}$ $= \text{max. } 1.3 \text{ V}$
Insulation cathode-to-heater (cathode positive)	$r_{k,f} = \text{min. } 2 \text{ M}\Omega$
Insulation between two arbitrary electrodes	$r = \text{min. } 20 \text{ M}\Omega$

OPERATING CHARACTERISTICS for use in computer circuits (each section)

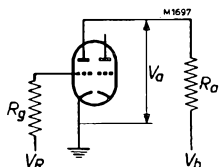

Fig. 17. Diagram for defining V_b , V_a , R_a , R_g and R_u .

Anode supply voltage	$V_b = 150 \text{ V}$
Anode series resistor	$R_a = 20 \text{ k}\Omega$
Grid series resistor	$R_g = 47 \text{ k}\Omega$
Grid supply voltage	$V_R = 0 - 10 \text{ V}$
Anode current	$I_a = 5.6^3) \text{ } 0 \text{ mA}^4)$
Difference between cut-off voltages of both sections	$V_R - V_R' (I_a = 0.1 \text{ mA}) = \text{max. } 2.0 \text{ V}$

LIMITING VALUES (absolute limits; each section)

Anode voltage at zero anode current	$V_{a0} = \text{max. } 600 \text{ V}$
Anode voltage	$V_a = \text{max. } 300 \text{ V}$
Anode dissipation	$W_a = \text{max. } 2 \text{ W}$
Direct grid voltage (negative)	$-V_g = \text{max. } 100 \text{ V}$
Peak grid voltage	$-V_{gp} = \text{max. } 200 \text{ V}$

2) Obtained by means of $R_k = 250 \Omega$.

3) Min. 5.0 mA; max. 6.2 mA.

4) Max. 0.1 mA.

The E 90 CC and E 92 CC

Direct grid voltage (positive)	$+V_g = \text{max. } 0 \text{ V}$
Direct grid current	$I_g = \text{max. } 250 \mu\text{A}$
Peak grid current	$I_{gp} = \text{max. } 1 \text{ mA}$
Direct cathode current	$I_k = \text{max. } 15 \text{ mA}$
Peak cathode current	$I_{kp} = \text{max. } 75 \text{ mA}^{5)}$
Grid series resistor	$R_g = \text{max. } 1 \text{ M}\Omega^{6)}$ $= \text{max. } 0.5 \text{ M}\Omega^{7)}$
Voltage between cathode and heater	$V_{kf} = \text{max. } 100 \text{ V}$
Bulb temperature	$t_{bulb} = \text{max. } 170^\circ\text{C}$

Remarks: For stable operation it is advisable to restrict R_{kf} to values $< 20 \text{ k}\Omega$.
The E 90 CC is not intended for applications which are critical as to microphony or hum.

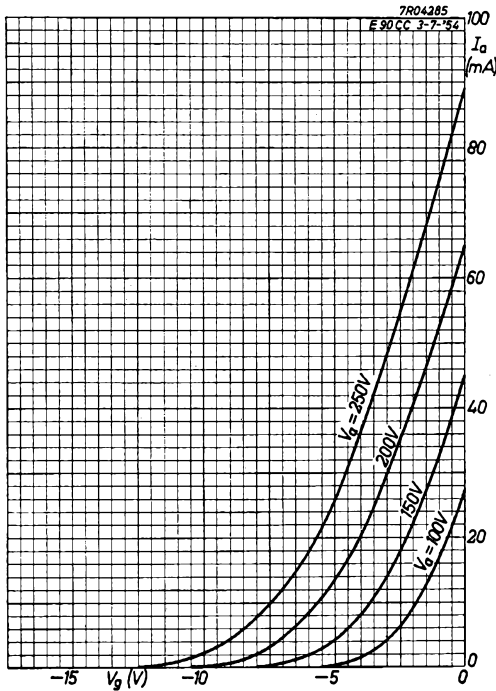

Fig. 18. Anode current I_a of the E 90 CC as a function of the grid voltage V_g with the anode voltage V_a as parameter.

5) $T_{av} = \text{max. } 10 \text{ msec.}$
6) With automatic grid bias.
7) With fixed grid bias.

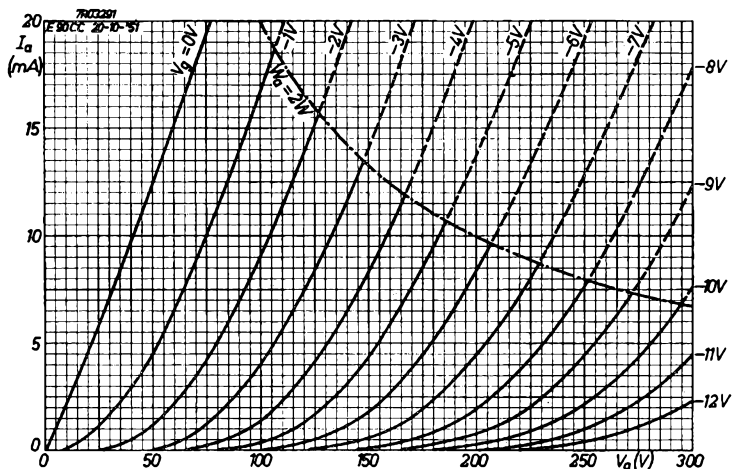

Fig. 19. Anode current I_a of the E 90 CC as a function of the anode voltage V_a with the grid voltage V_g as parameter.

DECADE COUNTER WITH FOUR TUBES E 90 CC
WITH A MAXIMUM COUNTING RATE OF 200 000 p/s

Fig. 20 shows the basic diagram of a decade counter, equipped with four double triodes. In this figure the coupling between the various stages is indicated. The operation of the circuit is as follows (cf. Fig. 21).

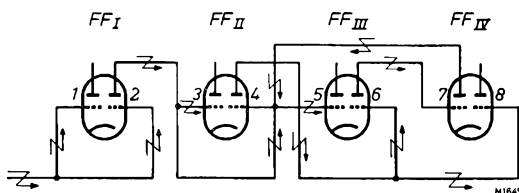

Fig. 20. Basic diagram of a decimal counter composed of four multivibrators.

For the first three input pulses, the counter operates normally according to a cascade circuit of bi-stable multivibrators. When the fourth pulse is applied, FF_{II} is reversed and tube section 4 becomes conducting, so that a pulse is applied to the grids of tube sections 6 and 8. FF_{IV} is thus reversed, and triode section 7 becomes



conducting. Simultaneously, on account of the feedback circuit connected to the anode of tube section 7, a pulse is fed to the triode sections 4 and 5, so that FF_{II} and FF_{III} are returned to the conditions occupied before the fourth pulse was applied.

From the fifth pulse onwards the pulses are counted normally. After the ninth pulse all left-hand triode sections are conducting, so that all multivibrators are reversed by the tenth pulse. The counter has then returned to its original (zero) condition.

Owing to the presence of the feedback circuit, the value that must be allotted to the conducting right-hand sections are 1, 2, 4 and 2 respectively, and not successive powers of 2 (i.e. 1, 2, 4 and 8), as is the case with a normal binary counter.

In the definite circuit shown in Fig. 22, ten neon pilot lamps are used for the visual indication. These are arranged in such a manner that only one lamp will burn at a time at every stable position of the counter. This has been accomplished by taking advantage of the potential differences between the anodes of the various triode sections. When, for example, the seventh pulse has been applied, the triode sections 1, 4, 5 and 7 are conducting, whereas the triode sections 2, 3, 6 and 8 are cut off (see Fig. 21). Fig. 23 shows the voltage levels of the upper and lower terminals of the neon lamps. The following potential differences across the lamps can be distinguished:

potential difference	0	$V_b - V_1$	$V_1 - V_a$	$V_b - V_a$
across lamp number	1, 3, 5, 9	0, 2, 4, 8	6	7

In this table the potential at the tapping of the anode resistor of the tube sections 1 and 2, when these are conducting, is denoted by V_1 , and the potential at the anode of a conducting tube section by V_a .

The table reveals that the voltage $V_b - V_a$ occurs only across the terminals of one lamp (number 7). This voltage is higher than the other voltages and exceeds the ignition voltage of the lamps, whereas the other voltages are smaller than the burning voltages of the lamps, so that in the example discussed only lamp 7 will be alight.

The counter can be reset to zero by pressing the pushbutton switch S (Fig. 22). The positive voltage across resistor R_8 is then applied to the grids of the right-hand triode sections, which causes the latter to become conducting. All multivibrators the left-hand sections of which are conducting will thus be reversed.

Number of pulses applied	Multi-vibrator Tube section	M1650							
		FF_I		FF_{II}		FF_{III}		FF_{IV}	
		1	2	3	4	5	6	7	8
0		○	×	○	×	○	×	○	×
1		×	○	○	×	○	×	○	×
2		○	×	×	○	○	×	○	×
3		×	○	×	○	○	×	○	×
4		○	×	×	×	×	×	×	○
5		×	○	×	○	○	×	×	○
6		○	×	○	×	×	○	×	○
7		×	○	○	×	×	○	×	○
8		○	×	×	×	×	○	×	○
9		×	○	×	○	×	○	×	○
10		○	×	○	×	○	×	○	×

○ Tube cut off × Tube conducting
 × Tube temporarily conducting

Fig. 21. Diagram showing the operation of the circuit of Fig. 20.

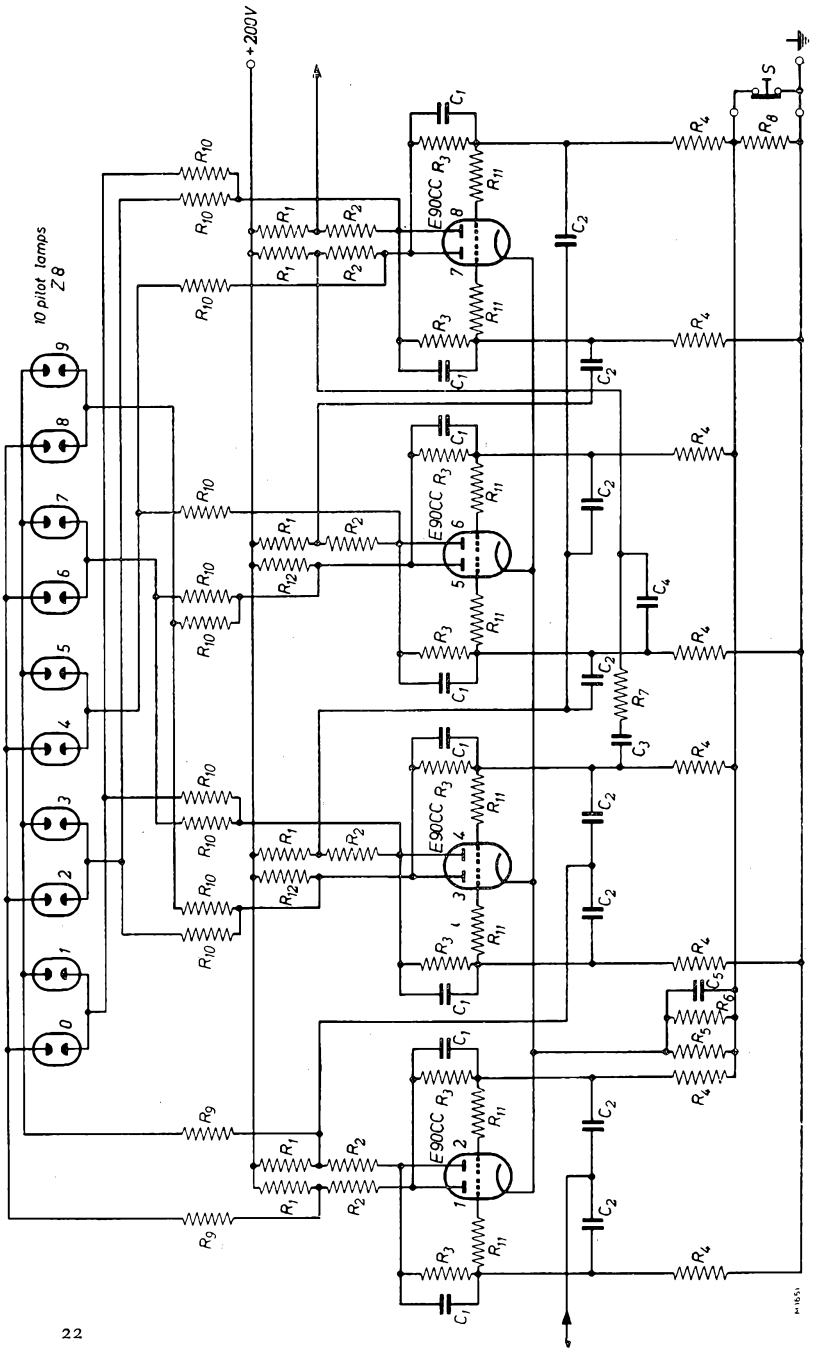

Fig. 22. Actual circuit diagram of a decade counter with four tubes E90CC (maximum counting speed 200 000 pulses per second).

PARTS LIST

R_1	=	8.2 k Ω	\pm 2%,	1 W;	5333C/8K2
R_2	=	6.8 k Ω	\pm 2%,	1 W;	5333C/6K8
R_3	=	47 k Ω	\pm 1%,	1/2 W;	5332D/47K
R_4	=	15 k Ω	\pm 1%,	1/8 W;	5330D/15K
R_5	=	1.2 k Ω	\pm 2%,	2 W;	5334C/1K2
R_6	=	22 k Ω	\pm 10%,	1/2 W;	AR1001A/22K
R_7	=	10 k Ω	\pm 10%,	1/2 W;	AR1001A/10K
R_8	=	680 k Ω	\pm 10%,	1 W;	AR1002A/680E
R_9	=	220 k Ω	\pm 5%,	1/2 W	AR1001B/220K
R_{10}	=	470 k Ω	\pm 5%,	1/2 W	AR1001B/470K
R_{11}	=	1 k Ω	\pm 10%,	1/2 W;	AR1001A/1K
R_{12}	=	15 k Ω	\pm 2%,	2 W;	5334C/15K
C_1	=	82 pF	\pm 5%;		AC3003B/82E
C_2	=	33 pF	\pm 5%;		AC3003B/33E
C_3	=	68 pF	\pm 5%;		AC3003B/68E
C_4	=	68 pF	\pm 5%;		AC3003B/68E
C_5	=	10 000 pF	\pm 10%;		5325A/10K

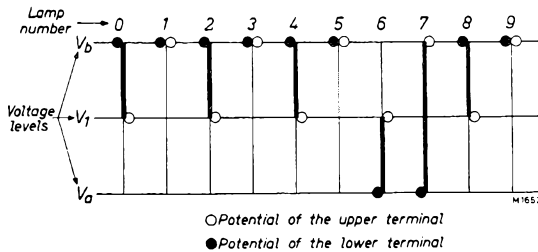

Fig. 23. Voltage levels at the terminals of the indication lamps after the 7th pulse has been applied.

To obtain satisfactory operation of the counter, the input pulses must have an amplitude ranging from 35 to 70 V with a maximum rise time of 1.5 μ sec.

If signals which do not satisfy the above requirements are to be counted, a monostable multivibrator can be used as an input pulse shaper, the circuit diagram of which is shown in Fig. 24. This multivibrator is also equipped with an E 90 CC. It responds to:

- (a) sinusoidal voltages of at least 10 V (r.m.s. value) with a frequency ranging from 20 c/s to 200 kc/s. At frequencies lower than 20 c/s it may be necessary to use a higher input voltage.
- (b) negative-going pulses having an amplitude exceeding 20 V and a duration of at least 1 μ sec with a repetition rate from zero up to 200 000 p/s. In the case

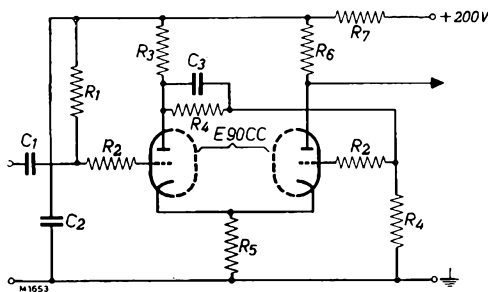

Fig. 24. Additional input pulse shaper for the circuit of Fig. 22.

PARTS LIST

R_1	=	1 M Ω \pm 10%, 1/2 W;	AR1001A/1M
R_2	=	1 k Ω \pm 10%, 1/2 W;	AR1001A/1K
R_3	=	5.6 k Ω \pm 2%, 1 W;	5333C/5K6
R_4	=	47 k Ω \pm 2%, 1/4 W;	5331C/47K
R_5	=	8.2 k Ω \pm 2%, 2 W;	5334C/8K2
R_6	=	5.6 k Ω \pm 5%, 1 W;	AR1002B/5K6
R_7	=	3.9 k Ω \pm 10%, 1 W;	AR1002A/3K9
C_1	=	0.47 μ F \pm 10%;	5325A/470K
C_2	=	0.1 μ F \pm 10%;	5325A/100K
C_3	=	22 pF \pm 10%;	AC3001A/22E

of rectangular equidistant pulses, the maximum duration is half the period of the input signal.

Fig. 25 shows a photograph of an experimental counter according to the circuit diagram of Fig. 22.

DECADE COUNTER WITH A MAXIMUM COUNTING RATE OF 1 000 000 PULSES PER SECOND

The counter shown in Figs 26 and 27 differs from the one described above by the addition of live double diodes EAA 91 and a germanium diode OA 73. In this way the counting rate has been raised to 10^6 p/s. The essential modifications are discussed below.

The circuit is so designed that the grid voltage of the non-conducting tube sections is very close to the cut-off value. To prevent the positive voltage steps that occur at the anodes of the right-hand triode sections from unintentionally reversing the following multivibrators, diodes are used for coupling the subsequent stages, so that only negative voltage steps are passed.

The positive-going pulses that appear after differentiation of the input signal are led off to earth by the germanium diode OA 73.

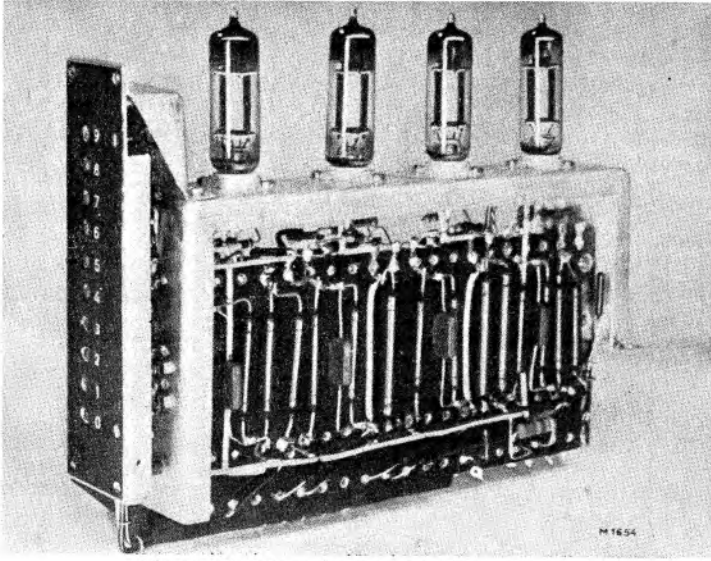

Fig. 25. Experimental counter according to Fig. 22.

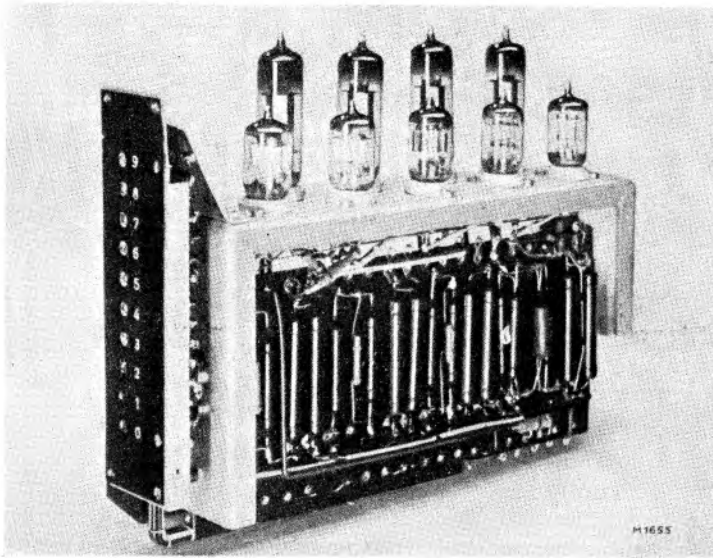

Fig. 26. Photograph of the circuits of Fig. 27.

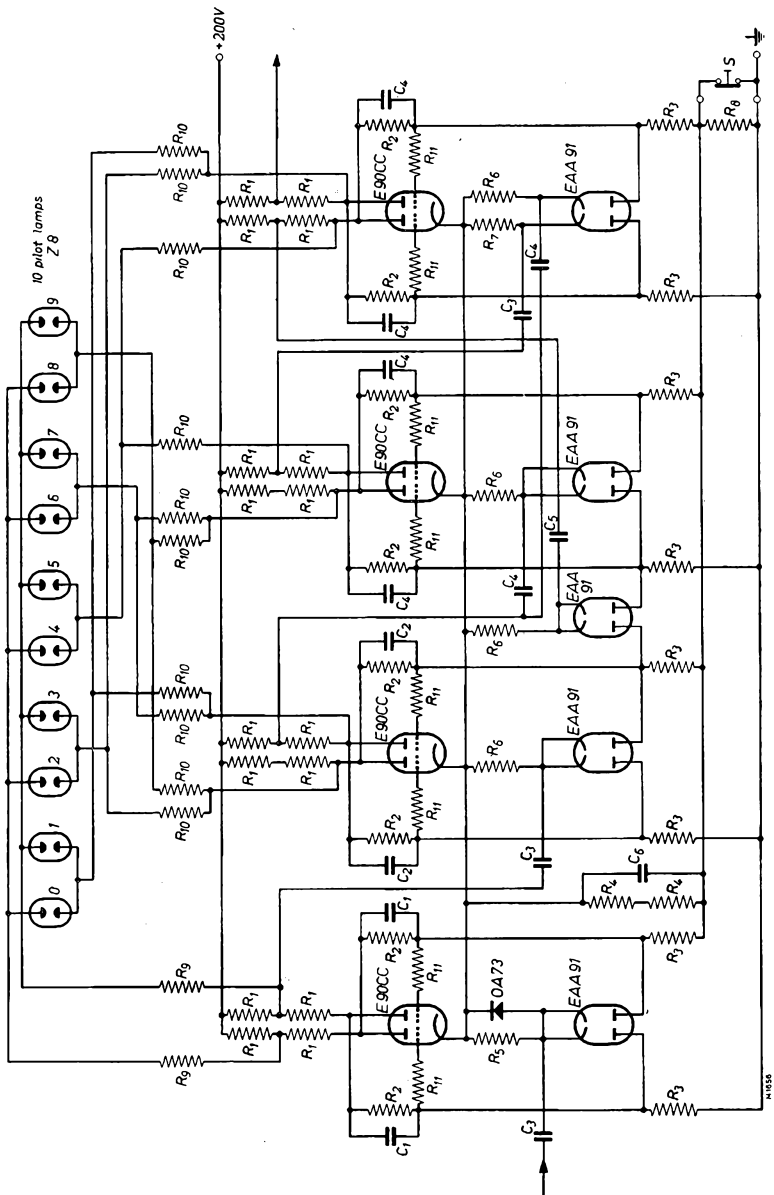

Fig. 27. Circuit diagram of a decade counter equipped with four tubes E90CC, five tubes EAA91 and one germanium diode QA73. (The maximum counting rate is 10^6 pulses per second.)

PARTS LIST

R_1	=	3.9 k Ω \pm 2%, 2 W;	5334C/3K9
R_2	=	68 k Ω \pm 1%, 1/2 W;	5332D/68K
R_3	=	15 k Ω \pm 1%, 1/8 W;	5330D/15K
R_4	=	270 Ω \pm 2%, 2 W;	5334C/270E
R_5	=	3.3 k Ω \pm 10%, 1/2 W;	AR1001A/3K3
R_6	=	10 k Ω \pm 10%, 1/2 W;	AR1001A/10K
R_7	=	33 k Ω \pm 10%, 1/2 W;	AR1001A/33K
R_8	=	470 Ω \pm 10%, 1 1/2 W;	AR1003A/470E
R_9	=	220 k Ω \pm 5%, 1/2 W;	AR1001B/220K
R_{10}	=	470 k Ω \pm 5%, 1/2 W;	AR1001B/470K
R_{11}	=	1 k Ω \pm 10%, 1/2 W;	AR1001A/1K
C_1	=	15 pF \pm 5%;	AC3001B/15E
C_2	=	18 pF \pm 5%;	AC3001B/18E
C_3	=	22 pF \pm 5%;	AC3001B/22E
C_4	=	33 pF \pm 5%;	AC3003B/33E
C_5	=	68 pF \pm 5%;	AC3003B/68E
C_6	=	10 000 pF \pm 10%;	5325A/10K

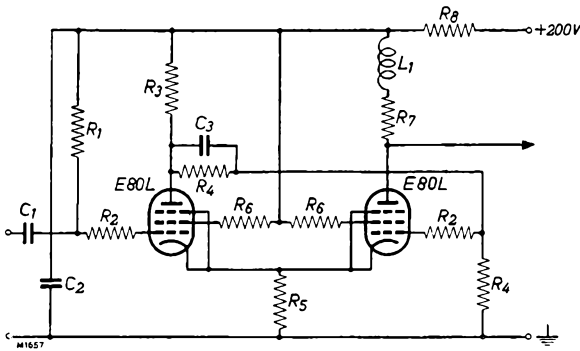

Fig. 28. Additional input pulse shaper for the circuit of Fig. 27.

PARTS LIST

R_1	=	1.5 M Ω \pm 10%, 1/2 W;	AR1001A/1M5
R_2	=	1 k Ω \pm 10%, 1/2 W;	AR1001A/1K
R_3	=	2.2 k Ω \pm 2%, 3 W;	2 \times 5333C/4K4 parallel
R_4	=	68 k Ω \pm 1%, 1/4 W;	5331D/68K

BASE CONNECTIONS AND DIMENSIONS

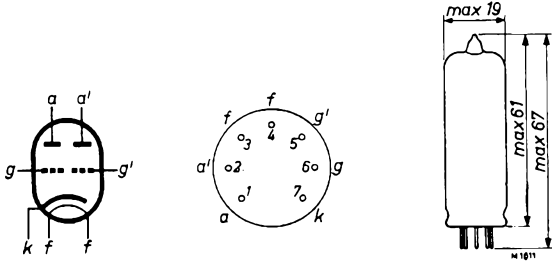

Fig. 30. Electrode arrangement, electrode connections and maximum dimensions in mm (miniature base).

TYPICAL CHARACTERISTICS (each section)

Anode voltage	$V_a = 150$	V
Grid voltage	$V_g = -1.7$	V
Anode current	$I_a = 8.5 \pm 4$	mA
Mutual conductance	$S = 6.0 \pm 1.5$	mA/V
Amplification factor	$\mu = 50$	

Anode current	$V_b = 150$ V	} $I_a = \text{max. } 0.1$ mA
	$R_a = 20$ k Ω	
	$V_g = -10$ V	
	$R_g = 47$ k Ω	

Difference between cut-off voltages of both sections	$V_b = V_{b'} = 150$ V	} $V_g - V_{g'} = \text{max. } \pm 2$ V
	$R_a = R_{a'} = 20$ k Ω	
	$I_a = I_{a'} = 0.1$ mA	

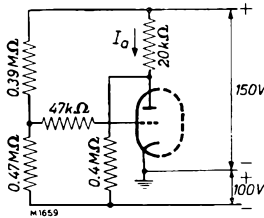

Fig. 31. Circuit in which $I_a = \left\{ \begin{array}{l} \text{minimum } 5.1 \text{ mA} \\ \text{maximum } 5.9 \text{ mA} \end{array} \right.$

The value of the grid series resistor is not critical. All other resistors should have a tolerance of maximum $\pm 1\%$.

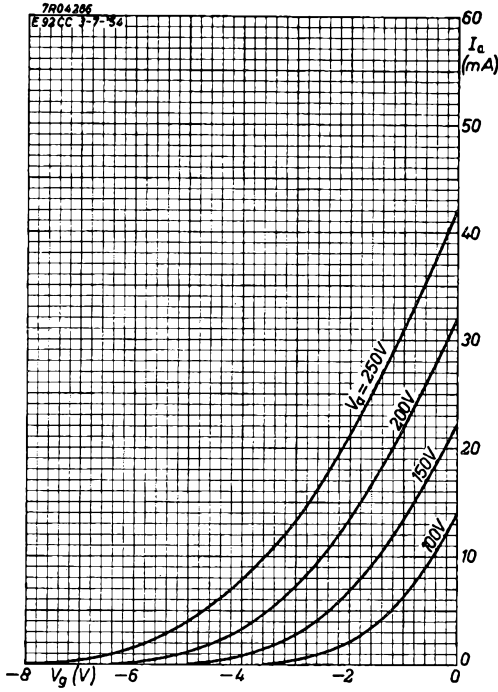

Fig. 32. Anode current I_a of the E 92 CC as a function of the grid voltage V_g with the anode voltage V_a as parameter.

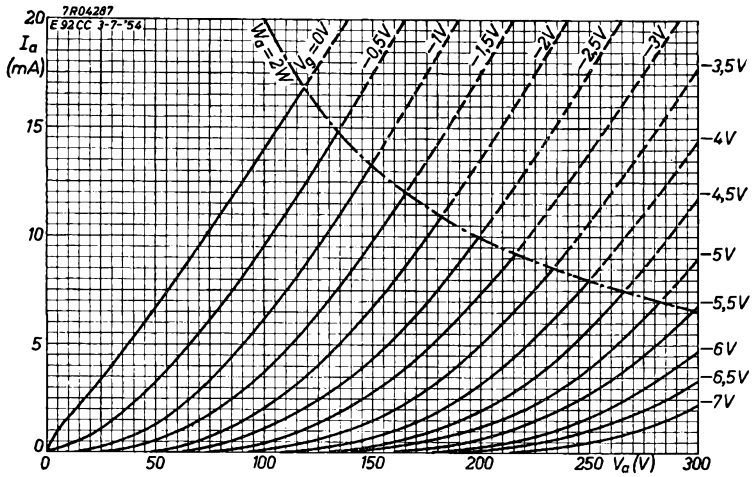

Fig. 33. Anode current I_a of the E 92 CC as a function of the anode voltage V_a with the grid voltage V_g as parameter.

LIMITING VALUES (absolute limits; each section)

Anode voltage at zero anode current	$V_{a0} = \text{max.}$	600 V
Anode voltage	$V_a = \text{max.}$	300 V
Anode dissipation	$W_a = \text{max.}$	2.0 W
Direct grid voltage (negative)	$-V_g = \text{max.}$	100 V
Peak grid voltage	$-V_{gp} = \text{max.}$	200 V
Direct grid voltage (positive)	$+V_g = \text{max.}$	0.5 V
Direct grid current	$I_g = \text{max.}$	250 μA
Peak grid current	$I_{gp} = \text{max.}$	1000 μA
Direct cathode current	$I_k = \text{max.}$	15 mA
Peak cathode current	$I_{kp} = \text{max.}$	75 mA
Grid series resistor	$R_g = \text{max.}$	1 $M\Omega$ ¹⁾
		= max. 0.5 $M\Omega$ ²⁾
Voltage between cathode and heater	$V_{kh} = \text{max.}$	100 V
Averaging time	$T_{av} = \text{max.}$	0.01 sec
Bulb temperature	$t_{bulb} = \text{max.}$	170 $^{\circ}\text{C}$

Remark: The E 92 CC is not intended for applications critical as to microphony or hum.

DECADE COUNTER WITH FOUR TUBES E 92 CC
WITH A MAXIMUM COUNTING RATE OF 150 000 p/s

Fig. 34 shows the circuit diagram of a decade counter, which, apart from the values of the circuit elements and its lower power consumption, is identical to the counter with four tubes E 90 CC described on page 20.

The input pulse must have an amplitude of at least 30 V at a maximum rise time of 1 μsec . If the decade should react to rectangular negative-going pulses, an amplitude of at least 30 V and a duration of at least 2 μsec is required; the minimum duration of these pulses depends slightly on the amplitude.

The counter does not react to positive voltage excursions having an amplitude of less than four times the minimum negative-going pulse at the same rise time.

Due to the small time constant of the differentiating input filter $C_1 \cdot R_4$ (approximately 0.7 μsec), the counter will, however, respond to rectangular positive-going pulses with an amplitude of about 30 V and a duration of approximately 2 μsec or more. In this case the trailing edge appears as a negative-going pulse at the grids of the first double triode.

¹⁾ With automatic grid bias.

²⁾ With fixed grid bias.

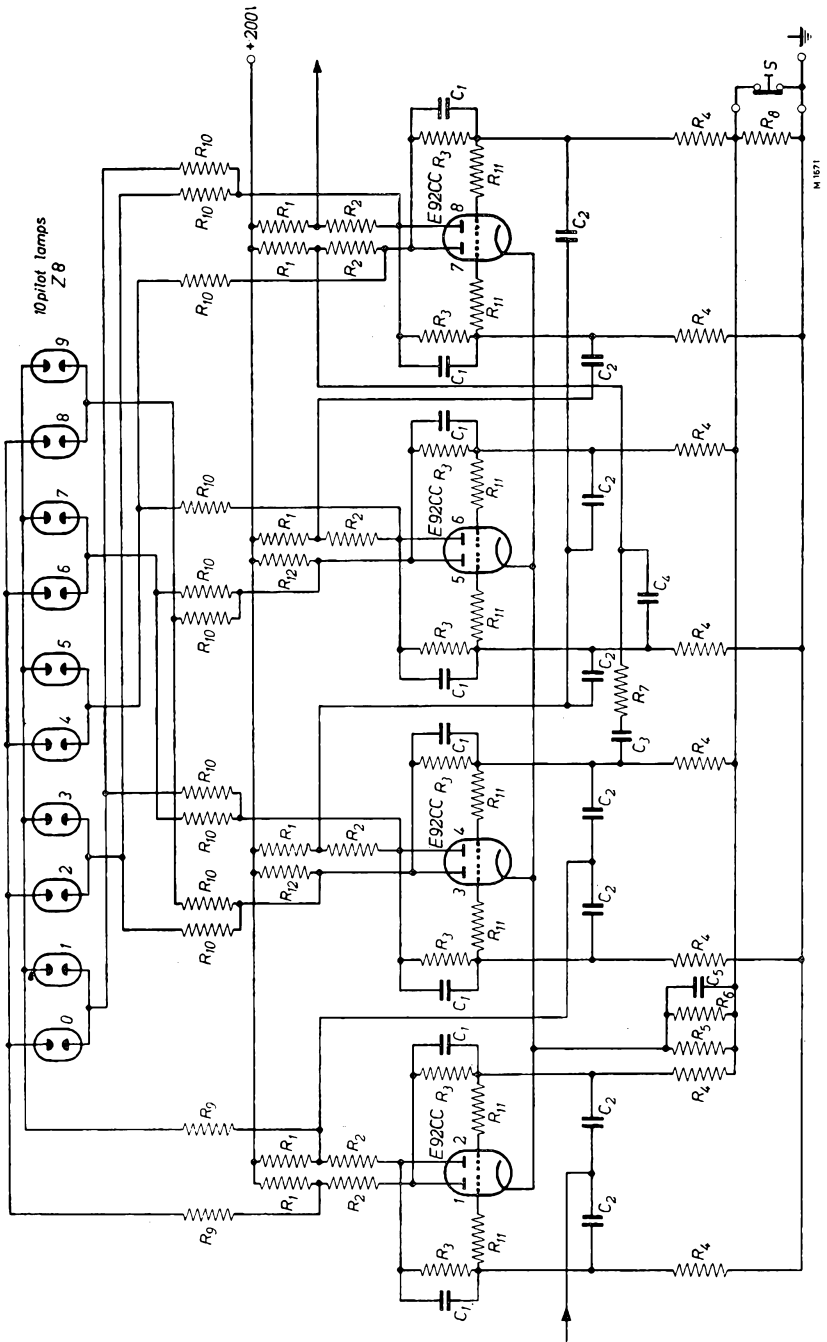
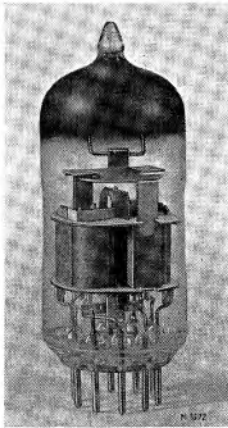

Fig. 34. Circuit diagram of a decade counter with four tubes E92 CC having a maximum counting rate of 150 000 pulses per second.

PARTS LIST

R_1	$=$	$12\text{ k}\Omega \pm 2\%$	$1\text{ W};$	$5333\text{C}/12\text{K}$
R_2	$=$	$15\text{ k}\Omega \pm 2\%$	$1\text{ W};$	$5333\text{C}/15\text{K}$
R_3	$=$	$68\text{ k}\Omega \pm 2\%$	$1\text{ W};$	$5333\text{C}/68\text{K}$
R_4	$=$	$22\text{ k}\Omega \pm 2\%$	$1/4\text{ W};$	$5331\text{C}/22\text{K}$
R_5	$=$	$2.2\text{ k}\Omega \pm 2\%$	$2\text{ W};$	$5334\text{C}/2\text{K}2$
R_6	$=$	$22\text{ k}\Omega \pm 10\%$	$1/2\text{ W};$	$\text{AR}1001\text{A}/22\text{K}$
R_7	$=$	$22\text{ k}\Omega \pm 10\%$	$1/2\text{ W};$	$\text{AR}1001\text{A}/22\text{K}$
R_8	$=$	$1\text{ k}\Omega \pm 10\%$	$1/2\text{ W};$	$\text{AR}1001\text{A}/1\text{K}$
R_9	$=$	$0.22\text{ M}\Omega \pm 5\%$	$1/4\text{ W};$	$\text{AR}1000\text{B}/220\text{K}$
R_{10}	$=$	$0.47\text{ M}\Omega \pm 5\%$	$1/4\text{ W};$	$\text{AR}1000\text{B}/470\text{K}$
R_{11}	$=$	$1\text{ k}\Omega \pm 10\%$	$1/2\text{ W};$	$\text{AR}1001\text{A}/1\text{K}$
R_{12}	$=$	$27\text{ k}\Omega \pm 2\%$	$2\text{ W};$	$5334\text{C}/27\text{K}$
C_1	$=$	$100\text{ pF} \pm 5\%$		$\text{AC}3003\text{B}/100\text{E}$
C_2	$=$	$33\text{ pF} \pm 5\%$		$\text{AC}3003\text{B}/33\text{E}$
C_3	$=$	$100\text{ pF} \pm 5\%$		$\text{AC}3003\text{B}/100\text{E}$
C_4	$=$	$68\text{ pF} \pm 5\%$		$\text{AC}3003\text{B}/68\text{E}$
C_5	$=$	$10\text{ 000 pF} \pm 10\%$		$5325\text{A}/10\text{K}$

THE E 88 CC



89518

Fig. 35. The E 88 CC (actual size).

This double triode differs both physically and electrically from the E 90 CC and E 92 CC. The tube is provided with a noval base, so that both cathodes and the screen, mounted between the two triode sections, could be connected to separate pins. The separate cathodes offer the possibility of using the sections as individual amplifiers, for example in a cascode circuit, as a cathode follower and in special computer circuits.

The electrode system of the E 88 CC is fixed in a calibrated bulb. This tube has a frame grid with stretched wires of $7.5\ \mu$ diameter, so that a small spacing between cathode and grid could be realized without the risk of short circuits between these electrodes. As a consequence, the ratio of the mutual conductance to the capacitance is relatively high.

The E 88 CC combines the advantages of the E 90 CC and the E 92 CC in having both a low anode-to-grid capacitance ($C_{ag} = 1.4\text{ pF}$) and a low internal resistance ($R_i = 2400\ \Omega$); a high counting rate and a high sensitivity can thus be obtained when this tube is used in multivibrator circuits.

Vacuum tubes for use in high-speed computers

TECHNICAL DATA OF THE E 88 CC (tentative)

Heating: indirect by a.c. or d.c.; parallel supply only

Heater voltage $V_f = 6.3 \text{ V}$

Heater current $I_f = 0.3 \text{ A}$

CAPACITANCES (without external shield)

Anode to all other electrodes	$C_{a(k+f+s)} = 1.8 \text{ pF}$
Anode to cathode + heater	$C_{a(k+f)} = 0.5 \text{ pF}$
Grid to all other electrodes	$C'_{a(k+f)} = 0.4 \text{ pF}$
Grid to cathode + heater	$C_{g(k+f+s)} = 3.3 \text{ pF}$
Anode to grid	$C_{g(k+f)} = 3.3 \text{ pF}$
Anode to cathode	$C_{ag} = 1.4 \text{ pF}$
Cathode to heater	$C_{ak} = 0.2 \text{ pF}$
As grounded-grid amplifier	$C_{kf} = 2.7 \text{ pF}$
	$C_{a(g+f+s)} = 3.0 \text{ pF}$
	$C_{k(g+f+s)} = 6.0 \text{ pF}$

Between two sections

$C_{aa'} =$	35 mpF	$C_{a'g} <$	5 mpF
$C_{gg'} <$	5 mpF	$C_{gk'} <$	5 mpF
$C_{ag'} <$	5 mpF	$C_{g'k} <$	5 mpF

BASE CONNECTIONS AND DIMENSIONS

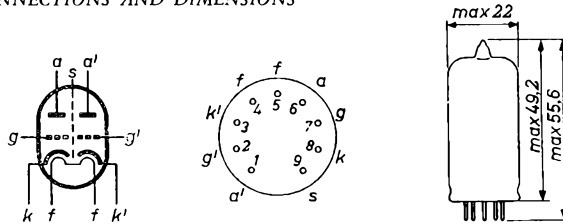

Fig. 36. Electrode arrangement, electrode connections and dimensions in mm.

TYPICAL CHARACTERISTICS AS CASCODE AMPLIFIER¹⁾

Anode supply voltage	$V_{ba} =$	100 V
Grid supply voltage	$V_{bg} =$	+ 9 V
Cathode bias resistor	$R_k =$	680 Ω
Anode current	$I_a =$	15 mA
Mutual conductance	$S =$	12.5 mA/V
Amplification factor	$\mu =$	33

¹⁾ Anode supply voltage measured with respect to the grounded terminal of the cathode resistor (Fig. 37).

Equivalent noise resistance	$R_{eq} = 300 \Omega$
Alternating grid voltage	$V_g = 0.75 V_{rms}^2)$

TYPICAL CHARACTERISTICS IN COMPUTER CIRCUITS

Anode supply voltage	$V_{ba} = 150 V$
Grid voltage ($I_a = 0.1 mA$)	$V_g = -7 V$
Anode current ($V_a = 150 V$)	$I_a < 5 \mu A$
Anode current ($V_g = -15 V$)	$I_a = 33 mA^3)$

LIMITING VALUES (design centre) (each section)

Anode current at zero anode current	$V_{av} = \text{max. } 400 V$
Anode voltage	$V_a = \text{max. } 220 V$
Anode voltage ($W_a \leq 0.8 W$)	$V_a = \text{max. } 250 V$
Anode dissipation	$W_a = \text{max. } 1.5 W$
Grid dissipation	$W_g = \text{max. } 0.03 W$
Grid series resistor	$R_g = \text{max. } 1 M\Omega^4)$
Grid series resistor	$R_g = \text{max. } 0.5 M\Omega^5)$
Grid series resistor ($I_a \leq 5 mA$)	$R_g = \text{max. } 1 M\Omega^5)$
Direct grid voltage (negative)	$-V_g = \text{max. } 100 V$
Peak grid voltage (negative)	$-V_{gp} = \text{max. } 200 V^6)$
Cathode current	$I_k = \text{max. } 20 mA$
Peak cathode current	$I_{kp} = \text{max. } 100 mA^6)$
Voltage between cathode and heater	
(cathode positive)	$V_{kf} = \text{max. } 120 V$
(cathode negative)	$= \text{max. } 60 V$
Bulb temperature	$t_{bulb} = \text{max. } 170^\circ C$

Insulation klf: The maximum heater-to-cathode current at a heater-to-cathode voltage of 60 V (cathode negative) is 6 μA ; at a heater-to-cathode voltage of 120 V (cathode positive) the maximum heater-to-cathode current is 6 μA .

Inverse grid current: At a heater voltage of 6.3 V, $V_a = 90 V$, and $I_a = 15 mA$; the maximum grid current is 0.5 μA .

2) A.C. voltage for start of grid current ($I_g = 0.3 \mu A$).

3) Measured under the conditions according to Fig. 38.

4) With automatic grid bias.

5) With fixed grid bias.

6) $T_{pulse} = \text{max. } 200 \mu sec$; duty cycle = max. 10%.

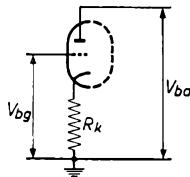

Fig. 37.

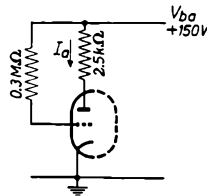

Fig. 38.

THE E 91 H



89519

Fig. 39. The E 91 H (actual size).

sion is minimized and the risk of a stable operating point being reached is avoided.

TECHNICAL DATA OF THE E 91 H

Heating: indirect by a.c. or d.c.;
parallel supply

Heater voltage

$$V_f = 6.3 \text{ V}^1)$$

Heater current

$$I_f = 270 \text{ mA}^1)$$

CAPACITANCES (without external shield):

Anode to all other electrodes	C_a	$= 7.6 \text{ pF}$
Grid No. 1 to all other electrodes	C_{g1}	$= 5.4 \text{ pF}$
Grid No. 3 to all other electrodes	C_{g3}	$= 7.1 \text{ pF}$
Anode to grid No. 1	C_{ag1}	$< 0.08 \text{ pF}$
Anode to grid No. 3	C_{ag3}	$< 0.35 \text{ pF}$
Grid No. 1 to grid No. 3	C_{g1g3}	$< 0.2 \text{ pF}$

The E 91 H is a miniature "dual control" heptode specially designed for use as a gate tube in computers.

The cut-off voltages of both control grids g_1 and g_3 are low (approx. -10 V each). Hence the tube can easily be controlled by a multivibrator circuit equipped with an E 90 CC or E 92 CC.

If no special provision were made, secondary emission of g_3 would take place when its potential is lower than that of the adjacent screen grids g_2 and g_4 , and the current towards g_3 might even become negative. Due to the presence of the grid leak resistor connected to the third grid, a stable operating point might then occur (see Fig. 40), and this would render the gate inoperative when the positive voltage at g_3 happens to exceed a certain value. The third grid has therefore been blackened, so that secondary emis-

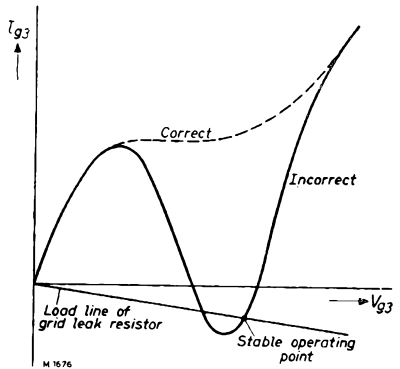

Fig. 40. Diagram showing the occurrence of a stable operating point when the grid current becomes negative.

¹⁾ The maximum deviation of I_f at $V_f = 6.3 \text{ V}$ is $\pm 13.5 \text{ mA}$. In order to obtain a prolonged tube life, the maximum variation of V_f should be less than $\pm 5\%$ (absolute limits).

BASE CONNECTIONS AND DIMENSIONS

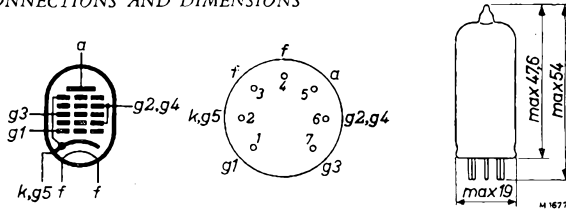
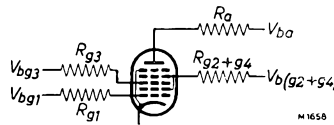

Fig. 41. Electrode arrangement, electrode connections and maximum dimensions in mm (miniature base).

TYPICAL CHARACTERISTICS

Fig. 42. Diagram defining the various symbols.



Anode supply voltage	V_{ba}	=	150	150	150	150	V
Screen-grid supply voltage	$V_{b(g2+g4)}$	=	75	75	75	75	V
Grid No. 1 supply voltage	V_{bg1}	=	0	0	-10	0	V
Grid No. 3 supply voltage	V_{bg3}	=	0	-10	0	+55	V
Anode series resistance	R_a	=	20	20	20	—	k Ω
Screen-grid series resistance	$R_{(g2+g4)}$	=	470	470	470	—	Ω
Grid No. 1 series resistance	R_{g1}	=	47	47	47	—	k Ω
Grid No. 3 series resistance	R_{g3}	=	47	47	47	—	k Ω
Anode current	I_a	>	5.0				
		<	6.5	<0.2	<0.2	—	mA
Grid No. 3 current	I_{g3}	=	—	—	—	>	0 mA

INSULATION *k_{if}*
 At $V_{kf} = 120$ V

$r_{kf} = \text{min. } 8 \text{ M}\Omega$

INVERSE GRID CURRENT

At $V_{ba} = 150$ V	$R_{g3} = 20$ k Ω
$V_{b(g2+g4)} = 75$ V	$R_a = 470$ k Ω
$V_{bg1} = -1.5$ V	$R_{(g2+g4)} = 47$ k Ω
$V_{bg3} = -1.5$ V	$R_{g1} = 47$ k Ω
Inverse grid No. 1 current	$-I_{g1} = \text{max. } 0.2 \mu\text{A}$
Inverse grid No. 3 current	$-I_{g3} = \text{max. } 0.2 \mu\text{A}$

LIMITING VALUES (absolute limits)

Anode voltage at zero anode current	$V_{a0} = \text{max. } 500$ V
Anode voltage	$V_a = \text{max. } 250$ V

Screen-grid voltage at zero screen-grid current	$V_{(g2+g1)0}$	= max.	500 V
Screen-grid voltage	$V_{(g2+g4)}$	= max.	100 V
Direct voltage of grid No. 3 (negative)	$-V_{g3}$	= max.	100 V
(positive)	$+V_{g3}$	= max.	0 V
Peak voltage of grid No. 3 (negative)	$-V_{g3p}$	= max.	200 V
(positive)	$+V_{g3p}$	= max.	90 V
Direct voltage of grid No. 1 (negative)	$-V_{g1}$	= max.	100 V
(positive)	$+V_{g1}$	= max.	0 V
Peak voltage of grid No. 1 (negative)	$-V_{g1p}$	= max.	200 V
Anode dissipation	W_a	= max.	1.0 W
Screen-grid dissipation	$W_{(g2+g4)}$	= max.	1.0 W
Grid No. 1 dissipation	W_{g1}	= max.	0.5 W
Grid No. 3 dissipation	W_{g3}	= max.	0.5 W
Direct cathode current	I_k	= max.	20 mA
Peak cathode current	I_{kp}	= max.	70 mA
Voltage between cathode and heater	$V_{h/f}$	= max.	120 V
Grid No. 1 series resistance	R_{g1}	= max.	0.5 M Ω ¹⁾ = max. 1.0 M Ω ²⁾
Grid No. 3 series resistance	R_{g3}	= max.	0.5 M Ω ¹⁾ = max. 0.1 M Ω ²⁾

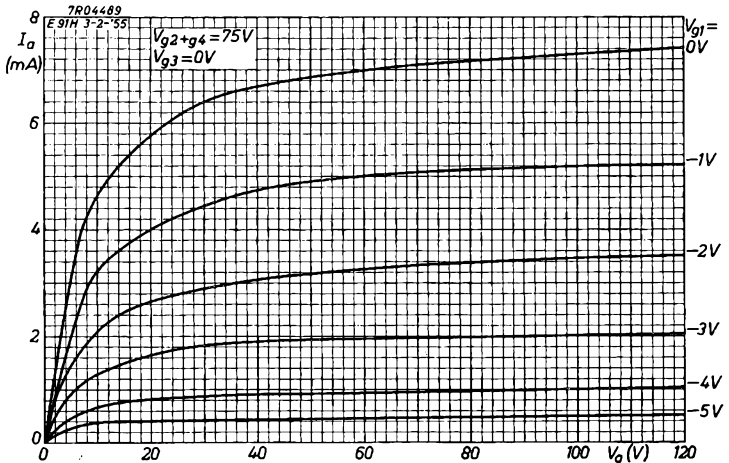

Fig. 43. Anode current I_a of the E91H as a function of the anode voltage V_a with the voltage V_{g1} at grid No. 1 as parameter.

1) With fixed bias. 2) With automatic bias.

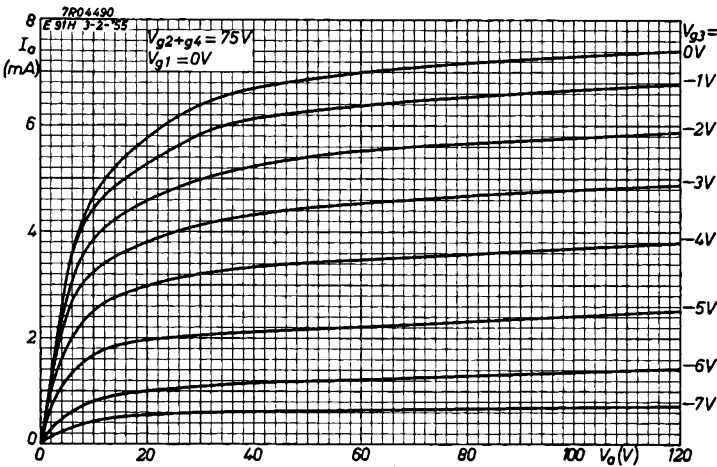

Fig. 44. Anode current I_a of the E 91 H as a function of the anode voltage V_a with the voltage V_{g3} at grid No. 3 as parameter.

PRACTICAL GATE CIRCUIT WITH THE E 91 H

Fig. 45 shows the circuit diagram of a gate circuit with the E 91 H as gate tube. The voltage level at the third grid is determined by the anode voltage of one of the sections of a multivibrator equipped with the E 90 CC. The operation of the circuit has already been discussed on page 11.

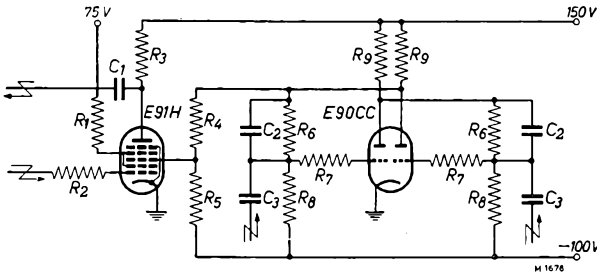

Fig. 45. Practical gate circuit with the E 91 H.

- $R_1 = 470 \Omega \pm 10\%, 1/2 \text{ W}; \text{ AR1001A/470E}$
- $R_2 = 47 \text{ k}\Omega \pm 10\%, 1/2 \text{ W}; \text{ AR1002A/47K}$
- $R_3 = 18 \text{ k}\Omega \pm 10\%, 1 \text{ W}; \text{ AR1002A/18K}$
- $R_4 = 220 \text{ k}\Omega \pm 2\%, 1/4 \text{ W}; \text{ 5331C/220K}$

R_5	$=$	$220 \text{ k}\Omega \pm 2\%, 1/4 \text{ W};$	$5331C/220K$
R_6	$=$	$220 \text{ k}\Omega \pm 2\%, 1/4 \text{ W};$	$5331C/220K$
R_7	$=$	$1 \text{ k}\Omega \pm 10\%, 1/2 \text{ W};$	$AR1001A/1K$
R_8	$=$	$220 \text{ k}\Omega \pm 2\%, 1/4 \text{ W};$	$5331C/220K$
R_9	$=$	$22 \text{ k}\Omega \pm 10\%, 1 \text{ W};$	$AR1002A/22K$
C_1	$=$	$39 \text{ pF} \pm 10\%;$	$AC3003A/39E$
C_2	$=$	$100 \text{ pF} \pm 10\%;$	$AC3003A/100E$
C_3	$=$	$47 \text{ pF} \pm 10\%;$	$AC3003A/47E$

THE E 1 T

The E 1 T is a decade counter tube with a directly readable indication. Its construction is in principle similar to that of a cathode-ray tube; the performance as a counter is based on the deflected ribbon-shaped electron beam having ten stable positions.

In broad outlines, the electrode system consists of an electron gun, focusing electrodes, two deflection electrodes, suppressor grids, a slotted electrode and an anode. The tube is used in a special circuit, in which the anode is connected to one of the deflection electrodes. When a pulse, which must satisfy certain requirements concerning amplitude and rise time, is applied to the other deflection electrode, the beam is shifted from one stable position to the next. When the beam has reached its final position (9), it will be reset to position zero by a following pulse, whilst, at the same time, an output pulse is supplied by which the next decade can be advanced one position¹⁾.



89526

Fig. 46. Photograph of the E 1 T (actual size).

¹⁾ For further details, reference is made to the following publications:
 "E 1 T Decade Counter Tube" (No. 20/D/4602 E 12/54), containing a detailed treatise on the tube and its applications.
 "Decade Counting Units" (No. 32/014/B/E), dealing with counters, composed of plug-
 gable units, in which the E 1 T is incorporated.

TUBES FOR USE IN LOW-SPEED COMPUTERS

Out of the family of cold-cathode tubes, the "trigger" tubes are particularly suitable for use in low-speed counters.

A trigger tube is a low-pressure rare-gas filled tube containing at least three electrodes, namely a non-heated cathode, an anode and a "starter" electrode, which has a similar function as the control grid of a thyratron. The cathode is often coated to obtain a low work function.

In a three-electrode trigger tube six different kinds of discharge are generally possible, but only two of these are of interest in counter circuits, namely the one between anode and cathode and that between starter and cathode. The operation of a trigger tube is based on the phenomenon that a fairly low value of the transfer current (i.e. the current flowing from the starter to the cathode) can initiate the main discharge — between anode and cathode — at an anode voltage that otherwise would not be high enough to ignite the tube. The anode voltage of the ignited tube has a fairly low value and is independent of the anode current.

Two conditions can be distinguished, the trigger tube being either ignited or extinguished, so that it can serve as a bi-stable element in counters. The counting rate is of the order of 1000 pulses per second.

Special features of trigger tubes are:

- (1) small dimensions,
- (2) directly visible indication of its electrical condition.
- (3) absence of a heater, hence:
 - (a) no heater power,
 - (b) no heating-up time,
 - (c) no power consumption when extinguished,
 - (d) no heater breakdown,
 - (e) long life (up to a few thousand hours of operation, depending on its use).

THE Z 50 T

The Z 50 T is a small three-electrode trigger tube, suitable for use as a bi-stable element in low-speed counters. The connecting leads of the tube can be soldered directly in the wiring. The tube can easily be mounted in a rubber supporting ring (see Fig. 49), which can be inserted in an aperture of the chassis or front panel.

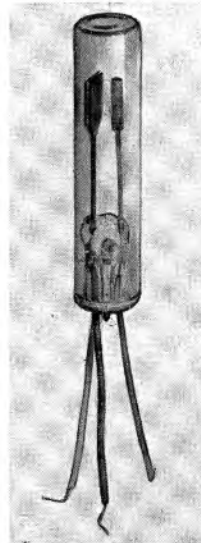

Fig. 47. The Z 50 T (actual size).

89525

Tubes for use in low-speed computers

The Z 50 T has a maximum counting rate of 1000 pulses per second. Some ambient illumination is required to ensure satisfactory operation and to avoid undue delay of ignition.

**TECHNICAL DATA OF THE Z 50 T
BASE CONNECTIONS AND DIMENSIONS**

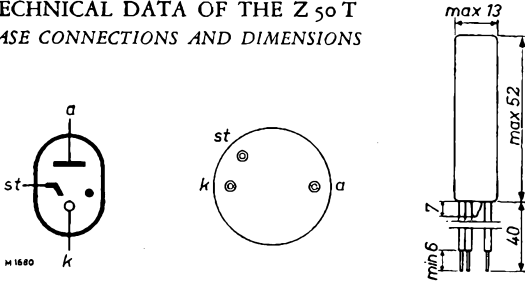

Fig. 48. Electrode arrangement, electrode connections and maximum dimensions in mm.

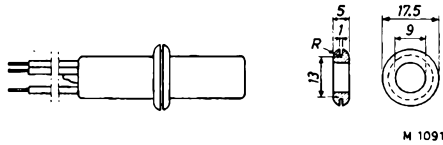

Fig. 49. Dimensions of rubber supporting ring.

TYPICAL CHARACTERISTICS

	min.	nom.	max.	
Anode voltage at which breakdown will not occur in any tube $V_{a\ ign}$	= 175	—	—	V
Starter breakdown voltage at $V_a = 130$ V				
$C_{k-st} = 56\ 000$ pF ¹⁾ $V_{st\ ign}$	= 66 ²⁾	71 ²⁾	80 ²⁾	V
Anode voltage ($I_a = 2$ to 6 mA) V_a	= 54	61	67	V
Starter transfer current at $V_a = 130$ V $I_{st\ transf}$	= —	50	100	μ A
Ionisation time T_{ion}	= —	—	50	μ sec ⁴⁾
De-ionisation time $T_{d\ ion}$	= —	—	200	μ sec ⁵⁾

1) Capacitor between starter and cathode.
 2) Tube exposed to some light. Full sunlight or complete darkness should be avoided.
 3) When anode current pulses with a short duration and an average current of less than 2 mA are applied (e.g. in oscillators, counting circuits), $V_{st\ ign}$ may increase to 95 V.
 4) Tube exposed to at least 60 lux.
 5) The de-ionization time is defined as the minimum duration of the negative square step voltage applied to the anode, required for extinguishing the tube (starter and cathode interconnected via a resistor). This time depends on the amplitude of the negative step, i.e. the voltage at the anode during the extinguishing time, on the anode voltage at the tube after removal of the step voltage, and also on the current through the tube before the negative step is applied.

LIMITING VALUES (absolute limits)

Cathode current I_k	= min.	2 mA ³⁾
	= max.	6 mA ⁶⁾
Peak cathode current I_{kp}	= max.	24 mA ⁶⁾
Ambient temperature t_{amb}	= min.	-40 °C
	= max.	+60 °C

Life expectancy and mounting

The life expectancy is 6000 hours current life at 6 mA d.c.

The tube should be so mounted that ambient light can impinge on the cathode. Tubes must be protected against shock and vibration; therefore it is recommended to use the rubber supporting ring type 40645 (see Fig. 49). This ring should be mounted in a chassis aperture of 15 mm diameter (chassis plate 1 mm).

RING COUNTER WITH EIGHT TUBES Z 50 T

Fig. 50 shows two stages of a ring counter, equipped with the trigger tubes Z 50 T, and having a maximum counting rate of approx. 1000 pulses per second. The anodes of the tubes are interconnected and, moreover, connected to a positive voltage with respect to the cathode via a common resistor. The cathode of T_1 is connected to the starter of T_2 via a resistor. The pulses to be counted are fed simultaneously to the starters of all tubes via a common lead.

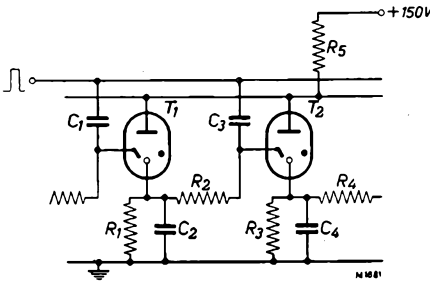

Fig. 50. Two stages of a ring counter equipped with the tubes Z 50 T.

PARTS LIST

$R_1 = R_3 =$	12 k Ω \pm 2%, 1/2 W;	5332C/12K
$R_2 = R_4 =$	0.47 M Ω \pm 10%, 1/2 W;	AR1001A/470K
$R_5 =$	10 k Ω \pm 5%, 1/2 W;	AR1001B/10K
$C_1 = C_3 =$	470 pF \pm 10%;	AC3003A/470E
$C_2 = C_4 =$	33.000 pF \pm 10%;	5325A/33K

⁶⁾ When used at a continuous current of α mA ($\alpha > 6$), the tube life will be shortened by a factor of about $(6/\alpha)^3$ to $(6/\alpha)^4$.

To explain the operation of the circuit it will be assumed that tube T_1 is conducting. A direct voltage is then present across the cathode resistor R_1 , which forms a positive bias for the starter of tube T_2 . The anode voltage of T_2 has such a value that T_2 cannot ignite at this bias.

A positive-going pulse, which is insufficient to ignite tubes without a positive starter bias, is now applied to all starters; as a result, only tube T_2 ignites, and current starts to flow through this tube. Since the cathode resistor of T_1 is bypassed by a large capacitor, the cathode voltage of T_1 will temporarily remain almost constant, so that, due to the voltage drop across the common anode resistor, the anode voltage of T_1 will drop below the burning voltage and this tube will therefore be extinguished.

The cathode current of T_2 produces a voltage drop across its cathode resistor, so that the tube following T_2 attains a positive starter bias. When the next positive pulse is applied to the common pulse lead, the following tube will therefore ignite, whereas T_2 is extinguished.

By means of the glow discharge of the tubes it can be seen which lamp is burning.

When ten of the stages shown in Fig. 50 are connected in cascade, and the output of the tenth is connected to the input of the first, a decade-counter (ring counter) is obtained.

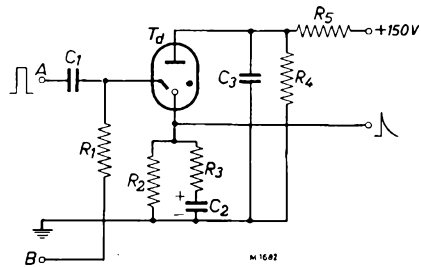

Fig. 51. Interstage pulse shaper for the coupling between two decades.

PARTS LIST

R_1	=	0.47 M Ω	\pm 10%,	1/2 W;	AR1001A/470K
R_2	=	0.33 M Ω	\pm 2%,	1/2 W;	5332C/330K
R_3	=	10 k Ω	\pm 10%,	1/2 W;	AR1001A/10K
R_4	=	0.56 M Ω	\pm 2%,	1/2 W;	5332C/560K
R_5	=	68 k Ω	\pm 2%,	1/2 W;	5332C/68K
C_1	=	470 pF	\pm 10%;		AC3003A/470E
C_2	=	1000 pF	\pm 10%;		5308A/1K
C_3	=	0.1 μ F	\pm 10%;		5325A/100K

Passing the pulses from one decade to the next requires a special self-quenching circuit, since no suitable positive pulse is available from the ninth stage. Such

a self-quenching circuit (pulse shaper and pulse amplifier) is shown in Fig. 51.

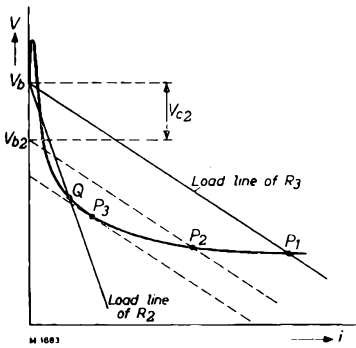

Fig. 52. Diagram showing the operation of the circuit of Fig. 51.

decreases (V_{b2}), so that the load line of R_3 is shifted vertically, and the intersection point is thus shifted to the left (P^2). Capacitor C_2 continues to be charged until P has arrived at the point of contact P_3 . The voltage across the tube then becomes too low to maintain the glow discharge, so that the tube is extinguished. Since the stable point Q , determined by the load line of R_2 , is situated at the left of P_3 , this condition is never reached.

After the tube has been extinguished, C_2 will be discharged via R_2 and R_3 until the initial condition is re-established.

THE Z 70 U

The Z 70 U is a sub-miniature trigger tube with very small dimensions (bulb diameter 10 mm; height max. 25 mm). The Z 70 U has four electrodes; the extra electrode, the "primer", is a sharp pin that is very close to the anode. During operation, a continuous glow discharge is maintained between the anode and the primer, so that some ions are always present in the tube. The main discharge can therefore be initiated without any delay, so that the tube can be used in complete darkness.

Similar to the Z 50 T, the Z 70 U has connecting leads, which, together with its small dimensions, offer the possibility of mounting the tube in printed wiring.

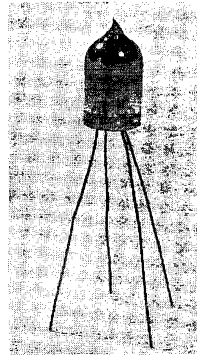

Fig. 53. Photograph of the Z 70 U (actual size).

¹⁾ R_2 is much larger than R_3 , so that its influence may be neglected.

TECHNICAL DATA OF THE Z 70 U (advance data)
 BASE CONNECTIONS AND DIMENSIONS

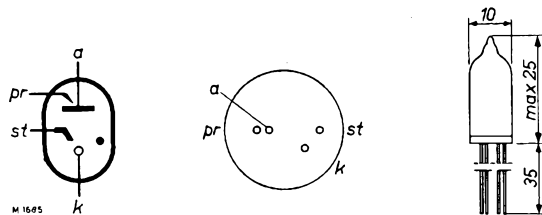

Fig. 54. Electrode arrangement, electrode connections and maximum dimensions in mm.

TYPICAL CHARACTERISTICS

Starter-to-cathode breakdown voltage	$V_{st\ ign}$	$= 145 \pm 6\text{ V}$
Anode voltage drop at an anode current of 3 mA $V_a (I_a = 3\text{ mA})$		$118 \pm 3\text{ V}$
Anode breakdown voltage (cold)	} starter at cathode po- tential	} $V_{a\ ign} = \text{min. } 330\text{ V}$ $V_{a\ ign} = \text{min. } 310\text{ V}$
(warm; $I_a = 3\text{ mA}$)		
Transfer current at anode voltage of 250 V . . .	$I_{st\ trans}$	$= 20\ \mu\text{A}$
Average continuous anode current ($T_{av} = 1\text{ sec}$)	I_a	$= \text{max. } 3\text{ mA}$
Continuous current range (steady flow of current)	I_a	$= 0.5 - 3\text{ mA}$
Forward peak cathode current	I_{kp}	$= 1 - 12\text{ mA}$
Minimum primer to cathode ignition voltage . . .	V_{a-pr}	$= \text{min. } 210\text{ V}$
Minimum resistance in primer circuit	R_{pr}	$= \text{min. } 10\text{ M}\Omega$
Typical primer current	I_{pr}	$= 3\ \mu\text{A}$
Maximum primer current	I_{pr}	$= \text{max. } 5\ \mu\text{A}$

Notes: The tube can be mounted in a metal clamp connected to the chassis.
 During operation, manual touching should be avoided.
 The tube gives a bright glow when ignited.

EXPERIMENTAL DECADE COUNTER WITH EIGHT TUBES Z 70 U

Fig. 55 shows the circuit diagram of an experimental bi-quinary decade counter equipped with eight tubes Z 70 U.

The circuit comprises a ring counter with the tubes T_1 to T_5 (scale-of-five circuit), a scale-of-two circuit (T_6 and T_7) and a pulse shaper (T_8), which supplies an output pulse to the following decade.

The principle of operation is based on the fact that each series of ten input pulses is divided into two groups of five pulses, the latter being counted by the scale-of-five circuit. The scale-of-two circuit discriminates between the first and second group. As a consequence, any number of counted pulses between 0 and 9

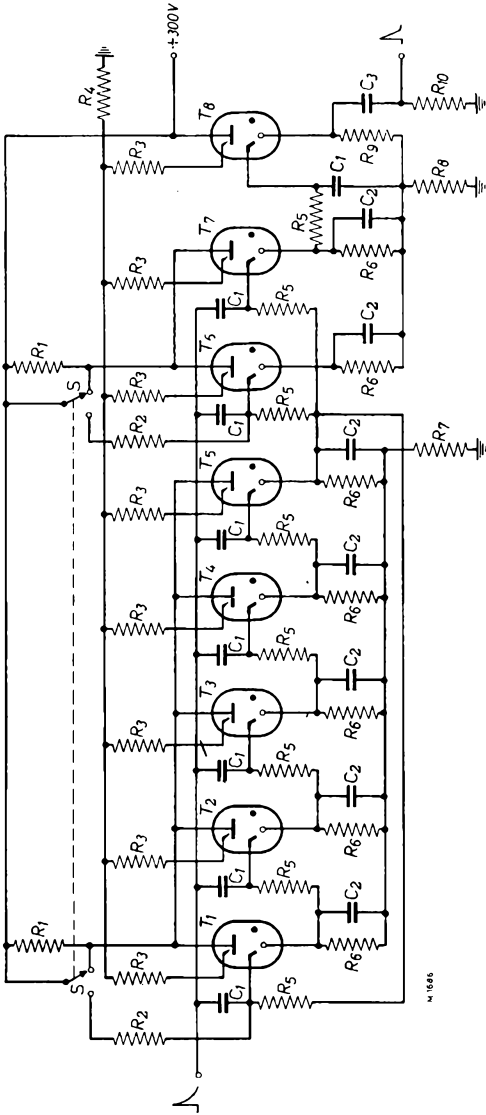

Fig. 55. Circuit diagram of a bi-quinary decade counter with 8 tubes: Z 70 U.

R_1	$\pm 10\%$, $\frac{1}{2}$ W;	AR1001A/12K	R_8	$\pm 10\%$, $\frac{1}{2}$ W;	AR1001A/33K
R_2	$\pm 10\%$, $\frac{1}{2}$ W;	AR1001A/560K	R_9	$\pm 10\%$, $\frac{1}{2}$ W;	AR1001A/680K
R_3	$\pm 10\%$, $\frac{1}{2}$ W;	AR1001A/10M	R_{10}	$\pm 10\%$, $\frac{1}{2}$ W;	AR1001A/27K
R_4	$\pm 10\%$, $\frac{1}{2}$ W;	AR1001A/1M2	C_1	$\pm 10\%$	AC3003A/100E
R_5	$\pm 10\%$, $\frac{1}{2}$ W;	AR1001A/1M2	C_2	$\pm 10\%$	53-5A/4K7
R_6	$\pm 10\%$, $\frac{1}{2}$ W;	AR1001A/56K	C_3	$\pm 10\%$	53-5A/2K2
R_7	$\pm 5\%$, $\frac{1}{2}$ W;	AR1001B/27K			

is indicated by two tubes simultaneously: one of the tubes of the scale-of-five and one of the tubes of the scale-of-two circuit.

As shown in Fig. 55, the tubes T_1 to T_5 have a common non-bypassed cathode resistor (R_7). This has the same effect as the common anode resistor of the circuit of Fig. 50. T_6 and T_7 also have a common cathode resistor (R_8), and their starters are coupled to the cathode of T_5 via two resistors R_9 . The incoming pulses are applied simultaneously to the starters of T_1 to T_7 . The operation of the circuit is as follows (see Fig. 56).

In position zero, the tubes T_1 and T_6 are ignited. When an input pulse is applied, T_2 ignites and T_1 is extinguished due to the voltage drop across R_7 . Tube T_6 remains ignited because its anode voltage is not changed.

After four pulses have been applied, T_3 and T_6 are ignited; T_6 and T_7 have a positive starter bias. The fifth pulse therefore ignites both T_1 and T_7 , whereas T_5 and T_6 are extinguished. From the fifth pulse on, T_7 remains ignited until the tenth pulse (which arrives when T_3 is again ignited) causes T_6 to ignite, so that T_7 is extinguished. Now the initial condition is restored.

Number of pulses	Tube number	1	2	3	4	5	6	7	8
0		×	○	○	○	○	×	○	○
1		○	×	○	○	○	×	○	○
2		○	○	×	○	○	×	○	○
3		○	○	○	×	○	×	○	○
4		○	○	○	○	×	×	○	○
5		×	○	○	○	○	○	×	○
6		○	×	○	○	○	○	×	○
7		○	○	×	○	○	○	×	○
8		○	○	○	×	○	○	×	○
9		○	○	○	○	×	○	×	○
10		×	○	○	○	○	×	○	×

× Tube ignited ○ Tube extinguished

Fig. 56. Diagram showing the operation of the circuit of Fig. 55.

The counting rate of the circuit described above is approx. 3000 pulses per second. It is limited by the unavoidable fairly large time constants, determined by the values of the circuit elements. If a rectangular input pulse is applied, it should have an amplitude of approx. 80 V at a duration of 15 to 30 μ sec. Fig. 57 shows an experimental set-up according to the circuit of Fig. 55, whilst Fig. 58 depicts a counter equipped with three of these units.

When T_7 is ignited, T_8 has a positive starter bias. If, due to the arrival of the tenth pulse, T_6 ignites, the sudden voltage drop across R_8 is fed to the starter of T_8 via C_1 . This additional voltage at the starter of T_8 causes the latter to ignite. A pulse is then produced across R_{10} , which is fed to the next decade. T_8 is self-quenching and will be extinguished before the next tenth pulse arrives.

The counter can be reset to zero by setting the switch S in the left-hand position, thus applying a high positive voltage to the starters of T_1 and T_6 , which causes these tubes to become ignited.

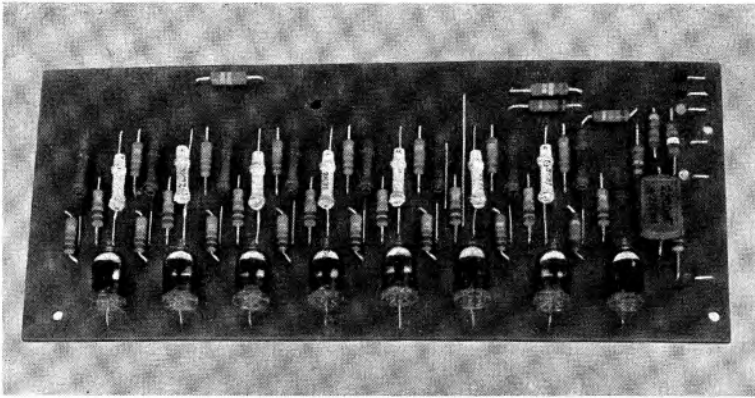

89523

Fig. 57. Photograph of an experimental set-up of the circuit of Fig. 55.

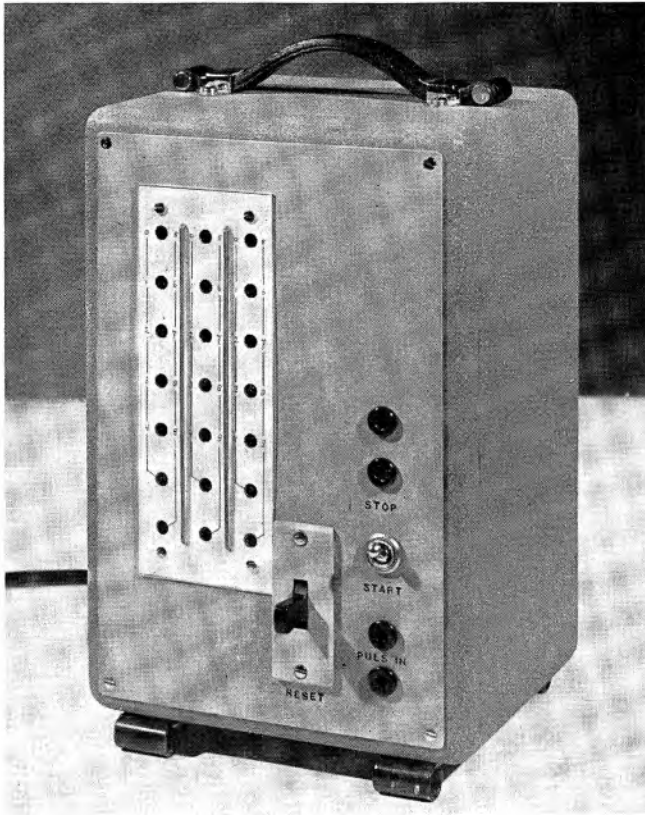

89522

Fig. 58. Counter composed of three bi-quinary decade counters equipped with the Z 70 U.

CONSTRUCTIONAL

In digital computers, circuits such as bi-stable multivibrators, decade counters, gates, pulse shapers etc. are used in large numbers. Generally, the variety of these circuits is relatively small. This has led to the construction of plug-in units, containing the circuits mentioned above. In view of the large quantity of units involved, these can conveniently be manufactured in mass production. Moreover, they offer the user several advantages, namely:

- (a) The computers in which the units are to be plugged, need only be equipped with power supplies, input and output circuits, female plugs and wiring. This facilitates the construction and the carrying out of modifications.
- (b) Since all circuit elements are incorporated in the units, failures of these elements can easily be remedied by simply replacing the unit involved.
- (c) During the time that a defective unit is under repair, the computer need not be taken out of service, because spare units can directly be inserted.

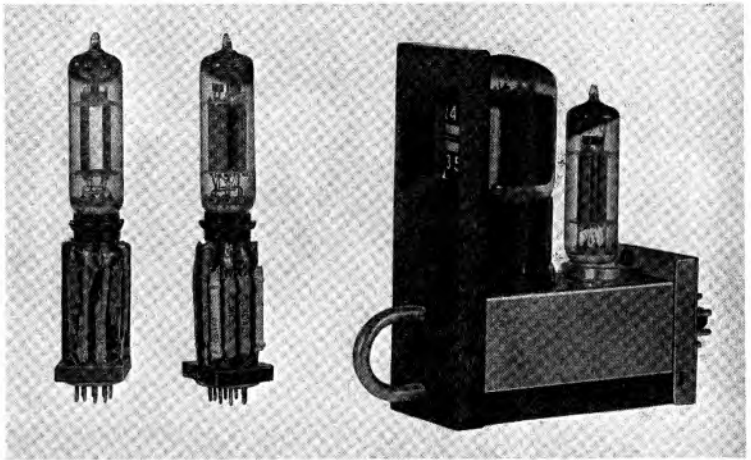

89521

Fig. 59. Photograph of some experimental plug-in units; at the left: multivibrator circuit with the E 90 CC; centre: amplifier circuit with the E 90 CC; at the right: decade counter with the E 1 T and the E 90 CC.

Fig. 59 shows some experimental units of this kind; at the left a bi-stable multivibrator with the E 90 CC can be seen. The circuit is mounted on a tube base that fits into a corresponding socket, mounted at the front panel of the

computer. The centre unit is an amplifier with an E 90 CC; it is built on the same lines as the other units. The right-hand unit consists of a combination of a decade counter tube E 1 T with an E 90 CC. These tubes are mounted on a small chassis. Below the chassis the other circuit elements (resistors and capacitors) are mounted.

Small units, such as the bi-quinary counter depicted in Fig. 57, can be mounted in printed wiring.

PHILIPS' TECHNICAL LIBRARY

Philips' Technical Library comprises 4 series of books:

- a. Electronic Valves
- b. Light and Lighting
- c. Miscellaneous
- d. Popular series

Series a, b and c in cloth binding 6" × 9", gilt. The dimensions of the popular series, coloured "integral" binding, are 5¾" × 8¼".

Most of these books are published in 4 languages: English, French, German and Dutch.

a. Series on ELECTRONIC TUBES

- Book I "Fundamentals of Radio-Valve Technique", by J. Deketh
Book II "Data and Circuits of Receiver and Amplifier Valves"
Book III "Data and Circuits of Receiver and Amplifier Valves", 1st Suppl.
Book IIIA "Data and Circuits of Receiver and Amplifier Valves", 2nd Suppl.,
by N. S. Markus and J. Otte
Book IIIB "Data and Circuits of Receiver and Amplifier Valves", 3rd Suppl.,
by N. S. Markus and J. Vink
Book IIIC "Data and Circuits of Television Receiving Valves", by J. Jager
Book IV "Application of the Electronic Valve in Radio Receivers and Amplifiers",
Volume I, by B. G. Dammers, J. Haantjes, J. Otte and H. van Suchtelen
Book V Ditto, Volume 2
Book VII "Transmitting Valves", by P. J. Heyboer and P. Zijlstra
Book VIIIA "Television Receiver Design" 1, by A. G. W. Uitjens
Book VIIIB "Television Receiver Design" 2, by P. A. Neeteson
Book IX "Electronic Valves in Pulse Technique" by P. A. Neeteson
Book X "Analysis of bistable Multivibrator Operation", by P. A. Neeteson
Book XI "U.H.F. Tubes for Communication and Measuring Equipment"
Book XII "Tubes for Computers"
Book XIII "Industrial Rectifying Tubes"

Book IIIB and XIII are in active preparation.

b. Series "LIGHT AND LIGHTING"

1. "Physical Aspects of Colour", by P. J. Bouma
2. "Gas Discharge Lamps", by J. Funke and P. J. Oranje
3. "Fluorescent Lighting", by Prof. C. Zwicker c.s.
4. "Artificial Light and Architecture", by L. C. Kalff (size 7" × 11")
5. "Artificial Light and Photography", by G. D. Rieck and L. H. Verbeek (size 7" × 11")
6. "Manual for the Illuminating Engineer on Large Size Perfect Diffusors", by H. Zijl
7. "Calculation and Measurement of Light", by H. A. E. Keitz
8. "Lighting Practice", Volumes I, II and III, by Joh. Jansen
9. "Illuminating Engineering Course", by H. Zijl

Book 4 in German only. The English edition of book 8 is in preparation.

c. Series "MISCELLANEOUS"

- a. "Television", by Fr. Kerkhof and W. Werner
- b. "Low-Frequency Amplification", by N. A. J. Voorhoeve
- c. "Metallurgy and Construction", by E. M. H. Lips
- d. "Strain Gauges", by Prof. J. J. Koch
- e. "Introduction to the study of Mechanical Vibrations", by G. W. v. Santen
- f. "Data for X-Ray Analysis" I, by W. Parrish and B. W. Irwin (size 8.2" × 11.6"), paper bound
- g. "Data for X-Ray Analysis" II, by W. Parrish, M. G. Ekstein and B. W. Irwin (size 8.2" × 11.6"), paper bound
- h. "X-Rays in Dental Practice", by G. H. Hepple
- i. "Industrial Electronics Handbook", by R. Kretzmann
- j. "Introduction to TV-Servicing", by H. L. Swaluw and J. v. Woerd
- k. "From the Electron to the Superhet", by J. Otte, Ph. F. Salverda and C. J. van Willigen
- l. "How Television works", by W. A. Holm
- m. "The Cathode Ray Oscilloscope", by J. Czech
- n. "Industrial Electronics Circuits", by R. Kretzmann
- o. "Medical X-Ray Technique", by G. J. van der Plaats and L. Penning
- p. "Electrical Discharges in Gases", by F. M. Penning
- q. "Tube Selection Guide", compiled by Th. J. Kroes

Books l, o and p are in active preparation.

d. "POPULAR SERIES"

Our "Popular Series" is intended to meet the growing demand for works on technical subjects written in a way that can be readily understood by the less advanced reader. Popular as used here does not mean superficial, but intelligible to a wider public than is catered for by the other more specialized books in Philips Technical Library.

1. "Remote Control by Radio", by A. H. Bruinsma
2. "Electronic Valves for L. F. Amplification", by E. Rodenhuis
4. "Battery Receiving Valves", by E. Rodenhuis
5. "Germanium Diodes", by S. D. Boon
6. "Introduction to the Cathode Ray Oscilloscope", by Harley Carter
7. "From Microphone to Ear", by G. Slot
8. "Valves for A. F. Amplifiers", by E. Rodenhuis
9. "Robot Circuits", by A. H. Bruinsma

Books 4 and 9 are in preparation.

PHILIPS JOURNALS

- a. Philips Technical Review
- b. Philips Research Reports
- c. Philips Telecommunication Review
- d. Philips Serving Science and Industry
- e. Medicamundi
- f. Electronic Applications