



# SPECIAL EFFECTS SYSTEM

CATALOG

**B**.2650

## FEATURES

- More than 150 effects to choose from—wipes, split-screens, picture insets, block, wedge, circular and multiple frequency patterns
- Pre-selection of effects—by means of plug-in selector cards
- Instant pushbutton selection of any pre-selected effect
- Handles color, monochrome, or a combination of the two
- Switching time is only 0.1 microseconds—transition line is invisible when same picture is applied to both video inputs
- Fader lever control for simplified operation
- Illuminated arrows indicate correct direction of lever movement at any time
- Black level precisely and automatically fixed—regardless of difference in picture content between video signals
- Stable setup adjustments—no changes required for entire repertoire of effects
- Provides traveling matte or special pattern effects when used with external keying signal

2KB

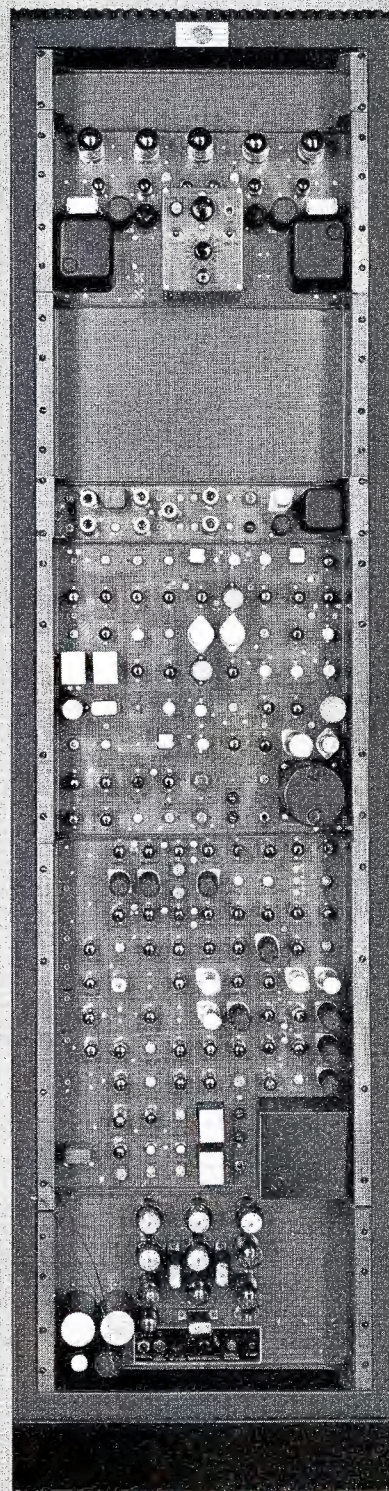



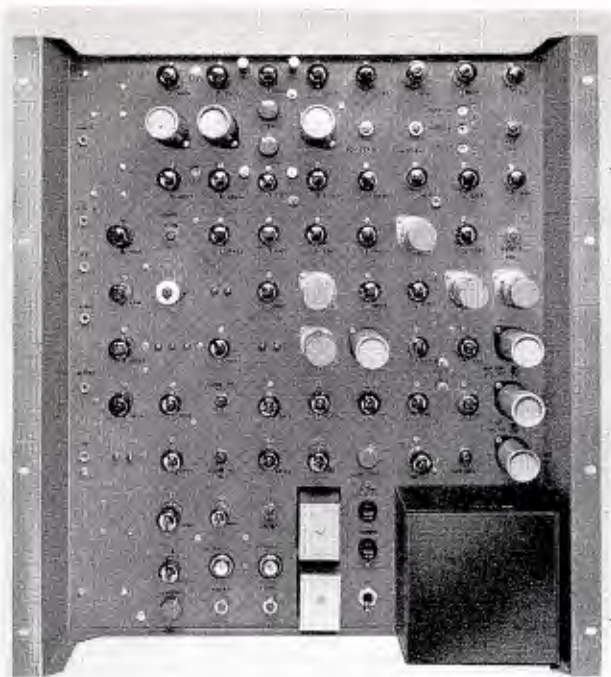

TA-25 Special Effects Amplifier.

## USES

The RCA Special Effects System offers the ultimate in convenience for selection and presentation of program effects. It provides as many as 154 transitional and split-screen effects—horizontal and vertical wipes, diagonal and pointed wipes, corner insets, horizontal and vertical splits, rectangular, circular and diamond-shaped iris effects and multiple frequency patterns. In addition a keying signal can be supplied from an external camera source for such effects as inset letters, trademarks, self-keyed video insets and traveling mattes.

## DESCRIPTION

The RCA Special Effects System consists of a TA-25 Amplifier, a TG-25 Generator, a Remote Clipping Line Control Panel, a Multiple Frequency Effects Generator, an Effects Pattern Selection Panel, a Fader Lever Control Assembly and a WP-25 Effects Power Supply. This equipment is described in detail on the following pages along with complete equipment specifications.

### TA-25 Special Effects Amplifier

The RCA Special Effects Amplifier, Type TA-25, is used to key out certain picture areas from selected backgrounds and to insert picture material from other sources into the keyed out areas. When used with the TG-25 Special

Effects Generator, it becomes a transitional device for wiping off one picture and introducing another. The amplifier may also be keyed by a signal generated by a film or live camera focused on a pattern containing lettering or figures of any desired shape.

The amplifier may also be used to produce self-keying or "traveling matte" effects consisting of a live subject keyed into a background picture. In this case the background picture can be produced from a slide, film or live studio camera. The picture to be inset into the background is produced by a second camera focused on the desired subject which is posed in front of a black backdrop. The signal from the second camera is applied to input A of the amplifier and also to the keying signal input. The background signal is applied to input B. The amplifier then generates a keying signal corresponding to the outline of the live subject, inserting the image of the subject into the area carved out of the background. Thus subject matter can be made to appear in front of a variety of backgrounds readily available from slides and film. Careful control of lighting and signal levels is essential for the successful use of this type of effect.

The TA-25 Special Effects Amplifier is contained on a 21" bathtub chassis. All connections are made at the rear of the chassis and all setup adjustments are available at the front.

The TA-25 has three video inputs: picture A, picture B, and keying signal. In operation the A and B inputs are sampled for the presence of color burst. If burst is present on either of these inputs it is gated to the amplifier output. This feature makes simultaneous use of monochrome and color signals possible.

The keying signal is amplified, clipped to remove any traces of noise which might produce spurious keying, and then clamped to insure stability of the keying action and sharp edges at the borders of the patterns. The keying signal gain and the clipping level are adjustable to insure optimum purity of keying for any signal which might be used for the purpose. When used with the Special Effects Generator signal this is simply a set-up adjustment at the Special Effects Amplifier. For special uses such as self-inserts, critical adjustment may be helpful at a switcher or camera control position. For this reason, a Remote Clipping Level Control Panel, MI-40336, is available. When external keying signals are used, it is especially important that this control panel be mounted at a location readily accessible to technical personnel. For instance, any changes in the externally generated signals can be



compensated at the video switcher control position by immediate adjustment of the clipper level and keying gain controls. The Remote Clipping Level Control Panel is a standard 2-21/32 by 11-1/16 inch panel which may be mounted in the MI-26252 remote control panel console mounting adaptor or in the MI-26278 console well mounting adaptor.

After the keying signal has been processed, it is applied to a high speed electronic switching circuit which performs the actual keying operation. This switching circuit admits the signal from channel A whenever the keying signal is at black, and admits the signal from channel B whenever the keying signal is white. The switching function is extremely fast and clean in operation. Because the transition from one picture source to another occurs in less than 0.1 microsecond, there is no visible transition line when the same picture is applied to both picture

inputs of the amplifier. The output of the switch is sampled by an error detector which determines the difference in black level between pictures A and B. A correction signal is then fed back to the switch to equalize black level, regardless of what changes may take place in the input signals or in level due to wipe action.

The amplifier has two outputs. One of these can be either composite or non-composite; the other, non-composite only. Both outputs are sending end terminated.

A tally-light control circuit monitors the keying signal in the clipper and operates appropriate relays for the application of tally voltages to the video switching circuits. If a wipe is made from camera A to camera B, camera A's tally lights come on when the camera A signal is first selected; camera B's tallies come on when the wipe is started. Camera A's tallies go off when the wipe is completed, leaving B's tallies on.

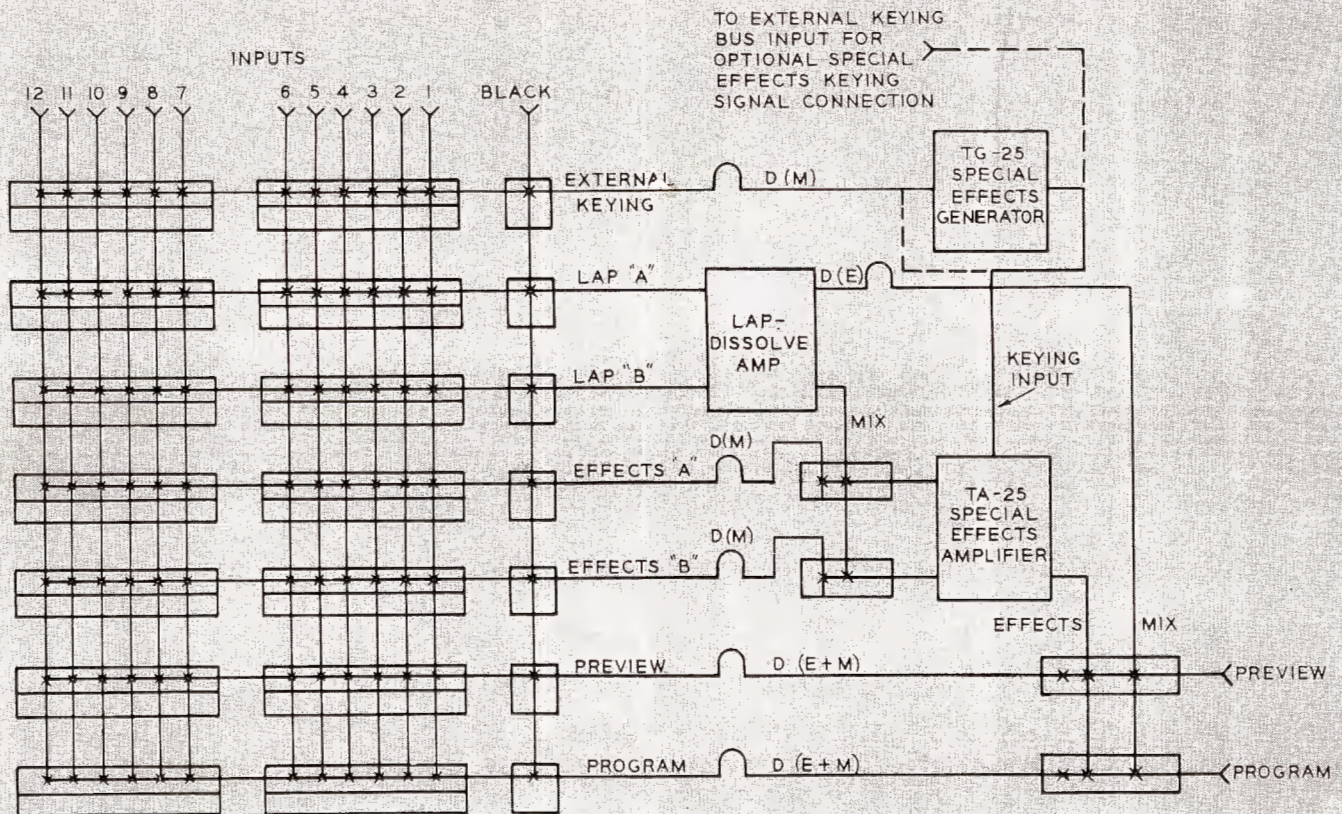

Functional Diagram of RCA Special Effects System, integrated into a TS-40 Transistorized Switching System for maximum flexibility and operating convenience.



## TG-25 Special Effects Generator

The TG-25 Special Effects Generator, MI-40337, is used for generating the various effects. This equipment has been designed specifically as a source of keying signals to be used with the RCA TA-25 Special Effects Amplifier. The generator is contained on a 17½ inch bathtub chassis. All connections are made at the rear of the chassis; all adjustments from the front.

All of the rectangular sawtooth and triangular waveforms necessary to produce the 88 effects shown on Chart A are generated by horizontal and vertical drive signals from the local sync generator. Relays are used to switch the various waveforms to the proper signal path. The use of relays makes possible instantaneous selection of the desired effect.

The generator circuitry is stabilized to minimize the effects of differences in tube and component characteristics and also against the effects of aging. Controls are provided for the setup adjustment of symmetry and centering and require touch-up only once in a period of several days as a part of the regular station maintenance practice.

TG-25 Special Effects Generator.

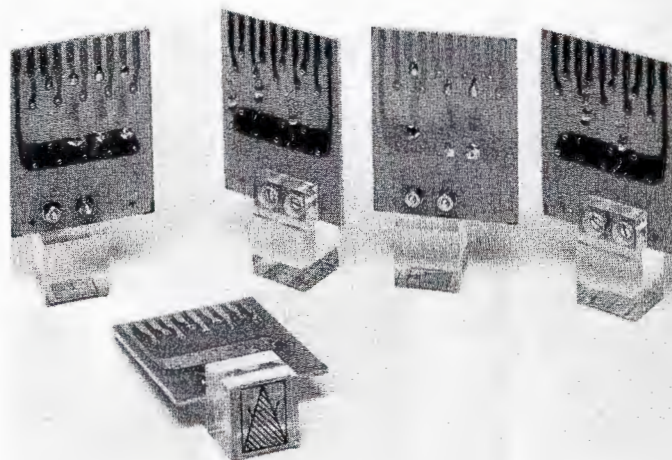
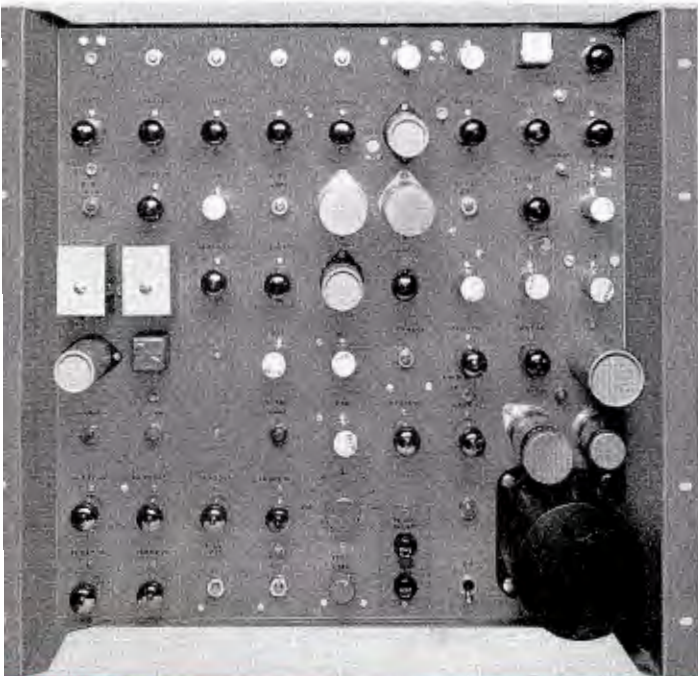

Multiple Frequency Effects Pattern Selectors showing Etched Circuitry and identifying Special Effects Knob.

## Multiple Frequency Effects Generator

The Multiple Frequency Effects Generator, MI-40354, provides a wider selection of effects patterns than are available with the TG-25. These patterns, illustrated on Chart B, number 66, making a total of 154 patterns available to the system. The multiple frequency patterns are generated by triggering the basic multi-vibrator circuits in the TG-25 with higher frequency pulses than the basic horizontal and vertical drive pulses. In addition parabolic waveforms are generated to produce patterns with rounded edges; the most common example being the circular iris.

The Multiple Frequency Effects Generator circuits are mounted on a 5¼ inch bathtub chassis which is designed to be mounted directly above the TG-25 Effects Generator. The connections to the TG-25 are all plug-in for ease of installation.

Ten effects selector cards (starred on Chart B) are supplied with each Multiple Frequency Effects Generator. Additional effects are available in kit form as MI-40355. The kit contains cards and diodes for making up an additional 10 effects.



## Effects Pattern Selection Panel

The Effects Pattern Selection Panel, MI-40338, has been designed to simplify the selection and presentation of effects. It contains two rows of pushbutton switches and a row of illuminated plug-in pattern selection cards. Ten pushbuttons in the selector row allow instantaneous selection of any one of 10 pattern pre-selector cards. Ten of these cards—one for each pushbutton—can be pre-selected and plugged into the slots corresponding to the pushbuttons.

The plug-in card consists of a printed wiring board having several terminal connections and an illuminated molded handle on which is a small illustration showing the effect which this card will produce. Semi-conductor diodes are connected between terminals on the board. The connection of the diodes determines what effect will be produced by that particular card.

Twenty of the cards corresponding to the most frequently used effects (indicated by star on Chart A) are supplied with each pattern selection panel. In addition there is a kit containing cards and diodes so that the user can make up an additional set of five cards for another five effects. Special Effects Kit, MI-40352, is also available on separate order for those users who wish to have a wider choice of effects. This kit contains cards and diodes for 10 additional patterns. Supplied with each kit is a sheet of transparent effects pattern illustrations which can be cut out and fastened to the card handles when the effects have been chosen.

Switcher Control Panel with Special Effects Control Lever Assembly mounted in upper right corner.

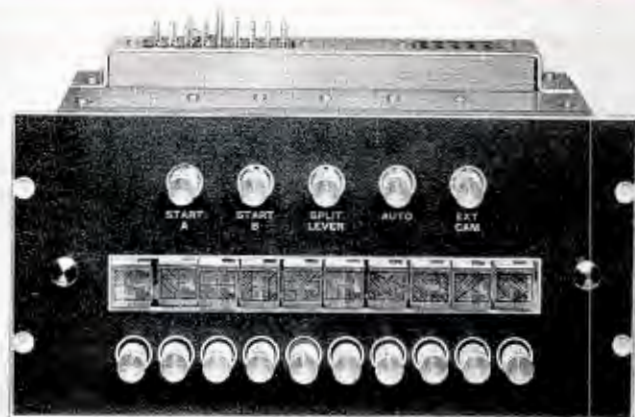
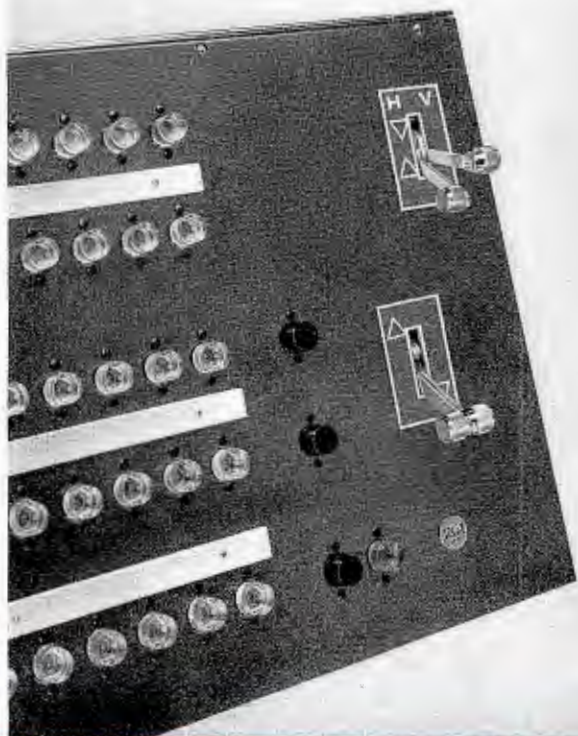

Special Effects Selection Panel.

The pattern selection panel should be mounted adjacent to the video switching control panel so that it will be easily accessible to the programming personnel. The panel is the same size as two standard remote control panels, or 11-1/16 by 5-11/32 inches. It can be mounted in a console by providing a MI-26252 remote control panel console mounting adaptor for it. It is recommended that wherever possible the Effects Pattern Selection Panel be made a part of the video switching control panel. A Trim Frame, MI-40353, is also available on special order for mounting the panel in a flat table top.

## Effects Control Lever Assembly

The mechanism used to control the effects is known as the Effects Control Lever Assembly, MI-40340. It is similar to the Lap-Dissolve Control Lever Assembly used in RCA remote controlled video switchers. This assembly may be conveniently mounted on the switcher control panel at the end of the two rows of pushbuttons used to select the video inputs to the TA-25 Special Effects Amplifier. The position of the levers then indicates video busses with which the effect starts and ends.

An escutcheon supplied with the lever assembly has two arrows indicating the proper direction of movement of the levers. Assume that the wipe is to be made from picture A to picture B, pausing several seconds somewhere in the center of the raster. The levers start from position A opposite the picture A video selection buttons. While the director moves the levers, the arrow pointing to the B position remains lit. If he pauses, it indicates to the director in which direction he must move the lever to complete the effect. When the end position is reached, this arrow goes out and the arrow pointing to the A position comes on.



# SPECIFICATIONS

## Electrical Specifications

### TA-25 Special Effects Amplifier

#### Input Impedance:

Picture A and picture B:

For use with bridging input lines.....High (1 megohm shunted by 22 microfarads)

Modified for use with TS-40 Video Switcher...75 ohms  $\pm 5\%$ , driven by TS-40 coupling circuit plate

Sync .....High

Blanking .....High

Horizontal Drive.....High

#### Keying Signal:

For use with bridging input lines.....High

Modified for use with TS-40 Video Switcher...75 ohms  $\pm 5\%$ , driven by TS-40 coupling circuit plate

#### Output Impedance (Source and Load):

Output No. 1.....75 ohms, source terminated

Output No. 2.....75 ohms, source terminated

#### Input Signal Requirements:

Picture A and B.....0.7 volts, non-composite

Keying Signal.....0.7 volts, non-composite

Sync.....3.5 to 5.0 volts

Blanking.....3.5 to 5.0 volts

Horizontal Drive.....3.5 to 5.0 volts

#### Output Signal Values:

Picture Component.....0-1.0 volts peak-to-peak

Sync Component (Output No. 2 only).....0-0.6 volts peak-to-peak

Frequency Response..... $\pm 0.5$  db, 200 kc to 7.5 mc

Tilt (60 cycle square wave).....Less than 2%

Differential Gain.....Less than 0.25 db, 10-90% APL

Differential Phase.....Less than 1°, 10-90% APL

Output Isolation.....Better than 40 db (60 cycles to 4 mc)

Black level shift due to H wipe.....0.5% maximum

Transition time.....0.1 microseconds

Picture channel delay.....0.055 microseconds

Signal Crosstalk.....Better than 50 db (60 cycles to 4 mc)

#### Power Requirements:

DC.....+280 volts, 220 ma;

From WP-25 power supply; +150 volts, 160 ma;

-150 volts, 200 ma

AC.....105 to 125 volts or 205 to 240 volts,

50/60 cycles, 125 watts

#### Tube Complement:

12-12A7 3-12AX7 4-6AU8 2-5726

8-6BQ7A 1-6AS6 1-6AB4 2-6197

2-6CB6 2-6CQ8 5-5687

### TG-25 Special Effects Generator

#### Input Signal Requirements:

Horizontal Drive.....3.5 to 5.0 volts

Vertical Drive.....3.5 to 5.0 volts

Blanking.....3.5 to 5.0 volts

External Camera.....0.7 volts, non-composite

Output Signal Level.....0.7 volts peak-to-peak

#### Output Impedance:

Source.....150 ohms

Load.....75 ohms

#### Power Requirements:

DC.....24 volts (for relays), 1/2 amp; +280 volts, 70 ma;

From WP-25 Power Supply: +150 volts, 180 ma;

-150 volts, 140 ma

AC.....105 to 125 volts or 205 to 240 volts, 50/60 cycles, 25 watts

#### Tube Complement:

11-12A7 4-6AU8 4-6CQ8

3-6BQ7A 1-6CL6 1-12AU7

### Multiple Frequency Effects Generator

Input signals are from TG-25 Generator

Output signals go to TG-25 Generator

#### Power Requirements:

DC.....+280 volts, 19 ma;

From WP-25 Power Supply: +150 volts, 33 ma;

-150 volts, 32 ma

AC.....105 to 125 volts or 205 to 240 volts, 50/60 cycles, 50 watts

#### Tube Complement:

5-12A7

2-12AU7A

### WP-25 Power Supply

Power Output.....+150 volts dc, 450 ma and -150 volts dc, 450 ma

Power Requirements.....105 to 125 volts, or 205 to 240 volts, 50/60 cycles, 450 watts

#### Tube Complement:

4-12AX7 5-6080 2-5651

NOTE: A 580-D or WP-15 Power Supply is required for a source of +280 volts DC, 309 ma. In addition, a source of 24 volts DC, 1/2 ampere is required.

## Mechanical Data & Ordering Information

Equipment Supplied	Height (inches)	Width (inches)	Depth (inches)	Weight (pounds)	Stock Identification
TA-25 Special Effects Amplifier	21	19	8 1/4	33	MI-40335-A
Remote Clipping Level Control	2-21/32	11 1/8	2	2	MI-40336
TG-25 Special Effects Generator	15-3/4	19	10 1/4	27	MI-40337
Effects Pattern Selection Panel*	5-11/32	11 1/8	8 1/8	10	MI-40338
Multiple Frequency Effects Generator†	5 1/4	19	7 1/2	8	MI-40354
WP-25 Effects Power Supply	10 1/2	19	13 1/4	54	MI-40339
Effects Control Lever Assembly	2 7/8	1 5/8	2 1/4	11	MI-40340
Accessory Equipment:					
Set of 10 Effects Pattern Selectors				2	MI-40352
Set of 10 Multiple Frequency Effects Pattern Selectors				2	MI-40355
WP-15 Power Supply Regulator	3 1/2	19	10 3/8	12	MI-26088-B
WP-15 Power Supply Rectifier	7	19	11	59	MI-26087-B
580-D Power Supply	10 1/2	19	12	58	MI-21523-C
BR-84D Cabinet Rack	84	22	18	195	MI-30951-D84
Trim Frame					MI-40353

\* Including 20 Effects Pattern Selector Modules.

† Including 10 Multiple Frequency Effects Pattern Selector Modules.

### Rack Layout Using WP-15B or 580-D Power Supplies.

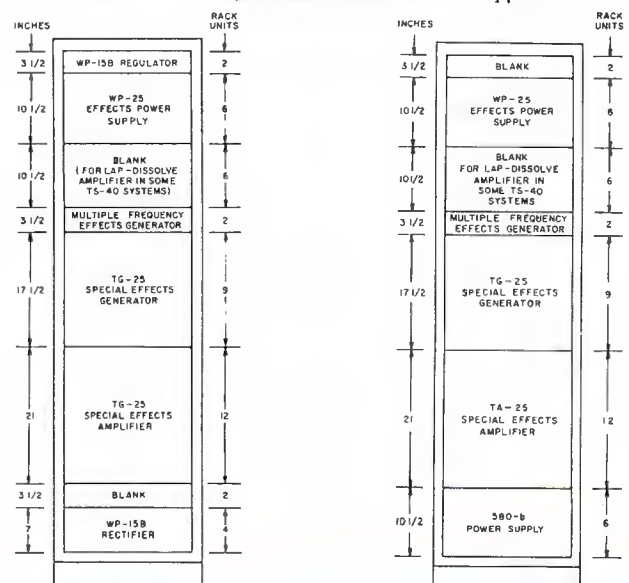

### Block and Wedge Special Effects Patterns

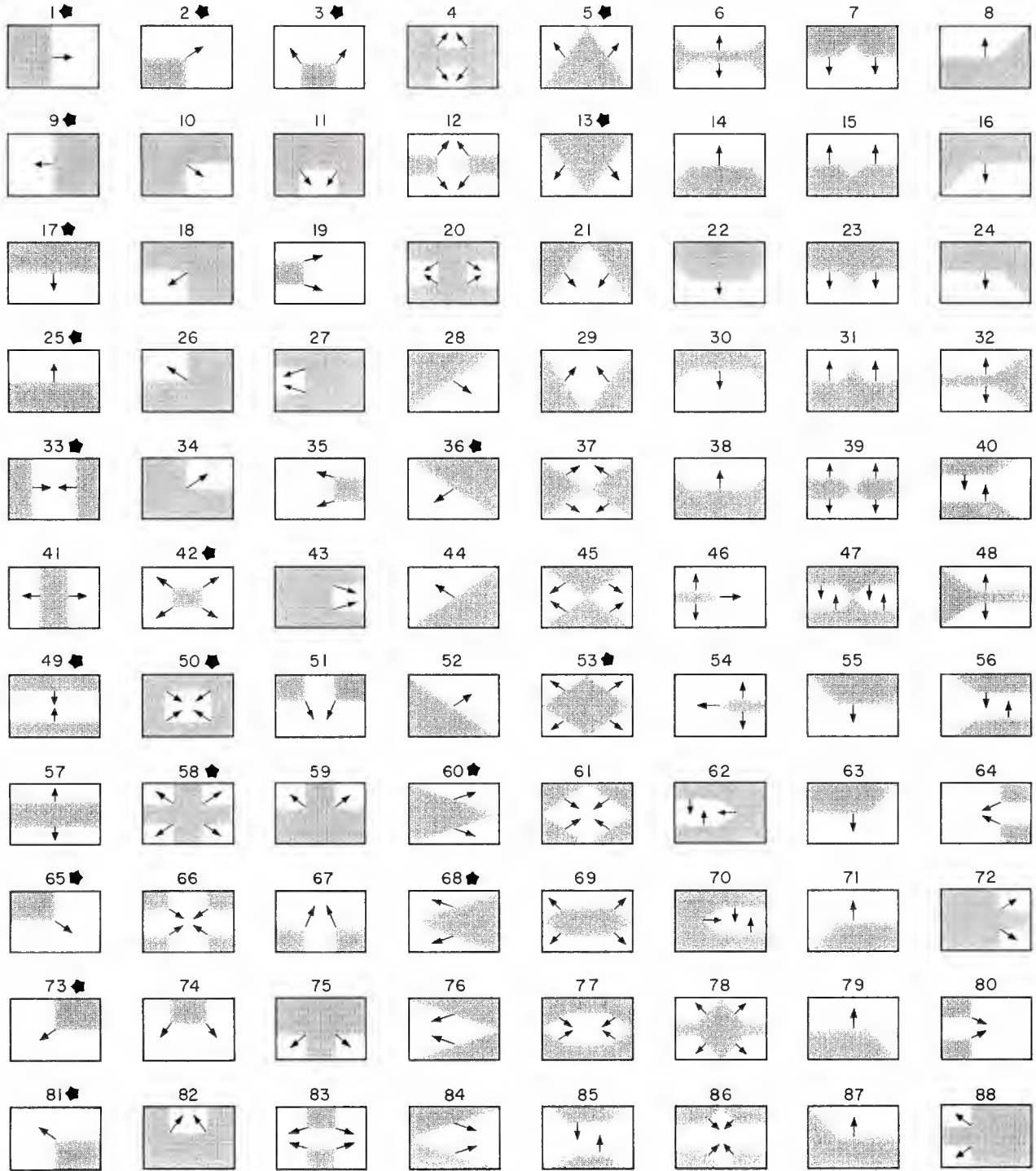



## Multiple Frequency and Circular Special Effects Patterns

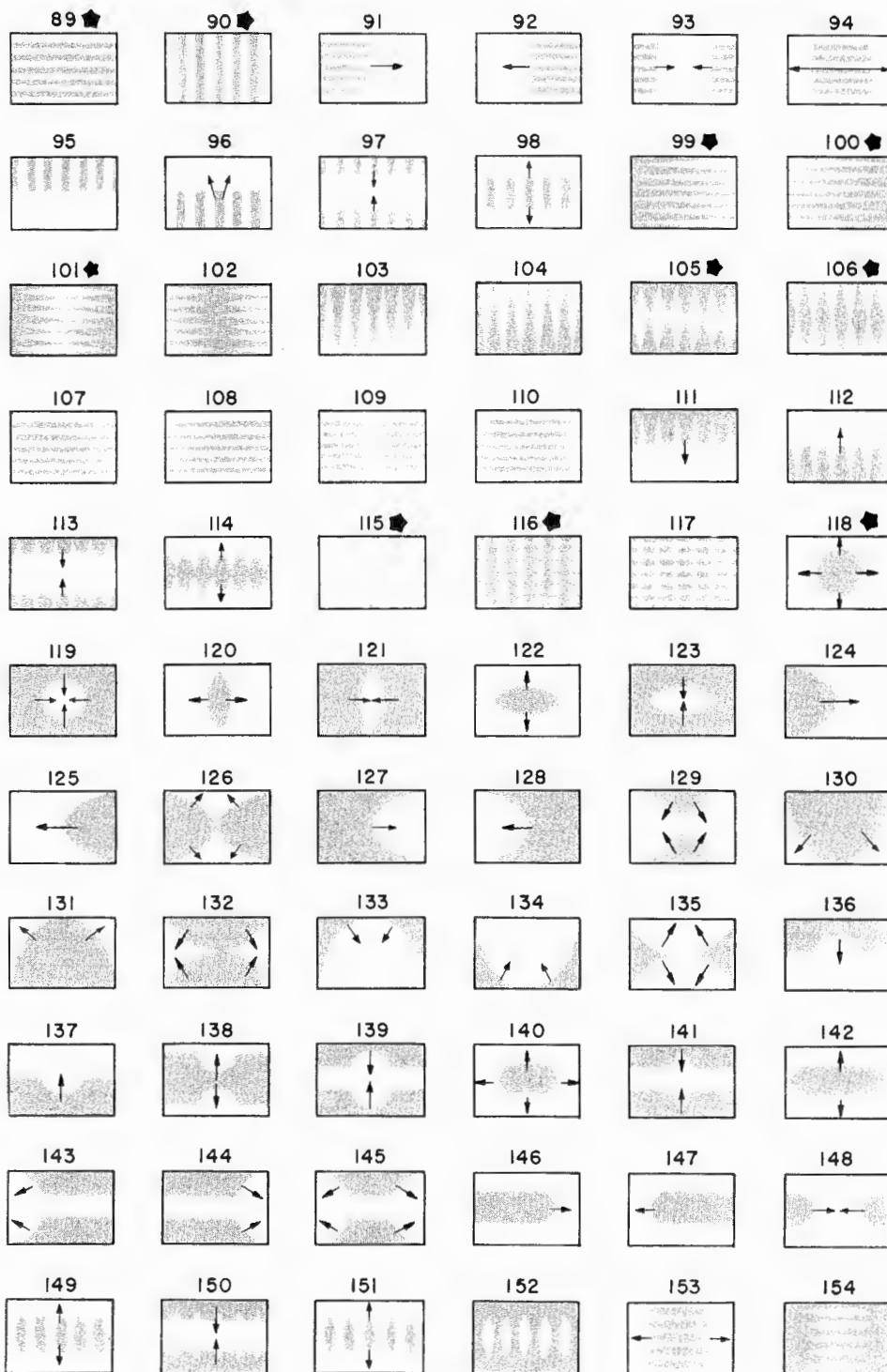

**RADIO CORPORATION OF AMERICA**  
Broadcast & Television Equipment  
Camden, N. J.

TMK(s) ®

PRINTED  
IN  
U.S.A.