

RCA wvistor TUBES

for Industrial and
Military Applications

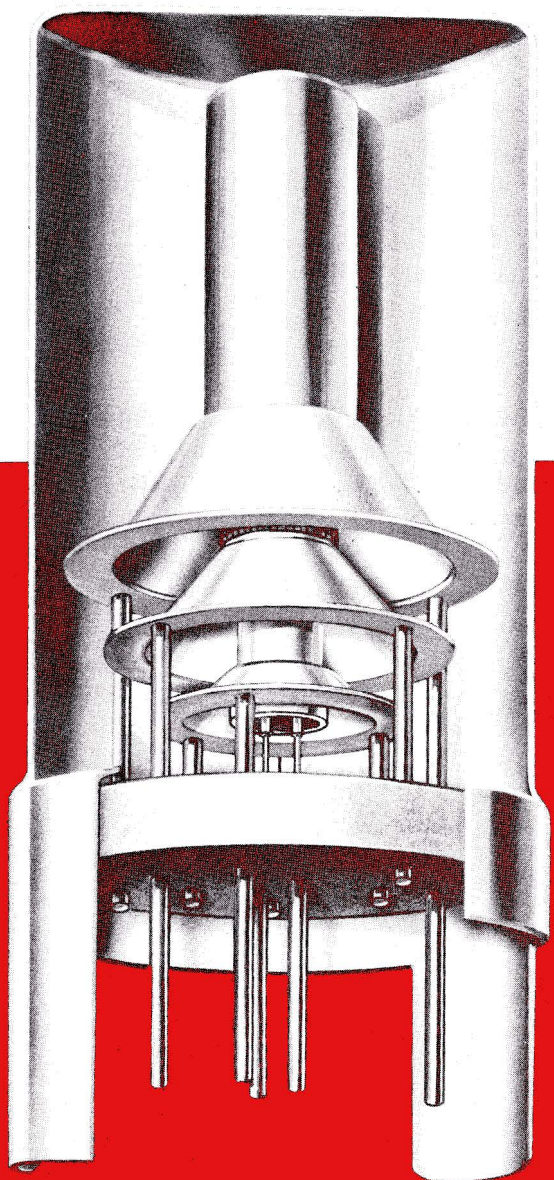

- ☑ High reliability
- ☑ High resistance to nuclear radiation, shock, and vibration
- ☑ Small size
- ☑ Low drain
- ☑ Exceptional uniformity of characteristics
- ☑ RCA dark heater



RCA

Nuvistor Tubes

For Industrial and Military Applications

General

This brochure presents data for eight industrial-nuvisor receiving-type tubes including three types designed to meet Military Specifications.

The nuvisor design, developed by RCA, utilizes a light-weight, cantilever-supported, cylindrical electrode structure housed in an all-ceramic-and-metal envelope (See *CUTAWAY VIEWS* on page 4). This unique design represents a combination of materials, processes, and fabrication techniques which has provided a major breakthrough in electron-tube performance, reliability, and size.

This combination of strong structural assembly with all-brazed connections and seals, all-ceramic-and-metal construction, and high-temperature processing provides very small tubes which give dependable performance under extreme environmental conditions, such as thermal or mechanical shock, continuous vibration, and high temperature.

Another important and novel feature of the nuvisor design is the use of two peripheral lugs of unequal width which (1) provide visual and/or mechanical indexing, (2) provide protection for the base pins, and (3) permit safe, easy, and rapid insertion of tubes into sockets.

The advantages of the nuvisor design are numerous. The cylindrical symmetry of the electrode structure assures a uniform emission pattern. This symmetry together with the cantilever construction permits the use of close-tolerance jigs for extremely precise tube assembly. High-temperature brazing of the assemblies in these jigs eliminates the need for spot-welding and produces a virtually strain-free structure. The inherent

symmetry of the assembly of these tubes also eliminates the need for mica spacers and thus removes one of the usual limitations to high-temperature operation.

The basic design of nuvisor tubes makes it possible to maintain a high degree of control over the fabrication of parts and assemblies. Consequently, extremely close electrode spacings with an exceptionally high degree of mechanical uniformity can be achieved. The precise control over processing also contributes to exceptional uniformity of electrical characteristics from tube to tube.

Because the nuvisor tube contains no glass or mica components, has a short low-mass structure, and is processed at very high temperatures, it is capable of operating reliably under severe environmental conditions.

The RCA Dark Heater

Each of the nuvisor types described in this brochure utilizes the RCA Dark Heater. This heater operates at temperatures as much as 350 degrees Kelvin below the 1500-to-1700-degree-Kelvin temperatures required by conventional heaters.

The reduced heater operating temperature results in greatly increased tube life and reliability. The lower internal stresses in the heater wire and the smaller thermal change during heater warm-up minimize recrystallization and thus assure long heater life. Other advantages of the RCA dark heater include (1) substantially less change in heater shape, which greatly reduces the possibility of heater damage and heater shorts, (2) extremely stable current characteristics throughout life to assure con-

stant cathode temperature, (3) significant reduction in ac leakage and hum to eliminate "spikes" or pulse leakage currents sometimes present in conventional heaters, and (4) greater margin of safety within established maximum heater-cathode-voltage ratings.

Nuvistor-Tube Reliability

RCA nuvistors are especially suited for use in applications where long-term reliability and uniformity of characteristics from tube to tube are critical design considerations.

Samples of nuvistor type RCA-7586 have been life-tested (for over 1,600,000 tube-hours) both at maximum-rated conditions and at typical-operating conditions. The results of these life-tests indicate that the lot failure rate per 1000 hours for the 7586 is only 0.475 per cent at a confidence level of 95 per cent to 10,000 hours.

Nuvistor Performance in Presence of Nuclear Radiation

RCA nuvistors are suited for use in electronic equipment that must perform dependably in the presence of nuclear-radiation fields.

RCA nuvistors have been exposed to both pulse and steady-state nuclear radiation as specified in the Neutron Radiation Damage Test, Military Standard MIL-STD-446A dated 25 November 1960. The specific test exposure levels and results are:

Pulse Nuclear Radiation. Nuvistor types RCA-7586 and 7587 were operated in a 15-kc amplifier circuit and monitored during exposure to pulse nuclear radiation having an integrated total neutron flux of 2×10^{12} neutrons per square centimeter. *The recovery of the output signal for both the 7586 and 7587 occurred in less than 0.5 millisecond after the end of the radiation pulse.*

Steady-State Nuclear Radiation. Samples of nuvistor type RCA-7586 were exposed to steady-state nuclear radiation having an integrated total neutron flux

of 10.8×10^{16} neutrons per square centimeter. *All of the 7586 nuvistor tubes remained operable and exhibited an average change in transconductance of less than 1 per cent.*

The results of these tests indicate that *"the RCA nuvistor is in a class of active electronic-circuit components least susceptible to catastrophic failure from nuclear radiation."*

INDUSTRIAL-TYPE NUVISTORS

The eight industrial-type nuvistors described below are specifically designed for use in industrial applications where compactness, low power drain, low-plate-voltage operation, exceptional uniformity of characteristics from tube to tube, ability to withstand severe mechanical shock and vibration, and ability to operate over a wide temperature range are primary design requirements.

Each of these nuvistor tube types is rigidly controlled during manufacture, is subjected to rigorous tests, and may be operated at maximum ratings at any altitude.

RCA-7586 is a general-purpose, medium-mu triode for use in high-gain, low-noise amplifier applications at frequencies up to 400 Mc, and as an oscillator tube having excellent stability over a wide range of frequencies. This tube is also capable of giving reliable performance in applications such as "on-off" control involving long periods of standby operation.

RCA-7587 is a general-purpose, double-ended, sharp-cutoff tetrode for use in rf-, if-, and video-amplifier applications, mixer applications, and "on-off" control applications.

RCA-7895 is a general-purpose, high-mu triode for use in high-gain, low-noise amplifier applications at frequencies up to 400 Mc, as an oscillator tube over a wide range of frequencies, and in "on-off" control applications.

RCA-8056 is a medium-mu triode specifically designed for operation with plate-supply voltages of 12 to 50

volts. This tube is especially useful in low-noise rf-amplifier, if-amplifier, control, multivibrator, cathode-follower, and other applications requiring a device having a high input impedance.

When used with a low-voltage power supply, the 8056 can provide high gain with low noise in small-signal amplifier applications at frequencies up to 350 Mc.

RCA-8058 is a double-ended, high-mu triode for use in cathode-drive-amplifier applications at frequencies up to 1200 Mc, and as an oscillator tube having excellent stability over a wide range of frequencies. The 8058 is particularly suitable for cathode-drive applications because the metal shell is used as the grid terminal.

The double-ended construction of the 8058 provides a high degree of isolation between the input and output circuits. Furthermore, this tube features (1) a specially designed cathode

which assures very low heater-cathode leakage, (2) high transconductance at low plate current, (3) high perveance, and (4) three base-pin connections for the cathode to minimize lead inductance and permits flexibility in circuit design.

NUVISTORS DESIGNED TO MEET MILITARY SPECIFICATIONS

JAN-7586 is similar to the RCA-7586 described above but is designed to meet Military Specification MIL-E-1/1397A dated 5 July 1962.

JAN-7587 is similar to the RCA-7587 described above but is designed to meet Military Specification MIL-E-1/1434A dated 11 June 1963.

JAN-7895 is similar to the RCA-7895 described above but is designed to meet Military Specification MIL-E-1/1433A dated 11 June 1963.

CUTAWAY VIEWS

Showing Cylindrical Electrodes and Tripod-Like Supports

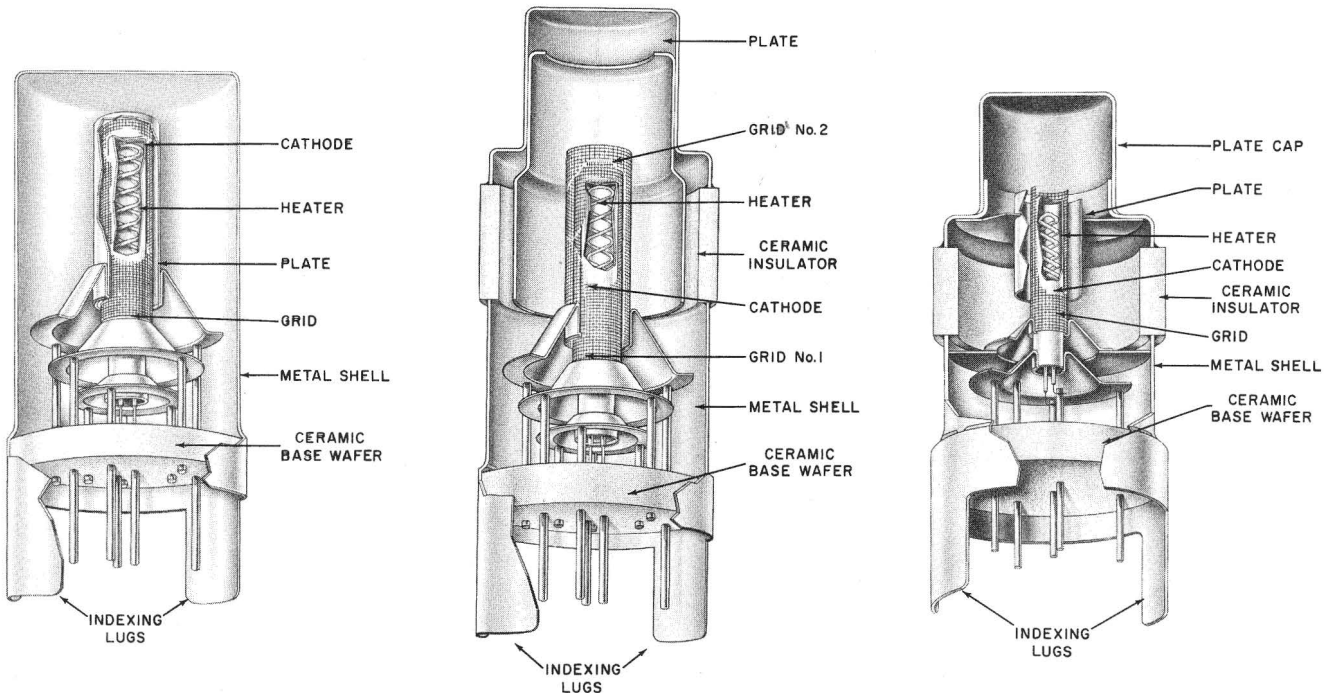

Typical Single-Ended Nuvistor Triode

Typical Double-Ended Nuvistor Tetrode

Typical Double-Ended Nuvistor Triode

DIMENSIONAL OUTLINES

All Dimensions in Inches

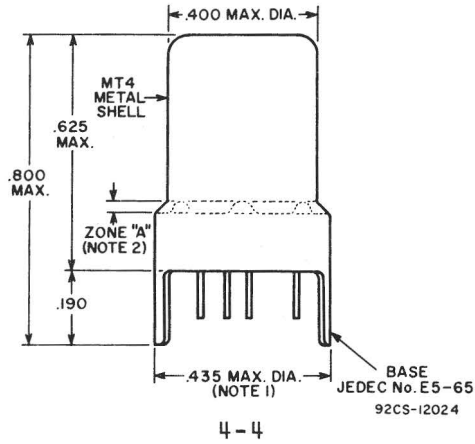

Types
7586
7895
8056

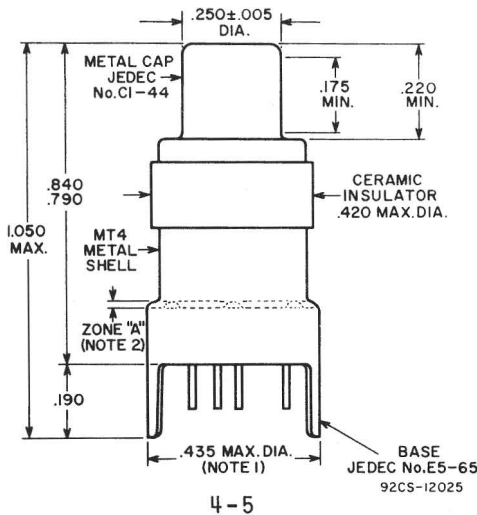
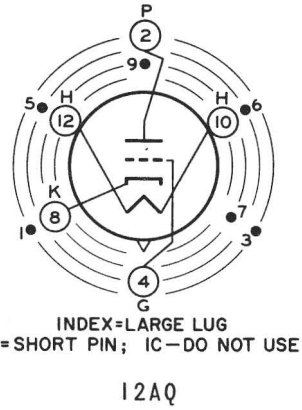

Type
7587

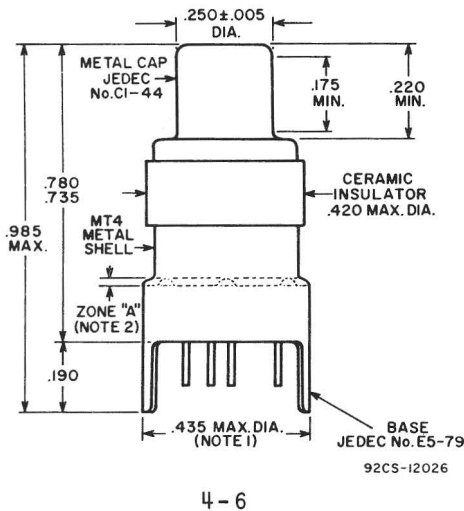
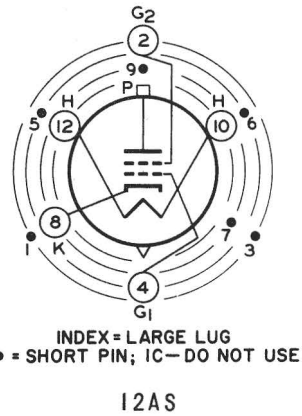

Type
8058

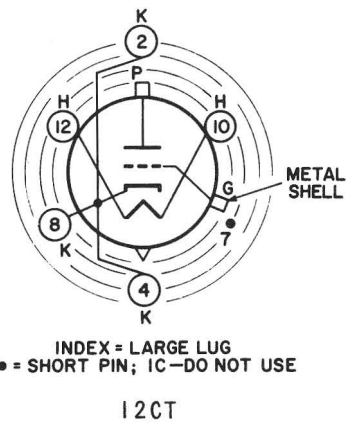

NOTE 1: MAXIMUM OUTSIDE DIAMETER OF 0.440" IS PERMITTED ALONG 0.190" LUG LENGTH.

NOTE 2: METAL-SHELL TEMPERATURE SHOULD BE MEASURED IN ZONE "A".

For
SOCKET & CONNECTOR INFORMATION,
 see Page 14

ELECTRICAL DATA

TYPE	CLASSIFICATION	INTENDED APPLICATIONS AND FEATURES	SPECIAL TESTS AND CONTROLS										RCA DARK HEATER Rated Center Values			
			Shock	Fatigue	Variable-Frequency Vibration	Low-Pressure Voltage Breakdown	Heater Cycling	Intermittent Shorts	Interelectrode Leakage	LIFE TEST						
										Early-Hour Stability	100-Hour Performance	1000-Hour Performance	1000-Hour Standby	Volts	Amp	
7586	Medium-Mu Triode	General-purpose type capable of providing high gain with low noise in amplifier applications up to 400 Mc. Excellent stability as oscillator tube over a wide range of frequencies. Reliable performance in "on-off" control applications involving long periods of standby operation.	✓	✓	✓	✓	✓	✓	✓	✓	✓	✓	✓	✓	6.3	0.135
JAN-7586	Medium-Mu Triode	Same as 7586 but, in addition, designed to meet indicated Military Specification.	✓	✓	✓	✓	✓	✓	✓	✓	✓	✓	✓	✓	6.3	0.135
7587	Sharp-Cutoff Tetrode	Double-ended, general-purpose type for rf-, if-, and video-amplifier, mixer, and "on-off" control applications.	✓	✓	✓	✓	✓	✓	✓	✓	✓	✓	✓	6.3	0.150	
JAN-7587	Sharp-Cutoff Tetrode	Same as 7587 but, in addition, designed to meet indicated Military Specification.	✓	✓	✓	✓	✓	✓	✓	✓	✓	✓	✓	6.3	0.150	
7895	High-Mu Triode	General-purpose type capable of providing high gain with low noise in amplifier applications up to 400 Mc. Excellent stability as oscillator tube over a wide range of frequencies. Also "on-off" control applications.	✓	✓	✓	✓	✓	✓	✓	✓	✓	✓	✓	6.3	0.135	
JAN-7895	High-Mu Triode	Same as 7895 but, in addition, designed to meet indicated Military Specification.	✓	✓	✓	✓	✓	✓	✓	✓	✓	✓	✓	6.3	0.135	
8056	Medium-Mu Triode	Low-plate-voltage (12 to 50 volts) type for low-noise rf- and if-amplifier, control, multivibrator, and cathode-follower applications.	✓	✓	✓	✓	✓	✓	✓	✓	✓	✓	✓	6.3	0.135	
8058	High-Mu Triode	Double-ended type for cathode-drive-amplifier applications up to 1200 Mc. Has excellent stability as an oscillator tube over a wide range of frequencies.	✓	-	✓	✓	✓	✓	✓	-	-	-	✓	6.3	0.135	

MECHANICAL DATA

Type	Dimensional Outline JEDEC No.	Terminal-Diagram JEDEC Designation	Base		Operating Position	Weight (Approx.) Grams
			JEDEC No.	Pins		
7586	4-4	12AQ	E5-65	5-Pin	Any	1.9
7587	4-5	12AS	E5-65	5-Pin	Any	2.4
7895	4-4	12AQ	E5-65	5-Pin	Any	1.9
8056	4-4	12AQ	E5-65	5-Pin	Any	1.9
8058	4-6	12CT	E5-79	5-Pin	Any	2.2

ELECTRICAL DATA

CHARACTERISTICS, CLASS A ₁ AMPLIFIER										MAXIMUM RATINGS Absolute-Maximum Values For Operation at Any Altitude								Maximum Grid-Circuit Resistance ^d Megohms		TYPE
Plate Supply Volts	Plate Volts	Grid Supply Volts	Cathode Resistor Ohms	Grid Resistor Ohms	Amplification Factor	Plate Resistance Ohms	Transconductance μ mhos	Plate ma.	Cutoff Grid Volts at plate μ a = 10 ^a	Plate Supply Volts	Plate Volts	Grid Neg. Bias	Volts Pos. Peak	Grid ma.	Cathode ma.	Plate Dissipation Watts	Peak Heater-Cathode Volts	Fixed Bias	Cathode Bias	
75 - -	- 40 26.5	0 0 0	100 - -	- 0.5 M 0.5 M	35 35 31	3000 3000 4400	11500 11500 7000	10.5 7.5 2.8	-7 - -	330	110	55	4	2	15	1	\pm 100	0.5	1	7586
For data, refer to MIL-E-1/1397A, 5 July 1962 ^b																				JAN-7586
125	-	0 ^c	68	-	-	0.2 M	10600	10	-4.5 ^c	330	250	55 ^c	2 ^c	2 ^c	20	2.2	\pm 100	0.5 ^c	1 ^c	7587
Grid-No.2 supply volts = 50 Grid-No.2 ma. = 2.7 Grid-No.2 supply volts = 330, grid-No.2 volts = 110, grid-No.2 input = 0.2 watt																				
For data, refer to MIL-E-1/1434A, 11 June 1963 ^b																				JAN-7587
110	-	0	150	-	64	6800	9400	7	-4	330	110	55	2	2	15	1	\pm 100	0.5	1	7895
For data, refer to MIL-E-1/1433A, 11 June 1963 ^b																				JAN-7895
24	-	0	100	-	11.5	1530	7500	8.7	-5@50 μ a	-	50	55	2	2	15	0.45	\pm 100	10 ^e	10 ^e	8056
110	-	0	47	-	70	5600	12400	10	-5	330	150	55	0	0	15	1.5	\pm 100	0.5	1	8058

^a Unless otherwise specified.

^b A copy of this specification may be obtained from:
Specifications Division
Naval Supply Depot
5801 Tabor Avenue
Philadelphia 20, Pa.

^c Grid No. 1.

^d For operation at metal-shell temperature of 150° C unless otherwise specified. For operation at other metal-shell temperatures, see accompanying GRID-CIRCUIT-RESISTANCE CHARTS.

^e For operation at metal-shell temperatures up to 150° C.



7586
7895
8056



7587



8058

GRID-CIRCUIT-RESISTANCE CHARTS

7586

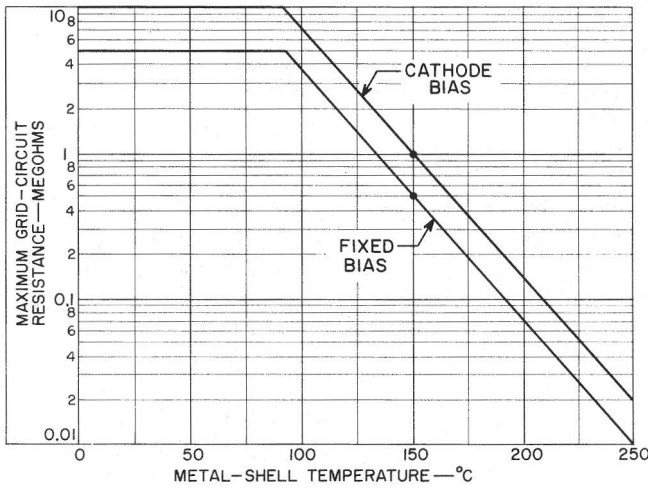

92CS-11911

7587

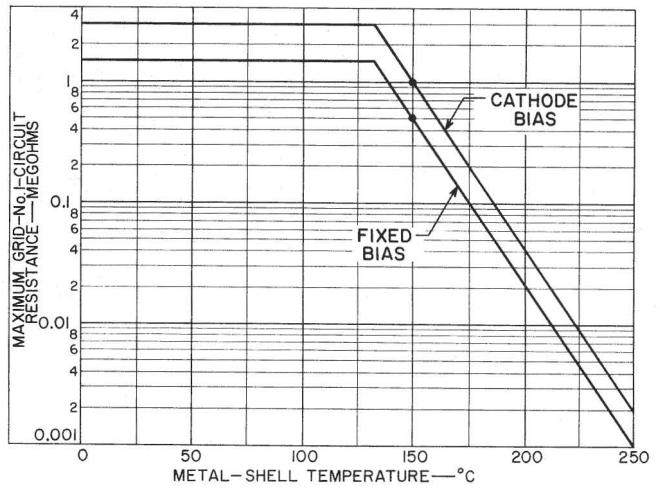

92CS-11896

7895

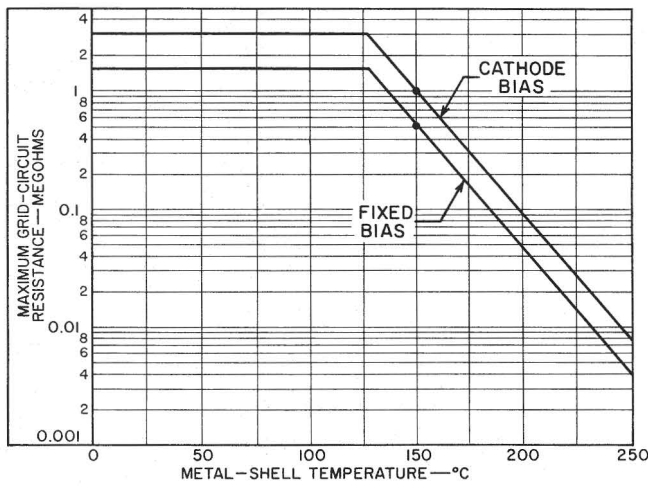

92CS-12023

8056

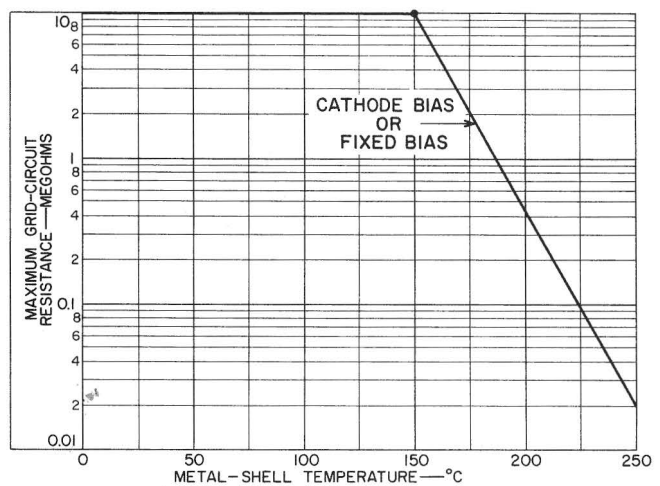

92CS-11479R1

8058

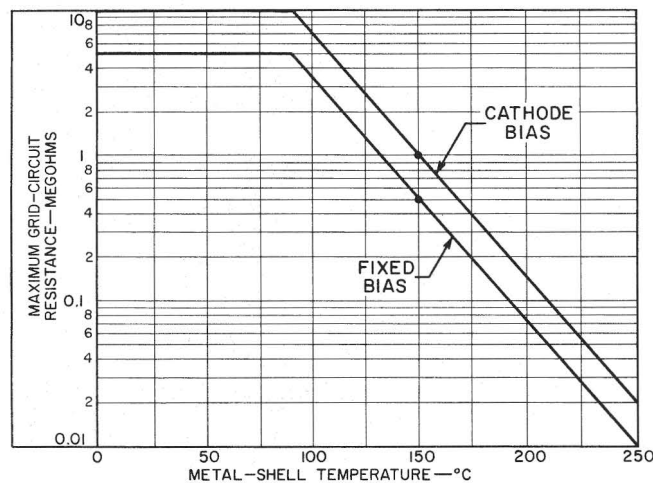

92CS-12022

AVERAGE CHARACTERISTICS

7586

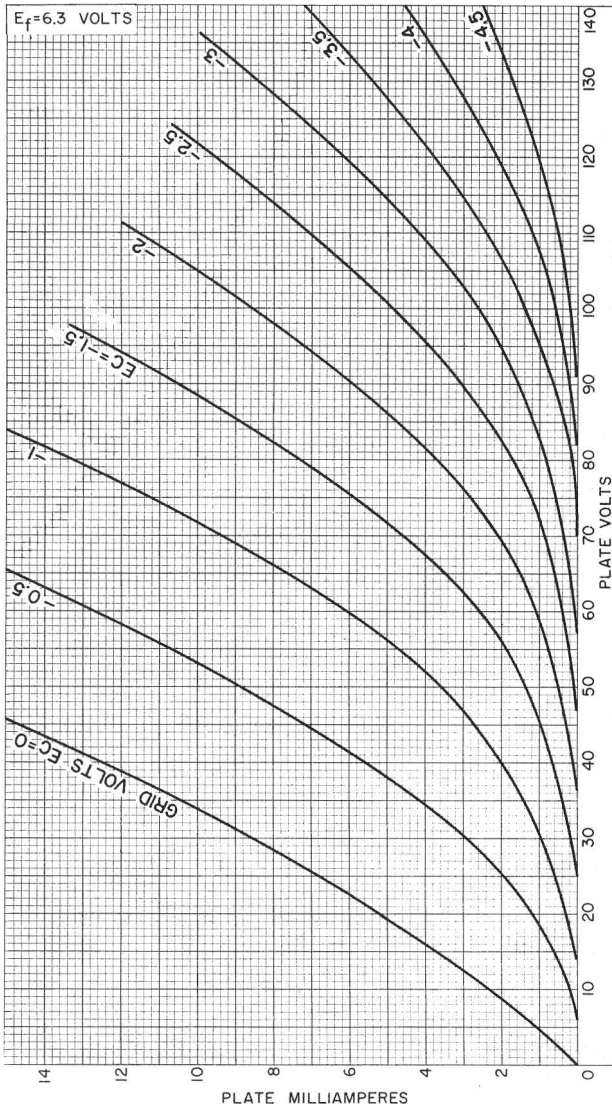

92CM-10460R2

7587

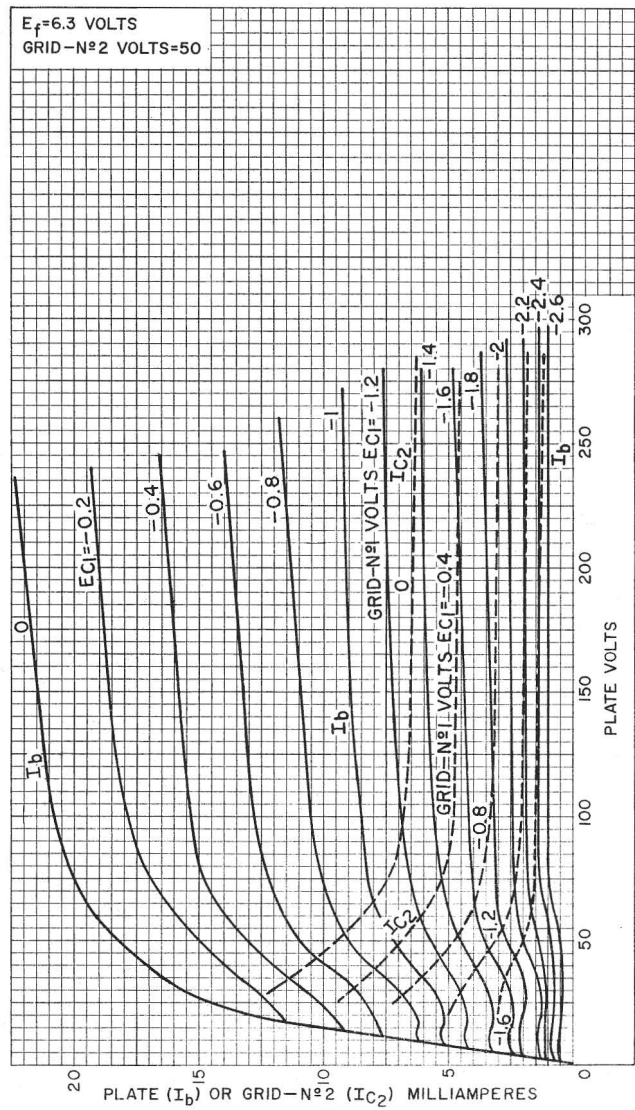

92CM-10926R1

AVERAGE CHARACTERISTICS

7895

8056

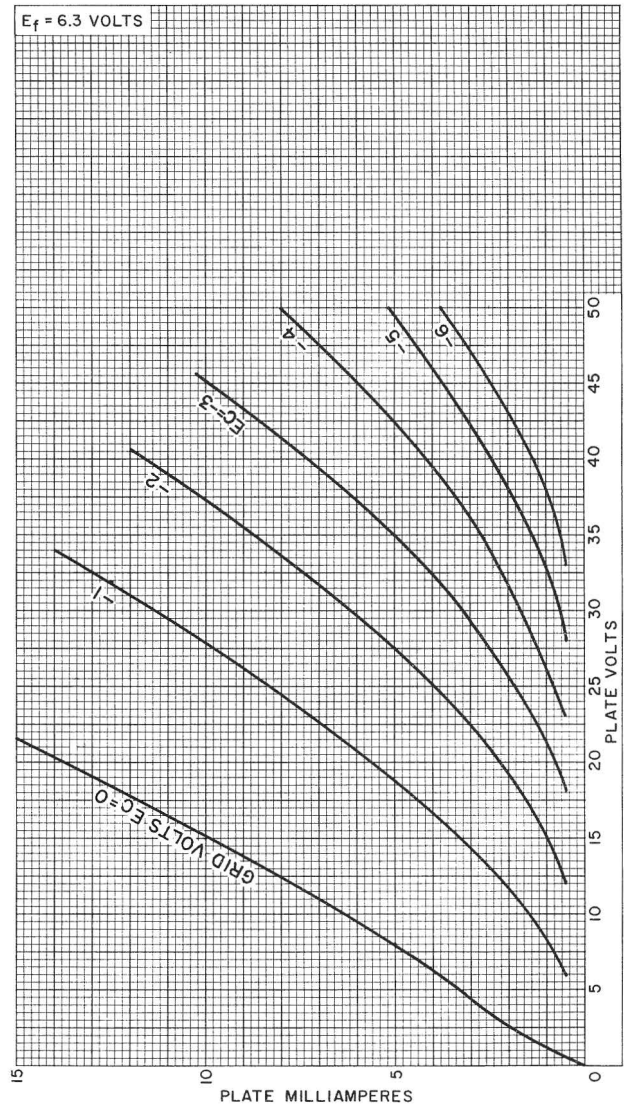
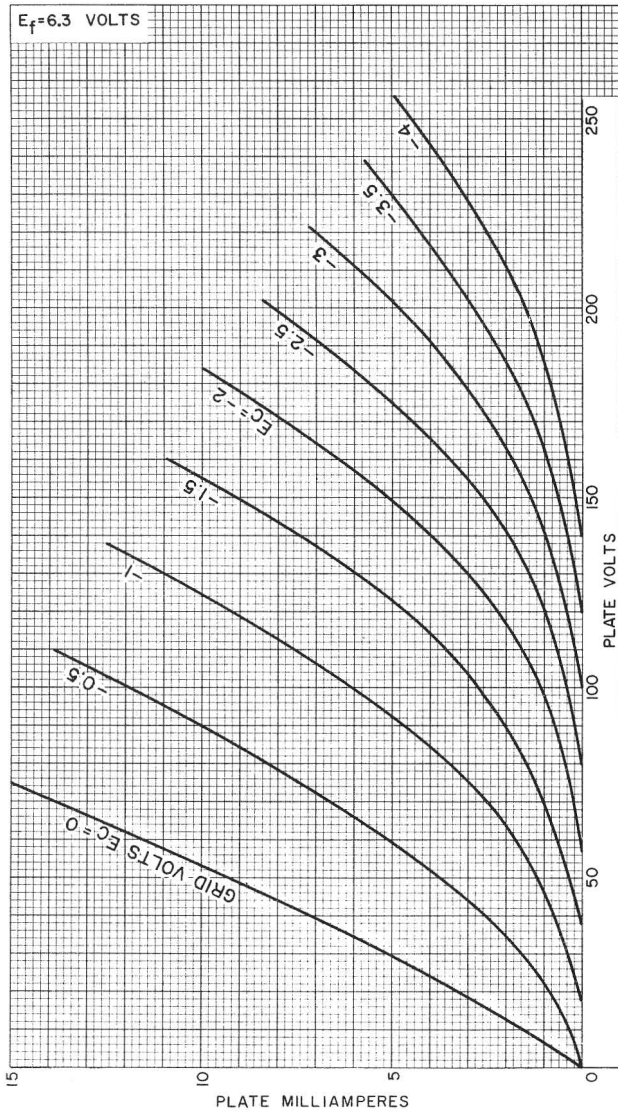

AVERAGE CHARACTERISTICS

8058

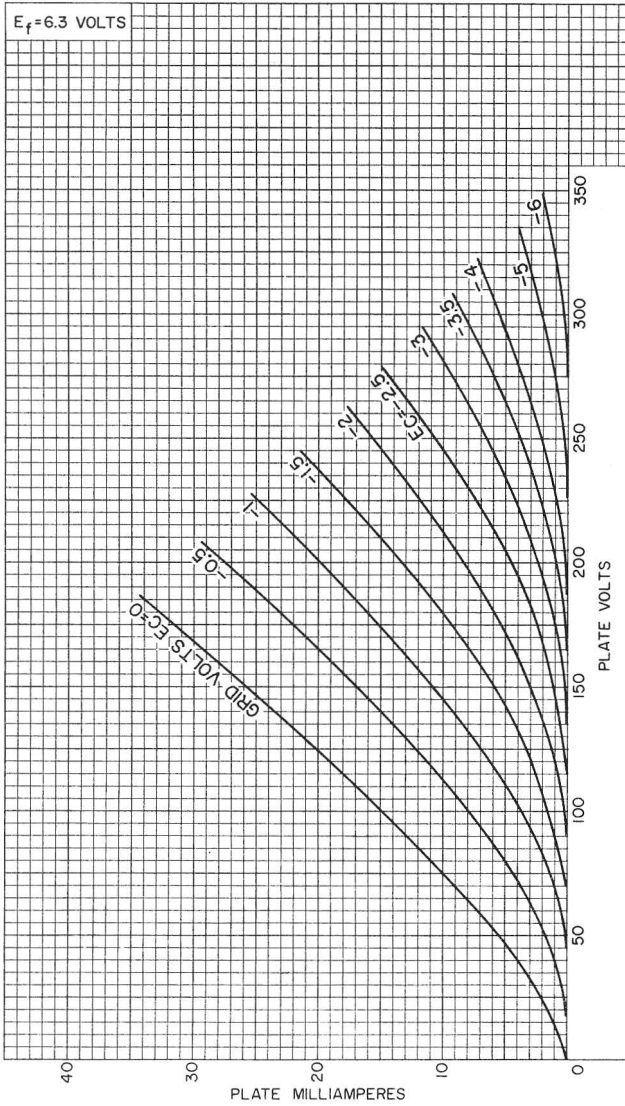

7586

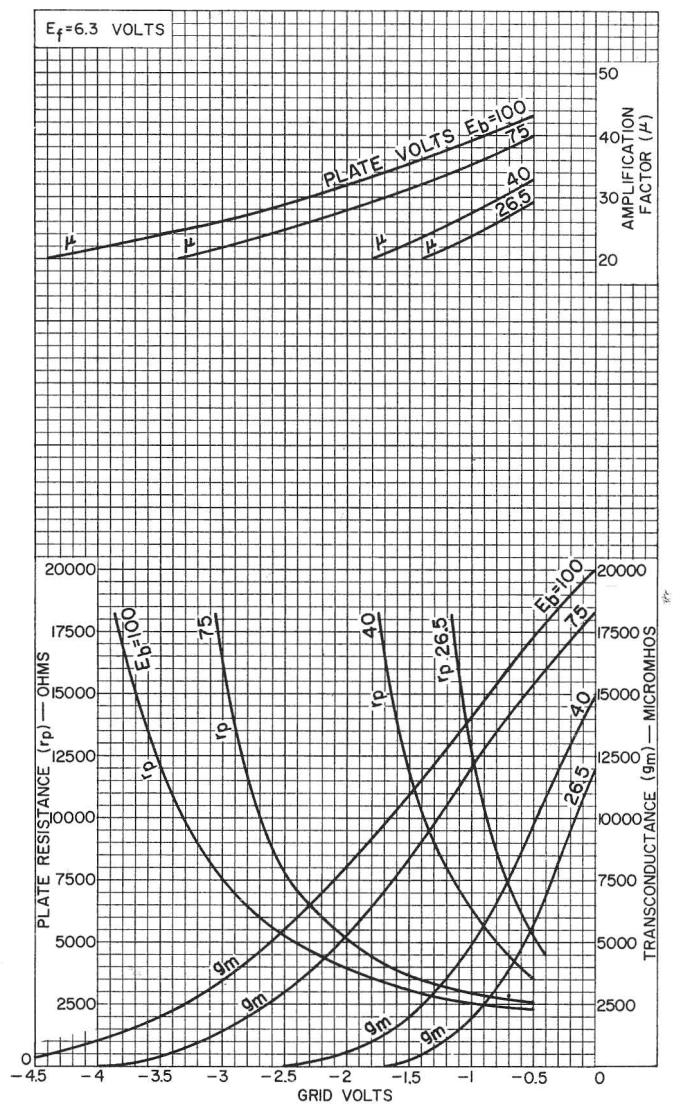

AVERAGE CHARACTERISTICS

7587

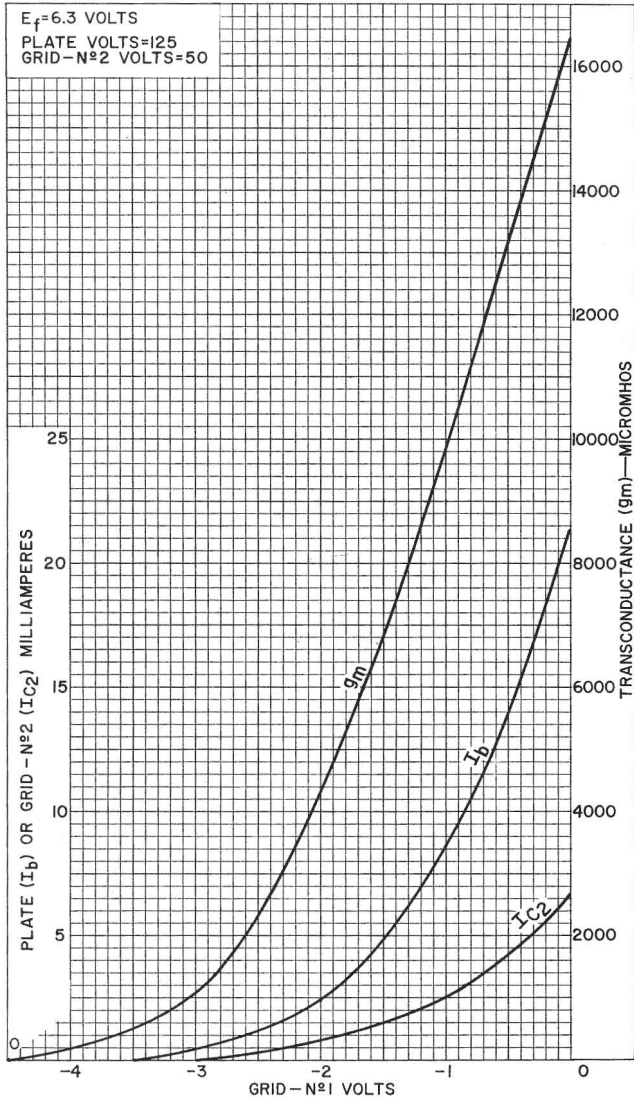

92CM-10927

7895

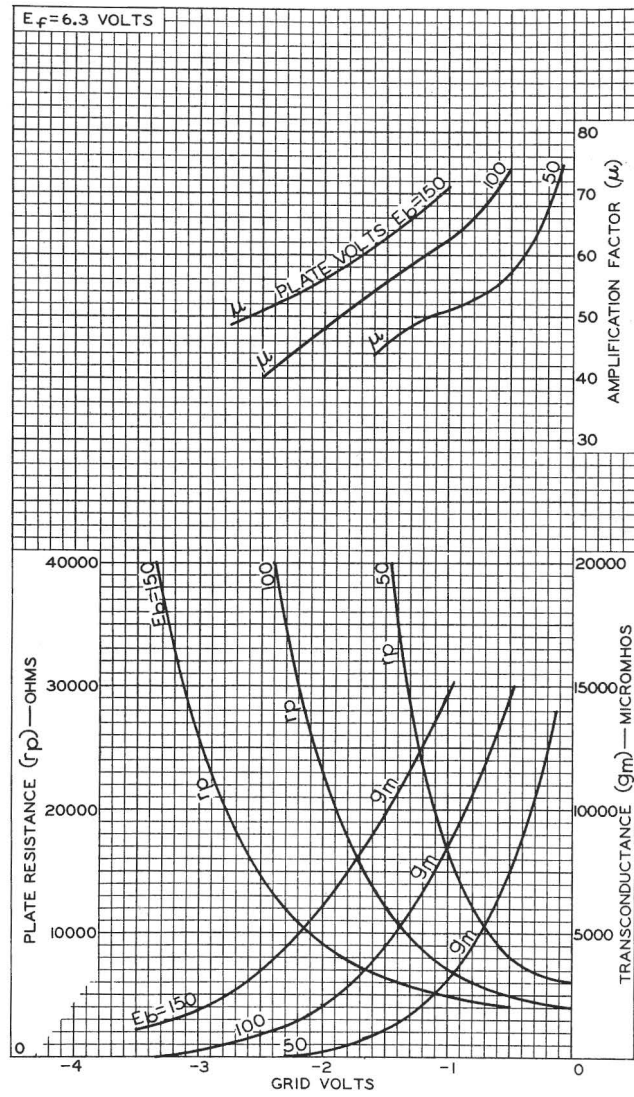

92CM-10967

AVERAGE CHARACTERISTICS

8056

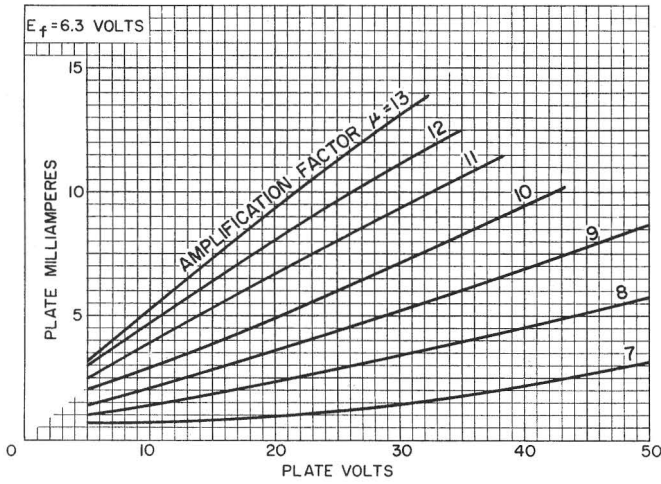

92CS-11471R1

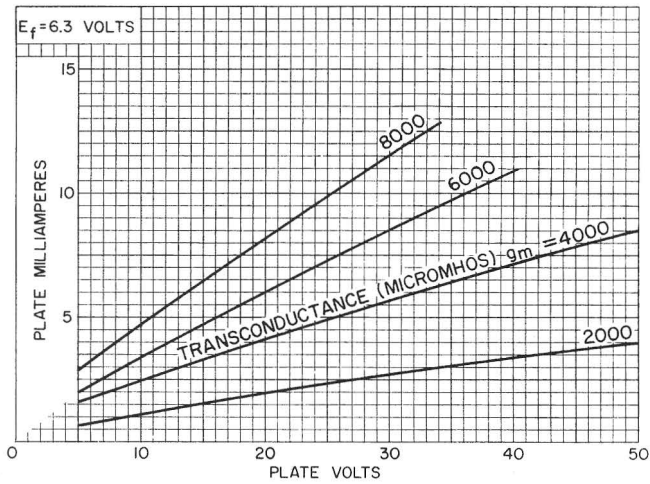

92CS-11470R2

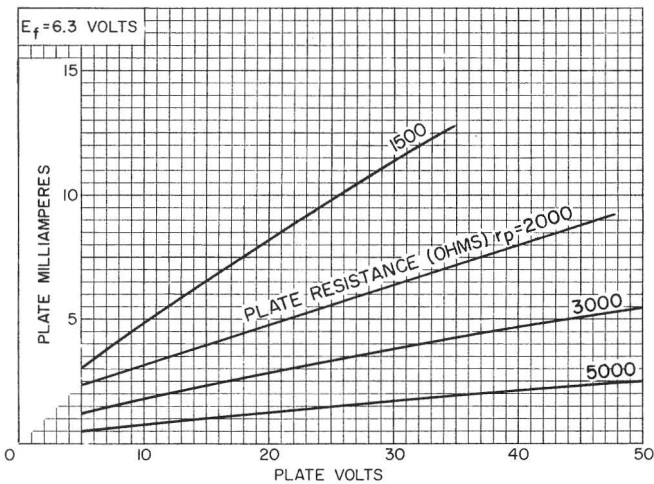

92CS-11465R2

8058

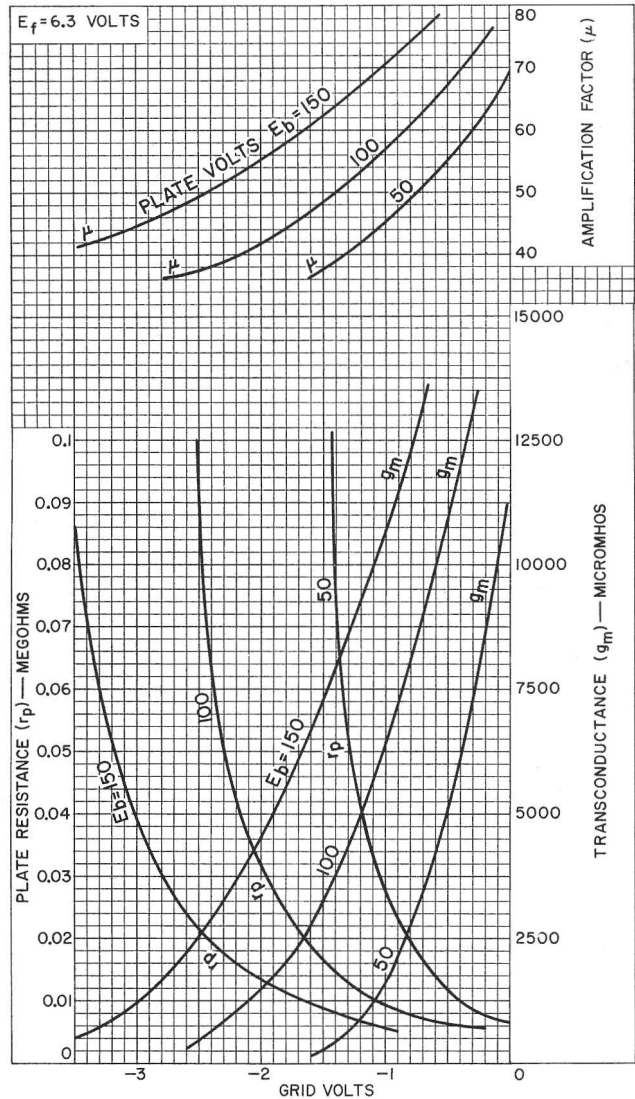

92CM-11410

SOCKET & CONNECTOR INFORMATION

The sockets listed below by manufacturer's or distributor's part number have 5 contacts and an annular groove designed to mate, respectively, with the 5 base pins and the 2 indexing lugs of the bases utilized on the 8 RCA industrial nuvistor tubes described in this

brochure. Information on sockets having different casting materials, contact materials, or finishes, may be obtained from the manufacturers. Sockets having mechanical and electrical characteristics comparable to these sockets may be available from other component manufacturers.

Description		Manufacturer or Distributor and Part No.		
		Cinch Mfg. Co. ^f	Cinch-Jones Sales Division ^g Distributors	Industrial Electronic Hardware Corp. ^h
Application	Mounting			
General Purpose Type	Crimp mounting	133 65 10 001	5NS	MSN 0905-1 MSN 0905-2 MSN 0905-3
	Flange mounting	133 65 10 003	5NS-1	-
	Printed Board ("Stand-off")	133 65 10 009	5NS-2	-
UHF Heat-Dissipating Type	Crimp mounting	133 65 10 041	5NS-3	-

^f 1026 South Homan Avenue, Chicago 24, Illinois.

^g Cinch-Jones Sales Division of Cinch Mfg. Co.

^h 109 Prince Street, New York 12, N.Y.

Nuvistor types 7587 and 8058 utilize a JEDEC No. C1-44 top cap. Cinch Mfg. Co. Part Nos. 6005 or 422 03 22 017, 6014 or 422 03 22 024, or equivalent "1/4-inch" connectors, may be used.

ADDITIONAL TECHNICAL & APPLICATION DATA

RCA also manufactures 7 other nuvistor tubes (types 2CW4, 6CW4, 13CW4; 2DS4, 6DS4; 2DV4, 6DV4) intended for home-entertainment equipment. Technical information on these types and additional information on the 8 industrial nuvistor tubes described in this brochure, in the form of Technical Bulletins and Application Notes, is available upon request from:

Commercial Engineering Activity
RADIO CORPORATION OF AMERICA
Harrison, New Jersey

Technical Bulletins

For specific RCA industrial nuvistor types, technical bulletins giving characteristics range values for equipment design, special ratings and performance data, characteristic curves, and application information, are available. Be sure to mention the specific nuvistor type for which a technical bulletin is desired.

Application Notes

The following Application Notes for industrial nuvistor tubes are available:

AN-193 "Use of RCA-7587 Industrial Nuvistor Tetrode in RF and IF Applications."

AN-195 "Noise and Gain of the RCA-8056 Nuvistor Triode at 200 Megacycles."

AN-196 "Temperature Ratings and Thermal Considerations for Nuvistor Tubes."

FIELD SALES AND ENGINEERING SERVICE

RCA Field Sales and Engineering personnel specializing in RCA Industrial-Tube Products are available to Equipment Manufacturers, Government Activities, and Distributors at the following office locations:

Equipment Sales

32-36 Green St.
Newark 2, N.J.
485-3900

6801 E. Washington Blvd.
Los Angeles 22, Calif.
RAymond 3-8361

1838 El Camino Real
Burlingame, Calif.
OXford 7-1620

Merchandise Mart—Room 1154
Chicago 54, Ill.
527-2900

Government Marketing

415 S. Fifth St.
Harrison, N.J.
485-3900

224 N. Wilkinson St.
Dayton 2, Ohio
BALdwin 6-2366

1725 "K" St., N.W.
Washington 7, D.C.
FEderal 7-8500

Distributor Sales

36 W. 49th St.
New York, N.Y.
MUrray Hill 9-7200

Merchandise Mart—Room 2000
Chicago 54, Ill.
467-5900

80 "A" St.
Needham Heights 94, Mass.
HILLcrest 4-8480

7901 Carpenter Freeway
Dallas 7, Texas
MElrose 1-3050

6801 E. Washington Blvd.
Los Angeles 22, Calif.
RAymond 3-8361

1600 Keith Bldg.
1621 Euclid Ave.
Cleveland, Ohio
CHerry 1-3450

1121 Rhodes Haverty Bldg.
134 Peachtree St., N.W.
Atlanta, Georgia
524-7703

1725 "K" St., N.W.
Washington 7, D.C.
FEderal 7-8500

*7711 State Line—Suite 112
Kansas City 14, Mo.
EMerson 1-6462

* Engineering personnel are not available for consultation at this Distributor Sales office.

Information furnished by RCA is believed to be accurate and reliable. However, no responsibility is assumed by RCA for its use; nor for any infringements of patents or other rights of third parties which may result from its use. No license is granted by implication or otherwise under any patent or patent rights of RCA.

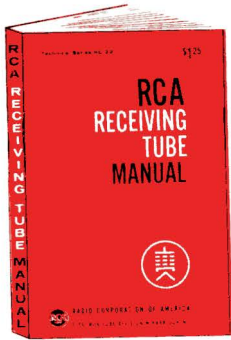

**RCA RECEIVING TUBE
MANUAL RC-22**

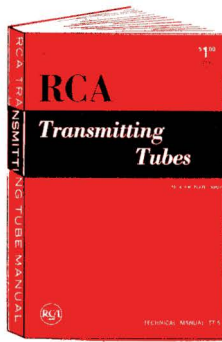

**RCA TRANSMITTING
TUBE MANUAL TT-5**

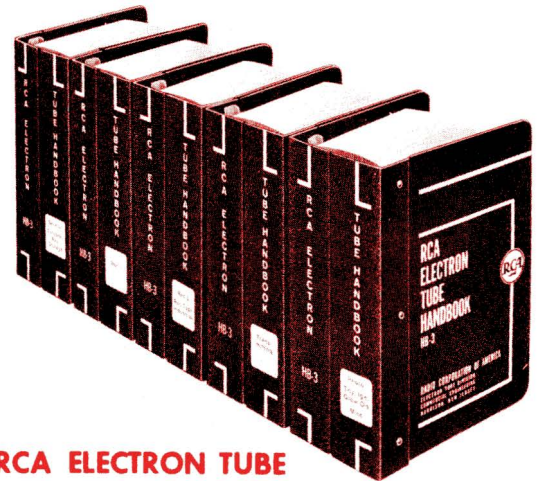

**RCA ELECTRON TUBE
HANDBOOK HB-3**

For Product Availability
Contact

Authorized **RCA** Distributor



RADIO CORPORATION OF AMERICA

ELECTRONIC COMPONENTS AND DEVICES

HARRISON, N. J.