



**B R O A D C A S T**

**AUDIO**

**E Q U I P M E N T**

*for*

**AM • FM • TELEVISION**

**(SECOND EDITION)**

**MICROPHONES**

**CONSOLES**

**CUSTOM EQUIPMENT**

**AMPLIFIERS**

**RACK EQUIPMENT**

**TURNTABLES**

**RECORDERS**

**SPEAKERS**



# BROADCAST AUDIO EQUIPMENT CATALOG

(Second Edition)

PRICE \$1.00



BROADCAST MARKETING DEPARTMENT

**RADIO CORPORATION OF AMERICA**

Engineering Products Division

Camden, N. J.

*Copyright 1955, Radio Corporation of America, Engineering Products Division, Camden, N. J.*

	Page
<b>Microphones</b>	<b>5</b>
<b>Consolettes</b>	<b>44</b>
<b>Amplifiers</b>	<b>61</b>
<b>Power Supplies</b>	<b>80</b>
<b>Rack Equipment</b>	<b>83</b>
<b>Turntables</b>	<b>98</b>
<b>Tape Recorders</b>	<b>109</b>
<b>Speakers</b>	<b>117</b>
<b>Test Equipment</b>	<b>134</b>
<b>Equipment Lists</b>	<b>140</b>
<b>Index</b>	<b>149</b>

## **ABOUT THIS CATALOG**

This Catalog is devoted solely to information on RCA audio equipment designed especially for broadcast station use. Other RCA Broadcast Equipment Catalogs contain similar information on video equipment, test equipment, AM, FM and TV transmitters, antennas, transmission line equipment and accessories.

The information contained in this catalog is intended to serve as a buying guide for the users of this type of equipment. In the belief that broadcast engineers want facts, rather than generalities, the content has purposely been kept brief and factual. Readers who desire more information or individual bulletins on particular equipment items are invited to write to the RCA Broadcast Representative in the RCA Regional Office nearest them (see opposite page).

### **OTHER RCA TECHNICAL PRODUCTS**

The RCA equipment described in this catalog is specifically designed for broadcast station use. In similar manner RCA builds electronic equipment for many other industries. These include: two-way radio and microwave radio communications equipment; a complete line of equipment for theatres; optical and magnetic film recording equipment; sound systems of all types; 16mm projectors and magnetic recorders; high-fidelity components for home music systems; industrial inspection equipment; scientific equipment, such as the electron microscope; industrial television systems; intercoms; tape recorders; TV Eye; Antenaplex systems; and many types of custom-built equipment for industry and the military services. Information, and catalogs or bulletins, describing these may be obtained from RCA Regional Offices.

# HOW TO ORDER

The RCA Broadcast Audio Equipment shown in this catalog is sold directly through RCA Broadcast Representatives, who are familiar with broadcast equipment and related problems. One or more of these RCA Representatives are located in each of the RCA Regional Offices listed below.

Orders for equipment shown in this catalog, or requests for additional information, should be directed to the nearest one of these offices. Complete information on the conditions under which RCA sells broadcast equipment is given on the following page.

## PRICES

The prices of the various equipment units shown in this catalog are given in a separate price list. Prices are listed in the order in which they are shown in the catalog. To determine the price of any equipment first note the page

on which it is shown in the catalog, then consult the price list in accordance with this page number. Equipments are identified by type and MI (Master Item) numbers which are used to identify apparatus on invoices and packing slips.

YOU CAN LOCATE YOUR NEAREST RCA REPRESENTATIVE FROM THIS LIST

## REGIONAL OFFICES

Front & Cooper Streets  
CAMDEN 2, NEW JERSEY  
Woodlawn 3-8000



36 West 49th Street  
NEW YORK 20, NEW YORK  
Circle 6-4030



1907-11 McKinney Avenue  
DALLAS 1, TEXAS  
Riverside 1371



1600 Keith Building  
CLEVELAND 15, OHIO  
Cherry 1-3450

2301 John Hancock Building  
200 Berkeley Street  
BOSTON 16, MASSACHUSETTS  
Hubbard 2-1700



522-533 Forsyth Building  
Forsyth and Luckie Streets, N.W.  
ATLANTA 3, GEORGIA  
Lamar 7703



340 Dierks Building  
KANSAS CITY 6, MISSOURI  
Harrison 6480



1560 North Vine Street  
HOLLYWOOD 28, CALIFORNIA  
Hollywood 9-2154

420 Taylor Street  
SAN FRANCISCO 2, CALIFORNIA  
Ordway 3-8027



1186 Merchandise Mart Plaza  
CHICAGO 54, ILLINOIS  
Delaware 7-0700



1625 K Street, N.W.  
WASHINGTON 6, D. C.  
District 7-1260



2250 1st Avenue, South  
SEATTLE 4, WASHINGTON  
Maine 8350



# RCA MICROPHONES

## General Information

The excellence of RCA microphones is the result of continued effort on the part of Engineering and Production personnel to produce a superior product. Out of this work have come the several types of broadcast microphones listed in the catalog. There is considerable overlap in the applications of the various types, but each does possess certain attributes which make it particularly well suited to some specific applications. These have been noted for each microphone in the catalog in order to assist in the selection of the microphone best suited for the intended application.

## High Quality Broadcast and Television Microphones

Broadcast-type microphones such as the Types 44-BX, 77-D and BK-1A all have certain common performance criteria which make them especially suited to this application. They have smooth response-frequency characteristics over the audio range, low distortion, high output levels, well-shielded output transformers to prevent hum pickup, and where necessary, are shock mounted to reduce the pickup of low frequency building rumble. Performance features which are unique to each particular type are listed and the applications discussed in the catalog.

## Public Address Microphones for Broadcast Use

Public Address Microphones have been designed as economy microphones. In general, frequency range and sensitivity have been sacrificed to some extent in order to gain ruggedness and lower cost. The response limitations should be borne in mind when these microphones are used in Broadcast applications.

## Unloaded Transformer Input

RCA Broadcast Microphones are designed to work into a microphone preamplifier whose input transformer is unloaded. Under this condition of operation the voltage appearing at the grid of the first tube results in a gain in signal-to-noise ratio of between 3 and 6 db as compared with a matched resistance load. The exact value will depend on whether the major source of thermal noise is in the microphone amplifier or in the microphone.

## Microphone Resistance Loading

Microphones in which the moving system is highly damped will in general have their frequency response characteristics little changed by electrical loading. The BK-1A and 77-D (in the pressure position) are examples of this.

Microphones which show output impedance variations with respect to frequency will have their response characteristics adversely affected by resistance loading. The Type 44-BX, and 77-D (in the bi-directional and uni-directional positions) are examples of this. Resistance loading of these microphones will generally result in a loss in low frequency response.

## 150 Ohms vs. 250 Ohms

When microphones are connected to unloaded input transformers, impedance matching is not a consideration and the effects of connecting microphones with an output impedance of 150 ohms to a microphone amplifier designed to operate from a 250 ohm source and vice versa will usually be of small consequence. The effect on the level is shown in the tabulation below.

Mic. Output Impedance	Level Change db	
	250	150
250	0	+2.2
150	-2.2	0
Amp. Input Designation	250	150

In addition there will be some change in the overall response-frequency characteristic of the system below 100 cycles and above 5000 cycles, the magnitude depending on the connection and the design of both the microphone and the amplifier input transformer. Variations in response with the usual broadcast quality microphone amplifiers will in most cases not exceed  $\pm 2$  db.

When microphones are connected to a resistance load the following changes in level will result when the output is referred to a matched condition.

Mic. Output Impedance	Level Change db	
	250	150
250	0	-2.5
150	+2.0	0
Load Impedance	250	150

## Microphones Shipped Less Plug

RCA microphones are supplied less the plug for connection to the wall outlet or amplifier system. This is done to allow the user to select any desired plug. As a convenience three types of Cannon plugs are cataloged and they may be ordered as an accessory if wanted.

## Microphone Mounting

RCA has standardized on the rugged  $\frac{1}{2}$ " pipe thread for broadcast microphone mounting. This size thread makes it easy to add microphone stand extensions, booms, etc., for they may be easily made up locally from standard  $\frac{1}{2}$ " pipe and fittings. Most of the stands listed may also be used with microphones having a  $\frac{5}{8}$ -27 thread by removing an adapter which is supplied as a part of the stand. Various adapters are available for microphones should the use of the  $\frac{1}{2}$ " pipe thread prove inconvenient.

**Effective Output Level**

When a microphone is connected to an unloaded input transformer its power output cannot be expressed in dbm because no appreciable power is delivered by the microphone. The logical approach to the problem is to arrive at some level figure which, when combined with the conventionally measured amplifier gain, will give the correct output level for the combination. This figure is listed in the catalog for each microphone and is called the Effective Output Level. It differs from the RETMA standard rating  $G_M$  in the value of sound pressure and source impedance. The RETMA rating computation is based on a source impedance of 150 ohms for all microphones having output impedances between 75 and 300 ohms, and on a sound pressure of 0.0002 dynes per square centimeter.

The Effective Output Level calculation is based on the nominal microphone impedance and on a sound pressure of 10 dynes/cm<sup>2</sup>.

The RETMA standard defines the system rating ( $G_M$ ) of a microphone as the ratio in decibels relative to 0.001 watt per 0.0002 dynes per square centimeter of the maximum electric power available from the microphone to the square of the undisturbed sound field pressure in a plane progressive wave at the microphone position. Expressed mathematically:

$$G_M = (20 \log_{10} \frac{E}{P} - 10 \log_{10} R_{MR}) - 50 \text{ db.}$$

where E = the open circuit voltage of the microphone  
 P = the undisturbed sound field pressure  
 $R_{MR}$  = the microphone rating impedance (150 ohm)  
 Electrical reference level = .001 watt  
 Sound pressure = .0002 dynes/sq. cm.

While this may look complex the application is simple. For all practical purposes the output level of the microphone is obtained by adding to  $G_M$ , the sound pressure level relative to 0.0002 dynes per square centimeter. The sound pressure level of the program material can be measured with any of the several available sound level meters. The exact relationship between  $G_M$  and the Effective Output Level is illustrated below for the case of the type 44-BX Velocity Microphone connected for 250 ohm output impedance.

$$G_M = -146 \text{ db} \\
 + 94 \text{ db} \text{ Sound pressure level for sound pressure of 10} \\
 \text{dynes per square centimeter} \\
 - 2 \text{ db} \text{ Correction for difference in source impedance} \\
 \text{250/150 ohms}$$

Effective Output Level -54 dbm.

**Hum Pickup Level**

An arbitrary standard 60 cycle a-c field of 10<sup>-3</sup> gauss has been established as a reference. It is fairly representative of fields measured at typical microphone locations in broadcast studios. The hum level is referred to .001 watt and is calculated in the same fashion as the Effective Output Level, using as the output voltage the voltage produced by the standard field.

Type No.	Use <sup>3</sup>	Directional Characteristic	Effective Output Level <sup>1</sup> and $G_M$ <sup>4</sup>	Output Impedance Ohms	Frequency Response cps	Hum Pick-up Level <sup>2</sup>	Finish	Stand
44-BX	Program Announce	Bi-directional	-54 dbm $G_M$ -146 db	30/150 250	50-15,000	-120 dbm	Satin Chrome & TV Gray	Floor, Boom
77-D	Program Announce	Poly-directional	-57 dbm $G_M$ -149 db	30/150 250	50-15,000	-125 dbm	Satin Chrome & TV Gray <sup>5</sup>	Desk, Floor, Boom
77-DX	Program Announce	Poly-directional	-53 dbm $G_M$ -147 db	30/150 250	50-15,000	-128 dbm	Satin Chrome & TV Gray	Boom, Desk, Floor
EK-1A	Program Announce	Non-directional	-53 dbm $G_M$ -145 db	30/150 250	60-10,000	-109 dbm	Satin Chrome & TV Gray	Desk, Floor
BK-4B	Interview Program	Non-directional	-61 dbm $G_M$ -153 db	30/150 250	70-15,000	-125 dbm	TV Gray	Hand, Floor
BK-5A	Program Announce	Uni-directional	-56 dbm $G_M$ -150 db	30/150 250	50-15,000	-128 dbm	TV Gray	Boom, Desk, Floor
BK-6A	"Off-Mike" Speech	Non-directional	-60 dbm $G_M$ -152 db	30/150 250	70-10,000	-116 dbm	TV Gray	Clip & Microphone Lanyard
SK-35	Sports Announce	Bi-directional	-58 dbm $G_M$ -150 db	200/15,000	50-10,000	-113 dbm	Satin Chrome & TV Gray	Hand, Desk, Floor
SK-45	Intercom & Talkback	Non-directional	-56 dbm $G_M$ -149 db	200/15,000	80-8,000	-109 dbm	TV Gray	Desk, Floor
SK-46	Radio & TV Announce	Bi-directional	-58 dbm $G_M$ -150 db	200/15,000	50-10,000	-113 dbm	Satin Chrome & TV Gray	Hand, Desk, Floor
MI-12016-A	Close Announce	Non-directional	-56 dbm $G_M$ -150 db	250	70-9,000	-95 dbm	Two-tone Umber Gray	Desk, Floor

<sup>1</sup> Reference level 0.001 watt, sound pressure 10 dynes per square centimeter. This corresponds to a rating by the proposed RETMA system at a sound pressure level of 94 db.

<sup>2</sup> Level referred to a hum field of 10<sup>-3</sup> gauss.

<sup>3</sup> For details refer to description of each particular type.

<sup>4</sup>  $G_M$  = (RETMA rating).

<sup>5</sup> Also available in TV Gray as MI-11006-C.



# VELOCITY MICROPHONE

## TYPE 44-BX



### USES

The 44-BX is intended primarily for AM, FM and TV studio use where a microphone of the highest quality of reproduction is desired.

It is designed for broadcast studio use and can be employed for: general program and announce; plays where the players may be grouped around the microphone; conference pickup where the participants are seated on opposite sides of a table; programs where studio acoustics are more live than optimum; programs where the microphones may be suspended overhead and angled to reduce audience noise; programs where the direction pattern permits orientation to eliminate undesirable reflections from walls.

For remote pickups it is useful for: general program and announce; plays and other stage presentations where the microphone may be suspended overhead and angled to reduce audience noise; programs where the directional properties reduce the effect of an overly reverberant location. The 44-BX microphone is not recommended for

### FEATURES

- Excellent reproduction of the entire audio frequency range
- No loss in quality with off axis pickup
- Artists may be placed on both sides of the microphone
- Pickup of reflected sound reduced
- Absence of pressure doubling, cavity and diaphragm resonance
- Response may be adjusted to provide best possible frequency characteristics for either vocal or musical pickup
- Unaffected by temperature humidity or air pressure

outdoor use because of the relative sensitivity of the microphone to wind.

### DESCRIPTION

The Type 44-BX Velocity Microphone is a bi-directional microphone in which the moving element is a thin, corrugated metallic ribbon supported at the ends and placed between the pole pieces of a magnetic circuit. Because of its light weight, the motion of the ribbon corresponds very closely to the velocity of the air particles and the voltage generated in it is, therefore, a reproduction of the sound waves which traverse it. An impedance matching transformer and compensating reactor are located in the base of the microphone and the upper perforated portion provides a windscreen of distinctive shape.

The 44-BX is attractively finished in satin chrome and a TV gray to harmonize with modern studio interiors. The yoke mounting permits a wide range of tilting angles and the shock mounting reduces undesirable pickup from floor vibrations.

SPECIFICATIONS

Directional Characteristics ..... Bi-directional  
 Output Impedances..... 30/150/250 ohms  
 Effective Output Level..... -54 dbm\*  
 RETMA Microphone Rating  $G_M$  (Sensitivity):  
 30 Ohm Output Impedance..... -150 db\*\*\*  
 150 Ohm Output Impedance..... -149 db\*\*\*  
 250 Ohm Output Impedance..... -146 db\*\*\*  
 Hum Pickup Level..... -120 dbm\*\*  
 Frequency Response..... 50-15,000 cycles  
 Finish..... TV gray and satin chrome  
 Mounting..... 1/2" pipe thread

Dimensions, overall:  
 Height (including cushion mounting)..... 12"  
 Width ..... 4 3/4"  
 Depth ..... 3 3/8"  
 Weight (unpacked, including mountings)..... 8 1/4 lbs.  
 Cable..... 3-conductor shielded, 30 feet (no plug)  
 Stock Identification ..... MI-4027-J

\* Referred to 0.001 watt and a sound pressure of 10 dynes/cm<sup>2</sup> (94 db level).

\*\* Referred to 0.001 watt and a 60 cycle hum field of 0.001 gauss.

\*\*\* RTMA Standard SE-105.

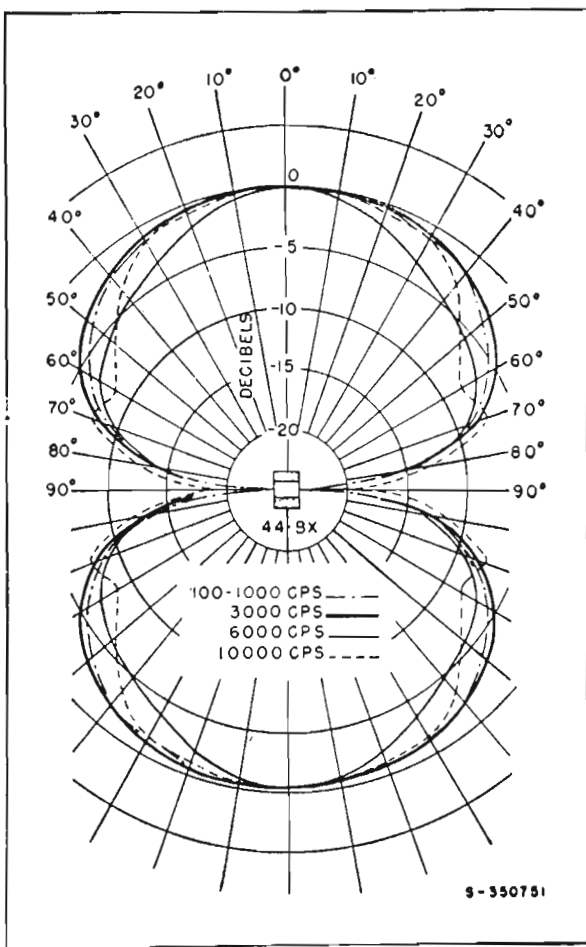

CHARACTERISTIC CURVES, 44-BX

◀ Directional Characteristics of 44-BX Velocity Microphone

Frequency Response Curves of 44-BX Velocity Microphone

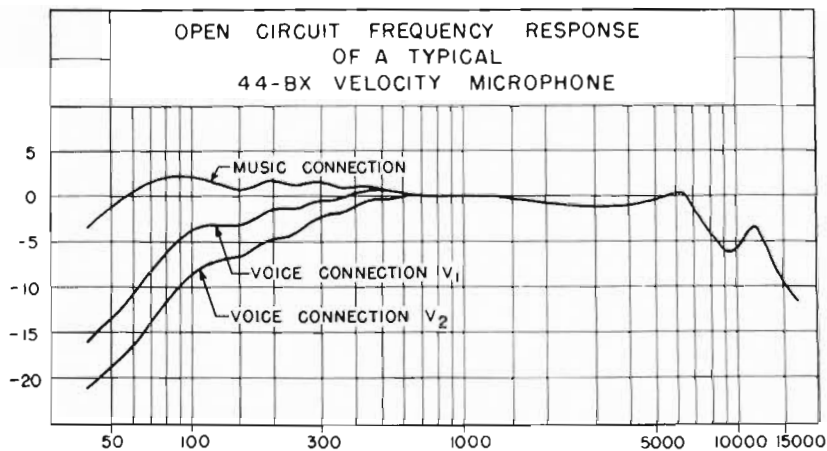

# POLYDIRECTIONAL MICROPHONE

## TYPE 77-D

### FEATURES

- High quality reproduction over the entire audio frequency range
- Selection of directional pattern to control ratio of direct-to-reverberant sound pickup
- Wide pickup angle on front as a uni-directional microphone
- Three position voice-music switch allows selection of the best operating characteristic
- Selection of directional pattern to eliminate unwanted sound
- Satisfactory operation in high hum fields because of exceptionally good shielding
- Efficient shock mounting
- Small size—lightweight for TV boom operation
- Attractive appearance



### USES

The RCA 77-D high-fidelity microphone provides a choice of directional pattern in its use in AM, FM and TV broadcast studios. As a bi-directional microphone, the 77-D can be used in place of the 44-BX with some loss in high frequency response. As a uni-directional microphone, the 77-D may be used to advantage in the following applications:

- (1) General programs and announce in studios.
- (2) Television booms—The required amount of microphone movement is reduced. The pickup of unwanted sound back of the microphone is reduced. The working distance to the microphone is increased.
- (3) Programs where it is desirable to cover a large area with a single microphone.
- (4) Programs where studio acoustics are more live than optimum.
- (5) Programs where it is desirable to eliminate audience noise originating behind the microphone.
- (6) Programs where the directional pattern permits orientation to eliminate undesirable reflections.
- (7) Programs where the announcer must work close to the microphone.

- (8) General programs and announce in remote locations.
- (9) Plays, stage presentations, banquets, news events where it is desirable to reduce the pickup of sound behind the microphone.
- (10) Programs where the directional properties will help to reduce the effects of an overly reverberant location.

As a non-directional microphone the following applications are suggested:

- (1) Announce in studios and remotes where the announcer must work very close to the microphone.
- (2) Out-of-door programs and announce where the microphone need only be protected against rain.

The 77-D is extremely versatile and experience has shown that its characteristics may be adjusted to cover almost any pickup condition.

**DESCRIPTION**

The moving element of the 77-D is a thin corrugated metallic ribbon clamped at the ends and suspended in the air gap of a magnetic circuit consisting of a permanent magnet and pole pieces. One side of the ribbon is open and the other is connected by means of a tube to a folded acoustically damped pipe contained in the center section of the microphone. Directly behind the ribbon there is an aperture in the connecting tube, the size of which may be varied by means of a rotating shutter. The position of the shutter determines the directional properties of the microphone. When the aperture is completely open, the microphone has a bi-directional pattern; when the aperture is completely closed, the microphone is non-directional; and with a critical size of opening the microphone becomes uni-directional. Other positions of the shutter result in patterns intermediate between the above three.

The position of the shutter may be selected by turning a slotted shaft which is brought out flush with the rear of the windscreen. The directional pattern corresponding to

the shutter position is indicated on a plate mounted on the screen and marked "U", "N" and "B". If desired, the microphone may be locked in the uni-directional position by means of a cover plate marked "U" which fastens over the indexed plate. The bottom portion of the microphone contains an impedance matching transformer and switch for selecting response characteristics for voice or music. The switch shaft is slotted and accessible through a hole in the bottom of the lower shell. The transformer is exceptionally well shielded against stray magnetic fields.

A protective cloth bag, MI-4087, is shipped with each microphone.

**SPECIFICATIONS**

Directional Characteristics.....	Adjustable, Bi-directional, Uni-directional, Non-directional		
Output Impedance .....	30/150/250 ohms		
Sensitivity of 77-D (250 ohm tap):			
Uni-directional .....	-57 dbm		
Bi-directional .....	-54 dbm		
Non-directional .....	-59 dbm		
RETMA System .....	G <sub>31</sub>		
	250 Ohm Tap	150 Ohm	30 Ohm
Uni-directional .....	-149	-152	-152
Bi-directional .....	-146	-147	-149
Non-directional .....	-151	-154	-154
Effective Output Level (Uni-directional).....	-57 dbm*		
Hum Pickup Level.....	-125 dbm**		
Frequency Response .....	50-15,000 cycles		
Finish.....	Satin chrome and TV umber gray		
Mounting.....	1/2" pipe thread		
Dimensions, overall:			
Height .....	11 1/2"		
Width .....	3 3/4"		
Depth .....	2 1/2"		
Weight (unpacked, including mountings).....	3 lbs.		
Cable.....	3-conductor shielded, 30 feet (no plug)		
Stock Identification .....	MI-4045-E		

**Accessories**

Protective Cloth Bag.....	MI-4087
---------------------------	---------

\* Referred to 0.001 volt and a sound pressure of 10 dynes/1cm<sup>2</sup>. This is equivalent to the proposed RETMA rating at a sound pressure level of 94 db.  
 \*\* Level referred to a hum field of 0.001 gauss.

# POLYDIRECTIONAL MICROPHONE

## TYPE 77-DX

### FEATURES

- High quality reproduction with greater sensitivity over entire audio frequency range
- Small size—lightweight for TV boom operation
- Choice of directional pattern to control ratio of direct-to-reverberant sound pickup
- Styled for either radio or TV applications
- Three-position voice-music switch allows selection of best operating characteristic
- Efficient shock mounting

### USES

The RCA Type 77-DX Polydirectional Microphone is primarily intended for broadcast use either in the radio or television studio. Two models are available. The MI-4045-F finished in satin chrome and a low-gloss umber gray enamel is intended for AM or FM stations, while the MI-11006-C microphone is intended for television use and is therefore completely finished in a low-gloss umber-gray enamel which eliminates glaring reflections. Both instruments are high-fidelity microphones of the ribbon type which may easily be adjusted to obtain a variety of directional patterns. If used outdoors the Type 77-DX may require some additional protection against the wind.

As a uni-directional microphone the 77-DX has a wide pick-up angle on front which may be used to advantage as a general programs and announce studio microphone and for television boom operation. It is recommended for use on programs where it is desirable to cover a large area with a single microphone, on programs where studio acoustics are more live than optimum, and programs where it is desirable to eliminate audience noise originating behind the microphone. The 77-DX can also serve as a bi-directional instrument in place of the 44-BX microphone on programs where the players are grouped around the microphone or are seated on opposite sides of a table. In the non-directional position, the microphone is excellent for announce work or for out-door locations.

### DESCRIPTION

The RCA Type 77-DX Polydirectional Microphone operates as a uni-directional, bi-directional or non-directional instru-



ment by positioning of a shutter to secure various areas of opening. The moving element is a thin corrugated metallic ribbon clamped at the ends and suspended in the air gap of a magnetic circuit consisting of an Alnico V permanent magnet and pole pieces. One side of the ribbon is open and the other is connected by means of a tube to a folded acoustically damped pipe contained in the center section of the microphone.

The tube connecting the back of the ribbon to the labyrinth is slotted directly behind the ribbon and fitted with the shutter which controls the directional properties of the microphone. When the opening is completely closed, the microphone operates as a non-directional pressure microphone; at the wide-open position the instrument becomes bi-directional. With the proper size opening the pattern becomes a cardioid by virtue of the phase shift which occurs. Openings smaller or larger than this critical size produce directional patterns with various sized rear lobes. Different amounts of low-frequency attenuation are obtained by a reactor shunting the output.

The shutter opening is operated by turning a slotted shaft which is brought out flush with the rear of the windscreen.

The shutter position is indicated on a plate mounted on the screen and marked "U", "N" and "B". Three additional markings "L-1", "L-2", and "L-3" are used as reference points for other directional patterns which may be obtained. If desired, the microphone may be locked in the uni-directional position by means of a cover plate marked "U". This fastens over the indexed plate. The bottom portion of the microphone contains an impedance matching transformer and switch for selecting response characteristics for voice or music. The switch shaft is slotted and accessible through a hole in the bottom of the lower shell. The transformer is exceptionally well shielded against stray magnetic fields.

The 77-DX will mount on any stand having a 1/2-inch pipe thread. Other stands will require a suitable adaptor. The microphone is cushion-mounted, and a fork mounting is provided so that the instrument may be fitted to the desired position. The microphone is connected for an output impedance of 250 ohms at the factory, but it may be adjusted for an output impedance of 30 or 150 ohms.

**SPECIFICATIONS**

Directional Characteristics.....	Adjustable, 6 positions (see curves)
Output Impedance.....	250 ohms, may be changed to 30 or 150 ohms
Load Impedance.....	Unloaded input transformer
RETMA System .....	G <sub>M</sub>
Effective Output Level (all output connections):	
Bi-directional.....	-50 dbm* G <sub>M</sub> = -144 db
Uni-directional.....	-53 dbm* G <sub>M</sub> = -147 db
Non-directional.....	-56 dbm* G <sub>M</sub> = -150 db
Hum Pick-up Level.....	-128 dbm**
Dimensions (overall).....	11 1/2" long, 3 3/4" wide, 2 1/4" deep
Weight:	
Microphone .....	3 lbs.
Cable .....	1 1/2 lbs.
Cable (MI-43-B, 3 conductor, shielded).....	30 ft., no plug
Mounting.....	1/2" pipe thread
Stock Identification:	
Satin Chrome .....	MI-4045-F
TV Gray .....	MI-11006-C

\* Sound Pressure = 10 dynes/cm<sup>2</sup>.  
 \*\* Referred to a hum field of 1 x 10<sup>-3</sup> gauss.

Typical Directional Patterns and Frequency Response Curves of 77-DX Polydirectional Microphone



Rear view of 77-DX Microphone

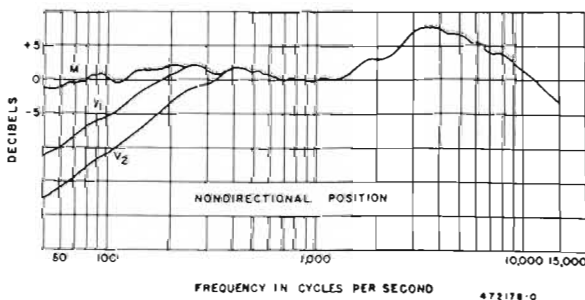
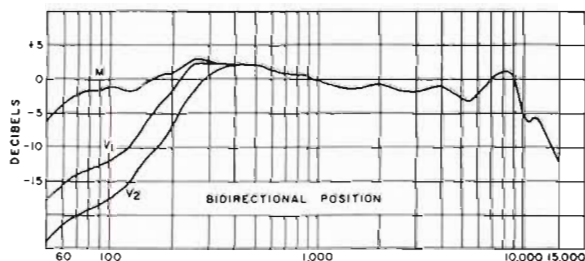
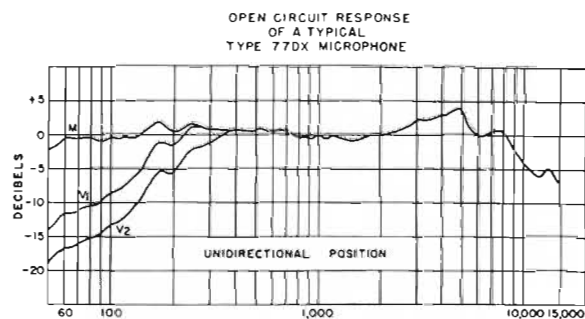
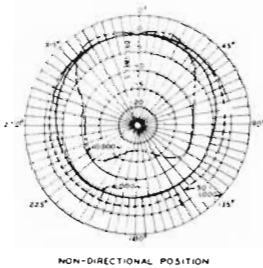
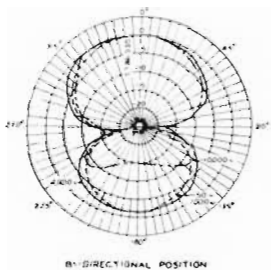
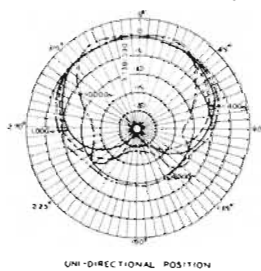

FREQUENCY IN CYCLES PER SECOND 472178-0

# PRESSURE MICROPHONE

## TYPE BK-1A



### FEATURES

- Smooth response over the essential audio frequency range
- Modern styling blends pleasingly with the television scene
- Removable from base for use as hand microphone or for mounting on floor stand
- Adjustable ball and socket swivel allows any desired direction
- Ideal for remote pickups—insensitive to wind and mechanical vibrations
- Non-reflective TV gray finish
- Frequency characteristic independent of source distance
- Light weight—small and portable

### USES

The high-fidelity BK-1A "Commentator" pressure microphone is designed for broadcast use in AM, FM and TV stations. Its construction makes it particularly well suited for remote pickups where, if used in the open air, the modern design practically eliminates the effect of air currents. The BK-1A features a smooth response and frequency range which make it suitable for reproducing both music and speech.

Rugged, insensitive to wind and mechanical vibration, the BK-1A is the ideal microphone for outdoor use where constant handling by the announcer is necessary. Highly styled, it effectively serves TV announce desk or conference programs where each participant has a microphone in the scene.

Characteristics of design and styling make the BK-1A desirable for: broadcasts where the microphone should blend with the scene; programs where the performer must work close to the microphone; and public address system use.

### DESCRIPTION

The BK-1A is a pressure actuated type microphone. The sound pressure actuates a lightweight molded diaphragm attached to an annular coil assembly which is placed within a magnetic field. An acoustic circuit, coupled to the diaphragm, is proportioned so that the diaphragm velocity remains essentially constant for a constant sound pressure from 60 to 10,000 cycles. The coil is connected to an impedance matching transformer providing output impedances of 30, 150, and 250 ohms.

Non-directional when mounted vertically, a semi-directional characteristic is obtained when horizontally mounted, in which case the BK-1A is essentially non-directional for frequencies below 2000 cycles—the higher frequencies attenuated more as the angle with the perpendicular to the diaphragm increases.

Versatility is assured by design which allows the BK-1A to be stand mounted on desk or floor or to be easily removed from the stand mountings for use as a hand microphone. A durable ball and socket joint located at the base of the stem makes selection of the best speaking angle easy, when used as a stand mounted microphone.

SPECIFICATIONS

Effective Output Level.....-52 dbm\*  
 Frequency Response.....60-10,000 cycles  
 Output Impedance.....30/150/250 ohms (connected for 250 ohms  
 when shipped)

RETMA Rating ( $G_{31}$ ):  
 250 Ohms.....-144 db  
 150 Ohms.....-147 db  
 30 Ohms.....-148 db

Directional Characteristic:  
 Semi-directional.....When mounted horizontally  
 Non-directional.....When mounted vertically  
 Recommended Load Impedance.....Unloaded input transformer  
 Hum Pickup Level.....-102 dbm (.001 gauss)  
 Length.....7 $\frac{3}{4}$ " (including mounting)

Diameter.....1 $\frac{7}{8}$ "  
 Weight.....18 oz. (less cable)  
 Cable.....3-conductor shielded, 30 feet (no plug)  
 Stand Fitting..... $\frac{1}{2}$ " pipe thread  
 Finish.....TV gray and chrome  
 Weight of Base.....19 oz.  
 Diameter of Base.....4 $\frac{3}{8}$ "  
 Stock Identification.....MI-11007

Accessories

Base, Type KS-11A.....MI-11008  
 Floor Stand, Type 90-AS.....MI-4098  
 Microphone Cable Plug, Male, Cannon Type.....MI-4630-B

\* Referred to one milliwatt and a sound pressure 10 dynes/cm<sup>2</sup>.

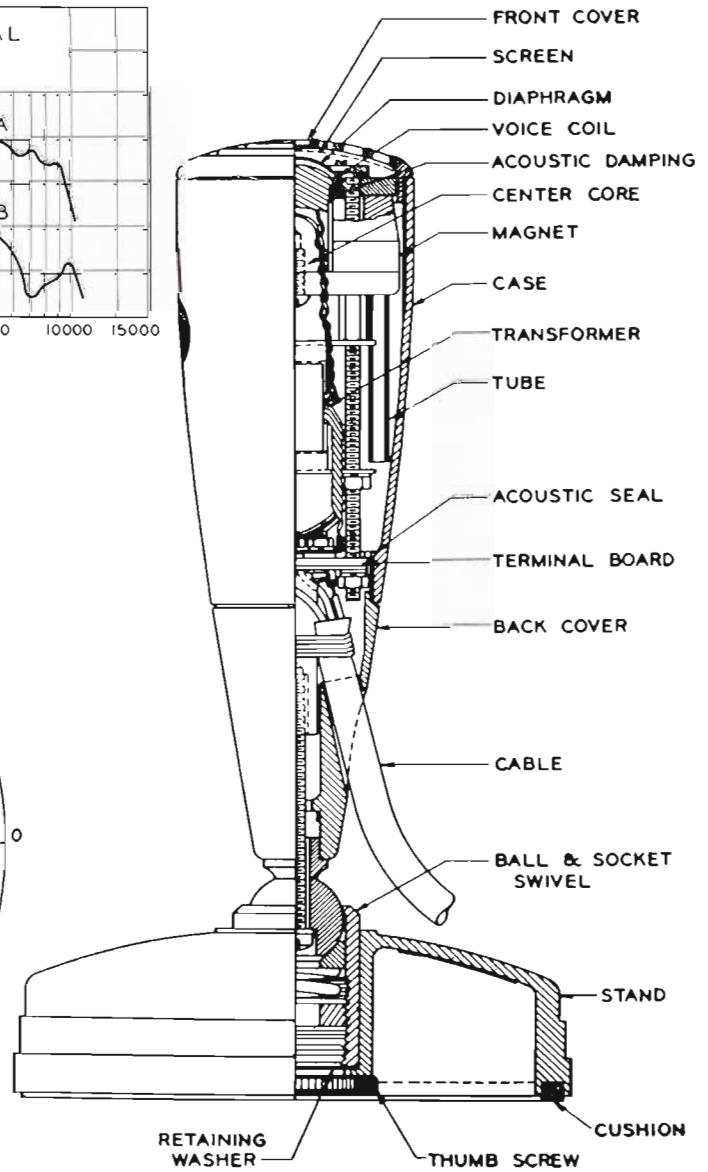
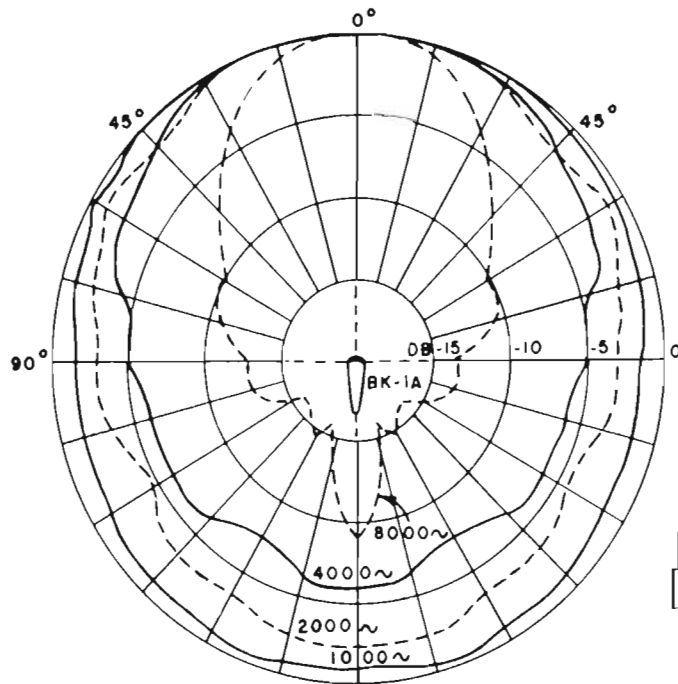
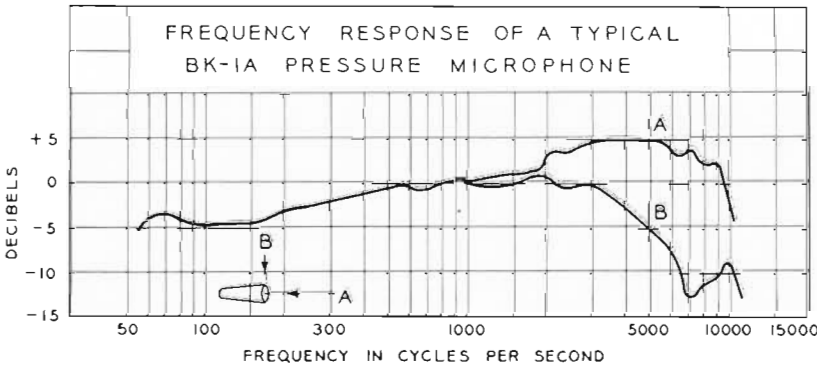



# RIBBON-PRESSURE MICROPHONE

TYPE BK-4B



## FEATURES

- Permits artist's or performer's face to be in full view
- Special low-gloss "TV gray" finish blends into studio scenes and practically eliminates reflections
- Unobtrusiveness, small size and slim construction are features ideal for television, banquet, night club, and convention uses
- Suitable for "mike-stand" or "carry-around" applications
- Light in weight (less than 1 lb.)—easy and comfortable to handle
- Ribbon-pressure type—contains no tubes, condensers, high-impedance circuits or special power supplies.
- Rugged construction — insensitive to mechanical shock

## USES

This ribbon-pressure microphone is ideal for use in television studio programs, conventions, banquets, night club scenes, or remotes where it is essential that the artists' features be in full view. In addition, the BK-4B will provide excellent service in AM and FM broadcast studios for general-purpose use.

The BK-4B is relatively insensitive to wind blasts and may be used for "carry-around" or "mike-stand" purposes. This microphone has the inherent characteristic for producing "naturalness" in its translation of voice and music.

## DESCRIPTION

The BK-4B is a miniature ribbon-pressure type microphone especially designed with a slim contour and styled to be unobtrusive. Sectional viewing discloses a small pickup horn connected to a short pipe which is in turn coupled to the front of the ribbon by means of a connector. The back of the ribbon is coupled to the damped, folded pipe or labyrinth by a second connector section. The ribbon impedance is practically a pure resistance of  $\frac{1}{4}$  ohm and is

stepped up to a standard line impedance by means of a transformer.

The BK-4B ribbon-type construction provides the broadcaster a small, high-quality microphone having smooth response and with freedom from non-linear distortion. Its low electrical impedance makes the BK-4B immune to wide variations in temperature and humidity. The straight-forward ribbon-pressure type design eliminates the need for tubes, condensers, high-impedance circuits, special amplifiers and power supplies.

The BK-4B is furnished with 30 feet of three-conductor shielded microphone cable and is equipped at the bottom with a standard  $\frac{1}{2}$  inch pipe thread for microphone stand mounting.

A holder, as shown in the above photo, is available as an accessory item to provide convenient floor-stand mounting and facilitate easy removal of the microphone from the holder for hand-held use. A plug adapter at the base of the microphone which permits quick disconnection of the cord from the microphone is available as an accessory item.

SPECIFICATIONS

Effective Output Level at 1000 Cycles.....	-61 dbm*
RETMA Rating $G_{31}$ :	
250 Ohms .....	-153 db
30/150 Ohms .....	-156 db
Frequency Range.....	70-15,000 cycles
Output Impedance.....	30/150/250 (connected for 250 ohms when shipped)
Recommended Load Impedance.....	Unloaded input transformer
Magnets .....	Alnico V
Moving System .....	Ribbon
Directional Characteristic .....	Non-directional
Hum Pickup Level.....	-125 dbm (.001 gauss)
Length .....	12"
Diameter .....	1 1/4"
Diameter at Pickup Point.....	7/8"
Length of Barrel Section.....	7"
Length of Tubular Section.....	5"

Weight .....	15 oz.
Cable.....	3-conductor shielded, 30 feet (no plug)
Mounting .....	1/2" pipe thread
Finish.....	TV gray (low gloss)
Stock Identification (with 30' of microphone cable, less plug) .....	MI-11005-B

Accessories

Floor Stand, Type 90-AS.....	MI-4098
Swivel Mount (used with MI-4092-E Base).....	MI-11009
Microphone Holder .....	MI-11068
Adaptor for Plug Connector.....	MI-11069
Female Connector (for MI-11069 Adaptor).....	MI-12058
Microphone Cable Plug, Male, Cannon Type.....	MI-4630-B

\* Referred to one milliwatt and a sound pressure of 10 dynes/cm<sup>2</sup>.

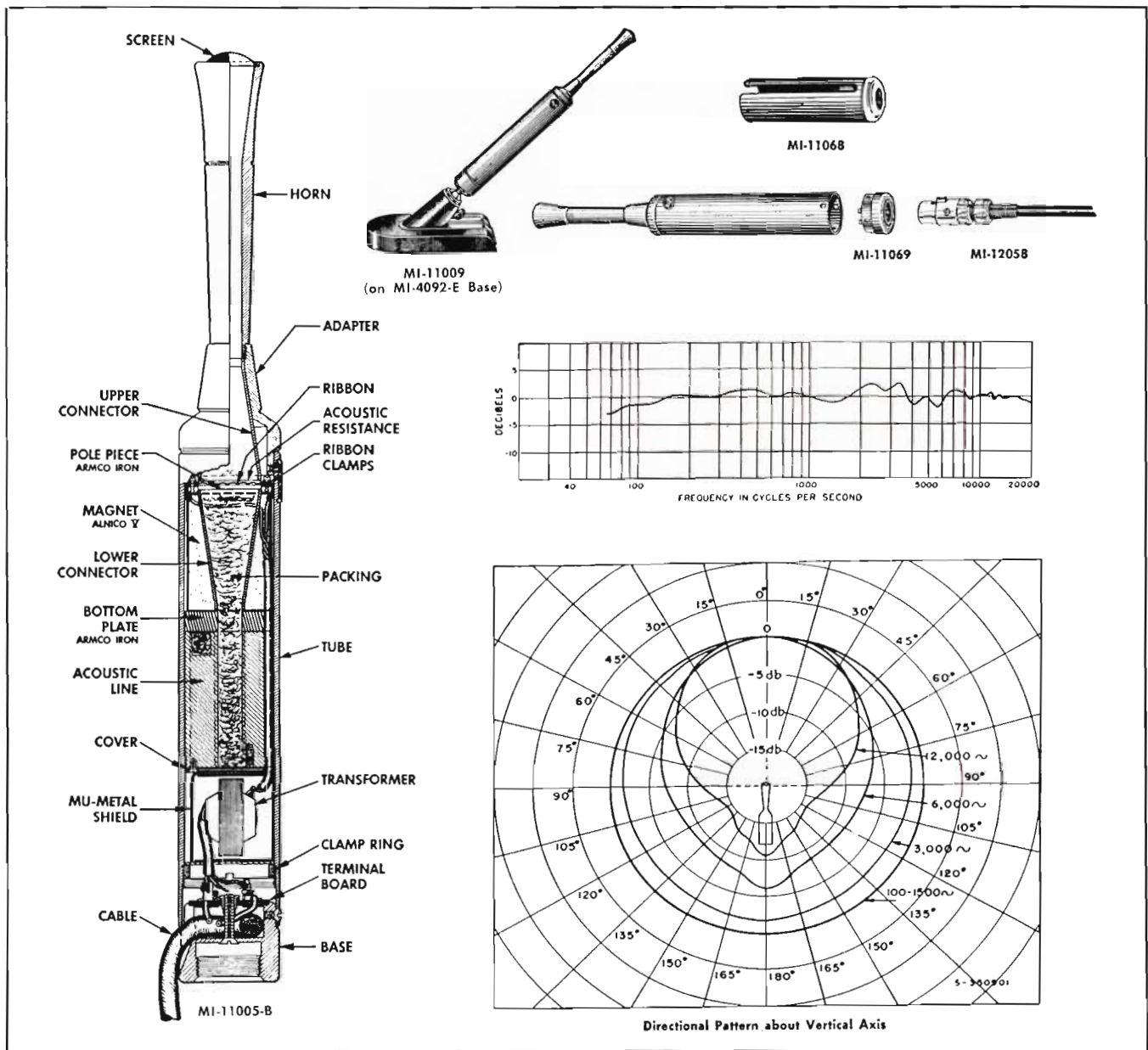

# UNIAXIAL MICROPHONE

## TYPE BK-5A

### FEATURES

- High quality reproduction over entire audio frequency range
- Improved unidirectional characteristic with wide pickup angle on front
- Simplifies microphone and camera placement problems—maximum sensitivity lies on major mechanical axis
- Small size—lightweight for TV boom operation
- Rugged construction—improved resistance to gun blasts
- Satisfactory operation in high hum fields because of exceptionally good shielding
- Wind screen for out-doors or fast-panning shots
- No rubber band mountings to replace
- Improved long-life flexible cable



### USES

The RCA Type BK-5A Uniaxial Microphone is a dependable, high-quality ribbon instrument possessing an improved unidirectional characteristic, and designed for broadcast use in AM, FM and TV stations. The microphone has a frequency response that is essentially uniform from 50 to 15,000 cycles. Its smooth response and frequency range make it ideal for reproducing both speech and music.

The microphone has been especially engineered with the television studio in mind. Since maximum sensitivity lies on

the major mechanical axis, it is a one axis, or uniaxial type microphone. This directional characteristic simplifies microphone and camera placement problems. Incorporated in the unit is a blast filter which effectively reduces damage to the microphone from gun blasts and other violent noises. In addition, the small size, light weight, unobtrusive yet attractive TV gray finish and appearance render it especially suitable for television, but it is also admirably suited to general broadcasting and high-fidelity sound systems.

**DESCRIPTION**

The Type BK-5A Microphone is a unidirectional microphone in which the moving element is a thin corrugated metallic ribbon clamped under light tension to cause it to vibrate at its own resonant frequency. The ribbon is placed between the pole pieces of a magnetic circuit. One side of the ribbon is open to the atmosphere and the other opens on an acoustical labyrinth which has phase-shift openings giving the instrument its improved unidirectional characteristics. The labyrinth of the microphone houses an impedance matching transformer and switch for selecting response characteristics for voice or music.

A unique feature of the BK-5A is a blast filter consisting of two separate cloth layers supported by perforated metal screens. The filters effectively reduce damage to the microphone from gun blasts and other violent noises required in broadcast programming. In addition, the transformer is exceptionally well shielded against stray magnetic fields and can perform satisfactorily in high hum fields. As further protection for the sensitive vibrating ribbon a wind screen is available for use with the instrument. Its use is recommended if the instrument is to be used outdoors.

The integration of the blast filter, acoustic phase-shift network and especially designed connector to couple the ribbon to the labyrinth is responsible for the unique uniaxial characteristic of the BK-5A, and uniform frequency response over the entire aural spectrum. The microphone is housed in a tri-sectional casting which blends functions and appearance into a coherent whole. It is supported by a fork mounting which has a 1/8" straight pipe thread to

BK-5A Microphone mounted on Type 91-C Desk Stand. RCA Standard Cushion Mount Adaptor (Stock #93973) is required in this application.



BK-5A Microphone with Wind Screen, MI-11011, and Boom Unit, MI-11012.



fit RCA cushion mountings for either desk or floor stands. An improved shock mount based on panel meter mounts designed for military use is incorporated in the Boom Unit. This new mount isolates the microphone effectively from its support and does not generate any noise. There are no rubber band mountings to wear out and need replacement. A 30-foot flexible cable, supplied with the microphone, makes use of tinned cadmium bronze wire to provide longer life.

The small size and axial directivity aid in placing the BK-5A in inconspicuous fixed locations. There are no shiny external parts to reflect light and draw attention to the instrument. The axial directivity combined with the Boom Mount (MI-11012) make the microphone very easy to handle to keep the sound source "in focus." The addition of the wind screen to this combination does not cause a loss of the sense of the pickup axis.

**SPECIFICATIONS**

**Performance Specifications**

Directional Characteristic .....	Unidirectional
Frequency Response.....	50 to 15,000 cycles
Output Impedance.....	250 ohms, may be changed to 30 or 150 ohms
Load Impedance.....	Unloaded input transformer
Effective Output Level at 1000 cps.....	-56 dbm
RETMA Rating (GM) (150 ohm connection).....	-150 dbm
*Hum Pickup Level.....	-128 dbm
Cable.....	3-conductor, shielded, 30 feet, no plug
Dimensions (overall).....	7" x 2 3/4" x 2 7/8"
Weight.....	1 pound, 11 ozs. (less cable)
Finish .....	Low-gloss TV gray enamel
Mounting.....	1/8" straight pipe thread (female)
Stock Identification .....	MI-11010

**Accessories**

Boom Unit .....	MI-11012
Wind Screen .....	MI-11011
Cushion Mounting Assembly.....	Stock No. 93973

\* Relative to a field of 1 x 10<sup>-3</sup> gauss.

# MINIATURE DYNAMIC MICROPHONE

TYPE BK-6A

## FEATURES

- Easily concealed in man's hand . . . in clothing . . . on TV settings
- Methods of mounting . . . by clip and lanyard for placing around neck . . . by clipping to lapel or among corsage . . . mounting beneath necktie
- Excellent speech balance when talking "off-mike"
- Wide-range frequency response
- Rugged construction . . . color and styling makes it blend with surroundings

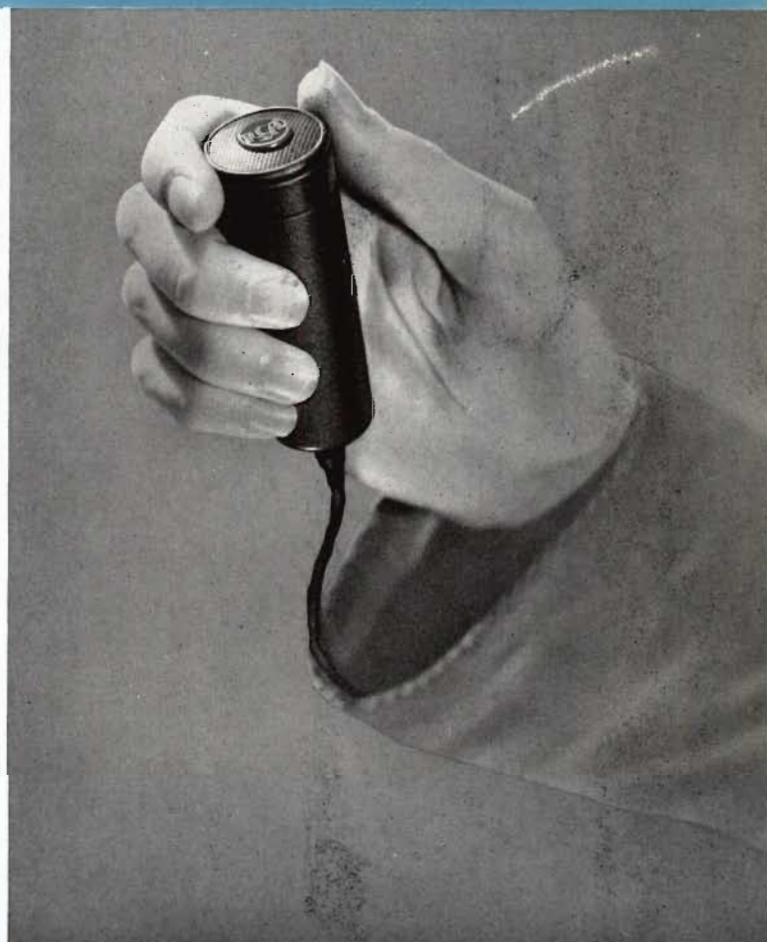

## DESCRIPTION

The BK-6A Dynamic Microphone is a high quality instrument of the pressure actuated type. It is especially designed for correct speech balance when used informally in television broadcasting interviews and public address applications.

The frequency response and directional characteristics of the BK-6A are designed to complement the characteristics of human speech. The result is a microphone which has excellent balance when the performer is talking "off-mike".

The BK-6A is especially designed to be suspended from the neck, resting on the chest. The low pitched chest sounds are attenuated. The microphone points straight up toward the lips, the position in which it is most sensitive to the sibilant sounds that would normally be lost. If it is desired to talk directly at the microphone, it should be held vertically so that the speaker talks across it, rather than

into it. In this way, the high pitched sounds are reproduced in proper balance.

The general rule is to talk across the BK-6A, either in an interview, a panel discussion, or with the microphone suspended around the neck. In this manner a balance, similar to the RCA 77-D in the Cardioid VI position, is obtained.

The BK-6A is designed as a speech microphone. It is not recommended for music pickup.

The BK-6A is especially recommended for television broadcasting. It may be worn by the performer; its small bulk and neutral color make it inconspicuous. The light weight and flexible cable permit free, unhampered movement of the performers. It may be wholly concealed in a man's hand during an interview. It is easily concealed on a set.

The styling blends readily with any props, and is pleasing where it is exposed to direct view.

**SPECIFICATIONS**

Output Impedance:  
 a. 30 Ohms ..... Solder tap  
 b. 150 Ohms ..... Solder tap  
 c. 250 Ohms ..... As shipped from factory

Load Impedance ..... Unloaded input transformer

Frequency Response ..... 70-10,000 cycles

Hum Pickup ..... -116 dbm (referred to a hum field of  $10^{-3}$  gauss)

Cable ..... 30 ft. flexible cable, two conductor, shielded

RETMA Sensitivity Rating ..... ( $G_M$ ) -152 db

Finish ..... TV gray

Mounting ..... Clip and microphone lanyard

Dimensions and Weight:  
 Length .....  $3 \frac{5}{32}$ "  
 Diameter .....  $1 \frac{3}{16}$ "

Weight (less cable) .....  $5 \frac{1}{2}$  ozs.

Stock Identification ..... MI-11013

**FREQUENCY RESPONSE CURVE**

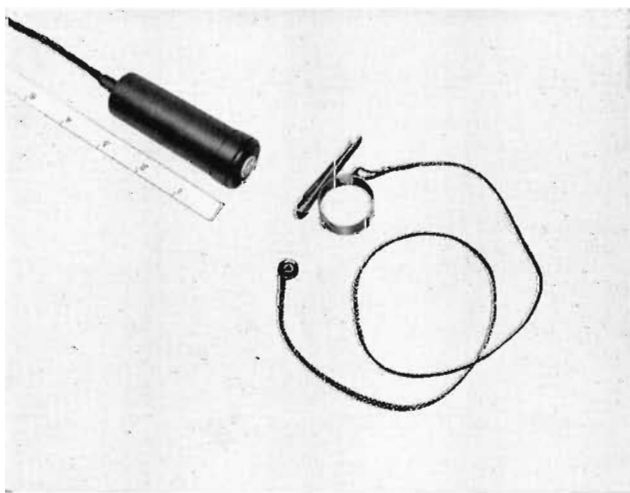
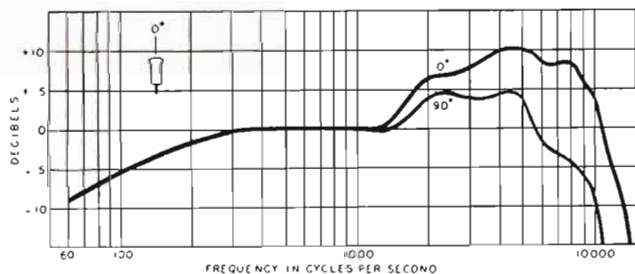

Size is compared to an inch scale . . . also shown are clip and lanyard for versatile mounting.



View showing BK-6A Microphone "secluded" in a corsage of flowers.



BK-6A Microphone used as a "necktie" mike. May be mounted beneath the necktie or exposed.

# Anti-Noise Velocity Microphone

TYPE SK-35



## FEATURES

- Close talking—yet a true high fidelity velocity microphone
- Anti-feed back characteristics
- Eliminates background noise
- Insensitive to wind
- Superior for field use—sportscasting
- Extremely rugged yet light weight and easily handled
- Advanced styling—with TV gray and satin chrome finish
- Adjustable impedance taps

## USES

The new RCA Type SK-35 "Anti-Noise" Velocity Microphone has been designed for close announce or program use where it is desirable to attenuate the pickup of extraneous noise. Its excellent response, bi-directional characteristics, and small size make it a valuable and versatile instrument in the AM, FM, or TV studio.

The SK-35 has proven especially useful for sports announcements, and for use in locations where the announcer can speak within one inch of the microphone. Background noise can be eliminated. It is also excellent for audience participation programs where feedback problems are normally encountered. Its small size and ease of handling especially commends it for such programs and for use in either studio or on remote location. The instrument is especially insensitive to wind and is highly recommended for outdoor use. The microphone is virtually shock proof and will take a high degree of abuse without altering performance characteristics.

## DESCRIPTION

The RCA SK-35 is a "close-talking" velocity microphone in which the moving element is a thin, corrugated metallic ribbon supported at the ends and placed between the poles of two small powerful magnets in a magnetic circuit. Because of its light weight, the motion of the ribbon corresponds very closely to the velocity of the air particles; therefore, the voltage generated by it is a faithful reproduction of the sound waves that traverse it. The ribbon is connected to the primary winding of a small efficient transformer whose secondary winding matches either 150-250 ohms or high impedance, as required. The change in impedance is easily accomplished by changing one soldered connection inside the microphone.

The excellent frequency response, high output level, absence of excitation due to breath, and anti-feed back characteristics are truly amazing. Above 1000 cycles, the discrimination against random unwanted sound is 19 db better than that obtained with a conventional pressure

**DESCRIPTION (Continued)**

microphone used at a distance of six inches. Below 1000 cycles, background noise discrimination increases to a value of 44 db at 100 cycles. The net result is a high-fidelity anti-noise microphone.

A swivel arrangement permits tilting the microphone back approximately 85°. Pleasing functional design incorporating excellent performance and rugged construction, attractively finished in TV gray and satin chrome, makes this microphone a welcome addition to any installation. A two conductor shielded cable permanently attached to the microphone is connected for low impedance operation as stocked.

**SPECIFICATIONS**

Directional Characteristics .....	Bi-directional
Output Impedance.....	200 ohms and 15,000 ohms*
Effective Output Level at 1000 cycles/second:	
Low Impedance .....	-58 dbm
G <sub>M</sub> .....	-150 db
High Impedance.....	-60 db below 1 volt
Hum Pickup Level:†	
Low Impedance .....	-113 dbm
High Impedance .....	-94 db below 1 volt
Frequency Range.....	50 to 10,000 cycles/sec.
Output Voltage:	
Low Impedance .....	117 μv/dyne/cm <sup>2</sup>
High Impedance .....	1020 μv/dyne/cm <sup>2</sup>
Mounting .....	5/8-27 fixture thread
Dimensions:	
Height .....	5 1/8"
Width .....	1 29/32"
Depth .....	1 3/8"
Finish.....	TV gray with satin chromium plated screen
Weight (less cable).....	13 ounces
Stock Identification .....	MI-12035

\* Stock with soldered connection to the 200 ohm tap.

† Relative to field of 1 x 10<sup>-3</sup> gauss.

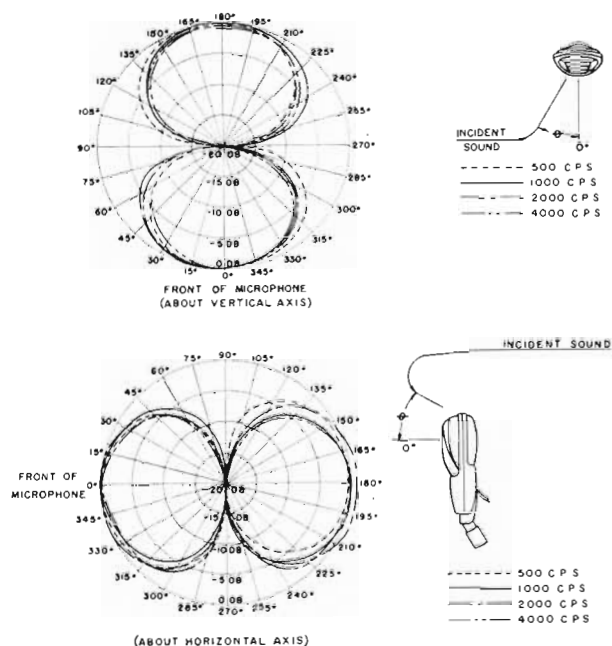

Directional Characteristics of the SK-35 Velocity Microphone.

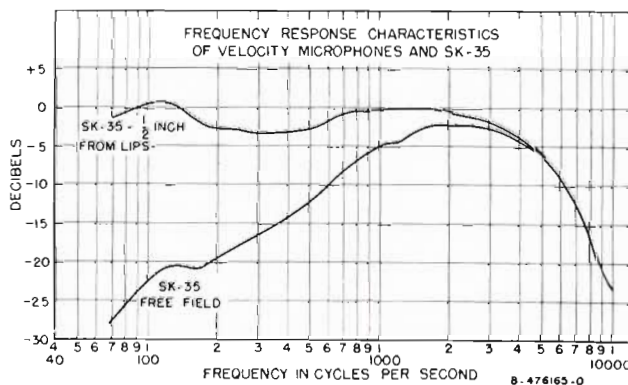



# PRESSURE MICROPHONE

## TYPE SK-45

### FEATURES

- Rugged construction
- Economical, light weight, small in size
- Attractive appearance
- High or low impedance
- Dynamic type
- Excellent for announce work
- Swivel mounting

### USES

The MI-12045-A Announce Microphone is suitable for talk-back or cue purposes. It may be used indoors or outdoors where a rugged, light weight microphone with good response to voice is required. It is a "close-talk" microphone.



### DESCRIPTION

This microphone is a pressure operated microphone employing the dynamic principle. The moving element is a thin molded diaphragm in which a single straight wire is embedded. This wire which is held in the airgap of a strong permanent magnet generates a small voltage of the same wave form as the sound acting on the diaphragm. The wire is connected to the primary of a small, but efficient transformer, in order to provide an output voltage sufficiently high to allow the output to be fed directly to the grid of the first input tube. The two conductor shielded cable is connected permanently to the microphone.

The change from high to low impedance (or low to high) is easily accomplished by changing one soldered connection in the head of the microphone.

A swivel arrangement allows tilting of the head forward or back through an arc of approximately 45 degrees each side of the vertical position. New streamlined design, rugged construction and attractive baked TV gray enamel finish makes this microphone a welcome addition to any installation.

SPECIFICATIONS

Directional Characteristics:  
 (Below 3000 cycles/sec.).....Non-directional  
 (Above 3000 cycles/sec.).....Semi-directional

Output Impedance.....200 ohms balanced or 15,000 ohms†

Output Level at 1000 Cycles/sec.:

Low Impedance .....-56 dbm  
 $G_M$  .....-149 db  
 High Impedance .....-59 db\*

Hum Pickup Level:

High Impedance .....-94 db\*\*  
 Low Impedance .....-109 dbm

Frequency Range......75 to 10,000 cycles/sec.

Mounting......5/8-27 fixture thread

Dimensions:

Height (including shank) .....5 3/8"  
 Width .....1 5/8"  
 Depth .....2"

Finish.....TV gray enamel

Weight, with Cable.....1 1/4 lbs.

Stock Identification:

Microphone and Cable (25 feet).....MI-12045-A

† Stocked with soldered connection to the 200 ohm tap.  
 \* Referred to 1 volt/dyne/cm<sup>2</sup>.  
 \*\* Hum field  $1 \times 10^{-3}$  gauss.  
 0 db = 1 volt.

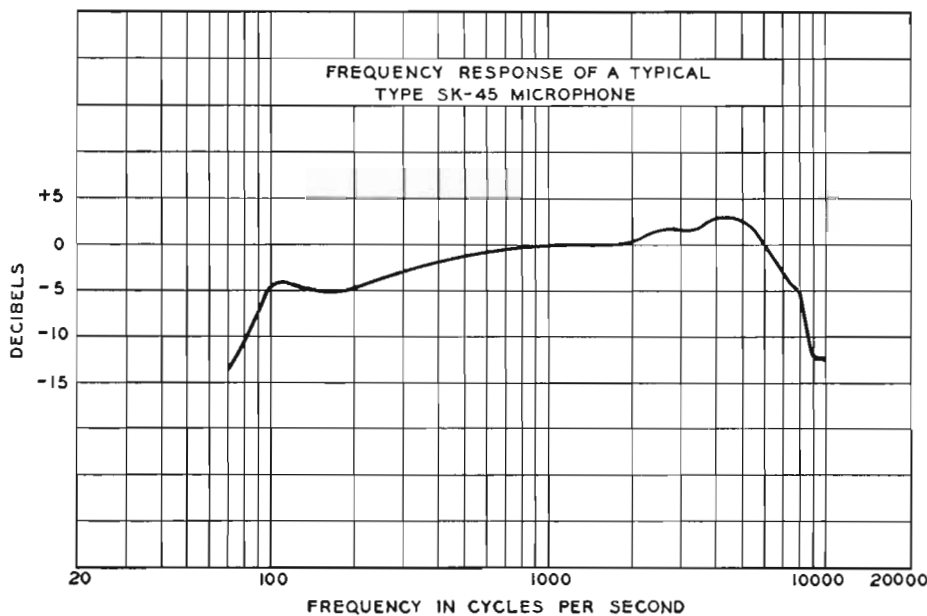
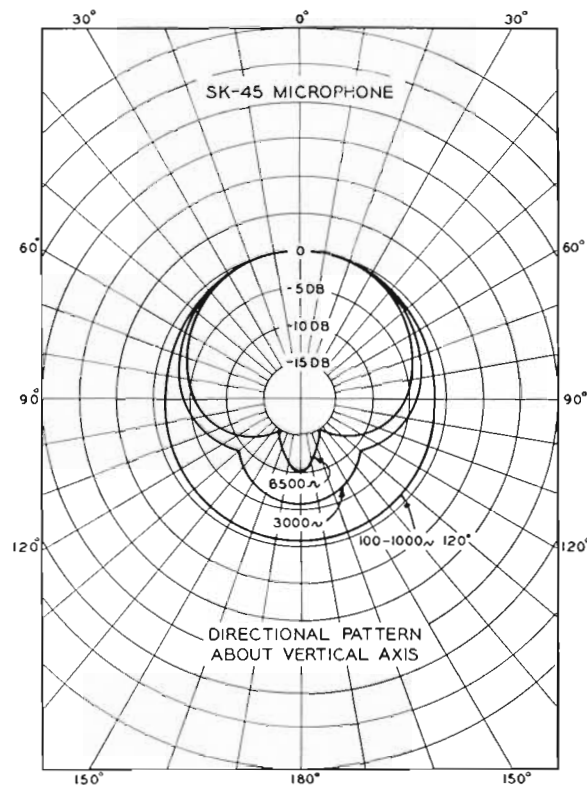

# PROGRAM VELOCITY MICROPHONE

TYPE SK-46



## FEATURES

- Bi-directional characteristics over wide frequency range
- Light weight, small in size
- Modern styling blends pleasingly with any background
- Adjustable impedance taps
- TV gray and satin chrome finish
- Swivel mounting
- Extremely rugged construction

## USES

The RCA Type SK-46 Program Velocity Microphone is useful for AM, FM and TV studio or control room announcing. Its excellent response, directional characteristics and small size makes it a valuable and versatile instrument where quality production of sound is desired. The directional characteristics reduce unwanted acoustical background noise, reflections and feedback. This makes the microphone appropriate for "on stage", announce booth and general indoor programs. The microphone is not recommended for outdoor use because of the relative sensitivity of this type unit to wind.

## DESCRIPTION

The SK-46 is a small light weight velocity microphone in which the moving element is a thin, corrugated metallic ribbon supported at the ends and placed between the

poles of two small powerful magnets in a magnetic circuit. Because of its light weight, the motion of the ribbon corresponds very closely to the velocity of the air particles; therefore, the voltage generated by it is a faithful reproduction of the sound waves that traverse it. The ribbon is connected to the primary winding of a small efficient transformer whose secondary winding matches either 150-250 ohms or high impedance, as required. The change in impedance is easily accomplished by changing one soldered connection inside the microphone. A swivel arrangement permits tilting the microphone back approximately 85°. Pleasing functional design incorporating excellent performance and rugged construction, attractively finished in TV gray and satin chrome, makes this microphone a welcome addition to any installation. A two conductor shielded cable permanently attached to the microphone is connected for low impedance operation as stocked.

SPECIFICATIONS

Electrical Specifications

- Directional Characteristics ..... Bi-directional
- Output Impedance ..... 200 ohms and 15,000 ohms\*
- Effective Output Level at 1000 cycles/second:
  - Low Impedance ..... -58 dbm
  - $G_M$  ..... -150 db
  - High Impedance ..... -60 db below 1 volt
- Hum Pickup Level:†
  - Low Impedance ..... -113 dbm
  - High Impedance ..... -94 db below 1 volt
- Frequency Range ..... 50 to 10,000 cycles/sec.
- Output Voltage:
  - Low Impedance ..... 117  $\mu\text{v}/\text{dyne}/\text{cm}^2$
  - High Impedance ..... 1020  $\mu\text{v}/\text{dyne}/\text{cm}^2$
- Mounting .....  $\frac{5}{8}$ -27 fixture thread
- Dimensions:
  - Height .....  $5\frac{1}{8}$ "
  - Width .....  $1\frac{29}{32}$ "
  - Depth .....  $1\frac{3}{8}$ "
- Finish ..... TV gray and satin chromium plated screen
- Weight (less cable) ..... 13 ounces
- Stock Identification ..... MI-12046

\* Stock with soldered connection to the 200 ohm tap.  
 † Relative to field of  $1 \times 10^{-3}$  gauss.

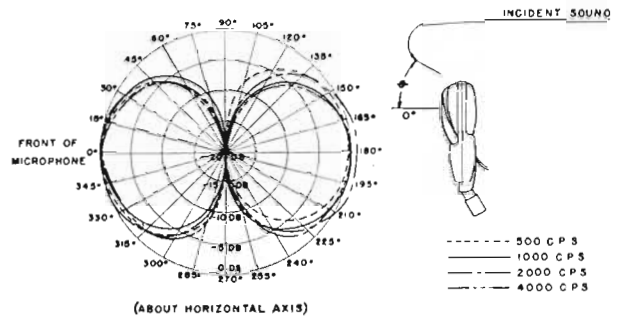
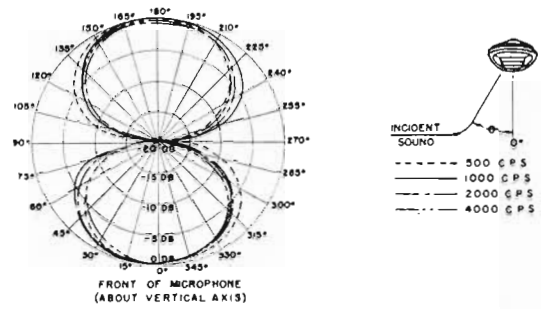

Directional Characteristics of the SK-46 Velocity Microphone.

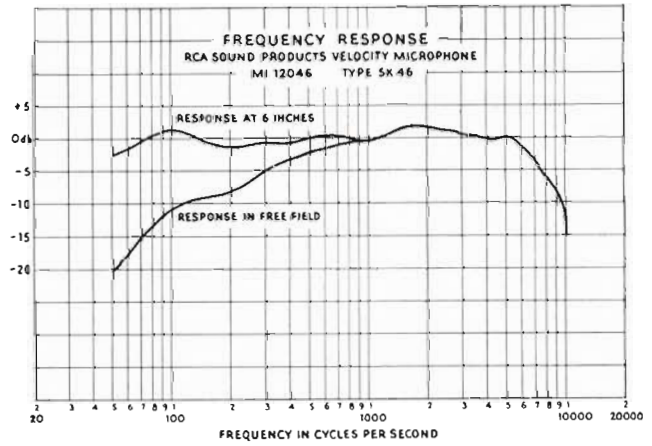

# AERODYNAMIC MICROPHONE

MASTER ITEM-12016-H

## FEATURES

- Light weight—small size—fits palm of hand
- Modern streamlined appearance
- Excellent for close talking application
- May be used outdoors—insensitive to wind noise
- Unaffected by temperature or humidity
- Alnico V magnet—high sensitivity with light weight
- High impedance output

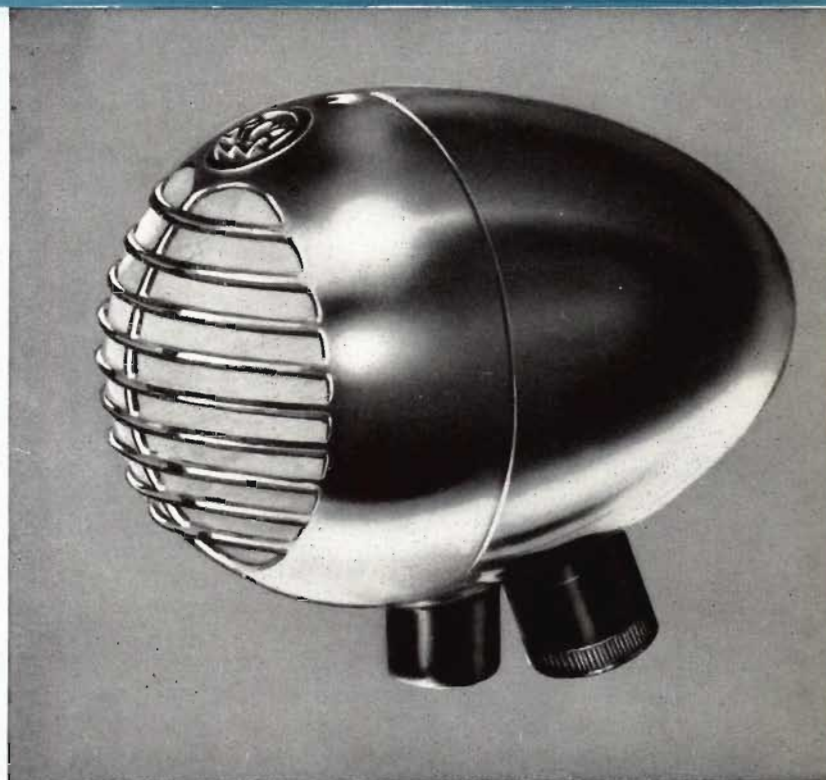

## USES

This microphone has excellent response for close talking announce purposes. Because of its light weight and small size, it is ideal for remote pickup and mobile use. It performs exceptionally well for paging and announcing operations into areas of high noise level because its rising high frequency characteristic gives excellent intelligibility. Another application for which this unit is especially suited, is for use of an individual soloist, where a second microphone, usually a velocity type, is used to pick up the musical accompaniment. Either a floor stand or a desk stand may be used as a mounting or it may be fitted with a handle for hand use in sports announce work.

## DESCRIPTION

The MI-12016-H Aerodynamic Microphone has been designed and constructed for dependable performance and rugged service. It is relatively insensitive to mechanical shock and wind disturbances and will withstand nominal exposure to moisture or rain due to its plastic diaphragm. The attractively styled case is composed of two zinc die cast sections. A  $\frac{1}{8}$ " female pipe thread is provided for mounting. The microphone comes complete with 25-foot cable and stand adaptor (MI-6229)  $\frac{1}{8}$ " to  $\frac{5}{8}$ "—27 fixture thread.

## SPECIFICATIONS

Type.....	Pressure operated moving coil type
Directional Characteristics.....	Non-directional
Output Impedance.....	250 ohms
Output Level.....	-55 dbm @ 1000 cycles/sec.*
RETMA Microphone Rating $G_{M}$ .....	-150 db
Hum Pickup Level.....	-95 db**
Frequency Range.....	200-9000 cycles/sec.
Mounting.....	$\frac{1}{8}$ " female pipe thread
Dimensions, Overall.....	2 $\frac{7}{8}$ " high, 2 $\frac{1}{16}$ " wide, 3 $\frac{3}{16}$ " deep
Finish.....	Two-tone umber gray
Weight (including cable).....	1 lb. 5 oz.
Cable.....	25 feet single conductor shielded, rubber or plastic covered
Stand Adaptor.....	$\frac{1}{8}$ " to $\frac{5}{8}$ "—27
Stock Identification.....	MI-12016-H

## Accessories

Stand Adaptor, $\frac{1}{8}$ " to $\frac{1}{2}$ " pipe thread.....	MI-12051
--------------------------------------------------------------------	----------

\* Level below 1 volt per dyne per square centimeter.

\*\* Level below 1 volt hum field 0.001 gauss.

# MICROPHONE DESK STANDS



MI-4095-A



MI-12066-B



MI-4096-A



MI-13240-A



MI-6427



MI-11008



MI-4092-E



MI-4058-C

## FEATURES

- A variety of Announce Stands to accommodate a variety of microphones
- Rugged construction
- Attractive appearance
- Easy to assemble or take apart
- Optimum design features built into each stand for its particular application
- Compact and convenient for portability
- Microphone Boom and Perambulator for TV applications

## BANQUET STAND MI-4095-A

### FEATURES

- Compact and convenient for portable use
- Rugged construction
- Easy to assemble or take apart
- Adjustable height
- Attractive appearance

### USES

This microphone stand is the ideal for banquets or other occasions where a sturdy, attractive and truly portable design is required. It can accommodate Type 77-D, BK-1A, and the SK-Type Microphones.

### DESCRIPTION

The MI-4095-A is of novel construction in that its base forms a compact carrying case for the entire stand. The hollow under side of the base casting accommodates the stand's three telescoping tubular sections and two fin type legs fold into the base sides. When unfolded the legs extend 5¼" from center of the vertical rod. The bottom of the base is covered with felt.

### SPECIFICATIONS

Height.....	Adjustable 10¾" to 24¾"
Base Dimensions.....	3⅝" x 10½" x 1⅝"
Microphone Mounting.....	½" pipe thread or ⅝"—27 fixture thread with adaptor removed
Weight .....	5 lbs.
Finish.....	Umber gray wrinkle and satin chrome
Stock Identification .....	MI-4095-A

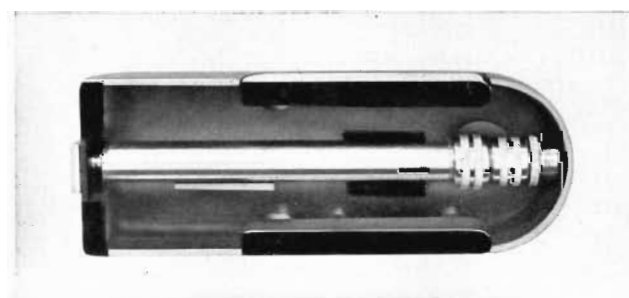

Three telescoping sections and 2 fin-type legs "tuck away" in bottom of base.

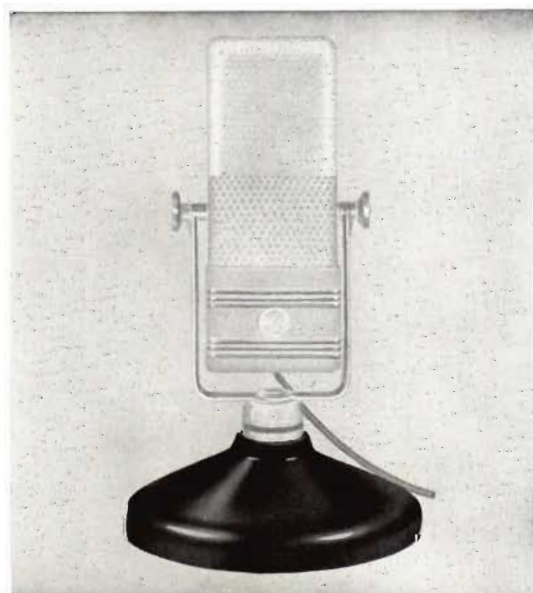

## ANNOUNCE STAND TYPE 91-A

(Specifically Designed for the  
Type 44-BX Microphone)

The 91-A is a simple but attractive desk stand for 44-BX Microphones. It is finished in TV gray and its base rests on three felt buttons. Height of the 44-BX center above desk is 8⅝". Base diameter, 7". Use only with Type 44-BX Microphone.

### SPECIFICATIONS

Weight (unpacked) .....	3½ lbs.
Stock Identification .....	MI-4058-C

## DESK STAND, TYPE 91-C

### FEATURES

- Small size
- Heavy base with felt covered bottom
- Adjustable height
- Attractive appearance

### USES

The 91-C is a heavy-based desk stand designed especially for studio or announce use. It is attractive in appearance and easily mounts the heaviest of studio microphones. It can accommodate Type 77-D, 77-DX, BK-1A, BK-4A, and BK-5A Microphones.

### DESCRIPTION

The 91-C is finished in umber gray with satin chrome trim. The base is felt covered to prevent marring the surface on which it is placed. The stand is provided with alternate mounting extensions—one 3/4" and one 1 3/4", the choice depending on the type microphone to be mounted.



### SPECIFICATIONS

Microphone Mounting.....	1/2" pipe thread
Base Dimensions.....	4 1/2" x 6 5/8" x 3/4"
Finish.....	Umer gray wrinkle with satin chromium trim
Weight .....	4 lbs.
Stock Identification .....	MI-4092-E



## ANNOUNCE STAND, MI-4096-A

This attractively-designed announce stand is adjustable from 8 to 10 1/2", making it ideal for use on a desk or table. It is finished in chromium and black and features a 7 1/2" base. The microphone mounting is a 5/8"—27 fixture thread. This stand can accommodate Type SK-45 and BK-1A Microphones.

Weight (unpacked).....	4 lbs.
Stock Identification .....	MI-4096-A

## DESK STAND, MI-13240-A

This sturdily constructed desk stand is ideal for use with the lighter microphones where a low cost stand is needed. The stand is 6" high and the 4 3/4"-diameter base is equipped with a rubber cushion. The stand is attractively finished in umber gray with polished chrome trim. As supplied the stand mounting is 1/8" pipe thread; with the adaptor removed the mounting is a 5/8"—27 fixture thread. For use with Type SK-35, SK-45 and SK-46 Microphones.

Weight (unpacked).....	14 ozs.
Weight (packed).....	1 1/2 lbs.
Stock Identification .....	MI-13240-A





## PUSHMIKE STAND, MI-6427

This smartly designed table stand features a built-in microphone switch and is suitable for use with SK-Type and BK-1A Microphones. The switch is of the D.P.D.T. long leaf anti-capacity type and permits turning the microphone on and off right at the microphone stand. It may also be used for "push-to-talk" operation or lock-in "Talk" position.

The stand is 4 $\frac{3}{4}$ " high with 5 $\frac{3}{4}$ " base and is attractively finished in chromium. The microphone mounting is for a  $\frac{5}{8}$ "—27 male or female thread. Stock MI-12055 Adaptor is available on separate order for microphone with  $\frac{1}{2}$ " pipe thread.

Weight (unpacked) ..... 1 $\frac{1}{8}$  lbs.  
 Stock Identification ..... MI-6427  
 (Includes MI-6425 Pushmike Adaptor and MI-6426 Base)



## DESK STAND, Type KS-11A

RCA's KS-11A desk stand was specifically designed for use with the type BK-1A "Commentator" Microphone. Its construction is simple, rugged and it is styled in dark umber gray finish. The BK-1A Microphone fits into the center hole and is secured by a knurled thumb screw and a retaining washer. A rubber cushion around its perimeter prevents marring of any surface.

Weight, packed ..... 1 $\frac{1}{2}$  lbs.  
 Finish ..... Dark umber gray  
 Stock Identification ..... MI-11008

## DESK STAND, Type KS-5A

This attractive base is designed primarily for use with the SK-Type microphones. It is of die cast metal 4 $\frac{1}{8}$ " long, 5 $\frac{3}{8}$ " wide and 1" high and is attractively finished in dark umber gray metalustre. The microphone is held rigidly in position by  $\frac{5}{8}$ "—27 thread bolt. The bottom is rubber cushioned giving adequate protection to any finely finished surface.

Weight (unpacked) ..... 1 $\frac{1}{4}$  lbs.  
 Stock Identification ..... MI-12066-B

The Type SK-5A Desk Stand provides an ideal mounting for the SK-46 Program Microphone shown here. Ruggedly built, and compact, it can not tip over.



# FLEXIBLE MICROPHONE STANDS

## FEATURES

- Quick clamp-positioning of microphones anywhere
- Goose neck swivel adjustable for individual use
- Attached or removed with one thumb screw
- Sturdy construction, strong tubing and castings
- Attaches easily to RCA announce microphones

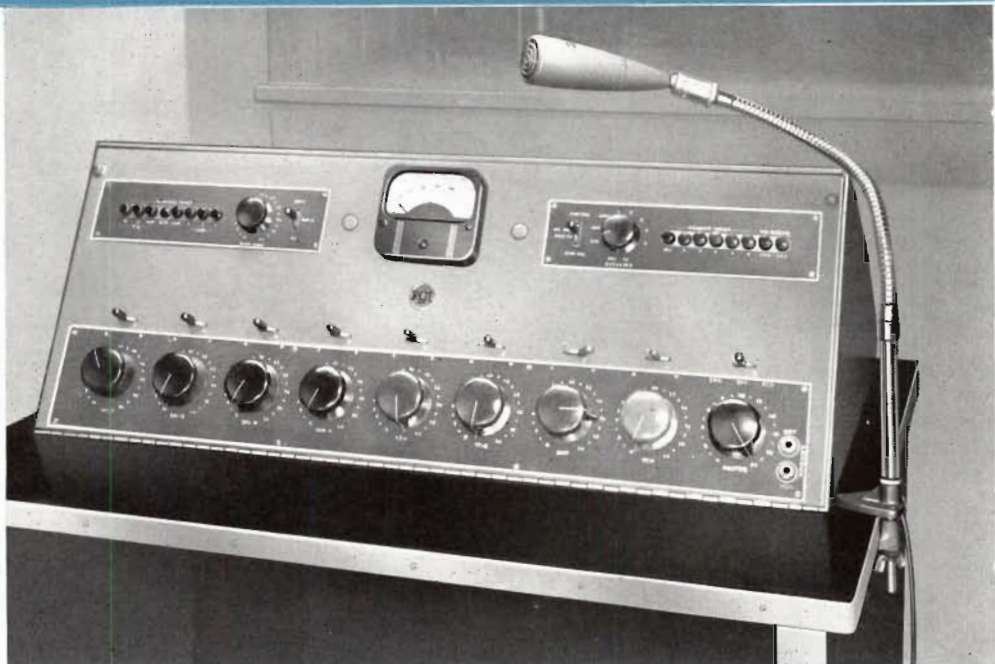

## USES

The MI-11745 and MI-11746 Flexible Microphone Stands are especially useful in locations where the microphone must be a permanent part of an installation yet must be adaptable to varying uses and be able to be pushed out of the way if necessary. These stands are particularly suitable for the BK-1A "Commentator" pressure microphone, but may be used with any of the smaller announce microphones such as the SK-35, SK-45, SK-46 and MI-12016-H.

Mounting Bracket, MI-11747, is designed for use with the flexible stands and may be easily clamped to the side of a console, desk, or other solid flat surface.

## DESCRIPTION

The Flexible Microphone Stands consist of a flexible gooseneck either 13" long (MI-11745) or 19" long (MI-11746) which is adjustable for individual use; and a bracket clamp (MI-11747) which has a 6" chrome stem and gray crackle-finish clamp. The gooseneck stands have a 5/8"-27 thread male fitting on one end and a 5/8"-27 thread female fitting on the other. They can be fitted directly to the SK-35 Type Microphones and the bracket clamp stem. For use with the BK-1A Microphone an MI-12055 Microphone Adaptor is required. Microphone Adaptor MI-6229 is required for mounting the MI-12016-H Aerodynamic Microphone.

## SPECIFICATIONS

### STANDS

Finish .....	Polished chrome
Mounting.....	5/8" 27-thread (male fitting on one end, female on other)
Weight:	
MI-11745 .....	1 lb.
MI-11746 .....	1 1/2 lbs.
Length:	
MI-11745 .....	13"
MI-11746 .....	19"

### BRACKET CLAMP

Finish:	
Base .....	Gray wrinkle
6" Stem .....	Polished chrome
Mounting:	
Base .....	5/8" 27-thread female
Stem .....	5/8" 27-thread male
Weight (Base and Stem).....	11 lbs.

### Stock Identification

13" Flexible Stand.....	MI-11745
19" Flexible Stand.....	MI-11746
Flexible Stand Bracket Clamp.....	MI-11747

### Accessories

Adaptor, 5/8"-27 Stand to 1/2" Mike.....	MI-12055
Adaptor, 5/8"-27 Stand to 1/8" Mike.....	MI-6229



# MICROPHONE FLOOR STANDS

TYPE 90-A, 90-AS, MI-4068-D, MI-6208, MI-4093-C

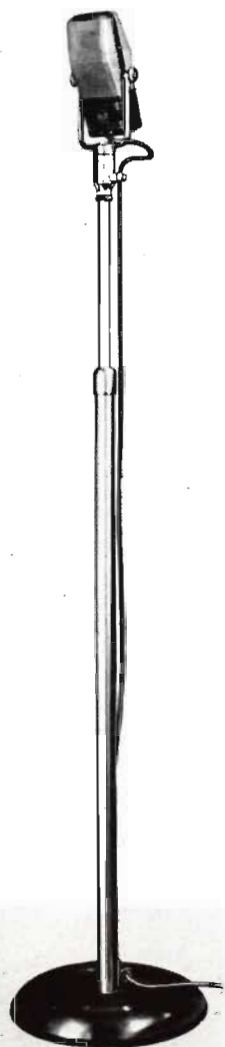

## FEATURES

- Hundreds giving excellent performance in leading broadcast studios
- Suitable for use with all RCA Microphones
- Large heavy base with equalizing projections assure sturdy support of microphone
- Simple non-slide, trouble-free clamping device
- Attractively finished in satin chrome

## USES

The Type 90-A Program Stand is used in broadcast studios where a stand is required which will be attractive in appearance and give stable support even to the heavier type of microphones. Use with Microphone Types 44-BX, 77-D, 77-DX, BK-1A, and BK-5A. The shorter 90-AS Stand is recommended for use with the BK-4B Microphone.

## DESCRIPTION

The 90-A Floor Stand is a sturdily constructed stand which will give stability to the heaviest microphones. The base is weighted and has equalizing projections which assure a firm position on an uneven floor. The column is equipped with a simple clamping device which permits height adjustments to be made easily and quietly without operating any release mechanism. The up and down operation is smooth and the locking operation positive. The patented clamp is mechanically simple and is ruggedly constructed to give years of service.

The stand as supplied may be used with any microphone having a  $\frac{1}{2}$ " pipe thread and by simply removing an adaptor fitting with any microphone having a  $\frac{5}{8}$ "—27 fixture thread.

The 90-A is finished in satin chrome to harmonize with RCA microphones. Cable guides are included to hold the microphone cord close to the stand at the base.

The Type 90-AS Stand is 12" shorter than the Type 90-A and is recommended for the BK-4B Microphone.

## SPECIFICATIONS

Height of Stand.....	Adjustable from 3'8" to 6'2"
Microphone Mounting.....	Standard $\frac{1}{2}$ " pipe thread or $\frac{5}{8}$ "—27 fixture thread
Diameter of Base.....	12 $\frac{1}{4}$ "
Weight (unpacked).....	33 lbs.
Finish .....	Satin Chrome
Stock Identification Type 90-A.....	MI-4090-A
Stock Identification Type 90-AS.....	MI-4098
Accessory Item—Cable Hook.....	MI-11099-A

## MICROPHONE STAND, MI-4068-D

### USES

The MI-4068-D Floor Stand is used in broadcast studios where some stability of support may be sacrificed for ease in moving from one spot to another. For use with the BK-1A, BK-5A, SK-45, 77-D, and 77-DX Microphones.

### DESCRIPTION

The column and telescoping tube are finished in polished chrome and the base in dark umber gray wrinkle to harmonize with RCA microphones. It has a smooth-operating clamping and release device.

The stand as supplied may be used with any microphone having a 5/8"-2 fixture thread. It is equipped with a heavy 12" base and is sturdily constructed.

### SPECIFICATIONS

Height of Stand.....	Adjustable from 34" to 62"
Microphone Mounting.....	5/8"-27 fixture thread
Diameter of Lower Tube.....	1"
Diameter of Base.....	12"
Weight (unpacked).....	14 lbs.
Finish:	
Base.....	Dark umber gray
Stand.....	Satin chrome
Stock Identification.....	MI-4068-D

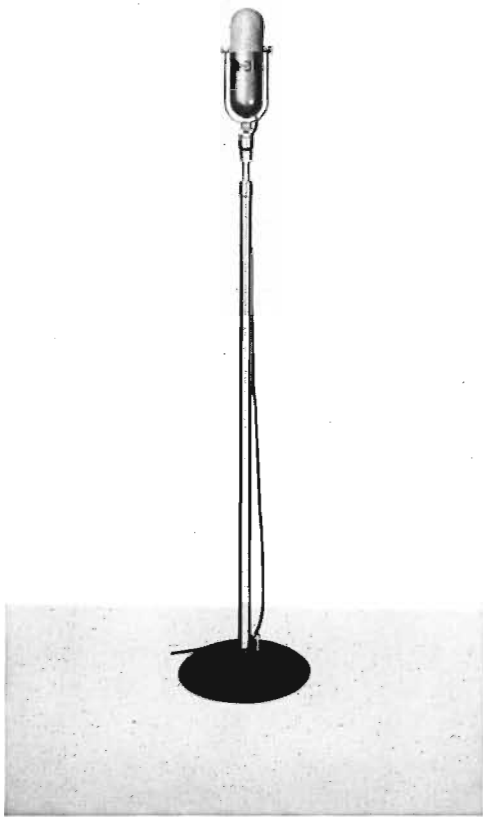

## CABLE HOOK, MI-11099-A

### USES

Can be quickly attached to or removed from the 90-A or any other 1 1/4" round tube stand. It provides a convenient method of holding the cable. It saves wear on the cable when it is not in use.

### DESCRIPTION

The Cable Hook is simple to install, and may be easily adjusted to the proper height. Merely tightening a smooth locking nut holds it in position.



### SPECIFICATIONS

Weight.....	15 oz.
Finish.....	Satin chrome
Hole Diameter.....	1 1/4"
Stock Identification.....	MI-11099-A

Bob Hope shown using the BK-4B Microphone which is mounted on the Type 90-AS Floor Stand.



## THREE-SECTION MICROPHONE STAND, MI-6208

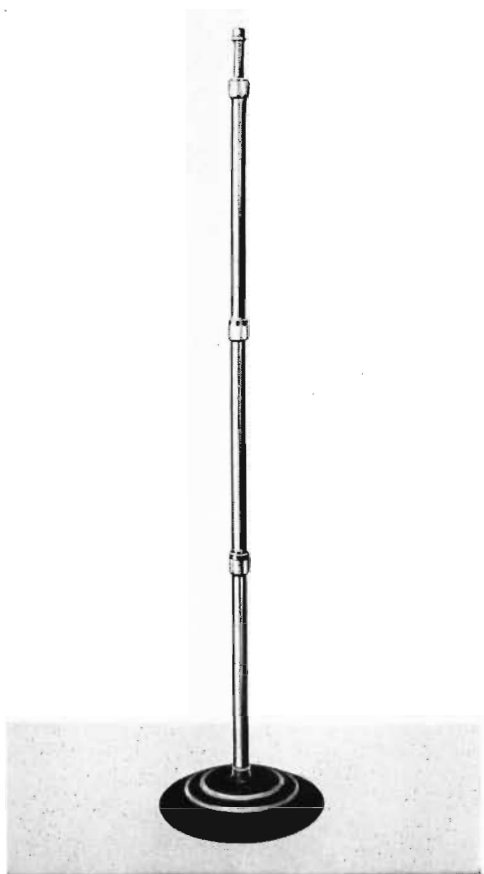

### FEATURES

- Utility stand for floor or banquet use
- Three sections for easy packaging or carrying
- Heavy ten-inch base
- Attractive appearance

### DESCRIPTION

The MI-6208 is a convenient and attractive stand for floor or banquet use. It is especially suitable for portable use since it may be taken apart into three sections for easy packing or carrying. The stand, which is in chrome, has a heavy 10" gray crackle base trimmed with satin-silver stripes. Use this stand with 77-D, 77-DX, 44-BX, BK-1A and BK-5A Microphones.

### SPECIFICATIONS

Height (for floor use—3 sections).....	Adjustable from 3' 11" to 5'
Height (for banquet use—2 sections).....	Adjustable from 1' 6" to 2' 7"
Microphone Mounting.....	5/8"—27 fixture thread
Finish:	
Stand .....	Polished chromium
Base.....	Umber gray wrinkle with satin-silver stripes
Weight (unpacked) .....	11 lbs.
Stock Identification .....	MI-6208

## PORTABLE MICROPHONE STAND, MI-4093-C

### DESCRIPTION

The 59-B is a folding, lightweight and rugged stand which is unexcelled for field use with the 77-D, 77-DX, BK-1A and BK-5A Microphones. It features a tripod base and a patented clutch arrangement which permits height adjustments to be quickly made without the operation of a mechanical release.

### SPECIFICATIONS

Height.....	Adjustable from 3' to 5'
Weight (unpacked) .....	3½ lbs.
Finish .....	Satin chrome
Microphone Mounting.....	1/2" pipe thread or 5/8"—27 fixture thread with adaptor removed
Stock Identification .....	MI-4093-C



# MICROPHONE BOOM AND STAND

## TYPE KS-3B



The Type KS-3B Boom Stand may be conveniently folded for storage or transportation as shown in inset.

### USES

The RCA Type KS-3B Microphone Boom and Stand affords proper microphone placement for: programs where the best microphone position cannot be reached with a conventional floor stand; piano pickup; orchestral pickup where the stand may be substituted for microphones suspended overhead; television programs where movement of the microphone is not required. This stand is recommended for use with the 77-D, 77-DX and BK-5A Microphones.

### DESCRIPTION

The KS-3B boom length and the counter balance overhang are easily adjustable, and the position selected is securely locked by wing-type handwheels. The microphone fitting is swivel mounted, thus eliminating the need of rotating the microphone when attaching it to the stand. Movement of the stand is quiet and easy because of the smooth-rolling

rubber-tired casters with which it is equipped. Once the stand is properly placed the casters can be locked by means of foot-operated locks. Cable supports are provided along the boom for the microphone cable.

For storage or for convenient transport the legs and the boom may be folded against the center column to make a relatively small package.

The KS-3B Boom Stand is finished in satin chrome and gray to harmonize with RCA microphones.

### FEATURES

- Sturdy construction, strong tubing and castings
- Large base with rubber-tired casters
- Easily adjusted over wide range of heights and boom lengths
- Positive locking adjustments
- Air cushion lowering brake, releases for easy lift
- Lightweight

### SPECIFICATIONS

Height of Stand.....	Adjustable from 5' 2" to 8' 8"
Horizontal Arm Adjustment (with overhang to rear).....	3' to 6'
Microphone Mounting.....	Standard 1/2" pipe thread 5/8"—27 fixture thread with adaptor removed
Weight (unpacked).....	.64 lbs.
Finish.....	Satin stainless steel and gray
Stock Identification .....	MI-11056

# MICROPHONE BOOM AND STAND

MI-11070

## FEATURES

- Suitable for both TV and AM—rotates "Mike" through 360° by convenient wheel
- Permits the operator to "spot" directional pattern of mike for best pickup
- Three sturdy telescopic aluminum sections provide "length" adjustments from 6 to 18 feet
- A shockproof rubber mount for microphone
- Mike cable enclosed in boom
- Vertical adjustment 4 to 8 feet
- Base mounted on rubber-tired casters



## USES

For broadcast AM and FM studio and Television applications the RCA MI-11070 Microphone Boom and Stand is used for: programs where the best microphone position cannot be reached with a conventional floor stand; piano pickup; orchestral pickup where the stand may be substituted for microphones suspended overhead; television programs of virtually all types. It is recommended for use with Type 77-D, 77-DX, and BK-5A Microphones.

## DESCRIPTION

The Microphone Boom Stand, MI-11070, telescopes from 6' 10" to 18' with remote control of microphone made possible at all positions by a rear handwheel which rotates 360 degrees. It is equipped with a self leveling, vibration damping mount. The microphone cable runs through the boom to avoid "snarls" and interference with the television scenes.

Perfect balance is maintained by an adjustable, 25 pound steel counterweight which slides on the boom and locks securely at any position. The counterweight is made of steel, plated satin chrome and the boom swivel is cast

aluminum with a bronze stand swivel. The stand swivel has a tension spring to keep the boom in position when balanced. The stand is a two-section telescoping super strut which combines rigidity and strength with minimum weight.

The vertical portion of the stand is constructed of telescopic steel tubing, and is adjustable in height from 4 feet to 8 feet. A Numo check and safety clamp are provided for the height adjustment. A spring shock absorber on the inner telescopic tube protects against shock if the height adjustment is carelessly loosened. The base is mounted on 4-inch rubber tired casters, and may be folded compactly for convenience in transportation or storage. A horizontal handle is provided at the top of the vertical section for convenience in dollying the stand.

## SPECIFICATIONS

Height of Stand.....	Adjustable from 4' to 8'
Horizontal Arm Adjustment.....	Telescopes 6' 10" to 18'
Microphone Mounting.....	Shockproof rubber mount with 1/2" pipe thread
Microphone Adjustment.....	Rear handwheel
Weight (approx.).....	70 lbs.
Finish.....	Satin, stainless steel and gray
Stock Identification .....	MI-11070

# MICROPHONE BOOM AND PERAMBULATOR

MI-26574

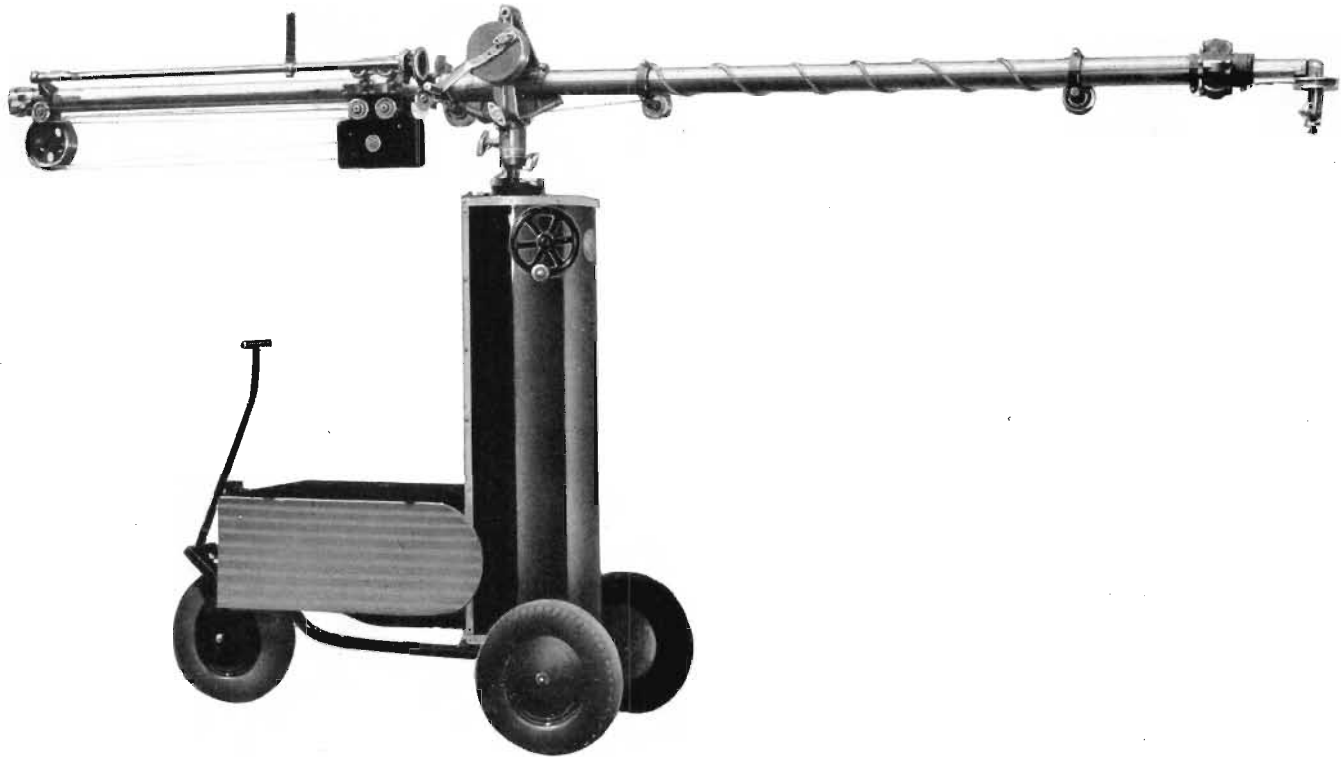

## FEATURES

- Boom and perambulator can be passed through narrow doorways
- Duraluminum tubing for boom assures rigidity and light weight
- "Gunning" device revolves directional microphones through 280°
- Radius of boom can be extended to 17 feet —retracted to 7 feet, 4 inches
- Boom fitted with adjustable counterbalance for different microphones
- Quiet in operation

## USE

The MI-26574 Microphone Boom and Perambulator is designed for use in broadcast or television studios. It enables the operator to quickly place the microphone with respect

to the sound source. He can closely follow the sound, or move from one source of sound to another easily and quietly. The boom accommodates such microphones as RCA Types 77-D, 77-DX, and BK-5A Microphones.



## DESCRIPTION

The perambulator is constructed of steel tubing with drop-rim type wheels and pneumatic tires. The steering wheel swivels 180° and can be clamped to hold a given radius. The tiller when pushed back operates a toggle brake on the steering wheel. It is also provided with steps which aid the operator in mounting the platform when it is elevated. Operated by a hand wheel, the elevating column raises the boom from a height of 6 feet, 5 inches to 9 feet, 5 inches. The operating platform raises with the boom. The wheel tread of the perambulator can be narrowed to 27 inches and the leaf portions of the table can be lowered to permit passing the perambulator through a 30-inch door.

A hand crank governs extension and retraction of the boom, and a hand rail controls elevation and horizontal traversal. As the boom is retracted, the microphone cable

is received on take-up sheaves. The movement of the telescoping member is counterbalanced by weights which can be adjusted to properly balance different microphones. Since many microphones are directional, the boom is fitted with a "microphone gunning" device which revolves the microphone through 280°.

## SPECIFICATIONS

### Dimensions:

Maximum Height (with boom pedestal elevated).....	9' 5"
Maximum Height (with pedestal lowered).....	6' 5"
Length of Boom:	
Extended .....	17'
Retracted .....	7' 4½"

### Weight:

Boom (with gunning device and counterweights).....	102 lbs.
Perambulator .....	421 lbs.

Stock Identification .....	MI-26574
Boom Only .....	MI-26574-1
Perambulator Only .....	MI-26574-2

The Microphone Boom and Perambulator (MI-26574) is particularly useful for large studios where greater mobility and manipulation is required.



# MICROPHONE ACCESSORIES



**MI-12058**  
Cord Connector



**MI-4620-B**  
Cord Connector



**MI-4630-B**  
Microphone Plug



**MI-11061**  
Cord Connector



**MI-11062**  
Microphone Plug

Type "P"

Type "XL"



**MI-11069**  
Receptacle



**MI-4624-A**  
Wall Receptacle

Type "UA"

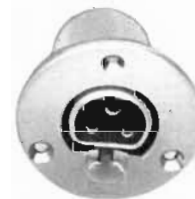

**MI-11063**  
Receptacle

## MICROPHONE PLUGS AND RECEPTACLES

RCA microphones are sold without plugs in order that the purchaser may use any type desired. Three series of Cannon plugs which meet requirements for reliability and ruggedness are stocked. These include the "UA" Ultimate series of plugs which have been designed as a result of RETMA recommendations, the "P" Type Connectors presently used in all RCA remote amplifiers, and the "XL" matched family of small 3-contact connectors.

The "UA" connectors are splash-proof and shock-proof, and have gold-plated contacts for low-loss and noise-free operation. Flat top construction provides positive polarization. All have thumb action latch-lock for quick insertion and firm engagement and a 1 3/4" rubber sleeve handle for firm easy grip.

The "P" connectors are desirable as panel receptacles and cable connectors for audio circuits. They accommodate wires up to No. 10, 15 ampere contact capacity and fea-

ture black phenolic insulation. The Cannon "XL" type plug, MI-12058, is available for use with the BK-4B microphone when it is desirable to have a quick means of disconnecting the microphone.

Description	Cannon Stock No.	RCA Stock Identification
Female Plug for Microphone Extension Cable (mates with UA-3-12).....	UA-3-11	MI-11061
Male Plug for Microphone Cable (mates with UA-3-11 and UA-3-13)....	UA-3-12	MI-11062
Flush Mounting Receptacle (mates with UA-3-12) .....	UA-3-13	MI-11063
Male Plug for Microphone Cords.....	P3-CG-12S	MI-4630-B
Wall Receptacle for Above Plug.....	P3-35	MI-4624-A
Note: The MI-4624-A Receptacle will fit in a standard a-c outlet box.		
Extension Cord—Female Connector.....	P3-CG-11S	MI-4620-B
Female Connectors—Extension Cord.....	XL-3-11	MI-12058
Male Connector for BK-4A.....		MI-11069

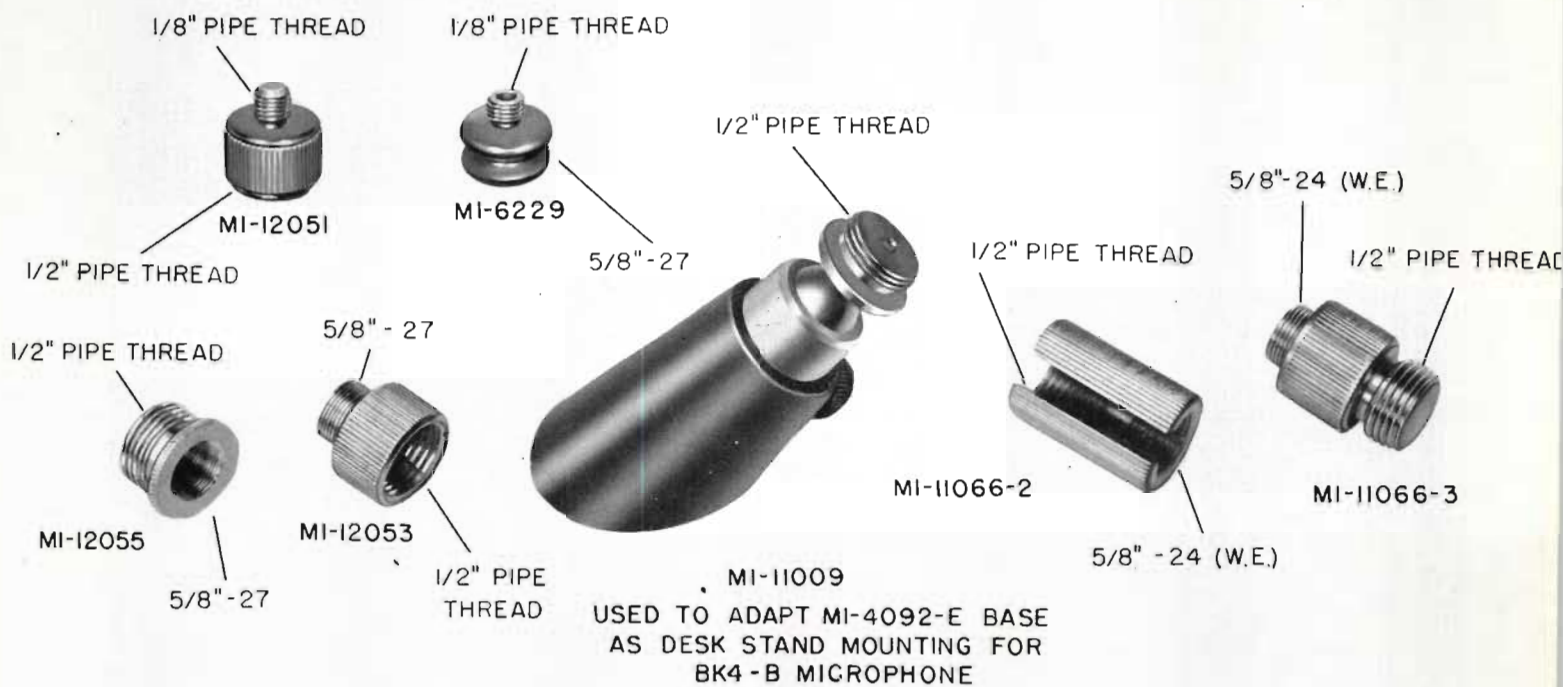

### MICROPHONE ADAPTORS

Here is a comprehensive stock of microphone adaptors suitable for microphones and stands used by broadcasters. The 1/2" standard pipe thread avails broadcasters of adaptors to suit any application.

Stand Thread	Microphone Thread	Stock Identification
1/2" pipe thread	1/8" pipe thread	MI-12051
1/2" pipe thread	5/8"-27	MI-12053
1/2" pipe thread	5/8"-24 (W.E.)	MI-11066-2
5/8"-24 (W.E.)	1/2" pipe thread	MI-11066-3
5/8"-27	1/8" pipe thread	MI-6229
5/8"-27	1/2" pipe thread	MI-12055
	1/2" pipe thread	MI-11009

### PUSHMIKE ADAPTOR, MI-6425

An adaptor with a built-in microphone switch of the D.P.D.T. long leaf anti-capacity type. The switch permits "push-to-talk" operation or locked-in "talk" position and may be used with any floor or table stand having 5/8"-27 fixture threads. The adaptor is an extremely light compact unit finished in chromium. It is 4 3/4" long, 1 3/16" in diameter and weight is 3/4 lbs. unpacked.

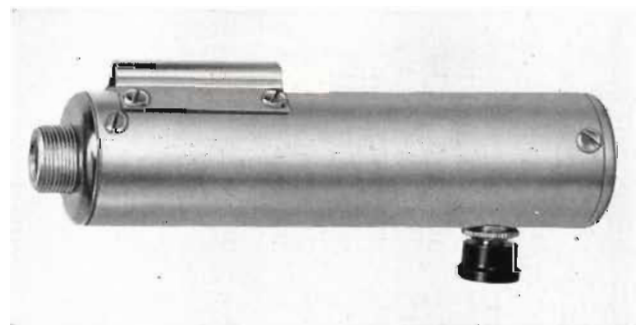

Fitting:  
 Bottom.....5/8"-27 fixture thread (female)  
 Top.....5/8"-27 fixture thread (female) with added 5/8"-27 thread, male nipple  
 Weight (unpackd).....3/4 lb.  
 Stock Identification .....MI-6425



Holder for Type BK-4B Microphone. Stock Identification ..... MI-11068

Microphone Holder, MI-11068, mounted on Type 90-A5 Floor Stand. Note how BK-4B Microphone may be easily removed for carry-around or interview use.

MI-11069 Adaptor and MI-12058 XL Type Connector used with the BK-4B Microphone to provide quick-disconnect feature.



## MICROPHONE CABLES

RCA microphone cables are of rugged construction and are jacketed with a neoprene compound to insure long life. They are especially designed for broadcast service either studio or remote.

### Cable MI-43-C

Use.....Cable for low impedance microphone circuits  
 Type.....Three conductor, twisted  
 Conductors.....Tinned cadmium bronze, stranded, equivalent to #20 AWG  
 Insulation.....Special rubber compound  
 Shield.....Tinned copper. Complete coverage without loss in flexibility  
 Outer covering.....Brown neoprene compound  
 Overall Diameter.....0.300 maximum  
 Stock Identification (specify length in feet).....MI-43-C

### Cable MI-13307

Type.....Two conductor, twisted  
 Conductors.....Stranded, equivalent to #16 AWG  
 Insulation.....Special rubber compound  
 Shield.....Tinned copper. Complete coverage without loss in flexibility  
 Outer Covering.....Black neoprene compound  
 Overall Diameter.....0.300 maximum  
 Stock Identification (specify length in feet).....MI-13307

### Cable MI-13322

Type.....Two conductor, twisted  
 Conductors.....Stranded cadmium bronze, equivalent to #24 AWG  
 Insulation.....Special rubber compound  
 Shield.....Conducting cotton with 60% coverage of tinned copper.  
 (Complete coverage with greater flexibility)  
 Outer Covering.....Brown neoprene compound  
 Overall Diameter.....0.215 maximum  
 Stock Identification .....MI-13322

## INTERCONNECTING CABLES

The majority of cables required to interconnect the various components of a broadcast audio assembly are of a special type and cannot be readily purchased from the local

electrical dealer. In order to avoid unnecessary installation delays, RCA carries in stock four of the generally used special type cables.

### Solid Conductor Cable, MI-33

Use.....General purpose Audio Transmission Line  
 Type.....Shielded twisted pair, each conductor solid #20 tinned copper wire, with Vinyl resin insulation covered with lacquered rayon braid.  
 Shield.....Tinned copper braid  
 Overall Diameter.....Approximately .170"  
 Color Code.....Red and black  
 Rating.....300 volts  
 Stock Identification (stocked in 1000 ft. rolls).....MI-33

### Stranded Conductor Cable, MI-34

Use.....Recommended for audio circuits where extra flexibility is required  
 Type.....Shielded, twisted pair, stranded, composed of 7—.010 tinned copper conductors equivalent to #22 AWG  
 Insulation.....Vinyl resin insulated with lacquered rayon braid  
 Shield.....Tinned copper braid  
 Overall Diameter.....Approximately .166"  
 Color Code.....Red and black  
 Rating.....300 volts  
 Stock Identification (stocked in 1000 ft. rolls).....MI-34

### Stranded Conductor Cable, MI-35

Use.....Especially recommended for 110 volt supply and filament circuits  
 Type.....Shielded, twisted pair, stranded, composed of 16—.010 tinned copper conductors equivalent to #18 AWG  
 Insulation.....Vinyl resin insulated with lacquered rayon braid  
 Shield.....Tinned copper braid  
 Overall Diameter.....Approximately .236"  
 Color Code.....Red and black  
 Rating.....300 volts  
 Stock Identification (stocked in 1000 ft. rolls).....MI-35

### Stranded Conductor Cable, MI-13306

Use.....General purpose Audio Transmission Line  
 Type.....Black Glazed Cotton covered shielded twisted pair, each conductor #22 AWG Stranded 71010, with Vinyl resin insulation covered with lacquered rayon braid.  
 Shield.....Tinned copper braid  
 Overall Diameter.....Approximately .200"  
 Color Code.....Red and black  
 Rating.....300 volts  
 Stock Identification (stocked in 1000 ft. rolls).....MI-13306

## CABLE LACING CORD

Lacing cord is available for general cable lacing and dressing uses. Cord is of strong material such as linen and hemp and thoroughly impregnated with a beeswax and paraffin mixture. Supplied in one pound spools as shown below.

Stock Identification	Type	Plys	Yds/lb	Average Break Strength
MI-11719-A	Na. 6 med.	4	580 ±35	30 lbs.



# STUDIO CONSOLETTA

TYPE BC-2B

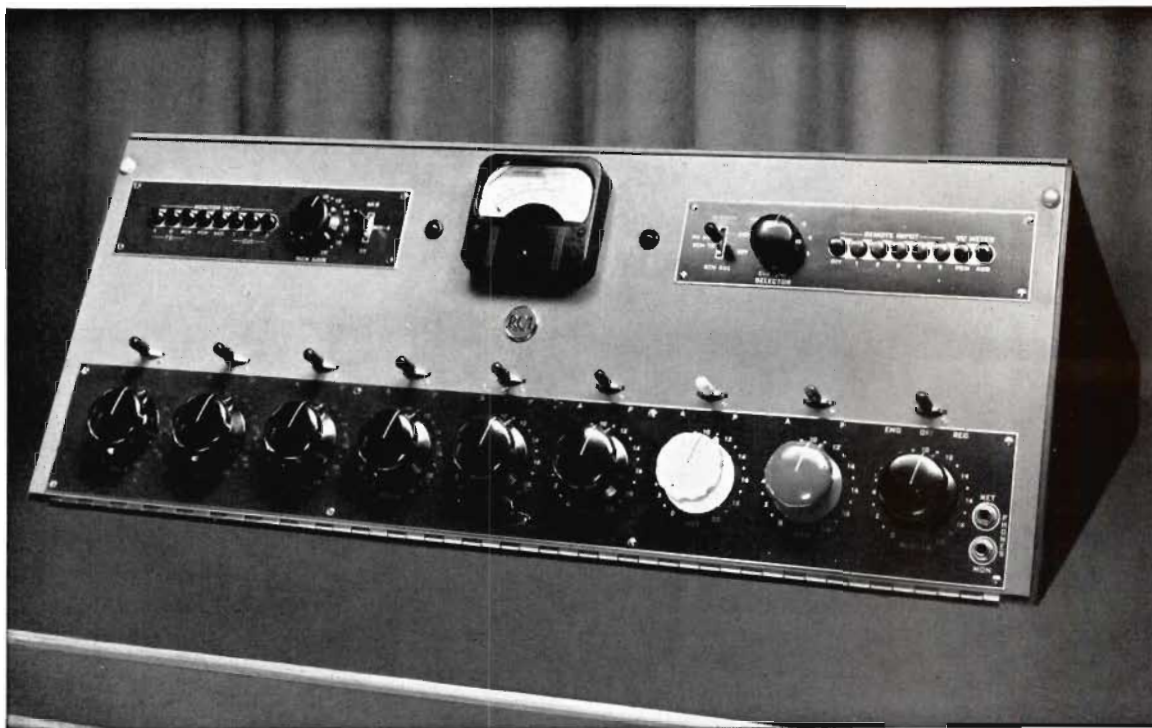

## FEATURES

- Complete high-fidelity speech input system for two studios, announce booth, two turntables, five remotes, and network
- Eight mixer positions—four preamps, two more can be added
- "Color-coded" controls quickly identify and tie related functions together
- Provides Intercom facilities between control and remote location
- Reliable leaf-type, cam-operated, interlocking pushbutton switches assure long life and positive action
- Compact amplifiers use low-noise, long-life, miniature tubes
- Turntable mixers with "built-in" cuing switches
- Override switch provided

## USES

Possessing great flexibility and featuring simplified operation, the BC-2B Consolette provides a high-fidelity speech input system for AM, FM and TV broadcast stations. This design incorporates eight mixer positions and provides all the amplifying control and monitoring facilities needed to accommodate two studios, announce booth microphone, control room microphone, two transcription turntables, five remote lines and three cue circuits.

The eight mixer positions which are provided are assigned so as to offer the greatest flexibility and operating ease. The first four are high level microphone channels with provisions for switching two additional microphones into the fourth channel. Positions five and six are assigned to turntables. The seventh mixer is used for network, and the eighth for remotes. Five line inputs to the remote mixer are selected by pushbutton switches. "Color-coded" knobs are used to quickly identify and tie related functions together, thus reducing operating errors and adding to the pleasing appearance. Space and wiring are included for an additional twin preamplifier in the turntable circuits.

## DESCRIPTION

The BC-2B is designed for operating convenience and ease of servicing, and offers a new concept of accessibility. The front panel tilts forward for easy access to all contacts, switches and gain controls. A removable top panel makes it possible to tilt the amplifier chassis back for amplifier maintenance. In addition, each amplifier is individually removable from the chassis.

Eight mixer positions are provided: The first four are high level microphone channels with provisions for switching two additional microphones into the fourth channel. Positions five and six are assigned to turntables. Space and wiring are included in the consolette for an additional twin preamplifier in the turntable circuits. The seventh mixer is used for network, and the eighth for remotes. Push-button switches select five line inputs to the remote mixer. Colored knobs and switches tie related functions together.

High quality components are used throughout the BC-2B. Interlocked push-button switches are cam operated leaf type, assuring years of trouble-free operation. Improved fast relay circuits for speakers reduce the possibility of key clicks and audio feedback.

The amplifiers are of a new, compact design which utilize low noise miniature tubes. The amplifier chassis are supported by rubber cushions to prevent transmission of vibration from the mounting frame to the amplifier tubes. The

mounting frame is pivoted to provide easy access to the wiring for service.

The preamplifiers have a gain of 40 db, two identical amplifiers are combined on a chassis. The program amplifier has a gain of 92 db and a maximum output level of 22 dbm to 600-ohm line after a 6 db pad. The monitor amplifier has a gain of 104 db which is sufficient to drive the monitor speakers directly from a microphone. The monitor amplifier may also be used in emergencies as a line amplifier if the program amplifier should fail.

The frequency response from any input to the line output is within  $\pm 1.5$  db from 30 to 15,000 cps. The total rms harmonic distortion is less than .5% from 100 to 15,000 cps at a line output level of 18 dbm. Pin jacks are provided in the cathode circuit of each amplifier stage for checking tube current.

A standardized illuminated volume indicator meter is calibrated in VU's and is equipped with a light dimmer for use in TV control rooms. Monitoring and network headset jacks are supplied and headphones may be connected to the output of the program channel, remote line push-keys, or the incoming network by means of a three position lever switch. Talkback facilities are included and permit talking back to either of the two studios or remote lines. An "Override-Remote" cue switch is provided which permits the remote operator to call in on any of the remote lines and over-ride the program on the control room speaker.

The power supply is a separate unit contained in a cabinet which may be wall or rack mounted (by means of MI-11650 Rack Mounting Kit). It consists of two independent circuits; one to supply power to the amplifiers, the other to the relays. The components, such as transformer, rectifier and filters, are mounted on a hinged chassis to provide access for installation and service. The total power input required is only 150 watts, 50 to 60 cps a-c at 100 to 130 volts. One MI-11313 Power Supply is required for the operation of the BC-2B Consolette. A second Power Supply may be used as an alternate power source, if the MI-11724 Transfer Switch Panel is installed.

Amplifier chassis frame swings up for servicing.

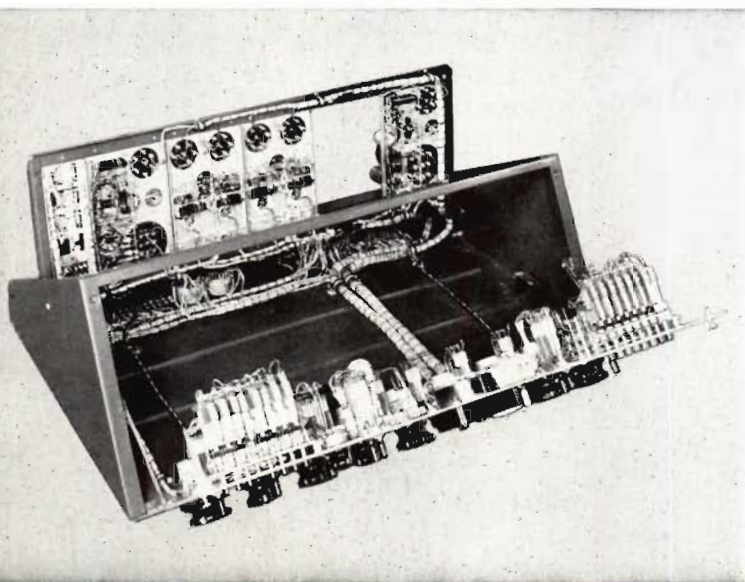

**SPECIFICATIONS**

Source Impedance:

Microphones.....30 or 150 ohms

Remote Lines.....150 or 600 ohms

Turntables.....150 ohms

Monitor Cue.....20,000 ohms

Load Impedance:

Line.....600 ohms

Speaker (total of four speakers).....Each 15 ohms

Headphone Output.....600 ohms

Output Level:

Line (distortion less than 0.5%  
50 to 15,000 cycles).....+18 dbm after a 6 db pad

Speaker (distortion less than 2%, 50 to 15,000 cycles).....8 watts

Gain (maximum microphone to line output).....108 db

Frequency Response.....±1.5 db 30 to 15,000 kc

Signal to Noise Ratio, Microphone to Program Line  
(68 db gain, +18 dbm output).....68 db

Power Input (105/125 volts, 50/60 cycles).....150 watts

Tube Complement:

Complete Tube Complement for Console (Kit MI-11297):  
3-6V6GT, 1-12AX7, 6-12AY7, 1-5879

Power Supply (Tube Kit MI-11294).....1-5R4GY

Dual Preamp (Tube Kit MI-11475).....2-12AY7 (selected)

Dimensions:

Console.....Length 33", Height 11¼" Depth 21¼"

Power Supply.....Length 14½", Height 10¾", Depth 8½"

Net Weight.....Console 114 lbs., Power Supply 32 lbs.

Finish:

Console.....Two-tone umber gray

Power Supply.....Dark umber gray

**Equipment Supplied**

BC-2B Console complete with 2 dual preamplifiers  
less tubes .....MI-11632

Power Supply .....MI-11313

**Accessories**

Tube Kit for BC-2B Console.....MI-11297

Tube Kit for MI-11241 Dual Preamp.....MI-11475

Tube Kit for MI-11313 Power Supply.....MI-11294

Dual Preamp\* .....MI-11241

Speaker Relay Kit (for announce booth speakers).....MI-11722

Studio Light Relay.....MI-11702-A

Studio Warning Lights ("On-Air" and "Audition").....MI-11706-1, 3

Console Signal Light Kit.....MI-11714-A

Transfer Switch Panel for Spare Power Supply.....MI-11724

Rack Mounting Kit for Power Supply.....MI-11650

Relay Mounting Strip (for two MI-11722).....MI-11733

\* Space is provided in the console for a third dual preamp.

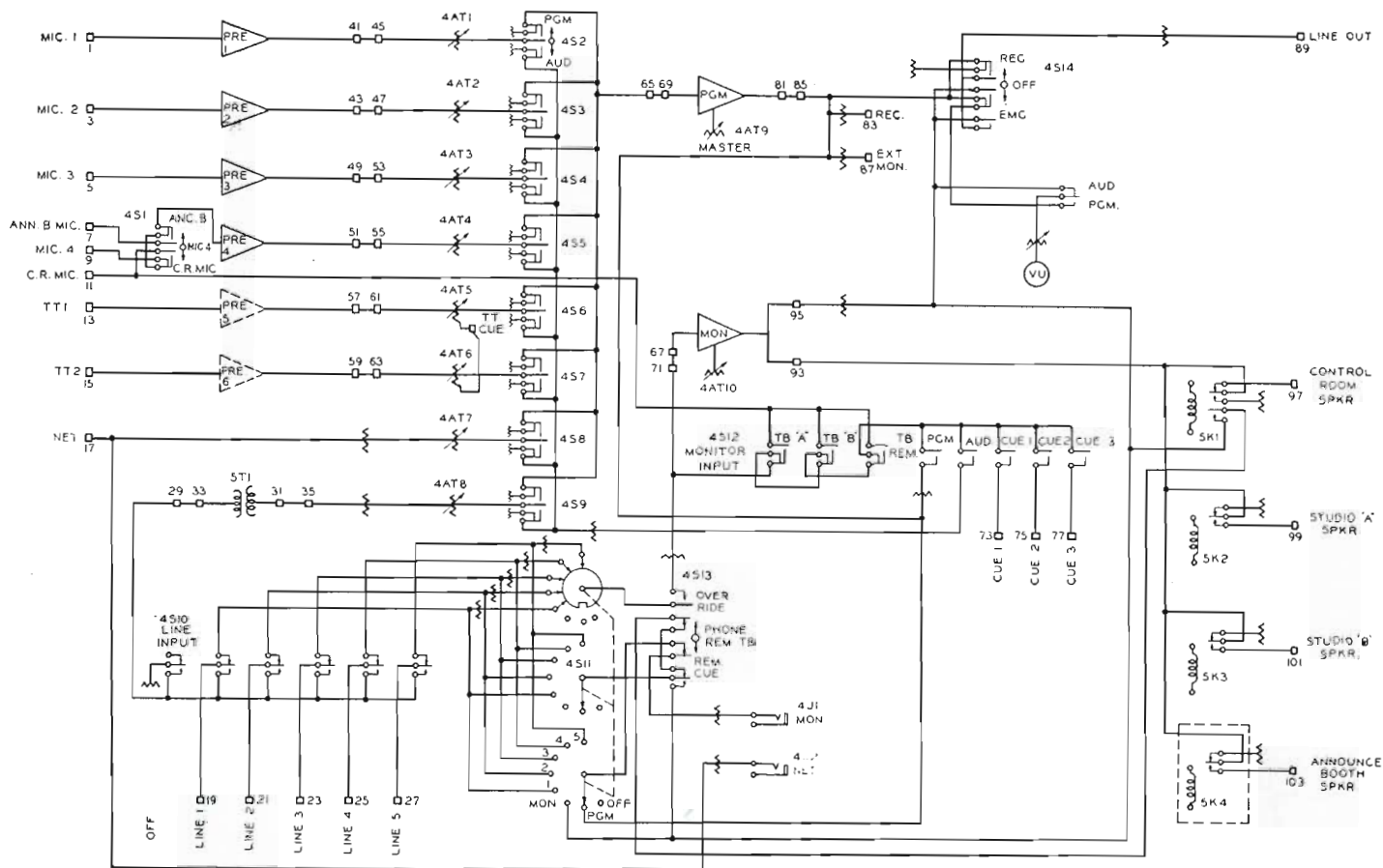

Simplified Block Diagram of BC-2B Console



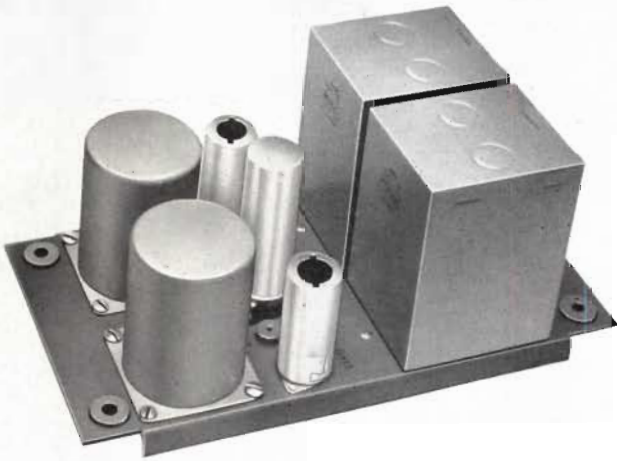

MI-11241 Dual Preamplifier. Can be added to BC-2B Consolette for Turntable Preamplifier.



MI-11313 Power Supply. Required with BC-2B Consolette.



MI-11724 Power Changeover Switch Panel. For use when two MI-11313 Power Supplies are used (one emergency).

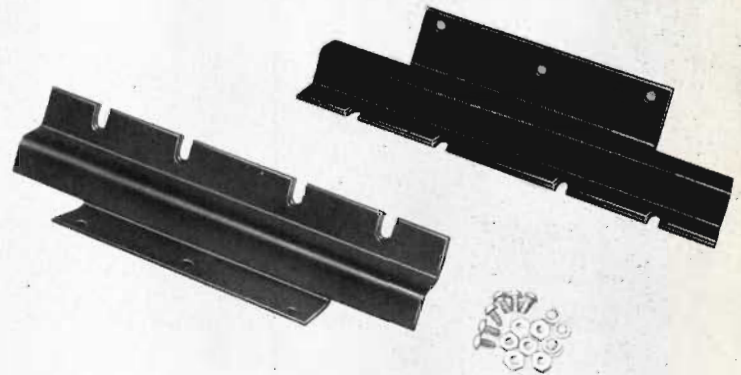

MI-11650 Rack-mounting Kit. For mounting MI-11313 Power Supply in cabinet rack.



MI-11714-A Signal Light Kit (on-air and preset).

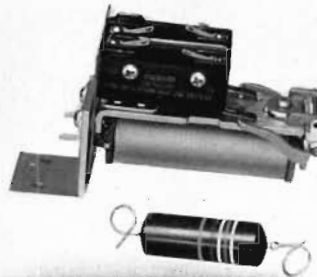

MI-11702-A Studio Light Relay (operates warning signs).

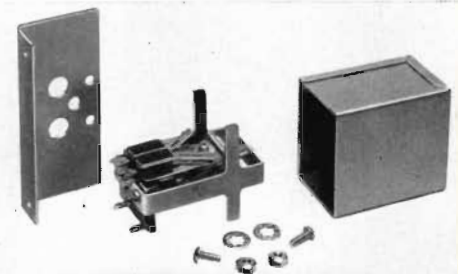

MI-11722 Speaker Relay Kit. Used for announce booth speaker cutoff.

# AUXILIARY MIXER CONSOLE

## TYPE BCM-1A

### FEATURES

- Triples mike inputs of BC-2B Consolette
- Matches BC-2B in styling and shape
- Uses same high quality amplifiers as BC-2B
- Allows "block-building" as required for added inputs

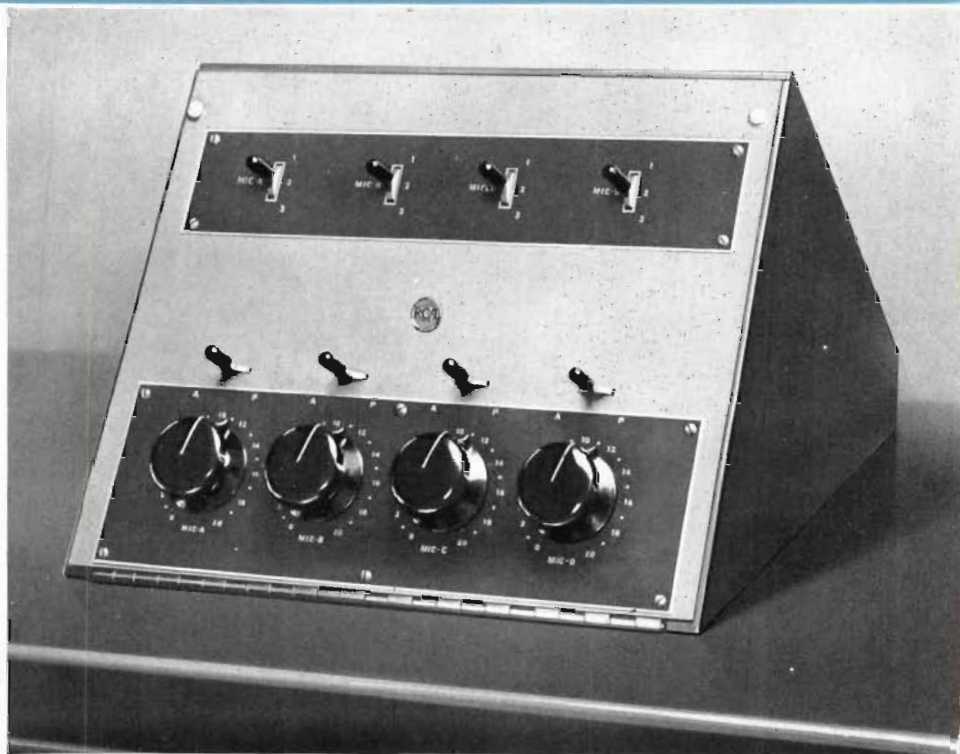

### USES

The BCM-1A Auxiliary Mixer was designed to fulfill the needs of Television and large AM studios which employ a larger number of microphones than the standard studio consolette can handle. The shape and styling of the BCM-1A match that of the BC-2B Studio Consolette and permit "side-by-side" desk-top operation with the BC-2B. The total overall length of the two units mounted in this fashion is only 49¾ inches.

### DESCRIPTION

The BCM-1A has four high level microphone mixers which together with the four microphone mixers of the BC-2B Consolette permit simultaneous use of eight microphones.

Four 3-position switches in the preamplifier input circuits permit a selection from twelve microphones which may be located in three different staging areas of the studio. The program and audition mixer buses may be connected directly to the program and audition mixer buses of the consolette. The mixer switches are interlocked with the speaker and warning light relay circuits of the consolette.

Two MI-11241 Dual Preamplifiers, the same as are used in the consolette, are mounted on a pivoted frame within the mixer turret. The same features of convenient access to all components for service are found in the BCM-1A or in the BC-2B Consolette. Power for the BCM-1A Auxiliary Mixer is furnished by one BX-1E Preamplifier Power Supply.

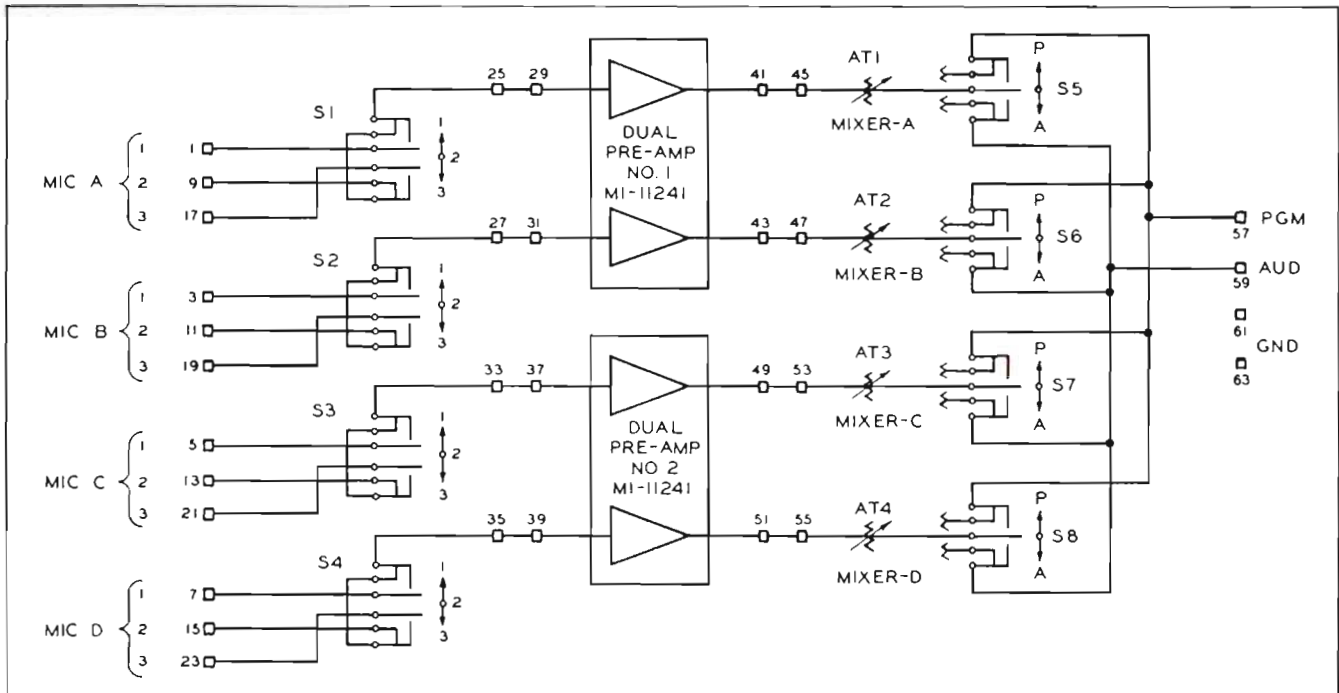

Block Diagram of Mixer Type BCM-1A

**SPECIFICATIONS**

- Amplifiers.....Two MI-11241 Dual Preamplifiers
- Audio Inputs.....Twelve microphone inputs (four may be used simultaneously)
- Source Impedance.....150/30 ohms
- Audio Outputs.....Program mixer bus (balanced) and audition mixer bus (balanced)
- Tube Complement.....4 selected 12AY7, not included
- Height, 11½"—depth, 21½"—length, 16¾"
- Slope of front panel 60°, top 30°
- Net Weight.....56 lbs. approximately
- Mounting.....Flat top desk
- Finish.....Turret and cover, dark umber gray, panel light umber gray
- Stock Identification—complete with two MI-11241 Dual Preamplifiers wired in place.....MI-11634

**Electrical Performance with BC-2B**

When the BCM-1A Auxiliary Mixer is directly connected to BC-2B Console Mixer Bus the performance is same as that shown for the BC-2B.

**Power Requirements:**

- Plate.....280 v., 16 ma, d-c
- Heater.....6.3 v., 1.2 amp, a-c

Control Circuits.....Eight connections to BC-2B Console required for interlock with speaker and signal light relay circuit. No power is required.

**Accessories**

- Tube Kit .....MI-11476
- Power Supply Required.....One Preamplifier Power Supply, MI-11305-D
- Power Supply Tube Kit.....MI-11262

View of the BCM-1A Auxiliary Mixer Console mounted alongside the BC-2B Studio Console. Additional microphone inputs and mixers are thus provided. Note that panel slope and styling are matched for best appearance.

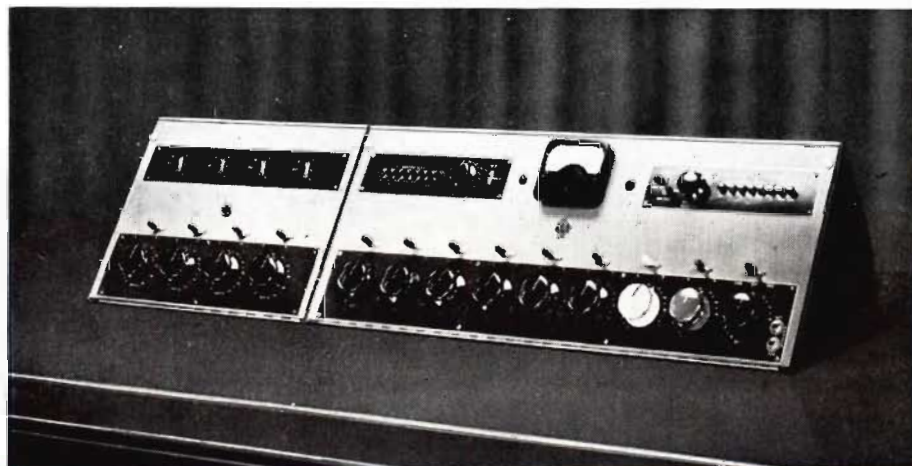

# AUDIO CONSOLE

## TYPE BC-4A

### FEATURES

- Easily expanded for dual-channel broadcast use
- Single BC-4A controls nine inputs—four simultaneously
- Paired BC-4A's double facilities—provide dual-channel operation
- Entirely self-contained, completely wired unit—no separate desk required
- Program and audition facilities
- Talkback or program cue to remote lines
- Three preamplifiers—all amplifiers RCA broadcast "plug-in" type
- High degree of accessibility



### USES

The exclusive feature of "add-a-unit" audio control incorporated in the BC-4A console permits "block building" as desired, without obsolescence to existing control equipment. The BC-4A is suitable for use either in combined studio/transmitter, or remote studio installations.

A single BC-4A provides adequate control and switching facilities for accommodating one studio, control booth, two turntables, network, remotes and tape recorder. Addition of a second BC-4A doubles facilities and permits complete dual-channel operation. The BC-4A Audio Console which combines a complete control console and an operating desk into a single unit, is ideally suited for "twin" or

side-by-side installations. For such applications, use of cover assembly and center turret filler panel (ES-11980) presents a neat, business-like appearance, and provides the necessary front panel space for mounting auxiliary monitoring, metering or switching controls. The BC-4A may also be used by Television Stations to provide audio sub-control, or to permit expansion of existing facilities.

### DESCRIPTION

The BC-4A Audio Console is a low-cost high quality Broadcast Audio Control equipment mounted in a smartly styled operating desk. The entire console and desk type housing are of all-metal construction finished in two-tone umber

gray, except for the convenient desk top which is supplied in a black, hard-surface composition.

A hinged front panel and removable cover provide complete access to turret-top components, such as the key-selector switches, controls, mixers, terminal blocks and wiring.

The VU meter and all switches and mixer controls essential to everyday programming are front-panel mounted. Extremely flexible in operation, the BC-4A handles nine separate inputs, with provisions for simultaneous mixing of four inputs. There is provision for feeding program cue or talkback to the remote lines. Headphone jacks are provided for network and remote line monitoring. Separate volume controls are provided for control room and studio speakers. Cue positions are incorporated on turntable mixers, and terminals are available for connecting a separate cueing amplifier. Separate audition and program channels are provided for maximum flexibility, and the monitoring amplifier may be switched from the turntable cue position, program line, or audition bus. All inputs are terminated when the switches are in the "off" position.

The BC-4A, which is a completely wired unit, has its amplifiers and power supplies mounted in the console pedestal underneath the switching unit. Snap-on panels (front, rear and sides) provide access to this area of the BC-4A. Six RCA plug-in broadcast amplifiers and their associated power supplies are mounted on a convenient shelf assembly in the lower unit. Three preamplifiers are utilized in the basic design and provision is made for the addition of external line equalizers. The preamplifiers plus a booster amplifier and an output amplifier utilize an



The BC-4A hinged front panel and removable back cover provide complete access to all components and wiring.

RCA BX-1E plug-in unit as a common power supply. In addition, a monitor amplifier and its own power supply are mounted in the lower section.

Since the BC-4A Audio Central is designed, built and wired to operate specifically as a complete unit, the Console Pedestal and Switching Units are not available as separate stock items. Amplifiers and power supplies are shipped separately—less tubes. A complete kit of tubes should be ordered separately as MI-11478.

A Cover Assembly and center turret filler panel are available (ES-11980) for twin BC-4A operation (see photo). It permits a unified installation and provides additional front panel space for auxiliary controls, as desired.

Closeup of the front panel of the BC-4A Audio Central. Mixers, VU meter, switches and all controls required during regular operation are front-panel mounted.



SPECIFICATIONS

Source Impedance:  
 Microphones .....150 ohms  
 Turntables .....150 ohms  
 Remote Lines .....150/600 ohms

Load Impedance.....600 ohms, output

Output Level.....+12 dbm (after 6 db pad)\*

Frequency Response.....±1.5 db, 30-15,000 cycles

Distortion to Line.....30 to 15,000 cycles, less than 1.5%  
 50 to 15,000 cycles, less than 1.0%

Noise Level.....-65 db

Power Input.....105/115/125 volts, 50/60 cycles, 150 watts  
 (BC-4A Performance fulfills all FCC and RETMA Specifications)

Dimensions, approximate:  
 Height .....39"  
 Top .....25" x 25" x 1"  
 Pedestal.....27" high, x 24" wide x 16" deep

Finish .....Two-tone umber gray

Approximate Shipping Weights:  
 BC-4A Switching and Control Turret plus Wired Pedestal.....160 lbs.  
 Six Amplifiers and Power Supplies.....65 lbs.

Stock Identification .....ES-11635  
 Consists of BC-4A complete with Switching and Control Turret, Console Pedestal, three preamplifiers, booster amplifier, output amplifier, monitor amplifier and associated power supplies. Furnished wired complete. Amplifiers and power supplies shipped separately (less tubes).

Accessories

Tube Kit for BC-4A consisting of 5-1620's, 7-6J7's, 1-6V6, and 2-5Y3's.....MI-11478

Cover Assembly and Center Turret Panel with necessary hardware—for twin BC-4A operation.....ES-11980

\* For those applications where output levels up to 30 dbm are required, an MI-11233A amplifier may be used to replace the MI-11231A line amplifier supplied with the basic equipment.

SIMPLIFIED BLOCK DIAGRAM — BC-4A

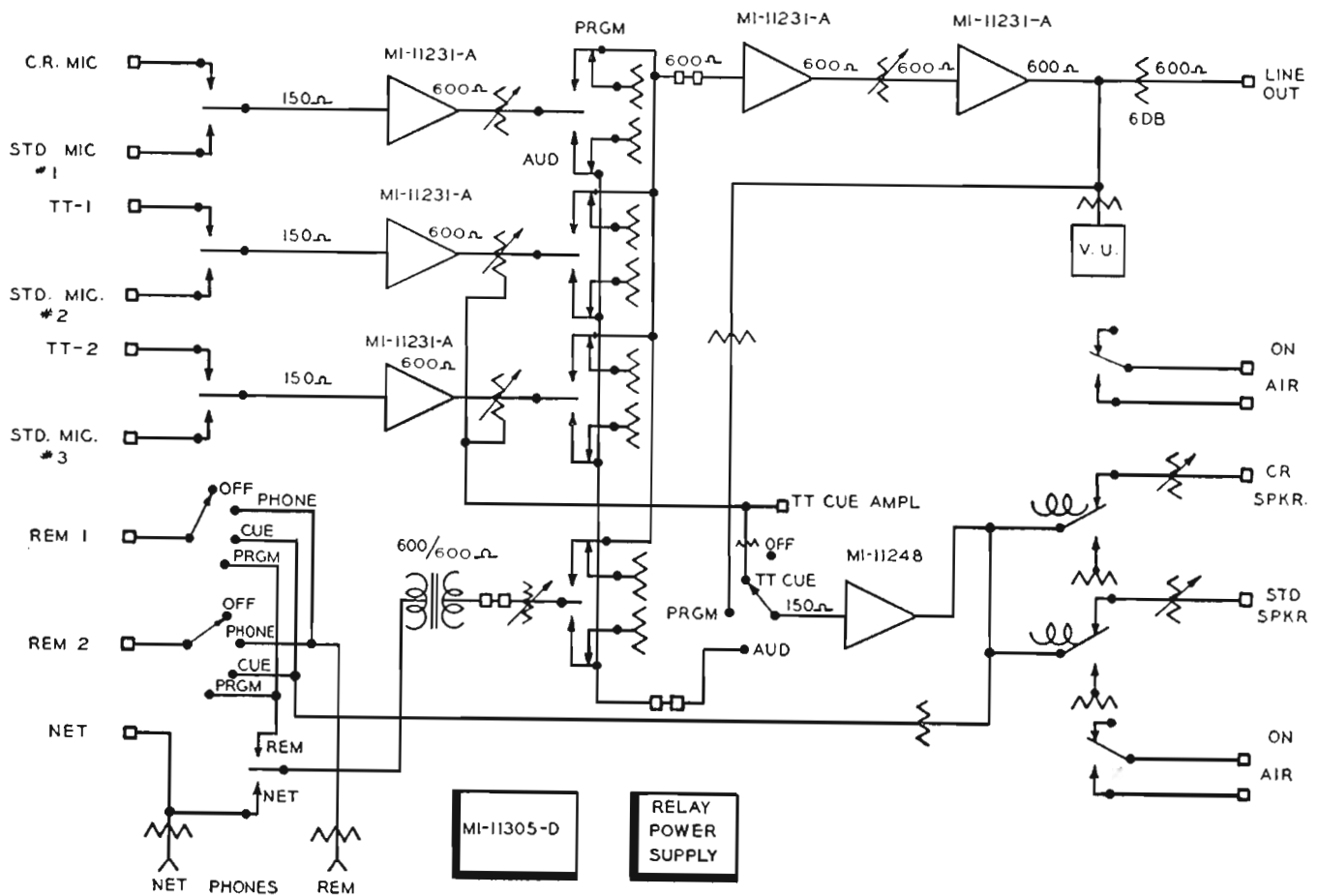

# MASTER SWITCHING CONSOLETTA

TYPE BCS-11A

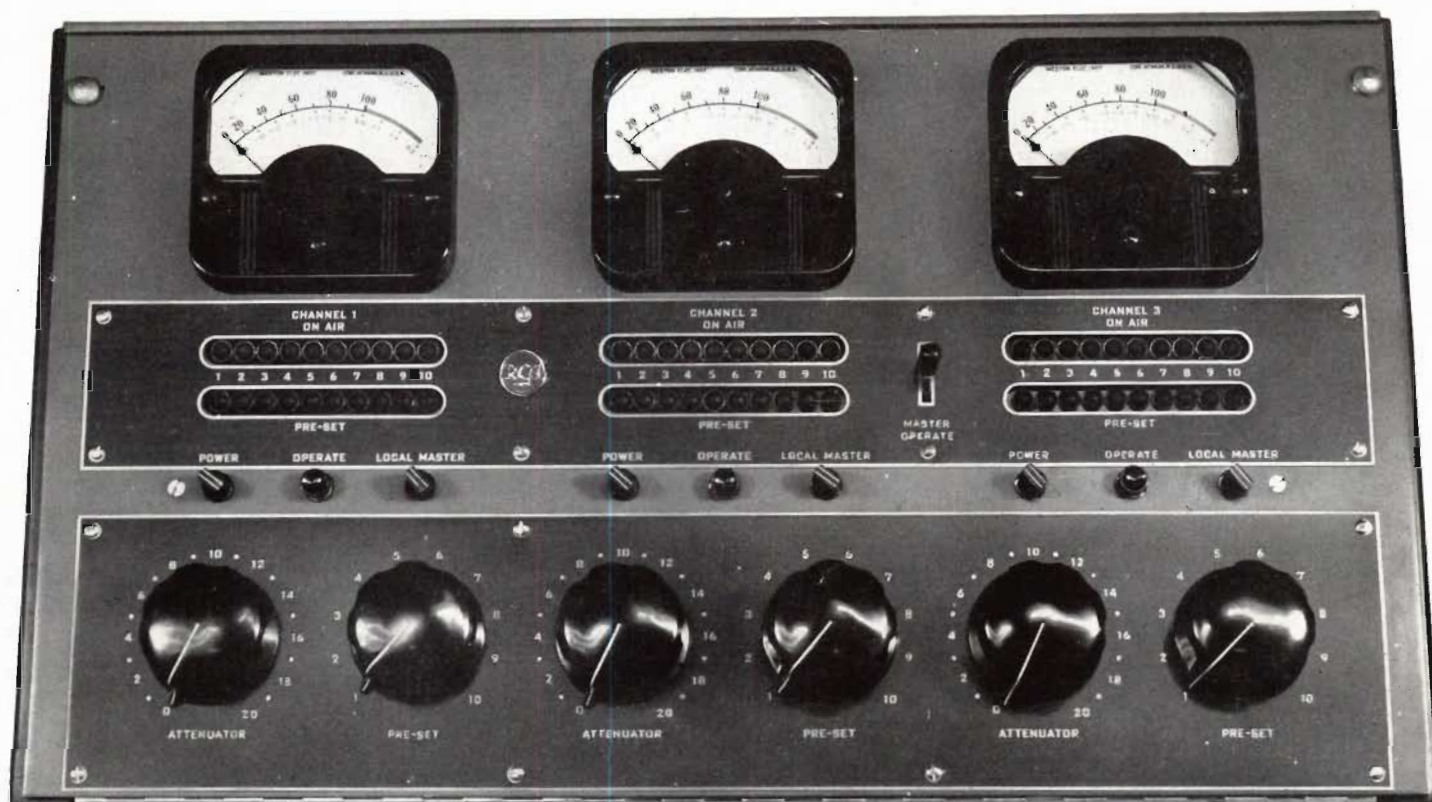

## FEATURES

- Provides complete pre-set master control of ten program sources to three outgoing lines
- Single, compact unit with removable top panel and hinged front panel for easy access to all components
- Enables economical desk-top installation and utilizes existing studio equipment
- Indicator Lamps show the preset and "on-air" input channels for each output channel
- VU Meters—are provided for each of the three channels and also serve as "active channel" indicators
- Combines many basic functions found in custom master control equipment
- Matches BC-2B Consolette in shape and styling
- Ideal for "side-by-side" operation with BC-2B Studio Consolette
- Power Switches—one for each channel to control relay power without disturbing the switching arrangement
- Master Operate Key—activates all outgoing channels simultaneously

**USES**

The BCS-11A Master Switching Console has been developed to meet the demands of many broadcast stations requiring master switching facilities for more than one channel. It may be used for the pre-set master switching of as many as ten program sources (inputs from studios, network, recording rooms, consolette outputs, remotes, etc.) to three outgoing lines.

The BCS-11A is styled to match the BC-2B Studio Console in shape and appearance, and may be installed for "side-by-side" operation. As used in these combinations, the BCS-11A makes possible a convenient, central

master studio control, utilizes existing studio consolettes, and permits economical desk-top installation.

Three groups of indicator pilots, (one group for each channel) show the "pre-set" studio and the "on-air" program source for the particular channel in use. Switching facilities for each outgoing channel provide for "pre-set" and "on-air" indicator lamps at the remote program source location to show its switching status. Provision is made for using the "line-key" at the program source to interlock the "on-air" indicator lamps at both the switching location and the program source.

Line selector switching is accomplished with special telephone type stepping relays. Solid silver contacts are used

Hinged front panel on BCS-11A Master Switching Console provides complete accessibility of components for easy maintenance.

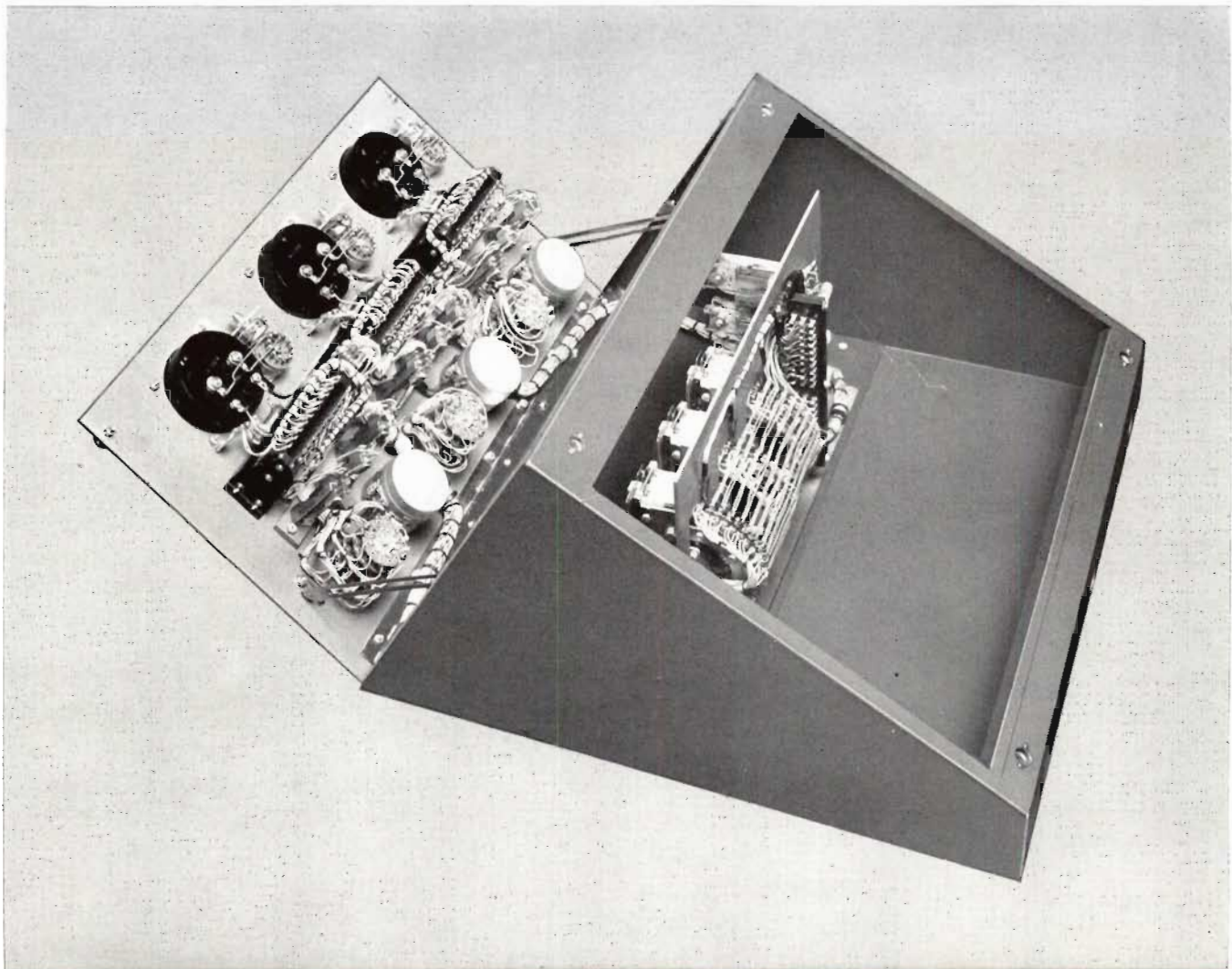



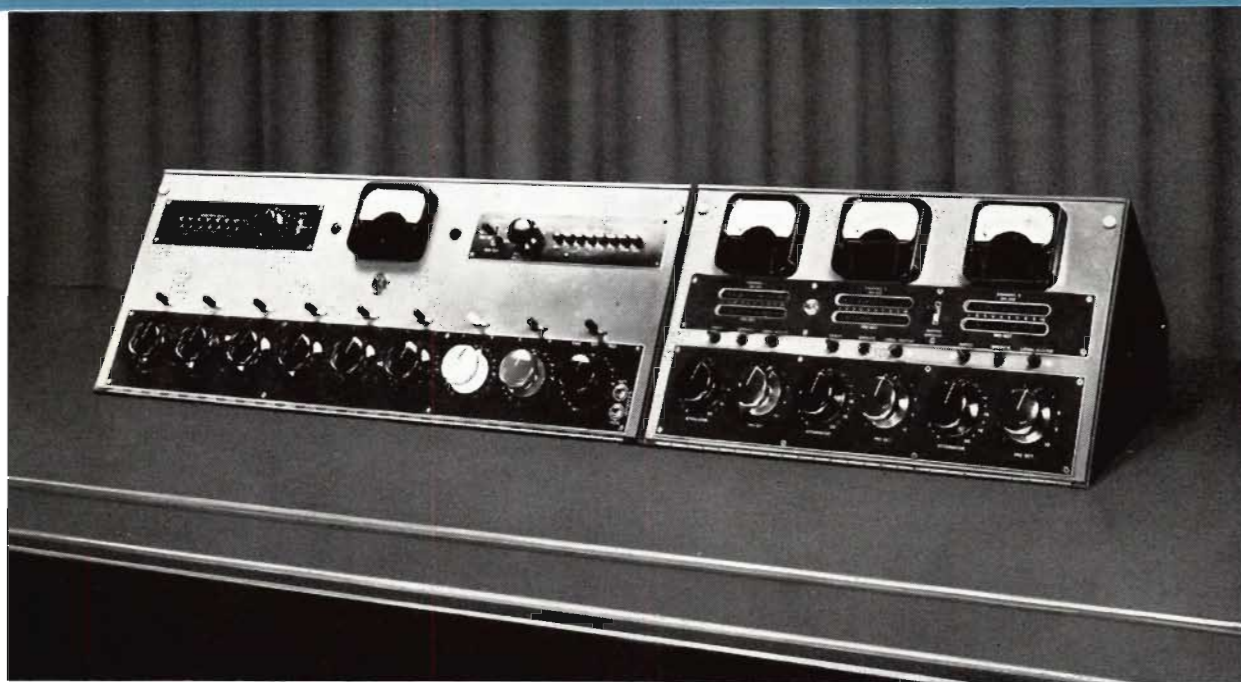

Side by side operation of BC-2B and BCS-11A combining program mixing and fading with output distribution.

for all audio circuits to provide optimum wear for a long period of service. The complete switching facilities of the BCS-11A are enclosed within a single, compact unit except for an external relay power supply. Space is provided in the BCS-11A housing for line transformers or fixed attenuators. Easy access to relays, terminal blocks and other components is permitted by a removable top panel and hinged front panel.

### DESCRIPTION

The BCS-11A Master Switching Consolette, from a design and operating standpoint, can be described best as a "semi-custom" equipment—since it combines many basic functions normally found in custom master control units. Because of this design similarity, the BCS-11A provides greatly increased flexibility for use with broadcast studio consolettes.

The new switching consolette incorporates facilities for the master switching of ten program sources to three outgoing lines. It is designed with stepping relays and provides pre-

set program source selection for all outgoing channels. All three outgoing channels may be used on any one program source.

A local-master selector switch for each outgoing channel permits either individual or collective switching of all channels. An "operate" button for each outgoing channel and a "master operate" key are provided to activate all outgoing channels either separately or simultaneously. Bridging type input permits operation from any audio line of 600 ohms or lower. A separate master attenuator is provided for each outgoing channel.

A power switch associated with each channel is provided to turn off all relay power to that channel without disturbing the switching arrangement. A relay power failure does not remove the program from the air, and return of power after a failure does not affect or alter the program switching. Separate illuminated VU meters are provided for each of three outgoing channels. VU meter lamps are activated by the channel power switch and serve as pilots to indicate an active channel.

**SPECIFICATIONS**

Input Channel Impedance.....	600 ohms or less
Load Impedance (output channel).....	600 ohms
Bridging Loss (for 600 ohm input).....	-32 db
Input Level (for values below).....	+14 dbm
Cross Talk between Inputs and Channels.....	Better than 70 db below program level
Noise Level.....	Better than 70 db below program level
Switching Transients.....	Better than 70 db below program level
Power Input (switching unit only).....	1.35 amp. 24 v. d-c
Power Input (switching unit and studio indicator lamps).....	1.6 amp. 24 v. d-c
Maximum Switching Time.....	Approximately 1/3 second

Dimensions:

Length .....	22 1/2"
Height .....	11 1/4"
Depth .....	21 1/2"
Weight .....	70 lbs.
Finish.....	Two-tone umber gray
Stock Identification .....	MI-11633

**Accessories**

Relay Power Supply.....	MI-11316
BA-11A or BA-21A Amplifier.....	MI-11231-A/MI-11244
BA-12A Amplifier .....	MI-11232
BA-13A or BA-23A Amplifier.....	MI-11233/MI-11246
Line Transformer .....	MI-11713
Pad, 6 db 600/600 Ohms.....	MI-4171-29
Transformer Speaker Coupling.....	MI-11731

Block diagram of BCS-11A Master Switching Console.

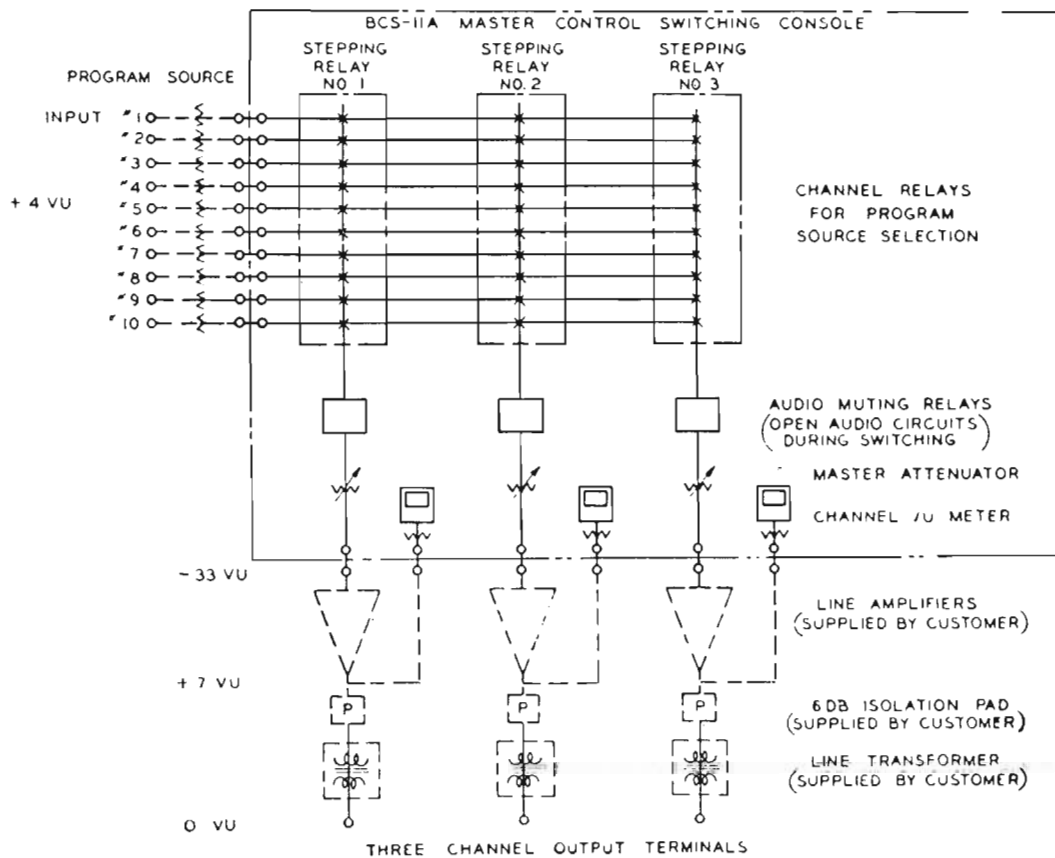

# CUSTOM AUDIO EQUIPMENT



WBAP, Fort Worth. The master control installation pictured here includes 16 deluxe audio equipment racks. These are just part of WBAP's modern six-studio layout. The master control installation features an "In-Line" design for handling 16 inputs and 10 outgoing channels.

## FEATURES

- Reduced operating expense
- Increased operating efficiency
- Instant "fool-proof" switching
- "Tailor-made" to satisfy your particular programming requirements
- Smoother operation (without jumps or breaks) . . . Sounds better to listeners
- Possibilities for new business . . . More programs handled
- Increased station prestige with clients
- RCA Custom Engineering Service available to all stations, large and small

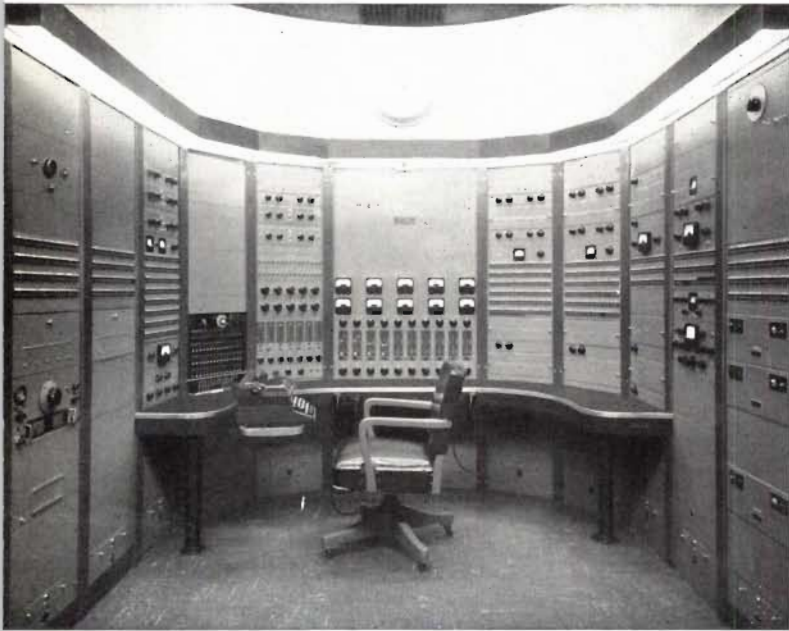

WNEW, New York. This master control installation—in WNEW's seven-studio lineup—is flanked on each side by five deluxe audio equipment racks. It has complete facilities for control and preset switching of seven studios to ten outgoing lines . . . and for feeding cues from any channel to any studio.

WMGM, New York. A deluxe custom-built studio console provides complete facilities for the control of WMGM's Studio "A" auditorium. The station's six modern studios and master control facilities feature deluxe custom-built audio.

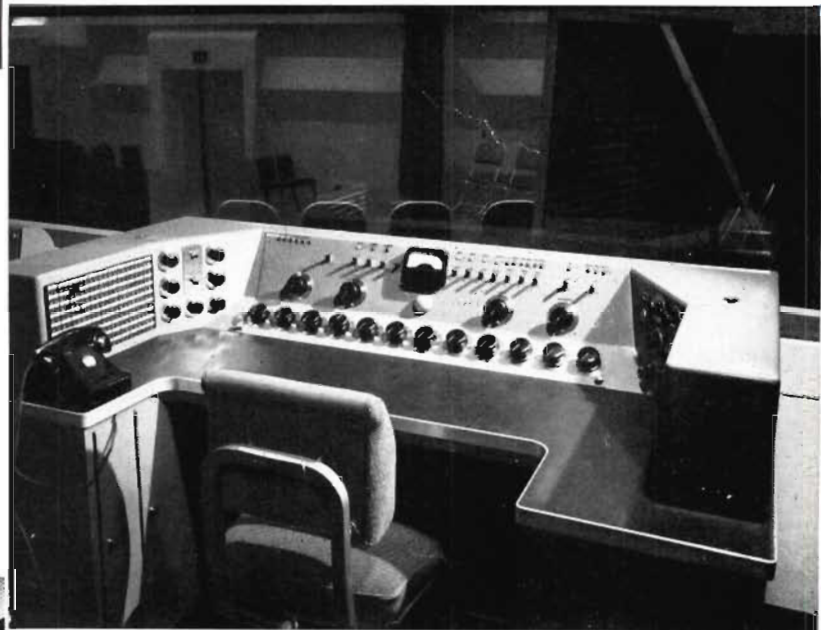

WJAC, Johnstown, Pennsylvania. In this speech input layout, custom-built matching-end consoles contain auxiliary switches and controls. They are used in conjunction with a standard 76-series consolette to provide increased flexibility and convenience.



In addition to a comprehensive line of standard studio control equipment, RCA specializes in custom designing and building complete speech-input systems to meet individual needs of stations and networks. RCA engineers have worked closely with the nation's leading broadcast engineers in the design, production and installation of many custom equipments, a few of which are pictured on these pages. Studio-control systems such as these are tailor-made, combining just the right facilities for the control of program operations and the reproduction of high-fidelity sound.

Since no two broadcast stations have the same operating requirements, equipment needs will differ for each installation, ranging from special equipment for small and

medium-size stations to more complex systems for the largest network installation. In planning new installations, RCA "Custom-built" equipment service is available to every AM, FM, or Television station on almost any working agreement desired. RCA "Custom-built" service includes the services of an entire RCA engineering staff. Broadcast station engineers, in some cases, may wish to lay out and design the system themselves, complete with specifications. In these instances, RCA will provide specifically built units or modify standard equipment to meet these specifications in every detail. On the other hand, where stations desire, RCA engineers will study station requirements, make overall and detailed layouts, and draw up specifications for equipment needed.

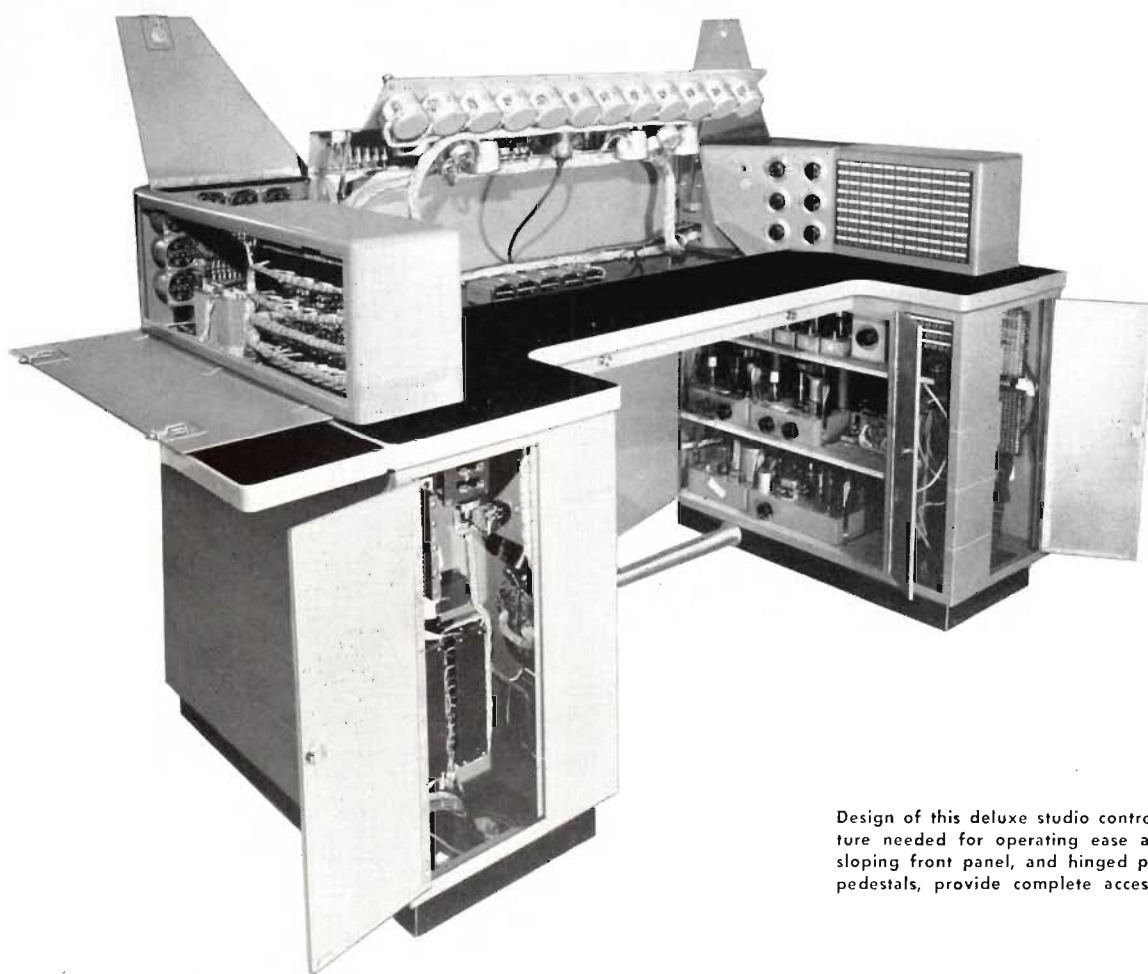

Design of this deluxe studio control console includes every feature needed for operating ease and convenience. The hinged sloping front panel, and hinged panel doors to all turrets and pedestals, provide complete accessibility to every component.

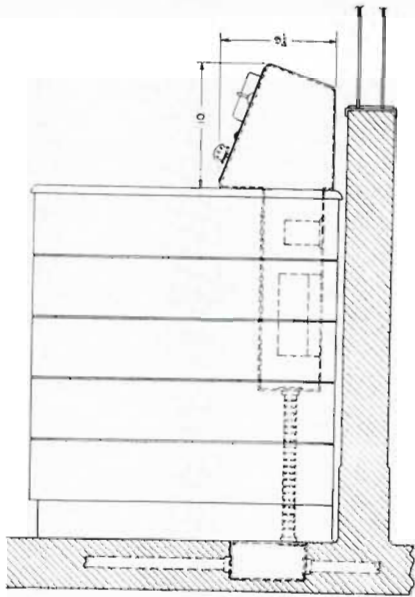

This cross-section view shows how the console at right was designed to permit some components to be mounted below the desk top. This results in small turret size and provides maximum visibility into the studio.

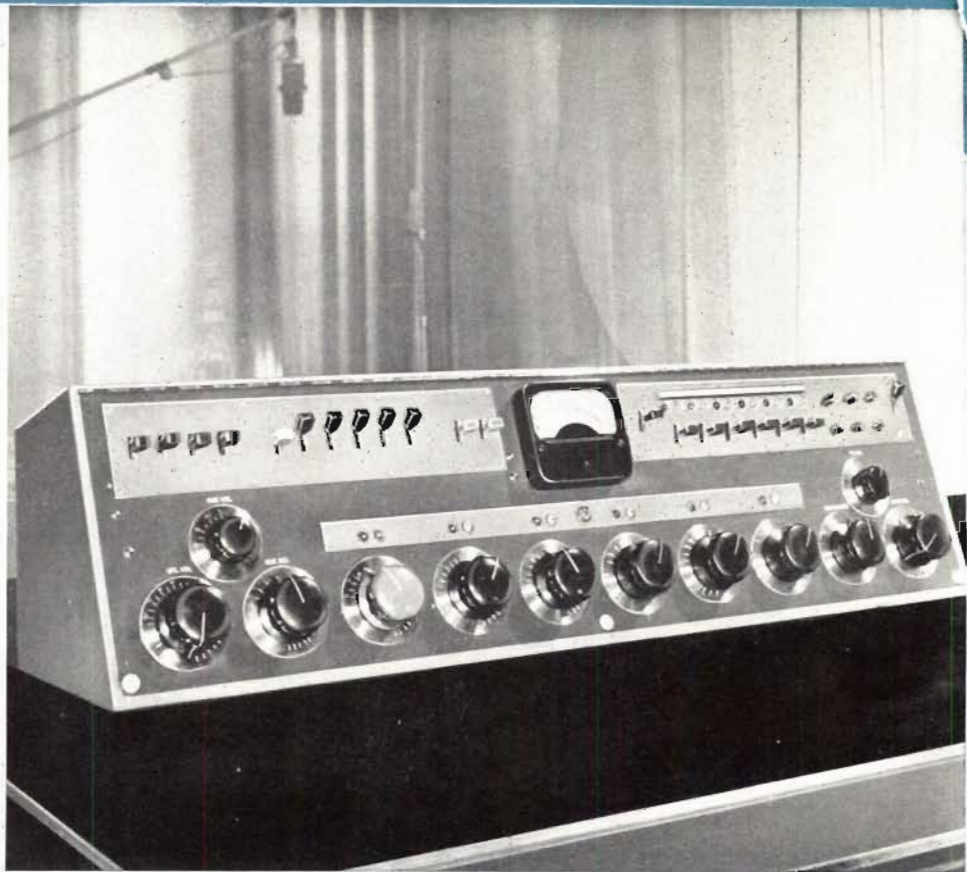

The studio console design shown above employs varied colored knobs and switch handles for easy and quick identification of individual controls. All escutcheons and dial plates are of attractive, long-wearing nickel silver.

Custom-built equipment can be designed for Television station requirements for audio, video and master control functions. Equipment for Television needs is discussed thoroughly under the heading "Custom Equipment for Television".

Pictured here is WOR-TV, New York. All programs are channelled through this master control room switching console. Eight master monitor housings accommodate facilities for six inputs and four outputs. Refinements include master or individual channel switching from "on-air" to "preset" circuits on each channel as well as simultaneous or independent video/audio switching on each channel.

# RCA BROADCAST AMPLIFIERS

The RCA line of high-fidelity speech input amplifiers has been designed to provide stations with studio, recording and portable remote amplifiers which will offer the maximum in fidelity, flexibility, convenience and reliability. All amplifiers are suitable for FM having a uniform response to 15,000 cycles. Distortion and noise levels have been reduced to a very low value through careful engineering design and construction.

Attention is invited to gain and level references in this catalog.

db—refers to gain.

dbm—sine wave power measurement referred to 1 mw.

VU—refers to average program level as read on a standard VU meter. This value is subject to considerable variation from dbm but is generally considered 10 db below peaks.

Allowance must be made for program peaks to avoid amplifier overloading, for example, a pre-amplifier rated at +10 db should not be operated at more than 0 VU.

## Summary of RCA Broadcast Amplifier Characteristics

Type	Usage	Max. Gain db	Max. Inout dbm*	Max. Output dbm*	Source Impedance Ohms	Load Impedance in Ohms	Type Mounting
BA-12A	Mic. Preamp. or Turntable Preamplifier	40	-22	+18	30/150/600	150/600	Chassis or Rack
BA-13A	Program Amp. Line Amp. Isolation Amp. Monitor Amp.	Matching 65 Bridging 28	Matching +10 Bridging +30	+33 2 Watts	150/600	5/7.5/18/150/600	Chassis or Rack
BA-21A	Preamplifier	Matching 40	Matching -10	+18	37.5/150/600	150/600	Chassis or Rack
	Isolation Amp. with MI-11278-E or F Bridging Gain Control	Bridging 4	Bridging +40	+18	10,000	150/600	Chassis or Rack
BA-23A	Program Amp. Line Amp. Isolation Amp. Monitor Amp.	Matching 68 Bridging 25	Matching -10 Bridging 27	+30	150/600	150/600	Chassis or Rack
BA-24A	Monitoring or Recording Amplifier	104	-30	+40 dbm 10 watts	37.5/150/600	4/8/16/150/600	Chassis or Rack
A-116	Monitoring or Recording Amplifier	50	Input 1 -4 to +32 v. Input 2 +10	+46 30 watts	Input 1 .25 meg. Input 2 .5 meg.	4/8/16/600	Chassis
50-W-2	Monitoring or Recording Amplifier	90	-40	+50 50 watts	100,000, 50, 250, 600, 20,000	4/8/16/32/600	Chassis
BA-6A	Limiting Amplifier	54	Minimum at Verge of Limiting -24	+30	150/600	600	Chassis or Rack
BC-2B	Studio Console	108	-30	+24	30/150	600 Pgm. 15 Monitor	Console
BCM-1A	Auxiliary Mixer	Depends on Application	-30	Depends on Application	30/150	Depends on Application	Console
BN-2A	Portable Remote Amplifier		-30	+18	30/150	600	Portable Carrying Case
SA-6C	Public Address Amp. Monitoring Amp.	Microphone 94 Phono 30	1.5 v. Phono	6 watts	Microphone† 85,000 Phono 250,000	4/8/16	Chassis

\* Reference level one milliwatt.

† May be converted to low impedance by using transformer MI-12399.

# UTILITY AMPLIFIER

## TYPE BA-12A

### FEATURES

- High output signal level allows use as line amplifier, turntable booster, microphone preamplifier or isolation amplifier (including line to line)
- Excellent frequency response— $\pm 1$  db 30 to 15,000 cycles
- Low distortion and hum level
- Self-contained power supply
- Compact — two BA-12A's may be mounted on one BR-2A shelf
- May be mounted inside turntable cabinet
- Plug-in electrolytic capacitors
- Plug-in chassis assures simplified servicing

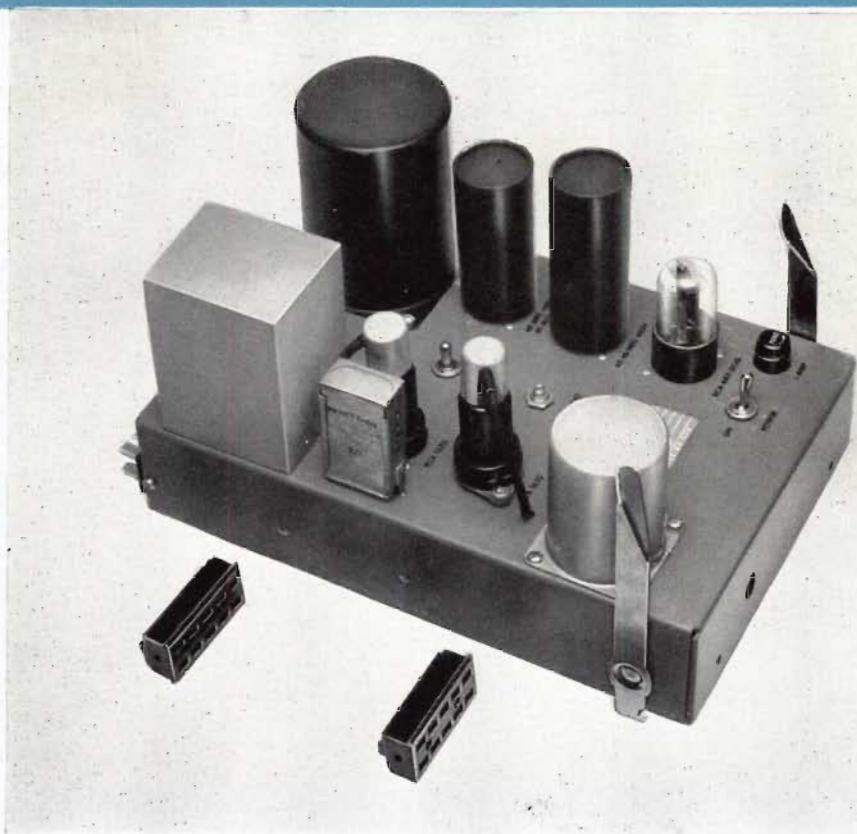

### USES

RCA's BA-12A is a versatile, two stage high-fidelity utility amplifier designed to serve as a microphone preamplifier, turntable booster amplifier, line amplifier or isolation amplifier—including line-to-line. Its high gain (40 db), extremely low noise level and low distortion make it an ideal unit for use as a microphone preamplifier, or turntable or booster amplifier. Its high output level makes it applicable for use as a line amplifier. It may also be used

as an isolation amplifier operating from a zero to +40 vu feeder bus by the addition of an MI-11278-E or MI-11278-F Bridging Volume Control. Where cabinet rack mounting is desired, two of these units may be installed in a single BR-2A Panel and Shelf Assembly. When used as a turntable booster amplifier, the BA-12A may be mounted inside the turntable cabinet.

### DESCRIPTION

The BA-12A Utility Amplifier obtains high gain from two RCA 1620 tubes; one operated as a pentode, the other as a triode. The tubes are mounted vertically and the first stage is shock mounted to prevent microphonics. The circuit is conventional with unloaded transformer input, resistance-capacitance coupling between stages and transformer output. The distortion and hum level has been

reduced to a very low value through proper circuit design and through the use of stabilized feedback.

The amplifier is complete with built in a-c power supply which eliminates the need for external rectifiers. The hum and noise level has been kept to a very low value through the use of specially shielded power and audio transformers. A switch is provided for metering a portion of



**DESCRIPTION (Cont'd)**

the cathode voltage of each tube when connected to a high resistance voltmeter such as the Type BI-1B.

With the addition of the MI-11278-E or MI-11278-F Volume Control Kit to provide a 10,000 ohm input, the BA-12A may also be used as a bridging or isolation amplifier. The MI-11278-F kit can be mounted on the BA-12A chassis and be adjusted by screw driver through one of access holes in the front panel of a BR-2A Shelf and Panel Assembly. The MI-11278-E is intended for panel mounting remote from the amplifier. With matching input, the BA-12A Amplifier has a maximum gain of 40 db. As a bridging amplifier, the BA-12A has a maximum gain of 4 db with the volume control at minimum loss position and bridging a 600-ohm line.

**SPECIFICATIONS**

**BA-12A AS PREAMPLIFIER, BOOSTER, OR LINE AMPLIFIER:**

Source Impedance.....	30/150/600 ohms
Input Impedance (unloaded input transformer)	Substantially above source impedance
Load Impedance (balanced or unbalanced).....	150/600 ohms
Maximum Input Level.....	-22 dbm
Maximum Output Level (less than 0.5 rms dist. 50-15,000 cps) .....	+18 dbm
Insertion Gain .....	40 db

**BA-12A AS ISOLATION AMPLIFIER (WITH MI-11278-C or -D VOLUME CONTROL):**

Source Impedance.....	30 to 600 ohms
Input Impedance (through Volume Control).....	10,000 ohms
Load Impedance (balanced or unbalanced).....	150/600 ohms
Maximum Input Level, Volume Control at max.:	
Bridging 600 Ohms.....	+14 dbm
Bridging 150 Ohms.....	+20 dbm

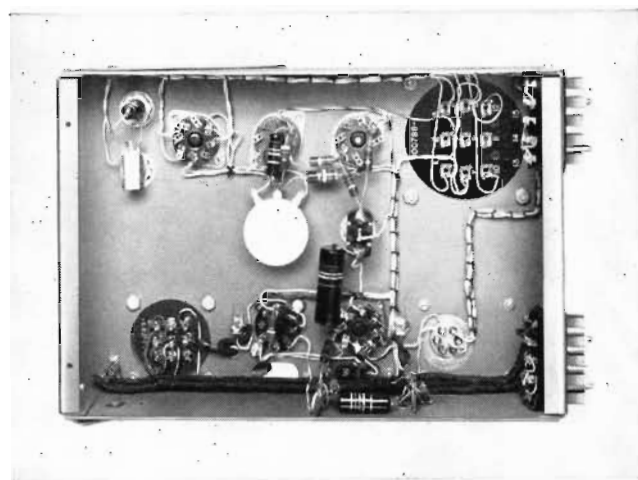

View of BA-12A Utility Amplifier Chassis showing component wiring

Maximum Output Level.....	+18 dbm
Maximum Gain, 600 Ohm Source.....	4 db

**BA-12A AS PREAMPLIFIER, BOOSTER AMPLIFIER OR ISOLATION AMPLIFIER:**

Frequency Response.....	±1 db 30-15,000 cps
Noise Level (input and output terminated).....	-80 dbm
Equivalent Input Noise.....	-120 dbm
A-c Power Input.....	105/125 volts, 50/60 cycles (15 watts)
Dimensions, Overall.....	Length 14", Width 8", Height 6½"
Finish .....	Umber gray
Weight (unpacked).....	11 lbs.
Stock Identification (less tubes).....	MI-11232

**Accessories**

Tube Kit (2 RCA 1620, 1 RCA 6X5GT/G).....	MI-11287
Volume Control Kit:	
Bridging (Panel Mounting).....	MI-11278-E
Bridging (Chassis Mounting).....	MI-11278-F
BR-2A Panel and Shelf Assembly (holds 2 BA-12A's).....	MI-11598-B/11599

# PROGRAM AMPLIFIER

TYPE BA-13A

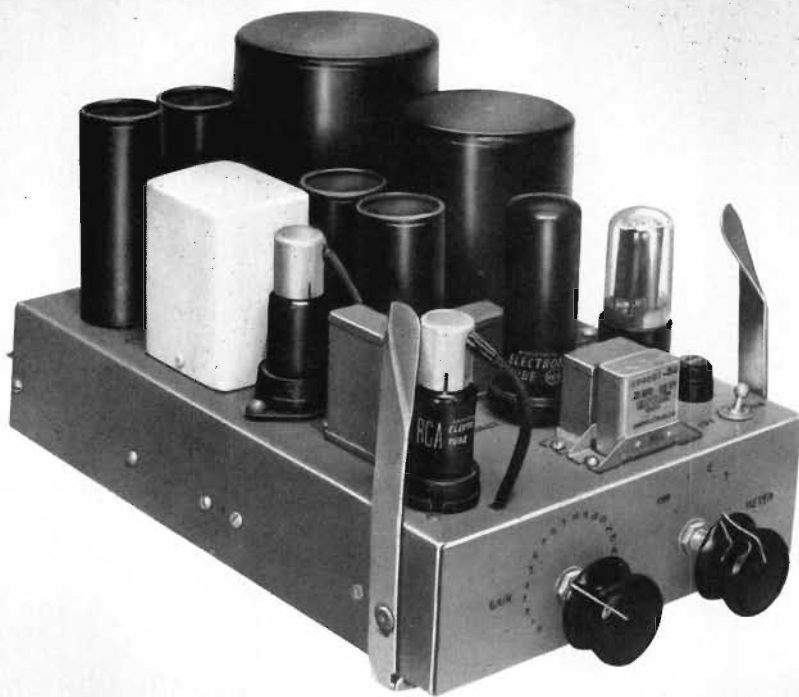

## FEATURES

- Plug-in type—may be mounted in cabinet or panel and shelf
- Employs oil-filled capacitors, plug-in electrolytics and terminal board connections throughout
- Maximum of accessibility and uninterrupted service is assured
- Excellent frequency response
- High gain—low distortion—low noise level
- Provision for cathode metering
- Economical in price

## USES

The new BA-13A Amplifier is one of the most versatile high-fidelity amplifiers yet designed for broadcast service. It incorporates special, high-quality, long-life components throughout and provides a maximum of accessibility to all circuit components. Its high gain and low distortion makes it ideal for use as: (1) Program or Line Amplifier, (2) Bridging Amplifier, (3) Isolation Amplifier, (4) Cueing Amplifier or Monitoring Amplifier with approximately 2 watts output.

The BA-13A is a plug-in type amplifier which has been designed for use with the BR-2A Panel and Shelf. This shelf permits quick and easy removal for servicing or interchanging units. The Type BR2A shelf assembly provides mounting space for the two Type BA-13A amplifiers.

## DESCRIPTION

The BA-13A employs the latest in mechanical layout and design, uses only oil-filled capacitors, resistors with plenty of wattage rating in reserve, and "plug-in" type electrolytics. Thus, long-life, trouble-free operation and extreme accessibility of parts is assured. All resistors are brought

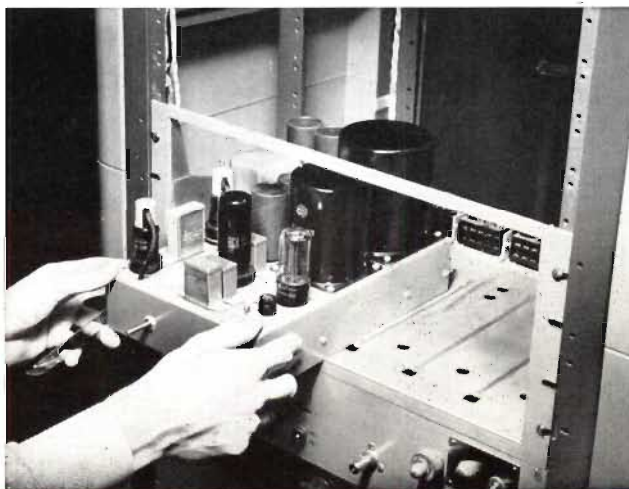



"Plug-in" type electrolytics provide long-life operation and maximum accessibility.

**DESCRIPTION (Cont'd)**

out to terminal boards for maximum convenience. The new BA-13A retains many of the electrical design features of its popular predecessor, the BA-3C. It is a three stage amplifier employing one RCA 1620 pentode first stage, one RCA 1622 beam power output tube. Excellent frequency response, high gain and low distortion have been provided in the design of this amplifier by use of resistance-capacitance interstage coupling and stabilized feedback. The noise level has been kept extremely low by the use of a dual volume control which simultaneously controls the gain of the first and second stages. When a step type control is required an MI-11233 amplifier should be ordered.

A special design feature of the BA-13A permits a boost of the low, the high or the low and high frequencies as shown in the accompanying frequency response curve. This feature aids in obtaining an overall system flat response since compensation may be added to overcome high frequency losses in the inter-connecting lines or inadequate low frequency response of associated equipment. High frequency compensation is easily made by changing one resistor and one capacitor. Low frequency compensation is effected by changing two resistors and adding two capacitors.

All external connections to the BA-13A are made through the ten-prong male plugs, which engage with two mating sockets supplied with the amplifier. Connections are provided from each cathode circuit through a selector switch to terminals on the plug in the back of the amplifier. These connections permit metering of tube conditions by means of a high resistance voltmeter such as the RCA Type BI-1B and Type BI-2B.

The amplifier is complete with built-in a-c power supply. The rectifier used is 1 RCA 5Y3GT.

**SPECIFICATIONS**

Source Impedance.....	150/600 ohms
Input Impedance (balanced—center tap grounded):	
a. Matching (50-15,000 cps).....	150/600 ohms
b. Bridging (50-15,000 cps).....	20,000 ohms (approx.)
Maximum Input Level:	
a. Bridging (less than .5% rms distortion 30 to 15,000 cycles).....	+30 dbm*
b. Matching (with less than .5% rms distortion 30 to 15,000 cycles).....	+10 dbm
Load Impedance (tapped transformer).....	5/7.5/18/150/600 ohms
Output Level:	
Less than .5% rms Distortion 30-15,000 Cycles.....	+18 dbm
Less than 1% rms Distortion 30-15,000 Cycles.....	+30 dbm
Less than 1% rms Distortion 50-15,000 Cycles (2 watts).....	+33 dbm
Gain Maximum:	
a. Matching Input (600 ohm line to 600 ohm load).....	65 db
b. Bridging Input (600 ohm terminated line to 600 ohm load).....	28 db
Frequency Response (30 to 15,000 cps).....	±1 db
Noise Level (for +30 dbm output, max. gain).....	-82 db
A-c Power Input, 100 to 130 volts, 50/60 cycles.....	55 watts
Dimensions, Overall.....	Length, 13¾"; Width, 8"; Height, 7⅛"
Finish.....	Light umber gray
Weight (unpacked).....	17½ lbs.
Stack Identification (less tubes):	
With Continuous Volume Control.....	MI-11233-A
With Step-by-Step Control.....	MI-11233

**Accessories**

Tube Kit (complete tube complement):	
2 RCA-1620, 1 RCA-1622, 1 RCA-5Y3GT/G.....	MI-11266
BR-2A Panel and Shelf Assembly.....	MI-11598-B/11599
Type BI-1B Meter Panel.....	MI-11388

\* dbm = db referred to one milliwatt when single frequency tone modulation is used.

# PREAMPLIFIER and ISOLATION AMPLIFIER

## TYPE BA-21A

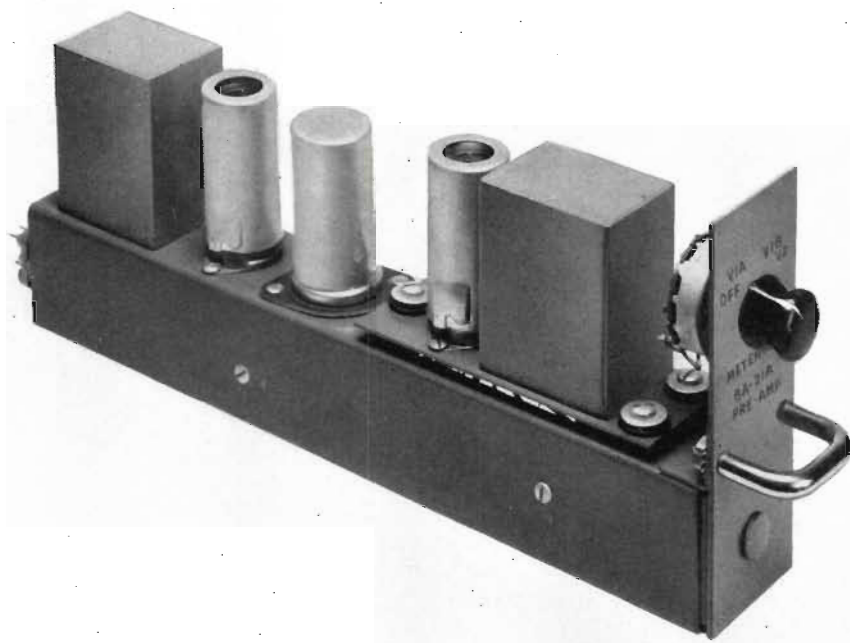

### FEATURES

- Printed-circuit wiring provides compact size and uniform performance
- Excellent frequency response  $\pm 1$  db 30 to 15,000 cycles
- Push-pull output provides high output with low distortion
- High output capability makes it useful as a booster or line amplifier
- 10 units may be mounted in one BR-22A Panel and Shelf . . . 5¼" high x 19" wide
- Hermetically sealed input and output transformers
- Improved plug-in unit and light weight affords ease of installation and removal

### USES

The BA-21A is an ideal unit for use as a microphone pre-amplifier, turntable preamplifier or booster amplifier. Its high output level makes it applicable as a line amplifier. It may also be used as an isolation amplifier operating from a zero to +40 vu feeder bus by the addition of an MI-11278-E or F Bridging Volume Control. The MI-11278-E control provides a knob for adjustments and the MI-11278-F control provides a screw-driver slot for adjustments. The small size of the BA-21A affords considerable mounting flexibility. It may be placed directly in a control console, control desk or transcription turntable cabinet. Where cabinet rack mounting is desired, one to ten of these units may be installed in a single BR-22A Panel and Shelf Assembly.

**DESCRIPTION**

The BA-21A has been designed to obtain high gain using one RCA MI-11299, selected 12AY7 tube in the input stage and one 12AY7 in the output stage. The tubes are mounted vertically and the first stage is shock mounted to prevent microphonics. The circuit is conventional with unloaded input transformer, resistance-capacitance coupling between stages and transformer output. The distortion and hum level has been reduced to a very low value through proper circuit design and through the use of stabilized feedback. Cross talk between units is -75 db, 30 to 15,000 cycles when mounted side by side and operated from the BX-21A Power Supply.

With the addition of the MI-11278-E or F volume control kit to provide a 10,000 ohm input, the BA-21A may also be used as a bridging or isolation amplifier. The MI-11278-E or F kits can be mounted on the BA-21A chassis and be adjusted by either knob or screw driver. The MI-11278-F can be used for panel mounting remote from the amplifier. As a bridging amplifier, the BA-21A has a maximum of 4 db gain with the volume control at minimum loss position and bridging a 600-ohm line. Approximately 80 db of isolation between output and input is obtained with the amplifier in this arrangement. A switch is provided for metering a portion of the cathode voltage of each tube when connected to a high-resistance voltmeter such as the Type BI-1B. The unit is designed to operate from the BX-21A Power Supply or its equivalent. The power requirements are 6.3 volts a-c or d-c at 0.6 amperes and 285 volts d-c at 10 ma. Up to ten BA-21A preamplifiers can be operated from one BX-21A Power Supply.

**SPECIFICATIONS**

<b>BA-21A AS PREAMPLIFIER:</b>	
Source Impedance.....	37.5/150/600 ohms
Input Impedance (unloaded input transformer).....	Substantially above source impedance
Load Impedance (balanced or unbalanced).....	150/600 ohms
Maximum Input Level.....	-22 dbm
Maximum Output Level.....	18 dbm
Gain.....	40 db ± 1 db
<b>BA-21A AS ISOLATION AMPLIFIER (with MI-11278 Series Volume Control):</b>	
Source Impedance.....	Up to 600 ohms
Input Impedance (through Volume Control).....	10,000 ohms
Load Impedance (balanced or unbalanced).....	150/600 ohms
Maximum Input Level, Volume Control at max.:	
Bridging 600 Ohms.....	14 dbm
Bridging 150 Ohms.....	20 dbm
Maximum Output Level.....	18 dbm
Maximum Gain.....	4 db
<b>BA-21A AS EITHER PREAMPLIFIER OR ISOLATION AMPLIFIER</b>	
Frequency Response.....	± 1 db 30-15,000 cps
Noise Level (Input and Output Terminated):	
Output.....	-82 dbm
Referred to Input.....	-122 dbm
Harmonic Distortion (18 db Output).....	0.75% at 30 cps
	0.5% at 50 to 15,000 cps
Plate Power Supply.....	285 volts d-c at 10 ma
Filament Supply.....	6.3 volts a-c or d-c at 0.6 amps
Dimensions, Overall.....	Length 12½", width 1⅝", height 4¼"
Finish.....	Umber gray
Weight (unpacked).....	2½ lbs.
Stock Identification (amplifier supplied less tubes).....	MI-11244

**Accessories**

Tube Kit (complete tube complement).....	MI-11482
1—MI-11299 RCA Selected 12AY7	
1—12AY7	
Bridging Gain Control Kit (Screw-driver adjustment).....	MI-11278-F
(Knob adjustment).....	MI-11278-E
BX-21A Preamplifier Power Supply (furnishes filament and plate power for 1 to 10 BA-21A Preamplifiers).....	MI-11317
Type BI-1B Meter Panel (umber gray).....	MI-11388
BR-22A Mounting Shelf for rack mounting 1 to 10 preamplifiers or 1 power supply and 6 preamplifiers.....	MI-11597

**TYPICAL FREQUENCY RESPONSE  
MI-11244 PRE-AMPLIFIER  
TYPE - BA-21A**

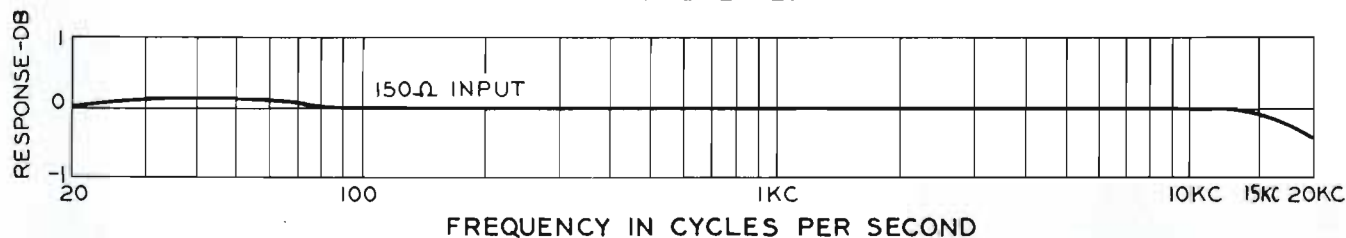

# PROGRAM AMPLIFIER

TYPE BA-23A

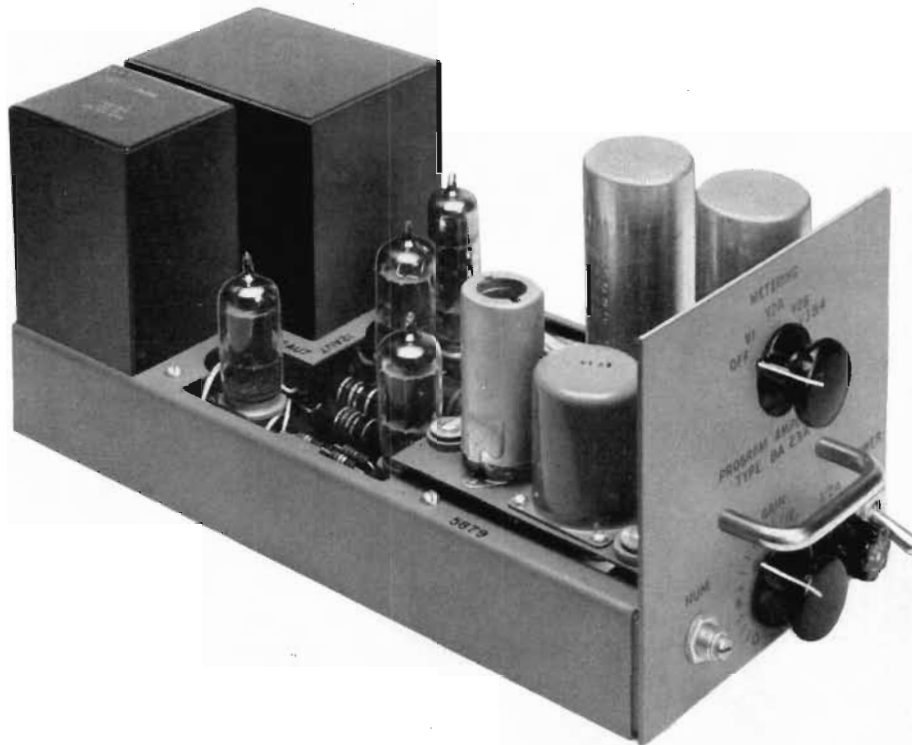

## FEATURES

- Printed-circuit wiring provides compact size and uniform performance
- Plug-in type for shelf mounting
- Maximum accessibility and dependable service
- Excellent frequency response
- High gain—low distortion—low noise level—high output
- Provision for tube metering
- Economical in price
- Small size
- Self contained power supply

## USES

The new BA-23A Program Amplifier is a very versatile high-fidelity amplifier designed for broadcast service. It incorporates special, high-quality, long-life components throughout and provides a maximum of accessibility to all circuit components. Its high gain and low distortion makes it ideal for use as: (1) Program or Line Amplifier, (2) Bridging Amplifier, (3) Isolation Amplifier.

The BA-23A is a plug-in type amplifier which has been designed for use with the BR-22A Mounting Shelf. This shelf permits quick and easy removal for servicing or interchanging units. The Type BR-22A Shelf provides mounting space for the 3 Type BA-23A amplifiers with space for one additional preamplifier.

**DESCRIPTION**

The BA-23A employs printed wiring to insure uniformity of performance. It uses resistors with plenty of wattage rating in reserve and hermetically sealed transformers. Thus long-life, trouble-free operation and extreme accessibility of parts is assured. Components on the printed circuit board can be easily replaced.

All connections to the BA-23A are made through a 15 prong connector at the back of the amplifier which plugs into a socket supplied with the amplifier. Connections are provided from each cathode circuit through a selector switch to terminals on the plug. These connections permit metering of tube conditions by means of a high resistance voltmeter such as the RCA Type BI-1B.

The BA-23A Program Amplifier has three stages of amplification with an additional phase splitter driving the push-pull-parallel output stage. The input stage utilizes a type 5897 low noise pentode. A 12AX7 twin triode is used as second stage and phase inverter. The push-pull output stage consists of two 12AU7 tubes having their sections connected in parallel. A 6X4 is used as full wave rectifier in the self-contained power supply.

The gain control follows the input transformer to permit high level input without overloading the input stage. A continuous composition type control is used in the MI-11246-A Program Amplifier, but space has been provided for a step type attenuator, if desired. A gain reduction of 15 db with a corresponding reduction in noise level may be obtained by changing a jumper on a voltage divider in the grid circuit of the second stage.

Inverse feedback is supplied from a tertiary winding of the output transformer to the cathode of the driver stage to stabilize gain and frequency response and to reduce distortion.

**SPECIFICATIONS**

Source Impedance.....	150/600 ohms balanced or unbalanced
Input Impedance (Matching).....	150/600 ohms
Input Impedance (Bridging).....	20,000 ohms
Load Impedance.....	150/600 ohms
Output Impedance.....	25/100 ohms
Maximum Input Level (Matching).....	-10 dbm
Maximum Input Level (Bridging).....	27 dbm
Maximum Gain (Matching).....	70 +1 db high, 55 ±1 db low
Maximum Gain (Bridging).....	33 ±2 db high, 18 ±2 db low
Frequency Response.....	±1 db 30-15,000 cps
Harmonic Distortion.....	0.5% rms max. at 30 dbm output, 30-15,000 cps
Noise Level (at output).....	-47 dbm at 70 db gain -62 dbm at 55 db gain
Metering Voltage.....	1.0 volt
Power Required.....	100-130 v, 50/60 cps 30 w (Transformer taps at 105, 115 and 125 v)

**Mechanical Dimensions:**

Length.....	Chassis 10 <sup>3</sup> / <sub>8</sub> " , overall 12 <sup>1</sup> / <sub>2</sub> "
Height.....	4 21/32"
Width.....	5"
Weight.....	9 lbs.
Finish.....	Light umber gray locquer
Mounting.....	Plug-in mounting on MI-11597 Mounting Shelf, Type BR-22A. The BA-23A Amplifier requires 3/10 of the shelf space. Three BA-23A Program Amplifiers may be mounted on one BR-22A Mounting Shelf with spoce for one additional BA-21A Preamplifier.
Stock Identification.....	MI-11246-A

**Accessories**

Tube Kit.....	MI-11480
	1 MI-11298, selected 5879; 1 12AX7; 2 12AU7; 1 6X4
Meter Panel, Type BI-1B (provides tube metering for 17 amplifiers).....	MI-11388
Mounting Shelf (for rack mounting of 3 BA-23A program amplifiers; requires 5 <sup>1</sup> / <sub>4</sub> " of vertical rack space).....	MI-11597
Step Attenuator.....	MI-11730-A

**FREQUENCY RESPONSE  
MI-11246-A PROGRAM AMPLIFIER  
TYPE - BA-23A**

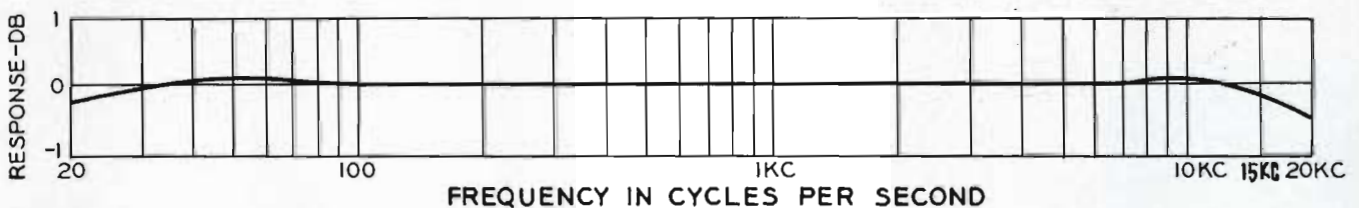

# MONITORING AMPLIFIER

TYPE BA-24A

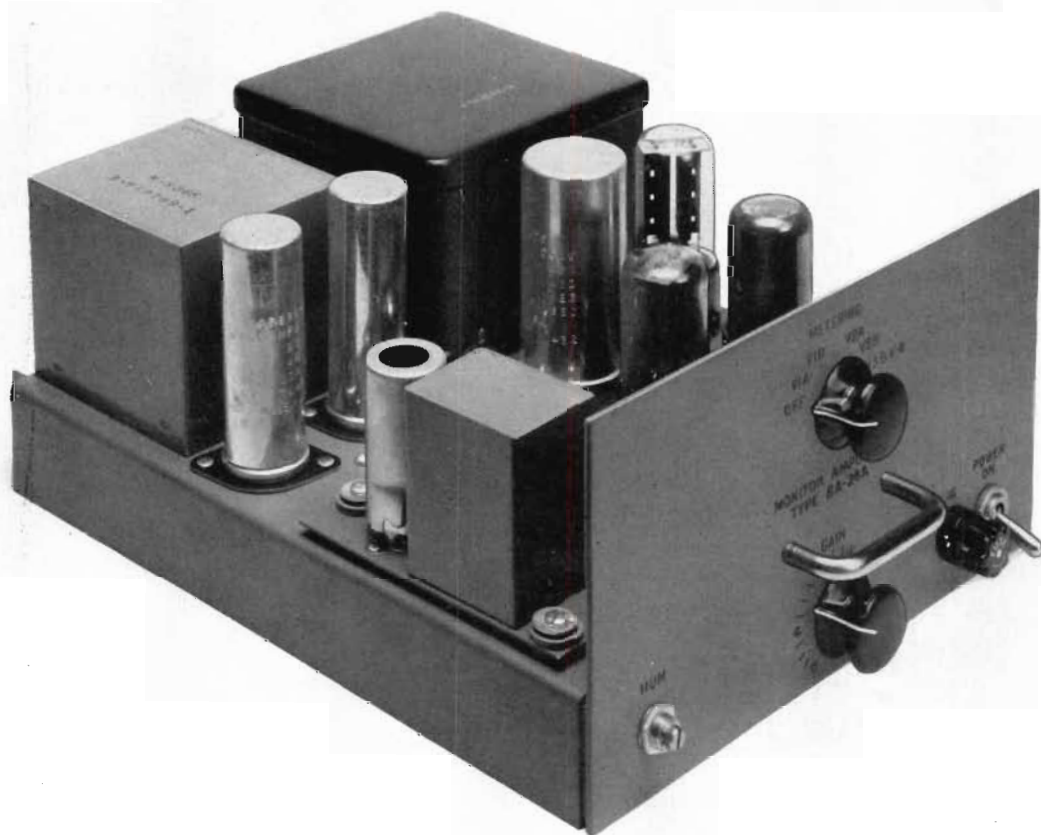

## FEATURES

- Printed-circuit wiring provides compact size and uniform performance
- Small size. Two units in 5¼" vertical rack space
- Frequency response 30 to 15,000 cycles
- Hermetically sealed transformers
- Suitable for emergency use as program amplifier
- Sufficient gain for direct operation of a speaker from turntable or microphone
- Plug-in mounting
- Self-contained power supply
- High gain—used directly in talk-back circuits, without preamplifier
- 8 watts output with low distortion—uses feedback
- Suitable for cabinet or shelf mounting
- Ideal for recording and playback applications
- Economical in price
- Tube metering circuits



**USES**

The BA-24A is a high fidelity, high gain flexible 8 watt amplifier suitable for monitoring, audition, recording, and talk-back applications or it may be used in emergencies as a program or line amplifier. It is ideal for transcription playback booths since its 105 db gain is sufficient to operate an (LC-1A) Speaker directly from the output of a (70-D) Turntable. The high gain feature also allows its use directly in studio talk-back circuits without an intervening preamplifier. The BA-24A is an excellent recording amplifier being suitable for both high quality recording and playback applications. Two may be mounted in a type BR-22A Mounting Shelf. The BA-24A has a plug-in type chassis using multi-conductor plugs.

**DESCRIPTION**

A high quality, high gain amplifier suitable for driving a loudspeaker directly from a microphone or turntable output. It has four stages of amplification with an interstage gain control. A phase splitter drives the push-pull output stage. Negative feedback is utilized to reduce distortion, stabilize gain and frequency response. The power supply is self-contained. The hum level is reduced to a minimum through the use of well shielded transformers, low noise tubes and careful circuit layout. A metering switch on the front panel is provided to check the condition of the tubes, with the metering voltage of 1 volt brought out at the connector plug.

**SPECIFICATIONS**

Source Impedance.....	37.5/150/600 ohms
Input Impedance.....	Unloaded transformer, high in comparison with source impedance
Load Impedance.....	4/8/16/150/600 ohms
Output Impedance (approx.).....	1.3/1.8/3/21/78 ohms
Maximum Input Level.....	-30 dbm
Maximum Gain.....	104 db $\pm$ 2 db
Frequency Response.....	$\pm$ 2 db 30-15,000 cps
Maximum Output Level.....	10 watts (40 dbm)
Harmonic Distortion.....	Less than 1% 100-7500 cps
At 8 W (39 dbm output).....	Less than 2% 50-15,000 cps
Noise Level.....	-122 dbm referred to input (-18 dbm at output at 104 db gain)
Metering Voltage.....	1 volt
Power Requirement.....	100-130 volts, 50-60 cps, 70 watts
Dimensions:	
Length.....	10 $\frac{3}{8}$ " , 12 $\frac{1}{2}$ " overall
Width.....	8 $\frac{3}{8}$ "
Height.....	4 21/32"
Weight.....	16 $\frac{1}{4}$ lbs.
Finish.....	Light umber gray
Mounting.....	Plug-in mounting on BR-22A Mounting Shelf. Requires half the shelf space (two amplifiers may be mounted on each shelf.)
Stock Identification.....	MI-11247

**Accessories**

BR-22A Mounting Shelf (mounts two BA-24A).....	MI-11597
Meter Panel (for 17 amplifiers) (BI-1B).....	MI-11388
Bridging (remote volume control).....	MI-11278-E or F
Tube Kit.....	MI-11481
1 MI-11299 (selected 12AY7), 1 12AX7, 2 6V6-GT/G, 1 5Y3-GT/G	

**FREQUENCY RESPONSE  
MI-11247 MONITOR AMPLIFIER  
TYPE - BA-24A**

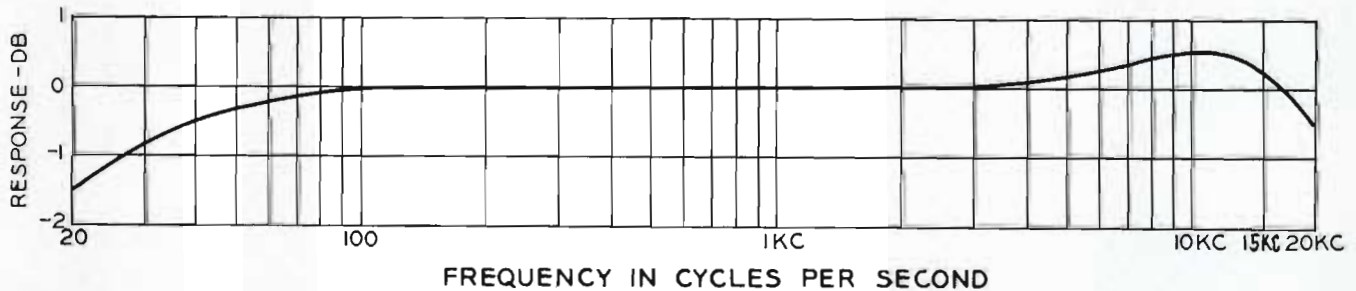

# MONITORING AMPLIFIERS

MI-11236A (50 WATT) AND MI-11229 (30 WATT)



50 Watt Amplifier  
MI-11236-A.

## FEATURES

- Low distortion—less than 1%
- Compact, lightweight units
- High quality components
- Low noise level
- Low phase shift distortion
- Simplified servicing

## USES

These McIntosh amplifiers, Model MC-30 (30 Watt) and Type 50W-2 (50 Watt) find particular application where higher power amplifiers are desired. These amplifiers provide high efficiency and low distortion features for use as broadcast monitoring or recording amplifiers or as general purpose amplifiers.



30 Watt Amplifier MI-11229.

SPECIFICATIONS

**Model MC-30 (30 Watt)**

Power Supply.....	117/125 volts, 60 cycles
Power Consumption.....	135 watts at 30 watts output 105 watts at zero signal output
Power Output.....	30 watts continuous
Frequency Response.....	20 to 30,000 cycles $\pm 1$ db at 30 watts output 15 to 50,000 cycles $\pm 5$ db at 30 watts output 10 to 100,000 cycles $\pm 1$ db at 15 watts output
Input Level:	
Input #1.....	0.5 volt to 30 volts with gain control
Input #2.....	2.5 volts
Harmonic Distortion.....	Less than 1/3% at 30 watts output or less, 20 to 20,000 cycles
Intermodulation Distortion.....	Less than 1/2% if instantaneous peak power is below 60 watts for any combination of frequencies 20 to 20,000 cycles.
Noise Level.....	90 db or more below rated output
Input Impedance.....	0.13 meg. for 2.5 volt input and 0.5 meg. for 0.5 volt input from 20 cycles to 40 Kc
Output Impedance.....	4, 8, 16 and 600 ohms (600 ohm is balanced to ground)
Phase Shift.....	20 cycles 3°, 20,000 cycles 9°
Tube Complement:	
Rectifier.....	5U4-GA
Pre-Amp.....	12AX7
Phase Inverter.....	12AU7
Voltage Amplifier.....	12BH7
Driver.....	12AX7
Output.....	2-1614
Dimensions.....	Length 13", Width 8", Height 8"
Net Weight.....	30.5 lbs.
Finish.....	Chrome and black
Stock Identification, with Tubes.....	MI-11229-A

**Model 50 W-2 (50 Watt)**

Power Supply.....	117 volts, 60 cycles
Power Consumption.....	185 watts at 50 watts output 120 watts at zero signal output
Power Output.....	50 watts continuous
Gain.....	Basic amplifier, 40 db, 70 db with pre-amp, 90 db maximum with transformer
Frequency Response.....	20 to 20,000 cycles $\pm 1$ db 10 to 100,000 cycles $\pm 3$ db
Distortion.....	Less than 1% at 50 watts output, 20 to 20,000 cycles
Intermodulation Distortion.....	Less than 1% for instantaneous peak power of 100 watts, 20 to 20,000 cycles
Noise Level.....	90 db below full output, 70 db when pre-amp is used
Input Impedance.....	100,000 ohms—without transformer 50, 250, 600 or 20,000 ohms—with transformer
Output Impedance.....	4, 8, 16, 32 ohms balanced or unbalanced and 600 ohms balanced with connections to octal plug
Tube Complement:	
Rectifier.....	2-5U4G
Amplifier.....	1-12AX7, 2-6J5, 2-6L6G or 5881
Dimensions.....	2 units, power supply and amplifier, each 8 1/8" x 6 3/4" x 5 1/4"
Net Weight (amplifier and power supply).....	55 lbs.
Finish.....	Gray hammertone
Stock Identification, with Tubes.....	MI-11236-A

**Accessories**

Transformer (input) (M-107).....	MI-11739
Preamplifier (B-100A).....	MI-11240



◀ The Type B-100A preamplifier, MI-11240, permits an additional gain of 30 db. It is installed by merely plugging it into the "Preamp" position on the amplifier chassis.

▶ The addition of Type M-107 Plug-In Input Transformer, MI-11739, provides input impedances of 600/250/50. It also provides additional gain of 12 db through the 600 ohm winding, 17 db through the 250 ohm winding and 26 db through the 50 ohm winding.



# LIMITING AMPLIFIER

## TYPE BA-6A

### FEATURES

- Prevents distortion and adjacent channel interference
- Economical in price—high-quality performance
- Provides for a more effective use of transmitter power
- Compact, plug-in unit—requires little rack space
- Complete rotary switch selection of metering of all key functions provided

### USES

The BA-6A Limiting Amplifier has been designed to provide economical, yet high-quality operation in the speech input channels of FM and AM broadcast and TV sound transmitters. It serves as an automatic means of limiting the audio signal peaks to a certain pre-determined level thereby preventing overmodulation or overloading with its consequent distortion and adjacent channel interference. This amplifier also provides for a more effective use of transmitter power by allowing the system to be operated as near maximum output as possible. It raises the average percentage modulation level several db without appreciably increasing the harmonic distortion.

The limiting characteristics of the BA-6A also readily adapt it for use in recording applications. For this use, it prevents over-cutting of the recording disc on heavy passages of music or speech and permits a marked improvement in the signal to noise ratio. Thus, the BA-6A Limiting Amplifier is an essential item for the successful operation of every broadcasting station and recording studio.

### DESCRIPTION

The BA-6A is a balanced, three-stage amplifier which uses commonly available tube types that do not require special selection or matching. The use of high-quality components and the straightforwardness of design, employing only 9 tubes including rectifier and voltage regulator, insure a maximum degree of reliability. Fewer tubes, fewer types

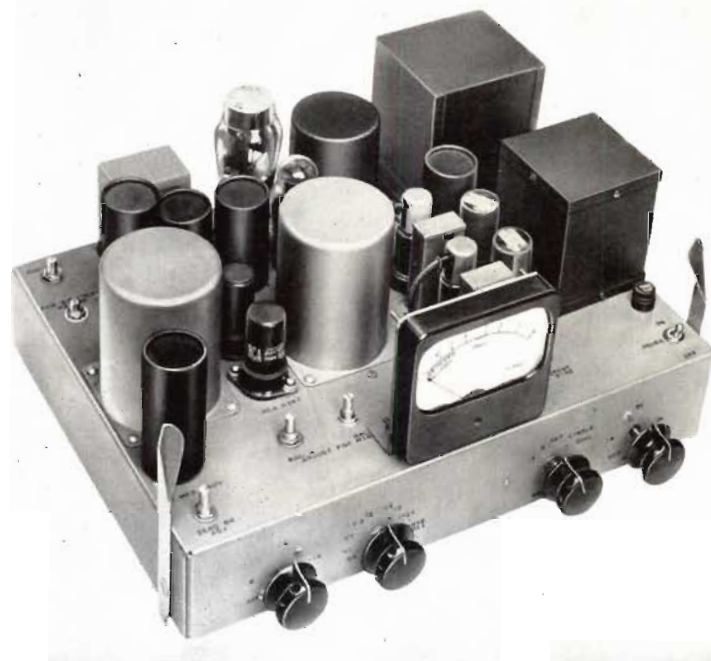

(only 6) and fewer stages of simplified design result in lower tube costs, low initial cost and reduced power input requirements.

The BA-6A Limiting Amplifier also incorporates those features which are found in other RCA high-quality broadcast audio amplifiers. The amplifier with its self-contained power supply is constructed on a plug-in chassis for shelf mounting and is therefore readily removable for inspection and service. All controls, tubes, and plug-in capacitors are accessible from the front.

A rotary selector switch permits use of the four-inch illuminated meter for measuring gain reduction, the cathode current of all amplifier tubes, tube balance and d-c filament voltage. Plate and heater power are available for operating a pre-amplifier in applications where additional gain is required. The rotary switch (BAL-LIM) provided on the front panel also permits selection of a filter with either a single or dual time constant. In the "single" position the attack time is 0.0006 seconds. In the "dual" position the recovery time is lengthened to two seconds on sustained peaks.

The input transformer matches a 600 and 150-ohm line. A dual attenuator controls the input signal which is applied to the control grids of two 6SK7 remote cut-off pentodes of the variable gain stage. To minimize "thump" over a wide range of gain reduction, both the screen and cathode voltages of these tubes are adjustable and thus any pair of tubes may be balanced over the entire operating range. Switches on the front panel permit making the balancing adjustments quickly and without external equipment by applying an internal 60-cycle signal to the 6SK7 grids and using the front-panel meter to indicate balance.

As an additional means of maintaining balance, the first stage is transformer coupled to the second stage. The output stage is capable of delivering 10 watts to an adjustable 600-ohm output attenuator pad which is calibrated in 1 db steps. A continuous fine output adjustment is also provided to set the output level exactly. This is an important feature since a fraction of a db change in output level might result in a large increase of distortion in certain types of transmitting equipment. A full wave rectifier, connected to the output stage through coupling capacitors and isolating resistors, provides the gain control voltage.

Step-by-step input and output volume controls are provided. These controls are equipped with "dbm" scales to indicate input and output levels at the verge of compression. Auxiliary adjustable controls are: (1) hum balance, (2) zero adjustment of gain reduction meter scale, (3) vernier control for output level, and (4) balance, (5) heater voltage. It also provides two positions for balancing of tubes in the first stage. A power switch and fuse are provided. For rack mounting the MI-11599 Shelf should be used. A special umber gray door panel with meter cut-out is supplied with the BA-6A amplifier.

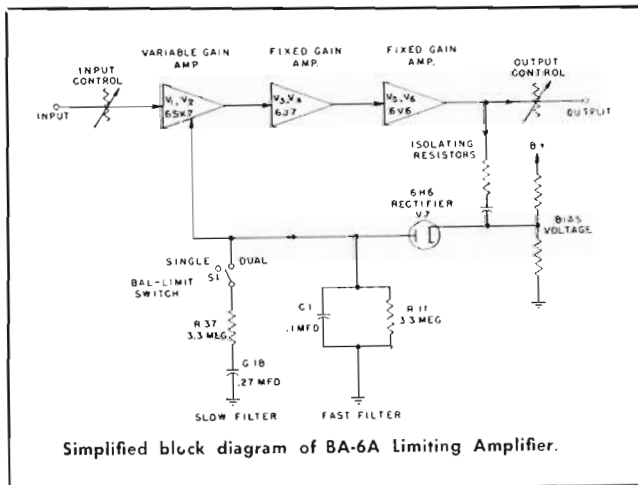

**SPECIFICATIONS**

Source Impedance.....600/150 ohms

Input Impedance.....600/150 ohms, balanced or unbalanced

Frequency Response:  
 (30 to 15,000 cps, 1000 cps reference)  
 Below verge of limiting.....±1 db  
 Up to 20 db gain reduction.....+1 to -2 db

Input Level:  
 Minimum (at limiting verge).....-24 dbm  
 Maximum .....+14 dbm

Output Level:  
 Maximum (limiting off) at 1000 cps.....38.5 dbm  
 At verge of limiting with output controls in  
 minimum attenuation position.....29.5 dbm ±1 db

Gain.....54 db ±1 db at 1000 cps, 600-ohm source  
 to 600-ohm load

Gain Controls:  
 Input.....20 steps, 2 db per step  
 Output.....20 steps, 1 db per step and fine adjustment

Signal-to-Noise Ratio.....83 db at verge of limiting

Harmonic Distortion (Total RMS) 12 db gain  
 reduction (100-15,000 cycles).....Less than 1%  
 No gain reduction, 30 dbm output.....Less than 0.6% 50-15,000 cps  
 Less than 1.2% 30 cps

Limiting Characteristic:  
 Output at verge of limiting.....29.5 dbm ±0.5 dbm, output control  
 in maximum gain position  
 Compression ratio above verge of limiting.....20 db into 2 db

Time Constants:

	Attack	Release
Single	600 microsec.	0.33 sec.
Dual, Fast Action	600 microsec.	0.33 sec.
Dual, Slow Action	0.9 sec.	2 sec.

Tube Complement (not included with amplifier).....MI-11289  
 2 RCA 6SK7, 2 RCA 6J7, 2 RCA 6V6GT,  
 1 RCA 6H6, 1 RCA OD3/VR150, 1 RCA 5R4GY

Power Required (Transformer taps provided for  
 105, 115, and 125 v.) (100 to 130 v., 50-60 cy.).....105 watts

Dimensions:  
 Chassis.....16<sup>3</sup>/<sub>16</sub>" long, 11<sup>3</sup>/<sub>4</sub>" wide, 3" high  
 Overall.....16<sup>3</sup>/<sub>16</sub>" long, 14" wide, 7<sup>5</sup>/<sub>8</sub>" high

Weight .....37 lbs.

Finish.....Dark umber gray

Mounting.....Plug-in mounting on MI-11599 Shelf

Stock Identification (including front panel less tubes).....MI-11225

**Accessories**

Tube Kit (complete tube complement).....MI-11289

Shelf .....MI-11599

# REMOTE AMPLIFIER

## TYPE BN-2A



### FEATURES

- High level mixing—15 to 20 db reduction in noise level
- Portable, compact and completely self-contained for a-c or battery operation
- Excellent frequency response  $\pm 1$  db 30 to 15,000 cycles
- Low distortion—less than 1% for complete range
- Complete range facilities for feeding the PA amplifier and the program channel simultaneously
- Battery Cover Pack MI-11279 available

### USES

The BN-2A is a lightweight, three channel amplifier designed especially for remote broadcast use. It has capacity for four microphone inputs, the third and fourth switchable to Channel 3. Program may be fed to the output channel and to a PA amplifier simultaneously. Also the cue circuit may be switched to isolate the remote amplifier and feed the PA direct. Monitoring facilities in both circuits are provided.

The input circuits are isolated in the same manner as a console, so that no special precautions are necessary in the grounding of microphones. Microphones with input impedances from 30 to 250 ohms can be accommodated by the same amplifier.

The unit is completely self-contained for a-c operations. By adding Battery Cover Kit, MI-11279, the unit can be operated on a-c or battery by the flip of a switch, the batteries being carried inside the unit.



Batteries may be neatly self-contained using Battery Cover Pack, MI-11279

**DESCRIPTION**

The BN-2A consists of a three stage, resistance-capacitance coupled amplifier combined with three individual input channels for each mixing stage. Each input channel uses a high quality balanced transformer with electrostatic shielding, operating into a non-microphonic RCA 1620 tube. These tubes are connected with each mixer in parallel to feed the first stage of the main amplifier. This stage employs another RCA 1620 pentode connected with feedback from the master gain control, which is a high grade step-by-step attenuator. The second and third stages each utilize a 6J7 pentode connected to the output transformer. Further feedback is taken from the plate of the last stage to the second stage cathode, resulting in an excellent frequency response with exceptionally low distortion. Each channel offers an overall gain of 92.5 db; more than adequate for any application. The high level mixing reduces microphonics and general noise level by at least 15 to 20 db. High level mixing also means unloaded input circuits, so that microphone response is better.

A line switch allows the operator to turn off the feed from the amplifier to the program line. Another switch connects the PA feed to the amplifier, or to the cue line with a third position for "Off". The volume to the PA feed is on a separate control.

The front panel is attractively styled and arranged to give centralized control of all circuits. The standard size VU

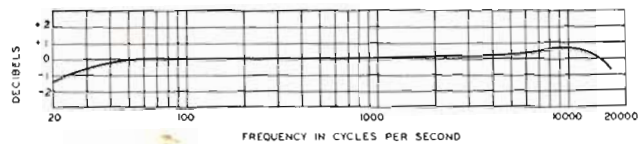

FREQUENCY RESPONSE OF A TYPICAL BN-2A REMOTE AMPLIFIER

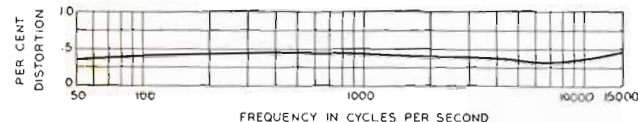

DISTORTION CHARACTERISTICS OF A TYPICAL TYPE BN-2A REMOTE AMPLIFIER WITH OUTPUT OF 18DBM.

meter is provided for measuring tube voltages in the cathode circuit and output level. A switch position for feeding +8 VU to line when the meter is reading 0 is also provided.

The steel case is ruggedly constructed with the front cover easily removed for quick operation. Accommodation for carrying spare tubes and fuses is provided within the case.

External connections located in the rear of the chassis include four, Cannon 3-conductor microphone receptacles and the 12-conductor plug for either a-c or battery operation. The power supply is built into the amplifier and employs one RCA 6X5GT full-wave rectifier tube.

If an emergency battery supply is desired, the top of the case can be removed by loosening four quick-disconnect screws and the MI-11279 kit added in its place. The battery unit plugs into the amplifier in the usual place and a standard extension cord can be used for the a-c. A switch allows quick switching to batteries if the a-c fails.

**SPECIFICATIONS**

Source Impedance.....	30/150 ohms
Load Impedance.....	500/600 ohms
Normal Output Level.....	+8 VU
Distortion (+18 db output 50 to 15,000 cycles).....	Less than 1% rms
Maximum Output Level (less than 1% rms distortion).....	+18 dbm
Maximum Gain (150 ohm source to 600 ohm load).....	92.5 db
Frequency Response.....	±1 db 30 to 15,000 cycles
Signal to Noise Ratio (18 db output, 68 db gain).....	70 db
A-c Power Input.....	105-125 volts, 50/60 cycles, 25 watts
Battery Operation:	
"A" Supply.....	6.3 volts (nominal) 2.1 amps. (incl. VU lamp)
"B" Supply.....	270 volts (nominal) 10 ma
Dimensions:	
Length.....	15"
Depth (with cover).....	9 1/2"
Height.....	10"
Weight.....	29 lbs. (complete with a-c cable and spare tubes)
Finish.....	Umber gray wrinkle
Stock Identification (less tubes).....	MI-11230

**Accessories**

Tube Kit (complete tube complement).....	MI-11269
4 RCA-1620, 2 RCA-6J7, 1 RCA-6X5GT	
Waterproof Cover for BN-2A.....	MI-11277
BN-2A Battery Cover (less batteries).....	MI-11279
Battery Kit for MI-11279.....	MI-11281

# BATTERY CONTAINER FOR BN-2A

MI-11279



## FEATURES

- Provides complete battery operation for BN-2A Portable Amplifier (1½ to 2 hours)
- Easily attached to BN-2A without alterations
- Employs standard "A" and "B" batteries
- Built-in switch selects a-c or battery operation

## DESCRIPTION

The Battery Cover, MI-11279, is designed for mounting on the BN-2A Portable Amplifier in place of the usual top cover supplied. The cover unit contains an a-c receptacle, a switch to select a-c or battery operation, and a clamp for holding two 6 volt "A" batteries (RCA #VS009, Eveready #744 or Burgess #F4P1 and four 67½ volt "B" batteries (RCA #VS016, Eveready #467 or Burgess #XX45). The battery pack will supply power to the BN-2A Portable Amplifier (requiring 6 volts at 2.1 amp. and 270 volts at 10 ma) for 1½ to 2 hours of continuous operation. With interval operation of 15 min. on, 15 min. off, the batteries will provide approximately 2 to 2½ hours service.

## SPECIFICATIONS

Weight (Battery Cover).....	6½ lbs.
Weight (Batteries).....	5 lbs.
Size, overall (adds only 5/8" to overall height of BN-2A).....	14¾" x 6½" x 3½"
Stock Identification (less batteries, with twist-lock connector).....	MI-11279

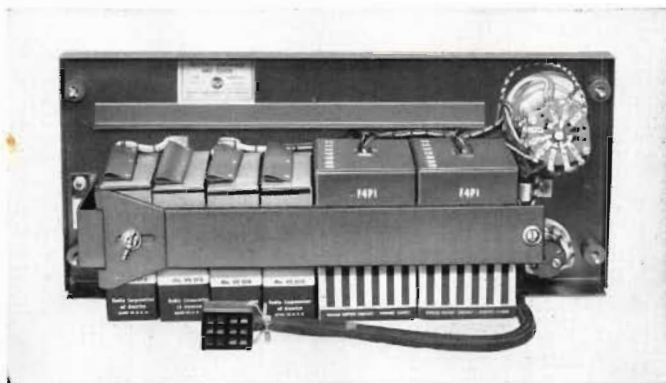

Rear view of Battery Cover showing batteries mounted in place

## Accessory

Battery Kit .....	MI-11281
-------------------	----------



# 6-WATT AMPLIFIER

## TYPE SA-6C

### FEATURES

- Excellent frequency response
- Noiseless mixing between channels
- High gain low noise circuitry
- High impedance inputs
- Microphone input easily converted to low impedance
- Compact, rugged, light weight construction



### DESCRIPTION

This 6-watt amplifier, MI-12722, has been designed for application in sound systems where a low audio power output is required. It has its own built-in power supply for furnishing a-c and d-c power for the audio tubes.

The SA-6C Amplifier is a 3-stage type with inverse feedback. One microphone input receptacle and one phonograph input, terminal board type, are provided. The phonograph input impedance is 250,000 ohms minimum; the microphone input impedance is 85,000 ohms minimum at 1,000 cps. This high microphone input impedance may be reduced so that a low impedance microphone can be used simply by plugging in an input transformer, RCA Type MI-12399, in the socket mounted on the chassis and provided for this purpose.

The microphone receptacle is a three prong Cannon Type XL-3-14, requiring Cannon Type XL-3-11, as a mating plug. The phonograph inputs are connected to the amplifier by means of two screws assembled on a terminal board, on one side of the amplifier, next to the microphone input receptacle.

Controls for this unit consist of: one microphone volume control, one phonograph volume control, and one master tone control/off-on switch combination. Effective tone control is provided by means of a variable high frequency attenuating type potentiometer. Each control is furnished with an appropriate knob.

The output transformer is equipped with taps for matching speaker load impedances of 4, 8, and 16 ohms. These taps are brought to the output terminal board in the rear of the chassis.

The chassis is finished in dull black lacquer. A bottom cover, also finished in dull black, is provided with four formed feet. A perforated top cover, MI-12724, handsomely finished in silver lacquer, may be used with this equipment, to complete the attractive appearance.

### SPECIFICATIONS

Power Required.....	117 volts, 50/60 cps, 50 watts
Power Output.....	6 watts at 1000 cps with a maximum of 3.0% distortion
Input Impedances:	
Microphone.....	85,000 ohms (minimum) at 1000 cps
Phonograph.....	250,000 ohms (minimum)
Output Impedances.....	4, 8, 16 ohms
Gain:	
Microphone Input, High Impedance.....	94 db minimum
Phonograph Input.....	1.5 volts maximum for 3 watts output
Frequency Response:	
Microphone.....	50 to 10,000 cps
Phonograph.....	50 to 10,000 cps
Distortion.....	*3.0% maximum at 1000 cps and 6 watts output
Noise.....	†Minimum 77 db below 6 watts ‡Minimum 57 db below 6 watts
Tone Control.....	-18 db ±3 db at 10,000 cps tilting from 1000 cps
Tube Complement (furnished with the unit):	
1 RCA Type 6J7	2 RCA Type 6V6GT
1 RCA Type 6SL7GT	1 RCA Type 6X5GT
Fuse (furnished with the unit).....	Type 3AG, 1 ampere
A-c Power Cord with Plug.....	Type SJ, 6 feet long overall
Dimensions (overall).....	Length 11 <sup>3</sup> / <sub>16</sub> " , Depth 8 <sup>7</sup> / <sub>16</sub> " , Height 6 <sup>1</sup> / <sub>4</sub> "
Weight, Unpacked.....	12 lbs.
Chassis and Bottom Cover Finish.....	Dull black lacquer
Stock Identification.....	MI-12722

### Accessories

Plug-in Transformer.....	MI-12399
Cover for Amplifier.....	MI-12724

\* Line voltage 117 volts, 60 cps.  
 † Volume and phono control minimum, tone control maximum.  
 ‡ Microphone, tone control maximum, phono control minimum with 16 ohm load.

# PREAMPLIFIER POWER SUPPLY

## TYPE BX-1E

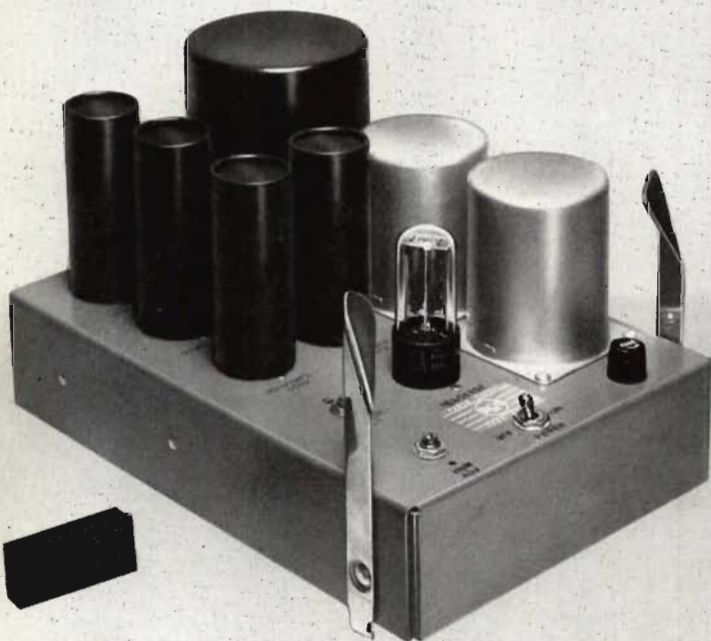

### FEATURES

- Exceptionally low hum level
- Plugs into BR-2A Shelf Assembly
- High capacity filter
- Filament supply hum balancing potentiometer
- Voltage variable 200 to 300 volts
- Supplies up to 7 BA-11A Preamplifiers

### USES

The Type BX-1E Preamplifier Power Supply is designed to provide d-c plate and a-c heater power for preamplifiers in which the hum level must be kept to a minimum. It is intended especially for use as a power supply for preamplifiers and isolation amplifiers such as the BA-11A.

### DESCRIPTION

The BX-1E is a plug-in unit designed primarily for mounting in the RCA Shelf Assembly Type BR-2A. Two of these power supplies can be installed as plug-in units in the BR-2A Shelf Assembly. Connection to the terminals is made through a quickly removable, multi-contact connector which fastens to the plug at the rear of the chassis.

The power supply circuit is a full-wave, high-vacuum tube rectifier with a choke-input filter. With a total of 320 microfarads of filter capacitance, the d-c output is exceptionally free from hum. The voltage is variable, by means of a screw driver adjustment, between 200 and 300 volts. The voltage output is very stable with any load up to fifty milliamperes. A hum balancing potentiometer, likewise a screw driver adjustment, is connected across the filament supply circuit.

The BX-1E is designed for operation on any a-c line voltage between 100 and 130 volts, 50 to 60 cycles. A one ampere, glass-enclosed, time-delay fuse is mounted on the front of the chassis. This fuse is unaffected by high transient currents.

### SPECIFICATIONS

Power Supply Required.....	100 to 130 volts, 50 to 60 cycles, 65 watts
Fuse.....	1 ampere, Type MDL
Power Output:	
D-c.....	180 to 285 volts, up to 50 ma
A-c.....	6.3 volts, up to 4.2 amperes
Output Hum Level.....	Approximately -134 db (below 50 ma d-c load at 250 volts d-c)
Dimensions and Weight:	
Length.....	12 $\frac{5}{8}$ "
Width.....	8 $\frac{1}{16}$ "
Height.....	7"
Weight.....	15 $\frac{1}{2}$ lbs.
Stock Identification (less tube).....	MI-11305-D

### Accessories

Tube Complement, 1 RCA-5Y3GT/G.....	MI-11262
Type BR-2A Panel and Shelf.....	MI-11598-B/11599

# PREAMPLIFIER POWER SUPPLY

## TYPE BX-21A

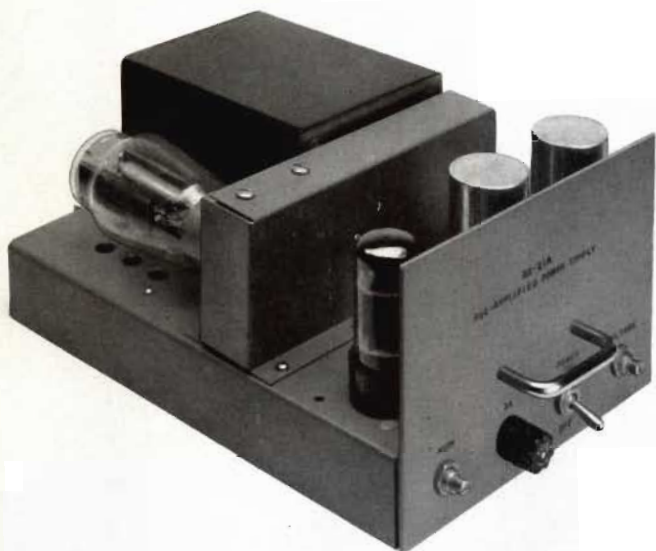

## FEATURES

- Regulated d-c output voltage
- Exceptionally low hum level
- Plugs into BR-22A Mounting Shelf
- Supplies up to 10 BA-21A Preamplifiers
- Heater supply hum balancing potentiometer

## USES

The Type BX-21A Preamplifier Power Supply is designed to provide d-c plate and a-c heater power for preamplifiers in which the hum level must be kept to a minimum. It is intended especially for use as a power supply for preamplifiers and isolation amplifiers such as the BA-21A.

## DESCRIPTION

The BX-21A is designed for operation on any a-c line voltage between 100 and 130 volts, 50 to 60 cycles. A two ampere, glass-enclosed, time-delay fuse is mounted on the front of the chassis. This fuse is unaffected by high transient currents.

The power supply consists of a full wave, high vacuum tube rectifier followed by resistance capacitance filtering. The output voltage is adjustable over a range of 245 to 295 volts and is maintained constant with variations in line voltage and loading by a series regulator tube in conjunction with a voltage reference and amplifier. This circuit also functions to reduce the ripple voltage. A metering voltage of 1 volt corresponding to nominal output voltage of 285 volts is available at connector plug for wiring to a meter panel.

## SPECIFICATIONS

Mounting.....	Plug-in on BR-22A Mounting Shelf. Requires 2/5 of the shelf space. Two BX-21A Power Supply units may be mounted on one shelf with additional space for two BA-21A Preamplifiers or 1 BX-21A Power Supply and 6 BA-21A Preamplifiers may be mounted on one shelf.
Power Required.....	100 to 130 volts, 50-60 cycles, 130 watts
Fuse.....	2 ampere, type MDL
Power Output:	
D-c.....	285 volts, up to 100 ma
A-c.....	6.3 volts, up to 6 amperes
Ripple Voltage.....	0.3 mv maximum
Dimensions and Weight:	
Length .....	12 1/2"
Width .....	6 1/8"
Height .....	4 21/32"
Weight .....	16 lbs.
Finish .....	Light umber gray
Regulation.....	0.5% no load to full load and line voltage variation of 5%
Stock Identification (less Tubes).....	MI-11317

## Accessories

Tube Complement, 1 5R4GY, 1 6BX7-GT, 1 12AX7, 1 OA2.....	MI-11479
Panel and Shelf, Type BR-22A, Umer Gray (for 2 Power Supplies).....	MI-11597
Type BI-1B Meter Panel (for 17 amplifiers or power supplies).....	MI-11388

# AMPLIFIER ACCESSORIES

## BRIDGING CONTROLS

### DESCRIPTION

The MI-11278-E and -F Bridging Volume Controls are designed to provide a high resistance bridging input circuit for connections between any low impedance source and the 150/600 ohm input terminals of an amplifier. The use of one of these units makes it possible to pick up program material conveniently from a program buss or any low impedance terminated line without disturbing the operation characteristics of the buss or the line. Any line of +40 dbm or below may be bridged. The MI-11278-F Volume Control is designed to be mounted on the chassis of such amplifiers as the BA-21A, BA-24A, or BA-11A. The center shaft of this control is notched for screwdriver adjustment. The MI-11278-E Volume Controls are designed for rear panel mounting on the same type amplifiers. They are supplied with dial knobs which mount on shafts extending through the panel.

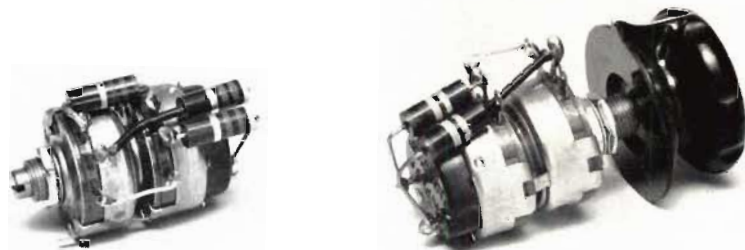

MI-11278-F

MI-11278-E

### SPECIFICATIONS

Input Impedances .....	20,000/10,000 ohms
Output Impedances .....	600/150 ohms
Insertion Loss* .....	.31/24 db
Maximum Input Level .....	+40 dbm
Overall Dimensions:	
Length:	
MI-11278-E .....	2 <sup>15</sup> / <sub>16</sub> "
MI-11278-F .....	2 <sup>3</sup> / <sub>16</sub> "
Diameter .....	1 <sup>3</sup> / <sub>8</sub> "
Weight .....	4 1/2 ozs.
Stock Identification:	
For Panel Mounting (with knob) .....	MI-11278-E
For Chassis Mounting (with screw-driver adjustments) .....	MI-11278-F

\* Bridging a 600-ohm line and operating into an amplifier with unloaded input requiring a source impedance equal to the output impedance of the control. The insertion loss when bridging a 150 ohm line is 42.5/36 db.

## VU METER AND ATTENUATORS

### DESCRIPTION

VU meters and attenuators are available as amplifier accessory equipment for indicating audio volume levels. Equipment is pictured at the left and may be ordered as follows:

- Simpson VU Meter.....Stock #53064
- Multiple Pad for calibrating the VU Meter  
to the desired reference level.....Stock #19328
- Zero Adjustment Pad.....Stock #19327

The complete kit is pictured at the left.

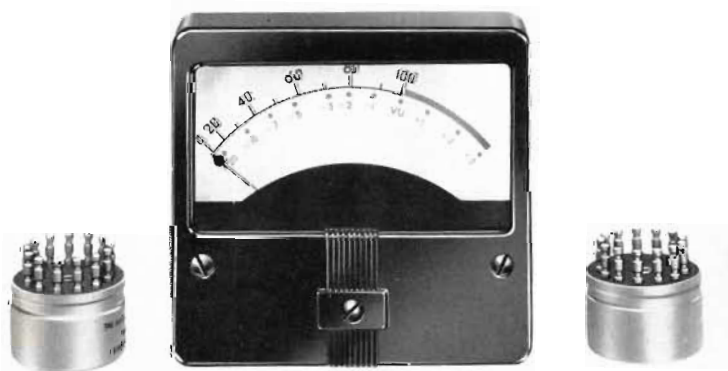

# STANDARD CABINET RACKS

## BR-84 SERIES



BR-84A

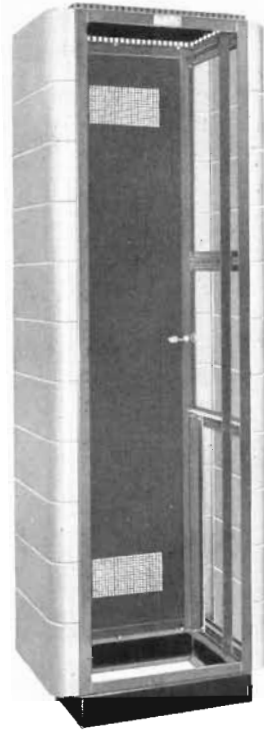

BR-84B



BR-84C

### FEATURES

- Cabinets are same height as RCA transmitters
- Total panel space 77"
- Available in many combinations to suit all studio applications
- Drilled and tapped for standard 19" panels
- Attractively styled to blend with all control room installations
- Suitable for fitting in a flush position to a side or rear wall
- Accommodates the heaviest equipment encountered in studio use
- Provides flexibility for future expansion

### USES

The BR-84 series cabinet rack program is another of the new feature lines of RCA. The cabinet program is presented after years of practical experience in finally developing a flexible scheme for accommodating broadcast equipment.

### DESCRIPTION

The five combinations of cabinets and accessories offer a versatile system for accommodating the user's immediate requirements with maximum accessibility for any future growth of the installation. Each rack may be mounted singly or, where desired, tandem together to facilitate the



BR-84D

BR-84E with Accessories

grouping of any number of cabinets. The cabinet is of sturdy metal construction, welded and bolted in one standard height and width. The ventilated top with slotted edges provides complete ventilation but protects the equipment from falling articles and dust. Vertical panel mounting angles have tapped holes at RMA standard locations to provide 77" of standard 19" panel mounting space. These angles may be installed to mount equipment within the cabinet, where doors are used, or flush with the front. When the latter method is desired, trim strips of neat design for panel mounting and clip fitting provide the finished appearance. The front and rear doors are of the universal type and may be hinged on the right or left side, to rotate in an arc of 180°. Electrical side shields are available in two sizes—21" for the center section, and 28" for the top and bottom sections. If found necessary after assembly, they may be fitted between racks of equipment. Terminal board mounting angles facilitate the mounting of power and audio blocks in a vertical or horizontal position. Additional terminal board mounting angles (MI-30527-G29) are available as accessories.

Units placed adjacently may be rigidly bolted together to produce a secure assembly. The cabinets are finished in a two-tone umber gray, with dimensional characteristics artistically blending with all RCA transmitters.

SPECIFICATIONS

Panel Width .....	19"
Panel Mounting Space (height).....	77"
Clearance for Door Swing.....	23"
Weight (BR-84A) .....	225 lbs.
Finish.....	Two-tone umber gray enamel except for the base which is black
Dimensions:	
Height .....	84"
Width—BR-84-A, -B (with side panels).....	28"
BR-84-C, -D, -E.....	22"
Width of Frame.....	22"
Depth of Frame.....	18"
Depth (including doors and handles).....	24 1/4"

Stock Identification:

Type BR-84A consisting of one frame, one base, one top cover, one front door (non-ventilated), one rear door (ventilated), one pair of side panels, one set of terminal board mounting angles and one set of panel mounting angles and instruction book.....	MI-30951-A84
Type BR-84B, same as BR-84A, less front door only.....	MI-30951-B84
Type BR-84C, same as BR-84A, less side panels only.....	MI-30951-C84
Type BR-84D, same as BR-84A, less side panels and front door.....	MI-30951-D84
Type BR-84E, same as BR-84A, less side panels, front and rear doors.....	MI-30951-E84

Accessories

One Door (non-ventilated) .....	MI-30530-G84
One Side Panel.....	MI-30541-G84
One Door (ventilated).....	MI-30535-G84
One Electrical Shield (for mid-section of rack)	
One Per Side.....	MI-30546-G21
One Electrical Shield (for top and bottom sections)	
Two Per Side.....	MI-30546-G28
*One Single Trim Strip .....	MI-30566-G84
*One Double Trim Strip Used where Two Cabinets Are Placed Together.....	MI-30568-G84
Terminal Board Mounting Bracket.....	MI-4570-A
Blank Panels .....	MI-4590 to 4599 Series
Audio Terminal Block .....	MI-4569
Power Terminal Strip.....	MI-4568
Set Terminal Board Mounting Angles.....	MI-30527-G29
Set Panel Mounting Angles.....	MI-30526-G84
Panel and Shelf Assembly.....	MI-11598-B/11599
Ground Bus Kit.....	MI-11728

\* Trim strips not required if front doors are used.

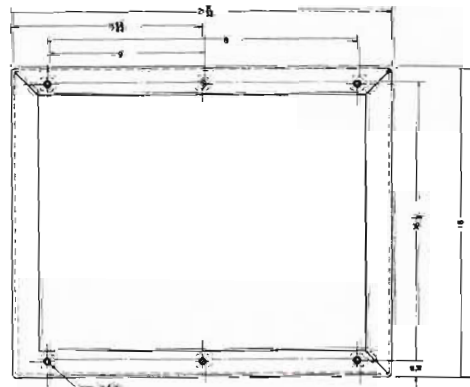

Layout and dimensions of cabinet base

# CABINET RACK

## TYPE BR-19A



### FEATURES

- Lightweight cabinets designed to blend with all control room installations
- Provides flexibility for future expansion
- Sturdily constructed of  $\frac{1}{16}$ " thick cold-rolled steel
- Drilled and tapped for standard 19" panels
- Modern streamlined styling

### USES

The BR-19A Cabinet has been designed to accommodate broadcast equipment. The cabinets are of lightweight steel construction and offer new cost economies. They provide facilities for mounting standard 19" panels and shelves.

### DESCRIPTION

The BR-19A Cabinet Rack is constructed of  $\frac{1}{16}$ " thick cold-rolled steel. It is provided with rear door only. All racks have quick detachable, new corner trims which are fastened to the front with two studs. This provides for rapid, finger-tip removal without the use of screwdrivers, etc. The cabinets are designed in keeping with modern streamlined styling, and have adequate ventilation through the use of rear, side, and top louvers and vents. Vertical corner mouldings cover the panel mounting screws and all panels fit into a recess so that the edges of panels are not exposed when the corner mouldings are removed.

The panel mountings consist of angle irons of  $\frac{7}{64}$ " thick steel. Holes are accurately drilled and tapped 12-24 thread on universal centers for all types of panels. The BR-19A cabinet is finished in a two-tone umber gray in keeping with other RCA studio equipment.

### SPECIFICATIONS

Panel Width .....	19"
Panel Mounting Space (height).....	77"
Clear Inside Depth.....	16 $\frac{3}{4}$ "
Finish.....	Dark and light umber gray wrinkle
Material.....	$\frac{1}{16}$ " thick cold-rolled steel
Overall Dimensions.....	83 $\frac{1}{2}$ " x 22" x 18"
Weight .....	140 lbs.
Stock Identification .....	MI-11550

# RACK ACCESSORIES

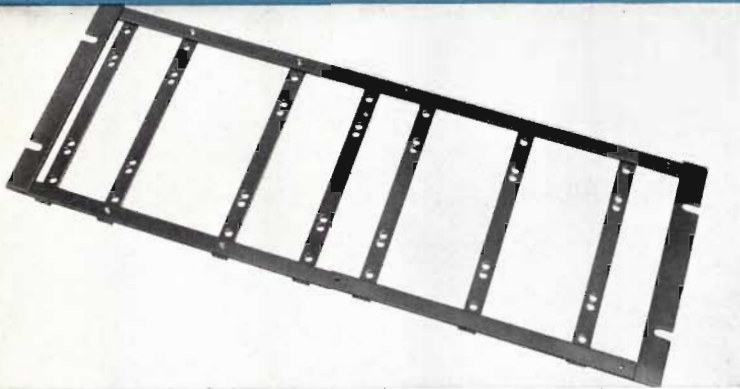

Terminal Block Mounting Bracket MI-4570-A.

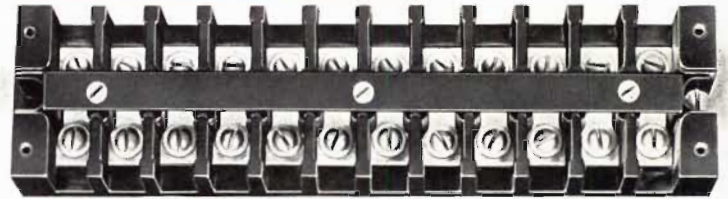

Power Terminal Block MI-4568 with cover removed.



Ground Bus Kit, MI-11728.

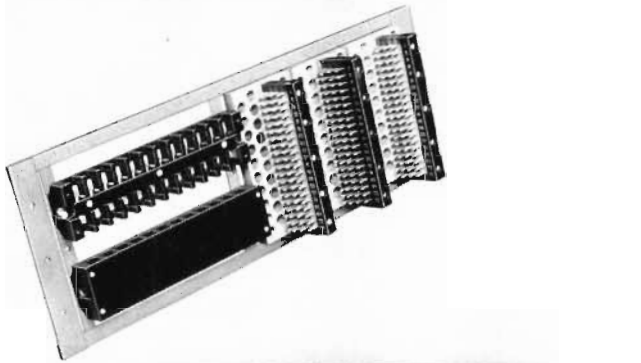

Terminal Block Mounting Bracket MI-4570-A with Terminal Blocks in position.

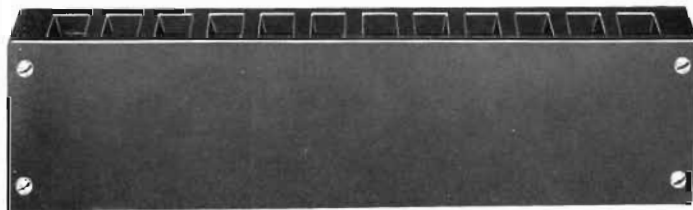

Power Terminal Block MI-4568.

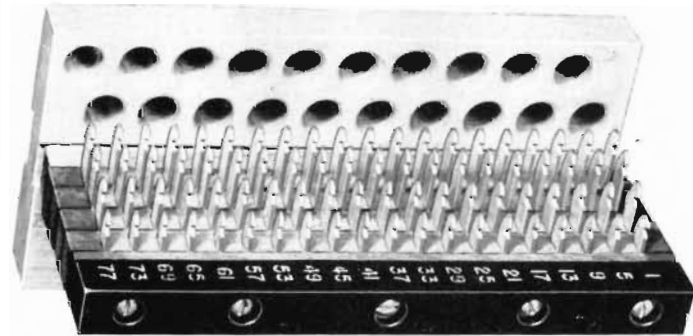

Audio Terminal Block MI-4569.

## BLANK PANELS

A complete line of 19" blank panels is carried in stock for filling spaces on racks and cabinets not occupied by equipment panels. These blanks are also suitable for applications where equalizers, transformers, switches or other items must be panel mounted by the user. The stock of panels includes all standard widths from 1 3/4" to 10 15/32". They are 3/16" sheet steel and are finished and notched to match standard racks—the BJ-24 and BJ-12.

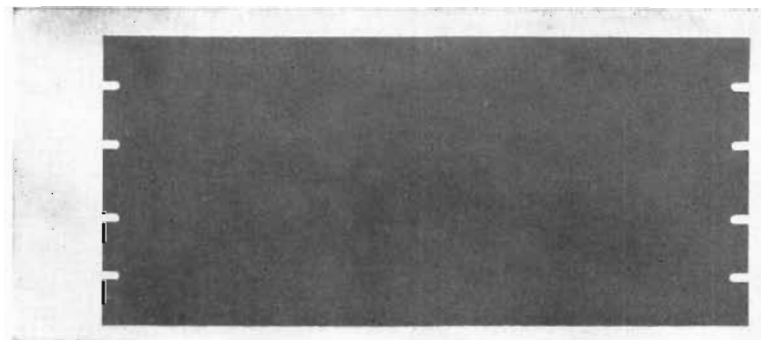

### Panel Width

1	23/32"	Blank Panel, Umber Gray	MI-4590-A
2	1/8"	" " Umber Gray	MI-4598-A
2	3/8"	" " Umber Gray	MI-4599-A
3	1/8"	" " Umber Gray	MI-4589-A
3	15/32"	" " Umber Gray	MI-4591-B
5	7/32"	" " Umber Gray	MI-4592-B
6	31/32"	" " Umber Gray	MI-4593-A
8	23/32"	" " Umber Gray	MI-4594-B
10	15/32"	" " Umber Gray	MI-4595-B



# JACK PANELS

## TYPES BJ-12 AND BJ-24

TYPE BJ-12

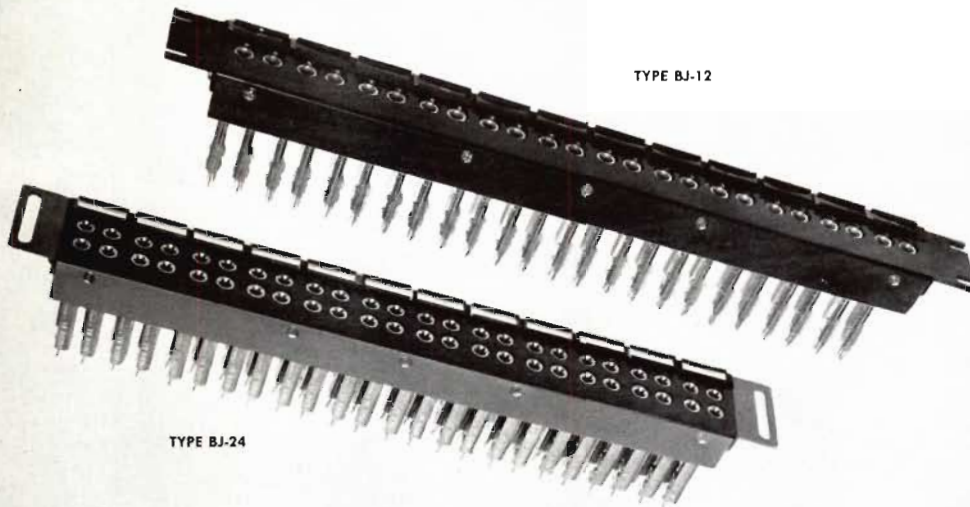

TYPE BJ-24

### FEATURES

- Offset ground lugs—easy to wire
- Spacing of jack pairs prevents cross-circuit patching
- Bakelite strip reinforced to prevent warping or breakage

### USES

Jack Panels, with their associated patch cords, are used with broadcast speech input systems to improve the overall operating flexibility. In addition to providing a convenient termination for program and order wire telephone circuits, closed-circuit jacks may be connected to provide "patch cord" access to the input and output circuits of individual units of the speech assembly. When connected for this purpose, the regular circuits are continuous through the jacks until a patch cord is inserted to make an external connection. With properly connected jacks, patch cords may be freely used in emergencies or for test purposes to interchange or transfer telephone lines, amplifiers, mixers, microphones, or other equipment items.

### DESCRIPTION

The BJ-24 consists of two rows of twelve double jacks mounted on thick black bakelite and furnished with designation card holders. The BJ-12 is similar to the BJ-24 but has only one row of twelve double jacks. The jack sleeves of the BJ-24 and BJ-12 are chromium plated.

### SPECIFICATIONS

Number of Jack Pairs		
BJ-24	.....	24
BJ-12	.....	12
Type of Jacks	.....	Double jacks of standard closed circuit type
Dimensions		
BJ-24	.....	2 1/8" x 19" BJ-12..... 1 3/4" x 19"
Weight (unpacked)		
BJ-24	.....	5 1/2 lbs. BJ-12..... 3 lbs.
Stock Identification		
BJ-24 (RCA Standard)	.....	MI-11645
BJ-12 (RCA Standard)	.....	MI-11646

Photo below shows Convenient Offset Ground Lugs

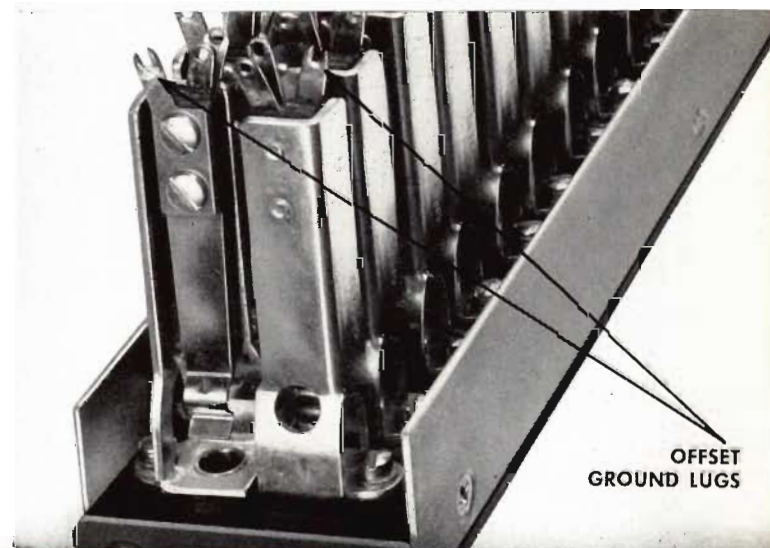

# JACK MATS AND PATCH CORDS

## JACK MATS

Jack Mats are available for covering 1, 2, 3, or 4 type BJ-24 Double Jack Strips.

### SPECIFICATIONS

- Single BJ-24 Jack Strip Mat, overall size.....19" x 3 15/32"  
Umber Gray .....MI-11647-1
- Double BJ-24 Jack Strip Mat, overall size.....19" x 5 7/32"  
Umber Gray .....MI-11647-2
- Triple BJ-24 Jack Strip Mat, overall size..... 19" x 6 31/32"  
Umber Gray .....MI-11647-3

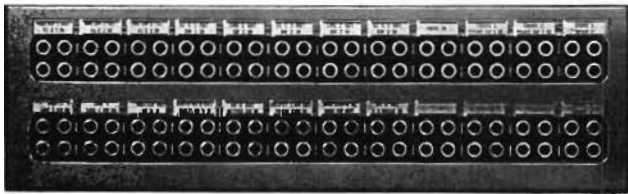

MI-11647-2 Double Jack Mat shown with two double jack strips

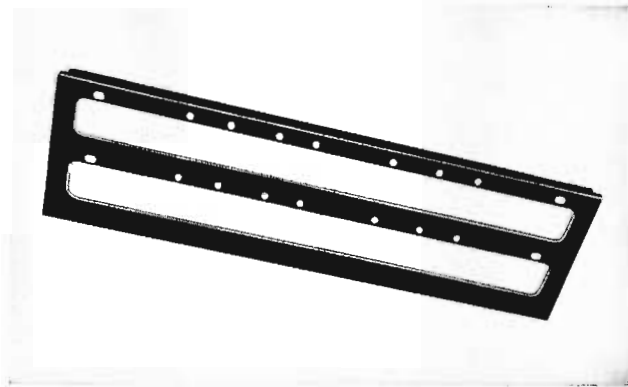

MI-11647-2 Double Jack Mat

View of RCA BR-84 Standard Racks as used at Radio Station WHBQ, Memphis, Tenn. RCA BJ-24 Jack Mats are used in these racks.

## PATCH CORDS

RCA maintains a stock of patch cords for the convenience of broadcasting stations. The W.E. Cord is the standard telephone type using two W.E. 241-A Double Plugs. The Audio Development Co. Cord is shielded and uses two of their Type PJ-1 Plugs which are interchangeable with the W.E. Type 241-A Plug. Three sizes of patch cords are available as listed below:

	Western Electric Co.	Audio Development Co.
Two Foot Cord Length.....	MI-4652-2A	MI-4652-2B
Four Foot Cord Length.....	MI-4652-4A	MI-4652-4B
Six Foot Cord Length.....	MI-4652-6A	MI-4652-6B



Western Electric Telephone  
Type Patch Cord



Audio Development Co.  
Shielded Type Patch Cord

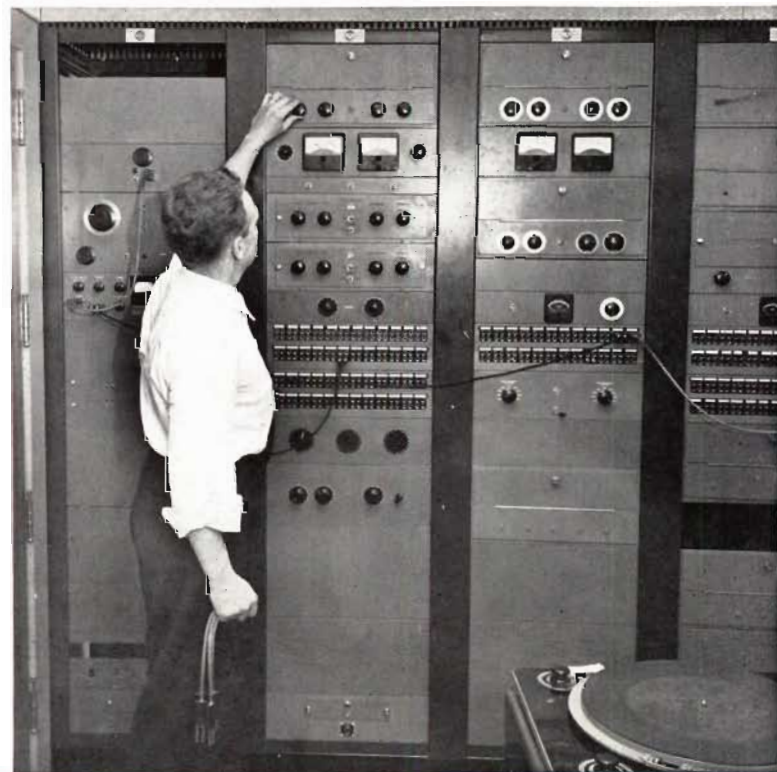

# PANEL AND SHELF

## TYPE BR-2A

### FEATURES

- High quality panel mounting for chassis type units
- Quick access to tubes
- Easy insertion and removal of units
- Provision for control shafts on front panel
- Conveniently installed from front of rack

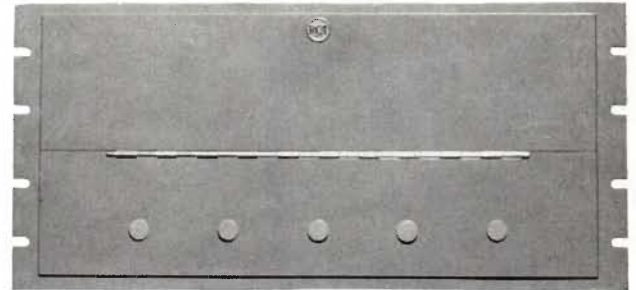

### USES

The BR-2A Panel and Shelf is capable of mounting the following quantities of specific equipments:

- 6—BA-11A Preamplifiers.
- 2—BA-13A Program Amplifiers.
- 2—BA-12A Booster Amplifiers.
- 2—BX-1E Power Supplies.
- 1—BA-14A Monitor Amplifier plus  
2—BA-11A Preamplifiers.

### DESCRIPTION

This shelf will mount in either the BR-19A or the BR-84 series of racks, or in any other standard 19" rack. It occupies 8¾" of panel space. Since the RCA plug-in amplifiers have a standard dimension in depth, they all fit perfectly in this shelf. They are slid into the shelf from the front and the connection plugs pushed into the receptacles at the rear. Guide bars fitting between the amplifiers assist in guiding them into position. All the plug-in amplifiers are equipped with levers which serve either to force them into position or to eject the plugs when dismantling them. The receptacles

Panel removed showing guide bars and receptacles.

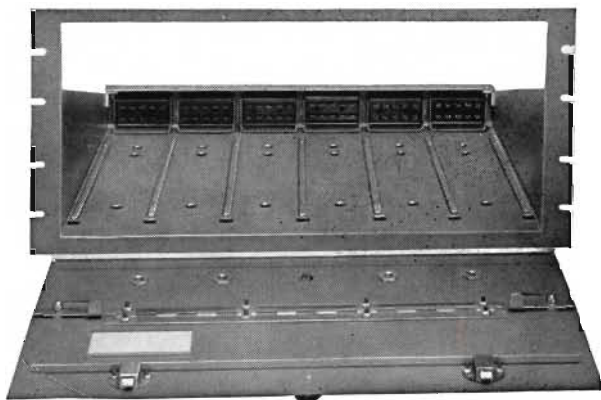

are mounted on individual U-shaped brackets, secured to the chassis of the shelf. They fit in such a manner that a small amount of free movement is permitted in all directions. This eases the alignment of the plugs and receptacles when the amplifiers are pushed into position. The brackets are constructed with a small protruding stop on the lower front edge, preventing the amplifier from being forced to the point where it would exert undue pressure on the receptacle. Provision is made for holding six of these receptacles. The holes in the chassis which are provided for fastening the brackets are slightly oversize to permit perfect alignment during initial installation. The wiring in back of the receptacles is protected by a steel cover which is fastened in place by two machine screws.

The opening in the front of the shelf is covered by a matching panel. This panel is hinged across the center so that the top half may be opened to gain access to the vacuum tubes of the amplifiers. The bottom half has five shaft holes to provide for any controls which the amplifiers may have. When not in use, these holes are covered by small removable buttons. The bottom of the shelf has several round holes for ventilation and also a number of square holes into which fit the amplifier insertion levers.

The shelf may be obtained separately, if desired, or the shelf and panel together, as appropriate. It is supplied complete with mounting brackets, guide bars, and receptacle cover. The receptacles themselves are supplied with the amplifiers, and therefore need not accompany the shelf.

### SPECIFICATIONS

Dimensions, overall:

Width .....	19"
Height .....	8¾"
Depth .....	12¾"
Inside Width .....	16⅞"

Weight, unpacked:

Shelf .....	12 lbs.
Panel .....	3 lbs.

Stock Identification:

Shelf (Umber Gray).....	MI-11599
Panel (Umber Gray).....	MI-11598-B

**FEATURES**

- Provides meter and switch for measuring cathode voltage of amplifier tubes
- Gives plate current indication of operating condition of tubes and circuits
- Up to 17 circuits may be metered by rotary selector switch

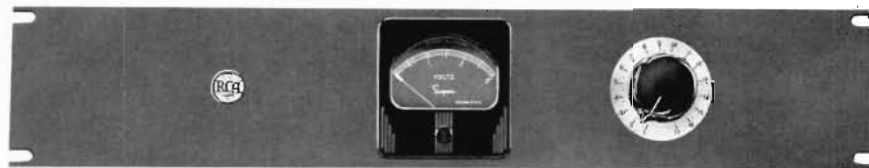

**USES**

The BI-1B Meter Panel provides a convenient means for checking the cathode bias voltages of amplifier tubes and thereby furnishes an indication of the operating conditions of amplifier tubes and circuits. Metering terminals are provided on the BA-11A, BA-12A and BA-13A Series Amplifiers for use with this panel. The mounting is for a BR-84 Series Standard cabinet rack.

**DESCRIPTION**

The BI-1B consists essentially of a meter and switch mounted on a standard 3 1/2", 3/16" thick steel panel. The meter is a 3.0 volt d-c voltmeter having a resistance of

20,000 ohms per volt. The double section switch has eighteen positions including the "off" position with the switch arms connected to the meter terminals. All connections to the panel are made to the switch contacts.

**SPECIFICATIONS**

D-c Voltmeter.....	0-3.0 volts, 20,000 ohm per volt
Metering Switch.....	17 position and "off," double pole
Dimensions (overall):	
Height .....	3 15/32"
Width .....	1 9/16"
Depth .....	2 1/4"
Weight (unpacked) .....	4 1/2 lbs.
Finish.....	Light umber gray
Stock Identification .....	MI-11388

**SWITCH AND FUSE PANEL, Type 57-D**

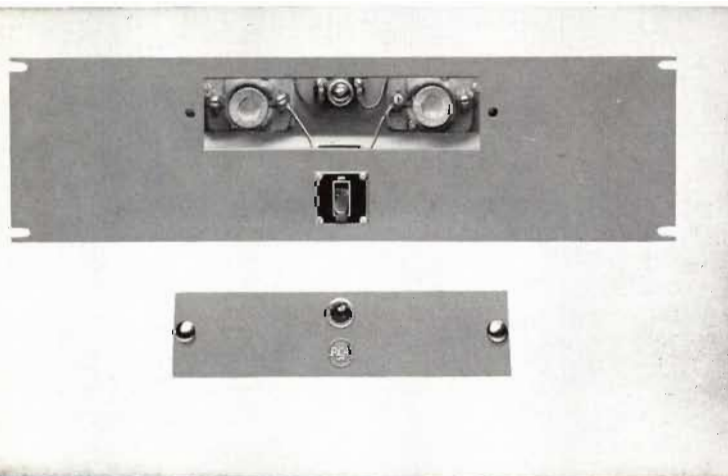

**FEATURES**

- Provides master switch and fuses for rack-mounted equipment
- Pilot lamp glows when equipment is on
- Removable door permits front panel access to fuses and pilot lamp

## 57-D Panel, (cont'd)

### USES

The Type 57-D Switch and Fuse Panel is designed for use as a master input control of the a-c power supply. Ordinarily one such panel is used with each rack or channel of speech input units. The mounting is for a BR-84 Series Standard cabinet rack.

### DESCRIPTION

On this panel are mounted and wired an indicator lamp with red cap, two single fuse blocks of the screw-plug type and a double-pole single-throw power switch. A re-

movable door permits front panel access to fuses and pilot lamp.

### SPECIFICATIONS

Switch.....	D.P.S.T., 250 volts, 30 amperes
Fuses (not furnished).....	Screw-plug type (rating depends upon equipment to be protected)
Dimensions, overall (panel thickness $\frac{3}{16}$ " ):	
Height .....	5 7/32"
Width .....	19"
Depth .....	3 1/2"
Weight (unpacked).....	8 1/2 lbs.
Stock Identification:	
Light Umber Gray.....	MI-4395-G

## VU METER PANEL, Type BI-5A

### FEATURES

- Measures audio volume levels from +4 to +40 vu
- Ten point selector connects up to 10 circuits
- Calibration curve supplied for loads other than 600 ohms
- Large illuminated VU meter

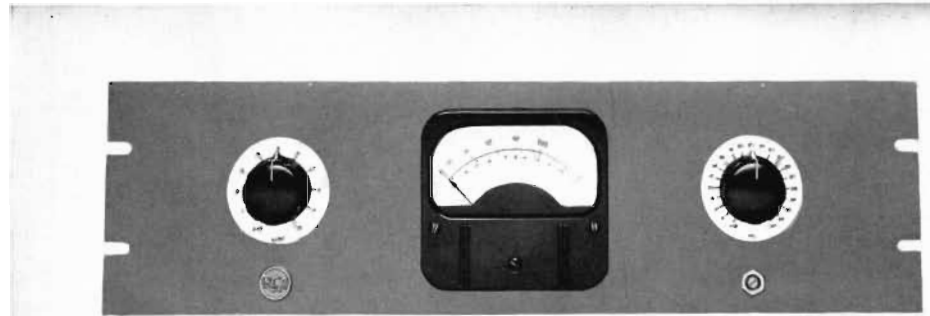

### USES

The BI-5A Meter Panel employs the industry standardized VU Meter which embodies closely controlled electrical and dynamic characteristics combined with deliberate pointer action, moderate pointer speed, and small pointer overswing. It is intended as an audio level indicator for broadcasting, recording or wherever it is desired to read the level of one or more audio circuits with a rack mounting type of instrument.

### DESCRIPTION

The volume indicator panel assembly includes the VU meter, a two circuit ten point selector switch, a variable step-by-step attenuator (4 to 40 db attenuation), and a vernier control for making a fine adjustment of the level reading over a range of  $\pm 0.5$  db. The attenuator has a 1 milliwatt reference position which enables a level reading of zero VU.

The VU meter scale is arranged with percent volts in black figures from "0" to "100" as the principal scale above the arc, and "vu" levels from "-20" to "0" to "+3" as supplementary figures in red below the arc.

The meter and attenuator are calibrated for use with a 600 ohm line, however, a calibration correction curve furnished with the instrument permits its use with loads other than 600 ohms. The ten point selector switch may be connected to any ten lines (or circuits). If one or more switch positions are connected to a jack strip, the number of circuits that may be monitored is unlimited. The meter is provided with the 6.3 volt lamp for illuminating the meter scale.

### SPECIFICATIONS

Input Impedance (except on 1 milliwatt step).....	7500 ohms
Attenuator Steps.....	1 milliwatt position, +4 to +40 db in 2 db steps and off position
No. of lines that may be measured.....	1 to 10 inclusive
Mounting.....	Standard Cabinet Rack
Dimensions:	
Height .....	5 1/4"
Width .....	19"
Depth .....	3 3/4"
Finish.....	Light umber gray
Weight (unpacked).....	7 1/2 lbs.
Stock Identification .....	MI-11265-F

**FEATURES**

- Permits control of audio bandwidth to produce a variety of sound effects
- Two front panel selector switches permit easy and quick change to desired sound effect



**USES**

The BE-21B furnishes a desirable means for producing a variety of special or unusual sound effects through control of the audio bandwidth of the transmitted program. It is especially useful in the production of dramatic plays for making programs sound "bassy" or "tinny" or for simulating the sound of telephone conversations, short wave radio communications or midget radios.

**DESCRIPTION**

The BE-21B consists of high and low pass filters assembled on a panel with two selector panel switches. The switches have nine positions each and are calibrated for high and low cut-off frequencies of 100, 250, 500, 1000, 2000, 3000, 4000, and 5000 cycles. There is also an "off" position on each switch. A key switch is provided for removing the filter from the circuit thus making it possible to preset the filter for the desired characteristics and insert it in the circuit instantly when required.

The 600 ohm input and output impedances of the filter enables it to be connected in any 600 ohm circuit or it may be used in a 250 ohm circuit with only a slight change in response characteristics.

**SPECIFICATIONS**

Source Impedance (unbalanced).....	600 ohms
Load Impedance .....	600 ohms
Input Level.....	-60 to +23 db*
Output Level (maximum) .....	+23 db*
Frequency Response.....	See curves
Insertion Loss.....	.1 db or less at frequencies remote from cut-off
Dimensions, overall	
Height .....	5 1/4"
Width .....	19"
Depth .....	5"
Weight (unpocked).....	15 lbs.
Finish.....	Light umber gray
Stock Identification .....	MI-11723

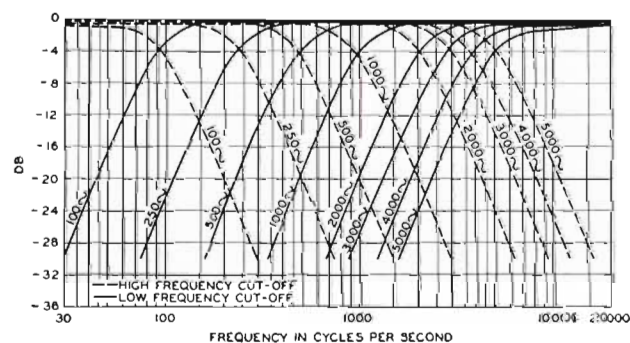

# MOUNTING SHELF

## TYPE BR-22A

### FEATURES

- High quality panel mounting for chassis type units
- Quick access to amplifiers and power supplies
- Easy insertion and removal of units
- Hinged front panel
- Conveniently installed from front of rack

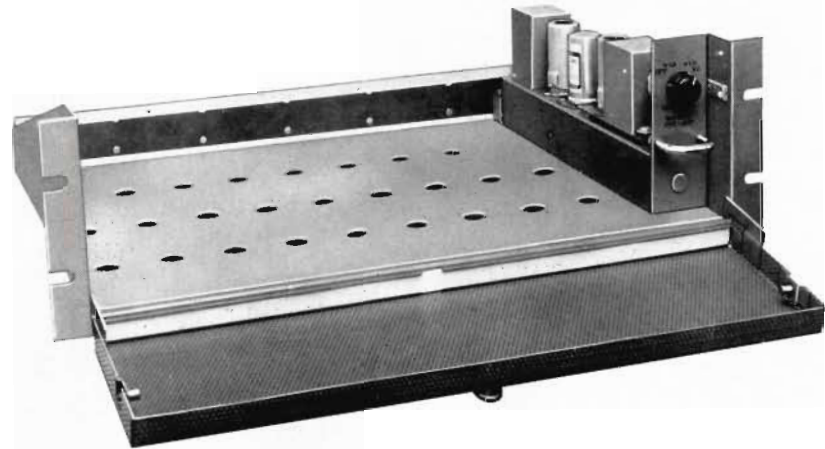

### USES

The BR-22A Mounting Shelf is capable of mounting the following quantities of specific equipments:

- 10 BA-21A Preamplifiers
- 3 BA-23A Program Amplifiers + 1 BA-21A
- 2 BX-21A Power Supplies + 2 BA-21A
- 2 BA-24A Monitor Amplifiers

### DESCRIPTION

This shelf will mount in the BR-84 series of racks, or in any other standard 19" rack. It occupies 5 $\frac{1}{4}$ " of panel space. Since the RCA plug-in amplifiers have a standard dimension in depth, they all fit perfectly in this shelf. They are slipped into the shelf from the front. The receptacles fit in such a manner that a small amount of free movement is permitted in all directions. This eases the alignment of the plugs and receptacles when the amplifiers are pushed into position. The wiring in back of the receptacles is protected by a cover which is fastened in place by two machine screws.

The opening in the front of the shelf is covered by a hinged panel, which may be opened to gain access to the amplifiers and any amplifier controls. The bottom of the shelf has ventilation holes.

A white paper designation strip which is protected by a transparent cellulose acetate strip on the inside bottom flange of the front panel is provided for marking the type number and function of the plug-in unit.

The front panel is perforated to provide additional ventilation. The installations where exposure of the amplifier controls is desired, the front panel may be disassembled from the shelf by removing two screws.

The amplifiers and power supplies are installed on the mounting shelf by means of guide strips and connector-receptacles which are included with each amplifier and power supply. The receptacles are assembled to the guide strip which is then attached to the mounting shelf.

### SPECIFICATIONS

#### Dimensions, Overall:

Width .....	19"
Height .....	5 7/32"
Depth .....	12 $\frac{1}{2}$ "
Inside Width .....	17 $\frac{1}{8}$ "
Weight, Unpacked.....	10 lbs.
Finish, Front.....	Two tone umber gray
Stack Identification .....	MI-11597

# LINE AND BRIDGING TRANSFORMERS

## DESCRIPTION

The following standard RCA transformers are stocked as a convenience to broadcasting stations. These transformers are of the highest quality design having excellent frequency response. They are provided with electrostatic shields between primary and secondary and are furnished with heavily shielded cases. Cores are of special high permeability steel. Terminals are at one end and diagrams of the connections are stenciled on the side of the case. Broadcasting stations may employ the RCA transformers between units with assurance that the overall fidelity of the system will be maintained.

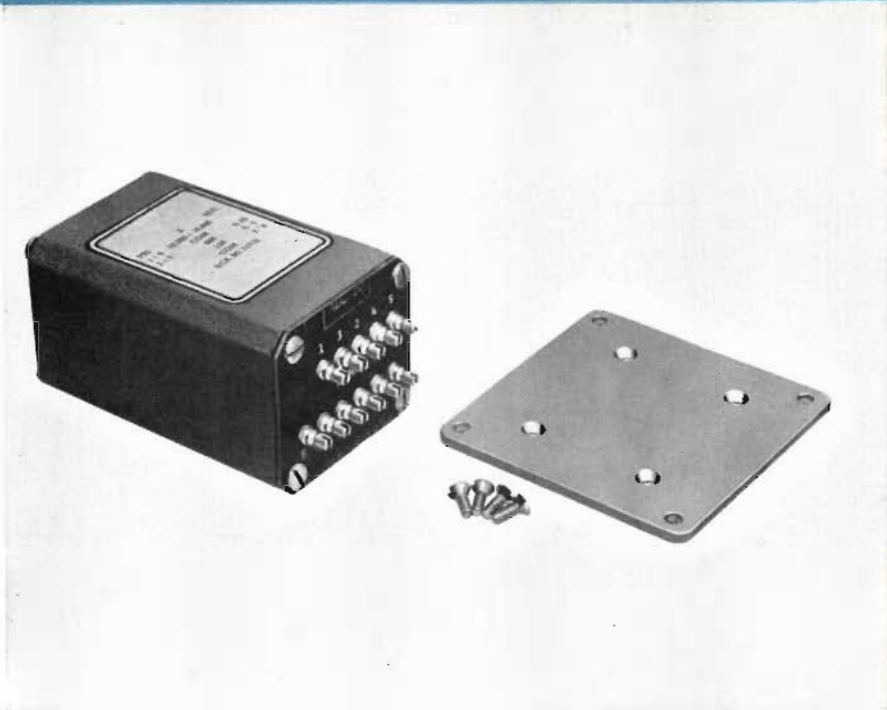

### LINE TRANSFORMER, MI-11713

The core structure, frequency characteristics and shielding of this transformer makes it an ideal unit for isolating line circuits. Its taps provide several combinations of available impedances. One to two of these transformers are very useful items to have around any broadcast station.

#### Specifications (MI-11713)

Frequency Response..... $\pm 1/2$  db 20 to 20,000 cps

Primary Impedances	Secondary Impedances
Ohms	Ohms
150	150
600	600

Stock Identification .....MI-11713

### BRIDGING TRANSFORMER, MI-11712

This transformer may be used as an input transformer for a bridging line amplifier or a monitoring amplifier. It may also be satisfactorily used where it is desired to bridge a program line to feed programs to other mixing or outgoing circuits such as normally employed in a master control room line distribution system.

#### Specifications (MI-11712)

Frequency Response..... $\pm 1/2$  db 20 to 20,000 cps.

Primary Impedances	Secondary Impedances
Ohms	Ohms
20,000	150
	600

Stock Identification .....MI-11712

## GENERAL SPECIFICATIONS for MI-11713 and MI-11712

Dimensions, overall:

Transformer.....4" x 2 11/32" x 1 7/8"  
 Baseplate.....3 1/4" x 3 1/4"

Mounting.....Four holes with center lines 2 3/4" x 2 3/4"

Weight.....2 lbs. 14 ozs.

Finish .....Aluminum gray



# PADS AND NETWORKS

## DESCRIPTION

RCA offers a comprehensive selection of attenuator pads, bridging pads and dividing networks. The pads and networks are well constructed and insulated with precision wound resistors, assuring no internal reflection. The terminals are accessible and securely mounted with the connections stenciled in an appropriate place. The fixed balanced "H" type is available in two types, one introducing a loss of 6 db, the other 10 db. The dividing networks are also available in two types, unbalanced and balanced "H" type, as tabulated below.

### Fixed Pads—Balanced "H" Type

Input Impedance.....	600 ohms
Output Impedance.....	600 ohms
Insertion Loss.....	.6 db
Stock Identification .....	MI-4171-29

### Fixed Pads—Balanced "H" Type

Input Impedance.....	600 ohms
Output Impedance.....	600 ohms
Insertion Loss.....	10 db
Stock Identification .....	MI-4171-30

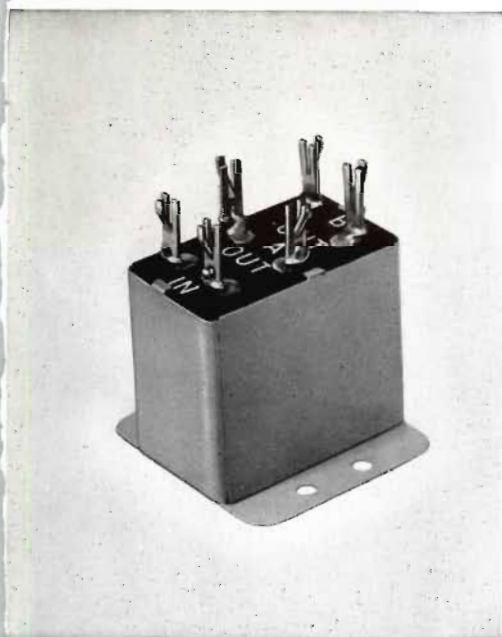

◀ MI-11705

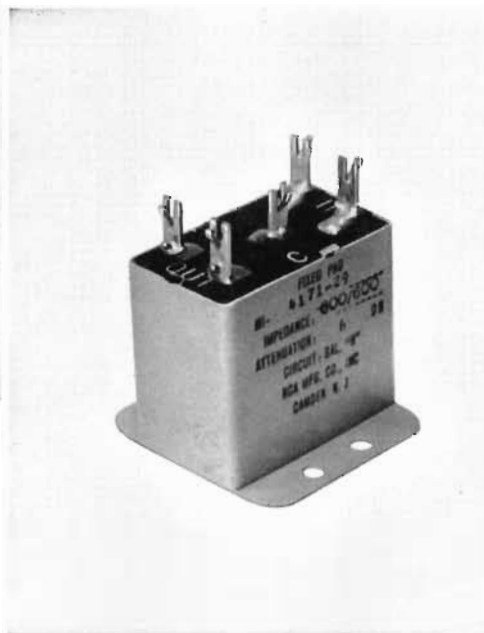

MI-4171-29 ▶

## Dividing Networks

Balanced Two-way, 600 ohms

Insertion Loss.....	.6 db
Stock Identification .....	MI-11704

Balanced Three-way, 600 ohms

Insertion Loss.....	9.5 db
Stock Identification .....	MI-11704-A

Balanced Four-way, 600 ohms

Insertion Loss.....	12 db
Stock Identification .....	MI-11704-B

Balanced Six-way, 600 ohms

Insertion Loss.....	15.6 db
Stock Identification .....	MI-11704-D

## Bridge Pad (Balanced)

Input Impedance.....	600 ohms to two 600 ohm lines— isolation between lines about 45 db
Insertion Loss.....	10 db
Stock Identification .....	MI-11705

# REGULATED POWER SUPPLY

MI-11316

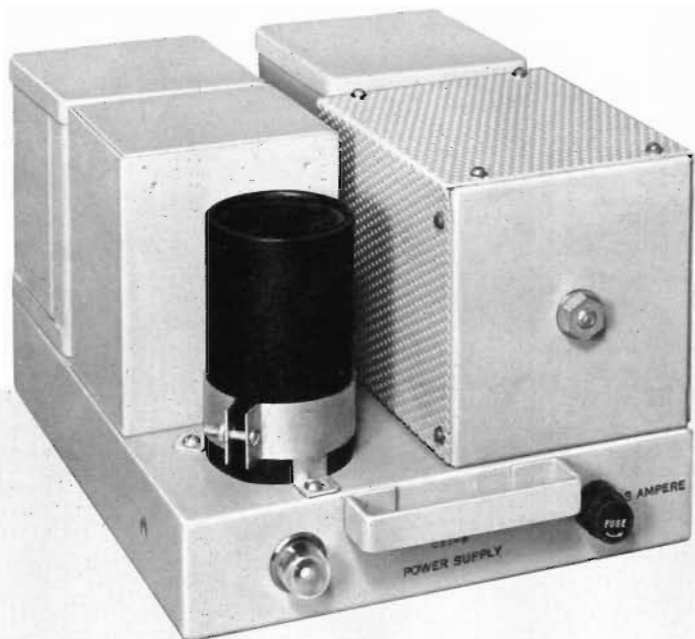

## DESCRIPTION

The MI-11316 is a selenium rectifier type power supply. It provides 3 amperes maximum 24 volts d-c, operating from a nominal 117 volts 50/60 cps source. This power supply is recommended for use with the TC-4A Basic Buy TV relay switching equipment. It is also required to operate the BCS-11A Master Switching Console.

This power supply may be mounted on a standard RCA Panel and Shelf, BR-2A.

## SPECIFICATIONS

Input.....110-125 volts 50/60 cps 200 V.A. or 125 watts  
 Output.....3 amperes, 24 volts d-c  
 Regulation.....Better than 5% voltage regulation, no load to full load  
 Ripple.....60 and 120 cycle components, less than 3% at full load

Size.....Length 9", Width 7 $\frac{3}{4}$ ", Height 5 $\frac{3}{4}$ "  
 Weight ..... 25 lbs.  
 Shipping Weight.....Approximately 30 lbs.  
 Finish.....Light gray baked enamel over zinc chromate primer on 16 gauge steel  
 Stock Identification .....MI-11316

### MI-11316 POWER SUPPLY SCHEMATIC DIAGRAM

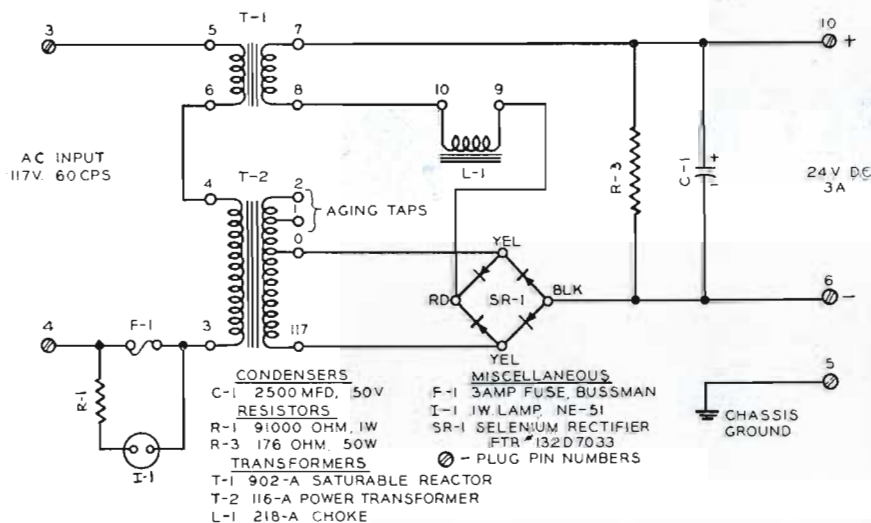

# STUDIO WARNING LIGHTS

MI-11706 SERIES



## FEATURES

- Modern styling
- Satin chrome finish
- Available in five types
- Uniform illumination
- Easily mounted

## USES

The MI-11706 series of warning lights is another new product to supplement the RCA line of modernistically designed studio equipment. These lights have been developed after many requests from broadcasters to furnish a studio warning light that has bold and uniformly illuminated lettering with an external design that would enhance the appearance of any studio.

## DESCRIPTION

The lights are constructed of satin finish cast aluminum with trimmed etchings and tastefully styled for all studio furnishings. The sign is an opaque black glass with frosted translucent 2" letters, using a 40 watt 12" lumiline lamp for a light source.

The interior or mounting base, containing the lamp, sockets and terminal strip for the a-c supply, is of separate metal

construction and insures adequate protection from wires short-circuiting. The complete interior is a wall mounting fixture and allows a new lamp to be replaced quickly by simply removing the outer case by two screws. The warning light is available with five signs as indicated below.

## SPECIFICATIONS

Dimensions: (overall of case)

Length .....	14"
Width .....	3 1/2"
Depth .....	2 1/16"
(Glass Sign Aperture)	
Length .....	9 3/4"
Width .....	2 3/4"

Weight (unpacked) ..... 3 1/2 lbs.

Stock Identification:

"ON-AIR" .....	MI-11706-1
"REHEARSAL" .....	MI-11706-2
"AUDITION" .....	MI-11706-3
"STANDBY" .....	MI-11706-4
"SILENCE" .....	MI-11706-5
Glass Only .....	MI-11718-1 to 5

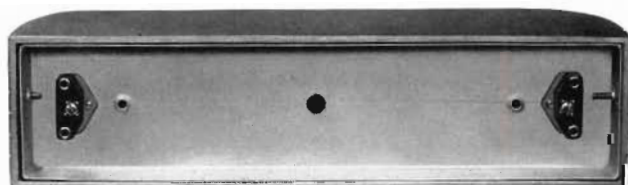

Back view showing simplicity of construction and outer case mounting screws

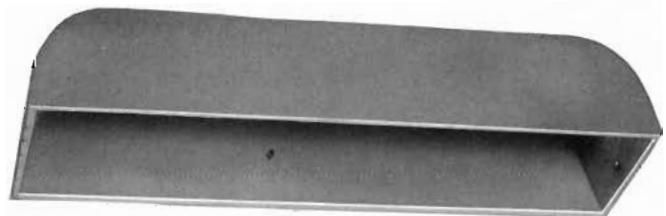

Outer case removed showing Lumiline illuminating lamp

# TRANSCRIPTION TURNTABLES

TYPES BQ-70E AND BQ-70F

## FEATURES

- Provides a high-quality driving mechanism for both standard and fine groove records
- Heavy-duty constant-speed synchronous motor with ample driving power
- Direct-coupled drive provides reliable timing
- Simple control knob permits easy selection of speed shown on dial plate
- Quiet operation. Cushion-mounted motor with silent on-off switch
- Ruggedly built to give years of satisfactory service



## USES

The Types BQ-70E and BQ-70F Transcription Turntables meet the continued demand for highest quality in the reproduction of broadcast transcriptions. They are the latest edition of the popular 70 Series transcription equipment. The BQ-70E and 70F Turntables provide highest quality reproduction of all vertical or lateral cut records. The BQ-70E is a two-speed turntable for 78 and 33 $\frac{1}{3}$  rpm records.

The BQ-70F Turntable is the same as the BQ-70E except for the inclusion of facilities for providing 45 rpm speed.

## DESCRIPTION

The equipment is housed in a wood cabinet of modern design. The cabinet is finished in two tones of umber gray and aluminum trim. A large hinged door is located on the front of the cabinet to permit ready access to the interior. When desired, this door may be completely removed from its hinges. A heat resistant, "Micarta" top is used. Ample

interior space is provided for mounting reproduction filters or amplifiers such as the RCA BA-12A when additional output level is required.

Above is a BQ-70E Turntable shown with reproducing equipment installed. Terminal boards are provided for a-c and audio connections and are accessible from the front of the cabinet.

The motor is a high torque synchronous type, cushion-mounted on the bottom shelf of the equipment, thus isolating motor noise from the cabinet. In order to insure the faithful reproduction of high quality records, the turntable platter has associated with it a separate specially designed flywheel 12" in diameter. The turntable platter and flywheel assembly is completely isolated from the motor through a series of mechanical filters and a spring clutch arrangement.

Both the BQ-70E and BQ-70F Turntables are supplied less tone arms, filter and filter selector switch. A hand rest is supplied.

## SPECIFICATIONS

Turntable Diameter .....	16"
Turntable Speed:	
BQ-70E.....	33 $\frac{1}{3}$ —78.26 $\pm$ 0.3% rpm
BQ-70F.....	33 $\frac{1}{3}$ —45—78.26 $\pm$ 0.3% rpm
Wow or Flutter at 78.26 rpm.....	0.2% half of peak-to-peak
Wow or Flutter at 45 rpm.....	0.25% half of peak-to-peak
Wow or Flutter at 33 $\frac{1}{3}$ rpm.....	0.3% half of peak-to-peak
Finish.....	Two-tone umber gray with aluminum trim
Weight (unpacked).....	140 lbs.
Power Supply.....	170 volts, 50 or 60 cycles
Power Consumption.....	35 watts
Dimensions, Overall:	
Height .....	29 $\frac{1}{2}$ "
Width .....	23 $\frac{1}{2}$ "
Depth .....	24 $\frac{3}{4}$ "

Stock Identification:

BQ-70E (60 cycle) (33 $\frac{1}{3}$ —78.26).....	MI-11816
BQ-70E (50 cycle) (33 $\frac{1}{3}$ —78.26).....	MI-11817
BQ-70F (60 cycle) (33 $\frac{1}{3}$ —45—78.26).....	MI-11818
BQ-70F (50 cycle) (33 $\frac{1}{3}$ —45—78.26).....	MI-11819

### Accessory Equipment

Lightweight Tone Arm.....	MI-11885-A
1 Mil Pickup Fine Groove.....	MI-11874-4
2.5 Mil Pickup Standard Groove.....	MI-11874-5
Lightweight Pickup Filter.....	MI-11888
Adjustable Spanner Wrench (for removing spanner nut which holds speed-reducing bearing).....	MI-11726



▲ Photo above shows the method of mounting the Lightweight Tone Arm. The BQ-70F Turntable shown here is essentially the same as the 70E, except that 45 rpm facilities have been added.

View below shows how Reproducing Filter, MI-11888 is mounted. Also apparent is the room available for mounting a preamplifier. Note that door may be removed from hinges.



# THREE-SPEED TRANSCRIPTION TURNTABLE

TYPE BQ-2A

## FEATURES

- Simplified speed changing mechanism for ease of operation and reduced maintenance
- Reliable, quick-start motor with ample driving power
- Provides a high-quality driving mechanism for 33 $\frac{1}{3}$ , 45 or 78 rpm records
- Rugged and simple construction—less parts to wear
- Very smooth starts—necessary with microgroove
- Rugged drive assembly and resonance-free wooden cabinet built to give many years of satisfactory service
- Superior performance at moderate cost



## USES

The RCA type BQ-2A Transcription Turntable meets broadcasting needs for a high-quality driving mechanism which will accommodate all types of commercial disc recordings up to 16" in diameter at speeds of 33 $\frac{1}{3}$ , 45 or 78 rpm. The drive assembly is extremely reliable and quiet, and meets all NARTB performance specifications, assuring fidelity in the reproduction of broadcast transcriptions.

The cabinet assembly not only provides a simplified mounting for the drive assembly, turntable and operating

controls, but allows ample room for housing the reproduction equipment. All standard types of broadcast tone arm equipment may easily be mounted on the cabinet and, if desired, two tone arms for various types of pickups can be accommodated. The cabinet has a spacious compartment where equalizer equipment and necessary amplifiers may be installed.

The BQ-2A Drive Mechanism is available as a separate unit for those stations which may wish to mount it in a custom built cabinet, bench, or table.

**RUGGED CONSTRUCTION**—Sturdy 16-inch turntable platter with large spindle accurately machined to give many years of service.

**QUIET OPERATION**—Cushion-mounted motor operated by silent mercury switch.

**ACCURATE PERFORMANCE**—Large sleeve bearing provides accurate turntable alignment.

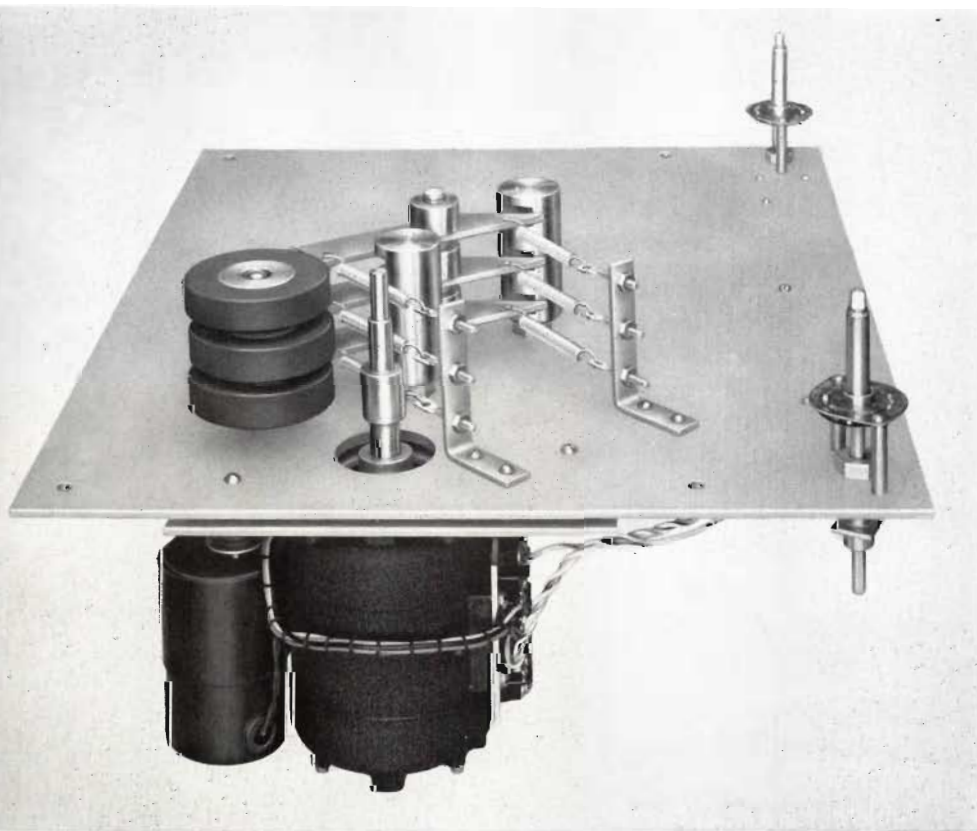
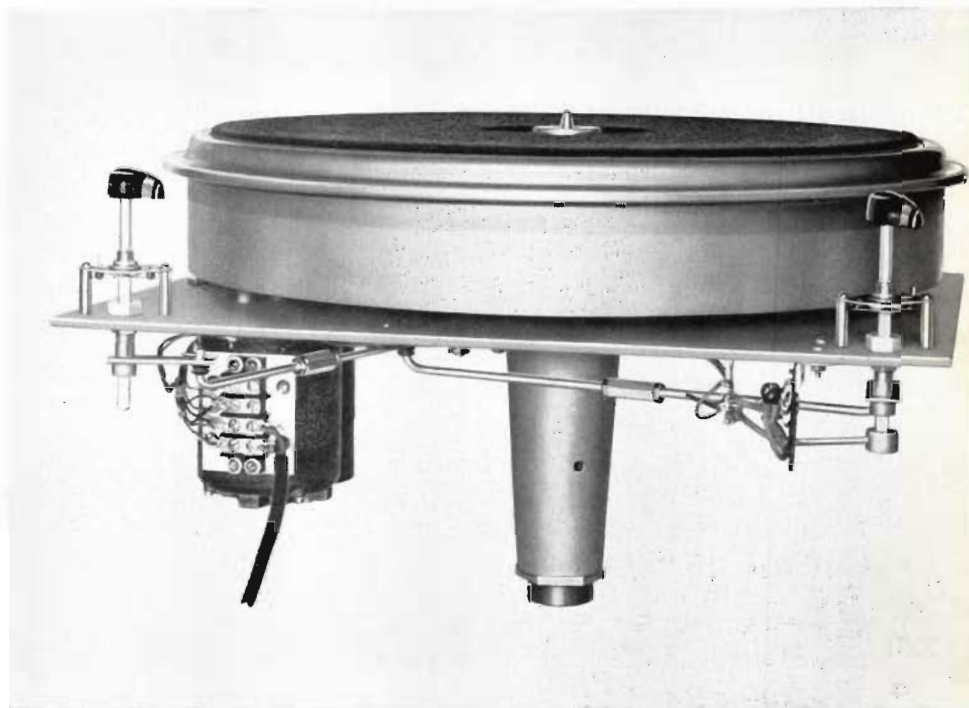

**FAST CUEING**—Reliable constant-speed synchronous motor provides ample driving power and quick smooth starts.

**GOOD DESIGN**—Simplified speed changing mechanism has minimum of moving parts, self-compensating neoprene idlers.

**LONG LIFE**—"Off-On" switch relieves idlers in "Off" position providing extended puck life—one of many long-life features.

**ACCURACY**—Separate speed selector and "Off-On" switches for positive on-speed starting.

**EASE OF OPERATION**—Quick speed change with or without turntable revolving; snap-up spindle for 45 rpm operation assures ease of record handling and proper centering.

## DESCRIPTION

The BQ-2A Turntable Drive Assembly is a three-speed, rim-drive type mechanism consisting of a high torque synchronous motor with a three-step diameter pulley coupled directly to the motor shaft. The speed of the turntable is determined by the ratio of diameters between the motor pulley and the turntable rim. Two models are provided, one for operation with 60 cycle power supply (MI-11830), and another for 50 cycle use (MI-11831). The only difference between the models is in the respective diameters of the three-step motor pulley since the motor with its capacitor is designed for both 60 and 50 cycle operation.

A cabinet of modern design is provided to house the turntable equipment. This wooden console has a durable two-tone, umber gray fabrikoid covering which is resistant to scuff and scratches, and will not chip like enamel or

lacquer surfaced cabinets. A cigarette-proof linoleum top with aluminum trim is provided. A large hinged door is located on the front of the cabinet to permit ready access to the interior. When desired, this door may be completely removed from its hinges. Ample interior space is available for mounting reproduction filters and booster amplifiers such as the RCA type BA-12A. The a-c power cord is brought through the bottom of the cabinet and connected to the motor terminal board.

A three-position speed selector switch is linked to a cam which allows the three rubber idlers to engage, one at a time, between the motor pulley and the turntable rim. An "Off-On" selector knob operates a mercury switch which energizes the motor and simultaneously engages or disengages the rubber idlers in the "On" or "Off" positions respectively.

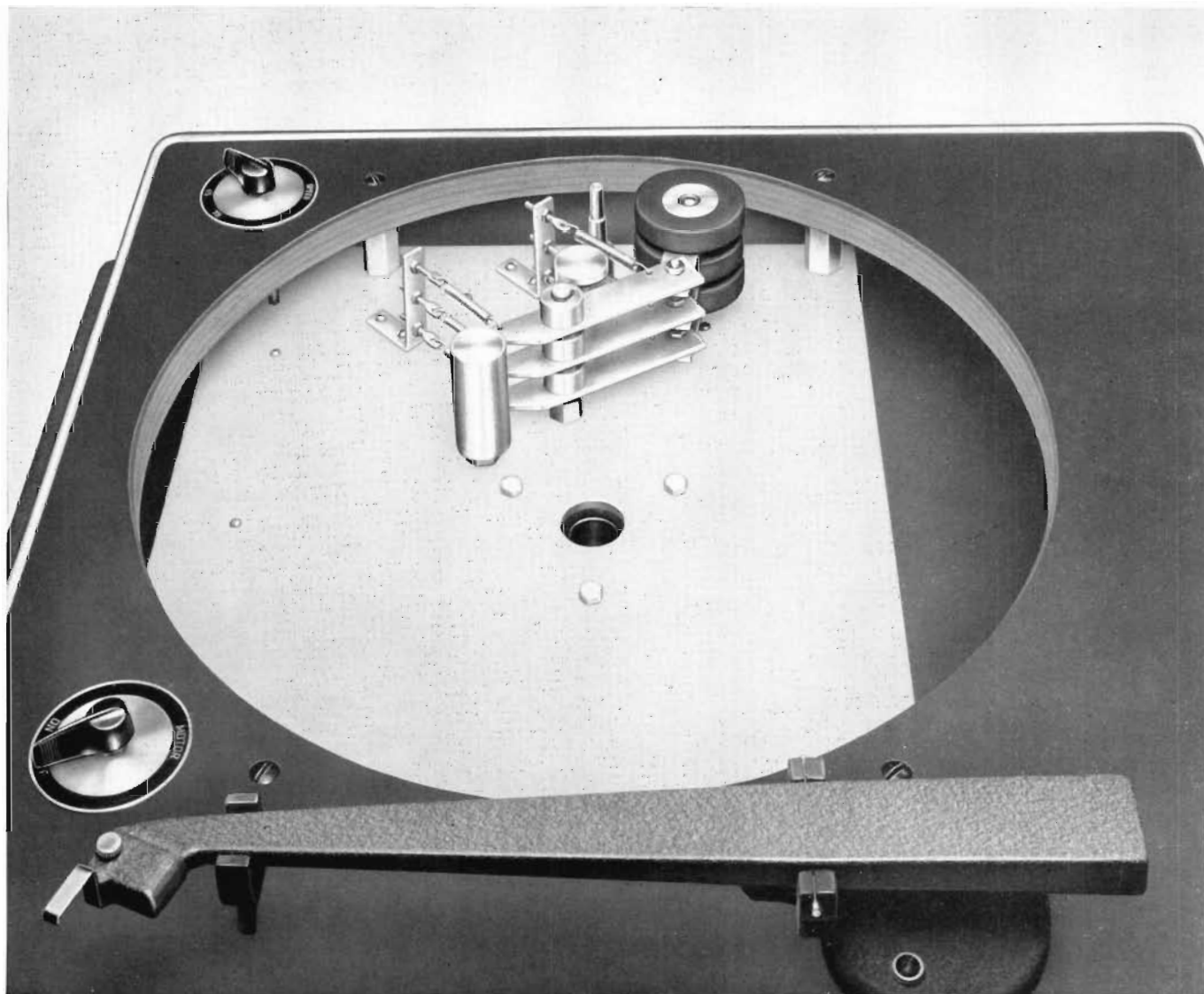



The turntable platter is a sturdy 14-pound aluminum casting. It and the spindle assembly are held in the main support casting in oilite bushings and the thrust is supported by a single ball at the bottom end of the spindle. The drive motor is mounted on a separate plate and supported by vibration mounts to eliminate rumble. All posts and shafts which provide bearings for cams and arms are assembled to a common plate to insure proper alignment.

A feature of the motor drive assembly is the use of a separate speed control which can be adjusted without motor starting between any combination of speeds. A separate starting switch is provided to handle cueing and routine operation in the most functional manner. This "On-Off" switch relieves the neoprene idlers when set to the "Off" position, thus providing extended puck life.

The BQ-2A Transcription Turntables are supplied less tone arms and filters. These are supplied as accessories and should be selected according to the type and variety of recordings to be played. A template is supplied with the Instruction Book and should be used as a guide in mounting controls, tone arms and filters on the RCA cabinet, or any other suitable cabinet, table or bench.

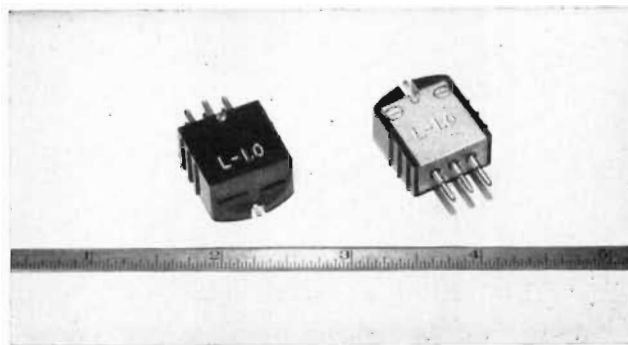

Plug-in Type Pickup Head, MI-11874-4, used with BQ-2A.

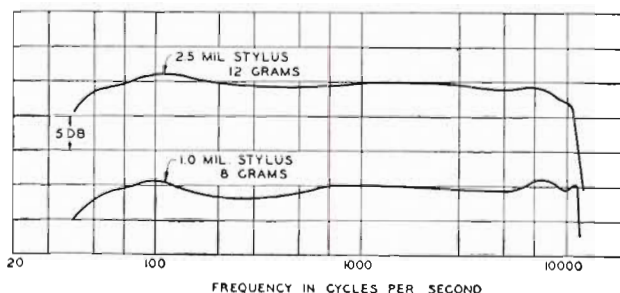

Typical response of Pickup, Tone Arm and Filter.

## SPECIFICATIONS

### Performance Specifications

Turntable Speed.....	33 1/3, 45 and 78.26 ±0.3%
Wow or Flutter:	
At 33 1/3 rpm.....	0.25% half of peak of peak
At 45 rpm.....	0.20% half of peak of peak
At 78 rpm.....	0.20% half of peak of peak
Motor.....	1/75 H.P., 1800 rpm at 60 cycles, 1500 rpm at 50 cycles, 50° C. temperature rise, 2 mf 300 working volts capacitor
Power Supply.....	105-125 volts, 50/60 cycles, single phase
Power Consumption.....	34 watts
Turntable Diameter .....	16"
Hub and Spindle Diameter:	
Hub for 45 rpm Records.....	1.5"
Spindle for 33 1/3 and 78 rpm.....	0.2835"
Overall Dimensions:	
Turntable Drive Unit.....	18" long, 18" wide, 11" high
Cabinet.....	23 1/2" wide, 24 3/4" deep, 28" high (adjustable 3/4")
Weight:	
Turntable Drive Unit.....	31 lbs
Cabinet .....	60 lbs.
Finish.....	Two tone umber gray fobrikoid with aluminum trim

### Equipment Supplied

BQ-2A Turntable and Cabinet including turntable drive assembly, console cabinet, turntable platter assembly and Instruction Book (IB-24780), but less reproducing equipment such as tone arms and amplifiers:

For 60 cycle operation.....	MI-11833
For 50 cycle operation.....	MI-11834

BQ-2A Turntable Drive Assembly, less console cabinet and reproducing equipment such as tone arms and amplifiers:

For 60 cycle operation.....	MI-11830
For 50 cycle operation.....	MI-11831

### Accessory Equipment

Lightweight Tone Arm (Less Pickup Head).....	MI-11885-A
1.0 Mil Fine Groove Diamond Stylus Pickup (for Lightweight Tone Arms).....	MI-11874-4
2.5 Mil Standord Groove Diamond Stylus Pickup (for Lightweight Tone Arms).....	MI-11874-5
Pickup Filter for Lightweight Tone Arms.....	MI-11888
BA-12A Booster Amplifier.....	MI-11232
BA-24A Monitoring Amplifier .....	MI-11247

# LIGHTWEIGHT TONE ARM

MI-11885-A

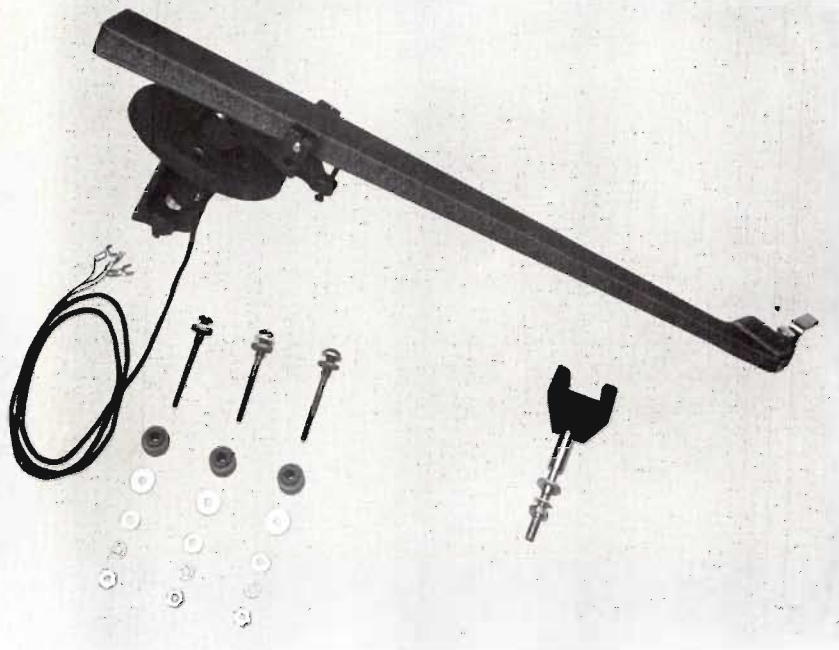

## FEATURES

- Used with RCA plug-in heads, provides high quality reproduction of 45 rpm and 33 $\frac{1}{3}$  rpm fine groove records, standard transcriptions and commercial records
- May be applied to existing turntables.
- Less than 4 degrees tracking error on any standard record
- Low mass and anti-friction pivots permit tracking on warped and eccentric records.

## USES

The new lightweight pickups and tone arm (MI-11874 series and 11885-A respectively) have been designed to fulfill the need for a high-quality broadcast pickup combination for playing fine groove records and standard transcriptions. A popular application of this new design is in combination with present Universal Pickups and RCA BQ-2A and 70-Series Turntables.

In such installations, the new unit provides the broadcaster with pickup and tone arm facilities for groove sizes associated with all three speeds. 70-Series Turntables are easily modified for the 45 rpm speed by means of MI-11883 Kit.

## DESCRIPTION

The lightweight tone arm is designed to function with two diamond stylus sizes (1 mil stylus for fine groove and 2 $\frac{1}{2}$  mil stylus for standard transcription and 78 rpm records). These are readily interchangeable as "plug-in" units.

Tone arm resonances have been carefully placed so that they are outside of the operating frequency range of the systems, thus assuring smooth response characteristics. Distortion due to tracking error in the arm and pickup has been reduced to a minimum by careful design. The anti-friction vertical and lateral pivots and

low mass allow the tone arm to track warped and eccentric records.

The required stylus forces are only a fraction of what was formerly considered necessary, thus assuring longer life for both the stylus and the record. Design of the pickup system permits interchange of the magnetic heads without necessitating any adjustment for correct stylus pressure. The stylus is readily visible, providing means for accurately spotting the pickup on the record.

## LIGHTWEIGHT TONE ARM (Cont'd)

### SPECIFICATIONS

Tracking Error, 16-inch Record (C. D. 12").....4° max.  
 Pivot Bearings.....Anti-resonant bearings in vertical and horizontal planes  
 Tone Arm Head Receptacle.....Quick-lock, plug-in type  
 Construction of Arm.....Aluminum casting  
 Length of Arm.....15"  
 Width of Arm.....Tapered 1½" to ¾"  
 Height of Arm.....Tapered 5/8" to 9/32"  
 Approx. Shipping Weight (arm, assembly, etc.).....3 lbs.  
 Mounting.....Approx. 12" from spindle center

**Stock Identification:**

Tone Arm (less pickup heads) includes assembly complete with tone arm rest and mounting hardware.....MI-11885-A



70-F Turntable with Pickup and Tone Arm installed at rear

## LIGHTWEIGHT PICKUP HEADS

### MI-11874-4 AND MI-11874-5

#### SPECIFICATIONS

#### Lightweight Lateral Magnetic Pickups

Output Pickup Impedance.....135 ohms @ 1000 cycles  
 Load Impedance.....Filter Output should be connected to unloaded input transformer of amplifier designed to operate from 250 ohm source (BA-11A or BA-12A).  
 Compensation Required.....MI-11888 Filter  
 Frequency Response.....(See curve)  
 Voltage Output.....Open circuit voltage at terminals of pickup head, reproducing 1000 cycle band of 6.1 cm/sec. test record is 11 millivolts.  
 Output Level at Filter Output.....Approx. -65 dbm  
 Hum Level.....-120 dbm  
 Pickup Weight.....MI-11874-4 (0.37 oz.); MI-11874-5 (0.51 oz.)  
 Stylus Force in combination with Tone Arm, MI-11885-A:  
 MI-11874-4.....8 grams      MI-11874-5.....12 grams  
 Stylus Tip Radius (Polished Diamond Stylus):  
 MI-11874-4 (for fine groove).....1.0 mil  
 MI-11874-5 (standard transcriptions).....2.5 mils  
 Overall Dimensions (plug-in pickup heads):  
 Excluding contact pins.....Width ¾", Depth ¾", Thickness 7/16"  
 Stock Identification:  
 1 mil, Pickup, Fine Groove (color, Red).....MI-11874-4  
 2.5 mil, Pickup, St'd Transcription (color, Green).....MI-11874-5

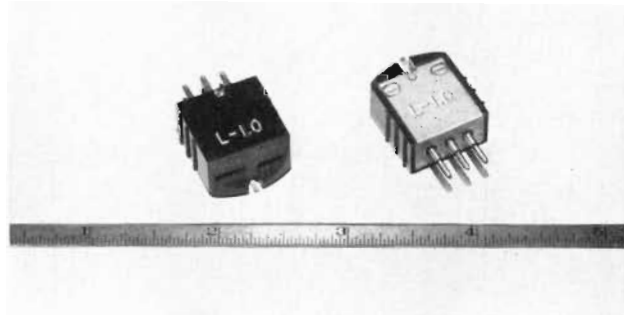

Plug-in Type Pickup Head, MI-11874-4

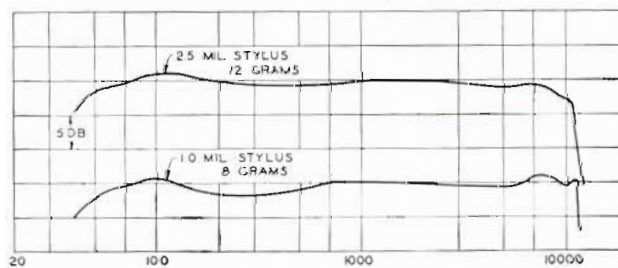

Typical response of Pickup, Tone Arm and Filter

See chart on page 108 for Equipment Combinations required for various records and transcriptions.

# PICKUP EQUALIZER

MI-11888

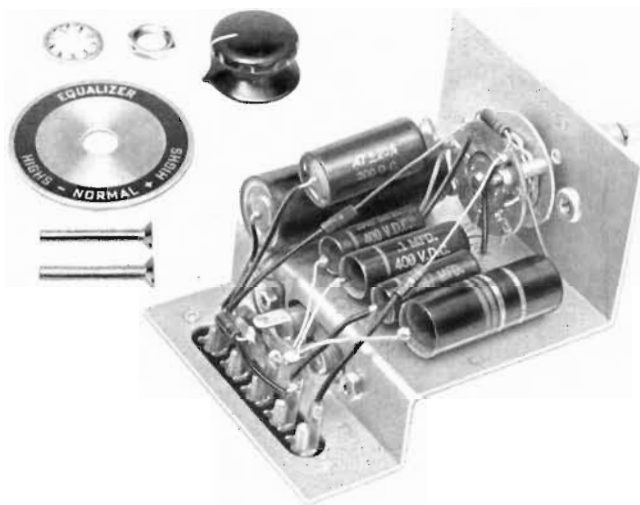

## USES

The MI-11888 Pickup Equalizer is used to filter the re-created audio frequencies of transcriptions before introduction into the audio amplifier system of broadcast and TV stations to achieve the most desirable response over the entire audio frequency range. The equalizer may be mounted in the RCA Type 70-series or the BQ-2A transcription turntables and is designed for use with the MI-11874-4 Pickup Head for the reproduction of 45 or 33 1/3 rpm lateral cut fine groove records and the MI-11874-5 Pickup Head for the reproduction of 78 or 33 1/3 rpm lateral cut standard groove records.

## DESCRIPTION

The MI-11888 Pickup Equalizer consists of a capacitor-resistor network mounted on a plate, and separate dial plate, control knob, and hardware for mounting it in a transcription turntable. The right hand front corner of RCA turntables has been designated as best site for the equalizer in order to reduce noise pickup to the lowest possible value.

The equalizer is designed to be used with any amplifier having an unloaded input transformer and which has a flat response when operated from a 150 ohm source. Examples of this type of amplifier are the RCA 12A Booster Amplifier, the BA-12A Preamplifier, the BA-24A Monitoring Amplifier and the microphone input of any RCA consolette. In order to compensate for variations in transcriptions, three responses can be chosen: (1) flat, (2) increased high frequencies, or (3) decreased high frequencies.

## FEATURES

- Adjustable high frequency response
- Follows NARTB curve
- Insensitive to hum pick-up
- Economical
- Compact—easy to mount in transcription turntables

## SPECIFICATIONS

Frequency Response.....	Variable over range of 30 to 10,000 cycles (see response curves)
Output Level:	
At 150 Ohms.....	Approximately -65 dbm (measured using RCA Test Record 12-5-51 at 1000 cycle reference level)
Output Impedance.....	150 ohms
Noise Level.....	Less than -120 dbm
Load Impedance.....	The output of the filter should be connected to the unloaded input transformer of an amplifier having a flat response and designed for operation from a 150 ohm source.
Dimensions Overall.....	3 5/16" long x 2 7/8" wide x 5 1/2" h1gh
Weight .....	3 1/4 lbs.
Stock Identification .....	MI-11888

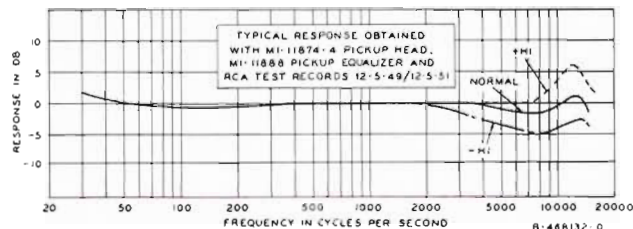

# 45 RPM CONVERSION KIT

MI-11883

## FEATURES

- Simple to add to present RCA turntables
- Quick speed changes
- Rugged construction for long service
- Quiet operation
- Accessory fine groove pickup and tone arm available

## DESCRIPTION

The 45 RPM Conversion Kit is made available to broadcasters for playing the new RCA 45 rpm records on any type 70-C or 70-D Transcription Turntable. The modification kit is easy to add to existing turntable and requires minimum investment by eliminating the expense of additional turntables. The kit consists of a ball-type speed reducer which is installed between the two flexible couplings in the main drive shaft of the 70-D turntable. In one position, the ball reducer is inoperative and the shaft is driven straight through at 78 rpm. In the other position, the ball reducer drives the shaft and flywheel at 45 rpm. The over-riding spring clutch is built into the new mechanism and is operative in both positions.

Speed change is accomplished by turning the motor control knob on the turntable deck. It may be shifted in either direction while the turntable is running. Three positions are provided: (1) an "Off" position which completely shuts down turntable by turning off motor, (2) a "78-33 $\frac{1}{3}$ " rpm

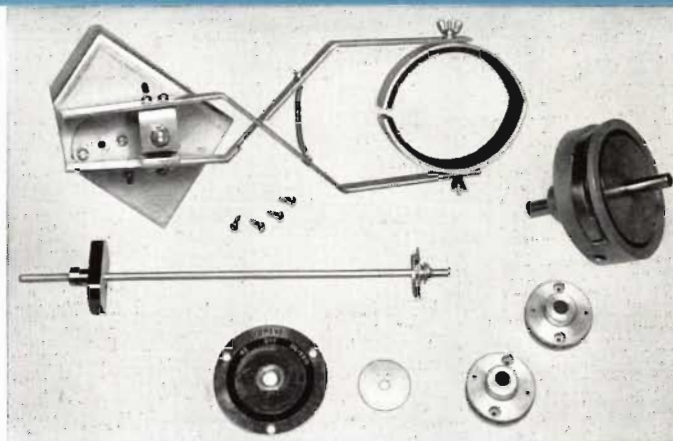

position which permits either speed by use of speed-change lever on turntable and (3) "45" rpm position which permits this speed with speed-change lever set at "78".

Also required but not included in this kit, is a second tone arm for fine groove playback (MI-11885-A).

## SPECIFICATIONS

Approximate Weight, Unpacked.....6 $\frac{1}{2}$  lbs.  
 Stock Identification .....MI-11883  
 (Kit includes clutch assembly (speed changer), arm assembly (brake), switch and cam shaft assembly, dial plate, 2 couplings and adapter hub.)

## Accessories

Lightweight Tone Arm.....MI-11885-A  
 1 Mil Pickup for Fine Grooves.....MI-11874-4  
 2.5 Mil Pickup for Standard Transcription.....MI-11874-5  
 Pickup Equalizer .....MI-11888

## 45 R.P.M. RECORD ADAPTOR, MI-11886



Arrow above points to the MI-11886, 45 RPM Adaptor, mounted on the 70-D Turntable

The MI-11886 Adaptor Plate is designed for use in playing 45 rpm records on standard transcription turntables. It adapts the turntable to accommodate 45 rpm records, but does not convert driving speed.

Constructed in a single, one-piece unit, the Adaptor Plate consists of an aluminum disc, 9 inches in diameter, with a center hub which adapts the turntable spindle to the 45 rpm record hole size. The disc surface is lined with felt from the outer edge to an inner diameter of 3 $\frac{3}{8}$  inches.

Record slippage due to pickup drag is eliminated by the felt covering on the disc surface. Records with as much as  $\frac{1}{2}$  inch of warp may be played without difficulty.

Stock Identification .....MI-11886

# TURNTABLE ACCESSORIES

RCA Makes available the following turntable accessories for special applications:

Gray Viscous Damped Transcription Tone Arm.....	108-B
Gray Equalizer for 108-B Transcription Tone Arm.....	602-C
GE Variable Reluctance Cartridge, replaceable 1.0 mil diamond stylus .....	RPX-145
GE Variable Reluctance Cartridge, replaceable 2.5 mil diamond stylus .....	RPX-146
GE Variable Reluctance Cartridge, replaceable 1.0/2.5 mil diamond dual stylus.....	RPX-147
GE Replacement Stylus Tip, 1.0 mil diamond.....	RPJ-01D
GE Replacement Stylus Tip, 2.5 mil diamond.....	RPJ-02D
GE Replacement Stylus Tip, 1.0 mil sapphire.....	RPJ-01S
GE Replacement Stylus Tip, 2.5 mil sapphire.....	RPJ-02S
Adaptor Kit (for using above cartridge and styli with MI-11885-A Tone Arm).....	MI-11890-A
Adaptor Kit (for using above cartridge and styli with BQ-1A Tone Arm).....	MI-11890-B

## TABLE FOR USE IN DETERMINING REPRODUCING EQUIPMENT REQUIRED TO PLAY DESIRED TYPES OF RECORDINGS

<i>TYPE OF RECORDS TO BE PLAYED</i>	<i>REPRODUCING EQUIPMENT REQUIRED</i>
Lateral transcriptions, 78 rpm records and fine groove records	MI-11885-A Lightweight Tone Arm MI-11874-4 1 Mil Lightweight Pickup Head MI-11874-5 2.5 Mil Lightweight Pickup Head MI-11888 *MI-4975 or MI-11887
Lateral transcriptions and 78 rpm records	MI-11885-A Lightweight Tone Arm MI-11874-5 2.5 Mil Lightweight Pickup Head MI-11888 Reproducing Filter
Fine groove records only	MI-11885-A Lightweight Tone Arm MI-11874-4 1 Mil Lightweight Pickup Head MI-11888

\* Filter available from existing equipment may be used.

# PROFESSIONAL TAPE RECORDERS

## TYPES RT-11B AND RT-12C



### FEATURES

- Rugged mechanical construction — heavy duty relays and solenoids
- Extremely accurate timing with synchronous capstan
- Automatic tape lifters reduce head wear during "fast forward" and "rewind"
- Split-second start and stop
- Frequency response flat to 15 kc at 7½ in./sec. or 15 in./sec.
- Push-button operation provided on the Recorder and on Remote Control Unit
- Smooth tape runs via sapphire guides
- Self-centering "snap-on" hub adaptors assure perfect reel alignment with reels

### USES

The RCA Magnetic Tape Recorders are professional units designed to meet rigid specifications and requirements set forth by broadcast engineers from all sizes of stations and recording studios. Such features as "quick-start," push-button control, and accurate timing make the RT-11's ideal for applications where time and reliability are prime factors. AM, FM and TV stations will find the recorders unsurpassed for (1) recording any type studio program, (2) recording programs for delayed broadcasts, (3) commercial accounts, (4) rehearsals, (5) auditions, and (6) for reference recording.

Taking advantage of the easy editing, dubbing and re-dubbing without loss of quality afforded by these machines, all recording can be done first on tape, even though the order is for acetate. This saves time and avoids spoiled discs, since several cuts can be made until a satisfactory one is arrived at from a production standpoint before dubbing to discs.

Broadcast Station Operators have become very adept at handling unusual assignments on this versatile equipment. The equipment can be used for delayed broadcasts, taped interviews or round table discussions. It offers a wide variety of service for auditions and air checks for clients and agencies. This equipment also provides an opportunity to build and recheck air shows for future use.

The RT-11B model is a standard rack-mounted professional tape recorder for convenient wall mounting in the AM, FM or Television station. It is especially recommended for studios requiring more than one tape recorder to handle the growing demand for recorded messages and tape facilities.

The RT-12C model is a convenient console version of the professional tape recorder suitable for installation in the control room adjacent to studio console or turntables as desired.

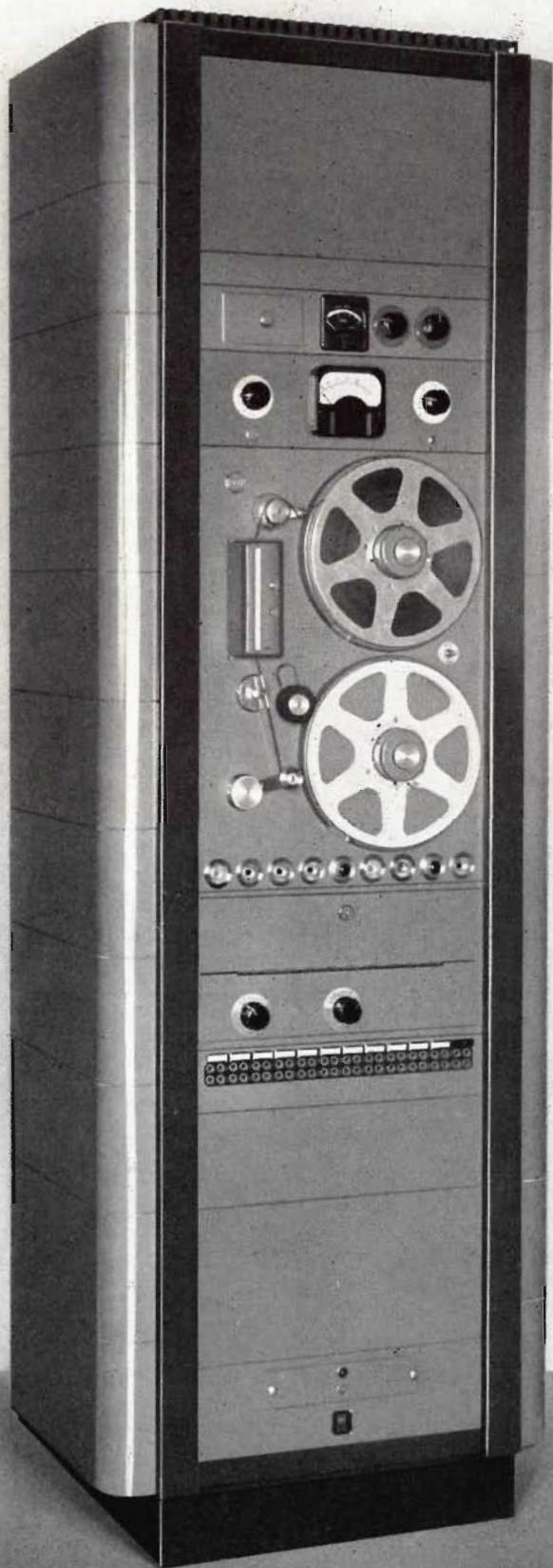

The RT-11B is a rack mounted magnetic tape recorder designed to meet rigid specifications and requirements of the broadcast station or recording studio. Tape threading is reduced to a simple and easy procedure, and self-centering, "snap-on" reel adaptors facilitate changing reels and assure perfect alignment.

## DESCRIPTION

The overall design of the RT-11B and RT-12C incorporates accurate timing, push-button operation, remote control, quick starting plus low wow and flutter. Tape can be started or stopped within 1/10 second and tape may be jockeyed back and forth for cueing during operation. Recording time can be held to  $\pm 2\frac{1}{2}$  seconds in a 30-minute run . . . and with synchronizing equipment (for which provision is made) timing can be held to 3/10 second on any length program.

The RCA Magnetic Tape Recorders consist basically of four major parts: the tape handling mechanism, power supply, recording amplifier and reproducing amplifier. The three magnetic heads ("erase," "record" and "reproduce") are a part of the tape handling mechanism.

The tape handling mechanism is designed to mount in a standard 19-inch cabinet rack. Its design is such that it may also be used in a horizontal console type machine, if desired. Careful mechanical layout provides the utmost convenience in threading and handling of tape.

All controls are recessed to avoid interference with tape during threading. Relay and solenoid operation enables interlocking of all functions and makes possible full remote control of the machine. A solenoid automatically lifts the

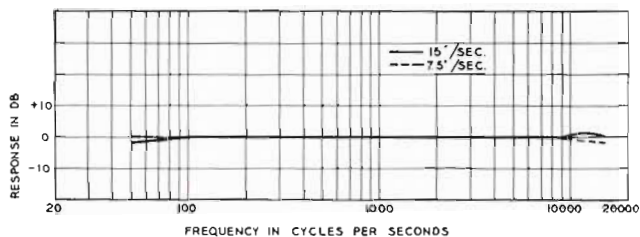

Typical response curve of RT-11B or RT-12C Tape Recorder.



tape on sapphire "lifters" during "fast-forward" or "reverse", eliminating the necessity for opening the head cover or rethreading. Tape alignment over the heads is held precisely by a floating casting. Thus smooth tape runs are assured. Automatic control stops the machine if tape is severed and applies reel brakes instantaneously. The complete system of control interlocking virtually eliminates the possibility of accidentally erasing a program and makes it impossible to snarl or spill the tape.

Control circuits consist of "ON-OFF," "Speed—7.5 or 15 in./sec.," "Start," "Record," "Fast Reverse," "Fast Forward," and "Stop." The major functions may also be extended to remote positions by use of Remote Control Unit, MI-11948.

A toggle switch turns on the a-c power. The capstan motor is started by this switch. Control circuits are not energized until the switch is on.

Standard NARTB reels are simply placed on the hub or removed without disturbing the hub itself. (No locating pins are needed.) Smaller RETMA reels may also be used.

Smooth tape motion is an outstanding design feature which is obtained with synchronous capstan operation and speed reduction drive through a toothed rubber belt and stabilized with a high-inertia, coupled-flywheel system. The system exhibits very low wow and flutter in starting and in operation.

The stabilizer, motor, capstan, pressure roller and heads are all mounted on a rigid casting which is in turn mounted in heavy rubber grommets in a three point suspension system.

The three heads (Erase, Record and Reproduce) employ the finest materials obtainable and are machined to tolerances comparable to those called for in optical work. Azimuth adjustment of the "Reproduce" and "Record" head is available by removing the front cover.

The amplifier portion of the tape recorder amplifier system is divided into three parts, each occupying one-third of a standard BR-2A shelf. The three units (power supply, recording amplifier and oscillator, and reproducing amplifier) are all standard RCA "plug-in" construction. A

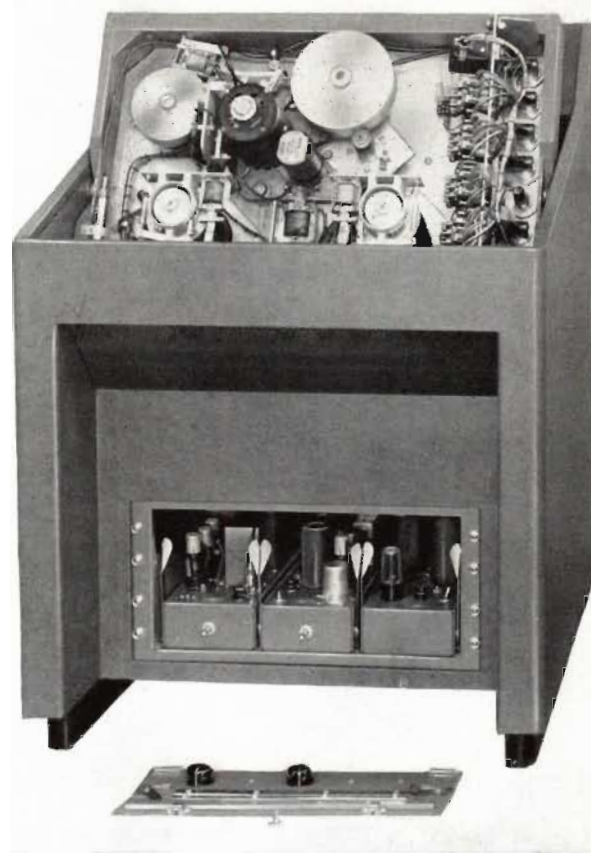

The RT-12C Magnetic Tape Recorder is a horizontal console type machine designed for operating convenience. Note complete accessibility of all components when top is raised and bottom panel is removed. All operating controls are brought to front of the console and amplifiers and power supplies are conveniently located in pedestal.

complete wiring harness is supplied with the recorder to facilitate installation. The same harness accommodates rack and shelf or console arrangements. Tube metering and VU meter connections are provided to allow the easy addition of accessory panels which must be ordered separately.

RCA Professional Tape Recorders have proved so dependable that remote control operation has become general practice. The engineer handling the program to be recorded can control the tape recorders "Start", "Stop", "Fast Forward", "Fast Reverse", and "Record". This speeds up operation by improving coordination so that a single engineer can easily handle the whole job, even when two machines are used to get special effects. A Record Indicator lamp shows when the machine is recording and simultaneously erasing what has been on the tape. All push buttons are recessed to avoid interference with tape handling.

**SPECIFICATIONS**

Power Source.....110-220 volts, a-c, 60 cycles  
 Power Consumption (Tape Drive Unit).....250 watts  
 Power Consumption (Amplifiers).....110 watts  
 Frequency Response:  
 15 in./sec..... $\pm 2$  db from 50 to 15,000 cps  
 7.5 in./sec..... $\pm 2$  db from 50 to 10,000 cps  
 $\pm 4$  db from 10,000 to 15,000 cps

Distortion:  
 Reference Recording Level.....3% total RMS harmonic distortion at 400 cps  
 Less than 2% distortion at 3 db below Reference Recording Level  
 Less than 1% distortion at 7 db below Reference Recording Level

Input for Reference Recording Level:  
 20,000 ohm Bridging.....-16 dbm minimum  
 150/600 ohm.....-53 dbm minimum. Gain control continuously variable

Output from Reference Recording Level.....+24 dbm  $\pm 2$  db  
 Distortion of reproduce amplifier at +24 dbm less than 1%. Gain control continuously variable.

Signal-to-Noise Ratio:  
 15 in./sec.....60 db  
 7.5 in./sec.....55 db  
 Unweighted output with zero signal input as referred to that output obtained from a tape recorded at Reference Recording Level.  
 Erasure of 1000 cps signal recorded at Reference Recording Level greater than 70 db.

Tape Speed:  
 Start (for playing).....0.1 second  
 Stop (for playing).....0.1 second  
 Rewind (standard 10 $\frac{1}{2}$ " reel).....1 minute  
 Play Speed.....15 and 7.5 in./sec.  
 Playing Time (10 $\frac{1}{2}$ " reel).....32 min. at 15 in./sec.  
 64 min. at 7.5 in./sec.  
 (Using standard NARTB reel with 2400 feet of tape)

Wow and Flutter (combined).....1% RMS at 15 in./sec.  
 .2% RMS at 7.5 in./sec.

Timing:  
 $\pm 5$  sec. in 30 min. at 15 in./sec. (machine to machine).  
 $\pm 2\frac{1}{2}$  sec. in 30 min. when played back on same machine at same temperature and humidity. Capstan is synchronous.

Dimensions:  
 Tape Drive Unit.....Length 24 $\frac{1}{2}$ "; Width, standard 19" rack mtg.  
 Amp. Panel and Shelf.....Height 8 $\frac{3}{4}$ "; Width, standard 19" rack mtg.  
 Reproducing Amplifier.....Height, 13 $\frac{3}{4}$ " (overall);  
 Width, 5 $\frac{3}{8}$ "; Height, 7"  
 Recording Amplifier.....Length, 3 $\frac{3}{4}$ " (overall);  
 Width, 5 $\frac{3}{8}$ "; Height, 6 $\frac{1}{4}$ "  
 Power Supply.....Length, 12 $\frac{3}{8}$ " (overall);  
 Width, 5 $\frac{3}{8}$ "; Height, 7 $\frac{1}{8}$ "

Push-button Remote Control Unit, MI-11948.

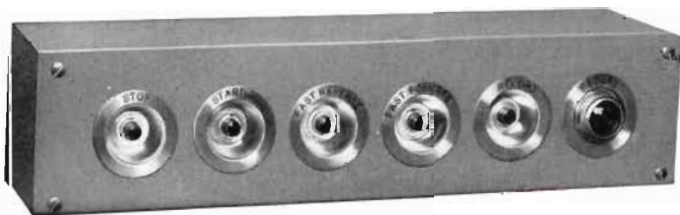

Weight: (Approximate)  
 Tape Drive Unit.....86 lbs.  
 Reproducing Amplifier .....10 lbs.  
 Recording Amplifier .....7 lbs.  
 Power Supply .....14 lbs.  
 Total Approximate Weight .....117 lbs.

Reels.....10 $\frac{1}{2}$ " NARTB; 7" RETMA

Tube Complement:  
 Recording Amplifier,  
 MI-11293.....2 RCA 1620, 1 RCA 6SN7, 1 RCA 6V6GT  
 Reproducing Amplifier,  
 MI-11296.....1 RCA 1620, 2 RCA 6J7, 1 RCA 6SN7GT  
 Power Supply, MI-11294.....1 RCA 5R4GY

**Equipment Supplied**

RT-11B Professional Tape Recorder (Rock Mounting).....MI-11911-B  
 Includes tape drive unit, separate erase, record and playback heads, amplifiers, power supply, two standard 10 $\frac{1}{2}$ " NARTB reels, two reel knobs, interconnection cable and one BR-2A panel and shelf assembly.

RT-12C Professional Tape Recorder (Console Mounting).....MI-11913-C  
 Includes console, matched tape recording-reproducing system, shelf for amplifier and power supply, panel shelf, and two empty NARTB reels.

**Accessories**

Tube Kit for Recording Amplifier.....MI-11293  
 Tube Kit for Power Supply.....MI-11294  
 Tube Kit for Reproducing Amplifier.....MI-11296  
 Console (included with RT-12C).....MI-11970-A  
 Remote Control Unit .....MI-11948  
 VU Meter Panel .....MI-11265-F  
 Blank Panel, 5-7/32" High.....MI-4592-B  
 Tube Meter Panel .....MI-11388  
 Cabinet Rack .....BR-84 Series  
 Switch and Fuse Panel (57-D).....MI-4395-G  
 Step Type Gain Control, Record Amplifier.....Stock No. 93784  
 Step Type Gain Control, Reproduce Amplifier.....Stock No. 93786  
 Tape Splicer .....MI-11937  
 Reel, NARTB Standard Hub.....MI-11932-2  
 Erase Head .....MI-11953-A  
 Reproduce Head .....MI-11954-A  
 Recording Head .....MI-11951-A  
 Recording Tape, 1/4" x 1200' on Plastic Reel.....MI-11924-3  
 Recording Tape, 1/4" x 2400' on NARTB Hub.....MI-11924-5  
 Recording Tape, 1/4" x 2400' on NARTB Reel.....MI-11924-6

Tape Splicer MI-11937.

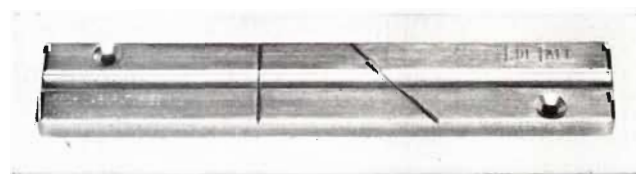

# Portable Tape Recording Equipment

## TYPES PT6-JAH & PT6-VAH



"Voyager" Tape Recorder, Type PT6-VAH.

### USES

The Magnecord Tape Recording Equipment provides satisfactory tape recording facilities for the small broadcast station, and the equipment will prove useful as standby equipment in stations which utilize heavy duty tape recording equipment for basic operations. Small and lightweight, it is ideally suited for portable operations.

Two portable models are available. The PT6-VAH "Voyager" is a lightweight portable unit combining in a single case the recorder-amplifier mechanism. It is a quick set-up unit desirable for recording away from the studio or in the laboratory. The PT6-JAH is an all-purpose Record/Reproduce Amplifier combined with the basic recorder as a two-unit equipment.

### DESCRIPTION

The PT6-AH Recorder is used with both the "Voyager" and PT6-J Record/Reproduce Amplifiers as a basic unit. It has separate erase and record/reproduce heads, and includes capstans for either 7½" or 15" per second operation. It is also available for three speeds by the addition of a 3¾-inch capstan. The unit has high forward speed, and may be used with an adaptor to increase reel size to 10½ inches if the standard 7-inch reel provided is not sufficient. The unit is housed in a leatherette finished case.

The PT6-J Record/Reproduce Amplifier Unit may be used for recording from a single microphone. It has an illuminated VU meter. The unit furnishes 10 watts of audio output, and may be used with internal monitor speaker or external speakers. The amplifier also has 600 ohm balanced line output, and may be used as a broadcast remote amplifier. It is available in portable carrying case or with an adaptor for rack mounting. Interconnecting cables are provided to connect the amplifier and recorder units.

The PT6-VAH "Voyager" portable single-case unit utilizes the same basic recorder unit as the PT6-JAH model, but it is provided with the PT6-V Amplifier. This amplifier features dual speed equalization, balanced low impedance microphone input and high impedance bridge input, an illuminated VU meter, and balanced or unbalanced 600 ohm output. It has a monitor jack for ear-phones.

### SPECIFICATIONS

Tape Speed.....	7½" and 15" per second
Additional Tape Speeds (extro).....	3¾", 7½" and 15" per second with two-speed motor or 3¾" and 7½" per second with 900 rpm motor
Standard Reel.....	7-inch (10½" with adaptor arms)
Rewind Time.....	40 sec.—1200'
Frequency Response.....	.50-15,000 cps
Signal-to-noise Ratio.....	54 db unweighted
Magnetic Heads.....	Erase and record/playback
Record Amplifier:	
PT6-JAH.....	50 to 250 ohm, balanced, low impedance
PT6-VAH.....	Balanced 50 to 250 ohm
Playback Amplifier:	
PT6-JAH.....	600 ohms, zero level, balanced
PT6-VAH.....	600 ohms, zero level, balanced or unbalanced
Dimensions:	
Tape Transport Panel.....	17" wide, 7" high
Amplifier Panel.....	17" wide, 7" high
Weight:	
PT6-JAH.....	50 lbs. in portable case
PT6-VAH.....	39 lbs. in portable case
Stock Identification:	
Lightweight Portable Tape Recorder.....	PT6-VAH
Standard Portable Tape Recorder.....	PT6-JAH

Type PT6-JAH Tape Recording Equipment.

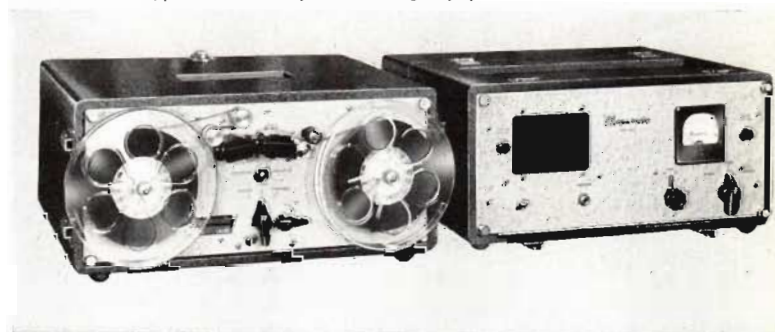

# CUSTOM TAPE EDITING EQUIPMENT



## FEATURES

- Rapid starting and stopping—fast rewind—accurate editing
- Individual torque motor provides fast-acting solenoid-operated breaking mechanism on each reel drive
- Completely rewinds 2400 feet of tape in one minute from dead stop
- Accommodates standard NARTB 10½ inch reels

## DESCRIPTION

RCA Custom-built Recording and Editing Equipment is available in either rack or console combinations. It may be designed to meet the particular requirements and specifications of individual applications. Such arrangements may be varied from those using a single tape recorder to installations involving many recorders. One very special arrangement of parts resulted in the editing machine shown

above. This console tape equipment facilitates the editing and playback of magnetic tape recordings. It provides a rapid, yet simple means of spotting, marking, cutting and splicing the tape and incorporates all features found in the Professional Tape Recorder. Vacuum equipment can be supplied for holding the tape in place during cutting and splicing.



▲  
End view of the Editing Machine illustrating how removable end panels make the amplifier easily accessible.

▶  
The entire motor board may be raised by means of a hinged panel to make control mechanism and wiring accessible.

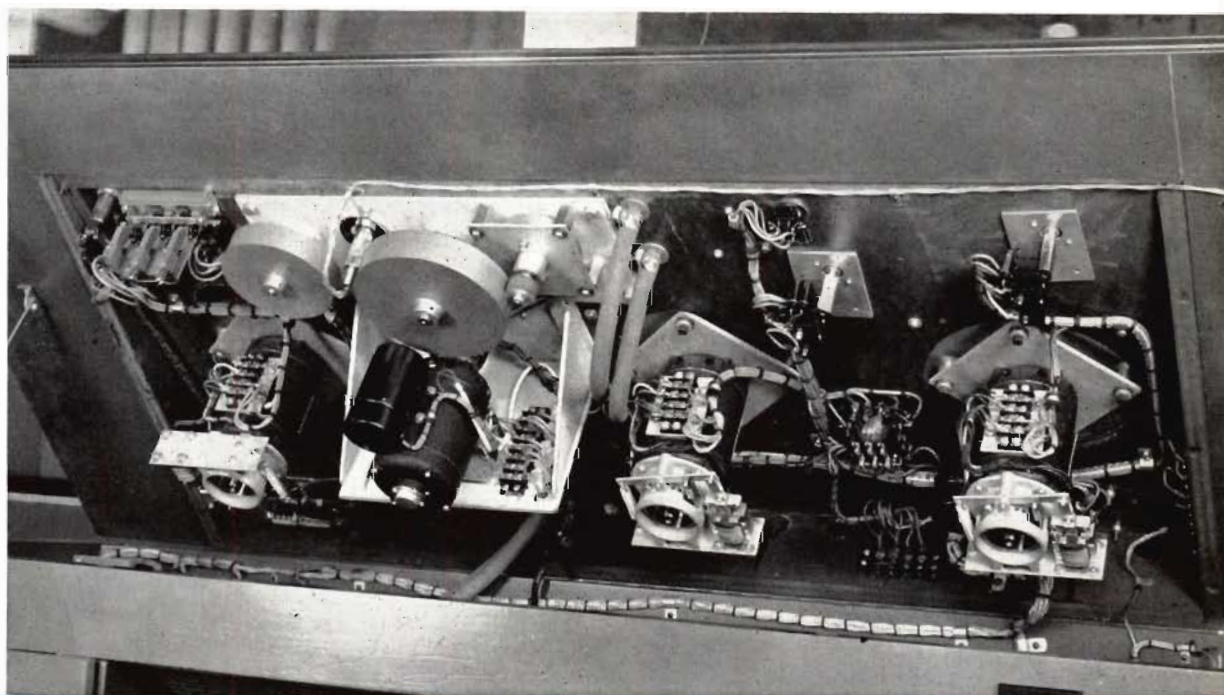

Three reel drive mechanisms are shown on the top panel. The left hand reel is used to supply program material to be edited, while the other two reels are used to take up the edited tape. The control circuits are so arranged that edited or discarded tape may be either run into a basket or wound on either reel as required, providing a flexible arrangement for editing operations. Normally, the center reel is used for the edited program while the right hand reel is used to hold the unwanted tape.

Using an NARTB standard 10½-inch reel as a basis for measurement, the editor will completely rewind 2400 feet of tape in one minute if started from a dead stop. Equally fast stopping and starting is available so that a complete stop from playing speed is made in approximately .1 of a second and a stopped tape can be started to wow-free speed in approximately .5 second.

### CONTROL SYSTEM

The control system is located in the lower left hand corner of the motor board and is built around a three position push-button switch, that the operator uses to select the required mode of operation.

The tape is started in "Fast Forward" or "Rewind" by pushing the designated button and stopped by the "Play" button. Switching from "Rewind" to "Fast Forward" or vice versa, is accomplished by pushing the button for the desired operation.

The tape is played back by pushing the "Play" button and manually lowering the capstan pressure roller. Raising the roller stops the tape.

# AM/FM RADIO TUNER

## TYPE ST-2

### FEATURES

- High signal-to-noise ratio—minimum distortion and interference
- Extended audio-frequency range from 20 to 15,000 cps
- Cathode-follower output stage permits use of up to 200-foot shielded cable between tuner and preamplifier
- Simplified mounting
- Indoor loop antenna eliminates outdoor antenna in most locations
- Provisions for FM tuning with and without AFC (to simplify tuning and prevent drift)

### USES

The RCA ST-2 AM/FM Radio Tuner is designed for use where a central radio receiver is to be used with a sound distribution system. Due to its wide range frequency characteristics and low distortion rating, the ST-2 Tuner is especially adaptable to broadcast systems. It is also handy for off-air monitoring. When connected to a high-fidelity audio amplifier and speaker it will provide radio reception at its very finest.

### DESCRIPTION

The ST-2 is a thirteen tube AM/FM tuner designed to operate on AM signals in the 540 to 1600 kilocycle band and FM signals in the 88 to 108 megacycle band. It operates from a low impedance loop antenna which eliminates the need for an outdoor antenna in most localities. Where necessary, a standard AM antenna or a 300 ohm FM dipole can be used.

As an AM Receiver the tube complement consists of a 6BJ6 r-f amplifier, 12AT7 mixer, 12AT7 oscillator, 6BJ6 1st i-f amplifier, 6AU6 2nd i-f amplifier, 6AL5 detector and 12AU7 audio amplifier and cathode follower.

As an FM tuner the tube complement consists of a 6CB5 r-f amplifier, 12AT7 FM mixer, 6BJ6 1st i-f amplifier, 6AU6 2nd i-f amplifier, 6AU6 3rd i-f amplifier, 2 6AU6 limiters, 6AL5 discriminator, 12AT7 oscillator A.F.C., 12AU7 audio amplifier and cathode follower. Rectifier tube is a 5Y3-GT. The output cathode follower allows for a broad loading



impedance range (10,000 or greater) still realizing the excellent frequency response and low distortion the receiver is capable of producing. All controls are conveniently located on the front panel. The large, legible, slide-rule type dial is edge lighted. The unit is equipped with power cord and plug.

### SPECIFICATIONS

Frequency Response.....	±1 db from 20 to 15,000 cps
Tuning Range:	
FM .....	88-108 mc
AM .....	540-1600 kc
Bandwidth:	
FM .....	190 kc
AM .....	8.5 kc
Sensitivity:	
FM .....	10 microvolts for 30 db noise quieting (on 300 ohm input)
AM .....	5 microvolts for 0.5 volt audio output
Audio Output.....	1.5 volts at less than 0.5% distortion
Output Impedance .....	For use with audio amplifier of 10,000 ohms or greater input impedance
Power Source.....	105-125 volts, 50/60 cps a-c
Power Consumption .....	65 watts
Antenna Inputs:	
FM .....	Two inputs, 300 or 72 ohms
AM.....	Low impedance, or high impedance
Dimensions.....	13 <sup>7</sup> / <sub>8</sub> " long, 7 <sup>1</sup> / <sub>4</sub> " high, 10 <sup>3</sup> / <sub>4</sub> " deep
Weight.....	17 lbs. (shipping)
Stock Identification .....	MI-12117

# RCA LOUDSPEAKERS

RCA offers to broadcasters a complete line of studio and station monitoring loudspeakers for use in mastering and auditioning booths, hallway installations, talk show applications, elevators and executives' offices. All RCA loudspeakers are designed to handle adequate power for the particular application for which they are designed. The LC-1A, representing the greatest advance in loudspeaker design, is obtainable for use in a choice of cabinet styles and finishes, thereby making it possible to conform to any of several interior decorating schemes. In addition, the LC-1A speaker mechanism may be obtained for those applications where it is desirable to use a special type, or custom-made, mounting.

In order to serve the wide variety of needs for loudspeakers around broadcasting stations, there is also included in this line a choice of permanent-magnet loudspeaker mechanisms. These mechanisms are intended to be mounted in one of the wall-mounting speaker housings. Loudspeaker Impedance Matching Transformers, MI-12368, MI-12369 and MI-11731 are designed for coupling a wide variety of outputs to these and many other types of loudspeakers. The quick-selection chart below provides a convenient reference for selecting the proper RCA loudspeaker combination.

## CHART SHOWING SPEAKER APPLICATIONS, RECOMMENDED HOUSINGS, AND SPECIFICATIONS

MI Number	Diameter (Inches)	Uses	Power Handling Capacity (Watts)	Frequency Range	Voice Coil Impedance (Ohms)	Floor Cabinet	Wall Housing
MI-11411-A LC-1A	15	Master program monitor, executive offices, clients' rooms, reception rooms, any application requiring maximum quality of sound reproduction	20	50-16,000 cps	15	MI-12464-B (Blonde) MI-12464-M (Mahogany) MI-11401	MI-11406
MI-12458	12	Program monitoring, executive offices, clients' rooms, reception rooms	10	50-16,000 cps	8	MI-12463-B (Blonde) MI-12463-M (Mahogany)	MI-13253
MI-12418-B	12	Utility monitoring, spare program monitor, studio and announce booth cue, offices	15	50-8500 cps	8		MI-13253
MI-11408	10	Utility monitoring, spare program monitor, studio and announce booth, cue, offices	10	80-7000 cps	4		MI-11407
MI-6333-D	10	Public Address, Studio talk-back, and intercom systems	20	60-7000 cps	6		MI-13253 with MI-13245-A
MI-12454 MI-12454-A	8	Turntable cueing, dressing rooms, intercom, paging systems	8	80-8500 cps	4		MI-6104

# 15-INCH SPEAKER MECHANISM

TYPE LC-1A



## FEATURES

- Excellent frequency response, uniform 50-15,000 cycles
- Wide angle sound radiation of all frequencies
- Low non-linear distortion
- Ideal for monitoring AM-FM television programs
- Alnico V magnets

## USES

The LC-1A is a "Broadcast Quality" loudspeaker with a low distortion, wide angle distribution, of extended frequency range, and specifically designed for use in recording studios, executive offices, reception rooms, sponsors' booths or any location that warrants a pleasant setting and tasteful styling.

For applications where it is desired to mount the mechanism on a wall baffle, ceiling, etc., the speaker mechanism may be used with assurance that the entire frequency range will be realized. The speaker's outstanding performance makes it ideal for wide frequency range wide angle radiation.

## DESCRIPTION

The LC-1A is a duo-cone speaker mechanism of the direct radiated type, consisting of high and low frequency units mounted co-axially together. The 2" high frequency cone and the aluminum wound voice coil has a low mass utilizing the wide angle of the shallow, low frequency cone to effect its remarkable directional pattern (see curve). An equilibrium has been reached between the electrical and mechanical design to impart a high frequency radiation of 120° arc with a loss of approximately 6 db at 15,000 cps. This eliminates the conventional "beam effect" usually experienced at this frequency.



The low frequency system employs a large diaphragm with a high mass voice coil and produces the most desirable directional pattern with a handling capacity of 20 watts. Low distortion has been accomplished by a carefully designed balance of many contributing factors. Distortion usually experienced when handling large power in the 100-1,000 cycles range is eliminated by using a high mass coil and a massive rigid cone, coupled with a low fundamental frequency peak of 40 to 50 cycles. Above this frequency the stiffness of the suspension system of the cone does not appreciably affect the velocity and, therefore, minimizes distortion.

A feature of construction is the use of acoustical domes—largely responsible for smooth response. The series of domes placed on the speaker's large cone breaks up the unit's symmetry and eliminates the interference normally characteristic of the symmetrical shape without sacrifice of either highs or lows.

The cross-over network utilizes the physical characteristics of the cones to mutually vibrate in unison over

the cross-over frequency region and merely employs one capacitor in the high frequency unit to limit its current at low frequencies.

**SPECIFICATIONS**

**LC-1A Speaker Mechanism**

Impedance (nominal).....	15 ohms
Frequency Response (see curve).....	40-15,000 cps
Directional Characteristic.....	See curve
Power Handling Capacity.....	20 watts
Non-linear Distortion (for 10 watt output, 50-15,000 cycles)	Less than 4% at 60 cycles
Weight (unpacked).....	21 lbs.
Dimensions:	
Diameter (cone).....	15 5/16"
Diameter (bolt fixing circle).....	16 1/4"
Diameter (overall frame).....	17"
Stock Identification.....	MI-11411-A
(Mechanism only)	

**Accessories**

LC-1A Speaker Cabinet (Blonde).....	MI-12464-B
LC-1A Speaker Cabinet (Mahogany).....	MI-12464-M
LC-1A Speaker Cabinet (Umber Gray).....	MI-11401
LC-1A Wall Speaker Housing.....	MI-11406
Power Attenuator.....	MI-11708-A

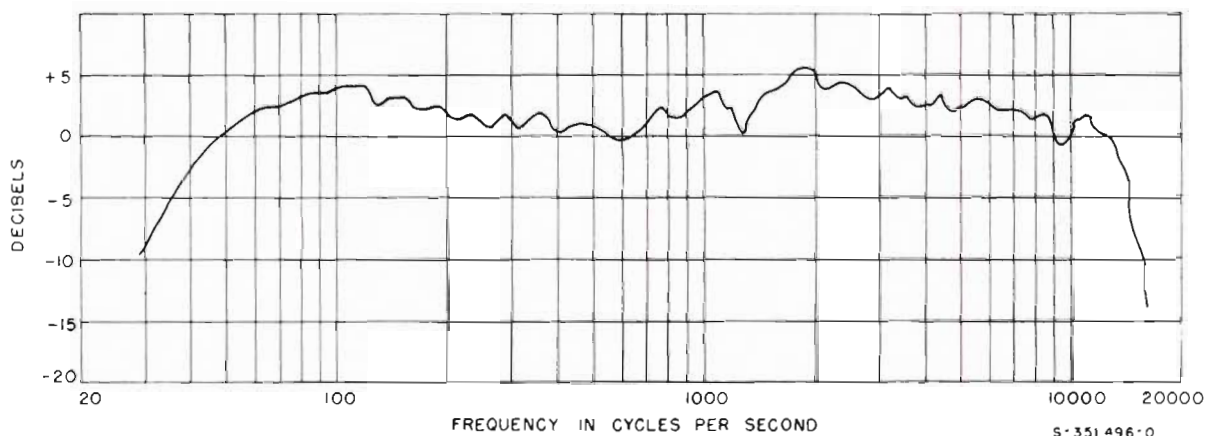

Frequency Response Curve of LC-1A Speaker.

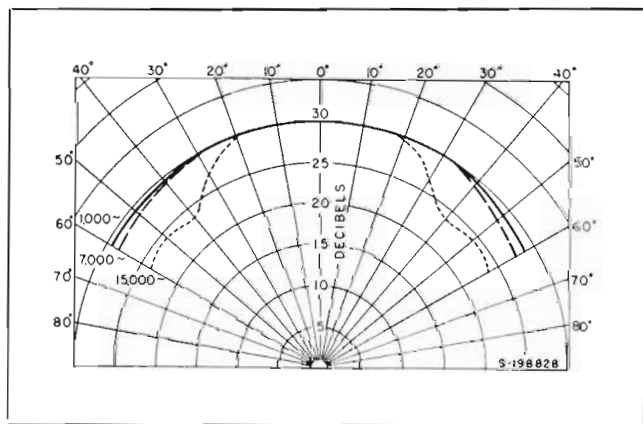

Directional Characteristics of LC-1A Speaker.

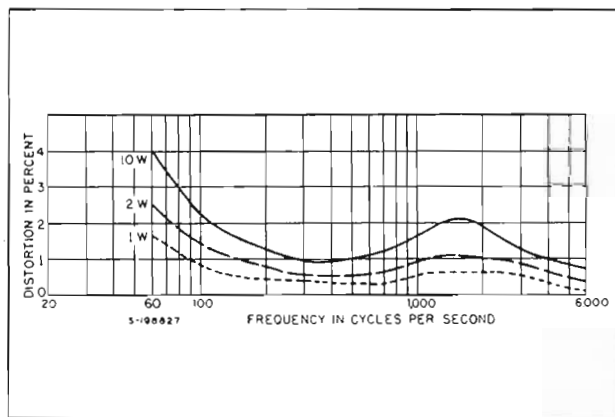

Harmonic Distortion of LC-1A Speaker.

# 12-INCH SPEAKER MECHANISM

TYPE SL-12



## FEATURES

- Excellent frequency response—50 to 16,000 cycles
- Low non-linear distortion
- Ideal for monitoring AM, FM and television programs
- Alnico V magnets
- Fits space-saving floor cabinets MI-12463-B or MI-12463-M

## USES

The Type SL-12 Speaker Mechanism provides "Broadcast Quality" reproduction when used with its companion floor housings MI-12463-B or MI-12463-M. This combination may be used in executive offices, reception rooms, sponsors' booths or any location requiring a pleasant setting and tasteful styling.

## DESCRIPTION

The SL-12 Speaker Mechanism is an extended-range single cone speaker. Its design provides uniform response from 50 to 16,000 cycles—avoiding frequency discrimination. The smooth response of the SL-12 is obtained by employing a curve-linear-shape cone of special pulp material. An outer suspension damping ring provides a matched terminating acoustical impedance. A distribution angle of more than 40° is obtained with the SL-12 Speaker Mechanism.

## SPECIFICATIONS

Voice Coil Impedance.....	8 ohms
Frequency Response.....	50 to 16,000 cycles
Power Handling Capacity.....	10 watts
Overall Diameter .....	12 7/32"
Overall Depth .....	6 1/8"
Weight .....	.00 lbs.
Stock Identification .....	MI-12458

### Accessories

SL-12 Floor Cabinet (Blonde).....	MI-12463-B
SL-12 Floor Cabinet (Mahogany).....	MI-12463-M
12" Wall Housing .....	MI-13253

# 12-INCH SPEAKER MECHANISM

MI-12418-B

## FEATURES

- High sensitivity
- Smooth frequency response
- Balanced listening characteristic
- Equipped with transformer
- Alnico V permanent magnet
- Excellent power handling capability

## USES

The MI-12418-B 12-inch Speaker Mechanism when used with its wall housing, MI-13253, is suitable for use in many locations such as: reception rooms, corridors, offices, dressing rooms, workshops, etc. It may be used as a talk back and cue speaker in studios.

## DESCRIPTION

This is a straight edge cone permanent magnet type speaker mechanism of good sensitivity. The permanent magnet uses the new Alnico V metal, which is the best available material for the purpose. It permits high flux density in a smaller and lighter magnet, which contributes to the high efficiency of the speaker. The MI-12418-B also

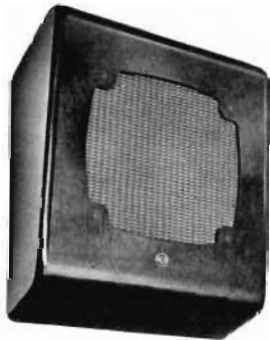

MI-13253

Wall Housing  
for use with  
12-inch Speaker  
MI-12418-B.



has the corrugated cone feature, which, by introducing just enough additional compliances, smooths and improves the frequency response characteristic. External metal parts of the MI-12418-B speaker are finished in umber gray metalustre. The speaker comes equipped with a matching transformer in place and wired to the speaker from the 6 ohm tap. Transformer impedances are 625, 1250, 2500, and 5000 ohms.

## SPECIFICATIONS

Voice Coil Impedance.....	6-8 ohms
Frequency Response.....	50 to 8500 cycles
Power Capability.....	10 watts maximum
Axial Sensitivity.....	97 db at 4 ft. with 1 watt input
Magnet Material.....	Alnico V
Diameter.....	12 1/8"
Depth.....	5 5/8"
Mounting Data.....	8 equally-spaced holes on 11 3/8" circle
Net Weight.....	4 lbs. 4 ozs.
Stock Identification.....	MI-12418-B

## Accessory

12" Wall Housing.....	MI-13253
-----------------------	----------

# 10-INCH SPEAKER MECHANISM

MI-11408



## FEATURES

- Ideal for use in station control rooms, clients' booths and studios in conjunction with MI-11407 Wall Housing
- Employs high-quality Alnico V permanent magnet
- Capable of handling 10 watts of undistorted output
- Excellent frequency response
- In combination with MI-11407 Wall Housing, provides "Broadcast Quality" monitoring

## USES

The MI-11408 Speaker Mechanism with its associated Wall Housing (MI-11407) is designed specifically to provide economical Broadcast Monitoring. Such applications include AM/FM and TV control rooms, clients' booths, offices and studios.

## DESCRIPTION

The MI-11408 Speaker employs a high-quality Alnico V permanent magnet and is capable of producing an undistorted output of 10 watts. The frequency response characteristic is such that the mechanism will give well balanced sound when used with its companion baffle. Speaker matching transformer MI-11731 is available for connecting to an 8-ohm or 15-ohm source. (Speaker voice coil impedance is 4 ohms).

## SPECIFICATIONS

Frequency Range .....	60-7000 cycles
Power Handling Capacity .....	10 watts
Voice Coil Impedance .....	4 ohms
Overall Diameter .....	10 1/8"
Overall Depth .....	4 1/4"
Weight (unpacked) .....	2 1/8 lbs.
Stock Identification .....	MI-11408

### Accessory

10" Wall Housing .....	MI-11407
------------------------	----------

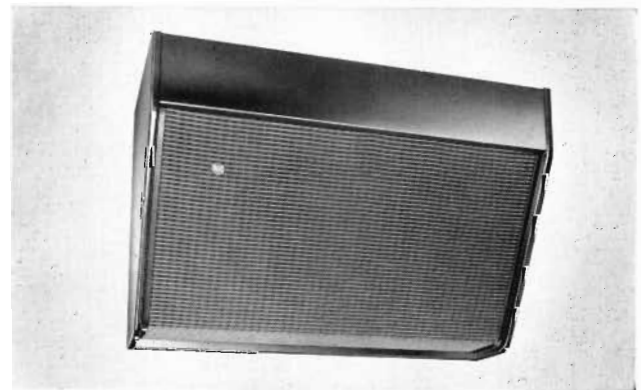

MI-11407 Wall Housing used to house the MI-11408 Speaker Mechanism

# 10-INCH SPEAKER MECHANISM

MI-6333-D



## FEATURES

- Good frequency range
- High power handling capacity
- Corrugated cone for smooth response
- Alnico V magnet
- Rugged construction
- Extremely high efficiency
- Moisture-resistant cone and voice coil

## USES

The MI-6333-D 10-inch cone-type speaker is particularly useful for those applications where large power handling is necessary such as in public address, studio talk-back, and intercom systems. It reproduces the human voice with unusual clarity and is ideal for use in noisy locations. The MI-6333-D speaker has a frequency response characteristic calculated to give optimum performance and tonal balance when used with the 12-inch wooden MI-13253 Wall Housing and the MI-13245-A Reducing Baffle.

## DESCRIPTION

The MI-6333-D Speaker is a 10-inch permanent magnet cone type mechanism. The cone is of one piece and is corrugated, which results in smoother characteristics and improved performance. The permanent magnet is of Alnico V metal insuring permanence and stability of the field. To make the speaker more rugged, the cone is made moisture-resistant and a baking-type resin cement is used throughout. This speaker has an unusually good frequency response characteristic and capably handles large amounts of power. The gap flux density is high, contributing to the speaker's high sensitivity.

## SPECIFICATIONS

Impedance.....	60 ohms at 400 cycles
Frequency Range.....	60 to 7000 cycles
Power Capacity.....	20 watts
Axial Sensitivity.....	95 db at 4 ft. with 1 watt input
Gap Flux Density.....	9500 lines/cm <sup>2</sup>
Magnet.....	Alnico V
Magnet Weight.....	6.8 ozs.
Diameter.....	10¼"

Depth.....	5⅝"
Mounting Data.....	4 equally spaced 9/32" x 7/32" holes on 9⅝" circle
Net Weight.....	3½ lbs.
Shipping Weight.....	5½ lbs.
Stack Identification.....	MI-6333-D

## Accessories

12" Wall Speaker Housing.....	MI-13253
Reducing Baffle.....	MI-13245-A

# 8-INCH SPEAKER

MI-12454



## FEATURES

- Acoustically balanced for wall baffles
- Multi-tap matching transformer
- Built for rugged use
- Alnico V permanent magnet
- High flux density and sensitivity
- Smooth wide range response

## USES

The MI-12454 Eight-Inch Speaker is designed to fulfill requirements for all indoor sound distribution and intercommunication applications using eight-inch speaker-baffles. It may be used with any standard eight-inch baffle. It is particularly well adapted for use as a broadcast speaker when used with baffle MI-6104.

## DESCRIPTION

The MI-12354 is an eight-inch cone-type speaker with a permanent magnet field. The Alnico V magnet is the best commercially available material providing high flux density, permanence and stability with a minimum of size and weight. This carefully engineered and ruggedly built speaker has a one piece stamped steel frame which is welded to the yoke assembly and zinc plated. The cone, voice coil assembly and suspension are moisture resistant. The air gap is accurately held in alignment by means of a brass centering ring welded in position. A spring brass magnet clamp, an RCA development, holds the magnet in place without the use of cement or solder. A multi-tap line matching transformer is provided to enable the 3.2 ohm voice coil to present impedances of 700, 14,00, 4000, 8000 or 16,000 ohms to a loudspeaker line.

The response characteristic is acoustically selected to produce a balanced listening quality when the speaker is mounted in a normal size wall mounting baffle such as MI-6104.

## SPECIFICATIONS

Power Handling Capability.....	8 watts
Axial Sensitivity.....	93 db @ 4 ft. with 1 watt input
Frequency Response.....	75-8000 cycles
Magnet Material and Weight.....	3.16 oz. Alnico V
Gap Flux Density.....	9000 lines/cm <sup>2</sup>
Voice Coil Impedance.....	3.2 ohms @ 400 cycles
Voice Coil Size.....	3/4"
Outside Diameter.....	8 1/4"
Depth.....	3 1/2"
Mounting Data.....	4 equally spaced holes on 7 5/8" bolt circle
Net Weight.....	31 oz.
Shipping Weight.....	16 to a carton—35 1/2 lbs.
Transformer Data:	
16,000 Ohms.....	Red-Black
8,000 Ohms.....	Red-Red/Black
4,000 Ohms.....	Red-Red/Yellow
1,400 Ohms.....	Black-Red/Black
700 Ohms.....	Red/Yellow-Red/Black
Stock Identification.....	MI-12454

## Accessories

8" Wall Speaker Housing..... MI-6104

# FLOOR CONSOLE CABINETS

MI-12463 AND MI-12464

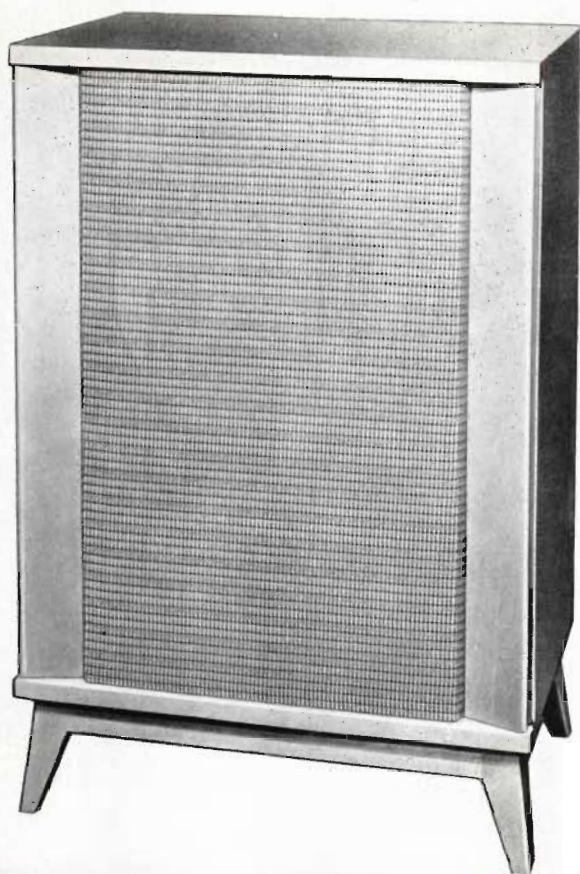

## USES

The MI-12463 and 12464 Floor Speaker Cabinets were designed by RCA acoustic engineers, in collaboration with one of the country's leading stylists, to house the LC-1A Duo-cone Speaker and the SL-12 Single-cone Speaker. The styling of these cabinets make them ideal for use in executive offices, reception rooms, sponsors' booths or any location that warrants a pleasing setting.

## DESCRIPTION

The cabinet is a bass reflex or phase inverter type. MI-12463-B and 12464-B are high luster, hand-rubbed birch finish cabinets with 6" matching legs. A mahogany version of the same cabinets—MI-12453-M and 12464-M—are available. Either cabinet may be mounted on its legs in a horizontal position.

## SPECIFICATIONS

Dimensions:	
For 15" Speaker (LC-1A).....	32" x 25" x 16"
For 12" Speaker (SL-12).....	32" x 25" x 12"
Matching Legs .....	6"
Weight .....	Approx. 50 lbs.
Stock Identification (Blonde SL-12 Housing).....	MI-12463-B
Stock Identification (Mahogany SL-12 Housing).....	MI-12463-M
Stock Identification (Blonde LC-1A Housing).....	MI-12464-B
Stock Identification (Mahogany LC-1A Housing).....	MI-12464-M

## FEATURES

- Maximum response at low frequencies
- Finishes and styling to blend with any surroundings
- Versatile cabinet design permits mounting cabinet either vertically or horizontally
- Designed specifically to complement LC-1A Speaker Mechanism
- Diagonally placed damping material absorbs cabinet resonance



# SPEAKER CONSOLE CABINET

TYPE MI-11401

## FEATURES

- Enhances speaker wide-angle radiation characteristics and frequency response
- Modern styling to blend with RCA broadcast equipment
- Solid plywood construction
- Ample space for mounting associated filter and amplifier if desired

## USES

The MI-11401 Speaker Console Cabinet has been designed to enhance the wide-angle radiation characteristics and frequency response of the LC-1A Duo-Cone Loudspeaker. The cabinet is ideal for use in broadcast station offices, reception areas, sponsors' booths and other studio locations since it is finished in a subdued umber-gray styling to blend with RCA's other studio equipment.

## DESCRIPTION

The MI-11401 Speaker Console Cabinet is a bass-reflex housing solidly constructed of  $\frac{3}{4}$ -inch plywood. It is 40 $\frac{5}{8}$  inches high, 27 $\frac{1}{8}$  inches wide and 15 inches deep and weighs 50 pounds exclusive of speaker mechanism. The cabinet is supplied complete with a speaker cut-off filter, and has facilities for mounting a Monitoring Amplifier and Remote Volume Control.

The MI-11707 Cut-off Filter is designed to attenuate the signal to the speaker at either 5 kc or 10 kc. A selector switch is supplied with the filter. The 15 kc switch position removes the filter from the circuit. When desired, a Monitoring Amplifier (MI-11247) and Volume Control (MI-11278-E) may be associated with the loudspeaker in the console. When the amplifier is not used in or near the cabinet and a speaker volume control is desired, the MI-11708-A Power Attenuator may be installed. This attenuator is designed to operate from a 15-ohm source and feed directly into the LC-1A speaker.



## SPECIFICATIONS

Dimensions:	
Height .....	40 $\frac{5}{8}$ "
Width .....	27 $\frac{1}{8}$ "
Depth .....	15"
Weight (less Speaker).....	50 lbs.
Finish .....	Umer gray
Stock Identification .....	MI-11401

### Accessories

Monitoring Amplifier, BA-24A.....	MI-11247
Volume Control .....	MI-11278-E
Power Attenuator for LC-1A.....	MI-11708-A



# WALL SPEAKER HOUSING

MI-11406

## FEATURES

- Designed to accommodate LC-1A Duo-Cone Speaker mechanism
- Ideal for broadcast control room use
- Umber gray finish to harmonize with companion equipment
- Can be mounted for long or short "throw" as desired
- Bass port is provided

## USES

The MI-11406 Speaker Housing is designed for broadcast studio and station monitoring applications and is ideal for wall or ceiling installations. Designed specifically for housing the LC-1A, Duo-Cone Speaker mechanism, the cabinet may also be used in auditioning booths, hallways, and executive offices.

## DESCRIPTION

This housing is constructed of heavy plywood, provides good acoustical properties, and is designed for high-quality performance without any sacrifice of the "Olson" duo-cone speaker performance.

The size and shape of the speaker housing (at end view, a 30, 60, 90 degrees modified triangle) is particularly



Front view of housing with grille cover removed to show LC-1A speaker mounting and bass port.



desirable for control room installations. It may be easily mounted to provide either a long or short "throw", as desired.

For best response, the housing is mounted so that both wall and ceiling form a part of the acoustical system. Thus, reinforcement from the ceiling may be utilized to raise the bass output and response at the low frequency end. A port is provided for increasing bass response and may be closed or opened, as required.

The overall speaker housing is approximately 17 $\frac{1}{8}$  x 21 $\frac{3}{4}$  x 37 $\frac{1}{2}$  inches with a sloping front which provides good sound radiation characteristics. The speaker mechanism and wiring are accessible through a removable grille which permits installation or servicing, without removing the cabinet from the wall.

The housing is finished in umber gray and has an attractive woven plastic grille. Its appearance matches the tone and styling of other studio equipment.

## SPECIFICATIONS

Dimensions (exterior):	
Length .....	37 $\frac{1}{2}$ "
Height .....	21 $\frac{3}{4}$ "
Depth .....	17 $\frac{1}{8}$ "
Finish.....	Umber gray with woven plastic grille cloth
Stock Identification .....	MI-11406
Weight .....	45 lbs.

# WALL SPEAKER HOUSING

MI-13253

## FEATURES

- Acoustically treated interior
- Completely enclosed cabinet
- Attractive woven plastic grille cloth
- Handsome sloping front design
- Solid 1/2-inch wood sides
- Heavy vibration-free construction

## USES

The MI-13253 Wall Housing with a 12-inch speaker mechanism (MI-12458 or MI-12418-B) or a 10-inch speaker (MI-6333-D) and reducing baffle (MI-13245-A) is suitable for use in many locations such as reception rooms, corridors, offices, dressing rooms, etc. It may also be used in a talk-back and cue system in studios.

## DESCRIPTION

The top, front and bottom of the Wall Speaker Housing, MI-13253, is one-piece walnut finish veneer. The sides are 1/2-inch solid wood. To insure extra strength, it is constructed with curved edges. The speaker opening is covered with two-tone grille cloth of woven plastic in a finish that matches the wood. The back of the unit is open and mounting brackets are furnished.

12-inch Speaker MI-12418-B which can be housed in the MI-13253 Wall Housing.

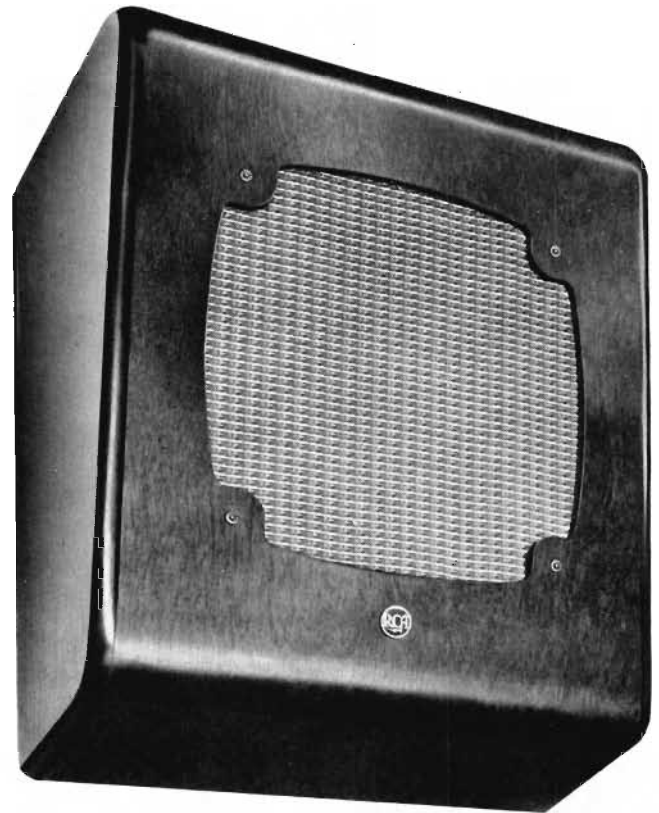

A reducing baffle, MI-13245-A, may be obtained which will adapt the MI-13253 housing to accommodate a 10-inch speaker mechanism such as the RCA MI-11408, or the MI-6333-D.

## SPECIFICATIONS

Dimensions (exterior):	
Height .....	16 1/2"
Width .....	14"
Depth .....	8 1/2" maximum
Weight.....	3 lbs., 10 oz.
Material .....	Wood
Finish .....	Walnut grained
Stock Identification:	
Wall Housing .....	MI-13253

## Accessories

Reducing Baffle to Mount 10" Speaker.....	MI-13245-A
12" Speaker Mechanism.....	MI-12458
12" Speaker Mechanism.....	MI-12418-B
10" Speaker Mechanism.....	MI-6333-D
10" Speaker Mechanism.....	MI-11408

# WALL SPEAKER HOUSING

MI-11407

## FEATURES

- Ideal for Station Control rooms, clients' booths, offices and studios
- In combination with MI-11408 Speaker, the Housing provides "Broadcast Quality" monitoring
- Styled to match companion RCA Broadcast Audio Equipment
- May be mounted for either 30° or 60° "throw" for long or short control rooms



## USES

The MI-11407 Wall Housing with its associated Speaker Mechanism is designed specifically to provide economical Broadcast Monitoring. Such applications include AM/FM and TV control rooms, clients' booths, offices and studios.

## DESCRIPTION

The MI-11407 Housing is designed to house the MI-11408 Speaker Mechanism and projects sound downward at an angle of 30° or 60°. This permits mounting of the unit to provide either a long or short "throw". The housing is solidly constructed of 1/2-inch plywood with dark umber gray finish. The grille is of plastic woven cloth and covers the entire front panel. The housing presents a neat, compact appearance and is of the smallest practical size commensurate with good performance.

## SPECIFICATIONS

### Dimensions (exterior):

Overall Height .....	15 3/4"
Overall Width .....	25"
Overall Depth (front to back).....	11 1/2"
Volume.....	2700 cu. in.
Approximate Weight (unpacked) .....	12 lbs.
Finish.....	Dark umber gray
Stock Identification .....	MI-11407



MI-11408 Speaker Mechanism  
used in the above MI-11407  
Wall Housing.

## Accessory

10" Speaker Mechanism.....	MI-11408
Matching Transformer (4-8-15 ohms).....	MI-11731

# WALL SPEAKER HOUSING

MI-6104

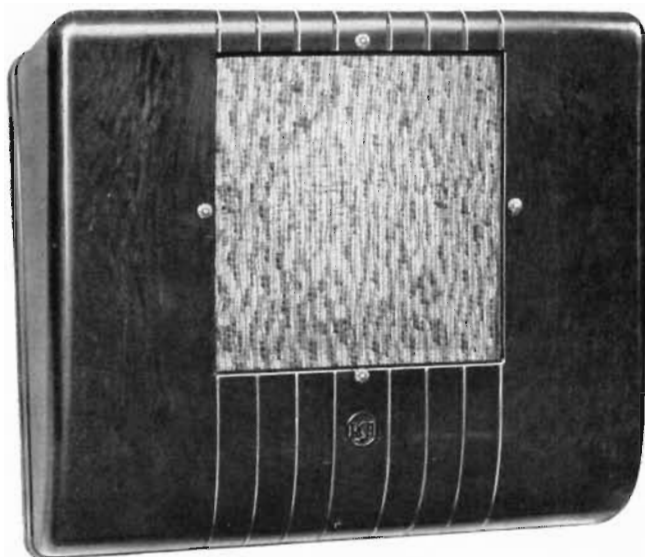

## USES

This molded plastic sloping front baffle will find many and varied uses. Its rich, walnut grained finish and pleasing lines make it especially attractive for use in studios, offices, corridors, small auditoriums, dressing rooms and numerous other places.

The RCA 8-Inch Speaker MI-12454 has a frequency response characteristic especially selected to give optimum performance and tonal balance when used in this baffle.

## DESCRIPTION

The MI-6104 baffle is molded of walnut grained fire resistant thermosetting plastic. It has four heavy reinforcing ribs on the inner surface which provide additional strength and rigidity and form a frame for the removable speaker insert. The face of the insert is covered with an attractive two-tone plastic grille cloth. It is held in place by four decorative head screws which also provide a secure mounting for a standard 8-inch speaker.

## FEATURES

- Made of fire resistant molded plastic
- Natural walnut grained finish
- Attractive modern design
- Matching two tone plastic grille cloth
- Sloping front for better coverage
- Sturdy construction—lifetime service
- Knockouts provided for volume control
- Can be painted to match walls

Two "knockouts" are provided, one on each side of the speaker opening, for installing a volume control and/or other control devices. A complete set of mounting hardware is also provided.

The housing has sufficient depth to permit the addition of a reducer sub-baffle for mounting speakers smaller than eight inches.

## SPECIFICATIONS

Standard Loudspeaker .....	8"
Material .....	Molded thermosetting plastic
Finish .....	Walnut grained
Dimensions:	
Width .....	15¼"
Height .....	12¼"
Depth (maximum) .....	5⅝"
Clearance (center of speaker) .....	4"
Mounting .....	Two brackets and hardware (supplied)
Stock Identification .....	MI-6104

### Accessory

8" Speaker Mechanism..... MI-12454

# LINE MATCHING SPEAKER TRANSFORMERS

MI-12368, MI-12369, AND MI-11731



MI-12368

## DESCRIPTION

This transformer has separate primary and secondary windings on a 7/8" x 3/4" core. The primary is tapped with 10" color coded leads to permit matching to a number of different speaker line impedances. The secondary is tapped with 10" color coded leads to match voice coil impedances of 4, 8, or 16 ohms.

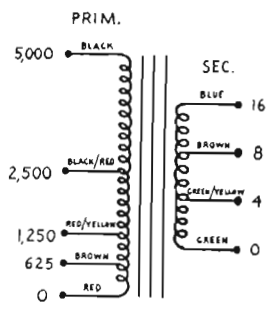

## SPECIFICATIONS

- Frequency Response.....±1/2 db from 60 to 10,000
- Distortion.....2% max. from 100 to 10,000 @ 8 watts
- Power Handling...Max. 16 watts of program material
- Mounting Centers .....3 1/8"
- Dimensions.....Height 2 1/4", Length 3 3/4", Width 2"
- Net Weight.....1 lb. 6 oz.
- Stock Identification .....MI-12368

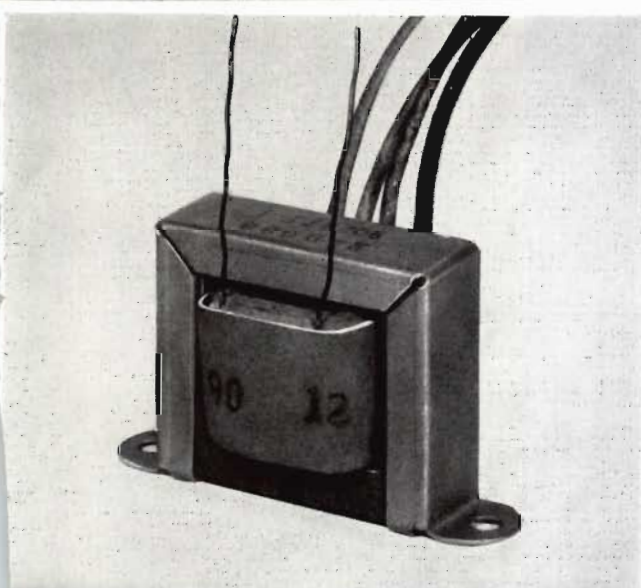

MI-12369

## DESCRIPTION

This transformer has separate primary and secondary windings on a 5/8" x 5/8" core. The primary winding is tapped with 10" color coded leads to match several different line impedances used in multiple speaker installations. The secondary matches any 3.2 to 4 ohm speaker

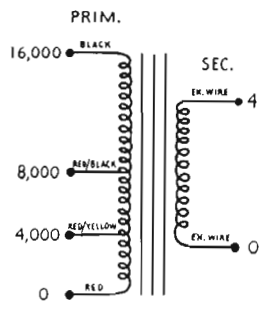

## SPECIFICATIONS

- Frequency Response.....1 db from 100 to 12,000 cycles
- Distortion.....2% max. from 100 to 8,000 @ 5 watts
- Power Handling.....Max. 8 watts program material
- Mounting Centers .....2 3/8"
- Dimensions.....Height 1 5/8", Length 2 13/16", Width 1 1/8"
- Net Weight .....10 oz.
- Stock Identification .....MI-12369



MI-11731

## DESCRIPTION

MI-11731 is a single-winding transformer used to match any combination of 4, 8 and 15 ohm speaker impedances. Soldering lugs are provided for making connections.

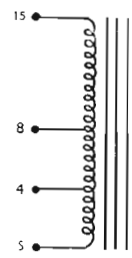

## SPECIFICATIONS

- Frequency Response.....±1.0 db from 60 to 10,000
- Distortion.....2% max. from 100 to 10,000
- Power Handling.....8 watts
- Mounting Centers .....2 3/8"
- Dimensions.....Height 1 21/32", Length, 2", Width 3/4"
- Net Weight .....10 oz.
- Stock Identification .....MI-11731

# INTERPHONE EQUIPMENT

## FEATURES

- Convenient intercom with studio personnel or remote line as desired
- Suitable for mounting to console, desk, or wall
- Designed to be compatible with RCA TV equipment
- Simple circuit with anti-side tone feature
- Regulated power supply

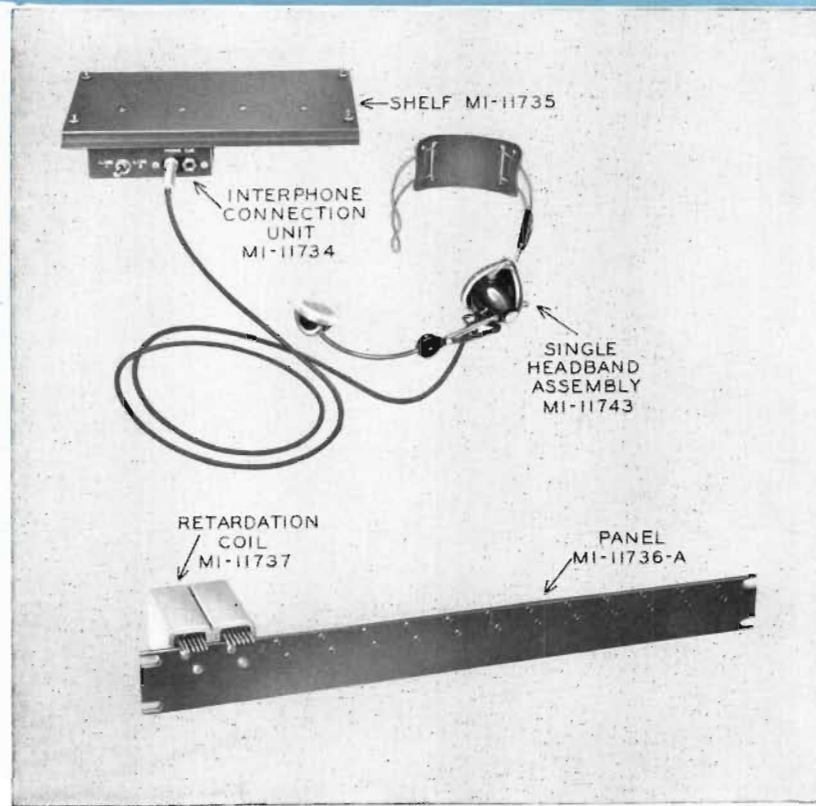

## USES

RCA Interphone Equipment is designed to provide convenient switching and headset connection facilities for an internal communication system. Such a system is particularly useful for the radio or television broadcast studio since it allows talking and listening with selected personnel

and with a conference bus or remote private line as desired. Any number of interphone connections may be used. The 24-volt d-c regulated power supply provides interphone power for a system using up to 30 headsets simultaneously.

## DESCRIPTION

Heart of the Studio Interphone System is the Interphone Connection Unit, MI-11734, which consists of a compact jack box designed for plate mounting. The unit consists of a simple circuit having an induction coil and capacitor to provide an anti-side tone feature. This results in local sounds being partially cancelled in the local earpiece. The circuit is housed in a small metal box having two phone jacks for use either with a single or a double headset as required, and a two-position toggle switch for selecting a local circuit or a remote line. A cable plug is mounted in the rear.

A Retardation Coil, MI-11737, permits simultaneous use of four carbon microphones such as one interphone connec-

tion unit and three camera headsets on a common battery or power supply. The coil permits a d-c power voltage to be imposed upon the two-wire telephone talking line. This audio frequency choke minimizes the effect of the power supply from lowering the two-wire telephone impedance at voice frequencies, and also allows adequate flow of direct current.

Mounting Panel, MI-11736-A, will permit mounting up to 14 retardation coils in the rack. Either a Single Headband Assembly, MI-11743, or a Double Headband Assembly, MI-11744, can be used for listening and talking with the Studio Interphone System.

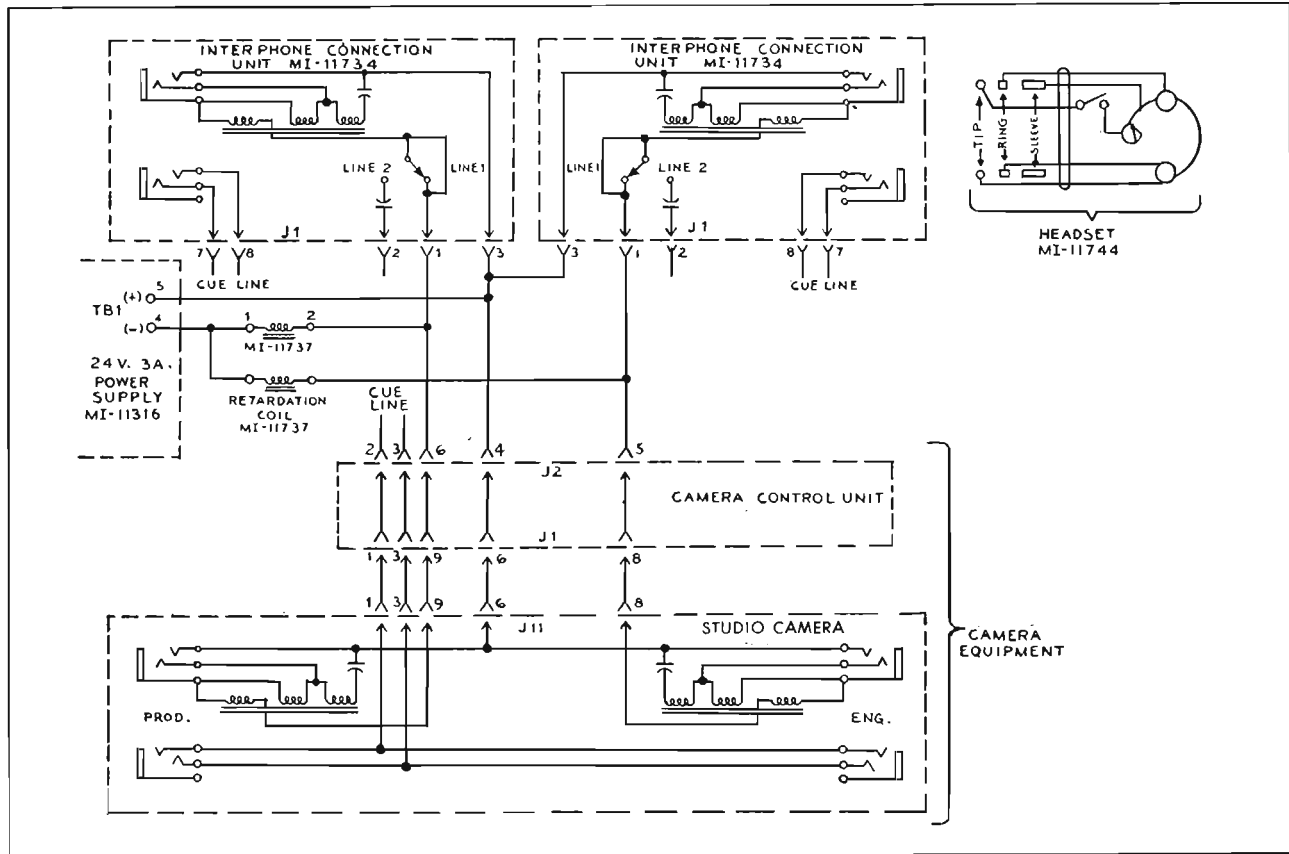

**SPECIFICATIONS**

- D-C Resistance (Headset):  
 Microphone Switch On.....70 ohms approximately  
 Microphone Switch Off.....Infinite
- Inductance at 1000 Cycles (Headset):  
 Microphone Switch On.....70 millihenries approximately  
 Microphone Switch Off.....245 millihenries
- D-C Resistance (Retardation Coil).....165 ohms  
 Inductance (Retardation Coil).....3.4 henries  
 Maximum Recommended Load Current.....125 ma d-c  
 Power Supply.....Regulated 24 volts, 3 amps, d-c
- Dimensions:  
 Interphone Connection Unit.....4<sup>5</sup>/<sub>8</sub>" x 4<sup>1</sup>/<sub>4</sub>" x 2<sup>3</sup>/<sub>16</sub>"  
 Retardation Coil.....4<sup>5</sup>/<sub>8</sub>" x 1 45/64" x 1<sup>3</sup>/<sub>16</sub>"  
 Mounting Plate.....11" x 6<sup>3</sup>/<sub>8</sub>"  
 Retardation Coil Panel, MI-11736.....19" x 1<sup>3</sup>/<sub>4</sub>" x <sup>3</sup>/<sub>16</sub>"  
 Retardation Coil Panel, MI-11736-A.....19" x 1<sup>3</sup>/<sub>4</sub>" x <sup>3</sup>/<sub>16</sub>"  
 Regulated Power Supply.....9" x 7<sup>3</sup>/<sub>4</sub>" x 5<sup>3</sup>/<sub>4</sub>"
- Weight:  
 Interphone Connection Unit.....1 lb., 11 ozs.  
 Retardation Coil.....15 ozs.  
 Retardation Coil Panel, MI-11736.....19 ozs.  
 Retardation Coil Panel, MI-11736-A.....18 ozs.  
 Single Headband Assembly.....6 ozs. (less cord)  
 Double Headband Assembly.....9 ozs. (less cord)  
 Regulated Power Supply.....25 lbs. (net)

**Stock Identification of Interphone Components:**

- Interphone Connection Unit.....MI-11734
- Retardation Coil.....MI-11737
- Shelf for Mounting MI-11734.....MI-11735
- Panel (Accommodating 5 Retardation Coils).....MI-11736
- Panel (Accommodating 14 Retardation Coils).....MI-11736-A
- Single Headband Assembly.....MI-11743
- Double Headband Assembly.....MI-11744
- Regulated Power Supply.....MI-11316

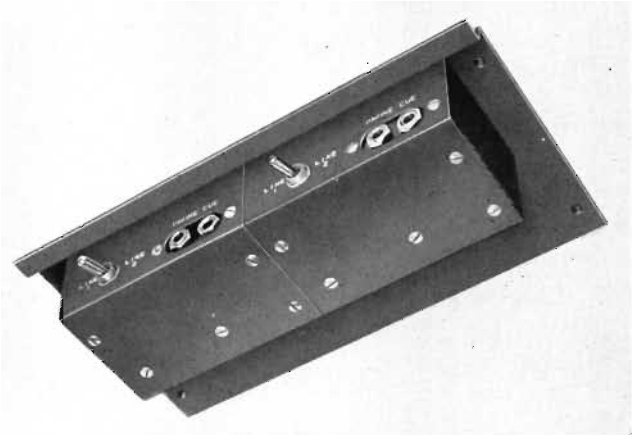

Console Shelf, MI-11735, has mounting accommodations for two Interphone Connection Units.

# DISTORTION AND NOISE METER

## TYPE WM-71A

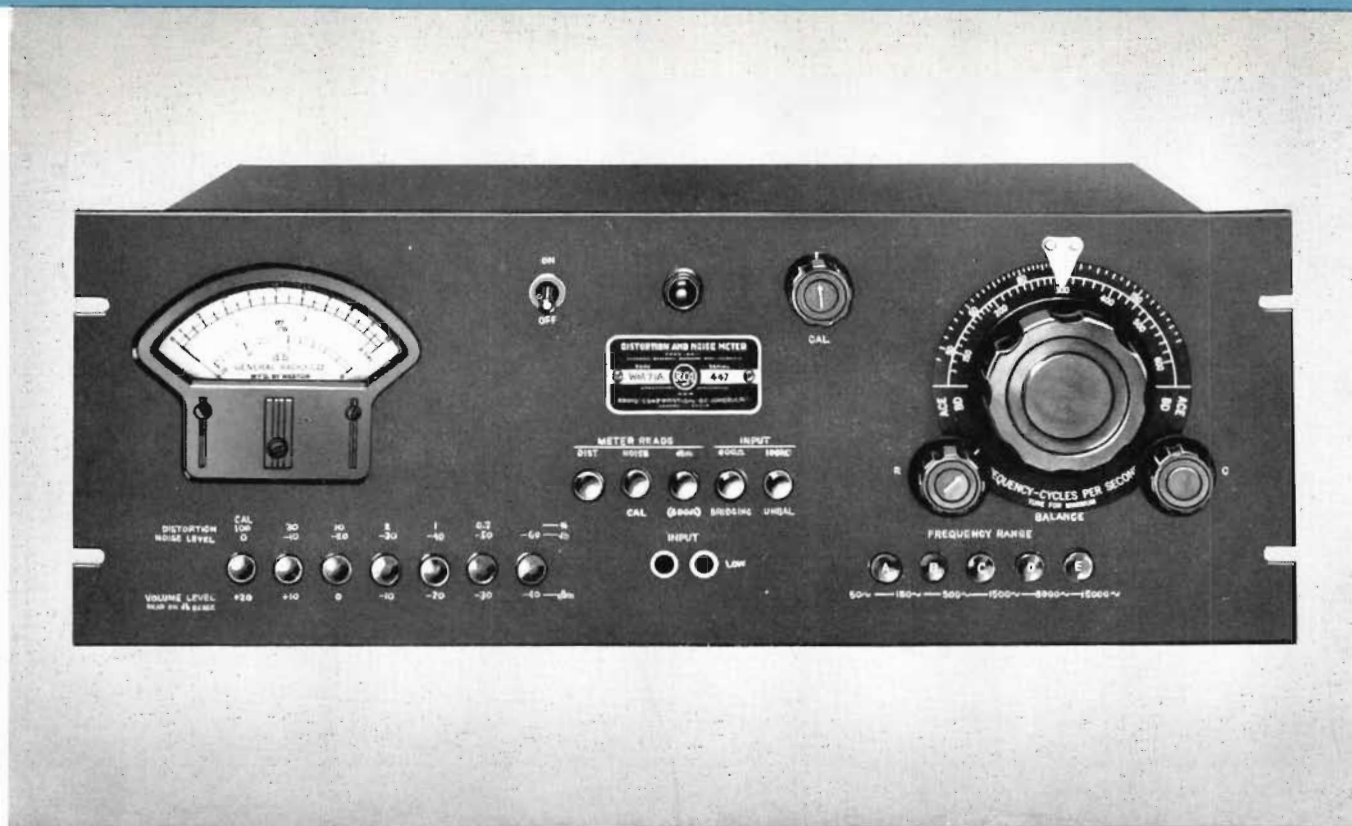

### FEATURES

- Quick frequency selection
- Can be used as a wide range highly sensitive voltmeter or VU meter
- Distortion measurements, as low as 0.1%, quickly and easily made by one tuning adjustment
- Requires no direct connection to audio oscillator
- Audio oscillator distortion can be measured
- Tapped power transformer permits operation on either 105-125 volts or 210-250 volts
- Audio frequency range 50 to 15,000 cycles for distortion measurements; 30 to 45,000 cycles for noise and hum measurements

### USES

Distortion and Noise Meter, RCA Type WM-71A, is a compact precision instrument for measuring the total distortion and the level of noise and hum in audio-frequency circuits. It permits continuous coverage of the audio frequency range, indicating directly the percentage of a-f distortion in modulators, speech amplifiers, a-f generators, receivers and other equipment employing audio frequencies. The instrument will give full-scale readings for distortion percentages as low as 0.3%, and is capable of measuring noise components at frequencies from 30 to 45,000 cycles.

The instrument has many uses in the communications laboratory and in the production testing of radio receivers as a wide-range, highly sensitive voltmeter for such measurements as signal-to-noise ratio, AVC characteristics and hum level. With the aid of an oscilloscope, individual hum and distortion components can be identified. When used with a linear detector such as the RCA Type BW-66E Amplitude-Modulation Monitor, the distortion and noise characteristics of broadcast and other radio-telephone transmitters can be measured.



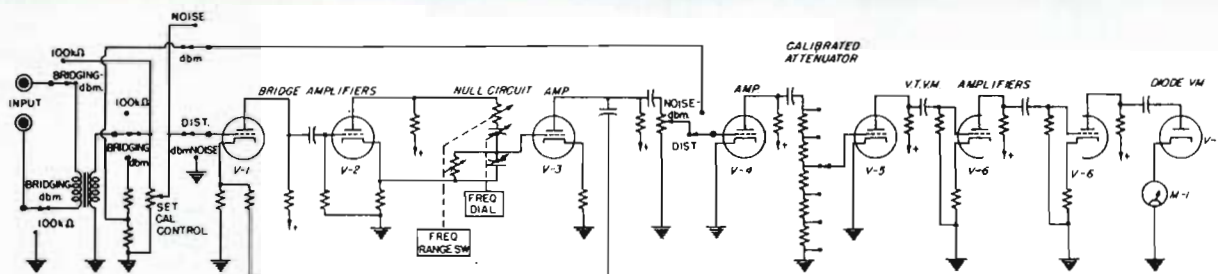

Elementary schematic circuit diagram of the WM-71A Distortion and Noise Meter.

**DESCRIPTION**

The WM-71A Distortion and Noise Meter consists essentially of a high-gain amplifier, an r-c interstage coupling unit, a calibrated attenuator for adjusting the sensitivity, and a panel meter to indicate amplifier output.

The r-c interstage coupling unit balances to a sharp null at the frequency to which it is tuned, the null frequency being continuously variable and controlled from the panel. Degeneration is employed to maintain high stability in the amplifier and to provide flat transmission characteristics except within an octave of the null point.

In measuring distortion the audio-frequency signal is applied to the instrument and the null point is obtained to balance out its fundamental frequency, leaving only its harmonics and other distortion components which are indicated in percentage directly on the panel meter. When the modulated output of a radio transmitter is to be measured, a linear rectifier is required to produce the audio envelope. Any linear detector system having an undistorted output of 1.5 volts can be used.

A switch on the front panel provides for switching out the null circuit so that the instrument can be used as an extremely sensitive voltmeter for measuring hum and noise levels. Since the WM-71A has only one tuning control plus a small trimmer, it can be quickly set to any frequency over its range. This is a time-saving feature in making a series of measurements. Two input circuits are provided: a transformer for bridging a 600-ohm line, and a direct connection to the 100,000-ohm gain control. Input terminals are provided at the rear of the instrument for direct connection to the modulation monitor.

The instrument is relay rack mounted. All essential controls are located on the front panel. A large meter with an easily read, illuminated scale is provided, and percentage, decibel and dbm calibrations are included. The power supply is voltage regulated so that line surges have no appreciable effect on the instrument.

**SPECIFICATIONS**

**Performance Specifications**

- Distortion Range.....Full scale deflections for 0.3%, 1%, 3%, 10% or 30% distortion
- Noise Measurement Range....-80 db below reference calibration level, or 80 db below an audio-frequency signal of zero dbm level, at maximum sensitivity.
- Audio-Frequency Range.....50 to 15,000 cycles (fundamental), for distortion measurements; 30 to 45,000 cycles for noise and hum measurements.
- Dbm Range.....Power-level range is from +20 to -60 dbm (0 dbm is one milliwatt in 600 ohms)
- Input Voltage Range.....1.2 to 30 volts for the 100-kilohm input, and 0.8 to 30 volts for the 600-ohm bridging input
- Accuracy.....Far distortion measurements ±5% of full scale for each range ± residual distortion as noted below; for noise and dbm measurements, ±5% of full scale.
- Residual Distortion Level:
  - 100-kilohm Input.....0.05%, max., below 7500 c. 0.10%, max., above 7500 c.
  - Bridging Input.....0.10%, max., between 50 and 70 c. 0.05%, max., between 70 and 7500 c. 0.10%, max., above 7500 c.
- Residual Noise Level.....Less than -80 db
- Input Impedance.....100,000 ohms unbalanced, and 600-ohm bridging input (10,000 ohms), balanced or unbalanced
- Power Line.....Tapped primary provides for operation on a-c line voltages of 105-125 volts, 50/60 cycles, single phase, or 210-250 volts, 50/60 cycles, single phase.
- Power Consumption.....65 watts

**Tube Complement**

- 4-6J5
- 1-6H6
- 1-6SN7-GT
- 1-6X5-GT
- 1-6K6-GT
- 2-OD3/VR150

- Dimensions.....19" wide, 7" high, 12" deep
- Weight .....37¾ lbs.
- Finish.....Umber gray lacquer

**Equipment Supplied**

- WM-71A Distortion and Noise Meter.....MI-30071-A
- Including electron tubes, line connector, interconnecting cable, instruction book (IB-4071-1), and spare fuses.

**Optional and Accessory Equipment**

- WA-28A Law Distortion Oscillator.....MI-30028
- BI-11A Transmission Measuring Set.....MI-11350

# AUDIO PUSH-BUTTON OSCILLATOR

TYPE WA-28A

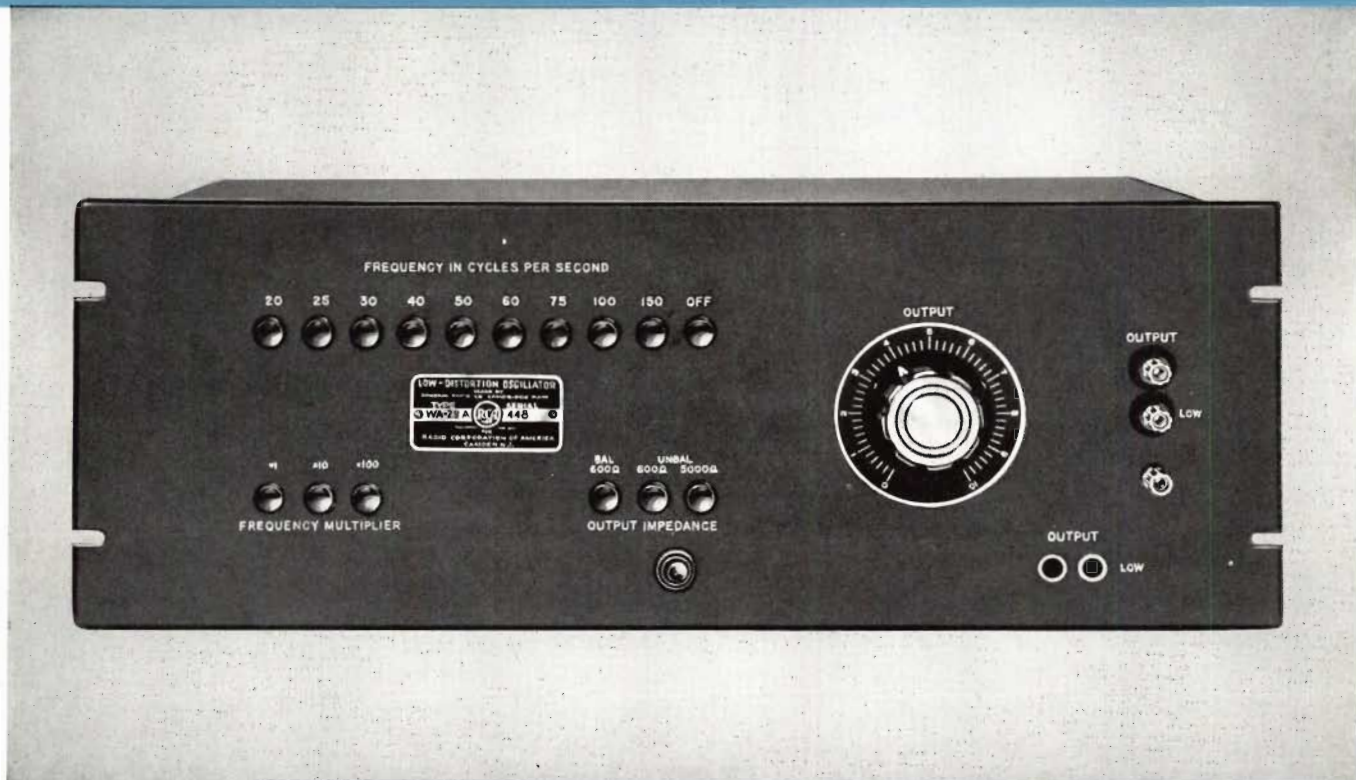

## FEATURES

- Very low distortion
- A high degree of frequency stability which makes this oscillator particularly adaptable for use with distortion meters employing r-c null networks
- Push-button selection of any one of 27 frequencies from 20 to 15,000 cycles
- Any other desired frequency within the normal range can be obtained by the use of plug-in resistors
- Duplicate output terminals on rear for relay-rack installation
- Chassis designed for mounting in standard equipment racks
- Ease of operation from front panel controls

## USES

The Type WA-28A Oscillator was designed particularly for use as a tone source for distortion measurements and as a power source for bridge measurements at audio frequencies. It is also satisfactory for use as a general-purpose laboratory oscillator.

The output frequencies include those recommended by the FCC for distortion measurements on broadcast transmitters. This oscillator is thus ideal for use with the Type WM-71-A Distortion and Noise Meter for rapid distortion measurements. The unusually pure waveform delivered by this oscillator at low frequencies makes distortion measurements possible at low frequencies.

## DESCRIPTION

The WA-28A oscillator is of the resistance-capacitance type and uses an inverse feedback. Separate feedback networks control the frequency and amplitude independently, thus providing high stability and low distortion. The degenerative feedback which controls the frequency is obtained by means of a parallel-T network including mica capacitors and wire-wound resistors. The regenerative network includes an automatic control system whereby a high

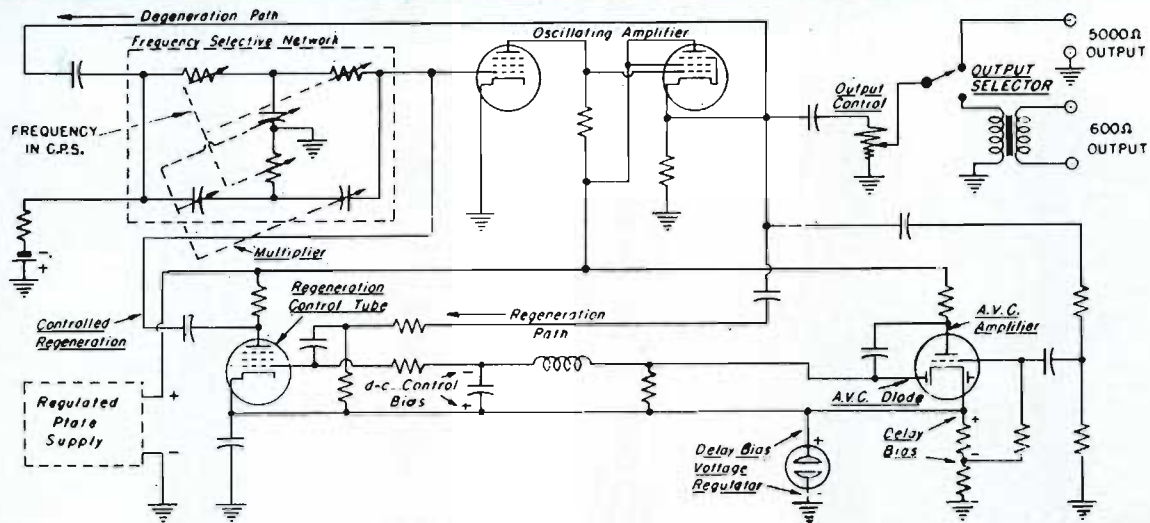

Elementary schematic circuit diagram of the WA-28A Low Distortion Oscillator.

degree of stability is obtained together with low harmonic distortion, without requiring any manual feedback adjustments.

The instrument is mounted on a chassis fitting standard equipment racks. Controls on the front panel include ten frequency push-button switches. Three other push-buttons select the output impedance and a control is provided for adjusting the output voltage. Three frequency multiplier switches and two output jacks are also provided. Terminals are located inside the instrument which permit any specific frequency between the limits of 20 and 15,000 cycles to be obtained by insertion of a set of three calibrated resistors. The values of these resistors for any frequency may be obtained from the chart.

The output impedances available are: a constant 600-ohms balanced to ground, a 600-ohms unbalanced, and a 5000-ohm unbalanced. The 600-ohm output positions use transformer coupling and therefore can be operated either into a balanced line or a grounded line. The internal impedance is essentially constant at 600 ohms. The 5000-ohm output position can be operated unbalanced only. The output control is a potentiometer, and consequently the output impedance is not constant. The total harmonic distortion of any of the outputs will not exceed 0.1% of 1% when operating between 40 and 7500 cycles, and is never more than 0.25% when operating at extreme frequencies. The operation of the instrument is substantially independent of climatic changes in temperature and humidity.

Jack-top binding posts with standard 3/4-inch spacing and standard Western Electric double output jack are provided on the panel. A ground terminal is also provided. A standard multipoint connector provides duplicate output terminals on the rear of the instrument for relay-rack

installation. These terminals are disconnected when a plug is inserted in the Western Electric-type panel jack. The instrument is provided with power cord, multipoint connector and spare fuses.

### SPECIFICATIONS

#### Performance Specifications

Frequency Range.....	27 fixed frequencies between 20 and 15,000 cycles
Frequency Calibration.....	Adjusted within 1 1/2% ±0.1 cycle
Frequency Stability.....	Less than 0.02% frequency drift per hour after the first 10 minutes of operation
Output Power.....	18 milliwatts into 600 ohms load, or 6.6 volts open circuit; 100 milliwatts into 5000 ohm load, or 30 volts open circuit; constant within ±1 db throughout frequency range.
Output Impedances.....	600-ohm balanced to ground 600-ohm unbalanced 5000-ohm unbalanced
Waveform Distortion:	
5000-ohm Output.....	Less than 0.1% between 40 and 7500 cycles Less than 0.15% at other frequencies
600-ohm Output.....	Less than 0.1% between 40 and 7500 cycles Less than 0.25% between 20 and 40 cycles Less than 0.15% above 7500 cycles
Power Supply.....	105 to 125 (or 210 to 250) volts, 50/60 cycles, single phase
Power Consumption.....	45 watts

#### Tube Complement

1-6Y6-G	1-6SJ7	1-6SK7
1-NE-17	1-6SQ7	1-6X5
1-6B4-G	1-6SL7-GT	1-OD3/VR150

Dimensions.....	19" wide, 7" high, 12" deep
Weight.....	32 1/2 lbs.
Finish.....	Light umber gray

#### Equipment Supplied

WA-28A Low-Distortion Oscillator, complete.....MI-30028-A  
Including electron tubes, line connector, multiple point connector, instruction book (IB-4028-1) and spare fuses.

#### Optional and Accessory Equipment

Noise and Distortion Meter, Type WM-71A.....	MI-30071-A
Transmission Measuring Set.....	MI-11350

# TRANSMISSION MEASURING SET

TYPE BI-11A

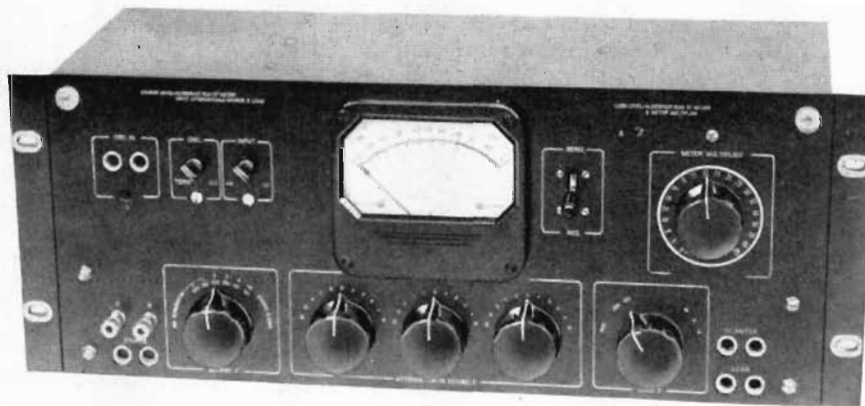

## FEATURES

- Simplifies measurement of transmission characteristics of audio systems and their components
- Eliminates lengthy calculations—direct reading
- $\pm 0.1$  db accuracy over frequency range of 20 to 20,000 cycles
- Automatic correction for changes in load impedance
- Output impedance switch for matching
- Wide range of load levels handled
- Hinged panel permits easy access to all components

## USES

The Transmission Measuring Set, Type BI-11A, is a simplified, accurate and direct-reading instrument designed for use in the following applications: (1) audio gain measurements; (2) audio loss measurements; (3) measurements of matching and bridging devices; (4) complex circuit measurements; (5) measuring mismatch loss and frequency response measurements. The instrument also may be used as an independent volume level indicator.

The instrument facilitates overall system measurements and may be used with the WA-28A Low Distortion Push-button Oscillator and the WM-71A Distortion and Noise Meter. It eliminates lengthy calculations and intricate setups. It is designed to provide accuracies conforming to FCC regulations and is particularly useful for broadcast stations in the master control room or at the transmitter.

## DESCRIPTION

The BI-11A Transmission Measuring Set consists of a volume indicator meter, input and output attenuators, an impedance matching system and jacks for convenient connections. A meter multiplier, which is geared to the load impedance shaft, provides an automatic correction for changes in load impedance. Convenient switches allow the volume indicator to be connected to the input of the attenuator system or to jacks for external connection. An

output impedance switch allows matching to 600-250-150-16-8-4 ohm circuits.

Level controls, switches, jacks and VI meter are located on the front of a standard 19 inch rack-type panel. The panel hinges forward to provide ready access to attenuators, jacks, switches and other components. Unit type assemblies (individual sections, such as source, attenuation and load) are readily removable for servicing. Each section is a complete assembly with its own jacks and terminal block.

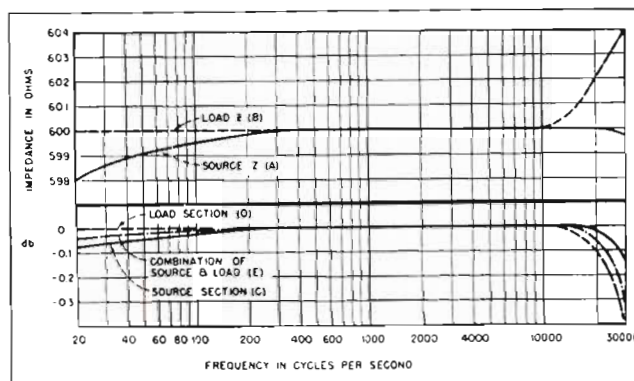

## SPECIFICATIONS

### Performance Specifications

Frequency Range.....	20 to 20,000 cycles
Accuracy (independent of level from +4 to -110 dbm):	
Overall.....	±0.1 db, 20 cycles to 20 kilocycles
Source and Load Impedances for Dial Indicators	
Over Entire Range.....	Within ±2%
Network Resistors .....	±1.0%

### Performance Specifications (Continued)

Source Characteristics:	
Shielded Output can be used equally well on either balanced or unbalanced equipment	
Ranges (in steps of 0.1 db).....	+4 to -110 db
	-10 to -124 db
Range of Impedance:	
Internally Terminated .....	600-150 ohms
Unterminated .....	600-250-150-30 ohms
Internal isolation network for operating into non-linear devices.	

### Load Characteristics (resistive load, ungrounded):

Range of Load Levels.....	+4 to +42 VU @ 600 ohms
Range of Impedance.....	600-250-150-16-8-4 ohms
Dimensions.....	19" wide, 7" high, 8¼" deep
Weight .....	19 lbs.
Finish.....	Light umber gray

### Equipment Supplied

Type BI-11A Transmission Measuring Set, complete.....	MI-11350
-------------------------------------------------------	----------

### Optional and Accessory Equipment

Low Distortion Push Button Oscillator.....	MI-30028-A
Distortion and Noise Meter.....	MI-30071-A

# RECOMMENDED EQUIPMENT LISTS AND TYPICAL AM STUDIO PLANS

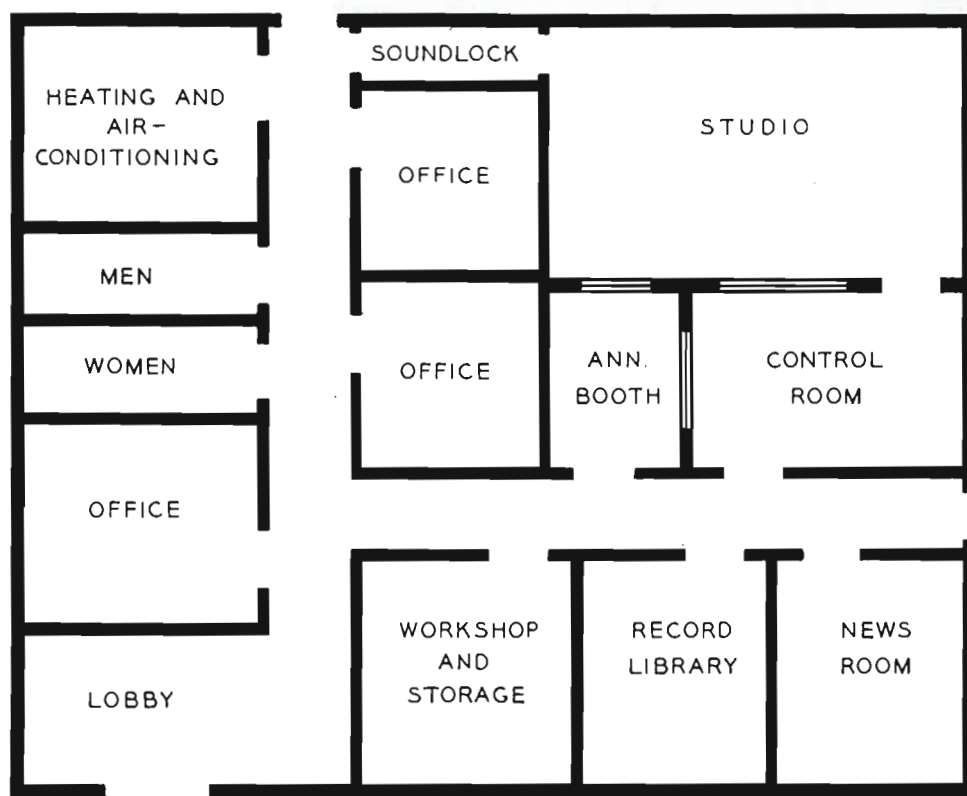

TYPICAL PLAN FOR SINGLE STUDIO AM OPERATION

A complete and diversified line of high-quality Broadcast Audio Equipment is made available by RCA to meet practically any conceivable set of operating or programming requirements. It is recognized by RCA that these requirements will vary widely in their scope—and will of necessity be somewhat different to satisfy each particular AM station's needs.

However, in an effort to assist the Broadcaster in making a proper selection of equipment, several typical or "average" equipment lists and studio floor plans are included. These lists and plans range from "basic minimum equipment" to that required for a multi-studio setup. This information should be used only as a guide since individual requirements must be considered carefully before a final selection can be made. The "minimum" equipment shown for a single AM or FM studio will successfully accommodate a small-station installation of one studio and a control room utilizing three microphones, two turntables, network and two remote lines.

For two studios or more, consideration should be given to more extensive equipment requirements such as

individual studio control and master control switching. RCA Broadcast Audio Engineers will gladly assist in planning master control installations, including custom switching when required.

Typical lists for "Remote" Equipment, Tape Recording, and Transmitter Monitoring are included. One transmitter monitoring list covers the equipment needed for combined studio/transmitter operation—the other is for use when the transmitter is at a separate location. Typical equipment lists are also available for "TV Audio" installations (see Catalog description under that title).

Four typical studio floor plans, and the following equipment lists are shown:

1. AM or FM—Single-Studio Minimum Equipment Requirements
2. AM or FM—Two-Studio Equipment Requirements
3. Multi-Studio Equipment Requirements
4. AM or FM Remote Equipment
5. Tape Recording Equipment
6. AM or FM Transmitter Audio and Monitoring Equipment

**I. AM or FM Minimum Studio Equipment Requirements**

(Suggested minimum equipment to handle one studio, announce booth, control room microphone, two turntables, network and remote lines)

Item No.	Quan.	MI Number	Description
1.	1	11635	BC-4A Audio Central
2.	1	11478	Tube Kit for BC-4A
3.	2	11833	BQ-2A Turntable with Cabinet
4.	2	11885	Lightweight Tone Arm
5.	2	11874-4	1 mil Lightweight Pickup
6.	2	11874-5	2.5 mil Lightweight Pickup
7.	2	11888	Transcription Filter

Item No.	Quan.	MI Number	Description
8.	1	12046	SK-46 Velocity Microphone
9.	1	4045-F	77-DX Polydirectional Microphone
10.	2	11007	BK-1A Pressure Microphone (for control room and announce booth)
11.	1	4098	90-AS Floor Stand
12.	1	12066-B	Desk Stand for SK-46
13.	1	4092-D	Desk Stand for 77-DX
14.	2	11008	Desk Stand for BK-1A
15.	4	4630-B	Cable Plug (male)
16.	4	4624-A	Wall Receptacle (female)
17.	2	11408	10-inch Speaker Mechanism
18.	2	11407	Wall Cabinet for MI-11408
19.	3	11731	Speaker Matching Transformer
20.	1000'	13306	Cotton-covered shielded Cable for audio wiring

**II. AM or FM Two-Studio Equipment Requirements**

(Suggested equipment list to handle two studios, announce booth, control room microphone, two turntables, network and remote lines)

Item No.	Quan.	MI Number	Description
1.	1	11632/11313	BC-2B Audio Console and Power Supply
2.	1	11294/11297	Tube Kit for BC-2B
3.	3	11706-1	"On-Air" Light
4.	3	11702-A	Signal Light Relay
5.	1	11722	Speaker Relay for Announce Booth
6.	2	11833	BQ-2A Turntables
7.	2	11885-A	Lightweight Tone Arm
8.	2	11874-4	1 mil Lightweight Tone Arm
9.	2	11874-5	2.5 mil Lightweight Pickup Head
10.	2	11888	Transcription Filter
11.	1	11241	Dual Preamplifier for Turntable Inputs to BC-2B
12.	1	11475	Tube Kit for Dual Preamplifier
13.	2	4027-J	44-BX Velocity Microphone
14.	2	4045-F	77-D Polydirectional Microphone
15.	3	11007	BK-1A Pressure Microphone (for control room and announce booth)
16.	2	4098	90-AS Floor Stand
17.	2	4058-C	91-A Desk Stand for 44-BX

Item No.	Quan.	MI Number	Description
18.	2	4092-E	91-B Stand for 77-DX
19.	3	11008	KS-11A Desk Stand for BK-1A
20.	7	4630-B	Cable Plug (male)
21.	5	4624-A	Wall Receptacle (female)
22.	1	30951-B84	BR-84B Cabinet Rack
23.	2	30566-G84	Single Trim Strip
24.	1	4570-A	Terminal Board Bracket
25.	1	4568	Power Terminal Strip
26.	1	4569	Audio Terminal Block
27.	1	11645	Double Jack Panel
28.	1	11647-1	Jack Panel Mat
29.	4	4652-2B	Two-Foot Patch Cord
30.	1	11247	BA-24A Monitor Amplifier (for house monitor)
31.	1	11481	Tube Kit for BA-24A
32.	1	11597	BR-22A Panel and Shelf Assembly
33.	2	11411-A	LC-1A Duo-Cone Speaker Mechanism (for control room and reception room)
34.	1	11406	Wall Housing for LC-1A
35.	1	12464-M	Mahogany Floor Cabinet for LC-1A
36.	3	11408	10-inch Speaker Mechanism (for studios and announce booth)
37.	3	11407	Wall Cabinet for MI-11408
38.	3	11731	Speaker Matching Transformers
39.	2000'	13306	Cotton-Covered Shielded Cable for audio wiring
40.	200'	35	Shielded Cable for filament wiring

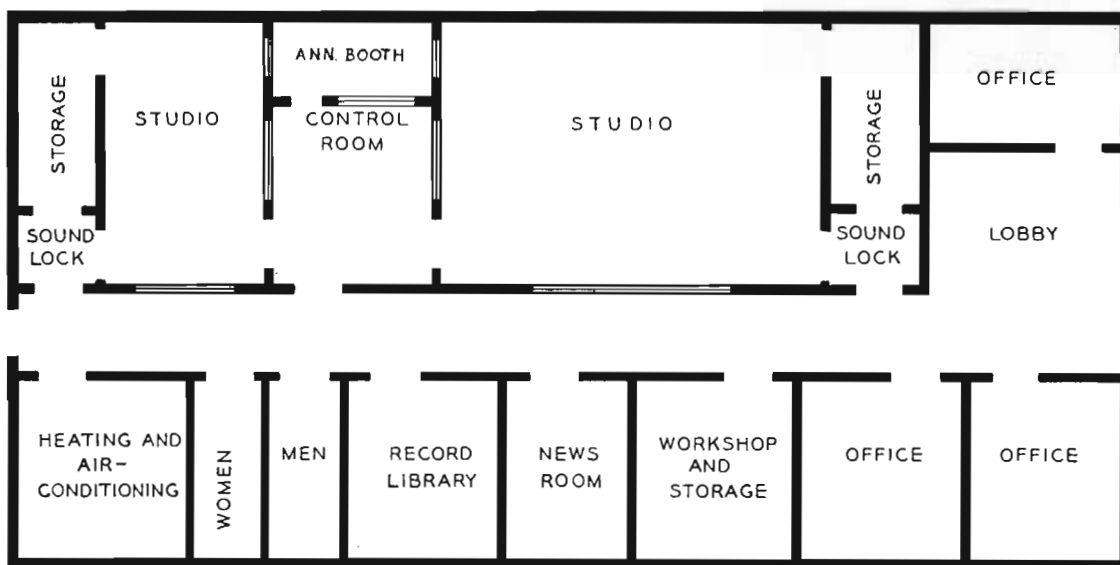

TYPICAL PLAN FOR TWO STUDIO AM OPERATION

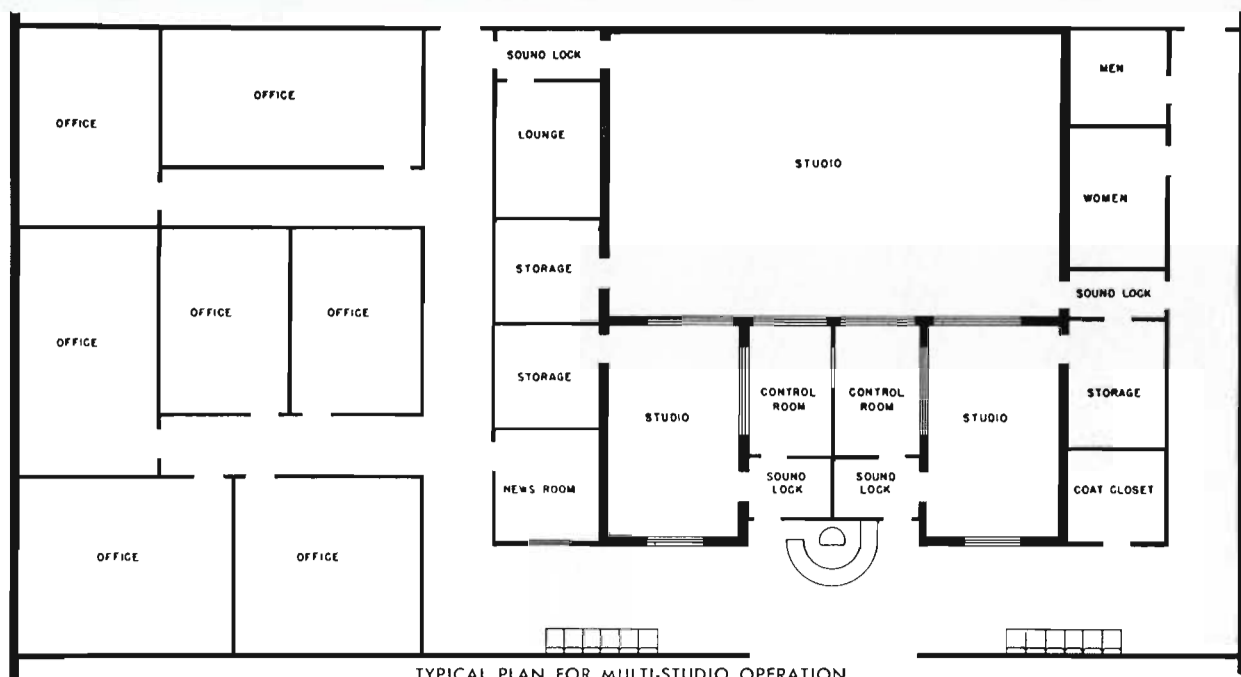

TYPICAL PLAN FOR MULTI-STUDIO OPERATION

### III. Multi-Studio Equipment Requirements

(Suggested equipment list to handle three studios and two control rooms, with master program switching facilities provided in one control room)

No.	Quan.	MI Number	Description	Item No.	Quan.	MI Number	Description
1.	2	11632/11313	BC-2B Audio Console	24.	2	30541-G84	Side Panel for BR-84D
2.	2	11294/11297	Tube Kit for BC-2B	25.	4	30566-G84	Single Trim Strip
3.	3	11706-1	"On-Air" Light	26.	1	30568-G84	Double Trim Strip
4.	3	11702-A	Signal Light Relay	27.	3	4570-A	Terminal Board Bracket
5.	4	11833	BQ-2A Turntable	28.	3	4568	Power Terminal Strip
6.	4	11885-A	Lightweight Tone Arm	29.	3	4569	Audio Terminal Block
7.	4	11874-4	1 mil Lightweight Pickup	30.	3	11645	Double Jack Panel
8.	4	11874-5	2.5 mil Lightweight Pickup	31.	3	11647-1	Jack Panel Mot
9.	4	11888	Transcription Filter	32.	12	4652-2B	Two-Foot Patch Cord
10.	2	11241	Dual Preamplifier for Turntable	33.	4	4652-4B	Four-Foot Patch Cord
11.	2	11475	Tube Kit for Dual Preamplifier	34.	2	11247	BA-24A Monitoring Amplifier
12.	2	4027-J	44-BX Velocity Microphone	35.	2	11481	Tube Kit for BA-24A
13.	3	4045-F	77-DX Polydirectional Microphone	36.	2	11597	BR-22A Mounting Shelf
14.	3	11007	BK-1A Pressure Microphone	37.	3	11411-A	LC-1A Duo-Cone Loudspeaker Mechanism
15.	3	4098	90-AS Floor Stand	38.	2	11406	Wall Housing for LC-1A
16.	2	4058-C	91-A Desk Stand for 44-BX	39.	1	12464-M	Mahogany Floor Cabinet for LC-1A
17.	3	4092-E	91-B Desk Stand for 77-DX	40.	3	11408	10-inch Speaker Mechanism
18.	3	11008	KS-11A Desk Stand for BK-1A	41.	3	11407	Wall Housing for MI-11408
19.	1	11056	KS-3B Boom Stand	42.	3	11731	Speaker Matching Transformers
20.	8	4630-B	Cable Plug (Male)	43.	1	11633	BCS-11A Master Switching Console
21.	10	4624-A	Wall Receptable (Female)	44.	1	11316	24-V 3 ampere d-c Power Supply
22.	1	30951-B84	BR-84B Cabinet Rack (for sub-control room)	45.	3	11233	BA-13A Program Amplifier
23.	2	30951-D84	BR-84D Cabinet Rack (for master control room)	46.	3	11266	Tube Kit for BA-13A
				47.	2	11598-B/11599	Shelf and Panel Assembly
				48.	3	11713	Line Transformer
				49.	4000'	13306	Cotton-Covered Shielded Cable for audio wiring
				50.	400'	35	Shielded Cable for filament wiring

### IV. Remote Equipment

Item No.	Quan.	MI Number	Description	Item No.	Quan.	MI Number	Description
1.	1	11230	Type BN-2A Remote Amplifier	6.	4	11007	Type BK-1A Pressure Microphone
2.	1	11269	Tube Kit for BN-2A	7.	2	11008	Type KS-11A Desk Stand for BK-1A
3.	1	11279	Battery Cover for BN-2A	8.	2	4093-C	Type KS-2A Portable Stand for BK-1A
4.	1	11281	Battery Kit for M1-11279	9.	6	4630-B	Microphone Cable Plug
5.	1	11277	Weatherproof Cover for BN-2A	10.	2	4620-B	Extension Cable Plugs
				11.	200'	43-B	Microphone Extension Cable



**V. (A) Professional Tape Equipment**  
(Rack-Mounted)

Item No.	Quan.	MI Number	Description
1.	1	11911-B	Type RT-11B Professional Tape Recorder
2.	1	11293/11294/11296	Tube Kit for RT-11B
3.	1	11948	Remote Control Unit for RT-11B
4.	1	30951-B84	Type BR-84B Cabinet less front door
5.	10	11924-3	Recording Tape 1/4" x 1200' on plastic reel
6.	10	11924-5	Recording Tape 1/4" x 2400' on NARTB hub
7.	4	11932-2	Reel, NARTB hub
8.	1	11937	Editall Tape Splicer

**V. (B) Professional Tape Equipment**  
(Console-Mounted)

Item No.	Quan.	MI Number	Description
1.	1	11913-C	Type RT-12C Professional Tape Recorder (console mounted)
2.	1	11293/11294/11296	Tube Kit for RT-12C
3.	1	11265-F	VU Meter Panel for RT-12C
4.	1	11948	Remote Control Unit for RT-12C Recorder Console
5.	10	11924-3	Recording Tape 1/4" x 1200' on plastic reel
6.	10	11924-5	Recording Tape 1/4" x 2400' on NARTB hub
7.	4	11932-2	Reel, NARTB hub
8.	1	11937	Editall Tape Splicer

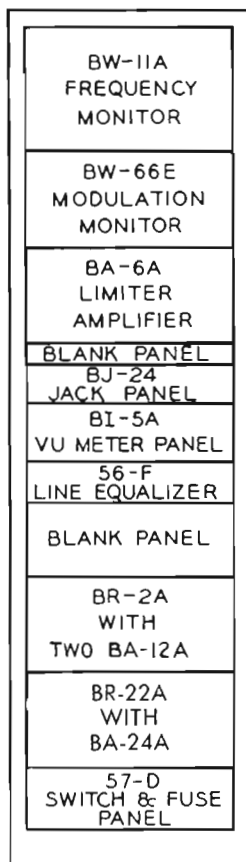

XMTR AT LOCATION  
REMOTE FROM STUDIO

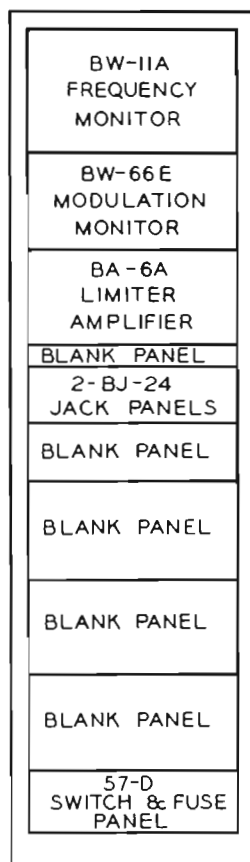

XMTR AND STUDIO  
AT SAME LOCATION

**VI. (A) AM Transmitter Audio and Monitoring Equipment**

(Transmitter and Studio at Same Location)

Item No.	Quan.	MI Number	Description
1.	1	11550	Type BR-19A Cabinet Rack
*2.	1	30011-A	Type BW-11A AM Frequency Monitor with crystal and one set of tubes
*3.	1	30066-A	Type BW-66E Modulation Monitor with one set of tubes
4.	2	11645	Type BJ-24 Double Jack Panel
5.	1	11647-2	Double Jack Panel Mat
6.	1	11225	Type BA-6A Limiting Amplifier
7.	1	11289	Tube Kit for BA-6A
8.	1	11599	Shelf for BA-6A
9.	3	4594-B	Blank Panel, 8 3/4"
10.	1	4592-B	Blank Panel, 5 1/4"
11.	1	4590-A	Blank Panel, 1 3/4"
12.	1	4395-G	Type 57-D Switch and Fuse Panel
13.	1	4570-A	Terminal Board Mounting Bracket
14.	1	4568	Terminal Power Strip
15.	1	4569	Terminal Audio Block
16.	1000'	33	Interconnecting Cable (rack wiring)
17.	1000'	35	Interconnecting Cable (a-c and filament circuits)

**VI. (B) AM Transmitter Audio and Monitoring Equipment**

(Transmitter at Location Remote from Studio)

Item No.	Quan.	MI Number	Description
1.	1	11550	Type BR-19A Cabinet Rack
*2.	1	30011-A	Type BW-11 AM Frequency Monitor with crystal and one set of tubes
*3.	1	30066-A	Type BW-66E Modulation Monitor with one set of tubes
4.	1	11225	Type BA-6A Limiting Amplifier
5.	1	11289	Tube Kit for BA-6A
6.	1	11599	Shelf for BA-6A
7.	1	12722	Type SA-6A Monitoring Amplifier with tubes
8.	1	11232	Type BA-12A Booster Amplifiers
9.	2	11287	Tube Kit for BA-12A
10.	2	11598-B/11599	Type BR-2A Panel and Shelf (Monitor and Booster Amplifiers)
11.	1	11645	Type BJ-24 Double Jack Panel
12.	1	11647-1	Single Jack Panel Mat
13.	1	11265-F	Type BI-5A VU Meter Panel
14.	1	4593-A	Blank Panel, 7"
15.	1	4570-A	Terminal Board Mounting Bracket
16.	1	4568	Terminal Power Strip
17.	1	4569	Terminal Audio Block
18.	1	4395-G	Type 57-D Switch and Fuse Panel
19.	3	4652-2B	2' Patch Card
20.	1	11007	Type BK-1A Pressure Microphone
21.	1	11008	Type KS-11A Desk Stand for BK-1A
22.	1	4630-B	Microphone Cable Plug
23.	1	4624-A	Microphone Wall Receptacle
24.	1	11833	Type BQ-2A Transcription Turntable with cabinet
25.	1	11885-A	Lightweight Tone Arm
26.	1	11874-4	1 mil Lightweight Pickup
27.	1	11874-5	2.5 mil Lightweight Pickup
28.	1	11888	Transcription Filter
29.	1	12458	Type SL-12 Monitoring Speaker
30.	1000'	33	Interconnecting Cable (rack wiring)
31.	1000'	35	Interconnecting Cable (a-c and filament circuits)

\* When used for FM, space occupied will be utilized for FM frequency and modulation monitor, Type GR-1170-A or HP-335B.

# RECOMMENDED AUDIO WIRING PRACTICES

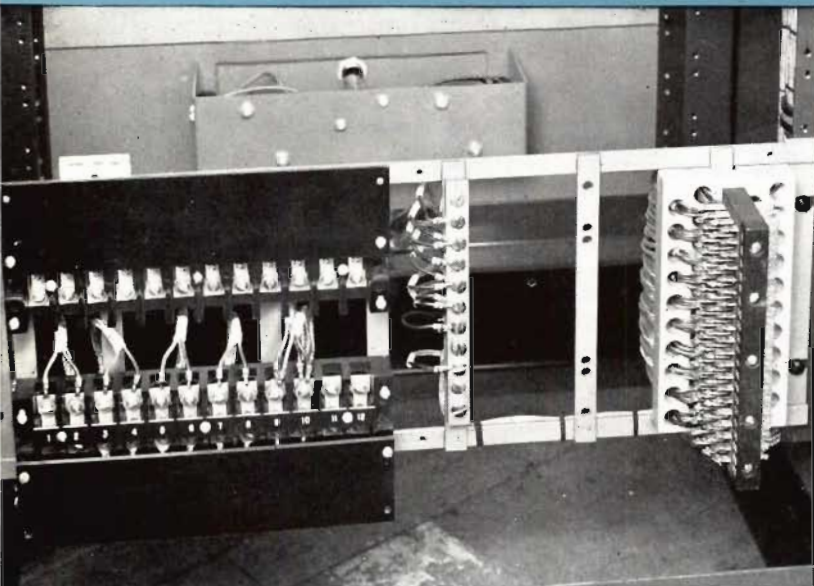

Fig. 1. Photo of terminals at bottom of rack. Power terminals are at left, ground buss in center and audio terminals at right.

Almost every studio undergoes minor modifications from time to time, and the subject of proper wiring practice is raised. Modern standards require careful elimination of noise and crosstalk from the program circuits. It is not uncommon to spend many hours wiring in new components, only to find their performance reduced by the wiring itself. A tested and proven standard practice can avoid much wasted time.

There are two basic philosophies employed in practical approaches to the noise problem. In one system every circuit shield is carefully isolated from its neighbors and grounded at one point only. In the other, all the shields of one unit (such as a rack) are put in such close contact that a brute-force ground is provided for any stray currents that might be present. This latter approach is taken in RCA equipment with modifications as follows:

Every rack, cabinet or desk is wired as a unit to terminal boards. The terminal boards are placed as near as possible, consistent with accessibility, to the point where the external circuits enter the unit. See Figs. 1 and 2 for examples.

In a rack, as viewed from the back, all audio cables are run on the right side of the rack; and all signal, a-c and d-c power cables are run on the left side. All audio circuits are twisted pair conductors shielded with a tinned copper braid. Separate cables are formed for:

- (a) Microphone outputs, preamplifier outputs and other audio circuits with levels below  $-20$  vu.

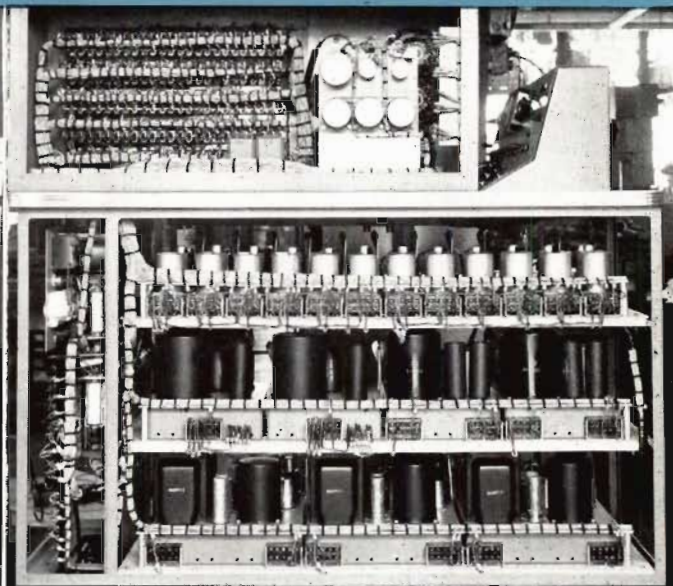

Fig. 2. View of wiring in a control desk. A-c circuits are below the shelves, and audio above.

- (b) Mixer, line and channel circuits up to  $+30$  vu.
- (c) Loudspeaker and other lines above  $+30$  vu.
- (d) At times further subdivisions are made for convenience in bulk or because levels are widely separated.

Each cable is bound with lacing cord so the shields are in tight contact for their entire length. Where two audio cables cross or join, they should either be definitely insulated or bound together. It is better to have tight contact than to risk an intermittent noise source made by casual contact.

The ends of the individual shields are terminated either with "wedge-on" collars or with plastic tape. The shields are grounded to a main ground bus near the terminal block. A shielded ground lead is run from each amplifier chassis to the ground bus.

The a-c and d-c power circuits are handled similarly. All a-c circuits should be in twisted pair, shielded cable. The a-c current should be balanced in each pair. That is, one pair should not be used for one side of a circuit and a second pair for the other side. If more than one pair is needed for the load, two or more pairs should be used with part of the load on each. Plus and minus plate potentials should be carried in single conductor shielded cable. Shields are tied off and grounded the same as the audio circuits.

Signal circuits do not require shielded wire. The frames of jacks should be tied together and grounded with a shielded wire the same as amplifier chassis.

In installing the equipment in a studio or control room the following rules have been found useful:

The pairs run in conduits should be grouped in the same general way as the cables in the racks. The audio conduits should be kept free from grounds to power conduits or power circuits. Low level audio circuits (less than -30 vu) should have the shields insulated from the conduits and from each other.

Splices should be avoided. Low level conduits should be well spaced from power conduits.

Signal and telephone circuits should not be run in the same conduit with program or power circuits. Telephone leads should be twisted pair. Power and audio grounds should consist of separate, heavy shielded leads to the main station ground.

TV circuits in general should be considered high level circuits and should therefore be kept away from low level audio circuits. In particular, pulsed lamp circuits should be routed as far away from projector photocell and preamplifier circuits as possible. Shields should be insulated from ground and the audio circuit and shield grounded only at the point of lowest level.

Typical good practice for microphones is shown in Fig No. 3a. In this case two conductor shielded wire, with insulation over the shield, is used for the conduit run and the microphone cord. Fig. No. 3b shows somewhat better practice in which 3-conductor shielded, insulated cable is used for the conduit run and microphone cord. This latter practice removes any ground current from the shield.

Turntable pickup circuits should be handled like microphones with particular care being taken to keep the motor power circuits and their shields away from the audio circuits.

The input to mixer circuits is usually at comparatively high level, but the output is frequently very close to

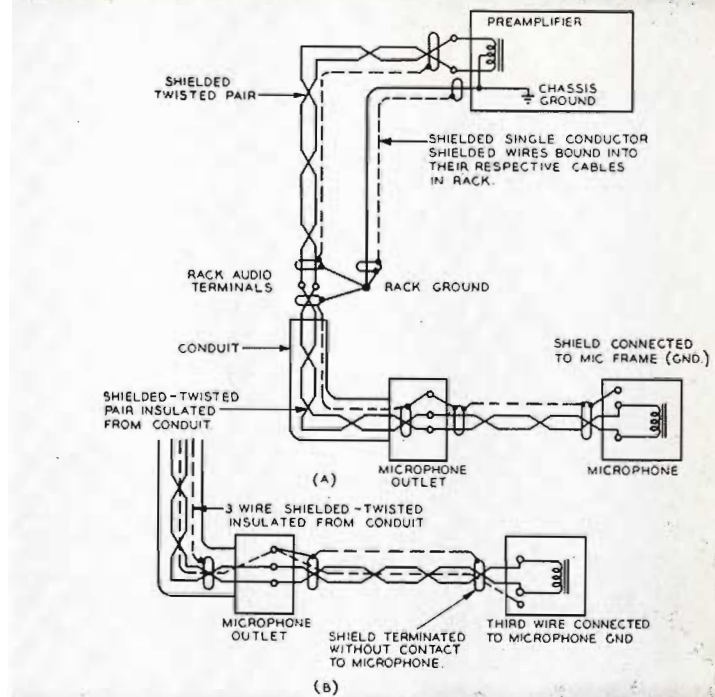

Fig. 3.

microphone level and the circuits should be treated in the same way. Fig. No. 4 shows typical good grounding practice in this respect. Unbalanced circuits may be used but are usually more difficult to handle if there is noise present. It will be noted that the only ground to this part of the system is at the point of lowest level and that all the circuits are balanced to ground. The center taps of the mixer attenuators are only tied to ground if special noise difficulty is encountered and tests indicate improvement. This occasionally happens on circuits which connect to remote lines or studio equipment with separate ground systems.

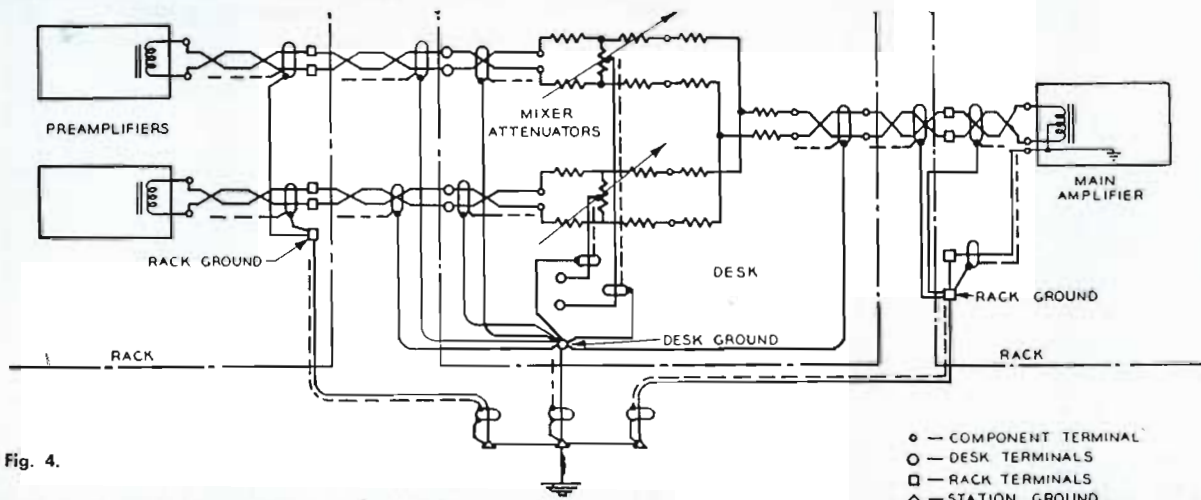
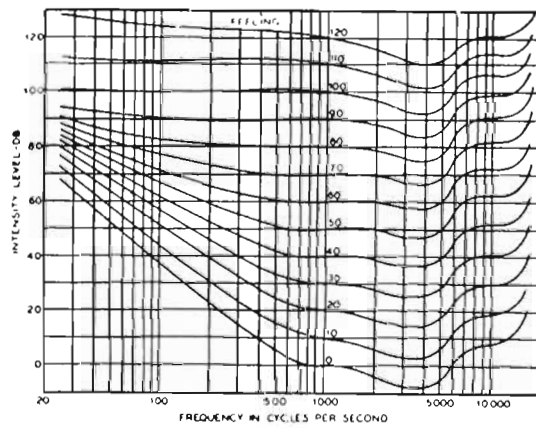

Fig. 4.

# AUDIO DATA SECTION

CONTOURS OF EQUAL LOUDNESS TO THE EAR



Loudness level contours.

Courtesy of the Acoustical Society of America

Impedance Loss, dB	600 Ohms		600 Ohms		600 Ohms		600 Ohms		600 Ohms		600 Ohms	
	R <sub>1</sub> Ohms	R <sub>2</sub> Ohms	R <sub>1</sub> Ohms	R <sub>2</sub> Ohms	R <sub>1</sub> Ohms	R <sub>2</sub> Ohms	R <sub>1</sub> Ohms	R <sub>2</sub> Ohms	R <sub>1</sub> Ohms	R <sub>2</sub> Ohms	R <sub>1</sub> Ohms	R <sub>2</sub> Ohms
0	0	∞	0	∞	0	∞	0	∞	0	∞	0	∞
0.1	3.58	50204	7.20	100500	3.60	100500	3.58	100500	7.2	50000	3.6	50000
0.2	6.82	26280	13.70	57380	6.85	57380	6.82	57380	13.8	26086	6.9	26086
0.3	10.32	17460	20.55	34900	10.28	34900	10.32	34900	21.0	17143	10.5	17143
0.4	13.79	13068	27.50	26100	13.80	26100	13.79	26100	28.2	12766	14.1	12766
0.5	17.20	10464	34.40	20920	17.20	20920	17.20	20920	35.4	10169	17.7	10169
0.6	20.9	8640	41.7	17230	20.85	17230	20.9	17230	43.2	8333	21.6	8333
0.7	24.2	7428	48.5	14860	24.25	14860	24.2	14860	50.4	7143	25.2	7143
0.8	27.5	6540	55.05	13100	27.53	13100	27.5	13100	57.6	6250	28.8	6250
0.9	31.02	5787	62.3	11600	31.2	11600	31.02	11600	65.4	5504	32.7	5504
1.0	34.5	5208	68.6	10440	34.3	10440	34.5	10440	73.2	4918	36.6	4918
1.5	51.8	3452	104.3	6950	52.1	6950	51.8	6950	113.4	3174	56.7	3174
2.0	68.8	2582	139.4	5332	68.7	5332	68.8	5332	153.4	2316	77.7	2316
2.5	85.9	2053	175.4	4195	87.7	4195	85.9	4195	200.4	1796	100.2	1796
3.0	102.7	1703	212.5	3505	106.2	3505	102.7	3505	247.6	1452	123.9	1452
3.5	119.2	1448	258.0	3021	129.0	3021	119.2	3021	297.6	1209	148.8	1209
4.0	135.8	1249	287.5	2651	143.8	2651	135.8	2651	351.0	1025	175.5	1025
4.5	152.2	1109	324.6	2365	162.3	2365	152.2	2365	407.4	883.7	203.7	883.7
5.0	168.1	987.6	364.5	2141	182.3	2141	168.1	2141	466.8	771.2	233.4	771.2
5.5	184.0	886.8	405.9	1956	203.0	1956	184.0	1956	530.4	678.7	265.2	678.7
6.0	199.3	803.4	447.5	1807	223.8	1807	199.3	1807	603.0	603.0	298.5	603.0
6.5	214.6	730.8	492.0	1679	243.6	1679	214.6	1679	667.8	539.8	333.9	539.8
7.0	229.7	685.2	537.0	1569	268.5	1569	229.7	1569	743.4	484.3	371.7	484.3
7.5	244.2	645.6	584.7	1475	292.4	1475	244.2	1475	822.6	437.6	411.3	437.6
8.0	258.4	607.6	634.2	1393	317.1	1393	258.4	1393	907.2	396.8	453.6	396.8
8.5	272.3	575.0	685.5	1322	342.8	1322	272.3	1322	996.6	361.2	498.3	361.2
9.0	285.8	545.0	738.9	1260	369.4	1260	285.8	1260	1091	329.9	545.5	329.9
9.5	298.9	518.0	794.4	1204	397.2	1204	298.9	1204	1191	302.2	595.5	302.2
10.0	312.0	491.6	854.1	1154	427.0	1154	312.0	1154	1297	277.5	648.5	277.5
11.0	336.1	367.4	979.8	1071	489.9	1071	336.1	1071	1529	235.5	764.5	235.5
12.0	359.1	321.7	1119	1002	559.5	1002	359.1	1002	1788	201.3	894	201.3
13.0	380.5	282.8	1273	946.1	636.3	946.1	380.5	946.1	2080	173.1	1040	173.1
14.0	400.4	249.4	1443	899.1	721.5	899.1	400.4	899.1	2407	149.6	149.6	149.6
15.0	418.8	220.4	1632	859.6	816.0	859.6	418.8	859.6	2773	129.8	1387	129.8
16.0	435.8	195.1	1847	826.0	923.2	826.0	435.8	826.0	3186	113.0	1508	113.0
17.0	451.5	172.9	2083	797.3	1042	797.3	451.5	797.3	3648	98.68	1824	98.68
18.0	465.8	152.5	2344	772.8	1172	772.8	465.8	772.8	4166	86.4	2083	86.4
19.0	478.0	136.4	2670	751.7	1322	751.7	478.0	751.7	4748	75.8	2374	75.8
20.0	490.4	121.2	2970	733.3	1485	733.3	490.4	733.3	5400	66.66	2700	66.66
22.0	511.7	95.9	3753	703.6	1877	703.6	511.7	703.6	6954	51.72	3477	51.72
24.0	528.8	76.0	4737	680.8	2369	680.8	528.8	680.8	8910	40.4	4455	40.4
26.0	542.7	60.3	5985	663.4	2992	663.4	542.7	663.4	11370	31.66	5685	31.66
28.0	554.1	47.8	7550	649.7	3775	649.7	554.1	649.7	14472	24.87	7236	24.87
30.0	563.0	37.99	9500	639.2	4750	639.2	563.0	639.2	18372	19.58	9186	19.58
32.0	570.6	30.16	11930	630.9	5967	630.9	570.6	630.9	23286	15.46	11643	15.46
34.0	576.5	23.95	15000	624.4	7500	624.4	576.5	624.4	29472	12.21	14736	12.21
36.0	581.1	18.98	18960	619.3	9480	619.3	581.1	619.3	37260	9.66	18630	9.66
38.0	585.1	15.11	23920	615.3	11910	615.3	585.1	615.3	47058	7.65	23529	7.65
40.0	588.1	12.00	30000	612.1	15000	612.1	588.1	612.1	59400	6.06	29700	6.06

Attenuator Networks.

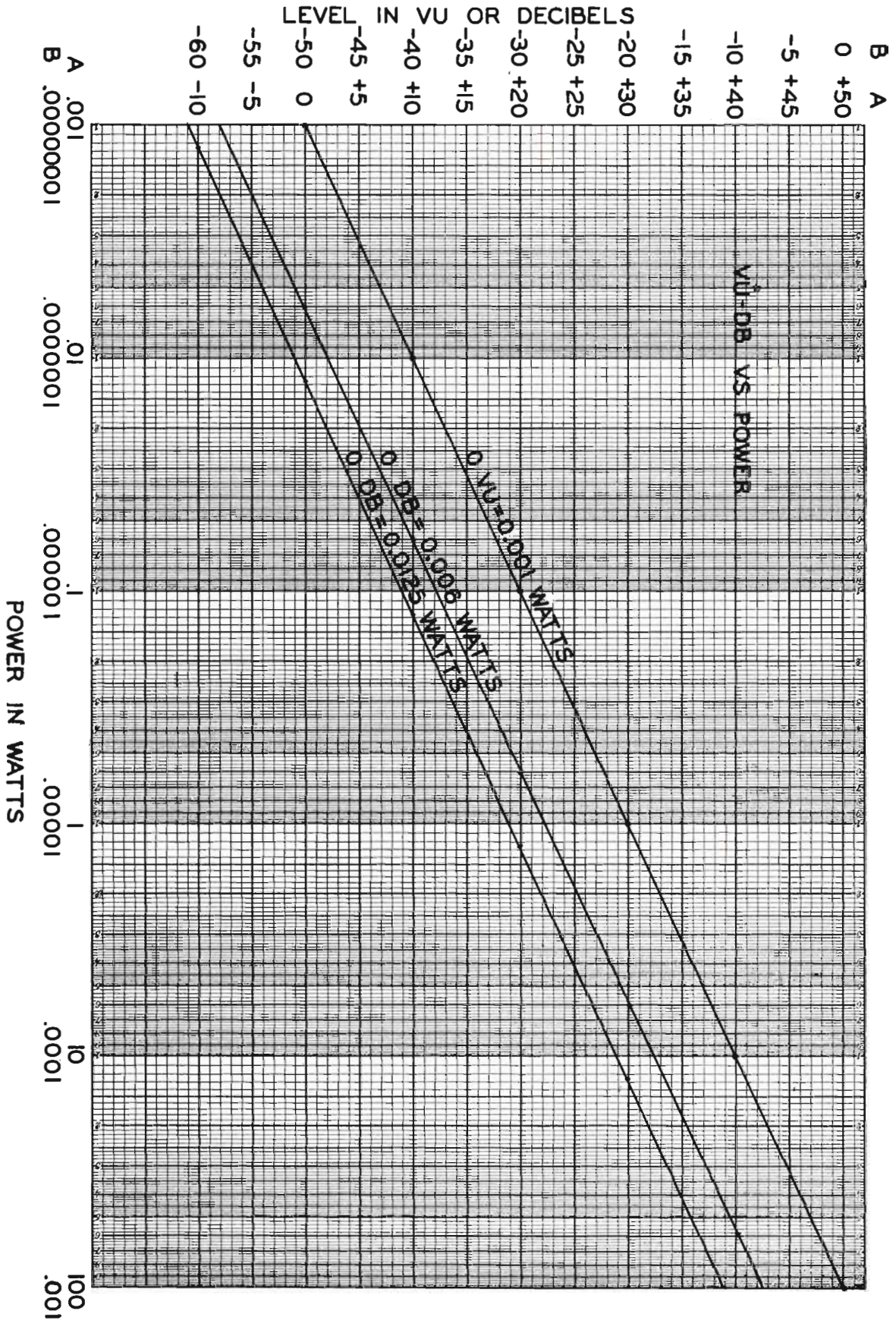

## MICROPHONES AND ACCESSORIES

Page	Type Number	Description	MI Number
5-6		General Information, Microphones	
7-8	44-BX	Velocity Microphone	4027-J
9-10	77-D	Polydirectional Microphone	4045-E
10		Spare Zipper Bag for 77-D	4087
11-12	77-DX	Polydirectional Microphone	4045-F
11-12	77-DX	Polydirectional Microphone (TV Low Lustre Gray)	11006-C
13-14	BK-1A	Pressure Microphone	11007
15-16	BK-4B	Ribbon-Pressure Microphone	11005-B
16		Microphone Holder for BK-4A/B	11068
17-18	BK-5A	Uniaxial Microphone	11010
18		Boom Mount for BK-5A	11012
18		Wind Screen for BK-5A	11011
19-20	BK-6A	Miniature Dynamic Microphone	11013
21-22	SK-35	Anti-Noise Velocity Microphone	12035
23-24	SK-45	Pressure Microphone	12045-A
25-26	SK-46	Program Velocity Microphone	12046
27		Aerodynamic Microphone	12016-H
28-29		Banquet Stand	4095-A
28-29	91-A	Announce Stand, Umber Gray	4058-C
30	91-C	Desk Stand	4092-E
30		Announce Stand $\frac{5}{8}$ " -27 Thread	4096-A
30		Desk Stand	13240-A
31		Pushmike Stand	6427
31	KS-11A	Desk Stand for BK-1A	11008
31	KS-5A	Desk Stand for SK-46	12066-B
32		Flexible Microphone Stand 13"	11745
32		Flexible Microphone Stand 19"	11746
32		Flexible Stand Bracket	11747
33	90-A	DeLuxe Program Stand	4090-A
33	90-AS	DeLuxe Program Stand for BK-4A/B	4098
34		Floor Stand, Siem 12071, Base 12072	4068-D
34		Cable Hook	11099-A
35		Three-Section Floor Stand, Stem 12073, Base 12074	6208
35	KS-2A	Portable Microphone Stand	4093-C
36	KS-3B	Boom Stand (6 ft. extended)	11056
37		Boom and Stand (18 ft. extended)	11070
38-39		Boom and Perambulator (17 ft. extended)	26574
39		Microphone Boom Only	26574-1
39		Perambulator Only	26574-2
40	UA-3-11	Female Plug for Microphone Extension Cable	11061
40	UA-3-12	Male Plug for Microphone Cable	11062
40	UA-3-13	Flush Mounting Receptacle	11063
40	P3-CG-12S	Male Plug for Microphone Cords	4630-B
40	P3-35	Wall Receptacle for Above Plug	4624-A
40	P3-CG-11S	Female Plug for Microphone Cords	4620-B
40	XL-3-11	Female Cord Connector	12058
40		Male Connector for BK-4A	11069
41		Adaptor, $\frac{1}{2}$ " Stand to $\frac{1}{4}$ " Mike (pipe thread)	12051
41		Adaptor, $\frac{1}{2}$ " Stand to $\frac{3}{8}$ " Mike (27 thread)	12053
41		Adaptor, $\frac{1}{2}$ " Stand to $\frac{3}{8}$ " Mike (W.E. 24 thread)	11066-2
41		Adaptor, $\frac{3}{8}$ " Stand (W.E. 24 thread) to $\frac{1}{2}$ " Mike	11066-3
41		Adaptor, $\frac{3}{8}$ " Stand (27 thread) to $\frac{1}{4}$ " Mike	6929
41		Adaptor, $\frac{3}{8}$ " Stand (27 thread) to $\frac{1}{4}$ " Mike	12055
41		Swivel Adaptor for BK-4B Mike to 4092-E Desk Base	11009
41		Pushmike Adaptor $\frac{5}{8}$ " -27 thread	6425
42		Three Conductor Mike Cable	43-C
42		Two Conductor Mike Cable	13307
42		Two Conductor Mike Cable	13322
43		Interconnecting Cable, Solid Conductor	33
43		Interconnecting Cable, Stranded	34
43		Interconnecting Cable, Stranded	35
43		Interconnecting Cable, Stranded	13306
43		Cable Lacing Cord	11719-A

## CONSOLETES AND ACCESSORIES

44-47	BC-2B	Studio Console with Dual Preamplifiers	11632
46-47		Power Supply for BC-2B	11313
46		Tube Kit for BC-2B	11297
46		Tube Kit for MI-11241 Dual Preamplifiers	11475
46		Tube Kit for MI-11313 Power Supply	11294
46		Relay Mount Strip (for two MI-11722)	11733
46-47		Dual Preamplifiers	11241
46-47		Speaker Relay Kit	11722
46-47		Studio Light Relay	11702-A
46-47		Console Signal Light Kit	11714-A

## CONSOLETTES AND ACCESSORIES (Continued)

Page	Type Number	Description	MI Number
46-47	.....	Transfer Switch Panel for Spare Power Supply.....	11724
46-47	.....	Rack Mounting Kit for Power Supply.....	11650
48-49	BCM-1A	Auxiliary Mixer Console.....	11634
49	.....	BCM-1A Tube Kit.....	11476
50-52	BC-4A	Audio Console.....	11635
52	.....	BC-4A Tube Kit.....	11478
52	.....	BC-4A Cover Assembly and Center Turret Panel.....	ES-11980
53-56	BCS-11A	Master Switching Console.....	11633
56	.....	Relay Power Supply for BCS-11A.....	11316
57-60	.....	Custom Audio Equipment	

## AMPLIFIERS AND ACCESSORIES

61	.....	Amplifier Quick Selection Chart	
62-63	BA-12A	Utility Amplifier.....	11232
63	.....	Tube Kit for BA-12A.....	11287
64-65	BA-13A	Program Amplifier (Continuous Control).....	11233-A
64-65	BA-13A	Program Amplifier (Step Control).....	11233
65	.....	Tube Kit for BA-13A.....	11266
66-67	BA-21A	Preamplifier and Isolation Amplifier.....	11214
67	.....	Tube Kit for BA-21A.....	11482
68-69	BA-23A	Program Amplifier.....	11246-A
69	.....	Tube Kit for BA-23A.....	11480
69	BR-22A	Mounting Shelf (for three BA-23A's).....	11597
70-71	BA-24A	Monitoring Amplifier.....	11247
71	.....	Tube Kit for BR-24A.....	11481
72-73	50-W2	50-Watt Monitoring Amplifier.....	11236-A
72-73	MC-30	30-Watt Monitoring Amplifier.....	11229-A
73	M-107	Transformer (input).....	11739
73	B-100A	Preamplifier.....	11240
74-75	BA-6A	Limiting Amplifier.....	11225
75	.....	Tube Kit for BA-6A.....	11289
76-77	BN-2A	Remote Amplifier.....	11230
77	.....	Tube Kit for BN-2A.....	11269
77	.....	Waterproof Cover for BN-2A.....	11277
78	.....	Battery Container for BN-2A.....	11279
78	.....	Battery Kit for BN-2A.....	11281
79	SA-6C	6-Watt Amplifier.....	12722
79	.....	Plug-In Transformer.....	12399
79	.....	Cover for SA-6C.....	12724

## POWER SUPPLIES

80	BX-1E	Preamplifier Power Supply.....	11305-D
80	.....	Tube Kit for BX-1E.....	11262
81	BX-21A	Preamplifier Power Supply.....	11317
81	.....	Tube Kit for BX-21A.....	11479
82	.....	Remote Bridging Volume Control, Panel Mounting.....	11278-E
82	.....	Remote Bridging Volume Control, Chassis Mounting.....	11278-F
82	.....	Simpson VU Meter.....	Stock # 53061
82	.....	Multiple Pad for Calibrating VU Meter.....	Stock # 19328
82	.....	Zero Adjustment Pad.....	Stock # 19327

## RACK AND MISCELLANEOUS EQUIPMENT

83-84	BR-84A	Standard Cabinet Racks.....	30951-A84
83-84	BR-84B	Standard Cabinet Racks.....	30951-B84
83-84	BR-84C	Standard Cabinet Racks.....	30951-C84
83-84	BR-84D	Standard Cabinet Racks.....	30951-D84
83-84	BR-84E	Standard Cabinet Racks.....	30951-E84
84	.....	Door (Non-Ventilated).....	30530-G84
84	.....	Side Panel.....	30541-G84
84	.....	Door (Ventilated).....	30535-G84
84	.....	Electrical Shield (for mid rack section).....	30546-G21
84	.....	Electrical Shield (for top and bottom rack sections).....	30546-G28
84	.....	Single Trim Strip.....	30566-G84
84	.....	Double Trim Strip.....	30568-G84
84	.....	Terminal Board Mounting Bracket.....	4570-A
84	.....	Audio Terminal Block.....	4569
84	.....	Power Terminal Strip.....	4568
84	.....	Set Terminal Board Mounting Angles.....	30527-G29



## RACK AND MISCELLANEOUS EQUIPMENT (Continued)

Page	Type Number	Description	MI Number
84		Set Panel Mounting Angles.....	30526-G84
84		Ground Bus Kit.....	11728
85	BR-19A	Cabinet Rack.....	11550
86		1 23/32" Blank Panel, Umber Gray.....	4590-A
86		2 1/4" Blank Panel, Umber Gray.....	4598-A
86		2 3/8" Blank Panel, Umber Gray.....	4599-A
86		3 1/8" Blank Panel, Umber Gray.....	4589-A
86		3 15/32" Blank Panel, Umber Gray.....	4591-B
86		5 7/32" Blank Panel, Umber Gray.....	4592-B
86		6 31/32" Blank Panel, Umber Gray.....	4593-A
86		8 23/32" Blank Panel, Umber Gray.....	4594-B
86		10 15/32" Blank Panel, Umber Gray.....	4595-B
87	BJ-24	Jack Panel.....	11645
87	BJ-12	Jack Panel.....	11646
88		Single BJ-24 Jack Strip Mat.....	11647-1
88		Double BJ-24 Jack Strip Mat.....	11647-2
88		Triple BJ-24 Jack Strip Mat.....	11647-3
88		Patch Cord, 2 ft. length.....	4652-2A & B
88		Patch Cord, 4 ft. length.....	4652-4A & B
88		Patch Cord, 6 ft. length.....	4652-6A & B
89	BR-2A	Panel, Umber Gray.....	11598-B
89	BR-2A	Shelf, Umber Gray.....	11599
90	BI-1B	Meter Panel.....	11388
90-91	57-D	Switch and Fuse Panel.....	4395-G
91	BI-5A	VU Meter Panel.....	11265-F
92	BE-21B	Variable Sound Effects Filter.....	11723
93	BR-22A	Mounting Shelf.....	11597
94		Line Transformer.....	11713
94		Bridging Transformer.....	11712
95		Fixed Pad (6 db) "H" Type.....	4171-29
95		Fixed Pad (10 db) "H" Type.....	4171-30
95		Balanced Two-way 600 Ohm Dividing Network.....	11704
95		Balanced Three-way 600 Ohm Dividing Network.....	11704-A
95		Balanced Four-way 600 Ohm Dividing Network.....	11704-B
95		Balanced Six-way 600 Ohm Dividing Network.....	11704-D
95		Balanced Bridge Pad.....	11705
96		Regulated Power Supply.....	11316
97		"ON-AIR" Studio Warning Light.....	11706-1
97		"REHEARSAL" Studio Warning Light.....	11706-2
97		"AUDITION" Studio Warning Light.....	11706-3
97		"STANDBY" Studio Warning Light.....	11706-4
97		"SILENCE" Studio Warning Light.....	11706-5
97		Glass for Warning Lights.....	11718-1 to 5

## TRANSCRIPTION EQUIPMENT

98-99	BQ-70E	Transcription Turntable (60 cycle).....	11816
98-99	BQ-70E	Transcription Turntable (50 cycle).....	11817
98-99	BQ-70F	Transcription Turntable (60 cycle).....	11818
98-99	BQ-70F	Transcription Turntable (50 cycle).....	11819
99		Adjustable Spanner Wrench.....	11726
100-103	BQ-2A	Three-Speed Transcription Turntable (60 cycle).....	11833
100-103	BQ-2A	Three-Speed Transcription Turntable (50 cycle).....	11834
100-103		Turntable Drive Assembly for BQ-2A (60 cycle).....	11830
100-103		Turntable Drive Assembly for BQ-2A (50 cycle).....	11831
104-105		Lightweight Tone Arm.....	11885-A
105		1 mil Fine Groove Pickup Head.....	11874-4
105		2.5 mil Standard Transcription Pickup Head.....	11874-5
106		Pickup Equalizer.....	11888
107		45 RPM Conversion Kit.....	11883
107		45 RPM Record Adaptor.....	11886
108	108-B	Gray Viscous Damped Transcription Tone Arm	
108	602-C	Gray Equalizer for 108-B Transcription Tone Arm	
108	RPX-145	GE Cartridge, replaceable 1 mil diamond stylus	
108	RPX-146	GE Cartridge, replaceable 2.5 mil diamond stylus	
108	RPX-147	GE Cartridge, replaceable 1/2.5 mil diamond dual stylus	
108	RPJ-01D	GE Replacement Stylus Tip, 1 mil diamond	
108	RPJ-02D	GE Replacement Stylus Tip, 2.5 mil diamond	
108	RPJ-01S	GE Replacement Stylus Tip, 1 mil sapphire	
108	RPJ-02S	GE Replacement Stylus Tip, 2.5 mil sapphire	
108		Adaptor Kit for using cartridge and styli with MI-11885-A Tone Arm....	11890-A
108		Adaptor Kit for using cartridge and styli with BQ-1A Tone Arm.....	11890-B

**TAPE RECORDERS**

Page	Type Number	Description	MI Number
109-112	RT-11B	Professional Tape Recorder (Rack Mounting).....	11911-B
109-112	RT-12C	Professional Tape Recorder (Console Mounting).....	11913-C
112	.....	Tube Kit for Recording Amplifier.....	11293
112	.....	Tube Kit for Power Supply.....	11294
112	.....	Tube Kit for Reproducing Amplifier.....	11296
112	.....	Console for Professional Tape Recorder.....	11970-A
112	.....	Remote Control Unit.....	11948
112	.....	Step Type Gain Control, Record Amplifier.....	Stock #93784
112	.....	Step Type Gain Control, Reproduce Amplifier.....	Stock #93786
112	.....	Tape Splicer.....	11937
112	.....	Reel, NARTB Standard Hub.....	11932-2
112	.....	Erase Head.....	11953-A
112	.....	Reproduce Head.....	11954-A
112	.....	Recording Head.....	11951-A
112	.....	Recording Tape, 1/4" x 1200' on Plastic Reel.....	11924-3
112	.....	Recording Tape, 1/4" x 2400' on NARTB Hub.....	11924-5
112	.....	Recording Tape, 1/4" x 2400' on NARTB Reel.....	11924-6
113	PT6-VAH	Lightweight Portable Tape Recorder	
113	PT6-JAH	Standard Portable Tape Recorder	
114-115	.....	Custom Tape Editing Equipment	

**TUNERS**

116	ST-2	AM/FM Radio Tuner.....	12117
-----	------	------------------------	-------

**SPEAKERS AND ACCESSORIES**

117	.....	Loudspeaker Information and Quick-Selection Chart	
118-119	LC-1A	15-Inch Speaker Mechanism.....	11411-A
119	.....	Power Attenuator.....	11708-A
120	SL-12	12-Inch Speaker Mechanism.....	12458
121	.....	12-Inch Speaker Mechanism.....	12418-A
122	.....	10-Inch Speaker Mechanism.....	11408
123	.....	10-Inch Speaker Mechanism.....	6333-D
124	.....	8-Inch Speaker Mechanism.....	12454
125	.....	Floor Console Cabinet for LC-1A Speaker (Blonde).....	12464-B
125	.....	Floor Console Cabinet for LC-1A Speaker (Mahogany).....	12464-M
125	.....	Floor Console Cabinet for SL-12 Speaker (Blonde).....	12463-B
125	.....	Floor Console Cabinet for SL-12 Speaker (Mahogany).....	12463-M
125	.....	Floor Cabinet Housing for LC-1A.....	11401
127	.....	Wall Speaker Housing for LC-1A.....	11406
128	.....	Wall Speaker Housing for 12" Speaker Mechanism.....	13253
128	.....	Reducing Baffle to Mount 10" Speaker Mechanism.....	13245-A
129	.....	Wall Housing for 10" Speaker Mechanism.....	11407
130	.....	Molded Plastic Baffle for 8" Speaker Mechanism.....	6104
131	.....	Matching Transformer (16 watt).....	12368
131	.....	Matching Transformer (8 watt).....	12369
131	.....	Matching Transformer (8 watt, single winding).....	11731
132-133	.....	Interphone Connection Unit.....	11734
132-133	.....	Retardation Coil.....	11737
132-133	.....	Shelf for Interphone Connection Unit.....	11735
132-133	.....	Panel for 5 Retardation Coils.....	11736
132-133	.....	Panel for 14 Retardation Coils.....	11736-A
132-133	.....	Single Headband Assembly.....	11743
132-133	.....	Double Headband Assembly.....	11744

**TEST AND MEASURING EQUIPMENT**

134-135	WM-71A	Distortion and Noise Meter.....	30071-A
136-137	WA-28A	Low Distortion Push-Button Oscillator.....	30028-A
138-139	BI-11A	Transmission Measuring Set.....	11350

**EQUIPMENT LISTS AND STUDIO PLANS**

140-143	.....	Recommended Equipment Lists and Typical AM Studio Plans	
141	.....	AM or FM Single Studio Minimum Equipment Requirements	
141	.....	AM or FM Two-Studio Equipment Requirements	
142	.....	Multi-Studio Equipment Requirements	
142	.....	AM or FM Remote Equipment	
143	.....	AM or FM Tape Recording Equipments	
143	.....	AM or FM Transmitter Audio and Monitoring Equipments	
144-145	.....	Recommended Audio Wiring Practices	
146-148	.....	Audio Data Section	
149-152	.....	Index	

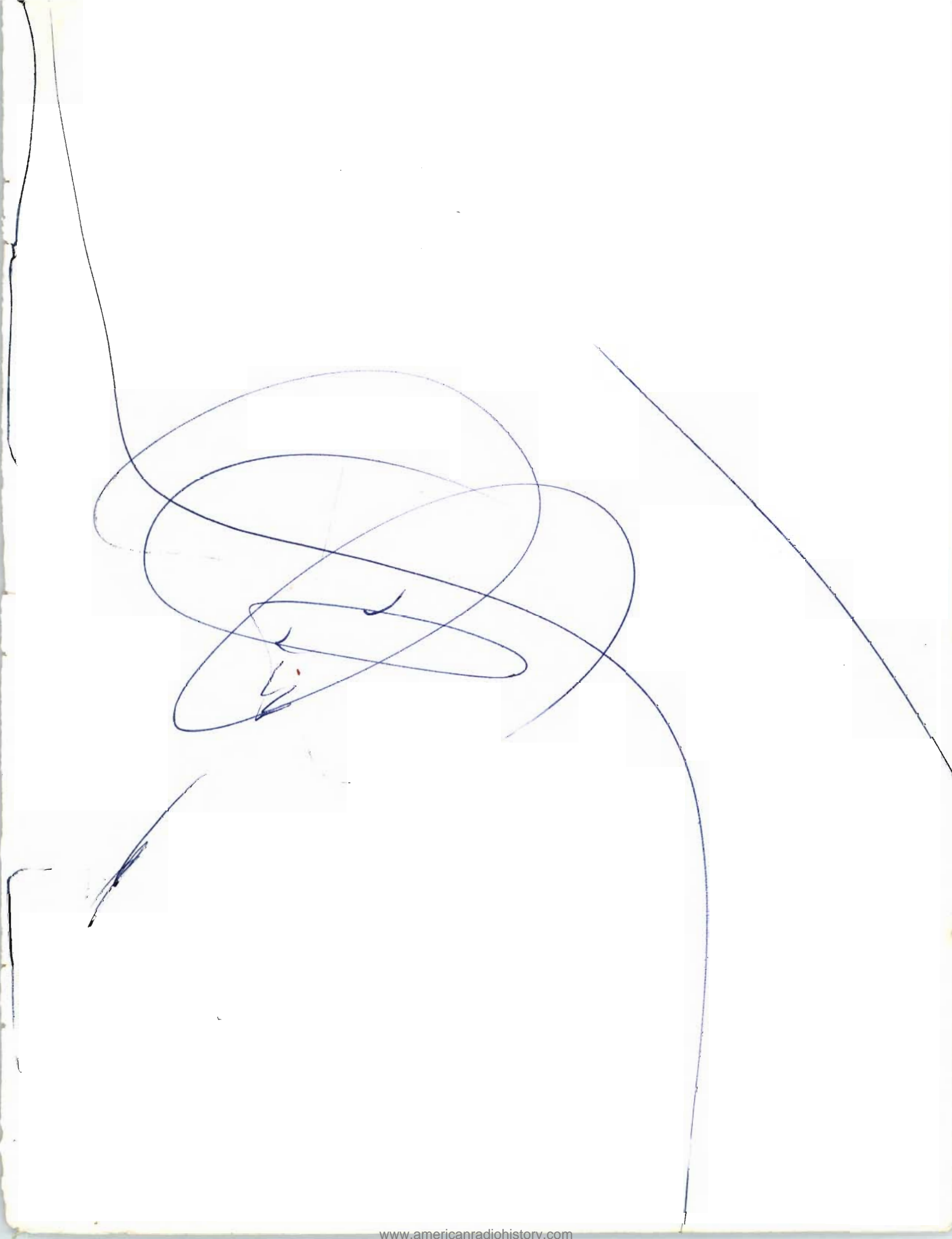

**RCA REGIONAL  
OFFICES**

**Atlanta 3, Ga.**

522 Forsyth Bldg., Lamar 7703

**Boston 16, Mass.**

200 Berkeley St., Hubbard 2-1700

**Camden 2, N. J.**

Front & Cooper Sts., Woodlawn 3-8000

**Chicago 54, Ill.**

1186 Merchandise Mart Plaza, Delaware 7-0700

**Cleveland 15, Ohio**

1600 Keith Bldg., Cherry 1-3450

**Dallas 1, Texas**

1907-11 McKinney Avenue, Riverside 1371-2-3

**Hollywood 28, Cal.**

1560 N. Vine St., Hollywood 9-2154

**Kansas City 6, Mo.**

1006 Grand Avenue, Harrison 6480-1-2

**New York 20, N. Y.**

36 W. 49th St., Circle 6-4030

**San Francisco 2, Cal.**

420 Taylor Street, Third Floor, Ordway 3-8027

**Seattle 4, Wash.**

2250 First Avenue, South, Main 8350

**Washington 6, D. C.**

1625 K St., N. W., District 7-1260



**BROADCAST MARKETING DEPARTMENT  
RADIO CORPORATION OF AMERICA  
ENGINEERING PRODUCTS DIVISION, CAMDEN, N. J.**