

*Received
Apr. 1970
New Equip.*

Transmitting AM | FM Equipment

Catalog Supplement

Broadcast Catalog Supplement

TO KEEP YOUR CATALOG UP TO DATE, this supplement contains material which either extends or supersedes that now existing in your AM- or FM-Radio Catalog. A new AM/FM catalog is in preparation for distribution later in the year. Until then, the combination of this supplement and your catalog gives you the complete product line.

Contents

	Catalog
AM Transmitters	B.6001 to B.6050
FM Transmitters	B.6500 to B.6535
FM Exciter	B.6556
Transmitter Monitors	B.6822 to B.6830
FM Transmitter Dummy Loads	B.4518
FM Antenna Equipment	B.6759 to B.6765

RCA Broadcast Sales Offices

Atlanta, Ga. 30329
14 Executive Park Dr. N.E.
404-634-6131

Austin, Texas 78767
8330 Burnet Rd.
Northwest Office Park Bldg.
Suite 134
512-453-8233
512-451-2500

Birmingham, Ala. 35223
Office Park Bldg. #10
Office Park Circle
205-871-1155

Boston Area
360 First Ave.
Needham Heights, Mass. 02194
617-444-7200

Burbank, Calif. 91505
2700 W. Olive Ave.
213-849-6741

Camden, N.J. 08102
Front & Cooper Sts.
609-963-8000

Charlotte, N.C. 28204
330 Charlottetown Center
704-333-3996

Chicago, Ill. 60606
120 S. Riverside Plaza
Gateway 11 Bldg.
Suite 1400
312-782-0700

Cincinnati, Ohio 45231
8234 Winton Rd.
513-522-8810

Cleveland, Ohio 44115
1600 Keith Bldg.
216-579-0880

Columbus, Ohio 43221
100 Henderson Rd.
614-451-1127

Dallas, Texas 75235
210-C Court Terrace
Exchange Park, N.
214-351-5361

Denver, Colo. 80211
2785 N. Speer Blvd.
Suite 346
303-433-8841

Detroit Area
20830 Rutland Ave.
Southfield, Michigan 48076
313-357-0080

Indianapolis, Ind. 46205
2511 E. 46th St.
Bldg. 1, Suite Q
317-546-8571

Kansas City Area
5750 W. 95th St.
Suite 111
Overland Park, Kansas 66207
913-642-3185

Memphis, Tenn. 38117
4990 Poplar Ave.
Suite 209
901-683-6371

Minneapolis, Minn. 55416
4522 Excelsior Blvd.
612-922-3303

New York, N.Y. 10036
1133 Ave. of the Americas
5th Floor
212-586-3000

Orlando, Fla. 32810
5330 Diplomat Circle
Suite 30
305-644-9135

San Francisco, Calif. 94104
343 Sansome St.
7th Floor
415-956-4818

Seattle, Wash. 98134
2246 First Ave., S.
206-622-8350

St. Louis, Mo. 63105
7733 Forsyth Blvd.
314-862-3660

Washington, D.C. Area
1901 N. Moore St.
Arlington, Virginia 22209
703-558-4212

West Palm Beach, Fla. 33403
3900 RCA Blvd.
Palm Beach Gardens 305-844-7351

OUTSIDE THE UNITED STATES

Buenos Aires, Argentina
RCA International Ltd.
Calle Paroissien 3960

North Ryde, N.S.W., Australia
RCA Limited
11 Khartoum Road

Middlesex, England
RCA Limited
Sunbury-on-Thames

Hong Kong
RCA International Ltd.
1927 Prince's Building
Chater Road

Mexico 6, D.F., Mexico
RCA CESD
Reforma 382—Room 201

1227 Geneva, Switzerland
RCA International Marketing, S.A.
2-4 Rue du Lievre

Montreal, Quebec, Canada
RCA Victor Company Ltd.
1001 Lenoir Street

Vancouver, B.C., Canada
2876 Rupert Street

Winnipeg, Man., Canada
2070 Notre Dame Ave.
St. James 21

Toronto, Ont., Canada
1450 Castlefield Ave.

RCA 1 KW AM Broadcast Transmitter, Type BTA-1R3

- Excellent frequency response
- Low distortion
- Circuit breaker overload protection
- Low operating costs



BTA-1R3 Transmitter with front door removed showing accessibility of tubes and components. Power amplifier and Modulator tubes are shown on top chassis; below is exciter chassis. All normal operating controls are on two side panels.

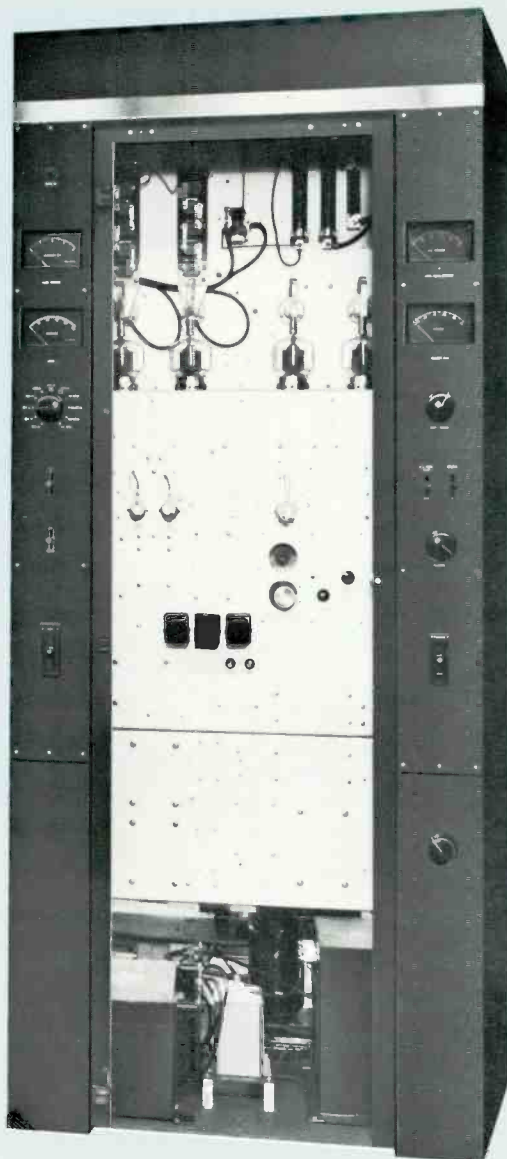
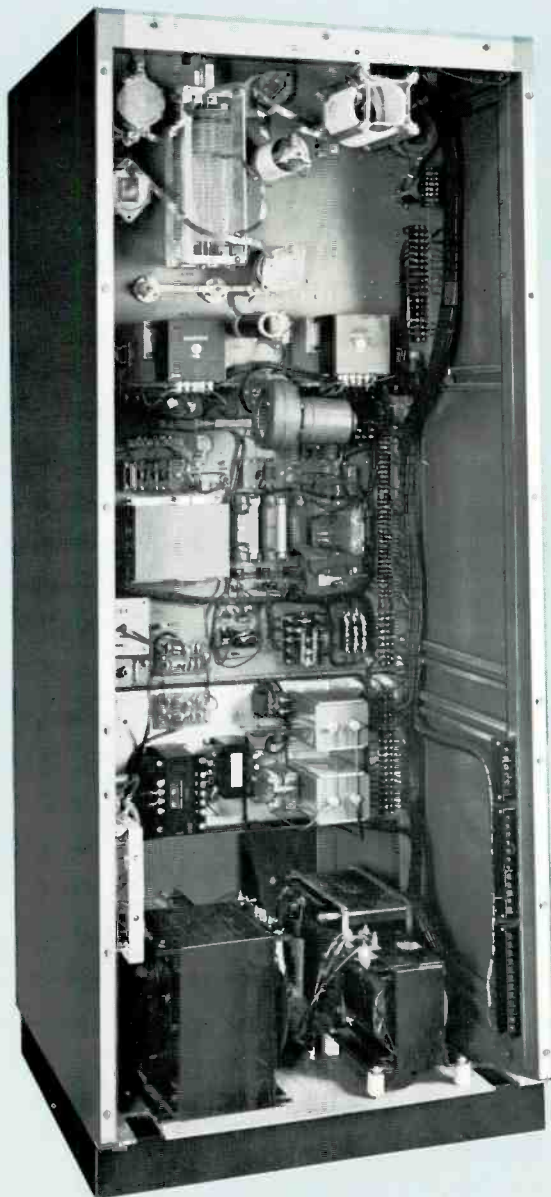

Rear view of BTA-1R3, with rear panels removed, showing vertical construction and accessibility of component parts.

Description

The RCA Type BTA-1R3, 1-kilowatt AM Broadcast Transmitter is designed for reliability, outstanding fidelity, and economical operation. It provides a high quality amplitude modulated signal at any frequency in the 535 to 1620 kilohertz band and is capable of producing a maximum of 1100 Watts.

Highly perfected audio circuits together with a large, high-quality transformer and reactor provide tremendous modulation capability and unusually High Fidelity sound. Stable, long-life tubes and avalanche diode rectifiers have been used throughout the transmitter. Circuit breakers—not fuses—provide complete overload protection.

Provision for remote control and simplified power cutback are reflected in the BTA-1R3 design. Front panel or remote control selection of any two power levels of 1000, 500 or 250 Watts is available. No unnecessarily complicated circuitry or superfluous parts have been included and all components are easily accessible for maintenance and inspection. The transmitter is designed for 208 or 240 Volt operation.

Functional Design

Improved functional design includes RCA's new color combination. Square construction permits locating the transmitter against the wall, or it can be installed against other equipment. The vertical construction makes it accessible from both front and rear for ease of maintenance. A single front panel tuning control provides simplified operation. Remote control provisions permit unattended operation of the transmitter.

Simplified Power Cutback

The BTA-1R3 easily fits into operations where power reduction at night is required. For "day-night" operation an optional Power Cutback Kit may be incorporated in the transmitter. By pressing a switch on the front or at a remote panel, the transmitter can be cut back in power to either 500 or 250 Watts. Efficient operation at the low power levels is achieved by reducing the high voltage by primary taps on the plate transformer.

Complete Accessibility

The entire transmitter is housed in a single steel cabinet that is mounted on a sturdy welded steel base. Control components are conveniently located on the

control panels on both sides of the front door and all meters are at eye level. Easy access is provided by a hinged front door and two interlocked removable panels. Most BTA-1R3 components are mounted on a vertical center chassis. Tubes and overload relays are mounted on the front and the other components are mounted on the rear. Larger power components are mounted on the base.

Solid State Power Supplies

Three power supplies are used: a low voltage supply for plate and screen voltages of all low voltage tubes, a bias supply for the modulator tubes, and a high voltage supply for the modulator and power amplifier tubes. All power supplies use avalanche diodes which results in lower power drain, cooler operation and more reliable performance.

Power Requirements

The transmitter operates from a 208-240 Volt, 60 Hz single phase power source for the main power. In addition, the crystal heaters require an additional 115 Volt power input. The transmitter can be modified for operation on 50 Hz AC current if desired.

Switchable Crystals

The BTA-1R3 offers the customer a choice of tube type or solid-state exciter-buffer. Both employ two switchable TVM-130B temperature controlled crystal units. These units maintain the frequency constant to within plus or minus five Hz. Selection of the desired crystal is by means of front panel switches and latching relays. The oscillator employs a broadband circuit with no adjustments.

Simple, Straightforward Circuitry

The buffer feeds a single 6146A driver tube which in turn feeds the power amplifier which consists of two 4-400A tubes connected in parallel. Tetrodes have been utilized throughout the RF section of the transmitter reducing the required stages and the power consumption. Tetrodes also eliminate the need of neutralization.

The modulator comprises two 2E26 tubes in push-pull resistance coupled to two 4-400A modulator tubes. The modulator tubes operate as a class AB₁ amplifier without grid current which results in an overall distortion of less than 2 percent up to 10,000 Hz.

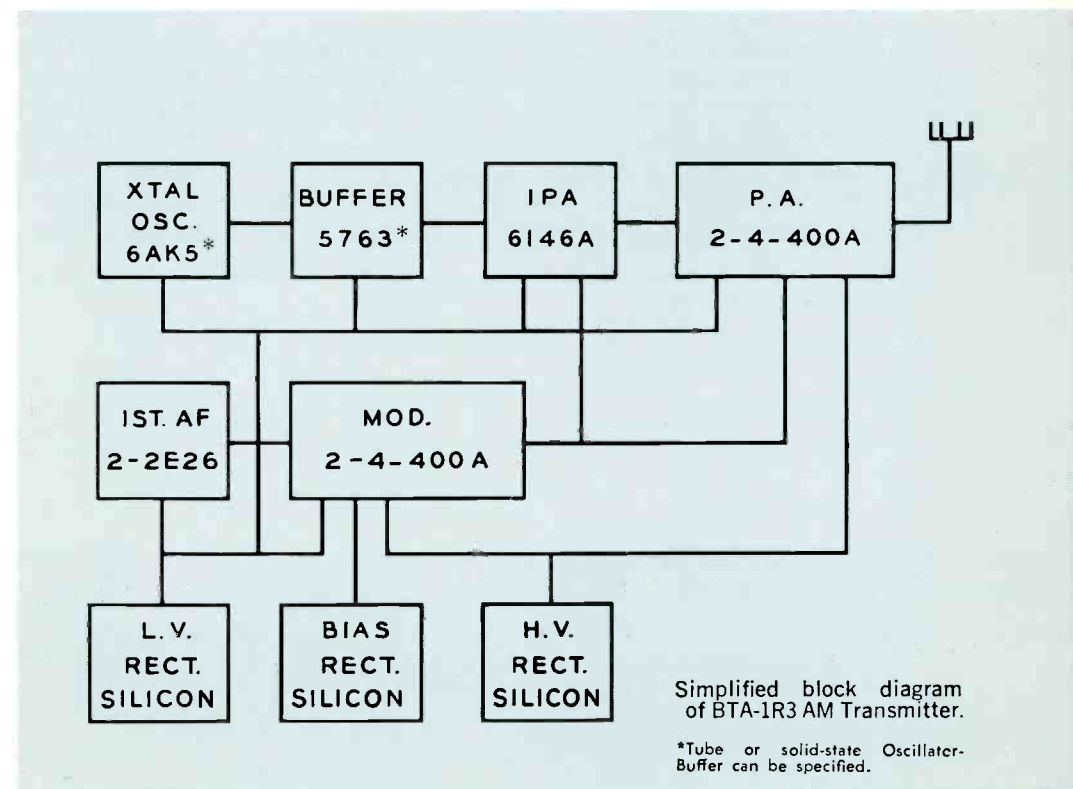

Specifications

Performance

AF Input Impedance	150/600 Ohms
AF Input Level (100% modulation)	+10 ±2 dBm
AF Response:	
50-7500 Hz	±1 dB
30-10,000 Hz	±1.5 dB
30-15,000 Hz	±3 dB
AF Distortion (95% modulation):	
50-10,000 Hz	2%
50-12,000 Hz	3%
Noise (below 100% modulation)	60 dB
Frequency Range	535-1620 kHz
Frequency Stability	±5 Hz
Type of Output	Single ended
Carrier Shift (0-100% modulation)	3%
Output Impedance	40-250 Ohms

Electrical

RF Voltage (for frequency monitoring)	10 V RMS 75 Ohms
RF Voltage (for modulation monitoring)	10 V RMS 75 Ohms
Power Output (nominal)	1000 Watts
Power Output Capability	1100 Watts
Power Supply	208/240 Volts
Line Frequency	60 Hz
Phase	1
Power Consumption:	
(0% modulation)	2900 Watts (approx.)
(100% modulation)	3900 Watts (approx.)
(average program modulation)	3200 Watts (approx.)
Power Factor	90%
Permissible combined line voltage variation and regulation	±5%
Crystal Heater Power Supply	115 Volts 50/60 Hz

Tube Complement

1	6AK5*	Crystal Oscillator
1	5763*	Buffer
1	6146A	Intermediate Power Amplifier
2	2E26	Audio Frequency Amplifier
2	4-400A	Modulator
2	4-400A	Power Amplifier

Mechanical

Height	84" (213.4 cm)
Width	34" (86.4 cm)
Depth	32½" (82.6 cm) (less door handle)
Weight (net)	1700 pounds (772 kg) (approx.)
Altitude Range	0-5000 ft. (0-1524 m)
Ambient Operating Temperature:	
(min.)	-20°C (-4°F)
(max.)	+45°C (113°F)

Accessories

Operating Spare Tube Kit	MI-27696-A
Recommended Minimum Spare Tube Kit	MI-27695-A
Type BTR-11B Remote Control System	ES-34280
Type BW-11A Frequency Monitor (Specify frequency)	ES-34042
Type BW-66F Frequency Monitor	MI-30066-B
Power Max (Negative Peak Limiter)	MI-34654
RF Ammeters	MI-7157-F Series
Ammeter Mounting Panel	MI-34656
Remote RF Pickup Unit (less meter)	MI-27966-B
Remote Antenna Meter	MI-27644 Series
Automatic Logging Equipment	On Application
Power Cutback Kit	MI-34079
Remote Power Adapt Kit	MI-34080
Oscillator-Buffer (Tube Type)	MI-27632-A
Oscillator-Buffer (Solid-State)	MI-27592

Ordering Information

Type BTA-1R3 1000-Watt AM Broadcast Transmitter
complete

ES-27238-D*
(*Ordering information should specify tube or solid-state type Oscillator Buffer.)

RCA 5-10 KW AM Broadcast Transmitter, Type BTA-5U2/10U2



- Outstanding sound
- High efficiency circuits
- High reliability
- Great overall economy
- Solid state oscillator and buffer

High Efficiency 5/10 Kilowatt Transmitter

Only Two
Tuning Controls

Dependable
Semi-Conductor
Power Supply

High
Efficiency
Cathode
and Plate
Resonators

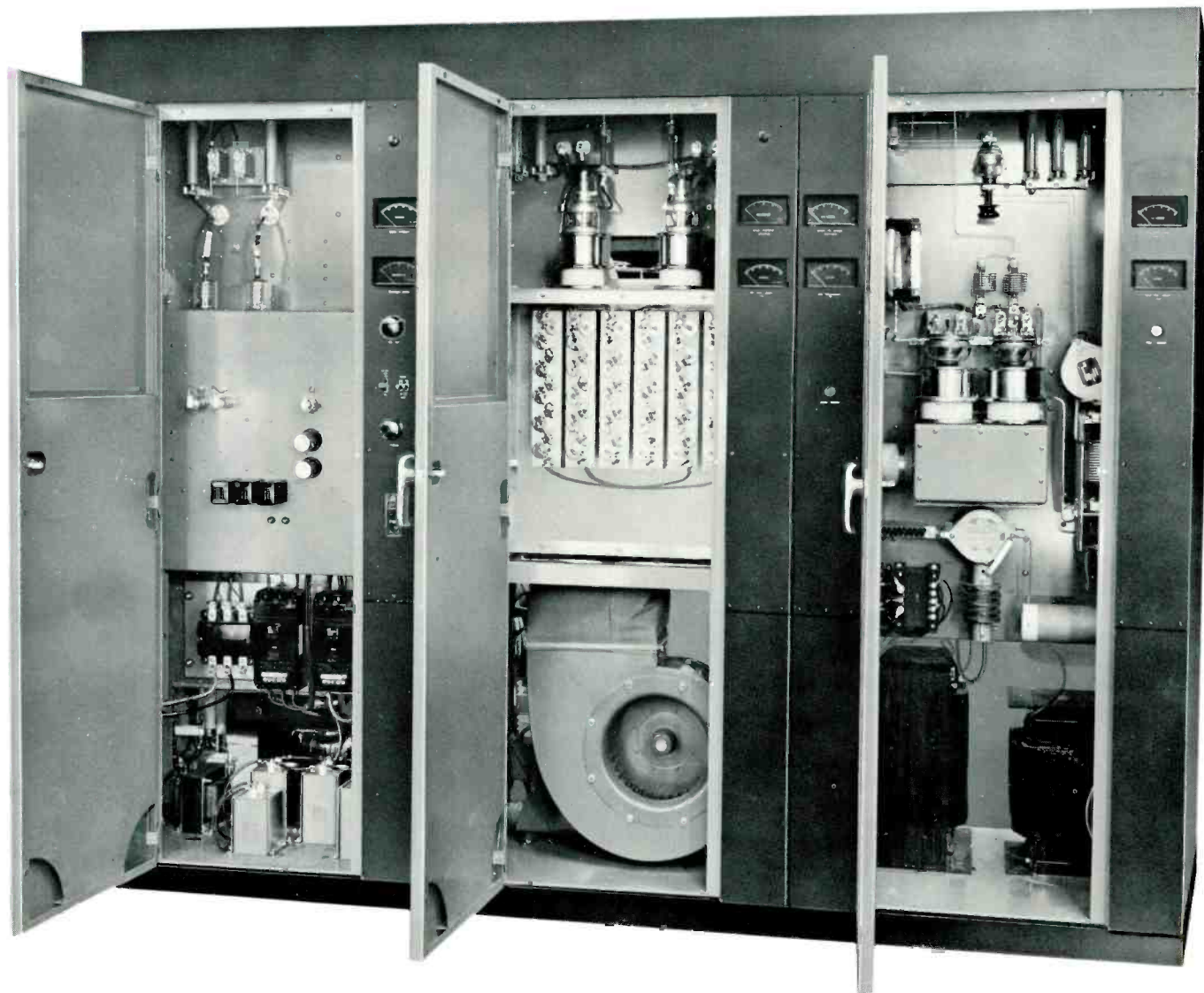

Built-in Remote
Control Provisions

Completely
Air Cooled

Self-contained 5-kW
Plate Transformer

5/10 KW AM Broadcast Transmitter, Type BTA-5U2/10U2

The BTA-10U2 is a 10 kW amplitude modulated, high fidelity, broadcast transmitter for operation in the standard band between 535 and 1620 kHz. The new model incorporates RCA's plug-in solid state Oscillator-Buffer, MI-27592 with two switchable, temperature-controlled crystal positions.

The RCA BTA-5U2 AM Broadcast Transmitter is the fully converted deluxe BTA-10U2 with a second 5762 Amplifier tube removed to provide 5 kW output. Both transmitters are outstanding in appearance and reliability, and meet requirements of the FCC and EIA.

The BTA-5U2/10U2 operates from a 208/240 Volt, 50/60 Hz, three-phase power source for the main power. The crystal heaters re-

quire an additional 115-Volt 50/60 Hz single phase AC power input. Both transmitters exceed nominal power output rating to compensate for losses in the antenna tuning equipment.

The spacious cabinet of the BTA-5U2 Transmitter permits internal mounting of the 5 kW plate transformer. There are provisions for easy conversion to higher power at a later date. The transmitter allows simplified power change to 1 kW or 500 Watts, if desired, by installing an optional Power Cutback Kit, MI-34646-A. Similarly, the BTA-10U2 can be operated at 5 kW, or at 1 kW. The BTA-5U2/10U2 is provided with an oil-filled modulation transformer for increased reliability.

Description

The BTA-5U2/10U2 is an air-cooled transmitter with numerous design improvements, including an important development in Class C amplifier design. The new high efficiency, plate modulated power amplifier permits one or two long-life 5762 tubes to deliver the nominal 5 or 10 kW with 5.5 or 10.6 kW power output capability. The plate efficiency appreciably exceeds that of a conventional Class C amplifier. As a result, considerable power savings can be realized. Referring to the simplified schematic, the circuit arrangement is very similar to a conventional Class C amplifier, except for the presence of two high efficiency resonators. The amplifier is stable and easy to adjust. The high-voltage, low-voltage and bias supplies employ silicon rectifiers throughout.

Other new design techniques of the transmitter provide simplified tuning, increased safety, longer tube life and improved performance. After initial adjustments, the transmitter can be tuned from the front panel. This is accomplished by only two controls. Provisions for manual or remote control operation are incorporated in the transmitter. For safety, all doors and panels are interlocked and grounding switches protect operating personnel. The transmitter is air-cooled by a single blower housed in the center cabinet.

Improved Mechanical Design

The transmitter is housed in three attractively styled cabinets made of anodized aluminized steel to provide improved magnetic and electrostatic shielding. The left cabinet, or cubicle, contains the Transmitter Driver. The center cabinet houses the Modulator and High Voltage Rectifier, and the Blower. In the right hand cabinet is located the Power Amplifier, and the 5-kW Plate Transformer. The plate transformer of the BTA-10U2 is an external unit which can be mounted near the cabinets.

Accessible Vertical Panel Construction

Each cabinet consists of end panels with wrap-around front edges formed to provide control panels, mounted on a sturdy, welded steel base. Vertical center chassis are fastened between the end panels to form a basic "H" cross section. Reach-in accessibility to transmitter components is afforded by hinged front doors located between the control panels. Rear access to each cabinet is provided by a hinged, interlocked door. Control components are conveniently located on the panels on both sides of the front doors where all meters are situated at eye level.

The matched cabinets are designed to combine an attractive appearance with the utmost in utility. Vertical construc-

tion permits easier maintenance and service. It also permits installation of the transmitter against a side wall, or allows other equipment to be placed on either side of the cabinet. The front doors of the transmitter give immediate access to the front of the vertical panels on which circuit components such as tubes and overload relays are mounted. Remaining small components are mounted on the rear of these chassis, while the larger power components are situated in the base of the cabinet.

Efficient Circuit Design

The BTA-5U2/10U2 Transmitter incorporates RCA MI-27592 solid state Oscillator with two, switchable, temperature-controlled crystal positions. Crystal stability is plus or minus 5 Hertz. The desired crystal can be selected by means of a front panel switch or by means of a remote-control switch since relays are built into the exciter. The oscillator employs broadband circuits that require no adjustments. This unit is built on an etched circuit panel easily accessible for service by removing the cover. The entire oscillator unit can be removed by disconnecting a cable-plug and retaining screws. Also a part of the basic exciter is the 6146 IPA stage which is operated very conservatively. A pair of 2E26 tubes is used as the first AF stage of the modulator circuit.

Select Features

REACH-IN ACCESSIBILITY

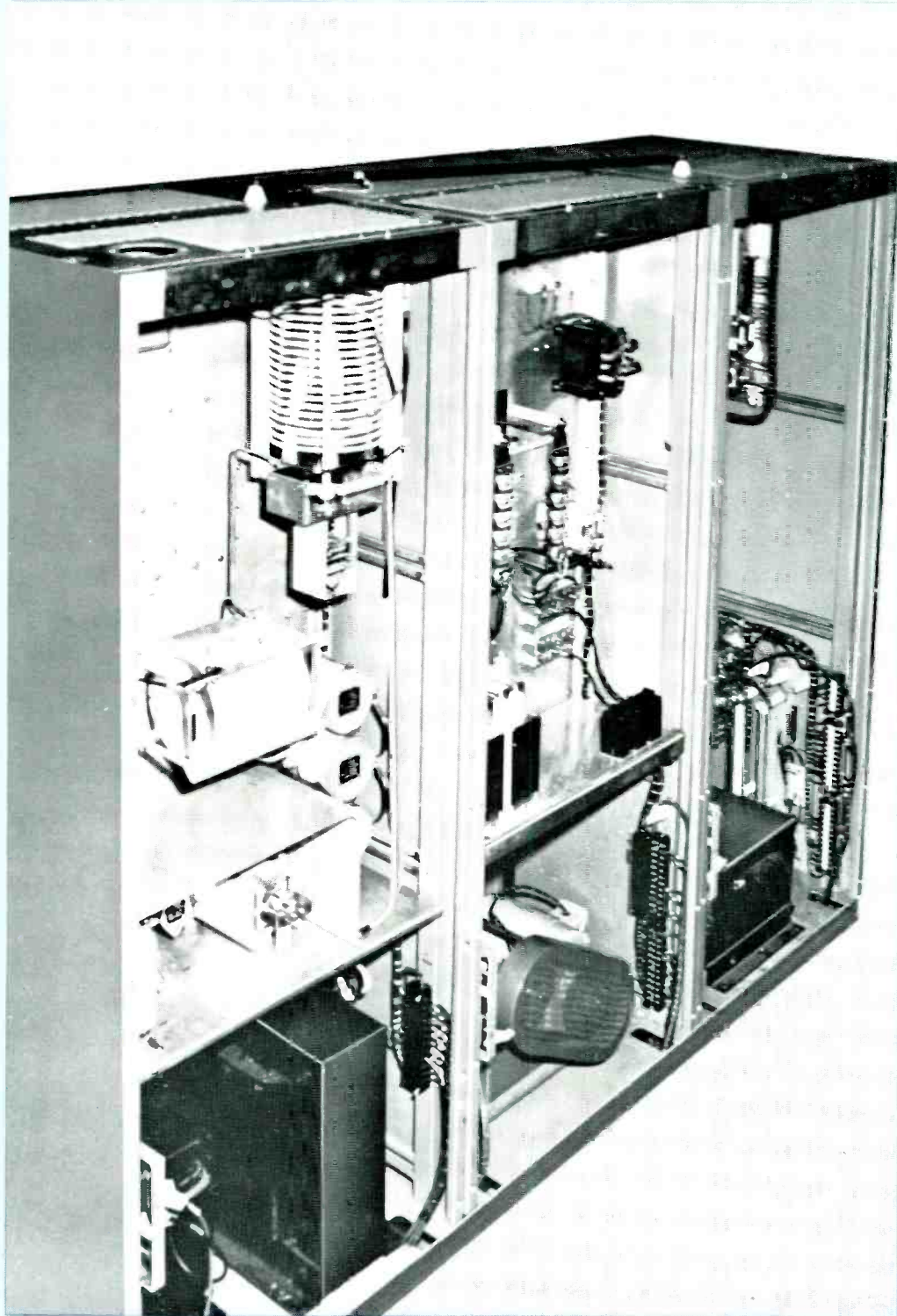

Rear view of transmitter with doors removed showing vertical construction permitting complete accessibility to all transmitter facilities. The modulation transformer and final PA tank circuitry are seen in foreground, rear of modulator and blower in center cabinet, while heavier components of driver are shown mounted on floor of third cabinet.

BUILT-IN REMOTE CONTROL

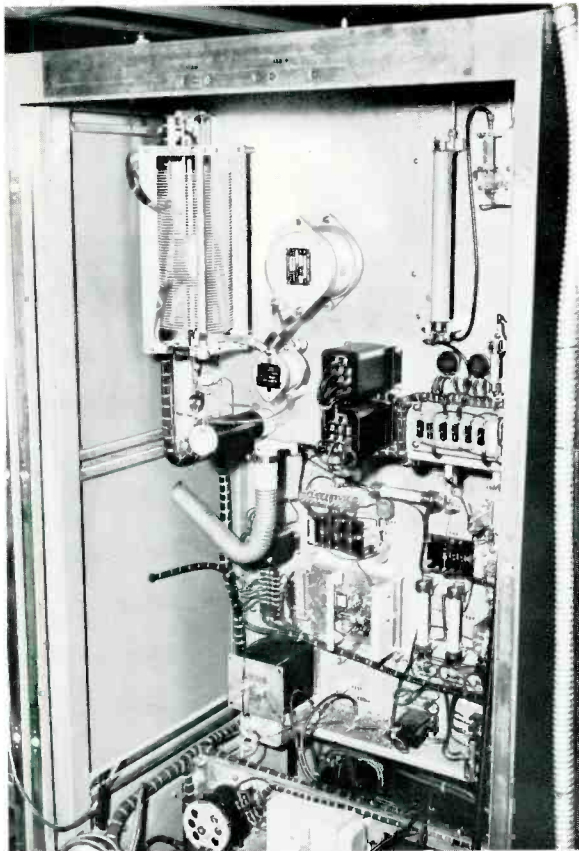

Rear view of BTA-10U2 exciter and control cabinet.

POWER ECONOMY



Modulator tubes and silicon high voltage rectifiers with cover removed.

STABLE CIRCUIT DESIGN

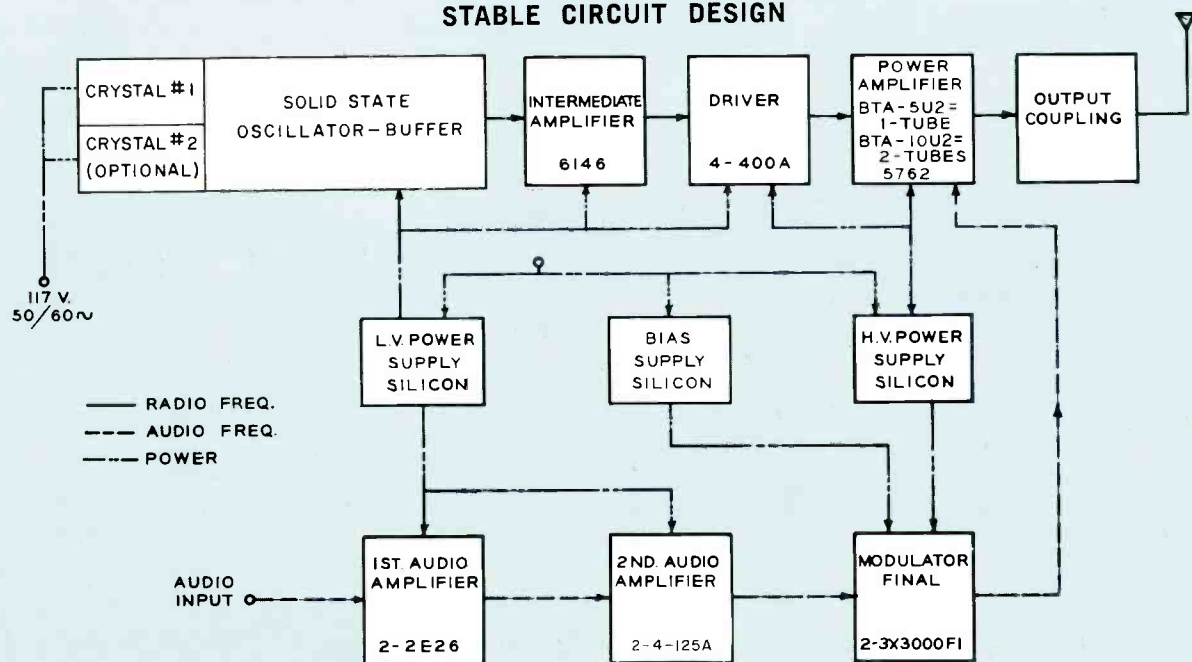

Block diagram of Type BTA-5U2 and BTA-10U2 Transmitters.

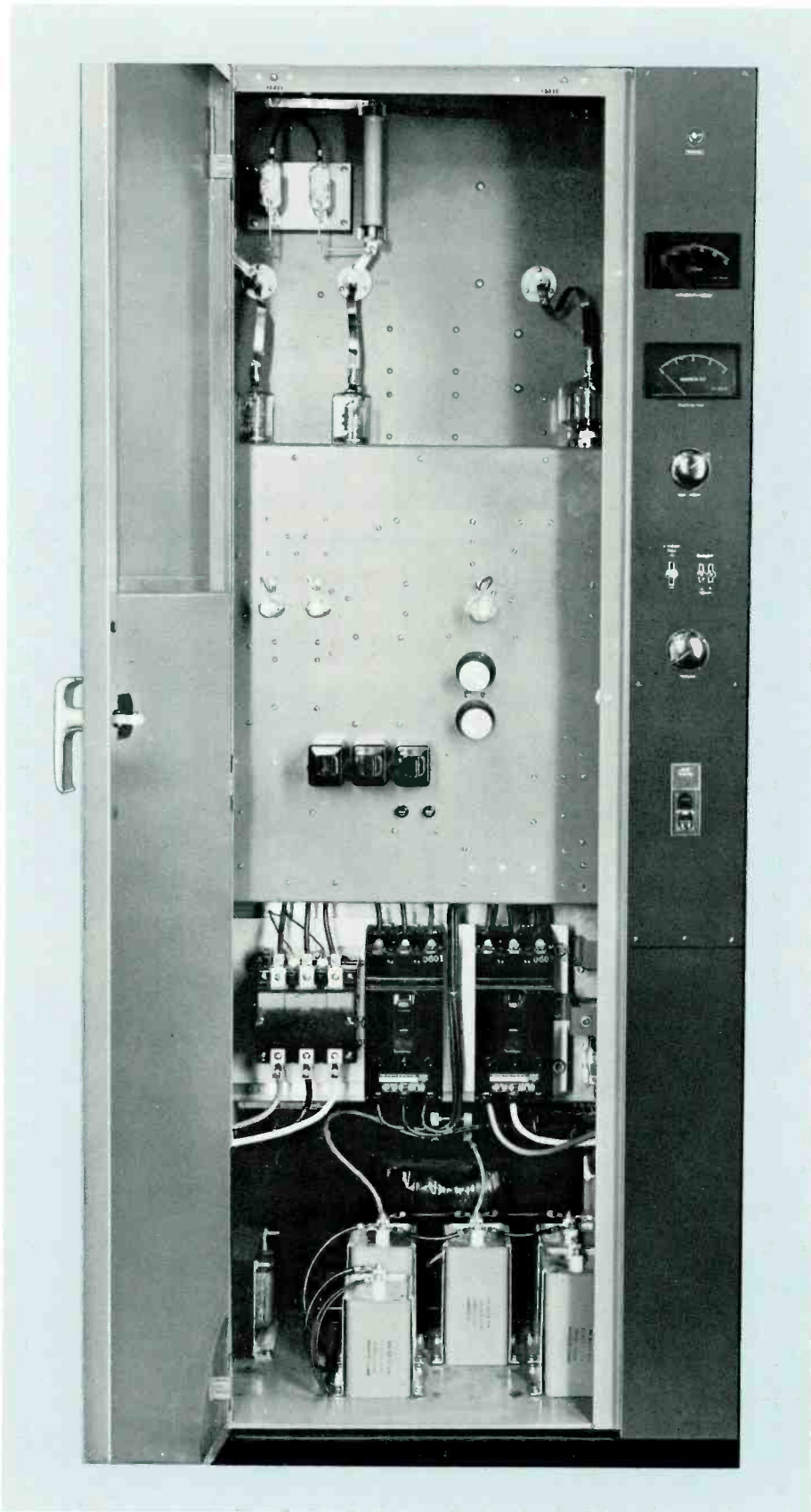

Driver cabinet including exciter and control panel.

The output of the 6146 IPA stage is broadband and requires no tuning. It drives a single 4-400A tube where tuning is accomplished by using a slug-tuned coil controlled from the front panel. This tube, in turn, drives one or two high-efficiency, long life 5762 output triodes. A front panel control of a vacuum variable capacitor tunes the plate circuit.

Broadband Neutralization

A new slug-tuned coil was developed for the power output adjustment and it is driven by a reversible motor. The motor is actuated at the front panel or by remote control. The second harmonic trap uses a slug-tuned coil, thus eliminating the possibility of contact pitting from high RF currents. Neutralization of the PA is achieved by a broadband transformer and a variable vacuum capacitor.

The modulator of the transmitter consists of a pair of 2E26 tubes located in the exciter portion, resistance coupled to drive two 4-125A second audio frequency amplifiers which, in turn, are resistance coupled to drive a pair of 3X3000F1 modulators. These modulator tubes are low mu triodes, drawing no grid current. They are capable of excellent response and fidelity. Due to the low plate dissipation of the new PA system, the power input of the modulator is also reduced affording appreciable power economies.

Dependable Semiconductor Power Supply

The BTA-5U2/10U2 incorporates RCA silicon rectifiers in the high-voltage circuits. This rectifier is ideal not only in a combined operation, but even more so in a remote-control application.

The rectifiers are hermetically sealed so they will not be adversely affected by weather conditions. They can operate at ambient temperatures ranging from -20 degrees to $+45$ degrees C and at altitudes up to 7500 feet above sea level. There is no significant aging of the forward drop characteristics. Across each of the individual silicon cells a resistor has been shunted so that they will all share equally the peak inverse voltage. RCA specifications have been set higher than EIA standards by adding an additional 30 percent peak inverse voltage safety factor.

Cooling System

The transmitter is completely air-cooled. Added refinements such as a delay relay have been built-in to keep the

blower system in operation for one minute after the transmitter has been shut down. The continued supply of air extends tube life. The exciter cabinet employs convection cooling. A louvered lower back panel and top grill panel provide good ventilation. In the second cabinet a blower air system distributes air to the modulator as well as to the Power Amplifier tubes in cabinet three.

Overload Protection

To provide additional reliability, improvements were made in the control and protective circuitry of the transmitter. All primary lines are protected by means of circuit breakers with instantaneous overload trip protection. Line and high-

voltage plate circuit breakers have additional built-in thermal protection. The 3-phase blower is protected by a contactor with a thermal cutoff in each phase. Relay switching is sequential so that filaments will not come on unless the blower is operating. Low voltage is delayed to allow proper filament heating. The high voltage is interlocked with the low-voltage and the bias supply so that it will come on only after the low-voltage and bias potentials are present. Overload protection is also provided in the low-voltage supply, the second AF stage, the IPA stage, the modulator, the PA stage and the high-voltage rectifier. They are instantaneous in action and each overload relay carries a spare set of contacts wired

to terminals that may be connected to an external indicator. A two cycle plate overload relay also permits the transmitter to return to the air automatically after one interruption has occurred.

Starting surges in the plate transformer, high voltage rectifier, and the filter capacitor are eliminated by the use of a step-start and damping circuit. This at one time was only available in the higher-power transmitters, but now longer life and added reliability are provided in the BTA-5U2/10U2 with the incorporation of these circuits for the suppression of starting transients. The damping circuits and the primary line reactors afford continuous protection against possible operational transients.

Typical floor plan for BTA-5U2 and BTA-10U2 transmitters. External plate transformers are required only for the BTA-10U2 transmitter since the transformer for the BTA-5U2 can be mounted in the PA cabinet.

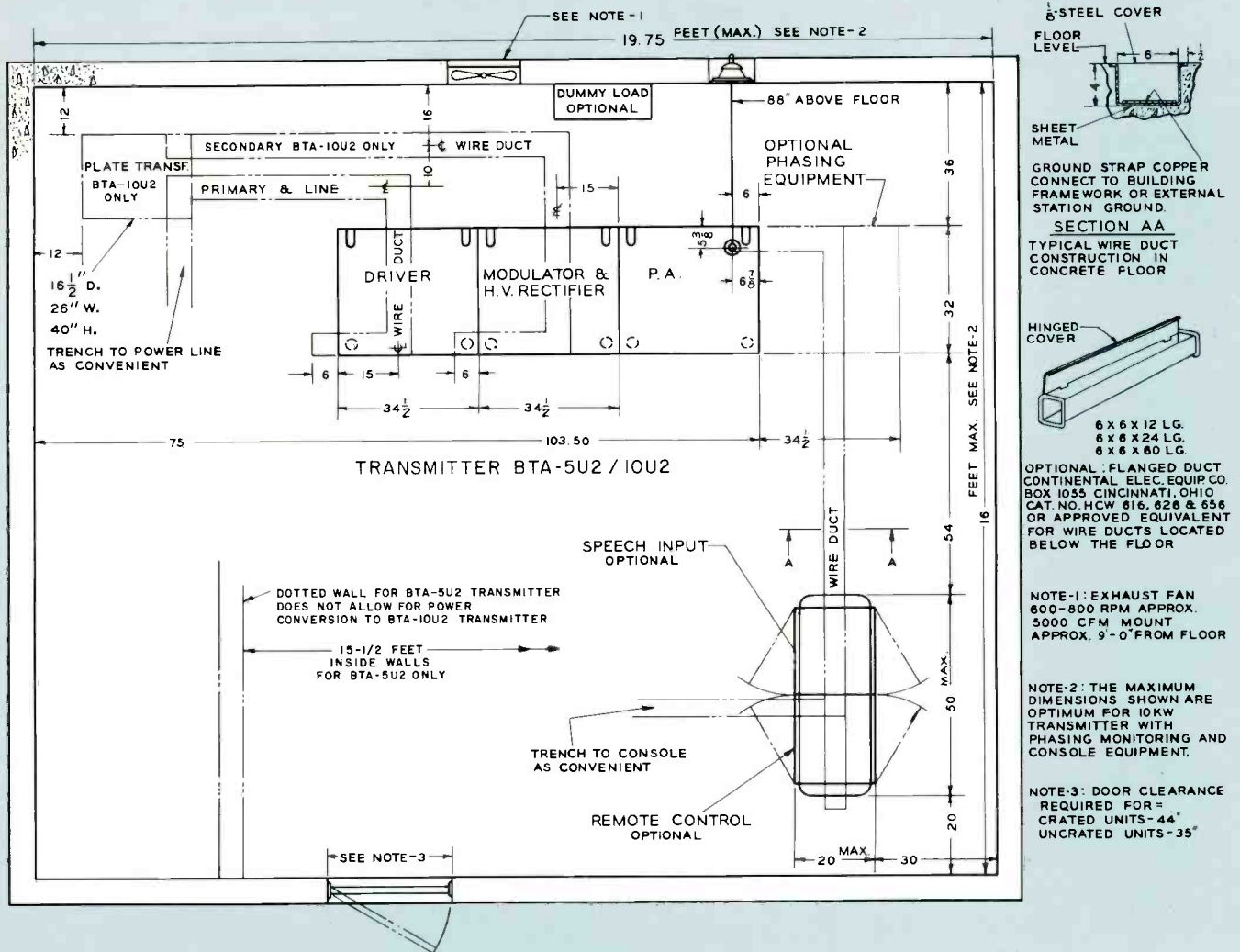

Specifications

Performance

AF Input Impedance	150/600 Ohms
AF Input Level (100% modulation)	+10 ±2 dBm
AF Response:	
50—7500 Hz	±1 dB
30—10,000 Hz	±1.5 dB
AF Distortion (95% modulation):	
50—10,000 Hz	2.5%
Noise (below 100% modulation)	60 dB
Frequency Range	535—1620 kHz
Frequency Stability	±5 Hz
Type of Output	Single Ended
Carrier Shift (0—100% modulation,	
400 Hz	3% at constant line voltage
	5% at normal line voltage regulation
Output Impedance	40—250 Ohms

Electrical

RF Voltage (for Frequency Monitoring)	10 Volts RMS 75 Ohms
RF Voltage (for Modulation Monitoring)	10 Volts 75 Ohms
Power Output (nominal):	
BTA-5U2	5000 Watts
BTA-10U2	10,000 Watts
Power Output Capability:	
BTA-5U2	5500 Watts
BTA-10U2	10,600 Watts
Power Source Required	208/240 Volts ±11 Volts
Line Frequency	50/60 Hz
Phase	3
Power Consumption:	
(0% modulation)	BTA-5U2 10.0 kW BTA-10U2 17.5 kW
(100% modulation)	14.5 kW 26.0 kW
(Average program modulation)	11.0 kW 21.0 kW
Power Factor	90% 90%
Permissible Combined Line Voltage Variation and Regulation	±5% ±5%
Crystal Heater Power	117 Volts 50/60 Hz
Tube Complement:	
1 6146 Intermediate Power Amplifier	
1 4-400A Driver	
2 2E26 1st Audio Frequency Amplifier	
2 6155/4-125A 2nd Audio Frequency Amplifier	
2 3X3000F1 Modulator	
1 5762 Power Amplifier for BTA-5U2	
2 5762 Power Amplifier for BTA-10U2	

Mechanical

Overall Height	88" or 223.5 cm
	(84" or 213.4 cm less floor channels)
Cabinet Height	84" or 213.4 cm
	(80" or 203.2 cm less floor channels)
Width	103½" or 262.9 cm
Depth	32" or 81.3 cm (less door handle)
Overall Depth	55" or 139.7 cm (with door open)
Net Weight:	
BTA-10U2 Transmitter	4700 lbs. or 2132 kg. (approx.)
Plate Transformer	600 lbs. or 272 kg. (approx.)
BTA-5U2 Transmitter	
including Plate Transformer	4850 lbs. or 2200 kg. (approx.)
Altitude Range	0—7500 ft. (0—2286 m)
Ambient Operating Temperature	-20°C (-4°F) min., +45°C (113°F) max.

Accessories

Complete Set of Operating Tubes (for BTA-5U2)	ES-34233
Complete Set of Operating Tubes (for BTA-10U2)	ES-27290
Filament Hours, Elapsed Time indicator*	MI-34684*
Type BTR-11B Remote Control System	ES-34280
Type BTA-20D Remote Control System	ES-561415
Antenna Tuning Equipment	ES-27256
Recommended Spare Tubes for BTA-5U2	
and BTA-10U2	ES-27291
Type BW-11A AM Frequency Monitor	ES-34042
Type BW-66F AM Modulation Monitor	MI-30066-B
Alarm Indicator	MI-27567
Power Conversion Kit (BTA-5U2 to BTA-10U2)	ES-34279-A
Power Cutback Kit 5 kW to 500/1000 W	MI-34646-A
Power Cutback Kit 10 kW to 500/1000 W	ES-34287
Power Cutback Kit 10 kW to 5 kW	ES-34286
Remote RF Pick-up Unit	
for powers up to 5-kW (less meter)	MI-27966-B
Remote RF Pick-up Unit for higher powers	
(less meter)	MI-28027-C
Remote Antenna Meter	MI-27644-A Series
RF Ammeter Mounting Hardware	MI-27713

*The 5U2/10U2 Transmitter has a blank meter bezel which may be replaced with an elapsed time indicator, MI-34684. Specify 50 or 60 Hertz.

Ordering Information

Type BTA-5U2 Transmitter (including 1 set of tubes and 1 crystal)	ES-27285-B
Type BTA-10U2 Transmitter (including 1 set of tubes and 1 crystal)	ES-27286-B
(specify operating frequency and output impedance)	

RCA 1-KW FM Broadcast Transmitter, Type BTF-1E2

- New solid-state exciter
- Available for mono or stereo
—with or without SCA
- Designed for remote control
- Direct FM exciter

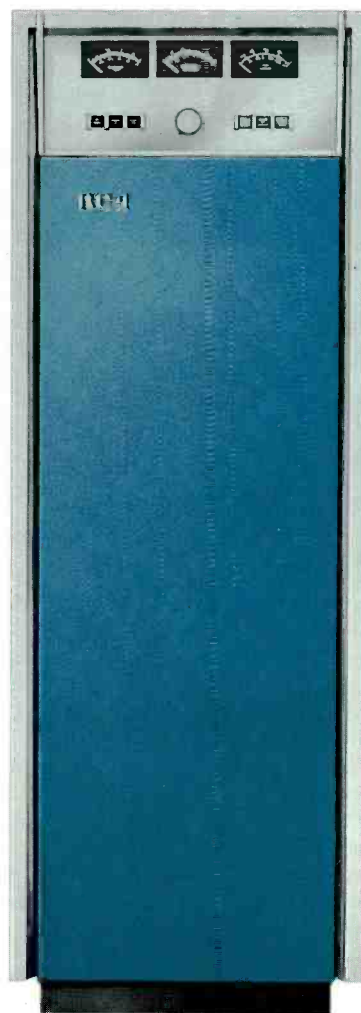

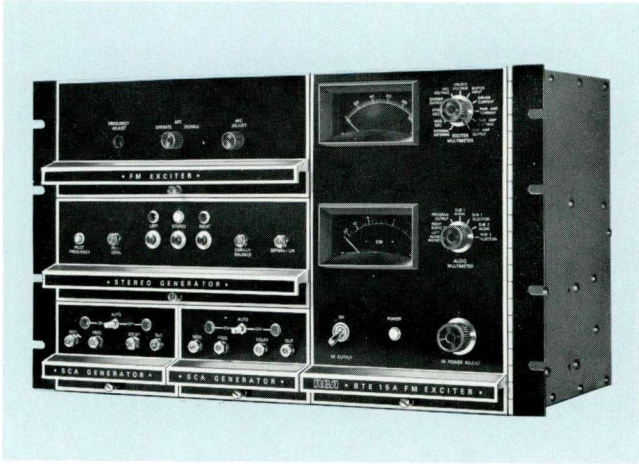

New solid-state FM Exciter system, Type BTE-15A, showing "Direct FM" exciter housed with optional stereo generator and SCA generator units.

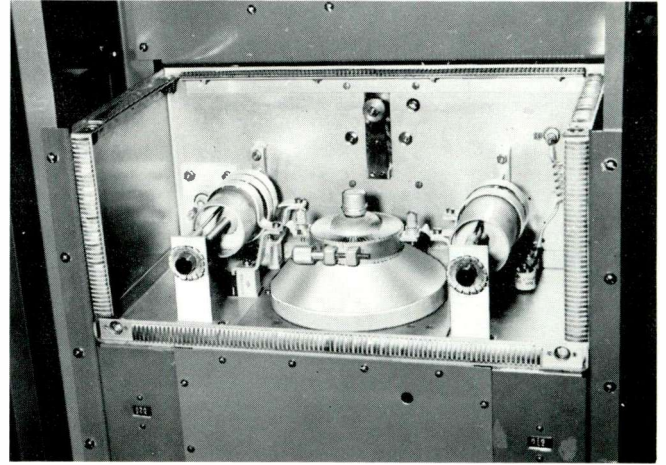

RF cavity with shielded cover removed.

Description

RCA's Type BTF-1E2 FM Transmitter provides 1,000 Watts output for stations operating in the 88 to 108 MHz band. It is designed to provide the finest possible performance and reliability, and is specifically built to meet the stringent requirements of multiplex and stereo service transmission. It is a simple and compact unit easy to install.

The BTF-1E2 Transmitter supplies the latest in FM broadcast techniques. Only one tube beyond the exciter is required to supply 1000 Watts output. No IPA stage is required. The transmitter is extremely stable because it incorporates RCA's time-proven "Direct FM" Exciter. This exciter requires no special tuning or setting up for standard or for multiplex operations. It has all solid-state components. Cross-talk and noise are kept to an absolute minimum.

Easy to Install and Operate

Other features incorporated in the BTF-1E2 include silicon rectifiers which provide long life with a minimum of maintenance. Accessibility is assured both front and rear by vertical chassis construction, surface mounting of components, and hinged mounting of the exciter. Mechanical and electrical overload protection is provided. To assure performance in accordance with FCC requirements, the transmitter is supplied with harmonic filter. Provisions for remote control have been provided in the transmitter.

High quality FM stereo transmission can be obtained by the addition of an RCA BTS-1B Stereo Generator. SCA programming may be transmitted simultaneously with stereo by the use of the optional BTX-1B subcarrier generator. The BTF-1E2 is type accepted for such simultaneous program transmission.

Single Cabinet

The Type BTF-1E2 FM Transmitter is completely housed in one cabinet with total floor dimensions of only 26 by 21 inches. The cabinet is functionally styled to present a pleasing appearance. All meters and operating controls are conveniently located. Front and rear hinged doors give easy access to all portions of the transmitter.

Located at the front are the overload relays, the 1 kW amplifier and RF box containing tuning dials for the amplifier. A control panel and screen supply are located next, followed by the hinged mounted exciter. Concealed in the bottom of the transmitter are the high voltage rectifier and power transformer. The rear of the transmitter gives access to the bias resistors, metering circuitry and blower, followed by the rear of the control panel and screen supply. A voltage regulating filament transformer is mounted on the control panel.

Solid-State FM Exciter

Excellent monaural, stereo and SCA

performance that more than meets industry and FCC standards are achieved by the new RCA modular, solid-state "Direct FM" exciter.

Simplified Circuits

Modulation of the temperature compensated basic on-frequency oscillator is achieved by applying the composite stereo or SCA signals from the BTS-1B and BTX-1B Generators, respectively, to a pair of push-pull varicap diodes which are coupled to the basic oscillator frequency determining resonant circuit. The output of the basic oscillator is isolated from the following buffer amplifier by a 10 dB resistive attenuator. Thus, the stability and modulation characteristics of the basic direct FM oscillator are not disturbed by following RF power amplifiers.

The output of the buffer amplifier, approximately 500 mW, is used to drive the 15-Watt, three-stage RF amplifier as well as the binary divider chain in the AFC circuit. The basic oscillator, buffer amplifier, and AFC circuit are mounted inside a shielded enclosure. The RF power amplifier is also completely shielded.

Automatic frequency control (AFC) for the on-frequency basic oscillator is achieved by taking a sample of the buffer output frequency and dividing it by two, 14 times. A low-frequency reference crystal operating at 1/1024th of the de-

sired output frequency is divided by two, 4 times. Integrated circuits operating in the saturated mode are used in both binary dividing chains. The outputs from the reference and basic oscillator binary dividers are phase compared in a time-sharing IC comparator. The output of the circuit, which represents the AFC error voltage, is filtered and applied to another pair of varicap diodes coupled to the basic oscillator tuned circuit. Thus, the basic oscillator is phase locked to the 1024th harmonic of the oven controlled reference crystal.

An off-frequency detector is incorporated in the design of the BTE-15A FM Exciter. When the basic oscillator frequency is not phase locked to the reference crystal, an AC component appears at the AFC output. This voltage is rectified to operate a relay whose contacts can be used to turn off the FM transmitter.

Two multimeters are located on the hinged door of the exciter in front of the regulated power supply section. One of these meters is used to indicate power supply and operating voltages within the exciter and 15-Watt RF Amplifier. The second meter is a peak-reading voltmeter that is used to indicate all modulating signal levels.

The RF power output of the BTE-15A can be continuously adjusted from the front panel control from 7 to 15 Watts. The primary power is turned on with a circuit breaker. RF output is turned on

with a front panel switch or by jumping contacts available on the rear of the unit. The exciter will tolerate load mismatches from short circuit to open circuit for a reasonable time without damaging the output transistor. Another safety feature prevents turning on the 41 kHz SCA subcarrier when the BTS-1B Stereo Generator is in the stereo mode.

Power Amplifier

The output of the exciter is fed to the input of the ceramic 4CX-1000A amplifier tube. The amplifier input circuit is a simple parallel resonant circuit, tuned by a variable inductance with resistance swamping for stability of operation. This stage is neutralized by varying inductance in series with the screen. The output circuit is a modified pi network, having a variable inductance across the tube capacity—which is used to adjust the loading. All capacitors in the final stage are of the fixed ceramic type. A blower mounted on the back of the RF compartment provides sufficient filtered air for cooling at stations operating below 7500 feet. The filament transformer is of the automatic regulator type and keeps filament voltage constant within one percent.

The power amplifier is new in many respects. The variable inductors use no sliding contacts. There are no variable capacitors in the power amplifier. A single tube, the 4CX1000A, is used in the BTF-1E2 power amplifier and it is driven directly by the output of the exciter in an exclusive RCA circuit.

Neutralizing Probe

A neutralizing probe is furnished with the transmitter. It utilizes the multimeter to indicate correct neutralization of the power amplifier.

The high voltage and screen power supplies make use of silicon rectifiers in a bridge circuit. This combined with choke input and adequate filtering results in an excellent well-regulated power source. A variable transformer is used in the primary of the screen power supply to control power output of the transmitter. Filament voltage regulation is provided for the 4CX1000A power amplifier tube.

Harmonic Filter

The harmonic filter supplied with all RCA FM transmitters is not a simple harmonic trap. The filter consists of an M-derived half-T section, several low-pass filter sections, and a constant-K, half-T section. The M-derived section provides rapid cut-off in the second harmonic region, and a termination impedance at one end of the filter of 50 Ohms. Attenuation of the harmonics is accomplished by the low-pass filter sections, while the constant-K, half-T section serves to give a termination impedance of 50 Ohms at the other end of the unit. The use of such a filter assures compliance with FCC requirements regarding spurious radiation, as all harmonics through the seventh are effectively attenuated.

Simplified Block Diagram of BTF-1E2 Transmitter, showing optional stereo and SCA.

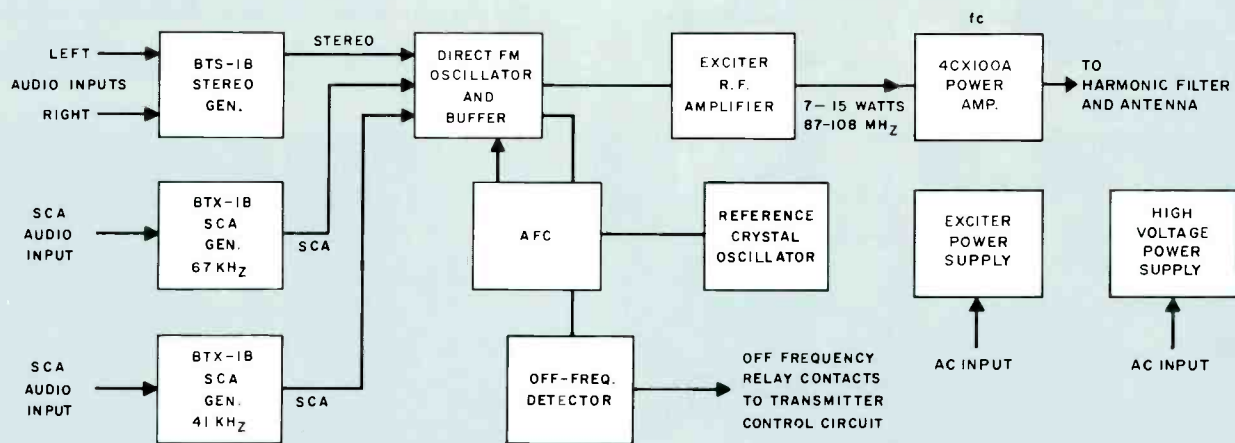

Protective Circuits

Power circuits are protected by magnetically tripped circuit breakers as well as overload relays. An interlock relay prevents application of plate power until the 4CX1000A filament has heated and the exciter has reached a stable operating condition. Overload relays are used in the high voltage and screen power supplies. There is also an interlock in the air blower circuit. If the blower should fail or air-flow be reduced below the proper level, the transmitter is taken off the air thus avoiding possible damage.

The overload relays are reset remotely or by means of an instantaneous key switch on the front panel. An overload indicator lamp signals when an overload

has taken place. All relays are easily accessible. Access to high voltage areas is protected by built-in high voltage shorting devices.

Control Features

The BTE-15A exciter has a self-contained multimeter. In the amplifier of the transmitter, provision is made for metering PA plate current, plate voltage, output power and VSWR; a probe is furnished for neutralizing the transmitter and is used in connection with the multimeter. All tuning controls are located on the front panel for easy accessibility. They include key switches for filament on-off, plate on-off, and overload reset. The variable power control is also

mounted on the front as are the overload indicator and plate power-on lights. The use of latching relays make it possible to control the transmitter with one button.

Remote Control Provisions

The BTF-1E2 transmitter incorporates connections for remote control and remote meter reading when combined with a remote control system such as the BTR-11B or BTR-20E. Terminals for transmitter on-off, plate on-off, overload reset, plate voltage, cathode current, and power output are provided. To control transmitter power output remotely, an accessory motor drive may be connected to the screen supply control.

Specifications

Performance

Type of Emission.....	F3 and F9
Frequency Range.....	.88 to 108 MHz
Power Output.....	250-1000 Watts
Output Impedance (1 $\frac{1}{2}$ " O.D. Line).....	50/51.5 Ohms
Frequency Deviation, 100% modulation.....	± 75 kHz
Modulation Capability.....	± 100 kHz
Carrier Frequency Stability.....	± 1000 Hz max.
Audio Input Impedance.....	600/150 Ohms
Audio Input Level— ¹ (100% mod.).....	$+10 \pm 2$ dBm
Audio Frequency Response— ² (50 Hz-15 kHz).....	± 1 dB max.
Pre-emphasis Network Time Constant.....	.75 or 50 μ s or flat as desired
Harmonic Distortion— ³ (50 Hz-15 kHz).....	0.5% or less
FM Noise Level (referred to 100% FM mod.).....	-65 dB max.
AM Noise Level (referred to 100% AM mod.).....	-50 dB max.
Subcarrier Input Level (100% mod.).....	-15 to $+10$ dBm adjustable
Subcarrier Input Impedance.....	600/150 Ohms bal.
Subcarrier Frequency.....	20-67 kHz
Main-to-Subchannel Crosstalk.....	-50 dB referred to ± 7.5 kHz deviation of the subcarrier by a 400 Hz tone. Main channel modulation 70% by 50-15,000 Hz tones.
Sub-to-Main-Channel Crosstalk.....	-60 dB referred to ± 7.5 kHz deviation of the main carrier by a 400 Hz tone. Subchannel modulated 100% (± 7.5 kHz/s) by 50-6000 Hz tones. Subcarrier modulated 30% on main carrier.

Electrical

Power Line Requirements:	
Line.....	240/208 Volts, single phase, 60 Hz ⁴
Slow Voltage Variation.....	$\pm 5\%$
Power Consumption.....	2800 Watts (approx.)
Power Factor (approx.).....	80%

Tube Complement

Power Amplifier:	1—4CX1000A
------------------	------------

Mechanical

Dimensions (overall).....	26" wide, 77" high, 20 $\frac{1}{2}$ " deep (66.04 cm, 195.58 cm, 52.23 cm)
Weight.....	790 lbs. (3.58 kg.)
Finish.....	Textured vinyl in midnight blue and shadow blue, satin aluminum trim
Altitude.....	7500 ft. max. (2290 m)
Ambient Temperature Range.....	-20° to +45°C

Accessories

Recommended Spare RF Transistors for Exciter.....	MI-560718
Spare Crystal and Oven (Specify operating frequency).....	MI-560717
Spare Transmitter Tube.....	MI-34709
1-kW RF Load and Wattmeter.....	MI-19196L/H
Type BTR-11B Remote Control System (10-function).....	ES-34280
Type BW-75A FM Frequency and Modulation Monitor.....	MI-560735
Type BW-85A FM Stereo Frequency and Modulation Monitor.....	MI-560740
Type BW-95A SCA Frequency and Modulation Monitor.....	MI-560745

¹ Level measured at input to pre-emphasis network.

² Audio Frequency response referred to 75 or 50 micro-second pre-emphasis curve.

³ Distortion includes all harmonics up to 30 kHz and is measured following a standard 75 or 50 micro-second de-emphasis network.

⁴ 50-Hz operation requires MI-34316-20 regulator.

Ordering Information

Type BTF-1E2 1-kW FM Broadcast TransmitterES-27279-C*

*Please specify assigned frequency, power-line frequency and altitude of installation and select a BTE-15A Exciter System from the following:

Mono.....	ES-560631
Mono and one SCA Channel.....	ES-560632
Mono and two SCA Channels.....	ES-560633
Stereo.....	ES-560634
Stereo and one SCA Channel.....	ES-560635
Stereo and two SCA Channels.....	ES-560636

RCA 5-KW FM Transmitter, Type BTF-5E1

- New solid-state exciter
- Ultra stable—easy to tune
- Available for mono or stereo
—with or without SCA
- Field-expandable
to 10 or 20 kW
- Ready for remote control

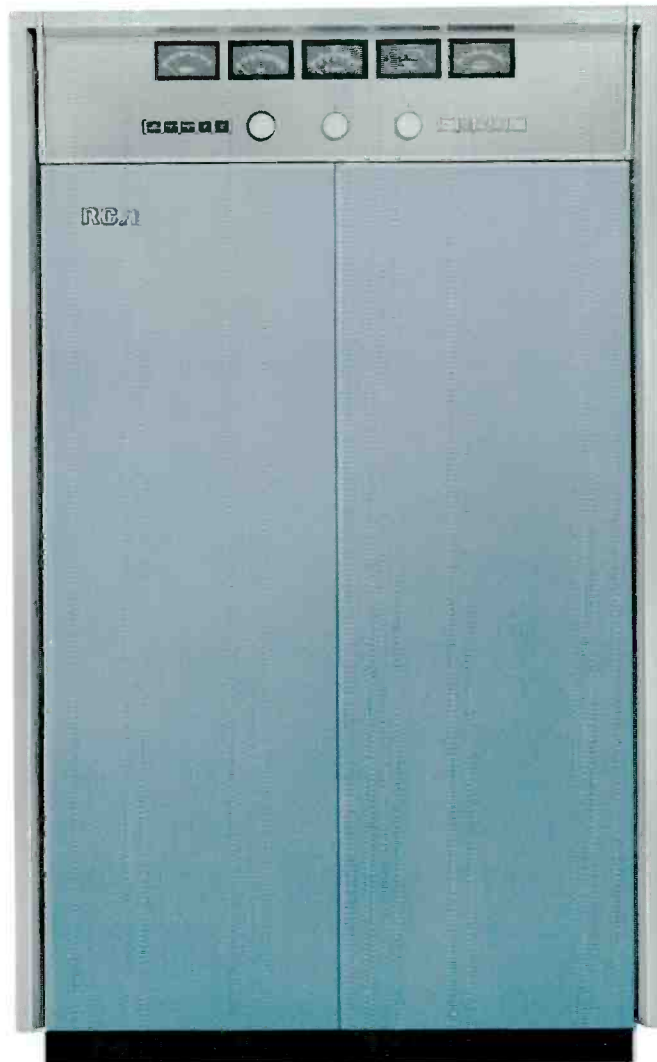

5-KW FM Broadcast Transmitter

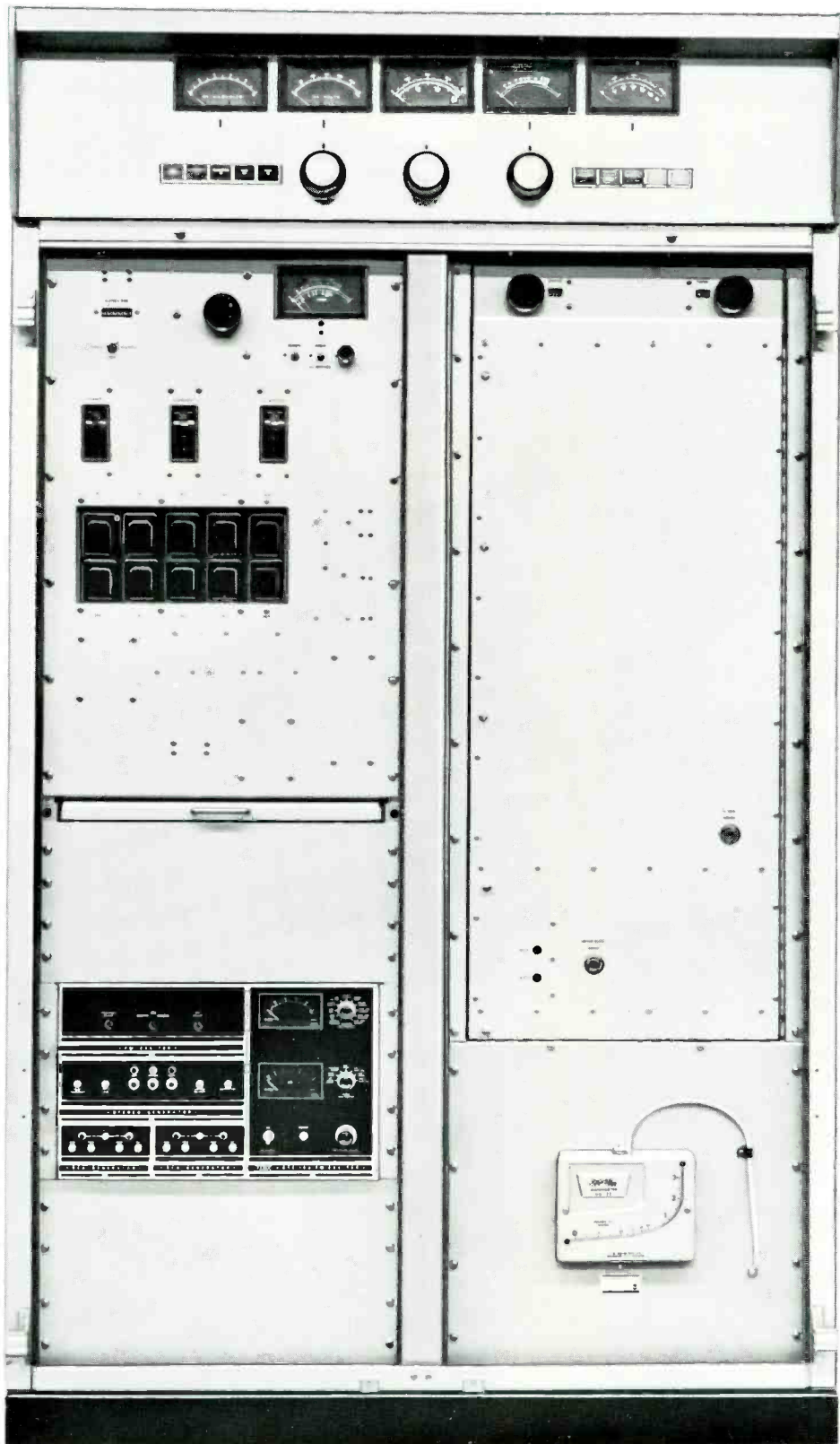

Centralized Controls

Ready for remote control

Self-protected against overload

Tilt down chassis for easy maintenance

Direct-FM Exciter

Eye-level metering

Complete Accessibility

Two Stages Follow Exciter—IPA and PA

"Filter-Minder" Manometer

Fully Air Cooled

Full-Fidelity FM Transmitter, Type BTF-5E1

RCA's Type BTF-5E1 FM Broadcast Transmitter provides 5,000 Watts output for stations operating in the 88 to 108 MHz band. It is designed to provide the finest possible performance and reliability, and is specifically built to meet or exceed the stringent requirements of multiplex service transmission. The equipment is FCC type accepted and meets all requirements for harmonic and spurious emission.

The BTF-5E1 employs a new exciter that uses the time-tested and field-proven *direct-FM* system. The circuit uses capacitive diodes as modulators of an oscillator to produce *direct FM*. Automatic frequency-control maintains oscillator frequency to close tolerances under virtually all operating conditions.

Because of its wide frequency response and extreme stability, the exciter (and the trans-

mitter) is ideally suited for multiplex and stereo programming.

The Type BTA-15A Exciter in the BTF-5E1 uses all solid-state components for long life and great dependability. For ease of tuning, the exciter has a built-in multimeter and highly-accessible test points permitting convenient metering and checking while operating.

Frequency response of the transmitter's main channel is 30 to 15,000 Hz (± 1 dB maximum) and the distortion over the same bandwidth is less than one-half of one percent.

The BTF-5E1 is designed specifically to be field-expandable to a 10- or 20-kW transmitter. It is noteworthy that this expansion is substantially electrical and there is virtually no increase in floor-space requirements.

Description

Mono or Stereo

The transmitter features a new exciter designed for stereo and multiplex. The exciter, including its self-contained power supply, is mounted on a single vertical chassis.

Two Stages Follow Exciter

From the 15-Watt output of the exciter, only two tubes generate the full 5-kW signal. A harmonic filter is included to reduce spurious radiation. Vacuum capacitors are used to tune the IPA plate and the PA grid.

Ready for Remote Control

The transmitter is designed and built for remotely-controlled operation. Internal wiring and terminals are provided for remote control of these transmitter functions: transmitter on/off; raise/lower output power and overload reset. Remote metering facilities for the PA include: cathode current; plate voltage and power output.

New Styling

Functional styling combined with fewer tubes permits the BTF-5E1 to be housed

in a single, double-door cabinet in a new midnight blue and shadow blue vinyl finish. For contrast, the meter panel is in bright aluminum and the cabinet is trimmed in satin-finished aluminum. The swing-out doors in the front and rear afford the excellent accessibility for which RCA transmitters are famous.

All operating controls and meters are mounted on a panel above the front doors.

BTE-15A FM Exciter

Excellent monaural, stereo and SCA performance that more than meets industry and FCC standards are achieved by the new RCA modular, solid-state "Direct FM" exciter.

Simplified Circuits

Modulation of the temperature compensated basic on-frequency oscillator is achieved by applying the composite stereo or SCA signals from the BTS-1B and BTX-1B Generators, respectively, to a pair of push-pull varicap diodes which are coupled to the basic oscillator frequency determining resonant circuit. The output of the basic oscillator is isolated from the following buffer amplifier by a

10 dB resistive attenuator. Thus, the stability and modulation characteristics of the basic direct FM oscillator are not disturbed by following RF power amplifiers.

The output of the buffer amplifier, approximately 500 mW, is used to drive the 15-Watt, three-stage RF amplifier as well as the binary divider chain in the AFC circuit. The basic oscillator, buffer amplifier, and AFC circuit are mounted inside a shielded enclosure. The RF power amplifier is also completely shielded.

"On Carrier" Frequency Operation

Automatic frequency control (AFC) for the on-frequency basic oscillator is achieved by taking a sample of the buffer output frequency and dividing it by two, 14 times. A low-frequency reference crystal operating at 1/1024th of the desired output frequency is also frequency divided by 16 in a binary chain. Integrated circuits operating in the saturated mode are used in both binary dividing chains. The outputs from the reference and basic oscillator binary dividers are phase compared in a time-sharing IC comparator. The output of the circuit, which represents the AFC error voltage, is filtered

Select Features

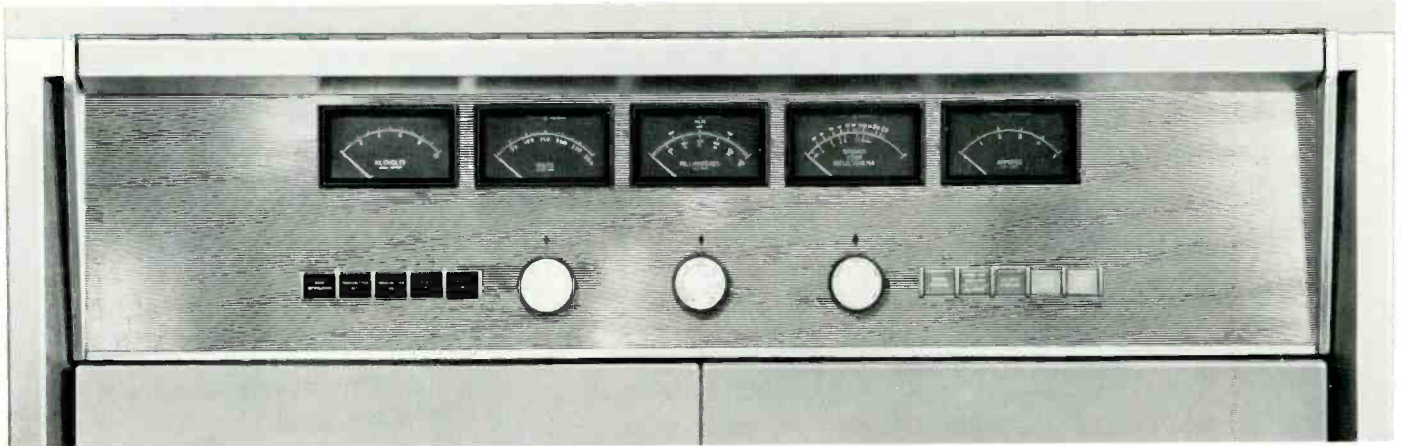

BTF-5E1 Control Panel. Tally lights and push-button controls simplify operation.

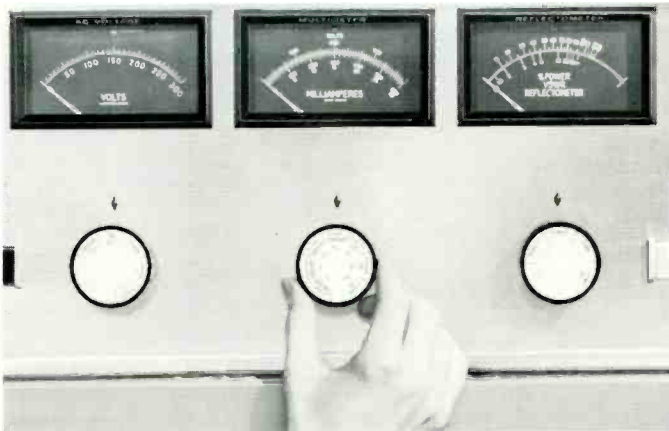

The large-diameter multimeter knobs speed log-keeping and minimize error.

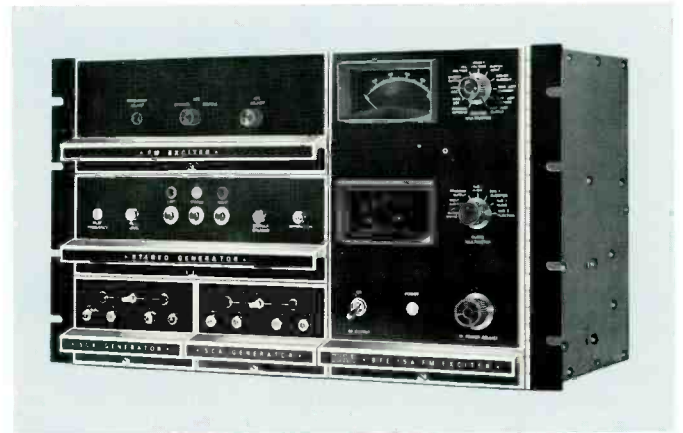

New solid-state FM Exciter system, Type BTE-15A, showing "Direct FM" exciter housed with optional stereo generator and SCA generator units.

and applied to another pair of varicap diodes coupled to the basic oscillator tuned circuit. Thus, the basic oscillator is phase locked to the 1024th harmonic of the oven controlled reference crystal.

An off-frequency detector is incorporated in the design of the BTE-15A FM Exciter. When the basic oscillator frequency is not phase locked to the reference crystal, an AC component appears at the AFC output. This voltage is rectified to operate a relay whose contacts can be used to turn off the FM transmitter.

Two multimeters are located on the hinged door in front of the regulated power supply section. One of these meters is used to indicate power supply and operating voltages within the exciter and 15-Watt RF Amplifier. The second meter

is a peak-reading voltmeter that is used to indicate all modulating signal levels.

The RF power output of the BTE-15A can be continuously adjusted from the front panel control from 7 to 15 Watts. The primary power is turned on with a circuit breaker. RF output is turned on with a front panel switch or by jumping the output contacts available on the rear of the unit. The exciter will tolerate load mismatches from short circuit to open circuit for a reasonable time without damaging the output transistor. Another safety feature prevents turning on the 41 kHz SCA sub-carrier when the BTS-1B Stereo Generator is in the stereo mode.

Class "C" Power Amplifiers

Two simplified, single-ended ampli-

fiers operating class "C" follow the exciter. The 250-Watt driver stage uses a Type 7203/4CX250B tube, and the final power amplifier uses a Type 4CX5000A (ceramic tetrode). Vacuum variable capacitors tune the pi network between driver and PA. The power amplifier, too, uses pi-network circuitry and tuning is accomplished by variable inductors operating at ground potential.

5-kW Class "C" Final Amplifier

The output tube, a ceramic tetrode, 4CX5000A, offers very high power-gain with little drive. Using this tube, only two stages of amplification are required between the exciter and the antenna for the 5,000-Watt output. Fewer components result in improved reliability.

Motor-Driven Power-Output Control

Power output is controlled by means of a motor-driven variable transformer which controls the low-voltage power supply. This supply controls the driver-plate and the screen voltages of both stages simultaneously. A separate grid bias supply increases transmitter stability and reliability. The use of semi-conductor (silicon) rectifiers reduces operating and maintenance costs.

Harmonic Filter Standard Equipment

To keep spurious emission to a minimum, a harmonic filter is standard equipment with the BTF-5E1. The filter consists of an "M"-derived "half-T" section, several low-pass filter sections, and a constant-"K", "half-T" section. Attenuation of the harmonics through the seventh is accomplished by the passband of the low-pass filter sections, while the constant-

"K", "half-T" section serves as a 50-Ohm termination impedance.

Self-Protected Against Overload

Power circuits are protected by magnetically-tripped circuit breakers in addition to overload relays. An interlock system prevents turn-on of plate power until all filaments have heated and the exciter has reached a proper operating condition. In addition, a latching relay automatically re-applies power to the transmitter once before locking-out in the event of brief overloads or power interruptions. The overload relays are reset by illuminated push button switches on the front panel. Separate tally-light indicators are provided for overloads in the driver, power amplifier and low-voltage rectifier circuits.

Fully Air-Cooled

Cooling air for the BTF-5E1 is supplied by a blower mounted below the

amplifier stages. Heavy sound insulation reduces blower noise to a minimum. The blower supplies forced air to both the IPA and PA stages.

Simplified Control

The transmitter has all operating controls and meters located on a panel just above the front doors. The push-button controls include: transmitter on/off, plate on/off, overload reset and power raise/lower. A cabinet disconnect switch, low-voltage circuit breaker, and filament control circuit breakers are located behind the left-hand door. The main- and low-power circuit breakers are located in the unitized rectifier cabinet. When servicing the BTF-5E1, operation of the disconnect switch removes all voltages from the transmitter cabinet. Personnel are also protected by fully interlocked rear doors in addition to interlocked doors on the PA cubicle.

Simplified Block Diagram of the BTF-5E1 Transmitter, showing optional stereo and SCA.

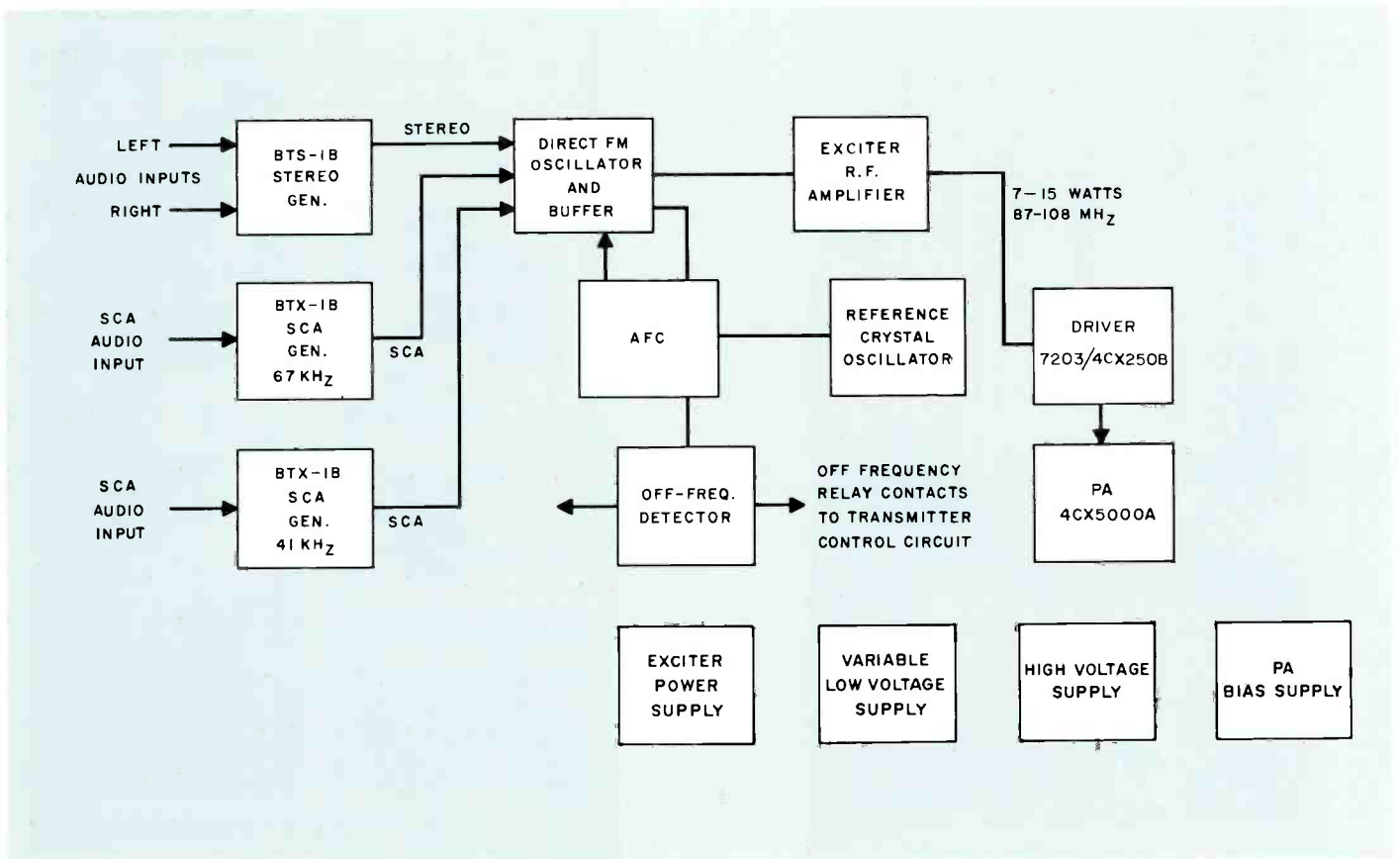

Full Metering

Six easy-to-read front-panel meters are provided for each amplifier. One for PA-plate voltage, another for PA-plate current, and a third for AC line and filament voltage. The remaining three are a reflectometer indicating output, a multimeter, and VSWR meter. Separate meters are used to measure the forward power and VSWR. The multimeter reads grid current, screen current and screen voltage of both power tubes. In addition the exciter has its own self-contained multimeter. This one provides complete information on operating conditions in the exciter.

Ready for Remote Control

Remote control provisions are included in the transmitter, and terminals are provided for use with remote control units such as the Type BTR-11B or BTR-20D and Automatic Logging Equipment. Additional terminals are provided for remote control of transmitter on/off, plate on/off, raise/lower power, and overload reset. Remote metering connections in the final amplifier for plate current, plate voltage, and power output are also provided.

High-Voltage Power Supply

The high-voltage power supply is housed in a unitized cabinet measuring

27 inches wide, 23 inches deep and 43 inches high. It can be installed at any convenient site in the station. The cabinet houses the high-voltage-plate transformer, a bank of plug-in semiconductor rectifiers, a line-circuit breaker, a high-voltage circuit breaker, and the plate contactor. Personnel are fully protected from shock through interlock and grounding switches.

The rectifier section comprises silicon-junction diodes (with equalizing resistors and capacitors) in a three-phase, full-wave-bridge circuit. Circuit breakers are used instead of fuses in the transmitter adding to the dependability, particularly when operating remote control.

ONLY TWO TUBES BETWEEN EXCITER AND OUTPUT—View showing interior of PA and IPA cabinet with the 4CX5000A ceramic tetrode and one 7203/4CX250B IPA tube below shelf.

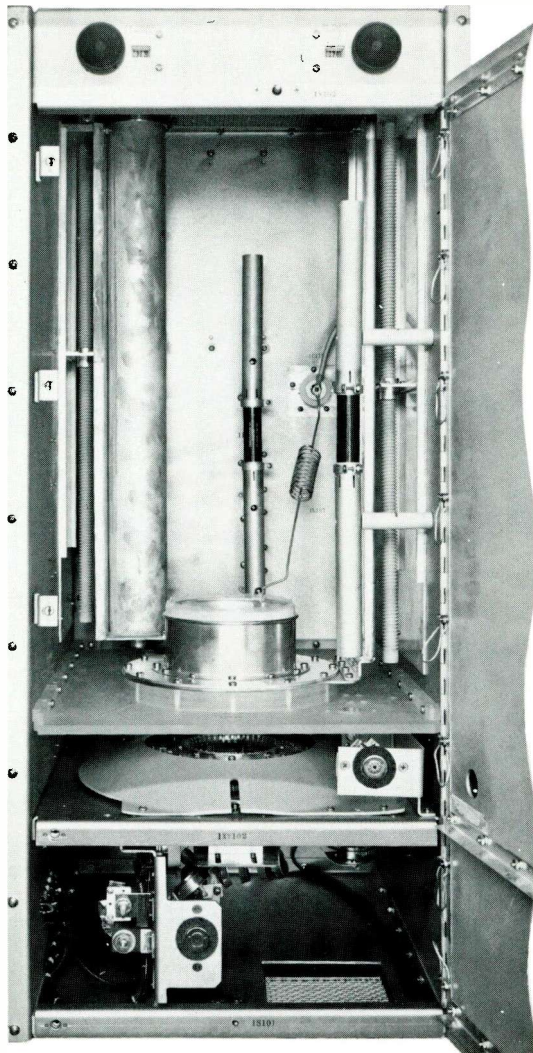

COMPLETE ACCESSIBILITY—Rear view of the BTF-5E1 revealing the clean, vertical construction of PA cavity to left and control panel to right.

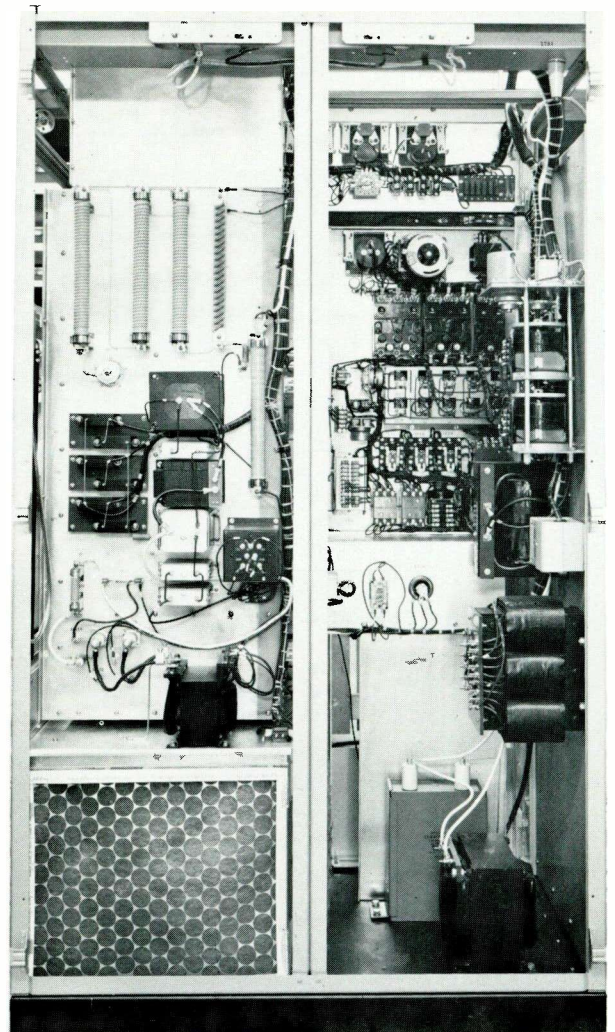

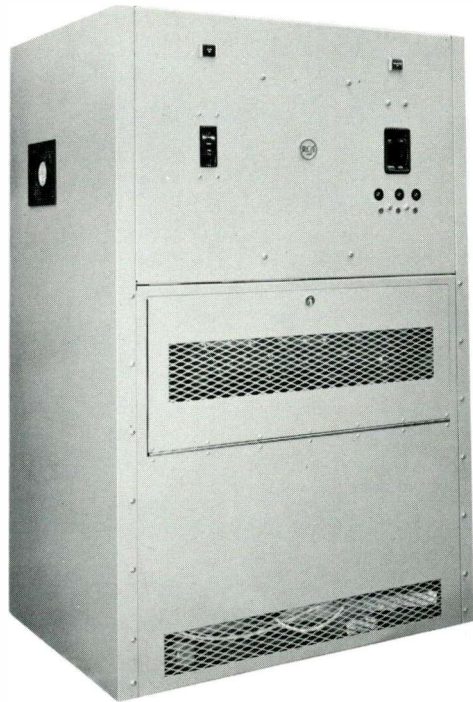

UNITIZED HIGH VOLTAGE POWER SUPPLY—With location not tied to the transmitter, the unitized power supply affords many installation and operating economies.

MODULAR SILICON RECTIFIERS—Quality components such as this plug-in silicon high-voltage rectifier are important elements in the BTF-5E1's superior performance.

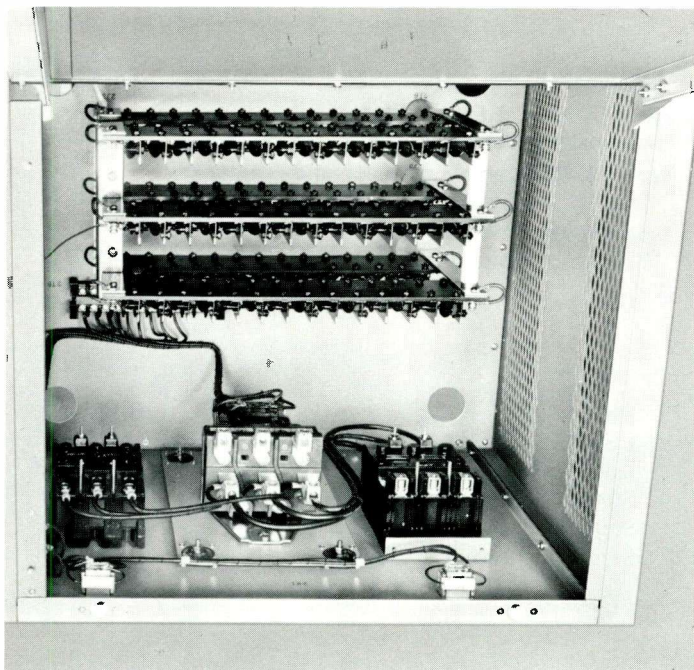

Specifications

Performance

Type of Emission.....	F3 and F9
Frequency Range.....	88 to 108 MHz
Power Output	5 kW
Output Impedance (3½" O.D. Line)	50 Ohms
Frequency Deviation 100% modulation	±75 kHz
Modulation Capability	±100 kHz
Carrier Frequency Stability	±1000 Hz max.
Audio Input Impedance	600/150 Ohms
Audio Input Level—*(100% mod.).....	+10 ±2 dBm
Audio Frequency Response—**(50-15,000 Hz)	±1 dB max.
Pre-emphasis Network Time Constant.....	75 or 50 μs, as desired
Harmonic Distortion—**(50-15,000 Hz)	0.5% or less
FM Noise Level (referred to 100% FM mod.).....	-65 dB max.
AM Noise Level (referred to 100% AM mod.).....	-50 dB max.
Subcarrier Input Level (100% mod.)	-15 to +10 dBm adjustable
Subcarrier Input Impedance	600/150 Ohms bal.
Subcarrier Frequency	20-67 kHz
Main-to-Subchannel Crosstalk....	-50 dB referred to ±7.5 kHz deviation of the subcarrier by a 400 Hz tone. Main channel modulation 70% by 50-15,000 Hz tones.
Sub-to-Main-Channel Crosstalk....	-60 dB referred to ±75 kHz deviation of the main carrier by a 400 Hz tone. Subchan- nel modulation 100% (±7.5 kHz) by 50-6000 Hz tones. Subcarrier modulated 30% on main carrier.

Electrical

Line Requirements:

Line.....	240/208 Volts, 3 phase, 50/60 Hz
Combined Line Voltage Variation and Regulation.....	±5%
Power Consumption.....	10,000 Watts (approx.)
Power Factor (approx.).....	90%

Crystal Heater:

Line	117 Volts, single phase, 50/60 Hz
Power Consumption.....	7½ Watts

Tube Complement

Driver:	1—7203/4CX250B
Power Amplifier:	1—4CX5000A

Mechanical

Dimensions (overall):	Transmitter	High-Voltage Power Supply
Width	48½" (123 cm)	27" (68.6 cm)
Height	77" (195.6 cm)	43" (109.2 cm)
Depth	32½" (82.5 cm)	23" (58.5 cm)
Weight (approx.)	1250 lbs. (567 kg.)	590 lbs. (267.6 kg.)
Finish	Textured Vinyl in midnight blue and shadow blue, satin-aluminum trim.	
Altitude	7500 ft.† (2290 M)	
Ambient Temperature Range.....	-20° to +45°C	

* Level measured at input terminal J1.

** Audio Frequency response referred to 50- or 75-microsecond pre-emphasis curve.

*** Distortion includes all harmonics up to 30 kHz and is measured following a standard 50- or 75-microsecond de-emphasis network.

† Blowers can be provided for operation at higher altitudes.

Specifications subject to change without notice.

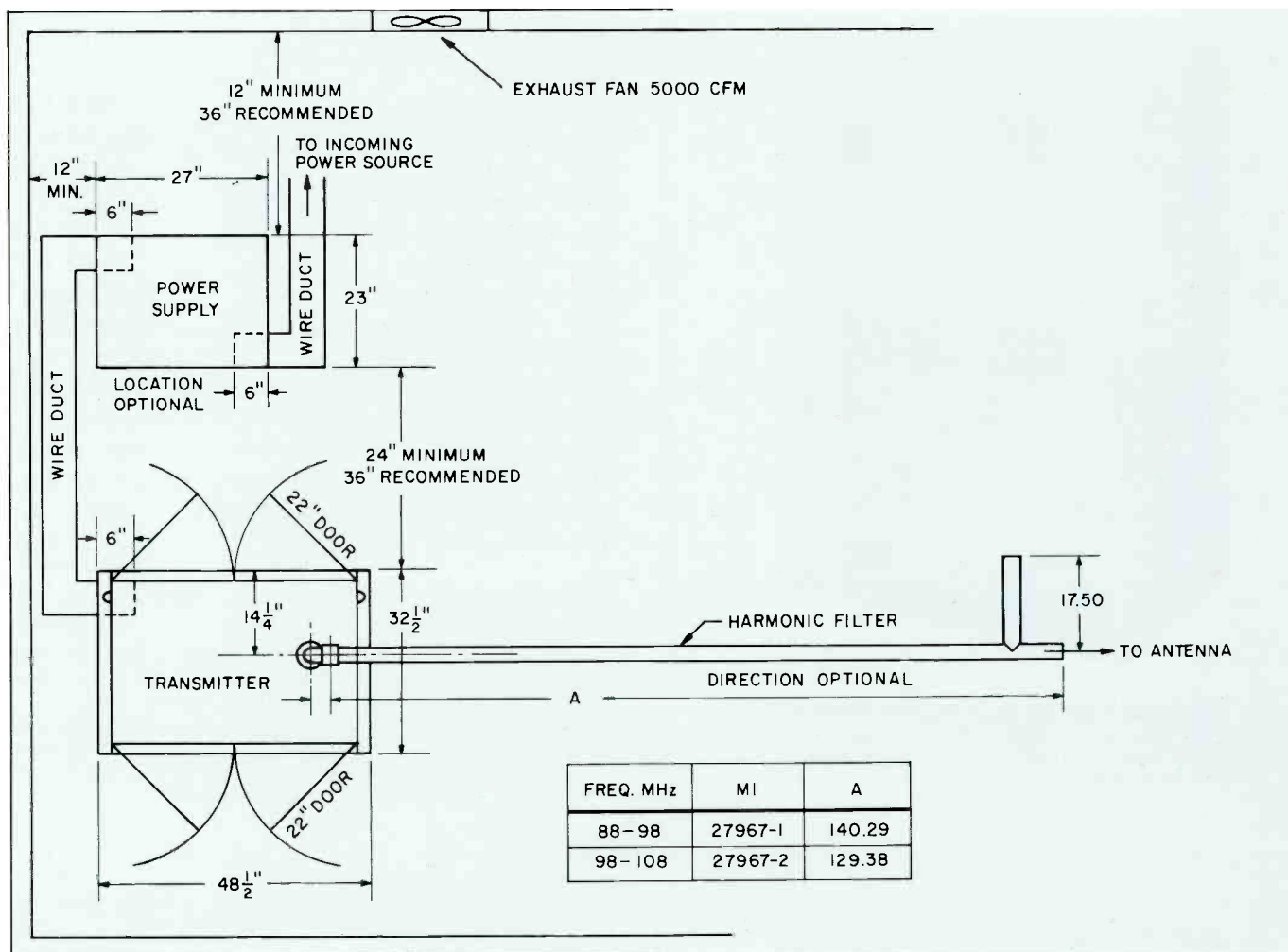

Space-saving floor plan of the BTF-5E1. The separate, unitized power supply may be installed in the basement, attic, closet, or other convenient place. (Wire duct and fan shown are not furnished.)

Accessories

- Recommended Spare RF Transistors for ExciterMI-560718
- Spare Crystal and Oven
(Specify operating frequency)MI-560717
- 5-kW RF Load and WattmeterMI-561422
- Type BTR-11B Remote Control System
(10-function) ES-34280

- Type BTR-20D Remote Control System
(20-function) ES-34274-C
- Type BW-75A FM Frequency and
Modulation MonitorMI-560735
- Type BW-85A Stereo Frequency and
Modulation MonitorMI-560740
- Type BW-95A SCA Frequency and
Modulation MonitorMI-560745

Ordering Information

Type BTF-5E1 5-kW FM Transmitter ES-560600*

*Please specify assigned frequency, power-line frequency, and altitude of installation and select BTE-15A Exciter System from the following:

- Mono ES-560631
- Mono and one SCA Channel ES-560632
- Mono and two SCA Channels ES-560633
- Stereo ES-560634
- Stereo and one SCA Channel ES-560635
- Stereo and two SCA Channels ES-560636

RCA 10-KW FM Transmitter, Type BTF-10E1

- New solid-state exciter
- Ultra stable—easy to tune
- Available for mono or stereo
—with or without SCA
- Power increase to 20-KW
- Ready for remote control



10-KW FM Broadcast Transmitter

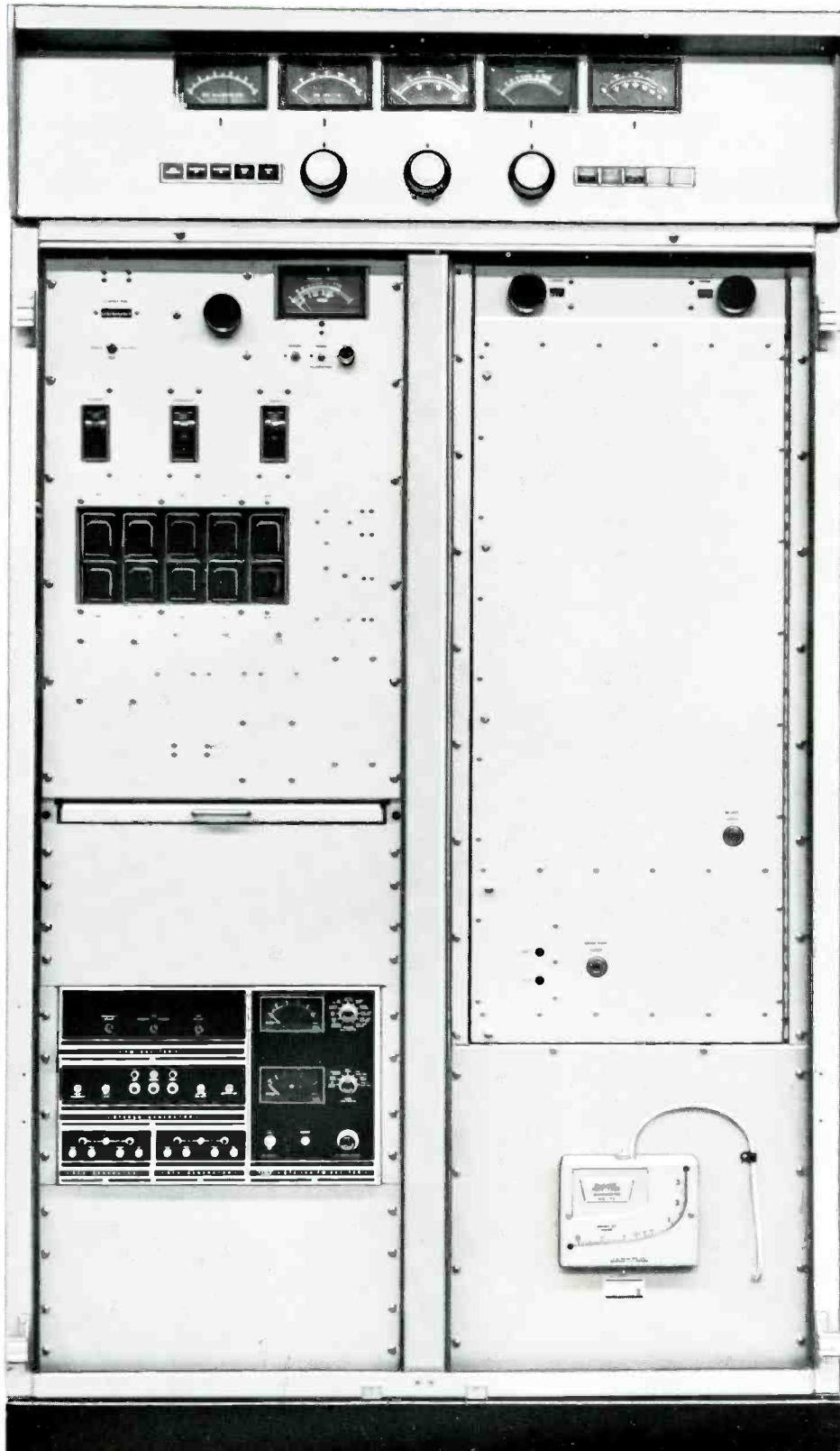

Eye-level
metering

Centralized
Controls

Ready for
remote control

Self-protected
against overload

Tilt down chassis
for easy maintenance

Direct-FM
Exciter

Complete
Accessibility

Two Stages Follow
Exciter—IPA and PA

"Filter-Minder"
Manometer

Optional Stereo
Sub-Carrier Generator

Fully
Air Cooled

Full-Fidelity FM Transmitter, Type BTF-10E1

RCA's Type BTF-10E1 FM Broadcast Transmitter provides 10,000 Watts output for stations operating in the 88-to-108 MHz band. It is designed to provide the finest possible performance and reliability, and is specifically built to meet or exceed the stringent requirements of multiplex service transmission. The equipment is FCC type accepted and meets all requirements for harmonic and spurious emission.

The BTF-10E1 employs a new type BTE-15A Exciter that uses the time-tested and field-proven RCA *Direct FM* System. The circuits employ all solid-state components. Their inherent long-life and cool operation assure extended reliability and lend themselves particularly to unattended, remote operation.

Frequency response of the transmitter's main channel is 30 to 15,000 Hz (± 1 dB maximum) and the distortion over the same bandwidth is less than one-half of one percent.

A new feature of the transmitter is the built-in manometer. This device indicates air-filter efficiency and warns of reduced cooling-air supply over the power tubes. Properly used, the manometer can add hundreds of hours to power-tube life.

The BTF-10E1 is designed specifically to be field-expandable to a 20-kW transmitter. It is noteworthy that this expansion is substantially electrical and there is no increase in floor-space requirement.

Description

Mono or Stereo

The transmitter features a new exciter designed for stereo and multiplex. The exciter, including its self-contained power supply, is mounted on a single vertical chassis.

Two Stages Follow Exciter

From the 15-Watt output of the exciter, only two tubes are required for full 10-kW output. A harmonic filter is included to reduce spurious radiation. Vacuum capacitors are used to tune the IPA plate and the PA grid. In the power amplifiers, all adjustments are at ground potential.

Ready for Remote Control

The transmitter is designed and built for remotely-controlled operation. Internal wiring and terminals are provided for remote control of these transmitter functions: transmitter on/off; output power raise/lower and overload reset. Remote metering facilities for the PA include: cathode current; plate voltage and power output.

New Styling

Functional styling combined with fewer tubes permits the BTF-10E1 to be housed in a single, double-door cabinet in a new midnight blue and shadow blue textured vinyl finish. For contrast, the meter panel is in bright aluminum and the cabinet is trimmed in satin-finished aluminum. The swing-out doors in the front and rear afford the excellent accessibility for which RCA transmitters are famous.

Operating controls and meters are mounted on a panel above the front doors.

Field Expandable to 20-kW

Since the BTF-10E1 is, basically, a 20-kW transmitter operating at 10-kW, it is readily modified, after installation, to a 20-kW output. It is noteworthy that this expansion in power capability requires no additional floor space.

Expansion of the power output is particularly valuable if the station using a BTF-10E1 decides to combine horizontally- and vertically-polarized signals. This feature avoids any change in floor plan as a result of the power increase.

BTE-15A FM Exciter

Excellent monaural, stereo and SCA

performance that more than meets industry and FCC standards are achieved by the new RCA modular, solid-state "Direct FM" exciter.

Simplified Circuits

Modulation of the temperature compensated basic on-frequency oscillator is achieved by applying the composite stereo or SCA signals from the BTS-1B and BTX-1B Generators, respectively, to a pair of push-pull varicap diodes which are coupled to the basic oscillator frequency determining resonant circuit. The output of the basic oscillator is isolated from the following buffer amplifier by a 10 dB resistive attenuator. Thus, the stability and modulation characteristics of the basic direct FM oscillator are not disturbed by following RF power amplifiers.

The output of the buffer amplifier, approximately 500 mW, is used to drive the 15-Watt, three-stage RF amplifier as well as the binary divider chain in the AFC circuit. The basic oscillator, buffer amplifier, and AFC circuit are mounted inside a shielded enclosure. The RF power amplifier is also completely shielded.

Select Features

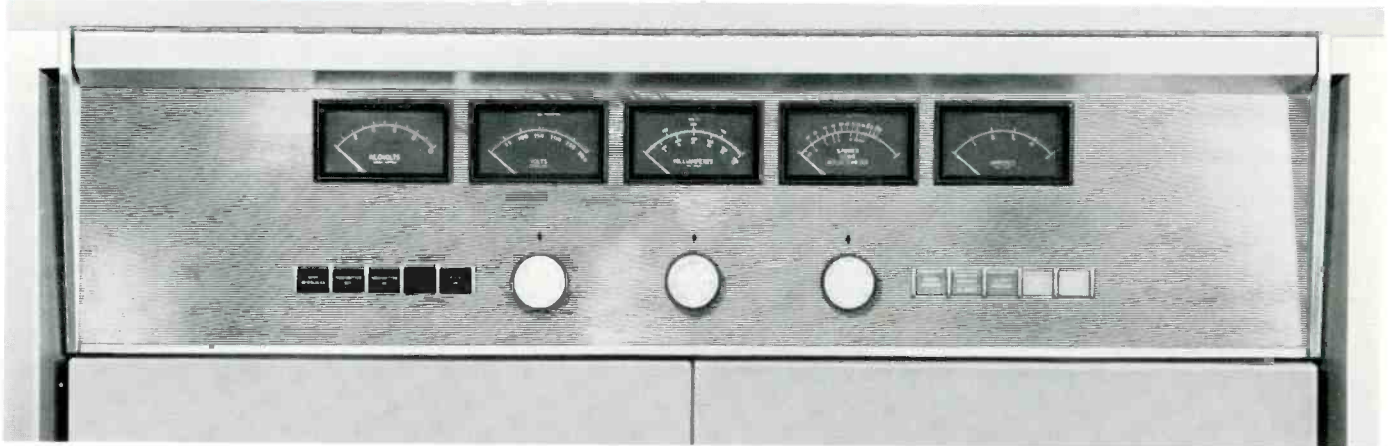

BTF-10E1 Control Panel. Tally lights and push-button controls simplify operation.

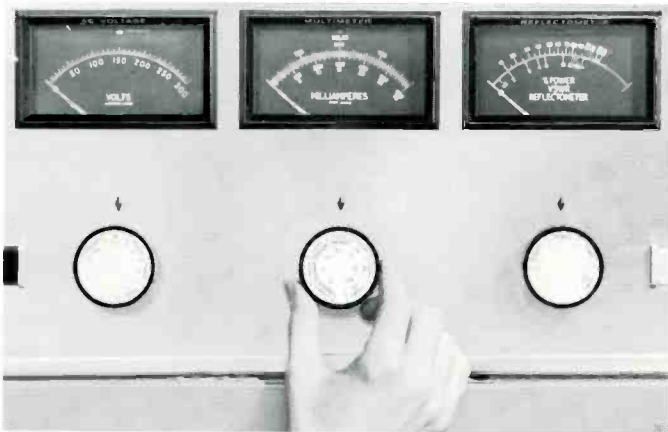

The large-diameter multimeter knobs speed log-keeping and minimize error.



New solid-state FM Exciter system, Type BTE-15A, showing "Direct FM" exciter housed with optional stereo generator and SCA generator units.

"On Carrier" Frequency Operation

Automatic frequency control (AFC) for the on-frequency basic oscillator is achieved by taking a sample of the buffer output frequency and dividing it by two, 14 times. A low-frequency reference crystal operating at 1/1024th of the desired output frequency is divided by two, 4 times. Integrated circuits operating in the saturated mode are used in both binary dividing chains. The outputs from the reference and basic oscillator binary dividers are phase compared in a time-sharing IC comparator. The output of the circuit, which represents the AFC error voltage, is filtered and applied to another pair of varicap diodes coupled to the basic oscil-

lator tuned circuit. Thus, the basic oscillator is phase locked to the 1024th harmonic of the oven controlled reference crystal.

An off-frequency detector is incorporated in the design of the BTE-15A FM Exciter. When the basic oscillator frequency is not phase locked to the reference crystal, an AC component appears at the AFC output. This voltage is rectified to operate a relay whose contacts can be used to turn off the FM transmitter.

Two multimeters are located on the hinged door in front of the regulated power supply section. One of these meters is used to indicate power supply and operating voltages within the exciter and

15-Watt RF Amplifier. The second meter is a peak-reading voltmeter that is used to indicate all modulating signal levels.

The RF power output of the BTE-15A can be continuously adjusted from the front panel control from 7 to 15 Watts. The primary power is turned on with a circuit breaker. RF output is turned on with a front panel switch or by jumping contacts available on the rear of the unit. The exciter will tolerate load mismatches from short circuit to open circuit for a reasonable time without damaging the output transistor. Another safety feature prevents turning on the 41 kHz SCA sub-carrier when the BTS-1B Stereo Generator is in the stereo mode.

Class "C" Power Amplifiers

Two simplified, single-ended amplifiers, operating in class "C", follow the exciter. The 250-Watt IPA stage uses a Type 7203/4CX250B tube, and the final power amplifier uses a Type 4CX10000A (ceramic) tetrode. Vacuum variable capacitors tune the pi network between driver and PA. The power amplifier, too, uses pi-network circuitry and tuning is accomplished by variable inductors operating at ground potential.

10-kW Class "C" Final Amplifier

The output tube, a ceramic tetrode, 4CX10000D, offers very high power-gain with little drive. Using this tube, only two stages of amplification are required between the exciter output and the antenna for the 10,000-Watt output. Fewer components result in improved reliability.

Motor-Driven Power-Output Control

Power output is controlled by means of a motor-driven variable transformer

which controls the low-voltage power supply. This supply controls the driver-plate and the screen voltages of both stages simultaneously. A separate grid bias supply increases transmitter stability and reliability. The use of semiconductor (silicon) rectifiers reduces operating and maintenance costs.

Harmonic Filter Standard Equipment

To keep spurious emission to a minimum, a harmonic filter is standard equipment with the BTF-10E1. The filter consists of an "M"-derived "half-T" sections, several low-pass filter sections, and a constant-"K", "half-T" section. Attenuation of all harmonics through the seventh is accomplished by the passband of the low-pass filter sections, while the constant-"K", "half-T" section serves as a 50-Ohm termination impedance.

Self-Protected Against Overload

Power circuits are protected by mag-

netically-tripped circuit breakers in addition to overload relays. An interlock system prevents turn-on of plate power until all filaments have heated and the exciter has reached a proper operating condition. In addition, a latching relay automatically re-applies power to the transmitter once before locking-out in the event of transient overloads or power interruptions. The overload relays are reset by illuminated push button switches on the front panel. Separate tally-light indicators are provided for overloads in the driver, power amplifier and low voltage rectifier circuits.

Fully Air-Cooled

Cooling air for the BTF-10E1 is supplied by a squirrel-cage blower mounted below the amplifier stages. Heavy sound insulation reduces blower noise to a minimum. The blower supplies forced air to both the IPA and PA stages.

Since the "drag" of a clogged air filter can reduce power-tube life, the transmit-

Simplified block diagram of BTF-10E1, showing optional stereo and SCA.

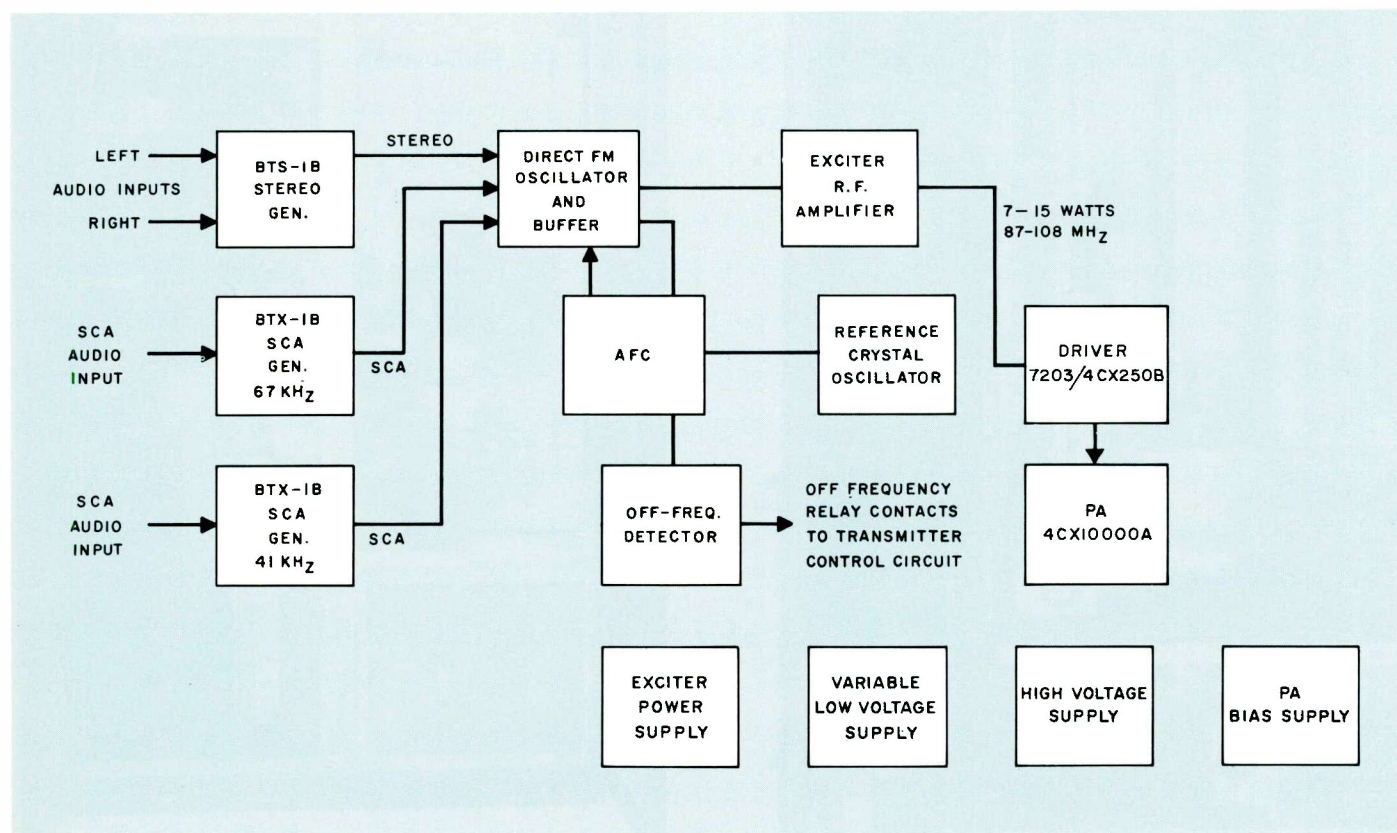

ter monitors this drag with a high-resolution manometer. This device senses the relative air pressure at the fan "side" of the fiber-glass filter in inches of water. Properly monitored, the manometer indicates when filter clog has reduced the volume of cooling air supplied to the power tubes. Maintenance of filter efficiency is very important in realization of the potential life of the power tubes.

Simplified Control

The transmitter has all operating controls and meters located on a panel just above the front doors. The push-button controls include: transmitter on/off, plate

on/off, overload reset and power raise/lower. A cabinet disconnect switch, low-voltage circuit breaker, and filament control circuit breakers are located behind the left-hand door. The main- and low-power circuit breakers are located in the unitized rectifier cabinet. When servicing the BTF-10E1, operation of the disconnect switch removes all voltages from the transmitter cabinet. Personnel are also protected by fully interlocked rear doors in addition to interlocked doors on the PA cubicle.

Full Metering

Six easy-to-read front-panel meters are

provided for each amplifier. One for PA-plate voltage, another for PA-plate current, and a third for AC line and filament voltage. The remaining three are a reflectometer indicating output, a multimeter and VSWR meter. Separate meters are used to measure the forward power and VSWR. The multimeter reads grid current, screen current and screen voltage of both power tubes. In addition to this metering, the exciter has its own self-contained multimeter. This one provides complete information on operating conditions in the exciter.

ONLY TWO TUBES BETWEEN EXCITER AND OUTPUT—View showing interior of PA and IPA cabinet with the 4CX10000A ceramic tetrode and one 7203/4CX250B IPA tube below shelf. These supply the necessary power for the full fidelity BTF-10E1.

COMPLETE ACCESSIBILITY—Rear view of the BTF-10E1 revealing the clean, vertical construction of PA cavity to left and control panel to right.

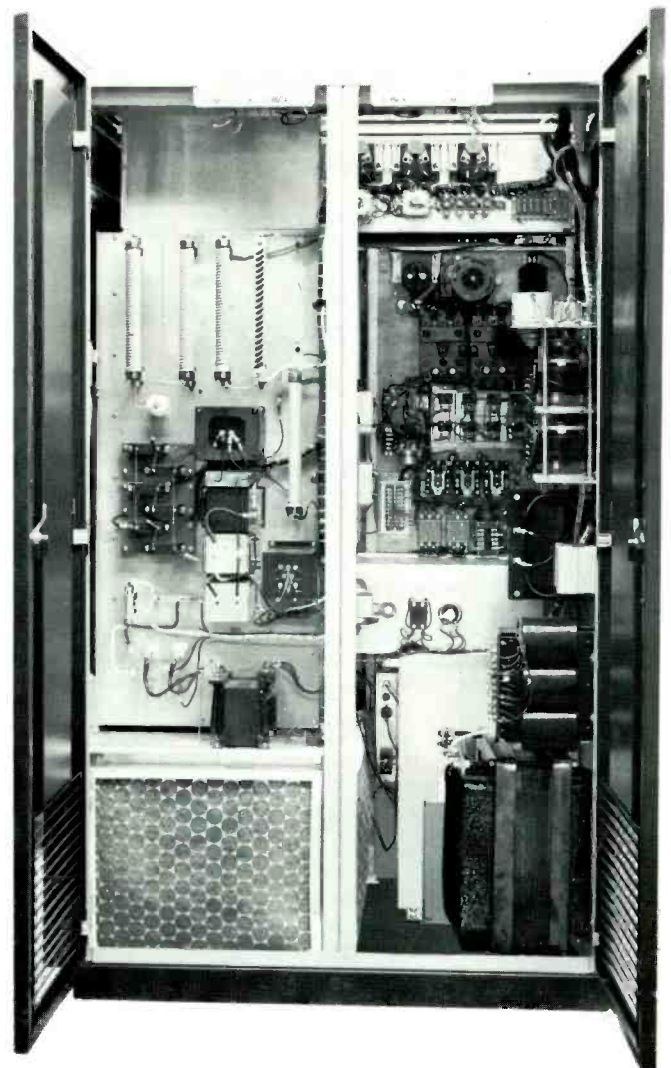
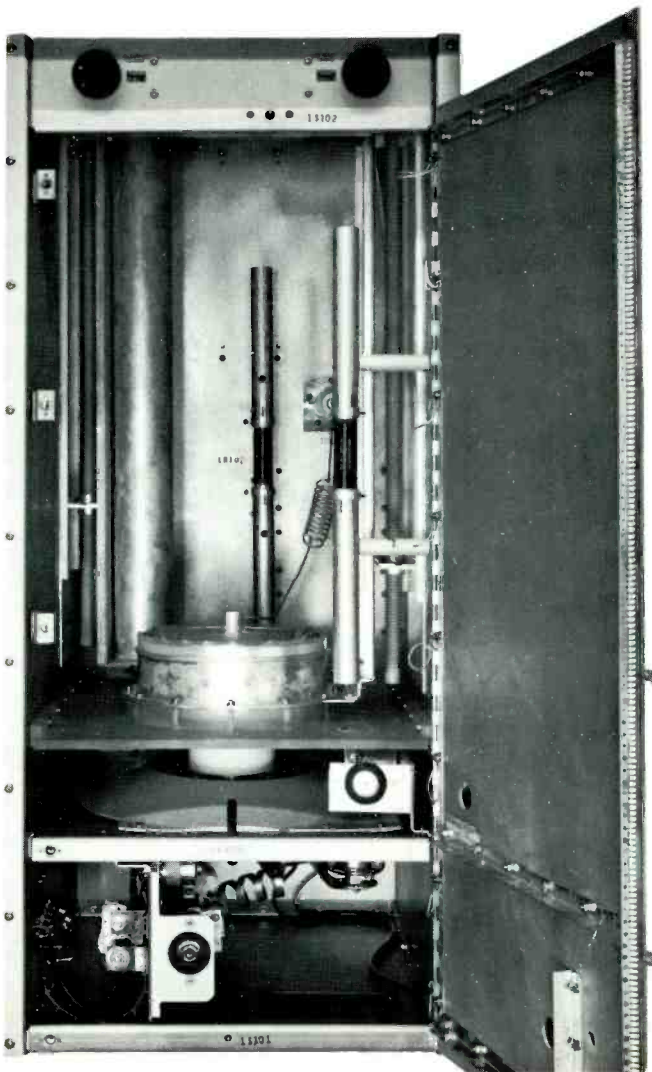

Specifications

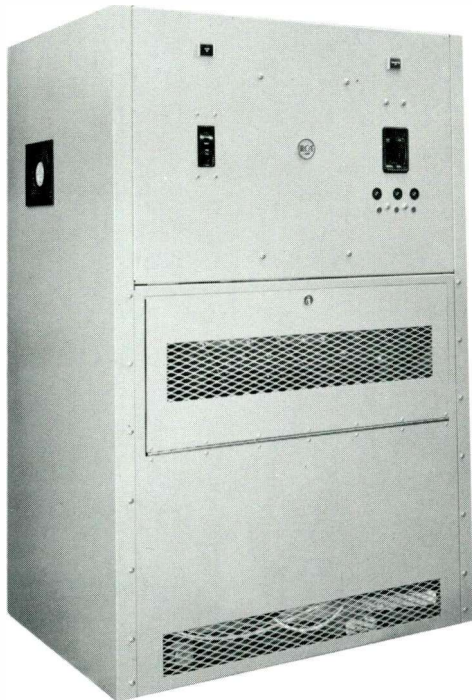

UNITIZED HIGH VOLTAGE POWER SUPPLY—With location not tied to the transmitter, the unitized power supply affords many installation and operating economies.

MODULAR SILICON RECTIFIERS—Quality components such as this plug-in silicon high voltage rectifier are important elements in the BTF-10E1's superior performance.

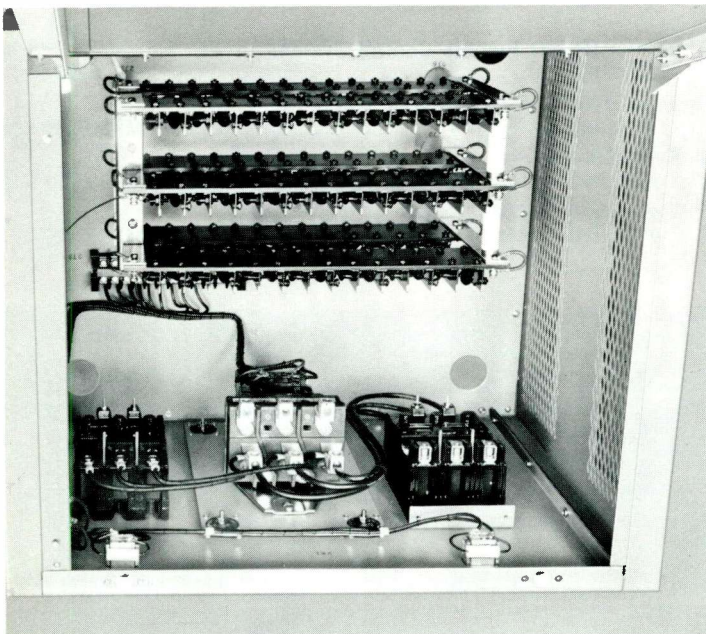

Performance

Type of Emission.....	F3 and F9
Frequency Range.....	.88 to 108 MHz
Power Output	10 kW
Output Impedance (3½" O.D. Line)	50 Ohms
Frequency Deviation 100% modulation.....	±75 kHz
Modulation Capability	±100 kHz
Carrier Frequency Stability.....	±1000 Hz max.
Audio Input Impedance.....	600/150 Ohms
Audio Input Level—*(100% mod.).....	+10 ±2 dBm
Audio Frequency Response—**(50-15,000 Hz)	±1 dB max.
Pre-emphasis Network Time Constant.....	75 or 50 μs, as desired
Harmonic Distortion—*** (50-15,000 Hz)	0.5% or less
FM Noise Level (referred to 100% FM mod.).....	-65 dB max.
AM Noise Level (referred to 100% AM mod.).....	-50 dB max.
Subcarrier Input Level (100% mod.)	-15 to +10 dBm adjustable
Subcarrier Input Impedance	600/150 Ohms bal.
Subcarrier Frequency	20-67 kHz
Main-to-Subchannel Crosstalk.....	-50 dB referred to ±7.5 kHz deviation of the subcarrier by a 400 Hz tone. Main channel modulation 70% by 50-15,000 Hz tones.
Sub-to-Main Channel Crosstalk.....	-60 dB referred to ±7.5 kHz deviation of the main carrier by a 400 Hz tone. Subchannel modulation 100% (±7.5 kHz) by 50-6000 Hz tones. Subcarrier modulated 30% on main carrier.

Electrical

Power Line Requirements:

Line.....	240/208 Volt, 3 phase, 50/60 Hz
Combined Line Voltage Variation and Regulation.....	±5%
Power Consumption.....	19,000 Watts (approx.)
Power Factor (approx.).....	90%

Tube Complement

Driver:

1—7203/4CX250B

Power Amplifier:

1—4CX10000A

Mechanical

Dimensions (overall):	Transmitter	High-Voltage Power Supply
Width	48½" (123 cm)	27" (68.6 cm)
Height	77" (195.6 cm)	43" (109.2 cm)
Depth	32½" (82.5 cm)	23" (58.5 cm)
Weight (approx.)	1300 lbs. (589.7 kg.)	840 lbs. (381 kg.)
Finish	Textured Vinyl in midnight blue and shadow blue, satin-aluminum trim.	
Altitude	7500 ft.† (2290 M)	
Ambient Temperature Range.....	-20° to +45°C	

* Level measured at input terminal J1.

** Audio Frequency response referred to 50- or 75-microsecond pre-emphasis curve.

*** Distortion includes all harmonics up to 30 kHz and is measured following a standard 50- or 75-microsecond de-emphasis network.

† Blowers can be provided for operation at higher altitudes.

Specifications subject to change without notice.

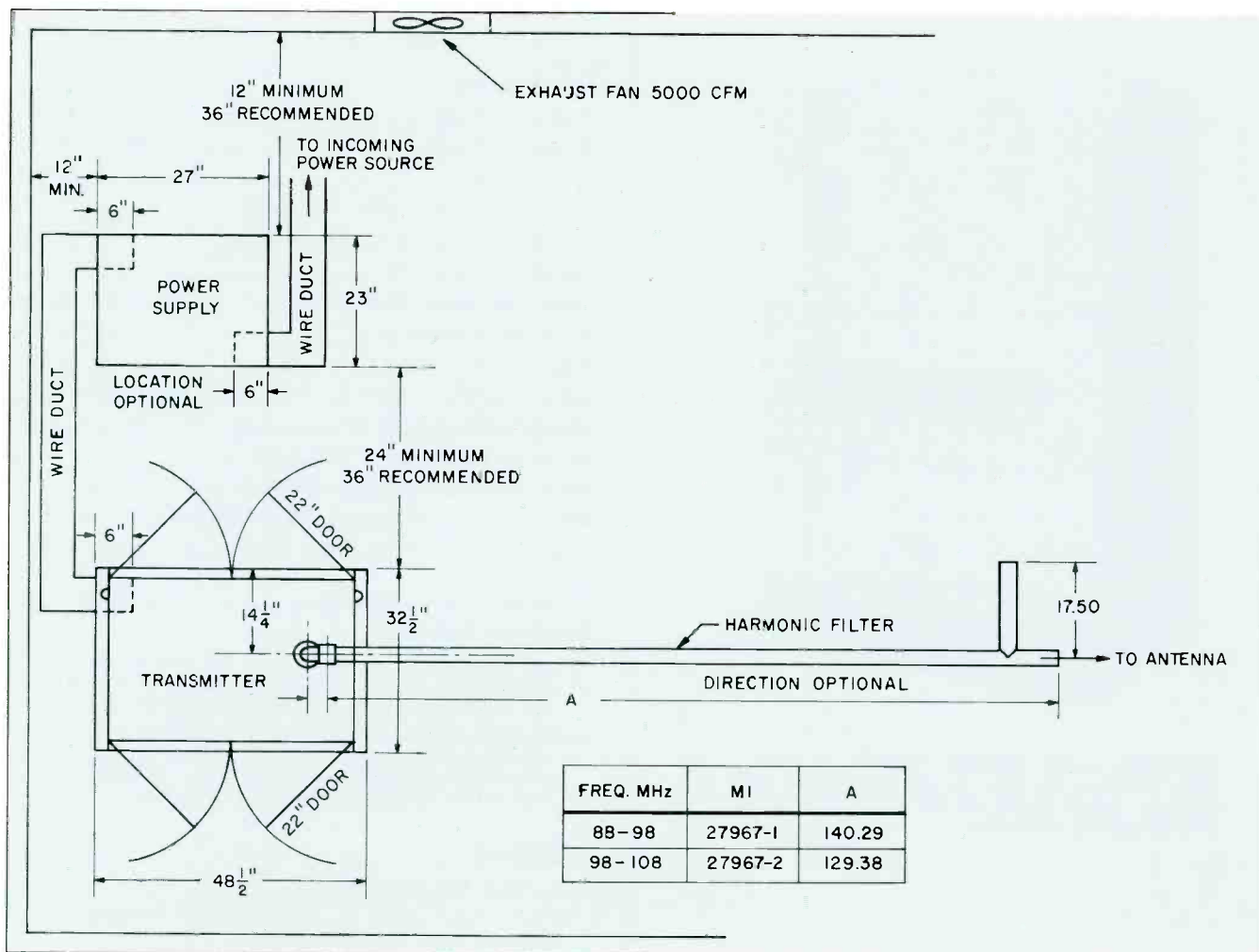

Space-saving floor plan of the BTF-10E1. The separate, unitized power supply may be installed in a basement, attic, closet or other convenient place. (Wire duct and fan shown are not furnished.)

Accessories

- Recommended Spare RF Transistors for ExciterMI-560718
- Spare Crystal and Oven
(Specify operating frequency)MI-560717
- Complete Set of Spare Tubes ES-560608
- 10-kW RF Load and WattmeterMI-19267
- Type BTR-11B Remote Control System
(10-function) ES-34280

- Type BTR-20D Remote Control System
(20-function) ES-34274-C
- Type BW-75A FM Frequency and
Modulation MonitorMI-560735
- Type BW-85A Stereo Frequency and
Modulation MonitorMI-560740
- Type BW-95A SCA Frequency and
Modulation MonitorMI-560745

Ordering Information

- Type BTF-10E1 10-kW FM Transmitter ES-560601
- Please specify assigned frequency, power-line frequency and altitude of installation and select BTE-15A Exciter System from the following:

- Mono ES-560631
- Mono and one SCA Channel ES-560632
- Mono and two SCA Channels ES-560633
- Stereo ES-560634
- Stereo and one SCA Channel ES-560635
- Stereo and two SCA Channels ES-560636

RCA 20-KW FM Transmitter, Type BTF-20E1

- New solid-state exciter
- Ultra stable—easy to tune
- Available for mono or stereo
—with or without SCA
- 100 KW ERP with 6-section
antenna
- Ready for remote control



20-KW FM Broadcast Transmitter

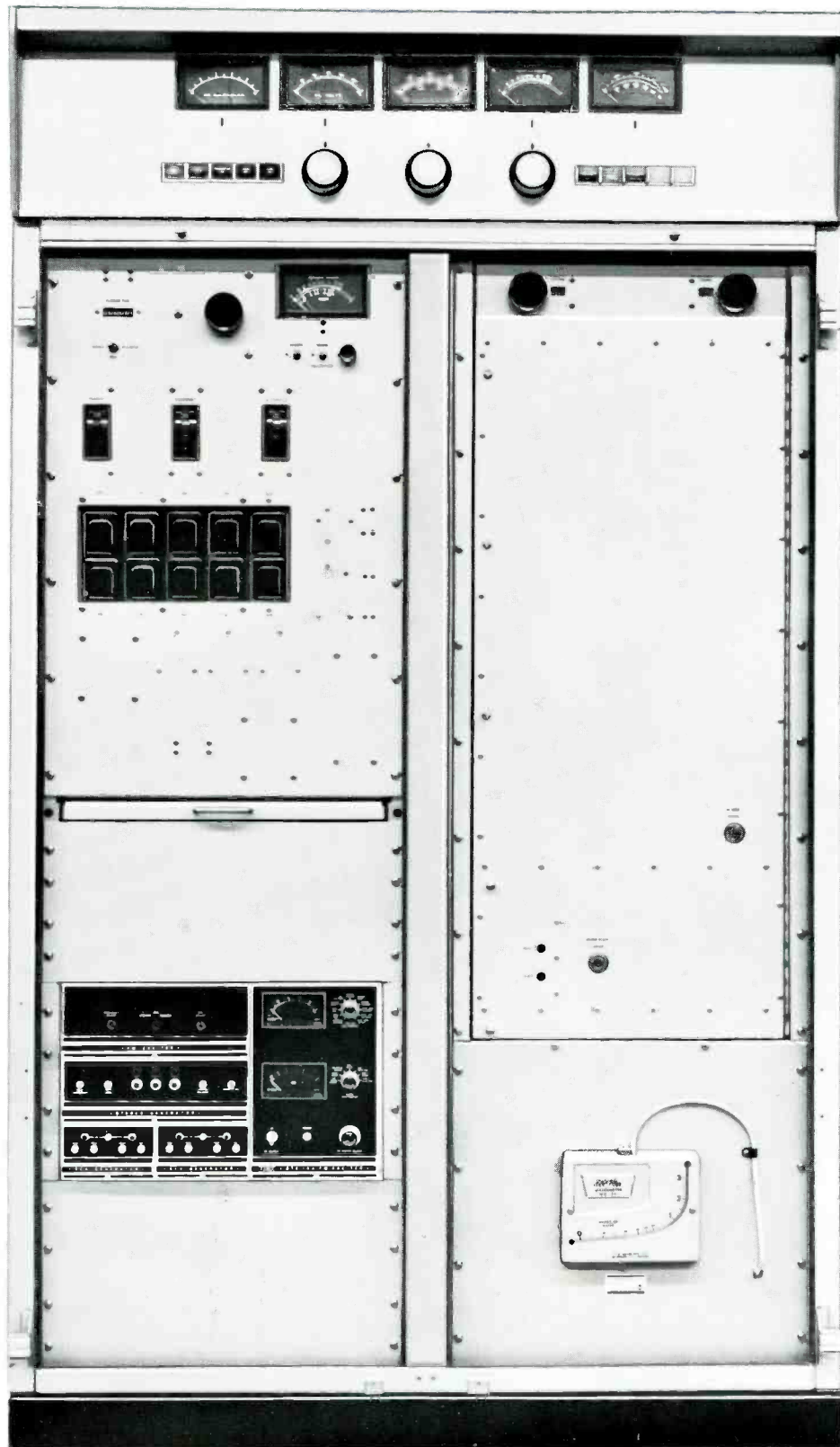

Centralized Controls

Ready for remote control

Self-protected against overload

Tilt down chassis for easy maintenance

Direct-FM Exciter

Eye-level metering

Complete Accessibility

Two Stages Follow Exciter—IPA and PA

"Filter-Minder" Manometer

Rack Space for Optional Stereo Sub-Carrier Generator

Fully Air Cooled

Full-Fidelity FM Transmitter, Type BTF-20E1

The RCA Type BTF-20E1 20-kW FM Broadcast Transmitter is designed for high-power operation in the standard FM band, 88-108 MHz, and is specifically engineered to meet and exceed the stringent requirements of multiplex service transmission and stereo programming as specified by the FCC.

The BTF-20E1 employs a new Type BTE-15A Exciter that uses the time-tested and field-proven *direct FM* system. The circuits employ all solid-state components. Their inherent long-life and cool operation assure extended reliability and lend themselves particularly to unattended, remote operation.

The transmitter features a Type 4CX-15000A Power Amplifier driven by two 7203/4CX250B tubes in the IPA stage.

Silicon-rectifier power supplies also provide long life and dependability. All RF circuits are single tuned for utmost tuning simplicity. Except for the high voltage power supply, the transmitter is housed in a single, modern-styled, two-door cabinet.

Frequency response of the transmitter's main channel is 30 to 15,000 Hz (± 1 dB maximum) and distortion over the same range is 0.5 percent or less.

A useful feature of the transmitter is the built-in manometer. This device indicates air filter efficiency and warns of reduced cooling-air supply over the power tubes. Properly used, this device can add hundreds of hours to tube life.

Description

Mono or Stereo

The transmitter features a new exciter designed for stereo and multiplex. The exciter, including its self-contained power supply, is mounted on a single vertical chassis.

Two Stages Follow Exciter

From the output of the exciter, only three tubes, two in the IPA and a ceramic-tetrode 4CX-15000A PA generate the full 20-kW signal. A harmonic filter is furnished to reduce spurious radiation.

Vacuum capacitors are used to tune the IPA plate and PA grid. In the power amplifier, all adjustments are at ground potential.

Ready for Remote Control

The transmitter has been designed and built for remote controlled operation. Terminals are provided for remote control of transmitter on/off, raise/lower power and overload reset, while remote metering connections for the PA include cathode current, plate voltage and power output.

New Styling

Functional styling together with fewer tubes and components has permitted the new BTF-20E1 transmitter to be housed in a single, double-door cabinet, in a new midnight blue and shadow blue finish, set off with aluminum meter panel and trim. Maximum accessibility is afforded by swing-out doors on the front and rear of the cabinet. All operating controls and meters used for rapid check of transmitter functions are located on a panel above the front doors. A separate unitized high-voltage power supply may be located anywhere in the FM station.

BTE-15A FM Exciter

Excellent monaural, stereo and SCA performance that more than meets industry and FCC standards are achieved by the new RCA modular, solid-state "Direct FM" exciter.

Simplified Circuits

Modulation of the temperature compensated basic on-frequency oscillator is

achieved by applying the composite stereo or SCA signals from the BTS-1B and BTX-1B Generators, respectively, to a pair of push-pull varicap diodes which are coupled to the basic oscillator frequency determining resonant circuit. The output of the basic oscillator is isolated from the following buffer amplifier by a 10 dB resistive attenuator. Thus, the stability and modulation characteristics of the basic direct FM oscillator are not disturbed by following RF power amplifiers.

The output of the buffer amplifier, approximately 500 mW, is used to drive the 15-Watt, three-stage RF amplifier as well as the binary divider chain in the AFC circuit. The basic oscillator, buffer amplifier, and AFC circuit are mounted inside a shielded enclosure. The RF power amplifier is also completely shielded.

Automatic frequency control (AFC) for the on-frequency basic oscillator is achieved by taking a sample of the buffer output frequency and dividing it by two, 14 times. A low-frequency reference crystal operating at 1/1024th of the desired

Select Features

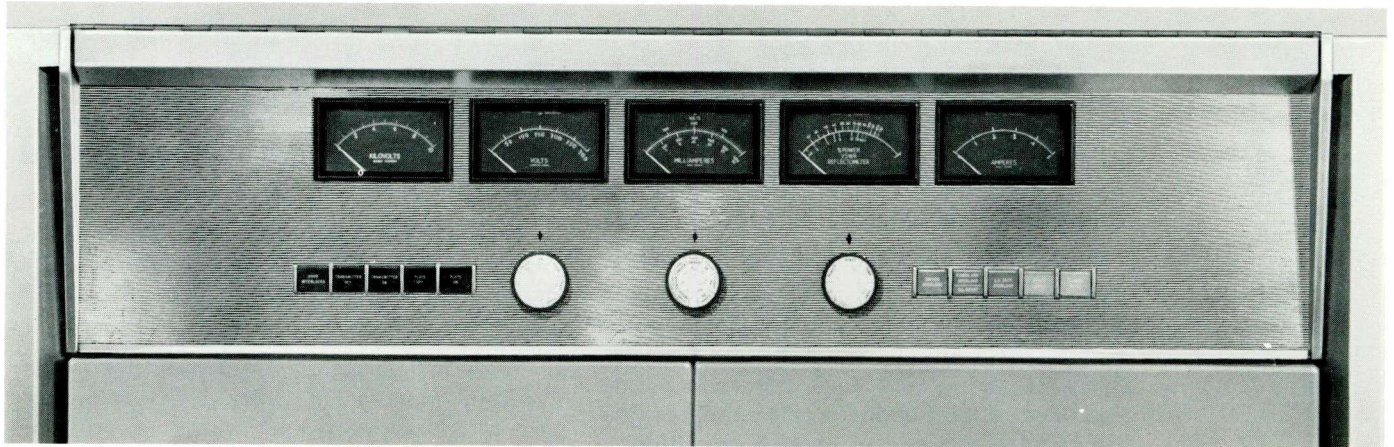

BTF-20E1 Control Panel. Tally lights and push-button controls simplify operation.

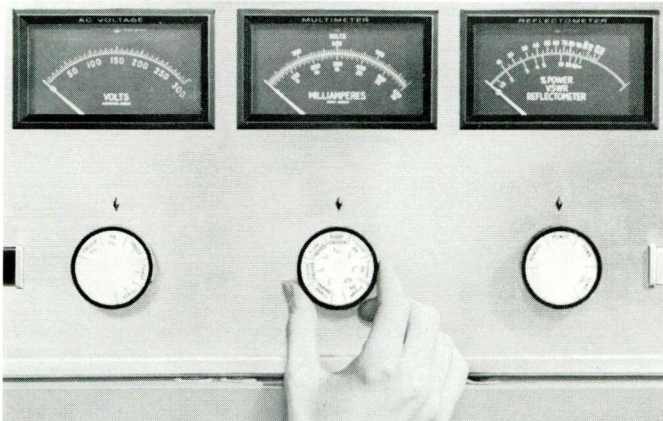

The large-diameter multimeter knobs speed log-keeping and minimize error.



New solid-state FM Exciter system, Type BTE-15A, showing "Direct FM" exciter housed with optional stereo generator and SCA generator units.

output frequency is divided by two, 4 times. Integrated circuits operating in the saturated mode are used in both binary dividing chains. The outputs from the reference and basic oscillator binary dividers are phase compared in a time-sharing IC comparator. The output of the circuit, which represents the AFC error voltage, is filtered and applied to another pair of varicap diodes coupled to the basic oscillator tuned circuit. Thus, the basic oscillator is phase locked to the 1024th harmonic of the oven controlled reference crystal.

An off-frequency detector is incorporated in the design of the BTE-15A FM Exciter. When the basic oscillator frequency is not phase locked to the reference crystal, an AC component appears at the AFC output. This voltage is rectified to operate a relay whose contacts can be used to turn off the FM transmitter.

Two multimeters are located on the hinged door in front of the regulated power supply section. One of these meters is used to indicate power supply and operating voltages within the exciter and 15-Watt RF Amplifier. The second meter is

a peak-reading voltmeter that is used to indicate all modulating signal levels.

The RF power output of the BTE-15A can be continuously adjusted from the front panel control from 7 to 15 Watts. The primary power is turned on with a circuit breaker. RF output is turned on with a front panel switch or by jumping contacts available on the rear of the unit. The exciter will tolerate load mismatches from short circuit to open circuit for a reasonable time without damaging the output transistor. Another safety feature prevents turning on the 41 kHz SCA sub-

carrier when the BTS-1B Stereo Generator is in the stereo mode.

Single-Ended Driver Amplifier

Two simplified, single-ended amplifiers (operating Class "C") follow the exciter. The IPA stage consists of two ceramic 7203/4CX250B tetrodes operating in parallel, and the final power amplifier is Type 4CX15000A tube. Variable vacuum capacitors are used to tune the interstage network between driver and PA.

20-kW Class "C" Final Amplifier

The power amplifier also uses pi-network circuitry, however, the tuning of this stage is accomplished by variable inductors operating at ground potential. The output tube is designed for very high power gain with little drive. Power output is controlled by means of a motor-driven variable transformer connected in the primary

of the low voltage power supply for the driver amplifier. This controls the IPA-plate and the PA-screen voltages simultaneously.

For increased transmitter stability and reliability, a separate grid bias supply is incorporated in the BTF-20E1. This supply, too, uses semi-conductor rectifiers.

Harmonic Filter Standard Equipment

To keep spurious emission at a minimum, the transmitter is furnished with a 6 1/8-inch harmonic filter as standard equipment. The filter consists of a series of transmission line elements with a uniform outer diameter conductor, a stepped inner conductor, and a shunt stub. The conductors are fabricated of a high-grade copper alloy. Attenuation of all harmonic radiation above channel limits is accomplished in an "M-derived" section, and a

series of "constant-K" T-sections. This design provides a broad passband with a sharp high-frequency cut-off and excellent attenuation of frequencies above the passband.

Self-Protected Against Overload

Power circuits are protected by magnetically-tripped circuit breakers in addition to overload relays. An interlocked system prevents turn-on of plate power until all filaments have heated and the exciter has reached a proper operating condition. In addition, a latching relay automatically re-applies power to the transmitter once before locking-out in the event of brief overloads or power interruptions. The overload relays are reset by illuminated push-button switches on the front panel. Separate tally-light indicators are provided for overloads in the driver, power amplifier and low voltage rectifier circuits.

Simplified Block Diagram of BTF-20E1 FM Transmitter, showing optional stereo and SCA.

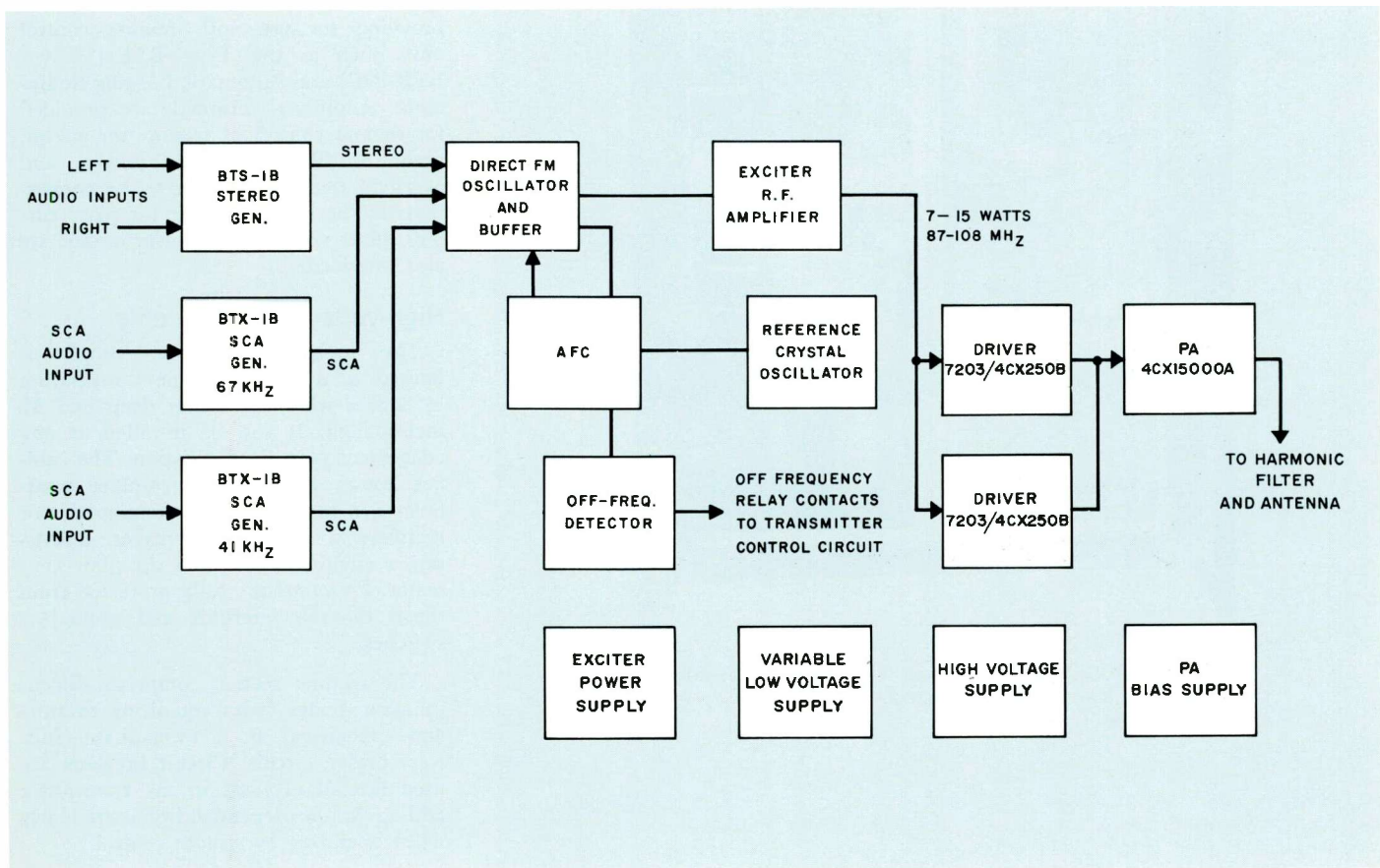

Fully Air-Cooled

Cooling air for the BTF-20E1 is supplied by means of a blower mounted below the amplifier stages. A manometer indicates the efficiency of the fiber-glass filter at the inlet and heavy sound insulation reduces blower noise to a minimum. The blower supplies forced air to both the IPA and PA stages.

Simplified Control

The transmitter has all operating controls and meters located on a panel just above the front doors. The push-button controls include: transmitter on/off, plate on/off, overload reset and power raise/lower. A cabinet disconnect switch, low-voltage circuit-breaker, and filament- and control-circuit breakers are located behind

the left-hand door. The main- and low-power circuit breakers are located in the rectifier unitized cabinet. When servicing the BTF-20E1, operation of the "disconnect" switch removes all voltages from the transmitter cabinet. Personnel are protected by fully interlocked rear doors, in addition to interlocked doors on the RF PA cubicle.

Full Metering

Six easy-to-read front-panel meters are provided for each amplifier. One for PA-plate voltage, another for PA-plate current, and a third for AC-line and filament voltage. The remaining three are a reflectometer indicating output, a multimeter and VSWR meter. Separate meters are used to measure the forward power and VSWR. The multimeter reads the grid current, the screen current and the screen voltage of both power tubes. In addition, the exciter has its own self-contained multimeter. This one provides complete information on operating conditions in the exciter.

Ready for Remote Control

Remote control provisions are included in the transmitter and terminals are provided for use with remote control units such as the Type BTR-11B (or BTR-20E) and Automatic Logging Equipment. Additional terminals are provided for remote control of transmitter on/off, plate on/off, raise/lower power, and overload reset. Remote metering connections in the final amplifier for plate current, plate voltage, and power output are also provided.

High-Voltage Power Supply

The high-voltage power supply is housed in a unitized cabinet measuring 32 inches wide, 23 inches deep and 49 inches high. It can be installed at any convenient place in the station. The cabinet houses the high-voltage-plate transformer, a bank of plug-in semiconductor rectifiers, a line-circuit breaker, a low-power circuit breaker, and the plate contactor. Personnel are fully protected from shock through interlock and grounding switches.

The rectifier section comprises silicon-junction diodes (with equalizing resistors and capacitors) in a three-phase, full-wave-bridge circuit. Circuit breakers are used instead of fuses in the transmitter adding to the dependability particularly when operating by remote control.

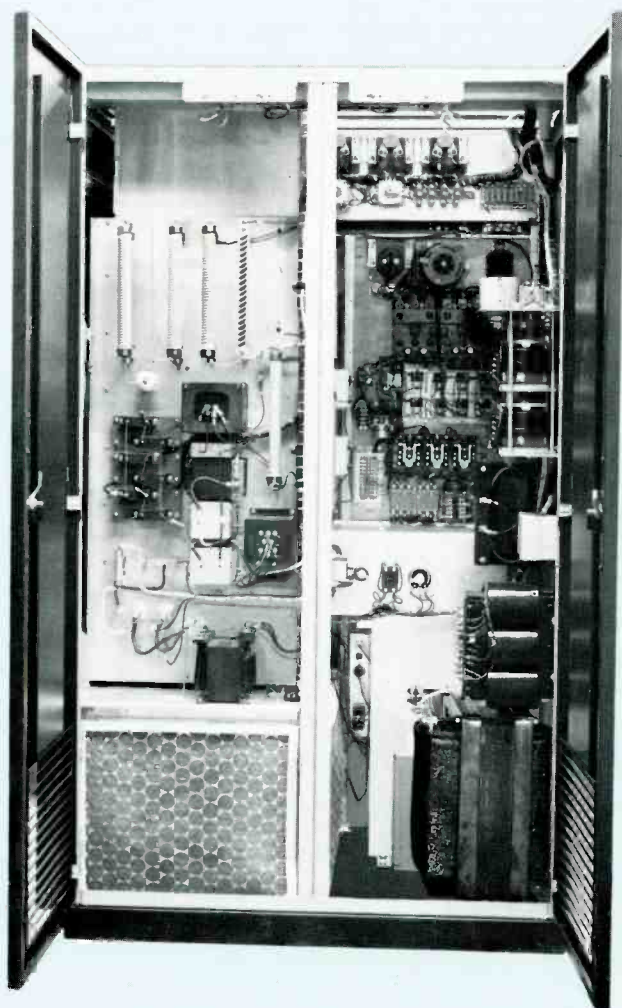

COMPLETE ACCESSIBILITY—Rear view of the BTF-20E1 revealing the clean, vertical construction of PA cavity to left and control panel to right.

Specifications

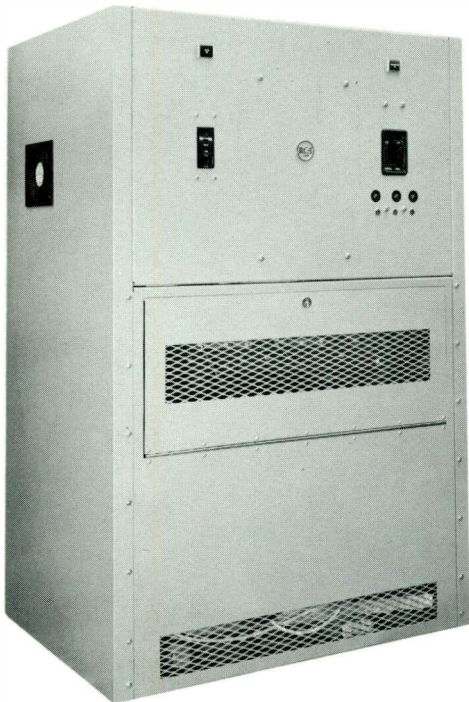

UNITIZED HIGH VOLTAGE POWER SUPPLY—With location not tied to the transmitter, the unitized power supply affords many installation and operating economies.

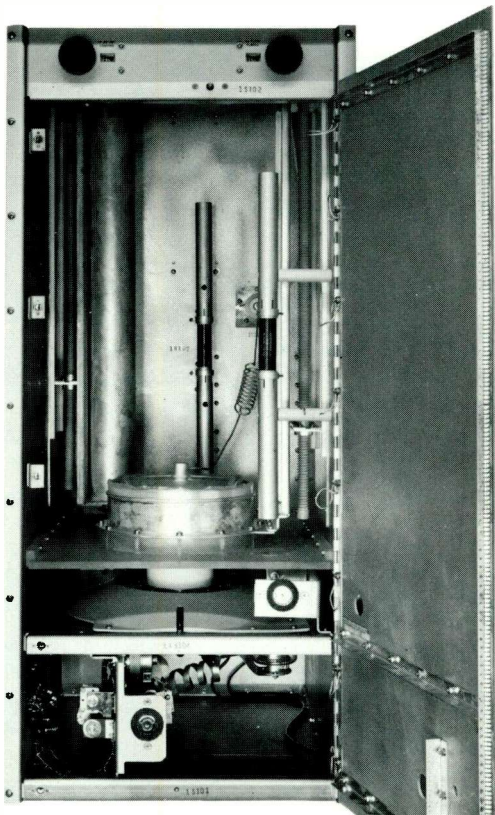

ONLY THREE TUBES BETWEEN EXCITER AND OUTPUT—View showing interior of PA and IPA cabinet with the 4CX15000A ceramic tetrode and two IPA tubes below shelf.

Performance

Type of Emission.....F3 and F9
 Frequency Range.....88 to 108 MHz
 Power Output20 kW
 Output Impedance (3/8" O.D. Line)50 Ohms
 Frequency Deviation 100% modulation.....±75 kHz
 Modulation Capability±100 kHz
 Carrier Frequency Stability.....±1000 Hz max.
 Audio Input ImpedanceResistive, 600/150 Ohms
 Audio Input Level—*(100% mod.).....+10 ±2 dBm
 Audio Frequency Response—**(50-15,000 Hz)±1 dB max.
 Pre-emphasis Network Time Constant.....75 or 50 μs, as desired
 Harmonic Distortion—**(50-15,000 Hz)0.5% or less
 FM Noise Level (referred to 100% FM mod.).....-65 dB max.
 AM Noise Level (referred to 100% AM mod.).....-50 dB max.
 Subcarrier Input Level (100% mod.)-15 to +10 dBm
 adjustable
 Subcarrier Input Impedance600/150 Ohms bal.
 Subcarrier Frequency20-67 kHz
 Main-to-Subchannel Crosstalk....-55 dB referred to ±7.5 kHz
 deviation of the subcarrier by a 400 Hz tone. Main channel
 modulation 70% by 50-15,000 Hz tones.
 Sub-to-Main-Channel Crosstalk....-60 dB referred to ±75 kHz
 deviation of the main carrier by a 400 Hz tone. Subchannel
 modulation 100% (±7.5 kHz) by 50-6000 Hz tones.
 Subcarrier modulated 30% on main carrier.

Electrical

Power Line Requirements:
 Line.....240/208 Volt, 3 phase, 50/60 Hz
 Combined Line Voltage Variation and Regulation.....±5%
 Power Consumption36,000 Watts (approx.)
 Power Factor (approx.).....90%

Tube Complement

Driver:
 2—7203/4CX250B
 Power Amplifier:
 1—4CX15000A

Mechanical

	Transmitter	High-Voltage Power Supply
Dimensions (overall):		
Width	48 1/2" (123 cm)	32" (81.3 cm)
Height	77" (195.6 cm)	49" (124.5 cm)
Depth	32 1/2" (82.5 cm)	23" (58.5 cm)
Weight (approx.)	1425 lbs. (646.4 kg.)	1025 lbs. (164.9 kg.)
Finish	Textured Vinyl in midnight blue and shadow blue, satin-aluminum trim.	
Altitude	7500 ft.† (2290 M)	
Ambient Temperature Range.....	-20° to +45°C	

* Level measured at input terminal J1.

** Audio Frequency response referred to 50- or 75-microsecond pre-emphasis curve.

*** Distortion includes all harmonics up to 30 kHz and is measured following a standard 50- or 75-microsecond de-emphasis network.

† Blowers can be provided for operation at higher altitudes.

Specifications subject to change without notice.

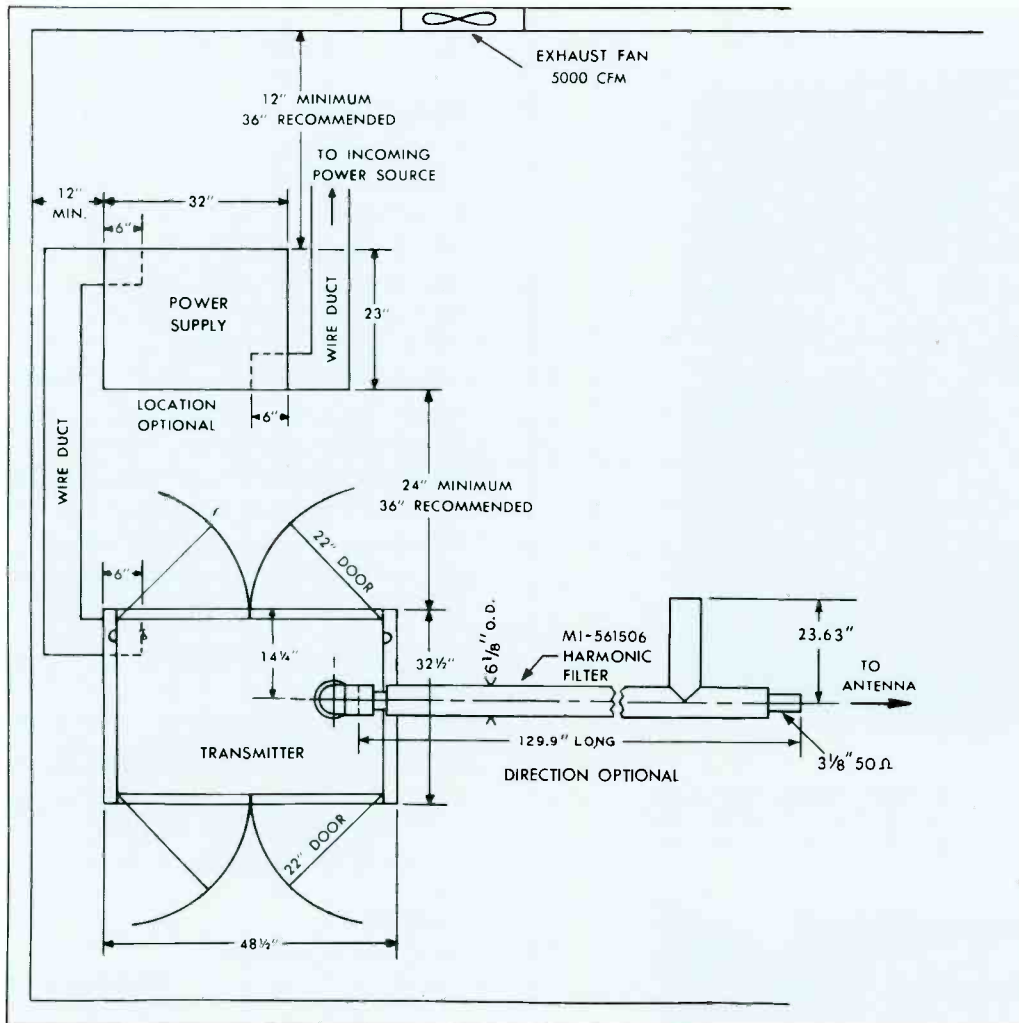

Space-saving floor plan of the BTF-20E1. The separate, unitized power supply may be installed in a basement, attic, closet or other convenient place. (Wire duct and fan shown are not furnished.)

Accessories

- Recommended Spare RF Transistors for ExciterMI-560718
- Spare Crystal and Oven
(Specify operating frequency)MI-560717
- Complete Set of Spare TubesES-560609
- 20-kW RF Load and Wattmeter (water-cooled)MI-19267-L/H
- Type BTR-11B Remote Control System
(10-function)ES-34280

- Type BTR-20D Remote Control System
(20-function)ES-34274-C
- Type BW-75A FM Frequency and
Modulation MonitorMI-560735
- Type BW-85A FM Stereo Frequency and
Modulation MonitorMI-560740
- Type BW-95A SCA Frequency and
Modulation MonitorMI-560745

Ordering Information

Type BTF-20E1 20-kW FM Transmitter ES-560602
 Please specify assigned frequency, power-line frequency and altitude of installation and select BTE-15A Exciter System from the following:

- MonoES-560631
- Mono and one SCA ChannelES-560632
- Mono and two SCA ChannelsES-560633
- StereoES-560634
- Stereo and one SCA ChannelES-560635
- Stereo and two SCA ChannelsES-560636

RCA 40-KW FM Transmitter, Type BTF-40E1

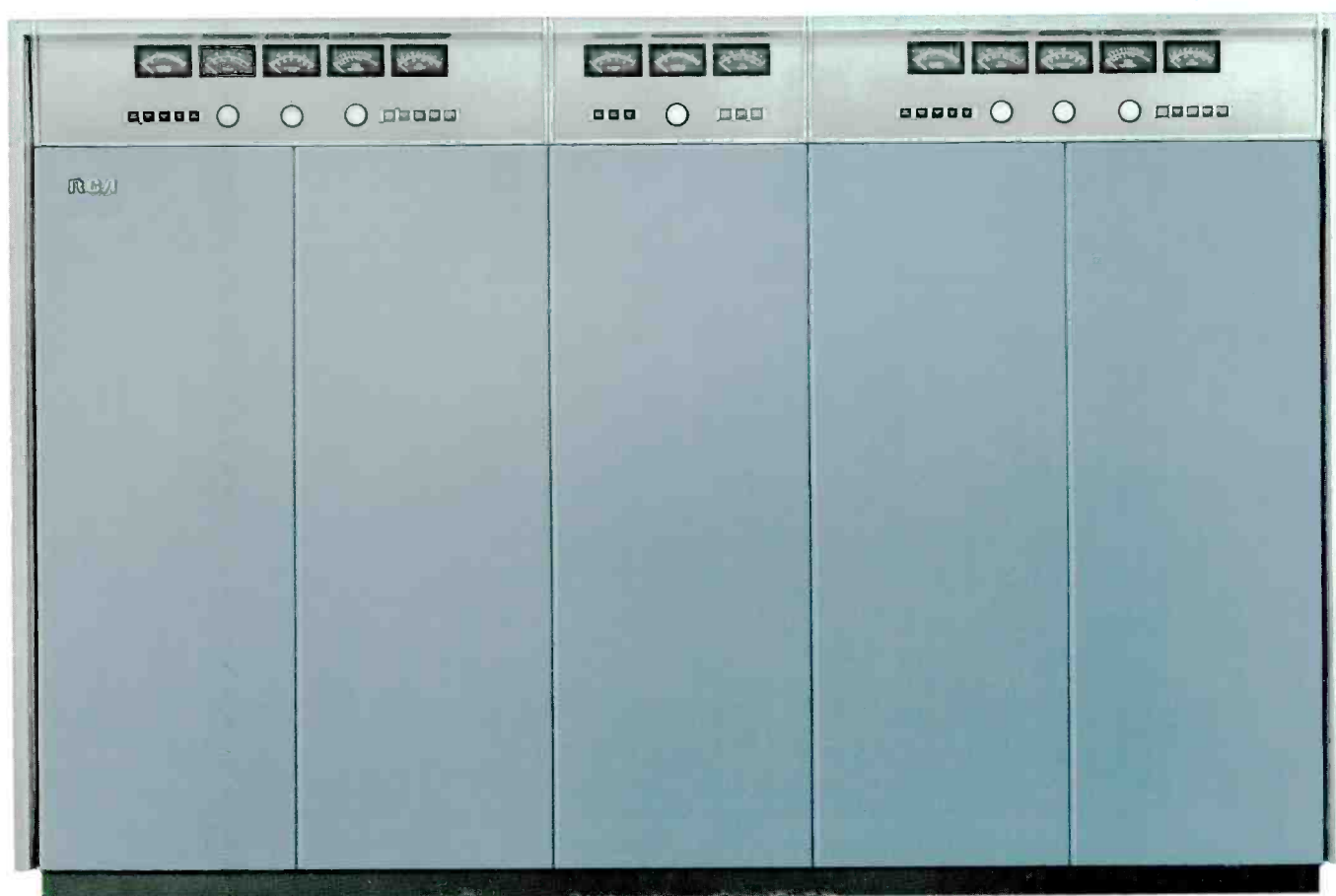

- Ultra stable—easy to tune
- New solid-state exciter
- Available for mono or stereo—with or without SCA
- Reliable dual RF amplifiers
- Ready for remote control

40-KW FM Broadcast Transmitter

Eye level Meters
and
Status Lights

Diplexed
Outputs

Complete
Circuit
Protection

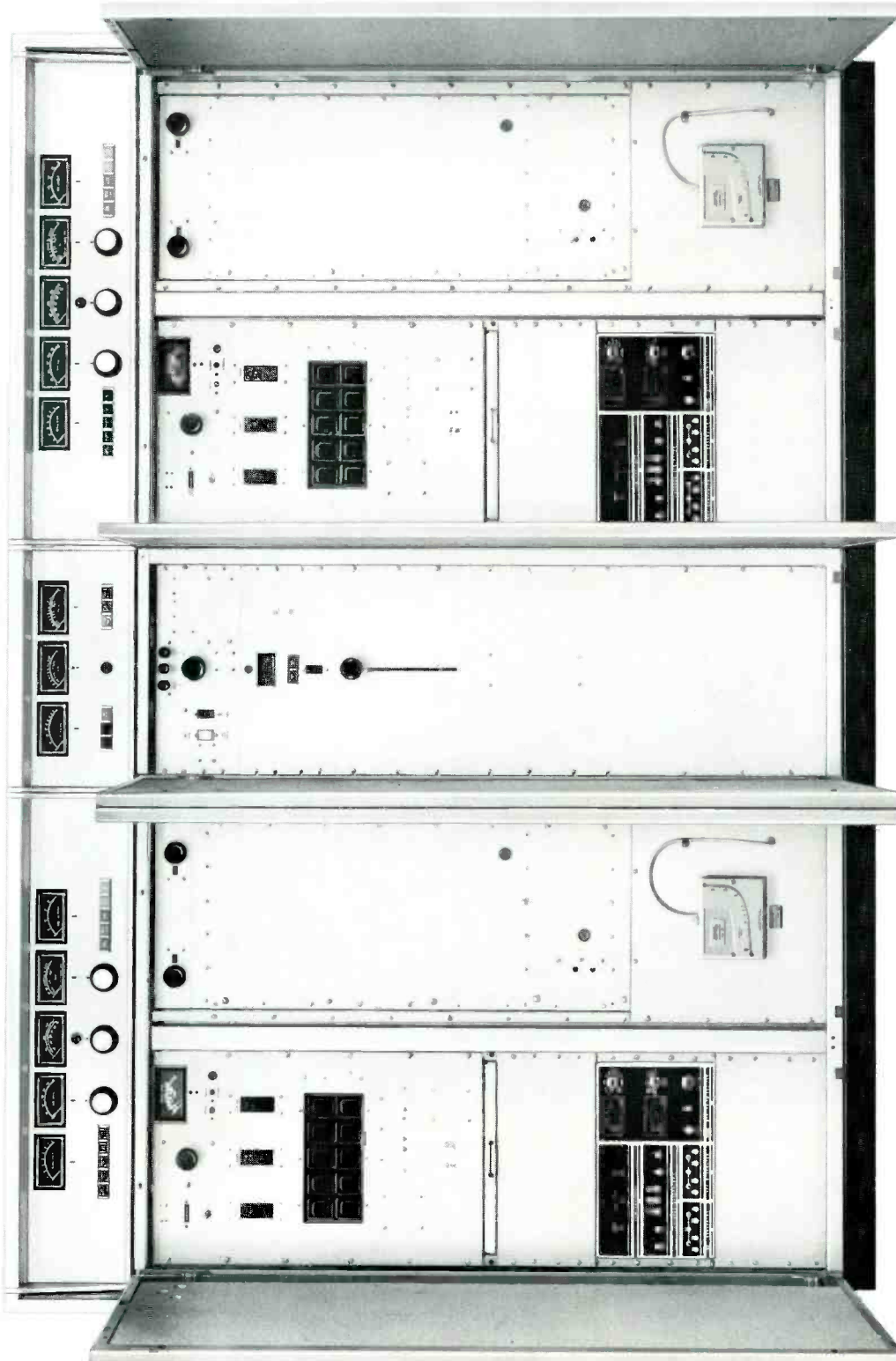

Spare
Exciter

Built-in
Remote
Control

Instant
Switching
to Spare
Exciter

New
Solid-State
FM
Exciter

Air
Flow
Indication

40-KW Full-Fidelity FM Transmitter, Type BTF-40E1

The RCA Type BTF-40E1, 40 kW FM Broadcast Transmitter is designed for high-power operation in the standard FM band, 88-108 MHz and is specifically engineered to meet and exceed the requirements of multiplex service transmission.

The transmitter consists of two twenty kW units driven from a single exciter. The use of exciter switching and an output diplexing system assures continuous operation even when one power amplifier or exciter is removed from service for maintenance or repair. The transmitter is housed in two cabinets separated by a control panel and the diplex assembly.

The BTF-40E1 employs a new Type BTE-15A Exciter that uses the time-tested and field-proven RCA *direct FM* system. The circuits employ all solid-state components. Their inherent long-life and cool operation assure

extended reliability and lend themselves particularly to unattended, remote operation.

Because of its wide frequency response and extreme stability, the exciter is ideally suited for multiplex and stereo programming, as specified by the FCC.

The BTF-40E1 uses silicon-rectifier power supplies for long life and dependability. For ease of tuning, the exciter has a built-in multimeter and accessible test points permitting metering and checking during operation. Built-in manometers can add hundreds of hours to tube life by indicating air filter efficiency and warning of reduced cooling-air supply over the power tubes.

Frequency response of the transmitter's main channel is 30 to 15,000 Hz (± 1 dB maximum) and distortion over the same range is 0.5 percent or less.

Description

The BTF-40E1 is a diplexed transmitter consisting of two 20E transmitters united by a mid-combining panel. The diplexed output combiner, a 3 dB Hybrid Coupler, and one 6 $\frac{1}{8}$ -inch Harmonic Filter, are external to the cabinets of the 40E1.

The combining panel consists of five sections, the first of which contains the following control and metering functions: six illuminated pushbuttons for operating the combined unit on, off, plate on, plate off, and to indicate transmitter overload, and output line VSWR overload. Also located here are three meters essential for operation of the 40E1. A "Reject Power" meter is used to indicate power into the air cooled reject load. The second, a "Reflected Output Power Meter," serves to indicate reflected power and to protect the transmitter from an unusually high VSWR in case of a line or antenna fault. The control can be adjusted to any value of VSWR. The third meter indicates "Power Output."

The second section in the combining panel is used to mount the set point module of the meter-control and to mount the reflectometer adjustments and controls. Below this, a third section contains illuminated switches for Exciter 1 or 2, control circuit line breaker, and a meter indicating reject power in the input balun. The fourth section has a control for adjustment of the line stretcher used for phasing the input circuits of the combined 20E units. The last section is a blank panel.

In the top of the combiner unit is a blower, thermostatically controlled, so that in case of failure of either of the 20-kW transmitters, the heat from the 10-kW reject loads will be removed from the cabinet. Each air cooled 5-kW load is also equipped with a thermo controlled fan for cooling.

The transmitter can be controlled as a 40-kW unit from the combining cabinet panel, or as individual 20-kW transmitters from their own control positions. The

BTF-40E1 transmitter, or the individual 20-kW sections can be operated by a remote control system.

Relays automatically switch all inputs, that is, stereo and two SCA channels from one exciter to the other. The primary power to each exciter is always fed from the transmitter that is not shut down.

Mono or Stereo

The transmitter features a new exciter designed for stereo and multiplex. The exciter, including its self-contained power supply, is mounted on a single vertical chassis.

Two Stages Follow Exciter

From the 15-Watt output of the exciter, only three tubes, two in the IPA and a ceramic-tetrode 4CX-15000A PA, generate the full 20-kW signal from each amplifier. A harmonic filter reduces spurious radiation. Vacuum capacitors tune the IPA plate and PA grid. All PA adjustments are at ground potential.

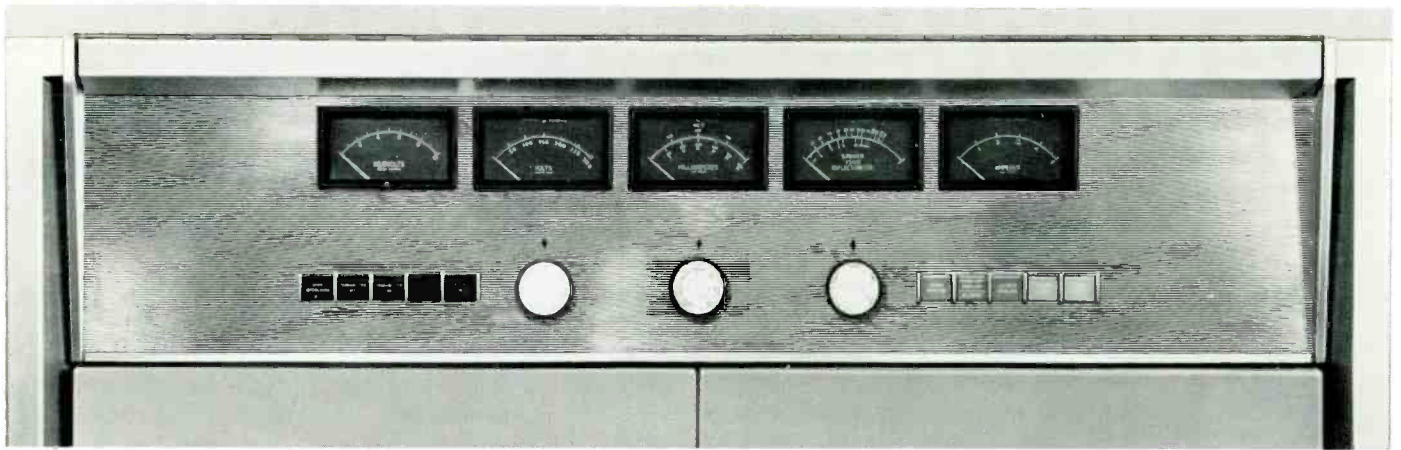

Control Panel of one of the diplexed 20-kW transmitter units. Tally lights and pushbutton controls permit operation of BTF-40E1 even when one power amplifier or exciter is removed from service. The large diameter multimeter knobs speed log keeping and minimize error.

New Styling

Functional styling together with fewer tubes and components has permitted the new BTF-40E1 transmitter and a control panel to be housed in two double-door cabinets. They employ the new midnight blue and shadow blue finish, set off with aluminum meter panel and trim. Swing-out doors on the front and rear of the cabinet give maximum accessibility. Two separate unitized high-voltage supplies may be located anywhere in the FM station.

New Solid-State FM Exciter

Excellent monaural, stereo and SCA performance that more than meets industry and FCC standards are achieved by the new RCA modular, solid-state "Direct FM" exciter.

Simplified Circuits

Modulation of the temperature compensated basic on-frequency oscillator is achieved by applying the composite stereo or SCA signals from the BTS-1B and BTX-1B Generators, respectively, to a

pair of push-pull varicap diodes which are coupled to the basic oscillator frequency determining resonant circuit. The output of the basic oscillator is isolated from the following buffer amplifier by a 10 dB resistive attenuator. Thus, the stability and modulation characteristics of the basic direct FM oscillator are not disturbed by following RF power amplifiers.

The output of the buffer amplifier, approximately 500 mW, is used to drive the 15-Watt, three-stage RF amplifier as well as the binary divider chain in the

Block diagram of the BTF-40E1 FM Transmitter.

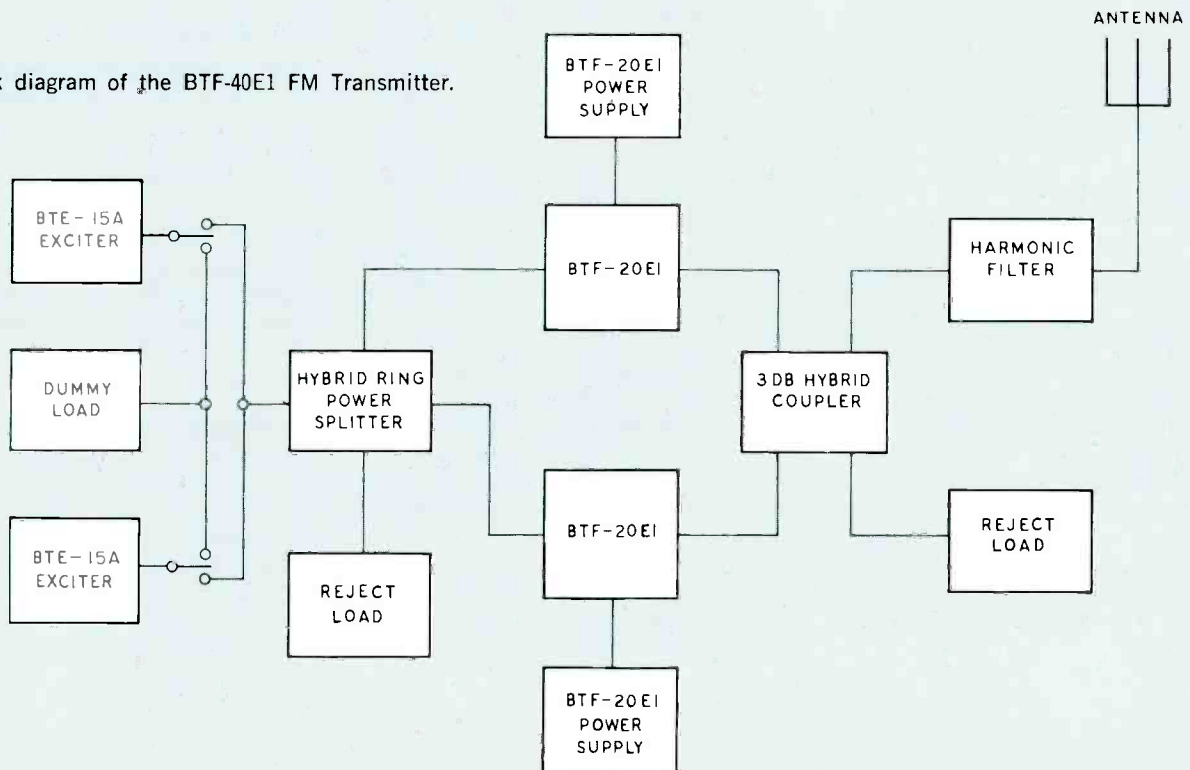

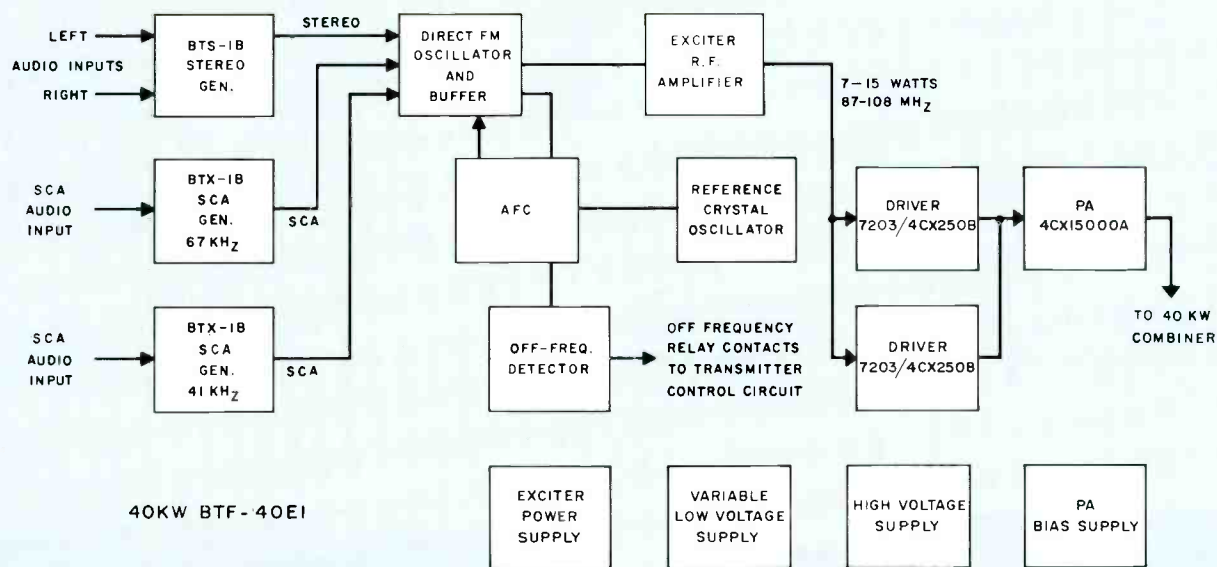

Block diagram of one of the diplexed 20-kW units of the BTF-40E1 Transmitter, showing optional Stereo and SCA.



New solid-state FM Exciter system, Type BTE-15A, showing "Direct FM" exciter housed with optional stereo generator and SCA generator units.

AFC circuit. The basic oscillator, buffer amplifier, and AFC circuit are mounted inside a shielded enclosure. The RF power amplifier is also completely shielded.

"On Carrier" Frequency Operation

Automatic frequency control (AFC) for the on-frequency basic oscillator is achieved by taking a sample of the buffer output frequency and dividing it by two, 14 times. A low-frequency reference crys-

tal operating at 1/1024th of the desired output frequency is divided by two, 4 times. Integrated circuits operating in the saturated mode are used in both binary dividing chains. The outputs from the reference and basic oscillator binary dividers are phase compared in a time-sharing IC comparator. The output of the circuit, which represents the AFC error voltage, is filtered and applied to another pair of varicap diodes coupled to the basic

oscillator tuned circuit. Thus, the basic oscillator is phase locked to the 1024th harmonic of the oven controlled reference crystal.

An off-frequency detector is incorporated in the design of the BTE-15A FM Exciter. When the basic oscillator frequency is not phase locked to the reference crystal, an AC component appears at the AFC output. This voltage is rectified to operate a relay whose contacts can be used to turn off the FM transmitter.

Two multimeters are located on the hinged door in front of the regulated power supply section. One of these meters is used to indicate power supply and operating voltages within the exciter and 15-Watt RF Amplifier. The second meter is a peak-reading voltmeter that is used to indicate all modulating signal levels.

The RF power output of the BTE-15A can be continuously adjusted from the front panel control from 7 to 15 Watts. The primary power is turned on with a circuit breaker. RF output is turned on with a front panel switch or by jumping contacts available on the rear of the unit. The exciter will tolerate load mismatches from short circuit to open circuit for a reasonable time without damaging the

output transistor. Another safety feature prevents turning on the 41 kHz SCA sub-carrier when the BTS-1B Stereo Generator is in the stereo mode.

Single-Ended Driver Amplifier

Two simplified, single-ended amplifiers (operating Class "C") follow the exciter in each 20-kW unit. The IPA stages consist of two ceramic 7203/CX250B tetrodes operating in parallel, and both final power amplifiers are Type 4CX15000A tubes. Variable vacuum capacitors are used to tune the interstage network between driver and PA.

20-kW Class "C" Final Amplifier

The power amplifiers also use pi-network circuitry, however, the tuning of

these stages is accomplished by variable inductors operating at ground potential. The output tubes are designed for very high power gain with little drive. Power output is controlled by means of motor-driven variable transformers connected in the primary of the low voltage power supply for the driver amplifiers. This controls the IPA-plate and the PA-screen voltages simultaneously.

For increased transmitter stability and reliability, separate grid bias supplies are incorporated in the BTF-40E1. These supplies also use semi-conductor rectifiers.

Harmonic Filter Standard Equipment

To keep spurious emission at a minimum, the transmitter is furnished with

a 6 $\frac{1}{8}$ -inch harmonic filter. The filter consists of a series of transmission line elements with a uniform outer diameter conductor, a stepped inner conductor and a shunt stub. The conductors are fabricated of a high-grade copper alloy. Attenuation of all harmonic radiation above channel limits is accomplished in an "M-derived" section, and a series of "constant-K" T-sections. This design provides a broad passband with a sharp high-frequency cut-off and excellent attenuation of frequencies above the passband.

Self-Protected Against Overload

Power circuits are protected by magnetically-tripped circuit breakers in addition to overload relays. An interlocked

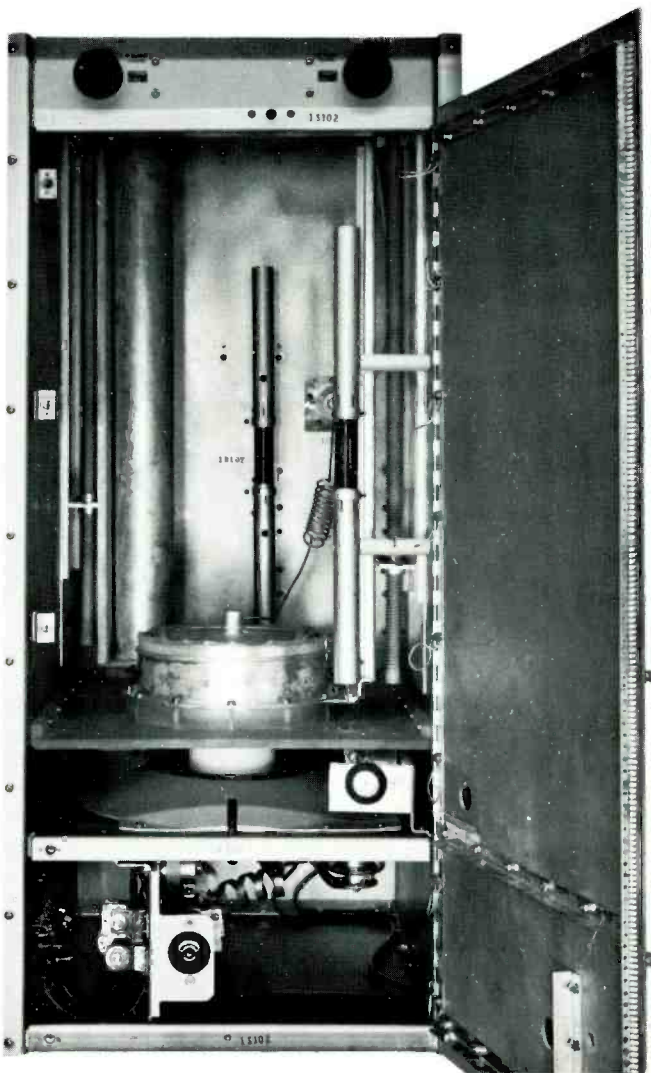

View showing interior of one of the two identical PA and IPA cabinets with the 4CX15000A ceramic tetrode and two IPA tubes below shelf.

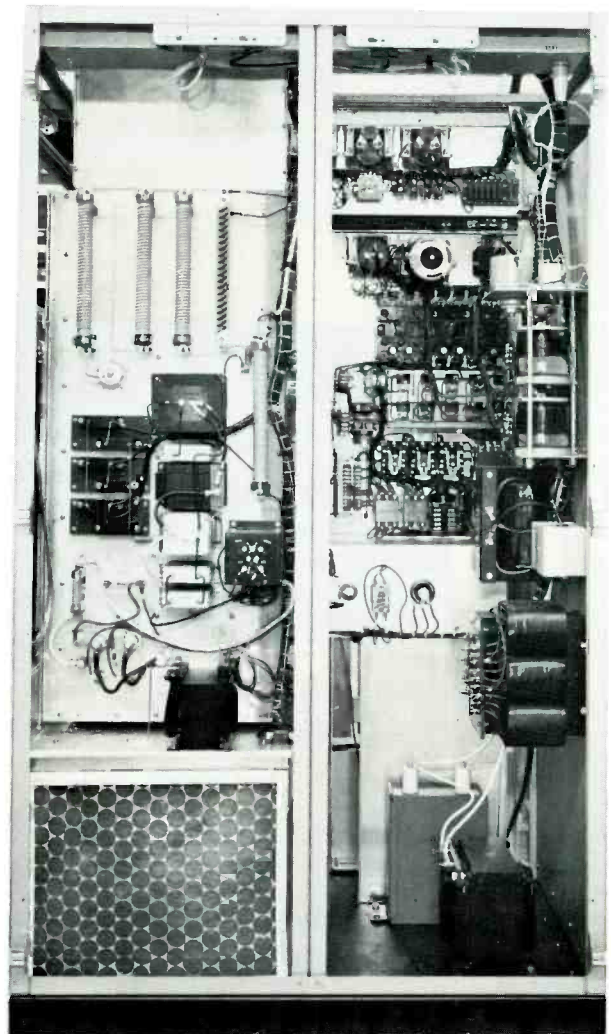

Complete accessibility. Rear view showing one of the amplifiers of the BTF-40E1 revealing the clean, vertical construction of PA cavity to left and control panel to right.

system prevents turn-on of plate power until all filaments have heated and the exciter has reached a proper operating condition. In addition, a latching relay automatically re-applies power to the transmitter once before locking-out in the event of brief overloads or power interruptions. The overload relays are reset by illuminated push-button switches on the front panel. Separate tally-light indicators are provided for overloads in the driver, power amplifier and low voltage rectifier circuits.

Fully Air-Cooled

Cooling air for the BTF-40E1 is supplied by the use of two blowers mounted below the amplifier stages. Manometers indicate the efficiency of the fiber-glass filter at the inlet and heavy sound insulation reduces blower noise to a minimum. The blowers supply forced air to all IPA and PA stages.

Simplified Control

In addition to the combining control panel already described, each 20-kW unit has operating controls and meters located on a panel just above the front doors. The push-button controls include: transmitter on/off, plate on/off, overload reset and power raise/lower. A cabinet

disconnect switch, low-voltage circuit-breaker, and filament- and control-circuit breakers are located behind the left-hand door. The main- and low-power circuit breakers are located in the rectifier unitized cabinet. When servicing the BTF-40E1, operation of the "disconnect" switch removes all voltages from the transmitter cabinet. Personnel are protected by fully interlocked rear doors, in addition to interlocked doors on the RF PA cubicles.

Full Metering

Six easy-to-read front-panel meters are provided for each amplifier. One for PA-plate voltage, another for PA-plate current, and a third for AC line and filament voltage. The remaining three are a reflectometer indicating output, a multimeter and VSWR meter. Separate meters are used to measure the forward power and VSWR. The multimeter reads the grid current, the screen current and the screen voltage of both power tubes. In addition, the exciter has its own self-contained multimeter, that provides complete information on operating conditions in the exciter.

Ready for Remote Control

Remote control provisions are included

in the transmitter. The Terminals are provided for use with remote control units such as the BTR-20 Series and BTG Series Automatic Logging Equipment. Additional terminals are supplied for remote control of transmitter on/off, plate on/off, raise/lower power, and overload reset. Remote metering connections in the final amplifier for plate current, plate voltage, and power output are also provided.

High-Voltage Power Supply

The high-voltage power supplies are housed in unitized cabinets each measuring 32 inches wide, 23 inches deep and 49 inches high. They can be installed at any convenient place in the station. The cabinets house the high-voltage-plate transformers, a bank of plug-in semiconductor rectifiers, a line-circuit breaker, a low-power circuit breaker, and the plate contactor. Personnel are fully protected from shock through interlock and grounding switches.

The rectifier section comprises silicon-junction diodes (with equalizing resistors and capacitors) in a three-phase, full-wave-bridge circuit. Circuit breakers are used instead of fuses in the transmitter adding to the dependability, particularly when operating by remote control.

Specifications

Performance

Type of Emission	F3 and F9
Frequency Range88 to 108 MHz
Power Output	40 kW
Output Impedance (6 1/8" O.D. Line)	50 Ohms
Frequency Deviation 100% modulation	±75 kHz
Modulation Capability	±100 kHz
Carrier Frequency Stability	±1000 Hz max.
Audio Input Impedance	600/150 Ohms
Audio Input Level—*(100% mod.)	+10 ±2 dBm
Audio Frequency Response—**(50-15,000 Hz)	±1 dB max.
Pre-emphasis Network Time Constant.....	75 or 50 μs, as desired
Harmonic Distortion—***(50-15,000 Hz)	0.5% or less
FM Noise Level (referred to 100% FM mod.)	-65 dB max.
AM Noise Level (referred to 100% AM mod.)	-50 dB max.
Subcarrier Input Level (100% mod.)	-15 to +10 dBm adjustable
Subcarrier Input Impedance	600/150 Ohms bal.
Subcarrier Frequency	20-67 kHz
Main-to-Subchannel Crosstalk.....	-50 dB referred to ±7.5 kHz deviation of the subcarrier by a 400 Hz tone. Main channel modulation 70% by 50-15,000 Hz tones.
Sub-to-Main-Channel Crosstalk.....	-60 dB referred to ±7.5 kHz deviation of the main carrier by a 400 Hz tone. Subchan- nel modulation 100% (±7.5 kHz) by 50-6000 Hz tones. Subcarrier modulated 30% on main carrier.

Tube Complement

Driver:	4—7203/4CX250B
Power Amplifier:	2—4CX15000A

Electrical

Power Line Requirements:	
Line	240/208 Volt, 3 phase, 50/60 Hz
Combined Line Voltage Variation and Regulation	±5%
Power Consumption	72,000 Watts (approx.)
Power Factor (approx.)	90%

Mechanical

Dimensions (overall):	Transmitter	High-Voltage Power Supply
Width	114 1/4" (288.2 cm)	64" (162.6 cm)
Height	77" (195.6 cm)	49" (124.5 cm)
Depth	32 1/2" (82.5 cm)	23" (58.5 cm)
Weight (approx.)	2950 lbs. (1336.4 kg)	2050 lbs. (329.8 kg.)
Finish	Textured Vinyl in midnight blue and shadow blue, satin-aluminum trim.	
Altitude	7500 ft. (2290 m)†	
Ambient Temperature Range	-20° to +45°C	

* Level measured at input to pre-emphasis network.

** Audio Frequency response referred to 50- or 75-microsecond pre-emphasis curve.

*** Distortion includes all harmonics up to 30 kHz and is measured following a standard 50- or 75-microsecond de-emphasis network.

† Blowers can be provided for operation at higher altitudes.

Specifications subject to change without notice.

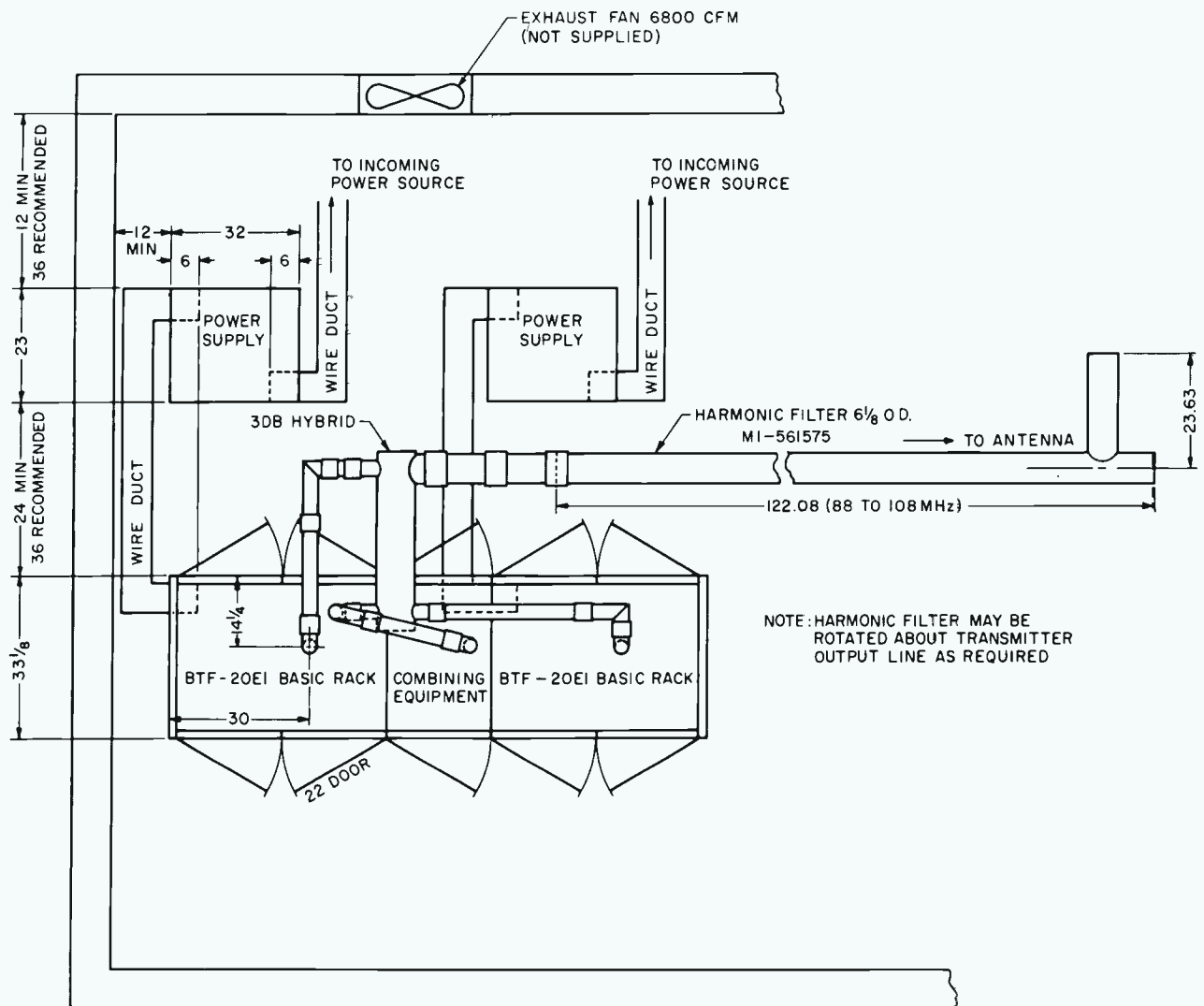

Space-saving floor plan of the BTF-40E1. The separate, unitized power supply may be installed in a basement, attic, closet or other convenient place. (Wire duct and fan shown are not furnished.)

Accessories

- Recommended Spare RF Transistors for ExciterMI-560718
- Spare Crystal and Oven
(Specify operating frequency)MI-560717
- Complete Set of Spare TubesES-560613
- 20-kW RF Load and WattmeterOn application
- Type BTR-11B Remote Control System
(10-function)ES-34280

- Type BTR-20D Remote Control System
(20-function)ES-34274-C
- Type BW-75A Frequency and
Modulation MonitorMI-560735
- Type BW-85A Stereo Frequency and
Modulation MonitorMI-560740
- Type BW-95A SCA Frequency and
Modulation MonitorMI-560745

Ordering Information

- Type BTF-40E1 40-kW FM TransmitterES-560606
- Please specify assigned frequency, power-line frequency, and altitude of installation and also select a Type BTE-15A Exciter System from the following:

- MonoES-560631
- Mono and one SCA ChannelES-560632
- Mono and two SCA ChannelsES-560633
- StereoES-560634
- Stereo and one SCA ChannelES-560635
- Stereo and two SCA ChannelsES-560636



- Latest modular design employing solid-state integrated circuits
- "Direct FM" modulation
- Excellent frequency response—low distortion and noise
- Simplified operation—easy to service
- Automatic muting of subcarrier
- Fully metered
- Off-frequency detector

RCA FM Exciter System, Type BTE-15A

Description

RCA's new FM Exciter Stereo System Type BTE-15A, with optional Stereo and SCA generator units provides on-air FM stations with an inexpensive means of broadcasting two or more services simultaneously over their regularly assigned broadcast channel. Stations can offer background music or other services while retaining presently scheduled FM mono or stereo broadcast programming. The use of the equipment for SCA and stereo is type accepted by the FCC.

The heart of the system is the new Type BTE-15A Exciter, an all solid-state unit utilizing integrated circuits, and employing RCA's "Direct FM" principle of operation. An important feature of the new exciter system is that it is fully metered using two meters to measure not only operating parameters but also modulating signals.

Stereophonic programming requires the use of an optional plug-in Stereo Generator, Type BTS-1B. One or two Type BTX-1B Subcarrier Generators

permit one or two additional program channels to be transmitted along with the regular FM mono program channel. This is accomplished by transferring the subchannel programs into the supersonic frequency range and frequency modulating the subchannel program on 41-67 kHz subcarriers. The FM supersonic carriers are then used to modulate the RF carrier. When a BTS-1B Stereo Generator is switched into the system only one BTX-1B SCA Generator on 67 kHz can be used.

BTE-15A FM Exciter

Excellent monaural, stereo and SCA performance that more than meets industry and FCC standards are achieved by the new RCA modular, solid-state, "Direct FM" exciter. This exciter can be substituted directly for the BTE-10C Exciter in present BTF-1E1 or BTF-5/10/20E FM Transmitters and can be operated into either short circuit or open circuit without damage to the output transistor.

New design features include a modular design that plugs into a frame accommodating the Exciter, Power Supply and Switching, BTS-1B Stereo and one or two BTS-1B SCA Generator modules. When operating monaural only, the BTS-1B Stereo Generator is replaced with another module. The exciter frame is 19 inches wide and designed for standard rack mounting. A module extender is provided to permit easy servicing of modules outside the main frame.

Circuits

Modulation of the temperature compensated basic on-frequency oscillator is achieved by applying the composite stereo or SCA signals from the BTS-1B and BTX-1B Generators, respectively, to a pair of push-pull varicap diodes which are coupled to the basic oscillator frequency determining resonant circuit. The output of the basic oscillator is isolated from the following buffer amplifier by a 10 dB resistive attenuator. Thus, the stability and modulation characteristics of the basic direct FM oscillator are not disturbed by the following RF power amplifiers.

The output of the buffer amplifier, approximately 500 mW, is used to drive the 15-Watt, three-stage RF amplifier as well as the binary divider chain in the AFC circuit. The basic oscillator, buffer amplifier, and AFC circuit are mounted inside a shielded enclosure. The RF power amplifier is also completely shielded.

Automatic frequency control (AFC) for the on-frequency basic oscillator is achieved by taking a sample of the buffer output frequency and dividing it by two, 14 times. A low-frequency reference crystal operating at 1/1024th of the desired output frequency is also frequency divided by 16 in a binary chain. Integrated circuits operating in the saturated mode are used in both binary dividing chains. The outputs from the reference and basic oscillator binary dividers are phase compared in a time-sharing IC comparator. The output of the circuit, which represents the AFC error voltage,

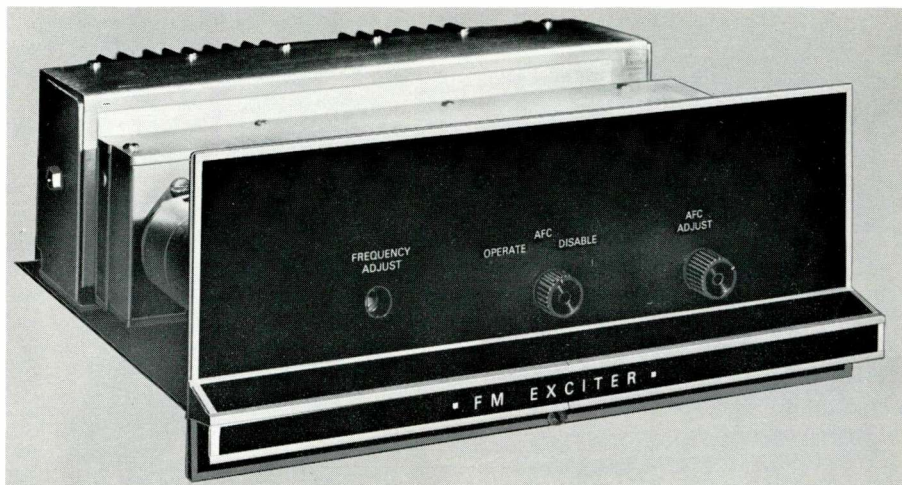

BTE-15A FM Exciter.

is filtered and applied to another pair of varicap diodes coupled to the basic oscillator tuned circuit. Thus, the basic oscillator is phase locked to the 1024th harmonic of the oven controlled reference crystal.

An off-frequency detector is incorporated in the design of the BTE-15A FM Exciter. When the basic oscillator frequency is not phase locked to the reference crystal, an AC component appears at the AFC output. This voltage is rectified to operate a relay whose contacts can be used to turn off the FM transmitter.

Two multimeters are located on the hinged door in front of the regulated power supply section. One of these meters is used to indicate power supply and operating voltages within the exciter and 15-Watt RF Amplifier. The second meter is a peak-reading voltmeter that is used to indicate key modulating signals.

The RF power output of the BTE-15A can be continuously adjusted from the front panel control from 7 to 15 Watts. The primary power is turned on with a circuit breaker. RF output is turned on with a front panel switch or by jumping contacts available on the rear of the unit. The exciter will tolerate load mismatches from short circuit to open circuit without damaging the output transistor. Another safety feature prevents turning on the 41 kHz SCA subcarrier when the BTS-1B Stereo Generator is in the stereo mode.

BTS-1B Stereo Generator

In the Model BTS-1B Stereo Generator, latest techniques have been employed to obtain the finest possible stereo operation. The LEFT and RIGHT input channels are identical, each having resistive input terminations, isolating transform-

ers, 15-kHz low-pass filters, and an operational amplifier for obtaining pre-emphasis. The pre-emphasis is convertible from 75 to 50 microseconds in the field, or can be removed entirely. The LEFT and RIGHT channels can be matched to within 1/2 percent gain difference and 1/2 degree phase difference from 30 to 15,000 Hz, including the 15-kHz low-pass filters. These filters are less than 0.5 dB down at 15-kHz, and greater than 50 dB down at 19 kHz and above. This insures an absolute minimum of disturbance to the pilot carrier and subcarrier regions by the program material.

The pre-emphasized and filtered LEFT and RIGHT audio signals are applied to a switching modulator which alternately switches between the two audio channels. The balanced and symmetrical 38-kHz switching signal is derived from a buffered 38-kHz output of a bi-stable multivibrator. The negligible amount of second harmonic (76 kHz) in the 38 kHz switching signal assures a minimum of interference to a 67 kHz SCA channel. The 76 kHz crystal-controlled signal driving the binary divider assures a frequency stable 38-kHz stereo subcarrier.

The output of the switching modulator, along with the sinusoidal pilot (less than 1 percent distortion) is applied to a phase linear filter to remove the third and all higher order harmonic components of the switching signal. The complete composite stereo signal, or a LEFT or RIGHT monaural signal, is selected by relays and applied to the input of an operational amplifier. The output of this amplifier is then applied to the wide-band input of the BTE-15A FM Exciter.

Switching between monaural right, monaural left, or stereo may be accomplished by front panel pushbuttons on

the BTS-1B or by momentary remote control contact closures. The selected mode is indicated by front panel lamps. Left, Right and Composite program outputs are also applied to a peak reading meter on the main frame of the BTE-15A FM Exciter.

BTX-1B SCA Generator

The Model BTX-1B SCA Generator, using all hermetically sealed metal cased integrated circuits and transistors, is a high performance unit designed to operate on either the 41-kHz or 67-kHz SCA channels. The audio input is applied to a resistive terminating pad and then to an isolating transformer before being amplified. An accessory 5-kHz low-pass filter must be inserted in the input to prevent higher order lower sidebands of the 67-kHz subcarrier from penetrating the upper regions of the stereophonic spectrum.

The audio amplifier includes an active pre-emphasis network outdating earlier passive schemes, and may be easily changed from 75 microsecond to 50 or 150 microsecond or adjusted for a flat response. The audio sensitivity of the BTX-1B is sufficiently high that line amplifiers are not required.

The processed audio input signal is then applied as modulation to a direct FM SCA generator, that includes a temperature compensating circuit for extreme frequency stability. A vernier center frequency control is available on the front panel.

Following this generator is a series diode muting gate, a buffer amplifier, and a wide-band low-pass filter to re-

move subcarrier harmonics. The total harmonic content of the subcarrier output is less than 1 percent and the incidental AM is less than 5 percent peak with 10 percent subcarrier modulation. The output of the low-pass filter is applied to another buffer amplifier and output level control for application to the multiplex input of the BTE-15A FM Exciter.

A sample of the pre-emphasized audio is used to drive a peak reading multimeter on the main frame of the BTE-15A. Automatic muting of the subcarrier is accomplished in the following manner. A portion of the pre-emphasized audio is applied to a variable gain amplifier and using an adjustable time constant, peak detected to operate a Schmitt trigger circuit. The output of the Schmitt trigger is shaped with a low-pass filter and used to turn on or off the series diode

muting gate. When audio is applied to the input of the BTX-1B, the muting diode gate is turned on to allow the subcarrier output to appear. In the absence of audio, the Schmitt trigger pauses for a selected time interval before turning off the diode muting gate. The subcarrier envelope rise and fall times are constant and so chosen to minimize "clicks and pops" in a SCA multiplex receiver. The amount of Schmitt trigger delay is adjustable with a front panel control. With this control, subcarrier muting can be adjusted to occur from 0.5 to 5 seconds after the audio input is removed. Two transistors are used to operate front panel lamps to indicate the on-off status of the subcarrier. Also, a front panel switch provides manual control of the subcarrier output, or the use of the automatic muting feature. The subcarrier also can be turned on or off remotely.

BTS-1B Stereo Generator.



BTX-1B SCA Generator.

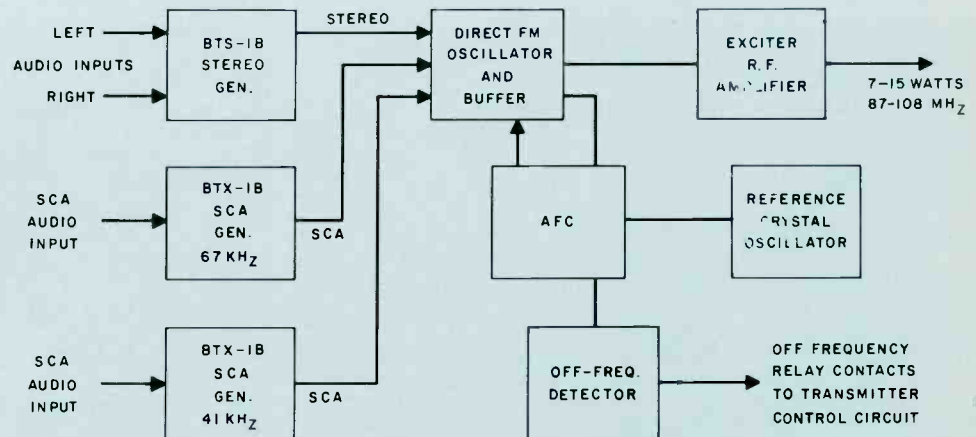

BTE-15A System.

Rear view of BTS-1B Stereo Generator with board raised to show easy access to printed circuit board.

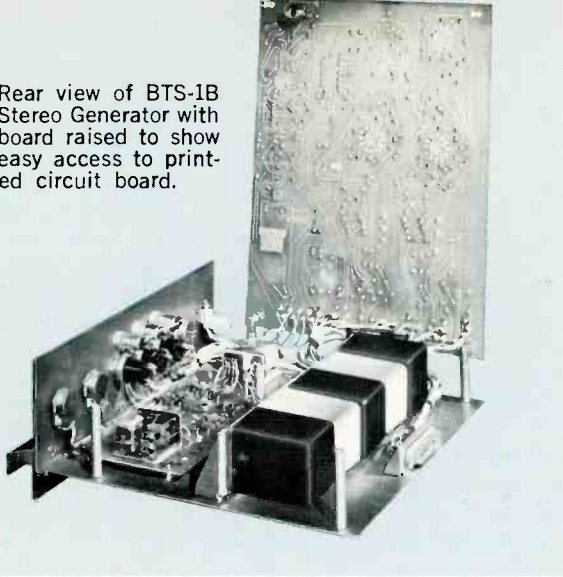

Specifications

TYPE BTE-15A EXCITER

Performance

Type of Emission	F3-F9
Frequency Range	87-108 MHz
Power Output	15 Watts
Output Impedance (BNC Connector)	50 Ohms
Frequency Deviation for 100% Modulation	± 75 kHz
Modulation Capability	± 125 kHz
Carrier Frequency Stability	± 1000 Hz
Audio Input Impedance	600/150 Ohm resistive
Audio Input Level (100% Modulation)	$+10 \pm 2$ dBm at 400 Hz
Audio Frequency Response:	
50 Hz-10 kHz—pre-emphasis 75 μ s	± 0.5 dB max.
10 kHz-15 kHz—pre-emphasis 75 μ s	± 1.0 dB max.
Pre-emphasis Network Time Constant	75 or 50 μ sec. as desired
Harmonic Distortion (50 Hz-15 kHz)	0.5% max.
FM Noise Level (referred to 100% FM mod. at 400 Hz)	-68 dB max.
AM Noise Level (referred to carrier voltage)	-60 dB max.

Electrical

Power Line Requirements:

Exciter:

Line	240/208 or 117 V, AC, 50/60 Hz, single phase
Slow Voltage Variations	$\pm 5\%$
Power Consumption	80 Watts max. (Including Stereo & SCA)

All specifications subject to change without notice.

Mechanical

Overall Dimensions	19" wide, 10½" high, 9" deep
Weight	40 lbs.
Maximum Altitude	7500 ft.
Ambient Temperature Range	-20°C to +60°C
Finish	Black Background with Aluminum Epoxy Trim

STEREO SUBCARRIER GENERATOR, TYPE BTS-1B

Performance

Pilot Carrier Stability	19 kHz ± 1 Hz
Subcarrier Suppression	-45 dB or better
Frequency Response, 30-10 kHz	± 0.5 dB max.
Frequency Response, 10 kHz-15 kHz	± 1.0 dB max.
Pre-emphasis	75 or 50 μ sec.
Left-Right Channel Separation	35 dB or better
Crosstalk-Stereophonic (main channel to subchannel)	45 dB
Crosstalk (subchannel to main channel)	45 dB
Harmonic Distortion (100% modulation by composite stereo)	1% or less

Mechanical

Obtains power from BTE-15A

Plugs into BTE-15A Exciter

41 kHz SCA Lockout when using Stereo

Stereo-Mono Remote Switching—Either Left or Right Channel can be Remotely Switched to give Mono Operation

TYPE BTX-1B SUBCARRIER GENERATOR

Performance

Type of Modulation	FM
Center Frequency Range of Subcarrier	30 kHz to 75 kHz
Output Voltage	4.0 Volts RMS into 10K Ohms
Frequency Deviation (100% subcarrier modulation)	$\pm 10\%$ of center frequency
Modulation Capability	$\pm 15\%$ of center frequency
Carrier Frequency Stability	$\pm 0.2\%$
Audio Input Impedance	600 Ohms bal.
Audio Input Level (100% modulation)	-15 to +10 dBm adjustable
Audio Frequency Response (30 Hz-10 kHz)*	± 1 dB [†]
Harmonic Distortion (50 Hz-10 kHz)	Less than 1% [†]
FM Noise Level (referred to 100% modulation)	-65 dB max.
AM Noise Level (referred to carrier)	-50 dB max.

*50 or 150 μ s pre-emphasis optional

[†]Without low pass filter, measured on a wideband detector.

Mechanical

Plugs into BTE-15A Exciter

Obtains Power from BTE-15A Exciter

Ordering Information

Main Frame for FM Exciter/Stereo/SCA (Includes integral Power Supply and Metering)	MI-560710	Blank Panel (To replace BTX-1B SCA)	MI-560715
Main Frame for Stereo (Includes integral Power Supply)	MI-560711	Monaural Input Adapter (Replaces BTS-1B Stereo Generator)	MI-560716
Main Frame for SCA (Includes integral Power Supply)	MI-560720	Oven with Crystal for BTE-15A Exciter (Specify operating Frequency)	MI-560717
BTE-15A FM Exciter	MI-560712	Recommended Spare RF Transistors	MI-560718
BTS-1B Stereo Generator	MI-560713	Module Extender	MI-560719
BTX-1B SCA Generator (Specify SCA Frequency)	MI-560714	5 kHz Low Pass Filter (for SCA)	MI-560721



- Fully solid-state circuitry
- Wide dynamic range
- Symmetrical (zero-axis) limiting
- Outstanding selectivity
- Linear phase bandwidth
- Wide dynamic range

RCA Monitor RF Amplifier, Type BW-100B

Description

The BW-100B Monitor RF Amplifier, an adjunct to the RCA BW-75A Frequency and Modulation Monitor is designed to allow use of the BW-75A at a point, usually the studio, remote from the transmitter site. The BW-100B amplifies an off-air signal (100 μ V or greater) to a 1-watt level without modification of the air-signal's characteristics other than amplitude.

Fully Solid-State Circuitry

Only solid-state circuitry offers the stability and dependability required of a device such as the BW-100B. However, the design is enhanced through the use of integrated circuits to reject interfering signals and provide large dynamic range.

Outstanding Selectivity

The combination of a high level of

selectivity and zero-axis limiters in the amplifier results in the rejection of unwanted signals (those of other stations in the area), thereby increasing the usefulness and accuracy of the monitored parameters. The BW-100B Amplifier's outstanding selectivity (see *Specifications*) is the result of a linear, balanced mixer system that down-converts the off-air signal to an intermediate frequency (10.7 MHz) amplifier, where it is amplified, filtered and then up-converted back to its precise, *original* frequency for coupling to the indicating monitor. This complete independence of frequency comes about because the *same* oscillator—operating at 10.7 MHz above air frequency—feeds both mixers simultaneously (see block diagram). Thus, the "input" signal is identical to the "output" signal in every respect except in amplitude and

is stripped of interfering signals. All I-F amplifier tuned circuits are specially designed and fabricated for maximum phase linearity and selectivity. The linear, balanced mixers are free of spurious responses.

Wide Dynamic Range

At the threshold of limiting, the BW-100B requires only 100 μ V to deliver a 1-watt signal to the monitor input. As the result of a highly linear pre-selector and a zero-axis limiter, the BW-100B handles input signals as large as 0.50 *volt* without overload. This represents a dynamic range of 70 dB. Symmetrical, "zero-axis" limiters maintain constant output level adjustable over an input variation of 70 dB. The output level is adjustable from zero to 1.0 watt across 50 ohms.

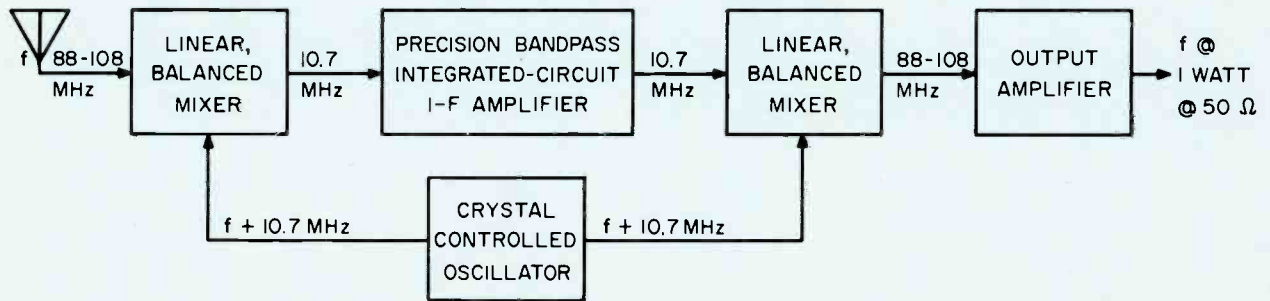

BW-100B Monitor RF Amplifier Block Diagram.

Specifications

Input Frequency Range	88 to 108 MHz	Phase Linear Bandwidth	± 300 kHz
Minimum Input Level (for threshold of limiting)	100 μ V	Image Rejection	Greater than 80 dB
Maximum Input Level	0.5 V	Response at ± 800 kHz	50 dB below that of center frequency
Input Impedances	50 to 75 ohms	Response at ± 400 kHz	25 dB below that of center frequency
Output Impedance	50 ohms	Power Requirements	117 V $\pm 10\%$, 50/60 Hz, 5 W.
Output Level	Adjustable to 1 watt	Dimensions	3½" (89mm) H, 19" (483mm) W, 10½" (267mm) D
Bandwidth (3 dB points)	± 225 kHz		

Ordering Information

BW-100B Monitor RF Amplifier
 (Specify operating frequency)MI-560738

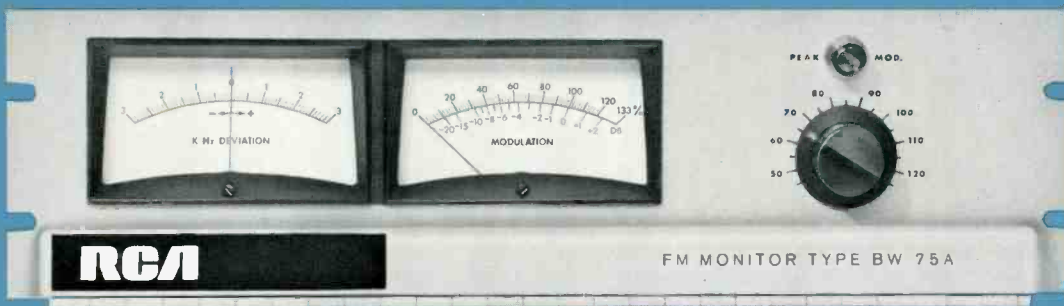

- Latest solid state design
- Front panel modulation calibrator
- Type approved for remote metering
- Total modulation meter responds accurately to peak amplitudes
- Provides pure signal for companion Stereo and SCA monitors

RCA FM Frequency & Mod. Monitor, Type BW-75A

Description

The Type BW-75A FM Frequency and Modulation Monitor is a wideband, all solid state instrument designed to meet all the latest requirements for monaural monitoring. In addition, it provides a virtually pure, distortionless demodulated signal to drive the companion BW-85A Stereo Monitor and the Type BW-95A SCA Monitor for multiplex monitoring. It is type approved for remote metering.

All frequency and modulation measurements are combined in the compact BW-75A that weighs only 14 pounds and is designed for mounting in standard mounting racks or cabinets. It is designed to accurately monitor FM transmitters over long periods of time and operate without adjustment week after week.

The BW-75A features a total modulation meter that responds accurately to the peak amplitude of the complex waveforms encountered in today's programming. The peak flasher is completely independent of modulation polarity in that it samples both positive and negative peaks simultaneously and automatically selects and registers the greater amplitude if the present level is exceeded. Calibration accuracy can be easily checked at any time by means of a front panel modulation calibrator.

Specifications

RF Input Sensitivity	0.2 to 10 Volts RMS
RF Input Impedance	50 Ohms
RF Frequency Range	88-108 MHz
Deviation Meter Range	± 3 kHz
Modulation Meter Range	133% (100% at 75 kHz)
Modulation Meter Accuracy	Better than 5% over entire scale
Peak Modulation Indicator	50 to 120%
Frequency Response	± 0.1 dB, 50-75,000 Hz, 3 dB down at 180 kHz
Distortion	0.1% max. 50-75,000 Hz
Stereo Separation	50 dB (at composite output jack)
Signal-to-Noise Ratio	75 dB with 75 μ sec de-emphasis
Outputs	4 wide band isolated outputs to drive the BW-85A and one or more Type BW-95A distortion meter output, and monitoring output
Remote Metering	Both carrier deviation and modulation meters may be remotely metered, 5,000 Ohms external loop resistance
Size	5 $\frac{1}{4}$ " high, 19" wide, 10 $\frac{1}{2}$ " deep
Weight	14 lbs.
Finish	Silver Panel

Ordering Information

Type BW-75A FM Frequency and Modulation Monitor	MI-560735
Type BW-85A Stereo Frequency and Modulation Monitor (Optional Unit)	MI-560740
Type BW-95A SCA Frequency and Modulation Monitor (Optional Unit)	MI-560745

35B



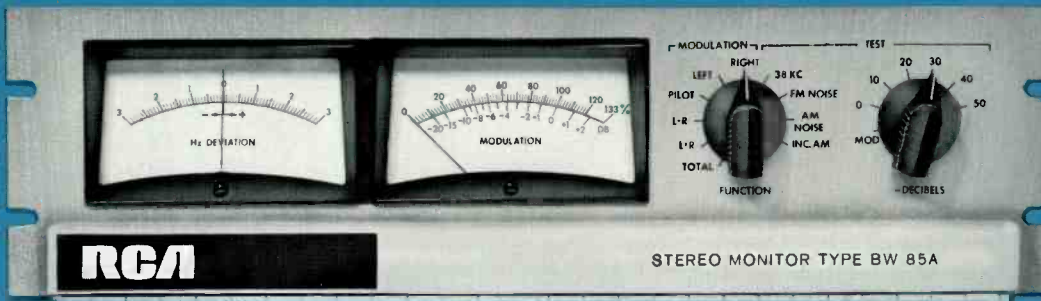

- Unique phase discriminator allows critical phase adjustments
- All solid state satellite unit operates off BW-75A Monitor
- Complete stereo monitoring and test functions
- Convenient front panel metering

RCA Stereo Frequency & Mod. Monitor, Type BW-85A

Description

The Type BW-85A Stereo Frequency and Modulation Monitor is an all solid state monitor on a compact rack-mounting chassis, designed for measuring all modulation characteristics of FM stereo. It provides additional facilities for making the proper periodic maintenance checks to insure maximum performance from stereo transmitters, and is type approved for remote metering. The monitor is designed for satellite operation with the companion Type BW-75A Frequency and Modulation Monitor, from which it receives a virtually pure, distortionless demodulated signal.

Complete front panel metering of FM noise, AM noise and incidental AM, as well as separation, crosstalk, pilot amplitude, and subcarrier suppression, is provided. A unique filter system allows the monitor to be used as an intermodulation analyzer for measuring stereo distortion directly in the frequency range of 5 to 15 kHz. Such measurements were previously impossible to the broadcaster with conventional techniques.

The BW-85A also features a pilot phase regeneration system that utilizes a phase discriminator so that a null reading is obtained with the correct phase, allowing the phase to be regenerated within ¼ degree. The BW-85A is calibrated with the modulation calibrator of the BW-75A.

Specifications

Pilot Frequency Meter Range±3 Hz
Pilot Frequency Meter Accuracy+0.2 Hz (0.001%)
Modulation Meter Range133% to -70 dB
Modulation Meter AccuracyBetter than 5% over entire scale
Frequency Response (L and R)±0.5 dB (50-15,000 Hz)
Separation45 dB (50-15,000 Hz) Meter Range -70 dB
Crosstalk60 dB (L+R) to (L-R) 60 dB (L-R) to (L+R) 60 dB SCA to (L+R), (L-R)

Outputs:

Left & Right Channel Monitoring600 Ohms, unbalanced
Left & Right Channel Test10 K, unbalanced
Distortion (Either Channel)0.2%
Signal-to-Noise Ratio (Either Channel)70 dB with 75 µsec. de-emphasis

Monitoring Modes (Modulation Meter)

Switched 133% to -70 dBLeft Channel Audio, Right Channel Audio, L+R, L-R, 38 kHz (May be measured with modulating frequencies greater than 5 kHz), 19 kHz Pilot Injection (12% full scale), Total Modulation, FM Noise, AM Noise, inc. AM.
-------------------------	--

Remote Metering Both pilot frequency and modulation meters may be remotely metered, 5000 Ohms external loop resistance

Size5¼" high, 19" wide, 10½" deep
Weight12 lbs.
FinishSilver Panel

Ordering Information

Type BW-85A Stereo Frequency and Modulation MonitorM1-560740
Type BW-75A FM Frequency and Modulation Monitor (Required Basic Unit)M1-560735
Type BW-95A SCA Frequency and Modulation Monitor (Optional Unit)M1-560745
Remote Control Panel (accessory for BW-85A)M1-560741





- Complete SCA monitoring to four channels
- SCA modulation calibrator
- Three deviation ranges (6, 4 and 2 kHz)
- Remote metering facilities
- Wideband discriminator—minimum distortion and crosstalk
- Rack or cabinet mounting
- Separate peak flasher for SCA modulation independent of polarity
- AM and incidental AM-noise test functions

RCA SCA Frequency and Modulation Monitor, Type BW-95A

Description

The Type BW-95A SCA Frequency and Modulation Monitor, used in conjunction with the BW-75A FM Frequency and Modulation Monitor, allows complete monitoring and test functions for subcarrier programming or remote telemetry applications. Four crystal-switch positions enable up to four channels to be operated and tested.

Totally integrated, the solid-state electronics of the BW-95A allow unlimited SCA frequency selection through a series of interchangeable crystals. With the appropriate crystals, it is possible to moni-

tor four subcarrier channels through push-button selection. A frequency change is simply a matter of a crystal change.

The BW-95A is a companion equipment to the RCA BW-75A and BW-85A monitors (see *Accessories*) and incorporates all the latest electronic-design techniques. Lightweight and occupying but 5¼ inches of rack space, it derives its signal, a virtually pure, distortionless demodulated signal from the BW-75A Monitor.

Features of the new BW-95A include three deviation ranges: Six, four and two

kHz for optimum operation. The six-kHz range is designed for normal mono operation. The four-kHz range is functional during simultaneous stereo and SCA, while the two-kHz range serves telemetry applications. The 30-kHz discriminator bandwidth assures minimum distortion and crosstalk. A separate SCA modulation-peak flasher operates independently of modulation polarity. A front-panel modulation calibrator, push-button actuated, allows quick check of calibration accuracy at any time.

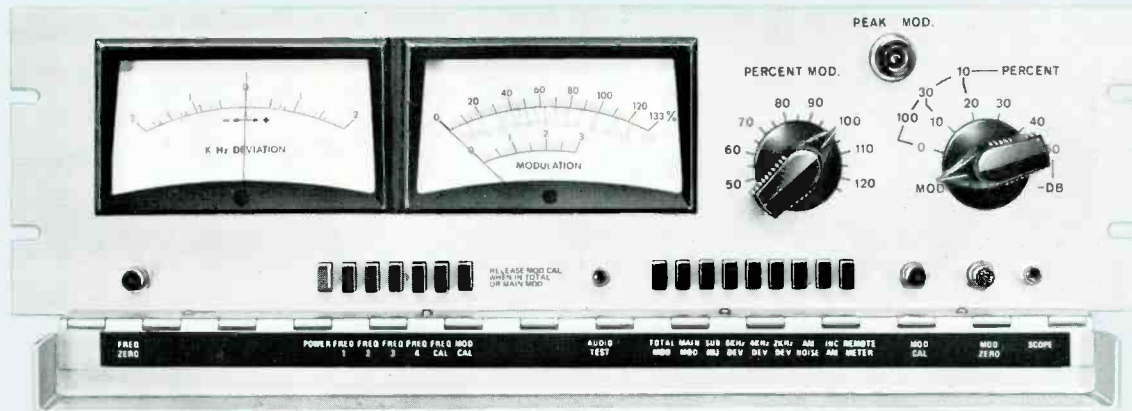

Note the several pushbutton controls to increase monitor flexibility. Ordinarily these controls are hidden behind the flip-down cover.

Specifications

Frequency Range	Any four SCA frequencies (switchable) up to 74 kHz
Deviation Meter Range	±2 kHz
Modulation Meter Range	133% (100% at ±6 kHz, ±4 kHz, or ±2 kHz, switched)
Modulation Meter Accuracy	Within 5% over entire scale
Maximum Modulation Frequency	5 kHz at 6 kHz deviation
SCA Modulation Calibrator	2 kHz
SCA Subcarrier	24 kHz to 74 kHz, four switched crystal positions. SCA subcarrier and deviation maintained in the FCC allowable total frequency deviation
SCA Injection Level	133% to 5%
Peak Modulation Indicator	Follows deviation scale 50 to 120%
Frequency Response	±1 dB, 50-5,000 Hz

Crosstalk Rejection	65 dB or greater
Crosstalk Meter Range	70 dB (10 dB steps)
Outputs	Distortion meter, aural monitor and oscilloscope
Remote Metering Facility	Both meters, separate circuits, 5000 Ohms external loop resistance
Size	5¼" (133 mm) H, 19" (583 mm) W, 10½" (267 mm) D
Weight	14 lbs. (5.5 kg)
Finish	Silver Enamel

Accessories

Type BW-75A FM Frequency and Modulation Monitor (Required Unit)	MI-560735
Type BW-85A Stereo Frequency and Modulation Monitor (Optional Unit)	MI-560740
Remote Control Panel (for BW-95A)	MI-560746

Ordering Information

Type BW-95A SCA Frequency and Modulation Monitor (Specify SCA subcarrier frequencies)MI-560745



- Combines dummy TV antenna and RF power-measurement functions
- Easily installed—occupies little space
- Power indications given directly in Watts
- Wide choice of ratings (1.2 to 50 kW) from 54 to 223 MHz

RCA VHF RF Loads and Wattmeters

Description

VHF RF Loads and Wattmeters are designed for use in measuring the power output of the aural and visual sections of VHF television transmitters. The load properly terminates the output of either the visual or aural transmitter and gives a measurement of the average RF power. It may also be used as a dummy antenna for transmitter tuning. A choice of ratings is available for any frequency between 54 MHz and 223 MHz and for any power level.

The RCA Series of RF Loads and Wattmeters consist of a resistor element for terminating a transmission line in its characteristic impedance, a ThruLine Unit, and a meter for measuring power dissipated.

The power dissipating section consists of a resistor unit immersed in a coolant liquid, which is cooled by air in the low power units, by tap water in the medium power units, and by forced water in high power loads. In order to prevent excessive use of tap water during the time the RF power is at a low level, a water saver is used in most cases. This consists of a thermostatically controlled solenoid valve which allows the water to flow only when needed.

The power measuring section consists

of a short length of transmission line (ThruLine), a meter, and a wattmeter element. A socket is provided on the side of the transmission-line-coupling section to accommodate a calibrated wattmeter element, which, when coupled to the transmission line, develops a DC current proportional to the forward wave voltage across the load resistor. This current is supplied to a meter calibrated to indi-

cate directly the power dissipated in the load.

The wattmeter element is a reflectometer which consists of a coupling loop, a crystal detector, and a filter network. The wattmeter element may be rotated 180 degrees in the transmission line housing. This permits it to indicate the incident power to the load, or the reflected power from the load.

Accessories

Inner Connector for MI-27791K Ungassed Line	MI-27791K-4B
Inner Connector for MI-19313 Coaxial Line	MI-19313-10
Coupling, Straight	MI-191136-8
Coupling, Straight	MI-19314C-7
Reducer, 3/8" to 1/8" Coaxial Line	MI-19113C-7
Reducer, 6/8" to 3/8" for MI-19113 Transmission Line	MI-19314C-13
Water Saver (replacement)	MI-27349

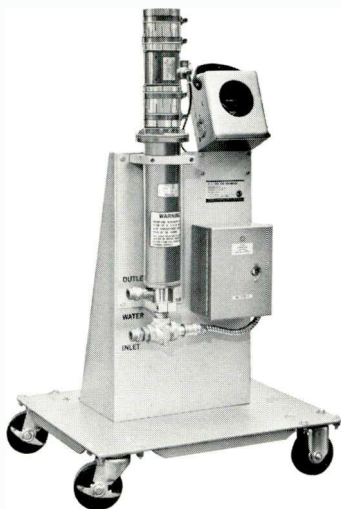

RCA Series of RF Loads and Wattmeters provide necessary tool in measuring aural and visual outputs of VHF Television Transmitters. Shown above, left to right, are the MI-19196 air-cooled 1200-Watt model, the MI-561422 air-

cooled 5-kW unit, and the MI-27396 water-cooled 7½-kW RF Load and Wattmeter. Pictured on the front page is the MI-19196 air-cooled 1200-Watt model. A large 50-kW RF Load and Wattmeter, MI-19191-A, not shown, available on special order.

Specifications

	MI-19196-L/H	MI-561422-L/H	MI-27396-L/H	MI-19267-L/H	MI-19191-A-L/H
Frequency Range	54 to 108 MHz 108 to 216 MHz	54 to 108 MHz 108 to 216 MHz	50 to 108 MHz 108 to 216 MHz	50 to 125 MHz 100 to 250 MHz	54 to 108 MHz 108 to 216 MHz
Power Rating (Ave.) (5000 ft. max. elev.)	1200 Watts	5 kilowatts	7.5 kilowatts	25 kilowatts	50 kilowatts
RF Input Impedance	50/51.5 Ohms	50/51.5 Ohms	50/51.5 Ohms	50/51.5 Ohms	50/51.5 Ohms
AC Power Input	—	110 Volts, 50/60 Hz single phase	—	115 Volts, 50/60 Hz, single phase	115/230 Volts, 50/60 Hz, single phase
Power Consumption	—	27 Watts	—	—	1.125 kW
Ambient Air Temperature:					
Maximum	45°C	45°C	45°C	60°C	45°C
Minimum	15°C	40°C	15°C	5°C	15°C
Mounting	Horizontal	Horizontal, vent plug upward	Floor (fixed or portable)	Floor (fixed or portable)	Floor (fixed or portable)
Coolant Capacity	1.7 gallons	2 gallons dielectric coolant	4 gallons	—	26 gallons
Water Required	None (air cooled)	None	4 gpm (30°C max.)	6 gpm (5°C max.) to 8 gpm (60°C)	20 gpm (30°C max.)
Water Connections	None	None	½" hose	Inlet and Outlet ¾" std. pipe	1¼" hose
Weight	48 lbs. (22 kg)	62 lbs. (28.12 kg)	175 lbs. (80 kg)	110 lbs. (50 kg)	1000 lbs. (454 kg)
Dimensions, Overall:					
Depth	32½" (83.66 cm)	31-29/32" (81.04 cm)	24" (60.96 cm)	20" (50.8 cm)	45½" (115.89 cm)
Width	6¾" (16.19 cm)	7¾" (19.69 cm)	20" (50.8 cm)	24" (60.9 cm)	24½" (62.55 cm)
Height	10¾" (27.3 cm)	15½" (39.69 cm)	46½" (118.43 cm)	44" (104 cm)	64" (162.56 cm)

Ordering Information

300/1200-Watt RF Load & Wattmeter for VHF Transmitter up to 2-kW picture rating; load is air-cooled and equipped with 3½", 50/51.5-Ohm unflanged fittingMI-19196-L/H

5-kW RF Load & Wattmeter for VHF Transmitter up to 6-kW picture rating; load is air-cooled and equipped with 3½", 50/51.5-Ohm unflanged fittingMI-561422-L/H

7.5-kW RF Load & Wattmeter for VHF Transmitter up to 12.5-kW picture rating; load is water-cooled and equipped with 3½", 50/51.5-Ohm unflanged fitting. Includes MI-27349 Water SaverMI-27396-L/H

25-kW RF Load & Wattmeter for VHF Transmitter up to 40-kW picture rating; load is water-cooled and equipped with 6¾", 50/51.5-Ohm unflanged fittingMI-19267-L/H

50-kW RF Load & Wattmeter for VHF Transmitter up to 84-kW picture rating; load is water-cooled and equipped with 6¾", 50/51.5-Ohm unflanged fittingMI-19191-A-L/H

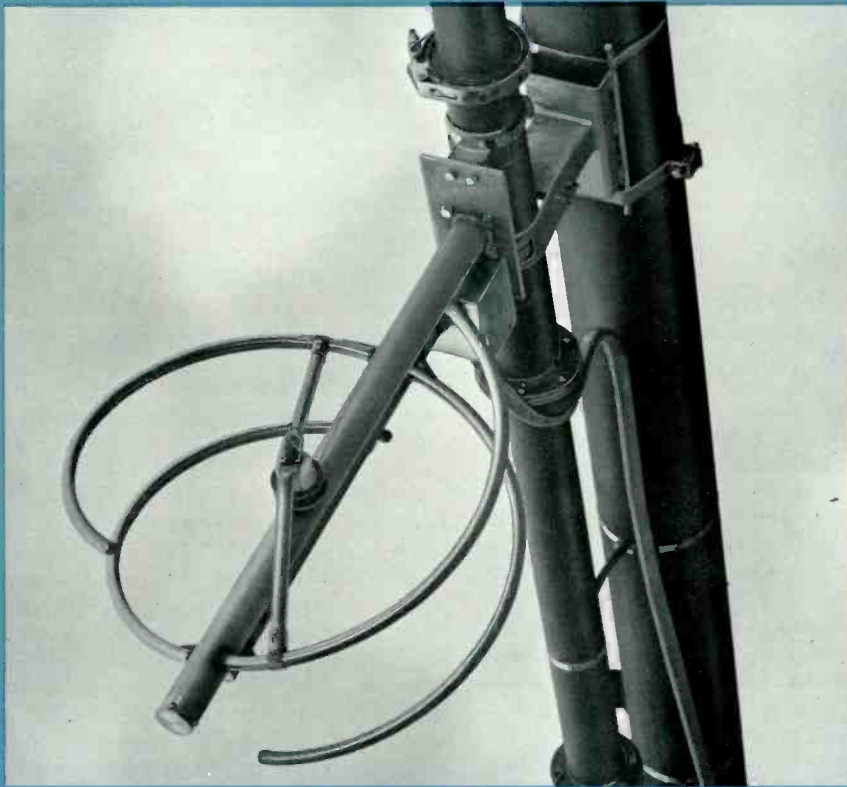

- Excellent bandwidth — 1.1:1 VSWR after field trim
- High power handling capability
- Lower initial installation and maintenance costs
- Efficient, factory replaceable deicers
- Lower windload

RCA Circularly Polarized FM Antenna, BFC Series

Description

The RCA BFC Series of Circularly Polarized FM Antennas is designed for use in monaural, stereo and multiplex FM broadcast service. These antennas provide a low standing wave ratio over a 200 kHz channel providing optimum conditions for stereo or multiplex operation.

The BFC Antenna radiates a circularly polarized wave intended to provide improved reception in FM automobile radios employing vertical whip antennas and in home receivers employing built-in or "line cord" antennas. The BFC Antenna can be used to advantage in any appli-

cation which previously required the use of separate vertically and horizontally polarized antennas of equal power gain and equal power input requirements. Use of the BFC Antenna provides the advantages of lower windload and weight plus reduced complexity and simplified installation requirements.

Power Gain

The new antenna features time proven sectionalized construction and materials and can be supplied with as many sections as are required for a given applica-

tion. The BFC Antenna radiates a circularly polarized wave, thus the power gain in the horizontally polarized plane or in the vertically polarized plane is approximately equal to the number of sections divided by two (the number of equivalent planes of polarization). When using circular polarization in place of simple horizontal polarization, the transmitter power can be doubled without exceeding the licensed horizontal effective radiated power since the additional power radiated is in other planes of polarization; or conversely, for a given

transmitter power, the antenna gain can be doubled for the same reason. An external power splitter is not required. The antennas are designated BFC-1B, BFC-2B, BFC-3B, etc., depending on the number of stacked sections required.

Rugged Construction

Mechanically, the antenna is designed for rugged service in all types of weather conditions, and will withstand wind velocities up to 110 miles per hour. Radiating elements are made of durable stainless steel that eliminates electrolysis and corrosion when bolted to the copper feed system. The design is flexible and permits ease of installation on the side of an existing tower, or pole mounting on top of towers or buildings. Mounting brackets are supplied with antennas for standard or conventional installations at no extra cost. Custom brackets can be supplied at extra cost for special or unusual types of installations. The antenna can be supplied with standard poles using either pedestal or socket mounts.

De-icing Provisions

De-icing equipment is an accessory item which must be ordered with the antenna. The de-icing equipment is recommended for most areas and especially where icing and sleet conditions are common. Radomes are available for use in areas where severe conditions exist. The de-icing equipment is designed to provide long life and trouble free operation and is factory replaceable.

Each bay of a BFC Antenna with de-icers has a current transformer which is mounted either on the pole or on a leg of the tower. This transformer, fed with 208/240 Volt single phase, delivers 3.0 Volts at about 250 Amperes. The output of this transformer is fed via a heavy teflon insulated wire which has high heat handling capability through each of the arms of the antenna and is grounded internally at the ends of the arms. The current passing back through the stainless steel arms heats the arms directly.

Sectionalized Construction

The RCA Type BFC Circularly Polarized FM Antenna is of sectionalized construction; each section consisting essentially of two crossed semi-circular radiators attached to a supporting frame and a section of 3/8-inch transmission line. The antenna input is provided with a 50 Ohm EIA flange for connection to other 3/8-inch transmission lines. Adaptors are available for other transmission line types and sizes. Standard antennas have power gains from approximately 0.5 to 8.0. Special designs are available on application. An adjustable transformer section is located near the input fitting. A voltage standing wave ratio of 1.1:1 or better can be achieved with a minimum of field trimming.

Radiation Pattern

The horizontally polarized azimuthal radiation pattern of the BFC antenna is essentially omnidirectional for top mounting. The extent of deviation from a cir-

cular pattern for a side mounted array is dependent on type and size of the tower. It is recommended that the array be mounted, if possible, above the top set of guys on a guyed tower. Where this is not possible the guys in the immediate area of the antenna should be broken by insulators every 3 1/2 feet for a distance of at least 14 feet. In addition, each guy in the vicinity of the antenna should be insulated at the point where it connects to the tower.

Mechanical Features

Each section consisting of two crossed semi-circular radiators is mounted on a short horizontal section of 1 5/8-inch transmission line fitted with an insulated central feed point and supported from the 3/8-inch feed system. Only one coaxial transmission line is used to feed all sections of the antenna, and the individual radiating sections are identical mechanically and electrically. The radiators are both shunt fed and mechanically supported by the interconnecting feed system which consists of modified lengths of RCA 3/8-inch rigid coaxial transmission line. The BFC-1B through BFC-7B Antennas terminate mechanically in a pressurized top cap with bleed valve and a bottom input flange for connection to the desired type of transmission line.

The type BFC-8B through BFC-16B Antennas are center fed through a matching tee and the lower and top radiators terminate mechanically in pressurized caps.

Mounting Dimensions and Feed Line Locations, BFC Series FM Antennas.

(See Table on opposite page)

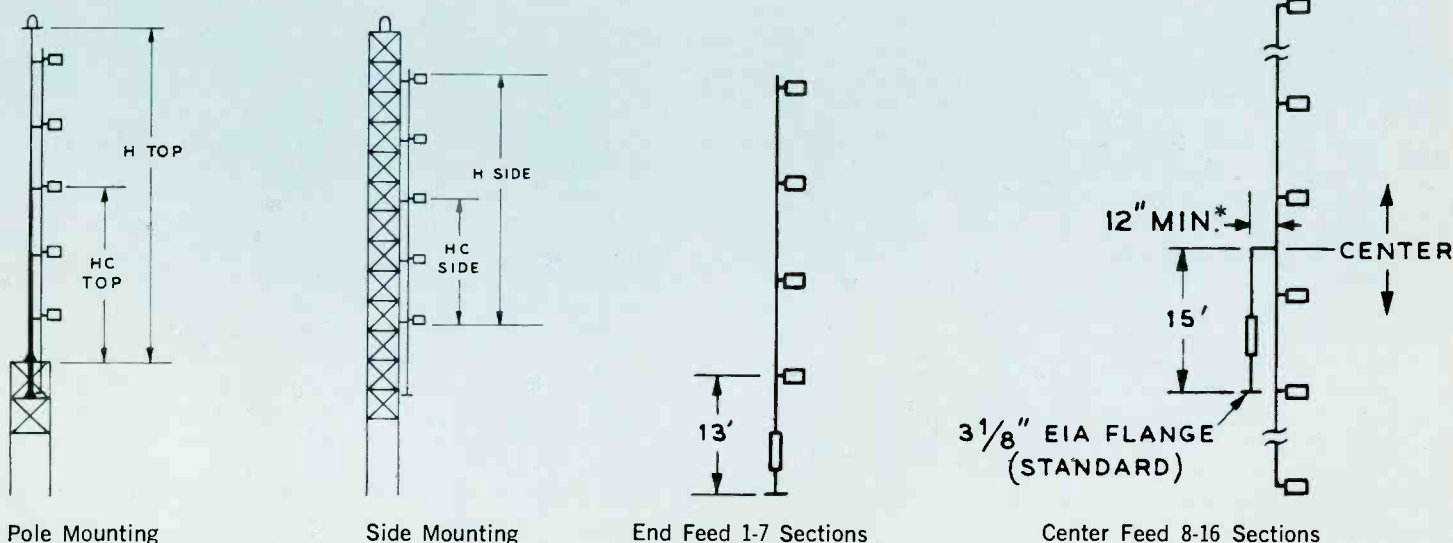

* Can be made to dimension desired to bring input line to correct support position.

Specifications

ELECTRICAL DATA										MECHANICAL DATA										
RCA Type	Gain				Field Intensity ¹	Power Rating ²				Freq. ³ MHz	Dimension in Feet					Windload at 50/33 PSF				
	Horizontal		Vertical			With Radomes		Without Radomes			Hc Top	Hc Side	H Top	H Side	Less De-Icers	With De-Icers	With Radomes			
	Power	dB	Field	Field		Power	dBk	Power	dBk											
BFC-1B	0.46	-3.37	0.678	0.678	93.2	10.0	10.0	4.0	6.02	5.0	.60	5.8	1.4	1.78	198	332				
BFC-2B	1.0	0	1.0	1.0	137.5	20.0	13.01	8.0	9.03	9.8	10.6	17.0	12.5	337	377	645				
BFC-3B	1.5	1.76	1.23	1.23	168.4	30.0	14.77	12.0	10.79	10.8	9.5	14.9	10.4	319	359	627				
BFC-4B	2.1	3.22	1.45	1.45	199.2	40.0	16.02	16.0	12.04	88	11.8	28.1	23.7	495	555	957				
BFC-5B	2.7	4.31	1.64	1.64	225.2	40.0	16.02	20.0	13.01	98	10.6	25.8	21.4	475	535	937				
BFC-6B	3.2	5.05	1.79	1.79	246.0	40.0	16.02	24.0	13.80	108	9.7	24.0	19.5	459	519	921				
BFC-7B	3.8	5.80	1.95	1.95	268.0	40.0	16.02	28.0	14.47	88	17.3	39.3	34.8	653	723	1269				
BFC-8B	4.3	6.34	2.07	2.07	285.2	40.0	16.02	32.0	15.05	98	15.6	35.9	31.4	623	703	1239				
BFC-10B	5.5	7.40	2.35	2.35	322.4	40.0	16.02	40.0	16.02	108	14.2	33.1	28.6	599	679	1215				
BFC-12B	6.6	8.20	2.57	2.57	353.2	40.0	16.02	40.0	16.02	88	27.3	50.4	46.0	810	911	1581				
BFC-14B	7.8	8.92	2.79	2.79	383.9	40.0	16.02	40.0	16.02	98	25.0	45.9	41.4	791	839	1510				
BFC-16B	8.9	9.49	2.98	2.98	410.2	40.0	16.02	40.0	16.02	108	23.2	42.2	37.7	763	839	1510				
										88	28.5	61.6	57.1	970	1090	1874				
										98	25.6	55.9	51.4	920	1040	1824				
										108	27.7	60.3	55.9	882	1000	1784				
										88	34.1	72.7	68.3	1128	1268	2183				
										98	30.7	65.9	61.5	1068	1208	2123				
										108	27.9	60.3	55.9	1020	1160	2075				
										88	39.6	83.9	79.4	1308	1468	2514				
										98	35.7	75.9	71.5	1238	1398	2454				
										108	32.4	69.4	68.0	1182	1342	2390				
										88	50.8	106.2	101.7	1625	1875	3165				
										98	45.7	96.0	91.5	1535	1735	3075				
										108	41.5	87.6	83.2	1483	1663	3003				
										88	62.0	128.5	124.0	1942	2182	3790				
										98	55.7	116.0	111.5	1832	2072	3680				
										108	50.6	105.8	101.3	1744	1984	3592				
										88	73.1	150.8	146.4	2258	2538	4414				
										98	65.7	136.0	131.6	2128	2408	4284				
										108	59.7	124.0	119.5	2088	2304	4244				
										88	84.3	173.1	168.7	2575	2895	5039				
										98	75.7	156.1	151.6	2425	2745	4889				
										108	68.8	142.1	137.7	2205	2625	4669				

¹ Effective free space field intensity at one mile in mV/m for one kilowatt antenna input power for either equivalent horizontally polarized component or equivalent vertically polarized component.

² Based on a 40° C. ambient. Multiply values by 0.6 for 50° C. ambient. BFC-5 and larger antennas with higher power input ratings can be made available on application.

³ Interpolate for in-between frequencies.

Specifications

Electrical:

Frequency rangeFactory tuned to any channel in the 88 to 108 MHz band

PolarizationCircular, clockwise

Power Gain (over dipole)
 Horizontal Polarization: Approximately equal to half the number of sections stacked (see table)
 Vertical Polarization: Approximately equal to half the number of sections stacked (see table)

Azimuthal Pattern
 Horizontal Polarization: Circularity ± 1.0 dB in free space
 Vertical Polarization: Circularity ± 1.0 dB in free space

VSWR at input (without field trimming)
 Top Mounting1.2:1 or better
 Side Mounting1.5:1 or better

VSWR at input (with field trimming)
 Top or Side Mounting 1.1:1 or better can be achieved over entire 200 kHz channel

Input Connection $3\frac{1}{8}$ ", 50 Ohm EIA flange

Power Input RatingSee table

Mechanical:

Windload50 psf for flat surfaces:
 33 psf for cylindrical surfaces (based on true extreme velocity of 110 mph. (see table of specific antenna windloads)

Section Dimensions:
 Height20" (50.80 cm)
 Diameter20.7" (52.58 cm)

Feed Point:
 BFC-1B through BFC-7BApprox. 13' below #1 radiator
 BFC-8B through BFC-16BCenter fed
 Feed point approx. 15' below center

Approximate Weight in Pounds:*

Type	Less Deicers	With Deicers	With Radome
BFC-1B	76	136	118
BFC-2B	137	257	221
BFC-3B	198	378	334
BFC-4B	259	499	427
BFC-5B	320	620	530
BFC-6B	381	741	633
BFC-7B	442	862	736
BFC-8B	513	993	849
BFC-10B	635	1235	1055
BFC-12B	757	1477	1261
BFC-14B	879	1719	1467
BFC-16B	1001	1961	1673

* Weight includes BFC Elements, Feed System to Input & Mounting Brackets (13" to 18" extension).

Ordering Information

Type BFC Circularly Polarized FM Antenna with standard support brackets for mounting on conventional towers (specify type or furnish tower drawings). Order by stock number as follows:

	Less Deicers	With Deicers	With Radomes
BFC-1B Single sec. FM antenna	ES-561921-A	ES-561921-B	ES-561921-C
BFC-2B Two sec. FM antenna	ES-561922-A	ES-561922-B	ES-561922-C
BFC-3B Three sec. FM antenna	ES-561923-A	ES-561923-B	ES-561923-C
BFC-4B Four sec. FM antenna	ES-561924-A	ES-561924-B	ES-561924-C
BFC-5B Five sec. FM antenna	ES-561925-A	ES-561925-B	ES-561925-C
BFC-6B Six sec. antenna	ES-561926-A	ES-561926-B	ES-561926-C
BFC-7B Seven sec. FM antenna	ES-561927-A	ES-561927-B	ES-561927-C
BFC-8B Eight sec. FM antenna	ES-561928-A	ES-561928-B	ES-561928-C
BFC-10B Ten sec. FM antenna	ES-561929-A	ES-561929-B	ES-561929-C
BFC-12B Twelve sec. FM antenna	ES-561930-A	ES-561930-B	ES-561930-C
BFC-14B Fourteen sec. FM antenna	ES-561931-A	ES-561931-B	ES-561931-C
BFC-16B Sixteen sec. FM antenna	ES-561932-A	ES-561932-B	ES-561932-C



- Conducts FM power across AM tower base insulator with minimum effect on AM tower operating impedance
- Standard EIA connections—easy to install
- Rugged design includes weather and lightning protection
- Inserts directly in pressurized FM coaxial transmission line

RCA AM-FM Antenna Isolation Units, Type BAF-15A/16A

Description

The RCA Type BAF-15A and BAF-16A FM-AM Isolation Units are designed to transfer FM power across the base insulator of an AM antenna tower to feed an FM antenna mounted atop the tower. The units provide isolation of FM and AM signals and efficient operation over the entire FM frequency range.

The BAF-15A Isolation unit is a rugged

pressurized copper section designed to mount directly in 1 $\frac{5}{8}$ -inch FM transmission line between transmitter and antenna by means of standard EIA* fittings. It serves as a 10-kW isolation unit and second harmonic filter providing high harmonic attenuation. The BAF-16A Isolation unit provides the same functions and is designed to fit in 3 $\frac{1}{8}$ " EIA co-

axial lines fed by transmitters with up to 40 kW FM power. Both units can be mounted to the tower leg by means of standard hangers. They are pressurized from the regular FM coaxial line and permit gas to pass through to thus pressurize the vertical run of line feeding the antenna. Protection against weather and lightning are design features.

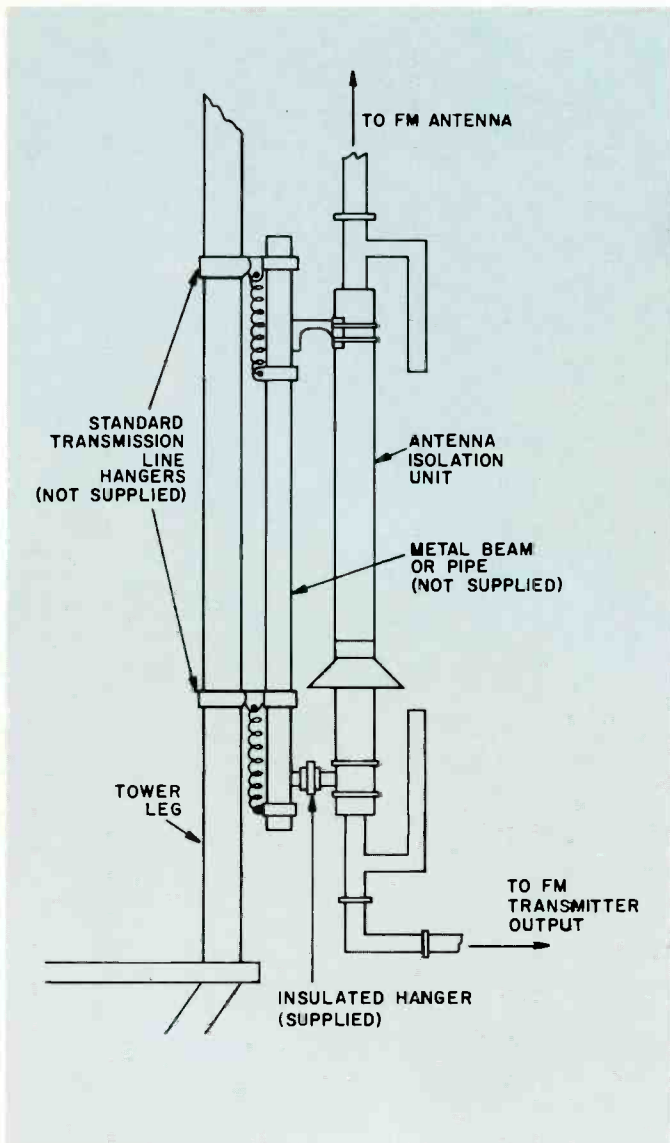

Specifications

TYPE BAF-15A

Frequency Range	88-108 MHz
Nominal Impedance	50 ohms
Maximum VSWR with 50 ohm Load	1.08
Maximum Operating Power FM	10 kW
Maximum Tower Base Voltage AM	10 kV peak
Insertion Loss	Less than 0.1 dB
Internal Capacitance to AM	130 pF
Maximum Gas Pressure for Pressurizing	30 psig
Weight	Approximately 55 lbs. (25 kg)
Dimensions	Diameter 3 3/8 inches (80mm) Length 130 inches (3300mm)
Connectors	Coaxial line (1 5/8-inch) EIA* (41mm)
2nd Harmonic Rejection	70 dB
4th Harmonic Rejection	50 dB
6th Harmonic Rejection	30 dB

TYPE BAF-16A

Frequency Range	88-108 MHz
Nominal Impedance	50 ohms
Maximum VSWR with 50 ohm Load	1.08
Maximum Operating Power FM	40 kW
Maximum Tower Base Voltage AM	14 kV
Insertion Loss	Less than 0.1 dB
Internal Capacitance to AM	130 pF
Maximum Gas Pressure for Pressurizing	12 psig
Weight	Approximately 100 lbs (45 kg)
Dimensions	Diameter 6 3/8 inches (156mm) Length 161 inches (4189mm)
Connectors	Coaxial line (3 1/8-inch) EIA (80mm)
2nd Harmonic Rejection	80 dB
4th Harmonic Rejection	60 dB
6th Harmonic Rejection	40 dB

*Use adapter (MI-19112-62) to connect with RCA 1 5/8" line.

Ordering Information

Type BAF-15A (10 kW) Isolation Unit

For assigned channels between:

88-93 MHz	MI-561573-1
93-98 MHz	MI-561573-2
98-103 MHz	MI-561573-3
103-108 MHz	MI-561573-4

Type BAF-16A (40 kW) Isolation Unit

For assigned channels between:

88-93 MHz	MI-561574-1
93-98 MHz	MI-561574-2
98-103 MHz	MI-561574-3
103-108 MHz	MI-561574-4



RCA 50 KW "Ampliphase" AM Transmitter, Type BTA-50J



- Excellent audio quality
- Wide range frequency response
- Only six tubes in transmitting circuits
- Proven stability
- Designed for remote control
- Over 110 percent positive modulation capability

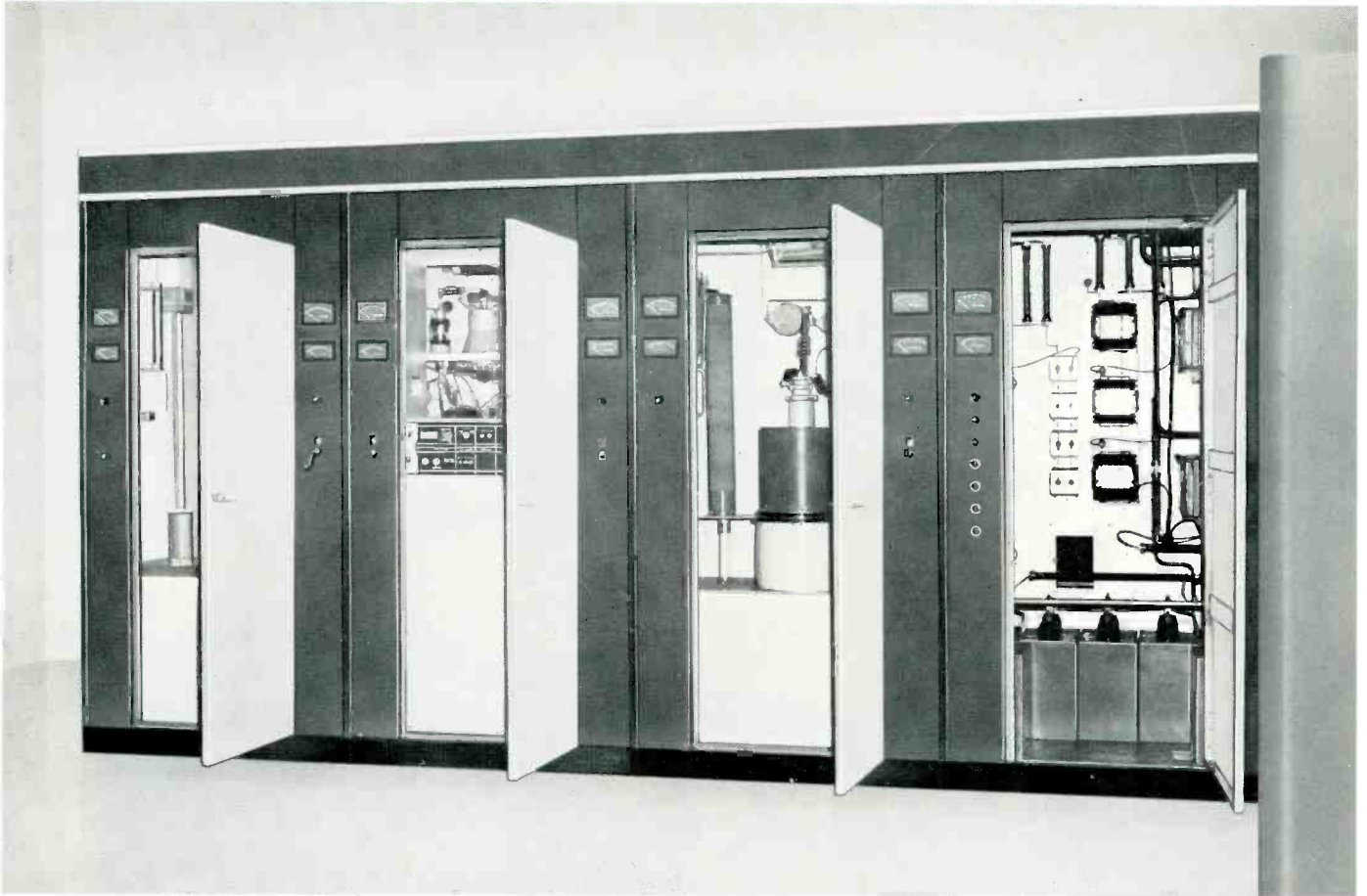

Compact in-line construction of BTA-50J showing left to right, left hand power amplifier, exciter, right hand power amplifier, and rectifier-control cubicle.

Description

The RCA Type BTA-50J AM Broadcast Transmitter is a completely air-cooled, 50-kW phase-to-amplitude modulated transmitter designed for high fidelity transmission in the standard broadcast band (535 kHz to 1620 kHz). It provides a signal containing exceptionally low distortion and extended frequency response. Measured response is flat within ± 3 dB from 35 Hz to 25,000 Hz. The equipment is capable of being modulated over the frequency range of 10 Hz to 30,000 Hz. Frequency response has been extended largely through the elimination of unnecessary transformers in the audio system as well as improved circuitry.

Low harmonic distortion with negligible carrier shift at maximum signal output has been achieved in the BTA-50J by selection of adequate power tube types and advanced solid state circuits in

the exciter-modulator-drive regulator design throughout the entire equipment. The design features an inherently linear system capable of continuous high modulation levels impervious to inadvertent overmodulation. For example, the transmitter may be modulated 100 percent at any frequency between 30 and 15,000 Hz continuously for many hours without detrimental effects to any of the component parts. A small amount of overall feedback is incorporated to provide the exceptional performance. With the feedback circuit removed, the BTA-50J will still meet the FCC specifications for audio frequency response, harmonic distortion and noise.

Lowest Operating Cost in 50-KW Transmitters

A number of new refinements as well as time tested features which have proven their worth are incorporated in RCA's

latest 50-kW transmitter. Power requirements are moderate for the equipment. Power amplifier plate efficiency of the order of 76 to 80 percent is obtained. Total power consumption for 50-kW carrier power will run approximately 94 kW, approximately 100 kW will be required for average levels of modulation, and approximately 130 kW will be required for 100 percent modulation.

Fewer major components, as compared to those required by many 50-kW transmitters, are used in the BTA-50J. In addition to the low cost of operation of the transmitter a Power Cutback Kit, MI-27688-B can be added which will permit operation at 10 kW.

Dual RF Chains

Two identical RF chains, each developing a power of 25 kW, are incorporated in this equipment. Since they are identi-

cal, servicing is made easy by comparison of the two chains. Components are directly interchangeable, which allows substitution for comparison purposes. All components are easily accessible which results in a minimum schedule for maintenance. In addition, fewer replacement parts are required for adequate protection against lost air time should a failure occur. Low power consumption, fewer major components and a reduced maintenance schedule make the BTA-50J operation cost the lowest in the 50-kW field.

Remote Control Operation

The transmitter has been designed with remote control operation in mind. Ready for use with standard RCA remote control equipment, all transmitter components and wiring are standard in the equipment for FCC required metering and control facilities. In addition, other optional metering and control facilities may be incorporated by utilizing components and wiring that is supplied with the equipment. Details relative to incorporating remote switching to an auxiliary transmitter, dummy load and auxiliary power supplies can be supplied according to the needs of the individual customer.

Lightweight Type 6697 Tubes in Final PA

One Type 6697 power amplifier tube is used in each of the two RF chains. Each amplifier tube is capable of delivering in excess of the normal 25 kW of modulated power to the common load. The Type 6697 is rated at 35 kW dissipation and under average modulation conditions it is only required to dissipate approximately 14 kW. Operation of the PA tubes so far below their maximum ratings assures the user of long tube life. In addition to providing long life, the 6697 is physically small in size and weighs only 29 pounds. One person, without the aid of mechanical assistance can quickly and easily replace any tube in the transmitter.

One Type 4CX5000A tube is used in each of the driver stages in the two RF chains. The 4CX5000A is also operated well below its maximum ratings and will give long trouble free service. The only other tubes used in the transmitter are the two 4-250A Intermediate Power Amplifier tubes. There are also four tubes in the monitor circuits. These are of the small, low cost variety. Tube complement is such that inventory cost for required spares is kept at a minimum while ade-

quate protection to the broadcaster is maintained.

Solid State Rectifiers Used Throughout

All power supplies utilize solid state rectifiers. The plate supplies, bias supply and low voltage supply use silicon units which are very conservatively rated to assure long life. The current rating of the units is such that any conceivable load fault is cleared without jeopardizing the diode units. The use of solid state rectifiers permit the transmitter to operate in ambient temperatures as low as -20 degrees centigrade.

Meets FCC Harmonic Suppression

A completely shielded two section low pass filter is incorporated in the BTA-50J. It consists of one pi (π) section and one T section and each inductive series element is completely shielded. Two series-tuned, shunt-connected traps are used to provide added attenuation of the second harmonic.

Transmitter Equipment

Type BTA-50J AM Broadcast Transmitter consists of four equipment cabinets, two of which house the power amplifiers, one the exciter unit and the fourth cabinet the rectifier and control unit. The high-voltage reactor is housed in the lower rear compartment of the exciter cabinet, and the IHV plate transformer in the lower rear compartment of the rectifier and control cabinet.

Each of the four transmitter cabinets measure 44 inches wide by 60 inches deep by 84 inches high, and consists of an all aluminum cubicle erected on a welded steel base. This cubicle consists of a series of panels fabricated and assembled to form a rigid structure. The use of aluminum eliminates unnecessary weight and provides excellent shielding to assure effective confinement of spurious energy. Maximum accessibility to all transmitter components are afforded by 28-inch wide, full-length front doors, while rear access is through two covers attached with quick-disconnect fasteners for easy removal.

A center vertical panel separates the cabinet into a front compartment and rear compartment which is further divided by a rear horizontal shelf into upper and lower compartments, giving each cabinet three basic totally shielded compartments in which to mount the electrical components. The eye-level meters, pilot lights and interlocks, mounted on

eight-inch wide panels flanking each of the front doors, are also shielded.

In the rear at the top of each cabinet there is a built-in wire duct which joins similar ducts of the adjacent cabinets to form a continuous duct on the four cabinets. This duct has a divider down the center on which the interconnection terminal boards are mounted. The rear half of the duct is used for interconnection wiring while the front half is used for internal cabinet wiring from the terminal boards. The internal wiring is carried through conduits to its destination in the cabinet thus shielding all power and control wiring from RF fields. Provision is also made at the top of the cabinets for the addition of an exhaust air duct.

Power Amplifiers

The left end cabinet and the third cabinet from the left end are identical and contain the final power amplifier stages. The 6697 tube and its grid circuits and part of the plate circuits are contained in the front portion of the cabinet. The upper rear section contains the plate tank coil, filament transformer and grid leak resistors. The lower rear section contains a low noise blower which cools the 6697 tube and its cabinet and the adjacent half of the exciter cabinet. The two 6697 power amplifiers are designed to supply equal amounts of power to the output network. Because of the balanced dissipation in the two 6697 PA tubes, less air pressure with resultant lower air flow is required for adequate cooling of the power amplifier cubicles. The lower rear panel contains an impingement type air filter for the blower. The PA cabinets are constructed so that the blowers and filters can be mounted externally to the cabinets, if so desired.

Solid State Exciter-Modulator

Located directly between the two power amplifier units is a cabinet that houses in its front section all the solid state components from the oscillator through the driver stages. The separate branches are assembled as mirror images for symmetrical feed to the PA units at left and right. The rear cabinet section contains the 50 kW common output circuit, harmonic filter, and reflectometer protective circuits.

Above are two vertical sub-compartments behind interlocked doors which contain the 4-250 and 4CX5000A stages. A meter panel for these stages is located at the bottom of these sub-compartments.

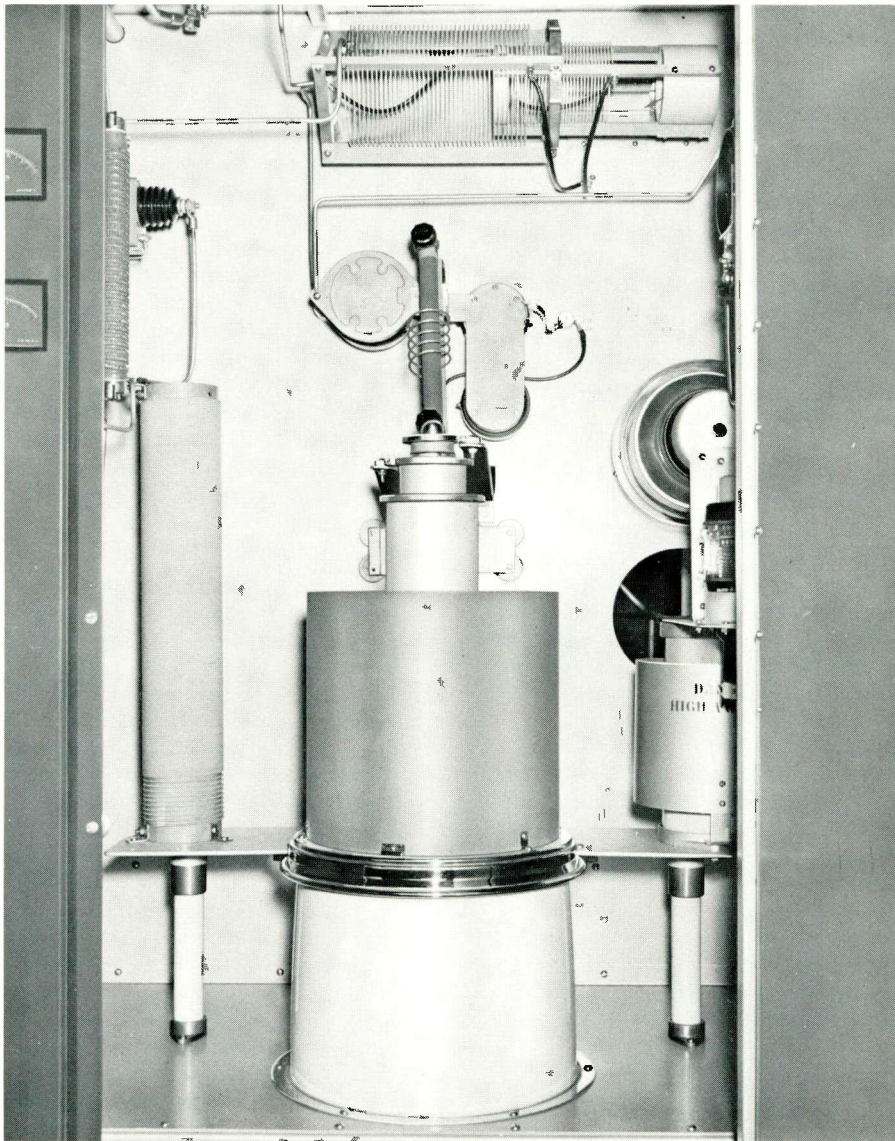

Close-up view of one of the dual final power amplifier stages. The new type 6697 tube together with grid circuits and part of the plate circuits are readily accessible from the front of the transmitter.

The common output capacitors of the two PA tanks and the harmonic filter are located in the upper rear of the cabinet. Sub-partitions are so arranged in this section that complete isolation and shielding is effected between the various sections of the filter and the output capacitor. The lower rear section of this cabinet contains high voltage filter reactor and driver DC filament supplies.

Provisions for Standby Operation

Space is provided in the exciter-modulator cabinet for the mounting of a second exciter-modulator unit. Each of the modulator-exciter units are complete

and arranged so that either may be selected instantly by means of cutover switches. Thus while modulator #1 is in operation, modulator #2 is in standby condition. These provisions with the extreme reliability designed into the high power stages essentially provides a second 50-kW transmitter for standby service.

Rectifier and Control Unit

The right hand cabinet contains the high power rectifiers, low power distribution components, and the majority of the control components. The front of the cabinet contains the solid state 15-kV, 5-kV, and low-voltage bias supplies. Also in-

cluded here are the high voltage grounding switches and the 15-kV filter capacitors. The top rear section of the cabinet contains the control relays, overload relays, distribution contactors, and the low power distribution circuit breakers. The distribution breakers and overload relays are readily accessible, even though recessed so that they will not be damaged or improperly operated. The bottom rear of the cabinet contains the 5-kV rectifier components including plate transformer.

The PA output circuit is a conventional pi-network type of tank circuit. Each tube has its own tank circuit, with a common output shunt element. Each network is adjusted to provide the proper load to the power amplifiers.

Drive Regulator

The drive regulator samples the audio signal, amplifies it, and applies a desired value to the grids of the second IPA, providing adequate drive to the final amplifiers as required by the level of audio input applied to the equipment. This technique contributes considerably to the overall linearity during modulation.

During periods of 100 percent modulation, the 6697 power amplifier tubes require 15-kV DC at 7.5 Amperes, which is obtained by using RCA silicon power rectifiers in a three phase full wave rectifier circuit. Two other plate voltages, 5-kV and 1-kV, are provided by separate silicon supplies. Bias voltages for all tubes are supplied by an additional supply. The high power distribution equipment for the transmitter consists of an electrically operated air circuit breaker, and a manually operated delta-wye switch for the 15-kV rectifier. The remaining transmitter power is distributed through a manually operated distribution circuit breaker to a 460 to 230-Volt distribution transformer to voltage regulators and thence to the various low power distribution circuit breakers.

Transmitter Control

Control circuits in the BTA-50J contain a number of features which are designed to provide maximum flexibility in control, protection and operation. Among these are choice of single-button or step-by-step starting, automatic timing and sequencing of starting operations, and location of transmitter faults by a system of indicators. Protection of the operator is achieved by a system of interlocking grounding devices; protection of the equipment by conventional relays and circuit breakers.



There are provisions for the protection of the equipment against transmission line irregularities and air failure. A reflectometer is incorporated in the BTA-50J that is sensitive to the changes in voltage to current ratio on the output transmission line to the antenna. A great change in transmitter load acts to remove the carrier by removing drive momentarily to allow any RF fault to clear. If, however, the fault persists after removing carrier several times, the plate power is automatically removed.

Control of the transmitter is accomplished from the front of the rectifier and control cabinet. All necessary wiring to allow control from a remote location or console has been provided. Lamps which show the status of the transmitter control circuits are also mounted on the front of this cabinet. The control ladder is arranged and interlocked so that the BTA-50J can either be turned on by operating the control switches in sequence or by leaving all control switches in the ON position with the exception of the start switch, which when operated to the ON position allows the transmitter to automatically come on.

Upper rear of exciter portion of the BTA-50J showing the combining and output networks.

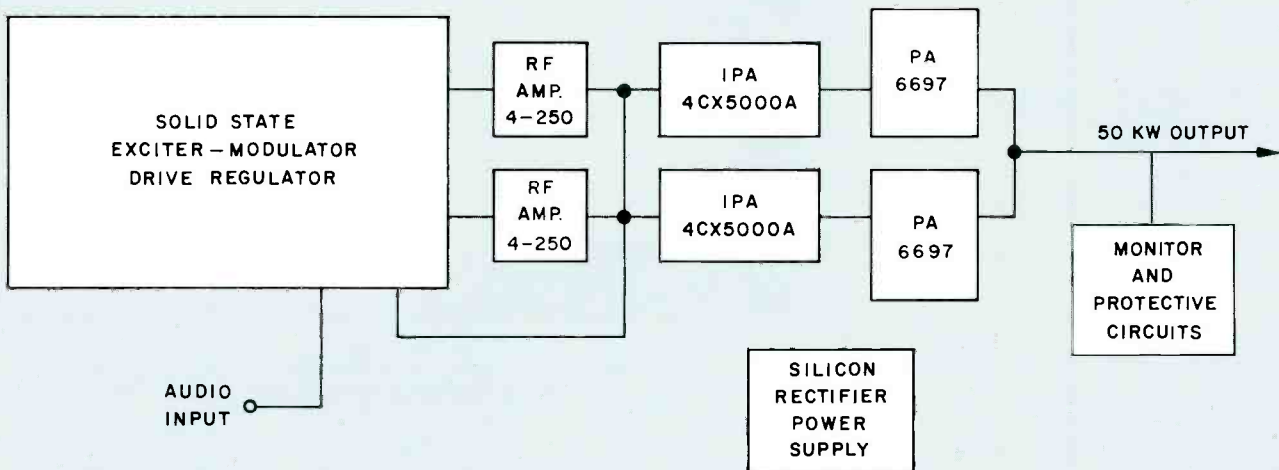

Simplified block diagram of the BTA-50J.

The two types of overload circuits used in this transmitter are the current type, instantaneous or time delay, that are connected directly in the tube circuit and rectifier ground leads, and the thermal magnetic circuit breakers connected in the AC power leads used as back up protection and disconnect switches. The transmitter circuitry is arranged so that an overload will either lock out the plate circuit or allow a single reclosure that will reset if there are no further overloads. In either case, when a lockout position has been reached, the transmitter can be reset by means of an overload reset control. The principal overload relays have indicating flags so that even after the overload has been cleared there is a record of which overload has operated. Another feature of the control circuit is provision of indication lamps on each cabinet that indicate the status of the interlock in that particular cabinet.

Installation and Layout

Outstanding features of the BTA-50J are the small floor space requirements and ease of installation of the transmitter. In general, the transmitter layout consists of three basic parts: the four in-line cabinets which contain the major part of the transmitter; the wall mounted switch-gear components; and the main plate transformers. The floor plan illustrates a typical layout of the complete equipment. Elimination of the need for under-floor cable trenches and considerable reduction in external air ducts, simplifies installation and reduces costs.

As shown in the layout, it is desirable to leave a passageway at the right end of the frontline cabinets since the circuit breakers and overload relays are most accessible from this end of the transmitter. The layout of the front line cabinets is such that a common exhaust duct can be used to carry off heated air from the transmitter.

Wall mounting as shown on the overall floor plan is suggested to make the BTA-50J most adaptable to existing transmitter buildings. The mounting of these components, however, is not critical as to location. They can be mounted in existing power distribution areas if desired. These components include the main plate circuit breaker, a delta-wye switch, a distribution circuit breaker, a 460 to 230-Volt bank of distribution transformers, and two single phase open delta connected regulators with their control panels. These components are wired through conduit and overhead ductwork to the main plate transformers and the transmitter cabinets.



Front section of the exciter-modulator containing all components from oscillator through the driver stages.

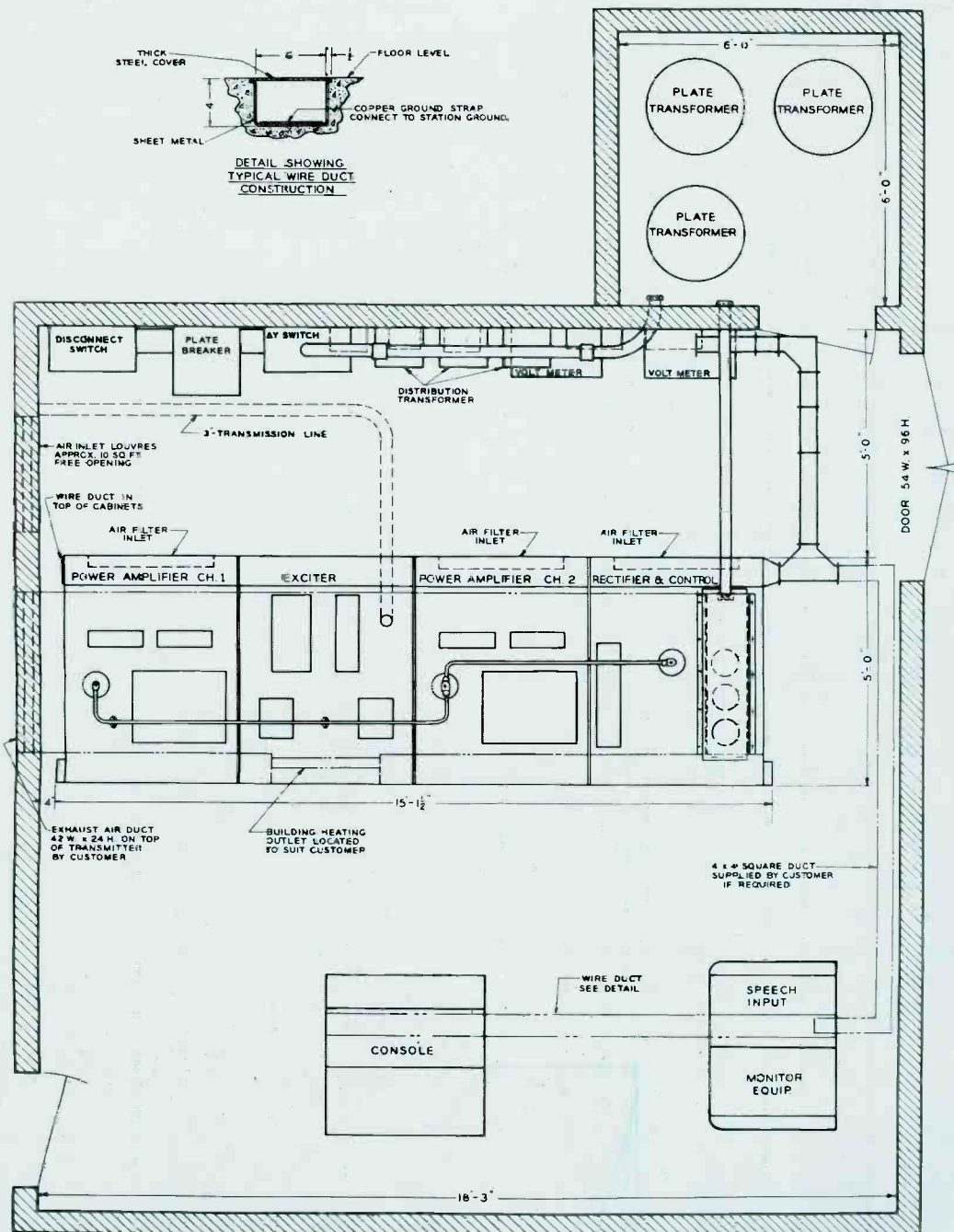

Typical floor plan for the BTA-50J Transmitter.

Specifications

General

Power Line Requirements:

Line460 Volts, 50/60 Hertz, 3 phase
 Combined Regulation and Variation ...Not more than $\pm 5\%$

Power Consumption94 kW (approx.) at zero modulation

Power Consumption100 kW (approx.) at average modulation

Power FactorBetter than 90%

Crystal Heaters110 Volts

Type of EmissionA3

Power Output (at transmitter terminals)56 kW (max.)

FrequencyAny specified between 535 and 1620 kHz

Frequency StabilityAssigned frequency ± 5 Hertz

Type ModulationPhase to amplitude

AF Input Impedance150/600 Ohms

Audio Input Level+10 ± 2 dBm

Audio Response ± 1.5 dB 30–10,000 Hz

AF DistortionLess than 3% RMS 50–7500 Hz

Noise Level60 dB below 100% modulation

Carrier ShiftLess than 5% neg. 100% modulation

Type OutputUnbalanced

Output Impedance51.5 Ohms or others specified

Spurious Emission (2nd Harmonic and above) ...83 dB down

Mechanical

Cabinet Size44" wide, 84" high, 63" deep
 (111.8 cm wide, 213.4 cm high, 160 cm deep)

Overall Weight12,000 lbs. approx. (545 kg)

Maximum Altitude7500 ft. (2286 m)

Ambient Temperature -20°C $+45^{\circ}\text{C}$

Maximum Cabinet Weight3,093 lbs., approx. (1403 kg)

PA Cabinet Weights (each)953 lbs., approx. (432 kg)

Plate Transformer Weight (total)820 lbs., approx. (372 kg)

Rectifier Weight3,093 lbs., approx. (1403 kg)

Exciter Weight1,241 lbs., approx. (563 kg)

Filter Reactor570 lbs., approx. (259 kg)

Tube Complement

RF Amplifier Section:

2	4-250A	Intermediate Power Amplifier
2	4CX5000A	Driver Amplifier
2	6697	Power Amplifier

Monitor Circuits:

1	1614	Frequency Monitor Amplifier
2	6AL5	Reflectometer
1	2D21	Thyratron Control

Accessories

Complete Set of Operating TubesES-27222-D

Recommended Spare Set of TubesES-27223-D

Type BTR-11B Remote Control Equipment
 (10 Functions)ES-34280

Type BTR-20D Remote Control Equipment
 (20 Functions)ES-561415

BTRX-40A—20 Position Extension for BTR-20C..MI-27556

50/10-kW Cutback Kit for BTA-50J
 TransmitterMI-27688-B

Dummy Load Schedule of Parts and
 InstructionsES-34234

BPA-50 Antenna Tuning UnitMI-28903-A/B

BPA-50 Antenna Tuner (230 Ohms)ES-28903-A

BPA-50 Antenna Tuner (70/51.5 Ohms)ES-28903-B

RF Ammeter (for BPA-50)MI-7147-Series

Remote RF Pickup Unit (less Meter)MI-28027-C

Remote Antenna MeterMI-7157-Series

Type BW-11A Frequency MonitorES-34042

Type BW-66F Modulation MonitorMI-30066-B

Automatic Logging EquipmentOn Application

Ordering Information

Type BTA-50J 50-kW AM Broadcast Transmitter with two crystals, remote meter, one set of operating tubes, silicon rectifiers, and one exciter. Does not include antenna tuning unit. (Specify operating frequency and output impedance)ES-27221-D