



B R O A D C A S T

AUDIO

E Q U I P M E N T

FOR

AM · FM · TELEVISION

—
(FIFTH EDITION)

CUSTOM EQUIPMENT
CONSOLES
AMPLIFIERS
TURNTABLES

RACK EQUIPMENT
SPEAKERS
RECORDERS
MICROPHONES

BROADCAST AUDIO EQUIPMENT CATALOG

(Fifth Edition)

PRICE \$1.00



RADIO CORPORATION OF AMERICA

Broadcast and Television Equipment

Camden 2, N. J.

	Page
Microphones	3
Consolettes	23
Custom Audio	41
Amplifiers	45
Power Supplies	64
Rack Equipment	67
Turntables	77
Recorders	83
Speakers	91
Test Equipment	97
Index	115

ABOUT THIS CATALOG

This Catalog is devoted solely to Audio Equipment designed to the standards required for radio and television broadcast applications. (These equipments may also be employed in many other studio applications requiring quality results.) Other RCA Broadcast Equipment Catalogs contain information on antennas, transmitting and transmission line equipment for AM, FM, and TV stations. There are also catalogs on video equipment: TV cameras, terminal, microwave, TV tape and film equipment, and mobile units.

The information contained in this catalog is intended to serve as a buying guide for the user. Complete specifications and ordering information are supplied. For more information on equipment items, or planning assistance, write to the RCA Broadcast Representative in the nearest RCA Sales Office (see Back Cover).

OTHER RCA TECHNICAL PRODUCTS

The RCA equipment described in this catalog is specifically designed for broadcast use, RCA also manufactures many other electronic products, including: two-way radio and microwave relay communications equipment; optical and magnetic film recording equipment; sound systems of all types; 16mm projectors and magnetic recorders; industrial inspection and automation equipment; scientific instruments, such as the electron microscope; closed-circuit television systems; and many types of custom-built equipment for industry, the military, educational and medical services. Information describing these products may be obtained from RCA Sales Offices.

PRICES

The prices of the various equipment units shown in this catalog are given in a separate price list. Prices are listed in the order in which they are shown in the catalog. To determine the price of any equipment first note the page on which it is shown in the catalog, then consult the price list in accordance with this page number. Equipments are identified by type and MI (Master Item) numbers which are used to identify apparatus on invoices and packing slips.

HOW TO ORDER

The RCA Broadcast Audio Equipment shown in this catalog is sold directly through RCA Broadcast Representatives, who are familiar with broadcast equipment and related problems. These RCA Representatives are located in convenient offices. Orders for equipment shown in this catalog, or requests for additional information, should be directed to the nearest RCA Sales Office.

RCA Microphones

General Information

The excellence of RCA microphones is the result of continued effort on the part of Engineering and Production personnel to produce a superior product. Out of this work have come the several types of broadcast microphones listed in the catalog. There is considerable overlap in the applications of the various types, but each does possess certain attributes which make it particularly well suited to some specific applications. These have been noted for each microphone in the catalog in order to assist in the selection of the microphone best suited for the intended application.

High Quality Broadcast and Television Microphones

Broadcast-type microphones such as the Types BK-1A, BK-5B, BK-6B, BK-11A and 77DX, all have certain common performance criteria which make them especially suited to this application. They have smooth frequency-response characteristics over the audio range, low distortion, high output levels, well-shielded output transformers to prevent hum pickup, and where necessary, are shock mounted to reduce the pickup of low frequency building rumble. Performance features which are unique to each particular type are listed and the applications discussed in the catalog.

Public Address Microphones for Broadcast Use

Public Address Microphones have been designed as economy microphones. In general, frequency range and sensitivity have been sacrificed to some extent in order to gain ruggedness and lower cost. The response limitations should be borne in mind when these microphones are used in Broadcast applications.

Unloaded Transformer Input

RCA Broadcast Microphones are designed to work into a microphone preamplifier whose input transformer is unloaded. Under this condition of operation the voltage appearing at the input of the first amplifier stage results in a gain in signal-to-noise ratio of between 3 and 6 db as compared with a matched resistance load. The exact value will depend on whether the major source of thermal noise is in the microphone amplifier or in the microphone.

Microphone Resistance Loading

Microphones in which the moving system is highly damped will in general have their frequency response characteristics little changed by electrical loading. The BK-1A and 77-DX (in the pressure position) are examples of this.

Microphones which show output impedance variations with respect to frequency will have their response characteristics adversely affected by resistance loading. The Type BK-5B, and 77-DX (in the bi-directional and uni-directional positions) are examples of this. Resistance loading of these microphones will generally result in a loss in low frequency response.

150 Ohms vs. 250 Ohms

When microphones are connected to unloaded input transformers, impedance matching is not a consideration and the effects of connecting microphones with an output impedance of 150 ohms to a microphone amplifier designed to operate from a 250 ohm source and vice versa will usually be of small consequence. The effect on the level is shown in the tabulation below.

Mic. Output Impedance	Level Change db	
	250	150
250	0	+2.2
150	-2.2	0
Amp. Input Designation	250	150

In addition there will be some change in the overall response-frequency characteristic of the system below 100 cycles and above 5000 cycles, the magnitude depending on the connection and the design of both the microphone and the amplifier input transformer. Variations in response with the usual broadcast quality microphone amplifiers will in most cases not exceed ± 2 db.

When microphones are connected to a resistance load the following changes in level will result when the output is referred to a matched condition.

Mic. Output Impedance	Level Change db	
	250	150
250	0	-2.5
150	+2.0	0
Load Impedance	250	150

Microphones Shipped Less Plug

RCA microphones are supplied less the plug for connection to the wall outlet or amplifier system. This is done to allow the user to select any desired plug. As a convenience, popular types of Cannon plugs are catalogued and they may be ordered as an accessory if desired.*

Microphone Mounting

RCA has standardized on the rugged $\frac{1}{2}$ -inch pipe thread for broadcast microphone mounting. This size thread makes it easy to add microphone stand extensions, booms, etc., for they may be easily made up locally from standard $\frac{1}{2}$ -inch pipe and fittings. Stands listed for use with microphones having $\frac{5}{8}$ "-27 thread will accommodate RCA Broadcast Microphones by the addition of an adapter.

* Microphones are shipped connected for 250 ohms since in normal usage an improved signal to noise ratio results when connected to a 150 ohm preamplifier input.

Effective Output Level

When a microphone is connected to an unlaaded input transformer its power output connat be expressed in dbm because na appreciable power is delivered by the micraphane. The lagonal approach to the prablem is ta arrive at same level figure which, when cambined with the can-ventianally measured amplifier gain, will give the correct output level for the cambination. This figure is listed in the catalog for each micraphane and is called the Effective Output Level. It differs from the EIA standard rating G_M in the value of saund pressure and saurce impedance. The EIA rating camputotian is based an a saurce impedance of 150 ohms far all micraphanes having output impedances between 75 and 300 ahms, and an a saund pressure of 0.0002 dynes per square centimeter.

The Effective Output Level calculation is based on the naminal micraphane impedance and an a saund pressure of 10 dynes/cm².

The EIA standard defines the system rating (G_M) of a micraphane as the ratia in decibels relative to 0.001 watt per 0.0002 dynes per square centimeter of the maximum electric power available from the micraphane to the

square of the undisturbed sound field pressure in o plone progressive wave at the micraphone position. Expressed mathematically:

$$G_M = (20 \log_{10} \frac{E}{P} - 10 \log_{10} R_{MR}) - 50 \text{ db.}$$

where E = the open circuit voltage of the microphone
 P = the undisturbed sound field pressure
 R_{MR} = the micraphane roting impedance
 Electrical reference level = .001 watt
 Saund pressure = .0002 dynes/sq. cm.

While this may loak complex the application is simple. Far oll practical purpases the output level of the micraphone is obtained by adding ta G_M , the saund pressure level relative ta 0.0002 dynes per square centimeter. The saund pressure level of the program material can be measured with any of the several available saund level meters.

Hum Pickup Level

An arbitrary standard 60 cycle a-c field of 10⁻³ gauss has been established as a reference. It is fairly representative of fields measured at typical microphone laca-tions in braodcast studios. The hum level is referred ta .001 watt and is calculated in the same fashian as the Effective Output Level, using as the output valtage the valtage produced by the standard field.

Chart Showing Microphone Applications, Chief Characteristics and Recommended Mounts

Type No.	Use ³	Directional Characteristic	Effective Output Level ¹ and G_M ⁴	Output Impedance Ohms	Frequency Response cps	Hum Pick-up Level ²	Finish	Stand
77-DX	Program Announce	Poly-directional	-53 dbm G_M -147 db	30/150 250	50-15,000	-128 dbm	Satin Chrome & TV Gray	Boom, Desk, Floor
BK-1A	Program Announce	Non-directional	-53 dbm G_M -145 db	30/150 250	60-10,000	-102 dbm	Satin Chrome & TV Gray	Desk, Floor
8K-58	Program Announce	Uni-directional	-56 dbm G_M -150 db	30/150 250	50-15,000	-128 dbm	TV Gray	Boom, Desk, Floor
BK-6B	"Off-Mike" Speech	Semi-directional	-67 dbm G_M -158 db	30/150 250	80-12,000	-112 dbm	TV Gray	Clip & Microphone Lanyard
8K-11A	Program Announce	Bi-directional	-56 dbm G_M -147 db	30/150 250	30-15,000	-130 dbm	Stainless Steel & Low Gloss Gray	Desk, Floor
BN-10A	Remote Program	Semi-directional	+6VU	600	80-12,000	-112 dbm	TV Gray	Hand
KU-6A	Program Announce	Vari-directional	-36 dbm (-51 dbm) G_M -128 db	30/150/ 250	50-18,000	-128 dbm	Shadow Blue Pepper Tone	Boom, Desk, Floor
MI-10006A/ MI-10008	Specialized Program	Uluro-directional	-36 dbm (-51 dbm) G_M -128 db	30/150/ 250	30-18,000	-128 dbm	Shadow Blue Pepper Tone	Boom
KU-3A	Program Announce	Uni-directional	-51 dbm G_M -148 db	30/150/ 250	50-12,000	-128 dbm	Two-Tone Umber Gray	Boom, Desk, Floor
SK-39	Close Up Announce	Non-directional	-55 dbm G_M -150 db	250	70-9000	-95 dbm	Umber Gray	Hand, Desk, Floor
SK-45B	Intercom & Talkback	Non-directional	-56 dbm G_M -147 db	200/15,000	70-12,000	-106 dbm	TV Gray	Desk, Floor
SK-46	Rodio & TV Announce	Bi-directional	-58 dbm G_M -150 db	200/15,000	50-10,000	-113 dbm	Satin Chrome & TV Gray	Hand, Desk, Floor

¹ Reference level 0.001 watt, saund pressure 10 dynes per square centimeter. This corresponds ta o rating by the proposed EIA system of a saund pressure level of 94 db.
² Level referred ta a hum field of 10⁻³ gauss.

³ For details refer ta description of each porticular type.

⁴ G_M = (EIA rating).

⁵ Also available in TV Gray as MI-11006-C.

Polydirectional Microphone

TYPE 77-DX

FEATURES

- High quality reproduction with greater sensitivity over entire audio frequency range
- Styled for either radio or TV applications
- Choice of directional pattern to control ratio of direct-to-reverberant sound pickup
- Three-position voice-music switch allows selection of best operating characteristic
- Efficient shock mounting

DESCRIPTION

The RCA Type 77-DX Polydirectional Microphone is primarily intended for broadcast use either in the radio or television studio. Two models are available. The MI-4045-F finished in satin chrome and a low-gloss umber gray enamel is intended for AM or FM stations, while the MI-11006-C microphone is intended for television use and is therefore completely finished in a low-gloss umber-gray enamel which eliminates glaring reflections. Both instruments are high-fidelity microphones of the ribbon type which may easily be adjusted to obtain a variety of directional patterns.

As a uni-directional microphone the 77-DX has a wide pick-up angle in front which may be used to advantage as a general program and announce studio microphone and for television boom operation. It is recommended for use on programs where it is desirable to cover a large area with a single microphone, on programs where studio acoustics are more live than optimum, and programs where it is desirable to eliminate audience noise originating behind the microphone. The 77-DX can also serve as a bi-directional instrument on programs where the players are grouped around the microphone or are seated on opposite sides of a table. In the non-directional position, the microphone is excellent for announce work or for out-door locations.



MI-11006-C

MI-4045-F

The RCA Type 77-DX Polydirectional Microphone operates as a uni-directional, bi-directional or non-directional instrument by positioning of a shutter to secure various areas of opening. The moving element is a thin corrugated metallic ribbon clamped at the ends and suspended in the air gap of a magnetic circuit consisting of an Alnico V permanent magnet and pole pieces. One side of the ribbon is open and the other is connected by means of a tube to a folded acoustically damped pipe contained in the center section of the microphone.

The tube connecting the back of the ribbon to the labyrinth is slotted directly behind the ribbon and fitted with the shutter which controls the directional properties of the microphone. When the opening is completely closed, the microphone operates as a non-directional pressure microphone; at the wide-open position the instrument becomes bi-directional. With the proper size opening the pattern becomes a cardioid by virtue of the phase shift which occurs. Openings smaller or larger than this critical size produce directional patterns with various sized rear lobes. Different amounts of low-frequency attenuation are obtained by a reactor shunting the output.

The shutter opening is operated by turning a slotted shaft which is brought out flush with the rear of the windscreen.

The shutter position is indicated on a plate mounted on the screen and marked "U", "N" and "B". Three additional markings "L-1", "L-2", and "L-3" are used as reference points for other directional patterns which may be obtained. The bottom portion of the microphone contains an impedance matching transformer and switch for selecting response characteristics for voice or music. The switch shaft is slotted and accessible through a hole in the bottom of the lower shell. The transformer is exceptionally well shielded against stray magnetic fields.

The 77-DX will mount on any stand having a 1/2-inch pipe thread. Other stands will require a suitable adaptor. The microphone is cushion-mounted, and a fork mounting is provided so that the instrument may be fitted to the desired position. The microphone is connected for an output impedance of 250 ohms at the factory, but it may be adjusted for an output impedance of 30 or 150 ohms.

SPECIFICATIONS

- Directional Characteristics..... Adjustable, 6 positions (see curves)
- Frequency Response..... 50-15,000 cps
- Output Impedance..... 250 ohms, may be changed to 30 or 150 ohms
- Load Impedance..... Unloaded input transformer
- EIA System G_M
- Effective Output Level (all output connections):
 - Bi-directional..... -50 dbm* G_M = -144 db
 - Uni-directional..... -53 dbm* G_M = -147 db
 - Non-directional..... -56 dbm* G_M = -150 db
- Hum Pick-up Level..... -128 dbm**
- Dimensions (overall)..... 11 1/2" long, 3 3/4" wide, 2 1/2" deep
- Weight (including 1 1/2 lb. cable)..... 4 1/2 lbs.
- Cable (MI-43-D, 3 conductor, shielded)..... 30 ft., no plug
- Mounting..... 1/2" pipe thread

Ordering Information

- Type 77-DX Palydirectional Microphone in protective cloth bag:
 - Satin Chrome Finish..... MI-4045-F
 - Law Luster Gray Finish..... MI-11006-C

* Sound Pressure = 10 dynes/cm².
 ** Referred to a hum field of 1 x 10⁻³ gauss.

Typical Directional Patterns and Frequency Response Curves of 77-DX Palydirectional Microphone



Rear view of 77-DX Microphone

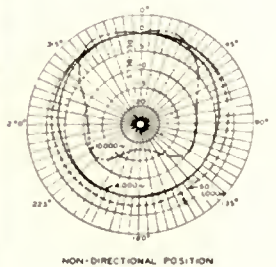
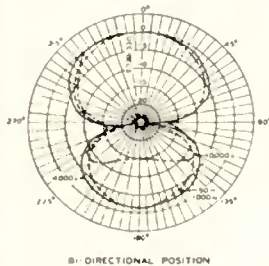
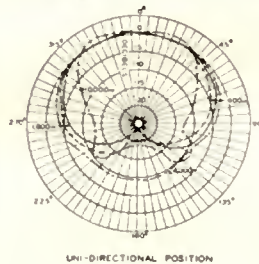

OPEN CIRCUIT RESPONSE OF A TYPICAL TYPE 77DX MICROPHONE

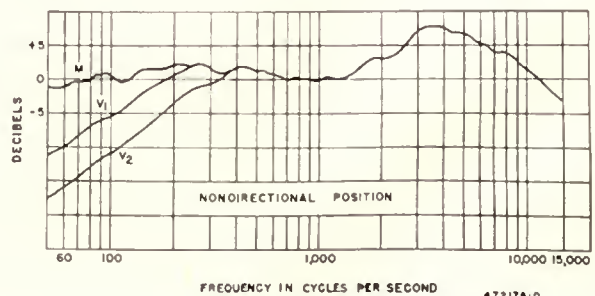
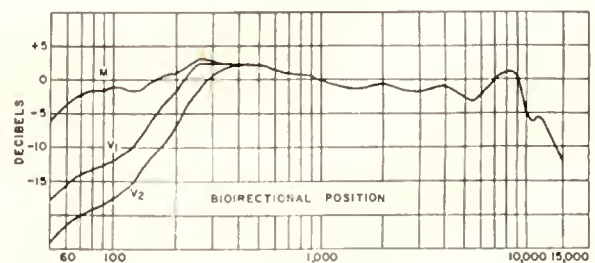
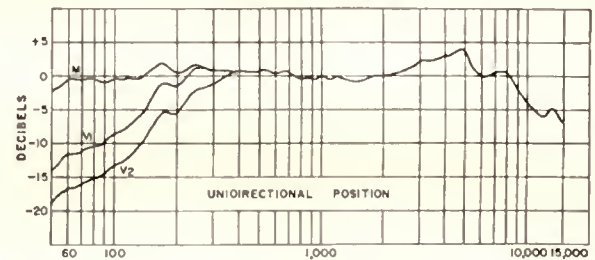

FREQUENCY IN CYCLES PER SECOND 472178-0

Pressure Microphone

TYPE BK-1A



FEATURES

- Lightweight rugged construction
- Convenient swivel mounting
- Ideal for interview type programs
- Attractive modern styling with non-reflective TV gray finish
- Not sensitive to wind or mechanical vibrations
- Frequency characteristic independent of source distance

DESCRIPTION

The BK-1A pressure microphone is designed for broadcast use in AM, FM and TV stations. Its construction makes it particularly well suited for remote pickups. The BK-1A features a smooth response and frequency range which make it suitable for reproducing both music and speech. Rugged, insensitive to mechanical vibration, the BK-1A is the ideal microphone for outdoor use where constant handling by the announcer is necessary. Pleasingly styled, it effectively serves TV announce desk or conference programs where each participant has a microphone in the scene, programs where the performer must work close to the microphone; and public address system use.

The BK-1A is a pressure actuated type microphone. Non-directional when mounted vertically, a semi-directional characteristic is obtained when horizontally mounted, in which case the BK-1A is essentially non-directional for frequencies below 2000 cycles—the higher frequencies are attenuated more as the angle with the perpendicular to the diaphragm increases.

Versatility is assured by design which allows the BK-1A to be stand mounted on desk or floor or to be easily removed from the stand mountings for use as a hand microphone. A durable ball and socket joint located at the base of the stem makes selection of the best speaking angle easy, when used on desk stand, MI-11008, shown above.

SPECIFICATIONS

Effective Output Level (referred to one milliwatt and a sound pressure 10 dynes/cm ²).....	-52 dbm
Frequency Response.....	60-10,000 cps
Output Impedance.....	30/150/250 ohms (connected for 250 ohms when shipped)
EIA Rating (G _M):	
250 Ohms	-144 db
150 Ohms	-147 db
30 Ohms	-148 db
Directional Characteristic:	
Semi-directional.....	When mounted horizontally
Non-directional.....	When mounted vertically
Recommended Load Impedance.....	Unloaded input transformer
Hum Pickup Level.....	-102 dbm (.001 gauss)
Length.....	7¾" (including mounting)
Diameter	17/8"
Weight.....	.18 oz. (less cable)
Cable.....	3-conductor shielded, 30 feet (no plug)
Stand Fitting.....	½" pipe thread
Finish.....	Low luster gray and chrome

Ordering Information

Type BK-1A Pressure Microphone..... MI-11007

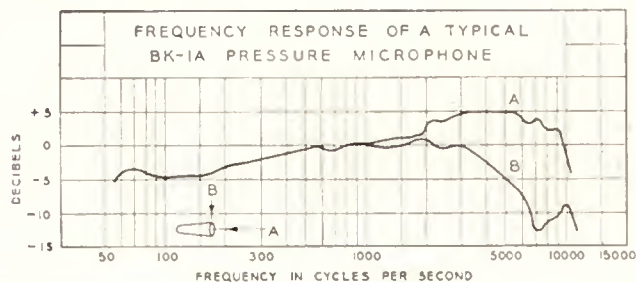

Uniaxial Microphone

TYPE BK-5B

FEATURES

- Superior control room microphone
- Improved unidirectional characteristic with wide pickup angle on front
- Three position voice-music switch allows selection of most desirable operating characteristic
- Simplifies microphone and camera placement problems—maximum sensitivity lies on major mechanical axis
- Small size—ideal for TV boom operation
- Exceptionally good shielding permits operation in high hum fields
- Improved long-life flexible cable and boom mount



BK-5B Microphone mounted on 91-C Desk Stand

DESCRIPTION

The RCA Type BK-5B Uniaxial Microphone is a dependable, high-quality ribbon instrument possessing an improved unidirectional characteristic, and designed for broadcast use in AM, FM and TV stations. The microphone has a frequency response that is essentially uniform from 50 to 15,000 cycles. Its excellent response and frequency range, combined with its unexcelled cardioid directional characteristic makes it ideal for reproducing both speech and music.

The microphone has been especially engineered with the television studio in mind. Since maximum sensitivity lies on the major mechanical axis, it is a one axis, or uniaxial type microphone. This directional characteristic simplifies microphone and camera placement problems. Incorporated in the unit is a blast filter which effectively reduces damage to the microphone from gun blasts and other violent noises. In addition, the small size, light weight, unobtrusive yet attractive gray finish and appearance render it espe-

cially suitable for television, but it is also admirably suited to general broadcasting and high-fidelity sound systems.

The Type BK-5B Microphone is a unidirectional microphone in which the moving element is a thin corrugated metallic ribbon clamped under light tension to cause it to vibrate at its own resonant frequency. The ribbon is placed between the pole pieces of a magnetic circuit. One side of the ribbon is open to the atmosphere and the other opens on an acaustical labyrinth which has phase-shift openings giving the instrument its improved unidirectional characteristics. The labyrinth of the microphone houses an impedance matching transformer and switch for selecting response characteristics for voice or music.

A unique feature of the BK-5B is a blast filter consisting of two separate cloth layers supported by perforated metal screens. The filters effectively reduce damage to the microphone from gun blasts and other loud noises encountered in broadcast programming. In addition, the transformer is exceptionally well shielded against stray magnetic

fields and can perform satisfactorily in high hum fields. As further protection for the sensitive vibrating ribbon a wind screen is available for use with the instrument. Its use is recommended if the instrument is to be used outdoors.

The integration of the blast filter, acoustic phase-shift network and especially designed connector to couple the ribbon to the labyrinth is responsible for the unique uniaxial characteristic of the BK-5B, and uniform frequency response over the entire aural spectrum. The microphone is supported on a cushion mounting which has a 1/2-inch internal pipe thread to fit RCA desk or floor stands. An improved shock mount based on panel meter mounts designed for military use is incorporated in the optional Boom Unit. This new mount isolates the microphone effectively from vibration and shock transmitted by the boom. There are no rubber band mountings to wear out. A 30-foot flexible cable, supplied with the microphone, makes use of tinned cadmium bronze wire to provide longer life.



BK-5B Microphone with Wind Screen, MI-11011, and Boom Unit, MI-11012.

FREQUENCY RESPONSE OF THE BK-5B MICROPHONE

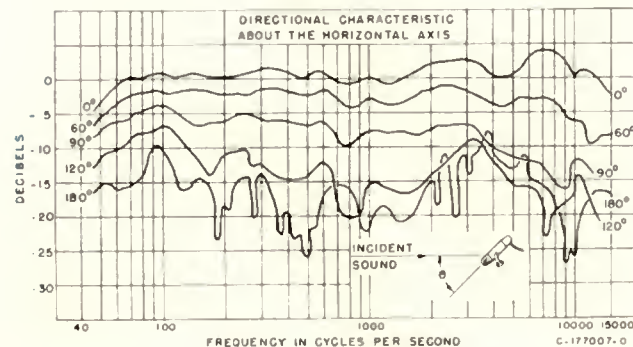
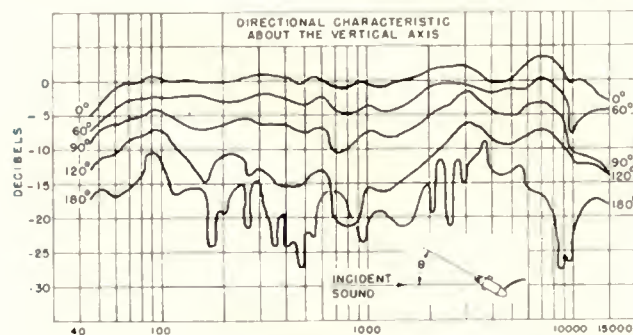
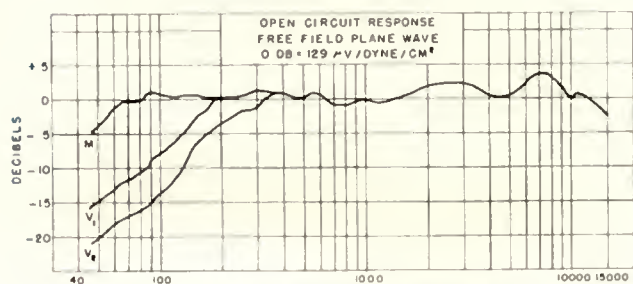

The small size and axial directivity aid in placing the BK-5B in inconspicuous fixed locations. There are no shiny external parts to reflect light and draw attention to the instrument. The axial directivity combined with the Boom Mount (MI-11012) make the microphone very easy to handle to keep the sound source "in focus." The addition of the wind screen to this combination does not cause a loss of the sense of the pickup axis.

SPECIFICATIONS

Performance Specifications

Directional Characteristic	Unidirectional
Frequency Response	50 to 15,000 cps
Output Impedance	250 ohms, may be changed to 30 or 150 ohms
Load Impedance	Unloaded input transformer
Effective Output Level at 1000 cps	
Sound Pressure 10 dynes/CM ²	-56 dbm
EIA Rating (GM) (150 ohm connection)	-150 dbm
Hum Pickup Level	
Relative to a field of 1 x 10 ⁻³ gauss	-128 dbm
Cable	3-conductor, shielded, 30 feet, no plug
Dimensions (overall)	7" x 2 3/4" x 2 7/8"
Weight	1 pound, 11 ozs. (less cable)
Finish	Low luster gray enamel
Mounting	1/2" pipe thread (female)

Ordering Information

Type BK-5B Uniaxial Microphone.....MI-11010-A

Accessories

Boom UnitMI-11012
 Wind ScreenMI-11011
 Desk Stand, Type 91-C.....MI-4092-E

Miniature Dynamic Microphone

TYPE BK-6B

FEATURES

- Lightweight microphone with excellent speech balance when talking "off mike"
- Easily concealed in man's hand . . . in clothing . . . on TV settings
- Clip type lanyard for ease of looping about neck
- Wide-range frequency response
- Rugged construction . . . color and styling makes it blend with surroundings



DESCRIPTION

The RCA Personal (Type BK-6B) Microphone is especially designed for correct speech balance when used informally in television broadcasting interviews and public address applications. The frequency response and directional characteristics are engineered to complement human speech so that the microphone has excellent balance when the performer is talking "off mike".

The BK-6B may be worn by the performer; its small bulk and neutral color make it inconspicuous. The light weight and flexible cable permit free, unhampered movement of the performer. It may be wholly concealed in a man's hand during an interview, or it may easily be concealed on a set. The styling blends readily with any props, and is pleasing where it is exposed to direct view. It is best used, suspended from the neck, resting on the chest, where it attenuates the low pitched chest sounds while at the same time it points straight up toward the lips, the position in which it is most sensitive to the sibilant sounds that would normally be lost.

A high quality instrument of the pressure actuated type, the Personal Miniature Dynamic Microphone has a frequency response from 80 to 12,000 cycles and a directional characteristic similar to the popular RCA 77-DX in the nondirectional voice "ONE" position. A special internal acoustic resonator is employed to support the response to lower frequencies and a damped resonator placed in front of the diaphragm reduces high frequency emphasis while extending the upper frequency limit. The result is a pleasing balance for speech when the microphone is used "off mike" or worn on the person.

The microphone as shipped from the factory is connected for an output impedance of 250 ohms. However the impedance may be changed to 30 or 150 ohms by a simple cable connection change. The special plastic meter diaphragm and coil assembly, output transformer and terminal board and bracket assembly are housed in a rugged and practically weather-proof case. The entire microphone



BK-6B Microphone used as a "necktie" mike. May be positioned beneath the necktie or exposed.

is only $2\frac{3}{16}$ inches long and $\frac{15}{16}$ -inch in diameter and weighs but 2.3 ozs., less the cable.

The cable, especially designed for the BK-6B unit, has unusual flexibility combined with long life under conditions of severe abuse. The conductors are of cadmium bronze for high flexibility and long flex life. The shield is carbon-impregnated, conducting cotton overlaid with a light metallic braid. The conducting cotton ensures complete electrostatic shielding and the light, metallic braid keeps the series resistance of the shield low without making the cable excessively stiff. The external jacket gives a tough, neutral colored, protective covering to the cable. A lanyard is furnished for mounting the microphone conveniently about the neck.



New type BK-6B Microphone shown with lanyard having clip fastener for convenient mounting.

SPECIFICATIONS

Output Impedance.....	250 ohms, can be changed to 30 or 150 ohms
Frequency Response.....	80-12,000 cps
Directional Characteristics.....	Semi-directional, see chart
Effective Output Level @ 1000 cps.....	-67 dbm (referred to a sound pressure of 10 d/cm ²)
EIA Sensitivity Rating.....	-158 db
Output Voltage (open circuit).....	48 mv/d/cm ²
Hum Pickup.....	-112 dbm (referred to a hum field of 1 mg.)
Cable.....	30 ft. flexible, two conductor, shielded, no plug
Mounting.....	Removable lanyard for suspending about neck
Overall Dimensions.....	$2\frac{3}{16}$ " long x $\frac{15}{16}$ " diameter
Weight.....	2.3 ozs., less cable
Finish.....	Low luster gray

Ordering Information

Type BK-6B Miniature Dynamic Microphone MI-11017-A

Accessories

Microphone Holder, Clamp Type.....	MI-12086
Microphone Stand, Adaptor Kit (for gooseneck).....	MI-11073
13" Flexible Microphone Stand.....	MI-11745
19" Flexible Microphone Stand.....	MI-11746

Directional Characteristics

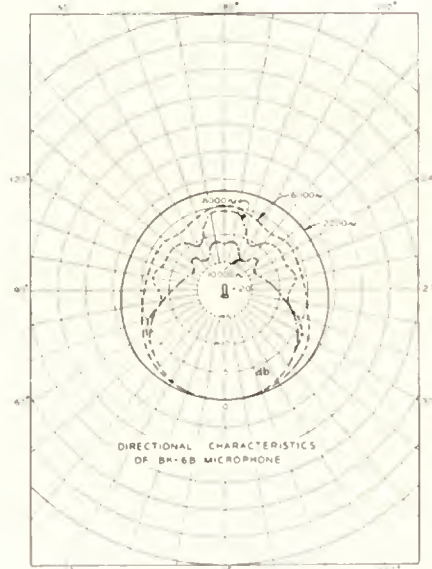

Frequency Response Curve

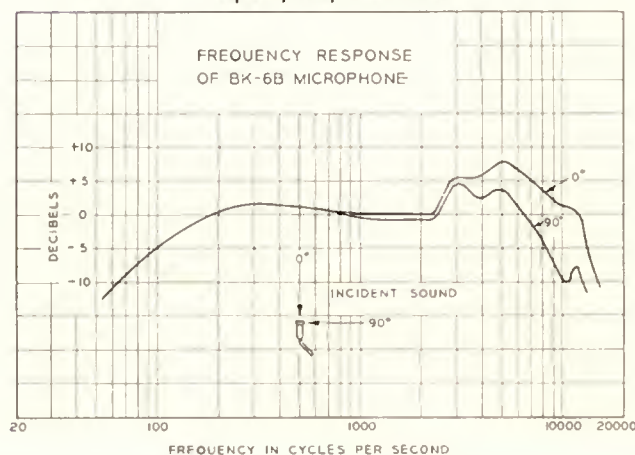

Velocity Microphone

TYPE BK-11A

FEATURES

- Exceptionally smooth frequency response 30 to 15,000 cps
- No loss in quality with off axis pickup
- Response may be adjusted to provide best possible frequency characteristics for either vocal or musical pickup
- Reduced pickup of reflected sound
- Bi-directional pickup
- Three position, voice music switch
- Unaffected by temperature, humidity or barometric pressure
- Rugged construction—stainless steel screen



BK-11A Microphone Mounted on MI-11008 Desk Stand

DESCRIPTION

The BK-11A is intended primarily for AM, FM and TV studio use where a microphone of highest quality reproduction is desired. It has the following general uses:

High fidelity music pickup for broadcast and sound recording purposes.

General program and announce.

Plays where the players may be grouped around the microphone.

Conference pickup where the participants are seated on opposite sides of a table.

Programs where studio acoustics are more live than optimum.

Programs where the microphones may be positioned to reduce audience noise.

Programs where the direction pattern permits orientation to eliminate undesirable reflections from walls.

The BK-11A Velocity Microphone is a dependable bi-directional microphone in which the moving element is a thin, corrugated metallic ribbon supported at the ends and placed between the pole pieces of a magnetic circuit. Because of its light weight, the motion of the ribbon corresponds very closely to the velocity of the air particles and the voltage generated in it is, therefore, a reproduction of the sound waves which traverse it. The microphone is free of the effects of cavity resonance, diaphragm resonance and pressure doubling. The BK-11A is well shielded against stray magnetic fields and can perform satisfactorily in high hum fields. Acoustically designed sturdy

stainless steel screens protect the microphone from mechanical injury. Internal shock and vibration isolation is provided between the case and the element. The bottom portion of the microphone contains the impedance matching transformer, frequency compensating reactor and three-point switch for selecting optimum frequency response characteristics for voice or music. The switch shaft is slotted and accessible through a hole in the mounting base. The microphone is supported by a swivel mounting which permits a 45 degree forward or backward tilt. It is designed to mate with the RCA MI-11008 and MI-4092-E desk stands or floor stands with a 1/2-inch standard pipe thread. A 30-foot flexible cable supplied with the micro-

phone makes use of tinned cadmium bronze wire to provide longer life.

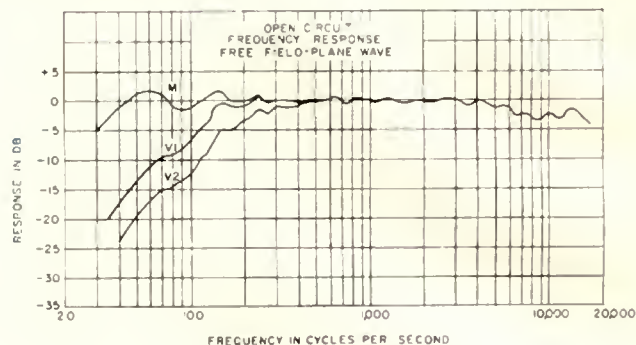

SPECIFICATIONS

Frequency Response.....	30 cps to 15,000 cps
Directional Characteristics	Bi-directional
Output Impedance.....	30, 150 and 250 ohms
Load Impedance.....	Unloaded input transformer
Effective Output Level of 1000 cps.....	-56 dbm (referred to a sound pressure of 10 dynes/cm ²)
EIA Rating (Gm - 250 ohms connection).....	-147 db
Hum Pickup Level (relative to field of 1 x 10 ⁻³ gauss).....	-130 dbm (M position)
Response Compensation:	
Switch V ₁	Approx. 6 db @ 100 cps
Switch V ₂	Approx. 11 db @ 100 cps
Cable.....	3 conductor, shielded, 30 ft. (no plug)
Stand Fitting.....	1/2" pipe thread

Provisions for tilting.....	Swivel providing up to ±45° tilt from vertical
Dimensions (overall).....	8" high, 2 7/8" wide, 2 3/8" deep
Weight	2 lbs. less cable
Finish	Low gloss deep umber gray and non-reflecting stainless steel

Ordering Information

Type BK-11A Velocity Microphone..... MI-11019

Accessories

Desk Stand, Type KS-11A	MI-11008
Desk Stand, Type 91-C	MI-4092-E
Portable Stand	MI-11021-1

Directional characteristics of Type BK-11A Velocity Microphone.

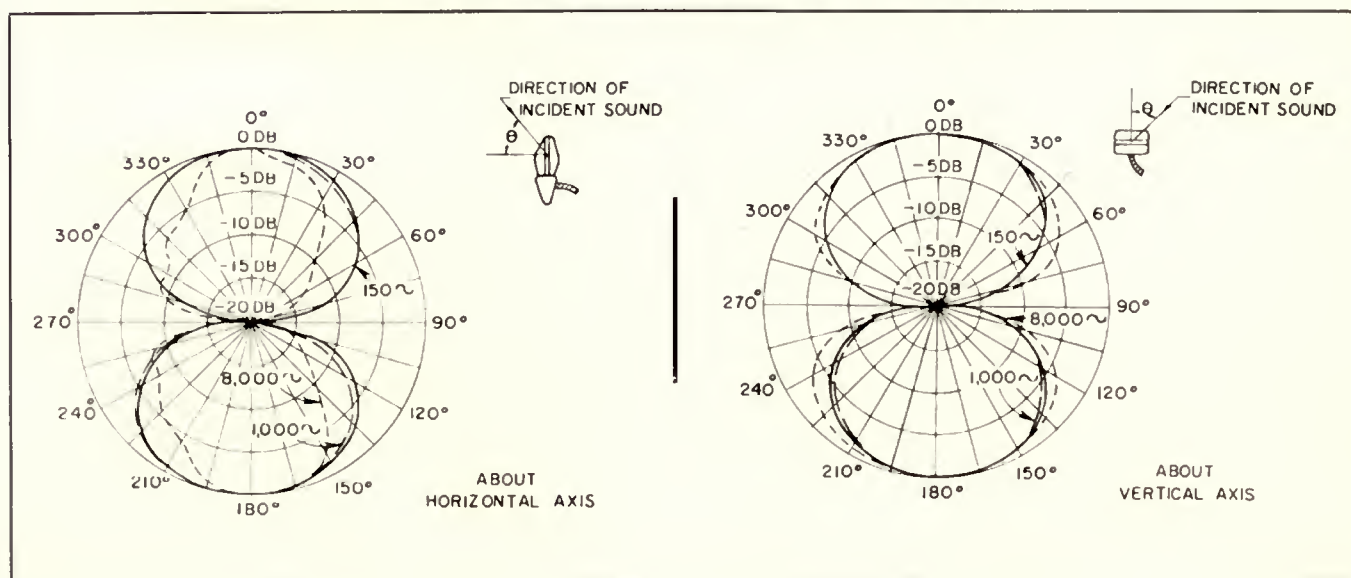

Program Velocity Microphone

TYPE SK-46



FEATURES

- Light weight, small in size
- Bi-directional characteristics over wide frequency range
- Adjustable impedance taps
- TV gray and satin chrome finish
- Swivel mounting
- Extremely rugged construction

DESCRIPTION

The RCA Type SK-46 Program Velocity Microphone is useful for AM, FM and TV studio or control room announcing. Its excellent response, directional characteristics and small size makes it a valuable and versatile instrument where quality production of sound is desired. The directional characteristics reduce unwanted acoustical background noise, reflections and feedback. This makes the microphone appropriate for "on stage", announce booth and general indoor programs. The microphone is not recommended for outdoor use because of the relative sensitivity of this type to wind.

SPECIFICATIONS

Directional Characteristics	Bi-directional
Output Impedance	200 ohms and 15,000 ohms
	Stacked with soldered connection to the 200 ohm tap.
Effective Output Level at 1000 cycles/second:	
Low Impedance	-58 dbm
GM	-150 db
High Impedance	-60 db below 1 volt
Hum Pickup Level: (relative to field of 1×10^{-3} gauss)	
Low Impedance	-113 dbm
High Impedance	-94 dbm below 1 volt
Frequency Range	50 to 10,000 cycles/sec.
Output Voltage:	
Low Impedance	117 $\mu\text{v}/\text{dyne}/\text{cm}^2$
High Impedance	1020 $\mu\text{v}/\text{dyne}/\text{cm}^2$
Mounting	$5/8''$ - 27 fixture thread
Dimensions	$5 1/8''$ high, $1-29/32''$ wide, $1 3/8''$ deep
Finish	TV gray and satin chromium plated screen
Weight (less cable)	13 ounces

Ordering Information

Type SK-46 Program Velocity Microphone with 25-foot cable... MI-12046

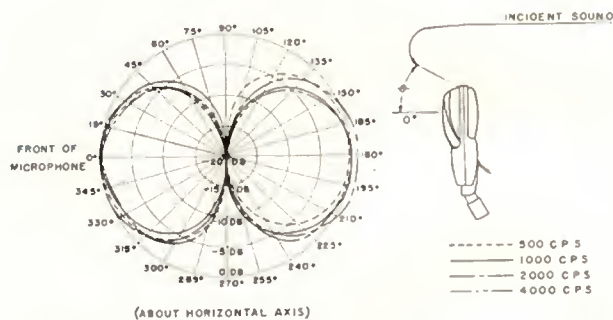
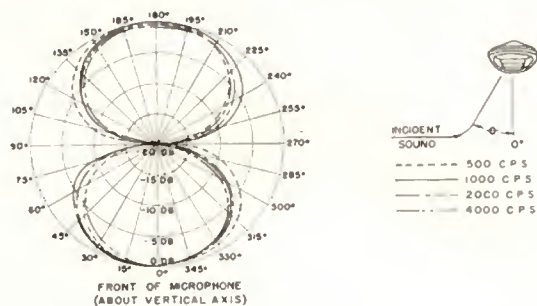

Directional Characteristics of the SK-46 Velocity Microphone.

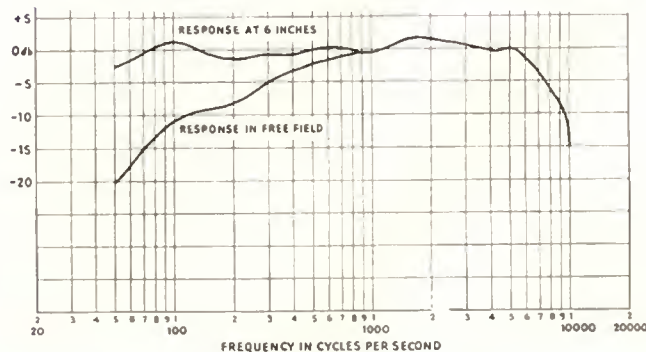

SK-45 PRESSURE MICROPHONE



FEATURES

- Rugged construction
- Economical, light weight, small in size
- Attractive appearance
- High or low impedance
- Dynamic type
- Excellent for announce work
- Swivel mounting

SPECIFICATIONS

Directional Characteristics:
 (Below 3000 cycles/sec.).....Non-directional
 (Above 3000 cycles/sec.).....Semi-directional
 Output Impedance.....150 to 200 ohms balanced or 15,000 ohms
 Stocked with soldered connection to the 200 ohm tap.
 Output Level at 1000 Cycles/sec.: (referred to 10 dynes per cm²)
 Low Impedance.....-56 db
 High Impedance.....-58 db
 EIA Rating (G_M).....-147 db
 Hum Pickup Level—Hum field 1 x 10⁻³ gauss
 0 db = 1 volt.....-106 dbm
 Frequency Range.....70 to 12,000 cycles/sec.
 Mounting.....5/8"—27 fixture thread
 Cable Length.....25 ft.
 Dimensions Overall.....5 1/2" high, 1 5/8" wide, 2" deep
 Finish.....Low luster gray enamel
 Weight, with Cable.....1 lb.

Ordering Information

Type SK-45B Pressure Microphone and Cable..... MI-12045-B

SK-39 AERODYNAMIC MICROPHONE



FEATURES

- Light weight—small size—fits palm of hand
- Excellent for close talking application
- May be used outdoors
 Minimum response from wind
 Unaffected by temperature or humidity
- Alnico V magnet
- Low impedance balanced output

SPECIFICATIONS

Frequency Response.....70 cps to 9,000 cps
 Directional Characteristics.....Non-directional for frequencies below
 2,000 cps; becoming less sensitive at the rear and sides as the
 frequency increases above 2,000 cps.
 Output Level:
 Effective Output Level.....-55 dbm, 180 x 10⁻⁶ V/dyne/cm²
 250 ohm output—open circuit
 EIA Microphone Rating G_M.....-150 db
 Hum Pickup Level.....-95 db (Hum field 0.001 gauss)
 Output Impedance.....250 ohms
 Mounting.....5/8"—27 fixture thread
 Finish.....Umber Gray
 Dimensions.....3 1/4" high, 2 7/8" wide, 2 3/4" deep
 Weight.....15 ounces, less cable
 Cable Length.....25 ft.—two conductor

Ordering Information

Type SK-39 Aerodynamic Microphone..... MI-12039-A

High-Output Unidirectional Microphone

TYPE KU-3A



FEATURES

- Higher output—6 db or more
- More uniform response over normal pickup angle
- Rugged and time tested
- Single ribbon element
- No power supply required

DESCRIPTION

The RCA KU-3A Unidirectional Microphone, for years the standard of quality comparison in the major motion picture industry, is proving popular with TV broadcasters in live studio programs especially where boom operation or a suspension microphone is indicated. The frequency response and output is very uniform over the normal front pickup angle of 90 degrees permitting broader tolerances in microphone handling on booms.

SPECIFICATIONS

Output Impedance.....	30, 150 or 250 ohms (connected for 250 ohms when shipped)
Load Impedance.....	Open circuit (unterminated transformer)
Effective Output Level at 1000 cycles/sec (10 dynes/cm ² input).....	-49 dbm at 30 ohms, -51 dbm at 150 and 250 ohms
Frequency Response.....	See diagram
Directional Characteristics.....	See curve
External Connection.....	12" long cable "pigtail" without plug
Finish.....	Flat two-tone umber gray
Dimensions.....	Length 8", width 3", depth 3 1/2"
Weight (less suspension mounting).....	2 lbs. 13 ozs.

Ordering Information

KU-3A Unidirectional Microphone, complete with Voice/Music switch, cable pigtail, and resilient mounting..... MI-10001-C

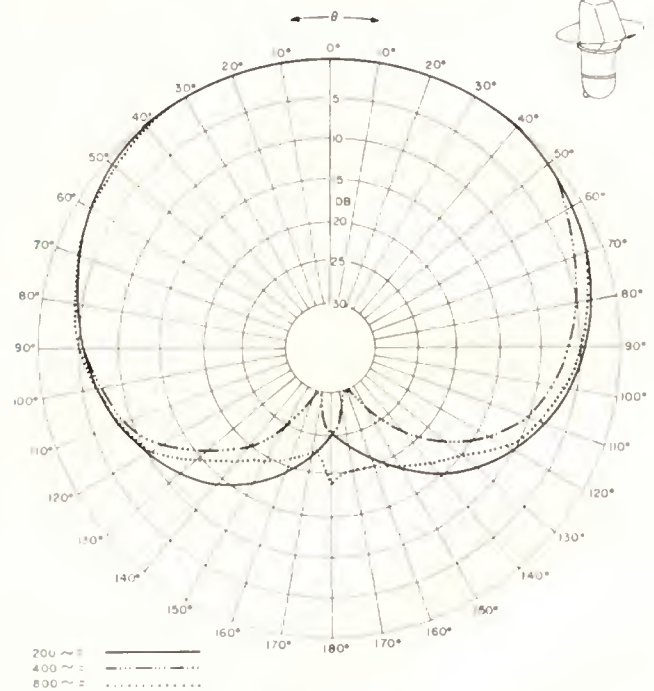

Horizontal Pattern of MI-10001-C Microphone.

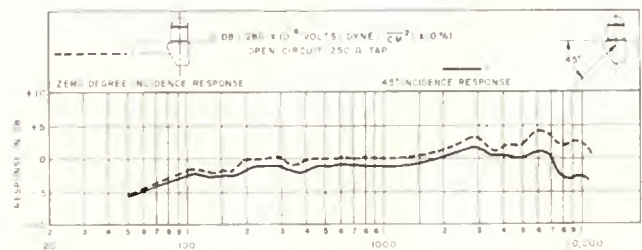

Frequency Response for MI-10001-C Microphone.

High-Sensitivity Varidirectional Microphone

MI-10006-A

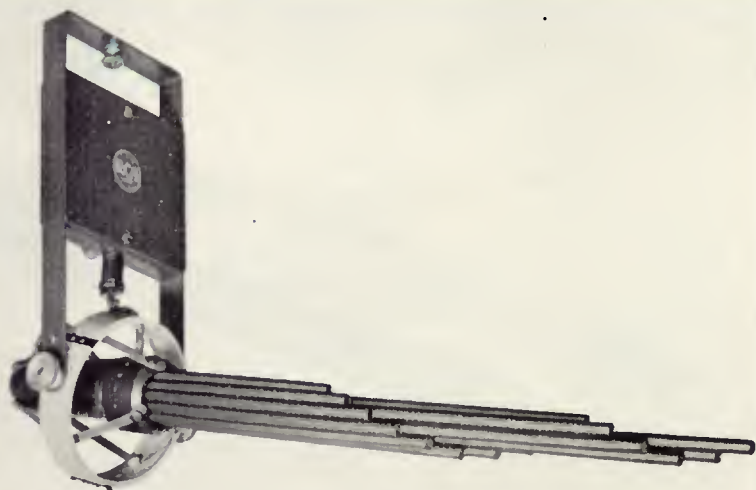

Varidirectional Microphone with Ultradirectional Attachment

FEATURES

- Lightweight
- High sensitivity
- Broad or very narrow directional pattern
- Practical rugged design
- Self-contained battery power

DESCRIPTION

The RCA Varidirectional Condenser Microphone is rugged and designed for today's practical production shooting schedules. A small lightweight dry battery supply, employing universally available batteries, will provide for over a year's operation of normal TV or motion picture recording work.

A quick removable accessory attachment, MI-10008, Ultradirectional Attachment, permits changing from a very narrow elliptical pickup pattern to that of a broad cardioid pattern. In using the narrow pickup attachment the microphone may be worked up to four times the distance away from the source of sound as with conventional microphones and obtain the same relative "presence" effect.

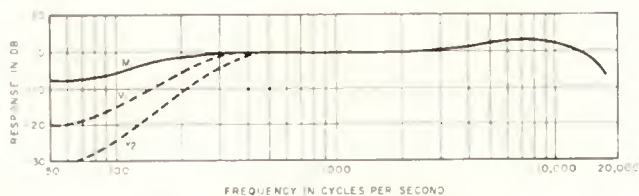

FREQUENCY RESPONSE OF MI-10006 VARIDIRECTIONAL MICROPHONE
M—MUSIC V₁ AND V₂ ARE STEPS OF VOICE FILTER

SPECIFICATIONS

Output Impedance.....	30, 150 or 250 ohms
Load Impedance.....	Open circuit (unterminated transformer)
Effective Output Level of 1000 cycles/sec (10 dynes/cm ²)	-33 dbm at 30 ohms -36 dbm at 150 ohms -36 dbm at 250 ohms
Open Circuit Output Voltage at 1000 cycles/sec (10 dynes/cm ²)008V at 30 ohms .012V at 150 ohms .016V at 250 ohms
EIA Rating (at 1000 cycles/sec).....	-128 db
External Connection.....	Plug receptacle on mounting, with mating plug and 25 ft. of boom type card furnished
Frequency Response.....	See diagram
Directional Characteristic.....	See curve
Finish.....	Microphone in RCA Shadow Blue; Hanger in RCA Pebble Tone
Length.....	6" without MI-10003 Windscreen! 8 3/4" with Windscreen 22" with MI-10008 Ultradirectional Attachment
Diameter.....	1 1/2" without MI-10003 Windscreen; 4 1/2" with Windscreen
Weight.....	1 lbs. 12 ozs. without MI-10003 Windscreen 2 lbs. 2 ozs. with MI-10003 Windscreen

Ordering Information

Varidirectional Microphone with small screen..... MI-10006-A

Accessories

Ultradirectional Attachment..... MI-10008
Large Windscreen for MI-10006-A
(used without MI-10008 Attachment)..... MI-10003

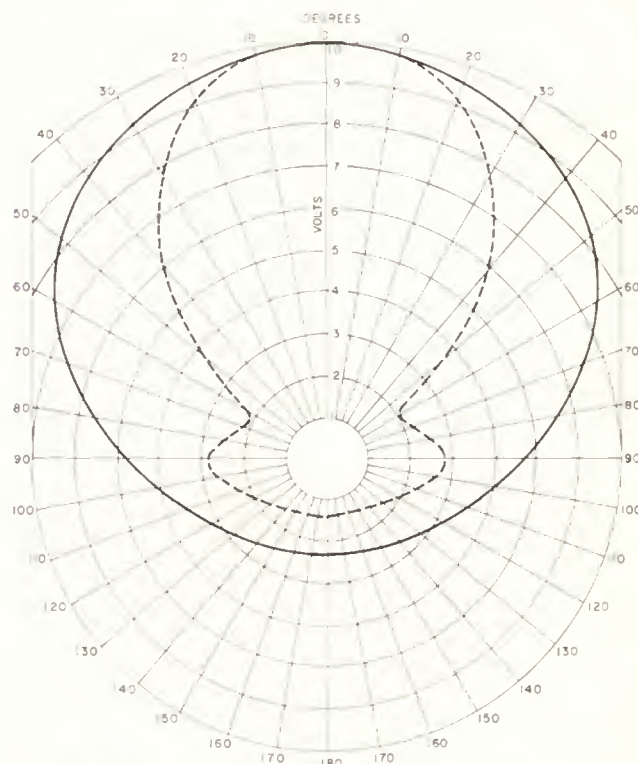

— MI-10006 VARIDIRECTIONAL MICROPHONE
--- MI-10006 VARIDIRECTIONAL MICROPHONE WITH MI-10008 ULTRADIRECTIONAL ATTACHMENT

Microphone - Amplifier

TYPE BN-10A

FEATURES

- Combines miniature microphone and transistor remote amplifier in convenient hand-held package
- Speech output level of +6 V.U. sufficient to feed phone lines direct
- Self-powered by small mercury battery
- Plug-in earphone for checking performance and receiving "cue" over phone line
- Wide-range frequency response



BN-10A Microphone Amplifier with case removed showing BK-6 Personal Type Microphone, remote amplifier, chamber, battery power supply and base with plug-in provision for cue earphone.

DESCRIPTION

The RCA Type BN-10A comprises a single channel remote amplifier to which has been added the miniature dynamic microphone to produce a compact microphone/remote amplifier easily held in one hand. The unit weighs less than a pound and is completely self-contained including its transistor amplifier and battery power supply. The +6 V.U. output of the microphone/amplifier is more than adequate for feeding telephone lines.

The BN-10A affords broadcasters a lightweight unit capable of handling single microphone remotes without the use of large remote amplifiers. The BN-10A is ideal for interviews, sports announcements, on-floor convention reports, and other remote broadcast uses. A built-in earphone jack makes it easy to hear telephone line cues as well as monitor the BN-10A output.

The microphone used in BN-10A equipments is RCA's Type BK-6B personal microphone designed for correct speech balance. The BK-6B has a frequency response of 80 to 12,000 cycles and it has semi-directional characteristics. The microphone chamber is completely sealed and isolated from the amplifier section to assure optimum performance of the microphone.

The built-in amplifier employs transistors. The circuit is designed for very low battery drain thus securing about 50 hours of service from the single E-134 mercury battery which is easily inserted in the BN-10A. The distortion of

the amplifier is less than 2 per cent for normal output. The amplifier itself has a frequency response of ± 1.5 db from 50 to 15,000 cycles.

A 30-foot line cord for connection to the phone line is supplied as well as a lightweight earphone. The earphone plugs into the base of the BN-10A. The battery is automatically turned on whenever the line cord is plugged into the BN-10A. The body of the BN-10A is finished in a low luster gray enamel. A convenient carrying case which accommodates microphone/amplifier, cord and earphone is also supplied with the BN-10A.

SPECIFICATIONS

Frequency Response	80-12,000 cps
Distortion	2% maximum
Output Level (for normal speech)	+6 V.U.
Load Impedance	600 ohms
Line Cord	30 ft. flexible, with cannon plug
Overall Dimensions	11 $\frac{3}{4}$ " long by 1 $\frac{1}{8}$ " dia.
Weight	14 oz.
Finish	Low luster gray
Battery	Eveready E-134

Ordering Information

Type BN-10A Microphone/Amplifier complete with 1 cord and plug, 1 E-134 battery, 1 carrying case, and 1 Earphone MI-11023-A

5MB

Microphone Stands and Accessories

FEATURES

- Rugged construction
- Attractive appearance
- Easy to assemble or take apart
- Compact and convenient for portability

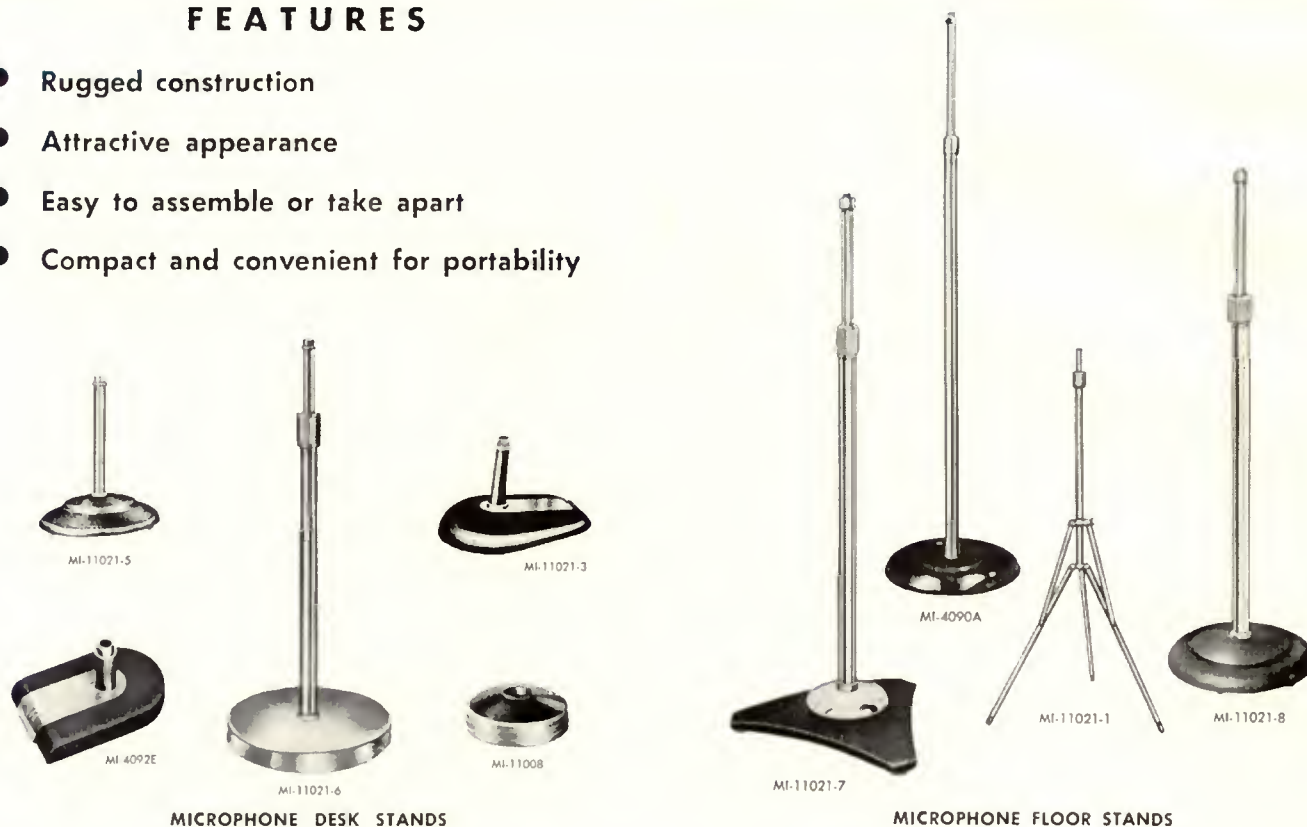

MICROPHONE DESK STANDS

Type No.	Mounting	Base Dimension	Height	Weight	Finish	Ordering Information
91-C	1/2" Pipe Thread	4 1/2" by 6 5/8"	3 1/4" to 13 3/4"	4 lbs.	Umber Gray Chrome Trim	MI-4092-E
KS-11A	1/2" Pipe Thread	4 3/8" diameter	—	1 1/2 lbs.	Dull Umber Gray	MI-11008
DS-10	5/8"—27 Fixture Thread	—	8" to 13"	1 1/2 lbs.	Dull Gray Chrome Trim	MI-11021-3
DS-5	5/8"—27 Fixture Thread	6" diameter	4"	2 lbs.	Gun Metal Shrivel Finish	MI-11021-5
TS-6	5/8"—27 Fixture Thread	8" diameter	14 1/2" to 16"	6 lbs.	Chrome	MI-11021-6

MICROPHONE FLOOR STANDS

Type No.	Mounting	Base Diameter	Height	Weight	Finish	Ordering Information
90-A	1/2" Pipe Thread 5/8"—27 Fixture Thread	12 1/4" diameter	44" to 74"	33 lbs.	Chrome	MI-4090-A
CS-1	5/8"—27 Fixture Thread	Collapsible	23" to 62"	5 lbs.	Chrome	MI-11021-1
MS-25	5/8"—27 Fixture Thread	12"	37" to 66"	15 lbs.	Chrome and Gray	MI-11021-7
MS-20	5/8"—27 Fixture Thread	17"	37" to 66"	22 lbs.	Chrome and Gray	MI-11021-8

BK-6B MICROPHONE HOLDER



Use.....To mount BK-6B
Microphone to floor or flexi-
ble stands.
Size.....2 5/8" lang x 1 1/8" dio.
Weight—Holder 2 oz.
Weight Kit..... B oz.

Ordering Information

BK-6B Microphone Holder,
5/8"—27 thread MI-12086

MICROPHONE STAND ADAPTOR KIT

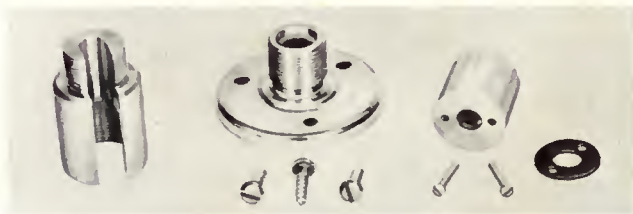

BK-6B Microphone Stand Adaptor Kit (Consisting of stand
adaptor flange, 3 topping screws, microphone adaptor,
2 machine screws and rubber gasket).....MI-11073

CABLE HOOK



Use..... Fits all microphones
Weight 15 oz.
Finish Polished chrome
Fits Stands 7/8" to 1 1/4" in diameter
Attachment One screw

Ordering Information

Cable Hanger MI-11099-B

MICROPHONE ADAPTORS

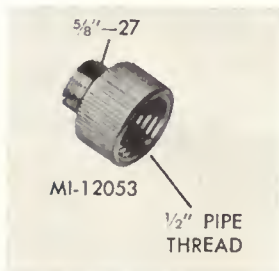

MI-12053

1/2" PIPE
THREAD

Stand
Thread

1/2" pipe thread
5/8"—27

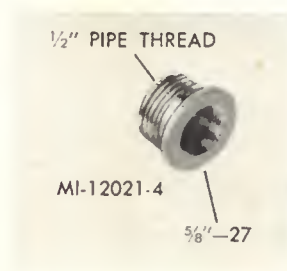

MI-12021-4

5/8"—27

Microphone
Thread

5/8"—27
1/2" pipe thread

Ordering
Information

MI-12053
MI-11021-4

GOOSENECK STANDS

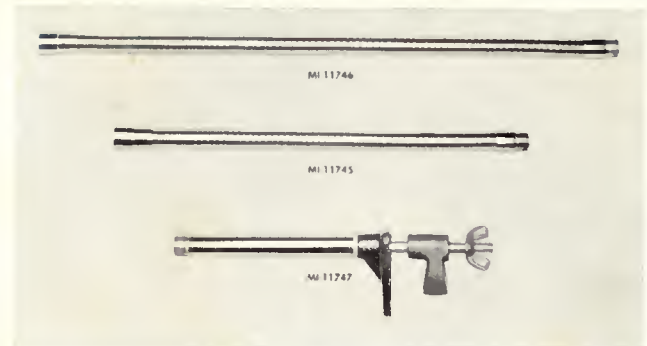

Ordering Information

13" Flexible Stand, chrome finish,
5/8"—27 thread, wt. 1 lb..... MI-11745
19" Flexible Stand, chrome finish,
5/8"—27 thread, wt. 1 1/2 lbs..... MI-11746
6" Stand Bracket Clamp, 5/8"—27 thread..... MI-11747

MICROPHONE CABLES

RCA microphone cables are of rugged construction and
are jacketed with a neoprene compound to insure long
life. They are especially designed for broadcast service
either studio or remote.

Low Impedance Cable, MI-43-D

Use..... Cable for low impedance microphone circuits
Type..... Three conductor, twisted
Conductors..... Tinned cadmium bronze, stranded,
equivalent to #20 AWG
Insulation..... Special rubber compound
Shield..... Tinned copper. Complete coverage without loss in flexibility
Outer covering..... Brown neoprene compound
Overall Diameter..... 0.300 maximum

Ordering Information

Specify length in 100-foot multiples..... MI-43-D

Heavy Duty Cable, MI-13307-A

Type..... Two conductor, twisted
Conductors..... Stranded, equivalent to #16 AWG
Insulation..... Special rubber compound
Shield..... Tinned copper. Complete coverage without loss in flexibility
Outer Covering..... Black neoprene compound
Overall Diameter..... 0.300 maximum

Ordering Information

Specify length in 100-foot multiples..... MI-13307-A

Lightweight Cable, MI-13322

Type..... Two conductor, twisted
Conductors..... Stranded cadmium bronze, equivalent to #24 AWG
Insulation..... Special rubber compound
Shield..... Conducting cotton with 60% coverage of tinned copper.
(Complete coverage with greater flexibility)
Outer Covering..... Brown neoprene compound
Overall Diameter..... 0.215 maximum

Ordering Information

Specify length in 100-foot multiples..... MI-13322

MICROPHONE PLUGS AND RECEPTACLES

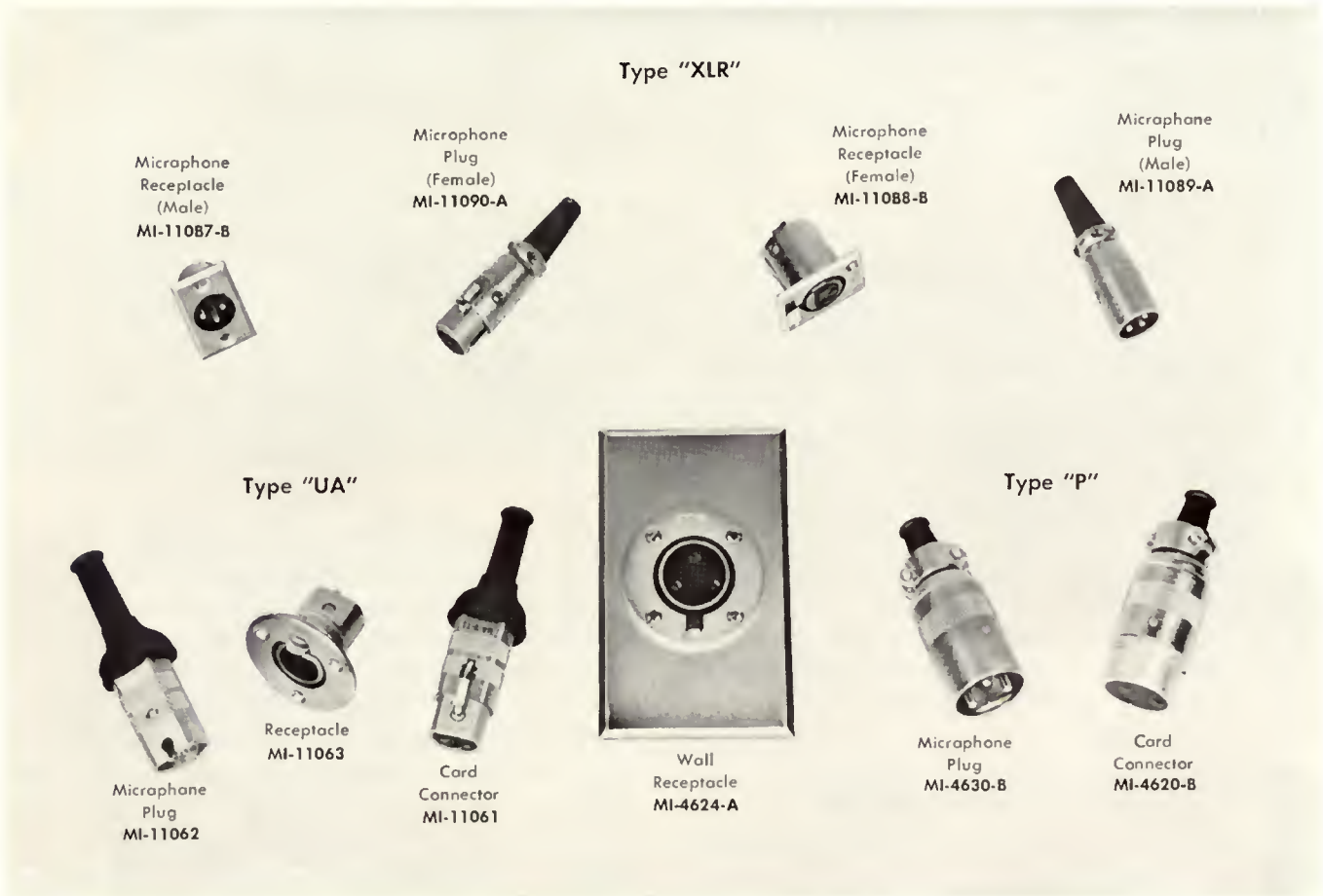

RCA microphones are sold without plugs in order that the purchaser may use any type desired. Three series of Cannon plugs which meet requirements for reliability and ruggedness are stocked. These include the "UA" series of plugs which have been designed as a result of EIA recommendations, the "P" Type Connectors and the "XLR" matched family of small 3-contact connectors.

The "UA" connectors have gold-plated contacts for low-loss and noise-free operation. Flat top construction provides positive polarization. All have thumb action latch-lock for quick insertion and firm engagement and a 1 3/4-inch rubber sleeve for card protection.

The "P" connectors are the original connectors for audio circuits. They accommodate wires up to No. 10, 15 ampere contact capacity. The Cannon connectors "XLR" type plugs and receptacles are miniature connectors especially favored by many users.

SPECIFICATIONS

Description	Cannon Stock No.	Ordering Information
Female Plug for Microphone Extension Cable (mates with UA-3-12).....	UA-3-11	MI-11061
Mole Plug for Microphone Cable (mates with UA-3-11 and UA-3-13)....	UA-3-12	MI-11062
Flush Mounting Receptacle (mates with UA-3-12)	UA-3-13	MI-11063
Male Plug for Microphone Cords.....	P3-CG-12S	MI-4630-B
Wall Receptacle for Above Plug.....	P3-35	MI-4624-A
Note: The MI-4624-A Receptacle will fit a standard o-c outlet box.		
Extension Cord—Female Connector.....	P3-CG-11S	MI-4620-B
Microphone Receptacle, Female.....	XLR-3-31	MI-11088-B
Microphone Receptacle, Male.....	XLR-3-32	MI-11087-B
Microphone Plug, Female.....	XLR-3-11C	MI-11090-A
Microphone Plug, Male.....	XLR-3-12C	MI-11089-A

Dual-Channel Audio Consolette

TYPE BC-7A

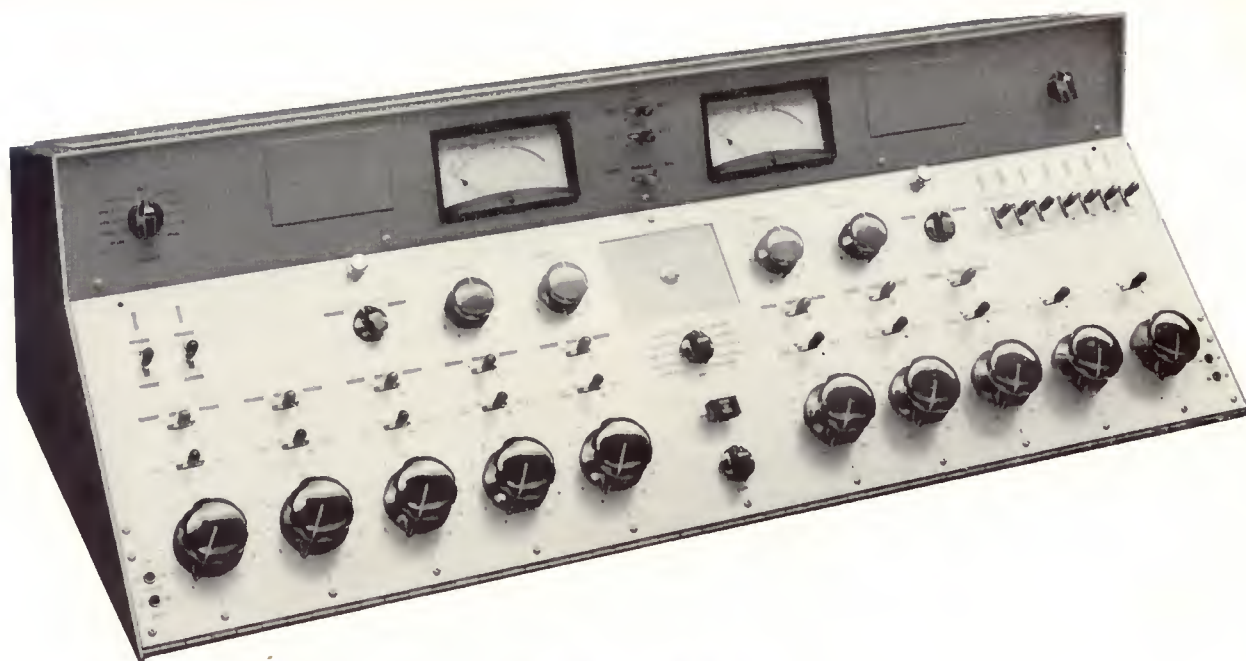

FEATURES

- Designed for stereo or dual channel operation
- Simultaneous mixing facilities for ten pre-selected program inputs—31 permanently wired sources available
- All transistor design
- Compact—self-contained
- 10 low impedance mixer positions
- Announce position may be split to feed both channels by use of optional preamplifier
- Cue mixers in 5 high level positions
- Provision for optional AGC meters
- All amplifiers and power supply are plug-in
- Master gain and monitor gain controls are ganged in stereo mode
- Control room and all studios may monitor in stereo
- Built-in cue monitor and intercom amplifier completely independent of program circuits
- Roving headphone monitor jack as well as phone jacks across output lines
- Provision for optional second monitoring amplifier
- Provisions for adding external auxiliary mixer

DESCRIPTION

The BC-7A Duol Chonnel Audio Console is a completely self-contained unit providing the broodcoster with both stereo or monaural mixing, switching, ond monitoring facilities, plus dependable plug-in transistor omplifiers, low impedonce mixing circuits, self-contained power supply ond built-in cue/intercom amplifier. Provisions ore included for installation of optianol AGC meters so the goin reduction of an external AGC amplifier may be observed while controlling program goin.

The BC-7A is normally supplied with five preamplifiers, two program amplifiers, one cue/intercom amplifier ond one monitor omplifier. With on additional preamplifier ond o second monitor omplifier, complete stereo monitoring is available. For stereo broodcasting the program master gain controls of the BC-7A are ganged together os ore the monitor gain controls by plocing the mode switch in the stereo position. A unique, smooth action, duol mixer control is used in all stereo mixing positions. The BC-7A consolette contains a total of ten mixer positions; five low level, each switchable to one of three inputs; three high level, each switchable to one of three inputs; and two line level, of which one is switchable to three, the other to four inputs. All amplifier inputs and outputs ore brought out to terminal connections within the consolette, so that wiring to jock fields moy eosily be accomplished.

Functional Design

The BC-7A Duol Chonnel Consolette is designed not only for greater operating convenience ond ease of servicing, but for oesthetic value os well. The double slope front panel, pleasing functional design, large illuminated VU meters ond completely uncluttered control panel highlight the simplicity ond beauty of the unit. The finish of the moin control panel is onodized, brushed oluminum while the housing ond upper panel is finished in o harmonizing blue color. The console is intended for flat top desk mounting.

All switching, mixing, ond aperiotionol controls ore contained on the moin control panel ond ore grouped and color coded for fast identification thus minimizing operator error. Permanent panel designations ore etched in black whereas designations which ore most subject to change, depending on individual needs, ore left blank. Uniform panel depressions, provided ot these locotions, accept o

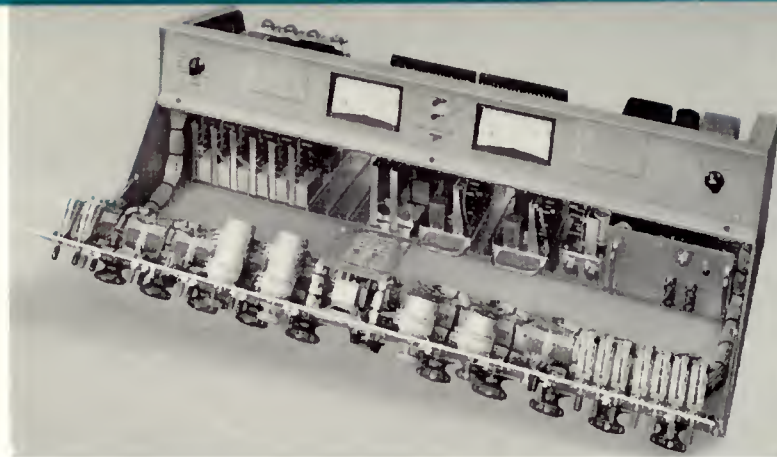

BC-7A with front panel lowered to show internal plug-in units, including left to right, preamplifiers, high-level isolation units, program amplifiers, cue amplifier and power supply.

wide assortment of pressure sensitive labels supplied with each unit. The labels provide a neat, permanent appearance to the consolette, yet can easily be changed when necessary.

Unitized Construction

Plug-in, unitized construction is the key to the flexibility of the BC-7A to meet the varying needs of TV ond AM broodcasters os well os recording stua applications. Six plug-in unit types are used in the BC-7A: the preamplifier, program omplifier, monitor amplifier, cue/intercom omplifier, power supply ond high level isolation unit.

The basic console consists of a wired housing including all operating controls, five dust-protected speaker muting relays, two VU meters, with provisions for adding two optional gain reduction meters, and guide assemblies for accepting plug-in units.

One feature of the design is the availability of the input and output circuits of all amplifiers ond input plug-in units on terminals. This facilitates ease in wiring to external sound effects equipment, compensating networks or jock panels. Another feature is the muting relay stopping panel, conveniently located behind the moin control panel ot the top, center. Any of the five muting relays may be strapped sa as ta be controlled by any combination of source selection lever keys associated with mixers 1 thru 8.

The power supply provides operating power for up to ten preamplifiers, two program amplifiers, five speaker muting relays os well os reserve power for operation of five additional optional warning light relays. The ten watt monitor amplifier ond the cue/intercom amplifier are self-powered.

Simplified functional drawing of the BC-7A Dual Channel Audio Console.

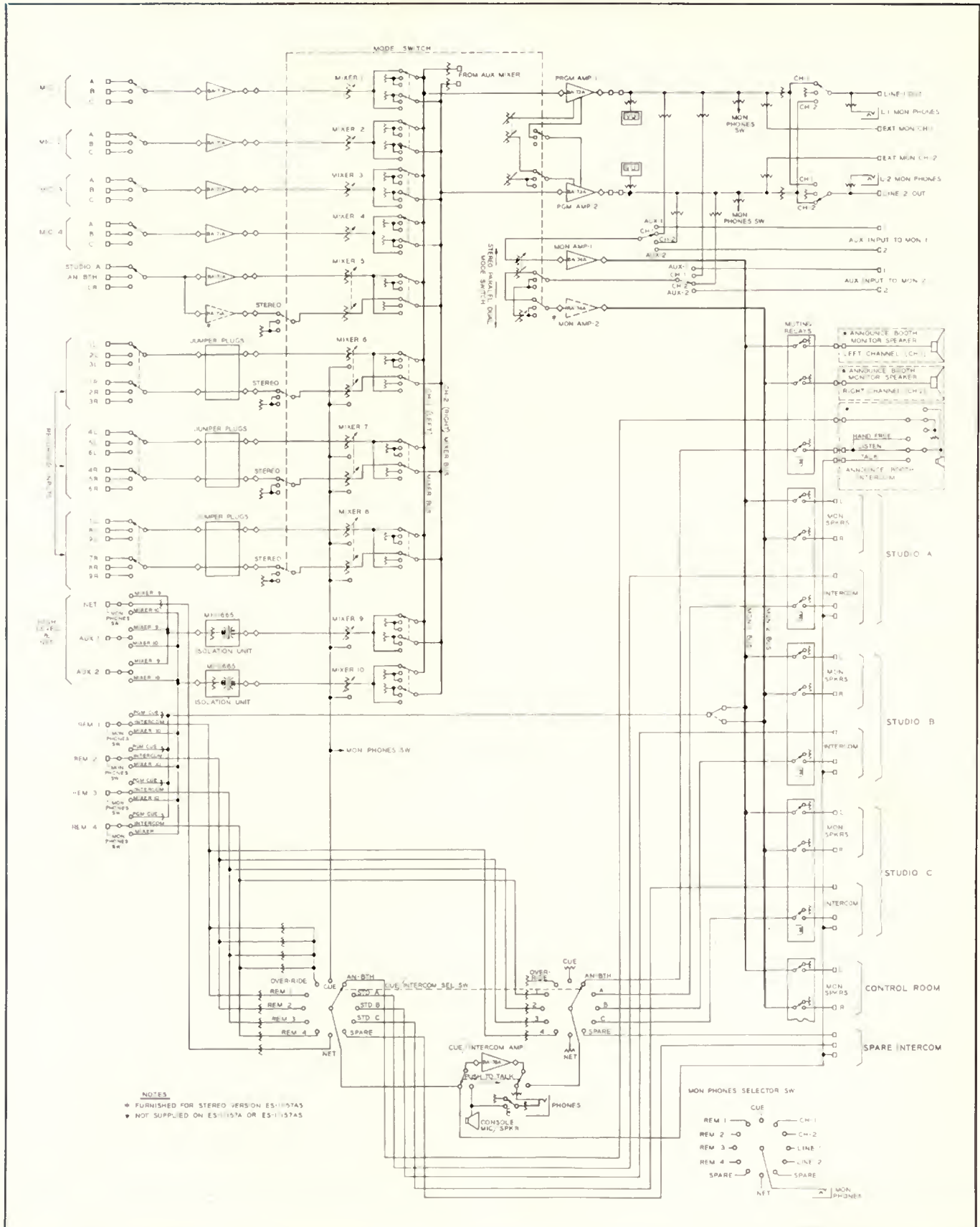

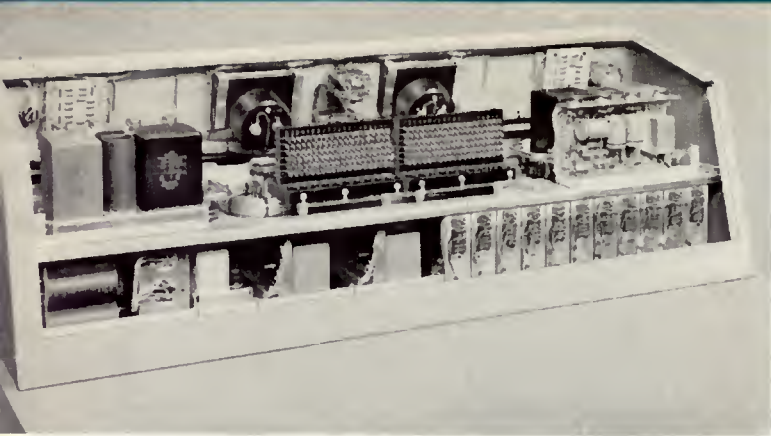

Rear of BC-7A with cover removed showing plug-in monitoring amplifiers and accessibility to external plug-in connection terminals.

Mixing Facilities

Each of the ten, low impedance mixing positions will accept one of three plug-in units: the preamplifier for low level sources; the high level isolation unit for balanced high level sources or a simple jumper plug for direct unbalanced input to the mixer. The standard console housing is supplied with dual attenuators in mixer positions 5, 6, 7 and 8.

The BCM-2A Auxiliary Mixer is designed as a companion piece to increase the number of available mixers by 5. One or more of the BCM-2A Auxiliary Mixer Units may be added. Convenient terminals are provided in the BC-7A console to extend the mixer bus to the BCM-2A.

SPECIFICATIONS

Mixers:

- 10 Selectable by lever key to either program channel.

Inputs:

- 15 Microphones switchable to five preamplifiers (microphone on mixer 5 may be split to feed both channels for stereo operation by addition of accessory preamplifier).
- 9 Turntable, tape or film, switchable to three high level mixers. (All three may be stereo operated.)
- 3 Network or high level, each switchable to either mixer No. 9 or mixer No. 10.
- 4 Remote lines, switchable to mixer No. 10, intercom, and program cue.
- 2 Spare monitor positions each channel.

Amplifiers:

- 5 Plug-in transistor preamplifiers (with provisions for five additional accessory preamplifiers).
- 2 Plug-in transistor program amplifiers with individual master gain controls. (Gain controls, ganged for stereo.)
- 1 Plug-in transistor cue/intercom amplifier.
- 1 Plug-in transistor monitor amplifier. Provisions are included for a second accessory monitor amplifier. Gain controls ganged for stereo.

Outputs:

- 2 Program lines (either channel may feed either or both lines).
- 2 External monitors (one for each channel).
- 5 Speakers per channel (provisions for 10 speakers, two per location for stereo operation when using optional second monitoring amplifier).

Source Impedance:

Microphones	37.5/150/600 ohms
Net and Remote Lines	600 ohms
Turntables	600 ohms
Tape	600 ohms
Film	600 ohms

Load Impedance:

Line	600 ohms
Speaker	16 ohms
Headphone	High Impedance

Output Level:

Program Channel	+18 dbm after 6 dbm isolation pad (each channel)
Monitor Amplifier	+40 dbm

Input Level:

Microphone Inputs (maximum)	-22 dbm
Turntable Input (maximum)	+18 dbm
Net or Remote Line (maximum)	+18 dbm

Gain:

Microphone Input to Program Line	105 db, can be increased to 111 db
Turntable or Remote Line to Program Line	64 db
Frequency Response	±1.5 db, 30 to 15,000 cps
Distortion:	
Program Channel	Less than .5%, 50-15,000 cps Less than .75%, 30 cps
Monitor Amplifier	Less than 1%, 50-15,000 cps
Signal to Noise Ratio:	
Microphone to Program Line (68 db gain, +18 dbm output)	68 db
Dimensions	39 1/4" wide, 12 1/2" high, 20" deep

Ordering Information

BC-7A Console Housing (less all plug-in modules)	MI-11657
BC-7A Console (for manual programming)	ES-11157-A
Including the following:	
1 BC-7A Console Housing	MI-11657
5 Preamplifiers, Type BA-71	MI-11658
2 Program Amplifiers, Type BA-73	MI-11659
1 Monitor Amplifier, Type BA-74	MI-11661-A
1 Cue/Intercom Amplifier, Type BA-78	MI-11662
2 High Level Isolation Units	MI-11665
1 Power Supply, Type BX-71	MI-11663-A
BC-7A Console (for stereo programming)	ES-11157-AS
Including the following:	
1 BC-7A Console Housing	MI-11657
6 Preamplifiers, Type BA-71	MI-11658
2 Program Amplifiers, Type BA-73	MI-11659
2 Monitor Amplifiers, Type BA-74	MI-11661-A
1 Cue/Intercom Amplifier, Type BA-78	MI-11662
2 High Level Isolation Units	MI-11665
1 Power Supply, Type BX-71	MI-11663-A

Accessories

Auxiliary Mixer Housing, Type BCM-2A (less all plug-in modules)	MI-11656
On-Air Light Relay	MI-11702-A
Warning Lights	MI-11706-Series
Type BA-71A Preamplifier (less guide assembly)	MI-11658
Type BA-73A Program Amplifiers (less guide assembly)	MI-11659
Type BA-74A Monitor Amplifiers (less guide assembly)	MI-11661-A
Type BA-78A Cue/Intercom Amplifiers (less guide assembly)	MI-11662
Type BX-71 Power Supply (less guide assembly)	MI-11663-A

Standard Audio Consolette

TYPE BC-3C



FEATURES

- Complete high-fidelity speech input system
- Modular construction, durable glass-epoxy circuit boards
- Compact size—entirely self contained (includes all amplifiers and power supply)
- Provides facilities for thirteen inputs
- Styling matches other RCA audio consolettes and TV terminal equipment
- Headphone selection of network, remote, and program line

DESCRIPTION

The RCA Type BC-3C Standard Audio Consolette is a compact, self-contained, high-fidelity speech-input system providing audio amplification, switching, control and monitoring facilities essential to the operation of medium size radio or television broadcast stations. This model incorporates eight mixer positions, which control thirteen inputs. The consolette is sufficiently flexible to accommodate two studios, announce booth, control room, transcription turntables and auxiliary input circuitry.

The Type BC-3C Standard Audio Consolette is a convenient audio control equipment mounted in a smartly styled housing of all-metal construction and finished in two-tone umber gray. A hinged front panel and removable cover provide access to tubes, switches, gain controls and other interior components. An etched panel contains all operating controls, an illuminated volume indicator calibrated in VU's, and a rack designed to hold script. The mixer controls are assigned so as to offer the greatest flexibility and operating ease.

The BC-3C will handle thirteen separate inputs with pro-

visions for simultaneous mixing of any eight inputs. There is provision for feeding program cue or talkback to remote lines. Headset switching is provided for network, program and remote line monitoring. Cue positions are incorporated on high level and turntable mixers. A separate audition channel is provided for maximum flexibility. The monitoring amplifier may be switched from the cue position, program line, audition bus, or external input. The output of an off-air receiver or modulation monitor can be connected to this external position. All inputs are terminated when the switches are in the off position.

The BC-3C is of modular construction with etched wiring on durable glass-epoxy sub-assemblies. It has self-contained amplifiers and power supply. Three preamplifiers are utilized in the design plus monitoring and booster equipment. Recommended operating practice is for the inclusion of separate BA-26 preamplifiers mounted in each turntable cabinet. The control circuits include two 24 volt relays for control room and studio speaker muting. The muting relays may be used to actuate "an air" light relays when such accessories are used.

SPECIFICATIONS

Inputs:

- 6 Microphones (4 Studio, 1 Control Room and 1 Announce Booth)..... 37.5/150/600 ohms
- 2 Turntable, 1 Tape, and 1 Auxiliary Inputs.....150 ohms
- 2 Remote Lines, 1 Network and 1 External Monitor.....600 ohms

Outputs:

- 1 Program Line & 2 Remote Lines Cue 600 ohms +18 dbm
- 2 Monitor Speakers 16 ohms 3 W each
- 1 External Monitor 600 ohms -6 dbm
- 1 Turntable Cue 150 ohms 1 V rms

Gain:

- Microphone to Program Line.....108 db
- Network or Remote to Program Line..... 32 db
- Turntable, Tape or Auxiliary to Program Line..... 64 db
- Microphone to Audition Speaker.....124 db
- Microphone to Program Speaker.....144 db
- Microphone to External Monitor..... 84 db
- Microphone to Remote Line (Cue).....106 db
- Network to Audition Speaker..... 48 db
- Network to Program Speaker..... 68 db

Frequency Response:

- Program ±1.5 db.....30-15,000 cps
- Monitor ±2.5 db.....30-15,000 cps

Harmonic Distortion:

- Program 18 dbm Output.....1% @ 30 cps; .75% @ 50 cps;
0.5% @ 100-15,000 cps
- Monitor 6 W Total.....1.5% @ 50-10,000 cps

Signal to Noise Ratio:

- Program Channel, Mixer and Master Gain controls set for 68 db Gain.....68 db below 18 dbm output

Tube Complement:

- 2 6V6-GT, 2 12AU7, 2 12AX7, 1 5R4GY, 5 12AY7, 5-MI-11299 (selected 12AY7)

Power Requirements:

100-130 volts a-c, 50/60 cycles, 155 watts

Dimensions:

33" wide, 11¼" high, 21¼" deep

Weight:

88 lbs.

Finish:

Two tone amber gray

Panel:

Reverse etched aluminum and dark amber gray

Ordering Information

- BC-3C Standard Console (less tubes)..... MI-11641-A
- BC-3C Standard Console (complete with tubes)..... ES-11103-A

Accessories

- Tube KitMI-11486-A
- On-Air Light Relay.....MI-11702-A
- Warning LightsMI-11706 Series
- BA-26A Equalized Preamplifier.....MI-11436
- Announce Booth Speaker Relay.....MI-11748
- Selected 12AY7 Tube.....MI-11299
- Cue Type Foder for BC-3C High Level Inputs.....MI-94136

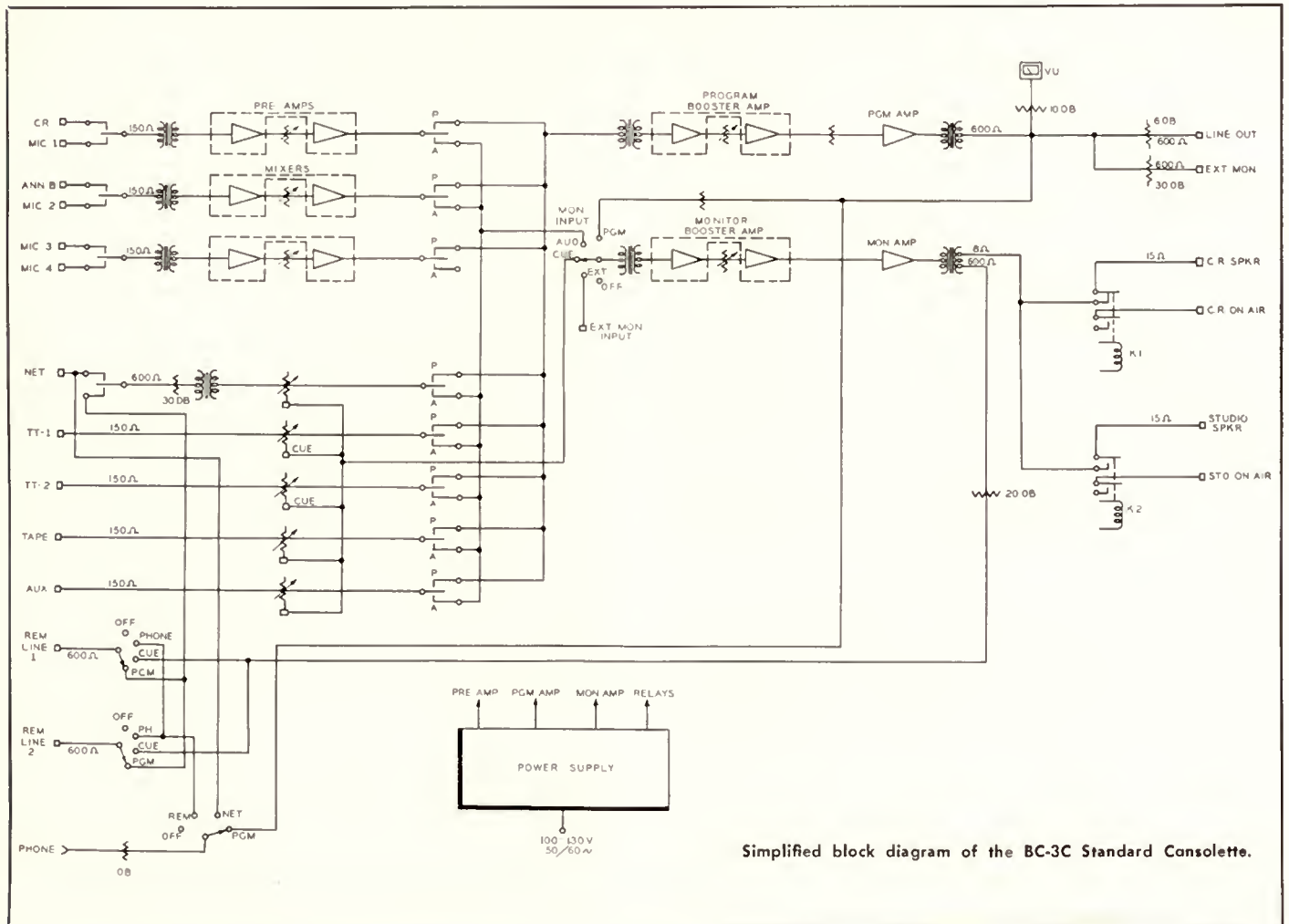

Simplified block diagram of the BC-3C Standard Console.

Audio Consolette

TYPE BC-5B



FEATURES

- Complete audio facilities for the small AM/FM/TV station
- Mixes four simultaneous inputs
- Entirely self-contained
- Talkback or program cue
- Modular construction—glass-epoxy circuit boards
- Flexible monitoring
- Head phone monitoring of network, remote and program line
- Easily expanded for dual-channel broadcast use

DESCRIPTION

The Type BC-5B Audio Consolette, MI-11637-A, provides audio amplification, switching control and monitoring facilities for the operation of a small radio or television broadcast station. This low-cost consolette is self-contained with the power supply for amplifiers and relays mounted in the unit. The exclusive feature of "add-a-unit" audio control incorporated in the BC-5B permits future expansion as desired. The consolette is suitable for use either in combined studio/transmitter or remote studio installations.

A single BC-5B provides high quality switching and control facilities for accommodating one studio, control booth, two turntables, network, remotes and tape recorder. Addition of a second BC-5B doubles facilities and permits complete dual-channel operation. The audio consolette may also be used by television stations to provide audio sub-control, or to permit expansion of existing facilities.

The BC-5B Audio Consolette provides extremely flexible audio facilities for the small broadcast station. It includes three mixing channels for low level microphones and

turntable inputs and one high level mixing channel, for network and remote line inputs. Nine input channels may be selected; the output of each mixer may be switched to either program or audition. A VU meter and all switches and mixer controls are front-panel mounted.

Cue positions are incorporated on turntable mixer controls. Terminals are available for connecting a separate cueing amplifier. Separatet audition and program channels are provided for maximum flexibility. The monitoring amplifier may be switched from the cue position, program line, audition bus or an external position providing off-air monitoring from an off-air receiver or modulation monitor. All inputs are terminated when the switches are in the "off" position.

The BC-5B is a completely wired unit and has self-contained amplifiers and relay power supply. Four pre-amplifiers are utilized in the basic design. The fourth pre-amplifier is supplied wired for low gain to permit its use with remote lines. It can be easily modified, however, for high gain if desired.

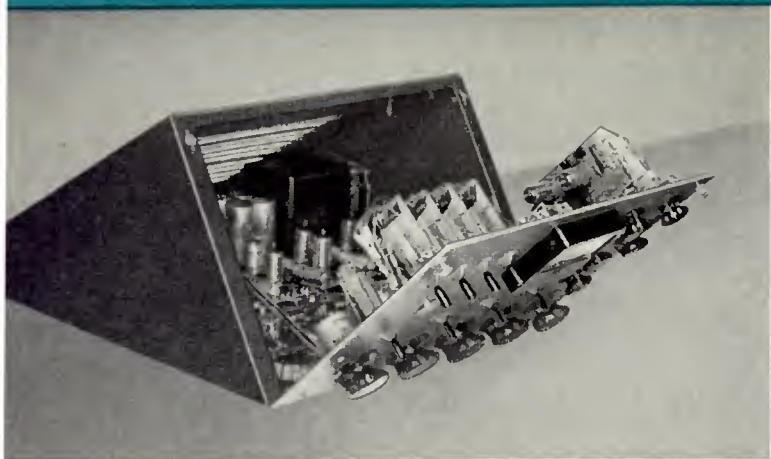

The BC-5B hinged front panel and removable top cover provide complete access to all components including amplifiers and power supply.

The Audio Console is of all-metal construction finished in two-tone umber gray. A hinged front panel and removable cover provide complete access to all components, such as the key-selector switches, controls, mixers, terminal blocks and wiring. The VU meter is illuminated. Muting relays provided in the unit may be used to operate ON AIR warning light relays when such accessory signals are desired.

SPECIFICATIONS

Electrical Specifications

Inputs:			
4 Microphone (3 Studio, 1 Control Room)	37.5/150/600 ohms		
2 Turntable	37.5/150/600 ohms		
2 Remote Lines	600 ohms		
1 Network	600 ohms		
1 External Monitor	150 ohms		
Outputs:			
1 Program Line	600 ohms	+18 dbm	
2 Monitor Speakers	16 ohms	3 W each	
1 External Monitor	600 ohms	-12 dbm	
2 Remote Lines Cue	600 ohms	+18 dbm	
1 Turntable Cue	50,000 ohms	1 V	
Gain:			
Microphone or Turntable Input to Program Line		108 db	
Microphone or Turntable Input to Speaker		125 db	
Frequency Response:			
Program ±1.5 db	30-15,000 cps		
Monitor ±2.0 db	30-15,000 cps		
Harmonic Distortion:			
Program (+18 dbm output)	1% at 30 cps; 0.75% at 50 cps;		
	0.5% 100 to 15,000 cps		
Monitor (6 watt total)	1.5% at 50 to 15,000 cps		

Signal to Noise Ratio	68 db below reference of program line output
	66 db below reference at monitor output
Power requirements	100-130 volts, 50/60 cps, 150 watts
Tube Complement:	
	1-5R4GY, 5-MI-11299 (selected 12AY7), 2-6V6-GT, 2-12AX7, 2-12AU7, 6-12AY7
Dimensions	19 1/2" wide, 11 1/2" high, 21 1/2" deep
Weight	66 lbs.
Finish	Two tone umber gray

Ordering Information

8C-5B Audio Console (less tubes)	MI-11637-A
BC-5B Audio Console (complete with tubes)	ES-11105-A

Accessories

Tube Kit for 8C-5B	MI-11483-A
Warning Lights	MI-11706 Series
Signal Light Relay	MI-11702-A
Announce Booth Speaker Relay	MI-11748
Selected 12AY7 Tube	MI-11299

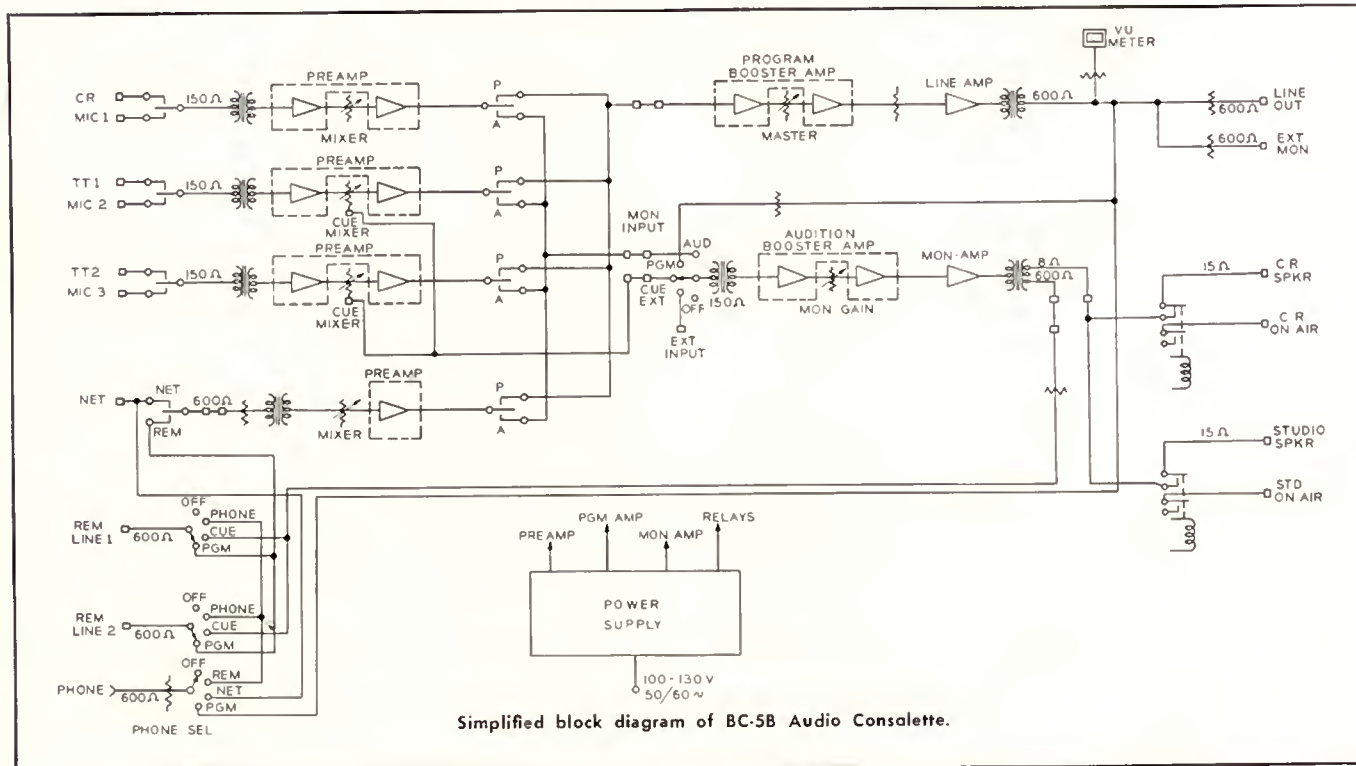

Dual-Channel Audio Console

TYPE BC-6B

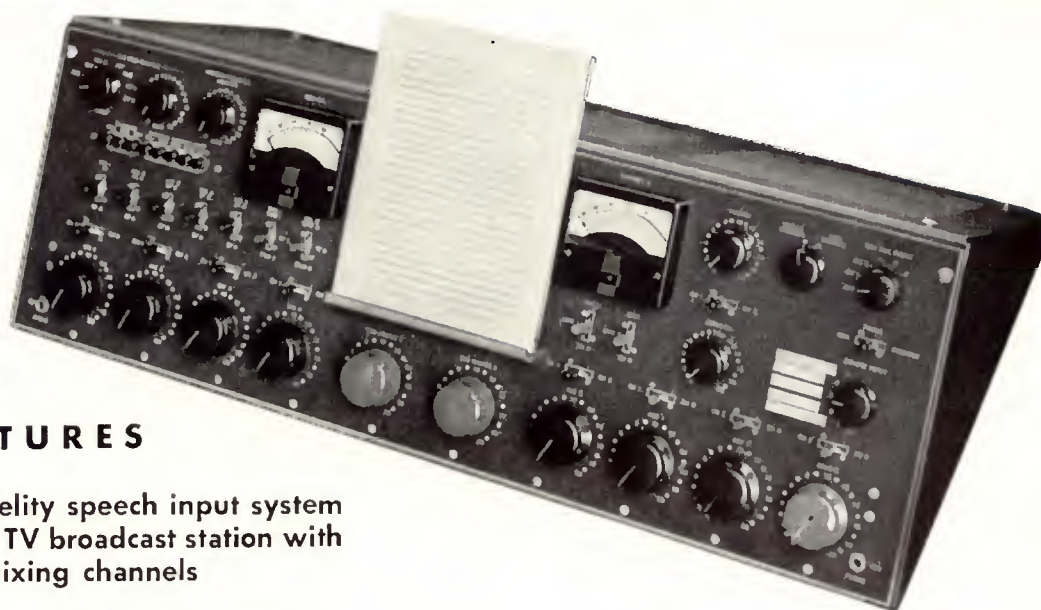

FEATURES

- Complete high-fidelity speech input system for larger radio or TV broadcast station with nine high level mixing channels
- Two program channels either to feed one or both program lines
- Incorporates new split-mixer technique
- Twenty-two inputs available
- Dual power supplies—one for each channel for greater reliability

DESCRIPTION

The RCA Type BC-6B Split-Mixer, Dual Channel Audio Console provides the audio amplification, switching, control and monitoring facilities essential to operation of the larger radio or television broadcast station. This console incorporates nine mixer positions and provides all the facilities needed to accommodate one or more studios, announce booth microphone, control room microphone, two transcription turntables, tape, film, five remote lines, network and three cue circuits.

The nine mixer positions provided are assigned so as to offer the greatest flexibility and operating ease. The first five are low level microphone channels each with dual microphone input. Positions six and seven are also low level inputs and may be used for either turntable, tape or film sources; while the eighth mixer is used for network. The final mixer has provisions for five remote line inputs selected by rotary switch. The latter four mixer positions also have cue type mixers.

The BC-6B Split Mixer, Dual-Channel Audio Console is designed for operating convenience and ease of servicing—all amplifiers, control facilities and power supplies being contained in a single housing which offers utmost accessibility to all components. The unit is suitable for mounting on a flat top desk, and is similar in styling and appearance to the RCA BC-3C and BC-5B consoles.

An etched panel contains all operating controls. It tilts forward for easy access to all switches, gain controls and other interior components. The two VU meters are illuminated. Monitoring and network headset jacks are supplied and headphones may be connected to the output of the program channels, remote lines, or the incoming network. Talkback facilities are included and permit talking back to studios, announce booth or remote lines. An Over-ride-Remote cue switch is provided which permits the remote operator to call in on any of the remote lines and over-ride the program on the control room speaker.

Highest quality components are used throughout the BC-6B. Interlocked push-button switches are common operated leaf type, assuring years of trouble-free operation. Improved fast relay circuits for speakers reduce the possibility of audio feedback. The amplifiers are of a new, compact design of modular construction having dip-soldered glass-epoxy etched wiring amplifier subassemblies.

The BC-6B has two power supplies, each powers a single channel and alternate pre-amplifiers thus providing greater continuity of service. Both are completely self-contained units.

SPECIFICATIONS

Inputs:
 10 Microphones30/150 ohms
 2 Tape, Turntable or Film.....150 ohms
 5 Remote Lines600 ohms
 1 Network600 ohms
 3 Cue Lines20,000 ohms

Outputs:
 2 Program Lines600 ohms +18 dbm
 2 External Monitors600 ohms -6 dbm
 5 Speakers15 ohms 6 watts total
 5 Remote Lines (cue).....600 ohms +18 dbm

Gain:
 Microphone or Turntable Input to Program Line.....108 db
 Microphone or Turntable Input to Speaker.....141 db
 Network or Remote Line to Program Line.....42 db
 Cue Lines to Speakers48 db

Frequency Response:
 Program±1.5 db 30 to 15,000 cps
 Monitor±2.5 db 30 to 15,000 cps

Harmonic Distortion:
 Program (+18 dbm output).....1% at 30 cps, 0.75% at 50 cps,
 0.5% at 100 to 15,000 cps
 Monitor (6 watt total).....1.5% at 50 to 15,000 cps

Signal to Noise Ratio, Microphone to Program Line
 (68 db gain, +18 dbm output).....68 db

Power Requirement:.....300 watts, 100/130 volts, 50/60 cycles a-c

Tube Complement

2-5R4-GY
 4-12AU7
 4-12AX7
 4-6V6-GT
 10-MI-11299 (RCA selected 12AY7)
 13-12AY7

Dimensions:.....38" wide, 11½" high, 21½" deep
Weight127 lbs.
Finish.....Two tone umber gray
Panel.....Reversed etched aluminum with dark umber gray enamel fill

Ordering Information

BC-6B Dual-Channel Audio Console including amplifiers,
 power supplies and instruction book, but less tubes.....MI-1163B-A
 BC-6B Dual Power Audio Console complete with tubes.....ES-11106-A

Accessories

Tube Kit for BC-6B Console.....MI-11484-A
 Announce Booth Speaker Relay.....MI-11748
 On-Air Light Relay.....MI-11702-A
 Warning LightsMI-11706 Series
 Selected 12AY7 Tube.....MI-11299

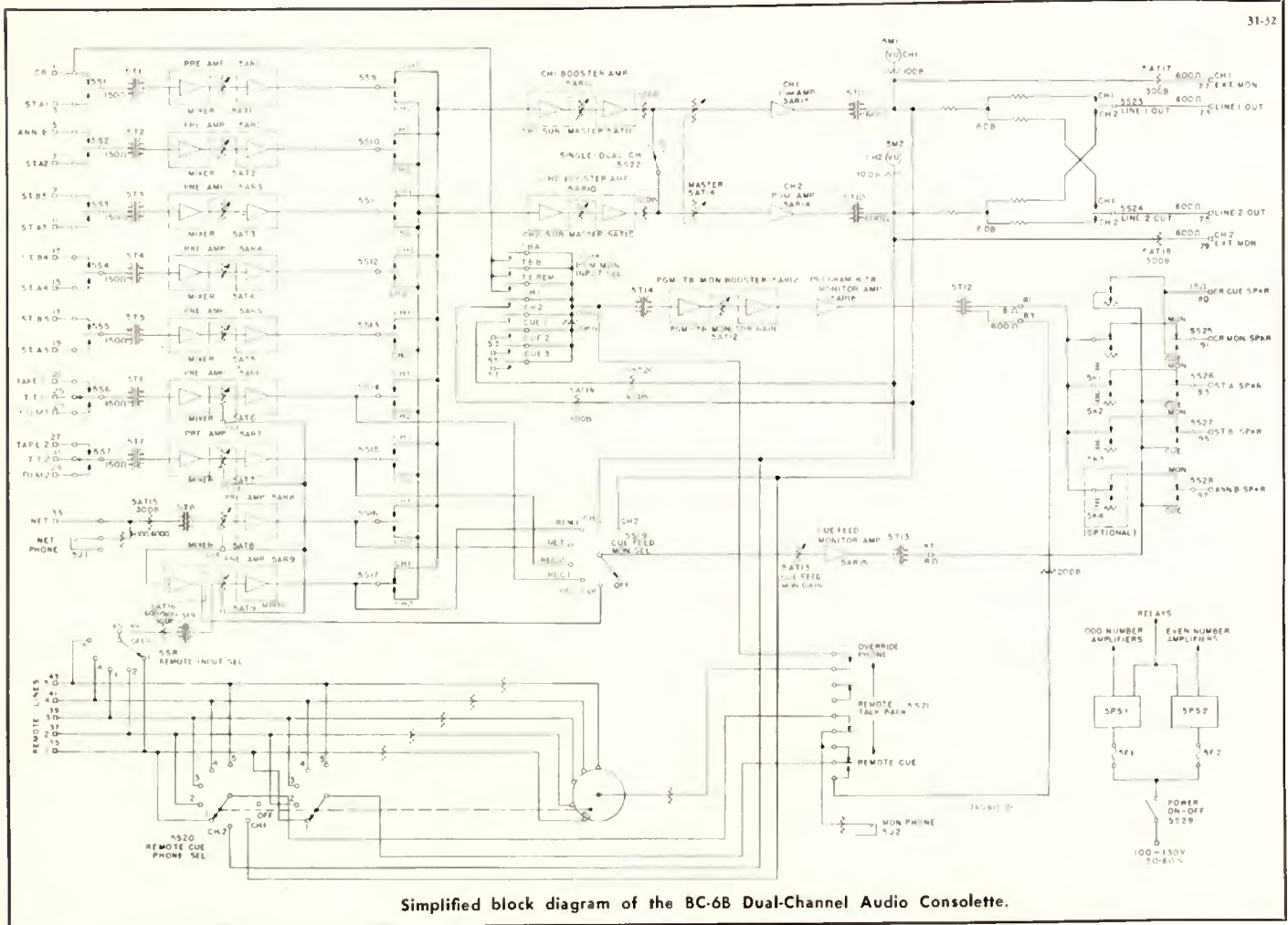

Portable Audio Console

TYPE BC-10A

FEATURES

- Portable dual turntable console simplifies remote operations
- Individual mixing controls for two turntables, plus switchable input for either of two microphones or remote input
- Solid state circuitry throughout
- Excellent frequency response—within ± 2 db 70 to 15,000 cps
- Break-down construction, console legs store in bottom recess for easy storage



DESCRIPTION

The Type BC-10A Portable Audio Console is a completely self-contained unit that greatly simplifies the problem of on-the-spot broadcasts and setting up of remote studios. The console has dual three-speed turntables with complete provisions for mixing as well as cueing recordings. A third mixer is available for use with either of two microphones or a remote line. A 50-db pad in the remote input permits a high level program source such as a tape recorder or remote amplifier to be fed into this position and controlled on the microphone fader.

The BC-10A Console features break-down construction which permits it to be conveniently transported. The four

console legs, when not in use, are stored in clips affixed to the bottom recess of the console. The durable fibreglass unit weighs less than 68 pounds.

The BC-10A is designed to give maximum performance. Frequency response is within plus or minus 2 db from 70 to 15,000 cps on the microphone channel. The turntable channels have built-in RIAA equalization and properly equalize the GE 4G-050 cartridge. Normal output level is plus 6 VU at 3 per cent or less distortion 70 to 10,000 cps. All preamplifiers as well as the remote amplifier and power supply utilize solid state devices.

Operating controls are conveniently located on a sloping panel between the two three-speed turntables. Three faders controlling the two turntable inputs and the microphone-remote input are at the bottom of the panel. In the center is the three-way microphone-remote switch. The PA level control for feeding to external PA equipment is located above to the left and the Master Gain Control to the upper right of the panel. An illuminated VU meter is provided in the upper center of the panel.

The receptacles for two microphones, terminals for the broadcast line, PA feed and monitor jock are located in

Close-up top view of audio console.

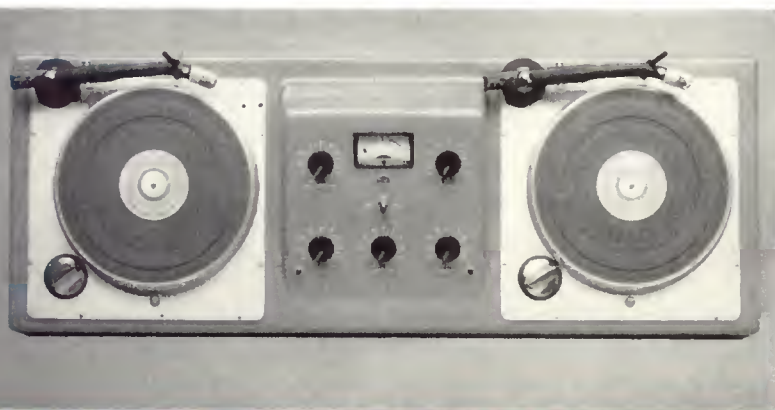

the audio panel on the bottom of the console under the left turntable. The AC receptacle and fuse are located on the AC panel under the unit on the right side. Eorphones, when plugged into the phone jock on the audio panel, can be used to manitor the program being fed to the brood-cast line or to cue the records on either turntable. High impedonce eorphones should be used for monitoring.

Electrical Description

The BC-10A employs etched wiring circuitry for the transistor amplifiers. The regulated power supply is located on a separate panel and uses diodes as full wave rectifiers. The turntable preamplifiers are equalized to the standard RIAA curve. The microphone preamplifier is similar to the turntable preamplifier but has flat response. The use of thermistors keeps the distortion low and the output constant if the ambient temperature exceeds 100 degrees. The unit is capable of operating in temperatures up to 150 degrees F.

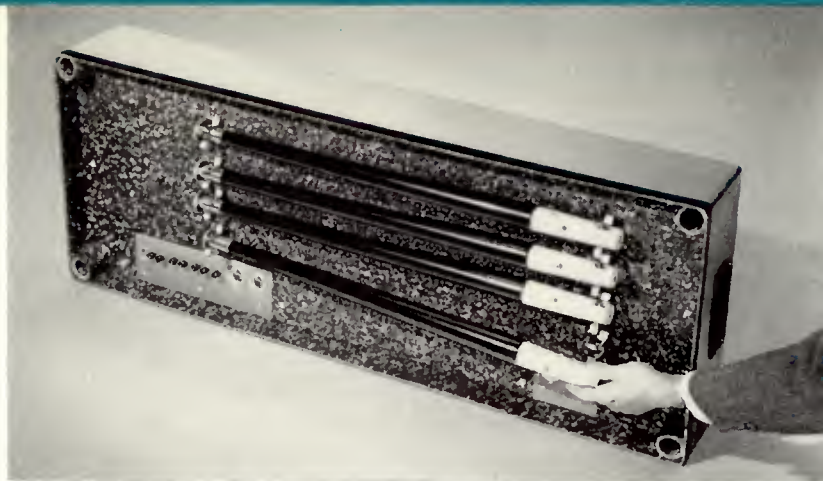

Bottom of BC-10A Console showing leg storage rack, audio panel at left, and AC receptacle at right.

The BC-10A's output is fed through a 3 db isolation pad to the broadcast line terminal and through isolation resistors to the monitor phone jack. A bridging transformer is used to isolate the feed to the PA system. A separate fader is used to control PA level.

SPECIFICATIONS

Frequency Response:
 Microphone Channel..... Within ± 2 db 70 to 15,000 cps
 Phana Channels..... Built in RIAA equalization and will properly equalize when used with a GE 4G-050 cartridge
 Output Level and Distortion
 (after built-in 3 db pad)..... +6 VU at 3% or less distortion
 70-10,000 cps normal; +12 VU maximum is emergency level
 Signal to Noise on Microphone Channel..... 56 db, relative noise at the input is -106 dbm
 Power Line..... 117 volts, single phase, 60 cycles

Transistor and Diode Complement:
 13-2N241A, 4-1N1488, 1-2N456, 1-1M12Z10
 Dimension Overall..... 44" long, 16 1/2" wide, 10" high
 Standing Height..... 31"
 Weight..... 68 lbs. approx.

Ordering Information

Type BC-10A Portable Audio Console complete, with two turntables, tone arms and pickups including power cord and plug..... MI-11655-A

Block Diagram of BC-10A Portable Audio Console.

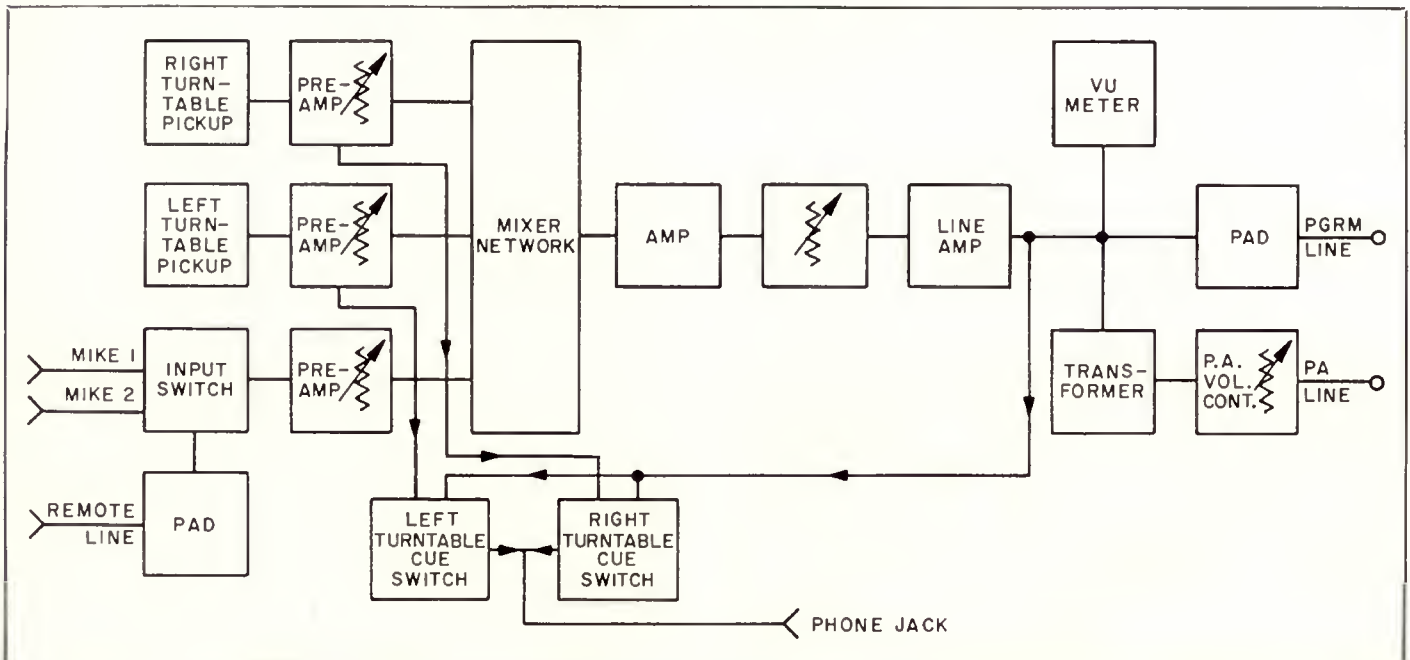

Auxiliary Mixer Consolette

TYPE BCM-2A

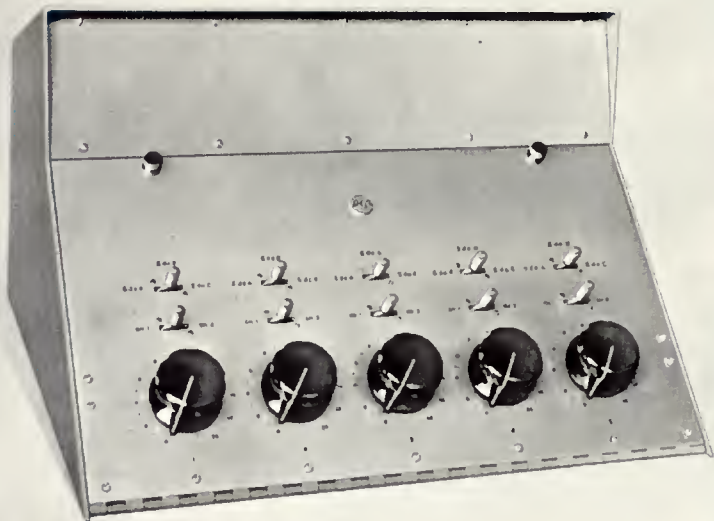

FEATURES

- Supplements facilities of BC-7A Dual Channel/Stereo Consolette
- Provides 5 mixing channels with 15 additional input sources
- Solid state electronics throughout
- Matches BC-7A in design and styling
- Plug-in units offer choice of low-level or hi-level input to each mixer
- Low impedance high level mixers
- Panel and shelf space for convenient customizing

DESCRIPTION

The BCM-2A Auxiliary Consolette is designed to supplement the BC-7A Dual-Channel/Stereo Consolette by providing five additional mixing channels and 15 inputs available on selector switches. Two units may be paralleled to increase the capacity to 10 mixers and 30 source inputs. The console is styled to match the BC-7A and is designed so that each mixer channel accepts a plug-in preamplifier, high level isolation unit or straight thru jumper plug, to accommodate a wide choice of input levels.

By the use of BA-71A Preamplifiers as booster amplifiers the 600 ohm outputs of the auxiliary console may be bridged into the BC-7A main mixer busses through terminals provided, or the BCM-2A may be fed into one of the high level monaural or high level stereo inputs of the BC-7A to provide submasters. Substitution of high level isolation units in place of booster amplifiers enables the auxiliary mixer outputs to be fed into microphone inputs of the BC-7A. The gain is such that when used with the BC-7A the same fader settings may be used as used on the BC-7A faders for equivalent input and output levels.

The BCM-2A has provision for its own self-contained power supply, and will supply an output level of up to +18 dbm, and may be strapped for a maximum gain of up to 77 db (65 db nominal). The console has ample panel space for additional equipment or controls including extra

space on the main panel plus a 4½ by 19-inch panel and a spare shelf for housing additional equipment such as BA-74A Monitor Amplifier, BA-73A Program Amplifier, BA-78A AGC Cue/Intercom Amplifier, isolation transformers, relays, compensators, equalizers, special effects filters or other special apparatus. These features make it possible to use the BCM-2A in many special custom sound applications. The BCM-2A has normal through terminals for convenient access to components in the system and there are spare terminals on the main terminal board for special use.

Console Controls

As in the BC-7A, all operational controls are contained on the main control panel and are functionally grouped for fast identification and operating ease. Permanent panel designations are etched in black, whereas, designations which are most subject to change, depending on individual needs, are left blank. Uniform panel depressions, provided at these locations, accept a wide assortment of pressure sensitive metal labels supplied with each unit. The labels provide a neat, permanent appearance to the consolette, yet can easily be changed when necessary.

Five faders or mixers are equally spaced across the main panel. Immediately above each fader is a FADER DELETION SWITCH (a three position lever key with a BLACK

hondle). Above each foder is also a SOURCE SELECTOR SWITCH (a three position lever key with a RED handle). Thus each switch is located above the mixer with which it is associated. Throwing a foder delegation switch to the left connects it to the LEFT (CH-1) mixer bus; throwing it to the right connects it to the RIGHT (CH-2) mixer bus. The center is on off position. Each of the five input selector keys permits selection of one of three inputs, thus the BCM-2A Auxiliary Consolette makes available 15 sources. Two BCM-2A Auxiliary Mixer Consolettes can be used with a BC-7A consolette to obtain a total of 61 sources available on switches.

Dual Channel Facilities

Three-position foder delegation keys and two mixer busses provide facilities suitable for dual channel operation (either stereo; program-audition; or two independent channels). The mixer delegation keys are pre-wired for stereo mixers so that any mixer can be conveniently replaced by a dual (stereo) mixer available from stock. Extra contacts are provided on the input selector switches so that, if desired, any input selector switch may be custom wired to simultaneously select both LEFT and RIGHT channels of a stereo source (i.e. stereo microphone, stereo tape, or stereo turntable). Terminals are provided on the main terminal block for a "RIGHT" input adjacent to the normal "LEFT" input.

Control Circuit Patch Board

As in the BC-7A, a muting relay stropping panel is conveniently located behind the main control panel and appears in the center front in a horizontal position when the main panel is hinged open. All terminals are functionally identified so that any of the five BC-7A muting relays may be stropped to be controlled by any combination of source selection lever keys.

Power Supply

The BCM-2A has provision for its own self-contained plug-in power supply, but it can be operated from the main power supply in the BC-7A if a total of no more than nine preamplifiers (including preamplifiers in the BC-7A) are supplied in addition to the two program amplifiers also located in the BC-7A.

The BCM-2A is intended for flat top desk mounting. The double slope front panel, pleasing functional design and simplicity of layout offer flexibility, great convenience and ease of operation. The finish of the main control panel is anodized brushed aluminum, while the housing and upper panel is finished in a harmonizing baked shadow blue enamel. The front panel hinges forward and the rear cover can be removed by latches.

SPECIFICATIONS

Mixers.....	5 low-impedance high-level
Amplifiers:	
Preamplifiers.....	5 Type BA-71A
Booster Amplifiers.....	2 Type BA-71A
Power Supply.....	1 Type BX-71A
Microphone Inputs.....	15-3 to each channel (any channel may have high level inputs if isolation units are used in place of preamplifiers)
Source Impedance (Preamplifier Input).....	37.5/150/600 ohms
Input Impedance (Preamplifier Input).....	Unloaded input transformer
Load Impedance.....	150/600 ohms
Outputs (from booster or isolation units).....	2—each 150/600 ohms
Gain (with controls set for max.).....	65 db nominal, may be stropped for up to 77 db
Maximum Output.....	+18 dbm
Frequency Response.....	±1 db 30-15,000 cps
Distortion.....	Less than .5%, 50-15,000 cps
Signal-to-Noise Ratio:	
Microphone to BC-7A Program Line Out (68 db gain +18 db output).....	At least 68 db
Dimensions Overall.....	19½" wide by 12½" high by 20" deep
Weight.....	Approx. 45 lbs. (no plug-in units)
	Power Supply—Approx. 14 lbs., Preamplifiers—Each Approx. 3 lbs.

Ordering Information

BCM-2A Consolette Housing (less all plug-in units).....	MI-11656
BCM-2A Auxiliary Mixing Consolette (for BC-7 Mixer Bus Bridging).....	ES-11155
Including the following:	
1 BCM-2A Consolette Housing.....	MI-11656
5 Preamplifiers, Type BA-71A.....	MI-1165B
2 Booster Amplifiers, Type BA-71A.....	MI-1165B
1 Power Supply, Type BX-71A.....	MI-11663-A
BCM-2A Auxiliary Mixing Consolette (for BC-7 Mixer Input).....	ES-11156
Including the following:	
1 BCM-2A Consolette Housing.....	MI-11656
5 Preamplifiers, Type BA-71A.....	MI-1165B
2 Isolation Units.....	MI-11665
1 Power Supply, Type BX-71A.....	MI-11663-A

Accessories

High Level Isolation Unit.....	MI-11665
Power Supply, BX-71A.....	MI-11663-A
Preamplifier, Type BA-71A.....	MI-11658

Interphone Equipment

FEATURES

- Production intercom with studio personnel or remote line as desired
- Can mount to console, desk, or wall
- Designed to be compatible with other RCA TV equipment
- Transistor amplifier or induction coil type interconnection units available
- Regulated power supply

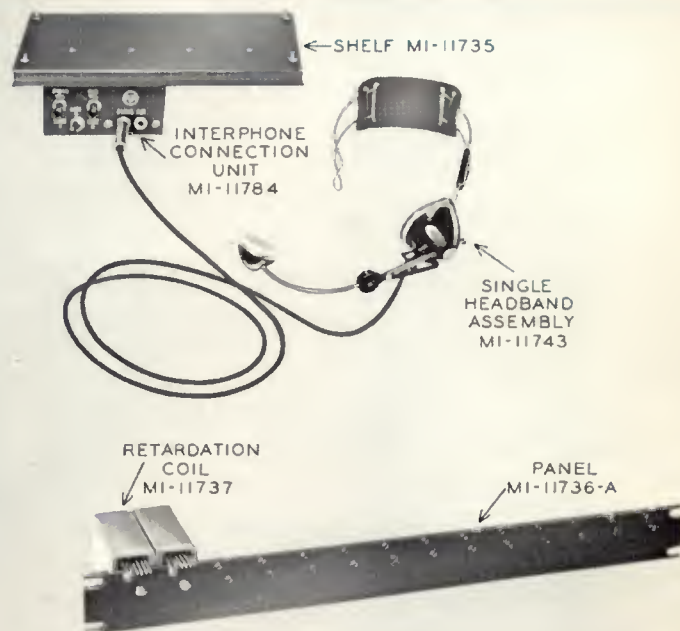

DESCRIPTION

RCA Interphone Equipment is designed to provide convenient line switching and headset connection facilities for a TV camera and studio communication system.

Heart of the RCA Interphone System is the Interphone Connection Unit. Two types of connection units are available. The MI-11784 Transistor Interconnection Unit must be used with RCA TK-12/32 and other late model Cameras having transistorized intercommunication systems built into the camera. The MI-11734 Induction Coil Interconnection unit is designed for use with early RCA studio and field type cameras. The two interconnection units can not be intermixed in a system.

The MI-11784 unit includes a single stage transistor amplifier, with bridge rectifier and sidetone compensation network with level control to adjust volume. Each person on the talking bus can adjust the volume to suit his individual requirement. On the front is a three-way switch for selection of three intercom lines, and the separate volume controls for "phone" and "cue" adjustment. The box also contains two jacks to accommodate single or double headsets. A 9-pin and a 12-pin cable connector plug on the rear are used for external connection. The entire unit is

housed in a box 4 $\frac{3}{8}$ inches wide, 2 $\frac{1}{2}$ inches high and 6 $\frac{3}{4}$ inches deep overall.

Operating power for the MI-11784 interphone unit is derived from the common-battery interphone circuit to which the interphone unit is connected. A bridge-rectifier is interposed in the line to the amplifier to maintain correct polarity of the amplifier regardless of the polarity of the interphone battery voltage. The sidetone compensation bridge is designed to hold the sidetone level to within 2 db of the received level for any number of connected stations up to 32.

The Transistor Interphone Connection Unit, MI-11784 can replace the MI-11734 unit where it is designed to modernize the system since the unit physically replaces the MI-11734 Connection Unit and will operate with virtually all commercially available TV headsets using carbon microphones. The substitution can be made only if the camera is modified by substituting an MI-11757 Transistor Amplifier for the induction coil in the interphone circuit. Other circuit changes as outlined in the instruction book are also required.

The Interphone Connection Unit, MI-11734, consists of a simple circuit having an induction coil and capacitor to provide an anti-sidetone feature. The circuit is housed in a compact box having two phone jacks for use either with a single or double headset as required, and a two-position toggle switch for selecting a local circuit or a remote line. A cable plug is mounted in the rear. It is designed to work in early intercom systems employing induction coils throughout.

All other components of the Interphone System are designed for operation with either Interconnection Unit.

The Retardation Coil, MI-11737, permits simultaneous use of four carbon microphones such as an interphone connection unit and three camera headsets on a common battery or power supply. The coil permits a d-c power voltage to be imposed upon the two-wire telephone talking line. The MI-11737 is an audio frequency choke which isolates the power supply from the telephone line at voice frequencies.

The MI-11736-A Mounting Panel is recommended for mounting retardation coils. The panels have standard mounting dimensions for use in the RCA BR-84 Series Racks.

The accessory, MI-11735 Shelf, is available for mounting the interphone connection units under the countertops of console housings on which switching units or camera controls are housed. The plate will accommodate one or two Interphone Connection Units.

Either a single or double headset identified as Single Headband Assembly, MI-11743 and Double Headband Assembly, MI-11744, can be used with RCA Interphone Equipment. One earphone unit of the double headband assembly is used for "cue" reception. Either type can be used in the same system.



MI-11784 Transistor Interphone Unit



Double Headband Assembly, MI-11744



Front and rear view of Induction Coil Interphone Unit, MI-11734.

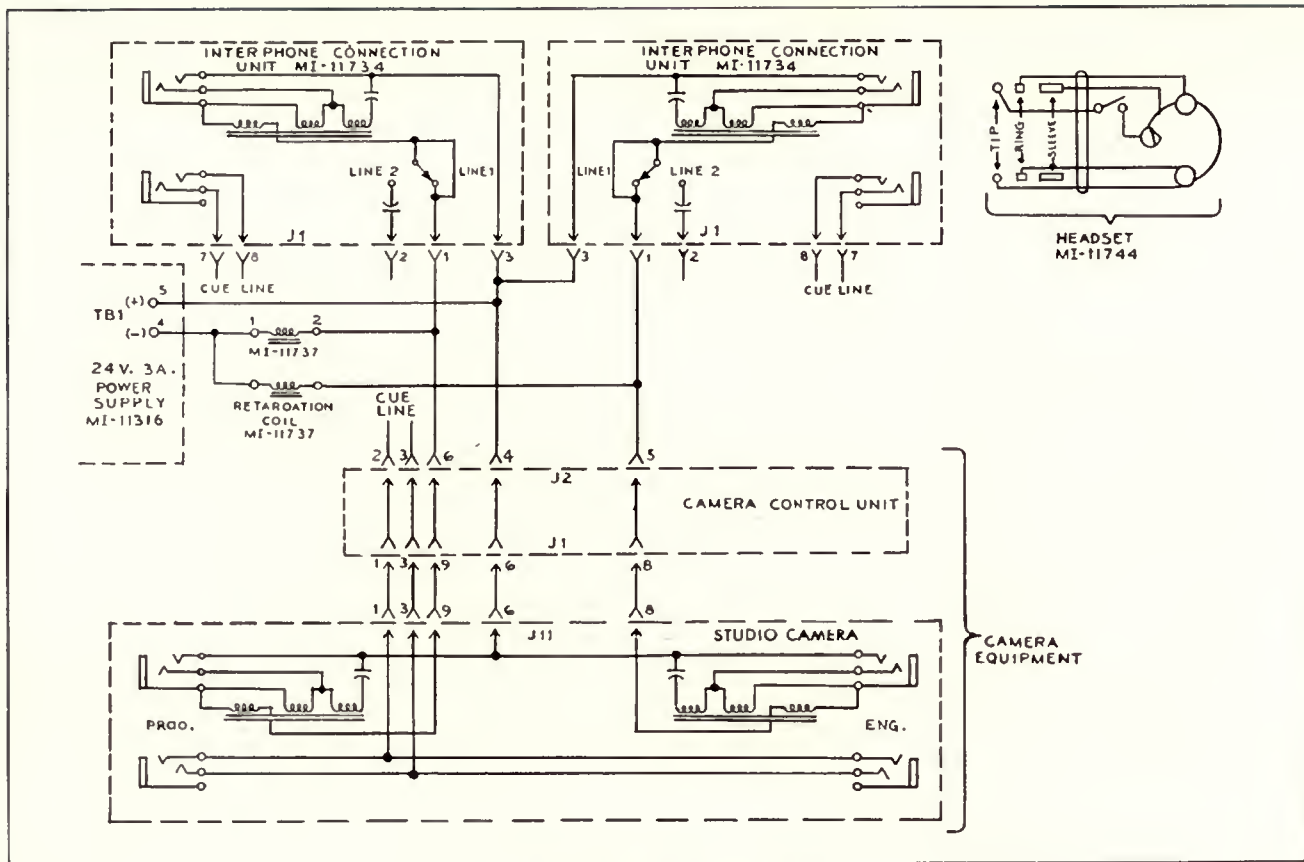

Schematic Diagram for Interphone

SPECIFICATIONS

Single or Double Headset

DC Resistance:	
Microphone Switch On	70 ohms approx.
Microphone Switch Off	Infinite
Inductance of 1000 Cycles:	
Microphone Switch On	70 millihenries approx.
Microphone Switch Off	245 millihenries
Weight:	
Single Headband Assembly	6 ozs. (less cord)
Double Headband Assembly	9 ozs. (less cord)

Transistor Interphone Connection Unit, MI-11784

Impedance	120 ohms
DC Voltage	8.5 volts (nominal)
DC Current	.95 ma. (approx.)
Dimensions Overall	4 5/8" wide, 2 1/2" high, 6 3/4" deep
Weight	3 lbs.

Interphone Connection Unit, MI-11734

Dimensions Overall	4 5/8" wide, 2 3/16" high, 4 1/4" deep
Weight	1 lb., 11 ozs.

Retardation Coil, MI-11737

DC Resistance	165 ohms
Inductance	3.4 millihenries
Maximum Recommended Load Current	125 ma d-c
Dimensions Overall	1 3/8" wide, 1.45/64" high, 4 5/8" deep
Weight	16 ozs.

Power Supply, MI-11316

Input	100-125 volts, 50/60 cps, single phase, 125 watts
Output	Regulated 24 volts, 3 amps. d-c
Dimensions Overall	7 3/4" wide, 5 3/4" high, 10 5/8" deep
Weight	25 lbs.

Power Supply, MI-11318-B

Input	100-130 volts, a-c, 60 cps, single phase, 144 watts
Output	Regulated 24 volts, 6 amps. d-c
Dimensions Overall	19" wide, 5 1/4" high, 9 3/4" deep
Weight	25 lbs.

Mounting Shelf

Capacity	Mounts one or two Interphone Connection Units
Dimensions	11" long, 6 3/8" wide
Weight	2 lbs. (approx.)

Retardation Coil Panel

Capacity	Mounts up to 14 retardation coils
Dimensions	19" wide, 1 3/4" high
Weight	18 ozs.

Ordering Information

Transistor Interphone Connection	MI-11784
Interphone Connection Unit	MI-11734
Retardation Coil	MI-11737
Shelf for Mounting MI-11734	MI-11735
Panel (accommodating 14 Retardation Coils)	MI-11736-A
Single Headband Assembly	MI-11743
Double Headband Assembly	MI-11744
Regulated Power Supply (24 V, D-C, 3 amps)	MI-11316
Regulated Power Supply (24 V, D-C, 6 amps)	MI-11318-A
Transistor Amplifier (Replacement for Induction Coil)	MI-11757

Custom Audio Equipment



Master Console with 22 individual mixers.

FEATURES

- Designs for Exact Customer Requirements
- Extensive Custom Engineering Service available for consultation
- Custom designs provide means for complete automation later, if desired
- Increased operating efficiency
- Reduced operating expense
- Instant "fool-proof" switching
- Increased station prestige with clients
- Possibilities for new business . . . More programs handled

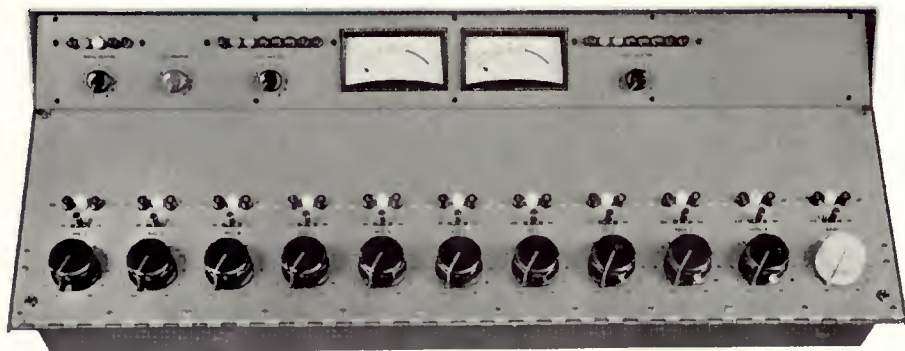

Custom three-channel audio control console shown is designed to match the three-channel master control shown on previous page. The eleven simultaneous mixers on this console and twenty-two on the master console offer exceptional flexibility for an AM-FM station.

In addition to a comprehensive line of standard studio control equipment, RCA specializes in custom designing and building complete speech-input systems to meet individual needs of stations and networks. Our engineers have worked closely with the nation's leading broadcast engineers in the design, production and installation of many custom equipments, a few of which are pictured on these pages. Studio-control systems such as these are tailor-made, combining just the right facilities for the control of program operations and the reproduction of high-fidelity sound.

Since no two broadcast stations have exactly the same operating requirements, equipment needs will differ for

each installation, ranging from special equipment for small and medium-size stations to more complex systems for the largest installation. In planning new installations, this "Custom-built" equipment service is available to every AM, FM, or Television station, and it includes the services of an entire RCA engineering staff. Broadcast station engineers, in some cases, may wish to lay out and design the system themselves, complete with specifications. In these instances, RCA will provide specifically built units or modify standard equipment to meet these specifications. On the other hand, where stations desire, RCA engineers will study station requirements, make overall and detailed layouts, and draw up specifications for equipment needed.

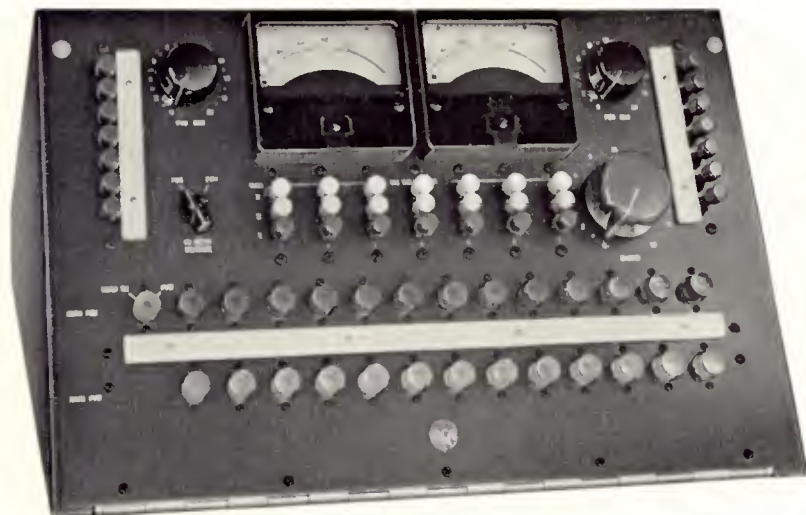

This master control panel with auxiliary microphone inputs and master and monitor gain controls, etc. was designed by RCA for Station WBNS. The console cabinet is designed for desk top mounting next to a standard BC-6B Consolelette. The front panel swings out affording complete accessibility.



Custom audio control console designed and built for Station KHJ's television studio. It includes complete mixing and cueing facilities for five microphones and an announce microphone, two turntables, one remote and three utility inputs.

Master control audio relay switching system recently installed at Station KSTP. Shown at right is compact control panel designed to fit a standard 22-inch console housing. Three VU meters for line, program and preview, monitor controls, pushbutton controls for preview and program busses and selectable auxiliary fader inputs are shown among other facilities. To the left are rack-mounted facilities including amplifier shelves, jack fields, and relay switcher.

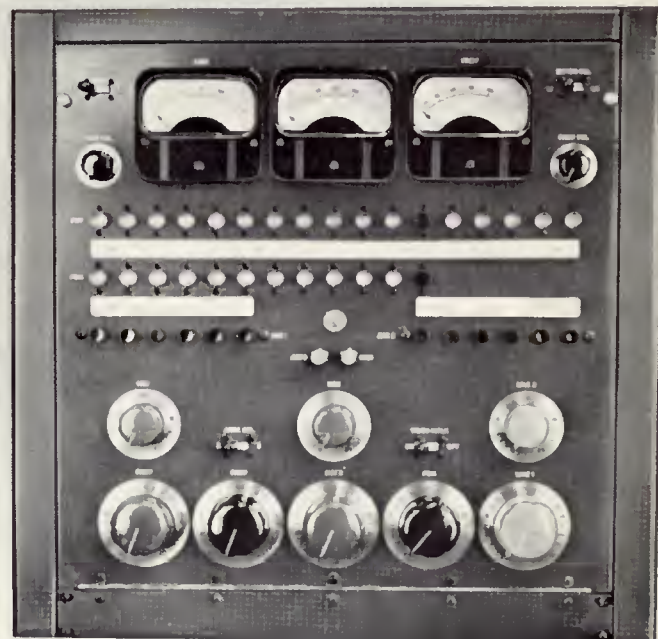

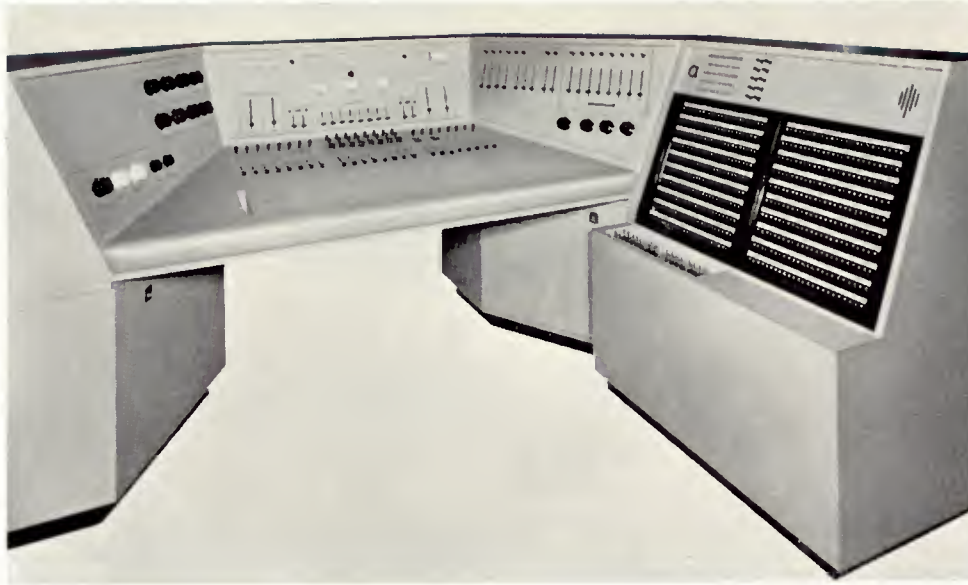

One of five custom master control consoles designed and built by RCA for the American Broadcasting Corporation. The console features solid state circuitry, sound effects controls, sub-mixers, equalizers, echo effects, monitor controls, unitized construction for complete accessibility. The left side of the console contains effects filters, space for another mixer module. In the center is the echo control, sub-master equalizers, VU meters. The desk portion contains mixing faders and submaster controls. To the right the console has monitor, and sound reinforcement controls and mixer module, below are four monitor selector knobs. Additional right housing is the patching wing unit.

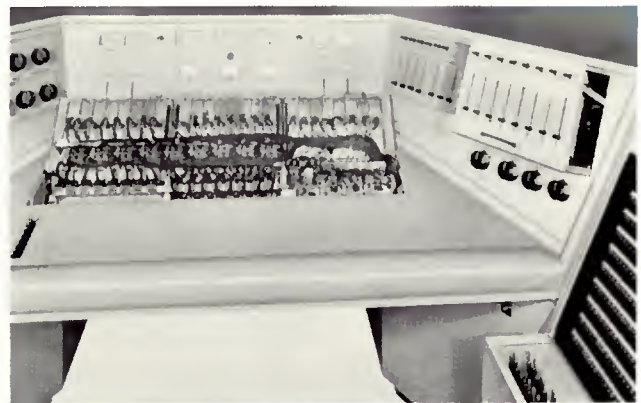

Desk top flipped over showing vertical faders, switches, and controls.

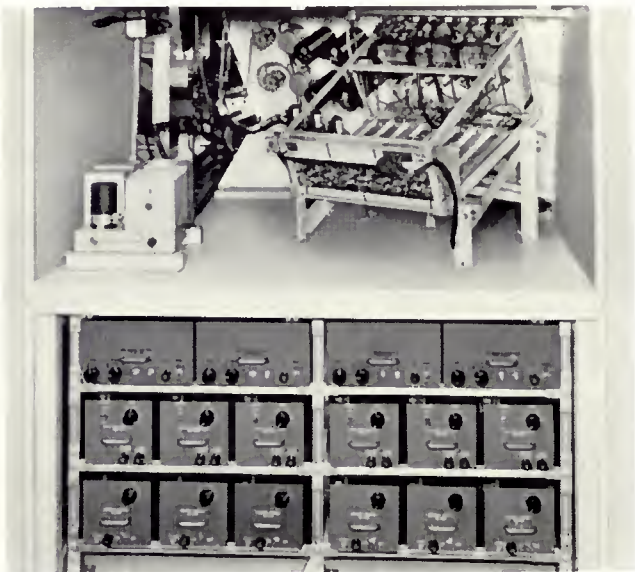

Rear view of left wing showing 24 volt power supply, effects filters and spare mixer module above, and four AGC amplifiers, 6 monitor amplifiers and 6 line amplifiers below.

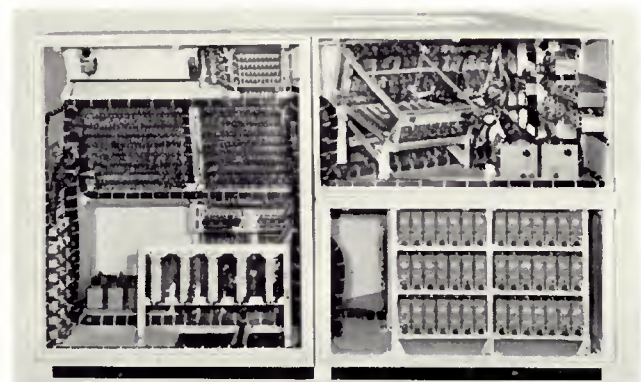

Rear view of patching wing unit showing jack fields, line coils, fixed pads, and terminal blocks. To the right is the rear view of the right wing of the console showing preamplifiers on bottom and above are mixer module and line and bridging coils with two monitor amplifiers.

Summary of RCA Broadcast Amplifiers

Type	Usage	Max. Gain db	Max. Input dbm	Max. Output dbm	Source Impedance Ohms	Load Impedance in Ohms	Power Requirements	Type Mounting
8A-31A *	Preamplifier	40 Low 46 High	-22/-28	+18	37.5/150/600	150/600	100-130 volts AC 50/60 cycles, 3.5 watts	Shelf
	Isolation Amp. with MI-11278-E F Bridging Gain Control	3 Low 9 High	30	+18	10,000	150/600	100-130 volts AC 50/60 cycles, 3.5 watts	Shelf
8A-33A *	Program Amp. Line Amp. Isolation Amp. Monitor Amp.	Matching 70 High, 55 Low Bridging 33 High, 18 Low	Matching -20 Bridging +18	+30	150/600	150/600	100-130 volts AC 50/60 cycles, 20 watts	Shelf
8A-348 *	Monitoring Amp. Recording Amp.	104	-30	+40 (10 watts)	37.5/150/600	4/8/16/150/600	100-130 volts AC 50/60 cycles, 25 watts at Rated Output	Shelf
8A-71A *	Preamplifier	40 Low 46 High	-22 Low, -28 High	+18	37.5/150/600	150/600	30 volts DC at 45 ma	Console or Shelf
	Isolation Amp. with MI-11278-E F Bridging Gain Control	3 Low 9 High	30	+18	1,000	150/600	Use BX-71A Power Supply	
8A-73A *	Program Amp. Line Amp. Isolation Amp. Monitor Amp.	Matching 70 High, 55 Low Bridging 33 High, 18 Low	Matching -20 Bridging +18	+30	150/600	150/600	30 volts DC at 300 ma Use BX-71A Power Supply	Console or Shelf
8A-74A *	Monitoring Amp. Recording Amp.	63	-23	+40 (10 watts)	37.5/150/600	4/8/16/150/600	100-130 volts AC 50/60 cycles, 30 watts	Console or Shelf
8A-78A *	Cue/Intercom Amplifier with AGC	90	-30	+30	150	50/8	117/235 volts AC 50/60 cycles, 8 watts at max. output	Console or Shelf
8A-26A *	Equalized Turntable Preamplifier	—	—	-20 dbm	—	150/600	100-130 volts AC 50/60 cycles, 2 watts	Turntable Cabinet
8A-6A	Limiting Amplifier	54	Minimum of Verge of Limiting -24	+30	150/600	600	100-130 volts AC 50/60 cycles, 150 watts	Chassis or Rock
8A-8A *	Cue Amplifier	53	Matching -24 Bridging +9	+30 (1 watt)	Matching 150/600 Bridging 10,000	3.2	117/235 volts AC 50/60 cycles, 13 watts	Table or Rock
8A-21A	Preamplifier	Matching 40	Matching -10	+18	37.5/150/600	150/600	285 volts DC at 10 ma and 6.3 volts AC or DC at 0.6 amps.	Chassis or Rock
	Isolation Amp. with MI-11278-E or F Bridging Gain Control	Bridging 4	Bridging +40	+18	10,000	150/600	Use BX-21A power supply	
8A-23A	Program Amp. Line Amp. Isolation Amp. Monitor Amp.	Matching 68 Bridging 25	Matching -10 Bridging 27	+30	150/600	150/600	100-130 volts AC 50/60 cycles, 30 watts	Chassis or Rock
8A-24A	Monitoring or Recording Amplifier	104	-30	+40 dbm 10 watts	37.5/150/600	4/8/16/150/600	100-130 volts AC 50/60 cycles, 70 watts	Chassis or Rock
8A-25A	AGC Program Amplifier	70	-25	+30	150/600	150/600	100-130 Volts AC 50/60 cycles, 55 watts	Chassis or Rock
8N-7A *	Remote Portable Amplifier	93.5	-20	+18	150/250 37.5/150 using MI-11776 Input Transformer	600	117/235 volts, 50/60 cycles, 5 watts or battery	Portable Case
8N-68 *	Remote Portable Amplifier	90	-40	+18	150/250 37.5/150 using MI-11776 Input Transformer	150/600	117 volts AC 50/60 cycles, 5 watts or battery	Portable Case
8N-10 *	Remote Amplifier	—	—	+6 VU	Self-contained BK-6 Microphone	600	battery, self-contained	Handheld

Gain and level references in RCA Amplifier Catalogs are defined as follows: db—refers to gain; dbm—sine wave power measurement referred to 1 mw; VU—refers to average program level as read on a standard VU meter. This value is subject to considerable variation from dbm but is generally considered 10 db below peaks.

* Transistor types.

Preamplifier and Isolation Amplifier

TYPE BA-31A

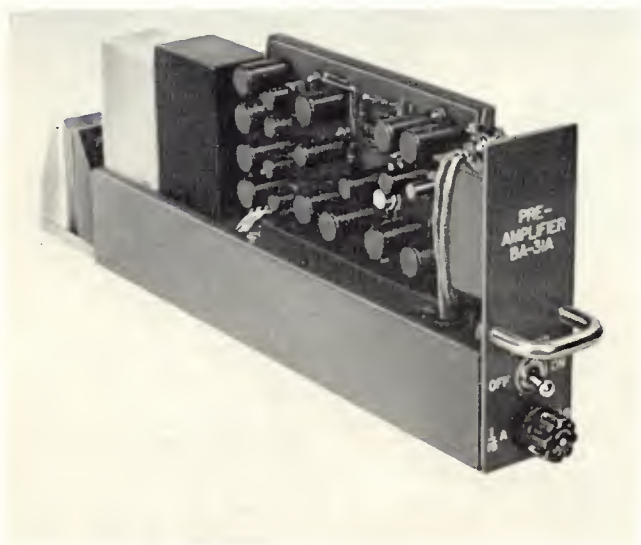

DESCRIPTION

The BA-31A Preamplifier is a small, compact unit featuring solid state circuitry and is intended for use as a microphone preamplifier, turntable preamplifier or booster amplifier. With the addition of the MI-11278-E or F volume control kit, which mounts external to the amplifier, the BA-31A is provided with a 20,000 ohm input and may be used as a bridging or isolation amplifier.

Cool operation, achieved by low power dissipation, makes possible a trouble-free, long-life expectancy for this amplifier. Noise level and distortion have been reduced to a very low value through proper circuit design and the use of stabilized feedback. Transistor selection to produce low noise is not required in the BA-31A. The amplifier is constructed with a plug-in type chassis and guide assembly that is designed for mounting on a BR-22 Shelf.

The BA-31A circuit consists of an unloaded input transformer, a two-stage negative feedback amplifier, and a four-transistor output amplifier. The output amplifier drives a transformer which can be strapped for 150 or 600 ohm loads. The power transformer isolates the amplifier from the power line, and an additional transistor in the power supply reduces ripple.

There are two matching gains available—40 or 46 db—selected by a strap. The unit is shipped with the gain strapped for 40 db. The frequency response is better than ± 1 db from 30 to 15,000 cps (referred to 1000 cps); and the noise level is -82 dbm or -76 dbm max. of output, depending on gain strapping. As a bridging amplifier, the BA-31A has a 9 db max. gain with the volume control at minimum loss position and bridging a 600-ohm line.

FEATURES

- Transistor design
- Long life expectancy—reduced maintenance
- Cool operation
- Self-contained power supply
- Excellent frequency response
- High gain, low noise circuitry
- Plug-in chassis for shelf mounting

SPECIFICATIONS

Source Impedance.....	37.5 ohm unbalanced; 150/600 ohm balanced or unbalanced		
Input Impedance			
Matching.....	Unloaded transformer, high in comparison with source impedance		
Bridging.....	20,000 ohms (using external bridging control)		
Load Impedance.....	600 ohms when shipped; may be changed to 150 ohms		
Maximum Input Level—Matching.....	-22 dbm low gain strapping -28 dbm high gain strapping		
Maximum Input Level—Bridging.....	30 dbm		
Gain Matching.....	40 ± 1 db low strapping (as shipped) 46 ± 1 db high strapping		
Gain Bridging.....	3 db low strapping, 9 db high strapping		
Frequency Response.....	Better than ± 1 db from 30 to 15,000 cps (referred to 1000 cps)		
Rated Output Level and Distortion.....	Total rms harmonic distortion at $+18$ dbm output less than 0.5% from 30 to 15,000 cps		
Hum and Noise Level.....	-82 dbm or -76 dbm max. at output, depending on gain strapping, measured from 30 to 15,000 cps		
Maximum Ambient Temperature.....	55°C (131°F)		
Transistor and Diode Complement			
1—2N1010	1—2N404	5—2N270	2—1N2069
Fuse.....	1/16 amp. 3AG Slow-Blow		
Power Requirements.....	117 volts, o-c, 50/60 cycles, 3.5 watts (with taps for 105, 115 and 125 volts)		
Overall Dimensions.....	4-21/32" high, 1 5/8" wide, 1 3/2" deep		
Weight.....	3 1/2 lbs.		
Finish.....	Light amber gray lacquer		
Mounting.....	Plug-in mounting on BR-22 Mounting Shelf requires 1/10 of the shelf		

Ordering Information

BA-31A Preamplifier (includes transistors and diodes)..... MI-11444

Accessories

Bridging Gain Control Kit	
With Screw-driver Adjustment.....	MI-11278-F
With Knob Adjustment.....	MI-11278-E
BR-22 Mounting Shelf for Rack Mounting.....	MI-11597-A
Spore Transistor and Diode Kit.....	MI-11780
Spore Guide Assembly (with receptacles).....	MI-11594-1

Program Amplifier

TYPE BA-33A



DESCRIPTION

The BA-33A is a high-fidelity Program Amplifier designed for broadcast service. It incorporates solid state circuitry providing the advantages of small, compact design, uniform performance, reduced power consumption and long-life expectancy for the amplifier. The high gain and low distortion of the unit make it an ideal choice for use as a program or line amplifier, bridging amplifier or as an isolation amplifier.

The BA-33A is a plug-in type designed for use with the BR-22B Mounting Shelf. This shelf permits quick, easy removal for servicing or interchanging units. Three BA-33A Program Amplifiers as well as one BA-31A Transistor Pre-amplifier can be accommodated on the mounting shelf. All connections are made through plugs at the back of the amplifier. The mating sockets and guide assembly are supplied with the amplifier. Etched wiring boards are used and the circuitry and all components are readily accessible.

The amplifier circuit consists of a loaded input transformer and a two-stage negative feedback preamplifier, followed by a continuously variable gain control that is adjustable from the front panel. The control connects to a negative feedback output amplifier employing five transistors. The output amplifier, in turn, drives an output transformer. Levels as high as +30 dbm (1 watt) can be supplied at the output. The self-contained power supply consists of a full-wave bridge rectifier and a three-section filter to assure low ripple. A strap is provided for either 55 or 70 db of maximum gain. The unit is shipped strapped for 70 db gain. A bridging pad is built into the amplifier.

FEATURES

- Transistor circuit design and etched wiring provide uniform performance
- Cool operation
- Long-life expectancy—reduced maintenance
- Self-contained power supply
- Excellent frequency response
- Front panel gain control
- Plug-in chassis for shelf mounting

SPECIFICATIONS

Source Impedance.....	600/150 ohms, balanced or unbalanced
Input Impedance	
Matching.....	Connected when shipped for 600 ohms; may be re-connected for 150 ohms
Bridging	20,000 ohms
Load Impedance.....	600 ohms when shipped; may be changed to 150 ohms
Maximum Input Level	
Matching	-20 dbm
Bridging	+18 dbm
Frequency Response.....	Better than ± 1 db, 30 to 15,000 cps (referred to 1000 cps)
Maximum Output Level.....	+30 dbm
Harmonic Distortion.....	0.5% rms max. +30 dbm output, 30 to 15,000 cps
Matching Gain	
High Gain Connection.....	70 ± 1 db
Low Gain Connection.....	55 ± 1 db
Bridging Gain	
High Gain Connection.....	33 ± 2 db
Low Gain Connection.....	18 ± 2 db
Maximum Ambient Temperature.....	55°C (131°F)
Noise Level at Output	
High Gain.....	-47 dbm max., 30 to 15,000 cps
Low Gain.....	-62 dbm max., 30 to 15,000 cps
Transistor and Diode Complement	
2-2N1010 2-2N526 3-2N553 4-1N3253	
Power Requirement.....	117 volts, a-c, 50/60 cycles, 20 watts (transformer taps at 105, 115 and 125 V)
Fuse.....	$\frac{3}{16}$ amp 3AG Slow-Blow
Overall Dimensions.....	4-21/32" high, 5" wide, 13 1/2" deep (11.8 cm high, 12.7 cm wide, 34.3 cm deep)
Weight.....	10 lbs. (4.5 kg.)
Finish.....	Light umber grey lacquer
Mounting.....	Plug-in mounting on BR-22B Mounting Shelf, requires 3/10 the shelf

Ordering Information

BA-33A Program Amplifier (includes transistors and diodes) MI-11446

Accessories

BR-22B Mounting Shelf.....	MI-11597-A
Step Attenuator (20 steps, 2 db per step, 5000 ohm).....	MI-11751-5
Spare Kit of Transistors and Diodes.....	MI-11781-A
Spare Guide Assembly (with receptacles).....	MI-11594-2

Monitoring Amplifier

TYPE BA-34B

FEATURES

- Completely transistorized
- Self-contained power supply
- High-gain—will accept microphone input level
- 10 watt output with very low distortion
- Plug-in chassis for shelf mounting
- Ideal for all broadcast monitoring
- Small, compact, with low heat dissipation

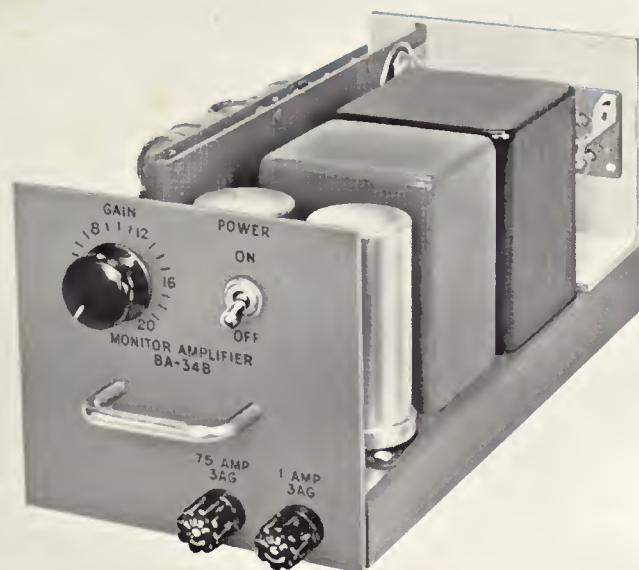

DESCRIPTION

The BA-34B Monitor Amplifier is a high fidelity amplifier, having 104 db gain and delivering a full 10 watts of audio power output. It is particularly designed for monitoring, audition, recording and "talk-back" applications. It may also be used as a program or a line amplifier for emergency use. It is ideal for playback of transcriptions and will operate on LC-1A speaker directly from the output of an equalized cartridge. The BA-34B is small in size and is designed for convenient plug-in installation in the BR-22 mounting shelf using the guide assembly supplied with the amplifier.

The use of transistors throughout the BA-34B provides a number of advantages including: small, compact design, low heat dissipation, greatly reduced power consumption and trouble-free, long-life expectancy for the amplifier. Power requirements have been reduced to 25 watts with corresponding low heat dissipation, and economical performance.

The circuit design of the Monitoring Amplifier is simple and straightforward. All circuit functions are accomplished by ten transistors, and two diodes which are used in the self-contained d-c power supply.

The BA-34B consists of two basic amplifiers, the first a two-stage preamplifier which connects through a gain-control to the input of a multistage power amplifier. The input preamplifier, having an unloaded input transformer

can be connected for 37.5, 150 or 600 ohm sources. A bridging volume control or the self-contained bridging pod may be used for high level inputs. Negative feedback stabilizes the gain of the two-transistor preamplifier.

Following the preamplifier are two low-level stages, followed by a dual transistor phase splitter, dual transistor driver, and dual class "B" output transistors which are in series with the driver. A thermistor adjusts the idling current of the output stage to compensate for temperature changes. Taps on the output transformer match 4, 8 and 16 ohm unbalanced loads as well as 150 and 600 ohm balanced loads. By using three separate feedback paths, the distortion drops to a low level. Long life silicon diodes are used in the self-contained power supply. Two fuses serve to protect the transistors and rectifiers from damage by an accidental short-circuit.

All controls are located on the front panel including the interstage gain control knob, a power ON-OFF toggle switch and two fuses—one a 3/4 amp AC line fuse, the other a 1 amp DC fuse. The entire amplifier is mounted on a plug-in type chassis. Connections to the BA-34B are made through two 8-prong blue ribbon connectors at the back of the amplifier which plugs into a socket supplied with the mounting assembly. All input connections are made through one plug, the output and d-c power through the other.

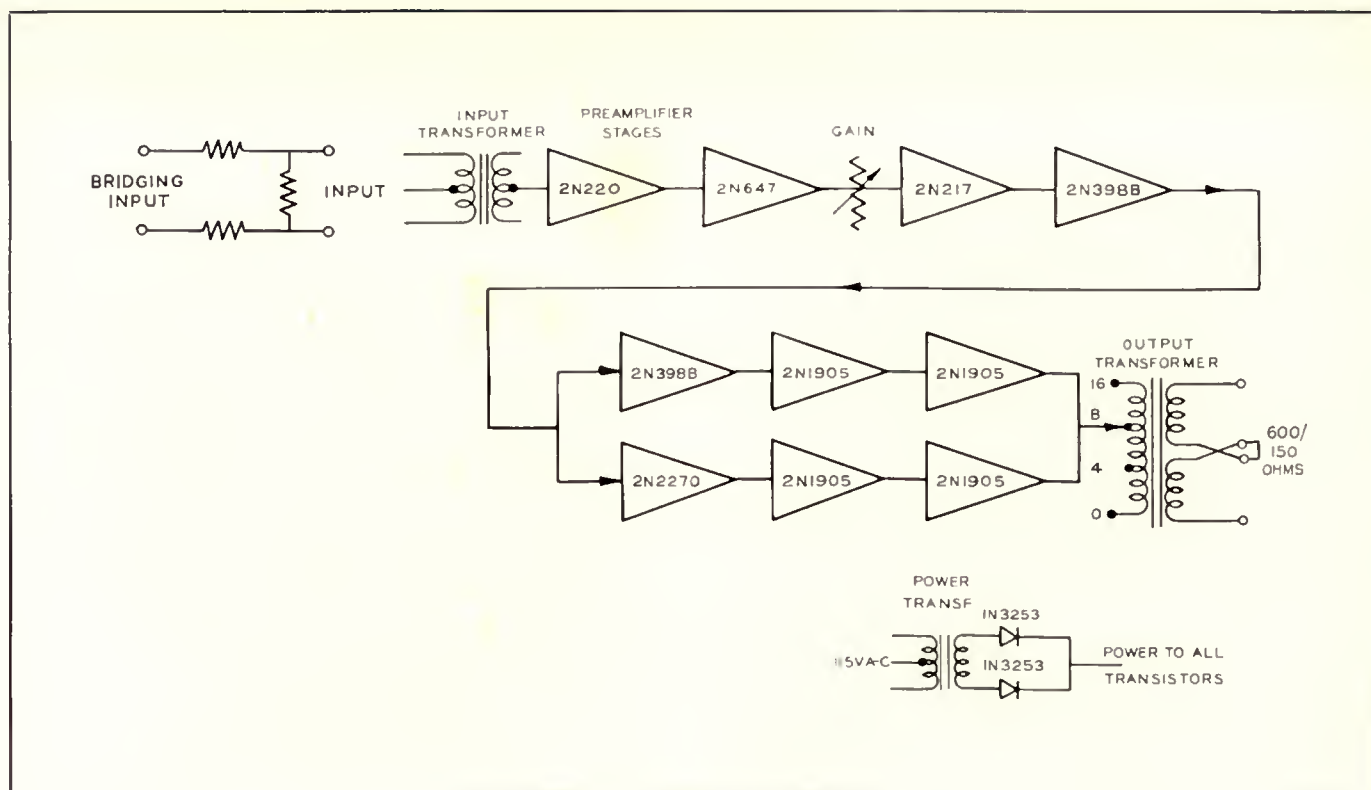

Block Diagram of BA-34B Monitoring Amplifier.

SPECIFICATIONS

Power Required.....100-130 volts, 50/60 cps,
30 watts at rated output, 10 watts (approx.) at normal speaker
volume. Taps at 105, 115 and 125 volts

Source Impedance.....150-ohm balanced source when shipped;
may be reconnected to operate from a 600 ohm balanced or
unbalanced, or a 37.5 ohm unbalanced source.

Input Impedance:

Matching..... Unloaded input transformer,
input impedance higher than source impedance for all frequencies
from 30 to 15,000 cps

Bridging..... 50,000 ohms

Load Impedance..... 150/600 ohms balanced or unbalanced
4/8/16 ohms unbalanced

Maximum Input Level:

Matching..... -30 dbm

Bridging..... +20 dbm

Maximum Gain:

Matching..... 103 db, ± 2 db

Bridging..... 53 db, ± 2 db

Average Power Output..... 10 watts (+40 dbm) max.

Frequency Response..... ± 2 db 30-15,000 cps

Noise Level (with 15 kc bandwidth)..... -120 dbm referred to input
-17 dbm at output at 103 db gain

Harmonic Distortion..... At 10 watt output (40 dbm)
and -30 dbm input less than 1%, 50 to 15,000 cps

Ambient Temperature..... 55°C max. (131° F)

Fuses..... .75 amp 3AG (AC)
1.0 amp 3AG (DC)

Transistor and Diode Complement:

1-2N217, 1-2N647, 2-1N3253, 1-2N220, 4-2N1905,
2-2N398B, 1-2N2270

Dimensions, Overall..... Length 13 1/8" width 5", height 4-31/32"

Weight..... 11 3/4 lbs.

Mounting..... Plug-in mounting on BR-22B Mounting shelf, requires
3/10 of space, three amplifiers may be mounted on each shelf

Ordering Information

BA-34B (includes transistors and diodes)..... MI-11437-B

Accessories

BR-22B Mounting Shelf (mounts 3 BA-34B's)..... MI-11597-A

Bridging Volume Control..... MI-11278-E/F

Spare Kit of Transistors and Diodes..... MI-11782-A

Spare Guide Assembly..... MI-11594-3

Consolette Preamplifier

TYPE BA-71A

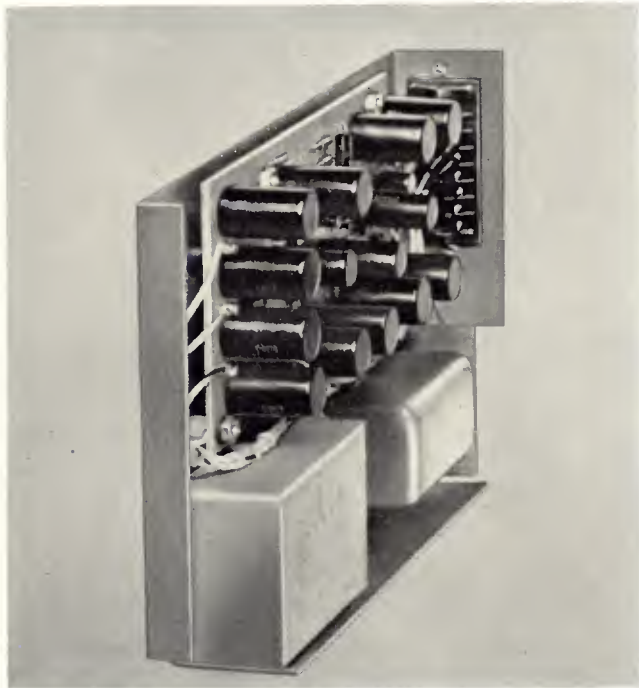

FEATURES

- Compact design—solid state circuitry
- Extremely low noise
- Minimum distortion
- Full range frequency response
- Companion program amplifier and power supply
- Convenient plug-in design

DESCRIPTION

The BA-71A is one of a series of transistorized amplifiers especially designed for use in consolettes or custom built audio systems. The BA-71A may be plugged directly in RCA consolettes such as the BC-7, BCM-2A and other types designed for its use or it may be used in custom audio applications when plugged into Accessory Guide Assembly MI-11759-1. The Guide Assembly with mating receptacle may be attached to a BR-22 shelf or mounted in any enclosure used in custom construction.

The BA-71A is designed primarily as a microphone pre-amplifier, but may also be used as an isolation or bridging amplifier with the addition of an externally mounted MI-11278-E or F volume control. The transistor circuitry is identical to the BA-31A preamplifier except that it does not contain a built in power supply. A single BX-71A power supply is used to power up to 22 BA-71A pre-

amplifiers. The BA-71A will deliver a +18 dbm output with not more than 0.5% distortion.

The use of transistors results in long life, low maintenance, and freedom from microphonics. The high output level of +18 dbm reduces the likelihood of overloading due to occasionally high microphone levels. Negative feedback is used to stabilize gain and reduce distortion to a very low level.

Two matching gains are available, 40 or 46 db selected by a stop. The unit is shipped with the gain stopped for 40 db. The frequency response is better than ± 1 db from 30 to 15,000 cps (referred to 1000 cps) and the noise level is -82 dbm or -76 dbm maximum of output, depending on gain stopping. As a bridging amplifier the BA-71A has a 9 db maximum gain with the volume control at minimum loss position and bridging a 600-ohm line.

SPECIFICATIONS

Source Impedance	37.5 ohm unbalanced; 150/600 ohm balanced or unbalanced
Input Impedance:	
Matching (unloaded input transformer)	Connected when shipped for 150 ohms. May be reconnected for 37.5 or 600 ohms
Bridging (using external bridging control)	20,000 ohms
Maximum Input Level:	
Matching	-22 dbm low gain stopping -28 dbm high gain stopping
Gain:	
Matching	40 db ± 1 db low gain stopping (as shipped) 46 db ± 1 db high gain stopping
Bridging	3 db low gain stopping, 9 db high gain stopping
Frequency Response	Better than ± 1 db from 30 to 15,000 cps (referred to 1000 cps)
Rated Output Level and Distortion	Total rms harmonic distortion at +18 dbm output less than 0.5% from 30 to 15,000 cps
Hum and Noise Level	-82 dbm or -76 dbm max. of output depending on gain stopping, measured from 30 to 15,000 cps; -122 dbm referred to input 50/15,000 cps
Power Requirements	30 volts, 45 ma from BX-71A
Transistor Complement:	1-2N1010, 1-2N404, 4-2N270
Maximum Ambient Temperature	55°C (131°F)
Finish	Cadmium plate with clear chromate dip
Mounting	Plug-in for BC-7 Console; Up to 10 Preamplifiers can be mounted on BR-22 shelf equipped with MI-11759-1 Guide Assemblies
Dimensions Overall	7 $\frac{5}{8}$ " long, 4 $\frac{5}{8}$ " high, 1 $\frac{3}{8}$ " wide
Weight	2 $\frac{1}{4}$ lb.

Ordering Information

BA-71A Consolette Preamplifier with transistors in place, less Guide Assembly	MI-11658
BA-71A Consolette Preamplifier complete with transistors and Guide Assembly	ES-11158

Accessories

Guide Assembly for BA-71A Transistor Preamplifier	MI-11759-1
Bridging Gain Control Kit:	
With Screw-driver Adjustment	MI-11278-F
With Knob Adjustment	MI-11278-E
BR-22 Mounting Shelf for Rock Mounting	
1 to 10 Preamplifiers	MI-11597-A

Consolette Program Amplifier

TYPE BA-73A

FEATURES

- High gain, low distortion
- Ideal for custom applications
- Very low noise level, -122 dbm
- Frequency response better than ± 1 db, 30 to 15,000 cycles
- Provisions for external volume control
- Accessory plug-in guide assembly for shelf mounting
- Solid state circuitry

DESCRIPTION

The BA-73A Program Amplifier is designed for use as a high-quality booster or program amplifier. There is provision for adding an external volume control which may be used as a Master Fader. Input and output transformers provide circuit isolation.

The BA-73A is one of a series of transistor amplifiers designed to plug-in directly into RCA consolettes such as the BC-7, BCM-2A and others. Accessory Guide Assembly, MI-11759-2 with mating receptacles permits the BA-73A to be mounted in a BR-22 Shelf or any enclosure used in custom construction. Up to three Program Amplifiers as well as one BA-71A Consolette Preamplifier can be accommodated on the BR-22 Shelf. Power for the amplifier is supplied by the Type BX-71A Power Supply. Up to three amplifiers may be operated by one BX-71 supply.

The BA-73A Amplifier incorporates full transistor circuitry providing the advantages of small, compact design, uniform performance, reduced power consumption and long life expectancy for the amplifier. The high gain and low distortion of the unit make it an ideal choice for any audio system. Etched wiring boards are used and all circuitry and components are readily accessible.

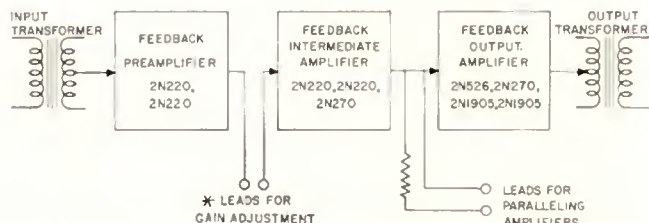

* Use external accessory gain control for adjustable gain, or 2 fixed resistors for fixed gain.



SPECIFICATIONS

Source Impedance.....	150/600 ohms, balanced or unbalanced
Input Impedance:	
Matching.....	Input transformer unloaded, with impedance higher than source impedance. Connected when shipped for 600 ohms; may be reconnected for 150 ohms
Load Impedance.....	Connected for 600 ohms when shipped; may be changed to 150 ohms
Maximum Input Level:	
Unloaded Input.....	-30 dbm
Loaded Input.....	-24 dbm
Frequency Response.....	Better than ± 1 db, 30 to 15,000 cps (referred to 1000 cps)
Rated Output Level.....	+24 dbm
Harmonic Distortion.....	Less than 0.5% rms +24 dbm output, 50 to 15,000 cps. Less than 0.25 at 1 kc, 24 dbm output
Gain:	
Unloaded Input.....	92 ± 1 db
Matching Input.....	86 ± 1 db
Noise Level.....	-122 dbm referred to the unloaded input
Power Requirements.....	30 volts, 300 ma drain from 8X-71A
Transistor Complement (supplied in place):	
4-2N220, 2-2N270, 1-2N526, 2-2N1905	
Ambient Temperature.....	55°C (131°F)
Overall Dimensions.....	9" long, 3 3/4" wide, 4 5/8" high
Weight.....	4 lbs.
Finish.....	Cadmium plate with clear chromate dip

Ordering Information

Type BA-73A Consolette Program Amplifier with transistors in place and less Guide Assembly.....	MI-11659-A
Type BA-73A Consolette Program Amplifier and Guide Assembly.....	ES-11159

Accessories

Shelf Guide Assembly for BA-73A Amplifier.....	MI-11759-2
BR-22 Mounting Shelf.....	MI-11597-A
Step Attenuator (external).....	MI-11751-5
BX-71A Transistor Power Supply.....	MI-11663-A

Consolette Monitor Amplifier

TYPE BA-74A



DESCRIPTION

The BA-74A Consolette Monitor Amplifier is designed for monitoring, audition and "talk back" applications. This high fidelity amplifier has 63 db gain and delivers a full 10 watts of audio power output. It may also be used as a program or a line amplifier.

The BA-74A is one of a series of matched transistorized plug-in amplifiers specifically designed for console and custom applications. It can be plugged into the BC-7A or other consoles or installed on the BR-22 mounting shelf with the aid of Accessory Mounting Guide, MI-11759-3. Three BA-74A Amplifiers may be mounted on one shelf. Its small size makes it very useful in many custom applications.

The circuit design of the Monitor Amplifier is simple and straightforward. All circuit functions are accomplished by 8 transistors and two diodes. The use of solid state components provides a number of advantages including: small, compact design, greatly reduced power consumption and

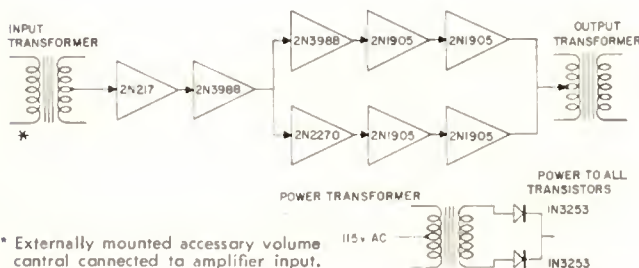

* Externally mounted accessory volume control connected to amplifier input.

FEATURES

- Solid state circuitry
- Self-contained power supply
- 10 watt output—very low distortion
- Small, compact, with low heat dissipation
- Plug-in guide assembly with mating plugs for custom applications

trouble-free, long-life expectancy for the amplifier. The power requirement is only 30 watts with corresponding low heat dissipation and economical performance.

SPECIFICATIONS

Source Impedance.....	600/150 ohms
Input Impedance.....	600/150 ohms nominal
Load Impedance.....	4/8/16/150/600 ohms
Maximum Input Level.....	-23 ±2 dbm
Maximum Gain.....	63 ±2 db
Frequency Response.....	+0, -2 db 30-15,000 cps 4, 8 and 16 ohms
	+0, -2 db 30-10,000 cps, +0, -3 db 10,000 to 15,000 cps
	150 and 600 ohms
Maximum Output Level.....	10 watts (40 dbm)
Harmonic Distortion.....	Less than 1% 50-15,000 cps at 10 watt output level
Noise Level.....	-47 dbm maximum, -50 dbm typical
Power Requirements.....	100-130 V, a-c, 50/60 cycles, 30 watts, (with taps for 105, 115 and 125 volts)
Transistor and Diode Complement (supplied in place):	
	2-1N3253, 4-2N1905, 2-2N3988, 1-2N2270, 1-2N217
Ambient Temperature.....	55°C (131°F) max.
Mounting.....	On guide strip provided with BC-7 console or using Guide Assembly MI-11759-3 for installation on BR-22 mounting shelf
Finish.....	Cadmium plate with clear chromate dip
Dimensions Overall.....	9 7/8" long, 5" wide, 4 5/8" high
Weight.....	11 lbs.

Ordering Information

Type BA-74A Consolette Monitor Amplifier,	
less Guide Assembly.....	MI-11661-A
Type BA-74A Consolette Monitor Amplifier	
with Guide Assembly.....	ES-11161

Accessories

Shelf Guide Assembly for BA-74A Monitor Amplifier.....	MI-11759-3
BR-22 Mounting Shelf (mounts 3 BA-74A's).....	MI-11597-A
Bridging Volume Control:	
With Screwdriver Adjustment.....	MI-11278-F
With Knob Adjustment.....	MI-11278-E

Transistor Cue/Intercom Amplifier

TYPE BA-78A

FEATURES

- Solid state circuitry
- Automatic gain control
- Self-contained power supply
- High gain—full output with mic level input
- One watt (+30 dbm) output with AGC
- Small compact design
- Console or shelf mounting

DESCRIPTION

The Type BA-78A Cue/Intercom Amplifier is a compact chassis-mounted equipment featuring solid state circuitry, automatic gain control and self contained power supply. It is designed specifically for plug-in use with the BC-7A transistor, consolette for intercom and cueing purposes. However, it may also be shelf mounted by use of accessory guide assembly, MI-11759-5.

The principal feature of the BA-78A is its ability to maintain essentially constant output for a wide variation of input level. Automatic gain control action is maintained over greater than a 25 db range. Output level changes are limited to approximately $\frac{1}{2}$ db for each 5 db input change over most of the operating range. The BA-78A amplifier is nominally a 1 watt amplifier but has an output capability of approximately 4 watts; therefore, with the overage output automatically regulated to about a one watt level, there is ample reserve power to handle speech peaks without objectionable clipping and to produce a loud enough signal to be heard at a considerable distance.

The normal output impedance of the BA-78A is 50 ohms to operate directly into a MI-38303 50-ohm combination microphone/speaker. Thus a suitable line impedance is provided without the necessity of extra line transformers. An 8 ohm output tap is also provided for special applications. The input impedance of the BA-78A is nominally 150 ohms and is designed to be operated directly from the MI-38303 micro/speaker, however, the 150 ohm input impedance is suitable for operation from a normal microphone. The gain of the BA-78A is approximately 90 db making it suitable for use with a BK-6B, SK-39, SK-45, BK-1A or similar 8 ohm microphone.

The BA-78A has a self-contained power supply with taps for 115V or 230V 50-60 cps operation making it easily adaptable to general applications independent of the BC-7A Consolette. Its relatively high power, high quality output makes it useful with other loudspeakers for applications where a communication channel with AGC would be advantageous.



SPECIFICATIONS

Power Required.....	115/230 volts, a-c, 50/60 cycles, 5 watts nominal
Source Impedance.....	50-150 ohms
Input Impedance.....	150 ohms nominal with center tap
Load Impedance.....	50 ohms floating, 8 ohms unbalanced
Effective Input Level.....	-60 dbm min. far verge of AGC action -30 dbm max. handled by AGC action
Output Level.....	Nominally set at 1 watt average (+30 dbm) by AGC action (Approx. 4 watts max. with program material)
AGC Action.....	Approx. $\frac{1}{2}$ db change in output level for each 5 db change in input level throughout operating range of at least 25 db
Gain.....	90 db with no gain reduction 65 db with max. gain reduction
Frequency Response.....	Better than $+1\frac{1}{2}$ db, 100 to 8,000 cps
Distortion.....	$2\frac{1}{2}\%$ or less above 400 cps; approx. 4% at 100 cps
Noise Level.....	At least 60 db below max. output (with no gain reduction)
Hum Level.....	-35 db or better at output of amplifier
Transistor and Diode Complement:	
Dimensions Overall.....	$4\frac{5}{8}$ " high, 3" wide, $8\frac{3}{8}$ " deep
Weight.....	3 lbs. approx.
Finish.....	Cadmium plate

Ordering Information

Type BA-78A Cue Amplifier, less guide assembly.....	MI-11662
Type BA-78A Cue Amplifier and Guide Assembly.....	ES-11162

Accessories

Guide Assembly for BA-78A Cue Amplifier.....	MI-11759-5
Type BR-22B Mounting Shelf.....	MI-11597-A

Pickup Equalizer-Preamplifier

TYPE BA-26A



DESCRIPTION

The RCA Type BA-26A Pickup Equalizer-Preamplifier is designed to provide both amplification and equalization of the output of studio transcription turntables employing RCA MI-11865 Universal Cartridge and MI-11866 Series Stylus. Low Impedance Broadcast types of variable reluctance Pickup Heads may be used by making a minor change in terminal connections of the BA-26A.

The equipment employs RCA low-noise type transistors in a three-stage amplifier utilizing selective feedback to achieve NAB/RIAA equalizing curve. A self-contained a-c power supply utilizing germanium rectifier provides essentially noise-free operation.

The Type BA-26A Pickup Equalizer-Preamplifier, MI-114436, is a compact transistor preamplifier with built-in equalization that conforms to industry standards. It has etched wiring assemblies contained in a shielded metal chassis which is designed to be mounted inside the turntable cabinet. A convenient slip-on cover is provided to allow access to component ports and transistors. An extended threaded shaft on a three-position filter switch allows ease of control from a knob on the top of the turntable. The switch provides for normal equalization, high frequency emphasis, and high frequency cut-off. This arrangement allows optimum performance for either AM, FM or TV broadcast operation.

The Equalizer-Preamplifier is conservatively designed for long life. The RCA Type 2N175 low-noise transistor is used in the input stage followed by two Type 2N109

transistors to provide the required gain and output capabilities. One Type 1N91 germanium rectifier is used in the a-c power supply. The unit exhibits complete freedom from microphonics that result from the use of vacuum tubes. An output transformer is employed to provide either balanced or unbalanced output impedances of 150 and 600 ohms. Etched wiring boards are utilized to provide stable trouble-free operation of the unit. By utilizing selective feedback within the amplifier itself it is unnecessary to use inductances to accomplish low-frequency equalization.

SPECIFICATIONS

Output Level ($E_{in} = 11$ mv at f of 1000 cps).....	-20 dbm ± 2 db
Distortion at -20 dbm from 50 to 15,000 cps.....	Less than 1.5%
Signal to Noise Ratio (Output level of -20 dbm and 150 ohm Resistor used at Input & Output).....	Better than 58 db
Output Impedance (balanced or unbalanced).....	150/600 ohms
Frequency Response.....	Standard RIAA equalization
Power Requirements.....	3 Taps: 105/115/125 volts a-c, 50/60 cycles, single phase, 2 watts
Dimensions (overall):	
Height (including extended knob shaft).....	10 $\frac{3}{4}$ "
Width.....	2 $\frac{1}{2}$ "
Depth.....	6 $\frac{5}{8}$ "
Weight.....	4 lbs.

Ordering Information

BA-26A Equalizer-Preamplifier (includes transistors and rectifier).....	MI-11436
--	----------

Accessory

Transistor & Rectifier Kit including 2 Type 2N109 Transistors, 1 Type 2N175 Transistor, and 1 Type 1N91 Rectifier.....	MI-11779
---	----------

The BA-26A Equalizer-Preamplifier can be mounted in either the BQ-2C Turntable as shown below or in the BQ-51A Turntable.



Limiting Amplifier

TYPE BA-6A

FEATURES

- Prevents distortion and adjacent channel interference
- Low cost—high-quality performance
- Provides for a more effective use of transmitter power
- Compact, plug-in unit—requires little rack space
- Complete rotary switch selection of metering of all key functions



DESCRIPTION

The BA-6A Limiting Amplifier has been designed to provide economical, yet high-quality operation in the speech input channels of FM and AM broadcast and TV sound transmitters. It serves as an automatic means of limiting the audio signal peaks to a certain pre-determined level thereby preventing overmodulation or overloading with its consequent distortion and adjacent channel interference. This amplifier also provides for a more effective use of transmitter power by allowing the system to be operated as near maximum output as possible. It raises the average percentage modulation level several db without appreciably increasing the harmonic distortion.

The limiting characteristics of the BA-6A also readily adapt it for use in any recording application. For this use, it prevents over-modulation of the recording medium on heavy passages of music or speech and permits a marked improvement in the signal to noise ratio.

The BA-6A is a balanced, three-stage amplifier which uses commonly available tube types that do not require special selection or matching. The use of high-quality components

and the straightforwardness of design, employing only 9 tubes including rectifier and voltage regulator, insure a maximum degree of reliability. Fewer tubes, fewer types (only 6) and fewer stages of simplified design result in lower tube costs, low initial cost and reduced power input requirements. The amplifier with its self-contained power supply is constructed on a plug-in chassis for shelf mounting and is therefore readily removable for inspection and service. All controls, tubes, and plug-in capacitors are accessible from the front.

A rotary selector switch permits use of the four-inch illuminated meter for measuring gain reduction, the cathode current of all amplifier tubes, tube balance and d-c filament voltage. Plate and heater power are available for operating a pre-amplifier in applications where additional gain is required. The rotary switch (BAL-LIM) provided on the front panel also permits selection of a filter with either a single or dual time constant. In the "single" position the attack time is 0.0006 seconds. In the "dual" position the recovery time is lengthened to two seconds on sustained peaks.

Transistor Cue Amplifier

TYPE BA-8A



DESCRIPTION

The RCA Type BA-8A Transistor Cue Amplifier is a compact, low-cost monitoring amplifier designed to provide high intelligibility whether used as a remote line, turntable cue or remote amplifier monitor. It provides an ideal monitor in the announce lounge, program director's office, news rooms, executive office, TV studio prep area, or other sites where it is essential to be informed on what is going on. Muting provisions are included in the amplifier so that when the unit is used in the control room or any location where a microphone will also be used, the muting terminals on the rear terminal board may be connected to a set of normally closed contacts on an external muting relay.

The completely encased amplifier and loudspeaker may be placed on the console or operations desk near the operator. The unit is attractively styled in umber gray metal housing, with rubber feet attached, and etched aluminum panel providing an attractive and pleasing appearance. The small size and light weight recommends the BA-8A for desk top installation. However, a mounting panel, MI-11449, is available for relay rack mounting, if desired. The front panel of the BA-8A contains the volume and input selector switch controls plus a near on-off indicator. A perforated metal grill serves as a protector for the 3 by 5-inch speaker.

The BA-8A Transistor Cue Amplifier consists of an input transformer, four stages of transistor amplification, an output transformer coupled to a loud speaker, and a power supply. Feedback circuits are employed. The power supply consists of a conventional half-wave silicon diode rectifier circuit and a power transformer.

FEATURES

- Low power consumption—transistors used throughout
- Frequency response peaked for high intelligibility
- Self contained diode power supply
- Input selector switch for ten inputs
- Speaker muting provisions
- Styled for desk or panel mounting

Up to ten inputs may be selected by the self-contained input selector switch. Connections to the amplifier are made at a rear terminal board where a plastic cable clamp is also provided for holding cables neatly in place. The number one input is wired for bridging a 600 ohm line, the other nine are matching inputs, but may be made bridging inputs by customer installation of the proper resistor network.

SPECIFICATIONS

Power Requirements	117/235 volt a-c, 50/60 cycles, single phase, 13 watts
Frequency Response	Compensated for high intelligibility
Input Impedance:	
Matching	600 ohms when shipped; may be connected for 150 ohms
Bridging	10,000 ohms
Input Level:	
Matching	-23 dbm \pm 2 dbm, minimum for +30 dbm (1 watt) output
Bridging	+8 dbm \pm 2 dbm, minimum for +30 dbm (1 watt) output
Gain	53 dbm (approx.)
Maximum Output Level	+30 dbm (1 watt)
Distortion	Less than 2% (measured with 1 watt output of 1 kc)
Muting Provision	Strapping on rear terminals marked MUTE
Loudspeaker Impedance	3.2 ohms
Loudspeaker Dimensions	3 by 5 inches elliptical, permanent magnet
Transistor and Diode Complement:	1-2N109, 1-2N404, 1-2N652, 1-2N456, 1-1N2069
Dimensions (Overall)	7 $\frac{1}{4}$ " wide, 3 $\frac{1}{2}$ " high, 8 $\frac{1}{8}$ " deep
Weight	6 $\frac{1}{2}$ lbs.
Finish	Umbre gray, etched aluminum panel

Ordering Information

BA-8A Transistor Cue Amplifier (includes transistors)	MI-11450
Accessory Rack Mounting Panel (for BA-8A)	MI-11449

Preamplifier and Isolation Amplifier

TYPE BA-21A

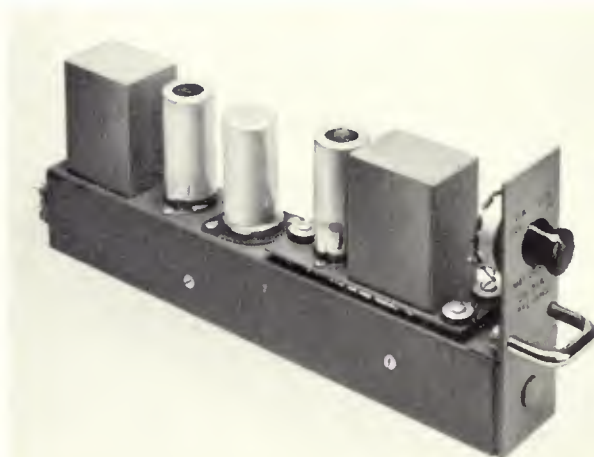

DESCRIPTION

The BA-21A is an ideal unit for use as a microphone preamplifier, turntable preamplifier or booster amplifier. Its high output level makes it applicable as a line amplifier. It may also be used as an isolation and bridging amplifier.

The BA-21A has been designed to obtain high gain using one RCA MI-11299, selected 12AY7 tube in the input stage and one 12AY7 in the output stage.

The first stage tube is shock mounted to prevent microphonics. The circuit is conventional with unloaded input transformer, resistance-capacitance coupling between stages and transformer output. The distortion and hum level has been reduced to a very low value through proper circuit design and through the use of stabilized feedback. Cross talk between units is -75 db, 30 to 15,000 cycles when mounted side by side and operated from the BX-21A Power Supply.

With the addition of the MI-11278-E or F volume control kit to provide a 10,000 ohm input, the BA-21A may also be used as a bridging or isolation amplifier. The MI-11278-E or F kits can be mounted on the BA-21A chassis and be adjusted by either knob or screw driver. The MI-11278-F can be used for panel mounting remote from the amplifier.

As a bridging amplifier, the BA-21A has a maximum of 4 db gain with the volume control at minimum loss position and bridging a 600-ohm line. Approximately 80 db of isolation between output and input is obtained with the amplifier in this arrangement. A switch is provided for metering a portion of the cathode voltage of each tube when connected to a high-resistance voltmeter such as the

Type BI-1B. The unit is designed to operate from the BX-21A Power Supply or its equivalent. The power requirements are 6.3 volts a-c or d-c at 0.6 amperes and 285 volts d-c at 10 ma. Up to ten BA-21A Preamplifiers can be installed in a single BR-22B Panel and Shelf assembly and operated from one BX-21A Power Supply.

SPECIFICATIONS

BA-21A AS PREAMPLIFIER:

Source Impedance.....	37.5/150/600 ohms
Input Impedance (unloaded input transformer).....	Substantially above source impedance
Load Impedance (balanced or unbalanced).....	150/600 ohms
Maximum Input Level.....	-22 dbm
Maximum Output Level.....	18 dbm
Gain.....	40 db ± 1 db

BA-21A AS ISOLATION AMPLIFIER (with MI-11278 Series Volume Control):

Source Impedance.....	Up to 600 ohms
Input Impedance (through Volume Control).....	10,000 ohms
Load Impedance (balanced or unbalanced).....	150/600 ohms
Maximum Input Level, Volume Control at max.:	
Bridging 600 Ohms.....	14 dbm
Bridging 150 Ohms.....	20 dbm
Maximum Output Level.....	18 dbm
Maximum Gain.....	4 db

BA-21A AS EITHER PREAMPLIFIER OR ISOLATION AMPLIFIER

Frequency Response.....	± 1 db 30-15,000 cps
Noise Level (Input and Output Terminated):	
Output.....	-82 dbm
Referred to Input.....	-122 dbm
Harmonic Distortion (18 db Output).....	0.75% at 30 cps 0.5% at 50 to 15,000 cps

Tube Complement:

1—Selected 12AY7, 1—12AY7

Plate Power Supply.....	285 volts d-c at 10 ma
Filament Supply.....	6.3 volts a-c or d-c at 0.6 amps
Dimensions, Overall.....	Length $12\frac{1}{2}$ "", width $1\frac{5}{8}$ "", height $4\frac{1}{8}$ "
Finish.....	Umber gray
Weight (unpacked).....	$2\frac{1}{2}$ lbs.

Ordering Information

BA-21A Preamplifier (less tubes).....	MI-11244-A
BA-21A Preamplifier (complete with tubes).....	ES-11121

Accessories

Tube Kit (complete tube complement).....	MI-11482
Bridging Gain Control Kit	
(Screw-driver adjustment).....	MI-11278-F
(Knob adjustment).....	MI-11278-E
BX-21A Preamplifier Power Supply (furnishes filament and plate power for 1 to 10 BA-21A Preamplifiers).....	MI-11317
Type BI-1B Meter Panel (umber gray).....	MI-11388
BR-22B Mounting Shelf for rack mounting 1 to 10 preamplifiers or 1 power supply and 6 preamplifiers.....	MI-11597-A

Program Amplifier

TYPE BA-23A

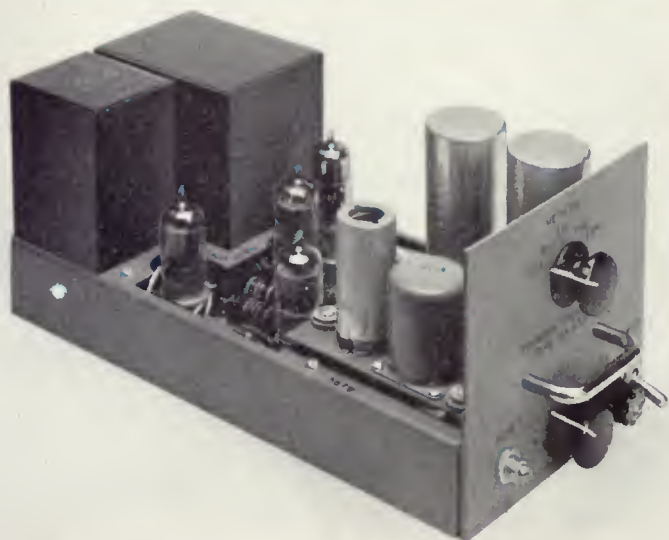

FEATURES

- Etched wiring provides compact size and uniform performance
- Plug-in type for shelf mounting
- High gain—low distortion—low noise level—high output
- Excellent frequency response
- Provision for tube metering
- Hermetically sealed transformers
- Self-contained power supply

DESCRIPTION

The new BA-23A Program Amplifier is a very versatile high-fidelity amplifier designed for broadcast service. It incorporates special, high-quality, long-life components throughout and provides a maximum of accessibility to all circuit components. Its high gain and low distortion makes it ideal for use as: (1) Program or Line Amplifier, (2) Bridging Amplifier, (3) Isolation Amplifier.

The BA-23A Program Amplifier has three stages of amplification with an additional phase splitter driving the push-pull-parallel output stage. The input stage utilizes a type 5897 low noise pentode. A 12AX7 twin triode is used as second stage and phase inverter. The push-pull output stage consists of two 12AU7 tubes having their sections connected in parallel. A 6X4 is used as full wave rectifier in the self-contained power supply.

The gain control allows the input transformer to permit high level input without overloading the input stage. A continuous compensation type control is used in the BA-23A Program Amplifier, but space has been provided for a step type attenuator, if desired. A gain reduction of 15 db with a corresponding reduction in noise level may be obtained by changing a jumper on a voltage divider in the grid circuit of the second stage.

Inverse feedback is supplied from a tertiary winding of the output transformer to the cathode of the driver stage to stabilize gain and frequency response and to reduce distortion.

SPECIFICATIONS

Source Impedance.....	150/600 ohms balanced or unbalanced
Input Impedance (Matching).....	150/600 ohms
Input Impedance (Bridging).....	20,000 ohms
Load Impedance	150/600 ohms
Output Impedance	25/100 ohms
Maximum Input Level (Matching).....	-10 dbm
Maximum Input Level (Bridging).....	27 dbm
Maximum Gain (Matching).....	70 \pm 1 db high, 55 \pm 1 db low
Maximum Gain (Bridging).....	33 \pm 2 db high, 18 \pm 2 db low
Frequency Response.....	\pm 1 db 30-15,000 cps
Harmonic Distortion.....	0.5% rms max. at 30 dbm output, 30-15,000 cps
Noise Level (at output).....	-47 dbm at 70 db gain -62 dbm at 55 db gain

Metering Voltage.....1.0 volt

Tube Complement:

1—Selected 5897, 1—12AX7, 2—12AU7, 1—6X4

Power Required.....100-130 v, 50/60 cps 30 w
(Transformer taps at 105, 115 and 125 v)

Mechanical Dimensions:

Length.....	Chassis 10 $\frac{3}{8}$ " , overall 12 $\frac{1}{2}$ "
Height	4 $\frac{21}{32}$ "
Width	5"
Weight	9 lbs.
Finish.....	Light umber gray lacquer

Mounting..... Plug-in mounting on MI-11597 Mounting Shelf, Type BR-22B. The BA-23A Amplifier requires 3/10 of the shelf space.

Three BA-23A Program Amplifiers may be mounted on one BR-22A Mounting Shelf with space for one additional BA-21A Preamplifier.

Ordering Information

BA-23A Program Amplifier (less tubes).....	MI-11246-A
BA-23A Program Amplifier (complete with tubes).....	ES-11123

Accessories

Tube Kit (complete tube complement).....	MI-11480
Meter Panel, Type BI-1B (provides tube metering for 17 amplifiers).....	MI-11388
Mounting Shelf (for rack mounting of 3 BA-23A program amplifiers; requires 5 $\frac{1}{4}$ " of vertical rack space).....	MI-11597-A
Step Attenuator	MI-11751-2

Monitoring Amplifier

TYPE BA-24A

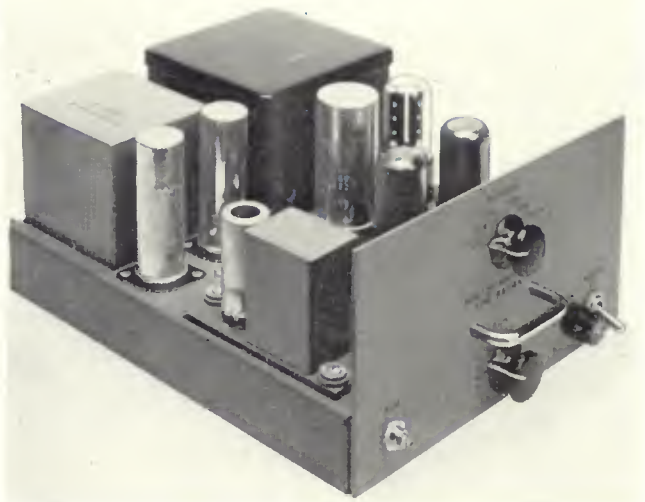

DESCRIPTION

A high quality, high gain amplifier suitable for driving a loudspeaker directly from a microphone or turntable output. It has four stages of amplification with an interstage gain control. A phase splitter drives the push-pull output stage. Negative feedback is utilized to reduce distortion, stabilize gain and frequency response. The power supply is self-contained. The hum level is reduced to a minimum through the use of well shielded transformers, low noise tubes and careful circuit layout. A metering switch on the front panel is provided to check the condition of the tubes, with the metering voltage of 1 volt brought out at the connector plug.

The BA-24A is a high fidelity, high gain flexible 8 watt amplifier suitable for monitoring, audition, recording, and talk-back applications or it may be used in emergencies as a program or line amplifier. It is ideal for transcription playback booths since its 105 db gain is sufficient to operate a speaker directly from the output of a turntable pickup equalizer. The high gain feature also allows its use directly in studio talk-back circuits without an intervening preamplifier. The BA-24A is an excellent recording amplifier being suitable for both high quality recording and playback applications. Two may be mounted in a type BR-22B Mounting Shelf. The BA-24A has a plug-in type chassis using multi-conductor plugs.

FEATURES

- Self-contained power supply
- High gain—used directly in talk-back circuits, without preamplifier
- 8 watts output with low distortion—uses feedback
- Suitable for cabinet or shelf mounting
- Ideal for recording and playback
- Tube metering circuits

SPECIFICATIONS

Source Impedance.....	37.5/150/600 ohms
Input Impedance.....	Unloaded transformer, high in comparison with source impedance
Load Impedance.....	4/8/16/150/600 ohms
Output Impedance (approx.).....	1.3/1.8/3/21/78 ohms
Maximum Input Level.....	-30 dbm
Maximum Gain.....	104 db \pm 2 db
Frequency Response.....	\pm 2 db 30-15,000 cps
Maximum Output Level.....	10 watts (40 dbm)
Harmonic Distortion at 39 dbm output.....	Less than 1% 100-7500 cps
	Less than 2% 50-15,000 cps
Noise Level.....	-122 dbm referred to input
	(-18 dbm at output at 104 db gain)
Metering Voltage.....	1 volt
Tube Complement:	
	1—Selected 12AY7, 1—12AX7, 2—6V6-GT/G, 1—5Y3-GT/G
Power Requirement.....	100-130 volts, 50-60 cps, 70 watts
Dimensions:	
Length.....	10 $\frac{3}{8}$ " , 12 $\frac{1}{2}$ " overall
Width.....	8 $\frac{3}{8}$ "
Height.....	4 21/32"
Weight.....	16 $\frac{1}{4}$ lbs.
Finish.....	Light umber gray
Mounting.....	Plug-in mounting on BR-22B Mounting Shelf. Requires half the shelf space (two amplifiers may be mounted on each shelf.)

Ordering Information

BA-24A Monitoring Amplifier (less tubes).....	MI-11247
BA-24A Monitoring Amplifier (complete with tubes).....	ES-11124

Accessories

Tube Kit (complete tube complement).....	MI-11481
BR-22B Mounting Shelf (mounts two BA-24A).....	MI-11597-A
Type BI-18 Meter Panel (for 17 amplifiers).....	MI-11388
Bridging Gain Control Kit:	
With Screw-driver Adjustment.....	MI-11278-F
With Knob Adjustment.....	MI-11278-E

AGC Program Amplifier

TYPE BA-25A

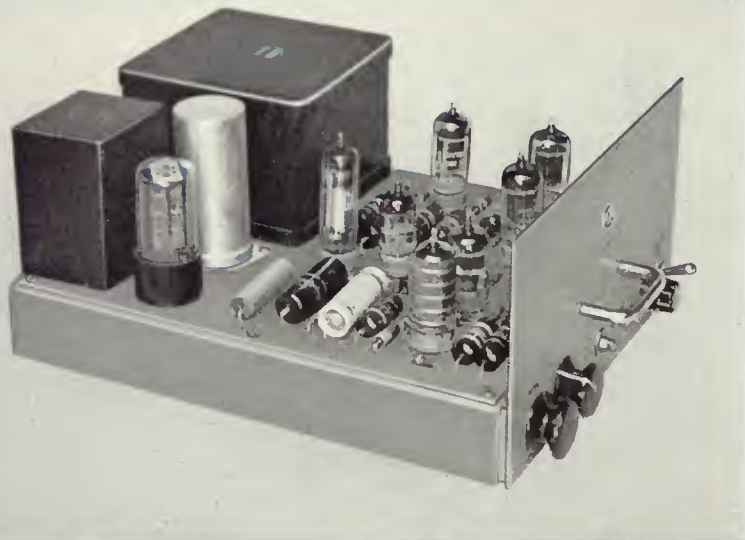

DESCRIPTION

The RCA Type BA-25A Automatic Gain Controlled Program Amplifier is an automatic level control unit designed to automatically control variations in audio program level. The unit is capable of maintaining a nearly constant average output level over wide variations of average input level.

The amplifier may also be used in conjunction with an external bias source for remote gain control or automatic fading. This permits unattended remote audio operation. It may also be used as a program line compressor or as a master gain control for program line. The BA-25A may be used as a microwave input audio control, as an automatic fader control, or as a straight program amplifier without level control by removal of one tube disabling the automatic level control circuit.

The new BA-25A Automatic Gain Controlled Program Amplifier is a small, compact amplifier mounted on a plug-in chassis for easy maintenance and replacement.

Two amplifiers can be mounted on the MI-11597-A Mounting Shelf. The circuitry of the BA-25A is straight forward. The amplifier consists of a phase inverter, variable gain stage, driver and output stage, signal rectifier, and a self contained power supply with voltage rectifier.

A metering switch is provided on the BA-25A which measures the cathode current of the amplifier tubes to obtain a quick indication of the tube conditions. Other controls, all located on the front panel include: a hum control for adjusting the hum level to a minimum, the power switch, threshold level control, and input level adjustment control. An external attenuator may be used for adjusting the output level where necessary.

FEATURES

- Feedback circuits provide excellent frequency response—low harmonic distortion
- Small, compact, plug-in construction
- Self-contained power supply
- Metering switch provides quick tube check
- Convenient front panel controls
- Stabilized bias voltage

SPECIFICATIONS

Input Impedance.....	150/600 ohms
Source Impedance	150/600 ohms
Output Impedance.....	30/120 ohms
Load Impedance.....	150/600 ohms
Maximum Input Level.....	-25 dbm
Maximum Output Level.....	+ 30 dbm
Maximum Noise Level, Output.....	Less than -46 dbm at 70 dbm gain
Frequency Response.....	±1 db from 30-15,000 cps
Harmonic Distortion.....	Less than 1% total RMS
	at 20 db output 30 to 15,000 cps
Gain, Maximum Below Verge of Compression.....	70 db ±1 db
Threshold of Compression:	
Compression Ratio.....	3:1 Output Level..... 5 dbm
	4:1 14 dbm
	5:1 18 dbm
	6:1 21 dbm
Attack Time Constant.....	12.5 milliseconds
Recovery Time Constant.....	1 sec.
Tube Complement:	
	1—OB2, 1—5Y3-GT, 1—6AL5, 2—12AU7, 1—12AX7, 1—MI-11299 selected 12AY7, 1—6386.
Power Requirements.....	100-130 volts, 50/60 cycles, 55 watts
Dimensions, Overall.....	12 1/2" long, 8 3/8" wide, 4 21/32" high
Finish.....	Light amber gray
Weight.....	15 lbs.

Ordering Information

BA-25A AGC Program Amplifier (less tubes).....	MI-11434
BA-25A AGC Program Amplifier (complete with tubes).....	ES-11125

Accessories

Tube Kit (complete tube complement).....	MI-11487
Type BR-22B Mounting Shelf (mounts 2 BA-25A's).....	MI-11597-A
Type BI-1B Meter Panel.....	MI-11388

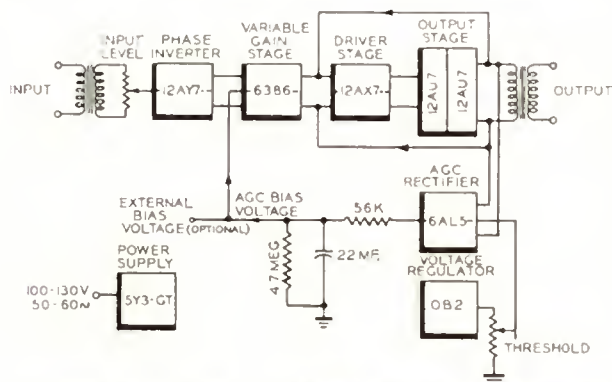

Simplified Block Diagram of BA-25A AGC Program Amplifier

Two-Channel Remote Amplifier

TYPE BN-7A

FEATURES

- Transistor circuitry
- Low-cost—high quality performance
- Self-contained A-C and battery supply
- Compact, portable case with tilt-rest cover
- Optional plug-in input transformers
- Separate PA gain control



DESCRIPTION

The Type BN-7A Portable Remote Amplifier, MI-11451, is designed for broadcast use, providing two separate input channels that can be operated either balanced or unbalanced. Transistors and germanium diodes are employed throughout. The BN-7A is completely self-contained for a-c or battery operation. For operating convenience, a pull-out chassis housing the batteries is removable from the front panel. A separate PA gain control is provided. Excellent frequency response and low harmonic distortion assure high quality performance.

The BN-7A Amplifier is styled for operating convenience. All amplifier components, controls, batteries and a-c power supply are mounted on a one piece chassis easily removable from the portable carrying case. This ruggedly-constructed steel case, is provided with a soft leather handle and finished in umber gray. The cover can be removed easily for quick set-up of the equipment. Special hinges permit the cover to be detached, reversed and used as a special tilt-rest for the amplifier case in applications where inclined positioning of the control panel is desired.

Located on the front panel are all operating functions including an illuminated VU meter, two mixer controls, the master control, phone jack, PA gain control, and power switch. For ease of servicing, the amplifier chassis may be withdrawn from the case thereby exposing all components.

Mercury cell batteries are self-contained in a convenient battery storage chamber located on a pull-out chassis accessible from the front panel. A rear cut-out in the case provides easy accessibility to the a-c power connector, fuse holder, microphone connectors and the output connec-

tions. Clips are provided in the cover of the carrying case for securing the 8-foot a-c power cord when not in use. The PA gain control bridges the output at the amplifier and allows the operator to conveniently control the level fed to external PA equipment.

SPECIFICATIONS

Input Connector.....	Type XL
Inputs	2 microphones (both may be used simultaneously) 150/250 ohms unbalanced, 37.5/150 ohms balanced when using MI-11776 Input Transformer
Output (balanced output 600/150 ohms) (shipped connected) for 600 ohms).....	+18 dbm (6 db isolation provided)
Gain.....	92.5 db \pm 2 db (150 ohm source on 150 ohm input to 600 ohm load)
Frequency Response.....	\pm 2 db from 30-15,000 cps
Harmonic Distortion (+18 dbm output mixer and master controls set for 68 db gain).....	Less than 1.5% 50-100 cps; less than 1% 100-15,000 cps
Noise Level Referred to Input.....	-118 dbm
Meter.....	3" VU illuminated
Power Requirements:	
AC Power.....	117/235 volts, 50/60 cycles, 5 watts
DC Power.....	6 batteries required (not supplied)
	5-PR Mallory Type TR135R 6.5 volts, 1-RCA VS036, D size, flashlight cell, 1.5 volts.
Transistor and Diode Complement:	
	2-2N220, 2-2N404, 1-2N274, 1-2N1090, 3-2N270, 2-1N91
Dimensions (overall).....	5 1/2" high, 14 1/2" wide, 10 1/2" deep
Weight.....	15 lbs. approx.
Finish.....	Two tone umber gray

Ordering Information

BN-7A Portable Two-Channel Remote Amplifier
including transistors and diodes but less batteries..... MI-11451

Accessories

Input Transformer (37.5/150 ohms).....	MI-11776
Spare Transistor and Diode Kit for BN-7A.....	MI-11785
Step Type Attenuator for BN-7A Master Controls.....	MI-11751-3
Step Type Attenuator for BN-7A Foder Controls.....	MI-11751-4

Four-Channel Remote Amplifier

TYPE BN-6B



DESCRIPTION

The BN-6B Four-Channel Portable Remote Amplifier is an extremely lightweight, transistor amplifier designed especially for remote broadcast use. It affords amplification and control facilities for broadcast programs remote from the studio, amplifying low level signals to a level suitable for transmission over a telephane line to the studio. Four separate input channels are provided that can be operated either single ended or balanced. Complete cueing and monitoring facilities are included. The equipment uses transistors and germanium diodes throughout, and is completely self-contained for a-c or battery operation.

The amplifier is a functionally styled unit in which an etched wiring board including amplifier components and transistors, controls, batteries and alternate a-c power supply are all contained in a portable carrying case. The steel case, finished in umber gray, is ruggedly constructed and provided with a convenient leather handle. The top cover can be removed easily for quick set-up of the equipment. Special hinges permit the lid to be detached, reversed, and used as a special tilt-rest for the amplifier case in applications where inclined positioning of the control panel is desired.

All controls are located on the front panel including an illuminated VU meter, four mixer controls, the master control, phone jack, cue switch, and power switch. For ease of servicing, the top cover may be detached and the amplifier chassis withdrawn from the case thereby exposing all components. Mercury cell batteries are self-

FEATURES

- Completely transistorized
- Full 8 VU output to line
- High level mixing on all four channels
- Self-contained AC and battery power supplies—front panel selection of power
- Lightweight—weighs only 15 pounds
- Amplified cue signal from studio
- Convenient and durable carrying case

contained in a convenient battery storage chamber located beneath the amplifier chassis. A rear cut-out in the case provides easy accessibility to the a-c power connector, fuse holder, microphone connectors and the output connections. Clips are provided in the cover of the carrying case for securing the 8-foot a-c power cord when not in use.

SPECIFICATIONS

Input Connector.....	Type XL		
Input.....	4 microphones (all may be used simultaneously) 150/30 ohms		
Output (balanced output 600/150 ohms).....	+18 dbm (5 db isolation provided)		
Gain.....	88 db \pm 2 db (150 ohm source on 150 ohm input to 600 ohm load)		
Frequency Response.....	\pm 1.5 db from 30 to 15,000 cps		
Harmonic Distortion (+18 dbm output mixer and master controls set for 65 db gain).....	Less than 1.5% 30-50 cps; less than 1% 50-10,000 cps; less than 3% 10,000-15,000 cps		
Noise Level Referred to Input.....	-122 dbm		
Meters.....	3-inch VU illuminated		
Transistor and Diode Complement:			
5-2N175	3-2N109	1-2N35 or 2N214	1-1N91
Dimensions.....	5 $\frac{3}{8}$ " high, 16 $\frac{1}{2}$ " wide, 10 $\frac{1}{2}$ " deep		
Weight.....	15 lbs. (approx.)		
Finish.....	Two tone umber gray		

Ordering Information

BN-6B Four-Channel Portable Remote Amplifier
complete with transistors and diodes (less batteries).....MI-11221-B

Accessories

Input Transformer (30/150 ohms).....	MI-11776
Transistor and Diode Kit for BN-6B.....	MI-11777
Step Type Attenuator for BN-6B Master Controls.....	MI-11751-3
Step Type Attenuator for BN-6B Fader Controls.....	MI-11751-4
Canvas Carrying Case.....	MI-11377-A

Consolette Power Supply

TYPE BX-71A

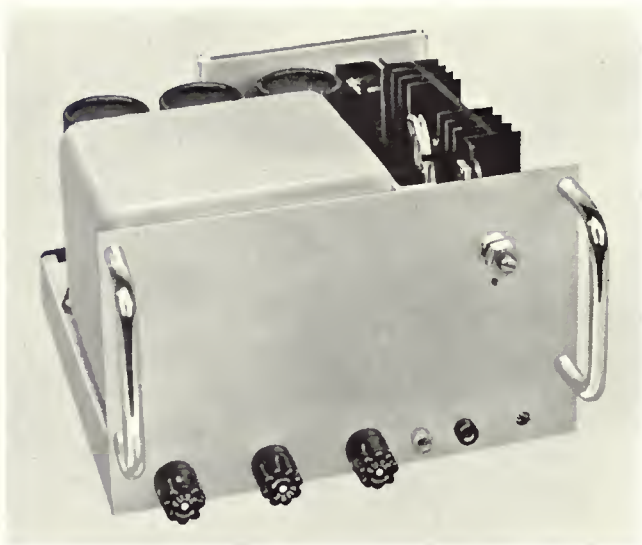

FEATURES

- Regulated d-c output voltage
- Solid state circuitry
- Exceptionally low hum level
- Supplies power for 22 BA-71A Preamplifiers or 3 BA-73A Program Amplifiers
- Guide assembly available for shelf mounting in custom applications
- 24 volt relay supply and 6 volt a-c meter lamp supply provided

DESCRIPTION

The Type BX-71A Consolette Power Supply delivers a well regulated d-c voltage for operation of the BA-70 Series preamplifiers and program amplifiers. As many as 22 Type BA-71A Consolette Preamplifiers or 3 Type BA-73A Consolette Program Amplifiers or any combination of the amplifiers with total current requirement up to 1000 ma can be operated simultaneously by one BX-71A. In addition, an unregulated 24 volt supply can power various relays, such as "On-Air" light relays, etc. A 6 volt a-c meter light supply is also provided. Two outputs for the regulated -30 volts d-c are provided; one for preamplifiers, the other for program amplifiers, to achieve maximum decoupling.

The BX-71A, MI-11663-A is designed to plug into the BC-7,

BCM-2A and other consolettes or it may be used in custom audio applications when plugged into an accessory Guide Assembly, MI-11759-A. One or two Guide Assemblies with mating receptacles may be attached to a Type BR-22 Shelf.

The power supply can be operated on any 115/230 volt, 50/60 cycle a-c line. Fuses, a DC Voltage Control, and two pin jacks for checking the -30 volt supply are located on the front panel.

The 30 volt power supply consists of a full-wave bridge rectifier, capacitor-input filter, and a five-transistor regulator. Three zener diodes supply a reference voltage which is compared with the output voltage. The output voltage is adjustable to maintain -30 volts under varying loads up to 1,000 ma capacity.

SPECIFICATIONS

Power Requirements..... 100 to 130, or 200 to 260 volts, a-c,
50/60 cycles, with taps at 105, 115, 125, 210, 230, and 250 volts

Power Output..... -30 volts at 1 amp., regulated;
24 volts at .56 amp., unregulated, 6 volt a-c at 1.5 amp.

Regulation..... 0.35% no load to full load

Ripple..... 0.15 mv max. on 30 volt supply

Fuse..... 1.5 and 1 ampere, slo-blow

Transistor & Diode Complement:
1-2N270, 2-2N456, 2-2N526, 1-2N1090, 6-1N3253, 2-1N751,
1-1N752

Mounting..... Plug-in for consoles; as ES-11163 can be
mounted in BR-22 and requires 2/5 of shelf space

Dimensions Overall..... 8 7/8" by 7 1/2" by 4 5/8"

Weight..... 14 lbs.
Finish..... Cadmium plate with clear chromate dip

Ordering Information

Type BX-71A Consolette Power Supply
less Guide Assembly..... MI-11663

Type BX-71A Consolette Power Supply
with Guide Assembly..... ES-11163

Accessory Equipment

Shelf Guide Assembly for BX-71A Power Supply..... MI-11759-A
Type BR-22 Shelf (for 2 power supplies)..... MI-11597-A

Preamplifier Power Supply

TYPE BX-21A

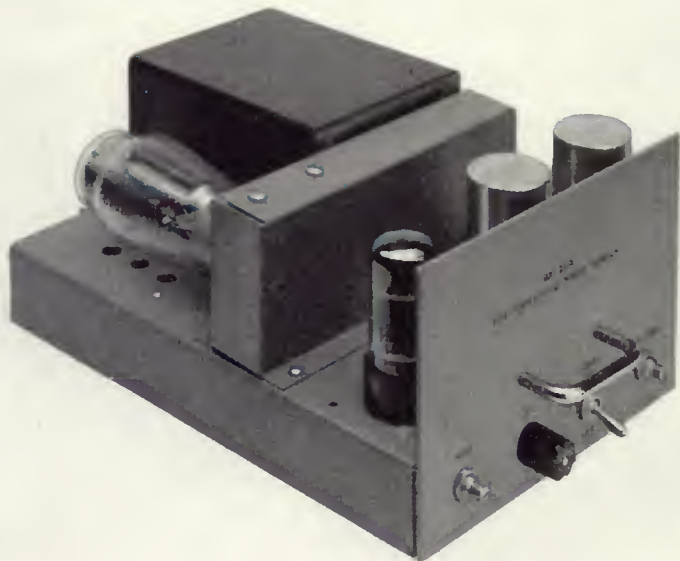

FEATURES

- Regulated d-c output voltage
- Exceptionally low hum level
- Plugs into BR-22B Mounting Shelf
- Supplies up to 10 BA-21A Preamplifiers
- Heater supply hum balancing potentiometer

DESCRIPTION

The Type BX-21A Preamplifier Power Supply is designed to provide d-c plate and o-c heater power for preamplifiers in which the hum level must be kept to a minimum. As many as ten Type BA-21A Preamplifiers can be operated by one power supply. The BX-21A is designed for quick plug-in mounting on the MI-11597-A Shelf.

The BX-21A is designed for operation on any o-c line voltage between 100 and 130 volts, 50 to 60 cycles. A two ampere, glass-enclosed, time-delay fuse is mounted on the front of the chassis. This fuse is unaffected by high transient currents. Controls are mounted on the front panel and consist of a "Power On-Off" toggle switch and two screwdriver adjustments for hum and voltage.

The power supply consists of a full wave, high vacuum tube rectifier using a capacitor input filter. The output voltage is adjustable over a range of 245 to 295 volts and is maintained constant with variations in line voltage and loading by a series regulator tube in conjunction with an amplifier and a voltage reference tube. This circuit also functions to reduce the ripple voltage. A metering voltage of 1 volt corresponding to nominal output voltage of 285 volts is available at connector plug for wiring to a meter panel.

SPECIFICATIONS

Mounting.....	Plug-in an BR-22B Mounting Shelf. Requires 2/5 of the shelf space. Two BX-21A Power Supply units may be mounted on one shelf with additional space for two BA-21A Preamplifiers, or 1 BX-21A Power Supply and 6 BA-21A Preamplifiers may be mounted on one shelf.
Power Required.....	100 to 130 volts, 50-60 cycles, 130 watts
Fuse.....	2 ampere, type MDL
Power Output:	
Plate Supply:	
Output Voltage.....	285 volts adjustable from 245 volts to 295 volts
Output Current.....	10-100 ma d-c
Ripple Voltage.....	0.3 mv max.
Regulation:	
Full Load to No Load.....	0.2%
±5% Line Voltage Variation.....	0.1%
Heater Supply:	
Voltage.....	6.3 volts
Current.....	6.0 amp a-c max.
Bias.....	32 volts approx. position
Metering.....	1 volt (four output of 285 volts using 20,000 ohm-per-volt meter)
Tube Complement:	
	1-5R4GY, 1-6BX7-GT, 1-12AX7, 1-OA2
Dimensions Overall.....	12 1/2" long, 4-21/32" high, 6 1/16" wide
Weight.....	16 lbs.
Finish.....	Light umber gray

Ordering Information

BX-21A Preamplifier Power Supply (less tubes).....	MI-11317
BX-21A Preamplifier Power Supply (complete with tubes).....	ES-11111

Accessories

Tube Kit (complete tube complement).....	MI-11479
Type BR-22B Shelf (for 2 Power Supplies).....	MI-11597-A
Type BI-1B Meter Panel	
(for 17 amplifiers or power supplies).....	MI-11388

Regulated Power Supplies

MI-11318-A, MI-11316 and MI-591318



6 Amp Power Supply, MI-11318-A

DESCRIPTION

The MI-11318-A Heavy Duty Regulated Power Supply will provide up to 6 amperes d-c at 24 volts to inductive, capacitive or resistive loads. The Supply finds use in Audio and Video relay switching systems, tally light circuits and other equipments requiring a constant d-c source with varying current loads. High reliability affording low cost maintenance makes the MI-11318-A Power Supply an excellent choice. Also available, with identical specifications for 220 volt 50 cycle operation is Regulated Power Supply, MI-591318.

The MI-11316 Power Supply may be used to supply up to 3 amperes a-c at 24 volts to inductive, capacitive or resistive loads. The ability of the power supply to maintain nearly constant output voltage from full load to no load makes it suitable for applications where current requirements are variable and a constant voltage is required. Low ripple voltage makes it suitable for applications where nearly pure d-c is required. Typical applications include relays, signal lights, and intercommunications equipment.

3 Amp Power Supply, MI-11316

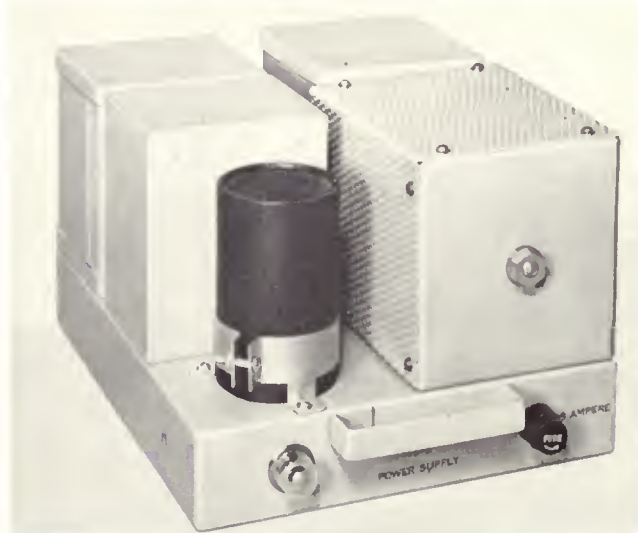

FEATURES

- Simplified design—low cost maintenance
- Silicon diode rectifiers
- Low ripple voltage
- Self regulating power transformer
- Constant DC voltage with variable loads

SPECIFICATIONS

6 Amp Power Supply, MI-11318-A

Input:	
60 Cycle Unit	100—130 volts o-c, 60 cps, single phase, 144 watts
50 Cycle Unit	200—260 volts o-c, 50 cps, single phase, 144 watts
Output	6 amperes, 24 volts d-c
Regulation	7.5% no load to full load, 2.5% 1/2 load to full load
Ripple Voltage	0.2 volt RMS maximum
Ambient Temperature	65°C max.
Finish	Light umber gray
Dimensions Overall	19" wide, 5 1/4" high, 9 3/4" deep
Weight	Approx. 25 lbs.

Ordering Information

110 volt, 60 cycle Regulated Power Supply	MI-11318-A
220 volt, 50 cycle Regulated Power Supply	MI-591318

3 Amp Power Supply, MI-11316

Input:	100—125 volts, 50/60 cps, single phase, 125 watts
Output:	3 amperes, 24 volts d-c
Regulation	Better than 5% voltage regulation, no load to full load
Ripple	60 and 120 cycle components, less than 3% of full load
Dimensions Overall	10 5/8" long, 7 3/4" wide, 5 3/4" high
Weight	25 lbs.
Finish	Light gray enamel

Ordering Information

Regulated Power Supply	MI-11316
------------------------	----------

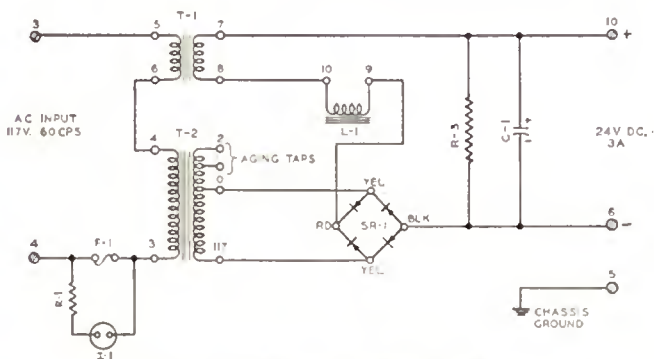

MI-11316 Power Supply Schematic Diagram

Cabinet Racks

BR SERIES

FEATURES

- Cabinets are same height as RCA transmitters—84 inches
- Total panel space 77 inches
- Available in many combinations to suit all studio applications
- Drilled and tapped for 19-inch panels
- Suitable for fitting in a flush position to a side or rear wall
- Accommodates the heaviest equipment encountered in studio use

DESCRIPTION

The BR-84 Series of Standard Cabinet Racks are designed for use in control rooms and similar installations. Each cabinet rack provides 77 inches of mounting space for installing amplifiers, jack panels, switch panels, oscillators, test or measuring equipment, and other broadcast equipment having 19-inch panel widths.

The five combinations of cabinets and accessories offer a versatile system for accommodating the user's immediate requirements with maximum accessibility for any future growth of the installation. Each rack may be mounted singly or, where desired, tandem together to facilitate the grouping of any number of cabinets. The cabinet is of sturdy metal construction, welded and bolted in one standard height and width. The ventilated top with slotted edges provides complete ventilation but protects the equipment from falling articles and dust. Vertical panel mounting angles have tapped holes at RMA standard locations to provide 77 inches of standard 19-inch panel mounting space. These angles may be installed to mount equipment within the cabinet, where doors are used, or flush with the front. When the latter method is desired, trim strips of neat design for panel mounting and clip fitting provide the finished appearance. The front and rear doors are of the universal type and may be hinged on the right or left side, to rotate in an arc of 180 degrees. Electrical side shields are available in two sizes—21 inches for the center section, and 28 inches for the top and bottom sections. If



BR-84A Standard Cabinet

BR-19A Economy Cabinet

found necessary after assembly, they may be fitted between racks of equipment. Terminal board mounting angles facilitate the mounting of power and audio blocks in a vertical or horizontal position. Additional terminal board mounting angles (MI-30527-G29) are available as accessories.

Units placed adjacently may be rigidly bolted together to produce a secure assembly. The cabinets are finished in a two-tone umber gray, with dimensional characteristics artistically blending with all RCA transmitters.

BR-19A Economy Cabinet

The BR-19A Economy Cabinet is designed to accommodate broadcast equipment. The cabinets are of lightweight steel construction and offer new cost economies. They provide facilities for mounting standard 19-inch panels and shelves.

The BR-19A Cabinet Rack is constructed of cold-rolled steel. It is provided with rear door only. All racks have quick detachable, new corner trims which are fastened to the front with two studs. The cabinets have adequate ventilation through the use of rear, side, and top louvers. Vertical corner mouldings cover the panel mounting screws. The BR-19A cabinet is finished in a two-tone umber gray in keeping with other RCA studio equipment.

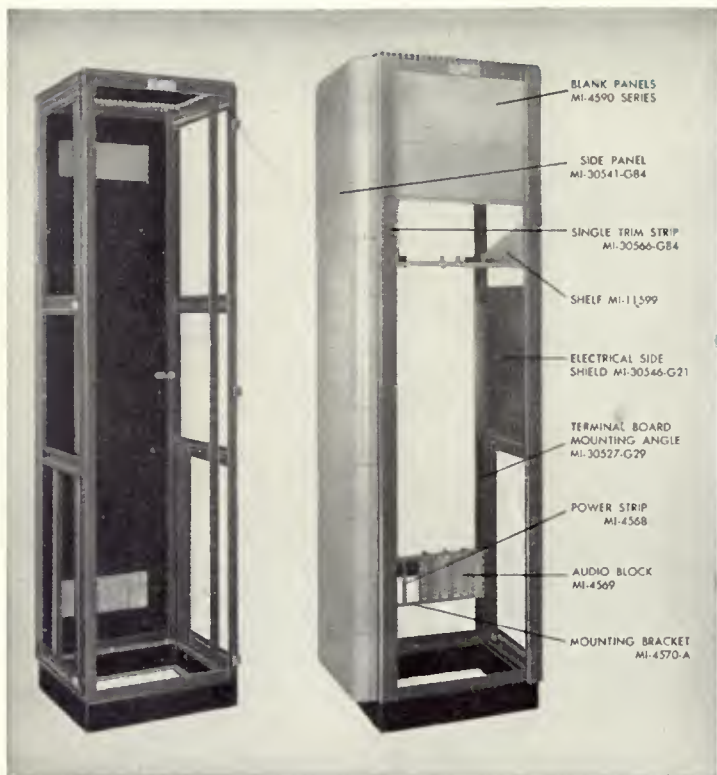

BR-84D

BR-84E with Accessories

- BLANK PANELS MI-4590 SERIES
- SIDE PANEL MI-30541-G84
- SINGLE TRIM STRIP MI-30566-G84
- SHELF MI-11599
- ELECTRICAL SIDE SHIELD MI-30546-G21
- TERMINAL BOARD MOUNTING ANGLE MI-30527-G29
- POWER STRIP MI-4568
- AUDIO BLOCK MI-4569
- MOUNTING BRACKET MI-4570-A

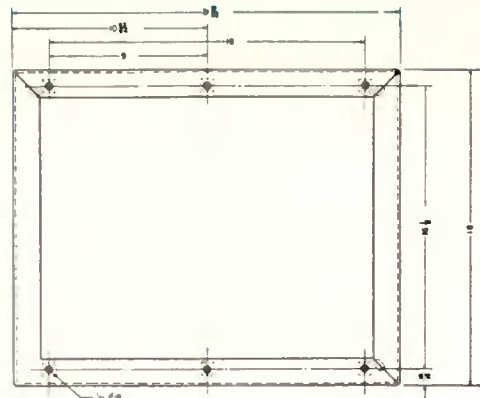

Layout and dimensions of BR-84 cabinet base.

SPECIFICATIONS

BR-84 STANDARD CABINET

Panel Width	19"
Panel Mounting Space (height).....	77"
Clearance for Door Swing.....	23"
Weight (BR-84A)	225 lbs.
Finish.....	Two-tone umber gray enamel except for the base which is black
Dimensions:	
Height	84"
Width—BR-84-A, -B (with side panels).....	28"
BR-84-C, -D, -E, -F	22"
Width of Frame.....	22"
Depth of Frame.....	18", with door handles 24½"

BR-19A ECONOMY CABINET

Panel Width	19"
Panel Mounting Space (height).....	77"
Clear Inside Depth.....	16¾"
Finish.....	Dark and light umber gray wrinkle
Material.....	⅜" thick cold-rolled steel
Overall Dimensions.....	83½" x 22" x 18"
Weight	140 lbs.

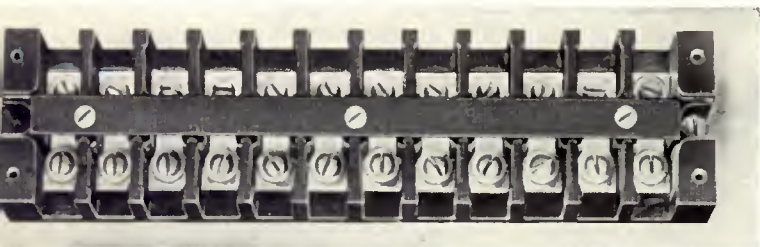

Power Terminal Block MI-4568 with cover removed.



Ground Bus Kit, MI-11728.

Ordering Information

- Type BR-84A consisting of one frame, one base, one top cover, one front door (non-ventilated), one rear door (ventilated), one pair of side panels, one set of terminal board mounting angles and one set of panel mounting angles and instruction book..... ES-30951-A84
- Type BR-84B, same as BR-84A, less front door only..... ES-30951-B84
- Type BR-84C, same as BR-84A, less side panels only..... ES-30951-C84
- Type BR-84D, same as BR-84A, less side panels and front door..... ES-30951-D84
- Type BR-84E, same as BR-84A, less side panels, front and rear doors..... ES-30951-E84
- Type BR-19A Economy Cabinet..... MI-11550

Accessories

FOR BR-84 CABINETS

- One Door (non-ventilated)..... MI-30530-G84
- One Side Panel..... MI-30541-G84
- One Door (ventilated)..... MI-30535-G84
- One Electrical Shield (for mid-section of rack)
 - One Per Side..... MI-30546-G21
- One Electrical Shield (for top or bottom sections)
 - Two Per Side..... MI-30546-G28
- One Single Trim Strip..... MI-30566-G84
- One Double Trim Strip for Two Cabinets..... MI-30568-G84
- Terminal Board Mounting Bracket..... MI-4570-A
- Audio Terminal Block..... MI-4569-A4
- Set Terminal Board Mounting Angles, 29"..... MI-30527-G29
- Set of 2 Panel Mounting Angles, 84"..... MI-30526-G84
- Rack Extension Kit (for TM-6C, etc.)..... MI-40408
- Rack Extension Kit (for TRT-1B Recorder)..... MI-40735

FOR BR-19A AND BR-84 CABINETS

- Blank Panels..... MI-4590 to 4595 Series
- Power Terminal Block..... MI-4568
- BR-2A Panel and Shelf Assembly..... MI-11598-B/11599
- BR-22B Panel and Shelf Assembly..... MI-11597-A
- Ground Bus Kit..... MI-11728

RACK ACCESSORIES



BLANK PANELS

A complete line of 19-inch blank panels is carried in stack for filling spaces in racks and cabinets not occupied by equipment panels. These blanks are also suitable for applications where equalizers, transformers, switches or other items must be panel mounted by the user. The stack of panels includes all standard widths from 1 3/4 inches to 10 1/2 inches. They are 3/16-inch sheet steel finished and notched to match standard racks.

Ordering Information

1 3/4" Blank Panel, Umber Gray.....	MI-4590-A
3 1/2" " " Umber Gray.....	MI-4591-B
5 1/4" " " Umber Gray.....	MI-4592-B
7" " " Umber Gray.....	MI-4593-A
8 3/4" " " Umber Gray.....	MI-4594-B
10 1/2" " " Umber Gray.....	MI-4595-B

Terminal Block Mounting Bracket MI-4570-A.



Audio Terminal Block MI-4569-A4.

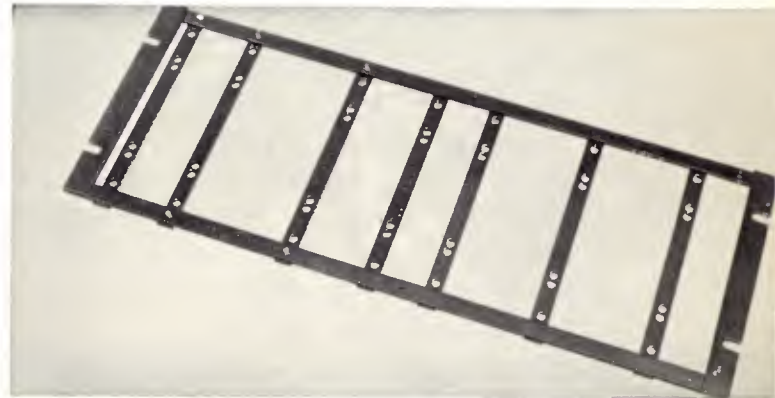

BI-1B METER PANEL



DESCRIPTION

The BI-1B Meter Panel provides a convenient means for checking the cathode bias voltages of amplifier tubes and thereby furnishes an indication of the operating conditions of amplifier tubes and circuits. Metering terminals are provided on the miniature series of amplifiers for use with this panel. The mounting is for a BR-84 Series Standard cabinet rack.

The BI-1B consists essentially of a meter and switch mounted on a standard 3 1/2", 3/16" thick steel panel. The meter is a 3.0 volt d-c voltmeter having a resistance of 20,000 ohms per volt. The double section switch has

eighteen positions including the "off" position with the switch arms connected to the meter terminals. All connections to the panel are made to the switch contacts.

SPECIFICATIONS

D-c Voltmeter.....	0-3.0 volts, 20,000 ohm per volt
Metering Switch.....	17 position and "off," double pole
Dimensions (overall):	
Height	3 15/32"
Width	19"
Depth	2 1/4"
Weight (unpocketed)	4 1/2 lbs.
Finish	Light umber gray

Ordering Information

BI-1B Meter Panel.....	MI-1138B
------------------------	----------

MOUNTING SHELF, TYPE BR-22B

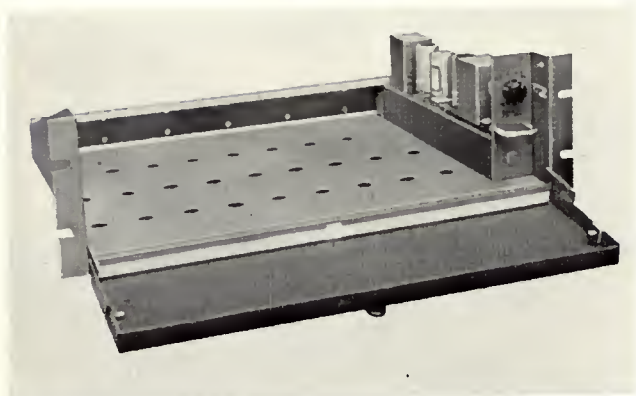

DESCRIPTION

The BR-22B Mounting Shelf is capable of mounting the following quantities of specific equipments:

- 10 BA-71A Preamplifiers or 10 BA-31A Preamplifiers or 10 BA-21A Preamplifiers
- 3 BA-73A Program Amplifiers or 3 BA-33A Program Amplifiers + 1 BA-31A Preamplifier or 3 BA-23A Program Amplifiers + 1 BA-21A
- 3 BA-74A Monitor Amplifiers or 3 BA-34B Monitor Amplifiers + 1 BA-31A or 2 BA-24A Monitor Amplifiers
- 2 BA-25A AGC Program Amplifiers
- 5 BA-78A Cue/Intercom Amplifier
- 2 BX-71A Power Supplies or 2 BX-21A Power Supplies + 2 BA-21A

This shelf will mount in the BR-84 series of racks, or in any 19 inch rack. It occupies 5 1/4 inches of rack space. RCA plug-in amplifiers fit perfectly in this shelf. They are slipped into the shelf from the front. The receptacles fit in such a manner that a small amount of free movement is permitted in all directions. This eases the alignment of the plugs and receptacles when the amplifiers are pushed into position. The wiring in back of the receptacles is protected by a cover which is fastened in place by two machine screws.

The opening in the front of the shelf is covered by a hinged panel, which may be opened to gain access to the amplifiers and any amplifier controls. The bottom of the shelf has ventilation holes.

The amplifiers and power supplies are installed on the mounting shelf by means of guide strips and connector receptacles which are included with each amplifier and power supply. The receptacles are assembled to the guide strip which is then attached to the mounting shelf.

SPECIFICATIONS

Dimensions, Overall:	
Width	19"
Height	5 7/32"
Depth	13 1/4"
Space for Mounting Equipment:	
Width	17 1/8"
Height	4 1/16"
Weight, Unpacked	10 lbs.
Finish, Front	Two tone umber gray

Ordering Information

BR-22B Mounting Shelf MI-11597-A

BR-2A PANEL AND SHELF

DESCRIPTION

The BR-2A Shelf is designed to mount the BA-6A Limiting Amplifier, while the panel and shelf can be used to mount the Relay Power Supply, MI-11316. This shelf will mount in either the BR-19A or the BR-84 series of racks, or in any other standard 19-inch rack. It occupies 8 3/4 inches of panel space.

SPECIFICATIONS

Dimensions, overall:	
Width	19"
Height	8 3/4"
Depth	12 3/4"
Inside Width	16 7/8"
Weight, unpacked:	
Shelf	12 lbs.
Panel	3 lbs.

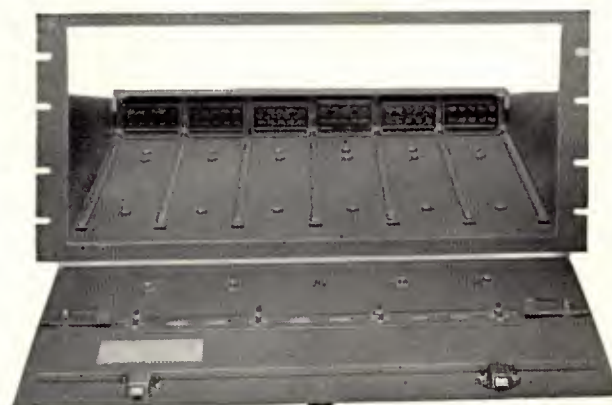

Panel removed showing guide bars and receptacles.

Ordering Information

Shelf (Umber Gray)..... MI-11599
 Panel (Umber Gray)..... MI-11598-B

Jack Panels, Mats and Cords

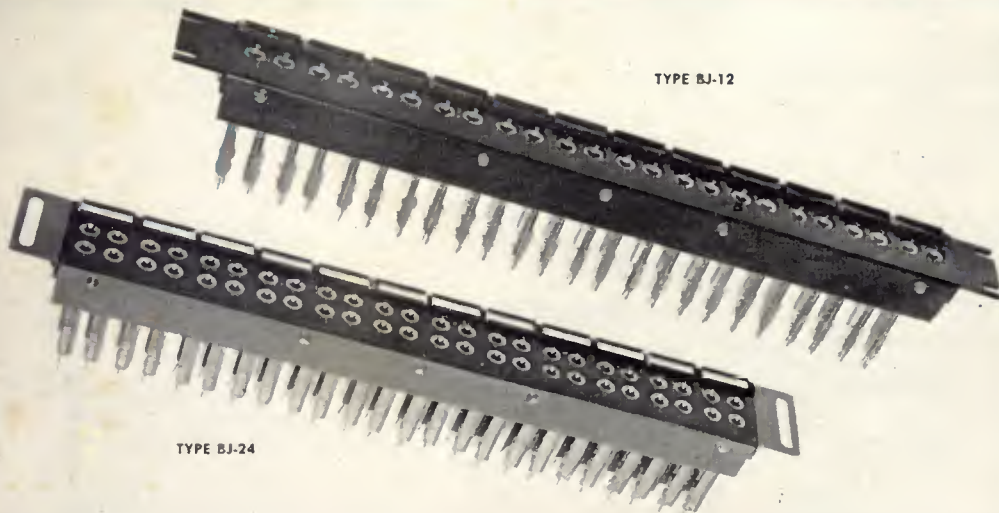

FEATURES

- Offset ground lugs—easy to wire
- Spacing of jack pairs prevents cross-circuit patching
- Bakelite strip reinforced to prevent warping or breakage

DESCRIPTION

Jock Panels, with their associated patch cards, are used with broadcast speech input systems to improve the overall operating flexibility. In addition to providing a convenient termination for program and order wire telephone circuits, closed-circuit jacks may be connected to provide "patch cord" access to the input and output circuits of individual units of the speech assembly. When connected for this purpose, the regular circuits are continuous through the jacks until a patch cord is inserted to make an external connection. With properly connected jacks, patch cards may be freely used in emergencies or for test purposes to interchange or transfer telephone lines, amplifiers, mixers, microphones, or other equipment items.

The BJ-24 consists of two rows of twelve double jacks mounted on thick black bakelite and furnished with designation card holders. The BJ-12 is similar to the BJ-24 but has only one row of twelve double jacks. The jack sleeves of the BJ-24 and BJ-12 are chromium plated. Tip-ring-sleeve jack panels are also available as MI-11666 (panel not shown).

Jock Mats are available for covering 1, 2, 3, or 4 type BJ-24 Double Jack Strips.

RCA maintains a stock of patch cords for the convenience of broadcasting stations. The cord is shielded and uses two Type PJ-1 Plugs which are interchangeable with the W.E. Type 241-A Plug. A choice of black or gray colored cord is available in three sizes. A two-foot black tip-ring-sleeve patch cord is also stocked.

SPECIFICATIONS

JACK PANELS	BJ-24	BJ-12	BJ-20TRS
Number of Jacks	24 pair	12 pair	20*
Dimensions	2 1/8" x 19"	1 3/4" x 19"	1 3/4" x 19"
Weight (unpacked)	5 1/2 lbs.	3 lbs.	3 lbs. (approx.)
JACK MATS			
Dimensions (Overall):			
Single BJ-24 Jack Strip Mat			17 7/8" x 3-5/32"
Double BJ-24 Jack Strip Mats			17 7/8" x 5-7/32"
Finish	Umber Gray		
PATCH CORD			
Overall Length	Available in two, four, or six foot lengths		

Ordering Information

Type BJ-24 (RCA Standard) Jack Panel	MI-11645	
Type BJ-12 (RCA Standard) Jack Panel	MI-11646	
Single BJ-24 Jack Strip Mat	MI-11647-1	
Double BJ-24 Jack Strip Mat	MI-11647-2	
Type BJ-20TRS (Tip-Ring-Sleeve) Jack Panel	MI-11666	
	Black	Gray
Two-foot Patch Card	MI-4652-B	4652-20
Four-foot Patch Card	MI-4652-4B	4652-40
Six-foot Patch Card	MI-4652-6B	4652-60
Two-foot Tip-Ring-Sleeve Patch Cord	MI-4652-D2	

*BJ-20TRS Jacks spaced 3/4" on centers.



MI-11647-2 Double Jack Mat

INTERCONNECTING CABLES

The majority of cables required to interconnect the various components of a broadcast audio assembly are of a special type and cannot be readily purchased from the local electrical dealer. In order to avoid unnecessary installation delays, RCA carries in stock five of the generally used special type cables.

Solid Conductor Cable, MI-33

Use.....General purpose Audio Transmission Line
 Type.....Shielded twisted pair, each conductor solid #20 tinned copper wire, with Vinyl resin insulation covered with lacquered rayon braid.
 Shield.....Tinned copper braid
 Overall Diameter.....Approximately .170"
 Color Code.....Red and black
 Rating.....300 volts

Ordering Information

#20 AWG Cable (order in 100 ft. multiples only).....MI-33

Stranded Conductor Cable, MI-34

Use.....Recommended for audio circuits where extra flexibility is required
 Type.....Shielded, twisted pair, stranded, composed of 7—.010 tinned copper conductors equivalent to #22 AWG
 Insulation.....Vinyl resin insulated with lacquered rayon braid
 Shield.....Tinned copper braid
 Overall Diameter.....Approximately .166"
 Color Code.....Red and black
 Rating.....300 volts

Ordering Information

#22 AWG Cable (order in 100 ft. multiples only).....MI-34

Stranded Conductor Cable, MI-35

Use.....Especially recommended for 110 volt supply and filament circuits
 Type.....Shielded, twisted pair, stranded, composed of 16—.010 tinned copper conductors equivalent to #18 AWG
 Insulation.....Vinyl resin insulated with lacquered rayon braid
 Shield.....Tinned copper braid
 Overall Diameter.....Approximately .236"
 Color Code.....Red and black
 Rating.....300 volts

Ordering Information

#18 AWG Cable (order in 100 ft. multiples only).....MI-35

Solid Conductor Cable, MI-13342-1

Use.....General purpose Audio Transmission Line
 Type.....Shielded twisted pair, tinned copper drain wire each conductor #22 tinned copper wire, cabled, with black vinyl jacket
 Insulation.....Vinyl
 Shield.....Tinned copper braid
 Overall Diameter.....Approx. .200"
 Color Code.....Red and black
 Rating.....200 volts

Ordering Information

#22 AWG Cable (order in 100 ft. multiples only).....MI-13342-1

Stranded Conductor Cable, MI-13342-2

Use.....General purpose Audio Transmission Line
 Type.....Shielded pair, each conductor #22 AWG (16 x 34) tinned copper wire, cabled, tinned copper drain wire, with black vinyl jacket.
 Insulation.....Vinyl insulated
 Shield.....Tinned copper braid
 Overall Diameter.....Approx. .210"
 Color Code.....Red and black
 Rating.....200 volts

Ordering Information

#22 AWG Cable (order in 100 ft. multiples only).....MI-13342-2

Cable Lacing Cord, MI-11719-A

Lacing cord is available for general cable lacing and dressing uses. Cord is of strong material such as linen and hemp and thoroughly impregnated with a beeswax and paraffin mixture. Supplied in one pound spools as shown above.

Ordering Information

	Type	Plys	Yds/lb	Average Break Strength
MI-11719-A	No. 6 med.	4	580 ±35	30 lbs.

STUDIO WARNING LIGHT



SPECIFICATIONS

Dimensions: (overall)
 Case.....14" long, 3 1/2" high, 2 1/16" deep (Glass Sign Aperture)
 Length.....9 3/4"
 Width.....2 3/4"
 Weight (unpacked).....3 1/2 lbs.

Ordering Information

"ON-AIR".....MI-11706-1
 Glass Only.....MI-11718-1
 Custom Glass Signs Available on Request.

Audio Accessories

VARIABLE AUDIO COMPENSATOR MI-10143-L-M-H

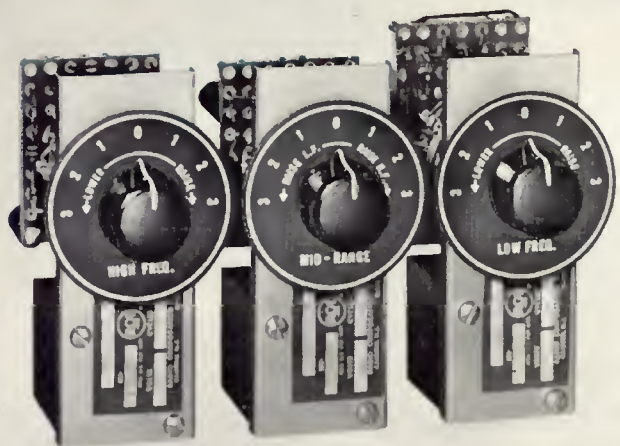

FEATURES

- Bridge "T" type, constant resistance
- Separate sections for low-mid-high range
- Three steps of "increase" and "decrease" compensation
- Requires small space back of panel
- Excellent frequency characteristics
- May be operated during program periods

DESCRIPTION

The RCA MI-10143-L-M-H is a three-section variable compensator designed to alter the frequency response of program audio signals to correct for system or microphone pickup deficiencies or to obtain special effects conditions. Designed as a sectional unit, up to three sections of variable audio compensators may be used in each circuit, as required, to obtain the desired compensation limits.

For convenience of circuit operation a transistor or tube type preamplifier is recommended to offset the insertion loss in the units. A key switch can be used to remove the compensator or group of compensators from the circuit and substitute a fixed loss. Therefore, it will facilitate program handling.

Small overall dimensions of each section of 4½-inch length, 1¾-inch width and 3¼-inch depth permit mounting in most conventional control panels and mixer consoles.

SPECIFICATIONS

Circuit Configuration.....	Bridge "T" type, constant resistance
Source Impedance.....	600 ohms
Input Impedance.....	600 ohms unbalanced
Output Impedance.....	600 ohms unbalanced
Load Impedance.....	600 ohms
Insertion Loss.....	10 db at 1000 cycles for MI-10143-L, 7 db for MI-10143-M, 10 db for MI-10143-H
Maximum Input Level.....	+4 dbm
Frequency Response.....	Flat from 26 to 20,000 cycles with no compensation. See curves for response with compensation.

Controls:

Each of the MI-10143-L-H sections have one seven-position selector switch, (3-raise, 3-lower, 1 zero position). The MI-10143-M section has one seven-position selector switch (3-raise LF, 3-raise HF, and 1 zero position) for each respective frequency range.

Dimensions of Each Section..... 4½" long, 1¾" wide, 3¼" deep

Ordering Information

Variable Audio Compensator (Low Frequency).....	MI-10143-L
Variable Audio Compensator (Mid-Frequency).....	MI-10143-M
Variable Audio Compensator (High Frequency).....	MI-10143-H

Accessory

BA-31A Transistor Preamplifier and Isolation Amplifier.....	MI-11444
---	----------

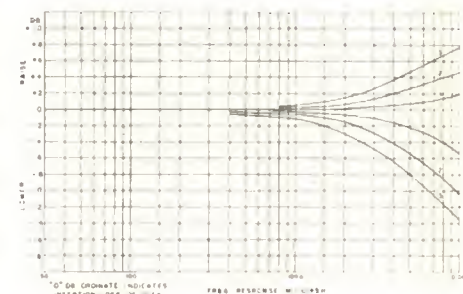
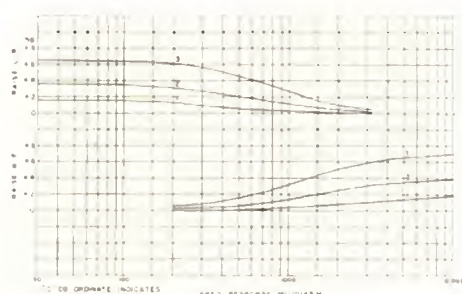
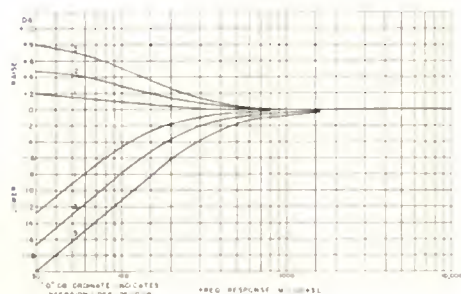



VU METER PANEL, Type BI-5A

The BI-5A Meter Panel employs the industry standardized VU Meter which embodies closely controlled electrical and dynamic characteristics combined with deliberate pointer action, moderate pointer speed, and small pointer over-swing. It is intended as an audio level indicator for broadcasting, recording or wherever it is desired to read the level of one or more audio circuits with a rack mounting type of instrument.

SPECIFICATIONS

Input Impedance (except on 1 milliwatt step).....	7500 ohms
Attenuator Steps.....	1 milliwatt position, +4 to +40 db in 2 db steps and off position
No. of lines that may be measured.....	1 to 10 inclusive
Mounting.....	Standard Cabinet Rack
Dimensions:	
Height	5 1/4"
Width	19"
Depth	3 3/4"
Finish.....	Light umber gray
Weight (unpacked).....	7 1/2 lbs.

Ordering Information

BI-5A VU Meter Panel.....MI-11265-F



BE-21B SOUND EFFECTS FILTER

The BE-21B furnishes a desirable means for producing a variety of special or unusual sound effects through control of the audio bandwidth of the transmitted program. It is especially useful in the production of dramatic plays for making programs sound "bossy" or "tinny" or for simulating the sound of telephone conversations, short wave radio communications or midget radios.

SPECIFICATIONS

Source Impedance (unbalanced).....	600 ohms
Load Impedance	600 ohms
Input Level	-60 to +18 dbm
Output Level (maximum).....	+18 dbm
Frequency Response.....	Variable
Insertion Loss.....	1 db or less at frequencies remote from cut-off
Dimensions, overall.....	5 1/4" high, 19" wide, 5" deep
Weight (unpacked).....	15 lbs.
Finish.....	Light umber gray

Ordering Information

BE-21B Variable Sound Effects Filter.....MI-11723

57-D SWITCH AND FUSE PANEL

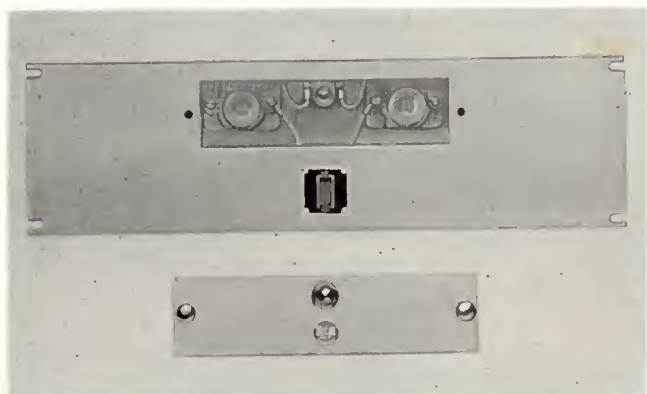

The Type 57-D Switch and Fuse Panel is designed for use as a master input control of the a-c power supply. Ordinarily one such panel is used with each rack or channel of speech input units. The mounting is for a BR-84 Series Standard cabinet rack.

On this panel are mounted and wired an indicator lamp with red cap, two single fuse blocks of the screw-plug type and a double-pole single-throw power switch. A removable door permits front panel access to fuses and pilot lamp.

SPECIFICATIONS

Switch.....	D.P.S.T., 250 volts, 30 amperes
Fuses (not furnished).....	Screw-plug type (rating depends upon equipment to be protected)
Dimensions, overall (panel thickness 3/8"):	
Height	5 1/4"
Width	19"
Depth	3 1/2"
Weight (unpacked).....	8 1/2 lbs.
Finish.....	Light umber gray

Ordering Information

57-D Switch and Fuse Panel.....MI-4395-G

VU METER AND ATTENUATORS

DESCRIPTION

VU meters and attenuators are available as amplifier accessory equipment for indicating audio volume levels. Equipment is pictured at the right and may be ordered as follows:

Ordering Information

Simpson VU Meter..... Stock # 53064
 Multiple Pad for calibrating the VU Meter
 to the desired reference level..... Stock # 19328
 Zero Adjustment Pad..... Stock # 19327

The complete kit is pictured at the right.

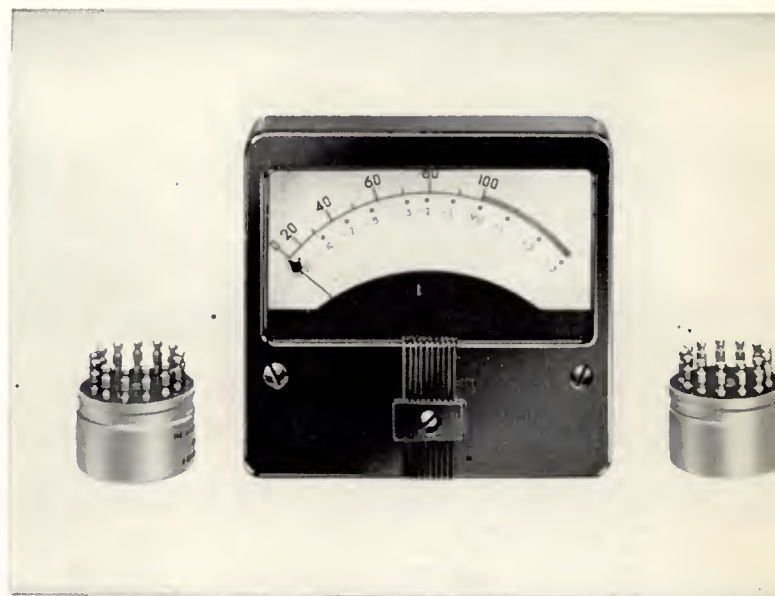

LINE EQUALIZER, Type BE-2A

SPECIFICATIONS

Source Impedance	150 or 600 ohms
Equalization Frequency Limit	15,000 cycles
Insertion Loss (minimum at 1000 cycles)	7 db
Equalization Range (see attenuation characteristic curve)	1 to 40 db
Mounting	Single hole
Dimensions	2 7/8" wide, 2 1/2" high, 3 3/8" deep
Weight	1 1/4 lbs.
Finish	Cadmium plote

Ordering Information

BE-2A Line Equalizer..... MI-11752

Accessories

Mounting Panel 3 1/2" x 19"..... MI-4591-B
 Line Transformer..... MI-11713

DESCRIPTION

The RCA Type BE-2A Line Equalizer is designed to equalize the non-linear frequency characteristics of a non-loaded telephone line. It is suitable for 15,000 cycle FM circuits. The small, low-cost unit is recommended for use on lines which are permanently installed and continuously used such as studio-to-transmitter lines and remote lines.

The BE-2A Line Equalizer employs parallel resonant circuits and consists of a capacitor, a reactor, a series of resistors, and a rotary selector switch for selecting different resistance values. The resonant frequency of this circuit is just above the operating frequencies of associated equipment, so that the frequency characteristics of the equalizer below resonance are of interest. Examination of these characteristics (shown in the chart) reveals that the more resistance in series with inductor, the less the low-frequency attenuation of the equalizer.

Frequency characteristic of Type BE-2A Line Equalizer.

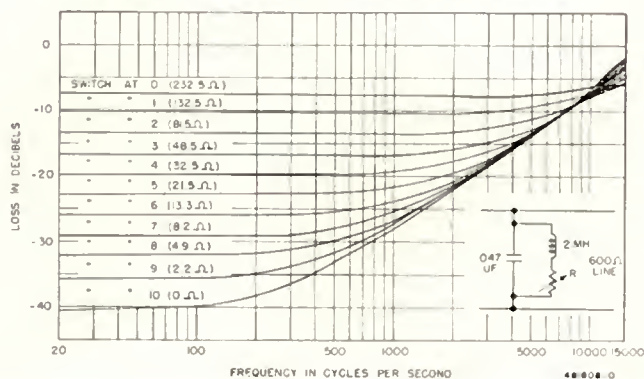

LINE AND BRIDGING TRANSFORMERS AND CONTROLS

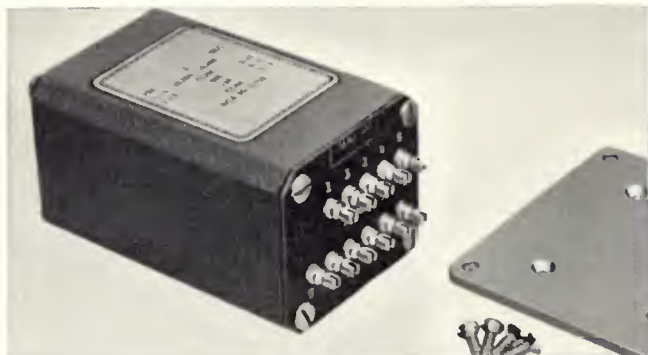

Line and Bridging Transformers.

Frequency Response.....	1/2 db 20 to 20,000 cps
Primary Impedances	
MI-11712 Bridging Transformer.....	20,000 ohms
MI-11713 Line Transformer.....	150/600 ohms
Secondary Impedances	
MI-11712 Bridging Transformer.....	150/600 ohms
MI-11713 Line Transformer.....	150/600 ohms
Finish.....	Aluminum gray
Overall Dimensions.....	4" x 2-11/32" x 1 7/8"
Boseplate.....	3 1/4" x 3 1/4"
	four hole mounting with center lines 2 3/4" x 2 3/4"
Weight.....	2 lbs. 14 ozs.

Ordering Information

Bridging Transformer.....	MI-11712
Line Transformer.....	MI-11713

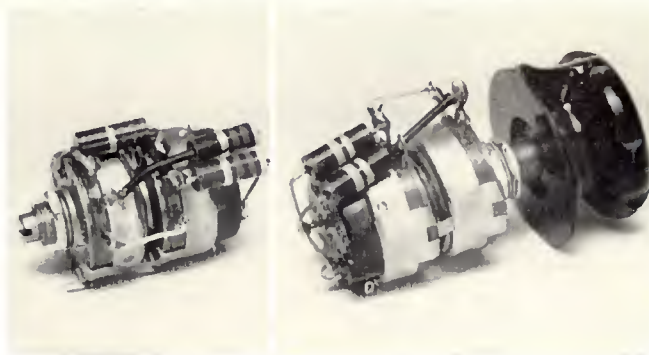

Bridging Volume Controls.

MI-11278-F

MI-11278-E

Input Impedances.....	20,000/10,000 ohms
Output Impedances.....	600/150 ohms
Insertion Loss*.....	31/24 db
Maximum Input Level.....	+40 dbm
Overall Dimensions:	
Length:	
MI-11278-E.....	2 5/8"
MI-11278-F.....	2 3/8"
Diameter.....	1 3/8"
Weight.....	4 1/2 ozs.

Ordering Information

For Panel Mounting (with knob).....	MI-11278-E
For Chassis Mounting (with screw-driver adjustment).....	MI-11278-F

* Bridging a 600-ohm line and operating into an amplifier with unloaded input requiring a source impedance equal to the output impedance of the control. The insertion loss when bridging a 150 ohm line is 42.5/36 db.

PADS AND NETWORKS

DESCRIPTION

RCA offers a comprehensive selection of attenuator pads, bridging pads and dividing networks. The pads and networks are well constructed and insulated with precision wound resistors, assuring no internal reflection. The terminals are accessible and securely mounted with the connections stenciled in on appropriate place. The fixed balanced "H" type is available in four types, introducing losses of 6 db, 10 db, 20 db or 40 db. The dividing networks are available as tabulated specifications.

SPECIFICATIONS

Fixed Pads:	
Balanced "H" Type, Input/Output impedance, 600 ohms, insertion loss of:	
6 db Pad.....	MI-4171-29
10 db Pad.....	MI-4171-30
20 db Pad.....	MI-4171-32
40 db Pad.....	MI-4171-39
Dividing Networks:	
Balanced 2-way, 600 ohms, 6 db insertion loss.....	MI-11704
Balanced 3-way, 600 ohms, 9.5 db insertion loss.....	MI-11704-A
Balanced 4-way, 600 ohms, 12 db insertion loss.....	MI-11704-B
Balanced 6-way, 600 ohms, 10 db insertion loss.....	MI-11704-D
Isolation Pod (Bridge Circuit):	
Balanced, input impedance 600 ohms to two 600 ohm lines, isolation between lines about 45 db, insertion loss 10 db.....	MI-11705

MI-4171-29

MI-11704-A

MI-11705

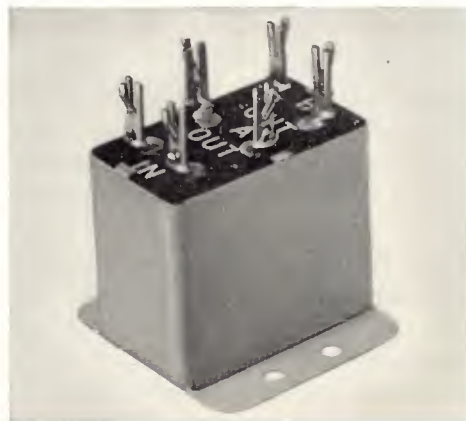

Three-Speed Turntable

TYPE BQ-2C

FEATURES

- Simplified speed changing mechanism for ease of operation and reduced maintenance
- Reliable, hysteresis synchronous motor provides quick smooth starts
- Plays 33 $\frac{1}{3}$, 45 or 78 rpm records
- Rugged and simple construction—fewer parts



DESCRIPTION

The RCA type BQ-2C Transcription Turntable meets broadcasting needs for a high-quality driving mechanism which will accommodate all types of commercial disc recordings up to 16 inches in diameter at speeds of 33 $\frac{1}{3}$, 45 or 78 rpm. The drive assembly is extremely reliable and quiet, and meets all EIA performance specifications, assuring fidelity in the reproduction of broadcast transcriptions.

The cabinet assembly not only provides a simplified mounting for the drive assembly, turntable and operating controls, but allows ample room for housing reproduction equipment. All standard types of broadcast tone arm equipment may easily be mounted on the cabinet and, if desired, two tone arms for various types of pickups can be accommodated. The cabinet has a spacious compartment where equalizer equipment and necessary amplifiers may be installed.

The BQ-2C Drive Mechanism is available as a separate unit for those stations which may wish to mount it in a custom built cabinet, bench, or table.

The BQ-2C Turntable Drive Assembly is a three-speed, rim-drive type mechanism consisting of a hysteresis synchronous motor with a three-step diameter motor shaft.

The speed of the turntable is determined by the ratio of diameters between the motor capstan and the turntable rim. Two models are provided, one for operation with 60 cycle power supply (MI-11830-C), and another for 50 cycle use (MI-11831-C). The only difference between the models is in the respective diameters of the three-step motor capstan since the motor with its capacitor is designed for both 60 and 50 cycle operation.

A cabinet of modern design is provided to house the turntable equipment. This wooden console has a durable two-tone, umber gray fabrikoid covering which is resistant to scuff and scratches, and will not chip like enamel or lacquer surfaced cabinets. A cigarette-proof linoleum top with aluminum trim is provided. A large hinged door permits ready access to the interior. Space is available for mounting reproduction filters and equalized preamplifiers such as the RCA type BA-26. The a-c power is connected to convenient terminals on the motor board.

A three-position speed selector switch is linked to a cam which allows the three rubber idlers to engage, one at a time, between the capstan and the turntable rim. An "Off-On" selector knob operates a mercury switch which

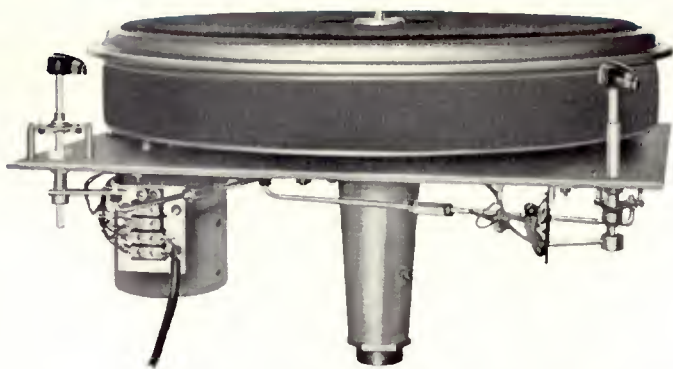

Sturdy 16-inch turntable platter with large spindle accurately machined to give many years of service. Quiet operation is provided by the cushion-mounted motor operated by a silent mercury switch.

energizes the motor and simultaneously engages or disengages the rubber idlers in the "On" or "Off" position respectively.

The turntable platter is a sturdy 14-pound aluminum casting. It and the spindle assembly are held in the main support casting in oilite bushings and the thrust is supported by a single ball at the bottom end of the spindle. A belt of foam rubber is affixed to the outside rim of the platter in order to eliminate any resonance effects. The drive motor is mounted on a separate plate and supported by vibration mounts to eliminate rumble. All posts and shafts which provide bearings for combs and arms are assembled to a common plate to insure proper alignment.



Simplified speed changing mechanism has minimum moving parts. "Off-on" switch relieves idlers in "off" position providing extended idler life.

A feature of the motor drive assembly is the use of a separate speed control which can be adjusted without motor stopping between any combination of speeds. A separate starting switch is provided to handle cueing and routine operation in the most functional manner. This "On-Off" switch relieves the idlers when set to the "Off" position, thus providing extended idler life.

SPECIFICATIONS

Performance Specifications

Turntable Speed.....	33 1/3, 45 and 78.26 ±0.3%
Wow or Flutter:	
At 33 1/3 rpm.....	0.25% half of peak of peak
At 45 rpm.....	0.20% half of peak of peak
At 78 rpm.....	0.20% half of peak of peak
Motor.....	1/100 H.P., 1800 rpm at 60 cycles, or 1/125 H.P., 1500 rpm at 50 cycles, 45° C. temperature rise, 2 or 3 mf 220 working volts capacitor.
Power Supply.....	105-125 volts, 50/60 cycles, single phase
Power Consumption.....	40 watts
Turntable Diameter.....	16"
Hub and Spindle Diameter:	
Hub for 45 rpm Records.....	1.5"
Spindle for 33 1/3 and 78 rpm.....	0.2835"
Overall Dimensions:	
Turntable Drive Unit.....	18" long, 18" wide, 11" high
Cabinet.....	23 1/2" wide, 24 3/4" deep, 28" high (adjustable 3/4")
Weight:	
Turntable Drive Unit.....	31 lbs
Cabinet.....	60 lbs.
Total Weight.....	91 lbs.
Finish.....	Two tone umber gray fabrikoid with aluminum trim

Ordering Information

BQ-2C Turntable and Cabinet including turntable drive assembly, console cabinet, turntable platter assembly and Instruction Book (18-24780), but less reproducing equipment such as tone arms and amplifiers:	
For 60 cycle operation.....	MI-11833-C
For 50 cycle operation.....	MI-11834-C
BQ-2C Turntable Mechanism for Custom Installations, less console cabinet and reproducing equipment such as tone arms and amplifiers:	
For 60 cycle operation.....	MI-11830-C
For 50 cycle operation.....	MI-11831-C

Accessory Equipment

16" Tone Arm (less Pickup Head).....	MI-11895
Universal Pickup Cartridge.....	MI-11865
Replaceable Stylus.....	MI-11866 Series
BA-34B Transistor (manitar amplifier).....	MI-11437-B
BA-24A Manitarng Amplifier.....	MI-11247
BA-26A Pickup Equalizer-Preamplifier.....	MI-11436

12-Inch Dual Speed Turntable

TYPE BQ-51A



FEATURES

- Precision, 2-speed rim-drive mechanism for 33 $\frac{1}{3}$ and 45 rpm records
- Pre-assembled tone arm on turntable saves installation time
- Provision for mounting second tone arm for greater versatility
- Smooth and rapid starts within a half revolution
- Available as a mechanism for custom-built installations

DESCRIPTION

The RCA BQ-51A Dual Speed Turntable fulfills the broadcaster's need for a high-quality turntable mechanism to accommodate commercial disc recordings up to 12 inches in diameter at speeds of 33 $\frac{1}{3}$ and 45 rpm. The BQ-51A is available as a mechanism for mounting in custom-built arrangements. It may also be obtained as a complete assembly with a styled cabinet, MI-11809.

The tone arm supplied with the BQ-51A accommodates the RCA Universal Pickup Cartridge, MI-11865, and associated styli, MI-11866 Series, for playing stereo or monaural recordings. It will also accept any standard low impedance, reluctance-type pickup that conforms to EIA standards. Provision for mounting a second tone arm, permits fast selection of either standard or microgroove playback.

The BQ-51A Dual Speed 12-inch Turntable is a 2-speed, rim-drive mechanism, utilizing a hysteresis synchronous motor. It is available for 60-cycle operation as MI-11810, or for 50-cycle by addition of MI-805365 Modification Kit. A 2-position speed selector switch is provided on the turntable assembly. An "Off-On" selector control operates a mercury motor switch and simultaneously engages or disengages the rubber idler wheels. This feature relieves the idlers from pressure when set to the "Off" position.

The turntable platter is a sturdy aluminum casting. The platter and spindle assembly is held in the main support casting by oilite bushings and the thrust is supported by a single ball at the bottom end of the spindle. A foam rubber belt on the outside rim of the platter eliminates resonance effects. The drive motor is mounted on a separate plate, supported by vibration mounts to eliminate rumble. All posts and shafts which provide bearings for combs and arms are assembled to a common plate to insure proper alignment.

The cabinet assembly, MI-11809, of functional design, affords a simplified mounting for the drive assembly mechanism, operating controls, preamplifiers and other accessories. It has a durable, amber-gray fibrikoid covering which is resistant to scuff and scratches. A 17 $\frac{5}{8}$ by 19 $\frac{5}{8}$ -inch hinged door is located on the front of the cabinet to permit ready access to the interior. A removable blank panel is located at the front of the cabinet just above the hinged door, which allows mounting of additional accessories.

Lightweight Tone Arms

MI-11895 and MI-11894



DESCRIPTION

RCA's Lightweight 16- and 12-inch Tone Arms, MI-11895 and MI-11894 together with the Universal Cartridge type pickups are designed to fulfill the need for a high-quality broadcast pickup combination for playing stereo and monaural fine-groove records, standard transcriptions and commercial records. A popular application of this new design is in combination with the present Universal Pickups and transcription turntables. In such installations, the unit provides the broadcaster with pickup and tone arm facilities for groove sizes associated with all three speeds. The tone arm will also accept any pickup that mounts on standard 1/2-inch mounting centers.

Tone arm resonance is outside of the operating frequency range of the system, thus assuring smooth response characteristics. Distortion due to tracking error in the arm and pickup has been reduced to a minimum by careful design. The anti-friction vertical and lateral pivots and low mass allow the tone arm to track warped and eccentric records.

The tone arm is hinged at the pivot center to allow easy access to the underneath portion of the arm, thus providing immediate access to the pickup and wiring. The tone arm handle provides finger-tip control directly behind the pickup stylus, thus enabling the user to sense by touch as well as to see more accurately where the stylus is being set down. The MI-11895 is designed for mounting on 16-inch turntables and the MI-11894 tone arm for mounting on 12-inch turntables. All necessary mounting hardware is included.

SPECIFICATIONS

Lightweight 16-Inch Tone Arm, MI-11895

Tracking Error, 16-inch Record (C.D. 12")	4° max.
Pivot Bearings	Anti-resonant bearings in vertical and horizontal planes
Tone Arm Head Receptacle	Quick-lock, plug-in type
Construction of Arm	Aluminum casting
Finish	Light amber gray wrinkle
Length of Arm	16 3/4"
Height of Arm	Adjustable
Weight (arm, assembly, etc.)	2 lbs. approx.
Mounting	Approx. 12" from spindle center
Leads	3-conductor and shield

Lightweight 12-Inch Tone Arm, MI-11894

Tracking Error, 12-inch Record	4° max.
Pivot Bearings	Anti-resonant in vertical and horizontal planes
Tone Arm Head Receptacle	Plug-in type
Arm Finish	Light amber gray
Length of Arm	12"
Width of Arm	Tapered 1 1/2" to 1/2"
Height of Arm	Tapered 3/4" to 1/4"
Approx. Shipping Weight (arm, assembly, etc.)	1 1/2 lbs.
Mounting	Approx. 8" from spindle center

Ordering Information

16-Inch Tone Arm (less pickup head) includes assembly complete with tone arm rest and mounting hardware	MI-11895
12-Inch Tone arm assembly (less pickup head) complete with tone arm rest and mounting hardware	MI-11894

Accessories

BA-26A Pickup Equalizer-Preamplifier	MI-11436
Universal Cartridge (less stylus)	MI-11865
0.7 mil Diamond Stylus	MI-11866-7
1.0 mil Diamond Stylus	MI-11866-10
2.5 mil Diamond Stylus	MI-11866-25

Universal Pickup Cartridge

MI-11865

FEATURES

- Plug-in unit
- Stereo or monaural—by connection
- Replaceable stylus—0.7, 1.0 or 2.5 mil
- May be used on any standard EIA tone arm

DESCRIPTION

The RCA Universal Pickup Cartridge and Replaceable Stylus, MI-11865 and MI-11866 provide a fully compatible unit for reproducing stereophonic and monophonic phonograph records in broadcast studios. It utilizes the moving magnet system which makes possible superior performance and simplified stylus replacement. The MI-11865 Cartridge is completely housed in a molded plastic case. The stylus MI-11866 may easily be removed and replaced without use of tools. This eliminates the need for ever sending the pickup out for repairs.

The cartridge proper is a three terminal device. The center pin is common and the outside pins are the left and right stereo outputs. In stereo use the head is connected in the usual manner with the left output going to the left equalizer and the right output, to the right equalizer. In monophonic use, the left and right outputs are paralleled. The cartridge plugs into the MI-11894 (12-inch) or MI-11895 (16-inch) tone arms, or may be mounted on arms with standard 1/2-inch mounting centers. It features low distortion, and excellent frequency response and very good channel separation. The diamond stylus and low tracking force insure long life for both the stylus and recordings.

Plug-in stylus assemblies, readily identified by their color are available in three types as shown in table below:

MI Number	Stylus (Tip Radius)	Function	Force (grams)	Color
11866-7	0.7 mil	Stereo records	4	Black
11866-10	1.0 mil	45 RPM and LP records	4	Red
11866-25	2.5 mil	Transcription and 78 RPM records	8	Green



SPECIFICATIONS

Electrical—each channel

Inductance	400 mh
DC Resistance.....	280 ohms
Output Voltage, at 1000 cps, 5 cm/sec.....	.005 volts
Channel Separation.....	20 db min. @ 1000 cps
Recommended Load Impedance.....	47,000 ohms
Number of Terminals.....	3

Mechanical

Length	1 5/16"
Width	3/4"
Height	1 1/8"
Weight	10.5 grams
Mounting.....	Plug-in (standard EIA mounting centers)
Recommended Stylus Force.....	(see table)

Ordering Information

Pickup Cartridge (less stylus assembly).....	MI-11865
Stylus Assembly 0.7 mil (black).....	MI-11866-7
Stylus Assembly 1.0 (red).....	MI-11866-10
Stylus Assembly 2.5 mil (green).....	MI-11866-25

Accessories

Tone Arm (12 inches).....	MI-11894
Tone Arm (16 inches).....	MI-11895
BA-26A Pickup Equalizer-Preamplifier (2 for stereo).....	MI-11436

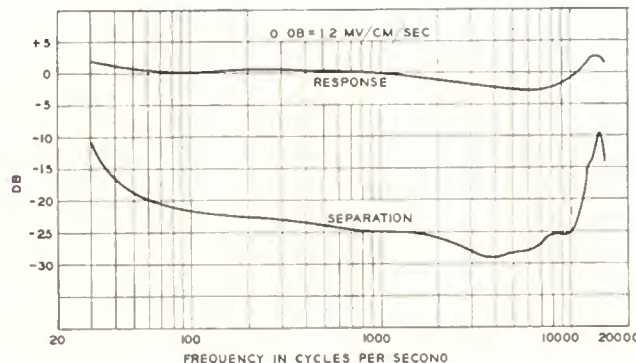

Professional Audio Tape Recorder

TYPE RT-21A



Completely Transistorized

The RCA Type RT-21A Professional Tape Recorder is designed to meet rigid specifications and requirements set forth by broadcast and studio engineers for magnetic monaural or stereo tape operations. Utmost flexibility is provided in this all new complete transistor design, permitting programs to be recorded with greater ease.

The RT-21A basic recorder is supplied in two sections: a tape transport and a control panel which includes one amplifier. These components readily enable either a custom or standard installation to be made. The equipment is normally supplied for rack mounting. Console Cabinet and portable carrying case are optional equipment.

Monaural or Stereo

The control panel of the RT-21A is divided into three sections. The left contains the monaural record/playback module, the center area contains provisions for a duplicate module (used for stereo recording) and the right side of the control panel contains operating controls in a convenient grouping.

The record/playback modules are similar in construction and are directly interchangeable. Front panel controls consist of the following: a record level control, playback level control, headset jack, bias adjustment and meter function selector to monitor, playback, record, bias and erase signals.

Continuously Variable Speed Control and Interlocked Record Operation

The operating controls consist of the following: variable cue speed and related cue delegate button, record, start, stop, fast forward and fast reverse. The control panel features an interlocked record operation. This means that to place the machine in the record mode, the record button must first be depressed and then the start button to

begin operation. This interlock feature may be defeated by simple internal strapping so that the record button may be depressed at any time for editing purposes, etc. A record tally indicator is also provided and illuminates only after the record button is depressed. Rewind may be selected from stop position only. All controls are DC relay operated. The necessary 24 volt dc control voltages are generated within the recorder and are also available for remote control purposes.

3¾ and 7½ in./sec. Tape Speed Provided (15 in./sec. available)

The RT-21A Tape Transport Panel accommodates either standard 10½-inch NAB reels or 7-inch EIA reels. Proper tape tension for 10½ or 7-inch reels is provided by means of a taggle switch at the lower right of the panel. Also located in this same area are the main power on-off switch and a switch for selecting either high or low tape speeds. Proper tape equalization is automatically selected by the speed change switch. If desired 7½ and 15-inch tape speeds can be provided.

Easy Threading . . . Sapphires Used to Lift and Guide Tape

Threading of tape is simple and can be done without removal or movement of the head cover. A microswitch located on the take-up tension arm turns off the machine in case of tape breakage or end of tape. Sapphire tape guides are used throughout.



Type RT-21A Stereo Audio Tape Recorder, ES-41921-AS showing single module for manual at left, a second module for stereo, center, and control unit on right below tape transport chassis.

SPECIFICATIONS

Tape Type.....	1/4" wide magnetic
Reels.....	10 1/2" dia. (NAB); 7" or smaller (EIA)
Tape Speed.....	7.5" and 3.75" per second 7.5" and 15" per second available
Starting Time.....	0.1 sec full speed
Stopping Time.....	2" of tape at 15 ips
Playback Timing Accuracy.....	±3.0 secs in 30 min.
Flutter and Wow.....	0.25% rms at 3.75 ips 0.15% rms at 7.5 ips 0.1% rms at 15 ips
Rewind Time.....	Approx. 90 sec for 2400 ft. an NAB reel
Track Width.....	Full track or half track
Frequency Response:	
15 ips.....	50—15,000 cps, ±2 db
7.5 ips.....	40—10,000 cps, ±2 db
3.75 ips.....	50—7,500 cps, ±2 db
Signal-to-Noise Ratio:	
15 ips.....	60 db full track
7.5 ips.....	55 db half track
3.75 ips.....	50 db half track
Record Input Impedance:	
Matching.....	150 ohms (600 ohms by strapping input transformer) input transformer)
Bridging.....	20,000 ohms
Record Input Levels:	
Matching.....	-70 to -20 dbm
Bridging.....	-30 to +20 dbm
Record Output Load.....	600 ohms
Record Output Level.....	+18 dbm max.
Playback Output Load.....	600 ohms
Playback Output Level.....	±18 dbm max.
Distortion at Maximum Recording Level.....	3% at 400 cps
Meter.....	3 1/2" illuminated, VU
Power Requirements.....	105—125 volts, 60 cps, single phase (50 cps optional); 110 watts manual; 130 watts stereo
Power Supplies (Amplifier and Control Circuit).....	Self-contained
Erase and Bias Oscillator Frequency.....	80 kc/s
Cue Speed.....	Continuously variable in either direction
Remote Control.....	Optional; all functions except variable cue speed
Dimensions (overall):	
Tape Transport.....	19" wide, 15 3/4" high, 9" deep
Amplifier Control Panel.....	19" wide, 5 1/4" high, 9" deep

DC Solenoid Operated Tape Lifters

These are employed to lift the tape away from all magnetic heads whenever the machine is in the fast forward or fast reverse mode of operation. When the cue mode is selected, tape is then lifted from all heads except the playback head. This permits the operator to listen to the audio as he jockeys the tape for final cueing via the continuously variable speed control.

Half-Track Recording with Full Track Option

A total of four magnetic head positions are available. The three heads normally supplied with the equipment provide dual half-track recording, erase and playback. Full-track heads are available. An optional fourth head may be used for time delay broadcast and other applications. A switchable dual quarter-track fourth head kit is available for playing pre-recorded stereo tapes. All azimuth head adjustments are available from the front panel by simply removing the snap-on protective cover.

Weight76 lbs.

Transistor and Diode Complement:

Record/Playback Amplifier:

3—2N1010, 1—2N404, 2—1N2069, 7—2N526, 8—2N270, 1—1N34A

Control Panel Module:

2—2N456, 2—2N247, 1—1N1316, 1—2N270, 4—1N1763

Tape Transport Assembly:

10—1N2069, 12—1N1763

Equipment Supplied

Type RT-21A Professional Audio Tape Recorder (Manual Dual Half Track).....	ES-41921-A
Comprising the following:	
1 Tape Transport (3 3/4 and 7 1/2 ips).....	MI-141121-A
1 Amplifier Module (MI-41351) and Control Panel.....	MI-141321
Type RT-21A Professional Audio Tape Recorder (Stereo).....	ES-41921-AS
Comprising the following:	
1 Tape Transport (3 3/4 and 7 1/2 ips).....	MI-141121-A
1 Amplifier Module (MI-41351) and Control Panel.....	MI-141321
1 Record/Playback Amplifier Module.....	MI-141351
Type RT-21A Professional Audio Tape Recorder (Full Track).....	ES-41930-A
Comprising the following:	
1 Tape Transport (7 1/2 and 15 ips).....	MI-141130-A
1 Amplifier Module (MI-41351) and Control Panel.....	MI-141321
Type RT-21A Professional Audio Tape Recorder (Full Track).....	ES-41920-A
Comprising the following:	
1 Tape Transport (3 3/4 and 7 1/2 ips).....	MI-141120-A
1 Amplifier Module (MI-41351) and Control Panel.....	MI-141321

Optional and Accessory Equipment

Record/Playback Amplifier Module.....	MI-141351
Portable Carrying Case.....	MI-141302
Console Cabinet.....	MI-141303
Remote Control Panel.....	MI-141301
Remote Control Housing.....	MI-141308
Amplifier Mounting Panel.....	MI-141307
Fourth Head Kit (quarter track).....	MI-141306
Switchable Fourth Head Kit (dual quarter track).....	MI-41602
Amplifier-Record/Playback Module.....	MI-141315-S
Stereo Connector Kit for RT-21 Cabinets.....	MI-41601
Spare Transistor Kit.....	#11A218

Cartridge Tape System

TYPE RT-7B



Playback Unit, Type RT-7B



Record Amplifier, Type BA-7B

FEATURES

- Immediate playback of taped commercials without threading or cueing
- Complete transistor circuitry
- Full range frequency response at 7.5 IPS
- Cue tone for precision starts
- Trip-cue circuit for automation
- Microphone or line level recording
- Synchronous motor runs only when cartridge is inserted
- Remote control provisions
- Each unit only 5¼ inches high for standard rack or console mounting
- Dependable, quiet operation

DESCRIPTION

The RCA Tape Cartridge System, Type RT-7B, places split second control of recorded programming at the broadcaster's fingertips. Broadcast material from "Quickie" spot announcements to complete programs may be recorded and stored ready for instant selection and playback. Delayed broadcast, spot announcement campaigns, production aids, themes, station breaks—anything that can be recorded may be handled by the RT-7B with a minimum of time and effort, even by non-technical personnel. With tape cartridges, cueing and threading of tape is unnecessary. The desired cartridge is selected, placed in the playback unit and forgotten until "Air" time when it is instantly played back at the touch of the start button. Transistor circuitry, low power consumption, light weight and simplicity of operation makes the RT-7B an ideal choice for remote program recording or playback from remote broadcast locations.

In the TV studio, automatic operation of a slide projector may be accomplished by the trip-cue feature of the RT-7B. An announcement requiring one or more slides may be recorded with trip cues which, in turn, can be used to operate the slide projector as the announcement progresses.

The RCA Tape Cartridge System consists of two separate units, the Type RT-7B Playback Unit and the BA-7B Record Amplifier. Both units have a uniform panel height of only 5¼ inches and a panel width of 19 inches for standard rack or console mounting.

The RT-7B Playback Unit has been designed to reproduce tape cartridges loaded with lubricated tape varying in length from 40 seconds to 31 minutes. The RT-7B consists of a tape deck, power supply, playback amplifier and cue circuitry all designed for continuous use and housed in covered chassis. At the left of the front panel a horizontal

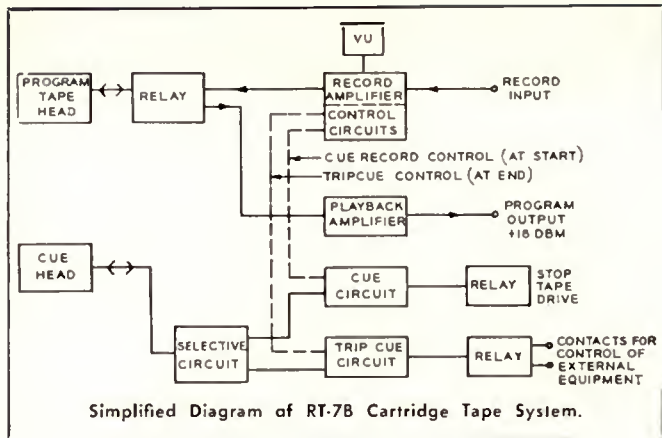

slot opening is provided for insertion of the tape cartridge. Manual controls, mounted to the right, include an "On-Off" toggle switch and "Start" and "Stop" pushbuttons. "Ready and Run" pilot lights indicate the operation condition of the equipment. Upon one insertion of a cartridge in the RT-7B, the "Ready" light comes on. When the "Start" button is depressed the "Run" light comes on and the tape moves across the playback and cue tape heads until a cue tone stops the equipment. At this point the "Ready" light is relit and the cartridge may be removed. Salenaid relays control the start and stop functions of the unit through impulses generated by a cue tone control circuit. These cue tone bursts are inserted automatically each time the tape is started during recording so that taped announcements may always be properly recued and ready for reuse.

A special feature of the RT-7B is the use of a second trip-cue circuit which is independent of the cue-tape circuit. This feature allows the broadcaster to record a second trip-cue tape immediately at the conclusion of the program material. The trip-cue, when activated, during playback can be used to start the next device in an automatic or semi-automatic system with split second timing.

The Record Amplifier, Type BA-7B, contains a 3-inch VU meter for correct level adjustments, an input gain control, trip-cue control, and a record set-up control and indicator lamp. The amplifier has sufficient gain to permit microphone recording and a bridging pad may be connected for recording at line level. Operating voltages for the BA-7B are supplied by the RT-7B Playback Unit. Careful consideration has been given to prevention of accidental recording. The recorder must be intentionally placed in the record mode before recording can be made, and drops out of this mode whenever the tape is stopped. A cue tone is automatically recorded each time the START button is operated when in the record mode. Used cartridges can be erased with accessory Bulk Eraser, MI-11992.

Both Playback Unit and Record Amplifier are well shielded against r-f pickup interference, so that the units may be used at broadcast transmitter locations. Etched wiring circuit boards with all components including transistors mounted in place are available as spares to enable a station to quickly substitute circuits in case of difficulty.

SPECIFICATIONS

Frequency Response.....	±2 db 50-12,000 cps at 7.5 ips ±4 db, 50 to 15,000 cps at 7.5 ips
Distortion.....	2% or less at normal recording level
Signal-to-Noise Ratio.....	55 db
Wow and Flutter.....	Less than 0.2% RMS
Tape Speed.....	7.5 ips
Power.....	115/230 volt, o-c, 50/60 cycles, single phase
Playing Time.....	1 sec. to 31 minutes in 3 basic cartridge sizes
Cueing Accuracy.....	Within 0.1 sec.
Starting Time.....	0.05 sec. or less
Output.....	+18 dbm, 150 or 600 ohms, balanced
Input Impedance.....	150 ohm matching, 20,000 ohm bridging
Input Level.....	-20 db maximum matching +18 dbm maximum bridging -70 dbm microphone
Bias Frequency.....	75 kc
Power.....	115/230 volt, a-c, 50/60 cycles, single phase
Power Consumption.....	Standby position—8 watts Ready position—29 watts Playback position—35 watts Record position—40 watts

Transistor and Diode Complement:

RT-7B Playback Unit		
6-2N220	1-2N301	2-2N404
1-2N406	7-2N586	1-2N1184B
1-1N60	1-1N721A	3-1N1763
1-1N3253	1-1R-66-4241	1-1R-CP-20
BA-7B Record Amplifier		
2-2N1010	3-2N526	1-2N406
1-2N586	1-1N3253	1-1N60

Finish.....	Umber gray and satin etched aluminum
Dimensions Overall:	
RT-7B.....	19" wide, 5 1/4" high, 12" deep
BA-7B.....	19" wide, 5 1/4" high, 10" deep
Weight:	
RT-7B.....	35 lbs.
BA-7B.....	11 lbs.

Ordering Information

RT-7B Playback Unit.....	MI-11957-B
BA-7B Recording Amplifier.....	MI-11958-B

Accessories

Spare Transistor & Diode Kit for RT-7B.....	MI-11490-A
Spare Transistor & Diode Kit for BA-7B.....	MI-11491-A
RT-7 Playback Amplifier Board.....	MI-11994-1
RT-7 Power Supply Board.....	MI-11994-2
RT-7 Cue Amplifier Board.....	MI-11994-3
RT-7 Trip-Cue Amplifier Board.....	MI-11994-4
BA-7B Record Amplifier Board.....	MI-11994-6
Module Extender for BA-7A and RT-7A/B.....	MI-11976
Module Extender for BA-7B.....	MI-11976-B
Other RT-7 System components and spares including remote control panels, automatic switcher, console cabinets, cartridges and cartridge storage racks, etc. are described in RCA Catalog B.1725.	

RT-7 Consoles and Cartridge Storage Cabinet



Four-Unit RT-7 Console, MI-11893, with Tape Cartridge Storage Cabinet, MI-11985, mounted above.

FEATURES

- Choice of attractively styled consoles for two or four RT-7 Playback/Record units
- Matching storage cabinet with large tape cartridge capacity
- Affords ease of identification and efficient handling of cartridges
- Flexible mounting system meets varying studio space requirements
- Adjustable cabinet spacers accommodate small or large cartridge
- Provisions for mounting automatic switcher, standard audio panels and other equipment

DESCRIPTION

RCA Tape Cartridge Consoles provide mountings at a convenient operating level for the RT-7 Tape Cartridge Playback Units and the BA-7 Tape Cartridge Record Amplifier. MI-11984 is a two-unit console designed to mount two playback units, or one playback unit and one recorder. MI-11983 Console is a four-unit cabinet to mount four playback or one recorder and three playback units with sufficient space at the rear to mount an Audio Automatic Switcher, MI-11982. A Tape Cartridge Storage Cabinet, MI-11985, provides ten shelves 1½ inches high which may be divided as desired to accommodate an assortment of all three series (300, 600 and 1200) of tape cartridges by positioning the eight specially designed spacer boards and 10 individual separators.

Consoles and cabinet are sturdily constructed of plywood with a gray, textured Textolite lamine finish. Holes in the cabinet accommodate interconnection cables and provide ventilation. Protective screens, attached to the rear frames also provide ventilation.

Convenient two-unit cabinet console for mounting one RT-7 Tape Cartridge Playback Unit and one BA-7 Record Amplifier, or two RT-7 Playback Units.



Cabinet MI-11985 is set up to store 80 small, 300 Series tape cartridges. To accommodate the larger 600 and 1200 series cartridges, in whatever combination desired, the separators and spacer boards must be adjusted or removed. The storage cabinet may be placed on top of the consoles. Two cabinets can be accommodated if placed back-to-back. Mounting feet have been provided so that the cabinet may be placed on the floor underneath the MI-11983 Console. There is room for two storage cabinets, one on each side of the cross bar.

SPECIFICATIONS

	2 Unit Console MI-11984	4 Unit Console MI-11983	Storage Cabinet MI-11985
Construction.....	Plywood	Plywood	Plywood
Finish.....	Gray Textured Textolite Laminote	Gray Textured Textolite Laminote	Gray Texture Textolite Laminote
Legs.....	17" long, removable	17" long, removable	—
Dimensions (overall)			
Width.....	20 ³ / ₄ "	40 ³ / ₄ "	35 ⁷ / ₈ "
Depth.....	19 ³ / ₁₆ "	19 ³ / ₁₆ "	9"
Height (less legs).....	13"	13"	16"
Height (with legs).....	30"	30"	—
Weight (approximate).....	25	40	30

Equipment Supplied

- Console Cabinet for two RT-7 or one RT-7 and one BA-7 Units complete with legs and mounting hardware.....MI-11984
- Console Cabinet for four RT-7 or three RT-7 and one BA-7 Units complete with legs, crossbar, and mounting hardware.....MI-11983
- Cartridge Storage Cabinet with dividers and spacer boards set up to store 80 small, 300 series tape cartridges.....MI-11985

AUDIO AUTOMATIC SWITCHER

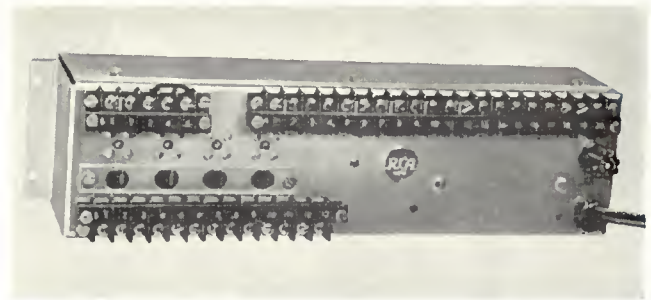

Audio Automatic Switcher, MI-11982, is an important unit in RCA's Cartridge Tape System affording a means to switch up to four RT-7 outputs to one console input. The switchers may be connected in tandem to service multiple playback units when desired.

SPECIFICATIONS

Operation	Sequential
Power Requirement.....	110/220 volts, o-c, 50/60 cycles, single phase
Line Cord and Plug.....	56" long
Fuse.....	1, slo-blo, rated 0.3 amps
Diode.....	1 Type 1N1763
Dimensions (overall).....	3 ¹ / ₄ " high, 13" wide, 2 ¹¹ / ₁₆ " deep
Weight	4 lbs.

Ordering Information

Audio Automatic Switcher complete with line cord and plug....MI-11982

REMOTE CONTROL PANELS, MI-11977 and MI-11979

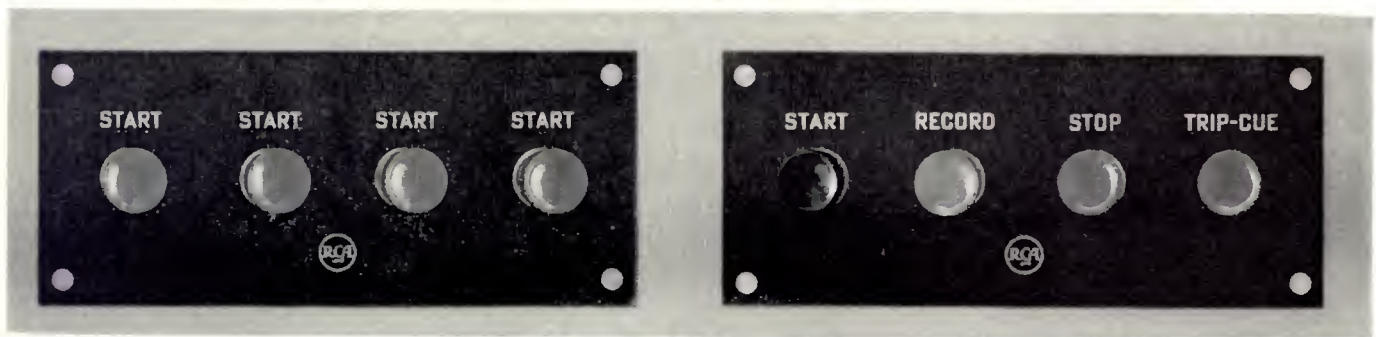

Remote Control Panel, MI-11977 provides a convenient means for remotely controlling from one to four RT-7 Cartridge Tape Playback Units. Through a rear terminal board connections may easily be made directly to the playback units. Four red pushbuttons on an aluminum panel labelled "START," control up to four units.

Remote control of the BA-7 Record Amplifier in the RT-7 Cartridge Tape System is provided by Remote Control Panel, MI-11979. Operational functions of the BA-7 can be transferred to the remote control panel with its four

pushbutton controls—START, RECORD, STOP, AND TRIP-CUE. The panel is identical in size and styling with the remote control panel for the RT-7 Playback Unit.

SPECIFICATIONS

Dimensions (overall).....	2 ¹ / ₂ " high, 6" wide, 2 ¹³ / ₁₆ " deep
Weight	1/2 lb.
Finish	Dark umber gray

Ordering Information

- Remote Control Panel for RT-7 Playback Unit Complete.....MI-11977
- Remote Control Panel for BA-7 Record Amplifier.....MI-11979

CARTRIDGE TAPE HEAD DEGAUSSER, MI-11995

The Cartridge Tape Head Degausser, MI-11995, is designed to facilitate demagnetizing of record-playback and erase heads of cartridge tape units. The unit is housed in a lightweight hand-grip case. It has a 1 $\frac{3}{8}$ -inch demagnetizing tip that can be conveniently inserted in the slot of the RT-7 Tape Cartridge housings. A momentary-contact ON-OFF pushbutton safety switch energizes the unit.

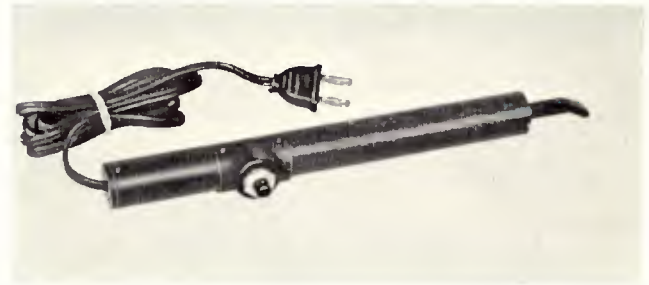

Long probe degausser (MI-11995) can easily be inserted in RT-7 Equipments to demagnetize heads without opening up playback-record units.

SPECIFICATIONS

Power Requirements.....117 volts, a-c, 50/60 cycles, single phase
 Switch.....Momentary contact, rating 8 amps.
 Line Cord.....5 ft. long
 Finish.....Black

Dimensions Overall.....9 $\frac{7}{8}$ " long, $\frac{7}{8}$ " diameter
 Weight.....9 oz.

Ordering Information

Cartridge Tape Head Degausser.....MI-11995

TAPE CARTRIDGES, MI-11988 SERIES

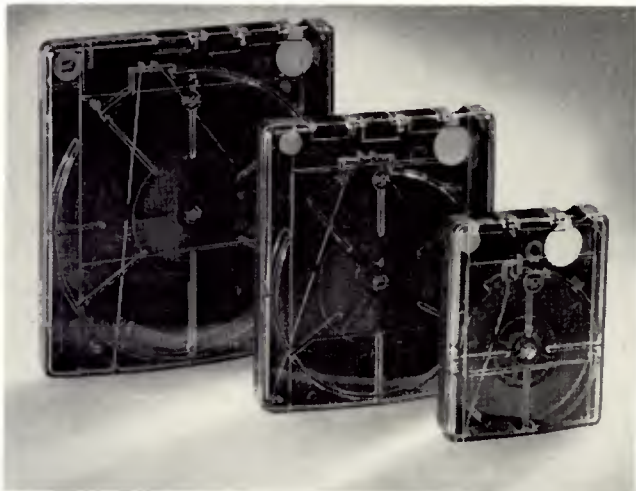

Series 1200, 600 or 300 (large, medium and small) tape cartridges offer broadcaster choice of playing time ranging from seconds to a half hour.

Cartridges, blank or tape loaded, for use with the RCA Type RT-7 Tape Cartridge System are made available in varying sizes and with convenient playing time ranging from 40 seconds to more than a half hour. Cartridge cases are plastic with clear top and RCA Light Umber Gray base. Cartridges are loaded with Type B151 single-coated lubricated tape, and wound for continuous-loop operation with the RT-7 Playback Unit. Special tape lengths are available to order.

Optional and Accessory Equipment

Azimuth Alignment Tape (10,000 and 14,000 cycles tone)
 Supplied in 300 series cartridge.....MI-11993-2
 Type 8151 Bulk Lubricated Tape (1700 feet on 7-inch reel) MI-11986
 Frequency Response Cartridge,
 calibrated, voice identified test frequencies.....MI-11993-1

Specifications and Ordering Information

Stock Identification	Series	Playing Time	Size Overall	Unit Weight	Packing	Total Weight
MI-11988-1	300	40 secs.	4" w x 5 $\frac{1}{8}$ " d x $\frac{7}{8}$ " h	3 oz.	6/box/MI	1 $\frac{1}{4}$ lbs.
MI-11988-2	300	70 secs.	4" w x 5 $\frac{1}{8}$ " d x $\frac{7}{8}$ " h	3 $\frac{1}{2}$ oz.	6/box/MI	1 $\frac{1}{2}$ lbs.
MI-11988-11	300	2 $\frac{1}{2}$ min.	4" w x 5 $\frac{1}{8}$ " d x $\frac{7}{8}$ " h	4 oz.	6/box/MI	1 $\frac{3}{4}$ lbs.
MI-11988-3	300	3 $\frac{1}{2}$ min.	4" w x 5 $\frac{1}{8}$ " d x $\frac{7}{8}$ " h	4 oz.	6/box/MI	1 $\frac{3}{4}$ lbs.
MI-11988-4	300	5 $\frac{1}{2}$ min.	4" w x 5 $\frac{1}{8}$ " d x $\frac{7}{8}$ " h	4 $\frac{1}{2}$ oz.	6/box/MI	2 lbs.
MI-11988-5	300	10 $\frac{1}{2}$ min.	4" w x 5 $\frac{1}{8}$ " d x $\frac{7}{8}$ " h	5 $\frac{1}{2}$ oz.	6/box/MI	2 $\frac{1}{4}$ lbs.
MI-11988-6	600	16 min.	6" w x 7" d x $\frac{7}{8}$ " h	10 oz.	2/box/MI	1 $\frac{1}{2}$ lbs.
MI-11988-7	1200	31 min.	7 $\frac{5}{8}$ " w x 8 $\frac{3}{8}$ " d x $\frac{7}{8}$ " h	13 oz.	2/box/MI	2 lbs.
MI-11988-8	300	blank	4" w x 5 $\frac{1}{8}$ " d x $\frac{7}{8}$ " h	2 $\frac{3}{4}$ oz.	6/box/MI	1 $\frac{1}{8}$ lbs.
MI-11988-9	600	blank	6" w x 7" d x $\frac{7}{8}$ " h	3 oz.	6/box/MI	1 $\frac{1}{4}$ lbs.
MI-11988-10	1200	blank	7 $\frac{5}{8}$ " w x 8 $\frac{3}{8}$ " d x $\frac{7}{8}$ " h	4 oz.	2/box/MI	10 oz.

CARTRIDGE TAPE BULK ERASER, MI-11992

Bulk Eraser, MI-11992, affords complete erasure of any 1/4-inch recorded reel of tape or tape cartridge. The eraser will demagnetize record-playback and erase heads, thus eliminating distortion and tape background noise problems.

The bulk eraser is housed in a plastic, hand-grip case measuring only 4 7/8 inches in diameter and 4 3/4 inches high overall. A momentary-contact, ON-OFF pushbutton safety switch prevents current being applied when not in use. To operate, simply plug into any a-c outlet and hold over the reel of tape, energize, then rotate the eraser around the tape for several seconds. Slowly withdraw the eraser from the tape to arms length before releasing on-off pushbutton.



SPECIFICATIONS

Power Consumption.....100-130 volts, 50/60 cycles, a-c,
single phase, 8.5 amps
Switch.....Momentary contact rating 15 amp a-c inductive
Line Cord.....8 ft. long
Dimensions (overall).....4 7/8" dia. by 4 3/4" high (including handle)
Weight.....4 lbs. approx.

Ordering Information

Bulk Eraser complete in plastic, hand-grip type case, furnished with 8-foot line cord, moulded rubber plug.....MI-11992

AUTOMATIC MAGNETIC TAPE ERASER, MI-10880



The new RCA Automatic Magnetic Tape Eraser is a self-contained unit mounted in a metal cabinet of table height requiring a floor space 22 inches square. The unit is designed to erase full reels of magnetic film or tape and will accommodate up to 15-inch reels.

Audio and video signals are erased down to the noise level of the magnetic medium in an automatic 18 second cycle. The erase cycle is fully automatic and controlled by a motor operated mechanism. Once the reel of tape is placed on the carriage and pushed into the operating position the erase cycle is set in motion without manual operation of any controls.

The use of an air core coil eliminates the possibility of "erosure spokes" so common in erasing with an iron core coil. Power factor correction with the air core coil provides a very high field strength from a nominal 12 ampere 220 volt input.

SPECIFICATIONS

Capacity.....6 rolls of 1/4" tape, 3 rolls of 1/2" tape;
2 rolls of 16mm film, 1 roll of 35mm film, or 1 roll of (2") TV tape
Roll or Reel Size.....Up to 2" height and 15" diameter
Erase Cycle.....18 seconds automatically controlled
Erase Coil.....Air Core Type (approx. 650 gauss)
Degree of Erasure.....Reduces a fully modulated signal
to the noise level of the magnetic medium
Power Requirements.....Approximately 12 amperes—220/115 volts
3 wire, 1 phase, 60 cycle (50 cycle units available on request)
Dimensions.....22" long, 21 5/8" wide, 37 1/4" high
Weight.....235 lbs.

Ordering Information

Automatic Magnetic Tape Eraser.....MI-10880

Duo-Cone Speaker Mechanism

TYPE LC-1A



FEATURES

- Excellent frequency response, uniform 40-16,000 cycles
- Low non-linear distortion
- Ideal for monitoring AM, FM and television programs
- Alnico V magnets
- Wide angle sound radiation of all frequencies

DESCRIPTION

The LC-1A is a "Broadcast Quality" loudspeaker with a low distortion, wide angle distribution, of extended frequency range, and specifically designed for use in recording studios, executive offices, reception rooms, sponsors' booths, control rooms or other locations that warrant the finest sound possible.

For applications where it is desired to mount the mechanism on a wall baffle, ceiling, etc., the speaker mechanism may be used with assurance that the entire frequency range will be realized. The speaker's outstanding performance makes it ideal for wide frequency range wide angle radiation.

The LC-1A Loudspeaker is a duo-cone coaxial speaker providing low distortion and broad frequency response over a wide angle. The two cones are direct radiators and are driven by separate voice coils. An electrical filter consisting of a 4 mf capacitor and the inductance of the low-frequency voice coil delivers the low frequencies to the large outer cone and the high frequencies to the small inner cone. The filter (or crossover network) reduces the response of the low-frequency unit above 1600 cycles, and that of the high-frequency unit below 1600 cycles.

Because of careful mechanical design, this speaker gives wide range smooth response from 60 to 15,000 cycles with low harmonic distortion and with very uniform distribution over a 140 degree angle. This outstanding performance is largely due to an important innovation in the LC-1A—the use of acoustical domes on the low-frequency cone and a diffractor on the high-frequency cone. The domes

and diffractor break up the unit's symmetry. This prevents reflections from the outer cone housing (caused by the unit's extremely wide dispersion angle) from combining with directly radiated sound to produce dips and peaks in the response.

Other features of the construction are: a sturdy die-cast aluminum frame; separate Alnico V magnets for high and low frequencies; a high-frequency voice coil wound with aluminum wire to get full high-frequency range; ample gap clearances and a low frequency diaphragm with natural cut-off effected by high mass and inductance voice coil and natural resonance not over 45 cycles. In addition, the high frequency diaphragm is mounted coaxially with the low frequency diaphragm and the two conical surfaces are in line. This minimizes out of phase components in the cross-over range. Smoother response is also obtained by the shallow angle of the diaphragm, and offset mounting which places the face of the diaphragm practically flush with the face of the baffle, and special dampening of H.F. and L.F. rim to minimize edge reflections.

A feature of construction is the use of acoustical domes—largely responsible for smooth response. The series of domes placed on the speaker's large cone breaks up the unit's symmetry and eliminates the interference normally characteristic of the symmetrical shape without sacrifice of either highs or lows.

The cross-over network utilizes the physical characteristics of the cones to mutually vibrate in unison over the cross-over frequency region and merely employs one capacitor

in the high frequency unit to limit its current at low frequencies.

The LC-1A is designed for housing either in the Olson Floor Cabinet, MI-11415, or Wall Mount Speaker Housing, MI-11406. The floor cabinet, functionally styled in walnut with satin finish, is especially designed to reduce variations in frequency response due to diffraction effects.

SPECIFICATIONS

LC-1A Speaker Mechanism

Impedance (nominal).....	15 ohms
Frequency Response (see curve).....	40-16,000 cps
Directional Characteristic.....	See curve
Distortion.....	See graph
Sensitivity.....	92.5 db (measured with 1 watt signal at 4 ft.)
Power Handling Capacity.....	20 watts
Non-linear Distortion (for 10 watt output, 50-15,000 cycles)	Less than 4% at 60 cycles

Dimensions:

Diameter (cone).....	15 5/16"
Diameter (bolt fixing circle).....	16 1/4"
Diameter (overall frame).....	17"
Depth.....	7 7/8"
Weight (unpacked).....	21 lbs.

Ordering Information

LC-1A 16" Duo-Cone Speaker Mechanism..... MI-11411-A

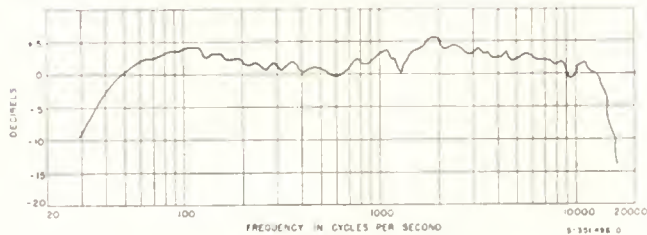

Frequency Response Curve of LC-1A Speaker.

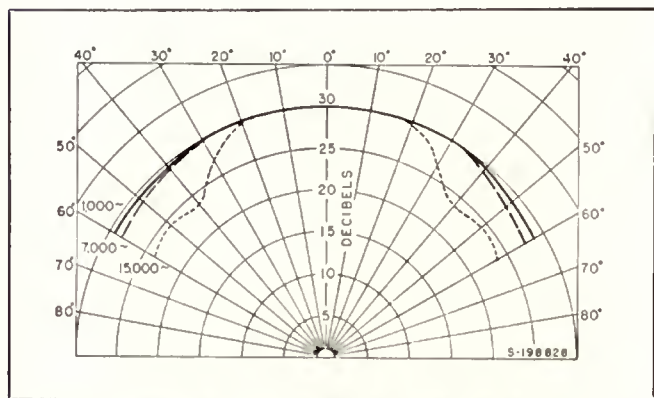

Directional Characteristics of LC-1A Speaker.

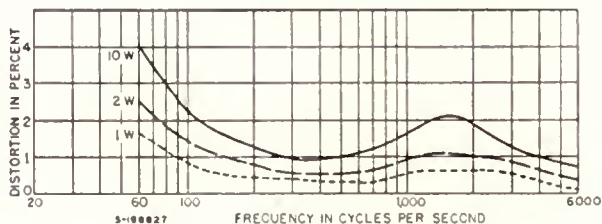

Harmonic Distortion of LC-1A Speaker.

LS-1A WALL HOUSING



SPECIFICATIONS

Mounting.....	30° or 60° angle
Dimensions:	
Height (max.).....	21 3/4"
Width (overall).....	37 1/2"
Depth (max.).....	17 1/8"
Finish.....	Umber gray with woven plastic grill cloth
Weight.....	45 lbs.

Ordering Information

LS-1A Wall Speaker Housing..... MI-11406

LS-11A FLOOR HOUSING



SPECIFICATIONS

Dimensions (Exterior):	
Height (including 4-inch legs).....	44"
Width.....	28 1/2"
Depth.....	16"
Finish.....	Satin Walnut
Weight.....	64 lbs.

Ordering Information

LS-11A Olson Floor Cabinet for LC-1A..... MI-11415

Loudspeakers and Accessories



SL-123A 12-INCH SPEAKER

Frequency Response.....	Uniform from 40 to 15,000 cycles (see curve)
Axial Sensitivity.....	97 db at 4 ft. with 1 watt input
Crossover Network.....	5000 cycles
Input Impedance.....	8 ohms
Power Handling Capacity.....	15 watts
Magnet Material.....	Alnico V
Magnet Weights:	
Low Frequency.....	14.5 ozs.
High Frequency.....	1.47 ozs.
Over-all Diameter.....	12-7/32"
Mounting Data.....	8 equally spaced holes on 11 ³ / ₁₆ " circle
Depth.....	6-5/32"
Weight.....	4 lbs.

Ordering Information

SL-123A 12-Inch Speaker Mechanism.....	MI-38314
LS-3A Wall Cabinet.....	MI-11407-A
Matching Transformer for 4 or 15 ohms.....	MI-11731

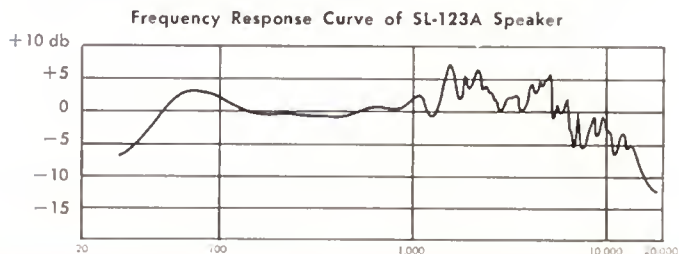

SL-12A 12-INCH SPEAKER

Frequency Response.....	50 to 15,000 cycles
Power Handling Capacity.....	10 watts
Magnet Weight.....	Alnico V 14.5 ozs.
Input Impedance.....	8 ohms (see curve)
Axial Sensitivity (at 4 ft., 1 watt).....	95 db
Cone Resonance (6 ¹ / ₂ cubic ft. cabinet).....	75 cps
Mounting Data (EIA).....	4 equally spaced holes on on 11 ³ / ₁₆ " bolt circle
Voice Coil Diameter.....	1"
Flux Density.....	11,500 Gauss
Overall Diameter.....	12 7/32"
Overall Depth.....	6 5/32"
Weight.....	4 lbs.

Ordering Information

SL-12A 12-Inch Speaker Mechanism.....	MI-38315-A
LS-3A Wall Cabinet.....	MI-11407-A
Matching Transformer for 4 or 15 ohms.....	MI-11731

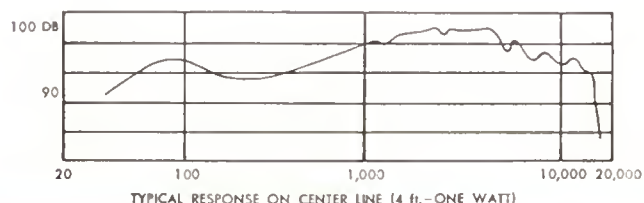

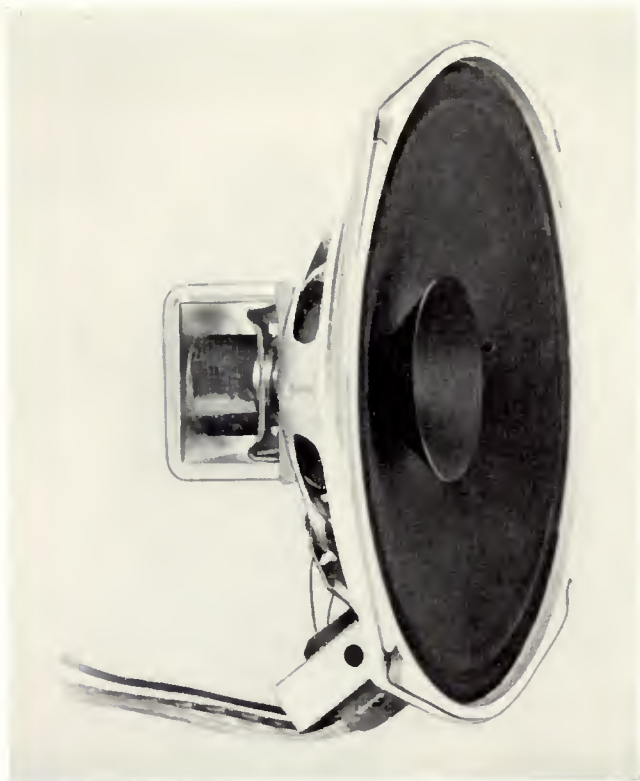

8-INCH UTILITY SPEAKER

Power Handling Capability.....	10 watts
Axial Sensitivity.....	96 db @ 4 ft. with 1 watt input
Frequency Response.....	50-15,000 cycles
Magnet Material and Weight.....	3.16 oz. Alnico V
Gap Flux Density.....	.9000 lines/cm ²
Voice Coil Impedance.....	3.2 ohms @ 400 cycles
Voice Coil Size.....	3/4"
Outside Diameter.....	8 1/4"
Depth.....	3 1/2"
Mounting Data.....	4 equally spaced holes on a 7 5/8" bolt circle
Net Weight.....	.31 oz.
Transformer Data:	
16,000 Ohms.....	Red-Black
8,000 Ohms.....	Red-Red/Black
4,000 Ohms.....	Red-Red/Yellow
1,400 Ohms.....	Black-Red/Black
700 Ohms.....	Red/Yellow-Red/Black

Ordering Information

B-Inch Utility Speaker with Transformer.....	MI-12454-B
B-Inch Speaker Cabinet.....	MI-6104

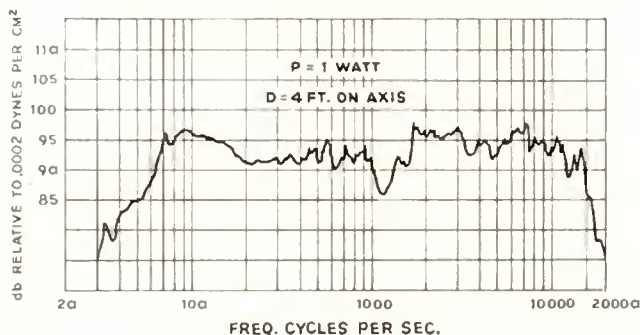

SL-8B 8-INCH SPEAKER

Frequency Response.....	50 to 18,000 cycles
Power Handling Capacity.....	10 watts
Magnet Weight.....	6.8 ounces
Input Impedance.....	8 ohms
Overall Diameter.....	8 1/8 inches
Depth.....	4 3/16 inches
Weight.....	2 3/4 pounds
Axial Sensitivity at 4 ft. 1 watt, see curve.....	.92 db
Cone Resonance (6 1/2 cubic ft. cabinet).....	74 cps
Mounting Data (EIA).....	4 equally spaced holes on a 7 5/8" bolt circle
Flux Density.....	9,000 Gauss

Ordering Information

SL-8B 8-Inch High Fidelity Speaker.....	MI-3B311-A
B-Inch Speaker Cabinet.....	MI-6104
Matching Transformer for 4 or 15 ohms.....	MI-11731

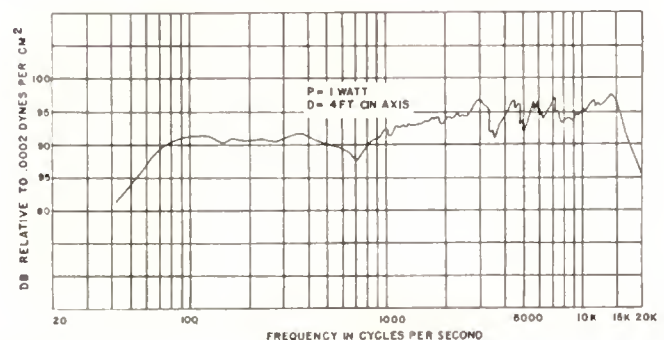



10-INCH CUE SPEAKER

Frequency Range 60-7000 cycles
 Power Handling Capacity 10 watts
 Voice Coil Impedance 4 ohms
 Overall Diameter 10 1/8"
 Overall Depth 4 1/4"
 Weight (unpocketed) 2 1/8 lbs.

Ordering Information

10-Inch Cue Speaker MI-11408
 Line Matching Speaker Transformer for 8 or 15 ohms MI-11731

LS-3A WALL HOUSING



Volume 2700 cu. in.
 Finish Dark umber gray
 Dimensions (overall) 16 3/16" high, 25" wide, 11 1/2" deep
 (front to back)
 Weight Approx. 12 lbs.

Ordering Information

LS-3A Wall Housing for 10- and 12-Inch Speakers MI-11407-A



10/12-INCH WOOD BAFFLE

Housing For standard 10" or 12" loudspeaker
 Material Top, front and bottom, one piece walnut
 finish veneer, reinforced wood sides, open back. Two-tone grill
 cloth of woven plastic matching walnut finish
 Finish Walnut grained
 Mounting Brackets furnished
 Dimensions 14" wide, 16 1/2" high, 8 1/2" deep (max.),
 clearance (center of speaker) 6 3/4"
 Weight 3 lbs. 10 oz.

Ordering Information

10/12-Inch Wood Baffle MI-13253-A/MI-13245-A

MOLDED PLASTIC BAFFLE

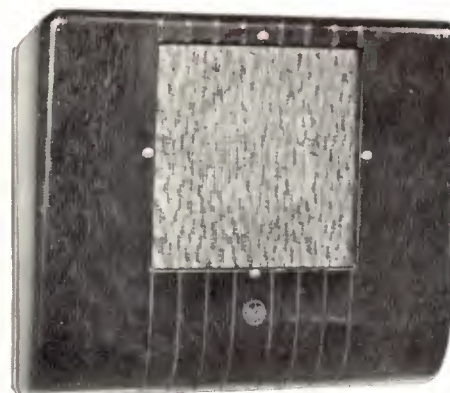

Housing For standard 8" loudspeaker
 Material Molded, walnut-grained, fire-resistant
 thermosetting plastic. Two-tone plastic grill cloth
 Mounting Two brackets and hardware supplied
 Dimensions 15 1/4" wide, 12 1/4" high, 5 5/8" deep (max.)
 4" clearance (center of speaker)
 Weight 3 1/4 lbs.

Ordering Information

Molded Plastic Baffle for 8-Inch Speaker MI-6104

LINE MATCHING TRANSFORMERS

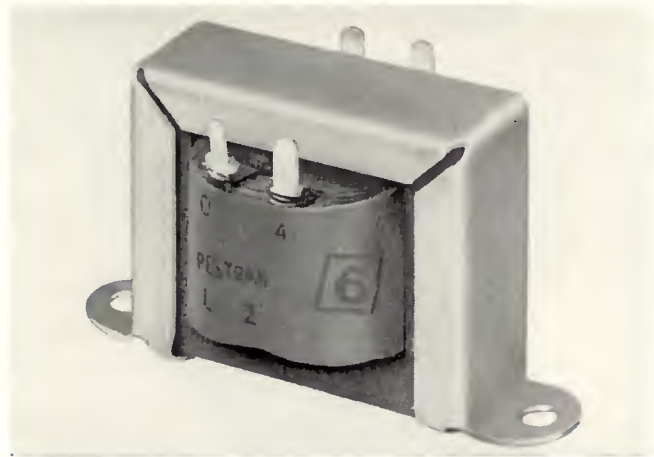
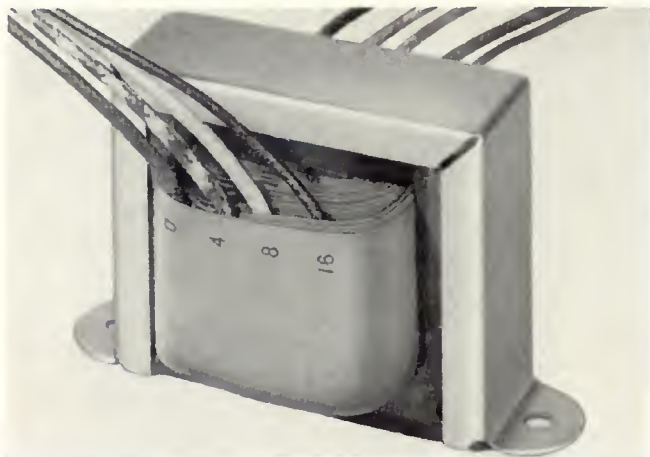

MI-12368 TRANSFORMER

Frequency Response..... $\pm 1/2$ db from 60 to 10,000
 Distortion.....2% max. from 100 to 10,000 @ 8 watts
 Power Handling...Max. 16 watts of program material
 Mounting Centers $3 1/8$ "
 Dimensions.....Height $2 1/4$ ", Length $3 3/4$ ", Width 2"
 Net Weight.....1 lb. 6 oz.

Ordering Information

Line Matching Speaker Transformer..... MI-12368

MI-11731 TRANSFORMER

Frequency Response..... ± 1.0 db from 60 to 10,000
 Distortion.....2% max. from 100 to 10,000
 Power Handling.....8 watts
 Mounting Centers $2 3/8$ "
 Dimensions...Height $1 21/32$ ", Length, 2", Width $3/4$ "
 Net Weight10 oz.

Ordering Information

Line Matching Speaker Transformer..... MI-11731

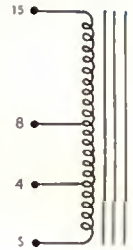
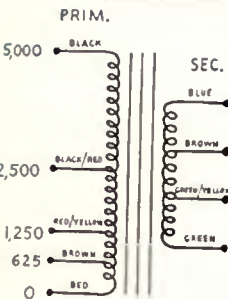

SPEAKER APPLICATIONS, RECOMMENDED HOUSINGS, SPECIFICATIONS

MI Number	Diometer (Inches)	Uses	Power Handling Capacity (Watts)	Frequency Range	Voice Coil Impedance (Ohms)	Cabinet
LC-1A (MI-11411-A)	15	Master program monitor, executive offices, clients' rooms, reception rooms, any application requiring maximum quality of sound reproduction	20	40-16,000 cps	15	LS-1A Wall (MI-11406) or LS-11A Floor (MI-11415)
SL-123A (MI-38314)	12	Program monitoring, executive offices, clients' rooms, reception rooms	15	40-16,000 cps	8	LS-3A (MI-11407-A)
SL-12A (MI-38315-A)	12	Program monitoring, executive offices, clients' rooms, reception rooms	10	50-16,000 cps	8	LS-3A (MI-11407-A)
MI-11408	10	Utility monitoring, spare program monitor, studio and on-nounce booth, cue, offices	10	60-7000 cps	4	LS-3A (MI-11407-A) or MI-13253-A/13245-A
MI-12454-B	8	Turntable cuing, dressing rooms, intercom, paging systems.	10	50-15,000 cps	4	MI-6104
SL-8B (MI-38311-A)	8	Program monitoring, executive offices, clients' rooms, reception rooms	10	50-18,000 cps	8	MI-6104

Distortion and Noise Meter

TYPE WM-71A



DESCRIPTION

Distortion and Noise Meter, RCA Type WM-71A, is a compact precision instrument for measuring the total distortion and the level of noise and hum in audio-frequency circuits. It permits continuous coverage of the audio frequency range, indicating directly the percentage of a-f distortion in modulators, speech amplifiers, a-f generators, receivers and other equipment employing audio frequencies. The instrument will give full-scale readings for distortion percentages as low as 0.3 per cent, and is capable of measuring noise components at frequencies from 30 to 45,000 cycles.

The instrument has many uses as a wide-range, highly sensitive voltmeter for such measurements as signal-to-noise ratio, AVC characteristics and hum level. With the aid of an oscilloscope, individual hum and distortion components can be identified. When used with a linear detector such as the RCA Type BW-66F Amplitude-Modulation Monitor, the distortion and noise characteristics of broadcast and other radio-telephone transmitters can be measured.

The WM-71A consists essentially of a high-gain amplifier, an r-c interstage coupling unit, a calibrated attenuator for adjusting the sensitivity, and a panel meter to indicate amplifier output. The power supply is voltage regulated so that line surges have no appreciable effect on the instrument.

A switch on the front panel provides for switching out the null circuit so that the instrument can be used as an extremely sensitive voltmeter for measuring hum and noise levels. Since the WM-71A has only one tuning control plus a small trimmer, it can be quickly set to any frequency over its range. This is a time-saving feature in making a series of measurements. Two input circuits are provided: a transformer for bridging a 600-ohm line, and a direct connection to the 100,000-ohm gain control. Input terminals are provided at the rear of the instrument for direct connection to the modulation monitor.

FEATURES

- Quick frequency selection
- Can be used as a wide range highly sensitive voltmeter or VU meter
- Distortion measurements, as low as 0.1 per cent, made by one tuning adjustment

SPECIFICATIONS

Distortion Range.....	Full scale deflections for 0.3%, 1%, 3%, 10% or 30% distortion
Noise Measurement Range....	-80 db below reference calibration level, or 80 db below an audio-frequency signal of zero dbm level, at maximum sensitivity.
Audio-Frequency Range.....	50 to 15,000 cycles (fundamental), for distortion measurements; 30 to 45,000 cycles for noise and hum measurements.
Dbm Range.....	Power-level range is from +20 to -60 dbm (0 dbm is one milliwatt in 600 ohms)
Input Voltage Range.....	1.2 to 30 volts for the 100-kilohm input, and 0.8 to 30 volts for the 600-ohm bridging input
Accuracy.....	For distortion measurements $\pm 5\%$ of full scale for each range \pm residual distortion as noted below; for noise and dbm measurements, $\pm 5\%$ of full scale.
Residual Distortion Level:	
100-kilohm Input.....	0.05%, max., below 7500 c. 0.10%, max., above 7500 c.
Bridging Input.....	0.10%, max., between 50 and 70 c. 0.05%, max., between 70 and 7500 c. 0.10%, max., above 7500 c.
Residual Noise Level.....	Less than -80 db
Input Impedance.....	100,000 ohms unbalanced, and 600-ohm bridging input (10,000 ohms), balanced or unbalanced
Power Line.....	Tapped primary provides for operation on a-c line voltages of 105-125 volts, 50/60 cycles, single phase, or 210-250 volts, 50/60 cycles, single phase.
Power Consumption.....	65 watts
Tube Complement:	
	4-6J5 1-6H6 1-6SN7-GT
	1-6X5-GT 1-6K6-GT 2-OD3/VR150
Dimensions.....	19" wide, 7" high, 13" deep
Weight.....	35½ lbs.
Finish.....	Umber gray lacquer

Ordering Information

WM-71A Distortion and Noise Meter.....	MI-30071-A
Including electron tubes, line connector, interconnecting cable, instruction book and spare fuses.	

Accessories

WA-28A Low Distortion Oscillator.....	MI-30028-A
BI-11A Transmission Measuring Set.....	MI-11350

Audio Push-Button Oscillator

TYPE WA-28A



DESCRIPTION

The Type WA-28A Oscillator was designed particularly for use as a tone source for distortion measurements and as a power source for bridge measurements at audio frequencies. It is also satisfactory for use as a general-purpose laboratory oscillator.

The output frequencies include those recommended by the FCC for distortion measurements on broadcast transmitters. This oscillator is thus ideal for use with the Type WM-71-A Distortion and Noise Meter for rapid distortion measurements. The unusually pure waveform delivered by this oscillator at low frequencies makes distortion measurements possible at low frequencies.

The WA-28A oscillator is of the resistance-capacitance type and uses an inverse feedback. Separate feedback networks control the frequency and amplitude independently, thus providing high stability and low distortion. The degenerative feedback which controls the frequency is obtained by means of a parallel-T network including mica capacitors and wire-wound resistors. The regenerative network includes an automatic control system whereby a high degree of stability is obtained together with low harmonic distortion, without requiring any manual feedback adjustments.

The instrument is mounted on a chassis fitting standard equipment racks. Controls on the front panel include ten frequency push-button switches. Three other push-buttons select the output impedance and a control is provided for adjusting the output voltage. Three frequency multiplier switches and two output jacks are also provided. Terminals are located inside the instrument which permit any specific frequency between the limits of 20 and 15,000 cycles to be obtained by insertion of a set of three calibrated resistors. The values of these resistors for any frequency may be obtained from the chart.

FEATURES

- Very low distortion
- High frequency stability for use with distortion meters employing r-c null networks
- Push-button selection of any one of 27 frequencies from 20 to 15,000 cycles

Jack-top binding posts with standard 3/4-inch spacing and standard Western Electric double output jack are provided on the panel. A ground terminal is also provided. A standard multipoint connector provides duplicate output terminals on the rear of the instrument for relay-rack installation. These terminals are disconnected when a plug is inserted in the Western Electric-type panel jack.

SPECIFICATIONS

Frequency Range.....	27 fixed frequencies between 20 and 15,000 cycles	
Frequency Calibration.....	Adjusted within 1½% ±0.1 cycle	
Frequency Stability.....	Less than 0.02% frequency drift per hour after the first 10 minutes of operation	
Output Power.....	18 milliwatts into 600 ohms load, or 6.6 volts open circuit; 100 milliwatts into 5000 ohm load, or 30 volts open circuit; constant within ±1 db throughout frequency range.	
Output Impedances.....	600-ohm balanced to ground 600-ohm unbalanced 5000-ohm unbalanced	
Waveform Distortion:		
5000-ohm Output.....	Less than 0.1% between 40 and 7500 cycles Less than 0.15% at other frequencies	
600-ohm Output.....	Less than 0.1% between 40 and 7500 cycles Less than 0.25% between 20 and 40 cycles Less than 0.15% above 7500 cycles	
Power Supply.....	105 to 125 (or 210 to 250) volts, 50/60 cycles, single phase	
Power Consumption.....	45 watts	
Tube Complement:		
1-6Y6-G	1-6SJ7	1-6SK7
1-NE-17	1-6SQ7	1-6X5
1-6B4-G	1-6SL7-GT	1-OD3/YR150
Dimensions.....	19" wide, 7" high, 12" deep	
Weight.....	32½ lbs.	
Finish.....	Light umber gray	

Ordering Information

WA-28A Low-Distortion Oscillator, complete.....MI-30028-A
Including electron tubes, line connector, multiple point connector, instruction book and spare fuses.

Accessories

Noise and Distortion Meter, Type WM-71A.....MI-30071-A
Transmission Measuring Set, Type BI-11A.....MI-11350

Transmission Measuring Set

TYPE BI-11A

FEATURES

- Simplifies audio measurement
- Eliminates lengthy calculations—direct reading
- ± 0.1 db accuracy over frequency range of 20 to 20,000 cycles
- Automatic correction for changes in load impedance

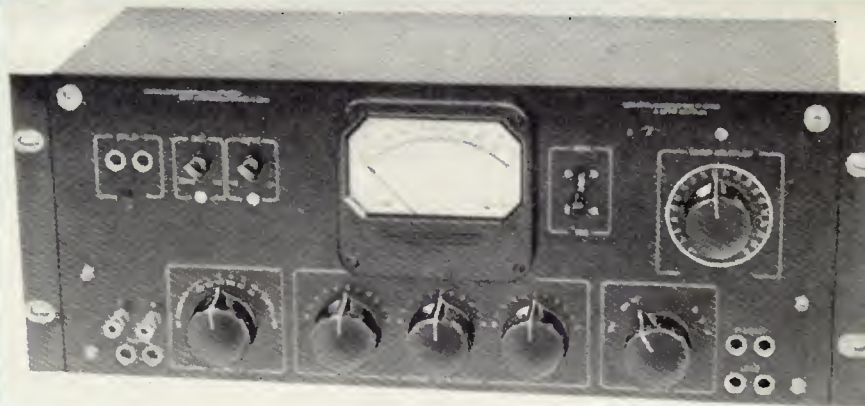

DESCRIPTION

The Transmission Measuring Set, Type BI-11A, is a simplified, accurate and direct-reading instrument designed for use in the following applications: (1) audio gain measurements; (2) audio loss measurements; (3) measurements of matching and bridging devices; (4) complex circuit measurements; (5) measuring mismatch loss and frequency response measurements. The instrument also may be used as an independent volume level indicator.

The instrument facilitates overall system measurements and may be used with the WA-28A Low Distortion Push-button Oscillator and the WM-71A Distortion and Noise Meter. It eliminates lengthy calculations and intricate setups. It is designed to provide accuracies conforming to FCC regulations and is particularly useful for broadcast stations in the master control room or at the transmitter.

The BI-11A Transmission Measuring Set consists of a volume indicator meter, input and output attenuators, an impedance matching system and jacks for convenient connections. A meter multiplier, which is geared to the load impedance shaft, provides an automatic correction for changes in load impedance. Convenient switches allow the volume indicator to be connected to the input of the attenuator system or to jacks for external connection. An output impedance switch allows matching to 600-250-150-16-8-4 ohm circuits.

Level controls, switches, jacks and VU meter are located on the front of a standard 19 inch rack-type panel. The panel hinges forward to provide ready access to attenuators, jacks, switches and other components. Unit type assemblies (individual sections, such as source, attenuation and load) are readily removable for servicing. Each section is a complete assembly with its own jacks and terminal block.

SPECIFICATIONS

Frequency Range.....	20 to 20,000 cycles
Accuracy (independent of level from +4 to -110 dbm):	
Overall.....	± 0.1 db, 20 cycles to 20 kilocycles
Source and Load Impedances for Dial Indicators	
Over Entire Range.....	Within $\pm 2\%$
Network Resistors.....	$\pm 1.0\%$
Source Characteristics:	
Shielded Output can be used equally well on either balanced or unbalanced equipment	
Ranges (in steps of 0.1 db).....	+4 to -110 db -10 to -124 db
Range of Impedance:	
Internally Terminated.....	600-150 ohms
Unterminated.....	600-250-150-30 ohms
Internal isolation network for operating into non-linear devices.	
Load Characteristics (resistive load, ungrounded):	
Range of Load Levels.....	+4 to +42 VU @ 600 ohms
Range of Impedance.....	600-250-150-16-8-4 ohms
Dimensions.....	19" wide, 7" high, 8 1/4" deep
Weight.....	25 lbs.
Finish.....	Light umber gray

Ordering Information

Type BI-11A Transmission Measuring Set..... MI-11350

Accessories

Low Distortion Push Button Oscillator..... MI-30028-A
Distortion and Noise Meter..... MI-30071-A

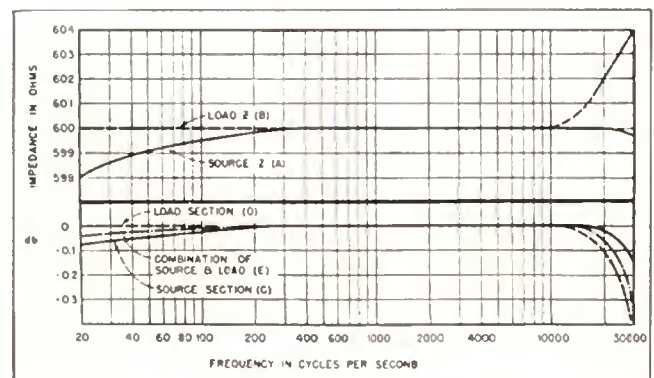

Transmission Measuring Set

MI-11351

FEATURES

- Simplifies measurement of transmission characteristics of audio systems
- Generates signals ranging from mike to line level
- Measures signals from noise to line levels
- Wide frequency range
- Self-contained low distortion oscillator



DESCRIPTION

The Transmission Measuring Set, Model 452A, is a simplified, accurate and direct-reading instrument designed for use in the following applications: (1) audio gain measurements; (2) direct audio voltage and level measurement; (3) signal to noise ratio; (4) frequency response measurements; (5) low distortion signal source for distortion measurements. This unit combines both measuring and generating devices into one compact and easily mounted instrument. The precision AC volt meter incorporated in the 452A permits direct measurements of all levels from noise to line.

The OUTPUT section of the instrument consists of a continuously variable oscillator which delivers +20 dbm into a precision decade attenuator followed by a repeat coil. A panel switch permits instantaneous stopping of the repeat coil to match loads of 50, 150, 250, or 600 ohms, all balanced. A panel switch permits the repeat coils to

be by-passed. Fine Output Control permit adjustment of signal output. When the "Meter Reads" switch is in the "Output Level" position, the output is read automatically on the meter. The meter reading is simply added to the reading of the decade attenuator. No correction factor for impedance setting is required.

The INPUT section consists of an amplifier AC voltmeter. An input repeat coil is switch strapped for matching or bridging circuits of 50, 150, 250, or 600 ohms balanced or unbalanced. A fifth position on this Input Impedance Selector connects the set's input terminals directly to the voltmeter, by-passing the repeat coil. The meter range switch is a decade attenuator of twelve positions. Levels above +20 dbm may only be read with the repeat coil out of the circuit ("high impedance" position). Because a linear meter movement is used, levels as low as -80 dbm may be read directly.

SPECIFICATIONS

GENERATOR:

Frequency Range:	
600 ohms unbalanced	9 cps-100 kc
50, 150, 250, and 600 ohms balanced	15 cps-50 kc
Frequency Accuracy	±1% (±1 cps)
Output Level Accuracy:	
600 ohms unbalanced	±¼ db 10 cps-100 kc
150 and 600 ohms balanced	±¼ db 15 cps-15 kc
50 and 250 ohms	±½ db 15 cps-50 kc
	Relative
Output Impedance Accuracy:	
600 ohms unbalanced	±5% 9 cps-100 kc
150 and 600 ohms balanced	±5% 30 cps-15 kc
50 and 250 ohms balanced	Relative
Distortion	0.1% max. 50 cps-15 kc up to +18 dbm output
Noise	80 db below full output
Output Level Range	Continuously variable from +20 dbm to -70 dbm

LEVEL-METER:

Calibration Accuracy:	
Unbalanced (10 Megohms)	±¼ db 10 cps-100 kc
150, 600 ohms balanced	±¼ db 15 cps-15 kc
50, 250 ohms balanced	±½ db 15 cps-50 kc
	Relative
Input Impedance Accuracy (Matching):	
150, 600 ohms balanced	±5% 30 cps-15 kc
50, 250 ohms balanced	Relative
Input Impedance (Bridging-1 kc)	Above 10 k ohms
Meter Scales	0.1 and 0.3 volts; -12 to +2 dbm
Meter Ranges in dbm at all nominal impedances	-60 dbm to +50 dbm in 10 db steps
Meter Residual Noise	40 db below full scale on all ranges
Tube Complement:	
	4-6AK5, 1-OA2, 1-6AU6, 1-5687, 1-5Z4
Power Requirements	115/230 volts a-c, 60 cy., 70 watts
Dimensions Overall	19" wide, 7" high, 10" deep
Weight	27 lbs.

Ordering Information

452 Waveforms Transmission Measuring Set including tubes MI-11351



455A TRANSMISSION MEASURING SET

DESCRIPTION

Waveforms' Inc. Model 455A Transmission Measuring Set permits simplified, accurate and direct-reading measurements for many audio applications including: audio gain, direct audio level and voltage, signal-to-noise ratio, frequency response, and low-distortion signal source for distortion measurements. Both measuring and generating devices are contained in a compact and easily rock-mounted Model 455A, or a convenient portable case Model 455A-R.

SPECIFICATIONS

Generator:

Frequency Range:	9 cps to 120 kc
600 ohm, unbalanced	35.7, 150, 250, and 600 ohms balanced
	15 cps—50 kc
Frequency Accuracy	±1% (±1 cps)
Output Level Accuracy:	
600 ohm, unbalanced	±1/4 db, 9 cps—120 kc
150 and 600 ohm balanced	±1/4 db, 15 cps—15 kc
37.5 and 250 ohm balanced	Relative
Output Impedance Accuracy:	
600 ohm, unbalanced	±5%, 9 cps—120 kc
150 and 600 ohm, balanced	±5%, 30 cps—15 kc
37.5 and 250 ohm, balanced	Relative
Distortion	1/10% max. 30 cps—15 kc up to +10 dbm output
Noise	80 db below full output
Output Level Range	Continuously variable from +20 dbm to -70 dbm

Level Meter:

Calibration Accuracy	±1/4 db 10 cps—100 kc
Input Impedance Accuracy	±5%
Input Impedance	150 and 600 ohms; + bridging (7500 ohms)
Scale	-10 dbm to 0 dbm

Power Requirements	115/230 volts, ac, 50-400 cycles
Dimensions (overall)	19" relay-rock panel, 7" high, 9" deep
Weight	20 lbs.

Ordering Information

Waveforms' Inc. Transmission Measuring Set with relay rack panel	Model 455A
Waveforms' Inc. Transmission Measuring Set in portable carrying case	Model 455A-R



454A ATTENUATOR BOX

DESCRIPTION

Waveforms' Model 454A Attenuator Box is a simple, non-electronic, portable instrument which will convert any oscillator into a complete accurate signal generator. A decade attenuator permits selection of levels from -95 dbm up to the full capability of the oscillator. (+8 dbm in the case of the Waveforms' Model 510B, or +20 dbm used with Waveforms' Model 401B.)

The Attenuator has a switch permitting the unit to be matched to any of four impedances.

SPECIFICATIONS

Input	Any oscillator (balanced or unbalanced)
Output	-95 dbm to +15 dbm (depending on power capability of the oscillator)
Output Reading Accuracy	±1/4 db, 30-15,000 cps ±1/2 db, 15-50,000 cps
Output Impedance Accuracy	±5%, 30-15,000 cps
Impedance Settings	37.5, 150, 250, and 600 ohms balanced or unbalanced regardless of input
Meter	Direct reading in dbm
Styling	Portable carrying case, or panel mounting
Finish	Gray enamel
Overall Dimensions:	
Portable Model 454A	7 1/2" high, 6" wide, 5" deep
Rock Model 454A-R	7" high, 19" wide, 5" deep
Weight	5 3/4 lbs. approx.

Ordering Information

Waveforms' Inc. Attenuator Box in portable carrying case	Model 454A
Waveforms' Inc. Attenuator Box in rock mounting panel	Model 454A-R

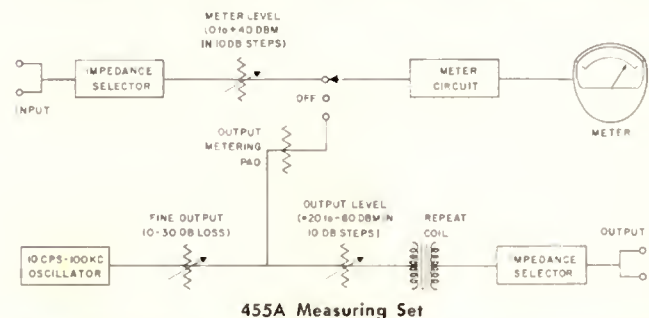

Extended Range Oscillator

MODEL 510B

FEATURES

- Lightweight portable instrument
- 18 cycles to 1.1 megacycles
- Distortion less than 2/10 per cent over useful range
- Constant output $\pm 1/2$ db
- Calibrated output voltage—Logarithmic control assures convenient adjustment at low levels

DESCRIPTION

Waveforms' Model 510B Extended Range Oscillator is a precision source of sinusoidal signals in the audio and ultrasonic range. This compact oscillator of extreme reliability, wide range and low distortion is an ideal instrument for studio, laboratory or rugged field service use. It is small enough to be carried conveniently in a briefcase, yet it covers the range of 18 cps-1.1 mc and delivers 10 volts to a 2,500-ohm load (output impedance is 400 ohms).

The total harmonic distortion of the output waveform of the Model 510B will be less than 2/10 per cent over most of the useful range, when operated with a high impedance load of 10,000 ohms or more. Some increase in distortion will occur near maximum output and at very low frequencies as shown in the curve. Distortion for load current of two milliamperes RMS is less than 1 per cent over most of the useful range. Noise is less than 3 millivolts. The output control is logarithmic and calibrated approximately in volts. This assures convenient adjustment at low levels.

For applications where it is necessary to operate the Model 510B with balanced output, bolt-on transformers provide balanced 600/150-ohm outputs. The transformer is supplied in a small matching case which is fastened securely to the bottom of the Model 510B as shown in the photograph. Strapping is provided so that the oscillator may be used with or without the transformer. The Model T-10 Balanced Matching Transformer provides 150 or 600 ohms balanced source, flat $\pm 1/2$ db from 20 cycles to 50 kc, with a maximum output of +8 dbm. Frequency Response is $\pm 1/2$ db from 20 cycles to 50 kc, and impedance transformer terminals will be 600 or 150 ohms, ± 5 per cent from 18 cycles to 50 kc. A T-11 Balanced Matching Transformer provides 135 or 600 ohms balanced source, flat $\pm 1/2$ db from 30 cps to 200 kc at 600 ohms or $\pm 1/2$ db from 20 cycles to 150 kc at 135 ohms, and power output +10 dbm.



Model 510B Extended Range Oscillator with optional Model T-10 Matching Transformer.

SPECIFICATIONS

Frequency Range	18 cps to 1.1 mc in five overlapping ranges: 18-210 cps, 180-2,100 cps, 1,800-21,000 cps, 18-210 kc, and 180 kc-1.1 mc
Distortion	Less than 2/10% over useful range when operated with high impedance load of 10,000 ohms or more; for load current of two milliamperes RMS will be less than 1% over useful range.
Output	Constant within $\pm 1/2$ db from 18 cps to 200 kc at any setting of output control above 0.1 volt
Output Level	10 volts open circuit; max. load current 4 ma RMS; max. output +15 dbm into 2000 ohm load
Output Control	Logarithmic control calibrated approx. in volts
Internal Impedance	400 ohms
Calibration Accuracy	$\pm 2\%$ from 18 cycles to 210 kc (+1% available on special order) $\pm 10\%$ to 1.1 mc
Stability	2/10% for line voltage range from 105 to 130 volts, and $\pm 1/2\%$ for temperature range from 0 to 50°C, from 18 cycles to 100 kc
Hum and Noise Level	$1/2$ millivolt or 60 db below signal, whichever is greater
Tube Complement:	1-6SJ7, 2-6AK6, 1-6X4
Power Supply	40 VA, 117 volts (nominal), 50-400 cycles
Finish	Gray enamel (unless otherwise specified)
Dimensions (overall)	6" high, 4 1/4" wide, 6" deep
Weight	6 lbs
Ordering Information	
Waveforms' Inc. Extended Range Oscillator	Model 510B
Waveforms' Inc. Matching Transformer (150/600 ohms balanced operation)	Model T-10
Waveforms' Inc. Matching Transformer (135/600 ohms balanced operation)	Model T-11

GENERAL PURPOSE OSCILLATOR, MODEL 401B

FEATURES

- 9 cycles to 120 kc
- 0.1 per cent distortion
- +22 dbm output
- Step attenuator

The Model 401B is a general purpose Audio Oscillator featuring +22 dbm power capability and an output attenuator. It has extended frequency range of 9 cycles to 120 kc, with constant output $\pm 1/2$ db and calibration accuracy of ± 2 per cent (± 1 per cent on special order). The stability is $\pm 1/2$ per cent with temperature and line voltage and maximum output is 20 volts open circuit or 10 volts into 600 ohms (+22 dbm). Distortion is less than 1/10 per cent. A step attenuator and logarithmic output control calibrated approximately in volts, for levels down to 1 millivolt is provided. Source impedance 600 ohms unbalanced. Power, 115/200 volts, ± 10 per cent, 50-4000 cps. Weight is 12 pounds.



Ordering Information

Waveforms' Inc. Audio Oscillator Model 401B

AMPLIFIER-VOLTMETER, MODEL 520A

FEATURES

- 10 cycles to 2 megacycles
- 1.0 millivolt full scale
- 12 ranges to 300 volts

The Model 520A is a stable, general purpose AC voltmeter, null indicator, and decade amplifier, featuring high input impedance for negligible circuit loading, full-wave average rectifier for minimum waveform error, and extremely low pick-up from stray fields and power line.

The meter range extends from 1.0 millivolt full scale to 300 volts, permitting measurements to 100 microvolts and useful indications at still lower levels; -60 to +50 dbm full scale in 10 dbm ranges. Its accuracy is ± 3 per cent, 20 cycles to 1 mc; or ± 5 per cent 10 cycles to 2 mc and stability is ± 1 per cent with line voltage from 105-130 volts. The input impedance is 10 megohms shunted by 24 mmf; and amplifier gain is 1000. The meter is protected against overload. The equipment weighs 6 lbs. The voltmeter consumes 40 watts, 50-400 cycles, 115/230 volts ± 10 per cent.



Ordering Information

Waveforms' Inc. Amplifier-Voltmeter Model 520A

Audio Test Equipment

MODEL 410 DISTORTION METER



SPECIFICATIONS

Distortion Meter
 Frequency Range..... From 20 through 20,000 cps
 and indicates harmonics up to 100,000 cps
 Distortion Levels..... As low as .1%
 Distortion ranges provided..... 1% full scale,
 3%, 10%, 30% and 100% (full scale)
 Signal Levels..... .1 volt to 30 volts rms
 Input Impedance..... 100,000 ohms

Voltmeter
 Input Impedance..... 1 megohm
 Frequency Range..... 20 to 200,000 cps
 Accuracy..... $\pm 5\%$ on measurements from .0005 volt to 300 volts
 Residual Noise..... Less than .02 millivolts
 Noise and db Measurements..... Instrument calibrated at 1 db steps
 from 0 db to -15 db. Attenuator provides additional ranges
 from -60 db to +50 db in 10 db steps

Voltmeter Output Terminals..... Provided for scope monitoring
 (.2 volt rms for full scale reading is provided on all ranges)
 Stability..... No appreciable shift in frequency response
 on line voltages between 105 and 125 volts
 Power Requirements..... 115 volts A.C., 50/60 cycles single phase,
 50 watts
 Dimensions Overall..... 11 $\frac{1}{4}$ " wide, 9" high, 9" deep
 Weight..... 11 lbs.
 Finish..... Two tone gray

Ordering Information

Barker and Williamson Distortion Meter..... Model 410

MODEL 210 AUDIO OSCILLATOR



SPECIFICATIONS

Frequency Range..... 10 cps to 100,000 cps
 Bands..... X 1-10 cps to 100 cps
 X 10-100 cps to 1000 cps
 X 100-1000 cps to 10,000 cps
 X 1,000-10,000 cps to 100,000 cps
 Frequency Dial..... 4 $\frac{3}{4}$ " diameter colibroted over 328°
 Frequency Response..... ± 1 db over entire range when connected
 to its characteristic 600 ohm output—Ref. of 5 KC
 Colibration..... $\pm 2\%$, over entire range. 10 cps to 100,000 cps
 Power Output..... Up to 10 volts into 600 ohm load
 Waveform Distortion..... Less than .2% at 5 volts output
 from 50-20,000 cps. Slightly higher at greater output levels and
 frequency extremes
 Output Impedance..... 600 ohms balanced, with center tap
 600 ohms unbalanced, 150 ohms unbalanced
 Hum and Noise Level..... 70 db down at 5 volts output
 Integral Power Supply..... Operates from 115 volts, AC,
 single phase, power consumption 50 watts
 Dimensions..... 6" wide, 9" high, 12" deep
 Weight..... 11 lbs.
 Finish..... Two-tone umber gray

Ordering Information

Barker and Williamson Audio Oscillator..... Model 210

Recommended Wiring Practices

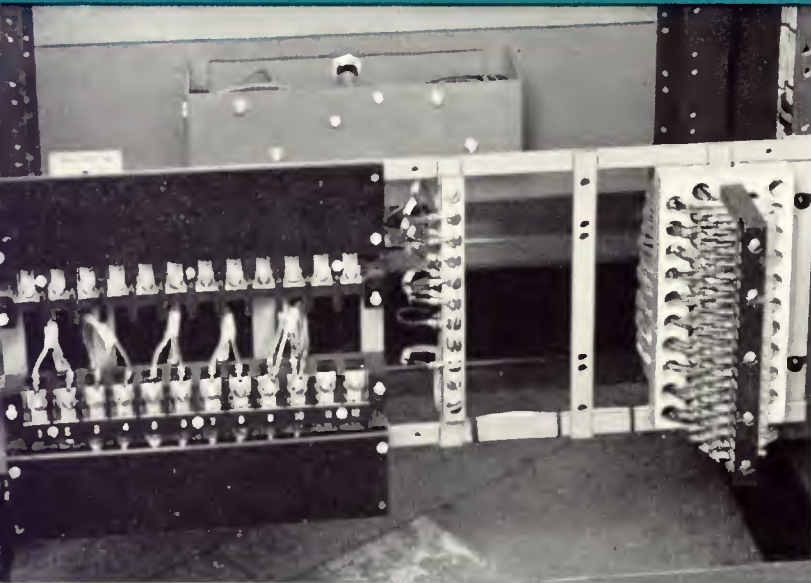

Photo of terminals at bottom of rack. Power terminals are at left, ground bus in center and audio terminals at right.

Almost every studio undergoes minor modifications from time to time, and the subject of proper wiring practice is raised. Modern standards require careful elimination of noise and crosstalk from the program circuits. It is not uncommon to spend many hours wiring in new components, only to find their performance reduced by the wiring itself. A tested and proven standard practice can avoid much wasted time.

There are two basic philosophies employed in practical approaches to the noise problem. In one system every circuit shield is carefully isolated from its neighbors and grounded at one point only. In the other, all the shields of one unit (such as a rack) are put in such close contact that a brute-force ground is provided for any stray currents that might be present. This latter approach is taken in RCA equipment with modifications as follows:

Every rack, cabinet or desk is wired as a unit to terminal boards. The terminal boards are placed as near as possible, consistent with accessibility, to the point where the external circuits enter the unit.

In a rack, as viewed from the back, all audio cables are run on the right side of the rack; and all signal, a-c and d-c power cables are run on the left side. All audio circuits are twisted pair conductors shielded with a tinned copper braid. Separate cables are formed for:

- (a) Microphone outputs, preamplifier outputs and other audio circuits with levels below -20 vu.
- (b) Mixer, line and channel circuits up to $+30$ vu.

- (c) Loudspeaker and other lines above $+30$ vu.
- (d) At times further subdivisions are made for convenience in bulk or because levels are widely separated.

Each cable is bound with lacing cord so the shields are in tight contact for their entire length. Where two audio cables cross or join, they should either be definitely insulated or bound together. It is better to have tight contact than to risk an intermittent noise source made by casual contact.

The ends of the individual shields are terminated either with "wedge-on" collars or with plastic tape. The shields are grounded to a main ground bus near the terminal block. A shielded ground lead is run from each amplifier chassis to the ground bus.

The a-c and d-c power circuits are handled similarly. All a-c circuits should be in twisted pair, shielded cable. The a-c current should be balanced in each pair. That is, one pair should not be used for one side of a circuit and a second pair for the other side. If more than one pair is needed for the load, two or more pairs should be used with part of the load on each. Plus and minus plate potentials should be carried in single conductor shielded cable. Shields are tied off and grounded the same as the audio circuits.

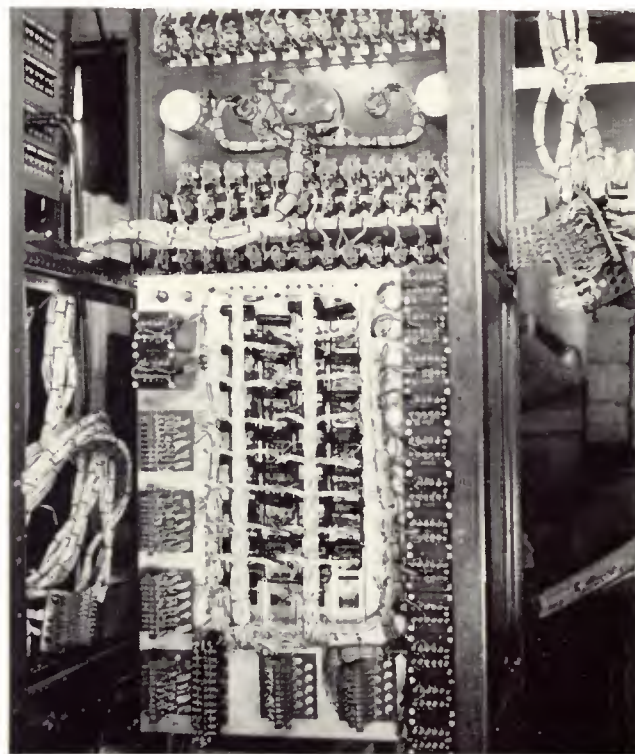

View of wiring at rear of a typical audio relay switcher and control panel. Equipment is mounted in standard broadcast rack.

Signal circuits do not require shielded wire.

The frames of jocks should be tied together and grounded with a shielded wire the same as amplifier chassis.

In installing the equipment in a studio or control room the following rules have been found useful:

The pairs run in conduits should be grouped in the same general way as the cables in the racks. The audio conduits should be kept free from grounds to power conduits or power circuits. Low level audio circuits (less than -30 vu) should have the shields insulated from the conduits and from each other.

Splices should be avoided. Low level conduits should be well spaced from power conduits.

Signal and telephone circuits should not be run in the same conduit with program or power circuits. Telephone leads should be twisted pair. Power and audio grounds should consist of separate, heavy shielded leads to the main station ground.

TV circuits in general should be considered high level circuits and should therefore be kept away from low level audio circuits. In particular, pulsed lamp circuits should be routed as far away from projector photocell and pre-amplifier circuits as possible. Shields should be insulated from ground and the audio circuit and shield grounded only at the point of lowest level.

Typical good grounding practice for microphones, in which two conductor shielded wire with insulation over the shield is used for conduit run and microphone card is shown in diagram (A) above. Below (B) shows somewhat better practice in which 3-conductor shielded, insulated cable is used for the conduit run and microphone card. This latter practice removes any ground current from the shield.

Turntable pickup circuits should be handled like micro-

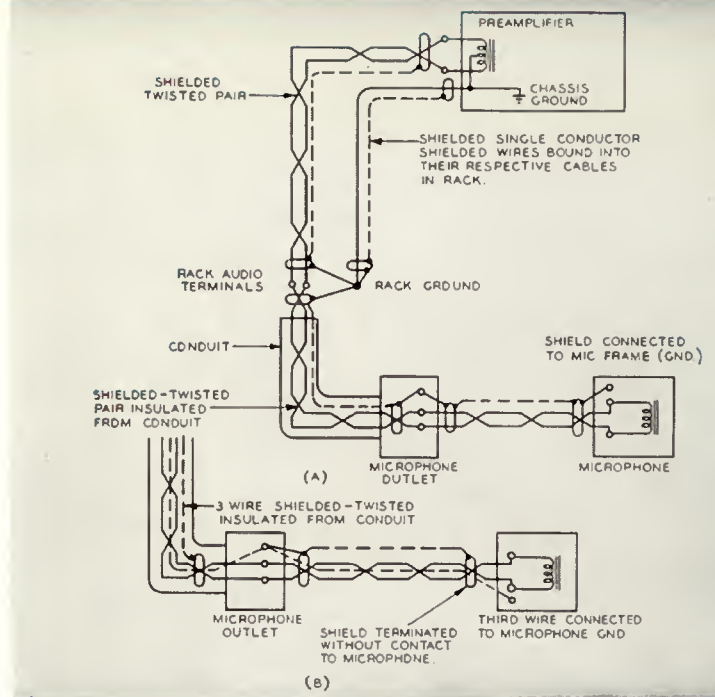

Diagram showing typical microphone grounding practices.

phones with particular care being taken to keep motor power circuits and shields away from audio circuits.

The input to mixer circuits is usually at comparatively high level, but the output is frequently very close to microphone level and the circuits should be treated in the same way. The diagram below shows good grounding practice in this respect. Unbalanced circuits may be used but are usually more difficult to handle if there is noise present. It will be noted that the only ground to this part of the system is at the point of lowest level and that all the circuits are balanced to ground. The center taps of the mixer attenuators are only tied to ground if special noise difficulty is encountered and tests indicate improvement. This may happen on circuits which connect to remote lines or studio equipment with separate ground systems.

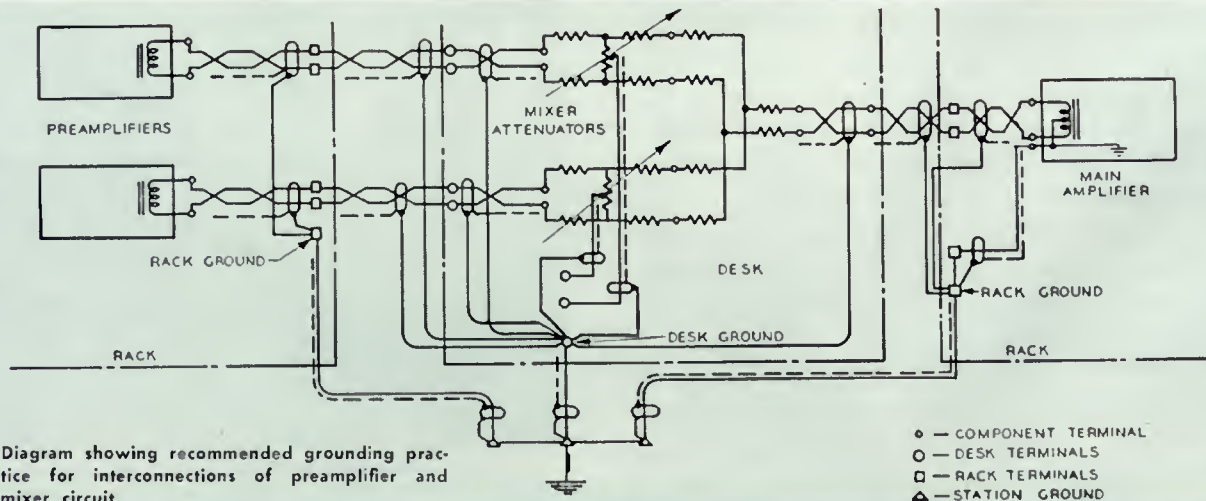

Diagram showing recommended grounding practice for interconnections of preamplifier and mixer circuit.

- ◇ — COMPONENT TERMINAL
- — DESK TERMINALS
- — RACK TERMINALS
- △ — STATION GROUND

Standards For Audio Facilities

FOR RADIO BROADCASTING SYSTEMS

(From EIA Standard TR-105-B and Standards Proposal No. 599 formulated under the cognizance of the EIA Engineering Committee TR-10 on Broadcasting Audio Facilities)

Reprinted through the courtesy of Electronics Industries Association

1. Standard Conditions for Systems Measurements for Audio Facilities for Radio Broadcasting Systems

In order to correlate the measurements made on audio facilities it is necessary to define and fix certain reference points; these follow:

1.1 STANDARD INPUT SIGNAL

The "Standard Input Signal" shall be a voltage of 2.45 millivolts, rms, in series with 150 ohms.

Note: For purposes of calculating insertion gain this corresponds to an input level of -50 dbm.

1.2 STANDARD OUTPUT LEVEL

The "Standard Output Level" for audio facilities for radio broadcasting systems shall be as follows:

1.2.1. For facilities feeding telephone lines the "Standard Output Level" shall be +18 dbm.

1.2.2. For facilities feeding radio transmitters the "Standard Output Level" shall be +12 dbm.

2. Electrical Performance Standards for Audio Facilities Systems for Radio Broadcasting

These standards cover the over-all performance of all audio facilities from the input terminals of the microphone pre-amplifier to the input terminals of the main transmitter, excluding the S-T link which may be either wire line or radio. No pre-emphasis is included in the audio facilities.

2.1 AUDIO-FREQUENCY RESPONSE

Definition

Audio-frequency response is the transmission efficiency expressed in db relative to that at 1000 cycles per second, within the specified frequency range.

Minimum Standard

The response shall lie between two limits. The upper of these limits shall be uniform from 50 to 15,000 cycles per second. The lower shall be uniform from 100 to 7,500 cycles per second, and 2 db below the upper limit. In addition, the lower limit shall be an additional amount down at 50 and at 15,000 cycles per second determined by decrease at a uniform rate of 1 db per octave below 100 cycles per second and 2 db per octave above 7,500 cycles per second.

Method of Measurement

Refer to 5.

2.2 AUDIO-FREQUENCY HARMONIC DISTORTION (SINGLE FREQUENCY)

Definition

The audio-frequency harmonic distortion is the rms* value of the harmonic voltages including, if within the band from 50 to 30,000 cycles, at least the second, third, fourth, and fifth harmonics of the applied single frequency, in per cent of the fundamental frequency value at the output of the equipment under test.

$$*rms = \sqrt{(E_2)^2 + (E_3)^2 + (E_4)^2 + (E_5)^2} \times \frac{100}{E_1}$$

where E_1 = rms value of fundamental voltage

E_2 = rms value of 2nd harmonic voltage

E_3 = rms value of 3rd harmonic voltage, etc.

Minimum Standard

Under specified conditions the audio-frequency harmonic distortion for fundamental frequencies shall not exceed 1.75% rms from 50 to 100 cycles per second, and 1.0% rms from 100 to 7,500 cycles per second, and 1.5% rms from 7,500 to 15,000 cycles per second at the standard output level. The limits for fundamental frequencies from 7,500 to 15,000 cycles per second are tentative as the present state of the art does not permit an authoritative statement of distortion limits for this frequency range based on subjective listening.

Method of Measurement

Refer to 5.

2.3 AUDIO-FREQUENCY SIGNAL-TO-NOISE RATIO

Definition

The audio-frequency signal-to-noise ratio is the numerical ratio between the sine-wave signal power required for standard output and the noise power measured with zero applied signal, received by the rated load impedance from the output of the equipment under test, expressed as a power ratio in decibels.

Minimum Standard

The signal-to-noise ratio shall be at least 65 db for a frequency band of 50 to 15,000 cycles per second for the system gain required for standard input signal and output level when measured with an instrument having a uniform audio frequency response in the band from 50 to 15,000 cycles per second.

Method of Measurement

Refer to 5.

3. Standards for Audio Facilities Components for Radio Broadcasting Systems

3.1 MICROPHONE

Definition

A microphone is an electro-acoustic transducer which generates electrical energy when placed in a sound field. A transformer or amplifier or both if intimately associated with the transducer in one housing shall be considered part of the microphone, and the term "microphone" shall apply to the combination.

Minimum Standard

The nominal impedance of all microphones intended for broadcasting service shall be 150 ohms ± 10 per cent when measured at a single frequency of 1000 cycles per second ± 10 per cent.

3.2 PRELIMINARY AMPLIFIER

Definition

A preliminary amplifier is an amplifier which operates from a microphone or other low-level source. Its function is to amplify the microphone output or other signal to a level that can be fed into a subsequent circuit without the signal-to-noise ratio being degraded thereby.

Minimum Standard

A preliminary amplifier, intended for broadcasting service shall be designed to operate from a source impedance and into a load impedance of 600/150 ohms.

3.3 BOOSTER AMPLIFIER

Definition

A booster amplifier is an amplifier which is connected in the main program line between the preliminary amplifier and the program amplifier.

Minimum Standard

A booster amplifier, intended for broadcasting service, shall be designed to operate from a source impedance and into a load impedance of 600/150 ohms.

3.4 PROGRAM AMPLIFIER

Definition

A program amplifier is an amplifier which is connected in the main program channel and is capable of delivering a standard output level.

Minimum Standard

A program amplifier, intended for broadcasting service, shall be designed to operate from a source impedance and into a load impedance of 600/150 ohms.

3.5 BRIDGING AMPLIFIER

Definition

A bridging amplifier is an amplifier whose internal input impedance is such that it may be connected across a circuit without appreciably affecting the circuit perform-

ance in any respect. Its function is to operate into program circuits or similar loads.

Minimum Standard

A bridging amplifier, intended for broadcasting service, shall be designed to operate across a circuit having an iterative impedance of 600/150 ohms and into a load impedance of 600/150 ohms.

3.6 MONITORING AMPLIFIER

Definition

A monitoring amplifier is an amplifier connected to a program circuit so as to provide a means of checking the program.

Minimum Standard

A monitoring amplifier, intended for broadcasting service, shall be designed to operate from a source impedance of 600/150 ohms and/or across a circuit having an iterative impedance of 600/150 ohms. In the latter case, the internal impedance shall be such that the amplifier may be connected across the program circuit without appreciably affecting the circuit performance. If intended to operate directly into loudspeaker lines, the amplifier shall deliver rated power output of 70 volts.

If intended to operate into loudspeaker voice coils, the amplifier shall operate into load impedances of 4 to 16 ohms inclusive.

4. Standard Definitions for Audio Facilities for Radio Broadcasting Systems

4.1 GAIN

Definition

4.1.1. *Insertion Gain* is the ratio, expressed in db, of the power delivered to the load, to the power which would be delivered to the same load before insertion of the amplifier or system.

4.1.2. *Bridging Gain* is the ratio, expressed in db, of the power delivered to the bridging amplifier load to the power in the load across which the input of the amplifier is bridged.

4.2 AUDIO-FREQUENCY RESPONSE

Definition

Audio-frequency response is the transmission efficiency expressed in db relative to that at 1000 cycles per second within the specified frequency range.

4.3 AUDIO FREQUENCY HARMONIC DISTORTION (Single Frequency)

Definition

The audio-frequency harmonic distortion is the rms* value of the harmonic voltages including, if within the band from 50 to 30,000 cycles, at least the second, third, fourth, and fifth harmonics of the applied single

frequency, in per cent of the fundamental frequency voltage at the output of the equipment under test.

$$*rms = \sqrt{(E_2)^2 + (E_3)^2 + (E_4)^2 + (E_5)^2} \times \frac{100}{E_1}$$

where E_1 = rms value of fundamental voltage
 E_2 = value of 2nd harmonic voltage
 E_3 = value of 3rd harmonic voltage, etc.

4.4 AUDIO-FREQUENCY SIGNAL-TO-NOISE RATIO

Definition

The audio-frequency signal-to-noise ratio is the numerical ratio between the sine-wave signal power required for standard output and the noise power measured with zero applied signal, received by the rated load impedance from the output of the equipment under test, expressed as a power ratio in decibels.

4.5 AMPLIFIER IMPEDANCES

4.5.1. Input Impedance

The input impedance is the internal input impedance measured at the input terminals of an amplifier.

4.5.2. Output Impedance

The output impedance is the internal output impedance measured at the output terminals of an amplifier.

4.5.3. Source Impedance

The source impedance is the impedance from which an amplifier is designed to operate.

4.5.4. Load Impedance

The load impedance is the impedance into which an amplifier is designed to operate.

5. Method of Measurement

5.1 CONDITIONS FOR TEST

5.1.1. General Conditions.

The facility under test shall be measured under the following conditions:

(a) Power Supply

The facility shall be operated from its rated power supply voltage and frequency. When a range of line voltage values is indicated for specified power input terminals the arithmetic mean of the voltage specified for this range shall be applied. The frequency of the power supply shall be within ± 2 per cent of the lowest frequency specified. The rms harmonic content of the power supply system shall not exceed 10 per cent.

(b) Vacuum Tubes

The vacuum tubes used shall not be specially selected but shall have the rated values and representative characteristics which appreciably affect the gain, distortion, and noise of the facilities under test. The

same set of tubes shall be used throughout the series of tests of frequency response, distortion and noise for any specific facility.

(c) Preliminary Operation

All measurements to determine compliance with minimum standards shall be made after the facility has been operated for not less than one hour and delivering an output at 1000 cycles per second 10 db less than the standard output for the facility.

EXPLANATORY

It is not the intent of this section to obviate the necessity of the facility operating satisfactory immediately after complete warmup of the vacuum tubes.

(d) Terminations

Terminations, as required, simulating source impedance and load impedance, respectively, shall be substantially non-reactive resistors having values within ± 5 per cent of the standard values for the source and load impedances, respectively, of the facility under test.

(e) Grounding

The facility under test shall have all ground or freedom from ground connections the same as specified for actual service operation. Proper shielding and grounding of the measuring circuits and equipment which may be necessary to preclude erroneous indications attributable to interaction between the measuring equipment and the facility under test is also assumed.

(f) Measuring Instruments

All measurements shall be made with instruments having sufficient accuracy to insure no appreciable error in the result of the measurement of the facility under test due to measuring instruments. In addition each instrument shall have self-calibrating means incorporated and/or sufficient inherent stability to allow duplication of any measurement after a one hour interval.

5.1.2. Gain Adjustments

(a) Gain

The gain control or controls of the facility under test shall be so set that standard output level is obtained at the output when standard input level at 1,000 cycles is applied.

If a VU meter is incorporated, it shall remain as normally connected and its multiplier shall remain as set for a signal which is 10 db below standard output level.

EXPLANATORY

This is to insure measurements of distortion caused by the meter at normal operating level. (See latest

issue ASA Standard C 16.5 which indicates that vu meters will safely withstand a continuous overload of five times the voltage required for reference deflections.)

(b) *Gain Control Settings*

If more than one gain control is incorporated in the facility under test, the attenuation necessary to obtain the required gain shall be, as nearly as possible, equally divided among all of the gain controls in the main transmission path of the facility. In any event the control settings shall remain the same for frequency response, distortion and noise measurements.

5.1.3. *Frequency Response Measurements*

(a) *General*

For frequency response measurements the spurious components of the signal source shall not represent more than 10 per cent (rms) of its output voltage. The testing technique shall be such that the input signal of the facility under test is held constant at standard input signal unless otherwise specified.

(b) *Testing Frequencies*

Measurements shall be made at 50, 100, 400, 1,000, 5,000, 7,500, 10,000 and 15,000 cycles per second as a minimum. In addition, further measurements at several intermediate frequencies shall be made if the response at any of the enumerated frequencies is more than 0.2 db different from the next higher or lower enumerated frequency.

(c) *Testing Levels*

Two gain frequency response tests shall be made. The first shall be at the standard input signal and the second shall be at a level 20 db lower.

5.1.4. *Single Frequency Harmonic Distortion*

(a) *General*

The test frequencies shall be obtained from an essentially distortion free source. The maximum distortion of this source shall be not more than 10 per cent of the distortion generated by the facility being measured or 0.1 of 1.0 per cent whichever is the greater. The rated accuracy of the measuring equipment shall include any distortion in the equipment. The output of the facility under test must be terminated by a resistor equivalent to its rated load impedance.

(b) *Testing Frequencies*

Harmonics shall be measured of fundamental frequencies of 50, 100, 400, 1,000, 5,000, 7,500, 10,000 and 15,000 cycles per second.

(c) *Testing Levels*

Harmonic measurements shall be made at two output levels. These levels shall be standard output level and a level 20 db lower than standard output level.

5.1.5. *Noise Measurement*

(a) *General*

The input of the facility under test shall be terminated in a resistor equivalent to the rated source impedance of the facility. If more than one input source is included in the facility (for example, several preliminary amplifiers) the gain controls and switches associated with such additional sources shall be so adjusted that only the input source for which the measurement is being made is active.

The signal level for determining the signal-to-noise ratio shall be measured at 1,000 cycles per second.

(b) *Measuring Instrument*

Measurement of steady state noise shall be made with a device having an audio frequency response flat within ± 2 db from 50 to 15,000 cycles per second and having the ballistic characteristics of the standard vu meter (see latest issue ASA C16.5) but reading the rms value of a complex wave. Measurement of pulse noise conditions has not been included because of lack of definition and equipment.

EXPLANATORY

Measurements made on these instruments incorporating average rather than rms rectifiers will give indications differing in general less than one db from the latter due to this difference. This is within the overall accuracy ordinarily obtained on this type of measurement.

5.1.6. *Intermodulation Distortion Measurement*

EXPLANATORY

There is not sufficient data available at time of this printing based on subjective observation to establish recommended conditions for test for intermodulation distortion.

5.2 TESTING CIRCUITS

5.2.1. *General*

A typical measuring system for audio facilities is shown in Figure 1. The input and output circuits include any requisite isolating coils, fixed matching networks and output load resistance as well as appropriate provision for the ground or lock of ground of the input and output terminals of the facility under test.

5.2.2. *Gain and Frequency Response*

(a) *Procedure*

Gain and frequency response are determined essentially by the settings of calibrated attenuators connected to the input and output of the facility under test while maintaining substantially constant deflections on the indicating instruments.

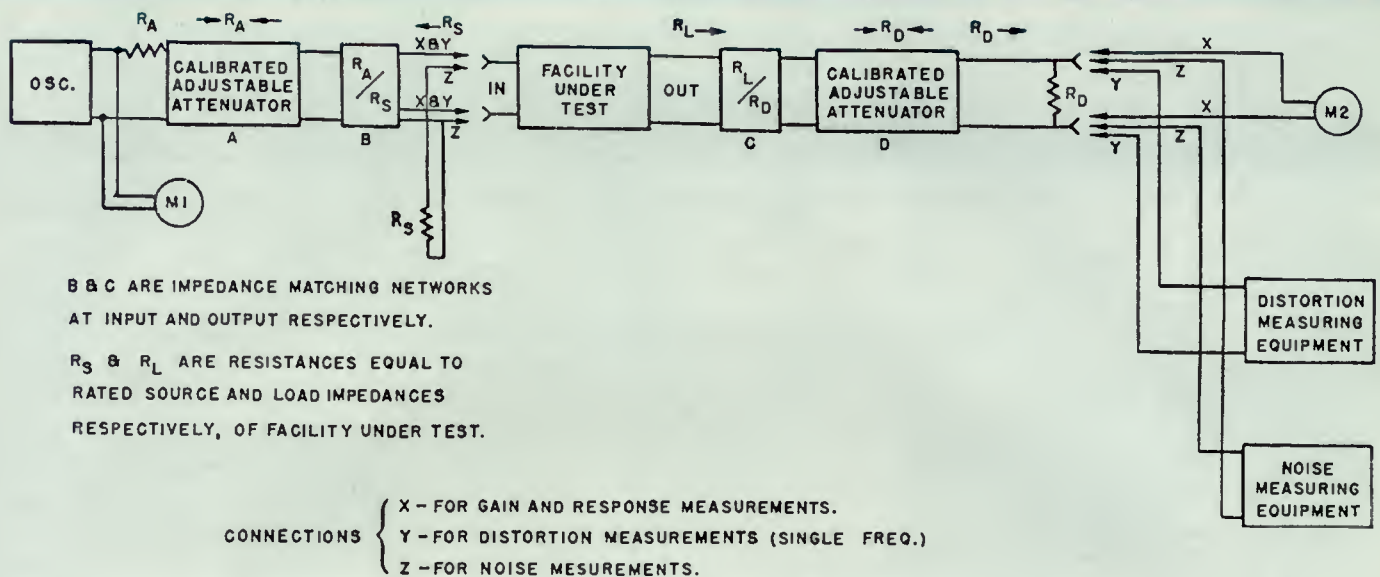

Figure 1. Typical Measuring System for Audio Facilities

Insertion Gain for Facility Under Test

$$= A + B + C + D + 10 \log_{10} \frac{4 (E_{M2})^2 R_A}{(E_{M1})^2 R_D}$$

(See Figure 1)

where A is the attenuation in db of the calibrated input attenuator

B is the attenuation in db of the input impedance matching network

C is the attenuation in db of the output impedance matching network

D is the attenuation in db of the calibrated output attenuator

E_{M1} is the voltage indicated by M1

E_{M2} is the voltage across the load resistor indicated by M2

R_A is a resistance equal to the iterative impedance of the calibrated input attenuator

R_D is a resistance equal to the iterative impedance of the calibrated output attenuator

(b) Accuracy

The measuring equipment shall have accuracy such that it shall not introduce errors greater than ± 1.0

Note: It is recommended that the attenuators used shall have an iterative impedance of 600 to 150 ohms.

db for absolute gain measurements nor greater than ± 0.2 db for frequency response measurements.

5.2.3. Single Frequency Harmonic Distortion

(a) Procedure

The same input and output attenuator networks as are utilized for gain and frequency response measurements may be employed. Special precautions may be necessary to insure that no component of the measuring system contributes harmonic distortion and that the distortion measurements are not masked by extraneous components. Ordinarily the instrument used will be either a wave analyzer or a distortion factor meter.

(b) Accuracy

The input impedance of the measuring instrument may be used in combination with a resistance to comprise the load which shall be within ± 1.0 per cent of the rated load impedance. The instrument used shall have accuracy such that it shall not introduce errors greater than 10.0 per cent of the indicated reading ± 0.1 per cent distortion.

5.2.4. Noise Measurement

A standard instrument meeting the requirements of 5.1.5 shall be used.

ATTENUATOR NETWORKS

Impedance Loss, dB	600 Ohms		600 Ohms		600 Ohms		600 Ohms		600 Ohms		600 Ohms	
	R ₁ Ohms	R ₂ Ohms	R ₁ Ohms	R ₂ Ohms	R ₁ Ohms	R ₂ Ohms	R ₁ Ohms	R ₂ Ohms	R ₁ Ohms	R ₂ Ohms	R ₁ Ohms	R ₂ Ohms
0	∞	∞	∞	∞	∞	∞	∞	∞	∞	∞	∞	∞
0.1	50204	50204	7.20	1005000	3.60	1005000	3.58	1005000	0	∞	0	∞
0.2	26280	26280	13.70	57380	6.85	57380	6.82	57380	3.58	1005000	3.6	50000
0.3	17460	17460	20.55	34900	10.28	34900	10.32	34900	6.82	57380	6.9	26086
0.4	13068	13068	27.50	26100	13.80	26100	13.70	26100	10.32	34900	10.5	17143
0.6	10464	10464	34.40	20920	17.90	20920	17.20	20920	13.70	26100	14.1	12766
0.6	8640	8640	41.7	17230	20.85	17230	20.9	17230	17.20	20920	17.7	10169
0.7	7428	7428	48.5	14880	24.25	14880	24.2	14880	20.9	17230	21.6	8333
0.8	6540	6540	55.05	13100	27.53	13100	27.5	13100	24.2	14880	23.2	7143
0.9	5787	5787	62.3	11600	31.2	11600	31.02	11600	27.5	13100	25.0	6250
1.0	5208	5208	68.6	10440	34.3	10440	34.5	10440	31.02	11600	26.7	5504
1.5	3452	3452	104.3	6950	52.1	6950	51.8	6950	34.5	10440	36.6	4918
2.0	2582	2582	139.4	5232	69.7	5232	68.8	5232	51.8	6950	44.4	3174
2.5	2053	2053	175.4	4195	87.7	4195	85.9	4195	68.8	5232	56.7	2316
3.0	1703	1703	212.5	3505	106.2	3505	102.7	3505	85.9	4195	77.7	1796
3.5	1448	1448	258.0	3021	129.0	3021	119.2	3021	102.7	3505	100.2	1452
4.0	1240	1240	287.5	2651	143.8	2651	135.8	2651	119.2	3021	123.9	1209
4.5	1109	1109	324.6	2365	162.3	2365	152.2	2365	135.8	2651	148.8	1025
5.0	987.6	987.6	364.5	2141	182.3	2141	168.1	2141	152.2	2365	175.5	883.7
5.5	886.8	886.8	405.9	1956	203.0	1956	184.0	1956	168.1	2141	203.7	883.7
6.0	803.4	803.4	447.5	1807	223.8	1807	199.3	1807	184.0	1956	233.4	771.2
6.5	730.8	730.8	492.6	1679	246.3	1679	214.6	1679	199.3	1807	265.2	678.7
7.0	685.2	685.2	537.0	1569	268.5	1569	229.7	1569	214.6	1679	298.5	603.0
7.5	652.6	652.6	584.7	1475	292.4	1475	244.2	1475	229.7	1569	333.9	539.8
8.0	625.0	625.0	634.2	1393	317.1	1393	258.4	1393	244.2	1475	371.7	484.3
8.5	525.0	525.0	685.5	1322	342.8	1322	272.3	1322	258.4	1393	411.3	437.6
9.0	487.2	487.2	738.9	1260	369.4	1260	298.9	1260	272.3	1322	453.0	396.8
9.5	453.0	453.0	794.4	1204	397.2	1204	312.0	1204	298.9	1260	498.3	361.2
10.0	421.0	421.0	854.1	1154	427.0	1154	336.1	1154	312.0	1204	545.5	329.9
11.0	367.4	367.4	970.8	1071	489.9	1071	359.1	1071	336.1	1204	595.5	302.2
12.0	321.7	321.7	1119	1002	539.5	1002	359.1	1002	359.1	1204	648.5	277.5
13.0	282.8	282.8	1273	946.1	596.3	946.1	380.5	946.1	359.1	1204	704.5	235.5
14.0	249.4	249.4	1443	899.1	621.5	899.1	400.4	899.1	380.5	946.1	764.5	201.3
15.0	220.4	220.4	1632	859.6	639.2	859.6	418.8	859.6	400.4	899.1	824.5	173.1
16.0	195.1	195.1	1847	826.0	657.2	826.0	438.8	826.0	418.8	859.6	884.5	149.6
17.0	172.9	172.9	2083	797.3	673.7	797.3	451.5	797.3	438.8	826.0	948.5	129.8
18.0	152.5	152.5	2344	772.8	689.2	772.8	465.8	772.8	451.5	797.3	1013.0	113.0
19.0	136.4	136.4	2670	751.7	703.3	751.7	474.8	751.7	465.8	772.8	1078.5	98.68
20.0	121.2	121.2	2970	733.3	718.5	733.3	480.4	733.3	474.8	751.7	1145.5	86.4
22.0	95.9	95.9	3753	703.6	736.6	703.6	511.7	703.6	480.4	751.7	1224.5	66.66
24.0	76.0	76.0	4737	680.8	750.8	680.8	528.8	680.8	511.7	733.3	1315.5	51.72
26.0	60.3	60.3	5985	663.4	769.2	663.4	542.7	663.4	528.8	703.6	1420.5	40.4
28.0	47.8	47.8	7550	649.7	775.5	649.7	554.7	649.7	542.7	703.6	1540.5	31.66
30.0	37.99	37.99	9500	639.2	4750	639.2	563.2	639.2	554.7	703.6	1680.5	24.87
32.0	30.16	30.16	11930	630.9	5967	630.9	570.6	630.9	563.2	703.6	1840.5	19.58
34.0	23.95	23.95	15000	624.4	7500	624.4	576.5	624.4	570.6	703.6	2030.5	15.46
36.0	18.98	18.98	18960	619.3	9480	619.3	581.1	619.3	576.5	703.6	2250.5	12.21
38.0	15.11	15.11	23820	615.3	11910	615.3	585.1	615.3	581.1	703.6	2500.5	9.66
40.0	12.00	12.00	30000	612.1	15000	612.1	588.1	612.1	585.1	703.6	2770.5	7.65

DECIBELS ABOVE AND BELOW REFERENCE LEVEL 1mw INTO 600 OHMS

Voltage applies to 600 ohm circuits only. Power applies to any impedance.

db down		Level dbm	db up	
Volts	Milliwatts		Volts	Milliwatts
0.774 6	1.000	-0+	0.774 6	1.000
0.690 5	.794 3	1	0.869 1	1.259
0.616 7	.631 0	2	0.975 2	1.585
0.548 4	.501 2	3	1.094	1.995
0.488 7	.398 1	4	1.228	2.512
0.435 6	.316 2	5	1.377	3.162
0.388 2	.251 2	6	1.546	3.981
0.346 0	.199 5	7	1.734	5.012
0.308 4	.158 5	8	1.946	6.310
0.274 8	.125 9	9	2.183	7.943
0.244 9	.100 0	10	2.449	10.000
0.218 3	.079 43	11	2.748	12.59
0.194 6	.063 10	12	3.084	15.85
0.173 4	.050 12	13	3.460	19.95
0.154 6	.039 81	14	3.882	25.12
0.137 7	.031 62	15	4.356	31.62
0.122 8	.025 12	16	4.887	39.81
0.109 4	.019 95	17	5.484	50.12
0.097 52	.015 85	18	6.153	63.10
0.086 91	.012 59	19	6.905	79.43
0.077 46	.010 00	20	7.746	100.00
0.043 56	.003 16	25	13.77	316.2
0.024 49	.001 00	30	24.49	1.000 Watt
0.013 77	.000 316	35	43.56	3.162 Watts
0.007 746	.000 100	40	77.46	10.00 Watts
0.004 356	3.16×10^{-5}	45	137.7	31.62 Watts
0.002 449	1.00×10^{-5}	50	244.9	100 Watts
0.001 377	3.16×10^{-6}	55	435.6	316.2 Watts
0.000 774 6	1.00×10^{-6}	60	774.6	1 000 Watts
0.000 435 6	3.16×10^{-7}	65	1 377	3 162 Watts
0.000 244 9	1.00×10^{-7}	70	2 449	10 000 Watts
0.000 137 7	3.16×10^{-8}	75	4 356	31 620 Watts
0.111 077 46	1.00×10^{-8}	-80+	7 746	100 000 Watts

USE OF TABLE

Table is tabulated in one db steps from 0 dbm to ±20 dbm; thereafter in five db steps to ±80 dbm. However, the table may be used in one db steps to ±80 dbm by noting that, except for decimal locations, the power levels repeat themselves every ±10 db and the voltage levels repeat every ±20 db.

Example 1. What is the voltage produced by a level of -56 dbm on a 600 ohms? Subtract 40 from 56, giving 16. Enter table at 16 dbm, read volts column on left as .1228 volts. Now enter table at 55 and 60 dbm; -56 dbm is between these two levels, so table shows correct answer as .001228 volts.

Example 2. What is the voltage produced by a level of -68 dbm on a 600 ohms? Subtract 60 from 68, giving 8. Enter table at 8 dbm, read volts column on left as .3084

volts. Now enter table at 65 and 70 dbm; -68 dbm is between these two levels, so the table shows correct answer as .0003084 volts.

Example 3. What is the voltage produced by a level of +33 dbm on a 600 ohms? Subtract 20 from 33, giving 13. Enter the table at 13 dbm, read volts column at right as 3.460 volts. Now enter table at 30 and 35 dbm; +33 dbm is between these two levels, so the table shows the correct answer as 34.6 volts.

CONTOURS OF EQUAL LOUDNESS TO THE EAR

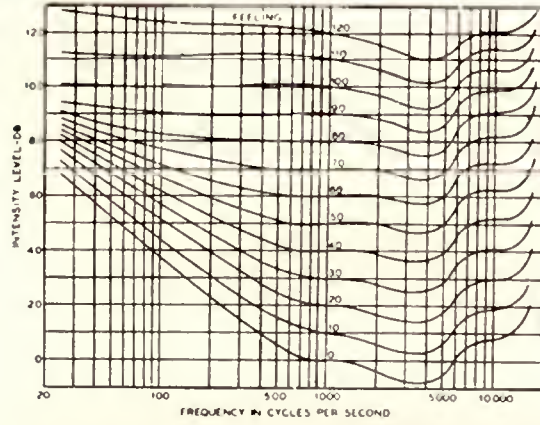

Loudness level contours.

Courtesy of the Acoustical Society of America

INDEX

MICROPHONES

<i>Page</i>	<i>Type Number</i>	<i>Description</i>	<i>MI Number</i>
3-4	General Information, Microphones	
5-6	77-DX	Polydirectional Microphone	4015-F
5-6	77-DX	Polydirectional Microphone (TV Low Luster Gray).....	11006-C
7	BK-1A	Pressure Microphone	11007
8-9	BK-5B	Uniaxial Microphone	11010-A
8-9	Boom Unit (for BK-5B)	11012
8-9	Wind Screen (for BK-5B)	11011
10-11	BK-6B	Miniature Dynamic Microphone	11017-A
12-13	BK-11A	Velocity Microphone	11019
14	SK-46	Program Velocity Microphone	12046
15	SK-45B	Pressure Microphone	12045-B
15	SK-39	Aerodynamic Microphone	12039-A
16	KU-3A	High-Output Unidirectional Microphone.....	10001-C
17	High-Sensitivity Varidirectional Microphone with Small Windscreen.....	10006-A
17	Ultradirectional Attachment	10008
17	Large Windscreen (for MI-10006 without MI-10008 Attachment)	10003
18	BN-10A	Microphone-Amplifier	11023-A

MICROPHONE STANDS AND BOOMS

19	91-C	Desk Stand	4092-E
19	KS-11A	Desk Stand (for BK-1A and BK-11A Microphones).....	11008
19	DS-10	Desk Stand (for SK Type Microphones).....	11021-3
19	DS-5	Desk Stand (for SK Type Microphones).....	11021-5
19	TS-6	Adjustable Banquet Stand	11021-6
19	90-A	Deluxe Program Stand	4090-A
19	CS-1	Collapsible Floor Stand	11021-1
19	MS-15	Floor Stand	11021-7
19	MS-20	Adjustable Floor Stand	11021-8
20	KS-3B	Microphone Boom and Stand	11056
20	BS-36	Floating Action Boom	11021-2
20	Microphone Boom and Stand	11070
20	Microphone Boom and Perambulator	26574
20	Boom Only	26574-1
20	Perambulator Only	26574-2
20	H-2	Boom Mounting for 77-DX Microphone	
20	M-2-MD-U	Adjustable Microphone Arm, Screw Mount	11020-1
20	M-2-MC	Adjustable Microphone Arm, Clamp Mount	11020-2
20	M-3MW	Adjustable Microphone Arm, Wall Mount	11020-3

MICROPHONE ADAPTORS

21	Microphone Holder and Adaptor Kit for BK-6B	12086
21	BK-6B Microphone Stand Adaptor Kit.....	11073
21	CH-1	Cable Hanger	11099-B
21	Adaptor 1/2" Pipe Thread Stand to 5/8"—27 Microphone Thread.....	12053
21	AD-1	Adaptor 5/8"—27 Stand to 1/2" Mike Pipe Thread.....	11021-1
21	Flexible Microphone Stand, 13-inch.....	11745
21	Flexible Microphone Stand, 19-inch.....	11746
21	Flexible Stand Bracket Clamp.....	11747

MICROPHONE CABLES

21	Microphone Cable, Low Impedance, Three Conductor, #20 A.W.G.	43-D
21	Microphone Cable, Heavy Duty, Two Conductor, #16 A.W.G.....	13307-A
21	Microphone Cable, Lightweight, Two Conductor, #24 A.W.G.....	13322

MICROPHONE PLUGS AND RECEPTACLES

<i>Page</i>	<i>Type Number</i>	<i>Description</i>	<i>MI Number</i>
22	UA-3-11	Female Plug for Microphone Extension Cable (Mates with UA-3-12)	11061
22	UA-3-12	Male Plug for Microphone Cable (Mates with UA-3-11 and UA-3-13)	11062
22	UA-3-13	Flush Mounting Receptacle (Mates with UA-3-12).....	11063
22	P3-CG-12S	Male Plug for Microphone Cords.....	4630-B
22	P3-35	Wall Receptacle for Male Plug P3-CG-12S.....	4624-A
22	P3-CG-11S	Female Plug for Microphone Extension Cord.....	4620-B
22	XLR-3-31	Female Microphone Receptacle.....	11088-B
22	XLR-3-32	Male Microphone Receptacle.....	11087-B
22	XLR-3-11C	Microphone Plug, Female.....	11090-A
22	XLR-3-12C	Microphone Plug, Male.....	11089-A

CONSOLETTES

23-26	BC-7A	Dual-Channel Audio Consolette (less all Plug-in Modules).....	11657
23-26	BC-7A	Dual-Channel Audio Consolette for Monaural Programming (in- cluding 5 BA-71A Preamplifiers, 2 BA-73A Program Ampli- fiers, 1 BA-74A Monitor Amplifier, 1 BX-71A Power Supply, 1 BA-78A Cue Amplifier, 2 High Level Isolation Units and 1 Console Housing).....	ES-11157-A
23-26	BC-7A	Dual-Channel Audio Consolette for Stereo Programming (includ- ing 6 BA-71A Preamplifiers and 2 BA-73A Program Ampli- fiers)	ES-11157-AS
27-28	BC-3C	Standard Audio Consolette (less tubes).....	11641-A
27-28	BC-3C	Standard Audio Consolette (complete with tubes).....	ES-11103-A
28	Tube Kit for BC-3C.....	11486
28	Selected 12AY7 Tube	11299
28	Cue Type Fader for BC-3C High Level Inputs.....	94136
28	Announce Booth Speaker Relay	11748
29-30	BC-5B	Audio Consolette (less tubes)	11637-A
29-30	BC-5B	Audio Consolette (complete with tubes)	ES-11105-A
30	Tube Kit for BC-5B.....	11483-A
31-32	BC-6B	Dual-Channel Audio Consolette (less tubes).....	11638-A
31-32	BC-6B	Dual-Channel Audio Consolette (complete with tubes).....	ES-11106-A
32	Tube Kit for BC-6B	11484-A
33-34	BC-10A	Portable Audio Console	11655-A
35-36	BCM-2A	Auxiliary Mixer Consolette (less all plug-in units).....	11656
35-36	BCM-2A	Auxiliary Mixer Consolette (for BC-7 Mixer Bus Bridging).....	ES-11155
35-36	BCM-2A	Auxiliary Mixer Consolette (for BC-7 Mixer Input).....	ES-11156
36	High Level Isolation Unit for BCM-2A.....	11665

CONSOLETTES AND STUDIO ACCESSORIES

37-40	Transistor Interphone Connection Unit.....	11784
37-40	Interphone Connection Unit	11734
37-40	Retardation Coil	11737
37-40	Shelf for Mounting MI-11734.....	11735
37-40	Panel (Accommodating 14 Retardation Coils).....	11736-A
37-40	Single Headband Assembly	11743
37-40	Double Headband Assembly	11744
37-40	Transistor Amplifier (Replacement for Induction Coil).....	11757

CUSTOM EQUIPMENT

41-44	Custom Audio Equipment	
-------	-------	------------------------	--

AMPLIFIERS

45	RCA Broadcast Amplifiers (Summary)	
46	BA-31A	Preamplifier and Isolation Amplifier.....	11444
46	Spare Transistor and Diode Kit for BA-31A.....	11780

AMPLIFIERS (Continued)

Page	Type Number	Description	MI Number
46	Spare Guide Assembly (with receptacles).....	11594-1
47	BA-33A	Program Amplifier	11446
47	Step Attenuator (20 steps, 2 db per step, 500 ohm).....	11751-5
47	Spare Kit of Transistors and Diodes for BA-33A.....	11781-A
47	Spare Guide Assembly (with receptacles).....	11594-2
48-49	BA-34B	Monitoring Amplifier	11437-B
48-49	Spare Kit of Transistors and Diodes for BA-34B.....	11782-A
48-49	Spare Guide Assembly	11594-3
50	BA-71A	Consolette Preamplifier with Transistors in Place but less Guide Assembly	11658
50	BA-71A	Consolette Preamplifier Complete with Transistors and Guide Assembly	ES-11158
50	Guide Assembly for BA-71A	11759-1
51	BA-73A	Consolette Program Amplifier with Transistors in Place but less Guide Assembly	11659-A
51	BA-73A	Consolette Program Amplifier Complete with Transistors and Guide Assembly	ES-11159
51	Guide Assembly for BA-73A	11759-2
52	BA-74A	Consolette Monitor Amplifier with Transistors in Place but less Guide Assembly	11661-A
52	BA-74A	Consolette Monitor Amplifier Complete with Transistors and Guide Assembly	ES-11161
52	Guide Assembly for BA-74A.....	11759-3
53	BA-78A	Transistor Cue/Intercom Amplifier with Transistors in Place but less Guide Assembly	11662
53	BA-78A	Transistor Cue/Intercom Amplifier Complete with Transistors and Guide Assembly	ES-11162
53	Guide Assembly for BA-78A	11759-5
54	BA-26A	Pickup Equalizer-Preamplifier (includes transistors and rectifier)	11436
54	Transistor and Rectifier Kit for BA-26A.....	11779
55-56	BA-6A	Limiting Amplifier (less tubes)	11225
55-56	BA-6A	Limiting Amplifier (complete with tube complement).....	ES-11126-A
56	Tube Kit for BA-6A	11289
57	BA-8A	Transistor Cue Amplifier (including transistors).....	11450
57	Rack Mounting Panel (for BA-8A).....	11449
58	BA-21A	Preamplifier and Isolation Amplifier (less tubes).....	11244-A
58	BA-21A	Preamplifier and Isolation Amplifier (complete with tubes).....	ES-11121
58	Tube Kit for BA-21A.....	11482
59	BA-23A	Program Amplifier (less tubes).....	11246-A
59	BA-23A	Program Amplifier (complete with tubes).....	ES-11123
59	Tube Kit for BA-23A.....	11480
59	Step Attenuator	11751-2
60	BA-24A	Monitoring Amplifier (less tubes).....	11247
60	BA-24A	Monitoring Amplifier (complete with tubes).....	ES-11124
60	Tube Kit for BA-24A.....	11481
61	BA-25A	AGC Program Amplifier (less tubes).....	11434
61	BA-25A	AGC Program Amplifier (complete with tubes).....	ES-11125
61	Tube Kit for BA-25A.....	11487
62	BN-7A	Two-Channel Remote Amplifier (including transistors and diodes but less batteries).....	11451
62	Spare Transistor and Diode Kit for BN-7A.....	11785
62	Step Type Attenuator for BN-7A Master Controls.....	11751-3
62	Step Type Attenuator for BN-7A Fader Controls.....	11751-4
63	BN-6B	Four-Channel Remote Amplifier (complete with transistors and diodes).....	11221-B
63	Input Transformer (30/150 ohms).....	11776
63	Transistor and Diode Kit for BN-6B.....	11777
63	Canvas Carrying Case.....	11377-A

POWER SUPPLIES

Page	Type Number	Description	MI Number
64	BX-71A	Console Power Supply (less Guide Assembly).....	11663
64	BX-71A	Console Power Supply (including Guide Assembly).....	ES-11163
64	Guide Assembly for BX-71A Power Supply.....	11759-4
65	BX-21A	Preamplifier Power Supply (less tubes).....	11317
65	BX-21A	Preamplifier Power Supply (complete with tubes).....	ES-11111
65	Tube Kit for BX-21A.....	11479
66	Regulated Power Supply—110 volt, 60 cycles.....	11318-A
66	Regulated Power Supply—220 volt, 50 cycles.....	591318
66	Regulated Power Supply.....	11316

RACK AND MISCELLANEOUS EQUIPMENT

67-68	BR-84A	Standard Cabinet Rack.....	ES-30951-A84
67-68	BR-84B	Standard Cabinet Rack, less front door.....	ES-30951-B84
67-68	BR-84C	Standard Cabinet Rack, less side panels.....	ES-30951-C84
67-68	BR-84D	Standard Cabinet Rack, less side panels and front door.....	ES-30951-D84
67-68	BR-84E	Standard Cabinet Rack, less side panels, and front and rear doors.....	ES-30951-E84
67-68	BR-19A	Economy Cabinet Rack.....	11550
68	Door (non-ventilated).....	30530-G84
68	Side Panel.....	30541-G84
68	Door (ventilated).....	30535-G84
68	Electrical Shield (for mid-rack section).....	30546-G21
68	Electrical Shield (for top and bottom rack sections).....	30546-G28
68	Single Trim Strip.....	30566-G84
68	Double Trim Strip.....	30568-G84
68	Terminal Board Mounting Bracket.....	4570-A
68	Set Terminal Board Mounting Angles.....	30527-G29
68	Set Panel Mounting Angles.....	30526-G84
68	Rack Extension Kit (for TM-6C, etc.).....	40408
68	Rack Extension Kit (for TRT-1B Recorder).....	40735
68	Audio Terminal Block.....	4569-A4
68	Power Terminal Block.....	4568
68	Ground Bus Kit.....	
69	1 $\frac{3}{4}$ " Blank Panel, Umber Gray.....	4590-A
69	3 $\frac{1}{2}$ " Blank Panel, Umber Gray.....	4591-B
69	5 $\frac{1}{4}$ " Blank Panel, Umber Gray.....	4592-B
69	7" Blank Panel, Umber Gray.....	4593-A
69	8 $\frac{3}{4}$ " Blank Panel, Umber Gray.....	4594-B
69	10 $\frac{1}{2}$ " Blank Panel, Umber Gray.....	4595-B
69	BI-1B Meter	Meter Panel.....	11388
70	BR-22B	Mounting Shelf.....	11597-A
70	BR-2A	Shelf.....	11599
70	BR-2A	Panel.....	11598-B

JACK PANELS, MATS AND CORDS

71	BJ-24	Jack Panel.....	11645
71	BJ-12	Jack Panel.....	11646
71	Single BJ-24 Jack Strip Mat.....	11647-1
71	Double BJ-24 Jack Strip Mat.....	11647-2
71	BJ-20TRS	Jack Panel (Tip-Ring-Sleeve).....	11666
71	Patch Cord, 2-foot Length (black shielding).....	4652-B
71	Patch Cord, 2-foot Length (gray shielding).....	4652-20
71	Patch Cord, 4-foot Length (black shielding).....	4652-4B
71	Patch Cord, 4-foot Length (gray shielding).....	4652-40
71	Patch Cord, 6-foot Length (black shielding).....	4652-6B
71	Patch Cord, 6-foot Length (gray shielding).....	4652-60
71	Patch Cord, 2-foot Length, Tip-Ring Sleeve (black).....	4652-D2
71	Patch Cord, Varied Length, Tip-Ring Sleeve, (black).....	On Request

CABLE

72	Interconnecting Cable, Shielded Pair, #20 A.W.G. Solid.....	33
72	Interconnecting Cable, Shielded Pair, #22 A.W.G. Stranded.....	34
72	Interconnecting Cable, Shielded Pair, #18 A.W.G. Stranded.....	35
72	Interconnecting Cable, Shielded Pair, #22 A.W.G. Solid.....	13342-1
72	Interconnecting Cable, Shielded Pair, #22 A.W.G. Stranded.....	13342-2
72	Cable Lacing Cord #6.....	11719-A
72	"On Air" Warning Studio Light.....	11706-1
72	Glass Only.....	11708-1
72	Custom Glass Signs.....	On Request

AUDIO ACCESSORIES

73	Variable Audio Compensator (low-frequency).....	10143-L
73	Variable Audio Compensator (mid-frequency).....	10143-M
73	Variable Audio Compensator (high-frequency).....	10143-H

AUDIO ACCESSORIES (Continued)

<i>Page</i>	<i>Type Number</i>	<i>Description</i>	<i>MI Number</i>
74	BI-5A	VU Meter Panel	11265-F
71	BE-21B	Variable Sound Effects Filter.....	11723
71	57-D	Switch and Fuse Panel.....	4395-G
75	Simpson VU Meter	Stock #53061
75	Multiple Pad for Calibrating the VU Meter to Desired Reference Level.....	Stock #19328
75	Zero Adjustment Pad	Stock #19327
75	BE-2A	Line Equalizer	11752
76	Bridging Transformer	11712
76	Line Transformer	11713
76	Bridging Volume Control (with knob for panel mounting).....	11278-E
76	Bridging Volume Control (with screwdriver adjustments).....	11278-F
76	Fixed Pad (6 db) "H" Type.....	4171-29
76	Fixed Pad (10 db) "H" Type.....	4171-30
76	Fixed Pad (20 db) "H" Type.....	4171-32
76	Fixed Pad (10 db) "H" Type.....	4171-39
76	Balanced Two Way 600 ohm Dividing Network.....	11701
76	Balanced Three Way 600 ohm Dividing Network.....	11704-A
76	Balanced Four Way 600 ohm Dividing Network.....	11704-B
76	Balanced Six-Way 600 ohm Dividing Network.....	11704-D
76	Balanced Bridge Pad	11705

TURNABLES

77-78	BQ-2C	Three-Speed Turntable and Cabinet (less reproducing equipment such as tone arm and amplifiers) for 60 cycle operation.....	11833-C
77-78	BQ-2C	Three-Speed Turntable and Cabinet (less reproducing equipment such as tone arm and amplifiers) for 50 cycle operation.....	11831-C
77-78	BQ-2C	Turntable Mechanism for Custom Installations, (less console cabinet and reproducing equipment such as tone arms and amplifiers) for 60 cycle operation.....	11830-C
77-78	BQ-2C	Turntable Mechanism for Custom Installations, (less console cabinet and reproducing equipment such as tone arms and amplifiers) for 50 cycle operation.....	11831-C
79-80	BQ-51A	12-Inch Dual Speed Turntable Mechanism for 60 cycle operation including tone arm, MI-11894 (less cabinet and pickup heads)	11810
79-80	BQ-51A	12-Inch Dual Speed Turntable Mechanism for 50 cycle operation including tone arm, MI-11894 and 50 cycle conversion kit (less cabinet and pickup heads).....	11810/806365
80	Cabinet Assembly for BQ-51A.....	11809
81	Lightweight 16-inch Tone Arm (less pickup head).....	11895
81	Lightweight 12-inch Tone Arm (less pickup head).....	11894
82	Universal Pickup Cartridge (less stylus assembly).....	11865
82	Stylus Assembly 0.7 mil (black).....	11866-7
82	Stylus Assembly 1.0 mil (red).....	11866-10
82	Stylus Assembly 2.5 mil (green).....	11866-25

RECORDING EQUIPMENT

83-81	RT-21A	Professional Audio Tape Recorder (Monaural Dual Half Track) ES-41921-A	ES-41921-A
83-84	RT-21A	Professional Audio Tape Recorder (Stereo).....	ES-11921-AS
83-81	RT-21A	Professional Audio Tape Recorder (Full Track, 7½ and 15 ips) ES-41930-A	ES-41930-A
83-81	RT-21A	Professional Audio Tape Recorder (Full Track, 3¾ and 7½ ips) ES-11920-A	ES-11920-A
81	Record/Playback Amplifier Module.....	141351
81	Portable Carrying Case	141302
81	Console Cabinet	141303
84	Remote Control Panel	141301
84	Remote Control Housing	141308
81	Amplifier Mounting Panel	141307
84	Fourth Head Kit (Quarter Track).....	141306
81	Switchable Fourth Head Kit (Dual Quarter Track).....	41602
84	Amplifier-Record/Playback Module	141351-S
81	Stereo Connector Kit for RT-21 Cabinets.....	41601
81	Spare Transistor Kit	Stock #11A218
85-86	RT-7B	Cartridge Tape Playback Unit.....	11957-B
85-86	BA-7B	Cartridge Tape Recording Amplifier.....	11958-B
86	Spare Transistor and Diode Kit for RT-7B.....	11490-A
86	Spare Transistor and Diode Kit for BA-7B.....	11491-A
86	RT-7 Playback Amplifier Board.....	11991-1

RECORDING EQUIPMENT (Continued)

Page	Type Number	Description	MI Number
86	RT-7 Power Supply Board.....	11994-2
86	RT-7 Cue Amplifier Board.....	11994-3
86	RT-7 Trip-Cue Amplifier Board.....	11994-4
86	BA-7B Record Amplifier Board.....	11994-6
86	Module Extender for BA-7A and RT-7A/B.....	11976
86	Module Extender for BA-7B.....	11976-B
87-88	RT-7 Console (2 unit).....	11984
87-88	RT-7 Console (4 unit).....	11983
87-88	RT-7 Storage Cabinet.....	11985
88	Audio Automatic Switcher.....	11982
88	Remote Control Panel for RT-7 Playback Unit.....	11977
88	Remote Control Panel for BA-7 Record Amplifier.....	11979
89	Cartridge Tape Head Degasser.....	11995
89	Azimuth Alignment Tape (10,000 and 14,000 cycles tone) supplied in 300 series cartridge.....	11993-2
89	B-151	Bulk Lubricated Tape (1700 feet on 7-inch reel).....	11986
89	Frequency Response Cartridge, calibrated, voice identified test frequencies.....	11993-1
89	Tape Cartridges for RT-7:	
		300 Series, 40 sec. playing time.....	11988-1
		300 Series, 70 sec. playing time.....	11988-2
		300 Series, 2½ min. playing time.....	11988-11
		300 Series, 3½ min. playing time.....	11988-3
		300 Series, 5½ min. playing time.....	11988-4
		300 Series, 10½ min. playing time.....	11988-5
		600 Series, 16 min. playing time.....	11988-6
		1200 Series, 31 min. playing time.....	11988-7
89	Blank Tape Cartridges for RT-7:	
		300 Series, Blank.....	11988-8
		600 Series, Blank.....	11988-9
		1200 Series, Blank.....	11988-10
90	Cartridge Tape Bulk Eraser.....	11992
90	Automatic Magnetic Tape Eraser.....	10880
LOUDSPEAKERS			
91-92	LC-1A	Duo-Cone Speaker Mechanism.....	11411-A
92	LS-1A	Wall Housing for LC-1A.....	11406
92	LS-11A	Floor Housing for LC-1A.....	11415
93	SL-123A	12-Inch Speaker Mechanism.....	38314
93	SL-12A	12-Inch Speaker Mechanism.....	38315-A
94	8-Inch Speaker Mechanism.....	12454-B
94	SL-8B	8-Inch Speaker Mechanism.....	38311-A
95	10-Inch Cue Speaker Mechanism.....	11408
95	LS-3A	Wall Housing for 10- and 12-inch Speakers.....	11407-A
95	10/12-Inch Wood Baffle.....	13253-A/13245-A
95	Molded Plastic Baffle for 8-Inch Speakers.....	6104
96	Line Matching Speaker Transformer (16 watts).....	12368
96	Line Matching Speaker Transformer (8 watts, single winding).....	11731
96	Speaker Applications, Recommended Housings, Specifications	
TEST EQUIPMENT			
97	WM-71A	Distortion and Noise Meter.....	30071-A
98	WA-28A	Audio Push-Button Oscillator.....	30028-A
99	BI-11A	Transmission Measuring Set.....	11350
100	Transmission Measuring Set.....	11351
101	455A	Transmission Measuring Set (with relay rack panel)	
101	455A-R	Transmission Measuring Set (in portable carrying case)	
101	454A	Attenuator Box in Portable Carrying Case	
101	454A-R	Attenuator Box in Rack Mounting Panel	
102	510-B	Extended Range Oscillator	
102	T-10	Matching Transformer (150/600 ohms balanced)	
102	T-11	Matching Transformer (135/600 ohms balanced)	
103	401B	General Purpose Oscillator	
103	520A	Amplifier-Voltmeter	
104	410	Distortion Meter	
104	210	Audio Oscillator	
105-106	Recommended Wiring Practices	
107-111	Standards for Audio Facilities	
112-114	Audio Reference Charts	

RCA BROADCAST SALES OFFICES

Atlanta 3, Ga.

1121 Rhodes-Hoverty Bldg., 524-7703

Camden 2, N. J.

Front & Cooper Streets, Woodlawn 3-8000

Charlotte 4, N. C.

504 Chorlottetown Moll, 333-3996

Chicago 54, Ill.

2000 Merchandise Mart Plazo, 467-5900

Cleveland 15, Ohio

1600 Keith Bldg., Cherry 1-3450

Dallas 35, Texas

7901 Carpenter Freeway, Melrose 1-3050

Dedham, Mass.

886 Washington Street, DAVIS 6-8850

Detroit 39, Mich.

12605 Arnold Street, Kenwood 4-5100

Hollywood 28, Calif.

1560 N. Vine Street, Hollywood 9-2154

Indianapolis, Ind.

501 N. LoSolle Street, Melrose 6-5321

Kansas City 15, Mo.

7711 State Line Road, Emerson 1-6770

Memphis, Tenn.

3189 Summer Avenue, Fairfax 4-4434

New York 20, N. Y.

36 W. 49th Street, MU 9-7200

Portland 12, Ore.

1841 N.E. Couch Street, Belmont 4-7297

San Francisco 2, Calif.

420 Taylor Street, Ordway 3-8027

Seattle 4, Wash.

2250 First Avenue, S., Moin 2-8350

Washington, D. C.

1725 K Street, N.W., Federal 7-8500

West Palm Beach, Fla.

4502 Broodwoy, 848-7639



RADIO CORPORATION OF AMERICA
BROADCAST and TELEVISION EQUIPMENT CAMDEN, NEW JERSEY