



SPARTA

Bauer | TRANSMITTER
PRODUCTS



QUICK REFERENCE PRODUCT GUIDE

AM TRANSMITTERS

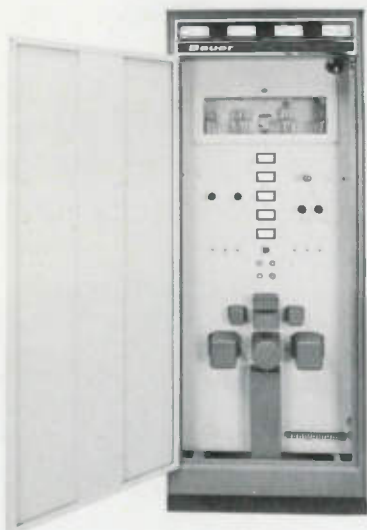

MODEL 707

1000/500/250/ WATTS

Best known of all BAUER transmitters – more than 400 in service all over the world. Front panel switch selects any two of the power levels shown above. Automatic voltage control, vacuum capacitor final tank tuning, oil-filled modulation transformer, built-in dummy antenna, remote control facilities including motor drive power trim control – just a few of the outstanding features that have been responsible for the success of this fine transmitter.

Size – 75" high, 30" wide, 25½" deep; self-contained.

Tube Complement – (4) 4-400A, (2) 6AG7, (2) 65J7,
(1) EL-34/6CA7

Additional Information – Write for Bulletin S-707

MODEL FB 3B – 3000 WATTS

The best buy on today's broadcast transmitter market – watts per dollar. Designed for use in countries where license requirements permit this power level. Two FB-3B's can also be used with the BAUER ferrite combiner for a full time 5 KW facility. In this type of operation, both transmitters operate simultaneously, being driven from a common oscillator. Should one drop off the air, the second remains on unaffected. The combiner control panel permits instantaneous switching to the load completely freeing one transmitter for maintenance. The FB-3B features vacuum capacitor final tank tuning and oil filled power components (plate transformer, modulation transformer and reactor and high voltage filter choke).

Tube Complement – (4) 4-1000A, (2) EL-34/6CA7,
(2) 12BY7A, (1) 6146B

Size – 75" high, 34" wide, 28" deep, self-contained.

Additional Information – Write for Bulletin S-3B

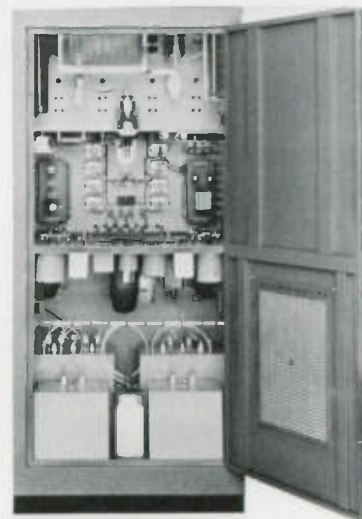

MODEL FB5V

5000/1000/500 WATTS

The first broadcast transmitter to utilize a plate modulated ceramic tetrode – the 4CX5000A with its 6KW capability. Reports of 20,000 hours of tube life are not uncommon with the FB5V. This transmitter features full metering (16 in all), two vacuum crystals and two oscillators, a tally light fault locating system and an oil filled modulation transformer. Station engineers continually remark about the simple, straight-forward circuitry of the FB5V and its clean, uncluttered layout that makes servicing an easy task.

Tube Complement – (3) 4CX5000A, (2) EL-34/6CA7,
(4) 12BY7A, (1) 6DQ5

Size – 75" high, 60" wide, 29" deep – self-contained.

Additional Information – Write for Bulletin S-5V

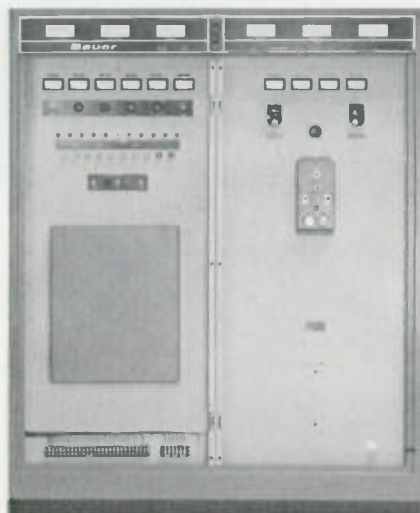

ACCESSORIES



MODEL ACU 301/305/310 ANTENNA COUPLING UNIT

Antenna coupling unit featuring full "Tee" network, input "J" plug and output meter with make-before-break switch — all components mounted in a weatherproof aluminum cabinet. Tower lighting choke and remote metering diode can be installed in ACU if required. A large antenna lead in bowl is supplied with hollow feed-thru to aid in wiring tower lights. Flanges are provided on rear of unit for either wall or pole mounting. Available in all power levels.

Size — 3' high, 3' wide, 24" deep

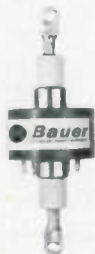

MODEL 380 PHASE SAMPLER

The Model 380 is used in directional antenna systems where dependable phase sampling is required. Mounts inside the tuning unit away from weather induced variations. Available in several sensitivities. For more information write for Bulletin S-380.



MODEL RMD-1 REMOTE METERING DIODE

Voltage type sampling diode for remote reading of antenna base current. All BAUER AM transmitters have required remote meter. For those installations that require a remote meter and panel can be supplied.



MODEL TLC TOWER LIGHTING CHOKE

Varnished #10 wire wound on heavy triple X tubing, 3 wire. Approximately 350 UH inductance. Available in separate housing if required. BAUER ACU series shown above has ample room for this lighting choke.



MODEL WRC-10 REMOTE CONTROL SYSTEM

Requires only single DC pair for positive transmitter control. Solid state. Has 10 raise, 10 lower commands — 10 metering channels plus calibration. Consists of studio unit (illustrated) and transmitter unit — both measure 5 1/4" x 19".

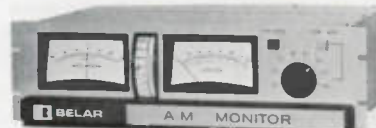

MODEL AMM-1 AM FREQUENCY AND MODULATION MONITOR

Features frequency and modulation monitoring all in one unit — separate 100% negative modulation peak indicator lamp — digital counter circuit will measure any standard broadcast band frequency spaced 10 KHZ — built in calibration circuitry — 100% solid state.



MODEL FIM-21 AM FIELD INTENSITY METER

A solid state precision test instrument for use in the standard broadcast band. Easily held — weighs only 11 1/2 lbs. Ceramic filter provides high selectivity and a uniform IF passband characteristic that does not vary with temperature. Power provided by six "D" cells that can be replaced easily without disassembly.



MODEL AM-19 ANTENNA MONITOR

Precision phase monitor provides measurement accuracy of ± 1.0 degree with a 0.5 degree resolution. Loop current indications are accurate to within $\pm 1.5\%$ with a resolution of 0.5%. Valid phase angle and loop current readings can be obtained without continual calibration or adjustment. All active circuitry is solid state.

OTHER AM-FM PRODUCTS AVAILABLE FROM SPARTA —

- TAPE CARTRIDGE EQUIPMENT
- AUDIO CONSOLES
- TURNTABLES
- MICROPHONES AND PICKUPS
- TAPE RECORDERS
- FM MONITORS
- FM ANTENNAS
- TOWERS
- CUSTOM PHASORS

SPARTA

Electronic Corporation

5851 Florin-Perkins Road (916 — 383-5353) Sacramento, California 95828

A DIVISION OF COMPUTER EQUIPMENT CORPORATION

AM TRANSMITTERS



MODEL FB-10J 10,000 WATTS

Note the uncluttered appearance of this fine transmitter. Similar to the FB5V in design, except for the use of 10KW power components and a 23KW rated final tube (4CX 15000A). Conservative operation for long tube life and minimum outlay of service dollars. Features a low ripple power supply that does not require a filter choke — direct result — better low frequency characteristics. Other features — oil filled modulation transformer, vacuum capacitor final tank tuning, built-in remote control facilities, two crystals/two oscillators, tally light overload indicator system.

Tube Complement — (2) 4CX5000A, (2) EL-34/6CA7,
(4) 12BY7A, (2) 8236, (1) 4CX15000A

Size — 75" high, 60" wide, 29" deep—self contained.

Additional Information — Write for Bulletin S-10J

MODEL FB-15A 15,000 WATTS

Basically, the same as the FB-10J except for the use of larger high voltage components to permit the higher power level — useful in countries where a 15,000 watt transmitter can be licensed. Easy to tune — excellent accessibility. Same tally light overload and recycle system as used on the FB-5V and FB-10J. Oil filled modulation transformer for reliable, long-term service.

Tube Complement — (2) 4CX5000A, (2) EL-34/6CA7,
(4) 12BY7A, (2) 8236, (1) 4CX15000A

Size — 75" high, 60" wide, 29" deep. External high voltage power supply is 36" high X 36" wide X 22" deep.

Additional Information — Write for Bulletin S-15A



MODEL 725 25,000 WATTS

A unique ferrite combiner housed in an oil filled container combines the output of two FB-15A transmitters. A matching rack panel that can be installed between the two transmitters or at some other location houses the switching panel. Other auxiliary equipment can be installed in this rack if desired as the switching panel utilizes only a small portion of the available space. Selection of either transmitter or combined operation can be done instantaneously without any off-air time.

Tube Complement — Same as FB15A above X two.

Size — Same as FB15A above X two. In addition, switcher rack assembly measures 75" high X 22" wide X 24" deep. Ferrite combiner measures 2' X 2' X 2'.

Additional Information — Write for Bulletin S-725

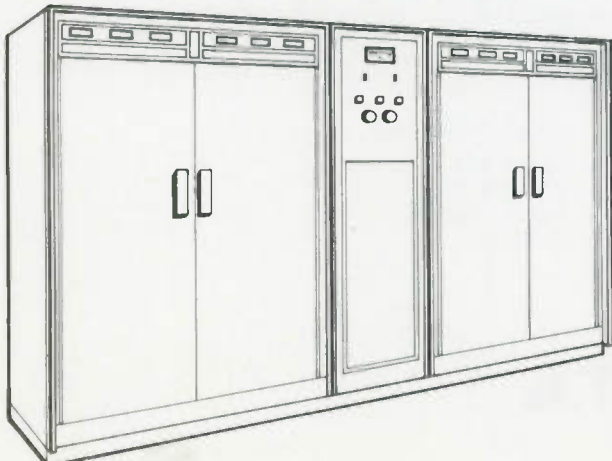

FM TRANSMITTERS

MODEL 660 — 10 WATTS

The heart of the entire line of BAUER FM transmitters, the Model 660, is 100% solid state — direct carrier FM. Plug-in stereo and SCA modules are available and can be installed in the system at any time. A particular operating convenience is the audio multimeter which not only checks all audio modulation levels but SCA injection as well. A DC multimeter permits an instantaneous check of all important parameters and a built-in metering probe permits servicing without additional test equipment. The Model 660 can be used as an exciter for most FM transmitters. The 660R, complete with its own rack cabinet, can serve as a 10 watt FM transmitter for educational service or as an FM band ST.

Tube Complement — None

Size — 19" wide, 12½" deep, 10½" high; Model 660R 20" wide, 20" deep, 12" high; self-contained.

Additional Information — Write for Bulletin S-660

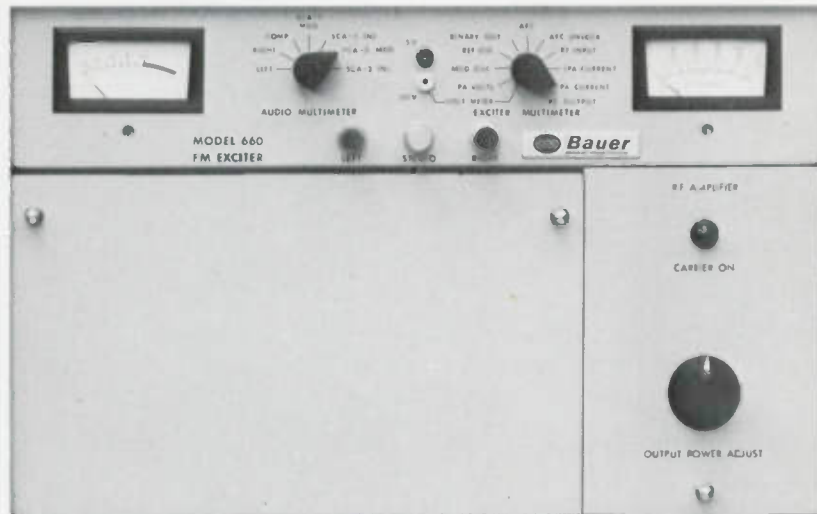

MODEL 600 250 WATTS

For standby or low power operation, the Model 600 is an economical choice. Utilizing a single 4CX250B, this transmitter is simple, straight-forward and compact. Incorporating the Model 660 exciter described above, it can generate a top quality FM signal at a minimal investment. All power supplies are solid state. Power line requirement is 115VAC 50/60 CPS.

Tube Complement — (1) 4CX250B

Size — 22" wide, 24" deep, 75" high; self-contained.

Additional Information — Write for Bulletin S-600

MODEL 607A 1600 WATTS

Competing in the market with 1000 watt transmitters, the Model 607A has a "bonus" 600 watts to help overcome transmission line losses or, perhaps, save an extra bay of antenna. Low cost zero bias triodes are used in a simple grounded grid circuit. Circuitry is straight-forward and all components are readily accessible. All remote control facilities including a motor driven power trim control are standard equipment.

Tube Complement — (1) 4CX250B, (2) 3-400Z

Size — 34" wide, 25½" deep, 75" high; self-contained

Additional Information — Write for Bulletin S-607A

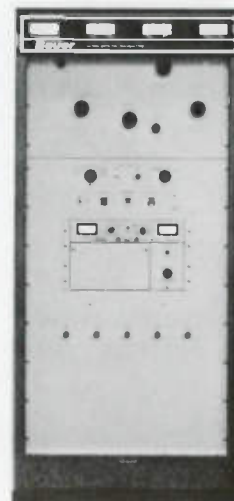

FM TRANSMITTERS

MODEL 602 — 2500 WATTS

The SPARTA/BAUER 602 transmitter and a 3-bay circularly polarized antenna make up the most economical package for full power Class A broadcasting. The 2500 watt output of the 602 along with the 1.5 gain of a 3-bay antenna easily delivers the maximum Class A signal. The output stage uses the new Stripline technique — another BAUER first in broadcast transmitter design. There are no moving contacts, no expensive-to-replace cavities, and the transmitters' broadband, drift-free performance optimizes stereo broadcasting. An oversize cooling system ensures long life for the 5CX1500A final tube.

The solid-state direct FM exciter provides multiple programming with plug-in stereo, mono and SCA modules. The exciter is fully metered — including peak modulation and SCA injection.

Tube Complement — (1) 4X150, (1) 5CX1500A

Size — 34'' wide, 25½'' deep, 75'' high

Additional Information — Write for Bulletin S-602

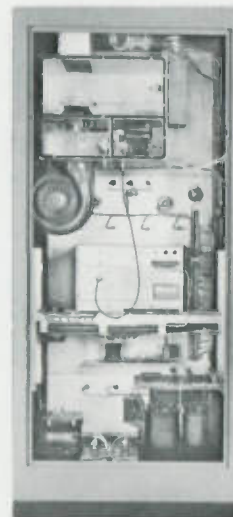

MODEL 603A5 — 5000 WATTS

The Model 603A5 is the only 5000 watt FM transmitter that was specifically designed for this power level. The tube type, cabinet size and circuitry were chosen to perform most economically at this power. The heart of this transmitter is the solid state model 660 exciter housed behind a swing-out front panel. Metering is complete and all remote control facilities are included in the basic transmitter price. An oversize blower insures long tube life. In addition, a husky flushing fan keeps all interior components at a comfortable operating level. This transmitter can be operated anywhere in the 3000 to 5000 watt range.

Tube Complement — (1) 4CX350A, (2) 5CX1500A

Size — 34'' wide, 25½'' deep, 75'' high

Additional Information — Write for Bulletin S-603A5

MODEL 620 — 20,000 WATTS

The SPARTA/BAUER 20 KW transmitter, Model 620, introduced the strip-line concept to broadcasting. The final amplifier has just 3 operating parts — no moving contacts — no front panel tuning controls. The broadband, grounded grid amplifier assures optimum performance without the usual knob-tweaking adjustments. The 620 is tuned once — and stays there. Other features — a tally light fault locator system, automatic control of power output and a high VSWR protection system. For super power, a second 20KW amplifier can be added and the outputs combined.

Tube Complement — (1) 4X150, (1) 5CX1500A, (1) 3CX15000A7

Size — 68'' wide, 34'' deep, 75'' high

Additional Information — Write for Bulletin S-620

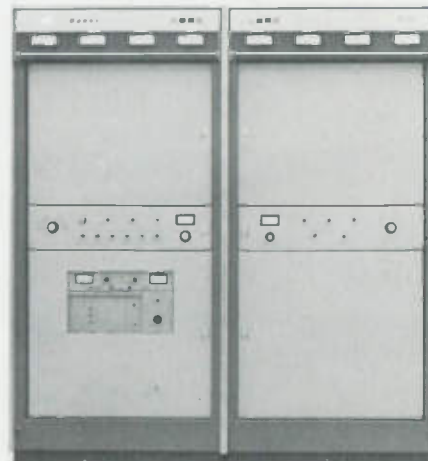



SPARTA
ELECTRONIC CORPORATION

**NEW PRODUCT
TECHNICAL BULLETIN**

MODEL 635 35 kw FM TRANSMITTER

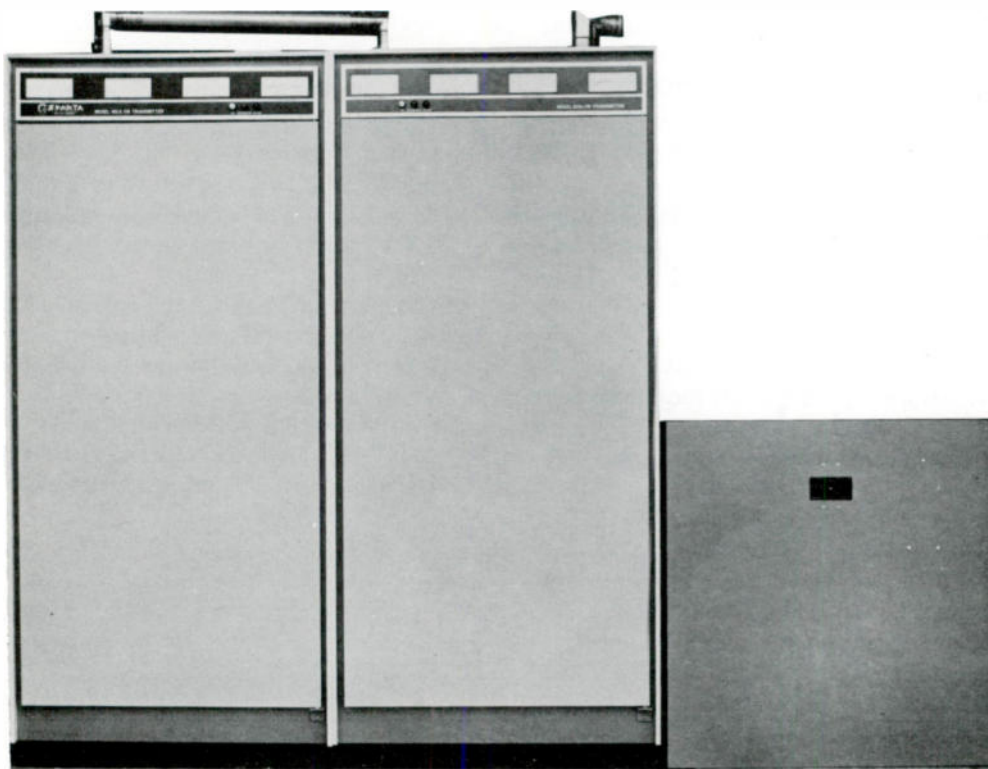

The Model 635 uses as its driver a complete Model 605B 5 kw Transmitter, offering automatic high-power backup whenever the super-power stage might require maintenance. Either mechanical or automatic switchover devices can be supplied for switching, as options.

The Model 635 uses the 680-Series FM Exciter, Stereo Generator (Model 682) and SCA Generator (Model 683) where applicable.

Standard features of the Model 635 include VSWR protection, Automatic Power Control, and the popular 'Tally Light' fault locator system. An outstanding economy feature of using the Model 635 to attain a 100,000 Watt circularly-polarized ERP is that it requires only a 6-bay antenna. An economy PLUS feature is that the antenna can be fed with 3 1/8" line, rather than the much more expensive 6" required for higher transmitter output power.

Accessibility and installation ease are integral parts of the Model 635, as they are in the complete Sparta AM and FM Transmitter line. The driver and final amplifier are in same-size cabinets,

with separate power supply, so that the complete unit can be installed in a variety of configurations to suit the transmitter building. Full size front and rear doors are coupled with swing-out front panels to allow maintenance access to every part of the transmitter, including control circuitry. Amplifier assemblies are reached through easily removed aluminum panels.

A full complement of on/off switches, and filament voltage controls are provided in both the driver and final amplifier sections. Overload relays are included in all important tube parameters. An automatic sequencing system prevents plate power turn on before all filaments are at correct temperature. The 'Tally Light' spotlights overload conditions through memory; it must be reset manually after it informs the engineer where the overload occurred. Brief overloads are ignored by using a positive recycle system which automatically cycles power off three times before lockout.

The high power performance of the 635 is achieved with very high reliability without continual fine adjustments, through a broadband grounded grid final amplifier.

SPECIFICATIONS:

MAXIMUM POWER OUTPUT: 35 KW.
AC INPUT POWER: 200/250 VAC 50/60 Hz 3-phase; 53 kW
at 0.9 power factor.
TUBE COMPLEMENT: One each 4CX250B, 3CX3000A7,
3CX20000A7.
WEIGHT, CUBAGE: 3,500 pounds, 92.7 cubic feet.
SIZE: Two cabinets each 34"W x 75"H x 25 1/2"D, and one
cabinet 34"W x 36"H x 25 1/2"D.
FREQUENCY RANGE: 88-108 MHz, tuned to specified
operating frequency.
RF OUTPUT IMPEDANCE: 50 ohms.
OUTPUT TERMINATION: 3 1/8" EIA flange.
FREQUENCY STABILITY: \pm 1,000 Hz after initial warmup.
TYPE OF MODULATION: Direct FM.
MODULATION CAPACITY: \pm 150 kHz.
RF HARMONICS: Suppression exceeds all FCC requirements.
ALTITUDE: To 7,500 feet.
AMBIENT TEMPERATURE RANGE: 0-50° Centigrade.
MAXIMUM VSWR: 1.7:1.

MONAURAL MODE

AUDIO INPUT IMPEDANCE: 600 ohms balanced.
AUDIO INPUT LEVEL: \pm 10 dBm \pm 2 dB for 100% modulation
at 400 Hz.
AUDIO FREQUENCY RESPONSE: Standard FCC 75 uS pre-
emphasis curve +0.25 to -0.5 dB 50-15,000 Hz.
DISTORTION: 0.5% or less 50-15,000 Hz.
FM NOISE: 65 dB below 100% modulation at 400 Hz.
AM NOISE: 55 dB below reference, carrier AM modulated
100% .
SYNCHRONOUS AM: -50 dB maximum at 400 Hz, due to
100% FM.

STEREOPHONIC MODE

PILOT STABILITY: 19 kHz \pm 1 Hz.
AUDIO INPUT IMPEDANCE: 600 ohms balanced, both
channels.
AUDIO INPUT LEVEL: + 10 dBm, both channels. \pm 1 dB
for 100% modulation at 400 Hz.
AUDIO FREQUENCY RESPONSE: Standard FCC 75 uS pre-
emphasis curve +0.25 to -0.5 dB 50-15,000 Hz, both
channels.
DISTORTION: 0.75% or less 50-15,000 Hz, both channels.
STEREO SEPARATION: -40 dB minimum or better
50-15,000 Hz.
SUBCARRIER SUPPRESSION: (main-to-subchannel or
subchannel-to-main) -65 dB below 100% modulation. 50 dB
below 100% modulation 50-15,000 Hz.
CROSSTALK: (main-to-subchannel or subchannel-to-main)
50 dB below 100% modulation 50-15,000 Hz.

SCA SPECIFICATIONS

FREQUENCY STABILITY: \pm 500 Hz.
FREQUENCY: 25-75 kHz. 41 or 67 kHz standard.
MODULATION: Direct FM.
MODULATION CAPABILITY: \pm 15% .
AUDIO INPUT IMPEDANCE: 600 ohms balanced.
AUDIO INPUT LEVEL: + 10 dBm for 100% modulation at
400 Hz.
DISTORTION: Less than 1.5% 50-7,500 Hz.
FM NOISE: 65 dB below reference. 15% deviation.
CROSSTALK: (subchannel-to-main) -60 dB or better.
CROSSTALK: (main-to-subchannel) 50 dB below 100%
modulation at 400 Hz.
AUTOMATIC MUTE LEVEL: -10 dBm at 400 Hz.
MUTING DELAY: Variable from 0.6-4 seconds.



SPARTA
ELECTRONIC CORPORATION

5851 FLORIN-PERKINS ROAD
SACRAMENTO, CALIFORNIA 95828

April 1975

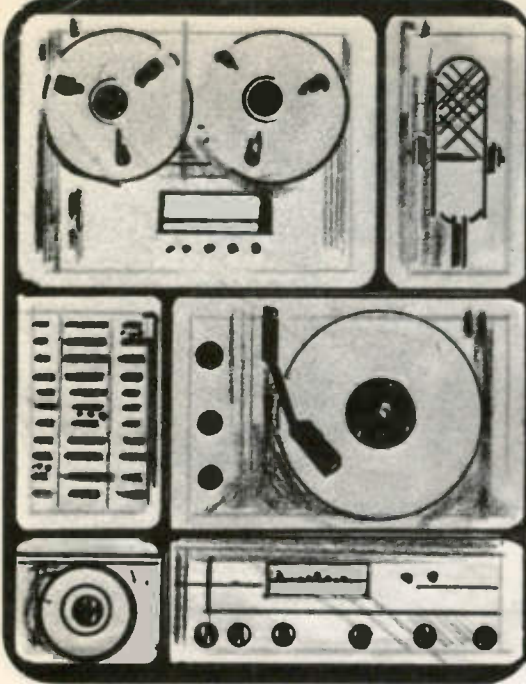

QUICK REFERENCE PRODUCT BROCHURE



SPARTA ELECTRONIC CORPORATION

5851 FLORIN-PERKINS ROAD SACRAMENTO, CALIFORNIA 95828 (916) 383-5353

14616 SOUTHLAWN LANE, ROCKVILLE, MARYLAND 20850 (301) 424-2920

A DIVISION OF COMPUTER EQUIPMENT CORPORATION



SHOWCASE SERIES AUDIO CONTROL ROOM CABINETS

Your studios can have the custom look of richness and quality without the expensive custom cost. The modular design concept gives a mix and match versatility among the many cabinet combinations to create a well-planned audio control center to fit most any requirement. Each piece of cabinetry has the craftsmanship of fine furniture with long-lasting durability. The efficiency and appearance of many existing studio arrangements can be greatly improved by one or more "Showcase" cabinets. Be sure to check the several "Showcase" groups including equipment that are offered at special package prices. Immediate custom quality can be yours at money-saving prices.

SPARTA-MATION SYSTEMS & DEVICES GIVE YOU COMPLETE PROGRAMMING CONTROL

SPARTA-MATION systems have been developed by people with years of successful broadcasting experience. Reliability is strongly emphasized through modern, straightforward design techniques. SPARTA-MATION can accommodate any number of different programming formats and can be extended to include such services as automatic network joining, program logging, and remote control. SPARTA-MATION devices can be used with and will interface with most any system. Stations throughout the world are improving their programming and increasing their profits. SPARTA-MATION systems offer more realistic value than any other, and are available on attractive financing programs.

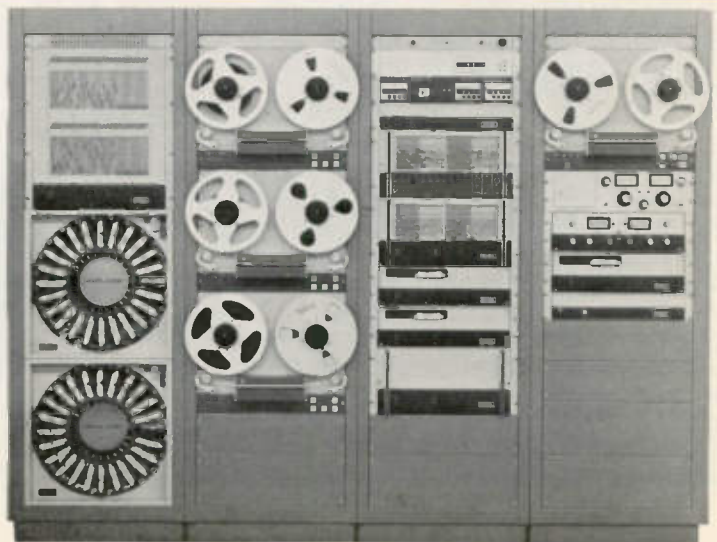

MONAURAL OR STEREO STUDIO CONTROL & REMOTE UNITS

MODEL AC-155B. A versatile monaural audio control center that combines maximum operational flexibility with professional quality in any location. A semi-permanent installation can become mobile at a moment's notice and enable you to cover more assignments and to produce added station revenue.

MODEL ASC-305B. A full-facility stereo audio control center that is tailor-made for production room chores, main control, or remote broadcast assignments. The equipment cabinet is of exceptionally fine construction and distinctive design with a very rugged and durable bonded plastic laminate finish. Accessories include a protective bench/lid, top-mounted utility shelf, and professional dynamic microphone with special gooseneck mounting.



FIVE-CHANNEL MONAURAL CONSOLE WITH 14 AUDIO SOURCE INPUTS

MODEL A-15B. A professional quality, transistorized, modestly priced console that offers features and audio mixing functions usually associated with larger, more expensive audio equipment. Five different audio input sources conveniently selected from a total of 14 may be mixed at one time. Outstanding features include all-channel cue system with separate cue amplifier, 8 watt monitor amplifier, 3 speaker muting relays, and an auxiliary 5 station, push-button bank for any custom switching requirement desired by the user. A special extender panel cabinet (EP-15) is also available which will add 5 more mixing channels to the Model A-15B.

EIGHT-CHANNEL MONAURAL MASTER CONSOLE WITH 22 AUDIO SOURCE INPUTS

MODEL A-20B. This newest console is in a class by itself when it comes to versatility and audio mixing. It features two high-quality line amplifiers for the program and audition outputs. Each output may be monitored by the large VU meter. Liberal use has been made of multiple push-button stations which provide for fast and direct switching among the 22 source inputs. Completely self-contained, the A-20B incorporates regulated power supply, 8 watt monitor and 1 watt cue amplifiers plus preamplifiers to accommodate up to 9 microphones. Modern styling and rugged cast metal construction with heavy-texture acrylic finish will assure you of its like-new look through years of service.

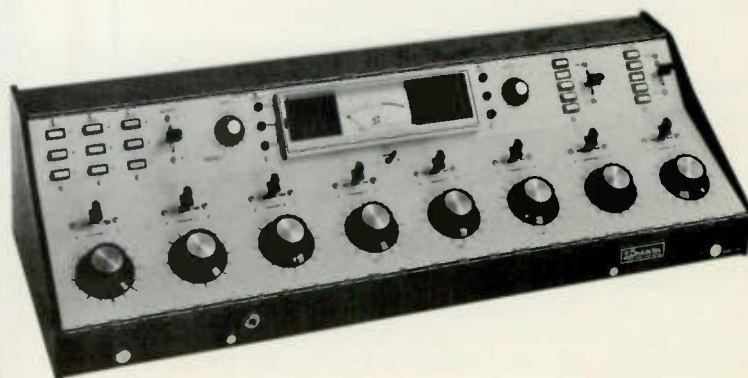



SPARTA

Bauer / TRANSMITTER
PRODUCTS

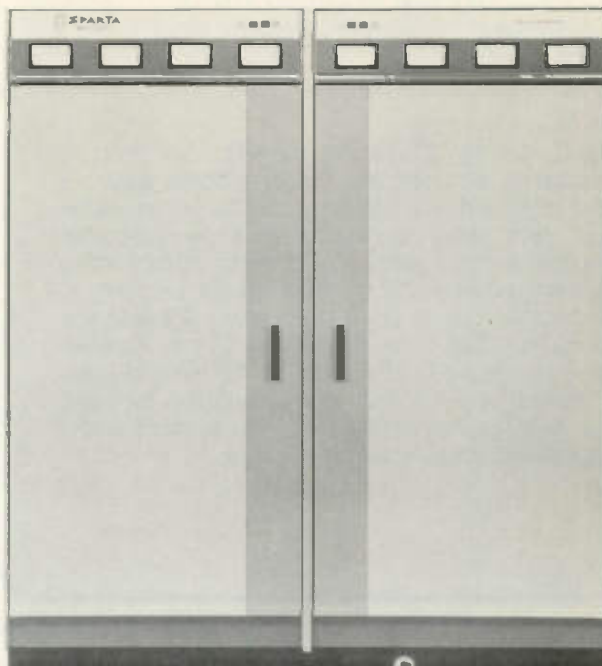

UNLIKE ORDINARY TRANSMITTERS...

SPARTA offers a fabulous selection of AM and FM transmitters. Each model has unique features that must be considered by every prospective and present Broadcaster alike. Reliability is highly emphasized by straight-forward engineering designs. Uncluttered layout makes routine servicing twice as easy. Quality components such as oil-filled modulation transformers, vacuum capacitor final tank tuning, and tally-light fault finding system are features found throughout the AM series. Solid-state direct exciter, new "Stripline" tuning technique, oversize cooling, and broadband grounded grid amplifiers are just a few of the FM features. Complete station "packages" including internationally famous JAMPRO FM antennas can easily be arranged on attractive terms. Let your SPARTAMAN provide you with complete information.

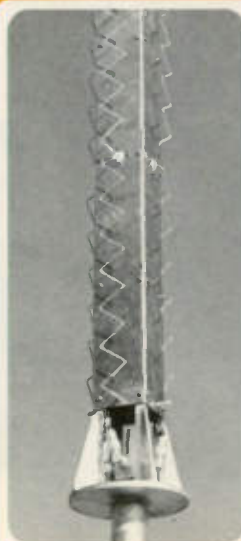

PROFESSIONAL TURNTABLE SYSTEMS & ACCESSORIES

MODEL GT-12 CUSTOM. Operator convenience is emphasized in this brand-new 12 inch turntable design. A special cueing feature is associated with the unique paddle-shaped motor switch conveniently located for one-handed record cueing. The 2 speeds may be quickly selected with a minimum of movement and the speed indicator lamp stays lit until the table is placed in a neutral position. A rugged one-piece rib cast base plate supports the 12 inch machined table which will accept LP's as well as 45's with no accessory adaptors required. Floor cabinet pedestals, tone arm, pickup cartridges, and equalized turntable preamplifiers can be supplied for complete turntable systems.



REMOTE BROADCAST MIXER AND LINE AMPLIFIER

MODEL RA-4. An attractive, full-capacity, 4-channel remote mixer with AC power that overrides the self-contained emergency battery supply. Audio sources to be mixed may be microphone or line level. Each mixer has a cue position that is monitored through the headphone station. Other features include a 700 Hz reference tone oscillator, external monitor output and provision to combine two or more units. MODEL RA-1. An inexpensive, quality, general purpose line amplifier or utility microphone remote amplifier. It features a fully integrated circuit design with extremely low current drain for a lifetime of dependable, trouble-free operation.

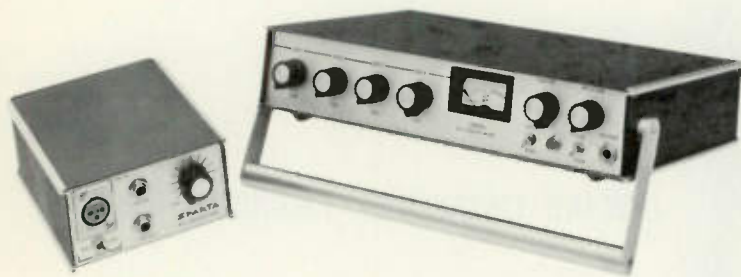

PORTABLE TAPE CARTRIDGE PLAYBACK UNIT

MODEL BP-22C. A perfect sales aid for broadcast time salesmen and other executives. Prerecorded tape cartridges of all types can be instantly played to add dramatic emphasis to any sales presentation. The latest electronic and mechanical developments including a servo motor have been incorporated. It offers both rechargeable battery and AC operation. The entire unit including its dynamic range speaker is packaged in an attractive attache case with business paper portfolio. External speaker jack plus automatic shut-off when lid is closed are just a few of its thoughtful features.



EIGHT-CHANNEL STEREO & DUAL CHANNEL MONAURAL CONSOLE

MODEL 910S. This master console will give you stereo, dual, or simultaneous programming at the flick of a switch. It incorporates all of the stereo inputs you will ever need—19 in all and its versatility includes a left plus right feed for combined AM/FM operation. 100% on the air backup is provided by the dual power systems and interchangeable plug-in circuit cards.

MODEL 910D. Fast-operating, fast-reading and quick cueing are standard advantages to the vertical attenuators used in the 910 series. This dual output channel monaural console is completely self-contained except for a small externally mounted power transformer assembly. Only 28 inches wide, it has more programming control and useful features than most audio consoles twice its size.



FIVE-CHANNEL STEREO CONSOLE WITH 9 STEREO INPUTS

MODEL AS-30B. Whether your stereo mixing requirement is for an automation system, production and recording studio, remote broadcast, or main studio audio control, the AS-30B fills the need at a very practical cost. Quick-acting direct push-button stations are used to switch many of its audio sources. Identical stereo line amplifiers are used in both the program and audition outputs to allow different programming to be controlled at the same time. Its compact, yet comfortable size, provides outstanding operator convenience. An excellent companion accessory is the Model MAS-50Q, 50-watt stereo monitor and cueing amplifier. A special extender panel cabinet (EP-30) is also available which will add 5 more stereo mixing channels to the Model AS-30B.



RACK-MOUNTING DUAL CHANNEL MONAURAL CONSOLE

MODEL A-16R. Its 8¾ inch rack space fits nicely into video consoles and elsewhere. It can easily handle audio mixing requirements from several studios at one time, including different programming through its dual channel output. Audio sources are quickly punched up through the 3 station push-button banks associated with each of the 5 mixing channels. In addition, an uncommitted 3 station push-button switch is provided for auxiliary use and a removable utility panel is also provided for custom features at the user's option. Completely self-contained, the A-16R has a powerful 8 watt monitor amplifier with separate cue amplifier and full-facility headphone station. The all solid-state design coupled with quality components assures long life and trouble-free operation.

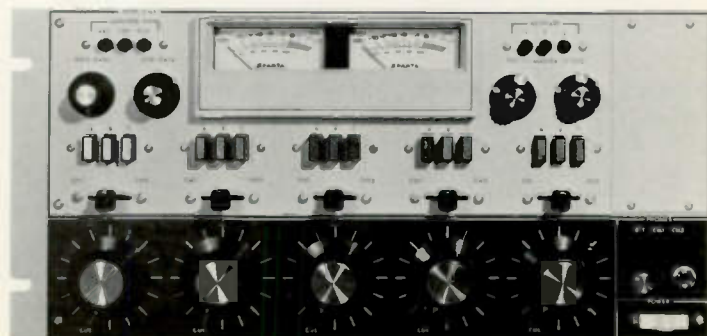
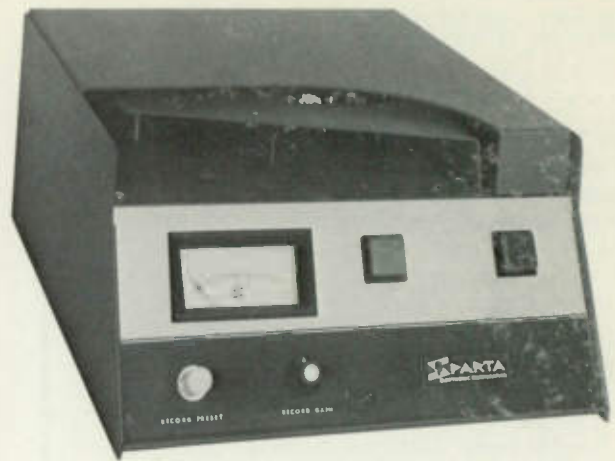
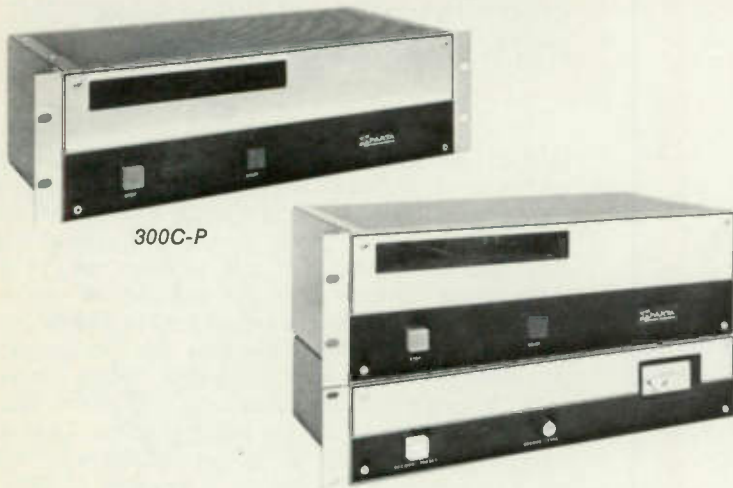

TABLE TOP TAPE CARTRIDGE SYSTEM

800C SERIES. A compact table-top cartridge system of ultra modern design including the most advanced transistorized circuitry. Its convenient size allows a number of units to be clustered in front of, or to each side of the console. The hinged top cover provides immediate access for inspection and cleaning of the transport and tape head components. SPARTA tape cartridge systems are designed to NAB standards and will accommodate any size tape cartridge within these standards. A new, larger capstan, direct drive motor transport (CH-6B) is used in all models. A new, heavy-cast, "True-Tangent" head mount is exclusive.



800C-RP



300C-P

300C-RP

RACK MOUNT CARTRIDGE SYSTEM

300C SERIES. Outstanding versatility is offered in a choice of 19 inch equipment rack installation or within accessory custom cabinets for table-top operation. Solid state amplifiers, relays and bias stages are mounted in individual plug-in housing for quick inter-change or replacement. In addition to the standard 1000 Hz stop cue tone, a 2nd and 3rd. cue tone option is available through the use of plug-in electronics which quickly extend the capabilities of the system. The addition of these auxiliary cue tones provides for the sequential and automated operation of external equipment. Another versatile feature is that the separate 300C Record Amplifier will plug into any 300C Playback transport to make a Record/Playback combination unit.

MULTI-CARTRIDGE PLAYBACK SYSTEMS

MC SERIES. The newest and most advanced concept for the handling of audio material recorded on tape cartridges. Each of the four deck modules is independent of the other, incorporating its own direct motor/capstan drive transport with individual program and cue amplifier playback transistorized electronics. This completely independent feature eliminates any concern of total system failure. Monaural and stereo systems are available and supplied for either horizontal 19 inch rack mounting or vertical operation using an optional accessory custom cabinet. Other accessories include a remote control unit and 2nd. and 3rd. cue tone electronics for sequential or automation programming.

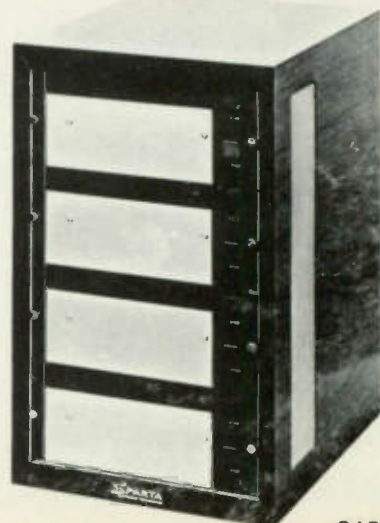

CABINET MOUNT

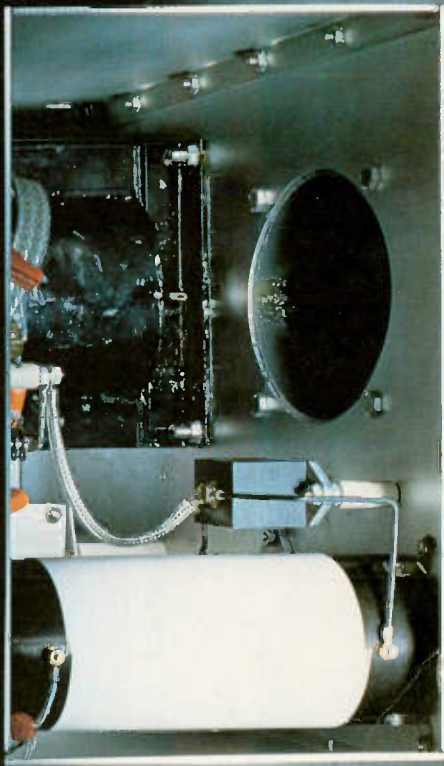

Model SS1000A

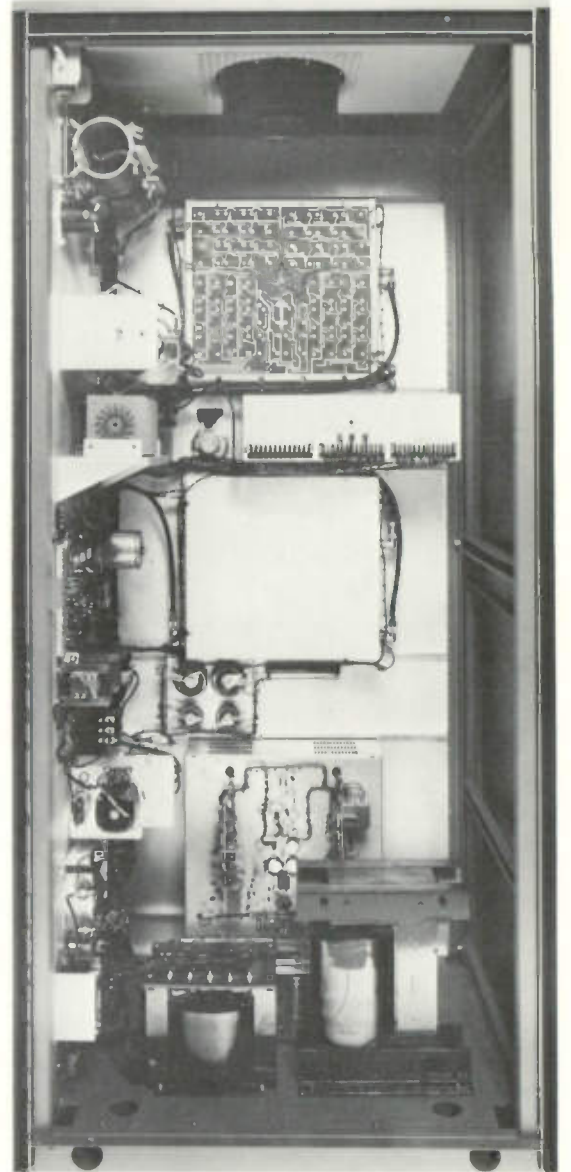
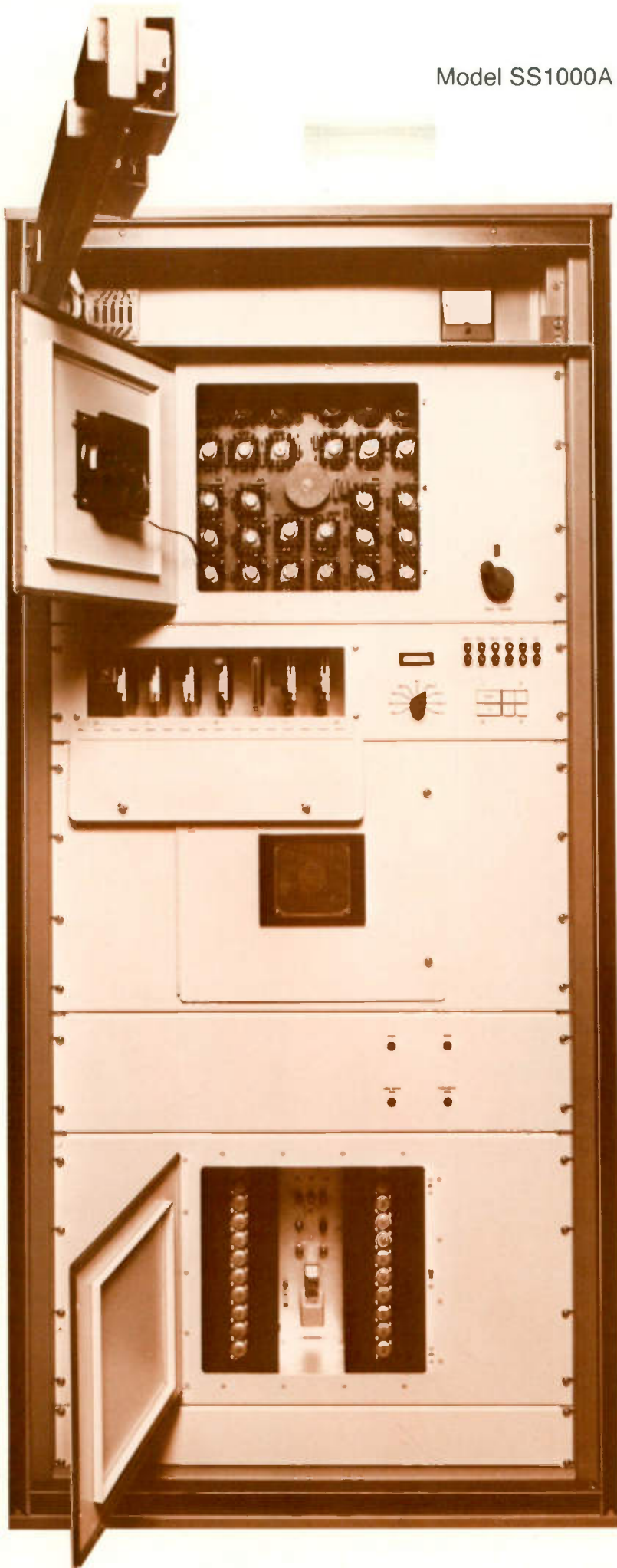

Front cover: Model 710C

Cetec Sparta tube type AM transmitter designs are aimed at absolute reliability achieved through state-of-the-art solid state technology coupled with classical vacuum tube design. The basic requirement is simplicity—with resultant dependability—and uncluttered, easy-maintenance interiors.

- All models use solid state oscillators, buffers and audio drivers. From 1 to 5 kW the RF driver is also solid state; at higher powers dual 6JE6 tubes are used as drivers.
- An ovenless crystal operating at four times carrier frequency is used for utmost stability.
- The 4CX5000A and 4CX15000A tube 'family' used reduces the number of RF section stages, producing consistent reports of tube life in excess of 15,000 hours!
- 125% modulation capability integral with the designs.
- Oil-filled modulation transformer has NEVER been known to fail in a score of years experience in these designs.
- Vacuum capacitor final plate tuning is standard.
- Step-start high voltage switching is standard in all power levels 2500 Watts and above.
- 'Tally Light' fault locator memory system, with 3-step overload recycling, is standard.
- Swingout meter panels across the top of each transmitter gives full display of all important parameters.

Access to the front panel switching and subsidiary metering is available through the (non-interlocked) front door, with control circuitry further accessible through front swingout panels. Rear access is through full-size interlocked steel doors. Every component is readily accessible; there are no rigid plate straps or filament leads to remove.

In addition to roominess and ease for the engineer maintaining the AM tube type transmitters, every safety precaution has been re-examined and no pains spared in assuring personnel safety. All high voltages are grounded when the rear doors are opened. And ALL voltages, including main supply, are removed from the cabinet.

Model 701B 1000/500/250 Watts Self-contained, plate-modulated, and capable of up to 1,100 Watts output, the 701B is supplied in the user's choice of any two powers listed above.

Parallel final tube operation is Class C—proven most reliable over many years of use, and the push-pull modulators are Class AB-1. The use of tetrode 4-500A tubes eliminates the need for neutralization.

A built-in dummy load capable of full power operation continuously is standard equipment. Remote control interface kits to match the user's choice of systems are optional.

Model 703B 2500 Watts The 703B has seen 3000 Watts service in many countries of the world where the power level is approved, before it became the first FCC type accepted FM transmitter for the 2.5 kW power level. It is similar to the Model 701B except for the use of 4-1000As and increased power supply capability. Power cutback is to either 1000 or 500 Watts. A dummy load is optional.

Model 705C 5000/1000/500 Watt This transmitter combines solid state drivers and only one tube type. It is housed in two cabinets, as are the 710C and 715C. High efficiency is achieved without the use of any special wave shaping circuitry, and maximum power capability is 6000 Watts, allowing more reserve for driving directional arrays. A single switch controls final plate voltage, audio, and RF drive simultaneously. Power cutback to either 1000 or 500 Watts is standard; a 2500 Watt cutback can be provided at slight additional cost.

Model 710C 10,000 Watt The 710C, capable of 12,000 Watts, and power levels above it follow the solid state RF driver with an additional RF drive unit consisting of two parallel operated 6JE6 tubes. For ease of tuning and testing the 710C has a built-in power cutback to 2500 Watts.

Model 715C 15,000 Watt Similar in all other respects to the Model 710C, the 715C differs in having a small external HV vault.

Model 725C 25,000 Watt Physically the 725C consists of twin 715C transmitters, a common RF drive system, and the unique Cetec Sparta broadband, low loss Ferrite Combiner. With its dual redundancy and power reserve to 30,000 Watts the 725C is a popular choice for high power, maximum reliability locations.

Options and Ordering All the above AM transmitters are delivered complete with tubes, transistors, and two crystals—tuned and tested on frequency. Remote control option for the Models 701B and 703B is the RMK-1, for all other models, the RMK-2. Constant Voltage Transformers maintain filament and low voltage supplies $\pm 1\%$ (60 Hz only). When ordering the Models 701B, 703B or 705C with power cutback, be sure to specify power levels desired.

Automatic Transmitter operation All of the AM models listed adapt to the many ATS systems available with the addition of the proper remote kit.

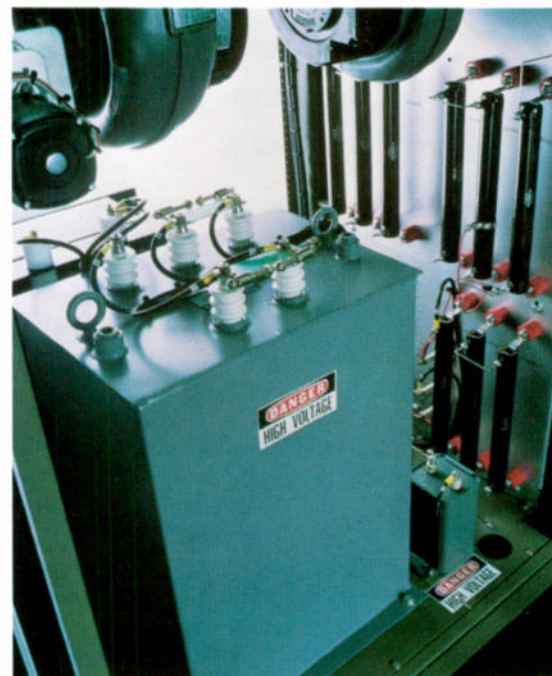

Top: Model 710C

Center: Model 710C; oil filled modulation transformers used in Cetec Sparta AM line have never been known to fail in a score of years experience.

Bottom: Model 710C

AM

The unique Cetec Sparta solid state AM transmitter design first embodied in the SS-1000A 1 kW model has been more thoroughly tested in both the laboratory and field than any other Sparta model up to this time. The care taken with the innovative approach to superb high-fidelity sound and high efficiency has resulted in two patent applications for circuitry design.

Outstanding features achieved include:

- A solid state design no more sensitive to load variations than a tube transmitter.
- Optimized RF 90% or better efficiency across the broadcast band.
- Single-ended Class B modulation.
- Optimized audio, less than 1% harmonic distortion through the mid-frequencies.
- Accurate, easy to read digital metering.
- Instantaneous power reduction.
- High overall efficiency, low power consumption.
- Quiet, air cooled operation using whisper fans.
- Instant on/off, no warm-up time.
- Interface built in for all ATS systems.

Sparta's line of solid state AM transmitters has been expanded to include models in 1,000, 2,500 and 5,000 watt power levels.

Familiar and dependable single-ended Class B modulation is used, combining optimized RF and audio devices. RF systems use square wave switching mode transistors with operating efficiencies of 90% or better over the broadcast band. Advanced circuitry and the latest transistors have produced a high power audio system easily capable of modulating the solid state series of AM transmitters to 125%.

The exclusive Sparta broad band combining system places no load limitation on the SS-1000A and does not require tuning.

Digital metering is used to simultaneously monitor combined collector currents and voltage. Either meter may be easily switched to substitute for the other, to meet the FCC requirements for a spare.

A motor driven variac controls power output, and a primary power switching system provides an 'on air' power cutback facility without program interruption.

All low level RF and control assemblies are on plug-in cards. PA and modulator transistors are individually replaceable with easy access through swing-out front doors. Indicating lamps signal any transistor failure. Operating efficiencies are much higher than tube transmitters, particularly at power cutback levels.

The SS-5000A consists of two 2500 watt (SS-2500A) transmitters in parallel operation. Included as a part of the system is a master RF drive unit, the exclusive Sparta ferrite combiner, a reject load and a combiner control panel. The system provides dual redundant operation at 5,000 watts or individual transmitter operation at 2,500 watts with further reduction to 1,000, 500 or 250 watts.

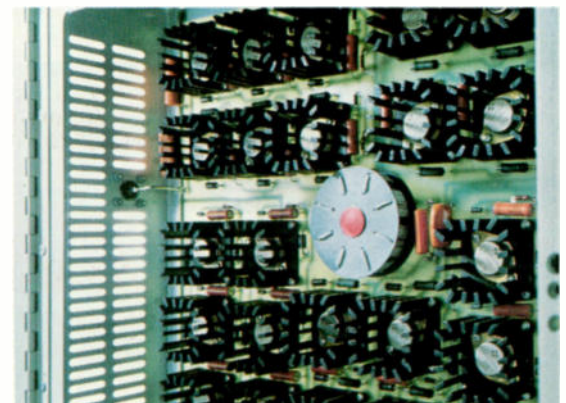
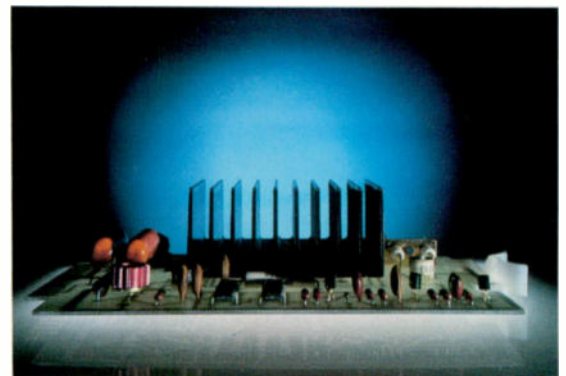

Top: Model SS1000A
Center: Model SS1000A; all low level RF and control assemblies are on plug-in boards.
Bottom: Model SS1000A; one of twin amplifier boards.

FM

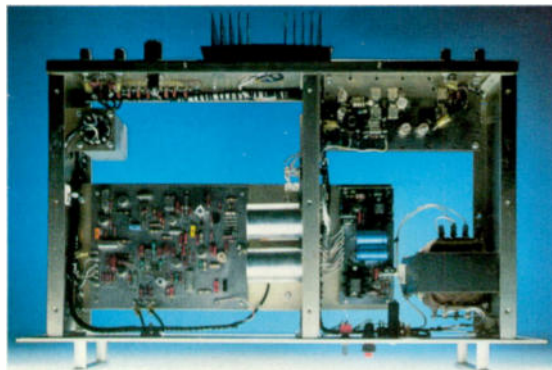
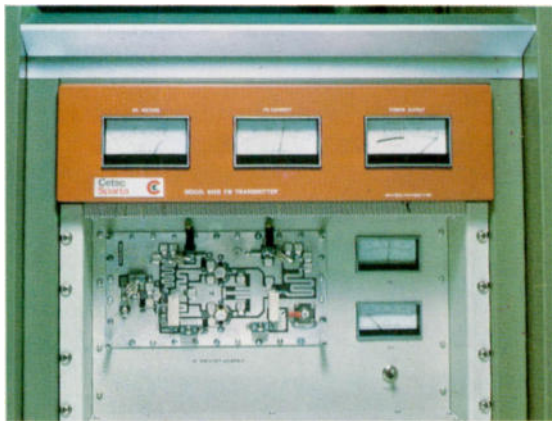

Cetec Sparta is the only broadcast equipment manufacturer in the world making BOTH AM AND FM solid state transmitters. The solid state 250 Watt Model 600B, introduced at the 1974 NAB Convention, is currently seeing service in such high-reliability locations as Eastern Canada, Colombia, Kenya, and many widely separated U.S. locations.

The second generation solid state Model 680 Direct FM Exciter, introduced a year earlier, also serves as a dependable 10 Watt educational band transmitter when fitted with the Model 681 meter panel.

Model 680 Exciter The simplicity of the 680 was obtained by designing for a minimum of parts, with state-of-the-art circuit techniques such as stripline RF amplifiers, and temperature-compensated Automatic Frequency Control. The oscillator is modulated by direct carrier frequency, with ovenless digital AFC.

- Oven burnouts eliminated; no crystal ovens or thermostat circuits.
- Wide bandwidth, minimal distortion, best stereo and SCA operation through direct FM.
- Short-circuit and open-circuit-proof stripline RF amplifier.
- Self-protecting IC-regulated power supplies.
- Better than -70 db FM noise.

The 680 is the 'heart' of all Cetec Sparta FM transmitters, and can be used to drive virtually any maker's FM transmitter. The 10 Watt transmitter version is type accepted as the Model 680/1.

Model 682 Stereo Generator As an integral part of the 680-Series the 682 was designed with utmost simplicity and reliability in mind. Only one front panel control is needed, and other adjustments have been minimized. An ultra-stable 76 kHz crystal oscillator output is digitally divided to produce the 19 and 38 kHz signals. The completely self contained 682 can be used either at the transmitter site or studio—producing a composite signal for STL—with equal ease; no extra power supply or adaptor is needed.

In brief, the 682 Stereo Generator:

- Is simple, with a minimum of components.
- Provides better than 40 dB separation (50-15,000 Hz).
- Has automatic subcarrier balance.
- Gives remote stereo/mono switching.
- Boasts LESS THAN 0.1% harmonic AND intermodulation distortion.

Model 683 SCA Generator Like the Model 682, the 683 SCA Generator is rack mounted, and self-powered. It can be used with any direct FM exciter. Switch-selectable muting chooses either constant subcarrier or automatic tuning when modulation is absent. Both 41 and 67 kHz versions are available. The 683:

- Has separate telemetry and program inputs.
- Has adjustable time-delay auto-muting; subcarrier is 'off' in the absence of input signal.

Model 600B 250 Watt FM Transmitter This transmitter was the FIRST ALL SOLID STATE BROADCAST transmitter to go into quantity production. Type accepted from 100 to 250 Watts, it uses the 680 Exciter to drive a pair of 125 Watt RF power amplifiers. The amplifiers are then combined in an untuned passive quarter-wave device. Isolating switches permit single amplifier operation, so that should one amplifier fail the transmitter stays on the air with 1/4 power.

The transmitter—and your station's signal—are further protected by built-in VSWR protection circuitry, fast-acting reed relays, and over-temperature switches. As either a standby or main transmitter the 600B offers these features to the FM operator:

- Instant high power backup.
- Automatic overload recycling.
- 'Tally Light' overload indicator memory system.
- Ability to be operated by a 12 Volt auto battery in an emergency.

A 500 Watt version of the Model 600B (the series will be redesignated SS100F, SS250F, and SS500F) is planned for production also.

Top: Model 600B
Center: Model 600B
Bottom: Model 680 Exciter

The Cetec Sparta tube type FM transmitter design proceeds from one to 50 kW with a clearly identifiable and continuing style. The underlying philosophy is to make use of readily available components of highest quality, operating in conservative modes and at less than full capacity for overall transmitter dependability and economy.

Several features of interest to both station management and engineering are common throughout the line:

- 'Tally Light' fault memory system for driver, IPA, final stages and VSWR; control circuit has automatic recycling with a signal lamp indication of the problem area.
- Reliable solid state 680 Direct FM Exciter for highest performance with reliable simplicity of design.
- Ready accessibility to all components.
- Metering of all important parameters, including elapsed time and AC line voltage.
- Fully remote controllable.
- Compatible with all ATS systems.

Models 601A and 602A 1 and 2.5 kW The 601A (type accepted from 700 to 1500 Watts) and the 602A (type accepted from 1000 to 2500 Watts) are nearly identical except for power supplies. The 601A serves as driver for the Model 610A 10 kW, and the 602A as driver for the Model 625 25 kW; the 10 and 25 kW amplifiers can be added at a later date with simple wiring changes should the user station increase its power to those levels.

The 601A and 602A feature RF stripline design, simplifying the tuning to a point where only two controls are needed. Each uses the 5CX1500A ceramic pentode at conservative levels. Both transmitters easily meet FCC requirements for spurious radiation with built-in harmonic filter. A high quality directional coupler is standard equipment.

Models 603 and 605B 3 and 5 kW The 603 (type accepted from 2500 to 3500 Watts) and the 605B (type accepted from 3500 to 5500 Watts) differ only in their power supplies and harmonic filters. Each uses one 3CX3000A7 ceramic triode in a grounded grid configuration, driven by one 4CX250BC tetrode. No neutralization or continual fine adjustments are needed. Providing stable tuning are vacuum variable capacitors in the driver stage.

Automatic Power Control is standard with the 603 and 605B; maximum power can be adjusted for, and legal power limit will not be exceeded during input power variations. Excellent operating economy is guaranteed with the 3CX3000A7 tube, designed especially for this application.

Models 610A and 625A 10 and 25 kW Differences in power supplies and final tubes mark the functional dividing point between the 610A (type accepted from 17,000 to 25,000 Watts). In either case the basic driver transmitter (see 601A and 602A, above) can be connected directly to the antenna for high-power backup.

Automatic Power Control, overload and 'Tally Light' protection with automatic recycling, VSWR protection, and total accessibility to components all apply to the 610A and 625A. Both units use a step-start high voltage system and a front panel control provides a low-power condition for tuning and emergency operation. The final tube in each of these transmitters is a ceramic triode in a grounded grid configuration, operating in both cases at about 80% efficiency. The tube in the 610A is the 3CX10000A7, and in the 625A is a 3CX15000A7.

The 610A is contained in two cabinets, while the 625A has an external HV vault. Installation handling is simplified as the driver and final amplifiers are shipped as separate cabinets, easily joined once in place.

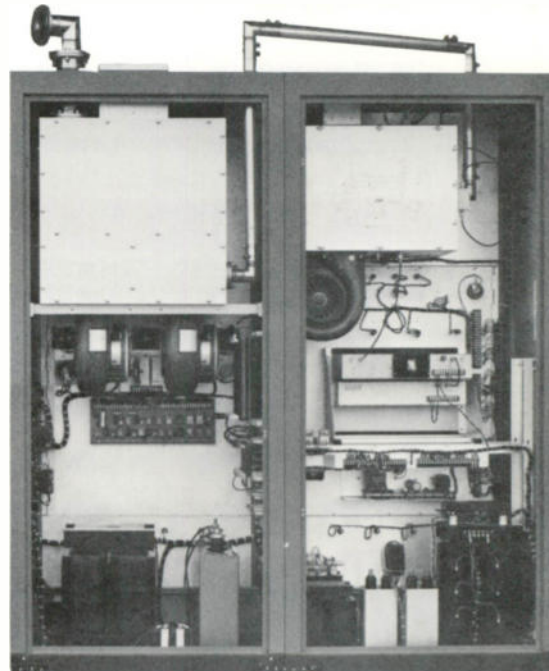
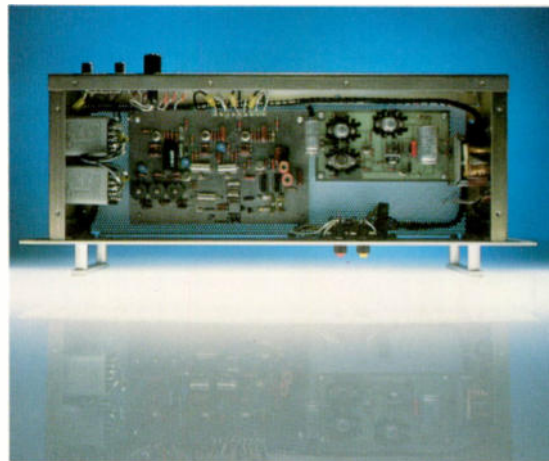
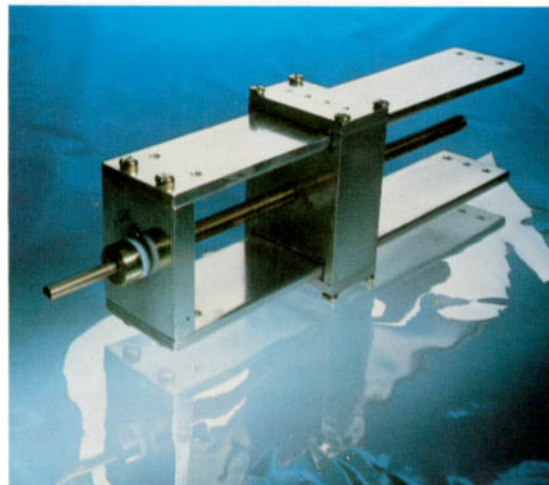

Top: The silver plated solid brass variable inductor assembly used in the medium and high power FM transmitters. Sliding contacts are kept in perfect alignment and from any breakage by this enormously rugged variable inductor.

Center: Model 682 Stereo Generator

Bottom: Model 610A

SIMPLIFIED BLOCK DIAGRAMS

MODEL 601A/602A

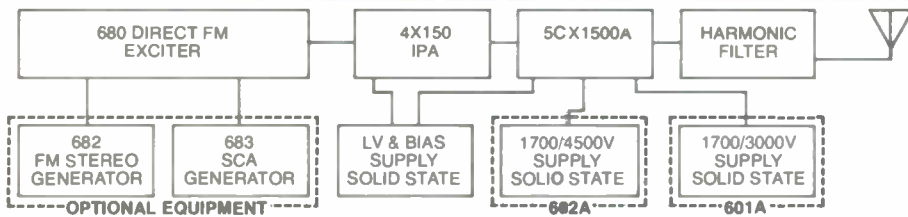

MODEL 603/605B

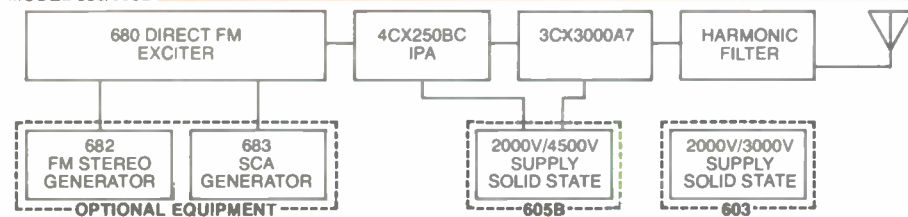

MODEL 610A/625A

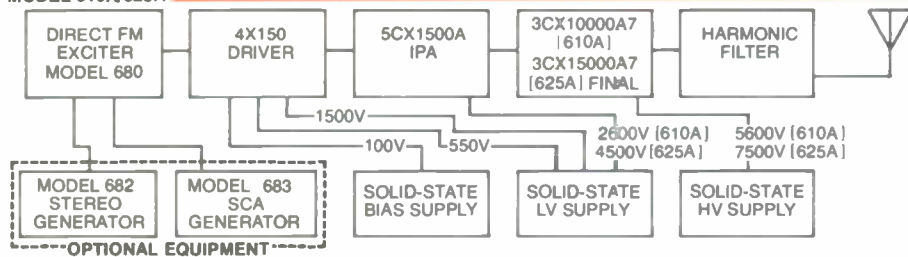

MODEL 701B, 703B

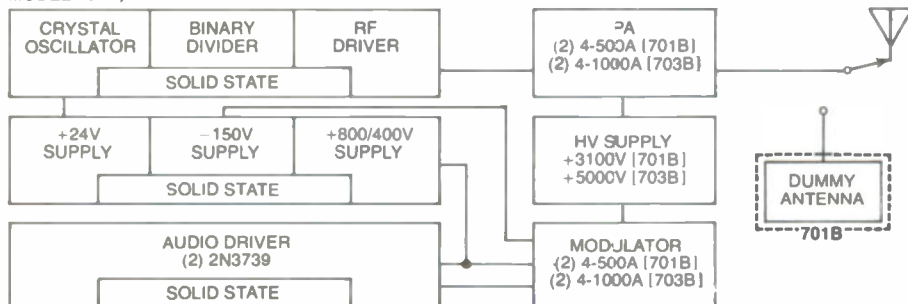

MODELS 705C, 710C, and 715C

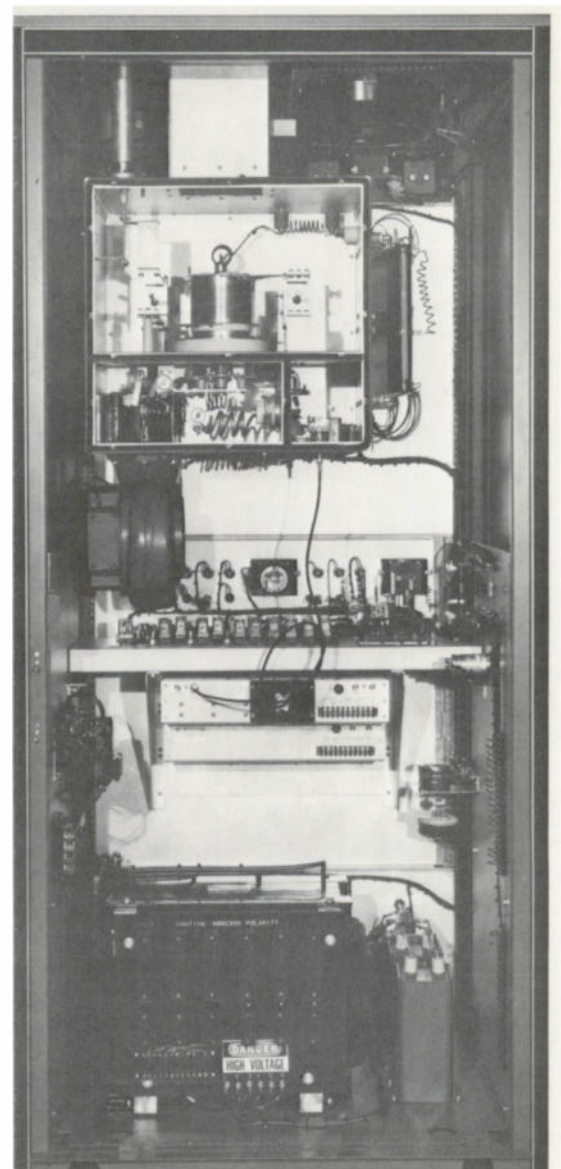
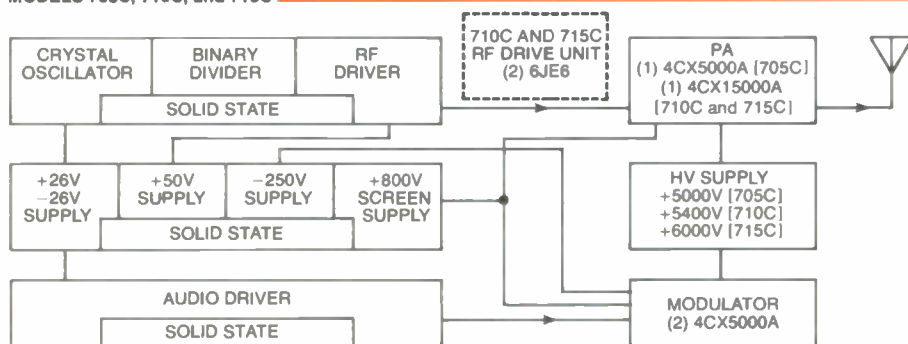

Model 603

Antenna coupling units, remote metering diodes, lighting chokes, phase samplers, rigid line or coax, fittings, monitor equipment and remote control systems are all available through the Cetec Broadcast Group District Managers domestically, or through the many overseas representatives of the Broadcast Divisions of Cetec Corporation.

For general sales information and the location of the CBG district manager in your area of the US, call Cetec Broadcast Group. The Divisions can be contacted directly for technical assistance and other information:

- CETEC JAMPRO**, Sacramento, CA (916) 383-1177
- CETEC SPARTA**, Sacramento, CA (916) 383-5353
- CETEC SCHAFER**, Goleta, CA (805) 968-0755
- CETEC CORPORATION**, El Monte, CA (213) 442-8840



Cetec Broadcast Group

The Broadcast Divisions of Cetec Corporation
75 Castilian Drive Goleta, California 93017

Cetec Sparta Audio Equipment/2



Front Cover: Series II Showcase, Centurion II 12-mixer stereo console with Equalizer, CR120 Cartridge Rack, Century II Tape Cartridge R/P and Playback machines on right, with Century IIC mono R/P on left, near GT12 Turntables. Chairs shown are not part of Sparta furniture groups. -

Besides the products described in this brochure, Cetec Broadcast Group offers:

Microphones selected from the lines of Shure, EV, Sony, and other established makers, including VEGA Wireless Microphones . . .

Microphone Accessories from Flexo, Shure, EV and others . . .

Speakers from the Argos 'Slim Line' series and others . . .

Reel/Reel recorders and reproducers by Ampex, Revox, Scully, Metrotech, Otari, ITC and other top makers.

For general sales information and the location of the CBG district manager in your area of the US, call Cetec Broadcast Group. The divisions can be contacted directly for technical assistance and other information:

CETEC JAMPRO, Sacramento, CA (916)383-1177

CETEC SPARTA, Sacramento, CA (916)383-5353

CETEC SCHAFER, Goleta, CA (805)968-0755

CETEC BROADCAST GROUP, Goleta, CA (805)968-1561

Cetec Sparta 'Showcase' control room cabinetry gives any station a custom look without custom cost. The designs have been carefully arrived at to provide the best in beauty, durability, and utility.

Basic material is carefully protected with heavy laminated plastic in woodgrain and a light decorator color chosen to enhance the appearance of both your studio and the audio equipment around which the 'Showcases' are designed. Finish of the laminated plastic work surfaces is 'velvet' which resists everyday usage marks to a surprising extent. Attention to detail by our cabinet shop is the equal of furniture grade workmanship anywhere in the nation.

The Showcase Series II beautifully finished design sets off either the Centurion I or II master control room console types, or the 3000-Series 10-mixer consoles.

A variation of the pictured Showcase II on the cover substitutes a small support pedestal where the turntable cabinet is not used. Usually a tape cartridge hutch is chosen to finish the studio furnishings, similar to the Showcase I group on this page. The tape cartridge storage hutch holds 128 'AA' carts.

The Showcase Series I was designed around the famous 1000-Series 8-mixer Sparta 'workhorse' consoles. This furniture style graces perhaps more US studios than any other such ready-made equipment. Series I furnishings are also available with the 3000-Series 10-mixer audio consoles.

Components of this Series are available individually, as well as in groups with equipment installed. The single or dual turntable cabinets and utility cabinets, in particular, have proven useful and handsome in many studio settings without other Sparta-made furniture.

Series I Showcase: Model 1040 stereo console in Group B (see Price List) configuration. Century II and IIC tape cartridge equipment is extra.



MA-Series Monitor Amplifiers have power to spare for driving speakers at studio listening levels. The all-new design of the mono MA25A and MAS50A stereo amplifiers is solid state, with easy removal of the single PC board. Power supply design is such that instantaneous program peaks will be faithfully reproduced.

Accessories include optional cue amplifiers (specify MA25A/Q or MAS50A/Q and SM3 muting/relay).

SP30 and SP40 Speaker Systems with solid oiled-walnut finish enclosures not only complement 'Showcase' studio groups, but are as handsome and functional as needed in any studio. The SP30 is a 3-way system of 10" cone woofer, 5" cone mid-range, and 4" 'Super Dome' tweeter with frequency dispersion of 160. Two controls inside the removable cloth grille adjust mid- and high-range frequencies from -6 to +2 dB.

The SP40 is a 4-way system of 15" woofer, 6.5" dome, 4" 'Super Dome', plus 3" cone tweeter. It employs dual environment-matching controls as in the SP30, and has two crossover systems. The SP40 reproduces profound bass fundamentals with great fidelity.

CR100 and CR120 Cartridge Racks both match the 'Showcase' studio furniture in appearance and quality. The CR100 is a wall mount container for 100 NAB 'AA' carts, while the 'lazy susan' CR120 holds 120 carts.



Left: MAS50A/Q Monitor Amplifier, with SP30 (left) and SP40 Speaker Systems. SP40 with grille removed to show 15" woofer, dual controls for adjusting speaker system for specific environment.

Below: CR100 (left) and CR120 Cartridge Racks with CE3 Tape Eraser, Sparta Premium (red cases) and Standard tape carts.



Right: ASC305B/C Studio/Remote Audio Control Center; difference between 'B' and 'C' versions is deluxe 1035 Console with step attenuators, synchronous turntable motors in 'C' model, instead of 1030 Console and 4-pole turntable motors. Note work surface extension; compare to AC155B/C below.

Below: 1015/1017 5-mixer mono console, as used in AC155B/C.



Sparta's Studio/Remote Audio Control Centers are still unique in the industry; no other such sturdy, handsome, and flexible units are available to the broadcaster or disco-DJ for portability where showmanship is vital!

The monaural AC155, using the 1015/1017 5-mixer consoles, and the stereo ASC305, which uses the 1030/1035 consoles, enjoy every design advantage of the 'Showcase' groups. The same fine materials are used and the rock-steady stance on remote location assures studio quality air sound.

In use the units' versatility can be improved by adding either or both the bench-lid combination, and utility shelf which provides working space for any assignment.



Above: 1030/1035 5-mixer stereo console.

Left: The AC155B/C monaural Studio/Remote Audio Control Center.

Not Pictured: Accessories for the Studio/Remote Audio Control Centers include the US5 Utility Shelf for tape cartridge and such equipment above console, and BL5 Bench-Lid which functions both as protection during transportation and operator's seat on location.

1000-Series Monaural Consoles. The Cetec Sparta Model 1020 (A20 Series) is probably one of the most widely used consoles in broadcasting. It has been produced, with periodic state-of-the-art updates, for quality and price conscious broadcasters around the world for over fifteen years! Its present production configuration assures absolute dependability under widely varying conditions of use. The Model 1015/1017 (A15 Series) despite its compact size gives the user fourteen inputs in five mixers. Its flexibility and handling ease have made it a production room and remote broadcast favorite everywhere it has seen use with nearly an entire generation of broadcasters. The 1015/1017 (the same basic console with different attenuators), like the Model 1020, represents constant upgrading of a basically fine design which today results in one of the most time-tested and use-proven consoles available at any price.

1000-Series Stereo Consoles. The Cetec Sparta fourth generation Model 1040 (AS40 design series) supplies stereo FM stations with a superb, flexible console for most control room operations. At the same time the 1040 costs less than comparable competing units because of its ten-year-plus history of continuous improvement. Great reliability at modest cost is the Model 1040 hallmark of excellence. The 5-mixer Model 1030/1035, with its nine stereo inputs, makes an excellent standby, production room, or remote broadcast unit. Its wide assortment of functions have been found ideally suited to many smaller FM stations as a control room main console as well. The 1030/1035 was originally produced (as the AS30 Series) concurrent with the rise of FM stereo, and was among the very first mixing consoles ever available for that medium.

*Right: Model 1017 5-mixer mono console
precision step attenuators.
Below: Model 1040 8-mixer stereo console;
precision step attenuators are standard in both
Models 1020 and 1040.*

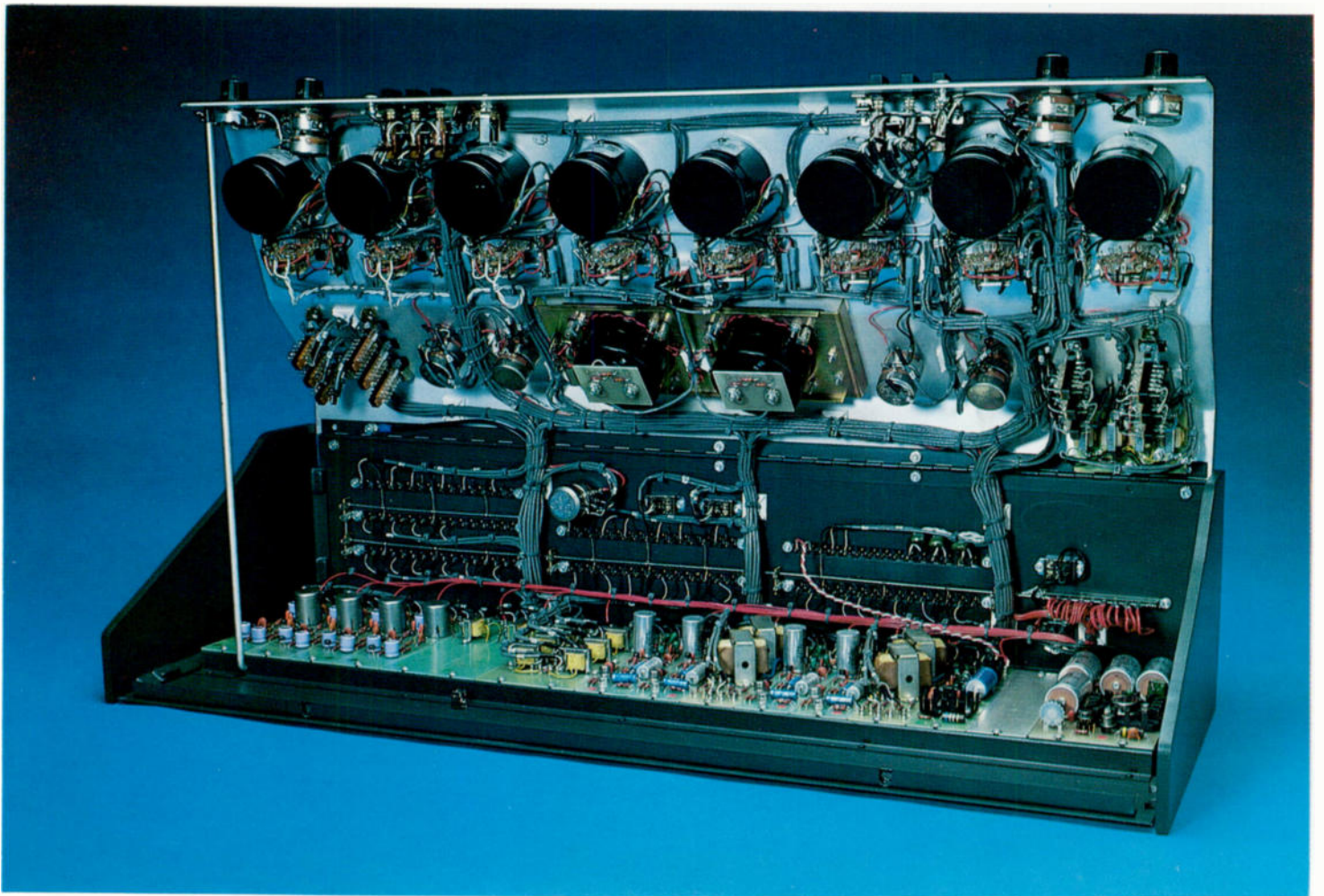
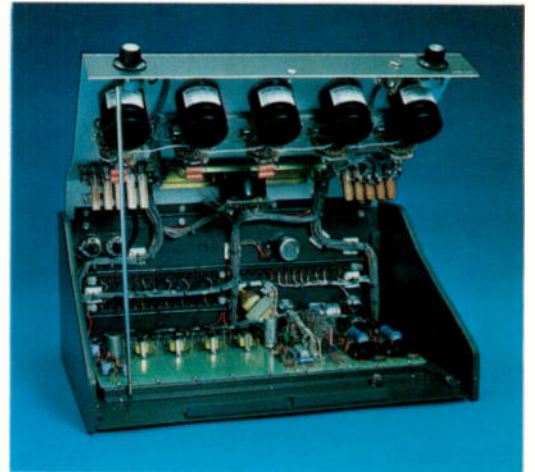

Functions; Model 1040.

The fourteen stereo inputs of this eight-mixer console are balanced among low and high levels, with optional exchange of low-for-high level mixing in one channel. The Precision Step Attenuators all have Cue position, which feeds an internal Cue amplifier; the gain is controllable, with external speaker output terminals. The standard mixer assignments for the Model 1040 are:

1 Low Level; pushbutton selection of three microphone sources and 'pan pot' which allows the R or L microphone to be panned between the channels, compensating for variations in levels. A total of five microphone inputs in the first mixer gives extreme flexibility.

2 Low Level; single microphone source.

3 High Level; single equipment source, with microphone preamp option.

4-6 High Level; single equipment sources.

7-8 High Level; each has 3-station pushbutton selector for assignment as the user sees fit.

Monitor/Muting; muting is provided for the microphone mixers, with the Cetec Sparta MA-Series monitor amplifier and its plug-in Muting Relay System.

Busses and Bridging; Audition and Program outputs employ identical values and components, so standby operation from Audition is possible. VU meters are switchable to monitor either buss. Each buss has balance controls; no significant change of total output level results from minor balancing changes. 10K ohm balanced bridging inputs used assure flexibility in changing from one source to another. 620 ohm resistors across source or console line ends can alter terminations if needed.



Model 1040 console; introduced as the Sparta AS40 series.

Functions; Model 1030/1035

Model 1030 designates standard rotary mixer controls, while the 1035 is equipped with Precision Step Attenuators. The 1030/1035 design accommodates the greatest number of types of sources possible among its nine inputs. Standard configuration for either model is:

1 Low Level; single microphone input.

2 High Level; single equipment source, with microphone preamp option.

3-4 High Level; single equipment sources.

5 High Level; pushbutton pre-selection of multiple inputs.

Note; a front panel selector permits microphones in Mixer 1 to drive the two output lines monaurally. Program amplifiers can be driven individually, monaurally, also.

Quick checking of stereo phasing of both types of sources is thus possible.

Unassigned pushbutton stations are provided for customized operation of the console.

Busses and Bridging; high and low-level preamps and input operations are quite similar to the Model 1040, above. Gain of the Audition amplifiers, however, is set by internal resistors to provide about the same level as Program. Audition output terminals are fed from Audition line amplifiers by a single-ended source impedance of 60 ohms, so the output can drive multiple loads with negligible attenuation.

Monitor/Muting is similar to the Model 1040 remarks; with the 1030/1035 either Program, Audition, or the user's choice of an external input may all be pushbutton selected for monitoring with the Cetec Sparta MAS-50Q Monitor Amplifier.

Functions: Model 1020.

All eight rotary Precision Step Attenuators have Cue position, and each is switchable to either Program or Audition channels. Talkback provision operates through mixer #1, with a switch which assigns its preamplifier output to terminals marked A and B on the rear panel. A small amplifier-speaker of the user's choice, when connected to those terminals, will give studio talkback where needed. The Headphone output has gain control and three pushbuttons to select what material is so monitored. An unassigned 3-position pushbutton switch is provided, with spare terminals on the rear panel, to provide features the user may determine. The 1020 standard configuration for mixer assignment is:

1-3 Low Level; each pushbutton selectable for three microphone sources. Muting is supplied normally for mixers 1-3, to operate with any one or combination of them. The user may determine other mixing positions to be muted, and change the connections to suit himself. Each relay provides muted monitor audio output, plus an isolated contact pair to control external equipment, or on-air lights. Additional low level preamplifiers may be installed to alter their arrangement.

4-6 High Level; single inputs for turntables and tape equipment.

7-8 High Level; each pushbutton selectable for five line level sources. A 3-position switch allows the selected input of either of these two mixers to be assigned to Mix (fed to normal mixing buss), Cue (for monitoring), or Feed (feed audio chosen by Monitor selection, Audition, Program, or Air down the selected remote line).

Busses and Bridging; the Program and Audition busses are identical, with the VU meter switch-selectable to monitor either one, or an external input such as Air. 10K ohm balanced bridging inputs are provided on all high-level stations, so that either 600 ohm line or high impedance sources can be accommodated. 620 ohm terminating resistors can be added if required or desired.



Model 1020 mono console; originally the A20 series.

Functions; Model 1015/1017.

The Model 1015 designates standard mixers, Model 1017 uses Precision Step Attenuators. All five rotary mixers have Cue position. Inputs to the individual mixers are dual, programmed by the operator into switches designated A or B. In addition, mixer #5 has a 5-position input selector which operates on the B side only. The Cue and Monitor amplifiers will accommodate speakers of 4-14 ohms impedance. Muting is operable from mixers 1-3, but relay operation is dependent upon what connections are made to the relay board; a variety of muting configurations is possible from the first three mixers. Each relay also supplies an isolated closure for control of external equipment or on-air lights. An auxiliary 5-station pushbutton network is provided at the left of the console for custom switching functions which may be dictated by user needs. Standard mixer arrangement for both the 1015/1017 models is:

1 Low Level; with A/B selection between two microphone inputs, can be exchanged with another mixer, omitted for all-high-level mixers, or an additional low level card placed in another mixer position.

2-4 High Level; with A/B selection between inputs.

5 High Level; single A input, and six B inputs, pushbutton selected.

Busses and Bridging; The monitor amplifier operates continuously through its own level control from the program amplifier. A public address amplifier output is also provided, with separate gain control for driving multi-speaker loads. An auxiliary 5-station pushbutton network is provided at the left of the console for customizing the user's switching functions.



Top: A16R 5-mixer monaural rack mount console. Lower Left: RA1 Utility Amplifier. Lower right: RA4 Remote Mixer.

Model A16R Monaural Console. This steel-enclosed, rugged five-mixer console, designed for rack mount or mobile station use, employs the same time-proven active circuits and power supply as the Models 1020 and 1040 consoles. The all-solid state A16R takes only 8.75" of standard rack space, but provides flexibility in audio switching out of proportion to its size. The five mono mixers each have three pushbutton selectors for fifteen total program channels.

1 Low Level; 150/250 ohm microphone level, or can be strapped for 50 ohm.

2-5 High Level; 10K ohm balanced. Input cards are identical in size, may be interchanged for varying the high/low input arrangement.

Monitor/Muting; monitor outputs include three muted from three separate relays, and one unmuted. Each relay closes from any combination of inputs selected on mixers 1-3. 'On air' light contact is also provided from each relay.

Model RA4 Remote Mixer.

The four mixers allow a choice of either microphone or high level inputs to each channel. Low level inputs can be 600 ohm terminated, or high impedance bridged. Both AC and DC battery supplies are internal; battery operation is automatic in case of line power failure. Ten dBm nominal program level is delivered into 600 ohms, with 22 dBm maximum. The headphone circuit, using high impedance phones only, allows monitoring of program out, or any cue position.

Model RA1 Utility Amplifier.

The RA1 is of full IC design, with a unique low current drain line amplifier. Separate line and microphone input connectors are provided; transient-free switching enables both operating modes to be used alternately while on the air without electronic noise. Audio equipment sources can be operated through the high impedance balanced bridging input.

As a microphone preamplifier the RA1 delivers up to +65 dB; as a line booster or remote amplifier the figure is up to +30 dB. The output level is 10 dBm nominal into 600 ohms, with a 22 dBm maximum.

SPECIFICATIONS:

SHOWCASE II SERIES

Floorplan: 93"W x 67"D x 56"H (height; cart hutch on utility cabinet) (236 x 170 x 142 cm).

Shipping

Console Desk: 48 lbs (21.8 kg), 2.9 cu ft (.08 cu meter).

Large Modesty Panel: (with complete Showcase) 9 lbs (4.1 kg), 1 cu ft (105.4 cu cm).

Small Modesty Panel: (Showcase without Turntable Cabinet) 8 lbs (3.6 kg), 1 cu ft.

Desk Support Pedestal: 63 lbs (28.6 kg), 9 cu ft (.25 cu meter).

Optional Desk Support Pedestal: (Showcase without Turntable Cabinet) 40 lbs (18.1 kg), 2 cu ft (.06 cu meter).

Complete Console Desk: (with both Support Pedestals and small Modesty Panel) 159 lbs (72.1 kg), 26 cu ft (.74 cu meter).

Utility Cabinet: 151 lbs (68.5 kg), 15.4 cu ft (.44 cu meter).

Tape Cartridge Hutch: (128 NAB 'AA' carts) 60 lbs (27.2 kg), 4.3 cu ft (.12 cu meter).

Dual Turntable Return: (complete with GT12 Turntables and preamps) 306 lbs (138.8 kg), 20 cu ft (.82 cu meter).

Showcase Series II cabinetry with equipment is shipped by padded van except for the securely boxed console the user has chosen. Console shipping data should be added to the other figures; see Audio Equipment/1 booklet for Centurion and 3000-Series Console figures.

SHOWCASE I SERIES

Floorplan: 83"W x 65"D x 51"H (height; cart hutch on utility cabinet) (211 x 165 x 130 cm).

Shipping

Console Desk: 75 lbs (34 kg), 16.1 cu ft (.46 cu meter).

Console Hood/Speaker: (fits 1020 or 1040 only) 15 lbs (6.8 kg), 4.2 cu ft (.12 cu meter).

Dual Turntable Cabinet: 120 lbs (54.4 kg), 11.5 cu ft (.33 cu meter).

Single Turntable Cabinet: 70 lbs (31.75 kg), 7.1 cu ft (.2 cu meter).

Tape Cart Storage Hutch: 60 lbs (27.2 kg), 11.5 cu ft (.33 cu meter).

Utility Cabinet: 168 lbs (76.2 kg), 11.5 cu ft.

STUDIO/REMOTE AUDIO CONTROL CENTERS

Floorplan: 54"W x 19"D x 34"H (height; 41" with Utility Shelf), (depth; 26" with work surface extended) (137 x 48 x 86 cm).

Shipping

AC155B/C: 170 lbs (77 kg), 17.7 cu ft (.5 cu meter).

ASC305B/C: 175 lbs (79.4 kg), 17.7 cu ft.

Bench-Lid: 70 lbs (31.7 kg), 17.7 cu ft.

Utility Shelf: 70 lbs, 17.7 cu ft.

MA25A MONITOR AMPLIFIER

Power Output: 25 Watts RMS continuous into 8 ohm load.

Frequency Response: ± 1 dB 20-80,000 Hz.

Distortion: Less than 0.3% THD at 25 Watts, 20-20,000 Hz.

IM Distortion: Less than 0.2% at all output levels.

Noise: 80dB below rated output.

Input Impedance: 10K ohms.

Load Impedance: 8 ohms.

Input: Less than 1 Volt RMS for rated output.

Contour: Switchable; + 12dB at 50 Hz.

Power: 117VAC 50/60 Hz (230VAC optional).

Size: 19"W x 9"D x 3.5"H (485 x 230 x 89 mm).

Shipping: MA25A; 8.5 lbs (3.83 kg).

MAS50A MONITOR AMPLIFIER

Channel Separation: 40dB.

Controls: Rear Panel; contour gain ganged for stereo, plus balance control.

Shipping: MAS50A; 9.5 lbs (4.15 kg).

All other specifications of MAS50A are identical to MA25A above.

SM3 MUTING/RELAY

Mounting: Outside of monitor amplifier chassis, behind face panel.

Shipping: add .875 lb (.39 kg) to weight of MA25 or MAS50.

CUE AMPLIFIER

Mounting: Within Monitor Amplifier chassis.

Power Output: 0.5 Watt.

Shipping: add .5 lb (.23 kg) to weight of MA25 or MAS50.

SP40 SPEAKER SYSTEM

Crossover Frequencies: 500, 2000, and 10,000 Hz.

Impedance: 8 ohms.

Frequency Response: 22-22,000 Hz.

Power Handling: 120 Watts peak.

Size: 17.5"W x 11.5"D x 26.5"H (440 x 290 x 670 mm).

Shipping: 43 lbs (19.5 kg).

SP30 SPEAKER SYSTEM

Crossover Frequencies: 600 and 1500 Hz.

Impedance: 8 ohms.

Frequency Response: 27-22,000 Hz.

Power Handling: 70 Watts peak.

Size: 13"W x 11.5"D x 22.5"H (330 x 290 x 570 mm).

Shipping: 33 lbs (15.0 kg).

CR100 CARTRIDGE RACK

Capacity: 100 NAB 'AA' carts.

Finish: Walnut grain laminated plastic over furniture grade particle board.

Size: 25"W x 5"D x 27.5"H (635 x 127 x 700 mm).

Shipping: 30 lbs (13.6 kg), 2.4 cu ft (.068 cu meter).

CR120 CARTRIDGE RACK

Capacity: 120 NAB 'AA' carts.

Finish: same as CR100, above.

Size: 15.25"W x 15.25"D x 29"H (requires 18" area to revolve in) (387 x 387 x 737 mm).

Shipping: 37 lbs (16.8 kg), 3 cu ft (.085 cu meter).

MODEL 1020

Mixers: Eight.

Inputs: Twenty-two. Three each, mixers 1-3; one each, mixers 4-6; five each, mixers 7 & 8. Plus external Monitor and Headphones.

Input Impedance: Microphone; 150/250 ohm balanced. High level; 10K ohm balanced bridging for source impedance of 600-10,000 ohms.

Input Levels: Low level; -55 dBm, preamplifiers standard in mixers 1-3, optional in mixers 4-8. High level; -10 dBm nominal, standard in mixers 4-8.

External Monitor; 1 volt RMS. External Headphones; 1 mW RMS.

Output Levels: Program and Audition; 8 dBm at 0 VU, 20 dBm maximum, 600 ohms balanced. Monitor; 8 Watts into 8 ohms.

Cue; 0.5 Watts into 4 ohms.

Output Lines: Program, Audition, Cue, Monitor, Headphones.

Response: Program and Audition; ± 2 dB, 20-20,000 Hz.

Distortion: Program and Audition; less than 0.5% THD at 8 dBm output. Monitor and Cue; less than 1% THD at rated output.

Signal-to-Noise: Below 65 dB at 0 VU out, with -55 dBm high-level input.

Crosstalk: Within 6 dB of noise.

Muting: Three internal relays operate from mixers 1-3 in any combination via internal patch panel. Each relay provides independent muted monitor out plus isolated closure for control of external equipment or on-air lights (115 VAC, 5A maximum).

Power: 115/230 VAC, 50/60 Hz.
Size: 28½"W x 10¾"D x 6½"H (710 x 271 x 165 mm).
Shipping: Console; 35 pounds (16 kilos).
1020 Options: Low-level preamplifiers in mixers 4-8.

MODEL 1015/1017

(Where not specified, same as Model 1020 above)

Mixers: Five.
Inputs: Fourteen. Two each, mixers 1-4; six for mixer 5.
Input Levels: Low-level; 55 dBm, preamplifiers standard in mixer 1, optional in mixers 2-5. High-level; -10 dBm nominal, standard in mixers 2-5, optional in mixer 1.
Output Levels: Program; 8 dBm at 0 VU, 22 dBm maximum, 600 ohms balanced. Monitor; 8 Watts into 8 ohms. Cue; 1 Watt into 4 ohms. PA; 1 volt nominal into 10,000 ohms.
Output Lines: Program, Monitor, Cue, Headphones, and PA.
Response: All outputs; ±2 dB, 20-20,000 Hz.
Size: 15½"W x 10¾"D x 6½"H (395 x 271 x 165 mm).
Shipping: Console; 26 pounds (11.8 kilos).
1015/1017 Options: Precision Step Attenuators, *specify Model 1017*; low-level preamplifiers in mixers 2-5; high-level preamplifier in mixer 1.

MODEL 1040

Mixers: Eight.
Inputs: Fourteen stereo pairs. Three in mixer 1; one each in mixers 2-6; three each in mixers 7-8.
Input Impedance: Microphone; 150/250 ohm balanced. High level; 10K ohm balanced bridging for source impedances of 600-10,000 ohms.
Input Levels: Low level; -55 dBm, preamplifiers standard in mixers 1 and 2, optional in mixer 3. High level; -10 dBm nominal from 600 ohm sources, standard in mixers 3-8.
Air and external monitor; 1 volt nominal into 10K ohms.
Output Levels: Program and Audition; 8 dBm into 600 ohms at 0 VU, 22 dBm maximum. Monitor; 1 volt nominal into high Z load. Cue; 1 Watt mixed mono into external 3.2-8 ohm speaker.
Headphones; 1 mW nominal into 10 K ohms.
Output Lines: Program, Audition, Monitor, Cue, and Headphones.
Response: All outputs; ±2 dB, 20-20,000 Hz.
Distortion: All outputs; less than 0.5% THD at normal operating levels. Less than 1.0% THD at maximum output.
Signal-to-Noise: 65 dB or more below 0 VU out (8 dBm), with -55 dB low level input. 75 dB or more below 0 VU out (8 dBm), with -10 dBm high level input.
Crosstalk: Within 6 dB of noise at normal operating levels.
Muting: Switch closure on Audition and Program for mixers 1-3, for control of external relays.
Power: 115/230 VAC, 50/60Hz.
Size: 28½"W x 10¾"D x 6½"H (710 x 271 x 165 mm). Power supply, Model PS8; 4¾"W x 6½"D x 3¼"H (120 x 165 x 83 mm).
Shipping: Console and Power supply boxed together; 37 pounds (16.75 kilos).
1040 Options: Low level preamplifier in mixer 3.

MODEL 1030/1035

(Where not specified, same as Model 1040 above)

Mixers: Five.
Inputs: Nine stereo pairs. One each in mixers 1-4; five in mixer 5; external Air Input.
Input Levels: Low level; -55 dBm, preamplifier standard in mixer 1, optional in mixer 2. High Level; -10 dBm nominal from 600 ohm sources, standard in mixers 2-5.
Size: 15½"W x 10¾"D x 6½"H (395 x 271 x 165 mm).
Shipping: 24 pounds, including power supply (12 kilos).
1030/1035 Options: Precision Step Attenuators, *Specify Model 1035*; low level preamplifier in mixer 2.

A16R CONSOLE

Mixers: Five.
Inputs: Fifteen.
Input Impedance: Microphone; 150/250 ohms, with 50 ohms optional. High level; 10K ohm balanced bridging for source impedance of 600-10,000 ohms.
Input Levels: Low level; -55 dBm, preamplifier standard in Mixer 1, optional for Mixers 2-5. High Level; -10 dBm nominal from 600 ohm sources, standard on Mixers 2-5.
Output Levels: Program; (two channels) 8 dBm into 600 ohms for 0 VU. 22 dBm maximum. Cue; 1 Watt, 3.2 ohms. Monitor; 8 Watts, 8 ohms. Headphones; 1 mW RMS into 10K ohms.
Output Lines: Twin Program, Cue, Monitor, Headphones.
Response: Program, Monitor, and Cue; within 2 dB 20-20,000 Hz.
Distortion: Program (both channels); less than 0.5% THD at normal operating levels. Monitor and Cue; less than 1.0% THD at rated output.
Signal-to-Noise: 65 dB or more below rated output with -55 dB low level input. 75 dB or more below rated output with -10 dB high level input.
Crosstalk: Within 6 dB of noise at normal operating levels.
Muting: Switch closure on both Program channels for Mixers 1-3, for control of external relays.
Power: 117/230 VAC, 50/60 Hz.
Size: 19"W x 12"D x 8¾"H (Standard rack mount) (480 x 305 x 221 mm).
Shipping: 37 pounds (16.75 kilos).

RA4 REMOTE MIXER

Mixers: Four.
Inputs: Four.
Input Impedance: Switch selectable for either low level (150/250 ohm microphones), or high level balanced bridging.
Input Levels: Low level; -55 dBm. High level; 0 dB nominal.
Output Levels: Program; 10 dBm into 600 ohms at 0 VU. 24 dBm maximum on AC operation, 18 dBm maximum on battery operation. Test tone oscillator; 700 Hz, 10 dBm at 0 VU, output via Master Gain. Headphones; monitor Program or Talkback, high impedance. Monitor Output; to external monitor amplifier.
Output Lines: Program, Test Tone, Headphones, Monitor.
Response: ±2 dB 50-15,000 Hz at all operating levels.
Distortion: Less than 0.5% THD at all operating levels. Typically 0.15% THD.
Signal-to-Noise: 57 dBm input. Equivalent input noise -112 dBm.
Power: 117 VAC or (2) 9V transistor batteries.
Size: 12"W x 9"D x 2"H (305 x 230 x 64 mm).
Shipping: 7 pounds (3.15 kilos).

RA1 UTILITY AMPLIFIER

Microphone: 150/250 ohms; can be jumpered for 50 ohms.
Line: 20K ohms balanced bridging (10K ohms, single-ended inputs). Removable 600 ohm terminating resistor installed.
Gain: Microphone, 65 dB maximum. Line; 30 dB maximum.
Output Level: 10 dBm into 600 ohms balanced, nominal. 22 dBm maximum.
Response ±1 dB 20-20,000 Hz.
Distortion: Less than 1.0% THD at all operating levels. Typically 0.5%.
Signal-to-Noise: 65 dB or more below 10 dBm output level.
Power: 117 VAC 50/60 Hz.
Power Output: 3 Watts maximum.
Size: 4½"W x 7"D x 2½"H (114 x 178 x 63.2 mm).
Shipping: 2½ pounds (1.14 kilos).



Cetec Broadcast Group

The Broadcast Divisions of Cetec Corporation
75 Castilian Drive Goleta, California 93017

SS-SERIES SOLID STATE AM TRANSMITTERS 1, 2.5, and 5 KILOWATTS

- 100% solid state, including PA and modulator
- Single-ended Class B modulation
- Optimized RF; 90% or better efficiency
- Optimized Audio; 0.1% harmonic distortion, lower- and mid-frequencies
- Digital metering
- VSWR protection not required for normal operation
- No operator-required tuning adjustments
- Instantaneous power reduction
- High overall efficiency, low power consumption
- Quiet air-cooled operation using whisper fans
- Instant On/Off; no warmup time
- Remote interface built-in for all standard systems
- Optional plug-in DC coupled speech processing equipment available

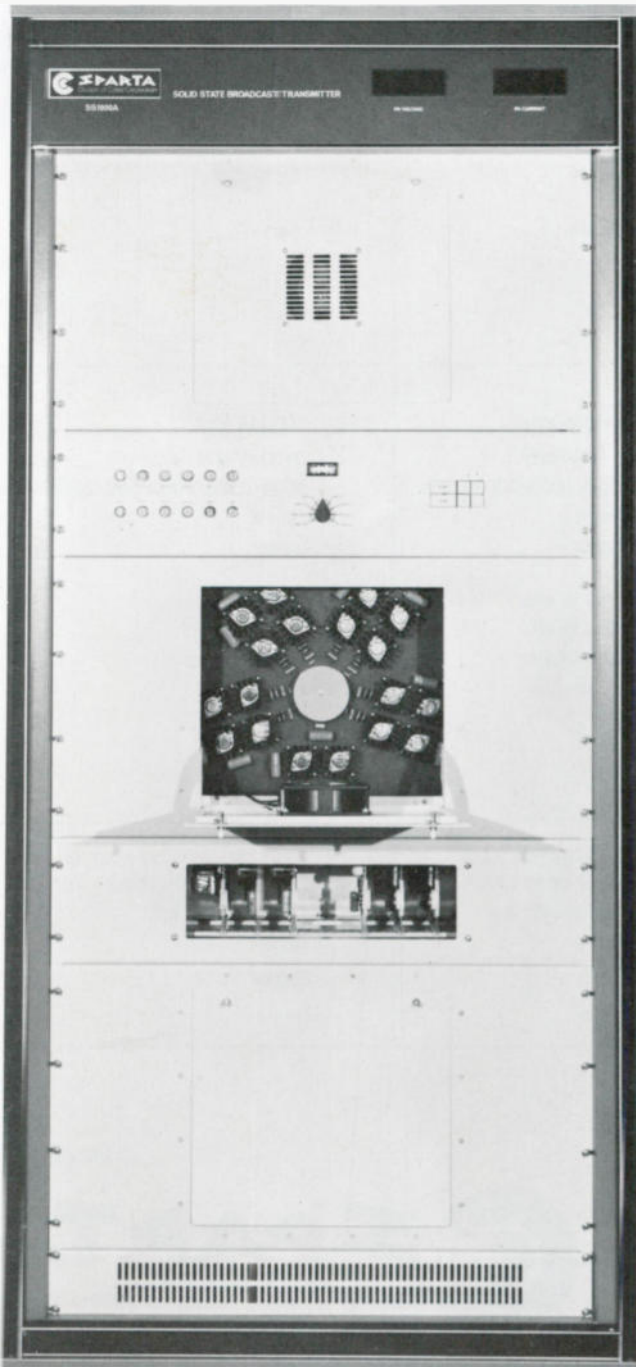

Sparta's line of solid state AM transmitters has been expanded to include models in 1,000, 2,500, and 5,000 Watt power levels; these are the SS1000A, SS2500A, and SS5000A, respectively.

Familiar and dependable single-ended Class B modulation is used, combining optimized RF and audio devices. RF systems use square wave switching mode transistors with operating efficiencies of 90% or better over the broadcast band. Advanced circuitry and the latest transistors have produced high power audio systems easily capable of modulating the SS Series of AM transmitters to 125%.

Digital metering is used to simultaneously monitor combined collector currents and voltage; either meter may be easily switched to substitute for the other, to meet the FCC requirements for a spare.

There are no front panel tuning controls; once output matching is set with an RF bridge no further adjustments are necessary.

A motor driven variac controls power output, and a primary power switching system provides an 'on air' power cutback facility without program interruption.

All low level RF and control assemblies are on plug-in cards. DC coupled speech processing equipment is available as an optional item; it simply is another card to plug into the same card cage space.

Overall operating efficiencies are approximately twice that of comparable tube models.

The SS5000A is formed of twin SS2500A transmitters operating in parallel through the unique Sparta Ferrite

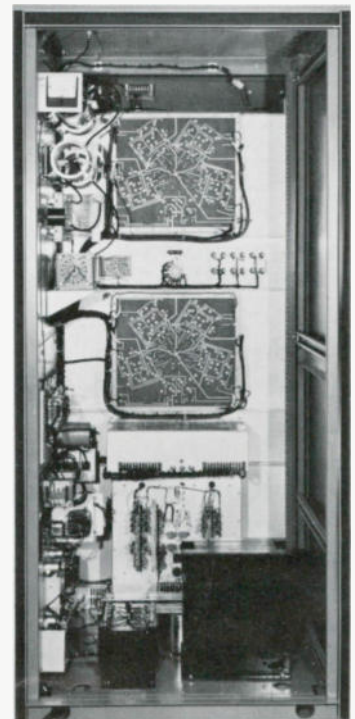

Combiner. This system, of course, provides instantaneous 2500 Watt backup with maximum protection against lost air time. Front panel switching selects

combined (5000 Watt) operation, or single transmitter operation (2500, 1000, or 500 Watts).

SPECIFICATIONS

PERFORMANCE	SS1000A	SS2500A	SS5000A *
AF INPUT IMPEDANCE	600 ohms	Same	Same
AF INPUT LEVEL, 100% MODULATION	+ 10 dBm ± 2 dB	Same	Same
AF RESPONSE, 20-10,000 Hz	± 1 dB	Same	Same
AF DISTORTION, 0-95% MODULATION, 30-10,000 Hz	1.5% or less	Same	Same
NOISE, BELOW 100% MODULATION, ALL POWER LEVELS	55 DB or better	Same	Same
FREQUENCY STABILITY	± 5 Hz	Same	Same
RF OUTPUT IMPEDANCE	50 ohms unbalanced	Same	Same
RF FREQUENCY RANGE	535-1620 KHz (one frequency as ordered)	Same	Same
CARRIER SHIFT, 100% MODULATION	Less than 2%	Same	Same
RF HARMONICS	Exceeds FCC & CCIR specifications	Same	Same
POSITIVE PEAK CAPABILITY AT FULL POWER OUTPUT	125% positive	Same	Same
ELECTRICAL			
POWER OUTPUT, NOMINAL	1000 Watts	2500 Watts	5000 Watts
POWER OUTPUT CAPABILITY	1200 Watts	2750 Watts	5500 Watts
POWER CUTBACK CAPABILITY	1000/500/250 Watts	2500/1000/500 Watts	5000/2500/1000/500/250 Watts
POWER SUPPLY	208/240 VAC Single phase	Same	Same
LINE FREQUENCY	50/60 Hz	Same	Same
POWER CONSUMPTION: ZERO MODULATION	1500 Watts	4050 Watts	8100 Watts
AVERAGE MODULATION	1700 Watts	4550 Watts	9100 Watts
100% MODULATION	2100 Watts	5300 Watts	10600 Watts
TYPE OF MODULATION	High level Class B	Same	Same
REMOTE CONTROL	Self-contained interface for all standard systems		
MECHANICAL			
SIZE	75.25"H x 35"W x 30"D (191 x 89 x 76.2 cm)	Same as SS1000A	75.25"H x 105"W x 30"D (191 x 267 x 76.2 cm)
WEIGHT	575 lbs (261 kg)	720 lbs (327 kg)	1900 lbs (864 kg)
ALTITUDE RANGE	0-12,500'	Same	Same
AMBIENT OPERATING TEMPERATURE	-20°C to +50°C	Same	Same
HUMIDITY RANGE	0-95% RH	Same	Same

* SS5000A consists of two 2500 Watt (SS2500A) transmitters in parallel operation. Master RF drive system, exclusive Sparta Ferrite Combiner, reject load and combiner control are mounted in third cabinet matching the transmitter cabinets. System provides dual redundant operation at 5000 Watts, or individual transmitter operation at 2500 Watts with further reduction to 1000 or 500 Watts.

March 1976



5851 Florin-Perkins Road, Sacramento, Ca. 95828
(916) 383-5353 • Telex 377-488 • Cable SPARTA

CENTER FREQUENCY RANGE OF SUBCARRIER:

Standard 41 or 67 kHz

OUTPUT VOLTAGE: At least 2 volts peak to peak into 10,000 ohms

FREQUENCY DEVIATION: + 10% of center frequency (100% subcarrier modulation)

MODULATION CAPABILITY: + 15%

CARRIER FREQUENCY STABILITY: 2,500 Hz over temperature range

AUDIO INPUT IMPEDANCE: 600 ohms balanced

AUDIO INPUT LEVEL: + 10dBm at 400 Hz (100% modulation)

AUDIO FREQUENCY RESPONSE: (30 to 7,500 Hz) ± 2dB referred to 75 usec pre-emphasis (convertible to 50 of 150 usec pre-emphasis)

HARMONIC DISTORTION: Less than 1.5% (50 to 7,500 Hz)

FM NOISE LEVEL: -65dB maximum (referred to 15% deviation)

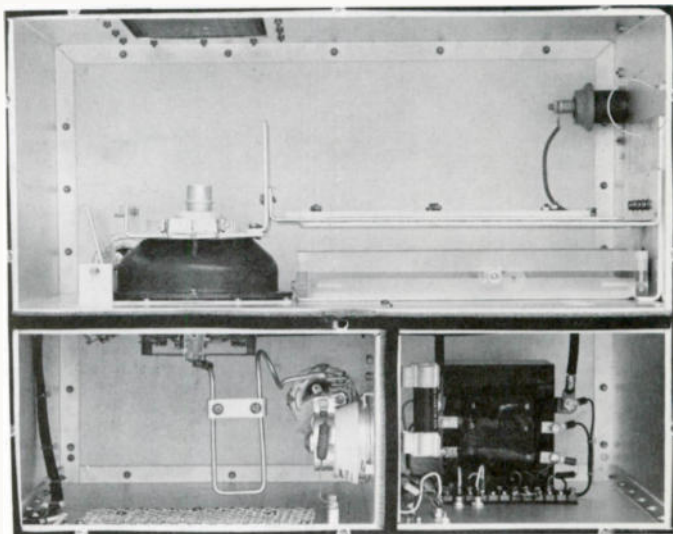

Model 601A-602A final cavity. The clean design of the transmitters—allowing easy access to all components—extends through all sections.

ORDERING INFORMATION:

The Models 601A and 602A are supplied complete with the Model 680 Exciter, crystal and oven, tubes and harmonic filter, factory tuned and tested on frequency. For stereo option specify Model 682 Stereo Generator. For SCA specify Model 683 SCA Generator, and further specify subcarrier frequency.

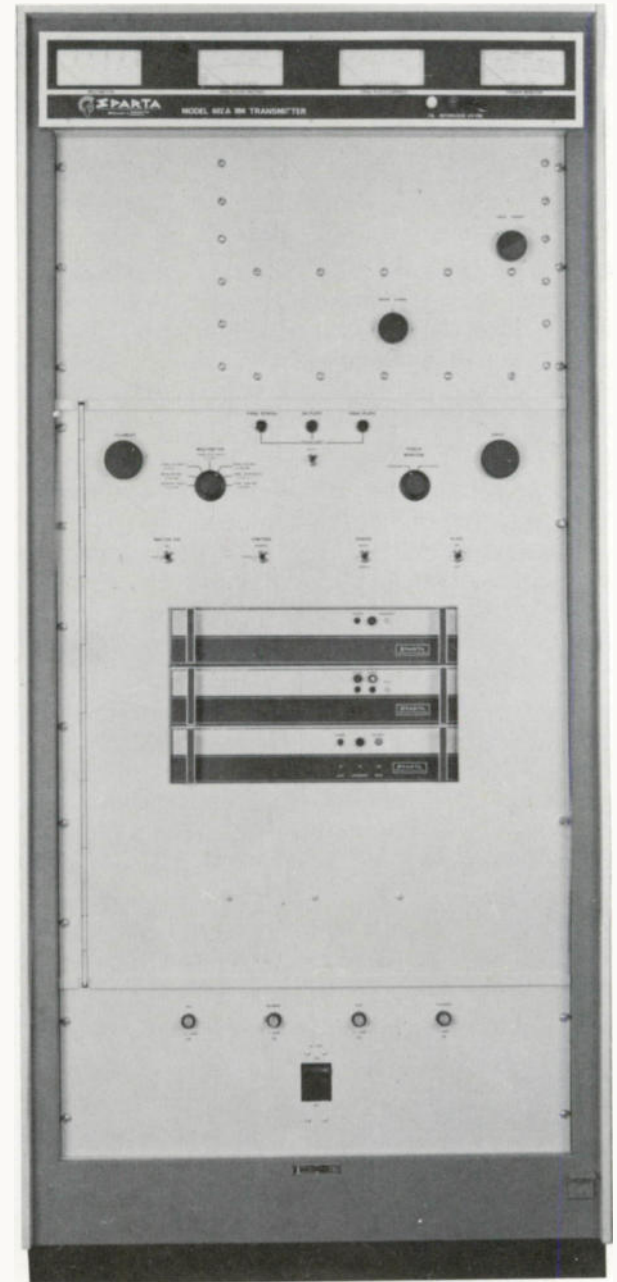
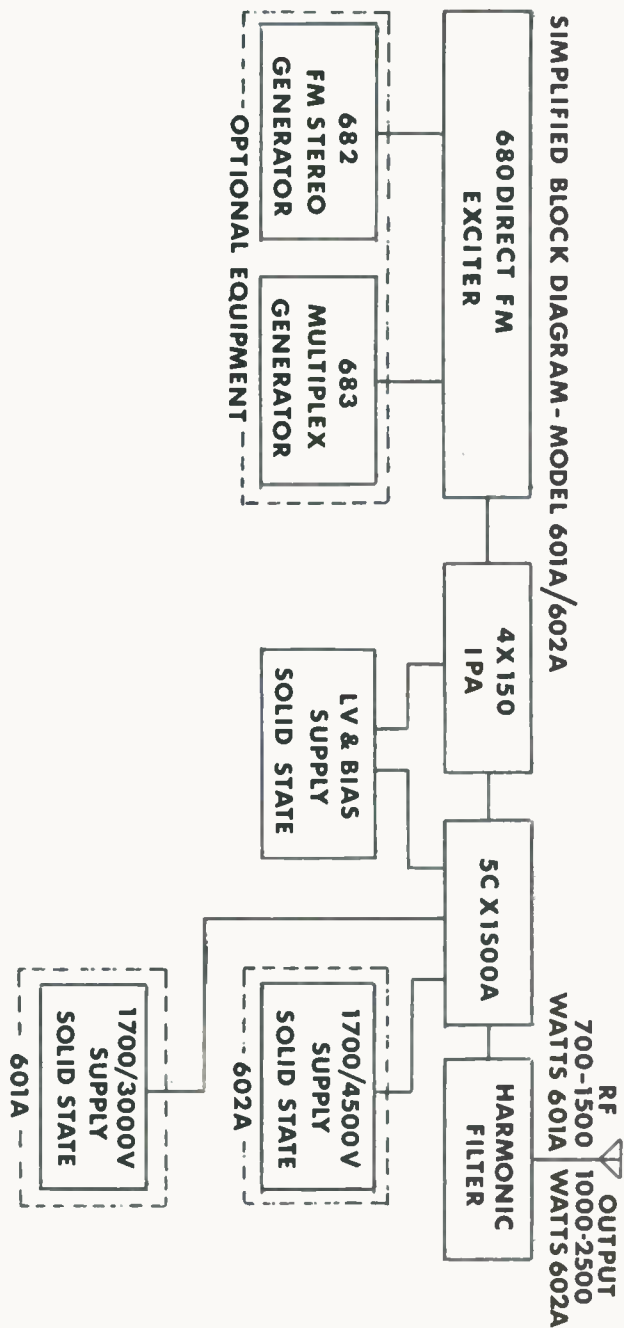

Models 601A and 602A FM Transmitters



5851 Florin-Perkins Road, Sacramento, Ca. 95828
(916) 383-5353 • Telex 377-488 • Cable SPARTA

MODELS 601A 1kW and 602A 2.5kW FM TRANSMITTERS

These modern transmitters belong together in one design series, and are largely identical with the exception of the high voltage power supplies. The Model 601A is type accepted from 700 to 1,500 Watts output. The model 602A is type accepted from 1,000 to 2,500 Watts; with 3-bay antenna it makes the most economical Class A full power package available.

Both transmitters use the Sparta Model 680 Direct FM Exciter, with optional 682 Stereo Generator and 683 SCA Generator (41 or 67 kHz).

A ceramic pentode, the 5 CX1500A, is common to both models. It is operated conservatively even at the higher 2500 Watt output power of the 602A. Neutralization is unnecessary. Tuning is straightforward and does not require continual adjustment to maintain optimum performance.

Driver plate current, final screen and final plate current are overload protected and monitored by a "Tally Light" system with a built-in memory. The low voltage power supply and the control system are readily accessible through a swing-out front panel. Full length hinged doors are provided front and rear. Since the front door is not interlocked it can be removed easily if a space problem exists.

In high power applications the 601A becomes the driver for the 10,000 Watt Model 610A, while the 602A is the driver for the 25,000 Watt Model 625A. Where licensing rules permit the higher power amplifier can be added at any time without major modifications of the lower power unit.

From the transmitter engineer's point of view the Sparta Models 601A and 602A leave nothing to be desired in ease of maintenance and reliability; the design is straightforward and uncluttered.

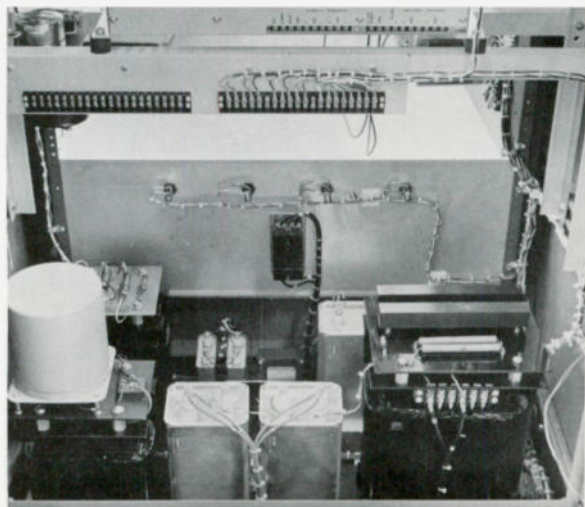

Model 601A lower cabinet, from rear.

Single phase power supply for both the 601A and 602A gives the user an economy bonus in installation and operation.

Specifications, Model 601A

POWER OUTPUT CAPABILITY: 700 to 1,500 Watts
LINE POWER CONSUMPTION: 3,300 Watts at 0.9 PF (1,500 Watts out)

The Model 601A specifications are otherwise identical to the Model 602A with the exception of the high voltage power supply, which operates at 3kv. See Model 602A specifications below.

Specifications, Model 602A

TYPE OF MODULATION: F3, F9 direct frequency modulation of mono, stereo, and SCA audio inputs.

POWER OUTPUT CAPABILITY: 1,000 to 2,500 Watts
FREQUENCY RANGE: 88 to 108 MHz

FREQUENCY STABILITY: ± 1 kHz after initial warmup

RF OUTPUT IMPEDANCE: 50 ohms nominal

MODULATION CAPABILITY: ± 150 kHz

FM NOISE: Better than 65dB below 100% modulation (mono, stereo and SCA) referred to 400 Hz

AM NOISE: Better than 50 dB below equivalent 100% AM

HARMONICS: At least 80 dB below fundamental

LINE POWER SUPPLY: 200-245 VAC, 50/60 Hz, single phase

LINE POWER CONSUMPTION: 5,400 Watts at 0.9 power factor (2,500 Watts out)

ALL AUDIO INPUTS: 600 ohms balanced $+ 10$ dBm ± 2 dB for 100% modulation (referred to 400 Hz).

POWER TUBE COMPLEMENT: 1 each 4 x 150 driver, 1 ea 5CX-1500A Power Amplifier (Exciter and power supplies are completely solid state).

CABINET SIZE: 75" high x 34" wide x 25-1/2" deep (101 x 86 x 65 cm), low pass filter included

WEIGHT: 1,000 pounds (453.6 Kg)

ALTITUDE: to 7,500 feet

AMBIENT TEMPERATURE: to 113°F (45°C)

MONAURAL OPERATION:

FREQUENCY RESPONSE: Within 1dB 50-15,000 Hz (referred to 75 usec pre-emphasis)

DISTORTION: Less than 0.5% 50-15,000 Hz.

STEREOPHONIC OPERATION:

PILOT CARRIER STABILITY: 19 kHz ± 1 Hz

SUBCARRIER SUPPRESSION: -45dB or better

FREQUENCY RESPONSE: $+ 0.25$ to -0.5 dB from

50-15,000 Hz (referred to 75 usec pre-emphasis)

PRE-EMPHASIS: 75 usec-convertible to 50 usec
LEFT-RIGHT CHANNEL SEPARATION: 40dB or better, 50 Hz to 15 kHz.

CROSSTALK-STEREOPHONIC: 50dB or better below 100% modulation, (main channel to subchannel) 50 to 15,000 Hz

CROSSTALK: 42dB or better below 100% modulation, (subchannel to main channel) 50 to 15,000 Hz

DISTORTION: 0.1% or less distortion of composite wave form (100% modulation by composite stereo)

SCA OPERATION:

AMBIENT TEMPERATURE LIMITS: $+ 5^{\circ}$ C to $+ 50^{\circ}$ C

TYPE OF MODULATION: FM

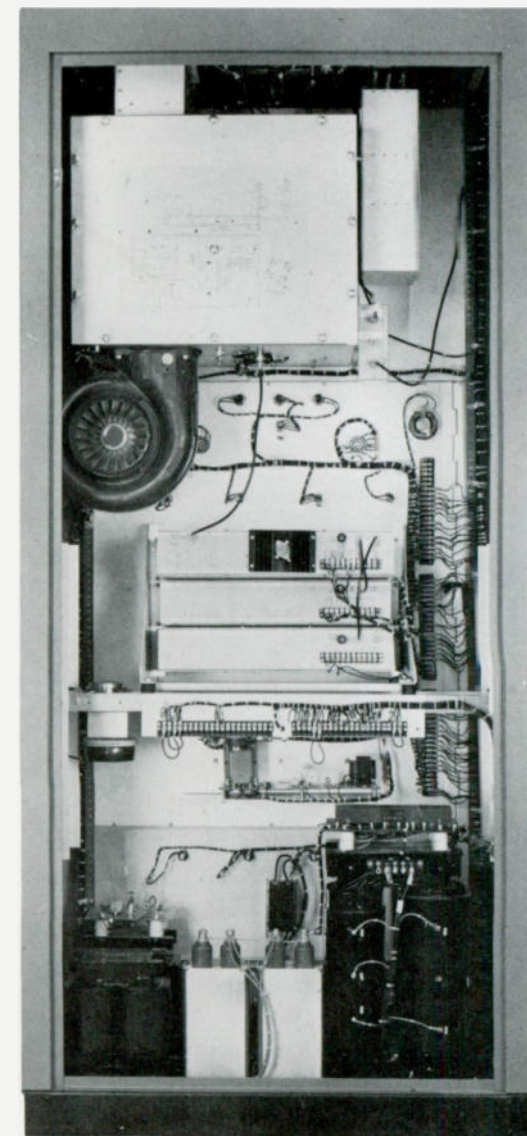

Model 602A interior.



SPRING 1966



**QUICK ACTION /
REFERENCE GUIDE**

Discovery—

*It lured men across the mountains.
It built the West.
And the West thrives today on that
anything-is-possible feeling!*

Among other discoveries made in the West by Sparta are:

The ECONOMY KING for 100,000 Watt ERP, the MODEL 635 FM Transmitter (below); this 35 kW power is offered only by Sparta, uses 3-1/8" line instead of 6", uses less power than dual competitive models, and only 6-bay antenna.

(Continued on Back Cover)



FM Transmitters. The Model 680 Direct FM Exciter is the standard 'heart' of the line at all power levels, with its companion components Model 682 Stereo and 683 SCA Generators. The 1 kW, 2.5 kW, and 5 kW FM transmitters are also used as the drivers of the modular high-powered units, the Model 610A 10kW, 625A 25 kW, and 635 35 kW.

The FM lineup in general (excepting the Model 600B all solid state) boasts 'Tally Light' fault locator system, easy-maintenance roomy interiors, and grounded grid finals which eliminate 'tweaking' adjustments. The modularity of the high powered models enables them to be installed in relatively cramped buildings; the modules can be arranged variously to suit conditions.

- (A) 601A 1,000 Watt
- (B) 602A 2,500 Watt
- (C) 603 3,000 Watt
- (D) 605B 5,000 Watt (This and lower power models are all single-cabinet)
- (E) 610A 10,000 Watt (Dual-cabinet, no power vault)
- (F) 625A 25,000 Watt (Triple-cabinet; similar to 635)
- (G) 635 35,000 Watt (Illustrated)
- (H) 650 Dual 50,000 Watt

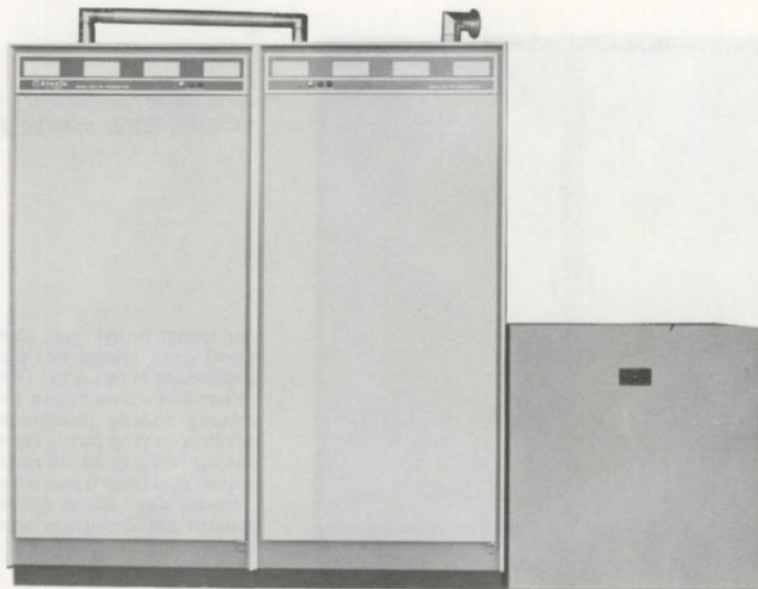

G

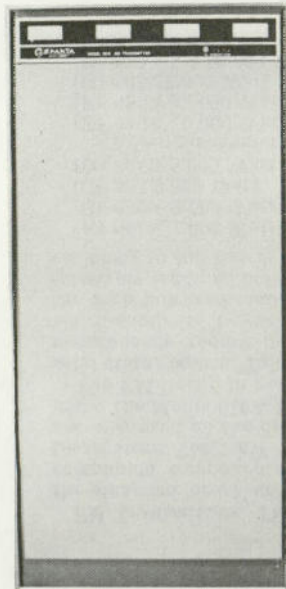

A

AM Transmitters. The entire Sparta line has been redesigned with solid state driver sections and new cabinetry for utmost economy and dependability. Maintenance is made easy through front and rear full-size doors and swingout panels, swingout meter bezels, and the 'Tally Light' fault locator memory system. Power ranges from less than 1 to 30 kW are standard, and dual redundant systems using the unique low-loss, broadband Sparta Ferrite Combiner are proving their worth in not only remote regions of the world, but in the U.S. also. The Model 701B (A) is descended from the famous 1kW Model 707. It and the Model 703B (next page) are single cabinet models; the Model 705C (B) to Model 730 are double cabinet or multi-cabinet.

- (A) 701B 250/500/1,000 Watt
- (B) 705C 500/1,000/5,000 Watt
- (C) 710C 10,000 Watt
- (D) 715C 15,000 Watt
- (E) 725C 25,000 Watt

NOT ILLUSTRATED OR MENTIONED ELSEWHERE: the Sparta solid state Model SS-1A 1 kW AM Transmitter, to be made available later in 1976.



B



A

Special Transmitters. The Model 600B FM Transmitter (A) was the **WORLD'S FIRST SOLID STATE BROADCAST** transmitter to go into quantity production. It can be operated with 12V auto battery in power outages! The Model 703B (B) originated in the 1960's as a 2-3 kW export model, is now type accepted for 2.5 kW AM power level in US. A Model 703B became the first 2.5 kW AM transmitter, in fact, to go on the air (Parker, AZ, KZUL) under the new power level authorization. The Model 680/1 10 Watt FM Transmitter (C) is proving to be the most popular educational broadcasting equipment. Based on the all-solid state Model 680 Direct FM Exciter, it uses the Models 682 and 683 Stereo and SCA Generators where required.

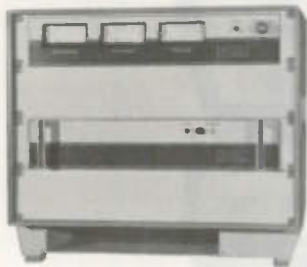

C

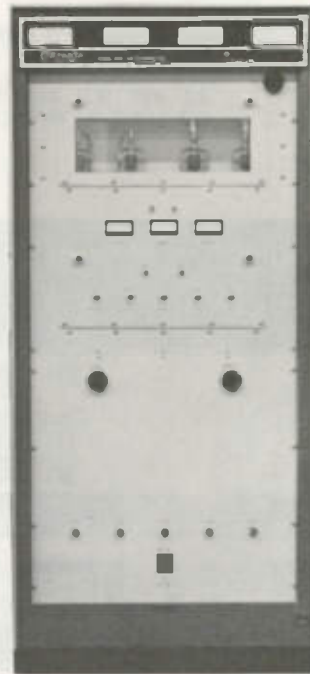

B

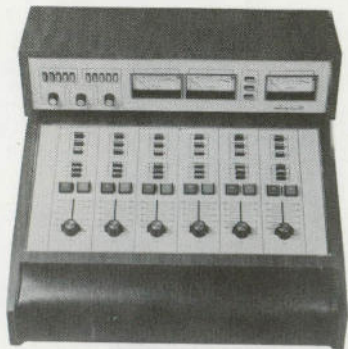

C



B

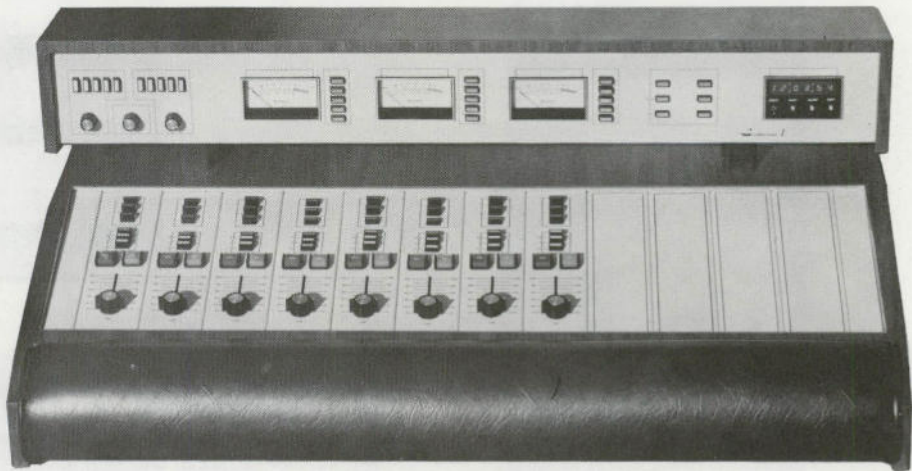

A

Centurion Monaural Consoles. Custom quality and features to match today's sophisticated AM and TV broadcast assignments. Centurion I (A) modular 8-12 mixer, offering 6-mixer Extender Panel (B) options. Centurion III (C) is 6-mixer Production Room or smaller control room monaural model.



D

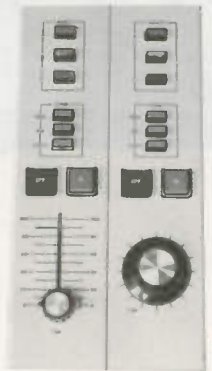

C

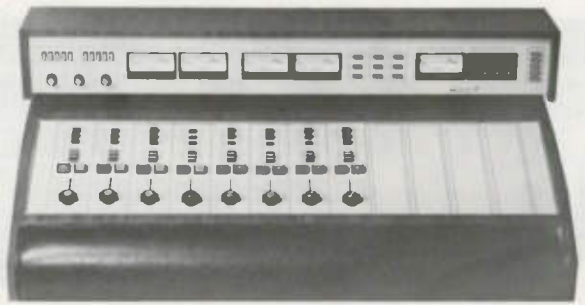

A

Centurion Stereo Consoles. Ultimate flexibility in FM stereo mixing without custom costs. Centurion II (A) is 8-12 mixer, also with 6-mixer Extender Panel options (not pictured). Centurion IV (B) is 6-mixer version, without Extender Panel option.



B

Centurion Console Options. Slide or rotary attenuators (C) are optional with any Centurion console. Equalization option (D) for any Centurion console fits trim-panel space on right side of cabinet exactly. Digital Clock optional with Centurion I and II consoles only. Peak Program Meters are optional in place of VU meters throughout the console series. Blackout meters are optional with monaural Centurion I and III consoles.

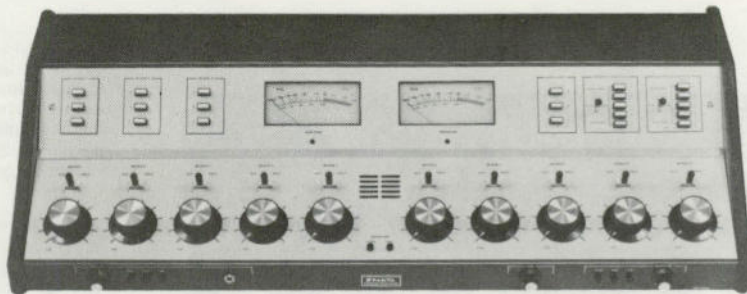

A

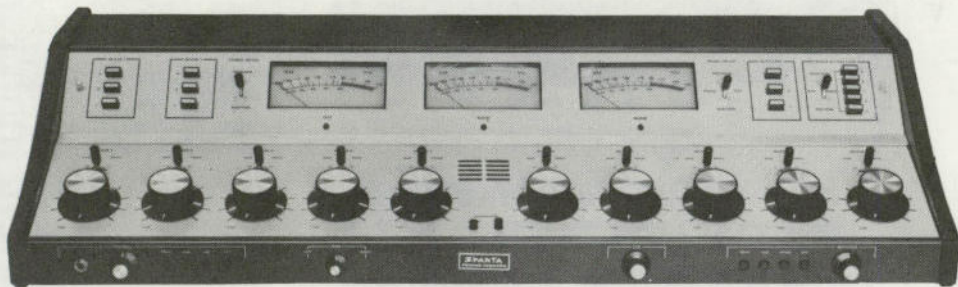

B

3000-Series 10-mixer Consoles.
The Model 3310 Monaural (A) and Model 3410 Stereo (B) were designed to fill the requirements of most master control room operations with the latest innovations in noiseless audio handling, with the utmost flexibility possible at moderate size and cost.



A

B



1000-Series Monaural Consoles. The industry's value leader, improved continuously over the last decade and more! The Model 1020 (A) offers eight mixers, while the Model 1015/1017 (B) gives you 5-mixer production room/remote super flexibility at modest cost.

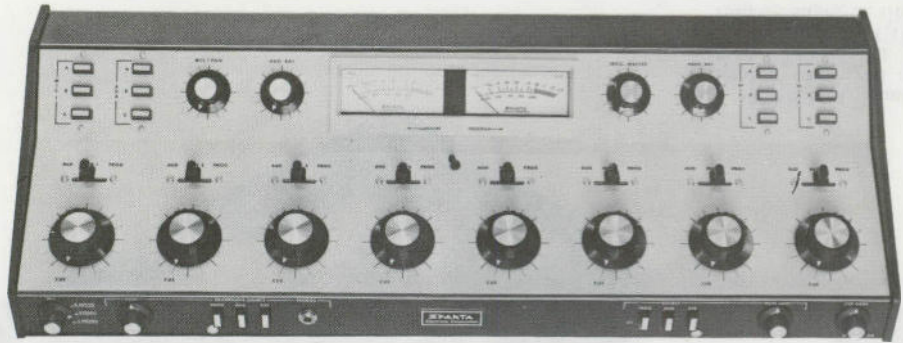

A



B

1000-Series Stereo Consoles. Improved since their inception as the industry's **FIRST** production stereo consoles, to provide full facility stereo quality with outstanding economy and dependability. Model 1040 (A) 8-mixer, and Model 1030/1035 5-mixer (B) cover the complete range of many FM stereo operations, and are often found in discotheques and other special audio operations.



- | | | | |
|-------------------------------|---------------------------------------|---------------------------------|--|
| <input type="checkbox"/> 1A/B | 601A & 602A FM Transmitters | <input type="checkbox"/> 6A | 3310 Mono Console |
| <input type="checkbox"/> 1C/D | 603 & 605B FM Transmitters | <input type="checkbox"/> 6B | 3410 Stereo Console |
| <input type="checkbox"/> 1E/F | 610A & 625A FM Transmitters | <input type="checkbox"/> 7A/B | 1000-Series Mono Consoles |
| <input type="checkbox"/> 1G | 635 FM Transmitter | <input type="checkbox"/> 8A/B | 1000-Series Stereo Consoles |
| <input type="checkbox"/> 1H | 650 FM Transmitter | <input type="checkbox"/> 9A/B/C | Accessory Audio Consoles |
| <input type="checkbox"/> 2A | 701B AM Transmitter | <input type="checkbox"/> 9D/E | Corinthian & Audio Accessories |
| <input type="checkbox"/> 2B | 705C AM Transmitter | <input type="checkbox"/> 10A/B | Showcase Series I & II |
| <input type="checkbox"/> 2C | 710C AM Transmitter | <input type="checkbox"/> 11A | AC155B Mono Audio Control Center |
| <input type="checkbox"/> 2D | 715C AM Transmitter | <input type="checkbox"/> 11B | ASC305B Stereo Audio Control Center |
| <input type="checkbox"/> 2E | 725C AM Transmitter | <input type="checkbox"/> 12A | Century II Tape Cart Equipment |
| <input type="checkbox"/> 3A | 600B FM Transmitter | <input type="checkbox"/> 13 | Century Series Tape Cart Equipment |
| <input type="checkbox"/> 3B | 703B AM Transmitter | <input type="checkbox"/> 14 | Tape Cartridge Equipment, Services & Accessories |
| <input type="checkbox"/> 3C | 680/1 FM Transmitter & Exciter Series | <input type="checkbox"/> 15 | Turnables & Accessories |
| <input type="checkbox"/> 4A/B | Centurion I & Extender | <input type="checkbox"/> 16 | FM Antennas & Transmitter Accessories |
| <input type="checkbox"/> 4C | Centurion III | | |
| <input type="checkbox"/> 5A/B | Centurion II & Extender | | |
| <input type="checkbox"/> 5C | Centurion IV | | |
| <input type="checkbox"/> 5C/D | Centurion Options & Accessories | | |

Please send me only the information checked, the information checked plus Sparta credit application and information, the information checked plus your sample proposal for the following equipment list: _____

Requested by: _____ Title _____

Call Letters _____ Street Address _____

Box Number (if any) _____ City _____ State _____ Zip _____

Telephone (country if outside US) () _____

Please check here if the address information above is new within the past 12 months . . . Thank you. Our radio station is:

AM FM AM/FM NON-COMMERCIAL _____ POWER

FIRST CLASS
PERMIT NO. 2579
SACRAMENTO
CALIFORNIA

BUSINESS REPLY MAIL

No postage necessary if mailed in USA

SPARTA

Division of Cetec Corporation

**5851 Florin-Perkins Road
Sacramento, Ca. 95828**

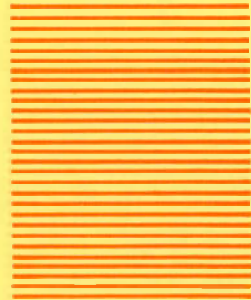



Division of Cetec Corporation

- | | | | |
|-------------------------------|---------------------------------------|---------------------------------|--|
| <input type="checkbox"/> 1A/B | 601A & 602A FM Transmitters | <input type="checkbox"/> 6A | 3310 Mono Console |
| <input type="checkbox"/> 1C/D | 603 & 605B FM Transmitters | <input type="checkbox"/> 6B | 3410 Stereo Console |
| <input type="checkbox"/> 1E/F | 610A & 625A FM Transmitters | <input type="checkbox"/> 7A/B | 1000 Series Mono Consoles |
| <input type="checkbox"/> 1G | 635 FM Transmitter | <input type="checkbox"/> 8A/B | 1000-Series Stereo Consoles |
| <input type="checkbox"/> 1H | 650 FM Transmitter | <input type="checkbox"/> 9A/B/C | Accessory Audio Consoles |
| <input type="checkbox"/> 2A | 701B AM Transmitter | <input type="checkbox"/> 9D/E | Corinthian & Audio Accessories |
| <input type="checkbox"/> 2B | 705C AM Transmitter | <input type="checkbox"/> 10A/B | Showcase Series I & II |
| <input type="checkbox"/> 2C | 710C AM Transmitter | <input type="checkbox"/> 11A | AC155B Mono Audio Control Center |
| <input type="checkbox"/> 2D | 715C AM Transmitter | <input type="checkbox"/> 11B | ASC905B Stereo Audio Control Center |
| <input type="checkbox"/> 2E | 725C AM Transmitter | <input type="checkbox"/> 12A | Century II Tape Cart Equipment |
| <input type="checkbox"/> 3A | 600B FM Transmitter | <input type="checkbox"/> 13 | Century Series Tape Cart Equipment |
| <input type="checkbox"/> 3B | 703B AM Transmitter | <input type="checkbox"/> 14 | Tape Cartridge Equipment, Services & Accessories |
| <input type="checkbox"/> 3C | 680/1 FM Transmitter & Exciter Series | <input type="checkbox"/> 15 | Turntables & Accessories |
| <input type="checkbox"/> 4A/B | Centurion I & Extender | <input type="checkbox"/> 16 | FM Antennas & Transmitter Accessories |
| <input type="checkbox"/> 4C | Centurion III | | |
| <input type="checkbox"/> 5A/B | Centurion II & Extender | | |
| <input type="checkbox"/> 5C | Centurion IV | | |
| <input type="checkbox"/> 5C/D | Centurion Options & Accessories | | |

Please send me only the information checked, the information checked plus Sparta credit application and information, the information checked plus your sample proposal for the following equipment list: _____

Requested by: _____ Title _____

Call Letters _____ Street Address _____

Box Number (if any) _____ City _____ State _____ Zip _____

Telephone (country if outside US) _____ () _____

Please check here if the address information above is new within the past 12 months . . . Thank you. Our radio station is:

AM FM AM/FM NON-COMMERCIAL _____ POWER

FIRST CLASS
PERMIT NO. 2579
SACRAMENTO
CALIFORNIA

BUSINESS REPLY MAIL

No postage necessary if mailed in USA

SPARTA

Division of Cetec Corporation

**5851 Florin-Perkins Road
Sacramento, Ca. 95828**

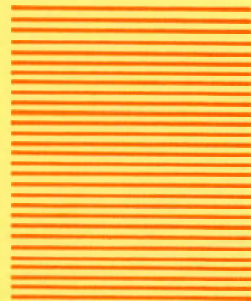



C

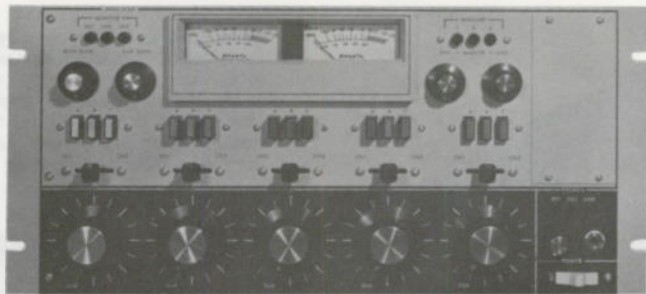

A

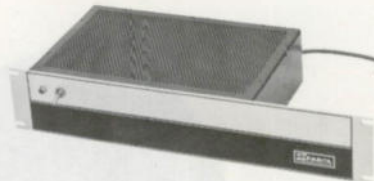

D

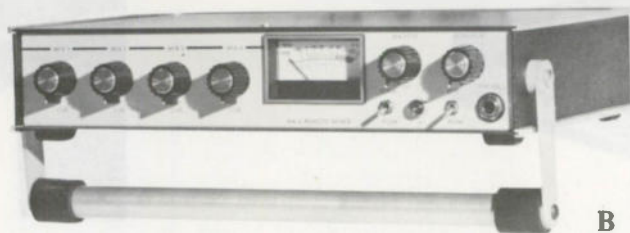

B



E

Studio/Remote Audio Equipment. The Model A16R 5-mixer dual channel mono rack mount console (A) has been a boon to TV audio and space-conscious engineers. The RA4 (B) and RA1 (C) remote amplifiers have literally dozens of broadcast uses. Studio equipment includes, among hundreds of items, MA-Series Monitor Amplifiers (D), a variety of microphones and stands, and SP30 and SP40 speaker systems (E).



B

'Showcase' studio furniture groups. Special package prices include not only the handsome, durable and convenient control room groups pictured, but audio equipment for all control room functions. Available in individual components, or combinations up to Group C configurations shown. Series I 'Showcase' (B) available with either 3000-Series or 1000-Series consoles. Series II 'Showcase' (A) accommodates either the 3000-Series or Centurion Series consoles.



A

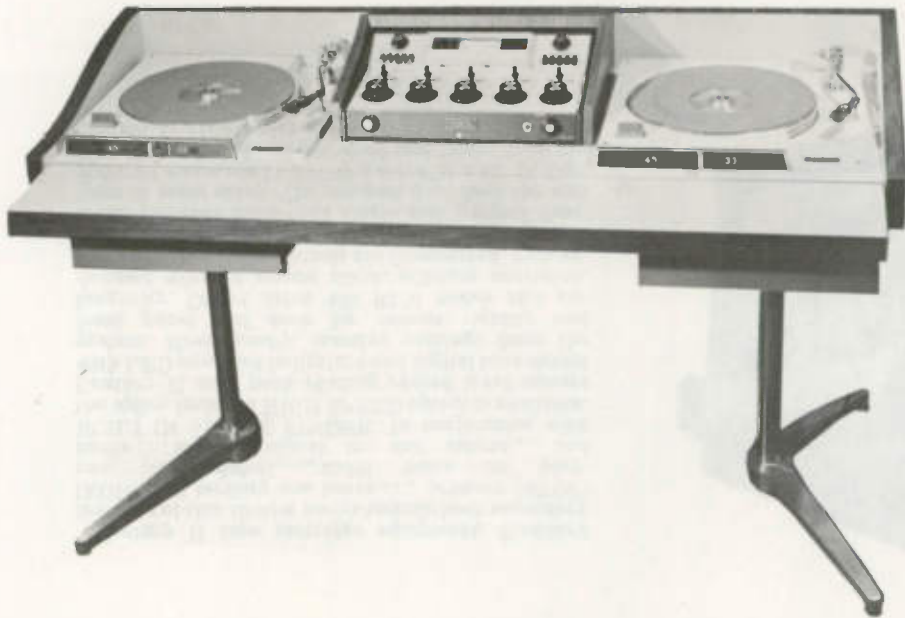

A



B

Studio/Remote Audio Control Centers. Another Sparta **FIRST**: comparable quality units are simply not available! Model AC155C (A) is monaural, with Model 1017 5-mixer deluxe (Precision Step Attenuators) console, GT12 sync Turntables, ST220 Tone Arms. Stereo Model ASC305C uses Model 1035 5-mixer deluxe (Precision Step Attenuators) console, GT12's. The Models AC155B mono and ASC305B stereo units (not pictured) feature standard Model 1015 and 1030 consoles, ST12 4-pole Turntables.

Options for both mono dual stereo units (B) include Bench-Lid combination, Utility Shelf (pictured with Century Series tape cart equipment; not included in basic prices), Sparta MIC6 microphone and gooseneck stand.

Century II tape cartridge equipment. Standard features of this all-new series include both secondary (EOM) and tertiary cue tones . . . primary (STOP) cue tone defeat . . . audio mute on playbacks . . . logging signal in- and output . . . and BUILT-IN SPLICE FINDER. In conjunction with the splice finder, a HIGH SPEED option is available. Century II uses peak reading record level meters with LED overload indicators and digital tone detect system. Mechanically, massive castings form the front panel and deck for utmost rigidity and longevity. Direct drive 450 RPM motor and air-damped solenoid assure silent, efficient operation. The keyboard style controls are illuminated, with external color codes, for easiest operation in any light level; switches have both single and 'ganged' functions in some cases. The compact dual desk top unit pictured measures 11-3/8"W x 5-1/4"H x 15" D. Configurations include single, dual and triple desk top mounts, and triple rack mount.



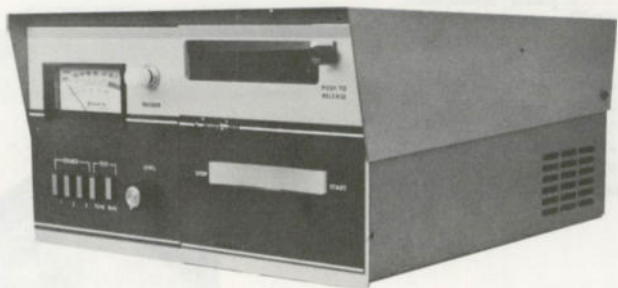

A

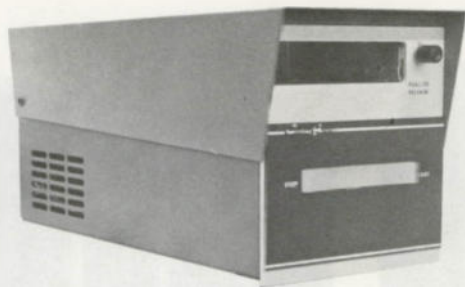

C

Century Series Tape Cartridge Equipment. Monaural Model 4610 or stereo 4620 Record/Playback systems with Flip-Top Module Covers (A: mono illustrated), Triple Rack Mount configurations (B) of R/P or all-playback systems, and Single Playback module with Flip-Top Module cover (C), as well as single modules without covers for custom station installation.

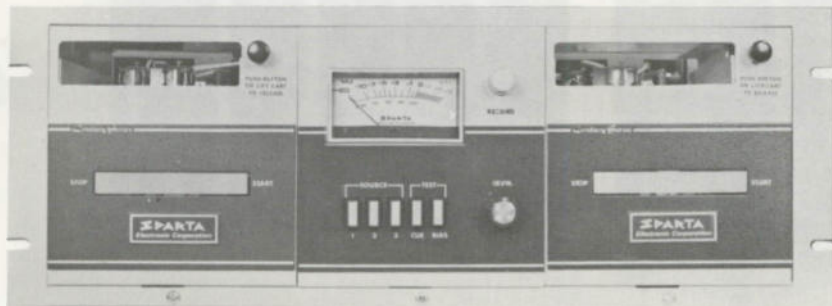

B



C



D



E

Tape Cartridge Services and Accessories. Floor, desk top (A) or wall (B) cart storage racks, repair/reload services, test tapes, Sparta Standard and Premium tape cartridges (C), CE3 Bulk Eraser (D) and Alignment Gauge (E) form only part of the equipment and services offered.



B

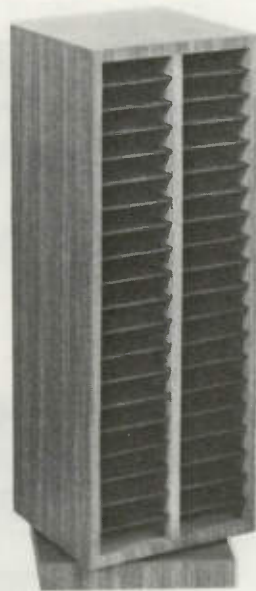

A



A



E

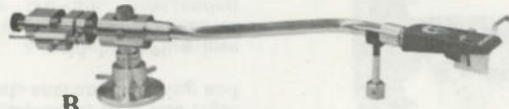

B



D

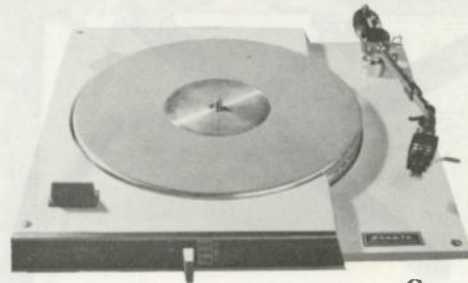

C

Turntables and Accessories. The GT12 Custom 12" Turntable (A) is available with ST220 (B), AT1005, or other Tone Arms. ST12 Turntable (C) has same specifications as GT12, but comes with 4-pole motor only, fewer deluxe features. Three-speed GT3-12 (not pictured) is available with standard platter for US 45 RPM records, or for export with flat platter suiting European style records. TEP-Series mono or stereo preamps (D) are standard, as is the Sparta 220S Pickup cartridge (E). Other accessories include single or dual 'Showcase' Turntable Returns; the dual model is pictured on page 1.

Antennas and Transmitter Options. Jampro FM antennas, designed and manufactured by Jampro/Division of Cetec Corporation in Sacramento, are a natural complement of Sparta FM transmitters at all powers. The Jampro line ranges from standby antennas through screen dipole and up to multiplexed arrangements for several powerful stations into one antenna.

Other accessories include test equipment, coax and rigid line, STL and monitoring equipment, antenna coupling and phasing units, and much more.

The Sparta Ferrite Combiner, a wideband low-loss device, enables dual-redundant AM broadcast systems of many types to be created for fail-safe, unattended operation. Many are in use in various parts of the world as well as the U.S.

FM dual-redundant transmitters are another area in which Sparta leads the equipment manufacturing field. In both AM and FM dual-redundant systems varieties of both manual and automatic switching systems, and special monitoring devices are available to suit any special requirement.

- (A) Jampro FM Antennas
- (B) Accessories to AM transmitters
- (C) Accessories to FM transmitters
- (D) Dual-redundant AM or FM systems

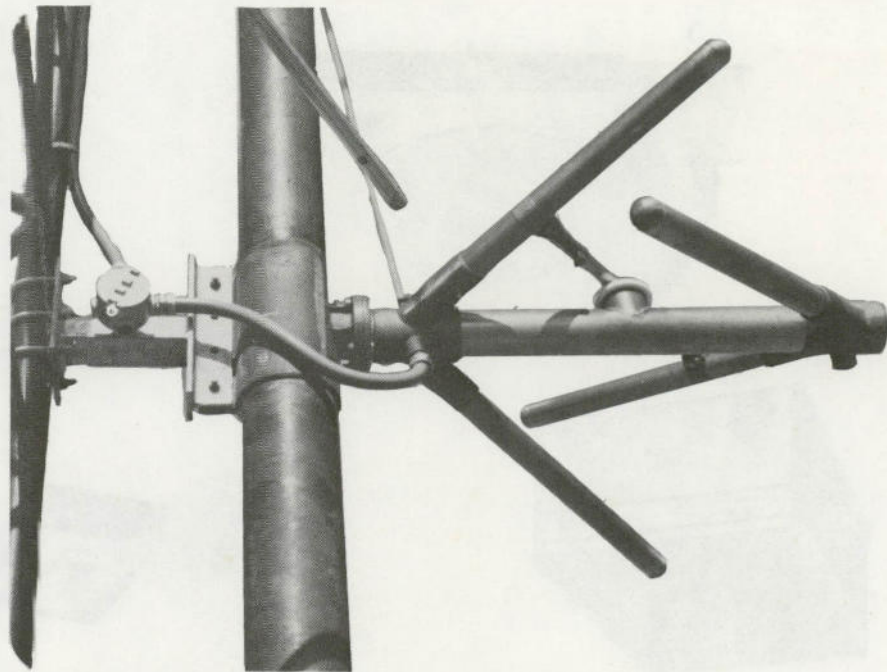

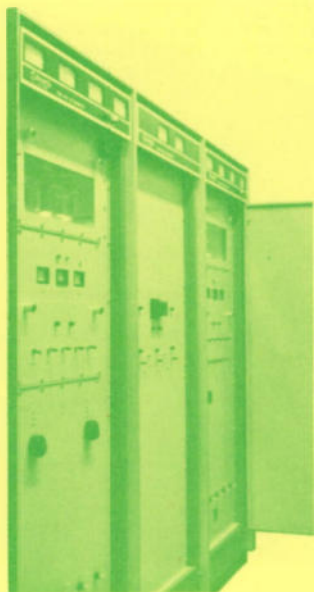

The unique near-zero loss, broadband SPAR-TA FERRITE COMBINER, which more efficiently than any other AM combining system allows high power with the redundancy needed for the automatic 'transmitter of the future'.

Model 705D 5 kW AM Dual Redundant Transmitter; KM-WX, Yakima, Washington. Twin Model 703B 2.5 kW AM Transmitters operating through the unique Sparta Ferrite Combiner.

The FIRST solid state broadcast transmitter ever to go into quantity production, the MODEL 600B FM.

The solid state ORIGINAL Sparta 1 kW AM Transmitter design, the new SS-1A.

**Model 730 30 kW AM Transmitter;
Radio Cadena Nacional, Colombia, SA**

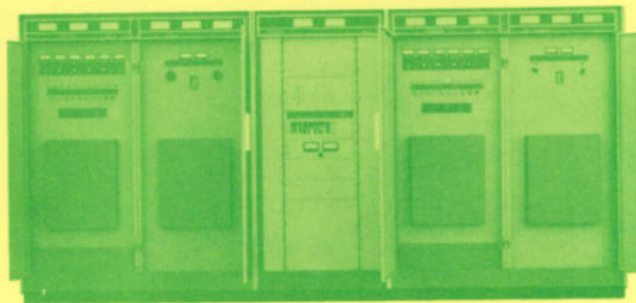

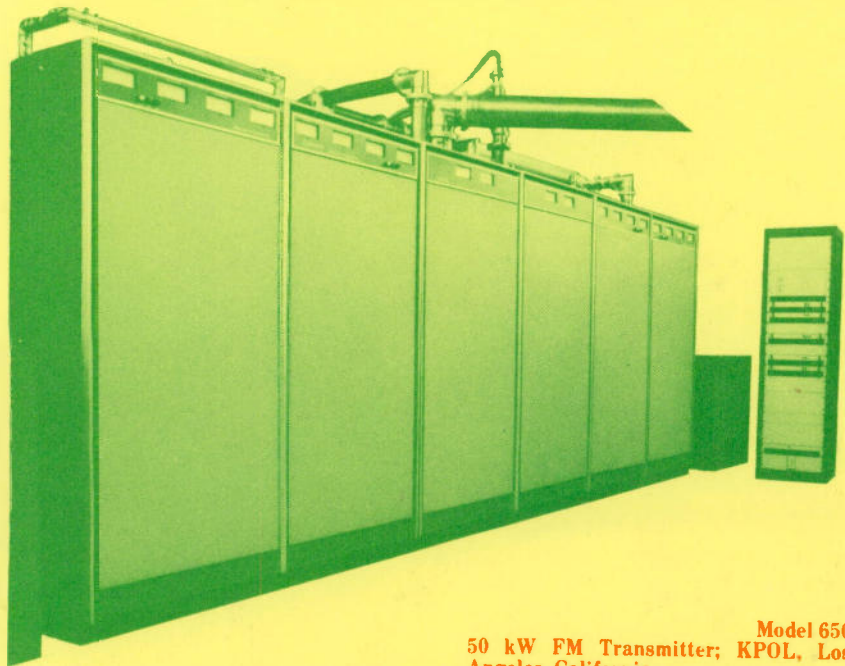

Model 650
50 kW FM Transmitter; KPOL, Los
Angeles, California

And there's more! In the audio field:

The Sparta Studio/Remote AUDIO CONTROL CENTERS were introduced in 1961, and there is still no equivalent product to be found!

The Sparta GT12 Turntables are the only broadcast quality machines with interchangeable well and platter, made possible through superior machining techniques.

This booklet will help you discover more about Sparta for yourself, and the range of professional broadcast equipment, the quality, and the price conscious values we have discovered that broadcasters want.

Thank you . . .



Models 610A and 625A FM Transmitters

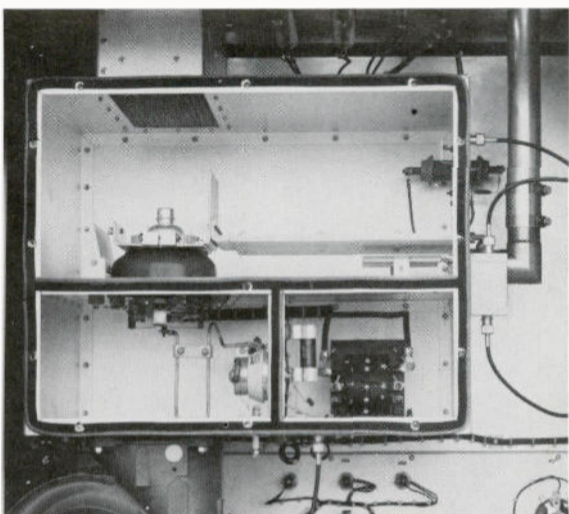
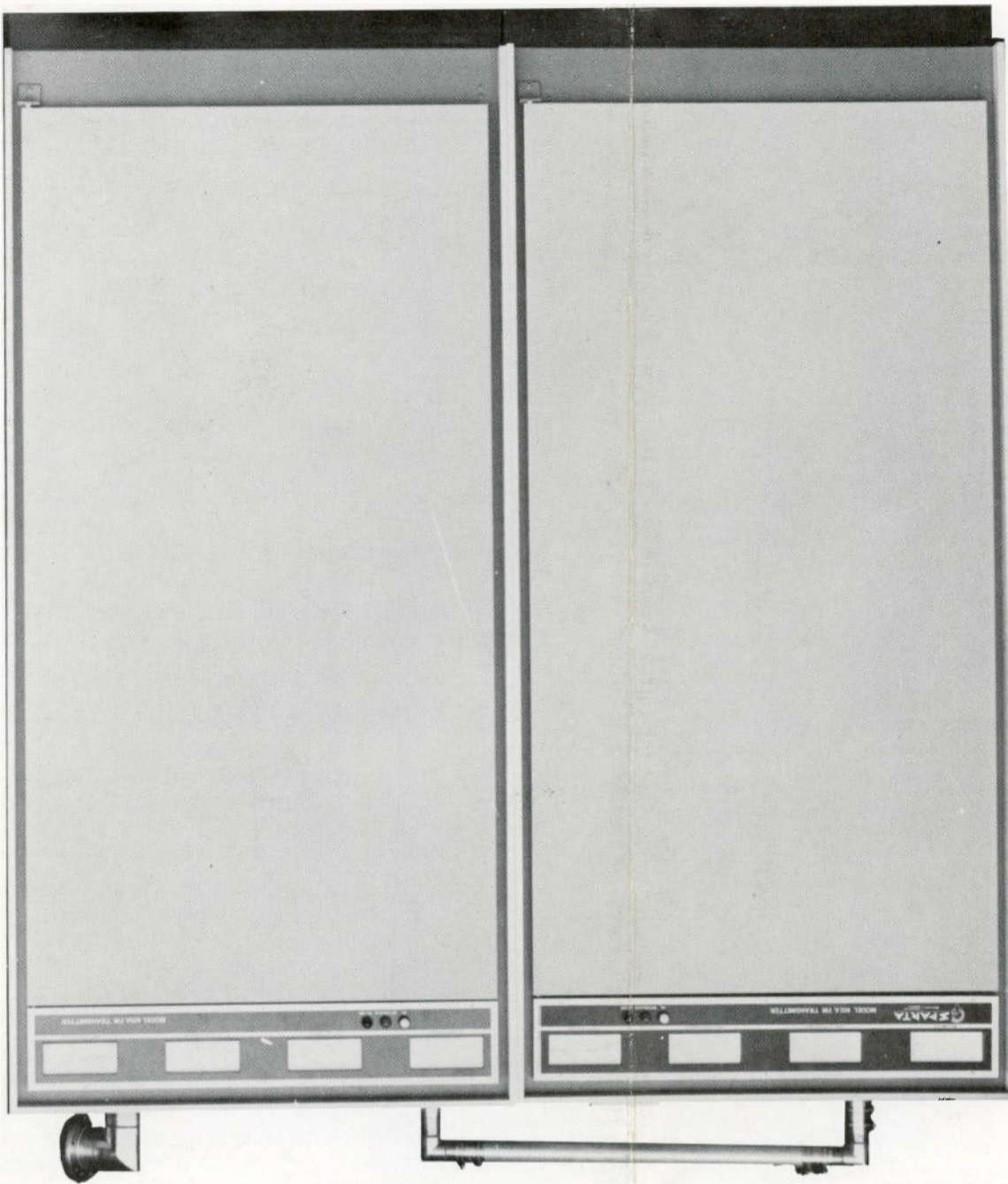

Upper section of 2,500 Watt driver in 625A. Output via rigid line proceeds to final amplifier or direct to antenna as needed. Note the simplified tuning system which operates without coils or moving contacts.

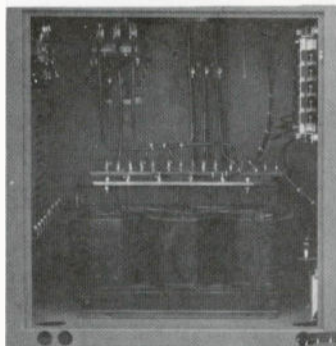

Model 625A

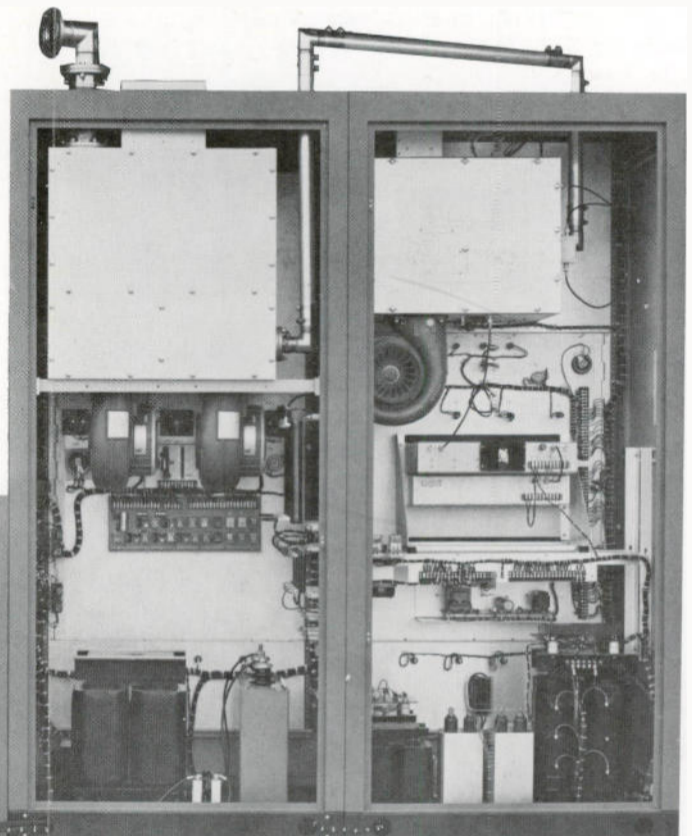

MODELS 610A 10kW and 625A 25kW TRANSMITTERS

Both the 610A and 625A offer high-power backup, since the first driver stage of each transmitter is formed by a complete lower-power transmitter. The Model 601A, operating at approximately 710 Watts, is the driver of the Model 610A. A complete Model 602A, operating at approximately 1,700 Watts, drives the Model 625A.

In either case the basic driver transmitter can be connected directly to the antenna feed for backup, while the high-power stage undergoes maintenance. As options either a mechanical or automatic switch-over device can be supplied. The alternative is physically connecting the driver output to the antenna feed line.

Both transmitters use the trouble free Sparta Model 680 Direct FM Exciter, with the optional Model 682 Stereo Generator and 683 SCA Generator (41 and 67 KHz) to suit station requirements.

The 610A is type accepted to operate at from 7.5-13 kW output. It has been designed for optimum useful size through a modern modular approach, into two

identical cabinets which can be installed variously to suit the buyer.

DUAL SYSTEMS

In addition to the basic 10kW and 25kW units both transmitters are available as 610A-plus-610A (or 625A-plus-625A) and 610A/610A (625A/625A). The former are actually two complete transmitters combined in a 3dB coupler giving power output of 26kW (or 50kW). Automatic switching systems are available that sense failure and provide direct feed to the antenna by a single transmitter. The 610A/610A system (or 625A/625A) consists of two separate transmitters operating as main/alternate-main transmitters.

MAXIMUM ACCESSIBILITY

Each driver and final amplifier is constructed in an identical cabinet and can be installed side-by-side or in different parts of the transmitter room; thus building sites can be utilized that might be prohibitive to larger single cabinet units.

Full size front and rear doors are used and since the front door is non-interlatched it can be removed if

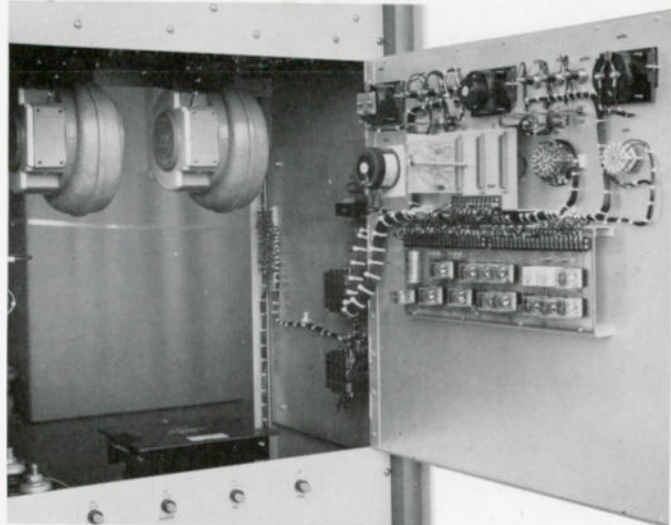

desired to gain additional room.

Access to control circuitry is available through a swingout front panel and to the amplifier assemblies through an easily removed aluminum panel.

CONTROL FEATURES

Both driver and final amplifier have a full complement of on-off switching and filament voltage control. When operated in the normal driver/final configuration, controls are interlatched so as to provide simple on-off functions, either local or remote. Overload relays are included in all important tube parameters. An automatic sequencing system prevents turn-on of plate power before all filaments are heated. A positive recycle system automatically cycles power off three times before lock-out in the event of brief overloads or power interruptions. Any overload condition is spotlighted through a memory type 'Tally Light' system.

GROUNDING GRID FINAL AMPLIFIER

The output tube, a ceramic triode, offers high power gain and full power apparent efficiency near 80%. The 610A utilizes a 3CX10000A7, the 625A a 3CX15000A7. These two tubes differ in filament structure only, the physical sizes being identical. Fixed inductive dividers are used to limit currents within sliding short circuits thus providing low loss, long life tuning circuits. Maintenance of maximum power output without daily "tweaking" of multiple controls is easily obtainable with either the 610A or 625A. Control of power output is accomplished by a motor driven screen rheostat in the IPA stage.

AUTOMATIC POWER CONTROL-VSWR PROTECTION

Two automatic supervisory functions are included as a standard part of the 610A and 625A. Output (forward) power is monitored continuously by a comparator circuit. Should power increase or decrease beyond pre-set levels automatic correction within the limits of the motorized screen control will take place.

Reverse (reflected power) is also monitored on a continuous basis and should VSWR exceed a pre-set level the transmitter will be shut down as a normal overload function.

POWER SUPPLY

The model 610A utilizes a 5,500 volt power supply, the 625A a 7,500 volt supply. The 610A power supply is self contained in the final amplifier cabinet. The 625A power supply is contained in an external vault measuring 34" wide x 25 1/2" deep x 36" high. It can be installed adjacent to the final amplifier or at any convenient location.

Both power supplies utilize step-start contacts which allow a "Y" or "Delta" configuration. A front panel switch makes use of this function to provide a low/high power operating condition.

Specifications: Model 610A

MAXIMUM POWER OUTPUT: 13kW.

601A DRIVER OUTPUT: 700-1,500 Watts.

AC INPUT POWER: 200/250 VAC, 50/60 Hz, 3-phase; 21 kW at 0.9 power factor.

TUBE COMPLEMENT: One each 4X150A, 5CX1500A, 3CX10000A7.

WEIGHT, CUBAGE: 2,600 lbs., 75.2 cu. ft.

SIZE: Two cabinets, each 34" W x 75" H x 25 1/2" D.

All other specifications—monaural, stereo, and SCA—identical with Model 625A.

Specifications: Model 625A

MAXIMUM POWER OUTPUT: 25kW.

602A DRIVER OUTPUT: 1,000-2,500 Watts.

AC INPUT POWER: 200/250 VAC, 50/60 Hz, 3-phase; 38kW at 0.9 power factor.

TUBE COMPLEMENT: One each 4X150A, 5CX1500A, 3CX15000A7.

WEIGHT, CUBAGE: 3,000 pounds, 92.7 cu. ft.

SIZE: Two cabinets each 34" W x 75" H x 25 1/2" D, and one cabinet 34" W x 36" H x 25 1/2" D.

FREQUENCY RANGE: 88—108MHz, tuned to specified operating frequency.

RF OUTPUT IMPEDANCE: 50 ohms.

OUTPUT TERMINATION: 3 1/8" EIA flange.

FREQUENCY STABILITY: ± 1,000 Hz after initial warmup.

TYPE OF MODULATION: Direct FM.

MODULATION CAPACITY: ± 95 Hz.

RF HARMONICS: Suppression exceeds all FCC requirements.

ALTITUDE: To 7,500 feet.

AMBIENT TEMPERATURE RANGE: 0—50° Centigrade.

MAXIMUM VSWR: 1.7:1.

Monaural Mode

AUDIO INPUT IMPEDANCE: 600 ohms balanced.

AUDIO INPUT LEVEL: + 10 dBm ± 2 dB for 100% modulation at 400 Hz.

AUDIO FREQUENCY RESPONSE: Standard 75 microsecond, FCC pre-emphasis curve +0.25 to -0.5 dB, 50-15,000Hz.

DISTORTION: 0.5% or less, 50-15,000Hz.

FM NOISE: 65dB below 100% modulation, referenced to 400 Hz.

AM NOISE: 55 dB below reference, carrier AM modulated 100%.

SYNCHRONOUS AM: -50 dB maximum at 400 Hz due to 100% FM.

Stereophonic Mode

PILOT STABILITY: 19kHz ± 1Hz.

AUDIO INPUT IMPEDANCE: (left and right) 600 ohms balanced.

AUDIO INPUT LEVEL: (left and right) ± 10 dBm + 1 dB for 100% modulation at 400 Hz.

AUDIO FREQUENCY RESPONSE: (left and right) Standard 75 microsecond, FCC pre-emphasis curve +0.25 to -0.5 dB, 50-15,000Hz.

DISTORTION: (left and right) 0.75% or less, 50-15,000 Hz.

STEREO SEPARATION: -40 dB minimum 50-15,000 Hz or better.

SUB-CARRIER SUPPRESSION: -65 dB below 100% modulation (main to sub-channel or sub-to main channel); 50 dB below 100% modulation, 50-15,000 Hz.

CROSSTALK: (main to sub-channel or sub to main channel) 50 dB below 100% modulation, 50-15,000 Hz.

SCA Specifications

FREQUENCY STABILITY: ± 500Hz.

FREQUENCY: Between 25 and 75 KHz, 41 or 67 KHz, standard.

MODULATION: Direct FM.

AUDIO INPUT IMPEDANCE: 600 ohms balanced.

AUDIO INPUT LEVEL: + 10 dBm for 100% modulation at 400 Hz.

DISTORTION: Less than 1.5%, 50-7,500 Hz.

FM NOISE: -65 dB maximum, referenced to 15% deviation.

CROSSTALK: (sub-channel to main channel) -60 dB or better.

CROSSTALK: (Main channel to sub-channel) 50 dB below 100% modulation, referenced to 400 Hz.

AUTOMATIC MUTE LEVEL: -10 dBm at 400 Hz.

MUTING DELAY: Variable from 0.6 to 4 seconds.

ORDERING INFORMATION:

The Models 610A and 625A are supplied complete with the Model 680 Exciter, crystal and oven, tubes and harmonic filter, factory tuned and tested on frequency. For stereo option specify Model 682 Stereo Generator. For SCA specify Model 683.

RF OUTPUT
610A-13000 WATTS
625A-25000 WATTS

SIMPLIFIED BLOCK DIAGRAM-MODEL 610A/625A

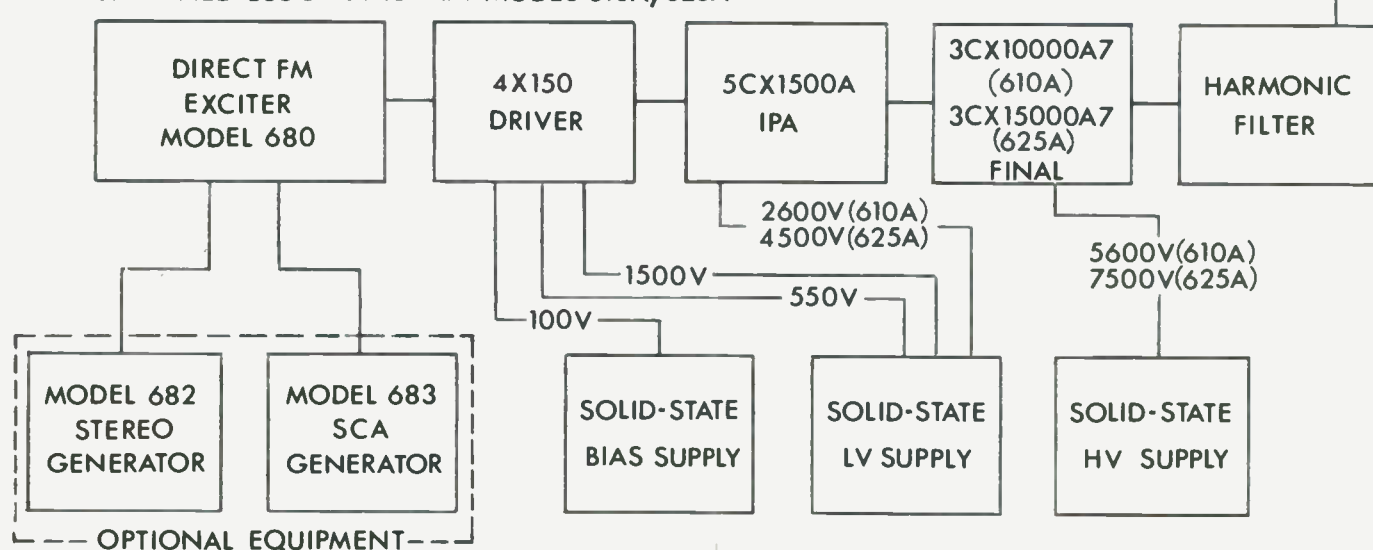

Specifications

RECORD INPUTS: Three, pushbutton selected.

INPUT IMPEDANCE: Balanced bridging -10 to +8 dBm.

AUDIO OUTPUT: 600 ohms balanced; +6 dBm nominal, +16 dBm maximum.

DRIVE AND TAPE SPEED: Shielded hysteresis synchronous motor drives non-magnetic dynamically balanced flywheel via dual 'Flutter Filter' belts; tape speed 7½ ips.

PLAYING TIME: :02-10:30 (NAB "A" cartridge).

WOW & FLUTTER: 0.2% or less.

EQUALIZATION: NAB standard, CCIR/IEC optional.

RESPONSE: ± 2 dB 50-15,000 Hz.

DISTORTION: 2% or less.

SIGNAL-TO-NOISE: 55 dB or better below saturation, mono record; 52 dB or better below saturation, stereo record.

CUE SIGNALS: 1 KHz standard NAB primary (stop) cue; 150 Hz secondary (EOM) cue; Form A contact closure, EOM signal.

POWER: 117 VAC, 60 Hz (others on special order).

DIMENSIONS: Single playback or record module, 6"H x 5 3/4"W x 14"D (153 x 145 x 355 mm); Dual PB or R/P, double above width; Triple Rack Mount, 7"H x 19"W x 14"D (177 x 482 x 355 mm);

SHIPPING: Single playback,



 **SPARTA**
Division of Cetec Corporation

Century Series

5851 Florin-Perkins Road, Sacramento, Ca. 95828
(916) 383-5353 • Telex 377-488 • Cable SPARTA

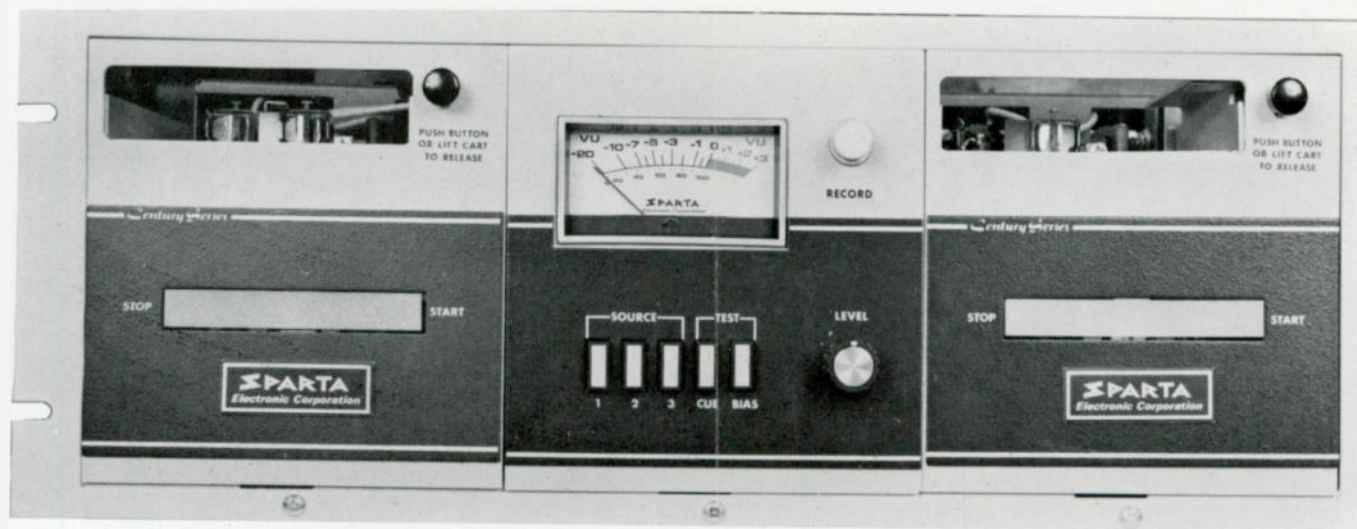

Century Series mono R/P and Playback in Triple Rack Mount

SPARTA CENTURY SERIES TAPE CARTRIDGE EQUIPMENT

The Century Series comprises a same-size-modular system of either monaural or stereo Record and Playback equipment. This flexibility is furthered by design of the Playback module to be replaceable, with addition of a record head, in any Record/Playback system: each is pre-wired to accept the record control plug. Wiring from module to module in a multiple array is facilitated by AC-out plugs being provided at the rear of each Playback.

The Century Series playback is supplied with accurate high-speed motor, coupled to the capstan flywheel by twin 'flutter filter' belts. The resulting indirect drive costs less, runs cooler, and is far less subject to motor manufacturing differences than even very expensive direct drive machines.

The pinch roller is raised to within 1/8" of the capstan upon inserting a cartridge preparatory to play. With this short distance to travel the pinch roller makes virtually no noise in contacting the capstan when play begins, eliminating expensive damping mechanisms.

The Century Series is equipped with the Sparta "True Tangent" non-magnetic HM-2 head mount, which is fully adjustable. The cartridge release mechanism has dual operation; it is activated by either tilting up the cartridge, or pushing a release button. A built-in audio switcher enables the outputs of several Century playbacks to be fed into one audio console mixer without other isolation equipment.

The cue channel output is amplified for either an automation control signal, or ease in checking cue tone quality. End-of-Message (EOM) cue tone is optional.

Recording with Century Series is made easier in the production room through pushbutton selection of three audio inputs, and VU meter testing of cue tone and bias record levels, as well as audio recording level. Tone detectors are Integrated Circuits, making for fewer components and giving reliable cue detection. ICs are plug-in, as are PC boards in both Playback and Record modules.

Single PC boards in Playback and Record modules are warranted by Sparta for a full year.

OTHER CENTURY SERIES FEATURES IN BRIEF

- 'Touch Bar' start/stop is illuminated red-green for visual indication of standby-end-play
- EOM auxiliary optional tone causes red side of 'Touch Bar' to flash while green remains 'on' during runout
- Record electronics has separate power supply
- Access to heads and adjustments is full and easy
- Deck plate is laminated for anti-warp without weight

CENTURY SERIES OPTIONS:

Remote control for all functions; EOM secondary cue signal; Triple Rack Mount; Single or Dual 'Fliptop' covers; special power requirements.

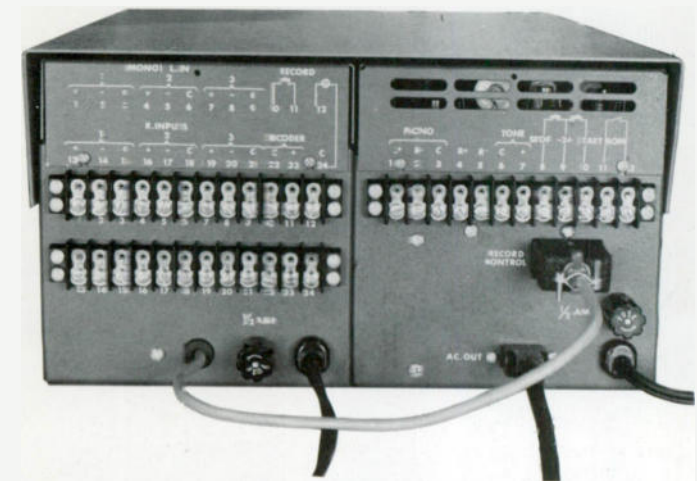

Rear of mono Century Series R/P, showing Record Control inter-connection, AC out of playback to record module, clearly indicated connections.

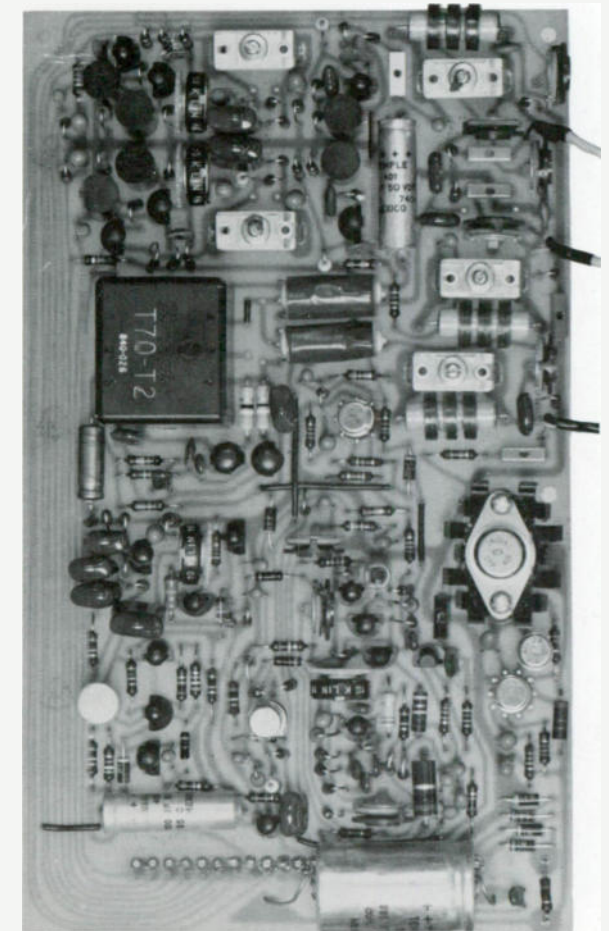

Century Series stereo record circuit board.

Specifications: Model 3310

MIXERS: Ten.

INPUTS: Twentyeight; 10 microphone and 18 line level.

INPUT IMPEDANCE: Microphone 50/150/250 ohms balanced. Line; 10 K balanced bridging (can be terminated in 600 ohms).

INPUT LEVELS: Microphone mixers 1, 2, 3, 4: nominal -55 dBm. Line level mixers 5-10; switch selected sensitivity of -10, 0, and + 10 dBm.

OUTPUT LEVELS: (Program and Audition identical) 8 dBm into 600 ohms for 0 VU indication. Twenty-two dBm maximum output. Monitor; 12 Watts RMS. Cue/Talkback; 5 Watts. Phones; 0.5 Watt to 4 ohm headset (high Z also useable).

RESPONSE: All program amplifiers within 1 dB 20-20,000 Hz at rated output. All monitor amplifiers \pm 1 20-20,000 Hz at rated output.

HARMONIC DISTORTION: All program amplifiers less than 0.3% 20-20,000 Hz at rated output; typically less than 0.1% at 1,000 Hz. All monitor amplifiers less than 0.5% 20-20,000 Hz at rated output; typically less than 0.3% at 1,000 Hz.

INTERMODULATION DISTORTION: All program amplifiers less than 0.05% at rated output; less than 0.2% at any operating level. All monitor amplifiers less than 0.5% at rated output of less. SMPTE measurement standards.

NOISE: 68 dB below + 8 dBm output, referenced to -55 dBm input 20-20,000 Hz unweighted. Equivalent input noise -123 dBm.

MUTING/CONTROL: Two separately muted monitor speaker outputs with contacts for 'on air' lights. Two more relays provided for control functions or additional muting.

POWER: 117V 50/60 Hz (230V optional).

SIZE: 37"W x 7½"H x 15½"D. (860 x 190 x 390 mm).

SHIPPING: Console and Power Supply; 79 pounds (36 kilos).



 **SPARTA**
Division of Cetec Corporation

5851 Florin-Perkins Road, Sacramento, Ca 95828
(916) 383-5353 • Telex 377-488 • Cable SPARTA

Model 3310 Monaural Console

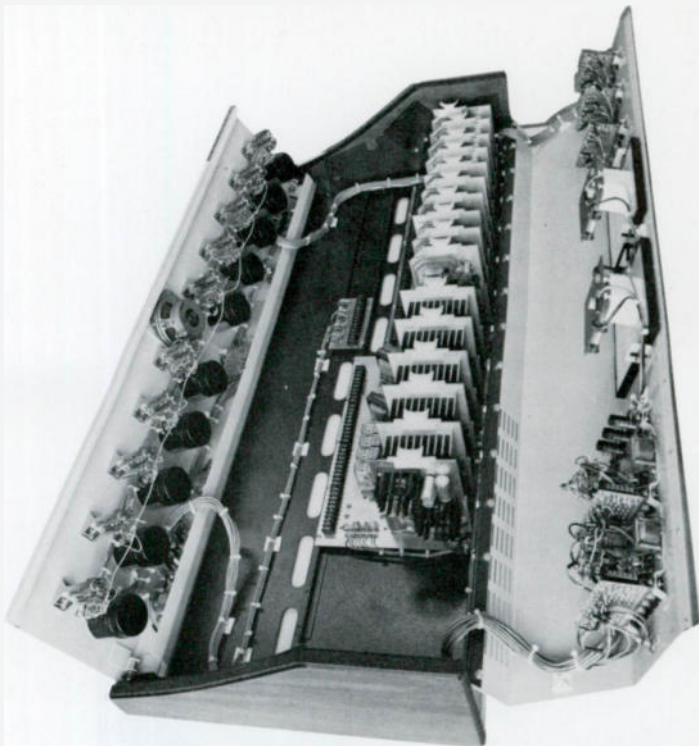

The 3000-Series dual-channel, medium priced line of both mono and stereo consoles neatly bridges the gap between the Sparta 1000-Series and Centurion Series in terms of capacity, features, performance and price. The 1000-Series offers both mono and stereo consoles of five- and eight-mixer capacity; the 3000-Series is ten-mixer only; the Centurion Series modularity permits eight-, nine-, ten-, eleven-, twelve-, eighteen-, and twenty-four mixer master control room flexibility.

MODEL 3310 FEATURES

The 10-mixer 3310 is supplied standard as a full dual-channel console, with precision step type cue-detent attenuators. Both Program and Audition circuits employ completely noiseless optically-coupled switching, with identical line level balanced outputs on each; both busses are metered.

Noiseless on/off remote control of all mixers is provided, so that newsmen or studio announcers can turn on their own microphones, or a video switcher can control the console for TV 'audio-follow-video' application.

A five-source bridging input at Mixer 8 permits connecting up to five cartridge playbacks without interaction; it works as well, of course, for a single input. Microphone preamps and line level input cards are interchangeable; the latter have three-position switches for -10, 0, and +10 dBm sensitivity as required.

The cue speaker is centrally mounted on the front panel, and also serves as the intercom microphone/speaker. 'Send/Mix' switches on Mixers 9 & 10 feed

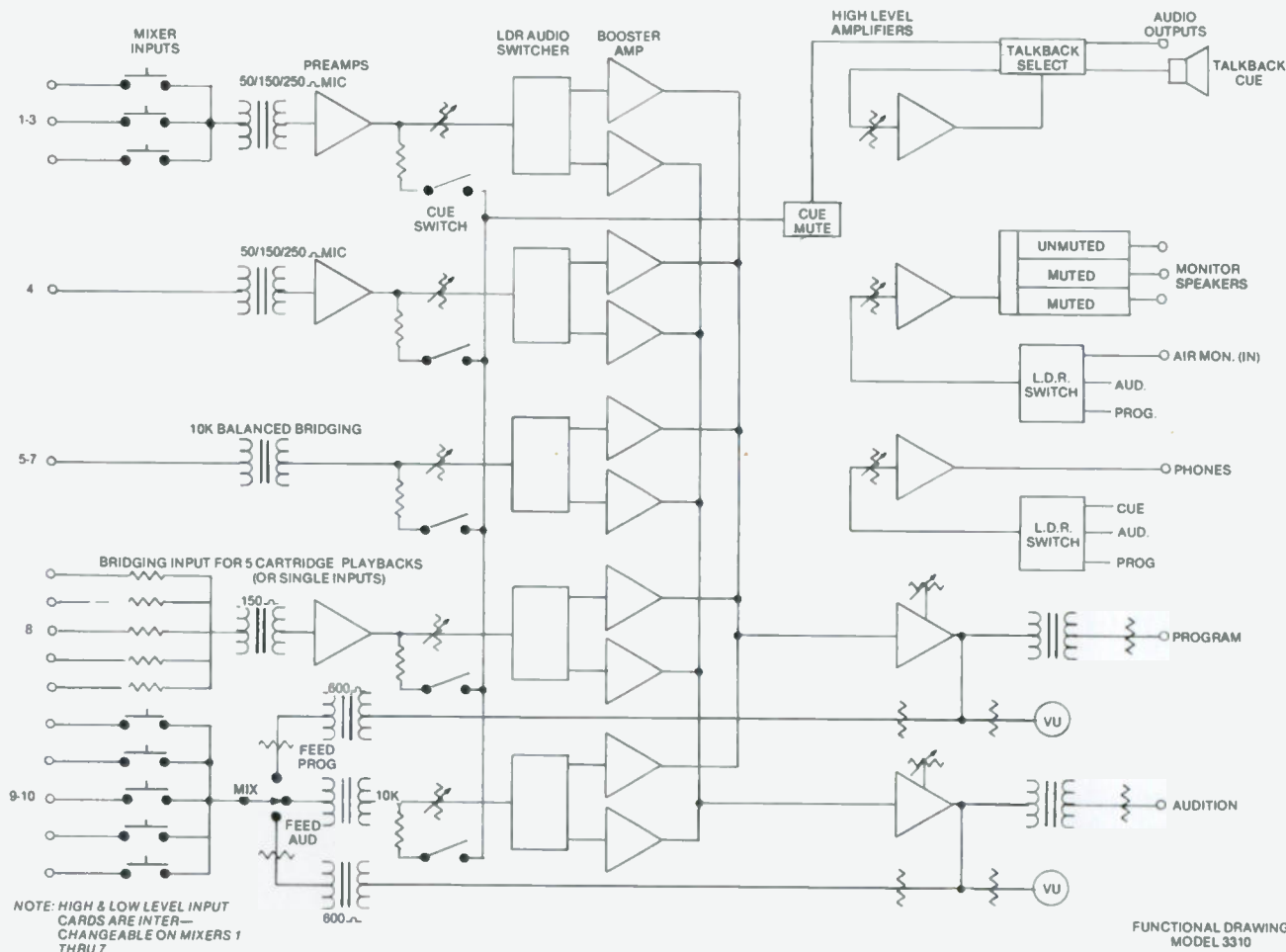

FUNCTIONAL DRAWING MODEL 3310

Program or Audition audio to any of five remote lines, or route the audio from a selected remote line to the console mixer. A built-in monitor amplifier delivers 12 Watts RMS per channel of high fidelity sound.

Besides the interchangeable microphone and line level amplifiers, only one other amplifier type is used; it functions as headset, cue, line, and monitor amplifier. All active circuits are plug-in, using the latest in IC technology.

Access to the console interior is via dual hinged front and top panels; all components and circuits are completely revealed in one motion. Inputs and outputs are made to barrier strips which are accessible from the front; cable entries are through slots in the bottom panel.

The 3310 is finished in tough polyurethane enamels, with woodgrain finish end caps. The VU meters are rear-lighted, and meters and control knobs are over-size for operator convenience.

MODEL 3310 OPITONS

The only option offered is for export; 230 VAC instead of the standard 117 VAC 50/60 Hz.

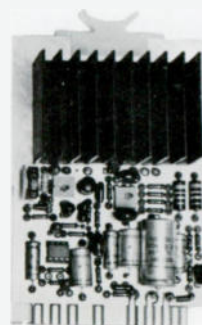
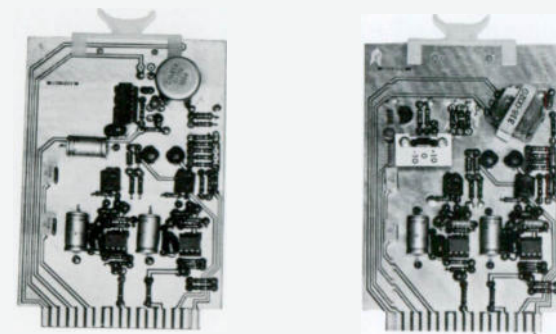

The plug-in printed circuit boards for the Model 3310 are; upper left, microphone input board... above, line level input board...at left, the line out amplifier board.

OPTIONAL EQUIPMENT: (factory installed) RMK-1 — Remote Control Kit, including control relay interface assembly and motor rheostat. CVT — Constant Voltage Transformer to maintain filament and low voltage supplies within $\pm 1\%$. 60 Hz only.

ORDERING INFORMATION: the 701B is supplied complete with tubes, transistors and crystal, tuned and tested on frequency. Specify one maximum and one switchable lesser power level between 250 and 1,000 Watts. If no specification is made the transmitter will be furnished in 1,000/250 Watt switchable configuration.

POWER REQUIREMENT: the 701B operates from 208-240 volt, 50/60 Hz, single phase power supply.

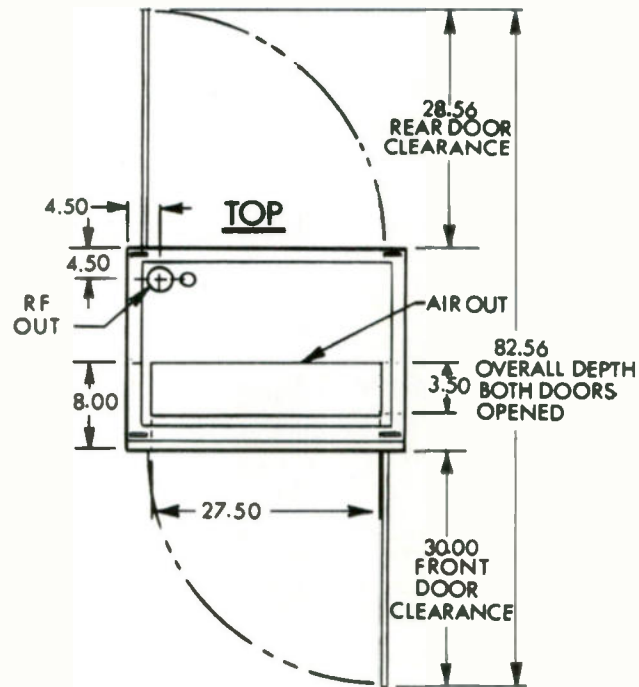

FLOORPLAN, MODEL 701B. Two alternatives should be kept in mind: (1) the FRONT door can be switched in the field to open in the opposite manner to the drawing, and (2) the RF output is standard at top of cabinet, but can also emerge exactly below the position in the drawing for trench feed to tower.

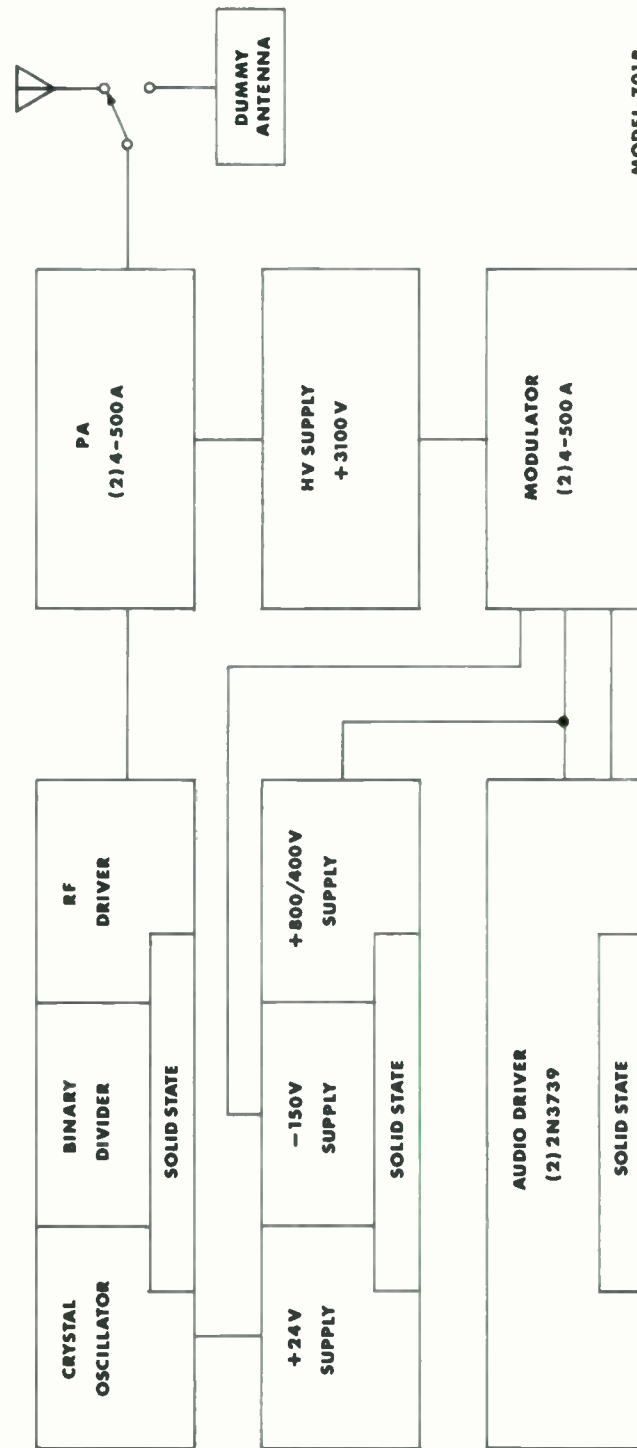

MODEL 701B

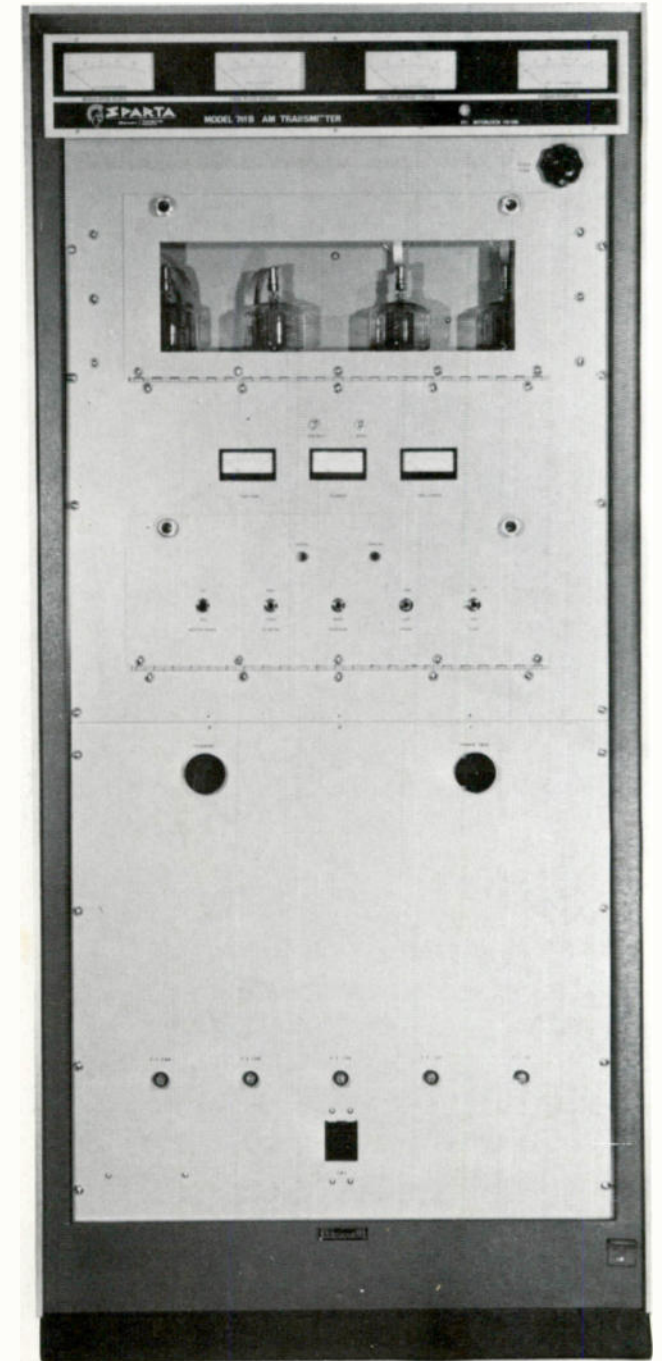

MODEL 701B
1000/500/250 Watt AM TRANSMITTER



SPARTA
ELECTRONIC CORPORATION

5851 Florin-Perkins Road, Sacramento, Ca. 95828
(916) 383-5353 • Telex 377-488 • Cable SPARTA
a Subsidiary of Cetelec Corporation

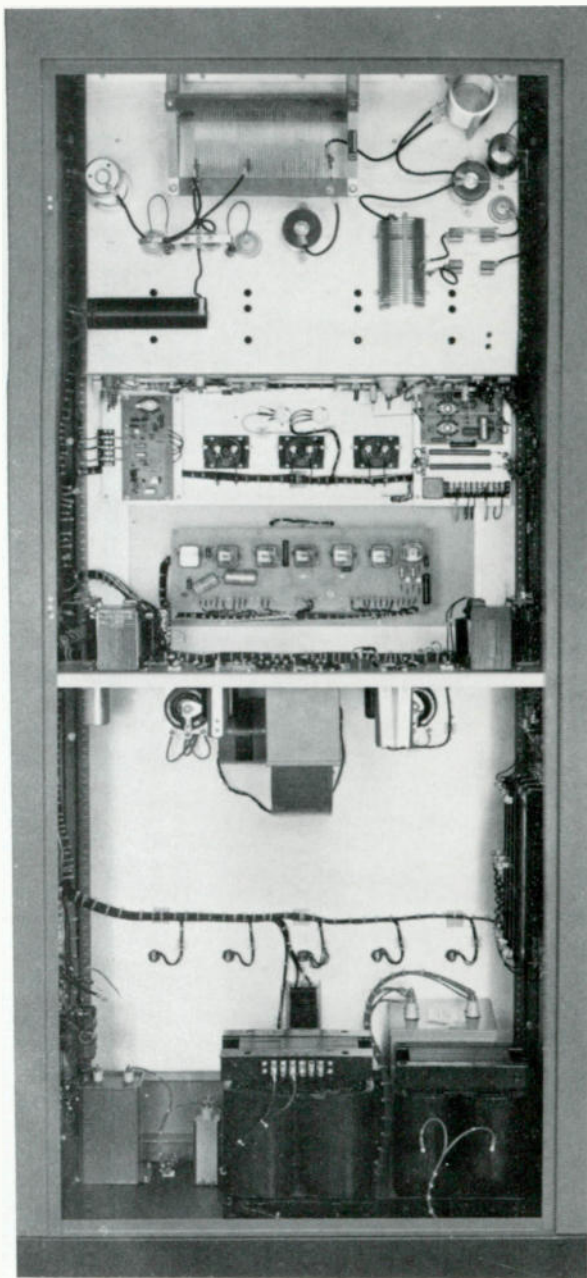

MODEL 701B
1000/500/250 Watt AM Transmitter

The Sparta 701B is a self-contained plate modulated AM transmitter capable of up to 1,100 Watts output in the 535 to 1620 KHz band.

Solid state devices are combined with only one tube type to provide a simple, highly dependable design. A high quality oil filled modulation transformer eliminates moisture deterioration and assures long lasting reliability. Another quality feature is the vacuum capacitor used for

plate tuning which eliminates arcing and roller coil freezing, associated with conventional tuning methods. The 'Tally Light' system will reduce downtime and help preventive maintenance by identifying the point of overload. The 701B has a dummy load as standard equipment.

Frequency response of the 701B is excellent, distortion is low, and 125% positive peak modulation capability is there for those who wish to use it.

Simultaneous full meter display of all important functions can be monitored with doors of the 701B closed. Access to the front panel switches and subsidiary metering is through a non-interlocked hinged front door, which can be changed to open from either side. Rear access is provided through a full-size, hinged and interlocked door. All control circuitry is mounted on a swing-down front panel for easy accessibility. There is only one front panel tuning control. Remote control interface kits are optional for the user's choice of systems.

The entire transmitter is housed in a single steel cabinet which is mounted on a sturdy 12-gauge steel base.

SIMPLIFIED POWER CUTBACK

The 701B is supplied in the user's choice of two powers. A single switch controls final plate voltage, audio, and RF drive simultaneously. (See 'Ordering Information')

SOLID STATE POWER SUPPLIES

All power supplies use encapsulated silicon bridge rectifiers which provide low power drain, cooler operation, and reliable performance. A single low voltage transformer provides bias voltage for the modulator tubes, 25 volts for the RF drive section, 800 volts for the modulator screens, and 400 volts for the solid state audio driver.

An epoxy-sealed plate transformer provides high voltage for the modulator and final amplifier tubes.

SOLID STATE OSCILLATOR AND RF DRIVER

Adding an extra measure of transmitter stability, the 701B utilizes a solid state oscillator and RF driver. An ovenless crystal operating in the highly stable area four times carrier frequency is used. Two binary divider IC's operating in tandem count down the oscillator to the desired carrier frequency. A buffer transistor follows the divider, then an output transistor that is matched to the final grids through an "L" network.

Type 4-500A tetrodes have been used in the RF section of the transmitter, reducing the required stages and the power consumption. Tetrodes also eliminate the need for neutralization.

The parallel operated final tubes operate in conventional Class C at an average efficiency of 75%. The built-in dummy load is capable of full power operation continuously.

HIGH QUALITY MODULATOR

A simple two stage transistor amplifier provides ample audio drive for two 4-500A tetrode modulator tubes operating Class AB-1. A high quality modulation transformer, sealed in oil, provides exceptional sound and modulation capability.

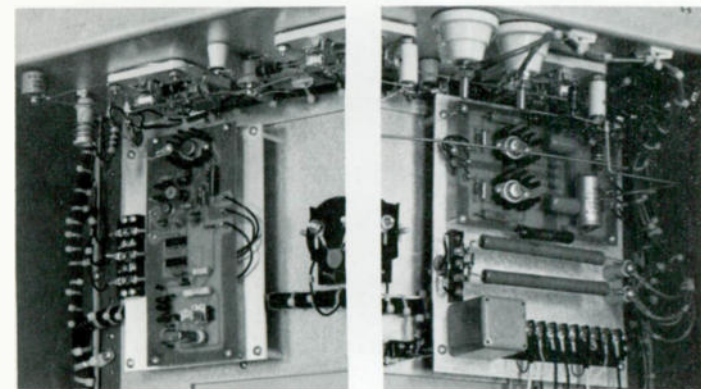

AUDIO DRIVER ASSEMBLY: the simplicity and space-saving design of the 2-stage transistor amplifier is evident in this closeup. Two 4-500A tetrodes operating AB-1 are powered by this stage (right). **RF DRIVER ASSEMBLY:** this solid state system enables a highly stable ovenless crystal to operate at its best frequency, the output being counted down to operating frequency (left).

Specifications:

- AF INPUT IMPEDANCE:** 600 ohms
- AF INPUT LEVEL:** +10 dBm \pm 2 dBm (100% Modulation)
- AF RESPONSE:** 50-10,000 Hz (95% Modulation) \pm 1.5 db (typical - \pm 1 db)
- AF DISTORTION:** 50-10,000 Hz (95% Modulation) less than 3% (typical - 1.5%)
- NOISE:** (below 100% Modulation) 1000 Watts — 55 db; 250 Watts — 52 db
- FREQUENCY RANGE:** 540-1600 KHz
- FREQUENCY STABILITY:** \pm 10Hz 0-50°C
- OUTPUT IMPEDANCE:** 50 Ohms unbalanced — others available on special order
- CARRIER SHIFT:** 3% or less (0-100% Modulation)
- DUMMY ANTENNA:** 50 Ohms — Capable full time operation 100% Program Modulation
- POWER OUTPUT:** 1000/500/250 Watts — Any combination of two power levels (capable 1100 Watts)
- POWER SUPPLY:** 208-240 volts \pm 5%, 50/60 Hz, Single Phase
- POWER CONSUMPTION:** (1000 Watts output — 90% PF) Approximate: 0% Modulation 2950 Watts; 30% Modulation 3400 Watts; 100% Modulation 4150 Watts
- AMBIENT OPERATING TEMPERATURE:** To 113°F
- ALTITUDE RANGE:** To 7500 — Higher Altitudes on special order
- SIZE:** 75" High, 34" Wide, 25½" Deep
- WEIGHT:** 1000 lbs. NET

The Audition Out pushbutton selection of the Centurion III allows feeding audio to three locations. It is a full three-channel board: Program, Audition and Utility are identical busses, the same as the Centurion I.

Centurion III options include slide or rotary attenuators and Peak Program Meters in place of the VU meters.

Specifications: Centurion III

MIXERS: Six.

INPUTS: Eighteen.

INPUT IMPEDANCE: 150 ohms balanced microphone; 600 ohms balanced medium and high level, automatically selected by INPUT LEVEL SWITCH.

INPUT LEVELS: Switch selectable on each module for -55 dBm, -10 dBm, or 0 dBm.

OUTPUT LEVELS: (three lines, identical) 8 dBm into 600 ohms for 0 VU indication. Twenty-two dBm maximum output. Monitor; 25 Watts RMS. Cue; 5 Watts to internal speaker. Phones; 1 Watt per channel to 4 ohm headset. High impedance phones also useable.

OUTPUT LINES: Program, Audition, Utility; Audition can be switch selected into any of 3 output lines.

RESPONSE: All amplifiers within 1 db, 20-20,000 Hz, at rated output.

DISTORTION: All amplifiers less than 0.5%, 20-20,000 Hz, at rated output. Typically less than 0.15% at 1,000 Hz.

SIGNAL-TO-NOISE: 70 db below +8 dBm output, referenced to -55 dBm input, 20-20,000 Hz unweighted. Equivalent input noise -125 dBm.

MUTING: Three muting relays, operated by any mixer or combination of mixers, for three speakers.

CONTROLS: Six Form A contacts, momentary or maintained (if strapped). Can be strapped to operate from selected mixers.

POWER: 117 V 50/60 Hz (230 V optional).

SIZE: Console, 23"W x 23½"D x 14"H (580 x 600 x 358 mm). Power Supply/Muting/Monitor Amplifier; 5¼" (133.35 mm) rack mount. Rack mount is 19" (482.6 mm) American standard.

SHIPPING: Console; 77 pounds (35 kilos) packed in 12.8 cubic foot (0.362 cubic meter) container. Power Supply/Monitor Amplifier/Muting; 23 pounds (10.5 kilos) packed in 1.75 cubic foot (.064 cubic meter) container.

CENTURION III OPTIONS: Slide or Rotary Precision Step Attenuators, Peak Program Meters in place of VU meters.

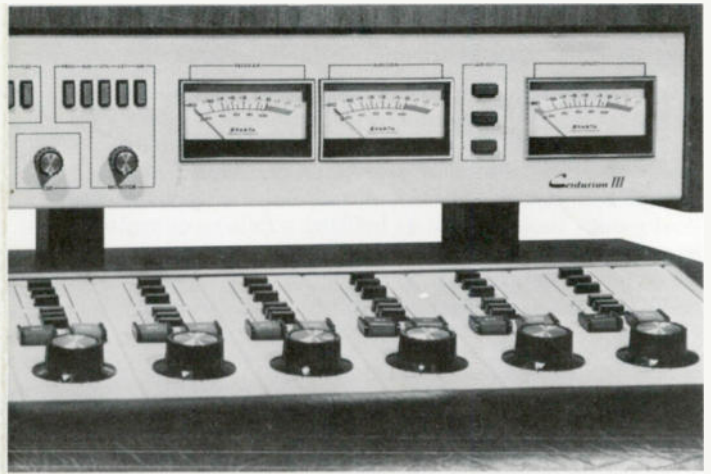

SPARTA
Division of Cetec Corporation

5851 Florin-Perkins Road, Sacramento, Ca 95828
(916) 383-5353 • Telex 377-488 • Cable SPARTA

CENTURION III
Monaural Console

The Centurion Console Concept

The Sparta Centurion series console line consists of six models; the monaural Centurion I and III and matching Extender Panel, and stereo Centurion II and IV and matching Extender Panel.

Physically the consoles consist of a lower bay (mixer modules and motherboard) and an upper bay (control systems). The Extender Panels are a lower bay only, with controlling functions carried out by the 'parent' console. Metal surfaces are finished in tough catalytic paints, control knobs are plastic/metal heavy duty combinations, casing for bays is of full 1/8" laminated plastic over industrial grade particle board, and the foam-filled armrest is covered with Naugahyde.

Underlying the entire series design was Sparta's desire to put an up-to-the-minute, uncomplicated, perfectly quiet and very flexible console within the financial reach of radio stations of every size and type. The Centurions, it was decided, should be of ample size and heavy duty construction as befitted a deluxe console expected to function faultlessly for many years. The roominess should assure easy accessibility to all industrial grade components in the totally modular construction style.

Scientific predictability of performance from console to console was thought to be essential for the design; this led to elimination of hard-wiring through using motherboard construction and space-age ground plane PC techniques.

Mixing arrangements were to be flexible through fully interchangeable mixing modules, each of which would be switch selectable for high, medium, or low level inputs so that equipment assignments to mixers could be changed at will. Another flexibility factor to be built in would be a variable number of mixing modules within a single unit design large enough to allow a dozen mixers. From this latter consideration the size of the console was determined; the standard large console has eight mixers, but single mixers may be added up to twelve total. Thus the station planning expanded control room functions may add mixing channels to an existing Centurion I or II console (Centurion III and IV are 6-mixer only), and if the total of twelve mixers proves insufficient, add one or two 6-mixer Extender Panels for an 18-mixer, 54-input or a 24-mixer, 72-input master control system.

These design aims have been fully realized in the broadcast console line which will become the industry's standard for years to come . . . the Sparta Centurion Series.

Centurion Series Power Supply

The power supply uses 3-terminal regulators, and is common to the entire Centurion console line, both mono and stereo. It is short circuit-proof, and has thermal overload protection, providing several fail-safe features.

Monitor amplifiers, power supply, muting relays and external control circuits are all contained within the 5.25" rack mount chassis.

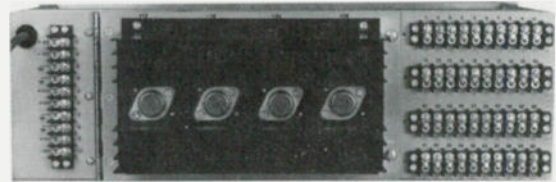

Plug-in boards are used for all three functions; one monitor amplifier board has three muting relays and 'on air' light contacts for up to 60 Watt bulbs . . . another PC board has six Form A relay contacts for the momentary or maintained 'start' of accessory audio equipment.

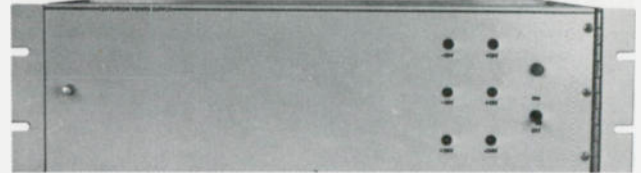

Six LED status indicators monitor the condition of all power circuits.

Centurion III Functional Description

The six-mixer Centurion III is electronically identical to the Centurion I and Monaural Extender Panel. It also shares many basic functional characteristics with the Centurion I. It differs mainly in that its design is for less demanding requirements of the production room or smaller station.

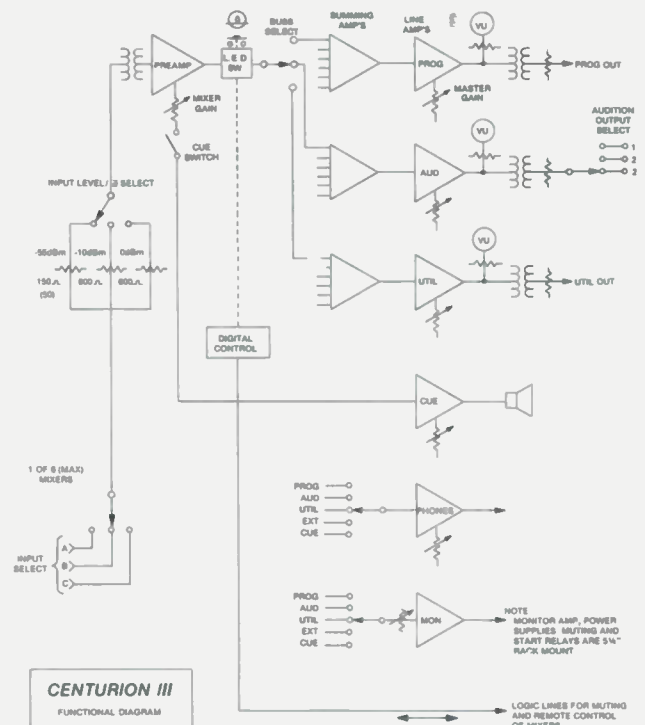

CARRIER FREQUENCY STABILITY: ± 500 Hz over temperature range

AUDIO INPUT IMPEDANCE: 600 ohms balanced

AUDIO INPUT LEVEL: + 10 dBm at 400 Hz (100% modulation)

AUDIO FREQUENCY RESPONSE: (50-7,500 Hz) ± 2 dB referred to 75 usec pre-emphasis (convertible to 50 or 150 usec pre-emphasis)

HARMONIC DISTORTION: Less than 1.5%, 50-7,500 Hz

FM NOISE LEVEL: -65 dB maximum, referred to 15% deviation

AUTOMATIC MUTE SENSITIVITY: -20 dB below 10% deviation or better, 100% modulation (muting is front panel controlled for on/off/automatic muting of subcarrier)

MUTING DELAY: Adjustable from 0.6 to 4 seconds, nominal

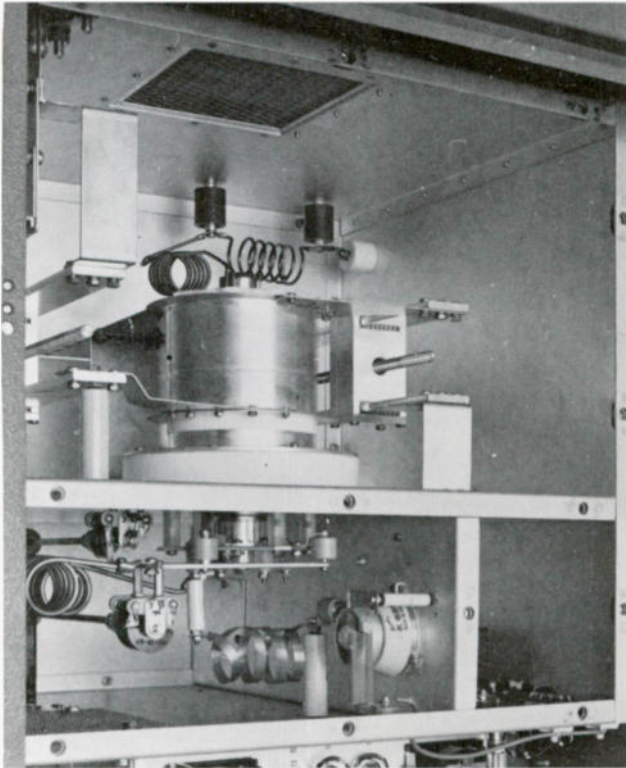

Model 605B final cavity. The clean design of the transmitters—allowing easy access to all components—extends through all sections.

ORDERING INFORMATION:

Model 603 and 605B are supplied complete with the Model 680 Exciter, crystal and oven, tubes and harmonic filter, factory tuned and tested on frequency. For stereo option specify Model 682 Stereo Generator. For SCA specify Model SCA Generator, and further specify subcarrier frequency.

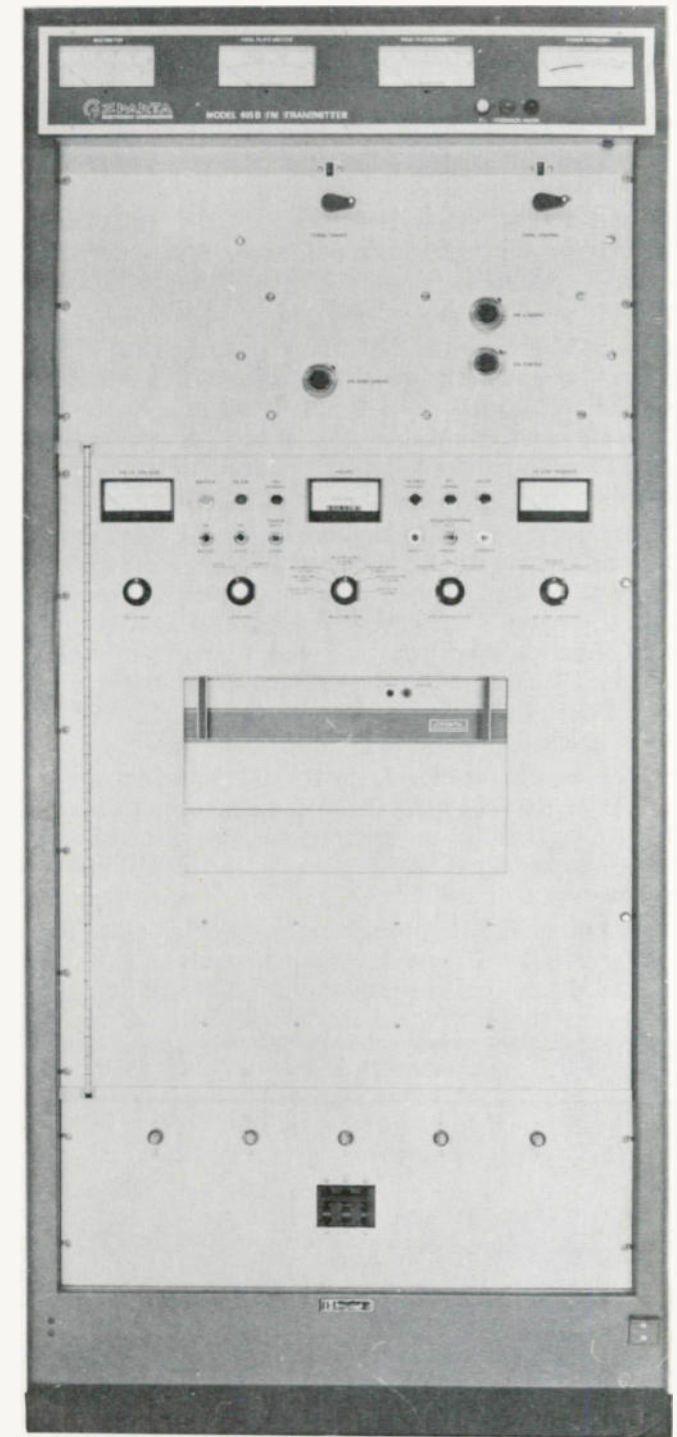
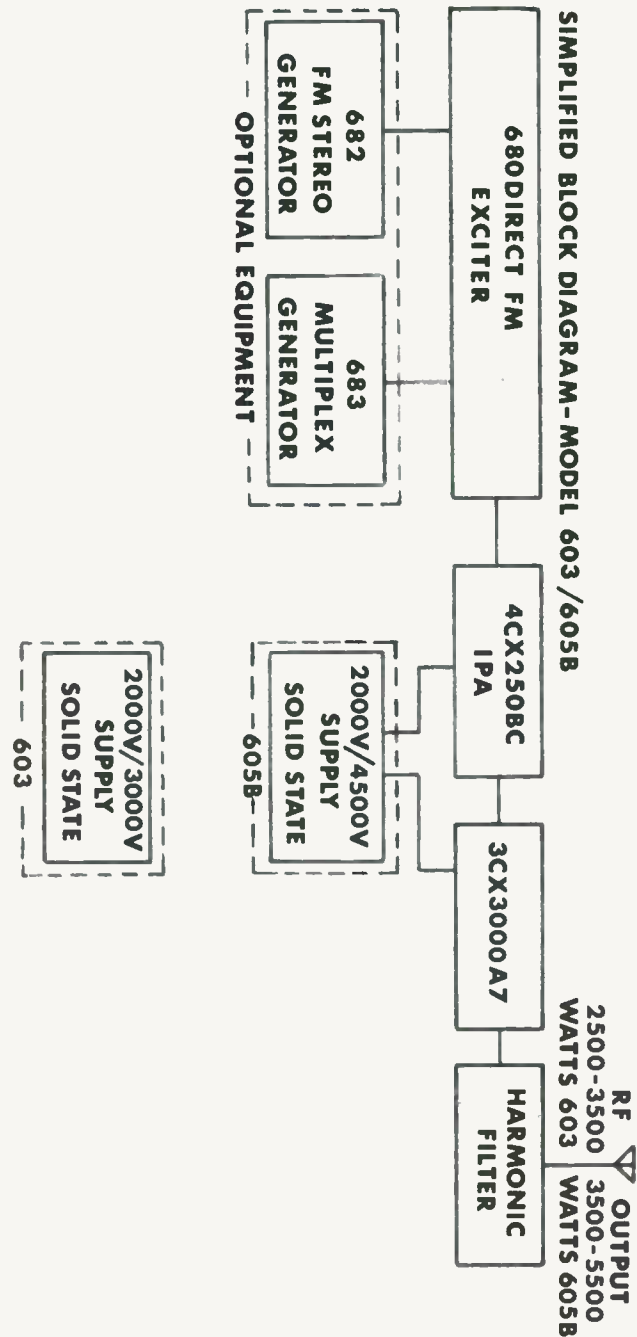

Models 603 and 605B FM Transmitters



5851 Florin-Perkins Road, Sacramento, Ca. 95828
(916) 383-5353 • Telex 377-488 • Cable SPARTA

Models 603 3 kw and 605B 5 kW FM Transmitters

These modern transmitters belong together in one design series, and are largely identical with the exception of the high voltage power supplies. The Model 603 is type accepted from 2,500 to 3,500 Watts output. The Model 605B is type accepted from 3,500 to 5,500 Watts.

Both transmitters use the Sparta Model 680 Direct FM Exciter, with optional 682 Stereo Generator and 683 SCA Generator (41 or 67 kHz).

One 3CX3000A7 ceramic zero bias triode, operated conservatively even at the highest output of the 605B, is common to both models. It is driven by a ceramic tetrode, 4CX250BC, which is housed in a separate aluminum enclosure for excellent RF shielding. tuning is straight forward, and does not require continual adjustment to maintain optimal performance.

Driver plate current, final screen and a final plate current are overload protected and monitored by a 'Tally Light' system with a built-in memory. The low voltage power supply and the control system are readily accessible through a swing-out front panel. Full length hinged doors are provided front and rear. Since the front door is not interlocked it can be removed easily if a space problem exists.

In high power applications the 605B becomes the driver for the 35,000 Watt Model 635. Where licensing rules permit the higher power amplifier can be added at any time without major modifications of the lower power unit.

From the transmitter engineer's point of view the Sparta Models 603 and 605B leave nothing to be desired in ease of maintenance and reliability; the design is straightforward and uncluttered.

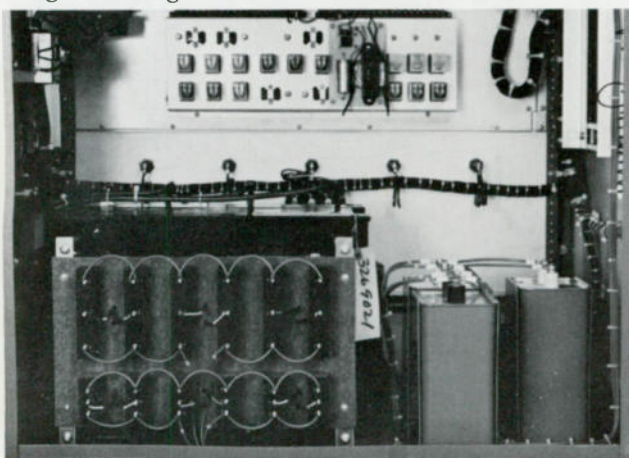

Model 603 lower cabinet, from rear.

Specifications: Model 603

POWER OUTPUT CAPABILITY: 2,500 to 3,500 Watts
LINE POWER CONSUMPTION: 5.7 kW at 0.9 PF (3,500 Watts out)

WEIGHT: 1,500 pounds (676 Kg)

The Model 603 specifications are otherwise identical to the Model 605B with the exception of the high voltage power supply, which operates at 3kV. See Model 605B specifications below.

Specifications: Model 605B

TYPE OF MODULATION: F3, F9 direct frequency modulation of mono, stereo, and SCA inputs

POWER OUTPUT CAPABILITY: 3,500 to 5,500 Watts

FREQUENCY RANGE: 88 to 108 MHz

FREQUENCY STABILITY: ± 1000 Hz

RF OUTPUT IMPEDANCE: 50 ohms nominal

MODULATION CAPABILITY: ± 150 KHz

FM NOISE: Better than 65 dB below 100% modulation (mono, stereo, and SCA) referred to 400 Hz

AM NOISE: Better than 50 dB below equivalent 100% AM

HARMONICS: Exceeds all FCC requirements

LINE POWER SUPPLY: 200-245 VAC, 50/60 Hz, 3-phase

LINE POWER CONSUMPTION: 8.9 kW at 0.9 power factor (5,500 Watts out)

ALL AUDIO INPUTS: 600 ohms $\pm 10\%$ balanced, +10 dBm ± 2 dB for 100% modulation (referred to 400 Hz)

POWER TUBE COMPLEMENT: 1 each 4CX250BC, 3CX3000A7

CABINET SIZE: 75" high x 34" wide x 25½" deep (101 x 86 x 65 cm), low pass filter included

WEIGHT: 1,700 pounds (771 Kg)

ALTITUDE: to 7,500 feet (2,285 meters)

AMBIENT TEMPERATURE: to 113°F (45°C)

Monaural Operation:

FREQUENCY RESPONSE: Within 1 dB 50-15,000 Hz (referred to 75 usec pre-emphasis)

DISTORTION: Less than 0.5% 50-15,000 Hz

Stereophonic Operation:

PILOT CARRIER STABILITY: 19 kHz ± 1 Hz

SUBCARRIER SUPPRESSION: -45 dB or better

FREQUENCY RESPONSE: ± 0.5 dB from 50-15,000 Hz (referred to 75 usec pre-emphasis)

PRE-EMPHASIS: 75 usec or 50 usec

SEPARATION: 40 dB or better, 50-15,000 Hz

CROSSTALK: (Main channel to subchannel and subchannel to main channel) 50 dB or better below 100% modulation, 50-15,000 Hz

DISTORTION: 0.1% or less distortion of composite wave form (100% modulation by composite stereo)

SCA Operation

AMBIENT TEMPERATURE LIMITS: + 5° C to = 50°C

TYPE OF MODULATION: FM

CENTER FREQUENCY RANGE OF SUBCARRIER: Standard 41 or 67 kHz

OUTPUT VOLTAGE: At least 2 Volts peak to peak into 10,000 ohms

MODULATION CAPABILITY: $\pm 15\%$ of subcarrier frequency (10% deviation = 100% modulation)

INJECTION RANGE: Subcarrier injection adjustable from 0 to 30%

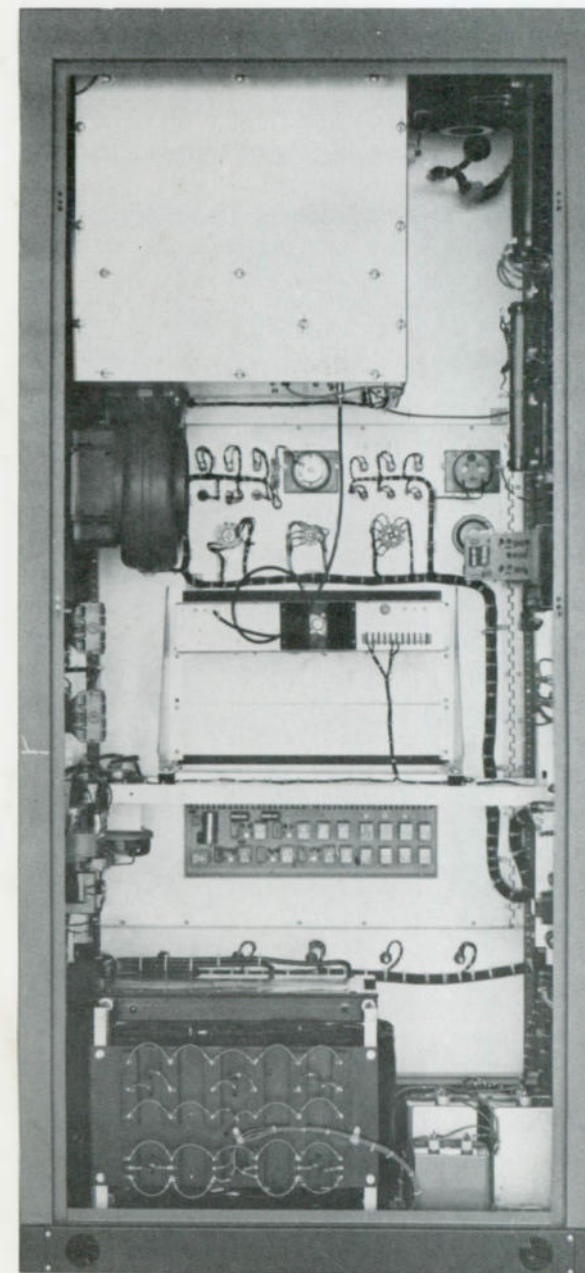

Model 605B interior.

slightly reduced noise, distortion and response specification

POWER CONSUMPTION: 2500 watts output - 90% PF approximate; 0% modulation - 5.95kW; average modulation - 6.7kW; 100% modulation - 8.4kW.

AMBIENT OPERATING TEMPERATURE: To 113° F

ALTITUDE RANGE: To 7500' — Higher Altitudes on special order.

SIZE: 75" high, 34" Wide, 25½" Deep

WEIGHT: 1500 lbs. NET

OPTIONAL EQUIPMENT: (factory installed) RMK-1 — Remote Control Kit, including control relay interface assembly and motor rheostat. CVT — Constant Voltage Transformer to maintain filament and low voltage supplies within $\pm 1\%$. 60 Hz only.

ORDERING INFORMATION: the 703B is supplied complete with tubes, transistors and two crystals, tuned and tested on frequency.

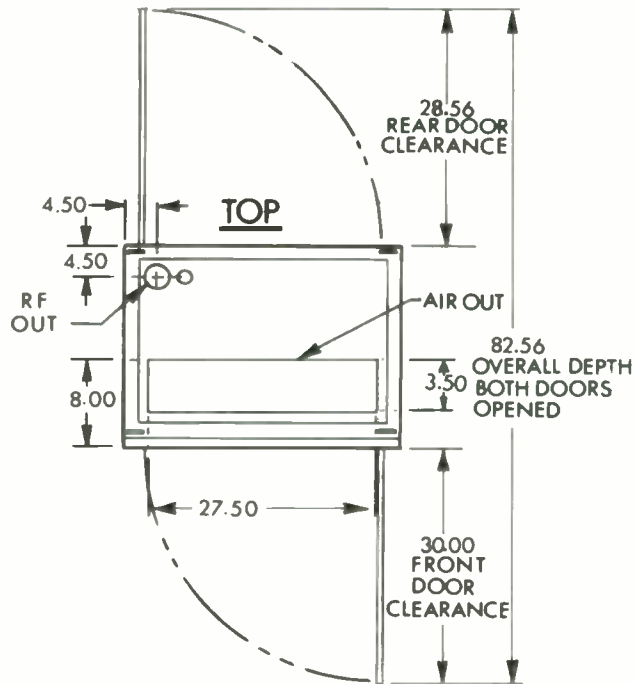

FLOORPLAN, MODEL 703B. Two alternatives should be kept in mind: (1) the FRONT door can be switched in the field to open in the opposite manner to the drawing, and (2) the RF output is standard at top of cabinet, but can also emerge exactly below the position in the drawing for trench feed to tower.

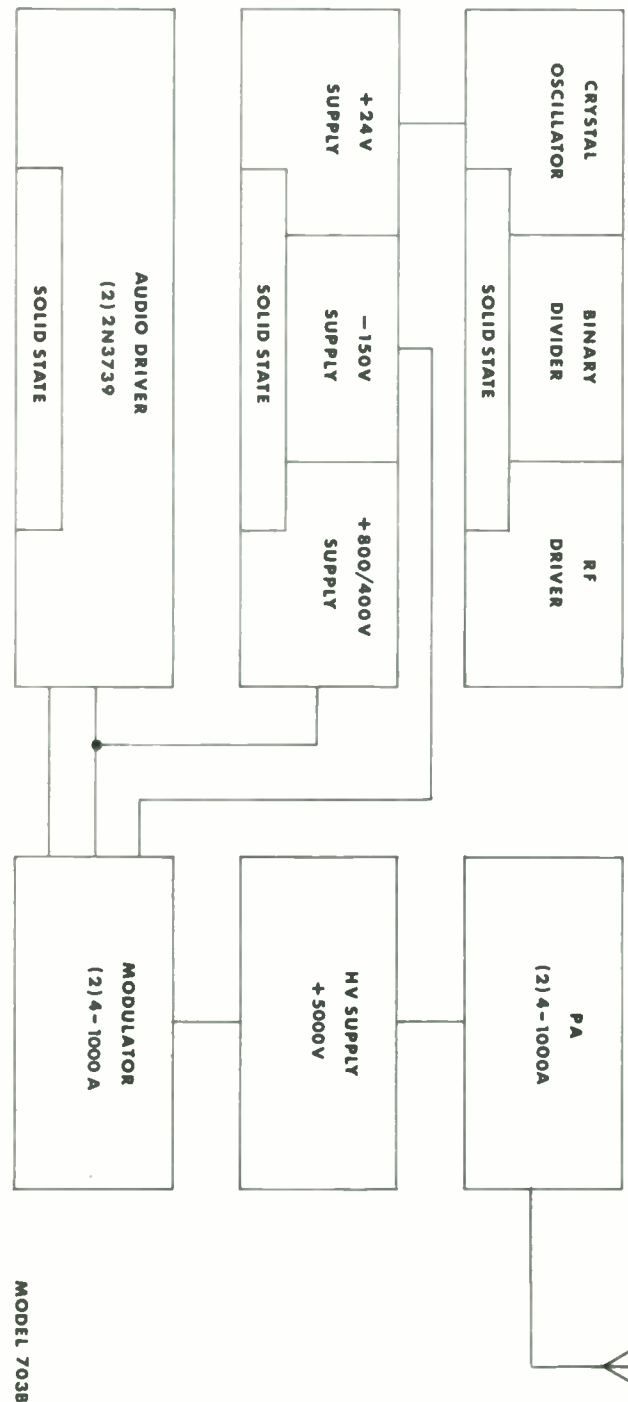

MODEL 703B



Model 703B 2.5 kW AM Transmitter



5851 Florin-Perkins Road, Sacramento, Ca. 95828
(916) 383-5353 • Telex 377-488 • Cable SPARTA

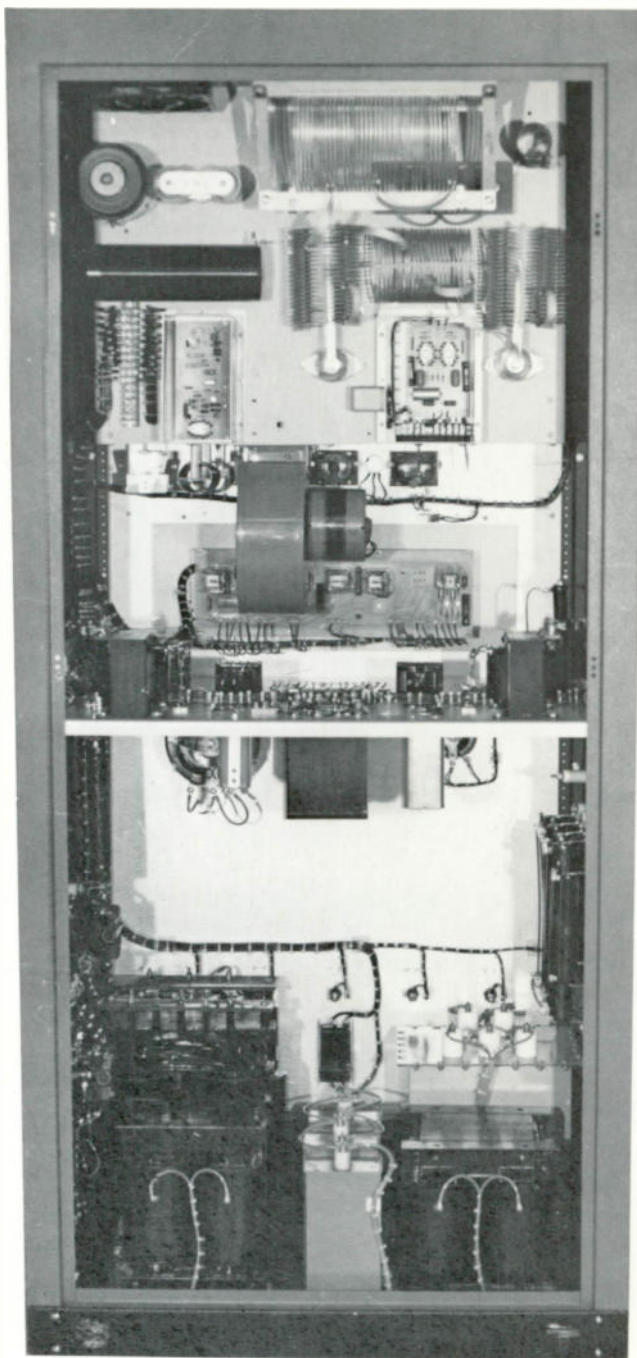

MODEL 703B
2500 Watt AM Transmitter

The Sparta 703B is a self-contained plate modulated AM transmitter capable of up to 3,000 Watts output in the 535 to 1620 KHz band.

Solid state devices are combined with only one tube type to provide a simple, highly dependable design. A high quality oil filled modulation transformer eliminates moisture deterioration and assures long lasting reliability. Another quality feature is the

vacuum capacitor used for plate tuning which eliminates arcing and roller coil freezing, associated with conventional tuning methods. The 'Tally Light' system will reduce downtime and help preventive maintenance by identifying the point of overload.

Frequency response of the 703B is excellent, distortion is low, and 125% positive peak modulation capability is there for those who wish to use it.

Simultaneous full meter display of all important functions can be monitored with doors of the 703B closed. Access to the front panel switches and subsidiary metering is through a non-interlocked hinged front door, which can be changed to open from either side. Rear access is provided through a full-size, hinged and interlocked door. All control circuitry is mounted on a swing-down front panel for easy accessibility. There is only one front panel tuning control. Remote control interface kits are optional for the user's choice of systems.

The entire transmitter is housed in a single steel cabinet which is mounted on a sturdy 12-gauge steel base.

POWER CUTBACK

For a minimal extra charge the 703B can be supplied with a power cutback to 1000 or 500 watts. A single switch controls final plate voltage, audio and RF drive simultaneously.

SOLID STATE POWER SUPPLIES

All power supplies use encapsulated silicon bridge rectifiers which provide low power drain, cooler operation, and reliable performance. A single low voltage transformer provides bias voltage for the modulator tubes, 25 volts for the RF drive section, 800 volts for the modulator screens, and 400 volts for the solid state audio driver.

An epoxy-sealed plate transformer provides high voltage for the modulator and final amplifier tubes.

SOLID STATE OSCILLATOR AND RF DRIVER

Adding an extra measure of transmitter stability, the 703B utilizes a solid state oscillator and RF driver. An ovenless crystal operating in the highly stable area four times carrier frequency is used. Two binary divider IC's operating in tandem count down the oscillator to the desired carrier frequency. A buffer transistor follows the divider, then an output transistor that is matched to the final grids through an "L" network.

Type 4-1000A tetrodes have been used in the RF section of the transmitter, reducing the required stages and the power consumption. Tetrodes also eliminate the need for neutralization.

The parallel operated final tubes operate in conventional Class C at an average efficiency of 75%.

HIGH QUALITY MODULATOR

A simple two stage transistor amplifier provides ample audio drive for two 4-1000A tetrode modulator tubes operating Class AB-1. A high quality modulation transformer, sealed in oil, provides exceptional sound and modulation capability.

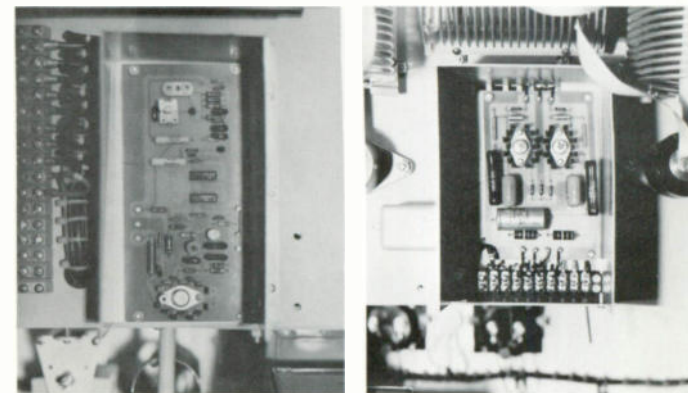

AUDIO DRIVER ASSEMBLY: the simplicity and space-saving design of the 2-stage transistor amplifier is evident in this closeup. Two 4-1000A tetrodes operating AB-1 are powered by this stage (right). **RF DRIVER ASSEMBLY:** this solid state system enables a highly stable ovenless crystal to operate at its best frequency, the output being counted down to operating frequency (left).

Specifications:

AF INPUT IMPEDANCE: 600 ohms

AF INPUT LEVEL: + 10 dBm \pm 2 dBm (100% Modulation)

AF RESPONSE: 50-10,000 Hz (95% Modulation) \pm 1.5 db (typical - \pm 1 db)

AF DISTORTION: 50-10,000 Hz (95% Modulation) less than 3% (typical - 1.5%)

NOISE: (below 100% Modulation) 2500 Watts — 60 db

FREQUENCY RANGE: 540-1600 KHz

FREQUENCY STABILITY: \pm 10Hz 0-50° C

OUTPUT IMPEDANCE: 50 Ohms unbalanced — others available on special order

CARRIER SHIFT: 3% or less (0-100% Modulation) Nominal - 2500 watts, capable - 3000 watts

POWER OUTPUT: Nominal - 2500 watts, capable - 3000 watts

POWER SUPPLY: 208/240 or 380/415 volts, \pm 5%, 50/60 Hz, three phase

Single phase available at extra cost and with

NOISE: -65 dB below 100% modulation.

CROSSTALK: -50 dB or better (-60 dB typical)

SEPARATION: 40 dB, 50 to 15,000 Hz or better.

POWER SUPPLY: 105-125 VAC, 50/60 Hz, 15W.

SIZE: 19"W x 31½"H x 6"D.

AMBIENT OPERATING TEMPERATURE: +5° Centigrade to +50 Centigrade.

MAXIMUM ALTITUDE: To 12,500 feet.

Specifications: Model 683 SCA Generator

CENTER FREQUENCY RANGE OF SUBCARRIER:

Standard 41 or 67KHz

INPUT IMPEDANCE: 600 ohms balanced.

INPUT LEVEL: +10 dBm at 400 Hz (100% modulation).

OUTPUT VOLTAGE: At least 2 volts peak to peak into 10,000 ohms.

FREQUENCY DEVIATION: +10% of center frequency (100% subcarrier modulation).

MODULATION CAPABILITY: +15%.

CARRIER FREQUENCY STABILITY: 2,500 Hz over temperature range.

FREQUENCY RESPONSE: ±2 dB ref. 75 usec. pre-emphasis (convertible to 50 or 150 usec. pre-emphasis).

HARMONIC DISTORTION: Less than 1.5% (50Hz to 7.5 KHz).

FM NOISE LEVEL: -65 dB maximum (ref. to 15% deviation).

SIZE: 19"W x 31½"H x 10"D.

AMBIENT OPERATING TEMPERATURE: +5° Centigrade to +50° Centigrade.

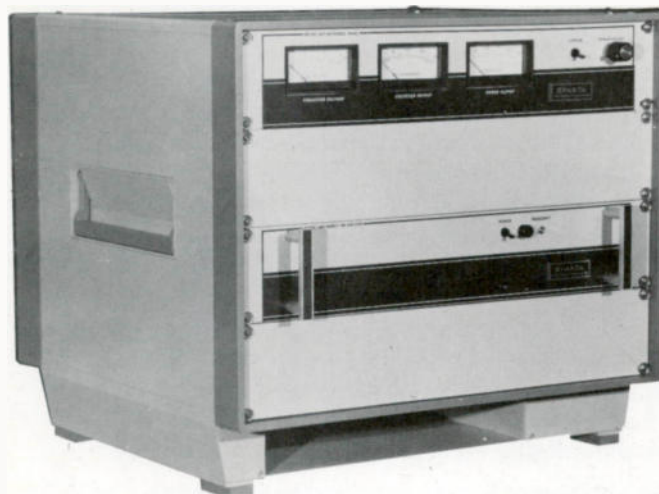

680 Series FM Exciter and Options



5851 Florin-Perkins Road, Sacramento, Ca. 95828
(916) 383-5353 • Telex 377-488 • Cable SPARTA



MODELS 680 and 680/1 EXCITER AND TRANSMITTER

The Model 680-680/1 FM Exciter/Transmitter is designed to function either as an exciter (Model 680) for an FM power amplifier, or as a 10 Watt FM broadcast transmitter (Model 680/1). The two units differ only in that the 680/1 incorporates a three-meter panel and low pass filter. The meter panel (Model 681) indicates collector voltage, current, and power output.

Long term reliability and simplified operation have been obtained by a design concept that utilizes minimum parts plus modern circuit techniques. automatic carrier balance, strip-line circuitry, and ovenless digital AFC control are a few of these.

The entire exciter is contained in a package measuring only 3.5" high by 19" wide and 10" in depth. There are only two front panel controls; an on/off switch and a fine frequency adjustment. No other field adjustments are needed.

The Model 680 interfaces with and replaces any type accepted FM exciter. It is capable of full stereo and SCA operation, using the Models 682 and 683 or other approved units.

PRE-EMPHASIS AMPLIFIER

Monaural signals are applied to the modulator via operational amplifier 1C1, the peripheral components of which provide the required 75 microsecond pre-emphasis characteristic. Wide band signals applied to inputs J1 and J2 bypass the pre-emphasis amplifier and connect to the modulator via compensated attenuators.

OSCILLATOR-MODULATOR

Transistors 1Q1 and varicap diodes 1D1 and 1D2 comprise a low noise, low distortion modulated oscillator operating on the carrier frequency. The center frequency is maintained within the required tolerance by a digital discriminator and crystal-controlled reference oscillator.

The RF signal from the oscillator is supplied to buffer amplifier 1Q2 which raises the level to approximately one Watt.

RADIO FREQUENCY AMPLIFIER

A two-stage stripline RF amplifier comprised of transistors 3Q1 and 3Q2 provides power amplification to 10 Watts with a minimum of components and adjustments. A rheostat connected between terminals 5 and 6 provides a means of

are identical with the Model 680 Direct FM Exciter, below.

Specifications: Model 680 Direct FM Exciter

FREQUENCY RANGE: 85-125 MHz.

MODULATION: F3 and F9.

POWER OUTPUT: 5-12½ Watts adjustable.

OUTPUT IMPEDANCE: 35.5-91 ohms, 50 ohms nominal.

MODULATION CAPABILITY: ± 150 KHz.

CARRIER FREQUENCY STABILITY: ± 1 KHz.

RF BANDWIDTH: 2.5 MHz at -3 dB power points.

INPUT LEVEL: 10 dB ± 2 dB at 400 Hz.

INPUT IMPEDANCE: (Monaural) 600 ohms + 10% balanced. (Wide-band) 1 K unbalanced.

FREQUENCY RESPONSE: (Monaural) + 0.25 to -0.5 dB from 75 uS curve.

(Wideband) ± 1.0 dB 20-25,000 Hz.

DISTORTION: 0.5% or less, all frequencies.

WIDEBAND PHASE RESPONSE: +0.25 from phase linearity.

HARMONIC ATTENUATION: 43 dB below carrier.

FM NOISE: 70 dB below 100% modulation at 400 Hz.

AM NOISE: At least 55 dB below carrier level.

LOAD VSWR: O-infinity at all phase angles.

POWER SUPPLY: 95-135 VAC 50/60 Hz, Single phase.

POWER CONSUMPTION: 35 Watts nominal.

SIZE: (Standard EIA rack mount) 19" W x 3½" H x 10" D.

SHIPPING: 680; 18 pounds (8.1 kilos). 682; add 7 pounds

(3.2 kilos). 683; add 12 pounds (5.2 kilos).

ALTITUDE RANGE: to 12,500 feet.

AMBIENT OPERATING TEMPERATURE: 0-45° Centigrade.

Specifications: Model 682 Stereo Generator

PILOT FREQUENCY STABILITY: + 1 Hz maximum.

INPUT IMPEDANCE: 600 Ohms, balanced.

INPUT LEVEL: + 10 dBm ± 2 dB at 400 Hz for 90% modulation.

FREQUENCY RESPONSE: + 0.25 to -0.5 dB from 50 Hz to 15,000 Hz (referred to 75-usec pre-emphasis).

DISTORTION: 0.1% of composite waveform or less.

balance adjustments.

In addition it provides for excellent stereo separation (40 dB or better from 50-15,000 Hz). A phase linear filter removes objectionable harmonics without distorting the phase between the main and subchannels.

A stereo on/off switch and indicator are located on the front panel, and provisions are made for remote control of this function.

Adjustments for the Model 680 are minimized through careful design. No special maintenance procedures are necessary. Components used should not exhibit problems throughout the life of the equipment. None of the active devices are operating with parameters known to cause time-dependent failure modes.

MODEL 683 S.C.A. GENERATOR

Like the 682 Stereo Generator, the Model 683 SCA Generator is rack mounted and self-powered. It can be used with any direct FM exciter. Two inputs are provided: one for program, and one for telemetry. Automatic muting when modulation is absent is front panel-selectable.

Incoming audio is fed to a 10 dB resistive pad followed by a transformer fed active pre-emphasis network which can be field connected for 75 or 150 microsecond time constants. A telemetry network bypasses the pre-emphasis section to allow the transmission of low frequency metering information. Provision is also made for the insertion of a 5 KHz low pass filter when the 683 is used within a stereo facility.



The modulated oscillator is followed by a diode gate, a buffer amplifier and a low pass filter which removes the harmonics of the oscillator waveform. The diode gate, providing a delay between the end of modulation and the muting of the subcarrier, is adjustable from the front panel.

Provision to switch the subcarrier on/off locally or remotely is a standard feature of the Model 683.

Specifications: Model 680/1 FM Transmitter

SIZE: (Standard EIA rack mount) 19"W x 7"H x 18"D. (In optional custom cabinet, with room for Models 682 and 683) 19½"W x 17"H x 18"D.

All electronic specifications of the Model 680/1

power output control when used as a 10 Watt transmitter (680/1).

REFERENCE OSCILLATOR AND SYNC DETECTOR

Transistor 1Q3 and its associated components comprise an overtone crystal oscillator. The crystal operating frequency is selected to equal the operating frequency plus 200 KHz, divided by two. The crystal is a special temperature-stable device optimized for operation in this circuit. It can easily meet frequency stability requirements without an oven.

The output of the oscillator and a small sample from the buffer amplifier are mixed in the synchronous detector, producing a 200 KHz sine wave.

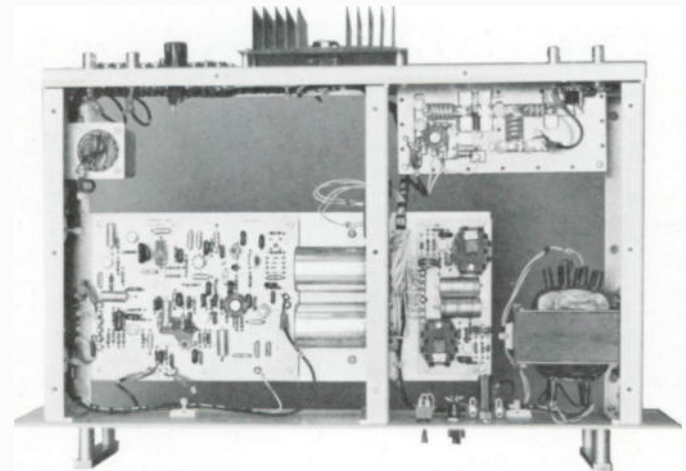

200 KHZ DISCRIMINATOR

The low level 200 KHz signal from the detector is applied to operational amplifier 1C2, connected as a clipper. The symmetrical square wave output of the clipper is differentiated into a sharply-peaked waveform by 1C32 and 1R31. The negative going edge of this waveform is used to trigger a monostable multivibrator, 1C3. This multivibrator provides an output pulse of uniform width regardless of the repetition rate of that pulse.

Because of this the duty cycle of the output waveform is dependent upon frequency. Simple integration of this signal by 1R34 and 1C35 produces a DC potential with an amplitude that is a function of frequency. Circuit constants chosen produce a DC voltage at 200 KHz of 2 volts. Since the function is linear the level will be 4 volts at 400 KHz and zero volts at zero frequency. 1C4 operates as a DC amplifier and comparator.

The voltage at the inverting input (pin 2) is set by 1R36 and determines the 'crossover point' of the discriminator and hence the center of the exciter.

The output of this amplifier is applied back to the

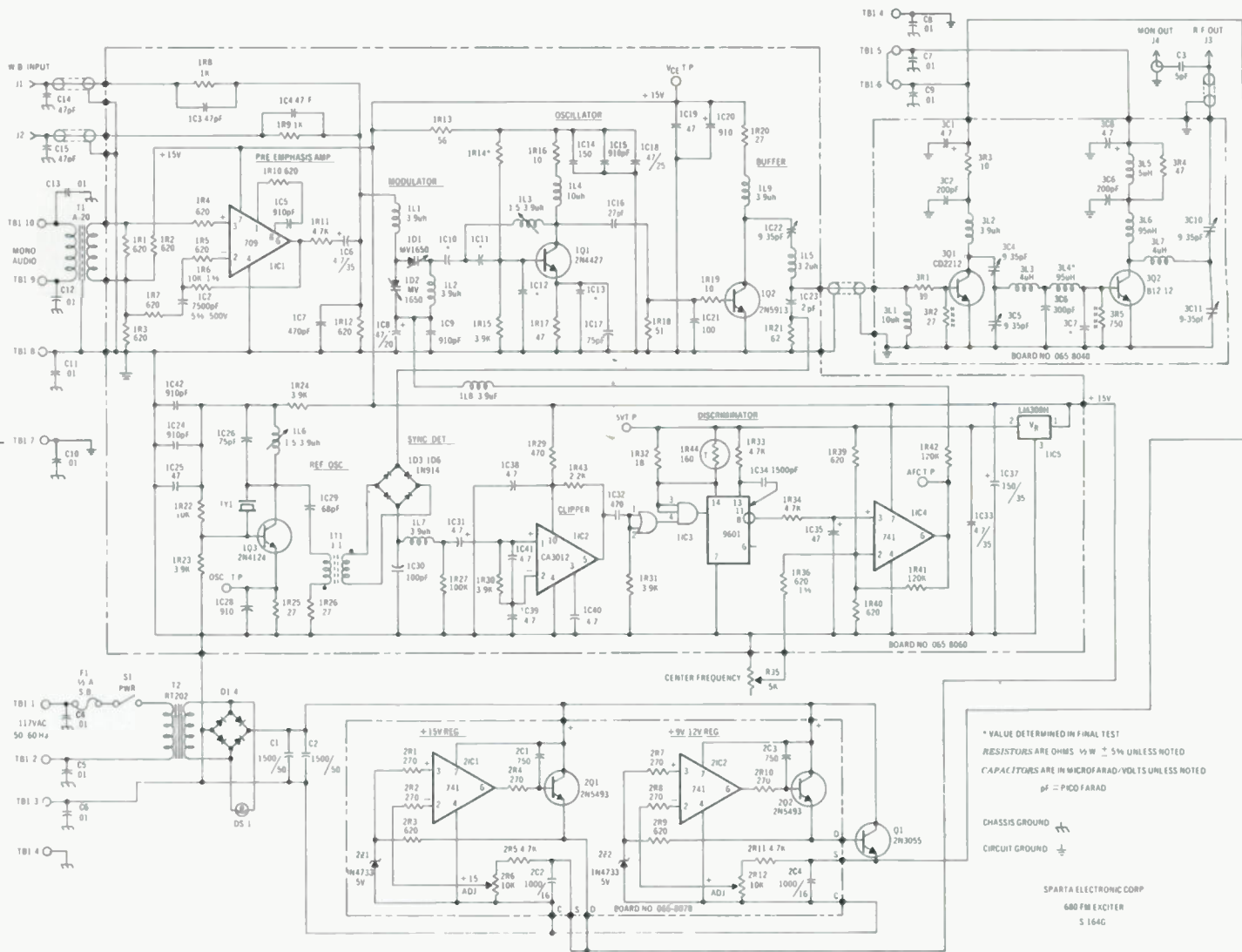

vari-cap modulator via 1R42 to set its bias and thus maintain the center frequency. Operating parameters of this critical stage are temperature compensated by thermistor 1R44 and regulator 1C5.

POWER SUPPLIES

Two independent regulated power supplies are used in the 680; one to supply the high current requirements of the RF amplifier board, the second to supply all other requirements. Both power supplies are self-protecting from short circuits.

682 STEREO GENERATOR

The Model 682 Stereo Generator is a self-powered rack mount unit designed for use with the Model 680 or other direct FM exciter. It can also be used to generate a composite stereo signal at the studio for transmission of an STL system.

Excellent stereo separation and crosstalk specifications are obtainable with the 682. Only one front panel control is needed for successful day-in/day-out operation. This control (pilot) sets pilot amplitude and adjusts the overall gain of the system.

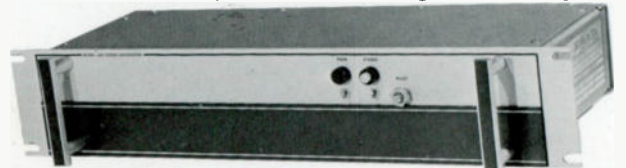

An ultra-stable 67 KHz oscillator provides a low distortion signal that is digitally divided to derive the 19 KHz pilot and the 38 KHz square wave signal used to alternately switch the left and right audio channels. Circuit design assures that the 38 KHz subcarrier suppression will be at least 65 dB below the modulated signal without the need for carrier

* VALUE DETERMINED IN FINAL TEST
RESISTORS ARE OHMS 1/4 W ± 5% UNLESS NOTED
CAPACITORS ARE IN MICROFARAD-VOLTS UNLESS NOTED
pf = PICO FARAD

CHASSIS GROUND
CIRCUIT GROUND

SPARTA ELECTRONIC CORP
680 FM EXCITER
S 164C

601A	1000 Watts	9,500.00
602A	2500 Watts	12,000.00
603	3000 Watts	14,000.00
605B	5000 Watts	16,500.00
610A	10,000 Watts	23,500.00
625A	25,000 Watts	32,500.00
635	35,000 Watts	39,000.00
650 Dual	50,000 Watts	On Request
	* 100% solid state	

A M MONITORS

713	Frequency and modulation monitor	2,150.00
732	Modulation monitor	1,390.00
732-09	Modulation monitor with carrier frequency output	1,565.00
704A	Remote meter and peak flasher panel	250.00
1900A	5 Hz/150 MHz digital frequency counter	495.00

F M MONITORS

723	Frequency and modulation monitor	2,250.00
724	Stereo monitor for Models 723 and 734	1,320.00
730	SCA monitor for Models 723 and 734	1,320.00
734	Modulation monitor only	1,485.00
734-02	Modulation monitor with carrier frequency output	1,660.00
704C	Remote meter and peak flasher panel, stereo	350.00
1900A	5 Hz/150 MHz digital frequency counter	495.00

ACCESSORIES

RMC-2AX-10	10-channel remote control, radio STL, analog	1,395.00
RMC-2AX-24	24-channel remote control, radio STL, analog	1,645.00
TRC15AW	15-channel remote control, single AC pair, analog	1,990.00
DRS-1AW	10-channel remote control, single AC pair, digital	3,950.00
DRS-1AR	10-channel remote control, wireless, digital	4,200.00
	NOTE: both DRS-1 systems can be expanded to 30-channel	
380	Phase sampler	165.00
FIM-2I	Field intensity meter, solid state	1,150.00

JAMPRO "PENETRATOR" FM ANTENNA: CIRCULARLY POLARIZED, 10kW PER BAY, 3 1/8" LINE

	WITHOUT DEICERS	* WITH DEICERS
JSCP-1	1-bay, 0.46/0.46 gain	1,600.00
JSCP-2	2-bay, 1.0/1.0 gain	2,450.00
JSCP-3	3-bay, 1.5/1.5 gain	3,600.00
JSCP-4	4-bay, 2.1/2.1 gain	5,800.00
JSCP-5	5-bay, 2.7/2.7 gain	6,000.00
JSCP-6	6-bay, 3.2/3.2 gain	7,250.00
JSCP-7	7-bay, 3.8/3.8 gain	8,400.00
JSCP-8	8-bay, 4.3/4.3 gain	10,150.00
JSCP-10	10-bay, 5.5/5.5 gain	11,600.00
JSCP-12	12-bay, 6.6/6.6 gain	13,600.00
JSCP-14	14-bay, 7.8/7.8 gain	15,500.00
JSCP-16	16-bay, 8.9/8.9 gain	17,500.00
JSCP*	Deicer on/off control, 1-3 bays only	95.00
JSCP*	Deicer automatic on/off control, any number of bays	385.00
JSCP*	Deicer auto-precision on/off control, any number of bays	925.00

JAMPRO "PERFORMER" FM ANTENNA: ELLIPTICALLY POLARIZED, 1 kW PER BAY, 1 5/8" LINE

JLCP-1	1-bay, 0.45/0.45 gain	1,000.00
JLCP-2	2-bay, 0.95/0.95 gain	2,000.00
JLCP-3	3-bay, 0.5/1.5 gain	2,500.00
JLCP-4	4-bay, 2.05/2.05 gain	3,000.00
JLCP-5	5-bay, 2.60/2.60 gain	4,000.00
JLCP-6	6-bay, 3.15/3.15 gain	6,000.00
JLCP-7	7-bay, 3.65/3.65 gain	7,000.00
JLCP-8	8-bay, 4.2/4.2 gain	8,000.00
JLCP-10	10-bay	9,500.00
JLCP-12	12-bay	11,000.00
JLCP	Deicers, per bay	235.00
JLCP	Deicer on/off control, 1-3 bays only	95.00
JLCP	Deicer automatic on/off control, any number of bays	385.00

ISOCOUPERS

7.5 kW	1 5/8" input/output (up to 7.5 kW)	850.00
20.0 kW	3 1/8" input/output (7.5 to 20.0 kW)	1,325.00

JAMPRO "BRUTE" FM ANTENNA: CIRCULARLY POLARIZED, 30 kW PER BAY, 6 1/8" LINE

JHCP	Custom engineered	On Request
------	-------------------	------------

JAMPRO BROADBAND CIRCULARLY POLARIZED "MULTI-STATION INPUT" FM TRANSMITTING ANTENNA: 88-106 MHz, VSWR 1.1/1 OVER 20 MHz

JSD3P or JSD4P	Custom engineered	On Request
----------------	-------------------	------------

ANTENNA COUPLING UNITS AND TUNING UNITS

ACU or ATU	Custom engineered	On Request
------------	-------------------	------------

This brochure does not cover the entire range of broadcast products supplied by Sparta. Please refer to the Sparta hard-bound catalog for complete information about professional quality Audio, Automation and AM or FM Transmitters available, or contact Sparta sales.

Our policy is one of continual improvement in design and manufacture; we reserve the right to change prices, specifications, or design without notice.

No order is binding upon Sparta Division of Cetec Corporation without acceptance in writing from the national/international sales office in Sacramento, California.

All equipment is supplied standard at 117 Volts, 60 Hz. Other power requirements are available.

Terms: Sparta-Charge, Open Account, Conditional Sale Contract, or Lease/Purchase Agreement. All prices are FOB source.

We're in the
business of
You.



5851 Florin-Perkins Road, Sacramento, Ca. 95828
(916) 383-5353 • Telex 377-488 • Cable SPARTA

BROADCAST EQUIPMENT PRICE SCHEDULE



SEPTEMBER 1,
1975

CENTURION SERIES CUSTOM AUDIO CONSOLES

CENTURION I, MONAURAL

2300	8-mixer, rotary attenuators	4,500.00
2305	8-mixer, slide attenuators	4,500.00

CENTURION III, MONAURAL

2500	6-mixer, rotary attenuators	3,000.00
2505	6-mixer, slide attenuators	3,000.00

CENTURION II, STEREO

2400	8-mixer, rotary attenuators	5,500.00
2405	8-mixer, slide attenuators	5,500.00

CENTURION IV, STEREO

2600	6-mixer, rotary attenuators	3,700.00
2605	6-mixer, slide attenuators	3,700.00

CENTURION ADD-ONS AND ACCESSORIES

2320	6-mixer mono Extender, rotary attenuators (Model I only)	2,000.00
2325	6-mixer mono Extender, slide attenuators (Model I only)	2,000.00
2340	Mono equalizer module	200.00
2350	Mono plug-in mixer module, rotary attenuator	225.00
2355	Mono plug-in mixer module, slide attenuator	225.00
2420	6-mixer stereo Extender, rotary attenuators (Model II only)	2,600.00
2425	6-mixer stereo Extender, slide attenuators (Model II only)	2,600.00
2440	Stereo equalizer module	300.00
2430	Stereo plug-in mixer module, rotary attenuator	285.00
2435	Stereo plug-in mixer module, slide attenuator	285.00
2450	DC24 digital clock (Models I and II only)	200.00
2655	Utility stereo VU meter (Model II only), installed	60.00

3000 - SERIES CONSOLES

3310	10-mixer, dual monaural	2,900.00
3410	10-mixer, dual stereo with separate mono	3,900.00

1000 - SERIES CONSOLES

MONAURAL MODELS

1015	A15B 5-mixer, standard	725.00
1017	A15B 5-mixer, step attenuators	850.00
A16R	5-mixer, dual channel, standard (rack mount)	1,500.00
1020	A20B 8-mixer, step attenuators	1,700.00
RA1	Utility microphone/line amplifier	120.00
RA4	4-channel, AC/battery remote amplifier	325.00

STEREO MODELS

1030	AS30B 5-mixer, standard	950.00
1035	AS30B 5-mixer, step attenuators	1,125.00
1040	AS40B 8-mixer, step attenuators	2,230.00

STUDIO/REMOTE AUDIO CONTROL SYSTEMS

MONAURAL MODELS

AC155B	Standard, 1015 console and ST12 turntables	1,700.00
AC155C	Custom, 1017 console with step attenuators, GT12 turntables	1,945.00

STEREO MODELS

ASC305B	Standard, 1030 console and ST12 turntables	2,025.00
ASC305C	Custom, 1035 console with step attenuators, GT12 turntables	2,320.00

AUDIO ACCESSORIES

BL5	Bench/lid combination for AC155 & ASC305 models	150.00
US5	Utility shelf, top mounting, for AC155 and ASC305 models	100.00
MIC6	EV635A microphone with gooseneck, for AC155 and ASC305 models	85.00
1088	Microphone preamp, installed or spare	35.00
MA25	25 Watt monaural monitor amplifier	185.00
MA25Q	25 Watt monaural monitor amplifier with cue	235.00
MA550	50 Watt stereo monitor amplifier	250.00
MA550Q	50 Watt stereo monitor amplifier with cue	300.00
SM3	Muting and relay accessory for MA-series	80.00
SP30	3-way 10" speaker system with enclosure	120.00
SP40	4-way 15" speaker system with enclosure	200.00

TURNTABLES AND ACCESSORIES

ST12	Standard 12" 2-speed turntable, 4-pole	225.00
GT12	Custom 12" 2-speed turntable, asynchronous	285.00
ST220	Tone arm, less cartridge	65.00
2205	Mono/stereo phono cartridge	15.00
225N	Replacement stylus for 2205	6.50
AT1005	Tone arm, precision stereo, less cartridge	80.00
M44C	Shure phono cartridge	17.95
N44C	Replacement stylus for M44C	9.75
500E	Stanton phono cartridge, elliptical stylus	19.25
5100B	Replacement stylus for 500E	11.00
500AL	Stanton phono cartridge	16.50
5107AL	Replacement stylus for 500AL	6.60
TEP3M	Mono equalized preamplifier	100.00
TEP3S	Stereo equalized preamplifier	150.00

SHOWCASE STUDIO CABINETRY: SERIES I

101-1A	Console desk for 1020 or 1040	275.00
--------	-------------------------------	--------

101-1-3	Console hood with cue speaker	125.00
101-3-4	Dual turntable return	300.00
101-3-5	Dual utility return	325.00
101-6	Tape cartridge storage hutch for 101-3-5	150.00
101-3-1	Rack bracket kit for 101-3-5	10.00
101-7	Single turntable return	200.00

SHOWCASE STUDIO CABINETRY: SERIES II

2711	Console desk for 3000- or Centurion series	375.00
2712	Support pedestal for 2711 (not required when 2713 is used)	85.00
2713	Dual turntable return	485.00
2715	Dual utility return	340.00
2716	Tape cartridge storage hutch for 2715	240.00

SHOWCASE SERIES I GROUPS: USING 1000-SERIES CONSOLES

Group A	8-mixer console with monitor amplifier/muting, using Series I cabinetry including: console desk, hood with speaker, dual turntable return, factory wired with two ST12 standard turntable systems installed	
	Mono.....	3,160.00
	Stereo.....	4,170.00
Group B	All of Group A, plus dual utility return with tape cartridge hutch	
	Mono.....	3,635.00
	Stereo.....	4,645.00
Group C	All of Groups A & B, plus Century Series tape cartridge record/playback and two playbacks with appropriate Flip-Top covers	
	Mono.....	5,600.00
	Stereo.....	7,250.00

SHOWCASE SERIES II GROUPS: USING 3000-SERIES CONSOLES

Group A	10-mixer console with Series II cabinetry including: console desk, dual turntable return factory wired with two GT12 custom turntable systems installed	
	Mono.....	4,640.00
	Stereo.....	5,790.00
Group B	All of Group A, plus dual utility return with tape cartridge hutch	
	Mono.....	5,220.00
	Stereo.....	6,370.00
Group C	All of Groups A & B, plus Century Series tape cartridge record/playback and two playbacks with appropriate Flip-Top covers	
	Mono.....	7,185.00
	Stereo.....	8,975.00

SHOWCASE SERIES II GROUPS: USING CENTURION I OR II CONSOLES

Group A	Basic 8-mixer console using Series II cabinetry including: console desk, dual turntable return, factory wired with two GT12 custom turntable systems installed	
	Mono.....	6,240.00
	Stereo.....	7,390.00
Group B	All of Group A, plus dual utility return with tape cartridge hutch	
	Mono.....	6,820.00
	Stereo.....	7,970.00
Group C	All of Groups A & B, plus Century Series tape cartridge record/playback and two playbacks with appropriate Flip-Top covers	
	Mono.....	8,785.00
	Stereo.....	10,575.00

CENTURY SERIES TAPE CARTRIDGE EQUIPMENT

4510	Monaural playback module	525.00
4515	Monaural playback module with NAB 150 Hz EOM auxiliary cue	555.00
4520	Stereo playback module	695.00
4525	Stereo playback module with NAB 150 Hz EOM auxiliary cue	725.00
4610	Monaural record/playback system	850.00
4615	Monaural record/playback system with NAB 150 Hz EOM aux cue	920.00
4620	Stereo record/playback system	1,150.00
4625	Stereo record/playback system with NAB 150 Hz EOM aux cue	1,220.00
4810	Single Flip-Top module cover	20.00
4820	Dual Flip-Top module cover	25.00
4830	Triple module rack mount housing	85.00
4850	Matching blank panel for 4830	15.00

TAPE CARTRIDGES AND ACCESSORIES

CR100	Cartridge rack, wooden, wall-mount, holds 100	90.00
CR120	Cartridge rack, revolving, wooden, holds 120	120.00
TR48	Cartridge rack, revolving, wire, holds 48	38.55
TR96	Cartridge rack, revolving, wire, holds 96	73.55
MR200	Cartridge rack, revolving, mobile wire floor model, holds 200	145.95
CE3	Cartridge and reel tape eraser	75.00
AG2	Tape cartridge equipment head alignment gauge	12.50
AL1	Cartridge, head alignment	7.50
CL1	Cartridge, test tape; 1 KHz at standard reference level	5.50
CL2	Cartridge, test tape; 1 KHz at -10 dB	5.50
NAB3	Cartridge, test tape; mono frequency response	18.00
NAB4	Cartridge, test tape; stereo frequency response	55.00

PREMIUM TAPE CARTRIDGES

0004	Empty	1.80
0004-02	Twenty seconds	2.00
0004-03	Forty seconds	2.10
0004-04	Seventy seconds	2.15
0004-05	One minute-thirty seconds	2.20
0004-06	One minute-forty seconds	2.25

0004-07	Two minutes-thirty seconds	2.35
0004-08	Three minutes-thirty seconds	2.50
0004-09	Five minutes-thirty seconds	2.80
0004-10	Seven minutes-thirty seconds	3.15
0004-11	Eight minutes-thirty seconds	3.35
0004-12	Ten minutes-thirty seconds	3.70

STANDARD TAPE CARTRIDGES

0001	Empty	1.70
0100	Twenty seconds	1.90
0102	Forty seconds	2.00
0104	Seventy seconds	2.05
0106	One minute-thirty seconds	2.10
0108	One minute-forty seconds	2.15
0110	Two minutes-thirty seconds	2.25
0114	Three minutes-thirty seconds	2.40
0118	Five minutes-thirty seconds	2.70
0025	Seven minutes-thirty seconds	3.05
0022	Eight minutes-thirty seconds	3.25
0122	Ten minutes-thirty seconds	3.60
M600	Empty (Sixteen minute capacity)	2.80
M600	Sixteen minutes	6.80
M1200	Empty (Thirty-one minute capacity)	4.35
M1200	Thirty-one minutes	10.50

REFURBISH AND RELOAD YOUR CARTRIDGES

0100R	Twenty seconds	1.05
0102R	Forty seconds	1.10
0104R	Seventy seconds	1.15
0106R	One minute-thirty seconds	1.20
0108R	One minute-forty seconds	1.25
0110R	Two minutes-thirty seconds	1.35
0114R	Three minutes-thirty seconds	1.50
0118R	Five minutes-thirty seconds	1.85
0025R	Seven minutes-thirty seconds	2.15
0022R	Eight minutes-thirty seconds	2.35
0122R	Ten minutes-thirty seconds	2.70
M600	Sixteen minutes	4.90
M1200	Thirty-one minutes	7.90

BULK TAPE AND LABELS

0501	Roll (500) Kum-Kleen blank labels	5.50
0600	1,800' reel lubed magnetic tape	4.95
0601	3,600' reel lubed magnetic tape	9.75

REEL/REEL TAPE RECORDERS AND REPRODUCERS

SPARTA CORINTHIAN 14" SERIES

4911	Monaural full track	1,500.00
4912	Monaural half track	1,500.00
4922	Stereo half track	1,750.00
4924	Stereo quarter track	1,750.00

Corinthian reel/reel reproducers have up to 16" reel capacity. Speeds are 3 3/4 and 7 1/2 IPS with foil reversing. Hubs are NAB and EIA. Tape tension arms are adjustable and air-damped. Level adjustments are on front panel. Three motors, direct drive capstan. 28" rack space required.

1102/4	Revox A77 2 or 4-track, stereo/mono, wood cabinet	959.00
1302/4	Revox A77 2 or 4-track, stereo/mono, uses 13-R	959.00
SSP	Revox A77 stainless steel faceplate	10.00
13-R	Revox A77 rackmount adaptor	19.00
FT	Revox A77 full track monaural modification	110.00
HS	Revox A77 2 1/2-15 IPS high speed modification	110.00
HA	Revox A77 NAB adaptor hubs, per pair	20.00
531R	Metrotech 10 1/2" reel, full track monaural	1,950.00
543R	Metrotech 10 1/2" reel, 2-track stereo	2,295.00
280B-FT	Scully 10 1/2" reel, full track, motion sensing	2,825.00
280-1	Scully 10 1/2" reel, half track monaural	2,925.00
280-2	Scully 10 1/2" reel, 2-track stereo, motion sensing	3,595.00
SX812	Crown 10 1/2" reel, half track monaural	1,395.00
SX822	Crown 10 1/2" reel, 2-track stereo	1,495.00
MX7300FU	Otari 10 1/2" reel, half or full track, three speeds	3,525.00
MX7300-2S	Otari 10 1/2" reel, 2 or 4-track, 2-channel, three speeds	3,000.00
MX5050-2S	Otari 10 1/2" reel, 2 or 4-track, 2-channel, 7 1/2 & 15 IPS	1,450.00

A M TRANSMITTERS

700	16 Watts *	495.00
701B	1000/500/250 Watts (any two powers)	8,250.00
703B	2500 Watts (second power option on request)	13,000.00
705C	5000/1000/500 Watts (any two powers)	25,000.00
710C	10,000 Watts	27,500.00
715C	15,000 Watts	32,500.00
725C	25,000 Watts	70,000.00
	* 100% solid state	

F M TRANSMITTERS

680	Direct FM Exciter *	2,350.00
680/1	10 Watt Transmitter, with cabinet *	2,750.00
682	Stereo Generator *	1,350.00
683	SCA Generator *	700.00
600B	250 Watts *	6,500.00

TA-720	Time Announcer: Uses a single cartridge with the 720 time announcements of up to 8 seconds in length. If the cartridge is advancing, the Controller automatically skips to the next event, without delay. No dead air. 8 3/4" panel rack mounting, with sliders. Pre-recorded Time Cartridge	650.00
TA-1440	Time Announcer: Uses a single reel of tape, for up to 24 hours of a m/pm time announcements. Ideal for custom time signals. Includes Revox 10 1/2" reel recorder. 22 3/4" rack space.	850.00
RS 124	Mono cartridge carousel for random or sequential operation of up to 24 tape cartridges. Includes decoder output for automatic logging systems. (19 1/4" Rack Panel.)	1,500.00
RS 224	Stereo cartridge carousel	1,650.00
RS-100B	Random Cartridge Access: Preselects 100 cartridge events. Provides control & audio switching for 1 random and 1 sequential Carousel into a single audio input of the Program Controller. Requires 21" rack space	1,395.00
RS-2B	Random Select Extender: Expands RS-100B to control 2 random Carousels plus 1 sequential Carousel into a single input. Must be ordered with RS-100B. 1 3/4" rack space.	425.00

For complete pricing of SPARTA-MATION systems & a variety of tape devices available, contact your representative or the factory.

REEL TAPE RECORDERS

R-311	Full Track Professional	1275.00
R-312	Half-Track Professional	1275.00
R-313	Two-Track Stereo Professional Plus Extra Four-Track Playback	1575.00
R-314	Four Track Stereo Professional Plus Extra Two-Track Playback Remote Control for R Series	1575.00
ER-350	150 Ohm Mike Input Transformer for R Series	60.00
TR-332	600 Ohm Line Input Transformer for R Series	16.50
TR-335	10K Ohm Bridging line input Transformer for R Series	16.50
TR-336	10K Ohm Bridging line input Transformer for R Series	16.50
TEC-10	Custom Console Cabinet for R Series	175.00
TEC-11	Portable Carrying Case for R Series	195.00
A-1200U	Two-Track or Four-Track Stereo	299.50
A-6010U	Four-Track Stereo, 2-direction	664.50
A-7010U	Four-Track Stereo, 2-direction	849.50
A-7030U	Two-Track or Four-Track	749.50
RC-101	Remote Control for A-1200U	20.00
RC-60/70	Remote Control for 60/70 series	40.00
TZ-707	600 ohm line input/output for 60/70 series	60.00

All Equipment is 117 Volts, 60 Hz Standard. Others are available.

Terms: Sparta-Charge; Open-Account; Conditional Sale Contract or Lease/Purchase Agreement up to five years. All prices are F.O.B. Sacramento.

IMMEDIATE SERVICE EAST AND WEST:
Factory Sales/Service (916) 383-5353
Telex 377-488
Sacramento, California

SPARTA/East Sales (301) 424-2920
Telex 89-456
Rockville, Maryland

All equipment items and descriptions in this brochure are necessarily condensed and do not completely show the many other broadcast products supplied by SPARTA. For more information about professional quality Reel-to-Reel Tape Recorders, Tone Arms and Cartridges, Microphones, AM and FM transmitters available through SPARTA, contact your SPARTAMAN sales engineer or the sales office of SPARTA ELECTRONIC CORPORATION.

Our policy is one of continual improvement in design and manufacture; and therefore, we reserve the right to change prices, specifications and design without notice.

No order is binding upon SPARTA ELECTRONIC CORPORATION until accepted in writing from the SPARTA home office in Sacramento, California.



SPARTA ELECTRONIC CORPORATION
5851 FLORIN-PERKINS ROAD, SACRAMENTO, CALIFORNIA 95828 (916) 383-5353
14816 SOUTHLAWN LANE, ROCKVILLE, MARYLAND 20850 (301) 424-2920
A DIVISION OF COMPUTER EQUIPMENT CORPORATION



BROADCAST EQUIPMENT PRICE SCHEDULE

MARCH 26, 1971

SPARTA
Electronic Corporation

Tape Cartridge Systems & Accessories

800 C-RP	Record/Playback	275.00
800 C-P	Playback	550.00
300 C-RP	Record/Playback	850.00
300 C-P	Playback	590.00
600 C-RP	Stereo Record/Playback (Rack Mount)	1175.00
600 C-P-RK	Stereo Playback (Rack Mount)	750.00
600 C-P	Stereo Playback (Desk Type)	695.00
AQ-RP	150/8 kHz Tone Record/Detector	125.00
AQ-P	150/8 kHz Tone Detector	75.00
CC3	Custom Cabinet (Specify size for 300 Series)	35.00
CC6	Custom Cabinet (Specify size for 600 Series)	35.00
MC-104		
C or R	Multi-Cartridge Playback	1850.00
MC-204	Multi-Cartridge Playback Stereo	2350.00
C or R	"R" For Horizontal rack installation. "C" For use with optional vertical custom cabinet	
CC-104	Custom Cabinet, MC Series "C"	60.00
CH-61C		
or R	Deck Module, Playback	425.00
CH-66C		
or R	Deck Module, Stereo Playback	550.00
PS-4B	Power Supply for Deck Modules	65.00
RC-4	Remote Control for MC Series	50.00
AQD-2	150/8 kHz Tone Detector (Each deck)	60.00
CD-15	Time Delay	450.00
M-1200TD	3-10 sec. Delay Cartridge	7.50
BP-22C	Briefcase Playback	195.00
CR-80	Revolving Cartridge Rack	65.00
CR-120	Revolving Cartridge Rack	85.00
CR-100	Wall Cartridge Rack	65.00
4A-SW	4-input Audio Switcher	200.00
CE-2	Bulk Reel/Cartridge Eraser	45.00
AL-1	Head Alignment Cartridge	6.50
DM-200	Head Demagnetizer	6.95
AG-2	Alignment Gauge	7.50
HM-2P	Head Mount (Playback)	20.00
HM-2RP	Head Mount (Record/Playback)	25.00

Audio Consoles & Accessories

910D	8 Mixer Monaural Dual Channel	2650.00
910S	8 Mixer Stereo	3150.00
915	5 Mixer Monaural	1295.00
A-20B	8 Mixer Monaural Dual Capability	1395.00
EP-20	Extender Console Cabinet for A-20B	210.00
A-15B	5 Mixer Monaural	650.00
EP-15	Extender Console Cabinet for A-15B	210.00
A-16R	5 Mixer Dual Monaural (Rack Mount)	1250.00
AS-30B	5 Mixer Stereo	850.00
EP-30	Extender Console Cabinet for AS-30B	250.00
1018	Additional or Spare Preamplifier	29.50
RA-1	Utility Microphone/Line Amplifier	95.00
RA-4	4 Channel, AC/Batt. Remote Amplifier	250.00
AC-155B	5 Mixer Studio/Remote	1450.00
ASC-305B	5 Mixer Stereo Studio/Remote	1750.00
BL-5	Bench Lld Combination	85.00
MIC-5	Microphone with Custom Mounting	65.00
US-5	Top-Mounted Utility Shelf	75.00
MA-25	25 Watt Monitor Amplifier	150.00
MAS-50	50 Watt Stereo Monitor Amplifier	210.00
MA-25Q	25 Watt Monitor/Cue Amplifier	195.00
MAS-50Q	50 Watt Stereo Monitor/Cue Amplifier	255.00
SM-3	Muting & Relay Accessory	45.00

Turntables & Accessories

TR-12-4	12" Standard; 4-Pole Motor	145.00
TR-12-SY	12" Standard; Sync. Motor	170.00
GT-12-4P	12" Custom; 4-Pole Motor	170.00
GT-12-SY	12" Custom; Sync. Motor	195.00
TEP-3M	Monaural Equalized Preamplifier	98.00
TEP-3S	Stereo Equalized Preamplifier	149.00
M232	12" Tone Arm (Less Cartridge)	33.00
M236	16" Tone Arm (Less Cartridge)	35.00
M44C	Phono Cartridge (Stereo/Mono) Includes N44C	17.95
N44C	Stylus for M44C	9.75

Showcase Console Room Cabinetry

101-1	Console Desk	225.00
101-1-3	Console Hood for A-20 with Speaker & Digital Clock	100.00
101-1-4	Digital Clock for custom mounting	45.00
101-1-4B	Digital Clock with housing	55.00
101-3-4	Dual Turntable Return (For 2 TC or equal)	250.00
101-3-5	Dual Utility Return	265.00
101-3-1	Rack Bracket Kit for 101-3	8.00
101-6	Cartridge Storage Hutch for 101-3-5	135.00
101-7	Single Turntable Return	170.00

Showcase Package Specials

GROUP #1	A-20B Console with Console Desk Hood with Digital Clock & Monitor/Cue Speaker Microphone, Dual Turntable Pedestal with Two GT-12-4 Custom Turntable Systems	2600.00
GROUP #2	All of Group #1, Plus Dual Utility Return Pedestal with Cartridge Hutch	2900.00
GROUP #3	All of Group #1 & #2, Plus a SPARTA-MATIC 800 C Tape Cartridge System of Two Playbacks & One Record/Playback	4700.00

AM Transmitters

707	(1000/500/250W) (Any two powers)	6,350.00
FB-3B	(3000W)	10,950.00
FB-5V	(5000/1000/500W) (Any two powers)	19,950.00
FB-10J	(10,000W)	23,500.00
FB-15A	(15,000W)	27,500.00
725	(25,000W)	62,500.00
T-12A	(Spare vacuum crystal for all AM transmitters)	90.00

FM Transmitters

660	(10W)	2,950.00
660R	(10W) w/cabinet	3,150.00
661	(Stereo Generator)	1,095.00
662	(SCA Generator)	595.00
607A	(1,600W)	7,500.00
602	(2,500W)	10,300.00
603A5	(5,000W)	14,950.00
620	(20,000W)	27,500.00
HR-1	(Spare oven & crystal for all FM transmitters)	80.00

Monitors - AM

AMM-1	Frequency & Modulation Monitor	1,500.00
TBM-8000	Frequency Monitor	975.00

Monitors - FM

FMM-1	Frequency & Modulation Monitor	1,550.00
FMS-1	Frequency & Modulation Monitor (Stereo)	1,350.00
SCM-1	Frequency & Modulation Monitor (SCA)	1,250.00
TBM-3500A	Modulation Monitor	1,000.00
TBM-4500A	Modulation Monitor Stereo	2,200.00
TBM-4000A	Modulation Monitor - SCA	2,200.00
TBM-2000A	Frequency & Modulation Monitor 1-SCA	1,200.00
TBM-2200	Stereo Modulation Monitor	1,200.00
TBM-1000A	FM Relay Receiver	300.00
TBM-2500B	RF Amplifier	485.00
RFA	RF Amplifier	400.00

Antenna Coupling Equipment

ACU-300	(1 KW)	595.00
ACU-301	(1 KW) Deluxe	750.00
ACU-305	(5 KW)	1,100.00
ACU-310	(10 KW)	1,450.00
LC-3	Lighting Choke (3 wire)	115.00
RMD-1	Remote Diode	35.00
JIC-3-1/8	AM/FM Isocoupler (20 KW)	1,100.00
JIC-1-5/8	AM/FM Isocoupler (7.5 KW)	795.00

Accessories

PBR-15AD	Remote control - single DC pair	1,295.00
PBR-15AW	Remote control - single AC pair	1,450.00

PBR-15AR	Remote control - radio STL	1,795.00
PBR-30AW	Remote control - single AC pair	2,585.00
PBR-30AR	Remote control - radio STL	2,735.00
380	Phase Sampler	165.00
FIM-21	Field Intensity Meter (solid-state)	1,050.00
120E	Field Intensity Meter (tube)	1,150.00
AM-19	Phase Monitor, Two Tower (add \$50.00 for each additional tower)	1,495.00
3005	Dummy Load 5 KW Modulated	450.00
3010	Dummy Load 10 KW Modulated	650.00

JAMPRO "PENETRATOR" FM ANTENNA
Circularly polarized 10KW per bay 3 1/8" line

JSCP-1	1 bay 0.46/0.46 power gain	1,250.00
JSCP-2	2 bay 1.0/1.0 power gain	1,890.00
JSCP-3	3 bay 1.5/1.5 power gain	2,730.00
JSCP-4	4 bay 2.1/2.1 power gain	3,570.00
JSCP-5	5 bay 2.7/2.7 power gain	4,410.00
JSCP-6	6 bay 3.2/3.2 power gain	5,150.00
JSCP-7	7 bay 3.8/3.8 power gain	6,190.00
JSCP-8	8 bay 4.3/4.3 power gain	6,750.00
JSCP-10	10 bay 5.5/5.5 power gain	8,200.00
JSCP-12	12 bay 6.6/6.6 power gain	10,500.00
JSCP-14	14 bay 7.8/7.8 power gain	12,280.00
JSCP-16	16 bay 8.9/8.9 power gain	13,650.00

Deicers, if any, add \$180/bay

JAMPRO "PERFORMER" FM ANTENNA
Elliptically polarized 1 KW per bay 1 5/8" line

JLCP-1	1 bay 0.45/0.45 power gain	600.00
JLCP-2	2 bay 0.95/0.95 power gain	1,200.00
JLCP-3	3 bay 1.5/1.5 power gain	1,750.00
JLCP-4	4 bay 2.05/2.05 power gain	2,350.00
JLCP-5	5 bay 2.60/2.60 power gain	2,850.00
JLCP-6	6 bay 3.15/3.15 power gain	3,475.00
JLCP-7	7 bay 3.65/3.65 power gain	3,975.00
JLCP-8	8 bay 4.2/4.2 power gain	4,550.00

Deicers, if any, add \$95/bay

SPARTA-MATION

1052	Automatic Program Controller: 10 regular audio channels (mono or stereo) plus net & fill music inputs. 52 overlapping events. Solid-state silence sensor. 8 3/4" custom rack housing with sliders.	2,350.00
------	--	----------

FX-52	Format Expander: Provides an additional 52 event format; using identical program board as 1052 Controller. Several FX-52's can be used with a single 1052 Program Controller. 8 3/4" rack space.	750.00
-------	--	--------

25-SEN	25 Hz Sensor/Filter: A highly selective amplifier & relay driver, including active high-pass filters to remove 25 Hz tones from program audio. 3 1/2" rack panel. Mono 325.00 Stereo 350.00	
--------	---	--

DC-24	Digital Clock & Predetermining Switch Panel: A 24 hour clock with pushbutton decade switches. Provides an accurate timing source & switching signals to join & leave network at exact second selected. 3 1/2" rack space apiece.	1,350.00
-------	--	----------

25-OSC	25 Hz Oscillator/Filter: Generates accurate 25 Hz tones for recording end cues on tape selections. Includes filters to remove low frequency components from program material. 3 1/2" rack mounting. Mono 350.00 Stereo 375.00	
--------	---	--

REM-25	Remote Reel-to-Reel Record Control: Provides remote control of Metrotech reel-to-reel tape recorder & 25-SEN Oscillator. Time delay circuits assure ease of recording & accurate spacing between selections. Table-top enclosure & 25' cable included.	210.00
--------	--	--------

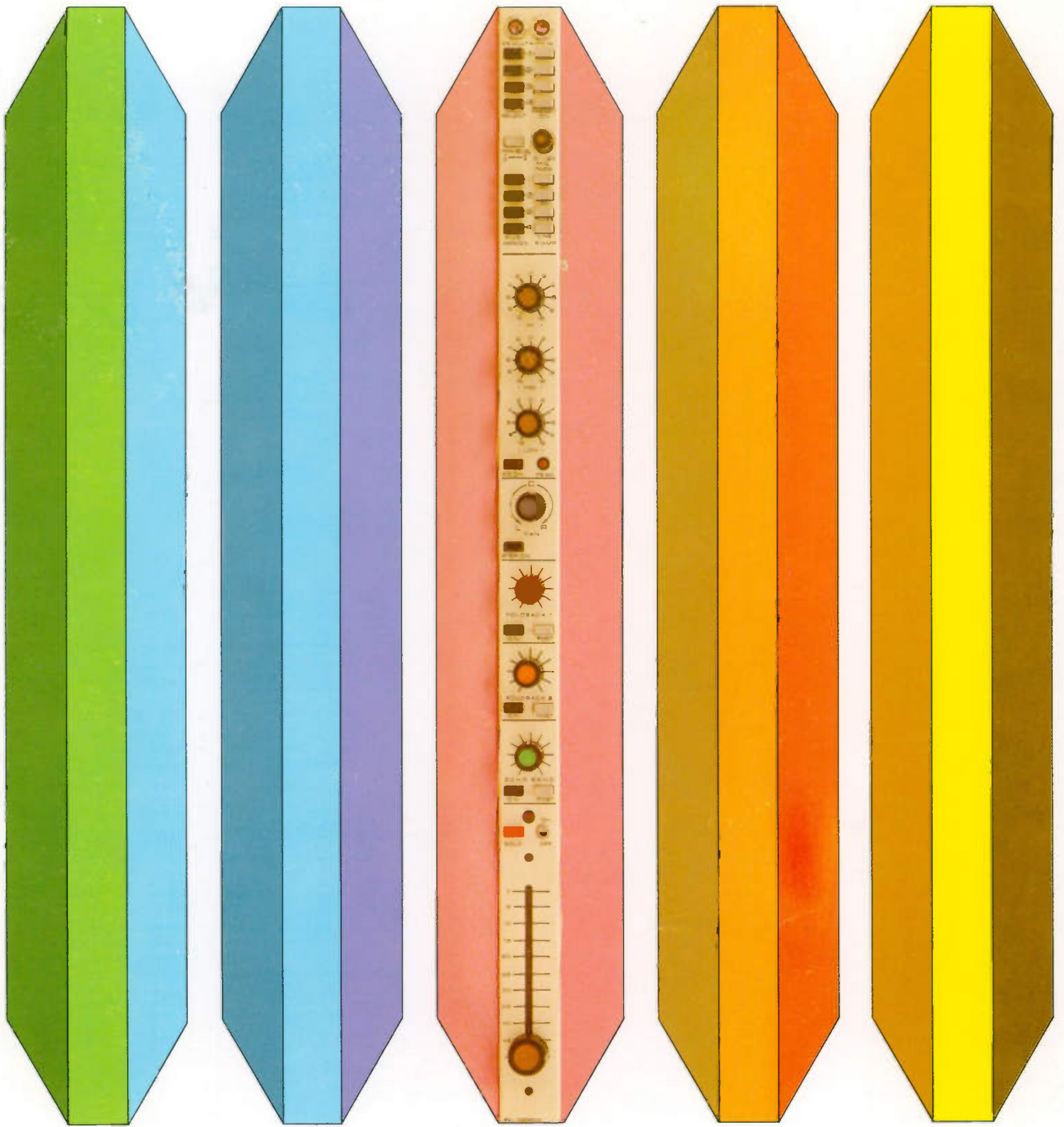

**Series 20A
Audio Console**

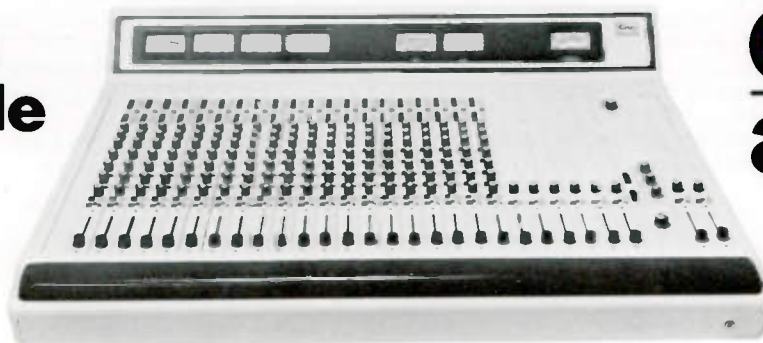

**Cetec
audio**

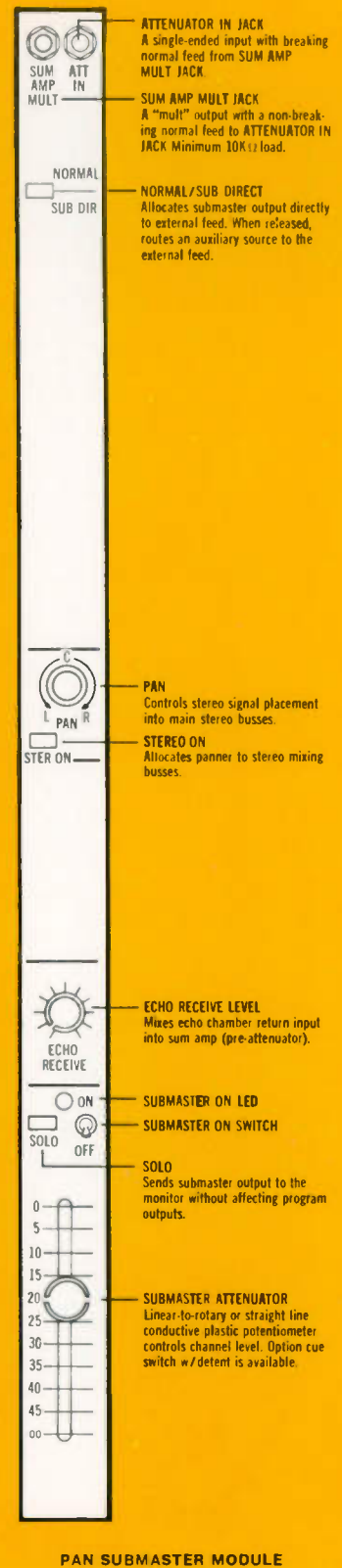
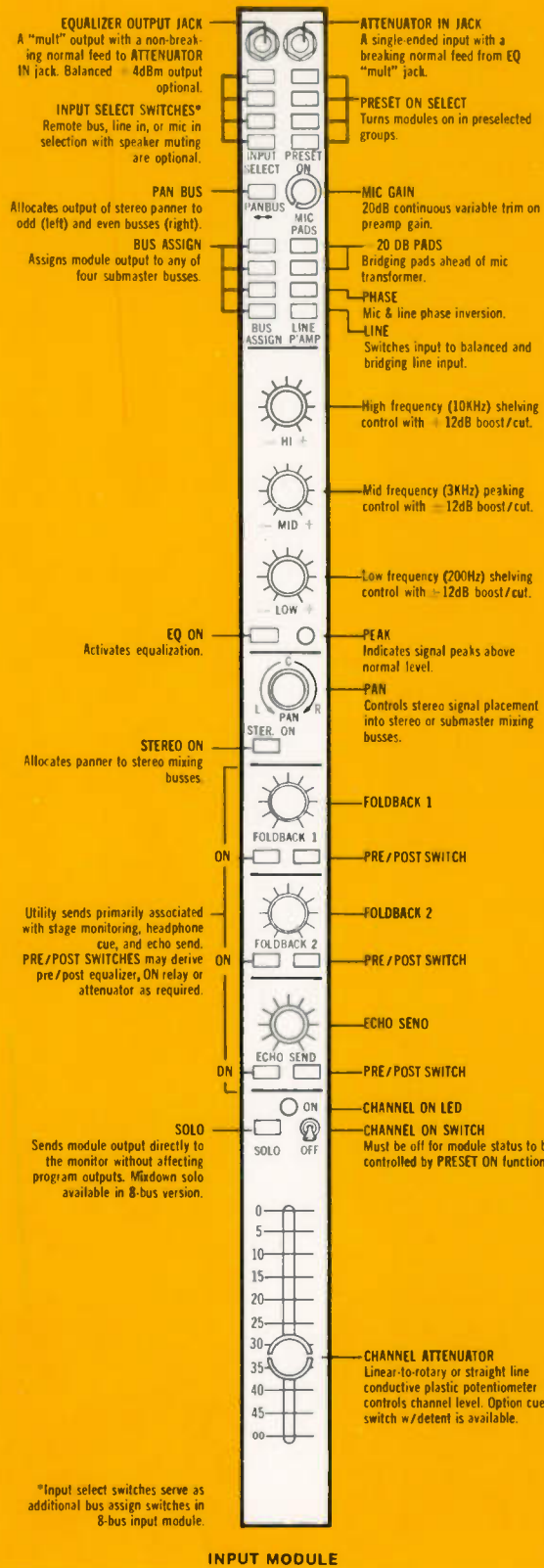
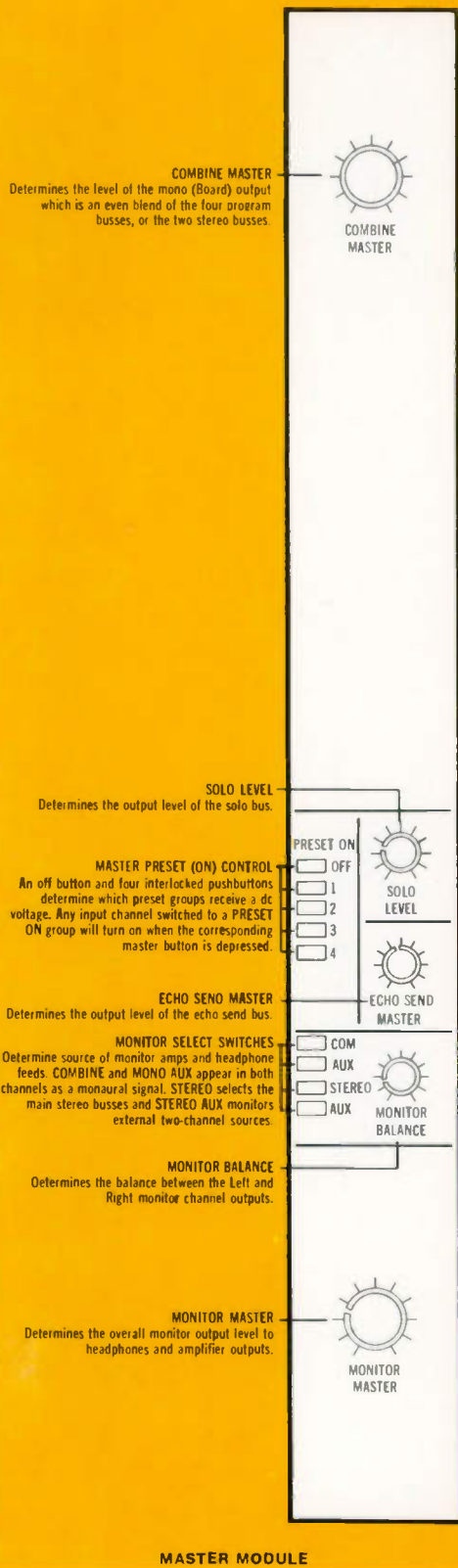

The Series 20 A Control Console is an example of the highly sophisticated, state of the art technological approach which has always been characteristic of products developed by Cetec Audio. The Series 20A, in its applications to today's television production, theatre and concert sound reinforcement requirements offers an exciting new approach to audio control. Versatility is the touchstone of the Series 20A design. The design is modular, with four Chassis/Enclosure sizes available: 2 - 1/2 ft. with 21 positions, 4 ft. with 31, 5 ft. with 39, and 6 ft. with 47 positions. But modularity now means more than choice of size or the ability to service and expand the system in the future. All Series 20A modules may be plugged into any position in the chassis while retaining their normal function and it is possible for the operator to customize the control surface for each show.

Versatility also means providing Interstage patch points for inserting equalizers, compressors, limiters, effects generators,

and for cross patching and source sharing. And because patch points are module-mounted the operator always knows where he is patched. When used with the PRESET ON function, source sharing can be a powerful tool for effecting fast set-up changes from scene to scene even with a limited number of microphones.

All functions of the Series 20A are tailored to the demands of real-time operation:

- **PRESET ON** — Control of this function on the input modules (four alternate-action switches) allows inputs to be activated in predetermined groups via the Preset On Master switches. By assigning distinct Preset On groups to the same submaster bus, preset mixes may be selected and cross-faded.
- **VARIABLE MICROPHONE PREAMPLIFIER Gain Control**— Provides continuously variable adjustment of preamp sensitivity.

ATTENUATOR IN JACK
A single-ended input with breaking normal feed from SUM AMP MULT JACK.

SUM AMP MULT JACK
A "mult" output with a non-breaking normal feed to ATTENUATOR IN JACK. Minimum 10K Ω load.



ECHO RECEIVE LEVEL
Mixes echo chamber return input into sum amp (pre attenuator).

SUBMASTER ON LED
SUBMASTER ON SWITCH

SOLO
Sends submaster output to the monitor without affecting program outputs.

SUBMASTER ATTENUATOR
Linear-to-rotary or straight line conductive plastic potentiometer controls channel level. Option cue switch w/detent is available.

BASIC SUBMASTER MODULE

OSCILLATOR PU calibrates tone level.

OSCILLATOR LEVEL

OSCILLATOR ON/FREQUENCY CONTROL Oscillator "illuminates" mixing busses when turned on unless SUBTONE button is depressed.

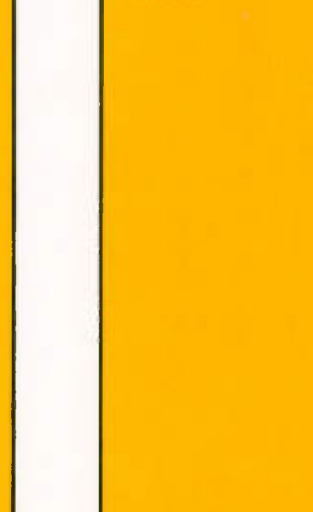

TALKBACK MIC GAIN CONTROL

TALKBACK MICROPHONE

SUBTONE
Mixes tone from Oscillator into mixing busses when TALK TO BUS SWITCH is depressed.

TALK TO BUS
Assigns microphone to mixing busses.

TALK TO FOLDBACK 1

TALK TO FOLDBACK 2

TALKBACK MODULE

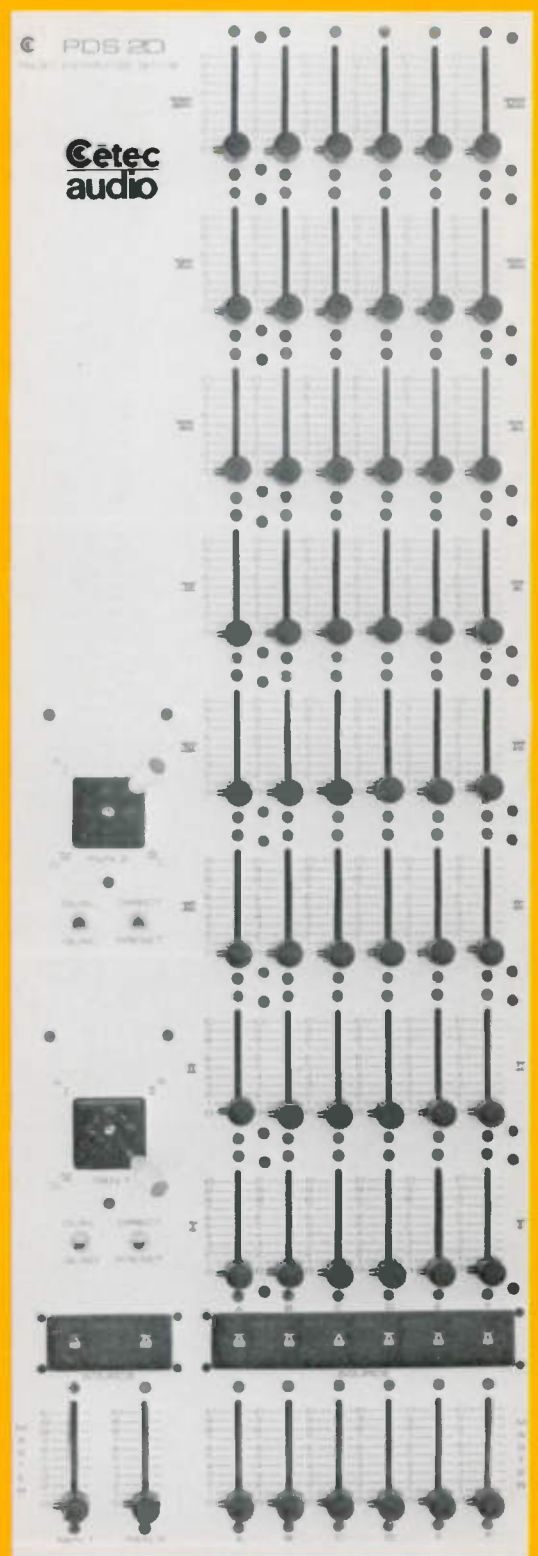

PRE-SET DISTRIBUTION SYSTEM MODULE

This insures smooth control of potential signal overdrive conditions with live microphones.

• **PEAK INDICATORS** — This is an LED which aids in adjusting pre-amplifier sensitivity by flashing on peaks at normal signal levels while warning of levels that are too high by more consistent illumination.

Functional flexibility is achieved by a wide range of standard options which include:

- Conductive plastic straight-line or linear-to-rotary attenuators.
- Balanced +4dBm feeds from the input module preamp, equalizer or output.
- Multiple mic or line input selection.
- Module interface jumpers that allow for an infinite variety of system organizations that are totally independent of module positions.

Versatility, real-time human engineering features, functional flexibility, and ultra professional specifications are what make the Cetec Audio Series 20A the true state of the art audio control console for television, theatre and sound reinforcement. It is a unique design that is in a class well above its price range.

The Pre-Set Distribution System module (PDS) is designed to control the outputs of a Series 20A console where complicated changes in mix content and signal placement are required. Especially useful for theatrical productions, PDS makes it possible to rehearse, preset, and perfect the mood, movement, and even the physical space relationships of voices, music, and effects. For television studios, PDS provides a separate sound reinforcement mix matrix for controlling feedback when microphones are used with a live audience.

SPECIFICATIONS

Equalization (all input channels)	3-Knob; Low-frequency shelving @ 200 Hz, mid-frequency peaking @ 3 kHz, high-frequency shelving @ 10 kHz. All controls provide 12 dB continuous boost or cut.
Solo	All inputs and sub masters have monitor solo buttons.
Echo	Echo send from each input module, and master send bus control in master module. Echo receive on each sub master module, or patchable per input.
Presetable (Mute)	Four Channels of Pre-Set Muting
Indicators	7 large illuminated VU meters for outputs. LED channel "ON" indicators, and Peak Level Indicators.
Amplifier Type	State of the art, discrete and integrated circuitry.
Physical Dimensions	31¼" or 49¼" or 61¼" or 73¼" wide X 39½" deep X 15½" high Table Top Mounting. Blank Panel (1½" X 27") Blank Panel (3" X 27") 2 Blanks Blank Panel (6" X 27") 4 Blanks Console Frame Size 2½' 21 available Blank positions. Console Frame Size 4' 31 available Blank positions. Console Frame Size 5' 39 available Blank positions. Console Frame Size 6' 47 available Blank positions.
Optional Features	Cue Switch on Input Faders, Remote Input Switching Modules, Portable Carrying Case, XLR-type Input and Output Connectors, Also available with balanced plus 4 dbm output per input.
Microphone Inputs	Source Impedance (Floating) — 150 Ohms Nominal Input Impedance — Bridging Nominal Level — -54, -34, -14 (Range switch with 0-20 dB trim) Maximum Level — +6 dBm
Line Inputs (Program Selection)	Source Impedance (Floating) — 600 Ohms Input Impedance (Bridging) — 50 K Ohms Minimum Nominal Level — + 4 dBm Maximum Level — +30 dBm
Monitor Input	Source Impedance (Floating) — 600 Ohms Input Impedance (Bridging) — 30 K Ohms Nominal Level — + 4 dBm Maximum Level — +24 dBm
Echo Return Input	Source Impedance (Floating) — 600 Ohms Input Impedance (Terminating) — 600 Ohms Nominal Level — +4 dBm Maximum Level — +24 dBm
Program, Echo Send, and Cue Outputs	Load Impedance — 600 Ohms Output Impedance (Floating) — Less than 60 Ohms Nominal Level — (600 Ohms) +4 dBm Maximum Level — +24 dBm
Monitor outputs	Load Impedance — Greater than 600 Ohms Output Impedance (Unbalanced) — 600 Ohms Nominal Level — +4 dBm Maximum Level — +24 dBm
Frequency Response	All Sections (With equalizers in flat position) — ±1 dB 30-20,000 Hz
Harmonic Distortion THD	Microphone Input + 4 dBm (30-20,000 Hz) — 0.10% Max. (.08% Typ.) +18 dBm (30-10,000 Hz) — 0.10% Max. (.08% Typ.) +22 dBm (30-10,000 Hz) — 0.15% Max. (.10% Typ.) +24 dBm (30-20,000 Hz) — 0.40% Max. (.30% Typ.) +27 dBm (30-20,000 Hz) Double Terminated — 0.5% Max. Line Input + 4 dBm (30-20,000 Hz) — 0.08% Max. (.065% Typ.) +18 dBm (30-10,000 Hz) — 0.08% Max. (.065% Typ.) +22 dBm (30-10,000 Hz) — 0.14% Max. (.10% Typ.) +24 dBm (30-20,000 Hz) — 0.30% Max. (.25% Typ.)
Intermodulation Distortion	(Microphone input with 600 Ohm termination on output) + 4 dBm — 0.05% Max. +18 dBm — 0.03% Max. +24 dBm — 0.04% Max.
Microphone Preamplifier E.I.N. Line Input Signal/Noise	(Equivalent Input Noise 30-20,000 Hz) — -127 dBm (30-20,000 Hz Unweighted Below Nominal Level) — -85 dBm
Crosstalk	Minimum 65 dB at 10 KHz throughout system circuitry (75 dB typical)
Headroom	(Above Nominal Level). Interstage — 26 dB All Outputs — 20 dB
Nominal Gain	(Program, Mic) — 54 dB
Maximum Gain	(Program, Mic) — 95 ±1 dB
Power Supply	Amplifier — ±15 VDC Relays & Lamps — ± 24 VDC

Cetec
audio

A DIVISION OF CETEC CORPORATION

13035 Saticoy Street, North Hollywood, California 91605 Phone: (213) 875-1900 TWX: 9104992669
Cetec, U.K., Sapphire House, 16 Uxbridge Road, Ealing, London W5 Phone: 01-579 9145 Telex: (851) 935847

SERIES 10 CONSOLE

Series 10	10 Channel Stereo Audio Control Center	\$ 6,485.00
Series 10M	Mono	5,935.00
Series 10E	Mono with Equalization	6,265.00
Series 10SE	Stereo with Equalization	6,815.00
Series 10QE	Quad with Equalization	7,365.00

SERIES 20A PRICE LIST

FRAMES, including Power Supply, V.U. Meters and Wiring

PHYSICAL DIMENSIONS:

2½' Cabinet with 21 available 1½ X 27" positions (52-0885101)	\$ 4,419.00
4' Cabinet with 31 available 1½ X 27" positions (52-0885102)	4,945.00
5' Cabinet with 39 available 1½ X 27" positions (52-0885103)	5,680.00
6' Cabinet with 47 available 1½ X 27" positions (52-0885104)	6,552.00
Spare Bipolar Power Supply (98-0870900)	752.00
XLR Option (Internally Mounted Panel)	Call Factory
Portable Case	Call Factory
Blank Panel (1½ X 27") 1 Position (35-0841000)	19.00
Blank Panel (3" X 27") 2 positions (35-0841100)	23.00
Blank Panel (6" X 27") 4 Positions (35-0841200)	28.00

INPUT SECTION:

Remote Input Module with 12 Position Rear Illuminated Pushbuttons (1½ X 27") (98-0826500)	\$ 300.00
Input Module with Linear to Rotary (1½ X 27") (98-0888803)	460.00
Input Module with Linear to Rotary 8-bus Version (1½ X 27") (98-0890103)	Call Factory
Above Inputs also available with Conductive Plastic Fader, add per module	60.00
Cue Detent Switching: add per module, (Linear to Rotary)	20.00
add per module (Plastic Fader)	40.00
Cue Output Module required for Cue Detent Switching: 1 per system (98-0870800)	200.00
Balanced +4dBm Output from Input Module (Preamp, equalizer or output) as required: add per module	35.00
Solo Derived Pre-Mute Relay & Fader	Please Specify
Foldback 1 & 2 Derived Pre/Post EQ	Please Specify
Foldback 1 & 2 Derived Pre/Post Mute Relay	Please Specify
Echo Send Derived Pre/Post Mute Relay	Please Specify
Line In Selection (4) Via Remote Sw	Please Specify
Mic In Selection (4) w/Speaker Mute Logic	Please Specify

OUTPUT SECTION:

Master Module (3 X 27") (98-0889000)	\$ 1,190.00
The following Sub-Masters are used for main busses, stereo Left and Right and Fold Back 1 & 2:	
Basic Sub-Master w/Linear to Rotary (1½" X 27") (98-0888903)	310.00
Pan Sub-Master w/Linear to Rotary (1½" X 27") (98-0890203)	320.00
Above Sub-Master Available With:	
Conductive Plastic Fader: add per module	60.00
Cue Detent Switching:	
add per module (Linear to Rotary)	20.00
add per module (Plastic Fader)	40.00
Solo Derived Pre Fader for Cueing	Please Specify
Talkback & Oscillator Module (Requires Master Module 98-0889001)	1,230.00
(1½" X 27") (98-0887500)	575.00
P.D.S. Pre-Set Distribution System (9' X 27") (98-0884300)	4,500.00
Typical Series 20A System Prices:	
12 Input with (1) Mono Output, (4) Main Outputs, (1) Stereo Output, Left & Right, (1) Fold Back Output, (1) Echo Send Output, and (1) Master Module in a 2½' frame	13,299.00
16 Input with (1) Mono Output, (4) Main Outputs, (1) Stereo Output, Left & Right, (2) Fold Back Outputs, (1) Echo Send Output, and Master Module in a 4' frame	16,022.00
24 Input with (1) Mono Output, (4) Main Outputs, (1) Stereo Output, Left & Right, (2) Fold Back Outputs, (1) Echo Send Output, and Master Module in a 5' frame	20,437.00
36 Input with (1) Mono Output, (4) Main Outputs, (1) Stereo Output, Left & Right, (2) Fold Back Outputs, (1) Echo Send Output, and Master Module in a 6' frame	26,801.00
8 Inputs with (8) P.D.S. Outputs, (1) Mono Output, (2) Main Outputs, (1) Stereo Left and Right Output, (1) Fold Back Output, and Master Module in a 2½' frame	15,339.00

TERMS AND CONDITIONS OF SALE

1. F.O.B. Factory, North Hollywood, California.
2. 20% Restocking charge on all returned items.
3. Prices subject to change without notice or obligation.
4. Non-Standard or special products may not be returned for credit or refund.
5. Claims – Upon receipt by carrier from Cetec the product becomes the property of consignee. All claims for damage, breakage or losses, concealed or obvious, must be made by the consignee to the carrier within time specified by ICC regulations. Claims of short shipment by Cetec must be made within five days of receipt of material.
6. Material returned to the factory for any reason must be shipped prepaid and will not be accepted unless Product Return Authorization Form has first been obtained from either the factory or your local representative.



MAIN OFFICE :

13035 Saticoy Street, North Hollywood, California 91605 Phone (213) 875-1900 TWX: 9104992669

EUROPEAN OFFICE :

Cetec U. K., Sapphire House, 16 Uxbridge Road, Ealing, London W5 2BP Phone: 01-579-9145 Telex: (851) 935847

announcing **SERIES 10 QUAD**

BROADCAST CONSOLE



For the growing quadrasonic broadcast industry, Cetec offers Series 10 Quad Broadcast Audio Console. Possessing all the proven features of our Series 10, S10 Quad provides the flexibility of 1, 2 or 4 channels at an economical price.

OPERATION

To serve the far-sighted broadcaster and enable him to be a stand alone in an also-ran market, Cetec proudly presents the Series 10 Quad version. Quad programming is relatively restricted in quantity. Stations need a combination stereo/quad console with the possibility of mono mixdown for A.M. simulcasting. Budgetary allowances dictate a moderate price for such an accomplishment without a concurrent sacrifice of quality and reliability. While this would normally be considered contradictory in today's marketplace with rising costs and subsequent lower standards, Cetec has brought off handsomely this impossible task.

The console can be operated as a standard stereo console, and when programming dictates, can be switched to accomplish quadrasonic transmission with only the operation of two switches, the input assign switch, and the output assign switch. To return to stereo from quad operation, the depression of only the output assign switch is needed.

MONITORING

The Series 10 Quad Console Monitoring System, in the control room is stereo. Left rear and left front monitoring is accomplished as a combined signal in the left speaker; the same occurs for the right front and rear channels in the right speaker. This is derived by the "Quad" Switch Position. The rear left and right can be switched into the monitor system by depressing the "rear" switch. The stereo front may be monitored by the "front" switch. "Mono" monitor switch combines all four channels and feeds them into both left and right



speakers. If true quad monitoring is necessary, the most economical approach is to obtain a quad amplifier designed explicitly for that purpose. The "Aux" and "Air" positions are stereo inputs. The VU Meter Switching in the "Air" position does not follow the output monitors, but picks up the true output of the console.

Cetec Audio

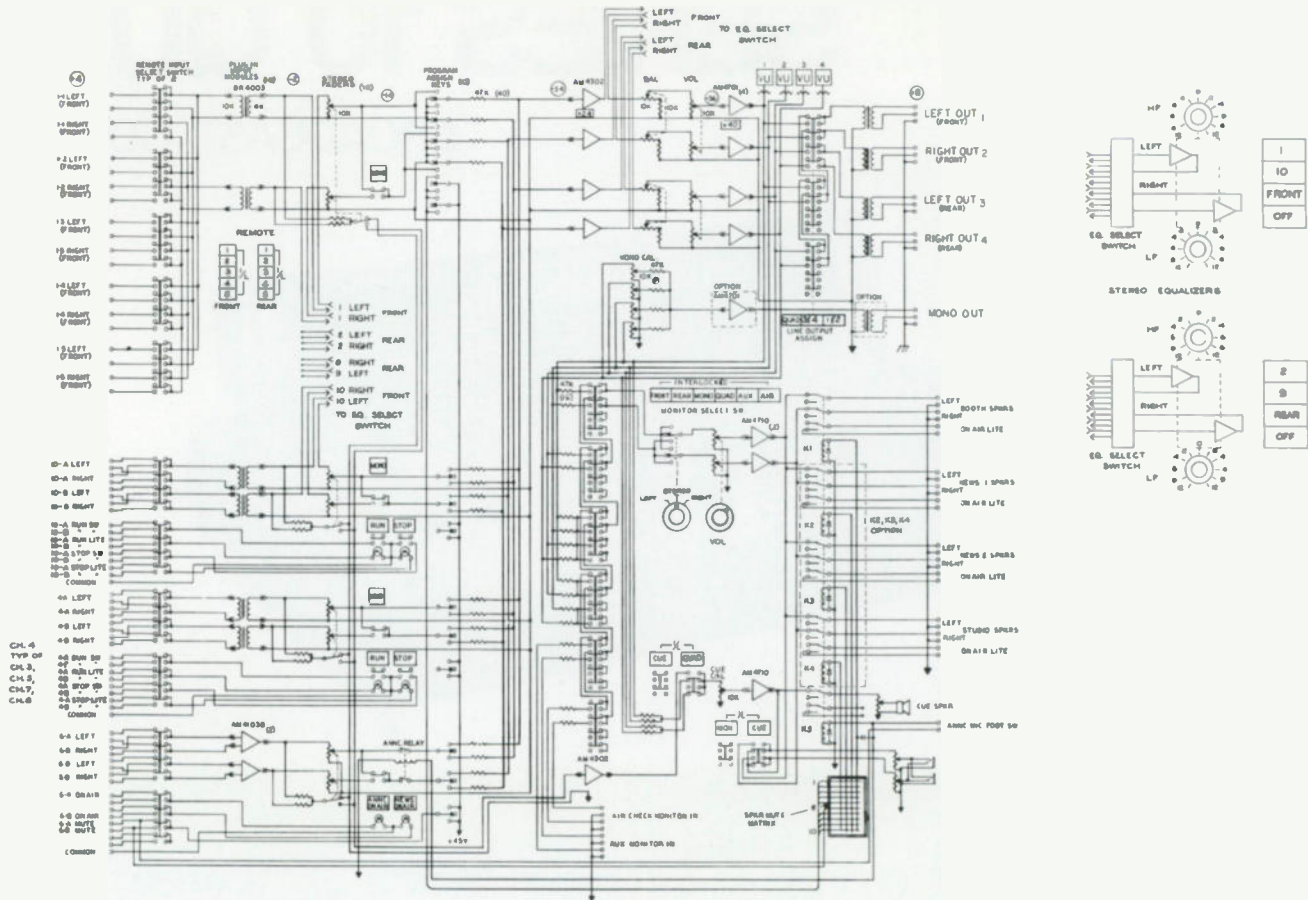

TECHNICAL SPECIFICATIONS

INPUT

Source Impedance: Microphone, 250 ohms nominal; balanced.
Line 15K ohm; balanced.

OUTPUT

Impedance: Will drive 150 or 600 ohm line balanced.

Level: Normal +8 dBm.
Maximum +24 dBm 600 ohm line.

Frequency Response: ±1 dB, 30 Hz to 15 kHz (without equalization),
from microphone or line input to program output.

Distortion: Less than 0.5% THD maximum at +18 VU output at any
frequency between 30 Hz and 15 kHz.

Noise: Signal-to-noise ratio at least -70 dB between 30 Hz and 15
kHz, referenced to +8 VU output and -50 dB microphone
input.

Power Requirements: 120 or 240 V, 50/60 Hz.

Dimensions: Height 13½" (34.29 cm)
Width 39" (99.06 cm)
Depth 26½" (67.31 cm)

Weight: Console: 100 lbs. (45 kg)
Power Supply: 20 lbs. (9 kg)

Shipping Weight: 200 lbs. (90 kg)

SERIES 10 EQUALIZER

OUTPUT: +20 db/5Kc

Frequency Response: (with EQ. in "OFF" position.)
±.5db 30Hz - 15KHz

Hi Frequency E.Q.: ±2; ±4; ±6; ±9 and ±12db @ 7.5KHz

Lo Frequency E.G.: ±2; ±4; ±6; ±9 and ±12db @ 100Hz

Distortion: @ +18db/5KHz (with EQ. in "OFF" position.)
.022% @ 30Hz
.014% @ 1KHz
.125% @ 15LHz

Noise: (with EQ. in "OFF" position.)
-82.6db with 100 KHz filter

Crosstalk: -76db below max output @ 15KHz



Cetec Audio

A Division of Cetec Corporation
13035 Saticoy Street
North Hollywood, California 91605
Phone: (213) 875-1900
TWX: 9104992669

EUROPEAN OFFICE

Cetec U. K., Sapphire House
16 Uxbridge Road, Ealing, London W5 2BP
Phone: 01-579-9145
Telex: 851935847

Series 10 Broadcast Console



Cetec Audio

series 10

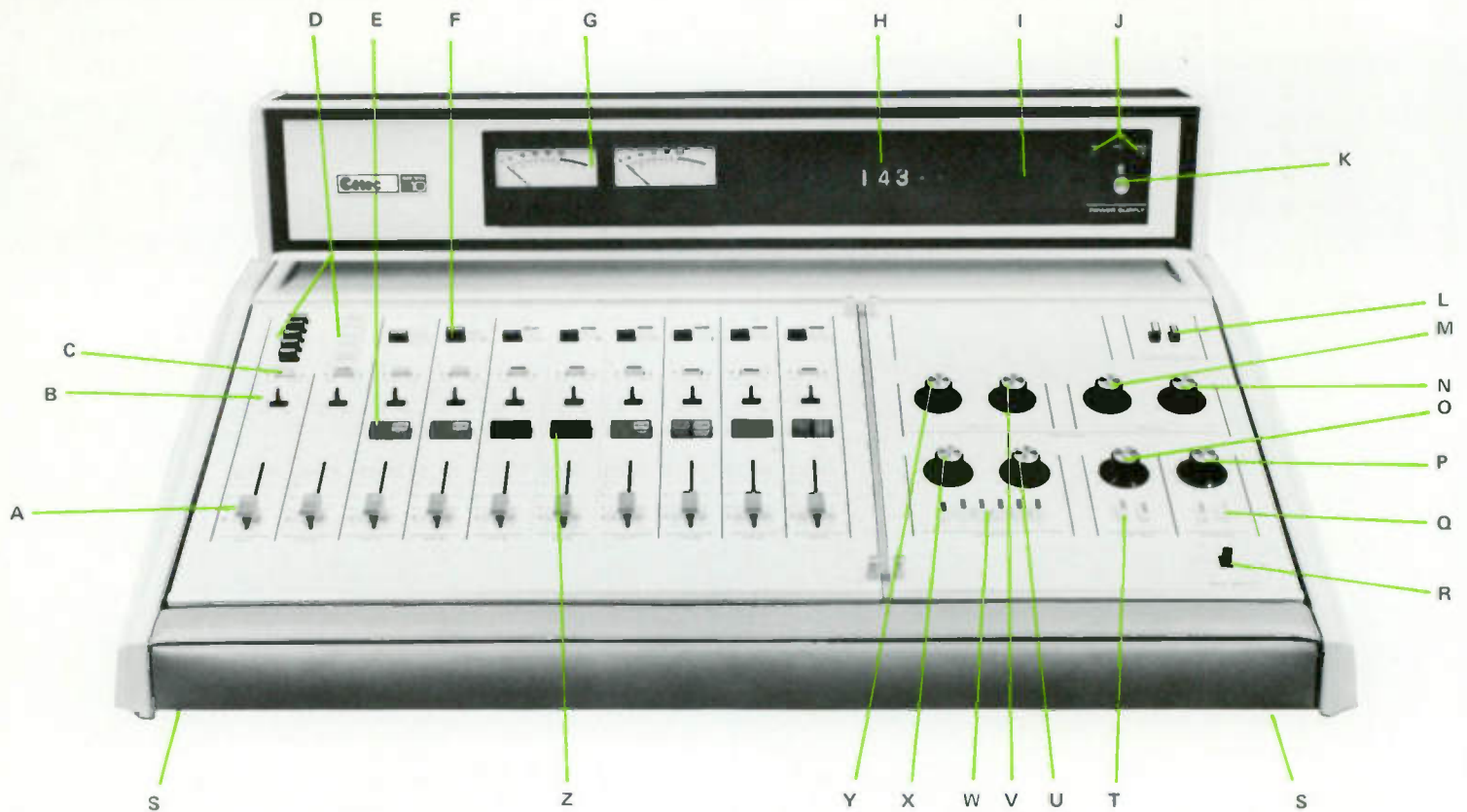

- A. Stepless, linear faders
- B. Audition/Program selector key
- C. Stereo/Mono input selector key
- D. Remote input source selector switches; channels 1 & 2 have a total of 10 remote stereo inputs
- E. Remote machine Run/Stop control
- F. Stereo input source selector; channels 3-10 have 2 stereo inputs each, a total of 16 stereo inputs
- G. Output VU meters
- H. Clock
- I. Cue Speaker
- J. Power Supply ON indicators
- K. Power Supply Mode switch
- L. Program line output source select switches
- M. Program stereo balance control

- N. Program amplifier level control
- O. Cue output level control
- P. Headphone output level control
- Q. Headphone source select switches
- R. Talkback switch; controls two separate talkback outputs (unwired)
- S. Headphone stereo output jack
- T. Cue source select switches
- U. Monitor output level control
- V. Audition amplifier level control
- W. Monitor source select switches
- X. Monitor stereo select switch
- Y. Audition stereo balance control
- Z. On-The-Air Lights for microphone input channel

In its unique combination of styling, construction and performance, Cetec's Series 10 Broadcast Console represents the most advanced stereo* broadcast console available. Printed circuit boards and flat ribbon wiring are used for nearly all interconnecting circuitry, assuring error-free assembly and an unusually clean and reliable interior. The modular amplifiers and other plug-in circuits are field proven and have a world-wide reputation for performance and dependability. Cetec has worked closely with one of California's leading industrial designers in achieving a console whose beauty will enhance the appearance of any modern studio.

*Quad version also available.

There is truly nothing else like the Series 10 on the market today.

Operating features of the Series 10 include: ten stereo input channels; provisions for remote stereo inputs; complete stereo output channels for both program and audition, either of which is switchable to monitor or broadcast; stereo monitor output with muting and on-the-air relays; built-in cueing amplifier and speaker; three-position talkback switch; stereo headphone output; remote stop/start controls for tape, cart machines or turntables; built-in clock; and two power supplies (remotely located), either of which can handle the full power requirements of the console.

INPUTS

The Series 10 Broadcast Console provides ten stereo input channels. Channels 1 and 2 each incorporate a five-position input selector switch. The switches permit individual selection of up to five remote stereo inputs per channel. The remaining eight channels contain provision for switch selection of either of two program sources per channel. Bridging transformers are supplied as standard equipment on all channels except channels 5 and 6. The latter each can have two low-impedance microphone pre-amplifiers.

OUTPUTS

Two stereo outputs are standard with the Series 10. The program output section is comprised of two line amplifiers operated at +8VU (+18 dBm maximum) into a 600 ohm balanced stereo line, and associated balance and level controls. The audition output section includes line-amplifiers and controls identical to the program output. A switch permits directing either the program or audition output to the program line. This duplication of output facilities provides an essential safeguard against on-the-air operating failures.

POWER SUPPLIES

Two identical power supplies are included as standard equipment—one provides power for the pre-amplifiers and line amplifiers; the other operates relays and monitor amplifiers. The power supplies mount external to the console. A 20 ft. interconnect cable is provided. A switch on the meter panel allows operation of the entire console from either supply, should one fail. This feature, together with the switchable output capability, assures the highest on-the-air reliability.

MONITORS

A 6-position pushbutton monitor-select switch permits selecting off-air, program, audition, monaural, or auxiliary 1 and 2 signals for monitoring. VU meters follow the monitor select, except for off-air. The MONO position

provides a compatibility check (Left plus Right) without disrupting the stereo output. Included in the monitor circuit are two power amplifiers (10 watts into an 8-ohm unbalanced line) and monitor level and balance controls. Stereo headphone output is taken off ahead of the monitor muting.

REMOTE START CONTROLS

Each stereo channel, except channels 1, 2, and 6, has a momentary remote stop/start pushbutton associated with it. These may be used for remote operation of the turntables and tape machines that provide inputs to the respective channels.

FADERS

Two-gang, straight-line stereo faders are provided in each of the 10 stereo input channels. Each fader has a cue circuit below the OFF position. Conductive-plastic resistor elements are used to provide stepless, continuously variable fading action.

INPUT SWITCHING

Input channels 3 through 10 have 3 selection switches each. The first switch permits selecting one of two stereo inputs; the second is a stereo/monaural selector for selecting either type of program source from the inputs available to that channel; the third switch is a 3-position program/off/audition switch that allows the operator to audition the inputs, turn the channel off, or broadcast the signal.

CUE AMPLIFIER

A plug-in amplifier (10 Watts into an 8-ohm unbalanced line) is provided for the cueing circuit. This drives an internal loudspeaker. The cue output is selectable to the stereo headphone jack, which has its own level control.

MUTING

The user can apply internal strapping so that the control room monitor will be muted when the control room microphone is assigned to Program. Provisions are made as an option for driving three additional stereo monitor speaker systems which can also be muted in the same way as the control room speakers.

VU METERS

Two illuminated VU meters are included as standard with the Series 10. VU meters follow the monitor select switch.

Easy opening front panels provide quick and efficient service capability.

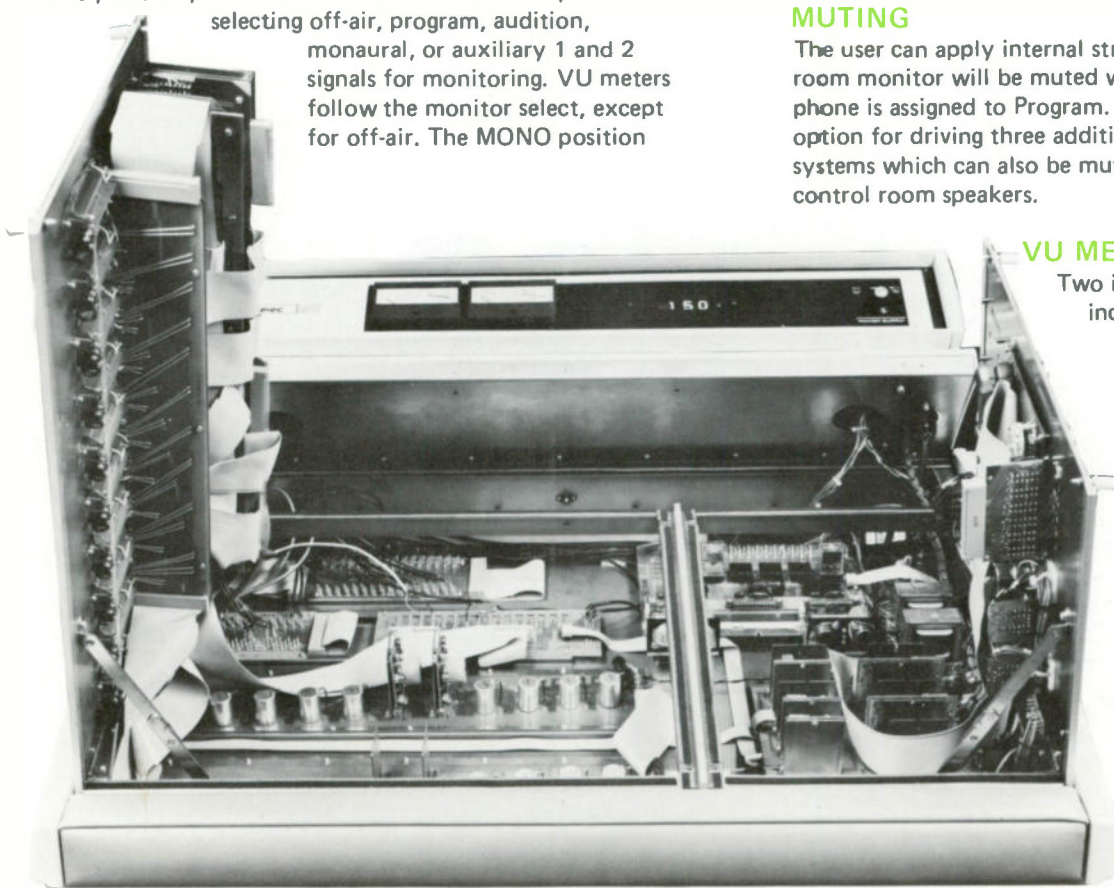

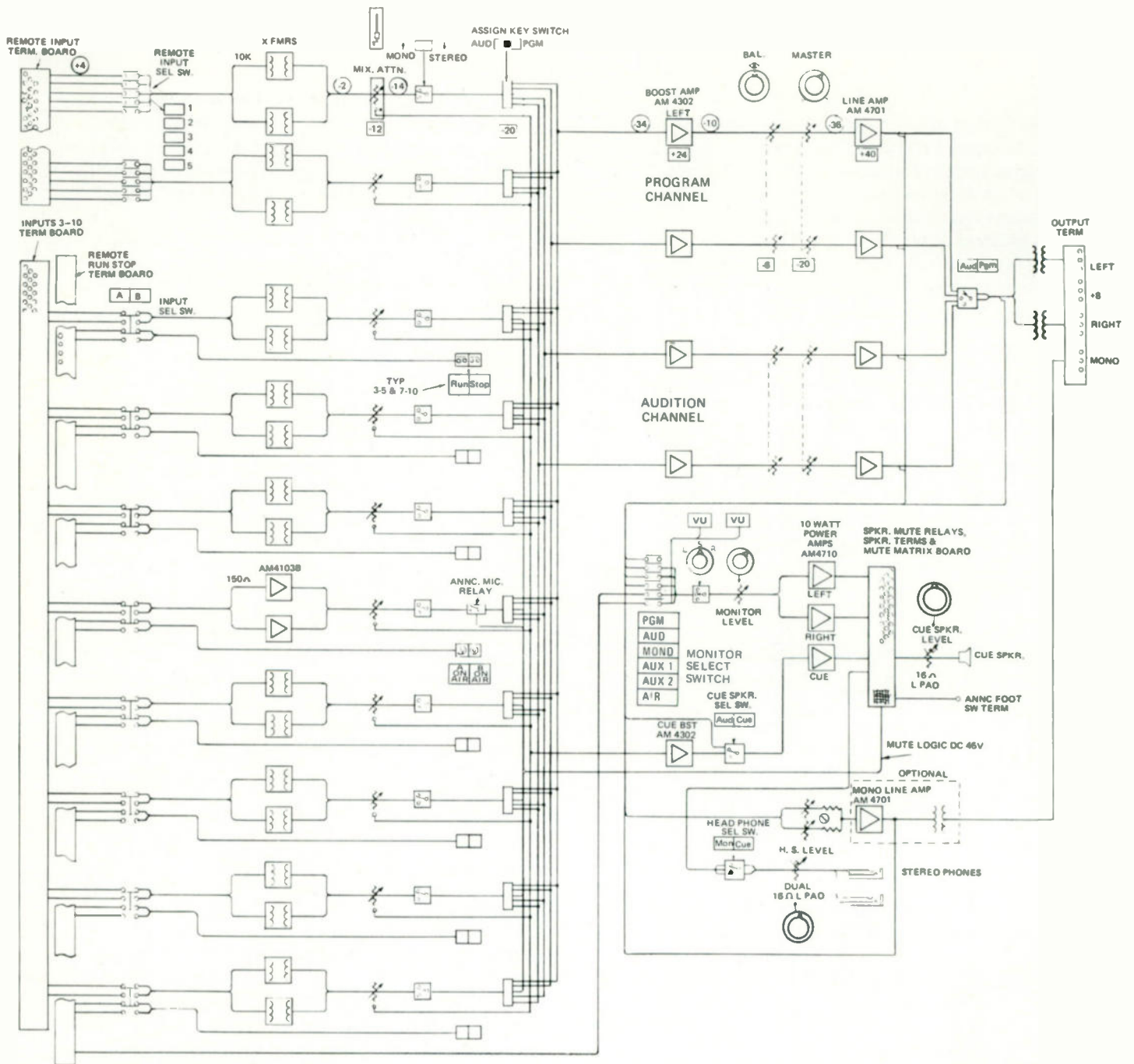

TECHNICAL SPECIFICATIONS

INPUT	
Source Impedance:	Microphone, 250 ohms nominal; balanced. Line 15K ohm; balanced.
OUTPUT	
Impedance:	Will drive 150 or 600 ohm line balanced.
Level:	Normal +8 dBm. Maximum +24 dBm 600 ohm line.
Frequency Response:	± 1 dB, 30 Hz to 15 kHz without equalization, from microphone or line input to program output.
Distortion:	Less than 0.5% THD maximum at +18 VU output at any frequency between 30 Hz and 15 kHz.
Noise:	Signal-to-noise ratio at least -70 dB between 30 Hz and 15 kHz, referenced to +8 VU output and -50 dB microphone input.
Power Requirements:	120 or 240 V, 50/60 Hz.
Dimensions:	Height 13½" (34.29 cm) Width 39" (99.06 cm) Depth 26½" (67.31 cm)
Weight:	Console: 100 lbs. (45 kg) Power Supply: 20 lbs. (9 kg)
Shipping Weight:	200 lbs. (90 kg)



Cetec Audio

A Division of Cetec Corporation
13035 Saticoy Street
North Hollywood, California 91605
Phone: (213) 875-1900
TWX: 9104992669

EUROPEAN OFFICE
Cetec U. K., Sapphire House
16 Uxbridge Road, Ealing, London W5 2BP
Phone: 01-579 9145
Telex: 837329

Program Automation Systems

Cetec 7000/1 Program Automation Controller (030-7001)

- 16 audio channels
- Random select capability on all audio channels
- Control terminal with 25-foot cable for system control and display
- Silence-sense and closed-loop alarm system
- Computer grade power supply
- System analysis maintenance module
- On-site system checkout and training of staff (3 days)
- Fully enclosed control rack
- 1000 events of memory
(System 7000 memory is expandable to 10,000 events)

	System A	System B	System C
	\$12,700	\$12,700	\$12,700
Crystal-controlled Real Time Clock with 100 events for 7-day advanced programming of all real-time system commands or functions. (030-7012)		\$ 1,800	\$ 1,800
Cetec Audiofile IIAs microprocessor controlled, 48-tray, random access, multi-cart stereo playback machine. Includes closed-loop control, 150Hz sensing, and all logic controls. (030-4303)	(1) \$10,900	(2) \$21,800	(4) \$43,600
Cetec Universal Interface Board for ITC 750 deck. Includes closed-loop control, 25 Hz sensing, and all logic controls. (030-7020-01)	(2) \$ 800	(4) \$ 1,600	(2) \$ 800
ITC Model 750 reel-reel deck, 7½ ips, stereo. (888-5000-46)	(2) \$ 3,140	(4) \$ 6,280	(2) \$ 3,140
Time Announce Unit, automatically announces time. Includes two ITC mono wide-play cart machines with 19-inch rack mount kits and two universal interface boards. (030-7025-1) (888-5000-09)			\$ 3,430
Deluxe brown rack cabinets containing complete system, wired and tested. 22" x 22" x 66½". (031-7001)	(2) \$ 900	(4) \$ 1,800	(4) \$ 1,800
TOTAL SYSTEM PRICE	\$28,440	\$45,980	\$67,270

NOTE: Cetec Broadcast Group has interfaced all good professional audio equipment into its systems. Ask your district Cetec Broadcast Group manager for individual machine prices and interfacing not noted here.

All complete system prices include three-day on-site checkout and training by CBG customer service engineers. Additional training is available at established rates.

Optional Equipment

Cetec Audiofile IIA microprocessor controlled, 48-tray, random access, multi-cart stereo playback machine. Includes closed-loop control, 150Hz sensing, and all logic controls. (030-4303)

\$10,900

Verified English Logging

Cetec's exclusive VEL system will provide a complete written log of every event aired, including time, exact run time, identification of sponsor and product, audio source and tray. Includes all encoding and decoding electronics, Anadex printer and additional LSI terminal. Record and FCC acceptable. (030-7017) (030-7045) (030-7014-20)

\$6,550

System 7000/Level II

Instant, selective access for program direction and management control:

- Expanded editing capabilities
 - Selective search features
 - Test mode to check programming
 - Local mode for enhanced system commands
 - Anadex printer for high speed printouts of requested information. (030-7002) (030-7045)
- \$3,975

Memory Load and Dump

Cetec's integrated system will load and dump on computer cassette all information in 7000 memory. Includes serial interface board and cassette machine. (030-7032)

\$945

System 7000 Controller spare parts kit
(030-7015)

\$475

MAPS Traffic and Accounting Systems

AM/FM System 1200R

- 1 Data General Nova Computer
64K bytes of memory
4-Port Multiplexer (5 devices)
- 1 10-million character disk drive
with three 5-million character disk cartridges
- 2 Video terminals
- 1 Printer (200 Characters per second)
- ABC Operating System
- MAPS 200 radio broadcast management system, Traffic and
billing integrated with accounts receivable, accounts payable,
payroll, asset depreciation and general ledger
- 3 Weeks of on-site training in system operation
- 1 Week of on-site training in accounting and billing functions
(See rates for additional training)

TOTAL SYSTEM PRICE \$58,900

Maintenance	Charge per month
Monthly hardware maintenance (Est.)	\$285
Monthly software support (Includes WATS line assistance and all MAPS system up-dates and enhancements)	\$150

AM/FM/HQ System 1300R

- 1 Data General Nova Computer
64K bytes of memory, 4-Port Multiplexer (5 devices)
- 2 10-million character disk drives
with six 5-million character disk cartridges
- 4 Video terminals
- 1 Printer (300 lines per minute)
- 1 Printer (200 characters per second)
- ABC Operating System
- MAPS 200 radio broadcast management system. Traffic and
billing integrated with accounts receivable, accounts payable,
payroll, asset depreciation, and general ledger
- 4 Weeks of on-site training in system operation
- 1 Week of on-site training in accounting and billing functions
(See rates for additional training)

TOTAL SYSTEM PRICE \$84,900

Maintenance	Charge per month
Monthly hardware maintenance (Est.)	\$433
Monthly software support (Includes WATS line assistance and all MAPS system up-dates and enhancements)	\$200

Communications Packages

MAPS System to/from remote terminal and printer at remote site

- 1 Video terminal
- 1 Printer (200 characters per second)
- 1 Communications concentrator
- 1 week on-site training
- Software for MAPS dial-up

\$12,450

Monthly hardware maintenance (Est.) \$ 45

At each MAPS System location

- 1 Communications concentrator
- Communications Software

\$2,500

MAPS System to MAPS System

- Communications software with custom file formatting,
each location

\$2,500

Note: Dataset and modem to be supplied by local telephone company at each location for all communications packages.

Optional Equipment	Price	Est. Monthly Maintenance
--------------------	-------	--------------------------

Terminals

Video terminal	\$ 1,600	\$19
----------------	----------	------

Printers

300 line per minute to replace 200 characters per second, add	\$ 3,000	\$ 33
Additional 200 CPS printer	\$ 3,900	\$ 28

Data Storage

10-million character disk drive (Add-on)	\$ 11,660	\$ 80
Additional disk cartridge	\$ 150	

Optional Training Programs

On-site training	\$1600 per week + expenses
------------------	-------------------------------

Training seminars (at San Diego offices)	\$250 per person, per day + expenses
---	---

Optional Sub-systems

Automation Loading	\$3000
Music Library	2000
Music Library with Playlist/Tape Control	3000
Music Library with Rotation Control	5000

Audio Systems

8000 Series Consoles

Monaural/Stereo Model

8630	8 mixer, slide attenuators	\$9,895
8665	Plug-in mixer module	595
8675	Equalizer module	695

Centurion Series Custom Audio Consoles

Centurion I Monaural

2300	8 mixer, rotary attenuators	7,400
2305	8 mixer, slide attenuators	7,200

Centurion II Stereo

2400	8 mixer, rotary attenuators	8,400
2405	8 mixer, slide attenuators	8,200

Centurion Add-ons and Accessories

2330	Mono plug in mixer module, rotary attenuator	340
2335	Mono plug in mixer module, slide attenuator	325
2340	Mono equalizer module	400
2430	Stereo plug in mixer module, rotary attenuator	425
2435	Stereo plug in mixer module, slide attenuator	400
2440	Stereo equalizer module	550
2450	Module extender circuit board	45
2655	Utility stereo VU meter (Model II only) installed	80

3000 Series Consoles

3310	10 mixer, dual channel monaural	5,250
3410	10 mixer, dual channel stereo, with separate mono	6,250

2000 Series Consoles

Monaural Models

2000	5 mixer, standard	1,695
2001	5 mixer, step attenuator	1,895
2005	8 mixer, step attenuator	2,695

Stereo Models

2002	5 mixer, standard	1,795
2003	5 mixer, step attenuator	2,195
2007	8 mixer, step attenuator	3,195

Studio/Remote Audio Control Systems

Monaural Models

2140	AC155B featuring 2000 console GT 12/SY turntables	\$3,540
2141	AC155C featuring 2001 console GT 12/SY turntables	3,740

Stereo Models

2150	ASC305B featuring 2002 console GT 12/SY turntables	3,740
2151	ASC305C featuring 2003 console GT 12/SY turntables	4,140

Audio Accessories

0032	MIC6 EV635A microphone with gooseneck for AC155 and ASC 305 models	110
4325	CE-3 cartridge and reel tape eraser	175

Turntables and Accesories

5200	GT 12/SY custom 12 inch 2 speed turntable with synchronous motor	395
5300	GT 3-12/SY custom 12 inch 3 speed turntable with synchronous motor	395
5070	ST200 tonearm, less cartridge	95
0250	Shure SC-35C phono cartridge	39
0251	Shure SS-35C replacement stylus for Shure SC-35C	12
0222	Stanton 500AL phono cartridge	32
0224	Stanton D5107AL stylus for 500AL cartridge	13
2260	TEP-3M mono equalized turntable preamplifier	200
2270	TEP-3S stereo equalized turntable preamplifier	250

Prices subject to change without notice. Equipment and services in USA, Possessions and Territories only.

The Cetec JSCP Series B FM broadcast antenna

True circular polarization, excellent VSWR bandwidth help make it a standard for the broadcast industry

- **Excellent Performance for Stereo, SCA and Quadraphonic Broadcasting**
- **Excellent VSWR Bandwidth**
- **Rugged Mechanical Construction and Mounting**
- **True Circular Polarization**
- **Two-Year Material and Workmanship Warranty**
- **Factory-Tuned on a "Customer" Structure**
- **Many Custom Options Available**

The Cetec B Series JSCP antenna is an improved version of a circularly polarized FM broadcast antenna that has become one of the industry standards. Each bay consists of a radiating element with associated $3\frac{1}{8}$ inch (79.4 mm) flange, and both are supported by a heavy casting bolted to the mounting bracket for that bay. The interbay feed lines are joined by $3\frac{1}{8}$ inch flanges, using molybdenum disulfide-coated, silver-plated inner conductor connectors for maximum contact life and minimum power loss. These special connectors are also used in the connection between the element and line.

The patented radiating element consists of four quarter-wave arms attached by bronze castings to a support boom, which also contains the element feed. A tuning cap, incorporating a large-radius tip, is supplied on each arm, which eliminates corona while facilitating field tuning, even to a slightly different operating frequency. The antenna system is fabricated of heavy gauge marine brass and copper throughout. The interbay line and element boom are pressurized up to the feed point by the transmission line pressurization system, with a pressure relief valve at the top of the antenna to allow pressurization-system purging without the necessity of access to the top of the antenna.

Power Rating

The JSCP is conservatively rated at 10KW per bay up to four bays, with a 40KW maximum rating for five bays and above.

VSWR Rating

The JSCP antenna has excellent VSWR bandwidth. To assure lowest VSWR, each antenna is completely assembled and tuned at the factory on a structure similar to

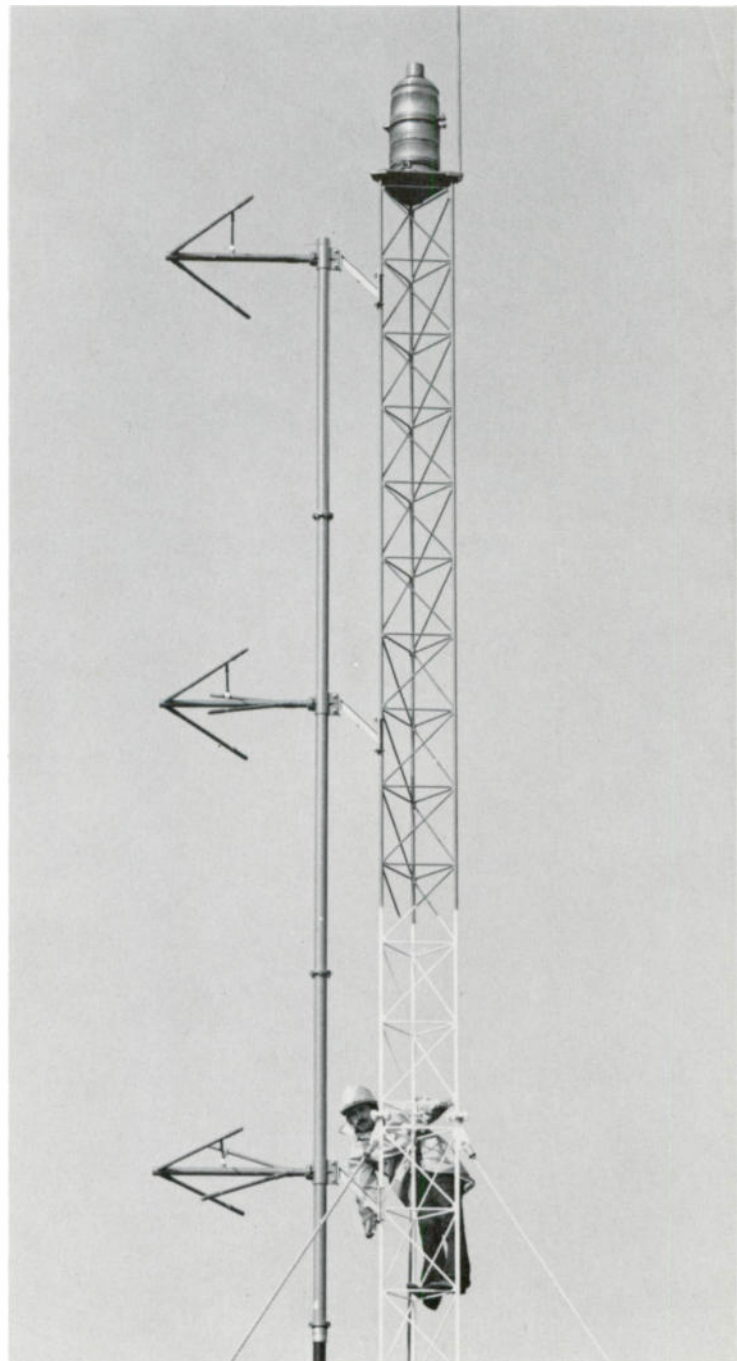

Cetec JSCP Series B FM Broadcast Antenna

that of the customer. The antenna must meet a VSWR of 1.1:1 or better \pm 200 KHz of carrier before it leaves the factory. Under normal conditions the antenna will not require field tuning to maintain the factory VSWR specification because of this factory tuning.

Stereo, SCA and Quadraphonic Operation

The JSCP antenna provides excellent performance for stereo, SCA and quadraphonic operation due to its wide VSWR bandwidth. The antenna provides a relatively flat, non-reactive load to the transmitter, keeping crosstalk between the main and subcarrier channels to a minimum. Since the antenna load is flat throughout the significant FM sideband frequencies, this antenna does not significantly contribute to synchronous AM noise.

Antenna Mounting

The JSCP antenna is supplied with standard galvanized brackets for round-leg mounting on uniform face towers.

Special galvanized brackets can be supplied at additional cost for mounting the JSCP on tapered towers, on poles, or for tower-face mounting. All hardware is included with mounting brackets. Custom antenna support poles can be supplied. Contact factory for pricing.

Radiation Pattern

The circularity of the JSCP element is \pm 1.0db in free space. The azimuth pattern will tend to be distorted somewhat by the structure on which the antenna is mounted.

Circularity on a steel pole is typically \pm 1.2db, with circularity on an 18 inch (0.46m) face tower typically \pm 1.9db, and on a 42 inch (1.07m) face tower typically \pm 4.8db. Cetec Antenna Pattern Measurement Service is available to ensure that there are no azimuth pattern nulls at the broadcaster's desired service area.

Beam Tilt and Null Fill

The JSCP antenna is optionally available with custom beam tilt and/or null fill to satisfy the requirements of the customer and consulting engineer, in order to optimize radiation toward the desired service area. Power gain figures at the horizontal plane will be affected by beam tilt or null fill; details supplied upon request.

Deicing

Electrical deicing equipment is available for the JSCP in installations where windloading from radomes would exceed the capabilities of the support structure or where icing occurs infrequently. The deicing system consists of a stainless steel sheathed high reliability heater element in each element plus the boom, providing a total of 500 watts of heating with 240 volts 50/60 hz applied. The system can be operated at one quarter power on 120 volts under light icing conditions in order to conserve electricity. The deicing system includes heaters, bay junction boxes and flexible interbay cable.

An optional precision thermostat system is available for use with the JSCP deicers. The thermostat turns on the

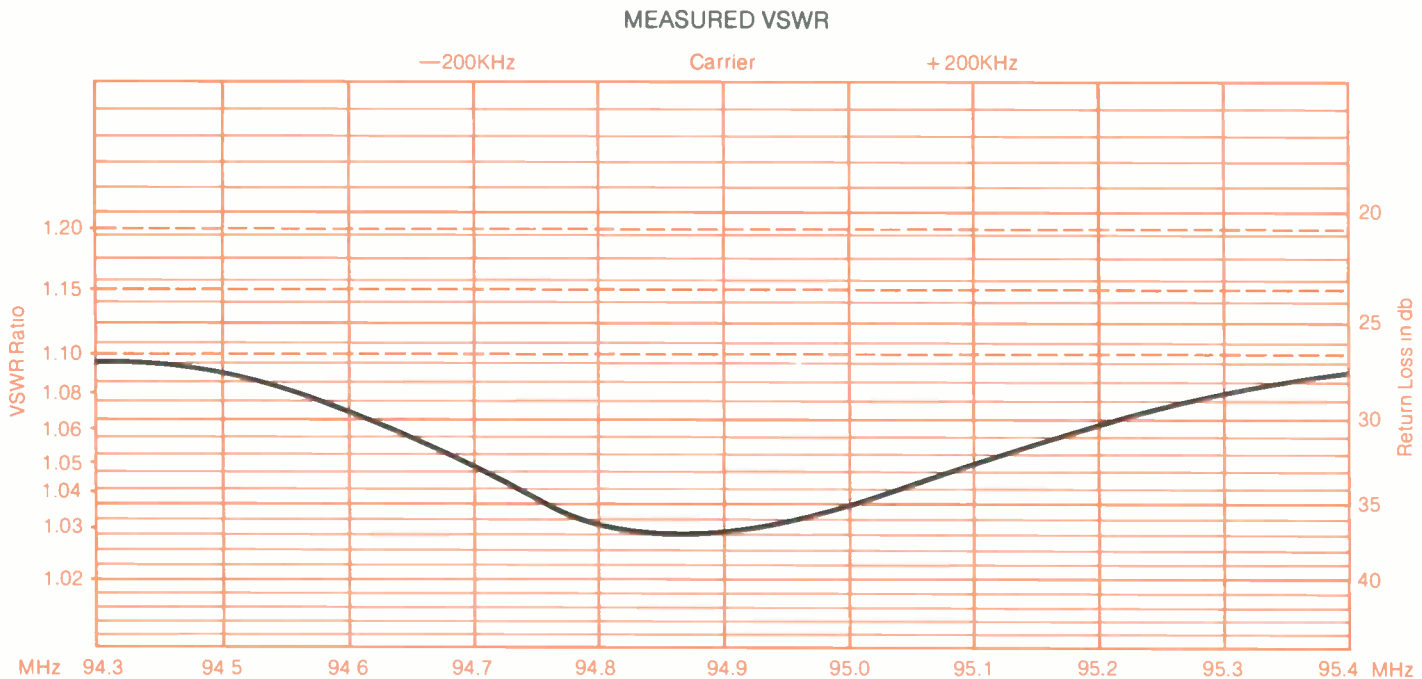

Typical Measured VSWR Plot of Four Bay JSCP-4 Antenna (K SAN-FM, Metromedia, Inc. Station, San Francisco, CA)

heaters only over the temperature range of 32° to 20°F (0° to -7°C), which is the range over which most icing occurs. The deicing control is intended to be connected directly to the heaters. If inductive loads, such as isolation transformers or coils, are to be used in the deicing line, contact the factory before ordering.

Radomes

Radomes are recommended for the JSCP antenna in environments where regular icing and sleet conditions prevail, in order to preserve the antenna's excellent VSWR specifications. The electrically transparent radomes completely enclose the radiating elements, attaching to both ends of a JSCP element specially designed for maximum strength and minimum windload.

Directional Antennas

Custom Directional antenna patterns are available to meet FCC requirements, or for use in countries where such directional antennas are readily useable. Nulls may be produced depending on protection requirements of azimuth heading and null depth. Full-scale antenna range testing and pattern certification are offered for directional antennas. Specific details for special requirements available upon request.

Dual Channel Antennas

Two stations operating on different frequencies may be fed into the JSCP antenna under certain circumstances; specific details for special requirements available upon request.

Horizontal/Vertical Ratio

Elliptically polarized JSCP antennas are available with up to a 60%/40% horizontal to vertical power ratio, depending upon configuration; specific details available upon request.

Tower Space Requirement and Antenna Input

Tower space requirement in feet for the JSCP antenna array is equal to $\left(\frac{984}{\text{frequency in mhz}}\right)$ (Number of bays - 1).

Tower space requirement in meters for the JSCP antenna array is equal to $\left(\frac{300}{\text{frequency in mhz}}\right)$ (number of bays - 1).

The input connector location and size for the JSCP is:

- One bay: at the bay itself (1 1/8 inch (41.3mm) EIA female)
- Two through five bays: Three feet (0.91m) below the bottom bay (3 1/8 inch (79.4mm) EIA female)
- Six and seven bays: Eight feet (2.44m) below the lowest bay (3 1/8 inch (79.4mm) EIA female)
- Eight through fourteen bays: Thirteen feet (3.96m) below array center (3 1/8 inch (79.4mm) EIA female)

Two Year Warranty

A limited warranty is offered on the JSCP antenna to the original purchaser of the antenna. The warranty covers defects in material and workmanship for a period of 24 months after the date of delivery of the antenna.



The JSCP electrically transparent radome encloses the specially designed radiating element.

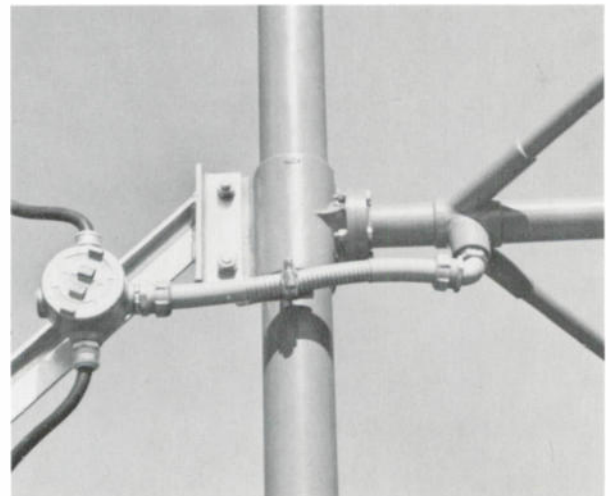

Deicer assembly insures maximum environmental protection.

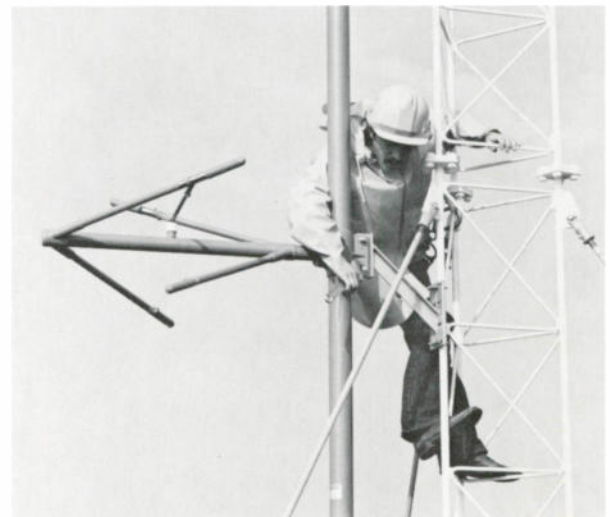

Rigger assembling JSCP antenna. Antenna assembly is quick and simple via EIA flanges, with the antenna bolted directly to the mounting bracket for maximum rigidity.

Cetec JSCP Series B FM Broadcast Antenna

Type No. — Bays	Power Gain Ratio	Gain In db	Field Gain	FS @ 1 Mile 1 KW, MV/M	Safe Power Rating	Net Weight With Mounting Brackets		Windloads At 50/33PSF (112 mph / 180 kmh) With Mounting Brackets	
JSCP-1 with deicers with radomes	0.46	—3.37	0.678	93.2	10KW	25 lbs.	(11.3 kg)	48 lbs.	(21.7 kg)
						34 lbs.	(15.4 kg)	57 lbs.	(25.9 kg)
						55 lbs.	(24.9 kg)	128 lbs.	(58.1 kg)
JSCP-2 with deicers with radomes	1.0	0.0	1.0	137.6	20KW	125 lbs.	(56.7 kg)	195 lbs.	(88.5 kg)
						143 lbs.	(64.9 kg)	219 lbs.	(99.3 kg)
						185 lbs.	(83.9 kg)	355 lbs.	(161.0 kg)
JSCP-3 with deicers with radomes	1.5	1.76	1.23	168.4	30KW	199 lbs.	(90.3 kg)	320 lbs.	(145.1 kg)
						225 lbs.	(102.0 kg)	368 lbs.	(166.9 kg)
						289 lbs.	(131.1 kg)	560 lbs.	(254.0 kg)
JSCP-4 with deicers with radomes	2.1	3.22	1.45	199.2	40KW	274 lbs.	(124.3 kg)	443 lbs.	(200.9 kg)
						308 lbs.	(139.7 kg)	516 lbs.	(234.1 kg)
						394 lbs.	(178.7 kg)	763 lbs.	(346.1 kg)
JSCP-5 with deicers with radomes	2.7	4.31	1.64	225.2	40KW	350 lbs.	(158.8 kg)	568 lbs.	(257.6 kg)
						393 lbs.	(178.3 kg)	664 lbs.	(301.2 kg)
						500 lbs.	(226.8 kg)	968 lbs.	(439.1 kg)
JSCP-6 with deicers with radomes	3.2	5.05	1.79	246.0	40KW	498 lbs.	(225.9 kg)	730 lbs.	(331.1 kg)
						506 lbs.	(229.5 kg)	851 lbs.	(386.0 kg)
						678 lbs.	(307.5 kg)	1210 lbs.	(548.8 kg)
JSCP-7 with deicers with radomes	3.8	5.80	1.95	268.0	40KW	532 lbs.	(241.3 kg)	854 lbs.	(387.4 kg)
						591 lbs.	(268.1 kg)	999 lbs.	(453.1 kg)
						742 lbs.	(336.6 kg)	1414 lbs.	(641.4 kg)
JSCP-8 with deicers with radomes	4.3	6.34	2.07	285.2	40KW	609 lbs.	(276.2 kg)	979 lbs.	(444.1 kg)
						677 lbs.	(307.1 kg)	1148 lbs.	(520.7 kg)
						849 lbs.	(385.1 kg)	1619 lbs.	(734.4 kg)
JSCP-9 with deicers with radomes	4.9	6.90	2.21	303.8	40KW	713 lbs.	(323.4 kg)	1122 lbs.	(508.9 kg)
						796 lbs.	(361.0 kg)	1316 lbs.	(596.9 kg)
						1025 lbs.	(464.9 kg)	1842 lbs.	(835.5 kg)
JSCP-10 with deicers with radomes	5.5	7.40	2.35	322.4	40KW	774 lbs.	(351.1 kg)	1265 lbs.	(573.8 kg)
						859 lbs.	(389.6 kg)	1483 lbs.	(672.7 kg)
						1074 lbs.	(487.2 kg)	2065 lbs.	(936.7 kg)
JSCP-11 with deicers with radomes	6.0	7.78	2.45	336.8	40KW	868 lbs.	(393.7 kg)	1388 lbs.	(629.5 kg)
						969 lbs.	(439.5 kg)	1632 lbs.	(740.3 kg)
						1240 lbs.	(562.4 kg)	2270 lbs.	(1029.6 kg)
JSCP-12 with deicers with radomes	6.6	8.20	2.57	353.2	40KW	929 lbs.	(421.4 kg)	1514 lbs.	(686.7 kg)
						1032 lbs.	(468.1 kg)	1780 lbs.	(807.4 kg)
						1289 lbs.	(584.7 kg)	2475 lbs.	(1122.6 kg)
JSCP-14 with deicers with radomes	7.8	8.92	2.79	383.5	40KW	1051 lbs.	(476.7 kg)	1760 lbs.	(798.3 kg)
						1158 lbs.	(525.2 kg)	2077 lbs.	(942.1 kg)
						1473 lbs.	(668.1 kg)	2885 lbs.	(1308.6 kg)



The Spiral CP/TV Antenna: Circularly polarized antennas for VHF/UHF transmission

- Best horizontal circularity:
 ± 1.0 dB VHF; ± 0.5 dB UHF
- Best axial ratio: 1.5 dB typical
- Beam tilt and null fill standard
- Very low VSWR:
less than 1.08 to 1 across 6 MHz channel
- Superior mechanical construction;
minimum windload
- Outstanding on-the-air performance and reliability

Cetec's circularly polarized *Spiral antenna provides the television broadcaster with a proven, in-use design, featuring superb performance in a rugged yet simple mechanical structure. The antenna is customized for each application and can be supplied for any single VHF or UHF channel: 2-70. Dependent upon system requirements, the Spiral is built in either two or three sections and provides omnidirectional, circularly polarized power gains from 2 to 15 (or even higher on special order).

The Cetec Spiral design provides an almost perfect horizontal pattern circularity of ± 1.0 dB (VHF) and ± 0.5 dB (UHF). Axial ratio, a true measure of performance of circularly polarized antennas, is excellent at only 1.5 dB. Electrical beam tilt and null fill are standard. The amount of each may be specified by the customer and his consultant to suit local conditions. Power input to the Spiral is via a standard 6 $\frac{1}{8}$ " EIA 50-ohm connector.

*The Cetec Spiral CP/TV antenna is produced under U.S. patent No. 3,906,509 dated September 16, 1975.

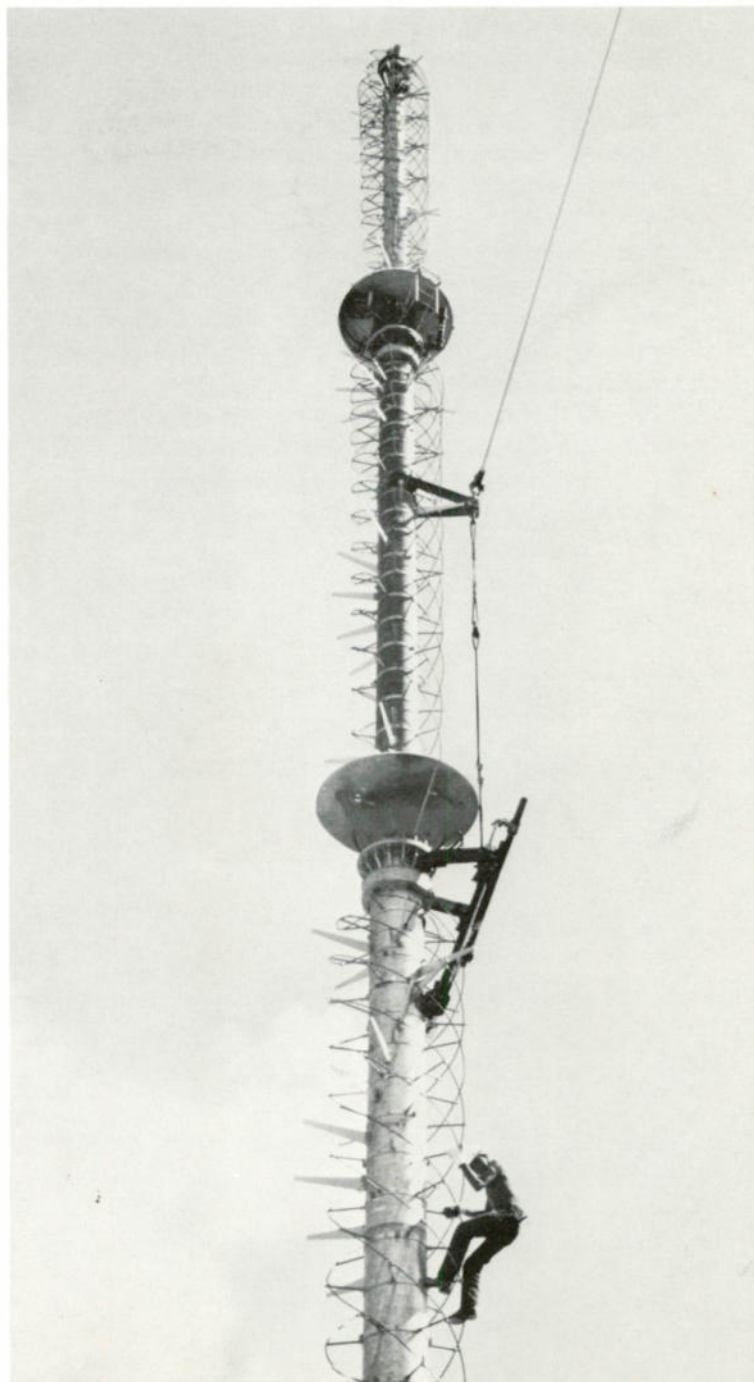

Three-bay Cetec Spiral was lifted to top of 1679-foot tower near Waco, Texas in mid-1979, and has performed brilliantly for KWTX, Channel 10, ever since.

The Cetec Spiral antenna consists of two or three pole sections, around which are multiple stainless steel rods, wound at specific pitch angles and spaced from the pipe by heavy-duty fiberglass-reinforced low-loss insulators. The array acts as a traveling wave antenna, with the main beam broadside to the support pole. It produces an omnidirectional azimuth pattern, with low axial ratio, and low VSWR. The pole diameter, length and number of spirals vary with the operating channel and gain required. Power is fed to the individual radiators by power dividers located at the top end of each section. The design readily allows for electrical beam tilt by setting the phase progression between the antenna sections. Null fill is produced by setting the spiral pitch angles for a given portion of the aperture.

The unique design of the Spiral almost completely eliminates pole-axis radiation, a problem that plagued earlier helical type antennas. This radiation component occurred along the vertical axis of the helices and tended to reduce true antenna gain and aperture efficiency. The Spiral virtually eliminates pole-axis radiation without the requirement for reactive radiator terminations. The ends of each helix radiator used on the Spiral are simply grounded to the pole for lightning protection.

Electrical design

Azimuth pattern

New design technology, coupled with comprehensive testing and development, give the Spiral the best horizontal circularity in the industry. The number of radiators, their spacing from the pole, and their pitch angles, all affect horizontal circularity. These parameters are selected and carefully controlled during manufacture to produce a maximum departure from true circularity of 1.0 dB for VHF Spirals and 0.5 dB for UHF Spirals.

Axial ratio

The value of the ratio of the major and minor axes of the polarization ellipse, for energy radiated at any azimuth angle, determines the axial ratio of a transmitting antenna. An axial ratio of unity represents true circular polarization. The degree to which a circularly polarized signal can illuminate randomly oriented receiving antennas, such as "rabbit-ears," depends upon the quality of the transmitting antenna's axial ratio. Similarly, ghost reduction capability of a circularly polarized signal depends upon the transmitting antenna's axial ratio quality; the lower the ratio, the better the ghost reduction.

The Cetec Spiral has nearly perfect axial ratio because in any *given* azimuth angle, the radiation points for the vertical and horizontal components of transmitted signal are coincident. The measured axial ratio of the Spiral is generally less than 1.5 dB.

VSWR bandwidth

The Cetec Spiral design naturally exhibits superb impedance bandwidth characteristics. To preserve these characteristics, the Spiral uses a simple branching-type feed system for each bay. Power is fed to each spiral radiator from a hybrid power splitter via flexible, 50-ohm feedlines. Each feedline is carefully impedance-matched to its designated spiral radiator, using a coaxial "L" section tuning stub. These stubs are factory-tuned, locked down, and sealed before shipment. The completed antenna has very low return loss and typically exhibits VSWR of less than 1.08:1 across the entire 6MHz TV channel.

Electrical beam tilt and null fill

In order to tailor the vertical radiation pattern to the local coverage requirements, beam tilt and null fill are supplied as standard. Up to 5 degrees of beam tilt and up to 20 percent of first null fill can be provided, as part of the customized design and fabrication of the antenna to meet the specific transmission requirements of the individual TV station.

Mechanical design

Support pole

The structure supporting the spiral radiators consists of two or three sections of thick-wall steel pipe, hot-dip galvanized after fabrication, with a 10 to 20-foot-long bury section, or a flange for tower top mounting. Each section can be raised individually using the bolt-on lifting lugs and assembled section by section on the top of the tower. Alternately, the antenna can be assembled on the ground and installed in one operation. The pole also includes insulated steps for convenient, safe climbing of the structure. The entire antenna is at ground potential, eliminating problems due to lightning.

Spiral radiators

Dependent upon channel and power requirements, between five and ten stainless steel spiral radiators are wound around the support pole and mounted to it with low loss fiberglass reinforced insulators and stainless steel hardware. The individual spiral elements are connected to DC ground at each end to provide lightning protection.

Although the Spiral design is relatively insensitive to ice build-up because pole diameter is not critical to performance, provision is made for electrical deicing of the spiral radiators with internal resistance heaters. Power supplied to the heaters can be either 240 volts single phase, or 208 volts three phase, at a rate of 15 watts per linear foot of spiral. The heater elements are terminated in a junction box at the base of the antenna.

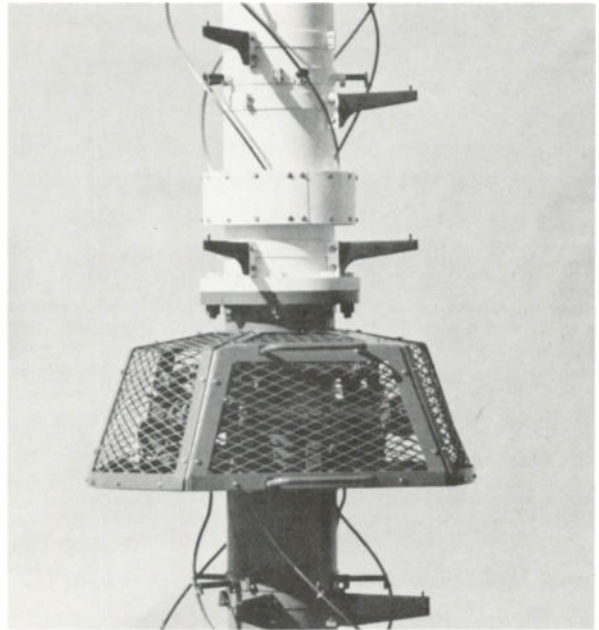

Power is fed to individual radiators by power dividers located at the top of each antenna section.

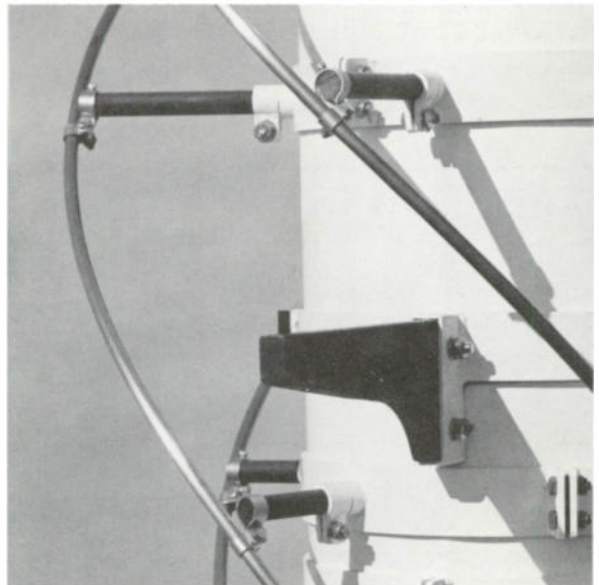

Insulated steps allow safe, convenient climbing of the antenna structure.

Feed system

The power is divided between the spiral radiators by a wideband power divider. The individual spiral radiators are fed the correct amount of power at the exact phase required through flexible coaxial cables. These cables are standard 50-ohm flexible, polyethylene, jacketed cable. The impedance of the spiral radiators is transformed to 50 ohms by individual "L" section tuners. The coaxial components used are conservatively rated for the power to be handled by the antenna.

Factory and range tests

An extensive series of pre-shipment tests are performed at the factory and on the test range to insure the proper operation of the antenna. The antenna is completely assembled and tested for compliance with published specifications. The plant tests include:

- 1) Azimuth pattern circularity
- 2) Vertical pattern measurements
- 3) Axial ratio measurements
- 4) VSWR of complete antenna
- 5) Dry air pressurization
- 6) Electrical deicing operation

Measured data, after final adjustments, is included in the instruction booklet supplied with the antenna.

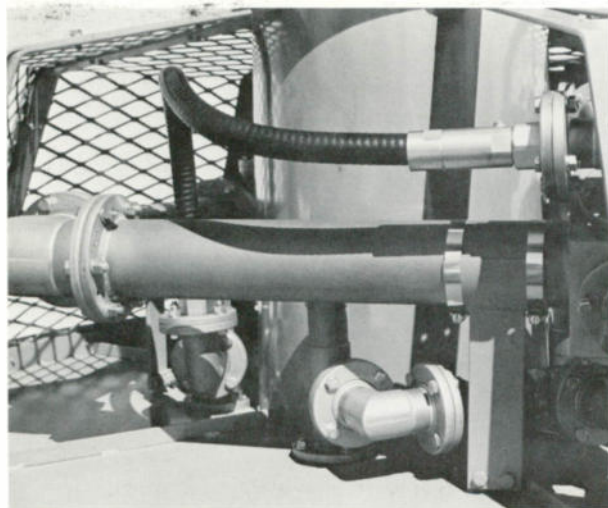

Closeup view of the feed system shows 50-ohm flexible, jacketed polyethylene cable.



Long view of a three-section Cefec Spiral antenna on test stand on the Sacramento Valley range.

Performance data

Horizontal Circularity	± 1.0 dB, VHF	± 0.5 dB, UHF
Axial Ratio	1.5 dB typical	
Input Power Rating	70kW, VHF	60 kW, UHF Higher Power input on request
VSWR over 6 MHz Channel	1.08 to 1 or better	
Antenna Input Impedance	50 ohms, nominal	
Safe Wind Velocity	With $\frac{1}{2}$ " ice — 112 mph	
Input Connector Size	EIA $\frac{6}{16}$ " standard	

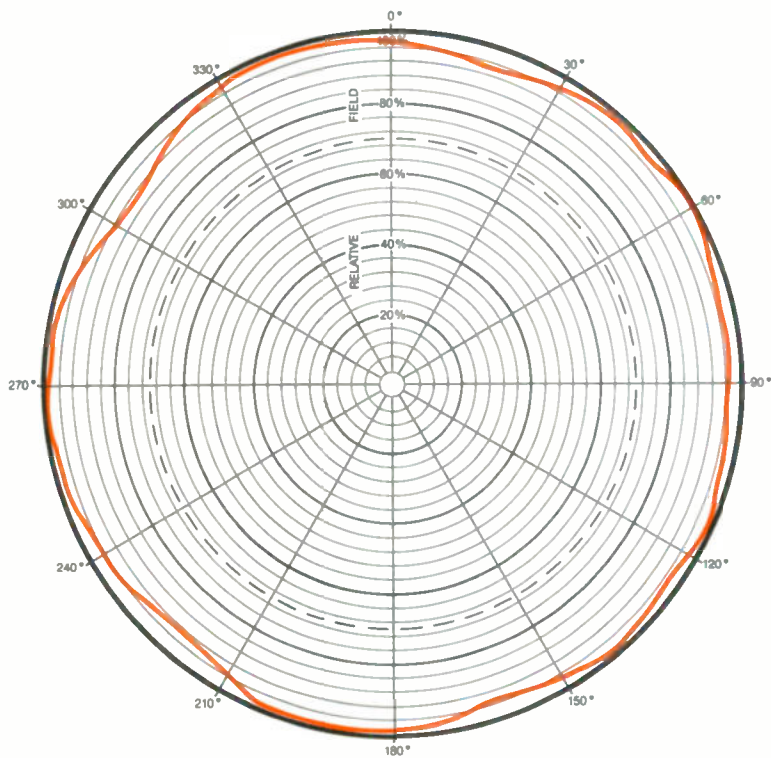

TYPICAL MEASURED AZIMUTH PATTERN

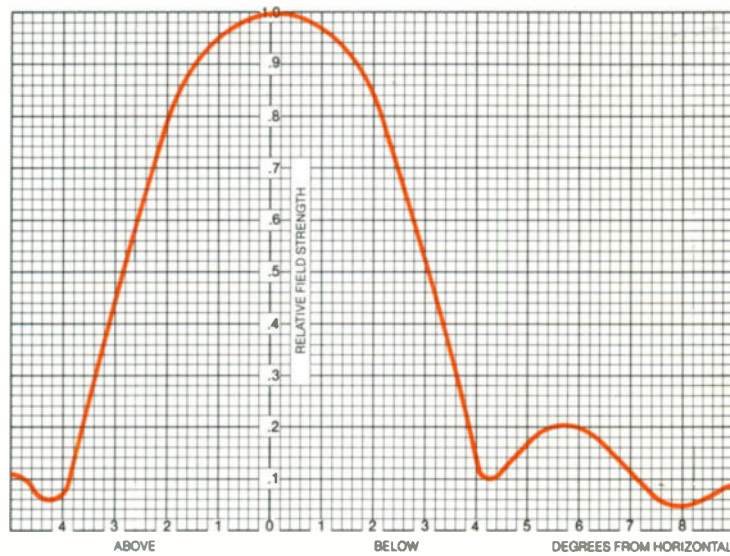

TYPICAL MEASURED VERTICAL PATTERN

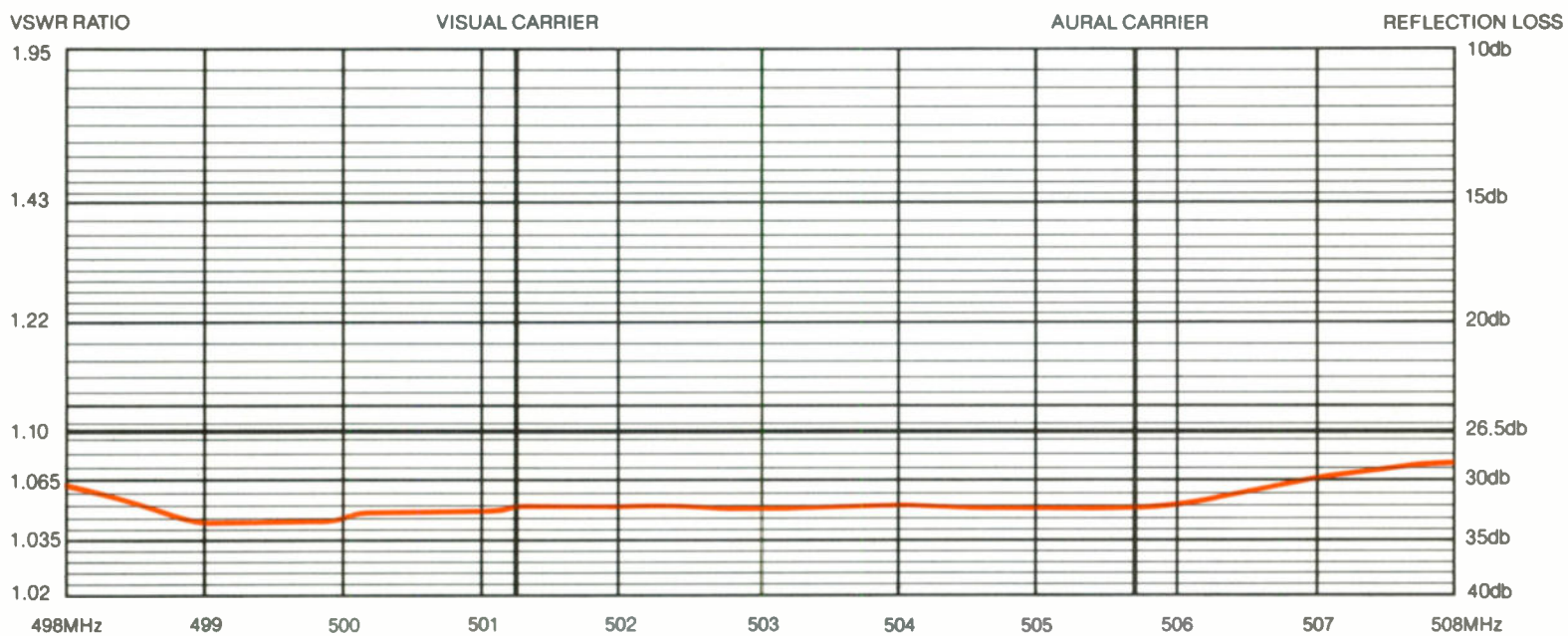

TYPICAL MEASURED VSWR

Cetec Spiral CP/TV Antenna

Specifications

VHF—Low Band, Two Sections

Channel	Gain	Antenna Height (ft.)	Estimated Weight (lbs.)	Spiral Diameter (ft.)	Estimated Wind Loading * Shear (lbs.)	Moment (KIPft.)
2	2.5	91	12,100	9.5	8,700	356
3	2.5	84	11,000	8.6	7,900	330
4	2.5	77	10,100	7.9	7,800	300
5	2.5	68	9,000	6.9	7,700	266
6	2.5	64	8,500	6.4	7,700	250

VHF—High Band, Two Sections

7	5.5	63	3,593	3.1	4,518	135
8	5.5	62	3,557	3.0	4,381	130
9	5.5	61	3,522	2.9	4,246	126
10	5.5	60	3,495	2.8	4,106	117
11	5.5	59	3,451	2.7	3,971	113
12	5.5	58	3,415	2.6	2,834	108
13	5.5	57	3,380	2.5	3,678	103

VHF—High Band—Three Sections

7	7.8	94	11,000	3.1	7,200	313
8	7.8	93	11,000	3.0	7,100	300
9	7.8	92	10,000	2.9	7,000	293
10	7.8	91	10,000	2.8	6,500	270
11	7.8	90	9,500	2.7	6,300	260
12	7.8	89	9,000	2.6	6,100	248
13	7.8	88	8,700	2.5	5,910	235

UHF—Three Sections

14-24	15	64	5,900	2.8	5,900	170
25-36	15	57	5,000	2.5	5,000	150
38-50	15	51	4,500	2.2	4,200	106
51-70	15	46	3,000	2.0	3,500	76

*Includes one-half inch radial ice.



Engineering / Manufacturing Operations: 6939 Power Inn Road, Sacramento, California 95828 (916) 383-1177

Sales Representatives: Broadcast Systems Inc., 8222 Jamestown Drive, Austin, Texas 78758 (800) 531-5232

(In Texas, call (512) 836-6014)



Cetec Broadcast Group

PRICE LIST

EFFECTIVE AUGUST 1st 1978
Equipment and Services in U.S.A.,
Possessions and Territories Only

Cetec Broadcast Group

Audio Systems

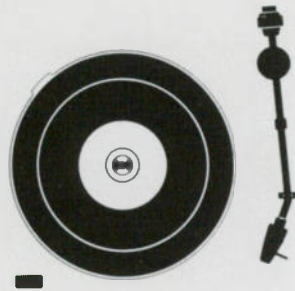

STUDIO/REMOTE AUDIO CONTROL SYSTEMS

MONAURAL MODELS

2140	AC155B featuring 1015 console GT 12/SY turntables	2,150.00
2141	AC155C featuring 1017 console GT 12/SY turntables	2,300.00

STEREO MODELS

2150	ASC305B featuring 1030 console GT 12/SY turntables	2,700.00
2151	ASC305C featuring 1035 console GT 12/SY turntables	2,900.00

AUDIO ACCESSORIES

2120	RA-1 utility microphone/line amplifier	175.00
8102	US-5 utility shelf, top mounting for AC155 and ASC305 models	150.00
0032	MIC6 EV635A microphone with gooseneck for AC155 and ASC305 models	95.00
2050	1018 microphone preamp card for 100 series consoles only	35.00
2200	MAS-50A 50 watt stereo monitor amplifier	425.00
2220	MAS-50A/Q 50 watt stereo monitor amplifier with cue	450.00
2230	SM-3 Muting relay accessory for MA series amplifier	125.00
0155	SP30 3 way 10 inch speaker system with enclosure	120.00
0151	SP40 3 way 15 inch speaker system with enclosure	200.00

TURNTABLES AND ACCESSORIES

5200	GT 12/SY custom 12 inch 2 speed turntable with synchronous motor	350.00 300.00
5300	GT 3-12/SY custom 12 inch 3 speed turntable with synchronous motor	300.00
All Models	230V and 50 Hz options	On Request
5070	ST220 tonearm, less cartridge	65.00 75.00
5080	AT1005 tonearm, precision stereo, less cartridge	85.00
0250	Shure SC-35C phono cartridge	26.50
0251	Shure SS-35C replacement stylus for Shure SC-35C	9.00
0252	Stanton 881S calibration standard phono cartridge	90.00
0253	Stanton D81 stylus for 881S	45.00
0254	Stanton 681EE phono cartridge	46.80
0255	Stanton D6800EE stylus for model 681EE	23.40
0222	Stanton 500AL phono cartridge	15.00
0224	Stanton D5107AL stylus for 500 AL cartridge	7.20
2260	TEP-3M mono equalized turntable preamplifier	100.00
2270	TEP-3S stereo equalized turntable preamplifier	175 150.00

CENTURION SERIES CUSTOM AUDIO CONSOLES

CENTURION I MONAURAL

2300	8 mixer, rotary attenuators	\$5,900.00
2305	8 mixer, slide attenuators	5,900.00

CENTURION II STEREO

2400	8 mixer, rotary attenuators	6,900.00
2405	8 mixer, slide attenuators	6,900.00

CENTURION ADD-ONS AND ACCESSORIES

2330	Mono plug in mixer module, rotary attenuator	300.00
2335	Mono plug in mixer module, slide attenuator	300.00
2340	Mono equalizer module	300.00
2430	Stereo plug in mixer module, rotary attenuator	350.00
2435	Stereo plug in mixer module, slide attenuator	350.00
2440	Stereo equalizer module	400.00
2450	Module extender circuit board	26.00
2650	DC 24 digital clock	200.00
2655	Utility stereo VU meter (Model II only) installed	60.00

3000 SERIES

3310	10 mixer, dual channel <i>monaural</i>	3,900.00
3410	10 mixer, dual channel <i>stereo</i> , with separate mono	4,900.00

1000 SERIES CONSOLES

MONAURAL MODELS

1015	A15B 5 mixer, standard	950.00
1017	A15B 5 mixer, step attenuator	1,100.00
1020	A20B 8 mixer, step attenuator	1,950.00

STEREO MODELS

1030	AS30B 5 mixer, standard	1,200.00
1035	AS30B 5 mixer step attenuator	1,400.00
1040	AS40B 8 mixer, step attenuator	2,450.00

NOTE: 1000 Series Stereo Consoles require accessory monitor amplifiers for studio use. See MAS-50A/Q and MAS 50A under Audio Accessories below. All other consoles contain built-in monitor and cue amplifiers.



SHOWCASE STUDIO CABINETRY: SERIES I

8111	Console desk for 1020 or 1040 audio console	485.00
8112	Console hood with cue speaker for 1020 or 1040 console	280.00
8113	Dual turntable cabinet	610.00
8114	Dual utility cabinet	635.00
8115	Console desk for 3310 or 3410 consoles	490.00
8116	Tape cartridge storage hutch for 8114	295.00
8117	Single turntable cabinet	490.00
8118	Rack bracket kit for 8114	20.00

SHOWCASE STUDIO CABINETRY: SERIES II

8201	Console desk for all Cetec Broadcast consoles	485.00
8202	Dual turntable cabinet	730.00
8203	Dual utility cabinet	545.00
8204	Tape cartridge storage hutch for 8203	335.00
8205	Support pedestal for 8201 (not required when 8202 is used)	135.00

CENTURY II TAPE CARTRIDGE EQUIPMENT

4010	Monaural playback module with 150 and 8kHz cue sensing	825.00
4020	Stereo playback module with 150 and 8kHz cue sensing	925.00
4110	Monaural record/playback module with 150 and 8kHz tone, splice finder	1,400.00
4120	Stereo record/playback module with 150 and 8kHz tones, splice finder	1,600.00
4130	Rackmount kit for all Century II (holds up to 3 Century II machines, or 1 "C" size machine, and 1 "A" size machine.	85.00
4135	Matching blank panel for "A" size machines.	15.00
4140	Matching blank panel for "C" size machines.	16.00
4145	Filler Panel for use with 1 "C" size and 1 "A" size cartridge machine.	6.00
All Models:	"C" size cartridge option add:	120.00
All Models:	High speed option add:	115.00
All Models:	230 Volts, 50 Hz	On Request

TAPE CARTRIDGES AND ACCESSORIES

8401	CR-100 wall mount wooden cartridge rack, holds 100	210.00
8402	CR-120 revolving wooden cartridge rack, holds 120	265.00
0211	TR-48 cartridge rack, revolving wire, holds 48 cartridges	49.50
0212	TR-96 cartridge rack, revolving wire, holds 96 cartridges	85.50
0210	MR-200 cartridge rack, revolving mobile wire floor model, holds 200	175.00
4325	CE-3 cartridge and reel tape eraser	80.00
0006	Fidelipac cartridge machine head height gage	21.00
0010	Fidelipac head insertion gage	5.00
0012	Fidelipac right angle zenith gage	24.00
0044	Tape head demagnetizer	15.00
0009	AL-1 test cartridge, 12 kHz, -10dB	20.00
0011	CL-1 test cartridge, 1 kHz, 0dB	18.00
0013	CL-2 test cartridge, 1 kHz, -10dB	18.00
0014	Frequency response tape, NAB 160 mil.	40.00

FIDELIPAC MASTERCART TAPE CARTRIDGES

0050	Empty	2.82
0051	Twenty seconds	3.21
0053	Forty seconds	3.29
0055	Seventy seconds	3.40
0057	One minute, thirty seconds	3.49
0059	One minute, forty seconds	3.69
0063	Two minutes, thirty seconds	3.76
0067	Three minutes, thirty seconds	3.99
0075	Five minutes, thirty seconds	4.46
0077	Seven minutes, thirty seconds	4.78
0079	Eight minutes	4.89
0083	Ten minutes, thirty seconds	5.34

FIDELIPAC 300 TAPE CARTRIDGES

0001	Empty	2.78
0100	Twenty seconds	3.18
0102	Forty seconds	3.26
0104	Seventy seconds	3.36
0106	One minute, thirty seconds	3.45
0108	One minute, forty seconds	3.52
0110	Two minutes, thirty seconds	3.70
0114	Three minutes, thirty seconds	3.93
0118	Five minutes, thirty seconds	4.41
0025	Seven minutes, thirty seconds	4.74
0022	Eight minutes	4.85
0122	Ten minutes, thirty seconds	5.32
0003	M600 Empty cartridge	4.46
0200	M600 sixteen minutes	9.45
0005	M1200 empty cartridge	6.16
0300	M1200 thirty one minutes	15.76

BULK TAPE AND LABELS

0501	Roll (500) blank tape cartridge labels	6.50
0600	Ampex 675 lubricated tape, 2100 feet 7 inch reel	7.25
0601	Ampex 675 lubricated tape, 4200 feet 10 inch hub	13.00
0603	Fidelipac 1800 feet 7 inch reel hot tape	8.85

AUDIO PROCESSING EQUIPMENT

AM

LA-3A	Universal Audio Products (UREI) Audio Leveler Amplifier (AM or FM)	396.00
BL-40	Universal Audio Products (UREI) Modulimiter	696.00
4300	Thomson CSF (Volumax AM Automatic Peak Controller)	1,030.00
4440A	Thomson CSF Audimax Monaural Automatic Level Controller	980.00
310B	Dorrrough Discriminate Audio Processor with asymmetrical AM limiter	1,800.00
5996	Pacific Recorders Multilimiter AM Audio limiter	895.00
5997	Pacific Recorders Multimax AM gated AGC Processor	1,295.00
5930	Marti CLA-40A Limiter	445.00

FM

8000	Optimod Model 8000 Stereo Audio Processor w/stereo generator	3,195.00
4111	Thomson-CSF Stereo FM Volumax Automatic Peak Controller	2,065.00
4450A	Thomson-CSF Audimax Stereo Automatic Level Controller	1,750.00
310C	Dorrrough Discriminate Audio Processor w/75 emphasis (two required for stereo)	1,800.00
5998	Pacific Recorders Multilimiter FM Audio Limiter (two required for stereo)	895.00
5999	Pacific Recorders Multimax FM gated AGC Processor (two required for stereo)	1,295.00
TFL-280	Moseley FM Audio Limiter (two required for stereo)	975.00 ea. 1,860.00 pr.

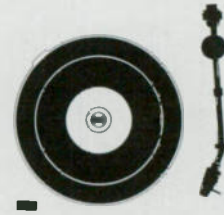

AUDIO HANDLING products from most of the industry's leading makers are also available through CBG. Audio processing equipment, phonograph pickup cartridges and styli, microphones and stands, speaker systems and a host of items to complete your station's studio, production room and remote requirements can all be supplied through your CBG district manager.



Automation

Cetec Broadcast Group Automation has installed hundreds of broadcast automation systems around the world, each designed to meet the format needs of its user.

All Cetec Broadcast Group district managers are trained to help you select the best system for your programming needs. Below is pricing information on popular SAMPLE systems. Your programming and operational requirements may need additional equipment.

Equipment quoted below is all Stereo.

SAMPLE I: SERIES 7000 CRT-PROGRAMMED SYSTEM

Part No.	Qty	Description	Unit Price	Total
030-7001	(1)	Cetec Series 7000 Automation Control with subroutine capability and 1,000 event memory.		9,900.00
888-5000-46/ 030-7020-1	(2)	ITC Model 750 reel/reel decks with universal interfacing, closed-loop control, including 25 Hz sensing plus all logic controls.	1610.00	3,220.00
030-4203	(1)	Audiofile II, microprocessor controlled, 48 tray, random access, multi-cart playback machine, closed-loop control, 150 Hz sensing and all logic controls.		7,600 6,995.00
031-7001	(2)	Deluxe rack cabinets containing complete system, wired and tested.	350.00	700.00
STEREO SERIES 7000 SYSTEM TOTAL:				<u>\$20,815.00</u>

SAMPLE II: SERIES 7000 CRT-PROGRAMMED SYSTEM

Part No.	Qty	Description	Unit Price	Total
030-7001/ 030-7012	(1)	Cetec Series 7000 Automation Control with subroutine capability, 3600 event memory, up to seven day walk-away programming, including Real Time Clock with network joining and other exact-timed events.		12,800 12,800.00
888-5000-46/ 030-7020-1	(4)	ITC Model 750 reel/reel decks with universal interfacing, closed-loop control, including 25 Hz sensing plus all logic controls.	1610.00	6,440.00
030-4203	(2)	Audiofile II, microprocessor controlled, 48 tray, random access, multi-cart playback machine, closed-loop control, 150 Hz sensing and all logic controls.	6995.00	13,990.00
031-7001	(4)	Deluxe rack cabinets containing complete system, wired and tested.	350.00	1,400.00
STEREO SERIES 7000 SYSTEM TOTAL:				<u>\$34,630.00</u>

SAMPLE III: SERIES 7000 CRT-PROGRAMMED SYSTEM

Part No.	Qty.	Description	Unit Price	Total
030-7001/ 030-7012	(1)	Cetec Series 7000 Automation Control with subroutine capability, 8000 event memory, up to seven day walk-away programming, including Real Time Clock with network joining and other exact timed events.		15,000.00
888-5000-46/ 030-7020-1	(2)	ITC Model 750 reel/reel decks with universal interfacing, closed-loop control, including 25 Hz sensing plus all logic controls.	1610.00	3,220.00
030-4203	(4)	Audiofile II, microprocessor controlled, 48 tray, random access, multi-cart playback machine, closed-loop control, 150 Hz sensing and all logic controls.	6995.00	27,980.00
030-7025-1	(1)	Time Announce Unit to automatically announce time, including two wide-play cart machines.		2,770.00
031-7001	(4)	Deluxe rack cabinets containing complete system, wired and tested.	350.00	1,400.00
STEREO SERIES 7000 SYSTEM TOTAL:				<u>\$50,370.00</u>

OPTIONS:

030-7017	(1)	Verified English Logging (for all Series 7000 Systems). Cetec's exclusive VEL system supplies complete written description of every event aired, including time, sponsor identification, audio source and tray. Record is FCC acceptable. Includes all encoding and decoding electronics, logging printer and CRT encoder.		5,605.00
030-7032	(1)	Memory Load and Dump (for all Series 7000 Systems). Cetec's integrated system will load or dump on computer cassette all information in 7000 memory. Includes serial interface board and cassette machine.		795.00

NOTE: Cetec Broadcast Group has interfaced all good professional audio equipment into its systems. Ask your district Cetec Broadcast Group manager for individual machine prices and interfacing not noted here.

All complete systems are field installed by CBG Customer Service Representatives.



Transmitters

SOLID STATE AM TRANSMITTERS

SS10A	Solid-state 10 Watt	650.00
SS1000A	Solid-state 1000/500/250 Watts	12,495.00

AM TRANSMITTERS

701B	1000/500/250 Watts (Any two powers)	10,950.00
703B	2500/1000/500 Watts (Any two powers)	16,000.00
705C	5000/1000/500 Watts (Any two powers)	27,750.00
710C	10,000 Watts	31,500.00
715C	15,000 Watts	34,500.00
725C	25,000 Watts	73,500.00

FM TRANSMITTERS

680	Direct FM Exciter, solid state	2,350.00
682	Stereo Generator, solid state	1,350.00
683	SCA Generator, solid state	750.00
680/1	10 Watt Transmitter with cabinet	2,750.00
600B	250 Watt, solid state	7,600.00
601A	1000 Watts	12,500.00
602A	2500 Watts	14,500.00
603	3000 Watts	17,500.00
605B	5000 Watts	19,500.00
610A	10,000 Watts	27,500.00
625A	25,000 Watts	38,000.00
650 Dual	50,000 Watts	On Request

NOTE: A wide and complete variety of equipment needed to complete any transmitter and tower installation is available through CBG and its district managers. Rigid line and coax, fittings, monitor equipment for AM, FM and stereo SCA, towers, lighting, STL and wire remote control systems, can be ordered from CBG. The manufacturers of these accessory items are only those known throughout the industry as reputable makers of top-quality equipment. Please ask your CBG district manager for makers, models, and prices.

SPARE PARTS: AM TRANSMITTERS

SS10A	Recommended spare transistor and diodes	62.00
SS1000A	Recommended spare transistors and diodes	386.00
701B	100% rectifier kit	194.00
701B	Recommended spare tube kit	170.00
701B	100% spare tube kit	340.00
703B	Recommended rectifier kit	194.00
703B	100% rectifier kit	428.00
703B	Recommended spare tube kit	400.00
703B	100% spare tube kit	800.00
705C	100% rectifier kit	449.00
705C	Recommended spare tube kit	530.00
705C	100% spare tube kit	1,590.00
710C	Recommended rectifier kit	788.00
710C	Recommended spare tube kit	1,425.00
710C	100% spare tube kit	1,935.00
715C	Recommended rectifier kit	314.00
715C	100% rectifier kit	746.00
715C	Recommended spare tube kit	1,425.00
715C	100% spare tube kit	1,935.00
725C	Recommended rectifier kit	314.00
725C	100% rectifier kit	1,491.00
725C	Recommended spare tube kit	1,425.00
725C	100% spare tube kit	3,870.00

SPARE PARTS: FM TRANSMITTERS

680, 680/1	Recommended spare transistor/diode kit	122.00
682	Recommended spare transistor/diode kit	79.00
683	Recommended spare transistor/diode kit	17.00
601A	100% spare rectifier kit	167.00
602A	100% spare rectifier kit	305.00
601A or 602A	100% spare tube kit	405.00
603	Recommended spare rectifiers	222.00
603	100% spare rectifiers	541.00
605B	Recommended spare rectifiers	222.00
605B	100% spare rectifiers	541.00
603 or 605B	100% spare tube kit	364.00
610A	Recommended spare rectifiers	279.00
610A	100% spare rectifiers	834.00
610A	100% spare tube kit	1,205.00
625A	Recommended spare rectifiers	643.00
625A	100% spare rectifiers	1,319.00
625A	100% spare tube kit	1,260.00

REMOTE CONTROL INTERFACE

All Models	Remote Meter panel	395.00
	For Model 701B	250.00
	For Model 703B	275.00
	For Models 705C/710C/715C	125.00
	For Models 601A/602A	125.00
	For Models 610A/625A	125.00

Cetec Broadcast Group

Jampro

Antennas ~ Services Options

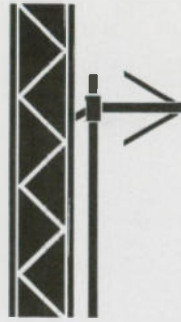

ELLIPTICALLY POLARIZED MODERATE POWER "PERFORMER" SERIES 1 1/2" LINE

JLCP-1	1-bay, 0.47 gain, 3 kW	970.00
JLCP-2	2-bay, 0.95 gain, 5 kW	1,595.00
JLCP-3	3-bay, 1.50 gain, 6 kW	2,280.00
JLCP-4	4-bay, 2.05 gain, 8 kW	3,015.00
JLCP-5	5-bay, 2.60 gain, 10 kW	5,350.00
JLCP-6	6-bay, 3.15 gain, 10 kW	6,420.00
JLCP-7	7-bay, 3.65 gain, 10 kW	7,490.00
JLCP-8	8-bay, 4.20 gain, 10 kW	8,560.00
JLCP-10	10-bay, 5.40 gain, 10 kW	10,165.00
JLCP-12	12-bay, 6.50 gain, 10 kW	11,770.00

FM ANTENNA PATTERN MEASUREMENT SERVICE

A representative bay of the customer's antenna is mounted on a full scale mock-up of the customer's support structure, the relative field pattern is then measured for both the horizontal and vertical polarization. For tower mounting, one set of measurements is made with the antenna face-mounted and another set of measurements made with the antenna leg-mounted skewed 30 degrees off the guy line. For pole mounting, a set of measurements is made with the antenna mounted at a standard distance from the support pole. Pricing for duplication of towers that must be fabricated for testing will be quoted on request, as will pricing for other non-standard structures. Additional measurements will be made if desired, on a time and material basis.

CIRCULARLY POLARIZED HIGH POWER "PENETRATOR" SERIES, 3 1/2" LINE

JSCP-1	1-bay, 0.47 gain, 10kW	1,910.00
JSCP-2	2-bay, 1.0 gain, 20kW	3,040.00
JSCP-3	3-bay, 1.5 gain, 30 kW	4,380.00
JSCP-4	4-bay, 2.1 gain, 40 kW	6,200.00
JSCP-5	5-bay, 2.7 gain, 40 kW	7,825.00
JSCP-6	6-bay, 3.2 gain, 40 kW	9,620.00
JSCP-7	7-bay, 3.8 gain, 40 kW	11,160.00
JSCP-8	8-bay, 4.3 gain, 40 kW	12,520.00
JSCP-10	10-bay, 5.5 gain, 40 kW	15,370.00
JSCP-12	12-bay, 6.6 gain, 40 kW	17,975.00

CIRCULARLY POLARIZED HIGH POWER "BRUTE" SERIES

JHCP-1B	1-bay, 0.47 gain, 30 kW	2,675.00
JHCP-2B	2-bay, 1.0 gain, 60 kW	4,815.00
JHCP-3B	3-bay, 1.6 gain, 80 kW	7,170.00
JHCP-4B	4-bay, 2.1 gain, 80 kW	9,950.00
JHCP-5B	5-bay, 2.7 gain, 80 kW	12,040.00
JHCP-6B	6-bay, 3.3 gain, 80 kW	14,285.00
JHCP-7B	7-bay, 3.9 gain, 80 kW	16,640.00
JHCP-8B	8-bay, 4.5 gain, 80 kW	18,405.00
JHCP-10B	10-bay, 5.7 gain, 80 kW	23,005.00
JHCP-12B	12-bay, 6.7 gain, 80 kW	24,610.00
JHCP-1SB	1-bay, standby antenna, pole mounted, 30 kW, 3" brass pipe and 3 1/2" input.	3,105.00

MULTI-STATION, CIRCULARLY POLARIZED HIGH POWER:

For use by two or more FM stations spread not more than 4 MHz apart.

JWCP-1B	1-bay, 0.47 gain, 30 kW	3,320.00
JWCP-2B	2-bay, 1.0 gain, 40 kW	6,045.00
JWCP-3B	3-bay, 1.6 gain, 50 kW	8,935.00
JWCP-4B	4-bay, 2.1 gain, 60 kW	13,055.00
JWCP-5B	5-bay, 2.7 gain, 80 kW	17,015.00
JWCP-6B	6-bay, 3.3 gain, 80 kW	18,565.00
JWCP-7B	7-bay, 3.9 gain, 80 kW	20,865.00
JWCP-8B	8-bay, 4.5 gain, 80 kW	21,830.00
JWCP-10B	10-bay, 5.7 gain, 80 kW	25,415.00
JWCP-12B	12-bay, 6.7 gain, 80 kW	26,750.00
JWSP-1SB	1-bay, standby antenna, pole mounted, 30 kW, 6 1/4" brass pipe, 6 1/2" input.	3,745.00

ANTENNA TYPE	TOWER MOUNT	POLE MOUNT
JSCP, JHCP, JWCP, JLCP,	1,500.00	1,000.00

BEAM, TILT, NULL FILL

JSCP, JHCP, JWCP	Beam tilt, any amount, each complete antenna.	500.00
JSCP, JHCP, JWCP	First null fill, any percentage, each complete antenna	500.00
JSCP, JHCP, JWCP	Both null fill and beam tilt, each complete antenna	750.00
JLCP	Beam tilt	400.00
JLCP	Null fill	400.00
JLCP	Both null fill and beam tilt	600.00

DEICING, RADOMES

JSCP	Deicers, per bay	325.00
JWCP, JHCP	Deicers, per bay	495.00
JLCP	Deicers, per bay	300.00
JSCP	Deicer control, 2-temperature, 6 or more bays (J125)	450.00
JSCP	Deicer control, 2-temperature, 1-5 bays (J110)	200.00
JWCP, JHCP	Deicer control, per antenna (J125)	450.00
JLCP	Deicer control, single step (J11)	150.00
JSCP	Radomes, per bay	550.00
JWCP, JHCP	Radomes, per bay	850.00
JLCP	Radomes, per bay	450.00

FCC DIRECTIONAL ANTENNAS

All Models On Application

FIELD ANTENNA SERVICE

All Models On Application

SPECIAL ANTENNA MOUNTING BRACKETS

JSCP, JHCP, JWCP, JLCP	Special brackets for poles, face mounting, or tapered towers, per bay	150.00
---------------------------------	---	--------

FM DIPLEXERS (MULTIPLEXERS)

JFMND- 10B	Ten kilowatts	18,000.00
JFMND- 25A	Twenty-five kilowatts	22,000.00
JFMND- 50A	Fifty kilowatts	24,000.00
JFMND- 80A	Eighty kilowatts	28,000.00
JFMND- 100A	One-hundred kilowatts	32,000.00

COMBINERS: 3dB TRANSMITTER COUPLERS

JDDC- 618FM	50 kW coupler (two 25 kW transmitters): 10" body, 3 1/8" ports, 6 1/8" output	4,650.00
JDDC- 318FM	25 kW coupler (two 10 or 12.5 kW transmitters): 6" body, 3 1/8" ports, output	3,250.00
JDDC- 158FM	10 kW coupler (two 5 kW transmitters): 3 1/8" body, 1 1/8" ports, output	2,350.00

HARMONIC FILTERS

JF-1-FM	1.8 kW, 1 1/8" input & output EIA flanges	600.00
JF-5-FM	7.5 kW, 1 1/8" input & output EIA flanges	990.00
JF-10-FM	12.0 kW, 3 1/8" input & output EIA flanges	1,100.00
JF-25-FM	25.0 kW, 3 1/8" input & output, EIA flanges	1,650.00
JF-50-FM	50.0 kW, 6 1/8" input & output EIA flanges	1,990.00

ISOCOUPERS

JIC-158	Up to 10 kW, 50 ohms, 1 1/8" in- & out	1,295.00
JIC-318L	10 to 25.0 kW, 50 ohms, 3 1/8" in- & out	2,295.00
JIC-318H	25 to 50 kW, 50 ohms, 3 1/8" in- & out	OnApplication

AM TOWER COUPLING AND SAMPLING EQUIPMENT

ATU-1	One kilowatt tuning unit	1,000.00
ATU-5	Five kilowatt tuning unit	1,350.00
ATU-10	Ten kilowatt tuning unit	1,800.00
ATU-20, -50, -100	Twenty, fifty, 100 kilowatt tuning units	OnApplication
LC-2J	Lighting Choke, two wire	125.00
LC-3J	Lighting Choke, three wire	160.00
JPS-1	Phase Sampling Transformer, 0-50A	300.00
JPS-2	Phase Sampling Transformer, 0-75A	300.00
JPS-3	Phase Sampling Transformer, 0-25A	300.00
JSL-G	Sampling Loop, grounded to tower	150.00
JSL-I	Sampling Loop insulated from tower	185.00
CRC-I	Compensated Rectifier Circuit for JPS	195.00



Our policy is one of continual improvement in design and manufacture, and therefore we reserve the right to change prices, specifications and design without notice.

Prices and options listed herein supersede all previously issued prices and options.

CETEC CORPORATION is an EQUAL OPPORTUNITY EMPLOYER.



1110 Mark Avenue
Carpinteria, California, 93013
Telephone: (805) 684-7686

The Cetec JSCP Series B FM broadcast antenna
True circular polarization, excellent VSWR bandwidth
help make it a standard for the broadcast industry

- **Excellent Performance for Stereo, SCA and Quadraphonic Broadcasting**
- **Excellent VSWR Bandwidth**
- **Rugged Mechanical Construction and Mounting**
- **True Circular Polarization**
- **Two-Year Material and Workmanship Warranty**
- **Factory-Tuned on a "Customer" Structure**
- **Many Custom Options Available**

The Cetec B Series JSCP antenna is an improved version of a circularly polarized FM broadcast antenna that has become one of the industry standards. Each bay consists of a radiating element with associated 1 $\frac{1}{8}$ inch (41.3 mm) flange, and both element and line are bolted to the mounting bracket for that bay. The interbay feed lines are joined by 3 $\frac{1}{8}$ inch flanges, using silver-plated inner conductor connectors for maximum contact life and minimum power loss.

The patented radiating element consists of four quarter-wave arms attached to a support boom, which also contains the element feed. A tuning cap, incorporating a large-radius tip, is supplied on each arm, which eliminates corona while facilitating field tuning, even to a slightly different operating frequency. The antenna system is fabricated of heavy gauge marine brass and copper throughout. The interbay line and element boom are pressurized up to the feed point by the transmission line pressurization system, with a pressure relief valve at the top of the antenna to allow pressurization system purging without the necessity of access to the top of the antenna.

Power Rating

The JSCP is conservatively rated at 10KW per bay up to four bays, with a 40KW maximum rating for five bays and above.

VSWR Rating

The JSCP antenna has excellent VSWR bandwidth. To assure lowest VSWR, each antenna is completely assembled and tuned at the factory on a structure similar to that of the customer. The antenna must meet a VSWR of 1.1:1 or better \pm 200 KHz of carrier before it leaves the factory. Under the normal conditions the antenna will not require field tuning to maintain the factory VSWR specification because of this factory tuning.

PAT NO. 3,541,570

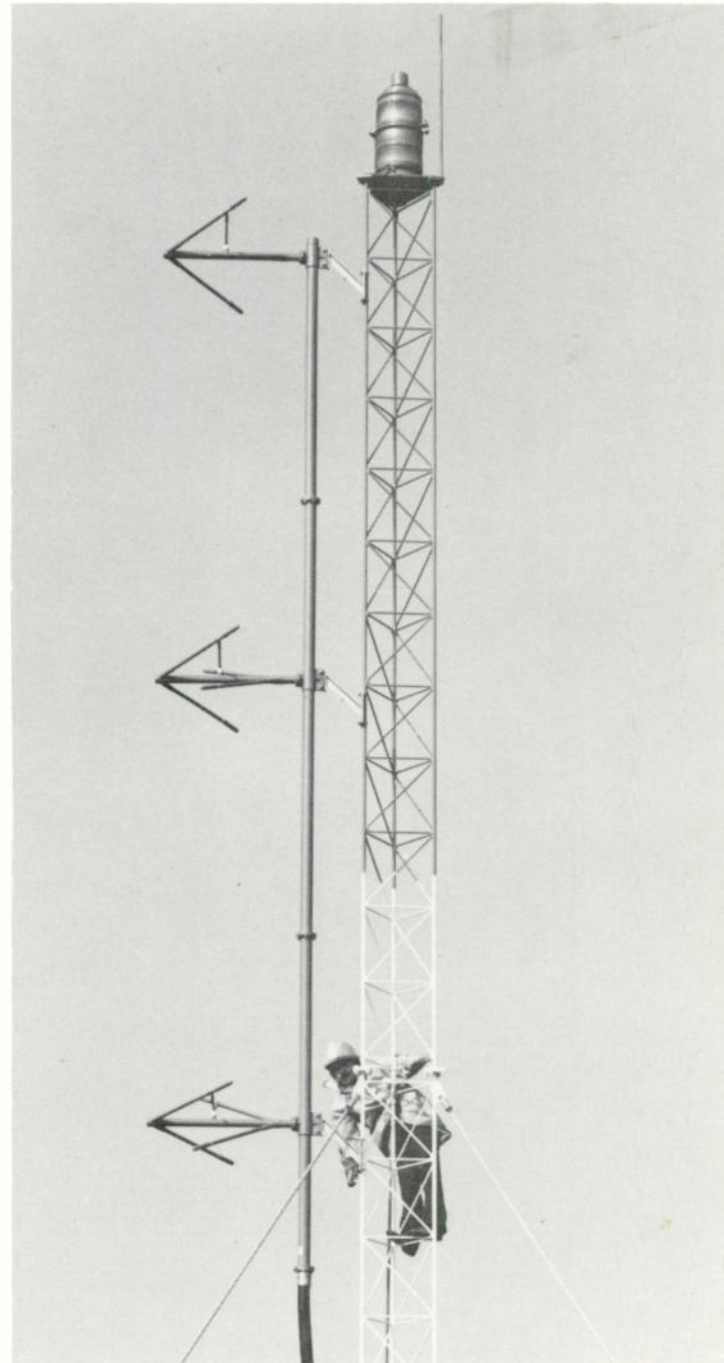

Cetec JSCP Series B FM Broadcast Antenna

Stereo, SCA and Quadraphonic Operation

The JSCP antenna provides excellent performance for stereo, SCA and quadraphonic operation due to its wide VSWR bandwidth. The antenna provides a relatively flat, non-reactive load to the transmitter, keeping crosstalk between the main and subcarrier channels to a minimum. Since the antenna load is flat throughout the significant FM sideband frequencies, this antenna does not significantly contribute to synchronous AM noise.

Antenna Mounting

The JSCP antenna is supplied with standard galvanized brackets for round-leg mounting on uniform face towers.

Special galvanized brackets can be supplied at additional cost for mounting the JSCP on tapered towers, on poles, or for tower-face mounting. All hardware is included with mounting brackets. Custom antenna support poles can be supplied. Contact factory for pricing.

Radiation Pattern

The circularity of the JSCP element is ± 1.0 dB in free space. The azimuth pattern will tend to be distorted somewhat by the structure on which the antenna is mounted. Circularity on a steel pole is typically ± 1.2 dB, with circularity on an 18 inch (0.46m) face tower typically ± 1.9 dB, and on a 42 inch (1.07m) face tower typically ± 4.8 dB. Cetec Antenna Pattern Measurement Service is available to insure that there are no azimuth pattern nulls at the broadcaster's desired service area.

Beam Tilt and Null Fill

The JSCP antenna is optionally available with custom beam tilt and/or null fill to satisfy the requirements of the

customer and consulting engineer, in order to optimize radiation toward the desired service area. Power gain figures at the horizontal plane will be affected by beam tilt or null fill; details supplied upon request.

Deicing

Electrical deicing equipment is available for the JSCP in installations where windloading from radomes would exceed the capabilities of the support structure or where icing occurs infrequently. The deicing system consists of a stainless steel sheathed high reliability heater element in each arm, plus the boom, providing a total of 500 watts of heating with 240 volts 50/60 hz applied. The system can be operated at one quarter power on 120 volts under light icing conditions in order to conserve electricity. The deicing system includes heaters, bay junction boxes and flexible interbay cable.

An optional precision thermostat system is available for use with the JSCP deicers. The thermostat turns on the heaters only over the temperature range of 32° to 20° F (0° to - 7°C), which is the range over which most icing occurs. The deicing control is intended to be connected directly to the heaters. If inductive loads, such as isolation transformers or coils, are to be used in the deicing line, contact the factory before ordering.

Radomes

Radomes are recommended for the JSCP antenna in environments where regular icing and sleet conditions prevail, in order to preserve the antenna's excellent VSWR specifications. The electrically transparent radomes completely enclose the radiating elements, attaching to both

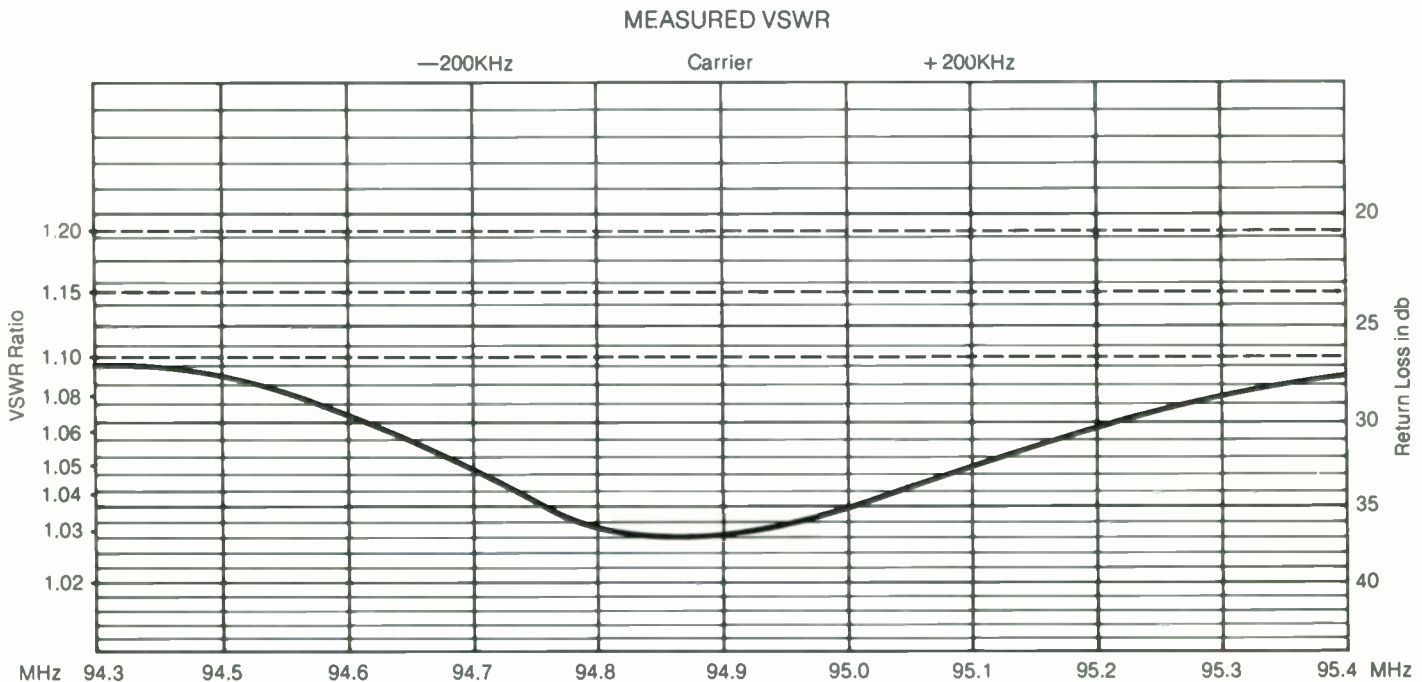

Typical Measured VSWR Plot of Four Bay JSCP-4 Antenna (KSAN-FM, Metromedia, Inc. Station, San Francisco, CA)

ends of a JSCP element specially designed for maximum strength and minimum windload.

Directional Antennas

Custom Directional antenna patterns are available to meet FCC requirements, or for use in countries where such directional antennas are readily useable. Nulls may be produced depending on protection requirements of azimuth heading and null depth. Full-scale antenna range testing and pattern certification are offered for directional antennas. Specific details for special requirements available upon request.

Tower Space Requirement and Antenna Input

Tower space requirement in feet for the JSCP antenna array

is equal to $\left(\frac{984}{\text{frequency in mhz}} \right) (\text{Number of bays} - 1)$.

Tower space requirement in meters for the JSCP antenna array is equal to $\left(\frac{300}{\text{frequency in mhz}} \right) (\text{number of bays} - 1)$.

The input connector location and size for the JSCP is:

- One bay: at the bay itself (1 $\frac{1}{8}$ inch (41.3mm) EIA male)
- Two through five bays: Three feet (0.91m) below the bottom bay (3 $\frac{1}{8}$ inch (79.4mm) EIA female)
- Six through eight bays: Eight feet (2.44m) below the lowest bay (3 $\frac{1}{8}$ inch (79.4mm) EIA female)
- Nine through fourteen bays: Thirteen feet (3.96m) below array center (3 $\frac{1}{8}$ inch (79.4mm) EIA female)

Two Year Warranty

A limited warranty is offered on the JSCP antenna to the original purchaser of the antenna. The warranty covers defects in material and workmanship for a period of 24 months after the date of delivery of the antenna.

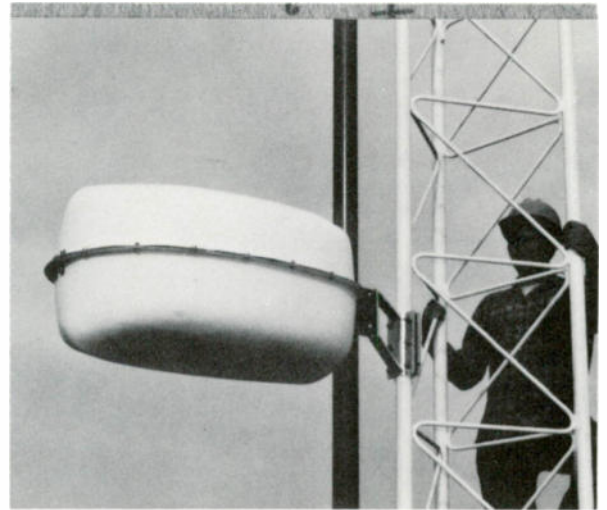

The JSCP electrically transparent radome encloses the specially designed radiating element.

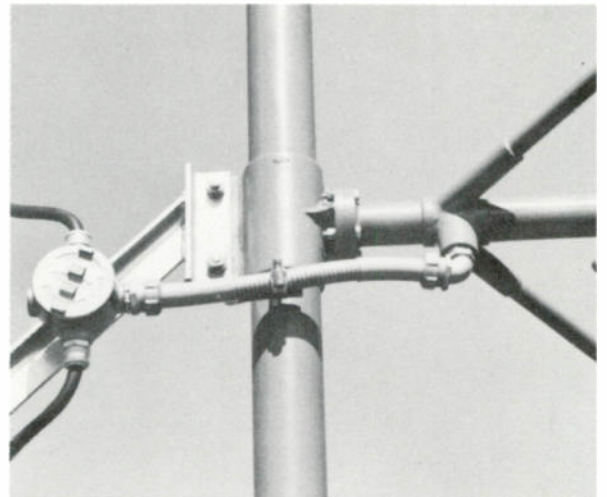

Deicer assembly insures maximum environmental protection.



Rigger assembling JSCP antenna. Antenna assembly is quick and simple via EIA flanges, with the antenna bolted directly to the mounting bracket for maximum rigidity.

Cetec JSCP Series B FM Broadcast Antennas

Type No. —Bays	Power Gain Ratio	Gain In dB	Field Gain	FS @ 1 Mile 1 KW, MV/M	Safe Power Rating	Input Feed Point	Net Weight With Mounting Brackets		Windloads At 50/33PSF (112 mph/180 kmh) With Mounting Brackets	
							lbs.	kg	lbs.	kg
JSCP-1 with deicers with radomes	0.46	-3.37	0.678	93.2	10KW	End	25 lbs.	(11. kg)	48 lbs.	(21.7 kg)
							34 lbs.	(15.4 kg)	57 lbs.	(25.9 kg)
							55 lbs.	(24.9 kkg)	128 lbs.	(58.1 kg)
JSCP-2 with deicers with radomes	1.0	0.0	1.0	137.6	20KW	End	125 lbs.	(56.7 kg)	195 lbs.	(88.5 kg)
							143 lbs.	(64.9 kg)	219 lbs.	99.3 kg)
							185 lbs.	(83.9 kg)	355 lbs.	(161.0 kg)
JSCP-3 with deicers with radomes	1.5	1.76	1.23	168.4	30KW	End	199 lbs.	(90.3 kg)	320 lbs.	(145.1 kg)
							225 lbs.	(102.0 kg)	368 lbs.	(166.9 kg)
							289 lbs.	(131.1 kg)	560 lbs.	(254.0 kg)
JSCP-4 with deicers with radomes	2.1	3.22	1.45	199.2	40KW	End	274 lbs.	(124.3 kg)	443 lbs.	(200.9 kg)
							308 lbs.	(139.7 kg)	516 lbs.	(234.1 kg)
							394 lbs.	(178.7 kg)	763 lbs.	(346.1 kg)
JSCP-5 with deicers with radomes	2.7	4.31	1.64	225.2	40KW	End	350 lbs.	(158.8 kg)	568 lbs.	(257.6 kg)
							393 lbs.	(178.3 kg)	664 lbs.	(301.2 kg)
							500 lbs.	(226.8 kg)	968 lbs.	(439.1 kg)
JSCP-6 with deicers with radomes	3.2	5.05	1.79	246.0	40KW	End	498 lbs.	(225.9 kg)	730 lbs.	(331.1 kg)
							506 lbs.	(229.5 kg)	851 lbs.	(386.0 kg)
							678 lbs.	(307.5 kg)	1210 lbs.	(548.8 kg)
JSCP-7 with deicers with radomes	3.8	5.80	1.95	268.0	40KW	End	532 lbs.	(241.3 kg)	854 lbs.	(387.4 kg)
							591 lbs.	(268.1 kg)	999 lbs.	(453.1 kg)
							742 lbs.	(336.6 kg)	1414 lbs.	(641.4 kg)
JSCP-8 with deicers with radomes	4.3	6.34	2.07	285.2	40KW	End	609 lbs.	(276.2 kg)	979 lbs.	(444.1 kg)
							677 lbs.	(307.1 kg)	1148 lbs.	(520.7 kg)
							849 lbs.	(385.1 kg)	1619 lbs.	(734.4 kg)
JSCP-9 with deicers with radomes	4.9	6.90	2.21	303.8	40KW	Center	713 lbs.	(323.4 kg)	1122 lbs.	(508.9 kg)
							796 lbs.	(361.0 kg)	1316 lbs.	(596.9 kg)
							1025 lbs.	(464.9 kg)	1842 lbs.	(835.5 kg)
JSCP-10 with deicers with radomes	5.5	7.40	2.35	322.4	40KW	Center	774 lbs.	(351.1 kg)	1265 lbs.	(573.8 kg)
							859 lbs.	(389.6 kg)	1483 lbs.	(672.7 kg)
							1074 lbs.	(487.2 kg)	2065 lbs.	(936.7 kg)
JSCP-11 with deicers with radomes	6.0	7.78	2.45	336.8	40KW	Center	868 lbs.	(393.7 kg)	1388 lbs.	(629.5 kg)
							969 lbs.	(439.5 kg)	1632 lbs.	(740.3 kg)
							1240 lbs.	(562.4 kg)	2270 lbs.	(1029.6 kg)
JSCP-12 with deicers with radomes	6.6	8.20	2.57	353.2	40KW	Center	929 lbs.	(421.4 kg)	1514 lbs.	(686.7 kg)
							1032 lbs.	(468.1 kg)	1780 lbs.	(807.4 kg)
							1289 lbs.	(584.7 kg)	2475 lbs.	(1122.6 kg)
JSCP-14 with deicers with radomes	7.8	8.92	2.79	383.5	40KW	Center	1051 lbs.	(476.7 kg)	1760 lbs.	(798.3 kg)
							1158 lbs.	(525.2 kg)	2077 lbs.	(942.1 kg)
							1473 lbs.	(668.1 kg)	2885 lbs.	(1308.6 kg)

Cetec Antennas

Antenna division of Cetec Corporation

6939 Power Inn Road, P.O. Box 28425, Sacramento, CA 95828 (916) 383-1177 Telex: 377321

Cetec Antennas Pattern Optimization Service



MEASURED PATTERNS BEFORE AND AFTER CORRECTION SERVICE

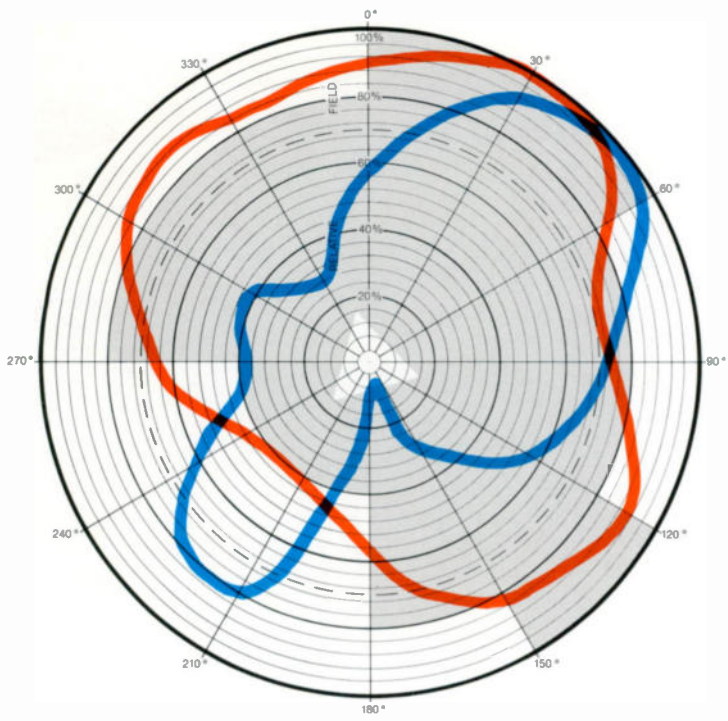

FIG. 1 FREQUENCY = 101.5MHZ TOWER = 42 INCH TRIANGULAR ORIGINAL CIRCULARITY = ± 10.97 DB ANTENNA FACE MOUNTED AFTER ADJUSTMENT, CIRCULARITY = ± 3.97 DB

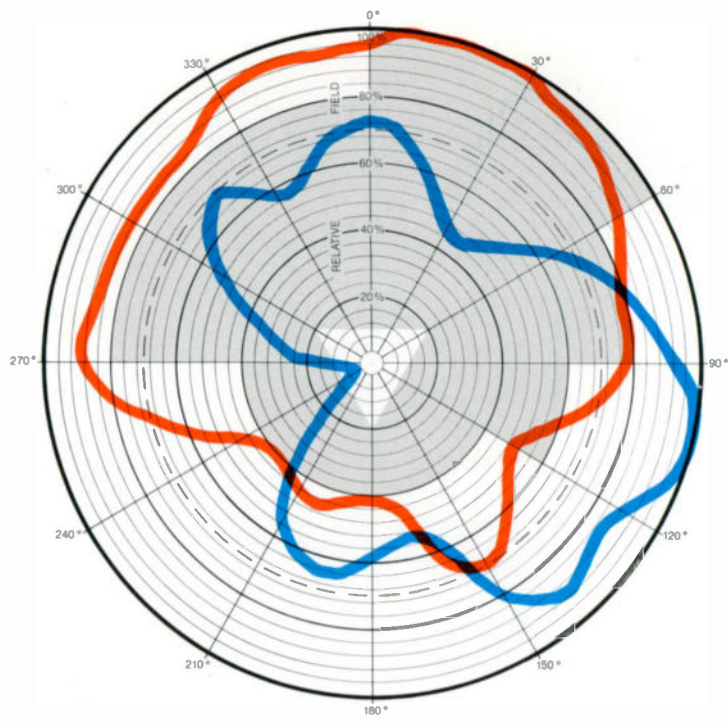

FIG. 2 FREQUENCY = 98.7MHZ TOWER = 5 FEET TRIANGULAR ORIGINAL CIRCULARITY = ± 10.00 DB ANTENNA LEG MOUNTED AFTER ADJUSTMENT, CIRCULARITY = ± 3.87 DB

LEGEND GRAY SCREEN— Broadcasters Desired Coverage

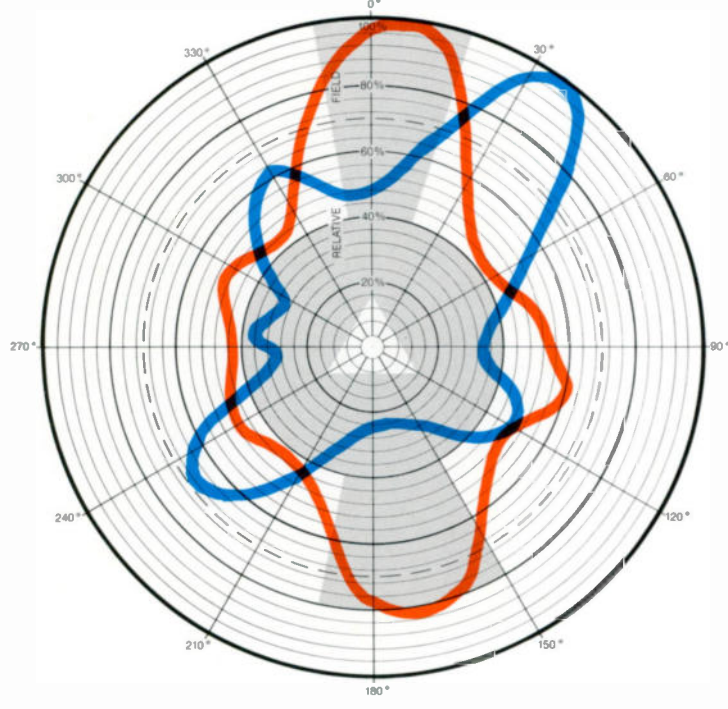

FIG. 3 FREQUENCY = 92.5MHZ TOWER = 5 FEET TRIANGULAR ORIGINAL CIRCULARITY = ± 7.45 DB ANTENNA FACE MOUNTED AFTER ADJUSTMENT, CIRCULARITY = ± 3.77 DB

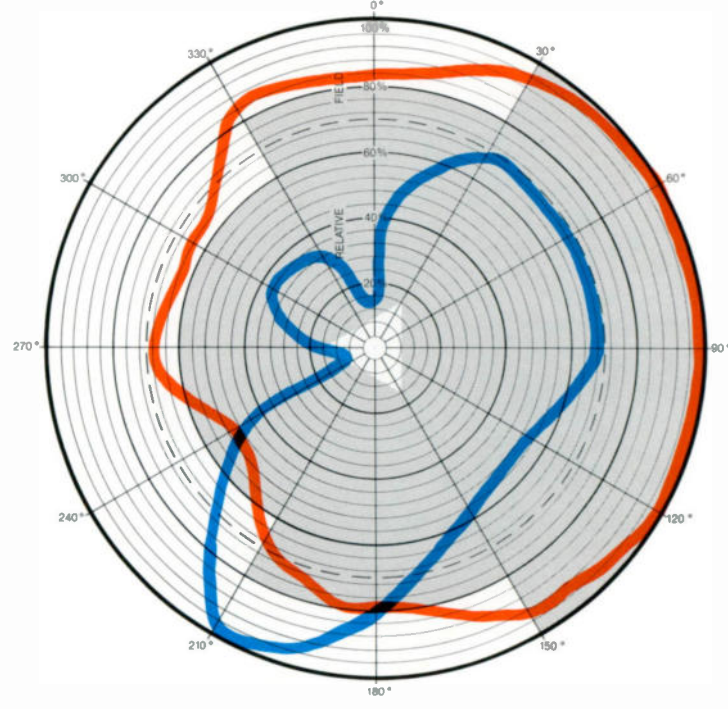

FIG. 4 FREQUENCY = 102.5MHZ TOWER = 42 INCH TRIANGULAR ORIGINAL CIRCULARITY = ± 10.55 DB ANTENNA LEG MOUNTED AFTER ADJUSTMENT, CIRCULARITY = ± 3.09 DB

These measured patterns were taken from the CETEC production files, during antenna pattern correction service. They are typical of what can be expected when FM antennas are arbitrarily mounted on the leg or face of common size towers. The measured patterns resulting from "best guess" types of mounting, without any pattern correction, are shown in BLUE. The shaded areas indicate the minimum field strengths desired by the broadcaster. The RED contour shows the measured field strength after the tower mounted antenna was pattern corrected with parasitic elements, mounted around the tower.

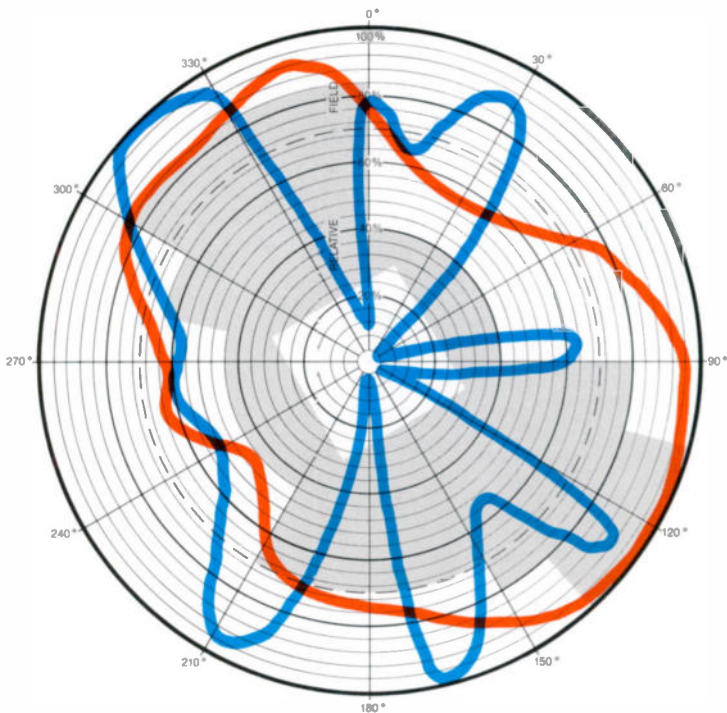

FIG. 5 FREQUENCY = 100.3 MHz TOWER = 5 FEET SQUARE
 ORIGINAL CIRCULARITY = $\pm 13.98\text{DB}$ ANTENNA LEG MOUNTED
 AFTER ADJUSTMENT, CIRCULARITY = $\pm 3.90\text{DB}$

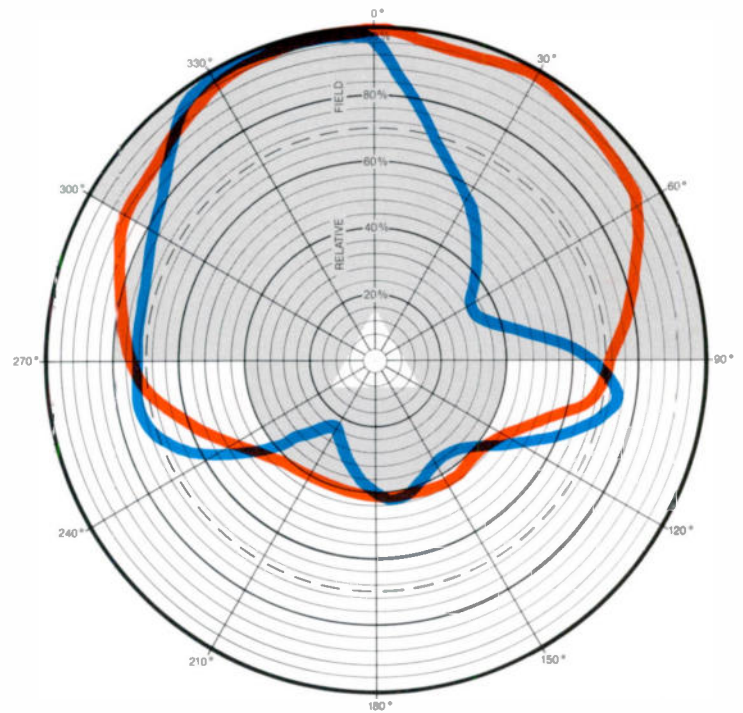

FIG. 6 FREQUENCY = 94.7 MHz TOWER = 30 INCH TRIANGULAR
 ORIGINAL CIRCULARITY = $\pm 6.58\text{DB}$ ANTENNA FACE MOUNTED
 AFTER ADJUSTMENT, CIRCULARITY = $\pm 3.95\text{DB}$

BLUE—Originally Measured Pattern RED—Corrected Final Pattern

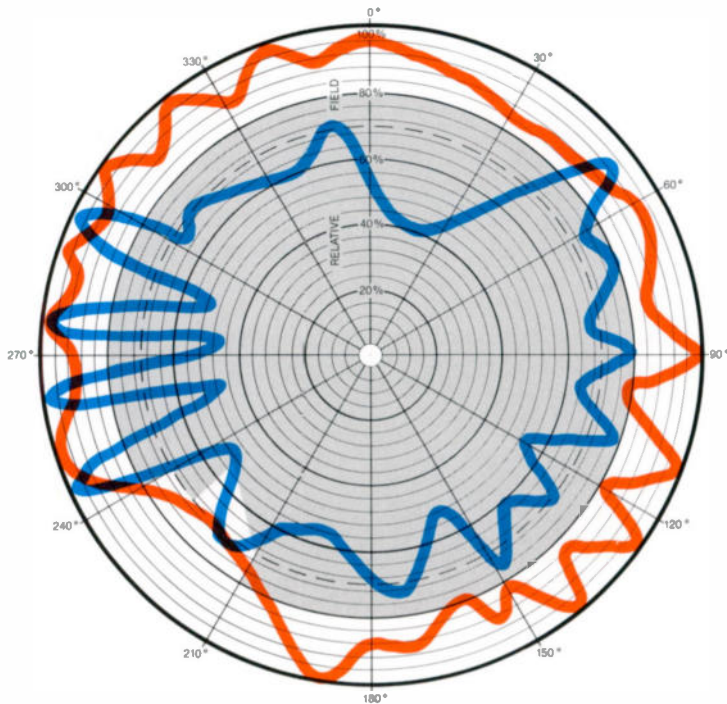

FIG. 7 FREQUENCY = 98.1 MHz TOWER = 6-14 INCH POLE
 ORIGINAL CIRCULARITY = $\pm 3.87\text{DB}$ ANTENNA SIDE MOUNTED
 AFTER ADJUSTMENT, CIRCULARITY = $\pm 1.42\text{DB}$

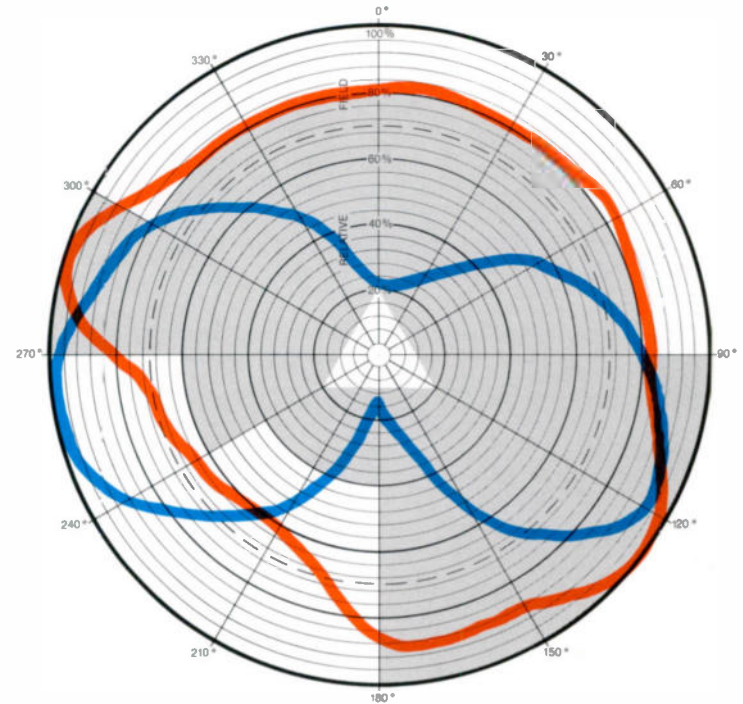

FIG. 8 FREQUENCY = 105.3 MHz TOWER = 24 INCH TRIANGULAR
 ORIGINAL CIRCULARITY = $\pm 8.54\text{DB}$ ANTENNA FACE MOUNTED
 AFTER ADJUSTMENT, CIRCULARITY = $\pm 3.98\text{DB}$

Pattern distortion is caused by the tower legs, horizontal and diagonal bracing, lighting conduits, coax lines, size and shape of the tower section, and other factors. Nulls as deep as 35DB have been measured. (three hundreds of 1% power!) 20DB nulls are quite common (1% power). Only by actual azimuth pattern measurements, on the operating frequency, on the tower, or a replica of it, can the field pattern be determined accurately. Mounting the antenna on the side of the tower or pole nearest the service area does not guarantee best results. Nulls may be pointed at the heart of the service area.

MEASURED PATTERNS BEFORE AND AFTER CORRECTION SERVICE

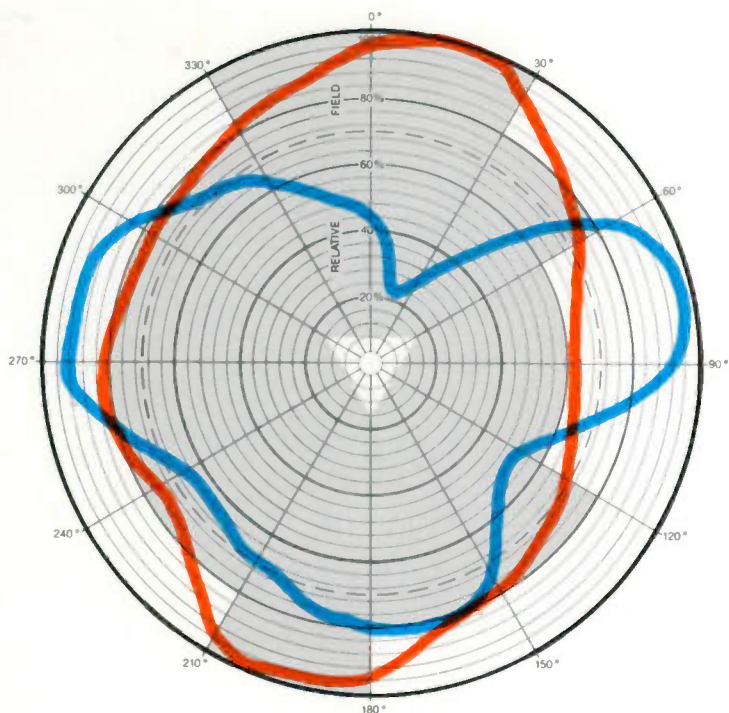

FIG. 9 FREQUENCY = 99.7MHZ TOWER = 18 INCH TRIANGULAR
ORIGINAL CIRCULARITY = $\pm 6.58\text{DB}$ ANTENNA LEG MOUNTED
AFTER ADJUSTMENT, CIRCULARITY = $\pm 2.08\text{DB}$

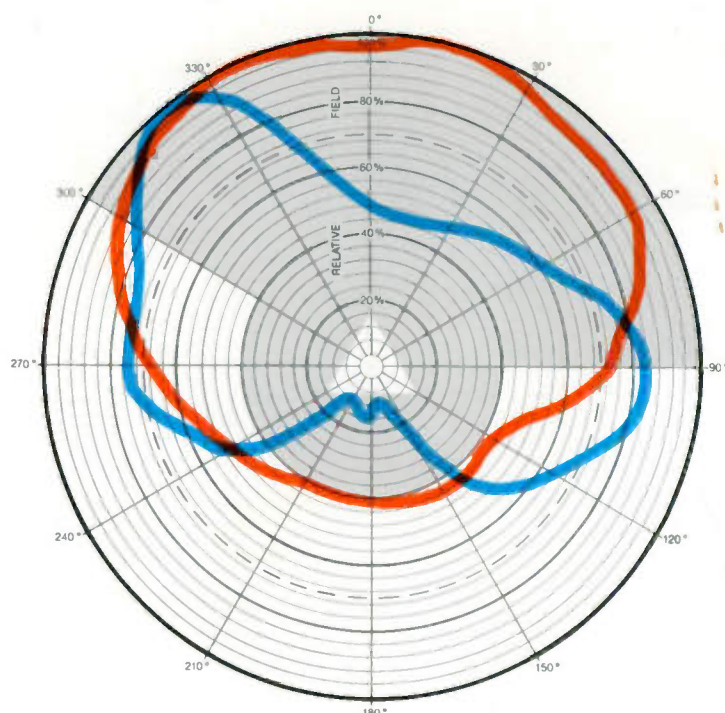

FIG. 10 FREQUENCY = 94.5MHZ TOWER = 7 FEET TRIANGULAR
ORIGINAL CIRCULARITY = $\pm 10.48\text{DB}$ ANTENNA LEG MOUNTED
AFTER ADJUSTMENT, CIRCULARITY = $\pm 3.75\text{DB}$

Cetec Antennas Pattern Optimization Service is used to improve the circularity of side-mounted Cetec FM antennas while repositioning the azimuth pattern null(s) to a heading that will be least detrimental to potential coverage.

The Cetec Antennas all-weather test range, located in the Sacramento Valley, is used for pattern measurement. One or more antenna bays are placed on an exact duplicate of the proposed antenna mounting structure for measurement, and parasitic elements are used to adjust the azimuth pattern in the horizontal polarization. Antenna positioning relative to the mounting structure is used to adjust the vertically polarized azimuth pattern. The parasitic elements are fabricated of steel and then hot dip galvanized for long life. Customized installation drawings are provided for ease of installation in the field. As a large number of variables, including number of antenna bays, mounting structure configuration and size, and orientation of the mounting structure relative to desired radiation directions, pricing for Pattern Optimization is on a custom basis.

Pricing may be obtained through Cetec Antennas who will request the pertinent pattern, antenna and structural information. Cetec Antennas stocks a number of standard mounting towers; where necessary, pricing will include any required tower duplication charges for proper testing.

PAT NO. 3,541,570



Antenna division of Cetec Corporation

6939 Power Inn Road, P.O. Box 28425, Sacramento, CA 95828 (916) 383-1177 Telex: 377321