



# HEATH June Flyer

There was no May Flyer. In fact the eight page April issue took so long to print, it was not mailed until the middle of May.

Last winter, we asked what kits were most desired. The answer overwhelmingly was a small convenient volt-ohmmeter--many of you sent suggestions for making it. The result is the Heathkit Handitester--more convenience

than ever offered in a hand type instrument--beautiful modern styled Bakelite case--conveniently located hearing aid type ohms adjust control placed right under your thumb--complete AC and DC voltage ranges to 5,000 volts and the usual Heath accuracy assured by 1% ceramic precision resistors--high quality dual half wave AC rectifier--but read all about it below.

**NEW**

## Heathkit HANDI-TESTER KIT

MORE FEATURES THAN EVER BEFORE

Beautiful streamline Bakelite case.  
AC and DC ranges to 5,000 Volts.  
1% Precision ceramic resistors.  
Convenient thumb type adjust control.  
400 Microampere meter movement.

Quality Bradley AC rectifier.  
Multiplying type ohms ranges.  
All the convenient ranges 10-30-300-1,000-5,000 Volts.  
Large quality 3" built-in meter.

The instrument all of you designed--the ranges you requested--beauty you'll enjoy for years and you can assemble it in a matter of minutes--an instrument for everyone. The handiest quality volt-ohmmeter of all. Small enough to put in your pocket yet a full 3" meter. Easy pictorial wiring diagrams eliminate all assembly problems. Uses only 1% precision ceramic divider resistors and wire wound shunts. Twelve different ranges. AC and DC ranges of 10-30-300-1,000-5,000 Volts. Ohms ranges of 0-3,000 ohms and 0-300,000 ohms. Milliampere ranges of 10 MA and 100 MA. Hearing aid type ohms adjust control fits conveniently under thumb for one hand adjustment. Banana type jacks for positive low resistance connections. Quality test leads included. The high quality Bradley instrument rectifier was especially chosen for linear scales on AC. The modern case was styled by Harrah Engineering for this instrument. The 400 microampere meter movement comes already mounted in the case protected from dust during assembly. An ideal classroom assembly instrument useful for a lifetime. Perfect for radio service calls, electricians, garage mechanics, students, amateurs and beginners in radio. The only quality volt-ohmmeter under \$20.00. An hour of assembly saves you one-half the cost and quality parts give you a better instrument. Order today. Shipping Wt. 2 lbs.



**\$13.50**



Note  
HANDY  
OHMS  
ADJUST

## NEW Heathkit FM TUNER KIT



**\$14.75**

An excellent way to get acquainted with F.M. This little super regenerative F.M. converter outperforms the big tuners. Amazing sensitivity. Easy to build as all coils and tuning condenser are wound and adjusted. Only the assembly and

wiring necessary. Like all Heathkits, it is 110 Volt 60 cycle transformer operated. Has 2 gang tuning condenser, slide rule calibrated dial, two tubes; complete instructions including pictorial makes assembly easy and pleasant. Assemble these tuners for your neighbors at a profit. Shipping Wt. 5 lbs.

Beautiful mahogany cabinet, extra.....\$3.75

## Heathkit HIGH FIDELITY PUSH PULL AMPLIFIER KIT

**\$14.95**

Amazing quality  $\pm 1\frac{1}{2}$  db. response between 20 cycles and 17,000 cycles achieved by phase inverter and push-pull circuit together with high quality Chicago Transformer cased output transformer. Husky RCA cased power transformer. Has pre-amplifier stage, approximately 14 watts output. Uses 6BL7 and 1619 (military type 2 $\frac{1}{2}$  Volt 6L6's). The price is made possible by use of high grade army surplus parts. Complete with four tubes, punched chassis and all parts (speaker extra). Has tone control. Shipping Wt. 20 lbs.

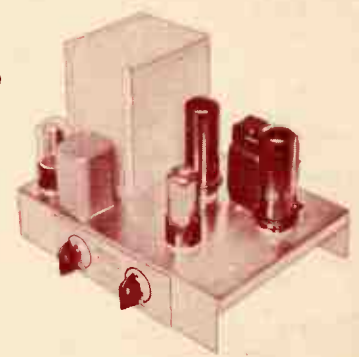

# Heathkit SIGNAL TRACER & UNIVERSAL TEST SPEAKER KIT

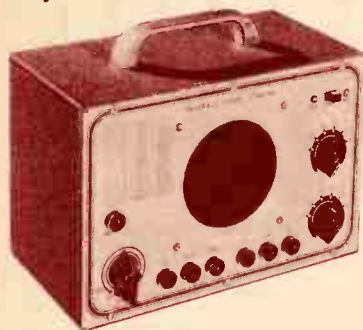

The popular Heathkit Signal Tracer has now been combined with a universal test speaker at no increase in price. The same high quality tracer follows signal from antenna to speaker--locates intermittents--defective parts quicker--saves valuable service time--gives greater income per service hour. Works equally well on broadcast, FM or TV receivers. The test speaker has assortment of switching ranges to match push-pull or single output impedance. Also tests microphones, pickups, PA systems. Comes complete--cabinet--110V. 60 cycle power transformer--tubes--test probe--all parts and detailed instructions for assembly and use. Shipping Wt. 8 lbs.

**\$19.50**

# Heathkit CONDENSER CHECKER KIT



Checks all types of condensers, paper-mica-electrolytic-ceramic over a range of .00001 MFD to 1,000 MFD. All on readable scales that are read direct from the panel. NO CHARTS OR MULTIPLIERS NECESSARY. A condenser checker anyone can read without a college education. A leakage test and polarizing voltage for 20 to 500 volts provided. Measures power factor of electrolytics between 0% and 50%. 110V. 60 cycle transformer operated complete with rectifier and magic eye tubes, cabinet, calibrated panel, test leads and all other parts. Clear detailed instructions for assembly and use. Why guess at the quality and capacity of a condenser when you can know for less than a twenty dollar bill. Shipping Wt. 7 lbs.

**\$19.50**

# Heathkit TELEVISION ALIGNMENT GENERATOR KIT

A television alignment generator within the price range of all. With every feature: Calibrated sweep width to 30 Mc.--main variable oscillator covers 0-110 Mc. and 165 to 220 Mc. in three bands--absorption marker for accurate identification of trace positions between 19 and 43 Mc.--10,000 to 1 step attenuator--mechanical driven inductive sweep for steady solid trace with variable phase control for single trace--AM modulation for trap and R.F. work. Every part supplied--110V transformer--tubes--all coils wound and calibrated--all test leads--complete instruction manual. Several large television institutes have adopted Heathkit T.V. generators as standard for their schools--manufacturers are using them in production lines--get yours now and be ready to handle T.V. service calls. Shipping Wt. 20 lbs.

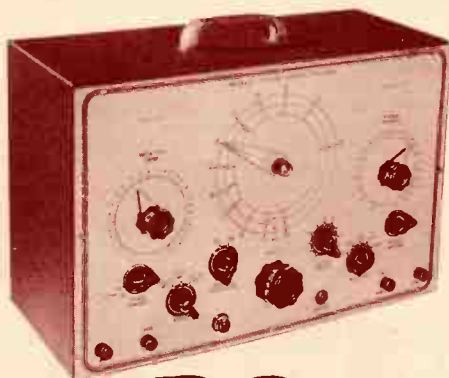

*Nothing ELSE TO BUY*

**\$39.50**

# INCREASING GAIN OF SCOPE AMPLIFIER

Several suggestions have been received from customers for increasing gain of Heathkit scopes as shown below. Both substitute a 6AC7 tube for the 6SJ7 in the amplifiers. The first increases the gain for audio purposes to .06 volt RMS per inch. The second is better for overall band width response and has a sensitivity of .25 volt RMS per inch. All parts not identified same as original.

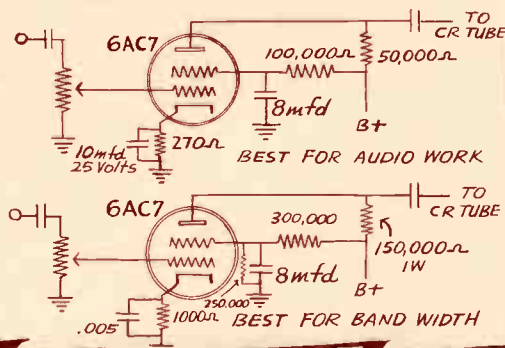

# Heathkit VACUUM TUBE VOLTMETER KIT

A new model V2 Heathkit VTVM with new 200 microampere meter, four additional ranges. New model has greater sensitivity and accuracy--still the highest quality features--shatterproof plastic full view meter face, push-pull electronic voltmeter circuit, linear scales--db. scales--11 megohm input resistance on DC--AC uses electronic rectification with 6H6 tube. All these features and still the amazing price of only \$24.50. Comes complete with cabinet--panel--three tubes--new Mallory switches--test prods and leads--1/2 ceramic divider resistors and all other parts. Shipping Wt. 8 lbs.



**\$24.50**

**R.F. PROBE KIT**  
NO. 309 R.F. Probe Kit uses 1N34 crystal to measure R.F. voltages with Heathkit VTVM. Will measure accurately to 100 Mc. and give good indication to 250 Mc. Reads on regular DC scales. Shipping Wt. 1 lb. \$6.50

**H.V. PROBE KIT**  
No. 310 Converts any Heathkit (or other 11 meg input) VTVM into a kilovoltmeter. Highly insulated 1% accuracy multipliers. Reads 3,000 V. on 300 V. scale and 10,000 V. on 1,000 V. scale--a necessity for television. Wt. 1 lb. \$4.50

# Heathkit 5" OSCILLOSCOPE KIT

The Heathkit Oscilloscope incorporates the best of parts. Power transformer with proper electrostatic shield built by Chicago Transformer Corp., Mallory switches, Centralab controls, Kenrad tubes--all the best. The scope itself has all the features. Instant switching direct to the CR tube plates--instant switching to external synchronization--instant switching to sweep generator or horizontal input--source of test voltage on front panel--sensitivity of 1/2 volt per inch deflection--good frequency response. And it is complete, aluminum cabinet, 2 color panel, all tubes, transformers, condensers, everything including instruction manual for assembly and use. Has sweep generator covering 15 cycles to 30,000 cycles--vertical and horizontal amplifiers--high and low voltage rectifiers. An oscilloscope provides endless sources of experimentation in radio, electronics, medicine and scientific research. Better get one. Shipping Wt. 24 lbs.

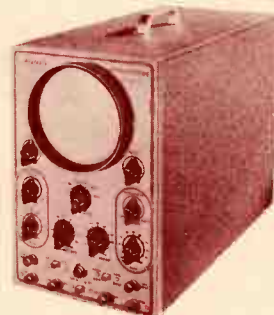

**\$39.50**

# Heathkit SIGNAL GENERATOR KIT

## \$19.50

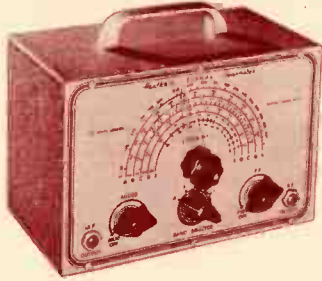

This RF Signal Generator Kit is rapidly becoming our most popular kit. Calibrated from 150 Kc. to over 100 Mc. with fundamentals to 34 Mc., it is adequate for every service need. An exceptionally complete assembly and use manual makes it a lot of fun to build and

no one needs to resort to slipshod methods of alignment when a quality Signal Generator Kit is available for less than a twenty dollar bill. The audio modulation is supplied by a relaxation type oscillator which also supplies a saw-tooth audio voltage for amplifier testing. The coils used are precision wound and factory calibrated eliminating the need for adjusting each band. The kit is complete with large calibrated scales on two color panel, grey crackle cabinet, 110V. 60 cycle power transformer, precision coils, test leads, tubes and all other parts. Shipping Wt. 8 lbs.

# Heathkit SINE & SQUARE WAVE AUDIO GENERATOR KIT

## \$34.50

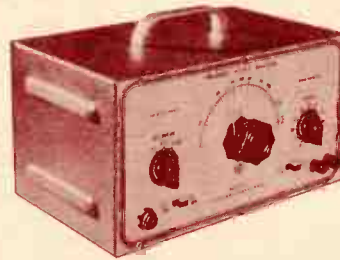

Experimenters and servicemen working with a square wave for the first time invariably wonder why it was not introduced before. The characteristics of an amplifier can be determined in seconds compared to several hours of tedious plotting using older methods. Stage by stage, amplifier testing is as easy as signal tracing. The low distortion (less than 1%) and linear output (± 1 db.) make this Heathkit equal or superior to factory built equipment selling for three or four times its price. The circuit is the popular RC tuning circuit using a four gang variable condenser. Three ranges 20-200, 200-2,000, 2,000-20,000 cycles are provided by selector switch. Either sine or square waves instantly available at slide switch. All components are of highest quality, cased 110V. 60 cycle power transformer. Mallory F.P. filter condensers, 5 tubes, calibrated 2 color panel, grey crackle aluminum cabinet. The detailed instructions make assembly an interesting and instructive few hours. Shipping Wt. 13 lbs.

# Heathkit BATTERY ELIMINATOR KIT

## \$22.50



Now a bench 6 Volt power supply kit for all auto radio testing. Supplies 5-7½ Volts at 10 Amperes continuous or 15 Amperes intermittent. A well filtered rugged power supply uses heavy duty selenium rectifier, choke input filter with 4,000 MFD of electrolytic filter. 0-15 Volt meter indicates output. Output variable in eight steps. Excellent for demonstrating auto radios. Ideal for servicing--can be lowered to find sticky vibrators or stepped up to equivalent of generator overload--easily constructed in less than two hours. Complete in every respect. Shipping Wt. 18 lbs.

# Heathkit ELECTRONIC SWITCH KIT

"Doubles the Utility  
of any Scope"

## \$34.50



An electronic switch used with any oscilloscope provides two separately controllable traces on the screen. Each trace is controlled independently and the position of the traces may be varied. The input and output traces of an amplifier may be observed one beside the other or one directly over the other illustrating perfectly any change occurring in the amplifier. Distortion, phase shift and other defects show up instantly, 110 Volt 60 cycle transformer operated. Uses 5 tubes (1 6X5, 2 6SN7's, 2 6SJ7's). Has individual gain controls, positioning control and coarse and fine sweeping rate controls. The cabinet and panel match all other Heathkits. Every part supplied including detailed instructions for assembly and use. Shipping Wt. 11 lbs.

**ORDER!**  
*Blank*

TO HEATH COMPANY  
BENTON HARBOR,  
MICHIGAN

FROM \_\_\_\_\_

Ship via \_\_\_\_\_

- \_\_\_\_\_ Parcel Post
- \_\_\_\_\_ Express
- \_\_\_\_\_ Freight
- \_\_\_\_\_ Best Way

ITEM	PRICE
_____ Heathkit Handi-Tester Kit _____	_____
_____ Heathkit FM Tuner Kit _____	_____
_____ Heathkit Amplifier Kit _____	_____
_____ Heathkit Signal Tracer Kit _____	_____
_____ Heathkit T.V. Alignment Gen. Kit _____	_____
_____ Heathkit VTVM Kit _____	_____
_____ Heathkit R.F. Probe Kit _____	_____
_____ Heathkit H.V. Probe Kit _____	_____
_____ Heathkit Condenser Checker Kit _____	_____
_____ Heathkit 5" Oscilloscope Kit _____	_____
_____ Heathkit Signal Generator Kit _____	_____

QUANTITY	ITEM	PRICE
_____	Heathkit Battery Eliminator Kit _____	_____
_____	Heathkit Audio Generator Kit _____	_____
_____	Heathkit Electronic Switch Kit _____	_____
_____	Heathkit Tube Checker Kit _____	_____
_____	Heathkit Impedance Bridge Kit _____	_____
_____	Heathkit All Wave Radio Kit _____	_____
_____	_____	_____
_____	_____	_____
_____	_____	_____

Enclosed find  Check  Money Order for \_\_\_\_\_

Please ship C.O.D.  Postage enclosed for \_\_\_\_\_ pounds.

# Heathkit TUBE CHECKER KIT

1. Has gear driven roller chart.
2. Has lever switching for speed.
3. Checks every tube element.
4. Large size--11"x14"x4" overall.
5. Checks new 9 pin miniatures.
6. Measures each element individually.
7. Complete range of filament voltages.
8. Uses beautiful shatter-proof full view meter.
9. Uses latest type lever switches.

Check the features and you will realize that this Heathkit has all the features you want. Speed--simplicity--beauty--protection against obsolescence. The most modern type of tester--measures each element--beautiful Bad-Good scale, high quality meter--the best of parts--rugged oversize 110V. 60 cycle power transformer--finest of Mallory switches--Centralab controls--quality wood cabinet--complete set of sockets for all type tubes including spare blank for future types--fast action gear driven roller chart uses brass gears to quickly locate and set up any type tube. Simplified switching cuts necessary time to minimum and saves valuable service time. Short and open element check. No matter what arrangement of tube elements, the Heathkit flexible switching arrangement easily handles it. Order your Heathkit Tube Checker today. See for yourself that Heath again saves you two-thirds and yet retains all the quality--this tube checker will pay for itself in a few weeks--better build it now. Complete with detailed instructions--all parts--cabinet--roller chart--ready to wire up and operate. Shipping Wt. 15 lbs.

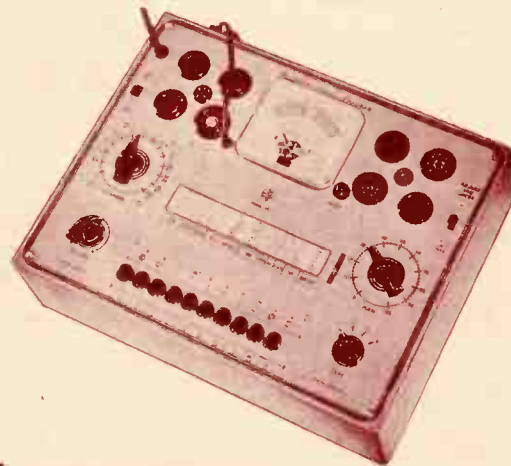

**\$29.50**

*Nothing ELSE TO BUY*

# Heathkit IMPEDANCE BRIDGE KIT

- \*Measures inductance from 10 microhenries to 100 henries.
- \*Capacitance from .00001 MFD to 100 MFD.
- \*Resistance from .01 ohm to 10 megohms.
- \*Dissipation factor from .001 to 1.
- \*"Q" from 1 to 1000.

An impedance bridge for everyone--the most useful instrument of all, which heretofore has been out of the price range of serious experimenters and service shops. Now at the lowest price possible. All highest quality parts. General Radio main calibrated control. General Radio 1000 cycle hummer. Mallory ceramic switches with 60 degree indexing--200 microamp zero center galvanometer-- $\frac{1}{2}$  of 1% ceramic non-inductive decade resistors. Professional type binding posts with standard  $\frac{3}{4}$ " centers. Beautiful birch cabinet. Directly calibrated "Q" and dissipation factor scales. Ready calibrated capacity and inductance standards of Silver Mica, accurate to  $\frac{1}{2}$  of 1% and with dissipation factors of less than 30 parts in one million. Provisions on panel for external generator and detector. Measure all your unknowns the way laboratories do--with a bridge for accuracy and speed.

Internal 6 volt battery for resistance and hummer operation. Circuit utilizes Wheatstone, Hay and Maxwell circuits for different measurements. Supplied complete with every quality part--all calibrations completed and instruction manual for assembly and use. Deliveries are limited. Shipping Wt. approximately 15 lbs.

**\$69.50**



# Heathkit 3-TUBE ALL-WAVE RADIO KIT



**\$8.75**

CABINET EXTRA

An ideal way to learn radio. This kit is complete, ready to assemble, with tubes and all other parts. Operates from 110V AC. Simple, clear detailed instructions make this a good radio training course. Covers regular broadcasts and short wave bands. Plug-in coils. Regenerative circuit. Operates loud speaker. Shipping Wt. 3 lbs.

ES30 Headphones.....per set \$1.00  
 $2\frac{1}{2}$ " Permanent Magnet Loudspeaker..... 1.95  
 Mahogany Cabinet..... 2.95

The HEATH COMPANY  
BENTON HARBOR, MICHIGAN

Sec. 562, P. L. & R.  
U. S. POSTAGE  
**1¢ Paid**  
Benton Harbor, Mich.  
Permit No. 273

POSTMASTER: Please notify sender on Form 3547 if not delivered for any reason.