



AMPLIFIERS
Pages A3-A50

CONTROL
Pages A101-A111

POWER SUPPLIES
Pages A201-A205

SHELVES AND CABINETS
Pages A301-A317

MICROPHONES & ACCESSORIES
Pages A401-A402

SPEAKERS & ACCESSORIES
Pages A501-A504

TRANSCRIPTION
Pages A601-A602

TRANSFORMERS
Pages A701-A705

AUXILIARY EQUIPMENT
Pages A801-A808

AUDIO

STUDIO & PORTABLE EQUIPMENT

DEFENSE ELECTRONICS DIVISION
TECHNICAL PRODUCTS OPERATION

GENERAL  ELECTRIC

SYRACUSE, NEW YORK



AMPLIFIERS

Broadcast Amplifiers, Ratings and Terminology	A3
Plug-in Uni-level Amplifier, Type BA-9-A	A7
Uni-level Amplifier, Type BA-9-B	A11
Transistor Cue, Talkback Amplifier, Type BA-28-A	A15
Audiomatic Limiting Amplifier, Type BA-7-A	A17
Transistor Monitor Amplifier, Type BA-24-A	A23
Transistor Monitor Amplifier, Type BA-34-A	A25
A-c Powered Program/Monitor Amplifier, Type BA-14-A	A29
Pre-amplifier, Type BA-20-A	A33
Transistor Pre-amplifier Module, Type BA-21-A	A35
Plug-in Pre-amplifier, Type BA-1-H	A37
Transistor Plug-in Pre-amplifier, Type BA-25-B	A39
Plug-in Program/Monitoring Amplifier, Type BA-12-C	A41
Transistor Program Amplifier, Type BA-22-A	A43
Plug-in Uni-level Pre-amplifier, Type BA-15-A	A45
Microphone Pre-amplifier, Type BA-30-A	A47
Equalized Monaural/Stereo Transcription Pre-amplifier, Type BA-23-A	A49

CONTROL

Transistorized Portable Amplifier, Type BA-26-A	A101
Transistorized Audio Console, Type BC-12-A	A105
Bridging Volume Control, Type FA-35-G	A111

POWER SUPPLIES

Plug-in Power Supply, Type BP-10-B	A201
Transistor Power Supply (25-volt), Type BP-20-A (Regulated)	A203
Transistor Power Supply (50/25-volt), Type BP-21-A (Regulated)	A205

SHELVES AND CABINETS

Broadcast Shelves, Types FA-23-B, FA-23-C, and FA-46-A	A301
Broadcast Shelf, Type FA-48-A1	A305
Cabinet Rack, Type PR-1-A and Accessory Items	A307
Control Console Base Cabinets, Types PR-16-B/C, PR-17-A	A313

MICROPHONES AND ACCESSORIES

Microphone Cable, Type FA-15-A, Plugs, Types FA-16-A, -B, and Receptacle, Type FA-16-C	A401
--	------

SPEAKERS AND ACCESSORIES

Monitoring and Wall Speakers, Types FS-1-B and FS-2-B	A501
Speakers, Types 850, 1201A, and 1203A	A503

TRANSCRIPTION

Transcription Equalizer, Type FA-12-B	A601
---	------

TRANSFORMERS

Line-to-Line Transformer, Type FA-40-B	A701
Bridging-to-Line Transformer, Type FA-41-C	A703
Line-to-Voice Coil Transformer, Type FA-42-A	A705

AUXILIARY EQUIPMENT

Interconnecting Cables, Types FA-19-J, FA-19-M, and FA-19-R	A801
Equalizer Panel, Type FA-14-A	A803
Equalizer Unit, Type FA-14-B	A804
Program Level Indicator Panel, Type FA-1-A, Switch and Fuse Panel, Type FA-4-A	A805
Sound Effects Filter Panel, Type FA-18-A	A806
Jack Strip, Type FA-2-A	A807
Jack Panels, Types FA-3-A, FA-3-B, and FA-3-C, and Patch Cords, Types FA-7-A, FA-7-B, and FA-7-C	A808



General Electric broadcast amplifiers operate over a frequency range of at least 50 to 15,000 cycles and will deliver their full rated power throughout this range. The distortion and noise are reduced to values suitable for the most exacting service.

Much care has been taken in the design of these amplifiers to assure maximum reliability of operation as well as convenience for servicing.

The ratings given throughout this catalog use the following gain and level ratings:

db—refers to gain or loss

dbm—single-frequency, sine wave power referred to 1 milliwatt

$$(\text{dbm} = 10 \log \frac{P}{0.001})$$

VU—Program level as read on a standard VU meter. Since program material is of a complex and transient nature, the VU meter indicates a level considerably under the instantaneous peak program level. In practical usage the amplifier dbm rating should exceed the VU level to be transmitted by at least 10 db.

The chart showing "Characteristics of G-E Broadcast Audio Amplifiers" lists the General Electric name and uses for each amplifier.

The following uses are defined in EIA Standard TR-105B dated November 1949:

PRELIMINARY AMPLIFIER

A preliminary amplifier operates from a microphone or other low-level source. A preliminary amplifier amplifies the microphone output or other signal to a level that can be fed into a subsequent circuit without the signal-to-noise ratio being degraded.

BOOSTER AMPLIFIER

A booster amplifier is connected in the main-program line between the preliminary amplifier and the program amplifier.

PROGRAM AMPLIFIER

A program amplifier is connected in the main-program channel and is capable of delivering standard output level.*

BRIDGING AMPLIFIER

A bridging amplifier internal input impedance is such that it may be connected across a circuit without appreciably affecting the circuit performance in any respect. The bridging amplifier operates into program circuits or similar loads.

MONITORING AMPLIFIER

A monitoring amplifier is connected to a program circuit to provide a means of checking the program.

The term "Program Amplifier" is now used in place of the nonstandard term "Line Amplifier" or "Main Amplifier." The term "Bridging Amplifier" is now used in place of "Isolation Amplifier."

* +18 dbm to lines or +12 dbm to transmitters.

DISCUSSION OF GAIN RATINGS

UNLOADED-INPUT TRANSFORMER (40-db gain)

When the full generated voltage of a microphone, turntable pickup, or similar device is applied to the input terminals of the amplifier which it is feeding, the operating conditions are referred to as those of an unloaded-input transformer since no resistance loading of the transformer, either primary or secondary, is used. Under these conditions the highest signal-to-noise ratio of a microphone-amplifier combination is obtained because the amplifier does not load the microphone.

Operating with an unloaded-input transformer, as explained above, a typical pre-amplifier has a gain of 40 db. This gain is defined as the ratio of "power delivered to the load" to the "power which would be delivered to the load" if the pre-amplifier were replaced by an ideal transformer connected to match the load and source impedance. The gain is determined as follows: (See Fig. 1 for diagram.)

A source resistance (R_s) fed by an oscillator is connected to a load resistance (R_L) of equal value. The oscillator output is adjusted until the power dissipated in R_L is -40 dbm, as indicated by the power measuring instrument P_1 . The output voltage of the oscillator, as indicated by voltmeter V is recorded, R_L is then disconnected for R_s and the oscillator, and the pre-amplifier is connected in place of R_L . A tap on the input transformer of the amplifier is used which is equal to the value of R_s (150-ohm tap for 150-ohm R_s). The output of the oscillator, as indicated by voltmeter V , is held constant at the value previously recorded. The resulting output as indicated by P_2 which the amplifier will deliver to its proper load resistor R_o , is zero dbm.

Thus the gain of the amplifier is 40 db.

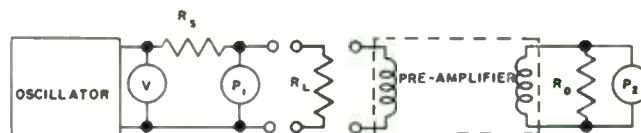

Fig. 1.

MATCHING INPUT (34-db gain)

When the input circuit of an amplifier constitutes a resistive load equal in value to the impedance of the source feeding it, the amplifier is said to have a matching input. Under these conditions the voltage at the terminals of the input transformer of the amplifier is only one half the voltage generated by the source. This constitutes a 6-db drop in the voltage input to the amplifier which effectively produces a 6-db decrease in amplifier gain as compared with the gain obtained with unloaded-input transformer operation. Thus, the gain of the amplifier with matching input is 34 db.

Broadcast Amplifiers

Ratings and Terminology

BRIDGING INPUT (10-db gain)

When an amplifier or similar low-impedance device is connected across a low-impedance line in such a way that only a small fraction of the energy in the line (insufficient to affect the operation of the line) is diverted into the amplifier, the amplifier is said to employ a bridging input. This is accomplished by stepping up the input impedance of the amplifier (to 10,000 or 20,000 ohms, for example) so that in connecting it across the low-impedance line (0-1000 ohms) it has negligible effect.

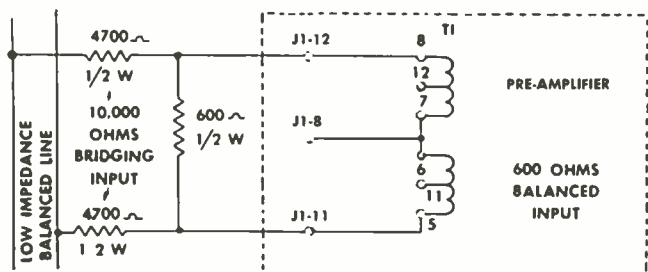

Fig. 2.

Figs. 2 and 3 show the circuits of resistive pads either of which, when connected to the 600-ohm input terminals of a typical pre-amplifier, converts the 600-ohm unloaded transformer input to a 10,000-ohm resistive-input impedance. With such a pad the amplifier may be "bridged" directly across a low-impedance line.

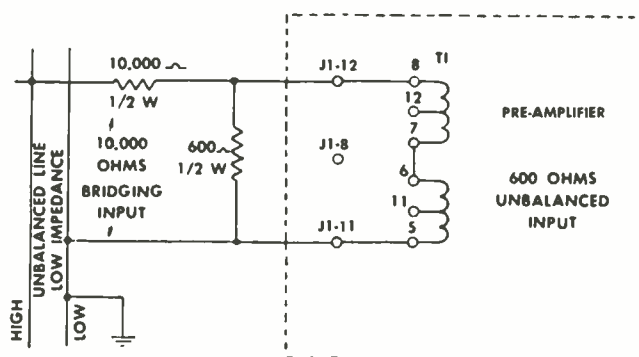
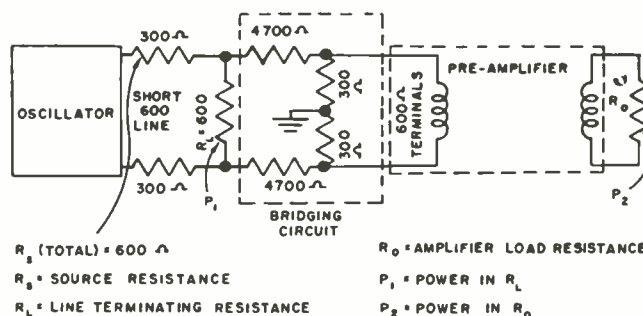

Fig. 3.

Used as a bridging amplifier, the pre-amplifier has a gain of 10 db, where the gain is defined as the ratio of the "power (P_1) in the 600-ohm line terminating resistance (R_L) to the output power (P_2) of the amplifier"; that is $GAIN (db) = \log P_2 \div P_1$. Fig. 4 shows the circuit employed in measuring gain with bridging input.



- R_L (TOTAL) = 600 Ω
- R_o = SOURCE RESISTANCE
- R_L = LINE TERMINATING RESISTANCE
- R_o = AMPLIFIER LOAD RESISTANCE
- P_1 = POWER IN R_L
- P_2 = POWER IN R_o

Fig. 4.

Broadcast Amplifiers

Ratings and Terminology

CHARACTERISTICS OF G-E BROADCAST AUDIO AMPLIFIERS

Type No. and Name	Use	Input (DBM)	Output (DB)	Gain (DB)	Source Impedance (Ohms)	Load Impedance (Ohms)	Self Contained Gain Control	Power Supply	Type of Mounting
BA-20-A Pre-amplifier (Plug-in)	Microphone Pre-amplifier Booster	-35 max 50 db gain -25 max 40 db gain	-10	40 or 50	50/150/250/600 Balanced or Unbalanced	600 Unbalanced	Interstage Gain control may be added	8 ma-25-v use BP-20-A or 25-v Section of BP-21-A	Plug-in fiber glass printed
BA-21-A	Microphone	-35 max 50 db gain -25 max 40 db gain	-10	40 or 50	50/150/250/600 Balanced or Unbalanced	600 Unbalanced	Gain control and mixer key included	8 ma-25-v use BP-20-A or 25-v Section of BP-21-A	Plug-in front panel module
BA-22-A Program Amplifier (Plug-in)	PGM Amplifier BD'G Amplifier I SO. Amplifier	-22 (matching)	+24	75	50/150/250/600 Balanced or Unbalanced	150/600 Balanced or Unbalanced	Accessory may be added	160 ma-50-v d-c use BP-21-A	Plug-in chassis
BA-23-A Equalized Stereo/Monaural Transcription Pre-amplifier	Two channel Transcription Pre-amplifier	High impedance Cartridge	-10	40 at 1000 CPS	High impedance	150/600 Balanced or Unbalanced	Self-contained	117 or 230 VAC 50/60 CPS Self- contained	T. T. Motor Board Mounting
BA-24-A Monitor Amplifier	Monitor or Distribution Amplifier	-25 max (matching)	+33	80	50/150/250/600 Balanced or Unbalanced	8/150/600 Balanced or Unbalanced	Accessory may be added	380 ma max -25-v use BP-20-A	Plug-in chassis
BA-25-A Pre-amplifier	Microphone Pre-amplifier Booster	-22 Max Matching	+18	46	50/150/250/600 Balanced or Unbalanced	150/600 Balanced or Unbalanced	Accessory may be added	18 ma-25-v use BP-20-A or 25-v Section of BP-21-A	Plug-in chassis
BA-26-A Portable Amplifier	Remote pick- ups. Auxiliary studio appli- cations	-25 max Lo-level inputs. 0 max hi-level input	+18 after 4 db pad	90	50/150/250/600 Balanced or Unbalanced	150/600 Balanced or Unbalanced	Four mic mixers, master, one hi- level set level control	95-135-v 50/60 cycles self-contained plus batteries	Enclosed in portable aluminum case
BA-28-A Cue/TB Amplifier	For cue, TB and Lo-level monitor applications	-22 max matching	+27	75	50/150/250/600 Balanced or Unbalanced	150/600 Balanced or Unbalanced	Accessory control may be added	160 ma-50-v d-c use BP-21-A	Plug-in chassis
BA-30-A Microphone Pre-amplifier	Microphone Pre-amplifier Mounted at Microphone	-14 max 20 DB Gain -24 max 30 DB Gain -34 max 40 DB Gain -50 max 56 DB Gain	+7	20 or 30 or 40 or 56	150 or 600 Unbalanced	150 or 600 Unbalanced	None	10 ma-15 to 25-v d-c 22-v battery or 25-v d-c supply	Mounts in MIC Line Between P3 Connectors
BA-34-A Monitor Amplifier	10 Watt Monitor Amplifier	-30 max Matching	+40	100	50/150/250/600 Balanced or Unbalanced	8/150/600 Balanced or Unbalanced	Gain control included	117 or 230 VAC 50/60 CPS self- contained regulated	Plug-in chassis

Broadcast Amplifiers

Ratings and Terminology

VOLUME LEVEL TO POWER AND VOLTAGE CONVERSION TABLE

Reference Level
0 dbm = 1 milliwatt, 600 ohms

Milliwatts	Volts	DBM
0.000001	0.0007746	-60
.000010	.002449	-50
.000100	.007746	-40
.001	.02449	-30
.010	.07746	-20
0.100	.2449	-10
1.000	.7746	0

Watts	Volts	DBM
0.001000	0.7746	0
.002512	1.228	+ 4
.006310	1.946	+ 8
.01000	2.449	+10
.1000	7.746	+20
1.000	24.49	+30
10.00	77.46	+40

RESISTIVE PADS

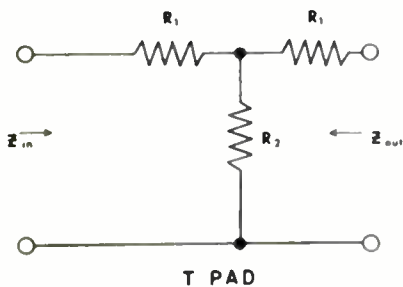

For impedances
other than 600 ohms,
multiply all resistors
by Factor $\frac{Z_x}{600}$

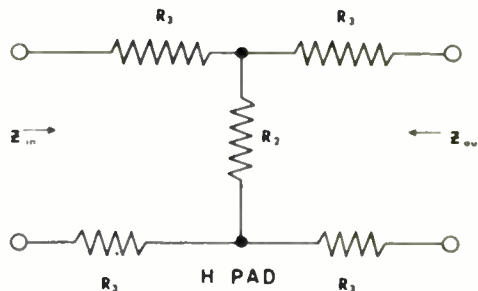

$Z_{in} = Z_{out} = 600 \text{ ohms}$

Loss in DB	EIA Resistor Values *			Loss in DB	EIA Resistor Values *		
	R ₁	R ₂	R ₃		R ₁	R ₂	R ₃
1/2	18	10000	8.2	16	430	200	220
1	36	5100	18	17	470	180	220
2	68	2700	36	18	470	150	240
3	100	1800	51	19	470	130	240
4	130	1200	68	20	510	120	240
5	160	1000	82	22	510	100	270
6	200	820	100	24	510	75	270
7	220	680	110	26	560	62	270
8	270	560	130	28	560	47	270
9	300	470	150	30	560	39	270
10	300	430	160	32	560	30	300
11	330	360	160	34	560	24	300
12	360	330	180	36	560	18	300
13	390	270	200	38	560	15	300
14	390	240	200	40	560	12	300
15	430	220	200				

* EIA resistor values nearest to the exact values are given.

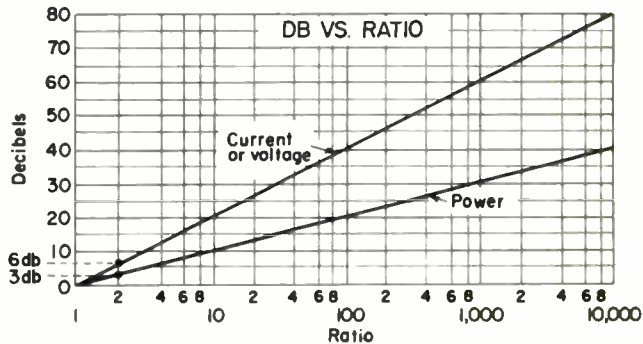
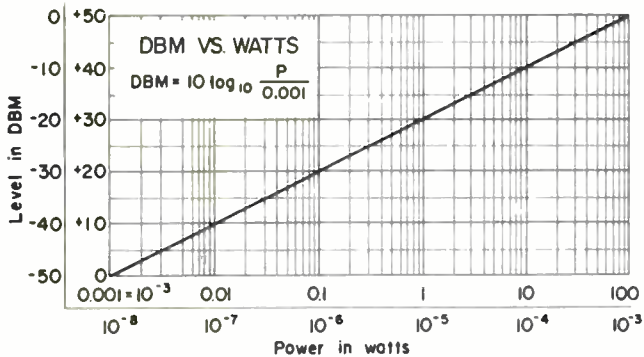

Plug-in Uni-level Amplifier

Type BA-9-A

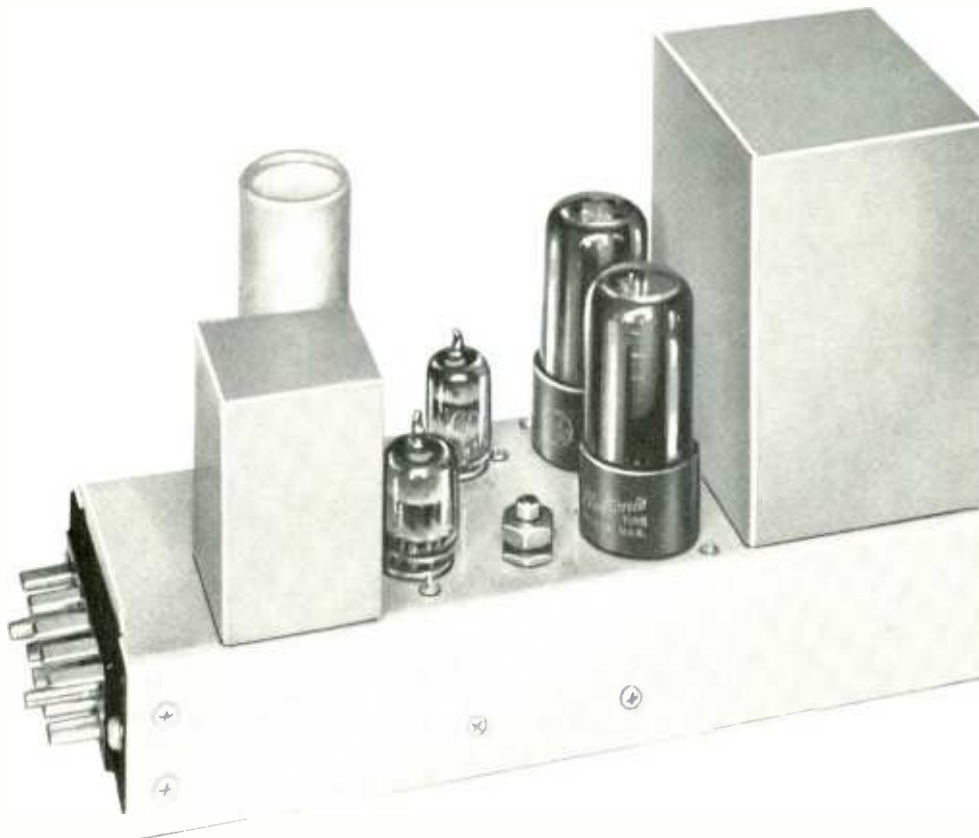

Plug-in uni-level amplifier, Type BA-9-A

FEATURES

● Versatile

Permits unattended remote audio operation

This amplifier used on an incoming remote line automatically controls level variations from an unattended remote amplifier. (See Fig. 3—Typical Applications)

Controls level differences between two or more program sources

Level differences automatically controlled between:

- (a) Turntables and/or projector outputs
- (b) Network incoming signal (when properly padded) and projectors, turntables, or announce mike pre-amp

May be used as a program line compressor

May be used as an automatic master gain control for program line

(See Fig. 1—Typical Applications)

May be used as a microwave input audio control

(See Fig. 4—Typical Applications)

May be used as an expander-compressor amplifier

With average program material set for 15 db of gain reduction, output will be compressed for incoming signals exceeding 15 db and expanded for signals below 15 db.

May be used as an automatic fader control

(See Fig. 2—Typical Applications)

May be used as a straight program amplifier with or without level control

Removal of one tube disables automatic level control and permits use as a normal program amplifier

● Physically and functionally interchangeable with Type BA-12-C plug-in program/monitor amplifier when used for program purposes

Can be used in Type BC-11-A audio console in place of the program amplifier to provide automatic master gain control for the console

● Small, compact, plug-in construction

- (a) Compact design permits four units to be mounted in seven inches of rack space
- (b) Plug-in construction speeds maintenance

● Used as a peak level control

Amplifier will operate over a 30 db range with only a 10 db change in output

● Used as an average level control device

Amplifier will operate over a 30 db range of input level with only a 10 db change in output level

● Variable threshold level

Amplifier will operate with the threshold level set at any output between +19 dbm and +30 dbm.

● Average program/dual recover switch

This switch permits use of amplifier as an average level control or as a peak level control

● Dual time constant eliminates program "pumping"

Recovery time is an automatic function of program material

Plug-in Uni-level Amplifier

Type BA-9-A

WHERE TO USE

The General Electric Type BA-9-A plug-in uni-level amplifier is an automatic level-control unit designed to automatically control variations in audio program level. This compact, plug-in unit replaces or may be used in addition to the Type BA-12-C plug-in program/monitoring amplifier when the latter is used as a program amplifier.

The Type BA-9-A uni-level amplifier may be used as an average level-control device or as a peak level-control amplifier.

Maximums of up to 30 db in program variations may be successfully controlled by this amplifier. Such variations are sometimes encountered when switching between the outputs of turntable pre-amps, projectors, or other sources. This amplifier may be used in any audio system where -34 dbm is available to its input.

DESCRIPTION

The Type BA-9-A plug-in uni-level amplifier is designed to replace the Type BA-12-C plug-in program/monitor amplifier when used as a program amplifier, and when features of automatic level-control are desired.

The Type BA-9-A amplifier, when operated at an output level of $+20$ dbm, supplies gain-control characteristics over a range of 30 db with a rise in output level of only 10 db. This is a 3:1 compression ratio. At $+30$ dbm output, the Type BA-9-A has a compression ratio over a 30 db range of 5:1.

The threshold control may be set for a range varying from 0 dbm at a compression ratio of 1.6:1, to $+30$ dbm at a compression ratio of 5:1. Recommended threshold level is $+20$ dbm with a resultant compression ratio of 3:1.

A switch is incorporated on the front of the amplifier which permits changes in attack and recovery time.

In the DOWN position of the switch, the amplifier has a dual recovery time—wherein the recovery time is an automatic function of the nature of the program material. For short, single peaks, approximately 0.9 seconds is required for 63 percent recovery of gain after the signal has dropped below the gain-reducing level. For sustained or rapidly recurring peaks, approximately 0.9 seconds is required for 40 percent of gain recovery, increasing automatically up to about 34 seconds for 90 percent of gain recovery. The typical attack time is approximately 11 milliseconds.

In the UP position of the switch, the amplifier is an average level-control device which will work on average levels of program material changes. In essence, single short peaks will not cause gain reduction, but sustained increases in over-all program level or rapidly reoccurring short peaks will cause automatic-gain reduction depending upon the over-all amplitude of the incoming signals. The typical attack time is approximately 62 milliseconds. The average recovery time is 13 seconds for 90 percent recovery.

These effects are accomplished by the use of a bias generator which in turn is composed of a full-wave rectifier circuit charging simple RC networks. The out-

put of the bias generator supplies a variable d-c bias to the control grids of a General Electric Type GL-6386 tube (a dual remote cutoff triode).

Gain reduction may be read on any standard VU meter. A third scale, in the form of a decal supplied with the amplifier, may be applied to the VU meter's face. By the use of a suitable switch connected between the VU meter multiplier and meter movement, gain reduction will be indicated over a 30 db range.

MECHANICAL SPECIFICATIONS

UNITS

One Type BA-9-A plug-in uni-level amplifier

DIMENSIONS

Depth: $10\frac{3}{4}$ inches

Height: $5\frac{3}{4}$ inches

Width: $3\frac{1}{2}$ inches

WEIGHT

6 lbs

MOUNTING

Four amplifiers may be mounted in one Type FA-23-B shelf which in turn mounts flush in the front of a standard EIA cabinet rack. Mounting height of the Type FA-23-B shelf (accessory) is seven inches (four rack units).

OPERATING CONDITIONS

Maximum ambient temperature: 113 F (45 C)

Maximum relative humidity: 95 percent

ELECTRICAL CONNECTIONS

POWER AND SIGNAL

Through Cinch-Jones 2400 series plug, plugging into female mate on Type FA-23-B shelf. Connections on plugs are solder terminal.

THRESHOLD BIAS VOLTAGE

Tip jacks

SAFETY PROVISIONS

No voltage applied to unit until plugged into mating source. No exposed voltages.

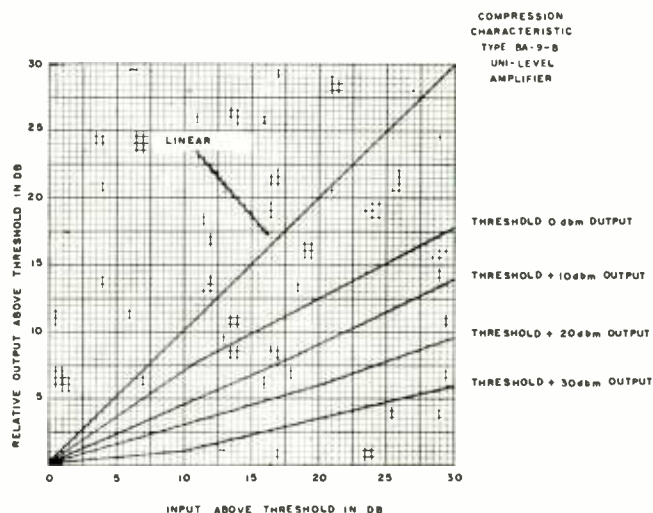

ELECTRICAL SPECIFICATIONS**CIRCUIT OPERATION**

Consists of a General Electric Type GL-6386 push-pull triode variable gain input stage supplying signal to a push-pull output stage utilizing two Type 6V6GT power tubes. The signal for the bias generator rectifier is supplied from the plates of the output stage. The bias generator uses a full wave rectifier Type 6AL5 whose output supplies a bias voltage to the control grids of the GL-6386 tube. A switch selects time constants so that either an average control of program material or a peak compression of program material is obtained.

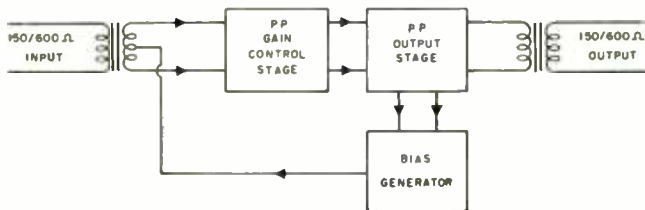

Simplified block diagram, plug-in uni-level amplifier, Type BA-9-A

PERFORMANCE**FREQUENCY RESPONSE**

+ or - 1 db, 50-15,000 cycles under any condition of gain reduction up to 30 db

GAIN

54 db

HARMONIC DISTORTION

(Threshold control set for +20 dbm output.) At any level up to 30 db of gain reduction, the total harmonic distortion between 100 and 15,000 cycles is 1½ percent or less; from 50 to 100 cycles the distortion rating is 2 percent or less.

OUTPUT NOISE

Less than -55 dbm

ATTACK TIME**Dual**

11 milliseconds

Average

62 milliseconds

RECOVERY TIME**(Dual)**

Single short peaks 0.9 seconds for 63 percent recovery
Sustained peaks 0.9 seconds for 40 percent recovery
34 seconds for 90 percent recovery

(Average)

13 seconds for 90 percent recovery

INPUTS**POWER**

Plate—300 volts d-c @ 77 milliamperes
Heater—6.3 volts a-c @ 1.55 amperes

SIGNALS

Threshold control @ 0 dbm output:
-54 dbm to -24 dbm input
Threshold control @ 20 dbm output:
-34 dbm to -4 dbm input
Threshold control @ 30 dbm output:
-24 dbm to +6 dbm input

INPUT IMPEDANCE

Unloaded transformer

SOURCE IMPEDANCE

150/600 ohms, shipped wired for 600 ohms. Balanced input.

OUTPUTS**SIGNAL**

150/600 ohms impedance, shipped wired for 600 ohms. Balanced output.
Threshold control @ 0 dbm:
0 dbm to +18 dbm output
Threshold control @ 20 dbm:
+20 dbm to +30 dbm output
Threshold control @ 30 dbm:
+30 dbm to +36 dbm output
(All signals below and up to threshold level, linearly amplified.)

TEST

Two tip jacks for threshold bias setting.

EXTERNAL VU METER (as Compressor meter)

Pins eight and nine on Cinch-Jones 2400 series plug.

EXTERNAL POWER SUPPLY

Type BP-10-B (Accessory).

CONTROLS

Threshold setting control.
Average program dual recovery switch.

TUBE COMPLEMENT

1—GL-6386
1—6AL5
2—6V6GT

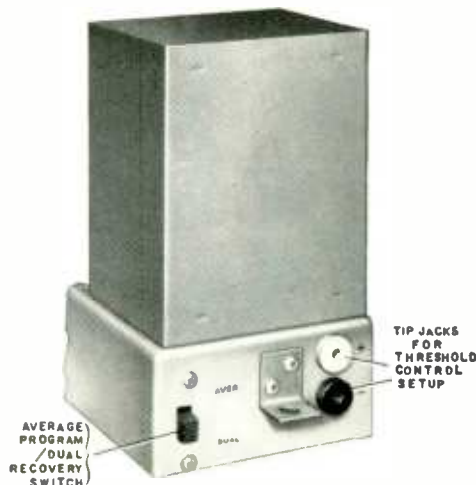

Tip jacks and switch, plug-in uni-level amplifier, Type BA-9-A

HOW TO ORDER

When ordering please specify:
Type BA-9-A plug-in uni-level amplifier. The type number includes the amplifier, one set of operating tubes, one gain reduction scale (decal) for applying to a standard 4-inch VU meter, and installation and operating instructions.

ACCESSORIES

1—Type FA-23-B shelf—for rack mounting four Type BA-9-A amplifiers
1—Type BP-10-B power supply
1—Type FA-46-A2 shelf for mounting four Type BA-9-A amplifiers in base cabinet
1—7774619P1 VU meter (for steel panels)
1—7774619P2 VU meter (for aluminum or non-magnetic panels)

Plug-in Uni-level Amplifier

Type BA-9-A

TYPICAL APPLICATIONS

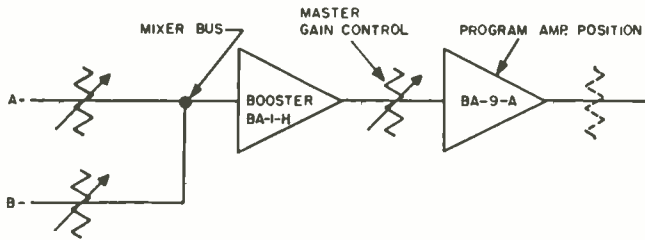

Fig. 1. The BA-9-A uni-level amplifier as an automatic level-control amplifier

The application of automatic level control to a studio system is outlined in Fig. 1.

The uni-level amplifier can be used to control level differences between two or more program sources, as a program line compressor, automatic master gain control, expander-compressor operation, or as a straight program amplifier.

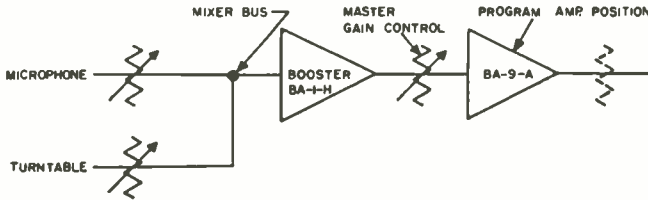

Fig. 2. Using the BA-9-A uni-level amplifier as an automatic fader control

The use of the "uni-level" amplifier as an automatic fader control is outlined in Fig. 2. In this application, the turntable signal level should be set so that it results in a GR scale reading of about two to three db of gain reduction. The microphone level at the mixer bus is set about 20 db higher than the turntable signal at the same point.

The microphone and turntable inputs can now be used together with no manual fading required. Whenever it is desired to use the microphone channel to

make an announcement, it is only necessary to talk into the microphone. The turntable will fade into the background and will be separated from the microphone announcement by 20 db.

The resultant increase in output signal level will be less than seven db, which can be easily handled by the transmitter limiting amplifier. Depending upon which position the AVER/DUAL switch is in will determine the speed with which the turntable level will return to normal.

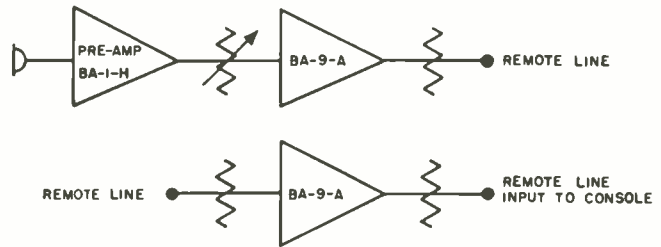

Fig. 3. Unattended remote operation

When it is desirable to operate the uni-level amplifier on unattended remote operations, either of the above single-line diagrams can be used. A typical setup would be to set levels so that what is considered a normal signal level causes about 15 db gain reduction. For a signal increase of ± 15 db line variations will be only 5 db.

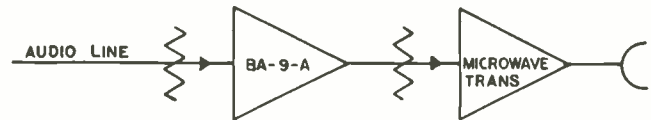
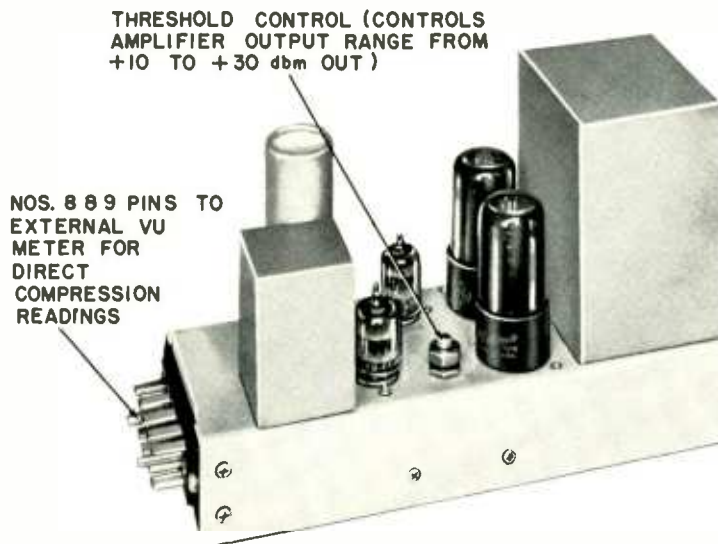

Fig. 4. Microwave relay application of the uni-level

The uni-level amplifier can be used to prevent excessive audio variations in an audio line feeding the audio input of a microwave system. Such an application is shown in Fig. 4.



Plug-pins and control, plug-in uni-level amplifier, Type BA-9-A

Uni-level Amplifier

Type BA-9-B



Uni-level amplifier, Type BA-9-B

FEATURES

- **A-c powered**
Requires only 110–125-volt a-c power for operation
- **Conserves rack space**
Will mount in any standard rack, utilizing only 3½-inch (2 RU) of vertical height
- **Versatile**
Permits unattended remote audio operation
This amplifier used on an incoming remote line automatically controls level variations from an unattended remote amplifier. (See Fig. 3—Typical Applications).
Controls level differences between two or more program sources
Level differences automatically controlled between:
 - (a) Turntables and/or projector outputs
 - (b) Network incoming signal (when properly padded) and projectors, turntables, or announce mike pre-amps
 May be used as a program line compressor
 May be used as an automatic master gain control for program line
 (See Fig. 1—Typical Applications)
 May be used as a microwave input audio control
 (See Fig. 4—Typical Applications)
 May be used as an expander-compressor amplifier
 With average program material set for 15 db of gain reduction, output will be compressed for incoming signals exceeding 15 db and expanded for signals below 15 db.
 May be used as an automatic fader control
 (See Fig. 2—Typical Applications)
 May be used as a straight program amplifier with or without level control
 Removal of one tube disables automatic level control and permits use as a normal program amplifier.

- **Functionally interchangeable with G-E Type BA-12-C plug-in program/monitor amplifier when used for program purposes**
- **Used as a peak level control**
Amplifier will operate over a 30 db range with only a 10 db change in output
- **Used as an average level control device**
Amplifier will operate over a 30 db range of input level with only a 10 db change in output level
- **Variable threshold level**
Amplifier will operate with the threshold level set at any output between +10 dbm and +30 dbm
- **Average program dual recovery**
Connection permits use of amplifier as an average level control or as a peak level control
- **Dual time constant eliminates program "pumping"**
Recovery time is an automatic function of program material
- **Easily serviced**
All components exposed for easy service when hinged-front panel is opened

WHERE TO USE

The General Electric Type BA-9-B uni-level amplifier is a rack-mounted, a-c powered version of the familiar and popular Type BA-9-A plug-in uni-level amplifier. It is intended for automatic level control applications in radio and TV stations, sound recording studios, and industrial and public address systems.

Radio and TV Stations

In radio and TV stations the amplifier may be used to control level differences between two or more medium level program sources, as a program-line compressor, as an automatic master gain control for program or remote line, for expander-compressor

Uni-level Amplifier

Type BA-9-B

operation (including automatic fading of music for voice-over-music announcements) or as a straight program amplifier.

Sound Recording Studios

In sound recording studios the amplifier may be used to control level differences between various voice or music signals, or as a compressor to be used prior to the recording amplifier.

Industrial or Public Address Systems

In industrial or public address systems, the uni-level amplifier may be used to eliminate "blasting" due to varying intensities of sound sources with consequent overloading of line or power amplifiers, as a compressor-expander to control and amplify weak or compress excessively strong input signals, or as a micro-wave audio input control.

Due to the unique design of the Type BA-9-B, this amplifier may be used as either an average level-control device or as a peak level-control amplifier.

Maximums of up to 30 db in program variations may be successfully controlled by this amplifier. It may be used in any audio system where -34 dbm is available to its input.

(See Typical Applications for detailed suggested use.)

DESCRIPTION

Essentially, the Type BA-9-B uni-level amplifier is the a-c powered, rack-mounted version of its plug-in counterpart, the Type BA-9-A uni-level amplifier. Other than its mounting and power supply, it is identical in performance and specification with the Type BA-9-A uni-level amplifier.

The Type BA-9-B uni-level amplifier is an automatic level-control device designed to functionally replace or supplement the Type BA-12-C program/monitor amplifier, when used as a program amplifier, or when features of automatic level-control are desired.

The Type BA-9-B amplifier, when operated at an output level of $+20$ dbm, supplies gain-control characteristics over a range of 30 db with a rise in output level of only 10 db. This is a 3:1 compression ratio. At $+30$ dbm output, the Type BA-9-B has a compression ratio over a 30 db range of 5:1.

The threshold control may be set for a range varying from 0 dbm at a compression ratio of 1.6:1, to $+30$ dbm at a compression ratio of 5:1. Recommended

threshold level is $+20$ dbm with a resultant compression ratio of 3:1.

A connection may be made in the amplifier which permits changes in attack and recovery time.

The unit as shipped is connected for dual recovery time—wherein the recovery time is an automatic function of the nature of the program material. For short, single peaks, approximately 0.9 second is required for 63 percent recovery of gain after the signal has dropped below the gain-reducing level. For sustained or rapidly recurring peaks, approximately 0.9 second is required for 40 percent of gain recovery, increasing automatically up to about 34 seconds for 90 percent of gain recovery. The typical attack time is approximately 11 milliseconds.

By strapping an adjacent terminal connection, the amplifier may be changed to an average level-control device which will work on average levels of program material changes. In essence, single short peaks will not cause gain reduction; but sustained increases in over-all program level or rapidly recurring short peaks will cause automatic-gain reduction depending upon the over-all amplitude of the incoming signals. The typical attack time is approximately 62 milliseconds. The average recovery time is 13 seconds for 90 percent recovery.

These effects are accomplished by the use of a bias generator which in turn is composed of a full-wave rectifier circuit charging simple RC networks. The output of the bias generator supplies a variable d-c bias to the control grids of a General Electric Type GL-6386 tube (a dual remote cutoff triode).

Gain reduction may be read on any standard VU meter. A third scale, in the form of a decal supplied with the amplifier, may be applied to the VU meter's face. By the use of a suitable switch connected between the VU meter multiplier and meter movement, gain reduction will be indicated over a 30 db range.

Space is provided behind the hinged-front panel for mounting an input and an output attenuator. These attenuators may be mounted on the hinged panel by the broadcaster to handle input or output levels of higher or lower values than those specified for uni-level operation.

A pilot light and an OFF-ON switch is located on the front panel for convenience. Total dimensions of the chassis (over-all) are height $3\frac{1}{2}$ inches, width 19 inches, and depth $7\frac{1}{2}$ inches. Weight is approximately 12 lbs.

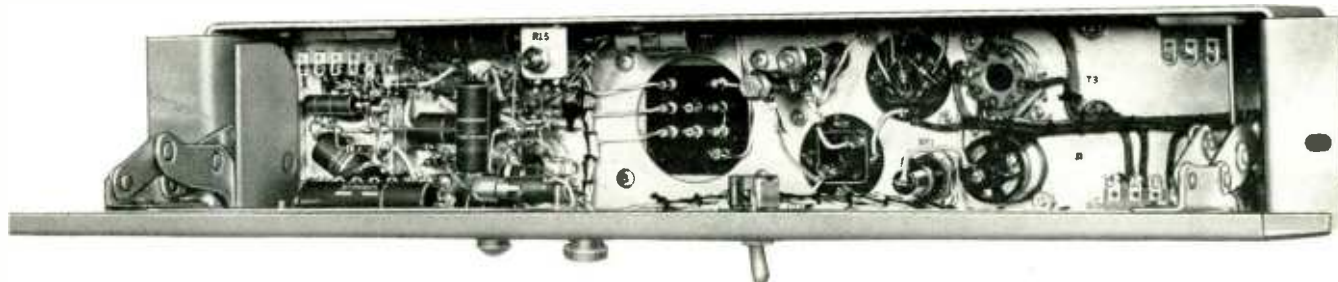

Uni-level amplifier (front view, panel open), Type BA-9-B

Uni-level Amplifier

Type BA-9-B

MECHANICAL SPECIFICATIONS

UNITS

One Type BA-9-B uni-level amplifier
One miniature motor base plug for a-c power

DIMENSIONS (Over-all)

Depth: 7 $\frac{1}{2}$ inches Width: 19 inches
Height: 3 $\frac{1}{2}$ inches (2 R.U.) Weight: 12 lbs

MOUNTING

Standard RETMA 19-inch. Cabinet-rack mounting.

OPERATING CONDITIONS

Maximum ambient temperature 113 F (45 C)
Maximum relative humidity 95 percent

ELECTRICAL CONNECTIONS

A-c power—Recessed miniature motor base receptacle and plug
Signal—Solder lug terminal strips
Gain Reduction—Solder lug terminal strips
Average Program/Dual Recovery—Strap on adjacent terminal

SAFETY PROVISIONS

No exposed voltages when hinged-front panel is closed. A-c switch provided on panel for independent operation of unit. Pilot, light on front panel indicated amplifier operation. A-c power-fused.

ELECTRICAL SPECIFICATIONS

CIRCUIT OPERATION

Consists of a General Electric Type GL-6386 push-pull triode variable gain input stage supplying signal to a push-pull output stage utilizing two Type 6V6GT power tubes. The signal for the bias generator rectifier is supplied from the plates of the output stage. The bias generator uses a full-wave rectifier Type 6AL5 whose output supplies a bias voltage to the control grids of the Type GL-6386 tube. A strap to an adjacent terminal will select the correct time constants to obtain the average control of program material. As shipped, the amplifier is connected for peak compression of program material.

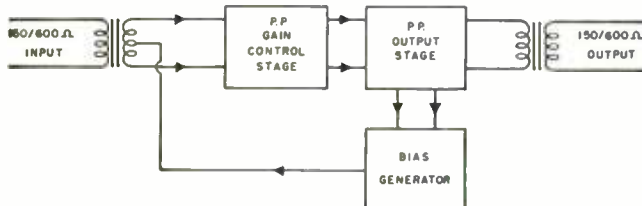

Simplified block diagram, Type BA-9-B uni-level amplifier

PERFORMANCE

FREQUENCY RESPONSE

+ or -1 db, 50-15,000 cycles under any condition of gain reduction up to 30 db

GAIN

54 db.

HARMONIC DISTORTION

(Threshold control set for +20 dbm output.) At any level up to 30 db of gain reduction, the total harmonic distortion between 100 and 15,000 cycles is 1 $\frac{1}{2}$ percent or less; from 50 to 100 cycles the distortion rating is 2 percent or less.

OUTPUT NOISE

Less than -50 dbm. (With 6V6GT)
-55 dbm. (With 5881)

ATTACK TIME

Dual	Average
11 milliseconds	62 milliseconds

RECOVERY TIME (Dual)

Single short peaks—0.9 second for 63 percent of recovery
Sustained peaks—0.9 second for 40 percent recovery
34 seconds for 90 percent recovery. (Average)
13 seconds for 90 percent recovery

INPUTS

Power—117-volt a-c 50/60-cycle, 65-watt (Note: B+ voltage is adjustable to 300-volt d-c for a-c inputs varying between 110-125 volts.)

SIGNALS

Threshold control (@ 0 dbm output: -54 dbm to -24 dbm input.
Threshold control (@ 20 dbm output: -34 dbm to -4 dbm input.
Threshold control (@ 30 dbm output: -24 dbm to +6 dbm input.
Input impedance—Unloaded transformer.
Source impedance—150/600 ohms, shipped wired for 600 ohms. Balanced input.

OUTPUTS

Signal—150/600 ohms impedance, shipped wired for 600 ohms. Balanced output.

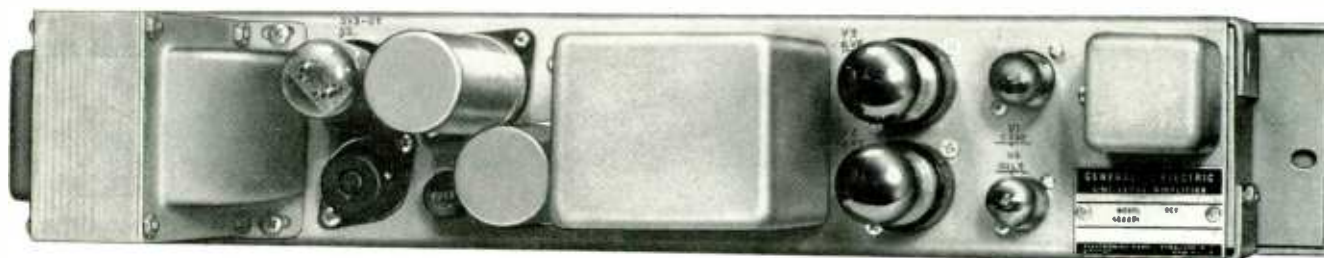
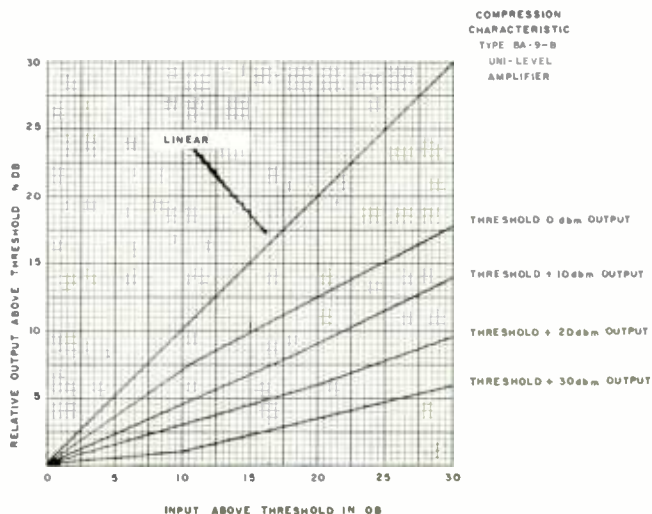

Uni-level amplifier (rear view) Type BA-9-B

Transistor Cue/Talkback Amplifier

Type BA-28-A, Plug-in

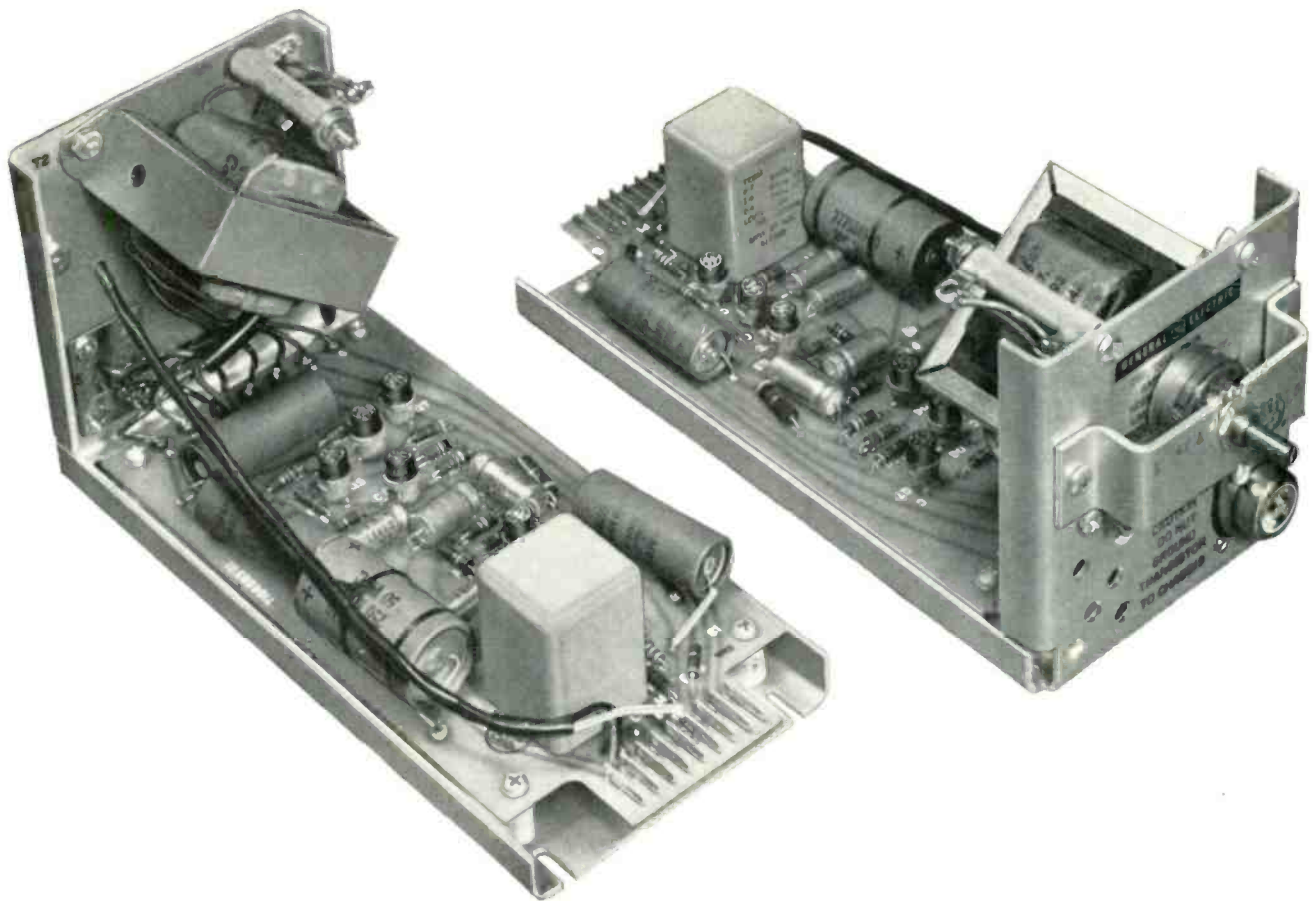

Cue/talkback amplifier Type BA-28-A

FEATURES

- All transistors—no tubes in the circuitry
- Space savings—mall, compact, light weight
- Low voltage—low power drain
- Plug-in construction for ease in maintenance
- Fiberglass wire board

WHERE TO USE

The General Electric Type BA-28-A transistor cue/talkback amplifier provides the gain necessary to raise an audio signal from mixer-bus level to a level (+27 dbm) sufficient for cuing and studio talkback service.

This amplifier is designed for use in the Type BC-21-A audio console for any custom console employing transistor amplifiers.

DESCRIPTION

The General Electric Type BA-28-A transistor cue/

talkback amplifier is a compact plug-in audio unit constructed on a printed-wire board and mounted on an "L" shaped aluminum frame.

This amplifier contains eight separate transistor stages. The first two stages are coupled directly in a Darlington compound connection. The second stage is capacitively coupled to the third stage which is directly coupled to the fourth stage. The fourth stage is a common emitter directly coupled to an emitter follower which is then directly coupled to another common emitter. The latter stage is directly coupled to a common collector Darlington compound connected output stage. This amplifier differs from the Type BA-22-A transistor program amplifier only in the quality of the output. In this unit, an open core and coil-type output transformer produces a lower quality output.

Transistor Cue/Talkback Amplifier

Type BA-28-A, Plug-in

MECHANICAL SPECIFICATIONS

Type number includes amplifier assembly, a set of transistors and a set of installation and operating instructions.

DIMENSIONS

Height—4½ inches Width—4¼ inches
Length—9⅝ inches Weight—2½ lbs

MOUNTING

Unit plugs into Type BC-21-A audio console or, by utilizing a Type FA-48-A equipment shelf, up to four of these units can be rack mounted in any standard EIA rack such as the Type PR-1-A equipment rack.

OPERATING CONDITIONS

Max ambient temperature, 131 F (55 C)
Max relative humidity, 95 percent

ELECTRICAL CONNECTIONS

All connections are made by a 9-pin plug which is attached to printed-wire board.

SAFETY PROVISIONS

No power is applied to the unit unless it is plugged into its mating socket. When the unit is plugged in and console closed there is no exposed voltage. The maximum voltage applied to the unit is 50 volts d-c.

ELECTRICAL SPECIFICATIONS

PERFORMANCE

Frequency Response: ± 2 db 100–10,000 cps
Gain: 75 db matching input
Distortion: 3 percent or less at +24 db (or rated output level)
Noise: S, N ratio of 60 db

POWER REQUIREMENTS

50 volts d-c at 160 ma

SIGNAL INPUT

Transformer matching—maximum input level —22 dbm

SIGNAL OUTPUT

600 ohms balanced or unbalanced—connected for 600 ohms balanced at +27 dbm output level

TRANSISTOR COMPLEMENT

3—2N324 General Electric
4—2N320 General Electric
1—2N553 Delco

COMPLIANCE

Complies with all applicable FCC and EIA specifications.

HOW TO ORDER

When ordering please specify: Type BA-28-A cue talkback amplifier (requires external power supply).

ACCESSORIES

Type FA-48-A equipment shelf.
Type BP-21-A 50 25-volt transistor power supply (regulated).

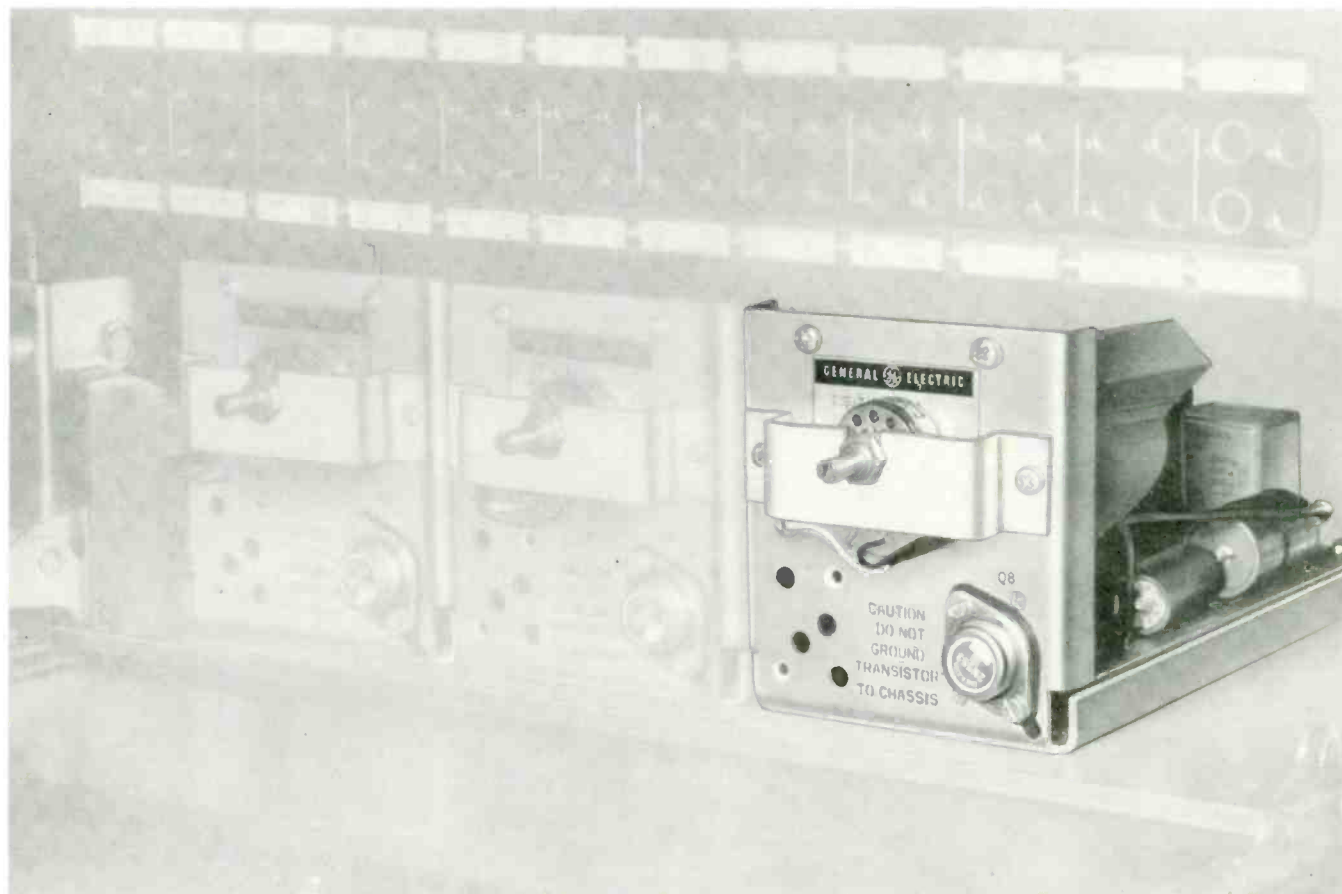

Cue/talkback amplifier Type BA-28-A installed in equipment shelf Type FA-48-A

Audiomatic Limiting Amplifier

Type BA-7-A



Audiomatic limiting amplifier, Type BA-7-A

FEATURES

- **“Thumping” virtually eliminated**
New design uses a new method for eliminating the “thump” component common to limiter actions
- **Greater limiting range**
The new audiomatic limiter incorporates a limiting range of 20 db, an increase of 8 db in limiting range over the popular General Electric Type BA-5-A limiter
- **Higher output level**
The new audiomatic limiter has an output level of +27 dbm, an increase of 15 dbm in output level as compared to the General Electric Type BA-5-A limiter
- **New program-controlled recovery circuit utilized**
This circuit permits large amounts of gain reduction with a negligible pumping effect
- **Two different types of recovery circuits offered**
The conventional dual RC type may be used, or the new program-controlled recovery circuit may be used
- **Attack time effectively zero**
Seventy microsecond attack time is obtained by means of a high-speed bias generator
- **Extremely low transient waveform distortion**
- **Very high compression above threshold of gain reduction action**
- **“Motor-boating” can not occur**
Automatic control voltage is not a function of the output voltage of the controlled amplifier eliminating “motor-boating”
- **Very low steady-state distortion and noise level due to inverse feedback circuits**
- **Instant accessibility**
Vertical rack-mounting chassis utilizes single-hinged front-cover panel
- **Compact**
Entire unit measures only 10½ inches high by 9 inches deep by 19 inches wide
- **Single unit**
All amplifiers and power supply are mounted on one small chassis
- **One VU meter supplies all required readings**
Single VU meter is used to read input level to control amplifiers, gain reduction, output level of limiter, and for balancing of modulator
- **No matched tubes required**
The Type BA-7-A audiomatic limiting amplifier uses only 18 tubes—none of which require matching
- **Plug-in connections**
All external connections are made on plugs. It is not necessary to solder or unsolder connections when installing or removing amplifier
- **Thoroughly shielded**
All transformers, oscillator, and RF power amplifier sections, plus tubes in RF section, are thoroughly shielded to prevent radiation and interaction
- **Excellent frequency response with low distortion up to practical limit of gain reduction. (See Electrical Specifications)**

Audiomatic Limiting Amplifier

Type BA-7-A

WHERE TO USE

The General Electric Type BA-7-A audiomatic limiting amplifier is a peak-limiting device designed to permit a substantial increase in the average program level without danger of any audio peaks exceeding a predetermined level.

The output of the Type BA-7-A audiomatic limiting amplifier is sufficient to drive any EIA, AM, FM, or TV audio transmitter to 100 percent modulation. It is readily adaptable for use in recording systems in the tape, disc, and motion picture sound recording industries. As such, it may be used either before or after pre-emphasis.

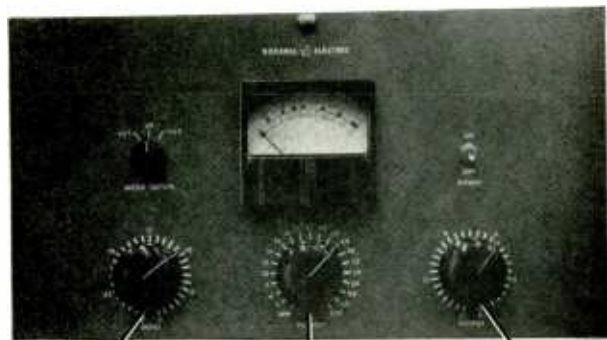

Input Level Control VU Meter Attenuator Output Level Control

Front panel of amplifier BA-7-A

DESCRIPTION

The General Electric Type BA-7-A audiomatic limiting amplifier is designed as a fast-acting, thumpless, peak-limiting audio amplifier. It incorporates two new outstanding features, the first being a new and effective method of eliminating the "thump" component common to all limiter actions. The second outstanding feature is the incorporation of the new program-controlled recovery circuit which permits the use of larger amounts of gain reduction with negligible pumping effect. These features are made possible by the use of a new method of limiting, namely the audio modulation of an RF carrier, the imposition of limiting action on this signal, and the demodulation of the RF to render a virtually thumpfree, peak-limited audio signal.

The use of this new design permits an 8 db increase in limiting range, a 15 db increase in output level, and a reduction in physical size as compared to the popular General Electric Type BA-5-A limiting amplifier. Attack time is effectively zero—being limited to approximately 70 microseconds by means of a high-speed generator. A switch is provided which will allow the amplifier to operate either on the new program-controlled recovery circuit where large amounts of gain reduction are expected, or on the conventional dual RC recovery circuit. Should conditions require it, this amplifier may be used in a backward acting mode of operation.

Mechanical Components

Mechanically, the audiomatic limiting amplifier is complete with power supply on one chassis. As such it requires only 10½ inches of vertical rack space, and 9 inches of rack depth. This vertical rack-mounted unit is equipped with a hinged-front panel allowing instant accessibility to the internal controls and components. Only 110 watts of 110-125 volts a-c power are required for its operation. All connections are made

Adjustments for Proper Compression Characteristics Selects Dual R.C. or Program Control Recovery Circuit

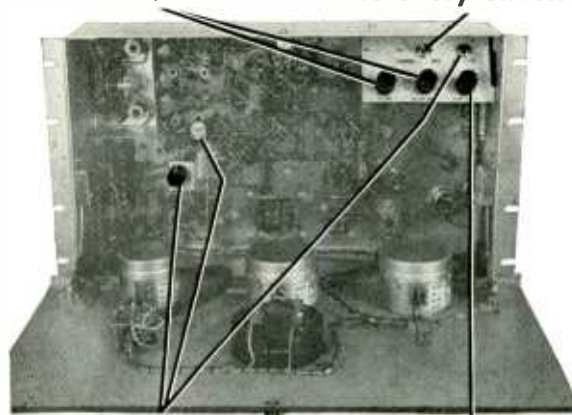

Controls for Adjusting Balance of Modulator Meter Zero Set for Gain Reduction Position

Front view of amplifier BA-7-A with front panel open to show interior controls

by means of a single 10-pin Cinch-Jones plug and a standard a-c plug and receptacles, located on the rear of the amplifier chassis. A VU meter is used to measure signal levels and gain reduction.

Electrical Components

Electrically, the audiomatic limiting amplifier consists of an amplifier and power supply mounted on one chassis. The amplifier incorporates five sections: a pre-amplifier, an oscillator and RF section, a bias generator, a control section and an output stage.

The operation of the limiting amplifier on the audio signal is as follows: The incoming audio signal is fed into the loaded input of the preamp stage. From here the signal is split in two paths, the first going to the balanced modulator in the control section, and the second to the bias generator. In addition to the audio signal, the balanced modulator receives a constant amplitude 10-megacycle carrier from the oscillator and RF amplifier section. This carrier is then amplitude-modulated by the audio signal, the main carrier is suppressed, and the resulting output signal, consisting of modulated sidebands only, is fed to the variable gain RF stage in the control section. Simultaneously the audio fed to the bias generator section is first passed through a voltage correction network, through a slope control, then to a voltage amplifier, a phase

Audiomatic Limiting Amplifier

Type BA-7-A

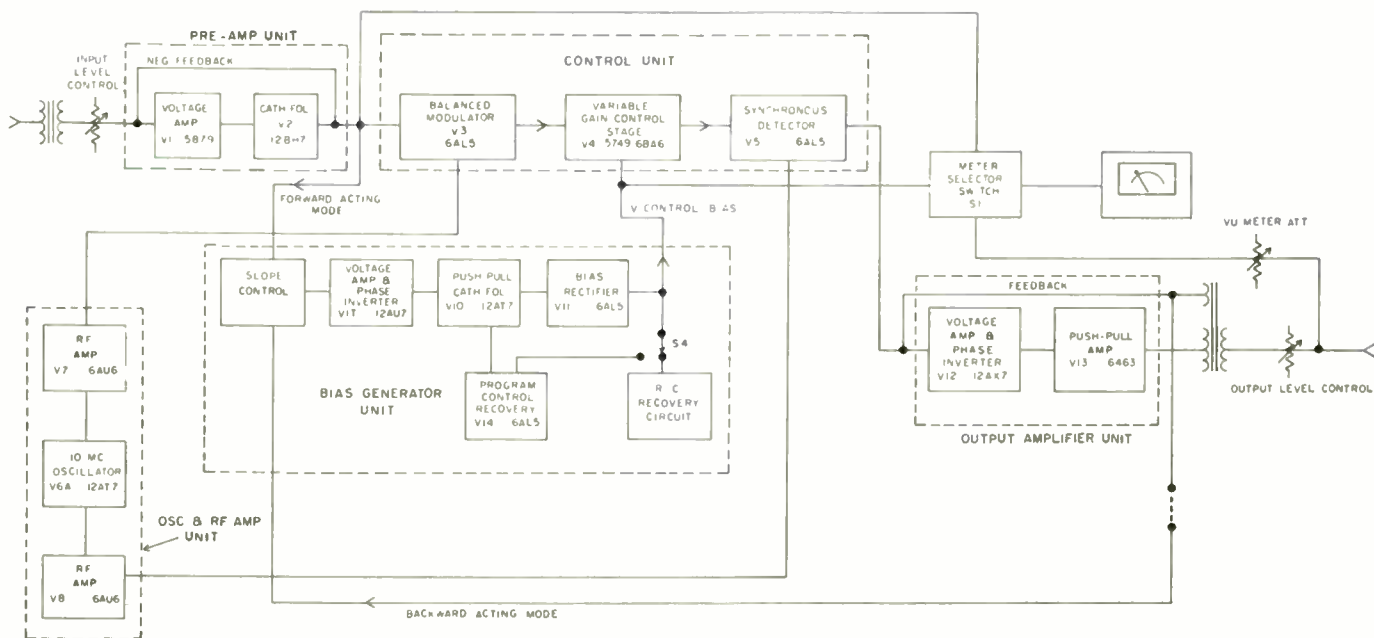

Simplified block diagram of amplifier BA-7-A

splitter, and then a push-pull cathode follower. The output of the cathode follower is split in two parts, the first being fed to the program control recovery circuit, the second being fed to a full-wave rectifier diode. The variable d-c voltage resulting from this latter diode's action is then applied to the grid of the variable gain RF stage in the control section. This variable d-c voltage has the effect of controlling the amplitude of the audio modulated sidebands. Since there is no carrier present at the grid of this control stage, the low frequency or thump component, created by varying the control voltage, is not passed through the RF circuit and thus is not detected later. These controlled sidebands are then passed to a synchronous detector which also receives a 10-megacycle constant amplitude carrier from the oscillator and RF section. The carrier and controlled sidebands are recombined and the resultant audio is detected. The audio signal is then fed to a voltage amplifier, a phase splitter, and then the push-pull output stage of the limiting amplifier. From a tertiary winding on the output transformer, voltage is fed back around the output unit. The secondary of the output transformer feeds the line through an output attenuator which is bridged by a VU multiplier attenuator. The VU meter is switched to read the output level, the amount of gain reduction, the input level to the balanced modulator, and can be used to check modulator balance.

Recovery of the amplifier is controlled by two different types of circuits, both located in the bias generator section. The first circuit is the conventional dual RC circuit. The second circuit is the new program-controlled recovery circuit. This latter recovery control is obtained by placing a diode in the discharge

path of a capacitor in the recovery circuit. The diode is biased to an equivalent voltage of 15 db of gain reduction. The amplitude of the audio trigger voltage from the cathode-follower (bias generator) output is adjusted to produce an artificial verge of 3 db. Thus, below 3 db of gain reduction the diode will not conduct, resulting in a very slow discharge rate and consequent slow recovery time of the amplifier. Between 3 db and 20 db of gain reduction the audio trigger voltage will cause the diode to conduct. This results in a voltage discharge of the capacitor which produces a normal amplifier-recovery rate. However, during the absence of program material the diode will cease to conduct and recovery of the amplifier will be appreciably slowed down. Hence, the audio-gain recovery is controlled by the variances in peak audio amplitudes, with the resulting advantage that large amounts of gain reduction may be used with negligible pumping effect. Where only small amounts of gain reduction from threshold to 6 db are required, the dual RC circuit should be used.

The recommended compression ratio for this amplifier operation is 20:1 when used in either the dual RC or program-controlled recovery operational mode. If used as a backward acting amplifier, the recommended compression ratio is 2:1.

Balanced tubes are not required in this unit. Only a simple adjustment of the modulator balance controls is necessary to balance the modulator. A push-button balance check switch provides an easy, rapid, and convenient means of checking the modulator balance.

Performance, distortion ratings, and other useful information may be found in the ELECTRICAL SPECIFICATIONS section.

Audiomatic Limiting Amplifier

Type BA-7-A

MECHANICAL SPECIFICATIONS

UNITS

1—BA-7-A audiomatic limiting amplifier

DIMENSIONS

Depth	9 inches	Width	19 inches
Height	10½ inches (6 rack units)	Weight	42 lbs

MOUNTING

Standard EIA 19-inch rack-mounting with hinged front panel

OPERATING CONDITIONS

Maximum ambient temperature: 113 F (45 C)
Maximum relative humidity: 95 percent

ELECTRICAL CONNECTIONS

Input and output audio signals made through a 10-pin Cinch-Jones plug and receptacle. A-c power made through standard a-c plug and receptacle

SAFETY PROVISIONS

Power supply primary fused. All exposed wiring normally covered by hinged front panel

VENTILATION

Normal rack ventilation. No blowers required

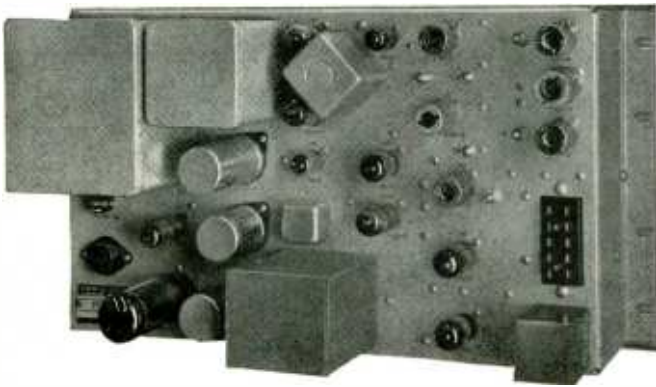

Rear view of BA-7-A amplifier

ELECTRICAL SPECIFICATIONS

Type of Circuit

(See block diagram of circuitry.) Audio signal is fed into preamplifier through an input transformer with terminated secondary into a 5879 voltage amplifier and 12BH7 cathode-follower output. The preamplifier incorporates inverse voltage feedback. The audio signal is then split into two paths, one into the balanced modulator using a 6AL5, the other into the bias generator circuit. A ten M/C constant amplitude carrier is generated by an oscillator consisting of one-half of a 12AT7 and amplified by a 6AU6 power amplifier. This carrier signal is fed to the balanced modulator and is modulated by the audio signal. The output of the modulator consists of sidebands only with the carrier suppressed. The sidebands are then fed to a variable gain RF stage using a 6BA6. The audio signal which is fed to the bias generator is passed through a voltage correction network; it is then fed into a 12AX7 voltage amplifier and phase splitter, which drives a 12AT7 push-pull cathode-follower. Full-wave rectification is then achieved by using a 6AL5 dual diode. This variable d-c voltage is then applied to the grid of

the variable gain RF stage (6BA6) to control the amplitude of the sidebands. The controlled sidebands are passed to a synchronous demodulator using a 6AL5. The demodulator receives a 10 M/C constant amplitude carrier from the same source as the balanced modulator for the detection process. The audio signal is then fed into a 12AX7 voltage amplifier and phase splitter which drives the push-pull 6463 amplifier output stage. Two different types of recovery circuits can be used, the conventional dual RC type or the new program recovery circuit.

Performance

OUTPUT LEVEL

Variation of ± 0.5 db from verge to 17 db of limiting +0.5 -1.5 db from 18 to 20 db of limiting

FREQUENCY RESPONSE

± 1 db from 50 to 15,000 cycles (from verge to 20 db of limiting)

DISTORTION

From verge to 12 db of gain reduction:
1 percent or less, 50 to 15,000 cycles
From 12 db to 20 db of gain reduction:
1.5 percent or less, 100 to 15,000 cycles
2.5 percent or less, 50 to 100 cycles

ATTACK TIME

Approximately 70 microseconds

COMPRESSION RATIO

Forward acting: 20:1
Backward acting: 2:1

RECOVERY TIME

Dual RC

Approximately 0.5 seconds for short peaks for 63 percent gain recovery. For sustained or rapidly recurring peaks, the recovery time is approximately the same for 50 percent recovery and increases to 10 seconds for 90 percent gain recovery

Program-controlled Recovery

Determined by type of program material

SIGNAL TO

Noise Ratio 65 dbm below ± 27 dbm output at threshold or below

Thump Ratio -45 db or better

TOTAL GAIN

Amplifier set at verge of limiting 57 dbm, ± 2 db

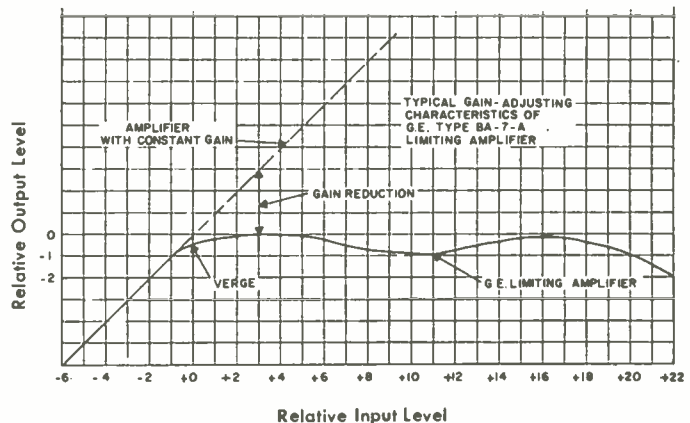

Audiomatic Limiting Amplifier

Type BA-7-A

INPUTS

Power

110 watts, 110 117 125 volts a-c, 50/60 cycles, single phase

Audio

600/150 ohms, balanced or unbalanced. Center tap on either side may be grounded as desired

Minimum input level at verge: -30 dbm

Maximum input level at verge: 0 dbm

Input level adjustable by 30 step, 1 db per step control

OUTPUTS

600-ohm unbalanced "T" (can be used to feed a balanced line). One side may be grounded if desired

OUTPUT LEVELS

+27 dbm. Output variable down to 12 dbm by use of "T" attenuator, 30 steps, 0.5 db per step

CONTROLS

Front Panel

Input level control (potentiometer)

VU multiplier ("T" attenuator)

VU meter switch (selects pre-amp output, gain reduction or amplifier)

Output level control ("T" attenuator, 0.5 db per step, 30 steps)

Power switch

Internal Chassis

Slope control (for adjusting gain reduction characteristics)

Delay bias control (for adjusting gain reduction characteristics)

Zero meter adjust control (zero setting of meter for gain reduction use)

Push-button balance check switch

Recovery selector switch (switches between dual RC and program controlled recovery)

TUBE COMPLEMENT

1-5879

1-12BH7

4-6AL5

1-6BA6

2-12AT7

2-6AU6

2-12AX7

1-6463

1-5U4GA

1-0B2

HOW TO ORDER

When Ordering Please Specify:

.....General Electric Type BA-7-A audiomatic limiting amplifier. (The type number includes the amplifier, one set of operating tubes, one 10-pin Cinch-Jones plug, one a-c plug, and installation and operating instructions.)



Transistor Monitor Amplifier

Type BA-24-A, Plug-in

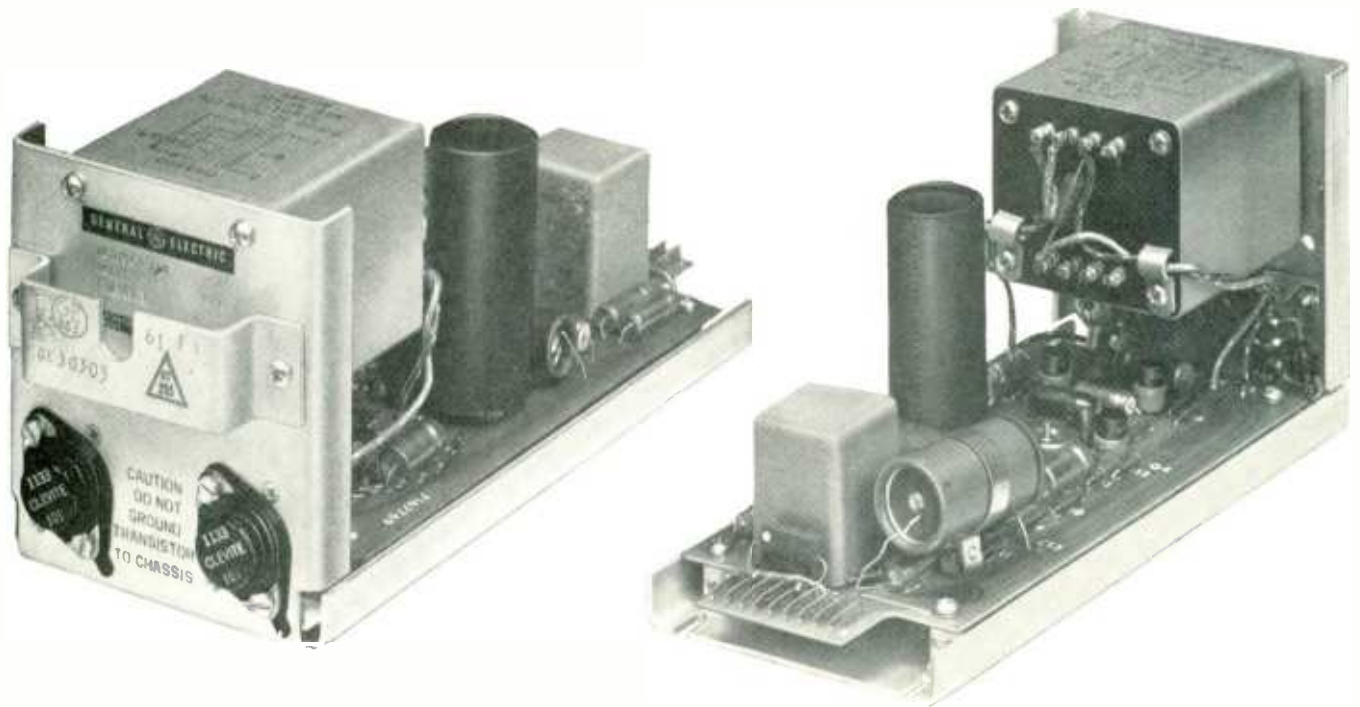

Type BA-24-A monitor amplifier

FEATURES

- All plug-in transistors—no tubes in the circuitry
- Plug-in amplifier construction for ease in maintenance
- Space saving—small, compact, lightweight
- Low voltage—low power drain
- Fiberglass wire board

WHERE TO USE

The General Electric Type BA-24-A transistor monitor amplifier is capable of bridging a number of different circuits and providing the gain necessary to raise an audio signal to loudspeaker level for aural evaluation of the program line, incoming remote lines and other sources.

DESCRIPTION

The Type BA-24-A transistor monitor amplifier is a compact, plug-in audio amplifier constructed on a printed-wire board and mounted on an "L" shaped aluminum frame.

This broadcast amplifier consists of unloaded input transformer which feeds a Darlington compound-connected stage. The third stage is an emitter follower which drives the common emitter fourth stage which in turn drives another common-emitter stage.

MECHANICAL SPECIFICATIONS

DIMENSIONS

Height	4 1/2 inches	Width	4 1/4 inches
Length	9 5/8 inches	Weight	2 1/2 lbs

MOUNTING

This amplifier plugs into the Type BC-21-A audio console or, by utilizing a Type FA-48-A shelf, up to four of these units may be rack mounted in any standard EIA rack such as the Type PR-1-A equipment rack.

OPERATING CONDITIONS

- Max cabinet ambient temperature, 131 F (55 C)
- Max relative humidity, 95 percent

ELECTRICAL CONNECTIONS

All electrical connections are made by a 9-pin plug which is attached to the amplifier wire board.

ELECTRICAL SPECIFICATIONS

PERFORMANCE

- Frequency Response: ± 2 db, 50–15,000 cps
- Gain: 80 db matching input
- Distortion: 1 1/2 percent or less at +33 dbm
- Noise: S N ratio, 60 db at +33 dbm output

Transistor Monitor Amplifier

Type BA-24-A, Plug-in

POWER REQUIREMENTS

25 volt d-c at up to 400 ma

SIGNAL INPUT

Matching input, maximum input level +25 dbm

SIGNAL OUTPUT

8/150 600 ohms at +33 dbm (2 watts)

CONTROLS

Not part of amplifier. Terminals provided for mounting a 750K ohm potentiometer inter-stage gain control

TRANSISTOR COMPLEMENT

- 5—2N324 General Electric
- 1—2N320 General Electric
- 2 —CTP-1123-Clevite
- 1—2N169A General Electric

COMPLIANCE

Complies with all applicable FCC and EIA specifications

HOW TO ORDER

When ordering, please specify Type BA-24-A transistor monitor amplifier (requires external power supply). The type number covers the amplifiers, a set of transistors, and a set of installation and operating instructions.

ACCESSORIES

- Type FA-48-A equipment shelf
- Type BP-20-A 25-volt power supply
- 2R74P25 750K carbon potentiometer

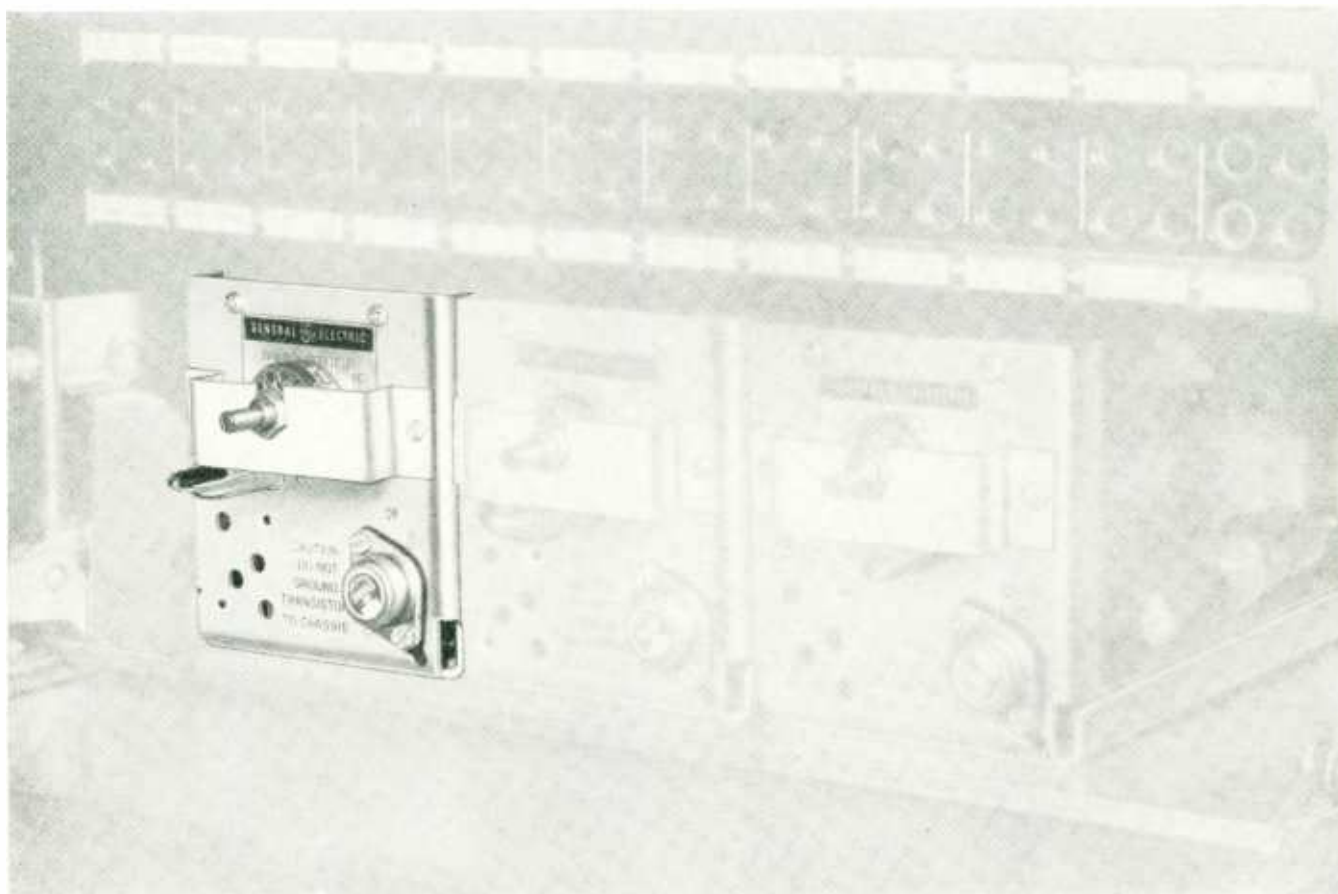

Type BA-24-A monitor amplifier, with interstage gain control, installed in Type FA-48-A equipment shelf

Transistor Monitor Amplifier

Type BA-34-A



Transistor monitor amplifier, Type BA-34-A

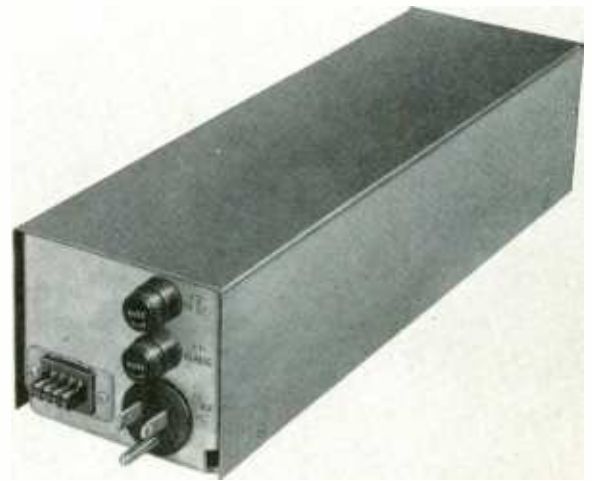

Monitor amplifier (rear view)

FEATURES

- **Extremely versatile**

May be connected for matching or bridging input
Both line- and voice-coil outputs have transformer isolation
Has multi-impedance inputs and outputs
Power-line voltage variations do not affect operation

- **High gain monitor amplifier**

100 db of gain (unloaded input)
Interstage gain control allows up to -30 dbm input without external attenuation

- **Compact**

3¼-inch height and 4-inch width permit four amplifiers to be mounted side-by-side on one shelf in 3½ inches of vertical-rack space

- **Plug-in construction permits easy removal for maintenance and service**

All external connections are made through one Amphenol blue ribbon connector (audio); and one Amphenol, U/L approved 3-wire a-c plug (power)
A conventional 2-wire a-c extension cord may also be used for a-c power connections. Mating sockets and mounting bracket are included with each amplifier

- **Contains built-in, regulated power supply**

The amplifier will operate with full power from 117 ± 15 volts, 50/60 cycles
The power transformer can be strapped for operation from 230 ± 15 volts, 50/60 cycles

- **Rated at ten watt output**

- **Uses readily available, low cost, low noise transistors**

The amplifier uses four 2N508's, two 2N1925's, one 2N214, two 2N2144's, and one 2N456A

Wide use of these transistor types in other amplifier designs reduces the necessity of stocking many different spares

All transistors, including the power transistors, plug into transistor sockets

- **Magnetically and electrically shielded transformers**

Hum pickup from this and adjacent equipment is minimized by the use of extra shielding in the transformers, and the use of a steel-amplifier cover

- **Stability is improved by the use of negative feedback**

An accidental short circuit of the output will not damage the output transistors, nor even blow the fuse, due to designed-in protection features

- **Excellent frequency response with low distortion**

± 1 db 30 to 15,000 cycles at +40 dbm output
1 percent or less harmonic distortion 50 to 15,000 cycles
1½ percent or less harmonic distortion 30 to 15,000 cycles

WHERE TO USE

The General Electric Type BA-34-A monitor amplifier is a versatile audio amplifier designed to serve as a general-purpose monitoring amplifier in radio and television stations, in recording studios, and in motion picture studios. It may be used as a monitor amplifier-bridging program or other lines to furnish power for studio speakers; a control to studio talkback amplifier, where the talkback microphone is fed into the Type BA-34-A without preamplification; a transcription cueing or audition amplifier (again without preampli-

Transistor Monitor Amplifier

Type BA-34-A

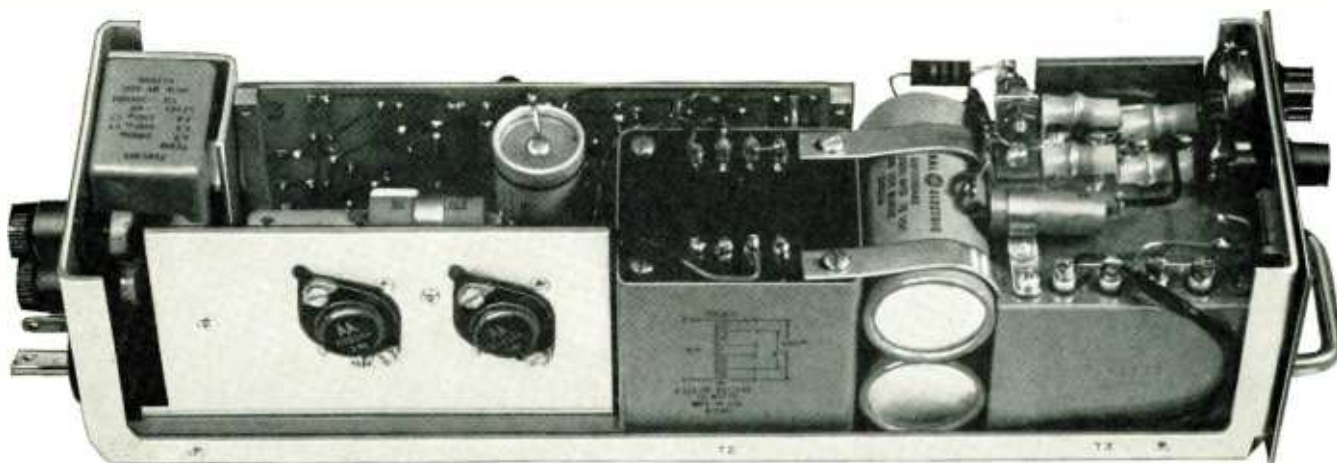

Monitor amplifier (inside view)

fication); or as a general-purpose amplifier to feed house monitor speakers. The unit contains its own built-in, regulated power supply; and is intended for shelf mounting in an audio rack, or as an attractive desk-top unit.

COMPLIANCE

Complies with all applicable FCC and EIA specifications. The a-c connector is of the grounded type and complies with U/L standards.

DESCRIPTION

The General Electric Type BA-34-A transistorized plug-in monitor amplifier will deliver to the output ten watts of power from a microphone source.

The monitor amplifier consists of an epoxy-fiberglass printed circuit board along with input, output, and power transformers, mounted in a "U" shaped alu-

minum frame. The front face contains a power switch, pilot light, and volume control, whereas the rear of the unit mounts two fuses and two connectors. All components are located with accessibility in mind, and are protected from dust and stray magnetic fields by means of a steel cover.

Transistors are used throughout for low heat, low power consumption, reliable, maintenance-free operation. Source impedances of 600/150/75 ohms feed an unloaded transformer input for best signal to noise ratio. The first stage is a modified Darlington compound, with interstage gain control, which feeds three more stages of amplification.

PNP-NPN phase reversing predriver stages are Darlington coupled to the output power transistors, which in turn feed a push-pull output to a single ended output transformer. Both 600/150-ohm line and 8-ohm voice-coil outputs are isolated from ground by the output transformer.

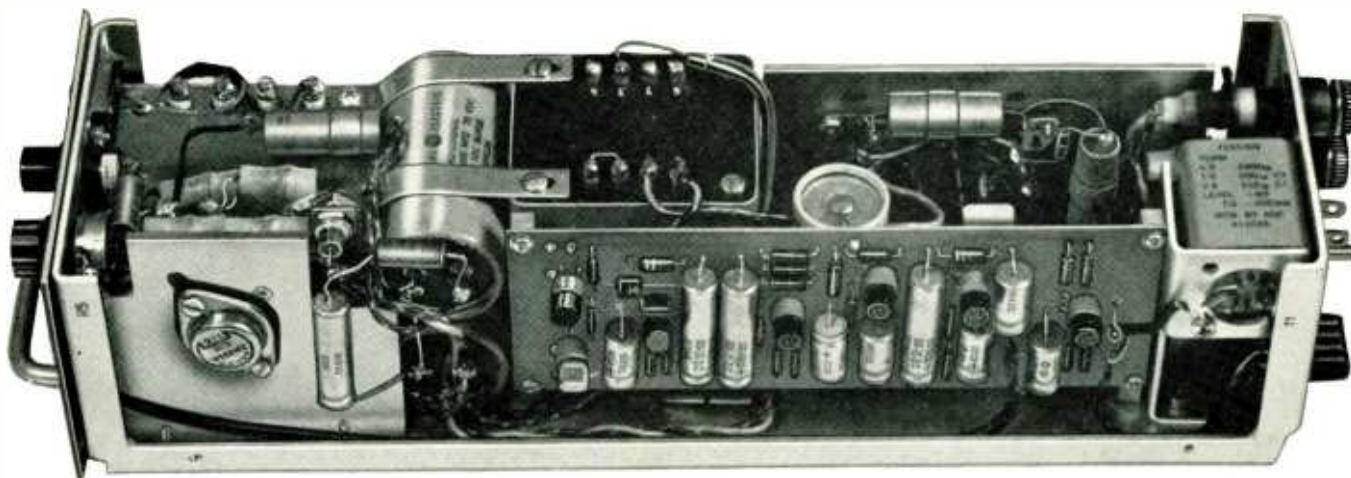

Monitor amplifier (inside view)

Transistor Monitor Amplifier

Type BA-34-A

The power supply is a low voltage, well filtered, transistor/zener regulated design. Power line variations will not affect operation; and it may be strapped to operate from 230 volts as well as 117 volts, 50/60 cycles.

MECHANICAL SPECIFICATIONS

UNITS

One Type BA-34-A single plug-in assembly

DIMENSIONS

Height	3 $\frac{1}{4}$ inches	Width	4 inches
Length	13 $\frac{3}{8}$ inches	Weight	9 lb

MOUNTING

Four amplifiers may be mounted in the Type FA-50-A shelf (accessory). Mating sockets and mounting bracket are furnished with each amplifier, so that the amplifier may be mounted in any other shelf of at least 3 $\frac{1}{2}$ -inch vertical space; or the amplifier may be placed in any appropriate location.

OPERATING CONDITIONS

Maximum ambient temperature—130 F (55 C)
Maximum humidity—95 percent

ELECTRICAL CONNECTIONS

Signal—One amphenol 8-pin blue ribbon connector
Power—One ground type a-c connector

SAFETY PROVISIONS

No voltage is applied until the amplifier is plugged into its mating sockets. The amplifier is equipped with an ON-OFF switch, and the power transformer primary is fused.

ELECTRICAL SPECIFICATIONS

PERFORMANCE

Frequency response: ± 1 db 30 to 15,000 cycles, +40 dbm output
Gain: 100 db
Harmonic distortion: 1 percent or less 50 to 15,000 cycles
1 $\frac{1}{2}$ percent or less 30 to 15,000 cycles

NOISE

—120 dbm relative input

POWER REQUIREMENTS

25 watts (at max output)

SIGNAL INPUTS

Input impedance—Unloaded transformer
Source impedance: 600/250/150/75 ohm connections
(Factory shipped 150 ohms)
Maximum input level: —30 dbm

SIGNAL OUTPUTS

Rated output +40 dbm (10 watts)
Output impedance—600/150/8 ohms
(Factory shipped 600 ohms)

TRANSISTOR COMPLEMENT

4 General Electric 2N508	2 DELCO 2N553
2 General Electric 2N1925	1 DELCO 2N456A
1 Sylvania 2N214	

HOW TO ORDER

When ordering, please specify: Type BA-34-A plug-in transistorized monitor amplifier.

ACCESSORIES

Type FA-50-A shelf (can also mount the Type BA-25-A and Type BA-20-A pre-amplifiers).
Type FA-35-G bridging volume control.



A-c Powered Program/Monitor Amplifier

Type BA-14-A

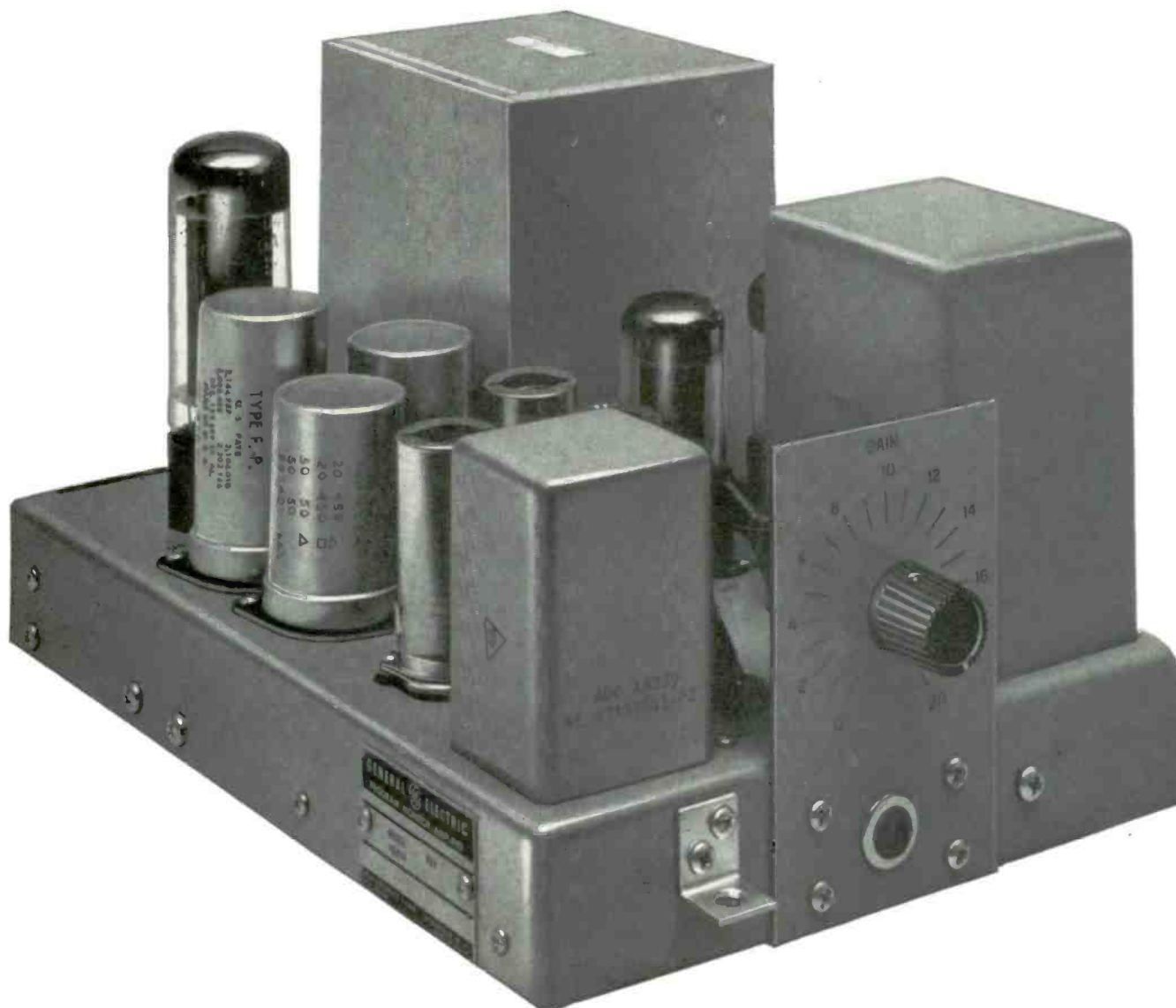

A-c powered program/monitor amplifier, Type BA-14-A

FEATURES

- **Versatile**
May be connected for matching or bridging input
Provides both line and voice-coil outputs
Can be connected for either program or monitor service
Has multi-impedance inputs and outputs
Will operate direct from a microphone or a line
- **High gain program or monitor amplifier**
60 db of program matching gain; 36 db of program bridging gain
105 db of monitor gain (unloaded input); 75 db of monitor bridging gain
- **Compact**
6 $\frac{3}{8}$ -inch height and 7-inch width permit two amplifiers to be mounted side-by-side on one shelf in 7 inches of vertical rack space
- **Plug-in construction and small height permit easy removal for maintenance or service type change**
All external connections are made on two 10-pin Jones plugs and sockets. Input connections (including fixed bridging pad) are made on one "2400" series plug, while a-c power and output connections are made on second "2400" series Jones plug. Mating sockets are mounted on accessory shelf
- **Contains built-in power supply**
Only 105 to 125 volts, 60-cycle, a-c needed to power this amplifier
- **Uses readily available low cost, low noise tubes**
Amplifier uses three 5879's, either two 6V6's or two 5881's, and a 5U4GA. 6V6's are used in program service, 5881's may be used for increased power in monitor service

A-c Powered Program/Monitor Amplifier

Type BA-14-A

- **Rated at 10-watt output in monitor use; 4-watt output in program use**
- **Magnetically and electrostatically shielded transformers effectively prevent hum pickup in this and adjacent medium or high level equipment**
- **Stability improved through use of negative feedback.**
Tertiary winding of output transformer supplies negative feedback to cathode of second stage
- **Excellent frequency response with low distortion**
Program amplifier: ± 1 db 30–15,000 cps
+30 dbm output less than 0.5 percent harmonic distortion (50–15,000 cps)
Monitor amplifier: ± 1 db 30–15,000 cps
+40 dbm output 1½ percent harmonic distortion
- **Continuous log taper volume control with db markings furnished and mounted on amplifier**
Precision step attenuator may be substituted by broadcaster, if desired. (See Electrical Specifications—Gain Control)
- **Variable frequency response made by internal adjustment, if desired**

APPLICATION

The General Electric Type BA-14-A program/monitoring amplifier is a versatile, dual-purpose audio amplifier designed to serve as a program or line amplifier, or as a general-purpose monitoring amplifier in radio and television stations, in recording studios, and in motion picture studios.

When connected as a program amplifier it may be used as a program or main amplifier, an isolation or bridging amplifier, a line amplifier, for medium power monitoring or as a cuing or audition amplifier.

When connected for monitoring service, it may be used as a monitor amplifier, bridging program or other lines to furnish power for studio speakers; a control-to-studio talkback amplifier, where the talkback microphone is fed into the Type BA-14-A without preamplification, a transcription cuing or audition amplifier (again without preamplification); or an emergency



Rear view of amplifier Type BA-14-A showing plug-in construction

program amplifier in the program channel of speech input systems.

This unit contains its own built-in power supply and is intended for shelf mounting in an audio rack. Simple, easily made internal connections and interchangeable tubes permit this amplifier to be quickly converted from program-to-monitor service, or vice-versa.

DESCRIPTION

The General Electric Type BA-14-A program/monitor amplifier is a four-stage, a-c powered unit designed to operate from either microphone or line level signals and to furnish power to drive either program lines or one or more speakers.

Either matching inputs of 600/250/150/30 ohms or a 10,000-ohm bridging input are available for matching or bridging any standard broadcast source impedance.

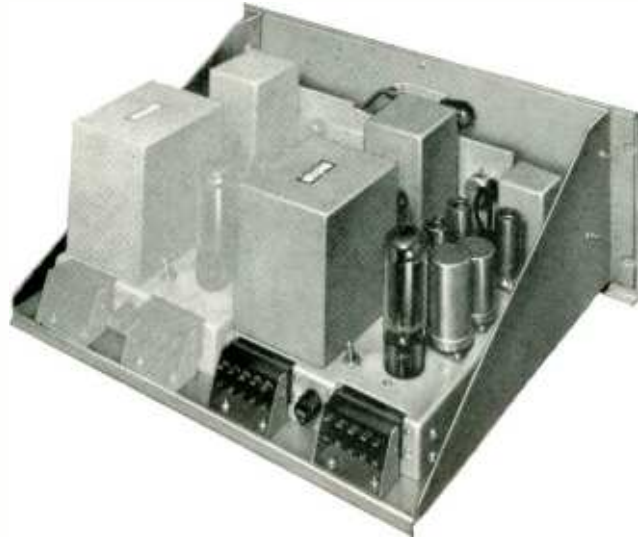

Amplifiers Type BA-14-A mounted in FA-23-C shelf

The output of the amplifier may be used to drive a 600/150 line and/or an 8/2 ohm voice-coil loud-speaker. Separate windings are used for the program and voice-coil sections of the output transformer, thus it is possible to use both speaker and line feed simultaneously (for low or medium level monitoring) if required. Negative feedback is supplied from a tertiary winding of the output transformer back to the cathode of the second stage.

The complete amplifier includes only four stages.* The first and second stages are conventionally connected 5879 pentode tubes. The third stage, also using a 5879 type tube, serves as a phase-splitter driving the push-pull output stage. When connected for program service, two 6V6 tubes are used in the output stage. However, when connected for monitoring service, additional power may be gained if 5881 type tubes are substituted for the two 6V6 tubes. A 5U4GA is used as a rectifier.

* In program service, the first stage is by-passed and the tube omitted from the socket.

A-c Powered Program/Monitor Program

Type BA-14-A

Changes from program to monitor service or vice-versa are easily made by changing five jumper straps located on easily accessible terminal boards under the chassis. These connections cut in or by-pass the first stage and change the voltages supplied to the tubes.

Impedance changes are made in the customary manner on the transformer terminals. As shipped, the amplifier is connected for program service with a 600-ohm input, an output of 600 ohms and 8 ohms, and minus the first-stage tube which is by-passed. For monitor purposes a tube kit (7145567), consisting of the first-stage 5879 and two 5881 output tubes, is available as an accessory item.

Frequency response and noise and distortion measurements for program and monitor services may be found under ELECTRICAL SPECIFICATIONS.

MECHANICAL SPECIFICATIONS

UNITS

One Type BA-14-A program/monitor amplifier, equipped with an Allen-Bradley potentiometer.

DIMENSIONS

Depth	13 inches	Weight	20 lbs
Height	6 $\frac{3}{8}$ inches	Width	7 $\frac{1}{2}$ inches

MOUNTING

Each amplifier mounts in an Type FA-23-C shelf (accessory). Two amplifiers may be mounted in this shelf which, in turn, may be mounted in a Type PR-1-A or other standard EIA Cabinet Rack. When so mounted, the rear of the amplifier plugs into two Jones "2400" series mating sockets on the Type FA-23-C shelf. These two plugs handle all input, output and power connections to this unit. The Type FA-23-C shelf includes four Jones sockets, spacer bar, and two knobs and shaft extensions.

OPERATING CONDITIONS

Maximum room ambient temperature—continuous operation	113 F (45 C).
Maximum room ambient temperature—5 percent of annual operating hours	122 F (50 C).
Maximum cabinet ambient temperature—continuous operation	122 F (50 C).
Maximum cabinet ambient temperature—5 percent of annual operating hours	140 F (60 C).
Maximum relative humidity	95 percent.

ELECTRICAL CONNECTIONS

Power and Signal

Two 10-pin, "2400" series Jones plugs (furnished on amplifier) mating to two 10-pin, "2400" series Jones sockets mounted on Type FA-23-C shelf (accessory).

SAFETY PROVISIONS

No voltage applied until amplifier is plugged into mating source. Amplifier is equipped with ON-OFF switch and red jewel indicator light. Power transformer primary is fused. No exposed voltages.

ELECTRICAL SPECIFICATIONS

Type of Circuit

PROGRAM SERVICE

Amplifier consists of a four-stage amplifier with the first stage by-passed. The input transformer is connected to the grid volume control of the second stage; said stage using a Type 5879 tube, pentode connected. The third stage, also a Type 5879, serves as a phase-splitter which, in turn, drives the two 6V6 tubes in the push-pull output stage. 15 db of negative feedback is supplied from the tertiary winding of the output transformer back to the second-stage cathode. A 5U4GA is used as a rectifier.

MONITOR SERVICE

In monitor service, the four stages of the amplifier are used to develop additional gain. Power output is increased by the change in plate voltage and substitution of higher power output tubes. The first two stages are conventionally connected pentode tubes of the 5879 type. The third stage, utilizing a 5879, serves as a phase-splitter which, in turn, drives two Type 5881 tubes in the push-pull output stage. Type 6V6 tubes may be used in place of the Type 5881 tubes with a slight reduction in power output. A Type 5U4GA tube serves as the rectifier. 10 db of negative feedback from the output transformer tertiary winding is supplied to the cathode of the second stage.

Performance

PROGRAM SERVICE

MONITOR SERVICE

FREQUENCY RESPONSE

+30 dbm out,
±1 db 30 to 15,000
cycles per second.

+40 dbm out (10
watts), 1 db 30 to
15,000 cycles per
second.

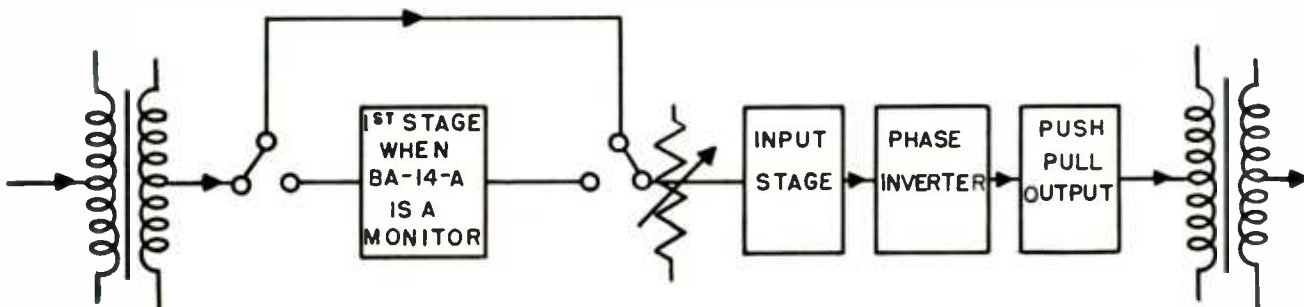

Block diagram of program/monitor amplifier Type BA-14-A, shown connected as a program amplifier

A-c Powered Program/Monitor Amplifier

Type BA-14-A

Performance (cont'd)

	PROGRAM SERVICE	MONITOR SERVICE
GAIN	Matching: 60 db Bridging: 36 db (for 600-ohm terminated source).	Unloaded transformer input: 105 db. Bridging input: 75 db (supplied with fixed bridging resistor on Jones Plug). Input stage bypassed: +40 dbm out Unloaded input: 66 db Loaded input: 60 db Bridging input: 36 db
OUTPUT	4 watts	10 watts
HARMONIC DISTORTION	+30 dbm out 50-15,000 cps less than 0.5 percent. 30 cycles—0.75 percent. +36 dbm out 30-15,000 cps less than 1 percent.	+36 dbm out 30-15,000 cps—1 percent +40 dbm out 30-15,000 cps—1½ percent.
NOISE	+30 dbm out, signal to noise ratio is 83 db. —53 dbm or less, unweighted. Noise remains constant regardless of position of gain control.	—18 dbm at maximum gain. Volume control set for 20 db loss. noise level will be —30 dbm. Low gain monitor —30 dbm.
MAXIMUM INPUT LEVEL MATCHING INPUT	0 dbm.	—35 dbm as high gain monitor. 0 dbm as low gain monitor.
BRIDGING INPUT	+24 dbm.	—5 dbm as high gain monitor. +30 dbm as low gain monitor with fixed resistors. +40 dbm as low gain monitor with FA-35-G bridging volume control.

Input Impedances

SOURCE IMPEDANCES

MATCHING

600/250/150/30 ohms, balanced or unbalanced.	600/250/150/30 ohms, balanced or unbalanced.
--	--

Performance (cont'd)

	PROGRAM SERVICE	MONITOR SERVICE
Bridging	0 to 1000 ohms, terminated resistive circuits, balanced or unbalanced.	0 to 1000 ohms terminated resistive circuits, balanced or unbalanced.
INPUT IMPEDANCES		
Matching	600/250/150/30 ohms, balanced or unbalanced.	600/250/150/30 ohms or unloaded transformer, balanced or unbalanced.
Bridging	10,000 ohms, balanced or unbalanced.	10,000 ohms, balanced or unbalanced.
Output Impedances		
LINE SPEAKER	600/150 ohms. 8/2 ohms.	600/150 ohms. 8/2 ohms.
Gain Control*	Log taper potentiometer continuously variable attenuation from 0 to infinity.	Log taper potentiometer continuously variable attenuation from 0 to infinity.

* The broadcaster may substitute 500,000-ohm Daven attenuator CP-130-Y, 2 db/step—30 step, for the gain control furnished, if desired.

Input Power

105/115/125 volts, a-c, 50/60 cycles, single phase, 85 watts

Tube Complement

Amplifier is shipped connected for program service and is equipped with tubes for this type service. For monitor service, see accessory listing for monitor service tube kit.

Program service	2—5879 2—6V6 1—5U4GA
Monitor service	3—5879 2—5881 1—5U4GA

HOW TO ORDER

When ordering please specify:

_____ General Electric Type BA-14-A program/monitor amplifier. (The type number includes the amplifier connected for program service, a set of operating tubes for program service, and an installation and instruction book.)

ACCESSORIES

7145567 —Monitor tube kit (consisting of 1—5879 tube and 2—5881 tubes).

FA-23-C —Shelf with four mating Jones sockets, two knobs, and two extension shafts. Shelf will mount two Type BA-14-A amplifiers.

Pre-amplifier

Type BA-20-A

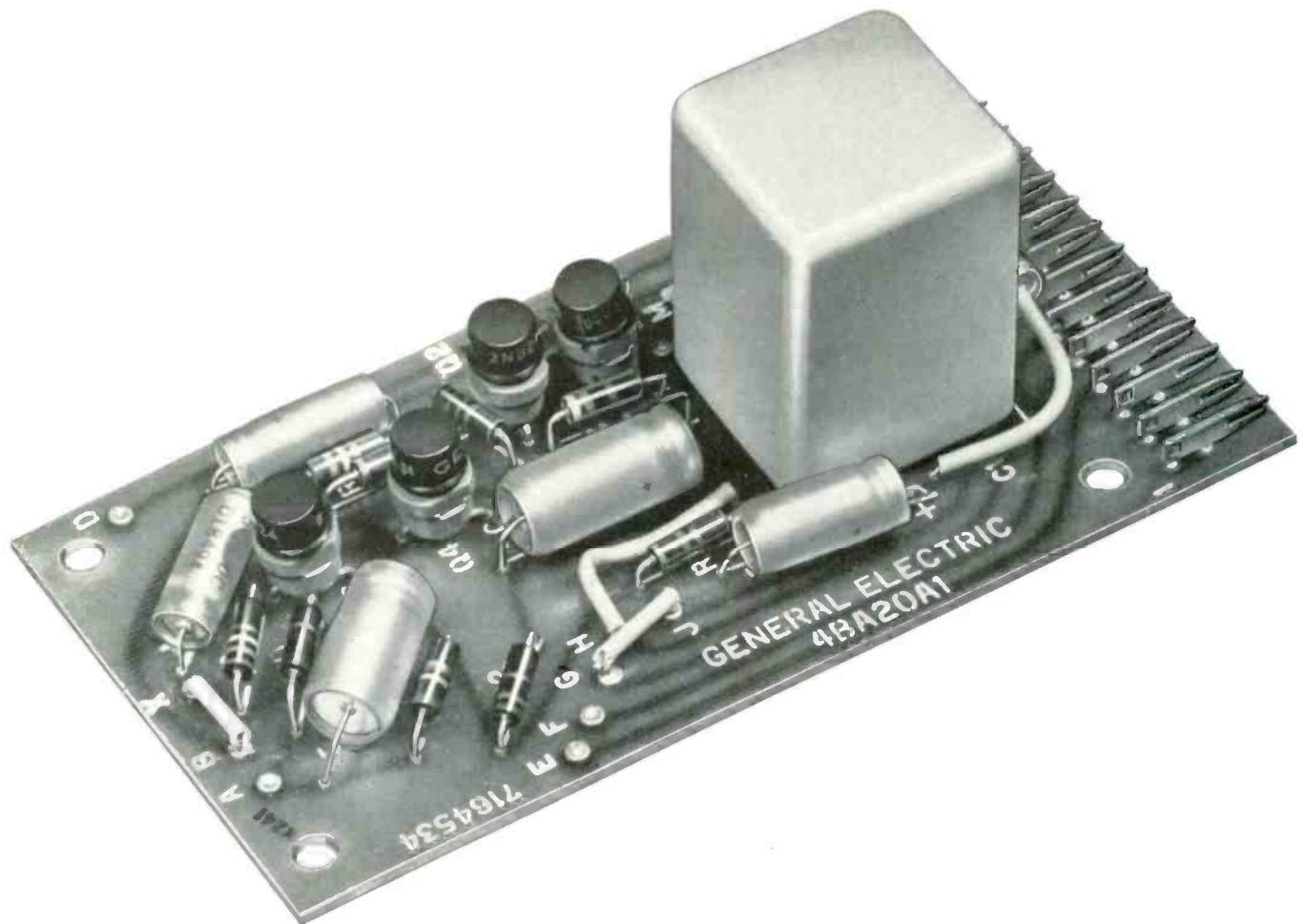

Pre-amplifier Type BA-20-A

FEATURES

- Small and compact
- Eight units plus eight Type FA-47-A line-to-line coils can be mounted in one 3¼-inch high rack-mounted shelf
- 50 or 40 db gain

WHERE TO USE

The General Electric Type BA-20-A pre-amplifier is a high-fidelity, plug-in pre-amplifier assembly designed to raise the level of microphone outputs to mixer level for broadcast applications. The use of printed wiring and complete transistorization makes the unit compact and easy to install and maintain.

The Type BA-20-A pre-amplifier is designed for use in custom console or audio systems, using transistor amplifiers Types BA-22-A, BA-24-A, or BA-28-A.

Power for the operation of these pre-amplifiers may be obtained from the Type BP-20-A transistor power supply or from any other well filtered 25-volt d-c supply.

DESCRIPTION

The General Electric Type BA-20-A pre-amplifier is a complete, plug-in, transistor pre-amplifier assembly.

The pre-amplifier is constructed on a fiberglass printed-wire board. The input, output, and power connections are made by means of a 13-pin connector assembly which is staked and soldered to the circuit board.

MECHANICAL SPECIFICATIONS

DIMENSIONS

Height	2 inches	Width	2¾ inches
Length	5½ inches	Weight	6 ounces

MOUNTING

The 13-pin connector of the pre-amplifier is inserted into a receptacle of the Type FA-49-A shelf. The accessory connector, G-E drawing C-777466-P1, is required if the pre-amplifier is to be mounted in any other type of installation.

Pre-amplifier

Type BA-20-A

OPERATING CONDITIONS

Maximum room ambient temperature continuous, 95 F (35 C)
 Maximum cabinet ambient temperature continuous 122 F (50 C)
 Maximum room ambient temperature 5 percent of time, 122 F (45 C)
 Maximum cabinet ambient temperature 5 percent of time, 131 F (55 C)
 Maximum relative humidity 95 percent

ELECTRICAL CONNECTIONS

All electrical connections are made through a 13-pin mounted at one end of the printed wire board.

SAFETY PROVISIONS

No power is applied to the unit unless it is plugged into its mating socket. The maximum voltage applied to the unit is 25 volts d-c.

ELECTRICAL SPECIFICATIONS

PERFORMANCE

Frequency Response— ± 1 db 50–15,000 C.P.S.
 Gain—50 db as shipped. May be set for 40 db gain by modification.
 Distortion—Less than 0.5 percent rated output levels.
 Noise—Equivalent to -120 dbm at the input, i.e. a 60 db S/N ratio with -60 dbm from a microphone. Measures 60 db below a -10 dbm output level.

SIGNAL INPUTS

Source Impedance—50/150/250/600 ohms balanced or unbalanced.
 Input Impedance—unloaded transformer.

SIGNAL OUTPUT

Between 300 and 1000 ohms unbalanced. A balanced output may be obtained by use of accessory Type FA-47-A line-to-line coil.

POWER INPUT

25 volts d-c at 8 m.a.

CONTROLS

Accessory—carbon potentiometer.

INTERCHANGEABILITY

This amplifier is not interchangeable with any existing unit.

TRANSISTOR COMPLEMENT

3 General Electric 2N324 transistors
 1 General Electric 2N320 transistor

HOW TO ORDER

When ordering please specify:

..... General Electric Type BA-14-A pre-amplifier.

ACCESSORIES

Type FA-49-A shelf
 Type FA-47-A line-to-line coil
 7777466P1 receptacle
 2R74P25 potentiometer

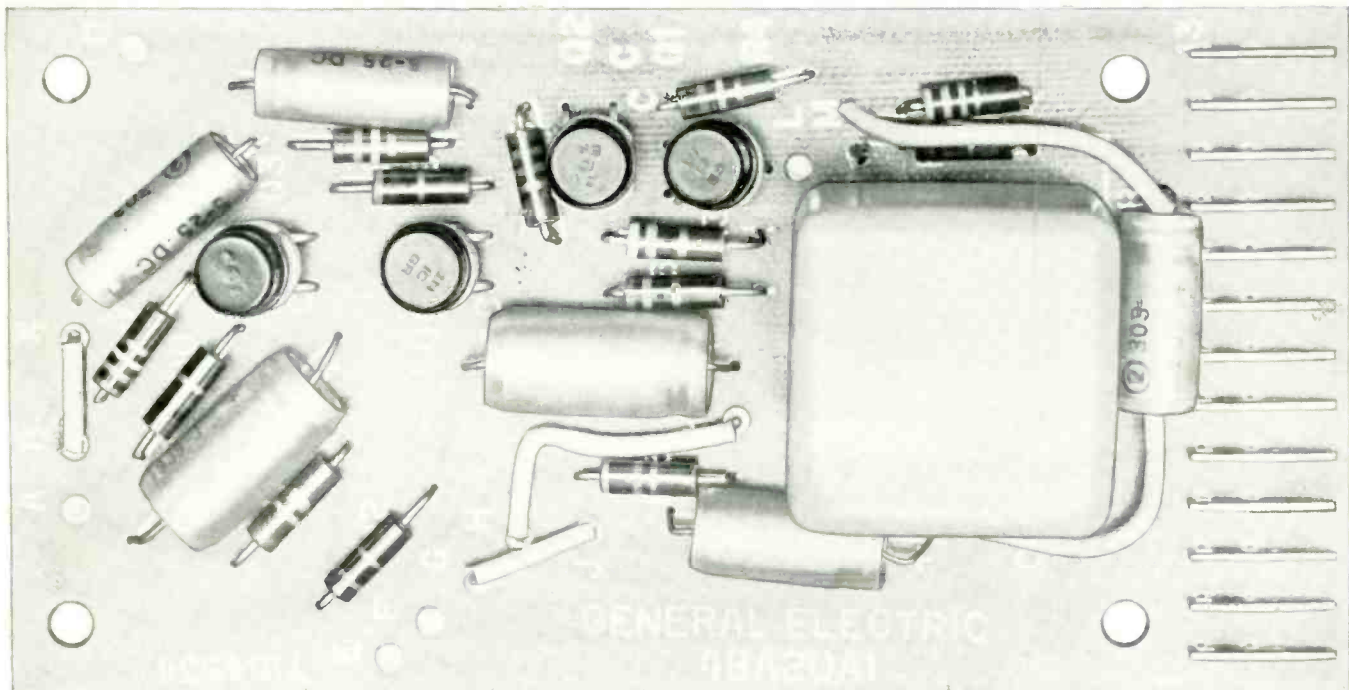

Pre-amplifier, Type BA-20-A (top view)

Transistor Pre-amplifier Module

Type BA-21-A, Plug-in

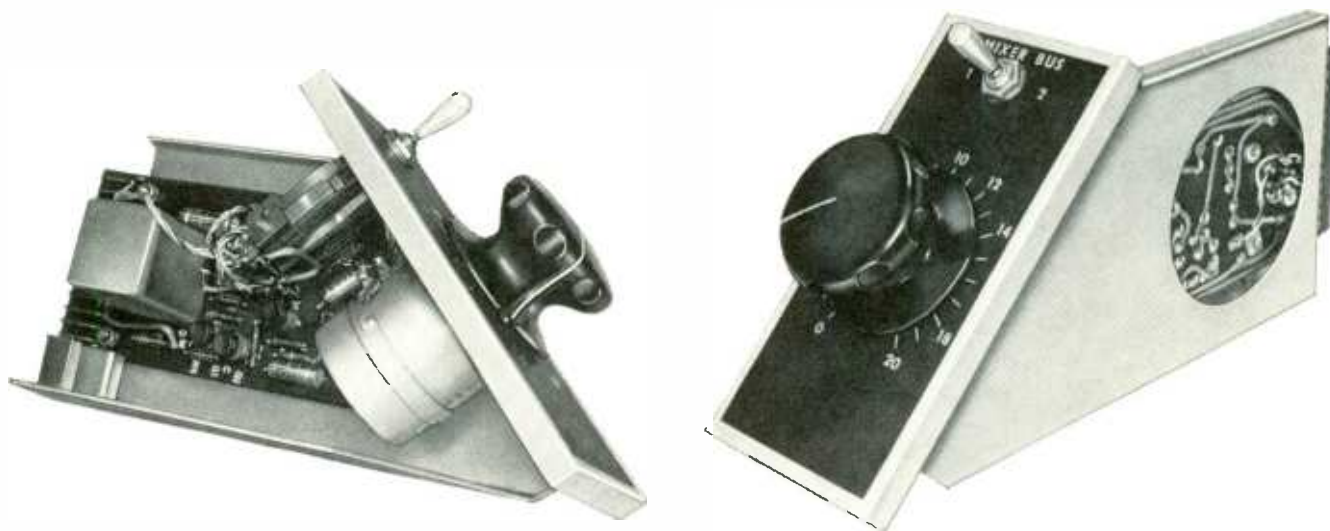

Preamplifier module, Type BA-21-A

FEATURES

- All transistor—no tubes in the circuitry
- Plug-in construction for ease in maintenance
- Space saving—small, compact, light weight
- Low voltage—low power drain
- Modular construction—amplifier, Daven fader, mixer key, and front panel make up complete plug-in unit
- Fiberglass wire board

WHERE TO USE

The General Electric Type BA-21-A transistor pre-amplifier module provides the gain necessary to raise the audio signal from a microphone to a level high enough to feed a mixer bus. This pre-amplifier is designed for use in the Type BC-21-A audio console or other custom-console systems employing transistor amplifiers.

DESCRIPTION

The General Electric Type BA-21-A transistor pre-amplifier consists of a plug-in audio unit of excellent broadcast quality which includes the amplifier chassis, etched-front panel, Daven step attenuator, three-position output-lever switch, and a mounting frame.

This amplifier is composed of four transistor stages. The first and second stages are directly coupled in a configuration known as the Darlington compound connection. The second stage is then capacitively

coupled to the third stage which is directly coupled to the emitter-follower output stage. An interstage gain control is located between the second and third stages. The unbalanced 600-ohm output of the amplifier drives a mixer bus.

MECHANICAL SPECIFICATIONS

UNITS

Type number covers the amplifier assembly, a set of transistors, and a set of installation and operating instructions.

DIMENSIONS

Height	Length	Width	Weight	Front Panel Slope
4 $\frac{1}{8}$ inch	9 $\frac{1}{2}$ inch	3 inch	1 $\frac{3}{4}$ lbs	45 degrees

MOUNTING

Unit plugs into Type BC-21-A audio console or a similar mounting arrangement using a 13-pin Elco receptacle.

OPERATING CONDITIONS

- Max room ambient temperature, cont. 95 F (35 C)
- Max cabinet ambient temperature, cont. 122 F (50 C)
- Max room ambient temperature, 5 percent of time, 113 F (45 C)
- Max cabinet ambient temperature, 5 percent of time, 131 F (55 C)
- Max relative humidity, 95 percent

ELECTRICAL CONNECTIONS

All electrical connections are made through a 13-pin plug mounted at one end of the printed wire board.

SAFETY PROVISIONS

No power is applied to the unit unless it is plugged into its mating socket. When the unit is plugged in and console closed there is no exposed voltage. The maximum voltage applied to the unit is 25 volts d-c.

Transistor Pre-amplifier Module

Type BA-21-A, Plug-in

ELECTRICAL SPECIFICATIONS

PERFORMANCE

Frequency Response: ± 1 db 50-15,000 cps.
Gain: 50 db (may be modified for 40 db if desired).
Distortion: $\frac{1}{2}$ percent or less at rated output level.
Noise: -70 dbm

POWER REQUIREMENTS

25 volts d-c at 8 ma

SIGNAL INPUTS

Levels (Max):
-35 db with amplifier connected for 50 db of gain.
-20 db with amplifier connected for 40 db of gain.
Impedances:
Input: Unloaded transformer
Source: 50/150/250/600 ohms balanced or unbalanced.

SIGNAL OUTPUT

-10 dbm; impedance between 300 and 1000 ohms (nominally 600 ohms) unbalanced.

CONTROLS

Daven type, adjustable in 2 db steps, no detents.

TRANSISTOR COMPLEMENT

3—2N324 General Electric
1—2N320 General Electric

COMPLIANCE

Complies with all applicable FCC and EIA specifications.

HOW TO ORDER

When ordering please specify: Type BA-21-A transistor pre-amplifier (requires external power supply).

ACCESSORIES

Type FA-47-A line-to-line transformer will provide a balanced 150 or 600 output from Type BA-21-A pre-amplifier module.

Type BP-20-A 25-volt transistor power supply (regulated).

7777466P4 ELCO 13-pin receptacle.

Plug-in Pre-amplifier

Type BA-1-H

FEATURES

- Plug-in construction permits easy removal for servicing
- Small, compact design. Six of these amplifiers can be mounted in 7-inch of rack space
- Simple two-stage circuit using printed-wire board makes parts easy to locate for maintenance
- Excellent plug-in contact efficiency. Unit uses Cinch-Jones "2400" series plugs
- Tubes are shielded by easily removed tube shields
- Transformers are of hum-bucking coil construction with magnetically shielded cases
- Chassis provides mounting hole to accommodate Type FA-35-G bridging volume control
- Uniformity of performance assured by use of printed-wireboard

WHERE TO USE

The General Electric Type BA-1-H plug-in pre-amplifier is designed for use as a microphone pre-amplifier or as a booster amplifier between mixer bus and the program amplifier of a studio-audio system. It can also be used as an isolation amplifier when provided with a suitable bridging resistance, such as Type FA-35-G bridging volume control.

This pre-amplifier, when used in conjunction with Type BA-12-C plug-in program/monitor amplifier, makes it possible to assemble a complete studio-audio system employing only two basic amplifier types.

DESCRIPTION

The Type BA-1-H plug-in pre-amplifier consists of a single plug-in unit that utilizes a printed-wire board on which are assembled all the amplifier components. This assembly is mounted in a wrap-around frame incorporating a ten-pin Cinch-Jones "2400" series plug.

Electrically, the Type BA-1-H consists of two resistance coupled stages using Type 5879 tubes. A feedback loop is used around the two stages. Specially designed input and output transformers with hum-bucking coil construction and alloy shields are used.

An unloaded transformer input is employed to give maximum gain and optimum signal-to-noise ratio from high-quality broadcast microphones.

A Type FA-35-G bridging volume control is available as an accessory. This control may be mounted in a hole which is available for this purpose on the Type BA-1-H amplifier. When mounted, this control provides a 10,000-ohm input impedance for use as a bridging or continuously variable-input volume control.

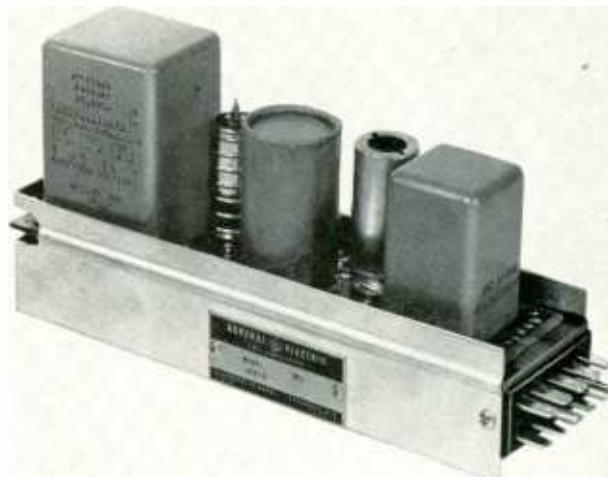

Plug-in pre-amplifier, Type BA-1-H

MECHANICAL SPECIFICATIONS

UNITS

Type number covers single plug-in assembly.

DIMENSIONS

Height	4 $\frac{5}{8}$ inches	Width	2 $\frac{7}{16}$ inches
Length	10 $\frac{1}{4}$ inches	Weight	2 $\frac{1}{2}$ lbs

MOUNTING

Six of these pre-amplifiers or three pre-amplifiers and one Type BP-10-B plug-in power supply can be mounted on a Type FA-23-B shelf (accessory) for rack mounting. Up to seven pre-amplifiers can be mounted in a Type BC-11-A audio console.

OPERATING CONDITIONS

Maximum cabinet ambient temperature:	130 F (55 C)
Maximum relative humidity:	95 percent

ELECTRICAL CONNECTIONS

All connections are made via a 10-pin "2400" series Cinch-Jones plug, which is the standard plug used on all our plug-in units.

SAFETY PROVISIONS

No B+ power is applied to the unit unless it is plugged into its mating connector. The exposed soldered eyelet points on the top side of the board are protected with an insulating coating of resin varnish.

ELECTRICAL SPECIFICATIONS

PERFORMANCE

Frequency Response:	± 1 db 50-15,000 cps.
Gain:	40 db

Plug-in Pre-amplifier

Type BA-1-H

Harmonic Distortion: 0.5 percent or less at +18 dbm,
50-15,000 cps.
Noise -80 dbm or less.

POWER REQUIREMENTS

0.3 ma at 6.3 volts a-c (filament power)
Filaments biased at +20 to +50 volts d-c (supplied by BP-10-B power supply).

SIGNAL INPUTS

Input Impedance Unloaded transformer.
Source Impedance: 30/150/250/600 ohms connections
(150 ohms as shipped.)

SIGNAL OUTPUTS

Rated output, +18 dbm; output impedance, 600/150 ohms;
600 ohms as shipped.

TUBE COMPLEMENT

2 Type 5879

INTERCHANGEABILITY

Electrically and mechanically interchangeable with previous Type BA-1-F plug-in pre-amplifier.

COMPLIANCE

Complies with all applicable FCC and RETMA specifications.

HOW TO ORDER

When ordering, please specify: Type BA-1-H plug-in pre-amplifier (requires an external power supply).

ACCESSORIES

Type BP-10-B plug-in power supply, for Types BA-1-H's and/or BA-12-C's. (Type BP-10-B uses 200 watts at 110 volts a-c and will supply power for 25 Type BA-1-H pre-amplifiers or three Type BA-12-C program/monitoring amplifiers.)

Type FA-23-B shelf, for mounting various plug-in amplifiers. The Type FA-23-B shelf requires seven inches of vertical-rack space, and will accommodate six Type BA-1-H pre-amplifiers, or four Type BA-12-C program/monitoring amplifiers, or Type BA-9-A uni-level amplifiers; or two Type BP-10-B power supplies or combinations of these plug-in units.

Type FA-35-G bridging volume control, for use with Type BA-1-H and BA-12-C amplifiers. It is designed to convert a 600-ohm amplifier input to a 10,000-ohm balanced-bridging service and may be used on line levels up to +40 dbm. When used with the Type BA-1-F it is connected ahead of the input transformer.

Transistor Plug-in Pre-amplifier

Type BA-25-B

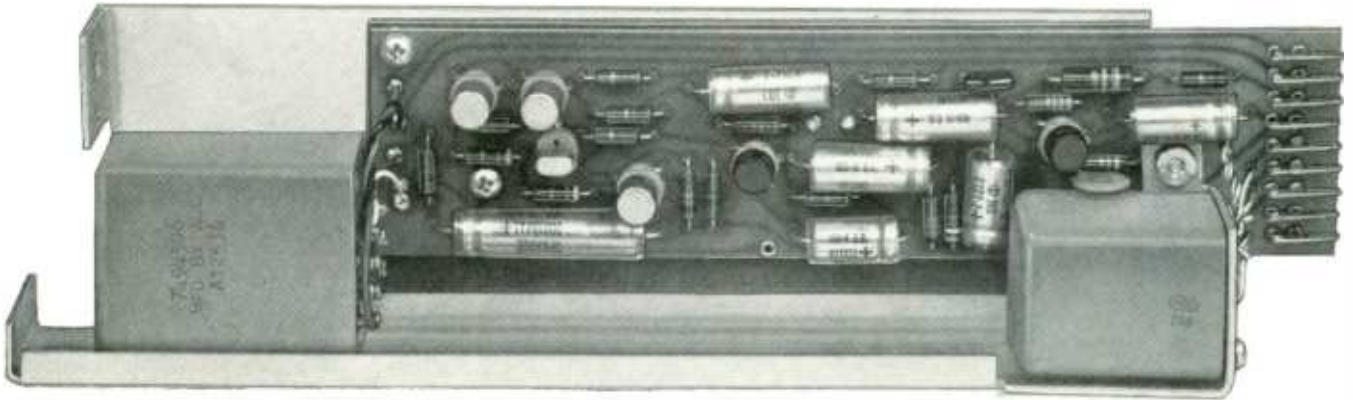

Transistor plug-in pre-amplifier, Type BA-25-B

FEATURES

- Plug-in construction permits easy removal for servicing
- Small, compact design. Ten of these amplifiers can be mounted in 3½ inches of rack space
- Amplifier is assembled on a rugged printed-wire fiberglass board
- Chassis provides mounting hole to accommodate the General Electric Type FA-35-G bridging volume control or an interstage gain control
- Uniformity of performance assured by use of printed wireboard

WHERE TO USE

The General Electric Type BA-25-B plug-in pre-amplifier is designed for use as a microphone pre-amplifier or as a booster amplifier between mixer bus and the program amplifier of a studio-audio system. It can also be used as an isolation amplifier when provided with a suitable bridging resistance, such as Type FA-35-G bridging volume control.

This pre-amplifier, when used in conjunction with the General Electric Type BA-22-A plug-in program amplifier, makes it possible to assemble a complete studio-audio system employing only two basic amplifier types.

DESCRIPTION

The General Electric Type BA-25-B transistorized plug-in pre-amplifier consists of a single plug-in unit. This unit is composed of an aluminum chassis and a fiberglass printed-wire board. All amplifier components, including the plug-in connector, except the input and output transformers are assembled on the fiberglass wire board. The two transformers mount directly to the aluminum chassis.

Electrically, the Type BA-25-B amplifier circuit is composed of two common emitter gain stages followed by a four transistor compound-connected single-ended push-pull output stage. All transistors plug into sockets on the amplifier board.

The input stage is unloaded to provide maximum gain and optimum signal-to-noise ratio from high quality broadcast microphones.

Circuit provisions have been included in the amplifier for the installation of an optional interstage gain control. Either an interstage gain control, or a conventional bridging gain control such as the Type FA-35-G, may be mounted on bracket which is part of the amplifier's basic chassis.

MECHANICAL SPECIFICATIONS

UNITS

Type number covers single plug-in assembly.

DIMENSIONS

Height	2 7/8 inches	Width	1 5/8 inches
Length	11 1/4 inches	Weight	1 lb, 5 oz

MOUNTING

Plug-in mounting. Ten of these pre-amplifiers can be mounted on a Type FA-50-A shelf (accessory) for rack mounting.

OPERATING CONDITIONS

Maximum cabinet ambient temperature:	130 F (55 C)
Maximum relative humidity:	95 percent

ELECTRICAL CONNECTIONS

All connections are made via a 9-pin Elco plug, which is the standard plug used on all our plug-in units.

SAFETY PROVISIONS

No power is applied to the unit unless it is plugged into its mating connector.

ELECTRICAL SPECIFICATIONS

PERFORMANCE

Frequency Response:	$\pm 1\frac{1}{2}$ db 50-15,000 cps and ± 1 db 30 to 15,000 cps
Gain:	+6 db

HARMONIC DISTORTION

0.5 percent or less at +18 dbm, 30 15,000 cps

NOISE

-120 dbm related to input

POWER REQUIREMENTS

18 MA at 25-volt, d-c

Transistor Plug-in Pre-amplifier

Type BA-25-B

SIGNAL INPUTS

Input Impedance: Unloaded transformer.
Source Impedance: 150/250/600 ohms connections (150 ohms as shipped).

SIGNAL OUTPUTS

Rated output, +18 dbm; output impedance, 600/150 ohms; 600 ohms as shipped.

TRANSISTOR COMPLEMENT

2 General Electric	2N508
1 SYL	2N214
3 RCA	2N270

COMPLIANCE

Complies with all applicable FCC and EIA specifications.

HOW TO ORDER

When ordering, please specify: General Electric Type BA-25-B plug-in pre-amplifier (requires an external power supply).

ACCESSORIES

Type BP-20-A power supply, for Type BA-25-B and/or Type BA-24-A.

Type FA-50-A shelf, for mounting various plug-in amplifiers. The Type FA-50-A shelf requires 3½ inches of vertical rack space, and will accommodate 10 Type BA-25-B pre-amplifiers, or Type 4BA-34-A monitor amplifiers.

Type FA-35-G bridging volume control, for use with Type BA-25-A amplifiers. It is designed to convert a 600-ohm amplifier input to a 10,000-ohm balanced-bridging service and may be used on line levels up to +40 dbm. When used with the Type BA-25-B it is connected ahead of the input transformer.

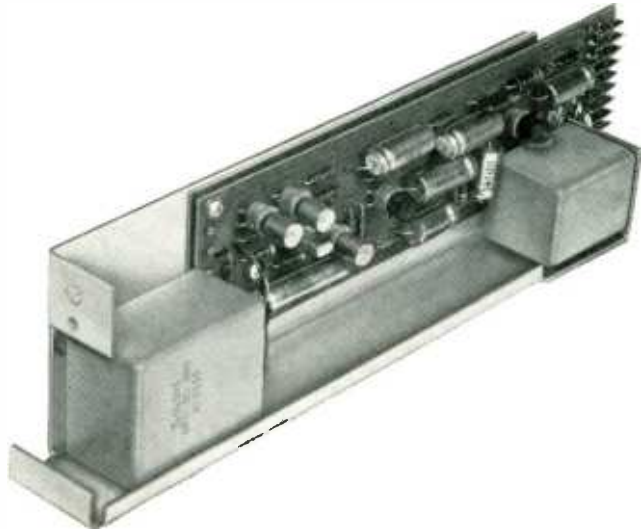
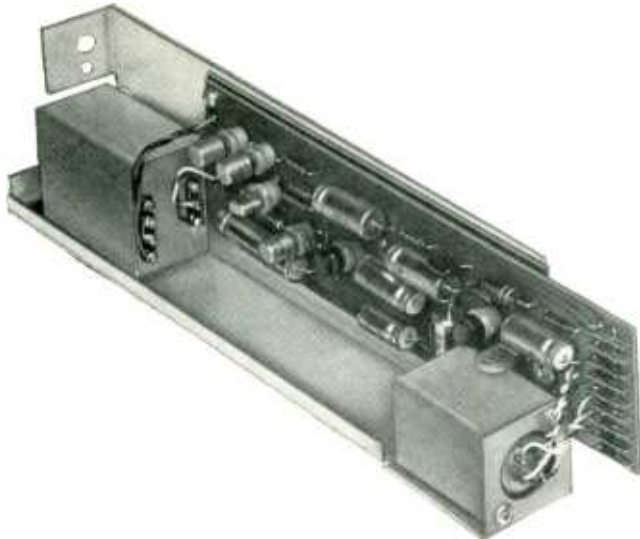

Plug-in Program/Monitoring Amplifier

Type BA-12-C

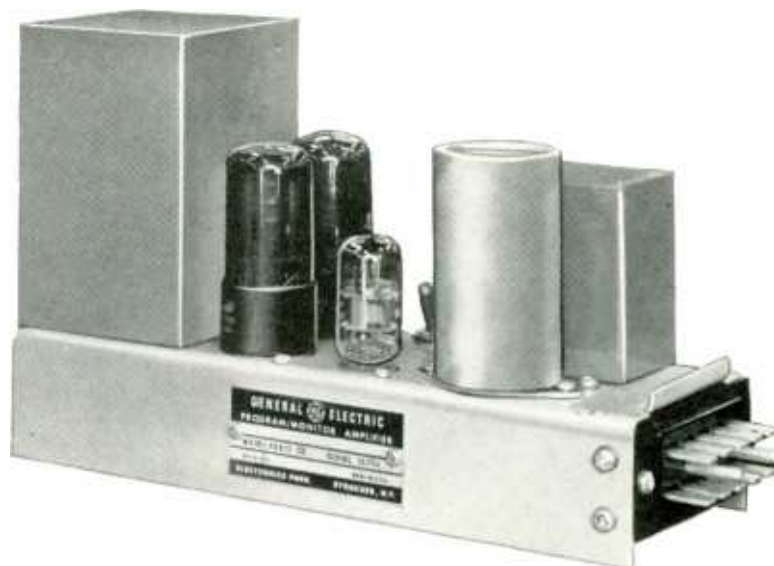

Plug-in program/monitoring amplifier, Type BA-12-C

FEATURES

- Small, compact design. Four of these amplifiers can be mounted in seven inches of rack space
- Plug-in construction with point-to-point wiring makes maintenance extremely easy
- Only two tube-types used
- Easy removal for servicing. Uses Jones "2400" series plug
- Chassis punched for addition of bridging controls and metering switches
- No shock hazard. Voltage is applied to the unit only when plugged into a mating source and when so plugged in, no voltage is exposed
- Fulfills all medium and high-level audio system requirements. Toggle switch allows selection of 56- or 71-db gain

WHERE TO USE

The General Electric Type BA-12-C, plug-in program/monitoring amplifier is a high fidelity, compact, fixed gain, plug-in audio unit, recommended for use as a program, line, monitoring or isolation amplifier.

DESCRIPTION

The General Electric Type BA-12-C plug-in program/monitor amplifier is a dual-purpose amplifier. By means of a switch, located on the chassis top, this amplifier may be instantly changed from a line amplifier to an 8-watt monitor amplifier.

With the switch set in low position, the amplifier serves as a program or line amplifier. In this position the amplifier has a gain of 56 db. With an output level of +30 dbm, the distortion is less than one-half of one percent with a maximum input of -26 dbm.

When the switch is in the high position, the amplifier may be used as a monitor amplifier with a gain of 71 db. In this application an output level of +39 dbm (8 watts) is possible with a distortion figure of less than 3 percent at maximum input level of -32 dbm.

Electrically the Type BA-12-C amplifier consists of a 5879 pentode input stage plus a triode-connected 5879 used as a split-load phase inverter and two 6V6 tubes in the push-pull output stage. Feedback from a tertiary winding on the output transformer is fed to the cathode of the first stage. For high-gain applications, the "HI" position of the switch decreases the feedback by 15 db.

Holes are provided on the chassis for installation of an accessory Type FA-35-G bridging volume control and two tube metering switches if such are desired.

The Type BA-12-C amplifier is equipped with a male, 10-pin "2400" series Jones plug for mating use in the General Electric Type BC-11-A console. It may also be mounted on an accessory Type FA-22-E tray with mating receptacle for rack use. When so mounted, the tray and amplifier combination is usually mounted on a Type FA-23-A standard cabinet-rack mounting shelf (accessory). Power can then be obtained from a rack-mounted Type BP-10-B power supply.

MECHANICAL SPECIFICATIONS

DIMENSIONS

Depth	10 $\frac{3}{4}$ inches	Width	3 $\frac{1}{2}$ inches
Height	5 $\frac{3}{4}$ inches	Weight	6 lbs

MOUNTING

Each Type BA-12-C amplifier mounts on a Type FA-22-E tray. Four of these trays mount on one Type FA-23-A shelf, occupying seven inches (four rack units) of cabinet space.

Plug-in Program/Monitoring Amplifier

Type BA-12-C

OPERATING CONDITIONS

Maximum ambient temperature: 113 F (45 C)
 Maximum relative humidity: 95 percent

SAFETY PROVISIONS

Voltage is applied to the unit only when it is plugged into a mating source and when so plugged, no voltage is exposed.

ELECTRICAL SPECIFICATIONS

Type of Circuit

Consists of a 5879 pentode input stage plus a triode connected 5879 used as a split-load phase inverter and two Type 6V6 tubes as the push-pull output. Feedback is used from a tertiary winding on the output transformer to the cathode of the input stage. For high gain applications, a switch is provided to decrease the feedback by 15 db.

PERFORMANCE

Program Amplifier (low gain position)

Frequency Range: 50-15,000 cps. ± 1 db
 Gain: 56 db
 Output Level and Distortion: +30 dbm (1 watt) $\frac{1}{2}$ percent or less distortion (maximum input -26 dbm)
 +39 dbm (8 watts) 1 percent or less distortion (maximum input -17 dbm)
 Output Noise: Less than -60 dbm

Monitoring Amplifier (high gain position)

Frequency Range: 50-15,000 cps. $\pm 1\frac{1}{2}$ db
 Gain: 71 db

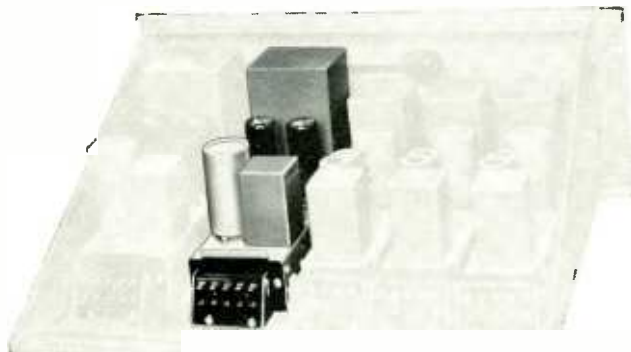

Plug-in program/monitoring amplifiers, Type BA-12-C plug-in pre-amplifiers, Type BA-1-F mounted in broadcast shelf, Type FA-23-A

Output Level and

Distortion: +39 dbm (8 watts) 3 percent or less distortion (maximum input -32 dbm)

For high level loudspeaker applications, the Type BA-12-C can be modified to give 15 watts output by using Type 6L6 or 5881 tubes, and increasing the B+ supply voltage.

SIGNAL INPUTS

Input Impedance: Unloaded transformer
 Source Impedance: 600/150 ohms; 600 ohms as shipped

POWER INPUTS

Filaments: 1.2 amps at 6.3 volts a-c
 Bias: Biased at +20 to +50 volts d-c
 B+ Requirement: 88 ma at 300 volts d-c (at 8 watts output)

OUTPUTS

Output impedance, 600/150 ohms; 600 ohms as shipped.

TUBE COMPLEMENT

2 Type 5879 (input and phase inverter)
 2 Type 6V6 (push-pull output)
 (Type 6L6 or Type 5881 tubes may be used to obtain higher power output when desired)

HOW TO ORDER

When ordering, please specify:
 Type BA-12-C plug-in program/monitoring amplifier (requires an external power supply).

ACCESSORIES

Type FA-22-E tray, for mounting Type BA-12-C.
 Type BP-10-B plug-in power supply, for BA-1-F's and/or BA-12-C's. (Type BP-10-B uses 200 watts at 110 volts a-c and will supply power for 25 Type BA-1-F pre-amplifiers or three Type BA-12-C program/monitoring amplifiers.)

Type FA-23-A shelf, for mounting plug-in units with trays. (Type FA-23-A occupies seven inches (four units of rack height) in a Type PR-1-A Cabinet Rack and will accommodate six pre-amps, Type BA-1-F, with trays, four Type BA-12-C program/monitoring amplifiers, with trays or two Type BP-10-B power supplies, with trays.)

Type FA-35-G, bridging volume control. (Bridging volume control for use with Type BA-1-F and Type BA-12-C amplifiers. It is designed to convert a 600-ohms amplifier input to a 10,000-ohm balanced-bridging service and may be used in line levels up to +40 dbm.)

Transistor Program Amplifier

Type BA-22-A, Plug-in

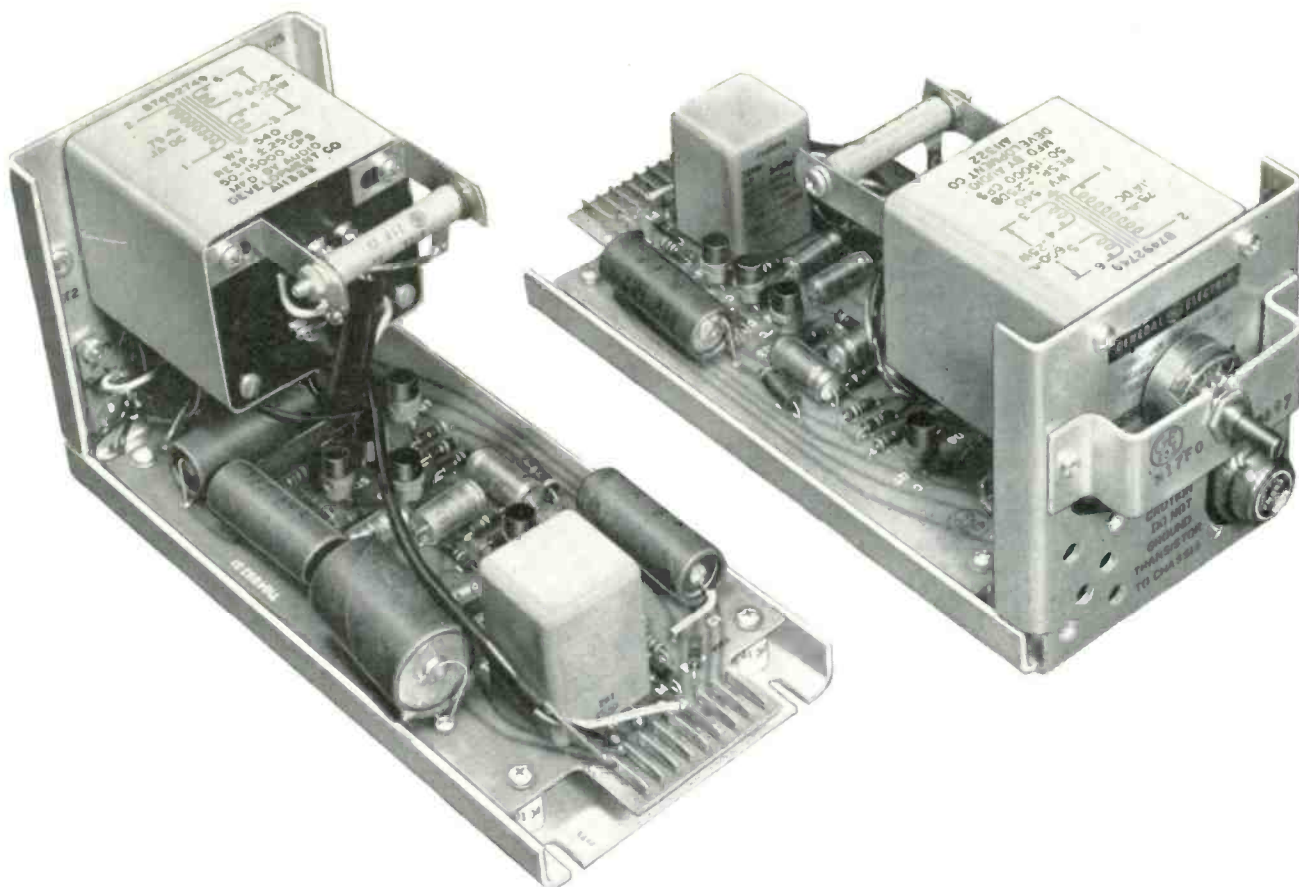

Program Amplifier Type BA-22-A

FEATURES

- All plug-in transistors—no tubes in the circuitry
- Low voltage—low power drain
- Plug-in construction for ease in maintenance
- Space saving—small, compact, lightweight
- Fibreglas wire board

WHERE TO USE

The General Electric Type B-22-A transistor program amplifier provides the gain necessary to raise an audio signal from mixer bus level to line output level of +24 dbm (+18 dbm and a 6 db pad).

This amplifier is designed for use in the Type BC-21-A audio console or any custom console employing transistor amplifiers.

DESCRIPTION

The Type BA-22-A transistor program amplifier is a compact plug-in audio unit constructed on a printed

fibreglas wire board and mounted on an "L" shaped aluminum frame.

This fine broadcast quality high fidelity amplifier contains eight separate transistor stages. The first two stages are coupled directly in a Darlington compound connection. The second stage is capacitively coupled to the third stage which is directly coupled to the fourth stage. The fourth stage is a common emitter directly coupled to an emitter follower which is then directly coupled to another common emitter. The latter stage is directly coupled to a common collector Darlington compound connected output stage. The master gain control is connected between stages two and three.

MECHANICAL SPECIFICATIONS

Dimensions

Height	4½ inches	Width	4¼ inches
Length	9⅝ inches	Weight	2¾ lbs

Transistor Program Amplifier

Type BA-22-A, Plug-in

MOUNTING

This amplifier plugs into the Type BC-21-A audio console or, by utilizing a Type FA-48-A shelf, up to four of these units may be rack mounted in any standard EIA rack such as the Type PR-1-A equipment rack.

OPERATING CONDITIONS

Max room ambient temperature, Cont. 95 F (35 C)
 Max cabinet ambient temperature, Cont. 122 F (50 C)
 Max room ambient temperature, 5 percent of time, 113 F (45 C)
 Max cabinet ambient temperature, 5 percent of time, 131 F (55 C)
 Max relative humidity, 95 percent

ELECTRICAL CONNECTIONS

All connections are made by a 9-pin plug which is attached to printed wire board.

SAFETY PROVISIONS

No power is applied to the unit unless it is plugged into its mating socket. When the unit is plugged in and console closed there is no exposed voltage. The maximum voltage applied to the unit is 50 volts d-c.

ELECTRICAL SPECIFICATIONS

PERFORMANCE

Frequency Response: ± 1 db 50-15,000 cps
 Gain: 75 db matching input
 Distortion: $\frac{1}{2}$ percent or less at +24 db (or rated output level)
 Noise: S/N ratio of 60 db

POWER REQUIREMENTS

50 volts d-c at 160 ma.

SIGNAL INPUT

Transformer matching—maximum input level — 27 dbm.

SIGNAL OUTPUT

150 600 ohms balanced or unbalanced—connected for 600 ohms at +24 dbm output level.

CONTROLS

Provisions are made for mounting an interstage control on the amplifier front when required. A 750K carbon potentiometer is recommended. When used in Type BC-21-A audio console, a daven, step-type control is used.

TRANSISTOR COMPLEMENT

3—2N324 General Electric
 4—2N320 General Electric
 1—2N553 Delco

COMPLIANCE

Complies with all applicable FCC and EIA specifications.

HOW TO ORDER

When ordering please specify: Type BA-22-A transistor program amplifier (requires external power supply).

Type number includes amplifier assembly, a set of transistors and a set of installation and operating instructions.

ACCESSORIES

Type FA-48-A equipment shelf
 Type BP-21-A 50/25 volt power supply
 2R74P25 750K carbon potentiometer

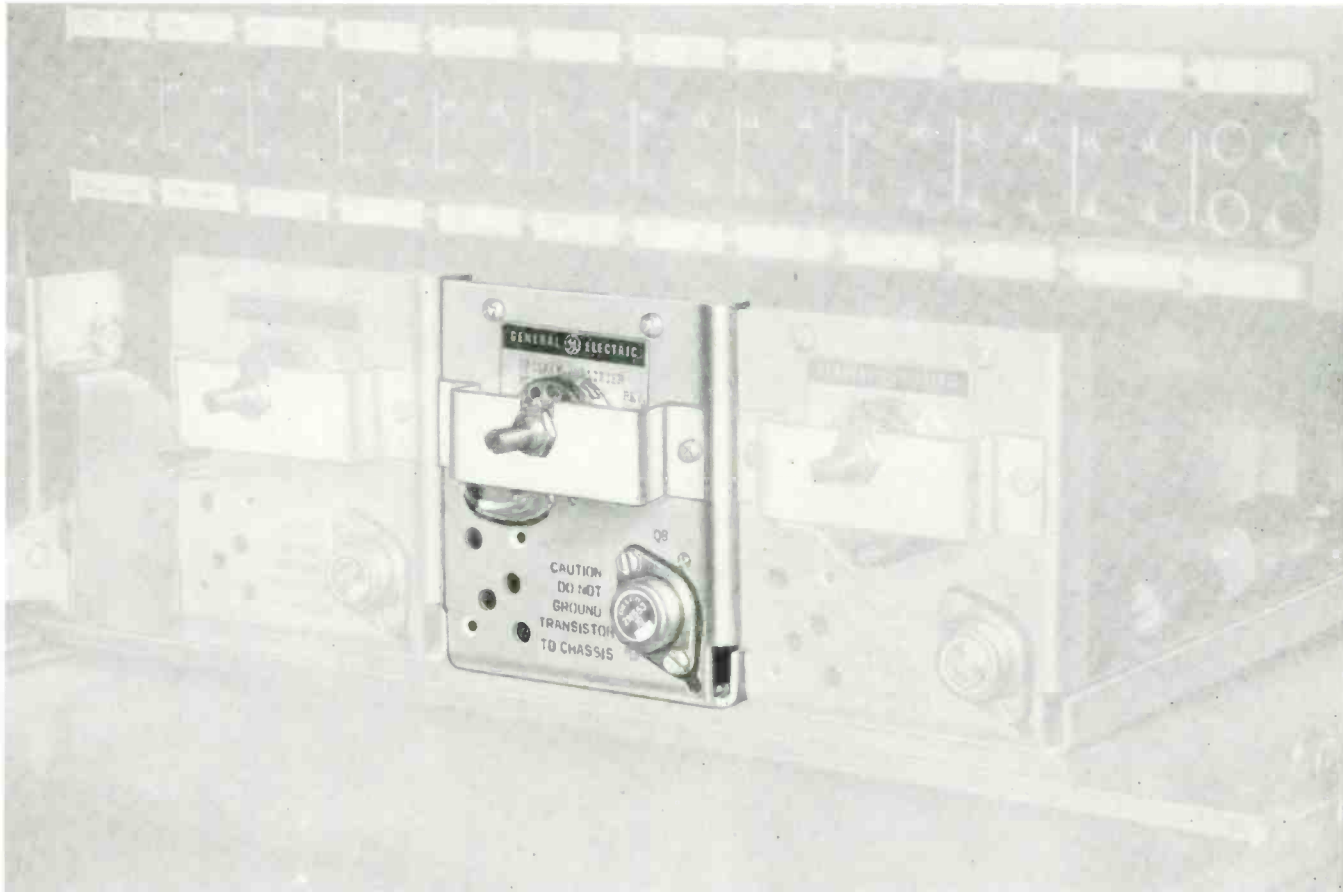

Program amplifier Type BA-22-A installed in a equipment shelf Type FA-48-A

Plug-in Uni-level Pre-amplifier

Type BA-15-A

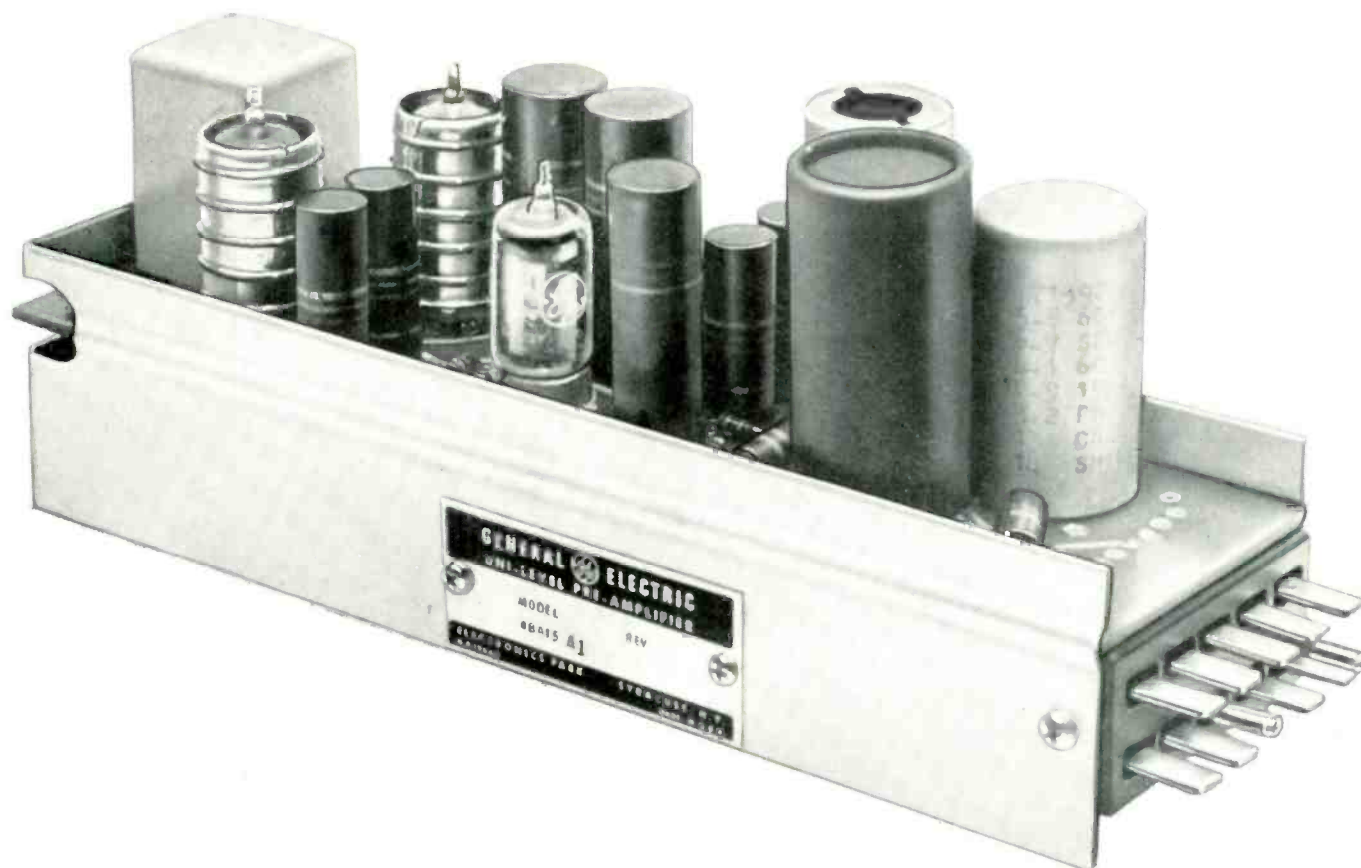

Plug-In uni-level pre-amplifier, Type BA-15-A

FEATURES

- **Versatile**
Relieves operators by permitting automatic level control in any microphone channel
May be used in variety of applications in AM-FM-TV-Recording studios, such as announce booths, boom mikes, and public address systems
Controls level difference between two or more microphone signals
Automatic gain control is applied when the microphone signal to the amplifier is -70 dbm or higher. Signals below -70 dbm are linearly amplified
- **High gain—60 db vs 40 db gain for standard pre-amplifiers**
- **Plug-in construction allows easy removal of pre-amplifiers for servicing**
- **Small compact design. Six of these units can be mounted in seven inches of rack space**
- **Tubes are shielded by easily removed tube shields**
- **Transformers are of hum-bucking coil construction with magnetically shielded cases**
- **Prevents blasting when two or more people are using same microphone**
- **Automatically adjusts audio level from close-in to six or eight feet from microphone**

WHERE TO USE

The General Electric Type BA-15-A plug-in uni-level pre-amplifier is a high-gain microphone pre-amplifier incorporating automatic-level control. This device is designed to automatically control variation in microphone signal levels. This compact plug-in unit may be used in place of the Type BA-1-F or Type BA-1-H pre-amplifiers.

Input level variations of up to 30 db may be successfully controlled by this pre-amplifier with only a 10 db change in the output signal level. Such variations are often encountered in boom microphone operation or in other cases where the relationship between the talent and the microphone is continuously changing. In addition, the uni-level pre-amplifier is a high gain unit having 60 db of gain as compared to a conventional pre-amplifier having 40 db of gain.

DESCRIPTION

The General Electric Type BA-15-A plug-in uni-level pre-amplifier is a single plug-in chassis which consists of a push-pull input stage (12AX7) supplying signal to a variable gain output stage (GL-6386). Signal for the bias generator is supplied from the plates of the output stage (GL6386) to a voltage amplifier stage (GL5670) connected in push-pull. The voltage amplifier supplies a signal to a full wave bias

Plug-in Uni-level Pre-amplifier

Type BA-15-A

rectifier stage (6AL5) whose output applies a bias voltage to the control grids of the variable gain stage.

MECHANICAL SPECIFICATIONS

UNITS

The type number covers the amplifier, one set of operating tubes, and installation and operating instructions.

DIMENSIONS

Height $4\frac{3}{4}$ inches Width $2\frac{1}{2}$ inches
Length $10\frac{1}{2}$ inches Weight $1\frac{1}{2}$ lbs

MECHANICAL

The size of this unit permits it to be used with our present line of plug-in amplifiers. The chassis size is that of the Type BA-1-H. It may be used to replace a Type BA-1-F or H, or any similar amplifier used as a microphone pre-amplifier of any studio audio system.

MOUNTING

Six uni-level pre-amplifiers can be mounted in seven inches of rack space using a Type FA-23-B shelf. Plug-in construction using a Jones 2400 series plug allows easy removal for servicing.

OPERATING CONDITIONS

Up to an external ambient of 45 C.
Up to 95 percent relative humidity.
Will withstand normal shipping.
Open-type construction allows natural ventilation.

ELECTRICAL CONNECTIONS

All connections are made to one 2400 series Jones connector mounted at end of chassis. The electrical connections to the Type BA-15-A Jones connector except for one connection are the same as our present line of plug-in amplifiers.

ELECTRICAL SPECIFICATIONS

PERFORMANCE

Frequency Response: ± 1 db 50-12,000 and $+1 -1.5$ (\bar{a}) 15,000 cycles under any gain condition up to 30 db gain reduction.
Gain: 60 db unloaded transformer input.

Harmonic Distortion: Below and up to threshold of gain reduction 0.5 percent—50 to 15,000 cps. With 30 db gain reduction 50 to 15,000 cps 1 percent.

Output Noise: -60 dbm.

Attack Time: 1 millisecond

Recovery Time: 0.9 seconds for 63 percent recovery.

POWER REQUIREMENTS

300-volt d-c 25 ma approximately.

6.3-volt a-c (@ 1.30 amps +20 to +50-volt d-c bias on filaments. 15.7 watts. (The Type BA-15-A uses an external power supply—suggested Type BP-10-B power supply.)

SIGNAL INPUTS

Microphone level and up to -40 dbm with 30 db gain reduction.

Source Impedance: 30/150/250/600 ohms.

Impedance: 150 ohms as shipped. Balanced or unbalanced.

Input Impedance: Unloaded transformer.

SIGNAL OUTPUTS

Threshold—10 dbm output 0 dbm at 30 db gain reduction. 150/600 ohms out. 600 ohms as shipped. Balanced or unbalanced.

TUBE COMPLEMENT

1—12AX7	1—6AL5
1—GL6386	1—GL5670

HOW TO ORDER

When ordering specify:
Type BA-15-A plug-in uni-level pre-amplifier to consist of one amplifier; one set of operating tubes and installation and operating instructions.

ACCESSORIES

- 1—Type FA-23-B shelf (mounts six Type BA-15-A amplifiers)
- 1—Type BP-10-B power supply will supply five Type BA-15-A amplifiers.

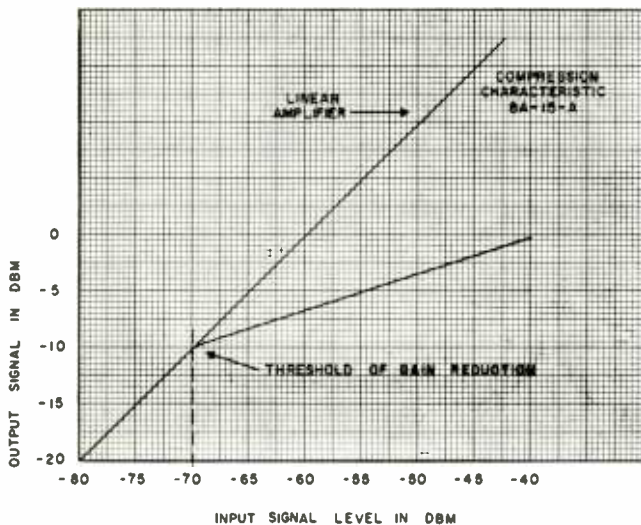

Microphone Pre-amplifier

Type BA-30-A



Microphone pre-amplifier, Type BA-30-A (actual size)

FEATURES

- Excellent frequency response with very low distortion
- Amplification of line noise is considerably reduced, since the signal is raised to a high level right near microphone
- Small size and little weight permits mounting at the end of a microphone boom
- Operates on 15- to 25-volt, d-c at 10 ma. Use a battery or any well-filtered power supply
- New General Electric PEP (Planar Epitaxial Passivated) silicon transistors used for a high degree of stability and ruggedness

WHERE TO USE

The General Electric Type BA-30-A transistorized microphone pre-amplifier is a boom microphone booster amplifier, a desk or a stand microphone pre-amplifier, or a microphone-to-line amplifier for remote applications. Gain settings of 20, 30, 40, or 56 db are available, with the change of one feedback resistor. With the gain set at 20 or 30 db, the level of a boom microphone is raised to a level which allows better control of the audio at the console. With the gain set at 40 db, a desk or a stand microphone output is raised to a sufficient level to feed directly into the high-level input of an audio-control console. Two microphones using two Type BA-30-A preamps could be used to feed a dual-mixing attenuator; enabling one knob control of a stereo microphone setup. With the gain set at 56 db gain, the Type BA-30-A microphone pre-amplifier may be used to feed a telephone line directly.

DESCRIPTION

Type BA-30-A microphone pre-amplifier consists of a fiberglass printed-circuit board, which mounts a P3 audio connector at each end. The entire assembly is covered by an aluminum sleeve.

The amplifier consists of three common emitter stages, which couple to an emitter-follower output stage. The input impedance is high to bridge the output of a 150- or 600-ohm microphone. The output impedance is low to feed either a 150- or 600-ohm load. The circuit is designed so that the signal does not "clip" nor become distorted at low supply voltages. For example, if the supply voltage decreases to 15-volt, only the gain has decreased by one-half db; but the distortion has not changed from its very low value.

MECHANICAL SPECIFICATIONS

UNITS

The type number covers the amplifier assembly, two Cannon P3 line connectors, three feedback resistors, a signal-coupling capacitor, a power supply bypass capacitor, a power supply isolating resistor, and an instruction booklet.

DIMENSIONS

Diameter	Length	Weight
1 1/8 inches	5 5/8 inches	4 oz

MOUNTING

Any position in the microphone line, between P3 audio connectors furnished with the unit, or any existing P3 connectors.

OPERATING CONDITIONS

Maximum ambient temperature—	60 C (140 F)
Maximum relative humidity	—95 percent

ELECTRICAL CONNECTIONS

Microphone input, and line output connectors plug directly into each end of the amplifier. Power supply connections can be made at the base of a microphone boom or at the audio console. No extra wires are needed. The d-c and audio share the same wiring. The signal is coupled out through a blocking capacitor.

SAFETY PROVISIONS

Power is removed from the amplifier when the line connector is removed. The line connector and the amplifier are keyed so that only the amplifier can mate with the line connector. A microphone connector is "blocked out" to prevent damage to a microphone by d-c voltage.

ELECTRICAL SPECIFICATIONS

PERFORMANCE

Gain: 20, 30 (factory shipped), 40, or 56 db
For gain settings of 20, 30, and 40 db
Frequency response: ± 1 db 30–15,000 CPS
Distortion: 1/2 percent or less at rated level
Noise: -70 dbm

POWER REQUIREMENTS

15- to 25-volt d-c at 10 ma
The following 22 1/2-volt batteries will give 150 hours continuous, up to 200 hours intermittent operation:
Neda No. 710
Eveready No. 763
Burgess No. 4156

SIGNAL INPUTS

Maximum input levels—
- 14 db with amplifier connected for 20 db gain
- 24 db with amplifier connected for 30 db gain
- 34 db with amplifier connected for 40 db gain
- 50 db with amplifier connected for 56 db gain
Impedances—
Input: High impedance
Source: 50 or 150 or 250 or 600 ohms unbalanced

SIGNAL OUTPUT

Level: +6 dbm max for all gain settings
Impedance: Low—to feed 150- or 600-ohm load

TRANSISTOR COMPLEMENT

4 - 2N2195 General Electric

COMPLIANCE

Complies with all applicable FCC and EIA specifications.

HOW TO ORDER

When ordering please specify: Type BA-30-A microphone pre-amplifier. (Requires external power supply.)

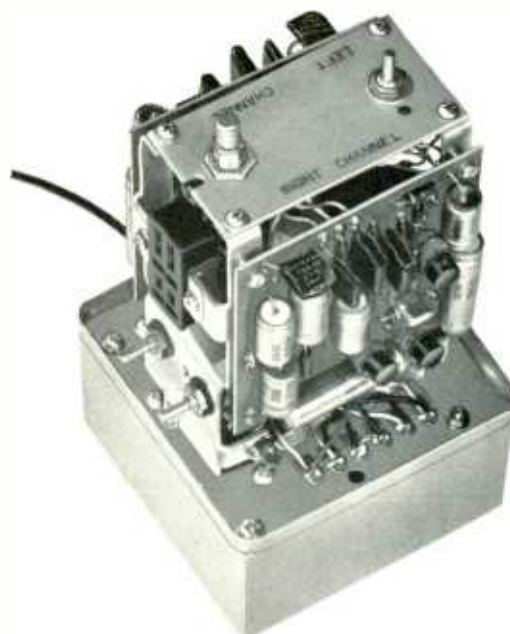

Equalized monaural/stereo transcription pre-amplifier, Type BA-23-A, with cover (left), with cover removed (right)

FEATURES

- Two complete amplifier channels
- Full RIAA low-frequency response
- Adjustable high-frequency response including RIAA position
- Sufficient level to feed directly into conventional mixer systems
- Completely transistorized
- Shielded output and power transformers
- Output circuits are 600/150 ohms and may be run either balanced or unbalanced
- Low distortion
- Built-in power supply—117/230 volts, 50/60 cycles

WHERE TO USE

The General Electric Type BA-23-A equalized transcription pre-amplifier is a transistorized dual-channel amplifier designed for stereo- or monaural-play-back applications.

It is designed to operate with high impedance stereo or monaural cartridges such as the General Electric Types VR-225, VR-1000, or other similar type cartridges. A four-position equalizer switch plus a monaural stereo output switch provide extreme operating flexibility.

DESCRIPTION

The complete dual amplifier and power supply is assembled into a single-cased unit. All signal input and output connections are made to the unit by means of a Jones 310 series connector. A fixed power-supply cord is provided for power-connection purposes.

Two operating controls are provided in this design. One is four-position switch for selecting response characteristics. The second switch is a MONAURAL/STEREO switch which permits selection of the out-

put modes of this dual-amplifier assembly. Both controls are located inside the basic assembly. Two-inch shafts provide adequate length for bringing the controls through the motor board.

A laminated plastic overlay plate is provided for mounting at the operating position on the motor board top.

The four response positions of the selector switch are:

1. FLAT
2. RIAA
3. RIAA WITH HIGH BOOST
4. RIAA WITH HIGH ATTENUATION

The FLAT position provides essentially unequalized high-frequency response from material recorded at a constant velocity.

The RIAA position provides a flat response characteristic for records recorded in accordance with the RIAA recording curve.

The RIAA HIGH BOOST position provides essentially flat RIAA equalization with a slight boost at the high end to compensate for record wear.

The RIAA HIGH ATTENUATION position produces RIAA equalization with a reduced high end response for use with "noisy" records.

When used as a STEREO transcription amplifier, two separate amplifiers provide stereo outputs. When used as a MONAURAL amplifier, the two channels are connected together at an inter-stage point and two identical monaural outputs are provided. This makes it possible to play monaural recordings, with a stereo cartridge by simply placing the MONAURAL/STEREO switch in the MON position.

Each amplifier channel is equipped with a level-set control for balancing the output level of the two channels. These controls are located on the plug-in side of the pre-amplifier assembly, since they are not normal operating controls.

Equalized Monaural/Stereo Transcription Pre-amplifier

Type BA-23-A

The self-contained power supply is designed to operate from either a 117-volt or 230-volt 50/60-cycle line. As normally shipped, the power supply is strapped for 117-volt a-c line operation.

MECHANICAL SPECIFICATIONS

DIMENSIONS

Depth	3 $\frac{7}{8}$ inches	Width	3 $\frac{7}{8}$ inches
Height	7 $\frac{1}{2}$ inches (excluding switch shafts)	Weight	Approx 3 lb 8 oz (unpacked)

MOUNTING

The amplifier mounts below the turntable motor board and the switches are designed to mount on the top of the turntable board.

ELECTRICAL SPECIFICATIONS

POWER INPUT

117/230 volts, 50/60 cycles
10 watts

TRANSISTOR AND DIODE COMPLEMENT

2-General Electric Type 2N508 4-General Electric Type 2N525
2-General Electric Type 2N1306 1-General Electric Type 1N91 Diode

OUTPUT LEVEL

When used with the General Electric variable reluctance cartridge, the output will be approximately -20 VU maximum from microgroove records.

NOISE LEVEL

-65 dbm

OUTPUT CIRCUITS

Load impedance: 600/150 ohms

Output connections: 600 or 150 ohms—balanced, or either side. may be grounded.

DISTORTION

$\frac{1}{2}$ percent or less, 30 to 15,000 cycles with up to -10 dbm. output. This includes equalizing circuits.

HOW TO ORDER

When ordering, please specify:
Type BA-23-A equalized stereo transcription pre-amplifier.

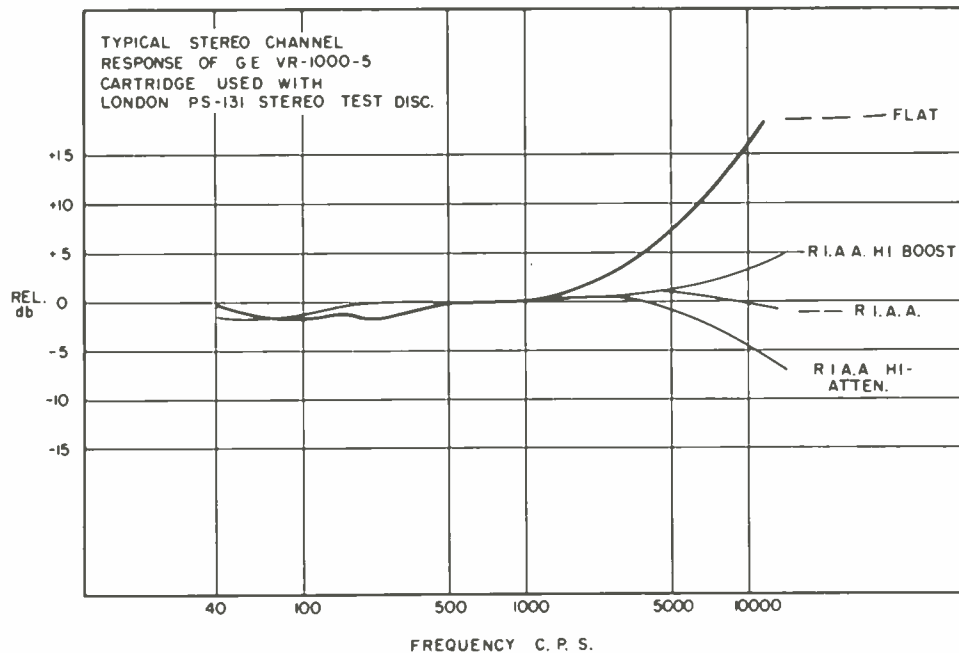

Transistorized Portable Amplifier

Type BA-26-A



Transistorized portable amplifier, Type BA-26-A

FEATURES

- Completely transistorized—not a tube in the circuitry
- Four microphone inputs, plus a high level input. All five inputs equipped with transformers
- Regulated, self-contained 95-135-volt 50/60-cycle a-c power supply
- Provisions for operating from self-contained batteries
- Built-in tone generator
- Provisions for paralleling portable amplifiers
- Amplified cue
- Small, lightweight design, weighs only 19½ lbs
- All transistors plug-in
- New laminated plastic front panel for ease of write-in and erase
- Built-in studio quality—designed for use on AM-FM-TV broadcast and recording audio applications
- Carrying handle functions as a base to set unit at a convenient operating angle

WHERE TO USE

The General Electric Type BA-26-A transistorized

portable amplifier is designed for all remote or auxiliary (emergency) studio audio mixing applications in AM-FM-TV or recording work.

Standard input and output impedances will make it possible to operate this transistorized portable amplifier in conjunction with other makes and models of broadcast audio equipment.

DESCRIPTION

The Type BA-26-A transistorized portable amplifier is suitable for use as a remote audio mixer and amplifier, capable of amplifying and mixing four microphones and one high-level source and feeding the output to a line at a +18 dbm level. The frequency response and distortion characteristics will be such that it will be suitable for use on AM-FM-TV and recording applications.

In addition to providing facilities for mixing five sources, this transistorized portable amplifier has a self-contained power supply and provisions for installing batteries. This will permit the operation of the transistorized portable amplifier from either a power line or its batteries.

A new feature includes a high-level input which may be used for mixing in a music source or as a means of coupling two or more Type BA-26-A transistorized portable amplifiers together to get additional mixing facilities.

Transistorized Portable Amplifier

Type BA-26-A

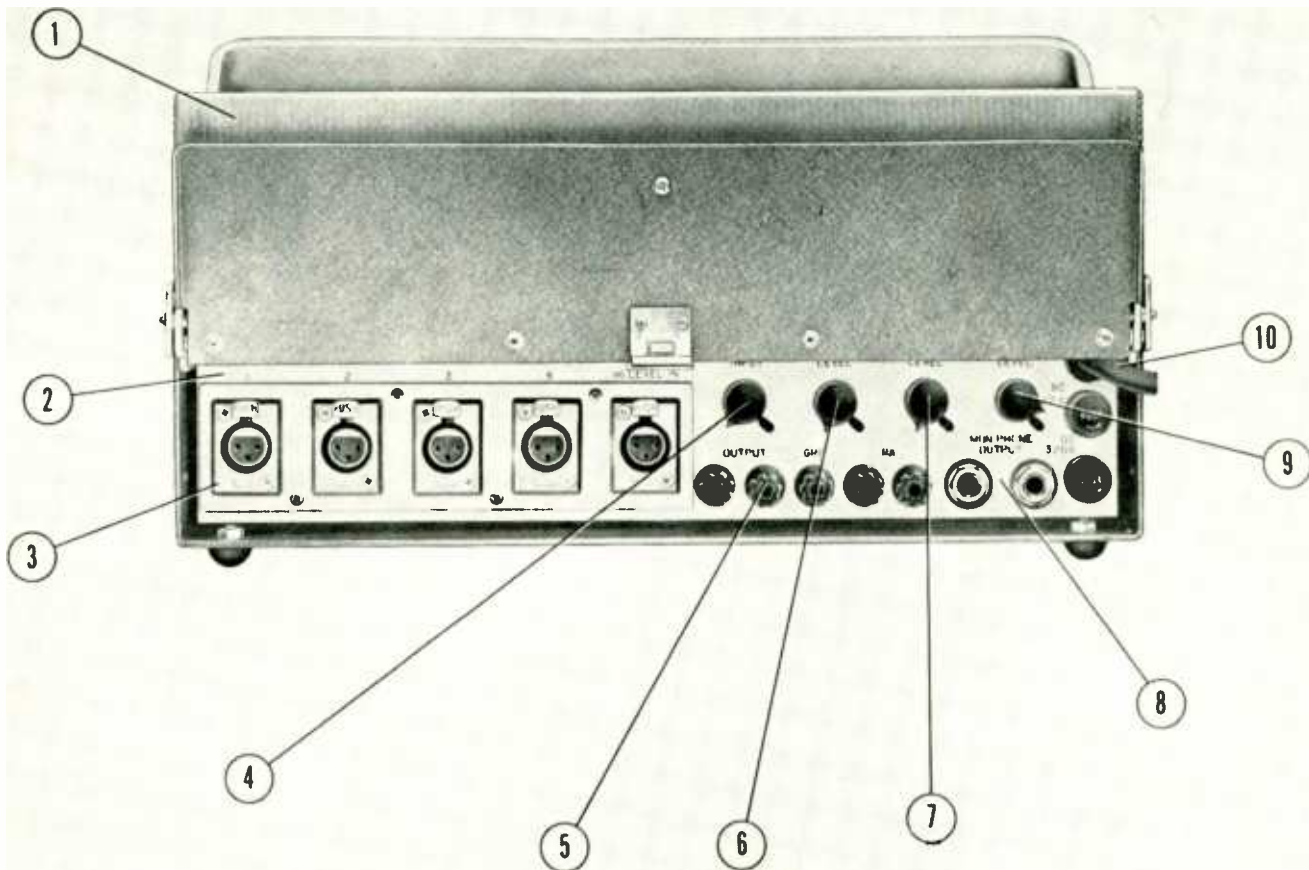

Transistorized portable amplifier, Type BA-26-A (rear cover opened)

- | | |
|--|--------------------------------|
| 1. Hinged cover | 6. Cue gain control |
| 2. Removable plate for mounting cannon P3 type receptacles | 7. Public address feed control |
| 3. XLR type input connectors | 8. Dual phone jacks |
| 4. High level gain control | 9. Head phone control |
| 5. Spring type binding posts for output and public address connections (5) | 10. Eight-foot power cord |

Transistorized Portable Amplifier

Type BA-26-A

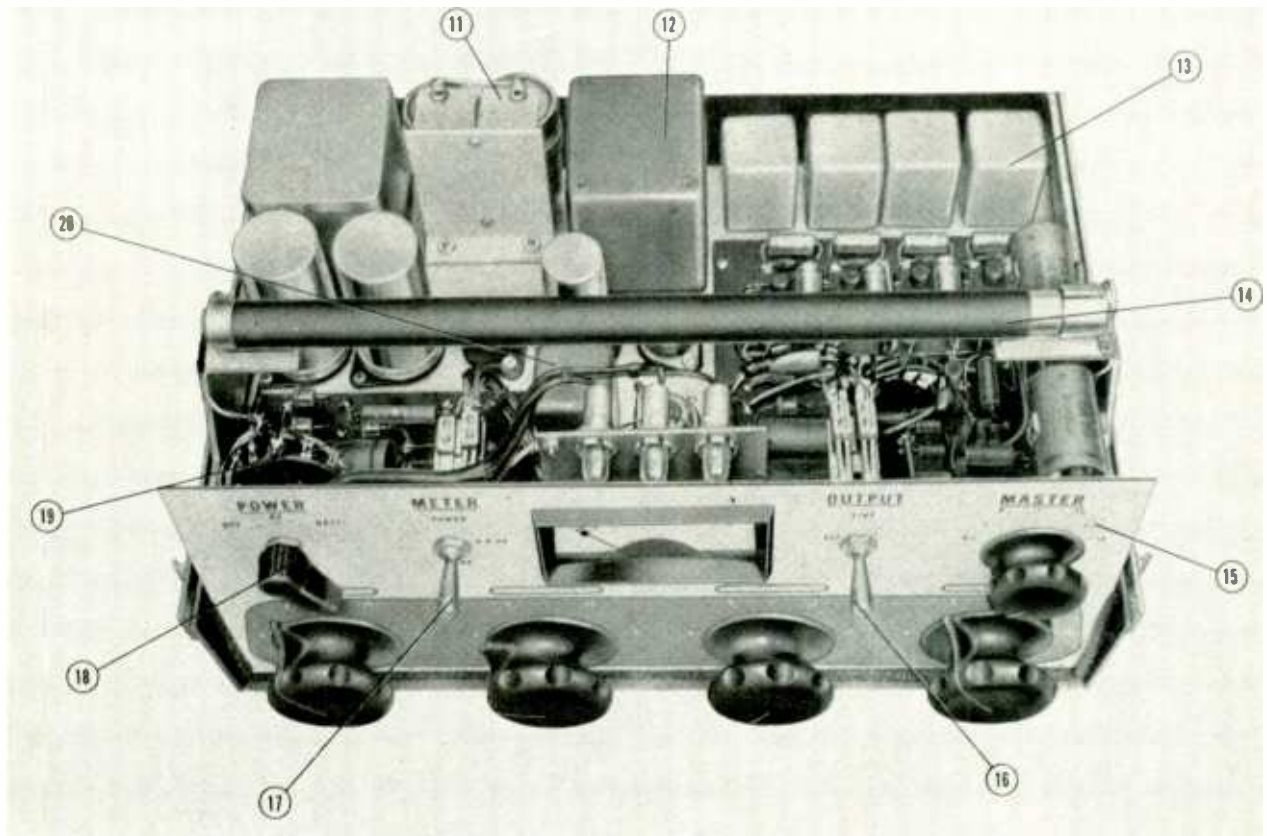

Transistorized portable amplifier, Type BA-26-A (top cover removed)

- | | |
|---|----------------------------------|
| 11. Meter light batteries | 16. Line ON/OFF/cue switch |
| 12. Output transformer | 17. Power check/+8VU/tone switch |
| 13. Microphone input transformer | 18. Power switch |
| 14. Mercury cells for amplifier battery operation (4) | 19. Regulated a-c power supply |
| 15. Laminated "write on" panel | 20. High level input transformer |

Transistorized Portable Amplifier

Type BA-26-A

MECHANICAL SPECIFICATIONS

DIMENSIONS

Depth 12 inches
Height 7 inches
Width 15 inches
Weight 19½ lb with batteries (18½ lb less batteries)

MOUNTING

Self-contained portable unit. Sets in position on four rubber feet or may be tilted at an angle by positioning handle under unit. Four rubber feet on the cover allow unit to sit on any surface in the carrying position

ELECTRICAL CONNECTIONS

All connections are accessible through a spring-loaded hinged rear cover. The connections include:

- 4 Microphone receptacles—Cannon XLR-31 receptacle. (Cannon P3-13 may be substituted by removal of XLR-31 mounting plate.)
- 1 High-level input receptacle—Cannon XLR-31. (Cannon P3-13 may be substituted by removal of XLR-31 mounting plate.)
- 1 Pair of spring-loaded binding posts for output line connections
- 1 Spring-loaded binding post for ground terminal
- 1 Pair of spring-loaded binding posts for public address output
- 2 Monitor phone output jacks
- 1 A-c cord (grounded-safety type)—adapter provided for two-wire plug

SAFETY PROVISIONS

Grounded a-c power plug provided
Completely enclosed
117 a-c max voltage
Binding post for grounding chassis

ELECTRICAL SPECIFICATIONS

PERFORMANCE

Program circuits

Frequency Response ± 1 db 50 to 15,000 CPS

Over-all Gain 90 db ± 2 db

Noise 65 db below +18 dbm output level

Distortion—1 percent or less at a +18 dbm out after a 4 db pad from 50 to 15,000

Battery operation in hours—Approximately 25 hours

Operating Temperature Range—Up to 55 5 percent of the time, 45 continuous

POWER REQUIREMENTS

Power Inputs

A-c Supply—95-135-volt, 50/60-cycle, 225 watts (approx)
Batteries—4 6½-volt cells
2 1½-volt flashlight cells

Signal Inputs

Impedances
50/150/600 ohms balanced or unbalanced

Levels

MIC level to -25 dbm (maximum)
High Level 0 to -20 dbm

Signal Outputs

Impedance Line
Output—150/600 ohm balanced or unbalanced
Mon. Phone Output—High Impedance output balanced
PA Output—150 ohms, balanced

Levels

Line—+18 dbm (after 4 db pad)
Mon. Phones—0 dbm (maximum adjustable)
PA Feed—-50 dbm

TRANSISTOR COMPLEMENT

- 8—2N527 General Electric
- 3—2N553 Delco
- 2—1N537 General Electric silicon diodes
- 1—1N517 International zener diode
- 2—1N91 General Electric germanium diodes

HOW TO ORDER

When ordering please specify Type BA-26-A transistorized portable amplifier.

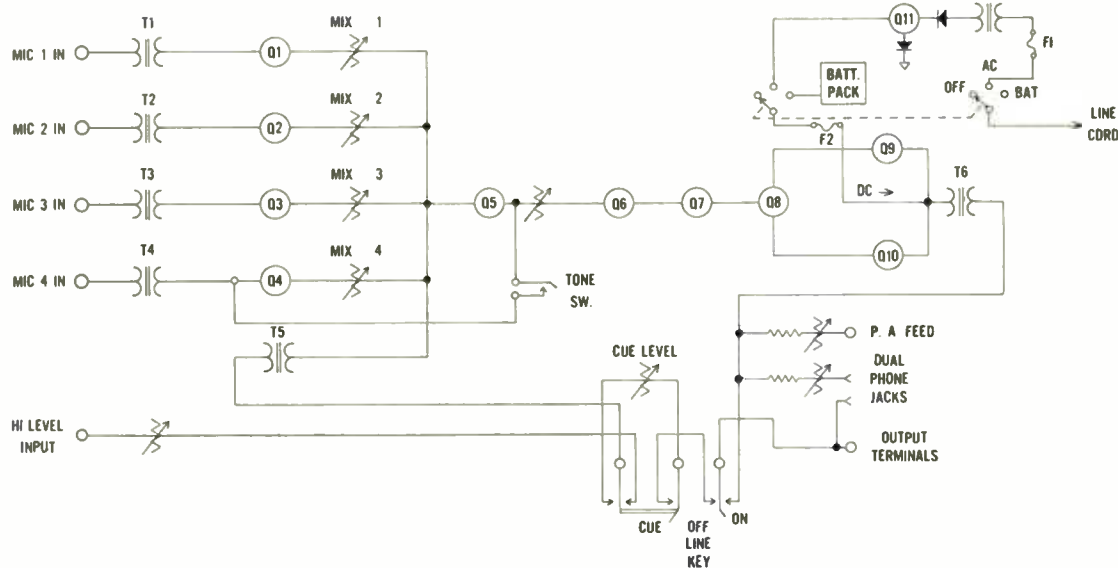



Transistorized audio console, Type BC-21-A

FEATURES

- Completely transistorized—not a tube in the circuitry
- Use of transistors eliminates need for special cooling provision
- Complete plug-in facilities for all amplifiers, and relay modules—amplifiers may be quickly and easily removed or replaced during service operations
- Buy as you need; console can be operated with less than full complement of preamplifiers; buy the basic package, add more later as you expand operations
- Clean, "crackle-free" switch; springleaf, telephone type lever keys used
- Noiseless fading and mixing—program controls are high quality Daven step-type attenuators
- Improved operational efficiency with color-coded controls; selector switches and associated lever key handles are color coded for instant recognition and prevention of operational error
- Dual channel operation provided in console design; addition of second program amplifier, second master gain module, and VU meter, plus minor terminal board changes, will permit simultaneous two-channel operation. Second VU meter mounting space is included in console for this purpose—no interaction between two program channels when so used
- Built-in cue/TB amplifier—console includes complete cue and talkback facilities with push-button selector switch and speaker

- Records, tapes and transcriptions easily cued. The OFF position of hi-level attenuators equipped with cue switch to feed input to cue amplifier

WHERE TO USE

The General Electric Type BC-21-A transistorized audio console is designed for studio and/or master audio control of radio and television stations.

This console provides all the facilities required for switching, mixing, and amplifying the outputs of microphones, turntables, tape mechanisms, projectors, remote and network lines, and other audio sources. It also supplies facilities for auditioning, cuing, monitoring remote lines and cue talkback circuits to studio and remote lines.

Completely transistorized, this all plug-in audio console may be used for single-channel operation or easily, quickly, and inexpensively modified for two-channel operation.

DESCRIPTION

The Type BC-21-A transistorized audio console consists of a desk unit containing four Type BA-21-A preamplifiers, a Type BA-22-A program amplifier, a Type BA-24-A monitor amplifier, and a Type BA-28-A cue/talkback amplifier and associated mixer, gain control and relay equipment. The Type BP-20-A 25-volt power supply and the Type BP-21-A 50 25-volt power supply are included in the basic package; but they are rack mounted outside of the console.

The preamplifiers, high level mixer controls, and master gain control are plug-in modules which make up most of the lower front section of the console. These

Transistorized Audio Console

Type BC-21-A

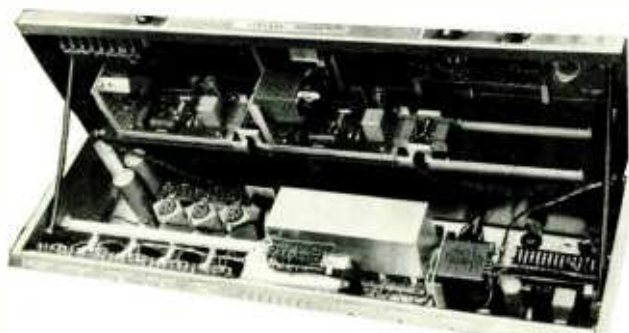

Console open showing cue/talkback and program amplifiers mounted in swing-up top and monitor amplifier in bottom of console at right. (Note: mounting space for additional program amplifier in top at right)

units are inserted from the front and become part of the control panel of the console. The cue/talkback and program amplifiers mount in the hinged top section of the console; while the monitor amplifier and plug-in relay modules are located in the console base.

This basic console handles up to eight low-level microphone inputs which are selected by means of microphone keys into the four preamplifiers. Up to ten inputs can be handled by addition of another pre-amplifier module (accessory).

Eight high level program sources such as turntables, tape and remotes or network are connected by means of three eight-position spring leaf push-button switch assemblies into three high level mixers.

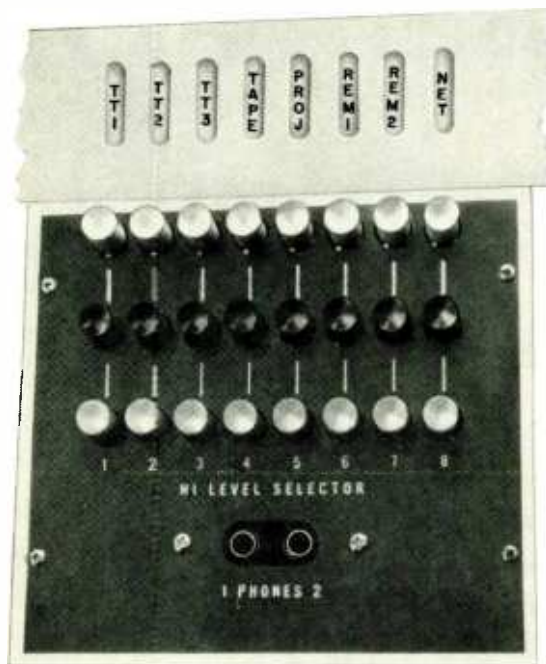

High level input selector panel

All audio sources feed into mixer bus keys which provide the means of selecting either the program bus or the audition bus. In the case of two-channel operation, the audition bus becomes program bus number two.

This console includes a master gain control module and provisions for mounting the second channel master gain control module. Space and connections are provided for the installation of a second program amplifier for dual channel operation.

By means of a 5-position monitor-selector switch, it is possible to connect the monitoring amplifier input to the program lines, the audition bus, or three external lines.

Two output line keys are incorporated making it possible to switch the program output to either of two lines when the console is used as a single-channel unit. In two channel applications, the line keys will connect either output line to either channel. In single channel operation, the keys control normal program output in one position and in the other position provide emergency program output from the monitoring amplifier.

A single VU meter with associated selector switch and pad is provided. By means of an extra meter hole and dual overlay panel a second VU meter may be mounted if desired.

This design incorporates a cue/talkback amplifier which with a push-button selector switch makes it possible to communicate with either of two studios, an announce booth, or NEMO lines without affecting monitor facilities. A 4-inch speaker is mounted on the console and serves as both TB mike and cue speaker. An eight-position push-button switch assembly provides for selection of six intercommunication positions, a cue position and a LISTEN/TALK operate button. The LISTEN/TALK button is red versus black for other positions.



Cue/talkback selector and gain control panel

For cue purposes, the talkback amplifier doubles as the cue amplifier. Cue faders are used in the three high-level mixer positions. The cue output of these faders is connected to a common bus brought up to a position on the cue talkback selector switch.

This console design includes speaker and warning light cut-off relays and associated circuitry. Provisions are made for operation of both audition and on-air warning lights. Relay control circuits provide for operation of two studios, an announce booth, and the control room speaker. Four printed wire board relay assemblies are supplied. These relay modules plug into the console proper.

This console provides a pair of phone jacks for monitoring each channel via a headset.

A spare key is provided (mounted adjacent to the two line keys) which may be wired by the customer for such purposes as feeding recorders, studio amplifiers, etc.

Transistorized Audio Console

Type BC-12-A

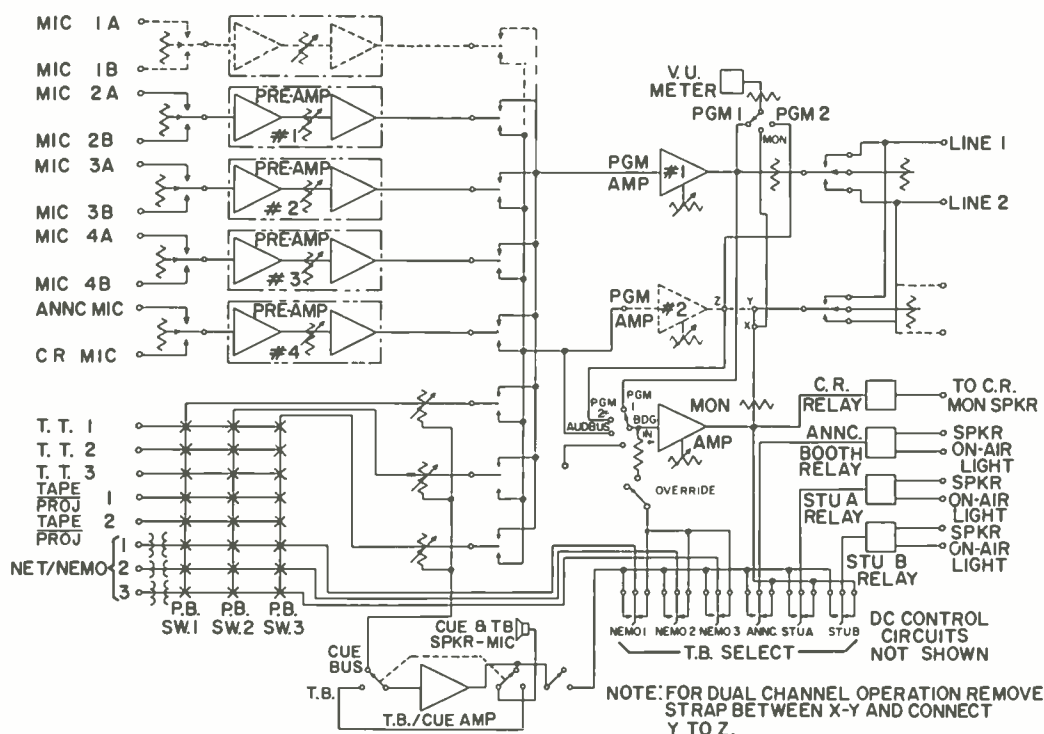

Line diagram of transistorized audio console, Type BC-21-A. Note how easily it can be modified for dual channel operation

An OVER-RIDE switch is included in the console design. This OFF/ON switch connects the three remote lines to the monitor speaker input. The only exception being that if a remote line is being fed program material for cue purposes that line is automatically disconnected from the over-ride bus.

A four-position switch makes it possible to selectively feed program material for remote cue purposes to any one of three remote lines. When a remote line is being fed cue, it is removed from the over-ride circuit.

A single VU meter is mounted in the console together with a four-position meter selector switch which provides the following selections:

- (a) OFF
- (b) CHAN 1 (Connects meter to Chan 1 output line.)
- (c) CHAN 2 (Connects meter to the monitor output. In a two-channel conversion, this position is reconnected to the No. 2 output line.)
- (d) EXT (This position connects the meter to a pair of terminals which may be used to meter some external audio circuit.)

Circuits associated with the monitor amplifier include a gain control and an input-selector switch. Both these controls are mounted on the upper right-hand-side of the console. The selector switch makes it possible to switch several lines to the monitor input. The positions in detail are:

- (a) OFF
- (b) CHAN 1 (Bridges monitor input to program channel No. 1 output.)
- (c) CHAN 2 (Connects Chan 2 (audition) mixer bus to the monitor input. In a two-channel

conversion this position is reconnected so that it bridges Chan 2 program output).

- (d) EXT 1 Bridges monitor input to three sets of
- (e) EXT 2 terminals for connection to three remote audio circuits.
- (f) EXT 3

MECHANICAL SPECIFICATIONS

UNITS

Type number covers the console assembly, four Type BA-21-A preamplifier modules, a Type BA-22-A program amplifier, a Type BA-24-A monitor amplifier, a Type BA-28-A cue/talkback amplifier, a Type BP-20-A 25-volt power supply, a Type BP-21-A 50/25-volt power supply, and associated equipment.

DIMENSIONS

(Exterior console dimensions)

Depth	Height	Length	Weight
17 inches	11 inches	38 inches	75 lb

MOUNTING

All amplifier chassis are plug in and mount in console. The console cabinet may be mounted on two Type PR-16-B/C base cabinets or any available desk of sufficient size. The power supplies mount



Monitor, VU meter and line output control panel

Transistorized Audio Console

Type BC-12-A



High level plug-in module

in one of the base cabinets or any standard EIA cabinet rack, such as the Type PR-1-A cabinet rack (accessory).

CONTROLS AND ADJUSTMENTS

- 5—Microphone selector keys
- 4—Mixer and mixer keys (part of preamplifier module)
- 3—Eight-position push-button selector switches for high level sources
- 3—High level mixers and mixer keys
- 1—Master gain control
- 1—Monitor selector switch
- 1—Monitor gain control
- 1—VU meter selector switch
- 2—Output keys
- 1—Eight-position push-button cue talkback selector switch
- 1—Over-ride switch
- 1—Cue/TB gain control
- 1—Spare key (utility)
- 1—Remote PGM cue selector switch
- 3—Line isolation transformers

ELECTRICAL SPECIFICATIONS

PERFORMANCE

Program Circuits

- Frequency Response: ± 2 db, 50 to 15,000 cps
- Gain: 105 db ± 2 db
- Noise: 65 db below +18 dbm out (with controls set for 68 db of gain)

Crosstalk (Nominal):

- At least 50 db down, 50-15,000 cps
- At least 80 db down, at 1000 cps
- Distortion: 1 percent or less at +18 dbm (after 6 db pad)

Monitor Circuits

- Frequency Response: ± 1 db, 50 to 15,000 cycles
- Distortion: $1\frac{1}{2}$ percent or less at +33 dbm

POWER REQUIREMENTS

- 110/117/125 volts, 50/60-cycle, single-phase, a-c, 90 watts (45 watts each power supply)
- 25 volts, d-c at 1-amp for the monitor amplifier and control relays, from the Type BP-20-A power supply.
- 50 volts, d-c at 500 ma for program amplifier and cue/talkback



Master gain control module

Transistorized Audio Console

Type BC-12-A

amplifier as well as 25 volts, d-c at 40 ma for the preamplifiers from the Type BP-21-A power supply.

SIGNAL INPUTS**Impedances**

Microphones: 10—30/150/250/600 ohms, balanced or unbalanced
 Turntables: 3—600 ohms, balanced or unbalanced
 Network or Remote Lines: 3—600/150 ohms, balanced or unbalanced
 Tape/Projectors: 2—600 ohms, balanced or unbalanced
 External Monitors: 3—20,000 ohms, balanced, bridging
 External VU: 1—7500 ohms, balanced, bridging

Levels

Low Level Inputs—Microphone level to -25 dbm
 High Level Inputs --10 to +18 dbm

SIGNAL OUTPUTS**Impedances**

Program Lines (Regular): 2—600 ohms, balanced
 Monitor Channel: 1—600/150/8 ohms, balanced
 Remote Cue (into NEMO line): 3—Bridging, balanced

Levels

Program output level—+18 dbm
 Monitor output level—+33 dbm (2 watts)

TRANSISTOR COMPLEMENT

1—2N277 Delco
 1—2N173 Delco
 1—2N169A General Electric
 3—2N441 Delco
 25—2N324 General Electric
 6—1N538 General Electric Silicon Diode
 10—2N320 General Electric
 2—CTP 1133 Clevite
 2—2N553 Delco

HOW TO ORDER

When ordering please specify Type BC-21-A transistorized audio console which includes:

1—Console cabinet
 4—Type BA-21-A preamplifier modules
 1—Type BA-22-A program amplifier
 1—Type BA-24-A monitor amplifier
 1—Type BA-28-A cue/talkback amplifier
 1—Type BP-20-A 25-volt power supply
 1—Type BP-21-A 50/25-volt power supply

ACCESSORIES

Type BA-22-A program amplifier for two-channel operations

Type BA-21-A preamplifier module for fifth position on console

Type BA-24-A monitor amplifier for auxiliary speaker operation

Type BP-20-A 25-volt power supply for extra monitor amplifiers (one BP-20-A will provide adequate power for two monitor amplifiers)

or

Dual channel kit 7168290 consisting of:

1—Type BA-22-A program amplifier for two-channel operation
 1—7164636 master gain module
 1—7477541-4 meter attenuator
 1—7492839-1 VU meter



Transistorized audio console, Type BC-21-A, for dual channel operation



Bridging Volume Control

Type FA-35-G

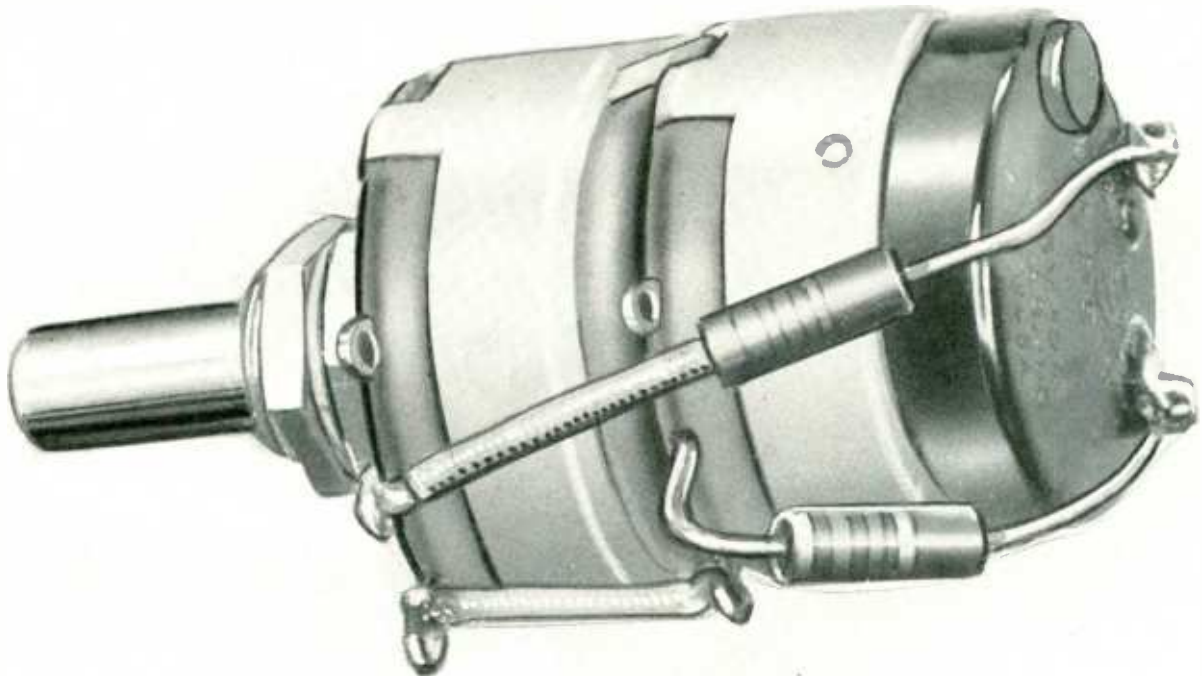

General Electric bridging volume control, Type FA-35-G

WHERE TO USE

The General Electric Type FA-35-G bridging volume control is designed to convert a 600-ohm input of an amplifier to 10,000 ohms balanced bridging service. It may be used on line levels up to +40 dbm.

DESCRIPTION

The General Electric Type FA-35-G consists essentially of a continuously variable dual potentiometer, a screwdriver control (a knob may be used), and a dummy switch section tandem-mounted to provide terminals for mounting two resistors and input connections to the control.

MECHANICAL SPECIFICATIONS

DIMENSIONS

Height $2\frac{1}{2}$ inches Weight 2 ounces
Diameter $1\frac{1}{8}$ inches

MOUNTING

The Type FA-35-G is designed to fit holes provided in the ends of the Type BA-1-F pre-amplifier and the Type BA-12-C program/monitor amplifier chassis. It may also be mounted on the Type BA-4-E monitoring amplifier or used in similar applications where a bridging gain control is required. A $\frac{3}{8}$ -inch hole is required for mounting in applications other than outlined above. (See outline diagram for internal chassis clearance dimensions.)

HOW TO ORDER

When ordering, please specify:
Type FA-35-G bridging volume control.

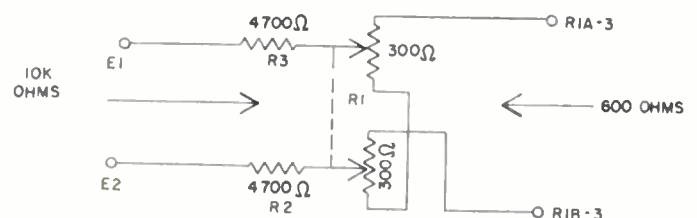
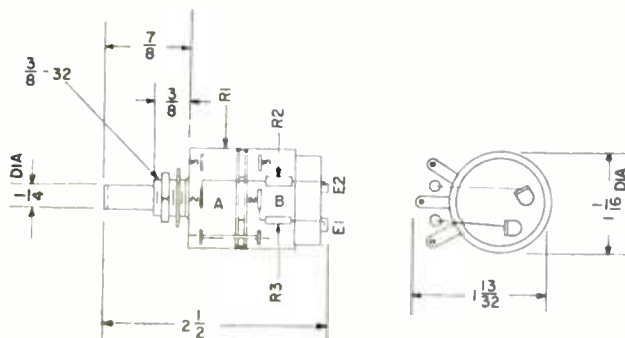

Outline and elementary diagrams, Type FA-35-G bridging volume control



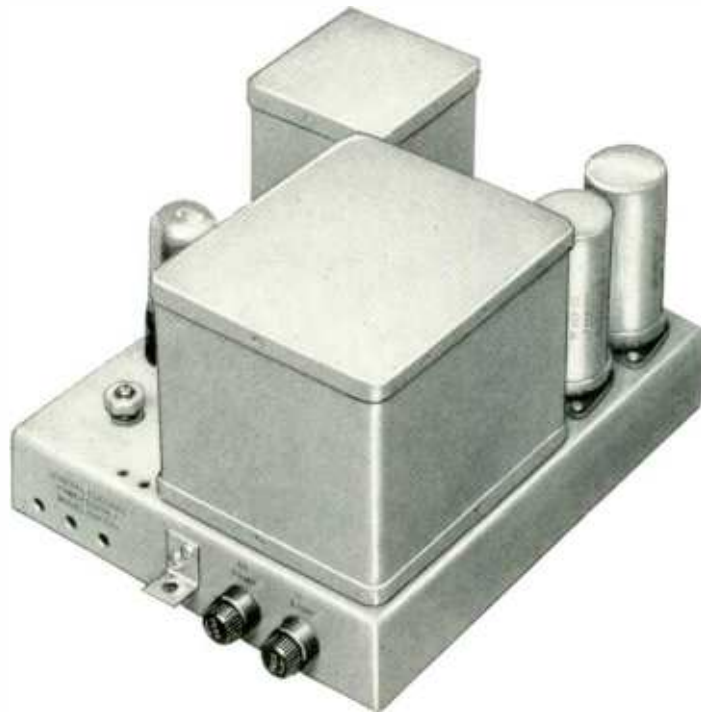

Plug-in power supply, Type BP-10-B

FEATURES

- Compact, plug-in construction
- Easy to remove, maintain and service
- Conservatively rated components
- Screwdriver control to adjust B+ voltage to current value

WHERE TO USE

The General Electric Type BP-10-B plug-in power supply is specifically designed to power plug-in audio amplifiers Types BA-1-F, BA-9-A and BA-12-C. It will also supply TV or other equipment which will operate from an unregulated supply of Type BP-10-B ratings.

DESCRIPTION

The Type BP-10-B is a plug-in unregulated power supply, constructed on a narrow recessed chassis with all controls and components marked. Fuses and operating controls are accessible from the front. A Jones plug that mates with a corresponding receptacle on the Type FA-22-F tray makes all necessary electrical contacts.

A voltage divider across the d-c output serves as a bleeder and as a source of low voltage d-c for biasing the filament supply 30 volts positive to minimize hum output from amplifiers.

One Type BP-10-B can supply power for up to 25 Type BA-1-F pre-amplifiers, or three Type BA-9-A uni-level amplifiers, or three Type BA-12-C program/monitor amplifiers at 300 volts B+.

MECHANICAL SPECIFICATIONS

DIMENSIONS

Depth	9 $\frac{3}{8}$ inches	Width	7 $\frac{3}{8}$ inches
Height	5 $\frac{1}{8}$ inches	Weight	25 lb (approx)

MOUNTING

The BP-10-B plugs into a Type FA-23-B shelf.

OPERATING CONDITIONS

May be operated in an external ambient of up to 113 F (45 C) and a relative humidity up to 95 percent.

SAFETY PROVISIONS

Wiring and terminals are enclosed in a grounded chassis. No exposed voltages because of plug-in construction.

ELECTRICAL SPECIFICATIONS

TYPE OF CIRCUIT

Full-wave, single-phase rectifier using two 5Y3 tubes in parallel. Use of parallel rectifiers increases power supply reliability under average load conditions. The filter is a pi-filter with a rheostat located in the B+ circuit just ahead of the output capacitor. Filament supply is maintained at +30-volt bias.

PERFORMANCE

Potentiometer adjustment to +300-volt for all loads from 40 ma to 230 ma. Maximum ripple, full load: 25 mv (120 cycles).

INPUTS

110/117/125-volt, 50/60-cycle, 200-watt single-phase.

OUTPUTS

40 to 230 ma adjustable to 300-volt d-c at nominal input transformer tap voltages; 4.5-amp at 6.4-volt a-c at 50-cycle, 7.5-amp at 6.4-volt a-c at 60-cycle; at 50 cycles this unit will supply three Type BA-12-C amplifiers or 15 Type BA-1-F amplifiers; at 60 cycles this unit will supply three Type BA-12-C amplifiers or 25 Type BA-1-F amplifiers.

Plug-in Power Supply

Type BP-10-B

INTERNAL POWER SUPPLIES

The Type BP-10-B also derives and establishes the filament winding at a positive bias of 30 volts.

CONTROLS AND ADJUSTMENTS

Voltage output can be adjusted to 300-volt d-c, by a screw-driver adjustment located above the chassis, under all load conditions from 40 to 230 ma. Fuses are removable from the front of the chassis.

TUBE COMPLEMENT

2 Type 5Y3GT/G

HOW TO ORDER

When ordering, please specify:
Type BP-10-B plug-in power supply.

ACCESSORIES

Type FA-23-A shelf, for mounting plug-in units with trays. (Type FA-23-A occupies seven inches—four units of rack height—in a Type PR-1-A cabinet rack and will accommodate six pre-amps, Type BA-1-F, four Type BA-12-C program/monitoring amplifiers, or two Type BP-10-B power supplies.)

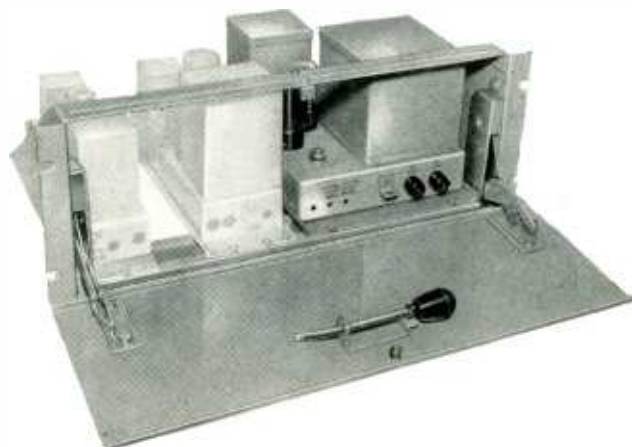
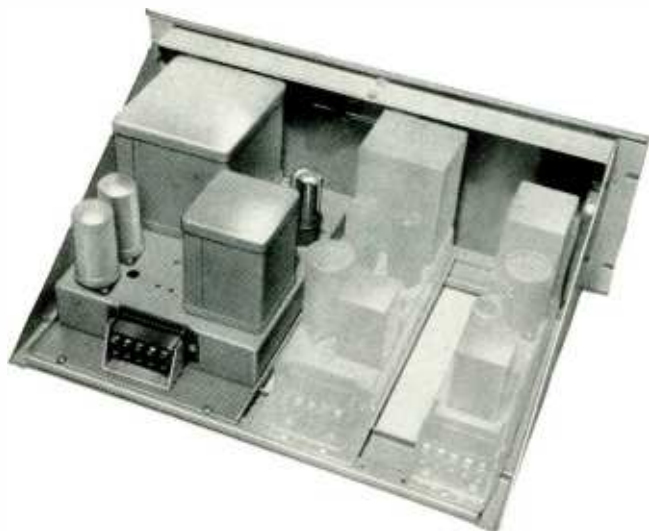

Plug-in power supply, Type BP-10-B, plus plug-in program/monitoring amplifier, Type BA-12-C; and plug-in pre-amplifier, Type BA-1-F, mounted in broadcast shelf, Type FA-23-A. (Front view, right, with shelf panel open.)

Transistor Power Supply (25-volt)

Type BP-20-A (Regulated)

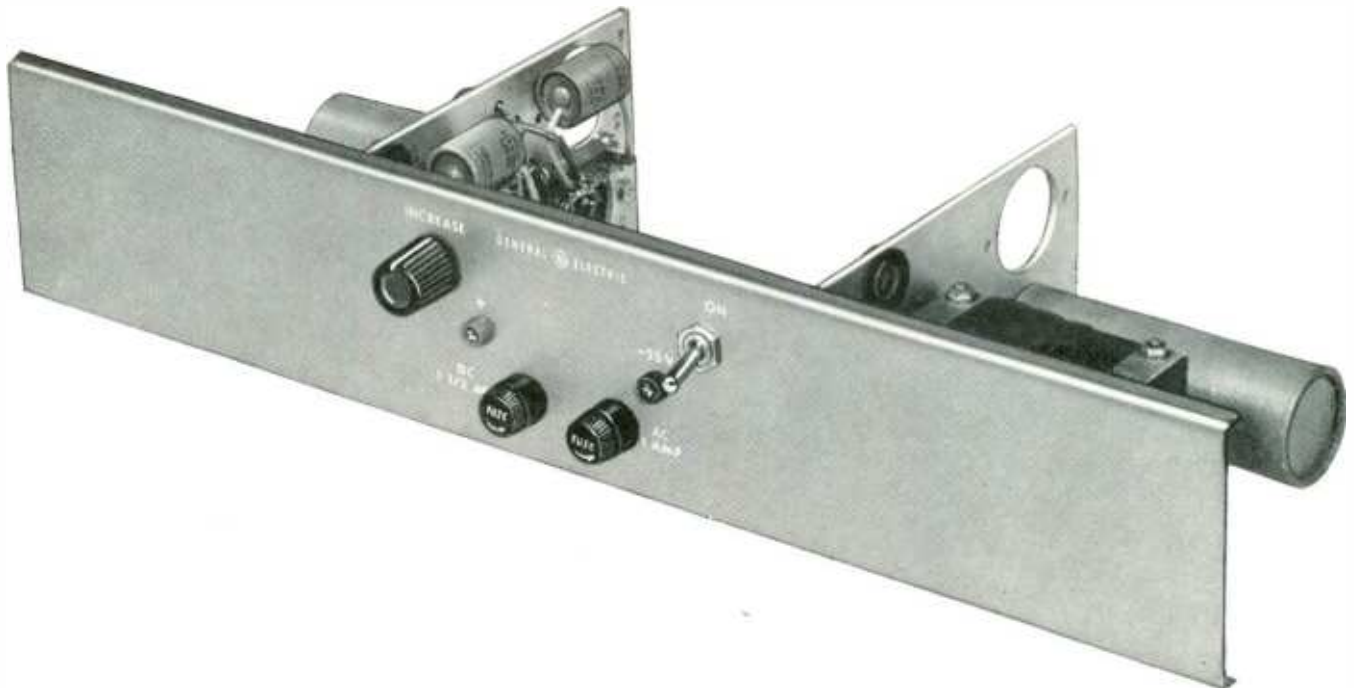

Transistor power supply (regulated), Type BP-20-A 25-volt

FEATURES

- All transistor—no tubes in circuitry
- Maintains constant regulated output voltage
- Full-wave rectification
- Fuses fully protect supply from overload
- Regulation adjustable for various line voltage conditions
- Voltage-adjust control and test jacks on front of panel
- Fuse posts on front of panel

WHERE TO USE

The General Electric Type BP-20-A 25-volt transistor power supply provides the regulated 25-volt d-c required for operation of the Type BA-24-A transistor monitor amplifier and control relays as used in the Type BC-21-A transistor audio console. In alternate applications, it can supply adequate power for two and in some cases three monitor amplifiers.

DESCRIPTION

The Type BP-20-A 25-volt transistor power supply employs silicon-rectifier cells in a full-wave center tapped circuit. The regulation is obtained by a transistorized series regulator circuit consisting of three transistors and a zener diode.

MECHANICAL SPECIFICATIONS**DIMENSIONS (Two rack units)**

Depth	6¼ inches	Width	19 inches
Height	3½ inches	Weight	5 lb, 11 oz

MOUNTING

Standard rack mounting

OPERATING CONDITIONS

Maximum room ambient temperature, continuous 113 F (45 C), 5 percent of the time 122 F (50 C).

Maximum cabinet ambient temperature—continuous 122 F (50 C), 5 percent of time, 113 F (55 C).

ELECTRICAL CONNECTIONS

A-c input and d-c output connections made on separate terminal boards

SAFETY PROVISIONS

Primary and secondary circuits are fused. Maximum voltage 117-volt a-c and 25-volt d-c.

ELECTRICAL SPECIFICATIONS**PERFORMANCE**

Output voltage changes less than 1 percent with load changes from no load to one ampere and input voltage changes of ± 10 volts. Less than one millivolt ripple with full load.

INPUT POWER REQUIREMENTS

110/117/125 volts a-c, 50-60-cycle, 45 watts

POWER OUTPUT

25 volts regulated d-c, 1 ampere

CONTROLS AND ADJUSTMENTS

ON-OFF switch
Voltage control potentiometer

TRANSISTOR COMPLEMENT

1—2N277 (Delco) 1—2N324 (General Electric)
1—2N441 (Delco)

HOW TO ORDER

When ordering please specify Type BP-20-A 25-volt transistor power supply.

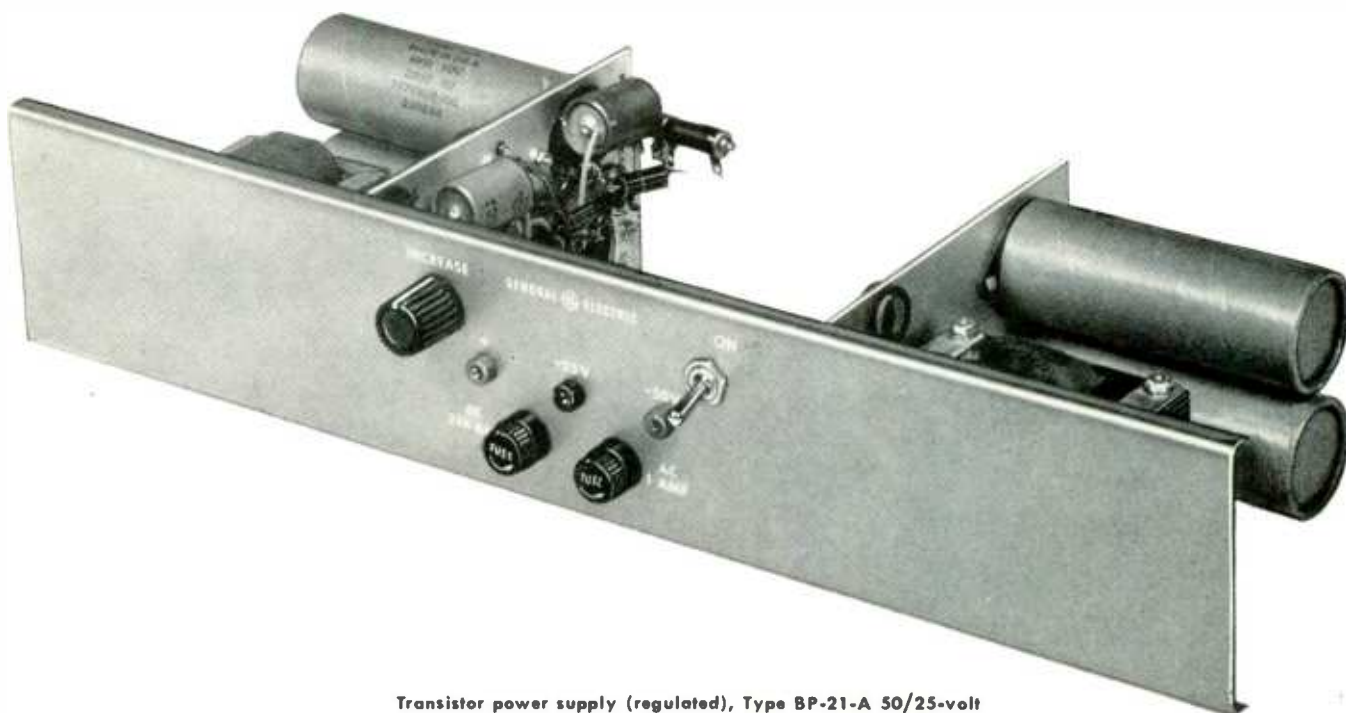

Transistor power supply (regulated), Type BP-21-A 50/25-volt

FEATURES

- All transistor—no tubes in the circuitry
- Maintains constant regulated output voltage
- Full-wave rectification
- Fuses fully protect supply from overload
- Regulation adjustable for various line voltage conditions
- Voltage-adjust control and test jacks on front panel

WHERE TO USE

The General Electric Type BP-21-A 50/25-volt transistor power supply provides the regulated 50-volt d-c for operation of up to two Type BA-22-A transistor program amplifiers and a Type BA-28-A transistor cue/talkback amplifier. It also furnishes the regulated 25-volt d-c required by up to five Type BA-21-A transistor preamplifiers.

In alternate applications, a single power supply will supply up to four program and/or cue amplifiers.

DESCRIPTION

The Type BP-21-A 50/25-volt transistor power supply employs silicon-rectifier cells in a full-wave bridged circuit. The regulation is obtained by a transistorized series regulator circuit which employs four transistors and a zener diode. An additional circuit using a choke coil, capacitor, and an adjustable resistor supplies the 25-volt d-c required for the preamplifiers.

MECHANICAL SPECIFICATIONS**DIMENSIONS (Two rack units)**

Depth	6 $\frac{1}{4}$ inches	Width	19 inches
Height	3 $\frac{1}{2}$ inches	Weight	5 lb, 11 oz

OPERATING CONDITIONS

Maximum room ambient temperature, continuous 113 F (45 C), 5 percent of the time 122 F (50 C)

Maximum cabinet ambient temperature—continuous 122 F (50 C), 5 percent of time, 131 F (55 C)

ELECTRICAL CONNECTIONS

A-c input and d-c output connections made on separate terminal boards

SAFETY PROVISIONS

Primary and secondary circuits are fused. Maximum voltage 117-volt a-c and 50-volt d-c.

ELECTRICAL SPECIFICATIONS**PERFORMANCE**

Output voltage changes less than 1 percent with load changes from no load to 560 ma or with input voltage changes of ± 10 volts. Less than 750 microvolts ripple with full load.

INPUT POWER REQUIREMENTS

110/117/125-volt d-c, 50–60-cycle, 45 watts.

POWER OUTPUT

50 volts (regulated) d-c, 560 ma
25 volts (regulated) d-c, 40 ma

CONTROLS AND ADJUSTMENTS

ON-OFF switch, voltage adjust

CONTROL POTENTIOMETER

A slide-wire resistor mounted on the chassis makes it possible to adjust the 25-volt output for 32 to 40 ma loads.

TRANSISTOR COMPLEMENT

1—2N173 (Delco)	1—2N324 (General Electric)
2—2N441 (Delco)	4—1N538 (General Electric)

HOW TO ORDER

When ordering please specify Type BP-21-A 50/25-volt transistor power supply.



Broadcast Shelves

Types FA-23-B, FA-23-C, and FA-46-A



Front view of Type FA-23-B shelf

FEATURES

- **Easy to service and maintain**
Hinged front panels permit easy, quick replacement of amplifiers, or power supplies.
- **Space saving**
Construction of shelf, occupying only seven inches of vertical rack space, permits many amplifier combinations to be compactly mounted in a small area.
- **Improved rack appearance**
Door, when closed, covers all shelf mounting hardware. Shelf panel matches other General Electric rack-mounted audio panels.
- **Easy amplifier replacement**
Extractor tool, clipped to inside of front panel, permits rapid and easy withdrawal of amplifiers for maintenance or service.
- **Type FA-23-C panel adapted for mounting of controls and indicating light jewels**
Type FA-23-C shelf is equipped with shaft extensions for Type BA-14-A controls. Front panel is equipped with two control scales and plug buttons for both the controls and indicator light jewels.
- **Mounts many amplifier combinations**
Spacer bars and mating receptacles may be mounted in any desired manner to permit use of different types of General Electric audio amplifiers. Shelf base is drilled to mount spacer bars and receptacles.

Type FA-23-B

The General Electric Type FA-23-B broadcast shelf is designed to mount in a standard EIA 19-inch cabinet or relay rack. This shelf, occupying only seven inches of vertical rack space, provides mounting space

for General Electric plug-in audio amplifiers in any of the following combinations:

- Six Type BA-1-F pre-amplifiers, or
- Four Type BA-9-A uni-level amplifiers, or
- Four Type BA-12-C program/monitor amplifiers, or
- Two Type BA-3-A equalized transcription pre-amplifiers, or
- Two Type BP-10-B power supplies.

Combinations of the various units are possible such as mounting three Type BA-1-F pre-amplifiers and two Type BA-12-C program/monitor amplifiers or two Type BA-9-A uni-level amplifiers on a single Type FA-23-B shelf.

The plug-in audio equipment may be easily inserted in or withdrawn from the mating receptacles mounted on the shelf. An extractor tool, clipped to the shelf door, aids in quick removal of amplifiers through the front of the rack.

Type FA-46-A

The General Electric Type FA-46-A broadcast shelf is identical to the unit just described less the front panel and hinges.

Type FA-23-C

The General Electric Type FA-23-C broadcast shelf is designed to permit rack mounting of the General Electric Type BA-14-A program/monitor amplifiers. This shelf, similar in appearance, size, and function to the Type FA-23-B broadcast shelf, differs in that the front panel of the Type FA-23-C shelf contains four holes with plug buttons, control decals for the operating controls, and the indicating light jewels of the Type

Broadcast Shelves

Types FA-23-B, FA-23-C, and FA-46-A

BA-14-A program/monitor amplifier. If a front panel volume control is not required, the Type BA-14-A can be mounted in a Type FA-23-B shelf. Both shelves are furnished with the same number of mating Jones receptacles and spacer bars.

DESCRIPTION

The General Electric Type FA-23-B, FA-23-C and FA-46-A broadcast shelves are designed to mount the General Electric line of plug-in audio amplifiers and power supplies in standard 19-inch EIA cabinet or relay racks. Through the use of these shelves, from two to six amplifiers or power supplies (depending upon the type) may be mounted in only seven inches of rack space.

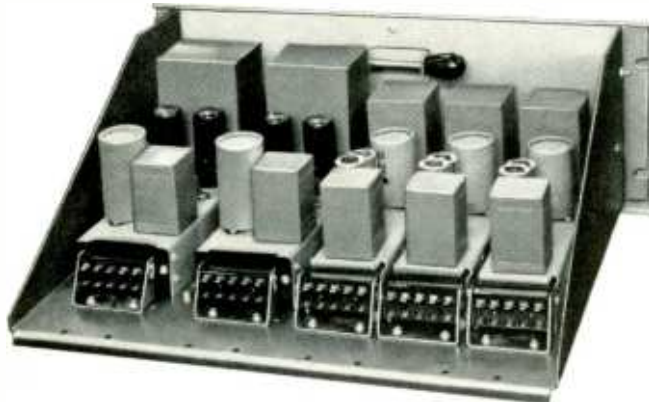

Rear view of Type FA-23-B shelf, showing mounted Type BA-1-F and Type BA-12-C amplifiers

These shelves are identical in construction, size, and appearance except for the addition of four holes (with plug buttons furnished) and two scales on the front panel of the Type FA-23-C shelf and the lack of front panel and hinges on the Type FA-46-A.



Front view of Type FA-46-A shelf

All models are equipped with five spacer bars, six 10-pin Cinch-Jones 2400 series receptacles, and special brackets. The bases of the shelves are drilled to permit mounting the spacer bars and receptacles in different configurations. Both the spacer bars and receptacle brackets are drilled and tapped for this purpose.

Essentially the shelves consist of a drilled, horizontal plate, two mounting flanges, and a spring loaded, hinged front panel. The mounting flanges, an integral part of the horizontal base, are folded up vertically and are notched with standard EIA slots for rack mounting in a 19-inch cabinet or rack. A clip,

mounted on the inside of the front panel of the Type FA-23-B and Type FA-23-C holds the extractor tool for ready use whenever it becomes necessary to remove or insert an amplifier or power supply.



Front view of Type FA-23-B shelf, with front panel open

All steel parts are given a rust-proof plating of cadmium.

The front panel of the Type FA-23-B shelf is painted a dark metalustre blue and is devoid of holes or control designations.

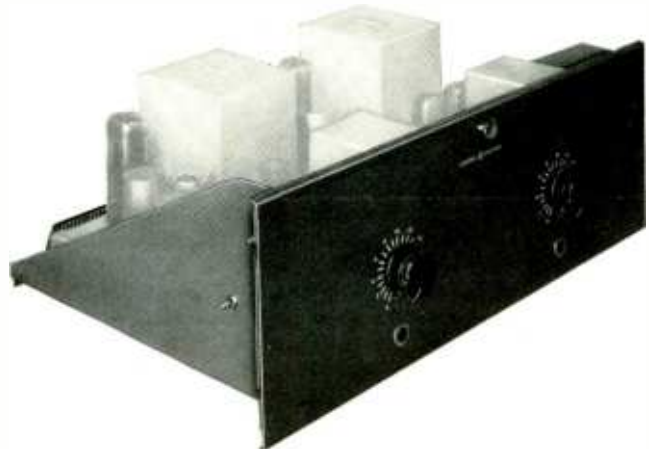

Front view of Type FA-23-C shelf, showing front panel control of mounted Type BA-14-A amplifiers

The front panel of the Type FA-23-C shelf is painted a dark metalustre blue, and is provided with four holes and two calibrated scales. These holes and scales are used for mounting the two indicator light jewels and for passage of the extension shafts of volume controls in the Type BA-14-A program/monitor amplifiers. The knobs furnished are the push-on type permitting ready insertion or removal of the knobs whenever it becomes necessary to open the front panel.

A shelf utilizes fourteen inches of space between the rear of the front mounting surface and the rear of the shelf. When these shelves are mounted in a General Electric Type PR-1-A cabinet rack, the No. 12-24 mounting screws (furnished) are hidden from sight by the exclusive General Electric rolled front panel and cabinet design, an important contribution to the neat appearance of your control or equipment room.

Broadcast Shelves

Types FA-23-B, FA-23-C, and FA-46-A

MECHANICAL SPECIFICATIONS

UNITS

Type FA-23-B

- 1—FA-23-B shelf
 - 5—Drilled and tapped spacer bars, with screws
 - 6—Cinch-Jones S-2410 10-pin female connectors with special shelf mounting brackets
 - 1—Extractor tool
- Mounting screws

Type FA-46-A2

As above less extractor tool, front panel and hinges

Type FA-23-C

- 1—Shelf with panel plug buttons and two calibrated scales
 - 2—Extension shafts
 - 2—Control knobs and springs
 - 5—Drilled and tapped spacer bars, with screws
 - 6—Cinch-Jones S-2410 10-pin female connectors with special shelf mounting brackets
 - 1—Extractor tool
- Mounting screws

DIMENSIONS (Four rack units)

Depth	13 $\frac{5}{8}$ inches	Width	19 inches
Height	6 $\frac{1}{8}$ inches	Weight	9 lb

MOUNTING

Type FA-23-B, FA-23-C and FA-46-A shelves bolt to the front of the cabinet or relay rack with No. 12-14 round head screws (furnished). They may be mounted in any standard 19-inch width cabinet or relay rack with at least 14-inch clearance between the front panel and the rear door.

FINISH

Front panel—General Electric dark metalustre blue
Shelf base and hardware—cadmium plated for rust prevention

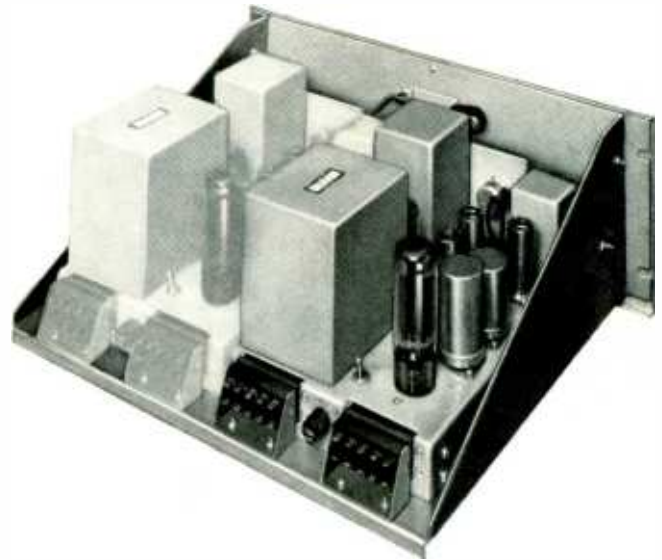

Rear view of Type FA-23-C shelf, showing mounted Type BA-14-A amplifiers

HOW TO ORDER

When ordering please specify:
 _____ General Electric Type FA-23-B broadcast shelf. (Type number includes shelf, panel, spacers, connectors and brackets, extractor tool, mounting screws, and installation instructions.)
 or
 _____ General Electric Type FA-23-C broadcast shelf. (Type number includes shelf, panel with scale and plug buttons, spacers, connectors and brackets, extractor tool, extension shafts, push-on knobs, and installation instructions.)
 or
 _____ General Electric Type FA-46-A broadcast shelf. (Type number includes shelf, spacers, connectors and brackets, mounting screws, and installation instructions.)

Broadcast Shelf

Type FA-48-A1

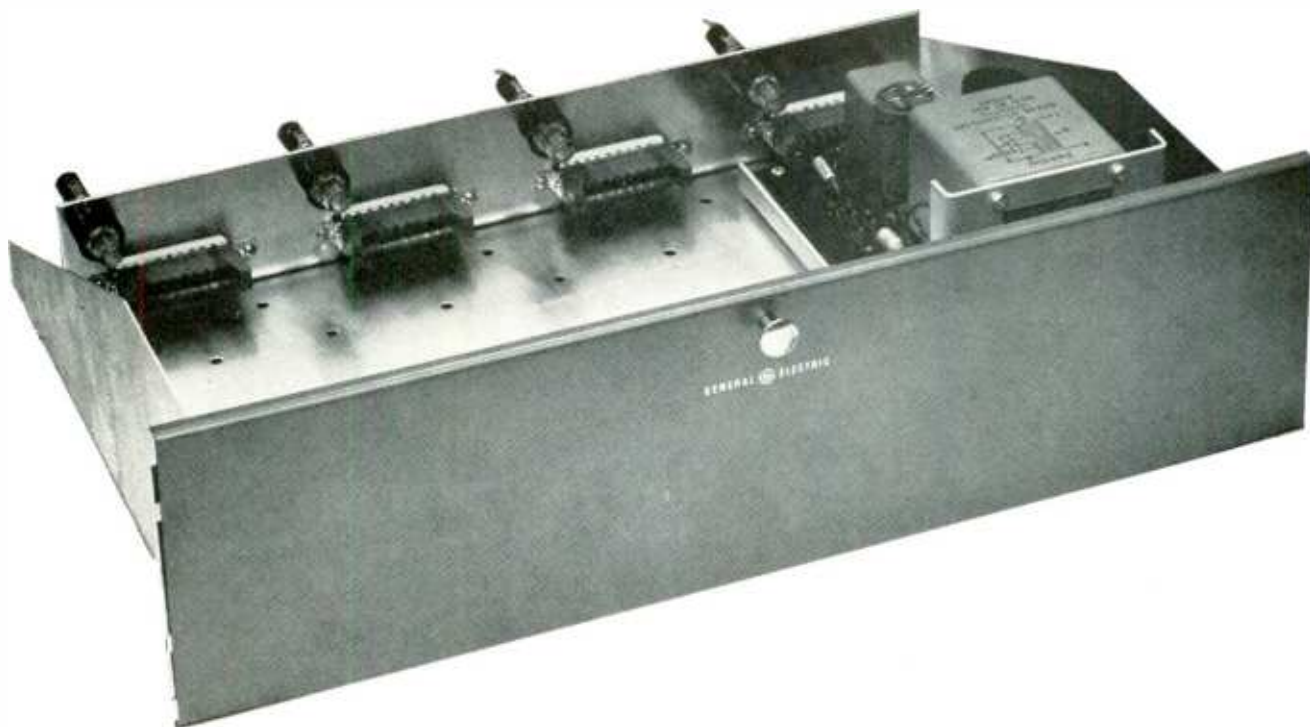

Broadcast shelf, Type FA-48-A1

FEATURES

- Fits any standard rack. The Type FA-48-A1 broadcast shelf is designed to fit 19-inch EIA cabinet rack.
- Easy to maintain and service. Hinged front panels permit easy, quick replacement of amplifiers
- Space saving. Shelf occupies only 5¼ inches of rack space

WHERE TO USE

The General Electric Type FA-47-A1 broadcast shelf is designed for mounting the General Electric line of plug-in, transistorized audio amplifiers. This shelf occupies five and one quarter inches of vertical-rack space and is equipped to accommodate four of the following plug-in amplifier types:

- Type BA-22-A program amplifier
- Type BA-24-A monitor amplifier
- Type BA-28-A cue/talkback amplifier

DESCRIPTION

The General Electric Type FA-48-A1 broadcast shelf is designed to mount the General Electric line of plug-in amplifiers. This shelf consists of a horizontal plate equipped with two vertical end-mounting brackets, a hinged-front panel, four plug-in connectors, four fuse-holders with indicator lights, and four adhesive backed write-in strips. The end brackets are provided with mounting slots and screws for fastening the shelf

in a standard 19-inch cabinet or rack. The hinged front panel covers the front of the shelf and conceals the mounting screws. The shelf must have at least 13½ inches clear depth between the front mounting surface and the rear door of a rack cabinet.

MECHANICAL SPECIFICATIONS**DIMENSIONS**

Depth	13 $\frac{5}{8}$ inches	Width	19 inches
Height	5 $\frac{1}{4}$ inches	Weight	6 lb

MOUNTING

The Type FA-48-A1 shelf bolts to the front of the cabinet or rack with No. 12-24 mounting screws (furnished). They may be mounted in any 19-inch-wide cabinet or rack with at least 13½-inch clearance between the front panel and the rear door.

FINISH

Front panel—General Electric dark metalustre blue outside and inside. Chassis—cadmium plated.

HOW TO ORDER

When ordering please specify: General Electric Type FA-48-A1 broadcast shelf.

ACCESSORIES

- Type BA-22-A1 program amplifier
- Type BA-24-A1 monitor amplifier
- Type BA-28-A1 cue/talkback amplifier

Broadcast Shelf

Type FA-48-A1

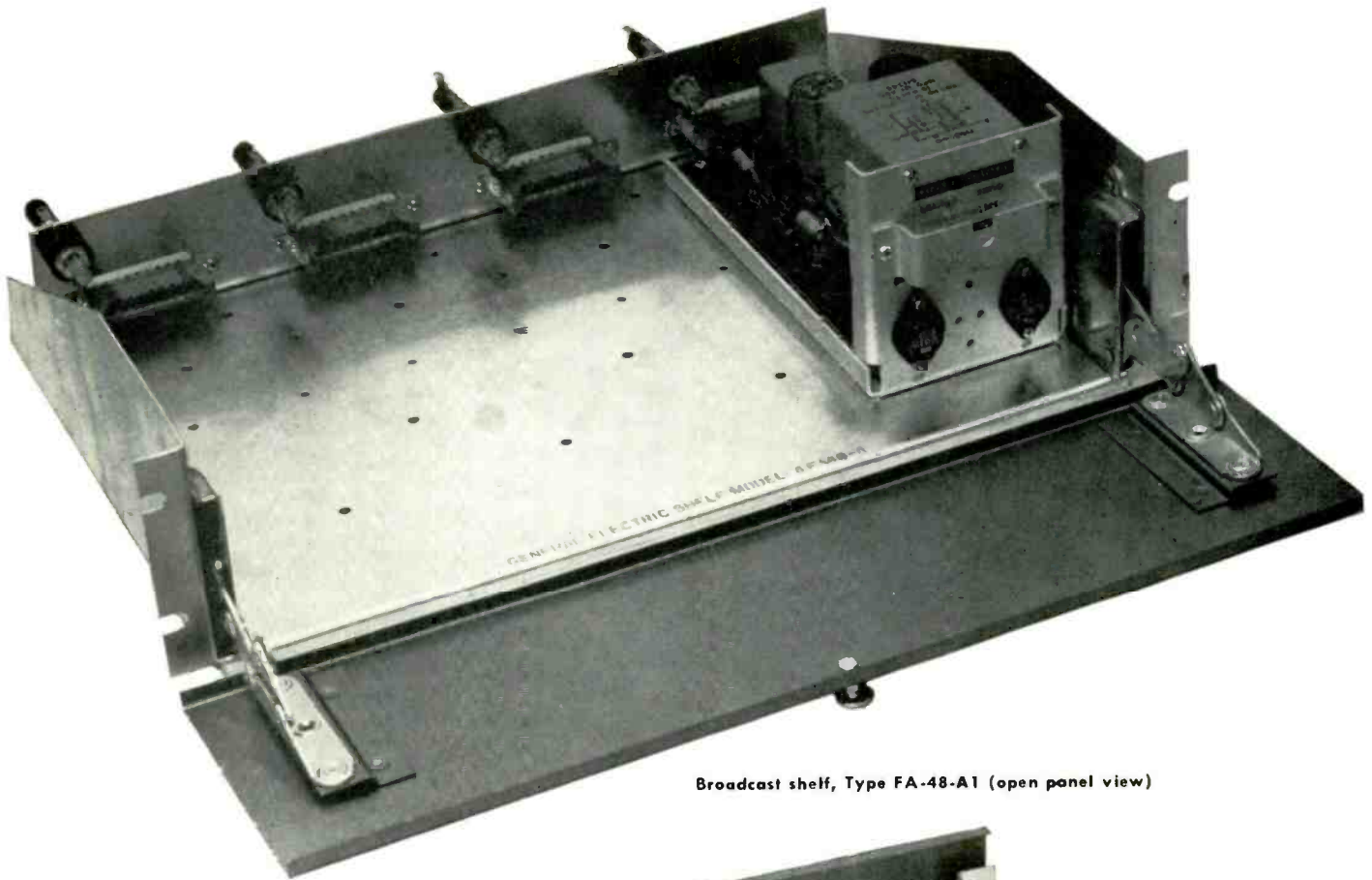

Broadcast shelf, Type FA-48-A1 (open panel view)

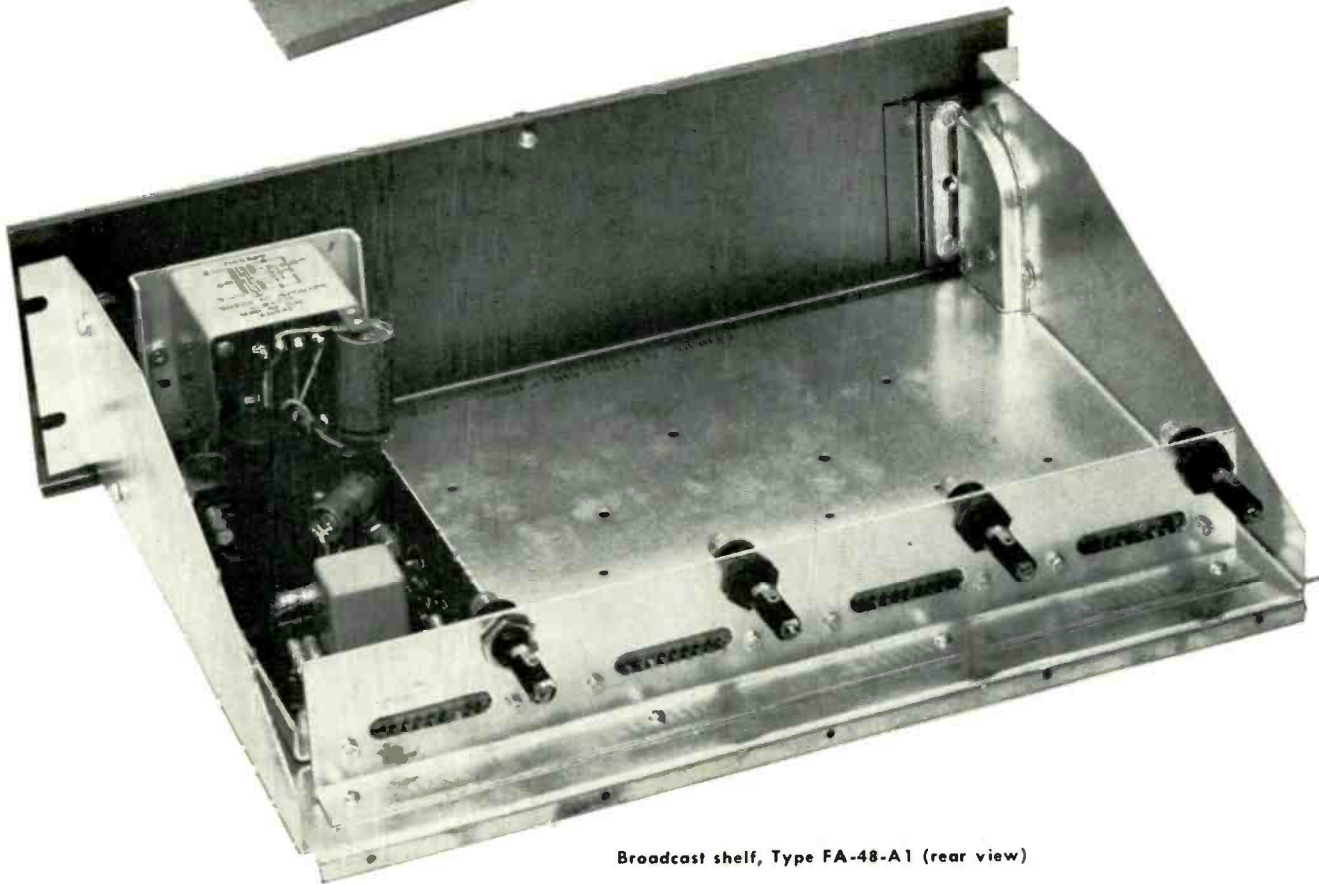

Broadcast shelf, Type FA-48-A1 (rear view)

Cabinet Rack

Type PR-1-A and Accessory Items

FEATURES

- **Versatile**
Adaptable for mounting either broadcast audio, or television chassis and panels, removable front and rear doors are arranged for left or right opening. Chassis and panels may be mounted in a number of various positions from the front (in which case the front door is not used) to the rear of the cabinet on the movable equipment mounting angles spaced for 19-inch rack-mounted equipment.
- **Ease of wiring**
Harnesses are eliminated by use of Type PR-5-A wiring ducts which have removable covers providing maximum accessibility to accessory wiring.
- **Accessibility**
Emphasized by convenient locations for terminal boards and wiring cables and absence of awkward trim strips.
- **Sturdy**
Welded skin construction with welded stiffeners in the front door.
- **Attractive**
Panel edges are concealed by recessed front mounting surface.
- **Excellent ventilation**
Natural draft characteristics in addition to provision for connection to a pressurized system.
- **Safe**
High-voltage door-interlock switch kits (Cat. No. 7460330-G4) are available to attach to the Type PR-1-A cabinet rack so that high voltages are grounded when either the front or rear doors are opened.

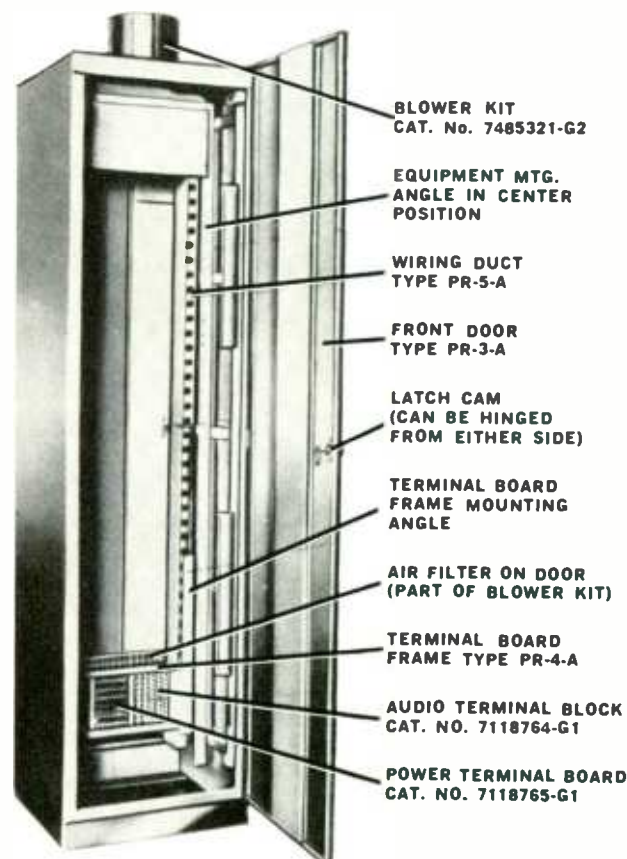

Cabinet rack, Type PR-1-A, and accessory items

WHERE TO USE

The General Electric Type PR-1-A cabinet rack provides space for mounting any broadcast or television audio and video chassis and panels designed for installation in a standard 19-inch rack.

DESCRIPTION

The Type PR-1-A cabinet rack consists of a rigid welded-sheet steel cabinet with an open front and a hinged-rear door. Two equipment mounting angles and two short terminal board frame mounting angles, each containing No. 12-24 tapped holes located in accordance with EIA standards, are provided with each rack. The front door is available as an accessory.

The outstanding feature of the Type PR-1-A is its versatility. Any combination of General Electric audio and video chassis plus other manufacturers' standard rack equipment can all be mounted in the same rack. This is possible because of the three locations for the equipment mounting angles within the rack. Front, intermediate, and rear mounting positions are provided. A neat and uniform appearance can be maintained even when units of different types are installed.

The front position of the mounting angle is for panel-mounted equipment that will be approximately flush with the front edge of the rack, without a front door, as in conventional audio practice. This position is $\frac{1}{2}$ -inch behind the front surface of the cabinet shell so as to recess the audio panels slightly within the front surface of the cabinet and thus conceal the panel edges.

The intermediate position is $4\frac{1}{8}$ inches behind the front surface of the cabinet shell and is intended for any standard panel-mounted units such as jack-panels, audio amplifiers, standard test equipment, and some front-mounted television units when a front door is used. With this type of mounting, the front door is used to screen an otherwise heterogeneous appearance and to provide a closed rack so that pressurized ventilation, if used, will be more effective.

The rear position is ideal for mounting television power supplies, video amplifiers, and other chassis-type television units with or without the use of a front door. The mounting surface of the angle in this position is located $11\frac{1}{8}$ inches behind the front surface of the cabinet shell. Combinations of front, intermediate, and rear positions may also be used in the cabinet.

The rear door is hinged on the right-hand side when the rack is shipped. As with the front door, the hinges may be reversed and the door swung from the left-hand side if desired.

Ventilation openings provided in the cabinet rack consist of two perforated grilles in the rear door, a large cut-out in the cabinet top, and cabinet base. A horizontal rectangular dust plate about one inch below the top cut-out protects equipment in the cabinet from dust and other foreign matter. This plate may be removed if an air duct or fan is attached to the cabinet top for forced ventilation.

Three horizontal mounting channels on each side of

Cabinet Rack

Type PR-1-A and Accessory Items

the cabinet interior with nine tapped holes in each channel are used for mounting the vertical equipment mounting angles in any of three locations and for mounting such cabinet accessory items as wiring ducts, cabling straps.

SPECIFICATIONS

TYPE PR-1-A CABINET RACK

Consists of a cabinet shell and ventilated rear door, a pair of equipment mounting angles, a pair of terminal-board frame mounting angles, a set of mounting hardware, and two instruction books.

DIMENSIONS

Total height	83 $\frac{1}{8}$ inches
Vertical mounting space	77 inches (44 rack units)
Total width	22 inches
Total depth	23 $\frac{3}{4}$ inches

WEIGHT 130 lbs

MOUNTING

The Type PR-1-A cabinet rack is floor mounted. Mounting space 77 inches high (44 rack units), 19 inches wide, and 21 inches deep is available for mounting chassis and panels.

OPERATING CONDITIONS

It is considered good practice to limit the cabinet air temperature rise to 10 C or 15 C over the room ambient temperature for most applications. Natural (non-forced) ventilation will dissipate about 350 watts of heat for a 10 C rise in cabinet air temperature and about 525 watts for a 15 C rise.

ACCESSORIES (Description)

Type PR-2-A, Hinged Panel Assembly

This assembly serves as a front cover and access panel for various television units which mount on equipment mounting angles fastened in the intermediate or rear (center-of-rack) positions of a Type PR-1-A cabinet rack when a front door can not be used with the rack. When a monitor is mounted, with a Type PR-19-C monitor cabinet rack adapter kit, in a cabinet rack, a Type PR-3-A front door can not be used because the front panel of the monitor must be visible. If power supplies, utility video amplifier groups, etc., are "center of rack" mounted in the same cabinet rack, Type PR-2-A hinged panel assembly is available to close up the front of the cabinet rack flush with the front panel of the monitor. This arrangement has the same effect as a front door so that any normal method of air-cooling the equipment in the cabinet rack can be employed. Since the panel is hinged, the units mounted behind it are quite accessible.

Type PR-3-A, Front Door

Similar to rear door except for the omission of perforated grilles. Weight is approximately 40 lb. It may be mounted for either right- or left-hand opening.

Type PR-4-A, Terminal Board Frame

Weight is 3 lb. The terminal board frame provides mounting holes to accommodate three audio terminal blocks, ML-7118764-G1, and three power terminal boards, ML-7118765-G1. By relocating the two middle straps, the frame will mount six power-terminal boards and one audio-terminal block. It is recommended that one terminal-board frame be installed

near the bottom of each cabinet to provide mounting facilities for the required terminal boards.

Type PR-5-A, Wiring Duct

Weighing 12 lb, the wiring duct is a metal channel with 42 slots fitted with rubber grommets. It is recommended that two wiring ducts, Type PR-5-A, be mounted in each cabinet rack; one on the right-hand side (facing rear of cabinet) for audio or video inter-unit wiring, and one on the left-hand side for power, metering, and control inter-unit wiring.

Type PR-7-A, Mounting Angles

The mounting angles consist of a pair weighing 14 lb and of the following dimensions: 1 $\frac{1}{2}$ inches by 1 $\frac{1}{2}$ inches by 80 $\frac{5}{8}$ inches long. Each is of zinc-plated steel and includes angle mounting hardware. These angles are for use when it is desirable to mount panels or chassis on two mounting locations at the same time, such as mounting "bathtub" chassis with General Electric equipment in the Type PR-1-A rack.

Type PR-8-A, Cabling Straps

The cabling straps consist of a pair of steel straps $\frac{1}{2}$ -inch wide by $\frac{1}{8}$ -inch thick by 73 inches long, in addition to hardware for mounting in the cabinet rack. These straps mount vertically in the rear of the cabinet in place of the wiring duct, and serve as an inexpensive means for supporting cabinet inter-unit wiring.

Type PR-9-A, Mounting Frame

Ten inches (six rack units) to mount video and sync amplifier groups.

Type PR-9-E, Mounting Frame

Eight and three quarter inches (five rack units) to mount TS-2-A switching components.

Type PR-9-F, Mounting Frame

Fifteen and three quarter inches (nine rack units) to mount TS-2-A switching components.

Type PR-19-D, Adapter Kit

The adapter kit is 21 inches (twelve rack units) and is used to mount Type TM-21-A monitor.

Cat. No. 7118764-G1 Audio Terminal Block

Weighing one lb, this unit is an 80-terminal (four rows of 20 each) solder-lug, telephone-type block. For terminal frame mounting, each block is furnished with mounting hardware.

Cat. No. 7118765-G1 Power Terminal Board

This unit consists of an eight-terminal, screw-type terminal board, and marker strip. Mounting hardware is included with each terminal board for mounting on the Type PR-4-A terminal board frame.

Cat. No. 7460330-G4 Door-interlock Switch Kit

This kit consists of mounting hardware and an interlock switch which can be attached at either the front or the rear of the Type PR-1-A cabinet rack so that high-voltage circuits will be de-energized when either the front or the rear doors are opened. The stiffening channel on both the front and the rear doors are wide enough to permit the mounting of from one to three General Electric door interlock switch kits for either door.

Cabinet Rack

Type PR-1-A and Accessory Items

Cat. No. 7485321-G2 Blower Kit

This kit consists of aluminum plate baffles, rubber molding, blower, and filter. The blower is mounted on a plate which, in turn, is mounted on top of the Type PR-1-A cabinet rack. The blower is operated by a 1/50-hp, 1550-rpm, 115-volt single-phase 50/60-cycle, 50-watt motor fitted with composition lifetime bearings and delivering 400 CFM of air. The filter is comprised of 9 ⁹/₁₆-inch by 15 ⁹/₁₆-inch by 1-inch replaceable-type filter, mounting frame, and hardware for mounting on inside bottom of rear door.

Cat. No. 7140995-G1 Filter

Available for use without blower in negative pressure systems.

Cat. No. 7772418-P1 to P11 "Bath Tub"

Type chassis mounting brackets. These are the brackets which are available where throughout the data book references are made to brackets available to adapt chassis to RCA rack mounting. To adapt a General Electric chassis, the pair of normally included short brackets are removed and two of the following deep brackets are substituted in their place. Mounted in any 19-inch rack with competitive chassis, which have permanently attached deep brackets, the vertical front surfaces of the two makes of chassis will be in the same plane. For information in ordering brackets for chassis of various height, the following table is listed:

Height of Chassis Inches	Rack Units	Order Two Brackets Cat. No.
3 ¹ / ₂	2	7772418-P1
5 ¹ / ₄	3	7772418-P2
7	4	7772418-P3
8 ³ / ₄	5	7772418-P4
10 ¹ / ₂	6	7772418-P5
12 ¹ / ₄	7	7772418-P6
14	8	7772418-P7
15 ³ / ₄	9	7772418-P8
17 ¹ / ₂	10	7772418-P9
19 ¹ / ₄	11	7772418-P10
21	12	7772418-P11

HOW TO ORDER

When ordering, please specify:

Type	Description
PR-1-A	Cabinet rack. The Type PR-1-A includes one cabinet shell and rear door; one pair equipment mounting angles, Type PR-7-A; two angles (to mount PR-4-A frame); mounting hardware and two instruction books.

ACCESSORIES

Type	Description
PR-2-A	Hinged panel assembly (seven-inch, four rack units, in height)
PR-3-A	Front door
PR-4-A	Terminal board frame
PR-5-A	Wiring duct
PR-7-A	Pair of equipment mounting angles. Type PR-7-A includes two angles; and mounting hardware.
FA-6-A/B/C/D/E/F/G	Blank panels for filling blanks when front mounting other equipment.

Cabinet Rack

Type PR-1-A and Accessory Items

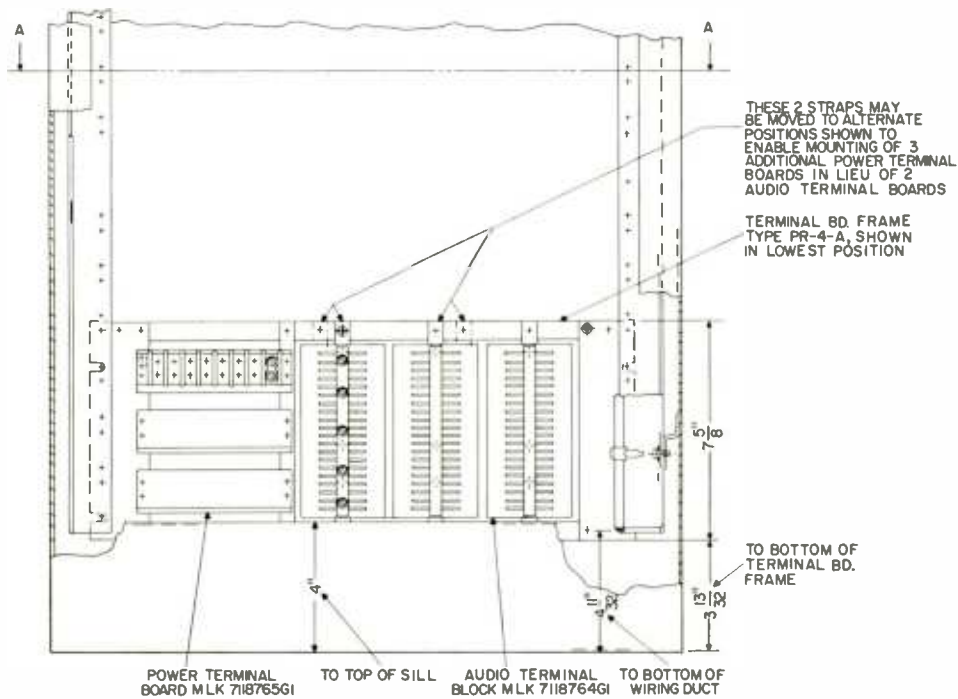
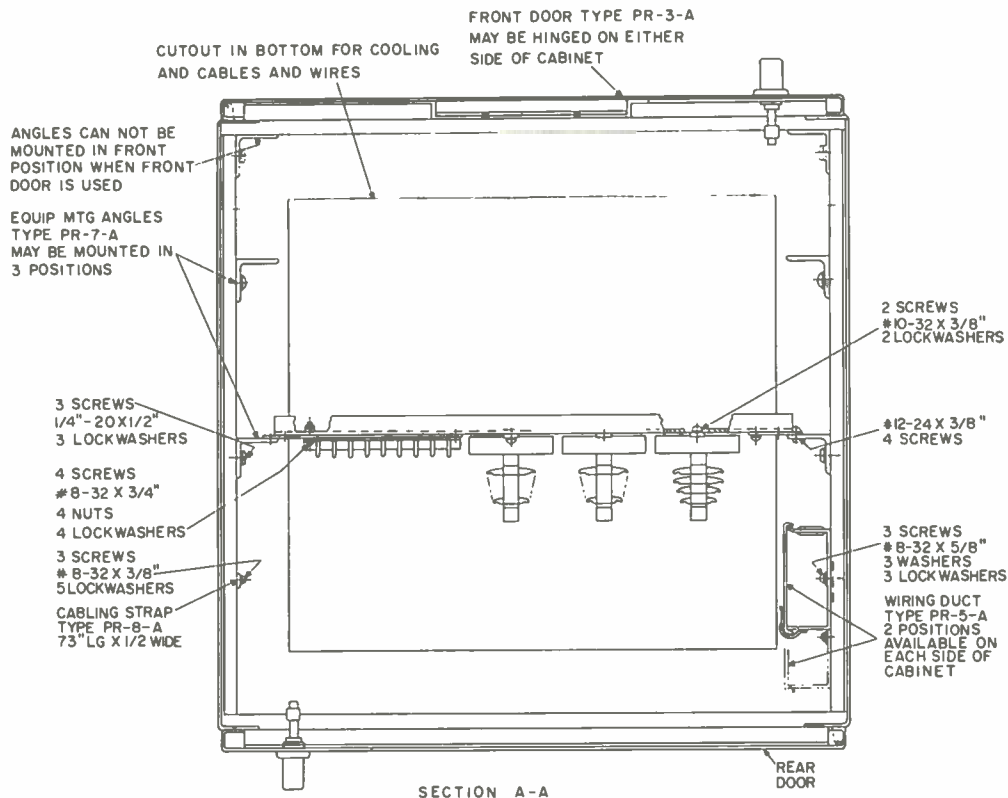

REAR VIEW
(WITH REAR DOOR NOT SHOWN)

CABINET RACK TYPE PR-1-A INCLUDES:
1- REAR DOOR
1 PAIR- EQUIPMENT MOUNTING ANGLES 77 1/2" LONG
1 PAIR- TB FRAME MOUNTING ANGLES 40 3/4" LONG
44- #12-24 X 3/8" EQUIPMENT MTG. SCREWS
1 DUST COVER, WITH MOUNTING HARDWARE

ACCESSORIES AVAILABLE ARE:
FRONT DOOR, TYPE PR-3-A
TERMINAL BOARD FRAME, TYPE PR-4-A
WIRING DUCT, TYPE PR-5-A
HINGED PANEL PR-2-A - 7" HIGH
EQUIPMENT MOUNTING ANGLES, TYPE PR-7-A
CABLING STRAPS, TYPE PR-8-A
AUDIO TERMINAL BLOCK, MLK-7118764GI
POWER TERMINAL BOARD, MLK-7118765GI
BLANK PANELS-FA-6-A-HEIGHTS OF 1 3/4
INCREMENTS FROM 1 23/32 TO 12 7/32

Installation of accessories in cabinet rack, Type PR-1-A

Cabinet Rack

Type PR-1-A and Accessory Items

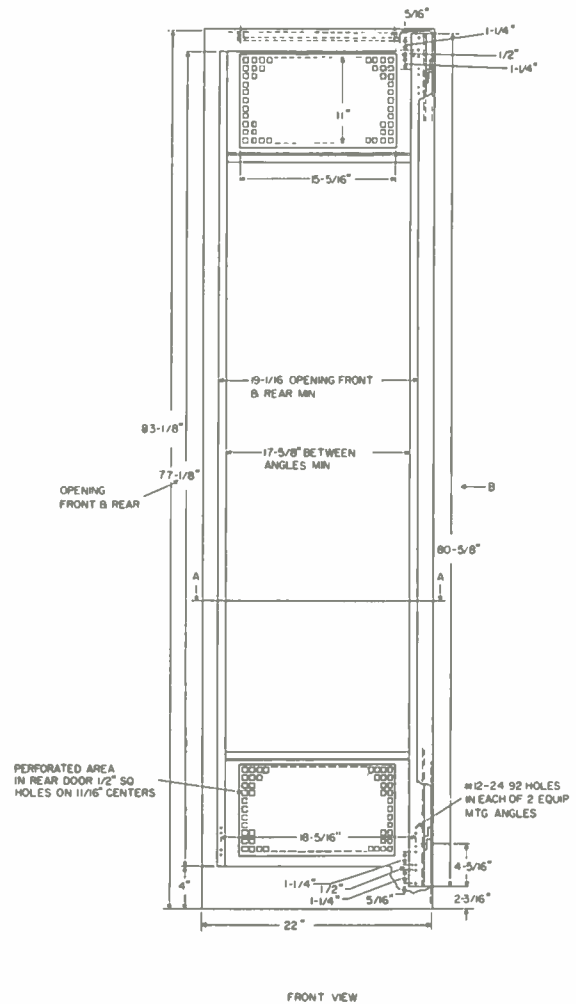
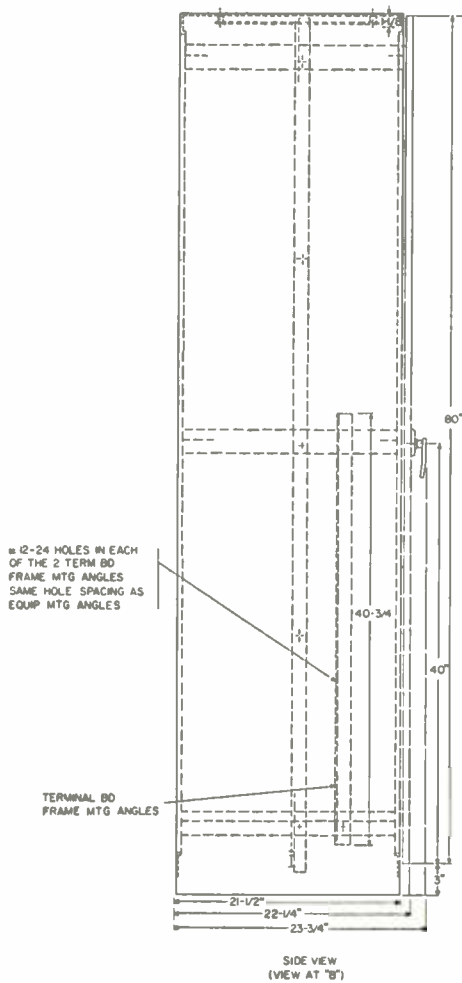
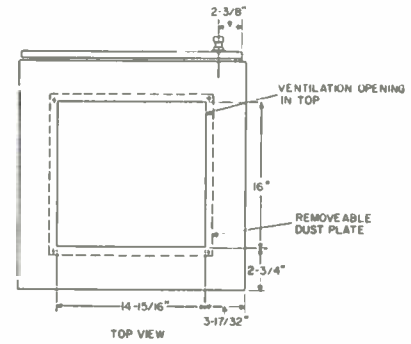
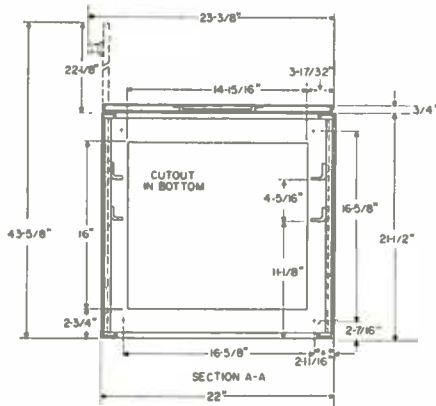

Outline of cabinet rack, Type PR-1-A

Cabinet Rack

Type PR-1-A and Accessory Items

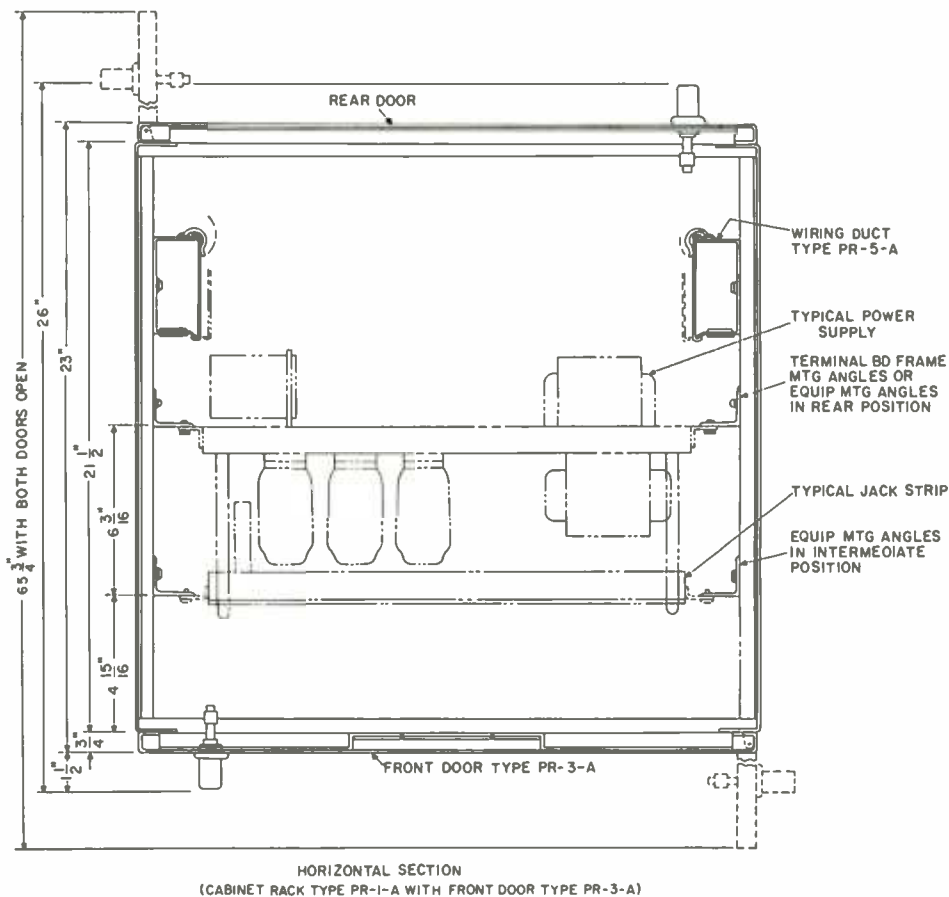
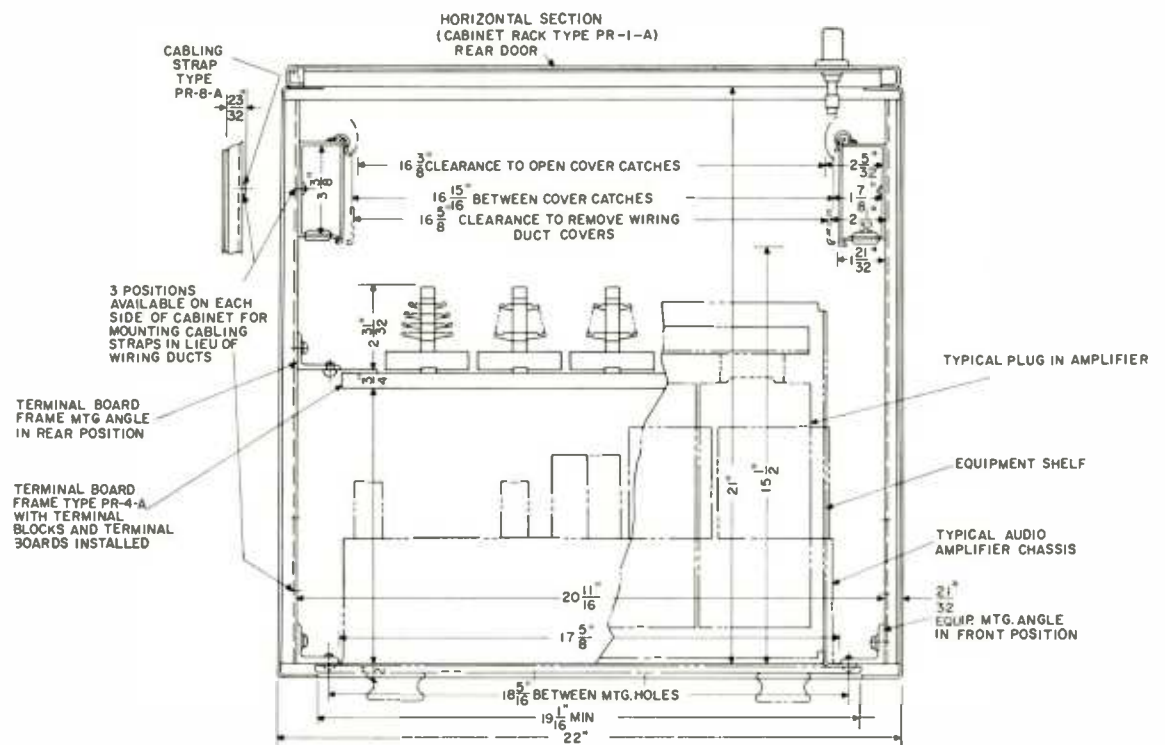

Inside clearances in cabinet rack, Type PR-1-A, with accessories installed

FEATURES● **Pleasing, functional appearance**

Cabinets and desks mate with other General Electric cabinetry and are designed to match in appearance and operating levels. Ample leg room, correctly designed desk height, and control mounting angle minimize operator fatigue and speed operations.

● **Block built design**

Cabinets and desk are mated so that they may be bolted together in a line or used as single units. Turret is designed to fit and fasten to base cabinet or desk.

● **Designed for ease of installation and maintenance**

Ample and convenient ports (in bottom, rear, and both sides) for cable entrances. The Type PR-16-B/C both have two cutouts in the metal part of the desk top; the Type PR-16-C has these openings covered with a removable metal panel and a linoleum top. Removal of linoleum and panel provide opening for flush surface mounting of control equipment. Dividing strip (between the two openings on the desk top) is readily removed for installation of single larger control units. Type PR-16-B/C front and rear panels are removable for equipment installation and service.

● **Turret cabinet mounted control panel may be tilted forward**

The Type PR-17-A turret cabinet accepts piano hinge or throw-out type mounted panels.

● **RETMA-Standard 19-inch rack mounting facilities in Type PR-16-B/C base cabinet**

Equipment mounting angles are provided in base cabinet for mounting of chassis and associated equipment. Mounting angles may be moved forward or backward three inches from center position.

● **All cabinets and desks sturdily constructed of steel**

Easily cleaned desk tops. Smooth matte black linoleum desk tops are easily cleaned.

WHERE TO USE

The General Electric control console cabinets, Types PR-16-B C, PR-17-A, and desk, Type PR-18-A are matched units designed to support and permit surface, internal or angle mounting of General Electric audio and video control equipment.

The end caps, Types PR-11-A and PR-11-B are designed to dress up the appearance of control console base cabinets and to serve as a support for the ends of the Type PR-18-A desk.

DESCRIPTION**PR-16-B/C Control Console Base Cabinets**

The Type PR-16-B/C control console base cabinets are designed to mount and house video control panels, relays, and chassis. They also serve as the floor-mounted support of the Type PR-17-A turret cabinet.

These two base cabinets serve as the basic cabinets for most horizontally operated video controls. When used with the Type PR-17-A turret cabinet, audio or video control panels may be flush-mounted at an angle of 60 degrees from the horizontal to improve operational efficiency.

Type PR-16-B Base Cabinet

The Type PR-16-B base cabinet consists of a vertical cabinet 19 $\frac{1}{4}$ inches wide, 28 $\frac{3}{16}$ inches high, and 21 $\frac{3}{32}$ inches deep. The front top of this cabinet protrudes out to form a desk surface 19 $\frac{1}{4}$ inches wide and 36 inches deep. The desk surface is covered with smooth matte black linoleum except for two panel openings, providing desk mounting space for two 5 $\frac{1}{2}$ -by 15-inch studio-control panels. If only one control panel is used, a blank panel and dress panel are provided to cover the remaining space.

The center dividing strip between the two openings is held in place by four screws and nuts. This strip may be readily removed to provide space for an 11- by 15-inch control panel.

Both front and rear base cabinet panels are removable for installation and service of equipment. The rear panel contains ventilation grilles at both top and bottom. Internally there are two equipment angle-mounting brackets for mounting standard size rack panels or chassis up to 24 inches in height. These angles, normally located near the center of the cabinet, may be moved forward or backward 3 inches either side of center. They may also be reversed so that equipment may be mounted from the front or the rear of the cabinet. Distance between the inner edges of the mounting brackets is 17 $\frac{5}{8}$ inches.

Cable ports are located on both sides and the rear. The side ports line up with those of other General Electric cabinets (such as the Type PR-12-A). Buttons are provided to close the unused ports. Holes are provided on either side for attachment of other units or end caps. The bottom is open for passage of inter-connecting cables. In the bottom corners are four $\frac{1}{2}$ -inch-diameter mounting holes for rigid floor mounting.

Type PR-16-C Base Cabinet

The PR-16-C base cabinet is identical to the Type PR-16-B base cabinet, except for the desk top. The entire surface of the PR-16-C desk top is covered with smooth matte black linoleum. Underneath the linoleum is a blank-metal panel 10 $\frac{5}{8}$ inches by 15 inches, which covers two equipment mounting holes identical in size to those in the Type PR-16-B base cabinet. Each opening is 5 inches by 13 $\frac{7}{8}$ inches in size and, with removal of the linoleum and blank-metal panel, will accept two standard 5 $\frac{1}{2}$ -inch by 15-inch control panels. As in the Type PR-16-B cabinet, the dividing strip is also readily removed to make way for a single larger 11-inch by 15-inch control panel. This cabinet is primarily intended for use where additional desk space is required, yet it contains the necessary openings for control mounting for future use.

Type PR-17-A Turret Cabinet

The Type PR-17-A turret cabinet is a desk-mounted unit with hinged front brackets for mounting audio and master-control panels. The unit mounts on the Type PR-16-B/C base cabinet and is secured to the cabinet through four mounting holes mating those in the base cabinet. The bottom of this cabinet contains a 14-inch by 18 $\frac{3}{4}$ -inch opening for ease in cable installation and maintenance. The cabinet is supplied with throw-out type hinges, with additional provision for mounting panels with a piano hinge. When using the

Control Console Base Cabinets

Types PR-16-B/C, PR-17-A

latter type hinge, the throw-out hinge may be removed if necessary.

This cabinet will accept flush-front mounting audio or video equipment of 14 inch height and 19 inch width, when mounted on throw-out or piano hinge. It may also be mounted on the Type PR-18-A desk.

Type PR-18-A Desk

The Type PR-18-A desk is primarily designed to support the larger General Electric Type BC-11-A audio control console. It will, in addition, accommodate the Type PR-17-A turret cabinet.

The desk top consists of a sturdily constructed wooden top, surfaced with matte black linoleum. It is supported at the ends by the use of Type PR-11-A and Type PR-11-B end caps. It is enclosed by a rear metal panel. The desk top itself is hardwood-edged, $\frac{3}{4}$ -inch plywood, reinforced with 2-inch angle iron. The unit is 39 inches wide (44 inches with end caps), $28\frac{3}{16}$ inches high and 36 inches deep. This unit may be used as an all-purpose desk to support other video or audio cabinets.

Types PR-11-A and PR-11-B End Caps

The Types PR-11-A and PR-11-B are, respectively, right and left end caps. These end caps are formed steel sections used to dress up the appearance of the Type PR-16-B/C base cabinets as well as other cabinets of this type in the General Electric equipment line. Only two caps are required to finish off the end appearances of a single Type PR-16-B/C base cabinet or a group of them bolted together.

The Type PR-11-A and B end caps are used as end supports for the Type PR-18-A desk.

MECHANICAL SPECIFICATIONS

UNITS

- 1—Type PR-16-B base cabinet (includes the cabinet, one subpanel, one dress panel, a removable front and rear panel, two equipment mounting brackets, and cable knock-out buttons).
- 1—Type PR-16-C base cabinet (includes the cabinet with top completely covered by linoleum, one subpanel, a removable front and rear panel, two equipment mounting brackets, and cable knock-out buttons).
- 1—Type PR-11-A right-end cap.
- 1—Type PR-11-B left-end cap.
- 1—Type PR-17-A turret cabinet (includes cabinet, throw-out hinge, and mounting hardware).

- 1—Type PR-18-A desk (includes one PR-11-A and one Type PR-11-B end cap and a top and rear panel).

DIMENSIONS

See drawings.

MOUNTING

The PR-16-B/C base cabinets are floor mounting units.

The PR-17-A is desk mounting.

The PR-18-A is floor mounting.

The PR-11-A & B mount on the sides of base cabinets and are not equipped with holes for floor mounting.

CONSTRUCTION

Formed welded-steel construction. Type PR-18-A desk top, $\frac{3}{4}$ -inch plywood with 2-inch angle iron reinforcement. All operating desk surfaces covered with matte black linoleum.

FINISH

General Electric metalustre blue.

VENTILATION

All units are cooled by natural air convection currents. Rear panels of PR-16-B/C contain ventilation grilles at top and bottom.

HOW TO ORDER

When ordering, please specify:

Type PR-16-B control console base cabinet

(The Type number includes one cabinet with two internal equipment mounting brackets, one subpanel, one dress panel, cable knock-out buttons, and installation and operating instructions.)

Type PR-16-C control console base cabinet

(The Type number includes one cabinet with two internal equipment mounting brackets, one subpanel, cable knock-out buttons, and installation and operating instructions.)

Type PR-11-A right-end cap

(The Type number includes the end cap, mounting hardware, and installation instructions.)

Type PR-11-B left-end cap

(The Type number includes the end cap, mounting hardware, and installation instructions.)

Type PR-17-A turret cabinet

(The Type number includes the cabinet, throw-out hinges, mounting hardware, and installation and operating instructions.)

Type PR-18-A desk cabinet

(The Type number includes the top, rear panel, one Type PR-11-A end cap, one Type PR-11-B end cap, and installation and operating instructions.)

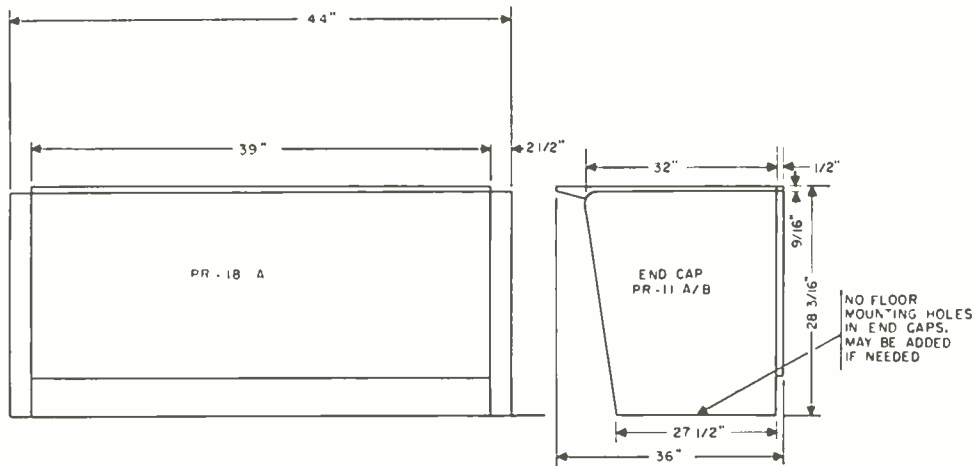

Outline drawing, Type PR-18-A desk

Control Console Base Cabinets

Types PR-16-B/C, PR-17-A

COMPONENTS

	Description	For Use with	Dimensions in Inches			Weight in Lb
			Depth	Height	Width	
 <p>Type PR-18-A desk</p>	36- by 39-inch desk top of hardwood—edged 3/4-inch plywood reinforced with 2-inch angle iron and covered with 1/8-inch matte black linoleum.	Type BC-11-A console	36	28 3/16	44	150
End Caps						
 <p>Metal panel and dividing strip under linoleum readily removed</p>	The end cap description is identical to that of the end caps, left and right, on the Type PR-18-A desk.	Type PR-10-A/B/C, Type PR-12-A and Type PR-16-B/C base cabinets	29	27 1/2	2 1/2	35
Control Console						
 <p>Type PR-11-B left-end cap Type PR-16-C console cabinet Type PR-11-A right-end cap</p>	Linoleum can be cut and a 10 1/8 by 15-inch metal panel under linoleum can be exposed two 5 by 13 7/8-inch opening. Also, the dividing strip can be removed to make one 10 1/2- by 13 7/8-inch opening (to fit an 11- by 15-inch panel).	Other cabinets where added desk space is required.	36	28 3/16	19 1/4	60
 <p>Type PR-16-B console cabinet</p>	Sub-panel and blue-topped dress panel can be removed to expose second 5- by 13 7/8-inch opening. Dividing strip can be removed to make one 10 1/2- by 13 7/8-inch opening (to fit an 11- by 15-inch panel).	Types TC-21-A, TC-28-A, TC-29-A, TC-34-A, TC-35-A, TC-39-A, TC-40-A panels	36	28 3/16	19 1/4	60
 <p>Type PR-17-A turret cabinet</p>	14 1/8- by 19 1/4-inch external dimensions of front surface. 13 5/8- by 18-inch opening in front surface.	Types TC-15A, TC-36A and transmitter control panels	24	12 7/8	19 1/4	30

Control Console Base Cabinets

Types PR-16-B/C, PR-17-A

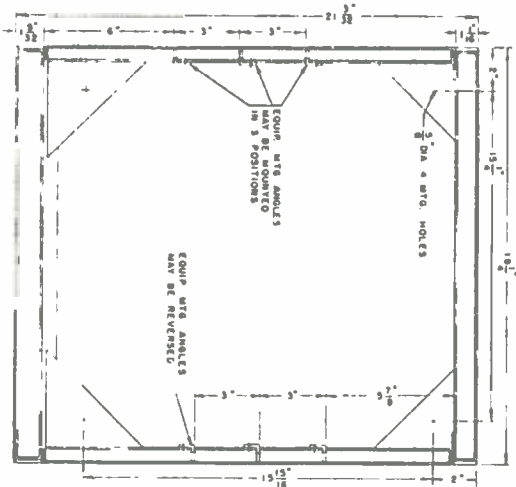

SECTION D-D
CROSS SECTION (LOOKING DOWN) OF PR-16-B/C
BASE CABINET
(APPROX HALF-WAY DOWN CABINET)

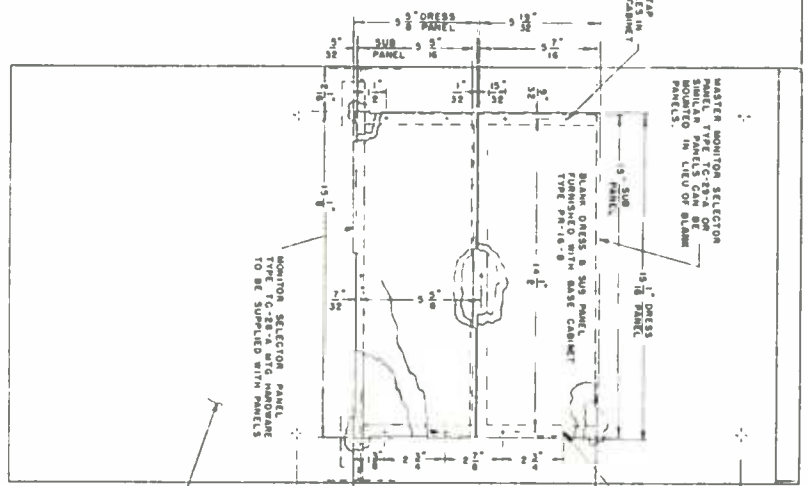

VIEW AT C
TOP VIEW OF PR-16-B/C
BASE CABINET

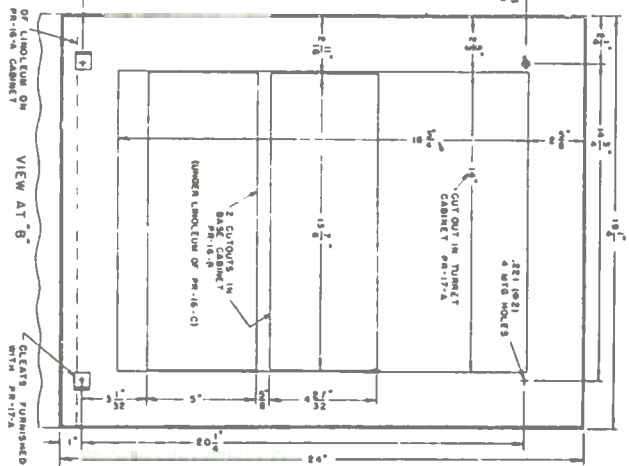

VIEW AT B
BOTTOM VIEW OF PR-17-A TURRET CABINET

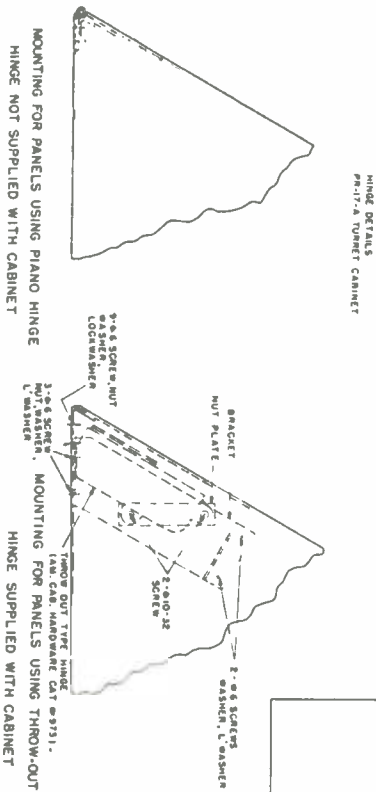

HINGE DETAILS
PR-17-A TURRET CABINET

Outlines and clearances of cabinets, Types PR-16-B/C and PR-17-A

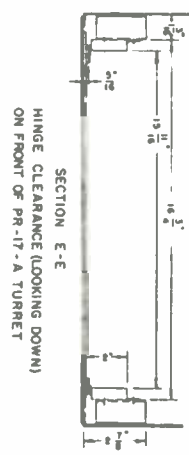

SECTION E-E
HINGE CLEARANCE (LOOKING DOWN)
ON FRONT OF PR-17-A TURRET



Microphone Cable, Plugs, and Receptacle

Type FA-15-A • Type FA-16-A, B • Type FA-16-C

MICROPHONE CABLE
TYPE: FA-15-A

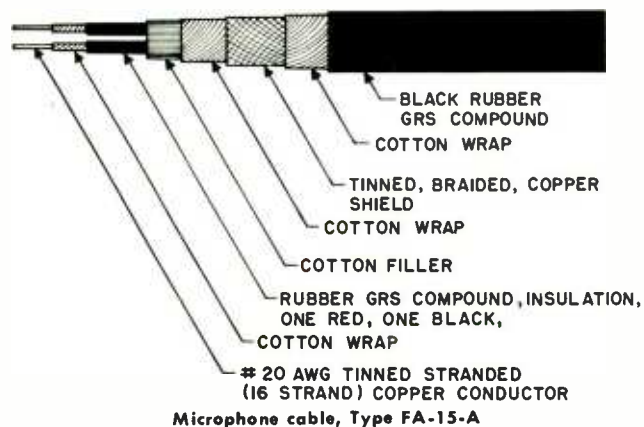

FEATURES

- Lies straight in use; but high flexibility permits easy coiling for storage purposes
- Ruggedly constructed for long, efficient service
- Tough outer GRS compound jacket resists abrasion and abuse giving thorough protection to inside shielding and conductors

WHERE TO USE

The General Electric Type FA-15-A microphone cable is a two-conductor, shielded, rubber-covered, flexible, water-proof cable designed primarily for use with low impedance microphones in television and broadcast studios. It may be used also for the make-up of extension cables and as replacement for old cables.

MECHANICAL AND ELECTRICAL SPECIFICATIONS

LOT LENGTH

250 feet per spool

VOLTAGE RATING

600 volts, a-c

OUTSIDE DIAMETER

0.320-inch

This cable consists of two No. 20 AWG (16 strands per conductor), stranded, tinned copper conductors with a cotton wrap over each conductor. Rubber GRS compound insulation is placed over the cotton wrap; insulation colored white on one conductor, black on the other. The two conductors are then twisted with cotton fillers and a cotton wrap is placed over them. A tinned copper braided shield is placed over this assembly. This shield is covered with another cotton wrap. The entire assembly is enclosed within a black rubber GRS compound jacket.

HOW TO ORDER

When ordering, please specify:
_____ spools (250 feet each) of Type FA-15-A microphone cable.

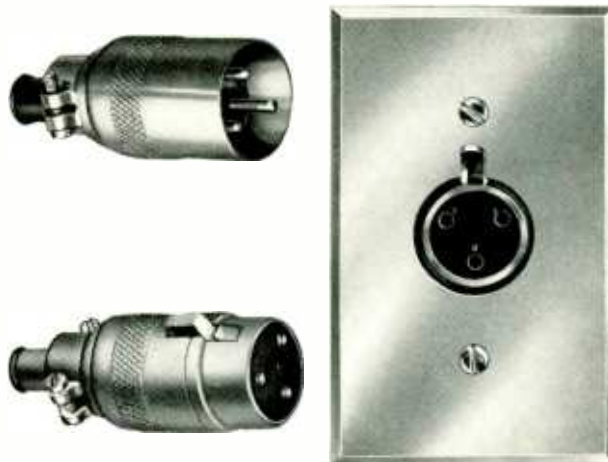

Male microphone plug, Type FA-16-A, female microphone plug, Type FA-16-B, and microphone wall receptacle, Type FA-16-C

FEATURES

- **Easily installed**
Large solder pots on pin ends permit easy installation with excellent electrical and mechanical connection of wires.
- **Positive locking device**
A push of the male plug into the wall receptacle or mating plug automatically locks the two together.
- **Quick, easy disconnect**
Thumb latch allows immediate disconnect of lock and easy withdrawal of plug.
- **Rugged construction**
Steel shell with phenolic-mounted contacts assures long, dependable life.
- **Rubber bushed cable clamp**
The Clamp takes strain from connections and aids in prolonging cable life. Clamp is integral part of plug shell.
- **Large pin-type male contacts**
Assure good connections with mating plug or receptacle.

WHERE TO USE

General Electric microphone plugs and wall receptacle are ruggedly designed units patterned after a trouble-free type of self-locking, quick disconnect plug, and receptacle. They are furnished with three standard contacts and have either a satin chrome or zinc plate finish.

Microphone Cable, Plugs, and Receptacle

Type FA-15-A • Type FA-16-A, B • Type FA-16-C

MECHANICAL AND ELECTRICAL SPECIFICATIONS

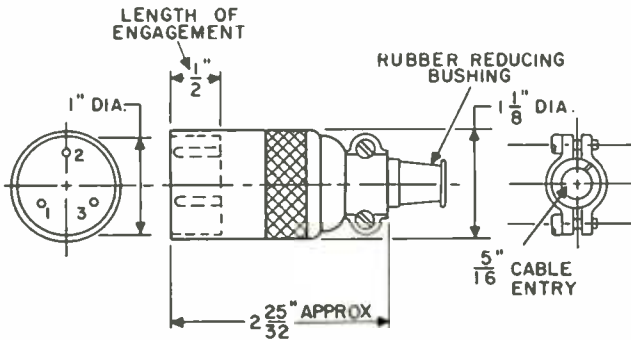

Male microphone plug, Type FA-16-A

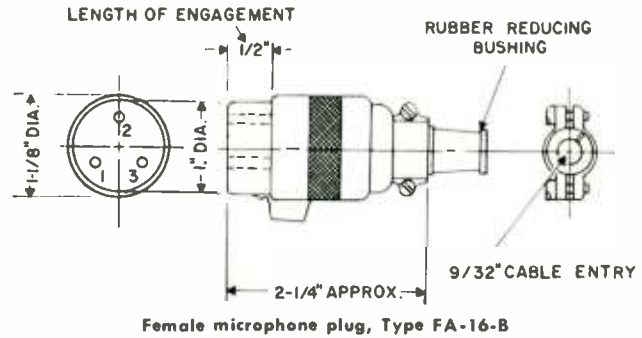

Female microphone plug, Type FA-16-B

The steel shell and zinc cable clamp are finished in satin chrome. Phenolic insulation is used to mount the contact pins. Cable entry is $\frac{5}{16}$ inch, through rubber reducing bushing. Shell has circular groove in interior to accept latch of female connector or wall receptacle. The three male contacts are so spaced that they **cannot be** inserted in a receptacle in the wrong position. The contacts terminate in tinned solder pots for wire connections. Dimensions shown on previous drawing.

The die-cast zinc shell is finished in satin chrome. Insulation is black phenolic compound with contacts anchored within. Cable entry is $\frac{9}{32}$ inch, through a rubber reducing bushing. A thumb-operated locking latch locks on inside rim of mating male plug shell when the units are pushed together. Encasements of the three female contacts are so located that the male plug **cannot be** wrongly positioned on insertion. The contact encasements terminate in solder pots for wire connections. See preceding drawing for dimensions.

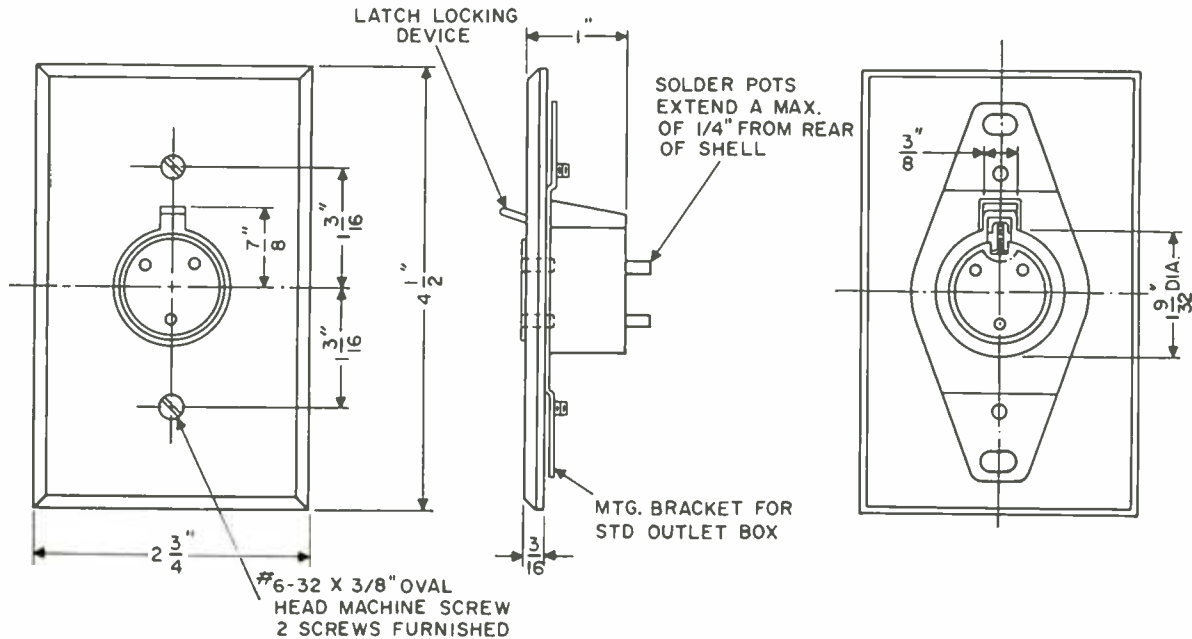

Microphone wall receptacle, Type FA-16-C

This unit is a single-gang, flush-mounting, wall receptacle with female latch-locking unit. It has a die-cast zinc shell and is finished in zinc plate. Insulation is black phenolic compound. Encasements of the three female contacts terminate in solder pots. A male plug is automatically locked into this receptacle by the locking latch engaging in a groove on the inside rim of the plug shell when the plug is inserted. The thumb-operated latch releases the lock. This receptacle fits all standard wall outlet boxes similar to General

Electric Outlet Box SP-5800. See drawing on Type FA-16-C receptacles for dimensions.

HOW TO ORDER

When ordering, please specify:
Microphone plug, male, Type FA-16-A
Microphone plug, female, Type FA-16-B
Microphone wall receptacle, female, Type FA-16-C

Monitoring and Wall Speakers

Types FS-1-B and FS-2-B

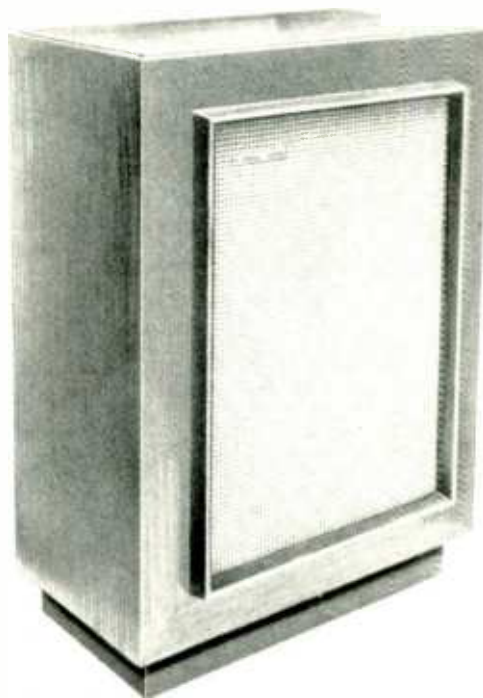

Monitoring speaker, Type FS-1-B (Type FS-4-A cabinet)

FEATURES

Monitoring Speaker, Type FS-1-B

- **Rich full bass**
Assured by use of ample cabinet volume and bass-reflex design.
- **Wide range response**
Use of famous General Electric speaker Type 1201A provides a uniform response, free from objectionable peaks, over the useful range of 50 to 13,000 cycles per second.
- **High wattage capacity**
Non-warping aluminum foil base voice coil is unaffected by changes in moisture or temperature.
- **Low driving power required**
Speaker is highly efficient.
- **Contemporary styling of cabinet**
Carefully selected woods and contemporary cabinet styling complement the appearance of any studio.
- **Line-to-voice-coil transformer included**

WHERE TO USE

Monitoring Speaker, Type FS-1-B

The Type FS-1-B monitoring speaker is designed for critical high-quality monitoring of broadcast program material in AM-FM and TV broadcast studios. It is ideally suited for every application requiring a pleasing, wide range response coupled with an attractive appearance. The Type FS-1-B monitoring speaker will provide unexcelled reproduction of music and speech in clients' rooms, control rooms, and studios. Its range extends from 50 to 13,000 cps.

Studio Wall Speaker, Type FS-2-A

The Type FS-2-A studio wall speaker is a low-cost speaker and housing combination for general-purpose use in studios, offices, and recording rooms of broadcast studios.

FEATURES

Studio Wall Speaker, Type FS-2-B

- **Good sound distribution**
Cabinet front sloped for best sound distribution.
- **Good frequency reproduction**
Uses General Electric 1201A speaker.
- **Attractively styled cabinet**
Attractive walnut-finish wood used in cabinet construction.
- **Line-to-voice-coil transformer included**
- **Economical**
Speaker and cabinet combination low in price.

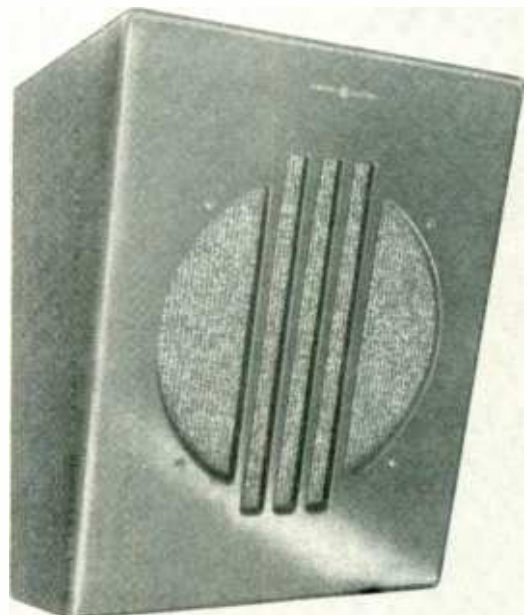

Studio Wall Speaker, Type FS-2-B (FS-3-A Housing)

Monitoring and Wall Speakers

Types FS-1-B and FS-2-B

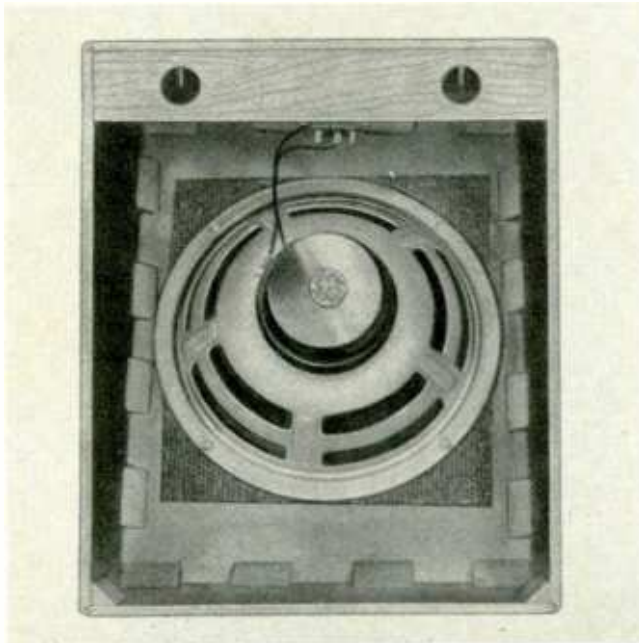

Studio wall speaker, Type FS-2-B, rear, showing voice-coil transformer

DESCRIPTION

Monitor Speaker, Type FS-1-B

The Type FS-1-B monitoring speaker is composed of the Type FS-4-A monitoring speaker cabinet, a 1201A loudspeaker, and a Type FA-42-A line-to-voice-coil transformer.

The speaker used in the cabinet employs a curvilinear molded cone for efficient dispersion of its wide range reproduction. The heavy Alnico V permanent magnet provides a high sensitivity with reliable, quiet operation.

The interior surfaces of the cabinet are treated with special sound-absorptive material.

While the cabinet is designed for floor mounting, it may be readily wall mounted, if required.

Studio Wall Speaker, Type FS-2-B

The Type FS-2-B studio wall speaker consists of a Type FS-3-A wall speaker housing, a 1201A speaker and a Type FA-42-A line-to-voice-coil transformer.

The cabinet is especially constructed and braced for wall mounting. Its sloping front panel assures good distribution of sound when the speaker is located out of the way at or near ceiling level. Its external walnut finish harmonizes pleasingly with other studio fixtures.

A line-to-voice-coil transformer, included with this model, will provide correct matching to several line impedances or parallel speaker operation.

MECHANICAL SPECIFICATIONS

UNITS

Type FS-1-B monitoring speaker including floor cabinet, speaker, and line-to-voice-coil transformer.

Type FS-2-B studio wall speaker, including wall mounting cabinet, speaker, and line-to-voice-coil transformer.

Type FS-3-A wall speaker housing only.

Type FS-4-A monitoring speaker cabinet only.

DIMENSIONS (in inches)

	TYPE FS-1-B	TYPE FS-2-B
Speaker:	12	12
Cabinet:		
Depth:	14 $\frac{1}{2}$	9 $\frac{3}{4}$
Height:	26	18
Width:	25	14 $\frac{5}{8}$

WEIGHT 70 lbs approx 10 lbs approx

MOUNTING

Type FS-1-B floor mounting.

Type FS-2-B. Wall mounting with drilled holes to facilitate easy mounting or take-down.

FINISH

Walnut.

CONNECTIONS

Type FS-1-B and Type FS-2-B—solder terminals on transformer taps.

ELECTRICAL SPECIFICATIONS

TYPES FS-1-B AND FS-2-B

Frequency response: 50-13,000 cps.

Power handling capacity: 25 watts, music and speech.

Field: Alnico V permanent magnet, 14.5 ounces.

TRANSFORMER INPUT IMPEDANCE

600/1200/1800/2400 ohms.

HOW TO ORDER

When ordering, please specify:

Type FS-1-B monitoring speaker. (The type number includes one Type FS-4-A cabinet, one 1201A speaker, one Type FA-42-A line-to-voice-coil transformer, and installation and operating instructions.)

Type FS-2-B studio wall speaker. (The Type number includes one Type FS-3-A wall housing, one 1201A speaker, one Type FA-42-A line-to-voice-coil transformer, and installation and operating instructions.)

Type FS-3-A wall speaker housing.

Type FS-4-A monitoring speaker cabinet.

ACCESSORIES

Type FA-19-J interconnecting cable.

Speakers

Types 850, 1201A, and 1203A

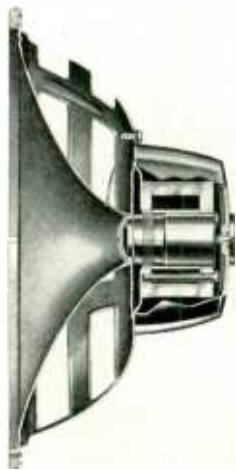

Cut-away view speaker, Type 1201A



Speaker, Type 1201A

FEATURES

- **High wattage handling capacity**
Made possible by use of non-warping aluminum foil base voice coils.
- **Faithful reproduction**
Assured by molded, scientifically designed General Electric cones.
- **High efficiency**
Due to liberal use of Alnico V magnet material.
- **Rigidly constructed**
All-welded construction insures rigidity and provides optimum controlled flux density.
- **Attractive appearance**
Lustrous finish is specially protected to preserve beauty and effectiveness.
- **Wide range**
The 1201A and 1203A speakers uniformly cover the frequency range from 50 to 13,000 cycles-per-second.

WHERE TO USE

General Electric loudspeakers are designed for critical high quality monitoring of broadcast program material in AM-FM and TV broadcast studios. They may be depended upon to provide excellent reproduction of music and speech in recording, control, and studio monitoring applications.

The Types 850, 1201A and 1203A speakers are wide-range speakers for use in broadcast control and studio monitoring.

DESCRIPTION

General Electric loudspeakers are designed by audio engineers and produced under exacting conditions of quality control.

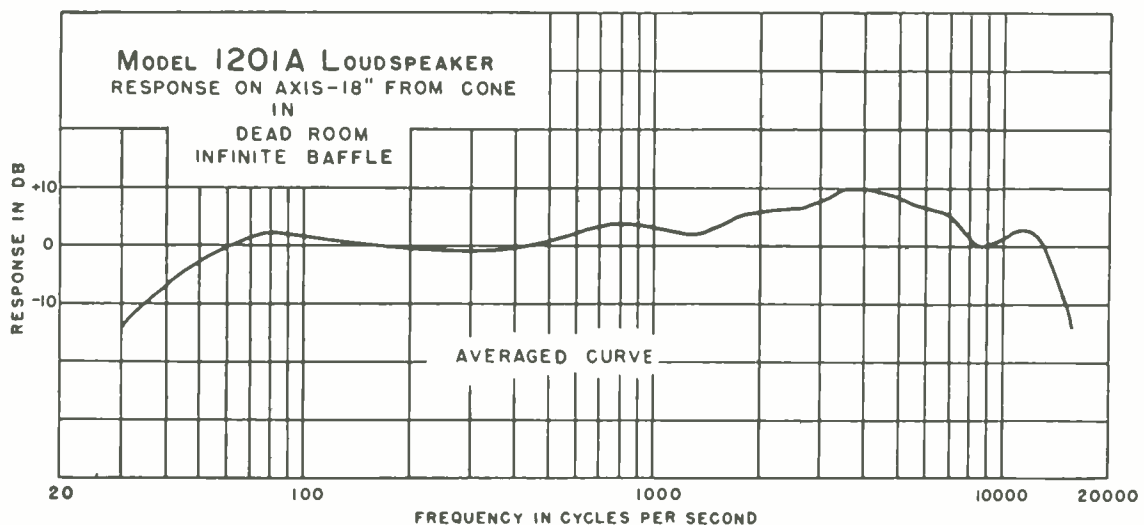

Speakers

Types 850, 1201A, and 1203A

Speaker, Type 850

The Type 850 speaker is a wide range unit, 8 inches in diameter with a 15-watt handling capacity.

Speakers, Types 1201A and 1203A

The Type 1201A and 1203A speakers are wide range units, 12 inches in diameter and with 25-watt handling capacities. They differ only in their Alnico V magnet weight; the 1201A having a 14.5-ounce magnet compared to a 9-ounce magnet in the 1203A, with a consequent increase in efficiency in the 1201A.

All speakers employ non-warping aluminum foil base voice coils with molded, scientifically designed circular cones. All-welded frame construction is employed to insure rigidity and controlled flux density. Alnico V magnet material is used for increased efficiency.

Due to careful design and quality control in manufacture, these speakers offer a uniform response, with freedom from objectionable peaks over their useful response ranges.

MECHANICAL AND ELECTRICAL SPECIFICATIONS

UNITS

Wide range speakers: Types 850, 1201A, 1203A.

MOUNTING

All speakers are equipped with four mounting holes on the circumference of the frame designed to accept No. 8 machine screws.

DIMENSIONS AND WEIGHTS

Type*	Diameter Over-all Size (In inches)	Mtg. Hole Centers (In inches)	Depth Gasket to Yoke or Cover (In inches)	Shipping Weight
850	7 $\frac{1}{2}$	7 $\frac{5}{8}$	3 $\frac{3}{4}$	2 lb 10 oz
1201A	12 $\frac{3}{32}$	11 $\frac{9}{16}$	5 $\frac{7}{8}$	6 lb 8 oz
1203A	12 $\frac{3}{32}$	11 $\frac{9}{16}$	5 $\frac{7}{8}$	5 lb 2 oz

Type*	Size* (In inches)	Shape* Cone	Alnico V		V.C.		Baffle Open Inches
			Mag. Wt.	Power Rating	V.C. Diam. (In inches)	Imp. Ohms	
850†	8	Round	6.8 oz	15w	1	8.0	6 $\frac{7}{8}$
1201A†	12	Round	14.5 oz	25w	1 $\frac{1}{4}$	8.0	10 $\frac{3}{4}$
1203A†	12	Round	9.0 oz	25w	1 $\frac{1}{4}$	8.0	10 $\frac{3}{4}$

* The General Electric Company manufactures a complete line of original and replacement speakers in a variety of shapes, sizes, and ratings not shown here. For information concerning these latter speakers, please consult your local General Electric distributor.

† Wide range speakers recommended for broadcast studio and monitoring applications.

CONNECTIONS

Types 1201A, 850 and 1203A Screw terminals.

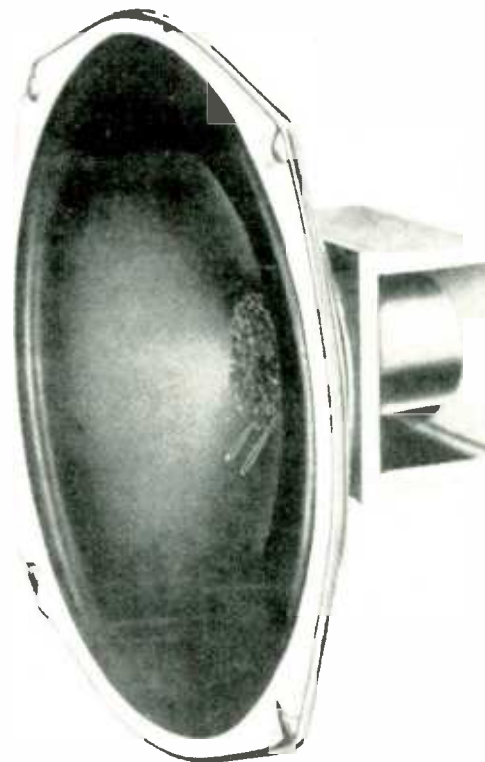

Speaker, Type 850

HOW TO ORDER

When ordering, please specify:

Type _____,

Wide range speaker

ACCESSORIES

Type FS-4-A monitoring speaker cabinet (for 12-inch speaker).

Type FS-3-A wall speaker cabinet (for 12-inch speaker).

Type FA-42-A line-to-voice-coil transformer.

Type FA-19-J interconnecting cable.

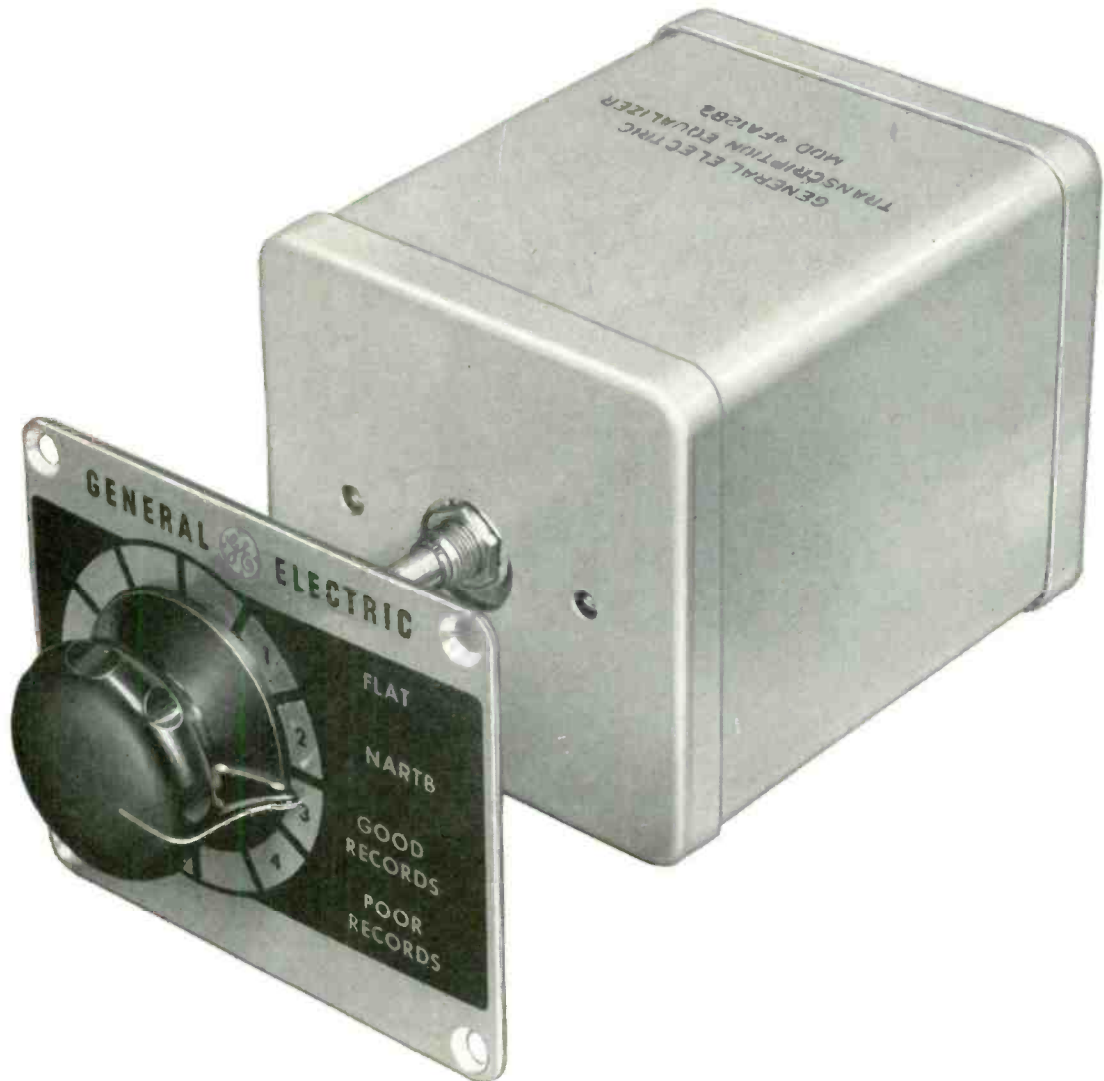

Transcription equalizer, Type FA-12-B

FEATURES

- Pleasing record reproduction—full low-frequency response and adjustable high-frequency response
- Easy to install—single unit construction
- Low hum pickup because of adequate magnetic shielding
- Connections simplified—outputs may be run balanced or unbalanced
- Convenient to use—connects to any microphone pre-amplifier

WHERE TO USE

The General Electric Type FA-12-B transcription equalizer is an adjustable network for use with professional-type General Electric cartridges, 4GS-01D, 4GS-02D and 4GD-01D-02D, for broadcast reproduction of lateral transcriptions and records.

DESCRIPTION

The Type FA-12-B transcription equalizer is a single unit housed in a rectangular steel case. It has a

low-impedance output which will work into the unloaded input of any microphone pre-amplifier. It includes a four-position switch which provides control of high-frequency response.

The FLAT position provides essentially flat high-frequency response from material recorded at constant velocity above 700 cps. The NAB position provides an essentially flat reproduction of material recorded in accordance with the NAB lateral curve. This position may also be used for reproduction of 78-rpm vinylite base and "hi-fi" records. The GOOD RECORDS position provides a high-frequency response somewhat more attenuated than that given by the NAB position. The fourth position, marked POOR RECORDS, provides a high-frequency response considerably more attenuated than that given by the NAB position. (See average performance characteristic curves.)

All switch positions provide low-frequency response essentially the complement of the NAB curve.

Transcription Equalizer

Type FA-12-A

Experience has shown that the NAB position is ideal for high-quality transcriptions and both wide-groove (0.003-inch) and micro-groove (0.001-inch) types of records. For worn transcriptions and average good records, the GOOD RECORDS position provides the most pleasing response. Noisy and distorted records require the POOR RECORDS position. The FLAT position is useful for the reproduction of instantaneous recordings and other special records cut with a FLAT recording characteristic.

MECHANICAL SPECIFICATIONS

DIMENSIONS

	Can (In inches)	Dial Plate (In inches)
Depth	4 $\frac{1}{8}$...
Length	3 $\frac{3}{8}$	3 $\frac{5}{8}$
Width	3 $\frac{1}{4}$	3
Weight	2 lb	...

MOUNTING

Tapped mounting holes are provided at the top (switch end) of the case to enable mounting the Type FA-12-B to the under side of the top panel of a transcription turntable with its switch shaft passing vertically through a clearance hole drilled in the top panel. The switch shaft is made extra long so as to accom-

modate various thicknesses of transcription turntable top panels. A knob and escutcheon plate are supplied for mounting above the transcription equalizer on the control surface of the transcription turntable. External connections to the pickup and to the amplifier are made on a terminal board located at the bottom of the equalizer case. Although the equalizer components are completely enclosed in a protective metal case containing inner mu-metal shields, the removal of two case screws enables rapid access to the components should servicing be necessary.

ELECTRICAL SPECIFICATIONS

OUTPUT CIRCUITS

Load Impedance

Designed to work into either a 150/250- or 30/50-ohm unloaded input

Output Connections

Balanced, or either side may be grounded

Output Level

An output level of approximately -55 VU maximum is obtained when reproducing 78 rpm shellac records; -60 VU maximum from micro-groove records

TYPICAL REPRODUCTION RESPONSE

See average performance characteristic curve.

HOW TO ORDER

When ordering, please specify:
Type FA-12-B transcription equalizer.

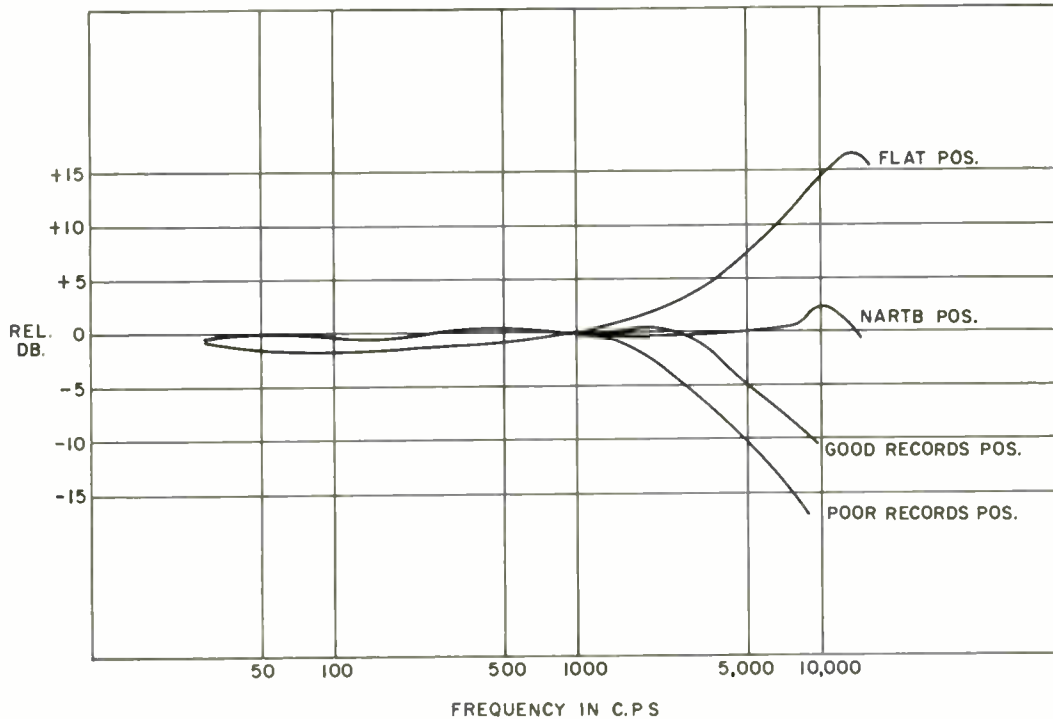

Average performance characteristics of the transcription equalizer with the "new orthophonic" test record and General Electric 4GS-01D or 4GD-01D-02D cartridge using the 1-mil diamond stylus

Line-to-Line Transformer

Type FA-40-B

WHERE TO USE

The General Electric Type FA-40-B line-to-line transformer is designed for use as a high quality repeat coil in telephone lines, or for isolation and impedance-matching in output circuits of low- and medium-level amplifiers.

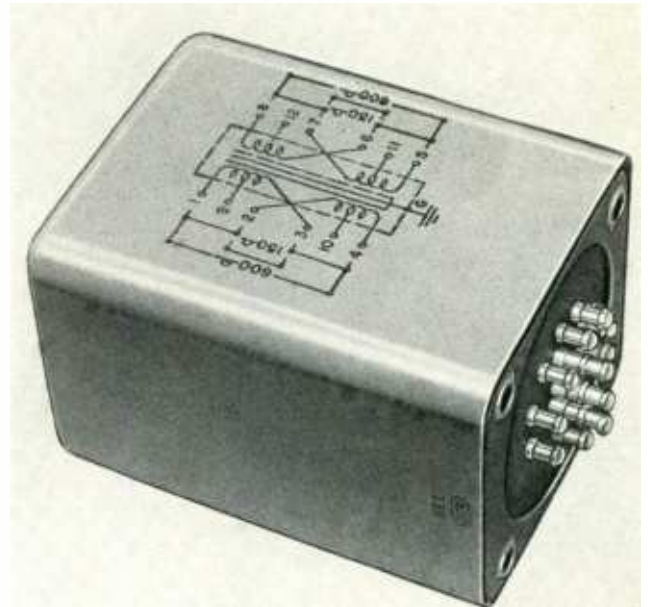

Line-to-line transformer, Type FA-40-B

MECHANICAL SPECIFICATIONS

DIMENSIONS (Over-all)

- Height 3 1/8 inches, maximum
- Width 2 1/8 inches, maximum
- Depth 2 5/8 inches, maximum
- Weight Approx 1 3/4 lb

MOUNTING

No. 6-32-8 tapped inserts

HOW TO ORDER

When ordering, please specify:
Type FA-40-B line-to-line transformer.

CONNECTIONS

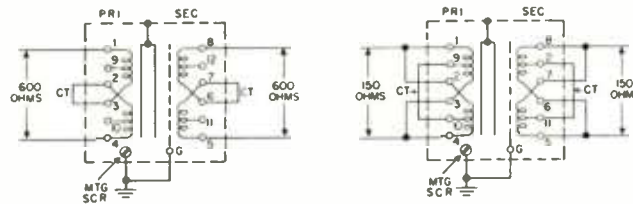

CENTER TAPS MAY BE GROUNDED AS DESIRED

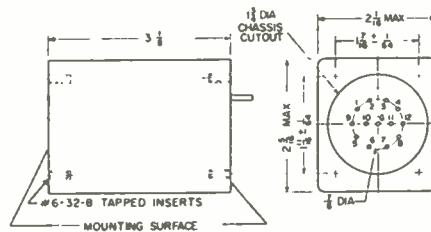

Installation drawing for transformer, Type FA-40-B



WHERE TO USE

The General Electric Type FA-41-C bridging-to-line transformer is designed for use in connecting a 600- or 150-ohm device across a low-impedance program circuit without appreciably affecting the performance of that circuit.

MECHANICAL SPECIFICATIONS

DIMENSIONS (Over-all)

Depth 2 ⁵/₁₆ inches
 Height 3 ¹/₄ inches
 Width 2 ¹/₈ inches
 Weight Approx ³/₄ lb

MOUNTING

¹/₄-inch—No. 6-32 tapped inserts

ELECTRICAL SPECIFICATIONS

FREQUENCY RANGE

In excess of 50 to 15,000 cycles, $\pm 1\frac{1}{2}$ db

IMPEDANCES

20,000 ohms to 600 ohms
 5,000 ohms to 150 ohms

MAXIMUM OPERATING LEVEL

+15 dbm at 50 cycles on secondary (corresponds to approx 38 volts on 20,000-ohm primary)

BRIDGING LOSS

19 db (See installation drawing below)

CONNECTIONS

See installation drawing below

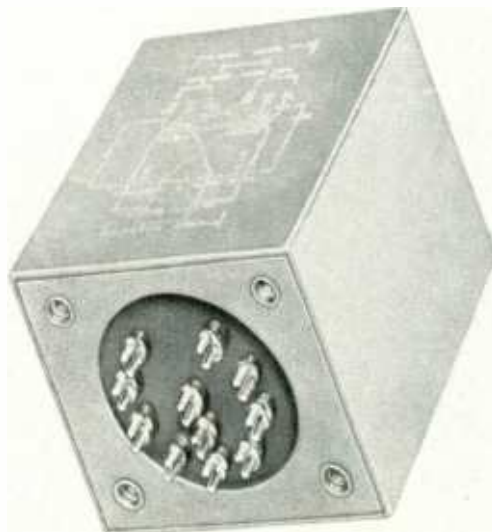

Bridging-to-line transformer, Type FA-41-C

HOW TO ORDER

When ordering, please specify:
 Type FA-41-C bridging-to-line transformer.

CONNECTIONS

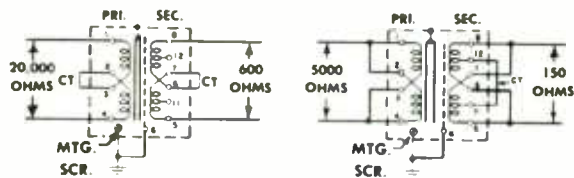

CENTER TAPS MAY BE GROUNDED AS DESIRED

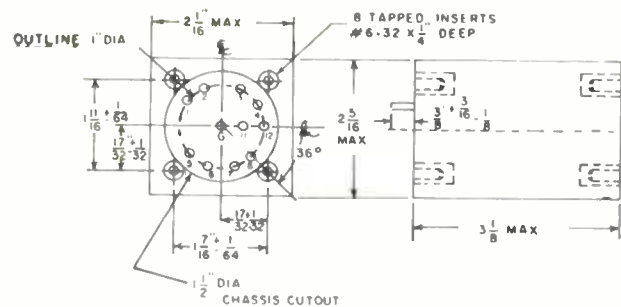

BRIDGING LOSS:

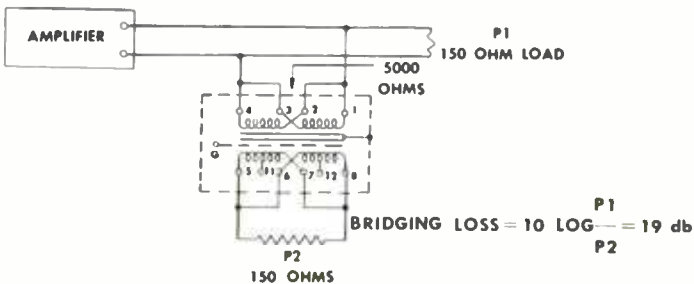
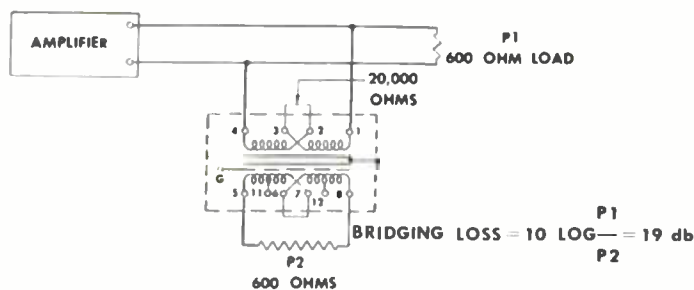

Installation drawing for transformer, Type FA-41-C

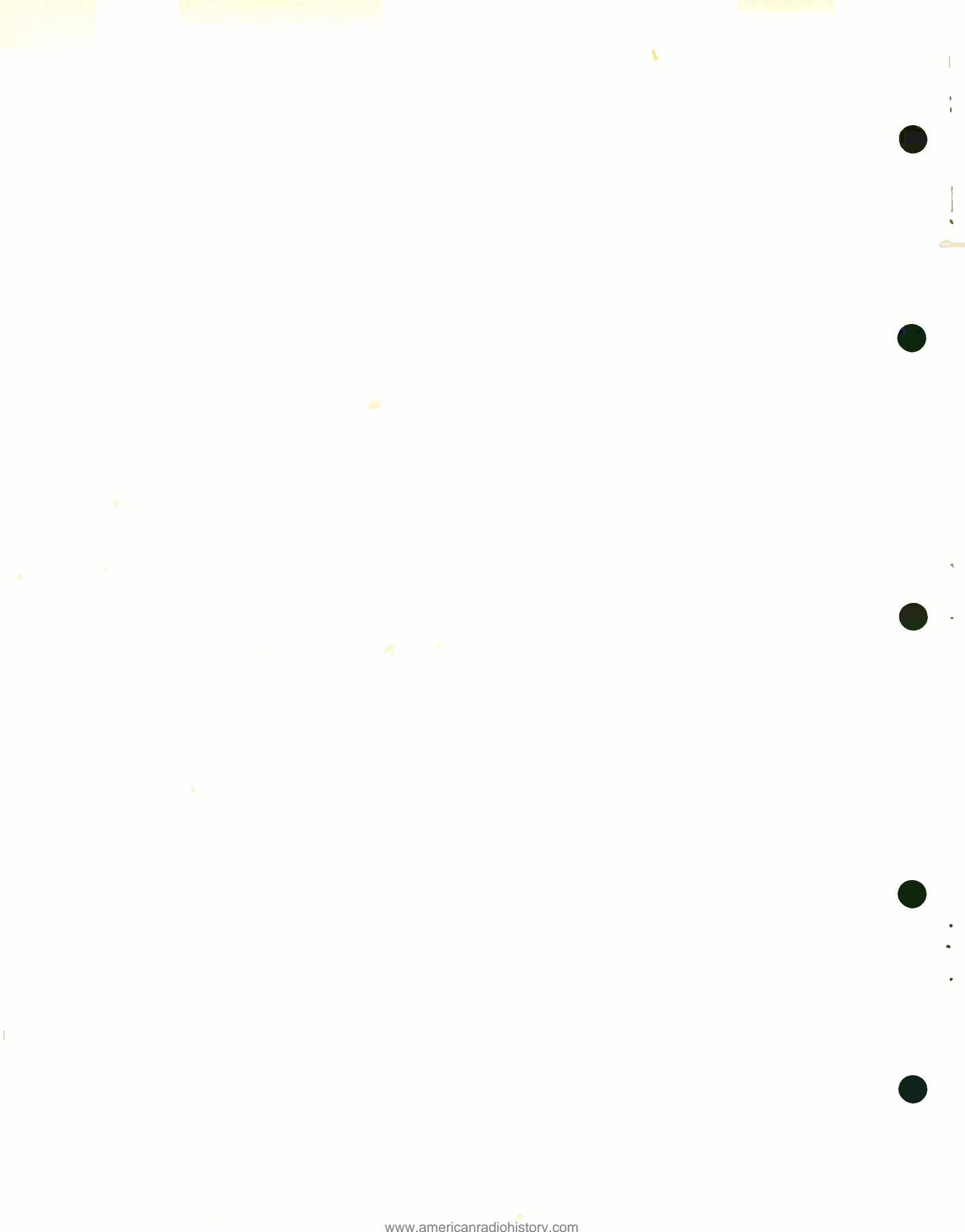

FEATURES

- Multiple primary taps. Permits paralleling of speakers across a single output
- Multiple secondary taps. Permits use of transformer with all common voice coil impedances
- Terminal impedances clearly marked. All terminal impedances are clearly marked on the coil adjacent to the terminal
- Frame bright plated to resist corrosion

WHERE TO USE

The General Electric Type FA-42-A line-to-voice coil transformer is designed to match a 600-ohm amplifier output to single- or multiple-speaker voice coils. It is provided with multiple primary and secondary taps for this purpose.

DESCRIPTION

The General Electric Type FA-42-A line-to-voice coil transformer utilizes core and coil construction with solder lug-type terminals.

Multiple primary terminals permit the use of from one to four speakers across the output of any 600-ohm amplifier.

Multiple secondary terminals permit the proper matching of any speaker with a voice coil impedance range of from 3.2 ohms to 16 ohms. Three taps are provided for this purpose.

All terminals are situated on the coils and are clearly marked for ready identification of their impedances.

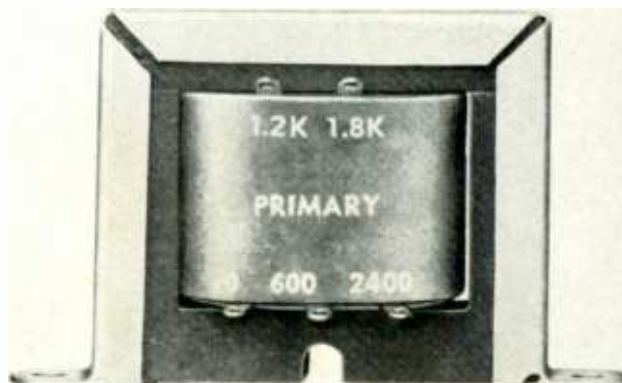
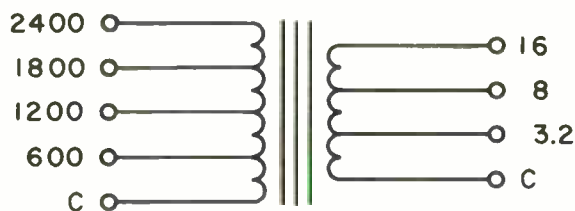
TRANSFORMER CIRCUIT

Line-to-voice coil transformer, Type FA-42-A

MECHANICAL SPECIFICATIONS**UNITS**

1—Type FA-42-A line-to-voice coil transformer

DIMENSIONS

Height 2 inches Width 2 $\frac{3}{8}$ inches
Length 3 $\frac{1}{4}$ inches Weight 14 oz

MOUNTING HOLES

Two— $\frac{1}{8}$ -inch diameter on 2 $\frac{1}{8}$ -inch centers

CONNECTIONS

Solder-type terminals, protruding from coil

MARKINGS

Terminal impedances marked adjacent to them on coil surface

CONSTRUCTION

Open frame, core and coil construction

ELECTRICAL SPECIFICATIONS**PERFORMANCE**

Frequency response: ± 2 db, 60–8000 cps
Power handling capacity: 5 watts with less than 3 percent distortion

PRIMARY IMPEDANCES

600/1200/1800/2400 ohms

SECONDARY IMPEDANCES

3.2/8/16 ohms

HOW TO ORDER

When ordering, please specify:
Type FA-42-A line-to-voice coil transformer.



Interconnecting Cables

Types FA-19-J, FA-19-M, and FA-19-R

Type FA-19-J



Type FA-19-M

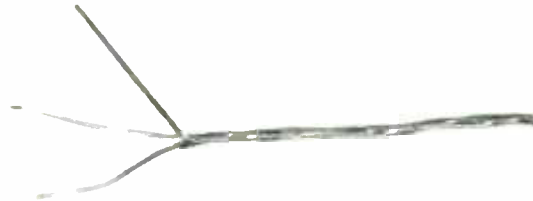

Type FA-19-R



FEATURES

- Small outside diameter of Types FA-19-M and FA-19-R enables use of greater number of cables in a small conduit. Outside diameter only 0.152 inches
- Easily stripped and prepared for soldering
- Third bare conductor in full length contact with shield provides excellent grounding in audio cables (Types FA-19-M and FA-19-R). No need to solder ground to shield
- Wrap-around shield in audio cables easily removed during making of connection. No need to fray out shield as with braided type
- Audio cables insulated from each other by over-all polyvinyl jackets on each cable. Permits common grounding at one point
- Sold in 500-foot, nonreturnable spool lots

WHERE TO USE

The General Electric interconnecting cables, Types FA-19-J, FA-19-M, and FA-19-R are used for power, audio, or circuit control connections. Each of the three types has special characteristics and recommended uses. All of the three cables are designed and manufactured to give long, efficient, trouble-free service. Types FA-19-M and FA-19-R cables have been made with very small outside diameters to permit their use in large numbers in small conduits or other small-diameter wiring channels.

DESCRIPTION

The Types FA-19-M and FA-19-R interconnecting cables are small-diameter, two-conductor, shielded

cables designed for use in low or intermediate level audio circuits. Both cables are No. 22 AWG two-conductor, shielded with over-all nylon jackets. The Type FA-19-M employs solid conductors, while the Type FA-19-R uses stranded conductors. A unique feature of these two cables is the third, bare ground wire included under the shielding and in contact with it for the entire length of the cable.

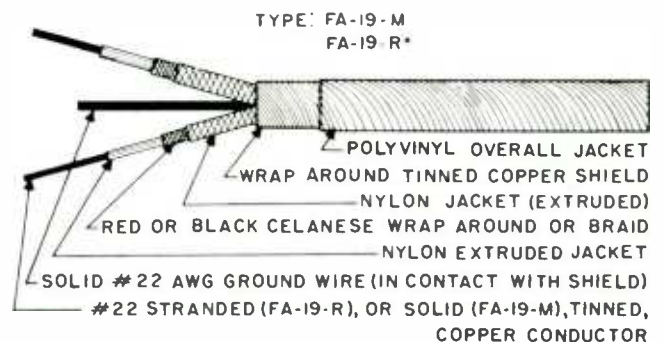

* Utilizes stranded bare ground wire.

The Type FA-19-M is recommended for general-purpose audio wiring within ducts, conduits, and cabinets, where vibration is at a minimum. The Type FA-19-R is recommended for use inside cabinet racks where some vibration or occasional wire movement can be expected. Both cables afford ground control by permitting the shield to be grounded only at those

Interconnecting Cables

Types FA-19-J, FA-19-M, and FA-19-R

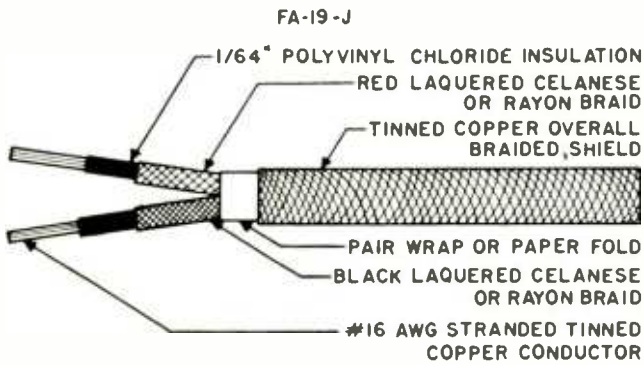

points desired. Both are capable of carrying 1.8 amperes at 400 volts d-c.

The Type FA-19-J interconnecting cable is a medium-diameter, two-conductor shielded cable designed for use in power and high-level audio circuits. Primarily intended for handling power, this cable is composed of two No. 16 AWG stranded conductors with heavy insulation and an over-all braided, tinned copper shield. This cable is recommended for power use up to 8.0 amperes at 600 volts and for use in high-level audio circuits where shielding is desired, as in ducts, conduit, and cabinets.

SPECIFICATIONS—MECHANICAL AND ELECTRICAL

TYPE FA-19-J

Two No. 16 AWG, stranded, tinned copper conductors with $\frac{1}{8}$ -inch, black polyvinyl chloride insulation on each conductor. One conductor covered with black lacquered celanese or rayon braid; second conductor covered with red lacquered celanese or rayon braid. The two conductors are twisted and given a pair wrap or paper fold, with a tinned copper, braided over-all shield. Length per spool, 500 feet. Rated voltage: 600 volts d-c at 8 amperes. Outside diameter: 0.245 inches.

TYPE FA-19-M

Two No. 22 AWG, solid, tinned copper conductor with nylon extruded insulation. One conductor has a black celanese wrap; second conductor has red celanese wrap. A nylon jacket is extruded over the celanese wrap of each conductor. One No. 22 solid, tinned copper ground wire is twisted with the two identified conductors and the whole included in a wrapped, tinned copper shield. A polyvinyl jacket covers over-all. Cable is furnished on 500-foot spools. Rated voltage: 400 volts d-c at 1.8 amperes. Outside diameter: 0.152 inches.

TYPE FA-19-R

Two No. 22 AWG, stranded, tinned copper conductors with nylon extruded insulation. One conductor covered with black celanese wrap; second conductor covered with red celanese wrap. Over the celanese wraps on each conductor is extruded a nylon jacket. One No. 22, stranded, tinned copper ground wire is twisted with the two identified conductors and the whole included in a wrapped, tinned copper shield. A polyvinyl jacket covers over-all. Cable is furnished on 500-foot spools. Rated voltage: 400 volts d-c at 1.8 amperes. Outside diameter: 0.52 inches.

RECOMMENDED NUMBER OF CABLES IN ONE CONDUIT

Conduit Size (Nominal)

Cable	In Inches										
	½	¾	1	1¼	1½	2	2½	3	3½	4	4¼
Type FA-19-J.....	2	4	7	13	17	28	40	62	83	107	135
Type FA-19-M.....	6	10	17	28	38	63	88	138	185	238	300
Type FA-19-R.....	6	10	17	28	38	63	88	138	185	238	300

HOW TO ORDER

When ordering, please specify:

Type No. FA-19_____ Interconnecting cable; _____ feet; _____ spools.

Equalizer Panel

Type FA-14-A



Equalizer panel, Type FA-14-A

FEATURES

- Provides equalization for two lines
- Front-panel adjustment in steps of 3 db
- Equalizes short lines up to 15,000 cycles—longer lines up to 10,000 cycles
- Simple clamp-type mount permits flexibility of mounting on any standard rack

WHERE TO USE

The General Electric Type FA-14-A equalizer panel is designed to equalize the nonlinear characteristics of one or two nonloaded telephone lines for substantially flat frequency response to 10,000 or 15,000 cycles per second, depending on line characteristics and termination. The Type FA-14-A would normally be used on lines which are not continuously operating and do not require the permanent installation of a fixed equalizer.

MECHANICAL SPECIFICATIONS

DIMENSIONS

Depth	4 $\frac{1}{8}$ inches	Width	19 inches
Height	3 $\frac{1}{2}$ inches	Weight	5 lb

MOUNTING

The equalizer panel is designed for vertical mounting on a standard 19-inch EIA relay or cabinet rack. A clamp-type mounting, not visible from the front, is provided to mount the panel in any desired location on a rack.

ELECTRICAL SPECIFICATIONS

TYPE OF CIRCUIT

The Type FA-14-A equalizer consists of two separate and complete Type FA-14-B equalizers mounted on a single panel. Parallel-resonant circuits consisting of a capacitor, a reactor, and logarithmically tapered resistances are used in each equalizer unit. These resistances are selected by a rotary switch located on the front panel. Input and output connections of the Type FA-14-A are available on terminal boards.

The electrical specifications for each of the sections of the equalizer panel are the same as the specifications for the equalizer unit, Type FA-14-B.

HOW TO ORDER

When ordering, please specify:
Type FA-14-A equalizer panel.



Equalizer panel, Type FA-14-A, rear view

Equalizer Unit

Type FA-14-B

FEATURES

- Equalizes up to 10,000 or 15,000 cycles depending on line length and termination
- Easily connected for equalization in steps of 3 db or less
- Small size allows flexibility of mounting

WHERE TO USE

The General Electric Type FA-14-B equalizer unit is a semi-fixed unit recommended for use on lines which are permanently installed and continuously used, such as studio-to-transmitter lines and remote or "nemo" lines. It is designed to equalize nonlinear characteristics of non-loaded telephone lines for substantially flat frequency response up to 10,000 or 15,000 cycles-per-second, depending on line characteristics and terminations.

MECHANICAL SPECIFICATIONS

DIMENSIONS (Two rack units)

Depth 3 inches Width $3\frac{7}{8}$ inches
 Height $3\frac{3}{4}$ inches (Includes mounting)
 Weight $1\frac{1}{2}$ lb

MOUNTING

Mounting flanges on the bottom of the case make it adaptable for mounting on any flat surface.

ELECTRICAL SPECIFICATIONS

TYPE OF CIRCUIT

The Type FA-14-B equalizer unit consists of a reactor, a capacitor, and associated resistors mounted in a rectangular metal case. A solder-lug terminal board is provided on one end of this case for adjusting the resistance and for connecting the unit to the line.

LINE IMPEDANCE

600 or 150 ohms

EQUALIZATION ABILITY (dependent on line length)

Line termination 150 ohms: 30 to 15,000 cps
 Line termination 600 ohms: 30 to 10,000 cps



Equalizer unit, Type FA-14-B

INSERTION LOSS (600-ohm source and load)

(See frequency characteristics curve)
 R = 8 ohms: 41-db max at 30 cycles,
 2.5-db min at 11,000 cycles
 R = 180 ohms: 8-db max at 30 cycles,
 7-db min at 11,000 cycles

EQUALIZATION RANGE

Refer to frequency characteristics curve.

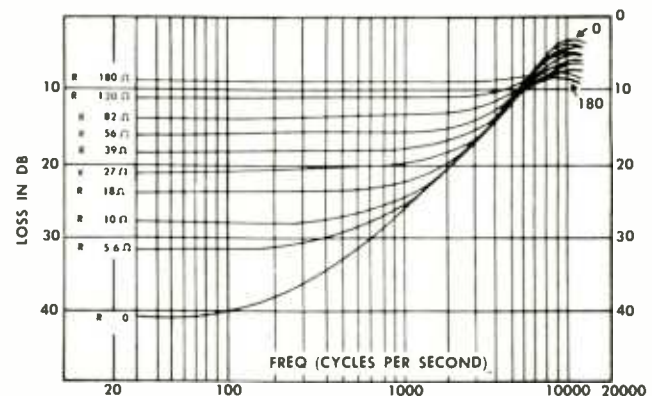

Frequency characteristics, 600-ohm source and load

HOW TO ORDER

When ordering, please specify:
 Type FA-14-B equalizer unit.

Program Level Indicator Panel, Type FA-1-A

Switch and Fuse Panel, Type FA-4-A



Program level indicator panel, Type FA-1-A

FEATURES

- Measures levels from +4 to +42 VU
- May be switched to any of ten program lines
- Uses large size, illuminated standard VU meter
- Clamp-type mounting for easy installation

WHERE TO USE

The General Electric Type FA-1-A program level indicator panel provides a means of measuring accurately the program level of up to ten 600-ohm audio lines. The level of lines having other impedances may be measured by applying suitable correction factors. Program-level readings obtained with this unit are in "volume units" (VU). When used to make steady-state, single-frequency measurements, the readings obtained are in dbm.

DESCRIPTION

The unit includes a two-circuit, ten-point selector switch (plus an OFF position), a variable step-type attenuator which provides readings of from +4 to +42 VU (or dbm) in 2-db steps, a VU meter, and a calibrating potentiometer for making a fine adjustment of the level reading over a range of $\pm 1/2$ dbm. The illuminated VU meter has two scales: the upper scale is calibrated in percent, ranging from 0 to 100; the lower scale is calibrated in VU, ranging from -20 to +3. A source of 6.3 volts at 0.3-amp is required for illumination.

MECHANICAL SPECIFICATIONS**DIMENSIONS**

Depth	3 $\frac{3}{8}$ inches
Height	5 $\frac{7}{8}$ inches (3 RU)
Width	19 inches
Weight	4 $\frac{1}{2}$ lb

MOUNTING

The unit mounts on a standard 19-inch RETMA relay or cabinet rack. A clamp-type mounting, which is not visible from the front, is provided to mount the panel in any desired location on the rack.

VU SCALE

"B" Scale

ELECTRICAL SPECIFICATIONS

Input impedance	7500 ohms
Measurement range (600-ohm lines)	+4 to +42 VU (or dbm) in 2-db steps
Number of lines that may be measured	1 to 10, inclusive

HOW TO ORDER

When ordering, please specify:
Type FA-1-A program level indicator panel.

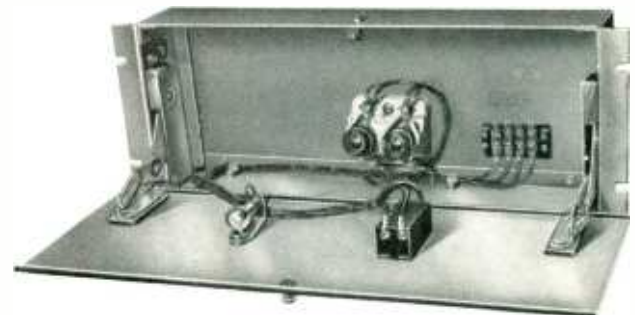

Switch and fuse panel, Type FA-4-A (front panel open)

FEATURES

- Easy access to fuse block through hinged-front panel
- Unused surface on removable back plate readily fitted with additional equipment
- Attractively styled for any cabinet mounting

WHERE TO USE

The General Electric Type FA-4-A switch and fuse panel provides a master-power switch, indicator lamp, and fuse protection for an entire cabinet or relay rack.

DESCRIPTION

Power circuits running through the Type FA-4-A switch and fuse panel are activated by the switch. Dual fuses protect equipment from surges and shorts in the power line. The panel light indicates that the line is in use, or, with switch on and light out, indicates circuit trouble. The hinged-front panel allows easy access to the fuse block on the inside back plate for inspection or replacement of fuses. Two fuses of the screw-plug type are required, but are not furnished since their rating depends upon the load to be protected. On the removable back plate are approximately 100 square inches of unused surface which may be used to mount additional terminal distribution blocks, filament or line transformers, line pads, equalizers, relays, and other appropriate components. A $\frac{7}{8}$ -inch diameter hole is provided at each end of the chassis for connecting external wires.

MECHANICAL SPECIFICATIONS**DIMENSIONS**

Depth (behind panel)	3 $\frac{3}{8}$ inches
(over-all)	4 $\frac{5}{8}$ inches
Height	6 $\frac{3}{8}$ inches (4 RU)
Width	19 inches
Weight	5 $\frac{1}{2}$ lb

ELECTRICAL SPECIFICATIONS

Switch	DPST, 20-amp, 125-volt
Fuses (not furnished)	Plug type; rating dependent on equipment to be protected; 20-amp maximum
Lamp	Mazda No. 6S6, 120-volt, at 6 watts

HOW TO ORDER

When ordering, please specify:
Type FA-4-A switch and fuse panel.

Sound Effects Filter Panel

Type FA-18-A



Sound effects filter panel, Type FA-18-A

FEATURES

- Simple control of desired bandwidth
- Gives variety of "bassy" or "tinny" effects
- Telephone conversation effect may be created
- Helps to eliminate static from overseas or short-wave pickups and rebroadcasts. Clarifies speech intelligence
- Easy installation and operation
- Telephone-type key permits instant switching in or out of audio circuit

WHERE TO USE

The General Electric Type FA-18-A sound effects filter panel provides control of program bandwidth, enabling the user to obtain unusual dramatic sound effects. Speech and music may be made "bassy" or "tinny" and "telephone-quality" effects may be simulated.

DESCRIPTION

The Type FA-18-A sound effects filter panel consists of adjustable high- and low-pass filter sections mounted on a panel. Each of the filters are connected to a variable cutoff frequency-selector switch controlled by a front-panel knob. Each switch has eight cutoff positions (100, 250, 1000, 2000, 3000, 4000, and 5000 cycles) and an OFF position. A key switch is

provided to connect or disconnect the filter circuit so that the filter may be preset at any time for desired characteristics and inserted in the circuit when required.

MECHANICAL SPECIFICATIONS

DIMENSIONS

Depth (including front panel control)	8 $\frac{5}{8}$ inches
Height	5 $\frac{7}{32}$ inches (three rack units)
Width	19 inches
Weight	9 lb

MOUNTING

The sound effects filter panel is designed for vertical mounting on a standard 19-inch relay or cabinet rack. A clamp-type mounting, not visible from the front, is provided to mount the panel in any desired location on a rack.

ELECTRICAL SPECIFICATIONS

Source Impedance:	600 ohms (unbalanced)
Operating Level:	-40 to +20 dbm
Load Impedance:	600 ohms (unbalanced)
Insertion Loss:	1 db or less at passed frequencies

HOW TO ORDER

When ordering, please specify:
Type FA-18-A sound effects filter panel.

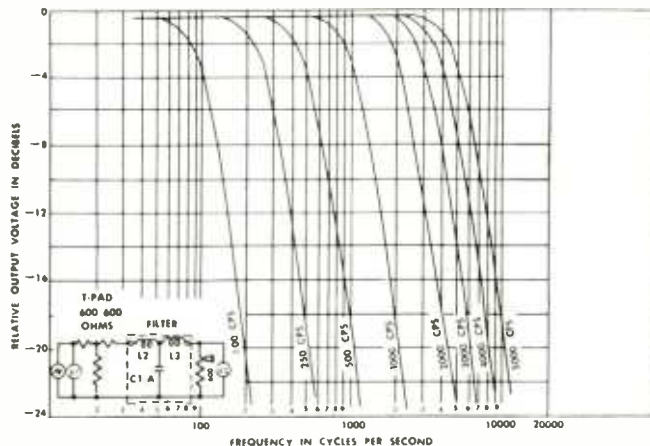

Typical attenuation characteristics of high-frequency cut-off section of sound effects filter panel, Type FA-18-A

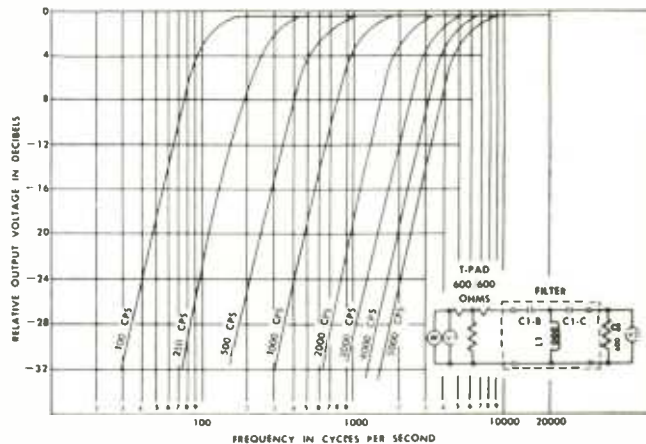

Typical attenuation characteristics of low-frequency cut-off section of sound effects filter panel, Type FA-18-A

Jack Strip

Type FA-2-A



Jack strip showing common ground, Type FA-2-A

FEATURES

● Easily wired ground terminals

The jacks used on these jack strip assemblies are provided with **special off-set sleeve (or grounding) terminals**, designed so that the sleeve terminals fall in a line down the center of the assembly when two rows of jacks are mounted on the strip. This makes it possible to ground all sleeves by simply passing a single straight length of bus wire through all sleeve terminals. Results are savings in labor, time, and wiring space.

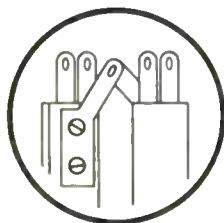

● Increased strength

The two-sided construction of this jack adds rigidity, reducing the possibility of wire breakage, and makes a smoother operating jack-strip assembly.

● Easily mounted

The vertically slotted end-mounting brackets permit some vertical movement of the jack strip. This facilitates the mounting of the strip when used in conjunction with odd sized rack-mounted equipment.

● The Type PV-14-A card holder kit

The card holder kit is available for labeling of the jack strips where the strips are to be mounted within the rack instead of front flush mount.

WHERE TO USE

The General Electric Type FA-2-A jack strips are used in amplifier racks to permit rapid isolation, selection, and monitoring of individual amplifiers by means of patch cords. They are also used in studio- and master-control room consoles and racks to permit "patching" of the various remote, local, and audition programs into the desired transmitter, remote, and monitoring channels.

DESCRIPTION

The General Electric Type FA-2-A jack strip consists of 48 jacks, mounted in two rows on heavy black



Jack strip, Type FA-2-A

Textolite* board. All jacks are of the tip and sleeve type with an additional normally closed contact making the jack suitable for use on "normalled through" circuits.

Jacks are mounted on $\frac{5}{8}$ -inch horizontal centers so as to mate properly with General Electric patch cords (Types FA-7-A, B & C) and other manufacturers' standard, double-plug patch cords.

MECHANICAL SPECIFICATIONS

DIMENSIONS

Height	2 $\frac{1}{8}$ inches
Width	18 $\frac{1}{8}$ inches
Depth	3 $\frac{5}{8}$ inches approx
Weight	5 $\frac{1}{2}$ lb

MOUNTING

Mounting brackets at the end of the strip are vertically slotted to fit a standard 19-inch EIA cabinet or relay rack. Two No. 12-24 screws are supplied to mount each jack strip. Jack panels, Type FA-3-A, -B, and -C, may be used with the Type FA-2-A to provide designation cards above and below each jack pair.

ELECTRICAL SPECIFICATIONS

Number of jack pairs	24
Type of jack	Tip and sleeve with normalled-through contact

HOW TO ORDER

When ordering, please specify:
Type FA-2-A jack strip.

ACCESSORIES

Type PV-14-A card holder kit
Type FA-7-A / B / C 2-, 4-, or 6-foot patch cords
Type FA-3-A / B / C single, double or triple jack panels

* Registered trade-mark of General Electric Company.

Jack Panels • Patch Cords

Types FA-3-A, FA-3-B, and FA-3-C

Types FA-7-A, FA-7-B, and FA-7-C

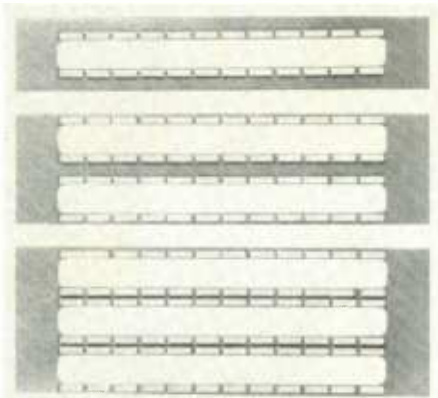

From top, jack panels, Types FA-3-A, FA-3-B and FA-3-C



Patch cords, Types FA-7-A, -B and -C

DESCRIPTION

Jack panels are available for covering one, two or three General Electric Type FA-2-A jack strips.

Designation cards inserted behind clear plastic strips are mounted in card holders on each panel above and below each pair of jack openings.

SPECIFICATIONS

Type No.	Description	Height (In Inches)	Weight (In Lb)
FA-3-A	Single jack panel	3	1 ¼
FA-3-B	Double jack panel	5	1 ¾
FA-3-C	Triple jack panel	6	2

MOUNTING

A mounting is furnished with each panel to secure it to the rack strip so that no mounting screws will be exposed.

HOW TO ORDER

When ordering, please specify:
Type FA-3- . . . jack panel.

DESCRIPTION

General Electric patch cords consist of two insulated copper conductors shielded with tinned copper braid and covered with heavy black cotton braid. A six-inch length at either end is reinforced so that the two-conductor double plug may be securely mounted. The plug at either end is interchangeable with the W.E. Type 241-A double plug. The shield of the cord is connected to the sleeves of both plugs.

SPECIFICATIONS

General Electric patch cords are available in three sizes:

Type No.	Cord Length
FA-7-A	2 feet
FA-7-B	4 feet
FA-7-C	6 feet

HOW TO ORDER

When ordering, please specify:
Type FA-7- . . . patch cord.

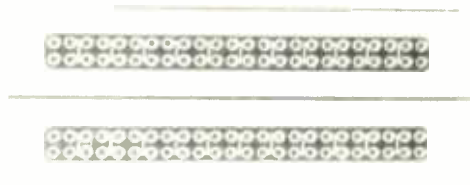

Use of jack panel provides a neat flush mounting of jack strips in a rack





DISTRICT OFFICES

WILLIAM G. BROUGHTON
General Electric Co.
1 River Road
Bldg. 33, Room 204
Schenectady, New York
Express 3-9110

LEWIS F. PAGE
General Electric Co.
20 Lexington Avenue
Room 2129
New York, New York
Plaza 1-1311

EARL H. PLATT
General Electric Co.
1013 Williamson Bldg.
Cleveland, Ohio
Superior 1-6822

JAMES M. COMER, JR.
1330 W. Peachtree St., N. W.
Room 517
Atlanta, Georgia
Trinity 5-6691

THOMAS F. BOST, JR.
1330 W. Peachtree St., N. W.
Room 517
Atlanta, Georgia
Trinity 5-6691

VERNON H. RUSSELL
General Electric Co.
478 N. W. Highway
Des Plaines, Illinois
Cypress 9-3369

ROBERT E. LAUTERBACH
General Electric Co.
Bldg. 27
3628 W. 95th Street
Shawnee Mission, Kansas
Mitchell 9-7131

JAMES H. DOUGLAS
General Electric Co.
4447 N. Central Expressway
Room 400
Dallas, Texas
Lakeside 6-0426

HUGH W. GRANBERRY
General Electric Co.
565 Broadway
Redwood City, California
Emerson 8-4681

ROBERT W. COCHRAN
General Electric Co.
Suite 210
232 North Lake Avenue
Pasadena, California
Murray 1-5965

JOHN F. WATTER
General Electric Co.
777 14th St., N. W.
927 Wyatt Bldg.
Washington, D. C.
Executive 3-3600

HAROLD H. CONDO
General Electric Co.
Division Street Plant
Room 11—3rd Floor
Syracuse, New York
Granite 6-4411—Ext. 6305

In Canada: Canadian General Electric Co., Ltd., Broadcast Equipment Sales, 830 Lansdowne Ave., Toronto, Ontario. Outside the U.S.A. and Canada: International General Electric Co., Inc., 150 E. 42nd St., New York, N. Y.

GENERAL  ELECTRIC