

1967

▲ A HOWARD W. SAMS PUBLICATION



The Broadcast Industry

BUYERS GUIDE

A comprehensive directory of products and services for the broadcast-communications industry . . . containing: complete alphabetical product and service listing, manufacturer listing with products and services, and addresses of manufacturers and their representatives. **\$1.50**

Prepared by the staff of
Broadcast Engineering®

World Radio History

RIKER IS

VIDEOMNIFEROUS



VID'-I-OM-NIF'-ĒRəS

The omnipotent ability to produce all varieties and forms of Video Terminal, Studio and Test Equipment for TV Broadcasting.

RIKER MAKES THEM ALL:

**VIDEO SWITCHING EQUIPMENT •
SYNC EQUIPMENT • DISTRIBUTION
EQUIPMENT • VIDEO PROCESSING
AMPLIFIERS • SPECIAL EFFECTS •
AUTOMATED PROGRAMMING SYS-
TEMS FOR SWITCHERS • VIDEO
TEST EQUIPMENT • VIDEOTAPE
DROPOUT COMPENSATORS**



**Riker Video Industries, Inc., 100 Parkway Drive So.,
Hauppauge, N.Y. 11787. Phone: 516-543-5200.**

Atlanta • Los Angeles • Detroit • Washington, D.C. • Dallas

WITH TOTAL

VIDEOCOLORABILITY

**PARTIAL LISTING OF
AVAILABLE EQUIPMENT:**



- ENCODED COLOR BAR GENERATOR
- COLOR BAR GENERATOR
- COLOR SYNC GENERATOR
With burst flag
- SUBCARRIER REGENERATOR
For precise color locking to remote color signals
- BAR & DOT GENERATOR
- COLOR VIDEO SWITCHING SYSTEMS
- ADDITIVE/NON-ADDITIVE MIXER
For finest color and monochrome inserts
- BLACK BURST GENERATOR
Provides color burst while in black
- BURST FLAG GENERATOR
- COLOR SPECIAL EFFECTS GENERATOR
- TEST SIGNAL GENERATORS
Test all your color facilities
- COLORIZER
Colors a monochrome camera output. Range from a single color to complete traversing spectrum. Use with special effects to attain unlimited number of multi-color combinations or produce a color picture from a monochrome source.
- 3.58 MC PHASE SHIFTER
- PLUS MANY OTHERS



**Riker Video Industries, Inc., 100 Parkway Drive So.,
Hauppauge, N.Y. 11787. Phone: 516-543-5200.**

Atlanta • Los Angeles • Detroit • Washington, D.C. • Dallas

Look carefully at
every issue of
Time,
Life,
Newsweek, and
U.S. News & World Report.
For a year.

Count the microphones
you see in every picture.

You'll find more E-V microphones than all
other U.S. brands combined.

You'll find more E-V microphones than
all foreign brands combined.

You'll find E-V microphones shown 3.77
times more often than any other brand.

When the chips are down, professional
sound engineers for radio, TV, motion
pictures, and critical sound
reinforcement choose Electro-Voice.

What's new about that?

Nothing.

It's been going on for years!



ELECTRO-VOICE, INC.
Dept. 171VG, 639 Cecil Street
Buchanan, Michigan 49107

Electro-Voice®
SETTING NEW STANDARDS IN SOUND



Prepared by the staff of
Broadcast Engineering®

the broadcast industry

BUYERS GUIDE

CONTENTS

✦ product directory	9
✦ guide to manufacturers	41
✦ representatives	67
✦ engineering data	129
✦ consulting engineers	157
✦ index to advertisers	162

publisher
Howard W. Sams

general manager
Donald W. Bradley

editor
William E. Burke

managing editor
James M. Moore

associate editor
Harold E. Hale

research librarian
Bonny Howland

production
Esther M. Rainey, *Manager*

circulation
Pat Osborne, *Manager*

advertising sales offices
Hugh Wallace, *Sales Manager*

central and midwestern
Roy Henry
Howard W. Sams & Co., Inc.
4300 West 62nd St.
Indianapolis, Ind. 46206
291-3100

eastern
Gregory C. Masefield
Howard W. Sams & Co., Inc.
3 West 57th St.
New York 19, New York
MU 8-6350

southwestern
C. H. (Jake) Stockwell
C. H. Stockwell Co., 4916 West 64th St.
Mission, Kansas, RA 2-4417

western
LOS ANGELES OFFICE
G. R. (Jerry) Holtz
The Maurice A. Kimball Co., Inc.
2008 West Carson St., Suites 203-204
Torrance, California, 90501
320-2204

SAN FRANCISCO OFFICE
The Maurice A. Kimball Co., Inc.
580 Market St., Room 400
San Francisco 4, California
EX 2-3365

foreign
LONDON W.C. 2, ENGLAND
John Ashcraft, Leicester Square
Whitehall 0525

Copyright © 1967
by Howard W. Sams & Co., Inc.

The Broadcast Industry BUYERS GUIDE is published by Howard W. Sams & Co., Inc. Editorial, Circulation, and Advertising headquarters: 4300 West 62nd Street, Indianapolis, Indiana 46206.

This Guide has been compiled from listing form as completed by the manufacturers and submitted to us by an editorial deadline date. The publisher is not responsible for errors or omissions in editorial content.

Advertisers and advertising agencies assume liability for all content (including text, representation, and illustrations) of advertisements printed and also assume responsibility for any claims arising therefrom made against the publisher.

Reproduction or use, without express permission, of editorial or pictorial content, in any manner, is prohibited. No patent liability is assumed with respect to the use of the information contained herein.



EIMAC POWER GRID TUBES and Accessories

(24 hour factory delivery on most distributor orders)

At EIMAC you'll find the most complete line of power grid tubes available today: triodes, tetrodes, pulse modulators, diodes, zero-bias tubes, ceramic tubes, glass tubes, air cooled, water cooled and vapor cooled tubes. And there are more to come! Continuing EIMAC projects are ever increasing the scope of power grid tube capabilities.

Tube Type	User Price	Socket Type	Socket Price	Chimney Type	Chimney Price
2-01C	\$ 18.00	None	\$	None	\$
2C39A	20.75	Jettron No. 76-020	None
3CPN10A5/7815	30.75	Jettron No. 76-020	None
3CPX100A5/7815R	30.75	Jettron No. 76-020	None
3CV30,000A1	710.00	SK-1300	78.50	None
3CV30,000A3	590.00	SK-1300	78.50	None
3CW5000A1	280.00	(See Note 1)	None
3CW5000A3	245.00	(See Note 1)	None
3CW5000F1	260.00	None	None
3CW5000F3	250.00	None	None
3CW5000H3	240.00	None	None
3CW10,000H3	356.00	None	None
3CW20,000A1	560.00	SK-1300	78.50	None
3CW20,000A3	455.00	SK-1300	78.50	None
3CW20,000A7	710.00	SK-1300	78.50	None
3CW20,000H3	455.00	None	None
3CW25,000A3	480.00	SK-1300	78.50	None
3CW30,000H3	510.00	None	None
3CW40,000H3	620.00	None	None
3CW100,000H3	2,320.00	None	None
3CX100A5/7289	26.50	Jettron No. 76-020	None
3CX100F5/8250	34.00	Jettron No. 76-020	None
3CX1000A7/8283	250.00	SK-860	38.00	SK-816	7.00
		SK-870	40.00	SK-816	7.00
3CX2500A3	200.00	(See Note 1)	None
3CX2500F3	205.00	None	None
3CX2500H3	240.00	None	None
3CX3000A1	210.00	(See Note 1)	None
3CX3000A7	255.00	(See Note 1)	None
3CX3000F1	220.00	None	None
3CX3000F7	260.00	None	None
3CX5000A3	356.00	SK-1300	78.50	None
3CX5000H3	356.00	None	None
3CX10,000A1/8158	490.00	SK-1300	78.50	SK-1306	6.50
3CX10,000A3/8159	490.00	SK-1300	78.50	SK-1306	6.50
3CX10,000A7/8160	530.00	SK-1300	78.50	SK-1306	6.50
3CX10,000H3	455.00	None	None
3CX15,000A3	510.00	SK-1300	78.50	SK-1306	6.50
3CX15,000H3	510.00	None	None
3CX20,000A3	580.00	SK-1300	78.50	None
3CX20,000H3	580.00	None	None
3W5000A1/8240	280.00	(See Note 1)	None
3W5000A3/8242	245.00	(See Note 1)	None
3W5000F1/8241	260.00	None	None
3W5000F3/8243	250.00	None	None
3X3000A1/8238	210.00	(See Note 1)	None
3X3000A7	255.00	(See Note 1)	None
3X3000F1/8239	220.00	None	None
3X3000F7/8162	260.00	None	None
3-400Z/8163	34.00	SK-410	6.50	SK-416	6.50
3-1000Z/8164	78.00	SK-510	6.50	SK-516	12.00
4-65A/8165	27.00	E. F. Johnson No. 122-101	None
4-125A	36.00	SK-400	17.50	SK-406	6.50
		SK-410	6.50	SK-406	6.50
4-250A	46.50	SK-400	17.50	SK-406	6.50
		SK-410	6.50	SK-406	6.50
4-400A/8438	48.00	SK-400	17.50	SK-406	6.50
		SK-410	6.50	SK-406	6.50
4-1000A/8166	131.50	SK-500	24.30	SK-506	12.00
		SK-510	6.50	SK-506	12.00
		SK-740	10.70	None
4CPX250K	68.50	(See Note 2)	None
4CS250H	69.50	None	None
4CV8000A	470.00	SK-1490	88.50	None
4CV20,000A	590.00	SK-310	114.00	None
4CV35,000A	825.00	SK-310	114.00	None
4CV100,000C/8351	2,350.00	SK-1510	250.00	None
4CV8000A	331.00	None	None
4CW2000A/8244	220.00	SK-800B	54.00	SK-806	8.50
		SK-810B	56.00	SK-806	8.50
		SK-890B	65.00	SK-806	8.50
		SK-300	103.00	SK-306	6.50
4CW10,000A	610.00	SK-300A	103.00	SK-316	9.65
4CW25,000A	825.00	SK-300	103.00	SK-306	6.50
		SK-300A	103.00	SK-316	9.65
4CW50,000C/8350	2,100.00	SK-1500	220.00	None
4CW100,000D	2,100.00	SK-1500	220.00	None
		SK-1510	250.00	None
4CX250B/7203	35.60	*See SK-600 Series Socket Listing	None
4CX250F/7204	38.00	*See SK-600 Series Socket Listing	None
4CX250K/8245	64.00	None	None
4CX250R/7580W	44.50	*See SK-600 Series Socket Listing	None
4CX300A/8167	54.00	*See 4CX125C Socket Listing	None
4CX300Y	105.00	*See 4CX125C Socket Listing	None
4CX350A/8321	48.50	*See SK-600 Series Socket Listing	None
4CX350F/8322	51.50	*See SK-600 Series Socket Listing	None
4CX600A	319.00	None	None
4CX1000A/8168	181.00	SK-800B	54.00	SK-806	8.50
		SK-810B	56.00	SK-806	8.50
		SK-890B	65.00	SK-806	8.50
		SK-820	140.00	SK-806	8.50
		SK-830	178.00	SK-806	8.50
4CX1000K/8352	193.00	None	None

Note (1): None, but the following collsets are available from EIMAC: 149575 (innerline filament collet); 149576 (outer line filament collet)
 Note (2): None, but the following collsets are available from EIMAC: 008290 (heater pin connection); 008291 (cathode collet); 008292 (control grid collet); 008294 (anode collet); 882931 (screen grid collet)

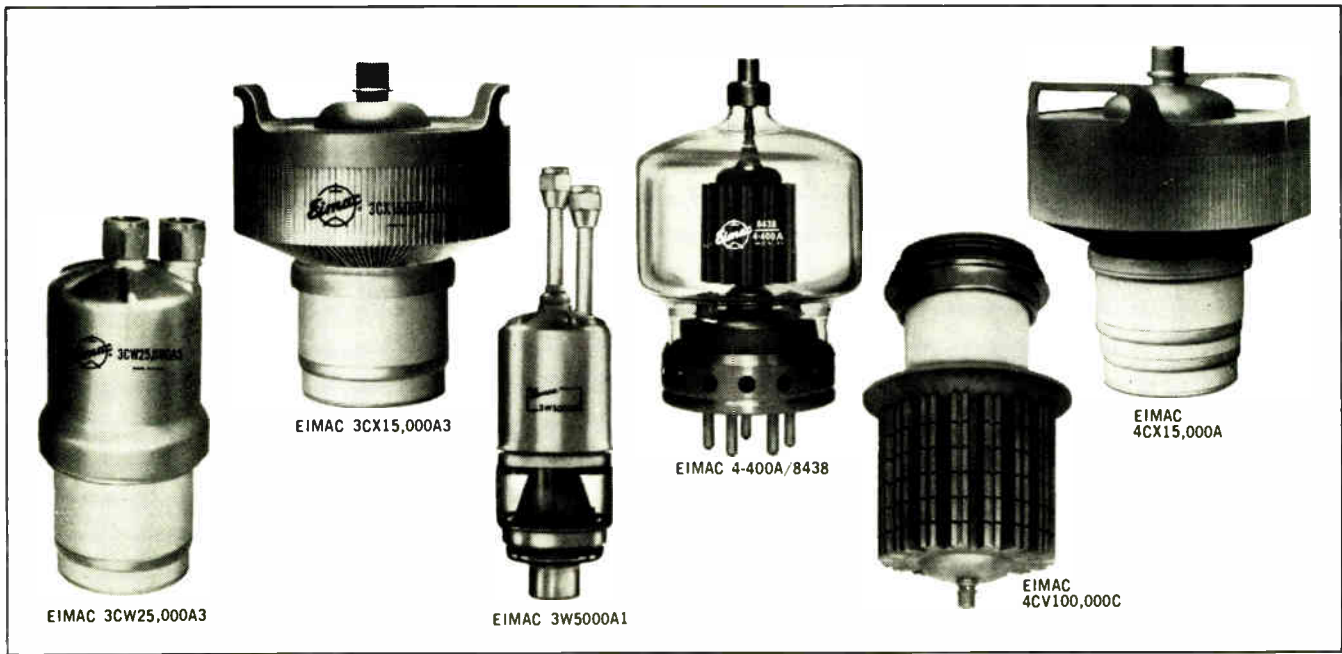

Tube Type	User Price	Socket Type	Socket Price	Chimney Type	Chimney Price	Tube Type	User Price	Socket Type	Socket Price	Chimney Type	Chimney Price
4CX1500B/8660	205.00	*See 4CX100A Series Socket Listing				8166/4-1000A	131.50	SK-500	24.30	SK-506	12.00
4CX3000A/8169	420.00	SK-1400A	107.00	SK-1406	6.50			SK-510	6.50	SK-506	12.00
4CX5000A/8170	495.00	SK-1470A	107.00	SK-1406	6.50	8167/4CX300A	54.00	*See 4CX125C Series Socket Listing			
4CX5000R/8170W	705.00	SK-300	103.00	SK-306	6.50	8168/4CX1000A	181.00	SK-800B	54.00	SK-806	8.50
4CX10,000D/8171	550.00	SK-300A	103.00	SK-316	9.65			SK-810B	56.00	SK-806	8.50
4CX15,000A/8281	695.00	SK-300	103.00	SK-306	6.50	8169/4CX3000A	420.00	SK-890B	65.00	SK-806	8.50
		SK-300A	103.00	SK-316	9.65	8170W/4CX5000R	705.00	SK-1400A	107.00	SK-1406	6.50
		SK-300	103.00	SK-306	6.50			SK-1470A	107.00	SK-1406	6.50
		SK-300A	103.00	SK-316	9.65	8171/4CX10,000D	550.00	SK-300	103.00	SK-306	6.50
		SK-1306	6.50	SK-1306	6.50					SK-316	9.65
4CX35,000C/8349	1,765.00	SK-1500	220.00	None	8172/4X150G	58.00	None	None
4E27A/5-125B	45.00	SK-1510	250.00	None	8173/4W20,000A	2,030.00	None	None
		E. F. Johnson	None	823B/3X3000A1	210.00	None	None
		No. 122-237	None	8239/3X3000F1	220.00	None	None
4W20,000A/8173	2,030.00	None	None	8240/3W5000A1	280.00	None	None
4X150A/7034	23.15	*See SK-600 Series Socket Listing				8241/3W5000F1	260.00	None	None
4X150D/7035	29.00	*See SK-600 Series Socket Listing				8242/3W5000A3	245.00	None	None
4X150G/8172	58.00	None	None	8243/3W5000F3	250.00	None	None
4X250B	35.60	*See SK-600 Series Socket Listing				8244/4CW2000A	220.00	SK-800B	54.00	None
4X250F	35.60	*See SK-600 Series Socket Listing						SK-810B	56.00	None
4X500A	127.50	SK-900	68.50	SK-906	15.00			SK-890B	65.00	None
5-500A	58.50	SK-400	17.50	None	8245/4CX250K	64.00	None	None
		SK-410	6.50	None	8250/3CX100F5	34.00	Jettron	None
5CX1500A	218.00	SK-840	61.25	SK-806	8.50	8281/4CX15,000A	695.00	No. 76-D20	SK-306	6.50
5CX3000A	437.00	Y-386	114.00	None			SK-300A	103.00	SK-316	9.65
304TH	83.00	E. F. Johnson	None					SK-1306	6.50
		No. 124-213	None	8283/3CX1000A7	250.00	SK-860	38.00	SK-816	7.00
304TL	83.00	E. F. Johnson	None			SK-870	40.00	SK-816	7.00
450TH	85.00	No. 124-213	None	8321/4CX350A	48.50	*See SK-600 Series Socket Listing			
450TL	85.00	E. F. Johnson	None	8322/4CX350F	51.50	*See SK-600 Series Socket Listing			
450TL	85.00	No. 123-211	None	8349/4CX35,000C	1,765.00	SK-1500	220.00	None
575A	20.15	E. F. Johnson	None	8350/4CW50,000C	2,100.00	SK-1500	220.00	None
592/3-200A3	55.00	No. 123-211	None	8351/4CV100,000C	2,350.00	SK-1510	250.00	None
673	20.15	E. F. Johnson	None	8352/4CX1000K	193.00	SK-820	140.00	SK-806	8.50
		No. 123-211	None			SK-830	178.00	SK-806	8.50
750TL	224.00	E. F. Johnson	None	8438/4-400A	48.00	SK-400	17.50	SK-406	6.50
		No. 123-206	None			SK-410	6.50	SK-406	6.50
869B	138.00	E. F. Johnson	None	8561/4CX300Y	105.00	SK-711A	25.70	SK-606	0.75
869B/L	138.00	No. 124-214	None			SK-760	10.70	None
5867A	30.60	None	None	8660/4CX1500B	205.00	SK-770	10.70	None
6155	36.00	SK-410	6.50	SK-406	6.50			SK-800B	54.00	SK-806	8.50
6156	42.00	SK-410	6.50	SK-406	6.50			SK-810B	56.00	SK-806	8.50
6696A	1,105.00	SK-410	6.50	SK-406	6.50	KY21A	33.80	SK-890B	65.00	SK-806	8.50
6697A	1,330.00	None	None			E. F. Johnson	None
7034/4X150A	23.15	None	None	RX21A	32.80	No. 122-225	None
7035/4X150D	29.00	None	None			E. F. Johnson	None
7203/4CX250B	35.60	None	None			No. 122-225	None
7204/4CX250F	35.60	None	None			No. 122-225	None
7211	88.50	None	None						
7257	45.00	Jettron	None						
7289/3CX100A5	26.50	No. 76-D20	None						
7480	1,590.00	SK-410	6.50	None						
7580W/4CX250R	44.50	Jettron	None						
7698	88.50	No. 76-D20	None						
7815/3CPN10A5	30.75	Jettron	None						
7815R/3CPX100A5	30.75	No. 76-D20	None						
7843	51.00	Jettron	None						
8158/3CX10,000A1	490.00	No. 76-D20	None						
8159/3CX10,000A3	490.00	None	None						
8160/3CX10,000A7	530.00	*See SK-600 Series Socket Listing									
8163/3-400Z	34.00	SK-1300	78.50	SK-1306	6.50						
8164/3-1000Z	78.00	SK-1300	78.50	SK-1306	6.50						
8165/4-65A	27.00	SK-1300	78.50	SK-1306	6.50						
		SK-410	6.50	SK-416	6.50						
		SK-510	6.50	SK-516	12.00						
		E. F. Johnson	None						
		No. 122-101	None						

***SK-600 Series Socket Listing**

For the following tubes, use the socket and chimney schedule shown below:

Tubes	Socket Type	Socket Price	Chimney Type	Chimney Price
4X150A/7034	SK-600	11.25	SK-606	0.75
4X150D/7035	SK-600A	11.25	SK-606	0.75
4X250B	SK-610	11.25	SK-606	0.75
4X250F	SK-620	12.00	SK-606	0.75
4CX250B/7203	SK-620A	15.00	SK-636B	11.00
4CX250F/7204			SK-626	0.75
4CX250R/7580W			SK-636B	11.00
4CX350A/8321			SK-626	0.75
4CX350F/8322			SK-636B	11.00
7203/4CX250B			SK-626	0.75
7204/4CX250F	SK-630A	15.00	SK-636B	11.00
7580W/4CX250R			SK-626	0.75
8321/4CX350A	SK-64J	6.90	SK-606	0.75
8322/4CX350F	SK-65D	8.50	None
7034/4X150A				
7035/4X150D				

Prices subject to change without notice. Write for complete specifications on any tube to Power Grid Tube Marketing.



EIMAC 4CX5000R



EIMAC 4X250B



EIMAC 5-500A

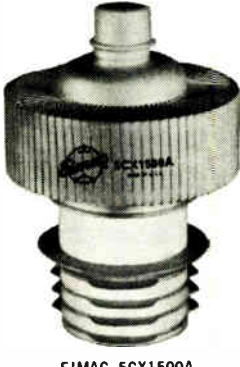

EIMAC 5CX1500A



EIMAC 6697A



EIMAC
Division of Varian
San Carlos, California 94070

MEMO

TO: General Manager
FROM: Director of Engineering

Like for you to look over this Computer-Programmer. I've been checking into what's available and this looks like the one for us, for several reasons:

1. It's a pretty sophisticated system. We could integrate our entire studio operation—master control switching, studio switching, audio functions, machine controls—the whole works.

2. All the peripheral equipment—machine control interfaces, video and audio switching gear, etc.—comes with it.

3. Most important—it works! It's made by Sarkes Tarzian, Inc. in Bloomington, Ind. They're the only ones I've found with actual computer experience in broadcasting—in both large and small stations. This 4th generation model of theirs has all the bugs worked out. Looks like they meet our basic criteria: they've got the experience, the equipment, and they've applied both.

What do you think?

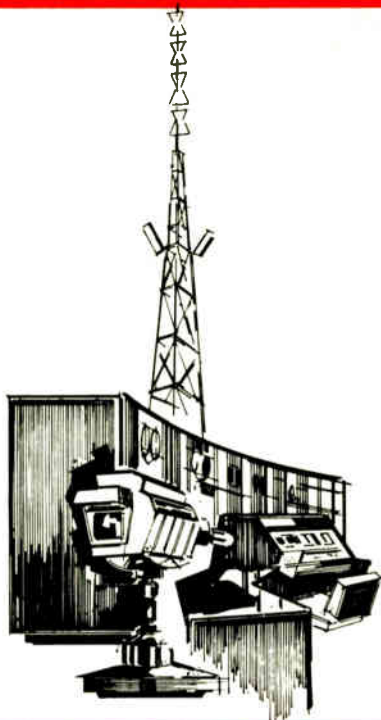

PRODUCT DIRECTORY

The listings in this section have been compiled from questionnaires completed by manufacturers and service organizations across the nation. It contains over 650 major product classifications. For a specific manufacturer, see Guide to Manufacturers.

ACOUSTIC MATERIALS

ATLAS SOUND
HARTLY PRODUCTS
ROBINS INDUSTRIES CORP.
SINGER PRODUCTS CO.

ADAPTERS, CONNECTOR

AMECO, INC.
AMERICAN CABLE ELECTRONICS
AMPHENOL DISTRIBUTOR DIVISION
APPLIED ELECTRO-MECHANICS
ATLAS SOUND
BIRNS & SAWYER
BLONDRÉ-TONGUE LABORATORIES
G C ELECTRONICS COMPANY
GENERAL RADIO CO
HEWLETT-PACKARD CO.
IMPEX ELECTRONICS CORP
JERROLD ELECTRONICS CORP
MICROWAVE ASSOCIATES, INC.
PRODELIN, INCORPORATED
ROBINS INDUSTRIES CORP.
SWITCHCRAFT, INC.
THE TECHNICAL MATERIAL CORP
TROMPFER ELECTRONICS

ADAPTERS, FM STEREO

CALBEST ELECTRONICS
G C ELECTRONICS COMPANY
HEATH CO
IMPEX ELECTRONICS CORP
KARG LABORATORIES
MCMARTIN INDUSTRIES
SINGER PRODUCTS CO

ADAPTERS, TEST

AMECO, INC.
RIENBACH CO
DELTA ELECTRONICS, INC.
G C ELECTRONICS COMPANY
HEWLETT-PACKARD CO.
JERROLD ELECTRONICS CORP
MICROLAB / FXR

ADAPTERS, TUBE

ETMAC DIVISION OF VARIAN

ALARM, FAULT

BIONIC INSTRUMENTS, INC.
BIRD ELECTRONIC CORPORATION
HOUSTON ELECTRONICS CO.
HUGHEY & PHILLIPS
JERROLD ELECTRONICS CORP
MALLORY DISTRIBUTOR PRODUCTS
MOSELEY ASSOCIATES INC.
SINGER PRODUCTS CO.
SPENCER-KENNEDY LABORATORIES
TREPAC CORPORATION OF AMERICA

ALARM, INTRUDER

BIONIC INSTRUMENTS, INC.
ELECTRONICS ESSENTIALS OF CCC
THE JAMES FLOYD FORD CO

HOUSTON ELECTRONICS CO.

ALARM, SIGNAL

BIONIC INSTRUMENTS, INC.
DELTA ELECTRONICS, INC.
THE JAMES FLOYD FORD CO
MINNESOTA MINING - 3 M
SINGER PRODUCTS CO.
TREPAC CORPORATION OF AMERICA

AMMETERS, AC

ALLIED ELECTRONICS CORP
API INSTRUMENTS CO.
COLUMBIA ELECTRIC MFG CO
G E INDUSTRIAL SALES OPERATION
GENERAL ELECTRIC CO
HEWLETT-PACKARD CO.
HICKOK ELECTRICAL INSTRUMENT
INSTRUMENT LABORATORIES CORP
THE SINGER CO - METRICS DIV
TRIPLETT ELECTRICAL INSTRUMENT
YOKOGAWA ELECTRIC WORKS

AMMETERS, AC, THERMOCOUPLE

API INSTRUMENTS CO.
G E INDUSTRIAL SALES OPERATION
THE SINGER CO - METRICS DIV
TRIPLETT ELECTRICAL INSTRUMENT
YOKOGAWA ELECTRIC WORKS

AMMETERS, DC

ALLIED ELECTRONICS CORP
API INSTRUMENTS CO.
COMU ELECTRONICS
COLUMBIA ELECTRIC MFG CO
G E INDUSTRIAL SALES OPERATION
GENERAL ELECTRIC CO
HEWLETT-PACKARD CO.
HICKOK ELECTRICAL INSTRUMENT
INSTRUMENT LABORATORIES CORP
THE SINGER CO - METRICS DIV
TRIPLETT ELECTRICAL INSTRUMENT
YOKOGAWA ELECTRIC WORKS

AMMETERS, RF

G E INDUSTRIAL SALES OPERATION
HEWLETT-PACKARD CO.
THE SINGER CO - METRICS DIV
TELESIS CORPORATION
TELETRONIX
TRIPLETT ELECTRICAL INSTRUMENT
YOKOGAWA ELECTRIC WORKS

AMPLIFIER, AF, AGC

ALTEC LANSING
AMECO, INC.
AMPLIFIER CORP OF AMERICA
BAUER ELECTRONICS CORPORATION
CCA ELECTRONICS CORPORATION
CENTRAL DYNAMICS CORPORATION
ELECTRONIC SYSTEM ENGINEERING
GATES RADIO COMPANY
MARTI ELECTRONICS

MELCOR ELECTRONICS
RCA BROADCAST PRODS.
ROUND HILL ASSOCIATES
SINGER PRODUCTS CO.
STEPHENS ELECTRONICS
TELETRONIX
VISUAL ELECTRONICS CORP
WARD ELECTRONIC INDUSTRIES
WILKINSON ELECTRONICS, INC

AMPLIFIER, AF, COMPRESSING

ALTEC LANSING
AMPLIFIER CORP OF AMERICA
BAUER ELECTRONICS CORPORATION
C B S LABORATORIES
CCA ELECTRONICS CORPORATION
CENTRAL DYNAMICS CORPORATION
COLLINS RADIO COMPANY
ELECTRONIC SYSTEM ENGINEERING
GATES RADIO COMPANY
MARTI ELECTRONICS
MELCOR ELECTRONICS
ORBIT RADIO
RCA BROADCAST PRODS.
ROUND HILL ASSOCIATES
SINGER PRODUCTS CO.
SOUTHWESTERN COMMUNICATIONS
STANCIL-HOFFMAN CORPORATION
STEPHENS ELECTRONICS
TELETRONIX
TREPAC CORPORATION OF AMERICA
VEGA ELECTRONICS CORPORATION
VISUAL ELECTRONICS CORP
WARD ELECTRONIC INDUSTRIES

AMPLIFIER, AF, GENERAL PURPOSE

ALMA ENGINEERING INC
ALTEC LANSING
AMPLIFIER CORP OF AMERICA
BAUER ELECTRONICS CORPORATION
CCA ELECTRONICS CORPORATION
CENTRAL DYNAMICS CORPORATION
CENTURY PROJECTOR CORPORATION
CROWN INTERNATIONAL
DAYTON ELECTRONIC PRODUCTS CO
DELTA ELECTRONICS, INC.
ELECTRO-VOICE INC
ELECTRONICS ESSENTIALS OF CCC
FAIRCHILD RECORDING EQUIPMENT
FISHER BERKELEY CORPORATION
GATES RADIO COMPANY
G F VISUAL COMMUNICATIONS PROO
GENERAL RADIO CO
INTERNATIONAL GOOD MUSIC
LANG ELECTRONICS, INC
LANGEVIN
MARANTZ COMPANY
MARTI ELECTRONICS
MCMARTIN INDUSTRIES
MELCOR ELECTRONICS
MID AMERICA ELECTRONICS CORP

MULTRONICS
NORTH AMERICAN PHILIPS CO
ORBIT RADIO
PERMOFLUX CORPORATION
RCA BROADCAST PRODS.
ROUND HILL ASSOCIATES
H. H. SCOTT, INCORPORATED
SCULLY RECORDING INSTRUMENTS
SOUNDSCRAFT INDUSTRIES
SOUTHWESTERN COMMUNICATIONS
STANCIL-HOFFMAN CORPORATION
STEPHENS ELECTRONICS
TELETRONIX
TREPAC CORPORATION OF AMERICA
VISUAL ELECTRONICS CORP
WARD ELECTRONIC INDUSTRIES

AMPLIFIER, AF, MONAURAL

ALMA ENGINEERING INC
ALTEC LANSING
BAUER ELECTRONICS CORPORATION
BROWNING LABORATORIES, INC.
CCA ELECTRONICS CORPORATION
CENTRAL DYNAMICS CORPORATION
CROWN INTERNATIONAL
DAYTON ELECTRONIC PRODUCTS CO
ELECTRO-SOUND ACOUSTICS
ELECTRONICS ESSENTIALS OF CCC
GATES RADIO COMPANY
G E VISUAL COMMUNICATIONS PROO
GREGORY AMPLIFIER CORP
JETRONIC INDUSTRIES, INC.
JOHNSON ELECTRONICS, INC.
LANGEVIN
MAGNECOR
MARANTZ COMPANY
MCMARTIN INDUSTRIES
MELCOR ELECTRONICS
ORBIT RADIO
PERMOFLUX CORPORATION
RCA BROADCAST PRODS.
RECORDING EQUIPMENT COMPANY
ROUND HILL ASSOCIATES
RUSSCO ELECTRONICS MFG.
H. H. SCOTT, INCORPORATED
SCULLY RECORDING INSTRUMENTS
SOUTHWESTERN COMMUNICATIONS
STANCIL-HOFFMAN CORPORATION
STEPHENS ELECTRONICS
TELETRONIX
VIKING OF MINNEAPOLIS
VISUAL ELECTRONICS CORP
WILKINSON ELECTRONICS, INC

AMPLIFIER, AF, PEAK LIMITING, AM

ALTEC LANSING
BAUER ELECTRONICS CORPORATION
C B S LABORATORIES
CCA ELECTRONICS CORPORATION
COLLINS RADIO COMPANY
FAIRCHILD RECORDING EQUIPMENT

We'll do a m for you free!

Great solid-state profit-boosters! They let you realize the full potential of your transmitter. And any one or all will work for 30 days free! If they haven't proved their worth by then, ship them back. We'll even pay the freight.

30 day trial offer limited to U.S.A. only.

Audimax is an automatic level control guaranteed to outperform ordinary compressors, limiters or AGCs. It can increase effective program power up to 4:1.

Volumax is an automatic peak controller that overcomes the inherent limitations of peak limiters. Its microsecond regulation virtually doubles the efficiency of Audimax. Result: a combined increase in effective program power of up to 8:1.

The FM Volumax is a totally new concept in automatic peak control that solves FM overmodulation problems created by pre-emphasized audio signals. It offers positive prevention of FM overmodulation and SCA crosstalk without distortion.

Audimax thinks smart. Its solid state logic circuitry monitors incoming signal and compares it with its memory of average program content over a preceding period of time. This gives



Audimax the ability to adapt to changing program gain situations and react in the same way a human engineer would.

Its remarkable Gated Gain Stabilizer enables Audimax to maintain constant gain during prolonged program pauses. It eliminates the fade-out of background effects or "swish-up" of background noise.

A special Return-to-Zero function

operates when standby conditions occur. Audimax waits about 10 seconds, keeping gain steady at the last correct setting.

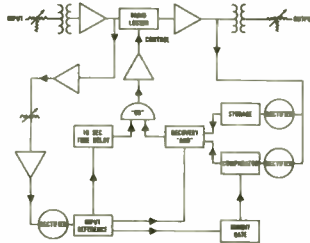

When its memory is convinced that the program has ended, it slowly returns to normal gain. Background effects are held at natural levels, and proper level is assured upon resumption of program.

Audimax boosts overall average levels while automating control functions. Average modulation can be increased by 6 dB, which represents a 300% increase in radiated program power.

Specifications: Audimax III, Mod. 444, \$665. Frequency Response, flat within 1 dB, from 50 to 15,000 cps; Harmonic Distortion, less than 1% from 50 to 15,000 cps at +16 dBm output; Noise Level, below -60 dBm at normal gain; Control Characteristic, ± 10 dB of gain control; Gated Gain Stabilizer, threshold adjustable from -24 dB to normal output; Return-to-Zero Function, returns gain to normal during pauses greater than 10 seconds; Maximum Gain, 50 dB; Input and Output Impedance, 600 ohms, balanced or unbalanced (150 ohms optional); Normal Output Level, +11 VU; Maximum Output, +25 dBm; Minimum Input Level, -30 VU; Physical Dimensions, standard 19" rack mounting, 3 1/2" high, 9 5/8" deep; Power Requirements, 15 watts at 115/230 volts AC, 50/60 cps; Shipping Weight, 17 lbs.; Audimax III S,

Model 445, specially coupled for Stereophonic Operation, \$1390.

Volumax makes each watt work harder. The only similarity between Volumax and conventional peak limiters is that it also prevents overmodulation by instantaneous program peaks. But with conventional limiters, program level must be reduced so that limiting of peaks won't cause drastic distortion and "pumping". Conventional limiters usually moderate pumping by using long recovery times. Thus, in intervals immediately following high peaks, valuable modulation capability is wasted as limiter recovers from reduced gain.



Volumax, however, analyzes all program material, automatically chooses the most appropriate regulation speed and limiting action is gentle or micro-second fast, depending on the nature of the program waveform. Result: a more even, pleasant sound that can be safely transmitted at twice the program power usually expected with conventional limiters.

While Audimax controls average program levels, Volumax precisely controls transmitter modulation. Used together, they can raise effective program power by factor of nearly 8:1.

Bonus for AM Broadcasters: Since Volumax can be operated asymmetrically at the user's option, limiting levels for negative peaks may be kept below the 100% modulation level, while positive peaks may be allowed to exceed 100%, thus boosting effective coverage still further.

onth's work

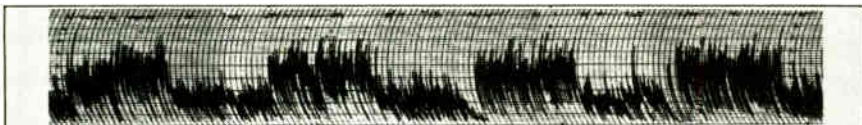

Under carefully controlled test conditions, the performance of a Volumax was compared with a popular conventional peak limiter by a non-CBS affiliated broadcasting network. Both devices were adjusted for comparable limiting and peak output resulting in 100% modulation. At five-minute intervals the two units were alternately switched into the transmission circuit and the off-the-air demodulated signals were compared in a monitoring receiver. The above chart of a recording VU meter shows the results. Volumax provided nearly twice the modulation level of the conventional limiter.

Specifications: Volumax, Mod. 400, \$665. Input and Output Impedance, 600 ohms, balanced or unbalanced; Input Level, -24 to +8 dBm; Maximum Output Level, controlled peaks +21 dBm; noncontrolled peaks +25 dBm; Maximum Gain, 50 dB; Noise Level, below -70 dB re +21 dBm output; Frequency Response, flat within 1 dB, 50 to 15,000 cps throughout normal control range; Attack Time, less than 1 microsecond or 2 milliseconds, depending on program waveform; Recovery Time, 140 milliseconds; Maximum Operating Temperature, 55° C; Power Requirements, 15 watts at 115/230 volts AC, 50/60 cps; Physical Dimensions, fits standard 19" rack, 3½" high, 9⅞" deep; Shipping Weight, 17 lbs.

FM Volumax now solves the classic FM pre-emphasis dilemma. Musical effects such as cymbal crashes can easily cause overmodulation up to 300%.

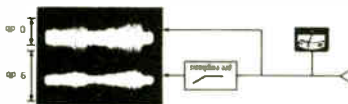

(Diagram and oscilloscope photos show audio peak levels of cymbal crash with and without pre-emphasis.) To transmit such a signal safely, an FM broadcaster would have to reduce his low frequency

modulation level to approximately 35% and operate with less than 1/8 of his authorized maximum program power. Various methods of control have been tried from time to time. Limiting before pre-emphasis, controls low frequencies but doesn't permit much increase in program levels. Limiting after pre-emphasis, controls overmodulation, but often means severe pumping and sudden losses in level. Clipping after pre-emphasis, removes only offending peaks, and creates new problems of serious distortion.



Solution: the new FM Volumax works like a recording-session engineer who moves certain instruments away from the microphones and requires others to play softer. It uses time-varying functions to control low and high frequency amplitudes separately, and instantaneous final limiting to prevent overmodulation. A new method of dynamic frequency compensation adjusts high frequency levels and processes all frequencies at reference level, without distortion.

Amplitude response of FM Volumax. At low levels, frequency response is flat over

entire range. At maximum levels, response is the inverse of the pre-emphasis slope. Thus, maximum output is always precisely equal to the 100% modulation level, after transmitter pre-emphasis.

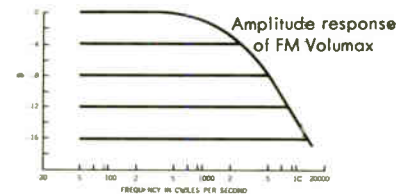

Specifications: FM Volumax, Mod. 410, \$695. Input and Output Impedance, 600 ohms, balanced or unbalanced (150 ohms optional); Input Level, -24 to +8 dBm; Maximum Peak Output Level, +21 dBm; Maximum Gain, 50 dB; Noise Level, below -70 dB re +21 dBm output; Frequency Response, flat within 1 dB, 50 to 15,000 cps, 20 dB below maximum level; 75 microsecond slope at maximum; 50 microsecond or other contours possible with simple field modification; Harmonic Distortion, less than 1% from 50 to 15,000 cps throughout entire control range; Attack Time, less than one microsecond or 2 milliseconds depending on program waveform; Recovery Time, 140 milliseconds (low frequencies), 10 milliseconds (high frequencies); Maximum Operating Temperature, 55° C; Power Requirements, 15 watts, at 115/230 Volts AC, 50/60 cps; Physical Dimensions, standard 19" rack, 3½" high, 9⅞" deep; Shipping Weight, 18 lbs.; FM Volumax, Model 411, specially coupled for Stereophonic Operation, \$1390.

All prices F.O.B. Stamford, Connecticut.



GATES RADIO COMPANY
G E VISUAL COMMUNICATIONS PROD
KAMN RESEARCH LABORATORIES
RCA BROADCAST PRODS.
ROUND HILL ASSOCIATES
SINGER PRODUCTS CO.
SOUTHWESTERN COMMUNICATIONS
TELETRONIX
VISUAL ELECTRONICS CORP
WARD ELECTRONIC INDUSTRIES
WILKINSON ELECTRONICS, INC

AMPLIFIER, AF.

PEAK LIMITING, FM
PEAK LIMITING, FM
BAUER ELECTRONICS CORPORATION
C B S LABORATORIES
CCA ELECTRONICS CORPORATION
COLLINS RADIO COMPANY
FAIRCHILD RECORDING EQUIPMENT
GATES RADIO COMPANY
ROUND HILL ASSOCIATES
SINGER PRODUCTS CO.
SOUTHWESTERN COMMUNICATIONS
TELETRONIX
VISUAL ELECTRONICS CORP
WILKINSON ELECTRONICS, INC

AMPLIFIER, AF, REMOTE

ALMA ENGINEERING INC
ALTEC LANSING
CCA ELECTRONICS CORPORATION
ELECTRONIC SYSTEM ENGINEERING
GATES RADIO COMPANY
G E VISUAL COMMUNICATIONS PROD
LANGEVIN
ORBIT RADIO
PERMOFLUX CORPORATION
RCA BROADCAST PRODS.
ROUND HILL ASSOCIATES
H. H. SCOTT, INCORPORATED
SINGER PRODUCTS CO.
SOUTHWESTERN COMMUNICATIONS
STANCLIFF-HOFFMAN CORPORATION
STEPHENS ELECTRONICS
TAPECASTER ELECTRONICS
TELETRONIX
TREPAC CORPORATION OF AMERICA
VISUAL ELECTRONICS CORP
WARD ELECTRONIC INDUSTRIES

AMPLIFIER, AF, REVERBERATION

AMPLIFIER CORP OF AMERICA
AUDIO INSTRUMENT CO
BAUER ELECTRONICS CORPORATION
CALIFONE/ROBERTS
GREGORY AMPLIFIER CORP
NORTH AMERICAN PHILIPS CO
ORBIT RADIO
ROUND HILL ASSOCIATES
SINGER PRODUCTS CO
SOUTHWESTERN COMMUNICATIONS
STEPHENS ELECTRONICS
VISUAL ELECTRONICS CORP

AMPLIFIER, AF, STEREO

ALLIED ELECTRONICS CORP
ALMA ENGINEERING INC
ALTEC LANSING
BAUER ELECTRONICS CORPORATION
CALBEST ELECTRONICS
CENTRAL DYNAMICS CORPORATION
CROWN INTERNATIONAL
ELECTRO-SOUND ACOUSTICS
ELECTRO-VOICE INC
ELECTRONICS ESSENTIALS OF CCC
GATES RADIO COMPANY
G E VISUAL COMMUNICATIONS PROD
HEATH CO
JETRONIC INDUSTRIES, INC.
KARG LABORATORIES
KOSS ELECTRONICS, INC.
JAMES B LANSING SOUND CO
MAGNECORD
MARANTZ COMPANY
MELCOR ELECTRONICS
ORBIT RADIO
PERMOFLUX CORPORATION
RCA BROADCAST PRODS.
ROUND HILL ASSOCIATES
RUSSCO ELECTRONICS MFG.
H. H. SCOTT, INCORPORATED
SCULLY RECORDING INSTRUMENTS
SETCHELL CARLSON INCORPORATED
SONY CORPORATION OF AMERICA
SOUTHWESTERN COMMUNICATIONS
STEPHENS ELECTRONICS
TELETRON INDUSTRIES CORP
VIKING OF MINNEAPOLIS

AMPLIFIER, BRIDGING

ALMA ENGINEERING INC
ALTEC LANSING
AMECO, INC.
AMPLIVISION CORPORATION
ANACONDA ASTRODATA CO
BAUER ELECTRONICS CORPORATION
C-COR ELECTRONICS
DELTA ELECTRONICS, INC.
GATES RADIO COMPANY
INTERNATIONAL NUCLEAR CORP.
JERROLD ELECTRONICS CORP
LANGEVIN
LINDSAY SPECIALTY PRODUCTS
ORBIT RADIO
RCA BROADCAST PRODS.
ROUND HILL ASSOCIATES
H. H. SCOTT, INCORPORATED
SINGER PRODUCTS CO.
SOUNDCRAFT INDUSTRIES
SOUTHWESTERN COMMUNICATIONS
SPENCER-KENNEDY LABORATORIES

STANCLIFF-HOFFMAN CORPORATION
STEPHENS ELECTRONICS
THE TECHNICAL MATERIEL CORP
WARD ELECTRONIC INDUSTRIES

AMPLIFIER, CATV

AMECO, INC.
AMERICAN ELECTRONIC LABS
AMPLIVISION CORPORATION
ANACONDA ASTRODATA CO
KEITH ANDERSON CO
BALL BROTHERS RESEARCH
BENCO TELEVISION ASSOCIATES
BLONDER-TONGUE LABORATORIES
C-COR ELECTRONICS
CRAFTSMAN ELECTRONICS PRODUCTS
ENTRON INC
GBC AMERICA CORPORATION
JERROLD ELECTRONICS CORP
KAISER-COX
LINDSAY SPECIALTY PRODUCTS
MICROMEGA
ROUND HILL ASSOCIATES
SPENCER-KENNEDY LABORATORIES
TELESIS CORPORATION

AMPLIFIER, CLAMPING

RAYTHEON CO EQUIPMENT DIVISION

AMPLIFIER, DC

ALTEC LANSING
BAUER ELECTRONICS CORPORATION
BIRNS & SAWYER
C-COR ELECTRONICS
CDHU ELECTRONICS
GENERAL RADIO CO
MELCOR ELECTRONICS
MILES REPRODUCER CO
MOSELEY ASSOCIATES INC.
VIDEON CORPORATION

AMPLIFIER, DISTRIBUTION

ALMA ENGINEERING INC
ALTEC LANSING
AMECO, INC.
AMPLIVISION CORPORATION
ANACONDA ASTRODATA CO
APPLIED ELECTRO-MECHANICS
ASCO SONOCRAFT CORP
BALL BROTHERS RESEARCH
BLONDER-TONGUE LABORATORIES
BROADCAST ELECTRONICS, INC
CCA ELECTRONICS CORPORATION
C-COR ELECTRONICS
CENTRAL DYNAMICS CORPORATION
COHU ELECTRONICS
COOKE ENGINEERING COMPANY
DELTA ELECTRONICS, INC.
DYNAIR ELECTRONICS, INC.
INTERNATIONAL NUCLEAR CORP.
JERROLD ELECTRONICS CORP
LINDSAY SPECIALTY PRODUCTS
MARCONI DIVISION
MCMARTIN INDUSTRIES
MELCOR ELECTRONICS
NORTH AMERICAN PHILIPS CO
ORBIT RADIO
RCA BROADCAST PRODS.
RIKER VIDEO INDUSTRIES
ROUND HILL ASSOCIATES
SARKES-TARZIAN
SPENCER-KENNEDY LABORATORIES
SYLVANIA-COMM. ELECTRONICS DIV
TELEMET COMPANY
TELEQUIP CORPORATION
TELEVISION UTILITIES CORP
VIDEON CORPORATION
VISUAL ELECTRONICS CORP
VITAL INDUSTRIES
WARD ELECTRONIC INDUSTRIES

AMPLIFIER, KEYING

RCA BROADCAST PRODS.
RIKER VIDEO INDUSTRIES
TELEMET COMPANY

AMPLIFIER, MASKING

C B S LABORATORIES
RCA BROADCAST PRODS.
RIKER VIDEO INDUSTRIES

AMPLIFIER, PULSE

ALMA ENGINEERING INC
ALTEC LANSING
APPLIED ELECTRO-MECHANICS
C-COR ELECTRONICS
CENTRAL DYNAMICS CORPORATION
COHU ELECTRONICS
DYNAIR ELECTRONICS, INC.
GENERAL RADIO CO
INTERNATIONAL NUCLEAR CORP.
MARCONI DIVISION
MICROWAVE ASSOCIATES, INC.
RCA BROADCAST PRODS.
RIKER VIDEO INDUSTRIES
SARKES-TARZIAN
STEPHENS ELECTRONICS
SYLVANIA-COMM. ELECTRONICS DIV
TELEMET COMPANY
TELEQUIP CORPORATION
VISUAL ELECTRONICS CORP
WARD ELECTRONIC INDUSTRIES

AMPLIFIER, RF, GENERAL PURPOSE

AMECO, INC.
AMPLIVISION CORPORATION
KEITH ANDERSON CO
BLONDER-TONGUE LABORATORIES
CCA ELECTRONICS CORPORATION
C-COR ELECTRONICS
GATES RADIO COMPANY
GENERAL RADIO CO
JERROLD ELECTRONICS CORP
MCMARTIN INDUSTRIES
MICROMEGA
MULTRONICS

RCA BROADCAST PRODS.
RHG ELECTRONICS LABORATORY
SINGER PRODUCTS CO.
STANDARD ELECTRONICS CORP

AMPLIFIER, RF, PEAK LIMITING

BELAR ELECTRONICS LABORATORY
CCA ELECTRONICS CORPORATION
MCMARTIN INDUSTRIES
MICROWAVE ASSOCIATES, INC.
RCA BROADCAST PRODS.
RHODE & SCHWARZ SALES CO. -USA
SINGER PRODUCTS CO.

AMPLIFIER, RF, POWER

AMERICAN ELECTRONIC LABS
KEITH ANDERSON CO
BAUER ELECTRONICS CORPORATION
CCA ELECTRONICS CORPORATION
C-COR ELECTRONICS
CONTINENTAL ELECTRONICS MFG
COURIER COMMUNICATIONS
EIMAC DIVISION OF VARIAN
GATES RADIO COMPANY
G E VISUAL COMMUNICATIONS PROD
GENERAL RADIO CO
F JOHNSON COMPANY
MCMARTIN INDUSTRIES
MICROWAVE ASSOCIATES, INC.
MILES REPRODUCER CO
MULTRONICS
RCA BROADCAST PRODS.
RHG ELECTRONICS LABORATORY
SINGER PRODUCTS CO.
THE TECHNICAL MATERIEL CORP
TELETRONIX

AMPLIFIER, SENSING

APPLIED ELECTRO-MECHANICS
BROADCAST PRODUCTS COMPANY
HOUSTON ELECTRONICS CO.
INTERNATIONAL GOOD MUSIC
RIKER VIDEO INDUSTRIES
SCHAFER ELECTRONICS
WARD ELECTRONIC INDUSTRIES

AMPLIFIER, STABILIZING

BALL BROTHERS RESEARCH
CENTRAL DYNAMICS CORPORATION
INTERNATIONAL NUCLEAR CORP.
MARCONI DIVISION
RCA BROADCAST PRODS.
RIKER VIDEO INDUSTRIES
SYLVANIA-COMM. ELECTRONICS DIV
TELEMET COMPANY
TELEQUIP CORPORATION
VISUAL ELECTRONICS CORP
VITAL INDUSTRIES
WARD ELECTRONIC INDUSTRIES

AMPLIFIER, TV, BOOSTER

AMECO, INC.
AMPLIVISION CORPORATION
ANACONDA ASTRODATA CO
BENCO TELEVISION ASSOCIATES
BLONDER-TONGUE LABORATORIES
C-COR ELECTRONICS
CRAFTSMAN ELECTRONICS PRODUCTS
THE FINNEY CO
JERROLD ELECTRONICS CORP
LINDSAY SPECIALTY PRODUCTS
MICROWAVE ASSOCIATES, INC.
RCA BROADCAST PRODS.
TELEMET COMPANY

AMPLIFIER, TV, VIDEO

ALMA ENGINEERING INC
AMPLIVISION CORPORATION
APPLIED ELECTRO-MECHANICS
BALL BROTHERS RESEARCH
BLONDER-TONGUE LABORATORIES
CATEL COMPANY
C-COR ELECTRONICS
CENTRAL DYNAMICS CORPORATION
COHU ELECTRONICS
DYNAIR ELECTRONICS, INC.
GBC AMERICA CORPORATION
G E VISUAL COMMUNICATIONS PROD
INTERNATIONAL NUCLEAR CORP.
MARCONI DIVISION
RAYTHEON CO EQUIPMENT DIVISION
RCA BROADCAST PRODS.
RIKER VIDEO INDUSTRIES
SARKES-TARZIAN
STANDARD ELECTRONICS CORP
TELEMET, INC.
TELEMET COMPANY
TELEQUIP CORPORATION
VIDEON CORPORATION
VISUAL ELECTRONICS CORP
VITAL INDUSTRIES
WARD ELECTRONIC INDUSTRIES

AMPLIFIER, VIDEO, SWEEP

ALMA ENGINEERING INC
AMPLIVISION CORPORATION
BLONDER-TONGUE LABORATORIES
HEWLETT-PACKARD CO.
RCA BROADCAST PRODS.
RHODE & SCHWARZ SALES CO. -USA
VISUAL ELECTRONICS CORP

ANALYZERS, DISTRTION

AUDIO INSTRUMENT CO
BARKER & WILLIAMSON
GENERAL RADIO CO
HEWLETT-PACKARD CO.
MARCONI INSTRUMENTS
NORTHEAST ELECTRONICS CORP
RHODE & SCHWARZ SALES CO. -USA
THE SINGER CO - METRICS DIV
WAVEFORMS, INCORPORATED

ANALYZERS, HARMONIC

BARKER & WILLIAMSON

GENERAL RADIO CO
HEWLETT-PACKARD CO.
MARCONI INSTRUMENTS
RHODE & SCHWARZ SALES CO. -USA
THE SINGER CO - METRICS DIV

ANALYZERS, INTERMODULATION

AUDIO INSTRUMENT CO
THE SINGER CO - METRICS DIV

ANALYZERS, NOISE

GENERAL MICROWAVE CORPORATION
GENERAL RADIO CO
HEWLETT-PACKARD CO.
NORTHEAST ELECTRONICS CORP
RHODE & SCHWARZ SALES CO. -USA
H. H. SCOTT, INCORPORATED
THE SINGER CO - METRICS DIV

ANALYZERS, SIDERANO

DYNATR ELECTRONICS, INC.
RCA BROADCAST PRODS.
RHODE & SCHWARZ SALES CO. -USA
THE SINGER CO - METRICS DIV
THE TECHNICAL MATERIEL CORP
WARD ELECTRONIC INDUSTRIES

ANALYZERS, SPECTRUM

TEKTRONIX INC

ANALYZERS, VIDEO

COLORADO VIDEO
HEWLETT-PACKARD CO.
KRS INSTRUMENTS DIVISION
RHODE & SCHWARZ SALES CO. -USA
THE SINGER CO - METRICS DIV
VIDEON CORPORATION

ANCHORS, GUY

ADVANCE INDUSTRIES
AMECO, INC.
RINRACH CO
G C ELECTRONICS COMPANY
LIBERTY TOWER MFG. CO
LITTLE JOE ENTERPRISES

ANTENNAS, AM

ADVANCE INDUSTRIES
ANTENNA PRODUCTS COMPANY
CCA ELECTRONICS CORPORATION
GATES RADIO COMPANY
JAMPRO ANTENNA COMPANY
JERROLD ELECTRONICS CORP
RCA BROADCAST PRODS.
SCALA RADIO CORPORATION
SINGER PRODUCTS CO.
STAINLESS, INC.
SWAGER TOWER CORPORATION
TELETRONIX
TRYLON INCORPORATED
VISUAL ELECTRONICS CORP

ANTENNAS, CATV

ADVANCE INDUSTRIES
AMECO, INC.
ANTENNA PRODUCTS COMPANY
BLONDER-TONGUE LABORATORIES
CUSH CRAFT
HY-GAIN ELECTRONICS
JAMPRO ANTENNA COMPANY
JERROLD ELECTRONICS CORP
KAISER-COX
LINDSAY SPECIALTY PRODUCTS
SCALA RADIO CORPORATION
SCIENTIFIC-ATLANTA
SITCO ANTENNA CO.
TECHNICAL APPLIANCE CORP

ANTENNAS, FM

ALFORD MANUFACTURING COMPANY
ALLIED ELECTRONICS CORP
AMECO, INC.
ANTENNA PRODUCTS COMPANY
APPARATUS DEVELOPMENT CO
BLONDER-TONGUE LABORATORIES
BROWNING LABORATORIES, INC.
CCA ELECTRONICS CORPORATION
COLLINS RADIO COMPANY
THE FINNEY CO
GATES RADIO COMPANY
G C ELECTRONICS COMPANY
JAMPRO ANTENNA COMPANY
JERROLD ELECTRONICS CORP
LINDSAY SPECIALTY PRODUCTS
MARTI ELECTRONICS
MCMARTIN INDUSTRIES
RCA BROADCAST PRODS.
ROBINS INDUSTRIES CORP.
SCALA RADIO CORPORATION
SINGER PRODUCTS CO
SITCO ANTENNA CO.
TECHNICAL APPLIANCE CORP
TELETRONIX
THOMSON ELECTRIC CO
VISUAL ELECTRONICS CORP

ANTENNAS, LF

MULTRONICS

ANTENNAS, MF

MULTRONICS

ANTENNAS, MICROWAVE

ADVANCE INDUSTRIES
AMECO, INC.
AMERICAN ELECTRONIC LABS
ANDREW CORPORATION
DEMORAY - BONARDI DIVISION
FORT WORTH TOWER CO., INC.
JERROLD ELECTRONICS CORP
LITTON EDUCATIONAL TELE DIV
MICRO-LINK SYSTEMS/VARIAN ASSO
MOTOROLA COMMUNICATIONS
NARDA MICROWAVE CORPORATION
PRODELIN, INCORPORATED
RAYTHEON CO EQUIPMENT DIVISION

for TOP PERFORMANCE in TV ANTENNAS

VHF SUPER TURNSTILE

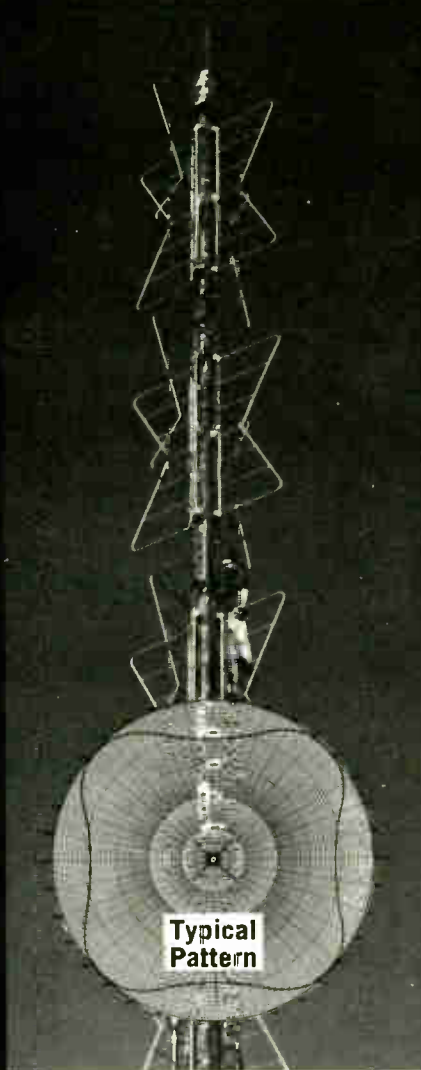

Typical
Pattern

DESCRIPTION
Improved mechanical construction
Wide variety of Gains
Power rating to 50 kw
Beam tilting and null fill available at no increase in cost

UHF ZIG ZAG

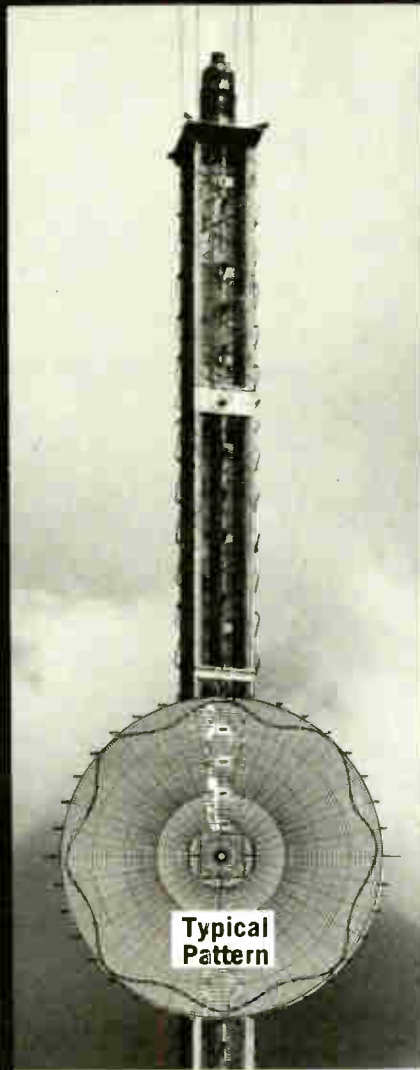

Typical
Pattern

DESCRIPTION
Simple panel construction
All copper elements
All Teflon insulated
Low VSWR
Inputs to 60 kw
Gain of about 30 per panel

CORNER REFLECTORS



Typical
Pattern

DESCRIPTION
Wide variety of frequencies from Channel 2 through 83
Low VSWR
Versatile for fill in or directionals
Gains of generally around 10 per corner

J A M P R O

- TV Antennas
- Coax Switches
- Notch Diplexers
- FM Antennas
- Harmonic Filters
- ETV Antennas

**ANTENNA
COMPANY**
6939 POWER INN ROAD

COMPANY
SACRAMENTO CALIFORNIA

RCA BROADCAST PRODS.
ROMHE & SCHWARZ SALES CO. -USA
SCIENTIFIC-ATLANTA
SINGER PRODUCTS CO
STAINLESS, INC.
TECHNICAL APPLIANCE CORP
VISUAL ELECTRONICS CORP

ANTENNAS, MOBILE

ANDREW CORPORATION
F & M SYSTEMS COMPANY
GATES RADIO COMPANY
G C ELECTRONICS COMPANY
HY-GAIN ELECTRONICS
JERROLD ELECTRONICS CORP
HFRB KRECKMAN CO
LINDSAY SPECIALTY PRODUCTS
MARTI ELECTRONICS
MOTOROLA COMMUNICATIONS
PRODELIN, INCORPORATED
RCA BROADCAST PRODS.
SINGER PRODUCTS CO
TECHNICAL APPLIANCE CORP
UTICA CORPORATION
WATERS MANUFACTURING

ANTENNAS, REMOTE PICKUP

HERB KRECKMAN CO

ANTENNAS, TV

ALFORD MANUFACTURING COMPANY
ALLIED ELECTRONICS CORP
BLONDER-TONGUE LABORATORIES
FMCEE
THE FINNEY CO
GATES RADIO COMPANY
G C ELECTRONICS COMPANY
G E VISUAL COMMUNICATIONS PROD
JAMPRO ANTENNA COMPANY
JERROLD ELECTRONICS CORP
LINDSAY SPECIALTY PRODUCTS
MARCONI DIVISION
PACIFIC TOWER CO
RCA BROADCAST PRODS.
SCALA RADIO CORPORATION
SINGER PRODUCTS CO.
TECHNICAL APPLIANCE CORP
THOMSON ELECTRIC CO
VISUAL ELECTRONICS CORP

ANTENNAS, TV, MASTER-COMMUNITY

AMECO, INC.
AMPLIVISION CORPORATION
ANTENNA PRODUCTS COMPANY
BENCO TELEVISION ASSOCIATES
BLONDER-TONGUE LABORATORIES
CUSH CRAFT
THE FINNEY CO
JERROLD ELECTRONICS CORP
LINDSAY SPECIALTY PRODUCTS
SCALA RADIO CORPORATION
SCIENTIFIC-ATLANTA
SITCO ANTENNA CO.
STAINLESS, INC
TECHNICAL APPLIANCE CORP

ANTENNAS, 2500 MHZ

ALFORD MANUFACTURING COMPANY
AMERICAN ELECTRONIC LABS
ANDREW CORPORATION
JAMPRO ANTENNA COMPANY
JERROLD ELECTRONICS CORP
LITTON EDUCATIONAL TELE DIV
NARDA MICROWAVE CORPORATION
PRODELIN, INCORPORATED
RAYTHEON CO EQUIPMENT DIVISION
RCA BROADCAST PRODS.
SCIENTIFIC-ATLANTA
TECHNICAL APPLIANCE CORP

ANTENNAS, SYSTEMS, HF

DELTA ELECTRONICS INC

ARMS, PHONOGRAPH -

SEE ARMS, TONE

ARMS, TONE

THE ASTATIC CORPORATION
EUPHONICS MARKETING
GATES RADIO COMPANY
GOTHAM AUDIO CORPORATION
GRAY RESEARCH & DEVELOPMENT CO
KOSS ELECTRONICS, INC.
RCA BROADCAST PRODS.
SHURE BROTHERS, INC.
SINGER PRODUCTS CO
SONY CORPORATION OF AMERICA

ATTENUATORS, AUDIO

ALTEC LANSING
AMECO, INC.
CENTRALAB
FAIRCHILD RECORDING EQUIPMENT
GENERAL RADIO CO
HEWLETT-PACKARD CO.
JORDAN ELECTRIC COMPANY
LANGEVIN
MALLORY DISTRIBUTOR PRODUCTS
MICROLAB / FXR
PAINTON INCORPORATED
ROMHE & SCHWARZ SALES CO. -USA
SOUNDCRAFT INDUSTRIES
SOUTHWESTERN COMMUNICATIONS
STEPHENS ELECTRONICS
TELEONIC INDUSTRIES
TROMPETER ELECTRONICS

ATTENUATORS, FIXED

ALTEC LANSING
BIRD ELECTRONIC CORPORATION
GENERAL MICROWAVE CORPORATION
GENERAL RADIO CO
GOTHAM AUDIO CORPORATION
HEWLETT-PACKARD CO.
HOLLAND ELECTRONICS INC
JERROLD ELECTRONICS CORP
JORDAN ELECTRIC COMPANY

LANGEVIN
MICROLAB / FXR
MICROWAVE ASSOCIATES, INC.
NARDA MICROWAVE CORPORATION
PAINTON INCORPORATED
RCA BROADCAST PRODS.
ROMHE & SCHWARZ SALES CO. -USA
THE SINGER CO - METRICS DIV
SOUTHWESTERN COMMUNICATIONS
TROMPETER ELECTRONICS

ATTENUATORS, IMPEDANCE MATCHING

ALTEC LANSING
AMECO, INC.
HOLLAND ELECTRONICS INC
JERROLD ELECTRONICS CORP
MICROLAB / FXR
MICROWAVE ASSOCIATES, INC.
NARDA MICROWAVE CORPORATION
OHMITE MANUFACTURING COMPANY
PAINTON INCORPORATED
ROMHE & SCHWARZ SALES CO. -USA
SOUTHWESTERN COMMUNICATIONS
TROMPETER ELECTRONICS

ATTENUATORS, MICROWAVE

AMECO, INC.
DEMORNAY - BONARDI DIVISION
GENERAL MICROWAVE CORPORATION
GENERAL RADIO CO
HEWLETT-PACKARD CO.
JERROLD ELECTRONICS CORP
MICROLAB / FXR
MICROWAVE ASSOCIATES, INC.
NARDA MICROWAVE CORPORATION
PRODELIN, INCORPORATED
ROMHE & SCHWARZ SALES CO. -USA
SCIENTIFIC-ATLANTA
THE SINGER CO - METRICS DIV
TELEONIC INDUSTRIES

ATTENUATORS, RF

AMECO, INC.
BENCO TELEVISION ASSOCIATES
BIRD ELECTRONIC CORPORATION
BLONDER-TONGUE LABORATORIES
GENERAL MICROWAVE CORPORATION
GENERAL RADIO CO
HEWLETT-PACKARD CO.
HOLLAND ELECTRONICS INC
JERROLD ELECTRONICS CORP
MARCONI INSTRUMENTS
MICROLAB / FXR
MICROWAVE ASSOCIATES, INC.
NARDA MICROWAVE CORPORATION
PAINTON INCORPORATED
PRODELIN, INCORPORATED
ROMHE & SCHWARZ SALES CO. -USA
SCIENTIFIC-ATLANTA
THE SINGER CO - METRICS DIV
SINGER PRODUCTS CO.
TELEONIC INDUSTRIES
TOWNSEND ASSOCIATES
TROMPETER ELECTRONICS
WATERS MANUFACTURING

ATTENUATORS, VIDEO

AMECO, INC.
CENTRAL DYNAMICS CORPORATION
HOLLAND ELECTRONICS INC
NARDA MICROWAVE CORPORATION
PAINTON INCORPORATED
ROMHE & SCHWARZ SALES CO. -USA
SARKES-TARZIAN
SCIENTIFIC-ATLANTA
TELEONIC INDUSTRIES
TROMPETER ELECTRONICS

AUTOMATION, EQUIPMENT

AITKEN COMMUNICATIONS

AMECO, INC.
BROADCAST ELECTRONICS, INC
BROADCAST PRODUCTS COMPANY
CCA ELECTRONICS CORPORATION
CENTRAL DYNAMICS CORPORATION
CHRONO-LOG CORPORATION
CONTINENTAL ELECTRONICS MFG
DELTA ELECTRONICS, INC.
F & M SYSTEMS COMPANY
GATES RADIO COMPANY
HANCOCK TELECONTROL
INTERNATIONAL GOOD MUSIC
KRS INSTRUMENTS DIVISION
MACARTA INC.
MACKENZIE LABORATORIES
MID AMERICA ELECTRONICS CORP
ORBIT RADIO
RCA BROADCAST PRODS.
RIKER VIDEO INDUSTRIES
SARKES-TARZIAN
SCHAFER ELECTRONICS
SCULLY RECORDING INSTRUMENTS
SINGER PRODUCTS CO
S. STERLING COMPANY
TAPECASTER ELECTRONICS
TELESIS CORPORATION
TREPAC CORPORATION OF AMERICA
TROMPETER ELECTRONICS
VISUAL ELECTRONICS CORP
WARD ELECTRONIC INDUSTRIES

BACKGROUND MUSIC SERVICE

AMECO, INC.
ASCO SONOCRAFT CORP
BROWNING LABORATORIES, INC.
CCA ELECTRONICS CORPORATION
CINE SONIC SOUND
THE JAMES FLOYD FORD CO
INTERNATIONAL GOOD MUSIC
MAGNE-TRONICS, INC.
MCMARTIN INDUSTRIES
MINNESOTA MINING - 3 M
MOTOROLA COMMUNICATIONS
ORBIT RADIO
SCHAFER ELECTRONICS

SINGER PRODUCTS CO
SOUTHWESTERN COMMUNICATIONS
ALBERT SCHULTZ, INC

RALLASTS, LAMP

GENERAL ELECTRIC CO
SDLA ELECTRIC

RALLUS

AMECO, INC.
AMERICAN ELECTRONIC LABS
KEITH ANDERSON CO
ANTENNA PRODUCTS COMPANY
APPARATUS DEVELOPMENT CO
BLONDER-TONGUE LABORATORIES
THE FINNEY CO
GENERAL RADIO CO
JERROLD ELECTRONICS CORP
RIKER VIDEO INDUSTRIES
ROMHE & SCHWARZ SALES CO. -USA
SCALA RADIO CORPORATION
SINGER PRODUCTS CO.
SITCO ANTENNA CO.
STANDARD ELECTRONICS CORP
THE TECHNICAL MATERIEL CORP
TELEONIC INDUSTRIES
TRYLON INCORPORATED

BASE STATIONS

GATES RADIO COMPANY
MARTI ELECTRONICS
RCA BROADCAST PRODS.
SINGER PRODUCTS CO
UTICA CORPORATION

BATTERIES, DRY CELL

BURGESS BATTERY COMPANY
RCA ELECTRONIC COMPONENTS

BATTERIES, LEAD ACID

IMPEX ELECTRONICS CORP
SINGER PRODUCTS CO

BATTERIES, NICKEL CADMIUM

BERKEY TECHNICAL CORP
BIRNS & SAWYER
COLORTRON INDUSTRIES - BERKEY
G E CAPACITOR DEPARTMENT
GENERAL ELECTRIC CO
IMPEX ELECTRONICS CORP
SINGER PRODUCTS CO.

BATTERIES, OTHER

GENERAL ELECTRIC CO

BLOWERS AND FANS

AMECO, INC.
BUO RADIO, INC
OYANCOOL MANUFACTURING CO
ENCLOSURE CORP
RCA BROADCAST PRODS.
ROTRON MANUFACTURING COMPANY
SIGMA INDUSTRIES
SINGER PRODUCTS CO.

BOXES, DECADE, CAPACITOR

AEROVIX CORP.
GENERAL RADIO CO
HEATH CO

BOXES, DECADE, INDUCTOR

AEROVIX CORP.
GENERAL RADIO CO
UNITED TRANSFORMER COMPANY

BOXES, DECADE, RESISTOR

AEROVIX CORP.
GENERAL RADIO CO
HEATH CO
JORDAN ELECTRIC COMPANY
OHMITE MANUFACTURING COMPANY

BRIDGES

ALFORD MANUFACTURING COMPANY
ALTEC LANSING
AMECO, INC.
BLONDER-TONGUE LABORATORIES
DELTA ELECTRONICS INC
GENERAL ELECTRIC CO
GENERAL MICROWAVE CORPORATION
GENERAL RADIO CO
HEATH CO
HEWLETT-PACKARD CO.
HICKOK ELECTRICAL INSTRUMENT
JERROLD ELECTRONICS CORP
MARCONI INSTRUMENTS
ROMHE & SCHWARZ SALES CO. -USA
YOKOGAWA ELECTRIC WORKS

BROADCAST PROGRAMMING SERVICE

AMECO, INC.
ASCO SONOCRAFT CORP
BISCAYNE AUDIO COMPANY
THE JAMES FLOYD FORD CO
HOUSTON ELECTRONICS CO.
INTERNATIONAL GOOD MUSIC
ORBIT RADIO
SCHAFER ELECTRONICS
ALBERT SCHULTZ, INC
TELEVISION, INC.

BUILDINGS, PREFABRICATED -

SEE PREFABRICATED BUILDINGS

CABINETS, METAL

ACHE VISIBLE RECORDS
ALLIED ELECTRONICS CORP
AMECO, INC.
BUD RADIO, INC
BURKE & JAMES
CCA ELECTRONICS CORPORATION
COOK ELECTRIC COMPANY
DATA INSTRUMENT DIVISION
ENCLOSURE CORP
GATES RADIO COMPANY

G E VISUAL COMMUNICATIONS PROD
HARWOOD MFG. CO.
JERROLD ELECTRONICS CORP
LANG ELECTRONICS, INC
MCMARTIN INDUSTRIES
METROPOLITAN ELECTRIC MFG CO
NEUMADE PRODUCTS CORPORATION
RCA BROADCAST PRODS.
SCHAFER ELECTRONICS
SCIENTIFIC-ATLANTA
SPENCER-KENNEDY LABORATORIES
VENT-RAK INCORPORATED
WABER ELECTRONICS, INC.

CABINETS, PLASTIC

RCA BROADCAST PRODS.

CABINETS, STORAGE, DISC

ACHE VISIBLE RECORDS
GATES RADIO COMPANY
GRINNAN FIXTURE COMPANY
HARWALD COMPANY
NEUMADE PRODUCTS CORPORATION
WALLACH & ASSOCIATES

CABINETS, STORAGE, FILM

ACHE VISIBLE RECORDS
GRINNAN FIXTURE COMPANY
HARWALD COMPANY
MINNESOTA MINING - 3 M
NEUMADE PRODUCTS CORPORATION
RCA BROADCAST PRODS.
WALLACH & ASSOCIATES

CABINETS, STORAGE

MAGNETIC TAPE
ACHE VISIBLE RECORDS
BROADCAST ELECTRONICS, INC
BURKE & JAMES
COOK ELECTRIC COMPANY
GRINNAN FIXTURE COMPANY
MINNESOTA MINING - 3 M
NEUMADE PRODUCTS CORPORATION
RCA BROADCAST PRODS.
SINGER PRODUCTS CO
WALLACH & ASSOCIATES

CABINETS, STORAGE

MAGNETIC TAPE, CARTRIDGE
BROADCAST ELECTRONICS, INC
BROADCAST PRODUCTS COMPANY
SPARTA ELECTRONIC CORPORATION

CABINETS, STORAGE, SLIDE

WALLACH & ASSOCIATES

CABINETS, WOOD

BROADCAST PRODUCTS COMPANY
BURKE & JAMES
GATES RADIO COMPANY
GRINNAN FIXTURE COMPANY
LANG ELECTRONICS, INC
LITTLE JOE ENTERPRISES
MARANTZ COMPANY
SETCHELL CARLSON INCORPORATED

CABLE, ARMORED

ALLIED ELECTRONICS CORP
ALPHA WIRE
AMPHENOL DISTRIBUTOR DIVISION
BIRNBACH CO
BOSTON INSULATED WIRE & CABLE
PHELPS DODGE
SUPERIOR CABLE CORPORATION

CABLE, ASSEMBLIES

ALPHA WIRE
AMECO, INC.
AMPHENOL DISTRIBUTOR DIVISION
ANDREW CORPORATION
BOSTON INSULATED WIRE & CABLE
COHU ELECTRONICS

D & B ELECTRONICS COMPANY
G C ELECTRONICS COMPANY
GENERAL RADIO CO
GIBBS MFG. AND RESEARCH CORP.
ITT CANNON ELECTRIC
JERROLD ELECTRONICS CORP
PHELPS DODGE
ROBINS INDUSTRIES CORP.
ROME CABLE DIV OF ALCOA
SAXTON PRODUCTS
SINGER PRODUCTS CO.
SOUTHWESTERN COMMUNICATIONS
SUPERIOR CABLE CORPORATION
SYLVANIA-COMM. ELECTRONICS DIV
TELEQUIP CORPORATION
TIMES WIRE AND CABLE
TROMPETER ELECTRONICS
WECKESSER COMPANY, INC.

CABLE, CAMERA
BOSTON INSULATED WIRE & CABLE

CABLE, CATV, HARDWARE

AMECO, INC.
AMPHENOL DISTRIBUTOR DIVISION
AMPLIVISION CORPORATION
ANACONDA ASTRODATA CO
ANDREW CORPORATION
COPPERWELD STEEL COMPANY
CRAFTSMAN ELECTRONICS PRODUCTS
DIAMOND EXPANSION BOLT CO INC
JERROLD ELECTRONICS CORP
KAISER-COX
PHELPS DODGE
PRODELIN, INCORPORATED
SIGMA INDUSTRIES
SPENCER-KENNEDY LABORATORIES
SUPERIOR CABLE CORPORATION
TELEMET COMPANY
TELEQUIP CORPORATION
TIMES WIRE AND CABLE

CABLE, COAXIAL, FLEXIBLE

ALPHA WIRE

Why is Belden specified by most broadcast engineers?

Belden designs and manufactures a complete line of audio, camera, and control cables to meet every TV and radio broadcasting, recording studio, and remote control need.

Many Belden Audio and Broadcast Cables feature Beldfoil* shielding. This superior cable shield provides 100% protection against crosstalk . . . increases electrical reliability . . . reduces cable diameter and weight . . . is easier to terminate . . . usually lower in cost. Here is just a part of this complete line, available from stock. Ask your Belden Electronics Distributor for complete information. Request also a copy of the latest Belden Electronics Catalog.



*Belden U.S. Pat. 3,032,604
Belden Trademark—Reg. U.S. Pat. Off.

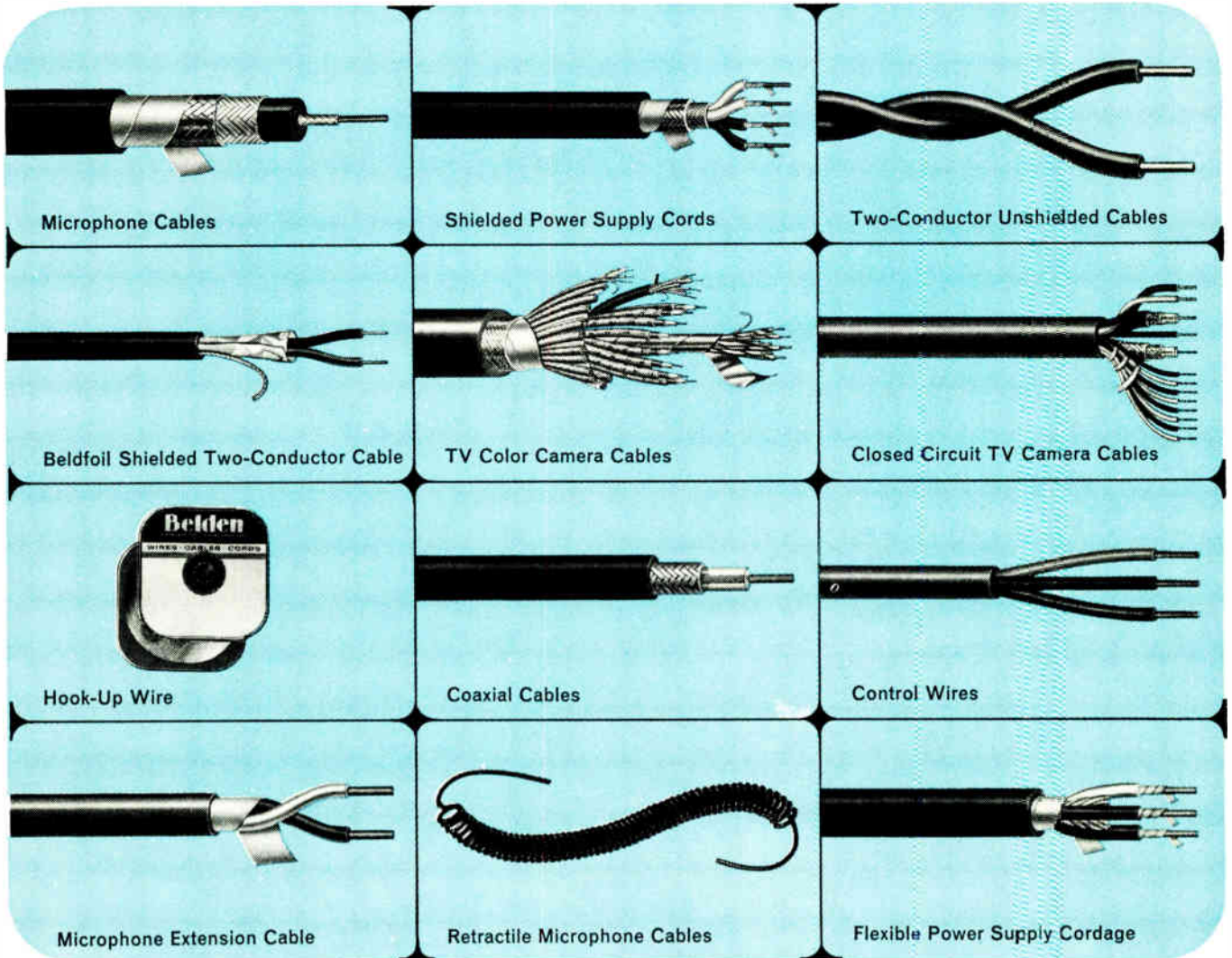

8-5-6

see your Belden Electronics Distributor



electronic wire and cable

BELDEN MANUFACTURING COMPANY • P.O. Box 5070-A • Chicago, Illinois 60680

**Two of the three major networks use
Norelco cameras for their prime-time color shows.**

**If that doesn't convince you to buy a
Norelco 3-tube Plumbicon* color camera,
take a trip on us.**

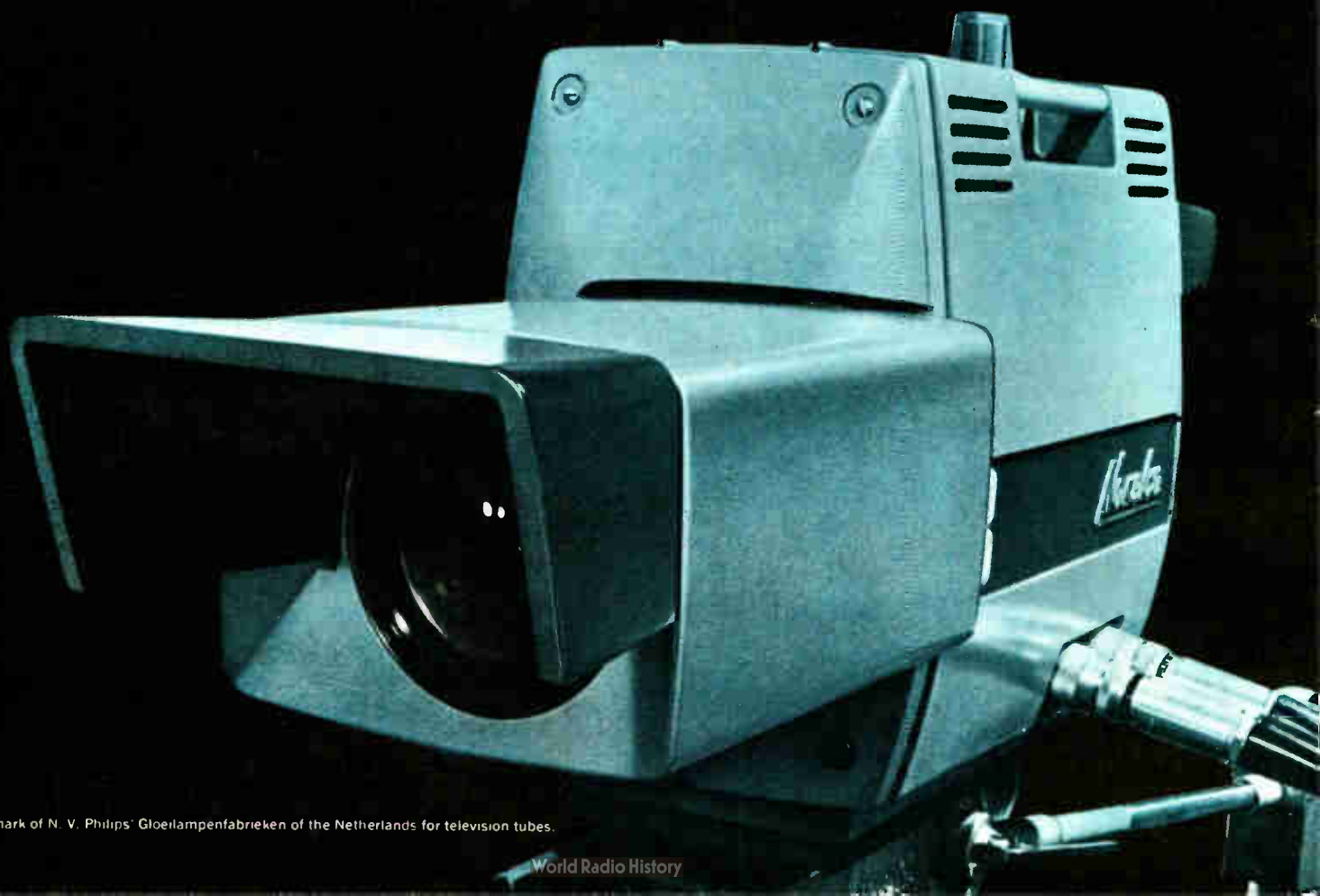

Trademark of N. V. Philips' Gloeilampenfabrieken of the Netherlands for television tubes.

World Radio History

This is an invitation to discover—at our expense—the practical, everyday reasons why you should now be using the new Norelco 3-tube Plumbicon rather than any other color TV camera on the market. Do this. Call, or write us direct. We'll schedule and pay for a trip to a station now using the Norelco 3-tube Plumbicon TV camera—subject to the availability of the station's time and technical personnel. They'll tell you and show you why they chose the new Norelco. You'll see it in program action. You'll learn for yourself—at no cost to yourself—why the Norelco Plumbicon TV camera is used for more programming than all other new generation makes.

Here's a partial list of stations now using the new Norelco

EAST	
STATION	LOCATION
WNHC-TV	New Haven, Connecticut
WNEW-TV	New York
REEVES SOUND STUDIO	New York
SOUTH	
WAGA-TV.	Atlanta, Georgia
WJBF-TV	Augusta, Georgia
WCYB-TV	Bristol, Virginia/Tenn.
WKRG-TV	Mobile, Alabama
WSPA-TV	Spartanburg, S.C.
MIDWEST	
WFIE-TV	Evansville, Indiana
WFRV-TV	Green Bay, Wisconsin
WISH-TV	Indianapolis, Indiana
WEST	
KABC-TV	Los Angeles, California
KTTV	Los Angeles, California
KXTV	Sacramento, California

When you visit one of these stations you'll be able to separate the facts from the fiction regarding color TV cameras. Facts and fiction like this:

FICTION: A 4-tube camera produces a sharper picture than a 3-tube color camera.

FACT: This concept is as obsolete as the 12-cylinder car. The Norelco 3-tube PC-70 Plumbicon Color Camera produces a sharper color and monochrome picture than any 4-tube camera. Reason: the first practical application of the unique "contours-out-of-green" principle provides both horizontal and vertical aperture correction. The contour signal produced from the green channel, is simply fed to all three channels.

RESULT: A startling increase in color and monochrome sharpness — on the home receiver—plus the same tolerance to misregistration that a fourth tube provides. All with one less tube, less maintenance, minimum operational make-ready time and trouble-free color matching.

FICTION: "Contours-out-of-green" creates an excessive noise problem.

FACT: Absolutely not. But some 4-tube cameras do have a noise problem. Check the "specs." You'll discover that these 4-tube models recommend a fixed gamma of 0.5. We provide continuously variable gamma and recommend an 0.45 operating point. This stretches blacks and gives you more detail in dark areas and shadows. A gamma of 0.5 hides noise by compressing blacks. Result: the 4-tube camera loses dark area detail and literally demands the use of flat lighting.

FICTION: By this time next year Norelco will be selling a

four tube camera.

FACT: Definitely not. We made the best possible 4-tube camera but decided not to sell it. While using it to compare 3-tube vs. 4-tube, we discovered what every 4-tube manufacturer has since learned: 4-tube resolution is inherently less than 3-tube; that extra light split to the Y channel reduces the light to the RGB channels, causing noticeable lag. (Try moving a light object against a dark background with a camera using 4 photo conductor pick-up tubes. You'll see what we mean.)

FICTION: The Norelco PC-70 is made in Holland and won't be in full production for years.

FACT: The PC-70 camera is made by Norelco in Mt. Vernon, N. Y., where existing and constantly expanding facilities are meeting the demand for the most economical, easiest to use and maintain, color TV camera available today.

Other reasons to choose the Norelco PC-70:

A simple but remarkable 3-way beam split prism that eliminates the need for shading controls. (Because of their complicated beam split, many 4-tube models require as many as 16 shading controls.)

No magenta cast, a problem even some of the newest 4-tube cameras haven't solved.

Lens interchangeability.

No set-up operating controls in the camera head except for tube-focus and back-focus positions. Eliminates the need for a two-man set-up and for hectic on-the-set adjustments.

Now get all the reasons to choose the Norelco PC-70. Get them from the men behind the camera, Today, call our sales representative, Visual Electronics, or call us directly.



NORTH AMERICAN PHILIPS COMPANY, INC.
900 South Columbus Avenue, Mount Vernon, New York 10550

AMFCO, INC.
 AMPHENOL DISTRIBUTOR DIVISION
 ANACONDA ASTRODATA CO
 ANDREW CORPORATION
 ANSONIA WIRE AND CABLE CO
 BELDEN MANUFACTURING CO
 BOSTON INSULATED WIRE & CABLE
 GENERAL RADIO CO
 GOTHAM AUDIO CORPORATION
 ITT WIRE & CABLE DIVISION
 JAMPHO ANTENNA COMPANY
 JERROLD ELECTRONICS CORP
 PHELPS DOUG
 PRODELIN, INCORPORATED
 RCA BROADCAST PRODS.
 ROME CABLE DIV OF ALCOA
 SAXTON PRODUCTS
 SINGER PRODUCTS CO.
 SPENCER-KENNEDY LABORATORIES
 SUPERIOR CABLE CORPORATION
 TELEQUIP CORPORATION
 TENSOLITE INSULATED WIRE CO.
 TIMES WIRE AND CABLE
 VISUAL ELECTRONICS CORP

CABLE, COAXIAL, RIGID

ALPHA WIRE
 AMPHENOL DISTRIBUTOR DIVISION
 ANDREW CORPORATION
 ANTENNA PRODUCTS COMPANY
 ITT WIRE & CABLE DIVISION
 JAMPHO ANTENNA COMPANY
 JERROLD ELECTRONICS CORP
 PHELPS DOUG
 PRODELIN, INCORPORATED
 RCA BROADCAST PRODS.
 SAXTON PRODUCTS
 SINGER PRODUCTS CO.
 SUPERIOR CABLE CORPORATION
 TECHNICAL APPLIANCE CORP
 TELEQUIP CORPORATION
 TIMES WIRE AND CABLE
 VISUAL ELECTRONICS CORP

CABLE, DIRECT-BURIAL

ALPHA WIRE
 AMECO, INC.
 AMPHENOL DISTRIBUTOR DIVISION
 ANACONDA ASTRODATA CO
 ANDREW CORPORATION
 BELDEN MANUFACTURING CO
 BIRNBACH CO
 ITT WIRE & CABLE DIVISION
 JERROLD ELECTRONICS CORP
 PHELPS DOUG
 ROME CABLE DIV OF ALCOA
 SAXTON PRODUCTS
 SUPERIOR CABLE CORPORATION
 TELEQUIP CORPORATION
 TIMES WIRE AND CABLE

CABLE, SHIELDED, AUDIO

ALLIED ELECTRONICS CORP
 ALPHA WIRE
 AMPHENOL DISTRIBUTOR DIVISION
 BELDEN MANUFACTURING CO
 BIRNBACH CO
 BOSTON INSULATED WIRE & CABLE
 G C ELECTRONICS COMPANY
 G E VISUAL COMMUNICATIONS PROD
 GOTHAM AUDIO CORPORATION
 LENZ ELECTRIC MANUFACTURING CO
 RCA BROADCAST PRODS.
 ROBINS INDUSTRIES CORP.
 ROME CABLE DIV OF ALCOA
 SAXTON PRODUCTS
 SINGER PRODUCTS CO.
 SUPERIOR CABLE CORPORATION
 TELEQUIP CORPORATION
 TENSOLITE INSULATED WIRE CO.

CABLE, TELEPHONE

ALPHA WIRE
 AMFCO, INC.
 ANSONIA WIRE AND CABLE CO
 BELDEN MANUFACTURING CO
 BIRNBACH CO
 FISHER BERKELEY CORPORATION
 ITT WIRE & CABLE DIVISION
 LENZ ELECTRIC MANUFACTURING CO
 ROME CABLE DIV OF ALCOA
 SAXTON PRODUCTS
 SUPERIOR CABLE CORPORATION

CALIBRATION SERVICE, FREQUENCY

EIDSON ELECTRONIC COMPANY
 ELECTRONICS ESSENTIALS OF CCC
 F & M SYSTEMS COMPANY
 HERB FITZGERALD COMMUNICATIONS
 AND ELECTRONICS
 HEWLETT-PACKARD CO.
 RADIO AIDS
 S. STERLING COMPANY

CALIBRATION SERVICE, INSTRUMENT

DATA INSTRUMENT DIVISION
 EIDSON ELECTRONIC COMPANY
 ELECTRONICS ESSENTIALS OF CCC
 THE JAMES FLOYD FORD CO
 HEWLETT-PACKARD CO.
 INSTRUMENT LABORATORIES CORP
 S. STERLING COMPANY

CALORIMETERS

RIO ELECTRONIC CORPORATION
 THE ENGLISH ELECTRIC CORP.
 MARCONI INSTRUMENTS
 NARDA MICROWAVE CORPORATION
 RCA BROADCAST PRODS.

CAMERA, MOUNTING EQUIPMENT

AMECO, INC.
 E J BAUGHMAN CO
 BERKEY TECHNICAL CORP
 BIRNS & SAWYER
 HURKE & JAMES

COMU ELECTRONICS
 COLORTAN INDUSTRIES - BERKEY
 HOUSTON FEARLESS CORPORATION
 MOTOROLA COMMUNICATIONS
 POWER-OPTICS INCORPORATED
 RCA BROADCAST PRODS.
 SYLVANIA-COMM. ELECTRONICS DIV
 TELEQUIP CORPORATION
 TELEVISION UTILITIES CORP
 TRAD CORPORATION
 UP-RIGHT SCAFFOLDS
 VISUAL ELECTRONICS CORP

CAMERA, REMOTE

CONTROL EQUIPMENT
 AMECO, INC.
 AMPLIVISION CORPORATION
 COMU ELECTRONICS
 DELTA ELECTRONICS, INC.
 MOTOROLA COMMUNICATIONS
 POWER-OPTICS INCORPORATED
 SYLVANIA-COMM. ELECTRONICS DIV
 TELEQUIP CORPORATION
 TELEVISION UTILITIES CORP
 VISUAL ELECTRONICS CORP

CAMERAS, FILM, CINE

AMECO, INC.
 ARRIFLEX CORP OF AMERICA
 BECKMAN & WHITLEY
 BIRNS & SAWYER
 BLONDER-TONGUE LABORATORIES
 HURKE & JAMES
 EASTMAN KODAK COMPANY
 D. B. MILLIKEN COMPANY
 MINNESOTA MINING - 3 M
 NORTH AMERICAN PHILIPS CO
 PRECISION LABORATORIES
 RCA BROADCAST PRODS.
 TELEVISION UTILITIES CORP
 TRAD CORPORATION
 VISUAL ELECTRONICS CORP

CAMERAS, FILM, STILL

BIRNS & SAWYER
 BLONDER-TONGUE LABORATORIES
 HURKE & JAMES
 EASTMAN KODAK COMPANY
 MINNESOTA MINING - 3 M
 NORTH AMERICAN PHILIPS CO
 PRECISION LABORATORIES

CAMERAS, OSCILLOSCOPE

AMECO, INC.
 BENRUS
 HEWLETT-PACKARD CO.
 D. B. MILLIKEN COMPANY
 THE SINGER CO - METRICS DIV
 TEKTRONIX INC
 TRAD CORPORATION

CAMERAS, TV, COLOR

AMECO, INC.
 AMPEX CORPORATION
 AMPLIVISION CORPORATION
 ASCO SONOCRAFT CORP
 BLONDER-TONGUE LABORATORIES
 COMU ELECTRONICS
 G E VISUAL COMMUNICATIONS PROD
 MARCONI DIVISION
 NORTH AMERICAN PHILIPS CO
 RCA BROADCAST PRODS.
 SARKES-TARZIAN
 VISUAL ELECTRONICS CORP

CAMERAS, TV, MONOCHROME

AMECO, INC.
 AMPEX CORPORATION
 AMPLIVISION CORPORATION
 BLONDER-TONGUE LABORATORIES
 COMU ELECTRONICS
 COLORADO VIDEO
 DAGE BELL CORPORATION
 DIAMOND ELECTRONICS
 DIECRAFT, INC
 G E VISUAL COMMUNICATIONS PROD
 MARCONI DIVISION
 MARYLAND TELECOMMUNICATIONS
 MOTOROLA COMMUNICATIONS
 NORTH AMERICAN PHILIPS CO
 RCA BROADCAST PRODS.
 SARKES-TARZIAN
 SONY CORPORATION OF AMERICA
 SYLVANIA-COMM. ELECTRONICS DIV
 TELEMATION, INC.
 TELEVISION UTILITIES CORP
 THOMSON ELECTRIC CO
 VISUAL ELECTRONICS CORP

CAPACITORS, FIXED, GENERAL

BUD RADIO, INC

CAPACITORS, FIXED, AIR

G E CAPACITOR DEPARTMENT
 GENERAL RADIO CO
 TRW ELECTRONICS

CAPACITORS, FIXED, CERAMIC

AEROVOX CORP.
 AMERICAN ELITE
 CENTRALAB
 CORNELL-DUBILIER ELECTRONICS
 G E CAPACITOR DEPARTMENT
 JENNINGS RADIO MANUFACTURING
 MALLORY DISTRIBUTOR PRODUCTS
 MINNESOTA MINING - 3 M
 SINGER PRODUCTS CO.
 TRW ELECTRONICS

CAPACITORS, FIXED, ELECTROLYTIC

AEROVOX CORP.
 AMERICAN ELITE
 AMPEREX ELECTRONIC CORP
 CORNELL-DUBILIER ELECTRONICS
 GENERAL ELECTRIC CO
 MALLORY DISTRIBUTOR PRODUCTS

OHMITE MANUFACTURING COMPANY
 SINGER PRODUCTS CO.

CAPACITORS, FIXED, FILM

AEROVOX CORP.
 AMERICAN ELITE
 AMPEREX ELECTRONIC CORP
 CORNELL-DUBILIER ELECTRONICS
 DEARBORN ELECTRONICS INC
 GENERAL ELECTRIC CO
 MALLORY DISTRIBUTOR PRODUCTS
 THE NOVA COMPANY
 SINGER PRODUCTS CO.
 TEXAS INSTRUMENTS
 TRW ELECTRONICS

CAPACITORS, FIXED, METALLIZED

AEROVOX CORP.
 ALTEC LANSING
 CENTRALAB
 CORNELL-DUBILIER ELECTRONICS
 DEARBORN ELECTRONICS INC
 THE NOVA COMPANY
 TRW ELECTRONICS

CAPACITORS, FIXED, MICA

AEROVOX CORP.
 ALTEC LANSING
 CORNELL-DUBILIER ELECTRONICS
 G E CAPACITOR DEPARTMENT
 GENERAL RADIO CO
 MINNESOTA MINING - 3 M
 SINGER PRODUCTS CO.

CAPACITORS, FIXED, OIL-FILLED

AEROVOX CORP.
 ALTEC LANSING
 DEARBORN ELECTRONICS INC
 ENGINEERING ASSOCIATES
 G E CAPACITOR DEPARTMENT
 GENERAL ELECTRIC CO
 SINGER PRODUCTS CO.

CAPACITORS, FIXED, PAPER

AEROVOX CORP.
 ALTEC LANSING
 CORNELL-DUBILIER ELECTRONICS
 DEARBORN ELECTRONICS INC
 GENERAL ELECTRIC CO
 SINGER PRODUCTS CO.

CAPACITORS, FIXED, OTHER

AEROVOX CORP.
 ALTEC LANSING
 AMPEREX ELECTRONIC CORP
 COOK ELECTRIC COMPANY
 CORNELL-DUBILIER ELECTRONICS
 DEARBORN ELECTRONICS INC
 G E CAPACITOR DEPARTMENT
 GENERAL ELECTRIC CO
 GENERAL RADIO CO
 JENNINGS RADIO MANUFACTURING
 MALLORY DISTRIBUTOR PRODUCTS

CAPACITORS, VARIABLE

ALTEC LANSING
 AMERICAN ELITE
 BUD RADIO, INC
 CARDWELL CONDENSER CORP
 CENTRALAB
 GENERAL RADIO CO
 JENNINGS RADIO MANUFACTURING
 E F JOHNSON COMPANY
 ROANWELL CORPORATION
 SARKES-TARZIAN
 SINGER PRODUCTS CO.
 SOLITRON DEVICES
 TRW ELECTRONICS

CARRIER CURRENT EQUIPMENT

BAUER ELECTRONICS CORPORATION
 LOW POWER
 ORBIT RADIO

CARTRIDGES, MAGNETIC TAPE

AMERLINE CORPORATION
 AUDIO DEVICES
 BROADCAST ELECTRONICS, INC
 CINE SONIC SOUND
 DISPLAY TECHNOLOGIES INC
 GATES RADIO COMPANY
 INTERNATIONAL GOGO MUSIC
 JOA CARTRIDGE SERVICE
 KRS INSTRUMENTS DIVISION
 MACARTA INC.
 MACKENZIE LABORATORIES
 MAGNETIC MEDIA CORPORATION
 MARATHON PRODUCTS CORP.
 MILES REPRODUCER CO
 MINNESOTA MINING - 3 M
 RCA BROADCAST PRODS.
 REEVES SOUNDCRAFT
 SHURE BROTHERS, INC.
 SINGER PRODUCTS CO.
 SPARTA ELECTRONIC CORPORATION
 TAPECASTER ELECTRONICS
 VIKING OF MINNEAPOLIS
 VISUAL ELECTRONICS CORP

CARTRIDGES, PHONO

THE ASIATIC CORPORATION
 BENJAMIN ELECTRONIC SOUND CORP
 ELECTRO-VOICE INC
 EUPHONICS MARKETING
 FAIRCHILD RECORDING EQUIPMENT
 G E DISTRIBUTOR SALES FORCE
 GOTHAM AUDIO CORPORATION
 GRADO LABORATORIES, INC
 RCA BROADCAST PRODS.
 SINGER BROTHERS, INC.
 SINGER PRODUCTS CO
 SONY CORPORATION OF AMERICA
 SPARTA ELECTRONIC CORPORATION

CARTRIDGES, TAPE,
RECORDING SERVICE
 AMPEX CORPORATION
 CINE SONIC SOUND
 MARATHON PRODUCTS CORP.
 ORBIT RADIO

CASES, PORTABLE

ELECTRONIC EQUIPMENT
 ENCLOSURE CORP
 HEWLETT-PACKARD CO.

CATV EQUIPMENT & COMPONENTS -

ALSO SEE OTHER CATEGORIES.

AMECO, INC.
 AMERICAN CABLE ELECTRONICS
 AMERICAN ELECTRONIC LABS
 AMPLIVISION CORPORATION
 ANACONDA ASTRODATA CO
 BALL BROTHERS RESEARCH
 BENCO TELEVISION ASSOCIATES
 BLONDER-TONGUE LABORATORIES
 C-COR ELECTRONICS
 COMU ELECTRONICS
 ELECTROLINE TV EQUIPMENT INC.
 ENTRON INC
 JERROLD ELECTRONICS CORP
 KAISER-COX
 PRUZAN COMPANY
 SIGMA INDUSTRIES
 SPENCER-KENNEDY LABORATORIES
 TAPE-ATHON CORPORATION
 TELEMATION, INC.
 TELEQUIP CORPORATION
 TELEVISION UTILITIES CORP
 TRW ELECTRONICS
 UTILITY TOWER CO.

CATV, CABLE TERMINALS

AMECO, INC.
 AMERICAN PAMCO, INC
 ANACONDA ASTRODATA CO
 BENCO TELEVISION ASSOCIATES
 ENTRON INC
 JERROLD ELECTRONICS CORP
 KAISER-COX
 SIGMA INDUSTRIES
 SUPERIOR CABLE CORPORATION
 TELEMET COMPANY
 TELEQUIP CORPORATION
 TELEUIP PRODUCTS CO.

CATV, CHANNEL AMPLIFIERS

AMECO, INC.
 AMERICAN ELECTRONIC LABS
 AMPLIVISION CORPORATION
 ANACONDA ASTRODATA CO
 KEITH ANDERSON CO
 BENCO TELEVISION ASSOCIATES
 BLONDER-TONGUE LABORATORIES
 C-COR ELECTRONICS
 ENTRON INC
 JERROLD ELECTRONICS CORP
 KAISER-COX
 SPENCER-KENNEDY LABORATORIES
 TELESIS CORPORATION

CATV, HEAD-END EQUIPMENT

AMECO, INC.
 AMERICAN ELECTRONIC LABS
 AMPLIVISION CORPORATION
 ANACONDA ASTRODATA CO
 KEITH ANDERSON CO
 BENCO TELEVISION ASSOCIATES
 BLONDER-TONGUE LABORATORIES
 C-COR ELECTRONICS
 DYNAIR ELECTRONICS, INC.
 ENTRON INC
 INTERNATIONAL GOOD MUSIC
 JERROLD ELECTRONICS CORP
 KAISER-COX
 ROMN MANUFACTURING CO.
 SPENCER-KENNEDY LABORATORIES
 TELEMET COMPANY
 TELESIS CORPORATION
 TELEVISION UTILITIES CORP

CATV, ORIENTATION EQUIPMENT

AMECO, INC.
 AMERICAN CABLE ELECTRONICS
 AMERICAN ELECTRONIC LABS
 AMPEX CORPORATION
 AMPLIVISION CORPORATION
 BLONDER-TONGUE LABORATORIES
 CATEL COMPANY
 CENTRAL DYNAMICS CORPORATION
 COMU ELECTRONICS
 JERROLD ELECTRONICS CORP
 KAISER-COX
 TELEMATION, INC.
 TELEQUIP CORPORATION
 TELESIS CORPORATION
 TELEVISION UTILITIES CORP

CAVITIES, MICROWAVE

AMPEREX ELECTRONIC CORP
 DEMORNAY - BONAROI DIVISION
 MICROBAR / FXR
 MICRO-LINK SYSTEMS/VARIAN ASSO
 MICROWAVE ASSOCIATES, INC.
 NAROA MICROWAVE CORPORATION
 RCA ELECTRONIC COMPONENTS

CHARGERS, BATTERY

AMPHENOL DISTRIBUTOR DIVISION
 BIRNS & SAWYER
 COLORTAN INDUSTRIES - BERKEY
 G C ELECTRONICS COMPANY
 GENERAL ELECTRIC CO
 IMPEX ELECTRONICS CORP
 ONAN DIVISION
 SINGER PRODUCTS CO

CHASSIS - SEE HARDWARE

CHOKES, WAVEGUIDE
 OENORNAY - BONAROI DIVISION
 MICRO-LINK SYSTEMS/VARIAN ASSO
 MICROWAVE ASSOCIATES, INC.
 NAROA MICROWAVE CORPORATION
 PAINTON INCORPORATED

CHOPPERS
 OAK MANUFACTURING CO
 TOWNSENO ASSOCIATES

CIRCUIT BREAKERS
 CCA ELECTRONICS CORPORATION
 G C ELECTRONICS COMPANY
 G E INDUSTRIAL SALES OPERATION
 GENERAL ELECTRIC CO
 HOUSTON ELECTRONICS CO.
 LITTLE FUSE, INC.
 MALLORY DISTRIBUTOR PRODUCTS

CIRCUITS, PRINTED
 AMECO, INC.
 SINGER PRODUCTS CO.
 SOLITRON DEVICES
 TOWNSENO ASSOCIATES
 TREPAC CORPORATION OF AMERICA
 VITRO ELECTRONICS

CLAMPS, CABLE
 AMECO, INC.
 ANDREW CORPORATION
 BIRNBACH CO
 OIAMOND EXPANSION BOLT CO INC
 G C ELECTRONICS COMPANY
 SUPERIOR CABLE CORPORATION
 THE THOMAS & BETTS CO
 WECKESSER COMPANY, INC.

CLAMPS, COMPONENT
 ELECTROVFR, INCORPORATED
 TELEMFT COMPANY
 THF THOMAS & BETTS CO

CLAMPS, GROUND
 AMECO, INC.
 THE THOMAS & BETTS CO

CLAMPS, TUBE
 THE THOMAS & BETTS CO

CLEANERS, CHEMICAL -
 ALSO SEE SOLVENTS
 BROADCAST ELECTRONICS, INC
 G C ELECTRONICS COMPANY
 J W GIBSON CO, INC

CLEANERS, LENS
 DUOTONE COMPANY INC
 THE TEXWIPE COMPANY

CLEANERS, OTHER -
 ALSO SEE SOLVENTS
 DUOTONE COMPANY INC
 G C ELECTRONICS COMPANY
 NEUMAD PRODUCTS CORPORATION
 THE TEXWIPE COMPANY

CLIPS, TEST
 BIRNBACH CO
 ELECTRONICS ESSENTIALS OF CCC
 G C ELECTRONICS COMPANY
 HEWLETT-PACKARD CO.
 INDUSTRIAL DEVICES, INC.

CLOCKS & CHRONOGRAPHS
 CCA ELECTRONICS CORPORATION
 CENTRAL DYNAMICS CORPORATION
 CHRONO-LOG CORPORATION
 G E SUPPLY COMPANY
 GENERAL RADIO CO
 GIBBS MFG. AND RESEARCH CORP.
 RCA BROADCAST PRODS.
 RIKER VIDEO INDUSTRIES
 TEXAS ELECTRONICS

COILS - ALSO SEE INDUCTANCES

COILS, ANTENNA LOADING
 BARKER & WILLIAMSON
 CCA ELECTRONICS CORPORATION
 COLLINS RADIO COMPANY
 DELTA ELECTRONICS INC
 GATES RADIO COMPANY
 MULTRONICS
 PRODELIN, INCORPORATED
 RCA BROADCAST PRODS.
 TRW ELECTRONICS

COILS, CHOKE, AF
 ADC PRODUCTS
 ALTEC LANSING
 PERMOFLUX CORPORATION
 TRW ELECTRONICS
 UNITED TRANSFORMER COMPANY

COILS, CHOKE, RF
 ALTEC LANSING
 BARKER & WILLIAMSON
 CALBEST ELECTRONICS
 CCA ELECTRONICS CORPORATION
 O & B ELECTRONICS COMPANY
 GATES RADIO COMPANY
 E F JOHNSON COMPANY
 TRW ELECTRONICS

COILS, DEFLECTION AND FOCUSING
 AMERICAN ELITE
 CLEVELAND ELECTRONICS
 DEFLECTION COMPONENTS DIV
 CONRAC
 LAKE ELECTRONICS, INC.
 SINGER PRODUCTS CO.
 TELEQUIP CORPORATION
 TRW ELECTRONICS

COILS, DEGAUSSING
 G E ELECTRONICS COMPANY

COILS, HYBRID
 ADC PRODUCTS
 ALTEC LANSING
 RCA BROADCAST PRODS.
 UNITED TRANSFORMER COMPANY

COILS, TELEPHONE
 ADC PRODUCTS
 ALTEC LANSING
 RCA BROADCAST PRODS.
 SINGER PRODUCTS CO.
 UNITED TRANSFORMER COMPANY

COMMUNICATIONS SYSTEMS, CB
 ALTEC LANSING
 AMPHENOL DISTRIBUTOR DIVISION
 BROWNING LABORATORIES, INC.
 COURIER COMMUNICATIONS
 F & M SYSTEMS COMPANY
 HEATH CO
 F F JOHNSON COMPANY
 MILES REPRODUCER CO
 MOSELEY ASSOCIATES INC.
 THE NOVA COMPANY
 PRODELIN, INCORPORATED
 RCA ELECTRONIC COMPONENTS
 SINGER PRODUCTS CO.
 UTICA CORPORATION

COMMUNICATIONS SYSTEMS, INTERCOM, WIRED
 ALTEC LANSING
 AMERICAN ELITE
 AMERICAN GLOSO ELECTRONICS
 ASCO SONOCRAFT CORP
 ATLAS SOUND
 CALBEST ELECTRONICS
 CENTRAL DYNAMICS CORPORATION
 DELTA ELECTRONICS, INC.
 F & M SYSTEMS COMPANY
 FISHER BERKELEY CORPORATION
 THE JAMES FLOYD FORD CO
 HEATH CO
 ITT TELECOMMUNICATIONS
 MCMARTIN INDUSTRIES
 MILES REPRODUCER CO
 RCA BROADCAST PRODS.
 SOUTHWESTERN COMMUNICATIONS
 ULTRA AUDIO PRODUCTS
 VISUAL ELECTRONICS CORP
 WARD ELECTRONIC INDUSTRIES

COMMUNICATIONS SYSTEMS, INTERCOM, WIRELESS
 ASCO SONOCRAFT CORP
 DELTA ELECTRONICS, INC.
 F & M SYSTEMS COMPANY
 FISHER BERKELEY CORPORATION
 THE JAMES FLOYD FORD CO
 HEATH CO
 E F JOHNSON COMPANY
 MILES REPRODUCER CO
 ROUND HILL ASSOCIATES
 SOUTHWESTERN COMMUNICATIONS
 UTICA CORPORATION

COMMUNICATIONS SYSTEMS, LAND MOBILE
 ALTEC LANSING
 AMERICAN ELITE
 AMPEX CORPORATION
 ATLAS SOUND
 CCA ELECTRONICS CORPORATION
 F & M SYSTEMS COMPANY
 THE JAMES FLOYD FORD CO
 J M ELECTRONICS COMPANY
 E F JOHNSON COMPANY
 MARTI ELECTRONICS
 MILES REPRODUCER CO
 MOSELEY ASSOCIATES INC.
 MULTRONICS
 THE NOVA COMPANY
 PRODELIN, INCORPORATED
 RCA BROADCAST PRODS.
 SINGER PRODUCTS CO
 SOUTH SHORE RADIO TELEPHONE
 UTICA CORPORATION

COMMUNICATIONS SYSTEMS, MICROWAVE
 ALTEC LANSING
 AMERICAN ELECTRONIC LABS
 AMERICAN ELITE
 AMPLIVISION CORPORATION
 F & M SYSTEMS COMPANY
 ITT TELECOMMUNICATIONS
 JERROLO ELECTRONICS CORP
 LENKURT ELECTRIC CO., INC.
 MARTI ELECTRONICS
 MICROLAB / FXR
 MICRO-LINK SYSTEMS/VARIAN ASS
 MICROWAVE ASSOCIATES, INC.
 MOSELEY ASSOCIATES INC.
 PRODELIN, INCORPORATED
 RCA BROADCAST PRODS.
 RHG ELECTRONICS LABORATORY
 SARKES-TARZIAN
 STAINLESS, INC.

COMMUNICATIONS SYSTEMS, MULTIPLEX
 AMERICAN ELITE
 BELAR ELECTRONICS LABORATORY
 BROWNING LABORATORIES, INC.
 F & M SYSTEMS COMPANY
 ITT TELECOMMUNICATIONS
 LENKURT ELECTRIC CO., INC.
 MCMARTIN INDUSTRIES
 MOSELEY ASSOCIATES INC.
 RCA BROADCAST PRODS.
 RHG ELECTRONICS LABORATORY
 SINGER PRODUCTS CO.
 TOWNSENO ASSOCIATES

FULL COLOR FIDELITY WITH **COLORVUE** SOLID-STATE CATV TRUNK-LINE AMPLIFIERS

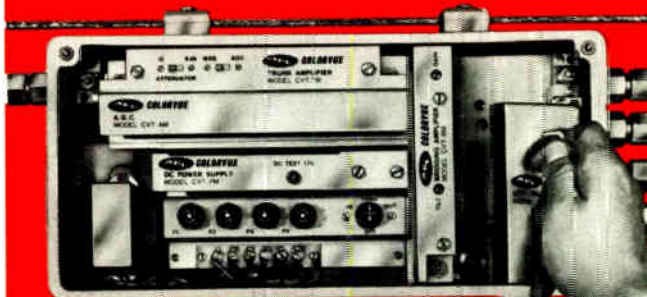

**HIGH OUTPUT • HIGH GAIN
 LOW NOISE • FLAT RESPONSE
 TRUE PLUG-IN MODULARITY**

Looking for high-grade color distribution, plus easy field maintenance and low inventory costs? Then see COLORVUE... the solid-state amplifier with the 48dbmv output and 26db operating gain over all 12 channels, low noise figure and VSWR, ± 0.25 db response flatness and 5C to 220MHz, bandwidth.

And it's truly modular! Just one basic housing and five individual units that plug in—in the field—in seconds and with 1 to 4 feeder lines.

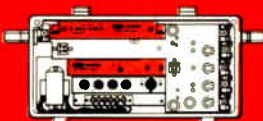

Basic housing with Trunk Amplifier / DC Power Supply (2 modules).



Basic housing with Trunk Amplifier / AGC / DC Power Supply (3 modules).

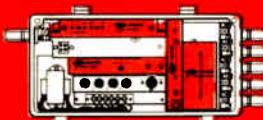

Basic housing with Trunk Amplifier / Bridging Amplifier / Off-Trunk Splitter / DC Power Supply (4 modules).



Basic housing with Trunk Amplifier / AGC / Bridging Amplifier / Off-Trunk Splitter / DC Power Supply (5 modules).

Yes, COLORVUE is great... the result of AEL's exceptional capabilities. Want to know more? Drop us a line or call us at 215/822-2929.



CATV DIVISION

**American
 Electronic
 Laboratories, Inc.**

RICHARDSON ROAD, COLMAR, PA.
 215/822-2929 • TWX 510/561-4978

Correspondence: P.O. Box 552, Lansdale, Pennsylvania 19446

COMMUNICATIONS SYSTEMS

TELEPRINTER
F & M SYSTEMS COMPANY
SINGER PRODUCTS CO
TREPAC CORPORATION OF AMERICA

COMPUTER EQUIPMENT

AMPEX CORPORATION
CHRONO-LOG CORPORATION
DISPLAY TECHNOLOGIES INC
GENERAL ELECTRIC CO
HANCOCK TELECONTROL
HARVEY RADIO CO, INC.
HEATH CO
MINNESOTA MINING - 3 M
SARKES-TARZIAN
S. STERLING COMPANY

COMPUTER SERVICES

ACME VISIBLE RECORDS
THE JAMES FLOYD FORD CO
S. STERLING COMPANY

CONNECTORS, AF & MICROPHONE

AMPHENOL DISTRIBUTOR DIVISION
DIALIGHT CORPORATION
ELECTRONICS ESSENTIALS OF CCC
G C ELECTRONICS COMPANY
GENERAL RADIO CO
GOTHAM AUDIO CORPORATION
ITT CANNON ELECTRIC
RCA BROADCAST PRODS.
SWITCHCRAFT, INC.
TROMPETER ELECTRONICS

CONNECTORS, ANTENNA

AMECO, INC.
AMERICAN PAMCOR, INC
AMPHENOL DISTRIBUTOR DIVISION
AMPLIVISION CORPORATION
BLONDER-TONGUE LABORATORIES
G C ELECTRONICS COMPANY
ITT CANNON ELECTRIC
JERROLD ELECTRONICS CORP
PHELPS DODGE
PRODELIN, INCORPORATED
ROHDE & SCHWARZ SALES CO. -USA
THE TECHNICAL MATERIEL CORP
TROMPETER ELECTRONICS

CONNECTORS, COAXIAL CABLE

AMECO, INC.
AMERICAN CABLE ELECTRONICS
AMERICAN PAMCOR, INC
AMPHENOL DISTRIBUTOR DIVISION
AMPLIVISION CORPORATION
ANACONDA ASTRODATA CO
ANDREW CORPORATION
BENCO TELEVISION ASSOCIATES
BLONDER-TONGUE LABORATORIES
COOKE ENGINEERING COMPANY
CRAFTSMAN ELECTRONICS PRODUCTS
ENGINEERING ASSOCIATES
ENTRON INC
G C ELECTRONICS COMPANY
GENERAL RADIO CO
ITT CANNON ELECTRIC
JERROLD ELECTRONICS CORP
KAISER-COX
NARDA MICROWAVE CORPORATION
PHELPS DODGE
PRODELIN, INCORPORATED
RCA BROADCAST PRODS.
ROHDE & SCHWARZ SALES CO. -USA
SIGMA INDUSTRIES, INC.
SINGER PRODUCTS CO.
SPENCER-KENNEDY LABORATORIES
SUPERIOR CABLE CORPORATION
THE TECHNICAL MATERIEL CORP
TELETRONIX
THE THOMAS & BETTS CO
TIMES WIRE AND CABLE
TROMPETER ELECTRONICS
VISUAL ELECTRONICS CORP
VITRO ELECTRONICS

CONNECTORS, POWER

AMECO, INC.
AMERICAN PAMCOR, INC
AMPHENOL DISTRIBUTOR DIVISION
ITT CANNON ELECTRIC
ROHDE & SCHWARZ SALES CO. -USA
THE THOMAS & BETTS CO
WABER ELECTRONICS, INC.

CONNECTORS, RF

AMECO, INC.
AMERICAN PAMCOR, INC
AMPHENOL DISTRIBUTOR DIVISION
AMPLIVISION CORPORATION
ANDREW CORPORATION
BIRD ELECTRONIC CORPORATION
CRAFTSMAN ELECTRONICS PRODUCTS
ENGINEERING ASSOCIATES
ENTRON INC
GENERAL RADIO CO
ITT CANNON ELECTRIC
JERROLD ELECTRONICS CORP
MICROWAVE ASSOCIATES, INC.
NARDA MICROWAVE CORPORATION
PHELPS DODGE
PRODELIN, INCORPORATED
ROHDE & SCHWARZ SALES CO. -USA
SUPERIOR CABLE CORPORATION
SWITCHCRAFT, INC.
THE TECHNICAL MATERIEL CORP
THE THOMAS & BETTS CO
TIMES WIRE AND CABLE
TROMPETER ELECTRONICS
VITRO ELECTRONICS

CONSOLE, AUDIO, AM

ALMA ENGINEERING INC
AMPEX CORPORATION
BAUER ELECTRONICS CORPORATION
CCA ELECTRONICS CORPORATION

COLLINS RADIO COMPANY
CROWN INTERNATIONAL
FAIRCHILD RECORDING EQUIPMENT
G E VISUAL COMMUNICATIONS PROD
GOTHAM AUDIO CORPORATION
HOUSTON ELECTRONICS CO.
IMPEX ELECTRONICS CORP
MID AMERICA ELECTRONICS CORP
RCA BROADCAST PRODS.
SINGER PRODUCTS CO
SPARTA ELECTRONIC CORPORATION
STEPHENS ELECTRONICS
TELETRONIX
UNITED RADIO SUPPLY, INC
VISUAL ELECTRONICS CORP
WILKINSON ELECTRONICS, INC

CONSOLE, AUDIO, FM

ALMA ENGINEERING INC
ALTEC LANSING
AMPEX CORPORATION
ANCHA ELECTRONICS
BAUER ELECTRONICS CORPORATION
CCA ELECTRONICS CORPORATION
COLLINS RADIO COMPANY
FAIRCHILD RECORDING EQUIPMENT
GATES RADIO COMPANY
GOTHAM AUDIO CORPORATION
HARVEY RADIO CO, INC.
HOUSTON ELECTRONICS CO.
IMPEX ELECTRONICS CORP
LITTLE JOE ENTERPRISES
MID AMERICA ELECTRONICS CORP
ORBIT RADIO
RCA BROADCAST PRODS.
SINGER PRODUCTS CO
SOUTHWESTERN COMMUNICATIONS
SPARTA ELECTRONIC CORPORATION
STANDARD ELECTRONICS CORP.
STEPHENS ELECTRONICS
TELETRONIX
ULTRA AUDIO PRODUCTS
VISUAL ELECTRONICS CORP
WARD ELECTRONIC INDUSTRIES
WILKINSON ELECTRONICS, INC

CONSOLE, AUDIO, PORTABLE

ALMA ENGINEERING INC
ALTEC LANSING
AMPEX CORPORATION
BAUER ELECTRONICS CORPORATION
CCA ELECTRONICS CORPORATION
DATA INSTRUMENT DIVISION
DELTA ELECTRONICS, INC.
GATES RADIO COMPANY
G E VISUAL COMMUNICATIONS PROD
GOTHAM AUDIO CORPORATION
HARVEY RADIO CO, INC.
HOUSTON ELECTRONICS CO.
IMPEX ELECTRONICS CORP
LANG ELECTRONICS, INC
LITTLE JOE ENTERPRISES
MID AMERICA ELECTRONICS CORP
NORTH AMERICAN PHILIPS CO
ORBIT RADIO
RCA BROADCAST PRODS.
SINGER PRODUCTS CO
SOUTHWESTERN COMMUNICATIONS
SPARTA ELECTRONIC CORPORATION
STEPHENS ELECTRONICS
STEPHENS ELECTRONICS
TELETRONIX
ULTRA AUDIO PRODUCTS
VISUAL ELECTRONICS CORP
WARD ELECTRONIC INDUSTRIES

CONSOLE, AUDIO, RECORDING

ALMA ENGINEERING INC
ALTEC LANSING
AMERICAN ELITE
AMPEX CORPORATION
ANCHA ELECTRONICS
ASCO SONOCRAFT CORP
BAUER ELECTRONICS CORPORATION
CCA ELECTRONICS CORPORATION
DATA INSTRUMENT DIVISION
FAIRCHILD RECORDING EQUIPMENT
GATES RADIO COMPANY
G E VISUAL COMMUNICATIONS PROD
GOTHAM AUDIO CORPORATION
HARVEY RADIO CO, INC.
HOUSTON ELECTRONICS CO.
IMPEX ELECTRONICS CORP
LANG ELECTRONICS, INC
LITTLE JOE ENTERPRISES
MID AMERICA ELECTRONICS CORP
NORTH AMERICAN PHILIPS CO
ORBIT RADIO
RCA BROADCAST PRODS.
SINGER PRODUCTS CO
SOUTHWESTERN COMMUNICATIONS
SPARTA ELECTRONIC CORPORATION
STEPHENS ELECTRONICS
TELETRONIX
ULTRA AUDIO PRODUCTS
UNITED RADIO SUPPLY, INC
VISUAL ELECTRONICS CORP
WARD ELECTRONIC INDUSTRIES
WILKINSON ELECTRONICS, INC

CONSOLE, AUDIO, TV

ALMA ENGINEERING INC
ALTEC LANSING
AMPEX CORPORATION
ANCHA ELECTRONICS
BAUER ELECTRONICS CORPORATION
BLONDER-TONGUE LABORATORIES
CCA ELECTRONICS CORPORATION
CENTRAL DYNAMICS CORPORATION
COLLINS RADIO COMPANY
DATA INSTRUMENT DIVISION
FAIRCHILD RECORDING EQUIPMENT
GATES RADIO COMPANY
G E VISUAL COMMUNICATIONS PROD

GOTHAM AUDIO CORPORATION
HOUSTON ELECTRONICS CO.
INTERNATIONAL NUCLEAR CORP.
LAKE ELECTRONICS, INC.
LITTLE JOE ENTERPRISES
MARYLAND TELECOMMUNICATIONS
MID AMERICA ELECTRONICS CORP
ORBIT RADIO
RCA BROADCAST PRODS.
SARKES-TARZIAN
SINGER PRODUCTS CO.
SOUTHWESTERN COMMUNICATIONS
SPARTA ELECTRONIC CORPORATION
STANDARD ELECTRONICS CORP
STEPHENS ELECTRONICS
S. STERLING COMPANY
SYLVANIA-COMM. ELECTRONICS DIV
TELETRONIX
ULTRA AUDIO PRODUCTS
VISUAL ELECTRONICS CORP
WARD ELECTRONIC INDUSTRIES
WILKINSON ELECTRONICS, INC

CONSOLE, CABINETS AND HARDWARE

ALTEC LANSING
ASCO SONOCRAFT CORP
BAUER ELECTRONICS CORPORATION
BUD RADIO, INC
DATA INSTRUMENT DIVISION
ENCLOSURE CORP
GATES RADIO COMPANY
GRINNAN FIXTURE COMPANY
LANG ELECTRONICS, INC
LITTLE JOE ENTERPRISES
RCA BROADCAST PRODS.
SCIENTIFIC-ATLANTA
SINGER PRODUCTS CO.
SPARTA ELECTRONIC CORPORATION
"EQUIP CORPORATION"
"TELEVISION UTILITIES CORP"
VENT-RAK INCORPORATED

CONSOLE, KITS

AMPEX CORPORATION
BAUER ELECTRONICS CORPORATION
DATA INSTRUMENT DIVISION
FAIRCHILD RECORDING EQUIPMENT
GOTHAM AUDIO CORPORATION
"EQUIP CORPORATION"
TELEVISION UTILITIES CORP

CONSOLE, VIDEO, PORTABLE

ALMA ENGINEERING INC
AMPEX CORPORATION
AMPLIVISION CORPORATION
CENTRAL DYNAMICS CORPORATION
DATA INSTRUMENT DIVISION
RIKFR VIDEO INDUSTRIES
SARKES-TARZIAN
SONY CORPORATION OF AMERICA
S. STERLING COMPANY
SYLVANIA-COMM. ELECTRONICS DIV
"EQUIP CORPORATION"
TELEVISION UTILITIES CORP
WARD ELECTRONIC INDUSTRIES

CONSOLE, VIDEO, STUDIO

ALMA ENGINEERING INC
AMPEX CORPORATION
AMPLIVISION CORPORATION
CENTRAL DYNAMICS CORPORATION
DATA INSTRUMENT DIVISION
MARYLAND TELECOMMUNICATIONS
MID AMERICA ELECTRONICS CORP
RCA BROADCAST PRODS.
RIKFR VIDEO INDUSTRIES
SARKES-TARZIAN
SONY CORPORATION OF AMERICA
S. STERLING COMPANY
SYLVANIA-COMM. ELECTRONICS DIV
"EQUIP CORPORATION"
TELEVISION UTILITIES CORP
WARD ELECTRONIC INDUSTRIES

CONVERTERS

ALTEC LANSING
AMECO, INC.
AMPLIVISION CORPORATION
KEITH ANDERSON CO
F W BELL, INC
RENCO TELEVISION ASSOCIATES
RIRMS & SAWYER
BLONDER-TONGUE LABORATORIES
GENERAL ELECTRIC CO
GIBBS MFG. AND RESEARCH CORP.
JERROLD ELECTRONICS CORP
KAHN RESEARCH LABORATORIES
MICROWAVE ASSOCIATES, INC.
MINNESOTA MINING - 3 M
THE SINGER CO - METRICS DIV
STANDARD KOLLSMAN INDUSTRIES
THE TECHNICAL MATERIEL CORP

CODLING UNITS, TUBE

ETMAC DIVISION OF VARIAN

COPYING EQUIPMENT

MINNESOTA MINING - 3 M

COROS, DIAL

BIRNBACH CO
G C ELECTRONICS COMPANY
SINGER PRODUCTS CO.
UNITED STATES PLASTIC ROPE

COROS, LACING

BIRNBACH CO
G C ELECTRONICS COMPANY

COROS, PATCH

ADC PRODUCTS
APPLIED ELECTRO-MECHANICS

AUDIO ACCESSORIES
BIRNBACH CO
CCA ELECTRONICS CORPORATION
CENTRAL DYNAMICS CORPORATION
COLTRAM INDUSTRIES - BERKEY
COOKE ENGINEERING COMPANY
D & H ELECTRONICS COMPANY
ELECTRONICS ESSENTIALS OF CCC
HOLLAND ELECTRONICS INC
RCA BROADCAST PRODS.
ROBINS INDUSTRIES CORP.
SARKES-TARZIAN
SINGER PRODUCTS CO.
SWITCHCRAFT, INC.
THE TECHNICAL MATERIEL CORP
TROMPETER ELECTRONICS
VITRO ELECTRONICS

COROS, SET

RFIDEN MANUFACTURING CO
BIRNBACH CO
D & B ELECTRONICS COMPANY
ITT WIRE & CABLE DIVISION
SINGER PRODUCTS CO.
WARER ELECTRONICS, INC.

CORES, TRANSFORMER AND COIL

SINGER PRODUCTS CO.

COUNTERS, FREQUENCY

ENGINEERING ASSOCIATES
GENERAL RADIO CO
HEWLETT-PACKARD CO.
HICKOK ELECTRICAL INSTRUMENT

COUPLERS

AMECO, INC.
BIRD ELECTRONIC CORPORATION
CONTINENTAL ELECTRONICS MFG
CRAFTSMAN ELECTRONICS PRODUCTS
DEMNORAY - RONARDI DIVISION
G C ELECTRONICS COMPANY
E F JOHNSON COMPANY
MICROLAR / FXR
MICROWAVE ASSOCIATES, INC.
MULTRONICS
NARDA MICROWAVE CORPORATION
RCA BROADCAST PRODS.
ROHDE & SCHWARZ SALES CO. -USA
SINGER PRODUCTS CO.
STANDARD ELECTRONICS CORP
WARER ELECTRONICS, INC.

CRYSTALS, PIEZOELECTRIC

CRYSTAL ELECTRONIC COMPANY
ELECTRONIC RESEARCH COMPANY
G E DISTRIBUTOR SALES FORCE
MINNESOTA MINING - 3 M
PIEZO CRYSTAL COMPANY
PRECISION PIEZO SERVICE
RCA BROADCAST PRODS.
TRW ELECTRONICS

CUTTERS, DISC - SEE LATHE**DECALCOMANIAS**

W H BRADY CO
G C ELECTRONICS COMPANY
MINNESOTA MINING - 3 M

DEHUMIDIFIERS

PALL TRINITY MICRO CORP

DELAY DEVICES, AF

AUDIO INSTRUMENT CO
BAUER ELECTRONICS CORPORATION
S. HIMMELSTEIN AND CO.
SINGER PRODUCTS CO.
TAPECASTER ELECTRONICS
TRPAC CORPORATION OF AMERICA
UNITED TRANSFORMER COMPANY

DELAY LINES

ANDREW CORPORATION
AUDIO INSTRUMENT CO
CENTRAL DYNAMICS CORPORATION
GENERAL RADIO CO
JERROLD ELECTRONICS CORP
KAPPA NETWORKS, INC
MICROWAVE ASSOCIATES, INC.
PHELPS DODGE
RCA BROADCAST PRODS.
ROHDE & SCHWARZ SALES CO. -USA
UNITED TRANSFORMER COMPANY

DEMAGNETIZERS, BULK TAPE

AEROVOX CORP.
AMPEX CORPORATION
AMPLIFIER CORP OF AMERICA
BROADCAST ELECTRONICS, INC
G C ELECTRONICS COMPANY
HEWLETT-PACKARD CO.
JOA CARTRIDGE SERVICE
RCA BROADCAST PRODS.
ROBINS INDUSTRIES CORP.
SINGER PRODUCTS CO.
THE SOUND SCRIBER CORP.
SPARTA ELECTRONIC CORPORATION

DEMAGNETIZERS, HEAD

AMPEX CORPORATION
AMPLIFIER CORP OF AMERICA
AUDIO DEVICES
BROADCAST ELECTRONICS, INC
G C ELECTRONICS COMPANY
JOA CARTRIDGE SERVICE
RCA BROADCAST PRODS.
ROBINS INDUSTRIES CORP.
SPARTA ELECTRONIC CORPORATION

DEMODULATORS

AMECO, INC.
BELAR ELECTRONICS LABORATORY
OYNAIR ELECTRONICS, INC.
G E VISUAL COMMUNICATIONS PROD

RAYTHEON

THE BEST VALUE IN STUDIO EQUIPMENT

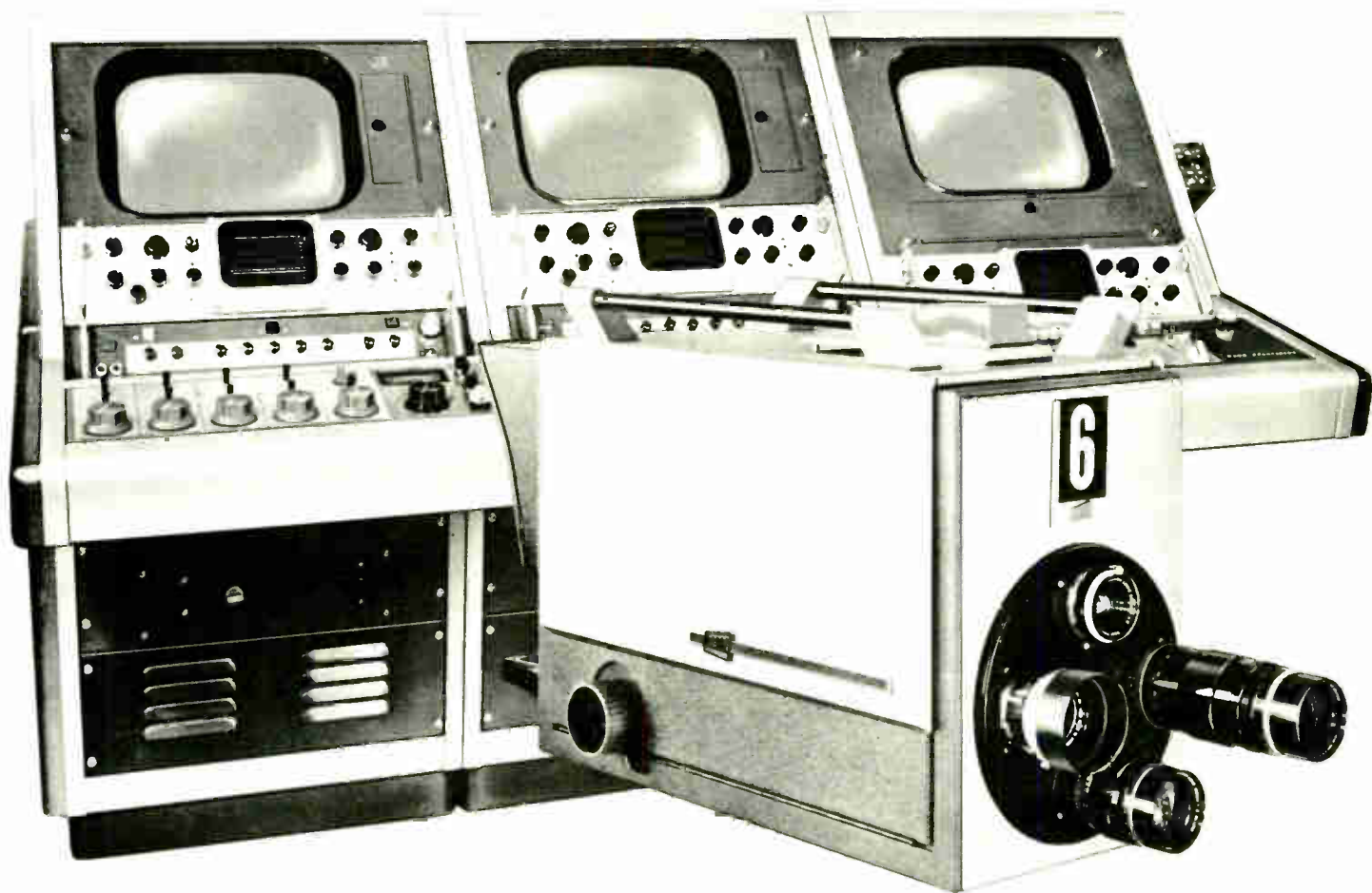

Whatever your requirements—commercial or educational broadcasting, CATV, closed circuit television, or 2500 mHz ITV, Raytheon offers the best value in television studio equipment. Whether you need a single component or a complete studio, Raytheon's years of experience in building television equipment for the broadcast industry, schools and the military, assures you of the ultimate in quality and years of satisfactory service.

Raytheon's experienced television consultants are at your service... why not discuss your needs with one of them today? There's no obligation, of course.

RAYTHEON TELEVISION SYSTEMS

RAYTHEON

DAGE-BELL CORPORATION

A SUBSIDIARY OF RAYTHEON COMPANY

455 Sheridan Avenue, Michigan City, Indiana 46360

JERROLD ELECTRONICS CORP
RCA BROADCAST PRODS.
RHOWE & SCHWARZ SALES CO. -USA
STANDARD ELECTRONICS CORP
WARD ELECTRONIC INDUSTRIES

DESICCANTS

G C ELECTRONICS COMPANY
PALL TRINITY MICRO CORP

DESIGNATION CARDS & STRIPS

ACME VISIBLE RECORDS

DETECTORS, MICROWAVE

DEMORNAY - BONARDI DIVISION
GENERAL ELECTRIC CO
GENERAL RADIO CO
HEWLETT-PACKARD CO.
JERROLD ELECTRONICS CORP
MICROLAB / FXR
MICRO-LINK SYSTEMS/VARIAN ASSO
MICROWAVE ASSOCIATES, INC.
NARDA MICROWAVE CORPORATION
RHOWE & SCHWARZ SALES CO. -USA
SYLVANIA-SEMICONDUCTOR DIV.

DETECTORS, STANDING WAVE

BIRD ELECTRONIC CORPORATION
BLONDER-TONGUE LABORATORIES
DEMORNAY - BONARDI DIVISION
GENERAL RADIO CO
HEWLETT-PACKARD CO.
MICROLAB / FXR
MICRO-LINK SYSTEMS/VARIAN ASSO
NARDA MICROWAVE CORPORATION
RHOWE & SCHWARZ SALES CO. -USA

DIAL POINTERS - SEE HARDWARE

DIALS, INSTRUMENT

AMPHENOL DISTRIBUTOR DIVISION
G C ELECTRONICS COMPANY
GENERAL RADIO CO
MALLORY DISTRIBUTOR PRODUCTS
TEXAS ELECTRONICS

DIALS, TELEPHONE

ITT TELECOMMUNICATIONS

DIODES - SEE SEMICONDUCTORS

DIPLEXERS

ALFORD MANUFACTURING COMPANY
G E VISUAL COMMUNICATIONS PROD
JAMPRO ANTENNA COMPANY
MICROLAB / FXR
MICROWAVE ASSOCIATES, INC.
PHELPS DODGE
PRODELIN, INCORPORATED
RCA BROADCAST PRODS.
STANDARD ELECTRONICS CORP
VISUAL ELECTRONICS CORP
BLONDER-TONGUE LABORATORIES

DISPLAY EQUIPMENT, TV

BLONDER-TONGUE LABORATORIES
C B S LABORATORIES
CENTRAL DYNAMICS CORPORATION
COMU ELECTRONICS
COLORADO VIDEO
CONRAC
DISPLAY TECHNOLOGIES INC
GRIMMAN FIXTURE COMPANY
ITI ELECTRONICS, INC.
MARCONI DIVISION
MARYLAND TELECOMMUNICATIONS
MICRO-LINK SYSTEMS/VARIAN ASSO
MIRATEL ELECTRONICS, INC
Q-TV SALES & DISTRIBUTING CORP
SARKES-TARZIAN
SYLVANIA-COMM. ELECTRONICS DIV
TELEQUIP CORPORATION
TELEVISION UTILITIES CORP

DIVIDERS, FREQUENCY

DEMORNAY - BONARDI DIVISION
GENERAL ELECTRIC CO
GENERAL RADIO CO
MICROWAVE ASSOCIATES, INC.
RHOWE & SCHWARZ SALES CO. -USA
TV CABLE SUPPLY CO
VIDEON CORPORATION

DIVIDERS, POWER

ALFORD MANUFACTURING COMPANY
CONTINENTAL ELECTRONICS MFG
DEMORNAY - BONARDI DIVISION
EMCEE
GATES RADIO COMPANY
MICROLAB / FXR
NARDA MICROWAVE CORPORATION
PRODELIN, INCORPORATED
SCIENTIFIC-ATLANTA
STANDARD ELECTRONICS CORP

DIVIDERS, VOLTAGE

ENGINEERING ASSOCIATES
GENERAL ELECTRIC CO
GENERAL RADIO CO
IRC, INC.
JENNINGS RADIO MANUFACTURING
THE SINGER CO - METRICS DIV

DOLLIES, CAMERA

BIRNS & SAWYER
BLONDER-TONGUE LABORATORIES
COLORTRON INDUSTRIES - BERKEY
HOUSTON FEARLESS CORPORATION
RCA BROADCAST PRODS.
SYLVANIA-COMM. ELECTRONICS DIV
TELEQUIP CORPORATION
TELEVISION UTILITIES CORP
THOMSON ELECTRIC CO
VISUAL ELECTRONICS CORP
WABER ELECTRONICS, INC.

DOLLIES, TEST EQUIPMENT

RCA BROADCAST PRODS.
THE SINGER CO - METRICS DIV
TEKTRONIX INC
TELEQUIP CORPORATION
WABER ELECTRONICS, INC.

DRAFTING EQUIPMENT

VALUE INCORPORATED

DROPOUT COMPENSATOR, VIDEO TAPE

AMPEX CORPORATION
MINNESOTA MINING - 3 M
RCA BROADCAST PRODS.
RIKER VIDEO INDUSTRIES
VISUAL ELECTRONICS CORP

DUCTS, VENTILATION

BURKE & JAMES

DUCTS, WIRING

WABER ELECTRONICS, INC.

DUMMY LOAD

AMERICAN ELECTRONIC LABS
BARKER & WILLIAMSON
BIRD ELECTRONIC CORPORATION
CCA ELECTRONICS CORPORATION
CONTINENTAL ELECTRONICS MFG
D & B ELECTRONICS COMPANY
DEMORNAY - BONARDI DIVISION
GATES RADIO COMPANY
JAMPRO ANTENNA COMPANY
LITTLE JOE ENTERPRISES
MICROLAB / FXR
PRODELIN, INCORPORATED
RCA BROADCAST PRODS.
RHOWE & SCHWARZ SALES CO. -USA
STANDARD ELECTRONICS CORP
THE TECHNICAL MATERIEL CORP
WATERS MANUFACTURING

EARPHONES, HEADPHONES

AMPEX CORPORATION
ASCO SONOCRAFT CORP
THE ASTATIC CORPORATION
G C ELECTRONICS COMPANY
GOTHAM AUDIO CORPORATION
HEATH CO
JENSEN MANUFACTURING
KOSS ELECTRONICS, INC.
NORTH AMERICAN PHILIPS CO
PERMOFLUX CORPORATION
RCA BROADCAST PRODS.
ROANWELL CORPORATION
SINGER PRODUCTS CO

ECHO DEVICES - SEE AMPLIFIERS

REGENERATION DEVICES

EDITORS, AUDIO TAPE

AMPEX CORPORATION
ASCO SONOCRAFT CORP
BIRNS & SAWYER
ORBIT RADIO
ROBINS INDUSTRIES CORP.
SCULLY RECORDING INSTRUMENTS

EDITORS, FILM

BIRNS & SAWYER
BURKE & JAMES
HARWALD COMPANY
THE KALART COMPANY
MINNESOTA MINING - 3 M
NEUMADE PRODUCTS CORPORATION
PRECISION LABORATORIES
RCA BROADCAST PRODS.

EDITORS, VIDEO TAPE

AMPEX CORPORATION
BIRNS & SAWYER
GOTHAM AUDIO CORPORATION
PRECISION LABORATORIES
RCA BROADCAST PRODS.
VISUAL ELECTRONICS CORP

EDUCATION FACILITIES, EQUIPMENT

ASCO SONOCRAFT CORP
AUDIO INSTRUMENT CO
CENTRAL DYNAMICS CORPORATION
CROWN INTERNATIONAL
DELTA ELECTRONICS, INC.
HARWALD COMPANY
JENSEN MANUFACTURING
KRS INSTRUMENTS DIVISION
NORTH AMERICAN PHILIPS CO
TELEMATON, INC.

EDUCATION FACILITIES, SCHOOLS

HOWARD W SAMS & CO INC
GRANTHAM SCHOOLS, INC

ELECTRIC MOTORS - SEE HARDWARE

ENCLOSURES, SPEAKER

ALTEC LANSING
ASCO SONOCRAFT CORP
ELECTRO-SOUND ACOUSTICS
ELECTRO-VOICE INC
HARTLEY PRODUCTS
NORTH AMERICAN PHILIPS CO
RCA BROADCAST PRODS.
TRUSONIC

ENHANCERS, TV IMAGE

LABORATORIES
COLORADO VIDEO
DYNASCENCES CORPORATION
G C ELECTRONICS COMPANY

MARCONI DIVISION

SARKES-TARZIAN

EQUALIZERS, AUDIO EMPHASIS

ALTEC LANSING
CCA ELECTRONICS CORPORATION
G E VISUAL COMMUNICATIONS PROD
GOTHAM AUDIO CORPORATION
GRAY RESEARCH & DEVELOPMENT CO
LANGEVIN
MELCOR ELECTRONICS
MILES REPRODUCER CO
PULSE TECHNIQUES, INC.
RCA BROADCAST PRODS.
SOUTHWESTERN COMMUNICATIONS

ERASERS, MAGNETIC - SEE HEADS

AND DEMAGNETIZERS

EXCITERS, FM

AMERICAN ELECTRONIC LABS
BELAR ELECTRONICS LABORATORY
CCA ELECTRONICS CORPORATION
COLLINS RADIO COMPANY
GATES RADIO COMPANY
KAHN RESEARCH LABORATORIES
MARCONI DIVISION
MARTI ELECTRONICS
MOSELEY ASSOCIATES INC.
RCA BROADCAST PRODS.
RHG ELECTRONICS LABORATORY
SINGER PRODUCTS CO
STANDARD ELECTRONICS CORP
TELETRONIX
TOWNSEND ASSOCIATES
VISUAL ELECTRONICS CORP
WILKINSON ELECTRONICS, INC

EXPOSURE METER -

SEE METERS, LIGHT

FACSIMILE EQUIPMENT

SINGER PRODUCTS CO

FILM, PHOTOGRAPHIC

EASTMAN KODAK COMPANY
MINNESOTA MINING - 3 M
NEUMADE PRODUCTS CORPORATION

FILM, PROCESSING SERVICE

AKME FILM & VIDEOTAPE LABS
EASTMAN KODAK COMPANY

FILTERS, ANTENNA

AMFCO, INC.
BENCO TELEVISION ASSOCIATES
BIRD ELECTRONIC CORPORATION
BLONDER-TONGUE LABORATORIES
CCA ELECTRONICS CORPORATION
GATES RADIO COMPANY
JAMPRO ANTENNA COMPANY
JERROLD ELECTRONICS CORP
PRODELIN, INCORPORATED
TELETRONIX

FILTERS, AUDIO

ADC PRODUCTS
AEROVOX CORP.
ALTEC LANSING
G E VISUAL COMMUNICATIONS PROD
GENERAL RADIO CO
LANGEVIN
ORBIT RADIO
RCA BROADCAST PRODS.
RECORDING EQUIPMENT COMPANY
RHOWE & SCHWARZ SALES CO. -USA
STEPHENS ELECTRONICS
TREPAC CORPORATION OF AMERICA
T T ELECTRONICS
UNITED TRANSFORMER COMPANY

FILTERS, RF

FILTERS, RF
ADC PRODUCTS
AEROVOX CORP.
AMFCO, INC.
AMERICAN ELECTRONIC LABS
BIRD ELECTRONIC CORPORATION
BLONDER-TONGUE LABORATORIES
CCA ELECTRONICS CORPORATION
CONTINENTAL ELECTRONICS MFG
CORNELL-DUBILIER ELECTRONICS
DELTA ELECTRONICS INC
GATES RADIO COMPANY
G E VISUAL COMMUNICATIONS PROD
GENERAL RADIO CO
HOLLAND ELECTRONICS INC
ITT CANNON ELECTRIC
JAMPRO ANTENNA COMPANY
JERROLD ELECTRONICS CORP
KAPPA NETWORKS, INC
MICROLAB / FXR
MICROWAVE ASSOCIATES, INC.
NARDA MICROWAVE CORPORATION
PRODELIN, INCORPORATED
RECORDING EQUIPMENT COMPANY
RHOWE & SCHWARZ SALES CO. -USA
STANDARD ELECTRONICS CORP
TELETRONIX
T T ELECTRONICS

FILTERS, OTHER

ALTEC LANSING
BURKE & JAMES
COLORTRON INDUSTRIES - BERKEY
CORNELL-DUBILIER ELECTRONICS
ELECTRONIC RESEARCH COMPANY
ENTRON INC
JAMPRO ANTENNA COMPANY
PALL TRINITY MICRO CORP
PIEZO CRYSTAL COMPANY
RCA BROADCAST PRODS.
STANDARD ELECTRONICS CORP
TELEMET COMPANY
TRW ELECTRONICS

T T ELECTRONICS
UNITED TRANSFORMER COMPANY
WATERS MANUFACTURING

FIXTURES - SEE HARDWARE

FLASHERS, TOWER

ELECTRONIC LIGHTS, INC.
GATES RADIO COMPANY
HOUSTON ELECTRONICS CO.
HUGHEY & PHILLIPS
RCA BROADCAST PRODS.
SWAGER TOWER CORPORATION

FRAMES, MOUNTING

MINNESOTA MINING - 3 M

FREQUENCY-MEASUREMENT SERVICES

SEE CALIBRATION SERVICE,
FREQUENCY

FUSES

G C ELECTRONICS COMPANY
GENERAL ELECTRIC CO
ITT WIRE & CABLE DIVISION
LITTLEFUSE, INC.
SINGER PRODUCTS CO.

GAUSSMETER

F W BELL, INC

GENERATORS, FM, STEREO

GENERATORS, FM, STEREO
AMERICAN ELECTRONIC LABS
BELAR ELECTRONICS LABORATORY
CATEL COMPANY
CCA ELECTRONICS CORPORATION
GATES RADIO COMPANY
HEATH CO

GENERATORS, FM, SUBCARRIER

AMERICAN ELECTRONIC LABS
AMPLIVISION CORPORATION
CCA ELECTRONICS CORPORATION
GATES RADIO COMPANY
GIBBS MFG. AND RESEARCH CORP.
MARTI ELECTRONICS
MOSELEY ASSOCIATES INC.
RCA BROADCAST PRODS.
H. H. SCOTT, INCORPORATED
SINGER PRODUCTS CO
STANDARD ELECTRONICS CORP
WILKINSON ELECTRONICS, INC

GENERATORS, POWER, ELECTRIC MOTOR

COLUMBIA ELECTRIC MFG CO
GENERAL ELECTRIC CO
GENERATORS, POWER, GASOLINE ENGINE
ONAN DIVISION
GENERATORS, POWER, WIND & THERMOELECTRIC
KEITH ANDERSON CO

GENERATORS, POWER, ELECTRIC MOTOR

COLUMBIA ELECTRIC MFG CO
GENERAL ELECTRIC CO

GENERATORS, POWER, GASOLINE ENGINE

ONAN DIVISION

GENERATORS, POWER, WIND & THERMOELECTRIC

KEITH ANDERSON CO

GENERATORS, SIGNAL, AF

BARKER & WILLIAMSON
CCA ELECTRONICS CORPORATION
DELTA ELECTRONICS, INC.
ENGINEERING ASSOCIATES
GENERAL RADIO CO
GIBBS MFG. AND RESEARCH CORP.
HEATH CO
HICKOK ELECTRICAL INSTRUMENT
INSTRUMENT LABORATORIES CORP
INTERNATIONAL GOOD MUSIC
JERROLD ELECTRONICS CORP
MARCONI INSTRUMENTS
NORTHEAST ELECTRONICS CORP
RCA BROADCAST PRODS.
RCA ELECTRONIC COMPONENTS
RHOWE & SCHWARZ SALES CO. -USA
THE SINGER CO - METRICS DIV
STEPHENS ELECTRONICS
TREPAC CORPORATION OF AMERICA
WAVEFORMS, INCORPORATED

GENERATORS, SIGNAL, COLOR BAR

AMPHENOL DISTRIBUTOR DIVISION
HEATH CO
HICKOK ELECTRICAL INSTRUMENT
MARCONI DIVISION
RCA BROADCAST PRODS.
RCA ELECTRONIC COMPONENTS
RIKER VIDEO INDUSTRIES
TELEMET COMPANY
TELEQUIP CORPORATION
VIDEON CORPORATION
VISUAL ELECTRONICS CORP

GENERATORS, SIGNAL, OOT BAR

COMU ELECTRONICS
HEATH CO
HICKOK ELECTRICAL INSTRUMENT
LAKE ELECTRONICS, INC.
MARCONI DIVISION
RCA BROADCAST PRODS.
RCA ELECTRONIC COMPONENTS
RIKER VIDEO INDUSTRIES
TELEMET COMPANY
TELEQUIP CORPORATION
VIDEON CORPORATION
VISUAL ELECTRONICS CORP

only
3M
 gives
 you
 true
 Color ○
 Dropout ○
 Restoration ●

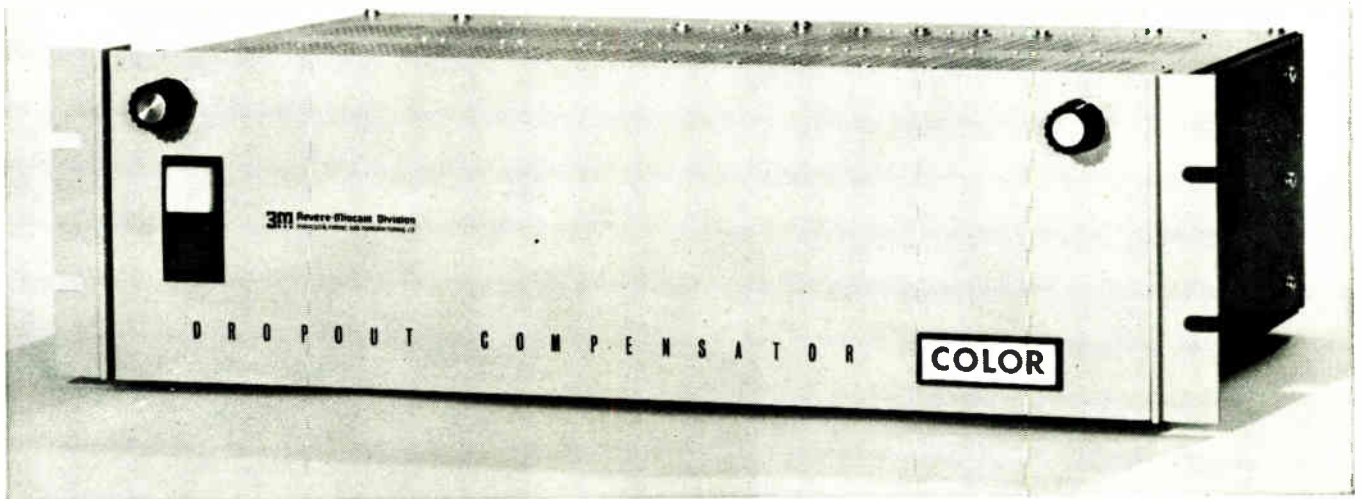

Revere-Mincom conquers the Color Dropout Problem

When color VTR is subjected to ordinary dropout compensation techniques, some improvement may result. Often, however, these primitive techniques generate effects more distracting than the dropout itself. Two examples: 1. Switching transients due to FM substitution. 2. Color phase inversion caused by one-line information delay.

Revere-Mincom's Color Dropout Compensator solves the problem of keeping the Danube blue, Hornets green, and signals in the pink. It's compatible with all time correction units, Hi-Band, Low Band, Color and Monochrome.

For more information about color dropouts and Revere-Mincom's Color DOC, write for this booklet:

Compensating for Dropouts in Color Television Recording by Howard Green, Director 3M

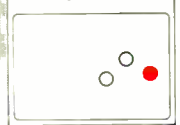

Revere-Mincom Division **3M** COMPANY

300 SOUTH LEWIS ROAD • CAMARILLO, CALIFORNIA 93010

Please send me a copy of the booklet, "Compensating for Dropouts in Color Television Recording."

Name _____ Position: _____

Company _____

Address _____

City _____ State _____ Zip _____

GENERATORS, SIGNAL, MARKER
BLONDER-TONGUE LABORATORIES
GIBBS MFG. AND RESEARCH CORP.
HICKOK ELECTRICAL INSTRUMENT
JERROLD ELECTRONICS CORP
LAKE ELECTRONICS, INC.
RCA ELECTRONIC COMPONENTS
TEKTRONIX INC
VIDEON CORPORATION
VISUAL ELECTRONICS CORP

GENERATORS, SIGNAL, PULSE
DATAPULSE DIVISION
GIBBS MFG. AND RESEARCH CORP.
HEWLETT-PACKARD CO.
HICKOK ELECTRICAL INSTRUMENT
LAKE ELECTRONICS, INC.
NARDA MICROWAVE CORPORATION
RIKER VIDEO INDUSTRIES
SPENCER-KENNEDY LABORATORIES
TEKTRONIX INC
TELEQUIP CORPORATION
TRAD CORPORATION
VIDEON CORPORATION
VISUAL ELECTRONICS CORP

GENERATORS, SIGNAL, RF
AMECO, INC.
AMPHENOL DISTRIBUTOR DIVISION
BLONDER-TONGUE LABORATORIES
CCA ELECTRONICS CORPORATION
ENGINEERING ASSOCIATES
GENERAL RADIO CO
GIBBS MFG. AND RESEARCH CORP.
HEATH CO
HEWLETT-PACKARD CO.
HICKOK ELECTRICAL INSTRUMENT
JERROLD ELECTRONICS CORP
MARCONI INSTRUMENTS
MICROWAVE ASSOCIATES, INC.
NARDA MICROWAVE CORPORATION
RCA ELECTRONIC COMPONENTS
ROHDE & SCHWARZ SALES CO. -USA
THE SINGER CO - METRICS DIV
THE TECHNICAL MATERIEL CORP
TELEQUIP CORPORATION
TELONIC INDUSTRIES
TRIPLETT ELECTRICAL INSTRUMENT
WILKINSON ELECTRONICS, INC

GENERATORS, SIGNAL, SPECIAL EFFECT
ALMA ENGINEERING INC
APPLIED ELECTRO-MECHANICS
BALL BROTHERS RESEARCH
CENTRAL DYNAMICS CORPORATION
COLORADO VIDEO
RCA BROADCAST PRODS.
RIKER VIDEO INDUSTRIES
H. H. SCOTT, INCORPORATED
TELEQUIP CORPORATION
VIDEON CORPORATION
VISUAL ELECTRONICS CORP

GENERATORS, SIGNAL, SQUARE WAVE
DATAPULSE DIVISION
ENGINEERING ASSOCIATES
GENERAL RADIO CO
GIBBS MFG. AND RESEARCH CORP.
HEATH CO
JERROLD ELECTRONICS CORP
LAKE ELECTRONICS, INC.
TEKTRONIX INC
TELEQUIP CORPORATION
VIDEON CORPORATION
VISUAL ELECTRONICS CORP
WAVEFORMS, INCORPORATED
TELEQUIP CORPORATION

GENERATORS, SIGNAL, TV SYNCHRONIZING
BLONDER-TONGUE LABORATORIES
CENTRAL DYNAMICS CORPORATION
COMU ELECTRONICS
COLORADO VIDEO
DAGE BELL CORPORATION
G E VISUAL COMMUNICATIONS PROD
LAKE ELECTRONICS, INC.
MARCONI DIVISION
MARYLAND TELECOMMUNICATIONS
RCA BROADCAST PRODS.
RIKER VIDEO INDUSTRIES
SARKES-TARZIAN
SYLVANIA-COMM. ELECTRONICS DIV
TELEMAT, INC.
TELEMET COMPANY
TELEQUIP CORPORATION
VIDEON CORPORATION
VISUAL ELECTRONICS CORP

GENERATORS, SIGNAL, VITS
CENTRAL DYNAMICS CORPORATION
RIKER VIDEO INDUSTRIES
TELEMET COMPANY
TELEQUIP CORPORATION
VIDEON CORPORATION
VISUAL ELECTRONICS CORP

GROMMETS - SEE HARDWARE

HARDWARE, CHASSIS
BUD RADIO, INC
O & B ELECTRONICS COMPANY
ELECTRONICS ESSENTIALS OF CCC
G C ELECTRONICS COMPANY
TELEQUIP CORPORATION
VENT-RAK INCORPORATED

HARDWARE, DIAL POINTERS
G C ELECTRONICS COMPANY
TELEQUIP CORPORATION

HARDWARE, FIXTURES, HOLDING
BUD RADIO, INC
TELEQUIP CORPORATION

HARDWARE, GENERAL
AMECO, INC.
BIRNBACH CO
ELECTROVERT, INCORPORATED
ELECTRONICS ESSENTIALS OF CCC
G C ELECTRONICS COMPANY
ROBINS INDUSTRIES CORP.
SWITCHCRAFT, INC.
TELEQUIP CORPORATION

HARDWARE, GROMMETS
BIRNBACH CO
ELECTROVERT, INCORPORATED
ELECTRONICS ESSENTIALS OF CCC
G C ELECTRONICS COMPANY

HARDWARE, LOUVERS, VENTILATING
BUD RADIO, INC

HARDWARE, MOUNTS
ADVANCE INDUSTRIES
BUD RADIO, INC
ELECTRONICS ESSENTIALS OF CCC
ROBINS INDUSTRIES CORP.
TELEQUIP CORPORATION
H. WILSON CORPORATION

HARDWARE, PANEL
BUD RADIO, INC
COOK ELECTRIC COMPANY
E F JOHNSON COMPANY
TELEQUIP CORPORATION
VITRO ELECTRONICS

HARDWARE, RACK
BIRNBACH CO
BUD RADIO, INC
COOK ELECTRIC COMPANY
ELECTRONICS ESSENTIALS OF CCC
GATES RADIO COMPANY
G C ELECTRONICS COMPANY
MCMARTIN INDUSTRIES
SARKES-TARZIAN
TELEQUIP CORPORATION
VITRO ELECTRONICS

HARDWARE, RETAINING RINGS
CRAFTSMAN ELECTRONICS PRODUCTS

HARDWARE, TOOLS - SEE TOOLS
AMECO, INC.
ELECTRONICS ESSENTIALS OF CCC
G C ELECTRONICS COMPANY
H. K. PORTER INC.
SINGER PRODUCTS CO.
THE THOMAS & BETTS CO
UPSON BROS.
XCELITE INCORPORATED

HARDWARE, TUBING, METAL
ELECTRONICS ESSENTIALS OF CCC

HARDWARE, TUBING, PLASTIC
BIRNBACH CO
ELECTRONICS ESSENTIALS OF CCC
G C ELECTRONICS COMPANY
MINNESOTA MINING - 3 M
SIGMA INDUSTRIES

HEAD-END EQUIPMENT
SEE CATV HEAD-END EQUIPMENT
AMECO, INC.
AMERICAN ELECTRONIC LABS
AMPLIVISION CORPORATION
ANACONDA ASTRODATA CO
BENCO TELEVISION ASSOCIATES
BLONDER-TONGUE LABORATORIES
C-COR ELECTRONICS
DYNAIR ELECTRONICS, INC.
ENTRON INC
JERROLD ELECTRONICS CORP
KAISER-COX
ROHN MANUFACTURING CO.
SPENCER-KENNEDY LABORATORIES

HEADS, DISC RECORDING
AUDIO DEVICES
FAIRCHILD RECORDING EQUIPMENT
GOTHAM AUDIO CORPORATION
KOSS ELECTRONICS, INC.
LIPPS, INC.
SCULLY RECORDING INSTRUMENTS
SINGER PRODUCTS CO.

HEADS, ERASE, MAGNETIC
AMPEX CORPORATION
BROADCAST ELECTRONICS, INC
FAIRCHILD RECORDING EQUIPMENT
JOA CARTRIDGE SERVICE
LIPPS, INC.
MAGNA-TECH CORPORATION
NORTONICS COMPANY, INC
RCA BROADCAST PRODS.
ROBINS INDUSTRIES CORP.
SCULLY RECORDING INSTRUMENTS
SINGER PRODUCTS CO.
SONY CORPORATION OF AMERICA
TELECTRO INDUSTRIES CORP
MINNEAPOLIS MAGNETICS

HEADS, RECORDING, MAGNETIC
AMPEX CORPORATION
BROADCAST ELECTRONICS, INC
FAIRCHILD RECORDING EQUIPMENT
JOA CARTRIDGE SERVICE
LIPPS, INC.
MAGNA-TECH CORPORATION
MINNEAPOLIS MAGNETICS
MINNESOTA MINING - 3 M
NORTONICS COMPANY, INC
PRECISION LABORATORIES
RCA BROADCAST PRODS.
ROBINS INDUSTRIES CORP.
SCULLY RECORDING INSTRUMENTS
SINGER PRODUCTS CO
SONY CORPORATION OF AMERICA

SPARTA ELECTRONIC CORPORATION
TAPECASTER ELECTRONICS
TELECTRO INDUSTRIES CORP

HEAT SINKS
BIRNBACH CO
DELCO RADIO DIV
EIMAC DIVISION OF VARIAN
G C ELECTRONICS COMPANY
INTERNATIONAL RECTIFIER
SOLITRON DEVICES

HEATING ELEMENTS
GENERAL ELECTRIC CO

HOLDERS, CRYSTAL
E F JOHNSON COMPANY
MICROLAB
MICROWAVE ASSOCIATES, INC.

HOLDERS, FUSE
G C ELECTRONICS COMPANY
LITTLEFUSE, INC.
SINGER PRODUCTS CO.

HOUSINGS, ANTENNA
BENCO TELEVISION ASSOCIATES
CCA ELECTRONICS CORPORATION
GATES RADIO COMPANY

IMAGE MOTION
STABILIZATION SYSTEM
DYNASCENCES CORPORATION

INDUCTANCES - ALSO SEE COILS

INDUCTANCES, FIXED
ADC PRODUCTS
CCA ELECTRONICS CORPORATION
GENERAL RADIO CO
HEWLETT-PACKARD CO.
E F JOHNSON COMPANY
KAPPA NETWORKS, INC
LAKE ELECTRONICS, INC.
J. W. MILLER CO.
MULTRONICS
UNITED TRANSFORMER COMPANY

INDUCTANCES, VARIABLE
CCA ELECTRONICS CORPORATION
DELTA ELECTRONICS INC
GENERAL RADIO CO
E F JOHNSON COMPANY
KAPPA NETWORKS, INC
J. W. MILLER CO.
MULTRONICS
UNITED TRANSFORMER COMPANY

INDUSTRIAL TV - ALSO SEE TV, CLOSED CIRCUIT
AMPEX CORPORATION
ANACONDA ASTRODATA CO
BALL BROTHERS RESEARCH
BIONIC INSTRUMENTS, INC.
BLONDER-TONGUE LABORATORIES
CENTRAL DYNAMICS CORPORATION
COMU ELECTRONICS
COLORADO VIDEO
DAGE BELL CORPORATION
DYNAIR ELECTRONICS, INC.
GBC AMERICA CORPORATION
G E VISUAL COMMUNICATIONS PROO
GENERAL ELECTRIC CO
ITI ELECTRONICS, INC.
JERROLD ELECTRONICS CORP
LAKE ELECTRONICS, INC.
MARCONI DIVISION
MARYLAND TELECOMMUNICATIONS
MJRTEL ELECTRONICS, INC
POWER-OPTICS INCORPORATED
RCA BROADCAST PRODS.
RIKER VIDEO INDUSTRIES
SETCHELL CARLSON INCORPORATED
SONY CORPORATION OF AMERICA
S + STERLING COMPANY
SYLVANIA-COMM. ELECTRONICS DIV
TELEMET COMPANY
TELEQUIP CORPORATION
TELEVISION UTILITIES CORP

INSULATORS, ANTENNA
ANTENNA PRODUCTS COMPANY
BIRNBACH CO
CENTRALAB
G C ELECTRONICS COMPANY
L F JOHNSON COMPANY
UNITED STATES PLASTIC ROPE

INSULATORS, FEED THROUGH
BIRNBACH CO
CENTRALAB
G C ELECTRONICS COMPANY
E F JOHNSON COMPANY

INSULATORS, STAND-OFF
ANTENNA PRODUCTS COMPANY
BIRNBACH CO
CENTRALAB
G C ELECTRONICS COMPANY
E F JOHNSON COMPANY

INSULATORS, OTHER
BIRNBACH CO
BUCHANAN ELECTRICAL CORP
CENTRALAB
G C ELECTRONICS COMPANY
E F JOHNSON COMPANY
UTILITY TDWR CO.

INTEGRATED CIRCUITS
AEROVOX CORP.
AMERICAN ELITE
CENTRALAB
GENERAL ELECTRIC CO
ITT CANNON ELECTRIC

MICROWAVE ASSOCIATES, INC.
MOTOROLA SEMICONDUCTOR
RCA ELECTRONIC COMPONENTS
TEXAS INSTRUMENTS
VITRO ELECTRONICS

INVERTERS, DC TO AC, CHOPPER
ALTEC LANSING
GIBBS MFG. AND RESEARCH CORP.

INVERTERS, DC TO AC, SOLID STATE
ALTEC LANSING
ELECTRO PRODUCTS LABORATORIES
ITI ELECTRONICS, INC.
POWER SOURCES
SINGER PRODUCTS CO
TEXAS ELECTRONICS
TOPAZ INCORPORATED
TREPAC CORPORATION OF AMERICA

INVERTERS, DC TO AC, VIBRATORS
ALTEC LANSING
BIRNS & SAWYER
CORNELL-DUBILIER ELECTRONICS
SONY CORPORATION OF AMERICA

JACK PANEL ASSEMBLIES
ADC PRODUCTS
AUDIO ACCESSORIES
CENTRAL DYNAMICS CORPORATION
COOKE ENGINEERING COMPANY
D & B ELECTRONICS COMPANY
ELECTRONICS ESSENTIALS OF CCC
HOLLAND ELECTRONICS INC
PHELPS DODGE
RCA BROADCAST PRODS.
SARKES-TARZIAN
SINGER PRODUCTS CO.
SOUTHWESTERN COMMUNICATIONS
S. STERLING COMPANY
SWITCHCRAFT, INC.
THE TECHNICAL MATERIEL CORP
TREPAC CORPORATION OF AMERICA
TROMPETER ELECTRONICS
VISUAL ELECTRONICS CORP
VITRO ELECTRONICS

JACKS
ADC PRODUCTS
AUDIO ACCESSORIES
BIRNBACH CO
CENTRAL DYNAMICS CORPORATION
COOKE ENGINEERING COMPANY
ELECTRONICS ESSENTIALS OF CCC
G C ELECTRONICS COMPANY
GENERAL RADIO CO
E F JOHNSON COMPANY
MALLORY DISTRIBUTOR PRODUCTS
PHELPS DODGE
ROBINS INDUSTRIES CORP.
SINGER PRODUCTS CO.
SWITCHCRAFT, INC.
THE TECHNICAL MATERIEL CORP
THOMSON ELECTRIC CO
TROMPETER ELECTRONICS
VISUAL ELECTRONICS CORP
VITRO ELECTRONICS

JOINTS, ROTARY, COAXIAL
ANDREW CORPORATION
GENERAL RADIO CO
MICRO-LINK SYSTEMS/VARIAN ASSO
SCIENTIFIC-ATLANTA

JOINTS, ROTARY, WAVEGUIDE
ANDREW CORPORATION
DEMORNY - BONARDI DIVISION
MICRO-LINK SYSTEMS/VARIAN ASSO
MICROWAVE ASSOCIATES, INC.

KITS
AEROVOX CORP.
ALLIED ELECTRONICS CORP
HEATH CO
UPSON BROS.
WABER ELECTRONICS, INC.

KNOBBS
BIRNBACH CO
G C ELECTRONICS COMPANY
GENERAL RADIO CO
MALLORY DISTRIBUTOR PRODUCTS
OHMITE MANUFACTURING COMPANY
PATINOT INCORPORATED
SINGER PRODUCTS CO.
TELEQUIP CORPORATION
TELETRONIX

LAMP ASSEMBLIES
ATLAS SOUND
D & B ELECTRONICS COMPANY
DIALIGHT CORPORATION
ELECTRONICS ESSENTIALS OF CCC
HARWOOD MFG. CO.
HUGHEY & PHILLIPS
INDUSTRIAL DEVICES, INC.
ROBINS INDUSTRIES CORP.
VENT-RAK INCORPORATED

LAMPS, ARC
ENGINEERING ASSOCIATES
MOLE-RICHARDSON CO.

LAMPS, EXCITER
G E DISTRIBUTOR SALES FORCE

LAMPS, GLOW
DIALIGHT CORPORATION
G E DISTRIBUTOR SALES FORCE
INDUSTRIAL DEVICES, INC.
MOLE-RICHARDSON CO.

LAMPS, PANEL
ADC PRODUCTS
AUDIO ACCESSORIES



FOR PROFESSIONAL REEL-TO-REEL MACHINES

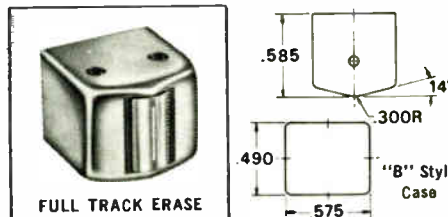
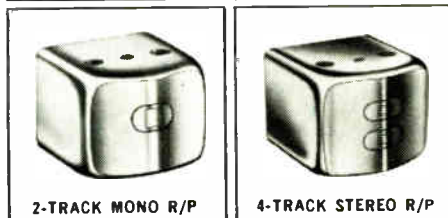
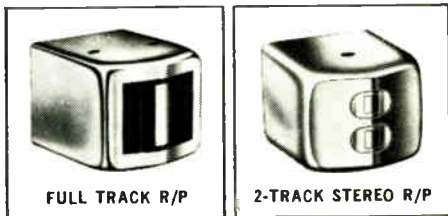

Head Mounting Brackets for Professional Machines



QK-76 with Nortronics Head

QK-76 contains all hardware and illustrated instructions necessary to adapt a Nortronics head to the shield cup of an Ampex head nest. Includes: precision cast aluminum block; spacers; screws; connector plug—all other parts necessary are utilized from the original Ampex equipment... Net Each **\$12.00**

QK-35 is a special base-mount bracket kit for adapting Nortronics no-mount heads for replacement of Brush heads, or in any application requiring a large base-mounting stud. (Stud is 1/4" - 28 x 5/8") Net Each **\$2.00**

FOR CARTRIDGE MACHINES



YOUR LOCAL DISTRIBUTOR STOCKS THE FULL LINE OF NORTRONICS TAPE HEADS AND ACCESSORIES

QUICK-KITS (Head Mounting Assemblies)—Tape Guides—Alignment Tape—Connector Assemblies—Bias Oscillator Transformers—Replacement Heads for over 1500 models ... Consult your distributor for full information.

Manufacturer and Model Numbers	Original Function	Nortronics Head + Quik-Kit	Net, † Less Quik-Kit	
AMPEX 300, 350, 354, 400 Series NOTE: On PR-10, 600, 900 and 1200 Series, use QK-66 instead of QK-76.	Record, Full Track	8001 + 76	\$36.00	
	Play, Full Track	8000 + 76	36.00	
	Erase, Full Track (for all but 380 series)	8109 + 76	30.00	
	Erase, Full Track (for 300 series only)	8106 + 76	30.00	
	Record Mono, 2-Track	8401 + 76	22.00	
	Play Mono, 2-Track	8400 + 76	22.00	
	Erase Mono, 2-Track	8504 + 76	18.00	
	Record Stereo, 2-Track	8201 + 76	32.00	
	Play Stereo, 2-Track	8200 + 76	32.00	
	Erase Stereo, 2-Track	8304 + 76	26.00	
3200	Record Stereo, 4-Track	8604 + 76	30.00	
	Play Stereo, 4-Track	8600 + 76	30.00	
	Erase Stereo, 4-Track	8701 + 76	26.00	
	Record, Full Track	8004 + 76	40.00	
	Play, Full Track	8008 + 76	36.00	
	Record Stereo, 2-Track	8214 + 76	32.00	
	Play Stereo, 2-Track	8210 + 76	32.00	
	Record Stereo, 4-Track	8614 + 76	30.00	
	Play Stereo, 4-Track	8610 + 76	30.00	
	Record Mono, 2-Track	8414 + 76	22.00	
Play Mono, 2-Track	8402 + 76	22.00		
CROWN 701, 801, BX801, 1001, 1401	Play only or Record/Play, Full Track	8006 + 35	36.00	
	Record, Full Track	8001 + 35	36.00	
	Erase, Full Track	8102 + 35	30.00	
	Play only or Record/Play Stereo, 2-Track	8209 + 35	32.00	
	Record Stereo, 2-Track	8201 + 35	32.00	
	Erase Stereo, 2-Track	8304 + 38	26.00	
	712, 822, BX822, 1022, 1422/8	Play only or Record/Play Mono, 2-Track	8403 + 35	22.00
		Record Mono, 2-Track	8404 + 35	22.00
		Erase Mono, 2-Track	8504 + 38	18.00
	702, 802, BX802, 1002, 1402/8	Play only Mono, 2-Track	8406 + 66	22.00
Play only Stereo, 4-Track		8608 + 66	30.00	
A51, A314	Play only or Record/Play Stereo, 4-Track	8608 + 66	30.00	
	Record Stereo, 4-Track	8608 + 66	30.00	
	Erase Stereo, 4-Track	8701 + 38	26.00	
A54, A324	Record, Full Track	8005 *	40.00	
	Play Mono, 2-Track	8408 *	22.00	
	Erase, Full Track	8102 *	30.00	
*No QK required	Play, Full Track (Optional)	8006 *	36.00	
	Record Stereo, 2-Track	8203 *	35.00	
	Play Stereo, 2-Track	8202 *	35.00	
1022 *No QK required	Erase Stereo, 2-Track	8302 *	26.00	
	Record Stereo, 4-Track	8602 *	30.00	
	Play Stereo, 4-Track	8607 *	30.00	
1024 *No QK required	Erase Stereo, 4-Track	8702 *	26.00	
	Record, Full Track	8001 + 35	36.00	
	Play, Full Track	8000 + 35	36.00	
P60, P75, M90 *No QK required	Erase, Full Track	8105 + 35	30.00	
	Record, Full Track	8002 *	68.00	
	Play, Full Track	8003 *	54.00	
R.C.A. RT21 *No QK required	Erase, Full Track	8110 *	68.00	
	Record Stereo, 2-Track	8206 *	42.00	
	Play Stereo, 2-Track	8205 *	54.00	
*No QK required	Erase Stereo, 2-Track	8307 *	48.00	

NO-MOUNT and REAR-MOUNT HEADS FOR ATC, Collins, Gates, KRS, Macarta, RCA, Sparta, Tapecaster

FOR REPLACEMENT OR NAB CONVERSION. FULL LISTINGS IN NORTRONICS BULLETIN 7230A. SEND FOR YOUR COPY.

No-Mount Head Bracket Assembly for Cartridge Machines

QK-114 installs two no-mount dual channel heads for monophonic use, or two no-mount three channel heads for stereo operation. Left head is for recording; right head for playback. Requires heads similar to 2000 Series. Completely assembled and semi-aligned Net Each **\$13.60**

QK-115 installs two no-mount monophonic 2-track heads (see monitor conversion information below). Requires heads similar to 3000 Series. Completely assembled and semi-aligned Net Each **\$13.60**

BOTH QK-114 AND QK-115 FURNISHED WITH CARTRIDGE HOLD-DOWN SPRING AND CARTRIDGE GUIDE RAIL.

NAB CONVERSION TO MONITOR—As all professional users of tape equipment know, superior results can be achieved by using a special record-only head plus a separate playback head. Professionals also appreciate the ability to be able to monitor a tape as it is being recorded. Nortronics offers a conversion to monitor operation to update cartridge machines.

NORTRONICS COMPANY, INC.

8101 Tenth Avenue North • Minneapolis, Minnesota 55427 • Phone: (612) 545-0401

OIALIGHT CORPORATION
ELECTRONICS ESSENTIALS OF CCC
G E DISTRIBUTOR SALES FORCE
INDUSTRIAL DEVICES, INC.
J. G. MCALISTER
MOLE-RICHAROSON CO.
SINGER PRODUCTS CO.

LAMPS, PROJECTION

G E DISTRIBUTOR SALES FORCE
MOLE-RICHAROSON CO.
H. WILSON CORPORATION

LATHE, DISC RECORDING

FAIRCHILD RECORDING EQUIPMENT
GOTHAM AUDIO CORPORATION
KOSS ELECTRONICS, INC.
SCULLY RECORDING INSTRUMENTS
SINGER PRODUCTS CO
SOUTHWESTERN COMMUNICATIONS

LEADER, FILM

PRO-TEX REEL BANO COMPANY

LEADS, TEST

ELECTRONICS ESSENTIALS OF CCC
E-Z-HOOK TEST PRODUCTS
G C ELECTRONICS COMPANY

LENSES, OPTICAL, FIXED

ALBION OPTICAL COMPANY
AMECO, INC.
AMPX CORPORATION
BIRNS & SAWYER
BURKE & JAMES
COHU ELECTRONICS
GRAY RESEARCH & DEVELOPMENT CO
MINNESOTA MINING - 3 M
POWER-OPTICS INCORPORATED
RVA BROADCAST PRODS.
SYLVANIA-COMM. ELECTRONICS DIV
TELEQUIP CORPORATION
TELEVISION UTILITIES CORP
TRAO CORPORATION
VISUAL ELECTRONICS CORP
ZOLOMATICS CORPORATION
ZOOMAR, INC.

LENSES, OPTICAL, ZOOM

ALBION OPTICAL COMPANY
AMECO, INC.
AMPX CORPORATION
BIRNS & SAWYER
BURKE & JAMES
COHU ELECTRONICS
LAKE ELECTRONICS, INC.
MINNESOTA MINING - 3 M
POWER-OPTICS INCORPORATED
RVA BROADCAST PRODS.
SYLVANIA-COMM. ELECTRONICS DIV
TELEMATIION, INC.
TELEQUIP CORPORATION
TELEVISION UTILITIES CORP
TELEVISION ZOOMAR
TRAO CORPORATION
VISUAL ELECTRONICS CORP
ZOLOMATICS CORPORATION
ZOOMAR, INC.

LETTERS AND NUMBERS

PRESSURE SENSITIVE

W H BARRY CO.

LIFTS, AERIAL, TRUCK MOUNTED

HUNT-PIERCE CORP
TELSTA CORPORATION

LIGHTING, TV, COMPONENTS

BIRNS & SAWYER
BURKE & JAMES
CENTURY LIGHTING, INC.
COLORTRAN INDUSTRIES - BERKEY
HARWOOD MFG. CO.
LIGHTING & ELECTRONICS, INC.
J. G. MCALISTER
METROPOLITAN ELECTRIC MFG CO
MOLE-RICHAROSON CO.
PACIFIC TOWER CO
RCA BROADCAST PRODS.
TELEQUIP CORPORATION
TELEVISION UTILITIES CORP
VISUAL ELECTRONICS CORP

LIGHTING, TV, CONTROLS

CENTURY LIGHTING, INC.
COLORTRAN INDUSTRIES - BERKEY
HOUSTON ELECTRONICS CO.
LIGHTING & ELECTRONICS, INC.
METROPOLITAN ELECTRIC MFG CO
MOLE-RICHAROSON CO.
RCA BROADCAST PRODS.
TELEQUIP CORPORATION
TELEVISION UTILITIES CORP
VISUAL ELECTRONICS CORP

LIGHTING, TV, SYSTEMS

CENTURY LIGHTING, INC.
COLORTRAN INDUSTRIES - BERKEY
ELECTRONIC LIGHTS, INC.
LIGHTING & ELECTRONICS, INC.
J. G. MCALISTER
METROPOLITAN ELECTRIC MFG CO
MOLE-RICHAROSON CO.
PACIFIC TOWER CO
RCA BROADCAST PRODS.
SYLVANIA-COMM. ELECTRONICS OIV
TELEQUIP CORPORATION
TELEVISION UTILITIES CORP
VISUAL ELECTRONICS CORP

LIGHTNING ARRESTERS

AMECO, INC.
BIRNBACH CO
CONTINENTAL ELECTRONICS MFG
G C ELECTRONICS COMPANY
GENERAL ELECTRIC CO

MOLE-RICHAROSON CO.
TELEVISION UTILITIES CORP
UP-RIGHT SCAFFOLOS

LIGHTS, TOWER, OBSTRUCTION

ROHN MANUFACTURING CO.

LIMITERS - SEE AMPLIFIERS

LOG BOOKS OR SHEETS

ACME VISIBLE RECORDS
ROBINS INDUSTRIES CORP.

LOUVRES, VENTILATING -

SEE HARWARE

LUBRICANTS

G C ELECTRONICS COMPANY

MAINTENANCE SERVICES, AM

AMERICAN ELECTRONIC LABS
AMPX CORPORATION
ASCO SONOCRAFT CORP
CCA ELECTRONICS CORPORATION
DRESSER CRANE HOIST & TOWER
EITEL ELECTRONICS
LIBERTY TOWER MFG. CO
LITTLE JOE ENTERPRISES
ORBIT RADIO
RCA SERVICE COMPANY
SOUTHWESTERN COMMUNICATIONS

MAINTENANCE SERVICES,

CARTRIDGE TAPE

JOA CARTRIDGE SERVICE

MAINTENANCE SERVICES, FM

AMERICAN ELECTRONIC LABS
AMPX CORPORATION
ASCO SONOCRAFT CORP
CCA ELECTRONICS CORPORATION
DRESSER CRANE HOIST & TOWER
EITEL ELECTRONICS
LIBERTY TOWER MFG. CO
LITTLE JOE ENTERPRISES
ORBIT RADIO
RCA SERVICE COMPANY
SOUTHWESTERN COMMUNICATIONS
STANOARO ELECTRONICS CORP .

MAINTENANCE SERVICES, MICROWAVE

AMECO, INC.
AMERICAN ELECTRONIC LABS
EITEL ELECTRONICS
LIBERTY TOWER MFG. CO
RCA SERVICE COMPANY

MAINTENANCE SERVICES,

STEEPLE JACK

LIBERTY TOWER MFG. CO
LITTLE JOE ENTERPRISES
RCA SERVICE COMPANY
SWAGER TOWER CORPORATION
TRYLON INCORPORATED
UTILITY TOWER CO.

MAINTENANCE SERVICES, TV

AMPX CORPORATION
CENTRAL DYNAMICS CORPORATION
DRESSER CRANE HOIST & TOWER
EITEL ELECTRONICS
THE JAMES FLOYD FORO CO
RCA SERVICE COMPANY
SARKES-TARZIAN
STANOARO ELECTRONICS CORP
TELEVISION UTILITIES CORP
TOWNSEND ASSOCIATES

METERS, DB AND VU

ALTEC LANSING
API INSTRUMENTS CO.
C B S LABORATORIES
G E INDUSTRIAL SALES OPERATION
GOTHAM AUDIO CORPORATION
MCMARTIN INDUSTRIES
NORTHEAST ELECTRONICS CORP
RCA BROADCAST PRODS.
ROBINS INDUSTRIES CORP.
TRIPLETT ELECTRICAL INSTRUMENT
YOKOGAWA ELECTRIC WORKS

METERS, DB AND VU, WIDE RANGE

ALTEC LANSING
C B S LABORATORIES
G E INDUSTRIAL SALES OPERATION
H. H. SCOTT, INCORPORATED
YOKOGAWA ELECTRIC WORKS

METERS, FIELD STRENGTH

AMPHENOL DISTRIBUTOR DIVISION
ANACONDA ASTRODATA CO
BENCO TELEVISION ASSOCIATES
BLONDER-TONGUE LABORATORIES
ENGINEERING ASSOCIATES
JERROLO ELECTRONICS CORP
MCMARTIN INDUSTRIES
RCA BROADCAST PRODS.
RHOHE & SCHWARZ SALES CO. -USA
THE SINGER CO - METRICS OIV
TV CABLE SUPPLY CO
VITRO ELECTRONICS
WILKINSON ELECTRONICS, INC
YOKOGAWA ELECTRIC WORKS

METERS, FLUTTER & WOW

ALBION OPTICAL COMPANY
AMPLIFIER CORP OF AMERICA
GOTHAM AUDIO CORPORATION
MCOM, INC

METERS, FREQUENCY

BELAR ELECTRONICS LABORATORY
BLONDER-TONGUE LABORATORIES
ENGINEERING ASSOCIATES
GENERAL RADIO CO
HEWLETT-PACKARD CO.

HICKOK ELECTRICAL INSTRUMENT
LAMPKIN LABORATORIES INC
MCMARTIN INDUSTRIES
MICROLAB / FXR
NAROA MICROWAVE CORPORATION
RCA BROADCAST PRODS.
RHOHE & SCHWARZ SALES CO. -USA
THE SINGER CO - METRICS OIV
WATERS MANUFACTURING
WAVEFORMS, INCORPORATED
YOKOGAWA ELECTRIC WORKS

METERS, FREQUENCY CALIBRATING

ENGINEERING ASSOCIATES
GENERAL RADIO CO
HEWLETT-PACKARD CO.
MICROLAB / FXR
NAROA MICROWAVE CORPORATION
RHOHE & SCHWARZ SALES CO. -USA
TV CABLE SUPPLY CO

METERS, LIGHT

BURKE & JAMES
ELECTRONIC SYSTEM ENGINEERING
GAMMA SCIENTIFIC, INC.
G E SUPPLY COMPANY
YOKOGAWA ELECTRIC WORKS
ZOOMAR, INC.

METERS, PHASE ANGLE

ENGINEERING ASSOCIATES
GENERAL ELECTRIC CO
HEWLETT-PACKARD CO.
HICKOK ELECTRICAL INSTRUMENT
RHOHE & SCHWARZ SALES CO. -USA
THE SINGER CO - METRICS OIV
YOKOGAWA ELECTRIC WORKS

METERS, POWER

BIRD ELECTRONIC CORPORATION
CCA ELECTRONICS CORPORATION
ENGINEERING ASSOCIATES
GENERAL MICROWAVE CORPORATION
HEWLETT-PACKARD CO.
MARCONI INSTRUMENTS
NAROA MICROWAVE CORPORATION
RHOHE & SCHWARZ SALES CO. -USA
THE SINGER CO - METRICS OIV
YOKOGAWA ELECTRIC WORKS

METERS, STANDING WAVE

BIRD ELECTRONIC CORPORATION
DELTA ELECTRONICS INC
OEMORNAV - BONAROI DIVISION
ENGINEERING ASSOCIATES
GENERAL MICROWAVE CORPORATION
HEWLETT-PACKARD CO.
NAROA MICROWAVE CORPORATION
RHOHE & SCHWARZ SALES CO. -USA
STANOARO ELECTRONICS CORP .
THE TECHNICAL MATERIEL CORP

METERS - SEE SPECIFIC TYPE

API INSTRUMENTS CO.
COHU ELECTRONICS
HEWLETT-PACKARD CO.
HICKOK ELECTRICAL INSTRUMENT
LAMPKIN LABORATORIES INC
MCMARTIN INDUSTRIES
THE SINGER CO - METRICS OIV

MICROPHONE STANDS & BOOMS

ALTEC LANSING
AMERICAN GELOSO ELECTRONICS
THE ASTATIC CORPORATION
E J BAUGHMAN CO
CENTURY LIGHTING, INC.
G C ELECTRONICS COMPANY
GOTHAM AUDIO CORPORATION
HOUSTON FEARLESS CORPORATION
MOLE-RICHAROSON CO.
NORTH AMERICAN PHILIPS CO
RCA BROADCAST PRODS.
RCA ELECTRONIC COMPONENTS
SHURE BROTHERS, INC.
SINGER PRODUCTS CO.
SYLVANIA-COMM. ELECTRONICS OIV
TELEVISION UTILITIES CORP
TURNER MICROPHONE CO
VISUAL ELECTRONICS CORP

MICROPHONES, CONDENSER

ALTEC LANSING
AMERICAN ELITE
GOTHAM AUDIO CORPORATION
NORTH AMERICAN PHILIPS CO
RCA ELECTRONIC COMPONENTS
SINGER PRODUCTS CO.
SONY CORPORATION OF AMERICA
SPARTA ELECTRONIC CORPORATION
SYNCRON CORPORATION
TRUSONIC
VEGA ELECTRONICS CORPORATION
VISUAL ELECTRONICS CORP

MICROPHONES, DYNAMIC

ALTEC LANSING
AMERICAN ELITE
AMERICAN GELOSO ELECTRONICS

AMPX CORPORATION
THE ASTATIC CORPORATION
CALIFONE/ROBERTS
ELECTRO-VOICE INC
GATES RADIO COMPANY
G C ELECTRONICS COMPANY
MCMARTIN INDUSTRIES
MILES REPRODUCER CO
NORTH AMERICAN PHILIPS CO
PERMOFLUX CORPORATION
RCA BROADCAST PRODS.
RCA ELECTRONIC COMPONENTS
ROBINS INDUSTRIES CORP.
SHURE BROTHERS, INC.
SINGER PRODUCTS CO
SONY CORPORATION OF AMERICA
SPARTA ELECTRONIC CORPORATION
SYLVANIA-COMM. ELECTRONICS OIV
TURNER MICROPHONE CO
VISUAL ELECTRONICS CORP

MICROPHONES, VELOCITY

RCA BROADCAST PRODS.
RCA ELECTRONIC COMPONENTS
SINGER PRODUCTS CO.
VISUAL ELECTRONICS CORP

MICROPHONES, WIRELESS

AMERICAN GELOSO ELECTRONICS
MILES REPRODUCER CO
SINGER PRODUCTS CO
SONY CORPORATION OF AMERICA
SPARTA ELECTRONIC CORPORATION
TRUSONIC
VEGA ELECTRONICS CORPORATION
VISUAL ELECTRONICS CORP

MICROWAVE COMPONENTS

ALFORD MANUFACTURING COMPANY
AMECO, INC.
AMERICAN ELITE
AMPREX ELECTRONIC CORP
ANDREW CORPORATION
BIRD ELECTRONIC CORPORATION
CAROWELL CONDENSER CORP
OEMORNAV - BONAROI DIVISION
EIMAC DIVISION OF VARIAN
ENGINEERING ASSOCIATES
ELECTRONICS ESSENTIALS OF CCC
GENERAL ELECTRIC CO
GENERAL RADIO CO
HEWLETT-PACKARD CO.
JERROLO ELECTRONICS CORP
LITTON EDUCATIONAL TELE OIV
MICROLAB / FXR
MICRO-LINK SYSTEMS/VARIAN ASSO
MICROWAVE ASSOCIATES, INC.
MOTOROLA SEMICONDUCTOR
NAROA MICROWAVE CORPORATION
PHELPS OODCO
PRODELIN, INCORPORATED
RAYTHEON CO EQUIPMENT DIVISION
RCA BROADCAST PRODS.
RHG ELECTRONICS LABORATORY
RHOHE & SCHWARZ SALES CO. -USA
SCIENTIFIC-ATLANTA
SOLITRON DEVICES
SYLVANIA-SEMICONDUCTOR OIV.
TEXAS INSTRUMENTS

MICROWAVE SYSTEMS, STL

AMECO, INC.
COLLINS RADIO COMPANY
OEMORNAV - BONAROI DIVISION
F & M SYSTEMS COMPANY
JERROLO ELECTRONICS CORP
LENKURT ELECTRIC CO., INC.
LITTON EDUCATIONAL TELE OIV
MARTI ELECTRONICS
MICROLAB / FXR
MICRO-LINK SYSTEMS/VARIAN ASSO
MICROWAVE ASSOCIATES, INC.
MOSELEY ASSOCIATES INC.
PRODELIN, INCORPORATED
RAYTHEON CO EQUIPMENT DIVISION
RCA BROADCAST PRODS.
RHG ELECTRONICS LABORATORY
SARKES-TARZIAN
SINGER PRODUCTS CO
TELETRONIX
VISUAL ELECTRONICS CORP

MICROWAVE SYSTEMS, 2500 MHZ

AMERICAN ELITE
OEMORNAV - BONAROI DIVISION
EMCEE
F & M SYSTEMS COMPANY
ITT TELECOMMUNICATIONS
JERROLO ELECTRONICS CORP
LITTON EDUCATIONAL TELE OIV
MICROLAB / FXR
MICRO-LINK SYSTEMS/VARIAN ASSO
PRODELIN, INCORPORATED
RAYTHEON CO EQUIPMENT DIVISION
RCA BROADCAST PRODS.
RHG ELECTRONICS LABORATORY

MICROWAVE SYSTEMS, OTHER

CAROWELL CONDENSER CORP
EMCEE
F & M SYSTEMS COMPANY
JERROLO ELECTRONICS CORP
MICROLAB / FXR
MICRO-LINK SYSTEMS/VARIAN ASSO
MICROWAVE ASSOCIATES, INC.
NAROA MICROWAVE CORPORATION
RAYTHEON CO EQUIPMENT DIVISION
RCA BROADCAST PRODS.
RHG ELECTRONICS LABORATORY
METERS - ALSO SEE CONDENSER
AMERICAN GELOSO ELECTRONICS
BAUER ELECTRONICS CORPORATION
BIRNS & SAWYER
BLONDER-TONGUE LABORATORIES
CENTRAL DYNAMICS CORPORATION

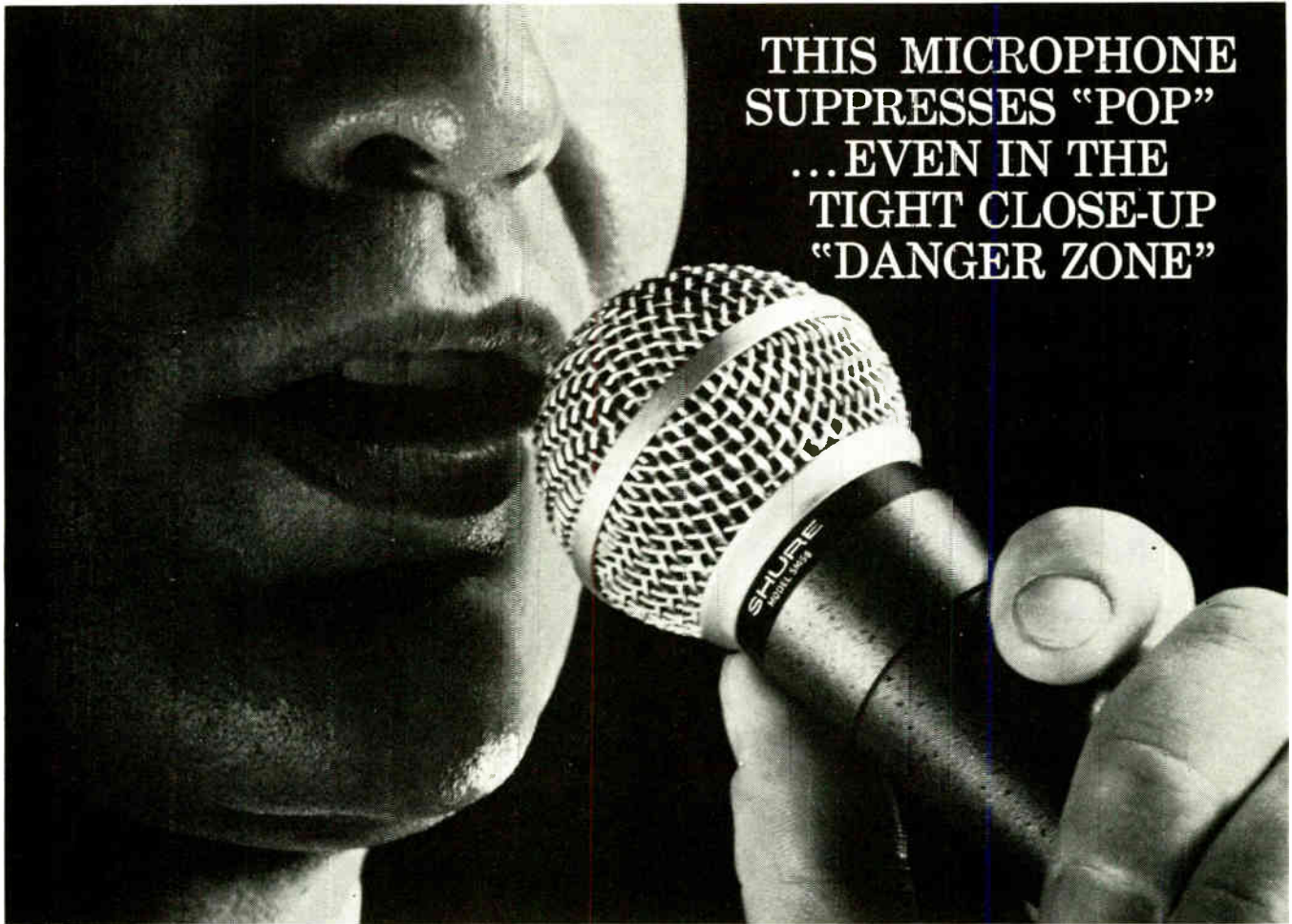

**THIS MICROPHONE
SUPPRESSES "POP"
...EVEN IN THE
TIGHT CLOSE-UP
"DANGER ZONE"**

The Shure SM58 *self-windscreened* unidirectional microphone is ideal for broadcast uses such as remote news, sports, interview and vocal recordings because it eliminates or minimizes the irritating "pop" caused by explosive breath sounds. With the SM58 you will have the peace-of-mind assurance that you're delivering the quality audio that goes with pop-free pickup. It's great for studio announcing, too—or wherever the announcer or vocalist has the audio-degrading habit of "mouthing" the microphone. Of course, the same filters that eliminate pop also do away with the necessity for an add-on windscreen in outdoor uses.

On the other hand, the unusually effective unidirectional cardioid pickup pattern (uniform at *all* frequencies, in *all* planes) means that it is a real problem-solver where background noise is high or where the microphone must be operated at some distance from the performer. incidentally,

but very important, the SM58 tends to control the low frequency "boominess" that is usually accented by close-up microphones.

All in all, close up or at a distance, the Shure SM58 solves the kind of ever-present perplexing problems the audio engineer may have felt were necessary evils. The SM58 might well be the finest all-purpose hand-held microphone in manufacture today. And, all things considered, it is moderate in cost.

Other features: the complete pop-proof filter assembly is instantly replaceable in the field, without tools. Filters can be easily cleaned, too. Stand or hand operation. Detachable cable. Rubber-mounted cartridge minimizes handling noise. Special TV-tested non-glare finish.

For additional information, write directly to Mr. Robert Carr, Manager of Professional Products Division, Shure Brothers, Inc., 222 Hartrey Ave., Evanston, Illinois 60204.

SHURE SM58

SELF-WINDSCREENED UNIDIRECTIONAL DYNAMIC MICROPHONE

OTHER SHURE PROFESSIONAL MICROPHONES... FOR SUPERIOR AUDIO



**MODEL SM5
CARDIOID BOOM DYNAMIC**

Because its cardioid directional pattern is uniquely uniform with frequency and symmetrical about its axis, the SM5 is singularly independent of the effects of environment. Even in extreme shooting situations (such as with tight sets, low ceilings, hard walls, low microphone angles, traffic or air-conditioner noise and rumble and changing distance) the SM5 minimizes sound coloration and ambient noise pickup.



**MODEL SM76
3/4" OMNIDIRECTIONAL
DYNAMIC**

Ideal for interviews and audience participation, yet unusually smooth wide range response (40-20 KC) for critical music reproduction. Instantly detachable from stand. Steel case with Cannon connector.



**MODEL SM50
OMNIDIRECTIONAL
DYNAMIC**

Self-windscreened and pop-free for news, sports, remotes, and interviews. Also ideal for many studio and control room applications. Comfortably balanced for hand or stand use. Natural response.

FAIRCHILD RECORDING EQUIPMENT
GOTHAM AUDIO CORPORATION
HARVEY RADIO CO. INC.
HOUSTON ELECTRONICS CO.
LANG ELECTRONICS, INC.
MICROLAB / FXR
NORTH AMERICAN PHILIPS CO
ORBIT RADIO
RCA BROADCAST PRODS.
SHURE BROTHERS, INC.
SINGER PRODUCTS CO
SOUNDRAFT INDUSTRIES
SOUTHWESTERN COMMUNICATIONS
SPARTA ELECTRONIC CORPORATION

MOBILE EQUIPMENT

AMERICAN ELITE
AMERICAN GELOSD ELECTRONICS
AMPEX CORPORATION
ANDREW CORPORATION
ATLAS SOUND
CENTRAL DYNAMICS CORPORATION
COURIER COMMUNICATIONS
F & M SYSTEMS COMPANY
GATES RADIO COMPANY
G E COMMUNICATION PRODUCTS
J M ELECTRONICS COMPANY
J F JOHNSON COMPANY
MARTI ELECTRONICS
MICROWAVE ASSOCIATES, INC.
MOSELEY ASSOCIATES INC.
THE NOVA COMPANY
RCA BROADCAST PRODS.
SINGER PRODUCTS CO
SYLVANIA-COMM. ELECTRONICS DIV
UTICA CORPORATION
H. WILSON CORPORATION

MOBILE EQUIPMENT, TV

ELECTRONIC MOBILE UNITS
TELE - DEVICES CO.

MODULATORS, TV

AMECO, INC.
BLONDER-TONGUE LABORATORIES
CATEL COMPANY
DYNAIR ELECTRONICS, INC.
EMCEE
INTERNATIONAL NUCLEAR CORP.
JERROLD ELECTRONICS CORP
MARCONI DIVISION
RHMDE & SCHWARZ SALES CO. -USA
STANDARD ELECTRONICS CORP.
SYLVANIA-COMM. ELECTRONICS DIV
TELEQUIP CORPORATION
TOWNSEND ASSOCIATES

MONITORS, AM SYSTEMS

ALTEC LANSING
BELAR ELECTRONICS LABORATORY
CCA ELECTRONICS CORPORATION
COLLINS RADIO COMPANY
GATES RADIO COMPANY
G E VISUAL COMMUNICATIONS PROD
MELCOR ELECTRONICS
RCA BROADCAST PRODS.
SINGER PRODUCTS CO
SOUTHWESTERN COMMUNICATIONS
TREPAC CORPORATION OF AMERICA
VISUAL ELECTRONICS CORP
VITRO ELECTRONICS
WILKINSON ELECTRONICS, INC

MONITORS, FM SYSTEMS, MONO

ALTEC LANSING
AMECO, INC.
BELAR ELECTRONICS LABORATORY
BROWNING LABORATORIES, INC.
CCA ELECTRONICS CORPORATION
COLLINS RADIO COMPANY
GATES RADIO COMPANY
HEWLETT-PACKARD CO.
KARG LABORATORIES
MCMARTIN INDUSTRIES
MELCOR ELECTRONICS
RCA BROADCAST PRODS.
SINGER PRODUCTS CO.
SOUTHWESTERN COMMUNICATIONS
UTICA CORPORATION
VISUAL ELECTRONICS CORP
VITRO ELECTRONICS

MONITORS, FM SYSTEMS, SCA

BELAR ELECTRONICS LABORATORY
CCA ELECTRONICS CORPORATION
COLLINS RADIO COMPANY
GATES RADIO COMPANY
MCMARTIN INDUSTRIES
RCA BROADCAST PRODS.
SINGER PRODUCTS CO
VISUAL ELECTRONICS CORP

MONITORS, FM SYSTEMS, STEREO

AMECO, INC.
BELAR ELECTRONICS LABORATORY
CCA ELECTRONICS CORPORATION
COLLINS RADIO COMPANY
GATES RADIO COMPANY
GOTHAM AUDIO CORPORATION
KARG LABORATORIES
MCMARTIN INDUSTRIES
MELCOR ELECTRONICS
RCA BROADCAST PRODS.
SINGER PRODUCTS CO.
VISUAL ELECTRONICS CORP

MONITORS, FREQUENCY

AMECO, INC.
BELAR ELECTRONICS LABORATORY
CCA ELECTRONICS CORPORATION
COLLINS RADIO COMPANY
GATES RADIO COMPANY
G E VISUAL COMMUNICATIONS PROD
HEWLETT-PACKARD CO.
LAMPKIN LABORATORIES INC
MCMARTIN INDUSTRIES

MICROLAB / FXR
RCA BROADCAST PRODS.
THE SINGER CO - METRICS DIV
SINGER PRODUCTS CO
TELETRONIX
VISUAL ELECTRONICS CORP
WILKINSON ELECTRONICS, INC

MONITORS, MODULATION

LAMPKIN LABORATORIES INC

MONITORS, PHASE

GATES RADIO COMPANY
MICROLAB / FXR
MULTRONICS
RCA BROADCAST PRODS.
VISUAL ELECTRONICS CORP
VITRO ELECTRONICS

MONITORS, POWER

F W BELL, INC
BIRD ELECTRONIC CORPORATION

MONITORS, VIDEO

AMECO, INC.
AMPEX CORPORATION
AMPLIVISION CORPORATION
BLONDER-TONGUE LABORATORIES
COMU ELECTRONICS
CONRAC
DIAMOND ELECTRONICS
G E VISUAL COMMUNICATIONS PROD
LAKE ELECTRONICS, INC.
LAVIOLETTE ELECTRONICS
MARCONI DIVISION
MARYLAND TELECOMMUNICATIONS
MIRAFEL ELECTRONICS, INC
RCA BROADCAST PRODS.
SARKES-TARZIAN
SETCHELL CARLSON INCORPORATED
THE SINGER CO - METRICS DIV
SONY CORPORATION OF AMERICA
SYLVANIA-COMM. ELECTRONICS DIV
TELEMET COMPANY
TELEQUIP CORPORATION
TELEVISION UTILITIES CORP
VISUAL ELECTRONICS CORP

MONITORS, WAVEFORM

COLORADO VIDEO
HEWLETT-PACKARD CO.
MARCONI DIVISION
RCA BROADCAST PRODS.
THE SINGER CO - METRICS DIV
SONY CORPORATION OF AMERICA
SYLVANIA-COMM. ELECTRONICS DIV
TEKTRONIX INC
VISUAL ELECTRONICS CORP

MONITORS, ELECTRIC - SEE HARDWARE

TOWNSEND ASSOCIATES

MONITORS, ANTENNA, FIXED

AMECO, INC.
ANDREW CORPORATION
GATES RADIO COMPANY
G C ELECTRONICS COMPANY
JERROLD ELECTRONICS CORP
LIBERTY TOWER MFG. CO
PRODELIN, INCORPORATED
RAYTHEON CO EQUIPMENT DIVISION
RCA BROADCAST PRODS.
ROHM MANUFACTURING CO.
SCIENTIFIC-ATLANTA
TECHNICAL APPLIANCE CORP
TELEQUIP CORPORATION

MONITORS, ANTENNA, MOBILE

GATES RADIO COMPANY
G C ELECTRONICS COMPANY
PRODELIN, INCORPORATED
RAYTHEON CO EQUIPMENT DIVISION
RCA BROADCAST PRODS.
TECHNICAL APPLIANCE CORP
TELEQUIP CORPORATION
UTICA CORPORATION
WATERS MANUFACTURING

MONITORS, INSTRUMENT

ATLAS SOUND
BIRNS & SAWYER
TELEQUIP CORPORATION
UTICA CORPORATION

MONITORS, VIBRATION AND SHOCK

ELECTROVERT, INCORPORATED
MINNESOTA MINING - 3 M

MULTIPLIXERS

DAGE BELL CORPORATION
RCA BROADCAST PRODS.
SYLVANIA-COMM. ELECTRONICS DIV
TELEMETATION, INC.
VIDEOON CORPORATION

NAMEPLATES

D & B ELECTRONICS COMPANY
MINNESOTA MINING - 3 M

NARROW BAND FM EQUIPMENT

AMECO, INC.
AMPLIVISION CORPORATION
COURIER COMMUNICATIONS
MARTI ELECTRONICS
MOSELEY ASSOCIATES INC.
SINGER PRODUCTS CO
STANDARD ELECTRONICS CORP
TOWNSEND ASSOCIATES
UTICA CORPORATION

NEEDLES, CUTTING - SEE STYL

NEEDLES, PLAYBACK - SEE STYL

NETWORKS, MATCHING, AUDIO

ALTEC LANSING

GATES RADIO COMPANY
HARTLEY PRODUCTS
LANGEVIN
SOUTHWESTERN COMMUNICATIONS
STEPHENS ELECTRONICS

NETWORKS, MATCHING, RF

ALFORD MANUFACTURING COMPANY
AMECO, INC.
AMPLIVISION CORPORATION
CCA ELECTRONICS CORPORATION
NARDA MICROWAVE CORPORATION
TELEVIC INDUSTRIES

NETWORKS, PHASING

AMERICAN ELECTRONIC LABS
AMPLIVISION CORPORATION
CCA ELECTRONICS CORPORATION
COLLINS RADIO COMPANY
GATES RADIO COMPANY
JERROLD ELECTRONICS CORP
MULTRONICS
RCA BROADCAST PRODS.
SINGER PRODUCTS CO.
SOUTHWESTERN COMMUNICATIONS
WARD ELECTRONIC INDUSTRIES

OHMMETERS

COMU ELECTRONICS
ENGINEERING ASSOCIATES
GOTHAM AUDIO CORPORATION
HEATH CO
HEWLETT-PACKARD CO.
HICKOK ELECTRICAL INSTRUMENT
INSTRUMENT LABORATORIES CORP
RCA ELECTRONIC COMPONENTS
TRIPLETT ELECTRICAL INSTRUMENT
YOKOGAWA ELECTRIC WORKS

OSCILLATORS, AF AND RF

ALSO SEE GENERATORS
BENRUS
CCA ELECTRONICS CORPORATION
ENGINEERING ASSOCIATES
GENERAL RADIO CO
GIBBS MFG. AND RESEARCH CORP.
HEATH CO
HEWLETT-PACKARD CO.
MARCONI INSTRUMENTS
MICROLAB / FXR
NARDA MICROWAVE CORPORATION
RCA BROADCAST PRODS.
RHMDE & SCHWARZ SALES CO. -USA
SCIENTIFIC-ATLANTA
SOUNDRAFT INDUSTRIES
TREPAC CORPORATION OF AMERICA
WAVEFORMS, INCORPORATED

OSCILLATORS, AM

CCA ELECTRONICS CORPORATION
ELECTRONIC RESEARCH COMPANY
ENGINEERING ASSOCIATES
GATES RADIO COMPANY
GENERAL RADIO CO
GIBBS MFG. AND RESEARCH CORP.
HEATH CO
HICKOK ELECTRICAL INSTRUMENT
MARCONI INSTRUMENTS
MICROLAB / FXR
RHMDE & SCHWARZ SALES CO. -USA
SOUTHWESTERN COMMUNICATIONS

OSCILLATORS, FM

BELAR ELECTRONICS LABORATORY
CCA ELECTRONICS CORPORATION
ELECTRONIC RESEARCH COMPANY
GATES RADIO COMPANY
GIBBS MFG. AND RESEARCH CORP.
HEATH CO
HICKOK ELECTRICAL INSTRUMENT
MARCONI INSTRUMENTS
RHMDE & SCHWARZ SALES CO. -USA
SOUTHWESTERN COMMUNICATIONS
STANDARD ELECTRONICS CORP.

OSCILLATORS, TV

GATES RADIO COMPANY
GIBBS MFG. AND RESEARCH CORP.
HEATH CO
HICKOK ELECTRICAL INSTRUMENT
RIKER VIDEO INDUSTRIES
RHMDE & SCHWARZ SALES CO. -USA
STANDARD ELECTRONICS CORP
TELEMET COMPANY
VIDEOON CORPORATION

OSCILLATORS, OTHER

EIMAC DIVISION OF VARIAN
ELECTRONIC RESEARCH COMPANY
ENGINEERING ASSOCIATES
GIBBS MFG. AND RESEARCH CORP.
MARCONI INSTRUMENTS
NARDA MICROWAVE CORPORATION
RHMDE & SCHWARZ SALES CO. -USA
TELEVIC INDUSTRIES
WAVEFORMS, INCORPORATED

OSCILLOSCOPES

ALTEC ELECTRONICS CORP
BENRUS
COLORADO VIDEO
DATA INSTRUMENT DIVISION
ENGINEERING ASSOCIATES
HEATH CO
HEWLETT-PACKARD CO.
HICKOK ELECTRICAL INSTRUMENT
ITI ELECTRONICS, INC.
RCA BROADCAST PRODS.
RCA ELECTRONIC COMPONENTS
TEKTRONIX INC
TELEQUIP CORPORATION

OVENS, CRYSTAL

ELECTRONIC RESEARCH COMPANY
SINGER PRODUCTS CO.
TRW ELECTRONICS

PANELS - SEE HARDWARE

PANELS, INSTRUMENT

FOR RACK MOUNTING -
ALSO SEE HARDWARE
BUD RADIO, INC
COLDTRAM INDUSTRIES - BERKEY
GENERAL ELECTRIC CO
SOUTHWESTERN COMMUNICATIONS
TELEQUIP CORPORATION
VENT-RAK INCORPORATED
YOKOGAWA ELECTRIC WORKS

PAPER, CHART AND GRAPH

ENGINEERING ASSOCIATES
MINNESOTA MINING - 3 M
SCIENTIFIC-ATLANTA

PHASING UNITS - SEE

NETWORKS, PHASING

PHONOGRAPH TURNTABLES -

SEE TURNTABLES

PICKUP, MUSICAL INSTRUMENTS

CUSTOM CRAFT DESIGNS

PLOWS, CABLE LAYING

F. B. RYAN MFG. COMPANY, INC.

PLUGS, COAXIAL

ADC PRODUCTS
AMECO, INC.
AMERICAN PAMCOR, INC
AMPHENOL DISTRIBUTOR DIVISION
ENGINEERING ASSOCIATES
ELECTRONICS ESSENTIALS OF CCC
GENERAL RADIO CO
JAMPRO ANTENNA COMPANY
PHELPS DODGE
RCA BROADCAST PRODS.
ROBINS INDUSTRIES CORP.
SINGER PRODUCTS CO.
THE TECHNICAL MATERIEL CORP
TROMPETER ELECTRONICS

PLUGS, PHONE

ADC PRODUCTS
AMPHENOL DISTRIBUTOR DIVISION
AUDIO ACCESSORIES
BIRNBACH CO
ELECTRONICS ESSENTIALS OF CCC
G C ELECTRONICS COMPANY
MALLORY DISTRIBUTOR PRODUCTS
RCA BROADCAST PRODS.
ROBINS INDUSTRIES CORP.
SINGER PRODUCTS CO.
SWITCHCRAFT, INC.

POLE CLIMBING EQUIPMENT

AMECO, INC.
PRUZAN COMPANY

POTENTIOMETERS, CARBON

AMERICAN ELITE
AMPHENOL DISTRIBUTOR DIVISION
CENTRALAB
GOTHAM AUDIO CORPORATION
IRC, INC.
OHMITE MANUFACTURING COMPANY
SINGER PRODUCTS CO.

POTENTIOMETERS, WIREWOUND

ALTEC LANSING
AMPHENOL DISTRIBUTOR DIVISION
CENTRALAB
ENGINEERING ASSOCIATES
GENERAL RADIO CO
IRC, INC.
OHMITE MANUFACTURING COMPANY
PAINOTN INCORPORATED
SINGER PRODUCTS CO.
WATERS MANUFACTURING

POWER SUPPLIES, AC

ADC PRODUCTS
ALTEC LANSING
AMECO, INC.
ANACONDA ASTRODATA CO
BIRNS & SAWYER
BLONDER-TONGUE LABORATORIES
COMU ELECTRONICS
CORNELL-DUBILIER ELECTRONICS
D & B ELECTRONICS COMPANY
ENGINEERING ASSOCIATES
FAIRCHILD RECORDING EQUIPMENT
GATES RADIO COMPANY
GENERAL ELECTRIC CO
GENERAL RADIO CO
GIBBS MFG. AND RESEARCH CORP.
GREGORY AMPLIFIER CORP
HEATH CO
JERROLD ELECTRONICS CORP
POWER SOURCES
THE SINGER CO - METRICS DIV
SOLA ELECTRIC
SORENSEN OPERATION-RAYTHEON CO
STACO, INC.
STANDARD ELECTRONICS CORP
TELEQUIP CORPORATION
TREPAC CORPORATION OF AMERICA

POWER SUPPLIES, DC

ADC PRODUCTS
ALMA ENGINEERING INC
ALTEC LANSING
AMECO, INC.
BIRNS & SAWYER
BLONDER-TONGUE LABORATORIES
CENTURY PROJECTOR CORPORATION
COMU ELECTRONICS
CORNELL-DUBILIER ELECTRONICS
DELTA ELECTRONICS, INC.
ELECTRO PRODUCTS LABORATORIES
ENGINEERING ASSOCIATES

Tektronix Television Instruments

Type 526 Vectorscope for Chroma-Signal Displays

color encoder adjustments
differential phase measurements
differential gain measurements
vertical-interval-test-signal (VITS)
displays
video tape-recorder setup



Measuring amplitude changes and phase shifts can be done accurately, conveniently, and independently with the Vectorscope. The Vectorscope presents relative phase and amplitude displays (of chrominance information in the N.T.S.C. color signal). Dual-trace capability permits simultaneous display of two color signals for precise matching of phase and amplitude. In addition to the vector display, the Vectorscope can present the chroma signal demodulated along any phase-angle with respect to time.

Type 526 Vectorscope \$1665
Size is 8 $\frac{1}{4}$ " high, 19" wide, and 18" deep.
Weight is ~ 45 pounds. Designed for rack mounting.

Type 529/RM529 for Waveform Monitoring

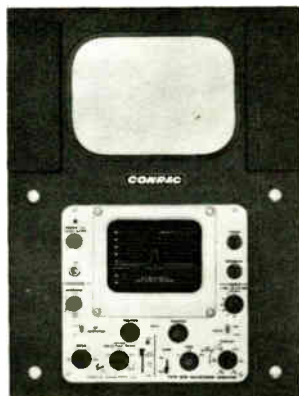
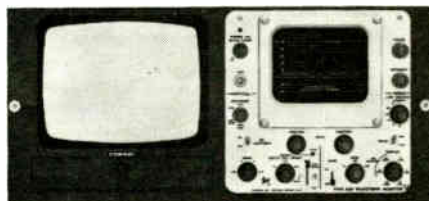
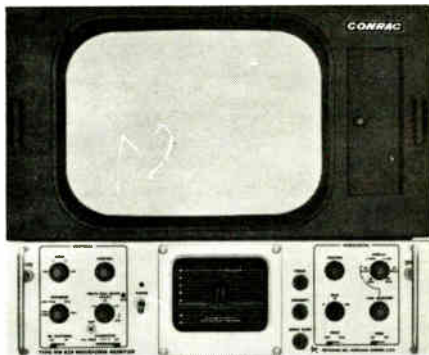

vertical-interval-test-signal (VITS)
displays
sine-squared pulse and bar testing
transmitter modulation monitoring
YRBG or RGB displays (with color-
processing amplifiers)
video signal-level monitoring
bandwidth measurements
differential-gain measurements

In waveform-monitoring applications, the Type 529 and RM529 offer 2 LINE and 2 FIELD displays plus calibrated sweep rates of 0.25 H/cm, 0.125 H/cm, 0.025 H/cm with X5 Magnifier, and 0.005 H/cm with X25 Magnifier. They provide 4 response characteristics necessary to monitor VITS—FLAT to 8 MHz (which assures excellent waveform fidelity for sine-squared testing with 2T, T, and 1/2T pulses), HIGH PASS 3.58 MHz, center frequency, LOW PASS—18 dB at 500 kHz, and IEEE 1958 STD 23-S-1. Other characteristics include a backporch type DC restorer, a positive-going field selector, and a full-field line-selector including digital VIT line selection.

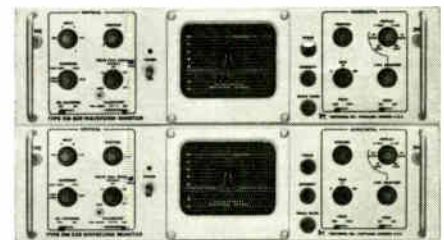
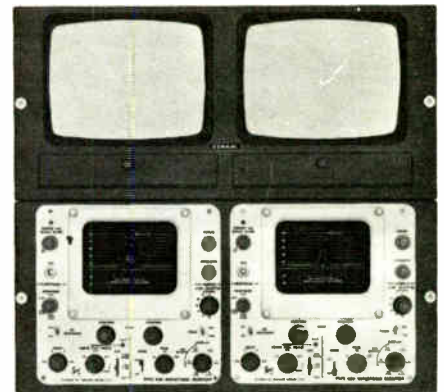

Type 529 Waveform Monitor . . . \$1050
(8 $\frac{1}{4}$ " high, 8 $\frac{1}{2}$ " wide, 19" deep, weighs 24 pounds.)

Rack Mount Type RM529 \$1100
(5 $\frac{1}{4}$ " high, 19" wide, 20" deep, weighs 27 pounds.)

Power consumption of each model is ~ 80 watts — no fan used.

U.S. Sales Prices, f.o.b. Beaverton, Oregon

Tektronix, Inc.



For complete information, contact your nearby Tektronix field engineer or write:
Tektronix, Inc., P.O. Box 500, Beaverton, Oregon 97005

ENTRON INC
FAIRCHILD RECORDING EQUIPMENT
FISHER BERKELEY CORPORATION
GATES RADIO COMPANY
G E VISUAL COMMUNICATIONS PROD
GENERAL ELECTRIC CO
GENERAL RADIO CO
HEATH CO
HEWLETT-PACKARD CO.
INTERNATIONAL NUCLEAR CORP.
LANGVIN
MELCOR ELECTRONICS
POWER SOURCES
RCA BROADCAST PRODS.
SOLA ELECTRIC
SORENSEN OPERATION-RAYTHEON CO
SOUNDCRAFT INDUSTRIES
SOUTHWESTERN COMMUNICATIONS
STACO, INC.
STANDARD ELECTRONICS CORP.
STEPHENS ELECTRONICS
SYLVANIA-COMM. ELECTRONICS DIV
TELEQUIP CORPORATION
TOWNSEND ASSOCIATES
TREPAC CORPORATION OF AMERICA
VIDEON CORPORATION

POWER SUPPLIES, PRECISION

ALTEC LANSING
COMU ELECTRONICS
ENGINEERING ASSOCIATES
GIBBS MFG. AND RESEARCH CORP.
HEATH CO
HEWLETT-PACKARD CO.
SOLA ELECTRIC
TELEQUIP CORPORATION
TRW ELECTRONICS
VIDEON CORPORATION

PREAMPLIFIERS, AUDIO

AITKEN COMMUNICATIONS
ALMA ENGINEERING INC
ALTEC LANSING
AMECO, INC.
AUDIO INSTRUMENT CO
BAUER ELECTRONICS CORPORATION
CCA ELECTRONICS CORPORATION
CENTRAL DYNAMICS CORPORATION
CENTURY PROJECTOR CORPORATION
CROWN INTERNATIONAL
DELTA ELECTRONICS, INC.
FAIRCHILD RECORDING EQUIPMENT
G E VISUAL COMMUNICATIONS PROD
GENERAL RADIO CO
GREGORY AMPLIFIER CORP
KOSS ELECTRONICS, INC.
LANGVIN
MARANTZ COMPANY
MARTI ELECTRONICS
MCMARTIN INDUSTRIES
MELCOR ELECTRONICS
MICROWAVE ASSOCIATES, INC.
MILES REPRODUCER CO
NORTH AMERICAN PHILIPS CO
ORBIT RADIO
PERMOFLUX CORPORATION
O R K ELECTRONIC PRODUCTS
RCA BROADCAST PRODS.
RECORDING EQUIPMENT COMPANY
RUSSCO ELECTRONICS MFG.
SCHAFER ELECTRONICS
H. H. SCOTT, INCORPORATED
SCULLY RECORDING INSTRUMENTS
SHURE BROTHERS, INC.
SONY CORPORATION OF AMERICA
SOUNDCRAFT INDUSTRIES
SOUTHWESTERN COMMUNICATIONS
SPARTA ELECTRONIC CORPORATION
STANCI-LOFFMAN CORPORATION
STEPHENS ELECTRONICS
TREPAC CORPORATION OF AMERICA
UTICA CORPORATION
WARD ELECTRONIC INDUSTRIES

PREAMPLIFIERS, VIDEO

AMECO, INC.
BLONDER-TONGUE LABORATORIES
CENTRAL DYNAMICS CORPORATION
GATES RADIO COMPANY
INTERNATIONAL NUCLEAR CORP.
JERROLD ELECTRONICS CORP
TELEQUIP CORPORATION
VIDEON CORPORATION
WARD ELECTRONIC INDUSTRIES

PREFABRICATED BUILDINGS

FORT WORTH TOWER CO., INC.
UTILITY TOWER CO.

PRESSURIZATION EQUIPMENT,

TRANSMISSION LINE
ANDREW CORPORATION
GATES RADIO COMPANY
THE MCINTIRE COMPANY
RCA BROADCAST PRODS.
SIGMA INDUSTRIES

PRINTERS, TELETYPE

SINGER PRODUCTS CO
TREPAC CORPORATION OF AMERICA

PROBS, OSCILLOSCOPE

DATA INSTRUMENT DIVISION
ELCTRONICS ESSENTIALS OF CCC
G C ELECTRONICS COMPANY
HEWLETT-PACKARD CO.
RCA ELECTRONIC COMPONENTS
TEKTRONIX INC
TELEMET COMPANY

PROBS, TEST LEAD

F W BELL, INC
ELECTRONICS ESSENTIALS OF CCC
E-2-HOOK TEST PRODUCTS
G C ELECTRONICS COMPANY
HEWLETT-PACKARD CO.

E F JOHNSON COMPANY
RCA ELECTRONIC COMPONENTS

PROCESSORS, FILM, B & W

BURKE & JAMES
THE JAMES FLOYD FORD CO
HOUSTON FEARLESS CORPORATION
MICRO RECORD CORP.
RCA BROADCAST PRODS.

PROCESSORS, FILM, COLOR

BURKE & JAMES
HOUSTON FEARLESS CORPORATION
MICRO RECORD CORP.
RCA BROADCAST PRODS.
TELEVISION ZOOMAR

PROJECTORS, FILM

ARRIFLEX-SIEMENS
BIRNS & SAWYER
BURKE & JAMES
CENTURY PROJECTOR CORPORATION
EASTMAN KODAK COMPANY
THE KALART COMPANY
MARCONI DIVISION
PRECISION LABORATORIES
RCA BROADCAST PRODS.
SINGER PRODUCTS CO.
SYLVANIA-COMM. ELECTRONICS DIV
TELEVISION UTILITIES CORP
TRAID CORPORATION
VISUAL ELECTRONICS CORP

PROJECTORS, FILM, REAR

ROBINS INDUSTRIES CORP.

PROJECTORS, SLIDE

AMPLIFIER CORP OF AMERICA
BURKE & JAMES
DISPLAY TECHNOLOGIES INC
EASTMAN KODAK COMPANY
GRAY RESEARCH & DEVELOPMENT CO
HARWALD COMPANY
THE KALART COMPANY
PRECISION LABORATORIES
RCA BROADCAST PRODS.
SINGER PRODUCTS CO.
SYLVANIA-COMM. ELECTRONICS DIV
VISUAL ELECTRONICS CORP
ZOOMATICS CORPORATION

PROJECTORS, TV, LARGE SCREEN

GENERAL TELEVISION NETWORK

BACKS, MOUNTING -

ALSO SEE HARDWARE
AMECO, INC.
RUD RADIO, INC
CENTURY PROJECTOR CORPORATION
COOK ELECTRIC COMPANY
DATA INSTRUMENT DIVISION
FAIRCHILD RECORDING EQUIPMENT
GATES RADIO COMPANY
G E VISUAL COMMUNICATIONS PROD
MICROWAVE ASSOCIATES, INC.
NEUMADE PRODUCTS CORPORATION
RAYTHEON CO EQUIPMENT DIVISION
RCA BROADCAST PRODS.
SCHAFER ELECTRONICS
WABER ELECTRONICS, INC.

RADAR, WEATHER

RCA BROADCAST PRODS.

RADOMES

ANDREW CORPORATION
FORT WORTH TOWER CO., INC.
JERROLD ELECTRONICS CORP
PRODELIN, INCORPORATED
SCIENTIFIC-ATLANTA
TECHNICAL APPLIANCE CORP

RECEIVERS, AM

ALLIED ELECTRONICS CORP
AMERICAN ELITE
BENJAMIN ELECTRONIC SOUND CORP
CALBEST ELECTRONICS
CCA ELECTRONICS CORPORATION
DELCO RADIO DIV
ELFCTRO-VOICE INC
G F SUPPLY COMPANY
HEATH CO
KAHN RESEARCH LABORATORIES
MARCONI INSTRUMENTS
NORTH AMERICAN PHILIPS CO
ROHDE & SCHWARZ SALES CO, -USA
SETCHELL CARLSON INCORPORATED
SINGER PRODUCTS CO
TELECTRO INDUSTRIES CORP
UTICA CORPORATION
VITRO ELECTRONICS

RECEIVERS, FM

ALLIED ELECTRONICS CORP
ALTEC LANSING
AMECO, INC.
AMERICAN ELITE
BELAR ELECTRONICS LABORATORY
BENJAMIN ELECTRONIC SOUND CORP
CALBEST ELECTRONICS
CCA ELECTRONICS CORPORATION
DAYTON ELECTRONIC PRODUCTS CO
DELCO RADIO DIV
ELECTRO-VOICE INC
GATES RADIO COMPANY
HEATH CO
JOHNSON ELECTRONICS, INC.
KARG LABORATORIES
MARANTZ COMPANY
MARCONI INSTRUMENTS
MARTI ELECTRONICS
MCMARTIN INDUSTRIES
MILES REPRODUCER CO
NORTH AMERICAN PHILIPS CO
RHG ELECTRONICS LABORATORY
ROHDE & SCHWARZ SALES CO, -USA

H. H. SCOTT, INCORPORATED
SETCHELL CARLSON INCORPORATED
SINGER PRODUCTS CO
SONY CORPORATION OF AMERICA
TELECTRO INDUSTRIES CORP
UTICA CORPORATION
VEGA ELECTRONICS CORPORATION
VITRO ELECTRONICS

RECEIVERS, HF

AMERICAN ELECTRONIC LABS
AMERICAN ELITE
BENJAMIN ELECTRONIC SOUND CORP
JOHNSON ELECTRONICS, INC.
KAHN RESEARCH LABORATORIES
MARCONI DIVISION
MARCONI INSTRUMENTS
NARDA MICROWAVE CORPORATION
RHG ELECTRONICS LABORATORY
ROHDE & SCHWARZ SALES CO, -USA
SCIENTIFIC-ATLANTA
SINGER PRODUCTS CO
THE TECHNICAL MATERIEL CORP
TELECTRO INDUSTRIES CORP
VITRO ELECTRONICS

RECEIVERS, MULTIPLEX

BELAR ELECTRONICS LABORATORY
BROWNING LABORATORIES, INC.
CCA ELECTRONICS CORPORATION
CONRAC
ELFCTRO-VOICE INC
HEATH CO
JOHNSON ELECTRONICS, INC.
JOHNSON ELECTRONICS, INC.
KARG LABORATORIES
MARANTZ COMPANY
MCMARTIN INDUSTRIES
H. H. SCOTT, INCORPORATED
SINGER PRODUCTS CO
TELECTRO INDUSTRIES CORP
VITRO ELECTRONICS

RECEIVERS, SCA

BELAR ELECTRONICS LABORATORY
BROWNING LABORATORIES, INC.
CALBEST ELECTRONICS
CCA ELECTRONICS CORPORATION
DAYTON ELECTRONIC PRODUCTS CO
KARG LABORATORIES
MARTI ELECTRONICS
MCMARTIN INDUSTRIES
SINGER PRODUCTS CO

RECEIVERS, TV, COLOR

AMECO, INC.
CONRAC
G F SALES AND DISTRIBUTION
HEATH CO
SETCHELL CARLSON INCORPORATED

RECEIVERS, TV, MONOCHROME

AMECO, INC.
CONRAC
G F SALES AND DISTRIBUTION
HEATH CO
SETCHELL CARLSON INCORPORATED
SONY CORPORATION OF AMERICA
SYLVANIA-COMM. ELECTRONICS DIV

RECORDERS, DISC, MAGNETIC

AMPEX CORPORATION
AMPEX CORPORATION
COLORADO VIDEO
FAIRCHILD RECORDING EQUIPMENT
MILES REPRODUCER CO
MVR CORPORATION

RECORDERS, FILM, LIGHT

MINNESOTA MINING - 3 M
TELEVISION UTILITIES CORP

RECORDERS, FILM, MAGNETIC

CENTURY PROJECTOR CORPORATION
MINNESOTA MINING - 3 M
STANCI-LOFFMAN CORPORATION
TELEVISION UTILITIES CORP

RECORDERS, MAGNETIC TAPE,

AUDIO
ALLIED ELECTRONICS CORP
AMERICAN ELITE
AMERICAN GELOSO ELECTRONICS
AMPEX CORPORATION
AMPLIFIER CORP OF AMERICA
AUDIO INSTRUMENT CO
BROADCAST ELECTRONICS, INC
CALIFONE/ROBERTS
COMPUTRON INC
CROWN INTERNATIONAL
FAIRCHILD RECORDING EQUIPMENT
GENERAL RADIO CO
GOTHAM AUDIO CORPORATION
HEATH CO
IMPEX ELECTRONICS CORP
INTERNATIONAL GOOD MUSIC
JETRONIC INDUSTRIES, INC.
JOA CARTRIDGE SERVICE
KRS INSTRUMENTS DIVISION
MARCATA INC.
MACKENZIE LABORATORIES
MAGNA-TECH CORPORATION
MAGNETEC
METROTECH INCORPORATED
MILES REPRODUCER CO
MINNESOTA MINING - 3 M
NORTH AMERICAN PHILIPS CO
RCA BROADCAST PRODS.
SCHAFER ELECTRONICS
SCULLY RECORDING INSTRUMENTS
SONY CORPORATION OF AMERICA
THE SOUND SCRIBER CORP.
STANCI-LOFFMAN CORPORATION
STEPHENS ELECTRONICS
MATTHEW STUART & CO, INC
TAPECASTER ELECTRONICS
TAPF-ATHON CORPORATION

TELECTRO INDUSTRIES CORP
VIKING OF MINNEAPOLIS
VISUAL ELECTRONICS CORP

RECORDERS, MAGNETIC TAPE,

AUDIO, CARTRIDGE
BROADCAST ELECTRONICS, INC
COLLINS RADIO COMPANY
GATES RADIO COMPANY
KRS INSTRUMENTS DIVISION
LACROSSE ELECTRONICS, INC.
MACKENZIE LABORATORIES
RCA BROADCAST PRODS.
SPARTA ELECTRONIC CORPORATION
TAPECASTER ELECTRONICS
VIKING OF MINNEAPOLIS

RECORDERS, MAGNETIC TAPE,

LOGGING
AMPEX CORPORATION
CROWN INTERNATIONAL
KRS INSTRUMENTS DIVISION
MAGNEFORM
METROTECH INCORPORATED
MILES REPRODUCER CO
MINNESOTA MINING - 3 M
SCHAFER ELECTRONICS
STANCI-LOFFMAN CORPORATION
TAPE-ATHON CORPORATION
TELECTRO INDUSTRIES CORP
VIKING OF MINNEAPOLIS

RECORDERS, MAGNETIC TAPE,

VIDEO
AMPEX CORPORATION
AMPLIVISION CORPORATION
MINNESOTA MINING - 3 M
MVR CORPORATION
NORTH AMERICAN PHILIPS CO
RCA BROADCAST PRODS.
SONY CORPORATION OF AMERICA
TELECTRO INDUSTRIES CORP
VISUAL ELECTRONICS CORP

RECORDERS, PAPER

LOGGING AND GRAPHIC
API INSTRUMENTS CO
BAUER ELECTRONICS CORPORATION
ENGINEERING ASSOCIATES
GENERAL ELECTRIC CO
GENERAL RADIO CO
HEATH CO
HEWLETT-PACKARD CO.
NESCO INSTRUMENTS DIV.
ROHDE & SCHWARZ SALES CO, -USA
SCIENTIFIC-ATLANTA
YOKOGAWA ELECTRIC WORKS

RECORDERS, VIDEO, KINESCOPE

VAE-TRONICS INC.

RECORDING SERVICE, AUDIO, TAPE

THE JAMES FLOYD FORD CO

RECORD PLAYERS - SEE TURNTABLES

RECORDS, BLANK, ACETATE,

FOR RECORDING
ASCO SOUNDCRAFT CORP
DUOTONE COMPANY INC
SINGER PRODUCTS CO
TRANSCO PRODUCTS, INTL

RECORDS, BLANK, LACQUER,

FOR RECORDING
AUDIO DEVICES
REFEVES SOUNDCRAFT
SINGER PRODUCTS CO.
TRANSCO PRODUCTS, INTL

RECORDS, SOUND EFFECT

SPEEDY-O ENTERPRISES

RECORDS, TEST

C B S LABORATORIES

RECTIFIERS - ALSO SEE

SEMICONDUCTORS
CCA ELECTRONICS CORPORATION
ETIMAC DIVISION OF VARIAN
GENERAL ELECTRIC CO
HEINTZ & KAUFMAN, LTD
INTERNATIONAL RECTIFIER
MOTOROLA SEMICONDUCTOR
SARKES-TARZIAN
SOLITRON DEVICES
STANDARD ELECTRONICS CORP.
TEXAS INSTRUMENTS
WILKINSON ELECTRONICS, INC

RECTIFIERS, SELENIUM

AMERICAN ELITE
GENERAL ELECTRIC CO
INTERNATIONAL RECTIFIER
IRC, INC.
SARKES-TARZIAN
SINGER PRODUCTS CO.

REELS, CABLE, AUTOMATIC

INDUSTRIAL DEVICES, INC.
INDUSTRIAL ELECTRIC REELS
VENT-RAK INCORPORATED

REELS, FILM

AMERLINE CORPORATION
BIRNS & SAWYER
BURKE & JAMES
HARWALD COMPANY
NEUMADE PRODUCTS CORPORATION
STANCI-LOFFMAN CORPORATION

REELS, TAPE

AMERLINE CORPORATION
AUDIO DEVICES

SPARTA-MATIC[®] TAPE CARTRIDGE SYSTEMS*



800C SERIES
Space saving, compact, table-top convenience • Transistorized modular electronics • Super-silent operation • Hinged lid for easy internal access



300C SERIES
Rack, table-top or cabinet mounting • Transistorized plug-in modules • 2nd and 3rd tone cue option • Separate record amplifier • Full remote operation

NEW SPARTA ENGINEERED CH-5 TAPE CARTRIDGE TRANSPORT



Direct motor capstan drive eliminates belt driven assembly • Hysteresis synchronous motor with lifetime lubricated ball bearings • Exclusive super-silent solenoid system • Precision crafted for years of maintenance free service



BP-211C BRIEFCASE CARTRIDGE PLAYBACK
Provides quick and convenient tape cartridge auditioning • Excellent sales aid unit • Rechargeable battery and A/C operation • Extension speaker • Cartridge storage • Samsonite attache case with business paper portfolio

MC-104

MULTI-CARTRIDGE PLAYBACK
Provides four independent plug-in CH-5 tape cartridge transports • Compact design for table-top (illustrated) or rack mount installation • Individual transistorized electronics • Manual or sequential operation • Multi tone and audio switcher options



CD-15 TIME DELAY & REVERB UNIT

Time delay of 3 seconds to 31 minutes • Provides "before-air" censorship of conversational programming • Selective reverberation effects.



*
**ALL SPARTAMATIC
SYSTEMS EXCEED NAB
STANDARDS**

†
**ALL SPARTA CONSOLES
EXCEED FCC PROOF OF PERFORMANCE
SPECIFICATIONS**

SPARTA AUDIO EQUIPMENT AND ACCESSORIES †



**AS-30
STEREO AUDIO CONSOLE**
Five stereo mixer channels • 14 stereo audio inputs • Monitor, cueing & muting terminal facilities provided • All transistorized modular electronics • Selectable stereo/mono mode control

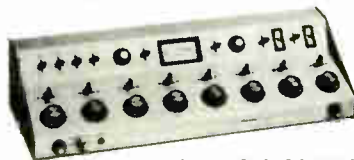

A-20 STUDIO CONTROL CONSOLE
Full facility audio control center • All transistorized • Eight mixers • Twenty-two inputs • Self-contained power supply • 5 watt monitor and .5 watt cue amplifier • Accommodates eight preamps (three supplied) • Individual electronic modules • Studio talkback provisions • Functional, space-saving compactness • All inputs and output are transformer balanced



A-15 AUDIO CONSOLE
14 audio inputs • Five mixing channels • Built in monitor, cueing & muting systems • All transistorized modular electronics • Three line outputs plus P.A., headphone & external speaker output • Accommodates up to four preamps



RA-5 REMOTE MIXER
Two mixers • 3 audio inputs • Line test oscillator • P.A. output • 30 hour battery operation • Shoulder strap carrying case included



AC-155 STUDIO/REMOTE UNIT

Recording studio • Remote broadcast • Main studio control • Full broadcast facility • Monitor & cue system • Muting • P. A. output • Solid state removable console • Two 3-speed custom turntable systems • Six low-level and eight high-level inputs •



SHOWCASE CABINETRY
Console Desk • Dual & Single turntable Returns • Utility Returns with Cartridge Hutch • Mix'n Match for a Custom Look



**FIDELIPAC
TAPE
CARTRIDGES**
All sizes and standard lengths in stock • Cartridge recondition and reloading service.



**CE-2
CARTRIDGE
ERASER**
Faster and total erasing of cartridges and reels up to 10 1/2"



SPARTA ELECTRONIC CORPORATION

5851 FLORIN-PERKINS ROAD, SACRAMENTO, CALIFORNIA 95828
(916) 383-5353



TC-12 CUSTOM TURNTABLE
Instant acceleration • Heavy-duty professional quality • Positive 3-speed lever control • Plays 45's without adapter • Trouble free performance

EXPORT SALES: SPARTA INTERNATIONAL CORPORATION
95 BROAD STREET, NEW YORK, N.Y. 10004

All prices subject to change

BIRNS & SAWYER
BROADCAST ELECTRONICS, INC
EASTMAN KODAK COMPANY
MAGNECOR
MINNESOTA MINING - 3 M
REEVES SOUNDRAFT
ROBINS INDUSTRIES CORP.
SONY CORPORATION OF AMERICA
STANDARD RECORD MFG. CO.
WIDE RESPONSE

REFLECTORS, PASSIVE
ADVANCE INDUSTRIES
FORT WORTH TOWER CO., INC.
MASTER TOWER CO
MICROFLECT COMPANY INC.
RCA BROADCAST PRODS.
ROHN MANUFACTURING CO.
STAINLESS, INC.
UTILITY TOWER CO.

REGULATORS, CURRENT
G E SUPPLY COMPANY
GENERAL ELECTRIC CO
SOLA ELECTRIC

REGULATORS, VOLTAGE
ALTEC LANSING
CCA ELECTRONICS CORPORATION
G E SUPPLY COMPANY
GENERAL ELECTRIC CO
GENERAL RADIO CO
SOLA ELECTRIC
STACO, INC.

RELAYS, ANTENNA
COOK ELECTRIC COMPANY
E F JOHNSON COMPANY

RELAYS, BREAK IN
ESSEX WIRE CORPORATION

RELAYS, COAXIAL
ENGINEERING ASSOCIATES
JENNINGS RADIO MANUFACTURING
STRUTHERS-DUNN
TROMPETER ELECTRONICS
VISUAL ELECTRONICS CORP

RELAYS, GENERAL PURPOSE
ALLIED ELECTRONICS CORP
COOK ELECTRIC COMPANY
CORNELL-DUBILIER ELECTRONICS
ESSEX WIRE CORPORATION
GENERAL ELECTRIC CO
JENNINGS RADIO MANUFACTURING
OHMITE MANUFACTURING COMPANY
RBM CONTROLS
SIGMA INSTRUMENTS INC.
STRUTHERS-DUNN

RELAYS, LATCHING
AMERICAN ELITE
CORNELL-DUBILIER ELECTRONICS
GENERAL ELECTRIC CO
JENNINGS RADIO MANUFACTURING
OHMITE MANUFACTURING COMPANY
RBM CONTROLS
SIGMA INSTRUMENTS INC.
STRUTHERS-DUNN

RELAYS, LIGHT INDICATING
HUGHES & PHILLIPS
OHMITE MANUFACTURING COMPANY

RELAYS, OVERLOAD
API INSTRUMENTS CO.
CORNELL-DUBILIER ELECTRONICS
ENGINEERING ASSOCIATES
ESSEX WIRE CORPORATION
GENERAL ELECTRIC CO
G-V CONTROLS INC.
JENNINGS RADIO MANUFACTURING
OHMITE MANUFACTURING COMPANY
SIGMA INSTRUMENTS INC.
STRUTHERS-DUNN

RELAYS, PHOTOELECTRIC
CORNELL-DUBILIER ELECTRONICS
GENERAL ELECTRIC CO
HOUSTON ELECTRONICS CO.
HUGHES & PHILLIPS
SIGMA INSTRUMENTS INC.
STEPHENS ELECTRONICS

RELAYS, PLUG IN
CORNELL-DUBILIER ELECTRONICS
ESSEX WIRE CORPORATION
RBM CONTROLS
SIGMA INSTRUMENTS INC.
STEPHENS ELECTRONICS
STRUTHERS-DUNN
TREPAC CORPORATION OF AMERICA

RELAYS, POWER
CORNELL-DUBILIER ELECTRONICS
ENGINEERING ASSOCIATES
ESSEX WIRE CORPORATION
GENERAL ELECTRIC CO
JENNINGS RADIO MANUFACTURING
OHMITE MANUFACTURING COMPANY
RBM CONTROLS
SIGMA INSTRUMENTS INC.
STRUTHERS-DUNN

RELAYS, SEQUENCING
CORNELL-DUBILIER ELECTRONICS
ESSEX WIRE CORPORATION
SIGMA INSTRUMENTS INC.
STRUTHERS-DUNN
TREPAC CORPORATION OF AMERICA
TROMPETER ELECTRONICS

RELAYS, STEPPING
CORNELL-DUBILIER ELECTRONICS

ENGINEERING ASSOCIATES
JENNINGS RADIO MANUFACTURING
STRUTHERS-DUNN
TROMPETER ELECTRONICS

RELAYS, TELEPHONE
COOK ELECTRIC COMPANY
CORNELL-DUBILIER ELECTRONICS
ENGINEERING ASSOCIATES
ESSEX WIRE CORPORATION
ITT TELECOMMUNICATIONS
RBM CONTROLS
SIGMA INSTRUMENTS INC.

RELAYS, THERMAL
BLONDFR-TONGUE LABORATORIES
DIALIGHT CORPORATION
ESSEX WIRE CORPORATION
GENERAL ELECTRIC CO
G-V CONTROLS INC.

RELAYS, TIME DELAY
AMPERITE CO
CORNELL-DUBILIER ELECTRONICS
DIALIGHT CORPORATION
ENGINEERING ASSOCIATES
ESSEX WIRE CORPORATION
GENERAL ELECTRIC CO
HOUSTON ELECTRONICS CO.
OHMITE MANUFACTURING COMPANY
RBM CONTROLS
STRUTHERS-DUNN
TREPAC CORPORATION OF AMERICA
G-V CONTROLS INC.
MOLE-RICHARDSON CO.

REMOTE CONTROL SYSTEMS
ALBION OPTICAL COMPANY
BAUER ELECTRONICS CORPORATION
ANDREW CORPORATION
BIONIC INSTRUMENTS, INC.
CENTRAL DYNAMICS CORPORATION
CONTINENTAL ELECTRONICS MFG
DELTA ELECTRONICS, INC.
ENGINEERING ASSOCIATES
F & M SYSTEMS COMPANY
GATES RADIO COMPANY
GENERAL ELECTRIC CO
HANCOCK TELECONTROL
MARTI ELECTRONICS
MOSELEY ASSOCIATES INC.
ORBIT RADIO
SCHAFFER ELECTRONICS
SINGER PRODUCTS CO.
SOUTHWESTERN COMMUNICATIONS
TELETRONIX
VISUAL ELECTRONICS CORP
TREPAC CORPORATION OF AMERICA

RESISTORS, FIXED, CARBON
AEROVOX CORP.
AMERICAN ELITE
AMPEREX ELECTRONIC CORP
G C ELECTRONICS COMPANY
IRC, INC.
OHMITE MANUFACTURING COMPANY
PAINTON INCORPORATED
SINGER PRODUCTS CO.
TEXAS INSTRUMENTS

RESISTORS, FIXED, NONINDUCTIVE
GENERAL RADIO CO
IRC, INC.
OHMITE MANUFACTURING COMPANY
VISHAY RESISTOR PRODUCTS DIV

RESISTORS, FIXED, PRECISION
AEROVOX CORP.
AMPHENOL DISTRIBUTOR DIVISION
GENERAL RADIO CO
IRC, INC.
JORDAN ELECTRIC COMPANY
MALLORY DISTRIBUTOR PRODUCTS
OHMITE MANUFACTURING COMPANY
PAINTON INCORPORATED
TEXAS INSTRUMENTS
VISHAY RESISTOR PRODUCTS DIV

RESISTORS, FIXED, WIREWOUND
AMPHENOL DISTRIBUTOR DIVISION
GENERAL ELECTRIC CO
GENERAL RADIO CO
HAMILTON HALL RESISTOR CORP.
IRC, INC.
JORDAN ELECTRIC COMPANY
MALLORY DISTRIBUTOR PRODUCTS
OHMITE MANUFACTURING COMPANY
PAINTON INCORPORATED
SINGER PRODUCTS CO.

RESISTORS, FIXED, OTHER
AEROVOX CORP.
AMPEREX ELECTRONIC CORP
GENERAL ELECTRIC CO
IRC, INC.
OHMITE MANUFACTURING COMPANY
PAINTON INCORPORATED

RESISTORS, VARIABLE, CARBON
AMPHENOL DISTRIBUTOR DIVISION
MALLORY DISTRIBUTOR PRODUCTS
OHMITE MANUFACTURING COMPANY
SINGER PRODUCTS CO.

RESISTORS, VARIABLE, WIREWOUND
AMPHENOL DISTRIBUTOR DIVISION
ENGINEERING ASSOCIATES
G C ELECTRONICS COMPANY
GENERAL RADIO CO
IRC, INC.
MALLORY DISTRIBUTOR PRODUCTS
OHMITE MANUFACTURING COMPANY
PAINTON INCORPORATED
WATERS MANUFACTURING

REVERBERATION DEVICES -
ALSO SEE AMPLIFIERS
AMPLIFIER CORP OF AMERICA
BAUER ELECTRONICS CORPORATION
CLEVELAND ELECTRONICS
SPEAKER DIVISION
FOURCH RECORDING EQUIPMENT
GOTHAM AUDIO CORPORATION
GREGORY AMPLIFIER CORP
LITTLE JOE ENTERPRISES
ORBIT RADIO
SINGER PRODUCTS CO
STEPHENS ELECTRONICS
VISUAL ELECTRONICS CORP

REWINDERS, FILM
BURKE & JAMES
CENTURY PROJECTOR CORPORATION
HARWALD COMPANY
NEUMADE PRODUCTS CORPORATION
RCA BROADCAST PRODS.

REWINDERS, TAPE
HARVEY RADIO CO, INC.

RHEOSTATS
ENGINEERING ASSOCIATES
GENERAL ELECTRIC CO
GENERAL RADIO CO
MALLORY DISTRIBUTOR PRODUCTS
NEUMADE PRODUCTS CORPORATION
OHMITE MANUFACTURING COMPANY

RINGS, RETAINING - SEE HARDWARE

RODS, GROUND
AMPLIVISION CORPORATION

SAFETY DEVICES, CLIMBING
AIR SPACE DEVICES
PRUZAN COMPANY

SCHOOLS, FACILITIES & EQUIPMENT
SEE EDUCATION FACILITIES

SCRAMBLERS, SPEECH
SINGER PRODUCTS CO
TREPAC CORPORATION OF AMERICA

SCREENS, PROJECTION, FRONT
ASCO SONOCRAFT CORP
BIRNS & SAWYER
BURKE & JAMES
RAVEN SCREEN CORPORATION
VISUAL ELECTRONICS CORP

SCREENS, PROJECTION, REAR
BURKE & JAMES
DISPLAY TECHNOLOGIES INC
RAVEN SCREEN CORPORATION
VISUAL ELECTRONICS CORP
H. WILSON CORPORATION

SEMICONDUCTOR DIODES
AMERICAN ELECTRONIC LABS
AMERICAN ELITE
AMPEREX ELECTRONIC CORP
G E DISTRIBUTOR SALES FORCE
GENERAL ELECTRIC CO
HEWLETT-PACKARD CO.
INTERNATIONAL RECTIFIER
IRC, INC.
MICROLAB / FXR
MICROWAVE ASSOCIATES, INC.
MOTOROLA SEMICONDUCTOR
OHMITE MANUFACTURING COMPANY
RCA ELECTRONIC COMPONENTS
SARKES-TARZIAN
SINGER PRODUCTS CO.
SOLITRON DEVICES
SYLVANIA-SEMICONDUCTOR DIV.
TEXAS INSTRUMENTS
THOR ELECTRONICS
TRW ELECTRONICS

SEMICONDUCTOR RECTIFIERS,
GENERAL
CENTURY PROJECTOR CORPORATION
G E DISTRIBUTOR SALES FORCE
GENERAL ELECTRIC CO
INTERNATIONAL RECTIFIER
IRC, INC.
MALLORY DISTRIBUTOR PRODUCTS
MOTOROLA SEMICONDUCTOR
RCA ELECTRONIC COMPONENTS
SARKES-TARZIAN
SINGER PRODUCTS CO.
SOLITRON DEVICES
SYLVANIA-SEMICONDUCTOR DIV.
TEXAS INSTRUMENTS
THOR ELECTRONICS
TRW ELECTRONICS

SEMICONDUCTOR RECTIFIERS,
HIGH VOLTAGE
G E DISTRIBUTOR SALES FORCE
INTERNATIONAL RECTIFIER
MOTOROLA SEMICONDUCTOR
RCA ELECTRONIC COMPONENTS
SARKES-TARZIAN
SINGER PRODUCTS CO.
SOLITRON DEVICES
TEXAS INSTRUMENTS
THOR ELECTRONICS
TRW ELECTRONICS
WILKINSON ELECTRONICS, INC

SEMICONDUCTOR RECTIFIERS,
POWER
G E DISTRIBUTOR SALES FORCE
GENERAL ELECTRIC CO
INTERNATIONAL RECTIFIER
MALLORY DISTRIBUTOR PRODUCTS
MOTOROLA SEMICONDUCTOR

RCA ELECTRONIC COMPONENTS
SARKES-TARZIAN
SINGER PRODUCTS CO.
SOLITRON DEVICES
SYLVANIA-SEMICONDUCTOR DIV.
TEXAS INSTRUMENTS
THOR ELECTRONICS
WILKINSON ELECTRONICS, INC

SEMICONDUCTOR RECTIFIERS,
SILICON CONTROLLED - SCR
AMPEREX ELECTRONIC CORP
DELCO RADIO DIV
G E DISTRIBUTOR SALES FORCE
GENERAL ELECTRIC CO
INTERNATIONAL RECTIFIER
IRC, INC.
MOTOROLA SEMICONDUCTOR
RCA ELECTRONIC COMPONENTS
SARKES-TARZIAN
TEXAS INSTRUMENTS
THOR ELECTRONICS

SEMICONDUCTORS, THYRISTORS
AMPEREX ELECTRONIC CORP
G E DISTRIBUTOR SALES FORCE
INTERNATIONAL RECTIFIER
IRC, INC.
MOTOROLA SEMICONDUCTOR
RCA ELECTRONIC COMPONENTS
TEXAS INSTRUMENTS
THOR ELECTRONICS

SEMICONDUCTORS, TRANSISTORS, AF
AMERICAN ELITE
AMPEREX ELECTRONIC CORP
DELCO RADIO DIV
G E DISTRIBUTOR SALES FORCE
INTERNATIONAL RECTIFIER
LAKE ELECTRONICS, INC.
MOTOROLA SEMICONDUCTOR
RCA ELECTRONIC COMPONENTS
SINGER PRODUCTS CO.
SOLITRON DEVICES
SYLVANIA-SEMICONDUCTOR DIV.
TEXAS INSTRUMENTS
THOR ELECTRONICS

SEMICONDUCTORS, TRANSISTORS, FE
AMPEREX ELECTRONIC CORP
G E DISTRIBUTOR SALES FORCE
MOTOROLA SEMICONDUCTOR
RCA ELECTRONIC COMPONENTS
TEXAS INSTRUMENTS
THOR ELECTRONICS

SEMICONDUCTORS, TRANSISTORS, GENERAL
AMPEREX ELECTRONIC CORP
DELCO RADIO DIV
G E DISTRIBUTOR SALES FORCE
GENERAL ELECTRIC CO
INTERNATIONAL RECTIFIER
LAKE ELECTRONICS, INC.
MOTOROLA SEMICONDUCTOR
RCA ELECTRONIC COMPONENTS
SINGER PRODUCTS CO.
SOLITRON DEVICES
SYLVANIA-SEMICONDUCTOR DIV.
TEXAS INSTRUMENTS
THOR ELECTRONICS
TRW ELECTRONICS

SEMICONDUCTORS, TRANSISTORS, RF
AMERICAN ELITE
AMPEREX ELECTRONIC CORP
G E DISTRIBUTOR SALES FORCE
INTERNATIONAL RECTIFIER
MOTOROLA SEMICONDUCTOR
RCA ELECTRONIC COMPONENTS
SOLITRON DEVICES
SYLVANIA-SEMICONDUCTOR DIV.
TEXAS INSTRUMENTS
THOR ELECTRONICS
TRW ELECTRONICS

SERVICES, FREQUENCY-MEASUREMENT
SEE CALIBRATION SERVICES,
FREQUENCY

SERVICES, INSTALLATION
GRINNAN FIXTURE COMPANY
GULF ELECTRO-SALES INC

SERVICES, MAINTENANCE -
SEE MAINTENANCE SERVICES

SHIELDINGS, TUBE
ELECTRONICS ESSENTIALS OF CCC

SHIFTERS, PHASE, MICROWAVE
DEMORNAY - BONARDI DIVISION
MICROWAVE ASSOCIATES, INC.
NARDA MICROWAVE CORPORATION
PRODELIN, INCORPORATED

SHUNTS, METER
ENGINEERING ASSOCIATES
G E INDUSTRIAL SALES OPERATION
GENERAL ELECTRIC CO
THE SINGER CO - METRICS DIV
TRIPLETT ELECTRICAL INSTRUMENT

SLIDES, CHASSIS
BUDD RADIO, INC
CHASSIS TRAK
ELECTRONICS ESSENTIALS OF CCC
ROBINS INDUSTRIES CORP.
VENT-RAK INCORPORATED

SLOTTED SECTIONS
ALFORD MANUFACTURING COMPANY
DEMORNAY - BONARDI DIVISION
MICROLAB / FXR
MICRO-LINK SYSTEMS/VARIAN ASSO

NARDA MICROWAVE CORPORATION
PHELPS DODGE
PRODELIN, INCORPORATED
ROHDF & SCHWARZ SALFS CO. -USA

SOCKETS, CRYSTAL

E F JOHNSON COMPANY

SOCKETS, LAMP

AUDIO ACCESSORIES
DIALIGHT CORPORATION
ELECTRONICS ESSENTIALS OF CCC
F F JOHNSON COMPANY

SOCKETS, TUBE

AEROVOX CORP.
EIMAC DIVISION OF VARIAN
ELECTRONICS ESSENTIALS OF CCC
G C ELECTRONICS COMPANY
E F JOHNSON COMPANY

SOLDER

G C ELECTRONICS COMPANY
SINGER PRODUCTS CO.

SOLVENTS AND CLEANERS

G C ELECTRONICS COMPANY
HARWALD COMPANY
NEUMADE PRODUCTS CORPORATION
ROBINS INDUSTRIES CORP.

SOUND SYSTEMS, OUTDOOR

ALTEC LANSING
AMERICAN GELOSO ELECTRONICS
AMPEX CORPORATION
APPLIED ELECTRO-MECHANICS
ATLAS SOUND
AUDIO INSTRUMENT CO
GREGORY AMPLIFIER CORP
HARVEY RADIO CO., INC.
HOUSTON ELECTRONICS CO.
JENSEN MANUFACTURING
JAMES B LANSING SOUND CO
MCMARTIN INDUSTRIES
NORTH AMERICAN PHILIPS CO
RCA BROADCAST PRODS.
SOUTHWESTERN COMMUNICATIONS
TRUSONIC

SOUND SYSTEMS, PORTABLE

ALTEC LANSING
AMERICAN GELOSO ELECTRONICS
AMPEX CORPORATION
APPLIED ELECTRO-MECHANICS
CALIFONE/ROBERTS
CENTURY PROJECTOR CORPORATION
GREGORY AMPLIFIER CORP
HARVEY RADIO CO., INC.
HOUSTON ELECTRONICS CO.
JENSEN MANUFACTURING
MCMARTIN INDUSTRIES
NORTH AMERICAN PHILIPS CO
ORBIT RADIO
RCA BROADCAST PRODS.
SINGER PRODUCTS CO.
SONY CORPORATION OF AMERICA
SOUTHWESTERN COMMUNICATIONS
TRUSONIC

SOUND SYSTEMS, THEATER

ALTEC LANSING
AMPEX CORPORATION
ATLAS SOUND
AUDIO INSTRUMENT CO
CENTURY PROJECTOR CORPORATION
GREGORY AMPLIFIER CORP
HARVEY RADIO CO., INC.
HOUSTON ELECTRONICS CO.
JENSEN MANUFACTURING
JAMES B LANSING SOUND CO
MCMARTIN INDUSTRIES
MID AMERICA ELECTRONICS CORP
NORTH AMERICAN PHILIPS CO
RCA BROADCAST PRODS.
TRUSONIC

SPEAKER COMPONENTS

ALTEC LANSING
AMERICAN GELOSO ELECTRONICS
ATLAS SOUND
CALBEST ELECTRONICS
ELECTRO-VOICE INC
ELECTRONICS ESSENTIALS OF CCC
JENSEN MANUFACTURING
JAMES B LANSING SOUND CO
NORTH AMERICAN PHILIPS CO
PERMOFLUX CORPORATION
RCA BROADCAST PRODS.
SINGER PRODUCTS CO
SONY CORPORATION OF AMERICA
TRUSONIC

SPEAKERS

ALTEC LANSING
AMERICAN ELITE
AMERICAN GELOSO ELECTRONICS
AMPEX CORPORATION
ATLAS SOUND
CALIFONE/ROBERTS
CCA ELECTRONICS CORPORATION
CENTURY PROJECTOR CORPORATION
CLEVELAND ELECTRONICS
SPEAKER DIVISION
ELECTRO-SOUND ACOUSTICS
ELECTRO-VOICE INC
GATES RADIO COMPANY
GREGORY AMPLIFIER CORP
HARTLEY PRODUCTS
JENSEN MANUFACTURING
KOSS ELECTRONICS, INC.
LAKE ELECTRONICS, INC.
JAMES B LANSING SOUND CO
MCMARTIN INDUSTRIES
NORTH AMERICAN PHILIPS CO
OAKTRON INDUSTRIES, INC.
PERMOFLUX CORPORATION
RCA BROADCAST PRODS.

SETCHELL CARLSON INCORPORATED
SINGER PRODUCTS CO
SONY CORPORATION OF AMERICA
TRUSONIC
TRW ELECTRONICS

SPLICERS, MAGNETIC TAPE & FILM

BIRNS & SAWYER
BROADCAST ELECTRONICS, INC
BURKE & JAMES
G C ELECTRONICS COMPANY
HARWALD COMPANY
THE KALART COMPANY
MINNESOTA MINING - 3 M
NEUMADE PRODUCTS CORPORATION
PRECISION LABORATORIES
RCA BROADCAST PRODS.
ROBINS INDUSTRIES CORP.
SPARTA ELECTRONIC CORPORATION

STANDS, TELEVISION MONITOR

GENERAL TELEVISION NETWORK

STL EQUIPMENT

ANDREW CORPORATION
CCA ELECTRONICS CORPORATION
COLLINS RADIO COMPANY
JERROLD ELECTRONICS CORP
MARTI ELECTRONICS
MCMARTIN INDUSTRIES
MICRO-LINK SYSTEMS/VARIAN ASSO
MOSELY ASSOCIATES INC.
RCA BROADCAST PRODS.
RHG ELECTRONICS LABORATORY
SARKES-TARZIAN
SINGER PRODUCTS CO
TELEMET COMPANY
TELETRONIX
TREPAC CORPORATION OF AMERICA
VISUAL ELECTRONICS CORP

STROBE, DISC

G C ELECTRONICS COMPANY
GENERAL RADIO CO
LANG ELECTRONICS, INC
ROBINS INDUSTRIES CORP.

STROBE, LIGHT

BERKEY TECHNICAL CORP
ELECTRONIC LIGHTS, INC.
G C ELECTRONICS COMPANY
GENERAL RADIO CO
ROBINS INDUSTRIES CORP.

STYLI, CUTTING

THE ASTATIC CORPORATION
DUOTONE COMPANY INC
SINGER PRODUCTS CO.
TRANSCO PRODUCTS, INTL

STYLI, PLAYBACK

THE ASTATIC CORPORATION
DUOTONE COMPANY INC
SHURE BROTHERS, INC.
TRANSCO PRODUCTS, INTL

SWITCHERS

ALMA ENGINEERING INC
AMECO, INC.
AMERICAN PANCOR, INC
BLONDER-TONGUE LABORATORIES
CENTRAL DYNAMICS CORPORATION
COHU ELECTRONICS
DYNAIR ELECTRONICS, INC.
G E VISUAL COMMUNICATIONS PROD
INTERNATIONAL GOOD MUSIC
INTERNATIONAL NUCLEAR CORP.
JENNINGS RADIO MANUFACTURING
RCA BROADCAST PRODS.
RIKER VIDEO INDUSTRIES
SCHAFFER ELECTRONICS
SOUTHWESTERN COMMUNICATIONS
SYLVANIA-COMM. ELECTRONICS DIV
TELEMATION, INC.
TREPAC CORPORATION OF AMERICA
VIDEON CORPORATION
VISUAL ELECTRONICS CORP
WARD ELECTRONIC INDUSTRIES

SWITCHES, COAXIAL

ALFORD MANUFACTURING COMPANY
AMERICAN ELECTRONIC LABS
ANDREW CORPORATION
BARKER & WILLIAMSON
BIRD ELECTRONIC CORPORATION
BLONDER-TONGUE LABORATORIES
ENGINEERING ASSOCIATES
JAMPRO ANTENNA COMPANY
JENNINGS RADIO MANUFACTURING
JERROLD ELECTRONICS CORP
MICROLAB / FXR
MICROWAVE ASSOCIATES, INC.
NARDA MICROWAVE CORPORATION
PRODELIN, INCORPORATED
SINGER PRODUCTS CO.
THE TECHNICAL MATERIEL CORP
TROMPETER ELECTRONICS
WATERS MANUFACTURING

SWITCHES, CROSSBAR

CENTRAL DYNAMICS CORPORATION
INTERNATIONAL NUCLEAR CORP.
ITT TELECOMMUNICATIONS
JENNINGS RADIO MANUFACTURING
TROMPETER ELECTRONICS

SWITCHES, FOOT

ATLAS SOUND
GENERAL ELECTRIC CO

SWITCHES, ILLUMINATED

DIALIGHT CORPORATION
DONALD P. MOSSMAN, INC.
OAK MANUFACTURING CO
ROBINS INDUSTRIES CORP.



**SAF-T-CLIMB
SAVES A LIFE!**

Saf-T-Climb — the only 100% positive safe climbing device — prevents falls from any vertical structure, above or below ground.

And, Saf-T-Climb is simplest to install, simplest to use — even on convex and concave structures. Galvanized, aluminum or stainless Saf-T-Notch Rail attaches rigidly to structure.

Worker wears belt snapped to manganese bronze Saf-T-Lok Sleeve with patented locking pawl that limits falls to 6-inch maximum. Widely approved; proven in use for over 12 years.

For informative
brochure write:

AIR SPACE DEVICES, INC. 
Safety Tower Ladder Division
Dept. 8G67, P.O. Box 338,
Paramount, Calif., 90723.
Phone: (213) 774-4905.

STEPHENS ELECTRONICS
SWITCHCRAFT, INC.

SWITCHES, INTERLOCK
GENERAL ELECTRIC CO
DONALD P. MOSSMAN, INC.
OAK MANUFACTURING CO
SWITCHCRAFT, INC.

SWITCHES, KNIFE
BIRNBACH CO
ENGINEERING ASSOCIATES
G C ELECTRONICS COMPANY
E F JOHNSON COMPANY
METROPOLITAN ELECTRIC MFG CO

SWITCHES, LEVER
CENTRALAB
GENERAL ELECTRIC CO
MALLORY DISTRIBUTOR PRODUCTS
DONALD P. MOSSMAN, INC.
OAK MANUFACTURING CO
SWITCHCRAFT, INC.

SWITCHES, MECHANICALLY ACTUATED
ENGINEERING ASSOCIATES
GENERAL ELECTRIC CO
JENNINGS RADIO MANUFACTURING
OAK MANUFACTURING CO
OHMITE MANUFACTURING COMPANY
WABER ELECTRONICS, INC.

SWITCHES, MULTICONTACT
ALTEC LANSING
CENTRALAB
HICKOK ELECTRICAL INSTRUMENT
LANGEVIN
DONALD P. MOSSMAN, INC.
OAK MANUFACTURING CO
PAINTON INCORPORATED
SWITCHCRAFT, INC.

SWITCHES, PUSHBUTTON
AMERICAN ELITE
BIRNBACH CO
CENTRALAB
G C ELECTRONICS COMPANY
GENERAL ELECTRIC CO
MALLORY DISTRIBUTOR PRODUCTS
DONALD P. MOSSMAN, INC.
OAK MANUFACTURING CO
PAINTON INCORPORATED
SWITCHCRAFT, INC.

SWITCHES, ROTARY
ALTEC LANSING
AMERICAN ELITE
CENTRALAB
ENGINEERING ASSOCIATES
G C ELECTRONICS COMPANY
GENERAL ELECTRIC CO
INDUSTRIAL DEVICES, INC.
JENNINGS RADIO MANUFACTURING
JERROLD ELECTRONICS CORP
LANGEVIN
MALLORY DISTRIBUTOR PRODUCTS
OAK MANUFACTURING CO
OHMITE MANUFACTURING COMPANY
PAINTON INCORPORATED
SINGER PRODUCTS CO.

SWITCHES, SLIDE
AMERICAN ELITE
BIRNBACH CO
CENTRALAB
ELECTRONICS ESSENTIALS OF CCC
G C ELECTRONICS COMPANY
OAK MANUFACTURING CO
SINGER PRODUCTS CO.
SWITCHCRAFT, INC.

SWITCHES, SNAP
ELECTRONIC RESEARCH COMPANY
ELECTRONICS ESSENTIALS OF CCC
GENERAL ELECTRIC CO
E F JOHNSON COMPANY
OAK MANUFACTURING CO
ROBINS INDUSTRIES CORP.
SINGER PRODUCTS CO.

SWITCHES, TELEPHONE TYPE
ITT TELECOMMUNICATIONS
DONALD P. MOSSMAN, INC.
SWITCHCRAFT, INC.

SWITCHES, THERMAL
ELECTRONIC RESEARCH COMPANY
GENERAL ELECTRIC CO
G-V CONTROLS INC.

SWITCHES, TOGGLE
AMERICAN ELITE
BIRNBACH CO
ELECTRONICS ESSENTIALS OF CCC
G C ELECTRONICS COMPANY
GENERAL ELECTRIC CO
PAINTON INCORPORATED
ROBINS INDUSTRIES CORP.
SINGER PRODUCTS CO.

SWITCHES, WAVEGUIDE
AMERICAN ELECTRONIC LABS
ANDREW CORPORATION
DEMORNAY - BONARDI DIVISION
MICROLAB / FXR
MICROWAVE ASSOCIATES, INC.

SWITCHING MATRIXES
ALMA ENGINEERING INC
AMERICAN PAMCOR, INC
ANDREW CORPORATION
CENTRAL DYNAMICS CORPORATION
COMU ELECTRONICS
DELTA ELECTRONICS INC
INTERNATIONAL NUCLEAR CORP.
JENNINGS RADIO MANUFACTURING

MULTRONICS
SARKES-TARZIAN
SCHAFFER ELECTRONICS
S. STERLING COMPANY
SWITCHCRAFT, INC.
TELEMET COMPANY
TROMPETER ELECTRONICS
WARD ELECTRONIC INDUSTRIES

SWITCHING SYSTEMS
ALMA ENGINEERING INC
AMERICAN PAMCOR, INC
ANDREW CORPORATION
CENTRAL DYNAMICS CORPORATION
COMU ELECTRONICS
DYNAIR ELECTRONICS, INC.
F & M SYSTEMS COMPANY
GATES RADIO COMPANY
HANCOCK TELECONTROL
INTERNATIONAL GOOD MUSIC
INTERNATIONAL NUCLEAR CORP.
ITT TELECOMMUNICATIONS
JENNINGS RADIO MANUFACTURING
RCA BROADCAST PRODS.
RIKER VIDEO INDUSTRIES
SARKES-TARZIAN
STEPHENS ELECTRONICS
S. STERLING COMPANY
SWITCHCRAFT, INC.
TELEQUIP CORPORATION
TREPAC CORPORATION OF AMERICA
TROMPETER ELECTRONICS
VIDEON CORPORATION
VISUAL ELECTRONICS CORP
VITAL INDUSTRIES
WARD ELECTRONIC INDUSTRIES

TAPE DECKS, MAGNETIC
AMPEX CORPORATION
AMPLIVISION CORPORATION
ASCO SONOCRAFT CORP
AUDIO INSTRUMENT CO
BROADCAST ELECTRONICS, INC
CONTINENTAL ELECTRONICS MFG
CROWN INTERNATIONAL
DISPLAY TECHNOLOGIES INC
GATES RADIO COMPANY
IMPEX ELECTRONICS CORP
INTERNATIONAL GOOD MUSIC
JETRONIC INDUSTRIES, INC.
KRS INSTRUMENTS DIVISION
MACKENZIE LABORATORIES
MAGNA-TECH CORPORATION
MAGNECOR
MINNESOTA MINING - 3 M
RCA BROADCAST PRODS.
SCHAFFER ELECTRONICS
SINGER PRODUCTS CO
STACO, INC.
STANCIL-HOFFMAN CORPORATION
TELECTRO INDUSTRIES CORP
VIKING OF MINNEAPOLIS
VISUAL ELECTRONICS CORP

TAPE DUPLICATORS
AMPEX CORPORATION
ASCO SONOCRAFT CORP
BIONIC INSTRUMENTS, INC.
CROWN INTERNATIONAL
HARVEY RADIO CO, INC.
LANG ELECTRONICS, INC
MAGNA-TECH CORPORATION
MAGNECOR
MINNESOTA MINING - 3 M
SINGER PRODUCTS CO
TELECTRO INDUSTRIES CORP
VIKING OF MINNEAPOLIS
VISUAL ELECTRONICS CORP

TAPE, MAGNETIC RECORDING, AUDIO
ALLIED ELECTRONICS CORP
AMERICAN GELOSIO ELECTRONICS
AMPEX CORPORATION
ASCO SONOCRAFT CORP
THE ASTATIC CORPORATION
AUDIO DEVICES
BIRNS & SAWYER
BROADCAST ELECTRONICS, INC
BURGESS BATTERY COMPANY
COMPUTRON INC
DUOTONE COMPANY INC
EASTMAN KODAK COMPANY
IMPEX ELECTRONICS CORP
JDA CARTRIDGE SERVICE
MACARTA INC.
MAGNETIC MEDIA CORPORATION
MINNESOTA MINING - 3 M
RCA BROADCAST PRODS.
REEVES SOUNDRAFT
ROBINS INDUSTRIES CORP.
SARKES-TARZIAN
SINGER PRODUCTS CO
TAPECASTER ELECTRONICS
WIDE RESPONSE

TAPE, MAGNETIC RECORDING, AUDIO, CARTRIDGE
AUDIO DEVICES
BROADCAST ELECTRONICS, INC
MINNESOTA MINING - 3 M
SPARTA ELECTRONIC CORPORATION

TAPE, MAGNETIC RECORDING, COMPUTER
AMPEX CORPORATION
AUDIO DEVICES
COMPUTRON INC
MAGNETIC MEDIA CORPORATION
MEMOREX CORPORATION
MINNESOTA MINING - 3 M
REEVES SOUNDRAFT

TAPE, MAGNETIC RECORDING, TEST
AMPEX CORPORATION
AUDIO DEVICES
COMPUTRON INC

GATES RADIO COMPANY
MINNEAPOLIS MAGNETICS
MINNESOTA MINING - 3 M
NDRTRONICS COMPANY, INC
ORBIT RADIO

TAPE, MAGNETIC RECORDING, VIDEO
AMECO, INC.
AMPEX CORPORATION
AMPLIVISION CORPORATION
ASCO SONOCRAFT CORP
COMPUTRON INC
MAGNETIC MEDIA CORPORATION
MEMOREX CORPORATION
MINNESOTA MINING - 3 M
RCA BROADCAST PRODS.
REEVES SOUNDRAFT
SONY CORPORATION OF AMERICA
TELEVISION UTILITIES CORP

TAPE, MAGNETIC, GRAPHIC
KRS INSTRUMENTS DIVISION
MINNESOTA MINING - 3 M

TELEPHONE EQUIPMENT
ALTEC LANSING
AMERICAN ELITE
AUDIO INSTRUMENT CO
BROADCAST ELECTRONICS, INC
COOK ELECTRIC COMPANY
ELECTRONICS ESSENTIALS OF CCC
THE JAMES FLOYD FORD CO
HEWLETT-PACKARD CO.
ITT TELECOMMUNICATIONS
ROANWELL CORPORATION
TELEMET COMPANY

TERMINAL BLOCKS
ADC PRODUCTS
AMERICAN PAMCOR, INC
BUCHANAN ELECTRICAL PRODS CORP
COOK ELECTRIC COMPANY
ELECTRONICS ESSENTIALS OF CCC
GENERAL ELECTRIC CO
RCA BROADCAST PRODS.
SINGER PRODUCTS CO.
THE THOMAS & BETTS CO

TERMINAL BOARDS
ADC PRODUCTS
BUCHANAN ELECTRICAL PRODS CORP
D & B ELECTRONICS COMPANY
ELECTRONICS ESSENTIALS OF CCC
GENERAL ELECTRIC CO
RCA BROADCAST PRODS.
SINGER PRODUCTS CO.
THE THOMAS & BETTS CO
UTILITY PRODUCTS CO.

TERMINAL CARDS
ACME VISIBLE RECORDS
BUCHANAN ELECTRICAL PRODS CORP
D & B ELECTRONICS COMPANY

TERMINAL STRIPS
ADC PRODUCTS
BIRNBACH CO
BUCHANAN ELECTRICAL PRODS CORP
D & B ELECTRONICS COMPANY
ELECTRONICS ESSENTIALS OF CCC
RCA BROADCAST PRODS.
SINGER PRODUCTS CO.
VITRO ELECTRONICS

TERMINALS, BARRIER
BUCHANAN ELECTRICAL PRODS CORP
ELECTRONICS ESSENTIALS OF CCC
RCA BROADCAST PRODS.
THE THOMAS & BETTS CO

TERMINALS, HIGH VOLTAGE
AMERICAN PAMCOR, INC
ELECTRONICS ESSENTIALS OF CCC
PHELPS DODGE

TERMINALS, LUG
AMERICAN PAMCOR, INC
BIRNBACH CO
BUCHANAN ELECTRICAL PRODS CORP
ELECTRONICS ESSENTIALS OF CCC
G C ELECTRONICS COMPANY
HOLLINGSWORTH SOLDERLESS
TERMINAL CO
SINGER PRODUCTS CO.
THE THOMAS & BETTS CO

TERMINALS, SOLDER
BIRNBACH CO
BUCHANAN ELECTRICAL PRODS CORP
ELECTRONICS ESSENTIALS OF CCC
G C ELECTRONICS COMPANY
SINGER PRODUCTS CO.

TERMINALS, SOLDERLESS
AEROVOX CORP.
AMERICAN PAMCOR, INC
BIRNBACH CO
BUCHANAN ELECTRICAL PRODS CORP
ELECTRONICS ESSENTIALS OF CCC
G C ELECTRONICS COMPANY
HOLLINGSWORTH SOLDERLESS
TERMINAL CO
SINGER PRODUCTS CO.
THE THOMAS & BETTS CO

TESTERS, BATTERY
GENERAL ELECTRIC CO
GOTHAM AUDIO CORPORATION
HICKOK ELECTRICAL INSTRUMENT
MALLORY DISTRIBUTOR PRODUCTS
SINGER PRODUCTS CO.

TESTERS, CAPACITOR
CONNELL-DUBILIER ELECTRONICS
GENERAL RADIO CO
HICKOK ELECTRICAL INSTRUMENT
RHODE & SCHWARZ SALES CO. -USA

TESTERS, INSULATION
ENGINEERING ASSOCIATES
GENERAL ELECTRIC CO
GENERAL RADIO CO
GOTHAM AUDIO CORPORATION
RHODE & SCHWARZ SALES CO. -USA
SINGER PRODUCTS CO
TELEMET COMPANY
YOKOGAWA ELECTRIC WORKS

TESTERS, SEMICONDUCTOR
AMERICAN ELECTRONIC LABS
DELTA ELECTRONICS, INC.
HICKOK ELECTRICAL INSTRUMENT
RHODE & SCHWARZ SALES CO. -USA
SOLITRON DEVICES
TEKTRONIX INC
TRIPLETT ELECTRICAL INSTRUMENT

TESTERS, VACUUM TUBE
ALLIED ELECTRONICS CORP
ENGINEERING ASSOCIATES
HICKOK ELECTRICAL INSTRUMENT
RCA ELECTRONIC COMPONENTS
TEKTRONIX INC
TRIPLETT ELECTRICAL INSTRUMENT

THYRISTORS - SEE SEMICONDUCTORS

TIMERS, ELECTRIC
BIONIC INSTRUMENTS, INC.
BURKE & JAMES
CURTIS INSTRUMENTS
ENGINEERING ASSOCIATES
GENERAL ELECTRIC CO
GIBBS MFG. AND RESEARCH CORP.
G-V CONTROLS INC.
HICKOK ELECTRICAL INSTRUMENT
MALLORY DISTRIBUTOR PRODUCTS
SELA ELECTRONICS CO.

TIMERS, MANUAL
THE ELMOR COMPANY
JULES RACINE CO INC

TOOLS, CLAMPS
AMECO, INC.

TOOLS, CRIMPERS
AEROVOX CORP.
AMECO, INC.
AMERICAN PAMCOR, INC
BLONDFR-TONGUE LABORATORIES
BUCHANAN ELECTRICAL PRODS CORP
HOLLINGSWORTH SOLDERLESS
TERMINAL CO
MATHIAS KLEIN & SONS
MINNESOTA MINING - 3 M
H. K. PORTER INC.
THE THOMAS & BETTS CO

TOOLS, CUTTERS
MATHIAS KLEIN & SONS
H. K. PORTER INC.
THE THOMAS & BETTS CO
XCELITE INCORPORATED

TOOLS, HAND
ELECTRONICS ESSENTIALS OF CCC
HOLLINGSWORTH SOLDERLESS
TERMINAL CO
MATHIAS KLEIN & SONS
H. K. PORTER INC.
SINGER PRODUCTS CO.
THE THOMAS & BETTS CO
UPSON BROS.
XCELITE INCORPORATED

TOOLS, PLIERS
MATHIAS KLEIN & SONS
SINGER PRODUCTS CO.
XCELITE INCORPORATED

TOOLS, PUNCH, CHASSIS
GREENLEE TOOL COMPANY

TOOLS, SCREWDRIVERS
ELECTRONICS ESSENTIALS OF CCC
G C ELECTRONICS COMPANY
MATHIAS KLEIN & SONS
SINGER PRODUCTS CO.
UPSON BROS.
XCELITE INCORPORATED

TOOLS, SOLDERING IRONS, GUN
SINGER PRODUCTS CO.

TOOLS, SOLDERING IRONS, INDUSTRIAL
SINGER PRODUCTS CO.
UNGAR ELECTRIC TOOLS

TOOLS, WRENCHES
ELECTRONICS ESSENTIALS OF CCC
MATHIAS KLEIN & SONS
XCELITE INCORPORATED

TOWERS, ANTENNA, CATV, HEAD-END
ADVANCE INDUSTRIES
AMECO, INC.
AMPLIVISION CORPORATION
ANTENNA PRODUCTS COMPANY
BLAW-KNOX COMPANY
DRESSER CRANE HOIST & TOWER
FORT WORTH TOWER CO., INC.
HY-GAIN ELECTRONICS
JERROLD ELECTRONICS CORP
KLINE IRON & STEEL COMPANY
LIBERTY TOWER MFG. CO



At Rochester, N. Y., this self-supporting tower gives the WOKR antenna 306.5' elevation above the ground.

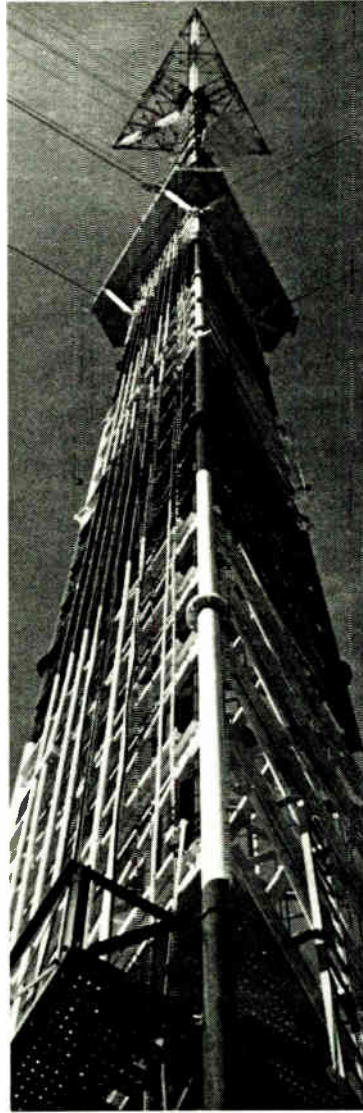

Candelabra® tower carries 3 antenna as high as 1549' above ground for KCRA-TV, KOVR, KXTV.

TOWERS BY DRESSER FOR TV, RADIO, MICROWAVE, RADAR

TV AND RADIO BROADCAST ANTENNA TOWERS—Types: guyed or self-supporting. Can be insulated. Guyed available with fixed or pivoted base. *Heights:* available in any height. *Wind Loads:* 20 lb. through 90 lb. available as standard. Heavier loads available when required. *Antenna Loads:* designs available for any single TV or radio antenna, or any combination of antennas in stacked, side-mounted, or Candelabra (R) arrangements.

MICROWAVE TOWERS—Types: guyed or self-supporting. *Heights:* 50' through 300' available as standard. Greater heights available when required. *Wind Loads:* 30 lb. and 40 lb. loads standard. Heavier loads available when required. *Antenna Loads:* design available to support any combination of microwave equipment.

RADAR TOWERS—Types, heights and loads custom-designed to meet any requirement for support of radar equipment. Extensive experience in the design of radar structures for the Government.

SPECIAL DESIGNS—Large, experienced engineering staff and well-equipped fabricating plant capable of creating and fabricating towers of any kind, height or type for any requirement.

TOWER ELEVATORS—All steel elevator for TV and radio towers, rated for 750 lb. load, radio controlled, completely equipped with automatic safeties.

TOWER ERECTION AND INSPECTION—Complete tower erection and inspection service under supervision of graduate engineers.

DRESSER

CRANE, HOIST & TOWER DIVISION

one of the Dresser Industries
(formerly Dresser-Ideco Co.)

885 Michigan Ave., Columbus, Ohio 43215
Phone area 614, 299-2123 • TWX 614-759-0672
Branch: 2314 Redondo Beach Blvd., Gardena, Calif. 90247

LITTLE JOE ENTERPRISES
MASTER TOWER CO
MICROFLECT COMPANY INC.
PACIFIC TOWER CO
RDHM MANUFACTURING CO.
STAINLESS, INC.
SWAGER TOWER CORPORATION
UNITED STATES TOWERS
UP-RIGHT SCAFFOLDS
UTILITY TOWER CO.

TOWERS, ANTENNA, RECEIVING

ADVANCE INDUSTRIES
AMECO, INC.
ANTENNA PRODUCTS COMPANY
DRESSER CRANE HOIST & TOWER
FORT WORTH TOWER CO., INC.
FLINE IRON & STEEL COMPANY
LIBERTY TOWER MFG. CO
LITTLE JOE ENTERPRISES
MASTER TOWER CO
MICROFLECT COMPANY INC.
PACIFIC TOWER CO
RDHM MANUFACTURING CO.
SINGER PRODUCTS CO
STAINLESS, INC.
SWAGER TOWER CORPORATION
TRYLON INCORPORATED
UNITED STATES TOWERS
UP-RIGHT SCAFFOLDS
UTILITY TOWER CO.

TOWERS, ANTENNA,

TRANSMITTING, AM

ADVANCE INDUSTRIES
ANTENNA PRODUCTS COMPANY
BLAW-KNOX COMPANY
CCA ELECTRONICS CORPORATION
DRESSER CRANE HOIST & TOWER
FORT WORTH TOWER CO., INC.
GATES RADIO COMPANY
JAMPRO ANTENNA COMPANY
KLINE IRON & STEEL COMPANY
LIBERTY TOWER MFG. CO
LITTLE JOE ENTERPRISES
MASTER TOWER CO
MICROFLECT COMPANY INC.
GUNNAR A OLSEN CORP
PACIFIC TOWER CO
RCA BROADCAST PRODS.
RDHM MANUFACTURING CO.
SINGER PRODUCTS CO
STAINLESS, INC.
SWAGER TOWER CORPORATION
TRYLON INCORPORATED
UNITED STATES TOWERS
UP-RIGHT SCAFFOLDS
UTILITY TOWER CO.
VISUAL ELECTRONICS CORP

TOWERS, ANTENNA,

TRANSMITTING, FM

ADVANCE INDUSTRIES
ANTENNA PRODUCTS COMPANY
BLAW-KNOX COMPANY
CCA ELECTRONICS CORPORATION
DRESSER CRANE HOIST & TOWER
FORT WORTH TOWER CO., INC.
GATES RADIO COMPANY
JAMPRO ANTENNA COMPANY
KLINE IRON & STEEL COMPANY
LIBERTY TOWER MFG. CO
LITTLE JOE ENTERPRISES
MASTER TOWER CO
MICROFLECT COMPANY INC.
GUNNAR A OLSEN CORP
PACIFIC TOWER CO
RCA BROADCAST PRODS.
RDHM MANUFACTURING CO.
SINGER PRODUCTS CO
STAINLESS, INC.
SWAGER TOWER CORPORATION
TRYLON INCORPORATED
UNITED STATES TOWERS
UP-RIGHT SCAFFOLDS
UTILITY TOWER CO.
VISUAL ELECTRONICS CORP

TOWERS, ANTENNA,

TRANSMITTING, TV

ADVANCE INDUSTRIES
ANTENNA PRODUCTS COMPANY
BLAW-KNOX COMPANY
DRESSER CRANE HOIST & TOWER
FORT WORTH TOWER CO., INC.
GATES RADIO COMPANY
JAMPRO ANTENNA COMPANY
KLINE IRON & STEEL COMPANY
LIBERTY TOWER MFG. CO
MASTER TOWER CO
MICROFLECT COMPANY INC.
GUNNAR A OLSEN CORP
PACIFIC TOWER CO
RCA BROADCAST PRODS.
RDHM MANUFACTURING CO.
SINGER PRODUCTS CO.
STAINLESS, INC.
SWAGER TOWER CORPORATION
TRYLON INCORPORATED
UNITED STATES TOWERS
UP-RIGHT SCAFFOLDS
UTILITY TOWER CO.
VISUAL ELECTRONICS CORP

TRANSFORMERS, AUDIO, ISOLATION

ADC PRODUCTS
ALLIED ELECTRONICS CORP
ALTEC LANSING
ESSEX WIRE CORPORATION
GOTHAM AUDIO CORPORATION
LAFAYETTE RADIO ELECTRONICS
PERMOFLUX CORPORATION
RCA BROADCAST PRODS.
ROHDE & SCHWARZ SALES CO. -USA
STACO, INC.

TRW ELECTRONICS
UNITED TRANSFORMER COMPANY

TRANSFORMERS, AUDIO, MATCHING

ADC PRODUCTS
ALLIED ELECTRONICS CORP
ALTEC LANSING
ATLAS SOUND
ESSEX WIRE CORPORATION
GENERAL RADIO CO
GOTHAM AUDIO CORPORATION
LAFAYETTE RADIO ELECTRONICS
LAKE ELECTRONICS, INC.
PERMOFLUX CORPORATION
RCA BROADCAST PRODS.
ROHDE & SCHWARZ SALES CO. -USA
STACO, INC.
TRW ELECTRONICS
TV CARLE SUPPLY CO
UNITED TRANSFORMER COMPANY

TRANSFORMERS, AUDIO,

DRIVE OUTPUT
ADC PRODUCTS
ALLIED ELECTRONICS CORP
ALTEC LANSING
ESSEX WIRE CORPORATION
LAFAYETTE RADIO ELECTRONICS
LAKE ELECTRONICS, INC.
MILFS REPRODUCER CO
PERMOFLUX CORPORATION
STACO, INC.
TRW ELECTRONICS
UNITED TRANSFORMER COMPANY

TRANSFORMERS, AUTO

ADC PRODUCTS
ALLIED ELECTRONICS CORP
ALTEC LANSING
CRAFTSMAN ELECTRONICS PRODUCTS
ESSEX WIRE CORPORATION
GENERAL ELECTRIC CO
GENERAL RADIO CO
HUGHES & PHILLIPS
LAFAYETTE RADIO ELECTRONICS
PERMOFLUX CORPORATION
SINGER PRODUCTS CO.
SOLA ELECTRIC
STACO, INC.
TRW ELECTRONICS
UNITED TRANSFORMER COMPANY

TRANSFORMERS, COUPLING

ADC PRODUCTS
ALTEC LANSING
ESSEX WIRE CORPORATION
PERMOFLUX CORPORATION
TRW ELECTRONICS
UNITED TRANSFORMER COMPANY

TRANSFORMERS, FILAMENT

ADC PRODUCTS
ALLIED ELECTRONICS CORP
ALTEC LANSING
ENGINEERING ASSOCIATES
ESSEX WIRE CORPORATION
GENERAL ELECTRIC CO
LAFAYETTE RADIO ELECTRONICS
LAKE ELECTRONICS, INC.
PERMOFLUX CORPORATION
SOLA ELECTRIC
STACO, INC.
TRW ELECTRONICS
UNITED TRANSFORMER COMPANY

TRANSFORMERS, GENERAL

ADC PRODUCTS
ALLIED ELECTRONICS CORP
ALTEC LANSING
ANACONDA ASTRODATA CO
ESSEX WIRE CORPORATION
G E INDUSTRIAL SALES OPERATION
GENERAL ELECTRIC CO
LAFAYETTE RADIO ELECTRONICS
LAKE ELECTRONICS, INC.
PERMOFLUX CORPORATION
SINGER PRODUCTS CO.
SOLA ELECTRIC
STACO, INC.
TRW ELECTRONICS
TV CARLE SUPPLY CO
UNITED TRANSFORMER COMPANY

TRANSFORMERS, PLATE

ADC PRODUCTS
ALLIED ELECTRONICS CORP
ALTEC LANSING
ESSEX WIRE CORPORATION
LAKE ELECTRONICS, INC.
PERMOFLUX CORPORATION
SOLA ELECTRIC
STACO, INC.
TRW ELECTRONICS
UNITED TRANSFORMER COMPANY

TRANSFORMERS, POWER

ADC PRODUCTS
ALLIED ELECTRONICS CORP
ALTEC LANSING
ENGINEERING ASSOCIATES
ESSEX WIRE CORPORATION
GENERAL ELECTRIC CO
HUGHES & PHILLIPS
LAFAYETTE RADIO ELECTRONICS
LAKE ELECTRONICS, INC.
PERMOFLUX CORPORATION
SOLA ELECTRIC
STACO, INC.
TRW ELECTRONICS
UNITED TRANSFORMER COMPANY

TRANSFORMERS, RF

ADC PRODUCTS
ALLIED ELECTRONICS CORP
AMERICAN CABLE ELECTRONICS
ANTENNA PRODUCTS COMPANY

BARKER & WILLIAMSON
BLONDER-TONGUE LABORATORIES
CRAFTSMAN ELECTRONICS PRODUCTS
D & B ELECTRONICS COMPANY
ESSEX WIRE CORPORATION
KAPPA NETWORKS, INC.
LAKE ELECTRONICS, INC.
MICROLAB / FXR
J. W. MILLER CO.
THE TECHNICAL MATERIEL CORP

TRANSFORMERS, TRANSISTOR

ADC PRODUCTS
ALLIED ELECTRONICS CORP
ESSEX WIRE CORPORATION
GOTHAM AUDIO CORPORATION
LAFAYETTE RADIO ELECTRONICS
LAKE ELECTRONICS, INC.
STACO, INC.
TRW ELECTRONICS
UNITED TRANSFORMER COMPANY

TRANSFORMERS, VARIABLE

ALLIED ELECTRONICS CORP
ENGINEERING ASSOCIATES
ESSEX WIRE CORPORATION
GENERAL ELECTRIC CO
GENERAL RADIO CO
LAKE ELECTRONICS, INC.
WHITE MANUFACTURING COMPANY
STACO, INC.
TRW ELECTRONICS
UNITED TRANSFORMER COMPANY

TRANSISTORS -

SFE SEMICONDUCTORS

TRANSLATOR SYSTEMS

AMPLIFICATION CORPORATION
KEITH ANDERSON CO
RFCO TELEVISION ASSOCIATES
CATEL COMPANY
EMCEE
F & M SYSTEMS COMPANY
LITTON EDUCATIONAL TELE DIV
TOWNSEND ASSOCIATES

TRANSMISSION LINES

AMECO, INC.
ANDREW CORPORATION
ANTENNA PRODUCTS COMPANY
COPPERWELD STEEL COMPANY
GATES RADIO COMPANY
JAMPRO ANTENNA COMPANY
JERROLD ELECTRONICS CORP
MICROWAVE ASSOCIATES, INC.
NARDA MICROWAVE CORPORATION
PHELPS ODGEE
RCA BROADCAST PRODS.
TRYLON INCORPORATED
VISUAL ELECTRONICS CORP

TRANSMISSION TEST SETS

NARDA MICROWAVE CORPORATION
PHELPS ODGEE
RCA BROADCAST PRODS.
RIKER VIDEO INDUSTRIES
VISUAL ELECTRONICS CORP
WAVEFORMS, INCORPORATED

TRANSMITTER KITS

ALLIED ELECTRONICS CORP
BAUER ELECTRONICS CORPORATION
CCA ELECTRONICS CORPORATION
GATES RADIO COMPANY
E F JOHNSON COMPANY
MILES REPRODUCER CO
SINGER PRODUCTS CO

TRANSMITTERS, AM, LOW POWER

BAUER ELECTRONICS CORPORATION
LOW POWER

TRANSMITTERS, AM, 25^W WATT

AMERICAN ELECTRONIC LABS
BAUER ELECTRONICS CORPORATION
CCA ELECTRONICS CORPORATION
COLLINS RADIO COMPANY
GATES RADIO COMPANY
E F JOHNSON COMPANY
SINGER PRODUCTS CO
TELETRONIX

TRANSMITTERS, AM, 1KW

AMERICAN ELECTRONIC LABS
BAUER ELECTRONICS CORPORATION
CCA ELECTRONICS CORPORATION
COLLINS RADIO COMPANY
GATES RADIO COMPANY
E F JOHNSON COMPANY
MARCONI DIVISION
RCA BROADCAST PRODS.
SINGER PRODUCTS CO
TELETRONIX
VISUAL ELECTRONICS CORP
WILKINSON ELECTRONICS, INC

TRANSMITTERS, AM, 5KW

AMERICAN ELECTRONIC LABS
BAUER ELECTRONICS CORPORATION
CCA ELECTRONICS CORPORATION
COLLINS RADIO COMPANY
CONTINENTAL ELECTRONICS MFG
GATES RADIO COMPANY
RCA BROADCAST PRODS.
ROHDE & SCHWARZ SALES CO. -USA
SINGER PRODUCTS CO
TELETRONIX
VISUAL ELECTRONICS CORP
WILKINSON ELECTRONICS, INC

TRANSMITTERS, AM, 10KW

AMERICAN ELECTRONIC LABS
AMERICAN ELITE
BAUER ELECTRONICS CORPORATION

CCA ELECTRONICS CORPORATION
COLLINS RADIO COMPANY
CONTINENTAL ELECTRONICS MFG
GATES RADIO COMPANY
MARCONI DIVISION
RCA BROADCAST PRODS.
ROHDE & SCHWARZ SALES CO. -USA
SINGER PRODUCTS CO
TELETRONIX
VISUAL ELECTRONICS CORP
WILKINSON ELECTRONICS, INC

TRANSMITTERS, AM, 25 KW

AMERICAN ELECTRONIC LABS
BAUER ELECTRONICS CORPORATION
CCA ELECTRONICS CORPORATION
CONTINENTAL ELECTRONICS MFG
GATES RADIO COMPANY
RCA BROADCAST PRODS.
SINGER PRODUCTS CO
VISUAL ELECTRONICS CORP

TRANSMITTERS, AM, 50 KW

AMERICAN ELECTRONIC LABS
AMERICAN ELITE
BAUER ELECTRONICS CORPORATION
CCA ELECTRONICS CORPORATION
CONTINENTAL ELECTRONICS MFG
GATES RADIO COMPANY
MARCONI DIVISION
RCA BROADCAST PRODS.
SINGER PRODUCTS CO
TELETRONIX
VISUAL ELECTRONICS CORP

TRANSMITTERS, AM, OVER 50 KW

AMERICAN ELITE
CCA ELECTRONICS CORPORATION
CONTINENTAL ELECTRONICS MFG
GATES RADIO COMPANY
MARCONI DIVISION
SINGER PRODUCTS CO

TRANSMITTERS, AM, TO ORDER

EITEL ELECTRONICS

TRANSMITTERS, FM

MILES REPRODUCER CO
ROHDE & SCHWARZ SALES CO. -USA
THOMSON ELECTRIC CO

TRANSMITTERS, FM, 10 WATTS

AMERICAN ELECTRONIC LABS
CCA ELECTRONICS CORPORATION
GATES RADIO COMPANY
MARTI ELECTRONICS
MOSELEY ASSOCIATES INC.
SINGER PRODUCTS CO

TRANSMITTERS, FM, 50 WATTS

GATES RADIO COMPANY

TRANSMITTERS, FM, 100 WATTS

CCA ELECTRONICS CORPORATION
MARTI ELECTRONICS
RHG ELECTRONICS LABORATORY
SINGER PRODUCTS CO

TRANSMITTERS, FM, 250 WATTS

AMERICAN ELECTRONIC LABS
CCA ELECTRONICS CORPORATION
GATES RADIO COMPANY
SINGER PRODUCTS CO
STANDARD ELECTRONICS CORP.
TELETRONIX

TRANSMITTERS, FM, 1 KW

AMERICAN ELECTRONIC LABS
BAUER ELECTRONICS CORPORATION
CCA ELECTRONICS CORPORATION
COLLINS RADIO COMPANY
GATES RADIO COMPANY
MARCONI DIVISION
RCA BROADCAST PRODS.
RHG ELECTRONICS LABORATORY
SINGER PRODUCTS CO
STANDARD ELECTRONICS CORP.
TELETRONIX
WILKINSON ELECTRONICS, INC

TRANSMITTERS, FM, 3 KW

BAUER ELECTRONICS CORPORATION
CCA ELECTRONICS CORPORATION
GATES RADIO COMPANY
TELETRONIX
VISUAL ELECTRONICS CORP

TRANSMITTERS, FM, 5 KW

AMERICAN ELECTRONIC LABS
AMERICAN ELITE
CCA ELECTRONICS CORPORATION
COLLINS RADIO COMPANY
GATES RADIO COMPANY
MARCONI DIVISION
RCA BROADCAST PRODS
SINGER PRODUCTS CO
STANDARD ELECTRONICS CORP.
TELETRONIX
VISUAL ELECTRONICS CORP
WILKINSON ELECTRONICS, INC

TRANSMITTERS, FM, 7.5 KW

AMERICAN ELECTRONIC LABS
BAUER ELECTRONICS CORPORATION
GATES RADIO COMPANY
WILKINSON ELECTRONICS, INC

TRANSMITTERS, FM, 10 KW

AMERICAN ELECTRONIC LABS
AMERICAN ELITE
BAUER ELECTRONICS CORPORATION
CCA ELECTRONICS CORPORATION
COLLINS RADIO COMPANY
GATES RADIO COMPANY
RCA BROADCAST PRODS

CONTINENTAL'S TYPE 317C_____

Within 18 months following its introduction, Continental had sold 13 Type 317C transmitters. Here's why:

OVERALL EFFICIENCY:

62% or better

PLATE EFFICIENCY:

80% or better

POWER CONSUMPTION:

82 kw @ 0 modulation

92 kw @ 30% modulation

120 kw @ 100% modulation

SELF-CONTAINED: compact design assures minimum installation cost. The 317C uses only 62 sq. ft. of total floor space. Blower is contained within transmitter cabinet. One neat package for the world's most efficient 50 kw AM broadcast transmitter.

THE WORLD'S MOST EFFICIENT 50KW
AM BROADCAST TRANSMITTER!

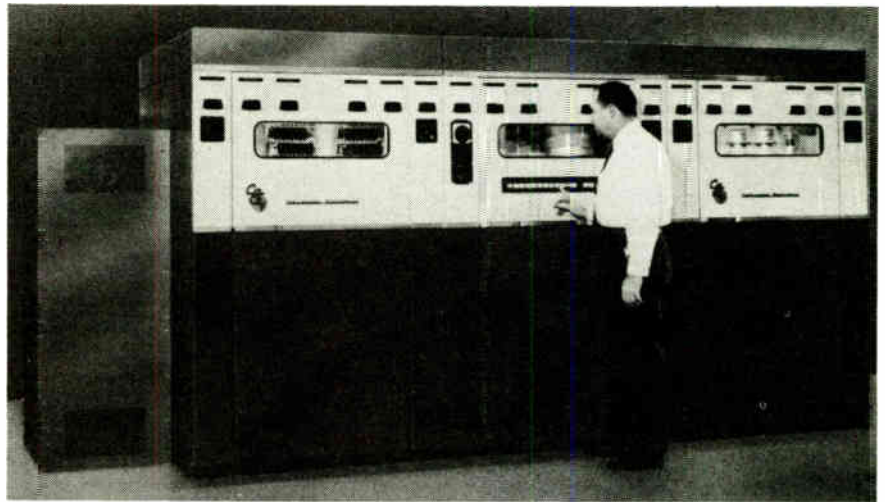

OTHER CONTINENTAL BROADCAST TRANSMITTERS range in power from 5,000 watts to 1,000,000 watts.

CONTINENTAL'S PROLOG-AUTOMATIC PROGRAMMING & LOGGING AS EASY AS TYPING UP YOUR STATION LOG!

Prolog uses your station log to provide any degree or combination of unattended, automatic or manual-live operation desired. Your log can be prepared on any standard electric typewriter, or you can use any of the auto-typing, IBM punch-card and similar equipment in use today. PROLOG uses your established programming format; nothing changes unless you want to change it. That's PROLOG: simple and flexible!

For additional information on Continental transmitters or PROLOG Systems, write Commercial Sales Dept; Continental Electronics Mfg. Co.; Box 17040, Dallas, Texas 75217

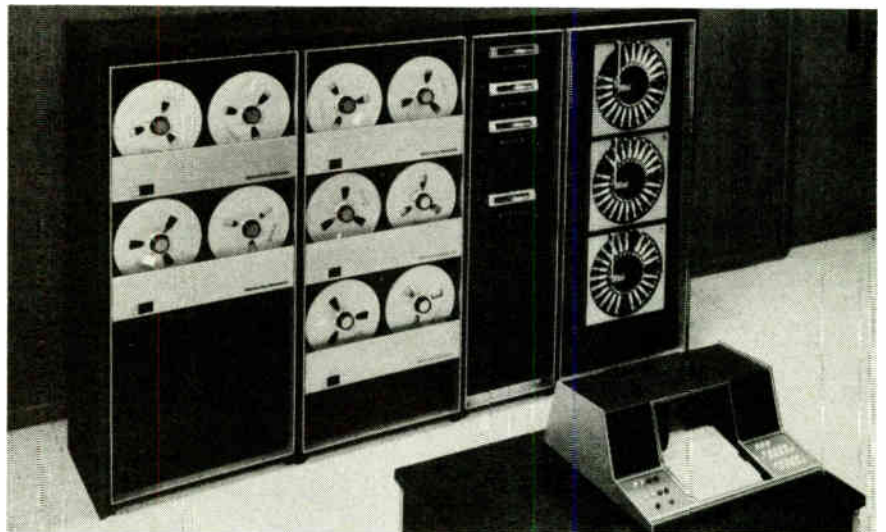

Continental Electronics 
A SUBSIDIARY OF **LTV** ELECTROSYSTEMS, INC.

RHG ELECTRONICS LABORATORY
STANDARD ELECTRONICS CORP.
TELETRONIX
VISUAL ELECTRONICS CORP
WILKINSON ELECTRONICS, INC

TRANSMITTERS, FM, 15 KW
CCA ELECTRONICS CORPORATION
GATES RADIO COMPANY

TRANSMITTERS, FM, 20 KW
AMERICAN ELECTRONIC LABS
BAUER ELECTRONICS CORPORATION
CCA ELECTRONICS CORPORATION
COLLINS RADIO COMPANY
GATES RADIO COMPANY
RCA BROADCAST PRODS
SINGER PRODUCTS CO
STANDARD ELECTRONICS CORP.
VISUAL ELECTRONICS CORP
WILKINSON ELECTRONICS, INC

TRANSMITTERS, FM, 40 KW
CCA ELECTRONICS CORPORATION
GATES RADIO COMPANY
RCA BROADCAST PRODS

TRANSMITTERS, FM, 50 KW
AMERICAN ELITE

TRANSMITTERS, FM, 100 KW
AMERICAN ELITE

TRANSMITTERS, FM, TO ORDER
EITEL ELECTRONICS

TRANSMITTERS, TV
ROHDE & SCHWARZ SALES CO. -USA
THOMSON ELECTRIC CO

TRANSMITTERS, TV, 1 WATT
KEITH ANDERSON CO
EMCEE

TRANSMITTERS, TV, 10 WATTS
KEITH ANDERSON CO

TRANSMITTERS, TV, 20 WATTS
EMCEE

TRANSMITTERS, TV, 60 WATTS
UTICA CORPORATION

TRANSMITTERS, TV, 100 WATTS
EMCEE
GATES RADIO COMPANY

TRANSMITTERS, TV, 500 WATTS
GATES RADIO COMPANY
STANDARD ELECTRONICS CORP

TRANSMITTERS, TV, 1 KW
MARCONI DIVISION
FMCEE
SARKE-S-TARZIAN

TRANSMITTERS, TV, 2 KW
RCA BROADCAST PRODS

TRANSMITTERS, TV, 3 KW
TOWNSEND ASSOCIATES

TRANSMITTERS, TV, 5 KW
GATES RADIO COMPANY
MARCONI DIVISION
RCA BROADCAST PRODS
STANDARD ELECTRONICS CORP.

TRANSMITTERS, TV, 6 KW
RCA BROADCAST PRODS

TRANSMITTERS, TV, 10 KW
G E VISUAL COMMUNICATIONS PROD
MARCONI DIVISION
STANDARD ELECTRONICS CORP.

TRANSMITTERS, TV, 11.5W
RCA BROADCAST PRODS

TRANSMITTERS, TV, 12 KW
RCA BROADCAST PRODS

TRANSMITTERS, TV, 15 KW
TOWNSEND ASSOCIATES
VISUAL ELECTRONICS CORP

TRANSMITTERS, TV, 25 KW
MARCONI DIVISION
RCA BROADCAST PRODS
STANDARD ELECTRONICS CORP.

TRANSMITTERS, TV, 30 KW
G E VISUAL COMMUNICATIONS PROD
RCA BROADCAST PRODS
TOWNSEND ASSOCIATES
VISUAL ELECTRONICS CORP

TRANSMITTERS, TV, 35 KW
STANDARD ELECTRONICS CORP.

TRANSMITTERS, TV, 50 KW
G E VISUAL COMMUNICATIONS PROD
RCA BROADCAST PRODS
STANDARD ELECTRONICS CORP.

TRANSMITTERS, TV, 55 KW
TOWNSEND ASSOCIATES
VISUAL ELECTRONICS CORP

TRANSMITTERS, TV, 70 KW
STANDARD ELECTRONICS CORP.

TRANSMITTERS, TV, 100 KW
G E VISUAL COMMUNICATIONS PROD
TOWNSEND ASSOCIATES

TRANSMITTERS, TV, 150 KW
RCA BROADCAST PRODS

TRANSMITTERS, TV, TO ORDER
FITTEL ELECTRONICS

TUBING - SEE HARDWARE

TURNTABLES, PHONOGRAPH
BENJAMIN ELECTRONIC SOUND CORP
DISPLAY TECHNOLOGIES INC
FAIRCHILD RECORDING EQUIPMENT
GOTHAM AUDIO CORPORATION
GRAY RESEARCH & DEVELOPMENT CO
KOSS ELECTRONICS, INC.
MARANTZ COMPANY
Q R K ELECTRONIC PRODUCTS
RCA BROADCAST PRODS.
RUSSCO ELECTRONICS MFG.
SINGER PRODUCTS CO
SONY CORPORATION OF AMERICA
SPARTA ELECTRONIC CORPORATION
TELETRON INDUSTRIES CORP
VISUAL ELECTRONICS CORP
THE SINGER CO - METRICS DIV

TV SYSTEMS, CLOSED CIRCUIT
AMECO, INC.
AMERICAN CABLE ELECTRONICS
AMPEX CORPORATION
AMPLIFIKON CORPORATION
ANACONDA ASTRODATA CO
BALL PROTHERS RESEARCH
BIONIC INSTRUMENTS, INC.
BLONDER-TONGUE LABORATORIES
CENTRAL DYNAMICS CORPORATION
COMU ELECTRONICS
COLORADO VIDEO
DAGE BELL CORPORATION
DIAMOND ELECTRONICS
DIECRAFT, INC
F & M SYSTEMS COMPANY
THE JAMES FLOYD FORD CO
GPC AMERICA CORPORATION
G E VISUAL COMMUNICATIONS PROD
GENERAL ELECTRIC CO
JERROLD ELECTRONICS CORP
J W ELECTRONICS COMPANY
KAISER-CD
THE KALART COMPANY
LITTON EDUCATIONAL TELE DIV
MARCONI DIVISION
MARYLAND TELECOMMUNICATIONS
MICRO-LINK SYSTEMS/VARIAN ASSO
MIRAFEL ELECTRONICS, INC
MVR CORPORATION
RCA BROADCAST PRODS.
RIKER VIDEO INDUSTRIES
SARKE-S-TARZIAN
SETCHELL CARLSON INCORPORATED
SIGMA INDUSTRIES
SONY CORPORATION OF AMERICA
SPENCER-KENNEDY LABORATORIES
STANDARD ELECTRONICS CORP.
S. STERLING COMPANY
SYLVANIA-COMM. ELECTRONICS DIV
TELFATION, INC.
TELEMET COMPANY
TELEQUIP CORPORATION
TELEVISION UTILITIES CORP
TELTRON, INC
THOMSON ELECTRIC CO

VACUUM TUBES, BALLAST
AMPERITE CO
LEWIS AND KAUFMAN, LTD.
THOR ELECTRONICS

VACUUM TUBES, CAMERA, IMAGE-ORTHOICON
AMPEREX ELECTRONIC CORP
THE ENGLISH ELECTRIC CORP.
G E PICKUP TUBE OPERATION
RCA ELECTRONIC COMPONENTS
TELEQUIP CORPORATION
TELTRON, INC
THOR ELECTRONICS
VISUAL ELECTRONICS CORP
WESTINGHOUSE ELECTRIC CORP

VACUUM TUBES, CAMERA, PLUMBICON
AMPEREX ELECTRONIC CORP
NORTH AMERICAN PHILIPS CO
VISUAL ELECTRONICS CORP

VACUUM TUBES, CAMERA, VIOICON
AMPEREX ELECTRONIC CORP
THE ENGLISH ELECTRIC CORP.
GBC AMERICA CORPORATION
G E PICKUP TUBE OPERATION
LEWIS AND KAUFMAN, LTD.
NORTH AMERICAN PHILIPS CO
RCA ELECTRONIC COMPONENTS
TELEQUIP CORPORATION
TELEVISION UTILITIES CORP
THOR ELECTRONICS
VISUAL ELECTRONICS CORP
WESTINGHOUSE ELECTRIC CORP

VACUUM TUBES, CATHODE RAY, OSCILLOSCOPE
TEKTRONIX INC

VACUUM TUBES, CATHODE RAY, TV, COLOR
G E DISTRIBUTOR SALES FORCE
RCA ELECTRONIC COMPONENTS
SINGER PRODUCTS CO
THOR ELECTRONICS
WESTINGHOUSE ELECTRIC CORP

VACUUM TUBES, CATHODE RAY, TV, MONOCHROME
AMERICAN ELITE
CONRAC
G E DISTRIBUTOR SALES FORCE

LEWIS AND KAUFMAN, LTD.
RCA ELECTRONIC COMPONENTS
SINGER PRODUCTS CO.
THOR ELECTRONICS
WESTINGHOUSE ELECTRIC CORP

VACUUM TUBES, RECEIVING
AMERICAN ELITE
AMPEREX ELECTRONIC CORP
CALVERT ELECTRONICS
G E DISTRIBUTOR SALES FORCE
HEINTZ & KAUFMAN, LTD
LEWIS AND KAUFMAN, LTD.
MICROWAVE ASSOCIATES, INC.
RCA ELECTRONIC COMPONENTS
SINGER PRODUCTS CO.
TELEQUIP CORPORATION
THOR ELECTRONICS
WESTINGHOUSE ELECTRIC CORP

VACUUM TUBES, TRANSMITTING
AMECO, INC.
AMERICAN ELITE
AMPEREX ELECTRONIC CORP
CALVERT ELECTRONICS
CCA ELECTRONICS CORPORATION
FIMAC DIVISION OF VARIAN
THE ENGLISH ELECTRIC CORP.
G E DISTRIBUTOR SALES FORCE
HEINTZ & KAUFMAN, LTD
JOA CARTRIDGE SERVICE
LEWIS AND KAUFMAN, LTD.
THE MACLETT LABORATORIES
MICROWAVE ASSOCIATES, INC.
RCA ELECTRONIC COMPONENTS
THOR ELECTRONICS
WESTINGHOUSE ELECTRIC CORP

VESTIGIAL SIDEBAND FILTERS
ALFORD MANUFACTURING COMPANY
G E VISUAL COMMUNICATIONS PROD
JAMPRO ANTENNA COMPANY
VISUAL ELECTRONICS CORP

VOLTMETERS, AC
ALLIED ELECTRONICS CORP
API INSTRUMENTS CO.
COMU ELECTRONICS
COLUMBIA ELECTRIC MFG CO
DATA INSTRUMENT DIVISION
ENGINEERING ASSOCIATES
G E INDUSTRIAL SALES OPERATION
GENERAL ELECTRIC CO
GENERAL RADIO CO
GOTHAM AUDIO CORPORATION
HEATH CO
HEWLETT-PACKARD CO.
HICKOK ELECTRICAL INSTRUMENT
INSTRUMENT LABORATORIES CORP
MOTOROLA COMMUNICATIONS
RCA ELECTRONIC COMPONENTS
ROHDE & SCHWARZ SALES CO. -USA
THE SINGER CO - METRICS DIV
TEXAS ELECTRONICS
TRIPLETT ELECTRICAL INSTRUMENT
WABER ELECTRONICS, INC.
WAVEFORMS, INCORPORATED
YOKOGAWA ELECTRIC WORKS

VOLTMETERS, DC
ALLIED ELECTRONICS CORP
API INSTRUMENTS CO.
COMU ELECTRONICS
COLUMBIA ELECTRIC MFG CO
DATA INSTRUMENT DIVISION
ENGINEERING ASSOCIATES
G E INDUSTRIAL SALES OPERATION
GENERAL ELECTRIC CO
GENERAL RADIO CO
HEATH CO
HEWLETT-PACKARD CO.
HICKOK ELECTRICAL INSTRUMENT
MOTOROLA COMMUNICATIONS
RCA ELECTRONIC COMPONENTS
ROHDE & SCHWARZ SALES CO. -USA
THE SINGER CO - METRICS DIV
TEXAS ELECTRONICS
TRIPLETT ELECTRICAL INSTRUMENT
YOKOGAWA ELECTRIC WORKS

VOLTMETERS, VACUUM TUBE
COMU ELECTRONICS
ENGINEERING ASSOCIATES
GENERAL RADIO CO
HEATH CO
HEWLETT-PACKARD CO.
HICKOK ELECTRICAL INSTRUMENT
INSTRUMENT LABORATORIES CORP
RCA ELECTRONIC COMPONENTS
ROHDE & SCHWARZ SALES CO. -USA
TRIPLETT ELECTRICAL INSTRUMENT
WAVEFORMS, INCORPORATED
BENRUS

WATTMETERS
F W BELL, INC
BIRD ELECTRONIC CORPORATION
ENGINEERING ASSOCIATES
G E INDUSTRIAL SALES OPERATION
GENERAL ELECTRIC CO
GENERAL MICROWAVE CORPORATION
MOTOROLA COMMUNICATIONS
RCA BROADCAST PRODS.
ROHDE & SCHWARZ SALES CO. -USA
THE SINGER CO - METRICS DIV
STANDARD ELECTRONICS CORP.
TRIPLETT ELECTRICAL INSTRUMENT
WATERS MANUFACTURING
YOKOGAWA ELECTRIC WORKS

WAVEGUIDE AND ASSOCIATED COMPONENTS
ANDREW CORPORATION
CARDWELL CONDENSER CORP
COOK ELECTRIC COMPANY

D & B ELECTRONICS COMPANY
DEMORAY - BONARDI DIVISION
GENERAL MICROWAVE CORPORATION
HEWLETT-PACKARD CO.
JERROLD ELECTRONICS CORP
MICROLAB / FXR
MICRO-LINK SYSTEMS/VARIAN ASSO
MICROWAVE ASSOCIATES, INC.
PHELPS DODGE
RCA BROADCAST PRODS.
SCIENTIFIC-ATLANTA
TECHNICAL APPLIANCE CORP

WEATHER INSTRUMENTS
AMCO, INC.
BECKMAN & WHITLEY
BLONDER-TONGUE LABORATORIES
TELFIS CORPORATION
TEXAS ELECTRONICS

WINDERS, CARTRIDGE
BROADCAST ELECTRONICS, INC

WIRE, BARE, COPPER
ALLIED ELECTRONICS CORP
ALPHA WIRE
AMECO, INC.
RELDEN MANUFACTURING CO
BIRNBACH CO
CCA ELECTRONICS CORPORATION
JAMPRO ANTENNA COMPANY
PACIFIC TOWER CO
RCA BROADCAST PRODS.
ROBINS INDUSTRIES CORP.
SAXTON PRODUCTS
SWAGER TOWER CORPORATION
UTILITY TOWER CO.

WIRE, BARE, COPPER STRAP
ALPHA WIRE
CCA ELECTRONICS CORPORATION
JAMPRO ANTENNA COMPANY
RCA BROADCAST PRODS.
SAXTON PRODUCTS
SWAGER TOWER CORPORATION
UTILITY TOWER CO.

WIRE, BARE, STEEL
COPPERWELD STEEL COMPANY
SAXTON PRODUCTS

WIRE, INSULATED, HIGH VOLTAGE
ALPHA WIRE
RELDEN MANUFACTURING CO
BIRNBACH CO
BOSTON INSULATED WIRE & CABLE
ITT WIRE & CABLE DIVISION
LENZ ELECTRIC MANUFACTURING CO
SAXTON PRODUCTS
SINGER PRODUCTS CO.
TENSOLITE INSULATED WIRE CO.

WIRE, INSULATED, HOOKUP
ALLIED ELECTRONICS CORP
ALPHA WIRE
RELDEN MANUFACTURING CO
BIRNBACH CO
ITT WIRE & CABLE DIVISION
LENZ ELECTRIC MANUFACTURING CO
RCA BROADCAST PRODS.
ROBINS INDUSTRIES CORP.
SAXTON PRODUCTS
SUPERIOR CABLE CORPORATION
TENSOLITE INSULATED WIRE CO.

WIRE, SHIELDED
ALLIED ELECTRONICS CORP
ALPHA WIRE
RELDEN MANUFACTURING CO
BIRNBACH CO
BOSTON INSULATED WIRE & CABLE
ITT WIRE & CABLE DIVISION
LENZ ELECTRIC MANUFACTURING CO
RCA BROADCAST PRODS.
ROBINS INDUSTRIES CORP.
SAXTON PRODUCTS
SINGER PRODUCTS CO.
TELEQUIP CORPORATION
TENSOLITE INSULATED WIRE CO.

WIRING & CABLING SERVICES
ALPHA WIRE
AMECO, INC.
APPLIED ELECTRO-MECHANICS
AUDIO ACCESSORIES
BOSTON INSULATED WIRE & CABLE
D & B ELECTRONICS COMPANY
ITT CANNON ELECTRIC
PALL TRINITY MICRO CORP
SAXTON PRODUCTS
TENSOLITE INSULATED WIRE CO.
VITRO ELECTRONICS

YOKES, DEFLECTION
AMERICAN ELITE
LAKE ELECTRONICS, INC.
SINGER PRODUCTS CO.
TELEQUIP CORPORATION

NEW FROM **EMCEE**

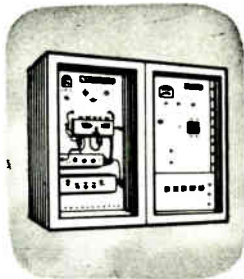

**1KW
TRANSLATOR**
UHF

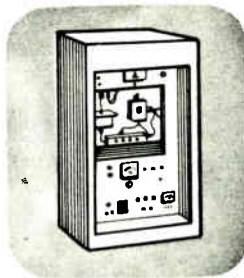

**1KW
TRANSMITTER**
UHF

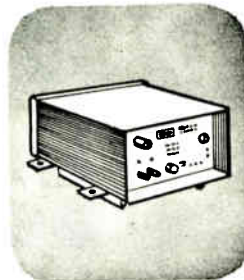

**1 WATT
TRANSISTORIZED
TRANSLATOR**
VHF ONLY

Send for full details . . . now



Electronics Missiles and Communications Inc.

160 EAST THIRO STREET, MT. VERNON, NEW YORK 10550

TELEPHONE: (914) 668-3012

Collins could sell FM transmitters for 20% less



BUT then they wouldn't be the best in the world

All Collins transmitters could be sold for less.

- Corners could be cut on transformers (narrowing safety margins for continuous operation).
- Less shielding could be used against spurious radiation (sacrificing some degree of stability).
- Standards on components, wiring, cabling and switches could be lowered.
- Collins' rigid testing could be bypassed.
- Meeting proper load conditions could be left to luck.
- Money devoted to research and development could be saved.
- Collins' 2-year warranty could be cut to the 1-year period of other manufacturers.

All these compromises could lower the price—as well as the *quality, performance and reliability* of the product—about 20%. But then Collins transmitters wouldn't be known for their careful engineering, conservatively-rated components, and precision manufacturing techniques.

Collins gives the broadcaster a discount in the form of quality and service. And that's worth a lot more than 20%.

For technical information on any FM transmitter ranging from 250w to 20kw, contact Collins Radio Company, Broadcast Communication Division, Dallas, Texas. Area Code 214, AD 5-9511.

COMMUNICATION / COMPUTATION / CONTROL



COLLINS RADIO COMPANY / DALLAS, TEXAS • CEDAR RAPIDS, IOWA • NEWPORT BEACH, CALIFORNIA • TORONTO, ONTARIO
Bangkok • Beirut • Frankfurt • Hong Kong • Kuala Lumpur • Los Angeles • London • Melbourne • Mexico City • New York • Paris • Rome • Washington • Wellington

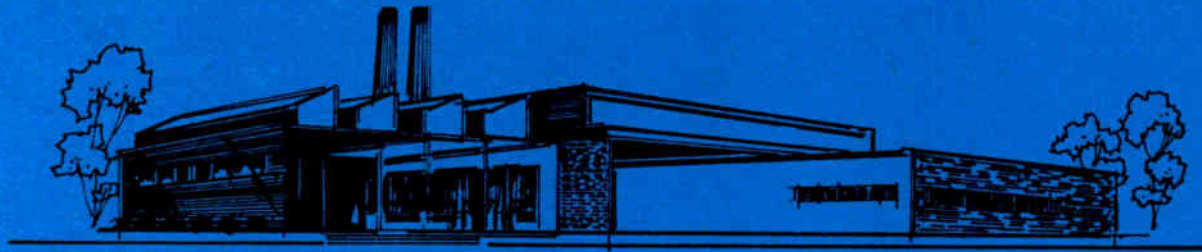

GUIDE TO MANUFACTURERS

A listing of over 450 manufacturers active in the broadcast industry.
For a specific product, see Product Directory.

ACME FILM & VIDEOTAPE LABS. FILM, PROCESSING SERVICE

ACME VISIBLE RECORDS

CABINETS, METAL
CABINETS, STORAGE, DISC
CABINETS, STORAGE, FILM
CABINETS, STORAGE,
MAGNETIC TAPE
COMPUTER SERVICES
DESIGNATION CARDS & STRIPS
LOG BOOKS OR SHEETS
TERMINAL CARDS

ADC PRODUCTS

COILS, CHOKE, AF
COILS, HYBRID
COILS, TELEPHONE
CORDS, PATCH
FILTERS, AUDIO
FILTERS, RF
INDUCTANCES, FIXED
JACK PANEL ASSEMBLIES
JACKS
LAMPS, PANEL
PLUGS, COAXIAL
PLUGS, PHONE
POWER SUPPLIES, AC
POWER SUPPLIES, DC
TERMINAL BLOCKS
TERMINAL BOARDS
TERMINAL STRIPS
TRANSFORMERS, AUDIO,
ISOLATION
TRANSFORMERS, AUDIO, MATCHING
TRANSFORMERS, AUDIO,
POWER OUTPUT
TRANSFORMERS, AUTO
TRANSFORMERS, COUPLING
TRANSFORMERS, FILAMENT
TRANSFORMERS, GENERAL
TRANSFORMERS, PLATE
TRANSFORMERS, POWER
TRANSFORMERS, RF
TRANSFORMERS, TRANSISTOR

AIR SPACE DEVICES, INC. SAFETY DEVICES, CLIMBING

ADVANCE INDUSTRIES

ANCHORS, GUY
ANTENNAS, AM
ANTENNAS, CATV
ANTENNAS, MICROWAVE
HARDWARE, MOUNTS
REFLECTORS, PASSIVE
TOWERS, ANTENNA,
CATV, HEAD-END
TOWERS, ANTENNA, RECEIVING
TOWERS, ANTENNA,
TRANSMITTING, AM
TOWERS, ANTENNA,
TRANSMITTING, FM

TOWERS, ANTENNA,
TRANSMITTING, TV

AEROVOX CORP.

BOXES, DECADE, CAPACITOR
BOXES, DECADE, INDUCTOR
BOXES, DECADE, RESISTOR
CAPACITORS, FIXED, CERAMIC
CAPACITORS, FIXED,
ELECTROLYTIC
CAPACITORS, FIXED, FILM
CAPACITORS, FIXED, METALLIZED
CAPACITORS, FIXED, MICA
CAPACITORS, FIXED, OIL-FILLED
CAPACITORS, FIXED, PAPER
CAPACITORS, FIXED, OTHER
DEMAGNETIZERS, BULK TAPE
FILTERS, AUDIO
FILTERS, RF
INTEGRATED CIRCUITS
KITS
RESISTORS, FIXED, CARBON
RESISTORS, FIXED, PRECISION
RESISTORS, FIXED, OTHER
SOCKETS, TUBE
TERMINALS, SOLDERLESS
TOOLS, CRIMPERS

AITKEN COMMUNICATIONS

AUTOMATION EQUIPMENT
PREAMPLIFIERS, AUDIO

ALBION OPTICAL COMPANY

LENSES, OPTICAL, FIXED
LENSES, OPTICAL, ZOOM
METERS, FLUTTER & NOW
REMOTE CONTROL SYSTEMS

ALFORD MANUFACTURING COMPANY

ANTENNAS, FM
ANTENNAS, TV
ANTENNAS, 2500 MHZ
BRIDGES
DIPLEXERS
DIVIDERS, POWER
MICROWAVE COMPONENTS
NETWORKS, MATCHING, RF
SLOTTED SECTIONS
SWITCHES, COAXIAL
VESTIGIAL SIDEBAND FILTERS

ALLIED ELECTRONICS CORP.

AMMETERS, AC
AMMETERS, DC
AMPLIFIER, AF, STEREO
ANTENNAS, FM
ANTENNAS, TV
CABINETS, METAL
CABLE, ARMORED
CABLE, SHIELDED, AUDIO
KITS
OSCILLOSCOPES
RECEIVERS, AM

RECEIVERS, FM
RECORDERS, MAGNETIC TAPE,
AUDIO

RELAYS, GENERAL PURPOSE
TAPE, MAGNETIC RECORDING,
AUDIO

TESTERS, VACUUM TUBE
TRANSFORMERS, AUDIO,
ISOLATION
TRANSFORMERS, AUDIO, MATCHING
TRANSFORMERS, AUDIO,
POWER OUTPUT
TRANSFORMERS, AUTO
TRANSFORMERS, FILAMENT
TRANSFORMERS, GENERAL
TRANSFORMERS, PLATE
TRANSFORMERS, POWER
TRANSFORMERS, RF
TRANSFORMERS, TRANSISTOR
TRANSFORMERS, VARIABLE
TRANSMITTER KITS
VOLTMETERS, AC
VOLTMETERS, DC
WIRE, BARE, COPPER
WIRE, INSULATED, HOOKUP
WIRE, SHIELDED

ALMA ENGINEERING

AMPLIFIER, AF,
GENERAL PURPOSE
AMPLIFIER, AF, MONAURAL
AMPLIFIER, AF, REMOTE
AMPLIFIER, AF, STEREO
AMPLIFIER, BRIDGING
AMPLIFIER, DISTRIBUTION
AMPLIFIER, PULSE
AMPLIFIER, TV, VIDEO
AMPLIFIER, VIDEO, SWEEP
CONSOLE, AUDIO, AM
CONSOLE, AUDIO, FM
CONSOLE, AUDIO, PORTABLE
CONSOLE, AUDIO, RECORDING
CONSOLE, AUDIO, TV
CONSOLE, VIDEO, PORTABLE
CONSOLE, VIDEO, STUDIO
GENERATORS, SIGNAL,
SPECIAL EFFECTS
POWER SUPPLIES, DC
PREAMPLIFIERS, AUDIO
SWITCHES
SWITCHING MATRIXES
SWITCHING SYSTEMS

ALPHA WIRE

CABLE, ARMORED
CABLE, ASSEMBLIES
CABLE, COAXIAL, FLEXIBLE
CABLE, COAXIAL, RIGID
CABLE, DIRECT-BURIAL
CABLE, SHIELDED, AUDIO
CABLE, TELEPHONE
WIRE, BARE, COPPER
WIRE, BARE, COPPER STRAP

WIRE, INSULATED, HIGH VOLTAGE
WIRE, INSULATED, HOOKUP
WIRE, SHIELDED
WIRING AND CABLING SERVICES

ALTEC LANSING

AMPLIFIER, AF, AGC
AMPLIFIER, AF, COMPRESSING
AMPLIFIER, AF,
GENERAL PURPOSE
AMPLIFIER, AF, MONAURAL
AMPLIFIER, AF,
PEAK LIMITING, AM
AMPLIFIER, AF, REMOTE
AMPLIFIER, AF, STEREO
AMPLIFIER, BRIDGING
AMPLIFIER, DC
AMPLIFIER, DISTRIBUTION
AMPLIFIER, PULSE
ATTENUATORS, AUDIO
ATTENUATORS, FIXED
ATTENUATORS,
IMPEDANCE MATCHING
BRIDGES
CAPACITORS, FIXED, METALLIZED
CAPACITORS, FIXED, MICA
CAPACITORS, FIXED, OIL-FILLED
CAPACITORS, FIXED, PAPER
CAPACITORS, FIXED, OTHER
CAPACITORS, VARIABLE
COILS, CHOKE, AF
COILS, CHOKE, RF
COILS, HYBRID
COILS, TELEPHONE
COMMUNICATIONS SYSTEMS, CB
COMMUNICATIONS SYSTEMS,
INTERCOM, WIRED
COMMUNICATIONS SYSTEMS,
LAND MOBILE
COMMUNICATIONS SYSTEMS,
MICROWAVE
CONSOLE, AUDIO, FM
CONSOLE, AUDIO, PORTABLE
CONSOLE, AUDIO, RECORDING
CONSOLE, AUDIO, TV
CONSOLE, CABINETS
AND HARDWARE
CONSOLE, AUDIO, AM
CONVERTERS
ENCLOSURES, SPEAKER
EQUALIZERS, AUDIO EMPHASIS
FILTERS, AUDIO
FILTERS, OTHER
INVERTERS, DC TO AC, CHOPPER
INVERTERS, DC TO AC,
SOLID STATE
INVERTERS, DC TO AC,
VIBRATORS
METERS, DB AND VU
METERS, DB AND VU, WIDE RANGE
MICROPHONE HARDWARE
MICROPHONE STANDS & BOOMS
MICROPHONES, CONDENSER

MICROPHONES, DYNAMIC
 MONITORS, AM SYSTEMS
 MONITORS, FM SYSTEMS, MONO
 NETWORKS, MATCHING, AUDIO
 POTENTIOMETERS, WIREWOUND
 POWER SUPPLIES, AC
 POWER SUPPLIES, DC
 POWER SUPPLIES, PRECISION
 PREAMPLIFIERS, AUDIO
 RECEIVERS, FM
 REGULATORS, VOLTAGE
 SOUND SYSTEMS, OUTDOOR
 SOUND SYSTEMS, PORTABLE
 SOUND SYSTEMS, THEATER
 SPEAKER COMPONENTS
 SPEAKERS
 SWITCHES, MULTICONTACT
 SWITCHES, ROTARY
 TELEPHONE EQUIPMENT
 TRANSFORMERS, AUDIO,
 ISOLATION
 TRANSFORMERS, AUDIO, MATCHING
 TRANSFORMERS, AUDIO,
 POWER OUTPUT
 TRANSFORMERS, AUTO
 TRANSFORMERS, COUPLING
 TRANSFORMERS, FILAMENT
 TRANSFORMERS, GENERAL
 TRANSFORMERS, PLATE
 TRANSFORMERS, POWER

AMECO, INC.

ADAPTERS, CONNECTOR
 ADAPTERS, TEST
 AMPLIFIER, AF, AGC
 AMPLIFIER, BRIDGING
 AMPLIFIER, CATV
 AMPLIFIER, DISTRIBUTION
 AMPLIFIER, RF,
 GENERAL PURPOSE
 AMPLIFIER, TV, BOOSTER
 ANCHORS, GUY
 ANTENNAS, CATV
 ANTENNAS, FM
 ANTENNAS, MICROWAVE
 ANTENNAS, TV,
 MASTER-COMMUNITY
 ATTENUATORS, AUDIO
 ATTENUATORS,
 IMPEDANCE MATCHING
 ATTENUATORS, MICROWAVE
 ATTENUATORS, RF
 ATTENUATORS, VIDEO
 AUTOMATION EQUIPMENT
 BACKGROUND MUSIC SERVICE
 BALUNS
 BLOWERS AND FANS
 BRIDGES
 BROADCAST PROGRAMMING SERVICE
 CABINETS, METAL
 CABLE, ASSEMBLIES
 CABLE, CATV, HARDWARE
 CABLE, COAXIAL, FLEXIBLE
 CABLE, DIRECT-BURIAL
 CABLE, TELEPHONE
 CAMERA, MOUNTING EQUIPMENT
 CAMERA, REMOTE
 CONTROL EQUIPMENT
 CAMERAS, FILM, CINE
 CAMERAS, OSCILLOSCOPE
 CAMERAS, TV, COLOR
 CAMERAS, TV, MONOCHROME
 CATV EQUIPMENT - ALSO SEE
 OTHER CATEGORIES
 CATV, CABLE TERMINALS
 CATV, CHANNEL AMPLIFIERS
 CATV, HEAD-END EQUIPMENT
 CATV, ORIGINATION EQUIPMENT
 CIRCUITS, PRINTED
 CLAMPS, CABLE
 CLAMPS, GROUND
 CONNECTORS, ANTENNA
 CONNECTORS, COAXIAL CABLE
 CONNECTORS, POWER
 CONNECTORS, RF
 CONVERTERS
 COUPLERS
 DEMODULATORS
 FILTERS, ANTENNA
 FILTERS, RF
 GENERATORS, SIGNAL, RF
 HARDWARE, GENERAL
 HARDWARE, TOOLS
 HEAD-END EQUIPMENT,
 SEE CATV HEAD-END EQUIPMENT
 LENSES, OPTICAL, FIXED
 LENSES, OPTICAL, ZOOM
 LIGHTNING ARRESTERS
 MAINTENANCE SERVICES,
 MICROWAVE
 MICROPHONE HARDWARE
 MICROWAVE COMPONENTS
 MICROWAVE SYSTEMS, STL
 MODULATORS, TV
 MONITORS, FM SYSTEMS, MONO
 MONITORS, FM SYSTEMS, STEREO
 MONITORS, FREQUENCY
 MONITORS, VIDEO
 MOUNTS, ANTENNA, FIXED
 NARROW-BAND FM EQUIPMENT
 NETWORKS, MATCHING, RF
 PLUGS, COAXIAL
 POLE CLIMBING EQUIPMENT
 POWER SUPPLIES, AC
 POWER SUPPLIES, DC
 PREAMPLIFIERS, AUDIO
 PREAMPLIFIERS, VIDEO
 RACKS, MOUNTING
 RECEIVERS, FM
 RECEIVERS, TV, COLOR
 RECEIVERS, TV, MONOCHROME
 SWITCHES
 TAPE, MAGNETIC RECORDING,
 VIDEO
 TOOLS, CLAMPS
 TOOLS, CRIMPERS

TOWERS, ANTENNA,
 CATV, HEAD-END
 TOWERS, ANTENNA, RECEIVING
 TRANSMISSION LINES
 TV SYSTEMS, CLOSED CIRCUIT
 VACUUM TUBES, TRANSMITTING
 WEATHER INSTRUMENTS
 WIRE, BARE, COPPER
 WIRING AND CABLING SERVICES

AMERICAN CABLE ELECTRONICS

ADAPTERS, CONNECTOR
 CATV EQUIPMENT - ALSO SEE
 OTHER CATEGORIES
 CATV, ORIGINATION EQUIPMENT
 CONNECTORS, COAXIAL CABLE
 TRANSFORMERS, RF
 TV SYSTEMS, CLOSED CIRCUIT

AMERICAN ELECTRONIC LABS.

AMPLIFIER, CATV
 AMPLIFIER, RF, POWER
 ANTENNAS, MICROWAVE
 ANTENNAS, 2500 MHZ
 BALUNS
 CATV EQUIPMENT - ALSO SEE
 OTHER CATEGORIES
 CATV, CHANNEL AMPLIFIERS
 CATV, HEAD-END EQUIPMENT
 CATV, ORIGINATION EQUIPMENT
 COMMUNICATIONS SYSTEMS,
 MICROWAVE
 DUMMY LOAD
 EXCITERS, FM
 GENERATORS, FM, STEREO
 FILTERS, RF
 GENERATORS, FM, SUBCARRIER
 HEAD-END EQUIPMENT,
 SEE CATV HEAD-END EQUIPMENT
 MAINTENANCE SERVICES, AM
 MAINTENANCE SERVICES, FM
 MAINTENANCE SERVICES,
 MICROWAVE
 NETWORKS, PHASING
 RECEIVERS, HF
 SEMICONDUCTOR DIODES
 SWITCHES, COAXIAL
 SWITCHES, WAVEGUIDE
 TESTERS, SEMICONDUCTOR
 TRANSMITTERS, AM, 250 WATT
 TRANSMITTERS, AM, 1 KW
 TRANSMITTERS, AM, 5 KW
 TRANSMITTERS, AM, 10 KW
 TRANSMITTERS, AM, 25 KW
 TRANSMITTERS, AM, 50 KW
 TRANSMITTERS, FM, 10 WATTS
 TRANSMITTERS, FM, 250 WATTS
 TRANSMITTERS, FM, 1 KW
 TRANSMITTERS, FM, 5 KW
 TRANSMITTERS, FM, 7.5 KW
 TRANSMITTERS, FM, 10 KW
 TRANSMITTERS, FM, 20 KW

AMERICAN FLITE

CAPACITORS, FIXED, CERAMIC
 CAPACITORS, FIXED,
 ELECTROLYTIC
 CAPACITORS, FIXED, FILM
 CAPACITORS, VARIABLE
 COILS, DEFLECTION
 AND FOCUSING
 COMMUNICATIONS SYSTEMS,
 INTERCOM, WIRED
 COMMUNICATIONS SYSTEMS,
 LAND MOBILE
 COMMUNICATIONS SYSTEMS,
 MICROWAVE
 COMMUNICATIONS SYSTEMS,
 MULTIPLEX
 CONSOLE, AUDIO, RECORDING
 INTEGRATED CIRCUITS
 MICROPHONES, CONDENSER
 MICROPHONES, DYNAMIC
 MICROWAVE COMPONENTS
 MICROWAVE SYSTEMS, 2500 MHZ
 MOBILE EQUIPMENT
 POTENTIOMETERS, CARBON
 RECEIVERS, AM
 RECEIVERS, FM
 RECEIVERS, HF
 RECORDERS, MAGNETIC TAPE,
 AUDIO
 RECTIFIERS, SELENIUM
 RELAYS, LATCHING
 RESISTORS, FIXED, CARBON
 SEMICONDUCTOR DIODES
 SEMICONDUCTORS,
 TRANSISTORS, AF
 SEMICONDUCTORS,
 TRANSISTORS, RF
 SPEAKERS
 SWITCHES, PUSHBUTTON,
 NONILLUMINATED
 SWITCHES, ROTARY
 SWITCHES, SLIDE
 SWITCHES, TOGGLE
 TELEPHONE EQUIPMENT
 TRANSMITTERS, AM, 10 KW
 TRANSMITTERS, AM, 50 KW
 TRANSMITTERS, AM, OVER 50 KW
 TRANSMITTERS, FM, 5 KW
 TRANSMITTERS, FM, 10 KW
 TRANSMITTERS, FM, 50 KW
 TRANSMITTERS, FM, 100 KW
 VACUUM TUBES, CATHODE RAY
 TV, MONOCHROME
 VACUUM TUBES, RECEIVING
 VACUUM TUBES, TRANSMITTING
 YOKES, DEFLECTION

AMERICAN GELOSO ELECTRONICS

COMMUNICATIONS SYSTEMS,
 INTERCOM, WIRED
 MICROPHONE HARDWARE
 MICROPHONE STANDS & BOOMS
 MICROPHONES, DYNAMIC

MICROPHONES, WIRELESS
 MIXERS - ALSO SEE CONSOLES
 MOBILE EQUIPMENT
 RECORDERS, MAGNETIC TAPE,
 AUDIO
 SOUND SYSTEMS, OUTDOOR
 SOUND SYSTEMS, PORTABLE
 SPEAKER COMPONENTS
 SPEAKERS
 TAPE, MAGNETIC RECORDING,
 AUDIO

AMERICAN PAMCOR, INC.

CATV, CABLE TERMINALS
 CONNECTORS, ANTENNA
 CONNECTORS, COAXIAL CABLE
 CONNECTORS, POWER
 CONNECTORS, RF
 PLUGS, COAXIAL
 SWITCHES
 SWITCHING MATRICES
 SWITCHING SYSTEMS
 TERMINAL BLOCKS
 TERMINALS, HIGH VOLTAGE
 TERMINALS, LUG
 TERMINALS, SOLDERLESS
 TOOLS, CRIMPERS

AMERLINE CORPORATION

CARTRIDGES, MAGNETIC TAPE
 REELS, FILM
 REELS, TAPE

AMPEREX ELECTRONIC CORP.

CAPACITORS, FIXED,
 ELECTROLYTIC
 CAPACITORS, FIXED, FILM
 CAPACITORS, FIXED, OTHER
 CAVITIES, MICROWAVE
 MICROWAVE COMPONENTS
 RESISTORS, FIXED, CARBON
 RESISTORS, FIXED, OTHER
 SEMICONDUCTOR DIODES
 SEMICONDUCTOR RECTIFIERS,
 SILICON CONTROLLED - SCR
 SEMICONDUCTORS, THYRISTORS
 SEMICONDUCTORS,
 TRANSISTORS, AF
 SEMICONDUCTORS,
 TRANSISTORS, FE
 SEMICONDUCTORS, TRANSISTORS,
 GENERAL
 SEMICONDUCTORS,
 TRANSISTORS, RF
 VACUUM TUBES, CAMERA,
 IMAGE-ORTHICON
 VACUUM TUBES, CAMERA,
 PLUMBICON R
 VACUUM TUBES, CAMERA, VIDICOM
 VACUUM TUBES, RECEIVING
 VACUUM TUBES, TRANSMITTING

AMPERITE CO.

RELAYS, TIME DELAY
 VACUUM TUBES, BALLAST

AMPEX CORPORATION

CAMERAS, TV, COLOR
 CAMERAS, TV, MONOCHROME
 CARTRIDGES, TAPE,
 RECORDING SERVICE
 CATV, ORIGINATION EQUIPMENT
 COMMUNICATIONS SYSTEMS,
 LAND MOBILE
 COMPUTER EQUIPMENT
 CONSOLE, AUDIO, AM
 CONSOLE, AUDIO, FM
 CONSOLE, AUDIO, PORTABLE
 CONSOLE, AUDIO, RECORDING
 CONSOLE, AUDIO, TV
 CONSOLE, KITS
 CONSOLE, VIDEO, PORTABLE
 CONSOLE, VIDEO, STUDIO
 DEMAGNETIZERS, BULK TAPE
 DEMAGNETIZERS, HEAD
 DROPOUT COMPENSATOR,
 VIDEO TAPE
 EARPHONES, HEADPHONES
 EDITORS, AUDIO TAPE
 EDITORS, VIDEO TAPE
 HEADS, ERASE, MAGNETIC
 HEADS, RECORDING, MAGNETIC
 INDUSTRIAL TV
 LENSES, OPTICAL, FIXED
 LENSES, OPTICAL, ZOOM
 MAINTENANCE SERVICES, AM
 MAINTENANCE SERVICES, FM
 MAINTENANCE SERVICES, TV
 MICROPHONES, DYNAMIC
 MOBILE EQUIPMENT
 MONITORS, VIDEO
 RECORDERS, DISC, MAGNETIC
 RECORDERS, MAGNETIC TAPE,
 AUDIO
 RECORDERS, MAGNETIC TAPE,
 LOGGING
 RECORDERS, MAGNETIC TAPE,
 VIDEO
 SOUND SYSTEMS, OUTDOOR
 SOUND SYSTEMS, PORTABLE
 SOUND SYSTEMS, THEATER
 SPEAKERS
 TAPE DECKS, MAGNETIC
 TAPE DUPLICATORS
 TAPE, MAGNETIC RECORDING,
 AUDIO
 TAPE, MAGNETIC RECORDING,
 COMPUTER
 TAPE, MAGNETIC RECORDING,
 TEST
 TAPE, MAGNETIC RECORDING,
 VIDEO
 TV SYSTEMS, CLOSED CIRCUIT

AMPHENOL DISTRIBUTOR DIVISION

ADAPTERS, CONNECTOR

CABLE, ARMORED
 CABLE, ASSEMBLIES
 CABLE, CATV, HARDWARE
 CABLE, COAXIAL, FLEXIBLE
 CABLE, COAXIAL, RIGID
 CABLE, DIRECT-BURIAL
 CABLE, SHELDED, AUDIO
 CHARGERS, BATTERY
 COMMUNICATIONS SYSTEMS, CB
 CONNECTORS, AF & MICROPHONE
 CONNECTORS, ANTENNA
 CONNECTORS, COAXIAL CABLE
 CONNECTORS, POWER
 CONNECTORS, RF
 DIALS, INSTRUMENT
 GENERATORS, SIGNAL, COLOR BAR
 GENERATORS, SIGNAL, RF
 METERS, FIELD STRENGTH
 PLUGS, COAXIAL
 PLUGS, PHONE
 POTENTIOMETERS, CARBON
 POTENTIOMETERS, WIREWOUND
 RESISTORS, FIXED, PRECISION
 RESISTORS, FIXED, WIREWOUND
 RESISTORS, VARIABLE, CARBON
 RESISTORS, VARIABLE,
 WIREWOUND

AMPLIFIER CORP. OF AMERICA

AMPLIFIER, AF, AGC
 AMPLIFIER, AF, COMPRESSING
 AMPLIFIER, AF,
 GENERAL PURPOSE
 AMPLIFIER, AF, REVERBERATION
 DEMAGNETIZERS, BULK TAPE
 DEMAGNETIZERS, HEAD
 METERS, FLUTTER & WOW
 PROJECTORS, SLIDE
 RECORDERS, MAGNETIC TAPE,
 AUDIO
 REVERBERATION DEVICES

AMPLIVISION CORPORATION

AMPLIFIER, BRIDGING
 AMPLIFIER, CATV
 AMPLIFIER, DISTRIBUTION
 AMPLIFIER, RF,
 GENERAL PURPOSE
 AMPLIFIER, TV, BOOSTER
 AMPLIFIER, TV, VIDEO
 AMPLIFIER, VIDEO, SWEEP
 ANTENNAS, TV,
 MASTER-COMMUNITY
 CABLE, CATV, HARDWARE
 CAMERA, REMOTE
 CONTROL EQUIPMENT
 CAMERAS, TV, COLOR
 CAMERAS, TV, MONOCHROME
 CATV EQUIPMENT - ALSO SEE
 OTHER CATEGORIES
 CATV, CHANNEL AMPLIFIERS
 CATV, HEAD-END EQUIPMENT
 CATV, ORIGINATION EQUIPMENT
 COMMUNICATIONS SYSTEMS,
 MICROWAVE
 CONNECTORS, ANTENNA
 CONNECTORS, COAXIAL CABLE
 CONNECTORS, RF
 CONSOLE, VIDEO, PORTABLE
 CONSOLE, VIDEO, STUDIO
 CONVERTERS
 GENERATORS, FM, SUBCARRIER
 HEAD-END EQUIPMENT,
 SEE CATV HEAD-END EQUIPMENT
 MONITORS, VIDEO
 NARROW-BAND FM EQUIPMENT
 NETWORKS, MATCHING, RF
 NETWORKS, PHASING
 RECORDERS, MAGNETIC TAPE,
 VIDEO
 RODS, GROUND
 TAPE DECKS, MAGNETIC
 TAPE, MAGNETIC RECORDING,
 VIDEO
 TOWERS, ANTENNA,
 CATV, HEAD-END
 TRANSLATOR SYSTEMS
 TV SYSTEMS, CLOSED CIRCUIT

ANACONDA ASTRODATA CO.

AMPLIFIER, BRIDGING
 AMPLIFIER, CATV
 AMPLIFIER, DISTRIBUTION
 AMPLIFIER, TV, BOOSTER
 CABLE, CATV, HARDWARE
 CABLE, COAXIAL, FLEXIBLE
 CABLE, DIRECT-BURIAL
 CATV EQUIPMENT - ALSO SEE
 OTHER CATEGORIES
 CATV, CABLE TERMINALS
 CATV, CHANNEL AMPLIFIERS
 CATV, HEAD-END EQUIPMENT
 CONNECTORS, COAXIAL CABLE
 HEAD-END EQUIPMENT,
 SEE CATV HEAD-END EQUIPMENT
 INDUSTRIAL TV
 METERS, FIELD STRENGTH
 POWER SUPPLIES, AC
 TRANSFORMERS, GENERAL
 TV SYSTEMS, CLOSED CIRCUIT

ANCHA ELECTRONICS

CONSOLE, AUDIO, FM
 CONSOLE, AUDIO, RECORDING
 CONSOLE, AUDIO, TV
 CONSOLE, AUDIO, AM

KEITH ANDERSON CO.

AMPLIFIER, CATV
 AMPLIFIER, RF,
 GENERAL PURPOSE
 AMPLIFIER, RF, POWER
 BALUNS
 CATV, CHANNEL AMPLIFIERS
 CATV, HEAD-END EQUIPMENT
 CONVERTERS

GENERATORS, POWER,
WIND AND THERMOELECTRIC
TRANSLATOR SYSTEMS
TRANSMITTERS, TV, 1 WATT
TRANSMITTERS, TV, 10 WATTS

ANDREW CORPORATION
ANTENNAS, MICROWAVE
ANTENNAS, MOBILE
ANTENNAS, 2500 MHZ
CABLE, ASSEMBLIES
CABLE, CATV, HARDWARE
CABLE, COAXIAL, FLEXIBLE
CABLE, COAXIAL, RIGID
CABLE, DIRECT-BURIAL
CLAMPS, CABLE
CONNECTORS, COAXIAL CABLE
CONNECTORS, RF
DELAY LINES
JOINTS, ROTARY, COAXIAL
JOINTS, ROTARY, WAVEGUIDE
MICROWAVE COMPONENTS
MOBILE EQUIPMENT
MOUNTS, ANTENNA, FIXED
PRESSURIZATION EQUIPMENT,
TRANSMISSION LINE
RADOMES
REMOTE CONTROL SYSTEMS
STL EQUIPMENT
SWITCHES, COAXIAL
SWITCHES, WAVEGUIDE
SWITCHING MATRICES
SWITCHING SYSTEMS
TRANSMISSION LINES
WAVEGUIDE AND
ASSOCIATED COMPONENTS

ANSONIA WIRE AND CABLE CO.
CABLE, COAXIAL, FLEXIBLE
CABLE, TELEPHONE

ANTENNA PRODUCTS COMPANY
ANTENNAS, AM
ANTENNAS, CATV
ANTENNAS, FM
ANTENNAS, TV,
MASTER-COMMUNITY
BALUNS
CABLE, COAXIAL, RIGID
INSULATORS, ANTENNA
INSULATORS, STAND-OFF
TOWERS, ANTENNA,
CATV HEAD-END
TOWERS, ANTENNA, RECEIVING
TOWERS, ANTENNA,
TRANSMITTING, AM
TOWERS, ANTENNA,
TRANSMITTING, FM
TOWERS, ANTENNA,
TRANSMITTING, TV
TRANSFORMERS, RF
TRANSMISSION LINES

API INSTRUMENTS CO.
AMMETERS, AC
AMMETERS, AC, THERMOCOUPLE
AMMETERS, DC
METERS, DB AND VU
METERS, SEE SPECIFIC TYPES
RECORDERS, PAPER,
LOGGING AND GRAPHIC
RELAYS, OVERLOAD
VOLTMETERS, AC
VOLTMETERS, DC

APPARATUS DEVELOPMENT CO.
ANTENNAS, FM
BALUNS

APPLIED ELECTRO-MECHANICS
ADAPTERS, CONNECTOR
AMPLIFIER, DISTRIBUTION
AMPLIFIER, PULSE
AMPLIFIER, SENSING
AMPLIFIER, TV, VIDEO
CORDS, PATCH
GENERATORS, SIGNAL,
SPECIAL EFFECT
SOUND SYSTEMS, OUTDOOR
SOUND SYSTEMS, PORTABLE
WIRING AND CABLING SERVICES

ARRIFLEX CORP. OF AMERICA
CAMERAS, FILM, CINE
PROJECTORS, FILM

ASCO SONOCRAFT CORP.
AMPLIFIER, DISTRIBUTION
BACKGROUND MUSIC SERVICE
BROADCAST PROGRAMMING SERVICE
CAMERAS, TV, COLOR
COMMUNICATIONS SYSTEMS,
INTERCOM, WIRED
COMMUNICATIONS SYSTEMS,
INTERCOM, WIRELESS
CONSOLE, AUDIO, RECORDING
CONSOLE, CABINETS
AND HARDWARE
EARPHONES, HEADPHONES
EDITORS, AUDIO TAPE
EDUCATION FACILITIES, EQPT
ENCLOSURES, SPEAKER
MAINTENANCE SERVICES, AM
MAINTENANCE SERVICES, FM
RECORDS, BLANK, ACETATE,
FOR RECORDING
SCREENS, PROJECTION, FRONT
TAPE DECKS, MAGNETIC
TAPE DUPLICATORS
TAPE, MAGNETIC RECORDING,
AUDIO
TAPE, MAGNETIC RECORDING,
VIDEO

THE ASTATIC CORPORATION
ARMS, TONE

CARTRIDGES, PHONO
EARPHONES, HEADPHONES
MICROPHONE STANDS & BOOMS
MICROPHONES, DYNAMIC
STYLI, CUTTING
STYLI, PLAYBACK
TAPE, MAGNETIC RECORDING,
AUDIO

ATLAS SOUND
ACOUSTIC MATERIALS
ADAPTERS, CONNECTOR
COMMUNICATIONS SYSTEMS,
INTERCOM, WIRED
COMMUNICATIONS SYSTEMS,
LAND MOBILE
LAMP ASSEMBLIES
MOBILE EQUIPMENT
MOUNTS, INSTRUMENT
SOUND SYSTEMS, OUTDOOR
SOUND SYSTEMS, THEATER
SPEAKER COMPONENTS
SPEAKERS
SWITCHES, FOOT
TRANSFORMERS, AUDIO, MATCHING

AUDIO ACCESSORIES
CORDS, PATCH
JACK PANEL ASSEMBLIES
JACKS
LAMPS, PANEL
PLUGS, PHONO
SOCKETS, LAMP
WIRING AND CABLING SERVICES

AUDIO DEVICES
CARTRIDGES, MAGNETIC TAPE
DEMAGNETIZERS, HEAD
HEADS, DISC RECORDING
RECORDS, BLANK, LACQUER,
FOR RECORDING
REELS, TAPE
TAPE, MAGNETIC RECORDING,
AUDIO
TAPE, MAGNETIC RECORDING,
AUDIO, CARTRIDGE
TAPE, MAGNETIC RECORDING,
COMPUTER
TAPE, MAGNETIC RECORDING,
TEST

AUDIO INSTRUMENT CO.
AMPLIFIER, AF, REVERBERATION
ANALYZERS, DISTORTION
ANALYZERS, INTERMODULATION
DELAY DEVICES, AF
DELAY LINES
EDUCATION FACILITIES, EQPT
PREAMPLIFIERS, AUDIO
RECORDERS, MAGNETIC TAPE,
AUDIO
SOUND SYSTEMS, OUTDOOR
SOUND SYSTEMS, THEATER
TAPE DECKS, MAGNETIC
TELEPHONE EQUIPMENT

BALL BROTHERS RESEARCH
AMPLIFIER, CATV
AMPLIFIER, DISTRIBUTION
AMPLIFIER, STABILIZING
AMPLIFIER, TV, VIDEO
CATV EQUIPMENT - ALSO SEE
OTHER CATEGORIES
GENERATORS, SIGNAL,
SPECIAL EFFECT
INDUSTRIAL TV
TV SYSTEMS, CLOSED CIRCUIT

BARKER & WILLIAMSON
ANALYZERS, DISTORTION
ANALYZERS, HARMONIC
COILS, ANTENNA LOADING
COILS, CHOKE, RF
DUMMY LOAD
GENERATORS, SIGNAL, AF
SWITCHES, COAXIAL
TRANSFORMERS, RF

BAUER ELECTRONICS CORPORATION
AMPLIFIER, AF, AGC
AMPLIFIER, AF, COMPRESSING
AMPLIFIER, AF,
GENERAL PURPOSE
AMPLIFIER, AF, MONAURAL
AMPLIFIER, AF,
PEAK LIMITING, AM
AMPLIFIER, AF,
PEAK LIMITING, FM
AMPLIFIER, AF, REVERBERATION
AMPLIFIER, AF, STEREO
AMPLIFIER, BRIDGING
AMPLIFIER, DC
AMPLIFIER, RF, POWER
CARRIER-CURRENT EQUIPMENT
CONSOLE, AUDIO, AM
CONSOLE, AUDIO, FM
CONSOLE, AUDIO, PORTABLE
CONSOLE, AUDIO, RECORDING
CONSOLE, AUDIO, TV
CONSOLE, CABINETS
AND HARDWARE
CONSOLE, KITS
DELAY DEVICES, AF
MIXERS - ALSO SEE CONSOLES
PREAMPLIFIERS, AUDIO
RECORDERS, PAPER,
LOGGING AND GRAPHIC
REMOTE CONTROL SYSTEMS
REVERBERATION DEVICES
TRANSMITTER KITS
TRANSMITTERS, AM, LOW POWER
TRANSMITTERS, AM, 250 WATT
TRANSMITTERS, AM, 1 KW
TRANSMITTERS, AM, 5 KW
TRANSMITTERS, AM, 10 KW

Color Problems?

AEM HAS THREE NEW ANSWERS

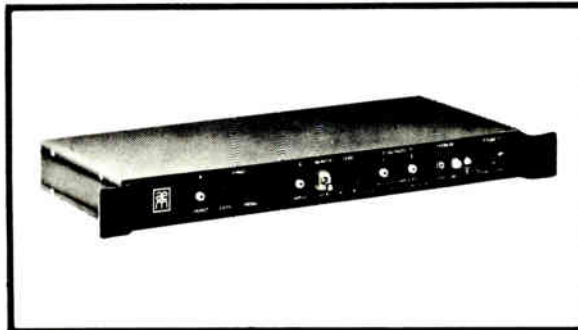

LAP AMPLIFIERS—Here's the new LDA-series of lap-dissolve amplifiers that AEM developed especially for color. Photo-electric cells, remotely controlled by DC circuitry, assure a velvety transition between two inputs. All solid state (silicon semiconductors exclusively), the LDA provides the signal handling characteristics of a high performance distribution amplifier. Differential phase and gain do not change even during the lap interval. Embarrassing color shifts and level changes become a thing of the past. And the price is just as attractive as the performance: LDA-1, \$555.00; LDA-2 (sync adding), \$585.00.

COLOR SENSORS—We are introducing a Color Sensor attachment to the LDA amplifiers which samples both incoming channels and then closes a relay when *either* input has color burst . . . gives your switching system the information it needs to react properly. LDA-1 with Color Sensor, \$595.00; LDA-2 with Color Sensor, \$625.00.

BURST GENERATOR—Our new black Burst Generator with CONTROLLED chroma background will allow you to control color fades to black or any hue. The variable chroma feature also acts as a source for coloring backgrounds of monochrome slides and movies. Color Burst Generator, just \$595.00; standard black Burst Generator, \$545.00.

Call or write for more information about AEM video equipment. Feature for feature, there is nothing comparable on today's market!

APPLIED ELECTRO MECHANICS, INC.

2350 Duke Street, Alexandria, Virginia 22314
PHONE: (703) 548-2166



TRANSMITTERS, AM, 25 KW
TRANSMITTERS, AM, 50 KW
TRANSMITTERS, FM, 1 KW
TRANSMITTERS, FM, 3 KW
TRANSMITTERS, FM, 7.5 KW
TRANSMITTERS, FM, 10 KW
TRANSMITTERS, FM, 20 KW

E. J. BAUGHMAN CO.
CAMERA, MOUNTING EQUIPMENT
MICROPHONE STANDS & BOOMS

BECKMAN & WHITLEY
CAMERAS, FILM, CINE
WEATHER INSTRUMENTS

BELAR ELECTRONICS LABORATORY
AMPLIFIER, RF, PEAK LIMITING
COMMUNICATIONS SYSTEMS,
MULTIPLEX
DEMODULATORS
EXCITERS, FM
GENERATORS, FM, STEREO
METERS, FREQUENCY
MONITORS, AM SYSTEMS
MONITORS, FM SYSTEMS, MONO
MONITORS, FM SYSTEMS, SCA
MONITORS, FM SYSTEMS, STEREO
MONITORS, FREQUENCY
OSCILLATORS, FM
RECEIVERS, FM
RECEIVERS, MULTIPLEX
RECEIVERS, SCA

BELDEN MANUFACTURING CO.
CABLE, COAXIAL, FLEXIBLE
CABLE, DIRECT-BURIAL
CABLE, SHIELDED, AUDIO
CABLE, TELEPHONE
CORDS, SET
WIRE, BARE, COPPER
WIRE, INSULATED, HIGH VOLTAGE
WIRE, INSULATED, HOOKUP
WIRE, SHIELDED

F. W. BELL, INC.
CONVERTERS
GAUSS METER
MONITORS, POWER
PROBES, TEST LEAD
WATTMETERS

BENCO TELEVISION ASSOCIATES
AMPLIFIER, CATV
AMPLIFIER, TV, BOOSTER
ANTENNAS, TV,
MASTER-COMMUNITY
ATTENUATORS, RF
CATV EQUIPMENT - ALSO SEE
OTHER CATEGORIES
CATV, CABLE TERMINALS
CATV, CHANNEL AMPLIFIERS
CATV, HEAD-END EQUIPMENT
CONNECTORS, COAXIAL CABLE
CONVERTERS
FILTERS, ANTENNA
HEAD-END EQUIPMENT,
SEE CATV HEAD-END EQUIPMENT
HOUSINGS, ANTENNA
METERS, FIELD STRENGTH
TRANSLATOR SYSTEMS

BENJAMIN ELECTRONIC SOUND CORP
CARTRIDGES, PHONO
RECEIVERS, AM
RECEIVERS, FM
RECEIVERS, HF
TURNABLES, PHONOGRAPH

BENRUS TECHNICAL PRODUCTS
CAMERAS, OSCILLOSCOPE
OSCILLATORS, AF AND RF,
SEE GENERATORS
OSCILLOSCOPES
VOLTMMETERS, TRANSISTORIZED

BERKEY TECHNICAL CORP.
BATTERIES, NICKEL CADMIUM
CAMERA, MOUNTING EQUIPMENT
STROBE, LIGHTS

BIONIC INSTRUMENTS, INC.
ALARM, FAULT
ALARM, INTRUDER
ALARM, SIGNAL
INDUSTRIAL TV
REMOTE CONTROL SYSTEMS
TAPE DUPLICATORS
TIMERS, ELECTRIC
TV SYSTEMS, CLOSED CIRCUIT

BIRD ELECTRONIC CORPORATION
ALARM, FAULT
ATTENUATORS, FIXED
ATTENUATORS, RF
CALORIMETERS
CONNECTORS, RF
COUPLERS
DETECTORS, STANDING WAVE
DUMMY LOAD
FILTERS, ANTENNA
FILTERS, RF
METERS, POWER
METERS, STANDING WAVE
MICROWAVE COMPONENTS
MONITORS, POWER
SWITCHES, COAXIAL
WATTMETERS

BIRNBACH CO.
ADAPTERS, TEST
ANCHORS, GUY
CABLE, ARMORED
CABLE, DIRECT-BURIAL
CABLE, SHIELDED, AUDIO
CABLE, TELEPHONE

CLAMPS, CABLE
CLIPS, TEST
CORDS, DIAL
CORDS, LACING
CORDS, PATCH
CORDS, SET
HARDWARE, GENERAL
HARDWARE, GROMMETS
HARDWARE, RACK
HARDWARE, TUBING, PLASTIC
HEAT SINKS
INSULATORS, ANTENNA
INSULATORS, FEED THROUGH
INSULATORS, STAND-OFF
INSULATORS, OTHER
JACKS
KNOBS
LIGHTNING ARRESTERS
PLUGS, PHONE
SWITCHES, KNIFE
SWITCHES, PUSHBUTTON,
NONILLUMINATED
SWITCHES, SLIDE
SWITCHES, TOGGLE
TERMINAL STRIPS
TERMINALS, LUG
TERMINALS, SOLDER
TERMINALS, SOLDERLESS
WIRE, BARE, COPPER
WIRE, INSULATED, HIGH VOLTAGE
WIRE, INSULATED, HOOKUP
WIRE, SHIELDED

BIRNS & SAWYER
ADAPTERS, CONNECTOR
AMPLIFIER, DC
BATTERIES, NICKEL CADMIUM
CAMERA, MOUNTING EQUIPMENT
CAMERAS, FILM, CINE
CAMERAS, FILM, STILL
CHARGERS, BATTERY
CONVERTERS
DOLLIES, CAMERA
EDITORS, AUDIO TAPE
EDITORS, FILM
EDITORS, VIDEO TAPE
INVERTERS, DC TO AC,
VIBRATORS
LENSES, OPTICAL, FIXED
LENSES, OPTICAL, ZOOM
LIGHTING, TV, COMPONENTS
MIXERS - ALSO SEE CONSOLES
MOUNTS, INSTRUMENT
POWER SUPPLIES, AC
POWER SUPPLIES, DC
PROJECTORS, FILM
REELS, FILM
REELS, TAPE
SCREENS, PROJECTION, FRONT
SPLICERS, MAGNETIC TAPE
AND FILM
TAPE, MAGNETIC RECORDING,
AUDIO

BISCAYNE AUDIO COMPANY
BROADCAST PROGRAMMING SERVICE

BLAW-KNOX COMPANY
TOWERS, ANTENNA,
CATV, HEAD-END
TOWERS, ANTENNA,
TRANSMITTING, AM
TOWERS, ANTENNA,
TRANSMITTING, FM
TOWERS, ANTENNA,
TRANSMITTING, TV

BLONDER-TONGUE LABORATORIES
ADAPTERS, CONNECTOR
AMPLIFIER, CATV
AMPLIFIER, DISTRIBUTION
AMPLIFIER, RF,
GENERAL PURPOSE
AMPLIFIER, TV, BOOSTER
AMPLIFIER, TV, VIDEO
AMPLIFIER, VIDEO, SWEEP
ANTENNAS, CATV
ANTENNAS, FM
ANTENNAS, TV
ANTENNAS, TV,
MASTER-COMMUNITY
ATTENUATORS, RF
BALUNS
BRIDGES
CAMERAS, FILM, CINE
CAMERAS, FILM, STILL
CAMERAS, TV, COLOR
CAMERAS, TV, MONOCHROME
CATV EQUIPMENT - ALSO SEE
OTHER CATEGORIES
CATV, CHANNEL AMPLIFIERS
CATV, HEAD-END EQUIPMENT
CATV, ORIENTATION EQUIPMENT
CONNECTORS, ANTENNA
CONNECTORS, COAXIAL CABLE
CONSOLE, AUDIO, TV
CONVERTERS
DETECTORS, STANDING WAVE
DIPLEXERS
DISPLAY EQUIPMENT, TV
DOLLIES, CAMERA
FILTERS, ANTENNA
FILTERS, RF
GENERATORS, SIGNAL, MARKER
GENERATORS, SIGNAL, RF
GENERATORS, SIGNAL,
TV SYNCHRONIZING
HEAD-END EQUIPMENT,
SEE CATV HEAD-END EQUIPMENT
INDUSTRIAL TV
METERS, FIELD STRENGTH
METERS, FREQUENCY
MIXERS - ALSO SEE CONSOLES
MODULATORS, TV
MONITORS, VIDEO
POWER SUPPLIES, AC

POWER SUPPLIES, DC
PREAMPLIFIERS, VIDEO
RELAYS, THERMAL
SWITCHES
SWITCHES, COAXIAL
TOOLS, CRIMPERS
TRANSFORMERS, RF
TV SYSTEMS, CLOSED CIRCUIT
WEATHER INSTRUMENTS

BOSTON INSULATED WIRE & CABLE
CABLE, ARMORED
CABLE, ASSEMBLIES
CABLE, CAMERA
CABLE, COAXIAL, FLEXIBLE
CABLE, SHIELDED, AUDIO
WIRE, INSULATED, HIGH VOLTAGE
WIRE, SHIELDED
WIRING AND CABLING SERVICES

W. H. BRADY CO.
DECALOMANIAS
LETTERS AND NUMBERS,
PRESSURE SENSITIVE

BROADCAST ELECTRONICS, INC.
AMPLIFIER, DISTRIBUTION
AUTOMATION EQUIPMENT
CABINETS, STORAGE,
MAGNETIC TAPE
CABINETS, STORAGE,
MAGNETIC TAPE, CARTRIDGE
CARTRIDGES, MAGNETIC TAPE
CLEANERS, CHEMICAL
DEMAGNETIZERS, BULK TAPE
DEMAGNETIZERS, HEAD
HEADS, ERASE, MAGNETIC
HEADS, RECORDING, MAGNETIC
RECORDERS, MAGNETIC TAPE,
AUDIO
RECORDERS, MAGNETIC TAPE,
AUDIO, CARTRIDGE
REELS, TAPE
SPLICERS, MAGNETIC TAPE
AND FILM
TAPE DECKS, MAGNETIC
TAPE, MAGNETIC RECORDING,
AUDIO
TAPE, MAGNETIC RECORDING
AUDIO, CARTRIDGE
TELEPHONE EQUIPMENT
MIXERS - ALSO SEE CONSOLES

BROADCAST PRODUCTS COMPANY
AMPLIFIER, SENSING
AUTOMATION EQUIPMENT
CABINETS, STORAGE,
MAGNETIC TAPE, CARTRIDGE
CABINETS, WOOD

BROWNING LABORATORIES
AMPLIFIER, AF, MONAURAL
ANTENNAS, FM
BACKGROUND MUSIC SERVICE
COMMUNICATIONS SYSTEMS, CB
COMMUNICATIONS SYSTEMS,
MULTIPLEX, FM
MONITORS, FM SYSTEMS, MONO
RECEIVERS, MULTIPLEX
RECEIVERS, SCA

BUCHANAN ELECTRICAL PROD CORP
INSULATORS, OTHER
TERMINAL BLOCKS
TERMINAL BOARDS
TERMINAL CARDS
TERMINAL STRIPS
TERMINALS, BARRIER
TERMINALS, LUG
TERMINALS, SOLDER
TERMINALS, SOLDERLESS
TOOLS, CRIMPERS

BUD RADIO, INC.
BLOWERS AND FANS
CABINETS, METAL
CAPACITORS, FIXED, GENERAL
CAPACITORS, VARIABLE
CONSOLE, CABINETS
AND HARDWARE
HARDWARE, CHASSIS
HARDWARE, FIXTURES, HOLOGING
HARDWARE, LOUVERS,
VENTILATING
HARDWARE, MOUNTS
HARDWARE, PANEL
HARDWARE, RACK
PANELS, INSTRUMENT,
FOR RACK MOUNTING
RACKS, MOUNTING
SLIDES, CHASSIS

BURGESS BATTERY COMPANY
BATTERIES, DRY CELL
TAPE, MAGNETIC RECORDING,
AUDIO

BURKE & JAMES
CABINETS, METAL
CABINETS, STORAGE,
MAGNETIC TAPE
CABINETS, WOOD
CAMERA, MOUNTING EQUIPMENT
CAMERAS, FILM, CINE
CAMERAS, FILM, STILL
DUCTS, VENTILATION
EDITORS, FILM
FILTERS, OTHER
LENSES, OPTICAL, FIXED
LENSES, OPTICAL, ZOOM
LIGHTING, TV, COMPONENTS
METERS, LIGHT
PROCESSORS, FILM, B-W
PROCESSORS, FILM, COLOR
PROJECTORS, FILM
PROJECTORS, SLIDE

REELS, FILM
REWINDERS, FILM
SCREENS, PROJECTION, FRONT
SCREENS, PROJECTION, REAR
SPLICERS, MAGNETIC TAPE
AND FILM
TIMERS, ELECTRIC

CALBEST ELECTRONICS
ADAPTERS, FM STEREO
AMPLIFIER, AF, STEREO
COILS, CHOKE, RF
COMMUNICATIONS SYSTEMS,
INTERCOM, WIRED
RECEIVERS, AM
RECEIVERS, FM
RECEIVERS, SCA
SPEAKER COMPONENTS

CALIFONE-ROBERTS
AMPLIFIER, AF, REVERBERATION
MICROPHONES, DYNAMIC
RECORDERS, MAGNETIC TAPE,
AUDIO
SOUND SYSTEMS, PORTABLE
SPEAKERS

CALVERT ELECTRONICS
VACUUM TUBES, RECEIVING
VACUUM TUBES, TRANSMITTING

CARDWELL CONDENSER CORP
CAPACITORS, VARIABLE
MICROWAVE COMPONENTS
MICROWAVE SYSTEMS, OTHER
WAVEGUIDE AND
ASSOCIATED COMPONENTS

CATEL COMPANY
AMPLIFIER, TV, VIDEO
CATV, ORIENTATION EQUIPMENT
GENERATORS, FM, STEREO
MODULATORS, TV
TRANSLATOR SYSTEMS, FM

CBS LABORATORIES
AMPLIFIER, AF, COMPRESSING
AMPLIFIER, AF,
PEAK LIMITING, AM
AMPLIFIER, AF,
PEAK LIMITING, FM
AMPLIFIER, MASKING
DISPLAY EQUIPMENT, TV
ENHANCERS, TV IMAGE
METERS, DB AND VU
METERS, DB AND VU, WIDE RANGE
RECORDS, TEST

CCA ELECTRONICS CORPORATION
AMPLIFIER, AF, AGC
AMPLIFIER, AF, COMPRESSING
AMPLIFIER, AF,
GENERAL PURPOSE
AMPLIFIER, AF, MONAURAL
AMPLIFIER, AF,
PEAK LIMITING, AM
AMPLIFIER, AF,
PEAK LIMITING, FM
AMPLIFIER, AF, REMOTE
AMPLIFIER, DISTRIBUTION
AMPLIFIER, RF,
GENERAL PURPOSE
AMPLIFIER, RF, PEAK LIMITING
AMPLIFIER, RF, POWER
ANTENNAS, AM
ANTENNAS, FM
AUTOMATION EQUIPMENT
BACKGROUND MUSIC SERVICE
CABINETS, METAL
CIRCUIT BREAKERS
CLOCKS
COILS, ANTENNA LOADING
COILS, CHOKE, RF
COMMUNICATIONS SYSTEMS,
LAND MOBILE
CONSOLE, AUDIO, AM
CONSOLE, AUDIO, FM
CONSOLE, AUDIO, PORTABLE
CONSOLE, AUDIO, RECORDING
CONSOLE, AUDIO, TV
CORDS, PATCH
DUMMY LOAD
EQUALIZERS, AUDIO EMPHASIS
EXCITERS, FM
FILTERS, ANTENNA
FILTERS, RF
GENERATORS, FM, STEREO
GENERATORS, FM, SUBCARRIER
GENERATORS, SIGNAL, AF
GENERATORS, SIGNAL, RF
HOUSINGS, ANTENNA
INDUCTANCES, FIXED
INDUCTANCES, VARIABLE
MAINTENANCE SERVICES, AM
MAINTENANCE SERVICES, FM
METERS, POWER
MONITORS, AM SYSTEMS
MONITORS, FM SYSTEMS, MONO
MONITORS, FM SYSTEMS, SCA
MONITORS, FM SYSTEMS, STEREO
MONITORS, FREQUENCY
NETWORKS, MATCHING, RF
NETWORKS, PHASING
OSCILLATORS, AF AND RF,
SEE GENERATORS
OSCILLATORS, AM
OSCILLATORS, FM
PREAMPLIFIERS, AUDIO
RECEIVERS, AM
RECEIVERS, FM
RECEIVERS, MULTIPLEX
RECEIVERS, SCA
RECTIFIERS - ALSO SEE SEMI-
CONDUCTORS & VACUUM TUBES
REGULATORS, VOLTAGE
SPEAKERS

STL EQUIPMENT
TOWERS, ANTENNA,
TRANSMITTING, AM
TOWERS, ANTENNA,
TRANSMITTING, FM
TRANSMITTER KITS
TRANSMITTERS, AM, 250 WATT
TRANSMITTERS, AM, 1 KW
TRANSMITTERS, AM, 5 KW
TRANSMITTERS, AM, 10 KW
TRANSMITTERS, AM, 25 KW
TRANSMITTERS, AM, 50 KW
TRANSMITTERS, AM, OVER 50 KW
TRANSMITTERS, FM, 10 WATTS
TRANSMITTERS, FM, 100 WATTS
TRANSMITTERS, FM, 250 WATTS
TRANSMITTERS, FM, 1 KW
TRANSMITTERS, FM, 3 KW
TRANSMITTERS, FM, 5 KW
TRANSMITTERS, FM, 10 KW
TRANSMITTERS, FM, 15 KW
TRANSMITTERS, FM, 20 KW
TRANSMITTERS, FM, 40 KW
VACUUM TUBES, TRANSMITTING
WIRE, BARE, COPPER
WIRE, BARE, COPPER STRAP

C-COR ELECTRONICS

AMPLIFIER, BRIDGING
AMPLIFIER, CATV
AMPLIFIER, DC
AMPLIFIER, DISTRIBUTION
AMPLIFIER, PULSE
AMPLIFIER, RF
GENERAL PURPOSE
AMPLIFIER, RF, POWER
AMPLIFIER, TV, BOOSTER
AMPLIFIER, TV, VIDEO
CATV EQUIPMENT - ALSO SEE
OTHER CATEGORIES
CATV, CHANNEL AMPLIFIERS
CATV, HEAD-END EQUIPMENT
HEAD-END EQUIPMENT,
SEE CATV HEAD-END EQUIPMENT

CENTRALAB

ATTENUATORS, AUDIO
CAPACITORS, FIXED, CERAMIC
CAPACITORS, FIXED, METALLIZED
CAPACITORS, VARIABLE
INSULATORS, ANTENNA
INSULATORS, FEED THROUGH
INSULATORS, STAND-OFF
INSULATORS, OTHER
INTEGRATED CIRCUITS
POTENTIOMETERS, CARBON
POTENTIOMETERS, WIREWOUND
SWITCHES, LEVER
SWITCHES, MULTICONTACT
SWITCHES, PUSHBUTTON,
NONILLUMINATED
SWITCHES, ROTARY
SWITCHES, SLIDE

CENTRAL DYNAMICS CORP.

AMPLIFIER, AF, AGC
AMPLIFIER, AF, COMPRESSING
AMPLIFIER, FM
GENERAL PURPOSE
AMPLIFIER, AF, MONAURAL
AMPLIFIER, AF, STEREO
AMPLIFIER, DISTRIBUTION
AMPLIFIER, PULSE
AMPLIFIER, STABILIZING
AMPLIFIER, TV, VIDEO
ATTENUATORS, VIDEO
AUTOMATION EQUIPMENT
CATV, ORIGINATING EQUIPMENT
CLOCKS
COMMUNICATIONS SYSTEMS,
INTERCOM, WIRED
CONSOLE, AUDIO, TV
CONSOLE, VIDEO, PORTABLE
CONSOLE, VIDEO, STUDIO
CORDS, PATCH
DELAY LINES
DISPLAY EQUIPMENT, TV
EDUCATION FACILITIES, EOPT
GENERATORS, SIGNAL,
SPECIAL EFFECT
GENERATORS, SIGNAL,
TV SYNCHRONIZING
GENERATORS, SIGNAL, VITS
INDUSTRIAL TV
JACK PANEL ASSEMBLIES
JACKS
MAINTENANCE SERVICES, TV
MIXERS - ALSO SEE CONSOLES
MOBILE EQUIPMENT
PREAMPLIFIERS, AUDIO
PREAMPLIFIERS, VIDEO
REMOTE CONTROL SYSTEMS
SWITCHERS
SWITCHES, CROSSBAR
SWITCHING MATRIXES
SWITCHING SYSTEMS
TV SYSTEMS, CLOSED CIRCUIT

CENTURY LIGHTING INC.

LIGHTING, TV, COMPONENTS
LIGHTING, TV, CONTROLS
LIGHTING, TV, SYSTEMS
MICROPHONE STANDS & BOOMS

CENTURY PROJECTOR CORPORATION

AMPLIFIER, AF
GENERAL PURPOSE
POWER SUPPLIES, DC
PREAMPLIFIERS, AUDIO
PROJECTORS, FILM
RACKS, MOUNTING
RECORDERS, FILM, MAGNETIC
REWINDERS, FILM
SEMI-CONDUCTOR RECTIFIERS,
GENERAL

SOUND SYSTEMS, PORTABLE
SOUND SYSTEMS, THEATER
SPEAKERS

CHASSIS TRAK
SLIDES, CHASSIS

CHRONO-LOG CORPORATION

AUTOMATION EQUIPMENT
CLOCKS
COMPUTER EQUIPMENT

CINE SONIC SOUND

BACKGROUND MUSIC SERVICE
CARTRIDGES, MAGNETIC TAPE
CARTRIDGES, TAPE,
RECORDING SERVICE

CLEVELAND ELECTRONICS

CDLS, DEFLECTION
AND FOCUSING

CLEVELAND ELECTRONICS

SPEAKER DIVISION
REVERBERATION DEVICES
SPEAKERS

COMU ELECTRONICS

AMMETERS, DC
AMPLIFIER, DC
AMPLIFIER, DISTRIBUTION
AMPLIFIER, PULSE
AMPLIFIER, TV, VIDEO
CABLE ASSEMBLIES
CAMERA, MOUNTING EQUIPMENT
CAMERA, REMOTE
CONTROL EQUIPMENT
CAMERAS, TV, COLOR
CAMERAS, TV, MONOCHROME
CATV EQUIPMENT - ALSO SEE
OTHER CATEGORIES
CATV, ORIGINATING EQUIPMENT
DISPLAY EQUIPMENT, TV
GENERATORS, SIGNAL, DOT BAR
GENERATORS, SIGNAL,
TV SYNCHRONIZING
INDUSTRIAL TV
LENSES, OPTICAL, FIXED
LENSES, OPTICAL, ZOOM
METERS - SEE SPECIFIC TYPES
MONITORS, VIDEO
OHMMETERS
POWER SUPPLIES, AC
POWER SUPPLIES, DC
POWER SUPPLIES, PRECISION
SWITCHERS
SWITCHING MATRIXES
SWITCHING SYSTEMS
TV SYSTEMS, CLOSED CIRCUIT
VOLTMETERS, AC
VOLTMETERS, DC
VOLTMETERS, VACUUM TUBE

COLLINS RADIO COMPANY

AMPLIFIER, AF, COMPRESSING
AMPLIFIER, AF,
PEAK LIMITING, AM
AMPLIFIER, AF,
PEAK LIMITING, FM
ANTENNAS, FM
COILS, ANTENNA LOADING
CONSOLE, AUDIO, AM
CONSOLE, AUDIO, FM
CONSOLE, AUDIO, TV
EXCITERS, FM
MICROWAVE SYSTEMS, STL
MONITORS, AM SYSTEMS
MONITORS, FM SYSTEMS, MONO
MONITORS, FM SYSTEMS, SCA
MONITORS, FM SYSTEMS, STEREO
MONITORS, FREQUENCY
NETWORKS, PHASING
RECORDERS, MAGNETIC TAPE,
AUDIO, CARTRIDGE
STL EQUIPMENT
TRANSMITTERS, AM, 250 WATT
TRANSMITTERS, AM, 1 KW
TRANSMITTERS, AM, 5 KW
TRANSMITTERS, AM, 10 KW
TRANSMITTERS, FM, 1 KW
TRANSMITTERS, FM, 5 KW
TRANSMITTERS, FM, 10 KW
TRANSMITTERS, FM, 20 KW

COLORADO VIDEO

ANALYZERS, VIDEO
CAMERAS, TV, MONOCHROME
DISPLAY EQUIPMENT, TV
ENHANCERS, TV IMAGE
GENERATORS, SIGNAL,
SPECIAL EFFECT
GENERATORS, SIGNAL,
TV SYNCHRONIZING
INDUSTRIAL TV
MONITORS, WAVEFORM
OSCILLOSCOPES
RECORDERS, DISC, MAGNETIC
TV SYSTEMS, CLOSED CIRCUIT

COLORTRON INDUSTRIES, INC.

BATTERIES, NICKEL CADMIUM
CAMERA, MOUNTING EQUIPMENT
CHARGERS, BATTERY
CORDS, PATCH
DOLLIES, CAMERA
FILTERS, OTHER
LIGHTING, TV, COMPONENTS
LIGHTING, TV, CONTROLS
LIGHTING, TV, SYSTEMS
PANELS, INSTRUMENT,
FOR RACK MOUNTING

COLUMBIA ELECTRIC MFG. CO.

AMMETERS, AC
AMMETERS, DC

BIRD RF POWER 50Ω Quality Instruments

New 50kW, 25 kW, 15 kW
RF COAXIAL
LOAD RESISTORS



TERMALINE®
Series 8700

Units weigh
only 13 lbs
and mount
directly on
1-5/8", 3-1/8"

or 6-1/8" line for low VSWR termination
to 800 MHz. Also ideal for accurate
power measurement with Series 6010
Calorimeters (2% typical).



FOR BIRD CATALOG, CONTACT

**BIRD ELECTRONIC
CORPORATION**

30303 AURORA RD. - CLEVELAND (SOLON) OHIO 44139
Phone 216-248-1200 • Cable BIRDELEC

FREE BULLETIN

(BI-MONTHLY)

HOW TO MEASURE TERMINATE ATTENUATE FILTER or SWITCH RF POWER*



Thurline®
Directional Wattmeter

Catalog, included with first
issue of "Watt's New From
Bird", covers:

Absorption & Directional Watt-
meters, Attenuators & Load
Resistors, Coaxial RF Filters,
Selector Switches.

*From 2 to 2200 MC and from 25
milliwatts to 250 kilowatts in
50-ohm coaxial line systems.



Use Reader Service
Card or Contact

**BIRD ELECTRONIC
CORPORATION**

CLEVELAND (SOLON) OHIO 44139
30303 AURORA RD., Phone 216-248-1200

GENERATORS, PDWER,
ELECTRIC MOTOR
VOLTMETERS, AC
VOLTMETERS, DC

COMPUTRON INC.
RECORDERS, MAGNETIC TAPE,
AUDIO
TAPE, MAGNETIC RECORDING,
AUDIO
TAPE, MAGNETIC RECORDING,
COMPUTER
TAPE, MAGNETIC RECORDING,
TEST
TAPE, MAGNETIC RECORDING,
VIDEO

CONRAC
COILS, DEFLECTION
AND FOCUSING
DISPLAY EQUIPMENT, TV
MONITORS, VIDEO
RECEIVERS, MULTIPLEX
RECEIVERS, TV, COLOR
RECEIVERS, TV, MONOCHROME
VACUUM TUBES, CATHODE RAY,
TV, MONOCHROME

CONTINENTAL ELECTRONICS MFG.
AMPLIFIER, RF, POWER
AUTOMATION EQUIPMENT
COUPLERS
DIVIDERS, POWER
DUMMY LOAD
FILTERS, RF
LIGHTNING ARRESTERS
REMOTE CONTROL SYSTEMS
TAPE DECKS, MAGNETIC
TRANSMITTERS, AM, 5 KW
TRANSMITTERS, AM, 10 KW
TRANSMITTERS, AM, 25 KW
TRANSMITTERS, AM, 50 KW
TRANSMITTERS, AM, OVER 50 KW

COOK ELECTRIC COMPANY
CABINETS, METAL
CABINETS, STORAGE,
MAGNETIC TAPE
CAPACITORS, FIXED, OTHER
HARDWARE, RACK
RACKS, MOUNTING
RELAYS, ANTENNA
RELAYS, GENERAL PURPOSE
RELAYS, TELEPHONE
TELEPHONE EQUIPMENT
TERMINAL BLOCKS
WAVEGUIDE AND
ASSOCIATED COMPONENTS

COOKE ENGINEERING COMPANY
AMPLIFIER, DISTRIBUTION
CONNECTORS, COAXIAL CABLE
CORDS, PATCH
JACK PANEL ASSEMBLIES
JACKS

COURIER COMMUNICATIONS
AMPLIFIER, RF, POWER
COMMUNICATIONS SYSTEMS, CB
MOBILE EQUIPMENT
NARROW-BAND FM EQUIPMENT

COPPERWELD STEEL CO
CABLE, CATV, HARDWARE
TRANSMISSION LINES
WIRE, BARE, STEEL

CORNELL-DUBILIER ELECTRONICS
CAPACITORS, FIXED, CERAMIC
CAPACITORS, FIXED,
ELECTROLYTIC
CAPACITORS, FIXED, FILM
CAPACITORS, FIXED, METALLIZED
CAPACITORS, FIXED, MICA
CAPACITORS, FIXED, PAPER
CAPACITORS, FIXED, OTHER
FILTERS, RF
FILTERS, OTHER
INVERTERS, DC TO AC,
VIBRATORS
POWER SUPPLIES, AC
POWER SUPPLIES, DC
RELAYS, GENERAL PURPOSE
RELAYS, LATCHING
RELAYS, OVERLOAD
RELAYS, PHOTOELECTRIC
RELAYS, PLUG-IN
RELAYS, POWER
RELAYS, SEQUENCING
RELAYS, STEPPING
RELAYS, TELEPHONE
RELAYS, TIME DELAY
TESTERS, CAPACITOR

CRAFTSMAN ELECTRONIC PRODUCTS
AMPLIFIER, CATV
AMPLIFIER, TV, BOOSTER
CABLE, CATV, HARDWARE
CONNECTORS, COAXIAL CABLE
CONNECTORS, RF
COUPLERS
HARDWARE, RETAINING RINGS
TRANSFORMERS, AUTO
TRANSFORMERS, RF

CROWN INTERNATIONAL
AMPLIFIER, AF,
GENERAL PURPOSE
AMPLIFIER, AF, MONAURAL
AMPLIFIER, AF, STEREO
CONSOLE, AUDIO, AM
EDUCATION FACILITIES, EQPT
PREAMPLIFIERS, AUDIO
RECORDERS, MAGNETIC TAPE,
AUDIO

RECORDERS, MAGNETIC TAPE,
LOGGING
TAPE DECKS, MAGNETIC
TAPE DUPLICATORS

CURTIS INSTRUMENTS
TIMERS, ELECTRIC

CUSH CRAFT
ANTENNAS, CATV
ANTENNAS, TV,
MASTER-COMMUNITY

CUSTOM CRAFT DESIGNS
PICKUP, MUSICAL INSTRUMENT

DAGE BELL CORPORATION
CAMERAS, TV, MONOCHROME
GENERATORS, SIGNAL,
TV SYNCHRONIZING
INDUSTRIAL TV
MULTIPLEXERS
TV SYSTEMS, CLOSED CIRCUIT

DATA INSTRUMENT DIV.
CABINETS, METAL
CALIBRATION SERVICE,
INSTRUMENT
CONSOLE, AUDIO, PORTABLE
CONSOLE, AUDIO, RECORDING
CONSOLE, AUDIO, TV
CONSOLE, CABINETS
AND HARDWARE
CONSOLE, KITS
CONSOLE, AUDIO, AM
CONSOLE, AUDIO, FM
CONSOLE, VIDEO, PORTABLE
CONSOLE, VIDEO, STUDIO
OSCILLOSCOPES
PROBES, OSCILLOSCOPE
RACKS, MOUNTING
VOLTMETERS, AC
VOLTMETERS, DC

DATAPULSE DIVISION
GENERATORS, SIGNAL, PULSE
GENERATORS, SIGNAL,
SQUARE WAVE

DAYTON ELECTRONIC PRODUCTS CO.
AMPLIFIER, AF,
GENERAL PURPOSE
AMPLIFIER, AF, MONAURAL
RECEIVERS, FM
RECEIVERS, SCA

D & B ELECTRONICS CO.
CABLE, ASSEMBLIES
COILS, CHOKE, RF
CORDS, PATCH
CORDS, SET
DUMMY LOAD
HARDWARE, CHASSIS
JACK PANEL ASSEMBLIES
LAMP ASSEMBLIES
NAMEPLATES
POWER SUPPLIES, AC
TERMINAL BOARDS
TERMINAL CARDS
TERMINAL STRIPS
TRANSFORMERS, RF
WAVEGUIDE AND
ASSOCIATED COMPONENTS
WIRING AND CABLING SERVICES

DEARBORN ELECTRONICS, INC.
CAPACITORS, FIXED, FILM
CAPACITORS, FIXED, METALLIZED
CAPACITORS, FIXED, OIL-FILLED
CAPACITORS, FIXED, PAPER
CAPACITORS, FIXED, OTHER

DELCO RADIO DIV
HEAT SINKS
RECEIVERS, AM
RECEIVERS, FM
SEMICONDUCTOR RECTIFIERS
SILICON CONTROLLED - SCR
SEMICONDUCTORS,
TRANSISTORS, AF
SEMICONDUCTORS, TRANSISTORS,
GENERAL

DELTA ELECTRONICS, INC. - N.C.
ADAPTERS, TEST
ALARM, SIGNAL
AMPLIFIER, AF,
GENERAL PURPOSE
AMPLIFIER, BRIDGING
AMPLIFIER, DISTRIBUTION
AUTOMATION EQUIPMENT
CAMERA, REMOTE
CONTROL EQUIPMENT
COMMUNICATIONS SYSTEMS,
INTERCOM, WIRED
COMMUNICATIONS SYSTEMS,
INTERCOM, WIRELESS
CONSOLE, AUDIO, PORTABLE
EDUCATION FACILITIES, EQPT
GENERATORS, SIGNAL, AF
POWER SUPPLIES, DC
PREAMPLIFIERS, AUDIO
REMOTE CONTROL SYSTEMS
TESTERS, SEMICONDUCTOR

DELTA ELECTRONICS INC - V A
ANTENNA SYSTEMS, HF
BRIDGES
COILS, ANTENNA LOADING
FILTERS, RF
INDUCTANCES, VARIABLE
METERS, STANDING WAVE
SWITCHING MATRIXES, ANTENNA

DEMORNAY-BONARDI DIVISION
ANTENNAS, MICROWAVE

ATTENUATORS, MICROWAVE
CAVITIES, MICROWAVE
CHOKES, WAVEGUIDE
COUPLERS, MICROWAVE
DETECTORS, MICROWAVE
DETECTORS, STANDING WAVE
DIVIDERS, FREQUENCY
DIVIDERS, POWER
DUMMY LOAD
JOINTS, ROTARY, WAVEGUIDE
METERS, STANDING WAVE
MICROWAVE COMPONENTS
MICROWAVE SYSTEMS, STL
MICROWAVE SYSTEMS, 2500 MHZ
SHIFTERS, PHASE, MICROWAVE
SLOTTED SECTIONS
SWITCHES, WAVEGUIDE
WAVEGUIDE AND
ASSOCIATED COMPONENTS

DIALIGHT CORPORATION
CONNECTORS, AF & MICROPHONE
LAMP ASSEMBLIES
LAMPS, GLOW
LAMPS, PANEL
RELAYS, THERMAL
RELAYS, TIME DELAY
SOCKETS, LAMP
SWITCHES, ILLUMINATED

DIAMOND ELECTRONICS
CAMERAS, TV, MONOCHROME
MONITORS, VIDEO
TV SYSTEMS, CLOSED CIRCUIT

DIAMOND EXPANSION BOLT CO., INC
CABLE, CATV, HARDWARE
CLAMPS, CABLE

DIETCRAFT, INC.
CAMERAS, TV, MONOCHROME
TV SYSTEMS, CLOSED CIRCUIT

DISPLIGHT TECHNOLOGIES
CARTRIDGES, MAGNETIC TAPE
COMPUTER EQUIPMENT
DISPLAY EQUIPMENT, TV
PROJECTORS, SLIDE
SCREENS, PROJECTION, REAR
TAPE DECKS, MAGNETIC
TURNTABLES, PHONOGRAPH

DRESSER CRANE HOIST & TOWER
MAINTENANCE SERVICES, AM
MAINTENANCE SERVICES, FM
MAINTENANCE SERVICES, TV
TOWERS, ANTENNA,
CATV, HEAD-END
TOWERS, ANTENNA, RECEIVING
TOWERS, ANTENNA,
TRANSMITTING, AM
TOWERS, ANTENNA,
TRANSMITTING, FM
TOWERS, ANTENNA,
TRANSMITTING, TV

DUTOTONE COMPANY, INC.
CLEANERS, LENS
CLEANERS, OTHER
RECORDS, BLANK, ACETATE,
FOR RECORDING
STYLI, CUTTING
STYLI, PLAYBACK
TAPE, MAGNETIC RECORDING,
AUDIO

DYANCOOL MANUFACTURING CO.
BLOWERS AND FANS

DYNAIR ELECTRONICS, INC.
AMPLIFIER, DISTRIBUTION
AMPLIFIER, PULSE
AMPLIFIER, TV, VIDEO
ANALYZERS, SIDEBAND
CATV, HEAD-END EQUIPMENT
DEMODULATORS
HEAD-END EQUIPMENT,
SEE CATV HEAD-END EQUIPMENT
INDUSTRIAL TV
MODULATORS, TV
SWITCHERS
SWITCHING SYSTEMS

DYNASCIENCES CORPORATION
ENHANCERS, TV IMAGE
IMAGE MOTION
STABILIZATION SYSTEM

EASTMAN KODAK COMPANY
CAMERAS, FILM, CINE
CAMERAS, FILM, STILL
FILM, PHOTOGRAPHIC
AND CHEMICALS
FILM, PROCESSING SERVICE
PROJECTORS, FILM
PROJECTORS, SLIDE,
NOT FOR VIDEO SYSTEMS
REELS, TAPE
TAPE, MAGNETIC RECORDING,
AUDIO

EIOSON ELECTRONIC COMPANY
CALIBRATION SERVICE,
FREQUENCY
CALIBRATION SERVICE,
INSTRUMENT
CRYSTALS, PIEZOELECTRIC
MONITORS, FREQUENCY

EIMAC DIV OF VARIAN
ADAPTERS, TUBE
AMPLIFIER, RF, POWER
COOLING UNITS, TUBE
HEAT SINKS
MICROWAVE COMPONENTS,
KLYSTRONS
OSCILLATORS, OTHER, RF

RECTIFIERS - VACUUM TUBES
SOCKETS, TUBE
VACUUM TUBES, TRANSMITTING

EITEL ELECTRONICS
MAINTENANCE SERVICES, AM
MAINTENANCE SERVICES, FM
MAINTENANCE SERVICES,
MICROWAVE
MAINTENANCE SERVICES, TV
TRANSMITTERS, AM, TO ORDER
TRANSMITTERS, FM, TO ORDER
TRANSMITTERS, TV, TO ORDER

ELECTROLINE TV EQUIP INC
CATV EQUIPMENT - ALSO SEE
OTHER CATEGORIES

ELECTRONIC LIGHTS, INC.
FLASHERS, TOWER
LIGHTING, TV, SYSTEMS
STROBE, LIGHTS

ELECTRONIC MOBILE UNITS
MOBILE EQUIPMENT, TV

ELECTRONIC RESEARCH COMPANY
CRYSTALS, PIEZOELECTRIC
FILTERS, OTHER
OSCILLATORS, AM
OSCILLATORS, FM
OSCILLATORS, OTHER
OVENS, CRYSTAL
SWITCHES, SNAP
SWITCHES, THERMAL

ELECTRONICS ESSENTIALS OF CCC
ALARM, INTRUDER
AMPLIFIER, AF,
GENERAL PURPOSE
AMPLIFIER, AF, MONAURAL
AMPLIFIER, AF, STEREO
CALIBRATION SERVICE,
FREQUENCY
CALIBRATION SERVICE,
INSTRUMENT
CLIPS, TEST
CONNECTORS, AF & MICROPHONE
CORDS, PATCH
CORDS, CHASSIS
HARDWARE, GENERAL
HARDWARE, GROMMETS
HARDWARE, MOUNTS
HARDWARE, RACK
HARDWARE, TOOLS
HARDWARE, TUBING, METAL
HARDWARE, TUBING, PLASTIC
JACK PANEL ASSEMBLIES
JACKS
LAMP ASSEMBLIES
LAMPS, PANEL
LEADS, TEST
MICROPHONE HARDWARE
MICROWAVE COMPONENTS
PLUGS, COAXIAL
PLUGS, PHONE
PROBES, OSCILLOSCOPE
PROBES, TEST LEAD
SHIELDINGS, TUBE
SLIDES, CHASSIS
SOCKETS, LAMP
SOCKETS, TUBE
SPEAKER COMPONENTS
SWITCHES, SLIDE
SWITCHES, SNAP
SWITCHES, TOGGLE
TELEPHONE EQUIPMENT
TERMINAL BLOCKS
TERMINAL BOARDS
TERMINAL STRIPS
TERMINALS, BARRIER
TERMINALS, HIGH VOLTAGE
TERMINALS, LUG
TERMINALS, SOLDER
TERMINALS, SOLDERLESS
TOOLS, HAND
TOOLS, SCREWDRIVERS
TOOLS, WRENCHES

ENCEE
ANTENNAS, TV
DIVIDERS, POWER
MICROWAVE SYSTEMS, 2500 MHZ
MICROWAVE SYSTEMS, OTHER
MODULATORS, TV
TRANSLATOR SYSTEMS
TRANSMITTERS, TV, 1 WATT
TRANSMITTERS, TV, 20 WATTS
TRANSMITTERS, TV, 100 WATTS
TRANSMITTERS, TV, 1 KW

ELECTRONIC SYSTEM ENGINEERING
AMPLIFIER, AF, AGC
AMPLIFIER, AF, COMPRESSING
AMPLIFIER, AF, REMOTE
METERS, LIGHT

ELECTRO PRODUCTS LABORATORIES
INVERTERS, DC TO AC,
SOLID STATE
POWER SUPPLIES, DC

ELECTRO-SOUND ACOUSTICS
AMPLIFIER, AF, MONAURAL
AMPLIFIER, AF, STEREO
ENCLOSURES, SPEAKER
SPEAKERS

ELECTROVERT, INCORPORATED
CLAMPS, COMPONENT
HARDWARE, GENERAL
HARDWARE, GROMMETS
MOUNTS, VIBRATION AND SHOCK

ELECTRO-VOICE, INC.
AMPLIFIER, AF,
GENERAL PURPOSE

Depco's

S/6

... means Solid State SCA Multiplex Equipment



S/6... New and Better Background Music. First with "FET Front End" in multiplex receivers. 3 new modular models and now a separate tuner. Whatever your needs — distance, selectivity, difficult terrain or big city interference — Depco's S-6 guarantees quality reception. Depco also has available solid state external 20 and 70 watt amplifiers — general purpose.

Other Products by Depco



TMG-1 Time Mark Generator... Portable, accurate, self-contained frequency source... 100 KHz, 1 MHz, 10 MHz... Also available, 455 KHz, 10.7 MHz, 30 MHz other frequencies upon request.



SA-2 Solid State Signal Analyzer, produced for U.S.A.F.— custom electronic equipment designed and produced to your specifications.



AN/TRC-68A U.H.F. Transceiver... Presently being produced for U.S. Army Signal Corps.

Depco®

DAYTON ELECTRONIC PRODUCTS COMPANY
117 E. Helena Street • Dayton, Ohio 45404 • 513/461-4951

AMPLIFIER, AF, STEREO
CARTRIDGES, PHONO
ENCLOSURES, SPEAKER
MICROPHONES, DYNAMIC
RECEIVERS, AM
RECEIVERS, FM
RECEIVERS, MULTIPLEX
SPEAKER COMPONENTS
SPEAKERS

THE ELMOR COMPANY

TIMERS, MANUAL-CHRONOGRAPH

ENCLOSURE CORP.

BLOWERS AND FANS
CABINETS, METAL
CASES, PORTABLE,
ELECTRONIC EQUIPMENT
CONSOLE, CABINETS
AND HARDWARE

ENGINEERING ASSOCIATES

CAPACITORS, FIXED, OIL-FILLED
CONNECTORS, COAXIAL CABLE
CONNECTORS, RF
COUNTERS, FREQUENCY
DIVIDERS, VOLTAGE
GENERATORS, SIGNAL, AF
GENERATORS, SIGNAL, RF
GENERATORS, SIGNAL,
SQUARE WAVE
LAMPS, ARC
METERS, FIELD STRENGTH
METERS, FREQUENCY
METERS, FREQUENCY CALIBRATING
METERS, PHASE ANGLE
METERS, POWER
METERS, STANDING WAVE
MICROWAVE COMPONENTS
OHMMETERS
OSCILLATORS, AF AND RF,
SEE GENERATORS
OSCILLATORS, AM
OSCILLATORS, OTHER
OSCILLOSCOPES
PAPER, CHART AND GRAPH
PLUGS, COAXIAL
POTENTIOMETERS, WIREWOUND
POWER SUPPLIES, AC
POWER SUPPLIES, DC
POWER SUPPLIES, PRECISION
RECORDERS, PAPER,
LOGGING AND GRAPHIC
RELAYS, COAXIAL
RELAYS, OVERLOAD
RELAYS, POWER
RELAYS, STEPPING
RELAYS, TELEPHONE
RELAYS, TIME DELAY
REMOTE CONTROL SYSTEMS
RESISTORS, VARIABLE,
WIREWOUND
RHEOSTATS
SHUNTS, METER
SWITCHES, COAXIAL
SWITCHES, KNIFE
SWITCHES, MECHANICALLY
ACTUATED
SWITCHES, ROTARY
TESTERS, INSULATION
TESTERS, VACUUM TUBE
TIMERS, ELECTRIC
TRANSFORMERS, FILAMENT
TRANSFORMERS, POWER
TRANSFORMERS, VARIABLE
VOLTMETERS, AC
VOLTMETERS, DC
VOLTMETERS, VACUUM TUBE
WATTMETERS

THE ENGLISH ELECTRIC CORP.

CALORIMETERS
VACUUM TUBES, CAMERA,
IMAGE-ORTHICON
VACUUM TUBES, CAMERA, VIDICON
VACUUM TUBES, TRANSMITTING

ENTRON, INC.

AMPLIFIER, CATV
CATV EQUIPMENT - ALSO SEE
OTHER CATEGORIES
CATV, CABLE TERMINALS
CATV, CHANNEL AMPLIFIERS
CATV, HEAD-END EQUIPMENT
CONNECTORS, COAXIAL CABLE
CONNECTORS, RF
FILTERS, OTHER
HEAD-END EQUIPMENT,
SEE CATV HEAD-END EQUIPMENT
POWER SUPPLIES, DC

ESSEX WIRE CORPORATION

RELAYS, BREAK-IN
RELAYS, GENERAL PURPOSE
RELAYS, OVERLOAD
RELAYS, PLUG-IN
RELAYS, POWER
RELAYS, SEQUENCING
RELAYS, TELEPHONE
RELAYS, THERMAL
RELAYS, TIME DELAY
TRANSFORMERS, AUDIO,
ISOLATION
TRANSFORMERS, AUDIO, MATCHING
TRANSFORMERS, AUDIO,
POWER OUTPUT
TRANSFORMERS, AUTO
TRANSFORMERS, COUPLING
TRANSFORMERS, FILAMENT
TRANSFORMERS, GENERAL
TRANSFORMERS, PLATE
TRANSFORMERS, POWER
TRANSFORMERS, RF
TRANSFORMERS, TRANSISTOR
TRANSFORMERS, VARIABLE

EUPHONICS MARKETING

ARMS, TONE
CARTRIDGES, PHONO

E-Z-HOOK TEST PRODUCTS

LEADS, TEST
PROBES, TEST LEAD

FAIRCHILD RECORDING EQUIPMENT

AMPLIFIER, AF,
GENERAL PURPOSE
AMPLIFIER, AF,
PEAK LIMITING, AM
AMPLIFIER, AF,
PEAK LIMITING, FM
ATTENUATORS, AUDIO
CARTRIDGES, PHONO
CONSOLE, AUDIO, AM
CONSOLE, AUDIO, FM
CONSOLE, AUDIO, RECORDING
CONSOLE, AUDIO, TV
CONSOLE, KITS
HEADS, DISC RECORDING
HEADS, ERASE, MAGNETIC
HEADS, RECORDING, MAGNETIC
LATHE - DISC RECORDING
MIXERS - ALSO SEE CONSOLES
POWER SUPPLIES, AC
POWER SUPPLIES, DC
PREAMPLIFIERS, AUDIO
RACKS, MOUNTING
RECORDERS, DISC, MAGNETIC
RECORDERS, MAGNETIC TAPE,
AUDIO
REVERBERATION DEVICES
TURNTABLES, PHONOGRAPH

THE FINNEY CO.

AMPLIFIER, TV, BOOSTER
ANTENNAS, FM
ANTENNAS, TV
ANTENNAS, TV,
MASTER-COMMUNITY
BALUNS

F & M SYSTEMS COMPANY

ANTENNAS, MOBILE
AUTOMATION EQUIPMENT
CALIBRATION SERVICE,
FREQUENCY
COMMUNICATIONS SYSTEMS, CB
COMMUNICATIONS SYSTEMS,
INTERCOM, WIRED
COMMUNICATIONS SYSTEMS,
INTERCOM, WIRELESS
COMMUNICATIONS SYSTEMS,
LAND MOBILE
COMMUNICATIONS SYSTEMS,
MICROWAVE
COMMUNICATIONS SYSTEMS,
MULTIPLEX
COMMUNICATIONS SYSTEMS,
TELEPRINTER
MICROWAVE SYSTEMS, STL
MICROWAVE SYSTEMS, 2500-MHZ
MICROWAVE SYSTEMS, OTHER
MOBILE EQUIPMENT
REMOTE CONTROL SYSTEMS
SWITCHING SYSTEMS
TRANSLATOR SYSTEMS
TV SYSTEMS, CLOSED CIRCUIT

FISHER BERKELEY CORPORATION

AMPLIFIER, AF,
GENERAL PURPOSE
CABLE, TELEPHONE
COMMUNICATIONS SYSTEMS,
INTERCOM, WIRED
COMMUNICATIONS SYSTEMS,
INTERCOM, WIRELESS
POWER SUPPLIES, DC

HERB FITZGERALD COMMUNICATIONS

AND ELECTRONICS
CALIBRATION SERVICE,
FREQUENCY

THE JAMES FLOYD FORD COMPANY

ALARM, INTRUDER
ALARM, SIGNAL
BACKGROUND MUSIC SERVICE
BROADCAST PROGRAMMING SERVICE
CALIBRATION SERVICE,
INSTRUMENT
COMMUNICATIONS SYSTEMS,
INTERCOM, WIRED
COMMUNICATIONS SYSTEMS,
INTERCOM, WIRELESS
COMMUNICATIONS SYSTEMS,
LAND MOBILE
COMPUTER SERVICES
MAINTENANCE SERVICES, TV
PROCESSORS, FILM, B-W
RECORDING SERVICE, AUDIO,
TAPE
TELEPHONE EQUIPMENT
TV SYSTEMS, CLOSED CIRCUIT

FORT WORTH TOWER CO.

ANTENNAS, MICROWAVE
PREFABRICATED BUILDINGS
RADOMES
REFLECTORS, PASSIVE
TOWERS, ANTENNA,
CATV, HEAD-END
TOWERS, ANTENNA, RECEIVING
TOWERS, ANTENNA,
TRANSMITTING, AM
TOWERS, ANTENNA,
TRANSMITTING, FM
TOWERS, ANTENNA,
TRANSMITTING, TV

GAMMA SCIENTIFIC, INC.
METERS, LIGHT

GATES RADIO COMPANY

AMPLIFIER, AF, AGC
AMPLIFIER, AF, COMPRESSING
AMPLIFIER, AF,
GENERAL PURPOSE
AMPLIFIER, AF, MONAURAL
AMPLIFIER, AF,
PEAK LIMITING, AM
AMPLIFIER, AF,
PEAK LIMITING, FM
AMPLIFIER, AF, REMOTE
AMPLIFIER, AF, STEREO
AMPLIFIER, BRIDGING
AMPLIFIER, RF,
GENERAL PURPOSE
AMPLIFIER, RF, POWER
ANTENNAS, AM
ANTENNAS, FM
ANTENNAS, MOBILE
ANTENNAS, TV
ARMS, TONE
AUTOMATION EQUIPMENT
BASE STATIONS
CABINETS, METAL
CABINETS, STORAGE, DISC
CABINETS, WOOD
CARTRIDGES, MAGNETIC TAPE
COILS, ANTENNA LOADING
COILS, CHOKER, RF
CONSOLE, AUDIO, FM
CONSOLE, AUDIO, PORTABLE
CONSOLE, AUDIO, RECORDING
CONSOLE, AUDIO, TV
CONSOLE, CABINETS
AND HARDWARE
CONSOLE, AUDIO, AM
DIVIDERS, POWER
DUMMY LOAD
EXCITERS, FM
FILTERS, ANTENNA
FILTERS, RF
FLASHERS, TOWER
GENERATORS, FM, STEREO
GENERATORS, FM, SUBCARRIER
HARDWARE, RACK
HOUSINGS, ANTENNA
MICROPHONES, DYNAMIC
MOBILE EQUIPMENT
MONITORS, AM SYSTEMS
MONITORS, FM SYSTEMS, MONO
MONITORS, FM SYSTEMS, SCA
MONITORS, FM SYSTEMS, STEREO
MONITORS, FREQUENCY
MONITORS, PHASE
MOUNTS, ANTENNA, FIXED
MOUNTS, ANTENNA, MOBILE
NETWORKS, MATCHING, AUDIO
NETWORKS, PHASING
OSCILLATORS, AM
OSCILLATORS, FM
OSCILLATORS, TV
POWER SUPPLIES, AC
POWER SUPPLIES, DC
PREAMPLIFIERS, VIDEO
PRESSURIZATION EQUIPMENT,
TRANSMISSION LINE
RACKS, MOUNTING
RECEIVERS, FM
RECORDERS, MAGNETIC TAPE,
AUDIO, CARTRIDGE
REMOTE CONTROL SYSTEMS
SPEAKERS
SWITCHING SYSTEMS
TAPE DECKS, MAGNETIC
TAPE, MAGNETIC RECORDING,
TEST
TOWERS, ANTENNA,
TRANSMITTING, AM
TOWERS, ANTENNA,
TRANSMITTING, FM
TOWERS, ANTENNA,
TRANSMITTING, TV
TRANSMISSION LINES
TRANSMITTER KITS
TRANSMITTERS, AM, 250 WATT
TRANSMITTERS, AM, 1 KW
TRANSMITTERS, AM, 5 KW
TRANSMITTERS, AM, 10 KW
TRANSMITTERS, AM, 25 KW
TRANSMITTERS, AM, 50 KW
TRANSMITTERS, AM, OVER 50 KW
TRANSMITTERS, FM, 10 WATTS
TRANSMITTERS, FM, 50 WATTS
TRANSMITTERS, FM, 250 WATTS
TRANSMITTERS, FM, 1 KW
TRANSMITTERS, FM, 3 KW
TRANSMITTERS, FM, 5 KW
TRANSMITTERS, FM, 7.5 KW
TRANSMITTERS, FM, 10 KW
TRANSMITTERS, FM, 15 KW
TRANSMITTERS, FM, 20 KW
TRANSMITTERS, FM, 40 KW
TRANSMITTERS, TV, 100 WATTS
TRANSMITTERS, TV, 500 WATTS
TRANSMITTERS, TV, 5 KW

GBC AMERICA CORP.

AMPLIFIER, CATV
AMPLIFIER, TV, VIDEO
INDUSTRIAL TV
MONITORS, VIDEO
TV SYSTEMS, CLOSED CIRCUIT
VACUUM TUBES, CAMERA, VIDICON

G C ELECTRONICS COMPANY

ADAPTERS, CONNECTOR
ADAPTERS, FM STEREO
ADAPTERS, TEST
ANCHORS, GUY
ANTENNAS, FM
ANTENNAS, MOBILE
ANTENNAS, TV
CABLE, ASSEMBLIES
CABLE, SHIELDED, AUDIO
CHARGERS, BATTERY
CIRCUIT BREAKERS

CLAMPS, CABLE
CLEANERS, CHEMICAL
CLEANERS, OTHER
CLIPS, TEST
COILS, DEGAUSSING
CONNECTORS, AF & MICROPHONE
CONNECTORS, ANTENNA
CONNECTORS, COAXIAL CABLE
CORDS, DIAL
CORDS, LACING
COUPLERS
DECALCOMANIAS
DEGASMETIZERS, BULK TAPE
DEGASMETIZERS, HEAD
DESSICANTS
DIALS, INSTRUMENT
EARPHONES, HEADPHONES
EMPHASERS, TV IMAGE
FUSES
HARDWARE, CHASSIS
HARDWARE, DIAL POINTERS
HARDWARE, GENERAL
HARDWARE, GROMMETS
HARDWARE, RACK
HARDWARE, TOOLS
HARDWARE, TUBING, PLASTIC
HEAT SINKS
HOLDERS, FUSE
INSULATORS, ANTENNA
INSULATORS, FEED THROUGH
INSULATORS, STAND-OFF
INSULATORS, OTHER
JACKS
KNOBS
LEADS, TEST
LIGHTNING ARRESTERS
LUBRICANTS
MICROPHONE HARDWARE
MICROPHONE STANDS & BOOMS
MICROPHONES, DYNAMIC
MOUNTS, ANTENNA, FIXED
MOUNTS, ANTENNA, MOBILE
PLUGS, PHONE
PROBES, OSCILLOSCOPE
PROBES, TEST LEAD
RESISTORS, FIXED, CARBON
RESISTORS, VARIABLE,
WIREWOUND
SOCKETS, TUBE
SOLDER
SOLVENTS AND CLEANERS
SPLICERS, MAGNETIC TAPE
AND FILM
STROBE, DISCS
STROBE, LIGHTS
SWITCHES, KNIFE
SWITCHES, PUSHBUTTON,
NONILLUMINATED
SWITCHES, ROTARY
SWITCHES, SLIDE
SWITCHES, TOGGLE
TERMINALS, LUG
TERMINALS, SOLDER
TERMINALS, SOLDERLESS
TOOLS, SCREWDRIVERS

G E VISUAL COMMUNICATIONS PROD

AMPLIFIER, AF,
GENERAL PURPOSE
AMPLIFIER, AF, MONAURAL
AMPLIFIER, AF,
PEAK LIMITING, AM
AMPLIFIER, AF,
PEAK LIMITING, FM
AMPLIFIER, AF, REMOTE
AMPLIFIER, AF, STEREO
AMPLIFIER, RF, POWER
AMPLIFIER, TV, VIDEO
ANTENNAS, TV
CABINETS, METAL
CABLE, SHIELDED, AUDIO
CAMERAS, TV, COLOR
CAMERAS, TV, MONOCHROME
CONSOLE, AUDIO, AM
CONSOLE, AUDIO, PORTABLE
CONSOLE, AUDIO, RECORDING
CONSOLE, AUDIO, TV
CONSOLE, AUDIO, FM
DEMODULATORS
DIPLEXERS
EQUALIZERS, AUDIO EMPHASIS
FILTERS, AUDIO
FILTERS, RF
GENERATORS, SIGNAL,
TV SYNCHRONIZING
INDUSTRIAL TV
MONITORS, AM SYSTEMS
MONITORS, FREQUENCY
MONITORS, VIDEO
POWER SUPPLIES, DC
PREAMPLIFIERS, AUDIO
RACKS, MOUNTING
SWITCHES
TRANSMITTERS, TV, 10 KW
TRANSMITTERS, TV, 50 KW
TRANSMITTERS, TV, 50 KW
TRANSMITTERS, TV, 100 KW
TV SYSTEMS, CLOSED CIRCUIT
VESTIGIAL SIDEBAND FILTERS

G E DISTRIBUTOR SALES FORCE

VACUUM TUBES
CARTRIDGES, PHONO
CRYSTALS, PIEZOELECTRIC
LAMPS, GLOW
LAMPS, EXCITER
LAMPS, PANEL
LAMPS, PROJECTION
SEMICONDUCTOR DIODES
SEMICONDUCTOR RECTIFIERS,
GENERAL
SEMICONDUCTOR RECTIFIERS,
HIGH VOLTAGE
SEMICONDUCTOR RECTIFIERS,
POWER

start with **SUPER SOUNDS FAIRCHILD**



New FAIRCHILD 42 input TV Network Mixer.



FAIRCHILD MASTER TAPE IMPROVEMENT SYSTEM

FAIRCHILD MTIS with "focused-gap" head design reduces bias-induced noise to a point where it is no greater than 2 db than the noise of virgin or bulk-erased tape. FAIRCHILD MTIS has an S/N ratio of 72 db on one track of a 4-track 1/2" tape. FAIRCHILD MTIS increases the recording level by 4 db over present standards, with the lowest harmonic, intermodulation, and cross-modulation distortion of only .5%. Only the FAIRCHILD MTIS comes in a compatible, convertible package allowing you to update your present tape transports to the highest quality "state-of-the-art" recording standards.



FAIRCHILD CONAX

The world-accepted standard to control high frequency spillovers due to pre-emphasis. Maintain high levels even with brass and crashing cymbals in FM and recording.

THE REVERBERTRON

The new compact reverberation system which gives your station that real big voice. With the Reverbertron you can have that Carnegie Hall effect as close as the gain control on the Reverbertron. And there's the added plus of an increase in apparent loudness of your station sound due to reverberation, as originally described by Dr. Maxfield.

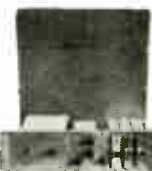

FAIRCHILD COMPACT COMPRESSOR MODEL 663

Allows creation of those up tight levels that contribute materially to presence and loudness combined with overload protection. The FAIRCHILD Model 663 Compact Compressor produces no distortion despite the amount of compression used... no thumps, no noise. The 663 provides adjustable release time and up to 20 db of compression. Model 663 NL comes with unity gain and additional gain if needed with +18 dbm output.



FAIRCHILD PROGRAM EQUALIZER MODEL 664NL



An ideal no loss equalizer for broadcast and recording. The FAIRCHILD Model 664NL allows the production of the "hot, solid commercial" sound standard with major recording studios; transforms any conventional console into "Big Board sound". 1 1/2" x 5 1/4" high unit provides equalization up to 10 db at 4, 6, 8, 10, or 15 KHZ and low end equalization up to 10 db. Rolloffs also provided. The Model 664NLB has equalization at 2, 3, 4, 5, and 7.5 KHZ for motion picture demands. The FAIRCHILD Program Equalizer contains equalization plus 18 dbm amplifier output. Put life into your sound with the FAIRCHILD Equalizer.

FAIRCHILD LIMITER MODEL 670

Fast attack Stereo Limiter (50 microseconds) with low distortion and absence of thumps. Sum and difference limiting position eliminates floating stereo image. Includes regular channel A and B limiting. Dual controls, dual meters provided. Used throughout the world. Flexible release times make it indispensable in stereo recording and broadcasting.



Why are 6 FAIRCHILD CONAX'S on top of the EMPIRE STATE BUILDING?



Several New York FM and TV stations, including WNE-TV, WPIX-FM, WPIX-TV, WOR-FM, WOR-TV, and WQXR-FM, value their transmission location on top of the Empire State Building and they also value their audience. The FAIRCHILD CONAX allows these stations to maintain high average listening levels without danger of over-modulation caused by high frequency spikes and thereby increasing fringe area coverage. The super-fast attack and release times of the FAIRCHILD CONAX makes this instantaneous control inaudible to the listener's ear. The FAIRCHILD CONAX does not "muddy-up" the top in an effort to control it. Easily integrated into existing systems, the FAIRCHILD CONAX does not obsolete conventional compressors or limiters — it actually improves their performance. Only the FAIRCHILD CONAX is the world accepted solution for high frequency pre-emphasis problems. Join the "1000 Club"... the satisfied users of the FAIRCHILD CONAX in recording and broadcasting throughout the world. Write to FAIRCHILD — the pacemaker in professional audio products — for complete details.

Write to FAIRCHILD — the pacemaker in professional audio products — for complete details.

FAIRCHILD

RECORDING EQUIPMENT CORPORATION
10-40 45th Ave., Long Island City 1, N. Y.

FAIRCHILD

RECORDING EQUIPMENT CORPORATION
10-40 45th Ave., Long Island City 1, N. Y.

SEMICONDUCTOR RECTIFIERS,
SILICON CONTROLLED - SCR
SEMICONDUCTORS, THYRISTORS
SEMICONDUCTORS,
TRANSISTORS, AF
SEMICONDUCTORS,
TRANSISTORS, FE
SEMICONDUCTORS, TRANSISTORS,
GENERAL
SEMICONDUCTORS,
TRANSISTORS, RF
VACUUM TUBES, CATHODE RAY,
TV, COLOR
VACUUM TUBES, CATHODE RAY,
TV, MONOCHROME
VACUUM TUBES, RECEIVING
VACUUM TUBES, TRANSMITTING

G E INDUSTRIAL SALES OPERATION

AMMETERS, AC
AMMETERS, AC, THERMOCOUPLE
AMMETERS, DC
AMMETERS, RF
CIRCUIT BREAKERS
METERS, DB AND VU
METERS, DB AND VU, WIDE RANGE
SHUNTS, METER
TRANSFORMERS, GENERAL
VOLTMETERS, AC
VOLTMETERS, DC
WATTMETERS

G E CAPACITOR DEPARTMENT

BATTERIES, NICKEL CADMIUM
CAPACITORS, FIXED, AIR
CAPACITORS, FIXED, CERAMIC
CAPACITORS, FIXED, MICA
CAPACITORS, FIXED, OIL-FILLED
CAPACITORS, FIXED, OTHER

G E SUPPLY COMPANY

CLOCKS
METERS, LIGHT
RECEIVERS, AM
REGULATORS, CURRENT
REGULATORS, VOLTAGE

G E SALES AND DISTRIBUTION

RECEIVERS, TV, COLOR
RECEIVERS, TV, MONOCHROME

G E COMMUNICATION PRODUCTS

MOBILE EQUIPMENT

G E PICKUP TUBE OPERATION

VACUUM TUBES, CAMERA,
IMAGE-ORTHICON
VACUUM TUBES, CAMERA, VIDICON

GENERAL ELECTRIC COMPANY

AMMETERS, AC
AMMETERS, DC
BALLASTS, LAMP
BATTERIES, NICKEL CADMIUM
BATTERIES, OTHER
BRIDGES
CAPACITORS, FIXED,
ELECTROLYTIC
CAPACITORS, FIXED, FILM
CAPACITORS, FIXED, OIL-FILLED
CAPACITORS, FIXED, PAPER
CAPACITORS, FIXED, OTHER
CHARGERS, BATTERY
CIRCUIT BREAKERS
COMPUTER EQUIPMENT
CONVERTERS
DETECTORS, MICROWAVE
DIVIDERS, FREQUENCY
DIVIDERS, VOLTAGE
FUSES
GENERATORS, POWER,
ELECTRIC MOTOR
HEATING ELEMENTS
INDUSTRIAL TV
INTEGRATED CIRCUITS
LIGHTNING ARRESTERS
METERS, PHASE ANGLE
MICROWAVE COMPONENTS
PANELS, INSTRUMENT,
FOR RACK MOUNTING
POWER SUPPLIES, AC
POWER SUPPLIES, DC
RECORDERS, PAPER,
LOGGING AND GRAPHIC
RECTIFIERS - ALSO SEE SEMI-
CONDUCTORS & VACUUM TUBES
RECTIFIERS, SELENIUM
REGULATORS, CURRENT
REGULATORS, VOLTAGE
RELAYS, GENERAL PURPOSE
RELAYS, LATCHING
RELAYS, OVERLOAD
RELAYS, PHOTOELECTRIC
RELAYS, POWER
RELAYS, THERMAL
RELAYS, TIME DELAY
REMOTE CONTROL SYSTEMS
RESISTORS, FIXED, WIREWOUND
RESISTORS, FIXED, OTHER
RHEOSTATS
SEMICONDUCTOR DIODES
SEMICONDUCTOR RECTIFIERS,
GENERAL
SEMICONDUCTOR RECTIFIERS,
POWER
SEMICONDUCTOR RECTIFIERS,
SILICON CONTROLLED - SCR
SEMICONDUCTORS, TRANSISTORS,
GENERAL
SHUNTS, METER
SWITCHES, FOOT
SWITCHES, INTERLOCK
SWITCHES, LEVER
SWITCHES, MECHANICALLY
ACTUATED

SWITCHES, PUSHBUTTON,
NONILLUMINATED
SWITCHES, ROTARY
SWITCHES, SNAP
SWITCHES, THERMAL
SWITCHES, TOGGLE
TERMINAL BLOCKS
TERMINAL BOARDS
TESTERS, BATTERY
TESTERS, INSULATION
TIMERS, ELECTRIC
TRANSFORMERS, AUTO
TRANSFORMERS, FILAMENT
TRANSFORMERS, GENERAL
TRANSFORMERS, POWER
TRANSFORMERS, VARIABLE
TV SYSTEMS, CLOSED CIRCUIT
VOLTMETERS, AC
VOLTMETERS, DC
WATTMETERS

GENERAL MICROWAVE CORPORATION

ANALYZERS, NOISE
ATTENUATORS, FIXED
ATTENUATORS, MICROWAVE
ATTENUATORS, RF
BRIDGES
METERS, POWER
METERS, STANDING WAVE
WATTMETERS
WAVEGUIDE AND
ASSOCIATED COMPONENTS

GENERAL RADIO COMPANY

ADAPTERS, CONNECTOR
AMPLIFIER, AF,
GENERAL PURPOSE
AMPLIFIER, DC
AMPLIFIER, PULSE
AMPLIFIER, RF,
GENERAL PURPOSE
AMPLIFIER, RF, POWER
ANALYZERS, DISTORTION
ANALYZERS, HARMONIC
ANALYZERS, NOISE
ATTENUATORS, AUDIO
ATTENUATORS, FIXED
ATTENUATORS, MICROWAVE
ATTENUATORS, RF
BALLUNS
BOXES, DECADE, CAPACITOR
BOXES, DECADE, INDUCTOR
BOXES, DECADE, RESISTOR
BRIDGES
CABLE, ASSEMBLIES
CABLE, COAXIAL, FLEXIBLE
CAPACITORS, FIXED, AIR
CAPACITORS, FIXED, MICA
CAPACITORS, FIXED, OTHER
CAPACITORS, VARIABLE
CLOCKS
CONNECTORS, AF & MICROPHONE
CONNECTORS, COAXIAL CABLE
CONNECTORS, RF
COUNTERS, FREQUENCY
DELAY LINES
DETECTORS, MICROWAVE
DETECTORS, STANDING WAVE
DIALS, INSTRUMENT
DIVIDERS, FREQUENCY
DIVIDERS, VOLTAGE
FILTERS, AUDIO
FILTERS, RF
GENERATORS, SIGNAL, AF
GENERATORS, SIGNAL, RF
GENERATORS, SIGNAL,
SQUARE WAVE
INDUCTANCES, FIXED
INDUCTANCES, VARIABLE
JACKS
JOINTS, ROTARY, COAXIAL
KNOBS
METERS, FREQUENCY
METERS, FREQUENCY CALIBRATING
MICROWAVE COMPONENTS
OSCILLATORS, AF AND RF,
SEE GENERATORS
OSCILLATORS, AM
PLUGS, COAXIAL
POTENTIOMETERS, WIREWOUND
POWER SUPPLIES, AC
POWER SUPPLIES, DC
PREAMPLIFIERS, AUDIO
RECORDERS, MAGNETIC TAPE,
AUDIO
RECORDERS, PAPER,
LOGGING AND GRAPHIC
REGULATORS, VOLTAGE
RESISTORS, FIXED,
NONINDUCTIVE
RESISTORS, FIXED, PRECISION
RESISTORS, FIXED, WIREWOUND
RESISTORS, VARIABLE,
WIREWOUND
RHEOSTATS
STROBE, DISCS
STROBE, LIGHTS
TESTERS, CAPACITOR
TESTERS, INSULATION
TRANSFORMERS, AUDIO, MATCHING
TRANSFORMERS, AUTO
TRANSFORMERS, VARIABLE
VOLTMETERS, AC
VOLTMETERS, DC
VOLTMETERS, VACUUM TUBE

GENERAL RADIO COMPANY
ADAPTERS, CONNECTOR
AMPLIFIER, AF,
GENERAL PURPOSE
AMPLIFIER, DC
AMPLIFIER, PULSE
AMPLIFIER, RF,
GENERAL PURPOSE
AMPLIFIER, RF, POWER
ANALYZERS, DISTORTION
ANALYZERS, HARMONIC
ANALYZERS, NOISE
ATTENUATORS, AUDIO
ATTENUATORS, FIXED
ATTENUATORS, MICROWAVE
ATTENUATORS, RF
BALLUNS
BOXES, DECADE, CAPACITOR
BOXES, DECADE, INDUCTOR
BOXES, DECADE, RESISTOR
BRIDGES
CABLE, ASSEMBLIES
CABLE, COAXIAL, FLEXIBLE
CAPACITORS, FIXED, AIR
CAPACITORS, FIXED, MICA
CAPACITORS, FIXED, OTHER
CAPACITORS, VARIABLE
CLOCKS
CONNECTORS, AF & MICROPHONE
CONNECTORS, COAXIAL CABLE
CONNECTORS, RF
COUNTERS, FREQUENCY
DELAY LINES
DETECTORS, MICROWAVE
DETECTORS, STANDING WAVE
DIALS, INSTRUMENT
DIVIDERS, FREQUENCY
DIVIDERS, VOLTAGE
FILTERS, AUDIO
FILTERS, RF
GENERATORS, SIGNAL, AF
GENERATORS, SIGNAL, RF
GENERATORS, SIGNAL,
SQUARE WAVE
INDUCTANCES, FIXED
INDUCTANCES, VARIABLE
JACKS
JOINTS, ROTARY, COAXIAL
KNOBS
METERS, FREQUENCY
METERS, FREQUENCY CALIBRATING
MICROWAVE COMPONENTS
OSCILLATORS, AF AND RF,
SEE GENERATORS
OSCILLATORS, AM
PLUGS, COAXIAL
POTENTIOMETERS, WIREWOUND
POWER SUPPLIES, AC
POWER SUPPLIES, DC
PREAMPLIFIERS, AUDIO
RECORDERS, MAGNETIC TAPE,
AUDIO
RECORDERS, PAPER,
LOGGING AND GRAPHIC
REGULATORS, VOLTAGE
RESISTORS, FIXED,
NONINDUCTIVE
RESISTORS, FIXED, PRECISION
RESISTORS, FIXED, WIREWOUND
RESISTORS, VARIABLE,
WIREWOUND
RHEOSTATS
STROBE, DISCS
STROBE, LIGHTS
TESTERS, CAPACITOR
TESTERS, INSULATION
TRANSFORMERS, AUDIO, MATCHING
TRANSFORMERS, AUTO
TRANSFORMERS, VARIABLE
VOLTMETERS, AC
VOLTMETERS, DC
VOLTMETERS, VACUUM TUBE

GENERAL TELEVISION NETWORK
PROJECTORS, TV, LARGE SCREEN
STANDS, TELEVISION MONITOR

GIBBS MFG. & RESEARCH CORP.
CABLE, ASSEMBLIES
CLOCKS
CONVERTERS
GENERATORS, FM, SUBCARRIER
GENERATORS, SIGNAL, AF

GENERATORS, SIGNAL, MARKER
GENERATORS, SIGNAL, PULSE
GENERATORS, SIGNAL, RF
GENERATORS, SIGNAL,
SQUARE WAVE
INVERTERS, DC TO AC, CHOPPER
OSCILLATORS, AF AND RF,
SEE GENERATORS
OSCILLATORS, AM
OSCILLATORS, FM
OSCILLATORS, TV
OSCILLATORS, OTHER
POWER SUPPLIES, AC
POWER SUPPLIES, PRECISION
TIMERS, ELECTRIC

J W GIBSON CO., INC.

CLEANERS, CHEMICAL

GOTHAM AUDIO CORPORATION

ARMS, TONE
ATTENUATORS, FIXED
CABLE, COAXIAL, FLEXIBLE
CABLE, SHIELDED, AUDIO
CARTRIDGES, PHONO
CONNECTORS, AF & MICROPHONE
CONSOLE, AUDIO, AM
CONSOLE, AUDIO, FM
CONSOLE, AUDIO, PORTABLE
CONSOLE, AUDIO, RECORDING
CONSOLE, AUDIO, TV
CONSOLE, KITS
EARPHONES, HEADPHONES
EDITORS, VIDEO TAPE
EQUALIZERS, AUDIO EMPHASIS
HEADS, DISC RECORDING
LATHE, DISC RECORDING
METERS, DB AND VU
METERS, FLUTTER & WDW
MICROPHONE HARDWARE
MICROPHONE STANDS & BODMS
MICROPHONES, CONDENSER
MIXERS - ALSO SEE CONSOLES
MONITORS, FM SYSTEMS, STEREO
OHMMETERS
POTENTIOMETERS, CARBON
RECORDERS, MAGNETIC TAPE,
AUDIO
REVERBERATION DEVICES
TESTERS, BATTERY
TESTERS, INSULATION
TRANSFORMERS, AUDIO,
ISOLATION
TRANSFORMERS, AUDIO, MATCHING
TRANSFORMERS, TRANSISTOR
TURNTABLES, PHONOGRAPH
VOLTMETERS, AC

HOUSTON FEARLESS CORP.

CAMERA, MOUNTING EQUIPMENT
DOLLIES, CAMERA
MICROPHONE STANDS & BODMS
PROCESSORS, FILM, B-W
PROCESSORS, FILM, COLOR

GRADD LABORATORIES, INC.

CARTRIDGES, PHONO

GRANTHAM SCHOOLS

EDUCATION FACILITIES, SCHOOLS

GRAY RESEARCH & DEVELOPMENT CO

ARMS, TONE
EQUALIZERS, AUDIO EMPHASIS
LENSES, OPTICAL, FIXED
PROJECTORS, SLIDE
TURNTABLES, PHONOGRAPH

GREENLEE TOOL COMPANY

TOOLS, PUNCH, CHASSIS

GREGORY AMPLIFIER CORP

AMPLIFIER, AF, MONAURAL
AMPLIFIER, AF, REVERBERATION
POWER SUPPLIES, AC
PREAMPLIFIERS, AUDIO
REVERBERATION DEVICES
SOUND SYSTEMS, OUTDOOR
SOUND SYSTEMS, PORTABLE
SOUND SYSTEMS, THEATER
SPEAKERS

GRINNAN FIXTURE COMPANY

CABINETS, STORAGE, DISC
CABINETS, STORAGE, FILM
CABINETS, STORAGE,
MAGNETIC TAPE
CABINETS, WOOD
CONSOLE, CABINETS
AND HARDWARE
DISPLAY EQUIPMENT, TV
SERVICES, INSTALLATION

GULF ELECTRO-SALES, INC.

SERVICES, INSTALLATION

G-V CONTROLS INC.

RELAYS, OVERLOAD
RELAYS, THERMAL
RELAYS, TIME DELAY
SWITCHES, THERMAL
TIMERS, ELECTRIC

HAMILTON HALL RESISTOR CORP.

RESISTORS, FIXED, WIREWOUND

HANCOCK TELECONTROL

AUTOMATION EQUIPMENT
COMPUTER EQUIPMENT
REMOTE CONTROL SYSTEMS
SWITCHING SYSTEMS

HARTLEY PRODUCTS

ACOUSTIC MATERIALS
ENCLOSURES, SPEAKER
NETWORKS, MATCHING, AUDIO

SPEAKERS
HARVEY RADIO CO., INC.
COMPUTER EQUIPMENT
CONSOLE, AUDIO, FM
CONSOLE, AUDIO, PORTABLE
CONSOLE, AUDIO, RECORDING
CONSOLE, AUDIO, AM
MIXERS - ALSO SEE CONSOLES
REWINDERS, TAPE
SOUND SYSTEMS, OUTDOOR
SOUND SYSTEMS, PORTABLE
SOUND SYSTEMS, THEATER
TAPE DUPLICATORS

HARWALD COMPANY

CABINETS, STORAGE, DISC
CABINETS, STORAGE, FILM
EDITORS, FILM
EDUCATION FACILITIES, EQPT
PROJECTORS, SLIDE
REELS, FILM
REWINDERS, FILM
SOLVENTS AND CLEANERS
SPLICERS, MAGNETIC TAPE
AND FILM

HARWOOD MFG. CO.

CABINETS, METAL
LAMP ASSEMBLIES
LIGHTING, TV, COMPONENTS

HAYDEN BOOK COMPANY

EDUCATION FACILITIES,
PUBLISHERS

HEATH COMPANY

ADAPTERS, FM STEREO
AMPLIFIER, AF, STEREO
BOXES, DECADE, CAPACITOR
BOXES, DECADE, RESISTOR
BRIDGES
COMMUNICATIONS SYSTEMS, CB
COMMUNICATIONS SYSTEMS,
INTERCOM, WIRED
COMMUNICATIONS SYSTEMS,
INTERCOM, WIRELESS
COMPUTER EQUIPMENT
EARPHONES, HEADPHONES
GENERATORS, FM, STEREO
GENERATORS, SIGNAL, AF
GENERATORS, SIGNAL, COLOR BAR
GENERATORS, SIGNAL, DFT BAR
GENERATORS, SIGNAL, RF
GENERATORS, SIGNAL,
SQUARE WAVE
KITS
OHMMETERS
OSCILLATORS, AF AND RF,
SEE GENERATORS
OSCILLATORS, AM
OSCILLATORS, FM
OSCILLATORS, TV
OSCILLOSCOPES
POWER SUPPLIES, AC
POWER SUPPLIES, DC
POWER SUPPLIES, PRECISION
RECEIVERS, AM
RECEIVERS, FM
RECEIVERS, MULTIPLEX
RECEIVERS, TV, COLOR
RECEIVERS, TV, MONOCHROME
RECORDERS, MAGNETIC TAPE,
AUDIO
RECORDERS, PAPER,
LOGGING AND GRAPHIC
VOLTMETERS, AC
VOLTMETERS, DC
VOLTMETERS, VACUUM TUBE

HEINTZ & KAUFMAN, LTD

RECTIFIERS - VACUUM TUBES
VACUUM TUBES, RECEIVING
VACUUM TUBES, TRANSMITTING

HEWLETT - PACKARD CO.

ADAPTERS, CONNECTOR
ADAPTERS, TEST
AMMETERS, AC
AMMETERS, DC
AMMETERS, RF
AMPLIFIER, VIDEO, SWEEP
ANALYZERS, DISTORTION
ANALYZERS, HARMONIC
ANALYZERS, NOISE
ANALYZERS, VIDEO
ATTENUATORS, AUDIO
ATTENUATORS, FIXED
ATTENUATORS, MICROWAVE
ATTENUATORS, RF
BRIDGES
CALIBRATION SERVICE,
FREQUENCY
CALIBRATION SERVICE,
INSTRUMENT
CAMERAS, OSCILLOSCOPE
CASES, PORTABLE,
ELECTRONIC EQUIPMENT
CLIPS, TEST
COUNTERS, FREQUENCY
DEMAGNETIZERS, BULK TAPE
DETECTORS, MICROWAVE
DETECTORS, STANDING WAVE
GENERATORS, FM, STEREO
GENERATORS, SIGNAL, PULSE
GENERATORS, SIGNAL, RF
INDUCTANCES, FIXED
METERS, FREQUENCY
METERS, FREQUENCY CALIBRATING
METERS, PHASE ANGLE
METERS, POWER
METERS, STANDING WAVE
METERS - SEE SPECIFIC TYPES
MICROWAVE COMPONENTS
MONITORS, FM SYSTEMS, MONO
MONITORS, FREQUENCY

get complete coverage
and combination rates
in your Domestic
and Foreign Markets

Look at the facts below to see how BROADCAST ENGINEERING and RADIO y TELEVISION give you complete coverage, both domestic and foreign, of the ever-expanding broadcast-communications market. And this complete coverage—almost 30,000 total circulation*—is now available with money-saving combination rates in both magazines.

To sell more at a lower cost, include these two influential publications, along with THE BROADCAST INDUSTRY BUYERS GUIDE, in your advertising program.

*November figures are projected totals based on business before adjustments. Any variation on the December 31st statement will be minimal.

CIRCULATION FACTS

Broadcast Engineering

November, 1966

123% INCREASE SINCE 1963—Circulation has increased almost 12,000 since 1963, giving you the most complete coverage of management and technical personnel of AM, FM, CATV and TV broadcast stations.

BUSINESS AND INDUSTRY		NOV
RADIO & TV STATIONS and NETWORKS:		
Classification by Title		
Owners, Presidents, Vice Presidents, general managers, and station managers		5,418
Chief engineers, engineers, supervisors and technicians		9,202
Company and other copies		624
	SUB TOTAL	15,244
CONSULTING ENGINEERS		817
RECORDING STUDIOS		688
MANUFACTURERS & DISTRIBUTORS of Electronic & other Broadcasting Equipment		1,914
GOVERNMENT AGENCIES, LIBRARIES & SCHOOLS		1,075
STUDENTS		194
CLOSED CIRCUIT TV		21
COMMUNITY ANTENNA & TELEVISION SYSTEMS		1,547
	TOTAL	21,500

Radio y Television

November, 1966

Circulation is controlled with 8120 going to owners, management and technical personnel at all AM, FM and TV stations in Latin American countries, Spain and other Spanish and Portuguese-speaking areas of the world. In addition, RADIO y TELEVISION goes to wholesalers, agents, distributors and manufacturers of broadcast-related electronic equipment in all these countries . . . plus radio and television stations in the United States with Spanish and Portuguese programming.

Argentina	598	Nicaragua	105
Bolivia	168	Panama	200
Brazil	1081	Paraguay	79
Colombia	477	Peru	471
Costa Rica	143	Philippines	46
Chile	363	Portugal	176
Dominican Republic	175	Puerto Rico	238
Ecuador	342	Spain	490
El Salvador	120	Uruguay	216
Guatemala	188	USA (Spanish Stations)	687
Honduras	161	Venezuela	400
Mexico	1048		
Miscellaneous	148	TOTAL	8120

Reach this
Combined
Circulation
of 29,620
at Lower Cost
with
Combination
Rates

Combination rates with BROADCAST ENGINEERING and RADIO y TELEVISION are available on request. EXAMPLE: 12 insertions in each publication earn the 24-time rate in both, or 6 insertions in each earn the 12-time rate in both.

MONITORS, WAVEFORM
OHMMETERS
OSCILLATORS, AF AND RF,
SEE GENERATORS
OSCILLOSCOPES
POWER SUPPLIES, DC
POWER SUPPLIES, PRECISION
PROBES, OSCILLOSCOPE
PROBES, TEST LEAD
RECORDERS, PAPER,
LOGGING AND GRAPHIC
SEMICONDUCTOR OIODES
TELEPHONE EQUIPMENT
VOLTMETERS, AC
VOLTMETERS, DC
VOLTMETERS, VACUUM TUBE
WAVEGUIDE AND
ASSOCIATED COMPONENTS

HICKOK ELECTRICAL INSTRUMENTS

AMMETERS, AC
AMMETERS, DC
BRIDGES
COUNTERS, FREQUENCY
GENERATORS, FM, STEREO
GENERATORS, SIGNAL, AF
GENERATORS, SIGNAL, COLOR BAR
GENERATORS, SIGNAL, DOT BAR
GENERATORS, SIGNAL, MARKER
GENERATORS, SIGNAL, PULSE
GENERATORS, SIGNAL, RF
METERS, FREQUENCY
METERS, PHASE ANGLE
METERS - SEE SPECIFIC TYPES
OHMMETERS
OSCILLATORS, AM
OSCILLATORS, FM
OSCILLATORS, TV
OSCILLOSCOPES
SWITCHES, MULTICONTACT
TESTERS, BATTERY
TESTERS, CAPACITOR
TESTERS, SEMICONDUCTOR
TESTERS, VACUUM TUBE
TIMERS, ELECTRIC
VOLTMETERS, AC
VOLTMETERS, DC
VOLTMETERS, VACUUM TUBE

S. HIMMELSTEIN AND COMPANY

DELAY DEVICES, AF

HOLLAND ELECTRONICS INC.

ATTENUATORS, FIXED
ATTENUATORS,
IMPEDANCE MATCHING
ATTENUATORS, RF
ATTENUATORS, VIDEO
CORDS, PATCH
FILTERS, RF
JACK PANEL ASSEMBLIES

HOLLINGSWORTH SOLDERLESS

TERMINAL COMPANY
TERMINALS, LUG
TERMINALS, SOLOERLESS
TOOLS, CRIMPERS
TOOLS, HAND

HOUSTON ELECTRONICS CO.

ALARM, FAULT
ALARM, INTRUDER
AMPLIFIER, SENSING
BROADCAST PROGRAMMING SERVICE
CIRCUIT BREAKERS
CONSOLE, AUDIO, AM
CONSOLE, AUDIO, FM
CONSOLE, AUDIO, PORTABLE
CONSOLE, AUDIO, RECORDING
CONSOLE, AUDIO, TV
FLASHERS, TOWER
LIGHTING, TV, CONTROLS
MIXERS - ALSO SEE CONSOLES
RELAYS, PHOTOELECTRIC
RELAYS, TIME DELAY
SOUND SYSTEMS, OUTDOOR
SOUND SYSTEMS, PORTABLE
SOUND SYSTEMS, THEATER

HUGHEY & PHILLIPS

ALARM, FAULT
FLASHERS, TOWER
LAMP ASSEMBLIES
RELAYS, LIGHT-INDICATING
RELAYS, PHOTOELECTRIC
TRANSFORMERS, AUTO
TRANSFORMERS, POWER

HUNT-PIERCE CORP

LIFTS, AERIAL, TRUCK-MOUNTED

HY-GAIN ELECTRONICS

ANTENNAS, CATV
ANTENNAS, MOBILE
TOWERS, ANTENNA,
CATV, HEAD-END

IMPX ELECTRONICS

ADAPTERS, CONNECTOR
ADAPTERS, FM STEREO
BATTERIES, LEAD ACID
BATTERIES, NICKEL CADMIUM
CHARGERS, BATTERY
CONSOLE, AUDIO, AM
CONSOLE, AUDIO, FM
CONSOLE, AUDIO, PORTABLE
CONSOLE, AUDIO, RECORDING
RECORDERS, MAGNETIC TAPE,
AUDIO
TAPE DECKS, MAGNETIC
TAPE, MAGNETIC RECORDING,
AUDIO

INDUSTRIAL DEVICES

CLIPS, TEST
LAMP ASSEMBLIES

LAMPS, GLOW
LAMPS, PANEL
REELS, CABLE, AUTOMATIC
SWITCHES, ROTARY

INDUSTRIAL ELECTRIC REELS

REELS, CABLE, AUTOMATIC

INSTRUMENT LABORATORIES CORP.

AMMETERS, AC
AMMETERS, DC
CALIBRATION SERVICE,
INSTRUMENT
GENERATORS, SIGNAL, AF
OHMMETERS
VOLTMETERS, AC
VOLTMETERS, VACUUM TUBE

INTERNATIONAL GOOD MUSIC

AMPLIFIER, AF
GENERAL PURPOSE
AMPLIFIER, SENSING
AUTOMATION EQUIPMENT
BACKGROUND MUSIC SERVICE
BROADCAST PROGRAMMING SERVICE
CARTRIDGES, MAGNETIC TAPE
CATV, HEAD-END EQUIPMENT
GENERATORS, SIGNAL, AF
RECORDERS, MAGNETIC TAPE,
AUDIO
SWITCHERS
SWITCHING SYSTEMS
TAPE DECKS, MAGNETIC

INTERNATIONAL NUCLEAR CORP

AMPLIFIER, BRIDGING
AMPLIFIER, DISTRIBUTION
AMPLIFIER, PULSE
AMPLIFIER, STABILIZING
AMPLIFIER, TV, VIDEO
CONSOLE, AUDIO, TV
MODULATORS, TV
POWER SUPPLIES, DC
PREAMPLIFIERS, VIDEO
SWITCHERS
SWITCHES, CROSSBAR
SWITCHING MATRIXES
SWITCHING SYSTEMS

INTERNATIONAL RECTIFIER

HEAT SINKS
RECTIFIERS - ALSO
SEE SEMICONDUCTORS
RECTIFIERS, SELENIUM
SEMICONDUCTOR DIODES
SEMICONDUCTOR RECTIFIERS,
GENERAL
SEMICONDUCTOR RECTIFIERS,
HIGH VOLTAGE
SEMICONDUCTOR RECTIFIERS,
POWER
SEMICONDUCTOR RECTIFIERS,
SILICON CONTROLLED - SCR

SEMICONDUCTORS, THYRISTORS
SEMICONDUCTORS,
TRANSISTORS, AF
SEMICONDUCTORS, TRANSISTORS,
GENERAL
SEMICONDUCTORS,
TRANSISTORS, RF

IRC, INC.

DIVIDERS, VOLTAGE
POTENTIOMETERS, CARBON
POTENTIOMETERS, WIREWOUND
RECTIFIERS, SELENIUM
RESISTORS, FIXED, CARBON
RESISTORS, FIXED,
NONINDUCTIVE
RESISTORS, FIXED, PRECISION
RESISTORS, FIXED, WIREWOUND
RESISTORS, FIXED, OTHER
RESISTORS, VARIABLE,
WIREWOUND
SEMICONDUCTOR DIODES
SEMICONDUCTOR RECTIFIERS,
GENERAL
SEMICONDUCTOR RECTIFIERS,
SILICON CONTROLLED - SCR
SEMICONDUCTORS, THYRISTORS

ITI ELECTRONICS

DISPLAY EQUIPMENT, TV
INDUSTRIAL TV
INVERTERS, DC TO AC,
SOLID STATE
OSCILLOSCOPES

ITT CANNON ELECTRIC

CABLE, ASSEMBLIES
CONNECTORS, AF & MICROPHONE
CONNECTORS, ANTENNA
CONNECTORS, COAXIAL CABLE
CONNECTORS, POWER
CONNECTORS, RF
FILTERS, RF
INTEGRATED CIRCUITS
WIRING AND CABLING SERVICES

ITT TELECOMMUNICATIONS

COMMUNICATIONS SYSTEMS,
INTERCOM, WIRED
COMMUNICATIONS SYSTEMS,
MICROWAVE
COMMUNICATIONS SYSTEMS,
MULTIPLY
DIALS, TELEPHONE
MICROWAVE SYSTEMS, 2500 MHZ
RELAYS, TELEPHONE
SWITCHES, CROSSBAR
SWITCHES, TELEPHONE TYPE
SWITCHING SYSTEMS, TELEPHONE
TELEPHONE EQUIPMENT

ITT WIRE & CABLE DIV

CABLE, COAXIAL, FLEXIBLE

CABLE, COAXIAL, RIGID
CABLE, DIRECT-BURIAL
CABLE, TELEPHONE
CORDS, SET
FUSES
WIRE, INSULATED, HIGH VOLTAGE
WIRE, INSULATED, HOOKUP
WIRE, SHIELDED

JAMPRO ANTENNA COMPANY

ANTENNAS, AM
ANTENNAS, CATV
ANTENNAS, FM
ANTENNAS, TV
ANTENNAS, 2500 MHZ
CABLE, COAXIAL, FLEXIBLE
CABLE, COAXIAL, RIGID
DIPLEXERS
DUMMY LOAD
FILTERS, ANTENNA
FILTERS, RF
FILTERS, HYBRID
PLUGS, COAXIAL
SWITCHES, COAXIAL
TOWERS, ANTENNA,
TRANSMITTING, AM
TOWERS, ANTENNA,
TRANSMITTING, FM
TOWERS, ANTENNA,
TRANSMITTING, TV
TRANSMISSION LINES
VEGETIGIAL SIDEBAND FILTERS
WIRE, BARE, COPPER
WIRE, BARE, COPPER STRAP

JENNINGS RADIO

CAPACITORS, FIXED, CERAMIC
CAPACITORS, FIXED, OTHER
CAPACITORS, VARIABLE
DIVIDERS, VOLTAGE
RELAYS, COAXIAL
RELAYS, GENERAL PURPOSE
RELAYS, LATCHING
RELAYS, OVERLOAD
RELAYS, POWER
RELAYS, STEPPING
SWITCHERS
SWITCHES, COAXIAL
SWITCHES, CROSSBAR
SWITCHES, MECHANICALLY
ACTUATED
SWITCHES, ROTARY
SWITCHING MATRIXES
SWITCHING SYSTEMS

JENSEN MANUFACTURING DIVISION

EARPHONES, HEADPHONES
EDUCATION FACILITIES,
PUBLISHERS
EDUCATION FACILITIES, EQPT
SOUND SYSTEMS, OUTDOOR
SOUND SYSTEMS, PORTABLE
SOUND SYSTEMS, THEATER
SPEAKER COMPONENTS
SPEAKERS

JERROLD ELECTRONICS

ADAPTERS, CONNECTOR
ADAPTERS, TEST
ALARM, FAULT
AMPLIFIER, BRIDGING
AMPLIFIER, CATV
AMPLIFIER, DISTRIBUTION
AMPLIFIER, RF,
GENERAL PURPOSE
AMPLIFIER, TV, BOOSTER
ANTENNAS, AM
ANTENNAS, CATV
ANTENNAS, FM
ANTENNAS, MICROWAVE
ANTENNAS, MOBILE
ANTENNAS, TV
ANTENNAS, TV,
MASTER-COMMUNITY
ANTENNAS, 2500 MHZ
ATTENUATORS, FIXED
ATTENUATORS,
IMPEDANCE MATCHING
ATTENUATORS, MICROWAVE
ATTENUATORS, RF
BALUNS
BRIDGES
CABINETS, METAL
CABLE, ASSEMBLIES
CABLE, CATV, HARWARE
CABLE, COAXIAL, FLEXIBLE
CABLE, COAXIAL, RIGID
CABLE, DIRECT-BURIAL
CATV EQUIPMENT - ALSO SEE
OTHER CATEGORIES
CATV, CABLE TERMINALS
CATV, CHANNEL AMPLIFIERS
CATV, HEAD-END EQUIPMENT
CATV, ORIGINATION EQUIPMENT
COMMUNICATIONS SYSTEMS,
MICROWAVE
CONNECTORS, ANTENNA
CONNECTORS, COAXIAL CABLE
CONNECTORS, RF
CONVERTERS
DELAY LINES
DEMODULATORS
DETECTORS, MICROWAVE
FILTERS, ANTENNA
FILTERS, RF
GENERATORS, SIGNAL, AF
GENERATORS, SIGNAL, MARKER
GENERATORS, SIGNAL, RF
GENERATORS, SIGNAL,
SQUARE WAVE
HEAD-END EQUIPMENT,
SEE CATV HEAD-END EQUIPMENT
INDUSTRIAL TV
METERS, FIELD STRENGTH
MICROWAVE COMPONENTS
MICROWAVE SYSTEMS, STL

MICROWAVE SYSTEMS, 2500 MHZ
MICROWAVE SYSTEMS, OTHER
MODULATORS, TV
MOUNTS, ANTENNA, FIXED
NETWORKS, PHASING
POWER SUPPLIES, AC
PREAMPLIFIERS, VIDEO
RADOMES
STL EQUIPMENT
SWITCHES, COAXIAL
SWITCHES, ROTARY
TOWERS, ANTENNA,
CATV, HEAD-END
TRANSMISSION LINES
TV SYSTEMS, CLOSED CIRCUIT
WAVEGUIDE AND
ASSOCIATED COMPONENTS

JETRONIC INDUSTRIES

AMPLIFIER, AF, MONAURAL
AMPLIFIER, AF, STEREO
RECORDERS, MAGNETIC TAPE,
AUDIO
TAPE DECKS, MAGNETIC

J M ELECTRONICS CO.

COMMUNICATIONS SYSTEMS,
LAND MOBILE
MOBILE EQUIPMENT
TV SYSTEMS, CLOSED CIRCUIT

JOA CARTRIDGE SERVICE

CARTRIDGES, MAGNETIC TAPE
DEMAGNETIZERS, BULK TAPE
DEMAGNETIZERS, HEAD
HEADS, ERASE, MAGNETIC
HEADS, RECORDING, MAGNETIC
MAINTENANCE SERVICES,
CARTRIDGE, TAPE
RECORDERS, MAGNETIC TAPE,
AUDIO
TAPE, MAGNETIC RECORDING,
AUDIO
VACUUM TUBES, TRANSMITTING

J F JOHNSON COMPANY

AMPLIFIER, RF, POWER
CAPACITORS, VARIABLE
COILS, CHOKE, RF
COMMUNICATIONS SYSTEMS, CB
COMMUNICATIONS SYSTEMS,
INTERCOM, WIRELESS
COMMUNICATIONS SYSTEMS,
LAND MOBILE
COUPLERS
HARDWARE, PANEL
HOLDERS, CRYSTAL
INDUCTANCES, FIXED
INDUCTANCES, VARIABLE
INSULATORS, ANTENNA
INSULATORS, FEED THROUGH
INSULATORS, STAND-OFF
INSULATORS, OTHER
JACKS
MOBILE EQUIPMENT
PROBES, TEST LEAD
RELAYS, ANTENNA
SOCKETS, CRYSTAL
SOCKETS, LAMP
SOCKETS, TUBE
SWITCHES, KNIFE
SWITCHES, SNAP
TRANSMITTER KITS
TRANSMITTERS, AM, 250 WATT
TRANSMITTERS, AM, 1 KW

JOHNSON ELECTRONICS, INC.

AMPLIFIER, AF, MONAURAL
RECEIVERS, FM
RECEIVERS, HF
RECEIVERS, MULTIPLEX
RECEIVERS, MULTIPLEX

JORDAN ELECTRIC COMPANY

ATTENUATORS, AUDIO
ATTENUATORS, FIXED
BOXES, DECADE, RESISTOR
RESISTORS, FIXED, PRECISION
RESISTORS, FIXED, WIREWOUND

KAHN RESEARCH LABORATORIES

AMPLIFIER, AF,
PEAK LIMITING, AM
CONVERTERS
EXCITERS, FM
RECEIVERS, AM
RECEIVERS, HF

KAISER-COX

AMPLIFIER, CATV
ANTENNAS, CATV
CABLE, CATV, HARWARE
CATV EQUIPMENT - ALSO SEE
OTHER CATEGORIES
CATV, CABLE TERMINALS
CATV, CHANNEL AMPLIFIERS
CATV, HEAD-END EQUIPMENT
CATV, ORIGINATION EQUIPMENT
CONNECTORS, COAXIAL CABLE
HEAD-END EQUIPMENT,
SEE CATV HEAD-END EQUIPMENT
TV SYSTEMS, CLOSED CIRCUIT

THE KALART COMPANY

EDITORS, FILM
PROJECTORS, FILM
PROJECTORS, SLIDE
SPLICERS, MAGNETIC TAPE
AND FILM
TV SYSTEMS, CLOSED CIRCUIT,
PROJECTORS

KAPPA NETWORKS, INC.

DELAY LINES
FILTERS, RF
INDUCTANCES, FIXED

INDUCTANCES, VARIABLE
TRANSFORMERS, RF

KARG LABORATORIES

ADAPTERS, FM STEREO
AMPLIFIER, AF, STEREO
GENERATORS, FM, STEREO
MONITORS, FM SYSTEMS, MONO
MONITORS, FM SYSTEMS, STEREO
RECEIVERS, FM
RECEIVERS, MULTIPLEX
RECEIVERS, SCA

MATHIAS KLEIN & SONS

TOOLS, CRIMPERS
TOOLS, CUTTERS
TOOLS, HAND
TOOLS, PLIERS
TOOLS, SCREWDRIVERS
TOOLS, WRENCHES

KLINE IRON & STEEL COMPANY

TOWERS, ANTENNA,
CATV, HEAD-END
TOWERS, ANTENNA, RECEIVING
TOWERS, ANTENNA,
TRANSMITTING, AM
TOWERS, ANTENNA,
TRANSMITTING, FM
TOWERS, ANTENNA,
TRANSMITTING, TV

KOSS ELECTRONICS

AMPLIFIER, AF, STEREO
ARMS, TONE
EARPHONES, HEADPHONES
HEADS, DISC RECORDING
LATHE, DISC RECORDING
PREAMPLIFIERS, AUDIO
SPEAKERS
TURNTABLES, PHONOGRAPH

HERB KRECKMAN CO

ANTENNAS, MOBILE
ANTENNAS, REMOTE PICKUP

KRS INSTRUMENTS DIVISION

ANALYZERS, VIDEO
AUTOMATION EQUIPMENT
CARTRIDGES, MAGNETIC TAPE
EDUCATION FACILITIES, EQPT
RECORDERS, MAGNETIC TAPE,
AUDIO
RECORDERS, MAGNETIC TAPE,
AUDIO, CARTRIDGE
RECORDERS, MAGNETIC TAPE,
LOGGING
TAPE DECKS, MAGNETIC
TAPE, RECORDING, GRAPHIC

LACROSSE ELECTRONICS

RECORDERS, MAGNETIC TAPE,
AUDIO, CARTRIDGE

LAFAYETTE RADIO ELECTRONICS

TRANSFORMERS, AUDIO,
ISOLATION
TRANSFORMERS, AUDIO, MATCHING
TRANSFORMERS, AUDIO,
POWER OUTPUT
TRANSFORMERS, AUTO
TRANSFORMERS, FILAMENT
TRANSFORMERS, GENERAL
TRANSFORMERS, POWER
TRANSFORMERS, TRANSISTOR

LAKE ELECTRONICS, INC.

COILS, DEFLECTION
AND FOCUSING
CONSOLE, AUDIO, TV
GENERATORS, SIGNAL, DOT BAR
GENERATORS, SIGNAL, MARKER
GENERATORS, SIGNAL, PULSE
GENERATORS, SIGNAL,
SQUARE WAVE
GENERATORS, SIGNAL,
TV, SYNCHRONIZING
INDUCTANCES, FIXED
INDUSTRIAL TV
LENSES, OPTICAL, ZOOM
MONITORS, VIDEO
SEMICONDUCTORS,
TRANSISTORS, AF
SEMICONDUCTORS, TRANSISTERS,
GENERAL
SPEAKERS
TRANSFORMERS, AUDIO, MATCHING
TRANSFORMERS, AUDIO,
POWER OUTPUT
TRANSFORMERS, FILAMENT
TRANSFORMERS, GENERAL
TRANSFORMERS, PLATE
TRANSFORMERS, POWER
TRANSFORMERS, RF
TRANSFORMERS, TRANSISTOR
TRANSFORMERS, VARIABLE
YOKES, DEFLECTION

LAMPKIN LABORATORIES

METERS, FREQUENCY
METERS - SEE SPECIFIC TYPES
MONITORS, FREQUENCY
MONITORS, MODULATION

LANG ELECTRONICS, INC.

AMPLIFIER, AF,
GENERAL PURPOSE
CABINETS, METAL
CABINETS, WOOD
CONSOLE, AUDIO, PORTABLE
CONSOLE, AUDIO, RECORDING
CONSOLE, CABINETS
AND HARDWARE
MIXERS - ALSO SEE CONSOLES
STROBE, DISCS
TAPE DUPLICATORS

LANGEVIN

AMPLIFIER, AF,
GENERAL PURPOSE
AMPLIFIER, AF, MONAURAL
AMPLIFIER, AF, REMOTE
AMPLIFIER, BRIDGING
ATTENUATORS, AUDIO
ATTENUATORS, FIXED
EQUALIZERS, AUDIO EMPHASIS
FILTERS, AUDIO
NETWORKS, MATCHING, AUDIO
POWER SUPPLIES, DC
PREAMPLIFIERS, AUDIO
SWITCHES, MULTICONTACT
SWITCHES, ROTARY

JAMES B LANSING SOUND CO

AMPLIFIER, AF, STEREO
SOUND SYSTEMS, OUTDOOR
SOUND SYSTEMS, THEATER
SPEAKER COMPONENTS
SPEAKERS

LAVIOLETTE ELECTRONICS

MONITORS, VIDEO

LENKURT ELECTRIC CO.

COMMUNICATIONS SYSTEMS,
MICROWAVE
COMMUNICATIONS SYSTEMS,
MULTIPLEX
MICROWAVE SYSTEMS, STL

LENZ ELECTRIC MFG. COMPANY

CABLE, SHIELDED, AUDIO
CABLE, TELEPHONE
WIRE, INSULATED, HIGH VOLTAGE
WIRE, INSULATED, HOOKUP
WIRE, SHIELDED

LEWIS AND KAUFMAN LTD.

VACUUM TUBES, BALLAST
VACUUM TUBES, CAMERA, VIDICON
VACUUM TUBES, CATHODE RAY,
TV, MONOCHROME
VACUUM TUBES, RECEIVING
VACUUM TUBES, TRANSMITTING

LIBERTY TOWER MFG. CO

ANCHORS, GUY
MAINTENANCE SERVICES, AM
MAINTENANCE SERVICES, FM
MAINTENANCE SERVICES,
MICROWAVE
MAINTENANCE SERVICES,
STEEPLEJACK
MOUNTS, ANTENNA, FIXED
TOWERS, ANTENNA,
CATV, HEAD-END
TOWERS, ANTENNA, RECEIVING
TOWERS, ANTENNA,
TRANSMITTING, AM
TOWERS, ANTENNA,
TRANSMITTING, FM
TOWERS, ANTENNA,
TRANSMITTING, TV

LIGHTING & ELECTRONICS

LIGHTING, TV, COMPONENTS
LIGHTING, TV, CONTROLS
LIGHTING, TV, SYSTEMS

LINDSAY SPECIALTY PRODUCTS LTD

AMPLIFIER, BRIDGING
AMPLIFIER, CATV
AMPLIFIER, DISTRIBUTION
AMPLIFIER, TV, BOOSTER
ANTENNAS, CATV
ANTENNAS, FM
ANTENNAS, MOBILE
ANTENNAS, TV
ANTENNAS, TV,
MASTER-COMMUNITY

LIPPS, INC.

HEADS, DISC RECORDING
HEADS, ERASE, MAGNETIC
HEADS, RECORDING, MAGNETIC

LITTELFUSE

CIRCUIT BREAKERS
FUSES
HOLDERS, FUSE

LITTLE JOE ENTERPRISES

ANCHORS, GUY
CABINETS, WOOD
CONSOLE, AUDIO, FM
CONSOLE, AUDIO, PORTABLE
CONSOLE, AUDIO, RECORDING
CONSOLE, AUDIO, TV
CONSOLE, CABINETS
AND HARDWARE
CONSOLE, AUDIO, AM
DUMMY LOAD
MAINTENANCE SERVICES, AM
MAINTENANCE SERVICES, FM
MAINTENANCE SERVICES,
STEEPLEJACK

REVERBERATION DEVICES

TOWERS, ANTENNA,
CATV, HEAD-END
TOWERS, ANTENNA, RECEIVING
TOWERS, ANTENNA,
TRANSMITTING, AM
TOWERS, ANTENNA,
TRANSMITTING, FM

LITTEN EDUCATIONAL TELEVISION

ANTENNAS, MICROWAVE
ANTENNAS, 2500 MHZ
MICROWAVE COMPONENTS
MICROWAVE SYSTEMS, STL
MICROWAVE SYSTEMS, 2500 MHZ
TRANSLATOR SYSTEMS
TV SYSTEMS, CLOSED CIRCUIT

for TOP PERFORMANCE in FM ANTENNAS

DUAL POLARIZED



DESCRIPTION
Any combination of elements
Any power split from 50-50 to 30-70
Can be mounted, interlace,
stacked or back to back
Mounting hardware furnished for
your tower.

DIRECTIONALIZED

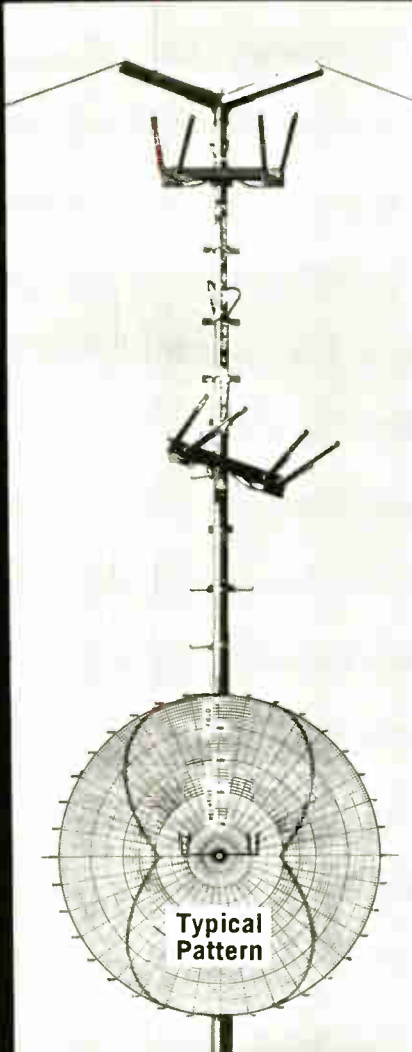

DESCRIPTION
Phased directional (shown)
Parasitic Directional
Can be made for pole or tower
mount.
Complete filing information
furnished along with
certified pattern

HORIZONTAL

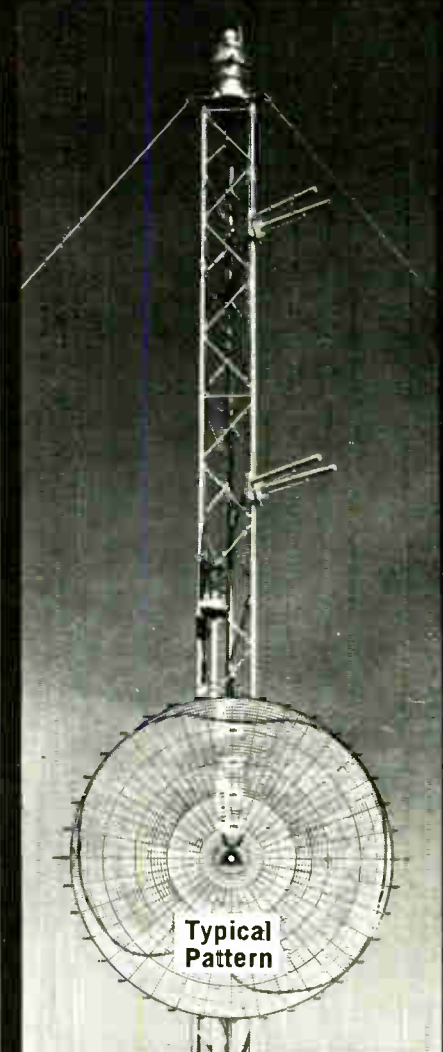

DESCRIPTION
Basic Jampro design with
in phase signal over full
modulation swing by use of
power divider feed system.
Input power up to 50 kw
Complete with
all hardware

J A M P R O

- TV Antennas
- Coax Switches
- Notch Diplexers
- FM Antennas
- Harmonic Filters
- ETV Antennas

**ANTENNA
COMPANY**
6939 POWER INN ROAD

COMPANY
SACRAMENTO CALIFORNIA

PHONE
AREA CODE 916
422-1177

LOW POWER BROADCAST EQUIP CO

CARRIER-CURRENT EQUIPMENT
TRANSMITTERS, AM, LOW POWER

MACARTA INC

AUTOMATION EQUIPMENT
CARTRIDGES, MAGNETIC TAPE
RECORDERS, MAGNETIC TAPE,
AUDIO
TAPE, MAGNETIC RECORDING,
AUDIO

THE MACHLETT LABORATORIES

VACUUM TUBES, TRANSMITTING

MACKENZIE LABORATORIES

AUTOMATION EQUIPMENT
CARTRIDGES, MAGNETIC TAPE
RECORDERS, MAGNETIC TAPE,
AUDIO
RECORDERS, MAGNETIC TAPE,
AUDIO, CARTRIDGE
TAPE DECKS, MAGNETIC

MAGNA-TECH CORPORATION

HEADS, ERASE, MAGNETIC
HEADS, RECORDING, MAGNETIC
RECORDERS, MAGNETIC TAPE,
AUDIO
TAPE DECKS, MAGNETIC
TAPE DUPLICATORS

MAGNECOR

AMPLIFIER, AF, MONAURAL
AMPLIFIER, AF, STEREO
RECORDERS, MAGNETIC TAPE,
AUDIO
RECORDERS, MAGNETIC TAPE,
LOGGING
REELS, TAPE
TAPE DECKS, MAGNETIC
TAPE DUPLICATORS

MAGNETIC MEDIA CORPORATION

CARTRIDGES, MAGNETIC TAPE
TAPE, MAGNETIC RECORDING,
AUDIO
TAPE, MAGNETIC RECORDING,
COMPUTER
TAPE, MAGNETIC RECORDING,
VIDEO

MAGNE-TRONICS, INC.

BACKGROUND MUSIC SERVICE

MALLORY DISTRIBUTOR PRODUCTS

ALARM, FAULT
ATTENUATORS, AUDIO
CAPACITORS, FIXED, CERAMIC
CAPACITORS, FIXED,
ELECTROLYTIC
CAPACITORS, FIXED, FILM
CAPACITORS, FIXED, OTHER
CIRCUIT BREAKERS
DIALS, INSTRUMENT
JACKS
KNOBS
PLUGS, PHONE
RESISTORS, FIXED, PRECISION
RESISTORS, FIXED, WIREWOUND
RESISTORS, VARIABLE, CARBON
RESISTORS, VARIABLE,
WIREWOUND
RHEOSTATS
SEMICONDUCTOR RECTIFIERS,
GENERAL
SEMICONDUCTOR RECTIFIERS,
POWER
SWITCHES, LEVER
SWITCHES, PUSHBUTTON,
NONILLUMINATED
SWITCHES, ROTARY
TESTERS, BATTERY
TIMERS, ELECTRIC

MARANTZ COMPANY

AMPLIFIER, AF,
GENERAL PURPOSE
AMPLIFIER, AF, MONAURAL
AMPLIFIER, AF, STEREO
CABINETS, WOOD
PREAMPLIFIERS, AUDIO
RECEIVERS, FM
RECEIVERS, MULTIPLEX
TURNTABLES, PHONOGRAPH

MARATHON PRODUCTS CORP.

CARTRIDGES, MAGNETIC TAPE
CARTRIDGES, TAPE,
RECORDING SERVICE

MARCONI DIVISION

AMPLIFIER, DISTRIBUTION
AMPLIFIER, PULSE
AMPLIFIER, STABILIZING
AMPLIFIER, TV, VIDEO
ANTENNAS, TV
CAMERAS, TV, COLOR
CAMERAS, TV, MONOCHROME
DISPLAY EQUIPMENT, TV
EMANCERS, TV IMAGE
EXCITERS, FM
GENERATORS, SIGNAL, COLOR BAR
GENERATORS, SIGNAL, DOT BAR
GENERATORS, SIGNAL,
TV SYNCHRONIZING
INDUSTRIAL TV
MODULATORS, TV
MONITORS, VIDEO
MONITORS, WAVEFORM
PROJECTORS, FILM
RECEIVERS, HF
TRANSMITTERS, AM, 1 KW
TRANSMITTERS, AM, 10 KW
TRANSMITTERS, AM, 50 KW

TRANSMITTERS, AM, OVER 50 KW
TRANSMITTERS, FM, 1 KW
TRANSMITTERS, FM, 5 KW
TRANSMITTERS, TV, 1 KW
TRANSMITTERS, TV, 5 KW
TRANSMITTERS, TV, 10 KW
TRANSMITTERS, TV, 25 KW
TV SYSTEMS, CLOSED CIRCUIT

MARCONI INSTRUMENTS

ANALYZERS, DISTORTION
ANALYZERS, HARMONIC
ATTENUATORS, RF
BRIDGES
CALORIMETERS
GENERATORS, FM, STEREO
GENERATORS, SIGNAL, AF
GENERATORS, SIGNAL, RF
METERS, POWER
OSCILLATORS, AF AND RF,
SEE GENERATORS
OSCILLATORS, AM
OSCILLATORS, FM
OSCILLATORS, OTHER
RECEIVERS, AM
RECEIVERS, FM
RECEIVERS, HF

MARTI ELECTRONICS

AMPLIFIER, AF, AGC
AMPLIFIER, AF, COMPRESSING
AMPLIFIER, AF,
GENERAL PURPOSE
ANTENNAS, FM
ANTENNAS, MOBILE
BASE STATIONS
COMMUNICATIONS SYSTEMS,
LAND MOBILE
COMMUNICATIONS SYSTEMS,
MICROWAVE
EXCITERS, FM
GENERATORS, FM, SUBCARRIER
MICROWAVE SYSTEMS, STL
MOBILE EQUIPMENT
NARROW-BAND FM EQUIPMENT
PREAMPLIFIERS, AUDIO
RECEIVERS, FM
RECEIVERS, SCA
REMOTE CONTROL SYSTEMS
STL EQUIPMENT
TRANSMITTERS, FM, 10 WATTS
TRANSMITTERS, FM, 100 WATTS

MARYLAND TELECOMMUNICATIONS

CAMERAS, TV, MONOCHROME
CONSOLE, AUDIO, TV
CONSOLE, VIDEO, STUDIO
DISPLAY EQUIPMENT, TV
GENERATORS, SIGNAL,
TV SYNCHRONIZING
INDUSTRIAL TV
MONITORS, VIDEO
TV SYSTEMS, CLOSED CIRCUIT

MASTER TOWER CO

REFLECTORS, PASSIVE
TOWERS, ANTENNA,
CATV, HEAD-END
TOWERS, ANTENNA, RECEIVING
TOWERS, ANTENNA,
TRANSMITTING, AM
TOWERS, ANTENNA,
TRANSMITTING, FM
TOWERS, ANTENNA,
TRANSMITTING, TV

J. G. MCALISTER

LAMPS, PANEL
LIGHTING, TV, COMPONENTS
LIGHTING, TV, SYSTEMS

THE MCINTIRE COMPANY

PRESSURIZATION EQUIPMENT,
TRANSMISSION LINE

MCMARTIN INDUSTRIES

ADAPTERS, FM STEREO
AMPLIFIER, AF,
GENERAL PURPOSE
AMPLIFIER, AF, MONAURAL
AMPLIFIER, DISTRIBUTION
AMPLIFIER, RF,
GENERAL PURPOSE
AMPLIFIER, RF, PEAK LIMITING
AMPLIFIER, RF, POWER
ANTENNAS, FM
BACKGROUND MUSIC SERVICE
CABINETS, METAL
COMMUNICATIONS SYSTEMS,
INTERCOM, WIRE
COMMUNICATIONS SYSTEMS,
MULTIPLEX
HARDWARE, RACK
METERS, DB AND VU
METERS, FIELD STRENGTH
METERS, FREQUENCY
METERS - SEE SPECIFIC TYPES
MICROPHONES, DYNAMIC
MONITORS, FM SYSTEMS, MONO
MONITORS, FM SYSTEMS, SCA
MONITORS, FM SYSTEMS, STEREO
MONITORS, FREQUENCY
PREAMPLIFIERS, AUDIO
RECEIVERS, FM
RECEIVERS, MULTIPLEX
RECEIVERS, SCA
SOUND SYSTEMS, OUTDOOR
SOUND SYSTEMS, PORTABLE
SOUND SYSTEMS, THEATER
SPEAKERS
STL EQUIPMENT

MELCOR ELECTRONICS

AMPLIFIER, AF, AGC
AMPLIFIER, AF, COMPRESSING

AMPLIFIER, AF,
GENERAL PURPOSE
AMPLIFIER, AF, MONAURAL
AMPLIFIER, AF, STEREO
AMPLIFIER, DC
AMPLIFIER, DISTRIBUTION
EQUALIZERS, AUDIO EMPHASIS
MONITORS, AM SYSTEMS
MONITORS, FM SYSTEMS, MONO
MONITORS, FM SYSTEMS, STEREO
POWER SUPPLIES, DC
PREAMPLIFIERS, AUDIO

MEMOREX CORPORATION

TAPE, MAGNETIC RECORDING,
COMPUTER
TAPE, MAGNETIC RECORDING,
VIDEO

METROPOLITAN ELECTRIC MFG. CO.

CABINETS, METAL
LIGHTING, TV, COMPONENTS
LIGHTING, TV, CONTROLS
LIGHTING, TV, SYSTEMS
SWITCHES, KNIFE

METROTECH INCORPORATED

RECORDERS, MAGNETIC TAPE,
AUDIO
RECORDERS, MAGNETIC TAPE,
LOGGING

MICOM, INC.

METERS, FLUTTER & WOW

MICROFLECT CO., INC.

REFLECTORS, PASSIVE
TOWERS, ANTENNA,
CATV, HEAD-END
TOWERS, ANTENNA, RECEIVING
TOWERS, ANTENNA,
TRANSMITTING, AM
TOWERS, ANTENNA,
TRANSMITTING, FM
TOWERS, ANTENNA,
TRANSMITTING, TV

MICROLAB/EXR

ADAPTERS, TEST
ATTENUATORS, AUDIO
ATTENUATORS, FIXED
ATTENUATORS,
IMPEDANCE MATCHING
ATTENUATORS, MICROWAVE
ATTENUATORS, RF
CAVITIES, MICROWAVE
COMMUNICATIONS SYSTEMS,
MICROWAVE
COUPLERS
DETECTORS, MICROWAVE
DETECTORS, STANDING WAVE
DIPLEXERS
DIVIDERS, POWER
DUMMY LOAD
FILTERS, RF
HOLDERS, CRYSTAL
METERS, FREQUENCY
METERS, FREQUENCY CALIBRATING
MICROWAVE COMPONENTS
MICROWAVE SYSTEMS, STL
MICROWAVE SYSTEMS, 2500 MHZ
MICROWAVE SYSTEMS, OTHER
MIXERS - ALSO SEE CONSOLES
MONITORS, FREQUENCY
MONITORS, PHASE
OSCILLATORS, AF AND RF,
SEE GENERATORS
SEMICONDUCTOR DIODES
SLOTTED SECTIONS
SWITCHES, COAXIAL
SWITCHES, WAVEGUIDE
TRANSFORMERS, RF
WAVEGUIDE AND
ASSOCIATED COMPONENTS

MICRO-LINK SYSTEMS

ANTENNAS, MICROWAVE
CAVITIES, MICROWAVE
CHOKES, WAVEGUIDE
COMMUNICATIONS SYSTEMS,
MICROWAVE
DETECTORS, MICROWAVE
DETECTORS, STANDING WAVE
DISPLAY EQUIPMENT, TV
JOINTS, ROTARY, COAXIAL
JOINTS, ROTARY, WAVEGUIDE
MICROWAVE COMPONENTS
MICROWAVE SYSTEMS, STL
MICROWAVE SYSTEMS, 2500 MHZ
MICROWAVE SYSTEMS, OTHER
SLOTTED SECTIONS
STL EQUIPMENT
TV SYSTEMS, CLOSED CIRCUIT
WAVEGUIDE AND
ASSOCIATED COMPONENTS

MICROMEGA

AMPLIFIER, CATV
AMPLIFIER, RF,
GENERAL PURPOSE

MICRO RECORD CORP.

PROCESSORS, FILM, B-W
PROCESSORS, FILM, COLOR

MICROWAVE ASSOCIATES, INC.

ADAPTERS, CONNECTOR
AMPLIFIER, PULSE
AMPLIFIER, RF, PEAK LIMITING
AMPLIFIER, RF, POWER
AMPLIFIER, TV, BOOSTER
ATTENUATORS, FIXED
ATTENUATORS,
IMPEDANCE MATCHING
ATTENUATORS, MICROWAVE
ATTENUATORS, RF

CAVITIES, MICROWAVE
CHOKES, WAVEGUIDE
COMMUNICATIONS SYSTEMS,
MICROWAVE
CONNECTORS, RF
CONVERTERS
COUPLERS
DELAY LINES
DETECTORS, MICROWAVE
DIPLEXERS
DIVIDERS, FREQUENCY
FILTERS, RF
GENERATORS, SIGNAL, RF
HOLDERS, CRYSTAL
INTEGRATED CIRCUITS,
MICROWAVE
JOINTS, ROTARY, WAVEGUIDE
MICROWAVE COMPONENTS
MICROWAVE SYSTEMS, STL
MICROWAVE SYSTEMS, OTHER
MOBILE EQUIPMENT
PREAMPLIFIERS, AUDIO
RACKS, MOUNTING
SEMICONDUCTOR DIODES
SWITCHES, PHASE, MICROWAVE
SWITCHES, COAXIAL
SWITCHES, WAVEGUIDE
TRANSMISSION LINES
VACUUM TUBES, RECEIVING
VACUUM TUBES, TRANSMITTING
WAVEGUIDE AND
ASSOCIATED COMPONENTS

MID AMERICA ELECTRONICS CORP

AMPLIFIER, AF,
GENERAL PURPOSE
AUTOMATION EQUIPMENT
CONSOLE, AUDIO, AM
CONSOLE, AUDIO, FM
CONSOLE, AUDIO, PORTABLE
CONSOLE, AUDIO, RECORDING
CONSOLE, AUDIO, TV
CONSOLE, VIDEO, STUDIO
SOUND SYSTEMS, THEATER

MILES REPRODUCER CO

AMPLIFIER, DC
AMPLIFIER, RF, POWER
CARTRIDGES, MAGNETIC TAPE
COMMUNICATIONS SYSTEMS, CB
COMMUNICATIONS SYSTEMS,
INTERCOM, WIRE
COMMUNICATIONS SYSTEMS,
INTERCOM, WIRELESS
COMMUNICATIONS SYSTEMS,
LAND MOBILE
EQUALIZERS, AUDIO EMPHASIS
MICROPHONES, DYNAMIC
MICROPHONES, WIRELESS
PREAMPLIFIERS, AUDIO
RECEIVERS, FM
RECORDERS, DISC, MAGNETIC
RECORDERS, MAGNETIC TAPE,
AUDIO
RECORDERS, MAGNETIC TAPE,
LOGGING
TRANSFORMERS, AUDIO,
POWER OUTPUT
TRANSMITTER KITS
TRANSMITTERS, FM,
UP TO 1 WATT

J. W. MILLER COMPANY

INDUCTANCES, FIXED
INDUCTANCES, VARIABLE
TRANSFORMERS, RF

D. B. MILLIKEN COMPANY

CAMERAS, FILM, CINE
CAMERAS, OSCILLOSCOPE

MINNEAPOLIS MAGNETICS

HEADS, ERASE, MAGNETIC
HEADS, RECORDING, MAGNETIC
TAPE, MAGNETIC RECORDING,
TEST

MINNESOTA MINING & MFG. CO.

ALARM, SIGNAL
BACKGROUND MUSIC SERVICE
CABINETS, STORAGE, FILM
CABINETS, STORAGE,
MAGNETIC TAPE
CAMERAS, FILM, CINE
CAMERAS, FILM, STILL
CAPACITORS, FIXED, CERAMIC
CAPACITORS, FIXED, MICA
CARTRIDGES, MAGNETIC TAPE
COMPUTER EQUIPMENT
CONVERTERS
COPYING EQUIPMENT
CRYSTALS, PIEZOELECTRIC
OECALOMANIAS
DROPOUT COMPENSATOR,
VIDEOTAPE
EDITORS, FILM
FILM, PHOTOGRAPHIC
FRAMES, MOUNTING
HARDWARE, TUBING, PLASTIC
HEADS, RECORDING, MAGNETIC
LENSES, OPTICAL, FIXED
LENSES, OPTICAL, ZOOM
MOUNTS, VIBRATION AND SHOCK
NAMEPLATES
PAPER, CHART AND GRAPH
RECORDERS, FILM, LIGHT
RECORDERS, FILM, MAGNETIC
RECORDERS, MAGNETIC TAPE,
AUDIO
RECORDERS, MAGNETIC TAPE,
LOGGING
RECORDERS, MAGNETIC TAPE,
VIDEO
REELS, TAPE
SLICERS, MAGNETIC TAPE
AND FILM

Renting Your Program Lines . . . ?

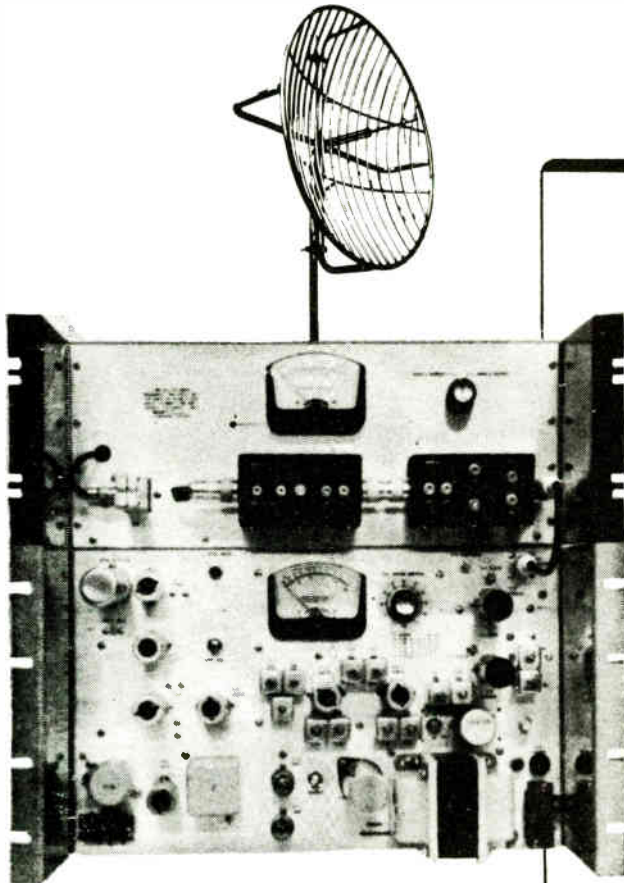

STUDIO-TRANSMITTER LINK
& INTER CITY RELAY 950 MHz

Marti STL and RPU equipment is specifically designed, engineered, and manufactured to provide two basic advantages for you, the Broadcaster First, the equipment is unique because it reduces your monthly line charges while increasing the revenue derived from greater flexibility in your remote programming. Secondly, it provides program quality and reliability at least equal to, and usually better than, its land counterpart.

The wide and varied uses of this STL and RPU equipment, adds up to one big advantage at the end of your fiscal year—**MORE NET PROFIT!** Write us for more profitable information concerning this equipment.

MARTI
NOT *Only*
MANUFACTURES
STL's & RPU's

*We
Perfect
them..!*



RADIO REMOTE PICK-UP
26-150-450 MHz

**MARTI HAS ALSO
PERFECTED THESE
ACCESSORIES . . .**



- Radio Remote Control Systems
- Telemetry Systems
- Sub-Carrier Generator & Receiver
- RPU & STL Antennas
- Automatic Relay Systems
- Communication Transmitters & Receivers
- FM Rebroadcast Receivers
- Transmission Line & Fittings
- Microphones
- Transcription Arms & Stylus
- Turntable & Microphone Preamps

MANUFACTURED BY A BROADCASTER FOR THE BROADCASTER

MARTI *Electronics* / P. O. BOX 661 • 817 MI 5-4091
World Radio History CLEBURNE, TEXAS 76031

TAPE DECKS, MAGNETIC
TAPE DUPLICATORS
TAPE, MAGNETIC RECORDING,
AUDIO
TAPE, MAGNETIC RECORDING,
AUDIO, CARTRIDGE
TAPE, MAGNETIC RECORDING,
COMPUTER
TAPE, MAGNETIC RECORDING,
TEST
TAPE, MAGNETIC RECORDING,
VIDEO
TAPE, RECORDING, GRAPHIC
TOOLS, CRIMPERS

MIRATEL ELECTRONICS, INC.
DISPLAY EQUIPMENT, TV
INDUSTRIAL TV
MONITORS, VIDEO
TV SYSTEMS, CLOSED CIRCUIT

MOLE-RICHARDSON CO.
LAMPS, ARC
LAMPS, GLOW
LAMPS, PANEL
LAMPS, PROJECTION
LIGHTING, TV, COMPONENTS
LIGHTING, TV, CONTROLS
LIGHTING, TV, SYSTEMS
LIGHTNING ARRESTERS
MICROPHONE STANDS & BOOMS
RELAYS, TIME DELAY

MOSELEY ASSOCIATES INC.
ALARM, FAULT
AMPLIFIER, DC
COMMUNICATIONS SYSTEMS, CB
COMMUNICATIONS SYSTEMS,
LAND MOBILE
COMMUNICATIONS SYSTEMS,
MICROWAVE
COMMUNICATIONS SYSTEMS,
MULTIPLY
EXCITERS, FM
GENERATORS, FM, STEREO
GENERATORS, FM, SUBCARRIER
MICROWAVE SYSTEMS, STL
MOBILE EQUIPMENT
NARROW-BAND FM EQUIPMENT
REMOTE CONTROL SYSTEMS
STL EQUIPMENT
TRANSMITTERS, FM, 10 WATTS

DONALD P. MOSSMAN, INC.
SWITCHES, ILLUMINATED
SWITCHES, INTERLOCK
SWITCHES, LEVER
SWITCHES, MULTICONTACT
SWITCHES, PUSHBUTTON,
NONILLUMINATED
SWITCHES, TELEPHONE TYPE

MOTOROLA COMMUNICATIONS
ANTENNAS, MICROWAVE
ANTENNAS, MOBILE
BACKGROUND MUSIC SERVICE
CAMERA, MOUNTING EQUIPMENT
CAMERA, REMOTE
CONTROL EQUIPMENT
CAMERAS, TV, MONOCHROME
VOLTMETERS, AC
VOLTMETERS, DC
WATTMETERS

MOTOROLA SEMICONDUCTOR PRODUCTS, INC.
INTEGRATED CIRCUITS
MICROWAVE COMPONENTS
RECTIFIERS - ALSO
SEE SEMICONDUCTORS
SEMICONDUCTOR DIODES
SEMICONDUCTOR RECTIFIERS,
GENERAL
SEMICONDUCTOR RECTIFIERS,
HIGH VOLTAGE
SEMICONDUCTOR RECTIFIERS,
POWER
SEMICONDUCTOR RECTIFIERS,
SILICON CONTROLLED - SCR
SEMICONDUCTORS, THYRISTORS
SEMICONDUCTORS,
TRANSISTORS, AF
SEMICONDUCTORS,
TRANSISTORS, FE
SEMICONDUCTORS, TRANSISTORS,
GENERAL
SEMICONDUCTORS,
TRANSISTORS, RF

MULTRONICS, INC.
AMPLIFIER, AF,
GENERAL PURPOSE
AMPLIFIER, RF,
GENERAL PURPOSE
AMPLIFIER, RF, POWER
ANTENNAS, LF
ANTENNAS, MF
COILS, ANTENNA LOADING
COMMUNICATIONS SYSTEMS,
LAND MOBILE
COUPLERS
INDUCTANCES, FIXED
INDUCTANCES, VARIABLE
MONITORS, PHASE
NETWORKS, PHASING
SWITCHING MATRIXES

MVR CORPORATION
RECORDERS, DISC, MAGNETIC
RECORDERS, MAGNETIC TAPE,
VIDEO
TV SYSTEMS, CLOSED CIRCUIT

MARDA MICROWAVE
ANTENNAS, MICROWAVE
ANTENNAS, 2500 MHZ

ATTENUATORS, FIXED
ATTENUATORS,
IMPEDANCE MATCHING
ATTENUATORS, MICROWAVE
ATTENUATORS, RF
ATTENUATORS, VIDEO
CALORIMETERS
CAVITIES, MICROWAVE
CHOKES, WAVEGUIDE
CONNECTORS, COAXIAL CABLE
CONNECTORS, RF
COUPLERS
DETECTORS, MICROWAVE
DETECTORS, STANDING WAVE
DIVIDERS, POWER
FILTERS, RF
GENERATORS, SIGNAL, PULSE
GENERATORS, SIGNAL, RF
METERS, FREQUENCY
METERS, FREQUENCY CALIBRATING
METERS, POWER
METERS, STANDING WAVE
MICROWAVE COMPONENTS
MICROWAVE SYSTEMS, OTHER
NETWORKS, MATCHING, RF
OSCILLATORS, AF AND RF,
SEE GENERATORS
OSCILLATORS, OTHER
RECEIVERS, MF
SHIFTERS, PHASE, MICROWAVE
SLOTTED SECTIONS
SWITCHES, COAXIAL
TRANSMISSION LINES
TRANSMISSION TEST SETS

NESCO INSTRUMENTS DIVISION
RECORDERS, PAPER,
LOGGING AND GRAPHIC

NEUMADE PRODUCTS
CABINETS, METAL
CABINETS, STORAGE, DISC
CABINETS, STORAGE, FILM
CABINETS, STORAGE,
MAGNETIC TAPE
CLEANERS, OTHER
EDITORS, FILM
FILM, PHOTOGRAPHIC
RACKS, MOUNTING
REELS, FILM
REWINDERS, FILM
RHEOSTATS
SOLVENTS AND CLEANERS
SPLICERS, MAGNETIC TAPE
AND FILM

NORTHEAST ELECTRONICS
ANALYZERS, DISTORTION
ANALYZERS, NOISE
GENERATORS, SIGNAL, AF
METERS, DB AND VU

NORTH AMERICAN PHILIPS COMPANY
AMPLIFIER, AF,
GENERAL PURPOSE
AMPLIFIER, AF, REVERBERATION
AMPLIFIER, DISTRIBUTION
CAMERAS, FILM, CINE
CAMERAS, FILM, STILL
CAMERAS, TV, COLOR
CAMERAS, TV, MONOCHROME
CONSOLE, AUDIO, PORTABLE
CONSOLE, AUDIO, RECORDING
EARPHONES, HEADPHONES
EDUCATION FACILITIES,
PUBLISHERS
EDUCATION FACILITIES, EQPT
ENCLOSURES, SPEAKER
MICROPHONE HARDWARE
MICROPHONE STANDS & BOOMS
MICROPHONES, CONDENSER
MICROPHONES, DYNAMIC
MIXERS - ALSO SEE CONSOLES
PREAMPLIFIERS, AUDIO
RECEIVERS, AM
RECEIVERS, FM
RECORDERS, MAGNETIC TAPE,
AUDIO
RECORDERS, MAGNETIC TAPE,
VIDEO
SOUND SYSTEMS, OUTDOOR
SOUND SYSTEMS, PORTABLE
SOUND SYSTEMS, THEATER
SPEAKER COMPONENTS
SPEAKERS
VACUUM TUBES, CAMERA,
PLUMBICON R
VACUUM TUBES, CAMERA, VIDICON

NORTRONICS COMPANY, INC.
HEADS, ERASE, MAGNETIC
HEADS, RECORDING, MAGNETIC
TAPE, MAGNETIC RECORDING,
TEST

THE NOVA CORPORATION
CAPACITORS, FIXED, FILM
CAPACITORS, FIXED, METALLIZED
COMMUNICATIONS SYSTEMS, CB
COMMUNICATIONS SYSTEMS,
LAND MOBILE
MOBILE EQUIPMENT

OKA MANUFACTURING CO.
CHOPPERS
SWITCHES, ILLUMINATED
SWITCHES, INTERLOCK
SWITCHES, LEVER
SWITCHES, MECHANICALLY
ACTUATED
SWITCHES, MULTICONTACT
SWITCHES, PUSHBUTTON,
NONILLUMINATED
SWITCHES, ROTARY
SWITCHES, SLIDE
SWITCHES, SNAP

OKAKRON INDUSTRIES
SPEAKERS

OHMITE MANUFACTURING COMPANY
ATTENUATORS,
IMPEDANCE MATCHING
BOXES, DECADE, RESISTOR
CAPACITORS, FIXED,
ELECTROLYTIC
KNOBS
POTENTIOMETERS, CARBON
POTENTIOMETERS, WIREWOUND
RELAYS, GENERAL PURPOSE
RELAYS, LATCHING
RELAYS, LIGHT-INDICATING
RELAYS, OVERLOAD
RELAYS, POWER
RELAYS, TIME DELAY
RESISTORS, FIXED, CARBON
RESISTORS, FIXED,
NONINDUCTIVE
RESISTORS, FIXED, PRECISION
RESISTORS, FIXED, WIREWOUND
RESISTORS, FIXED, OTHER
RESISTORS, VARIABLE, CARBON
RESISTORS, VARIABLE,
WIREWOUND
RHEOSTATS
SEMICONDUCTOR DIODES
SWITCHES, MECHANICALLY
ACTUATED
SWITCHES, ROTARY
TRANSFORMERS, VARIABLE

GUNNAR A. OLSEN CORP.
TOWERS, ANTENNA,
TRANSMITTING, AM
TOWERS, ANTENNA,
TRANSMITTING, FM
TOWERS, ANTENNA,
TRANSMITTING, TV

OMAN DIVISION
CHARGERS, BATTERY
GENERATORS, POWER,
GASOLINE ENGINE

ORBIT RADIO
AMPLIFIER, AF, COMPRESSING
AMPLIFIER, AF,
GENERAL PURPOSE
AMPLIFIER, AF, MONAURAL
AMPLIFIER, AF, REMOTE
AMPLIFIER, AF, REVERBERATION
AMPLIFIER, AF, STEREO
AMPLIFIER, BRIDGING
AMPLIFIER, DISTRIBUTION
AUTOMATION EQUIPMENT
BACKGROUND MUSIC SERVICE
BROADCAST PROGRAMMING SERVICE
CARRIER-CURRENT EQUIPMENT
CARTRIDGES, TAPE,
RECORDING SERVICE
CONSOLE, AUDIO, FM
CONSOLE, AUDIO, PORTABLE
CONSOLE, AUDIO, RECORDING
CONSOLE, AUDIO, TV
CONSOLE, AUDIO, AM
EDITORS, AUDIO TAPE
FILTERS, AUDIO
MAINTENANCE SERVICES, AM
MAINTENANCE SERVICES, FM
MIXERS - ALSO SEE CONSOLES
PREAMPLIFIERS, AUDIO
REMOTE CONTROL SYSTEMS
REVERBERATION DEVICES
SOUND SYSTEMS, PORTABLE
TAPE, MAGNETIC RECORDING,
TEST

PACIFIC TOWER CO.
ANTENNAS, TV
LIGHTING, TV, COMPONENTS
LIGHTING, TV, SYSTEMS
TOWERS, ANTENNA,
CATV, HEAD-END
TOWERS, ANTENNA, RECEIVING
TOWERS, ANTENNA,
TRANSMITTING, AM
TOWERS, ANTENNA,
TRANSMITTING, FM
TOWERS, ANTENNA,
TRANSMITTING, TV
WIRE, BARE, COPPER

PAINTON INCORPORATED

ATTENUATORS, AUDIO
ATTENUATORS, FIXED
ATTENUATORS,
IMPEDANCE MATCHING
ATTENUATORS, RF
ATTENUATORS, VIDEO
CHOKES, WAVEGUIDE
KNOBS
POTENTIOMETERS, WIREWOUND
RESISTORS, FIXED, CARBON
RESISTORS, FIXED, PRECISION
RESISTORS, FIXED, WIREWOUND
RESISTORS, FIXED, OTHER
RESISTORS, VARIABLE,
WIREWOUND
SWITCHES, MULTICONTACT
SWITCHES, PUSHBUTTON,
NONILLUMINATED
SWITCHES, ROTARY
SWITCHES, TOGGLE

PALL TRINITY MICRO CORP.
DEHUMIDIFIERS
DESICCANTS
FILTERS, OTHER
WIRING AND CABLING SERVICES

PERMOFLUX CORPORATION
AMPLIFIER, AF,
GENERAL PURPOSE

AMPLIFIER, AF, MONAURAL
AMPLIFIER, AF, REMOTE
AMPLIFIER, AF, STEREO
COILS, CHOKE, AF
EARPHONES, HEADPHONES
MICROPHONES, DYNAMIC
PREAMPLIFIERS, AUDIO
SPEAKER COMPONENTS
SPEAKERS
TRANSFORMERS, AUDIO,
ISOLATION
TRANSFORMERS, AUDIO, MATCHING
TRANSFORMERS, AUDIO,
POWER OUTPUT
TRANSFORMERS, AUTO
TRANSFORMERS, COUPLING
TRANSFORMERS, FILAMENT
TRANSFORMERS, GENERAL
TRANSFORMERS, PLATE
TRANSFORMERS, POWER

HELPS DODGE
CABLE, ARMORED
CABLE, ASSEMBLIES
CABLE, CATV, HARDWARE
CABLE, COAXIAL, FLEXIBLE
CABLE, COAXIAL, RIGID
CABLE, DIRECT-BURIAL
CONNECTORS, ANTENNA
CONNECTORS, COAXIAL CABLE
CONNECTORS, RF
DELAY LINES
DIPLXERS
JACK PANEL ASSEMBLIES
JACKS
MICROWAVE COMPONENTS
PLUGS, COAXIAL
SLOTTED SECTIONS
TERMINALS, HIGH VOLTAGE
TRANSMISSION LINES
TRANSMISSION TEST SETS
ASSOCIATED COMPONENTS
WAVEGUIDE AND

PIEZO CRYSTAL CO.
CRYSTALS, PIEZOELECTRIC
FILTERS, OTHER

H. K. PORTER INC.
HARDWARE, TOOLS
TOOLS, CRIMPERS
TOOLS, CUTTERS
TOOLS, HAND

POWER-OPTICS INCORPORATED
CAMERA, MOUNTING EQUIPMENT
CAMERA, REMOTE
CONTROL EQUIPMENT
INDUSTRIAL TV
LENSES, OPTICAL, FIXED
LENSES, OPTICAL, ZOOM

POWER SOURCES
INVERTERS, DC TO AC,
SOLID STATE
POWER SUPPLIES, AC
POWER SUPPLIES, DC

PRECISION LABORATORIES
CAMERAS, FILM, CINE
CAMERAS, FILM, STILL
EDITORS, FILM
EDITORS, VIDEO TAPE
HEADS, RECORDING, MAGNETIC
PROJECTORS, FILM
PROJECTORS, SLIDE
SPLICERS, MAGNETIC TAPE
AND FILM

PRECISION PIEZO SERVICE
CRYSTALS, PIEZOELECTRIC

PRODELIN, INCORPORATED
ADAPTERS, CONNECTOR
ANTENNAS, MICROWAVE
ANTENNAS, MOBILE
ANTENNAS, 2500 MHZ
ATTENUATORS, MICROWAVE
ATTENUATORS, RF
CABLE, CATV, HARDWARE
CABLE, COAXIAL, FLEXIBLE
CABLE, COAXIAL, RIGID
COILS, ANTENNA LOADING
COMMUNICATIONS SYSTEMS, CB
COMMUNICATIONS SYSTEMS,
LAND MOBILE
COMMUNICATIONS SYSTEMS,
MICROWAVE
CONNECTORS, ANTENNA
CONNECTORS, COAXIAL CABLE
CONNECTORS, RF
DIPLXERS
DIVIDERS, POWER
DUMMY LOAD
FILTERS, ANTENNA
FILTERS, RF
MICROWAVE COMPONENTS
MICROWAVE SYSTEMS, STL
MICROWAVE SYSTEMS, 2500 MHZ
MOUNTS, ANTENNA, FIXED
MOUNTS, ANTENNA, MOBILE
RADOMES
SHIFTERS, PHASE, MICROWAVE
SLOTTED SECTIONS
SWITCHES, COAXIAL

PRO-TEX REEL BAND COMPANY
LEADER, FILM

PRUZAN COMPANY
CATV, HARDWARE
POLE CLIMBING EQUIPMENT
SAFETY DEVICES, CLIMBING

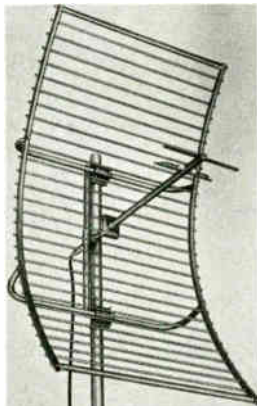
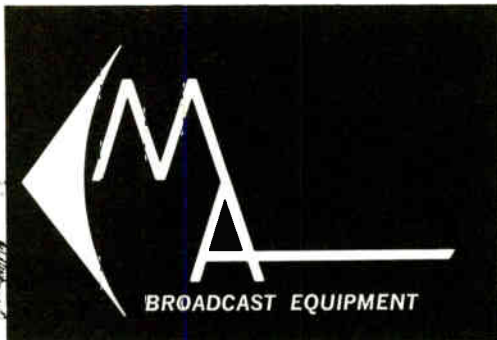

Scala PR-450 Antenna

AURAL STUDIO-TRANSMITTER LINKS

FOR FM - AM - TV - INTERCITY RELAY

Six years of continuous operation in broadcast service and 150 units in the field have established the Moseley STL as the accepted industry standard.

Model PCL-2B Low distortion, wide frequency response, and exceptionally good transient response. Designed for continuous duty, the PCL-2B is rated at 8 watts maximum output. For FM stereo use DUAL MODEL PCL-2B, a concept pioneered by Moseley Associates, Inc.

SOLID-STATE REMOTE CONTROL SYSTEMS

RADIO and WIRE

Model PBR-21 All transistorized 21 channel deluxe control system can be operated over single wire line or radio circuit. DC line continuity not required. A complete line of control subcarrier generators and detectors is available to adapt the PBR-21 to STL systems for radio control. All FM radio remote control systems compatible with stereophonic and SCA program operation. (Write for Technical Bulletin 213). PBR-21 Studio Control Unit illustrated at right.

Model WRC-10T Designed to operate over a SINGLE DC wire pair, this 10 channel all solid-state control system is dependable, accurate, and economical. 4" rectangular meter provided for easy readout.

Model SCS-1 Status/Control System Employing plug-in modules, this solid-state 8 channel system can be used as status indicator, fault reporting, or one-way control system. Will operate over single telephone line or narrow band radio channel.

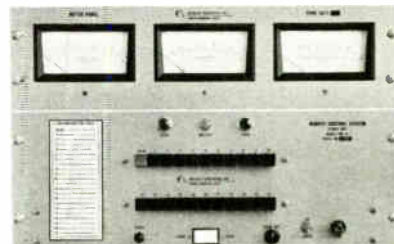

Model PBR-21

FM TRANSMISSION EQUIPMENT

LPE-10 SCG-3 SCG-4T

The Model SCG-4T SCA Subcarrier Generator illustrated is the newest FM product of Moseley Associates. Of all solid-state design, the Model SCG-4T contains a peak reading deviation meter calibrated directly in KHz. Muting circuitry is all electronic (no relays) for maximum reliability.

The Model LPE-10 direct FM 10 watt Exciter is FCC Type Accepted for stereo and SCA service as well as an educational transmitter (LPT-10). It is ideal as replacement exciter when updating old style FM transmitters. Model SCG-3 FM Stereo Generator connects directly into exciter. Wideband input capability of LPE-10 assures maximum transmission linearity of composite stereo waveform from SCG-3.



Model SCG-4T



Model RPL-1T

BROADCAST REMOTE PICKUP SYSTEMS

Model RPL-1 Designed for continuous duty, 30 watt high quality broadcast remote pickup transmitter provides studio sound away from home. Operating in the 148-174 MHz band, the RPL-1 Remote Pickup System has low distortion and wide frequency response, making it an excellent choice for FM stations.

450 MHz Solid-state Remote Pickup System Newly designed, this all solid-state system provides the broadcaster with a modern, high quality remote pickup unit for use on any of the 20 channels in Group N. Only JEDEC-registered silicon semiconductors used.

MOSELEY ASSOCIATES, INC.

135 NOGAL DRIVE, SANTA BARBARA, CALIFORNIA 93105
TELEPHONE 805-967-0424

PULSE TECHNIQUES

EQUALIZERS, AUDIO EMPHASIS

OR K ELECTRONIC PRODUCTS

PREAMPLIFIERS, AUDIO
TURNTABLES, PHONOGRAPH

Q-TV SALES & DISTRIBUTING

DISPLAY EQUIPMENT, TV

JULES RACINE CO., INC.

TIMERS, MANUAL

RADIO AIDS

CALIBRATION SERVICE,
FREQUENCY

RAVEN SCREEN CORPORATION

SCREENS, PROJECTION, FRONT
SCREENS, PROJECTION, REAR

RAYTHEON CO., EQUIPMENT DIV.

AMPLIFIER, CLAMPING
AMPLIFIER, TV, VIDEO
ANTENNAS, MICROWAVE
ANTENNAS, 2500 MHZ
MICROWAVE COMPONENTS
MICROWAVE SYSTEMS, STL
MICROWAVE SYSTEMS, 2500 MHZ
MICROWAVE SYSTEMS, OTHER
MOUNTS, ANTENNA, FIXED
MOUNTS, ANTENNA, MOBILE
RACKS, MOUNTING

RBM CONTROLS

RELAYS, GENERAL PURPOSE
RELAYS, LATCHING
RELAYS, PLUG-IN
RELAYS, POWER
RELAYS, TELEPHONE
RELAYS, TIME DELAY

RCA BROADCAST PRODS.

AMPLIFIER, AF, AGC
AMPLIFIER, AF, COMPRESSING
AMPLIFIER, AF,
GENERAL PURPOSE
AMPLIFIER, AF, MONAURAL
AMPLIFIER, AF,
PEAK LIMITING, AM
AMPLIFIER, AF, REMOTE
AMPLIFIER, AF, STEREO
AMPLIFIER, BRIDGING
AMPLIFIER, DISTRIBUTION
AMPLIFIER, KEYING
AMPLIFIER, MASKING
AMPLIFIER, PULSE
AMPLIFIER, RF,
GENERAL PURPOSE
AMPLIFIER, RF, PEAK LIMITING
AMPLIFIER, RF, POWER
AMPLIFIER, STABILIZING
AMPLIFIER, TV, BOOSTER
AMPLIFIER, TV, VIDEO
AMPLIFIER, VIDEO, SWEEP
ANALYZERS, SIDEBAND
ANTENNAS, AM
ANTENNAS, FM
ANTENNAS, MICROWAVE
ANTENNAS, MOBILE
ANTENNAS, TV
ANTENNAS, 2500 MHZ
ARMS, TONE
ATTENUATORS, FIXED
AUTOMATION EQUIPMENT
BASE STATIONS
BLOWERS AND FANS
CABINETS, METAL
CABINETS, PLASTIC
CABINETS, STORAGE, FILM
CABINETS, STORAGE,
MAGNETIC TAPE
CABLE, COAXIAL, FLEXIBLE
CABLE, COAXIAL, RIGID
CABLE, SHIELDED, AUDIO
CALORIMETERS
CAMERA, MOUNTING EQUIPMENT
CAMERAS, FILM, CINE
CAMERAS, TV, COLOR
CAMERAS, TV, MONOCHROME
CARTRIDGES, MAGNETIC TAPE
CARTRIDGES, PHONO
CLOCKS
COILS, ANTENNA LOADING
COILS, HYBRID
COILS, TELEPHONE
COMMUNICATIONS SYSTEMS,
INTERCOM, WIRED
COMMUNICATIONS SYSTEMS,
LAND MOBILE
COMMUNICATIONS SYSTEMS,
MICROWAVE
COMMUNICATIONS SYSTEMS,
MULTIPLY
CONNECTORS, AF & MICROPHONE
CONNECTORS, COAXIAL CABLE
CONSOLE, AUDIO, AM
CONSOLE, AUDIO, FM
CONSOLE, AUDIO, PORTABLE
CONSOLE, AUDIO, RECORDING
CONSOLE, AUDIO, TV
CONSOLE, CABINETS
AND HARDWARE
CONSOLE, VIDEO, STUDIO
CORS, PATCH
COUPLERS
CRYSTALS, PIEZOELECTRIC
DELAY LINES
DEMAGNETIZERS, BULK TAPE
DEMAGNETIZERS, HEAD
DEMODULATORS
DIPLEXERS
DOLLIES, CAMERA
DOLLIES, TEST EQUIPMENT
DROPOUT COMPENSATOR,
VIDEO TAPE

DUMMY LOAD

EARPHONES, HEADPHONES
EDITORS, FILM
EDITORS, VIDEO TAPE
ENCLOSURES, SPEAKER
EQUALIZERS, AUDIO EMPHASIS
EXCITERS, FM
FILTERS, AUDIO
FILTERS, OTHER
FLASHERS, TOWER
GENERATORS, FM, STEREO
GENERATORS, FM, SUBCARRIER
GENERATORS, SIGNAL, AF
GENERATORS, SIGNAL, COLOR BAR
GENERATORS, SIGNAL, DOT BAR
GENERATORS, SIGNAL,
SPECIAL EFFECT
GENERATORS, SIGNAL,
TV SYNCHRONIZING
HEADS, ERASE, MAGNETIC
HEADS, RECORDING, MAGNETIC
INDUSTRIAL TV
JACK PANEL ASSEMBLIES
LENSES, OPTICAL, FIXED
LENSES, OPTICAL, ZOOM
LIGHTING, TV, COMPONENTS
LIGHTING, TV, CONTROLS
LIGHTING, TV, SYSTEMS
METERS, DB AND VU
METERS, FIELD STRENGTH
METERS, FREQUENCY
MICROPHONE HARDWARE
MICROPHONE STANDS & BOOMS
MICROPHONES, DYNAMIC
MICROPHONES, VELOCITY
MICROWAVE COMPONENTS
MICROWAVE SYSTEMS, STL
MICROWAVE SYSTEMS, 2500 MHZ
MICROWAVE SYSTEMS, OTHER
MIXERS - ALSO SEE CONSOLES
MOBILE EQUIPMENT
MONITORS, AM SYSTEMS
MONITORS, FM SYSTEMS, MONO
MONITORS, FM SYSTEMS, SCA
MONITORS, FM SYSTEMS, STEREO
MONITORS, FREQUENCY
MONITORS, PHASE
MONITORS, VIDEO
MONITORS, WAVEFORM
MOUNTS, ANTENNA, FIXED
MOUNTS, ANTENNA, MOBILE
MULTIPLEXERS
NETWORKS, PHASING
OSCILLATORS, AF AND RF,
SEE GENERATORS
OSCILLOSCOPES
PLUGS, COAXIAL
PLUGS, PHONE
POWER SUPPLIES, DC
PREAMPLIFIERS, AUDIO
PRESSURIZATION EQUIPMENT,
TRANSMISSION LINE
PROCESSORS, FILM, B-W
PROCESSORS, FILM, COLOR
PROJECTORS, FILM
PROJECTORS, SLIDE
RACKS, MOUNTING
RADAR, WEATHER
RECORDERS, MAGNETIC TAPE,
AUDIO
RECORDERS, MAGNETIC TAPE,
AUDIO, CARTRIDGE
RECORDERS, MAGNETIC TAPE,
VIDEO
REFLECTORS, PASSIVE
REWINDERS, FILM
SOUND SYSTEMS, OUTDOOR
SOUND SYSTEMS, PORTABLE
SOUND SYSTEMS, THEATER
SPEAKER COMPONENTS
SPEAKERS
SPLICERS, MAGNETIC TAPE
AND FILM
STL EQUIPMENT
SWITCHERS
SWITCHING SYSTEMS
TAPE DECKS, MAGNETIC
TAPE, MAGNETIC RECORDING,
AUDIO
TAPE, MAGNETIC RECORDING,
VIDEO
TERMINAL BLOCKS
TERMINAL BOARDS
TERMINAL STRIPS
TERMINALS, BARRIER
TOWERS, ANTENNA,
TRANSMITTING, AM
TOWERS, ANTENNA,
TRANSMITTING, FM
TOWERS, ANTENNA,
TRANSMITTING, TV
TRANSFORMERS, AUDIO,
ISOLATION
TRANSFORMERS, AUDIO, MATCHING
TRANSMISSION LINES
TRANSMISSION TEST SETS
TRANSMITTERS, AM, 1 KW
TRANSMITTERS, AM, 5 KW
TRANSMITTERS, AM, 10 KW
TRANSMITTERS, AM, 25 KW
TRANSMITTERS, AM, 50 KW
TRANSMITTERS, FM, 1 KW
TRANSMITTERS, FM, 5 KW
TRANSMITTERS, FM, 11 KW
TRANSMITTERS, FM, 20 KW
TRANSMITTERS, FM, 40 KW
TRANSMITTERS, TV, 2 KW
TRANSMITTERS, TV, 5 KW
TRANSMITTERS, TV, 6 KW
TRANSMITTERS, TV, 11 KW
TRANSMITTERS, TV, 12 KW
TRANSMITTERS, TV, 25 KW
TRANSMITTERS, TV, 30 KW
TRANSMITTERS, TV, 50 KW
TRANSMITTERS, TV, 150 KW
TURNTABLES, PHONOGRAPH

TV SYSTEMS, CLOSED CIRCUIT
WATTMETERS
WAVEGUIDE AND
ASSOCIATED COMPONENTS
WIRE, BARE, COPPER
WIRE, BARE, COPPER STRAP
WIRE, SHIELDED

RCA ELECTRONIC COMPONENTS

BATTERIES, DRY CELL
CAVITIES, MICROWAVE
COMMUNICATIONS SYSTEMS, CB
GENERATORS, FM, STEREO
GENERATORS, SIGNAL, AF
GENERATORS, SIGNAL, COLOR BAR
GENERATORS, SIGNAL, DOT BAR
GENERATORS, SIGNAL, MARKER
GENERATORS, SIGNAL, RF
INTEGRATED CIRCUITS
MICROPHONE HARDWARE
MICROPHONE STANDS & BOOMS
MICROPHONES, CONDENSER
MICROPHONES, DYNAMIC
MICROPHONES, VELOCITY
OHMMETERS
OSCILLOSCOPES
PROBES, OSCILLOSCOPE
PROBES, TEST LEAD
SEMICONDUCTOR DIODES
SEMICONDUCTOR RECTIFIERS,
GENERAL
SEMICONDUCTOR RECTIFIERS,
HIGH VOLTAGE
SEMICONDUCTOR RECTIFIERS,
POWER
SEMICONDUCTOR RECTIFIERS,
SILICON CONTROLLED - SCR
SEMICONDUCTORS, THYRISTORS
SEMICONDUCTORS,
TRANSISTORS, AF
SEMICONDUCTORS,
TRANSISTORS, FE
SEMICONDUCTORS, TRANSISTORS,
GENERAL
SEMICONDUCTORS,
TRANSISTORS, RF
TESTERS, VACUUM TUBE
VACUUM TUBES, CAMERA,
IMAGE-ORTHICON
VACUUM TUBES, CAMERA, VIDICON
VACUUM TUBES, CATHODE RAY,
TV, COLOR
VACUUM TUBES, CATHODE RAY,
TV, MONOCHROME
VACUUM TUBES, RECEIVING
VACUUM TUBES, TRANSMITTING
VOLT METERS, AC
VOLT METERS, DC
VOLT METERS, VACUUM TUBE

RCA SERVICE COMPANY

MAINTENANCE SERVICES, AM
MAINTENANCE SERVICES, FM
MAINTENANCE SERVICES,
MICROWAVE
MAINTENANCE SERVICES,
STEEPLEJACK
MAINTENANCE SERVICES, TV

RECORDING EQUIPMENT COMPANY

AMPLIFIER, AF, MONAURAL
FILTERS, AUDIO
FILTERS, RF
PREAMPLIFIERS, AUDIO

REEVES SOUNDCRAFT

CARTRIDGES, MAGNETIC TAPE
RECORDS, BLANK, LACQUER,
FOR RECORDING
REELS, TAPE
TAPE, MAGNETIC RECORDING,
AUDIO
TAPE, MAGNETIC RECORDING,
COMPUTER
TAPE, MAGNETIC RECORDING,
VIDEO

RHG ELECTRONICS LABORATORY

AMPLIFIER, RF,
GENERAL PURPOSE
AMPLIFIER, RF, POWER
COMMUNICATIONS SYSTEMS,
MICROWAVE
COMMUNICATIONS SYSTEMS,
MULTIPLY
EXCITERS, FM
MICROWAVE COMPONENTS
MICROWAVE SYSTEMS, STL
MICROWAVE SYSTEMS, 2500 MHZ
MICROWAVE SYSTEMS, OTHER
RECEIVERS, FM
RECEIVERS, HF
STL EQUIPMENT
TRANSMITTERS, FM, 100 WATTS
TRANSMITTERS, FM, 1 KW
TRANSMITTERS, FM, 10 KW

RIKER VIDEO INDUSTRIES

AMPLIFIER, DISTRIBUTION
AMPLIFIER, KEYING
AMPLIFIER, MASKING
AMPLIFIER, PULSE
AMPLIFIER, SENSING
AMPLIFIER, STABILIZING
AMPLIFIER, TV, VIDEO
AUTOMATION EQUIPMENT
BALUNS
CLOCKS
CONSOLE, VIDEO, PORTABLE
CONSOLE, VIDEO, STUDIO
DROPOUT COMPENSATOR,
VIDEO TAPE
GENERATORS, SIGNAL, COLOR BAR
GENERATORS, SIGNAL, DOT BAR
GENERATORS, SIGNAL, PULSE

GENERATORS, SIGNAL,
SPECIAL EFFECT
GENERATORS, SIGNAL,
TV, SYNCHRONIZING
GENERATORS, SIGNAL, VITS
INDUSTRIAL TV
OSCILLATORS, TV
SWITCHERS
SWITCHING SYSTEMS
TRANSMISSION TEST SETS
TV SYSTEMS, CLOSED CIRCUIT

ROANWELL CORPORATION

CAPACITORS, VARIABLE
EARPHONES, HEADPHONES
TELEPHONE EQUIPMENT

ROBINS INDUSTRIES CORP.

ACOUSTIC MATERIALS
ADAPTERS, CONNECTOR
ANTENNAS, FM
CABLE, ASSEMBLIES
CABLE, SHIELDED, AUDIO
CORDS, PATCH
DEMAGNETIZERS, BULK TAPE
DEMAGNETIZERS, HEAD
EDITORS, AUDIO TAPE
HARDWARE, GENERAL
HARDWARE, MOUNTS
HEADS, ERASE, MAGNETIC
HEADS, RECORDING, MAGNETIC
JACKS
LAMP ASSEMBLIES
LOG BOOKS OR SHEETS
METERS, DB AND VU
MICROPHONE HARDWARE
MICROPHONES, DYNAMIC
PLUGS, COAXIAL
PLUGS, PHONE
PROJECTORS, FILM, REAR
REELS, TAPE
SLIDES, CHASSIS
SOLVENTS AND CLEANERS
SPLICERS, MAGNETIC TAPE
AND FILM
STROBE, DISCS
STROBE, LIGHTS
SWITCHES, ILLUMINATED
SWITCHES, SNAP
SWITCHES, TOGGLE
TAPE, MAGNETIC RECORDING,
AUDIO
WIRE, BARE, COPPER
WIRE, INSULATED, HOOKUP
WIRE, SHIELDED

ROHDE & SCHWARZ SALES CO-USA

AMPLIFIER, RF, PEAK LIMITING
AMPLIFIER, VIDEO, SWEEP
ANALYZERS, DISTORTION
ANALYZERS, HARMONIC
ANALYZERS, NOISE
ANALYZERS, SIDEBAND
ANALYZERS, VIDEO
ANTENNAS, MICROWAVE
ATTENUATORS, AUDIO
ATTENUATORS, FIXED
ATTENUATORS,
IMPEDANCE MATCHING
ATTENUATORS, MICROWAVE
ATTENUATORS, RF
ATTENUATORS, VIDEO
BALUNS
BRIDGES
CONNECTORS, ANTENNA
CONNECTORS, COAXIAL CABLE
CONNECTORS, POWER
CONNECTORS, RF
COUPLERS
DELAY LINES
DEMODULATORS
DETECTORS, MICROWAVE
DETECTORS, STANDING WAVE
DIVIDERS, FREQUENCY
DUMMY LOAD
FILTERS, AUDIO
FILTERS, RF
GENERATORS, FM, STEREO
GENERATORS, SIGNAL, AF
GENERATORS, SIGNAL, RF
METERS, FIELD STRENGTH
METERS, FREQUENCY
METERS, FREQUENCY CALIBRATING
METERS, PHASE ANGLE
METERS, POWER
METERS, STANDING WAVE
MICROWAVE COMPONENTS
MODULATORS, TV
OSCILLATORS, AF AND RF,
SEE GENERATORS
OSCILLATORS, AM
OSCILLATORS, FM
OSCILLATORS, TV
OSCILLATORS, OTHER
RECEIVERS, AM
RECEIVERS, FM
RECEIVERS, HF
RECORDERS, PAPER,
LOGGING AND GRAPHIC
SLOTTED SECTIONS
TESTERS, CAPACITOR
TESTERS, INSULATION
TESTERS, SEMICONDUCTOR
TRANSFORMERS, AUDIO,
ISOLATION
TRANSFORMERS, AUDIO, MATCHING
TRANSMITTERS, AM, 5 KW
TRANSMITTERS, AM, 10 KW
TRANSMITTERS, FM
TRANSMITTERS, TV
VOLT METERS, AC
VOLT METERS, DC
VOLT METERS, VACUUM TUBE
WATTMETERS

ROHN MANUFACTURING COMPANY
 CATV, HEAD-END EQUIPMENT
 HEAD-END EQUIPMENT,
 SEE CATV HEAD-END EQUIPMENT
 LIGHTS, TOWER, OBSTRUCTION
 MOUNTS, ANTENNA, FIXED
 REFLECTORS, PASSIVE
 TOWERS, ANTENNA,
 CATV, HEAD-END
 TOWERS, ANTENNA, RECEIVING
 TOWERS, ANTENNA,
 TRANSMITTING, AM
 TOWERS, ANTENNA,
 TRANSMITTING, FM
 TOWERS, ANTENNA,
 TRANSMITTING, TV

ROME CABLE DIV. OF ALCOA
 CABLE, ASSEMBLIES
 CABLE, COAXIAL, FLEXIBLE
 CABLE, DIRECT-BURIAL
 CABLE, SHIELDED, AUDIO
 CABLE, TELEPHONE

ROTRON MANUFACTURING COMPANY
 BLOWERS AND FANS

ROUND HILL ASSOCIATES

AMPLIFIER, AF, AGC
 AMPLIFIER, AF, COMPRESSING
 AMPLIFIER, AF,
 GENERAL PURPOSE
 AMPLIFIER, AF, MONAURAL
 AMPLIFIER, AF,
 PEAK LIMITING, AM
 AMPLIFIER, AF,
 PEAK LIMITING, FM
 AMPLIFIER, AF, REMOTE
 AMPLIFIER, AF, REVERBERATION
 AMPLIFIER, AF, STEREO
 AMPLIFIER, BRIDGING
 AMPLIFIER, CATV
 AMPLIFIER, DISTRIBUTION
 COMMUNICATIONS SYSTEMS,
 INTERCOM, WIRELESS

RUSSCO ELECTRONICS MFG.
 AMPLIFIER, AF, MONAURAL
 AMPLIFIER, AF, STEREO
 PREAMPLIFIERS, AUDIO
 TURNTABLES, PHONOGRAPH

F. B. RYAN MFG. CO.
 PLOWS, CABLE LAYING

HOWARD W. SAMS & CO. INC.
 EDUCATION FACILITIES,
 PUBLISHERS
 EDUCATION FACILITIES, SCHOOLS

SARKIS-TARZIAN

AMPLIFIER, DISTRIBUTION
 AMPLIFIER, PULSE
 AMPLIFIER, TV, VIDEO
 ATTENUATORS, VIDEO
 AUTOMATION EQUIPMENT
 CAMERAS, TV, COLOR
 CAMERAS, TV, MONOCHROME
 CAPACITORS, VARIABLE
 COMMUNICATIONS SYSTEMS,
 MICROWAVE
 COMPUTER EQUIPMENT
 CONSOLE, AUDIO, TV
 CONSOLE, AUDIO, AM
 CONSOLE, VIDEO, PORTABLE
 CONSOLE, VIDEO, STUDIO
 CORDS, PATCH
 DISPLAY EQUIPMENT, TV
 ENHANCERS, TV IMAGE
 GENERATORS, SIGNAL,
 TV SYNCHRONIZING
 HARDWARE, RACK
 JACK PANEL ASSEMBLIES
 MAINTENANCE SERVICES, TV
 MICROWAVE SYSTEMS, STL
 MONITORS, VIDEO
 RECTIFIERS - ALSO SEE SEMI-
 CONDUCTORS & VACUUM TUBES
 RECTIFIERS, SELENIUM
 SEMICONDUCTOR DIODES
 SEMICONDUCTOR RECTIFIERS,
 GENERAL
 SEMICONDUCTOR RECTIFIERS,
 HIGH VOLTAGE
 SEMICONDUCTOR RECTIFIERS,
 POWER
 SEMICONDUCTOR RECTIFIERS,
 SILICON CONTROLLED - SCR
 STL EQUIPMENT
 SWITCHING MATRIXES
 SWITCHING SYSTEMS
 TAPE, MAGNETIC RECORDING,
 AUDIO
 TRANSMITTERS, TV, 1 KW
 TV SYSTEMS, CLOSED CIRCUIT

SAXTON PRODUCTS INC.

CABLE, ASSEMBLIES
 CABLE, COAXIAL, FLEXIBLE
 CABLE, COAXIAL, RIGID
 CABLE, DIRECT-BURIAL
 CABLE, SHIELDED, AUDIO
 CABLE, TELEPHONE
 WIRE, BARE, COPPER
 WIRE, BARE, COPPER STRAP
 WIRE, BARE, STEEL
 WIRE, INSULATED, HIGH VOLTAGE
 WIRE, INSULATED, HOOKUP
 WIRE, SHIELDED
 WIRING AND CABLING SERVICES

SCALA RADIO CORPORATION

ANTENNAS, AM
 ANTENNAS, CATV
 ANTENNAS, FM
 ANTENNAS, TV

ANTENNAS, TV,
 MASTER-COMMUNITY
 BALUNS

SCHAFFER ELECTRONICS

AMPLIFIER, SENSING
 AUTOMATION EQUIPMENT
 BACKGROUND MUSIC SERVICE
 BROADCAST PROGRAMMING SERVICE
 CABINETS, METAL
 PREAMPLIFIERS, AUDIO
 RACKS, MOUNTING
 RECORDERS, MAGNETIC TAPE,
 AUDIO
 RECORDERS, MAGNETIC TAPE,
 LOGGING
 REMOTE CONTROL SYSTEMS
 SWITCHERS
 SWITCHING MATRIXES
 TAPE DECKS, MAGNETIC

ALBERT SCHULTZ, INC.

BACKGROUND MUSIC SERVICE
 BROADCAST PROGRAMMING SERVICE

SCIENTIFIC-ATLANTA

ANTENNAS, CATV
 ANTENNAS, MICROWAVE
 ANTENNAS, TV,
 MASTER-COMMUNITY
 ANTENNAS, 2500 MHZ
 ATTENUATORS, MICROWAVE
 ATTENUATORS, RF
 ATTENUATORS, VIDEO
 CABINETS, METAL
 CONSOLE, CABINETS
 AND HARDWARE
 DIVIDERS, POWER
 JOINTS, ROTARY, COAXIAL
 MICROWAVE COMPONENTS
 MOUNTS, ANTENNA, FIXED
 OSCILLATORS, AF AND RF,
 SEE GENERATORS
 PAPER, CHART AND GRAPH
 READERS
 RECEIVERS, HF
 RECORDERS, PAPER,
 LOGGING AND GRAPHIC
 WAVEGUIDE AND
 ASSOCIATED COMPONENTS

H. H. SCOTT, INC.

AMPLIFIER, AF,
 GENERAL PURPOSE
 AMPLIFIER, AF, MONAURAL
 AMPLIFIER, AF, REMOTE
 AMPLIFIER, AF, STEREO
 AMPLIFIER, BRIDGING
 ANALYZERS, NOISE
 GENERATORS, FM, STEREO
 GENERATORS, FM, SUBCARRIER
 GENERATORS, SIGNAL,
 SPECIAL EFFECT, NOISE
 METERS, DB AND VU, WIDE RANGE
 PREAMPLIFIERS, AUDIO
 RECEIVERS, FM
 RECEIVERS, MULTIPLEX

SCULLY RECORDING INSTRUMENTS

AMPLIFIER, AF,
 GENERAL PURPOSE
 AMPLIFIER, AF, MONAURAL
 AMPLIFIER, AF, STEREO
 AUTOMATION EQUIPMENT
 EDITORS, AUDIO TAPE
 HEADS, DISC RECORDING
 HEADS, ERASE, MAGNETIC
 HEADS, RECORDING, MAGNETIC
 LATHE, DISC RECORDING
 PREAMPLIFIERS, AUDIO
 RECORDERS, MAGNETIC TAPE,
 AUDIO

SELA ELECTRONICS CO.

TIMERS, ELECTRIC

SETCHELL CARLSON, INC.

AMPLIFIER, AF, STEREO
 CABINETS, WOOD
 INDUSTRIAL TV
 MONITORS, VIDEO
 RECEIVERS, AM
 RECEIVERS, FM
 RECEIVERS, TV, COLOR
 RECEIVERS, TV, MONOCHROME
 SPEAKERS
 TV SYSTEMS, CLOSED CIRCUIT

SHURE BROTHERS

ARMS, TONE
 CARTRIDGES, MAGNETIC TAPE
 CARTRIDGES, PHONO
 MICROPHONE HARDWARE
 MICROPHONE STANOS & BOOMS
 MICROPHONES, DYNAMIC
 MIXERS - ALSO SEE CONSOLES
 PREAMPLIFIERS, AUDIO
 STYLI, PLAYBACK

SIGMA INDUSTRIES

BLOWERS AND FANS
 BLOWERS, CATV, HARDWARE
 CATV EQUIPMENT - ALSO SEE
 OTHER CATEGORIES
 CATV, CABLE TERMINALS
 CONNECTORS, COAXIAL CABLE
 HARDWARE, TUBING, PLASTIC
 PRESSURIZATION EQUIPMENT,
 TRANSMISSION LINE
 TV SYSTEMS, CLOSED CIRCUIT

SIGMA INSTRUMENTS INC.

RELAYS, GENERAL PURPOSE
 RELAYS, LATCHING
 RELAYS, OVERLOAD
 RELAYS, PHOTOELECTRIC

RELAYS, PLUG-IN
 RELAYS, POWER
 RELAYS, SEQUENCING
 RELAYS, TELEPHONE

THE SINGER CO. - METRICS DIV.

AMMETERS, AC
 AMMETERS, AC, THERMOCOUPLE
 AMMETERS, DC
 AMMETERS, RF
 ANALYZERS, DISTORTION
 ANALYZERS, HARMONIC
 ANALYZERS, INTERMODULATION
 ANALYZERS, NOISE
 ANALYZERS, SIDEBAND
 ANALYZERS, VIDEO
 ATTENUATORS, FIXED
 ATTENUATORS, MICROWAVE
 ATTENUATORS, RF
 CAMERAS, OSCILLOSCOPE
 CONVERTERS
 DIVIDERS, VOLTAGE
 DOLLIES, TEST EQUIPMENT
 GENERATORS, SIGNAL, AF
 GENERATORS, SIGNAL, RF
 METERS, FIELD STRENGTH
 METERS, FREQUENCY
 METERS, PHASE ANGLE
 METERS, POWER
 METERS - SEE SPECIFIC TYPES
 MONITORS, FREQUENCY
 MONITORS, VIDEO
 MONITORS, WAVEFORM
 POWER SUPPLIES, AC
 SHUNTS, METER
 TURNTABLES, PHONOGRAPH
 VOLTMETERS, AC
 VOLTMETERS, DC
 WATTMETERS

SINGER PRODUCTS CO.

ACOUSTIC MATERIALS
 ADAPTERS, FM STEREO
 ALARM, FAULT
 ALARM, SIGNAL
 AMPLIFIER, AF, AGC
 AMPLIFIER, AF, COMPRESSING
 AMPLIFIER, AF,
 PEAK LIMITING, AM
 AMPLIFIER, AF,
 PEAK LIMITING, FM
 AMPLIFIER, AF, REMOTE
 AMPLIFIER, AF, REVERBERATION
 AMPLIFIER, BRIDGING
 AMPLIFIER, RF,
 GENERAL PURPOSE
 AMPLIFIER, RF, PEAK LIMITING
 AMPLIFIER, RF, POWER
 ANTENNAS, AM
 ANTENNAS, FM
 ANTENNAS, MICROWAVE
 ANTENNAS, MOBILE
 ANTENNAS, TV
 ARMS, TONE
 ATTENUATORS, RF
 AUTOMATION EQUIPMENT
 BACKGROUND MUSIC SERVICE
 BALUNS
 BASE STATIONS
 BATTERIES, LEAD ACID
 BATTERIES, NICKEL CADMIUM
 BLOWERS AND FANS
 CABINETS, STORAGE,
 MAGNETIC TAPE
 CABLE, ASSEMBLIES
 CABLE, COAXIAL, FLEXIBLE
 CABLE, COAXIAL, RIGID
 CABLE, SHIELDED, AUDIO
 CAPACITORS, FIXED, CERAMIC
 CAPACITORS, FIXED,
 ELECTROLYTIC
 CAPACITORS, FIXED, FILM
 CAPACITORS, FIXED, MICA
 CAPACITORS, FIXED, OIL-FILLED
 CAPACITORS, FIXED, PAPER
 CAPACITORS, VARIABLE
 CARTRIDGES, MAGNETIC TAPE
 CARTRIDGES, PHONO
 CHARGERS, BATTERY
 CIRCUITS, PRINTED
 COILS, DEFLECTION
 AND FOCUSING
 COILS, TELEPHONE
 COMMUNICATIONS SYSTEMS, CB
 COMMUNICATIONS SYSTEMS,
 LAND MOBILE
 COMMUNICATIONS SYSTEMS,
 MULTIPLEX
 COMMUNICATIONS SYSTEMS,
 TELEPRINTER
 CONNECTORS, COAXIAL CABLE
 CONSOLE, AUDIO, AM
 CONSOLE, AUDIO, FM
 CONSOLE, AUDIO, PORTABLE
 CONSOLE, AUDIO, RECORDING
 CONSOLE, AUDIO, TV
 CONSOLE, CABINETS
 AND HARDWARE
 CORDS, DIAL
 CORDS, PATCH
 CORDS, SET
 CORES, TRANSFORMER AND COIL
 COUPLERS
 DELAY DEVICES, AF
 DEMAGNETIZERS, BULK TAPE
 EARPHONES, HEADPHONES
 EXCITERS, FM
 FACSIMILE EQUIPMENT
 FUSES
 GENERATORS, FM, STEREO
 GENERATORS, FM, SUBCARRIER
 HARDWARE, TOOLS
 HEADS, DISC RECORDING
 HEADS, ERASE, MAGNETIC
 HEADS, RECORDING, MAGNETIC
 HOLDERS, FUSE
 INVERTERS, DC TO AC,
 SOLID STATE
 JACK PANEL ASSEMBLIES
 JACKS
 KNOBS
 LAMPS, PANEL
 LATHE, DISC RECORDING
 MICROPHONE STANDS & BOOMS
 MICROPHONES, CONDENSER
 MICROPHONES, DYNAMIC
 MICROPHONES, VELOCITY
 MICROPHONES, WIRELESS
 MICROWAVE SYSTEMS, STL
 MIXERS - ALSO SEE CONSOLES
 MOBILE EQUIPMENT
 MONITORS, AM SYSTEMS
 MONITORS, FM SYSTEMS, MONO
 MONITORS, FM SYSTEMS, SCA
 MONITORS, FM SYSTEMS, STEREO
 MONITORS, FREQUENCY
 NARROW-BAND FM EQUIPMENT
 NETWORKS, PHASING
 OVENS, CRYSTAL
 PLUGS, COAXIAL
 PLUGS, PHONE
 POTENTIOMETERS, CARBON
 POTENTIOMETERS, WIREWOUND
 PRINTERS, TELETYPE
 PROJECTORS, FILM
 PROJECTORS, SLIDE
 RECEIVERS, AM
 RECEIVERS, FM
 RECEIVERS, HF
 RECEIVERS, MULTIPLEX
 RECEIVERS, SCA
 RECORDS, BLANK, ACETATE,
 FOR RECORDING
 RECORDS, BLANK, LACQUER,
 FOR RECORDING
 RECTIFIERS, SELENIUM
 REMOTE CONTROL SYSTEMS
 RESISTORS, FIXED, CARBON
 RESISTORS, FIXED, WIREWOUND
 RESISTORS, VARIABLE, CARBON
 REVERBERATION DEVICES
 SCRAMBLERS, SPEECH
 SEMICONDUCTOR DIODES
 SEMICONDUCTOR RECTIFIERS,
 GENERAL
 SEMICONDUCTOR RECTIFIERS,
 HIGH VOLTAGE
 SEMICONDUCTOR RECTIFIERS,
 POWER
 SEMICONDUCTORS, AF
 SEMICONDUCTORS, TRANSISTORS,
 GENERAL
 SOLDER
 SOUND SYSTEMS, PORTABLE
 SPEAKER COMPONENTS
 SPEAKERS
 STL EQUIPMENT
 STYLI, CUTTING
 SWITCHES, COAXIAL
 SWITCHES, ROTARY
 SWITCHES, SLIDE
 SWITCHES, SNAP
 SWITCHES, TOGGLE
 TAPE DECKS, MAGNETIC
 TAPE DUPLICATOR
 TAPE, MAGNETIC RECORDING,
 AUDIO
 TERMINAL BLOCKS
 TERMINAL BOARDS
 TERMINAL STRIPS
 TERMINALS, LUG
 TERMINALS, SOLDER
 TERMINALS, SOLDERLESS
 TESTERS, BATTERY
 TESTERS, INSULATION
 TOOLS, HAND
 TOOLS, PLIERS
 TOOLS, SCREWDRIVERS
 TOOLS, SOLDERING IRONS, GUN
 TOOLS, SOLDERING IRONS,
 INDUSTRIAL
 TOWERS, ANTENNA, RECEIVING
 TOWERS, ANTENNA,
 TRANSMITTING, AM
 TOWERS, ANTENNA,
 TRANSMITTING, FM
 TOWERS, ANTENNA,
 TRANSMITTING, TV
 TRANSFORMERS, AUTO
 TRANSFORMERS, GENERAL
 TRANSMITTER KITS
 TRANSMITTERS, AM, 250 WATT
 TRANSMITTERS, AM, 1 KW
 TRANSMITTERS, AM, 5 KW
 TRANSMITTERS, AM, 15 KW
 TRANSMITTERS, AM, 25 KW
 TRANSMITTERS, AM, 50 KW
 TRANSMITTERS, AM, OVER 50 KW
 TRANSMITTERS, FM, 1D WATTS
 TRANSMITTERS, FM, 100 WATTS
 TRANSMITTERS, FM, 250 WATTS
 TRANSMITTERS, FM, 1 KW
 TRANSMITTERS, FM, 5 KW
 TRANSMITTERS, FM, 20 KW
 TURNTABLES, PHONOGRAPH
 VACUUM TUBES, CATHODE RAY,
 TV, COLOR
 VACUUM TUBES, CATHODE RAY,
 TV, MONOCHROME
 VACUUM TUBES, RECEIVING
 WIRE, INSULATED, HIGH VOLTAGE
 WIRE, SHIELDED
 YOKES, DEFLECTION

SITCO ANTENNA COMPANY

ANTENNAS, CATV
 ANTENNAS, FM
 ANTENNAS, TV,
 MASTER-COMMUNITY
 BALUNS

SOLA ELECTRIC
BALLASTS, LAMP
POWER SUPPLIES, AC
POWER SUPPLIES, DC
POWER SUPPLIES, PRECISION
REGULATORS, CURRENT
REGULATORS, VOLTAGE
TRANSFORMERS, AUTO
TRANSFORMERS, FILAMENT
TRANSFORMERS, GENERAL
TRANSFORMERS, PLATE
TRANSFORMERS, POWER

SOLITRON DEVICES

CAPACITORS, VARIABLE
CIRCUITS, PRINTED
HEAT SINKS
MICROWAVE COMPONENTS
RECTIFIERS - ALSO SEE SEMI-
CONDUCTORS & VACUUM TUBES
SEMI-CONDUCTOR DIODES
SEMI-CONDUCTOR RECTIFIERS,
GENERAL
SEMI-CONDUCTOR RECTIFIERS,
HIGH VOLTAGE
SEMI-CONDUCTOR RECTIFIERS,
POWER
SEMI-CONDUCTORS,
TRANSISTORS, AF
SEMI-CONDUCTORS, TRANSISTORS,
GENERAL
SEMI-CONDUCTORS,
TRANSISTORS, RF
TESTERS, SEMI-CONDUCTOR

SONY CORPORATION OF AMERICA

AMPLIFIER, AF, STEREO
ARMS, TONE
CAMERAS, TV, MONOCHROME
CARTRIDGES, PHONO
CONSOLE, VIDEO, PORTABLE
CONSOLE, VIDEO, STUDIO
HEADS, ERASE, MAGNETIC
HEADS, RECORDING, MAGNETIC
INDUSTRIAL TV
INVERTERS, DC TO AC,
VIBRATORS
MICROPHONES, CONDENSER
MICROPHONES, DYNAMIC
MICROPHONES, WIRELESS
MONITORS, VIDEO
MONITORS, WAVEFORM
PREAMPLIFIERS, AUDIO
RECEIVERS, FM
RECEIVERS, TV, MONOCHROME
RECORDERS, MAGNETIC TAPE,
AUDIO
RECORDERS, MAGNETIC TAPE,
VIDEO
REELS, TAPE
SOUND SYSTEMS, PORTABLE
SPEAKER COMPONENTS
SPEAKERS
TAPE, MAGNETIC RECORDING,
VIDEO
TURNTABLES, PHONOGRAPH
TV SYSTEMS, CLOSED CIRCUIT

SORENSEN OPERATION

POWER SUPPLIES, AC
POWER SUPPLIES, DC

SOUNDCRAFT INDUSTRIES

AMPLIFIER, AF,
GENERAL PURPOSE
AMPLIFIER, BRIDGING
ATTENUATORS, AUDIO
MIXERS - ALSO SEE CONSOLES
OSCILLATORS, AF AND RF,
SEE GENERATORS
POWER SUPPLIES, DC
PREAMPLIFIERS, AUDIO

THE SOUNDSCRIBER CORPORATION

DEMAGNETIZERS, BULK TAPE
RECORDERS, MAGNETIC TAPE,
AUDIO
RECORDERS, MAGNETIC TAPE,
LOGGING

SOUTH SHORE RADIO-TELEPHONE

COMMUNICATIONS SYSTEMS,
LAND MOBILE

SOUTHWESTERN COMMUNICATIONS

AMPLIFIER, AF, COMPRESSING
AMPLIFIER, AF,
GENERAL PURPOSE
AMPLIFIER, AF, MONAURAL
AMPLIFIER, AF,
PEAK LIMITING, AM
AMPLIFIER, AF,
PEAK LIMITING, FM
AMPLIFIER, AF, REMOTE
AMPLIFIER, AF, REVERBERATION
AMPLIFIER, AF, STEREO
AMPLIFIER, BRIDGING
ATTENUATORS, AUDIO
ATTENUATORS, FIXED
ATTENUATORS,
IMPEDANCE MATCHING
BACKGROUND MUSIC SERVICE
CABLE ASSEMBLIES
COMMUNICATIONS SYSTEMS,
INTERCOM, WIRED
COMMUNICATIONS SYSTEMS,
INTERCOM, WIRELESS
CONSOLE, AUDIO, FM
CONSOLE, AUDIO, PORTABLE
CONSOLE, AUDIO, RECORDING
CONSOLE, AUDIO, TV
CONSOLE, AUDIO, AM
EQUALIZERS, AUDIO EMPHASIS
JACK PANEL ASSEMBLIES
LATHE, DISC RECORDING
MAINTENANCE SERVICES, AM

MAINTENANCE SERVICES, FM
MIXERS - ALSO SEE CONSOLES
MONITORS, AM SYSTEMS
MONITORS, FM SYSTEMS, MONO
NETWORKS, MATCHING, AUDIO
NETWORKS, PHASING
OSCILLATORS, AM
OSCILLATORS, FM
PANELS, INSTRUMENT,
FOR RACK MOUNTING
POWER SUPPLIES, DC
PREAMPLIFIERS, AUDIO
REMOTE CONTROL SYSTEMS
SOUND SYSTEMS, OUTDOOR
SOUND SYSTEMS, PORTABLE
SWITCHERS

SPARTA ELECTRONIC CORPORATION

CABINETS, STORAGE,
MAGNETIC TAPE, CARTRIDGE
CARTRIDGES, MAGNETIC TAPE
CARTRIDGES, PHONO
CONSOLE, AUDIO, AM
CONSOLE, AUDIO, FM
CONSOLE, AUDIO, PORTABLE
CONSOLE, AUDIO, RECORDING
CONSOLE, AUDIO, TV
CONSOLE, CABINETS
AND HARDWARE
DEMAGNETIZERS, BULK TAPE
DEMAGNETIZERS, HEAD
HEADS, RECORDING, MAGNETIC
MICROPHONES, CONDENSER
MICROPHONES, DYNAMIC
MICROPHONES, WIRELESS
MIXERS - ALSO SEE CONSOLES
PREAMPLIFIERS, AUDIO
RECORDERS, MAGNETIC TAPE,
AUDIO CARTRIDGE
SPLICERS, MAGNETIC TAPE,
AND FILM
TAPE, MAGNETIC RECORDING,
AUDIO, CARTRIDGE
TURNTABLES, PHONOGRAPH

SPEEDY-O ENTERPRISES

RECORDS, SOUND EFFECT

SPENCER-KENNEDY LABORATORIES

ALARM, FAULT
AMPLIFIER, BRIDGING
AMPLIFIER, CATV
AMPLIFIER, DISTRIBUTION
CABINETS, METAL
CABLE, CATV, HARDWARE
CABLE, COAXIAL, FLEXIBLE
CATV EQUIPMENT - ALSO SEE
OTHER CATEGORIES
CATV, CHANNEL AMPLIFIERS
CATV, HEAD-END EQUIPMENT
CONNECTORS, COAXIAL CABLE
GENERATORS, SIGNAL, PULSE
HEAD-END EQUIPMENT,
SEE CATV HEAD-END EQUIPMENT
TV SYSTEMS, CLOSED CIRCUIT

STACO, INC.

POWER SUPPLIES, AC
POWER SUPPLIES, DC
REGULATORS, VOLTAGE
TAPE DECKS, MAGNETIC
TRANSFORMERS, AUDIO,
ISOLATION
TRANSFORMERS, AUDIO, MATCHING
TRANSFORMERS, AUDIO,
POWER OUTPUT
TRANSFORMERS, AUTO
TRANSFORMERS, FILAMENT
TRANSFORMERS, GENERAL
TRANSFORMERS, PLATE
TRANSFORMERS, POWER
TRANSFORMERS, TRANSISTOR
TRANSFORMERS, VARIABLE

STAINLESS, INC.

ANTENNAS, AM
ANTENNAS, MICROWAVE
ANTENNAS, TV
MASTER-COMMUNITY
COMMUNICATIONS SYSTEMS,
MICROWAVE
REFLECTORS, PASSIVE
TOWERS, ANTENNA,
CATV, HEAD-END
TOWERS, ANTENNA, RECEIVING
TOWERS, ANTENNA,
TRANSMITTING, AM
TOWERS, ANTENNA,
TRANSMITTING, FM
TOWERS, ANTENNA,
TRANSMITTING, TV

STANCIL-HOFFMAN CORPORATION

AMPLIFIER, AF, COMPRESSING
AMPLIFIER, AF,
GENERAL PURPOSE
AMPLIFIER, AF, MONAURAL
AMPLIFIER, AF, REMOTE
AMPLIFIER, BRIDGING
PREAMPLIFIERS, AUDIO
RECORDERS, FILM, MAGNETIC
RECORDERS, MAGNETIC TAPE,
AUDIO
RECORDERS, MAGNETIC TAPE,
LOGGING
REELS, FILM
TAPE DECKS, MAGNETIC

STANOARO ELECTRONICS CORP

AMPLIFIER, RF,
GENERAL PURPOSE
AMPLIFIER, TV, VIDEO
BALUNS
CONSOLE, AUDIO, FM
CONSOLE, AUDIO, TV
CONSOLE, VIDEO, STUDIO

COUPLERS

DEMODULATORS
DIPLEXERS
DIVIDERS, POWER
DUMMY LOAD
EXCITERS, FM
FILTERS, RF
FILTERS, OTHER
GENERATORS, FM, STEREO
MAINTENANCE SERVICES, FM
MAINTENANCE SERVICES, TV
METERS, STANDING WAVE
MODULATORS, TV
NARROW-BAND FM EQUIPMENT
OSCILLATORS, FM
OSCILLATORS, TV
POWER SUPPLIES, AC
POWER SUPPLIES, DC
RECTIFIERS - ALSO SEE SEMI-
CONDUCTORS & VACUUM TUBES
TRANSMITTERS, FM, 250 WATTS
TRANSMITTERS, FM, 1 KW
TRANSMITTERS, FM, 5 KW
TRANSMITTERS, FM, 10 KW
TRANSMITTERS, FM, 20 KW
TRANSMITTERS, TV, 500 WATTS
TRANSMITTERS, TV, 5 KW
TRANSMITTERS, TV, 10 KW
TRANSMITTERS, TV, 25 KW
TRANSMITTERS, TV, 35 KW
TRANSMITTERS, TV, 50 KW
TRANSMITTERS, TV, 70 KW
TV SYSTEMS, CLOSED CIRCUIT
WATTMETERS

STANDARD KOLLSMAN INDUSTRIES

CONVERTERS

STANDARD RECORD MFG. CO.

REELS, TAPE

STEPHENS ELECTRONICS

AMPLIFIER, AF, AGC
AMPLIFIER, AF, COMPRESSING
AMPLIFIER, AF,
GENERAL PURPOSE
AMPLIFIER, AF, MONAURAL
AMPLIFIER, AF, REMOTE
AMPLIFIER, AF, REVERBERATION
AMPLIFIER, AF, STEREO
AMPLIFIER, BRIDGING
AMPLIFIER, PULSE
ATTENUATORS, AUDIO
CONSOLE, AUDIO, AM
CONSOLE, AUDIO, FM
CONSOLE, AUDIO, PORTABLE
CONSOLE, AUDIO, PORTABLE
CONSOLE, AUDIO, RECORDING
CONSOLE, AUDIO, TV
FILTERS, AUDIO
GENERATORS, SIGNAL, AF
NETWORKS, MATCHING, AUDIO
POWER SUPPLIES, DC
PREAMPLIFIERS, AUDIO
RECORDERS, MAGNETIC TAPE,
AUDIO
RELAYS, PHOTOELECTRIC
RELAYS, PLUG-IN
REVERBERATION DEVICES
SWITCHES, ILLUMINATED
SWITCHING SYSTEMS

S. STERLING CO.

AUTOMATION EQUIPMENT
CALIBRATION SERVICE,
FREQUENCY
CALIBRATION SERVICE,
INSTRUMENT
COMPUTER EQUIPMENT
COMPUTER SERVICES
CONSOLE, AUDIO, TV
CONSOLE, VIDEO, PORTABLE
CONSOLE, VIDEO, STUDIO
INDUSTRIAL TV
JACK PANEL ASSEMBLIES
SWITCHING MATRICES
SWITCHING SYSTEMS
TV SYSTEMS, CLOSED CIRCUIT

STRUTHERS-DUNN

RELAYS, COAXIAL
RELAYS, GENERAL PURPOSE
RELAYS, LATCHING
RELAYS, OVERLOAD
RELAYS, PLUG-IN
RELAYS, POWER
RELAYS, SEQUENCING
RELAYS, STEPPING
RELAYS, TIME DELAY

MATTHEW STUART & CO.

RECORDERS, MAGNETIC TAPE,
AUDIO

SUPERIOR CABLE CORPORATION

CABLE, ARMORED
CABLE, ASSEMBLIES
CABLE, CATV, HARDWARE
CABLE, COAXIAL, FLEXIBLE
CABLE, COAXIAL, RIGID
CABLE, DIRECT-BURIAL
CABLE, SHIELDED, AUDIO
CABLE, TELEPHONE
CATV, CABLE TERMINALS
CLAMPS, CABLE
CONNECTORS, COAXIAL CABLE
CONNECTORS, RF
WIRE, INSULATED, HOOKUP

SWAGER TOWER CORPORATION

ANTENNAS, AM
FLASHERS, TOWER
MAINTENANCE SERVICES,
STEEPLEJACK
TOWERS, ANTENNA,
CATV, HEAD-END

TOWERS, ANTENNA, RECEIVING
TOWERS, ANTENNA,
TRANSMITTING, AM
TOWERS, ANTENNA,
TRANSMITTING, FM
TOWERS, ANTENNA,
TRANSMITTING, TV
WIRE, BARE, COPPER
WIRE, BARE, COPPER STRAP

SWITCHCRAFT, INC.

ADAPTERS, CONNECTOR
CONNECTORS, AF & MICROPHONE
CONNECTORS, RF
CORDS, PATCH
HARDWARE, GENERAL
JACK PANEL ASSEMBLIES
JACKS
PLUGS, PHONE
SWITCHES, ILLUMINATED
SWITCHES, INTERLOCK
SWITCHES, LEVER
SWITCHES, MULTICONTACT
SWITCHES, PUSHBUTTON,
NON ILLUMINATED
SWITCHES, SLIDE
SWITCHES, TELEPHONE TYPE
SWITCHING MATRICES
SWITCHING SYSTEMS

SYLVANIA-COMM. ELECTRONICS DIV

AMPLIFIER, DISTRIBUTION
AMPLIFIER, PULSE
AMPLIFIER, STABILIZING
CABLE, ASSEMBLIES
CAMERA, MOUNTING EQUIPMENT
CAMERA, REMOTE CONTROL
EQUIPMENT
CAMERAS, TV, MONOCHROME
CONSOLE, AUDIO, TV
CONSOLE, VIDEO, PORTABLE
CONSOLE, VIDEO, STUDIO
DISPLAY EQUIPMENT, TV
DOLLIES, CAMERA
GENERATORS, SIGNAL,
TV SYNCHRONIZING
INDUSTRIAL TV
LENSES, OPTICAL, FIXED
LENSES, OPTICAL, ZOOM
LIGHTING, TV, SYSTEMS
MICROPHONE HARDWARE
MICROPHONE STANDS & BOOMS
MICROPHONES, DYNAMIC
MOBILE EQUIPMENT
MODULATORS, TV
MONITORS, VIDEO
MONITORS, WAVEFORM
MULTIPLEXERS
POWER SUPPLIES, DC
PROJECTORS, FILM
PROJECTORS, SLIDE
RECEIVERS, TV, MONOCHROME
SWITCHERS

SYLVANIA-SEMICONDUCTOR DIV.

DETECTORS, MICROWAVE
MICROWAVE COMPONENTS
SEMI-CONDUCTOR DIODES
SEMI-CONDUCTOR RECTIFIERS,
GENERAL
SEMI-CONDUCTOR RECTIFIERS,
POWER
SEMI-CONDUCTORS,
TRANSISTORS, AF
SEMI-CONDUCTORS, TRANSISTORS,
GENERAL
SEMI-CONDUCTORS,
TRANSISTORS, RF

SYNCHRON CORPORATION

MICROPHONES, CONDENSER

TAPE-ATHON CORP.

CATV EQUIPMENT - ALSO SEE
OTHER CATEGORIES
RECORDERS, MAGNETIC TAPE,
AUDIO
RECORDERS, MAGNETIC TAPE,
LOGGING

TAPECASTER ELECTRONICS

AMPLIFIER, AF, REMOTE
AUTOMATION EQUIPMENT
CARTRIDGES, MAGNETIC TAPE
DELAY DEVICES, AF
HEADS, RECORDING, MAGNETIC
RECORDERS, MAGNETIC TAPE,
AUDIO
RECORDERS, MAGNETIC TAPE,
AUDIO, CARTRIDGE
TAPE, MAGNETIC RECORDING,
AUDIO

TECHNICAL APPLIANCE CORP

ANTENNAS, CATV
ANTENNAS, FM
ANTENNAS, MICROWAVE
ANTENNAS, MOBILE
ANTENNAS, TV
ANTENNAS, TV,
MASTER-COMMUNITY
ANTENNAS, 2500 MHZ
CABLE, COAXIAL, RIGID
MOUNTS, ANTENNA, FIXED
MOUNTS, ANTENNA, MOBILE
ROOMS
WAVEGUIDE AND
ASSOCIATED COMPONENTS

THE TECHNICAL MATERIEL CORP

ADAPTERS, CONNECTOR
AMPLIFIER, BRIDGING
AMPLIFIER, RF, POWER
ANALYZERS, SIDEBAND
BALUNS



Howard W. Sams Books FOR THE BROADCAST FIELD

Broadcast Engineering Notebooks

by *Harold E. Ennes*. An invaluable reference series for the use of broadcast station personnel. Provides the latest data required by engineers, technicians, operators, and students.

- Vol. 1. Television Tape Fundamentals. BEN-1
- Vol. 2. AM-FM Broadcast Operations. BEN-2
- Vol. 3. AM-FM Broadcast Maintenance. BEN-3
- Vol. 4. Television Systems Maintenance. BEN-4
- Each volume.....\$595

Design & Operation of Regulated Power Supplies

by *Irving M. Gottlieb*. Latest edition provides a full understanding of the design and operation of these increasingly important power supplies. Includes full design and circuitry data. 144 pages. RPS-2.....\$325

Understanding Amplitude Modulation

by *Irving M. Gottlieb*. Explains the principles used in the amplitude modulation of a carrier signal, and describes the various types of systems (tube and transistor), used to accomplish it. 160 pages. AMG-1.....\$325

Tube Substitution Handbook, 10th Ed.

Lists over 12,000 direct substitutions; includes hundreds of new substitutions. Covers substitutions for receiving, picture tubes, subminiature, industrial, and communication types. TUB-10.....\$175

Transistor Substitution Handbook, 6th Ed.

Lists thousands of direct substitutions; includes basing diagrams and polarity indications. Covers all types of transistors, both U.S. and foreign (including Japanese). SSH-6.....\$150

First-Class Radiotelephone License Handbook

by *Edward M. Noll*. Newest edition updated to cover the latest revision of the FCC Commercial Examination Element IV. Invaluable preparation for the exam as well as a thorough textbook for broadcast engineering training. 400 pages. BON-2.....\$525

Second-Class Radiotelephone License Handbook

by *Edward M. Noll*. New 3rd edition; complete study course for Elements I, II and III of the latest FCC exams. 336 pages. QAN-2.....\$475

Radio Operators License Handbook

by *Edward M. Noll*. Latest edition. This guide fully explains the laws, rules, regulations, and accepted operating procedures for those who operate radio equipment. 136 pages. RON-1.....\$325

Frequency Changers

by *Irving M. Gottlieb*. A one-source handbook covering basic principles; includes chapters on modulators, frequency multipliers, transmitters, and dividers; also covers commercial circuits. 224 pages. FCG-1.....\$495

Closed-Circuit TV Handbook

by *Leon A. Wortman*. The most comprehensive book on the subject. Describes systems and applications; invaluable for anyone planning, installing, operating, or maintaining CCTV. 288 pages. CLC-1.....\$750

Electronic Tests & Measurements

by *Robert G. Middleton*. A practical reference guide on how to measure such diverse properties as inductance, capacitance, resistance, frequency, distortion, impedance, transistor characteristics, zener point and many others. 288 pages. MET-1.....\$695

North American Radio-TV Station Guide

by *Vane A. Jones*. New 3rd edition. Lists frequencies, call letters, locations, power, etc., for all AM, FM, and TV stations (including UHF) in the U.S., Canada, Cuba, Mexico and West Indies. 128 pages. RSG-3.....\$195

Dictionary of Electronics Communications Terms

Complete and up-to-date definitions of terms used in broadcasting, microwave, 2-way radio, amateur, and CB radio systems. Includes over 2500 entries. COM-1.....\$385



HOWARD W. SAMS & CO., INC.

4300 WEST 62nd ST. • INDIANAPOLIS, INDIANA 46206

CONNECTORS, ANTENNA
CONNECTORS, COAXIAL CABLE
CONNECTORS, RF
CONVERTERS, FSK
CORDS, PATCH
DUMMY LOAD
GENERATORS, SIGNAL, RF
JACK PANEL ASSEMBLIES
JACKS
METERS, STANDING WAVE
PLUGS, COAXIAL
RECEIVERS, HF
SWITCHES, COAXIAL
TRANSFORMERS, RF

TEKTRONIX INC

ANALYZERS, SPECTRUM
CAMERAS, OSCILLOSCOPE
DOLLIES, TEST EQUIPMENT
GENERATORS, SIGNAL, MARKER
GENERATORS, SIGNAL, PULSE
GENERATORS, SIGNAL, SQUARE WAVE
MONITORS, WAVEFORM
OSCILLOSCOPES
PROBES, OSCILLOSCOPE
TESTERS, SEMICONDUCTOR
GENERATORS, SIGNAL, DOT BAR
GENERATORS, SIGNAL, TV SYNCHRONIZING
GENERATORS, SIGNAL, VITS
INDUSTRIAL TV
MONITORS, VIDEO
OSCILLATORS, TV
PROBES, OSCILLOSCOPE
STL EQUIPMENT
SWITCHING MATRICES
TELEPHONE EQUIPMENT
TESTERS, INSULATION
TV SYSTEMS, CLOSED CIRCUIT

TELEQUIP CORPORATION

AMPLIFIER, DISTRIBUTION
AMPLIFIER, PULSE
AMPLIFIER, STABILIZING
AMPLIFIER, TV, VIDEO
CABLE, ASSEMBLIES
CABLE, CATV, HARDWARE
CABLE, COAXIAL, FLEXIBLE
CABLE, COAXIAL, RIGID
CABLE, DIRECT-BURIAL
CABLE, SHIELDED, AUDIO
CAMERA, MOUNTING EQUIPMENT
CAMERA, REMOTE
CONTROL EQUIPMENT
CATV EQUIPMENT - ALSO SEE OTHER CATEGORIES
CATV, CABLE TERMINALS
CATV, ORIENTATION EQUIPMENT
COILS, DEFLECTION
AND FOCUSING
CONSOLE, CABINETS
AND HARDWARE

CONSOLE, KITS
CONSOLE, VIDEO, PORTABLE
CONSOLE, VIDEO, STUDIO
DISPLAY EQUIPMENT, TV
DOLLIES, CAMERA
DOLLIES, TEST EQUIPMENT
GENERATORS, SIGNAL, COLOR BAR
GENERATORS, SIGNAL, DOT BAR
GENERATORS, SIGNAL, PULSE
GENERATORS, SIGNAL, RF
GENERATORS, SIGNAL, SPECIAL EFFECT
GENERATORS, SIGNAL, SQUARE WAVE
GENERATORS, SIGNAL, TV SYNCHRONIZING
GENERATORS, SIGNAL, VITS
TESTERS, VACUUM TUBE
VACUUM TUBE, CATHODE RAY, OSCILLOSCOPE

TELETRON INDUSTRIES INC

AMPLIFIER, AF, STEREO
HEADS, ERASE, MAGNETIC
HEADS, RECORDING, MAGNETIC
RECEIVERS, AM
RECEIVERS, FM
RECEIVERS, HF
RECEIVERS, MULTIPLEX
RECORDERS, MAGNETIC TAPE, AUDIO
RECORDERS, MAGNETIC TAPE, LOGGING
RECORDERS, MAGNETIC TAPE, VIDEO
TAPE DECKS, MAGNETIC
TAPE DUPLICATORS
TURNTABLES, PHONOGRAPH

TELE-DEVICES CO

MOBILE EQUIPMENT, TV

TELEVISION, INC.

AMPLIFIER, TV, VIDEO
BROADCAST PROGRAMMING SERVICE
CAMERAS, TV, MONOCHROME
CATV EQUIPMENT - ALSO SEE OTHER CATEGORIES
CATV, ORIENTATION EQUIPMENT
EDUCATION FACILITIES, EOPT
GENERATORS, SIGNAL, TV SYNCHRONIZING
LENSES, OPTICAL, ZOOM
MULTIPLIXERS
SWITCHERS
TV SYSTEMS, CLOSED CIRCUIT

TELEMET COMPANY

AMPLIFIER, DISTRIBUTION
AMPLIFIER, KEYING
AMPLIFIER, PULSE
AMPLIFIER, STABILIZING
AMPLIFIER, TV, BOOSTER

AMPLIFIER, TV, VIDEO
CABLE, CATV, HARDWARE
CATV, CABLE TERMINALS
CATV, HEAD-END EQUIPMENT
CLAMPS, COMPONENT
FILTERS, OTHER
GENERATORS, SIGNAL, COLOR BAR
HARDWARE, CHASSIS
HARDWARE, DIAL POINTERS
HARDWARE, FIXTURES, HOLDING
HARDWARE, GENERAL
HARDWARE, MOUNTS
HARDWARE, PANEL
HARDWARE, RACK
INDUSTRIAL TV
KNOBS
LENSES, OPTICAL, FIXED
LENSES, OPTICAL, ZOOM
LIGHTING, TV, COMPONENTS
LIGHTING, TV, CONTROLS
LIGHTING, TV, SYSTEMS
MODULATORS, TV
MONITORS, VIDEO
MOUNTS, ANTENNA, FIXED
MOUNTS, ANTENNA, MOBILE
MOUNTS, INSTRUMENT
OSCILLOSCOPES
PANELS, INSTRUMENT, FOR RACK MOUNTING
POWER SUPPLIES, AC
POWER SUPPLIES, DC
POWER SUPPLIES, PRECISION
PREAMPLIFIERS, VIDEO
SWITCHING SYSTEMS
TV SYSTEMS, CLOSED CIRCUIT
VACUUM TUBES, CAMERA,
IMAGE-ORTHICON
VACUUM TUBES, CAMERA, VIDICON
VACUUM TUBES, RECEIVING
WIRE, SHIELDED
YOKES, DEFLECTION

TELESIS CORPORATION

AMMETERS, RF
AMPLIFIER, CATV
AUTOMATION EQUIPMENT
CATV, CHANNEL AMPLIFIERS
CATV, HEAD-END EQUIPMENT
CATV, ORIENTATION EQUIPMENT
WEATHER INSTRUMENTS

TELETRONIX DIVISION

AMMETERS, RF
AMPLIFIER, AF, AGC
AMPLIFIER, AF, COMPRESSING
AMPLIFIER, AF, GENERAL PURPOSE
AMPLIFIER, AF, MONAURAL
AMPLIFIER, AF, PEAK LIMITING, AM
AMPLIFIER, AF, PEAK LIMITING, FM
AMPLIFIER, AF, REMOTE

AMPLIFIER, RF, POWER
ANTENNAS, AM
ANTENNAS, FM
CONNECTORS, COAXIAL CABLE
CONSOLE, AUDIO, AM
CONSOLE, AUDIO, FM
CONSOLE, AUDIO, PORTABLE
CONSOLE, AUDIO, RECORDING
CONSOLE, AUDIO, TV
EXCITERS, FM
FILTERS, ANTENNA
FILTERS, RF
GENERATORS, FM, SUBCARRIER
KNOBS
MICROWAVE SYSTEMS, STL
MONITORS, FREQUENCY
REMOTE CONTROL SYSTEMS
STL EQUIPMENT
TRANSMITTERS, AM, 250 WATT
TRANSMITTERS, AM, 1 KW
TRANSMITTERS, AM, 5 KW
TRANSMITTERS, AM, 10 KW
TRANSMITTERS, AM, 50 KW
TRANSMITTERS, FM, 250 WATTS
TRANSMITTERS, FM, 1 KW
TRANSMITTERS, FM, 3 KW
TRANSMITTERS, FM, 5 KW
TRANSMITTERS, FM, 10 KW

TELEVISION UTILITIES CORP.

AMPLIFIER, DISTRIBUTION
CAMERA, MOUNTING EQUIPMENT
CAMERA, REMOTE
CONTROL EQUIPMENT
CAMERAS, FILM, CINE
CAMERAS, TV, MONOCHROME
CATV EQUIPMENT - ALSO SEE OTHER CATEGORIES
CATV, HEAD-END EQUIPMENT
CATV, ORIENTATION EQUIPMENT
CONSOLE, CABINETS
AND HARDWARE
CONSOLE, KITS
CONSOLE, VIDEO, PORTABLE
CONSOLE, VIDEO, STUDIO
DISPLAY EQUIPMENT, TV
DOLLIES, CAMERA
INDUSTRIAL TV
LENSES, OPTICAL, FIXED
LENSES, OPTICAL, ZOOM
LIGHTING, TV, COMPONENTS
LIGHTING, TV, CONTROLS
LIGHTING, TV, SYSTEMS
LIGHTNING ARRESTERS
MAINTENANCE SERVICES, TV
MICROPHONE STANDS & BOOMS
MONITORS, VIDEO
PROJECTORS, FILM
RECORDERS, FILM, LIGHT
RECORDERS, FILM, MAGNETIC
TAPE, MAGNETIC RECORDING, VIDEO

TV SYSTEMS, CLOSED CIRCUIT
VACUUM TUBES, CAMERA, VIDICON

TELEVISION ZODIAC COMPANY

LENSES, OPTICAL, ZOOM
PROCESSORS, FILM, COLOR

TELEPHONIC INDUSTRIES

ATTENUATORS, AUDIO
ATTENUATORS, MICROWAVE
ATTENUATORS, RF
ATTENUATORS, VIDEO
BALUNS
GENERATORS, SIGNAL, RF
NETWORKS, MATCHING, RF
OSCILLATORS, OTHER

TELSTA CORPORATION

LIFTS, AERIAL, TRUCK-MOUNTED

TELTRON, INC.

TV SYSTEMS, CLOSED CIRCUIT
VACUUM TUBES, CAMERA,
IMAGE-ORTHICON

TENSOLITE INSULATED WIRE CO.

CABLE, COAXIAL, FLEXIBLE
CABLE, SHIELDED, AUDIO
WIRE, INSULATED, HIGH VOLTAGE
WIRE, INSULATED, HOOKUP
WIRE, SHIELDED
WIRING AND CABLING SERVICES

TEXAS ELECTRONICS

CLOCKS
DIALS, INSTRUMENT
INVERTERS, DC TO AC,
SOLID STATE
VOLTMETERS, AC
VOLTMETERS, DC
WEATHER INSTRUMENTS

TEXAS INSTRUMENTS

CAPACITORS, FIXED, FILM
INTEGRATED CIRCUITS
MICROWAVE COMPONENTS
RECTIFIERS - ALSO
SEE SEMICONDUCTORS
RESISTORS, FIXED, CARBON
RESISTORS, FIXED, PRECISION
SEMICONDUCTOR DIODES
SEMICONDUCTOR RECTIFIERS,
GENERAL
SEMICONDUCTOR RECTIFIERS,
HIGH VOLTAGE
SEMICONDUCTOR RECTIFIERS,
POWER
SEMICONDUCTOR RECTIFIERS
SILICON CONTROLLED - SCR
SEMICONDUCTORS, THYRISTORS
SEMICONDUCTORS,
TRANSISTORS, AF
SEMICONDUCTORS,
TRANSISTORS, FE
SEMICONDUCTORS, TRANSISTORS,
GENERAL
SEMICONDUCTORS,
TRANSISTORS, RF

THE TEXWIDE COMPANY

CLEANERS, LENS
CLEANERS, OTHER

THE THOMAS & BETTS CO.

CLAMPS, CABLE
CLAMPS, COMPONENT
CLAMPS, GROUND
CLAMPS, TUBE
CONNECTORS, COAXIAL CABLE
CONNECTORS, POWER
CONNECTORS, RF
HARDWARE, TOOLS
TERMINAL BLOCKS
TERMINAL BOARDS
TERMINALS, BARRIER
TERMINALS, LUG
TERMINALS, SOLDERLESS
TOOLS, CRIMPERS
TOOLS, CUTTERS
TOOLS, HAND

THOMSON ELECTRIC CO.

ANTENNAS, FM
ANTENNAS, TV
CAMERAS, TV, MONOCHROME
DOLBY, CAMERA
JACKS
TRANSMITTERS, FM
TRANSMITTERS, TV
TV SYSTEMS, CLOSED CIRCUIT

THOR ELECTRONICS

SEMICONDUCTOR DIODES
SEMICONDUCTOR RECTIFIERS,
GENERAL
SEMICONDUCTOR RECTIFIERS,
HIGH VOLTAGE
SEMICONDUCTOR RECTIFIERS,
POWER
SEMICONDUCTOR RECTIFIERS,
SILICON CONTROLLED - SCR
SEMICONDUCTORS, THYRISTORS
SEMICONDUCTORS,
TRANSISTORS, AF
SEMICONDUCTORS,
TRANSISTORS, FE
SEMICONDUCTORS, TRANSISTORS,
GENERAL
SEMICONDUCTORS,
TRANSISTORS, RF
VACUUM TUBES, BALLAST
VACUUM TUBES, CAMERA,
IMAGE-ORTHICON
VACUUM TUBES, CAMERA, VIDICON

VACUUM TUBES, CATHODE RAY,
TV, COLOR

VACUUM TUBES, CATHODE RAY,
TV, MONOCHROME

VACUUM TUBES, RECEIVING

VACUUM TUBES, TRANSMITTING

TIMES WIRE AND CABLE

CABLE, ASSEMBLIES
CABLE, CATV, HARDWARE
CABLE, COAXIAL, FLEXIBLE
CABLE, COAXIAL, RIGID
CABLE, DIRECT-BURIAL
CONNECTORS, COAXIAL CABLE
CONNECTORS, RF

TOPAZ, INCORPORATED

INVERTERS, DC TO AC,
SOLID STATE

TOWNSEND ASSOCIATES

ATTENUATORS, RF
CHOPPERS - VERTICAL INTERVAL
CIRCUITS, PRINTED
COMMUNICATIONS SYSTEMS,
MULTIPLEX
EXCITERS, FM
MAINTENANCE SERVICES, TV
MODULATORS, TV
NARROW-BAND FM EQUIPMENT
POWER SUPPLIES, DC,
HIGH VOLTAGE
HIGH VOLTAGE
TRANSLATOR SYSTEMS
TRANSMITTERS, TV, 3 KW
TRANSMITTERS, TV, 15 KW
TRANSMITTERS, TV, 30 KW
TRANSMITTERS, TV, 55 KW
TRANSMITTERS, TV, 100 KW

TRAO CORP.

CAMERA, MOUNTING EQUIPMENT
CAMERAS, FILM, CINE
CAMERAS, OSCILLOSCOPE
GENERATORS, SIGNAL, PULSE
LENSES, OPTICAL, FIXED
LENSES, OPTICAL, ZOOM
PROJECTORS, FILM

TRANSCO PRODUCTS, INTL.

RECORDS, BLANK, ACETATE,
FOR RECORDING
RECORDS, BLANK, LACQUER,
FOR RECORDING
STYLUS, CUTTING
STYLUS, PLAYBACK

TREPAC CORPORATION OF AMERICA

ALARM, FAULT
ALARM, SIGNAL
AMPLIFIER, AF, COMPRESSING
AMPLIFIER, AF,
GENERAL PURPOSE
AMPLIFIER, AF, REMOTE
AUTOMATION EQUIPMENT
CIRCUITS, PRINTED
COMMUNICATIONS SYSTEMS,
TELEPRINTER
DELAY DEVICES, AF
FILTERS, AUDIO
GENERATORS, SIGNAL, AF
INVERTERS, DC TO AC,
SOLID STATE
JACK PANEL ASSEMBLIES
MONITORS, AM SYSTEMS
OSCILLATORS, AF AND RF,
SEE GENERATORS
POWER SUPPLIES, AC
POWER SUPPLIES, DC
PREAMPLIFIERS, AUDIO
PRINTERS, TELETYPE
RELAYS, PLUG IN
RELAYS, SEQUENCING
RELAYS, TIME DELAY
REMOTE CONTROL SYSTEMS
SCRAMBLERS, SPEECH
STL EQUIPMENT
SWITCHERS
SWITCHING SYSTEMS

TRIPLETT ELECTRICAL INSTR. CO.

AMMETERS, AC
AMMETERS, AC, THERMOCOUPLE
AMMETERS, DC
AMMETERS, RF
GENERATORS, SIGNAL, RF
METERS, DB AND VU
OHMMETERS
SHUNTS, METER
TESTERS, SEMICONDUCTOR
TESTERS, VACUUM TUBE
VOLTMETERS, AC
VOLTMETERS, DC
VOLTMETERS, VACUUM TUBE
WATTMETERS

TROMPETER ELECTRONICS

ADAPTERS, CONNECTOR
ATTENUATORS, AUDIO
ATTENUATORS, FIXED
ATTENUATORS,
IMPEDANCE MATCHING
ATTENUATORS, RF
ATTENUATORS, VIDEO
AUTOMATION EQUIPMENT
CABLE, ASSEMBLIES
CONNECTORS, AF & MICROPHONE
CONNECTORS, ANTENNA
CONNECTORS, COAXIAL CABLE
CONNECTORS, RF
CORDS, PATCH
JACK PANEL ASSEMBLIES
JACKS
PLUGS, COAXIAL
RELAYS, COAXIAL

RELAYS, SEQUENCING

RELAYS, STEPPING

SWITCHES, COAXIAL

SWITCHES, CROSSBAR

SWITCHING MATRIXES

SWITCHING SYSTEMS

TRUSONIC

ENCLOSURES, SPEAKER
MICROPHONE HARDWARE
MICROPHONES, CONDENSER
MICROPHONES, WIRELESS
SOUND SYSTEMS, OUTDOOR
SOUND SYSTEMS, PORTABLE
SOUND SYSTEMS, THEATER
SPEAKER COMPONENTS
SPEAKERS

TRW ELECTRONICS

CAPACITORS, FIXED, AIR
CAPACITORS, FIXED, CERAMIC
CAPACITORS, FIXED, FILM
CAPACITORS, FIXED, METALLIZED
CAPACITORS, VARIABLE
CATV EQUIPMENT - ALSO SEE
OTHER CATEGORIES
COILS, ANTENNA LOADING
COILS, CHOKER, AF
COILS, CHOKER, RF
COILS, DEFLECTION
AND FOCUSING
CRYSTALS, PIEZOELECTRIC
FILTERS, AUDIO
FILTERS, OTHER
OVENS, CRYSTAL
POWER SUPPLIES, PRECISION
SEMICONDUCTOR DIODES
SEMICONDUCTOR RECTIFIERS,
GENERAL
SEMICONDUCTOR RECTIFIERS,
HIGH VOLTAGE
SEMICONDUCTORS, TRANSISTORS,
GENERAL
SEMICONDUCTORS,
TRANSISTORS, RF
SPEAKERS
TRANSFORMERS, AUDIO,
ISOLATION
TRANSFORMERS, AUDIO, MATCHING
TRANSFORMERS, AUDIO,
POWER OUTPUT
TRANSFORMERS, AUTO
TRANSFORMERS, COUPLING
TRANSFORMERS, FILAMENT
TRANSFORMERS, GENERAL
TRANSFORMERS, PLATE
TRANSFORMERS, POWER
TRANSFORMERS, TRANSISTOR
TRANSFORMERS, VARIABLE

TRYLON INCORPORATED

ANTENNAS, AM
BALUNS
MAINTENANCE SERVICES,
STEEPLEJACK
TOWERS, ANTENNA, RECEIVING
TOWERS, ANTENNA,
TRANSMITTING, AM
TOWERS, ANTENNA,
TRANSMITTING, FM
TOWERS, ANTENNA,
TRANSMITTING, TV
TRANSMISSION LINES, OPEN WIRE

T T ELECTRONICS

FILTERS, AUDIO
FILTERS, RF
FILTERS, OTHER

TURNER MICROPHONE CO.

MICROPHONE HARDWARE
MICROPHONE STANDS & BODOMS
MICROPHONES, DYNAMIC

TV CABLE SUPPLY CO.

DIVIDERS, FREQUENCY
METERS, FIELD STRENGTH
METERS, FREQUENCY CALIBRATING
TRANSFORMERS, AUDIO, MATCHING
TRANSFORMERS, GENERAL

ULTRA AUDIO PRODUCTS

COMMUNICATIONS SYSTEMS,
INTERCOM, WIRED
CONSOLE, AUDIO, FM
CONSOLE, AUDIO, PORTABLE
CONSOLE, AUDIO, RECORDING
CONSOLE, AUDIO, TV
CONSOLE, AUDIO, AM

UNGAR ELECTRIC TOOLS

TOOLS, SOLDERING IRONS,
INDUSTRIAL

UNITED RADIO SUPPLY, INC.

CONSOLE, AUDIO, AM
CONSOLE, AUDIO, RECORDING

UNITED STATES PLASTIC ROPE

CORDS, DIAL
INSULATORS, ANTENNA

UNITED STATES TOWERS

TOWERS, ANTENNA,
CATV, HEAD-END
TOWERS, ANTENNA, RECEIVING
TOWERS, ANTENNA,
TRANSMITTING, AM
TOWERS, ANTENNA,
TRANSMITTING, FM
TOWERS, ANTENNA,
TRANSMITTING, TV

UNITED TRANSFORMER COMPANY

BOXES, DECADE, INDUCTOR
COILS, CHOKER, AF

COILS, HYBRID
COILS, TELEPHONE
DELAY DEVICES, AF
DELAY LINES
FILTERS, AUDIO
FILTERS, OTHER
INDUCTANCES, FIXED
INDUCTANCES, VARIABLE
TRANSFORMERS, AUDIO,
ISOLATION
TRANSFORMERS, AUDIO, MATCHING
TRANSFORMERS, AUDIO,
POWER OUTPUT
TRANSFORMERS, AUTO
TRANSFORMERS, COUPLING
TRANSFORMERS, FILAMENT
TRANSFORMERS, GENERAL
TRANSFORMERS, PLATE
TRANSFORMERS, POWER
TRANSFORMERS, TRANSISTOR
TRANSFORMERS, VARIABLE

UP-RIGHT SCAFFOLDS

CAMERA, MOUNTING EQUIPMENT
LIGHTNING ARRESTERS
TOWERS, ANTENNA,
CATV, HEAD-END
TOWERS, ANTENNA, RECEIVING
TOWERS, ANTENNA,
TRANSMITTING, AM
TOWERS, ANTENNA,
TRANSMITTING, FM
TOWERS, ANTENNA,
TRANSMITTING, TV

UPSON BROS.

HARDWARE, TOOLS
KITS
TOOLS, HAND
TOOLS, SCREWDRIVERS

UTICA CORP.

ANTENNAS, MOBILE
BASE STATIONS
COMMUNICATIONS SYSTEMS, CB
COMMUNICATIONS SYSTEMS,
INTERCOM, WIRELESS
COMMUNICATIONS SYSTEMS,
LAND MOBILE
MOBILE EQUIPMENT
MONITORS, FM SYSTEMS, MOND
MOUNTS, ANTENNA, MOBILE
MOUNTS, INSTRUMENT
NARROW-BAND FM EQUIPMENT
PREAMPLIFIERS, AUDIO
RECEIVERS, AM
RECEIVERS, FM
TRANSFORMERS, TV, 60 WATTS

UTILITY PRODUCTS CO

CATV, CABLE TERMINALS
TERMINAL BOARDS

UTILITY TOWER CO

CATV EQUIPMENT - ALSO SEE
OTHER CATEGORIES
INSULATORS, TOWER BASE
MAINTENANCE SERVICES,
STEEPLEJACK
PREFABRICATED BUILDINGS
REFLECTORS, PASSIVE
TOWERS, ANTENNA,
CATV, HEAD-END
TOWERS, ANTENNA, RECEIVING
TOWERS, ANTENNA,
TRANSMITTING, AM
TOWERS, ANTENNA,
TRANSMITTING, FM
TOWERS, ANTENNA,
TRANSMITTING, TV
WIRE, BARE, COPPER
WIRE, BARE, COPPER STRAP

VALUE INCORPORATED

DRAFTING EQUIPMENT

VEGA ELECTRONICS CORP

AMPLIFIER, AF, COMPRESSING
MICROPHONES, CONDENSER
MICROPHONES, WIRELESS
RECEIVERS, FM

VENT-BAK INCORPORATED

CABINETS, METAL
CONSOLE, CABINETS
AND HARDWARE
HARDWARE, CHASSIS
LAMP ASSEMBLIES
PANELS, INSTRUMENT,
FOR RACK MOUNTING
REELS, CABLE, AUTOMATIC
SLIDES, CHASSIS

VIDEON CORPORATION

AMPLIFIER, DC
AMPLIFIER, DISTRIBUTION
AMPLIFIER, TV, VIDEO
ANALYZERS, VIDEO
DIVIDERS, FREQUENCY
GENERATORS, SIGNAL, COLOR BAR
GENERATORS, SIGNAL, DT BAR
GENERATORS, SIGNAL, MARKER
GENERATORS, SIGNAL, PULSE
GENERATORS, SIGNAL,
SPECIAL EFFECT
GENERATORS, SIGNAL,
SQUARE WAVE
GENERATORS, SIGNAL,
TV SYNCHRONIZING
GENERATORS, SIGNAL, VITS
MULTIPLEXERS
OSCILLATORS, TV
POWER SUPPLIES, DC
POWER SUPPLIES, PRECISION
PREAMPLIFIERS, VIDEO

SWITCHERS
SWITCHING SYSTEMS

VIKING OF MINNEAPOLIS
AMPLIFIER, AF, MONAURAL
AMPLIFIER, AF, STEREO
CARTRIDGES, MAGNETIC TAPE
RECORDERS, MAGNETIC TAPE,
RECORDERS, MAGNETIC TAPE,
AUDIO
AUDIO, CARTRIDGE
RECORDERS, MAGNETIC TAPE,
TAPE DECKS, MAGNETIC
TAPE DUPLICATORS

VISHAY RESISTOR PRODUCTS
RESISTORS, FIXED,
NONINDUCTIVE
RESISTORS, FIXED, PRECISION

VISUAL ELECTRONICS CORP
AMPLIFIER, AF, AGC
AMPLIFIER, AF, COMPRESSING
AMPLIFIER, AF,
GENERAL PURPOSE
AMPLIFIER, AF, MONAURAL
AMPLIFIER, AF,
PEAK LIMITING, AM
AMPLIFIER, AF,
PEAK LIMITING, FM
AMPLIFIER, AF, REMOTE
AMPLIFIER, AF, REVERBERATION
AMPLIFIER, DISTRIBUTION
AMPLIFIER, PULSE
AMPLIFIER, STABILIZING
AMPLIFIER, TV, VIDEO
AMPLIFIER, VIDEO, SWEEP
ANTENNAS, AM
ANTENNAS, FM
ANTENNAS, MICROWAVE
ANTENNAS, TV
AUTOMATION EQUIPMENT
CABLE, COAXIAL, FLEXIBLE
CABLE, COAXIAL, RIGID
CAMERA, MOUNTING EQUIPMENT
CAMERA, REMOTE
CONTROL EQUIPMENT
CAMERAS, FILM, CINE
CAMERAS, TV, COLOR
CAMERAS, TV, MONOCHROME
CARTRIDGES, MAGNETIC TAPE
COMMUNICATIONS SYSTEMS,
INTERCOM, WIRED
CONNECTORS, COAXIAL CABLE
CONSOLE, AUDIO, AM
CONSOLE, AUDIO, FM
CONSOLE, AUDIO, PORTABLE
CONSOLE, AUDIO, RECORDING
CONSOLE, AUDIO, TV
CONSOLE, VIDEO, STUDIO
DIPLEXERS
DOLLIES, CAMERA
DROPOUT COMPENSATOR,
VIDEO TAPE
EDITORS, VIDEO TAPE
EXCITERS, FM
GENERATORS, SIGNAL, COLOR BAR
GENERATORS, SIGNAL, DOT BAR
GENERATORS, SIGNAL, MARKER
GENERATORS, SIGNAL, PULSE
GENERATORS, SIGNAL,
SPECIAL EFFECT
GENERATORS, SIGNAL,
SQUARE WAVE
GENERATORS, SIGNAL,
TV SYNCHRONIZING
GENERATORS, SIGNAL, VITS
JACK PANEL ASSEMBLIES
JACKS
LENSES, OPTICAL, FIXED
LENSES, OPTICAL, ZOOM
LIGHTING, TV, COMPONENTS
LIGHTING, TV, CONTROLS
LIGHTING, TV, SYSTEMS
MICROPHONE HARDWARE
MICROPHONE STANDS & BOOMS
MICROPHONES, CONDENSER
MICROPHONES, DYNAMIC
MICROPHONES, VELOCITY

MICROPHONES, WIRELESS
MICROWAVE SYSTEMS, STL
MONITORS, AM SYSTEMS
MONITORS, FM SYSTEMS, MOND
MONITORS, FM SYSTEMS, SCA
MONITORS, FM SYSTEMS, STEREO
MONITORS, FREQUENCY
MONITORS, PHASE
MONITORS, VIDEO
MONITORS, WAVEFORM
PROJECTORS, FILM
PROJECTORS, SLIDE
RECORDERS, MAGNETIC TAPE,
AUDIO
RECORDERS, MAGNETIC TAPE,
VIDEO
RELAYS, COAXIAL
REMOTE CONTROL SYSTEMS
REVERBERATION DEVICES
SCREENS, PROJECTION, FRONT
SCREENS, PROJECTION, REAR
STL EQUIPMENT
SWITCHERS
SWITCHING SYSTEMS
TAPE DECKS, MAGNETIC
TAPE DUPLICATORS
TOWERS, ANTENNA,
TRANSMITTING, AM
TOWERS, ANTENNA,
TRANSMITTING, FM
TOWERS, ANTENNA,
TRANSMITTING, TV
TRANSMISSION LINES
TRANSMISSION TEST SETS
TRANSMITTERS, AM, 1 KW
TRANSMITTERS, AM, 5 KW
TRANSMITTERS, AM, 10 KW
TRANSMITTERS, AM, 25 KW
TRANSMITTERS, AM, 50 KW
TRANSMITTERS, FM, 3 KW
TRANSMITTERS, FM, 5 KW
TRANSMITTERS, FM, 10 KW
TRANSMITTERS, FM, 20 KW
TRANSMITTERS, TV, 15 KW
TRANSMITTERS, TV, 30 KW
TRANSMITTERS, TV, 55 KW
TURNTABLES, PHONOGRAPH
VACUUM TUBES, CAMERA,
IMAGE-ORTHICON
VACUUM TUBES, CAMERA,
PLUMBICON R
VACUUM TUBES, CAMERA, VIDICON
VESTIGIAL SIDEBAND FILTERS

VITAL INDUSTRIES
AMPLIFIER, DISTRIBUTION
AMPLIFIER, STABILIZING
AMPLIFIER, TV, VIDEO
SWITCHING SYSTEMS

VITRO ELECTRONICS
CIRCUITS, PRINTED
CONNECTORS, COAXIAL CABLE
CONNECTORS, RF
CORDS, PATCH
HARDWARE, PANEL
HARDWARE, RACK
INTEGRATED CIRCUITS
JACK PANEL ASSEMBLIES
JACKS
METERS, FIELD STRENGTH
MONITORS, AM SYSTEMS
MONITORS, FM SYSTEMS, MONO
MONITORS, PHASE
RECEIVERS, AM
RECEIVERS, FM
RECEIVERS, HF
RECEIVERS, MULTIPLEX
TERMINAL STRIPS
WIRING AND CABLING SERVICES

VUE-TRONICS INC.
RECORDERS, VIDEO,
FILM, KINESCOPE

WABER ELECTRONICS INC.
CABINETS, METAL
CONNECTORS, POWER
CORDS, SET

COUPLERS
DOLLIES, CAMERA
DOLLIES, TEST EQUIPMENT
DUCTS, WIRING
KITS
RACKS, MOUNTING
SWITCHES, MECHANICALLY
ACTUATED
VOLTMETERS, AC

WALLACH & ASSOCIATES
CABINETS, STORAGE, DISC
CABINETS, STORAGE, FILM
CABINETS, STORAGE,
MAGNETIC TAPE
CABINETS, STORAGE, SLIDE

WARD ELECTRONIC INDUSTRIES
AMPLIFIER, AF, AGC
AMPLIFIER, AF, COMPRESSING
AMPLIFIER, AF,
GENERAL PURPOSE
AMPLIFIER, AF,
PEAK LIMITING, AM
AMPLIFIER, AF, REMOTE
AMPLIFIER, BRIDGING
AMPLIFIER, DISTRIBUTION
AMPLIFIER, PULSE
AMPLIFIER, TV, VIDEO
ANALYZERS, SIDEBAND
AUTOMATION EQUIPMENT
COMMUNICATIONS SYSTEMS,
INTERCOM, WIRED
CONSOLE, AUDIO, FM
CONSOLE, AUDIO, PORTABLE
CONSOLE, AUDIO, RECORDING
CONSOLE, AUDIO, TV
CONSOLE, VIDEO, PORTABLE
CONSOLE, VIDEO, STUDIO
DEMODULATORS
NETWORKS, PHASING
PREAMPLIFIERS, AUDIO
PREAMPLIFIERS, VIDEO
SWITCHERS
SWITCHING MATRIXES
SWITCHING SYSTEMS

WATERS MANUFACTURING
ANTENNAS, MOBILE
ATTENUATORS, RF
DUMMY LOAD
FILTERS, OTHER
METERS, FREQUENCY
MOUNTS, ANTENNA, MOBILE
POTENTIOMETERS, WIREWOUND
RESISTORS, VARIABLE,
WIREWOUND
SWITCHES, COAXIAL
WATTMETERS

WAVEFORMS, INCORPORATED
ANALYZERS, DISTORTION
GENERATORS, SIGNAL, AF
GENERATORS, SIGNAL,
SQUARE WAVE
METERS, FREQUENCY
OSCILLATORS, AF AND RF,
SEE GENERATORS
OSCILLATORS, OTHER
TRANSMISSION TEST SETS
VOLTMETERS, AC
VOLTMETERS, VACUUM TUBE

WECKESSER COMPANY
CABLE, ASSEMBLIES
CLAMPS, CABLE

WESTINGHOUSE ELECTRIC CORP.
VACUUM TUBES, CAMERA,
IMAGE-ORTHICON
VACUUM TUBES, CAMERA, VIDICON
VACUUM TUBES, CATHODE RAY,
TV, COLOR
VACUUM TUBES, CATHODE RAY,
TV, MONOCHROME
VACUUM TUBES, RECEIVING
VACUUM TUBES, TRANSMITTING

WIDE RESPONSE
REELS, TAPE
TAPE, MAGNETIC RECORDING,
AUDIO

WILKINSON ELECTRONICS, INC
AMPLIFIER, AF, AGC
AMPLIFIER, AF, MONAURAL
AMPLIFIER, AF,
PEAK LIMITING, AM
AMPLIFIER, AF,
PEAK LIMITING, FM
CONSOLE, AUDIO, AM
CONSOLE, AUDIO, FM
CONSOLE, AUDIO, RECORDING
CONSOLE, AUDIO, TV
EXCITERS, FM
GENERATORS, FM, STEREO
GENERATORS, FM, SUBCARRIER
GENERATORS, SIGNAL, RF
METERS, FIELD STRENGTH
MONITORS, AM SYSTEMS
RECTIFIERS - ALSO SEE
SEMICONDUCTORS
SEMICONDUCTOR RECTIFIERS,
GENERAL
SEMICONDUCTOR RECTIFIERS,
HIGH VOLTAGE
SEMICONDUCTOR RECTIFIERS,
POWER
TRANSMITTERS, AM, 1 KW
TRANSMITTERS, AM, 5 KW
TRANSMITTERS, AM, 10 KW
TRANSMITTERS, FM, 1 KW
TRANSMITTERS, FM, 5 KW
TRANSMITTERS, FM, 7.5 KW
TRANSMITTERS, FM, 10 KW
TRANSMITTERS, FM, 20 KW

W. WILSON CORPORATION
HARDWARE, MOUNTS
LAMPS, PROJECTION
MOBILE EQUIPMENT
SCREENS, PROJECTION, REAR

XCELITE INCORPORATED
HARDWARE, TOOLS
TOOLS, CUTTERS
TOOLS, HAND
TOOLS, PLIERS
TOOLS, SCREWDRIVERS
TOOLS, WRENCHES

YOKOGAWA ELECTRIC WORKS
AMMETERS, AC
AMMETERS, AC, THERMOCOUPLE
AMMETERS, DC
AMMETERS, RF
BRIDGES
METERS, DB AND VU
METERS, DB AND VU, WIDE RANGE
METERS, FIELD STRENGTH
METERS, FREQUENCY
METERS, LIGHT
METERS, PHASE ANGLE
METERS, POWER
OHMMETERS
PANELS, INSTRUMENT,
FOR RACK MOUNTING
RECORDERS, PAPER,
LOGGING AND GRAPHIC
TESTERS, INSULATION
VOLTMETERS, AC
VOLTMETERS, DC
WATTMETERS

ZOLOMATIC CORPORATION
LENSES, OPTICAL, FIXED
LENSES, OPTICAL, ZOOM
PROJECTORS, SLIDE

ZOOMAR, INC.
LENSES, OPTICAL, FIXED
LENSES, OPTICAL, ZOOM
METERS, LIGHT

Here's one way to kill a Teltron tube



Teltron image orthicons have long life characteristics. You'll grow old trying to wear them out. These tubes offer performance features surpassing the finest image orthicon's manufactured (monochrome or color applications) at a savings of 35% to 65% (computed on average hourly cost basis). Teltron tubes are guaranteed as long or longer than any competitors product, (for just about everything but smashing them with a hammer). Join the list of satisfied Teltron users. You'll agree that Teltron is the "Answer to a need".

Teltron tubes are die-hards.



7 BALA AVENUE, BALA CYNWYD, PA. 19004 Telephone 215-664-6672

When leading broadcast engineers insist on genuine EEV camera tubes, they must have good reasons.

They do. Plenty of them, in fact.

Television broadcasters the world over have come to rely almost exclusively on the unique combination of tube quality and long-life economy that only English Electric Valve — the world's foremost camera tube manufacturer — can provide.

Typical of this foremost camera tube line are . . .

ELCON-Target Image Orthicons

- Long life — 3 to 4 times longer
- Stable, non-stick target
- Uniform sensitivity and gamma throughout extended tube life
- No burn-in



ELCON Color-Matched Tubes

Matched color sets of ELCON Image Orthicon tubes are selected on the basis of camera control operating parameters, as well as tube sensitivities and signal current outputs. And, in most cases, the need for trimming with neutral density filters is completely eliminated . . . orbiting is not required . . . and sensitivity is improved.

Type	Description
4415E/ 4416E	3" tube—field mesh; matched set of three tubes.



ELCON 3" Image Orthicon

Non-field mesh and field mesh tubes with effective operational life of 3,000 to 5,000 hours. Full target warranty of 1,200 hours.

Type	Description
5820A/E	3" tube—non-field mesh
7293B	3" tube—field mesh
8093A/E	3" tube—field mesh; with close target-to-mesh spacing



ELCON 4 1/2" Image Orthicon

ELCON Target — JEDEC-designated; 3,000-5,000/hour operational life; 1,200/hour target warranty.

Type	Description
7295C	4 1/2" tube — field mesh.
7389C	4 1/2" tube — field mesh; with close mesh-to-target spacing.

1-inch Vidicons



1-inch Vidicons, Integral Mesh

Type	Description
P860	Utilizes new photosurface (similar to 8625, 8626) for high sensitivity, minimum lag; film or studio applications; monochrome or color
7038	Monochrome or color film camera applications; 600 ma filament
7735A	For studio and remote cameras; high sensitivity; 600 ma filament

1-inch Vidicons, Separate Mesh

- Highest quality pictures with minimal shading
- Low lag; reduced long-term sticking.
- Lower light level operation
- Photo-surface of 8625 and 8626 vidicons combine high "blue" sensitivity and reduced "red" sensitivity for correct panchromatic response to standard tungsten lighting
- Resolution exceeds 1,000 lines
- Beam landing errors minimized for improved signal output

Type	Description
8625	High sensitivity photosurface; preferred spectral response of 7038 type; 600 ma filament
8626	Equivalent to 8625, with 95 ma filament for transistorized cameras
8507	Low lag, high sensitivity characteristics; 600 ma filament
8541	Equivalent to 8507, with 95 ma filament for transistorized cameras
8572	Low lag characteristics for film application, monochrome or color; 600 ma filament

the
Blue
Ribbon
Line

Other tubes available for specific applications. World-wide patents applied for.

For complete information and prices on the Blue Ribbon quality EEV camera tube line, contact

VISUAL ELECTRONICS CORPORATION

356 west 40th street • new york, n.y. 10018 • (212) 736-5840

FIRST BY ANY STANDARD

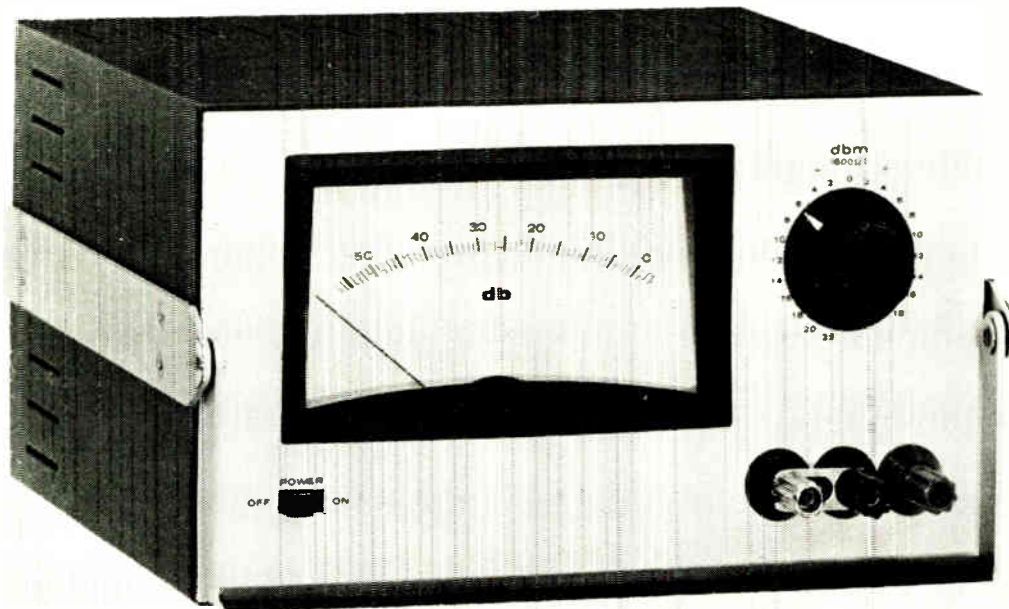

A new way to keep your signal clean.

CBS Laboratories presents its new Model 600 Wide Range Program Monitor.

This remarkable instrument can't censor "blue" comics, but it can keep you from transmitting cross-talk, studio noise and other sounds that may clutter your signal.

In fact, it's the first monitor to combine the latest developments in audio technology with the reliability of solid-state design for accurate audio measurement and analysis on a single 60 dB-wide scale.

Where the standard Volume Indicator measures only the top 23 dB of signal level logarithmically, this new Program Monitor displays information from +3 to -57 dB on a single linear, decibel scale, thus permitting accurate reading of low level audio material as well as line noise during program pauses. The 0 dB reference settings are adjustable from +18 to -22 dBm.

The 600 is also equipped with a separate DC output for graphic logging over the full 60 dB range or to drive a second meter for remote monitoring. It is also available in a standard 19-inch mounting rack from which it can be easily removed for portable use.

While not intended as a replacement for the standard Volume Indicator, the 600's meter ballistics are such that its readings are compatible with VU indications. It's a practical studio monitor as well as a valuable measuring tool.

SPECIFICATIONS:

Model 600 Wide Range Program Monitor, \$345. As shown above, without standard 19-inch mounting enclosure, \$305.

Reference Deflection (0 dB)	Adjustable from +18 to -22 dBm
Internal Noise Level	At least 15 dB below the -57 dB reading
Total Measurable Range	-79 to +21 dBm
Scale	Linear 60 dB-wide scale from -57 to +3 dB
DC Output	Linear volts dB output is 6 volts maximum at 5500 ohms impedance. Calibrated to provide remote monitoring
Frequency Range	50 to 15,000 cps
Linearity	± 1 dB
Input Impedance	15,000 ohms, bridging, balanced or unbalanced
Maximum Operating Temperature	55° C
Dimensions	In enclosure: 19" wide, 7" high, 10" deep Out of enclosure: 9" wide, 5" high, 10" deep
Power Requirements	12 watts, 115/230 volts AC
Shipping Weight	With enclosure: 14 lbs. Without enclosure: 9 lbs.

Technical series Professional Test records

Unique, high-precision tools designed to help audio and quality control engineers and test and service technicians to evaluate audio components, equipment and systems.

Each record has a complete series of tests. These eliminate the need for certain equipment, save hours of time, and make the record a productive tool in the laboratory, on the production line, and in field testing.

BTR 150 BROADCAST TEST RECORD

Developed especially to meet needs of broadcast engineers seeking a convenient signal source for testing and adjusting all audio equipment. It contains Volume Indicator ballistic calibration signals and is an essential tool for measuring phonographic pickup response. In providing complex waveforms for special tests, it replaces elaborate instrumentation generally unavailable in broadcast stations. Can be used to advantage by all AM, FM, TV and FM-Stereo broadcasters. **BTR 150, Net Ea. \$10.00**

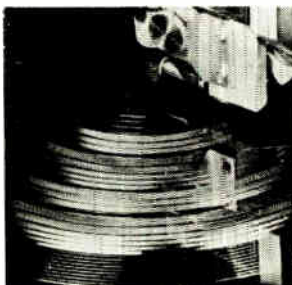

STR 130 RIAA FREQUENCY RESPONSE TEST RECORD

Designed for calibration of professional recording equipment and for testing response of professional and consumer record reproduction equipment. Rapid, accurate procedures replace lengthy and tedious adjustments. Time for production testing and quality control is reduced to a fraction of time required with conventional methods. Suitable for use with automatic curve tracer to provide permanent, visible records for precise evaluation. Instruction for use without automatic curve tracing included. **STR 130, Net Ea. \$10.00**

STR 100 STEREOGRAPHIC FREQUENCY TEST RECORD

Designed for evaluation of pickups and systems, it was recorded with a constant amplitude characteristic below 500 cps and a constant velocity characteristic above 500 cps. Tests include: Sweep Frequency (with the sweep rate synchronized with the General Radio Type 1521 A Recorder); Spct Frequency (with voice announcements); Channel Separation; Wave-length Loss and Stylus Wear (to pinpoint oversize or worn-out styli, and excessive pickup tracking force); Compliance; Phasing; Vertical and Lateral Tracking Tone Arm Resonance (to check system performance at low and sub-audible frequencies and thus reveal undamped resonances which may cause equipment over-loading). **STR 100, Net Ea. \$6.50**

CBS LABORATORIES
Stamford, Connecticut. A Division of
Columbia Broadcasting System, Inc.



Representatives

This listing is arranged alphabetically by manufacturer and contains the company name, address, telephone number, and TWX number; sales manager or other executives; brand names; and company representatives arranged alphabetically by states and countries.

ACME FILM & VIDEOTAPE

LABORATORIES
GENERAL MANAGER
MEL SAWELSON
COMPANY ADDRESS
1161 NORTH HIGHLAND AVE.
LOS ANGELES, CALIF. 90038
COMPANY REPRESENTATIVES
BOB TROUP, VP EASTERN SALES
400 MADISON AVENUE
NEW YORK, N. Y.
212 421-3400

ACME VISIBLE RECORDS, INC.

SALES MANAGER
J. B. MINCH
BRAND NAMES
FLEXOLINE
ELECTROFILE
ORDA-FLO
VERI-VISIBLE
CENTRAC
ASTRODMATIC
SUPER-VISIBLE
COMPANY ADDRESS
CROZET, VIRGINIA 22932
COMPANY REPRESENTATIVES
W. B. SHEA, R. MGR.
1111 CRENSHAW BLVD.
LOS ANGELES, CALIF. 90019
213-933-8595
B. E. SMITH, R. MGR.
675 CALIFORNIA STREET
SAN FRANCISCO, CALIF. 94108
415-781-5293
R. B. EVANS, R. MGR.
934 BANK OF GEORGIA BLDG.
ATLANTA, GA. 30303
404-521-0195
R. O. SHEALOR, R. MGR.
405 PARK AVENUE
NEW YORK, N.Y. 10022
212-PL9-3330
W. M. BRENT, R. MGR.
3121 EUCLID AVENUE
CLEVELAND, OHIO 44115
216-881-6660
D. D. SAGGESE, R. MGR.
BARCLAY BLDG.
BALA-CYNWYD, PA. 19004
215-TE9-6020
R. E. WEBB
REGIONAL MANAGER
7701 STEMMONS FREEWAY STE 131
DALLAS, TEXAS 75247
214-ME7-1330
REPS. IN OTHER COUNTRIES
R. B. MCARDLE, SALES MGR.
ACME SEELEY BUSINESS
SYSTEMS LTD.
32 MENDOTA ROAD
TORONTO 18, ONTARIO
416 259-8435

ADC PRODUCTS

SALES MANAGER
W. J. HOLMBECK
COMPANY ADDRESS
6405 CAMBRIDGE STREET
MINNEAPOLIS, MINN 55426
COMPANY REPRESENTATIVES
ADC SOUTHWESTERN SALES OFFICE
99 EAST MAGNOLIA BLVD.
SUITE 301
BURBANK, CALIFORNIA 91502
213-849-5821
ALLEN I. WILLIAMS COMPANY
4971 JACKSON STREET
DENVER, COLORADO 80222
303-388-4391
CES ASSOCIATES
P.O. BOX 1152
MELBOURNE, FLORIDA 32902
305-AL4-2183
JAY C. ANGEL & COMPANY
2743 PETERSON AVE., WEST
CHICAGO, ILLINOIS
312 UP 8-0653
V. J. HUNTOON & ASSOCIATES
908 BELMONT AVENUE
SPRINGFIELD, MASS
413-ST8-8516
V. J. HUNTOON & ASSOCIATES
272 CENTRE STREET
NEWTON, MASS. 02158
617-244-2278
R. G. RAGON, INC.
1136 WEST LARPEUR AVENUE
ST. PAUL, MINNESOTA 55113
612-488-6634
R. R. BURTON SALES CO., INC.
7546 TROOST AVENUE, RM. 20
P.O. BOX 5324
KANSAS CITY, MISSOURI 64131
816 JA 3-7865
R. R. BURTON SALES CO., INC.
SUITE 201, WOODSON PARK BLDG
2050 WOODSON ROAD
ST. LOUIS, MISSOURI 63114
314-JA6-2026
ALLEN I. WILLIAMS COMPANY
3221 SILVER AVENUE, SE
ALBUQUERQUE, NEW MEXICO 87106
505-AL5-9632
E. R. A., INCORPORATED
330 GREAT NECK ROAD
GREAT NECK, NEW YORK 11021
516-MU2-9320
T. FERGUSON SALES, INC.
228 WINTON ROAD NORTH
P.O. BOX 3893
ROCHESTER, NEW YORK 14610
716-482-7757
J. F. WULFETANGE DIVISION
P.O. BOX 293
4314 EAST GENESEE STREET
DEWITT, NEW YORK 13214

315-446-3330
K. O. BROWN & COMPANY
P.O. BOX 1791
GREENSBORO, N.C. 27402
919-BR3-5973
JAMES W. MURRAY & ASSOCIATES
P.O. BOX 11028
BEL RUE CREST CENTER
CINCINNATI, OHIO 45211
513-MO2-1616
C. A. ROBINSON COMPANY, INC.
P.O. BOX 51
4225 MAYFIELD ROAD
CLEVELAND, OHIO 44121
216-EV1-9049
T. J. RAY & COMPANY
P.O. BOX 5417
TULSA, OKLAHOMA 74104
918-NA7-1515
DANCO CORPORATION
GERMANTOWN PIKE AND
QUARRY HALL ROAD
FAIRVIEW VILLAGE, PA.
215-BR3-2600
JOHN A. GREEN COMPANY
7118 ENVOY COURT
DALLAS, TEXAS 75247
214 ME 1-7450
JOHN A. GREEN COMPANY
P.O. BOX 66506
ROOM 110, 3400 MONTROSE
HOUSTON, TEXAS 77006
713-JA6-2959
ALLEN I. WILLIAMS COMPANY
2461 SOUTH MAIN STREET
SALT LAKE CITY, UTAH 84115
801-466-8709
JOHN B. JOLLY
69 MARION STREET
SEATTLE, WASHINGTON 98104
MA3-7060
REPS. IN OTHER COUNTRIES
WILLER ENGINEERING & SALES CO
1800 AVENUE ROAD
TORONTO 12, ONTARIO
416-783-3373

ADVANCE INDUSTRIES

SALES MANAGER
G. S. CHESEN
COMPANY ADDRESS
705 DOUGLAS ST.
SIOUX CITY, IOWA 51101
712-252-4475

AEROVOX CORP.
SALES MANAGER
MATT SIMON
BRAND NAMES
AEROCUP
AEROFILM
AEROGLAZE
AEROLENE

AEROMET
AUTOPASS
CERAFIL
CERALAM
POLYCAP
CEROL
DURAMIC
81-ELECTRIC
COMPANY ADDRESS
740 BELLEVILLE AVE.
NEW BEDFORD, MASS. 02741
COMPANY REPRESENTATIVES
STANLEY K. WALLACE ASSOCIATES
3040 WHISPERING PINES CIRCLE
BIRMINGHAM, ALABAMA
205-822-2196
MEYER, ROSS & FLEMING
113 TENTH STREET
SAN FRANCISCO 3, CALIF.
HE 1-0652
AL J. RTSSI SALES
1017 E. LAS TUNAS DRIVE
SAN GABRIEL, CALIF. 91776
CU 3-7614 OR at 6-1476
CONNORS, INC.
2241 STACY DRIVE
DENVER, COLORADO 80221
303-428-1575
GERBER SALES COMPANY
31 BROADWAY
NEW HAVEN, CONN. 06515
777-6279
STANLEY K. WALLACE ASSOCIATES
3761 EAST 8TH AVENUE
MIAMI, FLORIDA
OX 1-1654
STANLEY K. WALLACE ASSOCIATES
P.O. BOX 67
LUTZ, FLORIDA
949-1817
STANLEY K. WALLACE ASSOCIATES
715 FLAMINGO DRIVE, S.W.
ATLANTA 11, GEORGIA
PL 3-8463
DOUGHERTY ENTERPRISES
P. O. BOX 3497
1164 WIMANU ST
HONOLULU, HAWAII 96811
510-281 & 504-987
ELLINGER SALES CORP.
6580 NORTHWEST HIGHWAY
CHICAGO, ILLINOIS 60631
312 763-1570
ELLINGER SALES CORP.
5214 FOREST AVENUE
FORT WAYNE, INDIANA
749-9955
ELLINGER SALES CORP.
309 FOURTH AVE., S.E.
CLARION, IOWA
515-532-3218
EARL K. MOORE COMPANY
5864 LOUISVILLE STREET

NEW ORLEANS, LOUISIANA 70124
 HU 8-2407
 GERBER SALES COMPANY
 48 PEARL STREET
 BROOKLINE, MASS. 02147
 BE 2-2425
 GERBER SALES COMPANY
 26 MAPLE COURT
 EAST LONGMEADOW, MASS. 01028
 413-525-3059
 ROBERT MILSK COMPANY
 1975 JAMES COUZENS HIGHWAY
 DETROIT, MICHIGAN 48235
 313-342-6660-1-2-3
 FRED B. HILL COMPANY
 6110 EXCELSIOR BLVD.
 MINNEAPOLIS, MINNESOTA 55416
 929-7813
 ELLINGER SALES CORP.
 4969 BANCROFT
 ST. LOUIS, MISSOURI 63109
 314-352-2027
 SIMBERKOFF SALES, INC.
 175 OAKWOOD AVE.
 ORANGE, NEW JERSEY
 201 674-4100
 SIMBERKOFF SALES, INC.
 176 STATE STREET
 ALBANY, NEW YORK
 518-465-1248
 SIMBERKOFF SALES, INC.
 14 JUNIOR AVENUE
 BUFFALO, NEW YORK
 716-823-8399
 STANLEY K. WALLACE ASSOCIATES
 RTE. 1 BOX 423
 MATTHEWS, NORTH CAROLINA
 704-847-9262
 C. H. DOLFUSS, JR. & COMPANY
 EAST 21ST AND PAYNE AVE.
 CLEVELAND 14, OHIO
 771-1270-1
 GENE S. ROOT & COMPANY
 809 WAINWRIGHT DRIVE
 PITTSBURGH, PA. 15228
 412-561-4125
 SIMBERKOFF SALES, INC.
 1021 LEVICK STREET
 PHILADELPHIA, PA.
 215-743-2512
 STANLEY K. WALLACE ASSOCIATES
 638 ROCHELLE DRIVE
 NASHVILLE 4, TENN.
 VE 2-0794
 THE EXPORT COMPANY
 9104 CADEM
 MEMPHIS, TENNESSEE
 363-4160
 THE EXPORT COMPANY
 2411 FARRINGTON STREET
 DALLAS, TEXAS 75207
 631-6270
 THE EXPORT COMPANY
 8811 GAYLORD
 HOUSTON, TEXAS 77024
 465-3031
 SIMBERKOFF SALES, INC.
 724 W-ARLINGTON TOWERS
 ARLINGTON, VIRGINIA
 703-525-5898
 DON SMITH SALES COMPANY
 2320 NORTH 45TH STREET
 SEATTLE, WASHINGTON
 ME 3-3160
 DON SMITH SALES COMPANY
 2404 WEST DALTON
 SPOKANE 13, WASHINGTON
 FA 5-4022

AIR SPACE DEVICES, INC.
 SALES MANAGER
 HAROLD A. LANE
 BRAND NAMES
 SAF-T-CLIMB
 COMPANY ADDRESS
 P.O. BOX 405
 NORTH HOLLYWOOD, CALIF. 91603

ALTEK COMMUNICATION, INC.
 PRESIDENT
 KENNETH ATKEN
 COMPANY ADDRESS
 301 S. LINCOLN ST.
 TAFT, CALIF. 93268
 805-765-5403

ALBION OPTICAL COMPANY INC.
 SALES MANAGER
 ROY M. LEAVESLEY
 BRAND NAMES
 DUOPANCHRO
 KINETAL
 ORTAL
 SENTAL
 SPEED PANCHRO
 TELEPANCHRO
 VARTAL
 VIDITAL
 COMPANY ADDRESS
 260 NORTH ROUTE 303
 WEST NYACK, NEW YORK 10994

ALFORD MANUFACTURING COMPANY
 SALES MANAGER
 HAROLD M. LEACH
 BRAND NAMES
 HYBRIDGE
 COMPANY ADDRESS
 299 ATLANTIC AVENUE
 BOSTON, MASS. 02110

ALLIED ELECTRONICS CORP.
 SUBSID. OF ALLIED RADIO CORP.
 SALES MANAGER
 R. G. PETERSON

BRAND NAMES
 KNIGHT-KIT
 KNIGHT
 COMPANY ADDRESS
 100 N. WESTERN AVE.
 CHICAGO, ILL. 60680
 COMPANY REPRESENTATIVES
 K. HILL
 960 N. SAN ANTONIO RD.
 LOS ALTOS, CALIF. 94022
 415-941-0524
 J. LIMEC
 ALLIED RADIO OF CALIF
 2085 E. FOOTMILL BLVD.
 PASADENA, CALIF.
 213-684-0730
 P. WHILE
 6767 E. 39TH AVENUE
 DENVER, COLO. 80207
 303-399-2250
 M. SIMMS
 600 KENNEDY STREET
 WASHINGTON, D. C. 20011
 202-291-5000
 C. SMITH
 4605 J. F. KENNEDY BLVD.
 TAMPA, FLA. 33609
 813-877-6791
 D. LAEMONT
 13831 FENKELL AVENUE
 DETROIT, MICH.
 313-836-0007
 J. LOVETANG
 4330 HIGHWAY 7
 MINNEAPOLIS, MINN. 55416
 612-920-5800
 M. SANDO
 255 NORTH GOODMAN ST.
 ROCHESTER, N.Y. 14602
 716-244-8750
 R. OFRIEL
 2975 FAR HILLS AVE.
 DAYTON, OHIO 45401
 513-298-9831
 J. WINTERMUTE
 3592 LEE ROAD
 CLEVELAND, OHIO 44120
 216-752-3290
 C. HOFFMAN, DIST. MGR.
 5622 DYER STREET
 DALLAS, TEXAS 75206
 214-369-2341
 H. KEENAN
 1020 FOURTH AVE., S.
 SEATTLE, WASHINGTON 98134
 206-442-8026
 H. MITCHELL
 3709 FOND DU LAC,
 MILWAUKEE, WISC. 53216
 414-444-2840

ALMA ENGINEERING INC.
 SALES MANAGER
 WILLIAM A ROSE
 BRAND NAMES
 ALMA
 COMPANY ADDRESS
 8090 ENGINEER ROAD
 SAN DIEGO, CALIF. 92111
 COMPANY REPRESENTATIVES
 S. S. KRINSKY & ASSOC.
 6311 YUCCA STREET
 HOLLYWOOD 28, CALIF.
 213-462-1133

ALPHA WIRE
 SALES MANAGER
 JOHN E. MYERS
 COMPANY ADDRESS
 711 LIDGERWOOD AVE.
 ELIZABETH, NEW JERSEY 07207
 201 925-8000
 COMPANY REPRESENTATIVES
 SHEFLER KAHN COMPANY
 PHOENIX, ARIZONA
 602-258-7893
 F. W. HOULTHROP ASSOC.
 OAKLAND, CALIFORNIA
 415-261-7676
 ALPHA WIRE
 TORRANCE, CALIFORNIA
 213-775-6871
 HYDE ELECTRONIC CO.
 DENVER, COLORADO
 303-936-3456
 GERBER SALES
 NEW HAVEN, CONN.
 203-777-6279
 MILLAR-HUTTO ASSOC.
 WINTER PARK, FLA.
 305-647-7407
 MILLAR-HUTTO ASSOC.
 ATLANTA, GA.
 404-876-0919
 BILL KOLANS COMPANY
 HONOLULU, HAWAII
 811-628
 RUSS GAWNE & ASSOC.
 CHICAGO, ILL.
 312-775-5981
 ALPHA WIRE
 CHICAGO, ILL.
 312-965-8300
 THOMAS & SIKUP
 INDIANAPOLIS, IND.
 317-251-4574
 FLORENCE & MEYER
 WICHITA, KANSAS
 316-264-2893
 GERBER SALES COMPANY
 EAST LONGMEADOW, MASS.
 413-525-3059
 GERBER SALES COMPANY
 WALTHAM, MASS.
 617-891-8040

SHALCO, INC.
 FERDALE, MICH.
 616 243-7607
 SHALCO, INC.
 GRAND RAPIDS, MICH.
 616-243-7607
 CLARK R. GIBB CO.
 MINNEAPOLIS, MINN.
 612-377-1200
 FLORENCE & MEYER
 KANSAS CITY, MO.
 816-561-7282
 FLORENCE & MEYER
 BERKLY, MO.
 315-521-6800
 HYDE ELECTRONICS CO.
 ALBUQUERQUE, N.M.
 505-265-8895
 MARSEY SALES
 ROCHESTER, N.Y.
 716-442-9700
 NEAL BEAR CORP.
 DAYTON, OHIO
 513-299-3566
 NEAL BEAR CORP.
 WEST RICHFIELD, OHIO
 216-659-3331
 BEIL & WHITAKER INC.
 READING, PA.
 215-779-2610
 NEBCO ASSOC.
 MONROEVILLE, PA.
 412-824-2111
 THE EXPORT COMPANY
 DALLAS, TEXAS
 214-631-6270
 THE EXPORT COMPANY
 HOUSTON, TEX.
 713-465-3031
 HYDE ELECTRONICS INC.
 SALT LAKE CITY, UTAH
 801-278-4465
 DON MILLER & ASSOC.
 RICHMOND, VA.
 703-353-5324
 DAVE MILLER SALES CO.
 SEATTLE, WASH.
 206-632-7070
 RUSS GAWNE & ASSOC.
 MILWAUKEE, WISC.
 414-354-8889
 REPS. IN OTHER COUNTRIES
 FRANK EAKIN, LTD.
 WESTON, ONTARIO
 416-741-7485

ALTEC LANSING, A DIVISION OF
LTV LING ALTEC, INC.
 VICE PRES. MARKETING
 M. S. MORRIS

BRAND NAMES
 PEERLESS ELECTRICAL PRODUCTS
 GONSET, INC.
 SEOUR
 REVOCOM
 MOALA
 GIANT VOICE
 COMPANY ADDRESS
 1515 S. MANCHESTER AVE.
 ANAHEIM, CALIF. 92803
 COMPANY REPRESENTATIVES
 JOHN G. HUMBLE
 237 ELM STREET
 SAN MATEO, CALIF. 94401
 415-343-1477
 ROGER J. FAUST
 22211 VAN OWEN STREET
 CANOGA PARK, CALIF. 91303
 213 616-6285
 STAN CLUMPH & ASSOC.
 1268 WEST NEVADA PLACE
 DENVER, COLORADO 80223
 303-744-6329
 NORMAN R. SCHNEIDER
 3777 MONTFORD DRIVE
 CHAMBLEE, GEORGIA 30005
 404-261-8930
 SHELDON SCHAK & ASSOC.
 6229 NORTH CALIFORNIA AVE.
 CHICAGO, ILLINOIS 60645
 312-338-7730
 JOE CLANCY & CO., INC.
 P.O. BOX 269
 ANGOLA, INDIANA 46703
 219-665-2561
 ROBERT J. PATTERI
 8805 BENSON DRIVE
 OVERLAND PARK, KANSAS 66212
 913-DUI-2699
 CHARLES L. RANGE, JR.
 9131 HOLLYOAK DRIVE
 BETHESDA, MARYLAND 20034
 301-365-1699
 JACK LIZARS
 P.O. BOX 64
 FRAMINGHAM, MASS. 01702
 617-879-2300
 CHUCK BERUBE
 P.O. BOX 177
 WESTFIELD, MASS. 01085
 413-562-6690
 BURCAW-COWAN & COMPANY
 18236 WEST MCNICHOLS ROAD
 DETROIT, MICHIGAN 48219
 313-KEE-7700
 CARMINE A. VIGNOLA ASSOC.
 P.O. BOX 569
 21 SCHELLRIDGE ROAD
 JEFFERSON CITY, MO. 65102
 314-635-1023
 BARTON W. FLOYD, JR.
 22 WAVERTON DRIVE
 ST. LOUIS, MO. 63124
 314-WY4-0390
 HAROLD A. MOYER COMPANY
 P.O. BOX 14

220 HADDON AVENUE
 HADDONFIELD, N.J. 08033
 609-HA9-7792
 JERRY GREENBERG & ASSOC.
 100 NORTH VILLAGE AVENUE
 ROCKVILLE CENTRE
 LONG ISLAND, N.Y. 11570
 516-OR8-3668
 J. W. LEHNER COMPANY
 367 BRYNHILD ROAD
 COLUMBUS, OHIO 43202
 614-268-5260
 RICHARD N. VAN DERVOET
 1308 BEACH AVENUE
 LAKEWOOD, OHIO 44107
 216-221-4004
 JACK LEHNER, JR.
 1773 - 18TH STREET
 CUYAHOGA FALLS, OHIO 44223
 216-928-7630
 AVCO SALES COMPANY
 P.O. BOX 30153
 2339 FARRINGTON
 DALLAS, TEXAS 75217
 214-363-3925
 W. K. WOOD, INC.
 P.O. BOX 46046
 10233 MARINE VIEW DRIVE, S.W.
 SEATTLE, WASHINGTON 98146
 206-935-9400
 RAYMOND P. KROGH
 2212 ST. CLAIR STREET
 RACINE, WISCONSIN 53402
 414-634-7467

AMECO, INC.
 SALES MANAGER
 R. DUANE MALL
 BRAND NAMES
 AMECOAX
 PACESETTER
 REMCOR
 COMPANY ADDRESS
 2949 W. OSBORN ROAD
 PHOENIX, ARIZONA 85017
 COMPANY REPRESENTATIVES
 FRANK HAMILTON
 627 SOUTH 45TH STREET
 BIRMINGHAM, ALABAMA
 404-261-1951
 MASON HAMILTON
 DICK OLD
 JOHN WESTFIELD
 PHOENIX, ARIZONA
 262-5500
 RUSH MENDENHALL
 566 VIA MANZANAS#3
 SAN LORENZO, CALIF
 415-775-4566
 JAMES CUNNINGHAM
 380 S. SIERRA MADRE BLVD
 APT. D
 PASADENA, CALIF.
 213 254-9892
 FRANK HAMILTON
 233 LAFAYETTE CIRCLE
 TALLAHASSEE, FLA.
 454-2623
 CHARLES AUER
 P. O. BOX 13441 STA. K
 ATLANTA, GA.
 261-1951
 CHARLES AUER
 106 HEATHER LANE
 COLLEGE PARK, GA.
 404-261-1951
 JON WESTFIELD
 1300 C AVENUE N. W.
 GREAT FALLS, MONTANA 59401
 406-454-2623
 LEO BORIN
 119 SOUTH 19TH STREET
 OMAHA, NEBRASKA 68102
 402-558-0323
 PHIL COLONE, JR.
 P. O. BOX 48
 ONEONTA, NEW YORK 13820
 518-434-9758
 THOMAS UMBREIT
 P. O. BOX 1335
 CINCINNATI, OHIO 45201
 513-321-8060
 THOMAS GOODALL
 905 NORTH 36TH STREET
 CORVALLIS, OREGON
 503-232-7051
 DEAUARD SWINDLER
 3443 S. E. 31 ST.
 PORTLAND, ORE.
 232-7051
 JAMES LOKER
 5 JEFFRY ROAD -M, R.
 MECHANICSBURG, PENN 17055
 717-737-3792
 CARL RICHARD
 ROBERT MC CANN
 P. O. BOX 3343
 HARRISBURG, PA.
 737-3792
 JOE D. MARLOWE
 P. O. BOX 102
 REEOSVILLE, PENN
 717-737-3792
 GEORGE MARTIN
 1120 STANLEY AVENUE
 CHAMBERSBURG, PENN 17201
 717-737-3792
 DEAN SCOTT
 EDWARD ABBOTT
 1334 MOTOR CIRCLE
 DALLAS, TEXAS 75207
 214 631-5516
 REPS. IN OTHER COUNTRIES
 RAY N. BENNETT
 624-736 GRANVILLE STREET
 VANCOUVER, B. C.

BROADCAST TRANSMITTERS

from



AEL's line of type accepted AM and FM Broadcast Transmitters features the following: ■ Designed for remote control — no kits necessary ■ Factory pretested at customer frequency ■ Running-time meter ■ One-button operation ■ Self-protecting circuit breakers ■ High-speed overload relays ■ Solid state power supplies ■ Automatic recycling ■ Attractive modern cabinets ■ Minimum size.

AM BROADCAST TRANSMITTERS

(powers available up to 100 KW)

- AM-1KA 1000 watts
- AM-5KA 5000 watts
- AM-10KA 10,000 watts

FM BROADCAST TRANSMITTERS

(powers available up to 40 KW)

- FM-1DA 10 watts
- FM-2.5HA 250 watts
- FM-1KA 1000 watts
- FM-5/7.5KA 5000/7500 watts
- FM-10KA 10,000 watts

Completely solid state stereophonic equipment will be in actual operation at the 1967 NAB Convention.

Write for complete details on AEL AM and FM Broadcast Transmitters



American Electronic Laboratories, Inc.

P. O. BOX 552, LANSDALE, PA. 19446 • (215) 822-2929

604-685-4723
PAUL LEWIS-WATTS
ALBERT DE BOER
3685 WESTON ROAD
WESTON, ONTARIO
416 248-1551

AMERICAN CABLE ELECTRONICS

EXECUTIVE VICE PRESIDENT
WM. J. BRESNAN
BRAND NAMES
WEATHER DATA
EMERG-ALERT
AMERICAN CABLE ELECTRONICS
JACK KENT COOKE, INC
COMPANY ADDRESS
9888 WILSHIRE BLVD.
BEVERLY HILLS, CALIF.
COMPANY REPRESENTATIVES
TED SWANSON
J. FRED WEBER
BEVERLY HILLS, CALIF.
213 273-4450

AMERICAN ELECTRONIC

LABORATORIES, INC.
SALES MANAGER
IRVIN A FAYE
BRAND NAMES
COLORVUE
COMPANY ADDRESS
P. O. BOX 552
LANSDALE, PA. 19446
COMPANY REPRESENTATIVES
MELVIN LUCAS
TELE-GUARD CORP
P. O. BOX 493
WEST SACRAMENTO, CALIF
916 482 6816
FRED CLARKE
778 LOWER COLONIAL DRIVE
ST PAUL, MINNESOTA
RICHARD WITKOVSKI
WITKO ELECTRONIC CORP
435 BRANIFF BUILDING
DALLAS, TEXAS
214 RT 1 5225

AMERICAN ELITE, INC.

SALES MANAGER & VICE. PRES.
BEN JACOBS
BRAND NAMES
TELEFUNKEN
AEG
COMPANY ADDRESS
48-50 34TH STREET
LONG ISLAND CITY, N. Y. 11101

AMERICAN GELOSO

ELECTRONICS, INC.
SALES MANAGER
ROBERT A. COHEN
BRAND NAMES
GELOSO
STEMOTAPE
AMPLIVOICE
ULTRVOX
AMPLIBOX
COMPANY ADDRESS
251 PARK AVENUE SOUTH
NEW YORK, NEW YORK 10010
COMPANY REPRESENTATIVES
SHEPPARD, WINTERS & STERN CO.
P.O. BOX 1210.
MAGNOLIA PARK STA.
BURBANK, CALIF.
ELVEY PROCTOR CO.
P. O. BOX 1205
1650 LAUREL AVE
SAN CARLOS, CALIF. 94071
415-593-1121
A. J. NELSON CO., INC.
1294 SOUTH BANNOCK STREET
DENVER, COLO. 80223
303-733-5528
GEORGE B. SMITH
193 QUAKER LANE SOUTH
WEST HARTFORD, CONN.
203-523-0512
GEORGE FENTON
P.O. BOX 7387
ORLANDO, FLORIDA
305-423-5720
H. K. DEWEES CO., INC.
3133 MAPLE DRIVE, N.E.
ATLANTA, GEORGIA 30305
404-261-7362
WILLIAM PILLER
515 HIBBARD ROAD
WILMETTE, ILL.
312-AL1-7681
ROBERT SMITH CO.
59 VERDALE STREET
BROOKLINE 46, MASS.
617-277-0017
G. TUGHAN & ASSOC.
6346 WEST MCNICHOLS
DETROIT, MICH. 48221
UN2-6867
JAMES LEE CO.
4241 TOLEDO AVENUE SOUTH
MINNEAPOLIS, MINN.
612-920-1525
CLAASEN CO.
308 NORTH MAIN STREET
FREMONT, NEBRASKA 68025
SID MENELY CO.
P.O. BOX 9802
OKLAHOMA CITY 18, OKLA.
405-J05-5084
H. D. LEWIS CO.
1801 J. F. KENNEDY BLVD.
PHILADELPHIA, PA.
215-L07-2068
CRUSOL, INC.

BOX 98
URBANIZACION HNAS. DAVILA.
BAYAMON, PUERTO RICO
785-3531
DON SMITH SALES CO.
2320 NORTH 45TH STREET
SEATTLE, WASH. 98103
206-ME3-3160
REPS. IN OTHER COUNTRIES
CANADIAN GELOSO ELECTRONICS
700 WESTON ROAD
TORONTO 9, ONTARIO

AMERICAN PAMCOR, INC

SALES MANAGER
DONALD F. MIERSCH
BRAND NAMES
COAXICOM
COAXICLAMP
TERMI-BLOK
SOLISTRAND
PLASTI-GRIP
AMPPOWER
PIDG
COMPANY ADDRESS
P. O. BOX 1776
PAOLI, PA. 19301
215 647-1000
COMPANY REPRESENTATIVES
AMERICAN PAMCOR INC
3138 W EL SEGUNDO BLVD
HAWTHORNE, CALIF 90250
213 SP 2-2251
AMERICAN PAMCOR INC
512 S AIRPORT BLVD
5 SAN FRANCISCO, CALIF 94080
415 589-7722
AMERICAN PAMCOR INC
2970 PEACHTREE ROAD NW
SUITE 550
ATLANTA, GA 30305
404 261-8712
AMERICAN PAMCOR INC
1145 BISHOP ST RM 206
HONOLULU, HAWAII
583-774
AMERICAN PAMCOR INC
5555 NORTHWEST HWY
CHICAGO, ILL 60630
312 RD 3-0882
AMERICAN PAMCOR INC
BEAR HILL OFF TOWER
60 HICKORY DRIVE
WALTHAM, MASS 02154
617 893-0137
AMERICAN PAMCOR INC
15800 WEST MCNICHOLAS
DETROIT, MICH 48235
313 835-1210
AMERICAN PAMCOR INC
COMMERCE TOWER BLDG RM 2006
KANSAS CITY, MO 64105
816 MA 1-6141
AMERICAN PAMCOR INC
SUITE 214
2510 BRENTWOOD BLVD
BRENTWOOD, MO 63144
314 962-9090
AMERICAN PAMCOR INC
80 WEST STREET
ENGLEWOOD, N. J 07631
201 LO 9-0626
AMERICAN PAMCOR INC
CARROUSEL TOWERS
8075 READING ROAD
CINCINNATI, OHIO 45237
513 821-6651
AMERICAN PAMCOR INC
20950 CENTER RIDGE ROAD
CLEVELAND, OHIO 44116
216 333-0307
AMERICAN PAMCOR INC
6509 W INTERSTATE
PORTLAND OREGON 97217
503 285-9841
AMERICAN PAMCOR INC
771 LANCASTER AVE
VILLANOVA, PA 19085
215 LA 9-5825
AMERICAN PAMCOR INC
MANOR OAK OFF BLDG
1910 COCHRAN RD
PITTSBURG, PA 15220
412 563-0803
PAMCOR INC
C/O R J CUEBAS
P O BOX 813
RIO PIEDRAS, P R 00928
AMERICAN PAMCOR INC
2267 VANTAGE ST
DALLAS, TEXAS 75207
214 ME 1-0850
AMERICAN PAMCOR INC
3130 S W FREWAY RM 207
HOUSTON, TEXAS 77006
713 522-1043

AMERLINE CORPORATION

SUBSID THE REVLON CORP
SALES MANAGER
F. O. GLAUBITZ
BRAND NAMES
AMERLINE
COMPANY ADDRESS
1800 W. FULLERTON AVE.
CHICAGO, ILL. 60614
COMPANY REPRESENTATIVES
STICKEL - MCALLISTER CO.
4357 MELROSE
LOS ANGELES, CALIF.
669-6621
JOHN F. THOMPSON
322 RIVERSIDE DRIVE
ORMOND BEACH, FLA.
677-2298

K & M SALES
1627 MAIN STREET
KANSAS CITY, MO.
GR1-1355
ROBERT CHESHIRE
271 MADISON AVENUE
NEW YORK, N.Y.
MU5-1890

AMPEREX ELECTRONIC CORP.
SALES MANAGER
TUBE DIVISION
JOHN MESSERSCHMITT
SEMICONDUCTOR DIVISION
ED MEAGHER
COMPANY ADDRESS
TUBE DIVISION
HICKSVILLE, N. Y. 11802
SEMICONDUCTOR DIVISION
SLATERSVILLE, R. I. 02876
COMPANY REPRESENTATIVES
A. B. ANDREWS
1308 S. 28TH ST., APT. 206
BIRMINGHAM, ALABAMA
205-251-4540
AMPEREX ELECTRONIC CORP.
801 E. CHARLESTON ROAD
PALO ALTO, CALIF. 94303
415 327 0461
W. J. BARRON COMPANY
1406 S. GRAND AVENUE
LOS ANGELES, CALIF. 90015
213 748 6191
SHEPHARD WINTERS STERN, INC.
4109 BURBAN BLVD.
BURBANK, CALIF. 91505
213 849 6671
TWX 910 498 2208
R. W. THOMPSON ASSOCIATES
4135 EL CAMINO WAY
PALO ALTO, CALIF.
415 321 6383
TWX 415 192 9308
R. W. THOMPSON ASSOCIATES
17071 VENTURA BLVD.
ENCINO, CALIF. 91316
213-783-4480
WILLIAM J. PURDY AGENTS
312 SEVENTH STREET
SAN FRANCISCO, CALIF. 94103
415-UN 3-3300
WILLIAM J. PURDY AGENTS
6527 WESTBROOK DRIVE
CITRUS HEIGHTS, CALIF. 95610
916-725-4065
MEL PEARSON & COMPANY
1860 SO. ACOMA STREET
DENVER, COLO. 80223
303-777-7878 & 777-8646
GERBER SALES COMPANY, INC.
P.O. BOX 2917, 31 BROADWAY
NEW HAVEN, CONN. 06515
203-5PT-6279

VECTOR SALES
662 BRIDGEPORT AVE.
MILFORD, CONN.
203-TR4-2112
MECHTRONICS SALES, INC.
7600 GEORGE AVE., NW RM. 208
WASHINGTON, D.C. 20012
202-291-6004
A. B. ANDREWS
BOX 124, ROUTE 5
ORLANDO, FLORIDA
305-PA3-8333
MILLAR HUTTO ASSOC., INC.
P.O. BOX 1603
WINTER PARK, FLA. 32790
305-MI 7-7407
MILLAR HUTTO ASSOC., INC.
P.O. BOX 7116, STATION C
1036 PEACHTREE STREET N.E.
ATLANTA, GA. 30309
404-876-0000 OR 872-6212
AMPEREX ELECTRONIC CORP.
360 EAST NORTH AVENUE
NORTHLAKE, ILL. 60164
312-562-1060, 61
DWIGHT SMITH ASSOCIATES, INC.
32 S. RIVER STREET
AURORA, ILL. 60504
312-TW 6-0828
THOMAS & SUKUP, INC.
2060 E. 54TH STREET
INDIANAPOLIS, IND. 46220
317-CL 1-4574-5
TWX 317-635-8075
CARTWRIGHT & BEAN
1812 BULLARD AVE.
METAIRIE, LA.
504-887-0482
BROTHERS & CONNEEN ASSOCIATES
6302 LINCOLN AVENUE
BALTIMORE, MD. 21209
301-764-7189
BROTHERS & CONNEEN ASSOCIATES
1808 GLEN RIDGE ROAD
BALTIMORE 34, MO.
301-764-7189
MECHTRONICS SALES, INC.
1123 MEADOWLARK DRIVE
BALTIMORE, MD.
301-242-4123
SCIENTIFIC SYSTEMS SALES CORP
8138 15TH AVENUE
HYATTSVILLE, MO. 20783
301-445-1130
GERBER SALES COMPANY, INC.
176 SECOND AVENUE
WALTHAM, MASS. 02154
617-891-8040
GERBER SALES COMPANY, INC.
P.O. BOX 447, 26 MAPLE COURT
E. LONGMEADOW, MASS. 01028
413-LA 5-3059

VECTOR SALES
774 PLEASANT STREET
BELMONT, MASS. 02178
617-489-1400
JACK M. THORPE CO.
640 HIDDEN LANE
DETROIT, MICH. 48236
313-884-4360
AMPEREX ELECTRONIC CORP.
8053 BLOOMINGTON FREWAY
MINNEAPOLIS, MINN. 55420
612-888-4681
CLARK R. GIBB CO.
2400 MENNEPIN AVE.
MINNEAPOLIS, MINN. 55405
612-377-1200
TWX 612-321-1460
OIPRO, INC.
P.O. BOX 1427
MARYLAND HEIGHTS, MO. 63042
314-432-3444
R. W. FARRIS CO., INC.
1715 BALTIMORE AVE.
KANSAS CITY, MO. 64108
816-WA 1-1757
TWX 314-872-8396
BROTHERS & CONNEEN ASSOCIATES
813 FORDHAM STREET
RIVERSIDE, N.J.
215-KI 3-8641
MICHAEL PAGE & ASSOCIATES
209 SAN PABLO S.E.
ALBUQUERQUE, N.M. 87108
505-265-8526
KANGAM SALES CORPORATION
1261 BROADWAY
NEW YORK, N.Y. 10001
212-MU 4-7772-3-4-5-6-7
TWX 710-581-2729
PASTON-HUNTER CO., INC.
3307 ERIE BLVD. E
P. O. BOX 129
DEWITT STATION
SYRACUSE, N. Y. 13214
315-446-2180
R. W. MITSCHER CO., INC.
496 ELLICOTT SQ. BLDG.
BUFFALO, NEW YORK 14203
716-854-2517
TWX 716-858-1144
R. W. MITSCHER CO., INC.
606 FOREST DRIVE
N. SYRACUSE, N. Y.
315 458-1321
SCIENTIFIC SYSTEMS SALES CORP
376 GREAT NECK ROAD
GREAT NECK, L. I., N.Y.
516 466-0953
TWX 516 466-0962
R. W. MITSCHER CO., INC.
16 LIMETREE LANE
LIVERPOOL, NEW YORK
315-652-7190
R. W. MITSCHER CO., INC.
ROUTE 82-A
SALT POINT, N.Y.
914-266-5976
R. W. MITSCHER CO., INC.
51 ELY DRIVE
FAYETTEVILLE, N.Y. 13066
315-446-4540
A. B. ANDREWS
P.O. BOX 2627, BRANCH
BANKING & TRUST CO. BLDG.
RALEIGH, N.C. 27602
919 839-5655
MILLAR HUTTO ASSOC., INC.
P.O. BOX 17566
4023 ARBOR WAY
CHARLOTTE, N.C. 28211
704-EM 6-2061
MULLIGAN & MATHIAS COMPANY
2011 RIVERSIDE DRIVE
COLUMBUS, OHIO 43221
614-486-2267
RICHARD LEGG COMPANY
P.O. BOX 25327
PORTLAND, OREGON 97225
503-292-8824
TWX 503-224-1060
BEIL & WHITAKER, INC.
3623 JACKSONWALD AVE.
REARING, PA. 19606
215-779-2610
PARAGON SALES COMPANY
111 SOUTH 22ND STREET
PHILADELPHIA, PENN. 19103
215-LO 3-7060
BROTHERS & CONNEEN ASSOCIATES
131 HARNED ROAD,
SPRINGFIELD, DELAWARE CO, PA.
215 KI 3-8641
BEIL & WHITAKER, INC.
BOX 384, R.D. #2
DOVER, PA. 17315
717-292-4071
BEIL & WHITAKER, INC.
1303 N. TROXELL STREET
ALLENTOWN, PA. 18103
215-434-5220
CARTWRIGHT & BEAN
560 SOUTH COOPER ST.
MEMPHIS, TENN. 38104
901-276-4442
DUNBAR ASSOCIATES
417 MEADOWS BLDG.
OALLAS, TEXAS 75206
214 363-2536
TWX 214 899-9172
LUND & COMPANY
2215 N. OLIVE STREET
DALLAS, TEXAS 75201
214-748-8829
MICHAEL PAGE & ASSOCIATES
5122 BURNET ROAD
P.O. BOX 9402

AUSTIN, TEXAS 78756
512-452-9503
LUND & COMPANY
P.O. BOX 36256
HOUSTON, TEXAS 77036
713-523-6756
MICHAEL PAGE & ASSOCIATES
BRANIFF BLDG., SUITE 435
EXCHANGE PARK
DALLAS, TEXAS 75235
214-351-4795
MEL PEARSON & COMPANY
288 CANYON ROAD
SALT CITY, UTAH 84103
801-364-7524

AMPERITE COMPANY
SALES MANAGER
T. WHALEN
COMPANY ADDRESS
600 PALISADE AVE.
UNION CITY, NEW JERSEY 07087

AMPEX CORPORATION
VP GEN MGR MARKETING DIVISION
ROBERT R. OWEN
SALES MANAGER
THOMAS W. HARLEMAN
BRAND NAMES
AMPEX
MARCONI
COMPANY ADDRESS
401 BROADWAY
REDWOOD CITY, CALIF 94063
415 367-2011
COMPANY REPRESENTATIVES
DISTRICT OFFICE
3322 S MEMORIAL PARKWAY
HOLIDAY OFF CTR, SUITE 27
HUNTSVILLE, ALA 35801
205 881 4271
TWX 205 533-2820
A A SROKA
WESTERN AREA MKTG MGR
8467 BEVERLY BLVD
LOS ANGELES, CALIF 90048
213 OL 3 1610
TWX 213 655-6535
K THOMPSON
SAN FRANCISCO REG MGR
2220 BAY ROAD
REDWOOD CITY, CALIF 94063
415 367 3861
TWX 415 364-9034
W BRUSS
LOS ANGELES REG MGR,
COMMERCIAL & GOV. PRODUCTS
8467 BEVERLY BLVD
LOS ANGELES, CALIF 90048
213 OL 3 1610
TWX 213 655-6535
K HERRING
LOS ANGELES REG MGR
8467 BEVERLY BLVD
LOS ANGELES, CALIF 90048
213 OL 3 1610
TWX 213 655-6535
L JORDAN
FLORIDA REG MGR
1980 NORTH ATLANTIC AVE
COCOA BEACH, FLA 32931
305 783 1811
TWX 305 783-1738
G SUDDUTH
ATLANTA REG MGR
3376 PEACHTREE RD
N E ATLANTA, GA
404 231 3480
TWX 404 231-1637
L HASE
CHICAGO REG MGR
10 KING ST
ELK GROVE VILLAGE, ILL 60007
312 439 4600
TWX 910 222-2864
N SCHMIDT
BOSTON REG. MGR,
235 BEAR HILL RD.
WALTHAM, MASS. 02154
617 899-2040
TWX 710 324-0364
E WENDT
MINNEAPOLIS REG MGR
4010 W 65TH ST
MINNEAPOLIS, MINN 55424
612 WA 7 5638
TWX 910 576-2806
WILLIAM SLOVER
EASTERN AREA MKTG MGR
75 COMMERCE WAY
HACKENSACK, N J 07661
201 489 7400
TWX 201 488-6715
R SIRINSKY
NEW YORK REG MGR
75 COMMERCE WAY
HACKENSACK, N J 07661
201 489 7400
TWX 201 488-6715
R BEENE
ALBUQUERQUE REG MGR
414 SAN MATEO BLVD. NE
ALBUQUERQUE, N.M. 35801
505 265 8507
TWX 910 989-1639
D CRESWELL
DAYTON REG MGR
333 W 1ST ST, SUITE 338
DAYTON, OHIO 45402
513 BA 8 5117
TWX 810 459-1714
G SULLIVAN
PHILADELPHIA REG MGR
947 YORK ROAD
ABINGTON, PA 19001
215 YU 7 7650

TWX 215 884-2822
W HEYWOOD
DALLAS REG MGR
2626 W MOCKINGBIRD LANE
SUITE 290
DALLAS, TEXAS 75235
214 FL 7 0481
TWX 214 899-9001
DISTRICT OFFICE
6001 GULF FREEWAY, ST C-134
HOUSTON, TEXAS 77023
713 WA 8 3741
TWX 713 571-1494
W CRAIG
WASHINGTON, O C REG MGR
3620 S 27TH ST
ARLINGTON, VA 22206
703 671 4000
TWX 710 955-9832
J HOPKINS
SEATTLE REG MGR
8434 RAINIER AVE
S SEATTLE, WASH 98118
206 PA 3 3170
TWX 206 998-9014

AMPHENOL DISTRIBUTOR DIVISION
SALES MANAGER
W. T. ADAMS
COMPANY ADDRESS
2875 SOUTH 25TH AVE.
BROOKVIEW, ILL. 60153
COMPANY REPRESENTATIVES
DON DE BASIO
401 EAST INDIAN SCHOOL ROAD
SUITE 209
PHOENIX, ARIZONA
602-264-9397-98
RICHARD COLT
17000 VENTURA, SUITE 306
ENCINO, CALIF.
213-788-8560
JAMES V. CLARIZIO
DISTRICT SALES OFFICE
1826 INDUSTRIAL WAY, SUITE 8
REDWOOD CITY, CALIF.
415-369-2981
RALPH NOFFKE
DISTRICT SALES OFFICE
709 W. LITTLETON BLVD.,
SUITE 200A
LITTLETON, COLO.
303-794-4269
EDMUND LEHMANN
DISTRICT SALES OFFICE
7600 GEORGIA AVENUE, N.W.
WASHINGTON, D.C.
202-829-9000
CHARLES W. KUCERA
OISTRCT SALES OFFICE
601 N. NEW YORK AVENUE,
SUITE 5
WINTER PARK, FLORIDA
305-647-5504
DISTRICT SALES OFFICE
3224 PEACHTREE RD., N.E.
ATLANTA, GEORGIA
404-235-1569
EARL ASSOCIATES
P.O. BOX 2845, 1638 KONA ST.
HONOLULU, HAWAII
808-996-953
JOHN M. KOYS
2801 S. 25TH AVENUE
BROADVIEW, ILLINOIS
312-261-2000
LESLIE M. DEVOE CO.
4010 WASHINGTON BLVD.
INDIANAPOLIS, INDIANA
317-283-1395
RICHARD PURINTON, INC.
11 MUZZEY STREET
LEXINGTON 73, MASS.
617-862-8300
ALLEN P. NEMETZ
DISTRICT SALES OFFICE
960 E. MAPLE RD., SUITE 116
BIRMINGHAM, MICHIGAN
313-646-1262
ROGER JENNE
7701 NORMANDEAL ROAD
MINNEAPOLIS, MINN.
612-927-6589
JOSEPH B. SVEHLA
DISTRICT SALES OFFICE
47 VILLAGE SQUARE
HAZELWOOD, MO
314-838-6996
ROBERT HEADE
DISTRICT SALES OFFICE
6525 S. CRESCENT BLVD.,
SUITE 212
PENNSAUKEN, N. J.
609-665-2870
RICHARD J. PARISSIDI
DISTRICT SALES OFFICE
2 LAGRANGE AVENUE
POUGHKEEPSIE, N. Y.
914-452-4220
STEPHEN R. KELLEHER
DISTRICT SALES OFFICE
310 NORTHERN BLVD.
GREAT NECK, L. I., N. Y.
516-482-4700
EDWARD B. SMITH
DISTRICT SALES OFFICE
6443 RIDINGS ROAD
SYRACUSE, N.Y.
315-437-2689
JOHN J. CARSELLI
DISTRICT SALES OFFICE
20545 CENTER RIDGE ROAD
SUITE 242
CLEVELAND, OHIO
216-331-9100
JOHN E. JANSEN

DISTRICT SALES OFFICE
 811 S. CENTRAL EXPRESSWAY,
 SUITE 295
 RICHARDSON, TEXAS
 214-235-8318
DONALD C. PERCELL
DISTRICT SALES OFFICE
 14444 SUNSET HIGHWAY & CD
 P D BOX 726
 BELLEVUE, WASHINGTON
 206 746-5363
REPS. IN OTHER COUNTRIES
DAI ICHI DENSHI KOGYO, KK#20,
 3 CHOME, YODYOGI, SHIBUYA-KU
 TOKYO, JAPAN
UMD - USINE METALLURGIQUE
 DOLDISE, S.A.
 17 AVENUE NIEL 75
 PARIS, FRANCE
UMD - USINE METALLURGIQUE
 DOLDISE, S.A.
 92 A98 AVENUE DE GRAY 39
 DDLE, FRANCE
AMPHENOL-BDRG ELECTRONICSGMBH
 8024 DEISENHOFEN
 BEI MUNICH, W. GERMANY
AMPHENOL LIMITED, THANET WAY
 WHITSTABLE, KENT, ENGLAND
AMPHENOL CANADA LIMITED
 44 METROPOLITAN ROAD
 SCARBOROUGH, ONT.
AMPHENOL CANADA LIMITED
 42 AYLWER AVENUE
 DTTAWA, ONTARIO
AMPHENOL CANADA LIMITED
 3285 CAVENDISH BLVD, RM 160
 MONTREAL, QUEBEC
AMPHENOL, S.A. DE C.V.
 CALLE DE PUENTE NO. 6
 MEXICO 22, D.F., MEXICO

AMPLIFIER CORP OF AMERICA

SALES MANAGER
 A. J. GILLETTE
BRAND NAMES
 MAGNERASER
 MAGNERASER JR
 MAGNETIC PROJECTOR
COMPANY ADDRESS
 75 FROST STREET
 WESTBURY, L.I., N. Y. 11590
SALES REPRESENTATIVES
ARRONDCS
 650 CLEVELAND, AVE
 RIVER VALE, N. J.

AMPLIVISION CORPORATION

SALES MANAGER
 GEORGE BROWNSTEIN
BRAND NAMES
 AMPLI-VISION
 BENCO
 GILBER
 SDNY
COMPANY ADDRESS
 2000 STONER
 LOS ANGELES, CALIF. 90025
 GR 8-7751
COMPANY REPRESENTATIVES
WM LASKY
 2000 STONER
 LOS ANGELES, CALIF. 90025
 GR 8-7751
LEONARD COHEN
 C/O AMPLIVISION
 PARAMOUNT BLDG SUITE 1300
 1501 BRADWAY
 NEW YORK, NEW YORK
 BR 9-8700

ANACONDA ASTRODATA CO

VP SALES & MKTG
 A. L. GINTY
MKTG MGR. CATV
 R. A. BROOKS
SALES MGR CATV SYSTEMS
 D. P. ROBERTS
MGR. DISTRIBUTION SALES, CATV
 P. LAZANICH
BRAND NAMES
 XDR
COMPANY ADDRESS
 1430 SOUTH ANAHEIM BLVD.
 P. D. BOX 3772
 ANAHEIM, CALIF. 92803
 714-635-0150
COMPANY REPRESENTATIVES
C R MANN
 SALES MGR WESTERN REGION
 1419 BONNIE DOONE TERRACE
 CORONA DEL MAR, CALIF
 714 675 1015
R. O. DOYLE
 SALES MGR S. E. REGION
 400 PINETREE STREET
 FOREST PARK, GA.
 404-366-7576
P. KJOE
 SALES MGR CENTRAL REGION
 RFD NO. 3
 FDRT DODGE, IOWA
 515-576-1313
C. C. MOODY
 SALES MGR. N. CENTRAL REGION
 13808 STEBENS ROAD
 BURNSVILLE, MINN
 612 890-2017
D. WATERS
 SALES MGR. N. E. REGION
 P. D. BOX 629
 THOUSAND ISLAND PARK, N. Y.
 315 482-9396
L. FELTS
 SALES MGR. S. CENTRAL REGION
 7839 CLAREMONT DRIVE
 DALLAS, TEXAS

ANCHA ELECTRONICS INC

PRESIDENT
 ROBERT F. ANCHA
COMPANY ADDRESS
 7011 WEST HIGGINS AVE.
 CHICAGO, ILL. 60656

KEITH ANDERSON CO

SALES MANAGER
 KEITH ANDERSON
COMPANY ADDRESS
 P. O. BOX 18
 BLACK HAWK, S. DAKOTA 57718
COMPANY REPRESENTATIVES
JUAN M. DRTIZ
 BDX 532
 GUAYAMA, PUERTO RICO
REPS. IN OTHER COUNTRIES
JOHN NANCE
 SKEENA BROADCASTERS
 BDX 1540
 TERRACE, B. C.
 L. D. STEWART
 WESTERN TELONICS
 110 BAYS WATER ROAD
 RUSHCUTTERS BAY
 N. S. W. AUSTRALIA
 31 64 34

ANDREW CORPORATION

SALES MANAGER
 ROBERT C. BICKEL
BRAND NAMES
 HELIAX
 HUBLOC
 UNIPOLE
COMPANY ADDRESS
 P.O. BOX 807
 CHICAGO, ILL. 60642
COMPANY REPRESENTATIVES
ANDREW CALIFORNIA CORPORATION
 941 E. MARYLAND
 CLAREMONT, CALIF.
 714-626-3505
ANDREW CALIFORNIA CORPORATION
 701 WELCH ROAD
 PALM ALTO, CALIF.
 415-323-3139
ANDREW CORPORATION
 P.O. BOX 5897
 WASHINGTON, D.C.
 202-654-7540
ANDREW INTERNATIONAL CORP.
 P.O. BOX 787
 CHICAGO, ILL.
 312-349-3300
ANDREW CORPORATION
 P.O. BOX 416
 RIDGWOOD, N.J.
 201-445-2500
ANDREW CORPORATION
 P.O. BOX 30506
 DALLAS, TEXAS
 214-235-1279
REPS. IN OTHER COUNTRIES
ANDREW ANTENNA SYSTEMS
 LOCHGELLY, FIFE, G.B.
 LOCHGELLY 561
ANDREW ANTENNA COMPANY, LTD.
 608 GATENSURRY STREET
 CDOUITLAM, NEW WESTMINSTER,
 BRITISH COLUMBIA
 604-936-6421
ANDREW ANTENNA COMPANY, LTD.
 P.O. BOX 177
 WHITBY, ONTARIO
 416-668-3348
ANDREW ANTENNA COMPANY, LTD.
 55 LITTLE ROCK AVENUE
 POINTE CLAIRE
 LACHINE, QUEBEC
 514 695-5365
ANDREW ANTENNAS PTY., LTD.
 437 ST KILDA RD, MELBOURNE
 VICTORIA, AUSTRALIA
 26-2824

ANSONIA WIRE & CABLE CO

SALES MANAGER
 DDN W. HOFFMAN
BRAND NAMES
 ANKOSEAL
 ANKOBOND
COMPANY ADDRESS
 111 MARTIN STREET
 ASHTON, R. I. D2864
 401-724-6400

ANTENNA PRODUCTS COMPANY

DIVISION OF ALL PRODUCTS CO

SALES MANAGER
 GRAY W. HAVENER
COMPANY ADDRESS
 P.O. BOX 520
 MINERAL WELLS, TEXAS 76067
COMPANY REPRESENTATIVES
WALTER A. LAUKAITIS
 618 ELLSWORTH DR.
 SILVER SPRING, MD.
 301 JU 5-3931
ASSOCIATED ELECTRONICS, INC.
 119 THE GREAT RD.
 BEDFORD, MASS.
 617 275-9020
TELESCO INTERNATIONAL CORP.
 171 MADISON AVENUE
 NEW YDRK, N.Y.
 212 MU 3-9420
M. J. FEIN & CO.
 HARWOOD BLDG.
 SCARSDALE, N.Y.
 914 GR 2-1100
EAC ASSOCIATES
 53-11 90TH STREET
 ELMHURST, N.Y. 11373
 212 DE 5-0606

API INSTRUMENTS CO

SALES MANAGER
 ROBERT W. PUGSLEY
COMPANY ADDRESS
 7100 WILSON MILLS ROAD
 CHESTERLAND, OHIO 44026
 216 423-3131
COMPANY REPRESENTATIVES
API INSTRUMENTS CO
 175 W WIEUCA RD N E
 ATLANTA, GA
 404 252-2445
API INSTRUMENTS CO
 1008 E NORTHWEST HWY
 MT PROSPECT, ILL 60057
 312 392-5770
THUNDERBIRD ENG CO
 4014 A WEST 95TH ST
 PRAIRIE VILLAGE, KANSAS
 913 642-7220
THUNDERBIRD ENG CO
 6405 E KELLOGG
 WICHITA, KANSAS
 316 684-3941
SAUL COHEN
 611 TRAPELD RD
 BOSTON, MASS
 617 894-6921
API INSTRUMENTS CO
 15042 FENKELL AVE
 DETROIT, MICH
 313 273-6078
ROBERT W. MARSHALL CO
 6106 EXCELSIOR BLVD
 MINNEAPOLIS, MINN
 612 929-0457
THUNDERBIRD ENG CO
 P O BOX 6156
 ST. LOUIS, MO.
 314 838-6688
API INSTRUMENTS CO
 162 RT 208 BOX 123
 DAKLAND, N J
 201 337-6163
TECHNICAL SALES INC
 P O BOX 182
 PULASKI, N Y
 315 298-5103
API INSTRUMENTS CO
 3545 W CHESTER PIKE
 NEWTOWN SQUARE, PA
 215 353-0772
CAREY-WDLF CO
 P O BOX 12425
 FT WORTH, TEXAS
 817 738-1702
CAREY-WDLF CO
 P O BOX 60338 4031 BRADWAY
 SUITE 103
 HOUSTON, TEXAS
 713 643-2114

APPARATUS DEVELOPMENT CO INC

BRAND NAMES
 FM/O
COMPANY ADDRESS
 DRAWER 153
 WETHERSFIELD, CONN. 06109
COMPANY REPRESENTATIVES
KDESSLER SALES
 818 N. FAIRFAX,
 LOS ANGELES, CAL.
 JAS. PIPER ASSOCIATES
 10 HAVEN,
 DOVER, MASS.
 L. D. RODDEY SALES
 4242 WATERBURY DR.
 CHARLOTTE, N. C.
 CHAS LUCAS SALES
 BDX 8506
 DALLAS, TEX
 VECTOR CORP
 307 WALL ST.
 SEATTLE, WASH

APPLIED ELECTRO MECHANICS INC

SALES MANAGER
 COL. GEDRGE GLEN
BRAND NAMES
 AEM
COMPANY ADDRESS
 2350 DUKE STREET
 ALEXANDRIA, VA. 22314
 703 548-2166
COMPANY REPRESENTATIVES
W. S. FLOGAUS
 6631 WAKEFIELD DRIVE
 ALEXANDRIA, VA. 22307
 703-768-4964

ARRIFLEX CORPORATION OF AMERICA

SALES MANAGER
 VICTOR JAMES
BRAND NAMES
 ARRIFLEX
 SIEMENS
COMPANY ADDRESS
 25-20 BRKLYN-QUEENS EXPY W
 WOODSIDE, NEW YORK 11377

ASCO SONOCRAFT CORP

SALES MANAGER
 FRED LISSER
BRAND NAMES
 ASCO
 ASCO/SONOCRAFT
COMPANY ADDRESS
 115 W. 45TH ST
 NEW YORK, N. Y. 10016
 JU 2-1750

THE ASIATIC CORPORATION

COMPANY ADDRESS
 BDX 12D
 CONNEAUT, OHIO 44030

COMPANY REPRESENTATIVES
BASSETT & MOORE
 12045 MAGNOLIA BLVD.
 NORTH HOLLYWOOD, CALIF. 91607
 877-7129
WILLIAM J. PURDY CO.
 312 SEVENTH ST.
 SAN FRANCISCO, CALIF. 94103
 415-863-3300
CONNORS, INC.
 2241 STACY DR.
 DENVER, COLORADO 80221
 428-1575
HOLLINGSWORTH & STILL
 3098 PIEDMONT RD. N. E.
 ROOM 100
 ATLANTA, GA. 30305
DOUGHERTY ENTERPRISES
 P. D. BOX 3497,
 1164 WAIMANU ST.
 HONOLULU, HAWAII 96811
MARKAL SALES CORP.
 5787 N. LINCOLN AVE.
 CHICAGO, ILLINOIS 60645
 LONGBEACH 1-7290
EDWIN A. SCHULZ CO.
 BDX 40305, 271 SHERWOOD DR.
 INDIANAPOLIS, INDIANA 46240
ANDERSON SALES CO.
 177 STATE ST.
 BOSTON, MASS. 02109
 617 CAPITOL 72980
ROBERT MILSK CO.
 19375 JAMES COUZENS HWY.
 DETROIT, MICHIGAN 48235
 313 342-6660
MEL E. FOSTER CO, INC.
 228 S. CEDAR LAKE RD.
 MINNEAPOLIS, MINN. 55405
MAURY E. BETTIS CO.
 3706 BRADWAY
 KANSAS CITY, MISSOURI
 417 LOGAN 1-0772
JERRY KIRSHBAUM & CO.
 1533 PENINSULA BLVD.
 HEWLETT, L. I. N. Y.
 FRANKLIN 4-0111
PASTON-HUNTER CO, INC.
 2002 TEALL AVE.
 SYRACUSE, N. Y. 13206
 315 437-2992
MIKE ROTH SALES CO.
 678 SO. GREEN RD.
 CLEVELAND, OHIO 44121
 EV 2-9090
DALE G. WEBER CO.
 WEATHERLY BLDG. SUITE 306
 PORTLAND, OREGON 97214
 503 234-0686
LOWERY ASSOC. CO.
 2801 W. CHESTER PIKE
 BROOMALL, PA. 19008
 EL 6-5300
CARTWRIGHT & BEAN
 CROSDSTOWN STA. BDX 760.
 560 S. COOPER ST.
 MEMPHIS, TENN.
 J. Y. SCHOONMAKER CO, INC.
 5328 REDFIELD
 P. O. BOX 35266
 DALLAS, TEXAS 75235
 214 ME1-8480

ATLAS SOUND DIVISION

AMERICAN TRADING & PRODUCTION CORP

SALES MANAGER
 JEROME W. HELLER
BRAND NAMES
 ATLAS
COMPANY ADDRESS
 10 POMERDY ROAD
 PARSIPPANY, N. J. 07054
COMPANY REPRESENTATIVES
BASSETT & MOORE
 12045 MAGNOLIA BLVD.
 N. HOLLYWOOD, CAL.
 213-766-2117
F. W. MOUTHRDP & ASSOCIATES
 1530 E. 12TH ST.
 OAKLAND, CAL.
 261-7676
GORDON MOSS ELECTRONICS
 P.O. BOX J
 GREELEY, COLORADO 80632
 353-1452
CARTWRIGHT & BEAN
 20100 NE 25TH COURT
 N. MIAMI BEACH, FLA.
 945-2962
CARTWRIGHT & BEAN
 395 TRITON RD.
 ORMOND BEACH, FLA.
 DR 7-3480
CARTWRIGHT & BEAN
 2505 NANCY STREET
 DRLANDO, FLA.
 GA 5-8284
CARTWRIGHT & BEAN
 3223 CAINS HILL PLACE NW
 ATLANTA, GA.
 237-2273
BRUCE CUMMING & ASSOCIATES
 6029 W. BELMONT AVENUE,
 CHICAGO, ILL.
 312 ME 7-3770
THOMAS & SUKUP
 2060 EAST 54TH ST.
 INDIANAPOLIS, IND.
 CL 1-4574
KDENIG-MYERS ASSOCIATES
 7603 DENNIS DRIVE
 DES MOINES, IOWA
 515 276-3777
KOENIG-MYERS ASSOCIATES

P. O. BOX, 374
SHAWNEE MISSION, KAN. 66201
HE 2-8300
CARTWRIGHT & BEAN
1812 BULLARD AVE
METAIRIE, LA.
504-887-0682
LOWERY ASSOCIATES
6200 ANNAPOLIS RD.
HYATTSVILLE, MD.
773-4977
ROBERT MILSK CO.
19375 JAMES CDUZENS HWY.
DETROIT, MICH
342-6660
JIM PIPER ASSOCIATES
BOX 21
SOUTH DUXBURY, MASS.
WE 4-2498
JIM PIPER ASSOCIATES
10 HAVEN ST
DOVER, MASS
449-1144
CLARK R. GIBB COMPANY
1311 W. 25TH STREET
MINNEAPOLIS, MINN.
612-377-1200
KOENIG-MYERS ASSOCIATES
2721 BELOIT DRIVE
BRIDGETON, MO.
PE 9-1655
GORDON MOSS ELECTRONICS
2418 BARCELONA DRIVE SW.
ALBUQUERQUE, NEW MEXICO
IRV BROWN CO.
401 KINGSTON BLVD.
BROOKLYN, N. Y.
HY 3-1379
PASTON-HUNTER CO, INC.
2002 TEALL AVENUE,
SYRACUSE, N. Y.
315-437-2992
F. A. DAUGHERTY
6025 WAYFIELD RD.
CLEVELAND, OHIO
449-1122
MARSHALL JAMES
3950 SOUTH ELMRAN
LAKE OSWEGO, ORE.
636-5777
COOPER-DAUGHERTY SALES CO.
112 OAKWOOD RD.
MCMURRAY, PA. 15317
941-6473
LOWERY ASSOCIATES
2801 WEST CHESTER PIKE
BRIDOMALL, PA.
EL 6-5300
LOWERY ASSOCIATES
1501 ALLISON STREET
HARRISBURG, PA.
233-0917
CARTWRIGHT & BEAN
560 S. COOPER ST.
MEMPHIS, TENN.
BR 6-4442
J. Y. SCHOONMAKER CO.
5328 REDFIELD AVE.
DALLAS, TEX.
ME 1-8480
J. Y. SCHOONMAKER CO.
107 WINNETKA,
SAN ANTONIO, TEXAS
DIAMOND-2-0251
NORTHWESTERN AGENCIES
4130 FIRST AVE.
SEATTLE, WASH.
WA 3-8882
BRUCE CUMMING & ASSOCIATES
5537 N. ARGYLE AVE.
MILWAUKEE, WIS.
372-7650
REPS. IN OTHER COUNTRIES
ATLAS RADIO CORPORATION
50 WINGOLD AVENUE
TORONTO, ONTARIO
416-RU 1-6174

AUDIO ACCESSORIES, INC
BRAND NAMES
AUDIO-LINE
COMPANY ADDRESS
GILSUM, N. H. 03448
COMPANY REPRESENTATIVES
KOESSLER SALES, CO.
818 NORTH FAIRFAX AVE
LOS ANGELES, CAL. 90046
213 653-1605
KOESSLER SALES, CO.
1485 BAYSHORE
SAN FRANCISCO, CAL. 94124
415 584-0818
S. GLASSMAN ASSOCIATES, INC.
28 PRESTWICK TERRACE
GLEN COVE N. Y. 11542
516 676-1039
DETI SALES
601 LODI ST.
RIO PIEDRAS, P R 00924
765-8080

AUDIO DEVICES, INC
SALES MANAGER
RICHARD VAUGHAN
BRAND NAMES
AUDIOTAPE
AUDIOPAK
AUDIOFILM
AUDIODISCS
AUDIOPOINTS
AUDEV
COMPANY ADDRESS
235 EAST 42ND STREET
NEW YORK, NEW YORK 10017
COMPANY REPRESENTATIVES
AUDIO DEVICES, INC.

1426 FLOWER ST.
GLENDALE, CALIF
213 245-6587
AUDIO DEVICES, INC.
16466 WOODACRES RD.
LOS GATOS, CALIF.
408 245-6802
KOESSLER SALES CO.
318 NO. FARIFAX AVE.
LOS ANGELES 46, CALIF.
213-853-1605
MEYER, ROSS & FLEMING
113 TENTH ST.
SAN FRANCISCO, CALIF. 94103
415-431-0652
R. G. BOWEN CO, INC.
721 SO. BROADWAY
DENVER 9, COLORADO
303-722-4641
AUDIO DEVICES, INC.
254 E. PACES FERRY RD N. E.
ATLANTA, GA.
404 237-0686
HOLLINGSWORTH & STILL
3098 PIEDMONT RD.
ATLANTA, GA.
404-261-398
AUDIO DEVICES, INC.
7321 NORTH HAMLIN AVE.
SKOKIE, ILL.
312 583-4161
FITZSIMMONS ASSOC.
6774 NORTHWEST HIGHWAY
CHICAGO, ILL
312-775-6990
AUDIO DEVICES, INC.
8605 CAMERON ST
SILVER SPRINGS, MD.
301 585-4845
A. G. RADAR
5 SCOTT DR.
FRAMINGHAM, MASS
617-449-0724
BURCAM-COWAN & CO.
18234 W. MCNICOLS RD.
DETROIT, MICH. 48219
313-KE3-7700
THE HEIMANN CO.
5603 LYNDALE AVE SO
MINNEAPOLIS, MINN.
612-827-0157
ALVIN THOMAS & CO.
1828 WALNUT ST.
KANSAS CITY, MO.
815-471-6750
C. T. CARLBERG & ASSOC.
P. O. BOX 3177 STATION D
ALBUQUERQUE, NEW MEXICO
505-265-1579
ROCKE INTERNATIONAL CORP.
1324 40TH STREET
NEW YORK, N. Y.
212 689-0200
WAXMAN CURRENT SALES, INC.
990 KENMORE, AVE.
NEAL BEAR CORP.
3435 STREETSBORO RD.
WEST RICHFIELD, OHIO
216-659-3331
INDEL SUPPLY CO.
6749 EAST 12TH ST.
TULSA, OKLA.
NEBCO ASSOC.
374 GREGORY AVE.
MONROEVILLE, PENN 15146
412-824-2111
CARTWRIGHT & BEAN
560 SD. COOPER ST.
CROSSTOWN STA.
MEMPHIS 4, TENN
901-276-4442
AUDIO DEVICES, INC.
8282 PARK PLACE BLVD, B-3
HOUSTON, TEX.
713 649-7182
RON MERRITT CO.
1320 PROSPECT ST.
SEATTLE, WASH. 98109
206 682-7337
REPS. IN OTHER COUNTRIES
ELECTRO-TEC MARKETERS, INC.
1624 WEST 3RD ST.
VANCOUVER, B. C.
736-6377
ALEX L. CLARK LTD.
3751 BLOOR ST.
ISLINGTON, ONTARIO
416-231-3203

AUDIO INSTRUMENT COMPANY INC
SALES MANAGER
A. T. ADAMS
COMPANY ADDRESS
311 MOUNTAIN RDAD
UNION CITY, N. J. 07087
COMPANY REPRESENTATIVES
AUDIO INDUSTRIES CORP.
1419 N. LA BREA AVE.
HOLLYWOOD, CALIF.
HO-5-4111
LOREN F. GREEN & ASSOCIATES
5218 WEST DIVERSEY AVE
CHICAGO, ILL.
312-286-6824
SLOAN & ASSOCIATES
452 HIGHLAND AVE.
MALDEN 48, MASS.
617 322-1153
ROCKE INTERNATIONAL CORP.
13 EAST 40TH ST.
NEW YORK, N. Y.
HW-0200
LANG ELECTRONICS, INC.
507 FIFTH AVE.

NEW YORK, N. Y.
212-MU2-7147
AUDI-ELECTRO CO.
1 LIMCKILN PIKE
GLENVIEW, PA.
TU-7-5210
M. K. WIDDEKIND & CO.
815 WEST EWING ST.
SEATTLE, WASH.
206-284-8020
REPS. IN OTHER COUNTRIES
ALEX L. CLARK LTD.
3751 BLOOR ST.
WEST ISLINGTON, TORONTO,
ONTARIO
416 BE 1-3303

BALL BROTHERS RESEARCH CORP
SALES MANAGER
W. A. DOUGLASS
COMPANY ADDRESS
P.O. BOX 1062
BOULDER, INDUSTRIAL PARK,
COLORADO 80302
COMPANY REPRESENTATIVES
ELSCO, ARIZONA
SCOTTSDALE, ARIZONA
REEVES ELECTRONICS
LOS ANGELES, CALIFORNIA
213 876-3300
REEVES ELECTRONICS
PALO ALTO, CALIFORNIA
415 326-0663
ELSCO, COLORADO
DENVER, COLORADO
303 433-2991
VIDEO ENGINEERING CO.
WASHINGTON, D. C.
202 882-6131
SOUTHEAST ELECTRONICS
JACKSONVILLE, FLORIDA
305 356-3007
ELECTRONIC EQUIPMENT, INC.
ATLANTA, GEORGIA
404 872-5622
VIDEO SYSTEMS, INC.
CHICAGO, ILLINOIS
312 677-9000
GENERAL TELEVISION NETWORK
DETROIT, MICHIGAN
313 548-2500
K & M ELECTRONICS
MINNEAPOLIS, MINNESOTA
612 927-6545
VIDEO SYSTEMS, INC.
ST. LOUIS, MISSOURI
314 772-3295
TELE-MEASUREMENTS
CLIFTON, NEW JERSEY
201 473-8822
SOUTHERN ENGINEERING &
SALES, INC.
TULSA, OKLAHOMA
918 622-1007
PEIRCE PHELPS, INC.
PHILADELPHIA, PENNSYLVANIA
215 477-9000
BLUFF CITY DISTRIBUTING CO.
MEMPHIS, TENNESSEE
901 276-4501
UNIVERSAL MAGNETICS INC.
DALLAS, TEXAS
214 631-4730
UNIVERSAL MAGNETICS INC.
HOUSTON, TEXAS
713 529-3105
ELECTRONIC SALES CORP
SALT LAKE CITY, UTAH
801 466-8631
MUTUAL ELECTRONIC SUPPLY
SEATTLE, WASHINGTON
206 632-2791

BARKER & WILLIAMSON, INC
SALES MANAGER
ELMER BUSH
COMPANY ADDRESS
CANAL STREET
BRISTOL, PENN. 19007

BAUER ELECTRONICS CORPORATION
SALES MANAGER
PAUL GREGG
BRAND NAMES
LOG-ALARM
PEAKMASTER
COMPANY ADDRESS
1663 INDUSTRIAL ROAD
SAN CARLOS, CALIF. 94070
COMPANY REPRESENTATIVES
JESS SWICEGOOD
P. O. BOX 1828
DOTHAN, ALA.
205 794-6339
EUGENE D. BRADLEY
1328 W. FLOWER
PHOENIX 13, ARIZ.
602 266-2292
R. W. PLATT
2317 SO. 25TH STREET
FORT SMITH, ARK. 72901
501 783-8492
RICHARD R. BROOKS
3706 W. 225TH STREET
TDRANCE, CALIF. 90505
213 373-2309
HENRY S. BROUGHALL
600 MARBLE STREET
BROOMFIELD, COLO. 80020
303 466-3851
ROBERT H. PEARSON
99-117 CHESTER WAY
AIEA, HAWAII 96701
GLENN E. WEBSTER
823 S. GREENWOOD AVE.

PARK RIDGE, ILL. 60068
312 823-8206
HERBERT L. ARMS
P. O. BOX 327
CORDON, IND.
812 738-5752
WILFRED FISHER
VANCLEVE, KY. 41385
606 666-9006
GEORGE WILSON
P. O. BOX 592
FERRIDAY, LA.
318 7200
HOWARD B. HAYES
18510 MUNCASTER ROAD
DERWOOD, MD. 20752
301 948-5863
J. GORDON KEYWORTH
BERKSHIRE DRIVE
WILLIAMSTOWN, MASS.
413 458-4538
AUBREY FELDER
P O BOX 546
BROOKHAVEN, MISS.
601 1298
OLIVER J. COBURN
P. O. BOX 636
LIBBY, MONTANA 59923
RICHARD W. BURDEN
342 LEXINGTON AVE.
MT. KISCO, N. Y. 10549
914 666-3730
HENRY A. BOGUSLANSKI
TELE-PROJECTS, INC.
30 EAST 42ND STREET
NEW YORK, N. Y. 10017
212 687-1255
JOHN D. BROOKS
200 STONEWALL STREET
ALBEMARLE, N. CAR.
704 982-5667
WILLIAM F. BAKER, JR.
WBKR BROADCAST SERVICE
1169 SYLVANIA ROAD
CLEVELAND HTS, OHIO 44121
382-0900
WILLIAM H. BRADLEY
200 COUNTRY CLUB ROAD
SAND SPRINGS, OKLA. 74063
918 245-5603
A. C. MCMILLIAN
16679 S. W. MAPLE CIRCLE
LAKE OSWEGO, OREGON 97034
503 636 6257
KENNETH B. ANDERSON
44 MCCRACKEN ROAD
GREENVILLE, PA. 16125
412 588-4320
JAMES CALDERON
AM-13 VILLA RICA
BAYAMON, PUERTO RICO
SAMUEL FIELDS
1009 SILVER STREET
RAPID CITY, S. DAK.
605 342-4372
CHESTER J. DAVIS
HARTSVILLE, TENN. 37074
374-2422
CHESTER FAISON
P O BOX 4727
DALLAS, TEXAS
214 826-1044

E. J. BAUGHMAN COMPANY
SALES MANAGER
E. C. BAUGHMAN
COMPANY ADDRESS
1914 N. COGSWELL RD.
SOUTH EL MONTE, CALIF 91733

BECKMAN & WHITLEY, INC
MARKETING MGR.
DONALD L. TUCKER
COMPANY ADDRESS
441 WHISMAN ROAD
MOUNTAIN VIEW, CALIF. 94040
COMPANY REPRESENTATIVES
HENRY GROSSMAN ASSOC.
519 S. 5TH AVENUE
MT. VERNON, NEW YDRK 10550
914 664-5393

BELAR ELECTRONICS LABORATORY
COMPANY ADDRESS
8329 DELAWARE AVENUE
UPPER DARBY, PENN. 19028

BELDEN MANUFACTURING COMPANY
SALES MANAGER
CHARLES O. ATWATER
BRAND NAMES
BELDOL
BELDFOL
CELENAMEL
CELLULINE
PERMOHME
POLY THERMALEGE
WELDOMM
98 PACKET
COMPANY ADDRESS
415 S. KILPATRICK AVE.
CHICAGO, ILLINOIS 60644
F. W. BELL, INC.
SALES MANAGER
RICHARD J. MACKESSY
BRAND NAMES
HALL-PAK
COMPANY ADDRESS
1356 NORTON AVENUE
COLUMBUS, OHIO 43212
614 294 4906
TWX 614 759 0193
COMPANY REPRESENTATIVES
PHYSIMETRICS
2105 DOGWOOD LANE
HUNTSVILLE, ALA. 35810

BBRC provides versatile, economical equipment to commercial stations—and also enhances the capabilities of educational TV stations, university workshops and closed circuit systems. All equipment is simple to install, easy to operate, and features the long-term stability and low maintenance of solid-state circuitry.

THE MARK VI Special Effects Generator is a moderately priced, self-contained unit designed to meet commercial black and white television broadcast standards. Two models are available: a standard rack-mounted Mark VI-A, and a remote-controlled Mark VI-AR (SHOWN BELOW). Both provide three basic wipes, external video keying, and independent selective matting of background information in any value of gray from black to white. The Mark VI can serve as an ideal standby generator, an auxiliary unit for a second studio, or can be used in mobile van operations. Prices start from \$1375.00.

THE MARK VII is an advanced Color Special Effects Generator designed for the most critical studio applications. The Mark VII is capable of color inserts (color matting). The output video of the unit can be the combination of background video and artificially-generated color inserts—with any color within the NTSC spectrum generated by manual control settings. A non-additive mixing technique, insensitive to variations in video brightness levels, is incorporated for new effects with lap dissolves. The basic system accepts a variety of monochrome or color signals in either composite or non-composite format at the inputs. In addition to keying effects, as many as fourteen wipes can be provided. Prices from \$1810.00. Write for additional information.

DEPENDABLE BROADCAST TELEVISION EQUIPMENT

FROM BALL BROTHERS
RESEARCH CORPORATION

THE MARK VIII Automatic Gain Control (AGC) Video Amplifier was developed to provide continuous monitoring of video signals from a variety of originating equipment. It is available in two models: one for use in studios where local drives can be supplied, and the other where drive pulses are derived from composite video signals originating outside the studio, or from VTR's. Both have full color capabilities, and are designed to compensate for both video and set-up levels over a $\pm 6\text{db}$ range. It is ideally suited to follow film chains and live cameras, or network originations. It is also used ahead of video tape recorders and standard transmission lines where signals are limited to precise levels to prevent distortion. Prices from \$3340.00.

THE MARK IX Video and Pulse Distribution Amplifiers were developed specifically for color studio operations. Up to ten video or pulse amplifiers (or any combination of both) can be plugged into the Mark IX chassis to provide as many as 40 isolated signal outputs at one central distribution point. The Mark IX Video Amplifier requires no high frequency adjustment because of its wideband frequency response characteristics. Differential gain and phase measurements are shown for all input signal conditions at 0.25 percent and 0.25 degrees, respectively. The Pulse Amplifier has highly isolated signal outputs with an impedance of 75 ohms terminated at the sending end. Each amplifier has bridging or looping input drive signal provisions. The active circuitry maintains constant pulse rise times of less than 50 nanoseconds and is compensated for possible component replacement. Pulse delay of less than 50 nanoseconds is measured at the output. Prices: Video Pulse Amplifier, \$255.00 each, Electronic Housing, \$275.00.

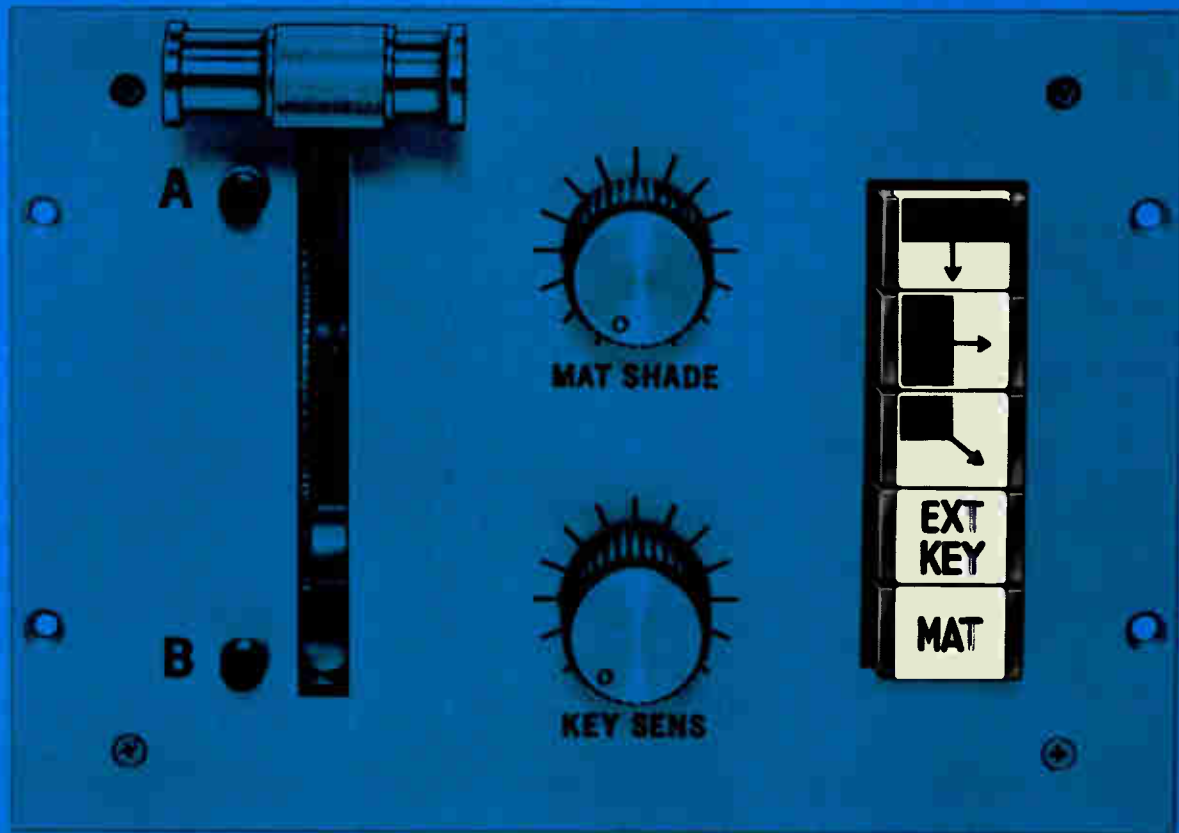

205 539-3274
 PAUL NURCHES COMPANY
 2396 E. FOOTHILL BLVD.
 PASADENA, CALIF. 91107
 213 796 5844
 STRAUBE ASSOCIATES
 483 WILLOW ROAD
 MENLO PARK, CALIF. 94025
 415 323-2476
 TWX 415-492-9266
 STRAUBE ASSOCIATES
 2888 TELEGRAPH AVE.
 BERKELEY, CALIF. 94705
 415 841-4450
 GORDON MOSS ELECTRONICS, INC.
 BDX J
 GREELEY, COLORADO 80632
 303 353-1452
 PHYSIMETRICS
 P.O. BOX 536, 502 SELKIRK DR
 WINTER PARK, FLA. 32789
 305 647-5722
 PHYSIMETRICS
 SUITE 518-PENTHOUSE,
 3176 PEACHTREE RD., N.E.
 ATLANTA, GA. 30326
 404 237-8278
 R. EDWARD STEMM, INC.
 5681 W. LAKE STREET
 CHICAGO, ILL. 60644
 312-379-2700
 TWX 312-265-1344
 ELECTRONIC COMPONENTS AND
 SERVICES
 611 TRAPELO RD
 WALTHAM, MASS 02154
 617 894 6921
 TWX 617 894 9857
 WKM ASSOCIATES, INC.
 1474 EAST OUTER DRIVE
 DETROIT, MICH. 48234
 313 892-2500
 R. EDWARD STEMM, INC.
 2715 LYNDALE AVE. S.
 MINNEAPOLIS, MINN. 55408
 612 822-8404
 LABTRONICS, INC.
 161 PICKARD BLDG.
 SYRACUSE, N.Y. 13211
 315 454-9314
 CANE TECHNICAL SALES, INC.
 555 E. BOSTON POST RD.
 MAMARONEK, N.Y. 10543
 914 698-4411
 JOSEPH PLASENCIA, INC.
 EXPORT ONLY
 521 FIFTH AVENUE
 NEW YORK, N.Y. 10017
 212 867 8084
 WKM ASSOCIATES, INC.
 6741 RIGOE RD.
 CLEVELAND, OHIO 44129
 216 885-5616
 TWX 216-845-2304
 WKM ASSOCIATES, INC.
 6085 FAR HILLS AVE.
 DAYTON, OHIO 45459
 513 298-7203
 TWX 513-944-0280
 F. W. BELL, INC.
 1356 NORTON AVENUE
 COLUMBUS, OHIO 43212
 614 294-4906
 TWX 614 789-0193
 DALE G. WEBER COMPANY
 SUITE 306, WEATHERLY BLDG.
 PORTLAND, OREGON 97214
 503 234-7671
 TYLER GRIFFIN COMPANY
 46 DARBY RD.
 PAOLI, PA. 19301
 215 647-1550
 WKM ASSOCIATES, INC.
 90 CLAIRTON BLVD.
 PITTSBURGH, PA. 15227
 412 892-2953
 TWX 412-525-2356
 CAREY-WOLF COMPANY
 BOX 12425, 3327 WINTHROP AVE
 FORT WORTH, TEXAS 76116
 817 738-1702
 TWX 817 891 8203
 CAREY-WOLF COMPANY
 BOX 60338
 HOUSTON, TEXAS 77060
 713 643-2114
 TWX 713-571-1123
 GORDON MDSS ELECTRONICS, INC.
 BOX 8022 FOOTHILLS SECTION
 1502 PRESTON STREET
 SALT LAKE CITY, UTAH 84108
 801 485 2870
 DALE G. WEBER COMPANY
 325 MARITIME BLDG.
 SEATTLE, WASH. 98104
 206 623-5990
 REPS. IN OTHER COUNTRIES
 MEGATRONIX LIMITED
 1800 AVENUE ROAD
 TORONTO 12, ONTARIO
 416 783-3329
 TWX 610 491-1713

BENCID TELEVISION ASSOCIATES
 SALES MANAGER - CANADA
 C. J. EVANS
 SALES MANAGER - US
 HARRY D. GRAY
 SUBSIDIARY
 BENCID TELEVISION CORP
 P O BOX 10068
 JACKSONVILLE, FLA. 32207
 904 399-9977
 COMPANY ADDRESS
 27 TABER ROAD
 REXDALE, ONTARIO, CANADA

BENJAMIN ELECTRONIC SOUND CORP

SALES MANAGER
 JAY MENDUKE
 BRAND NAMES
 ELAC
 MIRACDRD
 BENJAMIN
 COMPANY ADDRESS
 40 SMITH STREET
 FARMINGDALE, N.Y. 11735
 COMPANY REPRESENTATIVES
 ALASKA ELECTRONICS SUPPLY CO
 201 E. 4TH AVE., BDX 4-669
 ANCHORAGE, ALASKA
 BERNARD L. CAMN CO.
 420 MARKET STREET
 SAN FRANCISCO, CALIF.
 415 781-7981
 ELLARD STRASSNER CO.
 3121 LOS FELIZ BLVD.
 LOS ANGELES, CALIF. 90039
 213 666-1511
 HYDE ELECTRONICS CO.
 888 SO. LIPAN
 DENVER, COLORADO
 303 936-3456
 MATTLAND K. SMITH CO.
 31 16TH STREET, N.W.
 ATLANTA, GA.
 404 875-8031
 DOUGHERTY ENTERPRISES
 P.O. BOX 3497
 HONOLULU, HAWAII
 MARREL SALES CORP.
 5787 N. LINCOLN AVENUE
 CHICAGO, ILL.
 312 961-7290
 FRANK MCSWENEY & ASSOC
 4123 N. KEYSTONE AVENUE
 INDIANAPOLIS, IND.
 317 547-2112
 ART GAINES CO
 11151 VIERS MILL RD
 WHEATON, MD
 301 933 2550
 ANDERSON SALES CO.
 177 STATE STREET
 BOSTON, MASS.
 617 227-2980
 ROBERT MILSK CO.
 19375 JAMES COUZENS HWY.
 DETROIT, MICH.
 313 342-6660
 PAT AYLWARD & CO.
 3807 GRAND AVENUE
 MINNEAPOLIS, MINN.
 612 824-6266
 CARMINE VIGNOLA & ASSOC
 21 SCHELLRIDGE RD
 JEFFERSON CITY, MO
 314 635 1023
 ARNOLD KRAMERSON
 73 HICKS LANE
 GREAT NECK, N.Y.
 516 482-1589
 METROPOLITAN SALES CO.
 110 JERICHO TPKE.
 FLORAL PARK, N.Y.
 516 328-0120
 LES MORROW CO.
 3123 W. 17TH STREET
 CLEVELAND, OHIO
 216 231-5700
 FRANK WARUSS1
 312 RDCKFIELD RD.
 PITTSBURGH, PA.
 412 221-4676
 MARTIN WEINBERG & ASSOC.
 1122 E CLIVEDEN STREET
 PHILADELPHIA, PA.
 215 549-1122
 TECH-TRONIC SALES CO
 2920 WESLAYAN
 HOUSTON, TEXAS
 713 667-5003
 DAVID CHAMPLIN CO.
 12347 BOTHELL WAY, N.E.
 SEATTLE, WASH.
 206 362-0401

BENRUS-TECHNICAL PRODUCTS DIV

SALES MANAGER
 LOUIS A. RICCIO
 COMPANY ADDRESS
 30 CHERRY AVENUE
 WATERBURY, CONNECTICUT 06720
 COMPANY REPRESENTATIVES
 DIETRICH-HEFFNER ASSOC.
 2202 W. MAGNOLIA BLVD.
 BURBANK, CALIF.
 213 849-6871
 TWX 213 846-7801
 TECHNICAL ASSOC, INC.
 2319 EAST SOUTH STREET
 ORLANDO, FLORIDA 32803
 305 424-5681
 BARD ASSOCIATES, INC.
 LAGRANGE INDUSTRIAL PK.
 LAGRANGE, ILLINOIS
 312 354-0660
 TWX 312 352-7782
 LEEMARK ASSOCIATES
 P. O. BOX 6175
 LEAWOOD, KANSAS
 913 648-D124
 INSTRUMENT ASSOCIATES INC.
 30 PARK AVENUE
 ARLINGTON, MASS. 02174
 617 648-2922
 S. STERLING, CO.
 21230 10 - 1/2 MILE RD.
 SOUTHFIELD, MICHIGAN
 313 357-3700
 TWX 313 357-4615
 INSTRUMENTATION SALES CO.
 P. O. BOX 403

RIDGEWOOD, N. J.
 G15-3210
 TWX 444-2988
 AZTEC ENTERPRISES
 5206-B CONSTITUTION AVE.
 ALBUQUERQUE, NEW MEXICO
 505 268-6421
 FRATHDM COMPANY
 202 E. 44TH ST.
 NEW YDRK, N. Y. 10017
 212 687-9390
 J. D. RYERSON ASSOC. INC.
 425 MANOR DRIVE
 EAST SYRACUSE, N. Y.
 315 656-7419
 TWX 315 477-1132
 KASTLE ASSOCIATES
 354 NORTH MAIN ST.
 DOYLESTOWN, PENNA.
 215 348-4466
 NOAKES ENGINEERING
 2338 MACARTHUR BLVD.
 IRVING, TEXAS
 214 BL 5-0441
 THE JAY COMPANY
 2914 ANNANDALE ROAD
 FALLS CHURCH, VA. 22042
 703 534-7800
 ASSOCIATED INDUSTRIES
 3711 S. HUDSON STREET
 SEATTLE, WASHINGTON 98118
 206 PA 2-3347
 TWX 206 998-1202
 REPS IN OTHER COUNTRIES
 BRH ASSOCIATES LTD.
 6338 VICTORIA AVE.
 MONTREAL 26, QUEBEC
 514 733-5331

BERKEY TECHNICAL CORP

VP SALES
 HERBERT HOLLANDER
 BRAND NAMES
 ASCOR
 CAESAR-SALTZMAN
 ASCORLIGHT
 COMPANY ADDRESS
 25-15 50TH STREET
 NEW YORK CITY, N.Y. 11377
 COMPANY REPRESENTATIVES
 BERKEY TECHNICAL OF CALIF.
 COLORTRAN
 1015 CHESTNUT ST
 BURBANK, CALIF.
 ASCOR ELECTRONICS CORP.
 209 N. 151ST STREET
 N. MIAMI BEACH, FLORIDA
 BERKEY TECHNICAL CORP
 3701 MT VERNON AVE
 ALEXANDRIA, VA.
 REPS IN OTHER COUNTRIES
 BERKEY OF CANADA, LTD.
 3320 ELMBANK RD.
 MALTON, ONTARIO

BIONIC INSTRUMENTS, INC

SALES MANAGER
 BROADCAST EQUIPMENT
 D RIDGELY BOLGIANO
 SALES MANAGER
 HOSPITAL CCTV
 J WALVERN BENJAMIN
 COMPANY ADDRESS
 221 ROCK HILL ROAD
 BALA-CYNNWD, PA 19004

BIRD ELECTRONIC CORPORATION

VICE. PRES.-SALES
 M. A. RICKMAN
 BRAND NAMES
 THRULINE
 COAXWITCH
 SENTRYLINE
 TERMALINE
 WATCHER
 TENULINE
 COMPANY ADDRESS
 30303 AURORA ROAD
 SOLON, OHIO 44139
 216 248 1200
 TWX 216 248 6458
 COMPANY REPRESENTATIVES
 ALLGOOD ASSOCIATES, INC.
 3388 WEST 8TH STREET
 LOS ANGELES, CALIF. 90005
 213 383-4443
 TWX 213 380-8761
 O H BROWN CO.
 P O BOX 128
 PALO ALTO, CALIF. 94302
 415 321-8867
 TWX 415 492-9396
 BIRD ELECTRONIC CORP.
 235 BEAR HILL ROAD
 WALTHAM, MASSACHUSETTS 02154
 617 899-4162
 MAXWELL A. BROWN ASSOCIATES
 308 SECOND AVE.
 BRADLEY BEACH, N. J.
 201 775-7829
 REPS IN OTHER COUNTRIES
 LEIGH & HURWITZ PTY LTD.
 P. O. BOX 3236
 JOHANNESBURG, SOUTH AFRICA
 HANS BUCH & CO. A/S
 SVANEVEJ 6
 P. O. BOX 975
 COPENHAGEN NV, DENMARK
 DY ASEKO AB
 VUORIKATU 22
 HELSINKI 10, FINLAND
 TECHNIQUE ET PRODUITS
 63 B15 RUE D AGESSEAU
 BOULOGNE S/SEINE,
 SEINE, FRANCE
 WACKER GMBH

STETTENSTRASSE 9
 6 FRANKFURT AM MAIN
 W. GERMANY
 LIVINGSTON LABORATORIES, LTD.
 GREYCAINES ESTATE
 BEWISY MILL LANE
 N. WATFORD, HERTS., ENGLAND
 DOTT. ING. MARIO VIANELLO
 VIA L. ANELLI 13
 MILAN, ITALY
 VIA S. CROSE IN
 GERUSALEMME 97
 ROME, ITALY
 MORGENSTIERNE & CD A/S
 WESSELS GATE 6
 OSLO, NORWAY
 ATAO INGENIERDS
 ENRIQUE LARRETA 12
 MADRID 16, SPAIN
 ERIK FERNER AB
 P. O. BOX 56
 BROMMA, SWEDEN
 MEGEX-ZURICH, GMBH
 BADENERSTRASSE 582
 8048 ZURICH, SWITZERLAND
 WARBURTON FRANKI LIMITED
 307 KENT STREET
 SYDNEY, AUSTRALIA

BIRNBACH CO. INC

SALES MANAGER
 GEORGE ORTIZ
 BRAND NAMES
 BIRNBACH
 COMPANY ADDRESS
 435 HUDSON ST
 NEW YORK, NEW YORK 10014
 COMPANY REPRESENTATIVES
 BIRNBACH RADIO
 427 S HINDRY ST.
 INGLEWOOD, CALIF.
 213 673-2900
 ELECTRONIC MFG. CONS. INC
 226 E. VERM. SO
 COLORADO SPRINGS, COLO.
 R A CHOLMERS CO.
 349 PEACHTREE HILLS AVE NE
 ATLANTA, GA.
 404 233-3208
 DELTA SALES
 1407 N. ILLINOIS STREET
 INDIANAPOLIS, IND.
 317 ME 1-4136
 ORC CO.
 1643 BEACON STREET
 WABAN, MASS.
 617 332-9600
 CARMINE A. VIGNOLA & ASSOC.
 21 SCHELLRIDGE RD.
 JEFFERSON CITY, MO.
 314 635-1023
 JULES S BRESSLER, INC
 4808 BERGENLINE AVE.
 UNION CITY, N.J.
 201 864-9577
 CALLAHAN-FERGUSON CO.
 107 GREENHEDGE DR.
 CAMILLUS, N.Y.
 315 488-5518
 THOMAS SHELBY CO
 17 SO. WALNUT STREET
 NEW BREMEN, OHIO
 419 629-6511
 LOWERY ASSOCIATES CO.
 2801 WESTCHESTER PIKE
 BROOMAL, PA.
 215 JA 8 5170

BIRNS & SAWYER INC

SALES MANAGER
 CLIFFORD SAWYER
 BRAND NAMES
 AUREFLEX
 AURIBELL
 E-Z-SEE
 OMNITAR
 OMNIPPON
 COMPANY ADDRESS
 6424 SANTA MONICA BLVD.
 LOS ANGELES, CALIF 90038

BISCAYNE AUDIO COMPANY-

BROADCAST EQUIPMENT DIV
 COMPANY ADDRESS
 P.O. BOX 543
 DETROIT, MICHIGAN 48232

BLAW-KNOX COMPANY

BLAW-KNOX EQUIPMENT DIVISION
 SALES MANAGER
 ADVANCED PRODUCTS DEPT
 E S MILLER
 COMPANY ADDRESS
 P.O. BOX 1198
 PITTSBURGH, PA. 15230
 COMPANY REPRESENTATIVES
 THE THORSON COMPANY
 6824 MELROSE AVENUE
 LOS ANGELES, CALIF.
 MURRAY SOCOLOF
 2D13 BEDFORD STREET
 ROME, NEW YORK

BLOUNDER-TONGUE LABORATORIES, INC

SALES MANAGER
 RICHARD B. HELMOSKI
 BRAND NAMES
 BLOUNDER-TONGUE
 COMPANY ADDRESS
 9 ALLING STREET
 NEWARK, NEW JERSEY 07102
 COMPANY REPRESENTATIVES
 GRAHAM SISSON
 BOX 5357
 SAN JOSE, CALIF. 95129
 408 257-3302

MOULTHROP & HUNTER
165 ELEVENTH STREET
SAN FRANCISCO, CALIF
415 UN 3-7880
MIKE STOBIN COMPANY
14663 ARMINA STREET
VAN NUYS, CALIF.
213 ST 2-9421
HYDE ELECTRONICS COMPANY
888 SOUTH LIPAN STREET
DENVER, COLORADO
303 936-3455
W. F. HEMMINGER COMPANY, INC.
P.O. BOX 6008
SARASOTA, FLORIDA
813 625-6000
ERNEST C. SISSON
3057 RANLO DRIVE
DORAVILLE, GEORGIA
404 938-7085
BILL KOLANS COMPANY
P.O. BOX 2098
HONOLULU, HAWAII
C. HENRY LAIRD
23 W. 034 HACKBERRY DRIVE
GLEN ELLYN, ILLINOIS
312 HO 9-7193
GEORGE PETITT COMPANY
349 NORTH ASHLAND AVENUE
RIVER FOREST, ILLINOIS
312 CO 1-0342
HOEMIG SALES COMPANY
3405 BUTLER COURT
FORT WAYNE, INDIANA
219 483-6913
FORRISTAL-YOUNG SALES
5550 BUENA VISTA
MISSION, KANSAS
913 432-1420
W. A. HENDRICKSON COMPANY
291 FIRST PARISH RD.
SCITUATE, MASS.
617 LI 5-0652
J. MALCOLM FLORA, INC.
165 W. LIBERTY
PLYMOUTH, MICH.
313 GL 3-4296
MEL FOSTER COMPANY
228 S. CEDAR LAKE ROAD
MINNEAPOLIS, MINN.
612 374-2612
FORRISTAL-YOUNG SALES
7110 OAKLAND STREET
ST. LOUIS, MO.
314 MI 5-2360
L-C-A SALES, INC.
76 MAIN STREET
TUCKAHOE, N.Y.
914 WO 1-4700
LSM ASSOCIATES
ORCHARD PARK, PHELPS, N.Y.
315 548-4891
ATCHESON & ADAMS
P.O. BOX 9085
GREENSBORO, N.C.
919 272-6838
WELLER ELECTRONIC SALES, INC.
P.O. BOX 212
WORTHINGTON, OHIO
614 TU 5-7819
JACK F. MCKINNEY SALES CO.
1303 CHEMICAL STREET
DALLAS, TEXAS
214 ME 1-9450
M. K. WIDDEKIND COMPANY
815 W. EWING STREET
SEATTLE, WASH.
206 AT 4-8020
REPS IN OTHER COUNTRIES
R. J. BUCKLAND COMPANY
P.O. BOX 367 STATION B
LONDON, ONTARIO
BOSTON INSULATED
WIRE & CABLE COMPANY
SALES MANAGER
ROBERT COWEN
BRAND NAMES
B I W
ELAC
COMPANY ADDRESS
65 BAY STREET
DORCHESTER, MASS. 02125
COMPANY REPRESENTATIVES
W. E. ANOERSON
2825 HIGHLAND AVE. B-4
BIRMINGHAM, ALA.
205 323-2870
B I W. ELAC DIV.
141 NEVADA ST.
EL SEGUNDO, CALIF.
213 OR 8-6141
D. R. BUGBEE
11 PARKER FARMS RD.
WALLINGFORD, CONN.
203 265-1067
T. R. RUSSELL
4068 WESTERN AVE.
WESTERN SPRINGS, ILL.
312 246 2570
J. D. ALLEN
1438 LANGFORD ROAD
BALTIMORE, MD.
301 RI 7-3404
R. S. WILLIAMSON
34 BACON ST.
NATICK, MASS.
617 OL 3-8756
F. K. GUNTHER
56 MAPLE ST.
CHAGRIN FALLS, OHIO
216 247-6117
REPS IN OTHER COUNTRIES
B I W. LTD.
118 SHAW STREET
HAMILTON, ONTARIO
416 JA 9-7151

W. H. BRADY CO.
ADVERTISING MANAGER
J. A. PESCHECK
BRAND NAMES
PERMA-CODE
SIGNATURE PLATES
QUIK-LABEL
BRADY
COMPANY ADDRESS
727 W. GLENDALE AVE.
MILWAUKEE, WIS. 53209
BROADCAST ELECTRONICS, INC.
VICE. PRES. FOR SALES
JOHN L. NEFF
BRAND NAMES
SPOTMASTER
PORTAPAK
FIDELIPAC
COMPANY ADDRESS
8810 BROOKVILLE ROAD
SILVER SPRING, MARYLAND 20910
301 588 4983
COMPANY REPRESENTATIVES
WISE RADIO & TV SUPPLY INC
1001 TOWSON AVENUE
FORT SMITH, ARKANSAS
501 783-8925
WESTERN RADIO & TV SUPPLY CO
1415 INDIA STREET
SAN DIEGO 1 CALIFORNIA
714 239-0361
UNIVERSAL TAPEDEX
7660 GLORIA AVENUE
VAN NUYS, CALIFORNIA 91406
213 989-3370
BAUER ELECTRONICS CORP
1663 INDUSTRIAL ROAD
SAN CARLOS, CALIF.
FUJII-YA
1662 POST STREET
SAN FRANCISCO, CALIF 94115
415 346-7173
FIRST STATE ELECTRONICS INC
801 NORTH UNION ST
WILMINGTON, DELAWARE
CONTINENTAL ELECTRONICS WHLSL
457 WEST 28TH STREET
HIALEAH, FLORIDA
305 888-3511
FLAGLER RADIO CO INC
1068 WEST FLAGLER STREET
MIAMI, FLORIDA
305 373-1425
ACME SALES COMPANY
31 16TH STREET, N W
ATLANTA, GEORGIA
404 355-9267
WEBSTER ENGINEERING CO
823 SOUTH GREENWOOD AVENUE
PARK RIDGE, ILLINOIS
312 823-8206
MOTOROLA, INC
COMMUNICATIONS PRODUCTS DIV
4501 W AUGUSTA BLVD
CHICAGO, ILLINOIS
SARKES TARZIAN
EAST HILLSIDE DRIVE
BLOOMINGTON, INDIANA
812 332-7251
WILFRED FISHER
VANCLEVE, KENTUCKY
606 666-5006
B & R INC
15312 SANTA ROSA
DETROIT, MICHIGAN 48238
313 341-7990
FELDER ELECTRONIC
P O BOX 546
BROOKHAVEN, MISS.
601 833-6911
GENERAL SOUND AND VISUAL
62 CONGRESS STREET
PORTSMOUTH, NEW HAMPSHIRE
603 436-8963
VISUAL ELECTRONICS CORP.
356 WEST 40TH STREET
NEW YORK, NEW YORK
212 736 5840
GENERAL ELECTRIC
VISUAL COMMUNICATION PRODS.
BUILDING 7, ROOM G164,
ELECTRONICS PARK
SYRACUSE, NEW YORK
315 456-2869
ELECTRONICS MISSILES &
COMMUNICATIONS, INC.
160 EAST THIRO STREET
MOUNT VERNON, NEW YORK 10550
914 668-3012
LANG ELECTRONICS, INC
507 FIFTH AVE
NEW YORK, NEW YORK
212 682-7147
LEE-JEFFERIES INC
555 MADISON AVE
NEW YORK, NEW YORK
212 759-7220
ATWOOD RICHARDS, INC
625 MADISON AVE
NEW YORK, NEW YORK
WARREN RADIO COMPANY
1002 ADAMS STREET
TOLEDO 1, OHIO
GALLAGHER SERVICES
P O BOX 98
WHITE HAVEN, PENNSYLVANIA
717 443-9850
WILKINSON ELECTRONICS INC
1936 MACDADE BLVD
WOODLYN, PENN 19094
215 874-5236
ORTIZ ELECTRONICS CORP
MCKINLEY 210 DESTO
APARTADO 731
MAYAGUEZ, PUERTO RICO
JOSE ARTURO FERNANDEZ

KEEP TOMORROW'S
NEEDS IN MIND
TODAY WITH BELAR

ADD-ON
MONITOR
SYSTEM



The Belar ADD-ON MONITORING SYSTEM allows the broadcaster to fulfill his monitoring requirements as the needs arise. The basic unit is the FMM-1 Frequency and Modulation Monitor for monaural use, and when requirements call for SCA, add the plug in SCAM-1 SCA unit. And for stereo the FMS-1 Stereo unit completes the system.

Today's monitoring requirements make this system a must.

BELAR ELECTRONICS LAB.
Delaware & Montrose Avenues
Upper Darby, Pa. 19082

THE
ADD-ON
IS
COMPLETE

Pilot Frequency
38 KC Suppression
L + R Crosstalk
L - R Crosstalk
AM Noise or Inc. AM

The FMS-1 monitors and measures:

Total Modulation
L + R Modulation
L - R Modulation
Pilot Amplitude
Left or Right Channel

A stereo station must—the Belar FMS-1 monitors the 19 KC pilot frequency as well as all the modulation characteristics of FM stereo. The advanced solid-state circuitry guarantees that all FCC performance requirements for stereo monitors are exceeded so that precise, accurate proof-of-performance measurements can be made for the finest in stereo broadcasting.

FCC TYPE APPROVED

P O BOX 5124
 PUERTE DE TIERRA STA.
 SAN JUAN, PUERTO RICO 00906
 DIXIE RADIO SUPPLY CO
 1900 BARNWELL STREET
 COLUMBIA, SOUTH CAROLINA
 803 253-5333
 PEPPER SOUND STUDIOS INC
 47 SOUTH FLORENCE STREET
 MEMPHIS, TENNESSEE
 901 274-6674
 BLUFF CITY DISTRIBUTING CO
 234 EAST STREET
 MEMPHIS, TENN
 555 1212
 BROADCAST EQUIPT & SUPPLY CO
 P O BOX 3141
 BRISTOL, TENN 37623
 615 764-8032
 HOWELL COMPANY
 2873 PERSHING DRIVE
 EL PASO, TEXAS 79903
 915 566-3968
 WITKO ELECTRONICS INC
 435 BRANIFF BLDG
 DALLAS, TEXAS
 214 741-9225
 R & R ELECTRONIC SUPPLY CO
 1607 AVENUE C
 LUBBOCK, TEXAS 79408
 806 765-8089
 R & R ELECTRONIC SUPPLY CO
 914 WEST SEVENTH ST
 AMARILLO, TEXAS
 806 374-2869
 ELSCO
 2275 SW TEMPLE
 SALT LAKE CITY, UTAH 84115
 801 466-8631
 REPS IN OTHER COUNTRIES
 AMALGAMATED WIRELESS
 40, JALAN AMPANG
 KUALA LUMPUR, MALAYSIA
 SUNSHINE COMPANY LTD
 P O BOX 1462
 BANGKOK, THAILAND
 HERMAN ALLAN PADGETT
 GERENTE GENERAL
 APDO. 48
 COMAYAGUELA, D.C. HONDURAS
 MR. FRANZ KUBECKA
 UNTERE KIRCHGASSE 20
 8710 KITZINGEN, W. GERMANY
 DIRECT TV REPLACEMENTS LTD
 126 HAMILTON ROAD
 WEST NORWOOD
 LONDON SE 27, ENGLAND
 ATLANTIDA, S. A.
 9-11, RUE DU CLOS
 CASE EAUX-VIVES 103
 1211, GENEVE 6, SWITZERLAND
 NORTHERN ELECTRIC CO. LTD.
 590 BERRY STREET
 ST. JAMES WINNIPEG 21,
 MANITOBA
 NORTHERN ELECTRIC CO LTD
 250 STONEY STREET
 BELLEVILLE, ONTARIO
 NORTHERN ELECTRIC CO LTD
 143 LAKE SHORE BOULEVARD E
 TORONTO 2, ONTARIO
 NORTHERN ELECTRIC CO LTD
 1000 GUY STREET
 MONTREAL 25, QUEBEC
 I M E X
 IMPORTADORA MEXICANA
 APARTADO M-2910
 MEXICO, D.F., MEXICO
 SIMON GRAY PTY LTD
 28 ELIZABETH ST
 MELBOURNE, C 1, AUSTRALIA
 EQUIPOS E IMPLEMENTOS
 ELECTRONICOS
 LEON WALARDE 1080
 CASILLA 4087
 LIMA, PERU
 GENERAL ELECTRIC
 DE VENEZUELA, S A
 APARTADO 1666
 CARACAS, VENEZUELA

BROADCAST PRODUCTS COMPANY

SALES MANAGER
 JAMES C. WOODWORTH
 BRAND NAMES
 AUTOCLUE
 COMPANY ADDRESS
 18804 WOODWAY DRIVE
 DERWOOD, MARYLAND 20855
 301-942-1224

BROWNING LABORATORIES, INC

SALES MANAGER
 WILLIAM E. FOX
 COMPANY ADDRESS
 1269 UNION AVE
 LACONIA, NEW HAMPSHIRE 03246

BUCHANAN ELECTRICAL PRODUCTS

CORPORATION
 VICE PRESIDENT, SALES
 PAUL WANCE
 COMPANY ADDRESS
 1065 FLORAL AVE
 UNION, NEW JERSEY 07083
 COMPANY REPRESENTATIVES
 JAMES E. HEUSSER
 620 SUNDALE DR.
 BIRMINGHAM, ALA. 33235
 205 836-3896
 NORMAN F. ROSS
 P.O. BOX 187
 SCOTTSDALE, ARIZONA 85252
 602 WH 5-7262
 PETER W. JASIN
 3506 SKYLARK DRIVE

CONCORD, CALIF. 94520
 415 686-0905
 M. C. VAN YSELDYK
 412 SEATON STREET
 LOS ANGELES, CALIF. 90013
 213 MA 9-3855
 FRED A. PEASE CO.
 P O BOX 646, AURORA BRANCH
 DENVER, COLORADO 80010
 303 364-9391
 BELCHER AND ASSOC. INC.
 8751 ATLANTIC BLVD.
 JACKSONVILLE, FLA. 32211
 305 RA 4-7811
 BELCHER & ASSOC. INC
 61 NORTHEAST 2ND STREET
 MIAMI, FLORIDA 33132
 305 FR 1 1700
 BELCHER & ASSOC. INC
 1900 FIRST AVENUE, NORTH
 ST PETERSBURG, FLORIDA 33713
 813 862 7575
 JACK H. AWTRY
 34 PEACHTREE STREET, NW
 ATLANTA, GA. 30303
 404 525-4221
 WILLIAM E. NIVEN
 1168 WAIMANU STREET
 HONOLULU, HAWAII 96814
 512 6444
 DONALO E. ANDERSON
 600 WEST JACKSON BLVD.
 CHICAGO, ILL. 60606
 312 AN 3-7020
 WILLIAM E. JOBS
 3902 1/2 N. COLLEGE AVE.
 INDIANAPOLIS, IND. 46223
 317 WA 4-2560
 STRICKLAND ASSOCIATES
 P O BOX 19622
 NEW ORLEANS, LA 70119
 504 729 6586
 A D WILSON
 508 ST. PAUL STREET
 BALTIMORE, MD. 21202
 301 SA 7-1424
 HAROLD STANDISH
 3 WILSON DRIVE
 FRAMINGHAM, MASS. 01701
 617 879-1220
 HORTON ELECTRIC SALES CO
 24801 FIVE MILE ROAD
 DETROIT, MICH 48329
 313 534 2070
 MCCULLOCH-LEE CO.
 531 SOUTH 7TH STREET
 MINNEAPOLIS, MINNESOTA 55415
 612 FE 2-3644
 STRICKLAND ASSOCIATES
 152 CHIPPEWA CIRCLE
 JACKSON, MISS 39211
 601 366 6195
 THE RAY MARTIN CO.
 136 W. ADAMS
 KIRKWOOD, MO. 63122
 314 YO 6-8659
 CHARLES L. AREHART
 6621 STERLING
 RAYTOWN, MO. 64133
 816 FL 6-3488
 ED TABER & SONS
 3240 SOUTH 31ST STREET
 LINCOLN, NEBRASKA 68502
 402 423-4420
 WALDRON SALES ENGINEERING CO
 15 POND HILL ROAD
 MORRISTOWN, N J 07960
 201 536 5607
 TOM DESKIN
 317 COMMERCIAL, NE
 P O BOX 808
 ALBUQUERQUE, N.M. 87103
 505 242-3581
 A C SCHULTZ CO.
 BOX 2661 - AMHERST BRANCH
 2095 KENSINGTON AVENUE
 BUFFALO, N.Y. 14226
 716 839-1D10
 A C SCHULTZ CO
 7240 ROSEWOOD CIRCLE
 SYRACUSE, N Y
 315 458 6927
 KEN TODD
 949 PALMER ROAD
 BRONXVILLE, N.Y. 10708
 212 FA 4-5466
 MARK SALES AGENCY
 2947 BAYVIEW AVE
 WANTAGH, L I, N Y
 212 PL 7 6454
 C. CARROLL NIEDRINGHAUS
 BOX 424, ROUTE #1
 MATTHEWS, N.C.
 704 847-9288
 POGUE C. SHERRILL
 1117 LANETTE
 CINCINNATI, OHIO 45230
 513 231-9794
 VAUGHN O NEILL
 1090 HOMELAND DRIVE
 CLEVELAND, OHIO 44116
 216 331-4273
 AARON E GREENLEE
 200 SOUTH CLASSEN AVE.
 P O BOX 165
 MOORE, OKLA. 73060
 405 SW 4-2157
 MARTIN GERRARD
 523 N W EVERETT STREET
 PORTLAND, OREGON 97209
 503 CA 7-0593
 MYLES F. SMITH
 761 LINDSAY ROAD
 CARNEGIE, PA. 15106
 412 787-9363
 WILLIAM J. CUSICK

1114 EASTON ROAD
 ROSLYN, PA.
 215 885-3633
 HAL BEARD
 2160 YORK AVENUE
 MEMPHIS, TENN. 38104
 901 274-1744
 J. E. MORTON
 3500 MARTIN STREET
 FORT WORTH, TEXAS 76119
 817 JE 6-5290
 MC IVER & SLAVIN CO
 3200 AUDLEY STREET
 HOUSTON, TEXAS 77006
 713 JA 4-1155
 TAL AGENCIES, INC.
 1043 SIXTH AVE., S.
 SEATTLE, WASH. 98134
 206 MA 4-3355
 ANDERSEN ELEC. SALES
 8526 W VILLARD
 MILWAUKEE, WISC
 414 463 2072
 REPS. IN OTHER COUNTRIES
 MCKAY-MORTON WESTERN LTD
 P O BOX 157, STATION A
 CALGARY, ALBERTA
 CH 9 1664, 3 3534
 MCKAY-MORTON-WESTERN LTD
 11015 102ND STREET
 EDMONTON, ALBERTA
 GA 4 5211, 2 6664
 HARRY M. BROWN
 1533 NORTH PENDER STREET
 WEST VANCOUVER, B. C.
 WA 2-8963
 TED WESTON
 2515 PORTAGE AVENUE
 ST. JAMES, MANITOBA
 943-9165
 LLOYD G. DYKEMAN
 P O BOX 29
 ROTHSAY, NEW BRUNSWICK
 847-8390
 ESNA LIMITED
 271 PROGRESS AVENUE
 SCARBOROUGH, ONTARIO
 293-2431
 JOHN J. BYRON
 404 - 76TH AVENUE
 LA SALLE, QUEBEC
 748-8109

BUD RADIO, INC

COMPANY ADDRESS
 WILLOUGHBY, OHIO 44094
 COMPANY REPRESENTATIVES
 CARTWRIGHT AND BEAN
 2506 ASPEN AVE
 HUNTSVILLE, ALABAMA 35810
 852-4911
 JACK BERMAN CO., INC.
 5800 NORTH 19TH AVENUE
 PHOENIX 15, ARIZONA
 764-6578
 JACK BERMAN CO., INC.
 1751 SO. LA CIENEGA BLVD
 LOS ANGELES, CALIF. 90035
 UP 0-4711
 DAVID H ROSS COMPANY
 534 EL CAMINO REAL
 SAN CARLOS, CALIFORNIA
 591-4411
 R G BOWEN CO., INC.
 721 SOUTH BROADWAY
 DENVER, COLORADO 80209
 722-4441
 CARTWRIGHT & BEAN
 2505 NANCY STREET
 ORLANDO, FLA. 32806
 GA 5-8284
 CARTWRIGHT AND BEAN
 INDUSTRIALS ONLY
 20100 N E 25TH COURT
 NO MIAMI BEACH, FLA 33160
 945 2962
 CARTWRIGHT AND BEAN
 395 TRITON ROAD
 ORMOND BEACH, FLA 32074
 OR 7-3480
 CARTWRIGHT AND BEAN
 3223 CAINS HILL PLACE N. W.
 ATLANTA, GEORGIA 30305
 237-2273
 BRUCE CUMMING & ASSOCIATES
 6029 WEST BELMONT AVENUE
 CHICAGO, ILLINOIS 60634
 ME 7-3770
 SOUTHERN SALES CO.
 LAKESHORE DRIVE BOX 105
 ANGOLA, INDIANA 46703
 665-3961
 SOUTHERN SALES CO.
 6216 CARROLLTON AVE
 INDIANAPOLIS, INDIANA 46220
 253-3359
 SOUTHERN SALES CO.
 212 REPUBLIC BUILDING
 LOUISVILLE, KENTUCKY 40202
 583-6902
 CARTWRIGHT & BEAN
 1812 BULLARD AVENUE
 METAIRIE, LOUISIANA 70003
 834-8312
 HENRY P. SEGEL CO. INC.
 386 WASHINGTON STREET
 BROOKLINE 46, MASS
 232-7525
 JACK M. THORPE
 640 HIDDEN LANE
 DETROIT, MICHIGAN 48236
 884-4360
 THE CLARK R. GIBB CO
 2400 HENNEPIN AVENUE
 MINNEAPOLIS, MINN 55405
 FR 7-1200

DIPRO INCORPORATED
 7811 CARONDELET AVE
 ST. LOUIS, MISSOURI 63105
 PA 6-4770
 R. W. FARRIS CO INC
 1715 BALTIMORE AVE
 KANSAS CITY, MO. 64108
 421-1751
 HAROLD A. MOYER CO
 P. O. BOX 14
 220 HADDON AVE
 HADDONFIELD, N. J.
 429-7792
 C T CARLBERG & ASSOCIATES
 P O BOX 3177, STATION O
 2611 QUINCY, NE
 ALBUQUERQUE, N M 87110
 265 1579
 MARSEY SALES, INC.
 179 WINTON ROAD, N.
 ROCHESTER, NEW YORK 14610
 482-4133
 WILLGOLD ELECTRONIC SALES CO
 P. O. BOX 27
 100 NORTH VILLAGE AVENUE
 ROCKVILLE CENTRE, N Y 11571
 RD 4-4022
 CARTWRIGHT AND BEAN
 625 HARWYN DRIVE
 CHARLOTTE, N. C. 28205
 333-6457
 MIKE ROTH SALES CO
 678 SO. GREEN ROAD
 CLEVELAND, OHIO 44121
 382-9090
 OON H. BURCHAM CO.
 510 N.W. 19TH STREET
 PORTLAND 9, OREGON
 CA 7-3830
 CARTWRIGHT & BEAN
 560 SOUTH COOPER
 P O BOX 4760
 MEMPHIS, TENN. 38104
 276-4442
 LUND & COMPANY
 2216 NORTH OLIVE STREET
 DALLAS 11, TEXAS
 RI 8-8839
 R G BOWEN CO., INC.
 31 SO. 3RD STREET, EAST
 SALT LAKE CITY, UTAH 84111
 467-5128
 DON H. BURCHAM CO.
 422 FIRST AVENUE, W.
 SEATTLE, WASH. 98199
 AT 4-1121
 BRUCE CUMMING & ASSOCIATES
 4852 NORTH 24TH STREET
 MILWAUKEE 9, WISCONSIN
 UP 3-1381
 REPS IN OTHER COUNTRIES
 FRANK EAKIN, LTO
 9 MILVAN DR
 WESTON, ONTARIO
 741 7485

BURGESS BATTERY COMPANY

DIV. OF SERVEL, INC.
 VP GEN SALES MGR
 C. E. BALZ
 BRAND NAMES
 BURGESS
 COMPANY ADDRESS
 FREEPORT, ILL. 61032

BURKE & JAMES

BRAND NAMES
 BURKE & JAMES
 WATSON
 CARL MEYER
 COMPANY ADDRESS
 333 W. LAKE ST,
 CHICAGO, ILL 60606

CALBEST ELECTRONICS

SALES MANAGER
 T. DUBIN
 BRAND NAMES
 MUSI-PLEX
 COMPANY ADDRESS
 4801 EXPOSITION BLVD.
 LOS ANGELES, CALIF. 90016
 RE1-7291

CALIFONE/ROBERTS ELECTRONICS

DIV. OF RHEEM MFG. CO.
 SALES MANAGER
 MILT PHILLIPSON
 COMPANY ADDRESS
 5922 BOWCROFT STREET
 LOS ANGELES, CALIF. 90016
 COMPANY REPRESENTATIVES
 HARRY BARTON SALES CO.
 1255 POST STREET, SUITE 605
 SAN FRANCISCO, CALIF. 94109
 MR. JERRY FREED
 149 SO. ROXBURY DRIVE
 BEVERLY HILLS, CALIF
 PACIFIC AUDIO SALES
 1933 SOUTH BROADWAY
 LOS ANGELES, CALIFORNIA
 747 7314
 RON BOWEN & ASSOC.
 721 SO. BROADWAY
 DENVER, COLORADO
 FINE SALES CORPORATION
 1051 EAST 14TH STREET
 HIALEAH, FLORIDA 33010
 W. N. KENNON CO.
 7 CAMDEN ROAD, N. E.
 ATLANTA, GEORGIA
 PACIFIC ENTERPRISES
 1217 HOPAKA STREET
 HONOLULU, HAWAII

Fit Every Budget...including yours!

Video DA
#VA-1B
\$175.00



TV Modulator
#TM-2200
\$550.00

Aural/Visual
Separator
#VA-100
\$125.00

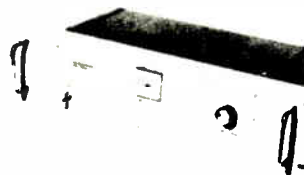

FM Modulator
#FMX-2000A
\$179.00

All Silicon Transistorized, Meets All Color Specifications.

CATEL Company 1375 Laurel Street
San Carlos, California 94070
415—592-3776

J. E. PAUL, INC.
5701 SHERIDAN ROAD
CHICAGO, ILLINOIS 60626
THE SAMPSON COMPANY
2244 SOUTH WESTERN AVENUE
CHICAGO, ILLINOIS
JOE CLANCY & CO., INC.
P. O. BOX 269
ANGOLA, INDIANA
FORRISTAL-YOUNG SALES CO.
5500 BUENA VISTA - SUITE 101
MISSION, KANSAS
JACK BLACK SALES CO.
11254 TRIANGLE LANE
WHEATON, MARYLAND
ARBETTER SALES
23 HARVARD STREET
BROOKLINE, MASS.
JOHN CULVER
28087 EAST RIVER ROAD
GROSSE ILE, MICHIGAN
D. NEUMAIER & ASSOC.
27610 SCHOOLCRAFT
LIVONIA, MICHIGAN
LOGAN YOUNG
FORRISTAL-YOUNG SALES CO
7110 OAKLAND STREET
ST. LOUIS, MISSOURI
BARON-THAL ASSOC.
411 THORNDEN STREET
SOUTH ORANGE, NEW JERSEY
MR. PHILIP WELCH
EASTERN DISTRIBUTION CENTER
1808 ROWLAND STREET
RIVERTON, N. J.
CARL T. CARLBERG & ASSOC.
2611 QUINCY STREET
P. O. BOX 3177 - STATION D
ALBUQUERQUE, NEW MEXICO
J. H. THAL ASSOCIATES
200 FIFTH AVE. - SUITE 1305
NEW YORK, N. Y.
JOE CORN COMPANY
3235 EASTBURN ROAD
CHARLOTTE, N. C.
ROBERT W. PETERS
25000 EUCLID AVE.
CLEVELAND, OHIO 44117
JAMES H. PODOLNY CO.
5912 PENN AVENUE
PITTSBURGH, PA.
SOUTHWEST SALES
112 MEYERLAND PLAZA MALL # 9
P. O. BOX 35536
HOUSTON 35, TEXAS
RICHARD WILKES ASSOCIATION
4509 140TH AVE. S. E.
BELLEVUE, WASHINGTON
TAYLOR ELECTRIC COMPANY
4080 N. PDST WASHINGTON RD.
MILWAUKEE 12, WISCONSIN

REPS IN OTHER COUNTRIES
J. M. NELSON
1224 EAST PENDER STREET
VANCOUVER, B C

CALVERT ELECTRONICS INC.
SALES MANAGER
LARRY LEMASTERS
BRAND NAMES
CALVERTRON
GOLD MONARCH
COMPANY ADDRESS
220 EAST 23RD STREET
NEW YORK, NEW YORK 10010

CARDWELL CONDENSER CORPORATION
COMPANY ADDRESS
80 E. MONTAUK HIGHWAY
LINDENHURST, N. Y. 11757

CATEL COMPANY
COMPANY ADDRESS
1375 LAUREL STREET
SAN CARLOS, CALIF. 94070
COMPANY REPRESENTATIVES
AIRTRONICS
1338 MISSION STREET
SAN FRANCISCO, CALIF.
MA 1 5500

CBS LABORATORIES, A DIVISION OF
COLUMBIA BROADCASTING SYSTEMS
MARKETING MANAGER
PROFESSIONAL PRODUCTS
ALEXANDER J AUTDTE
BRAND NAMES
AUDIMAX
CHROMAX
VISIMAX
VOLUMAX
COMPANY ADDRESS
227 HIGH RIDGE ROAD
STAMFORD, CONNECTICUT
203 325 4321

CCA ELECTRONICS CORPORATION
SALES MANAGER
BERNARD WISE
COMPANY ADDRESS
716 JERSEY AVENUE
GLOUCESTER CITY, N. J. 08030
COMPANY REPRESENTATIVES
H A KAZANJIAN
1447 BAYSHORE
PALO ALTO, CALIF
415 322-1803
ROBERT SIDWELL
P O BOX 40
PORT ST JOE, FLA
904 229-3866
STOKES GRESHAM, JR

7525 GYPSY HILL RD
INDIANAPOLIS, IND
317 251-2677
RICHARD V FLANAGAN
PIPER ASSOCIATES, INC
TEN HAVEN ST
DOVER, MASS
617 449-1144
C G CUNNINGHAM
RTE 1 BOX 51
TADS, N MEXICO
505 758-2688
GERALD LAINER
TELESCO INTERNATIONAL CORP
171 MADISON AVE
NEW YORK 16, N. Y.
GEORGE A WASLO
10860 GOSLIN RD
CINCINNATI, OHIO
513 931-1801
CLAUDE HILL
5139 S UTICA ST
TULSA, OKLAHOMA
918 WE 2-3523
HAROLD RAINEY
P O BOX 19126
OKLAHOMA CITY, OKLA
405 MU 5-7358
FRED CHASSEY
8612 GERMANTOWN AVE
PHILADELPHIA, PA
215 248-1380
BILL FRIEDMAN
SUITE 641 WESTERN SVGS BLDG
BROAD & CHESTNUT STS
PHILADELPHIA, PA
215 KI 6-4121
WILLIAM O BARRY
P O BOX 221
LEBANON, TENN
615 444-0305
JOHN MCCLAMROCK
143 SW 153RD ST
SEATTLE, WASH
206 CH 4-9391

C-COR ELECTRONICS, INC.
SALES MANAGER
ROBERT K. ARBOGAST
BRAND NAMES
C-COR
NOVACOR
COMPANY ADDRESS
60 DECIBEL ROAD
STATE COLLEGE, PA. 16801
COMPANY REPRESENTATIVES
ASTRODEL, INC.
349 FIRST STREET
LOS ALTOS, CALIF. 94023
415 948-3636
RF ASSOCIATES, INC.

1621 PDNTIUS AVENUE
LDS ANGELES, CALIF. 90025
213 478-1586
D. E. BOND ASSOC.
2149 S. CLERMONT STREET
DENVER, COLO. 80222
303 756-1234
GRA-MAR INC.
999 WOODCOCK ROAD, RM. 102
ORLANDO, FLORIDA 32802
305 841-2330
COMMUNICATIONS ENGINEERS
7100 N. WESTERN AVE.
CHICAGO, ILL. 60645
312 761-0548
COMMUNICATIONS ENGINEERS
2920 SHELBY
INDIANAPOLIS, INDIANA 46203
317 787-2241
EASTERN INSTRUMENTATION INC.
1002 INGLETSIDE AVE
BALTIMORE, MD. 21228
301 744-3675
ADELCO CORP.
56 PICKERING STREET
NEEDHAM, MASS. 02192
617 444-4754
COMMUNICATIONS ENGINEERS
7710 COMPUTER AVE.
MINNEAPOLIS, MINN. 55424
612 927-8465
F & F ASSOCIATES
58 ARCADIA ROAD
WOODCLIFF LAKE, N. J. 07680
201 778-6767
D. E. BOND ASSOC.
P. O. BOX 11331
ALBUQUERQUE, N. M. 87112
505 247-3442
F & F ASSOCIATES
461 OLD COUNTRY ROAD
WESTBURY, L. I., N. Y. 11590
516 334-1160
SYLVAN GINSBURY LTD.
72 WEST 45TH STREET
NEW YORK, N. Y. 10036
212 687-3213
TESCO ASSOCIATES
114 MILES AVENUE
SYRACUSE, N. Y. 13210
315 474-1586
REP/CORP.
2077 EMBURY PARK ROAD
DAYTON, OHIO 45414
513 275-5885
EASTERN INSTRUMENTATION INC.
613 CHELTENHAM AVE.
PHILA, PA. 19126
215 927-6269
D. E. BOND ASSOC.
P. O. BOX 12293

EL PASO, TEXAS 79912
915 532-4048
VIDAL ELECTRONICS CO.
3403 HIGH BLUFF DRIVE
DALLAS, TEXAS 75234
214 247-4252
PARATECH
9210 28TH N. W.
SEATTLE, WASHINGTON 98107
206 784-6447
REPS IN OTHER COUNTRIES
ELECTRONIC SYSTEMS LTD.
62 ALNESS STREET
DOWNSVIEW, ONTARIO
416 636-3673
ELECTRONIC SYSTEMS LTD.
6420 VICTORIA AVE, SUITE 17
MONTREAL 26, QUEBEC

CENTRALAB, THE ELECTRONICS
DIVISION OF GLOBE-UNION INC
MANAGER DISTRIBUTOR PRODUCTS
GEORGE MENA
COMPANY ADDRESS
P O BOX 591
MILWAUKEE, WISCONSIN 53201
COMPANY REPRESENTATIVES
LOGAN SALES COMPANY
P O BOX 1219
REDWOOD CITY, CALIF 94063
369 6726
R L STONE SALES CO
3600 MOTOR AVE
LOS ANGELES, CALIF 90034
UP O 5973
MCLLOUD RAYMOND CO
2151 S GRAPE ST
P O BOX 22044
DENVER, COLO 80222
SK 6 1589
S. K. MACDONALD INC.
217 RIGGS BANK BLDG.
14TH ST. AND PARK RD., NW
WASHINGTON, D.C. 20D10
CO 5-3938
FRANK C NICKERSON
2727 ALOHA AVE
WINTER PARK, FLA 32789
MI 7 4697
FRANK C NICKERSON CO
626 MEDLOCK RD
P O BOX 1185
DECATUR, GA 30033
ME 6 2752
BILL KOLANS & CO
P O BOX 2098
HONOLULU, HAWAII 96805
811 628
EARL T CHAMPION
4828 MAIN ST
SKOKIE, ILL 60D91
583 3960
LES M DEVOE CO
4010 WASHINGTON BLVD
INDIANAPOLIS, IND 46205
AT 3 1395
JERRY VRBIK
2818 A AVENUE N E
CEDAR RAPIDS, IOWA 524D2
365 0461
THE KANGAS-PENZNER CO
P O BOX 7505
7505 W 80TH ST
OVERLAND PARK, KANSAS
NI 8 4965
S K MACDONALD, INC
2016 WINFORD RD
BALTIMORE, MD 21214
ID 5 1760
STANLEY A. HARRIS CO., INC.
60 DEDHAM AVE.
NEEDHAM, MASS. 02192
444-4780
R. C. MERCHANT & CO., INC.
18411 W. MCNICHOLS S.
DETROIT, MICH. 48219
KE 5-6000
THE MEL FOSTER CO., INC.
228 S. CEDAR LAKE RD.
MINNEAPOLIS, MD. 55405
274-2612
NEWHOPE CORPORATION
6 E. 39TH STREET
NEW YORK CITY, N.Y. 10016
LE 2-7327
LEROY & MCGUIRE, INC.
RD. NO. 1
PHELPS, NEW YORK
KI 8-4891
LEROY & MCGUIRE, INC.
RD. NO. 4
AMSTERDAM, N.Y. 14532
VI 2-5979
MIKE ROTH SALES CO.
678 S. GREEN ROAD
CLEVELAND, OHIO 44121
EV 2-9090
ROBERT E. NESBITT CD
1324 E. 17TH PLACE
TULSA, OKLA.
LU 5-1234
S. K. MACDONALD INC.
1531 SPRUCE STREET
PHILADELPHIA, PA. 19102
KI 5-1205
S. K. MACDONALD INC.
10519 FRANKSTOWN RD.
PITTSBURGH, PA.
CH 1-7025
AL S. EMGELMAN CO.
3205 CRUMP AVE.
MEMPHIS, TENN. 38112
458-6623
ROBERT E. NESBITT CO.
1925 CEDAR SPRINGS
DALLAS, TEXAS 75201

899-8375
ROBERT E. NESBITT CO.
4810 HAZARD
HOUSTON, TEXAS 77006
JA 8-3811
MCLLOUD & RAYMOND CO.
BOX 16146, 4407 EBONY AVE.
SALT LAKE CITY, UTAH
AM 6 5002
JAMES J. BACKER CD.
221 W. GALER ST.
P O BOX 9077
SEATTLE, WASH 98119
AT 3 6470

CENTRAL DYNAMICS CORPORATION
SALES MANAGER
PETER MACFARLANE
BRAND NAMES
CD
COMPANY ADDRESS
903 MAIN STREET
CAMBRIDGE, MASS 02139

CENTURY LIGHTING INC.
VICE PRESIDENT - SALES
ROLLO GILLESPIE WILLIAMS
BRAND NAMES
INSTALITE R
LEKOLITE R
EDKOTRON R
MOBIL RAIL
C-CARD
THEATRON
C-1
CCR
FRESHELITE
COMPANY ADDRESS
3 ENTIN ROAD
CLIFTON, NEW JERSEY 07014
COMPANY REPRESENTATIVES
E. B. RICHEY
WHITMAN ASSOCIATES
823 CITY FEDERAL BLDG.
BIRMINGHAM, ALA.
AL 2-8079
TOM ED PEARCE
WHITMAN ASSOCIATES
208 PAYNE ROAD
WARRINGTON, FLORIDA
GL 5-8689
CENTURY LIGHTING, INC.
5432 W. 102ND ST.
LOS ANGELES, CALIF.
776-4600
E. J. JOHNSON CO.
P. O. BOX 5291
PHOENIX, ARIZONA
CENTURY LIGHTING, INC.
5432 W. 102ND ST.
LOS ANGELES, CALIF.
776-4600
CENTURY LIGHTING, INC.
2443 ASH STREET
PALO ATLO, CALIF.
327-3262
JACK BARTON
3858 12TH ST.
SACRAMENTO, CALIF.
HI 6-2394
N. L. ROUP AGENCY
1842 S. FAIRFAX STREET
DENVER 22, COLORADO
756-2711
VORLANDER LIGHTING, INC.
C/O R. M. BROWN
P. O. BOX 525
AVON, CONN.
ORCHARD 7-2311
DAVID BUTT
WHITMAN ASSOCIATES
3646 MAIN HIGHWAY
COCONUT GROVE, MIAMI
HI 8-6770
MARSHALL LOCHRIDGE
WHITMAN ASSOC.
3709 BARCELONA
TAMPA, FLA
836-6361
ROBERT S. MCGARITY
WHITMAN ASSOC.
1357 W. BEAVER STREET
JACKSONVILLE, FLA.
354-5985
E. D. JOHNSON
GEORGE GARDNER
WHITMAN ASSOCIATES
313 BONA ALLEN BLDG.
ATLANTA, GEORGIA
JA 1-0977
ROBERT S. MCGARITY
WHITMAN ASSOC.
415 SOUTH MAIN STREET
MOLTRYIE, GEORGIA
YU 5-1568
HAWAIIAN AIRE, INC.
45-552 KAM HIGHWAY
KANEHOE, HAWAII
EARL KOEHLER
RM. 1505D
MERCHANDISE MART
CHICAGO, ILLINOIS 60654
644-5567
PAUL ANGRICK
5119 MOONLIGHT DR.
INDIANAPOLIS, IND.
LIBERTY 6-4231
W. D. FAUST
1405 S. BROAD STREET
NEW ORLEANS, LA.
504-82-0571
EDWARD RUBIN
P. O. BOX 2667
BALTIMORE, MD.
BELMONT 5-4161
VORLANDER LIGHTING, INC.

80 BODLSTON ST
BDSTON, MASS.
MANCOCK 6-4927
E. BURTON WOLF ASSOC.
1230 W. FORREST AVE.
DETROIT, MICHIGAN
831-6190
WARREN ANDERSON
110 GLENWOOD AVE
MINNEAPOLIS 3, MINN.
338-0533
FELLNER BEAN
P. D. BOX 9064
JACKSON, MISS.
266-2558
VINCE DAWSON
P. 3. BOX 11056
KANSAS CITY, MO.
GL 3-6888
MANUFACTURERS SALES AGENCY
939 N. 24TH STREET
OMAHA, NEBRASKA
342-5757
D. S. J. SALES CO.
C/O J. L. BIRD
2600 E. OAKY BLVD.
LAS VEGAS, NEVADA
737-2929
SANFORD PEKELNEY
3-35 30TH STREET
FAIRLAWN, N. J.
SW 7-9261
JAMES P. SWANN
ELECTRIC LOCATOR & SALES CO.
P. O. BOX 425
3921 DELAMAR, N. E.
ALBUQUERQUE, N. M.
MARTIN M. GOLDMAN
SUDAN ASSOCIATES
79 ROBIN HILL
WILLIAMSVILLE, N. Y. 14221
716-632-1042
NORMAN TINDAL
WHITMAN ASSOCIATES
126 BULLIERS BLDG.
CHARLOTTE, N.C.
ED 4-9168
ERNEST W. WHITE, JR.
P. O. BOX 14166
KING CHARLES STATION
RALEIGH, N. C.
919-828-8116
GARY ROOF ASSOC.
1145 THIRD NATIONAL BLDG
DAYTON, 2 OHIO
BALDWIN 4-9813
GORDON F. STOFER BRDS.
P. O. BOX 2991
CLEVELAND 16, OHIO
333-0739
ROBERT NOTT CO.
2532 E. ADMIRAL BLVD.
TULSA 10, OKLA.
WE 4-4549
HARRY L. STEARNS
523 N. W. EVERETT ST.
PORTLAND, 9 OREGON
CA 7-0593
PAUL KYACK, INC.
P. O. BOX 220
PLYMOUTH MEETING, PA.
242-2112
MARK H. WAINWRIGHT
211 MELBON AVE
PITTSBURGH 35, PA.
CHURCHILL 2-3262
LUMI-PAR INC.
ELEANOR ROOSEVELT, 233
P. O. BOX 1376
MATO REY, P. R.
GEORGE W. GREENE
WHITMAN ASSOC.
P. O. BOX 416
2246 SUMTER ST
COLUMBIA, S. C.
AL 3-7451 AL 2-3032
GEORGE W. GREENE
WHITMAN ASSOC.
C/O ROY B. MCLEAN
P. O. BOX 9092
HANAHAN, S. C.
803 593-4054
J. E. MOORE
WHITMAN ASSOCIATES
P. O. BOX 5454
KNOXVILLE, TENN.
687-3578
BILLY COOK
CLOSE COOK ASSOCIATES
OF DALLAS
P. O. BOX 20591
DALLAS, TEXAS 75220
FL 1-5519
WAYNE D. CLOSE
CLOSE-COOK ASSOC.
P. O. BOX 12106
7245 SANTA FE DRIVE
HOUSTON, TEXAS
MISSION 3-2554
THOMAS P. HARRIS
WHITMAN ASSOC.
6037 BONNEAU ROAD
RICHMOND, VIRGINIA
CO 6-3185
A. WYNN MEREDITH
WHITMAN ASSOC.
3529B S. STAFFORD ST.
ARLINGTON, VA.
703-549-8513
A. CARL HUSTED JR.
404 27TH ST
VIRGINIA BEACH, VA.
703-428-8717
JACK MERRITT
1016 1ST AVE. SOUTH
SEATTLE, 4 WASHINGTON

MA 2-7975
GORDON PEARSON
STATEWIDE LIGHTING & EQUIP
3050 S. AMOR DRIVE
NEW BERLIN, WISCONSIN 53151
542-2184
REPS IN OTHER COUNTRIES
ARNON ADAR
33 HASHDOTIM ST
TEL AVIV, ISRAEL
CENTURY LIGHTING OF
CANADA LIMITED
P. O. BOX 185
REXDALE, ONTARIO
249-3355
SABINO ESCOBEDO GAMEROS
CIA MEXICANA DE
ILLUMINACION S. A.
MANUEL MA. CONTRERAS 96-501
MEXICO 4, D. F.
COL. SAN RAFAEL
JOHN B. STALEY
APARTADO 9294 CANDELARIA
CARACAS, VENEZUELA

CENTURY PROJECTOR CORP
BRAND NAMES
CENTURY
CINE-FOCUS
COMPANY ADDRESS
729-7TH AVE.
NEW YORK, NEW YORK 10019

CHASSIS TRAK INC
SALES MANAGER
LAWRENCE M. VAUGHN
BRAND NAMES
CHASSIS-TRAK
COMPANY ADDRESS
525 S. WEBSTER AVENUE
INDIANAPOLIS, INDIANA 46219
COMPANY REPRESENTATIVES
DYNAMICA ASSOCIATES
1011 INDUSTRIAL WAY
EAST BURLINGAME, CAL. 94010
415 344-2521
WILLIAMS ASSOCIATES INC.
4971 JACKSON STREET
DENVER, COLORADO 80216
303 388-4391
YOUNG & LAWRENCE ASSOC. INC.
601 NORTH NEW YORK AVE
WINTER PARK FLA. 32789
305 647-2528
RINGLAND M. KRUEGER CO.
5755 W. IRVING PARK RD.
CHICAGO, ILL. 60634
312 282-8444
THOMAS SUKUP CO.
2060 EAST 54TH STREET
INDIANAPOLIS, INDIANA 46220
317 251-4574
GENE ROSEN & ASSOC. INC.
9501 WADSWORTH DRIVE
BETHESDA, MARYLAND 20034
301 365-5113
COAKLEY, BOYD & ABBETT
BOX 248
NEEDHAM, MASS. 02192
617 444-5470
MARTIN VOGT CO.
2817 RAMLET ROAD
ROYAL OAK, MICHIGAN 48073
313 549-3355
HASSE ASSOCIATES
3825 YORK AVE. N
MINNEAPOLIS, MINN. 55422
612 588-0551
ENGINEERING SERVICES CO.
6717 VERNON AVENUE
ST. LOUIS, MISSOURI 63130
314 PA 6-2233
ROBERT L. RINGER CO.
P. O. BOX 114
GLEN ROCK, NEW JERSEY 07452
201 444-1434
MISSILETRONIC INC.
1321 EAST MOREHEAD STREET
CHARLOTTE, N. CAR. 28204
704 377-1922
COMPONENTS ENGINEERING CO.
7461 N. LINDEN LANE
CLEVELAND, OHIO 44130
216 843-2737
T. J. RAY CO.
8514 EAST 31ST PLACE
TULSA, OKLA. 74145
918 627 1515
RODGER MARTIN ASSOC.
P. O. BOX 1002
RELLAIRE, TEXAS 77401
713 MO 8-3877
ELECTRONIC SALES CORP.
P. O. BOX 6535
SEATTLE, WASH. 98116
206 WE 2-0330
REPS IN OTHER COUNTRIES
ELECTRONIC MARKETING
OF CANADA, LTD.
3600 BRADLEY AVE.
MONTREAL, QUEBEC
514 739-8052

CHRONO-LOG CORPORATION
SALES MANAGER
ARTHUR FREILICH
COMPANY ADDRESS
2583 W. CHESTER PIKE
BROOMALL, PA. 19008
COMPANY REPRESENTATIVES
S. S. KRINSKY & ASSOC.
6311 YUCCA ST
HOLLYWOOD, CALIF.
213 HO 2-1133
RIKER VIDEO INDUSTRIES

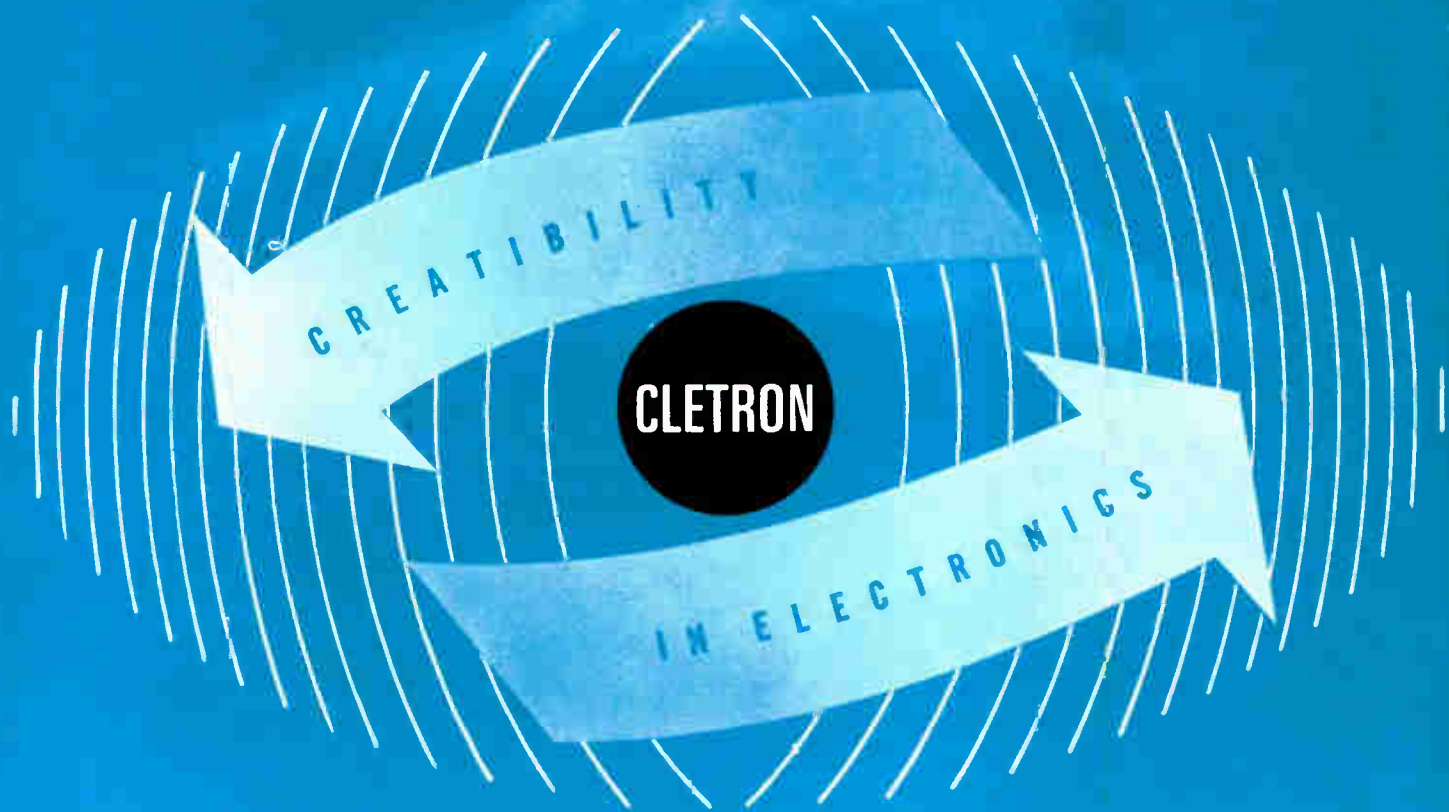

LEADERS IN TV CAMERA DEFLECTION COMPONENTS VIDICON / PLUMBICON / IMAGE ORTHICON

Cletron, manufacturer of Orthicon and Vidicon Deflection Components for Commercial and Military applications offers you quality-engineered products and services that have been incorporated as standards in the country's leading manufacturing companies of Television Camera Equipment.

Quality products by Cletron . . . Manufacturers of Deflection Components, Custom Transformers, and Sound Reproducing Devices . . .

Write today for additional technical literature, drawings, and engineering specifications on the complete line of Cletron Deflection Components.



CLEVELAND ELECTRONICS, INC.

Deflection Components Division

2900 Highland Road • Twinsburg, Ohio 44087 - U.S.A.

World Radio History

1336 MISSOURI AVE
WASHINGTON, D. C.
202 291-5923
RIKER VIDEO INDUSTRIES
146 OAKDALE DRIVE
FOREST PARK, GEORGIA
404 361-4118
WEBSTER ENGINEERING CO.
823 S. GREENWOOD AVE
PARK RIDGE, ILLINOIS
312 823-8206
RIKER VIDEO INDUSTRIES
33479 CINDY LANE
LIVONIA, MICHIGAN
313 427 3674
RIKER VIDEO INDUSTRIES
NORDEN LANE
HUNTINGTON STATION, N. Y.
516 MA 1-3568

CINE SONIC SOUND INC.
SALES MANAGER
JEROME SOLOMON
BRAND NAMES
CINE SONIC
EDOLITE
COMPANY ADDRESS
485-8TH AVE.
NEW YORK, NEW YORK 10001
LO-3-0584
COMPANY REPRESENTATIVES
H. SOLOMON
3710 THIRD
DETROIT, MICH
313-TE 2-1498

CLEVELAND ELECTRONICS, INC.
DEFLECTION COMPONENTS DIV.
SALES MANAGER
A. J. RINI
BRAND NAMES
CLETRON
COMPANY ADDRESS
200 HIGHLAND ROAD
TWINSBURG, OHIO 44087
COMPANY REPRESENTATIVES
CORCORAN ASSOCIATES
P.O. BOX 45897
LOS ANGELES, CALIF.
213 398-2675
LOGAN SALES COMPANY
P.O. BOX 1112
REWOOD CITY, CALIF.
415 369-1023
HYDE ELECTRONICS
888 SOUTH LIPAN STREET
DENVER 23, COLORADO
936-3456
V. AVIS MCCORVEY
2469 NORTH DECATUR ROAD
DECATUR, GEORGIA
404 636-2502
W. G. BROUILLETTE & ASSOC.
1558 NEWCASTLE AVE.
WESTCHESTER, ILL.
312 345-6500
R. D. WHITESELL & ASSOC.
6620 E. WASHINGTON ST.
INDIANAPOLIS, INDIANA
317 359-5374
TEO WHITTAKER
58 CLIFFE AVENUE
LEXINGTON, MASS. 02173
KAY SALES
4010 WASHINGTON ST.
KANSAS CITY, MO.
816 531-2014
IRV BROWN CO.
1500 CARROLL STREET
BROOKLYN 13, N.Y.
212 493-1379
DONALD HEVNER
1528 SPRING MILL ROAD
GLADWYNE, PA.
215 525-9727
ACE ASSOCIATES
143 S.W. 153RD STREET
SEATTLE, WASHINGTON
206 CH 4-9391
MASSEY ASSOCIATES
1 THOMAS CIRCLE
WASHINGTON, D. C.
202 628-1023
REPS. IN OTHER COUNTRIES
TRANCHANT ELECTRONIQUE S.A.
19-21 RUE MADAME SANZILLON
CLINCHY-SEINE-, FRANCE
T. J. SAS & SON
VICTORIA HOUSE
VERNON PLACE, HOLBORN
LONDON, W.C. 1, ENGLAND
SILVERSTAR LTD.
20 VIA DEI GRACCHI
MILANO, ITALIA
CALDWELL A/V EQUIP. CO., LTD.
135 MIDWEST ROAD
SCARBOROUGH, ONTARIO
ANGEL BARRANCO
AV. LIBERTADOR
RES. EL DARQUE APTD 14
CARACAS, VENEZUELA

CLEVELAND ELECTRONICS INC.
SPEAKER DIVISION
SALES MANAGER
OEWAYNE L. MARTIN
BRAND NAMES
CLETRON
COMPANY ADDRESS
1974 E. 61ST STREET
CLEVELAND, OHIO 44103
COMPANY REPRESENTATIVES
CORCORAN ASSOCIATES
BOX 45897
LOS ANGELES, CALIF
213 398-2675

LOGAN SALES CO
463 BREWSTER AVE
REDWOOD CITY, CALIF
415 369-3726
HYDE ELECTRONIC CO
888 SO LIPAN ST
DENVER, COLO
303 936-3456
MASSEY ASSOC
NO 1 THOMAS CIRCLE
WASHINGTON, D. C.
202 628-1023
V AVIS MCCORVEY
2187 BRIARCLIFF RD N E
ATLANTA, GA
404 636 2502
W G BROUILLETTE & ASSOC
1558 NEWCASTLE AVE
WESTCHESTER, ILL
312 345 6600
R O WHITESELL & ASSOC
6620 E WASHINGTON ST
INDIANAPOLIS, IND
317 FL 9 5374
NEAR INC
99 HIGHLAND AVENUE
SOMERVILLE, MASS
617 PR6-2262
KAY SALES CO
4010 WASHINGTON ST
KANSAS CITY, MO
816 JE1-2014
HENRY G RICHTER INC
1376 U S HIGHWAY NO 22
MOUNTAINSIDE, N J
201 A03-4615
GEORGE J GAY INC
P O BOX 214
BROCKPORT, NEW YORK
716 NE7-3776
IRV BROWN CO
1500 CARROLL ST
BROOKLYN 13, NEW YORK
212 493 1379
DONALD S HEVNER
1528 SPRING MILL RO
GLADWYNE, PA
215 LA5-9727
J EARL SMITH
1353 CHEMICAL STREET
OALLAS, TEXAS
214 ME1-1727
A C E ASSOCIATES
143 S W 153 ST
SEATTLE, WASH
206 CH4-9391
REPS IN OTHER COUNTRIES
TRANCHANT ELECTRONIQUE
19-21 RUE MADAME
OE SANZILLON
CLICHY, SEINE FRANCE
T J SAS & SON LTO
VICTORIA HOUSE, VERNON PLACE
HOLBORN, LONDON, ENGLAND

COMU ELECTRONICS, INC.
VP MARKETING
E. T. CLARE
TV PROO. LINE MGR.
R. H. BOULTO
BRAND NAMES
COMU
COMPANY ADDRESS
BOX 623
SAN DIEGO, CALIF. 92112
COMPANY REPRESENTATIVES
BCS ASSOCIATES, INC.
BOX 1273
HUNTSVILLE, ALA.
205 534-1648
COMU ELECTRONICS, INC.
292 LACIENEGA BLVDO., SO.
BEVERLY HILLS, CALIF.
213 655-5200
COMU ELECTRONICS, INC.
406 CHANNING AVE.
PALO ALTO, CALIF.
415 327-3911
WILLIAMS ASSOCIATES
4971 JACKSON STREET
DENVER, COLORADO 80216
303 388-4391
TECHNICAL INSTRUMENTS, INC.
575 BROAD STREET
BRIDGEPORT, CONN.
203 368-4582
BCS ASSOCIATES, INC.
BOX 6578
ORLANDO, FLA. 32803
305 841-3208
HUGH MARSLAND & CO.
6699 LINCOLN AVE.
CHICAGO, ILLINOIS 60645
312 676-1100
HUGH MARSLAND & COMPANY
6730 E. 19TH STREET
INDIANAPOLIS, IND.
317 356-4249
BARTLETT ASSOCIATES, INC.
7979 OLD GEORGETOWN ROAD
BETHESDA, MD.
301 656-3061
TECHNICAL INSTRUMENTS, INC.
122 WEST STREET
WILMINGTON, MASS. 01887
617 944-3930
S. STERLING CO.
21250-10-1/2 MILE ROAD
SOUTHFIELD, MICH. 48075
313 442-5656
HUGH MARSLAND & COMPANY
231 N. EDGEWOOD AVE.
MINNEAPOLIS, MINN.
612 245-4481
S. STERLING COMPANY
7849 NORTH LINDBERGH

HAZELWOOD, MO.
314 837-1221
FRIEDMAN ASSOCIATES
32 NORTH DAY STREET
ORANGE, NEW JERSEY 07052
201 673-2500
WILLIAMS ASSOCIATES
3221 SILVER AVE., S.E.
ALBUQUERQUE, N.M.
505 251-1638
COMU ELECTRONICS, INC.
325 MANVILLE RD.
PLEASANTVILLE, N.Y.
914 769-0111
J. A. REAGAN CO., INC.
41 WOODBURY RD.
NEW HARTFORD, N.Y.
315 732-3775
J. A. REAGAN CO., INC.
236 ERIE BLVD., EAST
SYRACUSE, N.Y.
315 471-7274
J. A. REAGAN CO., INC.
327 WESTMORELAND RD.
BUFFALO, N.Y.
716 632-2727
J. A. REAGAN CO., INC.
528 CRESTMONT RD.
BINGHAMTON, N.Y.
607 723-9661
J. A. REAGAN COMPANY, INC.
419 CENTRAL AVE.
ALBANY, NEW YORK 12206
518 436-9649
BCS ASSOCIATES, INC.
90X 6426
GREENSBORO, N.C.
919 273-1918
S. STERLING COMPANY
5827 MAYFIELD RD.
CLEVELAND, OHIO
216 442-8080
S. STERLING COMPANY
3300 S. DIXIE DRIVE
DAYTON, OHIO
513 298-7573
ARNOLD BARNES COMPANY
3510 MOCKINGBIRD LANE
MIDWEST CITY, OKLA.
405 737-5556
S. STERLING COMPANY
4232 BROWNSVILLE ROAD
PITTSBURGH, PA.
412 884-5515
BARTLETT ASSOCS, INC
BOX 72
WAYNE, PA 19087
215 688 7325
ARNOLD BARNES CO
BOX 709
RICHAROSON, TEXAS 75080
214 235-4541
ARNOLD BARNES COMPANY
3230 MERCER ST.
HOUSTON, TEXAS
713 622-9620
ARNOLD BARNES COMPANY
BOX 13069
SAN ANTONIO, TEXAS
512 342-7311
REPS IN OTHER COUNTRIES
WHITTAKER ELECTRONICS LTD.
1144 MILLSTREAM RD.
WEST VANCOUVER, B.C.
WHITTAKER ELECTRONICS LTD.
42 HOWENO AVE.
OTTAWA 5, ONTARIO
613 224-1221
WHITTAKER ELECTRONICS LTD.
1885 WILSON AVENUE
WESTON, ONTARIO
416 247-7454
WHITTAKER ELECTRONICS LTD.
BOX 216
ROXBORO, QUEBEC
514 684-3000

COLLINS RADIO COMPANY
ASST DIR BROADCAST COMM DIV
THEIL SHARPE
COLLINS RADIO COMPANY
820 EAST ARAPAHO
RICHAROSON, TEXAS 75080
BRAND NAMES
COLLINS
COMPANY ADDRESS
OALLAS, TEXAS 75207
COMPANY REPRESENTATIVES
K. A. BLAKE
P. O. BOX 57087,
LOS ANGELES, CALIF. 90057
DU 5-6421
A. P. WALKER
UNIVERSAL BUILDING,
WASHINGTON, D.C.
C. W. WALTERS
3658 COLEBROOK DRIVE,
JACKSONVILLE, FLORIDA 32210
SP 1-2978
R. O. LOOPER
P. O. BOX 207,
CLINTON, ILLINOIS 61727
935-5502
R. J. HENRY
ROUTE 2
ROANOKE, INDIANA
672-2906
J. L. LITTLEJOHN
12708 MYRTLE CIRCLE,
HOPKINS, MINNESOTA 55343
935-7011
R. C. EVANS
P. O. BOX 8026,
JACKSON, MISSISSIPPI 39204
939-4220
L. H. LEGGETT

1271 AVE. OF THE AMERICAS,
NEW YORK, NEW YORK
JU 6-5678
J. F. STANBERY
P. O. BOX 748,
GATLINBURG, TENNESSEE 37738
436-5497
J. H. SPECK
COLLINS RADIO COMPANY
DALLAS, TEXAS
AD 5-9511
J. L. HUMPHREYS
11514 MAPLE RIDGE ROAD,
RESTON, VIRGINIA 22070
471-7449
W. J. MONROE
2826 EMPIRE WAY SOUTH,
SEATTLE, WASHINGTON 98144
725-3385

COLORADO VIDEO, INC.
SALES MANAGER
GLEN SOUTHWORTH
COMPANY ADDRESS
BOX 928
BOULDER, COLORADO 80302
COMPANY REPRESENTATIVES
EDUCATIONAL ELECTRONICS
OF CALIFORNIA
NORTHRIDGE, CALIF.
213 349-1166
E-A, INC.
BALTIMORE, MARYLAND
301 825-2385
ADELCO CORPORATION
NEEDHAM, MASS.
617 444-4754
A. L. S. ELECTRONICS
ALBUQUERQUE, NEW MEXICO
505 298-2575
TELEPROJECTS, INC.
NEW YORK, N.Y.
212 687-1255
ACROMATIX ASSOC., INC.
FAIRVIEW VILLAGE, PENNA.
215 279-0377

COLORADO VIDEO, INC.
SALES MANAGER
GLEN SOUTHWORTH
COMPANY ADDRESS
BOX 928
BOULDER, COLORADO 80302
COMPANY REPRESENTATIVES
EDUCATIONAL ELECTRONICS
OF CALIFORNIA
NORTHRIDGE, CALIF.
213 349-1166
E-A, INC.
BALTIMORE, MARYLAND
301 825-2385
ADELCO CORPORATION
NEEDHAM, MASS.
617 444-4754
A. L. S. ELECTRONICS
ALBUQUERQUE, NEW MEXICO
505 298-2575
TELEPROJECTS, INC.
NEW YORK, N.Y.
212 687-1255
ACROMATIX ASSOC., INC.
FAIRVIEW VILLAGE, PENNA.
215 279-0377

COLORADO VIDEO, INC.
SALES MANAGER
GLEN SOUTHWORTH
COMPANY ADDRESS
BOX 928
BOULDER, COLORADO 80302
COMPANY REPRESENTATIVES
EDUCATIONAL ELECTRONICS
OF CALIFORNIA
NORTHRIDGE, CALIF.
213 349-1166
E-A, INC.
BALTIMORE, MARYLAND
301 825-2385
ADELCO CORPORATION
NEEDHAM, MASS.
617 444-4754
A. L. S. ELECTRONICS
ALBUQUERQUE, NEW MEXICO
505 298-2575
TELEPROJECTS, INC.
NEW YORK, N.Y.
212 687-1255
ACROMATIX ASSOC., INC.
FAIRVIEW VILLAGE, PENNA.
215 279-0377

COLORADO VIDEO, INC.
SALES MANAGER
GLEN SOUTHWORTH
COMPANY ADDRESS
BOX 928
BOULDER, COLORADO 80302
COMPANY REPRESENTATIVES
EDUCATIONAL ELECTRONICS
OF CALIFORNIA
NORTHRIDGE, CALIF.
213 349-1166
E-A, INC.
BALTIMORE, MARYLAND
301 825-2385
ADELCO CORPORATION
NEEDHAM, MASS.
617 444-4754
A. L. S. ELECTRONICS
ALBUQUERQUE, NEW MEXICO
505 298-2575
TELEPROJECTS, INC.
NEW YORK, N.Y.
212 687-1255
ACROMATIX ASSOC., INC.
FAIRVIEW VILLAGE, PENNA.
215 279-0377

COLORADO VIDEO, INC.
SALES MANAGER
GLEN SOUTHWORTH
COMPANY ADDRESS
BOX 928
BOULDER, COLORADO 80302
COMPANY REPRESENTATIVES
EDUCATIONAL ELECTRONICS
OF CALIFORNIA
NORTHRIDGE, CALIF.
213 349-1166
E-A, INC.
BALTIMORE, MARYLAND
301 825-2385
ADELCO CORPORATION
NEEDHAM, MASS.
617 444-4754
A. L. S. ELECTRONICS
ALBUQUERQUE, NEW MEXICO
505 298-2575
TELEPROJECTS, INC.
NEW YORK, N.Y.
212 687-1255
ACROMATIX ASSOC., INC.
FAIRVIEW VILLAGE, PENNA.
215 279-0377

COLORADO VIDEO, INC.
SALES MANAGER
GLEN SOUTHWORTH
COMPANY ADDRESS
BOX 928
BOULDER, COLORADO 80302
COMPANY REPRESENTATIVES
EDUCATIONAL ELECTRONICS
OF CALIFORNIA
NORTHRIDGE, CALIF.
213 349-1166
E-A, INC.
BALTIMORE, MARYLAND
301 825-2385
ADELCO CORPORATION
NEEDHAM, MASS.
617 444-4754
A. L. S. ELECTRONICS
ALBUQUERQUE, NEW MEXICO
505 298-2575
TELEPROJECTS, INC.
NEW YORK, N.Y.
212 687-1255
ACROMATIX ASSOC., INC.
FAIRVIEW VILLAGE, PENNA.
215 279-0377

COLORADO VIDEO, INC.
SALES MANAGER
GLEN SOUTHWORTH
COMPANY ADDRESS
BOX 928
BOULDER, COLORADO 80302
COMPANY REPRESENTATIVES
EDUCATIONAL ELECTRONICS
OF CALIFORNIA
NORTHRIDGE, CALIF.
213 349-1166
E-A, INC.
BALTIMORE, MARYLAND
301 825-2385
ADELCO CORPORATION
NEEDHAM, MASS.
617 444-4754
A. L. S. ELECTRONICS
ALBUQUERQUE, NEW MEXICO
505 298-2575
TELEPROJECTS, INC.
NEW YORK, N.Y.
212 687-1255
ACROMATIX ASSOC., INC.
FAIRVIEW VILLAGE, PENNA.
215 279-0377

COLORADO VIDEO, INC.
SALES MANAGER
GLEN SOUTHWORTH
COMPANY ADDRESS
BOX 928
BOULDER, COLORADO 80302
COMPANY REPRESENTATIVES
EDUCATIONAL ELECTRONICS
OF CALIFORNIA
NORTHRIDGE, CALIF.
213 349-1166
E-A, INC.
BALTIMORE, MARYLAND
301 825-2385
ADELCO CORPORATION
NEEDHAM, MASS.
617 444-4754
A. L. S. ELECTRONICS
ALBUQUERQUE, NEW MEXICO
505 298-2575
TELEPROJECTS, INC.
NEW YORK, N.Y.
212 687-1255
ACROMATIX ASSOC., INC.
FAIRVIEW VILLAGE, PENNA.
215 279-0377

COLORADO VIDEO, INC.
SALES MANAGER
GLEN SOUTHWORTH
COMPANY ADDRESS
BOX 928
BOULDER, COLORADO 80302
COMPANY REPRESENTATIVES
EDUCATIONAL ELECTRONICS
OF CALIFORNIA
NORTHRIDGE, CALIF.
213 349-1166
E-A, INC.
BALTIMORE, MARYLAND
301 825-2385
ADELCO CORPORATION
NEEDHAM, MASS.
617 444-4754
A. L. S. ELECTRONICS
ALBUQUERQUE, NEW MEXICO
505 298-2575
TELEPROJECTS, INC.
NEW YORK, N.Y.
212 687-1255
ACROMATIX ASSOC., INC.
FAIRVIEW VILLAGE, PENNA.
215 279-0377

COLORADO VIDEO, INC.
SALES MANAGER
GLEN SOUTHWORTH
COMPANY ADDRESS
BOX 928
BOULDER, COLORADO 80302
COMPANY REPRESENTATIVES
EDUCATIONAL ELECTRONICS
OF CALIFORNIA
NORTHRIDGE, CALIF.
213 349-1166
E-A, INC.
BALTIMORE, MARYLAND
301 825-2385
ADELCO CORPORATION
NEEDHAM, MASS.
617 444-4754
A. L. S. ELECTRONICS
ALBUQUERQUE, NEW MEXICO
505 298-2575
TELEPROJECTS, INC.
NEW YORK, N.Y.
212 687-1255
ACROMATIX ASSOC., INC.
FAIRVIEW VILLAGE, PENNA.
215 279-0377

COLORADO VIDEO, INC.
SALES MANAGER
GLEN SOUTHWORTH
COMPANY ADDRESS
BOX 928
BOULDER, COLORADO 80302
COMPANY REPRESENTATIVES
EDUCATIONAL ELECTRONICS
OF CALIFORNIA
NORTHRIDGE, CALIF.
213 349-1166
E-A, INC.
BALTIMORE, MARYLAND
301 825-2385
ADELCO CORPORATION
NEEDHAM, MASS.
617 444-4754
A. L. S. ELECTRONICS
ALBUQUERQUE, NEW MEXICO
505 298-2575
TELEPROJECTS, INC.
NEW YORK, N.Y.
212 687-1255
ACROMATIX ASSOC., INC.
FAIRVIEW VILLAGE, PENNA.
215 279-0377

COLORADO VIDEO, INC.
SALES MANAGER
GLEN SOUTHWORTH
COMPANY ADDRESS
BOX 928
BOULDER, COLORADO 80302
COMPANY REPRESENTATIVES
EDUCATIONAL ELECTRONICS
OF CALIFORNIA
NORTHRIDGE, CALIF.
213 349-1166
E-A, INC.
BALTIMORE, MARYLAND
301 825-2385
ADELCO CORPORATION
NEEDHAM, MASS.
617 444-4754
A. L. S. ELECTRONICS
ALBUQUERQUE, NEW MEXICO
505 298-2575
TELEPROJECTS, INC.
NEW YORK, N.Y.
212 687-1255
ACROMATIX ASSOC., INC.
FAIRVIEW VILLAGE, PENNA.
215 279-0377

COLORADO VIDEO, INC.
SALES MANAGER
GLEN SOUTHWORTH
COMPANY ADDRESS
BOX 928
BOULDER, COLORADO 80302
COMPANY REPRESENTATIVES
EDUCATIONAL ELECTRONICS
OF CALIFORNIA
NORTHRIDGE, CALIF.
213 349-1166
E-A, INC.
BALTIMORE, MARYLAND
301 825-2385
ADELCO CORPORATION
NEEDHAM, MASS.
617 444-4754
A. L. S. ELECTRONICS
ALBUQUERQUE, NEW MEXICO
505 298-2575
TELEPROJECTS, INC.
NEW YORK, N.Y.
212 687-1255
ACROMATIX ASSOC., INC.
FAIRVIEW VILLAGE, PENNA.
215 279-0377

COLORADO VIDEO, INC.
SALES MANAGER
GLEN SOUTHWORTH
COMPANY ADDRESS
BOX 928
BOULDER, COLORADO 80302
COMPANY REPRESENTATIVES
EDUCATIONAL ELECTRONICS
OF CALIFORNIA
NORTHRIDGE, CALIF.
213 349-1166
E-A, INC.
BALTIMORE, MARYLAND
301 825-2385
ADELCO CORPORATION
NEEDHAM, MASS.
617 444-4754
A. L. S. ELECTRONICS
ALBUQUERQUE, NEW MEXICO
505 298-2575
TELEPROJECTS, INC.
NEW YORK, N.Y.
212 687-1255
ACROMATIX ASSOC., INC.
FAIRVIEW VILLAGE, PENNA.
215 279-0377

COLORADO VIDEO, INC.
SALES MANAGER
GLEN SOUTHWORTH
COMPANY ADDRESS
BOX 928
BOULDER, COLORADO 80302
COMPANY REPRESENTATIVES
EDUCATIONAL ELECTRONICS
OF CALIFORNIA
NORTHRIDGE, CALIF.
213 349-1166
E-A, INC.
BALTIMORE, MARYLAND
301 825-2385
ADELCO CORPORATION
NEEDHAM, MASS.
617 444-4754
A. L. S. ELECTRONICS
ALBUQUERQUE, NEW MEXICO
505 298-2575
TELEPROJECTS, INC.
NEW YORK, N.Y.
212 687-1255
ACROMATIX ASSOC., INC.
FAIRVIEW VILLAGE, PENNA.
215 279-0377

COLORADO VIDEO, INC.
SALES MANAGER
GLEN SOUTHWORTH
COMPANY ADDRESS
BOX 928
BOULDER, COLORADO 80302
COMPANY REPRESENTATIVES
EDUCATIONAL ELECTRONICS
OF CALIFORNIA
NORTHRIDGE, CALIF.
213 349-1166
E-A, INC.
BALTIMORE, MARYLAND
301 825-2385
ADELCO CORPORATION
NEEDHAM, MASS.
617 444-4754
A. L. S. ELECTRONICS
ALBUQUERQUE, NEW MEXICO
505 298-2575
TELEPROJECTS, INC.
NEW YORK, N.Y.
212 687-1255
ACROMATIX ASSOC., INC.
FAIRVIEW VILLAGE, PENNA.
215 279-0377

COLORADO VIDEO, INC.
SALES MANAGER
GLEN SOUTHWORTH
COMPANY ADDRESS
BOX 928
BOULDER, COLORADO 80302
COMPANY REPRESENTATIVES
EDUCATIONAL ELECTRONICS
OF CALIFORNIA
NORTHRIDGE, CALIF.
213 349-1166
E-A, INC.
BALTIMORE, MARYLAND
301 825-2385
ADELCO CORPORATION
NEEDHAM, MASS.
617 444-4754
A. L. S. ELECTRONICS
ALBUQUERQUE, NEW MEXICO
505 298-2575
TELEPROJECTS, INC.
NEW YORK, N.Y.
212 687-1255
ACROMATIX ASSOC., INC.
FAIRVIEW VILLAGE, PENNA.
215 279-0377

COLORADO VIDEO, INC.
SALES MANAGER
GLEN SOUTHWORTH
COMPANY ADDRESS
BOX 928
BOULDER, COLORADO 80302
COMPANY REPRESENTATIVES
EDUCATIONAL ELECTRONICS
OF CALIFORNIA
NORTHRIDGE, CALIF.
213 349-1166
E-A, INC.
BALTIMORE, MARYLAND
301 825-2385
ADELCO CORPORATION
NEEDHAM, MASS.
617 444-4754
A. L. S. ELECTRONICS
ALBUQUERQUE, NEW MEXICO
505 298-2575
TELEPROJECTS, INC.
NEW YORK, N.Y.
212 687-1255
ACROMATIX ASSOC., INC.
FAIRVIEW VILLAGE, PENNA.
215 279-0377

COLORADO VIDEO, INC.
SALES MANAGER
GLEN SOUTHWORTH
COMPANY ADDRESS
BOX 928
BOULDER, COLORADO 80302
COMPANY REPRESENTATIVES
EDUCATIONAL ELECTRONICS
OF CALIFORNIA
NORTHRIDGE, CALIF.
213 349-1166
E-A, INC.
BALTIMORE, MARYLAND
301 825-2385
ADELCO CORPORATION
NEEDHAM, MASS.
617 444-4754
A. L. S. ELECTRONICS
ALBUQUERQUE, NEW MEXICO
505 298-2575
TELEPROJECTS, INC.
NEW YORK, N.Y.
212 687-1255
ACROMATIX ASSOC., INC.
FAIRVIEW VILLAGE, PENNA.
215 279-0377

COLORADO VIDEO, INC.
SALES MANAGER
GLEN SOUTHWORTH
COMPANY ADDRESS
BOX 928
BOULDER, COLORADO 80302
COMPANY REPRESENTATIVES
EDUCATIONAL ELECTRONICS
OF CALIFORNIA
NORTHRIDGE, CALIF.
213 349-1166
E-A, INC.
BALTIMORE, MARYLAND
301 825-2385
ADELCO CORPORATION
NEEDHAM, MASS.
617 444-4754
A. L. S. ELECTRONICS
ALBUQUERQUE, NEW MEXICO
505 298-2575
TELEPROJECTS, INC.
NEW YORK, N.Y.
212 687-1255
ACROMATIX ASSOC., INC.
FAIRVIEW VILLAGE, PENNA.
215 279-0377

COLORADO VIDEO, INC.
SALES MANAGER
GLEN SOUTHWORTH
COMPANY ADDRESS
BOX 928
BOULDER, COLORADO 80302
COMPANY REPRESENTATIVES
EDUCATIONAL ELECTRONICS
OF CALIFORNIA
NORTHRIDGE, CALIF.
213 349-1166
E-A, INC.
BALTIMORE, MARYLAND
301 825-2385
ADELCO CORPORATION
NEEDHAM, MASS.
617 444-4754
A. L. S. ELECTRONICS
ALBUQUERQUE, NEW MEXICO
505 298-2575
TELEPROJECTS, INC.
NEW YORK, N.Y.
212 687-1255
ACROMATIX ASSOC., INC.
FAIRVIEW VILLAGE, PENNA.
215 279-0377

COLORADO VIDEO, INC.
SALES MANAGER
GLEN SOUTHWORTH
COMPANY ADDRESS
BOX 928
BOULDER, COLORADO 80302
COMPANY REPRESENTATIVES
EDUCATIONAL ELECTRONICS
OF CALIFORNIA
NORTHRIDGE, CALIF.
213 349-1166
E-A, INC.
BALTIMORE, MARYLAND
301 825-2385
ADELCO CORPORATION
NEEDHAM, MASS.
617 444-4754
A. L. S. ELECTRONICS
ALBUQUERQUE, NEW MEXICO
505 298-2575
TELEPROJECTS, INC.
NEW YORK, N.Y.
212 687-1255
ACROMATIX ASSOC., INC.
FAIRVIEW VILLAGE, PENNA.
215 279-0377

COLORADO VIDEO, INC.
SALES MANAGER
GLEN SOUTHWORTH
COMPANY ADDRESS
BOX 928
BOULDER, COLORADO 80302
COMPANY REPRESENTATIVES
EDUCATIONAL ELECTRONICS
OF CALIFORNIA
NORTHRIDGE, CALIF.
213 349-1166
E-A, INC.
BALTIMORE, MARYLAND
301 825-2385
ADELCO CORPORATION
NEEDHAM, MASS.
617 444-4754
A. L. S. ELECTRONICS
ALBUQUERQUE, NEW MEXICO
505 298-2575
TELEPROJECTS, INC.
NEW YORK, N.Y.
212 687-1255
ACROMATIX ASSOC., INC.
FAIRVIEW VILLAGE, PENNA.
215 279-0377

DOUGHERTY ENTERPRISES
1164 WAIMANU ST
HONOLULU, HAWAII
510 281 & 504 987
WILLIAM J DOYLE CO
7426 N WESTERN AVE
CHICAGO, ILL
312 274-6685
BLIND & ASSOCIATES
1635 N GENT AVE
INDIANAPOLIS, INDIANA
317 635-6291
ALBERT N REINHERZ
59 HAMILTON ROAD
BELMONT 78, MASS
614 484-7784
BUTCHART - RATHSBURG
16637 E WARREN AVENUE
DETROIT, MICHIGAN
313 882-1717
DIPRO INC
P O BOX 1427
MARYLAND HEIGHTS, MO
314 432 3444
DIPRO INC
7811 CARONDELET
CLAYTON 5, MO
314 726-4770
R W FARRIS CO INC
1715 BALTIMORE
KANSAS CITY, MISSOURI
816 421-1751
WILLIAM TAUBER COMPANY
151 FAYETTE BLVD
SYRACUSE, NEW YORK
446-7094
L-C-A- SALES
76 MAIN STREET
TUCKAHOE, NEW YORK
914 961-4700
C L PUGH COMPANY
2144 RIVERSIDE DRIVE
COLUMBUS, OHIO
614 486-9678
A H HOFFMAN
6115 DENTON DRIVE AND
100 EXCHANGE PARK NORTH
DALLAS, TEXAS

CONRAC DIVISION,
GIANNINI CONTROLS CORP
SALES MANAGER
A. W. SEVERDIA
BRAND NAMES
CONRAC
COMPANY ADDRESS
600 N. RIMSDALE
COVINA, CALIF. 91722
COMPANY REPRESENTATIVES
PHILLIP R HURLBUT
C/O ELSCO
4533 N SCOTTSDALE RD
SCOTTSDALE, ARIZ.
ALFRED M KALLMAN
VISUAL ELECTRONICS CORP
1617 EL CENTRO AVE
HOLLYWOOD 28, CALIF.
ROBERT KUHL
VISUAL ELECTRONICS CORP
1208 POPLAR AVENUE
SUNNYVALE, CALIF.
RICHARD WHITE
ELSCO COLORADO, INC
2785 N SPEER BLVD
DENVER, COLO. 80211
LEWIS C RADFORD
VISUAL ELECTRONICS CORP
3202 LANIER DR
ATLANTA 19, GA.
LINTON D HARGREAVES
VISUAL ELECTRONICS CORP
409 S KENTUCKY
MASON CITY, IOWA
EDWARD S CLAMMER
VISUAL ELECTRONICS CORP
5940 AVON DRIVE
BETHESDA 14, MARYLAND
CHARLES R RICH
VISUAL ELECTRONICS CORP
2 LEONARD ST
ANNISQUAM, MASS.
JESSICA C RAFSKY AND
MORRIS A MAYERS
VISUAL ELECTRONICS CORP
356 W 40TH ST
NEW YORK, N Y 10018
JAMES HOWARD
VISUAL ELECTRONICS CORP
411 PRICE ST
THOMASVILLE, N.C.
P D THOMPSON
VISUAL ELECTRONICS CORP
2550 WEYMOUTH ROAD
WINSTON-SALEM, N.C.
A W GREESON
VISUAL ELECTRONICS CORP
219 HOMEWOOD AVE
GREENSBORO, N.C.
FELIX D BONVOULOIR
VISUAL ELECTRONICS CORP
1310 GREENVIEW DR
MIAMISBURG, OHIO
JOHN P GALLAGHER
VISUAL ELECTRONICS CORP
P O BOX 98
WHITE HAVEN, PA.
CHET SIEGRIST
VISUAL ELECTRONICS CORP
1107 CATHEDRAL ST
LEBANON, PA.
WAYNE MARCY
VISUAL ELECTRONICS CORP
4007 BELLAIRE
HOUSTON, TEXAS
ROBERT C BACON
VISUAL ELECTRONICS CORP

C/O ELSCO, BOX 15068
SALT LAKE CITY, UTAH
LYLE O KEYS
C/O ELSCO
P O BOX 15068
SALT LAKE CITY, UTAH 84115
SAM N KICHAS
C/O ELSCO
P O BOX 15068
SALT LAKE CITY, UTAH 84115

CONTINENTAL ELECTRONICS MFG. CO
SALES MANAGER
THOMAS B. MOSELEY
BRAND NAMES
MAGNIPHASE
PROLOG
COMPANY ADDRESS
P.O. BOX 17040
DALLAS, TEXAS 75217
COMPANY REPRESENTATIVES
DON W. CLARK
701 WELCH RD.
PALO ALTO, CALIF. 94304
415 321-5200
R. DENNIS MCGUIRE
701 N. MICHIGAN APT 1924
CHICAGO, ILL. 60611
312 787-4200
WILLIAM C. MIMS
925 LONGVIEW DR
ELLCOTT CITY, MD. 21043
301 465-0452
THOMAS S. BUTLER
P. O. BOX 145
RICHARDSON, TEX. 75080
214 325-1251

COOK ELECTRIC COMPANY
SALES MANAGER TELEPHONE PROD.
GERARD L. MEYER
COMPANY ADDRESS
2700 SOUTHPORT AVENUE
CHICAGO, ILLINOIS 60614
COMPANY REPRESENTATIVES
JAMES H. TATUM
3300 LOS PRADOS,
SAN MATEO, CALIF. 94403
415 349-1818
KENNETH J. PAUL
P. O. BOX 448
TALLAHASSEE, FLA. 32302
904 224-3526
ALBERT G. ULRICH
P. O. BOX 51
CARTHAGE, ILLINOIS 62321
217 222-6522
O. WM. LINDBERG
2 TALL ACRES DRIVE
PITTSFORD, N Y 14534
716 586-4900
JAMES A. CRANE
P. O. BOX 126
CARRBORO, N. C. 27510
919 929-1967
S. ALLEN SNYDER
645 PORTLAND WAY SOUTH
GALION, OHIO 44833
419 468-3313
CHARLES C. BROWNE
1023 SOUTH 11TH ST
KINGFISHER, OKLA. 73750
405 375-3789

COOKE ENGINEERING COMPANY
SALES MANAGER
DAVID L. LATHAM
BRAND NAMES
COJAX
COTERM
COMPANY ADDRESS
735 NORTH SAINT ASAPH ST
ALEXANDRIA, VIRGINIA 22314
COMPANY REPRESENTATIVES
EDWARD T. BUXTON
7 BOW STREET
CONCORD, MASS
617-EM9-2807

COPPERWELD STEEL COMPANY
WIRE AND CABLE DIVISION
SALES MANAGER
GEORGE HAMBURGER
BRAND NAMES
ALUMOWELD
COPPERWELD
AWAC
COMPANY ADDRESS
1000 MONONGAHELA AVE
GLASSPORT, PA 15045
412 461 4020
COMPANY REPRESENTATIVES
A. B. LEACH
WESTERN SALES MANAGER
736 WELLS FARGO BLDG
SAN FRANCISCO, CALIF 94104
415 433 3587
A. W. CONRAD
610 S. BROADWAY
LOS ANGELES, CALIF. 90014
213 625-8847
G. D. SEWICK
4214 EAST COLFAX AVENUE
DENVER, COLORADO 80220
303 388-6571
J. J. CAMPBELL, JR.
MANAGER GOVERNMENT SALES
1875 CONNECTICUT AVE NW
WASHINGTON, D C 20009
202 387 1890
F. W. NORR
11628 CARROLLWOOD DRIVE
TAMPA, FLORIDA 33618
813 935-8820
R. R. BALDRIGE
2030 PEACHTREE ROAD, NE

NOW... THE IDEAL COAXIAL PATCH FIELD for TV STATIONS consists of :

COTERM

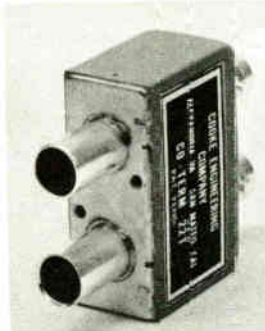

Normal thru coaxial circuits
without use of patchcords.

Source automatically termi-
nated in proper impedance when
load side is patched.

Permits testing of active circuit
without interruption of signal.

Extremely high density (22
jacks on 19" x 1-3/4" panel).

COJAX



COJAX has all features of
COTERM except self-termina-
tion of source when load side
is patched. Accepts same patch-
cord as COTERM.

**QUICK
DISCONNECT
CONNECTOR**



Unique snap locking feature
permits easy insertion and
removal even in extremely high
density patch fields.

Easy to install using standard
tools and available for wide
range of coaxial cables.

COOKE ENGINEERING COMPANY

735 N. Saint Asaph Street, Alexandria, Va.
Telephone: 703-548-3889

ATLANTA, GA. 30309
404 355-7447
R. C. RAASCH
MIDWESTERN SALES MANAGER
140 S DEARBORN STREET
CHICAGO, ILL 60603
312 726 2070
W. H. FRICK AND
G W BLANCHARD
140 S DEARBORN ST
CHICAGO, ILL 60603
312 726 2070
R. M. HEIL
MINNEAPOLIS, MINN
612 646 4911
D. R. PETTET
300 EAST ARMOUR BLVD.
KANSAS CITY, MO. 64111
916 LO 1-6400
W. P. RIECHMAN
340 PIERRE LACLEDE BLDG
ST LOUIS, MO 63105
614 291-9939
314 863 5121
M. E. BROWN
EASTERN SALES MANAGER
100 CHURCH STREET
NEW YORK, N Y 10007
212 BE 3 5600
H. J. YOUNG
100 CHURCH STREET
NEW YORK, N Y 10007
212 BE 3 5600
R. E. TAYLOR
1229 W. THIRD AVENUE
COLUMBUS, OHIO 43212
614 291-9939
R. C. MITTINGER
1000 MONONGAHELA AVE
GLASSPORT, PA 15045
412 461 4020
L. E. MCGUIRE
1403 STERICK BLDG
MEMPHIS, TENN 38103
901 JA 5 0565
A. W. HARDER
520 AQUA DRIVE
DALLAS, TEXAS 75218
214 RI 7-1470
R. CRAIG
DISTRICT MANAGER
P O BOX 866
BELLEVUE, WASH. 98004
206 GL 4-1233

5818 NORTH OAK TRAFFICWAY
KANSAS CITY, MO.
GL3-3202
TMC SALES CORP.
2465 LEMOINE AVENUE
PORT LEE, NEW JERSEY
201-944-8340
ALBUQUERQUE ELECTRONICS
2318 WISCONSIN, N. E.
ALBUQUERQUE, N. M.
505-298-2628
MESSINA ELECTRONICS
25 GREENMILL TERR.
WEST SENECA, NEW YORK
NR4-7445
MILLAR-HUTTO ASSOCIATES
P. O. BOX 17566
CHARLOTTE, N. C.
EM6-2061
BAHR, GREENLEAF & ASSOC. INC
14700 DETROIT AVENUE
CLEVELAND, OHIO
216-221-9030
STINSON ASSOCIATES
227 HAVERFORD AVE
NARBERTH, PENN.
MO4-5511
COVERT-NEWMAN CO.
300 MT. LEBANON BLVD.
PITTSBURGH, PA.
412 563-0303
PARVIN SALES CO.
P. O. BOX 307
ADDISON, TEXAS
714 EM3-8596
R. G. BOWEN CO. INC.
31 SO. 3RD. E.
SALT LAKE CITY, UTAH
801-364-6692
NORTHWESTERN AGENCIES
4130 FIRST AVE SO.
SEATTLE, WASHINGTON
206 MA3-8882
REPS IN OTHER COUNTRIES
ELECTRO TEC MARKETERS LTD.
1624 WEST THIRD AVE
VANCOUVER 9, B.C.
604-04-5711
RUTHERFORD AGENCIES
2705 BATES ROAD
MONTREAL 26, QUEBEC
731-7696

1718 W. MISHAWAKA ROAD
ELKHART, INDIANA 46514
COMPANY REPRESENTATIVES
DOBBS - STANFORD CO
569 LAUREL ST - P.O. BOX 266
SAN CARLOS, CALIF
415 591-0339
MARSHANK SALES CO
7422 MELROSE AVE
LOS ANGELES 46, CALIF
213 938-2591
DOW FITZGERALD
6231 S. CHURCH
TAMPA, FLA.
SAM LITTLE CO
2396 CONALLY DR
P O BOX 308
EAST POINT, GA
404 761-5353
JOHN GILL
1043 E 95TH ST
CHICAGO, ILL 60619
312 731-4404
CENTRAL ELECTRONICS SALES CO
P O BOX 591
INDIANAPOLIS, IND
317 923-2932
TECHREP ASSOCIATES
P O BOX 161
TOPSFIELD, MASS
617 887-8671
BUTCHART - RATHSBURG & ASSOC
16637 F WARREN AVE
DETROIT, MICH
313 882-1717
CENTRAL ELECTRONICS SALES CO
19217 FAIRPORT
DETROIT 5, MICH
313 526-5841
ELIAS ELECTRONICS
P O BOX 126 N E STATION
LIVONIA, MICH
313 476-1520
ROBERT SHAW
7800 KENRIDGE LANE
ST LOUIS, MO
314 962-7429
ELDISERCO
52 MEADOWBROOK DR
SOMERVILLE, N J
201 359-6492
METROREP
P O BOX 782
FRESHOLD, N J
212 462 1221
NILES CHRISTENSEN - EXPORT
SPRINGFIELD, N J
201 273-3822
TELESCO INTL - EXPORT
171 MADISON AVE
NEW YORK 16, N Y
212 683-9420
ROBERT WHITE
P O BOX 9408
SOLON, OHIO
216 248-1317
A C MCMILLAN
16679 S W MAPLE CIRCLE
LAKE OSWEGO, ORE
503 636-6257
DON MULL
P O BOX 313
FREDRICKSBURG, TEXAS
812 997-3388
REPS IN OTHER COUNTRIES
CALDWELL A/V EOPT CO
135 MIDWEST RD
SCARBOROUGH, ONTARIO

B AARON & CO
P O BOX 186
ROSLYN, L I, N Y
516 621-0630
REP TECH, INC
P O BOX 98
PICKARD BLDG
SYRACUSE, N Y
315 454-0761
BEDELE EQUIPMENT
6900 SILVERTON
CINCINNATI, OHIO
513 793-0140
BARCOCK-BOHAKER-STIDDARD
130 W LANCASTER
WAYNE, PA
215 MU 8-8288
LEE ASSOCIATES
432 WEST END
WINSTON-SALEM, S C
919 724-2406

CUSH CRAFT
SALES MANAGER
ROBERT W. CUSHMAN
COMPANY ADDRESS
621 HAYWARD STREET
MANCHESTER, NEW HAMP. 03103
COMPANY REPRESENTATIVES
BRADDOCK ASSOCIATES
P. O. BOX 305
HADDONFIELD, N.J. 08033
OHIO ASSOCIATES
P. O. BOX 728
LIMA, OHIO
CHESTER DREXLER CO.
3 LEE DRIVE
50, FARMINGDALE, L.I.,
NEW YORK 11737
IVAN HARRISON CO.
P. O. BOX 30241
DALLAS, TEXAS 75230
LOWELL, KINGS & ASSOCIATES
P. O. BOX 4116
OVERLAND PARK, KANSAS 66204
SAM LITTLE COMPANY
BOX 308
EAST POINT, GEORGIA 30044
LOWELL, KINGS & ASSOCIATES
P.O. BOX 26, CREVE COEUR STA
ST. LOUIS, MO. 63141
ELVEY-PROCTOR COMPANY
1650 LAUREL AVENUE
SAN CARLOS, CALIF.
JACK SPROCK SALES COMPANY
3520 W. BROWARD BLVD.
FT. LAUDERDALE, FLA. 33312
R. G. THOMPSON COMPANY
5836 PITTSBURGH AVE., SOUTH
MINNEAPOLIS, MINN., 55419
WALLACE & WALLACE
1206 MAPLE AVENUE
LOS ANGELES, CALIF. 90015
WILLIAM K. WOOD CO., INC.
P.O. BOX 46046
SEATTLE, WASH.
EMEC, INC.
16D TERMINAL DRIVE
PLAINVIEW, L.I., N.Y. 11803

CUSTOM CRAFT DESIGNS
SALES MANAGER
J E LICHTENSTEIN
COMPANY ADDRESS
2135 DREXEL ST
WEST HYATTSVILLE, MD 20783
301 422 7684

DAGE-BELL CORPORATION
SUBSID THE RAYTHEON COMPANY
SALES MANAGER
DALE SCHONMEYER
BRAND NAMES
DAGE
COMPANY ADDRESS
455 SHERIDAN AVENUE
MICHIGAN CITY, INDIANA 46403
COMPANY REPRESENTATIVES
HANK GREENSPAN
REGIONAL MANAGER
936 W FLORENCE AVE
INGLEWOOD, CALIF 9D301
213 678 9231
MERTON KNOLD
REGIONAL MANAGER
67D MIAMI CIRCLE, NE
ATLANTA, GEORGIA 3D324
404 233 3383
ORAL EVANS
REGIONAL MANAGER
455 SHERIDAN AVENUE
MICHIGAN CITY, INDIANA 46360
219 874 3251

DATA INSTRUMENT DIV
INDUSTRIAL ELECTRONIC HOWE CO
SALES MANAGER
FRANK BRIDGES
BRAND NAMES
TELEQUIPMENT
WIDNEY DORLEC
COMPANY ADDRESS
7300 CRESCENT BLVD.
PENNSAUKEN, NEW JERSEY D811D
COMPANY REPRESENTATIVES
W K GEIST CO
12D5 AIRWAY AVENUE
GLENDALE, CALIF
213 245 9501
CRANE ASSOC
19419 KESWICK STREET
VAN NUYS, CALIF
213 ST D 7972

CORNELL-DUBILIER ELECTRONICS
DIV. FED. PACIFIC ELECTRIC CO
SALES MANAGER
JOHN GYNN
CORNELL-DUBILIER ELECTRONICS
921 PROVIDENCE HWY
NORWOOD, MASS
COMPANY ADDRESS
50 PARIS STREET
NEWARK, NEW JERSEY D7101
COMPANY REPRESENTATIVES
DICK BELLEW CO
1005 WEST 4TH STREET
EL DORADO, ARKANSAS
501-UN3-8352
MOULTHROP & HUNTER
165 11TH STREET
SAN FRANCISCO, CALIF.
415 UN3-7880
HERB BECKER CO.
1140 CRENSHAW BLVD
LOS ANGELES, CALIF.
213-931-1257
J. H. FEDER, JR.
FOR HAWAII
4144 GLENCOE AVENUE
VENICE, CALIF.
213 UP D-6681
R. G. BOWEN CO, INC.
721 SOUTH BROADWAY
DENVER, COLORADO
303-722-4641
MILLAR-HUTTO ASSOC. INC.
P. O. BOX 1603
WINTER PARK, FLORIDA
305-MI7-74D7
MILLAR-HUTTO ASSOCIATES
1036 PEACHTREE ST. N. E.
P. O. BOX 7116 STATION C
ATLANTA, GEORGIA
404-TR6-0919
MARKAL SALES CORP.
5787 LINCOLN AVE
CHICAGO, ILLINOIS
312-LO1-7290
KNAGGS, COLLINS,
HAVERCAMP, HEMPE, INC.
NO. 6 BANK SQUARE
EAST ST. LOUIS, ILLINOIS
EX7-2398
MACNABB, SCHROEDER & LOOMIS
81D EAST 64TH ST
INDIANAPOLIS, INDIANA
317-CL1-4571
STINSON ASSOCIATES
123D3 STARLIGHT LANE,
BOWIE, MARYLAND
HE4-4126
W. A. HENDRICKSON CO.
291 FIRST PARIS ROAD
SCITUATE, MASS.
617-945-0652
BUTCHART-RATHSBURG & ASSOC.
16637 E. WARREN AVE
DETROIT, MICHIGAN
882-1717
STAM OLSEN & ASSOC.
4201 WOODDALE AVE
MINNEAPOLIS, MINN.
612-926-1158
KNAGGS, COLLINS,
HAVERCAMP, HEMPE, INC.

COURIER COMMUNICATIONS, INC.
A SUBSIDIARY OF
F.C.S.T. ELECTRONICS
COMMUNICATIONS, INC.
SALES MANAGER
S. D. KAPPEL
COMPANY ADDRESS
56 HAMILTON AVE.
WHITE PLAINS, NEW YORK 10601

CRAFTSMAN ELECTRONIC
PRODUCTS, INC
SALES MANAGER
JOSEPH H. GIBBS
115 KESSLER LANE
FAYETTEVILLE, N Y 13D66
BRAND NAMES
CRAFTSMAN
COMPANY ADDRESS
133 W. SENECA ST.
MANLIUS, NEW YORK 131D4
COMPANY REPRESENTATIVES
A-E-5
1559 CHESTER ST
AURORA, COLO
303 366-02D8
GETTLEMAN & LITTEKEN CO
3736 DEMPSTER ST
SKOKIE, ILL
312 588-0030
NEAR, INC
99 HIGHLAND ST
SOMERVILLE, MASS
617 776-2262
JOHN E. W. ANDERSON
5231 HUMBOLDT AVE
MINNEAPOLIS, MINN
612 823-6459
CARMINE A VIGNOLA
21 SCHELLRIDGE RD
JEFFERSON CITY, MO
314 635-1D23
STEVE FISHER
121 CEDAR LANE
TEANECK, N J
2D1 836-6661
WILLIAM TAUBER
151 FAYETTE BLVD
SYRACUSE, N Y
315 446-7094
SHAMROCK ELECTRONICS
1755 W MARKET ST
AKRON, OHIO
216 864-3090
JOHN MUSTICO
2D6 BUEYER RD
HAVERTOWN, PA
215 446-1961
ERNEST S WILKS
BOX 14466
DALLAS, TEXAS
214 242-5321
FLECHART & SULLIVAN, INC
321 N E 45TH ST
SEATTLE, WASH
2D6 633-4979

CROWN INTERNATIONAL
SALES MANAGER
CLYDE W. MOORE
BRAND NAMES
CROWN
COMPANY ADDRESS

REYNOLDS & ASSOC
PO BOX 1032
EAU GALLIE, FLORIDA
305 354 0520
KENNETH W MEYERS CO
7256 TOWMY AVENUE
CHICAGO, ILLINOIS
312 SP 4 6440
MALONE ENG ASSOC
7640 W NORTH AVENUE
ELMWOOD PARK, ILLINOIS
312 456 4031
INDUSTRIAL SALES CO
418 E BERRY STREET
FT WAYNE, INDIANA
219 742 7009
BROGER INST SALES INC
176 2ND STREET
WALTHAM, MASS
617 TW 1 8045
JAMES LEE CO
4241 TOLEDO AVENUE
MINNEAPOLIS, MINN
612 920 1525
LEEMARK ASSOC
2001 BIG BEN BLVD
ST LOUIS, MISSOURI
314 MI 5 1470
L & M ASSOC
511 VICTOR STREET
SADDLE BROOK, NEW JERSEY
201 843 8700
FRANK TYLISKI CO
330 NORTHERN BLVD
GREAT NECK, NEW YORK
516 466 9070
M FRIEDMAN ASSOC
7 HEATHER ROAD
BALA CYNWYD, PENNSYLVANIA
215 TE 9 3450
WEISS INST
6 BARTON DRIVE
PITTSBURGH, PENNA
412 371 3020
OATRONICS INC
7800 WEST GLEN DRIVE
HOUSTON, TEXAS
713 SD 2 9951
ARVA INC
1320 PROSPECT STREET
SEATTLE, WASH
206 MA 2 0177

**DATAPULSE DIVISION
OF DATAPULSE, INC.**
SALES MANAGER
M. B. COX, JR.
COMPANY ADDRESS
509 HINDRY AVE.
INGLEWOOD, CALIF. 90306
213 671-4334
TWX 910 328-6109
COMPANY REPRESENTATIVES
BCS ASSOCIATES, INC
2317 BOB WALLACE AVE., S W
HUNTSVILLE, ALA. 35805
HYTRONIC MEASUREMENTS
1017 NORTH THIRD STREET
PHOENIX, ARIZONA 85004
JOHN O'HALLORAN & ASSOCIATES
3268 ROSECRANS BLVD
SAN DIEGO, CALIF. 92110
JOHN O'HALLORAN & ASSOCIATES
3921 E BAYSHORE BLVD
PALO ALTO, CALIF. 94303
JOHN O'HALLORAN & ASSOCIATES
10700 VENTURA BLVD
N. HOLLYWOOD, CALIF. 91604
HYTRONIC MEASUREMENTS, INC.
1295 SOUTH BANNOCK STREET
DENVER, COLORADO 80223
INSTRUMENT CONSULTANTS, INC
2381 WHITNEY AVENUE
HAMDEN, CONN. 06518
BCS ASSOCIATES, INC
940 FERN DRIVE
ORLANDO, FLORIDA 32803
RIDGWAY ASSOCIATES, INC
3759 N HARLEM AVENUE
CHICAGO, ILLINOIS 60634
LEEMARK ASSOCIATES, INC
4518 W 89TH STREET
PRAIRIE VILLAGE, ILL. 60207
LEEMARK ASSOCIATES
P O BOX 6145
LEAWOOD, KANSAS
BRIMBERG ASSOCIATES, INC
110 E PENNSYLVANIA AVENUE
TOWSON, MARYLAND 21204
BRIMBERG ASSOCIATES, INC
814 THAYER AVENUE
SILVER SPRINGS, MD. 20910
INSTRUMENT CONSULTANTS, INC
P O BOX 25
WABAN, MASS. 02168
RIDGWAY ASSOCIATES, INC
7720 MORGAN AVENUE, SOUTH
MINNEAPOLIS, MINN. 55423
LEEMARK ASSOCIATES, INC
2001 BIG BEND BLVD
ST. LOUIS, MO. 63117
G CURTIS ENGEL & ASSOCIATES
210 S BROAD STREET
RIDGWOOD, NEW JERSEY 07451
HYTRONIC MEASUREMENTS, INC
205 SAN PABLO, S E
ALBUQUERQUE, N. M. 87108
J D RYERSON ASSOCIATES, INC.
P O BOX 1400
SYRACUSE, NEW YORK 13201
BCS ASSOCIATES, INC
1039 E WENDOVER AVENUE
GREENSBORO, N. C.
RIDGWAY ASSOCIATES, INC
22811 LORAIN ROAD
FAIRVIEW PARK, OHIO 44126

RIDGWAY ASSOCIATES, INC
2400 E DOROTHY LANE
DAYTON, OHIO 45420
AIREP ELECTRONICS, INC
8119 BELLAIRE BLVD
HOUSTON, TEXAS 77036
AIREP ELECTRONICS, INC
P O BOX 9555
OALLAS, TEXAS 75214
HYTRONIC MEASUREMENTS, INC
2022 S MAIN STREET
SALT LAKE CITY, UTAH 84115
HARRY LEVINSON
1211 E DENNY WAY
SEATTLE, WASH. 98122
REPS. IN OTHER COUNTRIES
TOSHNIWAL BROS PRV LTD
198 JAMSHEDJI TATA ROAD
ROMBAY 1, INDIA
TAIYO SHOJI COMPANY, INC.
16, 5 CHOME, SHIBA-SHIMBASHI
MINATO-KU, TOKYO, JAPAN
SELRAM ELECTRONICS
83, AVENUE DES MIMOSAS
BRUSSELS, BELGIUM
OLTRONIX A/S
MALTGAARDEVEJ 18
GENTOFF, DENMARK
OY FINDIP
MANNERHEIMINTIE 29,C
HELSINKI 25, FINLAND
TECHNIQUE ET PRODUITS
63, RUE D AGUESSEAU
BOULOGNE-5-SEINE, FRANCE
NEUMULLER & CO CMBB
SCHRAUOOLPHSTRASSE 2A
A MUNICH 13, WEST GERMANY
DYNAMCO INSTRUMENTS, LTD
25 SALISBURY GROVE
MYTCHETT, CAMBERLEY
SURREY, ENGLAND
SPECIAL-IND
VIA D. MANIN 33
MILAN, ITALY
ELOFYSCA N V-AMSTERDAM
WATERINGSCHANS 120
AMSTERDAM-C, HOLLAND
OATAMATIK
GRONLANOESLEIRET 31
OSLO, NORWAY
UNITRONICS
TOREE DE MADRID
PISO 12-OFICINA 9
PLAZA DE ESPAÑA
MADRID 13, SPAIN
SCANTELF AB
TENGDALHSGATAN 24
STOCKHOLM, SWEDEN
RAFRLDCHER AG
FOERRLTRUCKSTRASSE 110
ZURICH 8021, SWITZERLAND
EASTRONICS LTD
22 MAZE STREET
TEL AVIV, ISRAEL 22867
ATLAS INSTRUMENTS CORP
DIV OF ATLAS ELECTRONICS LTD
50 WINGOLO AVENUE
TORONTO, ONTARIO
ATLAS INSTRUMENTS CORP
DIV OF ATLAS ELECTRONICS LTD
342 1/2 ELGIN STREET
OTTAWA, ONTARIO
ATLAS INSTRUMENTS CORP
333 CAVENOISH BLVD
SUITE 390
MONTREAL, QUEBEC
SAMPLE ELECTRONICS PTY LTD
4 GRDSE STREET GLEBE
SYDNEY, N.S.W., AUSTRALIA
SAMPLE ELECTRONICS PTY LTD
9/11 CREMOREN STREET
RICHMOND E. I.
VICTORIA, AUSTRALIA

DAYTON ELECTRONIC PRODUCTS CO
COMMERCIAL SALES MANAGER
HANK JOSEFCZYK
COMPANY ADDRESS
117 E. HELENA ST.
DAYTON, OHIO 45404
513 461 4951

D & B ELECTRONICS CO
SALES MANAGER
VICTOR BRUNO
COMPANY ADDRESS
3611 ESSEX LANE
PHILADELPHIA, PA. 19114
215-NE7-2786

DEARBORN ELECTRONICS, INC
SUBSID SPRAGUE ELECTRIC CO
MARKETING MANAGER
CHARLES A. LITTLE
COMPANY ADDRESS
P.O. BOX 530
ORLANDO, FLORIDA 32802
COMPANY REPRESENTATIVES
SPRAGUE ELECTRIC CO
3550 N CENTRAL AVENUE
PHOENIX, ARIZONA 85012
602 279 5435
WM J PURDY OF CALIF
312 7TH STREET
SAN FRANCISCO, CALIF 94103
415 863 3300
SPRAGUE ELECTRIC CO
12870 PANAMA STREET
LOS ANGELES, CALIF 90066
213 870 0161
SPRAGUE ELECTRIC CO
5670 E EVANS AVENUE
DENVER, COLO 80222
303 756 3611
SPRAGUE ELECTRIC CO
3900 WISCONSIN AVE NW

WASHINGTON, D. C. 20016
202 244 6006
W BEN WIMBERLY CO
532 S FORT HARRISON
CLEARWATER, FLORIDA 33516
813 446 7072
W BEN WIMBERLY CO
500 S OSCEOLA STREET
ORLANDO, FLORIDA 32801
305 425 3083
SPRAGUE ELECTRIC CO
5942 W MONTROSE AVENUE
CHICAGO, ILLINOIS 60634
312 685 6400
SPRAGUE ELECTRIC CO
2511 E 46TH STREET
INDIANAPOLIS, INDIANA 46205
317 546 4911
ROTHENHEBER & CO., INC.
14211 CHESTERFIELD ROAD
ROCKVILLE, MO 20853
301 929 3388
TOM CRAWFORD AND SON
PO BOX 264
NORWOOD, MASS 02062
617 762 6914
SPRAGUE ELECTRIC CO
NDRTH ADAMS, MASS 01248
413 664 4411
SPRAGUE ELECTRIC CO
259 COLLINGWOOD
ANN ARBOR, MICH 48103
313 761 4080
DAYTON ENG SALES
1820 FAIRFIELD ROAD S
MINNETONKA, MINN 55343
612 545 2221
SPRAGUE ELECTRIC CO
391D LINDELL BLVD
ST LOUIS, MO 63108
314 535 7239
CLARFIELD-STOLLMAK ASSOC
175 WESTWOOD AVENUE
WESTWOOD, N J 07675
201 666 8989
C T CARLBERG & ASSOC
PO BOX 3177, STA D
ALBUQUERQUE, N M 87110
505 265 1579
JOSEPH F RIZZD CO - EXPDRT
ROOM 5710
EMPIRE STATE BLDG
NEW YORK, N Y 10001
212 736 0398
SPRAGUE ELECTRIC CO
928 BURKE STREET
WINSTON-SALEM, N.C. 27101
919 722 5151
SPRAGUE ELECTRIC CO
24 N MAIN STREET
CHAGRIN FALLS, OHIO 44022
216 247 6488
SPRAGUE ELECTRIC CO
224 LEO STREET
DAYTON, OHIO 45404
513 223 9187
ROTHENHEBER & CO., INC.
53 CRICKET AVENUE
ARMORE, PENNA 19003
215 642 6911
DELZELL & EVANS ASSOC
PO BOX 35093
DALLAS, TEXAS 75235
214 351-1839
SPRAGUE ELECTRIC CO
4601 AURORA AVENUE NORTH
SEATTLE, WASH 98103
206 632 7761
REPS. IN OTHER COUNTRIES
A DESKIN SALES CORP
1565 LOUVAIN STREET W
MONTREAL 11, QUEBEC
514 384 1420

DELCO RADIO DIV.
GENERAL MOTORS CORP.
SALES MANAGER
P A SANDBERG
COMPANY ADDRESS
700 E FIRMIN ST
KOKOMO, IND 46901
457 8461
BRANCH OFFICES
726 SANTA MONICA BLVD
SANTA MONICA, CALIF 90401
393 1465
5151 N HARLEM AVENUE
CHICAGO, ILL 60656
775 5411
57 HARPER STREET
DETROIT, MICH 48202
873 6560
324 CHESTNUT STREET
UNION, N J 07083
687 3770
1054 JAMES STREET
SYRACUSE, N Y 13203
474 6255

DELTA ELECTRONICS, INC
SALES MANAGER
LARRY MANCOCK
COMPANY ADDRESS
145 FAYETTE ST
WINSTON-SALEM, N.C. 27101
COMPANY REPRESENTATIVES
LONG ENGINEERING CO
961 BURKE STREET
WINSTON-SALEM, N.C. 27101
725-2306

DELTA ELECTRONICS INC
SALES MANAGER
ROBERT M FOLEY
COMPANY ADDRESS
4206 WHEELER AVENUE

ALEXANDRIA, VA 22304
COMPANY REPRESENTATIVES
REYNOLDS & ASSOC INC
P O BOX 1043
EAU GALLIE, FLA
305 254 0520
M J FEIN & CO
HARWOOD BLDG P O BOX 28
SCARSDALE, NEW YORK
914 GR 2 1100
ROCKE INTERNATIONAL CORP
13 EAST 40TH ST
NEW YORK, NEW YORK
MU 9 0200
ASHBY ASSOCIATES INC
CLAYPOOL BLDG SUITE 155
4130 LINCOLN AVE
OAYTON, OHIO
513 224-0561

DEMORNEY-BONARDI
DIV. OF DATAPULSE, INC.
SALES MANAGER
PAUL A. LIST
COMPANY ADDRESS
1313 N. LINCOLN AVE.
PASADENA, CALIF. 91103
213 681-7416
TWX 910 588-3282
COMPANY REPRESENTATIVES
W A BROWN & ASSOCIATES, INC
1314 BUFORD STREET, N W
HUNTSVILLE, ALA. 35801
R F ASSOCIATES, INC.
1621 PONTIUS AVENUE
LOS ANGELES, CALIF. 90025
RF ASSOCIATES, INC
800 SAN ANTONIO ROAD
PALO ALTO, CALIF. 94303
KELLEY ENTERPRISES
336 E 4TH STREET
LOVELAND, COLORADO 80537
W A BROWN & ASSOCIATES, INC
222 WEBER AVENUE
ORLANDO, FLA. 32803
W A BROWN & ASSOCIATES, INC
3039 N E 32ND AVENUE
FT. LAUDERDALE, FLA. 33308
RIDGWAY ASSOCIATES, INC
3759 N HARLEM AVENUE
CHICAGO, ILLINOIS 60634
PENZNER ASSOCIATES, INC
P D BOX 4362
OVERLAND PARK, KANSAS 66204
CONNAUGHTON & COMPANY
18 BOWMELL ROAD
BRIGHTON, MASS. 02135
RIDGWAY ASSOCIATES, INC
7720 MORGAN AVENUE SOUTH
MINNEAPOLIS, MINNESOTA 55423
PENZNER ASSOCIATES, INC
BOX 26, CREVE COEUR STATION
ST. LOUIS, MO. 63141
CENTRAL ASSOCIATES, INC
44 N DEAN STREET
ENGLEWOOD, N.J. 07631
CENTRAL ASSOCIATES INC
11 COMMERCIAL STREET
PLAINVIEW, L.I., N.Y. 11803
J D RYERSON ASSOCIATES INC
P O BOX 1400
SYRACUSE, NEW YORK 13201
W A BROWN & ASSOCIATES, INC
440 WEST-END BLVD
WINSTON-SALEM, N.C. 27101
RIDGWAY ASSOCIATES
2400 E DOROTHY LANE
DAYTON, OHIO 45420
RIDGWAY ASSOCIATES, INC
22811 LORAIN ROAD
FAIRVIEW PARK, OHIO 44126
R K P ASSOCIATES
107 FORREST AVENUE
NARBERTH, PA. 19072
MITCHELL SPEARS COMPANY
4944 JAMES AVENUE
FORT WORTH, TEXAS 76115
MITCHELL SPEARS COMPANY
HOUSTON OFFICE CENTER
ROOM 109C
HOUSTON, TEXAS 77023
W A BROWN & ASSOCIATES, INC
325 FIRST STREET
ALEXANDRIA, VIRGINIA 22314
RAY JOHNSTON COMPANY, INC
1011 NORTHEAST 69TH STREET
SEATTLE, WASH. 98115
REPS. IN OTHER COUNTRIES
TOSHNIWAL BROS PRV LTD
198, JAMSHEDJI TATA ROAD
BOMBAY-1, INDIA
P O BOX NIMONBASHI
173 TOKYO JAPAN
WEN CHANG HONG
IMPORTERS & EXPORTERS
NO 23, CHUNG-CHENG ROAD
TAINAN, TAIWAN
SHOSHIN SHOJI KAISHA, LTD
P O BOX NIMONBASHI
173, TOKYO, JAPAN
DANIEL DELGAY S A
BOITE POSTALE 919
58A CHAUSSEE DE CHARLEROL
BRUSSELS, BELGIUM
OLTRONIX A/S
MALTGAARDEVEJ 18
GENTOFFTE, DENMARK
MEGEX
105 QUAI BRANLEY
PARIS 15E, FRANCE
TALCO-GESELLSCHAFT FUR MESS
UND FUNKTECHNIK
FRANZ - PUELTERSTRASSE 15
MUNICH 8, WEST GERMANY
C T LONDON LIMITED
27 ASHLEY PLACE

WESTMINSTER
LONDON, SW1, ENGLAND
SPECIAL-IND
VIA D MANIM 33
MILAN, ITALY
ELOFYSICA N V-AMSTERDAM
WETERINGSCHANS 120
AMSTERDAM-C, HOLLAND
TELEINSTRUMENT AB
P O BOX 14
VALLINGBY, SWEDEN
MEGEX-ZURICH CO., LTD
BADENERSTRASSE 588
ZURICH, SWITZERLAND
M KOCHN
P. O. BOX 1447
JERUSALEM, ISRAEL
BRH ASSOCIATES
P O BOX 214
STATION O
TORONTO, ONTARIO
BRH ASSOCIATES
6338 VICTORIA AVENUE
MONTREAL 26, QUEBEC
B W COULTER & COMPANY
BOX 4138, GPD
M 5 W, AUSTRALIA

DIALIGHT CORPORATION
SALES MANAGER
H. W. GOODMAN
BRAND NAMES
DIALCO
DIALTRON
COMPANY ADDRESS
60 STEWART AVE.
BROOKLYN, NEW YORK 11237
COMPANY REPRESENTATIVES
F W MOUTHTHROP & ASSOC
1530 E 12 STREET
OAKLAND, CALIF 94606
AN 1 7676
JACK BERMAN CO
1751 S LA CIENEGA BLVD
LOS ANGELES, CALIF 90035
UP 0 4711
HYDE ELECTRONICS CO
888 S LIPAN STREET
DENVER COLO 80223
936 3456
HILL & GRAY, INC
821 GARFIELD
OAK PARK, ILL 60304
ES 8 7050
CHARLES SEGEL CO
799 WASHINGTON STREET
NEWTONVILLE, MASS 02160
969 6900
R C MERCHANT & CO
18411 W MC NICHOLS
DETROIT, MICH 48219
535 6000
R G RAGON, INC.
1136 W LARPEUR AVENUE
ST PAUL, MINN 55113
488 6634
ROBERT HORNE ASSOC
235 WANAQUE AVE
POMPTON LAKES, N. J. 07442
835 7400
ARTHUR PERKINS CO
104 MIDTOWN PLAZA
SYRACUSE, N. Y. 13210
478 3523
L D LOWERY, INC
2801 W CHESTER PIKE
BROOMALL, PA 19008
EL 6 5300
CARTWRIGHT & BEAN
560 S COOPER
MEMPHIS, TENN 38104
BR 5 1914

DIAMOND ELECTRONICS
SALES MANAGER - CCTV
R H RENKO
COMPANY ADDRESS
P O BOX 415
LANCASTER, OHIO 43130
COMPANY REPRESENTATIVES
W. E. SANDERSON & ASSOC.
5045 N. 12TH STREET
PHOENIX, ARIZONA 85014
277-0077
KING ENGINEERING CO., INC.
15720 VENTURA BLVD.
SUITE #416
ENCINO, CALIF. 91316
981 0161
ROSS EQUIPMENT CO.
7015 WEST 88TH AVE.
WHEAT RIDGE, COLORADO 80033
303 422-1845
EQUIPMENT SALES CO., INC.
P O BOX 6098
NEW HAVEN, CONN.
INDUSTRIAL ELECTRONICS, INC.
1389 SPRING STREET, NW
ATLANTA, GA. 30309
404 873-5504
DELTA SALES, INC.
1407 N. ILLINOIS STREET
INDIANAPOLIS, IND. 46204
317 ME 1-4136
DELTA ASSOCIATES
2801 BROADWAY
NEW ORLEANS, LOUISIANA
504 522-8382
AMERICAN MICROWAVE COMM. INC
P O BOX 216
ALPENA, MICH.
356-1510
IMPALA, INC.
ROOM 3
47 VILLAGE SQ. SHOPPING CTR.
HAZELWOOD, MO.

314 JA 2-1600
SENECA AUDIO-VISUAL
1880 HERTEL AVE.
BUFFALO, N.Y. 14214
855-5600
SQUIRES, INC.
474 YEARLING ROAD
COLUMBUS, OHIO 43213
614 237-8635
MARCO ELECTRONICS INC.
4623 FIFTEENTH STREET
PHILADELPHIA, PA. 19140
DA 4-2820
J. E. WOOD CO.
FREEDOM ROAD
MARS, PA.
412 PR 6-1800
SOUND PHOTO EQUIPMENT CO.
2107 BROADWAY
LUBBOCK, TEXAS 79401
806 PD 3-1997
TAFT BROADCASTING CO.
4801 SAN FELIPE
HOUSTON, TEXAS
TECHNO-LINK, INC.
4922 ELLENSBURG DRIVE
DALLAS, TEXAS
214 AD 9-3452
BERKNESS CONTRL & EQUIPMENT
308 WEST CARY STREET
RICHMOND, VIRGINIA
703 643-5357
SEATRONICS, INC.
5931-4TH AVENUE, SOUTH
SEATTLE, WASH. 98108
206 PA 5-4328
PHOTOART VISUAL SERVICE
840-44 W. PLANKINTON AVE.
MILWAUKEE, WISC. 53203
271-2292

DIAMOND EXPANSION BOLT CO INC
DIV. OF GENERAL CABLE CORP
VP SALES
C. W. FUMRER
ASST. SALES MGR.
R. C. NEARING
COMPANY ADDRESS
500 NORTH AVENUE
GARWOOD, NEW JERSEY 07027
COMPANY REPRESENTATIVES
E W COURTNEY
336 RITCH STREET
SAN FRANCISCO, CALIF
415 781 2753
J WRIGHT
2170 DE FOOR HILLS RD NW
ATLANTA, GEORGIA
404 355 9727
O KUFFER
3402 N HARLEM AVENUE
CHICAGO
312 237 1106
L SMITH
25 WARREN STREET
NEW YORK CITY, N Y
212 BA 7 6647
R LEISINGER
2001 PREBLE AVENUE
PITTSBURGH, PA
412 322 4008
R B WILBER
106 EXPRESS STREET
DALLAS, TEXAS
214 RI 8 6145

DIERCRAFT, INCORPORATED
SUBSIO OF BAUSCH & LOMB
SALES MANAGER
W. P. OCONNOR
BRAND NAMES
RAYSCAN
COMPANY ADDRESS
SPARKS, MARYLAND 21152

DISPLAY TECHNOLOGIES, INC.
SUBSID TELEPRO INDUSTRIES, INC
SALES MANAGER
HERBERT NETTLETON
67 W 44TH STREET
NEW YORK, N Y
BRAND NAMES
FIDELIPAC
PORTA-TAPE
PORTA-STEREO
PROJECTOR
STUDENT RESPONDER
TELEPRO
TELE PROMPTER
TV BLUE
WEATHERS
COMPANY ADDRESS
CHERRY HILL, N. J. 08034

DRESSER-CRANE HOIST & TOWER DIV
ONE OF THE DRESSER INDUSTRIES
SALES MANAGER
R. O. SLOAD
875 MICHIGAN AVE
COLUMBUS, OHIO 43215
BRAND NAMES
CANDELABRA-R
DRESSER
COMPANY ADDRESS
2314 REDNOO BEACH BLVD
GARDENA, CALIF. 90247
COMPANY REPRESENTATIVES
JOHN F MC VEY, JR
MGR - WESTERN DIVISION
2314 REDONDO BEACH BLVD
GARDENA, CALIF
321 9850
W. ROBERT MCKINNEY
J. ROGER HAYDEN
J. K. GROSECLOSE
875 MICHIGAN AVE.

COLUMBUS, OHIO 43224
614 299-2123

DUOTONE COMPANY INC
SALES MANAGER
STEPHEN NESTER
BRAND NAMES
DUOTONE
DUOTAPE
DUODISC
COMPANY ADDRESS
6875 S W 81ST STREET
SOUTH MIAMI, FLA. 33143
COMPANY REPRESENTATIVES
LOGAN SALES
463 BREWSTER AVENUE
REDWOOD CITY, CALIF 94063
415 369-6726
ROSS SALES CO
5007 LANKERSHIM BLVD
NORTH HOLLYWOOD, CALIF
766-8109
NELSON COMPANY INC
1294 SOUTH BANNOCK
DENVER, COLORADO 80223
303 733-5528
WINFIELD ELECTRONIC SALES CO
666 N E 125TH STREET
NORTH MIAMI, FLORIDA
PL 1-5566
PAUL HAYDEN ASSOCIATES
P O BOX 331
EAST POINT, GEORGIA
404-PO6-0261
MICHAEL ZINOELL
6434 N WASHTENAW AVE
CHICAGO 45 ILL
312 BR 4-7175
CHARLES SCHEFFLER CO
1133 MAVAJO TRAIL, RR 14
INDIANAPOLIS, INO 46260
317 CL3-6337
ALBERT N REINHERZ
59 HAMILTON RDAD
BELMONT 78, MASS.
617 484-7784
CARLEM COMPANY
1926 WELLESLEY AVE
ST. PAUL, MINN 55105
612 699-8004
KELLY-SCHMITZ-WINKELER ASSOC
7546 TROOST AVENUE
KANSAS CITY, MISSOURI
816 EM3-5651
THE NEWHOPE CORPORATION
6 EAST 39TH STREET
NEW YORK, NEW YORK 10016
212 532-7372
MAURY FARBER ASSOCIATES
203 JACKSON BUILDING
220 DELAWARE AVENUE
BUFFALO, NEW YORK
716 TL6-3543
MELCO SALES CO INC
74 FIFTH AVENUE
NEW YORK, NEW YORK 10011
212 AL5-8850
SINGER PRODUCTS CO INC
95 BRAD ST
NEW YORK N Y
212 WH4-8700
PERRY LOHSE & CO
529 RICHMOND RD
CLEVELAND 24, OHIO
381-7788
JOHN MUSTICO CO.
BOX 624- 206 BENLEY ROAD
HAVERTON, PA.
215 HI6-1961
THE TEXPORT COMPANY
2411 FARRINGTON STREET
DALLAS, TEXAS 75207
214 ME1-6270
JAMES J BACKER CO.
221 W GALER ST
P O BOX 9077
SEATTLE 99 WASH
206 AT3-6470

DYANCOOL MANUFACTURING
COMPANY INC
SALES MANAGER
FRANK STANGARONE
COMPANY ADDRESS
1 RUSSELL STREET
SAUGERTIES, NEW YORK 12477
COMPANY REPRESENTATIVES
R J MC CARDLE
40 TANNER STREET
HADDONFIELD, N.J.
609 429 8895
TOM MARDIN
315 SOUTHFIELD RD
FAYETTEVILLE, N.Y.
315 446 9280

DYNAMIR ELECTRONICS, INC
SALES MANAGER
DWAYN A. KELLER
COMPANY ADDRESS
6360 FEDERAL BOULEVARD
SAN DIEGO, CALIF. 92114

DYNASCIENCES CORPORATION
SALES MANAGER
CHARLES E. IRVIN
BRAND NAMES
DYNALENS
DYNASCIENCES
COMPANY ADDRESS
TOWNSHIP LINE RDAD
BLUE BELL, PA 19422
COMPANY REPRESENTATIVES
ALBION OPTICAL CO
15 W VIRGINIA AVE
WEST MYACK, N.Y. 10994
914 EL 8 4450

FASTMAN KODAK COMPANY
NOTION PICTURE AND EDUCATION
MARKETS DIVISION
K. M. MASON - SLS MGR
N Y SALES & ENGINEERING OFC
200 PARK AVENUE
NEW YORK, NEW YORK 10017
212 MU 7 7080
E. M. STIFLE - SLS MGR
CHICAGO SALES & ENGR. OFC.
130 EAST RANDOLPH DRIVE
CHICAGO, ILLINOIS 60601
312 236 7234
W. L. FARLEY, JR. - SLS MGR
HOLLYWOOD SALES & ENGR. DFC.
6677 SANTA MONICA BLVD
HOLLYWOOD, CAL. 90038
213-464-6131
BRAND NAMES
KODAK
FASTMAN
EXECUTIVE OFFICE ADDRESS
343 STATE STREET
ROCHFESTER, NEW YORK 14650
FILM DISTRIBUTION CENTERS
R GRANT
3250 VAN NESS AVE
SAN FRANCISCO, CALIF 94119
415 PR 6 6055
E MYLER
5315 PEACHTREE INOSTR BLVD
CHAMBLEE, GA 30005
404 GL 7 5711
R URRAN
6100 CEDAR SPRINGS RD
DALLAS, TEXAS 75235
214 FL 1 3221

EIOSOM ELECTRONIC COMPANY
SALES MANAGER
MERRILL EIDSON
COMPANY ADDRESS
1902 N. THIRD ST
TEMPLE, TEXAS 76001
817-PR3-3901

EIMAC DIVISION
DF VARIAN ASSOCIATES
SALES MANAGER
GEORGE M W BADGER
DIVISIONS & SUBSIDIARIES
DF VARIAN ELECTRON
ELECTRON TUBE AND
OEVICE GROUP
BOMAC DIVISION
SALEM ROAD
BEVERLY, MASS. 01915
617 922-6000
TWX 617 922-1987
CALIFORNIA AVE. OPERATION
601 CALIFORNIA AVENUE
PALO ALTO, CALIF. 94304
415 326-4000
TWX 415 492-9253
LEL DIVISION
AKRON STREET
COPIAGUE, L.I., N.Y. 11726
516 264-2200
TWX 516 691-5085
NATIONAL ELECTRONICS, INC.
A VARIAN SUBSIDIARY
GENEVA, ILL. 60134
312 232-4300
TWX 312 232 0590
PALO ALTO TUBE DIVISION
611 HANSEN WAY
PALO ALTO, CALIF. 94304
415 326-4000
TWX 415 492-9253
S-F-D LABORATORIES, INC.
A VARIAN SUBSIDIARY
800 RAHWAY AVENUE
UNION, N.J. 07083
201 687-0250
TWX 201 687-0333
VARIAN ASSOC. OF CANADA, LTD.
45 RIVER ROAD
GEORGETOWN, ONTARIO
416 877-6901
TWX 002-95628
COMPANY ADDRESS
301 INDUSTRIAL WAY
SAN CARLOS, CALIF 94070
592 1221
TWX 415 594 8842
SALES OFFICES
TUBE & DEVICE GROUP
OF VARIAN ASSOCIATES
77 THIRD AVENUE, WEST
SCOTTSDALE, ARIZONA 85251
602 947-5461
TWX 602 949-0165
2901 WILSHIRE BLVD
SANTA MONICA, CALIF
213 451 5877
TWX 213 468-1166
435 HARBOR BLVD.
BELMONT, CALIF. 94002
415 592-1841
TWX 415 594-8884
314 SOUTH MISSOURI
CLEARWATER, FLA. 33516
813 446-8513
TWX 813 442-2270
3110 MAPLE DR N E
SUITE 103
ATLANTA, GA 30305
404 261 4572
TWX 404 231 4881
EXECUTIVE PLAZA OFFICE BLDG.
205 W. TOWHY AVENUE
PARK RIDGE, ILL. 60068
312 825-6686
TWX 312 825-3334
400 WYMAN STREET
WALTHAM, MASS. 02154

617 891-4560
TWX 617-894-8594
2005 RDUTE 22
CDRNER FAIRWAY DRIVE
UNION, N.J. 07083
201 688-8800
TWX 201 687-9514
1500 KINGS HIGHWAY
CHERRY HILL, N.J., 08034
609 428-6800
TWX 609 429-4105
847 JAMES STREET
SYRACUSE, N.Y., 13203
315 472-7051
TWX 315 477-1240
SOUTHMOOR BUILDING
10 SOUTHMOOR CIRCLE
DAYTON, OHIO 45429
513 298-7318
TWX 513 944-0546
FIRST BANK & TRUST BLDG.
P O BOX 689
RICHARDSON, TEXAS 75081
214 235-2385
TWX 214 231-1403
1678 SOUTH PIONEER ROAD
SALT LAKE CITY, UTAH
801 487 7561
714 CHURCH STREET
ALEXANDRIA, VIRGINIA 22314
703 549-8205
TWX 703 931-4210

EITEL ELECTRONICS
SALES MANAGER
GEORGE E. EITEL
BRAND NAMES
EITELCO
COMPANY ADDRESS
P O BOX 830
211 E SHELTON
PRESCOTT, ARIZONA 86301
602 445 0691

ELECTROLINE TELEVISION
EQUIPMENT INC
PRESIDENT
MAURICE OLDFAN
980 NE 170 ST
N MIAMI BEACH, FLA 33161
305 949 0933
COMPANY ADDRESS
BOX 324
ULETA, FLA 33164
COMPANY REPRESENTATIVES
JEROME GUARDINO
16 EAST 23RD STREET
NEW YORK, N.Y., 10010
212 OR 3-5670
REPS. IN OTHER COUNTRIES
HENRY PALL
DOMINION SQUARE BLDG.
MONTREAL, QUEBEC
514 878-9489

ELECTRONIC LIGHTS, INC
SALES MANAGER
JAMES V. DANIELS
BRAND NAMES
SURGELITE
STROBELITE
COMPANY ADDRESS
1713 NORTH ASHLAND AVE
CHICAGO, ILL 60622

ELECTRONIC MOBILE UNITS
COMPANY ADDRESS
788 PATERSON AVE
EAST RUTHERFORD, N J
201 933 3555

ELECTRONIC RESEARCH COMPANY
SALES MANAGER
H. M. DANZIG
COMPANY ADDRESS
10000 WEST 75TH STREET
OVERLAND PARK, KANSAS 66204
COMPANY REPRESENTATIVES
WM J PURDY CO
312 SEVENTH ST
SAN FRANCISCO, CALIF
415 863 3300
SHEPARD WINTERS CO
4109 BURBANK BLVD
BURBANK, CALIF
213 849 6671
STAN PIERCE, INC
115 BALD HILL ROAD
NEW CANAAN, CONN
203 966 4630
ORBE, INC
300 31ST ST N, SUITE 439
ST PETERSBURG, FLA
813 894 0687
ORBE, INC
1020 GREGORY DR
MAITLAND, FLA
305 424 0978
ORBE, INC
476 LORIDANS DR, NE
ATLANTA, GA
404 233 6453
WHITMORE ASSOCIATES, INC
4750 N MILWAUKEE
CHICAGO, ILL
312 286 2442
FLORENCE & MEYER, INC
2900 WOODLAND
WICHITA, KANSAS
316 TE 8 7226
HARRY J WHITE CO
320 HILLEN RD
TOWSON, MD 21204
301 VA 8 6373
STAN PIERCE, INC

24 LINDEN ST
NORWOOD, MASS 02062
617 762 3164
FLORENCE & MEYER, INC
406 W 34TH ST
KANSAS CITY, MO
816 LD 1 7282
FLORENCE & MEYER, INC
BDX 5806
BERKLEY, MO 63134
316 JA 1 6800
COMP TECH SALES
BDX 50
RIVERDALE, N J 07457
201 835 0332
INTERNATIONAL ELECTRO-COMP CO7
BOX 353
PINE BROOK, N J 07058
201 335 1822
HARRY J WHITE CO
801 W MARLTON PIKE
CHERRY HILL, N J
609 428 2304
COMP TECH SALES
BOX 384
LYNBROOK, N Y 11563
516 593 2628
LAWRENCE SALES CO
BOX 1038
RICHARDSON, TEXAS
214 AD 5 5504
REPS IN OTHER COUNTRIES
ELECTROESIGN, LTD
9124 ST LAWRENCE BLVO
MONTREAL, QUEBEC
514 389 5914

ELECTRONICS ESSENTIALS

OF CCC, INC.
PRESIDENT
JOSEPH V MITCHELL
BRAND NAMES
VERAVOX
ARHC
COMPANY ADDRESS
4424 FURMAN AVE
BRONX, N Y 10466

EMCEE -
ELECTRONICS, MISSILES,
COMMUNICATIONS, INC
SALES MANAGER
GARR JOHNSON
BRAND NAMES
EMCEE
COMPANY ADDRESS
160-E-3 STREET
MT. VERNON, NEW YORK

ELECTRONIC SYSTEM ENGINEERING
SALES MANAGER
A. A. KAMINSKINE
BRAND NAMES
LIMPANDER
SPEEDMASTER
COMPANY ADDRESS
120 1/2 N CLEVELAND
CUSHING, OKLAHOMA 74023

ELECTRO PRODUCTS
LABORATORIES, INC
SALES MANAGER
R. H. NOVIC
BRAND NAMES
ELECTRO
COMPANY ADDRESS
6125 W. HOWARD
CHICAGO, ILLINOIS 60648
COMPANY REPRESENTATIVES
HYDE ELECTRONICS CO, INC
4710 N 16TH ST, SUITE 109
PHOENIX, ARIZ
602 264 5609
CARTER & ROSSNEY ASSOC
2600 W OLIVE AVE
BURBANK, CALIF
213 843 3292
LOGAN SALES CO
463 BREWSTER AVE
REDWOOD CITY, CALIF
415 369 6728
HYDE ELECTRONICS CO, INC
888 S LIPAN ST
DENVER, COLO
303 936 3456
COAKLEY, BOYD & ABBETT, INC
6 GAYWOOD DR
WATERBURY, CONN
203 756 8766
MURPHY & COTA
712 W VASSAR AVE
ORLANDO, FLA
305 424 2167
MURPHY & COTA
586 ARMOUR CIRCLE, N E
ATLANTA, GA
404 875 2525
GETTLEMAN & LITTEKEN CO
3736 DEMETER ST
SKOKIE, ILL
312 588 0030
FISHMAN ASSOCIATES
2060 E 54TH ST UNIT # 1
INDIANAPOLIS, IND
317 251 2401
COAKLEY, BOYD & ABBETT, INC
1424 HIGHLAND AVE
NEEDHAM, MASS
617 444 5470
DAVID MILSK CO
20110 OLYMPIA AVE
DETROIT, MICH
313 535 4012
A J WARNER CO
5022 29TH AVENUE S

MINNEAPOLIS, MINN
612 729 7371
PAUL G SCHOLZ CO
7309 E 109 TERRACE
KANSAS CITY, MO
816 761 6522
HYDE ELECTRONICS CO, INC
5206 CONSTITUTION AVE N E
ALBUQUERQUE, N M
505 265 8895
CALLBAKKE-FERGUSON CO
107 GREENHEDGE DR
CAMILLUS, N Y
315 488 5518
MURPHY & COTA
P O BOX 6365
GREENSBORO, N C
919 273 6288
LES A MORROW CO
3123 W 117TH ST
CLEVELAND, OHIO
216 251 5700
JOHN MUSTICO CO
312 BEWLEY ROAD
HAVERTOWN, PA
215 446 1961
JAMES H PODOLNY CO
5912 PENN AVE
PITTSBURGH, PA
412 441 0800
THE TEXPOR CO
5104 CAPEN ST
MEMPHIS, TENN
901 682 4777
THE TEXPOR CO
2411 FARRINGTON ST
DALLAS, TEXAS
214 631 6270
THE TEXPOR CO
8811 GAYLOR ROOM 206
HOUSTON, TEXAS
713 464 3031
HYDE ELECTRONICS CO, INC
3081 DELSA DR
SALT LAKE CITY, UTAH
801 278 4465
DOM SMITH SALES CO
2320 N 45TH ST
SEATTLE, WASH
206 633 3160
STEVE FISHER SALES CO
121 CEDAR LANE
TEANECK, NEW JERSEY
201 836 6661

ELECTRO-SOUND ACOUSTICS,

DIVISION OF RAYCO SOUND CO
SALES MANAGER & PRESIDENT
RAYMOND L. IHNDRIIS
BRAND NAMES
ESA
PRO-CLASSIC
FUGISTANCE
ELECTRO-SOUND ACOUSTICS
COMPANY ADDRESS
128 WHITMOOR TERRACE
SILVER SPRING, MARYLAND 20901
301 593 6455
COMPANY REPRESENTATIVES
BETTER ELECTRONICS CO
7114 WOODLAND AVE
TAKOMA PARK, MD 20012
301 589 8610

ELECTROVERT INC

SALES MANAGER
F. J. FARRELL
BRAND NAMES
CRADLECLIP
SPIROBAND
GROMMET STRIP
COMPANY ADDRESS
86 HARTFORD AVE
MT. VERNON, NEW YORK 10553
COMPANY REPRESENTATIVES
CONSTRUCTION SPECIALTIES
10 EAST SECOND STREET
SCOTTSDALE, ARIZONA
CLIFFORD L WOOLSEY
1029 N BRIGHTON ST
BURBANK, CALIF 91506
213 849 5341
J A WAUGAMAN ASSOC INC
2785 NORTH SPEER
DENVER, COLO 80211
303 292 3926
H R GROSS & CO
314 SOUTH MISSOURI AVE
P O BOX 1427
CLEARWATER, FLA 33517
813 446 6649
LOUIS E BRUNS CO
2210 NORTH 50TH TERRACE
KANSAS CITY, KANSAS
913 289 5242
ANSELL ENGINEERING CO
816 THAYER AVE
SILVER SPRING, MD
301 588 4222
CONTACT ASSOCIATES
7 CYPRESS DRIVE
BURLINGTON, MASS
617 272 5051-2-3
MURRAY A PERCIVAL CO
22511 SOUTHFIELD ROAD
SOUTHFIELD, MICH 48075
313 356 5710
WOOD CLEMONS CO
6701 PENNSYLVANIA AVE SO.
MINNEAPOLIS 23, MINN
612 866 3401
LOUIS E BRUNS CO
514 PARKWOOD AVE
KIRKWOOD, MISSOURI
J P DEARIE CO
P O BOX 66

MOUNTAIN LAKES, N J
201 334 4848
J B CLOUGH CO
4614 PROSPECT AVE
CLEVELAND, OHIO
216 431 2700
J B CLOUGH CO
3035 PORTSMOUTH AVE
CINCINNATI, OHIO
513 321 0478
HILLIARD ASSOCIATES
766 OLD YORK ROAD
JENKINTOWN, PENN
215 884 6100
WALTER N LASKA
530 SIXTH AVE
PITTSBURGH, PENN
412 471 0490
MORRIS SALISS
P D BOX 464
ROOSEVELT, PUERTO RICO
PHIL J SCANLON CO
P O BOX 70
RICHARDSON, TEXAS 75081
214 231 4661
DWHIGHT SMITH ASSOC
32 SOUTH RIVER STREET
AURORA, ILL 60504
315 896 0828
BILL WADDELL CO
10211 N.E. 31ST PLACE
BELLEVUE, WASH
206 822 3660

ELECTRO-VOICE, INC

VP SALES
LAWRENCE LEKASHMAN
BRAND NAMES
ARISTOCRAT R
CARDLINE R
ACOUSTIFOAM
ACOUSTALLOY R
CDP R
SONOCASTER
CY-D
STEREON R
FEATHERIDE R
LINE RADIATOR
SONOPHASE
SOUND SPOT R
MICHIGAN
MUSICASTER
RADAX
PATRICIAN R
POWER POINT
SENTRY
SUPER-SONAX
VARIABLE-D R
WOLVERINE R
COMPANY ADDRESS
638 CECIL STREET
BUCHANAN, MICHIGAN 49107
616 695 6833
COMPANY REPRESENTATIVES
EDWARD CAIN
3258 CAHABA HEIGHTS ROAD
BIRMINGHAM, ALABAMA 35243
205 967 3080
DICK BELLEW SALES COMPANY
1005 WEST 4TH STREET
EL DORADO, ARKANSAS
501 UN 3 8325
JACK CARTER
DICK SCHNEPP
2600 W OLIVE
BURBANK, CALIFORNIA 91505
213 843 3292
MEYER, ROSS & FLEMING
113 TENTH STREET
SAN FRANCISCO, CALIFORNIA
415 RA 10652
MC LOUD & RAYMOND
2151 S GRAPE STREET
P O BOX 22044
DENVER, COLORADO
303 756 1589
JOSEPH F HELLAUER, JR
46 ROCKEFER AVENUE
WEST HAVEN, CONNECTICUT 06516
203 923 0261
JACK SPROCH
3520 W BROWARD BOULEVARD
FT LAUDERDALE, FLA 33312
305 587 3792
MAYLAND K SMITH COMPANY
31 16TH STREET NW
ATLANTA, GEORGIA 30309
404 875 8031
RILL KOLANS & COMPANY
P O BOX 2098, 158 NOKAUEA
HONOLULU, HAWAII
811 628
J D BOSWELL SALES
25 PINE TRAIL
CANEYVILLE, ILLINOIS 62232
314 GE 6 2042
GENE CLEARS
20200 ASHLAND AVE
CHICAGO HEIGHTS, ILL
312 755 0055
HARRISON BLIND & ASSOCIATES
1635 GENT STREET NORTH
INDIANAPOLIS, INDIANA 46202
317 WE 5 6291
ELECTRONIC SALES CO
1310 HERTZ DRIVE, SE
CEDAR RAPIDS, IOWA 52403
319 364 4342
DICK BELLEW, JR
5042 D ST, ANTHONY AVE
NEW ORLEANS, LOUISIANA 70122
504 282 9629
DAVE BROTHERS
6302 LINCOLN AVENUE
BALTIMORE, MARYLAND
301 RO 4 7189

JOE RADIMAK
1808 GLEN RIDGE ROAD
DOWSON, MARYLAND
301 661 0713
MICHAEL SCOTT & COMPANY
336 WASHINGTON
WELLESLEY HILLS, MASS
617 CE 5 0102
RICHARD FLORA
294 MONEY CREEK AVENUE
ADA, MICHIGAN
616 676 1854
RILEY & PETCHELL
ELECTRONIC SALES
13209 FENKELL
DETROIT, MICHIGAN
313 VE 8 9100
RAY RIPLEY & ASSOC
6838 PILLSBURY AVE SO
MINNEAPOLIS, MINNESOTA
612 UN 6 8182
CHARLES SMITH
813 FORDHAM ROAD
RIVERSIDE, NEW JERSEY
609 MO 1 4581
M & S ASSOCIATES - MILITARY
P O BOX 185
HADDONFIELD, NEW JERSEY
609 HA 9 7055
CARDUMER SALES CORPORATION
P O BOX 900
WESTBURY, NEW YORK
516 333 8170
GORDON LE ROY
ORCHARO PARK
PHELPS, NEW YORK
315 548 4891
JAMES SCHMITTER
109 EASTON AVENUE
BUFFALO, NEW YORK
716 892 6551
DAVID E COON
218 EAST LAKE ROAD
OE RUYTER, NEW YORK
315 852 3374
JAMES CLYMER, JR
1605 CHATHAM AVENUE
CHARLOTTE, N CAROLINA
704 FR 6 5951
C L PUGH COMPANY
2144 RIVERSIDE DRIVE
COLUMBUS, OHIO 43221
614 486 9678
GEORGE CONNEEN
131 HARNED ROAD
SPRINGFIELD, OELAWARE CO, PA
215 543 8641
ELECTRO VOICE TENNESSEE
RANKIN ROAD
NEWPORT, TENNESSEE
615 623 2356
EDWARD MILLER
SUITE 251, MELSHIRE BLDG
1450 PRESTON FOREST SQUARE
DALLAS, TEXAS 75230
214 AD 9 3789
HUGH PUTMAN
914 WATEKAWAY
RICHARSON, TEXAS
214 AD 1 4353
JIM HANKOCK
6022 WIGTON
HOUSTON, TEXAS 77035
713 PA 9 0824
WM R LANPHEAR SALES
4031 STONEMAN AVE, NORTH
SEATTLE, WASHINGTON 98103
206 ME 3 4900
REPS IN OTHER COUNTRIES
ELECTRO TEC MARKETERS
1624 W THIRO STREET
VANCOUVER, B C
604 RE 6 6377
R C KAHNERT
359 ENFORD ROAD
RICHMOND HILLS, ONTARIO
416 886 4574
AURELE DES JARONIES
P O BOX 885
MONTREAL, QUEBEC
514 677 5033

THE ELMOR COMPANY
SALES MANAGER
S. WEINER
BRAND NAMES
GALLET
GALCO
GUINANO
SECURITY
COMPANY ADDRESS
29 E. MADISON ST
CHICAGO, ILLINOIS

ENCLOSURE CORP
PRESIDENT
R. D. EDELMAN
COMPANY ADDRESS
1701 INDUSTRIAL BLVD.
PENNAPOLIS, N. J. 08110
COMPANY REPRESENTATIVES
LEE ASSOCIATES
8100 S MEMORIAL PARKWAY
HUNTSVILLE, ALABAMA
205 881 0461
LEE ASSOCIATES
200 E MARKS STREET
ORLANDO, FLA
305 241 4445
LEE ASSOCIATES
12250 WILKINS AVENUE
ROCKVILLE, MARYLAND
301 949 48DD
MECHANICAL MARKETING ENG
20 CONGRESS AVENUE
CHELSEA, MASSACHUSETTS

617 889 2279
LEE ASSOCIATES
432 WEST END BOULEVARD
WINSTON-SALEM, NORTH CAROLINA
919 724 2406
C E SNOW
613 CHELTENHAM AVENUE
PHILADELPHIA, PENNSYLVANIA
215 CA 4 2626

ENGINEERING ASSOCIATES
COMPANY ADDRESS
434 PATTERSON ROAD
DAYTON, OHIO 45419
OFC AX3-1662 LAB AX 3-1462

ENGLISH ELECTRIC VALVE DIVISION
THE ENGLISH ELECTRIC CORP
COMPANY ADDRESS
ONE PARK AVE
NEW YORK, N Y 10016
DIRECT ALL INQUIRES
AS INDICATED
SOLE U S DISTRIBUTOR FOR
IMAGE-ORTHICON & VIDICON
CAMERA TUBES
VISUAL ELECTRONICS CORP
356 WEST 40TH ST
NEW YORK, N Y 10018
SOLE U S DISTRIBUTOR FOR
VACUUM TUBES, TRANSMITTING
CALVERT ELECTRONICS, INC
220 EAST 23RD STREET
NEW YORK, N Y 10010

ENTRON, INC
SALES MANAGER
JOHN RUSSELL
COMPANY ADDRESS
2141 INDUSTRIAL PKWY
SILVER SPRING, MARYLAND 20904
COMPANY REPRESENTATIVES
PAUL MC INNISH
231 B STOKES STREET
HUNTSVILLE, ALABAMA 35805
205 536 7259
WILLIAM JONES
3706 MONTGOMERY DRIVE
SANTA ROSA, CALIF 95404
RAY LA RUE
ATLANTA, GEORGIA 30319
404 634 4089
WILLIAM SAILOR
4983 HARBOR BOULEVARD
COLUMBUS, OHIO 43227
614 837 2259
ROBERT TAYLOR
P O BOX 1037
RICHARSON, TEXAS 75080
214 AD 5 7472
REPS IN OTHER COUNTRIES
OMER GIRARO
15 O ST PATRICE STREET
MAGOG, QUEBEC

ELECTRONIC MARKETING DIVISION
ESSEX WIRE CORPORATION
SALES MANAGER
DON ABERDEEN
BRAND NAMES
STANCOR
RBM
COMPANY ADDRESS
3501 W. MADISON
CHICAGO, ILLINOIS 60618
463 7400
SALES OFFICES
444 CAMELBACK ROAD WEST
PHOENIX, ARIZONA 85017
602 264 3578
112 GLASGOW AVENUE
INGLEWOOD, CALIFORNIA 90301
213 678 4711
165 ELEVENTH STREET
SAN FRANCISCO, CALIF 94103
415 863 7880
721 SOUTH BROADWAY
DENVER, COLORADO 80209
303 725 4661
3308 14TH STREET, NW
WASHINGTON, D C 20010
202 265 3938
1010 EXECUTIVE CENTER DRIVE
ORLANDO, FLORIDA 32803
305 241 5401
3098 PIEDMONT ROAD, NE
ATLANTA, GEORGIA 30305
404 261 5838
156 MOKAUEA
HONOLULU, HAWAII 96803
815 649
309 AVONDALE DRIVE
EAST PERIA, ILLINOIS 61611
309 699 3301
349 NORTH ASHLAND AVENUE
RIVER FOREST, ILLINOIS 60305
312 261 0342
1605 K AVENUE, NE
CEDAR RAPIDS, IOWA 52402
319 362 7825
5450 BUENA VISTA DRIVE
SHAWNEE MISSION, KANS 66205
913 432 2131
1812 BULLARD AVENUE
METAIRIE, LOUISIANA 70003
504 887 0482
5500 HARFORD ROAD
BALTIMORE, MARYLAND 21214
301 254 3380
336 WASHINGTON STREET
WELLESLEY HILLS, MASS D2181
617 235 D102
23529 WOODWARD AVENUE
FERNDALE, MICHIGAN 48220
313 547 4771
5364 KIMBALL AVENUE, SE

GRAND RAPIDS, MICHIGAN 49508
616 243 7606
3749 WEST BRADWAY
MINNEAPOLIS, MINNESOTA 55422
612 588 4663
47 VILLAGE SQUARE
HAZELWOOD, MISSOURI 63042
314 838 6446
2611 QUINCY STREET, NE
ALBUQUERQUE, NEW MEX 87110
505 265 1579
496 ELLICOTT SQUARE BUILDING
BUFFALO, NEW YORK 14203
716 854 2517
311 MEACHAM AVENUE
ELMONT, LI, NEW YORK 11003
516 437 8150
431 GREENWICH STREET-EXPORT
NEW YORK, NEW YORK 10013
212 966 2130
6717 WOODSTOCK DRIVE
CHARLOTTE, NO CAROLINA 28210
704 523 3327
150 EAST BROAD STREET
COLUMBUS, OHIO 43215
614 221 3363
510 N W 19TH AVENUE
P O BOX 2827
PORTLAND, OREGON 97208
503 226 4184
1531 SPRUCE STREET
PHILADELPHIA, PENN 19102
215 545 1205
106 NELBON AVENUE
PITTSBURGH, PENN 15235
412 241 7025
560 S COOPER STREET
MEMPHIS, TENNESSEE 38104
901 274 4442
2930 MERRELL ROAD
OALLAS, TEXAS 75220
214 357 4601
4810 HAZARO
HOUSTON, TEXAS 77006
713 529 3811
31 SOUTH THIRD, EAST
SALT LAKE CITY, UTAH 84111
801 364 4632
422 FIRST AVENUE, WEST
P O BOX 9285
SEATTLE, WASHINGTON 98119
206 284 1121
928 EAST WISCONSIN AVENUE
PEWAUKEE, WISCONSIN 53072
414 691 0622

EUPHONICS MARKETING
SALES MANAGER
HOWARD SOUTHER
BRAND NAMES
MINICONIC
COMPANY ADDRESS
173 W. MADISON ST
CHICAGO, ILLINOIS 60602

E-Z-HOOK TEST PRODUCTS
SALES MANAGER
ROBERT N YOUNGER
BRAND NAMES
E-Z-HOOK
COMPANY ADDRESS
1536 WOODBURN AVE
COVINGTON, KY 41012
COMPANY REPRESENTATIVES
ASH M. WOOD CO.
P O BOX 1158
ARCADIA, CALIF.
AT 7-0449 AND CU 3-1201
ROYAL A. STEHM CO.
662 IRVING PARK RD.
CHICAGO, ILL.
LA 5-8333
REPS IN OTHER COUNTRIES
LEN FINKLER LTD.
2 TYCOS DRIVE
TORONTO 19, ONTARIO
416 781-5231

FAIRCHILD RECORDING EQUIPMENT CORPORATION
SALES ADMINISTRATOR
M. P. MCLAUGHLIN
BRAND NAMES
AUTO-TEN
BALANCE/GARD
TRANS/GARD
BASS-X
COMPATILIZER
CONAX
DYNALIZER
INTEGRA
LIMITEN
MTIS
REVERBERTRON
COMPANY ADDRESS
10-40 45TH AVENUE
LONG ISLAND CITY, N Y 11101
SALES REPRESENTATIVES
WORLD WIDE PRODUCTS CO
BOX 429
N MIAMI BEACH, FLA
LOREN GREEN ASSOCIATES
5218 W DIVERSEY AVE
CHICAGO, ILLINOIS
MARTIN VOGT
2817 BAWLET ROAD
ROYAL OAK, MICHIGAN
BEN JOSEPH ASSOCIATES
BOX 486
GREAT NECK, LI, NEW YORK
H H SEAY COMPANY
3850 FAIRLINGTON DR
COLUMBUS, OHIO
ANTLE SMITH SALES CO
2721 BROOKFIELD AVE

DALLAS, TEXAS
WILLIAM K WOOD CD
5908 CALIFORNIA AVE
SEATTLE, WASHINGTON

THE FINNEY COMPANY
SALES MANAGER
TOM PFEIFFER
BRAND NAMES
FINCO
COMPANY ADDRESS
34 W. INTERSTATE ST.
BEDFORD, OHIO 44014

F & M SYSTEMS CO, DIVISION OF FISCHBACH & MOORE, INC
MARKETING MANAGER
M. C. BAIRD, JR.
COMPANY ADDRESS
2525 WALNUT HILL LANE
DALLAS, TEXAS 75220
COMPANY REPRESENTATIVES
J MORRIS
646 NORTH BEACHWOOD DRIVE
LOS ANGELES, CALIF 90004
213 466 2151
J DOUGLAS AMO
H ALSOP
1019 22ND ST. N W
WASHINGTON, D.C. 20037
202 333-0800
J LUTRELL
2525 WALNUT HILL LANE
DALLAS, TEXAS 75220
214 CH 1 2121

FISHER BERKELEY CORPORATION
SALES MANAGER
RAMP BRUSH
BRAND NAMES
EKATCOM
COMPANY ADDRESS
1475 POWELL STREET
EMERYVILLE, CALIF. 94608
COMPANY REPRESENTATIVES
ELLARD E STRASSNER CO
3121 LOS FELIZ BLVD
LOS ANGELES, CALIF
213 666 1511
JIM PIPER ASSOCIATES
10 HAVEN ST
DOVER, MASS
617 449 1144
CLARK R GIBB CO
2400 HENNEPIN AVENUE
MINNEAPOLIS, MINN
612 FR 7 1200
ROBERT FINLAY SALES CO
45 NORTH BROAD ST
RIDGEWOOD, N J
201 652 0088
JOHN O OLSEN CO
16201 SHAKER BLVD
CLEVELAND, OHIO
216 752 5444
WILLIAM L METCALFE
116 W FRANKLIN
CENTERVILLE, OHIO 45459
513 885 3722
RICHARD A STONE
1843 MANDELL ST
PITTSBURGH 16, PA
412 341 8391
TECHNO ASSOCIATES
P O BOX 20544
DALLAS, TEXAS
214 FL 7 9213

HERB FITZGERALD COMMUNICATIONS ELECTRONICS
SALES MANAGER
HERB FITZGERALD
COMPANY ADDRESS
635 E. 185TH ST.
CLEVELAND, OHIO 44119

THE JAMES FLOYD FORD COMPANY
GENERAL MANAGER
COMPANY ADDRESS
JFFCO BUILDING P.O.DRWR 839
CAPE GIRARDEAU, MO. 63701
314-334-6308
COMPANY REPRESENTATIVES
JAMES FLOYD FORD CO
BOX 761
CHICO, CALIFORNIA 95926

FORT WORTH TOWER CO, INC
PRESIDENT
T. W. MOORE
COMPANY ADDRESS
5201 BRIDGE ST PO BOX 8597
FORT WORTH, TEXAS 76112
817 536 5676
COMPANY REPRESENTATIVES
A C TILTON
5201 BRIDGE ST
FORT WORTH, TEXAS
817 536 5676

GAMMA SCIENTIFIC, INCORPORATED
SALES MANAGER
HAROLD P. FIELD
COMPANY ADDRESS
5841 MISSION GORGE RD.
SAN DIEGO, CALIF. 92120
COMPANY REPRESENTATIVES
GRIOT ASSOCIATES
3002 MIDVALE AVENUE
LOS ANGELES, CALIF. 90034
213 474-1587
GRIOT ASSOCIATES
56D SAN ANTONIO ROAD
PALO ALTO, CALIF. 94306
415 327-3996

NORTHEAST ASSOCIATES
BOX 1242
STAMFORD, CONN. 06904
203 323-3814
NORTHEAST ASSOCIATES
BOX 31
MARBLEHEAD, MASS. 01946
617 631-3688
KING ASSOCIATES
8012 CINDY LANE
BETHESDA, MD. 20034
301 469-7610

GATES RADIO COMPANY

SALES MANAGER
EUGENE O. EDWARDS
BRAND NAMES
ATC
AUTOMATIC TAPE CONTROL DIV
COMPANY ADDRESS
123 HAMPSHIRE STREET
QUINCY, ILLINOIS 62301
217-222-8202
U.S. BRANCH OFFICES
ED WILDER
1945 S FIGUEROA
LOS ANGELES, CALIF 90007
213 747 7129
EDWARD SHUEY
BROADCAST SALES
730 FEDERAL BLDG
1522 K STREET, N.W.
WASHINGTON, D.C.
202 223 5508
JOE ENGLE
800 SECOND AVENUE
NEW YORK, NEW YORK 10017
212 687 7971
JOE WOODS
STORE MANAGER
4019 RICHMOND AVENUE
HOUSTON, TEXAS 77027
713 666 4333

EXPORT

ARNE CLAPP
BROADCAST PRODUCT MGR
637 CRAIG STREET, WEST
MONTREAL, QUEBEC
514 866 6755
ROCKE INTERNATL CORP
TOM TUCKER, ASST MGR
COMMUNICATIONS DEPT
13 EAST 40TH STREET
NEW YORK, N.Y. 10016
212 MU 9 0200
TERRITORY MANAGERS
WILLIAM MOATS
PO BOX 20160
3220 MOCKINGBIRD LANE
BIRMINGHAM, ALA 35216
205 822 3625
ROBERT STEIGER
PO BOX 1914
SACRAMENTO, CALIF 95809
916 446 4470
HOWARD DEMPSEY
8171 ORCHARD DRIVE
DENVER, COLORADO 80221
303 429 5758
RICHARD SPRUILL
PO BOX 8735
JACKSONVILLE, FLORIDA 32211
904 721 2779
CLARENCE MORGAN
22235 BURDETTE STREET
GLEN ELLYN, ILLINOIS 60137
312 469 0847
PAUL TIMPE
19 WINDY HILL
QUINCY, ILLINOIS 62301
217 223 4701
STANLEY WHITMAN
BOX 2397, STATION A
WATERLOO, IOWA 50705
319 223 0561
THOMAS SCHOONOVER
7169 BURKENHEAD PLACE
LAMBERTVILLE, MICHIGAN 48144
313 856 3581
ROBERT HALLENBECK
11 RIDGECREST
LATHAM, NEW YORK 12110
518 785 9144
URLIN WHITMAN
2719 S HUDSON AVENUE
TULSA, OKLAHOMA 74114
918 836 4835
LEWIS DENES
BOX 584A, ROUTE 2
BORING, OREGON 97009
513 658 2684
NEIL ARVESCHOUH
PO BOX 414
GRANVILLE, PENNSYLVANIA 43023
614 294 2594
RAFAEL ACOSTA
PO BOX 89
RIO PIEDRAS, PUERTO RICO
JOE COLE
PO BOX 246
HALIFAX, VIRGINIA 24558
703 476 4514

GBC AMERICA CORPORATION

SALES MANAGER
HARRY LEFKOWITZ
BRAND NAMES
GBC
COMPANY ADDRESS
89 FRANKLIN STREET
NEW YORK, NEW YORK 10013
COMPANY REPRESENTATIVES
R MARK MARKMAN, CO
4142 LANKESSH BLVD
NO HOLLYWOOD, CALIF
213 TR 7 3368

F W MOUTHRUP ASSOC
1530 E 12TH ST
OAKLAND, CALIF
415 261 7676
KOETHER-COX CO
1325 INCA ST
DENVER, COLO
303 733 5561
J E JOYNER ASSOC
P O BOX 10821, STA A
ATLANTA, GA
404 758 7496
KLEM-STEFFEN INC
709 GARFIELD ST
OAK PARK, ILL
312 921 1200
GENE ROSEN ASSOC
9501 WADSWORTH DRIVE
BETHESDA, MD
301 365 5113
COAKLEY BOYD & ABBETT
1424 HIGHLAND AVE
NEEDHAM, MASS
617 444 5470
MAUREY E BETTIS CO
3706 BROADWAY
KANSAS CITY, MO
816 LO 1 0772
JOHN OLSEN CO
16201 SHAKER BLVD
CLEVELAND, OHIO
216 752 5444
MAYNARD SALES CO
158 EXPRESS ST
DALLAS, TEXAS
214 RI 2 2384
DAVE MILLER SALES CO
2323 NO 45TH ST
SEATTLE, WASH
206 ME 7 7070
REPS. IN OTHER COUNTRIES
ROBERT J BUCKLAND CO
P O BOX 367 STAT B
LONDON, ONTARIO
519 432 7731

G C ELECTRONICS COMPANY

SALES MANAGER
ED GALLAGHER
BRAND NAMES
AUDIOTEX
ELECTROCRRAFT
G C ELECTRONICS
SPEDEX
WALSCO
COLORMAGIC ANTENNA CO
COMPANY ADDRESS
400 S. WYMAN STREET
ROCKFORD, ILLINOIS 61101
COMPANY REPRESENTATIVES
JACK LOGAN & ASSOCIATES
801 MAHLER RD
BURLINGAME, CALIF
WESTERN ELECTRIC COMPONENTS
4301 BIRCH ST
NEWPORT BEACH, CALIF
ROCKMOUNT ENTERPRISES
3268 ZENITHA CT
GOLDEN, COLORADO
W F HAMILTON CO
5130 N ELSTON AVE
CHICAGO, ILLINOIS
D W MARCUS
P O BOX 453, 33 IRVING RD
NATICK, MASS
CHARLES F VANDERVOORT
1279 OSAGE ST
ST PAUL, MINN
PETERSON-RUDNICK ASSOCIATION
P O BOX 822
W CALDWELL, N J
JUD LEBRUN
1123 SW YAMHILL ST
PORTLAND, OREGON
MFG MKTG SERVICE
10202 BROCKBANK DR
DALLAS, TEXAS

G E VISUAL COMMUNICATIONS PROD

SALES MANAGER, BROADCAST SALES
ROBERT E LAUTERBACH
SALES MANAGER, FIELD SALES
ROBERT W COCHRAN
COMPANY ADDRESS
SYRACUSE, NEW YORK
COMPANY REPRESENTATIVES
ROBERT L MANAHAN
WHELAN BLDG, 701 WELCH RD
PALO ALTO, CALIF 94304
415 323 4108
R DONALD PETERSON
232 N LAKE AVE
PASADENA, CALIF 91101
213 795 1209
JOHN F WATTER
777 14TH ST N W
WASHINGTON, D C 20005
202 393 3600
JAMES M COMER, JR
RM 517
1330 W PEACHTREE ST NW
ATLANTA, GA 30309
404 875 6691
THOMAS F BOST, JR
117 SOUTH MAIN ST
MT PROSPECT, ILL 60056
312 255 3200
CURTIS I KRING
3628 W 95TH ST
SHAWNEE MISSION, KANS 66206
913 649 7131
GE VISUAL COMM PRODUCTS DEPT
6501 E NEVADA ST
DETROIT, MICH 48234
313 892 7600

HAROLD W MORSE
BOX 1021
SYRACUSE, N Y 13201
315 456 7738
JOHN H PAINTER
P O BOX 1021
SYRACUSE, N Y 13201
315 456 7309
LEWIS F PAGE
GRAYBAR BLDG 420 LEXINGTON
NEW YORK, N Y 10017
212 751 1311
EARL H PLATT
910 WILLIAMSON BLDG
CLEVELAND, OHIO 44114
216 781 6822
JAMES H DOUGLAS
4447 N CENTRAL EXPWY
DALLAS, TEXAS 75205
214 526 0426

G E DISTRIBUTOR SALES FORCE

COMPANY ADDRESS
GENERAL ELECTRIC COMPANY
OWENSBORO, KENTUCKY

G E INDUSTRIAL SALES OPERATION

COMPANY ADDRESS
GENERAL ELECTRIC COMPANY
SCHENECTADY, N Y

G E CAPACITOR DEPARTMENT

COMPANY ADDRESS
GENERAL ELECTRIC COMPANY
HUDSON FALLS, N Y

G E SUPPLY COMPANY

COMPANY ADDRESS
GENERAL ELECTRIC SUPPLY CO
BOSTON, MASS

G E SALES AND DISTRIBUTION

COMPANY ADDRESS
GENERAL ELECTRIC COMPANY
LOUISVILLE, KENTUCKY

GENERAL ELECTRIC COMPANY

COMMUNICATION PRODUCTS DEPT.
MANAGER MARKET DEVELOPMENT
J. A. LIGHTNER
COMPANY ADDRESS
GENERAL ELECTRIC COMPANY
P O BOX 4197
LYNCHBURG, VA 24502

G E PICKUP TUBE OPERATION

GENERAL ELECTRIC COMPANY
MANAGER BROADCAST SALES
E T CHACE
COMPANY ADDRESS
ELECTRONICS PARK
BLDG 6, ROOM 128
SYRACUSE, NEW YORK 13201

COMPANY REPRESENTATIVES
THEO W WEICKER
555 VETERANS BLVD
REDWOOD CITY, CALIF
415 369 7151
AVERY P LONG
201 UNIVERSITY AVE
DENVER, COLO
303 388 5771
VICTOR S SYZDEK
410 ASYLUM STREET
HARTFORD, CONN
203 527 0135
DONALD G REIK
777 14TH ST N W
WASHINGTON, D C
202 EX 3 3600
ROBERT P FISHER
2106 S LOUIS AVE
TAMPA, FLA
813 877-8365
CHARLES M LIDDIC
1330 W PEACHTREE ST
ATLANTA, GA
404 875 6691
JAMES H CHRYSLER AND
OTHO H ELLENBERGER
3800 N MILWAUKEE AVE
CHICAGO, ILL.
312 777-1600
JAMES D BROOKS
613 HIBERNIA NATL BANK BLDG
NEW ORLEANS, LA
504 525 4324
ROBERT A SECKLER
31 ST JAMES AVENUE
BOSTON, MASS
617 482 1800
RICHARD E LEVITRE
17220 W 8 MILE ROAD
SOUTHFIELD, MICH
313 444 8977
CARL A JOHNSON
4900 VIKING DRIVE
MINNEAPOLIS, MINN
612 927 5458
JOHN SIEBER
106 W 14TH STREET
KANSAS CITY, MO
816 221 4033
GARY H EVANS
1530 FAIRVIEW,
ST LOUIS, MO
314 429 6930
HAROLD F BOREIKO &
JOHN E SULLIVAN
200 MAIN AVENUE
CLIFTON, N J
201 472 8100
CLAUDE B CODINGTON
N. CONCOURSE OFFICE BLDG.
SYRACUSE, N Y
315 456 3412

LYNN E GREELEY
129 W TRADE ST
CHARLOTTE, N C
704 375 5571
ARTHUR M EFFRON
2621 VICTORY PARKWAY
CINCINNATI, OHIO
513 AV 1 2547
NORMAN VON ALLMEN
25000 EUCLID AVENUE
CLEVELAND, OHIO
216 266 2900
FLOYD S ANDERSON
3 PENN CENTER PLAZA
PHILADELPHIA, PA
215 LO 8 1800
CLAUDE F PEHOWSKI
875 GREENTREE ROAD
3 PARKWAY CENTER
PITTSBURGH, PA
412 921 8594
E KYLE COOPER
4447 N CENTRAL EXPRESSWAY
DALLAS, TEXAS
214 LA 1 1931
DAVID F BOOTH
3100 RICHMOND AVE
HOUSTON, TEXAS
713 524 3061

GENERAL ELECTRIC COMPANY

ELECTRONIC COMPONENTS SLS OPR

BRAND NAMES
ALUGARD
ALUMALYTIC
BONUS LINE
HI-BREAK
INDUCTROL
BYRANOL
TANTALYTIC
THE BIG LOOK
VAC-U-SEL
VOLT-PAC
COMPANY ADDRESS
1 RIVER ROAD
SCHENECTADY, NEW YORK 12305
SALES OFFICES
3550 N. CENTRAL AVENUE
SUITE 712, GUARANTY BANK BLD
PHOENIX, ARIZONA 85012
602 264-1751
11840 W. OLYMPIC BLVD.
LOS ANGELES, CALIF. 90064
213 BR 2-8566
555 VETERANS BLVD.
REDWOOD CITY, CALIF. 94063
415 369-7151
201 UNIVERSITY BLVD.
DENVER, COLO. 80206
303 388-5771
1285 BOSTON AVENUE
BRIDGEPORT, CONN. 06602
203 ED 4-1012
777 14TH STREET, N W
WASHINGTON, D. C. 20005
202 EX 3-3600
14 WEST GORE STREET
ORLANDO, FLORIDA 32806
305 425-8634
2106 S. LOIS AVENUE
P O BOX 10577
TAMPA, FLORIDA 33609
813 877-8311
3800 N. MILWAUKEE AVENUE
CHICAGO, ILL. 60641
312 777-1600
3606 S. CALHOUN STREET
FORT WAYNE, IND. 46806
219 744-2346
3750 N. MERIDIAN STREET
INDIANAPOLIS, IND. 46207
317 923-7221
210 SECOND STREET, S E
CEDAR RAPIDS, IOWA 52401
319 364-9149
31 ST. JAMES AVENUE
BOSTON, MASS. 02117
617 482-1800
17220 WEST 8 MILE ROAD
SOUTHFIELD, MICH. 78075
313 444-8977
4900 VIKING DRIVE, ROOM 108
MINNEAPOLIS, MINN. 55424
612 927-5458
106 W. 14TH STREET
KANSAS CITY, MO. 64105
816 221-4033
200 MAIN AVENUE
CLIFTON, N.J. 07014
201 472-8100
625 DELAWARE AVENUE
BUFFALO, N. Y. 14240
716 883-9210
425 NORTHERN BLVD.
GREAT NECK, N. Y. 11021
516 HN 6-8800
NORTHERN CONCOURSE OFFICE BLD
ROOM 112
NORTH SYRACUSE, N.Y. 13212
315 456-3412
129 TRADE ST., P O BOX 1969
CHARLOTTE, N.C. 28201
704 375-5571
25000 EUCLID AVENUE
CLEVELAND, OHIO 44117
216 266-2900
3430 S. DIXIE HIGHWAY
DAYTON, OHIO 45439
513 298-0311
3022 N W EXPRESSWAY
MAY-EX BLDG.
OKLAHOMA CITY, OKLA. 73112
405 943-9015
3 PENN CENTER PLAZA
PHILADELPHIA, PA. 19102
215 LO 8-1800

875 GREENTREE ROAD
3 PARKWAY CENTER
PITTSBURGH, PA. 15220
412 921-8594
1420 UNION AVENUE, ROOM 202
MEMPHIS, TENN. 38104
901 272-9641
4447 N. CENTRAL EXPRESSWAY
DALLAS, TEXAS 75205
214 LA 1-1931
CARROLL AVE., P D BOX 4217
LYNCHBURG, VA. 24501
703 846-7311
112 ANDOVER PARK EAST
P O BOX 6100
SEATTLE, WASH. 78051
206 CH 4-7750
615 EAST MICHIGAN STREET
MILWAUKEE, WISC. 53202
414 271-5000

GENERAL MICROWAVE CORPORATION

SALES MANAGER
MOR WIND
BRAND NAMES
TFT
COMPANY ADDRESS
155 MARINE STREET
FARMINGDALE, NEW YORK 11735
COMPANY REPRESENTATIVES
R F ASSOCIATES, INC
1621 PONTIUS AVE
LOS ANGELES, CALIF 90025
213 478 1586
BURLINGAME ASSOCIATES
7 WELLINGTON ST
WALTHAM, MASS 02154
617 894 1955
PALATINE ENG SALES, INC
8507 ST CHARLES ROCK RD
ST LOUIS, MD 63114
314 126 7055
BENNEWITZ ASSOCIATES
8310 CUTLER, NE
ALBUQUERQUE, N M 87110
505 299 8651
BERTRAM D AARON & CO
P O BOX 186
ROSLYN, N Y 11576
516 621 0630
DOOLITTLE ELECTRONICS CORP
P O BOX 97
FAYETTEVILLE, N Y 13066
315 637 3222
SYLVAN GINSBURY, LTD
72 W 45TH ST
NEW YORK, N Y 10036
212 MU 7 3213
M J MCDONALD CO
ROUTE 1
PFAFFTOWN, N C 27040
919 924 2182
ELECTRO SALES ASSOCIATES
DABEL STATION, BOX 143
DAYTON, OHIO 45420
513 426 5551
S & S ASSOCIATES
BORO LINE ROAD
KING OF PRUSSIA, PA 19406
215 265 3450
ARTHUR ENG SALES CO
11216 W MALLORY AVE
HALES CORNERS, WISC. 53130
414 GA 5 5919
REPS. IN OTHER COUNTRIES
ELECTRODESIGN, LTD
9124 ST LAWRENCE BLVD
MONTREAL 11, QUEBEC
514 389 5914

GENERAL RADIO COMPANY

SALES MANAGER
L. J. CHAMBERLAIN
BRAND NAMES
DURATRAK-R
ORTHONULL-R
STROBOTAC-R
SYNCHRONOMETER-R
VARIAC-R
COMPANY ADDRESS
22 BAKER AVENUE
W. CONCORD, MASS. 01781

GENERAL TELEVISION NETWORK

SALES MANAGER
R. RANDOLPH HIPPLER
BRAND NAMES
GIANTVIEW
COMPANY ADDRESS
901 LIVERNOIS
FERDALE, MICHIGAN 48220
COMPANY REPRESENTATIVES
JAN EDEN RECORDING & SOUND
1440 N MERIDIAN ST
INDIANAPOLIS, IND
638 1337
OHIO VALLEY SOUND
20 E CEDAR
EVANSVILLE, INDIANA
425 6173
AMERICAN SOUND SERVICE
675 WEST THIRD
COVINGTON, KENTUCKY
261 9024
BARNEY MILLERS INC
232 E MAIN STREET
LEXINGTON, KENTUCKY
252 9622
DOUGLAS TELEVISION CO
3804 LEXINGTON RD
LOUISVILLE, KY
895 3500
DOUGLAS TELEVISION CO
11715 MAIN ST
MIDDLETOWN, KY
245 4444

AUDIO COMMUNICATIONS CO
1191 WEINCKE ROAD
SAGINAW, MICHIGAN
793 1090
AUDIO EQUIPMENT COMPANY
15749 WYOMING AVE
DETROIT, MICHIGAN
864 1884
CLARKE H JDY CO
P O BOX 9695
BAY VILLAGE, OHIO
871 5900

GIBBS MANUFACTURING AND RESEARCH CORPORATION

VP SALES ENG
R. E. MDWRIS
PRODUCT SALES MANAGER
KENNETH D. SCOTT
COMPANY ADDRESS
459 NORTH MAIN STREET
JAMESVILLE, WISCONSIN 53545
COMPANY REPRESENTATIVES
TECH-SOURCES UNLIMITED
P O BOX 184
BURBANK, CALIF
213 849 6863
JAMES F HURLBUT CO
2240 50 ADAMS ST
DENVER, COLO 80210
303 756 2046
JAMES B GUTTRIDGE
2125 R STREET N W
WASHINGTON, D C 20008
202 667 2730
REYNOLDS & ASSOC INC
P O BOX 1043
EAU GALLIE, FLA
305 254-C520
M Q & ASSOCIATES
6713 N OLIPHANT AVE
CHICAGO, ILL 60631
312 774 8844
EDWARDS ASSOC
242 ST JOHNS AVE
NEW MARKET, NEW JERSEY 08854
201 752 2724
ALDEN W SMITH
PENURY PRIORY
DOYLESTOWN, PA
215 348 4651
R W MUREEN CO
5523 DYER STREET
DALLAS, TEXAS 75206
214 361 0735
CANE-JESSUP CO INC
P D BOX 250
BELLEVUE, WASH
206 454 0691

J. W. GIBSON CO., INC.

SALES MANAGER
DON A. OREAR
BRAND NAMES
MYSTIC
DERREASER
COMPANY ADDRESS
1255 WINDSOR STREET
INDIANAPOLIS, INDIANA

GOTHAM AUDIO CORPORATION

VICE PRESIDENT
HUGH S. ALLEN
BRAND NAMES
EMT
ELTRO
BEYER
DANNER
GOTHAM
KLEIN AND HUMMEL
LYREC
MULLER & WEIGER
NEUMAN
PREH
STUDER
TUCHEL
COMPANY ADDRESS
2 WEST 46TH STREET
NEW YORK, N. Y. 10036
212-265-4111
COMPANY REPRESENTATIVES
J-MAR ELECTRONICS, LTD
2 THORNCLIFFE PARK DR
TORONTO, 17, ONTARIO
416 421 9080

GRADO LABORATORIES, INC

COMPANY ADDRESS
4614 SEVENTH AVENUE
BROOKLYN, NEW YORK 11220

GRANTHAM SCHOOLS, INC.

PRESIDENT
DONALD J. GRANTHAM
COMPANY ADDRESS
1505 N. WESTERN AVE.
HOLLYWOOD, CALIF. 90027

GRAY RESEARCH & DEVELOPMENT CO.

SALES MANAGER
HY LEHRMAN
BRAND NAMES
GRAY
TELEJECTOR
TELOP
COMPANY ADDRESS
P.O. BOX 296
HARTFORD, CONN. 06101

GREENLEE TOOL COMPANY

SALES MANAGER
MARTIN J. TUCKETT
COMPANY ADDRESS
2136 TWELFTH STREET
ROCKFORD, ILLINOIS 61101

GREGORY AMPLIFIER CORP

SALES MANAGER
ROBERT A COHEN
BRAND NAMES
GREGORY
BRYAN
HANDI-AMP
ADD-VERB
COMPANY ADDRESS
3650 DYRE AVE
BRONX, N Y 10466
COMPANY REPRESENTATIVES
L H HARRIS
204 E HILLSDALE BLVD
SAN MATEO, CALIF
415 341 2909
GEO SMITH
188 BREWSTER RD
W HARTFORD, CONN
203 523 0512
LOREN F GREEN
5218 W DIVERSEY AVE
CHICAGO, ILLINOIS
312 AV 6 6824
ROBERT SMITH
59 VERNOLE ST
BROOKLINE, MASS
617 277 0017
KNAGGS-COLLINS-
HAVERCAMP & HEMPE INC
5818 N OAK TRAFFICWAY
BOX 10719
KANSAS CITY, MO
816 GL 3 3203
RONNY SINGER
102 SHORE VIEW DR
YONKERS, NEW YORK
914 779 2221
CARTWRIGHT & BEAN
560 S COOPER ST
MEMPHIS, TENN
901 276 4442

GRINMAN FIXTURE COMPANY

SALES MANAGER
JOHN F. GRINMAN
BRAND NAMES
GRINMAN
COMPANY ADDRESS
16041 GEORGETOWN ST. N.E.
MINERVA, OHIO 44657

GULF ELECTRO-SALES, INC.

COMPANY ADDRESS
7031 BURKETT STREET
HOUSTON, TEXAS 77021

G-V CONTROLS INC.

VP-MARKETING
GEORGE A. COMPTON
BRAND NAMES
G-V
COMPANY ADDRESS
101 OKNER PARKWAY
LIVINGSTON, N.J. 07039
COMPANY REPRESENTATIVES
A. R. TICE
13637 EAST BAILEY STREET
WHITTIER, CALIF.
213 696-4281
EDWARD McMULLEN
101 OKNER PARKWAY
LIVINGSTON, N.J. 07039
201 992-6200

HAMILTON HALL RESISTOR CORP

SALES MANAGER
KENNETH DEGNAN
BRAND NAMES
HALL-OHM
HALL-OHM
SERV-OHM
HALL-RITE
COMPANY ADDRESS
227 N. WATER STREET
MILWAUKEE, WISCONSIN 53202
COMPANY REPRESENTATIVES
FEATHERSTONE SALES CO
1355 MARKET ST
SAN FRANCISCO, CALIF
KL 2 2311
HENRY FELDMAN CO
P O BOX 66367
LOS ANGELES 66, CALIF
RI 9 8803
KOETHER-COX CO
1325 S INCA ST
DENVER 23, COLO
303 292 1466
KLEM-STEFFEN INC
417 HARRISON ST
OAK PARK, ILL 60204
312 921 1200
HOEMIG SALES CO
BUTLER COURT
FORT WAYNE, IND
219 483 6913
KANSAS SALES INC
Box 4116
OVERLAND PARK, KANSAS 66204
913 888 3200
W B BRAY SALES
ELM ST HOTEL 128
DEDHAM, MASS 02026
617 326 9220
DAVE MILSK CO
20110 OLYMPIA AVE
DETROIT, MICH 48240
313 KE 5 4012
L R MASSEY CO
BOX 724
GREENWOOD, MISS
GL 3 3038
T B LOWELL & ASSOC
BOX 26 CREVE COEUR

ST LOUIS, MO
314 MI 7 1111
S FISHER ELECTR SALES CORP
800 GREENWOOD AVE
BROOKLYN 18, N Y
768 2896
WILLIAM TAUBER
151 FAYETTE BLVD
SYRACUSE, N Y 13224
446 7094
C M FURMAN CO
1228 HARDING PLACE
CHARLOTTE, N C 28204
375 2332
H H SEAY CO
3850 FAIRLINDEN DR
COLUMBUS 21, OHIO
614 488 9994
HERMAN LEWIS CO
1510 PENN TOWERS
1801 PENNA BLVD
PHILADELPHIA, PA 19103
LO 7 2068
ANTLE SMITH SALES CO
P O BOX 20361
DALLAS, TEXAS
FL 7 7279
ELECTRONIC SALES
P O BOX 6535
SEATTLE, WASH 98116
WE 2 0330

HANCOCK TELECONTROL CORP

SALES MANAGER
WILLIAM E. BACON
BRAND NAMES
UNICON
COMPANY ADDRESS
143 SOUND BEACH AVENUE
DLO GREENWICH, CONN. 06830

HARTLEY PRODUCTS CORPORATION

PRESIDENT
ROBERT SCHMETTERER
BRAND NAMES
CAPRI
CONCERTMASTER
CONCERTMASTER JR.
HARTLEY-LUTH
HOLTON
HOLTON JR.
COMPANY ADDRESS
BARNETT PLACE
HO-HO-KUS, NEW JERSEY 07423
COMPANY REPRESENTATIVES
P H POWELL
3975 WESLIN AVENUE
SHERMAN OAKS, CALIF
213 ST 9-4078
ASSOCIATED ELECTRONICS
119 THE GREAT ROAD
BEDFORD, MASS
275-9020
C W DREESE & ASSOC
3710 CANTERBURY PL
INDEPENDENCE, MO
816 IN 1-7294
C C S BUTT
BOX 18045
HOUSTON, TEXAS 77023
JA 6-3101

HARVEY RADIO CO INC

SALES MANAGERS
ELI PASSIN
WALTER BACHMAN
FRANK RENALDI
COMPANY ADDRESS
60 CRDSSWAYS PARK WEST
WOODBURY, L. I. NEW YORK
COMPANY REPRESENTATIVES
FEDERAL FABRICATORS
VESTAL PARKWAY
BINGHAMTON, N.Y.
607-748-8211
HARVEY RADIO CO, INC
2 WEST 45TH STREET
NEW YORK, N.Y.
212 JU 2-1500

HARWAL COMPANY

SALES MANAGER
WILLIAM STELCHER
BRAND NAMES
INSPECT-O-FILM
PROTECT-O-FILM
CEMENT-O-FILM
SPlice-O-FILM
ADOMATIC
COMPANY ADDRESS
1245 CHICAGO AVE
EVANSTON, ILLINOIS 60202
312 328 7070

HARWOOD MFG CO

SALES MANAGER
J. H. LIPPMAN
BRAND NAMES
HARWOOD
COMPANY ADDRESS
446 W. SUPERIOR
CHICAGO, ILLINOIS 60610

HAYDEN BOOK COMPANY INC

SALES MANAGER
ALLAN E. BONDS
BRAND NAMES
HAYDEN BOOKS
RIDER BOOKS
JOHN F. RIDER BOOKS
RIDER PROGRAMMABLES
COMPANY ADDRESS
116 W. 14TH STREET
NEW YORK, NEW YORK 10011
COMPANY REPRESENTATIVES
SMDKIE CLENNY

GRAY

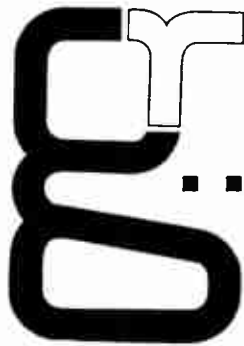

A DEFINITE
SUPERIORITY
IN BROADCAST
TONE ARMS

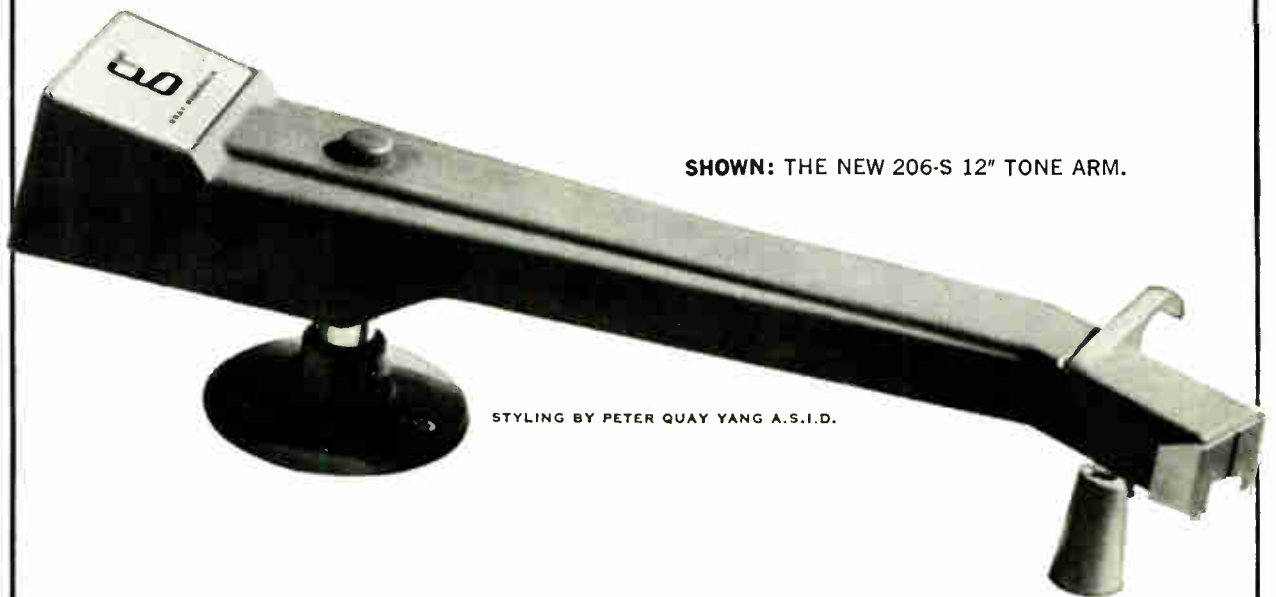

SHOWN: THE NEW 206-S 12" TONE ARM.

STYLING BY PETER QUAY YANG A.S.I.D.

The Gray Research family of quality products . . . The 208-S Tone Arm, The 602-C Broadcast Equalizer, The Telojector and The Telop, proudly announces its newest Member, The Gray 206-S, 12" professional broadcast Tone Arm.

WRITE or PHONE 203 289-2743

**GRAY RESEARCH AND DEVELOPMENT COMPANY, DIV.
BOX 296, HARTFORD, CONNECTICUT 06101**

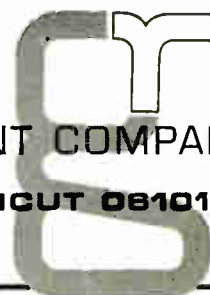

11256 BABBITT AVENUE
GRANADA HILLS, CALIF.
ROBERT KETZER
141 MISBRD WAY
KENWOOD, CALIFORNIA
PHILIP ALPERT
7742 SOUTH ESSEX
CHICAGO, ILLINOIS
WILLIAM J MARCUS
147-02 70TH ROAD
KEW GARDEN HILLS, NEW YORK
LEWIS HARRITON
BOX 54
MINISINK HILLS, PA.
ROBERT HOUSE
R. 2. LOT 2 RDUTE 1
GOODLETTSVILLE, TENNESSEE
WILLIAM R THOMAS
7313 DICKENSON STREET
SPRINGFIELD, VIRGINIA

HEATH COMPANY
DIRECTOR OF MARKETING
S. L. SHIPMAN
BRAND NAMES
HEATHKIT
COMPANY ADDRESS
BENTON HARBOR, MICH. 49022
616-983-3961

HEINTZ & KAUFMAN, LTD
SALES MANAGER
NATE BECKERMAN
BRAND NAMES
HEINTZ & KAUFMAN
COMPANY ADDRESS
3650 HAYDEN AVENUE
CULVER CITY, CALIF 90230

HEWLETT-PACKARD COMPANY
VP MARKETING
W. NOEL ELDRED
SALES MANAGER
JACK PETRAK
BRAND NAMES
OATAMEC
OELCON
DYMEC
HARRISON
HEWLETT-PACKARD
LPA
MOSELEY
SANBORN
COMPANY ADDRESS
1501 PAGE MILL ROAD
PALO ALTO, CALIF. 94304
COMPANY REPRESENTATIVES
HEWLETT-PACKARD
SOUTHERN SALES DIVISION
HOLIDAY OFFICE CTR., SUITE 18
HUNTSVILLE, ALABAMA 35801
205 881-4591
TWX 510 579-2204
HEWLETT-PACKARD
NEELY SALES DIVISION
3009 NO. SCOTTSDALE RD.
SCOTTSDALE, ARIZONA 85251
602 945-7611
TWX 602 949-0111
HEWLETT-PACKARD
NEELY SALES DIVISION
232 SD. TUCSON BLVD.
TUCSON, ARIZONA 85716
602 623-2564
TWX 602 792-2759
HEWLETT-PACKARD
NEELY SALES DIVISION
3939 LANKERSHIM BLVD.
N. HOLLYWOOD, CALIF. 91604
213 877-1282 AND 766-3811
TWX 910-499-2170
HEWLETT-PACKARD
NEELY SALES DIVISION
2391 CARLSBAD AVE.
SACRAMENTO, CALIF. 95821
916 482-1463
TWX 916-444-8683
HEWLETT-PACKARD
NEELY SALES DIVISION
1055 SHAFER STREET
SAN DIEGO, CALIF. 92106
714 223-8103
TWX 714-276-4263
HEWLETT-PACKARD
NEELY SALES DIVISION
1101 EMBARCADERO RD.
PALO ALTO, CALIF. 94303
415 327-6500
TWX 910-373-1280
HEWLETT-PACKARD
NEELY SALES DIVISION
7965 EAST PRENTICE
ENGLEWOOD, COLORADO 80110
303 771-3455
TWX 303-771-3056
HEWLETT-PACKARD
YEWELL SALES DIVISION
589 SAYBROOK RD.
MIDDLETOWN, CONN. 06458
203 346-6611
TWX 710-428-2036
HEWLETT-PACKARD
FLORIDA SALES DIVISION
2907 NORTHWEST 7TH ST.
MIAMI, FLORIDA 33125
305 635-6461
HEWLETT-PACKARD
FLORIDA SALES DIVISION
621 COMMONWEALTH AVE.
ORLANDO, FLORIDA 32803
305 425-5541
TWX 305-275-1234
HEWLETT-PACKARD
FLORIDA SALES DIVISION
410-150TH AVE., MADEIRA BEACH

ST. PETERSBURG, FLA. 33708
813 391-0211
TWX 813-391-0666
HEWLETT-PACKARD
SOUTHERN SALES DIVISION
3110 MAPLE DRIVE, N.E.
ATLANTA, GEORGIA 30305
404 233-1141
TWX 810-751-3283
HEWLETT-PACKARD
CROSSLEY SALES DIVISION
2501 WEST PETERSON AVE.
CHICAGO, ILLINOIS 60645
312 275-1600
TWX 910-221-0277
HEWLETT-PACKARD
CROSSLEY SALES DIVISION
3919 MEADOWS DR.
INDIANAPOLIS, IND. 46205
317 546-4891
TWX 317-635-4300
HEWLETT-PACKARD
SOUTHERN SALES DIVISION
SUITE 4, 3411 BARDSTOWN RD.
LOUISVILLE, KY, 40218
502 459-4140
TWX 810-535-3128
HEWLETT-PACKARD
HORMAN SALES DIVISION
6660 SECURITY BLVD.
BALTIMORE, MD. 21207
301 944-5400
HEWLETT-PACKARD
HORMAN SALES DIVISION
941 ROLLINS AVENUE
ROCKVILLE, MD. 20852
301 427-7560
TWX 710-828-9684
HEWLETT-PACKARD
YEWELL SALES DIVISION
MIDDLESEX TURNPIKE
BURLINGTON, MASS. 01804
617 272-9000
TWX 710-332-0382
HEWLETT-PACKARD
CROSSLEY SALES DIVISION
14425 WEST EIGHT MILE ROAD
DETROIT, MICH. 48235
313 342-5700
TWX 313-342-0702
HEWLETT-PACKARD
CROSSLEY SALES DIVISION
842 RAYMOND AVENUE
ST. PAUL, MINN. 55114
612 646-7881
TWX 910-563-3734
HARRIS-HANSON COMPANY
7916 PASEO STREET
KANSAS CITY, KANSAS 64131
816 444-9494
TWX 816-556-2423
HARRIS-HANSON COMPANY
2814 S. BRENTWOOD BLVD.
ST. LOUIS, MO. 63144
314 647-4350
TWX 314-962-3933
HEWLETT-PACKARD
ROBINSON SALES DIVISION
SHREWSBURY, NEW JERSEY
201 747-1060
HEWLETT-PACKARD
RMC SALES DIVISION
391 GRAND AVENUE
ENGLEWOOD, N.J. 07631
201 567-3933
HEWLETT-PACKARD
NEELY SALES DIVISION
6501 LOMAS BLVD., N.E.
ALBUQUERQUE, N.M. 87108
505 255-5586
TWX 910-989-1665
HEWLETT-PACKARD
NEELY SALES DIVISION
114 S. WATER STREET
LAS CRUCES, N.M. 88001
505 526-2486
TWX 505-524-2671
HEWLETT-PACKARD
RMC SALES DIVISION
236 EAST 75TH STREET
NEW YORK, N.Y. 10021
212 879-2023
TWX 710-581-4376
HEWLETT-PACKARD
SYRACUSE SALES DIVISION
800 LINCOLN AVENUE
ROCHESTER, N.Y. 14625
716 381-4120
TWX 716-221-1514
HEWLETT-PACKARD
SYRACUSE SALES DIVISION
82 WASHINGTON STREET
POUGHKEEPSIE, N.Y. 12601
914 454-7330
TWX 914-452-7425
HEWLETT-PACKARD
SYRACUSE SALES DIVISION
5858 EAST MOLLOY RD.
SYRACUSE, N.Y. 13211
315 454-2486
TWX 710-541-0482
HEWLETT-PACKARD
SOUTHERN SALES DIVISION
1923 N. MAIN STREET
HIGH POINT, N.C. 27622
919 882-6873
TWX 510-926-1516
HEWLETT-PACKARD
CROSSLEY SALES DIVISION
5579 PEARL ROAD
CLEVELAND, OHIO 44129
216 884-9209
TWX 216-888-0715
HEWLETT-PACKARD
CROSSLEY SALES DIVISION
1250 W. DOROTHY LANE

DAYTON, OHIO 45409
513 299-3594
TWX 513-944-0090
HEWLETT-PACKARD
ROBINSON SALES DIVISION
CAMP HILL, PA.
717 737-6791
HEWLETT-PACKARD
ROBINSON SALES DIVISION
144 ELIZABETH STREET
W. CONSHOHOCKEN, PA. 19428
215 248-1600 AND 828-6200
TWX 215-828-3847
HEWLETT-PACKARD
CROSSLEY SALES DIVISION
2545 MOSS SIDE BLVD.
MONROEVILLE, PA. 15146
412 271-5227
TWX 710-797-3650
HEWLETT-PACKARD
SOUTHWEST SALES DIVISION
P.O. BOX 7166, 3605 INWOOD RD
DALLAS, TEXAS 75209
214 357-1881 AND 332-6667
TWX 910 861-4081
HEWLETT-PACKARD
SOUTHWEST SALES DIVISION
P O BOX 22813
4242 RICHMOND AVE
HOUSTON, TEXAS 77027
713 667 2407
TWX 713 571 1353
HEWLETT-PACKARD
NEELY SALES DIVISION
1482 MAJOR STREET
SALT LAKE CITY, UTAH 84115
801 486-8166
TWX 801-521-2604
HEWLETT-PACKARD
SOUTHERN SALES DIVISION
2112 SPENCER ROAD
RICHMOND, VIRGINIA 23230
703 282-5451
TWX 710-956-0157
HEWLETT-PACKARD
NEELY SALES DIVISION
11656 N.E. 8TH STREET
BELLEVUE, WASH. 98004
206 454-3971
TWX 910-443-2303
HEWLETT-PACKARD
CONTRACT MARKETING DIV.
OLMSTED PLAZA
MIDDLETOWN, PA. 17057
717 944-7401
TWX 717-760-4816
HEWLETT-PACKARD
CONTRACT MARKETING DIV.
144 ELIZABETH STREET
W. CONSHOHOCKEN, PA. 19428
215 753-1811
TWX 215-820-3847
HEWLETT-PACKARD
CONTRACT MARKETING DIV.
225 BILLY MITCHELL ROAD
SAN ANTONIO, TEXAS 78226
512 434-4171
TWX 512-571-0955
REPS. IN OTHER COUNTRIES
HEWLETT-PACKARD LTD. - CANADA
2184 W. BROADWAY
VANCOUVER, B C
604 738 7520
TWX 610 922 5059
HEWLETT-PACKARD LTD. - CANADA
8270 MAYRAND STREET
MONTREAL, QUEBEC
514 735-2273
TWX 610-421-3484
HEWLETT-PACKARD LTD. - CANADA
1762 CARLING AVENUE
OTTAWA, ONTARIO
613 722-4223
TWX 610-562-1952
HEWLETT-PACKARD LTD. - CANADA
1415 LAWRENCE AVENUE WEST
TORONTO, ONTARIO
416 249-9196
TWX 610-492-2382
**THE HICKOK ELECTRICAL
INSTRUMENT COMPANY**
VICE PRES MARKETING
K F PETERSEN
COMPANY ADDRESS
10514 DUPONT AVENUE
CLEVELAND, OHIO 44108
COMPANY REPRESENTATIVE
HICKOK ELECT INST CO
1124 W MAGNOLIA BLVD
BURBANK, CALIF 91502
213 842 2145
HICKOK ELECT INST CO
46 TRAYNOR ST
HAYWARD, CALIF 94544
415 582 7179
HUGHES INTERNATIONAL
BLDG 334, M/S 40,
CENTINELA & TEALE
CULVER CITY, CALIF 90230
213 391 0711
GOROON MOSS ELECTRONICS
BOX 26172
DENVER, COLORADO 80226
303 936 4027
HOLLINGSWORTH & STILL INC
1010 EXECUTIVE CTR DR
ORLANDO, FLA 32803
305 241 5401
HOLLINGSWORTH & STILL INC
3098 PIEDMONT RD N E
ATLANTA, GEORGIA 30305
404 261 5838
GENE PIETY FACTORS INC
160 MOKAUEA ST BOX 2903
HONOLULU, HAWAII

810 185
HICKOK ELECT INST CO
7416 W BELMONT AVE
CHICAGO, ILL 60634
312 237 1373
LDWELL, KANGAS & ASSOC INC
BOX 4116
OVERLAND PARK, KANSAS 66204
913 888 3200
MORRIS-CUNNINGHAM ASSOC
720 E 65TH ST
INDIANAPOLIS, IND 46220
317 255 2458
EARL K MOORE CO
BOX 24430
NEW ORLEANS, LA 70124
504 488 2407
JOHNSON ASSOCIATES
81 MERRIMACK ST
LDWELL, MASS 01852
617 452 0413
JOHNSON ASSOCIATES
471 WASHINGTON ST
WILLESLEY HILLS, MASS
617 235 3977
NICK J LAUB
3749 BROADWAY WEST
MINNEAPOLIS, MINN 55422
612 588 4663
KELLY-SCHMITZ-WINKELER
2319 HAMPSTON AVE
ST LOUIS, MO 63110
314 781 6111
HICKOK ELECT INST CO
117 GERTRUDE AVE
PARAMUS, N J 07652
212 947 8016
GOROON MOSS ELECTRONICS
2418 BARCELONA DR S W
ALBUQUERQUE, N M 87105
505 877 9292
R W MITSCHER CO INC
496 ELLICOTT SQ BLDG
BUFFALO, N Y 14203
716 854 2517
R W MITSCHER CO INC
R.F.O. ROUTE 82A
SALTPONT, N Y
914 266 5875
R W MITSCHER CO INC
606 FOREST DRIVE
N SYRACUSE, N Y 13212
315 458 1321
HOLLINGSWORTH & STILL INC
6717 WOODSTOCK
CHARLOTTE, N C 28210
704 523 3327
HICKOK ELECT INST CO
10514 DUPONT AVE
CLEVELAND, OHIO 44108
216 541 8060
HAYS COMPANY
BOX E
RICHARDSON, TEXAS
214 231-1426

S. HIMMELSTEIN ANO COMPANY
SALES MANAGER
S. HIMMELSTEIN
BRAND NAMES
IMPELLOR
COMPANY ADDRESS
2500 ESTES AVENUE
ELK GROVE VILLAGE, ILL. 60007
COMPANY REPRESENTATIVES
KITTLESON COMPANY
416 N. LABREA AVE
LOS ANGELES, CALIF 90036
213- WE 3-7371
KITTLESON COMPANY
809 SAN ANTONIO RD
PALO ALTO, CALIF.
415-326-7410
EQUIPMENT SALES CO. INC.
P. O. BOX 6098
NEW HAVEN, CONN. 06517
203-248-5581
I B L ENGRING & SALES INC.
1444 CALHOUN ST
NEW ORLEANS, LA. 70118
504-895-4793
EQUIPMENT SALES CO, INC.
DANVERS, MASS
617-774-2400
ELECTRO SALES ASSOC. INC.
15324 MACK AVE
DETROIT, MICHIGAN 48224
313-886-2280
ELECTRO SALES ASSOC. INC.
335 EAST 200TH ST
CLEVELAND, OHIO 44119
216-486-1140
ELECTRO SALES ASSOC. INC.
DABEL STATION BOX 143
DAYTON, OHIO 45420
513-426-5551
I B L ENGRING & SALES INC.
5149 EAST 31ST ST.
TULSA, OKLAHOMA 74135
918 WE 6-6305
ELECTRO SALES ASSOC. INC.
201 PENN CENTER BLVD
PITTSBURGH, PENN 15235
412-371-9449
I B L ENGRING & SALES INC.
219 PRESTON ROYAL CENTER
SUITE 6
DALLAS, TEXAS 75230
214-EM 3-2921
I B L ENGRING & SALES INC.
3403 AUDUBON RD, 5
HOUSTON, TEXAS 77006
713 JA 3-8360
I B L ENGRING & SALES INC.
1903 WEST 34TH ST

When you want high efficiency delay lines specify **Kappa Super-η***



*SUPER-η LINES embody a new design principle providing the highest efficiency yet obtainable in lumped constant delay lines. Use of network synthesis techniques rather than conventional m-derived methods results in sharply improved delay line efficiency. Compared to ordinary lines of any given delay, KAPPA SUPER-η lines provide linear performance over a much greater band width. In addition these newly developed lines offer such outstanding advantages as: greater inherent reliability, smaller package size, and appreciable cost reduction.

SUPER-η LINES FOR VIDEO SYSTEMS

Impedance: 75 ohms (unless otherwise specified)
Amplitude Response: better than 0.1 db. flatness to 10 MHZ or higher
Ripple: within $\pm .05$ db to 10 MHZ or higher
Group Delay: linear within $\pm 1\%$ or \pm Insec, whichever is greater.
Group Delay Ripple: within $\pm 2\frac{1}{2}\%$ to 14 MHZ
K factor: better than .25% for T or 2T sin² pulse for both American and European systems
Cross talk: less than 46 db.

UPDATE YOUR VIDEO BROADCAST EQUIPMENT WITH KAPPA SUPER-η DELAY LINES!

Specify KAPPA for the most complete line of electro-magnetic delay lines...

STANDARD LUMPED CONSTANT DELAY LINES SERIES LC



Delay: 50 Nanoseconds to 1 second
 Bandwidth: DC to 250 MHZ
 Rise Time: As low as 2 Nanoseconds
 Impedance: 25 ohms to 50 K ohms

TRANSPONDER LINES SERIES C



Tap Spacing: 1.45 μ sec, or as required
 Tap Tolerance: $\pm .05$, or as required
 Delay-to-Rise-Time Ratio: 100 max.
 Temperature Stability: 50 ppm. °C or less

LOW DISTORTION LINES SERIES D



Distortion at Output: 2% max.
 Distortion at Taps: Less than 5% at any tap
 Distortion Limit: As low as 0.1% if required
 Delay Range: up to 100 usec.

PRECISION AUDIO DELAY LINES SERIES A



Delay Range: from 500 μ sec to 1 sec.
 Bandwidth: 70 KHZ (max.)
 Delay Linearity: nominally within $\pm 0.25\%$ available to within $\pm 0.05\%$

PRECISION DECADE DELAY UNITS SERIES DK

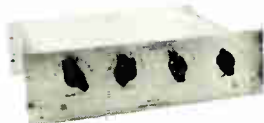

Variable delays available between input and output terminals in decade steps. Each decade has eleven (11) switch contacts and ten (10) delay increments so that the dial values overlap.

ULTRA MINIATURE DELAY LINES SERIES T



Delay Range: to 200 nsec.
 Delay/Rise Time: 10 max.
 Attenuation: .2 db max.
 Fully encapsulated

STANDARD DISTRIBUTED CONSTANT DELAY LINES SERIES DC



Delay Range: to 3 μ sec.
 Standard Tolerance: $\pm 5\%$ on Delay
 Delay-to-Rise-Time Ratio: 11 max.
 Distortion: $\pm 5\%$ (typical), $\pm 10\%$ max.

DELAY TRIMMERS: TINY TRIM[®] SERIES



Size: 1/4 Cubic Inch

PART NUMBER	SHIFT RANGE @ 3.58 MHZ	DELAY (Nano-sec.)	RISE TIME (Nano-sec.)	IMPEDANCE (ohms)
TT20D	25	20	5	500
TT30C	38	30	7.5	390
TT40D	50	40	10	500
TT50C	64	50	12.5	390
TT60C	75	60	15	330

Contact us for the name of your nearest representative or consult listing in this directory. Complete new catalog available.

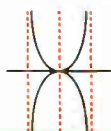

KAPPA NETWORKS, INC.

Delay Line Specialists • Manufacturing Engineers

165 ROOSEVELT AVENUE • CARTERET, NEW JERSEY 07008 • TEL. (201) 541-4226

D. S. LINZ
238 SHELMIER ST
PHILADELPHIA, PA.
215-ES 9-0734
PARVIN SALES CO.
BOX 307
ADDISON, TEX.
214-363-8596
R. JOHNSTON CO.
1011 NORTHEAST 69TH ST
SEATTLE, WASH.
LA 4-5170
REPS. IN OTHER COUNTRIES
E. S. GOULD LTD.
11 LOUVAIN ST.
MONTREAL, QUE.
514-288-5225

IMPEX ELECTRONICS CORPORATION
SALES MANAGER
H. ROBBINS
BRAND NAMES
IMPEX
COMPANY ADDRESS
213 SO. ROBERTSON BLVD.
BEVERLY HILLS, CALIF.

INDUSTRIAL DEVICES, INC.
SALES MANAGER
BERNARD SCHNOLL
BRAND NAMES
OMNI-GLOW
GLO-DOT
MINI-SLIDE
MINI-CATOR
LINE-O-LITE
SAFE-T-KLIP
COMPANY ADDRESS
EDGEWATER, N.J. 07020

INDUSTRIAL ELECTRIC REELS, INC.
SALES MANAGER
J C COSTELLO
BRAND NAMES
PORT-O-REELS
SPRING-O-MATIC
COLLECTRIC
COMPANY ADDRESS
1509 CHICAGO ST
OMAHA, NEBRASKA 68102
402 341 4600

INSTRUMENT LABORATORIES CORP.
COMPANY ADDRESS
315 WEST WALTON PLACE
CHICAGO, ILLINOIS 60610

INTERNATIONAL GOOO MUSIC INC.
SALES MANAGER
ROGAN JONES, JR.
BRAND NAMES
IGM
COMPANY ADDRESS
BDX 943,
BELLINGHAM, WASHINGTON 98225
206-733-4567
SALES REPRESENTATIVES
ROBERT POPKE
322 EUCLID
HIGHWOOD, ILLINOIS
312 433 1253
JOSEPH CURCIO
155-B GRANDVIEW AVE
FORDS, NEW JERSEY
201 442 2301
JOE TOMER
7542 MILLBROOK RD
COLUMBIA, S C
803 787 2597
IRVING LAW, JR
5585 BROADVIEW
TACOMA, WASH
206 927 3483

INTERNATIONAL NUCLEAR CORP
SALES MANAGER
GUY SWINDEL
COMPANY ADDRESS
608 MORRIS AVENUE
NASHVILLE, TENN 37204

INTERNATIONAL RECTIFIER
SALES MANAGER
ROBERT J. MUELLER
COMPANY ADDRESS
233 KANSAS STREET
EL SEGUNDO, CALIF. 90245
EXPORT DIVISION
INTERNATIONAL RECTIFIER
P O BOX 227
FORT LEE, NEW JERSEY
201 947 3311
COMPANY REPRESENTATIVES
SHEFLER-KAHN CO
2016 N 7TH ST
PHOENIX, ARIZONA
602 258-7893
TWX 602 255 0226
INTERNATIONAL RECTIFIER
2158 E MIDDLEFIELD RD
MOUNTAIN VIEW, CALIF
415 969 0660
INTERNATIONAL RECTIFIER
401 E MANCHESTER
LOS ANGELES, CALIF
213 678 2181
HYTRONIC MEASUREMENTS INC
1295 S BANNOCK ST
DENVER, COLO
303 733 3701
TWX 303 292 3052
INTERNATIONAL RECTIFIER
4230 S W 15TH ST
MIAMI, FLORIDA
305 445 5201

LOUIS D COHEN Y CIA
EXPORT - VENEZUELA
5323 SW 8TH STREET
MIAMI, FLORIDA
444-5111
INTERNATIONAL RECTIFIER
6453 LINCOLN AVE
CHICAGO, ILL
312 676 4090
INTERNATIONAL RECTIFIER
8605 CAMERON ST
SILVER SPRING, MARYLAND
301 589 3305
INTERNATIONAL RECTIFIER
361 MASSACHUSETTS AVE
ARLINGTON, MASS
617 643 7608
INTERNATIONAL RECTIFIER
26789 WOODWARD AVE RM 205
HUNTINGTON WOODS, MICH
313 548 1144
INTERNATIONAL RECTIFIER
5009A EXCELSIOR BLVD
MINNEAPOLIS, MINN
612 927 1200
INTERNATIONAL RECTIFIER
47 VILLAGE SQUARE
HAZELWOOD, MO.
314 838 6333
INTERNATIONAL RECTIFIER
1580 LEMOINE AVE
FORT LEE, N J
201 947 3311
SHEFLER-KAHN CO
408 PENNSYLVANIA ST S E
ALBUQUERQUE, NEW MEXICO
505 265 7077
INTERNATIONAL RECTIFIER
PAIKIN BLDG 2366 JAMES ST
SYRACUSE, N Y
315 437 8495
INTERNATIONAL RECTIFIER
1001 LEADER BUILDING
CLEVELAND, OHIO
216 771 5562
INTERNATIONAL RECTIFIER
3490 S DIXIE DR
KETTERING, OHIO
513 299 2635
INTERNATIONAL RECTIFIER
SUITE 208 SUBURBAN SQ BLDG
ARDMORE, PENN
215 475 5931
INTERNATIONAL RECTIFIER
811 S CENTRAL EXPRESSWAY
SUITE 253
RICHARDSON, TEXAS
214 231 2504
HYTRONIC MEASUREMENTS INC
2022 S MAIN ST
SALT LAKE CITY, UTAH
801 466 4294
ELECTRONIC SALES INC
6969 CALIFORNIA AVE SW
P O BOX 6535
SEATTLE, WASH
206 932 0330
REPS. IN OTHER COUNTRIES
M I PTY LTD
JOHANNESBERG TRANSVAAL
SOUTH AFRICA
USHA RECTIFIER CORP INDIA LTD
JEEVAN VIHAR
3, PARLIAMENT STREET
NEW DELHI 1, INDIA
40115
INTL RECTIFIER CORP JAPAN LTD
NISHIBA BUILDING
24, 1-CHROME KANDA SUDA-CHO
CHIYODA-KU
TOKYO, JAPAN
252 8991
SOLAR ELECTRONIC CENTER
129-A IBA STREET
QUEZON, PHILIPPINES
EL GALLITO COMMERCIAL
2DA AVENIDA ENTRE
CALLES 4 Y 6
SAN JOSE, COSTA RICA
2436/5967/7605
ELECTRONICA INDUSTRIAL
SALVADORENA
19 AVENIDA NORTE 312
SAN SALVADOR, EL SALVADOR
5557
ACCESORIOS ELECTRONICOS
APARTADO NO 614
TEGUCIGALPA, HONDURAS,
2-0656
SR GUILLERMO A VILORIA
P O BOX 1324
PANAMA, REPUBLIC OF PANAMA
2-3813-3474
ING OTFRIED RIEGER
10 MARKERGASSE
VIENNA III, AUSTRIA
73 46 84
INTL RECTIFIER EUROPE S A
38 AV DES ARTS
BRUSSELS 4, BELGIUM
11 17 38
INTERNATIONAL RECTIFIER A/S
TORDENSKJOLDSGADE 17
COPENHAGEN, DENMARK
11 25 77
OY FLINKENBERG AB & CO
BULEVARDI 28
HELSINKI, FINLAND
63 06 86
INT RECT CORP FRANCE S A R L
7 AV GEORGE V
PARIS 8E, FRANCE
225 73 82
INTERNATIONAL RECTIFIER GMBH
GUALETSTRASSE 15
FRANKFURT/MAIN 1, GERMANY

72 92 86
INTERNATIONAL RECTIFIER CO
GB LIMITED
HURST GREEN
OXFED, SURREY, ENGLAND
3125
INTERNATIONAL RECTIFIER CORP
ITALIANA SPA
84, STRADA DI LANZO
BORGARO/TORINESE, ITALY
57 20 85
N V DIODE
EMMASTRAAT 36A
HILVERSUM, NETHERLANDS
14 121
J M FEIRING AS
LILLETORVET 1
OSLO 1, NORWAY
41 43 45
ELECTROTECNICOS REUNIDOS LDA
AVENIDA DUQUE DAVILA 65
LISBON, PORTUGAL
41161
M GABARRO S A
RBLA CATALUNA 80
BARCELONA-8, SPAIN
215 19 00
A B NORDQVIST & BERG
SNOILSKYVAGEN 8
STOCKHOLM-K, SWEDEN
520050
INTERELECTRONIC E OERTLI
KIRCHENWEG 5
ZURICH 32, SWITZERLAND
34 84 47
MICHAEL PRUZAN INC
2 PRAGUE STREET
TEL-AVIV, ISRAEL
242756
DOUGLAS RANDALL OF CANADA LTD
126 MANVILLE ROAD
SCARBOROUGH, ONTARIO
416 751-7911
TWX 610-492-1382
DOUGLAS RANDALL OF CANADA LTD
1253 MCGILL COLLEGE
MONTREAL, QUEBEC
861-0562
INDUSTRIAS COMERCIALES SA
MEDELLIN 184
MEXICO 7, O.F., MEXICO
14-65-58/14-65-66
WARBURTON FRANKI INDUSTRIES
SYDNEY PTY LTD
307-315 KENT STREET
SYDNEY, AUSTRALIA
ARNOLD & WRIGHT LTD
171-173 TARANAKI STREET
WELLINGTON C3, NEW ZEALAND
54-078
RAYO ELECTRONICA SRL
BELGRANO 99D-60P,
BUENOS AIRES, ARGENTINA
38-1799/37-9476
PRODELEC S A
CAIXA POSTAL 12863
VILA MARIANA
SAO PAULO, BRAZIL
7-5729/7-7025
ALBERTO BEUTLER Y BOHMER LTDA
CASILLA 9483
SANTIAGO, CHILE
89141
ELECTROCENTROS LTDA
APARTADO AEREO 14312
BOGOTA, D.E., COLOMBIA
444-443/445-688/445-882
INTESA SA
P O BOX 5754
CORREO CENTRAL
LIMA, PERU
36539-PUEBLO LIBRE
SR HORACIO ASCMERI PETROCELLI
BOULEVAR GRAL.
ARTIGAS 635, AP 2
MONTEVIDEO, URUGUAY
LOUIS D COHEN Y CIA
FELIPE ELBERTO LOPEZ
APARTADO POSTAL 8363
CARACAS, VENEZUELA

IRC, INC.
VP, SALES & MARKETING
J. BURTON HENRY
BRAND NAMES
AMMO-PAK
CUBETRIM
EPIC
GBT
GRIP STRIP
MICROSTAK
NINEL-R
PRECISTOR
RESISTEG
REVODEX
SELECTREZ
COMPANY ADDRESS
401 N. BROAD STREET
PHILADELPHIA, PA. 19108
215 WA 2-8900
COMPANY REPRESENTATIVES
CARL HOWER & CO
P O BOX 1627
431 N WINFIELD SCOTT PLAZA
SCOTTSDALE, ARIZ 85252
602 947 4204
TWX 610 835 1281
JACK LOGAN & ASSOCIATES
801 MAHLER ROAD
BURLINGAME, CALIF 94010
415 697 5100
TWX 910 375 3382
ELLIOTT RECHT ASSOC
175 SO SAN ANTONIO ROAD
LOS ALTOS, CALIF
415 941 0336

TWX 415 949 7921
IRC SALES OFFICE
14827 VENTURA BLVD
SHERMAN OAKS, CALIF 91403
213 981 7722
TWX 213 783 2542
ELECTRONIC COMPONENT SALES CO
2340 W MAIN ST
LITTLETON, COLO 80120
303 798 8481
TWX 303 798 8114
RAY PERRON & CO
10 BRIARWOOD ROAD
FARMINGTON, CONN 06032
203 OR 7 9025
RAY PERRON & CO
36 LOUIS ST
TRUMBULL, CONN 06611
203 AM 8 9631
HOLLINGSWORTH & STILL
1010 EXECUTIVE CENTER DR
ORLANDO, FLA 32803
305 241 5401
TWX 305 841 3357
HOLLINGSWORTH & STILL
2098 PIEDMONT RD, NE
ATLANTA, GA 30305
404 261 5835
DOUGHERTY ENTERPRISES
1164 WAIMANU ST
P O BOX 3497
HONOLULU, HAWAII 96811
504 987
IRC SALES OFFICE
6020 DIVERSEY AVE
CHICAGO, ILL 60639
312 TU 9 5800
TWX 312 265 1206
MACNABB, SCHROEGER & LOOMIS
820 E 64TH ST
INDIANAPOLIS, INO 46220
317 251 4471
TWX 317 634 8747
MACNABB, SCHROEGER & LOOMIS
1123 W WILDWOOD
FORT WAYNE, IND 46800
219 745 8609
HALGIN SALES CO
5640 BUENA VISTA BOX 1245
MISSION, KANSAS 66222
913 RA 2 2441
TWX 913 552 7300
JACK F MCKINNEY SALES CO
2012 CONDON AVE
METAIRIE, LOUISIANA 70003
504 833 0976
RAY PERRON & CO
1870 CENTRE ST
BOSTON, MASS 02132
617 FA 3 1008
TWX 617 325 8627
S STERLING CO
21250 1D 1/2 MILE ROAD
SOUTHFIELD, MICH 48076
313 357 3700
TWX 313 357 4615
THE HEIMANN CO, INC
5603 LYNDALE AVE, S
MINNEAPOLIS, MINN 55419
612 827 5457
TWX 612 321 1053
NORTHPORT ENGINEERING, INC
2027 GRAND AVE
ST PAUL, MINN 55105
612 698 3841
TWX 612 551 0002
SMITH ENGINEERING ASSOC
2278 COMO AVENUE
ST PAUL, MINN 55108
HALGIN SALES CO
201 S CENTRAL AVE
CLAYTON, MO 63837
314 PA 1 4415
TWX 314 556 0520
RAY PERRON AND CO
19 CARON ROAD
RFD # 2
MANCHESTER, N H 03102
603 472 4091
ELCOM
P O BOX 3087 STA D
ALBUQUERQUE, N M 87100
505 344 8130
TWX 505 243 8378
IRC SALES OFFICE
1967 TURNBULL AVE
NEW YORK, N Y 10473
212 597 5500
TWX 212 824 7980
HOLLINGSWORTH & STILL
6717 WOODSTOCK DR
CHARLOTTE, N C 28200
704 723 3372
BAEHR-GREENLEAF ASSOC
9505 MONTGOMERY RD
CINCINNATI, OHIO 45242
513 426 5485
BAEHR-GREENLEAF ASSOC
14700 DETROIT AVE
CLEVELAND, OHIO 44107
216 AC 1 9030
BAEHR-GREENLEAF & ASSOC
3550 MAPLEWOOD DR
XENIA, OHIO 45385
513 426 5485
JACK F MCKINNEY SALES CO
P O BOX 3958
TULSA, OKLAHOMA 74101
918 742 4595
C K SHANKS & ASSOC
3104 S W 87TH AVE
PORTLAND, ORE 97225
503 292-5656
IRC SALES OFFICE
401 N BROAD ST
PHILADELPHIA, PA 19109

**You'll never
get a
blue face
from us.**



. . . nor a red one either, because there's no need to worry about your color signal when you use our TSA1 Clamping/Equalizing Video Amplifier. Tip clamping does it. No disturbance of color burst or other chrominance information in or about blanking or back porch levels. Gain . . . continuously adjustable from zero output to 6 db with no bounce. 28 db gain also available. Sync stretching or compressing. White stretching and clipping. All solid state. Fits standard rack. Heck man, don't take our word for it . . . TAKE 30 DAYS AND TRY IT OUT . . . AT OUR EXPENSE!

PRICE: \$850.00 EACH, F.O.B. NASHVILLE, TENN.

28 db gain \$75.00 additional, designated TSA1HG



We invite your inquiry . . . please write:

INTERNATIONAL NUCLEAR CORPORATION

"Transistorizing the Television Industry"

608 NORRIS AVENUE • NASHVILLE, TENN. • PHONE 615-254-3365

215 WA 2 8900
 TWX 215 569 8924
 COVERT & NEWMAN CD
 300 MT LEBANDN BLVD
 PITTSBURGH, PA 15234
 412 531 4471
 JACK F MCKINNEY SALES CO
 5458 EOITH ST
 BELLAIRE, TEXAS 77401
 713 665 3653
 JACK F MCKINNEY SALES CO
 1303 CHEMICAL ST
 DALLAS, TEXAS 75207
 214 WE 1 9450
 TWX 214 861 4232
 W T BLACKBURN ASSOC
 SEMICONDUCTORS ONLY
 P O BOX 20073
 DALLAS, TEXAS 75229
 214 FL 1 9991
 TWX 214 899 8518
 ELCOM
 P O BOX 2066
 SALT LAKE CITY, UTAH 84110
 801 262-3700

ITI ELECTRONICS, INC.
 SALES MANAGER
 W. FORD
 COMPANY ADDRESS
 369 LEXINGTON AVE.
 CLIFTON, N. J. 07315
 GREGORY 3-09000

ITT CANNON ELECTRIC
OIV INTERNATIONAL TELEPHONE
AND TELEGRAPH CORPORATION
 VP, DIRECTOR-MARKETING
 V. B. BENFER
 BRAND NAMES
 BOWSPRING
 CANNON R
 CENTI-B
 CENTI-K
 CENTI-LDC
 CENTI-STRIP
 CRIMP IMP
 DUAL-SHORE R
 GOLDEN-D
 MICROPIN R
 MICROSOCKET R
 MILLSOCKET
 MORPHO R
 NANO-K
 NANOSTRIP
 POS-ALINE R
 RING-LOC
 ROYAL-D
 50-MIL STRIP
 CAM-RAC
 MILSTRIP
 BUG PLUG
 COMPANY ADDRESS
 3208 HUMBOLDT STREET
 LOS ANGELES, CALIF 90031
 SALES/ENGINEERING OFFICES
 ITT CANNON ELECTRIC
 HOLIDAY OFFICE CENTER
 MEMORIAL PARKWAY
 HUNTSVILLE, ALABAMA 35801
 205 881-4740
 ITT CANNON ELECTRIC
 3625 N. 16TH ST SUITE 121
 PHOENIX, ARIZONA 85016
 602 264-5056
 ITT CANNON ELECTRIC
 1845 S. MANCHESTER AVE
 ANAHEIM, CALIF 92802
 714 638-0770
 ITT CANNON ELECTRIC
 2836 N. FIGUEROA ST
 LOS ANGELES, CALIF 90065
 213 225-1251
 ITT CANNON ELECTRIC
 96D SAN ANTONIO RD RM 13
 PALO ALTO, CALIF 94303
 415 323-9057
 ITT CANNON ELECTRIC
 2420 UNIVERSITY AVE
 SAN DIEGO, CALIF 92104
 714 297-3595
 ITT CANNON ELECTRIC
 300 E. HAMPDEN AVE SUITE 222
 ENGLEWOOD, COLO 80110
 303 761-1474
 ITT CANNON ELECTRIC
 730 HOPMEADOW STREET
 SIMSBURY, CONN 06070
 203 658-4435
 ITT CANNON ELECTRIC
 999 WOODCOCK RD SUITE 304
 ORLANDO, FLORIDA 32803
 305 841-4862
 ITT CANNON ELECTRIC
 1447 PEACHTREE ST N E,
 SUITE 1006
 ATLANTA, GEORGIA 30309
 404 873 2984
 DOUGHERTY ENTERPRISES
 P O BOX 3497
 1164 WAIMANU ST
 HONOLULU, HAWAII
 ITT CANNON ELECTRIC
 5245 N. ELSTON AVE
 CHICAGO, ILLINOIS 60630
 312 282-3410
 ITT CANNON ELECTRIC
 5202 BALTIMORE NATL PIKE
 BALTIMORE, MD 21229
 301 744-5965
 ITT CANNON ELECTRIC
 591 NORTH AVENUE
 WAKEFIELD, MASS 01880
 617 245-3850
 ITT CANNON ELECTRIC
 4725 EXCELSIOR BLVD RM4A

MINNEAPOLIS, MINN 55416
 612 920-2911
 ITT CANNON ELECTRIC
 9369 DLIVE BLVO SUITE 101
 OLIVETTE, MISSOURI 63132
 314 991-1630
 ITT CANNON ELECTRIC
 640 RAHWAY AVENUE
 UNION, NEW JERSEY 07083
 201 687-9500
 ITT CANNON ELECTRIC
 PICKARD BUILDING
 EAST MOLLOY ROAD
 SYRACUSE, NEW YORK 13211
 315 454-9241
 DULA ASSOCIATES INC
 1402 EAST MORFHEAD STREET
 P O BOX 096
 CHARLOTTE, N. C. 28204
 704 334-7090
 DULA ASSOCIATES INC
 3389 NOTTINGHAM ROAD
 P O BOX 5316
 WINSTOM-SALEM, N. C. 27103
 919 723-4205
 ITT CANNON ELECTRIC
 3691 LEE ROAD
 CLEVELAND, OHIO 44120
 216 991-7571
 ITT CANNON ELECTRIC
 3300 SOUTH DIXIE DRIVE
 KETTERING, OHIO 45439
 513 298-5258
 ITT CANNON ELECTRIC
 1510 RUSSELL ROAD
 PAOLI, PENNA 19301
 215 647-0212
 ITT CANNON ELECTRIC
 BRANIFF AIRWAYS BUILDING
 SUITE 415 EXCHANGE PARK
 DALLAS, TEXAS 75235
 214 357-8171
 ITT CANNON ELECTRIC
 1730 NASA BLVD SUITE 209
 HOUSTON, TEXAS 77058
 713 488-3110
 ITT CANNON ELECTRIC
 225 108TH AVENUE N E
 BELLEVUE, WASH 98004
 206 454-3903

ITT TELECOMMUNICATIONS,
DIV INTERNATIONAL TELEPHONE
TELEGRAPH CORP
 SALES MANAGER
 S. J. REJNIAK
 COMPANY ADDRESS
 320 PARK AVENUE
 NEW YORK, NEW YORK 10022
 COMPANY REPRESENTATIVE
 A. URSANO, REP MGR
 ITT TELECOMMUNICATIONS
 1801 MURCHIN DR
 BURLINGAME, CALIF. 94011
 415 697-5780
 P. K. COWELL, REG MGR
 ITT TELECOMMUNICATIONS
 10395 W. COLFAX AVENUE
 DENVER, COLO. 80215
 303 238-6361
 H. E. DUNCAN, REG MGR
 ITT TELECOMMUNICATIONS
 ND 4 EXECUTIVE PARK DR
 ATLANTA, GEORGIA 30329
 T. R. SMITH, REG MGR
 ITT TELECOMMUNICATIONS
 3207 D NIMITZ HIGHWAY
 HONOLULU, HAWAII 96819
 812-848
 R. F. SCHUESSLER, REG MGR
 ITT TELECOMMUNCIATIONS
 6650 S CICERO AVENUE
 CHICAGO, ILLINOIS 60638
 312 458-6300
 R. E. OBRIEN, REG MGR
 ITT TELECOMMUNICATIONS
 4010 WEST 85TH STREET
 EDINA, MINNESOTA 55435
 612 927-4636
 JACK T. SHRINER, REG MGR
 ITT TELECOMMUNICATIONS
 1006 GRANO AVENUE
 KANSAS CITY, MISSOURI 64106
 816 471-5433
 JACK H. WILKS, REG MGR
 ITT TELECOMMUNICATIONS
 731 JAMES STREET
 SYRACUSE, NEW YORK 13203
 315 472-8821
 K. H. BENNINGHOVEN, REG MGR
 ITT TELECOMMUNICATIONS
 419 BRANIFF BUILDING
 DALLAS, TEXAS 75235
 214 357-9271

ITT WIRE & CABLE DIVISION
CLINTON OPERATION
 SALES MANAGER
 VAUGHN N TANNAHILL
 BRAND NAMES
 ROYAL
 SURPRENANT
 SURCODUR
 COMPANY ADDRESS
 172 STERLING ST
 CLINTON, MASS 01510
 SALES OFFICES
 ITT WIRE & CABLE DIV.
 HOLIDAY OFFICE CENTER
 SUITE 104
 HUNTSVILLE, ALA.
 205 881-4040
 ITT WIRE & CABLE DIV.
 1 WEST ALAMEDA
 BURBANK, CALIF.
 213 843-3220

ITT WIRE & CABLE DIV.
 960 SAN ANTONIO RD.
 PALO ALTO, CALIF.
 415 321-7470
 ITT WIRE & CABLE DIV.
 1545 MINNESOTA STREET
 SAN FRANCISCO, CALIF.
 415 285-4800
 ITT WIRE & CABLE DIV.
 8444 FLORISSANT RD.
 ST. LOUIS, MO.
 314 521-3120
 ITT WIRE & CABLE DIV
 1510 RUSSELL RD.
 PAOLI, PA.
 215 644-1450
 ITT WIRE & CABLE DIV
 5013 BARTON PLACE SOUTH
 SEATTLE, WASH.
 206 723-8152
 COMPANY REPRESENTATIVES
 BRANDEL STEPHENS & CO., INC.
 135 E. COLONIAL OR.
 ORLANDO, FLA.
 305 425-3202
 R. D. CATELLIER INC
 4901 W. FULLERTON AVE.
 CHICAGO, ILL.
 312 237-6460
 BURGIN-KREH ASSOC.
 202 W. PENNSYLVANIA AVE
 TOWSON 4, MD.
 301 825-3212
 GERALD ROSEN CO.
 563 WORCESTER RD.
 NATICK, MASS.
 617 655-2211
 MULLIGAN-MATHIAS
 2144 RIVERSIDE DR.
 COLUMBUS, OHIO
 614 486-9678
 C. L. PUGH CO.
 2144 RIVERSIDE DR.
 COLUMBUS, OHIO
 614 486-9678
 A-E-PETSCH CO.
 807 E. ABRAMS STREET
 ARLINGTON, TEXAS
 817 277-1379

JAMPRO ANTENNA COMPANY
 SALES MANAGER
 BILL NEUMANN
 BRAND NAMES
 JAMPRO
 ANDREWS
 ROHN
 COMPANY ADDRESS
 6939 POWER INN ROAD
 SACRAMENTO, CALIF. 95828
 916-383-1177
 COMPANY REPRESENTATIVES
 BAUER ELECTRONICS
 1663 INDUSTRIAL ROAD
 SAN CARLOS, CAL
 591-9466
 GATES RADIO COMPANY
 QUINCY, ILLINOIS
 222-8202
 CCA ELECTRONICS CORP
 716 JERSEY AVE
 GLOUCESTER CITY
 CAMDEN CO, N J
 456-1716
 VISUAL ELECTRONICS
 356 WEST 40TH STREET
 NEW YORK, N. Y.
 736-5840
 TELESCO INTERNATIONAL CORP
 171 MADISON AVENUE
 NEW YORK, N.Y.
 COLLINS RADIO COMPANY
 DALLAS 7, TEXAS
 ADAMS 5-9511
 DU-VAL
 GULF STATES BLDG
 DALLAS, TEXAS
 RI 8-7754
 MARTI ELECTRONICS
 105 PDINDEXTER
 CLEBURNE, TEXAS
 MI 5-4091
 REPS. IN OTHER COUNTRIES
 THE CROW COMPANY
 79 LONDON STREET
 READING, BERKSHIRE, ENGLAND
 LANDAIRSEA, S. A.
 56 GATZAMBIDE
 MADRID, SPAIN

JENNINGS RADIO
MANUFACTURING COMPANY
 SALES MANAGER
 ROBERT E. JOHNSTON
 COMPANY ADDRESS
 970 MCLAUGHLIN AVENUE
 SAN JOSE, CALIF. 95108
 COMPANY REPRESENTATIVES
 JOHN J FISKE
 PO BOX 585
 ARCADIA, CALIF 91006
 213 447-7655
 WES SHELHAMMER
 215 BROOKSIDE AVE
 HOKOKUS, NEW JERSEY
 201 447-0277

JENSEN MANUFACTURING DIVISION,
THE MUTER COMPANY
 SALES MANAGER
 FRANK D. LINTERN
 COMPANY ADDRESS
 6601 SOUTH LARAMIE AVE.
 CHICAGO, ILLINOIS 60638

JERRDLO ELECTRONICS CORPDRATION
 SALES MANAGER
 CATV DIVISION
 JERRY HASTINGS
 SALES MANAGER
 DISTRIBUTOR SALES OIV.
 TOM SHEA
 SALES MANAGER
 COMMUNICATIONS OIV.
 VROMIN RILEY
 SALES MANAGER
 GOVERNMENT & INDUSTRIAL OIV.
 DOUGLAS VINING
 BRAND NAMES
 STARLINE
 ULTRA-TAP
 J-JACKS
 PARABEAM
 COLOR CAPTAIN
 CHANNEL COMMANDER
 PARALOG
 COMPANY ADDRESS
 401 WALNUT STREET
 PHILADELPHIA, PA. 19105
 COMPANY REPRESENTATIVES
 ROBERT GARNER
 1004 BELLE MEADE DRIVE
 BIRMINGHAM, ALABAMA
 205 836-7457
 JAMES FORGEY
 WESTERN REGIONAL SALES MGR
 1755 VETERANS BLVD
 REDWOOD CITY, CALIF
 415 365-5200
 ROBERT W. PESICK
 2186 SO HOLLY AVENUE
 DENVER, COLO
 305 SK 6-6283
 WILLIAM ROBINSON
 5 EASTERN REGIONAL SALES MGR
 1927 PIEDMONT CIRCLE, NE
 ATLANTA, GEORGIA 30324
 404 873-5546
 JAMES F SHANLEY
 CENTRAL REGIONAL SALES MGR
 PO BOX 2180
 W LA FAYETTE, IND 47906
 317 743-2055
 ROBERT BYRNE
 104 TUXEDO DRIVE
 SOUTH BEND, IND
 219 234-4458
 MELVIN GRAY
 40 LANTERN LANE
 SHARON, MASS
 617 828-0767
 JOHN DIECKMAN
 MIDWEST REGIONAL SALES MGR
 1336 ATLANTIC
 N KANSAS CITY, MO
 816 842-1130
 JOSEPH COMOWALL
 829 SD MAIN
 HORSENEADS, NEW YORK
 607 734-2515
 ANTHONY DE LOSS
 297 MO ROCKY FORK DRIVE
 GAINENVA, OHIO
 614 471-9243
 J C SPARKMAN
 3612 S E 82ND AVENUE
 PORTLAND, OREGON 97220
 503 255 1048
 HOWARD LOMAX
 N EASTERN REGIONAL SALES MGR
 401 WALNUT STREET
 PHILADELPHIA, PA 19105
 215 WA 5-9870
 JOSEPH CLIFFORD
 310 N 11TH STREET
 SUNBURY, PA
 717 286-2873
 RAY DAVIS
 23 S E T COURT
 WAKTONT, SOUTH DAKOTA
 605 665-3072
 W E DART
 S WESTERN REGIONAL SALES MGR
 145 PAYNE STREET
 DALLAS, TEXAS 75207
 214 RI 2-8076

JETRONICS INDUSTRIES, INC.
 SALES MANAGER
 R. A. MEYER
 COMPANY ADDRESS
 MAIN & COTTON STREETS
 PHILADELPHIA, PA. 19127

J M ELECTRONICS COMPANY
 BRAND NAMES
 J M
 COMPANY ADDRESS
 29 JOSEPHINE DRIVE
 HAMPTON, N.H. 03842

JOA CARTRIDGE SERVICE
 SALES MANAGER
 JOHN H. HENNINGER
 BRAND NAMES
 AUTOMATIC TAPE CONTROL
 BROADCAST ELECTRONICS
 EIMAC DIV. OF VARIAN
 MINNESOTA MINING & MFG
 NORTRONICS
 TELEPRO INDUSTRIES
 ROBINS INDUSTRIES INC
 MAGNASSER
 COMPANY ADDRESS
 132 HEACOCK LANE
 WYNCOTE, PA. 19095
 TU 6-7993
 AND
 P.O. BOX 3087
 PHILAOLPHIA, PA. 19150

AUSTIN, TEXAS 78703
512-GL 2-2064

HOLLAND ELECTRONICS, INC.
SALES MANAGER
FRANK MANDARANO
COMPANY ADDRESS
772 EAST 53RD STREET
BROOKLYN, NEW YORK 11203

HOLLINGSWORTH SOLDERLESS

TERMINAL COMPANY
SALES MANAGER
J. C. LUDWICK
COMPANY ADDRESS
NUTT & FRENCH CREEK RDS.
PHOENIXVILLE, PENN. 19460
COMPANY REPRESENTATIVES
BRANCH OFFICE
5557 CAHUENGA BLVD
N. HOLLYWOOD, CALIF.
213-887-1555
YOUNG & LAWRENCE ASSOC
70 MOSS LANE
WINTER PARK, FLORIDA
305 647 2528
GENE PIETY FACTORS, INC.
P. O. BOX 2903
160 MAHAUEA ST
HONOLULU-17, HAWAII
BRANCH OFFICE
819 MANNHEIM ROAD
WESTNESTER, ILL.
312-681-3724
WM S HUEY CO
8726 OAK ST
NEW ORLEANS, LA 70118
504 866 6341
BRANCH OFFICE
4 GORDON STREET
WALTHAM 54, MASS
617-899-0004
NORTHERN STATES SALES CO
1109 W 78 1/2 STREET
MINNEAPOLIS, MINN 55404
612 866 3468
MASTER INDUSTRIAL SUPPLY
5010 UNION BLVD
ST LOUIS, MO 63115
314 EV 5 4431
SIGMA ASSOCIATES
315 FRANKLIN PLACE
SOUTH ORANGE, N J
201 50 3 0573
FRANK W TAYLOR CO
P O BOX 86
DEWITT, NEW YORK
315 446 0422
M FRANCIS HAGER
ROUTE 1 BOX 423
MATTHEWS, N CAROLINA
704 847 9262
BRANCH OFFICE
17705 EUCLIO AVENUE
CLEVELAND 12, OHIO
216-KE-1-3411
T J HARRINGTON
BOX 12471
MEMPHIS, TENN 38112
901 452 2606
JOHN T. ROBBINS
8005 HAYDEN DRIVE
KNOXVILLE, TENNESSEE
615-588-2424
LUNO & COMPANY
2215-N OLIVE STREET
DALLAS 1, TEXAS
214 RI 8 8839
WM. R. LANPHEAR
4031 STONEMAY AVE NORTH
SEATTLE WASH 98103
206-AT-48150

HOUSTON ELECTRONICS COMPANY

SALES MANAGER
JAMES F. LOCKETT
COMPANY ADDRESS
7103 WALKWAY ST.
HOUSTON, TEXAS 77036
COMPANY REPRESENTATIVES
KOCH ENGINEERING & SALES CO.
13818 KINGSRIE LANE
HOUSTON TEXAS
713-323-7051

HOUSTON FEARLESS CORPORATION

SALES MANAGER
BERT ROSENBERG
BRAND NAMES
LABMASTER
COMPANY ADDRESS
11801 W OLYMPIC BLVD.
LOS ANGELES, CALIF. 90064
COMPANY REPRESENTATIVES
RONALO NARGI
103 CONSTOCK HILL ROAD
MORWALK, CONN
860 5225
JOHN PAYNTER
SUITE 401 1413 K ST N W
WASHINGTON, D C
EX 3 0800
BREEN LANSFORD
2126 MOHAWK TRAIL
MAITLAND, FLA
305 644 8512
GORDON TAYLOR
404 WEST OAK ST
ROME, NEW YORK
314 FF 7 4240
HOWARD INGLE
125 SHELDON DRIVE
CENTERVILLE, OHIO
CL 3 7111

HUGHEY & PHILLIPS, INC

SALES MANAGER
C. E. STEPHENS
COMPANY ADDRESS
3050 NORTH CALIFORNIA ST.
BURBANK, CALIFORNIA 91503
COMPANY REPRESENTATIVES
HENRY J. GEIST
19 BAYWATER DR.
DARIEN, CONN. 06820
203-324-7300
ROBERT L. LANG
6733 N. OLMSTEAD AVE
CHICAGO, ILL. 60631
312-774-3610
FAION LOTT
P. O. BOX 534
GLEN BURNIE, MARYLAND 21061
301-944-5155
WALTER C. WERNER
313 WOODLAND MANOR
NEW SHREWSBURY, N. J. 07724
201-542-0732
TOM SEARS
4801 READING STREET
DALLAS, TEXAS 75247
214-631-6280

HUNT-PIERCE CORPORATION

SALES MANAGER
CLAUDE B COPELAND
BRAND NAMES
SERVI-LIFT
SERVI-CLIP
COMPANY ADDRESS
230 OLD GATE LANE
MILFORD, CONN 06460
COMPANY REPRESENTATIVES
ARTHUR S. PARKER, JR. AND
HARRY W. KINGHORN
230 OLD GATE LANE
MILFORD, CONN.
878-7491
FRANK W. MORRIS
BOX 16773
OKLAHOMA CITY, OKLA.
842-1844
CARSON C. BITNER
824 RENEEL ROAD
NORRISTOWN, PA.
279-2255

HY-GAIN ELECTRONICS CORPORATION

SALES MANAGER
JACK C. SCHNEIDER
BRAND NAMES
HY-GAIN
COMPANY ADDRESS
NE HWY. 6 AT STEVENS CREEK
LINCOLN, NEBRASKA 68501
COMPANY REPRESENTATIVES
D BELLE SALES CO
1005 W. 4TH ST.
EL DORADO, ARK.
501-UM 3-8325
H. BECKER CO. INC.
1140 CRENSHAW BLVD
LOS ANGELES, CAL.
213-WE 1-1257
W. J. PURDY CO.
312 SEVENTH ST.
SAN FRANCISCO, CAL.
415-863-3300
AFS, INC.
1549 CHESTER STREET
AURORA, COLO.
366-0208
V. A. MCCORVEY
2187 BRIARCILIFF RD, NE
DECATUR, GA.
404-636-2502
W. LINZ & ASSOC.
4001 W. OEVON
CHICAGO, ILL
MU-5-6060
JACK WEST
6747 N. OCTAVIA AVE
CHICAGO, ILL
313-763-3500
E. O. MAGNUS & ASSOCIATES
EXPORT
5715 NO LINCOLN AVE
CHICAGO, ILL
312 334 1503
FISHMAN ASSOC.
BOX 40308
INDIANAPOLIS, INO.
CL-1-2401
COAKLEY, BOYD & ABBETT
1424 HIGHLAND AVE
NEEDHAM, MASS.
617-444-5470
ABM SALES, INC.
10116 PURITAN
DETROIT, MICH.
UN 2-1300
F. B. HILL CO.
5110 EXCELSOR BLVD
MINNEAPOLIS, MINN.
929-6727
FLORENCE & MEYER, INC.
406 WEST 34TH ST.
KANSAS CITY, MO.
816-LOI-7282
M. BETTAN SALES, INC.
77-15 164TH ST.
FLUSHING, N. Y.
OL 7-6659
PASTON-HUNTER CO. INC.
2002 TEALL AVE
SYRACUSE, N. Y.
437-2992
F. OHMAN
BOX 363
TWINSBURG, OHIO
216-425-7445

VIDEO

TEST TERMINATIONS



Type PL 259



Type N



Type BNC

HOLLAND ELECTRONICS Precision Test Terminations provide a simple, convenient method for accurately terminating pulse, video and RF coaxial cables. These terminations eliminate undesirable reflections and provide an easily accessible test terminal for checking waveform and level.

The terminating elements are low noise 1% metal film resistors and can be supplied in any value required.

TEST TERMINATION PLUGS



Tip Jack



Front View



Solder Lug

HOLLAND ELECTRONICS Coaxial Test Termination Plugs are designed for use in Pulse, Video and RF patching systems. These terminations provide a means of properly terminating a line in its characteristic impedance and in addition have access to the center conductor for examination of signal under terminated conditions.

Plugs contain a 1/2W, 1% tolerance low noise resistor. All contact surfaces are heavy gold plated. Choice of test terminal between solder lug or pin tip jack (for 0.080 dia. test probes) color coded, Green 50 ohms, Violet 75 ohms, White 93 ohms. Plugs are compatible with RCA or W.E. patching systems.

FIXED PAD ATTENUATORS



Type AUHF



Type AN



Type ABNC

HOLLAND ELECTRONICS Fixed Pad Attenuators are precision coaxial assemblies designed for use in pulse, video and RF circuits. Fully enclosed ruggedized metal construction provides shielding and protects the low noise 1% tolerance metal film resistors used in the attenuation networks. Careful design assures good high frequency response to 250 megacycles.

Attenuators are available in any desired db value from 1 through 60 db in 1 db steps. Standard impedances are 50, 75 and 93 ohms. Standard connectors are UHF, N and BNC. Type UHF and BNC attenuators are rated at 1/2 watt; type N at 1 watt. Special units can be supplied with any impedance or attenuation, multiple outputs, different input and output connectors, type TNC and C connectors, test terminals, etc. Impedance matching attenuators are also available.

HOLLAND ELECTRONICS, INC.

722 EAST 53 STREET · BROOKLYN, NEW YORK 11203 · 212-451-1132

F. F. JOHNSON COMPANY

SALES MANAGER
C. TRAVIS MARSHALL
BRAND NAMES
VIKING
MESSENGER
COMPANY ADDRESS
299 10TH AVENUE, S.W.
WASECA, MINNESOTA 56093
507-835-2050
COMPANY REPRESENTATIVES
LOGAN SALES COMPANY
REOWOOD CITY, CALIF
415 369-6726
WALLACE & WALLACE
LOS ANGELES, CALIF
213 747-0401
MCLOU & RAYMOND CO
DENVER, COLO
303 756-1589
MILLAR-HUTTO ASSOC., INC
ATLANTA, GEORGIA
404 867-0919
ELLINGER SALES CORPORATION
CHICAGO, ILLINOIS
312 763-1570
JERRY VRBIK CO
CEDAR RAPIDS, IOWA
319 365-0461
EARL K MOORE CO
NEW ORLEANS, LA
504 488-2407
PAUL R STURGEON, INC
CHESTNUT HILL, MASS
617 734-7710
A B M SALES, INC
DETROIT, MICHIGAN
313 862-1300
H A ROES & CO
KANSAS CITY, MISSOURI
816 221-0866
R W WITSCHER CO., INC
BUFFALO, NEW YORK
716 854-2517
F EDWIN SCHMITT CO
ELMONT, L.I., NEW YORK
516 437-8150
ROBURN AGENCIES, INC - EXPORT
NEW YORK, NEW YORK
212 966 2130-2
MC FAODEN SALES CO
COLUMBUS, OHIO
614 221-3363
S K MAC DONALD, INC
PHILADELPHIA, PA
215 545-1205
ROBERT E NESBITT CO
DALLAS, TEXAS
214 357-0601
F F JOHNSON CO SEATTLE OFFICE
MERCER ISLAND, WASHINGTON
206 232-6242
REPS. IN OTHER COUNTRIES
A C SIMMONDS & SONS, LTD.
TORONTO, ONTARIO
416 485-9111

JOHNSON ELECTRONICS, INC.

SALES MANAGER
RALPH L. WEBER
BRAND NAMES
JOHNSON-AIR
COMPANY ADDRESS
P.O. BOX 7, HWY. 17-92
CASSELLBERG, FLORIDA 32707
305 838-2111
COMPANY REPRESENTATIVES
MIKE NEWTON
HYDE ELECTRONICS CO., INC
4710 N 16TH STREET
SUITE 109
PHOENIX, ARIZONA 85015
602 264-5609
WAYNE WAINWRIGHT
TELEPACIFICOM
PO BOX 926
LOS GATOS, CALIF
408 354-1411
DICK HYDE
HYDE ELECTRONICS CO., INC
888 SO LIPAN STREET
DENVER, COLO 80223
303 936-3455
SCOTT ORMSBY
SCOTT ORMSBY SALES
230 20TH STREET
NEW ORLEANS, LA 70124
504 488-2414
LEE DAVIS
HYDE ELECTRONICS CO., INC
5206 CONSTITUTION AVE., NE
ALBUQUERQUE, N MEXICO 87110
505 265-8895
ERNEST L WILKS
EL WILCO
PO BOX 14466
DALLAS, TEXAS 75234
214 242-5321
PAUL POWERS
HYDE ELECTRONICS CO., INC
2422 CAMINO WAY
SALT LAKE CITY, UTAH 84121
801 278-4465

JORDAN ELECTRIC COMPANY

SALES MANAGER
BOYD M. BARTON
COMPANY ADDRESS
14707 KESWICK STREET
VAN NUYS, CALIF, 91405

KAMN RESEARCH LABORATORIES INC

BRAND NAMES
ECHOMPLEX

SYMMETRA-PEAK
VOICEPLEX
COMPANY ADDRESS
81 SOUTH BERGEN PLACE
FREEPORT, NEW YORK 11520

KAISER-COX CORPORATION

SALES MANAGER
WALT BAXTER
505 SO WOODBURY RD
PITMAN, N J 08071
609 589 0330
BRAND NAMES
PHONECIAN
KASIER-COX
THUNDERBIRD
OMPANY ADDRESS
2216 W. PEORIA AVE. BOX 9728
PHOENIX, ARIZONA 85020
COMPANY REPRESENTATIVES
JAMES TAGLIA
2292 N PEACHTREE COURT
CHAMBLEE, GEORGIA 30005
404 451 0013
CHARLES LEYRER
1099 D IRONGATE LANE
COLUMBUS, OHIO
GEORGE E BARRY
14622 CHERRY HILLS DRIVE
DALLAS, TEXAS 75234
214 247 4223

THE KALART COMPANY INC

EXEC. VP
L. QUARTIN
SALES MANAGER TELE-BEAM DIV
R. ZEITLER
BRAND NAMES
CRAIG
KALART
KALART VICTOR
SOUNDSTRIP
TELE-BEAM
VICTOR ANIMATOGRAPH
VICTOR SOUNDVIEWS
COMPANY ADDRESS
PLAINVILLE, CONN. 06062
COMPANY REPRESENTATIVES
MORT GOLOBERG
154 VALLEY ROAD
COS COB, CONN
JOHN J HARNETT
275 E 201ST STREET
BRONX 58, NEW YORK

KAPPA NETWORKS, INC

SALES MANAGER
STANLEY L PEARL
BRAND NAMES
TINY TRIM
SUPER-N
COMPANY ADDRESS
165 ROOSEVELT AVENUE
CARTERET, N J 07008
COMPANY REPRESENTATIVES
RAYMARG
P O BOX 515
SANTA CLARA, CALIF
248 5199
WESTERN ELECTRONIC COMPONENTS
4301 BIRCH ST
NEWPORT BEACH, CALIF
631 6110
BE-MAR ASSOCIATES
1016 ABINGTON ROAD
CHERRY HILL, NEW JERSEY
428 6390
BERTRAM D AARON & CO
P O BOX 186
ROSLYN, L I., NEW YORK
MA 1 0630
JOHN D OLSEN CO
16201 SHAKER BOULEVARD
CLEVELAND, OHIO
752 5444
JOHN O OLSEN CO
5939 STOKESWOOD COURT
CINCINNATI, OHIO
922 2176
BE-MAR ASSOCIATES
P O BOX 556
FALLS CHURCH, VIRGINIA
534 1004
REPS IN OTHER COUNTRIES
UNI-OFFICE, N V
P O BOX 1122
ROTTERDAM, HOLLAND

KARG LABORATORIES INC

SALES MANAGER
J. CURTIS
COMPANY ADDRESS
162 ELY AVENUE
SOUTH NORWALK, CONN. 06856

MATHIAS KLEIN & SONS

SALES MANAGER
C. F. CASTINO
COMPANY ADDRESS
7200 MCCORMICK RD.
CHICAGO, ILLINOIS 60645

KLINE IRON & STEEL COMPANY

SALES MANAGER
J. R. TROTTER
1225 HUGER STREET
COLUMBIA, S. C. 29202
AL 4-0301
BRAND NAMES
KIMCO
COMPANY ADDRESS
P O BOX 1013
COLUMBIA, S. C. 29202

KOSS ELECTRONICS INC

SALES MANAGER
GREG CORNEHLS
BRAND NAMES
ACQUITECH
REK-O-KUT
KOSS
COMPANY ADDRESS
2227 NORTH 31 STREET
MILWAUKEE, WISCONSIN 53208
COMPANY REPRESENTATIVES
F W MOULTHROP & ASSOC
1530 EAST 12 STREET
OAKLAND, CALIFORNIA 94606
415 261 7676
SHEPARD WINTERS STERN
4109 BURBANK BLVD
BURBANK, CALIF 91505
213 849 6671
JOHN ROWE & ASSOC
58 & VALLEY HWY, SUITE 2170
DENVER, COLO 80216
303 429 4595
JOSEPH ANDERSON
3138 BRINKLEY ROAD, APT 3
WASHINGTON, D. C. 20031
202 894-3455
DOW FITZGERALD
6231 SOUTH CHURCH
TAMPA, FLORIDA 33616
813 834 3981
R A CHALMERS
349 PEACHTREE HILLS AVE., NE
ATLANTA, GEORGIA 30305
404 233 3208
MARTIN BORISH
139 MAIN STREET
CAMBRIDGE, MASS 02142
617 354 3742
GROSSMAN SALES CO
339 AUBURN STREET
AUBURNDALE, MASS 02166
617 527 7753
CARMINE A VIGNOLA ASSOC
21 SCHELLRIDGE ROAD
JEFFERSON CITY, MO 65101
314 635 1023
BACH SALES CORP
26 MAHAN ROAD
OLD BETHPAGE, NEW YORK 11804
212 687 1240
SCHROEDER SALES CO
2254 EUCLID AVENUE
CLEVELAND, OHIO 44115
216 621 5074
BRENOAN OHARA
4952 WYNEFIELD AVENUE
PHILADELPHIA, PENN 19131
215 473 3654
MAYNARD SALES CO
158 EXPRESS STREET
DALLAS, TEXAS 75207
214 742 2384
VECTOR CORP
307 WALL STREET
SEATTLE, WASHINGTON 98121
206 623 6891
REPS. IN OTHER COUNTRIES
KOSS - IMPETUS
2 VIA BERNA
LUGANO, SWITZERLAND
91 38214
A. C. SIMMONDS & SONS
100 MERTON STREET
TORONTO, ONTARIO
416 485 9111

HERB KRECKMAN CO

SALES MANAGER
HERB KRECKMAN
BRAND NAMES
KRECO ANTENNAS
COMPANY ADDRESS
CRESCO, PA. 18326
COMPANY REPRESENTATIVES
WAMBLE SALES CO
3745 MARIE COOK DRIVE
MONTGOMERY, ALABAMA
205 272 4600
HOFFER ENTERPRISES
129 FIFTH AVE
ANCHORAGE, ALASKA
C H MITCHELL CO
18531 VENTURA BLVD
TARZANA, CALIF
881 2626
JOHN ANDERSON CO., INC
5231 HUMBOLT AVE
50 MINNEAPOLIS, MINN
612 823 6459
H A ROSS & CO
2601 CHERRY
KANSAS CITY, MO
816 221 0866
ED BRADDOCK
BOX 305
HADDONFIELD, N. J.
609 429 0087
CHESTER DREXLER
3 LEE DRIVE
50 FARMINGDALE, L.I., N.Y.
516 249 8206
OMIO ASSOC
BOX 728
LIMA, OHIO
VAUGNSVILLE 6500
WYBORN SALES CO
BOX 17070
DALLAS, TEXAS
214 381 4645
DON KOHLER
1152 4TH AVE NE
SEATTLE, WASHINGTON
206 363 1439

KRS INSTRUMENTS
DIV OF DATAPULSE, INC

SALES MANAGER
JAMES S. JOHNSON
BRAND NAMES
STACT
STACTAPE
COMPANY ADDRESS
1313 N. LINCOLN AVE.
PASADENA, CALIF. 91103
213 601 7416
TWX 910 588 3282
COMPANY REPRESENTATIVES
W A BROWN & ASSOCIATES, INC
1314 BUFORD STREET, N W
HUNTSVILLE, ALABAMA 25801
HYTRONIC MEASUREMENTS
1017 N THIRD ST
PHOENIX, ARIZONA 85004
THE THORSEN COMPANY
6824 MELROSE AVENUE
LOS ANGELES, CALIF. 90038
HYTRONIC MEASUREMENTS, INC
1295 SOUTH BANNOCK STREET
DENVER, COLO 80223
INSTRUMENT CONSULTANTS, INC
2381 WHITNEY AVENUE
HAMDEN, CONN 06518
W A BROWN & ASSOCIATES, INC
222 WEBER AVENUE
ORLANDO, FLORIDA 32803
W A BROWN & ASSOCIATES
3039 NE 32ND AVE
FORT LAUDERDALE, FLA 33308
RIDGWAY ASSOCIATES, INC
3759 N HARLEM AVENUE
CHICAGO, ILLINOIS 60634
LEEMARK ASSOCIATES, INC
4518 WEST 89TH STREET
PRAIRIE VILLAGE, ILL. 60207
WITKO ELECTRONICS
3919 WILLOW DR
WICHITA, KANSAS
BRIMBERG ASSOCIATES, INC
110 E PENNSYLVANIA AVE
TOWSON, MD. 21204
BRIMBERG ASSOCIATES, INC
814 THAYER AVENUE
SILVER SPRINGS, MD. 20910
INSTRUMENT CONSULTANTS, INC
P O BOX 25
WABAN, MASS. 02168
RIDGWAY ASSOCIATES, INC
7720 MORGAN AVENUE SOUTH
MINNEAPOLIS, MINN 55423
LEEMARK ASSOCIATES, INC
2001 BIG BEND BLVD
ST LOUIS, MO. 63117
WITKO ELECTRONICS
P O BOX 125
FAIRBURY, NEBRASKA
DATA REP ASSOCIATES
P O BOX 645
RIDGEWOOD, N J 07451
HYTRONIC MEASUREMENTS, INC
2055 SAN PABLO, S E
ALBUQUERQUE, N M 87108
J D RYERSON ASSOCIATES, INC
P O BOX 1400
SYRACUSE, N Y 13201
DATA REP ASSOCIATES
BOX 164, HUNTINGTON STATION
HUNTINGTON, N. Y.
W A BROWN ASSOCIATES, INC
440 WEST-END BLVD
WINSTON-SALEM, N.C. 27101
RIDGWAY ASSOCIATES, INC
22811 LORAIN ROAD
FAIRVIEW PARK, OHIO
RIDGWAY ASSOCIATES, INC
2400 E DOROTHY LANE
DAYTON, OHIO 45420
DATA REP ASSOCIATES
BOX 349
NORRISTOWN, PENN
WITKO INC
435 BRANIFF BUILDING
DALLAS, TEXAS
AIREP ELECTRONICS, INC
P O BOX 36211
HOUSTON, TEXAS 77036
AIREP ELECTRONICS, INC
P O BOX 9555
DALLAS, TEXAS 75214
HYTRONIC MEASUREMENTS, INC
2022 SOUTH MAIN STREET
SALT LAKE CITY, UTAH 84115
W A BROWN & ASSOCIATES, INC
325 FIRST STREET
ALEXANDRIA, VA 22314
THE THORSEN COMPANY
1767 15TH AVENUE SOUTH
SEATTLE, WASH 98144
REPS. IN OTHER COUNTRIES
DELTA EQUIPMENT S A
28 RUE DE TABELLON
BRUXELLES 5, BELGIUM
OMNI RAY GMBH
NYMPHENBURGER STRASSE 164
MUNICH 19, WEST GERMANY
ENVIRONMENTAL EQUIPMENTS, LTD
STATION YARD
WOKINGHAM, BERKS, ENGLAND
GENERAL TEST INSTRUMENTS, LTD
GLOUCESTER TRADING ESTATE
HUCCLECOTE, GLOUCESTER, ENG.
MEL SALES LIMITED
71 CROCKFORD BLVD
SCARBOROUGH, ONTARIO
MEL SALES LIMITED
P O BOX 1352, POSTAL STA. O
MONTREAL, QUEBEC
SIMON GRAY, PTY LTD
28 ELIZABETH STREET
MELBOURNE, CI, AUSTRALIA

LACROSSE ELECTRONICS INC
SALES MANAGER
KIT VAIL
COMPANY ADDRESS
P.O. BOX 102
LACROSSE, WISCONSIN 54601
782-6042

LAFAYETTE RADIO ELECTRONICS
SALES MANAGER
J. RUSSELL
BRAND NAMES
ARGONNE-R
COMPANY ADDRESS
111 JERICHO TURNPIKE
SYOSSET, L.I., N.Y. 11791

LAKE ELECTRONICS, INC
VICE PRESIDENT-MARKETING
R. J. TANCZOS
BRAND NAMES
LAKE-GERHARD
COMPANY ADDRESS
3311 PERKINS AVENUE
CLEVELAND, OHIO 44114
216 431 6212

LAMPKIN LABORATORIES INC
SALES MANAGER
DAVID A. BOYERS
COMPANY ADDRESS
BRADENTON, FLORIDA 33505

LANG ELECTRONICS, INC
COMPANY ADDRESS
507 FIFTH AVE
NEW YORK, NEW YORK 10017

LANGVIN, DIVISION SCIENTIFIC INDUSTRIES, INC
SALES MANAGER
JOHN SWANSON
BRAND NAMES
LANGVIN
COMPANY ADDRESS
1801 E. CARNEGIE AVE.
SANTA ANA, CALIF. 92705
546-8830
COMPANY REPRESENTATIVES
KOESSLER SALES CO
818 NORTH FAIRFAX AVE
LOS ANGELES, CALIF
213 OL 3 1605
RON BOWEN & ASSOC
721 SOUTH BROADWAY
DENVER 9, COLO.
303 SH 4 2501
J E JOYNER ASSOCIATES
P O BOX 10821 STA A
868 YORK AVE, SW
ATLANTA, GA 30310
404 758 7496
IRVING W. ROSE ASSOC
4734 N. AUSTIN AVE
CHICAGO, ILL
312 AV 2 6835
GENE ROSEN & ASSOC
9501 WADSWORTH DRIVE
BETHESDA, MARYLAND
301 365 5113
TECH REP ASSOC
BOX 161, 17 ANDREW ROAD
TOPSFIELD, MASS
617 887 8671
RILEY & PETCHELL ELECT SALES
13209 FENKELL
DETROIT 27, MICH.
313 VE 8 9100
SMITH-MEEKER ENGINEERING CO
157 CHAMBERS ST
NEW YORK, NEW YORK
212 WO 4 5510
THE M. SIMONS & SON CO., INC
EXPORT
150 BROAOWAY
NEW YORK, N. Y.
212 BA 7-5513
SCHROEDER SALES CO
2254 EUCLID AVE
CLEVELAND, OHIO
216 MA 1 5075
HAYS COMPANY
BOX E, 405 N. BOWSER
RICHARDSON, TEXAS
214 AD 1 1426
WILLIAM R. LANPHEAR CO
4031 STONEMAY NORTH
SEATTLE, WASH
206 ME 3 4900
REPS. IN OTHER COUNTRIES
E. J. PIGGOTT ENTERPRISES
274 CHURCH STREET
TORONTO, ONTARIO
416 363 9141

JAMES B LANSING SOUND CO
BRAND NAMES
JBL
COMPANY ADDRESS
3249 CASITAS AVE.
LOS ANGELES, CALIF. 90039

LAVIOLETTE ELECTRONICS
SALES MANAGER
DORIS A. LAVIOLETTE
COMPANY ADDRESS
26077 FARMFIELD ROAD
CALABASAS, CALIF. 91302

LENKURT ELECTRIC CO INC
SALES MANAGER
JAY NAUGLE
BRAND NAMES
AGAMP
DATATEL
LENKURT

MICROTEL
MOBILTEL
COMPANY ADDRESS
1105 COUNTY ROAD
SAN CARLOS, CALIFORNIA 94070
591 8461
COMPANY REPRESENTATIVES
KEN K. HIGGINS
LENKURT ELECTRIC CO., INC
845 THIRD AVE 12TH FLOOR
NEW YORK, N.Y. 10022
355 1507
M. C. ROYALTY
LENKURT ELECTRIC CO., INC
340 NORTHCREST BLDG
8609 NORTHWEST PLAZA DR
DALLAS, TEXAS 75225
363 0286

LENZ ELECTRIC MANUFACTURING COMPANY
SALES MANAGER
R. G. ZENDER
COMPANY ADDRESS
1751 NORTH WESTERN AVE.
CHICAGO, ILLINOIS 60647
COMPANY REPRESENTATIVES
R. HALES PRIMMORE & ASSOC
1225 E NORTHVIEW AVE
PHOENIX, ARIZONA
944 9631
PENWARDEN ASSOC, INC
14547 TITUS ST
VAN NUYS, CALIF
ST 2-4920
WINCO CORP
257 CASTRO ST
P O BOX 881
MOUNTAIN VIEW, CALIF
961 8510
MEL FOSTER CO., INC
228 SO CEDAR LAKE ROAD
MINNEAPOLIS, MINN
374 2612
NORMAN W. KATHRINUS & CO
2427 BRENTWOOD BLVD
ST LOUIS, MISSOURI
WO 2 5627
MCFADDEN SALES CO
150 EAST BROAD ST
COLUMBUS, OHIO
221 3363
DANCO CORP
GERMANTOWN PIKE &
QUARRY HALL ROAD
FAIRVIEW VILLAGE, PA
CH 8 1619
CAMPIO SALES CO
9002 CHANCELLOR ROW
DALLAS, TEXAS 75207
ME 1 3390

LEWIS AND KAUFMAN LTD.
DIRECTOR OF MARKETING
CHARLES A. TEPPER
BRAND NAMES
LEWIS & KAUFMAN
L & K
COMPANY ADDRESS
107 TRUMBULL STREET
ELIZABETH, NEW JERSEY 07206

LIBERTY TOWER MFG CO
SALES MANAGER
R. J. GRIFFITH
COMPANY ADDRESS
RT 45 NORTH, BOX 161
EFFINGHAM, ILLINOIS
COMPANY REPRESENTATIVES
GLEN GRIFFITH
DIETERICH, ILL
925 3032
E. A. MARTEN
EFFINGHAM, ILL
342 2835
A. D. GRIFFITH
EFFINGHAM, ILL
342 2835
B. J. GRIFFITH
EFFINGHAM, ILL.
342-2835
BILLY GRIFFITH
8900 N. E. 51ST
OKLAHOMA CITY, OKLA
PR 1 3743
ART GRIFFITH
7900 S SHIELDS
OKLAHOMA CITY, OKLA
ME 4 8779

LIGHTING & ELECTRONICS INC
SALES MANAGER
N. J. SONNENFELD
COMPANY ADDRESS
423 SOUTH BROADWAY
YONKERS, NEW YORK 10705
COMPANY REPRESENTATIVES
R C LURIE COMPANY
4718 N 35TH PARKWAY
PHOENIX 14, ARIZONA
602 264 5904
CALIFORNIA LIGHTING SALES
3035 WEST 7TH ST
LOS ANGELES 5, CALIF
213 388 3176
DESCO
6232 EEL COURT
N HIGHLANDS, CALIF
916 331 5249
GREGG M CLOOS CO
977 JACKSON ST
DENVER, COLORADO 80206
303 355 0660
WYMAN/YOUNG ASSOC
6 PRATT STREET
ROCKY HILL, CONN 06067

203 529 2019
K. DALE RHODES
333 N. OCEAN BLVD
DEERFIELD BEACH, FLORIDA
305 399 7389
DON REIMAN & ASSOC
419 NORTH AVE., N. E.
ATLANTA, GEORGIA 30305
404 231 1972
VERN WINN
1121 LONGWOOD CIRCLE
LOUISVILLE, KY 40223
502 895 9940
GREGORY-SALISBURY & CO INC
805 S FRONT STREET
NEW ORLEANS, LA 70130
504 524 5207
GREGORY-SALISBURY & CO INC
P O BOX 1126
RATON ROUGE, LA 70003
504 342 2873
RICHARD B MURDOCH
7300 BAYLOR AVE
COLLEGE PARK, MD 20741
301 GR 4 5790
WYMAN/YOUNG ASSOCIATES
128 ORCHARDVIEW AVE
WEST SPRINGFIELD, MASS 01089
413 738 2631
GERALD FINN
4892 FULLER AVE S E
GRAND RAPIDS, MICHIGAN 48211
616 534 8327
LIGHTING ASSOCIATES
1961 E MILWAUKEE AVE
DETROIT, MICH 48211
313 875 2757
GREGORY-SALISBURY CO INC
350 N MART PLAZA, BOX 9767
JACKSON, MISS 39026
601 EM 2 1671
P M ERWIN ASSOCIATES
3738 WASHINGTON BLVD
ST LOUIS 8, MO
314 JE 5 8651
TED STUART
47 DARTMOUTH DRIVE
DELRAN, NEW JERSEY
609 HO 1 6875
WILLIAM MAY & ASSOCIATES
57 FIRST STREET
PEQUANOCK, N J 07440
201 656 2578
RUSSELL ERICKSON AGENCY
1100 ALVAREDO DRIVE NE
ALBUQUERQUE, NEW MEXICO
505 242 9589
HEADQUARTERS
423 SOUTH BROADWAY
YONKERS, NEW YORK 10705
914 965 7050
WARREN A BRENNAN
15 PIERPORT DRIVE
WILLIAMSVILLE, N Y 08075
716 633 8225
FRANK SWEENEY AGENCY
225 TWIN HILLS DRIVE
SYRACUSE, N Y 14221
315 475 0662
S L BAGBY CO
322 W MOREHEAD ST
CHARLOTTE 1, N CAROLINA
704 334 2821
WARREN LEHR ASSOC. INC
1890 NORTHWEST BLVD
COLUMBUS, OHIO 43212
614 488 5939
ROBERT EIMS ASSOC
274 N 61ST STREET
OKLAHOMA CITY, OKLA
405 VI 3 0874
M B MOORE, JR & ASSOC
BOX 463
MYRTLE BEACH, S C 29577
803 449 5881
GREGORY-SALISBURY & CO INC
P O BOX 6166
MEMPHIS, TENN 38106
901 948 0496
W J CHILDERS
5811 MALETIO LANE
DALLAS, TEXAS 75230
214 AD 9 3684
MICHAEL PRICE
BOX 222
N SALT LAKE CITY, UTAH 84110
801 295 3435
LYNN H MORRIS
452 HIGH STREET BOX 349
SALEM, VIRGINIA 24153
703 389 5798

LINDSAY SPECIALTY PRODUCTS LTD
BRAND NAMES
LINDSAY
COMPANY ADDRESS
50 MARY ST., W
LINDSAY, ONTARIO

LIPPS INC
VICE PRESIDENT - SALES
BERNARD D. LIPPS
BRAND NAMES
LIPPS, INC
COMPANY ADDRESS
1630 EUCLID STREET
SANTA MONICA, CALIF. 90404
393-0449
COMPANY REPRESENTATIVES
WILLIAM F. LANGLEY
8219 RHEA AVE
NORTHBRIDGE, CALIF
349-6694

LITTELFUSE INC
VICE PRES & SALES MANAGER

WALTER A. CLEMENTS
BRAND NAMES
MICROFUSE
PICOFUSE
SLO-BLO
COMPANY ADDRESS
800 E NORTHWEST HWY
DESPAINES, ILL 60016
312 824-1188
COMPANY REPRESENTATIVES
HARRY MOORE SALES CO
4142 N 18TH
PHOENIX, ARIZONA
602 274 0060
WM. J. PURDY CO.
312 7TH STREET
SAN FRANCISCO, CALIF.
415 863 3300
JACK BERMAN CO., INC.
1751 S. LA CIENEGA
LOS ANGELES, CALIF.
213 870 4711
MCLOUD & RAYMOND COMPANY
2151 S. GRAPE
DENVER, COLORADO
303 756 1589
FRANK C. WICKERSON CO
1244 CLAIRMONT, STE 220
DECATUR, GEORGIA
404 636-2752
BILL KOLANS & COMPANY
P.O. BOX 2098
HONOLULU, HAWAII 96805
811 628
MARKAL SALES CORP
5787 N LINCOLN
CHICAGO, ILL 60645
312 561 7290
CRESCENT INTERNATIONAL
540 N. LAKE SHORE
CHICAGO, ILLINOIS
312 337 2292
DEVOE ASSOCIATES
4010 WASHINGTON BLVD.
INDIANAPOLIS, IND.
317 283 1395
THOMAS-MODRIN ASSOC., INC.
P.O. BOX 189
SHAWNEE MISSION, KANSAS
913 432 2131
CHARLES SEGAL CO.
799 WASHINGTON
NEWTONVILLE, MASS.
617 969 6900
R. C. MERCHANT & CO., INC.
18411 W. MCNICHOLS
DETROIT, MICH.
313 535 6000
NORTHERN STATE SALES CO
1109 W 78 1/2 ST
MINNEAPOLIS, MINNESOTA
612 333-2431
BRESSLER ASSOCIATES
4808 BERGENLINE
UNION CITY, N.J.,
201 864 9577
R. W. MITSCHER CO., INC
496 ELLICOTT SQ BLDG
BUFFALO, N.Y.
716 854 2517
NEAL BEAR CORPORATION
3435 STREETSBORO
WEST RICHFIELD, OHIO
216 659 3331
JOSEPH V. BELUSKO CO.
2355 N.W. QUIMBY
PORTLAND, OREGON
503 222 4279
NEBCO ASSOCIATES
1974 GREGORY AVENUE
MONROEVILLE, PA.
412 824-2111
SAMUEL A. JEFFRIES, INC.
105 FORREST
HARBERTH, PA.
215 664 8500
AL ENGELMAN CO.
P.O. BOX 12091
MEMPHIS, TENN.
901 458 6263
LUND & COMPANY
2215 N. OLIVE STREET
DALLAS, TEXAS
214 748 8839
REPS. IN OTHER COUNTRIES
PITT PRODUCTS, LTD.
87 WINGOLD AVENUE
TORONTO, ONT.
416 789 2621

LITTLE JOE ENTERPRISES
SALES MANAGER
ROBERT D. SIDWELL
COMPANY ADDRESS
400 3RD STREET
PORT ST. JOE, FLORIDA
COMPANY REPRESENTATIVES
JAMES H. VICKERS
P.O. BOX 40
PORT ST. JOE, FLORIDA
229 3866

LITTON EDUCATIONAL TELEVISION DIVISION
VICE PRESIDENT
HENRY SHAPIRO
COMPANY ADDRESS
210 WESTCHESTER AVENUE
WHITE PLAINS, NEW YORK 10604

LOW POWER BROADCAST EQUIPMENT COMPANY
SALES MANAGER
RICHARD H CROMPTON
COMPANY ADDRESS

248 SWEDSFORD ROAD
MALVERN, PA 19355
215 NI 4-4096

MACARTA INC.

SALES MANAGER
G. D. ANDREWS
BRAND NAMES
CAROUSEL
ROTA RAK
MACARTA
COMPANY ADDRESS
709 RAILROAD AVE.
WEST DES MOINES, IOWA 50265

THE MACHLETT LABORATORIES, INC.

A SUBSIDIARY OF RAYTHEON CO.
SALES MANAGER LG POWER TUBES
E. H. GILBERT
COMPANY ADDRESS
1063 HOPE STREET
SPRINGDALE, CONN. 06879
COMPANY REPRESENTATIVES
K G MORRISON
120 EL CAMINO REAL
SAN CARLOS, CALIFORNIA 94070
415 593 1021
R A HOFFMAN
2501 W 7TH STREET
LOS ANGELES, CALIFORNIA 90057
213 383 1277
D S FRANKEL
ROYCE BUILDING RM 1022
510 NO DEARBORN STREET
CHICAGO, ILLINOIS 60610
312 642 5316

MACKENZIE LABORATORIES

SALES MANAGER
A. R. TAYLOR
COMPANY ADDRESS
1357 N FAIR OAKS AVE
PASADENA, CALIF 91103
213 SY 8 6220

MAGNA-TECH CORPORATION

SALES MANAGER
RON MATTHEWS
BRAND NAMES
MAGNA-TECH
COMPANY ADDRESS
2300 AMPEX AVENUE
OPELIKA, ALA 36801
205 745 7346

MAGNECORD

DIVISION OF THE TELEX CORP.

MARKETING MANAGER
JAMES S ARRINGTON
BRAND NAMES
MAGNECORD
COMPANY ADDRESS
9600 ALDRICH AVE. SOUTH
MINNEAPOLIS, MINN. 55420
COMPANY REPRESENTATIVES
MAITLAND K SMITH CO.
3258 CAHABA RD.
BIRMINGHAM, ALA. 35243
205 967-3080
KOESSLER SALES COMPANY
4614 NORTH SEVENTH STREET
PHOENIX, ARIZONA 85014
DICK BELLEW SALES CO.
1005 W 4TH STREET
EL DORADO, ARKANSAS
501 863-8325
KOESSLER SALES CO.
818 W FAIRFAX AVENUE
LOS ANGELES, CALIF.
213 653-1605
EVANS MARKETING COMPANY
2803 GENEVA AVENUE
DALY CITY, CALIF.
415 584-0818
JOHN A ROWE & ASSOCIATES
58TH & VALLEY HWY.
DENVER, COLO. 80216
303 623-3030
MAITLAND K. SMITH CO.
1850 E DAYTON ST. CIRCLE
FT. LAUDERDALE, FLA.
305 587-7378
MAITLAND K SMITH COMPANY
31-16TH STREET, N W
ATLANTA, GA. 30309
A H PETERSON CO.
3647 W 62ND ST.
CHICAGO, ILL.
312 735-0846
ZIMMER SALES, INC.
5620 WOODWARD
MERRIAM, KANSAS
913 432-8900
BROTHERS & CONNEEN ASSOCIATE:
6302 LINCOLN AVENUE
BALTIMORE, MD. 21209
301 RO 4-7189
HETHERINGTON SALES CO.
97 BOGEL STREET
WESTON 93, MASS.
617 235-523
HETHERINGTON SALES CO.
100 HATHERLY ROAD
WALTHAM, MASS.
617 894-4849
RILEY & PETCHELL ELECTRONIC
13209 FENKELL AVENUE
DETROIT, MICH.
313 838-9100
MARTY BETTAN SALES CO.
77-15 164TH AVENUE
FLUSHING, N. Y. 11366
212 657-6659

WAXMAN CURRANT SALES, INC.
990 KENMORE AVENUE
BUFFALO, N.Y. 14216
716 873-0442

ROCKE INTERNATIONAL CORP.
EXPORT

13 E. 40TH STREET
NEW YORK, N.Y. 10016
212 MU 9-0200
MAITLAND K SMITH CO.
1605 CHATHAM AVE.
CHARLOTTE, N. C. 28205
704 376-5951
C L PUGH CO.
2144 RIVERSIDE DRIVE
COLUMBUS 21, OHIO
614 486-9678

TXW 614 759-0084
DALE G WEBER COMPANY
WEATHERLY BLDG., SUITE 306
PORTLAND, OREGON 97214
503 234-0686
BROTHERS & CONNEEN ASSOCS.
131 HARNED ROAD
SPRINGFIELD, DEL. CO., PA.
215 KI 3-8641
C L PUGH CO.
512 CRESTLINE DR.
PITTSBURGH34, PA.
412 531-2731

J Y SCHOONMAKER CO.
5328 REDFIELD AVENUE
DALLAS, TEXAS 75235
214 631-8480
TXW 214 631-8962
J Y SCHOONMAKER CO.
107 WINNETKA RD.
SAN ANTONIO, TEXAS 78229
512 342-0251

J Y SCHOONMAKER CO.
2711 BROAD STREET
HOUSTON, TEXAS
713 926-9510
DALE G. WEBER CO.
325 MARITIME BLDG.,
911 WESTERN AVENUE
SEATTLE, WASH, 98104
206 623-5990

REPS IN OTHER COUNTRIES
GEORGE BRILEY
MAGNECORD CANADA, LTD
3751 BLOOR STREET, WEST
ISLINGTON, ONTARIO
416 BE 1 3303
A D RUSSELL
MAGNECORD CANADA, LTD
2500 BATES ROAD ROOM 102
MONTREAL 29, QUEBEC
739 3026

MAURICE D CHAPMAN
MAGNECORD AUSTRALASIA PTY
MACQUARIE PLACE
SIDNEY, AUSTRALIA

MAGNETIC MEDIA CORPORATION

SALES MANAGER
RICHARD K. PEDERSEN
BRAND NAMES
MICRO MEDIA
COMPANY ADDRESS
616 FAYETTE AVE.
MAMARONECK, NEW YORK 10543
COMPANY REPRESENTATIVES
CHUCK HARPER
1933 SO BROADWAY
LOS ANGELES, CALIFORNIA
213 R 17 7314
FRED DOBBS
569 LAUREL STREET
P O BOX 266
SAN CARLOS, CALIF
415 591 0339
DICK MORRIS
915 CHEYENNE BOULEVARD
COLORADO SPRINGS, COLO
ROBERT REISS
70 JESSIE DRIVE
WEST HAVEN, CONNECTICUT
203 933 8542
JACK GEARTNER
235 LINCOLN ROAD
MIAMI BEACH, FLORIDA
305 531 0200
HEINZ THEILE
6611 NO CLARKE ST
CHICAGO, ILLINOIS
312 465 2622
CURTIS-MATHEWS SALES CO
760 N WESTLINK
WICHITA, KANSAS
ROD BUTCHART
RUTCHART RATHSBURG & ASSOC
16637 E WARREN AVENUE
DETROIT, MICHIGAN
313 882 1717
PAT AYLWARD
3807 GRAND AVENUE SOUTH
MINNEAPOLIS, MINNESOTA
612 824 6266
WALT LANDOME
75 PLANDOME
MANHASSET, NEW YORK
516 MA 7 6620
MAURY FARBER
22D DELAWARE AVENUE
BUFFALO, NEW YORK
716 TL 6 3543
LUKE RODDEY
115 EAST BOULEVARD
CHARLOTTE, N CAROLINA
WHITE ASSOCIATES
465 EAST HANLEY ROAD
MANSFIELD, OHIO
FRANK YARUSSI
312 ROCKFIELD ROAD
PITTSBURGH, PENNSYLVANIA

412 CA 1 4676
BRENDON O HARA
4952 WYNNFIELD AVENUE
PHILADELPHIA, PENNSYLVANIA
215 473 3654
KENNETH WYBORN
WYBORN ASSOCIATES
P O BOX 17070
DALLAS, TEXAS
214 381 4645
WILLIAM K WOOD
P O BOX 46046
5908 CALIFORNIA AVENUE, SW
SEATTLE 16, WASH.
206 WE 5-9400

MAGNE-TRONICS INC.

SALES MANAGER
A. J. KENDRICK
COMPANY ADDRESS
850 THIRD AVENUE
NEW YORK, N Y 10022

MALLORY DISTRIBUTOR

PRODUCTS CO.
SALES MANAGER
FRANK P. VENDELY
COMPANY ADDRESS
101 S. PARKER AVE, BOX 1558
INDIANAPOLIS, IND. 46206

MARANTZ COMPANY, INC.

SALES MANAGER
RICHARD BRUNELLE
C/O SUPERSCOPE, INC.
8150 VINELAND AVE
SUN VALLEY, CALIF
BRAND NAMES
MARANTZ
COMPANY ADDRESS
37-04 57TH STREET
WOODSIDE, NEW YORK 11377

COMPANY REPRESENTATIVES
H & K SALES, INC
3695 HAVEN AVENUE
MENLO PARK, CALIFORNIA
415 EM 9 6244

SUPERSCOPE INCORPORATED
8150 VINELAND AVENUE
SUN VALLEY, CALIFORNIA
213 875 0810
SATTER SALES COMPANY
3835 ELM STREET
DENVER, COLORADO
303 388 6376

J & B ASSOCIATES
380 NE 67TH STREET
MIAMI, FLORIDA
305 PL 1 9752
J & B ASSOCIATES
1000 PEACHTREE ST N E
ATLANTA, GEORGIA
404 241 6537

GENE PIETY FACTORS
P O BOX 2903
HONOLULU, HAWAII
SUPERSCOPE CHICAGO, INC
1601 SO WOLF ROAD
HILLSIDE, ILL
312 449 7264

MICHAEL SCOTT CO
336 WASHINGTON ST
WELLESLEY HILLS, MASS
617 CE 5 0102
SUPERSCOPE DETROIT, INC
17220 WEST 8 MILE ROAD
SOUTHFIELD, MICHIGAN
313 353 0212

NORTHERN STATES SALES
1109 W 78 1/2 STREET
MINNEAPOLIS, MINNESOTA
612 866 3468
CHARLES W DREESE
3710 CANTERBURY PLACE
INDEPENDENCE, MISSOURI
816 IN 1 7294

HAROLD A MOYER COMPANY
P O BOX 14
HADDONFIELD, NEW JERSEY
609 HA 9 7792
SUPERSCOPE N Y, INCORPORATED
56-16 37TH AVENUE
WOODSIDE, NEW YORK
212 446 7227

DELRAMA INTERNATIONAL-EXPORT
114D BROADWAY
NEW YORK NEW YORK
212 MU 3 5440
SHAMROCK ELECTRIC SALES INC
1755 WEST MARKET STREET
AKRON, OHIO
216 864 3D9D

MILLER & ASSOCIATES
1450 PRESTON FORREST SQUARE
DALLAS, TEXAS
214 AD 9 3789
SUPERSCOPE SEATTLE, INC
15000 NE 15TH STREET
BELLEVUE, WASHINGTON
206 SH 6 1550

MARATHON PRODUCTS CORP.

SALES MANAGER
B. D. BAGDASARIAN
COMPANY ADDRESS
370 SO MAIN STREET
HOLDEN, MASS 01520

MARCONI DIVISION

THE ENGLISH ELECTRIC CORP
COMPANY ADDRESS
ONE PARK AVE
NEW YORK, N Y 10016

MARCONI INSTRUMENTS

DIV ENGLISH ELECTRIC CORP

MANAGER/VICE PRESIDENT
WILLIAM A. BUCK
BRAND NAMES
MARCONI
EDDYSTONE

COMPANY ADDRESS
111 CEDAR LANE
ENGLEWOOD, N J 07631
201 567 0607
COMPANY REPRESENTATIVES
LEE ASSOCIATES INC
P O BOX 1506
HUNTSVILLE, ALA
205 539 0761

MOXON ELECTRONICS CORP
2311 PONTIUS AVE
LDS ANGELES, CALIF
213 272 9311
MOXON ELECTRONICS CORP
15 41ST AVE
SAN MATEO, CALIF
415 345 7961

MOXON ELECTRONICS CORP
2054 GARNET ST
SAN DIEGO, CALIF
714 274 6525
HYTRONIC MEASUREMENTS INC
1295 S BANNOCK ST
DENVER, COLO
303 733 3701

VECTOR SALES
267 W RUTLAND ROAD
MILFORD, CONN
203 874 2112
LEF ASSOCIATES INC
P O BOX 7896
ORLANDO, FLORIDA
305 241 4445

HAR-KOM HAWAII INC
2933 KOAPAKA STREET
HONOLULU, HAWAII
815 617
KENNETH W MEYERS CO
7256 W TOWNY AVE
CHICAGO, ILL 60648
312 774 6440

526 S ASSOCIATES
4405 EAST-WEST HWY
BETHESDA, MD
301 654 2420
VECTOR SALES
301 BELMONT ST
BELMONT, MASS
617 489 1400

GAINE ENGINEERING
20531 MACK AVE
DETROIT, MICH 48236
313 TU 1 3532
PALATINE ENGINEERING SALES
8587 ST CHARLES ROCK RD
ST LOUIS, MO 63114
314 426 7055

L & E ASSOCIATES
511 VICTOR ST
SADDLE BROOK, N J 07663
201 343 3070
HYTRONIC MEASUREMENTS INC
305 WASHINGTON S E
ALBUQUERQUE, N M
505 268 3941

LEE ASSOCIATES INC
P O BOX 906
WINSTON-SALEM, N C
919 724 2406
GAINE ENGINEERING
29603 BRUCE DRIVE
WILLOWICK, OHIO
216 WH 3 3731

L & E ASSOCIATES
P O BOX 4242
PHILADELPHIA, PA 19144
215 438 5666
S & S ASSOCIATES
BORO LINE ROAD
KING OF PRUSSIA, PA
215 265 3450

GAINE ENGINEERING
6 BARTON DRIVE
PITTSBURGH, PA
412 371 3020
READING INTL EQUIPMENT INC
P O BOX 12159
LOUISIANA STATION

SANTORCE, PUERTO RICO
SAN JUAN 723 5D3D
BRADEN ENGINEERING CO
2646 ANDJON DRIVE
DALLAS, TEXAS
214 352 4626

BRADEN ENGINEERING CO
313D SOUTHWEST FREEWAY
HOUSTON, TEXAS
713 JA 99881
HYTRONIC MEASUREMENTS INC
2022 SO MAIN ST
SALT LAKE CITY, UTAH
801 466 4924

J K DOOLEY CO INC
4110 STONEYWAY NORTH
SEATTLE, WASH 98119
206 ME 2 1618

MARTI ELECTRONICS

SALES AND MARKETING MANAGER
ROBERT E. RICHARDS
COMPANY ADDRESS
105 POINDEXTER, PO BOX 661
CLEBURNE, TEXAS 76031
COMPANY REPRESENTATIVES
GATES RADIO COMPANY
QUINCY, ILLINOIS
217 BA 2 8202

COLLINS RADIO COMPANY
DALLAS, TEXAS
214 AD 5 9511

YOU WON'T FIND A PANIC BUTTON ON A MAGNECORD!



When Magnecord engineered a long list of safety factors into their professional line of tape recorder/reproducers . . . they engineered the emergencies out! A sturdy die-cast mainplate, supporting the transport in every model, insures precise location of internal parts under the roughest operating conditions. Rigid die-cast head mounts eliminate alignment problems. Professional quality hysteresis synchronous

capstan motor and individual reel drive motors are heavy duty models, and the capstan shaft assembly is re-inforced for extra strength and longer life.

While you are taping, safe-guard operating features protect your thinnest tapes. With Magnecord you get top-notch performance and superb fidelity to keep your taping facility operating at maximum capacity, even after years of constant use. Ask a broadcaster who uses one . . . MagneCORDs are built to take it!

Write now for the full story on the complete line of durable quality MagneCORD tape instruments.

MagneCORD 8+ Reels now available from Audiotape®. See your local dealer.

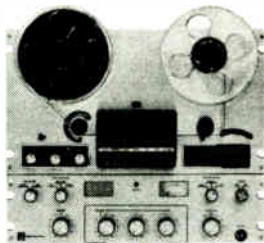

MAGNECORD MODEL 1021
Fully transistorized professional tape recorder / reproducer for monaural operation. For use in main or production control room.

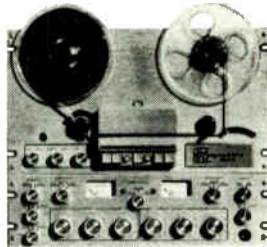

MAGNECORD MODEL 1022
Fully transistorized professional tape recorder / reproducer two channel (stereo) for use in main or production control room.



MAGNECORD MODEL 1028
Professional quality 2 channel (stereo) tape recorder / reproducer for recording master tapes. (10½" reel capacity) Available in ½- or ¼-track.



MAGNECORD MODEL 1048
Professional 2 channel (stereo) recorder/reproducer for use in main studio, production studio or conference recording. (10½" reel capacity) Model 1048 is available in ½- or ¼-track.

MagneCORD
 DIVISION OF THE
 TELEX CORPORATION
 P. O. Box 1526 / Tulsa, Oklahoma 74101
 MANUFACTURER OF TELEX HEADSETS
 AND OTHER FINE ACOUSTIC DEVICES

MARYLAND TELECOMMUNICATIONS,

INCORPORATED
SALES MANAGER
 JOHN D. ROCKWELL
BRAND NAMES
 MTI
COMPANY ADDRESS
 10534 YORK ROAD
 COCKEYSVILLE, MARYLAND 21030
COMPANY REPRESENTATIVES
 THOMAS ALBRIGHT
 SALES ENGINEER
 P O BOX 8173
 WICHITA, KANSAS
 316 MU 2 5378
 JAMES C KORCUBA
 REGIONAL SALES MANAGER
 DALE A ROSSWIG
 REGIONAL SALES MANAGER
 FRANCIS A HILDAGO
 SALES ENGINEER
 WILLIAM F LEE JR
 SALES ENGINEER
 COCKEYSVILLE OFFICE
 666 2727
 RONALD W GERMAN
 SALES ENGINEER
 104 PRINCETON ROAD
 EXTON, PA 19341
 215 363 6459

MASTER TOWER COMPANY

SALES MANAGER
 RICHARD KRONE
COMPANY ADDRESS
 119 MAIN ST, BOX 694
 SIDUX CITY, IOWA 51102
 258 0108

J. G. MCALISTER, INC.

BRAND NAMES
 BARDWELL
 MCALISTER
COMPANY ADDRESS
 1117 N MCCADDEN PL BOX 38368
 HOLLYWOOD, CALIF. 90038

THE MCINTIRE COMPANY

SALES MANAGER
 E. S. CHATLOS
BRAND NAMES
 MCINTIRE
COMPANY ADDRESS
 DKNER PARKWAY
 LIVINGSTON, NEW JERSEY 07039
COMPANY REPRESENTATIVES
 WM KRUSE
 707 BROOKSIDE DRIVE
 DANVILLE, CALIF 94526
 415 837 2421
 H A UTECH
 PO BOX 36
 PALATINE, ILLINOIS 60067
 HOME - 312 529 9722
 F C BUERK
 39-71 44TH STREET
 LONG ISLAND CITY, N.Y. 11104
 212 392 2881
 W ENTERLINE
 42D BELLEVUE AVENUE
 YONKERS, N.Y. 10703
 914 YO 5 0716
 T SMALL
 PO BOX 9380 - 200 RUPERT ST
 FT WORTH, TEXAS 76107
 817 ED 2 6353
 E FANICK
 10614 MOORBERRY
 HOUSTON, TEXAS 77043
REPS IN OTHER COUNTRIES
 R BENNER
 844 CALEDONIA ROAD
 TORONTO 19, ONTARIO
 781 2207

MCMARTIN INDUSTRIES, INC.

MARKETING DIRECTOR, BROADCAST
 DIANE HAVERTY
MARKETING MGR, AUDIO
 GARY SMITH
DISTRICT SALES MANAGER
 DDN S JONES
 130 CASA LINDA PLAZA, STE 14
 DALLAS, TEXAS
 214 DA 1-7256
DISTRICT SALES MANAGER
 LLOYD O PHILLIPS
 597 N. YORK STREET
 ELMHURST, ILL.
 312 279-1049
DISTRICT SALES MANAGER
 JACK M DUCART
 711-14TH STREET, NW, STE 914
 WASHINGTON, D. C.
 202 678-3279
COMPANY ADDRESS
 605 NDRTH 13TH STREET
 OMAHA, NEBRASKA 68102
COMPANY REPRESENTATIVES
 JOF CLANCY
 PO BOX 9212
 BIRMINGHAM, ALABAMA
 205 595 7114
 ROBERT F FISSELL
 4614 NORTH 7TH STREET
 PHOENIX, ARIZONA
 602 264 4031
 JACK CARTER AND TONY ROSSNEY
 2609 W OLIVE AVENUE
 BURBANK, CALIF
 213 847 1292
 RUDF JACORS
 1530 EAST 12TH STREET
 OAKLAND, CALIF
 415 261 7676
 JOHN GOVREAU

PO BOX 7102
 TAMPA, FLORIDA
 813 227 5051
 RURNIE HALPERN & ARTHUR COMF
 MANRFP CORPORATION
 PO BOX 429
 NORTH MIAMI BEACH, FLORIDA
 305 949 3457
 LARRY O HAWKINS
 2500 KALAKAUA AVENUE
 HONOLULU, HAWAII
 938 448
 ROBERT MILSK CO
 3231 N MERIDIAN
 INDIANAPOLIS, IND
 317 923 1545
 BILL KELLY
 7546 TROOST AVENUE
 KANSAS CITY, MO
 816 EM 3 5651
 ROBERT MILSK COMPANY
 3901 FERN VALLEY ROAD
 LOUISVILLE, KY
 502 584 5251
 ART GAINES
 11151 VIERS MILL RDAD
 WHEFATON, MARYLAND
 301 933 2550
 BILL KEFNE
 PROFESSIONAL BLDG
 ROOM G 14
 156 BROAD STREET
 LYNN, MASS
 617 595 1701
 ROBERT MILSK COMPANY
 19375 JAMES COUZENS HIGHWAY
 DETROIT, MICHIGAN
 313 342 6660
 ROBERT MILSK CO
 200 N DIVISION STREET
 GRAND RAPIDS, MICHIGAN
 616 451 0615
 H F WINKELER
 2319 HAMPTON AVF
 ST LOUIS, MO
 314 ST 1 6111
 JOEL JOSEPH
 PO BOX 486
 GREAT NECK, N. Y.
 516 HU 7 9395
 JAY ALLEN
 PO BOX 205
 NORTH SYRACUSE, N. Y.
 915 458 7470
 NEAL HUNTER & HARRY PASTON
 2002 TEALL AVENUE
 SYRACUSE, N.Y.
 315 437-2992
 JOHN L DE BURROS-EXPDRP
 ROCKE INTERNATIONAL CORP
 13 EAST 40TH STRFRET
 NEW YDRK, N. Y.
 212 MU 9 7200
 THOMAS WALKER, JR.
 PO BOX 8430
 ASHEVILLE, N. C.
 704 257 7092
 A W GREESON, JR
 219 HOWWOOD AVE
 GREENSBORO, N. C.
 919 292 1791
 MORT LIEBMAN
 PO BOX 21493
 GREENSBORO, N. C.
 919 274 0693
 PETE SEAY
 3850 FAIRLINGTON DRIVE
 COLUMBUS, OHIO
 614 451 6611
 A K WYBORNY
 PO BOX 17070
 DALLAS, TEXAS
 714 EV 1 4645
 J E HALL
 205 N 23DD WEST
 SALT LAKE CITY, UTAH
 801 328 0921
 ANDY SPROUL
 9210 - 28TH AVENUE, NW
 SEATTLE, WASH
 206 SU 4 6447
REPS IN OTHER COUNTRIES
 ARNE CLAPP
 GATES RADIO CO - CANADA LTD
 637 CRAIG STREET WEST
 MONTREAL, QUEBEC
 514 866 6755

MELCOR ELECTRONICS CORPORATION

SALES MANAGER
 JULIUS BRICK
COMPANY ADDRESS
 1750 NEW HIGHWAY
 FARMINGDALE, N.Y. 11735
COMPANY REPRESENTATIVES
 HOLZER AUDIO ENG
 14110 AETNA STREET
 VAN NUYS, CALIF
 787 7733
 HARVEY RADIO CO
 60 CROSSWAYS PARK, WEST
 WOODBURY, N. Y.
 WA 1 8700
 TOTAL ELECTRONICS INTL
 PO BOX 356
 301 MILL ROAD
 HEWLETT, N. Y.
 374 9620

MEMOREX CORPORATION

VICE PRES MARKETING
 EDWARD S SEAMAN
COMPANY ADDRESS
 118D SHULMAN AVE.
 SANTA CLARA, CALIF. 95050
COMPANY REPRESENTATIVES

WILLIAM A BEAVERS
 3777 CRESTBROOK ROAD
 MOUNTAIN BROOK, ALABAMA
 205 967 0545
 WESTERN REGION
 1045 GAYLEY AVENUE
 LOS ANGELES, CALIF 90024
 213 477 1018
 WILLIAM M GASKINS
 REGIONAL SALES MANAGER
 1887 MARVIEW DRIVE
 THOUSAND OAKS, CALIF 91360
 805 495 7758
 SETH P HENDERSON
 580 LUCERO AVENUE
 PACIFIC PALISADES, CAL 90272
 213 454 7218
 JAMES R BELLAH
 152 SOUTH MORTON AVENUE
 LOS ANGELES, CALIFORNIA
 213 467 9887
 SAN FRANCISCO OFFICE
 727 INDUSTRIAL ROAD
 SAN CARLOS, CALIF 94070
 415 593 1691
 WILLIAM PATSURI
 13325 VIA MADRONES DRIVE
 SARATOGA, CALIF 95070
 408 867 4677
 ROBERT H SENZ
 P O BOX 533
 EL GRANADA, CALIF
 415 726 5320
 DENVFR OFFICE
 601 BROADWAY STREET
 DENVER, COLORADO
 303 244 5473
 RICHARD H CRAIN
 880 CHERRY STREET, NO 601
 DENVER, COLORADO 80220
 ORLANDO OFFICE
 1 NORTH ROSALIND AVENUE
 ORLANDO, FLORIDA 32801
 305 424 3302
 JOHN C LORY
 ROUTE 2 SUBURBAN SHORES
 WINTER GARDEN, FLA 32787
 305 656 1691
 SOUTHERN REGION
 3166 MAPLE DRIVE N E
 ATLANTA, GA 30305
 404 231 4865
 JAMES T CANTRELL
 REGIONAL SALES MANAGER
 1770 SAXON PLACE N E
 ATLANTA 19, GEORGIA
 404 636 6916
 COMPUTER PRODS, PACIFIC LTD.
 P O BOX 8615
 HONOLULU, HAWAII 96815
 510 411
 RAY L HANSEN
 411 KAIOLU APT 701
 HONOLULU, HAWAII
 CENTRAL REGION
 595 NORTH YORK
 ELMHURST, ILLINOIS 60126
 312 834 8922
 VERN A KUELLMER
 REGIONAL SALES MANAGER
 616 PARKSIDE AVENUE
 ELMHURST, ILL 60126
 312 834 5891
 LARY L LINDSEY
 446 VILLA STREET
 VILLA PARK, ILLINOIS 60181
 312 833 9717
 WILLIAM W WILCOX
 20W 432 BELMONT PLACE
 ADDISON, ILLINOIS
 312 629 5844
 DAVID F HICKS
 8820 WESTERN AVENUE
 DES PLAINES, ILLINOIS
 312 827 1361
 CENTRAL ATLANTIC REGION
 4905 DELRAY AVENUE
 BETHESDA, MARYLAND 20814
 301 654 2545
 BRUCE C MCGILAWAY
 REGIONAL SALES MANAGER
 14501 MANOR DRIVE
 ROCKVILLE, MARYLAND 21793
 301 929 3045
 CHARLES H WAGNER
 4410 CAMBRIA AVENUE
 GARRETT PARK, MARYLAND 20766
 301 949 9340
 JOHN C WIEGERS
 11105 LAMPLIGHTER LANE
 POTOMAC, MARYLAND 20854
 301 299 6559
 BOSTON OFFICE
 8 HERRIMACK STREET
 LOWELL, MASS 01852
 617 454 1582
 JAMES R ARMSTRONG
 76 WESTCHESTER
 LOWELL, MASSACHUSETTS
 617 454 4267
 DETROIT OFFICE
 24638 NORTHWESTERN HWY
 SOUTHFIELD, MICHIGAN 48075
 313 353 2670
 CARL M KRUEGER
 29634 WESTBROOK PARKWAY
 SOUTHFIELD, MICHIGAN 48075
 313 356 2479
 ST. LOUIS OFFICE
 1750 BRENTWOOD BLVD
 ST. LOUIS, MISSOURI
 314 961 7070
 GERALD G HEITEL
 4 EAST RIDING AVENUE
 CHERRY HILL, NEW JERSEY 08034
 609 428 1192

NORTHEAST REGION
 225 ROUTE 46
 TOTOWA, NEW JERSEY 07512
 201 256 4100
 PHILADELPHIA OFFICE
 6705 PARK AVENUE
 PENNSAUKEN, NEW JERSEY 08110
 609 662 3047
 M GEORGE KULPER
 REGIONAL SALES MANAGER
 56 POPPLAR DRIVE
 MORRIS PLAINS, N J 07950
 201 538 8513
 HENRY ZEBROWSKI
 19 SUTTON PLACE
 VERDONA, NEW JERSEY
 201 CE 9 4758
 JOHN A BECKER
 RED BARN RD 2
 CALIFDN, NEW JERSEY
 201 638-8397
 ROBERT C FUNK
 58 WOODBURY WAY
 SYDSEET, NEW YORK
 516 921 0194
 DAYTON OFFICE
 HERMAN MILLER BLDG SUITE 232
 333 WEST FIRST STREET
 DAYTON, OHIO 45402
 513 223 9552
 ALFRED S DOMINE
 4408 WOODBINE
 DAYTON, OHIO 45420
 513 254 9482
 DALLAS OFFICE
 8609 NORTHWEST PLAZA DRIVE
 DALLAS, TEXAS 75225
 214 363 8977
 ROYE E GEISER
 9264 CLIFFMERE DRIVE
 DALLAS, TEXAS 75238
 214 348 0285
 CHARLES R SNEATH
 10111 BLUE COAT DRIVE
 FAIRFAX, VIRGINIA 22030
 703 273 4362

METROPOLITAN ELECTRIC MFG. CO.

SALES MANAGER
 CHARLES SHEVLIN
BRAND NAMES
 LUMITRON
COMPANY ADDRESS
 2250 STEINWAY ST.
 LONG ISLAND CITY, N Y 11105

METROTECH INCORPORATED

SALES MANAGER
 E. A. FEICHTMEIR
BRAND NAMES
 METROTECH
COMPANY ADDRESS
 670 NATIONAL AVE.
 MT. VIEW, CALIF. 94040

MICOM, INC

SALES MANAGER
 JOHN S AMES
COMPANY ADDRESS
 2570 LEGHORN STREET
 MOUNTAIN VIEW, CALIF

MICROFLECT COMPANY INC

SALES MANAGER
 GEORGE F. KREITZBERG
BRAND NAMES
 MICROFLECTOR
 K & KS
 L & M
 Q TOWERS
COMPANY ADDRESS
 3575 25TH STREET S E
 SALEM, OREGON 97302

MICROLAB/FXR

SALES MANAGER
 RAYMOND VINCENT
BRAND NAMES
 MICROLAB
 MICROLAB/FXR
 BOGART
 FXR
COMPANY ADDRESS
 TEN MICROLAB ROAD
 LIVINGSTON, N J 07039
 201 992 7700
 TWX 201 992 7362
COMPANY REPRESENTATIVES
 BARNHILL ASSOCIATES
 3D PIMA PLAZA SUITE 20
 SCOTTSDALE, ARIZ
 602 947 5493
 TWX 602 949 0132
 L & M ENGINEERING
 5140 WEST 106 ST
 INGLEWOOD, CALIF
 213 678 5409
 TWX 213 673 2160
 L & M ENGINEERING
 2620 THE ALAMEDA
 SANTA CLARA, CALIF
 408 243 6661
 BARNHILL ASSOCIATES
 1170 S SHERIDAN BLVD
 DENVER, COLO
 303 934 5505
 TWX 303 292 3124
 INSTRUMENT DYNAMICS INC
 345 NORTH MAIN ST
 WEST HARTFORD, CT
 203 233 5503
 TECHNICAL MARKETING INC
 755 W FAIRBANKS AVE
 WINTER PARK
 MAITLAND, FLORIDA
 305 647 6223
 TWX 305 647 0125

Mr. Engineer: Picture yourself behind this console

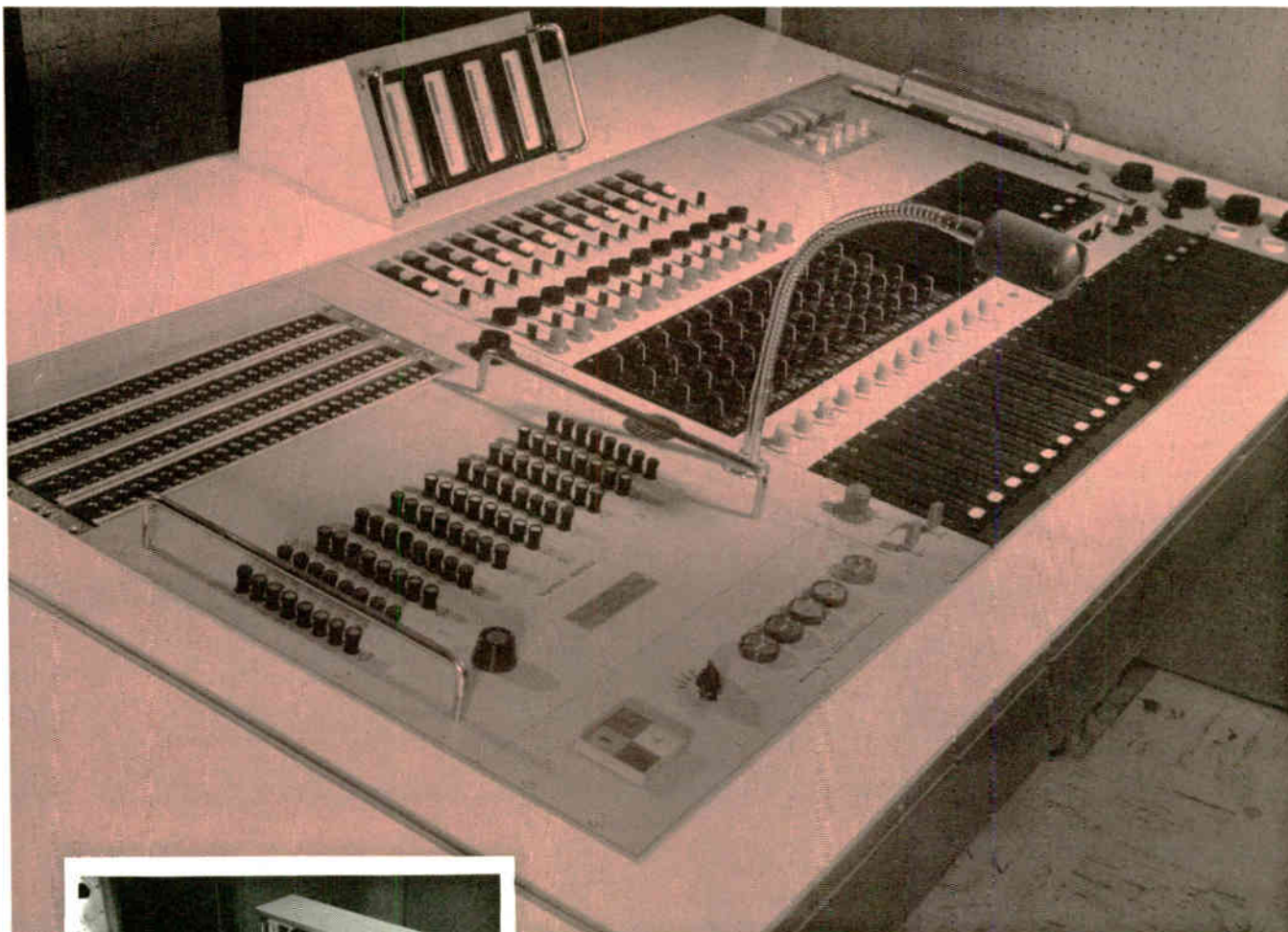

It's the Rolls-Royce of sound equipment – and you need the BEST in today's highly competitive broadcasting and recording market!

It's made by Mid-America Electronics Corp., which in its many years of experience has gained fame throughout the electronics world for the excellence of its custom-designed and custom-manufactured instruments.

These superb electronic creations make it possible to bring out the truly magnificent effects impossible to achieve with regular equipment.

Built to exacting standards, these studio units will bring you up-to-date with the latest broadcasting and recording installations.

When you require SOUND for ANY purpose, whether a small mixing console, or a complete studio, call or write . . .



MID-AMERICA ELECTRONICS CORP.

1515 Euclid Avenue • Cleveland, Ohio 44115
Telephone (216) 621-9362

HUGH MARSLAND CO, INC
231 N EDGEWOOD AVENUE
MINNEAPOLIS, MINN, 55426
612 L15-4481
SY STERLING COMPANY
7849 N LINDBERG BLVO
HAZLEWOOD, MISSOURI
314-837-1221
BARTLETT ASSOCIATES
470 MAMARONEK AVENUE
WHITE PLAINS, N.Y. 10605
914-949-6476
RS ASSOCIATES
1039 WENDOVER AVENUE
P O BOX 6426
GREENSBORO, N.C. 27405
919-273-1918
SY STERLING COMPANY
3300 S DIXIE DRIVE
DAYTON, OHIO 45449
513-298-7573
SY STERLING COMPANY
5827 MAYFIELD ROAD
CLEVELAND, OHIO 44124
216-442-8080
ARNOLD BARNES COMPANY
OKLAHOMA CITY OFFICE
3510 HOCKINGBIRD LANE
P O BOX 1086
MIDWEST CITY, OKLA.
405-737-6556
BARTLETT ASSOCIATES
130 W LANCASTER AVENUE
WAYNE, PENN. 19087
215-688-7325
SY STERLING COMPANY
4232 BROWNSVILLE ROAD
PITTSBURGH, PA. 15227
412-884-5515
ARNOLD BARNES COMPANY
740 S SHERMAN STREET
RICHAROSON, TEXAS 75080
214-235-4541
TWX 214-231-1405
ARNOLD BARNES COMPANY
3230 MERCER STREET
HOUSTON, TEXAS 77027
713-622-3620
ARNOLD BARNES COMPANY
11211 JANET LEE ROAD
BOX 13069
SAN ANTONIO, TEXAS 78213
512-342-7311
ELSCO
2275 SOUTH WEST TEMPLE
SALT LAKE CITY, UTAH 84115
801-466-8631
PARATECH
9210 28 AVENUE, NW
SEATTLE, WASH. 98115
206-784-6447
REPS IN OTHER COUNTRIES
MICROWAVE ASSOCIATES, INTL
HYDE HOUSE, THE HYDE
EDGEWARE ROAD
LONDON NW 9, ENGLAND
TEL. COLINDALE 2284
CANADIAN GENERAL ELECTRIC
830 LANSDOWNE AVENUE
TORONTO, ONTARIO
534-6511
ENGLISH ELECTRIC OF VENEZUELA
C A AVENIDA URANETA
EOIFICIO LUZ ELECTRICA,
2, PISO
CARACAS, VENEZUELA
54-51-16

MID AMERICA ELECTRONICS CORP
SALES MANAGER
FREDERICK C WOLF
COMPANY ADDRESS
1515 EUCLIO AVENUE
CLEVELAND, OHIO 44115

MILES REPRODUCER COMPANY
SALES MANAGER
J. M. KUHLIK
BRAND NAMES
FILMGRAPH
WALKIE-RECORDALL
RECORDOPHONE
OICTAFILM
SONABAND
TELEMIKE
VOCAPHONE
SOUNDTRAP
COMPANY ADDRESS
598 BROADWAY
NEW YORK, NEW YORK 10012
WA5-6985

J. W. MILLER COMPANY
SALES MANAGER
J. HALL
COMPANY ADDRESS
5917 SO. MAIN ST.
LOS ANGELES, CALIF. 90003

O. B. MILLIKEN COMPANY
SALES MANAGER
G. A. CRANOALL
COMPANY ADDRESS
131 N. FIFTH AVE.
ARCADIA, CALIF. 91006
COMPANY REPRESENTATIVES
C. H. HOLZAPFEL
501 PARK AVENUE N
WINTERPARK, FLORIDA
305 644 2929
W. E. SMITH
PO BOX 1141
LANGLEY PARK, MD
301 439 1133

MINNEAPOLIS MAGNETICS, INC.

SALES MANAGER
FRANK ZEMAN
COMPANY ADDRESS
2915 HUNTINGTON AVE
MINNEAPOLIS, MINN 55416

MINNESOTA MINING AND MANUFACTURING COMPANY
MAGNETIC PRODUCTS DIVISION
GENERAL SALES MANAGER
DANIEL E DENHAM
NATIONAL SALES MANAGER
AUDIBLE RANGE & VIDEO TAPE
WILLIAM H MAODEN
TELEVISION PRODUCTS DIV
SALES MANAGER
R V CLAPP
REVERE-MINCOM DIVISION
SALES & MARKETING MANAGER
R J BROWN
BRAND NAMES
DYNACHROME
DYNAPAN
SM BRAND PROFESSIONAL
RECORDER
SCOTCH BRAND
WOLLENSAK
FASTSCAN
TENZAR
REVERE
MINCOM
111-TM
175-TM
COMPANY ADDRESS
MINNESOTA MINING AND MFG CO
2501 HUDSON RO
ST PAUL, MINN 55119
COMPANY ADDRESS
REVERE-MINCOM DIVISION
300 SOUTH LEWIS ROAD
CAMARILLO, CALIF 93010
BRANCH OFFICES
MINNESOTA MINING MFG CO
446 NORTH LA BREA AVENUE
HOLLYWOOD, CALIFORNIA
213 931 1289
6023 SOUTH GARFIELD AVE
LOS ANGELES, CALIF 90022
213 723 6641
320 SHAW ROAD
S SAN FRANCISCO, CALIF 94080
415 761-1155
1750 PENNSYLVANIA AVE N W
SUITE 1100
WASHINGTON, D. C. 20006
202 298 9200
5925 PEACHTREE INO BOULEVARD
CHAMBLEE, GEORGIA 30005
404 451 1661
2880 UALENA STREET
MONOLULU, HAWAII 96819
996 483
6850 SO HARLEM AVENUE
ARGO P. O.
BEDFORD PARK, ILLINOIS 60502
312 585 7800
155 4TH AVENUE
NEEDHAM HEIGHTS, MASS 02194
617 449 0300
411 PIQUETTE AVENUE
DETROIT, MICH. 48202
313 875-7111
PO BOX 3211
935 BUSH AVENUE
ST PAUL, MINNESOTA 55101
612 733 1110
10725 BAUR BOULEVARD
PO BOX 510
ST LOUIS, MISSOURI 63166
314 991 1320
700 GRAND AVENUE
RIDGEFIELD, N. J. 07657
201 943 6700
330 GREENE STREET
PO BOX 369
BUFFALO, NEW YORK 14240
716 896 5214
2401 BREVARD STREET
PO BOX 151
HIGH POINT, N.C. 27261
919 883 0141
4835 PARA DRIVE
CINCINNATI, OHIO 45237
513 242 2313
12200 BROOKPARK ROAD
CLEVELAND, OHIO 44130
216 267 1800
5698 RISING SUN AVENUE
PHILADELPHIA, PA 19120
215 742 0200
2121 SANTA ANNA AVENUE
OALLAS, TEXAS 75228
214 327 7311
101 ANDOVER PARK WEST
ANDOVER INDUSTRIAL PARK
SEATTLE, WASHINGTON 98188
206 244 7200
COMPANY REPRESENTATIVES
REVERE-MINCOM DIVISION
N KIMMEL
300 SOUTH LEWIS ROAD
CAMARILLO, CALIF
805 482 1911
J B MC CRUMB
411 PIQUETTE AVENUE
DETROIT, MICHIGAN 48202
313 875-7111
T A CORNELLY
5698 RISING SUN AVE
PHILADELPHIA, PA 19120
215 742 0200
J L LANOIS
346 WYCLIFFE DRIVE
HOUSTON, TEXAS
713 465 6157

MIRATEL ELECTRONICS, INC.
SALES MANAGER
ROBERT H HANSEN
BRAND NAMES
MIRATEL
COMPANY ADDRESS
3600 RICHARDSON STREET
ST PAUL, MINN 55112
COMPANY REPRESENTATIVES
JAEGER ASSOCIATES, INC
999 WOODCOCK ROAD
ORLANDO, FLORIDA
305 277 5041
LAKE SYSTEMS CORPORATION
75 N BEACON STREET
WATERTOWN, MASS 02172
617 926 0914
DON J DUOLEY
P O BOX K
BRIGHT WATERS, NEW YORK
516 665 9134

MOLE - RICHARDSON COMPANY
SALES MANAGER
WARREN K. PARKER
BRAND NAMES
MOLE
MOLARC
MOLE-RICHARDSON
SOLARSPOT
MOLEQUARTZ
COMPANY ADDRESS
937 N SYCAMORE AVE.
HOLLYWOOD, CALIF. 90038

MOSELEY ASSOCIATES, INC.
DIRECT ALL INQUIRES TO
COMPANY ADDRESS
135 NOGAL ORIVE
P O BOX 3192
SANTA BARBARA, CALIF. 93105

DONALD P. MOSSMAN, INC.
SALES MANAGER
REN W. RIST
COMPANY ADDRESS
P.O. BOX 265
BREWSTER, NEW YORK 10509
COMPANY REPRESENTATIVES
MOSSMAN PACIFIC INCORPORATED
P O BOX 1105
COVINA, CALIFORNIA 91723
ENGINEERED SALES CO INC
4738 N HARLEM AVENUE
CHICAGO, ILLINOIS 60656
312 UN 7-8434
MOLER-FAOER ASSOCIATES
320 HILLEN ROAD
BALTIMORE, MARYLAND 21204
301 VA 5 1130
STAN PIERCE, INCORPORATED
24 LINDEN STREET
NORWOOD, MASSACHUSETTS 02062
617 762 3165
RALPH O ERNEST ASSOCIATES
12818 PURITAN AVENUE
DETROIT, MICHIGAN
313 UN 1 7311
G W MOLER COMPANY
P O BOX 240
HADDONFIELD, NEW JERSEY 08033
609 428 2440
REPS IN OTHER COUNTRIES
PAINTON & COMPANY LIMITED
KINGSTHORPE, NORTHAMPTON,
ENGLAND
BURLFC LIMITED
45 NORTHLINE ROAD
TORONTO 16, ONTARIO
416 PL 5 3377
BURLFC LIMITED
1179 DECARIE BOULEVARD
MONTREAL, QUEBEC
514 RI 4 0165
PAINTON-AUSTRALIA- PTY LTO,
101 MURPHY STREET
RICHMOND, VICTORIA AUSTRALIA

MOTOROLA COMMUNICATIONS AND ELECTRONICS INC
COMPANY ADDRESS
4501 W. AUGUSTA BLVD.
CHICAGO, ILL. 60651
COMPANY REPRESENTATIVES
GEORGE CARROLL
1616 ROLLINS ROAD
BURLINGAME, CALIF. 95010
415 697 3660
JACK CONSIDINE
2333 UTAH AVENUE
EL SEGUNDO, CALIF 90245
213 644 1101
WALLY MILLER
LAKE MIRROR ROAD
FOREST PARK, GEORGIA 30050
404 366 6035
PAT KING
1500 S HARLEM AVENUE
FOREST PARK, ILLINOIS 60130
312 771 8900
WARREN BORNHOEFT
325 ROESLER ROAD
GLEN BURNIE, MARYLAND 21061
301 761 4900
GEORGE HILKERT
15-00 POLLITT ORIVE
FAIR LAWN, NEW JERSEY 07410
201 791 1700
ED JOSEPHS
7138 ENVOY COURT
OALLAS, TEXAS 75207
214 ME 1 8410

MOTOROLA SEMICONDUCTOR PRODUCTS, INC A DIV OF
MOTOROLA, INC
SALES MANAGER
C J GOODMAN

5005 E MCDOWELL RO
PHOENIX, ARIZ 85008
BRAND NAMES
O PF TM
STAR TM
COMPATIBLE TM
MEG-A-LIFE TM
SURMETIC TM
MIDA TM
COMPANY ADDRESS
RDX 955
PHOENIX, ARIZONA 85001
602 273 6900
TWX 910 951 1334
COMPANY REPRESENTATIVES
ART POWELL, ESE MIL REP
HOLIDAY OFC CENTER SUITE 46
3322 S MEMORIAL PARKWAY
HUNTSVILLE, ALA 3580
205 881 5920
TWX 510 579 2209
DENTON SMITH, DSM
DICK GALLOWAY, DSM
2500 NORTH 44TH ST
SOUTHWEST SAV. & LOAN BLOC
PHOENIX, ARIZ 85008
602 773 6364
TWX 910 951 1334
JIM PAINE, AREA MANAGER
ROB VOGEL, RM
SAM WEPRIN, RM
SUNSET CENTER
6725 SUNSET BLVO
HOLLYWOOD, CALIF 90028
213 HO 7 0821
TWX 910 321 2303
JOE HAWKINS, RM
511 S BROOKHURST RD
FULLERTON, CALIF 92633
714 879 8111
TWX 910 592 1234
JIM NORD, RM
CHARLIE SHAW, DSM
DON SMITH, DSM
604 PRICE AVE
REDWOOD CITY, CALIF 94063
415 365 5413
TWX 910 378 5413
BILL LEF, DSM
7961 ENGINEER ROAD
SAN DIEGO, CALIF 92111
714 279 0010
TWX 910 335 1228
RON BAUMERT, DSM
1115 COLORADO BLVD RM 205
DENVER, COLO 80222
303 757 6123
TWX 910 931 2590
FRED TUCKER, DSE
2348 WHITNEY AVE
HAMDEN, CONN 06518
203 288 6478
TWX 710 465 3346
DAVE JOHNSON, RM
BILL MIATT, DSM
PAUL THORPE, DSM
520 SOUTH MAITLAND AVE
MAITLAND, FLA 32751
305 644 3422
TWX 810 853 0256
FRED STOLTING, DSM
LAKEVIEW BLDG RMS 210-211
NORTH PALM BEACH, FLA 33403
305 848 8651
TWX 510 952 6677
GLEN IAGGI, AREA MANAGER
HAL ONSAGER, W CENTRAL RM
FRED SOUFAL, E CENTRAL RM
KEN OLIPHANT, RM
5940 WEST TOWNY AVE
NILES, ILL 60648
312 647 9802
TWX 910 223 3662
BILL BRADY, OSM
MERCHANTS NATL BNK BLOC
ROOM 803
CEDAR RAPIDS, IOWA 52401
319 363 8244
TWX 910 525 1301
SAM MONTGOMERY, OSM
BOB SMITH, OSM
KEN SMYTH, OSM
6200 ANNAPOLIS RO SUITE 422
LANDOVER HILLS, MO 20784
301 772 1500
TWX 710 826 9665
GERRY MCGONAGLE, RM
PAUL YOCHUM, ACCT EXFC
176 SECONO AVENUE
WALTHAM, MASS 02154
617 891 8500
TWX 71C 324 0462
BOB BROWN, RM
21600 GREENFIELD RO STE 205
OAK PARK, MICH 48237
313 LI 2 2174
TWX 810 232 1681
BOB BOTHE, N CENTRAL RM
LEN ALTABELLO, ACCT EXEC
HANK MERINO, ACCT EXEC
7515 WAYSZATA BLVO STE 204
MINNEAPOLIS, MINN 55426
612 545 0251
TWX 910 576 2945
RON ALBERTER, OSM
6050 BROWN ROAD
ST LOUIS, MO 63134
314 JA 2 6565
LOU SMITH, AREA MGR
BERGEN MALL
PARAMUS, N J 07652
201 488 5100
TWX 201 488 5100
BILL BRYOIA, OSM
HERB GOLDSTEIN, OSM
JOHN MORAN, OSM

HUGH MARSLAND & CO INC
6699 LINCOLN AVE
CHICAGO, ILLINOIS
312 676 1100
TWX 312 677 6725

HUGH MARSLAND & CO INC
6730 EAST 19TH ST
INDIANAPOLIS, IND
317 356 4249

BARTLETT ASSOCIATES INC
4405 EAST-WEST HIGHWAY
BETHESDA, MD
301 656 3061

INSTRUMENT DYNAMICS, INC
WAKEFIELD INDUSTRIAL CENTER
TEAL ROAD
WAKEFIELD, MASS
617 245 5100
TWX 617 245 7479

M P ODELL CO
14027 PURIN AVE
DETROIT, MICHIGAN
313 838 7324

HUGH MARSLAND & CO INC
231 N EDGEWOOD AVE
MINNEAPOLIS, MINN
612 545 4481

HUGH MARSLAND & CO INC
12635 BIG BEND BLVD
ST LOUIS, MO
314 966 3646

HUGH MARSLAND & CO INC
P O BOX 8729
KANSAS CITY, MO
913 DP 1 2122

TXW 913 552 7308

BARNHILL ASSOCIATES
319 A WYOMING BLVD, NE
ALBUQUERQUE, N M
505 265 7766

TXW 505 243 8349

J A REAGAN CO INC
419 CENTRAL AVE
ALBANY, N Y
518 436 9649
TWX 518 474 3237

J A REAGAN CO INC
10 HUMPHREYS TERRACE
NEW HARTFORD, N.Y.
315 732-3775

J A REAGAN CO INC
528 CRESTMONT RD
BINGHAMTON, N Y
607 723 9661

J A REAGAN CO INC
327 WESTMORELAND RD
BUFFALO, N Y
716 632 2727

MACHINE & PRODUCTS CO-FRANCE
52 WALL STREET
NEW YORK, N Y
212 944 4370
TWX 710 581 6739

JAKE RUDISILL ASSOC INC
2009 N TRYON ST
CHARLOTTE, N C
704 377 6901

M P ODELL CO
26614 CENTER RIDGE RD
WESTLAKE, OHIO
216 871-8000
TWX 216 871-1390

M P ODELL CO
1250 W DOROTHY LANE
DAYTON, OHIO
513 298 9964

BARTLETT ASSOCIATES INC
130 W LANCASTER AVE
WAYNE PENN
215 688 7325
TWX 215 688 0959

M P ODELL CO
P O BOX 10595
PITTSBURGH, PA
412 371 1231

BARNHILL ASSOC
RICHARDSON, TEXAS
214 AD 1 2573

KEMCO INC
11520 BURDINE
HOUSTON, TEXAS
713 723 0400
TWX 713 571 1080

PARATECH
2208 N W MARKET ST
SEATTLE, WASH
206 783 3900

REPS IN OTHER COUNTRIES
RADIONICS LTD
4938 YONGE ST
WILLOWDALE, ONTARIO
416 222 3261

RADIONICS LTD
8230 MAYRAND STREET
MONTREAL 9, QUEBEC
514 739 5517

MICRO-LINK SYSTEMS/
VARIAN ASSOCIATES
SALES MANAGER
DAVID L. MCPHERSON
COMPANY ADDRESS
1375 AKRON STREET
COPIAGUE, L.I., N.Y. 11726
COMPANY REPRESENTATIVES
ARTHUR J. ROCK
WESTERN REGIONAL OFFICE
4940 EL CAMINO REAL
C/O BOX 201
LOS ALTOS, CALIF. 94022
415 326-4000
VERNON BERTRANO OR
PHIL JACOBSON
VIDEO SYSTEMS, INC.
6444 N. RIOGEWAY AVENUE

LINCOLNWOOD, ILL.
312 OR 7-9000
ROD MCARTHUR
VIDEO SYSTEMS, INC.
3743 GRAVOIS
ST. LOUIS, MO.
314 PR 2-3295
SEYMOUR TYLER
MICRO-LINK SYSTEMS
1375 AKRON STREET
COPIAGUE, N.Y. 11726
515 598-2240
EDWARD MILLING
TAFT BROADCASTING CO.
4808 SAN FELIPE ROAD
HOUSTON, TEXAS
713 NA 2-1010
FRANK LEINS
TAFT BROADCASTING CO.
435 BRANIFF TOWER BLDG.
DALLAS, TEXAS 75235
214 FL 1-9644
J. STANTON KECK
AERO MARC COMPANY
2304 RAINIER AVENUE, S.
SEATTLE, WASHINGTON
206 325-5880

MICROMEGA, DIVISION OF
AMPHENOL CORPORATION
SALES MANAGER
A. D. BERK
COMPANY ADDRESS
4134 DEL REY AVE.
VENICE, CALIF. 90291
COMPANY REPRESENTATIVES
VISUAL ELECTRONICS
356 W 40TH STREET
NEW YORK, N. Y.
PE 6 5840

MICRO RECORD CORPORATION
BRAND NAMES
MICRO RECORD
COMPANY ADDRESS
487-28 SOUTH AVE.
BEACON, NEW YORK 12508

MICROWAVE ASSOCIATES, INC
SALES MANAGER
COMMUNICATIONS EQUIPMENT
ERIK A STROMSTED
COMPANY ADDRESS
NORTHWEST INDUSTRIAL PARK
BURLINGTON, MASS 02114
COMPANY REPRESENTATIVES
BCS ASSOCIATES
2317 BOB WALLACE AVE. SW
P O BOX 1273
HUNTSVILLE, ALA. 35805
205-534-1648
COMMUNICATIONS ENGINEERING
3350 MT VIEW DRIVE
ANCHORAGE, ALASKA 99501
BR2-2305
ELSCO
4533 N SCOTSDALE RD.
U R BUILDING, SUITE 112
SCOTSDALE, ARIZ. 85251
602-946-4658
MICROWAVE ASSOCIATES, INC
9911 INGLEWOOD AVENUE
INGLEWOOD, CALIF. 90301
213-677-9115
ELLIOTT RECHT ASSOCIATES
175 S SAN ANTONIO ROAD
LOS ALTOS, CALIF. 94022
415-941-0336
AMPEX PANAMERICAN CO
EXPORT TO LATIN AMERICAN
P O BOX 4000
REDWOOD CITY, CALIF. 94061
415 367-2011
TWX 415 364-9014
ELSCO COLORADO
2785 N SPEER BLVD
DENVER, COLORADO 80211
303-433-2991
TECHNICAL INSTRUMENTS
575 BROAD STREET
BRIDGEPORT, CONN. 06604
203-368-4582
BCS ASSOCIATES
940 N FERN CREEK AVENUE
P O BOX 6578
ORLANDO, FLA.
305-425-2764
CAMERON G PIERCE & ASSOC.
22 LAIKI PLACE
KAILUA, HAWAII 96814
245-502
CAMERON G PIERCE & ASSOC.
1259 SOUTH BERETANIA ST
HONOLULU, HAWAII 96814
567-308
HUGH MARSLAND, CO, INC
6699 LINCOLN AVENUE
CHICAGO, ILLINOIS 60645
312 OR6-1100
HUGH MARSLAND CO, INC
6730 E 19TH STREET
INDIANAPOLIS, IND. 46219
317 FL6-4249
BARTLETT ASSOCIATES
7979 OLD GEORGETOWN ROAD
BETHESDA, MD, 20014
301-656-3061
TECHNICA INSTRUMENTS
122 WEST STREET
WILMINGTON, MASS. 01887
617-944-3930
SY STERLING COMPANY
21250 10 1/2 MILE ROAD
SOUTHFIELD, MICH. 48076
313-357-3700



Presenting Metrotech's Two-Direction Slow Speed Logger

12-16 Operating Days of Continuous, Unattended Logging Time for any Broadcast or Communications Requirement.

Tape cost less than 4¢ per hour — or \$1.00 for a 24-hour day.

Heavy duty Transport with latest solid state electronics is fully automatic and provides exceptional fidelity—3 db from 200–2700 cps with adjustable equalization.



A complete line of Professional Recorders/Reproducers, operating at standard speeds, is also available and surpasses all N.A.B. specifications.

Write today for six-page illustrated brochure and price information.

SERIES 500

METROTECH INC. 670 NATIONAL AVENUE ■
MOUNTAIN VIEW, CALIF.

333 JERICHO TURNPIKE
 JERICHO, N Y 11753
 516 822 2822
 TWX 510 221 1895
 STEVE KFLLY, RM
 WAYNE HOLZER, OSM
 3380 MONROE AVE
 ROCHESTER, N Y 14618
 716 DU 1 7220
 TWX 510 254 2893
 ROD OCONNOR, RM
 BEN GATES, ACCT EXEC
 P O BOX 1476
 POUGHKEEPSIE, N Y 12603
 914 GR 1 6655
 TWX 510 248 0015
 908 GRIFFIN, DSM
 3806 UNION RD SUITE B
 BUFFALO, N Y 14225
 716 685 1233
 TWX 710 263 1392
 FRANK MAHONEY, DSM
 AL WILCOX, DSM
 167 PICKARD BLDG
 E MOLLOY RD
 SYRACUSE, N Y 13211
 315 454 9373
 TWX 710 541 0486
 JERRY STEWART, ACCT EXEC
 ROB E ATKINSON, DSM
 PAUL KLEES BLDG RM 130
 3490 S DIXIE DR
 DAYTON, OHIO 45439
 513 298 9976
 TWX 810 459 1638
 LOU NORRIS, DSM
 BILL MILLER, DSM
 CHAGRIN LEE PLAZA BLDG STE B
 16611 CHAGRIN BLVD
 SHAKER HEIGHTS, OHIO 44120
 216 921 5260
 TWX 810 421 8267
 ROB BURNS, RM
 HANK STEIN, ACCT EXEC
 29 BALA AVENUE
 BALA CYNWYD, PENN 19004
 215 TE 9 7070
 TWX 510 662 4344
 JOE SEMMER, DSM
 VERN HARRIS, DSM
 P O BOX 30667
 DALLAS, TEXAS 75230
 214 AD 5 8385
 TWX 910 867 4700
 RICK CARSON, SE
 4000 AURORA AVE N STE 221
 SEATTLE, WASH 98103
 206 ME 2 7532
 TWX 910 444 2051

MULTRONICS, INC.
 SALES MANAGER
 FRANK J LITTLE, JR
 BRAND NAMES
 NORD
 COMPANY ADDRESS
 5712 FREDERICK AVE
 ROCKVILLE, MARYLAND

MVR CORPORATION
 SALES MANAGER
 FRANK GONZALEZ, JR.
 BRAND NAMES
 VIDEO DISC
 COMPANY ADDRESS
 470 SAN ANTONIO RD.
 PALO ALTO, CALIF 94306

NARDA MICROWAVE CORPORATION
 VICE PRESIDENT
 J. P. SCHINDLER
 BRAND NAMES
 NARDA MICROLINE-R
 COMPANY ADDRESS
 COMMERCIAL STREET
 PLAINVIEW, NEW YORK 11803
 COMPANY REPRESENTATIVES
 E. G. HOLMES AND ASSOCIATES
 4862 GOVERNORS DRIVE, W.
 HUNTSVILLE, ALABAMA
 205 837 6900
 O HALLORAN ASSOCIATES
 10700 VENTURA BLVD
 NORTH HOLLYWOOD, CALIF.
 213-TR 7-0173
 TWX 910 499 2190
 O HALLORAN ASSOCIATES
 3921 E BAYSHORE
 PALO ALTO, CALIF.
 415 DA 6-1493
 TWX 415 969 9144
 D. E. BOND ASSOCIATES
 2149 S. CLERMONT STREET
 DENVER, COLORADO 80222
 303 756 1234
 E G HOLMES AND ASSOCIATES
 316 1/2 S. BUMBY STREET
 ORLANDO, FLORIDA 32803
 305 CH 1 2128
 TWX 305 275 1599
 E. G. HOLMES AND ASSOCIATES
 3667 CLAIRMONT RD, N.E.
 CHAMBLEE, GA. 30005
 404-451-6161
 TWX 404 231 3417
 INDUSTRIAL ELECTRONIC INC.
 646 QUEEN STREET BOX 135
 HONOLULU, HAWAII
 506 095
 SCIENTIFIC SALES COMPANY
 7132 N HARLEM AVENUE
 CHICAGO, ILLINOIS 60631
 312 775 7595
 SCIENTIFIC SALES COMPANY
 3720 N COLORADO AVENUE
 INDIANAPOLIS, IND.

317 545 9950
 POLY-ONICS INC
 4434 WEST 90TH TERRACE
 LEAWOOD, KANSAS 66206
 913-NI 8-4173
 TWX 913 642 8388
 ELECTRONIC MARKETING ASSOC.
 11501 HUFF COURT
 KENSINGTON, MD 20795
 301-946-0300
 TWX 710 825 9645
 TRI-TEK INC
 155A BEDFORD STREET
 BURLINGTON, MASS.
 617 272 4550
 MICRO SALES CORP
 19341 TRINITY
 DETROIT, MICH.
 313 537 6460
 SCIENTIFIC SALES COMPANY
 6121 EXCELSIOR BLVD
 MINNEAPOLIS, MINNESOTA
 612 484 8022
 POLY-ONICS INC
 47 VILLAGE SQ SHPPING CNTR
 OFFICE NO 2
 HAZELWOOD, MISSOURI
 314 TE 7-0597
 TWX 314 921 3853
 SONCO
 CRYSTAL BROOK PROF. BLDG
 EATONTOWN, N.J.
 201-542-1441
 TWX 510 239 2810
 E. G. BOND ASSOCIATES
 P.O. BOX 11331
 ALBUQUERQUE, N.M.
 505 247 3442
 GRAY AND REED ASSOC. INC.
 9 DUNFORD STREET
 HUNTINGTON STA., N.Y. 11749
 GE 3 3333
 OSSMANN INSTRUMENTS, INC
 101 PICKARD DRIVE
 SYRACUSE, N Y 13211
 315 GL 4-2461
 TWX 315 477 1162
 DSSMANN INSTRUMENTS INC
 VESTAL PKWY EAST
 P O BOX 245
 VESTAL, N.Y. 13850
 607-785-9947
 TWX 607 772 0209
 OSSMANN INSTRUMENTS INC
 3100 MONROE AVENUE
 ROCHESTER 18, N.Y.
 716 LU 6-0380
 TWX 716 221 1513
 E G HOLMES AND ASSOCIATES
 430 W GASTON STREET
 GREENSBORO, N. C. 27401
 919 BR 2 0855
 MICRO SALES CORP
 T-17 EXECUTIVE BUILDING
 1250 WEST DOROTHY LANE
 DAYTON, OHIO 45409
 513-298-3033
 TWX 513 944 0450
 MICRO SALES CORP
 2000 LEE ROAD
 CLEVELAND, 18, OHIO
 216 371 0522
 SONCO
 556 WEST DEKALB PIKE
 KING OF PRUSSIA, PENN. 19406
 215-265-3250
 TWX 215 265 2656
 SONCO
 PARK PLACE OFFICE BLDG
 CAMP HILL, PENN.
 717 SO 1-0577
 TWX 717 761 0407
 D. E. BOND ASSOCIATES
 P.O. BOX 12293
 EL PASO, TEXAS
 915 532 4048
 VIDAL ELECTRONICS
 3403 HIGH BLUFF DRIVE
 DALLAS, TEXAS 75234
 214 CH 7 4252
 SHOWALTER-JUDD INC
 1806 SOUTH BUSH PLACE
 SEATTLE 44, WASHINGTON
 206 EA 4-7911
 TWX 206 998 0323
 REPS IN OTHER COUNTRIES
 HEIGHTEN SCIENTIFIC CO LTD
 P O BOX 1408
 TAIPEI, TAIWAN, CHINA
 MR. K LAL BHAKRI
 P O BOX 487
 NEW DELHI 1, INDIA
 MIDORIYA ELECTRIC CO LTD
 3-2-CHROME KYOBASHI, CHUO-KU
 TOKYO, JAPAN
 THE MODERN TRADING COMPANY
 P O BOX 7103 GHAFUO CHAMBERS
 VICTORIA ROAD
 KARACHI 3, PAKISTAN
 INGLOMARK
 INDUSTRIE-BELIEFERUNGS-
 GESELLSCHAFT
 MARKOWITSCH AND CO
 MARIAHILFER STRASSE 133
 VIENNA XV, AUSTRIA
 REGULATION-MESURE S P R L
 22 RUE SAINT-HUBERT
 BRUSSELS 15, BELGIUM
 HANDELSFIRMAET-DITZ-
 SCHWEITZER
 KONGENSGADE 59
 COPENHAGEN, DENMARK
 SALIES S A
 11 RUE LEON MORANE
 PARIS 15, FRANCE
 RONDE AND SCHWARZ VERTRIEBS-

GBMH
 HOHE STRASSE 160-168
 COLOGNE, WEST GERMANY
 ROHDE & SCHWARZ HANDELS-GBMH
 ERNST-REUTER-PLATZ 10
 BERLIN 10, GERMANY
 ROHDE & SCHWARZ VERTRIEBS-
 GBMH
 KORNFERSTRASSE 34
 HAMBURG 39, GERMANY
 ROHDE & SCHWARZ VERTRIEBS-
 GBMH
 KRIEGSTRASSE 39
 KARLSRUHE, GERMANY
 ROHDE & SCHWARZ VERTRIEBS-
 GBMH
 RRIENNER STRASSE 43
 MUNICH 2, GERMANY
 AVELEY ELECTRIC LTD
 SOUTH OCKFENDON
 ESSEX, ENGLAND
 KOSTAS KARAYANNIS
 18, ERMOU STREET
 ATHENS 126, GREECE
 DOTT, ING MARIO VIANELLO
 VIA L ANELLI, 13
 MILAN, ITALY
 553 081-553 811
 DOTT ING MARIO VIANELLO
 VIA S CROCE IN GFRUSALEMME
 ROMA, ITALY
 7-567 250 7-567 941
 INGENIEURSBUREAU PROJECTO
 PRINSENGRACHT 530
 AMSTERDAM, HOLLAND
 METRONIC
 P N BIORN TOLLBOGDGT 4
 OSLO, NORWAY
 AMERIKANSKA TELEPRODUKTER
 NYBOHOVSGRAND 56
 STOCKHOLM, SV., SWEDEN
 MEGEX ZURICH
 BADENERSTRASSE 588
 ZURICH 48, SWITZERLAND
 EASTRONICS LTD
 75 HAIFA RD P O BOX 21029
 MEVAG
 GALATA, BANKALAR CAD 71-73
 P O BOX 143
 ISTANBUL, TURKEY
 ALLAN CRAWFORD ASSOC. LTD.
 65 MARTIN ROSS AVENUE
 DOWNSVIEW, ONT.
 416 636 4910
 TWX 610 492 2119
 ALLAN CRAWFORD ASSOC. LTD.
 376 CHURCHILL AVENUE
 OTTAWA, ONT
 PA 5 1288
 ALLAN CRAWFORD ASSOC. LTD.
 6999 COTE DES NEIGES ROAD
 MONTREAL 26, QUEBEC
 739 6776
 TWX 610 421 3564
 WARBURTON FRANKI INDUSTRIES
 PTY LTD
 307 KENT STREET
 P O BOX 1523 G P O
 SYDNEY, AUSTRALIA
 WARBURTON FRANKI
 INDUSTRIES PTY LTD
 204 FLINDERS STREET
 GPO BOX 683F
 ADELAIDE, AUSTRALIA
 WARBURTON FRANKI
 INDUSTRIES PTY LTD
 13 CHESTER STREET
 FORTITUDE VALLEY, Q
 P O BOX 345
 BRISBANE, AUSTRALIA
 WARBURTON FRANKI
 INDUSTRIES PTY LTD
 220 PARK STREET
 SOUTH MELBOURNE
 P O BOX 536E
 MELBOURNE, I I
 VICTORIA, AUSTRALIA
 W G LEATHAM LTD
 58 KENT TERRACE
 WELLINGTON, NEW ZEALAND
 OELTA LTD
 APARTADO AEREO 12175
 BOGOTA, COLUMBIA

NESCO INSTRUMENTS
DIV OF DATAPULSE, INC
 SALES MANAGER
 M. B. CDX
 COMPANY ADDRESS
 509 HINDRY AVE.
 INGLEWOOD, CALIF. 90306
 213 671 4334
 TWX 910 328 6109
 COMPANY REPRESENTATIVES
 JOHN OHALLORAN & ASSOCIATES
 3268 ROSCRAWS BLVD.
 SAN DIEGO, CALIF 92110
 JOHN OHALLORAN & ASSOCIATES
 3921 E BAYSHORE BLVD.
 PALO ALTO, CALIF 94303
 JOHN OHALLORAN & ASSOCIATES
 10700 VENTURA BLVD.
 NORTH HOLLYWOOD, CALIF. 91604
 KELLEY ENTERPRISES
 336 E 4TH STREET
 LOWELAND, COLORADO 80537
 INSTRUMENT CONSULTANTS, INC
 2381 WHITNEY AVENUE
 HAMDEN, CONN 06518
 G F BOHMAN ASSOCIATES, INC
 7233 LAKE ELLENOR DRIVE
 ORLANDO, FLORIDA 32809
 RIDGWAY ASSOCIATES, INC
 3759 N HARLEM AVENUE
 CHICAGO, ILLINOIS 60634
 PENZNER ASSOCIATES, INC

P O BOX 4362
 OVERLAND PARK, KANSAS 66204
 BRIMBERG ASSOCIATES, INC
 814 THAYER AVENUE
 SILVER SPRING, MO 21204
 BRIMBERG ASSOCIATES, INC
 110 E PENNSYLVANIA AVENUE
 TOWSON, MD 21204
 INSTRUMENT CONSULTANTS, INC
 P O BOX 25
 WABAN, MASS 02168
 RIDGWAY ASSOCIATES, INC
 7720 MORGAN AVENUE, SOUTH
 MINNEAPOLIS, MINN 55423
 PENZNER ASSOCIATES, INC.
 BOX 76, CREVE COEUR STATION
 ST LOUIS, MO 63141
 CENTRAL ASSOCIATES
 44 NORTH DEAN STREET
 ENGLEWOOD, N J 07631
 J D RYERSON
 P O BOX 1400
 SYRACUSE, NEW YORK 13201
 CENTRAL ASSOCIATES
 11 COMMERCIAL STREET
 PLAINVIEW, L I, N Y
 RIDGWAY ASSOCIATES, INC
 22811 LORAIN ROAD
 FAIRVIEW PARK, OHIO 44126
 RIDGWAY ASSOCIATES, INC
 2400 E DOROTHY LANE
 DAYTON, OHIO 45420
 R & P ASSOCIATES
 107 FOREST AVENUE
 NARBERTH, PENN 19072
 AIREP ELECTRONICS, INC
 P O RDX 36211
 HOUSTON, TEXAS 77036
 AIREP ELECTRONICS, INC
 P O BOX 9555
 DALLAS, TEXAS 75214
 HARRY LEVINSON COMPANY
 1211 E DENNY WAY
 SEATTLE, WASH 98122
 REPS IN OTHER COUNTRIES
 BALI INTL AGENCIES
 P O BOX 1676
 BOMBAY 1-BR, INDIA
 MOHATTA MARKET BLDG
 PALTON ROAD
 R. ANKERSMIT LTD.
 90 RUE EDITH CAVELL
 UCCLE, BRUSSELS, BELGIUM
 BIE & BERNTSEN
 35 PILESTRODE
 COPENHAGEN, DENMARK
 OY FINDIP AB
 MANNERHEIMINTIE 29,C
 HELSINKI 25, FINLAND
 SEINA
 16 RUE DAGUESSEAU
 BOULOGNE-BELLANOURT
 SEINE, FRANCE
 NEUMULLER & COMPANY GBMH
 SCHRAUDOLDPHSTRASSE 2A
 8 MUNICH 13, W GERMANY
 GRIFFIN & GEORGE LTD
 EALING ROAD, ALPERTON
 WEMBLY, MIDDLESEX, ENGLAND
 SPECIAL-IND
 VIA D. MANIN 33
 MILAN, ITALY
 HUGO RISO A/S
 P O BOX 8
 TAASEN, OSLO 8, NORWAY
 HUGO RISO A/S
 TEKNISK IMPORT
 CARL GRONDANES
 VER-1, OSLO 8, NORWAY
 SCAN TELE AB
 TENGOHLSGATAN 24
 STOCKHOLM SO., SWEDEN
 N ZIVY & CIE, S A
 POSTFACH
 OBERWIL/BASEL, SWITZERLAND
 M KOCHN
 P O BOX 1147
 JERUSALEM, ISRAEL
 ATLAS INSTRUMENTS CORP
 DIV ATLAS ELECTRONICS LTD
 909 BEACH AVENUE
 VANCOUVER, B.C.
 ATLAS INSTRUMENTS CORP
 DIV OF ATLAS ELECTRONICS
 50 WINGOLD AVENUE
 TORONTO, ONTARIO
 ATLAS INSTRUMENTS CORP
 DIV ATLAS ELECTRONICS LTD
 342 1/2 ELGIN STREET
 OTTAWA, ONTARIO
 SAMPLE ELECTRONICS PTY LTD
 4 GROSE STREET, GLEBE
 SYDNEY, N.S.W., AUSTRALIA
 SAMPLE ELECTRONICS PTY LTD
 9/11 CREMORE STREET
 RICHMOND, VIC., AUSTRALIA
 SAMPLE ELECTRONICS PTY LTD
 8 MATIPO STREET
 AUCKLAND, NEW ZEALAND

NEUMADE PRODUCTS CORPORATION
 SALES MANAGER
 L E JONES
 BRAND NAMES
 DYNAMICS
 SUPER X
 FIRETITE
 SEALTITE
 NEUTYPE
 GRISWOLD
 NEUSCOPE
 NEUZIP
 NEULITE
 NEUVATOR
 RENOVEX
 SHOWTIMER

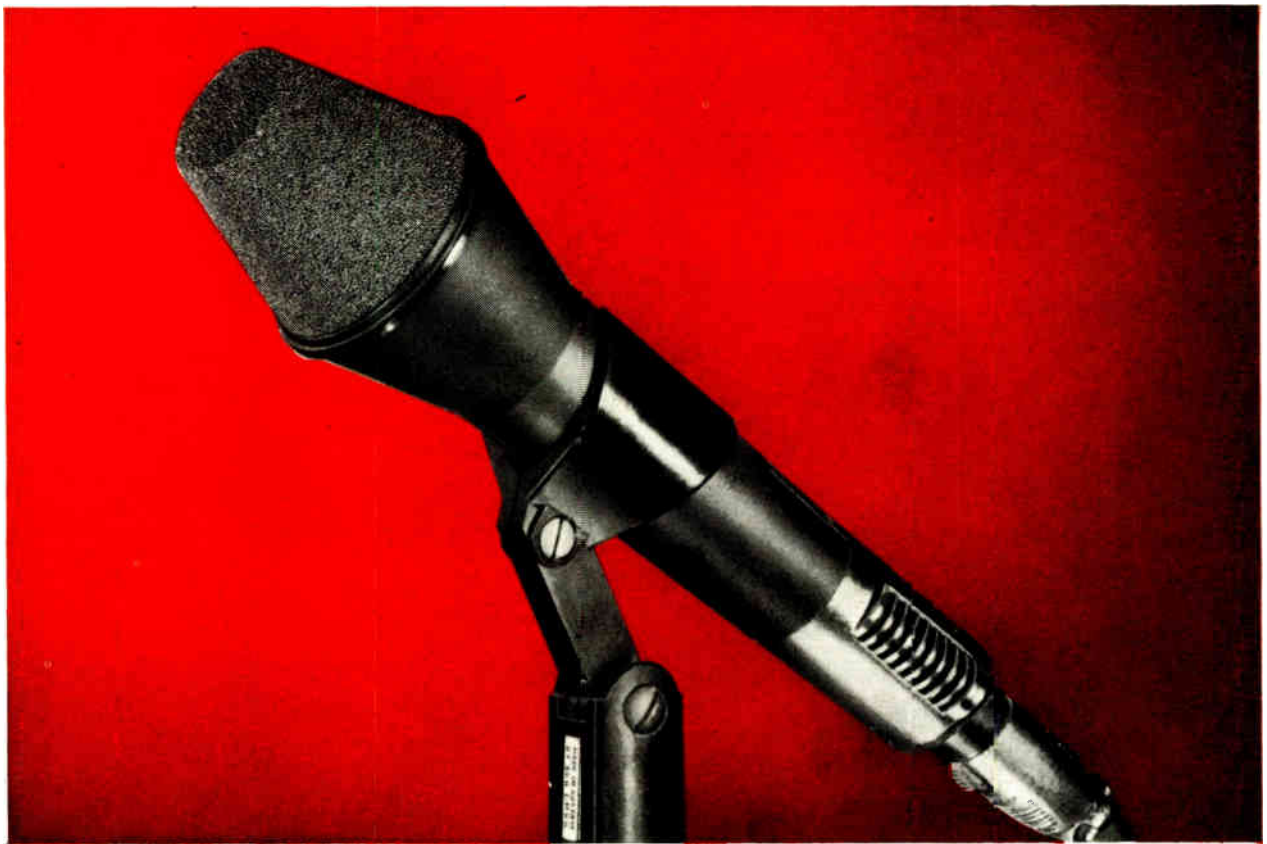

D-202ES — THE MOST NOTABLE ADVANCEMENT IN DYNAMIC MICROPHONE DEVELOPMENT

For Boom Operation—No frequency discriminating characteristics in off-axis pickup.



In the D-202ES, two independent microphone capsules are incorporated in a single microphone housing, connected by means of a cross-over network, free of phase distortion. Each of the capsules is optimally adjusted to a specific frequency pickup range; one for low frequencies, and the other for high frequencies. The cross-over is at 500 cps.

This unique arrangement achieves a wide, smooth frequency range (30-15,000 cps \pm 2 db) and a cardioid pattern with a front-to-back discrimination of never less than 20 db over the entire frequency range. In addition, the microphone offers a 90° off-axis response which is completely parallel to the 0° (on-axis) curve.

These features offer several advantages in practical applications: The flat frequency response enables control of feedback at any frequency. The uniform front-to-back discrimination of at least 20 db virtually eliminates feedback and offers almost complete freedom in microphone and speaker placement.

MADE IN AUSTRIA BY AKG GMBH

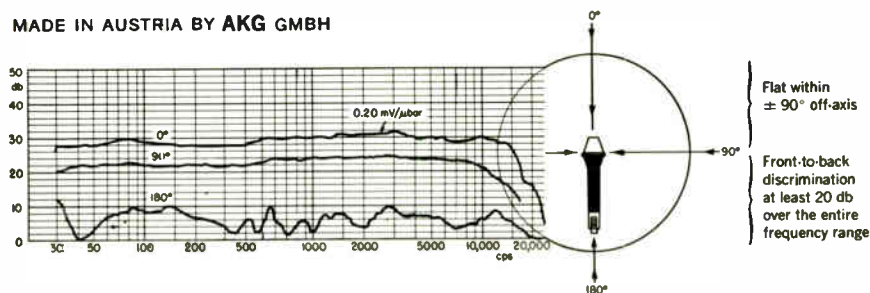

The parallel 90° off-axis response is of particular importance in sound reinforcement and recording applications, to achieve a natural reproduction of all frequencies introduced to the microphone \pm 90° off-axis.

The D-202ES utilizes a sintered bronze screen which is extremely rugged and protects the microphone systems from iron particles and dust. It also acts as a windscreen and is waterproof.

Norelco

**PROFESSIONAL
SOUND PRODUCTS**

NORTH AMERICAN PHILIPS COMPANY, INC.
Professional Products Division, 100 East 42nd St., New York, N. Y. 10017

SHOWMASTER
COMPANY ADDRESS
250 WEST 57TH STREET
NEW YORK, NEW YORK 10019

NORTH AMERICAN PHILIPS COMPANY

INC
MARKETING MANAGER
ROBERT L DIAMOND
MANAGER PROFESSIONAL SOUND
A BRAKMAN
BRAND NAMES
MORELCO
COMPANY ADDRESS
100 EAST 42ND ST
NEW YORK, NEW YORK 10017
PROF SOUND DEPT REPS
EVANS MARKETING COMPANY
2803 GENEVA AVENUE
DALY CITY, CALIF.
415 584 0818
KOESSLER SALES COMPANY
818 NORTH FARIFAX AVENUE
LOS ANGELES, CALIF. 90046
213 OL 3 1605
TELSCO, INC.
1781 SOUTH FILBERT COURT
DENVER, COLORADO 80222
303 765 0365
J B ANTHONY
P O BOX 343
WILTON, CONN.
203 PO 2 3829
WINFIELD ELECTRONIC SALES CO
666 NORTH EAST 125TH ST
NORTH MIAMI 61, FLORIDA
305 751 5566
LOREN F GREEN & ASSOC.
5218 WEST DIVERSEY AVENUE
CHICAGO, ILLINOIS 60639
312 AV 6 6824
DOUG COOK ASSOCIATES
1519 EAST 46TH STREET
INDIANAPOLIS, INO. 46205
317 253 0393
HETHERINGTON SALES
97 BOGLE STREET
WESTON 93, MASS.
617 CE 5 5323
SMITH ENGINEERING ASSOCIATES
2278 COMO AVENUE
ST. PAUL, MINNESOTA
612 646 5851
ROBERT SHAW COMPANY
7800 KENRIDGE LANE
WEBSTER GROVES, MISSOURI
314 WO 2 7429
L D RODDEY SALES COMPANY
P O BOX 11302
CHARLOTTE, N.C.
734 332 7232
CHARLES LUCAS SALES COMPANY
P O BOX 24632
DALLAS, TEXAS
214 WH 2 5958
RON HERRITT COMPANY
1320 PROSPECT STREET
SEATTLE, WASH. 98109
206 MU 2 7337
SALESMEN
JACK R DANIELS
ELSCO
4533 N SCOTTSDALE ROAD
SCOTTSDALE, ARIZONA 85251
ROBERT KUHL
VISUAL ELECTRONICS CORP
1208 POPLAR AVENUE
SUNNYVALE, CALIF 90046
ALFRED M KALLMAN
VISUAL ELECTRONICS CORP
1617 EL CENTRO AVENUE
HOLLYWOOD 28, CALIF
DICK WHITE
ELSCO COLORADO, INC
2875 N SPEER BLVD
DENVER, COLO 80211
LEWIS C RADFORD
VISUAL ELECTRONICS CORP
3203 LANIER DRIVE
ATLANTA 19, GEORGIA
LINTON D HARGREAVES
VISUAL ELECTRONICS CORP
409 SOUTH KENTUCKY
MASON CITY, IOWA
EDWARD S CLAMMER
VISUAL ELECTRONICS CORP
5940 AVON DRIVE
BETHESDA 14, MARYLAND
DANIEL T GREEN
VISUAL ELECTRONICS CORP
3 BUCKINGHAM ROAD
NATICK, MASS
ALLAN TIMMS
VISUAL ELECTRONICS CORP
621 BEVERLY DRIVE
MAGNOLIA, N J 08049
MORRIS A MAYERS
VISUAL ELECTRONICS CORP
356 WEST 40 STREET
NEW YORK, N Y 10018
JESSICA RAFSKY
VISUAL ELECTRONICS CORP
176 EAST 77 STREET
NEW YORK, N Y
JAMES HOWARD
VISUAL ELECTRONICS CORP
411 PRICE STREET
THOMASVILLE, N C
A W GREESON
VISUAL ELECTRONICS CORP
219 HOMEWOOD AVENUE
GREENSBORO, N C
P D THOMPSON
VISUAL ELECTRONICS CORP
2550 WEYMOUTH ROAD
WINSTON-SALEM, N C

FELIX D BONVOULOIR
VISUAL ELECTRONICS CORP
1310 GREENVIEW DRIVE
MIAMISBURG, OHIO
CHESTER A SIEGRIST
VISUAL ELECTRONICS CORP
1107 CATHEDRAL STREET
LEBANON, PENN
J P GALLAGHER
VISUAL ELECTRONICS CORP
P O BOX 98
WHITE HAVEN, PENN
WAYNE E MARCY AND
CARL HAYWORTH
VISUAL ELECTRONICS CORP
4007 BELLAIRE
HOUSTON, TEXAS
LYLE O KEYS
VISUAL ELECTRONICS CORP
2275 S W TEMPLE
SALT LAKE CITY, UTAH
NORTHEAST ELECTRONICS CORP
VICE PRESIDENT
H. E. COREY, JR.
COMPANY ADDRESS
P. O. BOX 425
CONCORD, NEW HAMPSHIRE 03301
NORTRONICS CO., INC
DISTRIBUTOR SALES MANAGER
THOR JOHNSON
COMPANY ADDRESS
8143-10TH AVE. NORTH
MINNEAPOLIS, MINN. 55427
COMPANY REPRESENTATIVES
IRVING W ROSE & ASSOC
4734 N AUSTIN
CHICAGO, ILL
312 282 6835
BARSTOW & OORAN, INC
1406 GRAND AVE
LOS ANGELES, CALIF
213 749 7438
NICKERSON-GRAY & ASSOC
2434 PARK BLVD
PALO ALTO, CALIF
415 326 0152
NORRIS & COMPANY
915 CHEYENNE BLVD
COLORADO SPRINGS, COLO
303 635 9319
JOHN STAWICKI
BOX 126 WESTBROOK RD
ESSEX, CONN
203 767 8566
V AVIS MCCORVEY CO
2469 N DECATUR RD
DECATUR, GEORGIA
404 636 2502
BURCAW-COWAN CO
18236 W MCNICHOLS RD
DETROIT, MICH
313 533 7700
JACK PERLING
1947 TERRACE RD
MINNEAPOLIS, MINN
612 927 8465
R R BURTON SALES
7546 TROOST AVE
KANSAS CITY, MO
816 523 7865
ARTRONICS COMPANY
630 CLEVELAND AVE
RIVER VALE, N J
201 664 8333
COMPONENT MARKETERS, INC
109 VALLEY ROAD
MONTCLAIR, N J
201 746 6717
PERRY LOMSE & CO
529 RICHMOND RD
CLEVELAND, OHIO
216 381 7788
MARTIN FRIEDMAN & ASSOC
7 HEATHER RD
PAR-NELL SALES
421 BUSTLETON PIKE
BALA CYNWYD, PA
215 839 3450
FEASTERVILLE, PA
215 357 7230
TECHNO ASSOCIATES
2324 SHORECREST DR
DALLAS, TEXAS
214 357 0213
DAVE CHAMPLIN CO
12347 BOTHELL WAY N E
SEATTLE, WASH
206 362 0401
REPS IN OTHER COUNTRIES
LEN FINKLER, LTO
2 TYCOS DR
TORONTO, ONTARIO
416 781 5231
THE NOVA CORPORATION
VICE PRES MARKETING
E. EUGENE VECKER
BRAND NAMES
BANNER
CAPCO
HALLMARK
T C I RANGER
T C I EAGLE
COMPANY ADDRESS
1601 BROADWAY
LUBBOCK, TEXAS
802-0643
COMPANY REPRESENTATIVES
CORONADO ELECTRONIC ASSOC
P O BOX 3176
SCOTTSDALE, ARIZONA
602 947 9060
GILLINGHAM ASSOCIATES
19501 ARAGON CIRCLE
MUNTINGTON BEACH, CALIF.

714 962 4111
COMARK
P O BOX 2086
SANTA ROSA, CALIF.
707 544 1044
MULVIN AND COMPANY
3843 E COLORADO BLVD
PASADENA, CALIF.
213 681 4591
HAL FORAKER COMPANY
P O BOX 1325
FREMONT, CALIF.
415 657 2213
CORONADO ELECTRONIC ASSOC
2654 S KRAMERIA
DENVER, COLORADO
303 757 6489
ELECTRONIC SALES INC
995 SOUTH CLERMONT 302
DENVER, COLORADO
303 756 4148
G F BOHMAN ASSOCIATES
7040 LAKE ELLENOR DR
ORLANDO, FLORIDA
305 855 0274
BLIND & ASSOCIATES
1635 N GENT AVENUE
INDIANAPOLIS, IND.
317 635 6291
MCALLISTER ASSOCIATES
5460 BUENA VISTA DR
MISSION, KANSAS
816 IN 17294
RILEY & PETCHELL ELEC SALES
13209 FENKELL AVENUE
DETROIT, MICHIGAN
313 VE 8 9100
GRANT SHAFFER COMPANY
14241 FENKELL AVENUE
DETROIT 27, MICHIGAN
313 BR 3 5390
COUNTRYMAN, WAGNER & BEHNER
560 N PRIOR AVE
ST. PAUL, MINNESOTA
612 645 9151
WARNER COMMUNICATIONS
7216 ST CHARLES ROCK RD
ST. LOUIS, MISSOURI
314 PA 6 6609
BRADDOCK ASSOCIATES
P O BOX 305
HAODONFIELD, N.J.
609 429 0087
RCM ASSOCIATES
115 LEGION PLACE
HILLSDALE, N.J.
201 666 0205
CORONADO ELECTRONIC ASSOC
P O BOX 11204
ALBUQUERQUE, N.M.
505 298 2575
CORONADO ELECTRONIC ASSOC.
P O BOX 1498
ALAMOGARDO, N.M.
505 437 1745
H V SALES
1 WEST TERRACE ROAD
GREAT NECK, L I, N.Y.
516 HU 7 1192
E W HOYER ASSOCIATES
P O BOX 51
DEWITT, N.Y.
315 GI 6 3523
TECHNICAL SALES CORPORATION
BOX 187 N OAYTON STATION
DAYTON, OHIO
513 222 6522
COMARK
P O BOX 637
MEDFORD, OREGON
503 772 7592
JADE ELECTRONICS ASSOC.
P O BOX 5735
PHILADELPHIA, PENN.
215 GL 5 3355
ANTLE-SMITH
P O BOX 20361
DALLAS, TEXAS
214 FL 7 7279
LOGAN RADIO COMMUNICATIONS
2110 AVENUE J
LUBBOCK, TEXAS
806 SH 4 1433
GEORGE WEINREICH & ASSOC
11554 E NORTHWEST HWY
DALLAS, TEXAS
214 321 2800
OAK MANUFACTURING COMPANY
DIV OAK ELECTRO/NETICS CORP
SALES MANAGER
PAUL W. WHEATON
BRAND NAMES
UNIDEX-TM
MODULIN-TM
COMPANY ADDRESS
MAIN STREET
CRYSTAL LAKE, ILL 60014
815 459 5000
TWX 910 634 3353
COMPANY REPRESENTATIVES
MARCO OAK INDUSTRIES DIV
P O BOX 4011
ANAHEIM, CALIF 92803
714 KE 5 6037
MARCO OAK INDUSTRIES DIV
VILLAGE CORNER SUITE O
4546 EL CAMINO REAL
LOS ALTOS, CALIF 94022
415 941 1237 8 9
TWX 415 949 7979
I W STRONG & ASSOC INC
635 CANOSA COURT
DENVER, COLO 80204
303 292 6900 1 2 3
RICHARD PURINTON INC

P O BOX 12
COLEBROOK, CONN 06021
203 379 2501
CARTWRIGHT & BEAN
20100 N E 25 COURT
NORTH MIAMI BEACH, FLA 33160
305 425 8284
CARTWRIGHT & BEAN
609 EAST COLONIAL DRIVE
ORLANDO, FLA. 32806
305 425-8284
CARTWRIGHT & BEAN
3223 CAINS HILL PLACE NW
ATLANTA, GEORGIA 30305
404 237-2273
OAK/ELECTRONICS CORP-EXPORT
CRYSTAL LAKE, ILLINOIS 60014
815 459-5000
JACK F MC KINNEY SALES CO
2012 CONDON AVENUE
METAIRIE, LOUISIANA 70003
504 887-1723
J W SHEFFER
4609 OLD FREDERICK ROAD
BALTIMORE, MARYLAND 21229
301 CE 3 0606-7
RICHARD PURINTON INC
11 MUZZEY STREET
LEXINGTON, MASS. 02173
617 862-8300
LLOYD F MURPHY & ASSOC
770 CHICAGO AVENUE
MINNEAPOLIS, MINNESOTA 55415
612 333 4511
TWX 612 321-0894
ROBERT BARTOS
804 E ESSEX AVENUE
GLENDALE, MO. 63122
314 CH 1-4351
HENRY RICHTER, INC.
1376 U S HIGHWAY NO 22
MOUNTAINSIDE, N.J. 07092
201 AO 3-4615
GRAY-WILLIAMS ASSOC
8 E MT VERNON AVENUE
HADDONFIELD, N.J. 08033
609 429 5300
TWX 609 429-3773
HENRY G RICHTER INC
P O BOX 251
FAYETTEVILLE, NEW YORK 13066
315 637-6713
HENRY G RICHTER INC
P O BOX 194
HUNTINGTON BAY, L.I.,
NEW YORK 11101
516 HA 1-1393
EUGENE J SCHOMBERG CO
3100 MONROE AVENUE
ROCHESTER, NEW YORK 14618
716 LU 6-0725
TWX 716 221-1513
WILLIAM J COLE
838 CARINI LANE
CINCINNATI, OHIO 45218
513 825-8516
JACK F MC KINNEY SALES CO
P O BOX 3958
TULSA, OKLAHOMA 74150
918 622-2967
CARTWRIGHT & BEAN
560 SOUTH COOPER STREET
P O BOX 4760
MEMPHIS, TENNESSEE 38104
901 276-4442
JACK F MC KINNEY SALES CO
1303 CHEMICAL STREET
DALLAS, TEXAS 75207
214 631-9450
JACK F MC KINNEY SALES CO
P O BOX 1024
BELLAIRE, TEXAS 77402
713 664-3653
M K WOODKIND CO, INC
815 W EWING STREET
SEATTLE, WASHINGTON 98119
206 284-8020
OAKTRON INDUSTRIES INC
SALES MANAGER
C. E. MATTHEWS
COMPANY ADDRESS
HWY 69 SOUTH
MONROE, WISCONSIN 53566
608 325 2121
COMPANY REPRESENTATIVES
ROBERT FISSELL COMPANY
4614 N 7TH STREET
PHOENIX, ARIZONA
602 264-4031
CARTER & ROSSNEY ASSOC, INC
2600 WEST OLIVE AVENUE
BURBANK, CALIFORNIA 91505
213 843-3292
EWING ASSOCIATES
935 TERMINAL WAY
SAN CARLOS, CALIFORNIA
415 591-0309
CONNORS, INC
2241 STACEY DRIVE
DENVER, COLORADO 80221
303 428-1575
WINFIELD ELECTRONIC SALES
666 N E 125TH STREET
NORTH MIAMI, FLORIDA
305 751-5566
MILLAR HUTTO ASSOCIATES
1036 PEACHTREE STREET NE
ATLANTA, GEORGIA
404 876-0919
KLEM STEFFEN, INC
417 HARRISON STREET
OAK PARK, ILL. 60204
KNAGGS, COLLINS,
HAVERCAMP, AND HEMPE INC,
NO. 6 BANK SQUARE

E. ST. LOUIS, ILLINOIS
618 EX 7-2398
KNAGGS, COLLINS,
HAVERCAMP, AND HEMPE INC.
5818 N. OAK TRAFFIC WAY
KANSAS CITY, MO.
816 453-3203
CHARLES LIENAU COMPANY
11411 AMHERST AVENUE
WHEATON, MARYLAND
301 949-6464
KEENE SALES COMPANY
ROOM 14G PROFESSIONAL BLDG
156 BRDAD STREET
LYNN, MASSACHUSETTS
617 595-1001
DAVID MILSK COMPANY
20110 OLMPA AVENUE
OETRDIT, MICHIGAN
313 535-4012
H M RICHARDSON COMPANY
9 EAST 22ND STREET
MINNEAPOLIS, MINNESOTA
612 335-7734
JACK BROWN ASSOCIATES
207 ROSEALE ROAD
YONKERS, NEW YORK
914 SP 9-7330
LSM ASSOCIATES
PHELPS, NEW YORK
315 548-4891
SHAMROCK ELECTRONIC SALES INC
1755 WEST MARKET STREET
AKRON, OHIO 44313
216 864-3090
TANNER COMPANY
486 BROADMOOR AVENUE
PITTSBURGH, PENN. 15228
412 561-4687
THE TEXPORT COMPANY
2411 FARRINGTON STREET
DALLAS, TEXAS 75207
214 631-6270
M K WIDDEKIND COMPANY, INC
815 W EWING STREET
SEATTLE, WASHINGTON 98119
206 284-8020

OHMITE MANUFACTURING COMPANY

SALES MANAGER
TOM OAVIS
BRAND NAMES
BROWN DEVIL R
TUBEOMH R
CORRIB R
POWR-RIB R
DIVIDOMH R
OETEROMH R
LITTLE DEVIL R
OHMITE R
OHMITRAN R
RITOHM R
TAN-O-MITE R
TALLY TAPE R
WIREWATT R
V. T. R
COMPANY ADDRESS
3601 HOWARD STREET
SKOKIE, ILL 60076
312 675-2600
TWX 312 677-6704
COMPANY REPRESENTATIVES
SHEFLER-KAHN COMPANY
P O BOX 1587
PHOENIX, ARIZONA 85001
602 AL 8-7893
TWX 602 295-0226 FAX
OHMITE MANUFACTURING COMPANY
201 TOWN & COUNTRY VILLAGE
PALO ALTO, CALIFORNIA 94301
415 DA 1-6953
OHMITE MANUFACTURING CO.
6115 SELMA AVENUE
HOLLYWOOD, CALIF. 90028
213 466-3434
MC LOUD & RAYMOND COMPANY
P O BOX 22044
DENVER, COLORADO 80222
303 SK 6-1589
TWX 303 292-2931
STANLEY K WALLACE ASSOCIATES
P O BOX 67
LUTZ, FLORIDA 33549
813 949-1817
VAL SKOL SALES, INCORPORATED
510 FT WAYNE BANK BLDG
FORT WAYNE, INDIANA 46802
219 742-9122
PAUL R. STURGEON CO., INC.
1330 BOYLSTON STREET
CHESTNUT HILL, MASS. 02167
617 734-7710
OHMITE MANUFACTURING CO
P O BOX 4773
DETROIT, MICHIGAN 48219
313 537 3960
FRED B HILL COMPANY
110 EXCELSIOR BOULEVARD
MINNEAPOLIS, MINNESOTA 55416
612 929 6727
TWX 910 576-2924
H A ROES AND COMPANY
2601 CHERRY STREET
KANSAS CITY, MISSOURI 64108
816 BA1 0866
TWX 816 556-2428
RUSS O SEBRIGHT & COMPANY
7120 WEST FLORISSANT AVENUE
ST LOUIS, MISSOURI 63136
CO 1-0055
OHMITE MANUFACTURING CO
P O BOX 148
PALISADES PARK, N.J. 07650
201 947-1777
OHMITE MANUFACTURING COMPANY
3700 EAST AVENUE

ROCHESTER, NEW YORK 14618
716 381 1890
TWX 716 221-1510
OHMITE MANUFACTURING CD
P O BOX 3084
CLEVELAND, OHIO 44117
216 IV 1-7626
SAMUEL K MACDONALD, INC
1531 SPRUCE STREET
PHILADELPHIA, PENN 19102
KI 5-1205
CARTWRIGHT & BEAN
P O BOX 760
CRDSTOWN STATIDN
MEMPHIS, TENNESSEE 38104
901 276-4442
J EARL SMITH COMPANY
1353 CHEMICAL STREET
OALLAS, TEXAS 75207
214 ME 1-1727
R K SOUTHB, INC
655 N E NORTHLAKE PLACE
SEATTLE, WASHINGTON 98105
206 ME 2-2450
REPS. IN OTHER COUNTRIES
C M ROBINSON AGENCIES
1550 ERIN STREET
WINNIPEG 3, MANITOBA
SP 4-1855-6
A C SIMMONDS & SONS LTD
100 MERTON STREET
TORONTO 7, ONTARIO
416 485-9111

GUNNAR A OLSEN CORPORATION

COMPANY ADDRESS
215-11 42ND AVE,
BAYSIDE, N.Y. 11361

ONAN DIVISION OF

STUDEBAKER CORPORATION
VP MARKETING
ROY E. MULLIN
SALES MANAGER
WILLIAM J. AUGER
BRAND NAMES
ONAN
COMPANY ADDRESS
2515 UNIVERSITY AVE, S E
MINNEAPOLIS, MINN 55414

ORBIT RADIO

SALES MANAGER
S. A. CISLER
BRAND NAMES
ORBEX
ORBIT
COMPANY ADDRESS
P. O. BOX 1644
1863 ARLINGTON ST
LOUISVILLE, KY 40201
895 1143

PACIFIC TOWER COMPANY

VICE PRESIDENT-SALES
GILBERT NIELSEN
COMPANY ADDRESS
6100 N. E. COLUMBIA BLVD.,
PORTLAND, OREGON 97218

PAINTON INCORPORATED

SALES MANAGER
HOWARD M. LAYTON
COMPANY ADDRESS
109 WHEELER AVE.
PLEASANTVILLE, NEW YORK 10570
914-769-1103

PALL TRINITY MICRO CORPORATION

VICE. PRES. SALES
NICHOLAS NICKDLAUS
BRAND NAMES
AMLOC-TM
EPOCEL-R
CERTIMESH-R
DELTADYNE-R
GRAVITAIN-R
HEAT-LES-R
HX-R
PETROSORB-R
PSS-R
RIGIMESH-R
SUPRAMESH-R
SURFAMAX-R
TRINOX-R
ULTIPOR-R
COMPANY ADDRESS
ROUTE 281
CORTLAND, NEW YORK 13046
COMPANY REPRESENTATIVES
GEO S EDWARDS CO., INC
PO BOX 5913
1913-27TH AVE S
BIRMINGHAM, ALABAMA 35209
205 879 1633
TWX 205 328 3826
FRANK A THOMAS CO
PO BOX 6415
1805 LIBERTY STREET
MOBILE, ALABAMA 36606
205 471 1593
TWX 205 342 5837
BROWNLEE & MORROW ENGR
1016 S 15TH STREET
PO BOX 3245-A
BIRMINGHAM, ALABAMA 35205
205 328 5650
TRIDENT ENGR CO,
16 BEALE STREET
SAN FRANCISCO, CALIF 94105
415 986 6558
RUBLY ENGINEERING CO., INC,
1787 LARK LANE

PO BOX 2156
SUNNYVALE, CALIF 94087
408 253 6106
TWX 478 287 6624
PALL WESTERN CORP
A I C BLOG- SOUTH
8050 FLORENCE AVE
DOWNEY, CALIF 90240
213 861 1297
TWX 213 531 7059
BROOKES ENGINEERING CO
1122-12TH STREET
DENVER, COLORADO 80204
303 222 5791
PONO TECH SALES, INC
3013 DIXWELL AVENUE
HAMOEN, CONN 06518
208 288 3278
DRU KILL COMPANY, INC
PO BOX 927
MAITLAND, FLORIDA 32751
305 647 4288
THOMAS ENGINEERING CO
222-14TH STREET, NW
ATLANTA, GEORGIA 30318
404 874 4291
ENPRO, INCORPORATED
1214 SOUTH 17TH AVE
MAYWOOD, ILLINOIS 60153
312 345 1613
H G KLUG CO., INC
C/O TECHNICAL ENGR
821 BRITON AVENUE
DIXON, ILLINOIS
815 288 1265
LADY ENGINEERING CO
PO BOX 1256
AVONDALE STATION
PADUCAH, KENTUCKY 42002
502 444 6494
PAUL CONOIT CO., INC
PO BOX 52796
2744 LOCKWOOD STREET
BATON ROUGE, LA
504 357 5511
JAMES R CHISHOLM CORP
92 HUTCHINSON STREET
CORNER ROUTE C-1
REVERE, MASS 02151
617 289 4100
STEPHEN E LORD CO
PO BOX 239
LEXINGTON, MASS 02173
617 274 7302
H A REED CO
19465 JAMES COUZENS HWY
OETROIT, MICHIGAN 48235
313 347 7474
THE INDUSTRA COMPANY
6504 WALKER STREET
MINNEAPOLIS MINN 55426
612 929 6224
THE CONDIT CO
4050 BROADWAY-ROOM 208
KANSAS CITY, MISSOURI 64111
816 561-4660
PROCESS ENGRING & EQUIP CO.
710 HANLEY INDUSTRIAL CT
ST LOUIS, MISSOURI 63144
314 644 2244
TWX 314 962-3930
OURKIN EQUIPMENT CO
3010 N LINDBERGH
ST. ANN, MISSOURI 63074
314 739-0100
THE ARCHIBALD CO
55 WEST BROADWAY
PO BOX 755
BUTTE, MONTANA 59701
406 723-8975
H G KLUG CO., INC
2029 N 67TH AVE
OMAHA, NEBRASKA 68104
402 553-1377
PALL TRINCOR CORP
135 CHESTNUT STREET
ROSELLE PARK, N. J. 07204
212 259 6779
TWX 201 245-0019
ALISON CONTROLS, INC
954 KINDERKAMACK ROAD
RIVER EDGE, N. J. 07661
201 265-3737
PALL TRINCOR CORPORATION
PROFESSIONAL BLDG
MERCHANTVILLE, N. J. 08109
609 665-0855
DWENS & Co., INC
24 JORDAN STREET
SKANEATELES, N.Y.
315 685-5771
DIMPEX ASSOC., INC.
SUITE 303 EAST
200 PARK AVENUE
NEW YORK, NEW YORK 10017
212 986-7967
OWENS & Co., INC
PO BOX 1405
BUFFALO, N.Y. 11214
716 835-9166
AMERICAN TRADING CO., INC
2 BROADWAY
NEW YORK, NEW YORK 10004
212 MA 5-6300
ABERNATHY-THOMAS ENGR. CO
3809 WEONA AVENUE
CHARLOTTE, N. CAROLINA 28209
704 525-2072
THE LESTER JOHNSON CO
3909 EAST 123RD ST
CLEVELAND, OHIO 44105
216 751 7040
TWX 216 752 8024
THE LESTER JOHNSON CO
PO BOX 41197
9870 SPRINGFIELD PIKE

CINCINNATI, OHIO 45241
513 771 2270
THE LESTER JOHNSON CO
PO BOX 3
WDRTHINGTON, OHIO 43085
614 889 8447
THE CONDIT CO
PO BOX 4753
3120 5D WINSTON AVENUE
TULSA, OKLAHOMA 74114
918 743 6651
TWX 918 923 3288
BILTMORE PRODUCTS CO., INC
PO BOX 7963
466 CASTLE SHANNON BLVD
PITTSBURGH, PENN 15234
412 563 3808
G L CLAPPER
7019 MEADE STREET
PITTSBURGH, PA 15208
412 241-3737
PORTILLA CORP
PO BOX 4349
376 BARBOSA AVENUE
SAN JUAN, PUERTO RICD 00905
766 6190
ABERNATHY-THOMAS ENGR. CO
341-345 W MARKET STREET
DRAWER A
KINGSPORT, TENN 37662
615 245 6151
TWX 615 221-5109
ABERNATHY-THOMAS ENGR. CO
PO BOX 8506
NASHVILLE, TENN 37211
615 833-248C
PAUL CONOIT CO., INC
PO BOX 207094
1025 LEWALL
HOUSTON, TEXAS 77025
713 747-0802,3,4
ENGINEERED EQUIPMENT INC
PO BOX 12125
409 EXEC PARK BLVD
ROOM 205
EL PASO, TEXAS 79912
915 533-4221
ENGINEERED EQUIPMENT, INC
3617 W STOREY
MIDLAND, TEXAS 79702
915 694-4997
OYNAMATION, INC.
PO BOX 3191
BON AIR, VIRGINIA 23235
703 272-5000
CANE JESSUP CO., INC
1433-130TH NE
PO BOX 250
BELLEVUE, WASHINGTON 98004
206 454 0691
TWX 206 742-0809
BILTMORE PRODUCTS CO., INC
411-1/2 D STREET
PO BOX 8643
S CHARLESTON, W. VA, 25303
304 744-9432
ALLIED CONTROLS CO
PO BOX 8283
4840 MAC CORKLE AVE., SW
S CHARLESTON, W. VA, 25303
304 768-7313
CHIPLEY & JENSEN, INC
3500 W SHERMAN BLVD
MILWAUKEE, WISCONSIN 53216
414 442-8170
REPS. IN OTHER COUNTRIES
MARUSHO INDUSTRIAL CO., LTD.
1-4-HOME
GINZA HIGASHI
CHO-KU, TOKYO, JAPAN
JOONGWON & CO., LTD.
60, 1-KA-MYUNG-DONG
CHUNG-KU, SEOUL, KOREA
8-4325
EURO ENGINEERS, LTD.
LEE WAH BANK BLDG
MEDAN PASAR
KUALA LUMPUR, MALAYSIA
SHAHI TRADING CORP
110, TAMIZ MARKET
MADANKANAN CHITTANGONG
EAST PAKISTAN
PALL U. K.
275-281 KING STREET
HAMMERSMITH,
LONDON W. 6, ENGLAND
RIVERSIDE 8924-8
INTL. PROCESS CONTROLS-HELLAS
15 VOULIS STREET
PD BOX 400
ATHENS 126, GREECE
238 536
INTERNAL PROCESS CONTROLS
46A SHALOM ALECHEM STREET
TEL AVIV, ISRAEL
233893
GRAHAM INSTRUMENTS, LTD.
4508-6TH STREET NE
CALGARY, ALBERTA
403 276-1275
THOMAS W MAC KAY & CON. LTD
1807 FIR STREET
VANCOUVER, BRITISH COLUMBIA
604 731-6561
SCARBOROUGH & GRANT CO
12 LE PAGE COURT
DOWNSVIEW, ONTARIO
416 633-4130
ASSOC INSTRUMENTATION &
CONTROLS, LTD.
2261 ROCKLAND ROAD
MONTREAL 16, QUEBEC
514 738-1167
PALL S. A.
APARTADO POSTAL NO. 199
CO. NAUCALPAN DE JUAREZ

EDD. DE MEXICO, MEXICO
27 11 37
PALL S. A.
EDIF. SANTOS DESP 405
MONTERREY, N.L., MEXICO
6 39 80
CASUCCI S C A
PUEYREDON 225-6 P
BUENOS AIRES, ARGENTINA
FERRETERIA AMERICANA
CALLE 12 N. 9-46
BOGOTA, COLOMBIA
LIGOLD INGENIEROS, S.A.
C/D JAVIER OTTO GOLD
AV. MILITAR 2576
LINCE, LIMA, PERU
INDOQUIP C A
APARTADO 10518
SABANA GRANDE
CARACAS, VENEZUELA
34 44 11

PERMOFLUX CORPORATION

SALES MANAGER
L. M. HEINEMAN
BRAND NAMES
DIMENCI-FONES
DUO-FONES
DIMINUETTE
EARSPEAKERS
LARGO
ROYAL BLUE
STEREO-FONES
TRUE STEREO
COMPANY ADDRESS
4111 SAN FERNANDO ROAD
P. O. BOX 6364
GLENDALE, CALIF. 91204

PHELPS DODGE ELECTRONIC

PRODUCTS CORPORATION
SALES MANAGER
DAVID M. MCGALLIARD
BRAND NAMES
FOAMFLEX
HELICAL MEMBRANE
RIGID LINE
SPIRAFIL
STYROFIL
STYROFLEX
TAPERLOK
WIRELOK
COMPANY ADDRESS
60 DODGE AVE. PO BOX 187
NORTH HAVEN, CONN. 06473

PIEZO CRYSTAL COMPANY

COMPANY ADDRESS
100 K STREET
CARLISLE, PA. 17013

H K PORTER INC

SALES MANAGER
W. S. BOSWORTH
COMPANY ADDRESS
74 FOLEY ST.
SOMERVILLE, MASS. 02143

POWER-OPTICS INCORPORATED

SALES MANAGER
JACK LITTLER
BRAND NAMES
EVERSHEO
POWER-OPTICS
COMPANY ADDRESS
PLYMOUTH MEETING, PA. 19462

POWER SOURCES

DIV TECHNICAL OPERATIONS, INC

SALES MANAGER
ROBERT R. SMYTH
BRAND NAMES
SINEVERTER
COMPANY ADDRESS
SOUTH AVENUE
HURLINGTON, MASS. 01803

PRECISION LABORATORIES

DIV. OF PRECISION

CINE EQUIPMENT CORP.

SALES MANAGER
IRWIN R. SHELDDON
BRAND NAMES
PRECISION
COMPANY ADDRESS
928-930 EAST 51ST STREET
BROOKLYN, N.Y. 11203

PRECISION PIEZO SERVICE

SALES MANAGER
C. E. PEARCE
COMPANY ADDRESS
427 MAYFLOWER ST.
BATON ROUGE, LA. 70802

PRODELIN INCORPORATED

SALES MANAGER
J. M. LEVERGOOD
BRAND NAMES
RIGID 800
SPIR-O-LINE
SPIR-O-FOAM
SPIR-O-LOK
COMPANY ADDRESS
P. O. BOX 131
HIGHTSTOWN, NEW JERSEY 08520
COMPANY REPRESENTATIVES
J. M. HAMILTON
2126 BANGOR WAY
ANAHEIM, CALIF 92805
714 776-3769
PRODELIN, INC.
901 AMERICAN STREET
SAN CARLOS, CALIF 94070
415 593-8277
C. E. LINDBERG

2654 SOUTH KRAMERIA
DENVER, COLORADO 80200
303 757-6489
GENE PIETY FACTORS, INC.
PO BOX 2903
160 MOKAUEA STREET
HONOLULU, HAWAII 96800
808 837-185
BENMFWITZ ASSOC.
8310 CUTLER, N.E.
ALBUQUERQUE, N M 87110
505 299-8651
APPLIED ENGRING SALES
SUITE 200
FIRST BANK & TRUST BLDG
RICHARDSON, TEXAS 75080
214 AD 1-1322
C C S BUTT
PO BOX 18045
HOUSTON, TEXAS 77023
713 JA 6-3101
ELECTRONIC SALES CORP
PO BOX 6535
6969 SW CALIFORNIA STREET
SEATTLE, WASH. 98116
206 WE 2-0330
ELECTRONIC PRODUCTS, INC.
3612 N GREENBAY AVENUE
MILWAUKEE, WISCONSIN 53212
414 264-3380
REPS. IN OTHER COUNTRIES
AFRD-SPACE TRONICS, LTD.
1080 PORT ROYAL AVENUE, W
MONTREAL 12, QUEBEC
514 331-6100

PRO-TEX REEL BAND COMPANY

BRAND NAMES
PRO-TEX
SEALEDREEL BAND
VINYL BAND
COMPANY ADDRESS
200 FILM BUILDING
CLEVELAND, OHIO 44114

PRUZAN COMPANY

VICE PRESIDENT - SALES
RUBIN SALANT
BRAND NAMES
PRUZAN
COMPANY ADDRESS
1963 1ST AVE SOUTH
SEATTLE, WASH 98134

PULSE TECHNIQUES, INC.

SALES MANAGER
W. O. SUMMERLIN
BRAND NAMES
PULTEC
COMPANY ADDRESS
1411 PALISADE AVENUE
WEST ENGLEWOOD, N. J. 07666

O R K ELECTRONIC PRODUCTS INC

SALFS MANAGER
BERT WILLIAMSON
COMPANY ADDRESS
2125 N BARTON AVE.
FRESNO, CALIF. 93703

O-TV SALES & DISTRIBUTING CORP

BRAND NAMES
O PROMPTER SYSTEMS
O VIDEOTYPERS
O TAPE DISPATCHER SYSTEM
O VERTICAL CRAWL SYSTEM
VIDEONOND PROMPTER PAPER
O DELUXE CRAWLS
COMPANY ADDRESS
342 W 40TH STREET
NEW YORK, NEW YORK 10018

JULES RACINE CO. INC

SALES MANAGER
MORGAN F. SMITH
BRAND NAMES
GALLFT
GALCO
RACINE
SECURITY
COMPANY ADDRESS
521 FIFTH AVENUE
NEW YORK CITY, N Y 10017
687 3060
COMPANY REPRESENTATIVES
JAMES DAWSON
215 W FIFTH STREET
LOS ANGELES, CALIF.
JOHN LA FRUIT
19 E MADISON STREET
CHICAGO, ILL.

RADIO AIDS

COMPANY ADDRESS
528 RAVINE AVE.
LAKE BLUFF, ILL. 60044

RAVEN SCREEN CORPORATION

SALES MANAGER
ERNEST D. REIF
BRAND NAMES
RAVEN SCREENS
COMPANY ADDRESS
124 EAST 124TH STREET
NEW YORK, NEW YORK 10035
212 LE 4-8408-9

RAYTHEON CO.

EQUIPMENT DIVISION

SALES MANAGER
JACK E. BANISTER
COMPANY ADDRESS
1415 BOSTON-
PROVIDENCE TURNPIKE

NDRWOOD, MASS. 02062
617 762-6700
COMPANY REPRESENTATIVES
DARYL HATFIELD
P O BOX 280
MOUNTAIN VIEW, CALIF.
415 968-8170
JOHN BARBER & PHIL CASS
349 PFACHTREE HILLS RD., N E
ATLANTA, GEORGIA
404 231-3350
ROBERT KANNEY
3158 DES PLAINES AVENUE
DES PLAINES, ILLINDIS
312 296-6677
ROBERT KELLER
P.O. BOX 9117
KANSAS CITY, MO.
816 SH 1-1560

RBM CONTROLS

DIV OF ESSEX WIRE CORP

SALFS MANAGER
WILLIAM T HOPKINS
BRAND NAMES
RBM
COMPANY ADDRESS
131 GODFREY ST
LOGANSPOUT, INDIANA 46947
COMPANY REPRESENTATIVES
MELCHIOR & MAC PHEARSON INC
8208 CHERRY ST
SAN CARLOS, CALIF 94070
415 591 7383
P F WILEY CO
1632 SILVERLAKE BLVD
LOS ANGELES, CALIF 90026
213 663 8028
FRANKLIN SALES CO
2149 S CLERMONT ST
DENVER, COLO 80222
303 757 1371
HOLLINGSWORTH & STILL
3098 PIEDMONT RD N E RM 100
ATLANTA, GA 30305
404 261 5838
C BAKAS
3501 W ADDISON ST
CHICAGO, ILL 60618
312 478 9151
POLY-ONICS INC
4434 W 90TH TERRACE
LEAWOOD, KANSAS 66206
913 648 4173
MICHAEL SCOTT CO INC
336 WASHINGTON ST
WELLESLEY HILLS, MASS 02181
617 235 0102
SHALCO INC
23529 WOODWARD AVE
FERNSDALE, MICH 48220
313 547 4771
L TOMALA
100 TUDOR ROAD
BERRIEN SPRINGS, MICH 49103
616 471 7721
R. HASSELBALCH
3230 E HENNEPIN
MINNEAPOLIS, MINN 55413
612 331 6370
J CASEY
5959 ST LOUIS AVE
ST LOUIS, MO 63120
314 382 9000
W PARKINS
199 LEE PLACE
HACKENSACK, N J 07602
201 487 9272
B MCCLEAN
4623 E GENESSE
DE WITT, N Y 13214
315 446 0800
ROBURN AGENCIES - EXPORT
431 GREENWICH ST
NEW YORK, N Y 10013
212 966 2130
J LEBEAU
4500 WILLOW PARK WAY
CLEVELAND, OHIO 44125
216 641-7550
J R LORIMER
2077 EMBURY PARK RD RM 5
DAYTON, OHIO 45414
513 277 8964
D H BURCHAM CO
510 N W 19TH AVE BOX 2827
PORTLAND, OREGON
503 226 4148
A ELDRIDGE & H JULES
RAILROAD & END STS
CONSHOHOCKEN, PA 19428
215 825 0635
W SMITH
2172 WHARF ST
MEMPHIS, TENN 38106
901 948 6607
TEXPORT CO
2411 FARRINGTON ST
DALLAS, TEXAS 75207
214 631 6270

COMPANY ADDRESS
131 GODFREY ST
LOGANSPOUT, INDIANA 46947
COMPANY REPRESENTATIVES
MELCHIOR & MAC PHEARSON INC
8208 CHERRY ST
SAN CARLOS, CALIF 94070
415 591 7383
P F WILEY CO
1632 SILVERLAKE BLVD
LOS ANGELES, CALIF 90026
213 663 8028
FRANKLIN SALES CO
2149 S CLERMONT ST
DENVER, COLO 80222
303 757 1371
HOLLINGSWORTH & STILL
3098 PIEDMONT RD N E RM 100
ATLANTA, GA 30305
404 261 5838
C BAKAS
3501 W ADDISON ST
CHICAGO, ILL 60618
312 478 9151
POLY-ONICS INC
4434 W 90TH TERRACE
LEAWOOD, KANSAS 66206
913 648 4173
MICHAEL SCOTT CO INC
336 WASHINGTON ST
WELLESLEY HILLS, MASS 02181
617 235 0102
SHALCO INC
23529 WOODWARD AVE
FERNSDALE, MICH 48220
313 547 4771
L TOMALA
100 TUDOR ROAD
BERRIEN SPRINGS, MICH 49103
616 471 7721
R. HASSELBALCH
3230 E HENNEPIN
MINNEAPOLIS, MINN 55413
612 331 6370
J CASEY
5959 ST LOUIS AVE
ST LOUIS, MO 63120
314 382 9000
W PARKINS
199 LEE PLACE
HACKENSACK, N J 07602
201 487 9272
B MCCLEAN
4623 E GENESSE
DE WITT, N Y 13214
315 446 0800
ROBURN AGENCIES - EXPORT
431 GREENWICH ST
NEW YORK, N Y 10013
212 966 2130
J LEBEAU
4500 WILLOW PARK WAY
CLEVELAND, OHIO 44125
216 641-7550
J R LORIMER
2077 EMBURY PARK RD RM 5
DAYTON, OHIO 45414
513 277 8964
D H BURCHAM CO
510 N W 19TH AVE BOX 2827
PORTLAND, OREGON
503 226 4148
A ELDRIDGE & H JULES
RAILROAD & END STS
CONSHOHOCKEN, PA 19428
215 825 0635
W SMITH
2172 WHARF ST
MEMPHIS, TENN 38106
901 948 6607
TEXPORT CO
2411 FARRINGTON ST
DALLAS, TEXAS 75207
214 631 6270

RCA BROADCAST & COMMUNICATIONS

PRODUCTS DIVISION

VP, BROADCAST SALES DEPT
E. C. TRACY
COMPANY ADDRESS
FRONT & COOPER ST
CAMDEN, N J 08102
COMPANY REPRESENTATIVES
J SMITH
OFF PARK BLDG 10
OFFICE PARK CIRCLE
BIRMINGHAM, ALA 35223
205 871 1155
M M CORBETT
R J NEWMAN

343 SANSOME ST 7TH FLOOR
SAN FRANCISCO, CALIF. 94104
415 956-4818
E FRDST
M ELLISON
2700 W OLIVE AVENUE
BURBANK, CALIF. 91505
213 849-6741
R F GOODSPEED
SUITE 223
2785 N SPEER BLVD.
DENVFR, COLO. 80211
303 477-6832
R E GILES
3900 MONET RD
PALM BEACH GARDENS
W PALM BEACH, FLA 33403
305 844 7351 EXT 2891
P G WALTERS
134 PEACH TREE ST N W
ATLANTA, GA 30303
404 524 7700
F A TIMBERLAKE
2000 MDSE. MART PLAZA
CHICAGO, ILL 60654
312 467 5900
R MELE
C RAASCH
501 N LASALLE STREET
INDIANAPOLIS, IND 46201
317 635-9000
E H HERLIHY
950 WATERTOWN ST
WEST NEWTON, MASS 02165
617 969 6010
W HAPPEL
2083R RUTLAND AVE
SOUTHFIELD, MICH 48076
313 357 0080
W G EBERHART
4522 EXCELSIOR BLVD
MINNEAPOLIS, MINN 55416
612 922 3303
V S MATTISON
SUITE 112, 7711 STATE LINE RD
KANSAS CITY, MO 64114
816 363-6770
D FREEMAN
7710 CARONDELET AVF
ST LOUIS, MO 63105
314 VO 2 3660
J GIMBEL
FRONT & COOPER STS
CAMDEN, N J 08102
609 963 8000
J SHIPLEY
J R SIMS
R VARDA
O F WAGNER
30 ROCKFELLER PLAZA, RM 1219
NEW YORK, N.Y. 10020
212 689-7200
R M WILLIAMS
330 CHARLOTTETOWN CENTER
CHARLOTTE, N C 28204
704 333 3986
W C WISEMAN
1600 KEITH BLDG
CLEVELAND, OHIO 44115
216 241 3450
D P ALLEN
WASHINGTON COUNTY
MEADOW LANDS, PA 15347
412 341 5294
B E FINCHER
2110 AIRWAYS BLVD
MEMPHIS, TENN 38114
901 743 9442
D A CRAWFORD
E H HOFF
210-C COURT TERRACE
EXCHANGE PARK NORTH
DALLAS, TEXAS
214 351-5361
J N BARCLAY
5425-B BURNET RD.
AUSTIN, TEXAS 78756
512 GL 3 8233
R HARDING
2246 FIRST AVE S
SEATTLE, WASH 98134
206 622 8350

RCA ELECTRONIC COMPONENTS

AND DEVICES

SALES MANAGER
J. A. HAIMES
COMPANY ADDRESS
415 SOUTH FIFTH ST
HARRISON, N. J. 07029
201 485 3900

RCA SERVICE CO

SALES MANAGER

WILLIAM D. ORENDO
COMPANY ADDRESS
CHERRY HILL OFFICES
CAMDEN, N J 08101

RECOROING EQUIPMENT COMPANY



SALES MANAGER
FRANCIS DANIEL
COMPANY ADDRESS
114 WEST 70 ST.
NEW YORK, NEW YORK 10023

REEVES SOUNDRAFT,

DIV. REEVES INDUSTRIES, INC.

SALES MANAGER
GEORGE P. PETETIN
BRAND NAMES
GOLDEN TONE
HANOI TAPE
MAGNA SEE
MICRO PLATE
MICROLAC

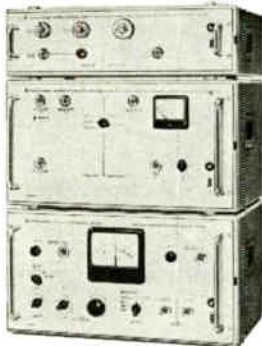
Measure Vital Characteristics of Broadcasting Systems*

VIDEO NOISE	GROUP DELAY	FIELD STRENGTH
UPSF VIDEO NOISE METER  <p>Designed for noise voltage measurements on TV cameras, film scanners, video tape recorders, radio links, coaxial lines, TV transmitters, receivers and transposer, with synch. Signals.</p> <ul style="list-style-type: none"> • 40 Hz to 5 MHz • 7 Measurement Ranges: 1/3/10/30/100/300/1000 mVpp • True RMS or Peak-to-Peak Indications 	LFM TEST ASSEMBLY  <p>Determine group (envelope) delay of video and TV transmission systems.</p> <ul style="list-style-type: none"> • 0.1 - 10 MHz and 25-250 MHz (ext. to 1 GHz) • ± 10 to ± 1000 nsec. • Using Type SWOF sweep system group delay is instantaneously displayed on CRT. 	HUZ FIELD STRENGTH METER  <p>Covers FM, TV, aircraft, police and mobile radio bands for determining propagation conditions, polarization and radiation patterns. Used as a selective voltmeter, it measures antenna gain and cable attenuation.</p> <ul style="list-style-type: none"> • 47 to 225 MHz • $1 \mu\text{V}$ to 100 mV • FM & AM Detection • Portable, Weights only 9 lbs. • Includes Built-In Rechargeable Batteries

VESTIGIAL SIDEBAND ANALYSIS In the presence of synch. signals

SWEEP GENERATOR/RECEIVER

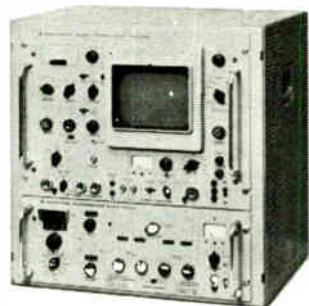

SWOF VIDEOSKOP A video sweep generator, tracking selective (3 kHz) receiver, and display unit. Range: Frequency, 20 kHz to 20 MHz, (1 GHz with sideband adapter); Sweep Width: 1 to 16 MHz, continuously variable; sweep duration 50 ms to 5.5 s.

HIGH QUALITY 1/2 W. X-MITTER

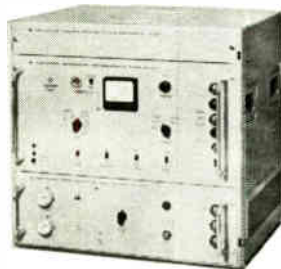

SBTF VESTIGIAL SIDEBAND SIGNAL GENERATOR Modulation of vision and sound signals is accomplished in the IF, thereby permitting use of plug-in heads for VHF & UHF. SBTF generates exceptionally high quality NTS signal for development and production testing of receivers, and as low power Xmitter.

STANDARD RECEIVER

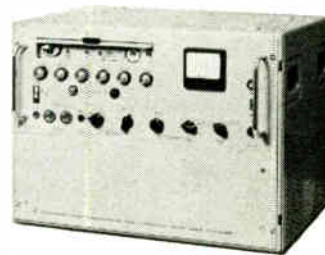

AMF TV DEMODULATOR A Nyquist demodulator as a ref. standard for TV Xmitter performance (B&W, color and sound). Video and audio frequency response, phase and group delay, intercarrier signal-to-noise ratio, etc. Models available for VHF and UHF.

* MEETS REQUIREMENTS OF ALL U.S.A. BLACK AND WHITE AND NTS COLOR SYSTEMS

LITERATURE AVAILABLE Write for the new R/S Folder featuring a complete line of measuring and test equipment for the broadcasting industry.

Get The Extra Capability,
Greater Reliability, and
Longer Useful Life Of ...



ROHDE & SCHWARZ

111 LEXINGTON AVENUE, PASSAIC, N. J. 07055 • (201) 773-8010

Inquiries outside the U.S.A.

should be directed to: Rohde & Schwarz, Muehlidorfstrasse 15, Munchen 8, West Germany.

SOUNDCRAFT
UNI LURF
COMPANY ADDRESS
15 GREAT PASTURE ROAD
DANBURY, CONN. 06813
COMPANY REPRESENTATIVES
HYDE ELECTRONICS CO INC
4710 N 16TH STREET SUITE 109
PHOENIX, ARIZONA
602 264-5609
SINAI-JOHNSON INC
845 JESSIE STREET
SAN FRANCISCO, CALIF.
415 861-6259
REEVES SOUNDCRAFT DIVISION
342 NORTH LABREA AVE
LOS ANGELES, CALIF.
213 931-1181
HYDE ELECTRONICS CO INC
888 SOUTH LIPAN ST
DENVER, COLORADO 80223
303 936-3456
R A CHALMERS & CO
349 PEACHTREE HILL AVE, NE
ATLANTA, GEORGIA 30305
404 233-3208
FARL ASSOCIATES
P O BOX 2845
HONOLULU, HAWAII 96803
569-6777
REEVES SOUNDCRAFT DIVISION
7310 WEST NORTH AVE
ELMHWOOD PARK, ILLINOIS
312 456-2940
HOEMIG SALES COMPANY
3405 BUTLER COURT
FORT WAYNE, INO. 46808
219 482-6913
JIM PIPER ASSOC.
10 HAVEN STREET
DOVER, MASS.
617 785-0513
A B M SALES INC
10116 PURITAN AVENUE
DETROIT, MICHIGAN
313 862-1300
LEONARD D ALLEN INC
P O BOX 205
NORTH SYRACUSE, N.Y.
315 458-7470
REEVE SOUNDCRAFT DIVISION
302 EAST 44TH STREET
NEW YORK, N.Y.
212 686-6451
F A OUGHERTY CO
6025 MAYFIELD ROAD
CLEVELAND, OHIO
216 449-1122
GENE S ROOT & CO
809 WAINWRIGHT DRIVE
PITTSBURGH, PA. 15228
412 561-4125
STINSON ASSOCIATES
227 HAVERFORD AVE
NARBERTH, PA.
215 664-5511
C C MCNICOL INC
811 NORTH ESTRELLA
EL PASO, TEXAS
915 566-2936
J Y SCHOONMAKER CO INC
5328 REDFIELD
DALLAS, TEXAS 75235
214 631-8480
HYDE ELECTRONICS CO INC
2422 CAMINO WAY
SALT LAKE CITY, UTAH
801 278-4465
W K WOOD CO INC
P O BOX 46046
SEATTLE, WASHINGTON
206 935-9400
REPS. IN OTHER COUNTRIES
APPLIED ELECTRONICS
40 TORLAKE CRESCENT
TORONTO 18, ONTARIO
416 251-1113
E S GOULD SALES CO LTD
11 LOUVAIN ST WEST
MONTREAL 11, QUEBEC
514 384-0453

RHG ELECTRONICS LABORATORY, INC
PRESIDENT & SALES MANAGER
RONALD B. HIRSCH
COMPANY ADDRESS
94 MILBAR BLVD.
FARMINGDALE L.I., N.Y. 11735
516 694-3100
COMPANY REPRESENTATIVES
CAIN & CO INC
15720 VENTURA BLVD
ENCINO, CALIF.
213 783-4700
CAIN & CO INC
175 SOUTH SAN ANTONIO ROAD
LOS ALTOS, CALIF.
415 948-6533
CAIN & CO INC
520 DAVIS BLDG
WASHINGTON, D.C.
202 296-8265
THEALL ENGINEERING SALES CO
C OF C BLDG P O BOX 922
MAYTLANO, FLORIDA 32751
305 647-4469
CAIN & CO INC
1735 BUFFALO GROVE ROAD
ARLINGTON HEIGHTS, ILL. 60004
312 253-3578
CAIN & CO INC
45 ESSEX STREET
MELROSE, MASS.
617 665-8600
CAIN & CO INC
P O BOX 261

SOUTH AMBOY, N.J.
201 727-1900
A L S ELECTRONICS
P O BOX 11373
ALBUQUERQUE, N.M.
505 298-2575
CAIN & CO INC
369 WHITE PLAINS ROAD
EASTCHESTER, N.Y.
914 OE 7-3445
KLM ASSOCIATES
9 HOLLYWOOD DRIVE
WHITESBORO, N.Y.
315 736-2450
KLM ASSOCIATES
201 SOUTH MAIN STREET
NO SYRACUSE, N.Y.
315 458-6214
KLM ASSOCIATES
8 REAR HILL DRIVE
PALMYRA, N.Y.
315 LY 7-9776
HAACKE CO
P O BOX 3032
DAYTON 31, OHIO
513 254-1191
CAIN & CO INC
670 RIDGE PIKE
LAFAYETTE HILL, PA.
215 828-3861
CAIN & CO INC
435 BRANIFF AIRWAYS BLDG
DALLAS, TEXAS
214 369-2897
PARATECH
9210 28TH STREET NW
SEATTLE, WASH.
206 784-6447
REPS. IN OTHER COUNTRIES
RIKEI TRADING CO LTD
KOZATO KAIKAN BLDG
NO 18-14 NISHT-SHIMBASHI
MINATOKU, TOKYO, JAPAN
591-52946
ESTABLISSEMENTS TRANCHANT
19 & 21 RUE
MADAME DE SANZILLON
CLINCHY-SEINE, FRANCE
WACKER GMBH
STETTENSTRASSE 9
AM MAIN
6 FRANKFURT, AM MAIN, GERMANY
MOTORDIESEL
CASELLA POSTALE NO 116
VIA MINZONI 5
LA SPEZIA, ITALY
STANDARD PRECISION INSTRUMENT
POSTBOX 12173
STOCKHOLM, SWEDEN
RAOIONICS LTO
376 CHURCHILL AVE
OTTAWA 3, ONTARIO
613 728-5333
RAOIONICS LTO
4938 YONGE STREET
WILLOWDALE, ONTARIO
416 222-3261
RADIONICS, LTO.
8230 MAYRAND STREET
MONTREAL 9, QUEBEC
514 RE 9-5517

RIKER VIDEO INDUSTRIES, INC
SALES MANAGER
BERNARD V. MUNZELLE
BRAND NAMES
COLORIZER
RIKER
CHRONOLOG
MINCOM
COMPANY ADDRESS
NORDEN LANE
MUNTINGTON STATION, N Y 11746
COMPANY REPRESENTATIVES
S. S. KRINSKY ASSOCIATES
6311 YUCCA AVE
HOLLYWOOD 28, CALIF
213 HO 2-1133
ROBERT WEBB
1336 MISSOURI AVE
WASHINGTON, D. C.
202-291-5923
CHARLES ABNEY
146 OAKDALE DRIVE
FOREST PARK, GEORGIA
404-361-4118
ROBERT E. LYNCH
33479 CINDY
LIVONIA, MICHIGAN
313-427-3674
HERMAN RUODLPH
8174 GREEN HOLLOW LANE
OALLS, TEXAS
214-R1 7-5082

ROANWELL CORPORATION
MARKETING MANAGER
METRO P. SIRKO
BRAND NAMES
CONFIDENCER
COMPANY ADDRESS
ROANWELL BLDG. 180 VARICK ST.
NEW YORK, N.Y. 10014
COMPANY REPRESENTATIVES
JEWETT COMPANY
P O BOX 172, 32-B E 1ST ST
SCOTTSDALE, ARIZONA
602 945-9711
AR/TEC INC
14 E STETSON DR P O BOX 727
SCOTTSDALE, ARIZONA
602 947-6304
JEWETT COMPANY
13111 VENTURA BLVD
N. HOLLYWOOD, CALIF.
213 789-8103

HI-CO ASSOCIATES
P O BOX 1317
WINTER PARK, FLA.
305 647-5030
INTELECT INC
30 N SCHOOL ST
HONOLULU HAWAII
560-910
AR/TEC INC
2800 CARDENAS DR, NE
ALBUQUERQUE, N.M.
505 268-3324
REGULUS INDUSTRIAL SALES CORP
7 HIGH STREET
HUNTINGTON, L I, N.Y.
516 271-7966
HOWELL SALES INC
235 S E 14TH STREET
GRAND PRAIRIE, TEXAS
214 262-5153
REPS. IN OTHER COUNTRIES
HEINZ CUNZ
NIEDENAU 62
FRANKFURT, AU MAIN,
W. GERMANY
722839
EMISCO LTO
850 BELFAST RD
OTTAWA 8, ONTARIO
613 236-0811
ELECTRONIC PRODUCTS
AUSTRALIA LTD
P O BOX 85 MT WAVERLY,
MELBOURNE VICTORIA AUSTRALIA
232-7120

ROBINS INDUSTRIES CORPORATION
SALES MANAGER
DANIEL SCHWARTZ
BRAND NAMES
FERRO DYNAMICS
FERRO TAPE
GIBSON GIRL-R
GENARCO
ROBINS-R
ROBINS 4/M
BRAND 5
SONORAMIC
COMPANY ADDRESS
15-58 127TH STREET
FLUSHING, NEW YORK 11356
212 445-7200
COMPANY REPRESENTATIVES
FRED WAMBLE SALES CO
3745 MARIE COOK DRIVE
P O BOX 3295
MONTGOMERY 9, ALABAMA
ALASKA INDUSTRIAL ELECT CORP
1101 15TH AVENUE
ANCHORAGE, ALASKA
BERNARD L CANN COMPANY
420 MARKET STREET
SAN FRANCISCO 11, CALIF.
MIKE STOBIN COMPANY
14633 ARMINA STREET
VAN NUYS, CALIF.
ELECTRO-TEK SALES INC
P O BOX 395
WESTMINSTER, COLORADO
PIETY FACTORS INC
160 MOKAUEA STREET
HONOLULU, HAWAII
RAY R HUTMACHER ASSOCIATION
6668 NORTHWEST HIGHWAY
CHICAGO 31, ILLINOIS
EDWIN A SCHULZ CO
721 SHERWOOD DRIVE
INDIANAPOLIS 40, INDIANA
CHARLES LIENAU & COMPANY
11411 AMHERST
WHEATON, MARYLAND
COAKLEY BOYD & ABBETT
1424 HIGHLAND AVENUE
P O BOX 248
NEEDHAM, MASS. 02192
J MALCOLM FLORA INC
165 W LIBERTY
PLYMOUTH, MICHIGAN
RAY RIPLEY & ASSOCIATES
7222 JAMES AVENUE SOUTH
MINNEAPOLIS 23, MINN.
CARMINE A VIGNOLA ASSOC
21 SCHELBRIDGE ROAD
P O BOX 569
JEFFERSON CITY, MO.
ELREP CORP
271 COLUMBUS AVENUE
TUCKAHOE, N.Y.
LSM ASSOCIATES
109 EASTON AVENUE
BUFFALO, N.Y. 14215
TELESCO INTERNATIONAL
171 MAOISON AVENUE
NEW YORK, N.Y.
ROGER M MINTHORNE CO
6565 S W MACAOAM AVENUE
PORTLAND 19, OREGON
JAMES H PODOLNY CO
5912 PENN AVENUE
PITTSBURGH 6, PA.
MAYNARD SALES CO
158 EXPRESS STREET
DALLAS 7, TEXAS

ROHDE & SCHWARZ SALES CO.,
USA, INC.
SALES MANAGER
RUDOLF FELDT
BRAND NAMES
OTAGRAPH
STEREOECCOOR
NYQUIST
COMPANY ADDRESS
BOX 148, 111 LEXINGTON AVE.
PASSAIC, N.J. 07055
COMPANY REPRESENTATIVES

W A BROWN AND ASSOC INC
1314 BUFORD STREET NW
HUNTSVILLE, ALABAMA 35801
205 536-8393
E G HOLMES & ASSOC INC
4862 GOVERNORS DRIVE WEST
HUNTSVILLE, ALABAMA 35803
205 837-6900
HOFFER ENTERPRISES
129 FIFTH AVENUE
ANCHORAGE, ALASKA 99501
HYDE ELECTRONICS CO
4710 N 16TH ST SUITE 109
PHOENIX, ARIZONA 85016
602 264-5609
V T RUPP CO
1182 LOS ALTOS AVE
LOS ALTOS, CALIF. 94022
415 948-1483
V T RUPP COMPANY
307 PARKMAN AVENUE
LOS ANGELES, CALIF. 90026
213 387-8224
V T RUPP COMPANY
3445 FIFTH AVENUE
SAN DIEGO, CALIF. 92103
714 298-8935
HYDE ELECTRONICS CO INC
888 SOUTH LIPAN STREET
DENVER, COLORADO 80223
303 936-3455
W A BROWN AND ASSOC INC
222 WEBER AVENUE
ORLANDO, FLORIDA 32803
305 425-5505
E G HOLMES AND ASSOC INC
316 1/2 SOUTH BUMBY STREET
ORLANDO, FLORIDA 32803
305 241-2128
W A BROWN AND ASSOC INC
1590 COOLEGGE ROAD
TUCKER, GEORGIA 30083
404 929-1674
E G HOLMES & ASSOC INC
3667 CLAIRMONT ROAD
CHAMBLEE, GEORGIA 30005
404 451-6161
LOREN F GREEN & ASSOC
5218 W DIVERSEY AVE
CHICAGO, ILLINOIS 60639
312 286-6824
INSTRUMENTS DYNAMICS INC
WAKEFIELD INDUSTRIAL PARK
WAKEFIELD, MASS. 01880
617 245-5100
TWIN REGION ELECT SALES INC
2547 MONROE
DEARBORN, MICHIGAN 48124
313 274-4661
LOREN F GREEN & ASSOC
3037 CENTRAL AVE N E
MINNEAPOLIS, MINN. 55418
612 781-1611
LOUIS A GARTEN & ASSOC
375 PASSAIC AVENUE
CALDWELL, N.J. 07007
201 226-7800
HYDE ELECTRONICS CO
5206 CONSTITUTION AVE NE
ALBUQUERQUE, N.M. 87110
505 265-8895
LOUIS A GARTEN & ASSOC
NEW YORK, N.Y.
212 269-4339
RJC ASSOCIATES
219 OAKRIDGE TERRACE
LIVERPOOL, N.Y. 13088
315 457-3220
W A BROWN AND ASSOC INC
440 WEST END BLVD
WINSTON-SALEM, N.C. 27101
919 725-5384
E G HOLMES & ASSOC INC
430 W GASTON STREET
GREENSBORO, N.C. 27401
919 272-0855
TWIN REGION ELECT SALES
20545 CENTER RIOGE ROAD
CLEVELAND, OHIO 44116
216 331-7650
TWIN REGION ELECTRONIC SALES
81 EAST STATE STREET
COLUMBUS, OHIO 43215
614 224-5533
LOUIS A GARTEN & ASSOC
947 OLD YORK ROAD
ARLINGTON, PA. 19001
215 927-1200
TWIN REGION ELECTRONIC SALES
201 PENN CENTER BLVD
PITTSBURGH, PENNA. 15235
412 824-1120
VIDAL ELECTRONICS CO
3403 HIGH BLUFF DRIVE
DALLAS, TEXAS 35234
214 247-4252
HYDE ELECTRONICS CO
2422 CAMINO WAY
SALT LAKE CITY, UTAH 84121
801 278-4465
W A BROWN & ASSOC INC
325 FIRST STREET
ALEXANDRIA, VIRGINIA 22305
703 836-1800

ROHN MANUFACTURING CO
SALES MANAGER
R. A. KLEINE
COMPANY ADDRESS
P O BOX 2000
PEORIA, ILL 61601
309 637-8416
TWX 309 697 1488
COMPANY REPRESENTATIVES
LOGAN SALES CO
P O BOX 1219
REWOOD CITY, CALIF

415 369 6726
 CHICK RYEL & CO
 P O BOX 762
 WOODLAND HILLS, CALIF
 213 883 8118
 R 6 D SALES CO
 420 S FEDERAL BLVD
 DENVER, CO
 303 934 5445
 MART HALLER INC - EXPORT
 P O BOX 1208
 MIAMI, FLA
 305 374 5225
 INTELECT, INC
 30 N SCHOOL ST
 HONOLULU, HAWAII
 566 366
 A M REPSUMER
 MIDWESTERN DIV SALES MGR
 P O BOX 2000
 PEORIA, ILL
 309 637 8416
 DAVID S FEHR
 EASTERN DIV SALES MGR
 509 WEBSTER ST
 MARSHFIELD, MASS
 617 834 9521
 STAN C OLSEN
 4201 WOODDALE AVE
 MINNEAPOLIS, MINN
 612 926 4158
 R W FARRIS CO INC
 1715 BALTIMORE AVE
 KANSAS CITY, MO
 816 421 1751
 DIPRO INC
 P O BOX 1427
 MARYLAND HEIGHTS, MO
 314 432 3444
 H E BLAKSLEY
 WESTERN DIV SALES MGR
 310 QUINCY ST
 RENO, NEVADA
 702 322 9300
 ANDREW A FOLEY ASSOC
 P O BOX 155
 MOORESTOWN, NEW JERSEY
 609 663-4545
 STEVE FISHER
 ELECTRONICS SALES CORP
 121 CEDAR LANE
 TEANECK, N J
 701 836 6661
 LEONARD D ALLEN INC
 P O BOX 205
 N SYRACUSE, N Y
 315 458 7470
 NEAL BEAR CORP
 3435 STREETSBOBO RD
 W RICHFIELD, OHIO
 216 659 2331
 NEBCO ASSOCIATES
 1974 GREGORY AVE
 MONROEVILLE, PA
 412 874 2111
 DIXIE ELECTRONIC ASSOC INC
 P O BOX 230
 MADISON, TENN
 615 895 5666
 MARION ATHANS
 P O BOX 134
 RICHARDSON, TEXAS
 214 231 3481
 JAS J BACKER CO
 221 W GALER ST
 SEATTLE, WASH
 206 283 6470
 REPS, IN OTHER COUNTRIES
 A L WHITEHEAD LTO
 P O BOX 25
 W VANCOUVER, B C
 604 922 1169
 R C KAHNERT SALES LTD
 359 ENFORD RD
 RICHMOND HILL, ONTARIO
 416 884 4574

ROME CABLE DIVISION
ALUMINUM CORP OF AMERICA

SALES MANAGER
 GLENN A BROADOCK
 BRAND NAMES
 ROME UNIFORM
 COMPANY ADDRESS
 421 RIDGE ST.
 ROME, NEW YORK
 COMPANY REPRESENTATIVES
 GORDON F BLACK
 715 OARIEN WAY
 SAN FRANCISCO, CALIF.
 F ROY CHRISTIAN
 715 SOUTH GILBERT ST
 ANAHEIM, CALIF.
 RICHARD E GATES
 2315 SUNNYSIOE RIDGE RD
 ROLLING HILLS, CALIF.
 RICHARD H CORZINE
 8803 HUMMINGBIRD AVE
 FOUNTAIN VALLEY, CALIF 92708
 FRANK K DUERT
 1961 MAR VISTA AVE
 ALTADENA, CALIF.
 E G GILMORE JR
 2629 WEST LINCOLN AVE
 MONTEBELLO, CALIF.
 ROBERT D GOLLY
 301 SCYAMORE ST
 SAN CARLOS, CALIF.
 STEWART JOHNSTON
 157 ELKINS PLACE
 ARCADIA, CALIF.
 H LEE RAWLINGS
 37 GRESHAM LANE
 ATHERTON, CALIF.
 GEORGE H REMELMAN
 631 PICO AVE

SAN MATEO, CALIF. 94400
 MICHAEL E SEMO
 1655 KAMSOCK DRIVE
 SUNNYVALE, CALIF. 94087
 ORIS O STEDMAN
 2304 WESTBORO AVE
 ALHAMBRA, CALIFORNIA
 JOHN W HAYES
 10 ODVER ROAD
 WESTPORT, CONNECTICUT
 DONALD A SEELERS
 7056 PONCE DELEON AVE
 JACKSONVILLE, FLORIDA
 THOMAS M MARTIN
 2860 PINE GROVE TERR NE APT3
 ATLANTA, GA. 30319
 WALTER J MCCANN
 3115 ASCOT COURT
 CHAMBLEE, GA.
 F DOYLE RUCKER
 3412 SPREADING OAK ORIVE SW
 ATLANTA, GA. 30311
 EUGENE C WEST
 1488 RUNNYMEADE N F
 ATLANTA, GA. 30319
 RICHARD T EDWARDS JR
 P O BOX 421
 27 W 186 CARREL ST
 WINFIELD, ILL. 60190
 ATO C SHANNON
 1313 NO 43RD ST
 EAST ST. LOUIS, ILL. 62204
 THOMAS C SPRIGGS
 1980 BERKELEY RD
 HIGHLAND PARK, ILLINOIS
 ROBERT K VAN SLYKE
 487 AZTEC DRIVE CAROL STREAM
 WHEATON, ILLINOIS 60187
 RICHARD BLAKE SHANNON
 1716 MINTURN LANE
 INDIANAPOLIS, INDIANA
 MISS NORMA BRACKMAN
 23 THAYER RD
 BELMONT, MASS. 02178
 R T GILDERSLEEVE
 18 ELLIOTT CIRCLE
 NO. EASTON, MASS. 02356
 T S GILDERSLEEVE
 WALPOLE STREET
 ODVER, MASS. 02030
 JOHN F MELAVIN
 331 BOYLSTON ST
 BROCKTON, MASS. 02400
 ALFRED J DAWSON
 3240 HARTSLOCK WOODS DRIVE
 BIRMINGHAM, MICH 48010
 313 626-1801
 ROBERT L JAFFRE
 7100 BROOKRIDGE DRIVE
 BIRMINGHAM, MICH. 48010
 PETER J LOPUSHINSKY
 RIVER GLEN APTS APTB-22
 32718 GRAND RIVER
 FARMINGTON, MICH. 48024
 J W CAMPBELL JR.
 1635 MONTICELLO DRIVE
 ST LOUIS, MO. 63138
 JERIAL L YOUNG
 2001 RAFT DR
 ST LOUIS, MISSOURI
 PAUL R OCONNOP
 401 HAMILTON ROAD
 RIDGEWOOD, NEW JERSEY
 EVERETT B JONES
 215 PETERSON DRIVE
 CAMILLUS, NEW YORK
 STEPHEN J LADDICK
 1943 JACKSON ROAD
 PENFIELD, NEW YORK
 JOHN A MAY
 6265 STAFFORD DRIVE
 NORTH OLMDST, OHIO 44070
 RAYMOND L SMARKEY
 10631 CINDERELLA OR
 CINCINNATI, OHID
 ROBERT R DAVIS
 3045 SOUTHWEST FAIRVIEW BLVD
 PORTLAND, ORE. 97201
 RICHARD A BIRD
 49 WOODBROOK WAY
 CHESTER, PA. 19014
 MISS MARGARET L JENNINGS
 1232 WISCONSIN AVE
 PITTSBURGH, PA. 15216
 G E ROLSTON JR
 12 HARVARO ORIVE
 MEDIA, PA. 19063
 ROBERT H SAWYER
 223 ROSEBRIAR AVE
 GLENSHAM, PA. 15116
 WILLIAM O BARWICK
 4326 WAYNESBORO
 HOUSTON, TEXAS
 G W PARKER
 14026 TANGLEWOOD COURT
 DALLAS, TEXAS
 E H LINHAROT
 10703 VALLEY FORGE ORIVE
 HOUSTON, TEXAS
 JOE WILKINSON
 7834 VILLA CLIFF
 OALLAS, TEX 75228
 OA 8-7913
 WILLIAM S WILLIAMS
 3000 CAMBRIDGE ST
 ARLINGTON, TEXAS 76010
 DAVID C MCMAHON
 8213 GALWAY LANE
 RICHMOND, VA. 23228
 THOMAS E MCCARTHY
 5233 127TH S E AVE
 BELLEVUE, WASH. 98004
 RUDY J MORAVEC
 4878 SO 78TH ST
 GREENFIELD, WIS. 53220

ROTRON MANUFACTURING

COMPANY, INC.
 SALES VP
 PAUL M. BEARD
 BRAND NAMES
 CARAVEL
 CENTRIMAX
 FEATHER
 MUFFIN
 SAUKER
 SENTINEL
 SKIPPER
 WHISPER
 COMPANY ADDRESS
 HASBROUCK LANE
 WOODSTOCK, NEW YORK 12498
 COMPANY REPRESENTATIVES
 FRYCO
 SCOTTSDALE, ARIZONA
 602 949-0120
 DEWCO SALES
 PALO ALTO, CALIF.
 ROTRON/PACIFIC
 GLENDALE, CALIF.
 213 849-3712
 GOSSARD AND ASSOCIATES
 DENVER, COLORADO
 303 985-0602
 G F BOHMAN ASSOCIATES
 ORLANDO, FLORIDA
 305 855-0274
 GASSNER AND CLARK
 CHICAGO, ILL.
 312 764-6121
 THOMAS AND MOORCIN ASSOC
 SHAWNEE MISSION, KANSAS
 913 432-2131
 CIRCUIT SALES COMPANY
 WAKEFIELD, MASS.
 617 245-5320
 CARRIER AND GABLE INC
 DETROIT, MICH.
 313 961-1786
 E C ELECTRONIC SALES
 MINNEAPOLIS, MINN.
 612 888-4626
 F F SYLVESTER ASSOCIATES
 SPRINGFIELD, N.J.
 201 376-3324
 MARTIN P ANDREWS INC
 FAYETTEVILLE, N.Y.
 315 637-3144
 F J CAMPISANO
 CINCINNATI, OHIO
 513 662-1616
 COMPONENTS ENGINEERING CO
 CLEVELAND, OHIO
 216 842-2737
 AMMON AND CHAMPION
 TULSA, OKLA.
 918 627-7670
 ROTRON ENGINEERING SALES OFF
 BALA-CYNYWD, PA.
 215 664-4337
 AMMON AND CHAMPION
 DALLAS, TEXAS
 214 357-8441
 AMMON AND CHAMPION
 HOUSTON, TEXAS
 713 729-1233
 RAY JOHNSTON COMPANY
 SEATTLE, WASHINGTON
 206 524-5170

ROUND HILL ASSOCIATES

SALES MANAGER
 R. E. MORRIS
 COMPANY ADDRESS
 434 SIXTH AVE.
 NEW YORK, NEW YORK 10011

RUSSCO ELECTRONICS MFG. INC.

SALES MANAGER
 RUSSELL C. FRIENO
 COMPANY ADDRESS
 6879 N. SUNNYSIDE
 CLOVIS, CALIF. 93612
 COMPANY REPRESENTATIVES
 OUNLAP ELECTRONICS
 1750 EAST MCKINLEY
 FRESNO, CALIF.
 485-3060
 HIGHLAND ASSOCIATES
 600 MARBLE STREET
 BROOMFIELD, COLORADO
 ELECTRONIC EQUIP INC
 526 PLASTER AVE NE
 ATLANTA, GEORGIA 30324
 876-8373
 BISCAVNE AUDIO CO.
 P O BOX 543
 OETROIT, MICH. 48232
 THE LEW-BONN CO
 1211 LASALLE AVE
 MINNEAPOLIS, MINN. 55403
 BROADCAST RECORDING SERV
 BOX 104 R R 1
 LDVELAND, OHIO
 RADIO SUPPLY INC
 P O BOX 1972
 724 NO HUOSON
 OKLAHOMA, OKLA.
 BROADCAST EQUIP & SUPPLY
 BRISTOL, TENN. 37623
 MARTI ELECTRONICS
 105 POINDEXTER
 CLEBURNE, TEXAS
 GAR-TRONIC
 3135 WESTERN AVENUE
 SEATTLE, WASH. 98121

F. B. RYAN MFG. CO., INC.

RESIDENT
 JIM F. RYAN
 BRAND NAMES
 RYAN

COMPANY ADDRESS
 BOX 451
 CHARITON, IOWA 50049

HOWARD W SAMS & CO INC

SALES MANAGER
 TOM SURBER
 BRAND NAMES
 PHOTOFACT
 COUNTER-FACTS
 SAMS TECHNICAL INSTITUTE
 SAMS TECHNICAL BOOKS
 P F REPORTER MAG
 BROADCAST ENGINEERING MAG
 RADIO Y TELEVISION MAG
 EDITORS & ENGINEERS
 AUDELS
 COMPANY ADDRESS
 4300 WEST 62ND STREET
 INDIANAPOLIS, INDIANA 46206
 317 291 3100

SARKES-TARZIAN INC

MARKETING MGR
 BROADCAST EQUIPMENT DIV
 RUSS 10E
 COMPANY ADDRESS
 EAST HILLSIDE OR.
 BLOOMINGTON, INDIANA 47401
 COMPANY REPRESENTATIVES
 MURPHY & COTA
 112 GALLATIN STREET S. W.
 HUNTSVILLE, ALABAMA
 205 536 9121
 W BERT KNIGHT CO
 P O BOX 11394
 PHOENIX, ARIZONA
 602 264 3578
 OLIVER BJERKE
 3237 BENTON
 SANTA CLARA, CALIF
 408 248 8975
 MOULTHROP & HUNTER
 165 11TH STREET
 SAN FRANCISCO, CALIF 94103
 415 UN 3 7880
 W BERT KNIGHT CO
 112 GLASGOW AVE
 INGLEWOOD, CALIF 90301
 213 678 4711
 MC LOUD & RAYMOND CO
 PO BOX 22044
 DENVER, COLORADO 80222
 303 SK 6 1589
 GERBER SALES CO INC
 31 BROADWAY ST P O BOX 2917
 NEW HAVEN, CONN
 203 SP M 6279
 MURPHY & COTA
 712 WEST VASSAR AVENUE
 ORLANDO, FLORIDA
 305 GA 4 2167
 NUBAR DONOYAN
 3620 RIDGEWOOD ROAD, NW
 ATLANTA, GEORGIA
 404 233 3311
 RICHARD J. DOUGHERTY
 931 WILLOW LANE
 DUNDEE, ILLINOIS
 312 428 2877
 JOHN G TWIST CO
 5222 W DIVERSEY
 CHICAGO, ILLINOIS 60639
 312 777 2250
 MORRELL & BEAVERS
 2644 NORTH SEVENTH
 TERRE HAUTE, INDIANA
 NORTH 3845
 LESLIE DE VOE CO
 4010 WASHINGTON BLVD
 INDIANAPOLIS, INDIANA 46205
 317 AT 3 1395
 THUMERBIRD SALES
 3802 W 95TH STREET
 LEANWOOD, KANSAS 66206
 913 NI 2 7220
 THUMERBIRD SALES
 6405 E KELLOGG
 WICHITA, KANSAS 67207
 316 684 3941
 J H ELECTRONIC SALES
 P O BOX 6844
 TOWSON, MARYLAND 21204
 301 VA 5 4441
 JOE RYAN
 201 CHESTNUT
 EAST LONGMEADOW, MASS
 413 525 6553
 GERBER SALES CO INC
 176 2ND AVENUE
 WALTHAM, MASS 02154
 617 891 8040
 GERBER SALES CO INC
 P O BOX 447
 EAST LONG MEADOW, MASS01461
 413 525 3059
 GRANT SHAFFER CO
 14241 FENKELL AVENUE
 DETROIT, MICHIGAN 48227
 313 BR 3 5390
 SCDDT ELECTRONIC SALES
 5209 W 60TH STREET
 MINNEAPOLIS, MINNESOTA 55423
 612 929 2985
 THUNORBERO SALES
 PO BOX 6156
 ST LOUIS MISSOURI 63145
 314 TE 8 6888
 SIMBERKOFF SALES INC
 71 VALLEY STREET
 SOUTH ORANGE, NEW JERSEY
 201 763 7900
 J H ELECTRONIC SALES
 P O BOX 159

MOORESTOWN, NEW JERSEY
609 665 6142
SIMBEROFF SALES INC
1072 SWEET ROAD
EAST AURORA, NEW YORK
716 652 1997
MURPHY & COTA
1106 BURKE STREET
WINSTON-SALEM, N. C. 27101
919 PA 4 0750
CHAS H DOLFUSS JR & CO
2108 PAYNE AVE
ROOM 707
CLEVELAND, OHIO 44114
216 PR 1 1270
GENE S ROOT & CO
809 WAINWRIGHT DR
PITTSBURGH, PENN. 15228
412 LO 1 4125
GORDON PETERS
PO BOX 912
ARLINGTON, TEXAS
817 275 0170
JOHN GUENTHER CO
4533 N CENTRAL EXPRESSWAY
DALLAS, TEXAS 75205
714 LA 8 6286
JACK RODEN
4704 GROVES LANE
FAIRFAX, VIRGINIA
703 273 6171
M K WIDDEKIND CO
PO BOX 9029
815 W EWING STREET
SEATTLE, WASHINGTON 98119
206 AT 4 8020

SAXTON PRODUCTS INC
SALES MANAGER
MARK KLEINER
BRAND NAMES
TWIN FOAM
LIFELINE
COMPANY ADDRESS
215 NORTH ROUTE 303
CONGERS, NEW YORK 10920
COMPANY REPRESENTATIVES
SINCLAIR ELECTRONICS
1085 CLARENON CRESCENT
OAKLAND 10, CALIFORNIA
415 451 3428
I R STERN & CO
P O BOX 1218
MAGNOLIA PARK STATION
BURBANK, CALIF
213 VI 9 1195
ELECTRONIC MFG CONSULTANTS
226 E VERMIJO
COLORADO SPRINGS, COLO
303 633 4795
JOHN COLAVECCHIO
122 GRANT STREET
HARTFORD, CONN
203 522 0596
FRANK MELLON & SONS
3457 DOVER STREET
SARASOTA, FLORIDA
813 955 8692
DAVID ABO
C/O SPA MOTEL
5414 N LINCOLN AVE
CHICAGO, ILL
PENZNER ASSOC
P O BOX 4362
OVERLAND PARK, KAN
913 DU 1 0004
ROBERT MILSK
19375 JAMES COUZENS HWY
DETROIT, MICH
313 342 6660
PENZNER ASSOC
4400A MINNESOTA AVENUE
ST LOUIS, MO
PHIL MELLER
609 WEST 189TH STREET
NEW YORK CITY, NEW YORK
E B MILLER ASSOC
200 FIFTH AVENUE
NEW YORK CITY, NEW YORK
PAUL & JERRY ASSOC
1133 BROADWAY
NEW YORK CITY, NEW YORK
212 675 3565
IRV GUDIN
29-10 137TH STREET
FLUSHING, L I NEW YORK
212 IN 3 3622
MIKE OAVIOOFF
67-28 78TH STREET
MIDDLEVILLAGE, NEW YORK
LARRY FLEINSTEIN
1515 ROBBINS ST
PHILADELPHIA, PA
215 LU 9 4893
C S BUTT
P O BOX 18045
HOUSTON, TEXAS 77023
713 JA 6 3101
SAM GILLER SALES
2614A ELM STREET
DALLAS, TEXAS
214 RI 8 7573

SCALA RADIO CORPORATION
BRAND NAMES
PARAFLECTOR
PARASLOT
COMPANY ADDRESS
1970 REPUBLIC AVE.
SAN LEANDRO, CALIF. 94577

SCHAFER ELECTRONICS
COMPANY ADDRESS
9119 DE SOTO AVENUE
CHATSWORTH, CALIF. 91311

ALBERT SCHULTZ INCORPORATED
VICE PRESIDENT
STANLEY ATSIOTIS
COMPANY ADDRESS
116 WEST 14 STREET
NEW YORK, NEW YORK 10011

SCIENTIFIC-ATLANTA INC
VICE PRES. MARKETING
S. M. KING
SALES MANAGER
TOM D. SMITH
BRAND NAMES
QUADRATE CHANNELER
ULTRA CHANNELER
SUPER CHANNELER
OPTIMA
SCIENTIFIC-ATLANTA
COMPANY ADDRESS
P. O. BOX 13654
ATLANTA, GA. 30324
COMPANY REPRESENTATIVES
SCIENTIFIC ATLANTA INC
1000 E WALNUT ST
PASADENA, CALIF 91106
213 796 1616
KELLEY ENTERPRISES
336 EAST FOURTH ST
LOVELAND, COLORADO 80537
303 667 1376
COZZENS & CUDAHY INC
125 OLD ORCHARD ARCADE
SKOKIE, ILL 60079
312 675 6700
SCIENTIFIC ATLANTA INC
5801 ANNAPOLIS RD
HYATTSVILLE, MD 20784
301 779 1515
SCIENTIFIC ATLANTA INC
235 BEAR HILL RD
WALTHAM, MASS D2154
617 899 4597
SCIENTIFIC ATLANTA INC
ROUTE 27 & PARSONAGE RD
MENLO PARK, NEW JERSEY 08837
201 549 7515
DB ASSOCIATES INC
3307 ERIE BOULEVARD
E. DEWITT, NEW YORK 13214
315 446 0220
MICRO SALES CORP
3300 SOUTH DIXIE DRIVE
DAYTON, OHIO 45439
513 298 3033
SCIENTIFIC ATLANTA INC
SUITE 435, BRANIFF TOWER
DALLAS, TEXAS 75235
214 357 1855
CAREY-WOLF COMPANY
3327 WINTHROP AVENUE
FORT WORTH, TEXAS 76116
817 738 1702
SHOWALTER-JUOD INC
1806 S BUSH PL
SEATTLE, WASH 98144
206 324 7911
REPS IN OTHER COUNTRIES
RADIONICS LIMITED
8230 MAYRANO ST
MONTREAL, QUEBEC
514 739 5517

H. H. SCOTT, INCORPORATED
BRAND NAMES
H. H. SCOTT
SCOTT
SCOTTKIT
SCOTTSMAN
OYNAURAL
COMPANY ADDRESS
111 POWDER MILL ROAD
MAYNARD, MASS. 01754
COMPANY REPRESENTATIVES
SHEFLER KAHN CO
P O BOX 1587
2017 NORTH 7TH ST
PHOENIX, ARIZ
602 AL 8 7893
W K GEIST CO
1205 AIR WAY P O BOX 5004
GLENDALE, CALIF 91201
213 745-9501
TWX 213 240 2190
JOHN FALSTAD
W K GEIST CO
P O BOX 746
CUPERTINO, CALIF 95129
415 968 1608
TWX 408 287 6614
R MARK MARKMAN CO
4142 LANERSHIM BLVD
NO HOLLYWOOD, CALIF 91602
213 877 3368
W K GEIST CO
7267 BARK LANE
SAN JOSE, CALIF
408 253 5433
F W MOULTHROP & ASSOC
1530 E 12TH ST
OAKLAND, CAL 94606
415 261-7676
TWX 415 891 9230
R & D SALES COMPANY
1468 SO FEDERAL BLVD
OENVER, COLORADO 80219
303 934 5445
DICKFRSON ENGR SALES CO
P O BOX 876
905 HARBOR CITY BOULEVARD
EAU GALLIE, FLORIDA 32935
305 254 1591
DOW FITZGERALD
R A CHALMERS & CO
P O BOX 19218
6231 S CHURCH ST
TAMPA, FLORIDA

R A CHALMERS & CO
349 PEACHTREE HILLS AVE N E
ATLANTA, GA 30305
404 233 3208-9
M ANO M LTD
P O BOX 9027
1754 ALA MAHAMOE ST
HONOLULU, HAWAII 96820
893 967
MIDWEST ELECTRONIC SALES
5707 W DIVISION STREET
CHICAGO, ILLINOIS 60651
312 626-0030
TWX 312 265 1415
JKM INC
6611 N CLARK ST
CHICAGO, ILL 60626
312 465 2622
GARLAND RED GRAHAM
MIDWEST ELECTRONIC SALES
5462 EAST 40TH ST
INDIANAPOLIS, INDIANA
317 547 3259
COURIER SALES
2070 E 54TH STREET, NO 6
INDIANAPOLIS, IND 46220
317 251 2401
W M HAGUE CO
1776 MASSACHUSETTS AVE
LEXINGTON, MASS 02173
617 862 5700
TECHNICAL RESOURCES INC-XPRT
600 MAIN STREET
WALTHAM, MASS 02154
617 899 3741-2
GROSSMAN SALES CO INC
339 AUBURN ST
AUBURNDALE, MASS 02166
617 LA 7 7753
RUTCHART RATHSBURG & ASSOC
15637 E WARREN AVE
DETROIT, MICH 48224
313 882-1717
TWX 313 886 1879
CLARK R GIBB CO
2400 HENNEPIN AVENUE
MINNEAPOLIS, MINN 55405
612 377 1200
CLARK R GIBB CO
1311 W 25TH ST
MINNEAPOLIS, MINN 55405
612 377 1200
TWX 612 321 1460
PATRICK S KLISE
5056 NEWTON AVE SO
MINNEAPOLIS, MINN 55419
ROBERT SHAW SALES CO
7800 KENRIDGE LANE
ST. LOUIS, MISSOURI 63119
314 962 7429
COMPONENT MARKETERS INC
109 VALLEY ROAD
MONTCLAIR, NEW JERSEY 07042
201 PJ 6 6717
JERRY CUCOLO
SHEFLER-KAHN CO
P O BOX 8342
408 PENN AVE SE
ALBUQUERQUE, N M
505 265 7077
BAKER & GEROLD ASSOCIATES
482 ST. PAUL STREET
ROCHESTER, NEW YORK 14605
716 232 5602
BAKER & GEROLD ASSOCIATES
HERBERT DRIVE
LATHAM, NEW YORK
518 785 8546
CRANE & EGERT CORP
127 ROCKAWAY AVENUE
VALLEY STREAM L I N. Y. 11582
516 561 7791
TWX 516 593 2077
MIKE ROTH SALES CO
678 SO GREEN ROAD
CLEVELAND, OHIO 44121
216 EV 2 9090
CRANE & EGERT CORP OF PHILA
107 WEST RIDGE PIKE
CONSHOHOCKEN, PENN 19428
215 277 0559
ESTERSON ASSOCIATES
1016 BETHLEHEM PIKE
PHILADELPHIA, PENNA 19118
215 233 2900
J Y SCHOONMAKER CO INC
P O BOX 35266
5328 REDFIELD AVENUE
DALLAS, TEXAS 75235
214 631-8480
TWX 214 631 8962
MIKE E PINGENOT
J Y SCHOONMAKER CO INC
P O BOX 26036 BLOG C
6001 GULF FREEWAY STE B 146
HOUSTON, TEXAS 77023
713 926 9510
HAL J MILLER SOUTHERN MGR
J T SCHOONMAKER CO INC
107 WINNETKA ROAD
SAN ANTONIO, TEXAS 78229
512 342 0251
AVCO SALES CO
P O BOX 30153
DALLAS, TEX
214 EM 3 3925
THE JAY CO INC
2914 ANNANDALE ROAD
FALLS CHURCH, VIRGINIA 22042
703 534 7800
RAY JOHNSTON CO INC
1011 N E 69TH STREET
SEATTLE, WASH 98115
206 LA 4-5170
TWX 910 444 2258
JOHN MORKIN

MIDWEST ELECTRONIC SALES
1317 GARFIELD AVE
WAUKESHA, WISCONSIN
414 547 5129
REPS IN OTHER COUNTRIES
MEGATONIX LIMITED
1870 AVENUE ROAD
TORONTO 12, ONTARIO
416 783-3329
TWX 610 491 1713

SCULLY RECORDING INSTRUMENTS CORPORATION
VICE PRESIDENT
H. H. BROSIUS
BRAND NAMES
SCULLY
COMPANY ADDRESS
480 BUNNELL STREET
BRIDGEPORT, CONN 06607
COMPANY REPRESENTATIVES
WILLIAM TABER
2619 LINCOLN AVENUE
ALAMEDA, CALIFORNIA
HOWARD HOLZFR
14119 AETNA STREET
VAN NUYS, CALIF
HAL MICHAEL
1419 N LARREA AVENUE
HOLLYWOOD, CALIF
CHARLES C FAULKNER
1125 OKIE STREET N E
WASHINGTON, O C
MARTIN VOGT
2817 BAMLET ROAD
ROYAL OAK, MICHIGAN
JAMES STELLOH
3547 S PINE AVENUE
MILWAUKEE, WISCONSIN

SFLA ELECTRONICS COMPANY
VICE PRESIDENT
S. L. HART
BRAND NAMES
MINICHRON
COMPANY ADDRESS
545 W. END AVE.
NEW YORK, NEW YORK 10024

SETCHELL CARLSON INC
SALES MANAGER
A. A. HAMILTON
COMPANY ADDRESS
530-5TH AVENUE N. W.
NEW BRITGTON, MINN. 55112
COMPANY REPRESENTATIVES
BARSTOW & DORAN
1406 SOUTH GRAND AVENUE
LOS ANGELES, CALIF 90015
213 RI 9 7706
F W MOULTHROP & ASSOCIATES
1530 EAST 12TH STREET
OAKLAND, CALIF
415 261 7676
NOR-CON LTD
2241 STACEY DRIVE
OENVFR, COLORADO 80221
301 429 1575
MAINLINE PRODUCTS INC
3400 NEW YORK AVENUE N E
WASHINGTON, O C 20002
202 835 5330
EARL ASSOCIATES
P O BOX 2845
HONOLULU, HAWAII 96803
878 996 953
LOYD YAFGER
1617 OJAL COURT
SPRINGFIELD, ILLINOIS 62704
217 446 6203
ANDERSON SALES COMPANY
177 STATE STREET
BOSTON, MASS 02109
617 CA 7 2980
ROBERT MILSK COMPANY
19375 JAMES COUZENS HWY
DETROIT, MICHIGAN
313 342 6660
ERDE HAVILAND ASSOCIATES INC
333 HEMPSTAD AVE
MALVERNE, L I NEW YORK
516 590 6500
MARSEY SALES INC
206 PARK AVENUE
ROCHESTER, NEW YORK 14607
716 442 9700
OON DORSEY COMPANY
RT. #2
NASHPORT, OHIO 43830
613 763 3894
DON H BURCHAM CO INC
510 N W 19TH AVENUE
PORTLAND, OREGON 97208
503 226 4148
BEIL & WHITAKER INC
3623 JACKSONWALD AVE
READING, PA 19606
215 375 6837
DIXIE ELECTRONIC ASSOC INC
109 WEBSTER STREET
MADISON, TENN 37115
615 895 5666
MAYNARD SALES COMPANY
158 EXPRESS STREET
DALLAS, TEXAS 75207
214 RI 2 2384

SHURE BROTHERS INC
SALES MANAGER
R. W. CARR
BRAND NAMES
SHURE
COMPANY ADDRESS
222 HARTREY AVE.
EVANSTON, ILL. 60204
COMPANY REPRESENTATIVES

"New York's Great New Sound is WNEW-FM- 'Where The Girls Are'— backed up by our Scully 280's."

MAX WEINER
Chief Engineer
WNEW, New York

WNEW-FM is only one of a growing parade of broadcasters who specify SCULLY recording equipment because its superior performance is proven by the toughest test of all; the daily grind of schedules that must be met without a hitch. SCULLY offers the finest solid-state instrumentation available plus exclusive plug-in construction . . . for minimum down-time, fast, easy repair when necessary, no complicated wiring disconnects or desoldering. Relays, modular sub-assemblies, electronic chassis solid-state amplifiers are all plug in.

"Seven Scully units in our FM control rooms give our recording crew the precision, flexibility and operational ease they demand."



Alison Steele, one of the three glamorous gals who make the new sound on WNEW-FM 14 hours daily.



Mr. Weiner, left, demonstrates Scully 280's to Program Director John Dale.

SCULLY RECORDING INSTRUMENTS CORPORATION

480 BUNNELL STREET, BRIDGEPORT, CONN. 06607 • TEL. (203) 335-5146

Makers of the renowned Scully Lathe, since 1919 symbol of precision in the recording industry.



JACK BERMAN CO INC
1751 S LA CIENEGA
LOS ANGELES, CALIF
UP 0 4711
F W MOULTHROP & ASSOC
1530 E 12TH ST
OAKLAND, CALIFORNIA
AN 1 7676
MILLAR-HUTTO ASSOCIATES INC
1036 PEACHTREE STREET N E
ATLANTA, GA
876 0919
GENE PIETY FACTORS INC
160 MOKAUEA ST BOX 2903
HONOLULU, HAWAII
83 7185
RAY R HUTMACHER ASSOC INC
6668 NORTHWEST HWY
CHICAGO, ILLINOIS
NE 1 9248
OREN W SMITH COMPANY
5255 NORTH LAWLER
CHICAGO, ILLINOIS
786 4476
FORRISTAL-YOUNG SALES CO
5500 BUENA VISTA SUITE 101
MISSION, KANSAS
432 1420
STANLEY A HARRIS CO INC
60 OGDHAM AVENUE
NEOHAM, MASS
444 4780
J MALCOLM FLORA INC
165 WEST LIBERTY
PLYMOUTH, MICHIGAN
GL 3 4296
NORTHERN STATES SALES COMPANY
1109 WEST 78 1/2 STREET
MINNEAPOLIS, MINN
866 3468
FORRISTAL-YOUNG SALES CO
7110 OAKLAND AVENUE
ST. LOUIS, MISSOURI
MI 5 2360
SIMBERKOFF SALES COMPANY
71 VALLEY STREET
SOUTH ORANGE, NEW JERSEY
763 7900
F EDWIN SCHMITT CO INC
311 MEACHAM AVENUE
ELMONT, L I, N Y
437 8150
MCFADEN SALES COMPANY
150 EAST BROAD STREET
COLUMBUS, OHIO
221 8363
SAMUEL K MACDONALD INC
1531 SPRUCE STREET
PHILADELPHIA, PENN
KI 5 1205
CAMION SALES COMPANY
9002 CHANCELLOR ROW
DALLAS, TEXAS
ME 1 3390
STEVENSON COMPANY
2045 WALKER LANE
SALT LAKE CITY, UTAH
277 2515
REPS IN OTHER COUNTRIES
C M ROBINSON AGENCIES
1500 ERIN STREET
WINNIPEG, MANITOBA
774 1855
A C SIMMONS & SONS LTD
100 MERTON STREET
TORONTO, ONTARIO
485 9111

SIGMA INDUSTRIES INCORPORATED
SALES MANAGER
K. C. MONROE
COMPANY ADDRESS
1115 O'BRIEN DRIVE
MENLO PARK, CALIF. 94025
COMPANY REPRESENTATIVES
R A YOUNG & CO
P O BOX 3884
GLENDALE, CALIF
213 245 3721
MOUNTAIN STATES MACHINERY CO
1526 BLAKE ST
DENVER, COLO
303 244 7421
WM F HEMMINGER CO INC
BOX 6008
SARASOTA, FLA
813 388 1800
HAWAIIAN LING & SUPPLY CORP
726 KOHOU ST
HONOLULU, HAWAII
964 889
COURIER SALES INC
2050 F 44TH NO 10
INDIANAPOLIS, IND
317 251 2401
GITRE CO INC
12909 W EIGHT MILE RD
DETROIT, MICH
313 341 9270
R W FARRIS CO INC
1715 BALTIMORE AVE
KANSAS CITY, MISSOURI
816 HA 1 1751
DIPRO INC
P O BOX 1427
MARYLAND HEIGHTS, MO
314 432 3444
R A COLUCCI CO
P O BOX 447
MINEOLA, L I, N Y
516 PT 6 0397
RUMSEY ELECTRIC CO
3RD & HUNTING PARK AVE
PHILA, PA
215 GL 5 9900
R L WRIGHT & ASSOC

P O BOX 17447
DALLAS, TEXAS
714 285 8701
M K WIDDEKIND CO INC
815 W EWING ST
SEATTLE, WASH
206 AT 4 8020

SIGMA INSTRUMENTS INCORPORATED
SALES MANAGER
FRANK BURRIDGE
COMPANY ADDRESS
170 PEARL STREET
BRAintree, MASS. 02185
COMPANY REPRESENTATIVES
TECHNICAL MARKETING INC
904 BOB WALLACE AVE ROOM 117
HUNTSVILLE ALABAMA
202 534 2487
WILLIAMS ASSOCIATES
1110 EAST MCOOWELL ROAD
PHOENIX, ARIZONA
602 254 6085
PENWARDEN ASSOCIATES
14547 TITUS ST
VAN NUYS, CALIF
213 787 4920
MCCARTHY-KELLY & ASSOC INC
279 NORTH BAY SHORE BLVD
SAN MATEO, CALIF
415 DI 2 8351
WILLIAMS ASSOCIATES
4971 JACKSON STREET
DENVER, COLORADO
303 388 4391
TECHNICAL MARKETING INC
P O BOX 237
LARGO, FLORIDA
813 596 0503
TECHNICAL MARKETING INC
1511 E ROBINSON ST
ORLANDO, FLORIDA
305 424 8531
SIGMA INSTRUMENTS INC
3158 DES PLAINES AVENUE
DES PLAINES, ILLINOIS
312 296 5595
LESLIE M DEVOE COMPANY
4010 WASHINGTON BLVD
INDIANAPOLIS, INDIANA
317 283 1395
JR SALES ENGR INC
3550 COTTAGE GROVE AVE S E
CEDAR RAPIDS, IOWA
319 365 5259
BARCOCK-BOHAKER-STIODARO
880 BONIFANT STREET
SILVER SPRING, MARYLAND
301 588 4047
W R HUMMON & ASSOCIATES
P O BOX 501
FARMINGTON, MICHIGAN
313 474 0661
RHODE ELECTRONIC SALES
2510 EAST 7TH AVENUE
ST. PAUL, MINNESOTA
612 777 8197
JOHN DURBIN COMPANY
12809 MANCHESTER ROAD
ST. LOUIS, MISSOURI
314 966 3003
SIGMA INSTRUMENTS INC
50 NORTH FRANKLIN TURNPIKE
MARRON PLOG
HO-HO-KUS, NEW JERSEY
201 652 2900-6
WILLIAMS ASSOCIATES INC
3221 SILVER AVENUE S E
ALBUQUERQUE, NEW MEXICO
505 255 9632
H C JOHNSON AGENCIES INC
P O BOX 215
FAYETTEVILLE, NEW YORK
315 637 9383
H C JOHNSON AGENCIES INC
111 MOUNT HOPE AVENUE
ROCHESTER, NEW YORK
716 232 2688
H C JOHNSON AGENCIES INC
P O BOX 86
BRANDYWINE STATION
SCHENECTADY, NEW YORK
518 374 5901
H C JOHNSON AGENCIES INC
8 LOS ROBLES STREET
WILLIAMSVILLE, NEW YORK
716 637 7880-1
O G W INC
1402 EAST MOREHEAD STREET
CHARLOTTE, N CAROLINA
704 334 7090
O G W INC
9389 NOTTINGHAM ROAD
WINSTON-SALEM, N CAROLINA
919 723 4205
JACK C HOFFSTETTER COMPANY
3605 NO OXIE DRIVE
DAYTON, OHIO
513 278 6721
JACK C HOFFSTETTER COMPANY
742 KENBRIDGE DRIVE
CLEVELAND, OHIO
216 449 0944
SEATRONICS INC
6415 CANYON COURT
PORTLAND, OREGON
503 292 8887
BARCOCK-BOHAKER-STIODARO
130 W LANCASTER AVE
WAYNE, PENNSYLVANIA
215 688 8288
P J SCALON CO INC
724 C SOUTH SHERMAN STREET
RICHARDSON, TEXAS
214 231 4661
WILLIAMS ASSOCIATES INC

2461 SOUTH MAIN STREET
SALT LAKE CITY, UTAH
801 466 8709
SFATRONICS INC
5931 4TH AVENUE SOUTH
SEATTLE, WASHINGTON
REPS IN OTHER COUNTRIES
FLCTRO-TEC MARKETERS LTD
1624 WEST THIRO AVENUE
VANCOUVER, BRITISH COLUMBIA
604 731 6377-8-9
ELECTRO-TEC MARKETERS LTD
211-1767 MAIN ST NO
WINNIPEG, MANITOBA
338 2884
O T SHAW COMPANY
5150 OUNDOAS STREET WEST
ISLINGTON, ONTARIO
416 231 2706
O T SHAW COMPANY
1966 GRAHAM BLVD
MONTREAL, QUEBEC
514 735 1541

**THE SINGER COMPANY,
METRICS DIVISION**
SALES MANAGER
MORTON G. SCHERAGA
BRAND NAMES
MARKETING MANAGER
SENSITIVE RESEARCH
PANORAMIC
EMPIRE
GERTSCH
COMPANY ADDRESS
915 PEMBROKE STREET
BRIDGEPORT, CONN. 06608
COMPANY REPRESENTATIVES
CARL A STONE ASSOCIATES
3855 CAROLFF AVE
CULVER CITY, CALIF
213 870 7771
WILLIAMS ASSOCIATES
4971 JACKSON ST
DENVER, COLORADO
303 388 4391
BARO ASSOCIATES
SHAWMUT @ BEACH STS
LA GRANGE, ILL
312 354 0660
INSTRUMENT ASSOCIATES
30 PARK AVE
ARLINGTON, MASS
617 648 2922
BURLINGAME ASSOCIATES
510 S FULTON AVE
MOUNT VERNON, N. Y.
914 664 7530
JAMES L HIGHSMITH & CO
3733 MONROE ROAD
CHARLOTTE, N. C.
704 333 7743
ARNOLD BARNES CO
740 S SHERMAN ST
RICHARDSON, TEX
214 235 4541
RUSH ORAKE ASSOCIATES
6133 MAYNARD AVE S
SEATTLE, WASH
206 725 2700
REPS IN OTHER COUNTRIES
WHITTAKER ELECTRONICS LTD
42 HOWDEN AVE
OTTAWA, ONT
612 224 1221

**SINGER PRODUCTS COMPANY
INCORPORATED**
SALES MANAGER
ALVIN J. SCHWARTZ
BRAND NAMES
SINTRONIC
COMPANY ADDRESS
95 BROAD STREET
NEW YORK, NEW YORK 10004

SITCO ANTENNA COMPANY
SALES MANAGER
GUSTAVE BERLINER
BRAND NAMES
SITCO
COMPANY ADDRESS
10330 NE MARX
PORTLAND, OREGON 97220

**SOLA ELECTRIC
DIV SOLA BASIC INDUSTRIES**
MARKETING MANAGER
S. E. SPELTZ
BRAND NAMES
SOLA R
SOLATRON R
MERC-HITE R
COMPANY ADDRESS
1717 BUSSE ROAD
ELK GROVE VILLAGE, ILL. 6000
439 2800
COMPANY REPRESENTATIVES
OICK BELLEW SALES CO
EL OORAOO, ARKANSAS
863 8375
SOLA ELECTRIC
LOS ANGELES, CALIF
254 9223
ELECTRONIC COMPONENT SALES
LITTLETON, COLO
798 8481
MILLAR-HUTTO ASSOC
WINTER PARK, FLORIDA
847 7407
MILLAR-HUTTO ASSOC
ATLANTA, GA
876 0919
HALGIN SALES
CEDAR RAPIDS, IOWA
363 5119

HALGIN SALES
MISSION, KANSAS
722 2441
OICK BELLEW SALES CO
NEW ORLEANS, LA
282 9629
TESSCO
TIMONIUM, MO
252 5610
NAT KRONSTAOT ASSOC
SILVER SPRING, MO
585 6141
SOLA ELECTRIC
NEOHAM HEIGHTS, MASS
444 8280
R C MERCHANT & CO
DETROIT, MICH
535 6000
R C MERCHANT & CO
BENTON HARBOR, MICH
925 4211
MEL FOSTER CO INC
MINNEAPOLIS, MINN
374 2612
HALGIN SALES
CLAYTON, MISSOURI
721 4415
SOLA ELECTRIC
ENGLEWOOD CLIFFS, N. J.
567 3880
SOLA ELECTRIC
CAMDEN, N. J.
365 7744
ELECTRONIC COMPONENT SALES
ALBUQUERQUE, N M
344 8130
HARRIES & KERSHAW
EAST AURORA, N Y
652 1221
HARRIES & KERSHAW
WEBSTER, N Y
671 6365
HARRIES & KERSHAW
FAYETTEVILLE, N Y
446 3112
MILLAR-HUTTO ASSOC
CHARLOTTE, N. C.
366 2061
SOLA ELECTRIC
CLEVELAND, OHIO
521 8038
SOLA ELECTRIC
CINCINNATI, OHIO
271 6870
ROBERT E NESBITT CO
DALLAS, TEXAS
537 4601
ROBERT E NESBITT CO
HOUSTON, TEXAS
528 3811
ELECTRONIC COMPONENT SALES
SALT LAKE CITY, UTAH
262 3700
NORTHWESTERN AGENCIES, INC
SEATTLE, WASHINGTON
623 8882
WALTER M BRAUN
MILWAUKEE, WIS
332 1040

SOLITRON DEVICES INCORPORATED
SALES MANAGER
ROBERT RUBIN
COMPANY ADDRESS
256 OAK TREE ROAD
TAPPAN, NEW YORK 10983
COMPANY REPRESENTATIVES
R MALES PRIOMORE & ASSOC.
1225 EAST NORTHVIEW AVENUE
PHOENIX, ARIZONA
602 944 9631
WEB ELECTRONIC ASSOCIATES
P O BOX 45734
5716 W MANCHESTER
LOS ANGELES, CALIF.
213 617 8297
WESTERN REGIONAL SALES OFFICE
6311 YUCCA STREET
HOLLYWOOD, CALIF. 90028
213 464 0006
WESTERN DIST. SALES OFFICE
C/O WINCO INC
P O BOX 881
MT VIEW, CALIF 94042
415 961 8510 OR 961 3599
ELECTRONIC SALES
995 S CLEMONT #302
DENVER, COLORADO 80222
303 756 4148
CENTRAL REGIONAL SALES OFFICE
C/O G MCL COLE COMPANY
6514 W HIGGINS ROAD
CHICAGO, ILLINOIS 60656
312 774 3339
TECHNICAL REPRESENTATIVES CO
4000 MEADOWS DRIVE
INDIANAPOLIS, INDIANA 46205
317 546 4967
TECHNICAL REPRESENTATIVES CO
707 ANTHONY WAYNE BANK BLDG
FT. WAYNE, INDIANA 46802
219 742 1891
ELECTRONIC SALES
1310 HERTZ DRIVE S E
CEDAR RAPIDS, IOWA
319 364 4342
JERRY BRESSON ASSOCIATES
511 N CHARLES STREET
BALTIMORE, MO.
301 MU 5 0100
CIRCUIT SALES COMPANY
LAKESIDE OFFICE PARK OOR 1
591 NORTH AVENUE
WAKEFIELD, MASS.
617 245 5320
NEW ENGLAND REGIONAL SALES OF

52 PICKERING STREET
NEEDHAM, MASS.
617 444 1152
THE HARTWICK-VAN AUKER CO
BOX 122 N E STATION
19831 PURLING BROOK ROAD
LIVONIA, MICH. 48152
313 476 5757
RHODE ELECTRONIC SALES
2510 EAST 7TH AVENUE
ST. PAUL, MINN. 55109
617 777 8197
JOHN DURBIN COMPANY
12809 MANCHESTER RD
ST. LOUIS, MO. 63131
314 966 3003
EASTERN REGIONAL SALES OFFICE
37 ELM STREET
WESTFIELD, N.J.
201 232 4243
G V L ASSOCIATES
338 GREEN STREET
SYRACUSE, NEW YORK
315 478 7712
S-J SALES ASSOCIATES
148-05 ARCHER AVENUE
JAMAICA, N.Y. 11435
212 AX 1 3232
JAKE RUDISILL ASSOCIATES
2009 NO TRYON STREET
CHARLOTTE, N.C. 28206
704 377 6901
THE WHELAN CORPORATION
2975 FAR HILLS AVENUE
DAYTON, OHIO 45419
513 298 9997
THE WHELAN CORPORATION
8323 CEDAR ROAD
CHESTERLAND, OHIO 44026
216 442 8340
JERRY BRESSON ASSOCIATES
107 FORREST AVENUE
NARBERTH, PA. 19072
215 TE 9 6770
W PAT FRALIA COMPANY
6100 CAMP BOWIE BLVD
P O BOX 12625
FORT WORTH, TEXAS 76116
317 738 2394
EASTERN REGIONAL SALES OFFICE
1121 ARLINGTON BLVD
T-321
ARLINGTON, VIRGINIA
501 725 1349
LARRABEE & ASSOCIATES
2117 SECOND AVENUE
SEATTLE, WASHINGTON
206 682 2358
REPS IN OTHER COUNTRIES
CANTRONICS LTD
17 DELLBANK ROAD
OONWNSVIEW, ONTARIO
CANTRONICS LTD
4252 BRAILLE AVENUE
MONTREAL, QUEBEC
416 636 3311

SONY CORPORATION OF AMERICA

SALES MANAGER
H. L. JOHNSON
COMPANY ADDRESS
516 WEST FLORENCE AVE.
INGLEWOOD, CALIF. 90301
COMPANY REPRESENTATIVES
V T RUPP CO
1182 LOS ALTOS AVE
LOS ALTOS, CALIF
REEVES ELECTRONICS INC
7512 SANTA MONICA BLVD
LOS ANGELES, CALIF 90046
213 876 3300
GENERAL ELECTRONICS INC
4158 PIEDMONT AVENUE
OAKLAND, CALIFORNIA
415 655 2711
GORDON ENTERPRISES INC
5362 NORTH CAHUENA BLVD
NORTH HOLLYWOOD, CALIFORNIA
213 766 3725
LANDERS ELECTRONIC
735 ROUTE 5
SOUTH WINDSOR, CONN 06074
JAMES R EBERLY CO
1207 POTOMAC ST N W
WASHINGTON, D C 20007
202 338 2277
COMMUNITY UTILITY INC
960 ORANGE AVE
WINTER PARK, FLA
VIDEOTRONICS INC
P O BOX 4313
ATLANTA, GEORGIA 30302
404 525 8687
INDUSTRIAL TELEVISION SER
5224 W OIVERSEY
CHICAGO, ILLINOIS
402 466 2331
WEBSTER ENGINEERING
823 SO GREENWOOD AVE
PARK RIDGE, ILLINOIS
VIDEO LEASING
154 EAST ERIE ST
CHICAGO, ILL
312 377 3286
ELECTRONIC TECHNICAL SERVICES
3844 NO COLLEGE AVE
INDIANAPOLIS, INDIANA
IMPERIAL EQUIPMENT COMPANY
2381 N 24TH ST
LAFAYETTE, INDIANA
OAVIS ELECTRONICS
W THIRD & JEFFERSON
WATERLOO, IOWA 50701
319 234 6626
RADIO SUPPLY COMPANY INC
115 LAURA

WICHITA, KANSAS 67211
316 AM 7 5216
AMERICAN SOUND SERVICE INC
675 WEST THIRD ST
COVINGTON, KENTUCKY 40208
502 261 9024
ELECTRONIC DEVICES INC
411 CENTRAL AVENUE
LOUISVILLE, KENTUCKY 40208
502 637 7720
LOUISIANA ELECTRONICS
3121 CONVENTION ST
BATON ROUGE, LOUISIANA
504 348 4962
INTERNATIONAL SOUND CORP
3589 PARK HEIGHTS AVENUE
BALTIMORE, MARYLAND 21215
301 FO 7 6409
DEMAMBRO SOUND EQUIPMENT
1095 COMMONWEALTH AVE
BOSTON, MASSACHUSETTS
617 254 7870
AMERICAN MICROWAVE
COMMUNICATIONS INC
204 NATL BANK BLDG BOX 216
ALPENA, MICHIGAN
517 356 1510
THALNER ELECTRONIC LABS
7150 JACKSON ROAD
ANN ARBOR, MICHIGAN
NORTHWEST ELECTRONICS
336 HOOVER ST N E
MINNEAPOLIS, MINNESOTA
ARMET CORPORATION
625 E MCDOWELL ROAD
JACKSON, MISSISSIPPI
601 353 3479
CRAMER ENGINEERING
8325 WORNALL ROAD
KANSAS CITY, MISSOURI 64114
816 DE 3 7914
NOTIFIER ENGINEERING INC
3700 N 56TH ST
LINCOLN, NEBRASKA
402 466 2331
REF TELEVISION
1200 W CHESTNUT ST
UNION, NEW JERSEY
201 678 8810
VIDEO MON SALES & SERVICE
1401 VALENCIA SOUTHEAST
ALBUQUERQUE, NEW MEXICO
VIDEO PROJECTS
143-78 94TH AVE
JAMAICA, N Y
ALCOR INC
215 SOUTH TIOGA STREET
ITHACA, NEW YORK 14850
607 4242
PIONEER STANOARD
ELECTRONICS INC
5403 PROSPECT AVENUE
CLEVELAND, OHIO
216 432 0010
MAGNETIC SERVIC CORP
1628 WEST FIRST AVENUE
COLUMBUS, OHIO
THE SONAX COMPANY
P O BOX 11415
OKLAHOMA CITY, OKLAHOMA 73314
405 CE 5 3611
COLUMBIA ELECTRONICS COMPANY
8755 S W CANYON ROAD
PORTLAND, OREGON 97225
503 292 2625
ALLIED SOUND INC
206 12TH AVE S
NASHVILLE, TENN 37203
SOUTHWEST SOUND EQUIPMENT CO
1518 N ST. MARYS
SAN ANTONIO, TEXAS
CA 6 9271
STROMBERG-CARLSON CORP
2341 FARRINGTON
DALLAS, TEXAS 75207
214 ME 1 5470
VIDEO WEST INCORPORATED
P O BOX 1087
PROVO, UTAH
801 373 5239
AERO MARC CO
2304 RAINIER AVE S
SEATTLE, WASHINGTON

SORENSEN OPERATION

RATHTON CO.
MARKETING MANAGER
ROBERT SLATER
COMPANY ADDRESS
RICHARDS AVENUE
NORWALK, CONN. 06856

SOUNDCRAFT INDUSTRIES

SALES MANAGER
JOHN G. GILLIAM
COMPANY ADDRESS
P. O. BOX 1745
ANN ARBOR, MICH. 48106
313 663 6656

THE SOUND SCRIBER CORPORATION

VICE PRESIDENT - SALES
FREDRICK A. BIERTUEMPFEL
BRAND NAMES
SOUND SCRIBER
COMPANY ADDRESS
6 MIDDLETOWN AVE.
NORTH HAVEN, CONN. 06473
COMPANY REPRESENTATIVES
ROBERT WELLM
1819 W 6TH ST
LOS ANGELES, CALIF
NOEL CIMINI
7025 W NORTH AVE
CHICAGO, ILLINOIS
JAMES MURPHY
8121 GEORGIA AVE

SILVER SPRING, MD
PHILLIP W HEYSE
2611 HAMILTON AVE
TRENTON, N JERSEY
RICHARD BIRD
913 STEMMONS TOWERS SO
DALLAS, TEXAS
REPS IN OTHER COUNTRIES
BLAIR-BEHNSEN LTD
835 CAMBIE ST
VANCOUVER, B C
JOHN PIERCE HOLDINGS LTD
103 BLAKE ST
TORONTO, ONTARIO
N MARTINEAU & SON
1019 BLEURY ST
MONTREAL, QUEBEC

SOUTH SHORE RADIO-TELEPHONE INC

PRFIDENT
JESS PETERS
COMPANY ADDRESS
6405 OLCOTT AVE.
HAMMND, IND. 46320
219-TILDEN 4-9320

SOUTHWESTERN COMMUNICATION

CENTRAL
SALES MANAGER
JESSE L. RIPPUS
COMPANY ADDRESS
1512 INOIAN WELLS RD. BOX 64
ALAMOGORDO, NEW MEXICO 88310

SPARTA ELECTRONIC CORPORATION

VICE PRESIDENT, SALES
JACK J. LAWSON
BRAND NAMES
SPARTA-MATIC
SPARTA
COMPANY ADDRESS
5851 FLORIN-PERKINS RD.
SACRAMENTO, CALIF. 95828
916-383-5353
COMPANY REPRESENTATIVES
JESS SWICEGOOD
PO BOX 1828
DOTHAN, ALABAMA 36302
SY 2-2161
EUGENE D BRADLEY
1328 W FLOWER
PHOENIX, ARIZONA 85013
AM 6-2292
RICHARD R. BROOKS
3704 W 225TH STREET
TORRANCE, CALIF 90505
373-2309

HIGHLAND ASSOC

C/O HENRY BROUGHALL
600 MARBLE STREET
BROOMFIELD, COLO 80020
466-3851
GLENN E WEBSTER
WEBSTER ENGR CO
823 SO GREENWOOD AVE
PARK RIDGE, ILLINOIS 60068
823-8206
HARRISON RADIO INC.
C/O HERBERT ARMS
BOX 327
CORYDON, INDIANA 47112
RE 8-5752
JIM PIPER ASSOCIATES
C/O JIM FLANAGAN
TEN HAVEN STREET
DOVER, MASS 02030
934-2498
DAVID VELDMSA
AUOIO DISTR. INC.
2342 DIVISION AVENUE SOUTH
GRAND RAPIDS, MICH 49507
GL 2-5495
CAROLINA RADIO SUPPLY
C/O ROBERT WINDSOR
838 HUFFMAN STREET
GREENSBORO, N.C. 27405
BR 3-6358
A C C HILLAN
16679 S W MAPLE CIRCLE
LAKE OSWEGO, OREGON 97403
636-6257
CAROLINA RADIO SUPPLY
C/O RUSS SUTTON
221 W WASHINGTON STREET
GREENVILLE, S.C. 29602

SPEEDY-O ENTERPRISES

COMPANY ADDRESS
6252 SANTA MONICA BLVD.
HOLLYWOOD, CALIF. 90038
REPS. IN OTHER COUNTRIES
G. W. MACKENZIE LTD.
433 JARVIS
TORONTO, ONTARIO

SPENCER-KENNEDY LABORATORIES

SALES MANAGER
DON LEMIRE
BRAND NAMES
COLORBURST
COLOR TAP
COMPANY ADDRESS NO. 1
1360 SOLDIERS FIELD ROAD
BOSTON 35, MASS
COMPANY ADDRESS NO. 2
5800 N 19TH AVE.
PHOENIX, ARIZONA
COMPANY REPRESENTATIVES
BILL BRYANT
BOX 430
FALKVILLE, ALABAMA
205-355-2712
WILLIAM MCGUCKIN
5800 N. 19TH AVE #210
PHOENIX, ARIZ.

602-264-2775
HEINZ MATUSCHKA
BOX 4426
SAN RAFAEL, CALIF 94903
415-472-1913
BOB GAULT
2233 LINDA JEAN DRIVE
INDEPENDENCE, KAN.
316-331-3078
LLOYD TATE
P. O. BOX 2731
HARRISBURG, PENN
717-766-2220
BRUCE FRAZIER
BOX 5387
FT. WORTH, TEXAS
817-244-2123

STACO, INCORPORATED

TECHNICAL SALES MGR.
DOUGLAS JAMES
BRAND NAMES
ADJUST-A-VOLT
STACO
COMPANY ADDRESS
2240 E. THIRD STREET
DAYTON, OHIO 45403
COMPANY REPRESENTATIVES
MURPHY & COTA
904 BOB WALLACE AVE SW
HUNTSVILLE, ALABAMA
THE RON MERRITT CO
P O BOX 171
ANCHORAGE, ALASKA
HYDE ELECTRONICS
2727 N CENTRAL AVE
PHOENIX, ARIZONA
WEST INC
SUITE 512
1 UNION BANK SQUARE
ORANGE, CALIF
STRAUBER ASSOCIATES
483 WILLOW ROAD
MENLO PARK, CALIF
HYDE ELECTRONICS
888 S LIPAN ST
DENVER, COLORADO
COAKLEY, BOYD & ABRETT
6 GAYWOOD DRIVE
WATERBURY, CONN
MURPHY & COTA
712 W VASSAR AVE
ORLANDO, FLORIDA
MURPHY & COTA
2110 PEACHTREE RD
ATLANTA, GEORGIA
SAFFRO & ASSOC
3736 DEMPSTER ST
SKOKIE, ILLINOIS
R D WHITESELL & ASSOC
6620 E WASHINGTON ST
INDIANAPOLIS, INDIANA
R D WHITESELL & ASSOC
203 W WAYNE ST
FT WAYNE, INDIANA
ELECTRONIC SALES CO
1310 HERTZ DRIVE SE
CEDAR RAPIDS, IOWA
R O WHITESELL & ASSOC
LEX MANOR BLDG, RM 223
3620 LEXINGTON ROAD
LOUISVILLE, KENTUCKY
EASTERN COMPONENTS INC
1002 INGLESIDE AVE
BALTIMORE, MARYLAND
COAKLEY, BOYD & ABBETT
P O BOX 248
1424 HIGHLAND AVENUE
NEEDHAM, MASS
R O WHITESELL & ASSOC
16801 WYOMING AVE
DETROIT, MICHIGAN
R O WHITESELL & ASSOC
303 FIDELITY BLOG
BENTON, HARBOR
CLARK R GIBB CO
2400 MEMPHIS AVE
MINNEAPOLIS, MINN
L HARRY & ASSOC
7603 FORSYTH, RM 103
CLAYTON, MISSOURI
HYDE ELECTRONICS
5206 CONSTITUTION NE
ALBUQUERQUE, NEW MEXICO
LEVINSON SALES CO
5 SUNRISE PLAZA
VALLEY STREAM, LI. N Y
ROBERT F LAMB CO
3407 DELAWARE AVE
BUFFALO, NEW YORK
ROBERT F LAMB CO
PO BOX
SYRACUSE, NEW YORK
ROBERT F LAMB CO
PO BOX 661 UPTOWN STA
KINGSTON, NEW YORK
ROBURN AGENCIES
431-435 GREENWICH ST
NEW YORK, NEW YORK
MURPHY & COTA
P O BOX 6365
GREENSBORO, N C
MURPHY & COTA
1106 BURKE ST
WINSTON-SALEM, N C
R O WHITESELL & ASSOC
1172 W GAILBRAITH RD
DAYTON, OHIO
STACO INCORPORATED
2240 EAST THIRD ST
CINCINNATI, OHIO
R O WHITESELL & ASSOC
21139 LORAIN AVENUE
CLEVELAND, OHIO
R O WHITESELL & ASSOC
1350 W FIFTH AVE
COLUMBUS, OHIO
R O WHITESELL & ASSOC

4133 S DIXIE AVE
DAYTON, OHIO
THE RDM MERRITT CO
2035 SW 58TH AVE
PORTLAND, OREGON
EASTERN COMPONENTS INC
613 W CHELTHAM AVE
PHILADELPHIA, PENN
R O WHITESSELL & ASSOC
PENN CENTER BLDG
201 PENN CENTER BLVD
PITTSBURGH, PENN
SCIENTIFIC SALES CO
777 SD CENTRAL EXPRESSWAY
RICHARDSON, TEXAS
HYDE ELECTRONICS
85 E SEVENTH SD
SALT LAKE CITY, UTAH
THE RDM MERRITT CO
1320 PROSPECT ST
SEATTLE, WASHINGTON
REPS. IN OTHER COUNTRIES
BURLEC SALES LTD
45 NORTHLINE ROAD
TORONTO, ONTARIO
BURLEC SALES LTD.
1179 DECARIE BLVD.
MONTREAL, QUEBEC

STAINLESS INCORPORATED
PRESIDENT
HENRY J. GUZEWICZ
VP IN CHARGE OF ENGR.
RICHARD J. EBERLE
COMPANY ADDRESS
THIRD STREET
NORTH WALES, PA. 19454

STANCIL-HOFFMAN CORPORATION
SALES MANAGER
WILLIAM V. STANCIL
BRAND NAMES
MINITAPE-R
COMPANY ADDRESS
921 NORTH HIGHLAND AVE.
HOLLYWOOD, CALIF. 90038

STANDARD ELECTRONICS CORP
SALES MANAGER
BILL ZILLGER
COMPANY ADDRESS
P. O. BOX 677
FREEHOLD, N. J. 07728
COMPANY REPRESENTATIVES
JIMMY EVANS
BIRMINGHAM, ALA
785 7421
PENINSULA ASSOCIATES
PALO ALTO, CALIF
322 1803
BEECHER HAYFORD
JACKSONVILLE, FLA
356 3007
GLENN WEBSTER
PARK RIDGE, ILL
823 8206
BILL STRINGFELLOW
ALBUQUERQUE, NEW MEXICO
AX B 2575
VISUAL ELECTRONICS INTL
NEW YORK, NEW YORK
DE 6 5840
LYLE KEYS
SALT LAKE CITY, UTAH
EL 9 7691
JOHN MCCLAMROCK
SEATTLE, WASH
CH 4 9391
REPS IN OTHER COUNTRIES
NORTHERN ELECTRIC
TORONTO, ONTARIO
363 8651

STANDARD KOLLSMAN INDUSTRIES INCORPORATED
SALES MANAGER
A. H. FORBES
COMPANY ADDRESS
2085 N. HAWTHORNE AVE.
MELROSE PARK, ILL. 60160

STANDARD RECORD MFG CO
SALES MANAGER
CAROLINE RAIKES
COMPANY ADDRESS
70 ND SAN GABRIEL BLVD
PASADENA, CALIF 91107
213 681 0537

STEPHENS ELECTRONICS
OWNER
JOHN F. STEPHENS
COMPANY ADDRESS
2302 NDRTH ONTARIO ST.
BURBANK, CALIF. 91504

S. STERLING COMPANY
SALES MANAGER
SAM COMBS
COMPANY ADDRESS
21250 10 1/2 MILE ROAD
SOUTHFIELD, MICHIGAN
313-357-3700
COMPANY REPRESENTATIVES
S STERLING CO
7849 N LINDBERGH
HAZELWOOD, MISSOURI
314 TE 7 1221
S STERLING CO
5827 MAYFIELD ROAD
CLEVELAND, OHIO
216 HI 2 8080
S STERLING CO
3300 S DIXIE DRIVE
DAYTON, OHIO
513 AX 8 7573

S STERLING CO
4232 BROWNSVILLE ROAD
PITTSBURGH, PENN
412 343 2844

STRUTHERS-DUNN INCORPORATED
SALES MANAGER
W. L. CAPEWELL
BRAND NAMES
DUNCO
COMPANY ADDRESS
LAMBS ROAD
PITMAN, N. J. 08071
COMPANY REPRESENTATIVES
APPLEBEE-CHURCH INC
13 OFFICE PARK CIRCLE
BIRMINGHAM, ALABAMA 35223
205 879 4417
VINSON ASSOCIATES INC
44 E INDIAN SCHOOL RD STE 6
SCOTTSDALE, ARIZONA 85252
602 947-7371
TWX 602 949 0122
LEDBETTER ASSOCIATES
2124 ARTHUR AVENUE
BELMONT, CALIFORNIA
415 591 7774
LEDBETTER ASSOCIATES
P D BOX 528
16618 VENTURA BLVD
ENCINO, CALIFORNIA 91316
213 789-8115
TWX 213 783 3345
R P MCALISTER
WEST COAST REG MGR
STRUTHERS-DUNN INC
P D BOX 224
ENCINO, CALIFORNIA
213 786 3233
VINSON ASSOCIATES INC
203 TUCKER BUILDING
3600 S LINCOLN
ENGLEWOOD, COLORADO 80110
303 789-2203
TWX 303 789 1649
J J GALLEHER COMPANY
P O BOX 1376
617-A CLEVELAND STREET
CLEARWATER, FLORIDA
813 446 7706
E C WILSON
SOUTHERN REG MGR
STRUTHERS-DUNN INC
1152 CLEVELAND AVENUE
CLEARWATER, FLORIDA
813 442 2817
APPLEBEE CHURCH INC
1958 A MONROE DR N E
P O BOX 13485
ATLANTA, GEORGIA 30324
404 875-7244
TWX 404 527 0042
REP INC
1483 MONROE DRIVE N E
ATLANTA, GEORGIA 30324
404 876 1591
ROCKFORD CONTROLS CO
21W181 HILL AVENUE
GLEN ELLYN, ILLINOIS 60137
312 469-6016
TWX 910 651 3250
R L HELLMOUND
MIDWESTERN REG MGR
STRUTHERS-DUNN INC
1167 WILMETTE AVENUE RM 208
WILMETTE, ILLINOIS
312 469 6016
REID ASSOCIATES INC
526 MMB BUILDING
CEDAR RAPIDS, IOWA 52401
319 362 6302
AVIDONICS ENGRG SALES CO
230 IDA P O BOX 786
WICHITA, KANSAS 67201
316 264 6201
STEMLER ASSOCIATES & CO
25 W PENNSYLVANIA AVE
TOWSON, MARYLAND 21204
301 828-8853
TWX 301 828 7046
ELECTRICAL APPARATUS CO
1200 SOLDIERS FIELD ROAD
BOSTON, MASS 02134
617 782 7440
ROBERT MCBRIDE CO INC
20830 RUTLAND
SOUTHFIELD, MICH
313 356 5724
E MELLUS & ASSOC INC
3758 N DUNLAP ST
ST. PAUL, MINN 55112
612 488-7293
TWX 612 551 0053
CARL P LOHR COMPANY
1110 S BRENTWOOD BLVD
ST. LOUIS, MISSOURI 63117
314 725-9794
TWX 314 556 0069
E A MAIS CO
P O BOX 9721
KANSAS CITY, MO 64137
816 761-3124
TWX 910 760 1663
PETER FISH KUNKEL CO
9322 MANCHESTER ROAD
ST. LOUIS, MO 63119
314 968-0300
TWX 910 760 1663
GRIMM, SIEGEL ASSOC INC
246 CLIFTON AVENUE
CLIFTON, N. J. 07011
201 773 5010
VINSON ASSOCIATES INC
BOX 3295 STATION D
ALBUQUERQUE, NEW MEX 87110
505 298-7442

TWX 505 243 8401
ROME ELECTRONICS INC
110 SPRING STREET
ROME, NEW YORK 13440
315 337 5400
H C ZANG AGENCY
64 PRAIRIE AVENUE
BUFFALO, NEW YORK 14207
716 877 3677
JAKE RUDISILL ASSOC INC
2009 N TRYON STREET
CHARLOTTE, N. C. 28206
704 377 6901
BEEBLE EQUIPMENT CO
P D BOX 36061
6900 SILVERTON AVENUE
CINCINNATI, OHIO 45236
513 793 0140
J L FINNICM & ASSOC
4500 EUCLID AVE RM 213
CLEVELAND, OHIO 44103
216 431 7477
RUSSELL F CLARK CO
10517 LINDBERG AVENUE
PITTSBURGH, PENNA 15225
412 242-9500
TWX 412 642 3196
STRUTHERS-DUNN INC
1505 RACE STREET
PHILADELPHIA, PA 19102
215 564-4020
TWX 215 569 8575
RANSOM INC
SUITE 919 100 N MAIN BLDG
MEMPHIS, TENN 38103
901 527 3194
VISTA ENGINEERING ASSOC
CENTRAL EXCHANGE SUITE 5 E
777 CENTRAL EXPRESSWAY NORTH
RICHARDSON, TEXAS
214 235 4547
TWX 214 231 1400
VISTA ENGINEERING ASSOC
1614 S POST DAK
HOUSTON, TEXAS 77027
713 622 5680
EICHER-RICHARDS COMPANY
5 WEST HARRISON STREET
SEATTLE, WASH 98119
206 284 1811
REPS IN OTHER COUNTRIES
RENFREW ELECTRIC CO
349 CARLAW AVENUE
TORONTO, ONTARIO 111
705 461-3511
TWX 610 491 2287

MATTHEW STUART & CO., INC.
COMPANY ADDRESS
3650 DYRE AVENUE
BRONX, NEW YORK 10466

SUPERIOR CABLE CORPORATION
VP MARKETING
J. H. BOWMAN
SALES MANAGER
JOHN W. ENGLISH
BRAND NAMES
SUPER SPLICE
HICKORY BRAND
CELL-D-AIR
COMPANY ADDRESS
P. O. BOX 489
HICKORY, N. CAROLINA 28601
COMPANY REPRESENTATIVES
RON J WESTWOOD
161 W 25TH AVENUE RM 207
SAN MATEO, CALIF
415 349 3003
FRANK L BOEDECKER
P O BOX 391
ETNA, CALIFORNIA
916 467 3790
L KENNETH POWLEY
DISTRICT SALES MANAGER
2199 NORTH DECATUR RD OFC 4
DECATUR, GEORGIA
404 636 9575
T J LYONS
DISTRICT SALES MANAGER
650 ROOSEVELT RD RM 207
GLEN ELLYN, ILLINOIS
312 858 0180
MAURICE STROBEL
38 W GLENLAKE AVENUE
ROSELLE, ILLINOIS
312 529 4499
C E SCHNEGELSBERGER
BROADWAY ROAD
FRANKLIN, KENTUCKY
502 586 6389
R E WIDLBERG
DISTRICT SALES MANAGER
1806 SWIFT SUITE 104A
NORTH KANSAS CITY, MO
816 421 6806
N C COX
DISTRICT SALES MANAGER
P O BOX 489
HICKORY, N CAROLINA
704 328 2171
ROCKY MOUNT DIVISION
HIGHWAY 301A NORTH BDX 1021
ROCKY MOUNT, N C 27801
919 446 8155
HOMER P ROELLE
DISTRICT SALES MANAGER
WYANDOT BLDG PUBLIC SQUARE
GALLON, OHIO
419 468 4715
MARVIN CHENAULT
DISTRICT SALES MANAGER
130 CASA LINDA PLAZA STE 34
DALLAS, TEXAS
214 321 3242
BROWNWOOD DIVISION

MORRIS SHEPARD DR PD BDX 698
BROWNWOOD, TEXAS 76801
915 645-2624
TWX 910 897 5580
ELECTRONICS DIVISION
1001 PAMELA DR PD BDX 579
EULESS, TEXAS 76039
817 283 2893
ELECTRONIC DIST SALES CORP
600 BLANTON TOWER
DALLAS, TEXAS 75235
214 357 7306

SWAGER TOWER CORPORATION
PRESIDENT
WILLIAM E. SWAGER
GENERAL MANAGER
JOHN A. MCAULAY
BRAND NAMES
DURA TOWER
COMPANY ADDRESS
P. O. BOX 498
FREMONT, INDIANA 46737
219-495-2525

SWITCHCRAFT, INC.
INDUSTRIAL SALES MANAGER
C. J. SCHULTZ
DISTRIBUTOR SALES MANAGER
A. F. ANDERSON
BRAND NAMES
THICK-PANEL JAX
MICRO-JAX
LITTEL JAX
T-JAX
TINI-JAX
LAMP-JAX
TINI-EXTENSION JAX
MT-JAX
SHIELDED JAX
HI-O JAX
TINI-O JAX
R-JAX
LF-JAX
EXTENSION JAX
SF-JAX
CV-JAX
T-JAX
W-JAX
TINI-JAX
TWIN-PLUG
CW PLUG
LUG PLUG
TINI-PLUG
MICRO-PLUG
FLAT-PLUG
Q-G CONNECTORS
SLIM-LINE CONNECTORS
MINI-CON CONNECTORS
SWITCHCRAFT/PREH CONNECTORS
MINI-MIX
MIX-AMP
GLO-BUTTON
Y-ADAPTER
TINI-TEE ADAPTER
LITTEL SWITCH
BUTTON SWITCH
CORD SWITCH
TINI-SWITCH
T-SWITCH
FF SWITCH
NF SWITCH
TF SWITCH
LITTEL-LITE SWITCH
MULTI-SWITCH
NF-LITE SWITCH
LEV-R SWITCH
TELEVER SWITCH
LEVER-LOCK SWITCH
FEATHER LEVER SWITCH
HOOK SWITCH
RS SWITCH
PUSH-PUSH SWITCHES
LK SWITCH
LEVER-LITE SWITCH
CORDETE SWITCH
CRODMASTER SWITCH
L-T SWITCH
MULTI-LITE PUSHBUTTONS
SHOWCASE PUSHBUTTONS
BDX SWITCH
DOUBLE-WIPE
COMPANY ADDRESS
5555 ND. ELSTON AVENUE
CHICAGO, ILL. 60630
312 774 1515
TWX 312 265 1314
COMPANY REPRESENTATIVES
DAVID H. ROSS COMPANY
534 EL CAMINO REAL
SAN CARLOS, CALIF. 94070
415-591-4411
PAUL F. WILEY COMPANY
1632 SILVERLAKE BLVD
LOS ANGELES, CALIF. 90026
213-663-8028
GORDON MOSS ELECTRONICS INC.
1530 13TH AVE P O BOX J
GREELEY, COLO 80632
303-353-1452
ANDERSON SALES CO.
DISTRIBUTOR ONLY
133 MANSFIELD AVE
WATERBURY, CONN 06705
203 753 2487
CARTWRIGHT AND BEAN
395 TRITON ROAD
DRMOND BEACH, FLA 32074
305-677-3480
CARTWRIGHT AND BEAN
INDUSTRIAL ONLY
609 E COLONIAL DRIVE
ORLANDO, FLORIDA 32803
305 425 8284
CARTWRIGHT AND BEAN

SERIES 700 BY TAPECASTER

YEARS AHEAD IN DESIGN

All solid state using highest quality silicon semiconductors

Designed to exceed NAB specifications

Full remote control features, START — STOP and RECORD PRESET

Designed for automation with auxiliary cue tone option

Premium Nortronics metal faced heads, Large illuminated control buttons

Hysteresis synchronous motor, Solid stainless steel top deck plate

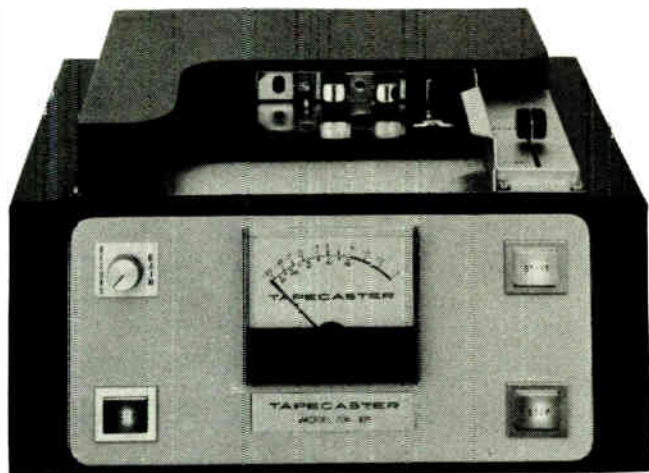

Model 700-RP \$450.00



Model 700-P \$300.00

TAPECASTER ELECTRONICS

Box 662, Rockville, Maryland 20851

DISTRIBUTOR ONLY
20100 N E 25TH COURT
NORTH MIAMI BEACH, FLA 33160
305 945 2962
CARTWRIGHT AND BEAN
3225 CAINS HILL PLACE N. W.
ATLANTA, GEORGIA 30305
404-237-2273
DOUGHERTY ENTERPRISES
110 WAIMANU ST
P. O. BOX 3497
HONOLULU, HAWAII 96814
578-987
SWITCHCRAFT, INC.
INDUSTRIAL ONLY
5555 NORTH ELSTON AVE
CHICAGO, ILLINOIS 60630
312 724 1515
TWX 312 265 1314
KLEM AND STEFFEN INC
DISTRIBUTOR ONLY
417 HARRISON ST
P. O. BOX 1116
OAK PARK, ILL 60204
312 848 6444
RINALDI SALES CO
SPECIAL INDUSTRIAL ACCOUNTS
5493 NORTHWEST HIGHWAY
CHICAGO, ILLINOIS 60630
312 763 4848
COMET CORPORATION - EXPORT
540 LAKE SHORE DRIVE
CHICAGO, ILLINOIS 60611
312-337-2292
THOMAS AND SUKUP INC
2060 EAST 54TH STREET
INDIANAPOLIS, INDIANA 46220
317-251-4574
THOMAS L. OSWELL INC
9724 LAMAR AVE
OVERLAND PARK, KANSAS 66207
913-449-6049
CARTWRIGHT AND BEAN
1810 BULLARD AVE
METAIRIE, LOUISIANA
TRINKLE SALES COMPANY
DISTRIBUTOR ONLY
456 QUARTERFIELD RD
GLEN HURNE, MD 21061
301 761 3439
KEW HANDALL COMPANY
821 SCARLETT OR
TOWSON, MARYLAND 21204
301-428-5310
ANDERSON SALES
177 STATE STREET
BOSTON, MASS 02109
617-727-2980
ANDERSON SALES CO
DISTRIBUTOR ONLY
34 COLIDGE AVE
WESTFIELD, MASS 01085

413 568 7004
R. C. MERCHANT & CO INC
18411 W. MCNICHOLS RD
OETRDIT, MICHIGAN 48219
313-935-6000
R. C. MERCHANT & CO INC
P. O. BOX 591
BENTON HARBOR, MICHIGAN 49623
616-925-4211
MEL FOSTER COMPANY INC
228 S. CEDAR LAKE ROAD
MINNEAPOLIS, MINN 55405
612-374-2612
KEN RANDALL COMPANY
250 HADDON AVENUE
COLLINGSWOOD, N. J. 08108
609-854-3323
TRINKLE SALES CO
MANOR BLDG-WEST
7675 MAPLE AVENUE
MERCHANTVILLE, N. J. 08019
609 663 0303
O. F. MASIN CO, INC.
140 BOSTON POST RD
LARCHMONT, NEW YORK 10538
914-834-7500
FRANK W. TAYLOR, INC
INDUSTRIAL ONLY
4455 E GENESEE ST
P. O. BOX 86
DEWITT, NEW YORK 13214
315 446 0422
CALLAHAN-FERGUSON CO
107 GREENHEDGE DRIVE
CAMILLUS, NEW YORK 13031
315-488-5518
CALLAHAN-FERGUSON CO
117 FAYETTE STREET
MANLIUS, NEW YORK 13104
CARTWRIGHT AND BEAN
625 HARVYN DRIVE
CHARLOTTE, N. C. 28205
704 333 6457
NEAL BEAR CORPORATION
3434 STREETSBOURD ROAD
WEST RICHFIELD, OHIO 44286
216-659-3331
NEAL BEAR CORPORATION
280 FAR HILLS AVENUE
DAYTON, OHIO 45419
514-299-3566
RON MERRITT COMPANY
SYLVAN BLDG RM 217
2034 S W 58TH AVE
PORTLAND, OREGON 97221
504 222 7337
NEBOG ASSOCIATES
1974 GREGORY AVENUE
MONROEVILLE, PENN 15146
412-824-2111
JOSE ARTURO FERNANDEZ
PONCE DE LEON 400 STOP 7 1/2

BOX 5124
PUERTO DE TIERRA 00906
PUERTO RICO
724-2854
CARTWRIGHT AND BEAN
560 SOUTH COOPER STREET
CROSSTOWN STATION
P. O. BOX 760
MEMPHIS, TENN 38104
901-276-4442
BRANUM SALES INC
2334 HAVENHURST STREET
P. O. BOX 14348
DALLAS, TEXAS 75234
214-247-7128
GORDON MOSS ELECTRONICS, INC
1502 PRESTON ST
P. O. BOX 8022
FOOTHILLS STATION
SALT LAKE CITY, UTAH 84108
801-485-2870
RON MERRITT COMPANY
1320 PROSPECT STREET
SEATTLE, WASH 98109
206-682-7337
KLEM-STEFFEN
13845 CAPITOL DRIVE
BROOKFIELD, WISCONSIN 53005
414-781-7596
REPS IN OTHER COUNTRIES
ATLAS RADIO CORP. LTD.
50 WINGOLD AVENUE
TORONTO 19, ONTARIO
416-781-6174

SYLVANIA ELECTRIC PRODUCTS INC.
COMMERCIAL ELECTRONICS DIV.
SALES MANAGER
MAURICE GROSS
BRAND NAMES
SYLVANIA
COMPANY ADDRESS
BURLINGTON RD., P O BOX 268
P O BOX 268
BEDFORD, MASS 01730
COMPANY REPRESENTATIVES
I G PISCIOTTA
1811 AORIAN ROAD
BURLINGAME, CALIF 94010
415 697 3500
KENNETH N THANSTROM
6505 EAST GAYHART ST
LOS ANGELES, CALIFORNIA
213 723 5371
J C WINING
1602 FLORIDA AVE BOX 7134
TAMPA, FLORIDA 33603
813 223 1726
CARL ROSEKRANS

2115 SYLVAN ROAD
ATLANTA, GA 30310
404 766 3633
RICHARD F PRISKE
2001 NORTH CORNELL AVE
MELROSE PARK, ILL 60160
312 345 0100
LEONARD FRANKWITZ
901 DEVERE DRIVE
SILVER SPRINGS, MD 20903
301 434 1299
HUGH GILLOGLY
BURLINGTON ROAD, BOX 268
BEDFORD, MASS 01730
617 275 0300
JAMES A OHIMOS
BURLINGTON ROAD, BOX 268
BEDFORD, MASS 01730
617 275 0300
RUSSELL A PILCHER
765 DEERFIELD RD
COLUMBUS, OHIO 43228
614 878 7880
LOU OIAMOND
7007 GULF FREEWAY BOX 26596
HOUSTON, TEXAS 77032
713 649 8306
REPS. IN OTHER COUNTRIES
A C STEWART
AUTOMATIC ELECTRIC SALES
185 BARTLEY DRIVE
TORONTO, ONTARIO

SYLVANIA ELECTRIC PRODUCTS, INC
SEMICONDUCTOR DIVISION
SALES MANAGER
F. FLOOD
COMPANY ADDRESS
100 SYLVAN ROAD
WOBURN, MASS

SYNCRON CORPORATION
PRESIDENT
WILLIAM HENNESSEY
COMPANY ADDRESS
10 GEORGE STREET
WALLINGFORD, CONN 06494
COMPANY REPRESENTATIVES
GILLINGHAM ASSOC
HUNTINGTON BEACH, CALIF.
WORLD WIDE PRODUCTS
N MIAMI BEACH, FLORIDA
PIPER ASSOCIATES
10 HAVEN ST
DOVER, MASS.
BERCOA
1174 OAY STREET
SEAFORD, N.Y.
PRES CLANCEY ASSOC
OKLAHOMA CITY, OKLAHOMA

TAPECASTER ELECTRONICS

BRAND NAMES
TAPECASTER
COMPANY ADDRESS
BOX 662, 12326 WILKINS AVE.
ROCKVILLE, MARYLAND 20851
301 942-6666

TAPE-ATHON CORPORATION

SALES MANAGER
TOM AVE
BRAND NAMES
TAPE-ATHON
COMPANY ADDRESS
523 S. HINDRY
INGLEWOOD, CALIF. 90307
COMPANY REPRESENTATIVES
VERNE LINSLEY CO
2902 W VILLA ST
PHOENIX, ARIZONA
THOMAS M. MORRIS ASSOCIATES
1315 EL SDLYO AVENUE
CAMPBELL, CALIFORNIA
ERNIE R. JENSEN & ASSOCIATES
5315 8TH AVENUE DRIVE WEST
BRADENTON, FLORIDA
EVERETT P. BEAN
3225 CAINS HILL PLACE N. W.
ATLANTA, GEORGIA 30305
BILL KOLANS & CO
P. O. BOX 1932
HONOLULU 5, HAWAII
EDWARD N. SEVERSEN
11435 CIRCLE DRIVE
LA GRANGE, ILLINOIS
DOUG COOK & ASSOCIATES
1519 EAST 46TH STREET
INDIANAPOLIS, INDIANA
SCOTT ORMSBY SALES
230 20TH STREET
NEW ORLEANS, LA. 70124
AB & T SALES CORPORATION
3620 QUEEN MARY DRIVE
OLNEY, MARYLAND
WALTER R. HATFIELD CO.
P. O. BOX 342
LEXINGTON 73, MASS 02173
RUTCHART-RATHSBURG & ASSOC.
16637 E. WARREN AVENUE
DETROIT, MICHIGAN
NORTHLAND ASSOCIATES
1012 19TH AVENUE SOUTH
MOORHEAD, MINNESOTA
J. G. BRALEY SALES
11336 HIGH RIDGE DRIVE
INDEPENDENCE, MO.
PASTON-HUNTER COMPANY INC.
P. O. BOX 129
DEWITT STATION
SYRACUSE, NEW YORK
GILBERT E. MILLER ASSOCIATES
P. O. BOX 171
JERICHO, L. I., NEW YORK
JAMES ELAM
625 HARMY DRIVE
CHARLOTTE, N. C. 28205
CHARLES F. PRICE
1224 HARTFORD AVENUE
CHARLOTTE, N. C. 28205
MARK PITKOW
8921 TURTON DRIVE
PHILADELPHIA, PA. 19115
JAMES CARTWRIGHT
P. O. BOX 760
CROSS-TOWN STATION
560 SOUTH COOPER STREET
MEMPHIS, TENN 38104
THE BILL WYLD COMPANY
1247 CAULDE
HOUSTON, TEXAS
M K WIDDEKIND CO INC
815 W EWING ST
SEATTLE, WASH 98119
REPS IN OTHER COUNTRIES
E. J. PIGGOTT ENTERPRISES
274 CHURCH STREET
TORONTO 1, ONTARIO
E. S. GOULD SALES CO LTD.
11 LOUVAIN ST WEST
MONTREAL, QUEBEC

6644 NORTHWESTERN AVE
CHICAGO, ILL.
312 764-6121
FAUST ASSOC.
1123 MEADOW LARK OR
BALTIMORE, MARYLAND
301 242-4123
TECHCOM ASSOCIATES
862 EAST STREET
TEWKSBURY, MASS.
617 851-9704
GEIST ASSOC INC
131 WOODLAND MANOR
NEW SHREWSBURY, N.J.
201 542-0732
POSITIVE CONSULTANT SERVICE
2255 ARBY COURT
HELLMORF, N.Y.
516 221-2262
DYNA-REPS
200 S GRANTS LANE
FT. WORTH, TEXAS
817 732-6621
EARL SELOVER
568 MARCHANT ROAD
NORFOLK, VIRGINIA
703 588-5194

TEKTRONIX, INC.

SALES MANAGER
DICK HERDMAN
BRAND NAMES
SCOPFMORILE
COMPANY ADDRESS
P O BOX 500
BEAVERTON, OREGON 97005
COMPANY REPRESENTATIVES
TEKTRONIX, INC
LOS ANGELES REGION OFFICE
SUITE 223, 1360 S ANAHEIM RD
ANAHEIM, CALIF. 92805
714 776-4963
TEKTRONIX, INC
PALO ALTO REGION OFFICE
960 N SAN ANTONIO ROAD
LOS ALTOS, CALIF. 94022
415 941-0484
TEKTRONIX INC
ATLANTA REGION OFFICE
SUITE 419
3384 PEACHTREE ROAD, NE
ATLANTA, GEORGIA 30326
404 237-5503
TEKTRONIX, INC
CHICAGO REGION OFFICE
3150 OES PLAINES AVENUE
DES PLAINES, ILL. 60018
312 299-7715
TEKTRONIX INC
PHILADELPHIA REGION OFFICE
383 NORTH KINGS HIGHWAY
CHERRY HILL, N.J. 08034
609 667-1154
TEKTRONIX, INC
LONG ISLAND REGION OFFICE
125 MINEOLA AVENUE
ROSLYN HGT., L. I., N.Y. 11577
516 HT 4-2308
TEKTRONIX INC
SYRACUSE REGION OFFICE
E MOLLOY RD & PICKARD DR
P O BOX 267
SYRACUSE, N.Y. 13211
315 455-6626
TEKTRONIX INC
DALLAS REGION OFFICE
SUITE 420 6434 MAPLE AVENUE
DALLAS, TEXAS 75235
214 FL 7-6301

TELECTRO INDUSTRIES, INC.

BRAND NAMES
PILOT
TELECTRO
COMPANY ADDRESS
100 ELECTRA LANE
YONKERS, NEW YORK 10704

TELE-DEVICES COMPANY

SYSTEMS ENGINEERING MGR.
MANFRED P. DORN
COMPANY ADDRESS
5223 GERMANTOWN AVE.
PHILADELPHIA, PA. 19144

TELEMATION, INC.

MARKETING MANAGER
RAY M. UNRATH
CATV SALES MANAGER
KENNETH L. LAWSON
ETV SALES MANAGER
ROBERT C. BACON
BRAND NAMES
WEATHER CHANNEL
NEWS CHANNEL
CHROMA-CHANNEL
SAV-A-CHANNEL
TELETECH
NEWS-A-THON
COMPANY ADDRESS
2275 SOUTH WEST TEMPLE
SALT LAKE CITY, UTAH 84115
801 466 8631

TELEMET COMPANY

SALES MANAGER
E. S. KING
BRAND NAMES
TELECHROME
TELEMET
COMPANY ADDRESS
185 DIXON AVENUE
AMITYVILLE, NEW YORK 11701
COMPANY REPRESENTATIVES
JOHN GUERRERO
3841 S MAIN STREET

SANTA ANA, CALIF.
714 KI 5-7171
CHARLES H GOLSEN
1539 BEECHCLIFF DRIVE N E
ATLANTA, GEORGIA
404 634-5766
D E CHAPMAN
670 N ELIZABETH ST
LOMBARD, ILL.
312 MA 7-6026
REPS. IN OTHER COUNTRIES
AFROMOTIVE ENGR PRODUCTS LTO
887 MONTÉE DE LIESSE
ST. LAURENT, QUEBEC
514 747-4781

TELEQUIP CORPORATION

COMPANY ADDRESS
224 GLEN COVE AVE. BOX 831
GLEN COVE, N.Y. 11542

TELEFIS CORPORATION

SALES MANAGER
JOSEPH MURPHY
COMPANY ADDRESS
645 N. MICHIGAN AVE.
CHICAGO, ILL. 60611

TELETRONIX DIVISION, BABCOCK

ELECTRONICS CORPORATION
DIRECTOR OF MARKETING
HENRY S. BROUGMALL
COMPANY ADDRESS
2952 RANDOLPH ST.
COSTA MESA, CALIF. 92626

TELEVISION UTILITIES CORP.

COMPANY ADDRESS
10-11 50TH AVENUE
LONG ISLAND CITY, N. Y. 11101

TELEVISION ZOOMAR COMPANY

SALES MANAGER
BILL PEGLER
BRAND NAMES
ZOOMAR
COMPANY ADDRESS
500 FIFTH AVE., SUITE 5520
NEW YORK, NEW YORK 10036

TELEONIC INDUSTRIES, INC.

SALES MANAGER
W. E. GREESON
BRAND NAMES
TELEONIC
COMPANY ADDRESS
60 NORTH FIRST AVE.
RFECH GROVE, INDIANA 46107
COMPANY REPRESENTATIVES
GENTRY ASSOCIATES
418 CLINTON BLDG
2109 W CLINTON STREET
HUNTSVILLE, ALA. 35805
205 534-9771 OR 536-5306
TWX 510 579-2220
T L SNITZER COMPANY
15 NORTH 40TH PLACE SUITE 6
PHOENIX, ARIZONA 85034
602 273-1673
TWX 602 255-0387
T L SNITZER COMPANY
5354 W PICO BLVD
LOS ANGELES, CALIF. 90019
213 938-2073
TWX 213 937-2378
T L SNITZER COMPANY
1020 CORPORATION WAY
PALO ALTO, CALIF. 94303
415 968-8304
TWX 415 969-9101
T L SNITZER COMPANY
317 14TH STREET
DEL MAR, CALIF. 92014
714 454-2191
TWX 714 277-3197
TELEONIC ENGR. CORPORATION
480 MERMAID AVENUE
P O BOX 277
LAGUNA BEACH, CALIF.
714 494-9401
TWX 910 596-1320
D E BOND ASSOCIATES
2149 S CLERMONT STREET
DENVER, COLORADO 80222
303 756-1234
GENTRY ASSOCIATES
2517 E EAST COLONIAL DRIVE
P O BOX 11096
ORLANDO, FLORIDA 32803
305 424-0730
TWX 510 579-2235
GENTRY ASSOCIATES
4152 49TH AVENUE SOUTH
ST. PETERSBURG, FLA. 33711
813 867-7820
GENTRY ASSOCIATES
201 NELSON STREET
EAU GALLIE, FLA. 32935
305 773-3411
GENTRY ASSOCIATES
P O BOX 13513 STA K
ATLANTA, GEORGIA 30324
404 233-3816
HAR-KOW HAWAII INC
2933 KOAPAKA STREET
HONOLULU, HAWAII
815-617
TWX 723-251
TECHNICAL REPS INC
247 SOUTH PINECREST
WICHITA, KANSAS 67218
316 682-4140
C E SNOW COMPANY
3720 FARRAGUT STREET
KENSINGTON, MD. 20795
301 949-1010

C E SNOW COMPANY
TERMINAL BLDG. SUITE 124C
FRIENDSHIP INTL. AIRPORT
BALTIMORE, MD. 21240
301 761-5757
ADDELCO CORPORATION
56 PICKERING STREET
NEEDHAM, MASS. 02192
617 444-4754
TWX 617 444-1931
GAINE ENGINEERING
20531 MACK AVENUE
DETROIT, MICHIGAN 48236
313 881-3532
TECHNICAL REPS INC
7049 LAUPHER LANE
HAZELWOOD, MO. 63042
314 821-1000
F & F ASSOCIATES
58 ARCADIA ROAD
WOODCLIFF LAKE, N.J. 07680
201 778-6767
D E BOND ASSOCIATES
P O BOX 11331
ALBUQUERQUE, N.M. 87112
505 247-3442
F & F ASSOCIATES
461 OLD COUNTRY ROAD
WESTBURY, L. I., N.Y. 11590
516 334-1160
TESCO ASSOCIATES
114 MILES AVENUE
SYRACUSE, N.Y. 13210
315 474-3291
GENTRY ASSOCIATES
P O BOX 197
JAMESTOWN, N.C. 27282
919 883-4521
GAINE ENGINEERING
29603 BRUCE DRIVE
WILLOWICK, OHIO 44095
216 943-3731
GAINE ENGINEERING
NO 6 BARTON DRIVE
PITTSBURGH, PENN. 15221
412 371-3020
C E SNOW COMPANY
613 CHELTENHAM AVENUE
PHILADELPHIA, PENN. 19126
215 224-2624
D E BOND ASSOCIATES
P O BOX 12293
EL PASO, TEXAS 79912
915 532-4048
TEXAS AVIONICS COMPANY
4515 PRENTICE STREET
DALLAS, TEXAS 75206
214 368-3566
TEXAS AVIONICS CO
1108 MEYER
SEABOROUGH, TEXAS 77586
713 474-3155
RUSH S DRAKE ASSOCIATES
6133 MAYNARD AVENUE SOUTH
SEATTLE, WASH. 98108
206 725-2700
TWX 206 998-1255
REPS. IN OTHER COUNTRIES
WHITTAKER ELECTRONICS LTD
1144 MILLSTREAM ROAD
WEST VANCOUVER, B.C.
604 926-3411
TWX 610 924-6033
WHITTAKER ELECTRONICS LTD
42 HOWDEN AVENUE
OTTAWA 5, ONTARIO
613 224-1221
TWX 610 562-1920
WHITTAKER ELECTRONICS LTD
1885 WILSON AVENUE
WESTON, ONTARIO
416 247-7454
TWX 610 492-2383
WHITTAKER ELECTRONICS LTD
P O BOX 216
ROXBORO, QUEBEC
514 684-3000
TWX 610 422-398D

TELSTA CORPORATION

SALES MANAGER
WILLIAM W. ALVING
BRAND NAMES
TELSTA
TELSTA LAMPLIGHTER
COMPANY ADDRESS
1700 INDUSTRIAL ROAD
SAN CARLOS, CALIF. 94070
415 591-7511
COMPANY REPRESENTATIVES
STONE F. KAHN
REG SLS MGR - EASTERN DIV.
P O BOX 9 HUGHES FORD ROAD
FREDERICK, MD. 21701
301 662-3264

TELTRON, INC.

SALES MANAGER
ANTHONY D. BAKER
7 BALA AVENUE
BALA CYNWYD, PA. 19004
BRAND NAMES
TELTRON
EDICOM
COMPANY ADDRESS
BOX 131, ROUTE 100 NORTH
BOVETOWN, PA. 19503
COMPANY REPRESENTATIVES
INDUSTRIAL ELECTRONIC SUPPLY
413 W MAIN STREET
EL DORADO, ARKANSAS
501 862-4901
WM J PURDY CO
312 7TH STREET
SAN FRANCISCO, CALIF.
415 863-3300

JOIN THE CLUB



Telemet Test Signal Generator, Model 3508B1
Multiburst/Stairstep/Ramp/Sine Sq. Pulse/Sine Sq. Window

OVER 300 of these units are in daily use throughout the television industry – and this doesn't include the individual test signal generator modules (3501, 3502, 3503, etc.), of which hundreds have been sold.

This kind of popularity doesn't just happen... it's the combined result of awareness of customer requirements, capable engineering, quality production and continuing service.

If you're not already a member of the Model 3508 club, why not join now? It costs no more to go first class.



TELEMET COMPANY

185 DIXON AVENUE, AMITYVILLE, N.Y. • PHONE (516) 541-3600

S S KRINSKY & ASSOC
6311 YUCCA STREET
MOLLYWOOD, CALIF.
213 465-0557

ROBERTS ASSOCIATES
2711 N E 9TH COURT
POMANO BEACH, FLORIDA
305 942-6373

TELECASTING SERVICES INC
1058 W WASHINGTON BLVD
CHICAGO, ILLINOIS
312 738-1022

K & M ELECTRONICS CO
7360 OHMS LANE
MINNEAPOLIS, MINN.
612 941-1330

TELTRON INC
7 BALA AVENUE
BALA CYNWYD, PA.
215 664-6672

BAKER MILLER TAYLOR CO
7 BALA AVENUE
BALA CYNWYD, PENN.
215 664-6672

JACK F MCKINNEY SALES CO
1303 CHEMICAL STREET
DALLAS, TEXAS
214 631-9450

WM LAMPHEAR CO INC
159 WESTERN AVE WEST
SEATTLE, WASHINGTON
206 633-6901

TENSOLITE INSULATED WIRE
CO., INC.

VICE PRES SALES
GEORGE W. HELLER
BRAND NAMES
TUFFLITE-TM
FLEXOLON
TENSOLON
TENSOLFLEX
COMPANY ADDRESS
WEST MAIN STREET
TARRYTOWN, NEW YORK 10591
914 631-2300
TWX 710 567-1202

COMPANY REPRESENTATIVES
CARTER ASSOCIATES, INC
201 WEST FIRST ST ROX 99
SCOTTSDALE, ARIZONA 85252
602 947 4355

STORM PRODUCTS
4049 TRANSPORT ST
PALO ALTO, CALIF 94303
415 326 2913
TWX 415 492 9283

STORM PRODUCTS
2251 FEDERAL AVE
LOS ANGELES, CALIF 90064
213 272-5371
TWX 213 490 3964

C F L COMPANY
1391 SOUTH INCA ST
DENVER, COLO 80223
303 777 4381

HATHAWAY ELECTRONICS, INC
DUCILLO BUILDING
CANAN, CONN 06018
203 824 7721

MASSEY ASSOCIATES
1 THOMAS CIRCLE N W
WASHINGTON, D C 20005
202 628 1023

CORBETT ASSOCIATES
2411 COVINA WAY
ST PETERSBURG, FLA 33712
813 867 2201

GOLTEN COMPANY INC
2750 WEST NORTH AVE
CHICAGO, ILL 60647
312 384 5959

REID ASSOCIATES
526 M N B BUILDING
CEDAR RAPIDS, IOWA 52401
319 362 6302

HATHAWAY ELECTRONICS, INC
7-11 MYSTIC STREET
ARLINGTON, MASS 02174
617 646 1380

BUSE SALES COMPANY
212 SEDCO ST BOX 68
ST CHARLES, MO 63301
314 739 1613

LAZOR ASSOCIATES, INC
280 EAST HIGHLAND DRIVE
ROCHESTER, NEW YORK 14610
716 473 8337

SHERIDAN ASSOCIATES INC
P O BOX 37646
CINCINNATI, OHIO 45237
513 761-5432
TWX 810 461 2670

SHERIDAN ASSOCIATES INC
P O BOX 7486
CLEVELAND, OHIO 44130
216 884-2001

SHERIDAN ASSOCIATES INC
BOX 37 RIVERDALE STATION
DAYTON, OHIO 45405
513 277 8911

GRIFFIN-CAMPBELL, INC
25 SKIPPACK PIKE
AMBLER, PENN 19002
215 646 7535

BLACKBURN ASSOCIATES
137 WALNUT HILL VILLAGE
BOX 20073
DALLAS, TEXAS 75220
214 351 9991

FARWEST AGENCIES
1210 SE 32ND ST BOX 805
BELLEVUE, WASH 98004
206 747-1515
TWX 206 742 0836

REPS. IN OTHER COUNTRIES
CANADA WIRE & CABLE CO LTD
POSTAL STATION R
TORONTO, ONTARIO
421 0440

TEXAS ELECTRONICS, INC.
SALES MANAGER
JIM YOUNG
COMPANY ADDRESS
5529 REDFIELD
P.O. BOX 7151 INWOOD STATION
DALLAS, TEXAS 75209

TEXAS INSTRUMENT INCORPORATED
SEMICONDUCTOR-COMPONENTS DIV.
SALES MANAGER
EDWARD P. ONEILL
BRAND NAMES
MICRO/G
SENSISOR
SILECT
TAB-PAC
TMIN-PAC
UNI/G

COMPANY ADDRESS
P. O. BOX 5012
DALLAS, TEXAS 75222
SALES OFFICES
SAHARA OFFICE PARK BLDG
SUITE 111
3313 MEMORIAL PARKWAY S W
HUNTSVILLE, ALABAMA 35801
881-4761
2535 W CAMELBACK RD SUITE 1D
PHOENIX, ARIZONA 85017
279-5531
1800 NORTH ARGYLE
HOLLYWOOD, CALIF, 90028
466-7251
5005 WEST CENTURY BLVD
SUITE 218
INGLEWOOD, CALIF, 90301
673-3943
230 CALIFORNIA AVE SUITE 201
PALM ALTO, CALIF, 94306
326-6770
1505 EAST 17TH ST SUITE 201
SANTA ANA, CALIF, 92701
547-6506
4158 ADAMS AVE
SAN DIEGO, CALIF, 92116
284-1181
GEOPHOTO SERVICES INC BLDG
2149 S HOLLY STREET
DENVER, COLORADO 80222
757-8329
300 AMITY ROAD
WOODBRIE, CONN. 06525
389-4521
1875 CONNECTICUT AVE NW
SUITE 913
WASHINGTON, D.C., 20009
234-9320
618 EAST SOUTH ST SUITE 114
ORLANDO, FLORIDA 32801
422-9894
SUITE 205 EXECUTIVE TOWERS
5901 N CICERO AVENUE
CHICAGO, ILLINOIS 60646
286-1000
33 WASHINGTON STREET
WELLESLEY HILLS, MASS. 02181
237-9750
SUITE 706, NORTHLAND TOWERS
15565 NORTHLAND DR
SOUTHFIELD, MICH, 48075
357-1703, 4 AND 5
GRIGGS-MIDWAY BLDG ROOM 154
1821 UNIVERSITY AVE
ST. PAUL, MINN, 55104
646-2755
US HIGHWAY #22 P O BOX 366
UNION, N.J., 07083
687-7200
P O BOX 87 2209 E MAIN
ENDICOTT, N.Y., 13760
785-9987
600 OLD COUNTRY RD,
GARDEN CITY, LI, N.Y.,
742-1515
131 FULTON AVE APT J2
POUGHKEEPSIE, N.Y., 12603
741-6095
501 EAST FAYETTE STREET
SYRACUSE, N.Y., 13202
476-4031
22035 CHAGRIN
CLEVELAND, OHIO 44122
751-2600
SUITE 205 PAUL WELCH BLDG
3300 SOUTH DIXIE DR
DAYTON, OHIO 45439
298-7513
1015 BARCLAY BLDG
ONE BELMONT AVE
BALA CYNWYD, PENN. 19004
839-6380
SRO DEPT.
P O BOX 5012
DALLAS, TEXAS 75222
235-2381
3334 RICHMOND AVE SUITE 102
HOUSTON, TEXAS 77006
526-3268
700-108 AVENUE N E
SUITE 102
BELLEVUE, WASH. 98004
454-0607

REPS. IN OTHER COUNTRIES
TEXAS INSTR ASIA LIMITED
404 TBR BUILDING
NO 59-2-CHROME, NAGATA-CHO
CHIYODA-KU, TOKYO, JAPAN
TEXAS INSTRUMENTS FRANCE
BOITE POSTALE 5

VILLENEUVE-LOUBET A. M.,
FRANCE
11 RUE
TEXAS INSTRUMENTS FRANCE
DE MADRID
PARIS 80, FRANCE
TEXAS INSTR DEUTSCHLAND GMBH
HILDESHEIMSTR. 19
HANDOVER, GERMANY
TEXAS INSTR DEUTSCHLAND GMBH
WOLFRAMSTRASSE 26
7 STRUTTART N. W. GERMANY
TEXAS INSTR DEUTSCHLAND GMBH
CLEMFENSTRASSE 30
8007 MUNICH 23. W. GERMANY
TEXAS INSTRUMENTS LIMITED
MANTON LANE
BEDFORD, ENGLAND
TEXAS INSTRUMENTS ITALIA SPA
VIA COLAUITTI NR 1
MILAN, ITALY
TEXAS INSTRUMENTS HOLLAND
KOLTHOFSINGEL 8
ALMELO, HOLLAND
TEXAS INSTRUMENTS HOLLAND N V
SEMICONDUCTOR BRANCH BENELUX
ENSCHDESESTRAAT 19
HENGELD-OV, NETHERLANDS
TEXAS INSTRUMENTS SWEDEN A B
TIMMERMANSGATEY 34
BOX 17116
STOCKHOLM 17, SWEDEN
TEXAS INSTRUMENTS INC
118 RUE DU RHONE
1204 GENEVA, SWITZERLAND
TEXAS INSTRUMENTS INC
280 CENTRE STR EAST
RICHMOND HILL, ONTARIO
889-7112
TEXAS INSTR DE MEXICO S A
PONIENTE 116 #489
COL IND VALLEJO
MEXICO 15, D.F.
TEXAS INSTR AUSTRALIA LTD
BOX 63 OLDMHAM ROAD
ELIZABETH, SOUTH AUSTRALIA
TEXAS INSTR ARGENTINA SAICP
PASSAGE PORTUGAL 361
BUENOS AIRES, SUC.5,
ARGENTINA
TEXAS INSTR ELECTRONICS
DO BRAZIL LTDA
RUA CESARIO ALVIM 770
CAIXA POSTEL 30-103
SAO PAULO 6, BRAZIL

THE TEXWIDE COMPANY

SALES MANAGER
EDWARD PALEY
BRAND NAMES
FOAM-SWABS
FREFON TF
OPTIC-CLOTH
TEXWIDE
COMPANY ADDRESS
P.O. BOX 315
HILLSDALE, NEW JERSEY 07642

THE THOMAS & BETTS CO

SALES MANAGER
J. DAVID PARKINSON
BRAND NAMES
COLOR-KEYED
CONNECTO-BLOK
SHIELD-KON SHIELDED
TY-RAP
SHUR-STAKE
STA-KON
COMPANY ADDRESS
36 BUTLER STREET
ELIZABETH, N. J. 07207
COMPANY REPRESENTATIVES
PAUL J. ROBINSON
145 SO. ANDERSON ST
LOS ANGELES, CALIF.
ANGELUS 8-3191
NOEL DEWEESE
23 BRODERICK RD.
BURLINGAME, CAL.
692-2323
I. W. STRONG & ASSOC.
635 CANOSA COURT
DENVER, COLORADO
292-6000
ROBERT H. WAGNER
P. O. BOX 19875, STATION N.
ATLANTA, GA.
355-6260
MYRON D. BIELAT
930 LEE STREET
ELK GROVE VILLAGE, LL.
439-3100
G. AUSTIN FINGER
178 FORBES RD.
BRAINTREE, MASS.
843-0373
EUGENE E. LOPER
P. O. BOX 12417
NO. KANSAS CITY, MO.
VICTOR 2-0337
E. J. DIXON
15 PARK PLACE
NEW YORK, N. Y.
RICHARD 7-8644
RICHARD D. PERRY
DAVIS BLDG. BOX 65
FAYETTEVILLE, N. Y.
637-9691
RICHARD G. MCCALL
2028 E. 7TH STREET
CHARLOTTE, N. C.
332-6423
EDWARD F. KRAMER
5826 STATE RD.
CLEVELAND, OHIO
888-0245

BILL R. CONNER
1015 CHESTNUT STREET
PHILADELPHIA, PA.
GL 9-1445
JOHN R. HUMBER
P. O. BOX 6445
HOUSTON, TEX.
JACKSON 8-1610
STROECKER INC.
212 EYRES BLDG.
2207 FIRST AVE., SOUTH
SEATTLE, WASH.
MAIN 3-0357
R. W. MOSTETLER
4920 W. WLIET STREET
MILWAUKEE, WISC.
GR 6-7470

THOMSON ELECTRIC CO., INC

SUBSIDIARY OF THOMSON-HOUSTON
VICE PRES MARKETING
ERNEST L STERN
COMPANY ADDRESS
50 ROCKEFELLER PLAZA
NEW YORK, NEW YORK 10020
212 CI 5 0444

THOR ELECTRONICS CORPORATION

SALES MANAGER
ROY GETTIS
COMPANY ADDRESS
741 LIVINGSTON STREET
ELIZABETH, N. J. 07207
COMPANY REPRESENTATIVES
HARRY HALINTON
6418 N CENTRAL AVENUE
CHICAGO, ILLINOIS
312 763-2131
MONATRON
20850 SHELTON RD
CLEVELAND, OHIO 44142
216 243-6500
HERMAN LEWIS
1801 JOHN F KENNEDY BLVD
PHILADELPHIA, PA. 19103
215 LO 7-2068

TIMES WIRE AND CABLE, DIV. OF

THE INTERNATIONAL SILVER CO.
VP SALES
R. W. BURTON
BRAND NAMES
TIMATCH
COILGRIP
COMPANY ADDRESS
358 HALL AVENUE
WALLINGFORD, CONN. 06492
COMPANY REPRESENTATIVES
DORTON ENTERPRISES INC
P O BOX 1297
SCOTTSDALE, ARIZONA
602 946-6213
WESTREP
P O BOX 569A
FULLERTON, CALIF. 92632
714 879-4090
MERV SOBOL
TECH SERVICE REP-WEST COAST
12191 PEARCE STREET
GARDEN GROVE, CALIF. 92640
213 624-6353
ELECTRONIC COMPONENTS SALES
2340 WEST MAIN STREET
LITTLETON, COLORADO 80120
303 798-8481
TWX 303 798-8114
J F KERRIGAN & COMPANY
P O BOX 5385
HAMDEN, CONN. 06518
203 288-2200
WILLIAM MCNAIR - CATV REP
385 HALL AVENUE
WALLINGFORD, CONN.
203 269-3385
F F DESMOND
EASTERN REG MGR
60 GREAT OAK RD
HUNTINGTON, CONN.
203 929-1945
CHARLES GERY
15 SAXONY DRIVE
TRUMBULL, CONN.
203 268-7240
GEARTNER ASSOCIATES INC
JACK GEARTNER
235 LINCOLN ROAD
MIAMI BEACH, FLA. 33139
305 538-8266
GEARTNER ASSOCIATES INC
2101 MOHAWK TRAIL
MAITLAND, FLORIDA 32751
305 647-4000
TWX 305 647-0442
GEARTNER ASSOCIATES INC
5999 S GROVE STREET
ST PETERSBURG, FLA.
813 867-1890
LOUIS C ESTES ASSOCIATES
SUITE 533-535
DECATUR FEDERAL BLDG
P O BOX 4071
DECATUR, GEORGIA 30031
404 373-8266-7
TWX 404 527-1093
GASSNER AND CLARK COMPANY
6644 N WESTERN AVENUE
CHICAGO, ILLINOIS 60645
312 764-6121
TWX 312 222-0903
PENZNER ASSOCIATES
BOX 4362
OVERLAND PARK, KANSAS 66204
J-W ELECTRONIC SALES
P O BOX 6844
TOWSON, MARYLAND
301 825-4440

FRANCIS COLEMAN
P O BOX 241
CLINTON, MASS.
617 894-1855
R C NDRDSTROM & COMPANY
123 W BROWN STREET
BIRMINGHAM, MICH. 48011
313 JO 4-6128
SCOTT ELECTRONIC SALES
5209 WEST 60TH STREET
MINNEAPOLIS, MINN.
612 929-2985
PENZNER ASSOCIATES
BOX 1912
BECHTOLD, STATION
ST. LOUIS, MO. 63118
ELECTRONIC COMPONENTS SALES
P O BOX 3087
ALBUQUERQUE, N.M.
505 344-8130
TWX 505 243-8378
JOSEPH P. SCANLON COMPANY
51 BLOOMFIELD PLACE
ROCHESTER, N.Y.
716 473-7533
C R CHARITY
2345 HENRY STREET
NORTH BELLMORE, L I, N. Y.
516 785-1598
ROCKE INTERNATIONAL CORP
FOREIGN SALES
13 EAST 40TH STREET
NEW YORK, N.Y. 10016
212 MU 9-020C
D G W INC
3389 NOTTINGHAM ROAD
P O BOX 5316
WINSTON-SALEM, N.C.
919 PA 3-4205
D G W INC
1402 E MOREHEAD STREET
P O BOX 6096
CHARLOTTE, N. C.
704 ED 4-7090
RIXAN ASSOCIATES
33 WEST STRATFORD AVENUE
DAYTON, OHIO
513 222-0011
AMMON AND CHAMPION COMPANY
P O BOX 12274
OKLAHOMA CITY, OKLA. 73112
405 WI 2-8222
SEATRONICS INC
6415 CANYON COURT
PORTLAND, OREGON 97221
503 292-8887
PRECISION ELECTRONICS INC
ROX 18
FT. WASHINGTON INOUST. PARK
FORT WASHINGTON, PA. 19034
AMMON AND CHAMPION COMPANY
P O BOX 35263
DALLAS, TEXAS
214 FL 7-8441
TWX 214 899-8306
AMMON AND CHAMPION COMPANY
P O BOX 35552
HOUSTON, TEXAS
713 PA 9-1233
TWX 713 571-3133
ELECTRONIC COMPONENTS SALES
P O BOX 2066
SALT LAKE CITY, UTAH
801 262-3700
SEATRONICS INC
5931 FOURTH AVENUE SOUTH
SEATTLE, WASH. 98108
206 PA 5-4328
TWX 917 444-2073
REPS. IN OTHER COUNTRIES
L E FORWOOD
A DESKIN SALES CORPORATION
840-R CAMBIE ROAD
RICHMOND, VANCOUVER, B.C.
604 278-8510
NICK WIEBE
A DESKIN SALES CORPORATION
27 CLAREMONT AVENUE
WINNIPEG 6, MANITOBA
204 453-1877
BILL BALFOUR
A DESKIN SALES CORPORATION
25 VALHALLA BLVD
SCARBOROUGH, ONTARIO
364-4505
A DESKIN SALES CORPORATION
1565 LOUVAIN STREET WEST
MONTREAL 11, QUEBEC
514 384-1420
TWX 617 421-3793
ANDR LUSSIER - CATV ONLY
SEATRONICS INC
2330 NICHOLAS PERROT
MONTREAL, QUEBEC
FF 4-2910

TOPAZ, INCORPORATED
SALES MANAGER
HUGH NUTTER
COMPANY ADDRESS
3802 HOUSTON ST.
SAN DIEGO, CALIF. 92110

TOWNSEND ASSOCIATES
SALES MANAGER
GEORGE R. TOWNSEND
CONTRACT ADMIN.
ROB BROMLEY
COMPANY ADDRESS
P O BOX 215
FEEDING HILLS, MASS. 01030

TRAID CORPORATION
VICE PRESIDENT - SALES
ROBERT W. KING
BRAND NAMES

AUTOMAX
PHOTOCORDER
COMPANY ADDRESS
777 FLOWER STREET
GLENDALE, CALIF. 91201
COMPANY REPRESENTATIVES
RICHARD FREEBOG AND
ROWLAND F. PETERSON
777 FLOWER STREET
GLENDALE, CALIF.
245-9393
VINCE KOENIG
1608 FOREST GLEN RD
SILVER SPRING, MD.
301-587-3003
LARRY HAMMAN
18450 LIVERNOIS
DETROIT, MICH.
313-861-8224
ED ZFLASNEY
2339 INWOOD PLAZA
DALLAS, TEXAS
214-FL1-5656

TRANSCO PRODUCTS, INTERNATIONAL
SALES MANAGER
M. ROTH
COMPANY ADDRESS
95 BROAD STREET
NEW YORK, NEW YORK 10034

TREPAC CORPORATION OF AMERICA
SALES MANAGER
W. W. WHITF
BRAND NAMES
DATATONE-R
TREPAC-R
COMPANY ADDRESS
30 W. HAMILTON AVE.
ENGLEWOOD, N. J. 07631
REPS. IN OTHER COUNTRIES
ELECTRONIC ENTERPRISES
46 KARANI BUILDING
NEW CHARNI ROAD
BOMBAY 4, INDIA
TOMINAGA & COMPANY LTD
TRASEN BLDG NO 5 NICHOME-
KORUNACHO NIMOMBASHI
CHUO-KU, TOKYO, JAPAN
TREPAC CORPORATION OF CANADA
1785 BOIS FRANCO ROAD
MONTREAL 9, QUEBEC
DISTRIBUTORS CORP. PTY. LTD
24-26 JOHNSTON STREET
FRITZROY, VICTORIA
AUSTRALIA

THE TRIPLETT ELECTRICAL
INSTRUMENT CO.
SALES MANAGER
N. A. TRIPLETT
COMPANY ADDRESS
286 HARMON ROAD
RLUFFTON, OHIO 45817
COMPANY REPRESENTATIVES
SHEFLER-KAHN CO INC
P O BOX 1587
PHOENIX, ARIZ. 85001
602 258-7893
MOUTHROP & HUNTER
165 ELEVENTH STREET
SAN FRANCISCO, CALIF. 94103
415 863-7880
HOWARD M SAUL & ASSOCIATES
5017 SAN VICENTE BLVD
LOS ANGELES, CALIF. 90019
213 938-3591
MASSEY ASSOCIATES INC
#1 THOMAS CIRCLE
WASHINGTON, D.C. 20005
202 628-1023
MILLAR-HUTTO ASSOCIATES INC
1036 PEACHTREE ST NE
ATLANTA, GA. 30309
404 876-0919
BILL KOLANS & CO
P O BOX 2098
HONOLULU, HAWAII 96805
811-62R
GEO PETTIT CO INC
349 N ASHLAND AVE
RIVER FOREST, ILL. 60350
312 369-8940
WALTER W BIEBERICH
2817 PLAZA DR
FT. WAYNE, IND. 46806
219 745-2928
THE CROCKETT SALES CO
E B WILLIAMS
1546 HARCOURT APT D
NEW ORLEANS, LA. 70124
504 288-2517
ARM SALES INC
10116 PURITAN AVENUE
DETROIT, MICH. 48238
313 862-1300
THE HEIMANN COMPANY INC
5603 LYNDALE AVE S
MINNEAPOLIS, MINN. 55419
612 827-5457
H A ROES & CO
26D1 CHERRY STREET
KANSAS CITY, MO. 64108
816 221-0866
FRANK W TAYLOR CO INC
4455 E GENESSEE
DEWITT, N.Y. 13214
315 446-0422
D F TOBIAS & CO INC
3D CHURCH STREET, RM 1612
NEW YORK, N.Y. 10007
212 267-4345
CHAS H DOLFUSS JR & CO
2108 PAYNE AVE., RM 707
CLEVELAND, OHIO 44114
216 771-1270
MASSEY ASSOCIATES INC

NOW- MONITOR AUDIO LEVELS AUTOMATICALLY

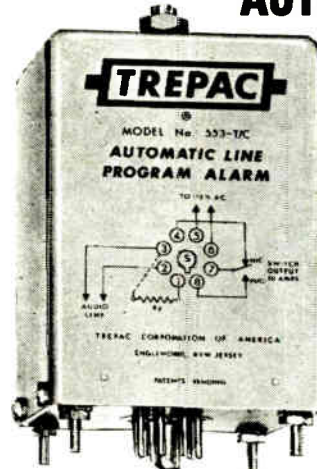

- TRANSISTORIZED
- COMPACT
- ACCURATE
- TROUBLE FREE
- RELIABLE

We Guarantee
it for 5 Years

TREPAC MODEL 553 T/C AUTOMATIC PROGRAM ALARM senses variations of signal level, and provides automatic control of alarm or other associated equipment. It eliminates the need for continuous personal attention. The unit is activated whenever line program audio level deteriorates below a preset threshold.

The output power "switches" either off or on as desired when audio level drops for a specific length of time. In the absence of a signal, the unit will "switch" off after a fixed duration. Whenever audio programming returns to its nominal level, the output control "switches" on. All "switching" is done automatically.

Accurate time control predetermines wide range of timing intervals available. The time duration (or delay) is adjustable from 0.1 seconds to as long as 30 minutes, depending on the application.

DATATONE® TRANSMITTERS RECEIVERS

MINIATURIZED TRANSISTORIZED SOLID/STATE NO TUNED REEDS NO TUNING FORKS

Sensibly priced!

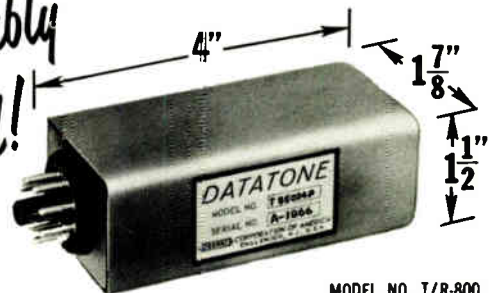

MODEL NO. T/R-800

SPECIFICATIONS

DATATONE TRANSMITTER: Designed to bridge a 600 ohm transmission line with less than 1 db loading and through contact closure deliver an undistorted tone signal level of 1 Milliwatt. Calibrated internal attenuator permits setting output level to required signaling condition by simple terminal strapping.

DATATONE RECEIVER: Designed to bridge a 600 ohm transmission line with less than 0.5 db loading, and close contacts or power an external relay load upon receiving a tone pulse from its companion transmitter. A full dynamic range of greater than 35 db and a sensitivity of -35 dbm with sharp skirt filters, assures reliable operation with adjacent channel separation of as little as 100 cycles.

Both units are rated for continuous operation over a temperature range of 0°C to 50°C from a 12/24/48 VDC supply.

TREPAC® CORPORATION OF AMERICA

SOLID STATE ELECTRONICS for TELECOMMUNICATIONS

30 W. HAMILTON AVE., ENGLEWOOD, N. J.
Phone: (201)-567-3810 TWX: 567-4977

1325 WEST CHESTER PIKE
HAVERTOWN, PA. 19083
215 789-2320
GENE S ROOT & CO
809 WAINWRIGHT OR
PITTSBURGH, PA. 15228
412 561-4125
JOSE ARTURO FERNANDEZ
P O BOX 5124
PUERTA DE TIERRA STA
PUERTO RICO 00906
724-2854
ADAMS-MCGREGOR INC
66 LAKEVIEW ROAD
LINCOLN, R.I. 02865
401 726-1300
LUND & COMPANY
2215 N OLIVE ST
DALLAS, TEXAS 75201
214 748-8839
F Y GATES CO INC
455 EAST 4TH S, RM 212
SALT LAKE CITY, UTAH 84111
801 359-1101
JAMES J BACKER CO
221 W GALER STREET
P O BOX 9327
SEATTLE, WASH. 98119
206 283-6470
REPS. IN OTHER COUNTRIES
C M ROBINSON AGENCIES LTD
1550 ERIN STREET
WINNIPEG 3, CANADA
204 774-1855
LEN FINKLER LTO
2 TYCOS DR
TORONTO 19, ONTARIO
416 781-5231

TROMPETER ELECTRONICS, INC.

SALES MANAGER
NILS STRIO
COMPANY ADDRESS
8936 COMANCHE AVE.
CHATSWORTH, CALIF. 91311
COMPANY REPRESENTATIVES
CURRIE AEROSPACE ASSOCIATES
P O BOX 1424
HUNTSVILLE, ALABAMA
205 536-5650
CARTER ASSOCIATES INC
201 W FIRST STREET
SCOTTSDALE, ARIZONA
602 947-4355
CURRIE AEROSPACE ASSOCIATES
P O BOX 13229
ORLANDO, FLORIDA
305 855-0863
KENNETH W MEYERS CO
7256 W TOUHY AVENUE
CHICAGO, ILLINOIS
312 SP 4-6440
PADDOCK-JOSLOW COMPANY
721 ELLSWORTH DRIVE
SILVER SPRING, MD.
301 JU 8-7866
VECTOR SALES INC
774 PLEASANT STREET
BELMONT, MASS.
617 IV 9-1400
L R HARRY AND ASSOC INC
P O BOX 588
GRANDVIEW, MO.
816 SO 3-3634
L & M ASSOCIATES
511 VICTOR STREET
SADDLE BROOK, N.J. 07663
201 843-8700
THE ROBERT F LAMB CO INC
3407 DELAWARE AVE
BUFFALO, N.Y.
716 876-3757
THE ROBERT F LAMB CO INC
EAST MOLLOY RD
SYRACUSE, N.Y.
314 454-2469
THE ROBERT F LAMB CO INC
259 FAIR STREET
KINGSTON, N.Y.
914 338-8833
MEASUREMENT INSTRUMENTS INC
4211 WOODBRIDGE
COLUMBUS, OHIO
614 451-1164
L & M ASSOCIATES
3801 BROOKVIEW ROAD
PHILADELPHIA, PA.
215 438-5666
CARTER ASSOCIATES INC
P O BOX 87
GARLAND, TEXAS
214 276-7151

TRUSONIC

SALES MANAGER
EMILE J. PETRE
BRAND NAMES
STEPHENS
STEPHENS TRU-SONIC
FREE CONE
STEREODOT
COMPANY ADDRESS
389 N. FAIR OAKS AVE.
PASADENA, CALIF. 91103
COMPANY REPRESENTATIVES
F W MOULTHROP COMPANY
1530 EAST 12TH STREET
OAKLAND 6, CALIF.
AN 1-7676
ROLAND OLANDER & COMPANY
6313 SANTA MONICA BLVD
LOS ANGELES 38, CALIF.
213 MO 9-6313
HYOE ELECTRONICS COMPANY
888 SOUTH LIPAN STREET
DENVER 23, COLORADO
303 936-3465/677

OREN H SMITH COMPANY
5255 NORTH LAWLER
CHICAGO, ILLINOIS 60630
286-4476
K G W SALES COMPANY
DAVIDSON BLDG
1627 MAIN STREET SUITE 500
KANSAS CITY 8, MISSOURI
GR 1-1355
HYOE ELECTRONICS COMPANY
5206 CONSTITUTION AVE N E
ALBUQUERQUE, N.M.
505 268-1111
ROYAL SOUND COMPANY INC
114 EAST FORTIETH STREET
NEW YORK, N.Y. 10D16
212 697-6837
MIKE ROTH SALES COMPANY
678 SOUTH GREEN ROAD
CLEVELAND 21, OHIO
EV 2-9990
BUSHNELL SALES COMPANY
P O BOX 20714
DALLAS, TEXAS 75220
214 FL 2-1845
ROSE MERRITT COMPANY
1320 PROSPECT STREET
SEATTLE, WASH. 98109
MU 2-7337
REPS. IN OTHER COUNTRIES
ENGINEERED SOUND SYSTEMS INC
167 KIPLING AVENUE SOUTH
TORONTO 18, ONTARIO

TRW ELECTRONICS

MARKETING MANAGER
R. L. ASHLEY
COMPANY ADDRESS
1100 GLENDON AVENUE
LOS ANGELES, CALIF. 90D24
COMPANY REPRESENTATIVES
HECHT-WENSCHE & ASSOC.
3825 NORTH 39TH AVENUE
PHOENIX, ARIZONA
602 272-6677
TRW SEMICONDUCTORS INC
650 N SEPULVEDA
EL SEGUNDO, CALIF. 90245
213 322-6685
GENE STRAUBE ASSOCIATES
483 WILLOW ROAD
MENLO PARK, CALIF.
415 841-4450
STRAUBE ASSOCIATES
P O BOX 1649
BOULDER, COLORADO
303 443-8600
CARTWRIGHT & BEAN
20100 N E 25TH COURT
NO MIAMI BEACH, FLA. 33160
305 677-3480
FLORIDA ELECTRONIC ENGR.
609 E COLONIAL DRIVE
ORLANDO, FLORIDA 32803
305 425-0032
CARTWRIGHT & BEAN
395 TRITON ROAD
ORMOND BEACH, FLORIDA
305 677-3480
CARTWRIGHT & BEAN
3223 CATINS HILL PLACE
ATLANTA, GEORGIA 30305
404 237-2273
JOHN G TWIST COMPANY
5222 DIVERSEY AVENUE
CHICAGO, ILL. 60639
312 SP 7-2250
TWX 312 265-1165
R O WHITESELL ASSOC.
CENTRAL BLDG RM 272
FORT WAYNE, IND. 46802
219 743-4411
TWX 219 241-0894
R O WHITESELL ASSOC
HEADQUARTERS
6620 E WASHINGTON ST
INDIANAPOLIS, IND. 46219
317 359-5374
TWX 317 635-9766
HERBERT B KIRKLAND ASSOC
210 FIFTH ST SE
CEDAR RAPIDS, IOWA 52401
319 363-6425
R O WHITESELL ASSOC
3620 LEXINGTON RD
LEX MANOR BLDG RM 223
LOUISVILLE, KY.
502 893-7303
CARTWRIGHT & BEAN
1812 BULLARD AVENUE
METAIRIE, LOUISIANA 70003
504 834-8312
TRW SEMICONDUCTORS INC
P O BOX 5654
BALTIMORE, MD. 21210
301 323-4300
TRW SEMICONDUCTORS INC
P O BOX 603
NORWOOD, MASS.
617 275-6076
R O WHITESELL ASSOC
303 FIDELITY BLDG
BENTON HARBOR, MICHIGAN
616 927-2041
R O WHITESELL ASSOC
16801 WYOMING AVE
DETROIT, MICHIGAN
313 862-2225
TWX 313 342-0648
E A DICKINSON ASSOC
P O BOX F
EXCELSIOR, MINN. 55331
612 476-5273
TWX 612 961-0471
L R HARRY ASSOC
P O BOX 588

GRANDVIEW, MO. 64D30
816 763-3634
L R HARRY ASSOC
7603 FORSYTHE
CLAYTON, MO. 63105
314 727-6123
TRW SEMICONDUCTORS INC
P O BOX 554
MONTVALE, N.J. 07645
201 484-5616
TRW SEMICONDUCTORS INC
P O BOX 67
EAST ISLIP, N.Y. 11730
516 433-3342
TRW SEMICONDUCTORS INC
P O BOX 24
CAMILLUS, NEW YORK
315 454-4451
TRW SEMICONDUCTORS INC
P O BOX 64
YORKVILLE, N.Y.
513 454-6451
MACHINE & PRODUCTS CO
FRANCE ONLY
52 WALL STREET
NEW YORK, N.Y. 10D05
212 WH 4-4370
CARTWRIGHT & BEAN
525 HARWYN DRIVE
CHARLOTTE, N.C. 28205
704 537-7965
R O WHITESELL ASSOC
1172 W GALBRAITH
CINCINNATI, OHIO 45231
513 521-2290; 91
TWX 513 577-1750
R O WHITESELL ASSOC
21139 LORAIN AVENUE
HAGEL BLDG.
CLEVELAND, OHIO 44126
216 333-2585
TWX 216 333-3250
R O WHITESELL ASSOC
1351 W FIFTH AVENUE
COLUMBUS, OHIO
614 488-9731
TWX 614 759-0680
R O WHITESELL ASSOC
4133 S DIXIE AVENUE
DAYTON, OHIO 45439
513 298-9546
TWX 513 944-0526
ARNESON ASSOC
P O BOX 12067
PORTLAND, OREGON 97212
503 646-3416
TRW SEMICONDUCTORS INC
P O BOX 11587
PHILADELPHIA, PA. 19116
215 687-1700
R O WHITESELL ASSOC
PENN CENTER BLDG
201 PENN CENTER BLVD
PITTSBURGH, PA. 15235
412 742-0100
CARTWRIGHT & BEAN
560 SOUTH COOPER STREET
P O BOX 760
MEMPHIS, TENN. 38104
901 276-4442
VISTA ENGINEERING
FIRST BANK & TRUST BLDG
SUITE 430
RICHARDSON, TEXAS 75080
214 235-4547
TWX 214 231-1400
VISTA ENGINEERING
7007 RATON DRIVE
HOUSTON, TEXAS
713 NA 2-5680
ARNESON ASSOC
74 S LUCILE STREET
SEATTLE, WASH. 98134
206 725-7664
E A DICKINSON ASSOC INC
3612 GREENBAY AVENUE
MILWAUKEE, WISCONSIN 53212
414 264-1080
REPS. IN OTHER COUNTRIES
MITSUBISHI TRW COMPANY
MITSUBISHI OENKI BLDG
2-12 MARUNOUCHI CHIYODO-KU
TOKYO, JAPAN
212-6111
E V JOHANSEN A/S
ST KONGENSGADE 93
COPENHAGEN K, DENMARK
PALACE 7510
TECHNIQUE ET PRODUITS
63 BIS RUE D AGUESSEAU
BOULOGNE, SUR SEINE, FRANCE
408-14-00
HEK-GMBH LUBECK
2400 LUEBECK
POSTLACH 1817, WEST GERMANY
52991
M C P ELECTRONICS
STATION WHARF WORKS
ALPERTON, WEMBLEY
MIDDLESEX, ENGLAND
WEMBLEY 1191
TELEINSTRUMENT AB
BOX 14,
VALLINGBY, SWEDEN
870345
BAERLOCHER AG
ZURICH, SWITZERLAND
51-429900
E G LOMAS LTO
227 LAURIER AVE W
OTTAWA, ONTARIO
613 CE 2-7106
JACOBY, MITCHELL
469-475 KENT STREET
SYDNEY, N.S.W. AUSTRALIA
26-2651

TRYLON, INCORPORATED
DIRECTOR OF MARKETING
THOMAS R. HUMPHREY
BRAND NAMES
TRYLON
COMPANY ADDRESS
ELVERSON, PA. 19520
COMPANY REPRESENTATIVES
SAM G HARRIS
2437 JACKSON PKWY
VIENNA, VA.
703 560-4545

T T ELECTRONICS, INC.
SALES MANAGER
J. F. SODAR
COMPANY ADDRESS
BOX 187
CULVER CITY, CALIF. 90230

TURNER MICROPHONE COMPANY
SALES MANAGER
DOUG BATTIN
BRAND NAMES
TURNER
COMPANY ADDRESS
902 17TH STREET
CEDAR RAPIDS, IOWA 52402
COMPANY REPRESENTATIVES
MORRIS F TAYLOR COMPANY
2328 3RD WAY NE
BIRMINGHAM, ALA. 35215
205 853-3673
WES ALDERSON COMPANY
8548 WASHINGTON BLVD
CULVER CITY, CALIF. 90231
213 VE 7-1398
LOGAN SALES COMPANY
463 BREWSTER AVENUE BOX 1219
REDWOOD CITY, CALIF. 94063
415 369-6726
GORDON MOSS ELECTRONICS INC
1530 13TH AVENUE
P O BOX J
GREELEY, COLORADO
303 353-1452
GORDON MOSS ELECTRONICS INC
P O BOX 26172
DENVER, COLORADO 80226
303 936-4027
COAKLEY BOYO & ABBETT INC
6 GAYWOOD DRIVE
WATERBURY, CONN.
203 756-8766
MORRIS F TAYLOR COMPANY
940 LAKE ELBERT DRIVE
WINTER HAVEN, FLORIDA 33880
813 CY 4-2941
MORRIS F TAYLOR COMPANY
P O BOX 488 MAIL
261 LAKE TRIPLE DR.
CASSELLBERRY, FLORIDA
305 838-0821
MORRIS F TAYLOR COMPANY
5908 KENNETH AVENUE
TAMPA, FLORIDA 33604
813 238 2738
WM M LINZ & ASSOC
4001 WEST OEVON
CHICAGO, ILLINOIS 60646
312 MU 5-6D60
MORRIS-CUNNINGHAM & ASSOC
6208 NORTH COLLEGE AVENUE
INDIANAPOLIS, INDIANA 46220
317 CL 5-2458
KELLY-SCHMITZ-WINKLER ASSOC
3831 43RD STREET
OES MOINES, IOWA
515 CR 9-9235
SCOTT ORMSBY SALES
230 20TH STREET
NEW ORLEANS, LOUISIANA 70124
504 488-2414
MORRIS F TAYLOR COMPANY
9431 GEORGIA AVENUE BOX 111
SILVER SPRING, MARYLAND 20907
301 JU 9-4002
MORRIS F TAYLOR COMPANY
3601 ADAMS DRIVE
SILVER SPRING, MD. 20902
301 WH 6-3569
COAKLEY BOYO & ABBETT INC
P O BOX 248 1424 HIGHLAND
NEEDHAM, MASS. 02192
617 444-5470
R A ALBRECHT COMPANY
221 LONESOME OAK ROAD
ROCHESTER, MICHIGAN 48063
313 651-7081
STAN CLOTHIER COMPANY INC
12 WEST 98TH STREET
MINNEAPOLIS, MINN. 55419
612 869-3231
SCOTT ORMSBY SALES CO
147 CARTER ROAD
BILOXI, MISS.
601 432-8467
KELLY-SCHMITZ-WINKLER ASSOC
7546 TROOST AVENUE
KANSAS CITY, MISSOURI 64131
816 EM 3-5651
KELLY-SCHMITZ-WINKLER ASSOC
2319 HAMPTON AVENUE
ST. LOUIS, MO. 63139
314 ST 1-6111
WILLGOLD ELECTRONIC SALES
18 OLD FARM ROAD
NORTH CALDWELL, N.J.
201 CA 6-8363
WILLGOLD ELECTRONIC SALES
53 ARTHUR DRIVE
PARSIPPANY, N.J. 07054
MORRIS F TAYLOR COMPANY
P O BOX 23
MARTLON, N.J. 08053

215 MA 2-0383
 GORDON MOSS ELECTRONICS INC
 2418 BARCELONA DRIVE S W
 ALBUQUERQUE, N.M., 87105
 505 877-9392
 WILLGOLD ELECTRONIC SALES
 100 NORTH VILLAGE AVE
 ROCKVILLE CENTRE, N.Y. 11571
 516 764-4022
 MARSEY SALES INC
 206 PARK AVENUE
 ROCHESTER, N.Y. 14607
 716 442-9700
 MORRIS F TAYLOR COMPANY
 1224 DRESDEN DR., WEST
 CHARLOTTE, N.C. 28205
 704 KE 7-4878
 LES A MORROW COMPANY
 3123 WEST 117TH STREET
 CLEVELAND, OHIO 44111
 216 CL 1-7700
 MORRIS F TAYLOR COMPANY
 201 PENN CENTER BLVD.
 PITTSBURGH, PA. 15235
 412 823-8400
 MORRIS F TAYLOR COMPANY
 APT 105, 9 RICHLAND LANE
 CAMP HILL, PA. 17011
 717 233-3112
 ERNEST L WILKS COMPANY
 1821 NORTH BROADWAY
 CARROLLTON, TEXAS
 214 CH 2-5321
 GORDON MOSS ELECTRONICS INC
 1502 PRESTON STREET
 BOX 8022 Foothills Station
 SALT LAKE CITY 8, UTAH
 801 485-2870
 M K WIDDEKIND COMPANY
 815 W EWING STREET
 SEATTLE, WASH. 98119
 AT 4-8020

TV CABLE SUPPLY COMPANY
 SALES MANAGER
 JAMES E. MORTON
 BRAND NAMES
 TVC
 VIDEO INSTRUMENT
 COMPANY ADDRESS
 BOX 38
 CARLISLE, PA. 17013

ULTRA AUDIO PRODUCTS
ELDOM INDUSTRIES, INC
 SALES MANAGER
 DON OLIVER
 BRAND NAMES
 SOUNDDESIGN
 CUSTOMIZER
 CIRCUITESTER
 SPECTACULITE
 COMPANY ADDRESS
 1140 S. ROBERTSON BLVD.
 LOS ANGELES, CALIF. 90035

UNGAR ELECTRIC TOOLS
ELECTRONIC DIVISION OF
ELDOM INDUSTRIES, INC
 SALES MANAGER
 W. L. NEMRENZ
 BRAND NAMES
 IMPERIAL
 MINI-TIP
 MICRO-TIP
 PRINCESS
 UNGAR
 COMPANY ADDRESS
 2701 W. EL SEGUNDO BLVD.
 HAWTHORNE, CALIF. 90252
 213 757-2151
 COMPANY REPRESENTATIVES
 MORRIS F TAYLOR CO
 2328 3RD WAY, NE
 BIRMINGHAM, ALA. 35215
 205 853-3673
 UNGAR SALES ASSOC
 317 GLASGOW AVE
 INGLEWOOD, CALIF 9D3D1
 213 678-3371
 ELVEY-PROCTOR CO
 1650 LAUREL ST
 SAN CARLOS, CALIF 94071
 415 593-1121
 KOETHER-COX CO
 1325 SOUTH INCA ST
 DENVER, COLO 80223
 303 773-5561
 MORRIS F TAYLOR CO
 5908 KENNETH AVE
 TAMPA, FLORIDA 33604
 813 238-2738
 G MCL COLE CO
 6514 WEST HIGGINS ROAD
 CHICAGO, ILL. 60656
 312 774-3535
 FRANK MCSWEENEY CO
 4123 N KEYSTONE BLVD
 INDIANAPOLIS, IND 46205
 317 547-2112
 STANLEY A HARRIS CO
 60 DEDHAM AVE
 NEEDHAM, MASS 02192
 617 444-4780
 ROBERT MILSK CO
 19375 JAMES COUZENS HWY
 DETROIT, MICH 48235
 313 342-6660
 RAY RIPLEY & ASSOC
 6838 PILLSBURY AVE SO
 MINNEAPOLIS, MINN 55423
 612 866-8682
 L R MASSEY CO
 304 E JEFFERSON ST
 GREENWOOD, MISS 38930

601 443-3038
 DIPRO INC
 P D BOX 1427
 MARYLAND HEIGHTS, MO 63042
 314 432-3444
 R W FARRIS CO INC
 1715 BALTIMORE AVE
 KANSAS CITY, MO 64108
 816 421-1751
 MORRIS F TAYLOR CO
 P D BOX 23
 MARLTON, N. J. 08053
 609 983-1712
 BITTAN ASSOC INC
 381 SUNRISE HWY
 LYNBROOK + LONG ISLAND, N Y
 516 593-3833
 LOUIS W APPELL CO
 11 WARRFN ST
 NEW YORK, N Y 10007
 212 964-4255
 LEDNARD D ALLEN CO
 P O BOX 205
 NORTH SYRACUSE, N Y 13212
 315 478-7470
 MORRIS F TAYLOR CO
 1224 DRESDEN DR., W
 CHARLOTTE, N. C. 28205
 704 537-4878
 RAHR-GREENLEAF & ASSOC
 14700 DETROIT AVE
 CLEVELAND, OHIO 44107
 216 221-9030
 MORRIS F TAYLOR CO
 4341 CARLISLE PIKE
 CAMP HILL, PA. 17011
 717 761-2958
 MORRIS F TAYLOR CO
 201 PENN CENTER BLVD.
 PITTSBURGH, PA. 15235
 412 823-8500
 M F KLICPERA CO
 P O BOX 2668
 HOUSTON, TEXAS 77001
 713 748-0874
 JAMES J BACKER CO
 2211 W GALER ST
 SEATTLE, WASH 98119
 206 283-6470

UNITED RADIO SUPPLY INC
INDUSTRIAL DIVISION
 SALES MANAGER
 JOHN RIES
 BRAND NAMES
 KUSTOM ELECTRONICS
 COMPANY ADDRESS
 829 W. BURNSIDE
 PORTLAND, OREGON 97209
 503-226-6334

UNITED STATES PLASTIC ROPE INC
 VICE PRESIDENT - SALES
 PETER M. LIND
 BRAND NAMES
 GLASTRAN
 COMPANY ADDRESS
 711 HAMILTON AVE.
 MENLO PARK, CALIF. 94025
 415-322-1881

UNITED STATES TOWERS
 OWNER
 JOHN J. HOKE
 COMPANY ADDRESS
 249 BARTOW LANE
 PETERSBURG, VA.
 732-9350

UNITED TRANSFORMER COMPANY
 SALES MANAGER
 J. R. BARRECA
 BRAND NAMES
 CAT
 COMPACT
 DECIOUNCER
 DI-T
 DI-T200
 DO-T
 DO-T400
 HIPERMALLOY
 HIT
 HVC VARIDUCTOR
 HVV VARIDUCTOR
 LAB
 LINEAR STANDARD
 MAT
 MET
 MINIDUCTOR
 MINIFILTER
 QUNCER
 PIP
 S SERIES
 SPECIAL SERIES
 SUBOUNCER
 SUB-SUBOUNCER
 TELE-MINIFILTER
 TVC VARIDUCTOR
 ULTRA-COMPACT
 UNITED
 UTC
 VARIDUCTOR
 VARIMATCH
 VARIPOWER
 VARITRAN
 VIC VARIDUCTOR
 PIL
 MAS
 FLATS
 FE
 FI
 FO
 COMPANY ADDRESS
 150 VARICK STREET
 NEW YORK, NEW YORK 10013
 212-AL5-3500

CAMPY REPRESENTATIVES
 CARTER ASSOCIATES INC
 P D BOX 94
 SCOTTSDALE, ARIZ 85252
 602 947-4355
 RECHT ASSOC
 175 S SAN ANTONIO RD
 LOS ALTOS, CALIF
 415 941-0336
 ELLARD F STRASSNER
 7121 LOS FELIZ BLVD
 LOS ANGELES, CALIF
 213 666-1511
 UTC PACIFIC DIV.
 3630 EASTHAM DRIVE
 CULVER CITY, CALIF
 213 870-9755
 FRANKLIN SALES CO
 2149 SOUTH CLERMONT ST
 DENVER, COLO. 80222
 303 757-1371
 GERBER SALES CO INC
 31 BROADWAY
 NEW HAVEN, CONN 06515
 203 777-6279
 MILLAR-HUTTO ASSOC INC
 P O BOX 1603
 WINTER PARK, FLA 32790
 305 647-7407
 MILLAR-HUTTO ASSOC INC
 1036 PEACHTREE ST N F
 P O BOX 7116, STA C
 ATLANTA, GA 30309
 404 876-0919
 WHITMORE ASSOC
 4750 N MILWAUKEE AVE
 CHICAGO, ILL 60630
 312 286-2442
 LORENZ SALES INC
 320 30TH STREET S E
 CEDAR RAPIDS, IOWA 52403
 319 366-0774
 L D LOWERY INC
 6200 ANNAPOLIS RO
 HYATTSVILLE, MD 20784
 301 773-4977
 GERBER SALES CO INC
 176 SECOND AVE
 WALTHAM, MASS 02154
 617 891-8040
 FRED B HILL CO
 6110 EXCELSIOR BLVD
 MINNEAPOLIS, MINN 55416
 612 929-6727
 HARRIS-HANSON CO
 2814 S BRENTWOOD BLVD
 ST LOUIS, MO 63144
 314 647-4350
 FRANK W TAYLOR CO INC
 4455 EAST GENESEE ST
 DEWITT, N Y 13214
 315 446-0422
 COMTRONIC ASSOC
 1551 FRANKLIN AVE
 MINEOLA 11, L I, N Y
 516 741-8966
 BEN MILLER
 P O BOX 72
 LITTLE NECK, N Y 11363
 212 224-4673
 MILLAR-HUTTO ASSOC INC
 112 SO SHARON AMITY RD
 P O BOX 17566
 CHARLOTTE, N C 28211
 704 366-5579
 BEK ASSOC INC
 330 SALEM AVE
 DAYTON, OHIO 45406
 513 278-1343
 L D LOWERY INC
 2801 WEST CHESTER PIKE
 ROOMALL, PA 19008
 215 356-5900
 GENE S BOOT & CO
 809 WAINWRIGHT DRIVE
 PITTSBURGH, PA 15228
 412 561-4125
 J Y SCHOONMAKER CO INC
 5328 REDFIELD BOX 35266
 DALLAS, TEXAS 75235
 214 631-8480
 J Y SCHOONMAKER CO INC
 6001 GULF FREEWAY
 HOUSTON, TEXAS 77023
 713 926-9510
 JAS. J BACKER CO
 221 WEST GALER ST
 P O BOX 9327
 SEATTLE, WASH 98119
 206 283-6470

UP-RIGHT SCAFFOLDS
 SALES MANAGER
 R. L. ESKER
 BRAND NAMES
 UP-RIGHT
 ROTA-LOCK
 COMPANY ADDRESS
 1013 PARDEE STREET
 BERKELEY, CALIF. 94710

UPSON BROTHERS INCORPORATED
 SALES MANAGER
 M. VELEPEC
 BRAND NAMES
 HOLD-E-ZEE
 ROL-TITE
 COMPANY ADDRESS
 65 BROAD STREET
 ROCHESTER, N. Y. 14614
 COMPANY REPRESENTATIVES
 G C RATCLIFF
 1738 E ORANGE OR
 PHOENIX, ARIZ 85016
 602 266-8238
 DONALD E SAVARD CO

126 E VALLEY BLVD
 ALHAMBRA, CALIF 91801
 283-0504
 WILLARD IHLEFELDO & ASSOC
 1201 SAN MARCO BLVD
 JACKSONVILLE, FLA 32217
 305 FL 9-5282
 ANDERSON SALES CO
 23 W CALENDAR AVE
 LAGRANGE, ILL 60525
 312 FL 2-1514
 F T HARSH CO
 15 FARM HILLS LANE
 HINGHAM, MASS 02043
 617 749-3555
 SIFMERS, GODDEN, OLSON
 324 N FIRST ST
 MINNEAPOLIS, MINN 55401
 612 FE 2-7793
 CHAS H KOSLOWSKY CD
 406 W 34TH ST
 KANSAS CITY, MO 64111
 816 WE 1-8088
 EXPORT AGENCIES CORP
 EXPORT ONLY
 50 BROADWAY
 NEW YORK, N.Y. 10004
 212 WH 4-1141
 HICKISS & HULBERT INC
 P O BOX 148
 KENT, OHIO 44240
 216 673-4416
 G W K VOIGHT CO.
 333 W STATE ST
 MEDIA, PA 19063
 215 LD 6-9021
 D R WERER
 P O BOX 534
 NORRISTOWN, PA 19001
 215 BR 5-4049
 LYNN & HEMPHILL
 2116 N PEARL ST
 DALLAS, TEXAS 75201
 214 RI 7-4745
 KENNETH L SHEPHERD CO
 2830 CANYON VIEW DR
 SALT LAKE CITY, UTAH 84109
 801 HU 4-5408
 DON RAYMOND
 90 S DEARBORN
 SEATTLE, WASH 98104
 206 682-0480
 REPS. IN OTHER COUNTRIES
 LYMAN AGENCIES LTD
 3765 E FIRST AVE
 BURNABY 2, B C
 604 299-7747
 S S LERNER AGENCIES
 137 WELLINGTON ST WEST
 TORONTO, ONTARIO
 416 JU 6-4587

UTICA CORPORATION
 NATIONAL SALES MANAGER
 ARTHUR FRIELICH
 BRAND NAMES
 TOWN & COUNTRY
 T & C
 UTI-COM
 UTI-CAL
 UTICA
 COMPANY ADDRESS
 2947 W. TOUHY AVENUE
 CHICAGO, ILLINOIS 60645
 COMPANY REPRESENTATIVES
 SOUTHWEST MARKETING
 133 E MCLELLAN BLVD
 PHOENIX, ARIZONA
 602 266-5361
 A HERMAN & ASSOC
 6611 SALT LAKE AVE
 BELL, CALIF
 588-1175
 MORTON FIELDS COMPANY
 8330 N SPRINGFIELD
 SKOKIE, ILLINOIS
 312 674-3018
 E D MAGNUS & ASSOC.
 5715 LINCOLN AVE
 CHICAGO, ILL
 312 334-1503
 W F REYER COMPANY
 538 LONE OAK ROAD
 PADUCAH, KY
 502 442-4176
 INDUSTRIAL COMPONENT CO
 908 W 46TH ST
 MINNEAPOLIS, MINN
 612 827-1703
 L R MASSEY COMPANY
 304 E JEFFERSON
 GREENWOOD, MISS.
 601 453-3038
 J W LEHNER COMPANY
 367 BRYNHILL ROAD
 COLUMBUS, OHIO
 614 268-5260
 TEX-ELEX
 4222 RICHMOND
 HOUSTON, TEXAS
 713 666-1636

UTILITY PRODUCTS COMPANY
 VICE PRESIDENT - SALES
 LOREN H. PEASE
 COMPANY ADDRESS
 3111 W. MILL ROAD
 MILWAUKEE, WISCONSIN 53209
 COMPANY REPRESENTATIVES
 E J PERKINS
 P O BOX 884
 GLENDALE, CALIF
 213 246-2034
 JOHN L MARSH ASSOC
 P O BOX 865

JUPITER, FLA
305 746-4911
ROBERT SPOFFORD
144 CARLYLE CIRCLE
PALM HARBOUR, FLA
813 937-3385
WM O HOLCOMB
541 KENILWORTH AVE
KENILWORTH, ILL
312 251-0028
L G WENDEGATZ
P O BOX 865
RAYTOWN, MO
816 FL 3-8300
R R KINYON
9216 CLAYTON RD
ST LOUIS, MO
314 WY 3-4348
J G MANN
860 KIMBALL AVE
WESTFLO, N J
201 233-2164
JAKE RUDISILL ASSOC INC
2709 N TRYON ST
CHARLOTTE, N C
704 377-6901
F R ANDERSON
987 DREXEL RD
LOWER MAKEFIELD TWP
YARDLEY, PA
715 HY 3-9134
JOHN P SMITH
P O BOX 2077
SAN ANGELO, TEXAS
915 655-2911

UTILITY TOWER COMPANY
SALES MANAGER
V. G. DUVALL
COMPANY ADDRESS
40X 12027
3200 N W 38TH STREET
OKLAHOMA CITY, OKLA. 73112
WI 6-5551
COMPANY REPRESENTATIVES
OAVCO ELECTRONICS
BAFERSVILLE, ARK.
BAUER ELECTRONICS CORP
SAN CARLOS, CALIF.
GATES RADIO CO
QUINCY, ILL.
UTILITY TOWER CO
MAYFIELD, KY
CH 7-3642
K & M ELECTRONICS
MINNEAPOLIS, MINN.
RADIO CORPORATION OF AMERICA
CAMDEN, N.J.
VISUAL ELECTRONICS CORP
NEW YORK, N.Y.
COLLINS RADIO CO
DALLAS, TEXAS
GENERAL ELECTRIC
LYNCHBURG, VA.

VALUE INCORPORATED
SALES MANAGER
CLIFFORD K. FEARN
BRAND NAMES
POLYANGLE
COMPANY ADDRESS
206 NORTH BROADWAY
PENNSVILLE, N. J. 0807D

VEGA ELECTRONICS CORPORATION
VICE PRESIDENT - MARKETING
CHARLES F. SWISHER
BRAND NAMES
SOUNSERVO
VEGA-MIKE
COMPANY ADDRESS
1161 RICHARD AVE.
SANTA CLARA, CALIF. 95050
COMPANY REPRESENTATIVES
DOBBS/STANFORD
P O BOX 266
SAN CARLOS, CALIF
415 591 0339
KOESSLER SALES CO
818 N FAIRFAX AVE
LOS ANGELES, CALIF
213 653 1605
SPARTA ELECTRONIC CORP
5851 FLORIN-PERKINS ROAD
SACRAMENTO, CALIF 95828
916 452 5353
JOHN B ANTHONY
P O BOX 343
WILTON, CONN
203 762 3629
LOREN F GREEN & ASSOC
5218 W OIVERSEY AVE
CHICAGO 39, ILL
312 AV 6 6824
MORRIS F TAYLOR CO
P O BOX 111
SILVER SPRING, MO
301 JU 9 4002
JIM PIPER ASSOC
TEN HAVEN ST
DOVER, MASS
617 449 1144
LOWELL-KANGAS & ASSOC INC
P O BOX 26
CREVE COEUR STATION
ST LOUIS, MO
314 ST 1 6290
SINGER PRODUCTS CO INC
95 BROAD STREET
NEW YORK, N Y 10004
212 WH 4 8700
SCHROEDER SALES CO
2254 EUCLIO AVE

CLEVELAND, OHIO
216 MA 1 5075
CHARLES LUCAS SALES CO
P O BOX 13632
DALLAS, TEXAS
214 WH 2 5958
STEVENSON CO
P O BOX 17495
SALT LAKE CITY, UTAH
801 CR 7 2515
VECTOR CORPORATION
307 WALL ST
SEATTLE, WASH
206 623 6891
REPS IN OTHER COUNTRIES
IMPETUS, S A
2 VIA BERNA
6900 - LUGANO
SWITZERLAND
91 3 R2 14
OIVERSIFIED ELECTRONICS
P O BOX 365
SCARROROUGH, ONTARIO
416 267 2701

VENT-RAK INCORPORATED
SALES MANAGER
JAMES L. WRIGHT, SR.
BRAND NAMES
CHASSIS-TRAK INC
VENT-RAK INC
COMPANY ADDRESS
525 S. WEBSTER AVE.
INDIANAPOLIS, INDIANA 46219
COMPANY REPRESENTATIVES
YOUNG & LAWRENCE ASSOC INC
107 WILLIAMS AVE S E
HUNTSVILLE, ALA 35801
205 536 0176
WILLIAMS ASSOC INC
1110 E MCOOWELL RD SUITE A2
PHOENIX, ARIZ 85004
602 254 6085
DYNAMIC ASSOC
1011 INDUSTRIAL WAY, EAST
RURLINGAME, CALIF 94010
415 344 2521
DYNAMIC ASSOC
5190 W WASHINGTON BLVD
LOS ANGELES, CALIF 90016
213 933 5833
WILLIAMS ASSOC INC
4971 JACKSON ST
DENVER, COLO 80216
373 388 4391
COAKLEY, BOYD, & ARRETT INC
6 GAYWOOD DRIVE
WATERBURY, CONN 06705
203 756 8766
YOUNG & LAWRENCE ASSOC INC
601 N NEW YORK AVE
WINTER PARK, FLORIDA 32789
305 647 2528
YOUNG & LAWRENCE ASSOC INC
2403 W WIND OEL MAR BLVD
ST PETERSBURG, FLORIDA 33726
813 360 7550
YOUNG & LAWRENCE ASSOC INC
2D25 PEACHTREE RD
N E SUITE 837
ATLANTA, GA 37309
404 355 1906
RINGLAND M KRUEGER CO
5755 W IRVING PARK RD
CHICAGO, ILL 60634
312 282 8444
THOMAS & SUKUP CO
2060 E FIFTY-FOURTH ST
INDIANAPOLIS, INO 46220
317 251 4574
ENGINEERING SERVICES CO
1026 THIRD AVE S E
CEDAR RAPIDS, IOWA 52403
319 366 1591
GENE ROSEN & ASSOC INC
9501 WAOSWORTH DRIVE
BETHESOA, MO 2D034
301 365 5113
COAKLEY, BOYD, & ABBETT INC
1424 HIGHLAND AVE BOX 248
NEEDHAM, MASS 02192
617 444 5470
MARTIN VOGT CO
2817 BAMLET ROAD
ROYAL OAK, MICH 48073
313 549 3355
MASSE & ASSOC
P O BOX 7707
3825 YORK AVE NORTH
MINNEAPOLIS, MINN 55422
612 588 0551
ENGINEERING SERVICES CO
6717 VERNON AVE
ST LOUIS, MO 63130
314 PA 6 2233
ENGINEERING SERVICES CO
7546 TROOST
KANSAS CITY, MO 64131
816 EM 3 6DDO
R L RINGER CO
P O BOX 114
GLEN ROCK, N J 07452
201 444 1434
WILLIAMS ASSOC INC
3221 SILVER AVE S E
ALBUQUERQUE, N MEX 871D6
505 255 1638
R L RINGER CO
P O BOX 51
OEWITT, NEW YORK 13214
MISSILETRONIC INC
1321 E MOREHEAD ST BOX 4375
CHARLOTTE, N CAROLINA 28204
704 377 1922
COMPONENTS ENG CO
7461 N LINDEN LANE

CLEVELAND, OHIO 44130
216 842 2737
COMPONENTS ENGINEERING CO
11720 KNOLLSPRINGS CT
CINCINNATI, OHIO 45246
513 825 8686
T J RAY CO
8514 EAST 31ST PLACE
TULSA, OKLAHOMA 74145
918 627 1515
ROGER MARTIN ASSOC
P O BOX 1002
4619 PENN OAK ST
RELLAIRE, TEXAS 77401
713 MO 8 3877
WILLIAMS ASSOC INC
24811 S MAIN STREET
SALT LAKE CITY, UTAH 84115
801 466 8709
ELECTRONIC SALES CORP
P O BOX 6535
SEATTLE, WASH 98116
206 WE 2 0330
REPS IN OTHER COUNTRIES
EUROELECTRON
47 OBRECHLAAN
BILLTHOVEN, HOLLAND
ELECTRONIC MARKETING CO
OF CANADA
3600 BARCLAY AVE
MONTREAL 26, QUEBEC
514 739 8052-53

VIDEON CORPORATION
SALES MANAGER
W. S. CRAIG
COMPANY ADDRESS
140 E. MAIN ST.
HUNTINGTON, NEW YORK 11743
516-427-6285

VIKING OF MINNEAPOLIS
DIVISION OF THE TELEX CORP
SALES MANAGER
RICHARD L. MORRIS
COMPANY ADDRESS
9600 ALORICH AVE. SO.
MINNEAPOLIS, MINN. 55420
612 881 2636
COMPANY REPRESENTATIVES
WORLD WIDE PROD
P O BOX 9212
BIRMINGHAM, ALA
205 595 7114
I R STERN & CO
4329 EAST TURNEY AVE
PHOENIX, ARIZ 85018
602 955 4703
I R STERN & CO
4109 BURBANK BOULEVARD
BURBANK, CALIF 91505
213 849 1195
MEYER, ROSS & FLEMING
113 10TH STREET
SAN FRANCISCO, CALIF 94103
415 431 0652
R & O SALES CO
1468 S FEDERAL BLVD
DENVER, COLO 80219
303 934 5445
WORLD WIDE PRODUCTS
1999 N E 150TH ST
NORTH MIAMI BEACH, FLA
305 949 3457
WORLD WIDE PRODUCTS
P O BOX 7102
TAMPA, FLA
813 227 5051
MANREP CORP
P O BOX 429
N MIAMI BEACH, FLA 3316D
305 949 3457
RAY HUTMACHER ASSOC INC
6668-6670 NORTHWEST HWY
CHICAGO, ILL 60631
312 631 3248
KELLY-SCHMITZ-WINKLER ASSOC
3831 43RD STREET
OES MOINES, IOWA 5031D
515 279 9235
GENE ROSEN & ASSOC INC
9501 WAOSWORTH DRIVE
BETHESOA, MO 20034
301 365 5113
MICHAEL SCOTT CO INC
336 WASHINGTON ST
WELLESLEY HILLS, MASS 02181
617 235 01D2
RAY RIPLEY ASSOC
6838 PILLSBURY AVE S
MINNEAPOLIS, MINN 55423
612 866 8682
KELLY-SCHMITZ-WINKLER ASSOC
7546 TROOST AVE
KANSAS CITY, MO 64131
816 363 5651
KELLY-SCHMITZ-WINKLER ASSOC
2319 HAMPTON
ST LOUIS, MO 63139
314 781 6111
L-C-A SALES INC
76 MAIN STREET
TUCKAHOE, N Y 10707
914 961 4700
LSM ASSOCIATES
109 EASTON AVE
BUFFALO, NEW YORK
716 852 3374
LSM ASSOC
218 EAST LAKE ROAD
OERUYTER, NEW YORK
315 852 3374
LSM ASSOCIATES
ORCHARO PARK
PHELPS, NEW YORK
315 548 4891

WORLD WIDE PRODUCTS
P O BOX 2493
GREENSBORO, N C
919 274 0693
SCHROEDER SALES CO
2254 EUCLID AVE
CLEVELAND, OHIO 44115
216 621 5074
CHARLES LUCAS SALES CO
2004 S BECKLEY AVE
DALLAS, TEXAS 75224
214 942 5958
WILLIAM R LANPHEAR CO
4031 STONEYWAY AVE N
SEATTLE, WASH 98103
206 633 4900

VISHAY RESISTOR PRODUCTS DIV
SALES MANAGER
J. R. CURLEY
BRAND NAMES
VISHAY
COMPANY ADDRESS
63 LINCOLN HIGHWAY
MALVERN, PA. 19355
COMPANY REPRESENTATIVES
SPACE ENGINEERING SALES INC
4306 GOVERNORS DRIVE SW
SUITE R
HUNTSVILLE, ALA
205 837 6060
E J FOLEY & ASSOC
3840 N JOKAKE DR
SCOTTSDALE, ARIZ
602 945 2665
MELCHIOR & MACPHERSON INC
820-R CHERRY STREET
SAN CARLOS, CALIF
415 591 7383
WESTERN CONTROLS
2630 SEAMAN AVE
EL MONTE, CALIF
213 443 9376
I W STRONG & ASSOC
635 CANOSA COURT
DENVER, COLO
303 292 6900
COMP REP ASSOCIATES
14 BOWLING GREEN AVE
NORTH HAVEN, CONN 06473
203 239 9762
W BEN WIMBERLY CO
532 S FT HARRISON AVE
CLEARWATER, FLA
813 446 7072
W BEN WIMBERLY CO
500 S OSCEOLA
ORLANDO, FLA
305 425 3083
TECHNICAL DEVICES INC
6416 N CENTRAL AVE
CHICAGO, ILL
312 774 8252
J A OOUGHERTY SALES CO
320 HILLEN ROAD
TOWSON, MO 21204
301 823 0431
COMP REP ASSOCIATES
116 GREAT PLAIN AVE
NEEDHAM, MASS 02192
617 444 2484
WILLARD SPENSER CO
21507 GREENFIELD RD
OAK PARK, MICH 48237
313 398 8005
PINKNEY & ASSOC
1925 NICOLLET AVE
MINNEAPOLIS 3, MINN
612 338 0523
DESIGN & SALES ENG CO
2050 WOODSON RD
ST LOUIS, MO
314 ST 1 3388
DESIGN & SALES ENG CO
3506 N W 58TH TERRACE
KANSAS CITY, MO 64133
816 GR 1 1640
BRESSLER ASSOC
4808 BERGENLINE AVE
UNION CITY, N J 07087
201 UN 4 9577
E E HARRIES & CO INC
15 CANTERBURY LANE
E AURORA, N Y 14052
716 652 1221
E E HARRIES & CO INC
110 FAYETTE CIRCLE
FAYETTEVILLE, N Y 13D66
315 637 9871
E E HARRIES & CO INC
216 SHOREWOOD DRIVE
WEBSTER, N Y
716 671 6365
OESING & SALES ENG CO
10217 E 4TH STREET
TULSA, OKLA 74127
918 LU 7 8474
ELECTRONIC SALES
1825 NORTH EMERSON ST
PORTLAND, OREGON 97217
503 289 0980
MASSEY ASSOC INC
1325 W CHESTER PIKE
HAVERTOWN, PA
215 JA 8 6384
TEXAS AVIONICS CO
4515 PRENTICE ST
DALLAS, TEXAS
214 EM 8 3566
TEXAS AVIONICS CO
1108 MYER
SEABROOK, TEXAS 77586
713 GR 4 3154
ELECTRONIC SALES
6969 CALIFORNIA ST
P O BOX 6535
SEATTLE, WASH

"VITAL" BROADCAST VIDEO PRODUCTS

EXAMINE OUR PERFORMANCE AND CONVENIENCE FEATURES

COLOR STABILIZING AMPLIFIER

Model VI-500 corrects a number of faults often encountered in television transmission. Also provides for independent control of video, sync. and chroma. Additional features include optional sync. addition to non-composite inputs, a 4v. p.-p. sync. output, cable loss equalizer, white stretch, white clip and four video outputs. Remote control of all major operational functions optional. Power supply regulation and temperature compensation contribute to high operational stability.

Clamping—More than 35 db. reduction of extraneous 60 Hz sine wave. Automatic Video Level Control—Holds output luminance peaks constant within 3% for input level change of -3 to +10 db. Attack and release times 0.05 seconds. Differential Gain—Less than 1%, 10% to 90% APL at 1 volt peak to peak output. Differential Phase—Less than 0.5°, 10% to 90% APL at 1 volt peak to peak output. Chroma Control—Varies chroma response +4 db. of unity. Price: with white stretch . . . \$1750.00; With non-composite color output . . . \$1850.00.

PULSE DISTRIBUTION AMPLIFIER

Model VI-20 delivers exceptionally clean pulses even when input pulses seriously degraded. Pulse reforming action eliminates overshoots, rounding, ringing, tilt, poor rise and fall times, and effects of line reflections. Output pulse shape and amplitude essentially independent of input pulse shape and amplitude, but timing remains unaltered. A unique feature is a front panel indicator lamp which flashes when pulses are lost.

Input Level—1.5 to 10 volts peak to peak negative into a 75 ohm termination, loop-through or bridging connection. Output Levels—All four outputs identical, 3.5 to 4.5 volts peak to peak, continuously adjustable. Less than 2% change in output amplitude for 5 to 1 change in input amplitude or -30% change in line supply voltage. Price of four amplifiers complete with rack mounting frame . . . \$1100.00.

VIDEO DISTRIBUTION AMPLIFIER

Model VI-10A features exceptionally low differential gain and phase and is designed for the most critical color or monochrome use. Plug-in construction, with self-contained regulated power supply, silicon semiconductors throughout and available with an optional accessory remote gain control.

Video Input—0.5 to 2 volts peak to peak; no significant change in performance for 2 volt, peak to peak. Outputs—All four outputs: 75 ohms, ±2%. Normal output levels: 1 volt, peak to peak. Isolation between outputs: 36 db. at 1 MHz. Gain—Continuously adjustable from -6 db. to +6 db. Differential gain—Less than 0.1%, 10% to 90% APL at 1 volt, peak to peak output, operating into any or all four output loads. Differential Phase—Less than 0.1°, 10% to 90% APL, at 1 volt, peak to peak output, operating into any of all four output loads. Frequency Response—±0.25 db. to 20 MHz Low Frequency Tilt—Less than 1% on a 60 Hz square wave. Signal to Noise Ratio—70 db. below 1 volt, peak to peak output. Price of four amplifiers complete with rack mounting frame . . . \$1100.00.

SYNC & BLANKING ADDER

Model VI-41 is used to add composite sync. and blanking pulses to as many as 12 video sources by resistive mixing. Pulses to be added are amplified to high level and fed through relatively high mixing resistances to video circuits. Isolation between video terminals to which pulses are added is not adversely affected.

Inputs—4 volts, peak to peak nominal, both sync. and blanking pulses. Inputs terminated in 75 ohms ±2%. Outputs—Sync. added to video: 0 to 0.5 volt, peak to peak, continuously adjustable. Blanking added to video: 0 to 0.15 volts, peak to peak, continuously adjustable. Less than 1% change in added pulse amplitude for any supply voltage from 85 to 140 volts. Overshoots, Rounding and Ringing—Each less than 1%. Tilt—Less than 0.5% on vertical blanking pulses. Price . . . \$275.00.

Built to meet your operating needs by engineers with extensive use experience. All comments or inquiries are welcomed.

CALL OR WRITE



VITAL INDUSTRIES

Dept. E.

3614 SOUTHWEST ARCHER ROAD
GAINESVILLE, FLORIDA
PHONE 378 1581

206 WE 2 0330
REPS IN OTHER COUNTRIES
WILLARD SPENSER CO
3238 CURRY ST
WINDSOR, ONTARIO
ELECTRO TEC MARKETERS LTD
1624 WEST THIRD AVE
VANCOUVER 9, B C
ALEX L CLARK LTD
206 HAMMOND BLDG
63 ALBERT STREET
WINNIPEG, MANITOBA
ELECTRO TEC MARKETERS LTD
1767 MAIN ST N OFF 211
WINNIPEG, MANITOBA
204 338 2884
ALEX L CLARK LTD
3751 BLOOR ST W
ISLINGTON, ONTARIO
416 231 3303
ALEX L CLARK LTD
2500 BATES ROAD RM 102
MONTREAL 29, QUEBEC
514 739 3231

VISUAL ELECTRONICS CORPORATION
VICE PRESIDENT - SALES
GEORGE H WAGNER
BRAND NAMES
VISUAL
FLCON
NORELCO
PLUMRICON R
ALLENIZED
COMPANY ADDRESS
356 WEST 40TH STREET
NEW YORK, NEW YORK 10018
COMPANY REPRESENTATIVES
JACK DANIELS
ELSCO
4533 N SCOTTSDALE ROAD
SCOTTSDALE, ARIZONA 85251
602 946 4658
ALFRED A KALLMAN
1617 EL CENTRO AVE
HOLLYWOOD 28, CALIF
213 466 6417
TWX 910 321 3853
ROBERT W KUHL
1208 POPLAR AVE
SUNNYVALE, CALIF
408 245 8696
RICHARD WHITE
ELSCO COLORADO, INC
2875 NORTH SPEER BLVD
DENVER, COLORADO 80211
303 433 7991
LEWIS RADFORD
4246 PEACHTREE ROAD
ATLANTA, GEORGIA
404 237 9202
TWX 810 751 8275

FELIX BONVOULOIR
KEMPER BLDG
20 NORTH WACKER DRIVE
CHICAGO, ILLINOIS
312 372 3383
TWX 312 222 0165
LINTON D HARGREAVES
409 SOUTH KENTUCKY
MASON CITY, IOWA
515 423 1971
EO CLAMMER
594C AVON DRIVE
BETHESDA, MARYLAND
301 365 1767
DANIEL GREEN
3 BUCKINGHAM ROAD
NATICK, MASS
617 237 0334
AL TIMMS
621 BEVERLY DRIVE
MAGNOLIA, NEW JERSEY
609 783 7120
MORRIS A MAYERS
JESSICA C RAFSKY
J P GALLAGHER
356 WEST 40 STREET
NEW YORK, NEW YORK 10018
212 736 5840
TWX 710 581 2810
HENDRIK J ANTONISSE
INTERNATIONAL HEADQUARTERS
356 WEST 40 STREET
NEW YORK, NEW YORK
212 736 5840
JAMES HOWARD
411 PRICE STREET
THOMASVILLE, N CAROLINA
919 476 4430
A W GREEFSON
319 HONEWOOD AVE
GREENSBORO, N CAROLINA
919 292 1791
PHILLIP D THOMPSON
2550 WEYMOUTH ROAD
WINSTON-SALEM, N CAROLINA
919 765 3157
CHESTER A SIEGRIST
1107 CATHEORAL STREET
LEBANON, PA
717 273 5691
CARL C HAYWORTH
1503 OCONNOR ROAD
IRVING, TEXAS
214 254 9063
WAYNE MARCY
4007 BELLAIRE
HOUSTON, TEXAS
713 668 4896
SAM KICHAS & ROBERT BACON
P O BOX 15068
SALT LAKE CITY, UTAH
801 466 8631

REPS IN OTHER COUNTRIES
VISUAL ELECTRONICS
CORPORATION CANADA LTD
VICTORIA STATION
MONTREAL 6, QUEBEC
514 481 5500
C R WEBSTER
VISUAL ELECTRONICS INTL
79 LONDON STREET
READING, BERKSHIRE, ENGLAND
ORE 4 50422
MIGUEL PEREYRA
VISUAL ELECTRONICS, S A
GENOVA 20
DESPECAHO 6
MEXICO 6, D. F.
28 88 82

VITAL INDUSTRIES
SALES MANAGER
WILLIAM BOEHME
BRAND NAMES
VITAL
COMPANY ADDRESS
3614 S. W. ARCHER ROAD
GAINESVILLE, FLORIDA 32601
COMPANY REPRESENTATIVES
PENINSULA ASSOCIATES
1447 BAYSHORE ROAD
PALO ALTO, CALIF.
415-322-1803
ELECTRONIC SALES CORP.
2275 S. W. TEMPLE
SALT LAKE CITY, UTAH 84115
801-466-8631
REPS IN OTHER COUNTRIES
CALDWELL A/V EQUIPMENT CO.
135 MIDWEST ROAD
SCARBOROUGH, ONTARIO
751-0881

VITRO ELECTRONICS
SALES MANAGER
JOHN BIRCH
BRAND NAMES
VUE-CLARKE
VITRO
COMPANY ADDRESS
919 JESUP-BLAIR DRIVE
SILVER SPRING, MD. 20910

VUE-TRONICS INC.
SALES MANAGER
FRED SILVA
BRAND NAMES
VUE-TRONICS
COMPANY ADDRESS
15844 STRATHERN ST
VAN NUYS, CALIF 91406

WABER ELECTRONICS INC
SALES MANAGER
ARNOLD GOLOMAN
BRAND NAMES
SKINSULATED CIRCUITRY
LAB-ON-WHEELS
POWERLINE
SKINNY MILTON
SKINNY MARIE
FAT PHOEBE
LONG JOHN
STRING BEAN
VARI-FINE
STEREO MAGIC
COMPANY ADDRESS
2000 N 2ND STREET
PHILADELPHIA, PA 19122
215 NE 4-3200
COMPANY REPRESENTATIVES
M K SMITH
2805 1/2 CAHABA RD
BIRMINGHAM, ALA
205 871 9341
HYDE ELECTRONICS CO INC
4710 N 16TH ST
PHOENIX, ARIZONA
602 264 5609
S LEWIS & ASSOC
BOX 352
N HOLLYWOOD, CALIF
213 877 0461
I BALLARD CO INC
556 CLAY ST
SAN FRANCISCO, CALIF
415 781 1781
HYDE ELECTRONICS CO INC
888 S LIPAN ST
DENVER, COLO
303 936 3456
M K SMITH CO
1845 TEMPLE DR
WINTER PARK, FLA
305 647 0026
M K SMITH CO
31-16TH ST N W
ATLANTA, GA
404 875 8031
G PIETY FACTORS INC
160 MOKAUEA ST
HONOLULU, HAWAII
808 837 185
HILL & GRAY INC
871 GARFIELD ST
OAK PARK, ILLINOIS
312 378 7050
R MILSK CO
3231 N MERIDIAN SUITE 72
INDIANAPOLIS, IND
317 923 1545
M F BETTIS CO
423 NORTH FOUNTAIN
WICHITA, KANSAS

316 MU 5 7441
R MILSK CO
6908 BEDFORD LANE
LOUISVILLE, KY
502 425 6984
SCOTT ORMSBY SALFS
730 20TH ST
NEW ORLEANS, LA
504 488 2414
R MILSK CO
19375 JAMES COUZENS HWY
DETROIT, MICH
313 342 6660
R MILSK CO
200 N DIVISION AVE RM 205
GRAND RAPIDS, MICH
616 451 0615
C R GIBR CO
2400 HFNNEPIN AVE
MINNEAPOLIS, MINN
612 377 1200
F A BETTIS CO
3718 BROADWAY
KANSAS CITY, MO
816 JE 1 1530
M E BETTIS CO
3706 BROADWAY
KANSAS CITY, MO
816 561 0772
M E BETTIS CO
9103 BESSERER
ST LOUIS, MO
314 MA 9 2099
HYDE ELECTRONICS CO INC
5206 CONSTITUTION NE
ALBUQUERQUE, NEW MEXICO
505 265 8895
HARRIS & ALDRICH SALES INC
42-34 195TH ST
FLUSHING, NEW YORK
212 357 7350
W TAUBER CO
151 FAYFITS BLVD
SYRACUSE, NEW YORK
315 446 7794
M K SMITH CO
1605 CHATHAM AVE
CHARLOTTE, N CAROLINA
704 376 5951
H LEWIS CO
1801 J F KENNEDY BLVD
PHILADELPHIA, PA
215 567 2068
TANNER CO
486 BROADMOOR AVE
PITTSBURGH, PA
412 561 4687
E L WILKS CO
1821 N BROADWAY
CARROLLTON, TEXAS
214 242 5321
HYDE ELECTRONICS CO INC
85 E 7TH ST S
SALT LAKE CITY, UTAH
801 355 5361
M K WIDDEKIND CO INC
815 W EWING ST
SEATTLE, WASH
206 284 8020

WALLACE & ASSOCIATES, INC.

SALES MANAGER
CHARLES O. WALLACH
BRAND NAMES
DISCABINETS
DISCOMBILE
MOBILE A-V CENTER
REELMOBILE
COMPANY ADDRESS
5701 EUCLID AVE.
P O BOX 18167
CLEVELAND, OHIO 44118

WARD ELECTRONIC INDUSTRIES

SALES MANAGER
G. KURT BUTENHOFF
BRAND NAMES
WARD
COMPANY ADDRESS
142 CENTRAL AVENUE
CLARK, NEW JERSEY 07066
201-382-3700
COMPANY REPRESENTATIVES
PAUL EDMONDS
WARD ELECTRONIC INDUSTRIES
17350 SUNSET BLVD
PACIFIC PALISADES, CALIF.
213 454-5731
PAUL AUDET
WARD ELECTRONIC INDUSTRIES
636 TRAVERS COURT
CHICAGO HGTS, ILL.
312 754-0076

WATERS MANUFACTURING, INC.

SALES MANAGER
ROBERT A. WATERS
COMPANY ADDRESS

533 BOSTON POST ROAD
WAYLAND, MASS. 01778

WAVEFORMS, INCORPORATED

SALES MANAGER
A. E. RYERS
COMPANY ADDRESS
333 6TH AVENUE
NEW YORK, NEW YORK 10014
212-929-2795
COMPANY REPRESENTATIVES
KOESSLER SALES CO
818 N FAIRFAX
LOS ANGELES 46, CALIF
OL 3-1605
KENNETH B MEYERS CO
7756 W TOUNY AVE
CHICAGO 48, ILL
SP 4-6440
BORDEWIECK ENG SLAES CO
221 GROVE STREET
BRAINTREE 84, MASS
VI 3-0865
HARRIS HANSEN CO
2814 SOUTH BRENTWOOD
ST LOUIS, MO
444-9494
RCA R6CP DIV
FRONT & COOPER STREET
CAMDEN, N J
WO 3-8000
HAYS CO
405 N BOWSER
RICHARDSON, TEXAS
231-1426

WECKESSER COMPANY, INC

SALES MANAGER
C. J. CZAPINSKI, JR.
BRAND NAMES
NY-GRIP
STRAP-TITE
TAB-LOC
ETHO-LOC
WEDGE LOCK
STRAINCHECK
COMPANY ADDRESS
4444 WEST IRVING PARK ROAD
CHICAGO, ILLINOIS 60641
312 282 8626
COMPANY REPRESENTATIVES
EMORY DESIGN & EQUIP. CO.
404 DEXTER AVENUE
BIRMINGHAM, ALA. 35213
205-871-1369
HOWE & HOWE SALES
4344 EAST INDIAN SCHOOL RD.
PHOENIX, ARIZONA 85016
602 265-9185
WESCO ELECTRONICS
2620 EAST WALNUT
PASADENA, CALIF. 91107
213 684-0880
WIN. W. TOMPKINS & CO.
3944 EL CAMINO REAL
PALO ALTO, CALIF. 94306
415 326-7940
FRANKLIN SALES COMPANY
2149 SOUTH CLERMONT
DENVER, COLO. 80222
303 757-1371
WHITEHEAD FASTENERS
P. O. BOX 190
WINDSOR, CONN 06095
203-680-4921
KELLY SCHMITZ-WINKLER
3831 43RD STREET
DES MOINES, IOWA 50310
515 CR 9-9235
WHITEHEAD FASTENERS
281 ALBANY
CAMBRIDGE, MASS 02139
617- TR6-4680
JENSEN-MORROW SALES
26711 WOODWARD AVENUE
ROYAL OAK, MICHIGAN 48070
313-544-3700
SERVCO
521 SOUTH 7TH STREET
MINNEAPOLIS, MINN 55415
612-339-8611
KELLY SCHMITZ-WINKLER
7546 TROOST AVE
KANSAS CITY, MISSOURI 64131
816-EM3-5651
KELLY-SCHMITZ-WINKLER
2319 HAMPTON AVENUE
ST. LOUIS, MO. 63139
314 ST 1-6111
MILTON LOSS
4322 NORTH 56TH STREET
OMAHA, NEBRASKA 68104
402 451-0124
WHITEHEAD FASTENERS
P. O. BOX 102, MILIK STA.
CARTERET, NEW JERSEY 07008
201-969-2000
WHITEHEAD FASTENERS

2128 ELMWOOD AVENUE
BUFFALO, N. Y. 14207
716-TR6-3100
WHITEHEAD FASTENERS
P. O. BOX 212
EAST SYRACUSE, N. Y. 13201
315-MO3-6241
INTERNATIONAL TECHNICAL PROD.
EXPORT
303 WEST 42ND STREET
NEW YORK CITY, N.Y. 10036
212 CI 6-2080
E. A. ALEXANDER COMPANY
15437 HEMLOCK POINT ROAD
CHAGRIN FALLS, OHIO 44022
216-ED8-6861
CHARLES W. THOMAS, INC.
4540 WORTH STREET
PHILADELPHIA, PENN 19124
215-PI4-3100
CONTACT ELECTRONICS
2403 FARRINGTON
DALLAS, TEXAS 75207
214 ME 1-9530
RAY JOHNSTON COMPANY, INC.
1011 NORTHEAST 69TH STREET
SEATTLE, WASH. 98115
206 LA 4-5170
C. S. POLACHEK & ASSOCIATES
4027 NORTH DOWNER AVE
MILWAUKEE, WIS. 53211
414-964-5565
REPS. IN OTHER COUNTRIES
NORTECH ELECTRONICS
1335 LAWRENCE AVENUE EAST
DON MILLS, ONTARIO
416 447-6471

WESTINGHOUSE ELECTRIC CORP.

ELECTRONIC TUBE DIVISION
MARKET MANAGER
L. L. GRANT
COMPANY ADDRESS
BOX 284
ELMIRA, N Y 49502
RE 9 3611
SALES OFFICES
ELECTRONIC COMPONENTS AND
SPECIALTY PRODUCTS
89 HOLIDAY OFFICE ENTER
HUNTSVILLE, ALABAMA
205 881-2591
1802nd S SANTA FE AVENUE
COMPTON, CALIF. 90224
213 636 0111
1102 N 21ST AVENUE BDX 6144
PHOENIX, ARIZONA 85005
602 258-7211
600 ST. PAUL AVENUE
LOS ANGELES, CALIF. 90017
213 482-9660
BLDG. 73, HENDY AVENUE
SUNNYVALE, CALIF. 94088
408 735-3011
55 W. FIFTH AVENUE
DENVER, COLO. 80204
303 534-8121
360 MARKET STREET
HARTFORD, CONN. 06103
203 249-5792
1625 K STREET, N.W.
WASHINGTON, D.C. 20006
202 628-8843
367 N. ORANGE AVENUE
ORLANDO, FLA. 32802
305 425-4511
1299 NORTHSIDE DRIVE, N.W.
ATLANTA, GEORGIA 30302
404 351-5200
10 SOUTH RIVERSIDE PLAZA
CHICAGO, ILL. 60606
312 461-7200
1560 STADIUM DRIVE
INDIANAPOLIS, IND. 46207
317 632-3301
1055 TAYLOR AVENUE
TOWSON, MARYLAND 21204
301 828-5400
800 BOYLSTON STREET
BOSTON, MASS. 02199
617 542-0600
5757 TRUMBULL AVENUE
DETROIT, MICH. 48232
313 872-7010
281 LEONARD STREET, N.W.
GRAND RAPIDS, MICH. 49504
616 456-1531
3501 S. HIGHWAY 100
MINNEAPOLIS, MINN 55416
612-927-6551
411 N. SEVENTH STREET
ST. LOUIS, MISSOURI 63101
314-421-6911
67 EVERGREEN PLACE
E. ORANGE, N J 07018
201-465-0222
43 W. FRONT STREET
RED BANK, N J 07771

201-747-5800
4301 OLD VESTAL ROAD BOX 148
JOHNSON CITY, N. Y. 13850
607-729-2258
1501 FRANKLIN AVENUE
MINNEOLA, NEW YORK 11501
516-248-9800
711 EXCHANGE STREET
ROCHESTER N. Y. 14603
716-232-4380
ILLUMINATING BLDG
55 PUBLIC SQUARE
CLEVELAND, OHIO 44113
716 579 2121
1306 FARR DRIVE
DAYTON, OHIO 45404
513-461-3720
3001 WALNUT STREET
PHILADELPHIA, PENN 19104
215-878-1300
CHATHAM CENTER OFFICE BLDG.
PITTSBURGH, PFNN 15222
412-255-3800
8400 JOHN W. CARPENTER FWY
DALLAS, TEXAS 75247
214-631-2811
567 DALLAS AVENUE
HOUSTON, TEXAS 77002
713-274-7791
3451 MARGINAL WAY
SEATTLE, WASH 98134
206-623-7001
53R N. BRADWAY AVENUE
MILWAUKEE, WISCONSIN 53201
414-276-1800

WIDE RESPONSE

SALES MANAGER
J. C. CUBBAGE
COMPANY ADDRESS
2926 BENTLEY AVE.
LOS ANGELES, CALIF. 90064
213-477-5840

WILKINSON ELECTRONICS, INC

BRAND NAMES
WILKINSON
COMPANY ADDRESS
1937 W MACDADE BOULEVARD
WOODLYN, PA. 19094

WILSON CORPORATION

SALES MANAGER
DAVID D. SCHWARTZ
BRAND NAMES
MOVIE-MOVER
WILSON
COMPANY ADDRESS
546 W. 119TH STREET
CHICAGO, ILL. 60628

XCELITE INCORPORATED

PRESIDENT
ARCH WARDEN
BRAND NAMES
XCELITE
COMPANY ADDRESS
THORNE AND BANK STREETS
ORCHARD PARK, NEW YORK 14127

YOKOGAWA ELECTRIC WORKS, INC.

SALES MANAGER
RIO IIMAMURA
BRAND NAMES
HANDI-CRANK
HANDI-MITE
YEW
COMPANY ADDRESS
1995 PALMER AVE.
LARCHMONT, NEW YORK 10538
COMPANY REPRESENTATIVES
HALLMARK STANDARDS INC
145 LIBRARY LANE
MAMARONECK, NEW YORK
914 OW 8-8460
REPS. IN OTHER COUNTRIES
STARK ELECTRONIC INST SALES
AJAX, ONTARIO
416 WH 2-2120

ZOLOMATICS CORPORATION

SALES MANAGER
CHARLES STENNING
COMPANY ADDRESS
5875 MELROSE AVE.
HOLLYWOOD, CALIF. 90038

ZOOMAR, INC

P SALES
WALTER P. STEVER
BRAND NAMES
ZOOMAR
OPTICOMETER
COMPANY ADDRESS
55 SEA CLIFF AVE.
GLEN COVE, N. Y. 11542

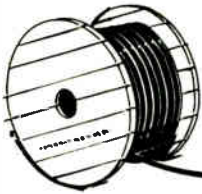

Ready!

SUPERIOR
L-O-N-G L-I-N-E
LOW-LOSS
COAXIAL TRUNK
CABLE

"6 AWG bare soft drawn copper conductor"



Maximum Attenuation db/100 ft. at 68°F			
Channel 6		Channel 13	
Nominal	0.52	Nominal	0.85
Maximum*	0.55	Maximum*	0.89

*These are limits as indicated by production to date. Until a permanent specification sheet is issued, these maximum values should be reconfirmed by our engineering department at the time of system design.

TRUSTWORTHY! When you look to SUPERIOR CABLE . . . you can depend on the data, depend on the promised performance . . . because SUPERIOR CABLE leads the industry in the determination to apply absolute quality controls, through every step of design and manufacture! Features of 4940: Cell-O-Air expanded polyethylene dielectric; "Coppergard" Shield; jackets marked with sequential footage at 2-foot intervals; reels fully sweep-tested.

- **FULL SPECTRUM CAPABILITY**
- **LONG TERM TRANSMISSION STABILITY**
- **BUILT-IN RELIABILITY**

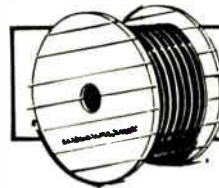

Every reel SWEEP-TESTED over its full length!
 Measured Ch. 13 attenuation stenciled on each reel of 4940.



5-YEAR GUARANTEE
ASK TO SEE IT!

For detailed information and prices, write



SUPERIOR CABLE

SUPERIOR CABLE CORPORATION / HICKORY, NORTH CAROLINA 28601

1967/The Broadcast Industry BUYERS GUIDE 127



MODEL CX 711

For the control room where simplicity is the key to accuracy.



MODEL CX 822

For the studio where flexibility means creative productions.

MADE ONLY IN AMERICA



Leadership

IN QUALITY DEPENDABILITY PERFORMANCE

ELECTRONIC ACHIEVEMENTS

- 👑 Performance as yet unequalled
- 👑 Two years proven Solid State circuitry
- 👑 Extremely low noise electronics
- 👑 Etched circuit modules

TRANSPORT DEPENDABILITY

- 👑 Patented Electro-Magnetic Brakes never need adjusting
- 👑 Complete head accessibility
- 👑 Precision Construction
- 👑 Low Wow and Accurate Tuning



CROWN recorders and players have been designed for continuous perfect performance. Skilled American craftsmen fabricate, assemble and individually adjust each CROWN to give you unequalled recording quality.

Our best salesmen are the studios and control rooms that have been using CROWN year after year. *Ask them!*



CROWN offers 40 models of players and recorders to meet your most specific and exacting requirements.

FOR COMPLETE
INFORMATION
WRITE OR PHONE
JOHN HAINES

Crown INTERNATIONAL

BOX 1000, ELKHART, INDIANA 46514 • PHONE (219) 523-4919



Engineering Data

A collection of data selected to be of value to the engineer or technician.

Courtesy Andrew Corporation

AUDIO NETWORKS

Unbalanced Configurations

Unbalanced networks encompass the T-type, taper pads, bridged-T, L-type, pi, ladder, and potentiometer.

You will notice, when looking through the network design equations, that the factor k appears in all equations. The k factor represents the ratio of current, voltage, or power corresponding to a given value of attenuation expressed in decibels.

To simplify the calculation of attenuator networks, the values of the most frequently used expressions, as tabulated by P. K. McElroy, are given in Table 1. Values for the expressions are substituted in the equations, thus saving much time and resulting in greater accuracy.

It is recommended, when large amounts of attenuation are required, that the loss be divided between two or more attenuator networks. This reduces the possibility of leakage at the higher frequencies and simplifies the construction, because some circuit element values become quite small as the attenuation is increased. As an example, if 80 dB of attenuation is required, it is far more practical to employ two tandem-connected 40-dB pads than to construct one of 80-dB loss. The 80-dB pad would require a shunt resistor of 0.12 ohms for a T-type attenuator, whereas in the 40-dB network it would be 12 ohms.

The given loss of an attenuator can only be obtained when the input and output circuits of the attenuator network are terminated in the design impedance. Although the terms input and output are frequently used in the discussion of attenuators, in reality there is no input or output to an attenuator; it makes no difference to the network which side is connected to the source or terminating circuit as long as the impedance match is satisfied. If a pad designed to operate between 600 ohms and 250 ohms is reversed, the pad will operate; however, the mismatch will cause a loss of level and may result in serious frequency distortion because of the impedance mismatch. The actual loss in decibels, for a given mismatch of impedance, is shown graphically in Fig. 1.

Material for the section "Audio Networks" has been adapted from the Howard W. Sams book Passive Audio Network Design, by Howard M. Tremaine.

T Configuration

A T-configuration network consists of three noninductive resistors, as shown in Fig. 2. T-type networks may be designed to operate between impedances of equal or unequal values. When properly designed, they will present an impedance match to both the source and load impedances regardless of the amount of loss. If the input and output impedance are of the same value, they are designated by the symbol Z . If they are of unequal values, symbols Z_1 and Z_2 are used. Symbols R_1 , R_2 , and R are used only with unequal impedances. For equal impedance R_1 appears in both the input and output sides, and the shunt resistor is then designated as R_2 (Fig. 2A). The resistor values for a pad to operate between *equal* impedances may be calculated:

$$R_1 = \left(\frac{k - 1}{k + 1} \right) Z$$

$$R_2 = \left(\frac{k}{k^2 - 1} \right) 2Z$$

where,

Z is the input and output impedance,
 R_1 is the series resistor,
 R_2 is the shunt resistor.

As an illustration, assume an attenuator is to be designed for a loss of 10 dB and is to operate in a 600-ohm circuit. Referring to Table 1, the k factor for R_1 at a loss of 10 dB is 0.519, and for R_2 it is 0.351; therefore:

$$\begin{aligned} R_1 &= 0.519 \times 600 \\ &= 311.4 \text{ ohms} \\ R_2 &= 0.351 \times 1200 \\ &= 421.2 \text{ ohms} \end{aligned}$$

Practical construction of this network would require two 310-ohm and one 420-ohm resistors.

Table 1. K Factors for Calculating Attenuator Loss Values

n(dB)	$r = \frac{1}{k}$	k	k ²	$\frac{k-1}{k+1}$	$\frac{k+1}{k-1}$	$\frac{k}{k-1}$	$\frac{k-1}{k}$	$\frac{k^2-1}{k}$	$\frac{k^2+1}{k^2-1}$	$\frac{k-1}{k} = 1-r$	$\frac{k}{k-1} = \frac{1}{1-r}$	$\frac{1}{k-1}$	n(dB)
0.05	0.994260	1.0057731	1.011579	0.0028783	347.43	86.8618	0.011513	173.73	0.0057396	174.22	173.22	0.05	
0.1	0.98855	1.011579	1.023292	0.0057562	173.73	43.4030	0.023029	86.866	0.011448	87.363	86.363	0.1	
0.2	0.97724	1.023292	1.047128	0.011512	86.866	21.713	0.046052	43.437	0.022762	33.933	32.933	0.2	
0.3	0.96605	1.035143	1.071520	0.017268	57.911	14.473	0.069093	28.965	0.033949	19.455	18.455	0.3	
0.4	0.95499	1.047128	1.096477	0.023022	43.437	10.854	0.092138	21.730	0.045007	22.219	21.219	0.4	
0.5	0.94406	1.059254	1.12202	0.028774	34.754	8.6810	0.11519	17.391	0.055939	17.877	16.877	0.5	
0.6	0.93325	1.071520	1.14815	0.034525	28.965	7.2427	0.13827	14.499	0.066746	14.982	13.982	0.6	
0.7	0.92257	1.083928	1.17490	0.040274	24.830	6.1974	0.16136	12.435	0.077428	12.915	11.915	0.7	
0.8	0.91201	1.096477	1.20227	0.046019	21.730	5.4209	0.18447	10.888	0.087988	11.365	10.365	0.8	
0.9	0.90157	1.10917	1.23027	0.051763	19.319	4.8168	0.20760	9.6853	0.098429	10.160	9.1600	0.9	
1.0	0.89125	1.12202	1.25893	0.057502	17.391	4.3335	0.23077	8.7237	0.10875	9.1954	8.1954	1.0	
1.1	0.88105	1.13501	1.28825	0.063237	15.814	3.9376	0.25396	7.9384	0.11895	8.4069	7.4069	1.1	
1.2	0.87096	1.14815	1.31826	0.068968	14.499	3.6076	0.27719	7.2842	0.12904	7.7499	6.7499	1.2	
1.3	0.86099	1.16145	1.34896	0.074695	13.388	3.3283	0.30046	6.7313	0.13901	7.1939	6.1939	1.3	
1.4	0.85114	1.17490	1.38038	0.080418	12.435	3.0888	0.32376	6.2579	0.14886	6.7176	5.7176	1.4	
1.5	0.84139	1.18850	1.41254	0.086132	11.610	2.8809	0.34711	5.8480	0.15861	6.3050	5.3050	1.5	
1.6	0.83176	1.20227	1.44544	0.091846	10.888	2.6991	0.37051	5.4899	0.16824	5.9439	4.9439	1.6	
1.7	0.82224	1.21618	1.47911	0.097551	10.251	2.5384	0.39394	5.1744	0.17776	5.6258	4.6258	1.7	
1.8	0.81283	1.23027	1.51356	0.103249	9.6853	2.3956	0.41744	4.8944	0.18717	5.3427	4.3427	1.8	
1.9	0.80353	1.24452	1.54882	0.108939	9.1794	2.2676	0.44099	4.6442	0.19647	5.0897	4.0897	1.9	
2.0	0.79433	1.25893	1.58489	0.11463	8.7241	2.1523	0.46460	4.4195	0.20567	4.8620	3.8620	2.0	
2.0	0.77625	1.28825	1.65959	0.12597	7.9384	1.9531	0.51200	4.0322	0.22375	4.4692	3.4692	2.2	
2.4	0.75858	1.31826	1.73780	0.13728	7.2842	1.7867	0.55968	3.7108	0.24142	4.1421	3.1421	2.4	
2.5	0.74989	1.33352	1.77828	0.14293	6.9666	1.7133	0.58363	3.5968	0.25011	3.9983	2.9983	2.5	
2.6	0.74131	1.34896	1.81970	0.14856	6.7313	1.6457	0.60765	3.4399	0.25829	3.8657	2.8657	2.6	
2.8	0.72444	1.38038	1.90546	0.15980	6.2579	1.5245	0.65594	3.2088	0.27556	3.6289	2.6289	2.8	
3.0	0.70795	1.41254	1.99526	0.17100	5.8480	1.4192	0.70459	3.0095	0.29205	3.4240	2.4240	3.0	
3.2	0.69183	1.44544	2.08930	0.18215	5.4899	1.3269	0.75361	2.8360	0.30817	3.2450	2.2450	3.2	
3.4	0.67608	1.47911	2.18776	0.19326	5.1744	1.2453	0.80302	2.6838	0.32392	3.0872	2.0872	3.4	
3.5	0.66834	1.49623	2.2387	0.19879	5.0304	1.2079	0.82789	2.6147	0.33166	3.0152	2.0152	3.5	
3.6	0.66069	1.51356	2.2909	0.20432	4.8944	1.1725	0.85289	2.5493	0.33931	2.9472	1.9472	3.6	
3.8	0.64565	1.54882	2.3988	0.21532	4.6442	1.1072	0.90314	2.4298	0.35435	2.8221	1.8221	3.8	
4.0	0.63096	1.58489	2.5119	0.22627	4.4194	1.0483	0.95393	2.3229	0.36904	2.7097	1.7097	4.0	
4.5	0.59566	1.67880	2.8184	0.25340	3.9464	0.92323	1.08314	2.0999	0.40434	2.4732	1.4732	4.5	
5.0	0.56234	1.77828	3.1623	0.28013	3.5698	0.82241	1.21594	1.9249	0.43766	2.2849	1.2849	5.0	
5.5	0.53088	1.88365	3.5481	0.30643	3.2633	0.73922	1.35277	1.7849	0.46912	2.1317	1.1317	5.5	
6.0	0.50119	1.99526	3.9811	0.33228	3.0095	0.66932	1.49407	1.6709	0.49881	2.0048	1.0048	6.0	
6.5	0.47315	2.1135	4.4668	0.35764	2.7961	0.60964	1.6403	1.5769	0.52685	1.89807	0.89807	6.5	
7.0	0.44668	2.2387	5.0119	0.38246	2.6146	0.55801	1.7920	1.4985	0.55332	1.80730	0.80730	7.0	
7.5	0.42170	2.3714	5.6234	0.40677	2.4584	0.51291	1.9497	1.4326	0.57830	1.72918	0.72918	7.5	
8.0	0.39811	2.5119	6.3096	0.43051	2.3228	0.47309	2.1138	1.3767	0.60189	1.66142	0.66142	8.0	
8.5	0.37584	2.6607	7.0795	0.45366	2.2043	0.43765	2.2849	1.3290	0.62416	1.60216	0.60216	8.5	
9.0	0.35481	2.8184	7.9433	0.47622	2.0999	0.40592	2.4636	1.2880	0.64519	1.54993	0.54993	9.0	
9.5	0.33497	2.9854	8.9125	0.49817	2.0074	0.37730	2.6504	1.2528	0.66503	1.50368	0.50368	9.5	
10.0	0.31623	3.1623	10.000	0.51950	1.9249	0.35137	2.8581	1.2222	0.68377	1.46247	0.46247	10.0	
10.5	0.29854	3.3497	11.220	0.54020	1.8512	0.32775	3.0512	1.1957	0.70146	1.42559	0.42559	10.5	
11.0	0.28184	3.5481	12.589	0.56026	1.7849	0.30616	3.2663	1.1726	0.71816	1.39245	0.39245	11.0	
11.5	0.26607	3.7584	14.125	0.57969	1.7251	0.28635	3.4923	1.1524	0.73393	1.36253	0.36253	11.5	
12.0	0.25119	3.9811	15.849	0.59848	1.6709	0.26811	3.7299	1.1347	0.74881	1.33545	0.33545	12.0	
12.5	0.23714	4.2170	17.783	0.61664	1.6217	0.25127	3.9799	1.1192	0.76286	1.31085	0.31085	12.5	
13.0	0.22387	4.4668	19.953	0.63416	1.5769	0.23568	4.2429	1.1055	0.77613	1.28845	0.28845	13.0	
13.5	0.21135	4.7315	22.387	0.65108	1.5360	0.22123	4.5202	1.0935	0.78865	1.26799	0.26799	13.5	
14.0	0.19953	5.0119	25.119	0.66733	1.4985	0.20780	4.8124	1.0829	0.80047	1.24926	0.24926	14.0	
14.5	0.18836	5.3088	28.184	0.68298	1.4642	0.19529	5.1204	1.0736	0.81164	1.23208	0.23208	14.5	
15.0	0.17783	5.6234	31.623	0.69804	1.4326	0.18363	5.4456	1.0653	0.82217	1.21629	0.21629	15.0	
15.5	0.16788	5.9566	35.481	0.71250	1.4035	0.17275	5.7887	1.0580	0.83212	1.20175	0.20175	15.5	
16.0	0.15849	6.3096	39.811	0.72639	1.3767	0.16257	6.1511	1.0515	0.84151	1.18834	0.18834	16.0	
16.5	0.14962	6.6834	44.668	0.73970	1.3519	0.15305	6.5338	1.0458	0.85038	1.17595	0.17595	16.5	
17.0	0.14125	7.0795	50.119	0.75246	1.3290	0.14413	6.9382	1.04071	0.85875	1.16449	0.16449	17.0	
17.5	0.13335	7.4989	56.234	0.76468	1.3077	0.13577	7.3655	1.03621	0.86665	1.15387	0.15387	17.5	
18.0	0.12589	7.9433	63.096	0.77637	1.2880	0.12792	7.8174	1.03220	0.87411	1.14402	0.14402	18.0	
18.5	0.118850	8.4139	70.795	0.78755	1.2698	0.12055	8.2950	1.02866	0.88115	1.13488	0.13488	18.5	
19.0	0.112202	8.9125	79.433	0.79823	1.2528	0.11363	8.8003	1.02550	0.88780	1.12638	0.12638	19.0	
19.5	0.105925	9.4406	89.125	0.80844	1.2369	0.10713	9.3347	1.02269	0.89407	1.11847	0.11847	19.5	
20.0	0.100000	10.0000	100.000	0.81818	1.2222	0.10101	9.9000	1.02020	0.90000	1.11111	0.11111	20.0	
20.5	0.094406	10.5925	112.202	0.82747	1.2085	0.095255	10.498	1.01799	0.90559	1.10425	0.10425	20.5	
21.0	0.089125	11.2202	125.893	0.83634	1.1957	0.089841	11.131	1.01601	0.91087	1.09785	0.097845	21.0	
21.5	0.084139	11.8850	141.254	0.84478	1.1837	0.084739	11.801	1.01426	0.91586	1.09187	0.091870	21.5	
22.0	0.079433	12.589	158.49	0.85282	1.1726	0.079935	12.510	1.01270	0.92057	1.08629	0.086291	22.0	
22.5	0.074989	13.335	177.83	0.86048	1.1621	0.075411	13.260	1.01126	0.92501	1.08107	0.081070	22.5	
23.0	0.070795	14.125	199.53	0.86777	1.1524	0.071148	14.054	1.01007	0.92921	1.07619	0.076190	23.0	
23.5	0.066834	14.962	223.87	0.87470	1.1432	0.067133	14.895	1.00897	0.93317	1.07162	0.071623	23.5	
24.0	0.063096	15.849	251.19	0.88130	1.1347	0.063348	15.786	1.00799	0.93690	1.06734	0.067345	24.0	
24.5	0.059566	16.788	281.84	0.88756	1.1267	0.059778	16.728	1.00712	0.94043	1.06334	0.063339	24.5	
25.0	0.056234	17.783	316.23	0.89352	1.1192	0.056413	17.727	1.00634	0.94377	1.05958	0.059584	25.0	
25.5	0.053088	18.836	354.81	0.89917	1.1121	0.053238	18.783	1.00565	0.94691	1.05607	0.056066	25.5	
26.0	0.050119	19.953	398.11	0.90455	1.1055	0.050246	19.903	1.00504	0.94988	1.05276	0.052762	26.0	
26.5	0.047315	21.135	446.68	0.90965	1.0993	0.047422	21.088	1.00449	0.95268	1.04966	0.049665	26.5	
27.0	0.044668	22.387	501.19	0.91448	1.0935	0.044757	22.342	1.00400	0.95533	1.04676	0.046757	27.0	
27.5	0.042170	23.714	562.34	0.91907	1.0881	0.042245	23.672	1.00356	0.95783	1.04403	0.		



Numbers your TV cameras can read without eye-strain.

Numbers, letters, symbols. If they're in lights, they can cause problems. Ghosts appear and bulbs burn out. Their images may permanently damage camera tubes. Now CBS Laboratories offers the way out: Model DDU-1A electro-mechanical indicator units with characters displayed on a flat plane for optimum readability with viewing angles as high as 145°.

Here's the perfect way to display election return figures, ball scores, stock market or commodity exchange quotations and similar information.

A vertical split-flap "book page" mechanism provides uniform reflectivity and maximum character clarity under both high and low ambient lighting conditions.

Our Digital Display Units are the business end of a complete digital display system, including power supply

and a compact digital display control that allow rapid selection of up to 192 digits, letters or symbols.

Operating power of only 2.7 watts per unit means cool operation and low power control circuitry. No power at all is required between postings.

Modular construction permits high packing density with significant space savings and maximum flexibility. Custom characters and colors are available on special order.

The DDU-1As are priced from \$32.50 to \$50.00 each, depending on quantity ordered. Our Model 192 Digital Display Control is priced at \$1094. Custom design controls for special applications are no problem. Our Display System Engineers will help to plan your total system.

SPECIFICATIONS:

Character Description Maximum of 12 characters; digits 1 through 9, 0 and 2 blank positions supplied on standard unit

Character Dimensions Height: 1½ inches
Width: 1¼ inches

Unit Dimensions Height: 2¾ inches
Width: 2 inches
Length: 7 inches

Unit Weight 1½ lbs.

Power Requirements Motor: 60 cycle, 115 volts, AC
Relay: 24 volts, DC

Operating Power Maximum of 2.7 watts required

Operating Speed Consecutive change:
0.25 seconds
Complete 12-step cycle:
3.0 seconds

Mounting Bottom mounting holes:
2 front, 2 rear

Connections Jones Type P-318-AB Connector.

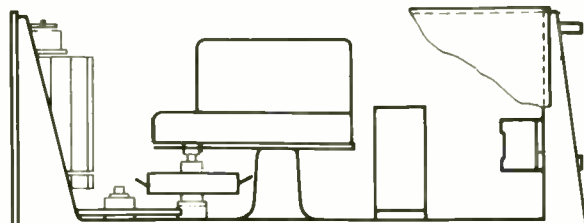

Model 192 Digital Display Control features fail-safe truth circuitry, automatic homing control, and provides positive control of up to 192 DDU-1As. Custom controls for larger systems are available.

CBS LABORATORIES
Stamford, Connecticut. A Division of
Columbia Broadcasting System, Inc.

34.5	0.018836	53.088	2,818.4	0.96302	1.03840	0.018843	53.069	1.00071	0.98116	1.01920	0.019198	34.5
35.0	0.017783	56.234	3,162.3	0.96506	1.03621	0.017788	56.216	1.00063	0.98222	1.01810	0.018105	35.0
36.0	0.015849	63.096	3,981.1	0.96880	1.03221	0.015853	63.080	1.00050	0.98415	1.01610	0.016104	36.0
37.0	0.014125	70.795	5,011.9	0.97214	1.02866	0.014128	70.781	1.00040	0.98588	1.01433	0.014328	37.0
37.5	0.013335	74.989	5,623.4	0.97368	1.02703	0.013338	74.976	1.00036	0.98666	1.01352	0.013516	37.5
38.0	0.012589	79.433	6,309.6	0.97513	1.02550	0.012591	79.420	1.00032	0.98741	1.01275	0.012750	38.0
39.0	0.0112202	89.125	7,943.3	0.97781	1.02270	0.0112216	89.114	1.00025	0.98878	1.01135	0.011348	39.0
40.0	0.0100000	100.000	10,000	0.98020	1.02020	0.0100010	99.990	1.00020	0.99000	1.01010	0.010101	40.0
40.5	0.0094406	105.925	11,220	0.98130	1.01906	0.0094414	105.916	1.00018	0.99056	1.00953	0.0095306	40.5
41.0	0.0089125	112.202	12,589	0.98233	1.01799	0.0089134	112.193	1.00016	0.99109	1.00899	0.0089926	41.0
42.0	0.0079436	125.89	15,849	0.98424	1.01601	0.0079436	125.88	1.00013	0.99206	1.00801	0.0080070	42.0
43.0	0.0070795	141.25	19,953	0.98594	1.01426	0.0070795	141.24	1.00010	0.99292	1.00713	0.0071301	43.0
43.5	0.0066834	149.62	22,387	0.98672	1.01346	0.0066834	149.61	1.00009	0.99332	1.00673	0.0067286	43.5
44.0	0.0063096	158.49	25,119	0.98746	1.01270	0.0063096	158.49	1.00008	0.99369	1.00635	0.0063496	44.0
45.0	0.0056234	177.83	31,623	0.98887	1.01131	0.0056234	177.83	1.00006	0.99438	1.00566	0.0056551	45.0
46.0	0.0050119	199.53	39,811	0.99003	1.01007	0.0050119	199.53	1.00005	0.99499	1.00504	0.0050370	46.0
46.5	0.0047315	211.35	44,668	0.99058	1.00951	0.0047315	211.35	1.000045	0.99527	1.00475	0.0047540	46.5
47.0	0.0044668	223.87	50,119	0.99111	1.00897	0.0044668	223.87	1.000040	0.99553	1.00449	0.0044869	47.0
48.0	0.0039811	251.19	63,096	0.99207	1.00799	0.0039811	251.19	1.000032	0.99602	1.00400	0.0039970	48.0
49.0	0.0035481	281.84	79,433	0.99293	1.00712	0.0035481	281.84	1.000025	0.99645	1.00356	0.0035607	49.0
50.0	0.0031623	316.23	100,000	0.99370	1.00634	0.0031623	316.23	1.000020	0.99684	1.00317	0.0031723	50.0
51.0	0.0028184	354.81	125,890	0.99438	1.00565	0.0028184	354.81	1.000016	0.99718	1.00283	0.0028264	51.0
52.0	0.0025119	398.11	158,490	0.99499	1.00504	0.0025119	398.11	1.000013	0.99749	1.00252	0.0025182	52.0
54.0	0.0019953	501.19	251,190	0.99602	1.00400	0.0019953	501.19	1.000008	0.99801	1.00200	0.0019992	54.0
55.0	0.0017783	562.34	316,230	0.99645	1.00356	0.0017783	562.34	1.000006	0.99822	1.00178	0.0017815	55.0
56.0	0.0015849	630.96	398,110	0.99684	1.00317	0.0015849	630.96	1.000005	0.99842	1.00159	0.0015874	56.0
57.0	0.0014125	707.95	501,190	0.99718	1.00283	0.0014125	707.95	1.000004	0.99859	1.00141	0.0014145	57.0
58.0	0.0012589	794.33	630,960	0.99749	1.00252	0.0012589	794.33	1.000003	0.99874	1.00126	0.0012605	58.0
60.0	0.0010000	1,000.0	10 ⁶	0.99800	1.00200	0.0010000	1,000.0	1.000002	0.99900	1.00100	0.0010010	60.0
65.0	0.00056234	1,778.3	3.1623 × 10 ⁶	0.99888	1.00112	0.00056234	1,778.3	1.000001	0.99944	1.00056	0.00056265	65.0
70.0	0.00031623	3,162.3	10 ⁷	0.99937	1.00063	0.00031623	3,162.3	1.000000	0.99968	1.00032	0.00031633	70.0
75.0	0.00017783	5,623.4	3.1623 × 10 ⁷	0.99964	1.00036	0.00017783	5,623.4	1.000000	0.99982	1.00018	0.00017786	75.0
80.0	0.00010000	10,000	10 ⁸	0.99980	1.00020	0.00010000	10,000	1.000000	0.99990	1.00010	0.00010001	80.0
85.0	0.000056234	17,783	3.1623 × 10 ⁸	0.99989	1.00011	0.000056234	17,783	1.000000	0.99994	1.00006	0.000056237	85.0
90.0	0.000031623	31,623	10 ⁹	0.99994	1.00006	0.000031623	31,623	1.000000	0.99997	1.00003	0.000031624	90.0
95.0	0.000017783	56,234	3.1623 × 10 ⁹	0.99996	1.00004	0.000017783	56,234	1.000000	0.99998	1.00002	0.000017783	95.0
100.0	0.000010000	10 ⁶	10 ¹⁰	0.99998	1.00002	0.000010000	10 ⁶	1.000000	0.99999	1.00001	0.000010000	100.0

(Courtesy Proceedings of the IRE.)

Taper Configuration

A taper pad is a T configuration (Fig. 2B) designed to operate between two circuits of unequal impedance. In this instance the symbols for the impedances become Z₁ and Z₂, with Z₁ being the larger of the two. The resistor values may be equated:

$$R_1 = Z_1 \left(\frac{k^2 + 1}{k^2 - 1} \right) - 2\sqrt{Z_1 Z_2} \left(\frac{k}{k^2 - 1} \right)$$

$$R_2 = Z_2 \left(\frac{k^2 + 1}{k^2 - 1} \right) - 2\sqrt{Z_1 Z_2} \left(\frac{k}{k^2 - 1} \right)$$

$$R_3 = 2\sqrt{Z_1 Z_2} \left(\frac{k}{k^2 - 1} \right)$$

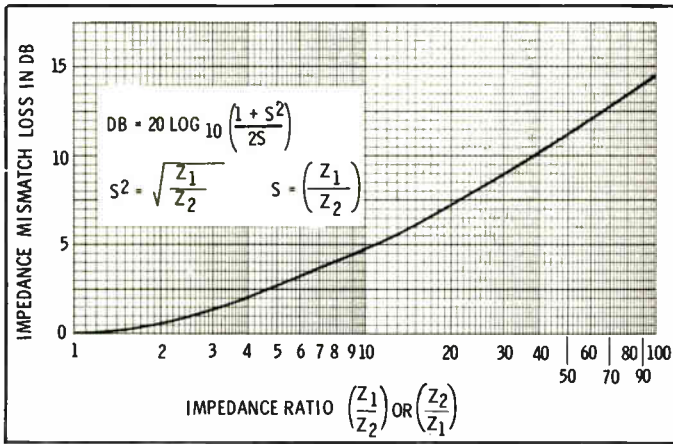

Fig. 1. Loss in level because of impedance mismatch.

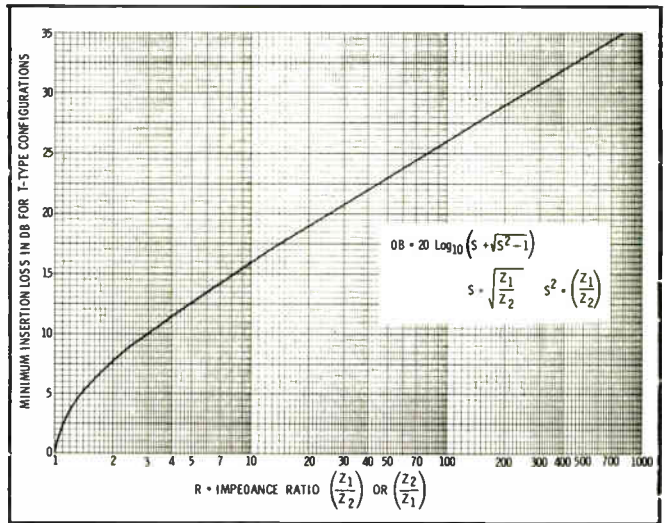

Fig. 3. Minimum loss chart for networks of unequal impedances.

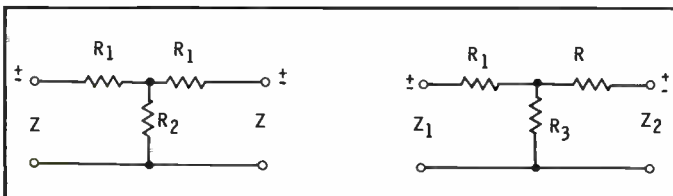

Fig. 2. Symbols used in the design of T-configuration networks.

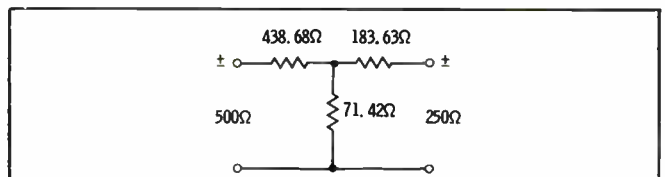

Fig. 4. Connections and circuit-element values for a 500- to 250-ohm taper pad with a 20-dB insertion loss.

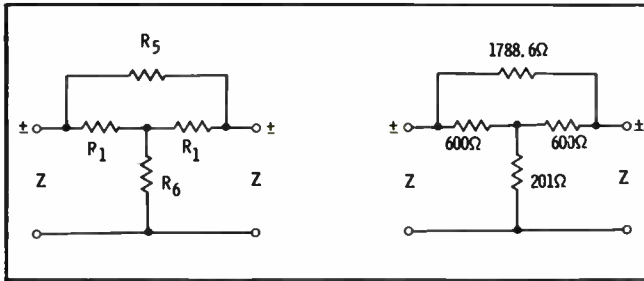

Fig. 5. Symbols and circuit-element values for a 600-ohm bridged-T attenuator with a 12-dB insertion loss.

the order of 6 dB, it could not be designed for such a loss. Using Table 1, the resistor values may now be calculated:

$$\begin{aligned} R_1 &= 500(1.0202) - 2(\sqrt{125,000}) \times 0.10101 \\ &= 510.1 - 2(353.55) \times 0.10101 \\ &= 510.1 - 71.42 \\ &= 438.68 \text{ ohms} \end{aligned}$$

$$\begin{aligned} R_2 &= 250(1.0202) - 2(\sqrt{125,000}) \times 0.10101 \\ &= 255.05 - 2(353.55) \times 0.10101 \\ &= 255.05 - 71.42 \\ &= 183.63 \text{ ohms} \end{aligned}$$

$$\begin{aligned} R_3 &= 2(\sqrt{125,000}) \times 0.10101 \\ &= 2(353.55) \times 0.10101 \\ &= 71.42 \text{ ohms} \end{aligned}$$

Practical values for the resistors would be 440, 185, and 72 ohms. The resistors are connected as shown in Fig. 4. If the 500-ohm side of the network is terminated in 500 ohms and an ohmmeter is connected across the 250-ohm side, the internal resistance will measure 250 ohms; when the procedure is reversed, the 500-ohm side will measure 500 ohms.

Bridged-T Configuration

The bridged-T attenuator is quite similar to the basic T network. The only difference in the configuration is the addition of the bridging resistor (R5), as shown in Fig. 5A. However, a bridged-T attenuator may only be used between circuits of equal impedance. In this network there are two resistors designated as R1, each resistor having a value equal to the line impedance; hence these values are known. This leaves only the bridging resistor (R5) and the shunt resistor (R6) to be determined. They are calculated as follows:

$$R_5 = (k - 1) Z$$

$$R_6 = \left(\frac{1}{k - 1} \right) Z$$

Assume that a bridge-T pad of 12-dB loss to work in a 600-ohm line circuit is to be designed. R1 will automatically equal 600 ohms. Solving for R5:

$$\begin{aligned} R_5 &= (3.981 - 1) \times 600 \\ &= 2.981 \times 600 \\ &= 1788.6 \text{ ohms} \end{aligned}$$

GENERAL PURPOSE MONITORS by MIRATEL

Now — get transistor reliability with Miratel general purpose monitors. Low first cost — minimum maintenance. High quality image resolution in all sizes — 8 to 23 inches. Also available in low cost vacuum tube type in kinescope sizes from 8 inches through 27 inches. Write for data and literature today. Miratel Electronics, Inc. 3620 Richardson St. New Brighton — St. Paul, Minn. 55112

... has more transistorized display experience than any other manufacturer

... is the first with large screen transistorized displays with 8 thru 27-inch picture tubes

... is the first with fully regulated all solid state monitors for both high and low voltages

... tests and certifies standard transistorized products to meet environmental requirements

Engineering Data

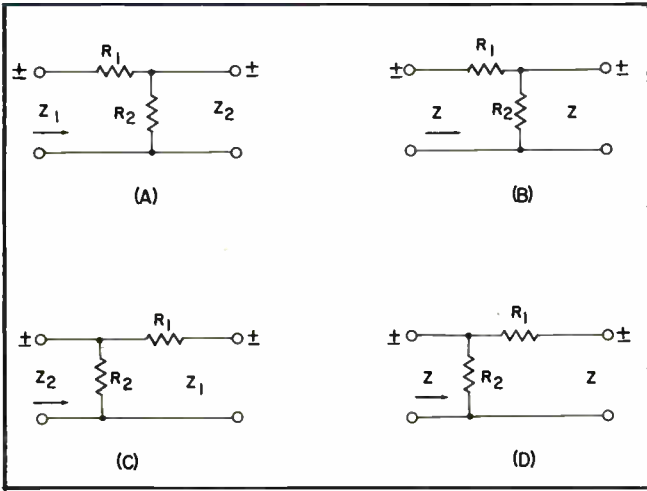

Fig. 6. L-type configurations.

Solving for R_2 :

$$R_2 = 0.335 \times 600 = 201 \text{ ohms}$$

For this problem, the first k factor was taken from column three and the second factor from column 12 of Table 1. The resistors are connected as shown in Fig. 5B.

L Configuration

An L configuration consists of two circuit elements connected to form an inverted letter L. Actually there are four variations of this basic configuration, as shown in Fig. 6. An L-type attenuator has a minimum loss like the taper pad described previously. L-type attenuators cannot be designed to reflect an impedance match in both directions, only in the direction indicated by the arrows in the illustrations.

If an L-type network is inserted into a circuit that is impedance sensitive, the circuit characteristics could be affected. L configurations should not be used, except when a minimum loss that cannot be satisfied by a T-type configuration is required. The minimum loss for an L-type network may be determined from the graph in Fig. 7. The procedure for using this graph is the same as described for the T configuration in Fig. 3.

For unequal impedances the match may be in the direction of the larger or smaller impedance, but not both, as shown in Figs. 6A and C. When an L-type network is connected to circuits of equal impedance (Figs. 6B and D), the circuits are matched in one direction, but not in the other. However, the network may be designed to match either of the terminating impedances.

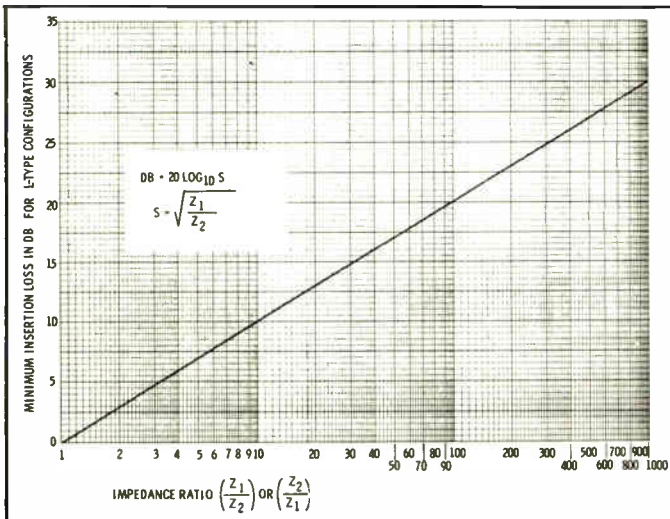

Fig. 7. Minimum loss graph for L-type attenuators.

The arrows in the illustrations indicate the direction of the impedance match. If the network is designed to match the impedance in the direction of the series resistor, the mismatch is always toward the shunt resistor. Impedance mismatch increases with an increase of loss. In some instances the ohmic value of the shunt resistor may become a fraction of an ohm, which can seriously affect the circuit in which it has been connected.

The configuration for an L-type network operating between unequal values of impedances (Z_1 and Z_2) is shown in Fig. 6A. Here the impedance match is toward the larger of the two (Z_1). The values of the resistors may be equated:

$$R_1 = \left(\frac{Z_1}{S} \right) \left(\frac{kS - 1}{k} \right)$$

$$R_2 = \left(\frac{Z_1}{S} \right) \left(\frac{1}{k - 1} \right)$$

where,

$$S = \sqrt{\frac{Z_1}{Z_2}}$$

For a condition where the impedances are equal and the impedance match is in the direction of the arrow (Fig. 6B), the values of the resistors are calculated:

$$R_1 = \left(\frac{k - 1}{k} \right) Z$$

$$R_2 = \left(\frac{1}{k - 1} \right) Z$$

If the impedances are unequal, and the impedance match is toward the smaller of the two impedances (Fig. 6C), the values of the resistors are determined by:

$$R_1 = \left(\frac{Z_1}{S} \right) (k - S)$$

$$R_2 = \left(\frac{Z_1}{S} \right) \left(\frac{k}{kS - 1} \right)$$

where,

$$S = \sqrt{\frac{Z_1}{Z_2}}$$

When the impedances are equal and the impedance match is in the direction of the shunt arm (Fig. 6D), the resistors are calculated by the following:

$$R_1 = (k - 1) Z$$

$$R_2 = \left(\frac{k}{k - 1} \right) Z$$

When selecting an L configuration, due consideration should be given to the effect it may have on the circuit into which it is to be connected. For example, if the series resistor is around 600 ohms, the shunt resistor approximately 60 ohms, and the configuration is used as an input or output termination for a transformer of an amplifier, there is no doubt that the frequency and distortion characteristics of the amplifier would be adversely affected. If the equipment terminated by the 60 ohms should happen to be a filter or equalizer, the frequency characteristics of these units would be *seriously* affected. Therefore, before considering the use of the L-type network, due consideration should be given to the effect on the circuit into which the network is to be connected.

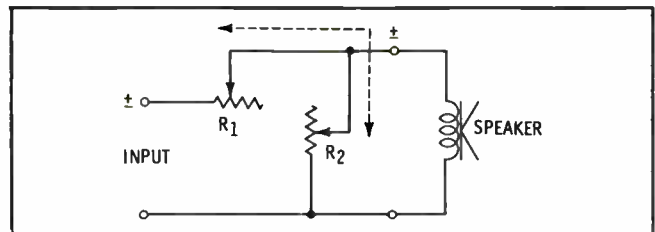

Fig. 8. L-type configuration used as speaker volume control.

Spotmaster



RA4CA REMOTE AMPLIFIER

RA-4CA Extremely lightweight, four channel, all solid state remote amplifier featuring self contained AC and battery power supplies. Uses easily obtainable, low cost standard "D" cells with up to 200 hours of battery life. Switches automatically from AC to battery operation if AC power fails. Rugged black armorhyde aluminum case with snap-on front cover. Recessed microphone plugs and line terminals on rear panel. PA feed control on front panel. Price **\$385.00**.



AD1A AUDIO DISTRIBUTION AMPLIFIER

The **AD1A** Audio Distribution Amplifier is specifically designed for distributing audio signals to multiple points within a studio system. Standard unit has five highly isolated output channels which may be expanded up to 25 channels by the addition of **AD1A-X** extenders. Audio and VU meter monitoring facilities of the incoming signal as well as all output channels are included. The audio level of each output channel is individually adjustable. Distortion less than 1%, frequency response 40 - 20,000 cps. 100% solid state. Basic unit price **\$365.00**.



**PORTAPAK 1
(REPRODUCER)**

PortaPak 1 The ideal sales tool for the busy Time Salesman. A completely portable, play anytime—anywhere, cartridge playback unit at low cost. Handles all size NAB cartridges and is powered from its own self-contained, rechargeable nickel cadmium battery with built-in re-charger. Lightweight, compact, stainless steel case with two watts audio amplifier and speaker. 100% solid state. Vinyl carrying case available. Basic unit price **\$179.50**.

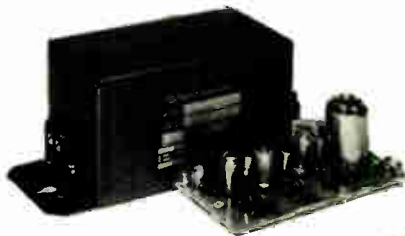

**TURNTABLE
PREAMPLIFIER TT-20A**

TT-20A An economical high reliability, all solid state, NAB equalized turntable pre-amplifier. Features low distortion, low noise level operation with minimum current drain. May be operated from battery supply or companion AC power supply (Model PB4-B). Designed for use with VR11 pickup cartridges. Minimum installation effort and expense. Basic unit price **\$46.50**.



**TAPE CARTRIDGE
WINDER TP-1B**

TP-1B The **SPOTMASTER** Tape Cartridge Winder is a rugged, dependable and field tested tape cartridge loader which fills a need in every operation using cartridge equipment. New or old cartridges may be wound to any length. Handles all NAB cartridge sizes and runs at 22½ ips. Worn tape in old cartridges easily replaced. Available with or without tape timer calibrated in minutes and seconds. (illustrated) Tape timer for use on all types tape recording equipment may be purchased separately. Basic unit price **\$94.50**.

RS-25



CARTRIDGE STORAGE RACKS

RM-100

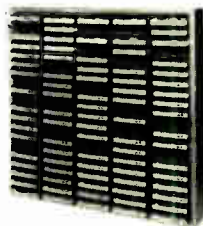

RACKS A full line of cartridge storage racks. The Model **RS-25** is welded steel construction handling 25 cartridges and designed for minimum space wall mounting. (only 4¾" wide X 34" long). The **RM-100**, in handsome formica trim, is designed for bench top or wall mounting. Measures only 2' X 2' and stores 100, series 300 cartridges. The **RS-200**, (not illustrated) is a Lazy Susan type all steel storage rack and stores 200 cartridges in minimum space. Rests on four heavy duty casters for floor mounting. Easily moves to new locations. Rack rotates on steel fabricated pedestal. Eight 25 unit rack sections are individually removable. Ideal for busy control rooms. Write for details. Price **\$12.50** up.



CARTRIDGES

CARTRIDGES A large stock of Fidelipac cartridges for off the shelf delivery in all standard tape lengths. Custom lengths available on request at nominal cost. Empty cartridges and lubricated tape for use with **TP-1B** Tape Cartridge Winder at economy prices.



**BROADCAST
ELECTRONICS, INC.**

8810 Brookville Road, Silver Spring, Maryland 20910
301-588-4983

Write for complete details

Prices subject to change without notice

Engineering Data

The question then arises as to why the L-type configuration is used at all. Contrary to the disadvantages of the L-type network, it does have certain advantages if employed in a circuit such as a volume control, voltage divider, volume indicator meter attenuator (multiplier), or in any circuit where the impedance match is not of great importance. However, the L-attenuator network cannot be employed for the VU meter; this instrument must see a constant impedance of 3,900 ohms.

The circuit for a speaker volume control using an L pad is given in Fig. 8. It will be observed, the series resistor of the network is toward the output of the amplifier. Mechanically, the two arms are mounted on a common shaft, and R_1 and R_2 are varied inversely with respect to each other.

Pi Configuration

The pi configuration, sometimes referred to as a delta pad (Fig. 9), may be designed to operate between equal or unequal impedances, balanced or unbalanced. The pi attenuator is not usually found in commercial sound installations, but it is used quite extensively in the telephone industry. The resistance values for impedance of *equal* values (Fig. 9A) may be calculated with the following formulas:

$$R_1 = \left(\frac{k+1}{k-1} \right) Z$$

$$R_2 = \left(\frac{Z}{2} \right) \left(\frac{k+1}{k} \right)$$

where,

R_1 is the series resistor,

R_2 is the shunt resistor,

Z is the input and output impedance.

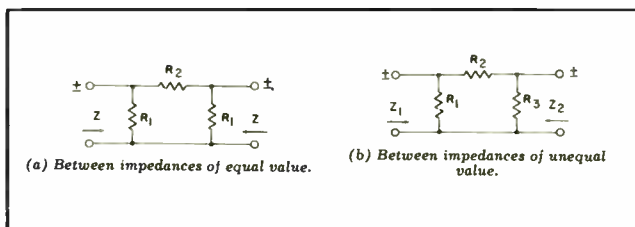

Fig. 9. Pi-type configurations.

For impedances of *unequal* values (Fig. 9B), the resistor values may be determined by the formulas:

$$R_1 = \left(\frac{k^2 - 1}{k^2 - 2kS + 1} \right) Z$$

$$R_2 = \left(\frac{\sqrt{Z_1 Z_2}}{2} \right) \left(\frac{k^2 - 1}{k} \right)$$

$$R_3 = \left(\frac{k^2 - 1}{k^2 - 2\frac{k}{S} + 1} \right) Z_2$$

where,

R_1 and R_3 are the shunt resistors,

R_2 is the series resistor,

Z_1 is the input impedance,

Z_2 is the output impedance,

S is equal to $\frac{\sqrt{Z_1}}{\sqrt{Z_2}}$

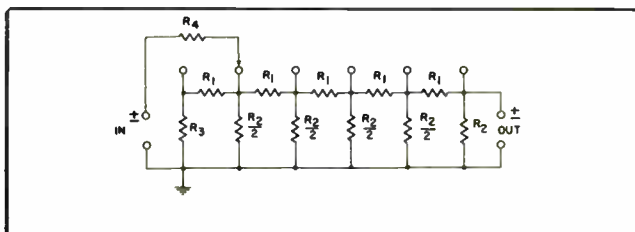

Fig. 10. Configuration for a ladder-type sound-mixer control.

Ladder Configuration

The ladder configuration consists of a group of pi pads connected in tandem; it is designed to operate between impedances of the same value. Attenuators using this configuration, which are only manufactured in variable form, are used extensively for sound-mixer controls.

One disadvantage of the ladder-type configuration (Fig. 10) is that it has a fixed insertion loss of 6 dB. This 6-dB loss is exclusive of the variable attenuation. The insertion loss is caused by the series and shunt resistors and the resistor in the slide-arm circuit. The 6-dB loss is divided as follows: 3.5 dB in the ladder network resistors (R_1 , R_2 , and R_3) and 2.5 dB in the series resistor (R_4).

Another disadvantage of the ladder configuration is that the impedance is not constant over the entire operating range; however, this is of no great consequence since it occurs at the maximum and minimum loss positions. In a sound mixer the controls are fed into a combining network which prevents the slight mismatch of the impedances from being reflected to the output of the mixer.

Ladder networks have better attenuation characteristics, allowing virtually an infinite cutoff to about 120 dB of loss; whereas the T type extends downward in the order of 100 dB. The advantages of the ladder configuration are: (1) as the attenuation is increased the contact noise decreases in proportion (contact noise remains constant with the T type), and (2) impedance mismatch effects decrease in a direct proportion to the number of controls in a mixer-combining network. (With four controls the impedance mismatch is negligible.) The values for the components of a ladder configuration may be calculated:

$$R_1 = \left(\frac{k^2 - 1}{2k} \right) Z$$

$$R_2 = \left(\frac{k+1}{k-1} \right) Z$$

$$R_3 = \frac{R_2 \times Z}{R_2 + Z}$$

$$R_4 = \frac{Z}{2}$$

where,

R_1 is the series resistor,

R_2 is the shunt resistor,

R_3 is the input shunt resistor,

R_4 is the series resistor in the contact arm,

Z is the impedance.

Note: The value of k is dependent on the loss per step and not the total loss. The loss per step should not exceed 1.3 dB. Also, the value of R_2 is halved for all but the output shunt resistor.

Ladder attenuators must be grounded at the low-potential side to prevent leakage at the higher frequencies.

Minimum-Loss Configuration

A minimum-loss pad is a network designed to operate between circuits of *unequal* impedance with a *minimum* insertion loss for a given impedance ratio. Minimum-loss ratios are given for L-type configurations in Fig. 7, and for the T configuration in Fig. 3. However, for those desiring to solve the minimum loss mathematically, the L pad may be calculated:

$$\text{dB} = 20 \log_{10} (S)$$

where,

$$S = \frac{\sqrt{Z_1}}{\sqrt{Z_2}}$$

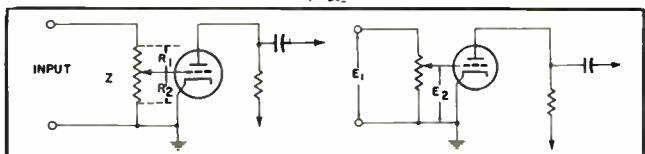

Fig. 11. Grid-circuit potentiometers.



CCA OFFERS FROM STOCK AM-FM BROADCAST TRANSMITTERS AT REALISTIC PRICES



DELUXE 1KW AM



DUAL RELIABLE 5KW AM

QUALITY AM

	DELUXE	DUAL RELIABLE
250W	\$3,495.	\$8,500.
500W	\$4,545.	\$9,500.
1KW	\$4,850.	\$11,500.
5KW	\$13,900.	\$19,500.
10KW	\$17,900.	\$31,500.
50KW	\$89,500.	\$104,000.

CCA offers an outstanding line of deluxe and "Dual Reliable" AM transmitters. All equipments stress conventional, high level plate modulation, standard parts; full accessibility, silicon rectifiers, minimum tube costs, minimum maintenance requirement, and lowest power consumption. "Dual Reliable" transmitters represent the epitome of conservative design.

3RD GENERATION FM

10W	\$1,295.	5KW	\$9,900.
250W	\$3,495.	10KW	\$13,500.
1KW	\$5,195.	15KW	\$17,500.
3KW	\$7,995.	20KW	\$22,500.
10KW Amplifier		\$9,900	

CCA is the only major equipment supplier which utilizes high mu, zero bias triodes. The use of these high power EIMAC triodes solve all the problems which "2nd Generation" tetrode designs exhibit. No need to neutralize, no complexities such as bias and screen supplies; and exceptional tube life with tremendous power output capability.



3KW FM



10KW FM

SC-1D MULTIPLEX SUBSIDIARY GENERATOR



The CCA SC-1D is an inexpensive but reliable subcarrier generator which can be used with all modern FM transmitters to achieve a 2nd broadcast channel.

LA-1D AUDIO LIMITING AMPLIFIER



A favorite of many broadcasters is the CCA LA-1D audio limiter. This "workhorse" prevents overmodulation and performs this task without "thumping" or introducing distortion. Front panel controls for gain, output and "recovery time" make operation of the LA-1D an "engineer's delight".

MODEL AMM-1D AM MODULATION MONITOR



A popular addition to the CCA product line is our FCC type approved AM modulation monitor. This instrument guarantees instantaneous supervision of transmitter operation and is an essential tool for every broadcaster.

CCA Electronics offers a complete broadcast package including materials supplied by outstanding vendors such as towers, antenna, transmission line and studio equipment. Contact your area CCA representative for a quotation.

CCA TRANSMITTER ACCESSORIES

AMM-1D AM Modulation Monitor	\$595.
AMF-1D AM Frequency Monitor	\$845.
LA 1D Audio Limiter	\$375.
AGC-1D AGC Audio Amplifier	\$320.
RC-1D Remote Control System	\$995.
RFA-FM Remote FM RF Amplifier	\$395.
RFA-AM Remote AM RF Amplifier	\$425.
LTJ Antenna Tuning Units	*
AM RF Loads	*
AM Antenna Phasors	*
SC 1D IM Subcarrier Generator	\$495.
SG-1D IM Stereo Generator	\$1295.

*PRICE BASED ON POWER



CCA ELECTRONICS CORPORATION
 716 JERSEY AVENUE, GLOUCESTER CITY, CAMDEN COUNTY, NEW JERSEY
 SPECIALISTS IN BEACON, BROADCAST, COMMUNICATION & AIRPORT TRANSMITTERS

Engineering Data

For the T (taper-pad) configuration:

$$\text{dB} = 20 \log_{10} (S + \sqrt{S^2 - 1})$$

$$S^2 = \frac{Z_1}{Z_2}$$

where,

Z_1 and Z_2 are the input and output impedances, Z_1 being the larger of the two.

Grid-Circuit Potentiometers

A grid-circuit potentiometer (abbreviated pot) is actually an L-type configuration and is used primarily for controlling the gain in a circuit where the load on the slider or unmatched side is practically an open circuit, such as the control grid of a vacuum tube (Fig. 11). The total resistance of such controls varies from 50,000 ohms to 1 megohm or greater. To illustrate the design procedure, assume a potentiometer having a resistance of 100,000 ohms with a total attenuation of 30 dB in steps of 10 dB is required. It will be noted in Fig. 11A that the upper portion of the control is designated as R_1 and the lower portion R_2 . Therefore:

$$R_1 = \left(\frac{1}{k}\right) Z$$

$$R_2 = (Z - R_1)$$

where,

Z is the total resistance of the potentiometer,
 R_1 and R_2 are the upper and lower portions of the resistance, depending on the position of the slider arm.

The factor $(1/k)$ is taken from Table 1. Solving for the first 10-dB step:

$$R_1 = 0.3162 \times 100,000$$

$$= 31,620 \text{ ohms}$$

$$R_2 = 100,000 - 31,620$$

$$= 68,380 \text{ ohms}$$

the second step (20 dB):

$$R_1 = 0.100 \times 100,000$$

$$= 10,000 \text{ ohms}$$

$$R_2 = 100,000 - 10,000$$

$$= 90,000 \text{ ohms}$$

and the third step (30 dB):

$$R_1 = 0.03162 \times 100,000$$

$$= 3,162 \text{ ohms}$$

$$R_2 = 100,000 - 3,162$$

$$= 96,838 \text{ ohms}$$

Taps will occur at 3,162 ohms, 10,000 ohms, and 31,620 ohms, upward from ground. The final design will consist of four resistors of 3,162, 6,838, 21,620, and 68,380 ohms for a total of 100,000 ohms. The resistors may consist of four carbon or wire-wound noninductive resistors, mounted on a switch frame.

Potentiometers may also be calibrated to indicate in terms of voltage, as shown in Fig. 11B. The voltage for any position may be computed:

$$E_2 = E_1 \left(\frac{R_1}{R_1 \times R_2} \right)$$

Table 2. Work Sheet for Calculating Resistor Values

Loss	$k-1$	R_5 (Ohms)	$\frac{1}{k-1}$	R_6 (Ohms)
0	—	Zero	—	Infinite
1	1.122	30.5	8.195	2048.7
2	1.258	64.5	3.862	965.5
4	1.584	146.0	1.700	425.0
6	1.995	248.0	1.004	221.0
10	3.162	540.5	0.462	115.5
15	5.623	1155.8	0.216	54.0
20	10.000	2250.0	0.111	27.8
25	17.783	4200.0	0.059	14.8
30	31.623	7650.0	0.0326	8.15

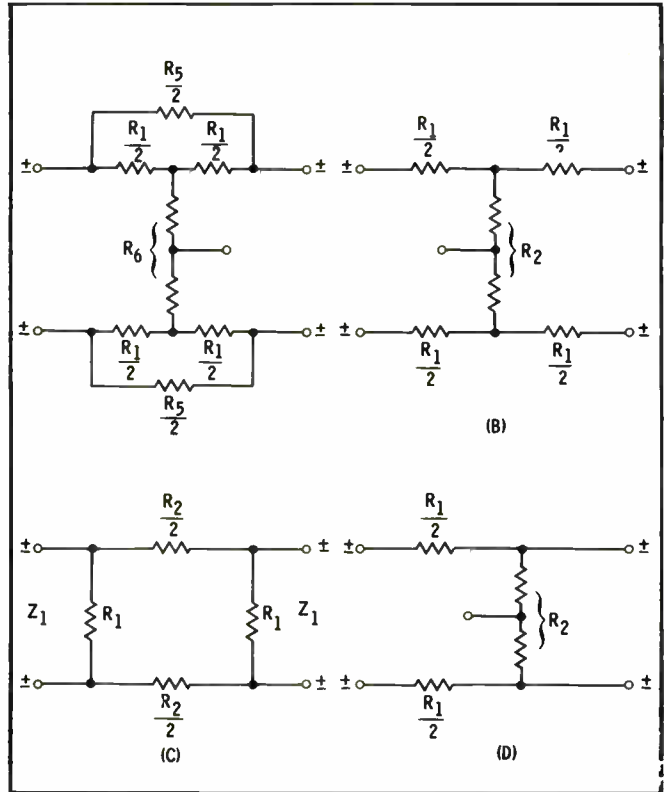

Fig. 12. Balanced networks.

As a rule, nonprofessional equipment uses potentiometers ranging from 100,000 ohms to 1 megohm in resistance. However, it is the practice in commercial equipment to keep the overall resistance to 50,000 ohms or less. To insure calibration accuracy, such controls are operated in the control grid of an amplifier stage, biased for class-A operation. In choosing the resistance value of a potentiometer, several factors must be considered. For example, if the control is to be used in the input of a high-gain triode, where the input impedance of the tube may be quite low at the higher frequencies, a low value of resistance is required. In addition, the input capacity to ground has a marked effect on the attenuation of the high frequencies; therefore, the lower the value of the potentiometer, the smaller this effect becomes. If grid current is permitted to flow in the input of a tube, the potentiometer will generate noise each time it is changed. Whenever possible, an input transformer with a potentiometer connected across the secondary of the transformer is recommended. When connected across a transformer, the potentiometer resistance is usually made equal to the secondary impedance of the transformer.

Variable Attenuator Design

In reality the design of a variable attenuator consists of designing a group of fixed attenuators that may be switched in and out of a circuit at will. Before starting a design, the impedance and configuration are selected. A table similar to that shown in Table 2 is prepared, and the desired values of loss, k -factors, and the calculated values of resistances are then entered in the appropriate column.

Assume a bridged-T attenuator of 250 ohms impedance, having a total loss of -30 dB which is variable in steps of 1 dB, is to be designed, using the equations given under the heading "Bridge-T Configuration." The value of k is taken from Column 3 and the value of $1/k - 1$ from Column 12 of Table 1. Since R_1 equals the 250-ohm line impedance, only R_5 and R_6 require calculation. For the sake of brevity, only nine of the loss steps have been calculated in Table 2.

It should be noted at the zero-loss position, R_5 has zero resistance and R_6 is infinite. In practice, at zero attenuation a high value of resistance is switched in R_6 to keep the circuit closed and to prevent contact noise. The value of the resistance depends on the impedance and loss of the network, but it should be of such a value that the pad is effectively out of the circuit.

The resistors are noninductively wound and mounted on a switch frame, with or without a detent. If possible, the entire unit should be mounted in a metal case to prevent damage to the resistors and reduce the possibility of pickup from extraneous electrical fields. The two switch arms are mounted on a common shaft, and the resistors are inserted inversely to each other, as for the L-type network. If over 40 dB of attenuation is required, the resistor coils must be carefully placed to reduce the possibility of leakage at the higher frequencies.

Variable attenuators can also be designed to match two impedances of unequal value, using a taper network as discussed under the heading "Taper Configuration." Such networks, however, are the exception rather than the rule. The procedure for their design is the same as for the equal-impedance network described previously.

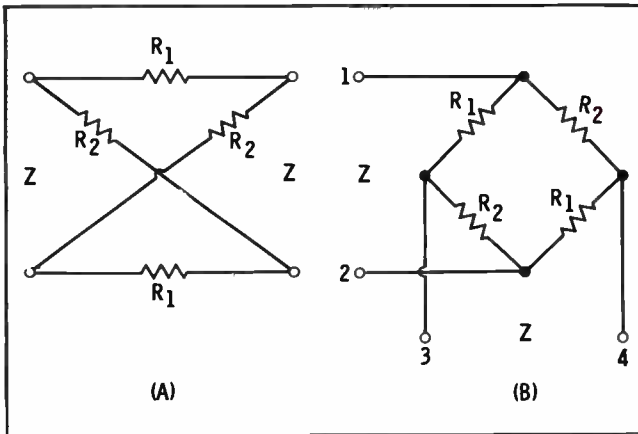

Fig. 13. Lattice network and its equivalent circuit.

Balanced Configurations

Basically a balanced configuration consists of designing an unbalanced network, dividing the values of the series resistors in half, and connecting the halves on each side of the configuration. Balanced configurations include the bridged-T, H, O, U, lattice, and ladder networks. If the network is to be grounded, the shunt resistor is tapped in the exact electrical center and connected to ground. It will be noted that only the values of series resistors are divided; the shunt resistor remains as for the unbalanced network.

Bridged-T, H, O, and U Configurations

The balanced bridged-T configuration is given in Fig. 12A. Here you will notice that series resistors R_1 (equal to the line impedance) are divided and connected in each side of the configuration. Resistor R_2 is treated in the same manner. The value of R_2 remains the same as for the unbalanced configuration, except that a tap has been added for the ground connection. For ease in winding, R_2 may be made into two separate resistors connected in series. The balanced configuration will exhibit the same characteristics as the unbalanced version.

The balanced T, or H pad as it is commonly known, is shown in Fig. 12B. Like the bridged-T, its series resistors are divided and connected in each half of the configuration. Except for being balanced, the H pad is similar in all other respects to the T configuration. H-type configurations may be designed for matching impedances of unequal value, as described for the taper pad.

The O configuration (Fig. 12C) is in reality a balanced pi pad. The addition of one resistor converts the pi pad into a balanced configuration. Only the series resistors (R_2) are divided. Resistors R_1 remain as for the pi pad. This configuration does not adapt itself to grounding; however, it may be used in any circuit where a balanced to ground pad is employed, or in a symmetrical circuit free from ground. The O network may be designed for circuits of equal or unequal impedances.

U pads (Fig. 12D) are balanced L configurations. The rules for impedance matching for the L configuration apply equally for the balanced U configuration.

Lattice Configuration

The lattice network is a true balanced configuration. Therefore individual treatment is required for solving its circuit element values. If it is used in an unbalanced configuration, it degenerates into a pi configuration.

The configuration for the lattice network is shown in Fig. 13A. The difference between this network and the O configuration is that the shunt resistors (R_2) are crossed over and connected to both the input and output circuits. The circuit element values may be calculated:

$$R_1 = \left(\frac{k - 1}{k + 1} \right) Z$$

$$R_2 = \left(\frac{k + 1}{k - 1} \right) Z$$

where,

- R_1 is the series resistor,
- R_2 is the shunt resistor,
- Z is the line impedance.

Lattice networks can only be employed in ungrounded circuits of equal impedance.

If an equivalent circuit is drawn for the lattice pad (Fig. 13B), it resembles a balanced bridge circuit. The principal difference is that resistors R_1 are lower in value than R_2 . This difference unbalances the bridge and permits the signal to pass attenuated in an amount controlled by the ratio of resistors R_1 and R_2 .

Ladder Configuration

It was mentioned earlier that the ladder configuration is only manufactured in the variable form and that it is used extensively in sound-mixer circuits. Ladder networks may also be designed for balanced operation. This is accomplished by connecting two unbalanced networks side by side as shown in Fig. 14. However, the circuit elements do not divide in the same manner as for other networks. If the unbalanced configuration in Fig. 10 is compared with the balanced network of Fig. 14, it will be observed that resistors R_1 are divided by two, but resistors R_2 are no longer $R_2/2$; instead, R_2 is now twice the value at the output as for the unbalanced configuration. R_2 remains at its original value each side of ground.

Bridging Configurations

A bridging (paralleling) pad is a special type of attenuator network designed to bridge one circuit while feeding another, without disturbing the impedance or frequency characteristics of the circuit bridged. In addition, the network can absorb only a fractional amount of power from the circuit bridged.

Two such networks are shown in Fig. 15. Fig. 15A is an unbalanced-L configuration. The difference between this configuration and the normal L configuration is that at the input side of the bridging pad (Z_1) the impedance is very high (10,000 to 30,000 ohms) while the other side (Z_2) matches the input impedance of the device being fed by the pad.

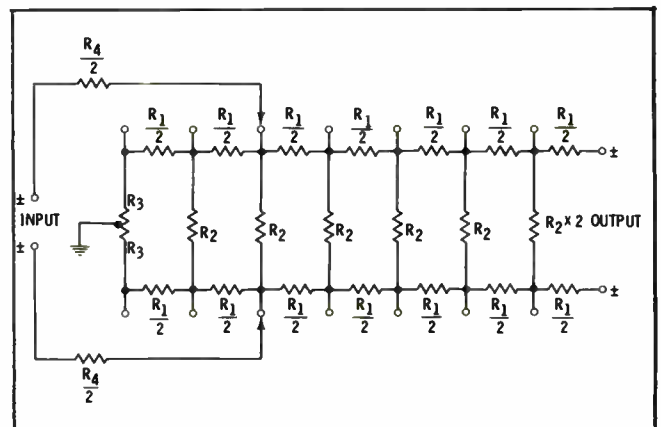

Fig. 14. A balanced ladder network.

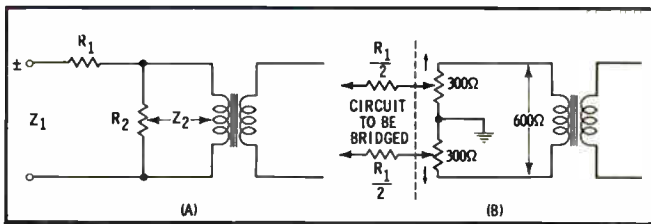

Fig. 15. Bridging input networks.

The loss of a bridging pad is stated for a given set of conditions; e.g., 40 dB of loss when bridging a 600-ohm circuit and feeding a 600-ohm circuit. If either the impedance bridged or series resistor R_1 is changed in value, the insertion loss of the pad will change. Resistor values for the more commonly used pads and insertion losses are given in Table 3. The stated loss of these networks will only be valid when they are bridging 600 ohms and feeding 600 ohms. The loss for the same configuration, but using other values of R_1 and impedance Z_2 , may be equated:

$$dB = 10 \log_{10} \left(\frac{Z_1}{Z_2} \right) + 20 \log_{10} \sqrt{\frac{Z_1}{Z_2} + \sqrt{\frac{Z_1}{Z_2}}} - 1$$

where,

Z_1 is the impedance of the circuit to be bridged,
 Z_2 is the impedance of the circuit fed by the network.

Bridging networks should be designed to have an input resistance of at least ten times that of the circuit to be bridged.

The configuration in Fig. 15A may be converted to a balanced network by dividing resistor R_1 by two and placing half in each side of the configuration. A variable 30,000- to 600-ohm pad is shown in Fig. 15B.

When a bridging pad is connected across a circuit, a slight loss of level (usually ignored) takes place in the circuit being bridged. However, this loss may be computed:

$$dB = 20 \log_{10} \frac{2B_{it} + R}{2B_{it}}$$

where,

B_{it} is the bridging input of the pad,
 R is the impedance of the circuit bridged.

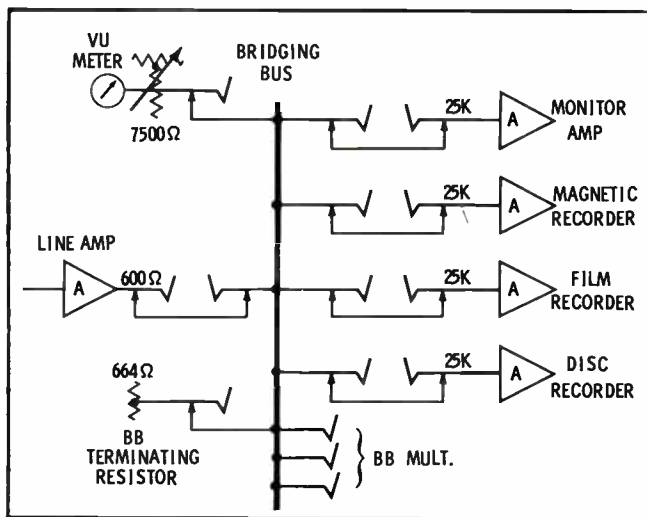

Fig. 16. A typical bridging-bus circuit.

Thus, for a pad of 10,000 to 600 ohms, bridged across a circuit of 600 ohms, the loss is

$$\begin{aligned} dB &= 20 \log_{10} \frac{20,000 + 600}{20,000} \\ &= 20 \log 1.03 \\ &= 20 \times 0.013 \\ &= 0.26 \text{ dB} \end{aligned}$$

Therefore, when a bridging pad of 10,000 ohms is connected across a circuit impedance of 600 ohms, the level in the 600-ohm circuit will drop 0.26 dB.

When the bridging pad is connected across a 600-ohm circuit, the impedance of the 600-ohm circuit will be lowered only 1 to 3%. This impedance reduction is of small consequence. This is the principal reason for using a bridging impedance of 20,000 to 30,000 ohms, although it may insert a considerable amount of loss. If the insertion loss of a bridging pad is too great, it may be replaced with a bridging transformer which has an insertion loss of 18 to 20 dB; however, if sufficient gain is available, the pad is the most economical.

A typical recording or broadcast studio-type bridging bus is shown in Fig. 16. The purpose of a bridging bus is to provide a circuit in the system where additional equipment may be connected. The bridging-bus circuit is a group of jacks connected in parallel and driven by an amplifier. It will be observed that the bridging bus and the equipment connected across the bus act as a load impedance for the amplifier driving the bus. The first step in bus-circuit design is to decide how many pieces of equipment will be permanently connected (normalised) across the bus.

For this illustration four bridging impedances of 25,000 ohms and a 7,500-ohm VU meter have been selected. A terminating resistor and three sets of bridging-bus multiple jacks for patching additional equipment are connected in parallel with the bridging bus. It will be assumed that any additional equipment to be patched across the bus will have a bridging impedance of at least 25,000 ohms and that the output impedance of the amplifier driving the bus is 600 ohms. First, the total impedance of the equipment permanently connected across the bus (exclusive of the bridging-bus termination) is determined. The four 25,000-ohm bridging inputs connected across the bus present a load resistance of 6,250 ohms. In parallel with this is the 7,500-ohm VU meter panel. Using Ohm's law for parallel circuits:

$$\begin{aligned} R_t &= \frac{6,250 \times 7,500}{6,250 + 7,500} \\ &= \frac{4.68 \times 10^7}{13.7 \times 10^3} \\ &= \frac{4.68 \times 10^3}{1.37} \\ &= 3,416 \text{ ohms} \end{aligned}$$

The next step is to determine the value of the bridging-bus terminating resistor which, when connected in parallel with 3,416 ohms, will reflect an impedance of 600 ohms. Again using Ohm's law for parallel resistors:

$$\begin{aligned} BB &= \frac{3,416 \times 600}{3,416 - 600} \\ &= \frac{2.05 \times 10^6}{2.81 \times 10^3} \\ &= \frac{2.05 \times 10^3}{2.81} \\ &= 729.53 \text{ ohms} \end{aligned}$$

Therefore, if the resistor of 729.53 ohms is connected in parallel with the bus and the foregoing load impedances, the amplifier will see 600 ohms.

Table 3. Resistor Values for Bridging Attenuators

R_1 (Ohms)	Loss (dB)	R_2 (Ohms)
30,000	40.1	600
25,000	38.5	600
20,000	36.8	600
15,000	34.2	600
10,000	30.7	600
7,500	28.3	600
5,000	24.9	600
3,000	20.8	600

Color!

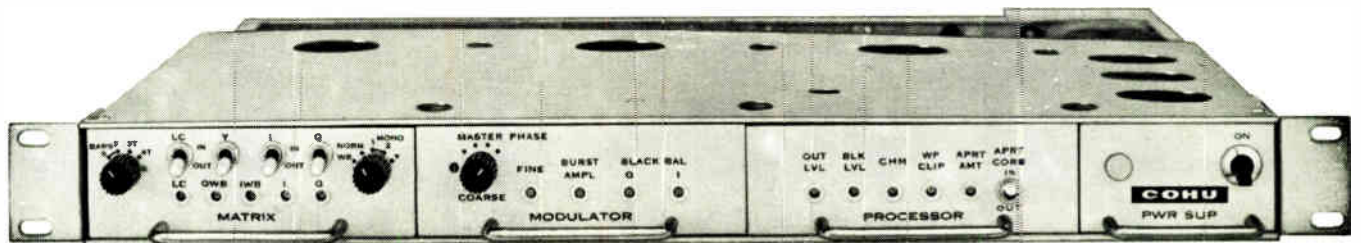

With this solid-state video encoder by Cohu!

Incorporates all these special features in 1¾ inches of rack space:

- Accepts RGB or RGBM inputs (requiring only sync, blanking and subcarrier inputs in addition); and provides three line outputs
- Includes integral NTSC full or split color-bar and burst-flag generators
- Provides RGBM-luminance correction, to compensate for gamma error introduced by the monochrome pickup tube without loss of resolution, and luminance channel aperture correction
- Utilizes silicon-transistorized plug-in circuit modules
- Has subcarrier phase adjustable over a 370° range
- Should red or blue signal fail, front panel switch provides immediate compatible monochrome output by routing green input to luminance channel

Cohu's Model 9830-071 exceeds all NTSC and FCC specs and is completely compatible with all color systems. Available as options: circuits for controlling camera-to-bar, green-to-y, color-to-monochrome and burst on-off functions from remote locations.

Cohu also stocks sync generator and accessory systems, monochrome/color switching matrix, switcher control and remote control units, pulse and video distribution amplifiers, and portable monochrome and color vidicon cameras. Get full details direct or from your nearest Cohu engineering representative.



Box 623
San Diego, Calif. 92112
Phone: 714-277-6700

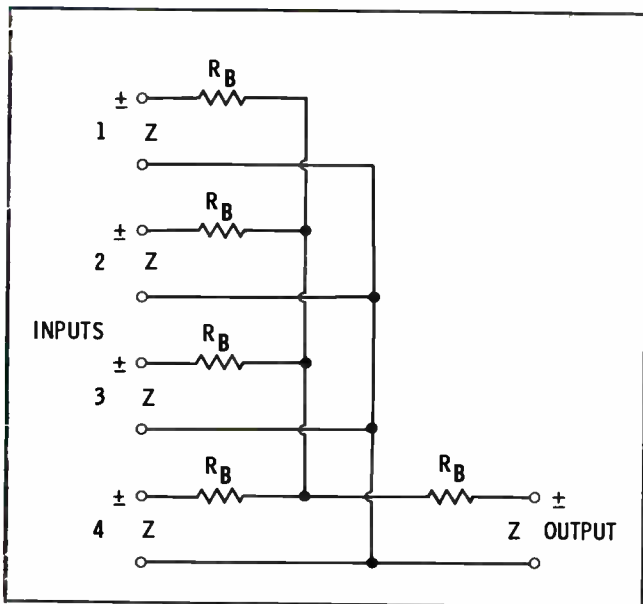

Fig. 17. A four-position combining network.

As a rule it is safe to load the output of a well designed amplifier to within 90% of its rated output impedance, which would be 540 ohms for a 600-ohm output impedance. This means that several more pieces of equipment could be patched across the bus without affecting the amplifier characteristics. If the bridging impedance is greater than 25,000 ohms, more equipment could be driven from the bus. Usually the bus impedance is set for around 625 ohms to permit additional equipment to be patched across the bus without loading the amplifier below 600 ohms.

If the bus is grounded on one side, unbalanced configurations are used. If the bus is balanced to ground or symmetrical, a balanced-type network is used. Standard bridging impedances used by the recording and broadcast industries include 7,500, 10,000, 25,000, and 30,000 ohms.

Combining Networks

Combining networks are employed to combine the inputs of several devices or lines. One of the most common uses for this type of configuration is in a sound-mixer circuit. Combining networks may be balanced or unbalanced, and they are usually confined to a common value of impedance.

The signal may consist of dialogue, music, and/or sound effects. The source may be a broadcast line, photographic film, or magnetic tape reproducers, phonograph records, a live pick-up, or a combination of all. The network must be designed so that changing the level of any one of the inputs has no effect on the level or frequency characteristics of the other signal sources. For broadcast and recording at least 10 positions are

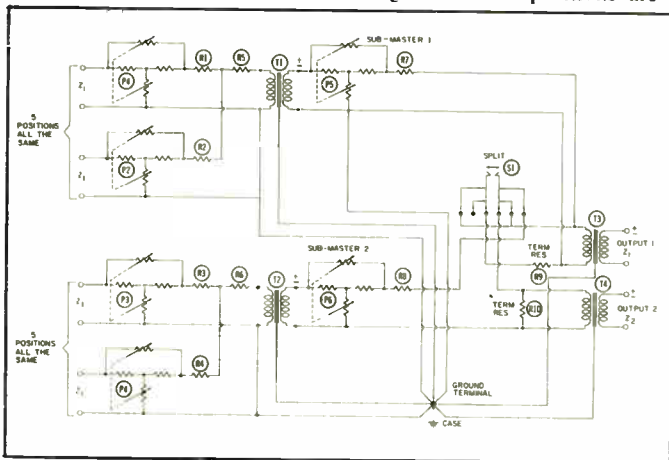

Fig. 19. A 10-position, split mixer network with keyswitch for combining the two sections into a single network.

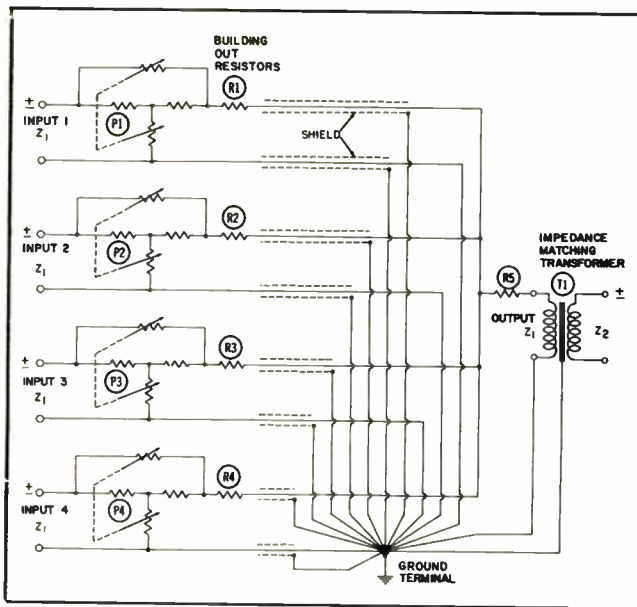

Fig. 18. A four-position, parallel-connected, unbalanced mixer network.

required; in many instances 20 or more are necessary. For recording purposes, equalizers, filters, and other devices are operated in conjunction with the combining networks, as shown in Fig. 17. The network consists of 5 resistors, designated as R_B . If the circuit is traced, it will be apparent that the five circuits are in parallel. The resistors provide isolation between the four input circuits and an impedance match for the four inputs and the output circuit. The value of the building-out resistors (R_B) may be calculated:

$$R_B = \left(\frac{N - 1}{N + 1} \right) Z$$

where,

- R_B is the building-out resistor,
- N is the number of input circuits,
- Z is the circuit impedance.

The loss of the network through any two branches is:

$$20 \log_{10} (N - 1)$$

where,

N is the total number of circuits (4 inputs and 1 output).

Using this equation, the loss for a four-position network is 12 dB. Unused circuits of a combining network must be terminated in a resistive load that is equal to the normal terminating impedance. This type of combining network is often used in sound mixers similar to the one shown in the schematic diagram of Fig. 18.

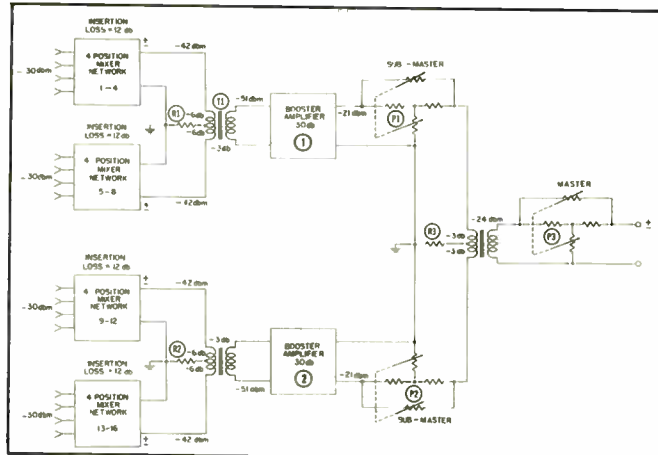

Fig. 20. A 16-position hybrid-coil mixer network.

A more elaborate mixer network and its associated equipment is shown in Fig 19. This network is termed a "split-mixer"; that is, it may be divided into two separate sections by means of a key switch (S1), or combined into a 10-position mixer. The ten positions are shown split into two groups of five positions each. Building-out resistors (R7 and R8) and submaster controls (P5 and P6) for adjusting the overall level of each group are located at the output of each group. Output transformers T3 and T4 may be used to feed a single or two separate recording channels. Such mixers are often used for recording where a vocal group and a large orchestra are located on separate stages during the recording session.

The controls may be of any configuration, provided they are unbalanced and therefore satisfy the impedance requirements. The common side of each mixer control is brought to a common ground point, using *individual* ground wires which are

shielded and covered with a protective plastic or cloth braid to prevent ground loops.

The unbalanced configuration may be changed to a balanced one by connecting half of each resistor in each side of the network as explained for other balanced networks. Of course, the mixer controls must also be changed to balanced configurations. Combining networks have a fixed loss caused by the resistance of the building-out resistors (R₁₁). Increasing the number of mixer positions increases the insertion loss of the network.

To simplify the design procedure of a mixer network, the values of the building-out resistors for networks of 150, 200, 500, and 600 ohms are tabulated in Table 4. For mixer networks of 12 positions or more it is recommended that the controls be separated into groups of four and then combined by means of hybrid coils, as shown in Fig. 20. (The loss and amplifier gains shown in Fig. 20 are for a typical mixer.)

Table 4. Values of Building-Out Resistors and Insertion Loss for Parallel Sound-Mixer Networks

Mixer Positions	Impedance 150Ω			Impedance 200Ω			Impedance 250Ω			Impedance 500Ω			Impedance 600Ω		
	R ₁₁ Ohms	Insertion Loss—dB		R ₁₁ Ohms	Insertion Loss—dB		R ₁₁ Ohms	Insertion Loss—dB		R ₁₁ Ohms	Insertion Loss—dB		R ₁₁ Ohms	Insertion Loss—dB	
		BT, T	Lad.		BT, T	Lad.		BT, T	Lad.		BT, T	Lad.		BT, T	Lad.
2	50.0	6.00	12.00	66.6	6.00	12.00	83.3	6.00	12.00	166.0	6.00	12.00	200.0	6.00	12.00
3	75.0	9.50	15.50	125.0	9.50	15.50	100.0	9.50	15.50	250.0	9.50	15.50	300.0	9.50	15.50
4	90.0	12.00	18.00	120.0	12.00	18.00	150.0	12.00	18.00	300.0	12.00	18.00	360.0	12.00	18.00
5	100.0	14.00	20.00	133.0	14.00	20.00	166.0	14.00	20.00	333.0	14.00	20.00	400.0	14.00	20.00
6	107.0	15.60	21.60	142.8	15.60	21.60	178.5	15.60	21.60	357.0	15.60	21.60	428.4	15.60	21.60
7	112.5	16.90	22.90	150.0	16.90	22.90	187.5	16.90	22.90	375.0	16.90	22.90	450.0	16.90	22.90
8	116.6	18.10	24.10	155.5	18.10	24.10	194.0	18.10	24.10	388.0	18.10	24.10	466.0	18.10	24.10
9	120.0	19.08	25.08	160.0	19.08	25.08	200.0	19.08	25.08	400.0	19.08	25.08	480.0	19.08	25.08
10	123.0	20.00	26.00	163.8	20.00	26.00	202.2	20.00	26.00	409.0	20.00	26.00	491.0	20.00	26.00
11	124.9	20.82	26.82	166.5	20.82	26.82	208.0	20.82	26.82	416.0	20.82	26.82	499.0	20.82	26.82
12	127.0	21.58	27.58	169.1	21.58	27.58	210.8	21.58	27.58	422.5	21.58	27.58	507.0	21.58	27.58

From the discontent of man...

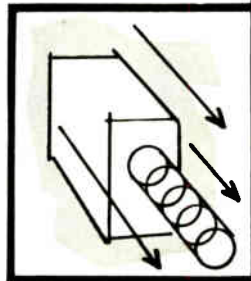
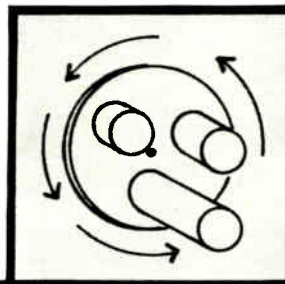

the world's best progress springs

Ella Wheeler Wilcox

Challenged by the limitations imposed by the cumbersome device of the turret, Zoomar has given the camera a new dimension—an exciting lifelike versatility approaching that of the human eye—a tool that dramatically helps to translate into being the skill and imagination of the engineer and operator. Zoomar, pioneer in the development of the zoom lens, continues its program of further progress and perfection.

Remote control zoom lenses for ITV cameras: Mark III, Mark IV, Mark VI, Mark X, Mark XX.

and the new compact mark IV-b

ZOOMAR, INC. GLEN COVE, N. Y. 11542 • 516 676-1900 HOLLYWOOD, CALIF. 90028 • 213 465-2788

DECIBEL TABLE

Courtesy Jampro Antenna Company

GIVEN: Decibels

TO FIND: Power and $\left\{ \begin{matrix} \text{Voltage} \\ \text{Current} \end{matrix} \right\}$ Ratios

TO ACCOUNT FOR THE SIGN OF THE DECIBEL

For negative (-) values of the decibel—Both voltage and power ratios are less than unity. Use the two left-hand columns.

For positive (+) values of the decibel—Both voltage and power ratios are greater than unity. Use the two right-hand columns.

← -dB+ →					← -dB+ →				
Voltage Ratio	Power Ratio	dB	Voltage Ratio	Power Ratio	Voltage Ratio	Power Ratio	dB	Voltage Ratio	Power Ratio
.9886	.9772	.1	1.012	1.023	.4732	.2239	6.5	2.113	4.467
.9772	.9550	.2	1.028	1.047	.4677	.2188	6.6	2.138	4.571
.9661	.9333	.3	1.035	1.072	.4624	.2138	6.7	2.163	4.677
.9550	.9120	.4	1.047	1.096	.4571	.2089	6.8	2.188	4.786
.9441	.8913	.5	1.059	1.122	.4519	.2042	6.9	2.213	4.898
.9333	.8710	.6	1.072	1.148	.4467	.1995	7.0	2.239	5.012
.9226	.8511	.7	1.084	1.175	.4416	.1950	7.1	2.265	5.129
.9120	.8318	.8	1.096	1.202	.4365	.1905	7.2	2.291	5.248
.9016	.8128	.9	1.109	1.230	.4315	.1862	7.3	2.317	5.370
.8913	.7943	1.0	1.122	1.259	.4266	.1820	7.4	2.344	5.495
.8810	.7762	1.1	1.135	1.288	.4217	.1778	7.5	2.371	5.623
.8710	.7586	1.2	1.148	1.318	.4169	.1738	7.6	2.399	5.754
.8610	.7413	1.3	1.161	1.349	.4121	.1698	7.7	2.427	5.888
.8511	.7244	1.4	1.175	1.380	.4074	.1660	7.8	2.455	6.026
.8414	.7079	1.5	1.189	1.413	.4027	.1622	7.9	2.483	6.166
.8318	.6918	1.6	1.202	1.445	.3981	.1585	8.0	2.512	6.310
.8222	.6761	1.7	1.216	1.479	.3936	.1549	8.1	2.541	6.457
.8128	.6607	1.8	1.230	1.514	.3890	.1514	8.2	2.570	6.607
.8035	.6457	1.9	1.245	1.549	.3846	.1479	8.3	2.600	6.761
.7943	.6310	2.0	1.239	1.585	.3802	.1445	8.4	2.630	6.918
.7852	.6166	2.1	1.274	1.622	.3758	.1413	8.5	2.661	7.079
.7762	.6026	2.2	1.288	1.660	.3715	.1380	8.6	2.692	7.244
.7674	.5888	2.3	1.303	1.698	.3673	.1349	8.7	2.723	7.413
.7586	.5754	2.4	1.318	1.738	.3631	.1318	8.8	2.754	7.586
.7499	.5623	2.5	1.334	1.778	.3589	.1288	8.9	2.786	7.762
.7413	.5495	2.6	1.349	1.820	.3548	.1259	9.0	2.818	7.943
.7328	.5370	2.7	1.365	1.862	.3508	.1230	9.1	2.851	8.128
.7244	.5248	2.8	1.380	1.905	.3467	.1202	9.2	2.884	8.318
.7161	.5129	2.9	1.396	1.950	.3428	.1175	9.3	2.917	8.511
.7079	.5012	3.0	1.413	1.995	.3388	.1148	9.4	2.951	8.710
.6998	.4898	3.1	1.429	2.042	.3350	.1122	9.5	2.985	8.913
.6918	.4786	3.2	1.445	2.089	.3311	.1096	9.6	3.020	9.120
.6839	.4677	3.3	1.462	2.138	.3273	.1072	9.7	3.055	9.333
.6761	.4571	3.4	1.479	2.188	.3236	.1047	9.8	3.090	9.550
.6683	.4467	3.5	1.496	2.239	.3199	.1023	9.9	3.126	9.772
.6607	.4365	3.6	1.514	2.291	.3162	.1000	10.0	3.162	10.000
.6531	.4266	3.7	1.531	2.344	.3126	.09772	10.1	3.190	10.23
.6457	.4169	3.8	1.549	2.399	.3090	.09550	10.2	3.236	10.47
.6383	.4074	3.9	1.567	2.455	.3055	.09333	10.3	3.273	10.72
.6310	.3981	4.0	1.585	2.512	.3020	.09120	10.4	3.311	10.96
.6237	.3890	4.1	1.603	2.570	.2985	.08913	10.5	3.350	11.22
.6166	.3802	4.2	1.622	2.630	.2951	.08710	10.6	3.388	11.48
.6095	.3715	4.3	1.641	2.692	.2917	.08511	10.7	3.428	11.75
.6026	.3631	4.4	1.660	2.754	.2884	.08318	10.8	3.467	12.02
.5957	.3548	4.5	1.679	2.818	.2851	.08128	10.9	3.508	12.30
.5888	.3467	4.6	1.698	2.884	.2818	.07943	11.0	3.548	12.59
.5821	.3388	4.7	1.718	2.951	.2786	.07762	11.1	3.589	12.88
.5754	.3311	4.8	1.738	3.020	.2754	.07586	11.2	3.631	13.18
.5689	.3236	4.9	1.758	3.090	.2723	.07413	11.3	3.673	13.49
.5623	.3162	5.0	1.788	3.162	.2692	.07244	11.4	3.715	13.80
.5559	.3090	5.1	1.799	3.236	.2661	.07079	11.5	3.758	14.13
.5495	.3020	5.2	1.820	3.311	.2630	.06918	11.6	3.802	14.45
.5433	.2951	5.3	1.841	3.388	.2600	.06761	11.7	3.846	14.79
.5370	.2884	5.4	1.862	3.467	.2570	.06607	11.8	3.890	15.14
.5309	.2818	5.5	1.884	3.548	.2541	.06457	11.9	3.936	15.49
.5248	.2754	5.6	1.905	3.631	.2512	.06310	12.0	3.981	15.85
.5188	.2692	5.7	1.928	3.715	.2483	.06106	12.1	4.027	16.22
.5129	.2630	5.8	1.950	3.802	.2455	.06026	12.2	4.074	16.60
.5070	.2570	5.9	1.972	3.890	.2427	.05888	12.3	4.121	16.98
.5012	.2512	6.0	1.995	3.981	.2399	.05754	12.4	4.169	17.38
.4955	.2455	6.1	2.018	4.074	.2371	.05623	12.5	4.217	17.78
.4898	.2399	6.2	2.042	4.169	.2344	.05495	12.6	4.266	18.20
.4842	.2344	6.3	2.065	4.266	.2317	.05370	12.7	4.315	18.62
.4786	.2291	6.4	2.089	4.365	.2291	.05248	12.8	4.365	19.05

Engineering Data

← -dB+ →				
Voltage Ratio	Power Ratio	dB	Voltage Ratio	Power Ratio
.2265	.05129	12.9	4.416	19.50
.2239	.05012	13.0	4.467	19.95
.2213	.04898	13.1	4.519	20.42
.2188	.04786	13.2	4.571	20.89
.2163	.04677	13.3	4.624	21.38
.2138	.04571	13.4	4.677	21.88
.2113	.04467	13.5	4.732	22.39
.2089	.04365	13.6	4.786	22.91
.2065	.04266	13.7	4.842	23.44
.2042	.04169	13.8	4.898	23.99
.2018	.04074	13.9	4.955	24.55
.1995	.03981	14.0	5.012	25.12
.1972	.03890	14.1	5.070	25.70
.1950	.03802	14.2	5.129	26.30
.1928	.03715	14.3	5.188	26.92
.1905	.03631	14.4	5.248	27.54
.1884	.03548	14.5	5.309	28.18
.1862	.03467	14.6	5.370	28.84
.1841	.03388	14.7	5.433	29.51
.1820	.03311	14.8	5.495	30.20
.1799	.03236	14.9	5.559	30.90
.1778	.03162	15.0	5.623	31.62
.1758	.03090	15.1	5.689	32.36
.1738	.03020	15.2	5.754	33.11
.1718	.02951	15.3	5.821	33.88
.1698	.02884	15.4	5.888	34.67
.1679	.02818	15.5	5.957	35.48
.1660	.02754	15.6	6.026	36.31
.1641	.02692	15.7	6.095	37.15
.1622	.02630	15.8	6.166	38.02
.1603	.02570	15.9	6.237	38.90
.1585	.02512	16.0	6.310	39.81
.1567	.02455	16.1	6.383	40.74
.1549	.02399	16.2	6.457	41.69
.1531	.02344	16.3	6.531	42.66
.1514	.02291	16.4	6.607	43.65

← -dB+ →				
.1496	.02239	16.5	6.683	44.67
.1479	.02188	16.6	6.761	45.71
.1462	.02138	16.7	6.839	46.77
.1445	.02089	16.8	6.918	47.86
.1429	.02042	16.9	6.998	48.98
.1413	.01995	17.0	7.079	50.12
.1396	.01950	17.1	7.161	51.29
.1380	.01905	17.2	7.244	52.48
.1365	.01862	17.3	7.328	53.70
.1349	.01820	17.4	7.413	54.95
.1334	.01778	17.5	7.499	56.23
.1318	.01738	17.6	7.586	57.54
.1303	.01698	17.7	7.674	58.88
.1288	.01660	17.8	7.762	60.26
.1274	.01622	17.9	7.852	61.66
.1259	.01585	18.0	7.943	63.10
.1245	.01549	18.1	8.035	64.57
.1230	.01514	18.2	8.128	66.07
.1216	.01479	18.3	8.233	67.61
.1202	.01445	18.4	8.318	69.18
.1189	.01413	18.5	8.414	70.79
.1175	.01380	18.6	8.511	72.44
.1161	.01349	18.7	8.610	74.13
.1148	.01318	18.8	8.710	75.86
.1135	.01288	18.9	8.811	77.62
.1122	.01269	19.0	8.913	79.43
.1109	.01230	19.1	9.016	81.28
.1096	.01202	19.2	9.120	83.18
.1084	.01175	19.3	9.226	85.11
.1072	.01148	19.4	9.333	87.10
.1059	.01122	19.5	9.441	89.13
.1047	.01096	19.6	9.550	91.20
.1035	.01072	19.7	9.661	93.33
.1023	.01047	19.8	9.772	95.50
.1012	.01023	19.9	9.886	97.72
.1000	.01000	20.0	10.000	100.00

VENT-RAK®

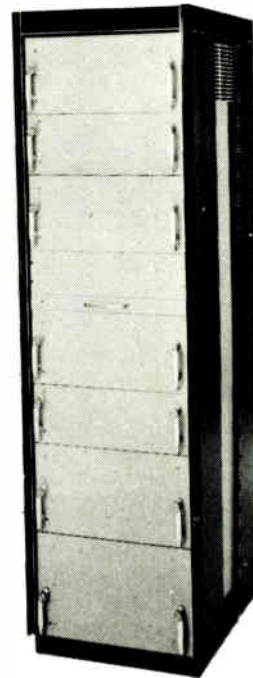

NEW
5000 Series

SLIM-LINE

**Modular
Electronic
Cabinets**

JUST—21.375" SLIM—10/32 tapped RETMA pattern all vertical posts. Heavy tubular 12 gauge frame and instantly removable side and rear panels — Panels and frame trimmed in functional black anodized extruded aluminum present simplicity yet functional streamlined appearance — Stocked in two-tone baked enamel finish in Dark Gray with Light Gray — or — Charcoal Brown with Black—40 sizes with panel space for 19" panels from 26¼" to 77" and depths of 24, 26, 28 and 30"—Priced from \$123.50 to \$207.00 F.O.B. Indianapolis, Indiana—Available from Distributor and Factory stock.

VENT-RAK®

**525 S. Webster Avenue
Indianapolis, Indiana 46219
Telephone (317) 359-5407**

COAXIAL CABLE DATA

Courtesy Andrew Corporation

Coaxial Transmission Line Attenuation and Power Rating

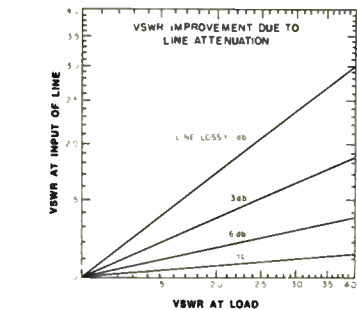
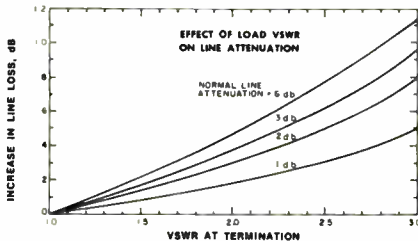
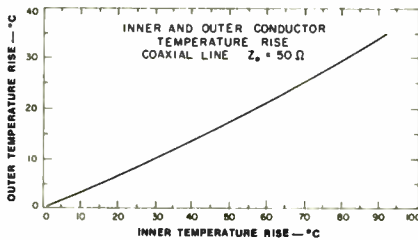
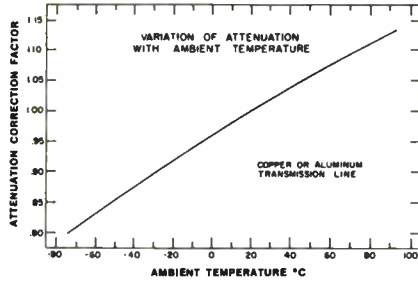

Attenuation

The following pages show the attenuation versus frequency characteristics of all standard Andrew rigid and HELIAX transmission lines. The values shown are for 24°C (75°F) ambient, and increase slightly with higher temperature or applied power, up to approximately 13% above the curves at full average power rating. The curve at left shows this relationship. Inner and outer conductor temperature rise is also shown for reference.

Effect of VSWR on Attenuation

When transmission line is attached to an antenna, the VSWR of the antenna increases the attenuation of the line. This effect is quite small for normal conditions. The curve shows increase in line loss versus VSWR.

Effect of Attenuation on VSWR

Antenna VSWR, as measured at the input to the connecting transmission line, is reduced by the attenuation of the line. The curves show this relationship.

Power Ratings

Peak and average power ratings are both required to describe fully the capabilities of a given transmission line. Typically, peak power ratings limit the line for low frequency or pulse usage while average power ratings limit the higher frequency usage.

Standard Peak Power Ratings

The permissible voltage between inner and outer conductor of a coaxial cable determines the peak power rating.

Voltage breakdown is independent of frequency, but varies with line pressure and VSWR. Peak power ratings are therefore generally stated for the following conditions: Unity VSWR, no modulation, and one atmosphere absolute dry air pressure. 100% AM modulation reduces the peak power rating by a factor of 4. Peak power rating is given by the following expression.

$$P_{pk} = \frac{(E_{rf})^2}{Z_0(1+M)^2 VSWR} (S_d)^2 \text{ watts}$$

Where M is modulation percentage expressed decimally, VSWR is voltage standing wave ratio on the line, S_d is dielectric strength of the pressurizing medium relative to air, E_{rf} is determined as follows: $E_{rf} = 0.247 E_p$, E_p is the DC production test voltage (the values in the table below are typical), and the constant 0.247 includes factors to relate DC voltage to RF voltage, to adjust to rms value, and includes a safety factor of 2. All of these factors are empirical and have been extensively verified.

Outer Conductor OD, inches	1/8	1/4	3/8	1/2	5/8	3/4	1
E_p volts	6,000	11,000	16,000	19,000	26,000	35,000	50,000

INCREASED PEAK POWER RATINGS can be obtained through pressurization or the use of high dielectric strength gases or both. Variation of peak power rating with absolute pressure and use of dry air and Sulfur Hexafluoride (SF_6) is shown at the right. These curves are based on voltage-pressure tests conducted on transmission lines and components.

STANDARD AVERAGE POWER RATINGS are determined by the safe long term operating temperature of the inner conductor when the cable is operated in a 40°C (104 F) ambient. The ratings are based upon an inner conductor temperature of 100°C (212°F) for HELIAX air dielectric coaxial cable (polyethylene) and 79°C (175°F) for foam HELIAX coaxial cable. Rigid line ratings are based upon an inner conductor temperature of 101°C (216 F).

The curve at the right indicates the variation of average power rating with ambient temperature. Average power rating may be calculated from the following:

$$P_{av} = \frac{16,360 \epsilon D}{dB_1} \text{ watts}$$

where P_{av} = average power rating for conditions described above.

D is OD of line in inches; dB_1 is measured attenuation derated for increase in loss at elevated temperature; and ϵ is heat emissivity coefficient of outer conductor in watts/in.²

For CW, AM, or FM applications, the average power rating of a cable is determined by derating the presented power curves according to VSWR. See expression below. SSB transmitters are generally rated by peak envelope power (PEP). Average power for these applications is considerably lower, typically about half the PEP. Television transmitter ratings are based on sync peak video power. Average power output for transmission line evaluation is 83% of nominal rating.

DERATING AVERAGE POWER FOR VSWR is accomplished by use of the derating factor (DF) calculated from the following formula.

$$D.F. = \frac{(VSWR^2 + 1)}{(2 VSWR)} + F^1 \frac{(VSWR^2 - 1)}{(2 VSWR)}$$

where F^1 is a factor that varies with frequency and line size. Select the factor from the curve at right.

INCREASED AVERAGE POWER RATINGS are achievable by (1) treating the conductor surfaces for greater heat emissivity, (2) pressurizing the line, (3) using a gas with a larger heat transfer coefficient and (4) combination of these. For special applications your Andrew sales engineer will supply complete information.

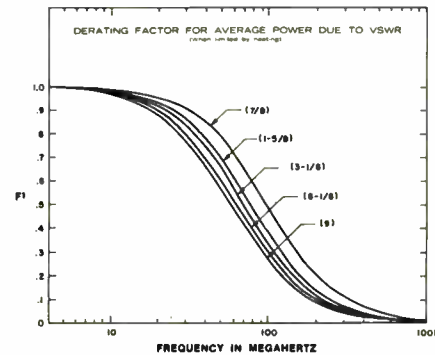
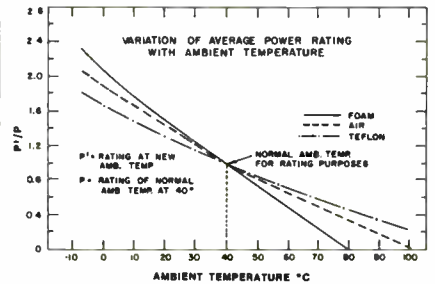
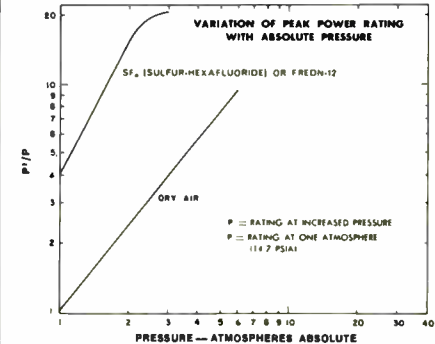

COAXIAL CABLE DATA

Courtesy Andrew Corporation

Attenuation of Helix Coaxial Cables

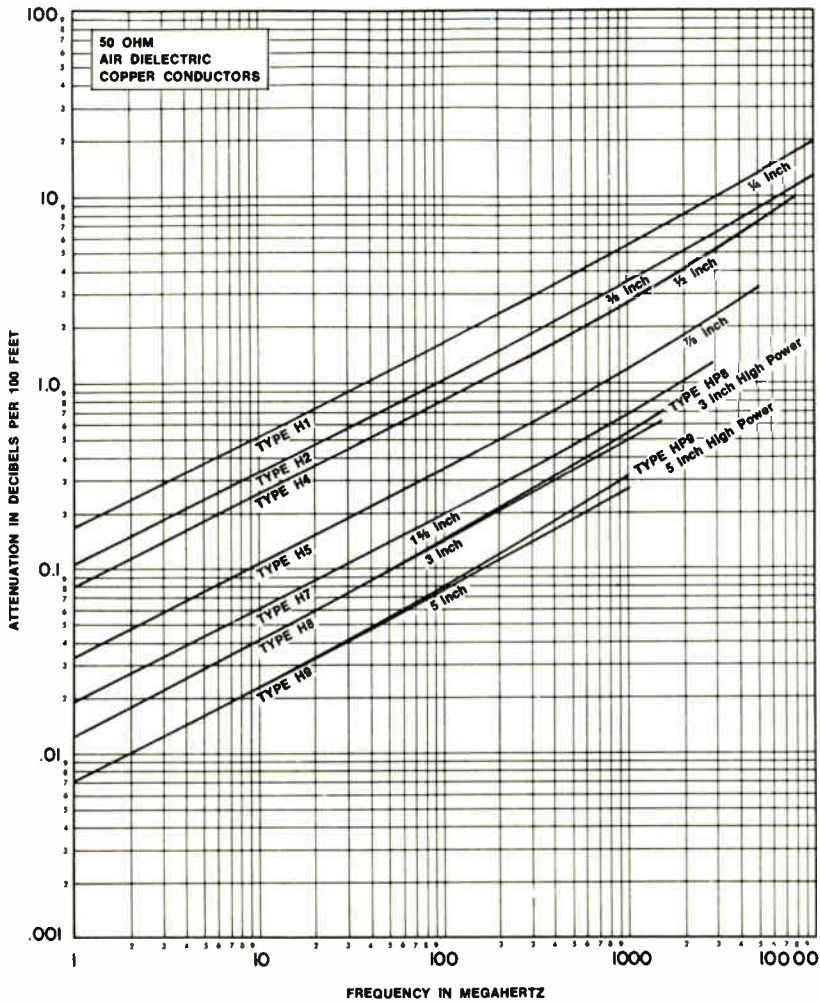

Power Rating of Helix Coaxial Cables

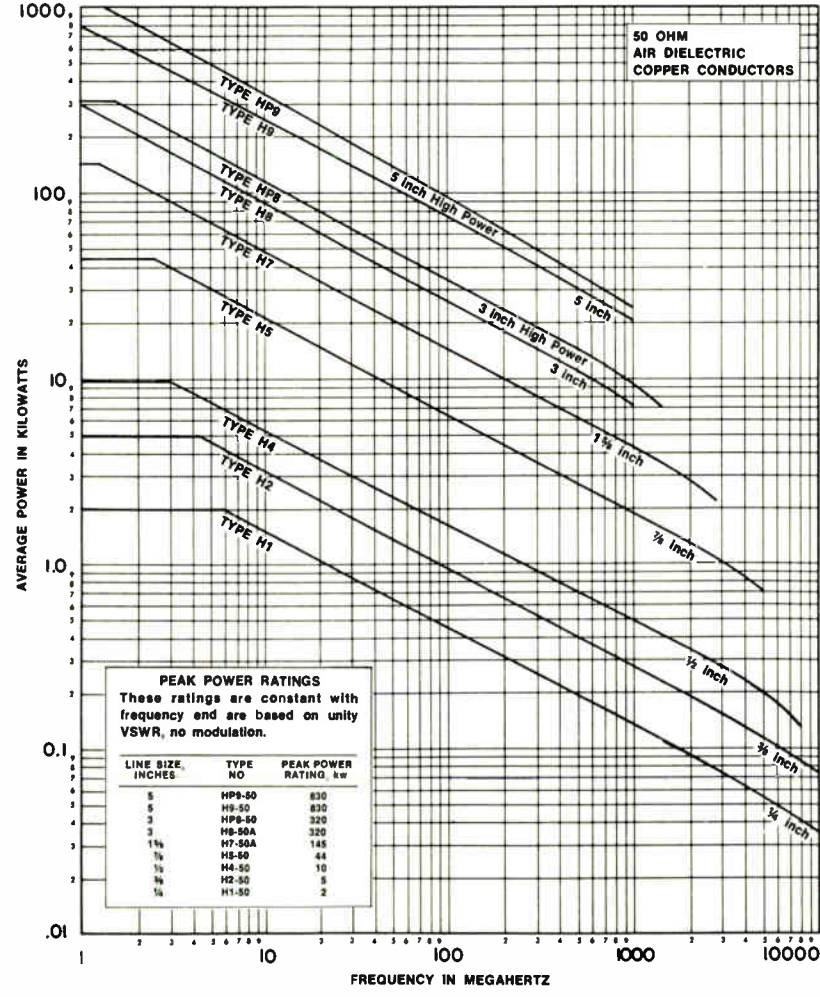

COAXIAL CABLE DATA

Courtesy Andrew Corporation

Attenuation of Helix Coaxial Cables

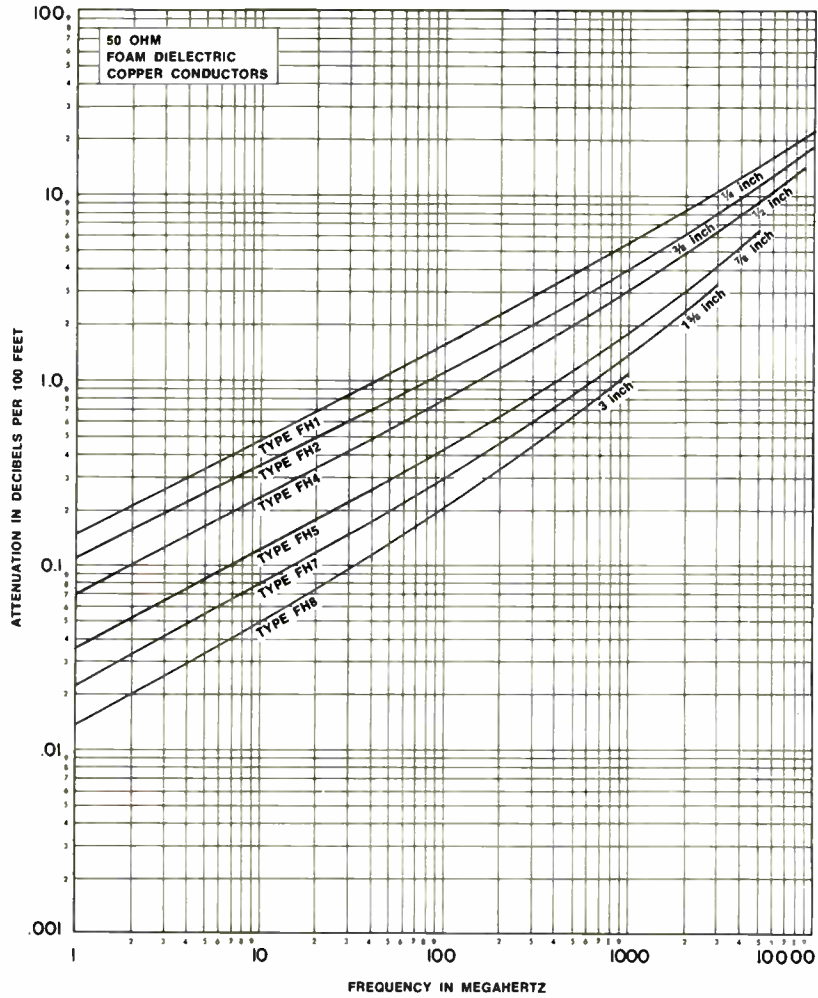

Attenuation curves based on:
VSWR 1.0:1.0
Ambient Temperature 24 C (75 F)

Conversion Data:
1 dB/100 feet 3.28 dB/100 meters
For 75 ohm cables, multiply values by .95.

Power Rating of Helix Coaxial Cables

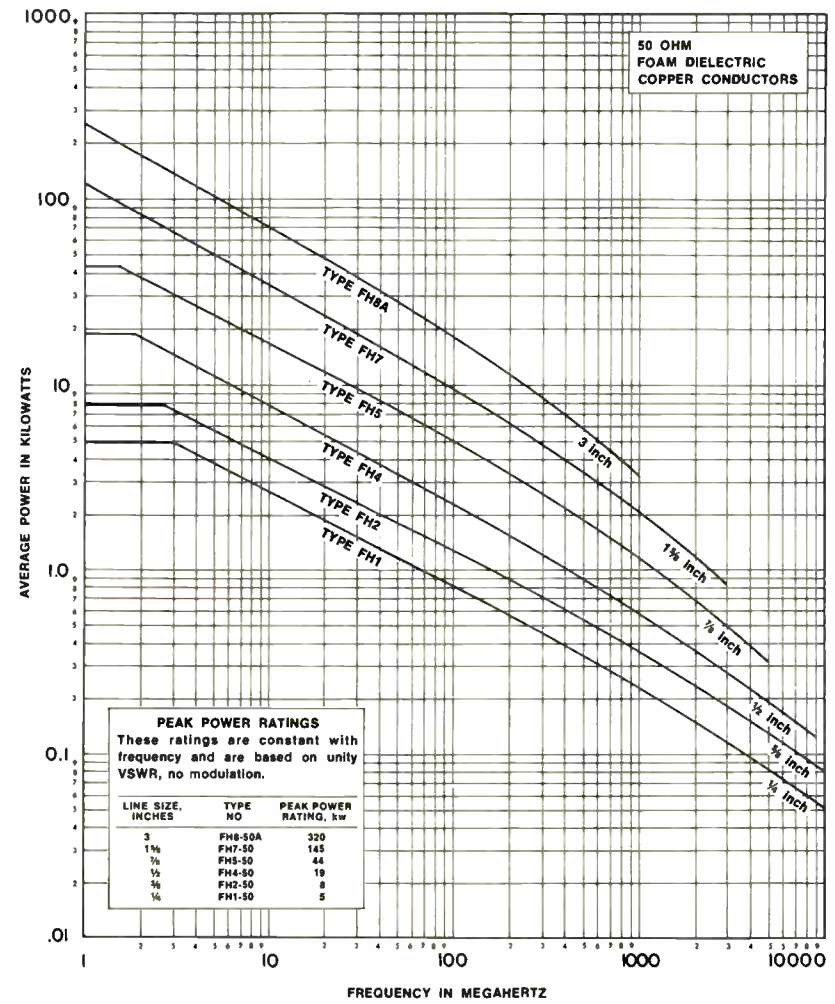

Power Ratings based on:
VSWR 1.0:1.0
Ambient Temperature 40 C (104 F)
Inner conductor temperature 79°C (175°F)

Conversion Data:
For ambient temperature 35°C (95°F), multiply values by 1.13

LOOK TO
WILKINSON
 FOR THE
**SIGNS OF
 EXCELLENCE!**

WILKINSON
 • FM
 TRANSMITTERS

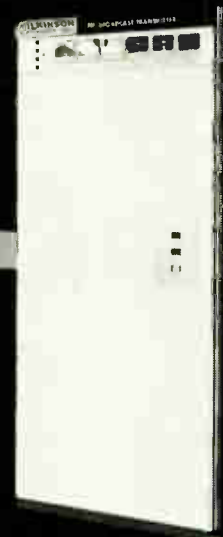

WILKINSON
 • AM
 TRANSMITTERS



WILKINSON
 • SOLID STATE AUDIO
 CONSOLES
 (Single channel
 and stereo)

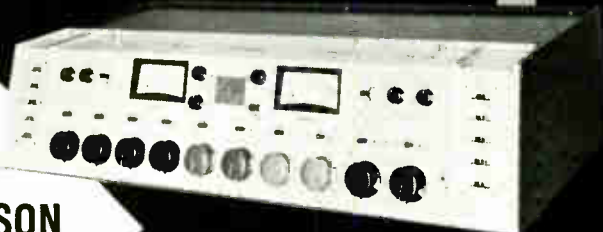

WILKINSON
 • DIRECT REPLACEMENT
 SILICON RECTIFIERS
 • COMPLETE ACCESSORY
 EQUIPMENT

WILKINSON
 • MULTIPLEX SCA
 GENERATORS
 • FM STEREO
 GENERATOR

WILKINSON
 • FIELD INTENSITY
 METERS
 • MODULATION
 MONITORS
 • FREQUENCY
 MONITORS
 • FM EXCITER



For complete details on WILKINSON ELECTRONICS equipment write today to:
WILKINSON ELECTRONICS, INC. ♦ 1937 MACDADE BLVD. • WOODLYN, PA. 19094
 TELEPHONE (AREA CODE 215) 874-5236 874-5237

COAXIAL CABLE DATA

Courtesy Andrew Corporation

Attenuation of Heliax Coaxial Cables

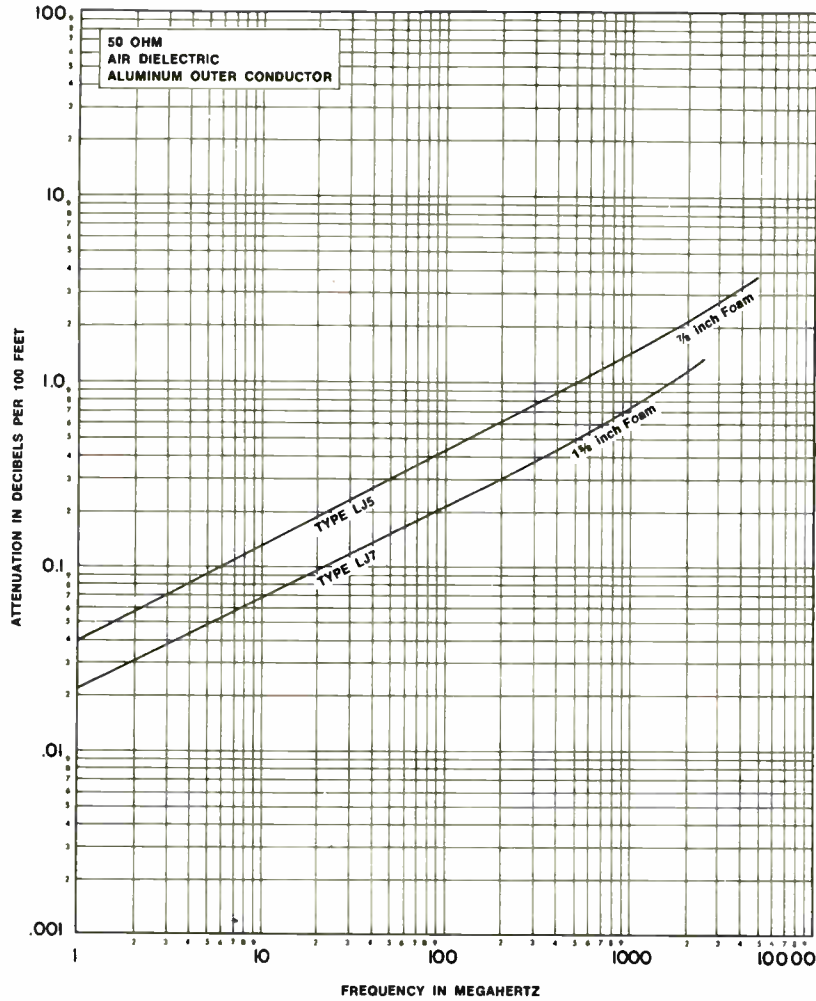

Attenuation curves based on:
VSWR 1.0:1.0
Ambient Temperature 24°C (75 F)

Conversion Data:
1 dB/100 feet 3.28 dB/100 meters
For 75 ohm cables, multiply values by .95.

Power Rating of Heliax Coaxial Cables

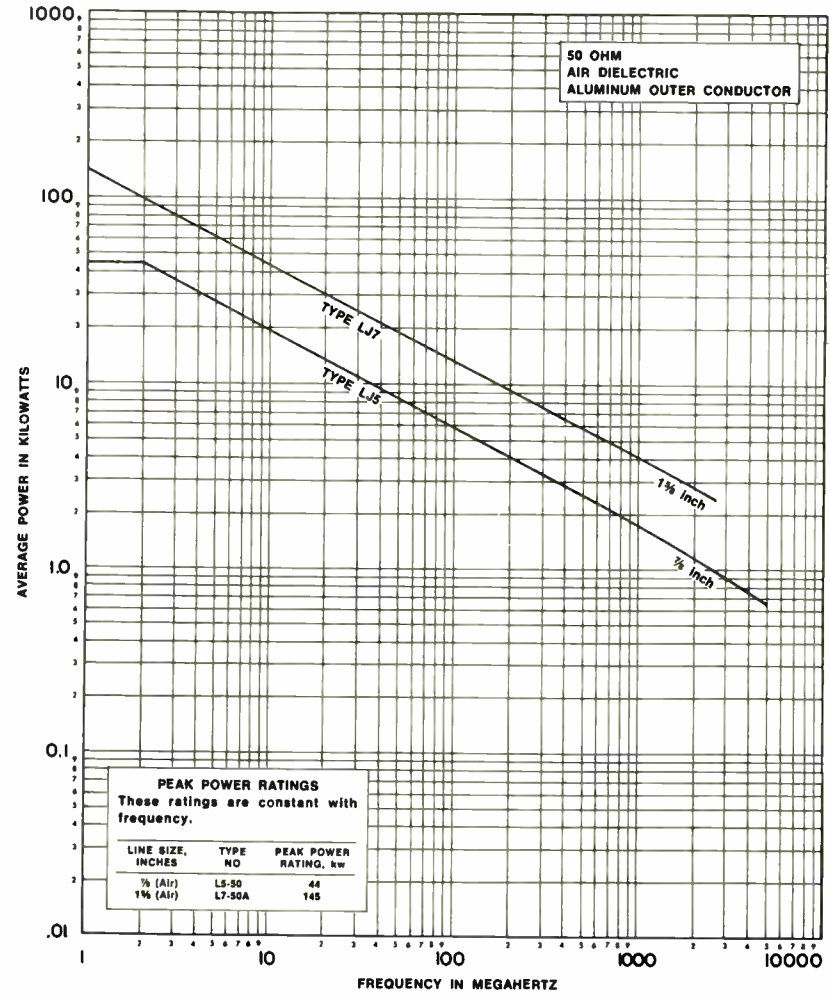

Power ratings based on:
VSWR 1.0:1.0
Ambient Temperature 40°C (104°F)
Inner conductor temperature 100°C (212°F)
One atmosphere absolute dry air pressure

Conversion Data:
For 75 ohm cables, multiply values by .7C.
For ambient temperature 35°C (95 F), multiply values by 1.08

NEMS • CLARKE

the equipment
most specified for antenna
and signal measurement



112 PHASE MONITOR

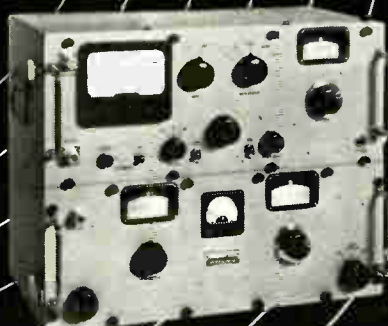

107A
FIELD INTENSITY MONITOR

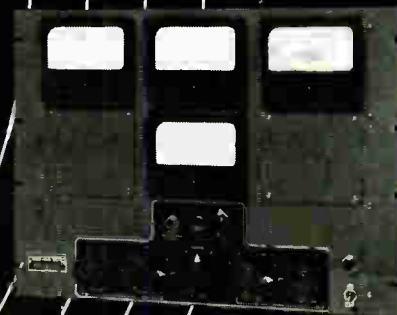

108E
PHASE MONITOR

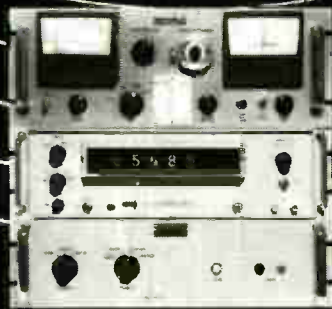

PPM-101
PRECISION PHASE MONITOR

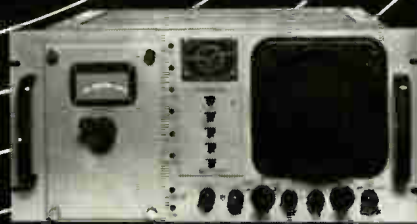

SDM-520
SPECTRUM DISPLAY MONITOR



FIM-135
FIELD INTENSITY METER

Over the years, the Nems-Clarke tradename has been the symbol of accuracy, quality and reliability in the field of antenna and signal measurements. Nems-Clarke equipment is FCC ap-

proved, and has been universally accepted as the standard of excellence throughout the industry. For further information on Nems-Clarke equipment, call or write:

V-28A

Vitro ELECTRONICS

Producers of NEMS-CLARKE Equipment • A Division Of Vitro Corporation Of America

919 Jesup-Blair Drive • Silver Spring, Maryland (301) 585-1000 • 2301 Pontius Avenue • Los Angeles 64, California (213) 477-6717

COAXIAL CABLE DATA

Courtesy Andrew Corporation

Attenuation of Heliax Coaxial Cables

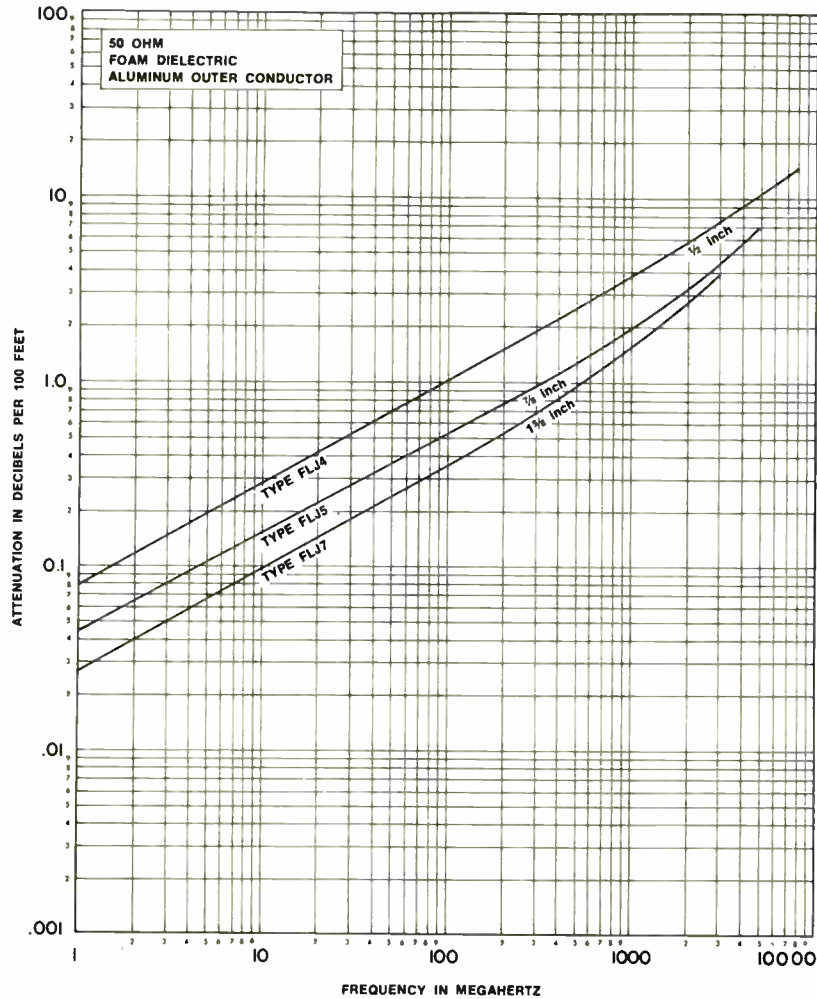

Attenuation curves based on:
VSWR 1.0:1.0
Ambient Temperature 24°C (75°F)

Conversion Data:
1 dB/100 feet = 3.28 dB/100 meters
For 75 ohm cables, multiply values by .95.

Power Rating of Heliax Coaxial Cables

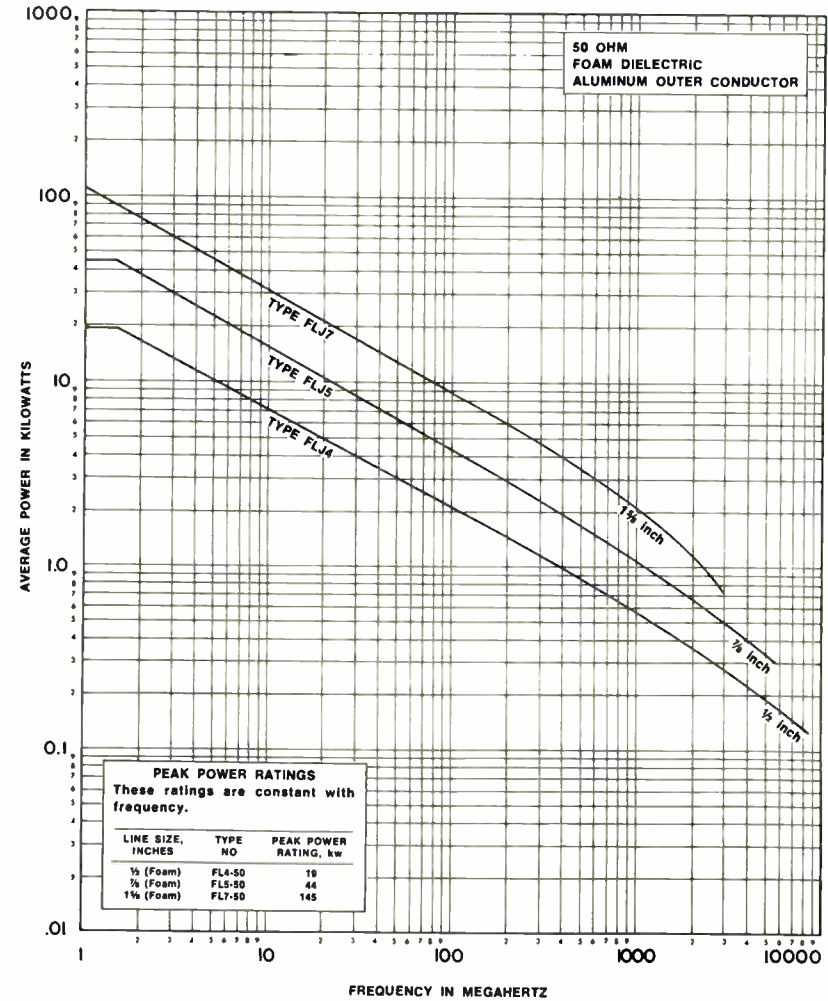

Power ratings based on:
VSWR 1.0:1.0
Ambient Temperature 40°C (104°F)
Inner conductor temperature 79°C (175°F)

Conversion Data:
For ambient temperature 35 C (95 F), multiply values by 1.13

**WORLD'S LARGEST SELLING
AND WORLD'S NEWEST**

Hand Size v-o-m's



MODEL 310
World's Largest Selling
Volt-Ohm-Milliammeter

MODEL 310-C
World's Newest
Volt-Ohm-Milliammeter

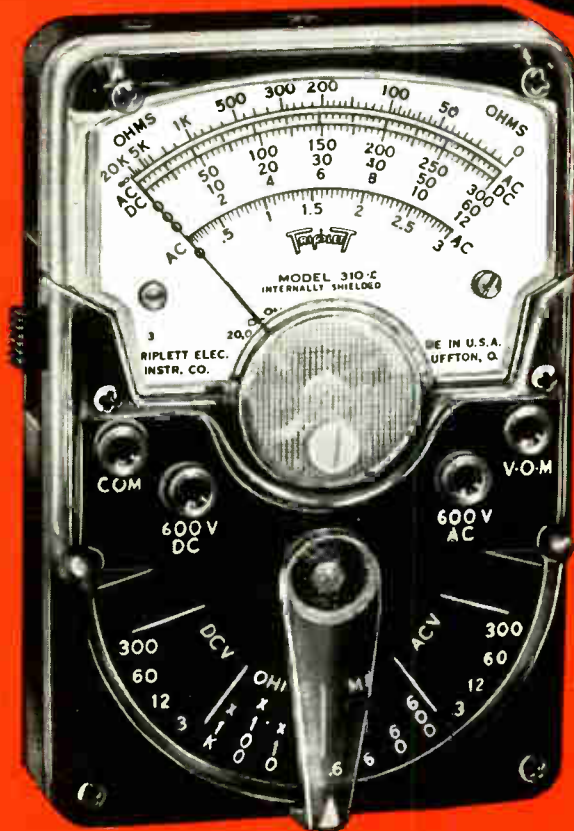

**BOTH TESTERS
SHOWN
ACTUAL SIZE**

1 HAND SIZE AND LIGHTWEIGHT, but with the features of full-size V-O-M's.

2 20,000 OHMS PER VOLT DC; 5,000 AC (310)—15,000 AC (310-C).

3 EXCLUSIVE SINGLE SELECTOR SWITCH speeds circuit and range settings. The first miniature V-O-M's with this exclusive feature for quick, fool-proof selection of all ranges.

SELF-SHIELDED Bar-Ring instrument; permits checking in strong magnetic fields. FITTING INTERCHANGEABLE test prod tip into top of tester makes it the common probe, thereby freeing one hand. UNBREAKABLE plastic meter window. BANANA-TYPE JACKS—positive connection and long life.

Model 310—\$42.00 Model 310-C—\$53.00 Model 369 Leather Case—\$4.00

ALL PRICES ARE SUGGESTED U.S.A. USER NET, SUBJECT TO CHANGE

310-C PLUS FEATURES

1. Fully enclosed lever range switch
2. 15,000 Ohms per volt AC (20,000 O/V DC same as 310)
3. Reversing switch for DC measurements

MODELS 100 AND 100-C

Comprehensive test sets. Model 100 includes: Model 310 V-O-M, Model 10 Clamp-on Ammeter Adapter; Model 101 Line Separator; Model 379 Leather Case; Model 311 leads. (\$78.00 Value Separate Unit Purchase Price.)

MODEL 100—U.S.A. User Net...\$74.00
MODEL 100 - C—
Same as above, but
with Model 310-C,
Net.....\$84.00



THE TRIPLETT ELECTRICAL INSTRUMENT COMPANY, BLUFFTON, OHIO

USES UNLIMITED: FIELD ENGINEERS • ELECTRICAL, RADIO, TV, AND APPLIANCE SERVICEMEN • ELECTRICAL CONTRACTORS • FACTORY MAINTENANCE MEN • ELECTRONIC TECHNICIANS • HOME OWNERS, HOBBYISTS
THE WORLD'S MOST COMPLETE LINE OF V-O-M's • AVAILABLE FROM YOUR TRIPLETT DISTRIBUTOR'S STOCK

COAXIAL CABLE DATA

Courtesy Andrew Corporation

Attenuation of Rigid Transmission Lines

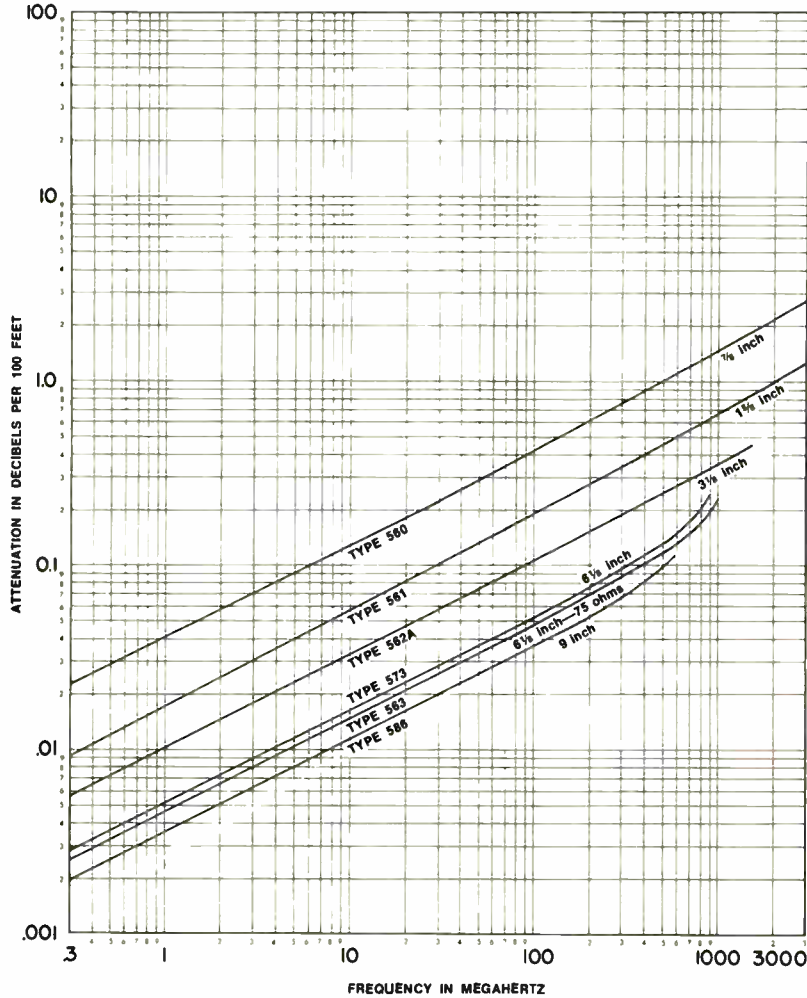

Attenuation curves based on:
VSWR 1.0:1.0
Ambient Temperature 24°C (75°F)

Conversion Data:
1 dB/100 feet = 3.28 dB/100 meters
Ambient Temperature 35°C (95°F)

Power Rating of Rigid Transmission Lines

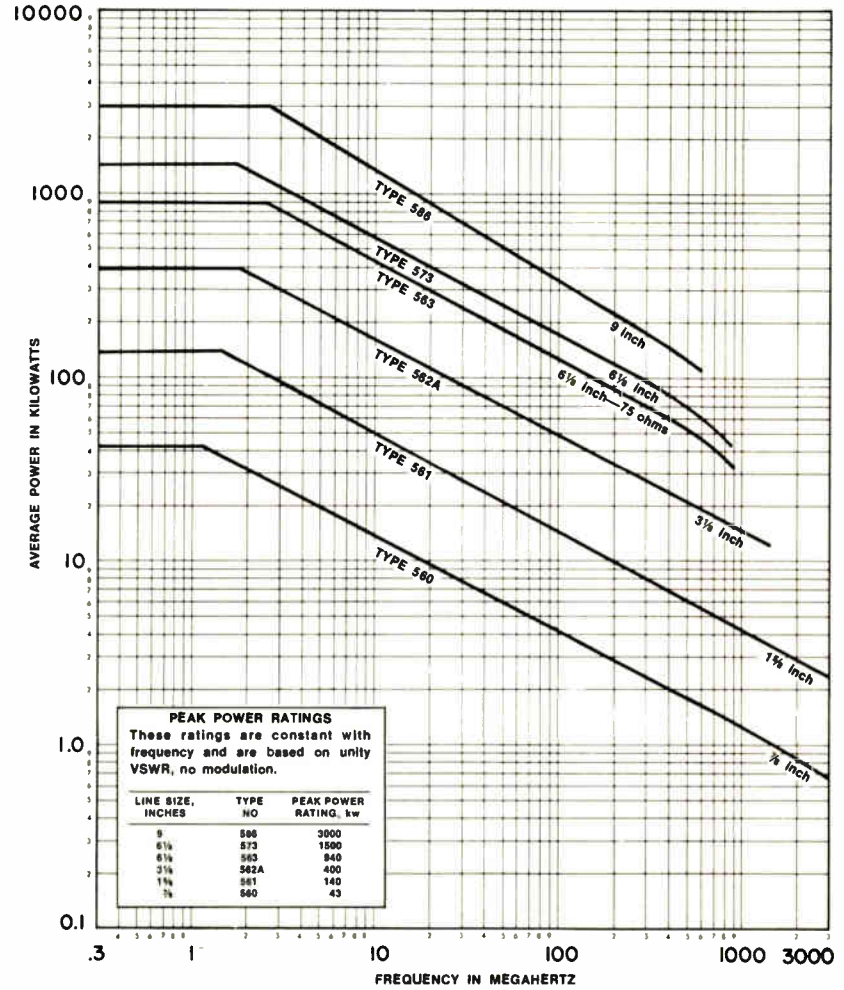

PEAK POWER RATINGS
These ratings are constant with frequency and are based on unity VSWR, no modulation.

LINE SIZE, INCHES	TYPE NO	PEAK POWER RATING, kw
9	586	3000
8 1/2	573	1500
8	563	840
6 1/2	562A	400
3	561	140
1 1/2	560	43

Power ratings based on:
VSWR 1.0:1.0
Ambient Temperature 40°C (104°F)
Inner conductor temperature 102°C (216°F)
One atmosphere absolute dry air pressure

Conversion Data:
For ambient temperature 35°C (95°F), multiply values by 1.08

TRANSMISSION LINES



HELIAX® FLEXIBLE COAXIAL CABLES



AIR DIELECTRIC—50 ohms								FOAM DIELECTRIC—50 ohms							
Size, in.	¼	⅜	½	¾	1 ½	3	5	Size, in.	¼	⅜	½	¾	1 ½	3	
Type No.	H1	H2	H4	H5	H7	H8	H9	Type No.	FH1	FH2	FH4	FH5	FH7	FH8	
Type No. Jacketed	HJ1	HJ2	HJ4	HJ5	HJ7	HJ8	HJ9	Type No. Jacketed	FHJ1	FHJ2	FHJ4	FHJ5	FHJ7	FHJ8	
Mox. Freq. GHz	23	15.5	10.9	5.2	2.63	1.64	960Mc	Mox. Freq. GHz	20	12	8.1	4.4	2.3	1.5	
Peak Power Rating, kw	2	5	9.8	44	145	320	830	Peak Power Rating, kw	5	8	19	44	145	320	
Velocity, %	85	85	91.4	91.6	92.1	93.3	93.0	Velocity	79	79	79	79	79	92	
Bending Radius, in.	2.5	3.7	5	10	20	30	50	Bending Radius, in.	2.5	3.7	5	10	20	50	
Net Wt. lbs./ft.	.07	.14	.20	.43	.72	1.2	3	Net Wt. lbs./ft.	.06	.12	.19	.36	1.06	3	



CONNECTORS



AIR DIELECTRIC—50 ohms								FOAM DIELECTRIC—50 ohms							
Size, in.	¼	⅜	½	¾	1 ½	3	5	Size, in.	¼	⅜	½	¾	1 ½	3	
EIA Flange	—	—	—	75AR	87R	78R	79R	EIA Flange	—	—	44AR	45AR	47R	48R	
"N" Jack	71N	72N	74N	75AN	87N	—	—	"N" Jack	41N	42N	44AN	45AN	47N	—	
"N" Plug	71W	72W	74W	75AW	—	—	—	"N" Plug	41W	42W	44AW	45AW	47W	—	
UHF Jack	—	—	74U	75AU	87U	—	—	UHF Jack	41U	—	44AU	45AU	—	—	
LC Jack	—	—	—	75AL	87L	78L	—	LC Jack	—	—	44AL	45AL	47L	—	
LC Plug	—	—	—	75AM	87M	—	—	LC Plug	—	—	44AM	45AM	—	—	
End Terminal	71T	—	74T	75AT	87T	—	—	End Terminal	—	—	44AT	45AT	—	—	
Splice	71Z	72Z	74Z	75AZ	87Z	78Z	79Z	Splice	—	—	44AZ	45AZ	47Z	48Z	
								UHF Plug	41P	42P	44AP	45AP	—	—	

WAVEGUIDES



HELIAX® ELLIPTICAL WAVEGUIDES

Flexible waveguide for use in microwave bands from 3.7 GHz to 13 GHz. Long lengths minimize layout and installation time. Connectors mate with MIL standard or EIA flanges.

Type No.	Frequency GHz	Attenuation Midband db/100'
EW-37	3.7- 4.2	.8
EW-44	4.4- 5.0	1.4
EW-56	5.6- 6.4	1.5
EW-59	5.9- 7.1	1.7
EW-71	7.1- 8.5	2.1
EW-85	8.5-10.0	2.8
EW-107	10.7-11.7	3.4
EW-122	12.2-13.2	4.3

RECTANGULAR and CIRCULAR WAVEGUIDES Stocked in commonly used sizes.

DEHYDRATORS—Type 1920, automatic dehydrator delivers dry air pressure at 5-8 psig with dew point of -37°F, output 1 cfm.

Low pressure dehydrators, dry air hand pumps, regulating and distribution systems, and alarm units are also available.



COAXIAL SWITCHES

Type 6750 (6 ½" line), Type 6740A (3 ½" line) and Type 6730A (1 ½" line) permit rapid switching of pairs of transmission lines operating into the UHF frequency band. Peak power ratings are 100 KW in 1 ½" size, 300 KW in 3 ½" size and 1500 KW in 6 ½" size. Control panel with indicators available for remote or manual control of Andrew switching systems.

RIGID TRANSMISSION LINES—Andrew offers a complete selection (½" to 9") of 50 ohm transmission lines and accessories. All items are fully compatible with applicable EIA standards.

CHARACTERISTICS					
Size	½"	1 ½"	3 ½"	6 ½"	9"
Type No.	560	561	562A	573	586
Mox. Freq. MHz	3000	2700	1600	750	440
Peak Power, kw	43	140	400	1500	3000
Weight, pounds per 20 ft. sec.	13	25	55	135	310



CHICAGO*
Andrew Corporation
P.O. Box 807
Chicago, Illinois, U.S.A. 60642
Phone: 312-349-3300

NEW YORK
Andrew Corporation
P.O. Box 416
Ridgewood, New York, U.S.A. 11435
Phone: 201-445-2500

WRITE FOR LATEST ANDREW FULL LINE CATALOG

WASHINGTON, D.C.
Andrew Corporation
P.O. Box 5897
Washington, D.C., U.S.A. 20014
Phone: 202-654-2540

DALLAS
Andrew Corporation
P.O. Box 30506
Dallas, Texas, U.S.A. 75240
Phone: 214-235-1279

LOS ANGELES*
Andrew California Corporation
941 E. Morylind Ave.
Clovermont, California, U.S.A. 91711
Phone: 714-626-3505

SAN FRANCISCO
Andrew California Corporation
701 Welch Road
Palo Alto, California, U.S.A. 94304
Phone: 415-323-3139

*Plants

MONTREAL
Andrew Antenna Company, Ltd.
55 Little Rock Avenue
Pointe Claire, Quebec, Canada
Phone: 514-695-5365

VANCOUVER
Andrew Antenna Company, Ltd.
917 Thermal Dr.
Coquitlam, N.W.
British Columbia, Canada
Phone: 604-936-6421

AUSTRALIA
Andrew Antennos Pty. Ltd.
437 St. Kilda Road
Melbourne, Victoria, Australia

EUROPE*
Andrew Antenna Systems
Lochgelly, Fife, Great Britain

TORONTO, ONTARIO*
Andrew Antenna Company, Ltd.
P.O. Box 177
Whitby, Ontario, Canada
Phone: (416) 668-3348
Toronto phone: (416) 364-4336

GATES

quick reference guide to products and coast-to-coast service

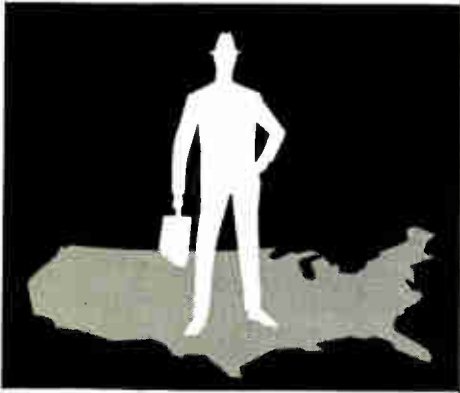

DISTRICT MANAGERS

Alabama, Birmingham: P.O. Box 20160
WILLIAM MOATS (205) 822-3625

California, Los Angeles: 1945 S. Figueroa
EDWARD WILDER (213) 747-7129

California, Sacramento: P.O. Box 1914
ROBERT STEIGER (916) 446-4470

Colorado, Denver: 8171 Orchard Drive
HOWARD DEMPSEY (303) 429-5758

District of Columbia
730 Federal Bldg., 1522 K Street, N.W.
EDWARD SHUEY and JOHN ANDRE
(202) 223-5508

Florida, Jacksonville: P.O. Box 8735
RICHARD SPRULL (904) 721-2779

Illinois, Glen Ellyn: 22W235 Burdette St.
CLARENCE MORGAN (312) 469-0847

Illinois, Quincy: 19 Windy Hill
PAUL TIMPE (217) 223-4701

Iowa, Waterloo: Box 2397, Station A
STANLEY WHITMAN (319) 233-0561

Michigan, Lambertville: 7169 Burkenhead Place
THOMAS SCHOONOVER (313) 856-3581

New York, Latham: 11 Ridgecrest
ROBERT HALLENBECK (518) 785-9144

New York, New York: 800 Second Avenue
JOE ENGLE (212) 687-7971

Oklahoma, Tulsa: 2719 S. Hudson Avenue
URLIN WHITMAN (918) 836-4835

Oregon, Boring: Route 2, Box 584A
LEWIS DENES (503) 658-2684

Pennsylvania, Pittsburgh
P.O. Box 11772, Mt. Lebanon
NEIL ARVESCHOUG (412) 343-4860

Puerto Rico, Rio Piedras: P.O. Box 89
RAFAEL ACOSTA

Texas, Houston: 4019 Richmond Avenue
LONDON ENGLAND (713) 666-4333

Texas, Houston: 4019 Richmond Avenue
JOE WOODS (713) 666-4333

Virginia, Halifax: P.O. Box 246
JOE COLE (703) 476-4514

Washington, D.C.
730 Federal Bldg., 1522 K Street, N.W.
WALTON AYER (202) 223-5508

The most complete broadcast equipment line in the industry . . .
available from two separate stock-carrying service centers:

AM, FM & TV Transmitters
Amplifiers, Audio, Video, RF
Antennas & Accessories
Audio Consoles & Accessories
Audio Systems & Components
Automation
Booms, Microphone
Cabinets, Racks, Panels
Cartridge Equipment, Automatic Tape
Chronometers, Clocks
Communications Systems
Consoles, Audio

Discs, Blank Recording
Filters, RF
Generators, Engine Driven
Headsets, Headphones
Heads, Magnetic Film, Magnetic
Tape, Disc Recording & Playback
Jack Panels & Accessories
Lights & Lighting
Loud Speakers & Accessories
Microphones & Accessories
Mobile Communications
Monitors, Audio & Video
Monitors, AM, FM & Phase
Phasing Equipment
Power Supplies
Racks & Cabinets
Recorders, Audio
Remote Broadcast Pickup Equipment
Speakers
Stands, Microphone
Switches & Accessories
Tape, Audio
Towers, Accessories, Services
Transcription Equipment
Transformers
Transistors
Transmission Line
Transmitters, AM, FM, TV, SSB, HF
Tubes
Tuning Units, Antenna
Turntables



**HARRIS
INTERTYPE
CORPORATION**

GATES

GATES RADIO COMPANY • QUINCY, ILLINOIS 62301, U.S.A.

A subsidiary of Harris-Intertype Corporation



CONSULTING ENGINEERS

A listing of known consulting engineers and their affiliations.

ADAIR, GEORGE P.
GEORGE P ADAIR ENGINEERING CO

GEORGE P. ADAIR ENGINEERING CO
901 TWENTIETH ST., N.W.
WASHINGTON, D.C. 20006
202 333-1116

STAFF
JOHN E DETTRA, JR
MANUEL MAYOBRE, JR.
WILLIAM J. HARDING
BRUCE M SMITH

ADCOCK, ANTHONY H.
INTERTEL, HOYLES, NIBLOCK

AKERMAN, BEN
2646 SHADY VALLEY DR., NE
ATLANTA, GEORGIA 30324
404 261-3125

AMOO, LLOYD R
188 W BAY BLVD
PORT HUENEME, CAL 93041
805 486 6844

ANDERSON, BURTON S.
ANDERSON RADIO ENGINEERING CO

ANDERSON RADIO ENGINEERING CO
P O BOX 1671
GREENVILLE, S. C. 29602
803 277-2876

ANDRUS, ALVIN H.
JANSKY & BAILEY

AUGUSTITUS, FRANK G.
A. D. RING & ASSOC.

BAILEY, STUART L.
JANSKY & BAILEY

BAKER, JOSEPH
JANSKY & BAILEY

BAKER, MARVIN C. JR.
GAUTNEY & JONES

BARGER, TED
CARL E SMITH CONS. RADIO ENGR

BARGHAUSEN, A. P.
VIR M. JAMES

BARKLEY & DEXTER LABS, INC.
50 FRANKFORT STREET
FITCHBURG, MASS. 01422
617 DIAMOND 3-3716

PRESIDENT
JAMES M. MORAN
STAFF
LAWRENCE R. DAY
NORMAN L. RIVERS
MARTIN W. MYLLYKANGAS
ERNEST A. CHARRON

ROBERT A. MATHIEU

BARNARD, ALVIN H.
SINGLETON & BARNARD

BARNWELL, M. J.
VIR M. JAMES

BARRON, KENNETH E.
INTERTEL, HOYLES, NIBLOCK

JOHN H. BATTISON
BOX 1534

ANNAPOLIS, MD.
301 263 6860

STAFF
M. HEWITT
D. SMITH

BEECHER, WILLIS C.
TRANSLUX BLDG.
WASHINGTON, D.C. 20005
202 393-5621

BEGUE, GEORGE P.
JANSKY & BAILEY

BEHR, LAWRENCE PRESIDENT
LAWRENCE BEHR ASSOCIATES, INC

LAWRENCE BEHR ASSOCIATES, INC.
2501 EAST FOURTH STREET
GREENVILLE, N. C. 27834

919 758-3966 OR 752-4971
PRESIDENT

LAWRENCE BEHR
VICE PRESIDENT

CARL V. VENTERS
VICE PRESIDENT

JASPER L. TRIPP JR.

E. E. BENHAM & ASSOC.
3141 CAHUENGA BLVD.
W. HOLLYWOOD, CALIF. 90028
213 466-3227

BENNETT, STANTON D
C/O FIELD EMISSION CORP
611 E THIRD ST
MCMINNVILLE, ORE 97128
472 5101

BENNS, WILLIAM E. JR.
111 RICHARDSON STREET
LOOKOUT MOUNTAIN, TENN. 37350
615 821-3555

BERGEN, SERGE
10828 FAIRCHESTER DRIVE
FAIRFAX, VA. 22030
703 273-2191

BERNARD ASSOC.
237 E. 39TH STREET

NEW YORK, N.Y. 10016
212 MURRAY HILL 6-7445

SENIOR PARTNER
BERNARD EICHWALD
ASSOCIATE
GERALD C. SHARPE

BIDLACK, CECIL S.
CARL E SMITH CONS. RADIO ENGR

BIRD, JAMES R.
936 VIRGINIA DR.

RIO VISTA, CALIF.
374-5101

ALSO
74-A STREET
CONCORD, CALIF.
415 682-7733

BITZER, RALPH J.
ARCADE BLDG.

ST. LOUIS, MO. 63101
314 GARFIELD 1-4954

STAFF
HARVEY DAY
THEODORE A. GILES

BLANCHARD, ROBERT R.
BROADCAST ENGINEERING SERVICE

BLANTON, K. G.
A. EARL CULLUM JR.

BLUMBERG, MARVIN
A. D. RING & ASSOC.

BOLOTIN, FREDERICK D.
CARL E SMITH CONS. RADIO ENGR

BOND, CLYDE H
BOND & OAKLEY

BOND & OAKLEY
P O BOX 2899
RENO, NEV 89505

322 9145
ASSOCIATES
CLYDE H BOND
RON OAKLEY

BOYER, L. W.
VIR M. JAMES

BRATTON, WILLIAM F JR
DAVID STEEL & ASSOC

BRAUN, CYRIL M.
14628 CLAUDE LANE
SILVER SPRINGS, MD. 20904
301 384-1529

BRAUN, WARREN 6
680 NEW YORK AVE

HARRISONBURG, VA 22801
703 434 4331

CHARLES E. BRENNAN
405 E. LINCOLN AVE.

MILWAUKEE, WIS. 53207
ASSOCIATES
E. RAY COOKE

PAUL E. LE SAGE
RALPH E. EVANS

BRIDGES, LOREN F.
CARL E SMITH CONS. RADIO ENGR

BROADCAST ENGINEERING SERVICE
490 CARR STREET
LAKEWOOD 26, COLO.

303 237-5968
STAFF
ROBERT R. BLANCHARD

BROWNE ASSOCIATES
TELECOMMUNICATIONS CONS

642 NORTH WOODWARD AVE
BIRMINGHAM, MICH 48011

JOHN F X BROWNE
BROWNE ASSOCIATES

CAPPERS, WILLIAM F. JR.
KEAR & KENNEDY

CARNES, FRANCES
L. M. CARR & ASSOC.

CARR, WILLIAM B.
4910 BLANEY AVE.

FORT WORTH, TEX.
817 BUTLER 1-1551

STAFF
LOUISE SESSIONS

CAVEGN, AMBROSE J.
KEAR & KENNEDY

CHAMBERS, G RUSSELL
414 FRENCH ST

WILMINGTON, DEL 19801
OL 8 7127

STAFF
ALBERT H SMITH

CHARRON, ERNEST A.
BARKLEY & DEXTER LABS., INC.

CHIPP, RODNEY D.
RODNEY D CHIPP & ASSOCIATES

RODNEY D CHIPP & ASSOCIATES
15 WARD STREET
BLOOMFIELD, N.J.

201 748 0777

CMUFD. ROBERT
CARL E. SMITH

CHURCHILL, DANIEL W.
14 LEWIS STREET
SPRINGFIELD, VT.
802 885-2950

CICCORICCO, FRANCIS A.
169 NORTH WEST STREET
HOMER, N.Y.
607 PIONEER 9-4400

COBB, MARIANNA WOODSON
3849 N. 30TH STREET
ARLINGTON, VA. 22207
703 JACKSON 7-7410

COMEN, JULES
JULES COMEN & ASSOC.

JULES COMEN & ASSOC.
729-15TH STREET, NW
WASHINGTON, D.C. 20005
202 EXECUTIVE 3-4616
PARTNERS
JULES COMEN
PAUL L. WIMMER
BERNARD R. SEGAL
ASSOCIATES
WILLIAM C. KING JR.
ALBERT F. CRIDER
EDWARD A. KMOSENA

COMEN, JULIUS
GEORGE C. DAVIS COMS. ENGR.

COLL, EDWARD T.
CARL E SMITH COMS. RADIO ENGR

COLLIGAN, FRANCIS S.
JOHN H. MULLANEY & ASSOC.

COMMERCIAL RADID EQUIPMENT CO.
1334 G STREET, NW
WASHINGTON, D.C. 20005
202 DISTRICT 7-1319
GENERAL MANAGER
EVERETT L. DILLARD
ENGINEERING MANAGER
EDWARD F. LORENTZ
STAFF
THOMAS J. ENGLISH
ROBERT GEMMAN
EARL JUDY

COOKE, E. RAY
CHARLES E. BRENNAN ENGINEERS

CREUTZ, JOHN
CREUTZ & SNOWBERGER

CREUTZ & SNOWBERGER
724 14TH STREET, NW
WASHINGTON, D.C. 20005
202 EXECUTIVE 3-5670
PARTNERS
JOHN CREUTZ
ARTHUR A. SNOWBERGER
ENGINEER
CHARLES SMITH

CRIDER, ALBERT F.
JULES COMEN & ASSOC.

CROSBY, MURRAY G.
93 MUTTONTOWN RD.
SYOSSETT, L.I., N.Y. 11791
516 WALNUT 1-6234

CROSS, JOHN S.
5416 AUDUBON RD
BETHESDA, MD 20014
OL 2 7817

CROY, JAMES R.
314 TRANS LUX BLDG
WASHINGTON, D C 20005
737 1210

CUELLAR, OSCAR LEON
207 PINA BLDG.
TUCSON, ARIZ. 85701
602 623-1121

A. EARL CULLUM JR.
INWOOD POST OFFICE
DALLAS, TEXAS 75209
214 631-8360
PARTNERS
D. A. PETERSON
T. A. WRIGHT
C. M. DANIELL
ASSOCIATES
DEWOLF SCHATZEL
L. F. HEITHECKER
K. G. BLANTON

CULVER, RONALD H.
LOHNES & CULVER

DAHLBERG, ELIZABETH L.
LOHNES & CULVER

DANIELL, C. M.
A. EARL CULLUM JR.

DAVEY, B. P.
VIR N. JAMES

DAVIS, GEORGE C.
GEORGE C. DAVIS CONSULTING ENGR

527 MUNSEY BLDG.
WASHINGTON, D.C. 20001
202 STERLING 3-0111
PARTNERS
GEORGE C. DAVIS
WALTER L. DAVIS
JULIUS COMEN
RALPH E. DIPPELL JR.

DAVIS, WALTER L.
GEORGE C. DAVIS COMS. ENGR.

OAY, HARVEY
BITZER, RALPH J

OAY, LAWRENCE R.
BARKLEY & OEXTER LABS., INC.

DEETERS, EDWARD W.
WILLIAM L. FOSS INC.

DELANOER, DOUGLAS B.
SILLIMAN, MOFFET & KOWALSKI

DE SANTIS, ROBERT V.
JANSKY & BAILEY

DETTRA, JOHN E JR
GEORGE P ADAIR ENGINEERING CO

DICKINSON, WILLIAM T.
JANSKY & BAILEY

DIGRUTTOLO, RODNEY L.
SILLIMAN, MOFFET & KOWALSKI

DILLARD, EVERETT L.
COMMERCIAL RADIO EQUIPMENT CO

DILTS, FREDERICK W.
HAMMETT & EDISON

DIPPELL, RALPH E. JR.
GEORGE C. DAVIS COMS. ENGR.

DORDAL, RAYMOND
A. D. RING & ASSOC.

DUNCAN, R. S.
JAMES C. McNARY

DU TREIL, L. J. M.
L. J. M. DU TREIL & ASSOC.
10044 GAIL CT.
NEW ORLEANS 23, LA.
504 721-2661
VICE PRESIDENT
L. J. M. DU TREIL

DU TREIL, LOUIS E.
JOHN H. MULLANEY & ASSOC.

EATOUGH, CHARLES D.
HAMMETT & EDISON

EDISON, EDWARD
HAMMETT & EDISON

ETCHWALD, BERNARD
BERNARD ASSOC.

EMPRESAS ELECTRONICAS
WALSER INC
WALSER INC
APARTADO 1005
SAN JUAN, PUERTO RICO
722 3970

ENGLISH, THOMAS J.
COMMERCIAL RADIO EQUIPMENT CO

ENSTROM, HOWARD L
JONES, ROBERT A

ESPY, DAWKINS
BOX 3127 OLYMPIC STATION
BEVERLY HILLS, CAL 90212
BR 2 3344

EVANS, RALPH E.
CHARLES E. BRENNAN

EVANS, R. M. PETER
INTERTEL, HOYLES, NIBLOCK

FEIKERT, GRANT S.
321 N. TWENTY-THIRD STREET
CORVALLIS, ORE.
503 753-7541

FLEET, JOHN H.
JOHN H. MULLANEY

FLOM, MORTON
5814 HUDSON AVE
MONTREAL 29, QUEBEC
514 484 4883

FM UNLIMITED INC.
5449 AUGUSTA BLVD.
CHICAGO, ILL. 60651
312 379-7557
PRESIDENT
CHARLES KLINE

FORD, M. H.
VIR N. JAMES

FORD, PAUL DEAN
R R 2, BOX 50
W. TERRE HAUTE, INO. 47885
812 DREXEL 8903

FORD, WILLIAM E.
PETE JOHNSON CONSULTING ENGR.

WILLIAM L. FOSS INC.
927 15TH STREET, NW
WASHINGTON 5, D. C.
REPUBLIC 7-3883
PRESIDENT
EDWARD W. DEETERS

FRAZER, EDWARD J.
INTERTEL, HOYLES, NIBLOCK

FRESE, GEORGE M.
1011 DENIS AVE.
EAST WENATCHEE, WASH. 98802
509 TURNER 4-4558

FREY, A ALBERT
ROBERT A JONES

FRIEDMAN, THOMAS B.
209 QUADRO VECCHIO DRIVE
PACIFIC PALISADES, CAL 90272
213 454-2837

FULLER, D. C.
VIR JAMES

GALL, FREDERICK
INTERTEL, HOYLES, NIBLOCK

GALLAGHER, CHARLES I.
GAUTNEY & JONES

GARLANO, GLADYS
LOUIS A. KING

GAUTNEY, GEORGE E.
GAUTNEY & JONES

GAUTNEY & JONES
930 WARNER BLDG.
WASHINGTON, D.C. 20004
202 NATIONAL 8-7757
PARTNERS
GEORGE E. GAUTNEY
CARL T. JONES
STAFF
MARVIN C. BAKER JR.
MELVIN E. LAWSON
HERMAN E. HURST JR.
THOMAS L. GREEN
GEORGE L. MORGAN JR.
CHARLES I. GALLAGHER

GEMMAN, ROBERT
COMMERCIAL RADIO EQUIPMENT CO

GILES, THEODORE A.
RALPH J. BITZER

GOOLEY, PAUL F.
PAUL GODLEY CO.

PAUL GODLEY CO.
P O BOX 798
UPPER MONTCLAIR, N.J. 07043
201 746-3000
OFFICES AND LABORATORIES
LITTLE FALLS, N. J.
STAFF
PAUL F. GODLEY
PAUL F. GODLEY JR.
CARSON W. KAUFFMAN
J. G. LITTLEFIELD

GODLEY, PAUL F. JR.
PAUL GODLEY CO.

GOLDBERG, BARNETT F
1138 BULL ST
COLUMBIA, S C 29201
803 253 8347

GRADICK, L. E.
VAN NOSTRAND RADIO ENGR SERV

GRAY, CLAUDE M.
BOX 602
BIRMINGHAM, ALA. 35201
205 TREMONT 1-3570

GREELY, C. E.
JANSKY & BAILEY INC.

GREEN, THOMAS L.
GAUTNEY & JONES

GREER, PALMER A.
ROUTE 1, WHITE HORSE RD.
GREENVILLE, S. C. 29611
803 246-3401

GURECKIS, PETER V.
JOHN H. MULLANEY & ASSOC.

GUY, RAYMOND F.
2320 N.E. 34TH COURT
LIGHTHOUSE POINT, FLA.

HAGERTY, WILLIAM H.
781 Foothill Drive
SAN MATEO, CALIF. 94402
415 341-2459

HALL, FLOYD
P O BOX 1017
CRESTLINE, CALIF. 92325
5852

HAMMETT & EDISON
BOX 68, INTL. AIRPORT
SAN FRANCISCO, CALIF. 94120
415 342-5208
PARTNERS
ROBERT L. HAMMETT
EDWARD EDISON
STAFF

CHARLES D. EATOUGH
LAWRENCE W. TEMPLETON
FREDERICK W. DILTS

HAMMETT, ROBERT L.
HAMMETT & EDISON

HARDING, WILLIAM J.
GEORGE P ADAIR ENGINEERING CO

HARPER, ERNEST E
2414 CHUCKANUT SHORE RD
BELLINGHAM, WASHINGTON 98225
RE 3 4198

HASKETT, JOHN O.
HASKETT & VOLKMAN

HASKETT & VOLKMAN
7265 MEMORY LANE
CINCINNATI, OHIO 45239
513 331-0307
PARTNERS
JOHN D. HASKETT
DONALD F. VOLKMAN

HATFIELD, J. B.
906 36TH AVENUE
SEATTLE, WASH.
206 EAST 4-7860

HAY, JAMES
LOUIS A. KING

HEAD, HOWARD T.
A. D. RING & ASSOC.

HEFFELFINGER, J. B.
9208 WYOMING PL.
KANSAS CITY, MO. 64114
816 HILAND 4-7010

HEITHECKER, L. F.
A. EARL CULLUM JR.

HEWITT, M.
JOHN H. BATTISON

HOGAN FAXIMILE CORP.
8600 BELLANCA AVENUE
LOS ANGELES, CALIF. 90045

HOGAN, JOHN V.
HOGAN FAXIMILE CORP.

HOLEY, W. J.
1146 BRIARCLIFF PLACE, NE
ATLANTA, GA. 30306
404 TRINITY 4-3328

HOWARD, GEORGE P.
JOHN H. MULLANEY & ASSOC.

HOYLES, HERBERT A.
INTERTEL, HOYLES, NIBLOCK

HURST, HERMAN E. JR.
GAUTNEY & JONES

HUTCHESON, GUY C.
1100 W ABRAM ST., BOX 808
ARLINGTON, TEX. 76011
817 CRESTVIEW 4-8721

HUTTON, WILLIAM G.
CARL E SMITH COMS RADIO ENGR

INTERTEL, HOYLES, NIBLOCK
1331 THIRD AVENUE
SEATTLE, WASH.
206 623-6836
CANADIAN OFFICES
1234 MARINE DR.
NORTH VANCOUVER, B.C.
604 985-3136
298 ELGIN STREET
OTTAWA, ONTARIO
613 236-0864
PARTNERS
HERT A. HOYLES
R. M. PETER EVANS
PETER A. NIBLOCK
DR. HANS J. VON BAEYER
FREDERICK GALL
ASSOCIATES
JOHN F. LEGG
EDWARD J. FRAZER
KENNETH E. BARRON
DR. HOWARD TREMAINE
TAK NEGORO
ROBERT A. STRANCHAN
H. GRANT MCCORMICK
ANTHONY H. ADCOCK
M. R. SMYTHE

ISBERG, R. A.
1215 HENRY ST.
BERKELEY, CALIF. 94709
415 526-1446

JACKER, EDWARD W.
420 S. CHASE STREET
LOMBARD, ILL. 60148
312 629-0942

JAMES, VIR N.
345 COLORADO BLVD.
DENVER, COLO. 80206
303 333-5562
ASSOCIATES
A. P. BARGHAUSEN
L. W. BOWER
B. P. DAVEY
M. J. BARNWELL
C. J. NYSTROM
D. C. FULLER
P. H. PARMELEE

M. W. OWEN
M. H. FORD
S. R. MILSTEN

JANSKY & BAILEY
DEPARTMENTS OF
ATLANTIC RESEARCH CORP
1812 K ST NW
WASHINGTON, D C 20006
202 296 6400
CONSULTANT
C. M. JANSKY JR.
PRESIDENT
STUART L. BAILEY
VICE PRESIDENT
DELMER C. PORTS
BROADCAST-TELEVISION DEPT
HEAD
OSCAR REED JR.
STAFF ENGINEERS
ALVIN H. ANDRUS
JOSEPH BAKER
GEORGE P. BEGUE
ROBERT V. DESANTIS
JEREMY F. PARKER
ROGER E. PETERSON
WILLIAM V. WEAKLEY
SYSTEMS DEPARTMENT
HEAD
JOHN J. RENNER

JANSKY, C. M. JR.
JANSKY & BAILEY

JOHNSON, EARL M. -PETE
PETE JOHNSON CONSULTING ENGR.

PETE JOHNSON CONSULTING ENGRS.
4112 MACCORKLE AVE., SE
CHARLESTON, W. VA.
304 DICKENS 2-6281
STAFF
EARL M. -PETE- JOHNSON
WILLIAM E. FORD
DONALD E. PAULEY

JONES, CARL T.
GAUTNEY & JONES

JONES, ROBERT A.
72 S. LAGRANGE RD.
LAGRANGE, ILL. 60525
312 352-2275
ASSOCIATES
HOWARD L ENSTROM
DONALD L MARKELY
STAFF
A ALBERT FREY

JUDY, EARL
COMMERCIAL RADIO EQUIP CO

KAUFMAN, CARSON W.
PAUL GODLEY CO.

KEAN, WALTER F.
19 E. QUINCY ST.
RIVERSIDE, ILL. 60546
312 HICKORY 7-2401
ASSOCIATES
GEORGE M. SKLOH
RONALD M. STEPHENS

KEAR, DR. FRANK G.
KEAR & KENNEDY

KEAR & KENNEDY
1302 18TH STREET, NW
WASHINGTON, D.C. 20036
202 483-9000
PARTNERS
DR. FRANK G. KEAR
ROBERT E. L. KENNEDY
SENIOR STAFF ENGINEER
WILLIAM F. CAPPERS JR
STAFF

MRS. EILEEN LATROBE-BATEMAN
AMBROSE J CAVEGN
NEIL M SMITH
JOHN L SADLER

KEEL, JOHN J.
1121 E. CAPITOL ST.
WASHINGTON, D.C. 20003
202 544-7943

KEMMAN, JAMES H.
SILLIMAN, MOFFET & KOWALSKI

KENNEDY, ROBERT E. L.
KEAR & KENNEDY

KERSHNER, STEPHEN W.
KERSHNER & WRIGHT

KERSHNER & WRIGHT
4206 WHEELER AVE.
ALEXANDRIA, VA. 22304
549-4633
PARTNERS
STEPHEN W. KERSHNER
CHARLES S. WRIGHT

KING, LOUIS A.
801 ENGLISH ST.
BRISTOL, TENN. 37621
615 SOUTH 4-3141
ASSOCIATES
EARL TOLLIVER
BOYD WRIGHT
GLADYS GARLAND

KING, WILLIAM C. JR.
JULES COHEN & ASSOC.

KIRKSEY, T. W.
BOX 8068

MINNEAPOLIS, MINN. 55416
612 935-7131

KLINE, CHARLES
FM INLIMITED INC.

KMOSENA, EDWARD A.
JULES COHEN & ASSOC.

KORONKA, STEPHEN
MSI INC

KOWALSKI, CARL L.
SILLIMAN, MOFFET & KOWALSKI

KRAMER, A. W.
DE FUMIAK SPRINGS, FLA.
305 TW 4-8041

ALSO
WASHINGTON, D.C.
202 REPUBLIC 7-8154

LAPPAS, FRANK
LAPPAS & LINDBERG

LAPPAS & LINDBERG CO.
141 W. JACKSON
CHICAGO, ILL. 60604
312 WABASH 2-1123
FRANK LAPPAS

LATROBE-BATEMAN, F.
KEAR & KENNEDY

LAUTZ, ROBERT F.
A. D. KING & ASSOC.

LAWRENCE, JAMES F. JR.
308 MONTEREY RD.
S. PASADENA, CALIF.

LAWSON, MELVIN E.
GAUTNEY & JONES

LEAPLEY, GRETCHEN M
SILLIMAN, MOFFET & KOWALSKI

LEDFORD, DONALD F.
A. D. KING & ASSOC.

LEE, PAUL H.
5209 BANGOR OR.
KENSINGTON, MD.
201 WHITEHALL 6-7238

LEE, WILLIAM P.
WLAK ELECTRONIC SERVICE INC.

LEGG, JOHN F.
HOYLES, NIBLOCK & ASSOC.

LE SAGE, PAUL E.
CHARLES E. BRENNAN ENGINEERS

LEGG, JOHN F.
INTERTEL, HOYLES, NIBLOCK

LITTLEFIELD, J. G.
PAUL GOOLEY CO.

LOHNES & CULVER
MUNSEY BLDG.
WASHINGTON, D.C. 20004
202 DISTRICT 7-8215

PARTNERS
GEORGE M. LOHNES
RONALD M. CULVER
ENGINEERS
LAVERNE M. POAST
ELIZABETH L. DAHLBERG
ASSOCIATES
FRED D. VEIHMEYER
GEORGE A. POWSTENKO

LOHNES, GEORGE M.
LOHNES & CULVER

LORENTZ, EDWARD F.
COMMERCIAL RADIO EQUIPMENT CO

LUBCKE, HARRY E.
2443 CRESTON WAY
HOLLYWOOD, CALIF. 90028
213 HOLLYWOOD 9-3266

LYNCH, CECIL
2460 ILLINOIS AVE.
MODESTO, CALIF. 95391
209 523-3955

MALARKEY, TAYLOR & ASSOC
1101 17TH ST NW
WASHINGTON, D C 20036
223 2345

MARKELY, DONALD L
ROBERT A JONES

MATHIEU, ROBERT A.
BARKLEY & DEXTER LABS., INC.

MATISANS, DONALD
DAVID STEEL & ASSOC

MATSON, WALLY
REGAL ENGINEERING CO

MAY, RUSSELL P.
711 14TH ST., NW
WASHINGTON, D.C. 20005
202 REPUBLIC 7-3984

MAYOBRE, MANUEL JR.
GEORGE P ADAIR ENGINEERING CO

WINFIELD SCOTT MCCrackEN
ASSOCIATES
2404 COLUMBIA PIKE

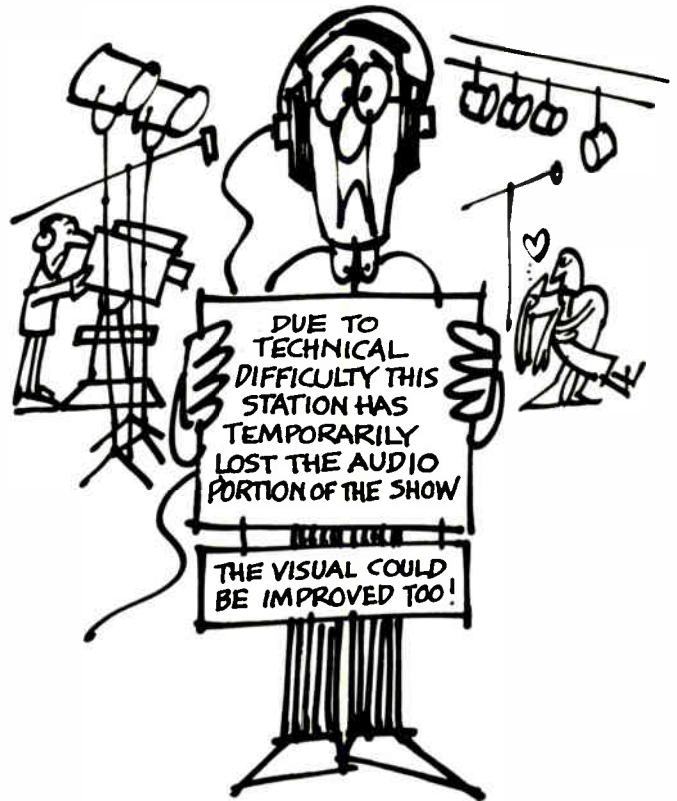

If you're keeping your AM, FM, and TV signals all to yourself... something's wrong!

When you need help, count on RCA Service Company, geared through experience to broadcasting's special needs for maintenance of complex station equipment. Getting the signal to your audience requires equipment in top condition. RCA Broadcast Service sees to that. With a background unmatched in the industry for this kind of work, RCA offers broadcasters protection they can count on—on a contract or per call basis.

Check some of the services available:

Camera Chains
Video Tape Recorder Service
TV Camera and Transmitter
Overhaul
Installation Supervision
Microphone and Pickup Repairs
Transmitter Performance
Measurements

Antenna Inspection
Measurements
Console Repairs
Microwave Service
TV Projector Service
Custom Fabrication
Teletypewriter Maintenance

To protect performance of your equipment, call our field office near you! Or contact Broadcast Service, RCA Service Company, Bldg. 203-1, Camden, N. J. 08101.



The Most Trusted Name in Electronics

ARLINGTON 4, VA.
703 JACKSON 8-8000

MCCORMICK, H. GRANT
INTERTEL, HOYLES, NIBLOCK

FRANK H. MCINTOSH & ASSOC.
4912 CORDELL AVENUE
WASHINGTON, D.C. 20014
202 652-4477

ALSO
MCINTOSH LABORATORY INC.
2 CHAMBERS STREET
BINGHAMTON, N.Y.
RA 3-5491

MCKENNA, JOHN R.
JOHN H. MULLANEY & ASSOC.

MCNARY, JAMES C.
NATIONAL PRESS BLDG.
WASHINGTON, D.C. 20004
202 DISTRICT 7-1205
STAFF
R. S. DUNCAN

MIDDLEBROOKS, JAMES L.
1244 EUCALYPTUS AVENUE
VISTA, CALIF.

MILSTEN, S. R.
VIR N. JAMES

MITCHELL, FRANK T. JR.
JANSKY & BAILEY

MITCHUM, MARTIN M.
P O BOX 69
ROLLA, MO.
314 364-1533

MOBLEY, MAL JR.
BROADCAST ENGR. SERVICES
BOX 235
NORTHBRIDGE, CALIF.
EMPIRE 3-6869

MOFFET, JOHN A.
SILLIMAN, MOFFET & KOWALSKI

MORAN, JAMES M., PRESIDENT
BARKLEY & DEXTER LABS., INC.

MORGAN, GEORGE L. JR.
GAUTNEY & JONES

MORRISSEY, T. G.
1640 BOULDER STREET
DENVER, COLO. 80211
303 GAND 7-6265

MOSTROM, ROBERT A.
CARL E SMITH CONS. RADIO ENGR

MSI INC
ROUTE 46 & CISCO RD
DENVER, CO. J 07834
201 627-7400
PRESIDENT
VICTOR J NEXON
CHIEF ENGINEER
GEORGE H PHELPS
STAFF ENGINEER
STEPHEN KOROMKA

MULLANEY, JOHN H.
JOHN H. MULLANEY & ASSOC.

JOHN H. MULLANEY & ASSOC.
DIVISION OF MULTRONICS INC.
5712 FREDERICK AVENUE
ROCKVILLE, MD. 20852
301 427-4666
PRESIDENT
JOHN H. MULLANEY
VICE PRESIDENT
PETER V. GURECKIS
STAFF ENGINEERS
JOHN R. MCKENNA
LOUIS R. DUTREIL
FRANCIS S. COLLIGAN
GEORGE P. HOWARD
JAMES F. PINKHAM

MUNN, E. HAROLD JR.
57 EDISON COURT, BOX 220
COLDWATER, MICH. 49036
517 278-6733
ASSOCIATES
E. H. MUNN JR.
LEWIS E. MUNN
VIRGIL ROYER

MUNN, E. H. JR.
E. HAROLD MUNN, JR.

MUNN, LEWIS E.
E. HAROLD MUNN JR.

MUSSELMAN, JOHN
CARL E SMITH CONS. RADIO ENGR

MYLLYKAGAS, MARTIN W.
BARKLEY & DEXTER LABS., INC.

MYSE, DARYAL A
12TH FLOOR 1815 H ST NW
WASHINGTON, D.C. 20006
202 REPUBLIC 7-4926

MEGORO, TAK
INTERTEL, HOYLES, NIBLOCK

NEXON, VICTOR J
MSI INC

NIBLOCK, PETER A.
INTERTEL, HOYLES, NIBLOCK

MYSTROM, C. J.
VIR N. JAMES

OAKLEY, RON
BOND & OAKLEY
OAKLEY, RON
445 CRUMMER LANE
RENO, NEV.
702 322-7538
STAFF
CYLDE H. BOND

ONEIL, BRIAN
HOYLES, NIBLOCK & ASSOC.

OWEN, M. W.
VIR N. JAMES

PARKER, JERMY F.
JANSKY & BAILEY

PARMELEE, P. H.
VIR N. JAMES

PAULEY, DONALD E.
PETE JOHNSON CONSULTING ENGR.

PETERSON, D. A.
A. EARL CULLUM JR.

PETERSON, ROGER E.
JANSKY & BAILEY

PHELPS, GEORGE H
MSI INC

PINKHAM, JAMES F.
JAMES H. MULLANEY & ASSOC.

POST, LAVERNE M.
LOHMES & CULVER

PORTS, DELMER C.
JANSKY & BAILEY

POWSTENKO, GEDRGE A.
LOHMES & CULVER

PURCELL, ROBERT L.
RAYMOND E. ROHRER & ASSOC.

REED, OSCAR W. B. JR.
JANSKY & BAILEY

REGAL ENGINEERING CO
1395 SW CARDINELL DR
PORTLAND, ORE 97201
223 2443

RENNER, JOHN J.
JANSKY & BAILEY

RICHARDSON, CLAIRE
L. H. CARR & ASSOC.

WILLIAM E. RICHARDSON & ASSOC.
1017 S.W. WASHINGTON
PORTLAND, ORE.
503 CAPITOL 8-7777

A. D. RING & ASSOC.
1710 H STREET, NW
WASHINGTON, D.C. 20006
202 298-6850
PARTNERS
ANDREW D. RING
HOWARD T. HEAD
MARVIN BLUMBERG
ASSOCIATES
DONALD F. LEDFORD
JOSEPH W. STIELPER
RAYMOND DORDAL
ROBERT F. LAUTZ
FRANK G. AUGUSTITUS

RING, ANDREW D.
A. D. RING & ASSOC.

RIVERS, NORMAN L.
BARKLEY & DEXTER LABS., INC.

RAYMOND E. ROHRER & ASSOC.
436 WYATT BLDG.
WASHINGTON, D.C. 20005
202 347-9781
ASSOCIATES
ROBERT L. PURCELL
PAUL K. STEWART
STAFF
LILLIAN F. WELLS

ROUNDTREE, J. G.
P O BOX 904A
AUSTIN, TEX. 78756
512 GLENDALE 2-3073

ROYER, VIRGIL
E. HAROLD MUNN JR.

RUSH, JACK
HAMMETT & EDISON

SADLER, J. D.
KEAR & KENNEDY

SAXDN, MERL
622 HOSKINS ST., P O BOX 575
LUFKIN, TEX. 75902
713 NEPTUNE 4-9558

SCHAIRER, NEIL J.
JANSKY & BAILEY

SCHATZEL, DEWOLF
A. EARL CULLUM JR.

SCHOTTLAND, FREDERIC D.
6513 WILMETT ROAD
BETHEDSA, MD. 20034
301 365-0011

SEABROOKE, HARRY
SILLIMAN, MOFFET & KOWALSKI

SEGAL, BERNARD R.
JULES COHEN & ASSOC.

SESSIONS, LOUISE
WILLIAM B. CARR & ASSOCIATES

SHARPE, GERALD C.
BERNARD ASSOC.

SHARP, NUGENT S.
1601 COLONIAL TERRACE
ARLINGTON 9, VA.
524-0489

SHARPE, GERALD C.
BERNARD ASSOC.

SILLIMAN, MOFFET & KOWALSKI
1405 G STREET, NW
WASHINGTON, D. C. 20005
202 REPUBLIC 7-6646
PARTNERS
ROBERT M. SILLIMAN
JOHN A. MOFFET
CARL L. KOWALSKI
STAFF ENGINEERS
DOUGLAS B DELAWDER
JAMES H KEMMAN
GRETCHEN H LEAPLEY
HARRY R SEABOKE

SILLIMAN, ROBERT M.
SILLIMAN, MOFFET & KOWALSKI

SINGLETON & BARNARD
4646 SW COUNCIL CREST DRIVE
PORTLAND, ORE. 97201
503 223-1201, 228-4393 AND
252-3535

SINGLETON, HAROLD C.
SINGLETON & BARNARD

SKLDM, GEORGE M.
WALTER F. KEAN

SMITH, ALBERT H
CHAMBERS, G RUSSELL

SMITH, BRUCE M
GEORGE P ADAIR ENGINEERING CO

SMITH, CARL E.
CARL E SMITH CONS. RADIO ENGR

CARL E. SMITH CONS. RADIO ENGR.
8200 SNOWVILLE ROAD
CLEVELAND, OHIO 44141
216 JACKSON 6-4386
PARTNERS
CARL E. SMITH
WILLIAM G. HUTTON
CECIL S. BIDLACK
ROBERT A. MOSTROM
FREDERICK D. BOLOTIN
ASSOCIATE
LOREN F. BRIDGES
STAFF
JOHN MUSSELMAN
H. W. VAN WAGENEN
EDWARD T. COLL
ROBERT M. SUBLETT
TED BARGER

SMITH, CHARLES
CREUTZ & SNOWBERGER

SMITH, D.
JOHN H. BATTISON

SMITH, FREDERICK A.
SEXCHANGE STREET
CHARLESTON, S.C. 29401
803 RA 3-1775

SMITH, JOHN W.
HOGAN FAXIMILE

SMITH, NEIL M.
KEAR & KENNEDY

SMYTHE, M. J.
HOYLES, NIBLOCK & ASSOC.
SMYTHE, M. R.
INTERTEL, HOYLES, NIBLOCK

SNOWBERGER, ARTHUR A.
CREUTZ & SNOWBERGER

STEED, VERNON H.
BOX 4742
RICHMOND, VA.

DAVID STEEL & ASSOC
2000 P ST NW SUITE 310
WASHINGTON, D C 20036
232 1010
DAVID L STEEL SR
ASSOCIATE
STAFF
DONALD MATISANS
WILLIAM F BRATTON JR

STEEL, DAVID L SR
DAVID STEEL & ASSOC

STEPHENS, RONALD M.
WALTER F. KEAN

STEWART, PAUL K.
RAYMOND E. ROHRER & ASSOC.

STIELPER, JOSEPH W.
A. D. RING & ASSOC.

STILES, WALTER J
SUITE 1623 TUCSON HOUSE
1501 MIRACLE MILE
TUCSON, ARIZONA 85705
602 792 2108

STRACHAN, ROBERT A.
INTERTEL, HOYLES, NIBLOCK

STRAIN, CHARLES E.
4556 NORTHSIDE DR., NW
ATLANTA, GA. 30327
404 BLACKBURN 5-4556

SUBLETT, ROBERT H.
CARL E SMITH CONS. RADIO ENGR

TAPP, JAY E.
T & T RADIO MEASUREMENTS CO

TAYLOR, ARCHER S
MALARKEY, TAYLOR & ASSOC

TEMPLETON, LAWRENCE W.
HAMMETT & EDISON

TENDICK, CULLEN B.
912 RODERICK AVENUE
OXFORD, CALIF. 93032
805 483-5243

TOLLIVER, EARL
LOUIS A. KING

TOWNE, ALFRED E
A E TOWNE ASSOCIATES INC

ALFRED E. TOWNE ASSOC. INC.
420 TAYLOR STREET
SAN FRANCISCO, CALIF. 94102
415 775-3100

TREMAINE, DR. HOWARD
INTERTEL, HOYLES, NIBLOCK

TRIPP, JASPER L. JR.
LAWRENCE BEHR ASSOCIATES

T & T RADIO MEASUREMENTS CO
2557 ATLANTIC AVENUE
LONG BEACH 6, CALIF.
213 GARFIELD 4-2015
ASSOCIATE
JAY E. TAPP

VAN NOSTRAND RADID ENGR SERVICE
P O BOX 3045
DECATUR, GA. 30032
404 241-5551
ASSOCIATES
W. L. VAN NOSTRAND
L. E. GRADICK

VAN NOSTRAND, W. L.
VAN NOSTRAND RADIO ENGR SERV

VAN WAGENEN, H. W.
CARL E SMITH CONS. RADIO ENGR

VEIHMEYER, FRED D.
LOHMES & CULVER

VENTERS, CARL V.
LAWRENCE BEHR ASSOCIATES

VIEMMEYER, FRED D.
LOHMES & CULVER

VOLKMAN, DONALD F.
HASKETT & VOLKMAN

VOLKMAN, DONALD F.
P O BOX 156
CENTERVILLE, IND. 47330
2753

VON BAEYER, DR. HANS J.
INTERTEL, HOYLES, NIBLOCK

WALSER, ROBERT J
EMPRESAS ELECTRONICAS

WEAKLEY, WILLIAM C.
JANSKY & BAILEY

WEBSTER, EDWARD M.
3133 COMM. AVE., NW
WASHINGTON, D.C. 20008
202 232-1523

WELLS, LILLIAN F.
RAYMOND E. ROHRER & ASSOC.

WHITMARSH, T. F.
HOGAN FAXIMILE CORP.

WILLIAMS, J. S.
JULES COHEN

WILLIAMS, KENNETH JR.
5915 6TH AVE. #14
TACOMA, WASH. 98406
206 SK 2-7200

WILLIAMS, MARTIN R.
7401 EAST 14TH STREET
INDIANAPOLIS, IND. 46219
317 FLEETWOOD 6-0388

WILLIAMS, NATHAN
110 ALGOMA BLVD.
DSHKOSH, WIS. 54901
414 235-3590

WINNER, PAUL L.
JULES COHEN & ASSOC.

WRATHALL, GRANT R.
APTOS-SANTA CRUZ., CAL 95003
408 MURRAY 8-3352

WRIGHT, BOYD
LOUIS A. KING

WRIGHT, CHARLES S.
KERSHNER & WRIGHT

WRIGHT, LOWELL R.
MUNSEY BLDG.
WASHINGTON, D.C. 20004
202 DISTRICT 7-1740

WRIGHT, T. A.
A. EARL CULLUM JR.

Spotmaster



**MODEL 505B
(REPRODUCER)**



**MODEL 500B
(RECORDER/REPRODUCER)**



MODEL 500BR (RECORDER/REPRODUCER)



**MODEL 405A
(REPRODUCER)**



**MODEL 400A
(RECORDER/REPRODUCER)**



MODEL 500BS — STEREO

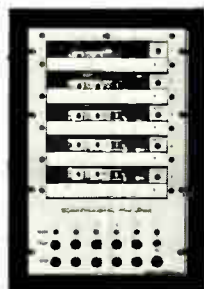

**MODEL 505B
(REPRODUCER)**

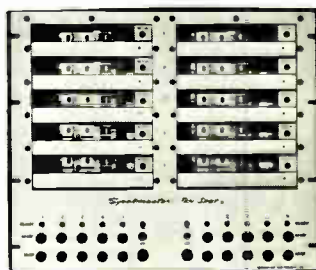

**MODEL 610B
(REPRODUCER)**

500/505 Super B SPOTMASTER Series 500 Super B cartridge equipment is unexcelled in performance and long term proven reliability. Available in models to meet every programming need: record/reproduce, reproduce only—compact or rack mounted. Specifications and performance equal or exceed NAB standards. Features include ease of operation, high reliability, solid state plug-in amplifiers, 1, 2 or 3 automatic electronics cueing tones, separate record and play heads, biased cue recording, hysteresis synchronous motor, selective test meter switch, triple zener controlled power supply, transformer output, feather touch illuminated push button switches and a one year parts and labor guarantee. Prices start at **\$510.00**.

400A/405A SPOTMASTER Series 400 equipment offers traditional SPOTMASTER performance and reliability for the economy minded station. Don't let their low price fool you. New solid state SPOTMASTER compact models are second-best only to the Super B Series. Offered in record-playback (Model 400) and playback-only (Model 405) versions, the compacts permit even the smallest station to enjoy SPOTMASTER pushbutton broadcasting. Compact units carry a 90-day parts and labor guarantee. Many of the features of the Super B equipment are included in the 400 series. Write for complete details. Prices begin at **\$415.00**.

Stereo SPOTMASTER stereo units are available in four different models. The compact 500B-S (combination record/reproduce); the compact 505B-S (reproduce only); the rack mount 500BR-S (combination record/reproduce); and the rack mount 505BR-S (reproduce only). Stereo equipment is a part of the Super B Series and carries essentially the same specifications. Prices begin at **\$645.00**. Write for complete details.

Model 610B SPOTMASTER TEN • SPOT (610B) and FIVE • SPOT (605B) multiple cartridge reproducer units are especially designed for use in broadcast stations, recording studios and other installations requiring the use of multiple cartridges on instant demand. Both units are capable of manual operation or may be incorporated into programmed automation systems making use of one, two or three NAB standard cueing tones. Each cartridge deck is removable from the front of the unit without affecting the operation of the remaining decks. A flywheel loaded common capstan supplies tape motive force, the flywheel in turn being driven by a heavy duty hysteresis synchronous motor. Each reproduce channel is separately equipped with cueing amplifiers and a program amplifier with the output level adjustable to +4 dbm by means of locking type controls. The amplifier power supply is transistorized and zener regulated. Facilities are provided on the rear panel for remote control and for inter connections between channels so as to permit automatic sequencing from channel to channel. All amplifiers are plug-in modular units. Enclosed plug-in relays are used throughout. Prices begin at **\$1750.00**.



**BROADCAST
ELECTRONICS, INC.**

8810 Brookville Road, Silver Spring, Maryland 20910
301-588-4983

Write for complete details

Prices subject to change without notice



AUDIO EQUIPMENT

FOR

BROADCASTING — TELEVISION — RECORDING
MOTION PICTURE — SOUND REINFORCEMENT

AUDIO DISTRIBUTORS, INC.

"OFF THE SHELF" DELIVERY ON

TAPE RECORDERS — DUPLICATORS — MICROPHONES — TURNTABLES
REVERB DEVICES — AMPLIFIERS — ATTENUATORS — EQUALIZERS
COMPRESSORS — SPEAKER SYSTEMS — BROADCAST CONSOLES
RECORDING CONSOLES — SOUND REINFORCEMENT EQUIPMENT

LANGEVIN	ALTEC	EMT	NAGRA	SWITCHCRAFT	FAIRCHILD
AMPEX	MCINTOSH	NEUMANN	TELEFUNKEN		
ATLAS	MAGNACORD	QRK	VIKING		
ELECTRO-VOICE	3M CO.	SPARTA	UHER		

AUDIO DISTRIBUTORS, INC.

616-4520309 2342 SOUTH DIVISION AVE.

GRAND RAPIDS, MICHIGAN 49507

WE BUY - SELL - TRADE

INDEX TO ADVERTISERS

Air Space Devices, Inc.....	33	Dayton Electronic Products Co.....	47	RCA Electronic Components & Devices	C4
Alford Manufacturing Co.....	C3	Dresser—Crane, Hoist & Tower Div.....	35	RCA Service Co.....	159
American Electronics Laboratories, Inc.	19, 69	Eimac Div. of Varian Associates.....	6, 7	Revere-Mincom Div., 3M Co.....	23
Andrew Corp.	155	Electronics Missiles & Communications, Inc.	39	Riker Video Industries, Inc.....	C2, 3
Applied Electro Mechanics, Inc.....	43	Electro-Voice, Inc.	4	Rohde & Schwarz.....	109
Audio Distributors, Inc.	162	Fairchild Recording Equipment Corp.....	49	Sarkes-Tarzian, Inc.	8
Ball Brothers Research Corp.....	73	Gates Radio Co.	156	Scully Recording Instruments Corp.....	113
Belar Electronics Lab.....	75	Gray Research & Development Co.....	89	Shure Brothers, Inc.	27
Belden Manufacturing Co.....	13	Holland Electronics, Inc.....	95	Sparta Electronic Corp.....	31
Bird Electronic Corp.....	45	Howard W. Sams & Co., Inc.....	51, 61	Superior Cable Corp.	127
Broadcast Electronics, Inc.....	135, 161	International Nuclear Corp.....	93	Tapecaster Electronics	117
Catel Co.	77	Jampro Antenna Co.....	15, 53	Tektronix, Inc.	29
CBS Laboratories, Div. of CBS	10, 11, 66, 131	Kappa Networks, Inc.....	91	Telemet Co.	119
CCA Electronics Corp.	137	Magnecord Div. of the Telex Corp.....	99	Teltron, Inc.	64
Cleveland Electronics, Inc.	79	Marti Electronics	55	Trepac Corporation of America.....	121
Cohu Electronics, Inc.....	141	Metrotech, Inc.	103	Triplett Electrical Instrument Co.....	153
Collins Radio Co.....	40	Mid-America Electronics Corp.....	101	Vent-Rak	145
Continental Electronics, a Subsidiary of LTV Electrosystems, Inc.....	37	Miratel Electronics, Inc.....	133	Visual Electronics Corp.	65
Cooke Engineering Co.....	81	Mosely Associates, Inc.....	57	Vital Industries	125
Crown International	128	Norelco, Professional Sound Products.....	105	Vitro Electronics, a Division of Vitro Corporation of America.....	151
Dage Bell Corp., a Subsidiary of Raytheon Co.	21	Norelco, Studio Equipment Division	16, 17	Wilkinson Electronics, Inc.....	149
		Nortronics Company, Inc.....	25	Zoomar, Inc.	143

AMCI BROADCAST EQUIPMENT for VHF and UHF-TV and FM

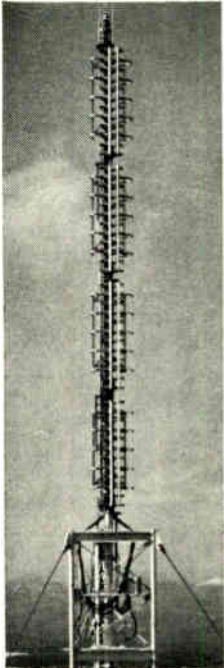

Directional VHF-TV
Transmitting Antenna

VHF-TV TRANSMITTING ANTENNAS

Mast or tower-corner mounted
DIRECTIONAL OR OMNIDIRECTIONAL
for Channels 5 to 13

Omnidirectional VHF-TV antennas with power gains up to 20. Directional VHF-TV antennas with power gains up to 36.

UHF-TV TRANSMITTING ANTENNAS

Mast, tower-corner, or truss-mounted
DIRECTIONAL OR OMNIDIRECTIONAL
for Channels 14 to 83

Omnidirectional UHF-TV antennas with power gains up to 50. Directional UHF-TV antennas with power gains up to 80.

FM TRANSMITTING ANTENNAS

Mast or tower-corner mounted
DIRECTIONAL OR OMNIDIRECTIONAL
For single or multi-station transmission.

SPECIAL PURPOSE ANTENNAS

Empire State Building Master FM Antenna: two rows of dipoles around 102nd floor observation level, duplexers within tower, and transmission line, designed, built, and installed in 1965, permit up to 17 FM stations to broadcast simultaneously from the same antenna.



Side-mounted
VHF-TV Transmitting
Antenna

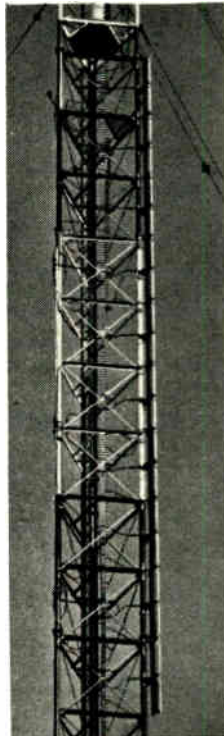

Side-mounted
UHF-TV Transmitting
Antenna

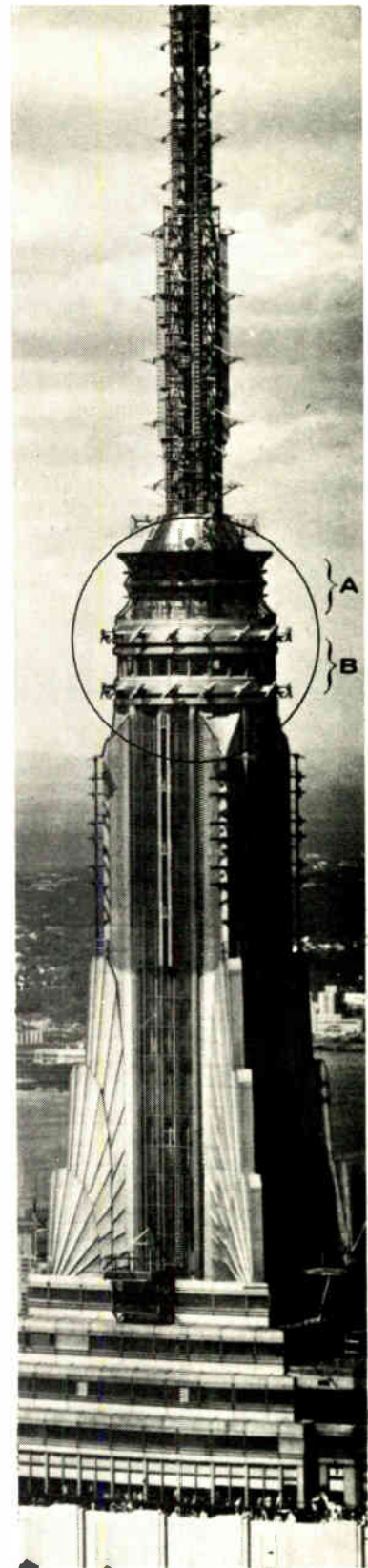

Special-purpose Antennas:
a) antenna array for WOR-TV channel 9
b) Empire State Building master FM antenna

DIPLEXING FILTERS

Temperature compensated. Aural-to-visual and visual-to-aural rejection over 30 db. For use with transmitters up to 50 kw.

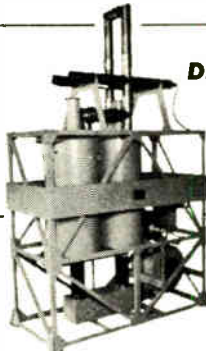

VESTIGIAL SIDE BAND FILTERS

Low insertion loss. Lower sideband of the color subcarrier frequency is attenuated 30 db. or more.

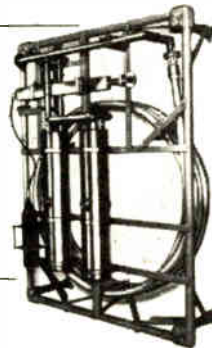

COAXIAL SWITCHES

For 6 1/8" or 3 1/8", coaxial transmission lines. SWR over a specified 100 mc band under 1.03, high peak power models under 1.06 over a specified 50 mc band. CW power rating equal to the mating transmission line.



OTHER PRODUCTS

- Standby Antennas
- Dipoles
- Power Dividers
- Hybrids
- Transfer Panels
- RF Terminations
- Impedance and Transfer Characteristic Plotters
- Variable Calibrated Attenuators
- Slotted Lines



ALFORD

MANUFACTURING COMPANY

120 Cross St., Winchester (Greater Boston), Mass. 01890

Telephone: 617-729-8050

TWX: 710-348-1063

Cable Address: AMCIBOS

World Radio History

Announcing...
for color and
black and white,
the new family of
RCA image orthicons
with a *big difference here*
that *shows up big here*

Now RCA brings you the "BIALKALI PHOTOCATHODE" in the new RCA-8673 and -8674 Image Orthicons. This major engineering innovation has greatly improved compatibility with its non-stick target, maintaining resolution and sensitivity over an extended tube lifetime and improving performance of *existing* color or black-and-white cameras. A simple change in a resistor chain provides proper voltages for a trio of these new Bialkali Photocathode Tubes. Wide-range, the 8673 and 8674 fit spectral requirements of all three channels... eliminating the need for another tube type for the blue channel.

Another big difference: the re-designed image section provides reduced distortion and freedom from "ghosts." These new tubes are available singly or as matched sets—a trio of 8673/S or 8674/S types for color service... types 8673 and 8674 for black and white. Main construction difference is in the target-to-mesh spacing. The closer-spaced 8673 enhances S/N ratio for quality performance under sufficient illumination. The 8674 has greater sensitivity under limited illumination. For complete information about the new RCA Bialkali Photocathode Image Orthicons, ask your RCA Broadcast Tube Distributor.

RCA Electronic Components and Devices, Harrison, N.J.



USE THIS CHART TO SELECT REPLACEMENT TYPES FOR THE TUBES YOU ARE NOW USING

UNDER SUFFICIENT LIGHTING LEVELS	
For color pick-up, If you're now using . . . You can replace with:	
4513/S	8673/S
7513/S	
For black & white pick-up, If you're now using . . . You can replace with:	
4513	8673
7513	
7513/L	
8093A	
8093A/L	
UNDER LIMITED LIGHTING LEVELS	
For color pick-up, If you're now using . . . You can replace with:	
4415S	8674S
4416S	
For black & white pick-up, If you're now using . . . You can replace with:	
7293A	8674
7293A/L	

AVAILABLE FROM YOUR RCA BROADCAST TUBE DISTRIBUTOR



The Most Trusted Name in Electronics

