

Bradley

BROADCAST & PRO AUDIO

Catalog 1998-1999

RECEIVED
OCT 14 1998
SBC

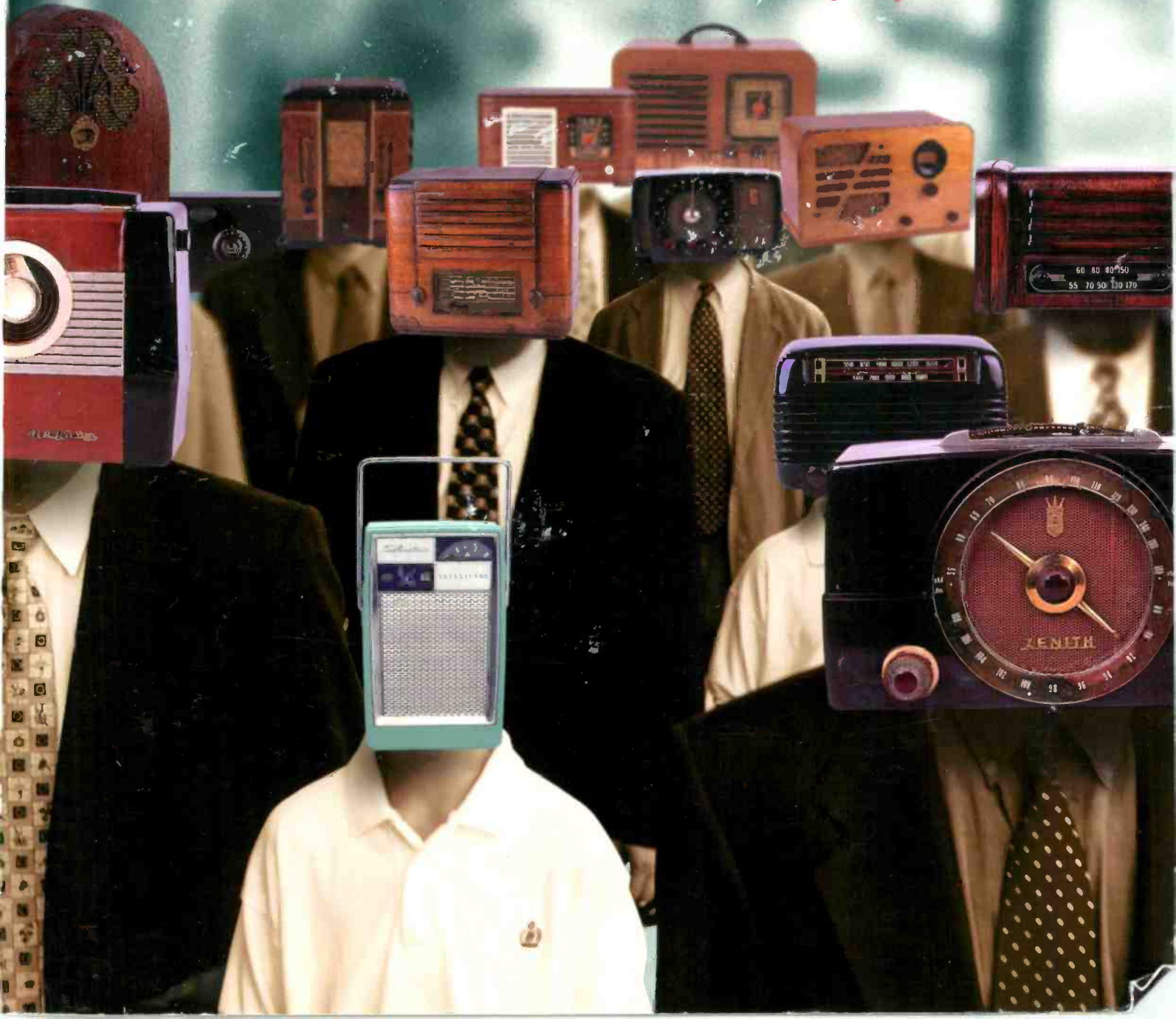

Nobody Does Decks Like Denon



Let's face it. When it comes to selecting CD and MiniDisc products for studio applications, it doesn't make any sense to work with consumer decks in a +4 dBu environment. Denon, the first name in digital, has developed the DN-C680 CD Player, DN-M1050R MiniDisc Player/Recorder and DN-T620 Combi-Deck specifically for these demanding applications.

DN-M1050R MiniDisc Recorder/Player

- AES/EBU, SPDIF, Balanced and Unbalanced Analog I/O
- PC Keyboard Port
- +/- 9.9% Pitch Control
- Optional SMPTE, FS Converter and Hot Start
- External Control (Serial RS-232C/422A, 9-pin, Parallel 25-pin)

DN-T620 Combi-Deck (CD & Cassette Deck)

- Variable Pitch +/- 12%
- Record CD to Cassette
- XLR Balanced I/O
- Dolby B Noise Reduction
- Wired Remote Control Terminal
- Cue To Music (CD)
- Auto Repeat (Cassette Deck)

DN-C680 CD Player

- AES/EBU, SPDIF, Balanced and Unbalanced Analog Out
- Optional SMPTE Kit and FS Converter Kit
- Variable Pitch +/- 9.9%
- External Control (Serial RS232C/422A, 9-pin, Parallel 25-pin)
- Auto Cue Function/Log Shuttle Wheel

Denon Electronics Division of Denon Corporation (USA), 222 New Rd., Parsippany, NJ 07054, (973) 575-7800
Denon Canada, Inc., 17 Denison St., Markham, Ontario, Canada L3R 1B5, (905) 475-4085
Labrador, S.A. de C.V., Zamora No. 154, 06140 Mexico, D.F., (52-5) 286-5509

Visit our web site: www.denon.com

DENON

The First Name in Digital Audio

Welcome to the 1998/1999 Bradley Broadcast Sales, Inc. Catalog!

This has been an exciting year of change and growth at Bradley, and our largest-ever catalog is proof of that! We have been busier than ever finding the newest and most exciting products for you, to make your jobs easier and more productive. I direct your attention specifically to several areas: Our new Installed Sound section has many useful items for indoor and outdoor PA and sound reinforcement applications. Our section on computer hardware and software has been expanded dramatically, and you've never seen so many choices in UHF wireless microphones as you'll see in this year's book.

There have been other important changes at Bradley as well. You'll probably notice that we've moved! Our new facility in Frederick, MD is larger and more efficient. We've also installed an all new business operating system (yes, it's year 2000 compliant!). What this means for you is faster order turnaround, and more of the products you want available from stock.

One thing that didn't happen: we weren't bought out by some mega-conglomerate. As a result, you can continue to depend on the quality of service you've come to expect from us; a friendly, human voice answering your call, and the prompt, knowledgeable service that is our hallmark.

For all of you who have been our loyal customers over the years, let me take this opportunity to thank you for your continued trust in us, and for those who haven't done business with Bradley before, let me invite you to find out why we say: Our Service Makes the Difference!

Art Reed
General Manager

Bradley BROADCAST & PRO AUDIO

7313-G Grove Road, Frederick, MD 21704

Toll-Free: 800-732-7665 • Tel: 301-682-8700 • Fax: 301-682-8377

Web: <http://www.bradleybroadcast.com>

Sales Office Hours
Business Office Hours

8:30 AM to 5:30 PM Eastern Time, Monday through Friday
9:00 AM to 5:00 PM Eastern Time, Monday through Friday

Bradley is a dealer of thousands of products from hundreds of manufacturers. Our customers are radio and TV managers, engineers, freelance reporters, oral historians, government buyers, voice-over specialists, librarians, educators, churches, sound crews, archivists, cable TV engineers, studio technicians, and many others whose business is in audio and broadcast. We're pleased to count you among them.

CONTENTS

1998-99

FIELD PRODUCTION	2
TELEPHONE INTERFACE & INTERCOM	13
MICROPHONES	23
RECORDING & PLAYBACK	45
MIXERS & CONSOLES	67
SOUND REINFORCEMENT	81
MONITORING	82
AUDIO PROCESSING	100
AUDIO INTERFACE	110
RF EQUIPMENT	127
FURNISHINGS	132
INDEX	142-143

Visit Bradley on line!

We're at

<http://www.bradleybroadcast.com>



PORTABLE DAT & MINIDISC RECORDERS

DIGITAL BRING IT BACK PACK

To help you with your field recording, we package the popular, portable TCD-D8 Sony DAT recorder with Audio-Technica's great AT822 stereo microphone with cable. \$1,199.00 value.



PACKAGE 9801 - ONLY \$969.00

TASCAM DA-P1 PORTABLE DAT

Not all professional DAT recorders cost as much as a small car. The DA-P1 from Tascam sports balanced XLR mic/line inputs with phantom power, unbalanced RCA, digital S/PDIF output, and rechargeable battery. You also get selectable sampling rates, a mic limiter, and a 20dB pad. For monitoring, the unit has a TRS headphone jack (no built-in speaker) and level control for any headphones.



The display shows program time, sampling rate, ABS time, and record margin; displaying counter mode is easy, as are counter reset, margin reset, and ID select. A hold switch prevents accidental operation. Standard accessories include a shoulder belt, AC adapter, and one battery.

DA-P1	60TEDAP1	MFR LIST	\$1,899.00
Porta-Brace Case	60PBARDAP1	MFR LIST	\$183.00
Extra battery	60TEBPD1	MFR LIST	\$100.00
Charger	60TECBD1	MFR LIST	\$75.00

CALL 1-800-732-7665 FOR BRADLEY PRICE

HHB PORTADAT

From Hollywood to Washington, the PORTADAT is on the job. The PDR1000 is built around a rugged direct-drive transport with four heads for confidence recording. The nickel metal hydride rechargeable battery runs the unit for two hours (juice it back up on the charger/12VDC supply, which is included and operates on all international mains voltages).



The unit has XLR balanced inputs, phantom power, AES/EBU and S/PDIF digital I/O, limiter, built-in speaker, and selectable sampling rates. A carrying case comes with it. Weight: 4.4 pounds including battery. This is a most impressive professional effort from HHB.

Ask us about the PDR1000-TC with time code for motion picture and other time-critical work.

PDR1000	60HHPDR1000	MFR LIST	\$3,495.00
PORTADAT with Time Code	60HHPDR100TC	MFR LIST	\$6,395.00
PORTADAT w/TC/MS/HM	60HHPDR10003	MFR LIST	\$6,995.00
Porta-Brace case	60HHCASE	MFR LIST	\$190.00

CALL 1-800-732-7665 FOR BRADLEY PRICE

SONY TCD-D8 DAT RECORDER

Best Seller



Sony's portable DAT recorder is the latest version of one of our most popular tools for collecting audio in the field. Now the deck is a sleek charcoal black. You can make 44.1kHz recordings from an analog source. Also, no longer must you hunt for an AC adapter; it comes packed with one.

This lightweight Sony recorder/player runs on four "AA" cells and weighs about a pound. Digital volume limiting, automatic date function, and audible cue are standard. It offers 20-22kHz audio at 48 and 44.1kHz sampling; 32kHz is also supported. Standard DAT tapes give you two hours of the highest fidelity audio, or four hours in long-play mode.

Sony also offers the optional SBM-1, a Super Bit Mapping 20-bit A/D converter for making the most of analog input recording, for use with the TCD-D8 and other digital recorders.

TCD-D8	60SOTCDD8	MFR LIST	\$899.95
SBM-1	60SOSBM1	MFR LIST	\$549.95
Mic Cable for TCD-D8 (feeds mono mic audio to both channels)	61WHENG6		only \$12.00
Car Battery Cord	60SODCCE260HG		only \$20.00

CALL 1-800-732-7665 FOR BRADLEY PRICE

SONY PCM-M1 DAT RECORDER

Every aspect of the Sony PCM-M1 has been optimized for field recording: from the die-cast magnesium body, to the low power-consumption circuitry incorporated into all stages of the PCM-M1. With the two supplied Nickel-Hydrate batteries, you can record for up to 3.5 hours. Standard AA batteries may also be used. Sony SBM-1 circuitry is used, improving mic S/N ratio by 3dB. An intelligent AGC system automatically sets the recording level in accordance with the input level in the DSP circuitry, preventing overloads. A full range Start-ID function allows automatic, manual or Level synchronized ID's to be recorded. This is a particularly useful feature in live recording, where a threshold must be set to prevent start ID's from being caused by crowd noise, instead of beginning of desired audio. Full digital in/out capability is standard, as is recording at 48kHz, 44.1kHz, and 32kHz. Weighing only 10oz, this unit is road-ready!



Sony PCM-M1 DAT Recorder	60SOPCMM1	\$995.95
--------------------------	-----------	----------



FIELD PRODUCTION

Bradley Broadcast • 7313-G Grove Road • Frederick, MD 21704 • 800-732-7665 • 301-682-8700 • Fax: 301-682-8377 • Web: <http://www.bradleybroadcast.com>

GET THE STORY PACKAGES!

Whatever your story, you'll capture it better with Bradley. We've put together a package which includes a Marantz PMD portable cassette recorder, an Audio-Technica AT 804 handheld mic (complete with stand adapter and coiled cord), Sony MDR-7506 stereo headphone (only the industry standard), an Audio-Technica AT8314 25' low-Z mic cable, a Mic-Eze 16" Rubberneck, and a Rowi Model 76 Clamp, as well as a Kaces KEB-20 gig bag (to put all this stuff in), and 10 cassette tapes—all at an incredible price. We have just about anything you'll need in the way of audio—broadcast, recording, field gear—you name it. And we're just a phone call away (and a toll-free one at that: 800-732-7665).

PACKAGE 9802 - ONLY \$699.00



DIGITAL GET THE STORY PACKAGE

Superb DAT recording in the field was never easier. Order the Tascam DA-P1 pro DAT recorder, described on the facing page, and add Audio-Technica's AT825 stereo microphone with cable, a total \$2,425.00 value.

PACKAGE 9803 - ONLY \$1,865.00



BRING IT BACK PACKAGES!

MONAURAL PACKAGE

The "Bring It Back" Mono Pack includes the Marantz PMD-222 cassette recorder with vinyl case, the professional Audio Technica AT804 mic, and a coiled ENG cable.

PACKAGE 9804 W/PMD-222 - ONLY \$479.00

PACKAGE 9805 W/PMD-221 - ONLY \$449.00

PACKAGE 9806 W/PMD-201 - ONLY \$389.00



STEREO PACKAGE

The "Bring It Back" Stereo Pack gives you Audio-Technica's AT822 stereo mic and the Marantz PMD-430 stereo cassette deck. Also included are a windscreen and adapter cables for the mic, a case for the recorder, and a 25' XLR to XLR cable with Cord-Lox. Valued at over \$1,000.00.

PACKAGE 9807 W/PMD-430 - ONLY \$779.00



SONY TCM 5000EV PRESSMAN

Best Seller

Four alkaline "C" cells provide about 20 hours of recording with this pro, three-head mono cassette deck. A warning signal in your headphones tells you when your tape is running out. Other features include built-in condenser mic, one touch recording, -20% to +40% pitch control, instant edit mode, one touch review, auto shutoff at the end of the tape, locking pause, VU meter/battery life indicator, tape counter, and earphone jack. In the voice activated mode, the unit will delay recording until the motors get up to speed. The result is gapless VOX operation. Mic input is 1/8" mini TS. AC Adapter not included.



TCM-5000EV

60SOTCM5000EV

\$489.00

EXTRA!

Bradley's special accessory kit includes a pair of Sennheiser HD 470 headphones, Rowi mic clamp, desk tripod mic stand, a 10" rubber gooseneck, 25' XLR-to-XLR mic cable with Cord-Lox strap, and a great Kaces gig bag to hold it all. A \$235 value.

PACKAGE 9808 - ONLY \$139.00

FIELD PRODUCTION



PORTABLE DAT & PC CARD RECORDERS

SONIFEX COURIER

The Courier recorder is the latest product to record onto removable PCMCIA (sold separately), hard disk or flash card. Courier records, plays and edits, with graphical display operated by a scrub wheel. Recording in a number of different audio formats, uncompressed (.wav) or with MPEG layer II compression, you can ensure that Courier will be compatible with your playback or editing system. You can also plug a modem into Courier to transfer data over telephone lines. Want to transfer audio? The Courier also comes in an ISDN model. Software updates are free of charge from the Sonifex website.

Courier features two balanced XLR mic/line inputs, phantom power, AES/EBU out, limiter, fader, headphones and built in speaker. All this in 3 pounds including the battery. Courier uses standard 8mm camcorder batteries giving you up to four hours run-time and comes with carry case, Nicad battery and universal 90V-240V power supply. Sample rates from 16 kHz to 48Khz and a full range of MPEG 2 layer II bit rates up to 384kbps may be selected.

Standard Courier	60SX COSTD	MFR LIST	\$3,650.00
ISDN Courier	60SX COISDN	MFR LIST	\$4,630.00

CALL 1-800-732-7665 FOR BRADLEY PRICE

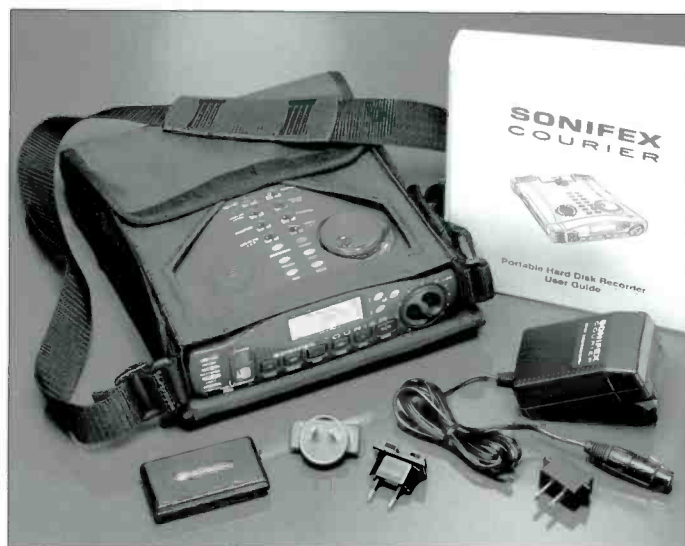

SONY MINIDISC PORTABLE RECORDER

Record on MiniDisc in the field with the MZ-B3. This stereo model has a built-in speaker and mono microphone, plus a 1/8" mini connector for stereo mic.



Since audio capacity doubles in mono, you can use one 74 minute disc to hold 148 minutes, or operate the unit in the normal stereo mode. Note, mono recordings are not compatible with many studio MD machines.

The MD format assures you of pristine, low-noise audio and convenient access functions. The MZ-B3 adds high-speed playback and powerful search features including a system that lets you mark sections of your audio for later retrieval.

Weight: 1 lb. with batteries (takes 3 "AA").

MZ-B3 Recorder/Player	60S0MZB3	MFR LIST	\$899.95
-----------------------	----------	----------	----------

CALL 1-800-732-7665 FOR BRADLEY PRICE

SONY MZ-R30 PORTABLE MINI DISC RECORDER

Take your MiniDisc show on the road. This full-featured recorder/player gives you everything you need. Use it to record, and then take it with you!



60S0MZR30 MFR LIST \$399.00
CALL 1-800-732-7665
FOR BRADLEY PRICE

NEW! CALL ABOUT THE SONY MZ-R50

- Sampling rate converter for recording various digital sources (DSS, DAT, CD)
- Digital synchronized recording capability
- Vertical Jog Dial for easy editing
- Track name search/select with Jog Dial
- Records in stereo or monaural (74 or 148 minutes on 74 minute disc)
- LCD on unit shows playback modes, titles and battery life
- Optical Digital Input
- LIP-12(H) Lithium Ion Battery Supplied
- Up to 15 hours playback time with LIP-12(H) and 2 "AA" cells
- Remote controller stereo headphones supplied
- Full editing features
- Digital Mega Bass® sound system with 3 position switch
- Position pointer shows current place on disc
- AVLS (Automatic Volume Limiter System)
- Date/Time stamp function

PLUG 'EM! BRADLEY ENG MIC CABLES

We know what kind of ENG cables you need: durable, high-quality, with a choice of straight or coiled. Our cables are for portable DAT and cassette recorders and will stand up to the rigors of field use. Straight cords are 6 feet long except as noted; coiled cords extend to over ten feet. Need something else? CALL US.

XLR female to XLR male, straight cable	61WHMK406	\$13.25
XLR female to XLR male, coiled cable	61GCENG5	\$35.60
XLR female to XLR male, straight (10')	61WHMK410	\$14.40
XLR female to 1/8" TRS mini, straight cable	61WHENG6	\$12.00
XLR female to 1/4" TS, straight cable	61WHENG4	\$12.00
XLR female to 1/8" TS mini, straight cable	61WHENG	\$12.00
XLR female to 1/4" TS, coiled cable	61WHENG2	\$28.00
XLR female to 1/8" TS mini, coiled cable	61WHENG3	\$28.00



FIELD PRODUCTION

MARANTZ PMD680 AND PMD690

Your future is in the cards, literally.

The new Marantz PMD680 and PMD690 use standard PCMCIA type III cards to store audio information. PC cards are credit-card sized memory cards that are available in either Flash or Hard Disk formats. Flash memory offers extreme reliability and shock resistance, while Hard disk PC cards offer more bytes for the buck.



A wide array of professional inputs and outputs are included to satisfy any recording environment. The 680 and 690 offer the choice of compressed or uncompressed recording. Each track of a recording is converted to an MS-DOS compatible file allowing almost any PC to read the files recorded on the PMD680 and PMD690. Download your recording easily to your PC by simply plugging the PCMCIA card into a PC card slot or via a parallel port. The PMD680 and PMD690 also provide onboard editing capability. Call your favorite Bradley Professional for the correct size PCMCIA card you need. PCMCIA cards sold separately. Available winter 1998/99.

Portable Digital Recorder-Mono	60MRPMD680	MFR LIST	\$799.00
Portable Digital Recorder-Stereo	60MRPMD690	MFR LIST	\$999.00

CALL 1-800-732-7665 FOR BRADLEY PRICE

PORTA BRACE

Best Seller

The sturdy Run Bag can be loaded many ways without just dumping one thing on top of another, but it retains the convenience of a lightweight bag. The main compartment has an adjustable divider. Inside walls have large slip pockets. Outside, you get two large zippered compartments for cables, plus two big slip pockets. Stand-up handles with leather grips and a lightweight shoulder strap allow for comfortable use. All sizes have main compartments of approximately 7" wide by 9-1/2" high.



Run Bag, 18" length	60PBRB1	MFR LIST	\$145.00
Run Bag, 21" length	60PBRB2	MFR LIST	\$150.00
Run Bag, 25" length	60PBRB3	MFR LIST	\$155.00
Run Bag, 30" length	60PBRB4	MFR LIST	\$174.00

CALL 1-800-732-7665 FOR BRADLEY PRICE

SEE PAGE 9 FOR MORE BAGS

MARANTZ PORTABLE CASSETTE RECORDERS

News reporters, oral historians, court reporters, and audio people of every stripe reach for Marantz cassette recorders. Their favorite: The PMD-222.



It's a three-head mono deck with a balanced XLR input for your favorite pro mic. These features help you in your work: speaker, VU meter, phone jack, pitch control, built-in electret condenser mic, two speeds, auto-shutoff, cue and review, memory rewind/replay, and 1/4" TRS headphone jack. It also has a switchable limiter, automatic noise-control switch, and metal tape capability. Three "D" cells give you 7-1/2 hours operation; the optional Ni-cad rechargeable provides 5-1/2. We love it.

PMD-222	60MR222	\$369.00
---------	---------	----------

The PMD-221 contains all features of the PMD-222, above, but the mic input is 1/8" TS mini.

PMD-221	60MR221	\$349.00
---------	---------	----------

The PMD-201 is a two-head version of the PMD-221, without memory rewind/play. Mic input is 1/8" TS mini.

PMD-201	60MR201	\$279.00
---------	---------	----------

Marantz on a budget: The PMD-101 is an affordable, two-head mono portable with ±20% pitch control, tape counter, line input/output RCA jacks, and a headphone jack. Use the built-in condenser or plug in your own mic with 1/4" connector. Tone control, low-battery LED, and two speeds are standard. AC Adapter not included.



PMD-101	60MR101	\$215.00
---------	---------	----------

The PMD-430 is the stereo big brother in this family, featuring dbx noise reduction and three heads. You also get 6% pitch control, illuminated VU meters, limiter, and Dolby B. Memory rewind, auto shut-off/replay, three step mic attenuator, and headphone jack round out the list of useful functions. Mic inputs are 1/4" TS, line inputs and outputs are RCA phono. Carrying case included. Does not record 1/2 speed.



PMD-430	60MR430	\$499.00
---------	---------	----------

Accessories:

Kases KEB20 Gig Bag	40KEKB20	\$22.50
Vinyl carrying case for PMD 221 and 201	60MRCLC221	\$35.00
All weather case for all models	60MRWPC221	\$20.00
Porta-Brace deluxe case for all PMD recorders	60PBAR222	\$175.00
Ni-cad battery pack for all PMD recorders	60MRRBD430	\$66.00
AC Adapter for all models	61MRAC	\$13.00



WHIRLWIND ACTIVE PRESS BOX

Toiling as we do near Washington, we know something about press events. When a passive mic box isn't enough, we recommend



Presspower. It accepts two inputs and feeds 16 transformer-isolated XLR outputs. You can send down a 1kHz tone so everyone can set their levels before the shouting starts. A VU meter and a headphone jack let you keep an eye and an ear on everything.

Presspower can run on AC or just four 9V batteries. It provides phantom power (+48VDC when running on AC, +12V from batteries). Inputs can be mic or line level; both have low cut filters. Twelve outputs are mic level, on XLR and 1/8" connectors, two outputs are line level fixed at 0dB, and two are adjustable line level. The variable outputs also appear on 1/4" TRS connectors. It is supplied with a carrying case and can be rack mounted.

Presspower 61WHPP \$1,799.00

WHIRLWIND MEDUSA PRESS BOXES

Here come the wolves in the press pack! But you're ready for them with your Medusa Press Box. It accepts a single line-level signal and gives you multiple mic level, 150 ohm output feeds. Designed to hold up under severe treatment, Whirlwind's cold-rolled steel boxes are on the job in punishing environments everywhere.



6 Channel 61WHPB06 \$229.00 12 Channel 61WHPB12 \$449.00
 16 Channel 61WHPB16 \$549.00 24 Channel 61WHPB24 \$839.00

WHIRLWIND PRESSMITE

Got a smaller event to cover? The new PressMite is a compact high performance press feed distribution box with 12 mic and 2 line outputs (all transformer isolated). It features a mic/line input with adjustable gain and a built-in headphone amp, and runs on two standard 9V batteries.



61WHPM \$795.00

GREAT FOR INSTALLED SOUND

ATI PRESSBOX/MIC DISTRIBUTION

The PB2X8 has phantom power and provides two low-noise mic/line inputs. Eliminate mic clutter with a single or back-up pair of mics. Feed each of eight transformer-isolated channels from either input or both mixed. Drive a high-level XLR and a medium- or low-level TRS line simultaneously from each output. Use as a 2X8 or stereo 1X4 DA, or a two-input mixer. Features include oscillator, low-cut, loop-through expansion, VU meter, and headphone output. Uses XLR, 1/4", and 3.5mm TRS jacks.

PB2X8 60AIPB2X8 MFR LIST \$1,399.00

CALL 1-800-732-7665 FOR BRADLEY PRICE

WHIRLWIND Q-BOX

The Q-box is the all-in-one audio line tester that you'll want in the toolbox for all applications, live sound, and installation work — anywhere you're running audio down an XLR cable. Use it to quick-check dynamic mics without firing up the entire system. Use the handy test tones for quick level setting or to identify which cable you're dealing with.



In one battery powered box (uses one 9V) you have a microphone, a speaker, a test tone generator, outputs for standard headphones, a 1/4" jack for line in or a 2kOhm (telephone) earpiece out, and voltage presence LED's for confirming phantom or intercom power. You can talk into it, listen to it, watch it, and clip it on your belt or equipment rack. Hook up one on either end of a line and you have a quick intercom. Use it to monitor a standard intercom feed or talk-back from the main audio console.



Q-Box 61WHQB \$169.00

WHIRLWIND MD-1 PORTABLE MIC-TO-LINE DRIVER

The new Whirlwind MD-1 combines a high quality mic/line input stage with a transformer-isolated line driver and independent headphone amplifier. Ideal for boom, parabolic and interview mics, the MD-1 provides phantom power, local monitoring, and a line-level balanced output for noise immunity over long cable runs.



Housed in a rugged steel chassis, the MD-1 comes with a belt clip and is powered by two 9V batteries. The MD-1's input stage features a level control with a 40dB range and a MIC/LINE input level switch, plus switchable 18V phantom power for condenser mics. The MD-1's output can be switch selected between the isolated gain stage and a straight loop-through.

The headphone volume control provides a 60dB range of adjustment to the post-transformer input signal or to signals inserted at the headphone Line-In jack. The MD-1 is an ideal general-purpose audio signal test and amplifier tool for the broadcast or production equipment box. It's another great audio problem solver from Whirlwind.

MD-1 Mic/Line Driver 61WHMD1 \$239.00



SHURE FIELD DEVICES

FP16A

A Bradley Best-Kept Secret, the FP16A is a handy field tool. It's a one-in, six-out audio DA for routing audio feeds, useful as a press bridge, at remote events, any place where you want multiple portable mic/line outputs. Includes phantom power, XLR transformer-balanced I/O (each switchable for mic or line), link jacks for ganging, and screwdriver-set gain controls. Run it on 120/240VAC or three 9V batteries for up to 20 hours. The battery supply automatically cuts in if you lose your AC power. Optional rack mount available.



FP16A 60SHFP16 MFR LIST \$645.00

CALL 1-800-732-7665 FOR BRADLEY PRICE

FP33

A step up from the popular FP32, this version is a portable stereo mixer with a 30dB reduction in self-noise, making it compatible with the latest digital stuff. Also: recessed panpots to prevent accidental movement; a dynamic range of 100dB; indicators for input levels, limiters, and low battery; and three kinds of phantom power for each input including 48V. The FP33 has three inputs, two outputs, and a cable to connect two mixers. Uses two 9V batteries.



FP33 60SHFP33 MFR LIST \$1,795.00

CALL 1-800-732-7665 FOR BRADLEY PRICE

SHURE SCM268 MICROPHONE MIXER



When you see the price attached to the SCM268 microphone mixer, you'd never guess that there are six transformers inside: four balanced XLR mic-level inputs, one balanced XLR mic/line input and one internal low stray field, toroidal power transformer. Why do you need all those transformers? They provide protection from RF interference, prevent ground loops and make the SCM268 exceptionally quiet.

Wait, there's more! In addition to the 6 transformers, the SCM268 includes five unbalanced aux level inputs, an LED peak output meter, one unbalanced aux level output, an IEC power cord connector, 12V phantom power for condenser microphones and built-in low cut filters on mic inputs. The internal toroidal power transformer makes the annoying "wall wart" a thing of the past.

SCM268 Microphone Mixer 60SHSCM268 MFR LIST \$395.00

CALL 1-800-732-7665 FOR BRADLEY PRICE

M367

The M367 mono mixer inherited quality from the M267 and added to it: it's 25dB quieter and has another two mic/line inputs, for a total of six. Other additions include 12 and 48V phantom, two XLR outputs, input peak LEDs, headphone monitor circuit, adjustable limiter threshold, and full meter illumination. Delayed power-on means no start-up "pop". Takes two 9V batteries.



M367 60SHM367 MFR LIST \$795.00

CALL 1-800-732-7665 FOR BRADLEY PRICE

FP42

The FP42 is a stereo sibling of the mono M367. Four balanced mic/line inputs with pan pots and phantom power are provided. Cue audio is routed to the stereo headphone jacks when a channel control pot is pulled out. Run it for eight hours on three 9V batteries, or plug into 120/240 VAC. Controls include mono/stereo switch, tone oscillator, limiter on/off, and headphone level control.

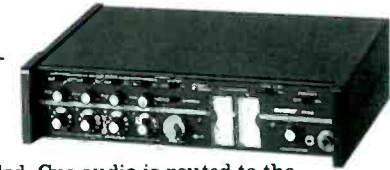

FP42 60SHFP42 MFR LIST \$1,240.00

Accessories:			
Porta-Brace Mixer Case for FP-33	60PBMX33	MFR LIST	\$170.00
Rack mount kit for M367	61SHA367R	MFR LIST	\$46.50
Rack mount kit for FP42 and FP16A	60SHA16R	MFR LIST	\$35.00

CALL 1-800-732-7665 FOR BRADLEY PRICE

SHURE FP 11 & FP22 AMPS

FP11 MIC/LINE AMP

Does your field gear accept mic-level audio? If not, here's a useful mic-to-line amp with adjustable gain of up to 84dB. It runs on a 9V battery and has both a balanced XLR mic input and a 1/8" TS mini input for a high level, high impedance source. The output is transformer balanced and appears on both an XLR connector and a set of spring contact binding posts. A switchable peak limiter and belt clip are included.



FP11 60SHFP11 MFR LIST \$340.00

CALL 1-800-732-7665 FOR BRADLEY PRICE

FP22 STEREO HEADPHONE AMP

Monitor your field audio in stereo. Power is by a 9V battery or 12-24VDC. The FP22 weighs 16 ounces and allows a mono signal and a stereo signal to be mixed any way you wish (with either or both signals, in either or both ears). Loop-through chaining, belt clip, XLR and phone jack are standard.

FP22 60SHFP22 MFR LIST \$395.00
Power Supply 60SHPS20 MFR LIST \$9.00

CALL 1-800-732-7665 FOR BRADLEY PRICE



ROLLS MX442

The MX442 field mixer is a breakthrough in price and performance for the broadcast and remote recording market. It features four XLR balanced inputs with phantom power, 20 dB pad and Lo-Cut switches. Each input has trim and volume controls, and a pan control for adjusting the signal placement in the stereo field. The large level meters may be switched to monitor the Right and Left channel outputs mono and stereo, monitor signal, or battery condition. The MX442 has two oscillators, one 20Hz tone with the Slate Mic, and a 400Hz tone for sound check and setup. An internally adjustable limiter with adjustable threshold is also included. The MX442 is powered by two 9V alkaline batteries and is housed in a light weight aluminum chassis.



Rolls MX442 Field Mixer 61RLMX442 MFR LIST \$1,050.00

CALL 1-800-732-7665 FOR BRADLEY PRICE

SHURE AUTOMATIC MIC MIXERS



With multiple mics come multiple headaches. Use too few, and you don't get adequate coverage. Use too many, and you get more background noise, and less gain before feedback on a PA. Ponder two solutions from Shure, one for the studio, one for the field. Both models distinguish between constant background noise and speech. Last-mic lock-on keeps one mic open when no one is talking, so you don't lose ambiance. Both have phantom power, limiter, linking capability, and rack mount.

The FP-410 is Shure's popular, portable automatic mixer, operating off either 120V or two 9V batteries. It has four mic/line inputs and two XLR outputs, one mic/line switchable, the other line level.

The SCM-810 is Shure's latest automatic mic mixer. Like the FP-410, it activates only those mics being addressed, minimizing poor audio caused by open mics. This mixer has eight mic/line channels. Each input has two-band EQ for setup in different mic environs. Logic terminals help with activation of external devices and external mic control. The I/O's are on removable header connectors; an optional adapter converts to XLR. Each channel also has a 1/4" phone jack for use as a direct output, gated channel output, send/receive insert, or external speech gate for mixing consoles.

FP-410	60SHFP410	MFR LIST	\$1,650.00
SCM-810	60SHSCM810	MFR LIST	\$1,650.00
RKC800 XLR adapter	60SHRKC800	MFR LIST	\$250.00

CALL 1-800-732-7665 FOR BRADLEY PRICE

**Bradley accepts MasterCard,
Visa, Discover, and AMEX.**



SPIRIT FOLIO POWERPAD

- 10 Inputs as standard (including the 2 track returns)
- 4 Mic Inputs
- 2 Stereo Inputs
- 2 x 30W RMS (4 ohms) power amplifier with overload and thermal protection
- 2-band EQ on every mono input
- Post-fade Auxiliary send on every input
- Dedicated Stereo Effects Return
- Global +48V Phantom Power
- Stereo Inputs equipped with switchable RIAA preamps for turntables
- Separate Mix outputs
- Peak and Avg. LED Metering
- Headphone Output

Folio Powerpad is Spirit's smallest and most affordable powered mixer, yet despite its small size, it more than meets Spirit requirements for professional DAT quality sound and features. Powerpad was specifically designed with the multimedia generation in mind. It's the easy way to incorporate microphones, CDs, Phonographs, and AV playback with your corporate presentation when reinforcement is required.

Spirit Folio Powerpad 60SFRW5427 MFR LIST \$399.95

CALL 1-800-732-7665 FOR BRADLEY PRICE

SKB RACKMOUNT CASES

These durable racks are made not of wood but of rigid polyethylene with welded frames, so they're half the weight of wood racks. The removeable latching front and rear covers seal tight. You know they travel well because they meet ATA specs. Rackable depth is 17" with cover. Cases have two carrying handles and can be stacked.



SKB Shock Rack Cases are similar and give extra protection with an internal, shock-absorber frame. Both the 8sp and the 12sp have a 20" usable depth.

One of SKB's best ideas was the **Pop-Up Rack**. Plop it in place, pull off the cover, pop up your gear at any angle. The 12-space frame has heavy-duty slide hinges. The interior is 8"H x 20-5/8"W x 23-1/2"D.

(Here's one that's not a rack: For stashing stuff, the **SKB-1713 Utility Case** is the way to go. Top lid is hinged at the back. 17" x 13" x 10-1/2".)

SHOCK RACK CASES

8 space	77SK908	\$379.00
12 space	77SK912	\$429.00

POP-UP RACK CASE

77SK19P12 \$139.00

UTILITY CASE (not pictured)

77SK1713 \$104.00



ATA RACKMOUNT CASES

2 space	77SK192	\$107.99	8 space	77SK198	\$179.99
4 space	77SK194	\$122.99	10 space	77SK1910	\$191.99
6 space	77SK196	\$137.99	12 space	77SK1912	\$203.99

KACES III EQUIPMENT CASES

This company wants to prove that they have a soft gig bag for every need. OK, that works for us. Our customers use lots of portable products, and Kaces makes very affordable bags for them. In fact, they're good enough to earn a Bradley Best-Kept Secret. You get sturdy web handles, tear-resistant nylon, thick padding, heavy-duty zippers, and lots of room for microphones, cables, and notepads.



Bags for many other products are available; give Bradley a call.

Kaces KEB20	for Marantz Portables, Shure FP31 & 32	40KEKB20	\$24.95
Kaces KEB22	for Mackie 1202	40KEKB22	\$25.95
Kaces KEB29	for Spirit Folio Mixer	40KEKB29	\$45.95
Kaces KEB30	for Mackie 1604 (includes strap)	40KEKB30	\$54.95
Kaces KEB31	for Mackie 1402	40KEKB31	\$37.95
Kaces MB6	Mic Bags (fits 6 mics)	40KEKMB6	\$89.95
Kaces MB12	Mic Bags (fits 12 mics)	40KEKMB12	\$99.95

MACKIE MIXER BAGS

If your mixer moves as much as you do, carry it correctly in a stylish and nearly indestructible mixer tote made just for your Mackie 1202VLZ, 1402VLZ and 1604VLZ. High-impact, high-density rigid internal foam offers superior drop protection. Choose from black nylon fabric or black suede-like stuff.

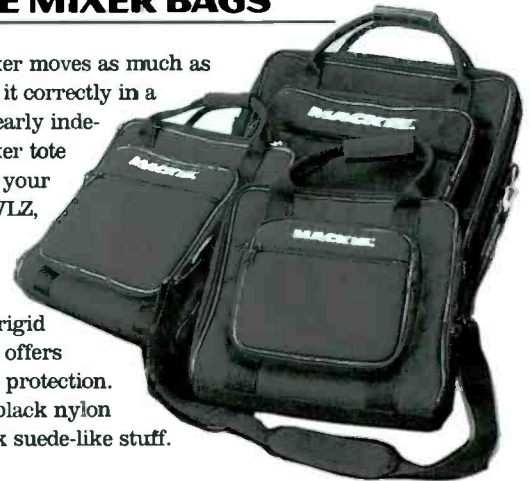

Black Nylon Fabric	60MD1202VLZD	MFR LIST	\$39.99
Black Nylon Fabric	60MD1402VLZD	MFR LIST	\$49.99
Black Nylon Fabric	60MD1604VLZD	MFR LIST	\$59.99
Black Suede Stuff	60MD1202VLZS	MFR LIST	\$49.99
Black Suede Stuff	60MD1402VLZS	MFR LIST	\$69.99
Black Suede Stuff	60MD1604VLZS	MFR LIST	\$89.99

CALL 1-800-732-7665 FOR BRADLEY PRICE

Turn to Page 72 for Mackie Mixers!



FIELD PRODUCTION ACCESSORIES

MODERN CASE "RACK BAGS"

Take a rack with you. These lightweight racks from Modern Case are made of sturdy plywood and surrounded by a half-inch of foam and cordura fabric. Straps let you carry them easily.

Order one space for a single small piece of gear, or go up to six rack spaces and 18" usable depth.

Shell depth	1SP	2SP	3SP	4SP	5SP	6SP
8"	\$55.00	\$58.00	\$61.00	\$65.00	\$72.00	\$83.00
10"	\$61.00	\$65.00	\$69.00	\$72.00	\$80.00	\$94.00
12"	\$70.00	\$72.00	\$76.00	\$80.00	\$89.00	\$98.00
15"	\$79.00	\$83.00	\$87.00	\$93.00	\$99.00	\$109.00
18"	\$92.00	\$97.00	\$102.00	\$104.00	\$112.00	\$123.00



GALAXY AUDIO FAR OUTLET

Long overdue, the Far Outlet personal power station, from Galaxy Audio, is a fully self-contained portable source of 110 volt, 60Hz, household current. About the size of a lunchbox and lightweight enough to carry in one hand, the Far Outlet provides up to 250 watts of continuous power and 400 watts at peak. An included accessory kit allows you to re-charge the Far Outlet from your car's battery or the 12V accessory outlet.

Personal Power Station 60GAFAROUT MFR LIST \$399.99
CALL 1-800-732-7665 FOR BRADLEY PRICE



LEATHERMAN TOOLS

Tired of searching for wire cutters or pliers? Bradley has the answer for YOU! Leatherman tools all come equipped with needlenose pliers, regular pliers, wire cutters and at least one knife blade. The Pocket Survival Tool II adds hard-wire cutters, a serrated knife, two files, a sharpening groove, ruler, bottle opener, 3 sizes of flat-blade screwdrivers, Phillips head screwdriver and scissors.

The Super Tool adds a clip-point knife, a wood saw, electrical crimper and wire stripper (sorry no scissors on this one). A must-have for anyone who works!

A) Leatherman PSTII

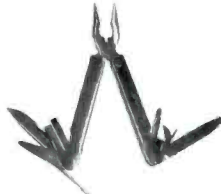

62LE61070101 \$49.99

B) Leatherman Minitool

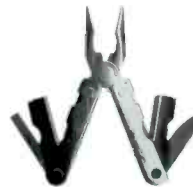

62LE62010001 \$37.99

C) Leatherman Supertool



62LE63010101 \$69.99

D) Leatherman Tool Adapter



62LE65010101 \$21.00

MARTI RPS-402 PHONE REMOTE MIXER (FORMERLY TELFAX GX440)

A mainstay for radio stations for many years, the RPS-402 features four mic channels and two aux inputs. Channel 4 doubles as a spotter channel, taking its input from either mic #4, Aux #2 or phone line #2, providing several alternatives for off-air cueing. A radio monitor input and four headphone connections are also included. A built-in peak limiter prevents phone line overload, and an Aux out jack is configurable for PA feeds or recording of just the send audio from the console, or a mix of send and received audio, from the RPS-402's second phone line input. This input is useful for airing telephone calls at the remote site, or for feeding more than one station or phone line.

Tone/pulse dialing, electronic ringer, and modular telephone jacks make connection and operation simple, and high capacity ni-cad batteries charge in 2-1/2 hours, ready for ten hours use. An 8-pin DIN accessory jack allows instant interfacing with low-frequency extenders, or other external processors. A transformer balanced OdBm signal is available on the DIN jack to feed dedicated loops, codecs, or cellular interfaces.

Loaded with features, this unit should be in every station's remote kit!

Marti RPS-402 62BRRRPS402 MFR LIST \$1,295.00
CALL 1-800-732-7665 FOR BRADLEY PRICE



FIELD PRODUCTION

JK AUDIO REMOTEMIX 3

Plug Remotemix 3 into any phone line or handset cord, and you have an instant Remote broadcast facility, IFB patch, or live interview station. Featuring two XLR mic inputs, RCA line in/out and two headphone jacks, plus a DTMF dial pad and VU meter, this powerful little mixer really brings it home! Runs on two 9V batteries, or included AC adapter. Functions as a telephone when attached directly to a phone line.



60JKMIX3 JK Audio Remotemix 3 MFR LIST \$895.00
 CALL 1-800-732-7665 FOR BRADLEY PRICE

CONEX CELLJACK FOR CELLULAR PHONE REMOTES

Feed great remote audio back to the studio with your Motorola bag phone and the new Conex CellJack. It's a compact cellphone adapter that connects to various broadcast devices with its balanced XLR input and line output, both transformer isolated. The XLR input gain is switchable, so it accepts either your dynamic mic or the output of a field mixer. Use the stereo headphone jack to monitor the cellphone; when your radio is plugged into the tuner input, its audio is fed to one side of the headset. Very nice.



An 18 in. interconnect cable is included with this palm-size problem solver. Call us.

CellJack 60CNJACK only \$225.00

PACKAGE 9809 - ONLY \$379.00

Great for cellular recording! Take the CellJack, an AT 804 field mic with coiled cable, and Sennheiser's HD470 headphones. Value: \$505.00.

JK AUDIO QUICKTAP IFB

This useful device connects to the handset cord of any phone, providing an IFB tap with both 1/8" mono jack with volume control, and a fixed output 600 ohm male XLR output. No batteries or AC are required for operation.



JK Audio Quicktap 60JKQT MFR LIST \$59.00
 JK Audio Quicktap IFB 60JKQTIFB MFR LIST \$125.00
 CALL 1-800-732-7665 FOR BRADLEY PRICE

COMREX HOTLINE POTS CODEC

The HotLine provides wideband two-way audio over a standard dial line. It employs an algorithm especially designed for use over low bit-rate modem connections and, unlike other units, the HotLine will provide quality audio over a wide range of modem connections: from 33.6 kbps down to 12 kbps. The HotLine algorithm adjusts frequency response based upon available bandwidth and runs a setup routine upon connection to determine at what speed a stable connection may be established. At 33.6 kb/s frequency response is 20Hz - 10kHz. The HotLine is an essential and economical addition to your audio toolbox. ISDN may not always be available or practical for your remote application, but POTS service is always readily available. HotLine provides great audio from anywhere, for the price of a phone call.



HotLine	60CCHOTLINE	MFR LIST	\$2,800.00
HotLine Studio Version	60CCHOTLINERM	MFR LIST	\$3,000.00
Softcase for Hotline	60CCSOFTCASE		\$50.00

CALL 1-800-732-7665 FOR BRADLEY PRICE

JK AUDIO REMOTE MIX 3x4

The Remote Mix 3x4, a multi-line hybrid and mixer, is the newest broadcast tool from JK Audio.



Designed to handle television IFB feeds and radio remote broadcasts, its combination of inputs, outputs and controls makes even the most complicated remote a simple one.

In television applications, IFB feeds can be monitored over up to 4 phone lines using the Remote Mix 3x4. One phone line can be in use while setting up the remaining lines making live broadcasts a snap.

Impromptu talk shows are no problem for this four-line hybrid with a monitor section that can be used to screen callers. In remote broadcast applications, the Remote Mix 3x4's three balanced XLR microphone inputs and three 1/4" TRS headphone jacks allow you to select between the mixer, main phone line or monitor phone line. Line LEDs light when a line is seized and flicker when the line is ringing.

The Remote Mix 3x4 operates for 10 hours on two 9V batteries or uses the AC adapter which is included.

Remote Mix 3x4 60JKRM3X4 MFR LIST \$1,795.00
 CALL 1-800-732-7665 FOR BRADLEY PRICE



CODECS & FREQUENCY EXTENDERS

COMREX DIGITAL AUDIO CODECS

Comrex offers several potent choices for sending audio over digital phone lines.

DXP.1 and **DXR.1** codecs deliver superb bi-directional mono feeds over ISDN or SW56 using the G.722 standard. On a 56 or 64 kb/s circuit, they produce 7.5kHz audio, and they upgrade automatically to 15kHz if the connection is 112 or 128 kb/s. The very low delay makes this an excellent choice for live programming such as talk, news, and sports.

The **DXP.1** is a portable unit with external AC supply, headphone output, and selectable mic/line input. The **DXR.1** is a rack mount unit with balanced line level I/O. Each requires a terminal adapter with IMUX (sometimes called "bonding") to send 15kHz on a BRI ISDN line.

The **DX-100** is a full mono/stereo apt-X encoding/decoding system. It's capable of bi-directional audio up to 15kHz and supports data rates from 56 to 256 kb/s. The low-noise, low-delay coding scheme makes it suitable for STL and studio-to-studio work.

The **DX-100** has IMUX which adds the data rate of two independent 56 or 64 kb/s data channels. Configure it for ISDN or Switched 56 operation, or for satellite, wireless modem, or fractional T1.

The **DX200 MusicLine** codec is an affordable way to send wide-band, bidirectional stereo audio over ISDN. It uses ISO/MPEG Layer II coding to send full bandwidth stereo over digital paths as low as 112 kb/s. A broadcaster, recording studio, or music service can send stereo using one ISDN or two Switched 56 lines, or send mono 11kHz on a single SW56 or 64 kb/s.

Choose among sampling rates of 24, 32, and 48kHz. The **DX200** encoder is configurable for output data rates (from 56 to 384 kb/s)



and it allows full stereo, joint stereo, dual mono, and mono operation. It now also has Turbo G.722 for low-delay work and backwards compatibility with almost all installed Layer II codecs. The **DX200's** built-in IMUX allows it to support transmission rates up to 256 kb/s.

The optional Control Panel is a 1RU unit with control buttons and LCD display to allow changing settings "on the fly."

All Comrex codecs have balanced analog I/O connectors. Data ports are DB25 (EIA-530), with a DB25-to-DB25 cable provided. Optional cables for connecting to X.21 or V.35 are available.

DXP.1	60CCDXP	MFR LIST	\$1,500.00
DXR.1	60CCDXR	MFR LIST	\$1,500.00
DX100	60CCDX100	MFR LIST	\$3,000.00
DX200	60CCDX200	MFR LIST	\$3,000.00
DX200 Control Panel	60CCDX200CP	MFR LIST	\$300.00

CALL 1-800-732-7665 FOR BRADLEY PRICE

JK AUDIO INLINE PATCH

New!

Whether you're a radio station, a TV Station or a cable talk show, you need the **INLINE PATCH**



Telephone Audio Interface from JK Audio.

The **Inline Patch** is a small box that connects between the base of an analog phone and the wall jack, allowing you to continue to talk on the phone and access audio on both sides of the call. With two back-to-back hybrids for complete control from both sides, the **Inline Patch** lets you mix sound bytes or conversation into your call.

One stereo output jack provides your voice on one channel and the caller's voice on the other channel. A second output jack contains a mix of both voices. A front panel control for each output offers all the control you'll ever need.

Inline Patch	60JKINLINE	MFR LIST	\$270.00
---------------------	-------------------	-----------------	-----------------

CALL 1-800-732-7665 FOR BRADLEY PRICE

COMREX FREQUENCY EXTENDERS

Everyone's talking about digital audio over phone lines, with good reason, but don't forget you can use frequency extension today to affordably upgrade any audio fed over standard phone lines.

One-line systems encode audio by shifting frequencies up by 250Hz. At the decode end, frequencies are downshifted to restore 2-1/2 octaves of program energy to the low end. For single-line encoding, put one **LXT/R** encoder/decoder at the studio, another in the field. It includes a built-in coupler for direct connection to the phone line.

Ask us about two-line systems (a full 5kHz audio connection), and three line (8kHz).

LXT/R one line encoder/decoder	60CLXTR	MFR LIST	\$850.00
Rack mount	60CCRATR	MFR LIST	\$30.00

CALL 1-800-732-7665 FOR BRADLEY PRICE

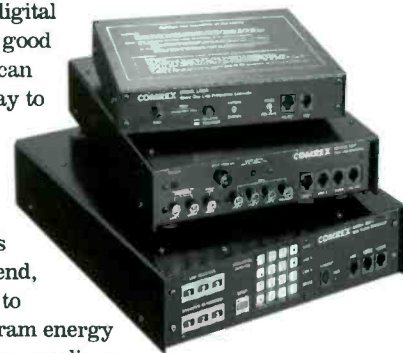

FIELD PRODUCTION

Bradley Broadcast • 7313-G Grove Road • Frederick, MD 21704 • 800-732-7665 • 301-682-8700 • Fax: 301-682-8377 • Web: <http://www.bradleybroadcast.com>

TELOS ZEPHYR DIGITAL TRANSCIVER

Harness the power of the digital telephone system. The Zephyr codec creates world-class audio for remote broadcasts, sports coverage, voice-overs, distribution of spots, recording studio feeds, ad hoc networks, and backup to microwave and satellite links. It was designed specifically for broadcast applications on ISDN and Switched 56.

Zephyr provides both the superb quality of Layer III and compatibility with installed Layer II-only equipment. With just the push of a button, you select the coding scheme to use.

Each ISDN line has two 64 kb/s channels on a single copper pair. Zephyr, on just one ISDN line, provides bi-directional, 20kHz stereo plus ancillary data transmission.

Layer-III allows 15kHz mono on a single ISDN channel or one SW56 line, reducing your transmission costs when sending mono material.

Zephyr - Stereo transmit & receive

with ISDN terminal adapter	60TSZ9202	MFR LIST	\$4,980.00
with X.21/V.35 interface	60TSZ9201	MFR LIST	\$4,580.00
with ISDN TA and X.21/V.35	60TSZ9200	MFR LIST	\$5,180.00

Zephyr - Mono transmit & stereo receive

with ISDN terminal adapter	60TSZ9102	MFR LIST	\$3,980.00
with X.21/V.35 interface	60TSZ9101	MFR LIST	\$3,580.00
with ISDN TA and X.21/V.35	60TSZ9100	MFR LIST	\$4,180.00

CALL 1-800-732-7665 FOR BRADLEY PRICE



- Each unit serves as both a transmitter or receiver.
- Versions with ISDN terminal adapter include built-in NT-1. Everything required for the ISDN connection is included.
- Versions with V.35/X.21 port connect to one or two Switched 56 lines. (External CSU/DSU required for Switched 56.) This port also provides compatibility with satellite links and other data paths.
- Full metering, call-duration timer, headphone jack, and straight-forward controls make operation easy.
- 20kHz stereo duplex audio can be sent on a single dial-up ISDN line or two Switched 56 lines using Layer III or Layer II coding.
- 7kHz transmission using G.722 is included for transmission to and from installed codecs.
- Transmit and receive coding schemes can be individually selected.
- Bi-directional, RS-232 serial data at 9600 bps for communications and control are transmitted simultaneously with the audio. Windows-based software is included at no charge.
- The split channel mode allows individual mono signals to be transmitted to separate sites.
- Four end-to-end parallel "contact-closures" can be used to control recorders and other devices. The first input can be used as a "panic dialer" to automatically connect to a frequently called or emergency number.
- The ISDN Telephone feature (G.711) allows Zephyr to dial any standard analog telephone line for low-grade voice communications.



COMREX NEXUS ISDN CODEC

Now you can produce quality digital audio from the road with ease. The NEXUS

portable ISDN codec is a Turbo G.722 device with built-in bonding terminal adapter and NT-1. Use it for 15kHz or 7.5kHz low delay, bi-directional mono audio. A front-panel keypad and LCD make it easy to use. Other features include auto dial, ten-number memory, switchable mic/line input, ancillary data capability, and audio output that lets the NEXUS return feed be mixed with local program audio.

Compact and built for the road, NEXUS weighs less than four pounds and measures 6.25" x 9.5" x 2".

NEXUS	60CCNEXUS	MFR LIST	\$2,300.00
NEXUS w/ Rack Mount	60CCNEXUSRM	MFR LIST	\$2,500.00
Softcase For Nexus	60CCSOFTCASE		\$50.00

CALL 1-800-732-7665 FOR BRADLEY PRICE



TELOS ZEPHYR EXPRESS



Sending live audio from the field via ISDN has never been easier. Meet ZephyrExpress, a full featured codec, ISDN terminal adapter, and audio mixing/monitoring system, all in a rugged road chassis.

Fans of the widely-used studio Zephyr will find the familiar features: MPEG Layers III and II, G.722 for widest compatibility, and G.711 for voice grade calling to any phone. It's brand new from the creative folks at Telos and from Bradley. We've been your Telos supplier longer than any other dealer. No one knows Telos like Bradley does.

ZephyrExpress	60TSZ9302	MFR LIST	\$5,280.00
---------------	-----------	----------	------------

Softcases available. Call your Bradley Professional for details.

CALL 1-800-732-7665 FOR BRADLEY PRICE

FIELD PRODUCTION/TELEPHONE INTERFACE



COMREX VECTOR POTS CODEC



The Vector delivers 15 kHz two-way audio on a standard phone line...at a realistic 24 kb/s, and is compatible with the Comrex HotLine, but incorporates a higher level coding algorithm that permits wider band audio at lower data speeds. The Vector contains plenty of mixing and monitoring facilities to make any remote a breeze. The Vector Mixer includes three headphone outputs on 1/4" phone jacks, three mic level inputs on XLR, with input 3 switchable to line level. Outputs include a line level XLR for PA feed, headphone output, and telco and phone set connections. All outputs are an externally controllable mix of local program audio and studio return. PA output can be muted with a front panel push switch.

Vector Field Unit	60CCVECTOR	MFR LIST \$4,500.00
Vector Rack Mount unit	60CCVECTORRM	MFR LIST \$4,500.00

CALL 1-800-732-7665 FOR BRADLEY PRICE

- Auto-Answer
- Automatically switches to HotLine mode if connected to a HotLine POTS Codec
- Quick-dial memory feature allows one button dialing.
- Last number redial with one button.
- Two contact closures are available. One is automatically enabled upon connection. The second is a momentary contact closure that can be initiated by pushing a button on the keypad.
- Twenty different international dialing protocols. Works on virtually any A/C power in the world.
- Internal peak limiter.
- Also available in a 2U rackmount version.
- Works at data rates as low as 9600 baud.
- Defaults to standard telephone mode if the telephone line is so bad that the modem cannot operate.
- A MaxRate can be preset to provide a "margin of safety."
- If errors occur, a one-button push (from either end) resets the modem to the next lowest data rate - without dropping the line.
- If the line quality deteriorates badly, the Vector will automatically renegotiate.
- The Vector features error correction, which can be enabled through simple menu options.
- The Vector requires either another Vector or a HotLine POTS Codec at the other end of the telephone line.



THE APT DRT 128 DIGITAL REPORTER TERMINAL

Portable and robust, the DRT 128 WorldNet Digital Reporter Terminal is designed for outside broadcast and limited bandwidth applications, delivering high quality audio over ISDN, using the apt-X coding algorithm. Balanced analog audio is available via XLR ports on the rear panel, while the microphone and headphone jacks make the terminal ideal for the mobile reporter. A numeric keypad and LCD display provide full status information. The DRT 128 provides reporters with a variety of transmission options - including stereo - to suit the individual application. An additional benefit is that the system can also be used to transmit data - uploading, for example, material from a journalist's laptop computer.

APT DRT 128	61APDRT128	MFR LIST \$3,975.00
--------------------	-------------------	----------------------------

CALL 1-800-732-7665 FOR BRADLEY PRICE

- Full duplex operation
- 32kHz and 16kHz sampling frequencies.
- apt-X data compression with negligible coding delay
- Embedded user auxiliary data facility
- Integral ISDN TA with international Telecom approval
- Two channel synchronizer and intelligent IMUX
- Stereo or mono operation
- Full compatibility with all APT codecs



INTRAPLEX OUTBACK MPEG LAYER II AUDIO CODEC FOR ISDN

The Intraplex OutBack digital audio codec is designed to facilitate high-fidelity audio broadcasts over the ISDN switched digital network. The OutBack provides ISO/MPEG Layer II audio coding at up to 20 kHz bandwidth, in a single unit that includes a built-in Terminal Adapter with S/T and U interfaces. G.722 audio coding is also included, offering 7 kHz bandwidth with low delay.

OUTBACK	60IPOUTBACK	MFR LIST \$2,495.00
HHAT-1 Handheld ASCII Terminal	60IPHAT1	MFR LIST \$450.00

CALL 1-800-732-7665 FOR BRADLEY PRICE

- Full two-way operation - encoding and decoding in the same box
- Simultaneous, bidirectional MPEG Audio Layer II or G.722 coding.
- Built-in ISDN Terminal Adapters with S/T and U interfaces
- Selectable sampling rate (MPEG only)
- Compatible with most other MPEG Audio Layer II ISDN codecs
- Simple user interface with "one-touch" call setup
- Auto-detection of the receive audio characteristics



TELEPHONE INTERFACE

MARTI SMARTI TELEPHONE REMOTE

The SMARTI RKS-411 and RKS-111 are capable of sending and receiving broadcast quality audio over a standard (POTS) telephone line. Utilizing the latest MPEG compression algorithms coupled with modern DSP technology, the SMARTI offers Broadcast Audio Quality with phone line convenience. For more than just "talk", the SMARTI handles complex audio. The SMARTI incorporates many features not found in other telephone remote equipment without the need for costly "ADD ON" items. IT'S ONE SMART BOX... or TWO.

RKS-411

- Four inputs using standard XLR connectors, mic/line switchable and individual level adjustments.
- Three headphone jacks using standard 1/4" connections with individual program/return fade pots.
- Supports up to 33.6 KBps depending upon the phone line.
- Front panel, 600 ohm monitor output via standard 1/4" plug.
- Return and Program audio line level adjustments.
- Internal switching power supply operates from 100 to 240 volts
- Software upgrades are done automatically via modem connection to MARTI.

RKS-411 62BRRKS411 \$2,800.00

RKS-111 FEATURES ARE THE SAME AS THE RKS-411 WITH THE EXCEPTION OF:

- One input using standard XLR connectors, mic/line switchable and individual level adjustments.
- One headphone jack using standard 1/4" connections with individual program/return fade pots.
- Rack mountable or field portable.

RKS-111 62BRRKS111 \$3,200.00



MUSICAM USA CODECS

The CDQ Prima series now incorporates Layer III coding, in addition to Musicam™, a digital audio enhancement to MPEG Layer II that is compatible with other Layer II codecs.

All models in the family are based on a common set of core features. configurable with different options, and you can upgrade any CDQPrima as your needs grow. Common features include an integrated support processor with the power of a high-end personal computer, world power supply, 18-bit AD/DA converters for better signal quality, plug-in communications modules, and AES/EBU so you're ready for the all-digital studio (optional on Model 110). You also get a dial keypad, downloadable software changes, and computer ports for external control. Each codec supports MPEG-I at 32 and 48kHz, and MPEG-II at 16 and 24Hz; each also contains G.722 ADPCM coding and will automatically detect which scheme is in use. No separate terminal adapters needed.

You can customize your codec with psychoacoustic parameter adjustment, multiple interface slots, alarm relay, inverse line multiplexing to use several ISDN lines at once, digital VU meter, SMPTE time code, and more.

CALL 1-800-732-7665 FOR LITERATURE AND A BRADLEY PRICE QUOTE.

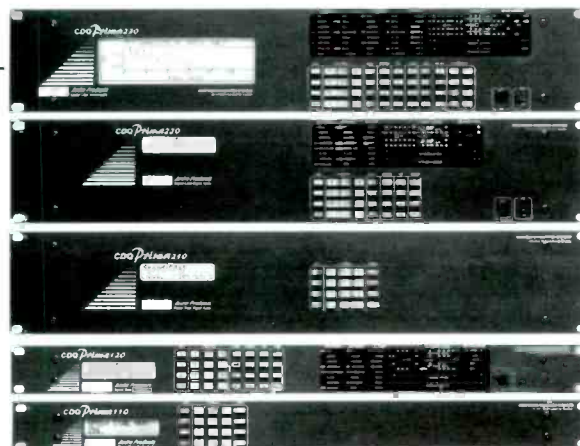

COMREX CODEC BUDDY

Codec Buddy is just that, a field unit designed for use with digital codecs like the ones we offer on pages 10-12. This versatile four-channel mixer is ideal for feeding cellular phones, POTS lines, and RPUs. Remotes using codecs require lots of feeds, including main channel to station, headphone audio for several people, PA feed, intercom audio for the engineer, backup feed, and more. With all these mixes, each with its own level, your remote site can look like a wiring nest. Use the Buddy instead. Most sites will require only a Buddy and a digital codec with terminal equipment.

Features include four XLR mic inputs (two of which also take line), four headphone outs, spotter input, sophisticated headphone mixer and matrix, a PA feed so local fans can hear talent and callers coming in on the return codec channel, a telco interface with coupler and dial pad, and a single-line frequency extender to enhance program transmission on a standard dial-up line or cellphone. Weight: eight pounds.

Codec Buddy 60CCCB MFR LIST \$2,500.00

CALL 1-800-732-7665 FOR BRADLEY PRICE

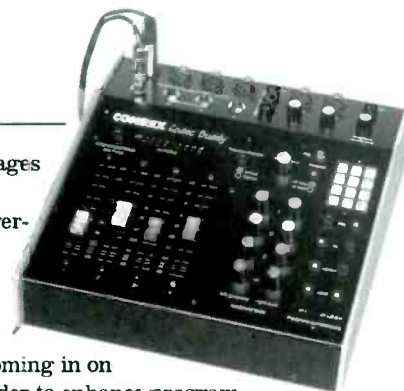

TELEPHONE INTERFACE

MUSICAM USA ROADRUNNER



RoadRunner is a "Swiss Army Knife" for any mono ISDN application, including broadcast remotes, network feeds, voice-over contributions and news reporting. Compact and portable, the RoadRunner can send and receive up to 20 kHz audio over 2 ISDN "B" channels or up to 15 kHz over 1 "B" channel. RoadRunner contains MUSICAM®, the enhanced compatible MPEG Layer 2 algorithm, as well as MPEG Layer 3 and G.722 to give you compatibility with more codecs worldwide than any other device in its class. RoadRunner's internal 3-channel mixer accepts 2 mic inputs and 1 mic/line input. Dual headphone monitor circuits give you independent mixing of both SEND and RECEIVE audio for each headphone. Additional outputs include balanced and unbalanced RETURN and unbalanced SEND. RoadRunner stores 256 Speed Dial setups and Quick Configurations, as well as 20 ISDN Terminal Adapter presets. RoadRunner Model RR103 comes complete with built-in ISDN Terminal Adapter with integrated NT1 for direct connection to your ISDN line.

RR103 for ISDN	61CCRR103	MFR LIST	\$2,800.00
RR101 for V.35	61CCRR101V35	MFR LIST	\$2,600.00
RR101 for X.21	61CCRR101X21	MFR LIST	\$2,600.00
RR101 for RS422	61CCRR101RS422	MFR LIST	\$2,600.00
TC1 Locking Airline Travel Case	61CCRR101	MFR LIST	\$250.00

CALL 1-800-732-7665 FOR BRADLEY PRICE

GENTNER MICROTREL

Microtel is bristling with connectors to make your job of connecting audio to a phone line easier.

It connects to a phone, replacing the handset with your mic and headphones. Inputs are provided for a mic (XLR) and an aux (1/8" TS mini). An additional input lets you feed the headphone bus with IFB or air monitor. Outputs are provided for headset (1/4" TRS) and high-level (1/8" TS mini), as well as an auxiliary feed jack for tape machines or dedicated loops. It's for IFB, news reporters, salespeople, anyone who needs to record calls or send audio. Uses one 9V battery.



Microtel	60GEMICRO	MFR LIST	\$272.00
AC adapter	60GEXFMR	MFR LIST	\$29.00

CALL 1-800-732-7665 FOR BRADLEY PRICE

GENTNER HYBRID COUPLER AND AUTO COUPLER

GENTNER HYBRID COUPLER

The economical Hybrid Coupler is nice for one-way audio feeds, news, and tele-marketing. It connects to a phone line via a modular jack, and provides a loop-through to a telephone set. A three position switch allows it to seize the line, simply tap the circuit, or be turned off. Its hybrid coil provides approximately 10dB of separation between send and receive, adjustable with a trimmer. The coupler is a passive device requiring no power.



Hybrid Coupler	60GEHC	MFR LIST	\$199.00
----------------	--------	----------	----------

CALL 1-800-732-7665 FOR BRADLEY PRICE

GENTNER AUTO COUPLER

Gentner's auto-answer, auto-disconnect units are intended for listen lines and IFB sends. Connect one at each audio source you wish to monitor by phone. They allow simultaneous send and receive upon connection. Balanced 600 ohm connections are provided for both send and receive audio, and a null trimmer pot maximizes isolation. This version hangs up the phone line at loop drop. A special CP version is used on lines where the phone company does not provide the loop drop signal. The decoder disconnects when it hears dial tone, busy signal, recorder signal, or ringback. Units operate on 117VAC from a provided external power supply.



Auto Coupler	60GEAC	MFR LIST	\$349.00
Auto Coupler CP	60GEACCP	MFR LIST	\$349.00

CALL 1-800-732-7665 FOR BRADLEY PRICE

TAC AUDIO COUPLER

Feed your precious audio from your field recorder into a phone, and listen while you're feeding. TAC, by Sound America, connects in series with the handset and is suitable for feeding news cuts, remotes, and sales demos. Great for Marantz and Sony decks. It connects with virtually any phone (except those with the dial in the handset). The low impedance input on both models is designed for cassette recorder outputs. TAC+ adds a high/low impedance selector and 60dB attenuator pad.



TAC	60SATAC	\$99.00
TAC+	60SATACP	\$110.50
Carrying Case	60SACASE	\$9.95

TELEPHONE INTERFACE



Remotes are Tough. Your Tools Should Be Too.

Remotes are tough enough in themselves. The last thing you need is equipment headaches. That's why JK Audio offers a full line of remote broadcasting equipment that's functional, rugged and easy to use. So whether your situation demands a

full-featured phone line hybrid/mixer or simply a telephone audio tap, JK Audio has the tools you need to face even the toughest remotes. For your free JK Audio product catalog, please ask Bradley Broadcast or email us at info@jkaudio.com.

JK Audio

Remote Broadcast Gear

JK Audio, Inc. • www.jkaudio.com • Email: info@jkaudio.com

LISTEN.



VECTOR

POTS CODEC

15 KHZ TWO-WAY AUDIO

ON ONE STANDARD PHONE LINE.

Check out the Comrex website for technical specifications.

www.comrex.com

COMREX

COMREX TELEPHONE COUPLERS

These couplers provide clean transformer connections between your telephone lines and external audio equipment. Designed for send or receive-only applications, they have modular telephone jacks for the phone line and for a telephone set.

The TCB-1 Manual Coupler provides a switched hold connection. Unbalanced audio in/out is on a single 1/4" TRS connector. The unit does not require power. The TCB-2 Auto-Answer Coupler answers the telephone line on the first ring and disconnects that line when the caller hangs up. An A/C power supply is included. If your CO does not provide loop drop, order the optional dial tone detect board.

TCB-1 Manual Coupler	60CCTCB1	MFR LIST	\$150.00
TCB-2 Coupler & Pwr Supply	60CCTCB2	MFR LIST	\$250.00
Dial tone detector for TCB-2	60CCDTD	MFR LIST	\$125.00

CALL 1-800-732-7665 FOR BRADLEY PRICE



EXCALIBUR HC-1 HANDI-COUPLER

Use the Handi-Coupler on remotes and around the station: on-air, production, the newsroom, the sales office, and in the sports kit. The HC-1 connects in series with the handset of any telephone using modular connectors. Since a connection to the telephone line is not required, the HC-1 can be used with almost any telephone in single or multi-line, modern electronic or older key systems.



Pressing the front panel button disconnects the handset and connects the external audio in/out jacks to the telephone. Releasing the button reconnects the handset, allowing normal use of the phone. External audio is connected via separate input and output jacks. Both inputs and outputs are 1/4" TRS jacks wired so that you may use either balanced or unbalanced connectors.

HC-1	60EXHC1	\$99.00
------	---------	---------

Take \$10 off the price of an Excalibur HC-1 when you buy any Marantz PMD recorder!

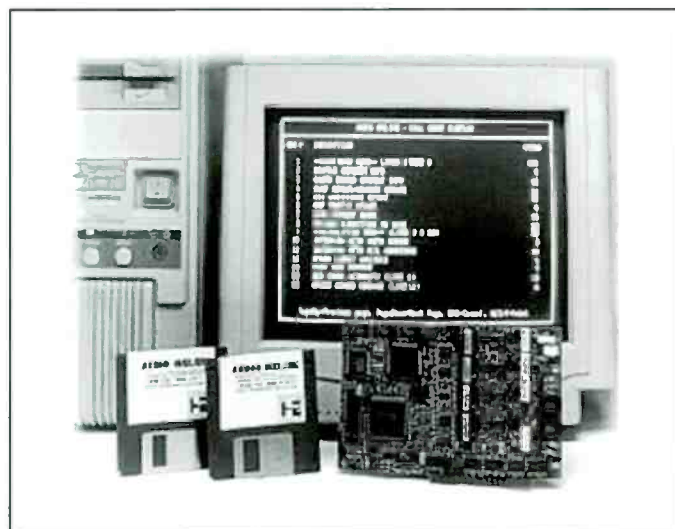

HENRY AUDIO ONLINE

Information System Problems? Audio Online™ is Your Solution! This hardware/software combo installs in minutes into any 386+ PC. Audio Online answers 2-16 phone lines with your choice of hundreds of messages. It provides literally hours of recording time, making it ideal for Concert Info... Weather/ski/surf reports... School closings... Traffic updates... Voting lines... Sports scores... Contest rules... you name it.

CALL YOUR BRADLEY PROFESSIONAL AT 1-800-732-7665 FOR AUDIO ONLINE PRICES

SOUND AMERICA R/SVP

News, sales, and PR types will use the "Record/Send Verywell Phone". It's a classic TouchTone™ desk phone with a coupler built in, so you can connect a cassette recorder or other source direct to the phone network with no loss of quality. Feed your audio down the line - use the handset to mix in voice or switch it to "mute". Also record phone conversations or make voicemail messages with music added. Mini 1/8" jacks for send and receive are provided. SVP is a send-only version. Want a push-to-talk handset? Order the PT-1 option with either model.

R/SVP	60SARSVP	\$147.00
R/SVP with PT1	60SARSVPPT1	\$166.00
SVP	60SASVP	\$129.00
PT-1 Option	60SAPT1	\$30.00



TELEPHONE INTERFACE



SYMETRIX 610 BROADCAST DELAY

Symetrix offers great value in the 610 talk delay, which gradually builds up 7.5 seconds of 14kHz stereo audio in memory. Push a button to dump the profanity and start the build-up again.



The 610 can be set up so that only half of the 7.5 second memory is deleted, retaining a reserve of 3.75 seconds. This lets the host bring up another caller without having to wait for memory to build from scratch, a feature which will be appreciated on fast-moving talk shows. Push "exit delay" at the end of the show, and the 610 gradually releases memory until you're operating in real time again. Connectors are XLR with switchable +4/+8 nominal level. The unit is bypassed if power is lost or the bypass switch pushed.

A cough button lets the host take a quick break with no dead air, great for taking a quick sip of water. No one will ever know.

610 60SV610 MFR LIST \$2,695.00

CALL 1-800-732-7665 FOR BRADLEY PRICE

EVENTIDE BD500 DIGITAL BROADCAST DELAY

Thousands of broadcast users made suggestions for Eventide's next model, and here's the result, a stereo delay with an enhanced version of their exclusive auto-



matic catch-up circuitry, optional digital I/O, and many conveniences.

When you push DUMP, you no longer have to worry about a few moments of unprotected airtime while the delay re-builds. The BD500 lets you divide the delay time into segments. Each time DUMP is pressed, only one segment is dumped. If another naughty word is spoken right away, push it again to dump the next segment of delay. So you might set up three segments, like this: [3 seconds], [3 seconds], [2.5 seconds], each an extra level of protection.

Standard stereo delay is 8.5 seconds, and more can be added. A new "sneeze" button edits audio to your delay, so the host can cough or make an aside without being heard and without a pause. Most front panel switches can now be remoted.

Analog XLR's are standard, with digital AES/EBU available optionally. It's all in one rack unit, and all built around Eventide's great algorithm that catches up quickly without degrading your audio.

BD500 60EVBD500 MFR LIST \$3,395.00

CALL 1-800-732-7665 FOR BRADLEY PRICE

EVENTIDE CLASSIC BROADCAST DELAYS

Consider Eventide your insurance policy.



When a no-no is uttered by your guest or caller, push Delete on the front panel or via a remote closure to bypass the delay line. It closes a relay contact to start any filler material. The mono delays are available in 6 and 12 second versions, and the stereo units offer 3 or 6 seconds.

These units have balanced inputs and outputs, and specifications that don't compromise audio quality. The mono BD941 and stereo BD942 are full 20kHz bandwidth.

Stereo, 6 sec delay	60EVBD9426	MFR LIST	\$2,395.00
Stereo, 3 sec delay	60EVBD9423	MFR LIST	\$1,995.00
Mono, 12 sec delay	60EVBD94112	MFR LIST	\$2,195.00
Mono, 6 sec delay	60EVBD9416	MFR LIST	\$1,795.00

CALL 1-800-732-7665 FOR BRADLEY PRICE

EXCALIBUR HYBRID ADAPTER



Use your favorite broadcast hybrid with most any phone: old, new, single or multi-line. It hooks up through the handset connector. With the button out, your phone works as normal. With the button in, the handset is disconnected and your hybrid is on line. The performance of the hybrid is the same as though it were connected directly. Connectors are modular phone jacks. **NOTE: Will not work with Gentner DH20, DH22, or SPH10 Hybrids**

Hybrid Adapter 60EXHA1 \$99.00



GENTNER TELESWITCH CALL DIRECTOR

Select multiple phone lines without the cost of a PBX or multi-line system. Up to five lines can be connected, placed on hold, and routed to your hybrid. Connections are on standard RJ-11C jacks. Other features include a conferencing mode, an input for audio-on-hold, and a telephone set connection. It's suited to talk shows and distance learning applications.

An external hybrid is required. An optional connectorized cable is available for use with the Gentner hybrid model you specify.

TeleSwitch	60GETS	MFR LIST	\$1,045.00
Hybrid cable	61GE830002XXX	MFR LIST	\$35.00

CALL 1-800-732-7665 FOR BRADLEY PRICE

GENTNER TS612 MULTI-LINE PHONE SYSTEM



Gentner's impressive system has two digital hybrids that let you conference up to four callers at once. The TS612 is sophisticated yet requires little training, and lets your operator screen and organize calls with ease. With new optional call-screening software, the screener can control the system right from a PC keyboard, with eight fields to describe each caller.

Choose between six and twelve lines, expandable to several studios and applications. No mix minus is required. A glance at the multi-color indicators shows the status of each line (ringing, in-use here, in-use elsewhere, unscreened-and-holding, screened-and-holding, and on-air). A VIP button puts a guest on a line that cannot be deselected or put on hold.

The control surface is unique and one of the best things about the TS612. It incorporates a phone handset, so you don't need a separate screener's phone. Your screener can talk with a caller while other callers are on the air. If you wish, you can add two more control surfaces to the basic system to add a second studio and an outside screener.

A NEXT feature selects the call that has been waiting the longest. A REC button allows simple recording of calls by triggering your tape deck.

The system allows direct connection to a PC or digital storage system via RS232. A new, optional network interface provides for expansion to accommodate up to ten studios. Up to ten TS612 systems can be networked using the same six or twelve common lines.

The TS612 is suited to talk shows, contests, business TV, and audience interaction.

TS612 Six-Line System	60GETS612	MFR LIST	\$3,149.00
With ScreenWair Software	60GETS612P1	MFR LIST	\$3,990.00
TS612 Twelve-Line System	60GETS61212	MFR LIST	\$4,195.00
With ScreenWair Software	60GETS612P2	MFR LIST	\$4,485.00
Network Interface	60GE910003220	MFR LIST	\$520.00
Extra Control Surface	60GETS612CS	MFR LIST	\$489.00

CALL 1-800-732-7665 FOR BRADLEY PRICE

Qualified government buyers, write for our GSA price list.

GENTNER DH-III, DH20 & SPH-10



Superior audio quality is the hallmark of the professional Gentner hybrid DH-III. Send-AGC provides consistent audio levels for your callers. The CUE button lets you screen calls off air; REC starts your tape recorder.

Automatic re-nulling allows the hybrid to be connected to a multi-line phone instrument used as an on-air selection device. Auto answer/auto disconnect, auto nulling, caller alert tone, and quiet switching on new line selection are also part of the DH-III story.

A simpler, economical alternative is the DH20, which omits the AGC, REC, and CUE functions but retains the performance quality through 16 bit processing with 2x oversampling, 10kHz sampling rate, automatic and continuous nulling, adjustable caller control (ducking), internal test tone generators, remote control capability, and single-space rack mount design.

The DH20 and DH22 are single and dual hybrids with all-new features. No mix-minus is required, as the units generate them internally. Auto-answer/disconnect are standard, as is a monitor amp for caller audio. The DH20 and DH22 automatically adapt to changing telephone line conditions, to provide superior audio quality at all times.

DH-III	60GEDH3	MFR LIST	\$1,895.00
DH-20	60GEDH2C	MFR LIST	\$995.00
DH-22	60GEDH2Z	MFR LIST	\$1,595.00

Also Available: Gentner SPH-10 Telephone Hybrid

A new, affordable analog telephone hybrid from Gentner, the SPH-10 incorporates exclusive audio filtering and equalization to eliminate unwanted noise and hum, while maximizing caller intelligibility. The SPH-10 includes a monitor speaker jack for hands-free call monitoring, and caller-only and caller plus send outputs for recording. I/O is via balanced XLR connectors, with telephone connection and loop-through on RJ-11 connectors. Worldwide compliant, the SPH-10 is CE/CSA approved, and accepts power supply voltages from 100 to 240 volts at 50/60 Hz.

SPH-10	60GESPH10	MFR LIST	\$499.00
--------	-----------	----------	----------

CALL 1-800-732-7665 FOR BRADLEY PRICE

Note: The DH-20, DH-22 and SPH-10 require "talk battery" to function. They will not work with handset adapters, switches, or PBX extensions that provide only a "dry" line.

RADIO SYSTEMS TI-101 INTERFACE

You'll find this affordable telco interface easy to install and set up. Connections are XLR for audio, banana posts for phone. Popular with smaller stations, this is a solid choice when you're watching the dollars carefully.



Connect pro audio mixers to phone lines and eliminate feedback and gating problems. Caller equalization, send limiter, caller mute, and conference linking are standard. The factory support from the folks at Radio Systems is very good.

TI-101	60RST1101	MFR LIST	\$495.00
--------	-----------	----------	----------

CALL 1-800-732-7665 FOR BRADLEY PRICE

TELEPHONE INTERFACE



HYBRIDS & ACCESSORIES

TELOS ONE DIGITAL TELEPHONE HYBRIDS

One of the best values in telephone hybrids anywhere, and year after year a customer favorite thanks to automatic adjustment to each call, sophisticated AGC on input and output, an advanced downward expander on the caller audio, and digital processing to reduce dramatically the chances for feedback when monitoring with open speakers.

Telos ONE has two outputs and a switchable mic/line input. Choose between rack mount and "modem case" versions, which can also rack mount with optional hardware.



The ONE plus ONE starts with two Telos ONE digital hybrids in a single rack unit chassis. Each hybrid functions independently. An internal mix-minus matrix cross couples the outputs of the two hybrids. In a dual hybrid application, you need only send the ONE plus ONE a single mix-minus. All of the Telos ONE features are included.



Telos ONE rack mount version	60TS1R	MFR LIST	\$1,050.00
Telos ONE modem case version	60TS1	MFR LIST	\$680.00
Telos ONE plus ONE	60TS11	MFR LIST	\$2,180.00

CALL 1-800-732-7665 FOR BRADLEY PRICE

TELOS 100 DELTA DIGITAL HYBRID



The digital signal processing of the 100 Delta includes a dynamic digital equalizer that examines the caller audio in three frequency bands within the context of the overall signal. The high and low bands are automatically equalized with reference to the mid band. The 100 Delta also boasts logarithmic (dB) dynamics control and context sensitive AGC. Together these processes offer increased caller intelligibility and matched levels.

The 100 Delta has two mixed inputs (one line level and one mic/line) and two outputs (one with caller audio and the other with a continuously adjustable mix of caller and mix-minus). This simplifies the creation of external mix-minuses. DUPLEX DEPTH can be adjusted for full-duplex, half-duplex, or any point in between. Two DEPTH settings can be stored and remotely selected. This allows remote switching, between a setup requiring more depth for maximum feedback suppression, and one where feedback is not a concern and maximum duplex conversation is desired. The 100 Delta performs well on even the toughest phone lines thanks to its extraordinary trans-hybrid loss and sophisticated processing.

100 Delta	60TS100D	MFR LIST	\$2,180.00
-----------	----------	----------	------------

CALL 1-800-732-7665 FOR BRADLEY PRICE

BRADLEY KNOWS TELOS

For longer than any other supplier, Bradley has brought you the power and audio quality of Telos phone interface equipment. From the latest digital codecs, to sophisticated hybrids, to muscular multi-line systems, Telos is in the vanguard, and Bradley knows Telos best! Call us to learn more about the fine products of Telos.

TELOS HYBRID ACCESSORIES

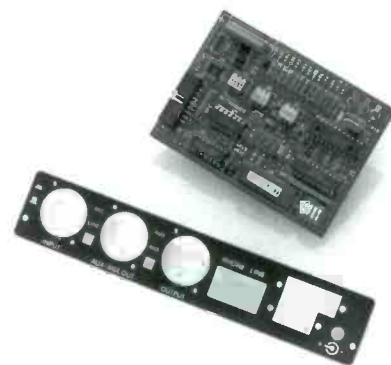

The Auto-Answer board has simple line SEIZE and DROP. The Super Auto-Answer features remote control of line SEIZE and DROP, selectable number of rings before answering, dial tone detector for failsafe line drop, DTMF decoder with open collector outputs, and other features. A special Super Auto-Answer version allows users of 1A2 Key Systems to select phone lines using a standard multi-button desk set.

Either can be used with the Telos 100 Delta, ONE, and ONE plus ONE.

Telos Auto-Answer		
60TS1AA	MFR LIST	\$50.00
Telos Super Auto-Answer		
60TS1SAAXX	MFR LIST	\$150.00

CALL 1-800-732-7665 FOR BRADLEY PRICE

TELEPHONE INTERFACE

TELOS ONE-X-SIX TALK SYSTEM



The ONE-x-Six is a phone system with all of the phone interface gear needed for talk show programming. A compact housing holds both a Telos ONE digital hybrid and a six-line broadcast phone system; a desktop Switch Console is included for one-person system control.

Use the ONE-x-Six to place calls, put callers on hold or on the air, and to conference. The system has sophisticated automatic gain control, super trans-hybrid loss of better than 40dB, program on hold feature, and special functions including control of external recorders and delays.

The ONE-x-Six is ideal for talk shows that seek Telos quality but don't need the even greater sophistication of the Telos Direct and 1A2 Interface Modules.

ONE-x-Six 60TS1X6 MFR LIST \$2,180.00

CALL 1-800-732-7665 FOR BRADLEY PRICE

TELOS DIRECT INTERFACE AND 1A2 INTERFACE MODULES

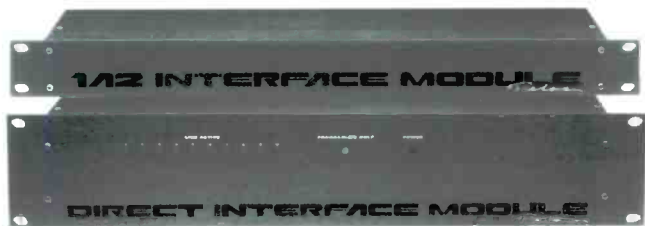

Here are two powerful choices for selection and control of multiple telephone lines in broadcast systems. The Direct Interface allows direct connection of up to 10 phone lines. It functions as a full broadcast phone system including program on hold and caller conferencing.

The 1A2 Interface Module makes use of standard 1A2 key telephone equipment. Each handles 10 phone lines and units can be coupled to handle up to 30 lines. Software upgrades for both interface modules add several functions such as AUTO-ANSWER, which automatically answers incoming calls and places them on hold.

The desktop Switch Console offers extensive line control, remote tape machine start/stop, and a BUSY-ALL mode that is great for clearing all lines before a contest. Other control options include drop-in modules for BE, PR&E, and other popular radio consoles. Screen your callers with phones, or use the powerful Assistant Producer software, described to the right.

Telos Direct Interface Module 60TS100DI MFR LIST \$1,840.00
Telos 1A2 Interface Module 60TS100KSI MFR LIST \$1,050.00
Telos Switch Console 60TS100SC MFR LIST \$650.00

CALL 1-800-732-7665 FOR BRADLEY PRICE

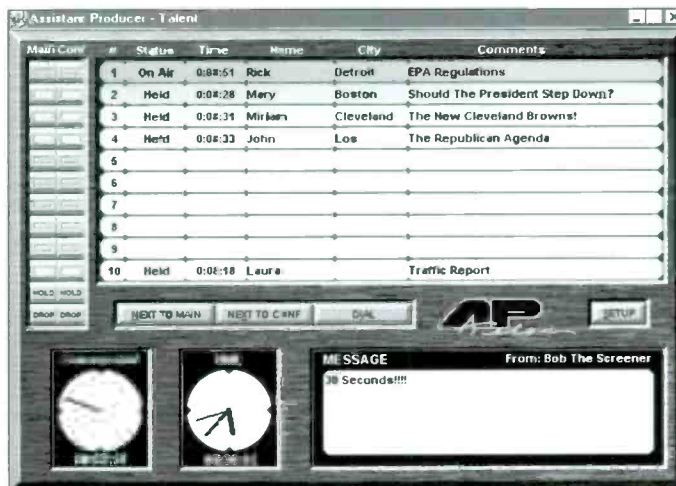

TELOS ASSISTANT PRODUCER

The new Assistant Producer for Windows talk management software offers a Windows 95 and NT-based client-server platform for call management. Integrating with all existing Telos talk show hardware, Assistant Producer enables the producer to provide the talent with caller information, send additional messages, and control the status of multiple telephone lines. Remote access is also available through the Internet and corporate intranets. Consequently, information can be delivered quickly and accurately throughout a talk facility, giving the Assistant Producer user a strong competitive advantage in daily efforts to deliver the most information, first.

Assistant Producer 60TS955 MFR LIST \$450.00

CALL 1-800-732-7665 FOR BRADLEY PRICE

TELEX RADIOCOM BTR-500/600 UHF

The Telex Radiocom BTR 500/600 UHF wireless intercom system offers the ultimate in reliable, high performance full duplex communications. Operating in the 520 to 760 MHz range, these units operate reliably at distances over 1000 feet. The base station and belt pack on the BTR500/600 have two UHF transmit frequencies and two UHF receive frequencies.



The BTR 600 series incorporates auto-switching two-channel frequency agile audio operation, permitting the belt pack user to select between two separate audio channels of communication. The BTR-600 series also includes a unique digital encryption process for those who need secure communications. Both systems are perfectly suited for stand-alone operation and easily expand up to 16 BTR/TR sets permitting up to 32 discrete full duplex channels. The BTR500/600 are fully compatible with the RTS TW and Audiocom party line intercoms, as well as RTS Digital Matrix systems and other 4 wire communication systems.

Call your favorite Bradley professional to configure the BTR 500/600 system that is right for you.
BTR500 Set 60TXBTR500SET MFR LIST \$2,450.00
BTR600 Set 60TXBTR600SET MFR LIST \$2,950.00

CALL 1-800-732-7665 FOR BRADLEY PRICE

TELEPHONE INTERFACE



THE TELOS LINK

Best Seller

From the Telos factory in Cleveland comes this very useful device to



connect intercom systems via phone lines. Your crew can communicate as effortlessly as if they were together in one location.

The Link allows natural, full-duplex communication without level or feedback problems, thanks to adaptive digital hybrid technology. Both the telco and comm paths use digital auto-nulling hybrids, so neither party misses a syllable. A digital audio processor performs automatic gain control, smart gain switching to enhance hybrid performance, high pass filtering to reduce hum and interference, pitch shifting for feedback reduction, and call signal generation.

The Link has an interface for RTS, Clear-Com, and other intercom systems. Other features include a "wet" single channel operation option to provide power to belt packs and metering for both intercom and telco levels. The auto-answer function lets field personnel simply call in to be connected. Rack mounting kits are available.

Note: The popular Telos ONE phone hybrid is available in versions for interfacing four-wire intercom systems with dial-up phone lines or two-wire intercoms. Call us for info.

The Link 60TS1L MFR LIST \$1,680.00

CALL 1-800-732-7665 FOR BRADLEY PRICE

TELEX INTERCOM SYSTEMS

You'll see the Telex name on TV every weekend, adorning the heads of coaches who stomp up and down the sidelines, their neck veins bulging as they direct their troops. Telex is built to take the abuse, not only on the field but in broadcast vans, theaters, and lecture halls.



Audiocom is versatile, capable of balanced or unbalanced formats, single or two channel lines, wet or dry operation, even in limited rack space. Components are modular, letting the system grow with you. You can set up simple belt pack party lines, or sophisticated, director-controlled networks with multiple channels, IFB's, and matrix control. Use standard mic cable to connect up to 22 channels of user stations, belt packs, speaker stations, and power supplies.



Radiocom is a wireless alternative to any intercom, performing like a wired system thanks to quality VHF highband companding, full duplex. It has a built in interface for connection to Audiocom balanced line systems, RTS, and other unbalanced systems such as Clear-Com.

CALL 1-800-732-7665 FOR A TELEX INTERCOM SYSTEMS BROCHURE

RTS SERIES 2100 WIRELESS INTERCOM

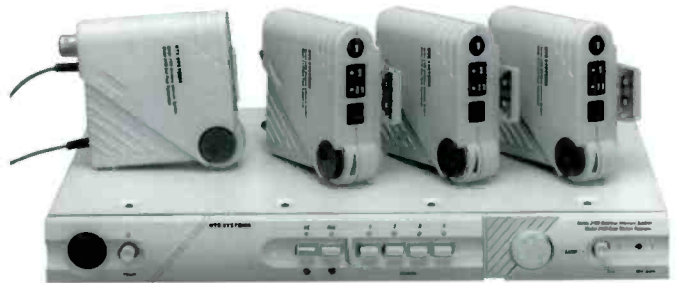

Communicate without wires. The RTS Series 2100 is a complete wireless intercom system that operates in the 150 to 216MHz band, protected from external radio and electrical interference. Four belt pack transceivers can operate with the Model 2105 base station, and when two base stations are chained together, up to eight headset stations can be tied into a full duplex communication network.

The rugged, lightweight Model 2110 belt packs offer up to 24 hour operation on a single battery and numerous operator convenience features. Two belt pack transceivers form a simple two person link, and the Series 2100 is easily used as an extension to your hard-wired intercom for unlimited possibilities.

2105 base station 60RT2105 MFR LIST \$1,625.00
2110 transceiver 60RT2110 MFR LIST \$550.00

CALL 1-800-732-7665 FOR BRADLEY PRICE

**We carry wired RTS Intercom Systems.
Call Bradley.**

CLEAR-COM INTERCOM SYSTEMS

Clear-Com likes to say that talk is cheap. They make high-quality intercom systems available at a low price. Clear-Com systems are simple to set up, very reliable, and expandable, suitable for churches, theaters, and concert halls. Call us for info on a Clear-Com system for you.



New from Clear-Com is the AB-100 On-Air Announcer's Console, a compact desktop unit designed for sports and live event broadcasting. It integrates all the inputs, outputs, and controls needed at the announce position, including intercom "talkback", IFB, and a mute button. The built-in headphone amp lets the talent hear program audio, IFB, and/or intercom audio. Dual volume controls let the operator set either side of the stereo headphone feed for the best mix of intercom and program levels.

Power it from most intercom and IFB systems, external DC, or the supplied AC adapter. Connect it to virtually any one- or two-channel intercom system.

AB-100 61CMAB100 MFR LIST \$925.00

CALL 1-800-732-7665 FOR BRADLEY PRICE AND CLEAR-COM LITERATURE

TELEPHONE INTERFACE

CONEX DT-55 REMOTE CONTROL BY TELEPHONE



If you need to control something remotely, do it by phone. The DT-55 answers a phone line, accepts your access code, then allows control of the SPDT relays and the remote monitoring of ten external switch contacts or logic levels.

Relays are magnetic latching. Each relay can be set, cleared, or activated momentarily. The DT-55 can also act in an interlocking mode: when a button is pressed, its associated relay is set, and all others are cleared. Tones indicate the status of the external inputs. Holes are provided for mounting to a surface or to a user-supplied, single space rack panel.

DT-55 60CNDT55 MFR LIST \$339.00

CALL 1-800-732-7665 FOR BRADLEY PRICE

AKG HSD200SR/OC AND HSC200R HEADSETS



Featuring a microphone with extremely high noise rejection, the HSD200SR/OC headset is ideal for use in very noisy working environments. There is no need to shout above the noise around you. The HSD 200 allows you to talk without straining your voice and prevents voice fatigue even after hours of use under difficult conditions. Designed for use with your PC, the HSD200 is perfect for classroom applications.

The new lightweight HSC200SR broadcast quality headset features the acclaimed C420 condenser microphone capsule. Separate user selectable response curves bring out the best in the voice of your on-air talent.



HSC200SR headset
60AKHSC200 MFR LIST \$330.00

HSD200SR/OC Headset
60AKHSD200 MFR LIST \$280.00

CALL 1-800-732-7665 FOR BRADLEY PRICE

MOTOROLA SPIRIT TWO-WAY RADIOS

Use two-ways when covering news events, rigging up a venue, climbing a tower at any job site. You don't need a base station; they work direct at a range of greater than five miles depending on the model and your location. They survive the four-foot drop test. All models include a belt-clip and rechargeable battery. Motorola quality is available to you at a low price.



Here are some popular models, with coded squelch and an audio-accessory jack. Four watt and up models include a drop-in charger, otherwise available as an option. We offer many other styles, including open squelch and itinerant frequencies for use beyond 75 miles of your place of business. Call Bradley for the list, plus pricing of cases, chest packs, earpieces, and headset mics.

CALL 1-800-732-7665 FOR BRADLEY PRICE

MB QUART COMMUNICATION HEADSETS



You've never heard of MB Quart, right? We hadn't either, but when we tried these headsets we knew you'd love them.

Virtually indestructible, (you can jump on them and they won't break) these rugged headsets come with a three-year manufacturer's warranty. Choose from three models: the MBK800 is a

closed ear design, wired for mono systems but can be ordered with stereo wiring.

The MBK800-B or C is also closed ear and is offered with split cable and

a choice of connectors. Choose model B with 1/4 inch stereo plug and 1/4 inch mono plug or C with 1/4 inch stereo plug and a mini 3.5mm plug. The MBK800E features a single, closed ear design with a XLR 4-pin female connector.

MBK800	62CTMBK300	MFR LIST	\$189.99
MBK800B	62CTMBK300B	MFR LIST	\$199.99
MBK800C	62CTMBK300C	MFR LIST	\$199.99
MBK800E	62CTMBK300E	MFR LIST	\$149.99

CALL 1-800-732-7665 FOR BRADLEY PRICE

TELEPHONE INTERFACE/MICROPHONES



BOOMSETS

TELEX HEADSETS

Intercom headsets must meet a different standard. They're worn constantly, so they must be lightweight and rugged. The audio needs to be clean and clear, targeting voice frequencies. Yet they can't bust your budget, because you have other things to spend your money on.



The PH-1 is a single-sided, full cushion monaural headset with dynamic, noise-cancelling boom mic with response of 100Hz-8kHz. Earphone output is 105dB. The PH-2 is a dual-sided version.

If you prefer a lightweight model, choose the PH-4 dual sided headset with 98dB earphone output, or the PH-8 single-side version. Mic response is 50Hz-10kHz.

All models listed have earphone impedance of 150 ohms and earphone response of 50Hz-15kHz; all have five foot cable terminated in a female XLR-4 connector. (For male connector, add "R" to the part number.)

PH-1	60TXPH1	MFR LIST	\$140.00
PH-4	60TXPH4	MFR LIST	\$150.00
PH-2	60TXPH2	MFR LIST	\$160.00
PH-8	60TXPH8	MFR LIST	\$140.00

CALL 1-800-732-7665 FOR BRADLEY PRICE

SENNHEISER HMD 25-1

The HMD 25-1 has comfortable closed supraural earpieces for good isolation, and a supercardioid mic with 50-12kHz response. Headphone response gives that great Sennheiser sound at 30-16kHz. The six-foot cable is unterminated.



HMD 25-1	60SNHMD251	\$360.00
----------	------------	----------

SHURE SM2

You'll be a hero for finding great headset quality at this price. It's for radio, TV, film, and video. The boom puts the mic on either side of the head. The mic is designed to be used very close to one corner of the mouth; it reduces distant noise effectively. The set is heavy duty but weighs less than 11 ounces and is soft against your ears. Mic response is 50-15kHz, headphones 100-8kHz. The cable is detachable for quick and easy changes between mono, stereo, or split feed headphone functions. Cable is unterminated.



SM2	60SHSM2	\$209.00
-----	---------	----------

BEYERDYNAMIC DT SERIES

Best Seller

The DT-290 is a double-sided headset with dynamic mic and five-foot cable. It's part of a new series of low profile, lightweight sets for sports commentating, great on camera. Modular parts make service simple. Single-sided and condenser versions are available.



Always popular, the DT-108 and 109 provide full bandwidth headphone audio; their noise-cancelling mics can handle considerable sound pressure from excitable air talent. The DT-109 is a dual-ear-muff model; the DT-108 has one earpiece. Headphones on the 108 and 109 are 400 ohms. With the DT-290, you now have a choice of 80 or 250 ohms. All mics are 200 ohms with other impedances available. Headset cables are unterminated. The 108 and 109 can be ordered with optional coiled cable and in balanced mic versions.

DT-290	60BEDT29080	MFR LIST	\$299.00
DT-109	60BE422045	MFR LIST	\$349.00
DT-108	60BE421790	MFR LIST	\$289.00

CALL 1-800-732-7665 FOR BRADLEY PRICE

CROWN HS MICROPHONES

Do you use Sony headphones? Crown's broadcast microphones are designed to fit onto the earpiece of your MDR-7506, either side. Turn a classic headphone into a classic headset!

The CM-311AHS is suitable when you're covering a sports event, soaring above the city in a traffic chopper, or working a news story. It rejects background and off-axis noise with a highly effective cardioid pattern.

The CM-312A with hypercardioid pattern is for quieter studio environments, talk shows, and location interviews. The mic is to the side of the mouth, inconspicuous and resistant to pops.

Both models adjust for comfort and come with a belt pack with XLR output connector, battery on/off switch, mute switch, and foam pop filters. Power your mic with phantom or a 9V battery.

Headphone not included.

CM-311AHS	60CRCM311HS	MFR LIST	\$299.00
CM-312A	60CRCM312HS	MFR LIST	\$279.00

CALL 1-800-732-7665 FOR BRADLEY PRICE



MICROPHONES

SENNHEISER K6 MODULAR MIC SYSTEM

Choose your mic capsule, add the powering module, and you're set with one of the most flexible mic systems around. Choose a lav system, or handheld ENG. Need to switch to a shotgun mic, or a podium style? Switch capsules simply by screwing them off and onto the K6. It runs on 12-48V phantom or for 150 hours on a single "AA" cell, and includes bass rolloff switch. Its output is balanced, low-impedance (200 ohms) and terminates in a 3-pin XLR.



All capsules are black and use back-electret technology. A single module plus a few interchangeable capsules provide you the flexibility you need in your mic kit.

Popular Systems:

MKE2-60 omni lavalier and K6 power supply 60SNMKE260C \$469.00
 ME64 ENG handheld and K6 power supply 60SNME64C \$399.00

Mic Capsules if bought separately:

ME65 for ENG, a new supercardioid handheld with high gain before feedback. 50-20kHz. 60SNME65 \$229.00

ME66 Short Shotgun combines supercardioid at low frequencies plus shotgun above 2000Hz. Light weight prevents fatigue in handheld use. 50-20kHz. 60SNME66 \$219.00

ME67 Spot Shotgun combines supercardioid at low frequencies plus shotgun above 2000Hz. An excellent value, great for TV or podium use. 50-20kHz. 60SNME67 \$309.00

ME64 Cardioid, tight pattern, high gain before feedback, good for speech. 50-20kHz. 60SNME64 \$169.00

MKE2-60 Omni Lavalier, less than 1/4" diameter, popular for broadcast or instrument use. 20-20kHz. 60SNMKE260 \$279.00

Powering Module: K6 (phantom and "AA") 60SNK6 \$219.00

Other modules available. Call for pricing on mounting hardware and windscreens.

ROLLS PB24 PHANTOM POWER PLUS

The PB24 battery powered phantom power adapter delivers all the clean transparent power needed for any microphone. This unit operates on battery or AC power.

Phantom Power Plus 61RLPB24 \$90.00



LIGHT WAVE SCREENS, MOUNTS & FISHPOLES

Protect your field shotgun from wind and handling noise. Super Screens provide great wind attenuation; add a Super Mount pistol grip for the best in mic isolation. Models to match mics in this section are listed; we can quote many others.

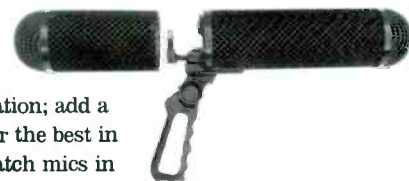

Light Wave fishpole booms have telescoping cam locks and provisions for internal wiring. Also available: several models of high-wind covers to provide further protection, including the classic Super-Sock, an oversized Super-Sock, and the Windmaster with 3/8" deep fur-like pile.

Light Wave Super Screens

For AT815B	60LWSS815	MFR LIST	\$280.00
For AT835B	60LWSS835	MFR LIST	\$270.00
For ECM 672	60LWSS672	MFR LIST	\$260.00
For MKH-416	60LWSS416	MFR LIST	\$260.00

Light Wave Super Mount Pistol Grips

For AT815B	60LWSM815	MFR LIST	\$145.00
For AT835B	60LWSM835	MFR LIST	\$140.00
For ECM 672	60LWSM672	MFR LIST	\$150.00
For MKH-416	60LWSM416	MFR LIST	\$140.00

Popular items include:

FP12 fishpole 4' to 12'	60LWFP12	MFR LIST	\$210.00
FP6 fishpole 28" to 6'	60LWFP6	MFR LIST	\$195.00
Super-Sock for Super Screen	60LWSSOXXX	MFR LIST	\$50.00
Super-Sock for Mini Screen	60LWMSOXXX	MFR LIST	\$35.00

CALL 1-800-732-7665 FOR BRADLEY PRICES

BIG EARS PARABOLIC REFLECTOR FROM SENNHEISER

Big Ears is a parabolic reflector that makes it possible to pickup sounds more than 200 feet away. Attach your mic and you'll hear the result of intensive study into the ideal reflective patterns.

Big Ears can be focused for the best performance. It's lightweight (five pounds) thanks to patented composite plastic. It's available in clear or in one of five see-through colors. Both the shape and thickness are molded to very tight tolerances. Two mounting plates in the handle accommodate wireless equipment. The handle and mic yoke detach for nested storage. The dish is shatter-resistant for the safety of the operator. Big Ears is not a toy: this is a high-end reflector for field use by demanding broadcasters, filmmakers, surveillance agencies, and other professionals. Microphone not included.



Big Ears 60SNBE3 MFR LIST \$1,249.00

CALL 1-800-732-7665 FOR BRADLEY PRICE

HANDHELD & SHOTGUN MICROPHONES

HANDHELD MICROPHONES FOR ENG/EFP

Best-Seller

BEYER M 58

Your friend with the "golden ears" will tell you how fine this mic sounds. The M 58 is a top-of-the-line handheld with a full 40-20kHz response. Its low mass diaphragm produces superb intelligibility. Shock mounted for low handling noise, the M 58 looks great on camera. The balanced 10" shank has a sweet feel in your palm. You'll find this mic in the field kits of some of the finest in our trade.

M 58	60BEM58	\$179.00
Mic clamp	61BEMKV8	\$17.95
Windscreen	60BEW58	\$18.00

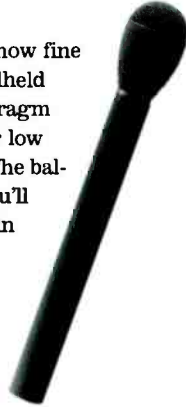

AUDIO-TECHNICA AT804

We're fond of this tough little omni. The hardened steel grille and die-cast case make it a nice choice for your ENG field kit. Frequency response is 50Hz to 15kHz; the mic has high sensitivity to match the input of most recorders and mixers. Carrying case, and stand adapter are provided.

AT804	60AT804	\$89.00
-------	---------	---------



SHURE VP64A

Over and over our customers tell us how pleased they are with this simple, affordable, durable field mic. The long handle on the VP64A provides an interviewer with better reach, and its styling looks great on camera. It uses a neodymium magnet for an output up to 6dB higher than competing models.

An internal shock mount reduces handling noise. Response: 50-12kHz. The VP64A includes a windscreen and stand adapter.

VP64A	60SHVP64	\$89.00
VP64 Long	60SHVP64AL	\$109.00



ELECTRO-VOICE 635

Perhaps the most widely used ENG microphone, the 635 is nicknamed "The Hammer" for good reason. Choose from a variety of configurations including an economical "six pack" without stand adapters. Fans of neodymium can order the 635N/D with greater output and an even more protective metal casing. E-V offers both in fawn beige or sleek black.

All flavors provide 80Hz to 13kHz response. The individual mics are packaged with stand adapter.

635A (beige)	60EL635A	\$105.00
635A/B (black)	60EL635AB	\$105.00
635N/D (beige)	60EL635ND	\$125.00
635N/D-B (black)	60EL635NDB	\$125.00
Windscreen	60EL314E	\$17.00
6-pack/635A	60EL635A6	\$569.00
6-pack/635A/B	60EL635AB6	\$569.00



EV 635L EXTENDED

A bigger, better, longer version of the classic 635A. It's 9-1/2". Good for interviews and attaching mic flags.

635L (beige)	60EL635L	\$129.00
635LB (black)	60EL635LB	\$129.00



Karry your mics in style with Kaces mic bags. See page 10!

SHOTGUN MICROPHONES

Can't get there from here? Grab a shotgun and listen in anyway. Most can be handheld, camera or boom mounted, or operated from a fishpole.

AUDIO-TECHNICA

Power the popular AT815B with either one "AA" cell or phantom 9-52V. At only nine ounces and under 19", this Audio Technica model won't load you down. Or consider the AT835B extended-range condenser. It combines the best attributes of cardioid and shotgun mics. Phantom or internal battery powered, the AT835B has high sensitivity and flat response. It is 14-1/2" long. Both models include bass rolloff, stand clamp, storage case, and windscreen.

AT815B	60AT815	\$279.00
AT835B	60AT835B	\$229.00

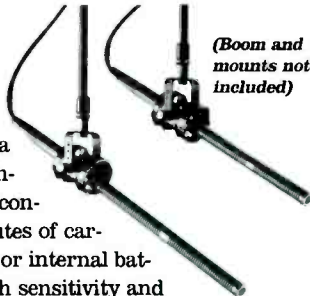

(Boom and mounts not included)

SENNHEISER



The Sennheiser MKH-416 is a specialized directional mic for interviews, podiums, and long-distance video work. It has a supercardioid/lobe shotgun pattern with good feedback rejection and 128dB/SPL. It's 10" long and weighs about six ounces, suitable for boom, fishpole, and cameras. Audio is full bandwidth; use 48V phantom or ask about the 12V A-B version. Also ask us about the MKH-70 ultra-directional, for crowded news conferences, movie and TV sets.

MKH-416 P48U3	60SNMKH416	\$1,247.00
---------------	------------	------------

MICROPHONES

AKG C535EB

The C535EB has the clean, open characteristics of AKG's best studio condensers, enhanced by a 2dB rise between 7 and 12 kHz to project vocals in front of the mix. An integral four-position switch tailors output level and bass roll-off for a variety of uses. A sharp LF cut at the full output level reduces pops and handling noise in vocal applications, while a gradual roll-off at the reduced output is ideal for most instrument applications. The C535EB requires 9-52V phantom power.

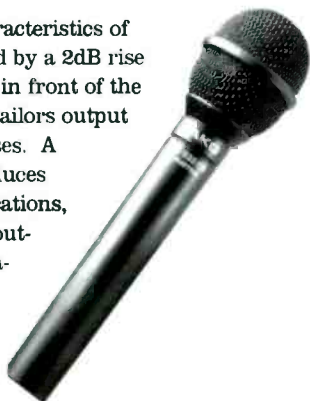

C535EB 60AKC535EB \$189.00

AUDIO-TECHNICA MB4000C

Bringing professional condenser mic quality to the stage at an affordable price, the MB4000C offers exceptional sound quality (frequency response of 50-18,000Hz), a multi-stage internal breath shield to reduce popping, internal shock-mounting, and other intelligent features.



It offers more clarity and high end than you can get from dynamic mics, along with smooth, silky transients. Perfect for live vocals in nearly any situation, especially considering its low price. Operates on 9-48V phantom power or 1.5V AA battery (not included).

MB4000C 60ATMB4000C \$79.00

AUDIO-TECHNICA UNITOOLS



Overcome commonly encountered sound installation challenges quickly with Audio-Technica's Unitools. They're rugged, compact, economical and easy to install. Unitools provide solutions for individualized custom applications that would otherwise require a fully equipped accessory rack costing much, much more!

Mic Limiter with adjustable threshold	60AT8686LIM	\$59.00
Voice operated switch with adjustable threshold	60AT8682GATE	\$59.00
2-to-1 Mic Combiner with balance control	60AT8681MIX	\$54.00
Mic Attenuator with switch function	60AT8684MUTE	\$54.00

AUDIO-TECHNICA PRO 8HE

DJs, musicians, and aerobics instructors need hands-free vocal pickup. This model is a headworn dynamic mic (no powering needed). Rotate the boom to put the mic on either side of your head. The pattern is hypercardioid, response is 200-18kHz, and impedance 600 ohms. It weighs only two ounces and comes with two windscreens, a clothing clip, and 16' cable with XLR. Please note, this is not a headset but a headworn mic with temple pads.

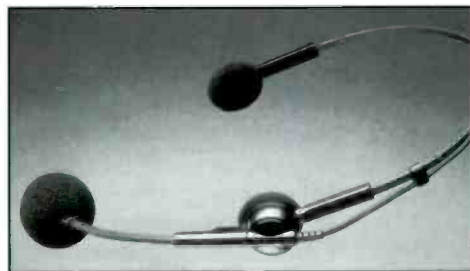

PRO 8HE 60ATPRO8HE \$85.00

CROWN GLM SERIES

Looking for that perfect microphone for instrument use? Look no further! Crown's GLM-100 miniature omnidirectional microphone has exceptionally wide, smooth frequency response specifically designed for musical instrument applications. An 8' cable with a male XLR connector is permanently attached and comes with the GLM-UM universal mount, GLM-WS2 windscreen and the GLM-TB tie bar. Order the GML-100/E, omnidirectional molded Mic capsule, for use with wireless microphone transmitters. Need a hypercardioid mic instead? The GLM-200 is the mic to choose. All three require 12-48V phantom power.



GLM-10C	60CRGLM100	MFR LIST	\$209.00
GLM-10CE	60CRGLM100E	MFR LIST	\$105.00
GLM-20C	60CRCLM200	MFR LIST	\$239.00

CALL 1-800-732-7665 FOR BRADLEY PRICE

BEYERDYNAMIC M 59 SPORT



The M 59 Sport dynamic microphone, from Beyerdynamic, has been specifically designed for close talking and interviewing in high noise level areas, making the M 59 an excellent choice for reporters and sports commentators. The diaphragm was designed with extra rigidity, increasing the intelligibility of the M 59 Sport.

Beyerdynamic M 59 Sport 60BEIM59 MFR LIST \$349.00

CALL 1-800-732-7665 FOR BRADLEY PRICE



HANDHELD MICROPHONES

AUDIO-TECHNICA STEREO MICROPHONES

Suitable for use with pro DAT and cassette machines, the AT825 from Audio Technica has two elements in an X/Y pattern. It produces wonderful stereo recordings and is mono compatible. Use an "AA" cell or phantom power. Switchable low cut filter and windscreen are included; the cable terminates in XLR's.



AT825 60AT825 MFR LIST \$525.00

Also Available: The AT822 stereo mic is ideal for use with portable DAT decks like the Sony MZR-30 and TCD-D8. It's similar to the AT825 but is designed for battery use only and outputs are unbalanced. You get two cables: One terminating with a 1/8" stereo mini-plug and the other with dual 1/8" mono mini-plugs with 1/4" phone plug adapters. A great field tool, a super value.

AT822 60AT822 MFR LIST \$399.00

CALL 1-800-732-7665 FOR BRADLEY PRICE

ELECTRO-VOICE RE50

It's like a mic within a mic. The omni RE50 has the same tailored response and high output of its cousin the 635A, and its resilient shock mount design gives plenty of isolation. The built-in windscreen is an effective pop filter. Also available in an N/DYM version; call for pricing.



RE50 60ELRE50 \$179.00
 RE50B 60ELRE50B \$179.00
 Windscreen 60EL376 \$24.00

AKG D-230

Improved!

The long handle of this 8-1/2" omni dynamic holds a mic flag nicely; the integrated windscreen rejects wind and pops. The matte, non-reflective finish is perfect on camera. Worth a listen for any field work. Response 40-20kHz, weight 8 oz. Internal shock absorber.



D-230 60AKD230 \$139.00

AUDIO-TECHNICA PHANTOM POWER SUPPLY

Can you do without the NEW Phantom supply from Audio-Technica? This phantom power supply delivers 48 volts in a single AC powered supply. Powers a single microphone.



48V Phantom Power Supply
 60AT8801 \$ 65.95

SHURE SM57 & SM58

Best Seller

For handheld or lectern use, the SM57 is a good choice. Presence boost and low end roll-off treat voice frequencies with wondrous care. Non-glare gray is ideal for stage or camera. Also a fine instrument mic. 40Hz to 15kHz.

The next step up is the SM58, used for voiceovers and ENG. It has a spherical windscreen and fixed bass roll-off to prevent popping or boominess close up. Order it with or without on/off switch. Also an outstanding music vocal mic. 50Hz to 15kHz. Both weigh about 10 oz. These dynamic cardioids are truly two of our best sellers.



SM57	60SH57	\$97.00
SM58	60SH58	\$119.00
SM58 with on-off switch	60SH58S	\$125.00
Windscreen for 57 Grey	61SHA2WSGY	\$9.95
Windscreen for 57 Black	61SHA2WSBK	\$9.95
Windscreen for 58 (ask for color choice)	61SHA58WSXX	\$4.75

AUDIO-TECHNICA ATM-63HE

Great for directional miking, the ATM-63HE has a hypercardioid pattern and very flat response of 50Hz-18kHz. It's a neodymium with improved shock mounting. Nice for high-end ENG. Weight 20 oz.

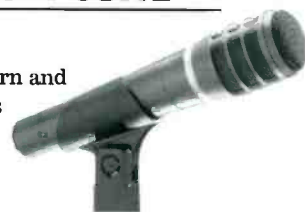

ATM-63HE 60ATM63 MFR LIST \$210.00

CALL 1-800-732-7665 FOR BRADLEY PRICE

SHURE BETA

Bradley is pleased to offer the premium BETA series from Shure. Three supercardioid mics with exceptional audio for demanding work and hardened steel grilles for long life.

BETA 58A: a dynamic mic for live vocal work, ENG, and VO's.
 BETA 57A: A dynamic mic for acoustic and electric music or miking a crowd.
 BETA 87A: an electret condenser mic for studio or performance vocals. The neodymium BETA 57A and 58A are 50-16kHz; BETA 87A is 50-18kHz. All weigh between six and nine ounces.



BETA 58A	60SHB58	MFR LIST	\$332.50
BETA 57A	60SHB57	MFR LIST	\$275.00
BETA 87A	60SHB87	MFR LIST	\$542.50

CALL 1-800-732-7665 FOR BRADLEY PRICE



ELECTRO-VOICE SUPERCARDIOID FIELD MICS



RE supercardioids are everywhere! The familiar slotted handle indicates Variable-D design that virtually eliminates unwanted bass boost in close-up work. All are fawn beige.

(1&2) Born in a TV studio, the RE15 is a broadcast and production workhorse. It has a built-in pop filter, bass roll-off switch, and hum-bucking coil. The supercardioid pattern makes it ideal for on-camera and studio recording. Response: 80-15kHz. The RE10 is a lower-price alternative with many of the same features, at 90-13kHz. Weight 6 oz.

RE15	60ELRE15	\$319.00
RE10	60ELRE10	\$209.00

(3&4) An exceptional ENG mic, suitable for the studio. Includes heavy-duty pop filter, hum-bucking coil, and switchable bass roll-off. Response: 80-15kHz. The RE11 is a moderately priced alternative with 90-13kHz response. Weight 8 oz.

RE16	60ELRE16	\$339.00
RE11	60ELRE11	\$229.00

(5) RE18 has an integral shock mount for superior handheld performance. This mount also dampens stand or lectern noises. Response: 80 to 15kHz. Weight 8 oz.

RE18	60ELRE18	\$359.00
------	----------	----------

Accessories:

Replacement clamp for RE series, except RE20/27.	60EL311	\$19.50
--	---------	---------

Colored windscreens for RE11, RE16, or RE50. Choose black, red, orange, yellow, green, blue, and violet.

Pop filter for RE18	60EL351	\$16.50
Windscreen for RE18	60EL338	\$29.00
Pop filter for RE11 and RE16	60EL376	\$24.00

Windscreen for RE10 and RE15 mics. Two piece design has zippered rear portion to cover shank of mic. Rear portion can be used on RE11 and RE16.

Security clamp for RE series, except RE20/27.	60EL340	\$32.00
---	---------	---------

Call Bradley for other EV accessories.

AUDIO -TECHNICA ATM-25

Here's a Bradley Best-Kept Secret. This is a surprisingly sweet mic at the price. The hypercardioid pattern rejects unwanted sounds and it withstands high SPL nicely. With a response that enhances male and female voices, the ATM-25 deserves to make your short list. Response: 30Hz to 15kHz. Weight 20 oz.

ATM-25	60ATATM25	MFR LIST	\$278.00
--------	-----------	----------	----------

CALL 1-800-732-7665 FOR BRADLEY PRICE

ELECTRO-VOICE RE20

A winner of our best seller award, and still one of the most popular broadcast and voice-over mics in the world. Smooth, extended, clean response. The cardioid RE20 rivals the finest (and most expensive) condenser mics, and it won't break your budget. Internal blast and shock protection, bass roll-off switch. 45Hz to 18kHz. Weight: 26 oz. This is a career-maker.



RE20	60ELRE20	MFR LIST	\$655.00
Shockmount for RE20	60EL309	MFR LIST	\$122.50
Clamp for RE20	60EL320	MFR LIST	\$32.50
Windscreen for RE20	60NEWS37	MFR LIST	\$30.00

CALL 1-800-732-7665 FOR BRADLEY PRICE

ELECTRO-VOICE RE27N/D

A beautiful mic based on the RE20, with even more high end thanks to the magnet's neodymium alloy design. It has three switchable filters: one high frequency, two low. It handles high sound pressure levels without breaking a sweat. An integral shock mount and blast filter are provided. 45Hz to 20kHz. Weight: 25 oz.



RE27N/D	60ELRE27	MFR LIST	\$732.00
---------	----------	----------	----------

CALL 1-800-732-7665 FOR BRADLEY PRICE

SENNHEISER MD421 II

The MD421 II continues the tradition of the MD 421 which has been one of Sennheiser's most popular dynamic mics for over 35 years. The new large diaphragm, dynamic element handles high sound pressure levels, making it a natural for recording. The MD421's full-bodied cardioid pattern, and five-position bass control make it an excellent choice for most instruments, as well as group vocals, or radio broadcast announcers. Frequency response: 30-17kHz. Weight: one pound. One listen and you'll know why it's a classic. Give your career a boost with the MD421 II.

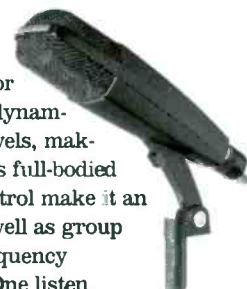

MD421II	605NMD421II	MFR LIST	\$485.00
---------	-------------	----------	----------

CALL 1-800-732-7665 FOR BRADLEY PRICES



MICROPHONES



STUDIO AND CONDENSER MICROPHONES

SHURE SM7

Voice-over work and other critical audio calls for the superb SM7. Expect 40Hz to 16kHz response, four selectable curves, symmetrical cardioid pattern, and internal air shock mount. Noise from wind, boom, and breath-pops is dampened by the integral foam windscreens. Weight: 27 oz.

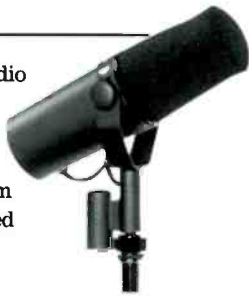

SM7	60SHSM7	MFR LIST	\$566.50
Spare Windscreens	61SH90KR2600	MFR LIST	\$15.50

CALL 1-800-732-7665 FOR BRADLEY PRICE

AKG C-414B/ULS

A large-diaphragm condenser mic with four switchable polar patterns (hypercardioid, cardioid, omni, and bi-directional). This is a truly professional studio mic in every way, and it features a built-in 3-position attenuator, selectable bass roll-off, 30Hz-20kHz frequency response, low impedance, and phantom power operation.

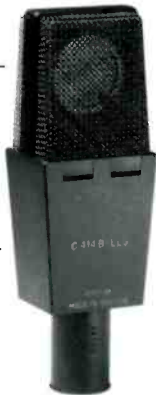

C-414/BULS	60AK414	\$899.00
------------	---------	----------

AUDIO-TECHNICA 30 SERIES



AT 3528

Looking to expand your studio? Start with the mics - and there's no better place to start than with Audio Technica's new 30 Series condenser mics. The AT 3528 is a small diaphragm cardioid pattern pencil mic, perfect for recording instruments and percussion. The AT 3525 is a large diaphragm cardioid pattern mic that can handle a broad range of applications, but is particularly suited to vocals. The catch is the price. These mics are less than you pay for lesser-quality dynamics... Phantom power only.



AT 3525

AT 3528 (3.7oz)	60ATATW3528	\$189.00
AT 3525 (8.1oz)	60ATATW3525	\$269.00

RAXXESS STOPPIT

Some of our fine mics come with their own external filters, but for those that don't, pick the Raxxess Stoppit filter. Eliminate the popping caused by hard consonants. Order just the screen, which comes with a sturdy stand mount, or choose the POMT package (pictured) which includes a 6" Stoppit, gooseneck, and steel stand clamp.

POMT Package	61RXPOMT	MFR LIST	\$42.95
6" Stoppit	61RXSTOP6	MFR LIST	\$19.95
8" Stoppit	61RXSTOP8	MFR LIST	\$22.95

CALL 1-800-732-7665 FOR BRADLEY PRICE

ELECTRO-VOICE RE2000

Critical recording demands ultra-low self-noise, great sensitivity, and wide dynamic range. Here they are, all in one condenser package: the RE2000. It's compatible with your finest digital audio recording equipment. E-V gives you response of 70-18,000Hz, an integral heating system that controls the heat and humidity of the mic, and its own external power supply so you need not rely on inconsistent power from a console phantom system.



Features include supercardioid pattern, gorgeous mid-size diaphragm for high output with smooth transient response, custom Jensen transformer for clean true 150-ohm output, and 12-dB-per-octave switchable low-frequency roll-off. The RE2000 comes with hard-shell case, external pop filter, power supply, shock mount system, stand adapter, and 20-foot cable. This is an exceptional professional microphone. Weight of mic with mount: 25.3 oz. plus power supply and cable.

RE2000	60ELRE2000	MFR LIST	\$2,450.00
--------	------------	----------	------------

CALL 1-800-732-7665 FOR BRADLEY PRICE

AKG C3000

AKG is leading the way at bringing expensive condenser performance within everyone's reach. The C3000 doesn't look like any other mic, but in performance it emulates the best AKG's. It includes a built-in spider shock absorber and the following switchable features: cardioid/ hypercardioid pattern, bass roll-off, and -10dB pad for close miking. Takes 9-52V phantom. A super, large-diaphragm performer. Weight 11 oz.



AKG C3000	60AKC3000	\$269.00
H15/22 Elastic Suspension	60AKH1522	\$179.00
N62E Phantom Supply (powers 2)	60AKN62E	\$116.00

CALL 1-800-732-7665 FOR BRADLEY PRICE



MICROPHONES

AUDIO-TECHNICA 4060 TUBE

New!

The 4060, the latest offering from Audio-Technica, brings back the vintage tube sound of years past with the versatile performance necessary for the most demanding studio applications. Wide dynamic range, low self-noise and high max SPL capability guarantee a carefully-controlled cardioid pattern that maintains uniform off-axis response. The 4060 has dual large-diaphragm elements for extended frequency response from 20-20,000 Hz. Hand-selected tubes are aged and individually tested to ensure peak performance. Accessories furnished with the 4060 include the AT8560 power supply, switchable 120V/230V input, AT8447 shock mount; 32.8' (10 m) special micro-power supply cable, AC power supply cable, power supply rack-mount adapters and protective mic case.

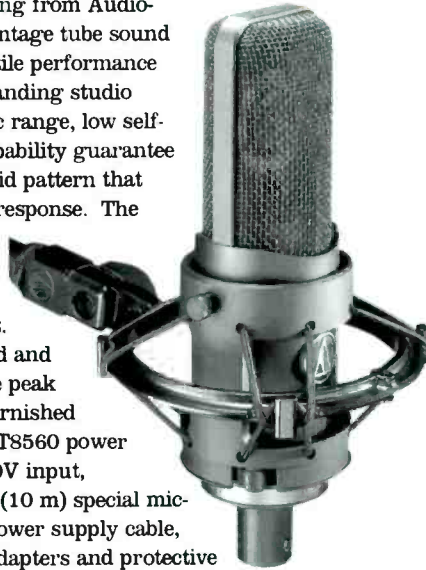

4060 Tube Mic 60AT4060 MFR LIST \$1,695.00

CALL 1-800-732-7665 FOR BRADLEY PRICE

AUDIO-TECHNICA 4050/CM5

Here's a warm, multi-pattern studio mic for demanding uses. Dual gold-plated, large-diaphragm, aged condenser elements provide response of 20-20kHz, dynamic range of 132dB, and SPL handling of 149dB, even more with the switchable 10dB pad. Patterns are cardioid, omni, and figure eight. Low-end roll-off switch, internal windscreen, and external shock mount are included. It operates with any remote phantom or simplex source supplying 48VDC. Weight: 16.9 oz.

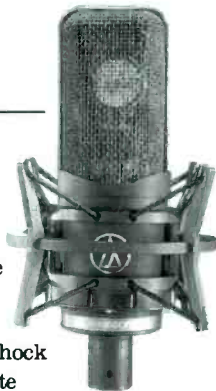

AT 4050/CM5 60AT4050CM5 \$599.00

AUDIO-TECHNICA 4033

The AT4033 is an affordable cardioid condenser mic, well-suited for digital applications. It boasts frequency response of 30Hz to 20kHz. Powered by an external 48V phantom source, the AT4033 can handle up to 140dB SPL (150dB SPL with the switchable 10dB pad) without distorting and has dynamic range of 123dB. It also has an 80Hz hi-pass filter to reduce sensitivity to popping. The mic is also available with a shock mount. Wt: 14.5 oz.



AT4033-SC (w/ stand clamp) 60AT4033SC \$399.00
 AT4033-SM (w/ shock mount) 60AT4033 \$399.00

NEUMANN TLM-193 CONDENSER

The familiar name, the incredible audio, the famous logo at the bottom... they're all here. The TLM-193 is a cardioid large-diaphragm condenser mic with 130dB dynamic range, 20Hz to 20kHz response, very low self-noise, and the rich Neumann sound. But the price—ay, there's the rub. It's less than half that of other famous Neumann condensers. Let us give you a quotation for this fine audio device. Requires 48V phantom power. Weight 1.08 lb.

TLM-193 60NETLM193 MFR LIST \$1,495.00
 W5-89 Windscreen 60NEWS89 MFR LIST \$30.00

CALL 1-800-732-7665 FOR BRADLEY PRICE



Best Seller

NEUMANN TLM 103

New!

Virtually every vocal recording through the history of recorded music couldn't have been done without Neumann. Neumann mics have always lent that unmistakable "Neumann sound" to recordings by the biggest and best artists ever. In the past, this unrivaled quality has always come at great cost. But no longer! The brand new TLM 103 is the Neumann for the rest of us. Using a new cardioid pattern condenser large-diaphragm capsule design that is modeled on the beloved U 87 capsule, it provides the sound you've always been after at a price previously unimaginable. If you want to enhance your recordings as much as possible, start at the very beginning: the microphone. From there, the rest will all fall into place. Requires 48 volt phantom power. Weight 1lb.

TLM 103 60NETLM103 MFR LIST \$995.00

CALL 1-800-732-7665 FOR BRADLEY PRICE



AKG SOLIDTUBE

New!

The heart of this large-diaphragm condenser transducer microphone is the ECC83 vacuum tube. The housing on the Solidtube provides a large air cavity for the capsule, creating an ideal environment for the acoustic properties of the large diaphragm.

Flip the side switch on the Solidtube to activate a 20dB pre-attenuation pad, enables the Solidtube to handle sound pressure levels up to 145 dB SPL.

The Solidtube comes packed in a rugged carry case complete with elastic shock mount suspension, windscreen, power supply and all connecting cables. Weight 2lbs.

AKG Solidtube 60AKSOLIDTUBE \$995.00



STUDIO AND CONDENSER MICROPHONES

SHURE SM81

For just a few hundred dollars you can enjoy a fine condenser mic. The SM81 is a unidirectional condenser with low distortion of 0.5% and 135dB SPL before clipping; the 10dB attenuator stretches upper limit to 145dB SPL. It also provides a selectable low frequency curve to compensate for proximity effect or disturbances. Weight: 8 oz.

SM81 60SH81 MFR LIST \$529.80

CALL 1-800-732-7665 FOR BRADLEY PRICE



AUDIO-TECHNICA AT837R

Now you can get UniPoint performance in a superior vocal mic. This handheld has an internal shock mount. The hypercardioid element can be swapped for three other optional patterns. Runs on 48V phantom only. Windscreen included.

AT837R 60AT837R \$159.00



AKG C1000S

AKG condenser quality is available in a moderate price range with the C1000S. It includes a pattern converter for cardioid or hypercardioid operation. Powering is via an internal 9V battery or external 12-48V phantom. The C1000S comes with a foam windscreen and stand adapter. Weight 9.7 oz.

C1000S 60AKC1000S \$179.00



AUDIO-TECHNICA ATM73AC

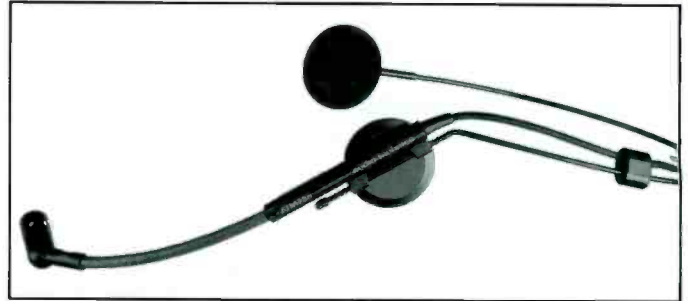

The ATM73AC from Audio-Technica is the perfect microphone for anyone requiring hands-free operation. The ATM73AC boasts a comfortable, unobtrusive headband design with front-of-mouth pickup. The belt-mounted power module operates on battery or phantom power with a 3' cable permanently attached between the microphone and power module. Included with your ATM73AC are windscreen, AT8530 power module (attached) and a battery.

ATM73AC 60ATM73AC \$109.00

AUDIO-TECHNICA TALKBACK MIC

The 16.25 in. gooseneck on this talkback mic lets you set it where you want it, and the subcardioid pickup pattern reduces noise. The response is 200Hz to 5kHz, great for simple voice communication. A low-Z XLR male connector on the base of the gooseneck plugs into your console.

AT808G 60AT808G \$105.00
Base w/Switch 60AT8615RS \$75.00

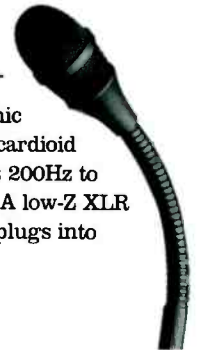

**Bradley knows fine audio mics. Call us for
AKG, Sennheiser, EV,
Sony, Neumann, Audio-Technica, Beyer,
Samson, DPA, Shure, Telex and Crown!**

STEWART POWER SUPPLIES

Deliver +48V to mics, direct boxes, any device needing phantom power. All versions include a PS-1 power supply, and you can combine models for up to 12 channels on one supply. Isolated outputs protect other equipment.

For field work, use the BPS-1 battery supply which uses two 9V's to produce +48V phantom power for a single mic. Belt clip and low-battery indicator included.

PM-1 one channel	60SEPM1	\$79.00
PM-2 two channel	60SEPM2	\$125.00
PM-4 four channel	60SEPM4	\$149.00
BPS-1 battery powered	60SEBPS1	\$95.00



MICROPHONES

Top 100 reasons to buy the new Audio-Technica 7000 Series wireless.



The new 7000 Series UHF wireless systems give you instant access to 100 PLL-synthesized channels, so you can enjoy bullet-proof UHF band operation wherever you go. But that's only the top 100 reasons. There's more.

You get true diversity operation for better reception, InvisibleLink® circuitry for optimum sound quality, plus a ground-lift switch, adjustable squelch control, and balanced and unbalanced audio output jacks. All this in your choice of a handheld or body-pack system.

And with the versatile UniPak™ body-pack system, you can select from an array of new Wireless Essentials™ accessories. Wireless Essentials offer lavalier, headworn and specialty microphones, plus a guitar/instrument cable and a Lo-Z mic cable, all pre-terminated for A-T wireless – providing you with the most versatile body-pack system available.

Want more reasons? Call, write or fax today. Because when you put them all together, you get the number one reason to buy the 7000 Series: excellent performance at a great value.



audio-technica.



ELIMINATE "STATIC."

[Particularly the kind from the accounting department.]

Sony's new Freedom™ Series wireless microphone systems mean you can say good-bye to virtually all unwanted noise, dropped signals and best of all, needless flak from the bean counters. Because with a fully configured "6-pack" receiver and your choice of handheld or body pack transmitters, you get six channels of diversity wireless in a compact, single rack space for under \$1000 a channel. And the Freedom Series' 94 channels provide a clean, clear signal

every time. For simple single channel applications, choose from Handheld, Lavalier, or Guitar Packs complete with a single channel receiver. The Freedom Series' products also provide full compatibility with Sony's extensive and widely-acclaimed 800 Series wireless product range. And the most welcome sort of sticker shock to the folks in finance. For more information, call (800) 635-SONY, ext. FREEDOM and check out our website at www.sony.com/proaudio

COMPLETE SYSTEMS FOR
**UNDER
\$1000
PER CHANNEL.**

<p>Body pack Transmitter WRT-BC5A</p> 	<p>Diversity Tuner WRR-800A</p> 	<p>Wireless Mic WRT-800A</p> 
		
<p>Easy to read LCD</p>	<p>Space diversity reception Auto multi-channel frequency agile programming</p>	<p>Battery level display</p>

©1998 Sony Electronics Inc. Reproduction in whole or part without written permission is prohibited. All rights reserved. Sony, Freedom Series, the Sony logo and the Freedom logo are trademarks of Sony. Features and specifications are subject to change without notice.

Freedom

SONY

AUDIO-TECHNICA BOUNDARY UNIPOINTS

For demanding surface-mounting situations, choose between omni and uni patterns of A-T's condenser plate mics. Both are about 2.5" wide, both run on either "AA" cell or 5-52V phantom and come with 25' cable. A good match for the SmartMixer on page 69.

AT841a omni 60AT841A \$205.00
 AT851a uni 60AT851A \$209.00



GREAT FOR INSTALLED SOUND

CROWN PRESSURE ZONE MICROPHONES



GREAT FOR INSTALLED SOUND

Crown PZM mics use the pressure zone at an acoustic boundary, such as a floor or table surface, to eliminate distortion and comb filtering problems.

(1) The PCC-160 is for stage floors, lecterns, and TV news desks. The large surface increases sensitivity and prevents phase problems; its supercardioid pattern minimizes background noise. Balanced low impedance output. 15' cable included. Takes 12-48V phantom.

(2) The PZM-185 has a balanced low impedance output. This model is suited to broadcast production, conferences, and recording. It's powered by an internal "N" cell or external phantom power. The male XLR connector is in the handle. No cable.

The Sound Grabber (not pictured) is a very affordable, portable PZM powered by an "AA" cell. It looks similar to the PZM-185 but has an unbalanced high-impedance output, 10' cable to 1/8" TS plug, and adapters for 1/4" TS phone and 3/32" TS applications. All models listed are black; the PCC-160 can also be ordered in white.

PCC-160	60CRPCC160	MFR LIST	\$309.00
PZM-185	60CR185	MFR LIST	\$199.00
Sound Grabber	60CRSG	MFR LIST	\$99.00

CALL 1-800-732-7665 FOR BRADLEY PRICE

Churches, courtrooms, and teleconferencing... call us for Automatic Mic Mixing products

AUDIO-TECHNICA UNIPOINT SERIES

Best Seller

UniPoints are a family of low profile specialty mics with great low frequency response and interchangeable heads for different patterns. They control feedback with exceptional rejection specs.



1. AT859QML

It plugs into any XLR jack for swift installation or removal. 9-52V phantom power only.

AT859QML 60AT859 \$123.00

2 & 3. AT857

The 857AMa can mount on a mic stand or its own threaded surface mount adapter. It has an on/off/roll-off switch and can run on "AA" cell or phantom. Its brother, the 857QMa, plugs directly into a female XLR connector and operates only on phantom power. Roll-off switch.

AT857AMa	60AT857AM	\$217.00
AT857QMa	60AT857	\$183.00

4. AT853A

Hang this one using the plastic coated, stainless steel hanger, or mount it on a stand adapter. It has an on/off/roll-off switch and can operate on "AA" cell or phantom.

AT853a	60AT853	\$183.00
AT853wa (white)	60AT853WA	\$207.00

ROLLS PB23 & PB223 PHANTOM POWER ADAPTER

The PB23 and PB223 provide the clean, efficient power that condenser microphones require. Both units offer a dc loop through jack for powering another identical unit. The PB223 has two adapters in one box.

Phantom Power Adapter	61RLPB23	\$60.00
Dual phantom Power Adapter	61RLPB223	\$75.00



LAVALIER MICROPHONES & ACCESSORIES

SONY LAVALIERS

Our customers choose Sony condenser lavs above all others. These mics ignore unwanted noise and give you the convenience of battery operation.

The ECM-77B, a mere 1.5 grams, is Sony's tiniest lavalier, an unobtrusive, high performance omni with the best bandwidth of the four. The popular ECM-55B has an omni pattern and is recommended for the widest applications. The ECM-66B has a uni pattern ideal for musical instruments.

The economical ECM-44 is omnidirectional; it includes a foam windscreen, while the other models include a metal mesh. All versions are matte black; all conveniently take "AA" cells; all but the 44B accept 48V phantom. Case and clips included. Also available: unterminated versions for wireless systems.

ECM-44B	605044B	\$165.00
ECM-55B	605055B	\$269.00
ECM-66B	605066B	\$299.00
ECM-77B	605077B	\$309.00

Also available: Colored windscreens, and holder-clip styles including double mic, pencil or safety-pin type, tiepin and necklace types. Call us for assistance.



CROWN CM-10



The Crown CM-10 is a miniature omnidirectional condenser lapel microphone perfect for professional broadcast and sound reinforcement use. Comes with 12-48V phantom power and has an 8' attached cable with 3-pin XLR output connector. Order the CM-10/E without the connector, for connection to a wireless mic transmitter. Color: black.

CM-10	60CRCM10	MFR LIST	\$149.00
CM-10/E	60CRCM10E	MFR LIST	\$98.00

AUDIO-TECHNICA AT831

It's a mini unidirectional condenser, best where feedback or room noise is a problem, and excellent for music instruments. Choose from two versions.

AT831R 9-52V phantom power only, with 25' cable,	
60AT831R	\$159.00
AT831b takes phantom and "AA" cell, with 6' cable,	
60AT831B	\$139.00



SHURE SM11

Pick this mic when you want a lavalier that doesn't require powering. Get small with the SM11, a tiny dynamic lav with optimized response, natural sound quality and Shure toughness. You also get a lavalier cord, tie bar, and tie tack.

SM11	60SH11	MFR LIST	\$116.50
------	--------	----------	----------

CALL 1-800-732-7565 FOR BRADLEY PRICE



SHURE MX SERIES LAVALIER MICROPHONES

The MX184 supercardioid condenser lav solves problems of extraneous sound and gain-before-feedback, so pick it for talk shows and other noisy environments. The cardioid MX185 provides an intermediate pattern for directional use. For less complex applications, the omni MX183 is an excellent choice. Both have a frequency response dip at 730Hz that minimizes the "chest resonance" effect; both include tie clip, cable, and beltpack preamp that takes phantom power only.



MX185 cardioid	60SHMX185	MFR LIST	\$280.00
MX184 supercardioid	60SHMX184	MFR LIST	\$290.00
MX183 omnidirectional	60SHMX183	MFR LIST	\$260.00

CALL 1-800-732-7665 FOR BRADLEY PRICE

DESK STANDS

1. The Atlas DS-7 is a heavy duty adjustable desk stand, our most requested, and available in chrome or ebony, both with black base.

Chrome	61ATDS7	\$18.50
Ebony	61ATDS7E	\$18.50

2 & 2A. Two popular collapsible mic tripods for tabletop mounting. Pick the style you like best, and put one in your field kit.

2. K&M	61KM12996	\$19.00
2A. AKG	60AK231	\$14.00

3. The AT8615 stand is metal, with XLR in's and out's for plug-in of podium and desk mics. Also available with push-on / push-off switch in the stand (not pictured).

AT8615	60AT8615	\$49.00
AT8615RS	60AT8615RS	\$75.00



MICROPHONES

MICROPHONE STANDS AND BOOMS

1. AKG KM-251 heavy duty, collapsible floor stand adjustable: 23" to 53".

Chrome	60AKKM251	\$69.00
Black	60AKKM251B	\$69.00

2. Atlas MS-12C basic stand with heavy duty base. Height span: 34"-62"

Chrome	61ATMS12C	\$24.50
Ebony	61ATMS12CE	\$24.50

3. Atlas MS-20 heavy duty mic stand with shock mounting. Height span: 37"-66"

Chrome	61ATMS20	\$67.50
Ebony	61ATMS20E	\$67.50

4. Shure S15 collapsible stand can be adjusted up to 14 feet. It is sturdy and stable enough to hold heavy microphones, yet weighs only five pounds. Easy to transport. Comes with vinyl carrying bag and cable strain relief.

60SHS15	\$169.00
---------	----------

5. ST-201A/2 professional two-section collapsible mic stand. Lightweight, yet stable. 36"-63"

Black	61KM201B	\$33.00
Chrome	61KM201	\$33.00

6. Atlas MS-25 heavy duty mic stand with shock mounting and triangle base so talent can step up close. Height span 38"-67"

61ATMS25	\$92.50
----------	---------

7. Atlas MS-4 three section version of the MS-20. Height span 25"-65"

61ATMS4	\$86.85
---------	---------

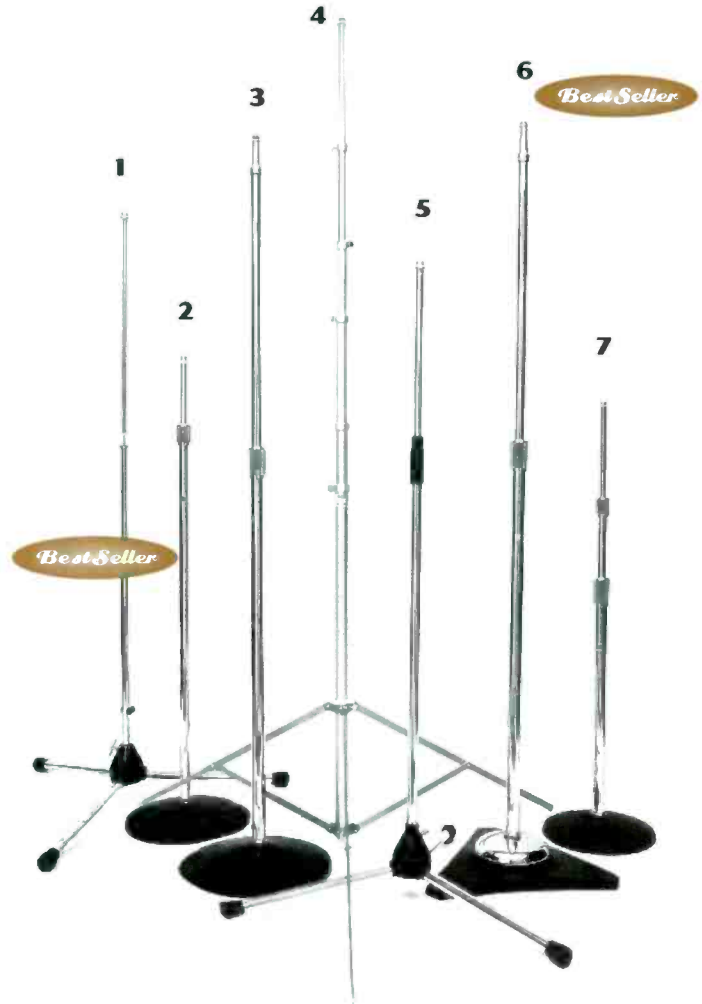

ATLAS PERFORMER SERIES BOOMS

We like them for their single hand adjust, swivel/clamp design, smooth positioning, and counterweights for mic balance.

BB77E Basic Boom, 34", black	61ATBB77E	\$18.00 (not shown)
BB77 Basic Boom, 34", chrome	61ATBB77	\$18.00 (not shown)
PB11XE: 16" - 24", black	61ATPB11XE	\$37.00
PB15E: 34", black	61ATPB15E	\$31.50
PB15: 34", chrome	61ATPB15	\$31.50
PB21XE: 25" - 38", black	61ATPB21XE	\$37.50
PB21X: 25" - 38", chrome	61ATPB21X	\$37.50



DON'T FORGET YOUR MIC CABLES! SEE PAGE 124.

MICROPHONES



MICROPHONE STANDS & ACCESSORIES

BOOM STANDS

1. Atlas SB-36 great boom/stand with a grip action clutch and air suspension. Stand extends from 50" to 74", boom length is 62".

w/ casters
61ATSB36W \$240.00
w/o casters
61ATSB36 \$212.50

2. Beyer GST 400 Boom Stand combo with black finish. Stand adjustable 35"-65". Boom fixed at 33". Tripod style base.

GST 400 60BEGST400 MFR LIST \$79.00

3. K&M Mic Boom Stand. A professional collapsible mic stand with adjustable 31" boom. Tripod base.

KM 271 61KM271 \$37.50

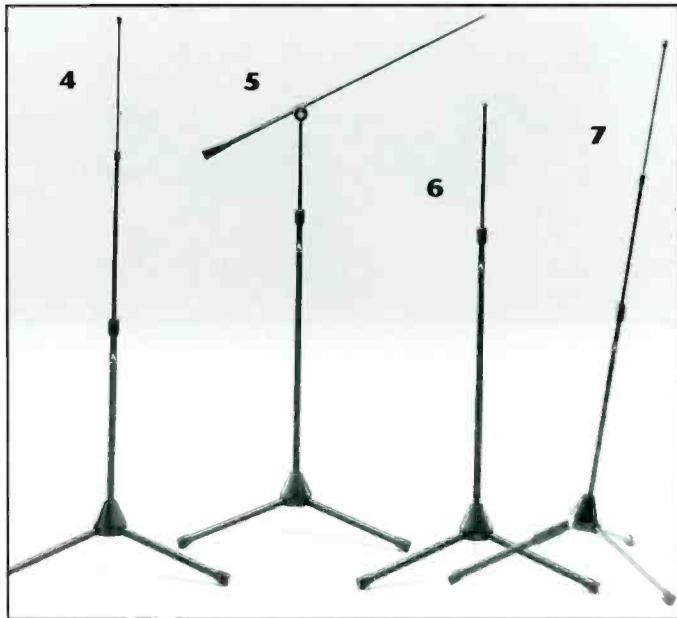

ATLAS PERFORMER SERIES STANDS

Metal tripods use Glide-n-Lock legs for secure positioning without knobs and screws. A wearproof clutch, rubber feet, and a flat ebony finish make them popular.

4. 3-section, 26" - 63" high 61ATTL343E \$75.00
5. Boom version of #6, below 61ATTL34BBE \$75.00
6. 2-section, 34" - 63" high 61ATTL34E \$57.00
7. Tilt-leg version of #4, above 61ATTL353E \$72.00

ULTIMATE LIBERTY STACKABLE MIC STANDS

The Ultimate Liberty has a unique clutch that makes it the easiest stand to adjust. Height ranges from 34" to 64", and the 10" diameter round base allows six stands to stack. Lifetime guarantee.

Black 61USMC07B \$37.50
Chrome 61USMC07C \$41.50



SCH-211/2 BOOM ARM

Collapsible boom extends to 38".

Black 61KM2112B \$22.00
Silver 61KM2112 \$22.00

GOOSENECKS



1. Atlas Goosenecks

6" Chrome	61ATGN6	\$6.50
6" Black	61ATGN6E	\$6.50
13" Chrome	61ATGN13	\$7.85
13" Black	61ATGN13E	\$7.95
19" Chrome	61ATGN19	\$9.75
19" Black	61ATGN19E	\$9.75

2. Mic-Eze Rubbernecks eliminate the noise. Don't tolerate creaking in your gooseneck! XLR versions are wired.

16" Neck	61ACR16	\$13.95
10" Neck	61ACR10	\$11.50
12" Neck w/XLR	61ACR12X1	\$49.00
18" Neck w/XLR	61ACR18X1	\$49.00

3. Atlas Gooseneck Mounting Flanges

a. AD-11B Female 5/8"-27

Chrome	61ATAD11B	\$4.65
Ebony	61ATAD11BE	\$4.65

b. AD-12B Male 5/8"-27

Chrome	61ATAD12B	\$4.65
Ebony	61ATAD12BE	\$4.65

c. AD-18B Heavy Duty Female

Chrome	61ATAD18B	\$8.15
--------	-----------	--------

MICROPHONES

DON'T BE SHOCKED!



(1 & 3) Tensimount spider mounts come in sizes to fit most microphones. Stand adapter required.

TM1 for mics up to 1-3/8" diameter	60AKTM1	\$22.90
TM2 for mics up to 2" diameter	60AKTM2	\$26.20
TM3 for mics up to 2-3/4" diameter	60AKTM3	\$29.50
Accessory: Mic stand adapter for Tensimount	61AKSA40	\$16.00

(2) Audio-Technica 8415 shock mount is designed for field production. The elastic suspension accommodates different sized mics.
60AT8415 \$51.00

(4) Audio-Technica AT8410 is a universal mount with clothes-pin clamp to fit most mics without extra sleeves or adapters. Special neoprene suspension cords isolate the mic in every direction.
60AT8410A \$49.00

(5) Sennheiser MZS100 is the best shock mount we offer. It attaches to any microphone with the mic's own stand adapter. A thumbscrew adjusts tension on the absorbing mechanism so it can be optimized for the weight of the mic.
60SNMZS100 \$89.00

SHURE A58WS WINDSCREENS

They fit most mics with ball heads. Choose among black, orange, red, blue, white, green, grey and yellow.



61SHA58WSXX \$4.75

**We accept Visa,
MasterCard, Discover
and AMEX!**

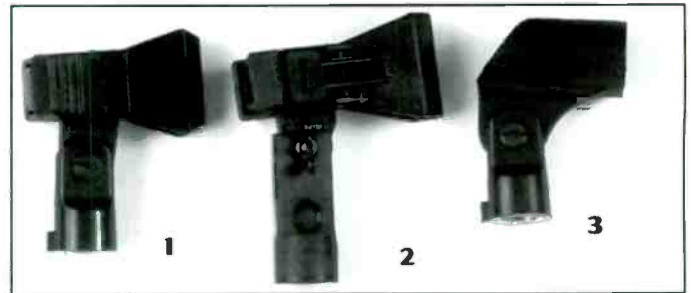

1. This clothes pin style, spring loaded swivel mic adapter fits most mics.
61BEMKV6 \$16.00

2. An unbreakable Mic-Eze holder with locking bolt and non-slip grip.
61ACM4 \$12.95

3. Swivel Adapter fits most Shure mics and many others thanks to its tapered sleeve.
61SF1 \$4.95

4. AKG KM235/1 twin mount for horizontal extension or installation of two mics on one stand. Three pivot points allow flexible mic positioning.
60AKKM235 \$15.00

5. Atlas VM-2 shock mount adapter reduces vibrations to mic.
61ATVM2 \$16.00

6. Atlas LO-2B allows quick disconnect of mic clamp.
Chrome 61ATLO2B \$11.50
Ebony 61ATLO2BE \$11.50

7. Atlas CO-1B clamps to mic stands or booms to allow attaching a second mic.
61ATCO1B \$12.95

8. MZA-217 5/8" external to 3/8" internal thread adapter.
61SNMZA217 \$3.00

9. Atlas SW-1B swivel attachment makes mic placement more convenient.
61ATSW1B \$19.50

10. Atlas CH-1B attaches to mic stand and provides a place to hang the mic cable.
61ATCH1B \$9.95



FOR MULTIPLE MIC MOUNTING:

Atlas TM-1 allows installation of two or three mics on a single stand.
61ATTM1 \$16.95

Shure A27M twin mount allows placing two mics vertically on one stand. Designed for M-S stereo.
61SHA27M \$64.00



MICROPHONE ACCESSORIES



LUXO STUDIO DESK MOUNTING ARMS

A. LUXO KM-1 MIC ARM

The KM-1 reaches 41" without external springs. Balanced for mics weighing two pounds. Requires mounting bracket or riser.

KM-1 Oyster	61LUKM1	\$59.00
KM-1 Black	61LUKM1B	\$59.00

B. LUXO LM-1 MIC ARM

Same reach as KM-1 above, but spring-loaded and balanced for mics weighing one pound. Requires mounting bracket or riser.

LM-1 Oyster	61LULM1	\$52.00
LM-1 Black	61LULM1B	\$52.00

Also available: Luxo LM-2 is similar to LM-1 but has a 26" reach.

LM-2 Oyster	61LULM2	\$52.00
LM-2 Black	61LULM2B	\$52.00

C. PRO RISER

Get a rise from your mic with this 12" metal pedestal, a convenient mount and longer reach for your Luxo arm.

Oyster	61LURISER	\$21.00
Black	61LURISERB	\$21.00

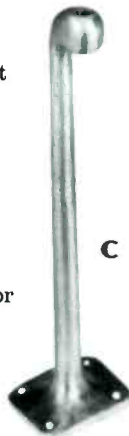

D. LUXO MOUNTING BRACKETS

These handy brackets make it easy to mount any of the arms on this page to virtually any surface.

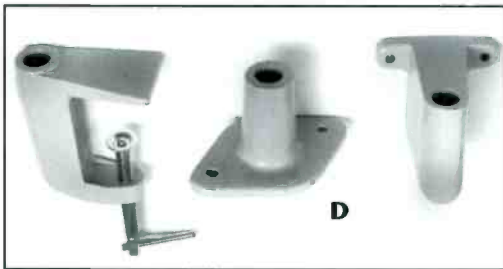

C-clamp Oyster	61LUABR	\$10.50
C-clamp Black	61LUABRB	\$10.50
Table mount Oyster	61LUCBR	\$10.50
Table mount Black	61LUCBRB	\$10.50
Wall mount Oyster	61LUBBR	\$10.50
Wall mount Black	61LUBBRB	\$10.50

Best Seller

ROWI CLAMP

If you have a field mic, you need a Rowi Clamp. Attach your microphone to almost any surface. The jaw opens to 1-1/2", and the mic adapter swivels.

Rowi Clamp	60BBRC	\$36.95
------------	--------	---------



ATLAS MIC ADAPTERS

Useful chrome adapters. If you don't see what you need, give us a call.

3/4" long, 5/8"-27M thread (shown)	61ATAD4B	\$4.60
3/8" pipe F to 5/8"-27F	61ATAD3B	\$4.60
Coupling; 5/8"-27F to 5/8"-27F	61ATAD5B	\$4.60
Coupling; 7/8"-27F to 7/8"-27F	61ATAD6B	\$6.45
3" long tube; 5/8"-27M thread each end	61ATAD7B	\$4.60
6" long tube; 5/8"-27M thread each end	61ATAD8B	\$4.60



O. C. WHITE MIC ARMS

Bradley can accommodate any mic with the right O.C. White arm. Beige, with models in black available by special order.

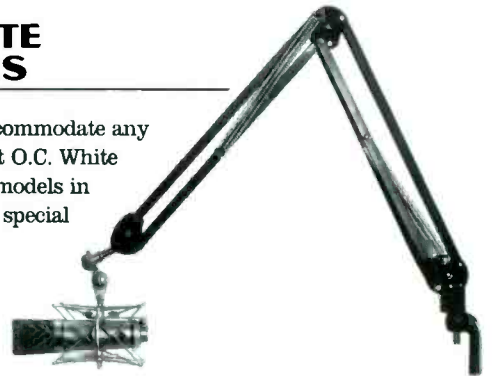

Single mic arm only	600CSMA	MFR LIST	\$98.00
Single mic arm with riser	600CSMARB	MFR LIST	\$135.00
Two-joint single mic arm	600CTJSMA	MFR LIST	\$188.25
Triple mic arm with riser	600CTMA	MFR LIST	\$441.00

CALL 1-800-732-7665 FOR BRADLEY PRICE

MIC SPLITTERS AND COMBINERS

Use Pro Co's MS-2 to split the signal from a low-Z mic to two mixers. Direct output, plus isolated output with ground lift. The MC-2 combines signals from two low-Z balanced mics to one input. One connector has polarity reverse switch. Both units use XLR connectors. (See our Audio Interface section for more accessories!)

MS-2 Splitter	60PCMS2	\$89.00
MC-2 Combiner	60PCMC2	\$89.00

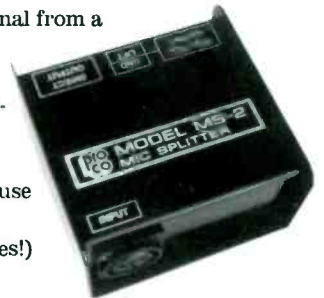

MICROPHONES

PRESONUS M80

Introducing the M80 Eight Channel Microphone Preamp featuring the Jensen® low noise balanced input transformer.

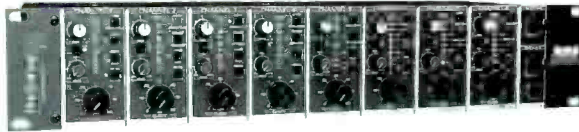

Each channel is designed with discrete Class A input amplifiers followed by a twin servo gain stage for ultra low noise and wide gain control. Features include Phase Reverse, Phantom Power, 20 dB Pad, Rumble Filter, +28dBu headroom and full output metering per channel. The M80 is designed with a low impedance stereo mix buss for assigning and panning any channel to the main stereo output connectors. It has a high gain headphone output for monitoring the main bus.

A special feature of the M80 is the Idss control on each channel. The Idss control adjusts the drain current on the input FET amplifier thus altering the even harmonic levels of the signal. A wide range of control is offered from 0% to 100%. This feature may be used to adjust the harmonics of the signal from absolutely pure (no harmonics) to simulation of the effects of tape saturation and tube "warmth".

Fully loaded with XLR balanced input/output connectors and TRS line inputs via Neutrik combo connectors, each channel is equipped with separate send and returns jacks for inserting dynamics processors. Mix output connectors are XLR for balanced signals and TRS for line level signals such as digital audio card inputs.

Housed in a double rack space, steel chassis; with a high quality blue anodized front panel, the M80 utilizes an internal power transformer with external access for international power requirements eliminating the need for a Wall Wart.

M80 60PNM80 MFR LIST \$1899.95

CALL 1-800-732-7665 FOR BRADLEY PRICE

ATI MIC PREAMPS

The Ultimike is a small preamp that can mount near the audio source and has an unusually quiet, active balanced instrumentation type input stage. Switchable limiter and low-cut filter are built in. Gain is adjustable, and a front jack gives 15dB of gain trim from a remote location with a 10K pot. Features include a phase reversing switch, 48V phantom, and XLR connectors.



The M1000 is a dual preamp for one stereo or two mono mics and a transformer output. Drive a pair of 600-ohm outputs from 50 to 250 ohm impedance mics. It uses XLR connectors. Call us for pricing on rack kits and versions of the M1000 with balanced differential outputs, and/or 48V phantom power.

Ultimike M100 60AIM100 MFR LIST \$349.00
M1000 transformer output 60AIM10001 MFR LIST \$429.00

CALL 1-800-732-7665 FOR BRADLEY PRICE

SAMSON UHF SERIES ONE UHF SYSTEM

Want the best possible wireless quality without paying a small fortune? The only way to go is UHF. Samson's True-Diversity UHF systems give you the crystalline sound and interference-free operation and stability that VHF can't touch, all with an outstanding array of features, a wide range of microphone options, and prices that are truly remarkable.

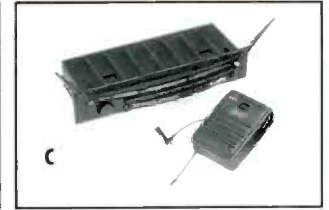
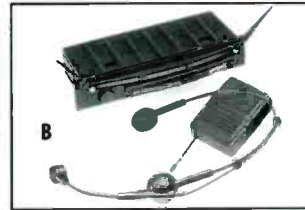

- | | | | |
|------------------------------|-------------|----------|----------|
| A) Hand-held System w/SM-58 | 60SSUHF158 | MFR LIST | \$589.99 |
| B) Head-worn System w/ATM-75 | 60SSUHF175 | MFR LIST | \$609.99 |
| C) Lavalier System w/AT831 | 60SAUHF1831 | MFR LIST | \$589.99 |

CALL 1-800-732-7665 FOR BRADLEY PRICE

- First truly affordable high performance UHF wireless system.
- Operates in the 800-806 MHz band.
- Super compact "beeper-size" belt-pack transmitter.
- 3-segment LED "battery-life" meter in transmitters.
- True Diversity technology (two independent receivers).
- One space, half-rack receiver equipped with (S.A.W.) Surface Acoustic Wave circuitry and tuned, molded antennas for stable reception.
- Balanced XLR output and unbalanced 1/4" output.
- Comprehensive receiver front-panel with multi-color RF Level meter, Squelch control, Audio Peak and Antenna A/B LED indicators and Power switch.
- Patent-pending direct Phase-Lock Loop transmitter technology.

SAMSON UM1 UHF MICRO SYSTEM

The UM1 System operates on the clear 800 MHz UHF frequency band. This, in conjunction with the UM1 receiver's advanced diversity circuitry, provides failsafe reception in all kinds of RF conditions. Providing superior audio, its extremely compact size allows it to fit seamlessly onto video cameras. The receiver also features a comprehensive metering layout and control scheme along with balanced and unbalanced outputs, and special antennas to further maximize reception. Along with 9V battery operation, the system also includes a special carry case and a host of other accessories.

- | | | | |
|-----------------------------------|------------|----------|----------|
| A) Hand-held System | 60SSW85SHQ | MFR LIST | \$499.99 |
| B) Lavalier System w/P3 Connector | 60SSW85P3 | MFR LIST | \$499.99 |

CALL 1-800-732-7665 FOR BRADLEY PRICE



WIRELESS MICROPHONES

AUDIO-TECHNICA 7000 SERIES FREQUENCY AGILE UHF SYSTEMS

You want a frequency agile wireless system for how much? Well, have we got a deal for you and all for under \$650! The 7000 Series offers you one hundred PLL-synthesized channels selectable channels operating at 700 MHz or 900 MHz. True Diversity operation selects the better signal from two independent receiver sections thus reducing dropouts. Two receivers can be mounted side-by-side in a single 19" rack space. The WTW-T76 handheld microphone/transmitter features a HI-ENERGY dynamic element with superior shock mounting.

ATW-7375 UniPak™ Body-pack System Components:

- ATW-7375 ATW-R73 receiver and ATW-T75 UniPak™ transmitter
- Select a Wireless Essentials™ microphone or cable to complete the system

ATW-7375 System 60ATATW7375 \$629.00

ATW-7376 Handheld Microphone System Components:

- ATW-7376 ATW-R73 receiver and ATW-T76 handheld unidirectional dynamic microphone/transmitter.

ATW-7376 System 60ATATW7376 \$619.00



AUDIO-TECHNICA 1900 SERIES UHF SYSTEMS

The 1900 Series UHF wireless system from Audio-Technica offers True Diversity operation, which automatically selects the better signal. Choose from one of 20 UHF frequencies for minimum interference. The rugged metal receiver case mounts in a standard 19" equipment rack. Transmitters feature dual-power battery save switches. Please specify frequency.

UniPak™ Body-pack System Includes:

- ATW-1951 ATW-R19 receiver and ATW-T51 UniPak™ transmitter.
- Select a Wireless Essentials™ microphone or cable to complete the system.

Unipak™ Body-pack System 60ATATW1951 \$399.00

Handheld Microphone System Includes:

- ATW-1952 ATW-R19 receiver and ATW-T52 handheld unidirectional dynamic microphone/transmitter.

Handheld System 60ATATW1952 \$449.00



AUDIO-TECHNICA 900 SERIES UHF SYSTEMS

The 900 Series brings the stellar performance and great reliability of UHF wireless to an entirely new price level. For the price of many VHF systems, you can go UHF. The great part is, Audio-Technica hasn't sacrificed quality or ease of use to bring you affordable UHF—the 900 Series is packed full of features, and with its multiple frequencies and various configurations, is also incredibly versatile.

UniPak™ Body-pack System Includes:

- AT-900 Series receiver and ATW-951 UniPak™ transmitter.
- Select a Wireless Essentials™ microphone or cable to complete the system.

Unipak™ BodyPack System 60ATATW951 \$319.00

Handheld Microphone System Includes:

- AT-900 Series receiver and ATW-952 handheld unidirectional dynamic microphone/transmitter.

Hand-held System 60ATATW952 \$349.00

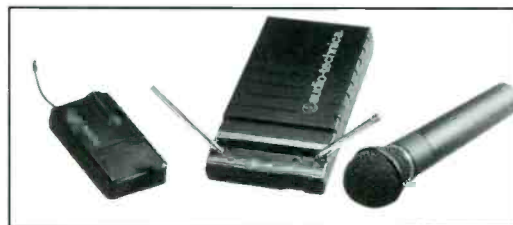

- True Diversity reception for great reliability
- Interference-resistant UHF band operation
- InvisibleLink™ circuitry for optimum sound quality
- 20 switchable frequencies
- Up to 10 systems can be used simultaneously
- Switches on transmitters can be set to "high" for maximum range or "low" for extended battery life
- Available with handheld transmitter or bodypack transmitter with headset or lavalier mic

Audio-Technica Wireless Essentials

AT831b Miniature Cardioid Condenser Mic

Terminated for use with UniPak transmitter. Includes clothing clip and windscreen.

60ATMT831CW MFR LIST \$114.00

ATM35 High-Intensity Cardioid Condenser Mic

Terminated for use with UniPak transmitter. Includes AT814 clip-on instrument mount.

60ATATM35CW MFR LIST \$162.00

ATM73a Headworn Cardioid Condenser Mic

Terminated for use with UniPak transmitter. Includes windscreen.

60ATATM73CW MFR LIST \$170.00

ATM75 Headworn Cardioid Condenser Mic

Terminated for use with UniPak transmitter. Includes windscreens and cable clip.

60ATATM75 MFR LIST \$170.00



MICROPHONES

SHURE UHF WIRELESS MICROPHONE SYSTEM

SYSTEM COMPONENTS:

Body-Pack Transmitter
choose a Shure lavalier microphone, headset, or instrument cable 60SHU1

Instrument Cable 60SHWA302

4' Mic Cable 60SHWA310

Hand-Held Microphone-Transmitter
with interchangeable microphone heads 60SHU2

Dual Channel MARCAD Diversity Receiver
with switching power supply 60SHU4D

Active Remote Antenna Kit 60SHUA830A

Antenna Distribution System 60SHUA840A

The Shure UHF frequency agile wireless system features their exclusive MARCAD® Diversity circuitry, which provides the combined benefits of two independent RF sections for remarkable sensitivity, improved reception and exceptional freedom from dropout.

The Shure UHF Wireless microphone system is a frequency-agile diversity system operating in the UHF band between 782 to 806 MHz in the U.S.A. Up to 20 UHF Wireless systems can be operated simultaneously in a single installation. Shure takes frequency-agility to new levels. While many systems offer you multiple channel options, Shure gives you an outstanding 191 fully selectable, user programmable frequencies from which to choose. Shure UHF systems function on a much less crowded operating band, with far less chance of interference from other sources. So wherever you set up the system, Shure's frequency-agility virtually guarantees that you will be able to find an available frequency. The Shure UHF Wireless components provide a complete and interchangeable system. Receivers and transmitters are not specifically matched, allowing any Shure UHF transmitter to work with any Shure UHF receiver.

CALL 1-800-732-7665 FOR BRADLEY PRICES



SHURE UA888 COMPUTER INTERFACE

The UA888 is a computer interface accessory that allows Shure UHF wireless microphone users to monitor and control the functions of up to 32 receivers from a remote site using an IBM compatible PC computer. The UA888 system is ideal for installed sound applications, such as theater houses of worship, and for touring sound and audio/video rental. The UA888 includes rack-mountable interface module, Microsoft Windows-based software and connecting cable for use with the Shure UHF Wireless U4S or U4D receivers.

60SHUA888 MFR LIST \$1,990.00 CALL 1-800-732-7665 FOR BRADLEY PRICE



AKG WMS300 UHF WIRELESS

AKG's WMS300 UHF system is designed to meet the demands of the working professional at an extremely competitive price. The WMS300 operates in the 766-805 MHz range. Choose from two different frequency sets, each offering a 20MHz spread. Systems are pre-programmed at the factory to operate on 16 sub-channels that are determined to be inter-modulation free. You can use up to eight systems concurrently without interference. Multi-channel users no longer have to flip through pages of manuals to determine the proper combination of frequencies.

Components:

SR 300 half rack receiver	60AKSR300	MFR LIST	\$906.00
HT300 hand-held transmitter w/ interchangeable heads	60AKHT300	MFR LIST	\$538.00
PT300 Bodypack transmitter	60AKPT300	MFR LIST	\$854.00



CALL YOUR FAVORITE BRADLEY PROFESSIONAL FOR A LISTING OF MICROPHONES AVAILABLE FOR THE PT300 BODYPACK THAT FIT YOUR SPECIFIC APPLICATION.

AUDIO-TECHNICA UHF ANTENNA DISTRIBUTION

The ATW-D70 and ATW-D90 UHF antenna distribution systems work with virtually any UHF wireless system. Each system provides two "1-in, 4-out" RF channels and connects a pair of antennas to as many as four diversity receivers. Included with your ATW-D70 or ATW-D90 are four DC interconnect cables to power up to four receivers; eight RF output cables and two rack mount adapters. The ATW-D70 and ATW-D90 rack mount in a single 19 inch rack space. Choose ATW-D70 for systems operating at 728-750 MHz and ATW-D90 for systems operating at 940-955 MHz.

Antenna Distribution System	60ATATWD70	MFR LIST	\$650.00
Antenna Distribution System	60ATATWD90	MFR LIST	\$650.00

CALL 1-800-732-7665 FOR BRADLEY PRICE



WIRELESS MICROPHONES

SONY UHF SYNTHESIZED SYSTEMS



Broadcast, sound reinforcement, Broadway... when you're handling critical wireless audio, ponder Sony UHF.

Synthesized control makes it easy to access up to 94 channels for virtually interference-free wireless operation. The space diversity system offers stable reception at extended operating distances. Presets are programmed into each tuner for instant configuration of systems using up to 11 channels simultaneously.

Sony wireless keeps getting better. The new WRT-860A68 is a bodypack transmitter that's 1/3 smaller than the popular WRT-820A and adds detachable antenna, higher power, and battery life indicator. The new WRT-867A68 is a hand-held dynamic mic that runs on a single "AA" cell and produces great vocal audio even though it's smaller than other Sony handhelds.

Tuners are one rack space tall and include rack ears. Antennas are purchased separately.

Call Bradley for the details and package pricing on these outstanding systems.

Tuners

WRR-820A Diversity Tuner	60SOWRR820A	MFR LIST	\$1,600.00
WRR-840A Dual Diversity Tuner	60SOWRR840A	MFR LIST	\$2,400.00
WRR-810A Portable Tuner with antenna (uses two "AA" cells)	60SOWRR810AXX	MFR LIST	\$1,325.00

Mics

WRT-810A Handheld Transmitter Mic	60SOWRT810AXX	MFR LIST	\$990.00
WRT-867A68 Handheld Transmitter Mic	60SOWRT867A68	MFR LIST	\$2,125.00
WRT-820A Bodypack Transmitter packages w/lavalier mic	60SOWRT820AXX	MFR LIST	Call
WRT-860A68 Bodypack Transmitter packages w/lavalier mic	60SOWRT860AXX	MFR LIST	Call

Antennas

AN-820A Antenna with built in amp	60SOAN820A	MFR LIST	\$183.00
WD-820A Antenna Distributor for using two antennas with up to four receivers	60SOWD820A	MFR LIST	\$1,450.00

CALL 1-800-732-7665 FOR BRADLEY PRICE

Don't see the system you're looking for? Your Bradley Professional knows wireless! Call Today: 1-800-732-7665

SONY FREEDOM UHF MIC SYSTEM

The latest additions to the Sony UHF wireless family bring Sony quality and features at a real-world price. There are two receiver types: the WRR800A, a single-channel, half-rack diversity tuner, and the WRR801A, a 6-bay diversity tuner for multi-channel use at one location. Each includes one WRU-801A receiver module.



The WRT800A handheld mic-transmitter features a cardioid electret condenser capsule, operates for up to twelve hours on a single AA battery, and includes a detachable mic holder for stand use. The WRT805A body-pack transmitter is designed for lavalier, headset mic, and/or guitar use. You may select guitar cable, any of three lavalier mics, or a headset style mic to use with the WRT805A. The Freedom series shares components with other Sony wireless systems, including the WD820A antenna divider, and AN820A UHF antennas. You can mix and match transmitters and receivers with previous Sony 800 series wireless systems in any combination.

WRR800A Tuner	60SOWRR800A	\$649.00
WRR801A Tuner	60SOWRR801A	\$1,040.00
WRU801A Receiver module	60SOWRU801A	\$449.00
WRT800A Handheld Transmitter	60SOWRT800A	\$449.00
WRT805A Bodypack Transmitter	60SOWRT805A	\$449.00
Sony GC-0.7MP Guitar cable	60SOGC07MP	\$50.00
Omni Lavalier mic	60S044BMP	\$160.00
Headset Microphone	60S0310BMP	\$120.00
UHF Antenna Divider	60SOWD820A	\$1,450.00
UHF Amplified Antenna	60SOAN820A	\$183.00

BEYERDYNAMIC U 400 UHF AND U 500 UHF WIRELESS

The U 400 and U 500 UHF systems from Beyerdynamic offer frequency agility. Up to 16 frequencies can be accessed within UHF channel 69. Both systems are designed as stand-alone units or for large theatre setups with the addition of antenna distribution amplifiers.



The U 400 and U 500 have a multi function LCD display, which shows the chosen frequency along with RF and VU level and antennae information. All of the systems are available in handheld or pocket transmitter format. The receivers are a compact half, 19-inch rack.

CALL YOUR FAVORITE BRADLEY PROFESSIONAL TO CONFIGURE THE U 400 OR U 500 SYSTEM THAT'S RIGHT FOR YOU.

MICROPHONES

TELEX USR100 UHF WIRELESS SYSTEM

The USR-100 frequency agile UHF wireless system from Telex features a unique pair of UP-UP channel slewing buttons that allow rapid selection. The 100 available channels, operating from 668.0 to 746.0 MHz, cover a full 12 MHz, virtually assuring multi unit performance in even the harshest of RF environments. The large readout display is active at all times, thereby allowing instant channel verification at a glance.



The heart of the USR-100 receiver is an on-board Programmable Integrated Circuit (PIC) Microprocessor. This PIC performs unprecedented functions in a wireless microphone receiver, and allows the marriage of digital precision with real analog sound to provide the best that both technologies have to offer. The PIC processor controls all metering functions on the USR-100. These include audio level, RF signal strength, diversity phase relationship, channel selection, channel spacing, and display indicators.

The tuning range of each individual USR-100 is established upon initial power up. Each of the available 100 channels then undergoes a tuning process, and this information is permanently stored in non-volatile memory, available for immediate recall. A rack kit is included with the USR-100.

Components:

- The LT-100 transmitter is a compact, rugged belt-pack designed to meet the needs of most any wireless user. It features 100 tunable channels, selectable hi/low power output, and adjustable mic gain. Tone coded squelch allows for single toggle switch operation. Two AA alkaline batteries provide up to 12 hours continuous use. Four-segment indicator displays battery level at the push of a button.
- The SH-100 transmitter is a full featured, elegantly styled handheld microphone transmitter, and has the same features as the LT-100.

USR-100H/L Combo Pack 60TX7123300X MFR LIST \$1,545.00

OTHER SYSTEM CONFIGURATIONS ARE AVAILABLE. CALL YOUR FAVORITE BRADLEY PROFESSIONAL FOR THE SYSTEM THAT MEETS YOUR SPECIFIC NEEDS.

AZDEN WIRED-TO-VHF WIRELESS CONVERTER

Turn your favorite dynamic wired mic into wireless with the Azden 31XT. This sleek transmitter plugs into the XLR connector of your mic. The unit is powered by a single "AA" cell for ten hours of operation. Adjustable audio level handles a variety of mics. Azden matches it up with four great receivers so you can choose the configuration you want. It's available on 17 different VHF frequencies.



Bradley carries the whole Azden family of wireless products, including headset, handheld, and body-pack systems. Call us for an info packet.

Each system shown includes a 31XT transmitter and the appropriate receiver. Optional rack kits are available.

211XT Non-diversity system	60AZ211XT	MFR LIST	\$405.00
111XT Non-diversity system (camera-mount receiver)	60AZ111XT	MFR LIST	\$585.00
311XT Diversity system	60AZ311XT	MFR LIST	\$485.00
221XT Two-channel system with two transmitters	60AZ221XT	MFR LIST	\$755.00

CALL 1-800-732-7665 FOR BRADLEY PRICE

DPA MINIATURE MICROPHONES

Okay, does the world really need another miniature microphone? Yes, if it is from Danish Pro Audio (DPA). The 4060, 4061 and 4062 omnidirectional Miniature Microphones from DPA Microphones use a newly designed pre-polarized condenser cartridge element with a vertical diaphragm. The microphone element is specifically designed to cope with humidity, sweat, wind and popping making the Miniature Microphone perfect for close mic applications.

The Miniature Microphone comes terminated with Sennheiser MicroDot. Adapters are available for virtually any UHF or VHF wireless systems allowing the user of multiple systems to use the DPA Miniature Microphone. Available in white, beige and black.

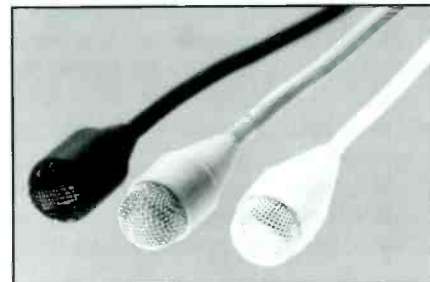

CALL YOUR FAVORITE BRADLEY PROFESSIONAL TO CHOOSE THE MODEL PERFECT FOR YOUR APPLICATION.



SHURE LX SERIES VHF SYSTEMS

Built on the popular L Series, the LX VHF wireless features 6dB quieter performance, detachable antennas, front-panel squelch, and rack hardware that can handle single or dual receiver setups. But it's still easy on your budget.

All bodypacks and transmitters have Shure's innovative battery "fuel gauge". Other features include mic/line level switch, 18-20 hour battery life, level meters for RF and audio, and in-line power supply instead of a "wall wart". The heart of LX is the LX4 MARCAD diversity receiver, really two radio receivers with exceptional audio and rejection of noise.

Handheld systems are available with a range of interchangeable Shure mic elements including premium BETA mics. Bodypack systems are available in several flavors of lavalier and instrument mics... even a headworn version for DJs and aerobics instructors.

The rack hardware can mount one or two receivers, with antennas in the rear. For front antennas, order the WA503 option, below. Also ask us about antenna splitters, antenna distribution for multiple systems, 1/2 wave antennas, and non-diversity systems.

CALL 1-800-732-7665 FOR BRADLEY PRICE

LX Series Diversity Bodypack Systems Each includes indicated microphone, bodypack transmitter, receiver, two 1/4 wave antennas, rack kit. Call for instrument plug-in and stage headworn versions.

LX14/83 with WL183A omni lav	60SHLX1483	MFR LIST	\$750.00
LX14/84 with WL184A uni lav	60SHLX1484	MFR LIST	\$798.00
LX14/93 with WL93 omni microlav	60SHLX1493	MFR LIST	\$750.00
LX14/98 with WL98 instrument mic	60SHLX1498	MFR LIST	\$900.00
LX14/10 with WH10TQG headworn mic	60SHLX1410	MFR LIST	\$756.00



LX Series Diversity Handheld Systems Each includes handheld transmitter with indicated mic element, receiver, two 1/4 wave antennas, rack kit, swivel adapter, and grip/switch cover.

LX24/58 with SM58 mic	60SHLX2458	MFR LIST	\$852.00
LX24/87 with SM87 mic	60SHLX2487	MFR LIST	\$924.00
LX24/BETA58 with BETA 58 mic	60SHLX24B58	MFR LIST	\$948.00
LX24/BETA 87 with BETA 87 mic	60SHLX24B87	MFR LIST	\$1,002.00

Accessories:

Front Mount Antenna Kit	60SHWA503	MFR LIST	\$32.40
Heavy Duty Carrying Case	60SHWA525	MFR LIST	\$200.00

SHURE SC SERIES VHF SYSTEMS

The SC Series VHF wireless lets you change frequencies on the spot so you can "dial away" from interference. Choose among eight frequencies (four in traveling models). A battery "fuel gauge" tells you how much life is left in the 9V battery.

Tone Key Squelch lets you power on or off without pops. Each receiver occupies a half-rack space; the hardware to mount one or two units is now included.

CALL 1-800-732-7665 FOR BRADLEY PRICE

SC Series Diversity Bodypack Systems

Each includes indicated mic, transmitter, receiver, two 1/4 wave antennas, rack kit. Call for instrument plug-in and stage headworn versions.

SC14/83 with WL183A omni lav	60SHSC1483	MFR LIST	\$948.00
SC14/84 with WL184A uni lav	60SHSC1484	MFR LIST	\$996.00
SC14/93 with WL93 omni microlav	60SHSC1493	MFR LIST	\$948.00
SC14/98 with WM98 instrument mic	60SHSC1498	MFR LIST	\$1,098.00
SC14/10 with WH10 headworn mic	60SHSC1410	MFR LIST	\$954.00

Call us for non-diversity versions.



SC Series Diversity Handheld Systems

Each includes handheld transmitter with indicated mic element, receiver, two 1/4 wave antennas, rack kit, swivel adapter, and grip/switch cover.

SC24/58 with SM58 mic	60SHSC2458	MFR LIST	\$1068.00
SC24/87 with SM87 mic	60SHSC2487	MFR LIST	\$1,140.00
SC24/BETA58 with BETA 58 mic	60SHSC24B58	MFR LIST	\$1,164.00
SC24/BETA 87 with BETA 87 mic	60SHSC24B87	MFR LIST	\$1,212.00

Accessories:

Front Mount Antenna Kit	60SHWA503	MFR LIST	\$32.40
Heavy Duty Carrying Case	60SHWA525	MFR LIST	\$200.00

MICROPHONES

**TASCAM DA-20MKII
DAT RECORDER**



Considering the jump to digital and worried about the cost? Looking for an affordable DAT option for a secondary studio? Tascam's new DA-20MKII may be your answer.

Record and play at all three major sampling frequencies (48, 44.1, and 32), including recording either analog or digital at 32kHz. It connects to the world with unbalanced RCA analog inputs and outputs as well as S/PDIF digital I/O. SCMS copy protection can be switched off. The specs, as usual with Tascam, are impeccable. The DA-20MKII occupies three rack spaces and includes a wireless remote.

DA-20MKII 6CTEDA20 MFR LIST \$899.00

CALL 1-800-732-7665 FOR BRADLEY PRICE

**TASCAM DA-30MKII
DAT RECORDER**

Best Seller



The Tascam DA-30MKII features a data/shuttle wheel, standard and long record modes, selectable copy ID provisions, and more. The shuttle wheel lets you find cuts fast, enter program numbers, and trim the ABS time display when setting Start or Skip ID positions.

Features include a parallel port for external control, digital I/O in both the AES/EBU (on XLR) and S/PDIF (coaxial) formats, start ID positioning, and +4dBm and -10dBV analog inputs and outputs. Recording is offered at 48kHz, 44.1kHz and 32kHz sampling frequencies. Ideal for audio track mastering.

DA-30MKII 60TEDA30 \$999.00

RCD-30 Wired Remote 60TERCD30 MFR LIST \$90.00

CALL 1-800-732-7665 FOR BRADLEY PRICE

PANASONIC DAT RECORDERS

All three of the Panasonic DAT family models described here provide analog inputs and outputs on balanced XLR, plus digital I/O in both the AES/EBU and S/PDIF formats. All come with rack kits and Panasonic's exceptional audio performance.

The SV-3800 inherits the features of its predecessor, the widely-hailed SV-3700, and improves on them with new 20-bit resolution DAC's for the best possible playback. A single-play function plays one cut to the next start ID, then stops (ideal for broadcast and live sound). A front-panel switch lets you choose +4 or -10 operation; attenuation is adjustable. A front-panel display keeps track of drum hours. Multiple digital I/O facilities are provided for connecting to many kinds of gear. And the familiar shuttle wheel is here, plus a shuttle search function that finds your cut and cues up to it. Choose the SV-3800 with confidence.



The SV-3900: This model is configured for sophisticated remote control uses. Control up to 32 machines on an ES-bus LAN. The unit also accepts P2 protocols for single machine/controller combinations.



The optional SH-MK390 remote is for network management of single or multiple decks, allowing event automation, multiple DAT duplication, and assembly editing. RS-422 serial control is available for external computer or editor control.

The SV-4100 (not pictured): Shines in specialized applications. Features include external sync for video post and stereo submix recording, Quick Start memory adjustable with one-frame resolution, synchronized frame-accurate editing, four locate points, and more.

SV-3800	60PASV3800	MFR LIST	\$1,695.00
SV-3900	60PASV3900	MFR LIST	\$2,895.00
SV-4100	60PASV4100	MFR LIST	\$2,650.00
RC410 wired Remote Control for 3800	60PARC410	MFR LIST	\$315.00
SH-MK390 Remote Control for 3900	60PAMK390	MFR LIST	\$495.00

CALL 1-800-732-7665 FOR BRADLEY PRICE

SONY PCM-R300 DAT RECORDER

- 44.1kHz (CD quality) recording
- Coaxial and optical digital interfaces
- Compatible with SCMS (Serial Copy Management System)
- Comes with rack-mount adapter for rack-mounting
- Wireless remote control included



A surprisingly affordable way to create DAT masters, the PCM-R300 is at home in any studio setting—large, project, or home. It gives you CD-quality masters on convenient DAT tapes, and can be connected to a wide range of audio devices.

PCM-R300 60SOPCMR300 MFR LIST \$995.00

CALL 1-800-732-7665 FOR BRADLEY PRICE



DAT AND HARD DISK RECORDERS

DA-60 MKII 4 HEAD TIME CODE DAT RECORDER

You won't find a better 4-head synchronizable DAT value than TASCAM's DA-60 MKII. With complete Sony P2 support, the DA-60 MKII behaves like a VTR and can be integrated with edit controllers and hard disk systems making it the perfect DAT for post-production environments. More importantly, its onboard synchronizer and improved servo system means virtually instant lock-up times. In addition, with advanced A/D and D/A converters, the DA-60 MKII delivers extremely high dynamic range and very high signal-to-noise ratios.



- 4-head design with confidence monitoring
- Memory start and rehearsal
- Differential power supplies for A/D and D/A converters
- Pre or post stripe time code
- TASCAM exclusive servo system enables jam sync time-code recording
- Seamless continuous timecode recording with onboard or external timecode generator
- Onboard Support of Sony P2 protocol

Tascam DA60MKII DAT Recorder 60TEDA60 MFR LIST \$6,499.00

CALL 1-800-732-7665 FOR BRADLEY PRICE

SONY PCM-R500 DAT RECORDER

With Sony's surprisingly affordable PCM-R500, you can switch in Super Bit Mapping. Signals with an apparent resolution of greater than 16 bits (the product of today's high-bit A/D's) can be recorded on a standard tape. This single-ended noise shaping system can transfer a 20-bit signal to a 16-bit medium without just "chopping off" four bits. The result: your recordings are smoother and clearer, especially at low levels, no matter what machine you play them on. A shuttle/jog wheel is provided for easy system operation of fast forward/rewind and AMS/program number selection.



The PCM-R500 has a robust four motor transport, analog I/O on balanced XLR connectors (adjustable from -12 to +4), digital I/O on both AES/EBU and S/PDIF, and no SCMS to worry about. A digital meter keeps track of head time. A rack kit and wireless remote are supplied; the unit also provides an 8-pin parallel connector for fader start and other control.

PCM-R500 6050PCMR500 MFR LIST \$1,695.00
PCM-R700 6050PCMR700 MFR LIST \$2,695.00

CALL 1-800-732-7665 FOR BRADLEY PRICE

TASCAM DA-302 DUAL DAT

Why hasn't anyone done this before? The Tascam DA-302 is two DAT decks in one 3-space rack mountable chassis that work independently, together or in a relay. Use the DA-302 for mastering, dubbing, duplication and logging. High speed dubbing, expandability and cost effectiveness make the DA-302 perfect for your busy production facility.



Tascam DA302 Dual DAT 60TEDA302 \$1399.00
Balancing Kit 60TELAD302 \$89.00

360 SYSTEMS INSTANT REPLAY HARD DISK SYSTEM

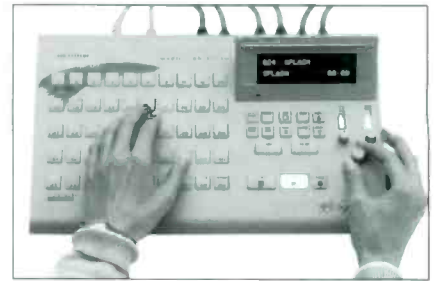

Listen up, radio stations, stadium scoreboard operators, theater sound technicians, TV audio engineers... this is what you've been asking for: powerful audio storage with instant access. Instant Replay is a digital recorder with the hard disk built in, and is available in 16 and 24 hour versions.

It stores up to 1,000 cuts, long or short, and lets you assign 500 at a time to 10 "banks" of 50 buttons. Jingles, effects, songs, commercials, any audio is at your fingertips.

To play a cut, just push its button. Audio starts instantly. Or create a playlist from the 50 hot keys, and set the list to play through or to cue up after each cut.

The display shows cut name, duration, bank number, and hot key number. The imbedded keyboard lets you name your cuts. Finding cuts is easy with the FIND command. A printer port lets you create copies of your cut or bank lists.

Features include 16 bit stereo audio, +4dBm analog I/O, and AES/EBU and S/PDIF digital I/O. A new GPI port allows remote start. Use the built-in D-NET to transfer audio at high speed to other Instant Replays or DigiCart/ITs. Also includes SCSI ports.

Instant Replay, 16 hours 60THDR55216 MFR LIST \$3,095.00
Instant Replay, 24 hours 60THDR55224 MFR LIST \$3,250.00

CALL 1-800-732-7665 FOR BRADLEY PRICE

360 Systems and Instant Replay have SCSI ports. Call for pricing on an external Zip drive today. 1-800-732-7665

RECORDING AND PLAYBACK

Bradley Broadcast • 7313-G Grove Road • Frederick, MD 21704 • 800-732-7665 • 301-682-8700 • Fax: 301-682-8377 • Web: <http://www.bradleybroadcast.com>

360 SYSTEMS SHORTCUT PERSONAL AUDIO EDITOR



Designed to replace reel-to-reel tape machines for fast editing of single or dual channel audio, the Shortcut offers digital and analog I/O, 16 bit linear uncompressed audio, one-touch instant recording, and non-linear editing with random access.

Designed for easy, intuitive operation, the Shortcut includes built-in speakers and selectable mic/line inputs. A large scrub wheel provides outstanding simulation of tape reel rocking, and is surrounded by large buttons which perform the major functions CUT, COPY, INSERT and ERASE. The front panel also features familiar tape transport controls, a qwerty keyboard for cut location and titling, and HOT KEYS for instant access to predetermined audio segments.

Shortcut is ideal for acquiring and quickly editing voice cuts. It is indispensable for news and call-in shows where speed and accuracy is essential. Operates on 90-250 volts, 50/60hz. for worldwide operation. No battery option is available.

Shortcut 4 hour editor 60THSC1803 MFR LIST \$3,250.00

CALL 1-800-732-7665 FOR BRADLEY PRICE

FORGET OPEN REEL LOGGING

Record up to 500 hours of your audio on one data-grade DAT tape. Use Eventide's loggers to capture your air signal, phone calls, the competition, just about anything. The VR-204 is a four-channel logger that lets you search your tapes by time, date, or channel. Units are rackable and include a speaker and headphone jack. The recorder can capture audio even while you're playing another tape back.



Normal response is up to 3400Hz. If you need more bandwidth (for delayed broadcast or "Best Of" shows, for example), ask us about the VR240 models, which accommodate up to 24 channels, and their high fidelity option.

VR-204 Record/Play Logger 60EVVR204 MFR LIST \$7,495.00
VP-204 Play Only 60EVVP204 MFR LIST \$6,495.00

CALL 1-800-732-7665 FOR BRADLEY PRICE

TASCAM MD-801 MINIDISCS



The MD-801 is designed for broadcast, industrial production, and conference use. We like it because you can title your MD cuts with a standard PC keyboard. Features include rack mount, +/-10 inputs and outputs, repeat playback, "jog" dial for editing in fine increments, RS-232 port, and a PC-2 connection for a computer keyboard for titling and cut location. If you record in mono, you double your disc capacity (up to 148 minutes). Connections are balanced XLR, unbalanced RCA, AES/EBU, and S/PDIF. SCMS is selectable. An optional RAM buffer allows instant start.

MD-801R Recorder/player 60TEM801R MFR LIST \$2,499.00
BU-801 RAM Buffer 60TEBU801 MFR LIST \$249.00

CALL 1-800-732-7665 FOR BRADLEY PRICE

TASCAM MD301 MINIDISC RECORDER & MD501 REPRODUCER



The MD-301 is a 2-track system designed for use in radio broadcast applications, live theater, concert halls and any other installation where easy-to-use random access edit capability is required. The MD-301 is also an outstanding recorder for use in the project studio or as a companion to Tascam's 564 Digital Portastudio. It features repeat play, shuffle play and program play modes as well as timer record/play functions, and has both S/PDIF RCA and TOS digital inputs and outputs. XLR balanced and RCA unbalanced analog I/O. The RC-3 wireless remote controller is included with the MD-301.

Choose the MD-501 for more extensive editing functions and the ability to control the unit from a standard PC keyboard. The MD-501 makes a terrific addition to any professional audio environment.

Tascam MD-301 60TEMD301 MFR LIST \$899.00
Tascam MD-501 60TEMD501 MFR LIST \$1,299.00



MINIDISC RECORDERS/PLAYERS

DENON MINIDISC FAMILY

Like DAT before it, MiniDisc is now far more popular among professional users than with the general consumer. The pros love the easy digital recording and fast playback access.

CART STYLE

The DN-990R recorder/player has a look that any broadcaster will find inviting. Rotary selector knob for titles and functions. Instant start. End monitor: hear the end of any cut at the touch of a button. Digital and balanced-analog I/O on XLR connectors. Serial and parallel control ports.



DUPLICATING

Use the new DN-045R to create complete copies of your MiniDiscs. The digital dubbing circuit bypasses the ATRAC compression for the best possible dub. Dubbing occurs at up to 3.5 times normal speed. Windows software, provided, allows editing during replication.

DN-990R Recorder/Player	60DEDN990R	MFR LIST	\$2,800.00
DN-981F Player w/Hot Start	60DEDN981F	MFR LIST	\$2,300.00
DN-045R Replicator	60EDN045R	MFR LIST	\$4,200.00

CALL 1-800-732-7665 FOR BRADLEY PRICE



DENON DN-M2000R DJ MINIDISC RECORDER

You're a DJ? You need the DN-M2000R MiniDisc recorder/player. What makes this a great MD for you? The DN-M2000R features end of message, seamless looping, pitch control, search, cue to music, and hot start. Comes rack mountable (3U) to store in your molded shockmount cases from SKB. Don't have one? We can supply that, too.

DN-M2000R	60DEDNM2000R	MFR LIST	\$1,250.00
-----------	--------------	----------	------------

CALL 1-800-732-7665 FOR BRADLEY PRICE



Accessories

SKB Case 8-space	775K908	\$379.00
SKB Case 12-space	775K912	\$429.99
SKB case 16-space	775K916	\$479.99

DENON DN-M1050R MINIDISC RECORDER AND PLAYER

The DN-M1050R from Denon is a MiniDisc recorder and player. A rugged, dependable machine that occupies three rack units, the DN-M1050R has digital inputs, pitch control, end of message, and cues to music. Great for busy broadcasters doing live and post work, the DN-M1050R has shockproof playback. The optional ACD-26HM remote provides hot start. Call your favorite Bradley Professional for more details.

DN-M1050R	60DEDNM1050R	MFR LIST	\$1,999.00
-----------	--------------	----------	------------

CALL 1-800-732-7665 FOR BRADLEY PRICE



MINIDISC ON A BUDGET

Many customers tell us they would like to use MiniDisc for digital audio recording and playback, but their budget won't let them.

Good news: Sony's MDS-JE520 is priced in the hundreds, not thousands, and includes all the standard MD functions: track naming, divide, combine, move, and erase, including "all track" erase. A jog dial controls editing and titling. You can set the recording level of the analog input. Analog and optical digital I/O are provided, as is a wireless remote.

MDS-JE520	6050MDSJE520	\$299.00
Raxxess Rack Mount	61RXMDSRM	\$47.50



RECORDING AND PLAYBACK

If you haven't already taken these out for a test drive, here's your chance.

Short/cut™ Editor

The perfect replacement for generations of reel-to-reel tape recorders. Short/cut delivers hard-disk storage, plus fast cut and paste waveform editing. Add an optional Zip™ drive and get low-cost copies. This editor is fast enough for on-air use, and tough enough for the road. So take Short/cut out for a test drive and watch it perform.

Short/cut is your next tape recorder, edit block and digital delivery system. It's Un-Reel.



Test drive theirs then test drive our DigiCart/II Plus. We've got more under the hood.



DigiCart®/II Plus

The new DigiCart/II Plus puts up to 50 hours of audio on hard disk, and now includes the popular Zip™ drive for low-cost storage. As always, it's your choice of linear or Dolby® AC-2 recording, plus precise editing and powerful playlisting capabilities. The new "Plus" model delivers all the reliability that has made DigiCart a broadcast standard, and it's now available at a great new price. Ask for a test drive, and put it through the paces at your station.

Instant Replay® 2.0

NEW • SCSI port supports external disk drives for expanded storage capacity. • Choose linear or Dolby® AC-2 recording format.

Instant Replay puts a thousand audio clips right at your fingertips. Sound effects, music, station ID's - up to 24 hours of your greatest material. And with 50 Hot-Keys, you can make your shows as spontaneous as you'd like. With everything titled, timed and ready to play, you'll find Instant Replay fast, fun and easy to use. So take us up on our offer to go for a test drive. It's on us.

Instant Replay. Instant sound effects. Instant music. Instant fun. Take it out for a joy ride.

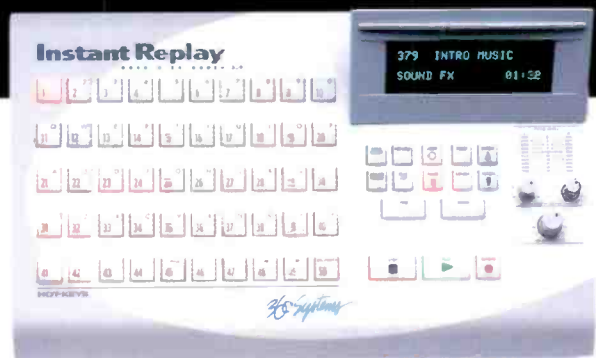

Attention call letter stations.* You're only a phone call away from a free 10-day Test Drive.

So try it out. We'll understand if you don't give it back.

(818) 991-0360

PROFESSIONAL DIGITAL AUDIO

For more information call (818) 991-0360 / Fax (818) 991-1360 / e-mail: info@360systems.com / Website: www.360systems.com

© 1997-360 Systems • Offer good in U.S. and Canada only

Introducing the PMD520



Another member of the
marantz[®]

“PERFECT 10.0”

The Dual Well 3-Head Cassette Deck that Sets a New Standard for Performance, Reliability, and Value...

Key Features

- 3-Head Design in Both Decks
- Loop-Through Output for Duplication
- Continuous Recording - 3 Minute Overlap
- Auto Bias Program
- Recessed Fine Speed Control ($\pm 3\%$)
- Removable Tape Wells

Additional Features

- Fully Independent Operation
- Tape Monitoring while Recording
- Simultaneous (Duplication) Recording
- Time Counters with Tape Size Selector
- Automatic Rewind
- Normal and High Speed Operation
- Record/Play Timer
- Tape Stop Alarm
- Dolby B/C & Hx Pro
- 25-Pin Contact Closure Control Port
- RC-5 Remote Port
- Optional Wired Remote (WRC220)
- Optional IR Remote (RC5PMD)
- Synchronized Start
- Record Mute
- Recessed Record Balance Controls
- Stereo LED Meters with Peak Hold
- Large Transport Control Buttons
- Headphone Jack with Level Control
- One Piece 3U Rackmount Chassis
- Detachable AC Cord
- Optional Balanced XLR Kit (XLR520PMD)

SUPERSCOPE[®]

Superscope Technologies, Inc.

Call Superscope Today for Details!

SONY MDS-B5 MINI-DISC RECORDER

The latest generation Sony MD recorder incorporates Direct Duplication Link, which enables high speed copying of the compressed signal on a MiniDisc, avoiding generation loss. This feature is also useful for eliminating fragmentation on heavily edited discs. Multi-access hot start of up to 10 tracks is provided via the supplied remote control, or via IBM® keyboard or parallel remote port. RAM-TOC edit lets you decide whether or not to save your edited recording to a master disc. You can also perform temporary editing of a pre-mastered disc. Monaural recording option allows up to 148 minutes on a disc. A $\pm 12.5\%$ vari-speed control is incorporated, along with next-track selection for playback while listening to the current selection. You may assemble seamless loops, move cuts, or divide and recombine audio with ease. Connectors: S/PDIF digital I/O, and analog +4dBm inputs on XLR.



MDS B5	6050MDSB5	MFR LIST	\$3,295.00
MDS B6P	6050MDSB6P	MFR LIST	\$2,300.00

CALL 1-800-732-7665 FOR BRADLEY PRICE

360 SYSTEMS DIGICART/II PLUS HARD DISK SYSTEM

"Like Fort Knox, with an ATM." If storing and retrieving audio is in your job description, consider DigiCart/II Plus. It's a treasury of accessible audio; a cart machine, a mini-workstation, a hard disk recorder in one package.

DigiCart/II Plus offers access to 10,000 cuts with just a few keystrokes. Make a selection, hit play, and audio is rolling immediately. While one cut plays, cue up the next.

Back-to-back cuts are seamless, so one machine can replace multiple audio sources. Playback choices include programmed playlists, which can be simple strings of cuts or sophisticated groupings of linear or rotating stacks.

DigiCart/II Plus stores up to 48 hours of stereo audio internally, and now features industry-standard Zip drives for removable media. An upgrade path is available for those who wish to convert their Bernoulli drives to Zip drives.

DigiCart/II Plus provides AES/EBU, AES/SMPTE 75 ohm, and S/PDIF digital I/O ports, as well as balanced analog I/O. It creates 16-bit recordings, either in linear mode or with Dolby AC-2 data reduction for extended recording time. Digital editing of heads, tails, fades, and gain is non-destructive and subframe accurate.

D-NET, standard with DigiCart II Plus, lets you transfer audio at high speed to other DigiCart/II's or Instant Replays. Comprehensive GPI and serial control interfaces let many broadcast automation systems "talk" to DigiCart/II. Also available: Added storage of up to 80 hours with the companion Hard Disk System.

2730 DigiCart/II Plus With 24 hour 3-GB hard disk	60TH2730	MFR LIST	\$3,995.00
---	----------	----------	------------

CALL 1-800-732-7665 FOR BRADLEY PRICE

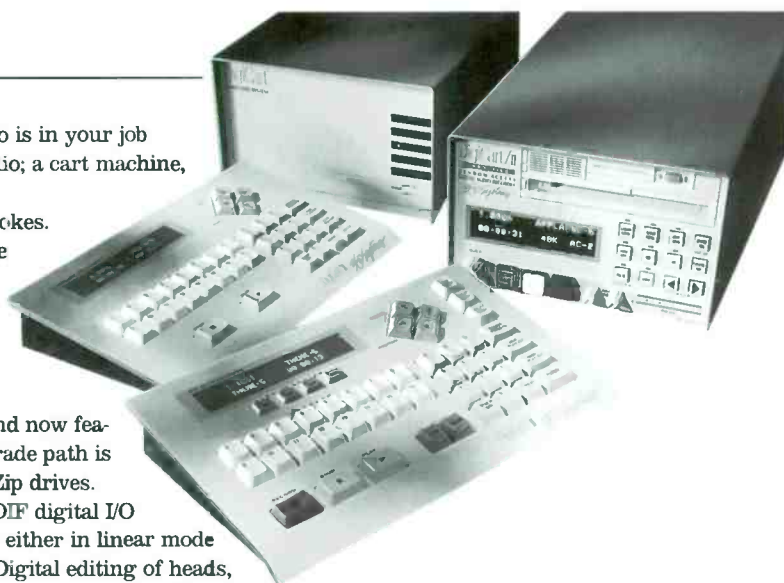

Accessories

The RC-220 Remote duplicates the machine's front panel and includes 16 presets for instant playback and a keypad for rapid cut selection. Controls up to four machines. The RC-205 Mini-keyboard Remote is useful for titling directories and files. It maps up to 100 cuts to "hot keys." Both are useful in production. The RC-210 Remote is a simplified control panel, designed for on-air playback.

RC-220	60THRC220	MFR LIST	\$745.00
RC-205	60THRC205	MFR LIST	\$130.00
RC-210	60THRC210	MFR LIST	\$595.00

CALL 1-800-732-7665 FOR BRADLEY PRICE



CD RECORDERS & DIGITAL RECORDING TOOLS

HBB CDR800 CD RECORDER



Why bother transferring your demos or masters to tape when you can press them to CDs for not much more money? (Actually, blank CDs are even cheaper than cassettes these days.) The versatile CDR800 allows you record to CD painlessly, by offering 5 different recording modes, automatically converting input signals to the appropriate 44.1kHz frequency for CDs, and recording in either pro (for studio use) or consumer (write-protected) CD formats. Your music—whether you're sending it to an A&R guy, selling it at a gig, or backing up your ADAT masters—sounds a whole lot better on CD.

CDR800 **60HHCDR800** **MFR LIST** **\$2,195.00**

CALL 1-800-732-7665 FOR BRADLEY PRICE

DIGITAL RECORDING TOOLS



Spectral Translator Plus enables 8-channel digital audio transfers between any of several digital formats including AES/EBU (4 pairs). Make digital dubs between Alesis ADAT, Tascam DA-88, Fostex RD-8, Sony PCM-800, or Yamaha DRU8, and monitor the transfers live.

Translator Plus **60SPTPLUS** **MFR LIST** **\$1,645.00**

CALL 1-800-732-7665 FOR BRADLEY PRICE



Symetrix 488 DYNA-Squeeze. If you record digital audio hot, you risk fatal clipping; if you record too low, you waste bits and risk noise and distortion. The eight-channel 488 squeezes your tracks toward the upper end of the recorder's dynamic range, giving recordings the feel of analog while preserving the clarity of digital.

488 **60SY488** **MFR LIST** **\$599.00**

CALL 1-800-732-7665 FOR BRADLEY PRICE



Symetrix 620 is an outboard 20-bit A/D converter with selectable dither and noise shape, for a reduction in distortion and increased resolution of low level signals in your 16-bit projects. Great for mixing to DAT or mastering CD's.

620 **60SY620** **MFR LIST** **\$999.00**

CALL 1-800-732-7665 FOR BRADLEY PRICE

MARANTZ CDR-620 AND CDR-615 COMPACT DISC RECORDERS



Create your own CD's for promotion, demos, and archiving. Studios, broadcasters, production houses, and museums will use it to prepare original recordings, make reference and demo discs from other media, store jingles and sound bites, and restore older recordings.

The CDR-620 is a write-once recorder with one-bit digital converters, sample rate converting, auto track incrementing and indexing from CD, DAT, DCC, and MD. The SCSI-II interface allows integration into a digital audio workstation system or PC.

The recorder allows you to stop your work and resume it later. Digital I/O includes AES/EBU and S/PDIF formats, balanced +4/-10 analog XLR in and +4 out. The wired remote gives full status and control, copy prohibit on/off, and emphasis on/off.

The CDR-615 is a more economical version of the CDR620. It does not have SCSI-II port capability, 2x speed recording, or AES/EBU inputs/outputs. The RC-620 remote comes standard with the CDR-615 and allows index recording and playing, defeatable copy prohibit, defeatable emphasis, and other features not addressable from the main unit.

CDR-620	60MRCDR620	MFR LIST	\$3,600.00
CDR-615	60MRCDR615	MFR LIST	\$2,300.00
RC-620	60MRRRC620CDR	MFR LIST	\$200.00

CALL 1-800-732-7665 FOR BRADLEY PRICE

MARANTZ CDR630 CD RECORDER



The Marantz CDR630 is the latest addition to their Professional CD Recorder line. It is the first Marantz model to record in the new CD-RW rewritable format, which allows the last track or the whole disc to be erased and re-recorded. Note that CD-RW discs can only be played back on a rewritable drive or a Multi-read capable drive. A wide array of inputs and outputs allow direct digital recording from CD, DAT, MD and PC's. A built-in sample rate converter allows any frequency between 32-48kHz to be input and converted to the CD standard. Analog sources may be input via unbalanced RCA or balanced XLR connection. A subcode converter is built-in to allow the CDR630 to automatically set the track numbers from these sources. The CDR630 can also automatically start recording, producing a copy of one track, or a whole tape or disc.

IR remote, Stereo RCA audio cables, and one Coaxial Digital cable are included with the unit.

Marantz CDR630 CD Recorder **60MRCDR630** **MFR LIST** **\$1,200.00**

CALL 1-800-732-7665 FOR BRADLEY PRICE

RECORDING AND PLAYBACK

Bradley Broadcast • 7313-G Grove Road • Frederick, MD 21704 • 800-732-7665 • 301-682-8708 • Fax: 301-682-8377 • Web: <http://www.bradleybroadcast.com>

ALESIS ADAT XT20 DIGITAL MULTITRACK RECORDER

- ADAT Type II format—records 16- or 20-bit digital audio (tapes are backwards-compatible with previous ADATs when saved in 16-bit format)
- On-board digital editing and 10-point autolocating
- New, faster transport with intelligent software control
- Solid aluminum die-cast chassis
- Better than CD audio quality (102dB dynamic range, 48kHz sample rate)
- Up to 16 XT20s can be linked for up to 128 tracks of recording
- Records on standard S-VHS videocassettes
- Both +4dBu balanced and -10dBu unbalanced connections



What's better than an ADAT-XT? A new, higher-resolution ADAT XT20! With its amazing 48kHz sampling rate and 20-bit digital audio quality, the ADAT XT20 surpasses even the most stringent audio standards, for truly professional digital recording and editing. Of course, it still uses inexpensive S-VHS tapes and works pretty much exactly like all previous ADATs. All ADAT tapes can be played and recorded on, using the ADAT XT20, and it will format tapes in 16-bit (as well as its standard, ADAT XT20-only 20-bit), so they are compatible with 16-bit ADATs as well. While the Alesis engineers were perfecting these new audio standards, they also saw fit to tweak the beloved ADAT a bit more, improving and speeding up the transport mechanism, refining and expanding the software control, and adding other smart features. The results? The finest ADAT to date—and that's saying a lot.

ADAT XT-20 60AEADATXT20 MFR LIST \$2,599.00

CALL 1-800-732-7665 FOR BRADLEY PRICE

ALESIS ADAT LX20 DIGITAL MULTITRACK RECORDER

- Recording Format: ADAT Type I (16-bit), ADAT Type II (20-bit) rotary head digital recording
- Eight Audio Channels
- Five specialized locate points
- Digital Conversion: Record (A/D): 20 bit linear codec converter, 64 times oversampling, single converter per channel; Playback (D/A): 20 bit linear codec, 128 times oversampling, single converter per channel
- Sample Rate: 44.1/48kHz, Selectable
- Frequency Response: 20Hz-20 kHz, ± 0.5dB
- Analog Inputs/Outputs: Sixteen phono (RCA) jacks (8 input, 8 output), unbalanced, -10dBv
- Digital Inputs/Outputs: 8-channel ADAT Optical jacks (1 in, 1 out)
- Synchronization: ADAT Sync Input and Output



For musicians, home studio owners, or users of other ADAT models wishing to supplement an existing system, the ADAT LX20™ provides an economical solution for capturing the power of the award-winning ADAT recording format. Even though the LX20 is the most affordable ADAT ever made, it offers the same 20-bit ADAT Type II digital recording format as the XT20 recorder, making it capable of producing professional-quality recordings. The LX20 is compatible with all ADAT-model recorders as well as peripheral devices like the BRC and third-party products like digital consoles, interfaces and more. Using the same Optical Digital Interface and Synchronization Interface as other ADATs, the LX20 may be the ideal recorder to add more tracks to an existing system. If you've waited on the sidelines of the digital recording revolution, the LX20 is the answer for affordable, 20-bit ADAT-quality recording.

ADAT LX-20 60AEADATLX20 MFR LIST \$1,899.00

CALL 1-800-732-7665 FOR BRADLEY PRICE

TASCAM DA-98 DIGITAL MULTITRACK RECORDER

The DA-98 takes all the advantages offered by the DTRS format and significantly ups the ante for the professional and post-production professional alike. With enhanced A/D and D/A converters, a comprehensive LCD display and full compatibility with the DA-88 and DA-38, the new DA-98 delivers the absolute best in digital multitrack functionality. An individual input monitor select switch allows one to easily check source tape levels.

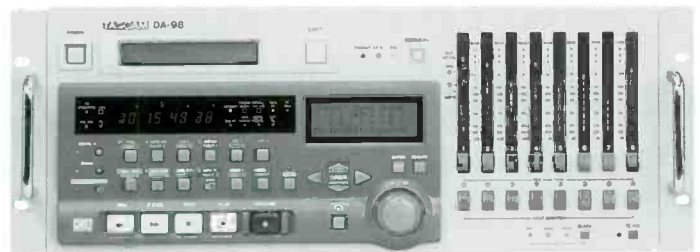

DA-98 60TEDA98 MFR LIST \$5,999.00
 DA-38 60TEDA38 MFR LIST \$2,599.00

CALL 1-800-732-7665 FOR BRADLEY PRICE



ALESIS M20 PROFESSIONAL 20-BIT DIGITAL AUDIO RECORDER

New from Alesis, the M20 Professional 20-Bit Digital Audio Recorder is a professional-quality modular digital multitrack tape recorder that was specifically created for commercial audio recording facilities, as well as high-end video and film post-production studios. Its sophisticated full-servo direct-drive transport, and true 20-bit capability brings modular digital multitrack recording up to a world-class level, with finely detailed audio that unquestionably surpasses even the best analog mastering recorders. The M20 was engineered for demanding, around-the-clock applications, which require the highest standard of audio quality as well as low maintenance, quick response and built-in SMPTE/ EBU time code synchronization. Using the same S-VHS tape and sample-accurate multi-unit synchronization that made the Alesis ADAT the most popular digital multitrack ever made, the M20 will revolutionize professional recording and post-production studios in the same way the original ADAT revolutionized the project studio world.

The Alesis M20 features the new ADAT Type II format, which records eight tracks of true linear 20-bit digital audio onto one tape. 20-bit recording offers greater sonic detail than 16-bit recording since each additional bit doubles the number of values that may be recorded, resulting in an increased dynamic range of up to 6dB. To capture this incredible fidelity, the M20 employs built-in, high-resolution, oversampling A/D and D/A converters. Unlike some hard disk recorders, the M20 uses a linear recording format, meaning that no data compression of any kind is applied to the signal going to or from tape. Plus, a 60-minute tape recorded in the ADAT Type II format holds over 3 gigabytes of audio data, with no upload or download time required...just pop in a new set of tapes and start recording.

60AEM20 MFR LIST \$6,999.00

CALL 1-800-732-7665 FOR BRADLEY PRICE



ALESIS CADI AUTOLOCATOR DESKTOP INTERFACE FOR M20

The CADI is a new remote control and autolocator specifically designed for use with the Alesis M20.

Connecting to the M20 via an Ethernet-style RJ-45 connector, the CADI may be operated hundreds of yards away from the M20 and still offer flawless control of the recorder's transport and track arming functions. Even the M20's jog/shuttle wheel may be operated from a remote location using the CADI. A bright, clear vacuum fluorescent display shows machine status and alphanumeric information such as the names of location points. The CADI can directly control up to eight M20's from its front panel, for a total of 64 tracks (plus time code and eight Aux tracks). Individual M20s may be taken offline from the remote, and individual indicators show when all machines in a system are in sample-accurate sync.

60AECADI MFR LIST \$1499.00

CALL 1-800-732-7665 FOR BRADLEY PRICE



RMD DIGITAL REMOTE METER DISPLAY FOR THE M20



The RMD is a digital remote meter display for the M20. Offering 32 meters with the capability of monitoring four M20's simultaneously, the RMD is the ticket to keeping an M20's audio levels under surveillance. The RMD's adjustable Peak Mode and Peak Clear mode may be set from the front panel of the M20 or the CADI, and a special fine metering mode allows you to set levels with 0.2dB accuracy. The RMD also provides eight LEDs on the front panel that warn of any error conditions or tape dropout problems. Mounts in any standard equipment rack.

60AERMD MFR LIST \$799.00

CALL 1-800-732-7665 FOR BRADLEY PRICE

HENRY DIGITAL RECORDER

Best Seller

Capture network feeds for delayed playback; put one at your translator site for station ID's. Record weather alerts or request-line calls; program "talking signs." DigiCord can hold 16 messages for play in any order without re-cue time (eight are accessible from a front panel switch; all 16 from the remote connector). Features include single or repeat modes and EOM output to start next event. Other features include battery backup to prevent memory loss, and the ability to record from mic or line.

DigiCord, 5kHz, 5:25 min. 60HEDC \$495.00

DigiCord, 8kHz, 2:40 min. 60HEDC8 \$495.00



RECORDING AND PLAYBACK

SONIC FOUNDRY PROFESSIONAL CD FACTORY

If you want to burn audio CDs on your PC, the Professional CD Factory is your "one-stop" solution. This newly developed package has everything a producer or musician needs to burn CDs to Red Book specs, including:



- **Sonic Foundry's CD Architect:** the software solution for creating CDs to Red Book spec. Also includes **Sound Forge XP**—an audio editing tool with dozens of professional effects and tools for mastering audio files.
- **Microboards PlayWrite 4080:** Panasonic 4 x 8 MKE-7502B CDR recorder—the latest generation CD Recordable system and de facto standard for multimedia applications. Also includes a PCI SCSI Card, SCSI cable, and two CDs.

625FCDFACTORY MFR LIST \$749.00
CALL 1-800-732-7665 FOR BRADLEY PRICE

SONIC FOUNDRY CD ARCHITECT

Design and build audio CDs with speed and precision using Sonic Foundry's CD Architect. Read audio from compact discs, record from DAT, or digitize material through your sound card. CD Architect includes dozens of professional effects and tools to process sound files. Simply arrange processed files in playlist and you're set to write a studio-quality audio CD. PQ editing is fully supported, including track times, sub-indices, ISRC codes, and the ability to generate printed cue sheets.

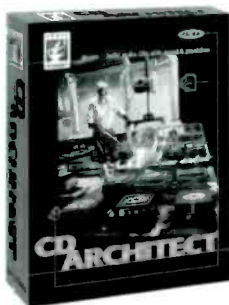

625FCDARCHITE MFR LIST \$395.00
CALL 1-800-732-7665 FOR BRADLEY PRICE

SONIC FOUNDRY ACID

ACID is a break-through loop-based music production tool from Sonic Foundry. It allows you to preview any loop before adding it to your mix, automatically matching the tempo and key in real time. ACID allows real-time changes to pitch and tempo to unlimited tracks (based on system RAM).

To further edit loops, ACID provides quick access to Sound Forge or other audio editors. Processed audio can be directly output as .WAV files or exported as digital audio tracks. ACID is also compatible with Sonic Foundry's CD Architect and direct-to-digital audic CD programs.

ACID includes a library with hundreds of loops in many different instruments and musical styles such as: Techno, Rock Rave, Break Beat, Funk, Country, Hip-hop, Disco, Alternative, House, Industrial, Guitar, Bass, Synthesizer, Drums, Vocal, Brass, Turntable Sound Effects, Ambient. Need more libraries? Call your favorite Bradley professional for information.

625FACID MFR LIST \$399.00
CALL 1-800-732-7665 FOR BRADLEY PRICE

SONIC FOUNDRY SOUND FORGE 4.5 PROFESSIONAL SOUND EDITING FOR WINDOWS

Produce studio-quality audio with an impressive set of effects, processes, and tools that includes Delay/Echo, Reverb, Dynamic Compression, Noise Gate, Pitch Bend/Shift, EQ and Resample. Match sound events to video in AVI files with frame accuracy. Sound Forge offers extensive file format support including WAV, AIF, AVI, ASF, and RealMedia. Its expandable plug-in architecture supports DirectX Audio Plug-Ins.

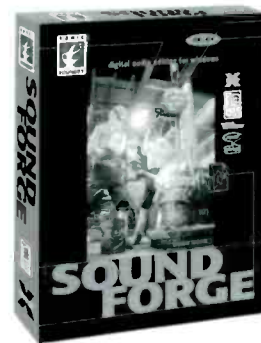

625FSOUNDFORGE4 MFR LIST \$499.00
CALL 1-800-732-7665 FOR BRADLEY PRICE

SONIC FOUNDRY SOUND FORGE XP

Use audio created in Sound Forge XP to heighten your Internet presence and bring your multimedia projects alive. Your PC and Windows-compatible sound card puts a virtual sound studio at your fingertips. Record, edit and process mono or stereo audio files quickly and easily using common shortcuts to drag and drop, copy, cut, and paste.

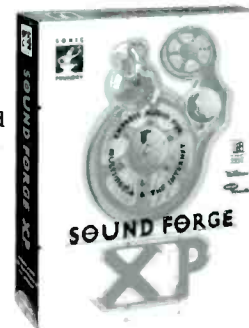

625FXP4 MFR LIST \$49.95
CALL 1-800-732-7665 FOR BRADLEY PRICE

Also available from Sonic Foundry:
Direct X Noise Reduction Plug-in Pack,
XFX1 Plug-in, XFX2 Plug-in Pack
and XFX3 Plug-in Pack.

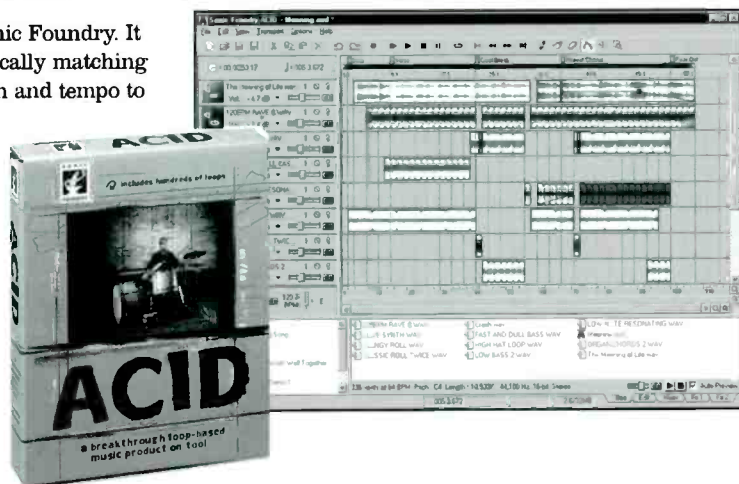

RECORDING AND PLAYBACK

SEK'D SAMPLITUDE 24/96

Taking on 24-bit, 96 kHz Multi-track processing, SEK'D has brought multi-track digital audio production tools to the next level! Samplitude 24/96 is the ultimate in host-based hard disk recording! Now you can create professional multi-track projects from start to finish in one program! Use Samplitude's host of audio processing tools to edit and sweeten your audio tracks. Complement the Samplitude DSP processing capabilities with DirectX plug-ins from third party developers or use the real-time mixing capabilities in the Mixer window.

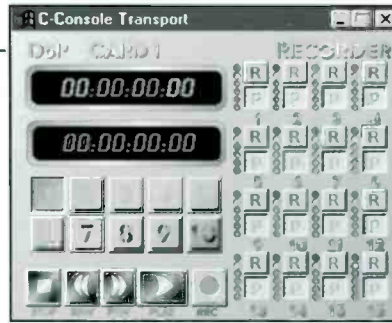

Samplitude 24/96 60SK2496 MFR LIST \$1,499.00
 CALL 1-800-732-7665 FOR BRADLEY PRICE

WAVES NATIVE POWER PACK: THE COMPLETE NATIVE AUDIO PROCESSING SYSTEM

Imagine a complete pro-audio system of Waves processing - from EQ to Reverb - with no DSP card needed! The Waves Native PowerPack uses the CPU of your Macintosh or PC to make your audio great, whether for recording, mixing, or multimedia. It is a complete system of software processors that plug into many audio-editing programs like Sound Forge and CakeWalk.

You need pro-audio equalizers, compressors, reverbs, and more to make your productions the best they can be. They're all in the PowerPack. Whether you make records, create multimedia titles, author audio for the Internet, design sounds for games, or just live in your project studio, the Waves Native PowerPack offers a complete solution with high-end processing, not scaled-down versions.

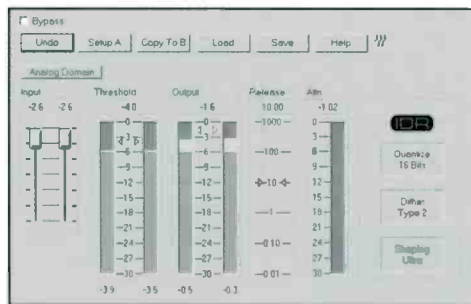

Power Pack 60WAPOWERPACK MFR LIST \$495.00
 CALL 1-800-732-7665 FOR BRADLEY PRICE

SEK'D PRODIF 32

This 24-bit stereo digital interface card is PCI plug-n-play ready. Designed for PC Windows 95/98, NT and MAC. Co-ax, S/PDIF, AES/EBU and analog out with optical/RCA and XLR outputs working simultaneously for possible signal distribution. Inputs and Outputs are ground-free transformer coupled.

PRODIF 32 60SKRODIF32 MFR LIST \$599.00
 CALL 1-800-732-7665 FOR BRADLEY PRICE

Bonus: Purchase Red Roaster 5.0 and Prodif 32 and receive Samplitude Basic 8-track recording and mixing software FREE!

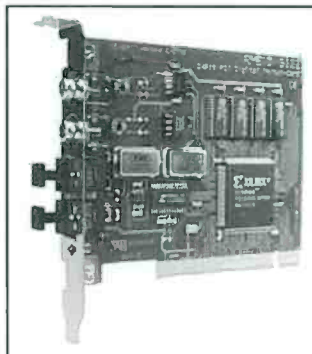

SEK'D RED ROASTER 5.0 CD AUTHORIZING SOFTWARE

The ultimate 24-bit CD-burning program with Direct-X support. Red Roaster also burns CD's on the fly (no image file required), mixes and burns simultaneously and has a built-in de-hisser making mastering from cassette and reel tape hiss-free.

RED ROASTER 5.0 60SKRED24 MFR LIST \$399.00
 CALL 1-800-732-7665 FOR BRADLEY PRICE

SOUND CARDS

THE CARDD PLUS (FOR PC'S)

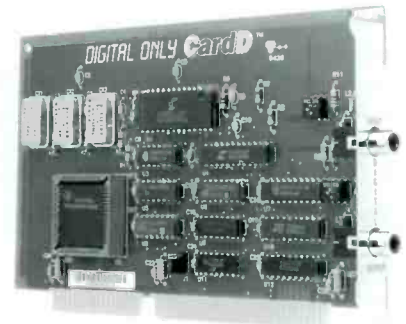

You need a quality sound card to get the most out of digital editing software. The CardD Plus plugs into your PC and provides professional digital audio with simultaneous record and play, selectable sampling rates of 48, 44.1, 32, and 22.05kHz, and real-time audio transfer. Connections are on RCA jacks, with levels selectable by jumper among +4, -10, and consumer. For direct digital I/O capability in the S/PDIF format, add the i/o CardD, which works with the driver in the CardD Plus, or the stand-alone Digital Only CardD, which has its own Windows driver. These cards are compatible with Windows 95 and Windows NT.

CardD Plus 60DATC01 MFR LIST \$595.00
i/o CardD 60DAIO01 MFR LIST \$245.00
Digital Only CardD 60DAD001 MFR LIST \$395.00

CALL 1-800-732-7665 FOR BRADLEY PRICE

Purchase any sound card, and receive Sound Forge XP for only \$29.95

Call us for TC Electronics Unity Plug-In

CREAMWARE CLAN—CUTMASTER LINEAR AREA NETWORK



CLAN is an advanced Client-Server audio system that serves as the backbone of your in-house audio distribution. Consisting of several integrated components, CLAN is a full-system approach to your networked audio requirements. The Server can be configured at graduated levels, so that a CLAN installation can be implemented over time, based on available budget. When you decide to expand, your existing Server license will be fully credited towards the new Server implementation. This modular approach makes possible the development of a large, sophisticated network in small, definable steps. The system can evolve through several phases of development according to your budget. The workstation components of the CLAN can be installed on advanced PCs running Win95. The Server software is available for Windows NT and Novell Netware.

CLAN is an open system. Read and write various linear and reduced audio formats in real time. Existing compressed audio material from other systems can be converted and transferred into the CLAN system at no additional cost.

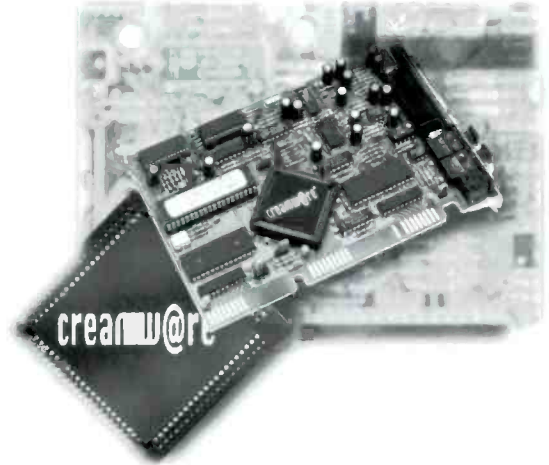

COMPONENTS:

- **CUTbase** is a MS-based Database. CUTbase manages incoming and outgoing audio data as well as all other information necessary to integrate the various CLAN components. From inclusive system-wide inquiries, previewing of all recorded or acquired audio, playlist logging and databasing of licensed material, to integrated tools for optimization, CUTbase, featuring heuristic query mechanisms and external archiving, has all the functions required for a networked installation.
- With **CUTmaster** you can quickly edit voice and music material with bit accuracy, use crossfades and parametric filters to clean up the existing audio, plus, read and write various linear and reduced audio formats. CUTmaster supports you with integrated pull down-menus; you won't be spending more time learning technique than getting work done. The answer you need is always only one mouse click away.
- For more extensive productions, such as jingles or radio production, use the exciting professional Realtime Tools of the **CUTmaster Pro**. The superior audio processing of the CUTmaster Pro's Expander, Compressor, Limiter, Noise-Gate, De-Esser, Delay Processor and Room Simulator make complete production on desktop a reality. CUTmaster Pro also features measurement and analysis modules - a Correlation meter, and a fully scalable, zoomable Spectrum Analyzer. If your jingle, audio clip, or voice-over is too long or too short - simply adjust it to the desired length with the integrated Time-Stretching tool.
- With a **CD-Writer** you can burn an audio CD directly from within CUTmaster without having to exit to an external application. Create your CD either track-by-track (TAO) or all in one session (DAO) with full international Redbook Standard support. Produce CD's with excellent audio quality, plus all the additional coding and information required to create a Master disc.
- Touch-up your archival or other standard audio material now stored on reel-to-reel tape, records, transcriptions or cassettes. With the **Osiris Restoration Package** you can restore sonically degraded recordings in real time, and burn a CD immediately afterwards! Old favorites can be aired again, with renewed life. And, like all audio processing in the CLAN, with extraordinary quality, as if it had been recorded yesterday.
- For a monitoring-only workstation, **CUTplayer** is the perfect tool! Listen to the first or last few seconds (or any part you like) of any audio clip from local station or audio server. Set markers while playing, check the total duration, the playing or remaining time—CUTplayer is ideal for auditioning your audio library.
- Want to take your studio on the road? The answer is **CUTmaster ToGo** - for your notebook! Connect ToGo to a database module. Since it outputs linear and various reduced audio formats, you are able to transmit directly to your broadcast station via ISDN or Modem.
- With **masterCART** you can edit playlists, audition and load jingles, trailers or ID's into the integrated CARTwall. Fades and crossfades are possible by using up to three stereo output channels. Connect the output channels to your console for live broadcasting.
- Finally, the longtime recorder **Event** completes the picture. You can choose between permanent or level-controlled recording modes (in which case the recording will consist of user-controlled discrete events). You can add either standard or additional comments and even set markers during recording. Great for sports events, or other types of long-form programming.

CALL YOUR FAVORITE BRADLEY PROFESSIONAL TO HELP YOU PICK THE CLAN SYSTEM JUST RIGHT FOR YOUR NEEDS.

creamw@re[®]

...delity at work.

RECORDING AND PLAYBACK



DIGITAL AUDIO LABS V8 SYSTEM

What if your PC had enough multi-track muscle and DSP horsepower to turn your favorite software into a world class studio? Meet the V8, the PC based hardware platform that's configured to your specifications and runs under your choice of software interfaces. The V8 main board already knows what's under the hood. Rather than wait for you to tell it what I/O peripherals and options are installed and where they are, it finds all attached components, registers them, and makes them available to your software. Add an audio hardware system specifically designed for third party software support with a robust sixteen track hard disk recording engine, a flexible real-time mixing console/routing system, and a signal processing reserve deep enough to satisfy the most demanding DSP software. Include a variety of high fidelity analog and digital I/O peripherals. Finally, put the system under the complete control of your favorite music and audio applications. Now you're driving the V8.

The V8's mixing and routing section is completely autonomous; it doesn't care whether disk channels, external inputs, or DSP plug-in channels feed the inputs. The V8's mixer can be used alone as a powerful, digital mixer with full automation and DSP plug-in support. Your V8 system isn't just a disk recorder and editor. It's an automated digital mixer with built-in, automated signal processing from the best DSP programmers in the business. Moreover, you can easily add more DSP as your software demands increase.

The V8 coaxes up to 16 simultaneous disk channels from off the shelf disk drives and interfaces. The V8 bus supports 16 channels in and 16 channels out at one time with a flexible routing scheme that allows any disk channel, mixer component, or I/O channel to be patched to or through any other. In addition, the V8's broad choice of analog and digital I/O peripherals can be combined and daisy chained to bring as many ins and outs under computer control as desired.

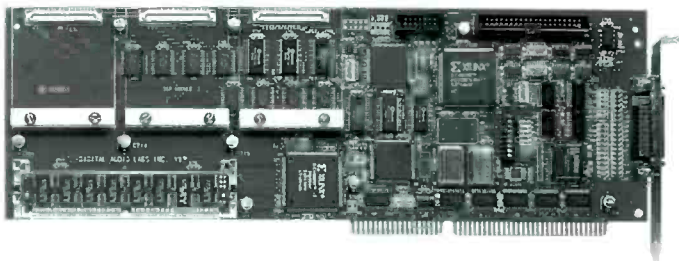

DIGITAL AUDIO LABS V8 MAIN BOARD

- Full length ISA 16-bit slot
- Sample Rates: 44.1k, 48k, and variable with external source
- Disk Channels: up to 16, depending upon system throughput
- Simultaneous I/O across V8 Bus: 16 in, 16 out (1 or more I/O peripherals required)
- Includes support for use of CardD Plus as stereo I/O

V8MB 60DAV8MB MFR LIST \$1,795.00

CALL 1-800-732-7665 FOR BRADLEY PRICE



DIGITAL AUDIO LABS BIG BLOCK

- Eight channel analog, stereo digital external interface (2 rack spaces)
- Balanced 1/4" TRS analog
- AES/EBU, coax and optical S/PDIF digital with front access to analog 1 and 2, AES/EBU and coax S/PDIF
- Level: +4 dB balanced and -10 dB unbalanced selectable via software

Big Block 60DAV8BB MFR LIST \$1,995.00

CALL 1-800-732-7665 FOR BRADLEY PRICE

DIGITAL AUDIO LABS DEUCE COUPE

- Stereo analog, stereo digital internal interface
- Balanced 1/4" TRS analog
- AES/EBU, coax and optical S/PDIF digital
- Level +4 dB balanced, -10 dB unbalanced jumper selectable

Deuce Coupe 60DAV8DC MFR LIST \$695.00

CALL 1-800-732-7665 FOR BRADLEY PRICE

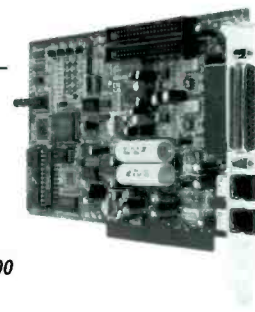

DIGITAL AUDIO LABS TIMING GEAR

The Timing Gear sync interface turns your V8 studio into a powerful full-featured audio sweetening facility. Once connected, the Timing Gear locks your V8's sample clock with subframe accuracy to your choice of video or LTC references, allowing tight synchronization of disk tracks. ADAT's, and DA98's to video.

Timing Gear 60DAV8TG MFR LIST \$695.00

CALL 1-800-732-7665 FOR BRADLEY PRICE

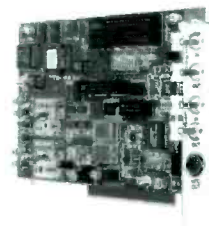

SEK'D SAMPLITUDE V8

Taking on Multi-track processing, SEK'D has brought multi-track digital audio production tools to the next level! Samplitude V8 is the ultimate in host-based hard disk recording! Now you can create professional multi-track projects from start to finish in one program! Use Samplitude's host of audio processing tools to edit and sweeten your audio tracks. Complement the Samplitude DSP processing capabilities with DirectX plug-ins from third party developers or use the real-time mixing capabilities in the Mixer window.

Samplitude V8 60SKSAMPV8 MFR LIST \$999.00

CALL 1-800-732-7665 FOR BRADLEY PRICE

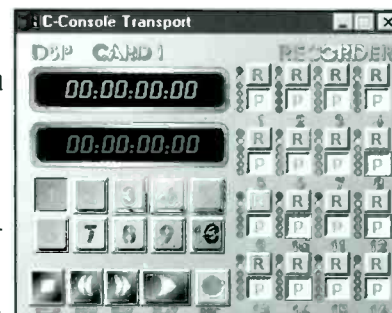

DIGITAL AUDIO LABS I/O PERIPHERALS FOR V8 SYSTEM

MDM CUSTOM FOR DA98

Tascam's DA98 eight track modular digital multitrack has built a reputation on its solid reliability and speedy transport. With the V8's MDM synchronization interface for DA98 and compatibles, you can completely and transparently marry hard disk and TDIF tape tracks into one unified recording, editing and playback system. With sixteen channels of TDIF format audio plus full synchronous transport control, one MDM Custom for DA98 actually allows you to interface two DA98 format machines.

60DAV8D98 MFR LIST \$795.00

CALL 1-800-732-7665 FOR BRADLEY PRICE

MDM CUSTOM FOR ADAT

- Internal interface for Alesis ADAT and compatibles
- Digital 8 channel interface for ADAT optical (ODI) audio format
- Transport control and sample accurate sync of multiple

60DAV8ADAT MFR LIST \$695.00

CALL 1-800-732-7665 FOR BRADLEY PRICE

DSP SUPERCHARGER

- Attaches to Main Board expansion socket (3 possible per Main Board)
- 2 Motorola 80 MHz 56002 per module
- Inter-processor support for multiple processor algorithms

60DAV8DSP1 MFR LIST \$495.00

CALL 1-800-732-7665 FOR BRADLEY PRICE

RAM INDUCTION MODULE

- Attaches to DSP Supercharger expansion socket (1 possible per DSP Supercharger)
- 128K fast SRAM for enhanced time-dependent algorithms

60DAV8RI128 MFR LIST \$295.00

CALL 1-800-732-7665 FOR BRADLEY PRICE

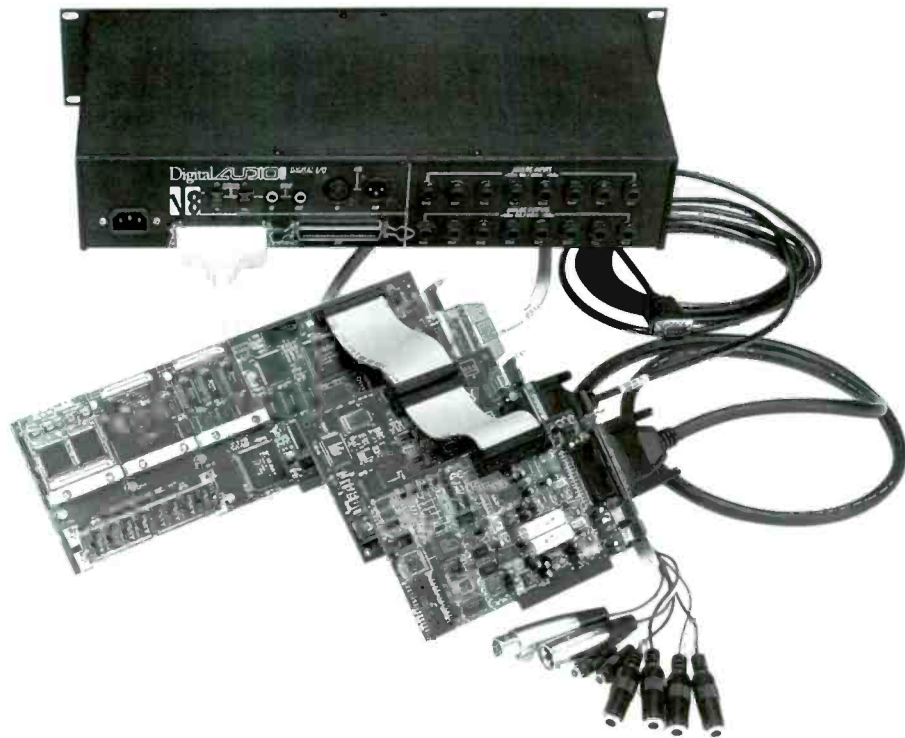

MINNETONKA MXTRAX FOR V8

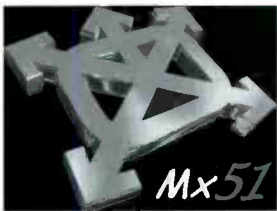

Turn your PC into a digital recording studio! The powerful combination of MxTrax software and V8 digital audio components make a complete digital audio production environment - add MX51 for surround sound recording. Set up your recording session to have any number of virtual tracks and mixer channels. The Windows environment provides easy access to all the tools you need for

recording, mixing, editing, and playback. Pull-down, pop-up menus and dialogs guide you every step of the way, making your recording process as easy as clicking the mouse. Features include: Full suite non-destructive editing tools, hot keys for zooming and editing, individual track resizing, instant zoom of multiple tracks while playing, unlimited undo/redo history with no reprocessing, cut, copy, and paste between projects and instantaneous, real-time mixer controls.

MXTRAX 60DAMXTRAX MFR LIST \$599.00

CALL 1-800-732-7665 FOR BRADLEY PRICE

MX51 60DAMX51 MFR LIST \$1,500.00

CALL 1-800-732-7665 FOR BRADLEY PRICE



Don't get stuck with obsolete hardware systems.

Keep your workstations current with V8 and save thousands in the process!

RECORDING AND PLAYBACK



CASSETTE MACHINES

TASCAM PROFESSIONAL CASSETTE MACHINES

Best Seller

Bradley offers many choices in audio cassette decks. For the



most critical audio recording we recommend this trio. They are rackable recorders with Dolby B and C noise reduction and Dolby HX Pro for extra headroom. Features include $\pm 12\%$ pitch, three locate markers, 25-pin parallel port, and separate left and right input controls. Signal-to-noise is 78dB using Dolby C, and metal tape response is at least 25Hz to 19kHz.

122 MKIII: A three-head cassette deck, well-suited for on-air use. Bias and level calibrations are on the front panel. Input level controls are gear/clutch coupled. The head system features Cobalt Amorphous heads with independent azimuth adjustment. Connectors are balanced (+4 dBm XLR) and unbalanced (-10 dBV, RCA on rear and 1/4" on front).

112 MKII: For Tascam pro performance in an economical machine, order the 112 MKII, a two-head deck with unbalanced connectors (-10 dBV, RCA on rear and 1/4" on front). A balancing kit with XLR connectors is optional.

112R MKII: (pictured) Choose this auto-reverse, three-head deck when you need extended recording and playback time. The head rotates 180 degrees for accurate playback alignment of both sides of the tape. The 112R MKII has unbalanced connectors like the 112 MKII.

BONUS! Get 5 free TDK SA60 cassettes with each purchase of a Tascam Cassette machine.

122 MKIII	60TE122MKIII	MFR LIST	\$1,349.00
112 MKII	60TE112MKII	MFR LIST	\$849.00
112R MKII	60TE112RMKII	MFR LIST	\$1,149.00

CALL 1-800-732-7665 FOR BRADLEY PRICE

Accessories:

LA-112 Balancing Kit (for 112 MKII & 112R MKII)	60TELA112	MFR LIST	\$100.00
RC-112R Remote Control (for 112R MKII)	61TERC112R	MFR LIST	\$250.00
RC-134 Remote Control (for 122 MKIII & 112 MKII)	61TERC134	MFR LIST	\$250.00

TASCAM DUAL CASSETTE MACHINES

The Tascam 202 MKIII has two auto-reversing wells with simultaneous record on both, and continuous playback capabilities. Built for studio use, the 202 MKIII is enhanced by twice-speed dubbing and a headphone jack. This model has one set of line I/O connectors plus front-panel mic inputs.



The exciting Tascam 302 is two independent cassette decks in one chassis. Each is capable of independent recording with its own set of line inputs and outputs, controls, noise reduction, and meters. It too has high-speed dubbing and continuous record/play between the wells. Extra features include pitch control, Cascade output (for multiple units in a duplication system), and Control I/O (for continuous recording and playback on multiple machines).



Both models rack mount and include Dolby B, C, & HX-Pro. Synchro Reverse makes two-sided tapes when one is longer than the other. Machines are high impedance, low level, unbalanced on inputs and outputs.

202 MKIII	60TE202MKIII	MFR LIST	\$529.00
302	60TE302	MFR LIST	\$699.00

Accessories:

RC-302 Wired Remote for 302	60TERC302	MFR LIST	\$65.00
WR-7000 Two Machine Synchro Cable for 302	60TEWR7000	MFR LIST	\$15.00

CALL 1-800-732-7665 FOR BRADLEY PRICES

READY TO RIP

Special: We package the fine Technics RS-TR575 dual cassette deck, below, with Excalibur's IHF-to-PRO interface amplifier IA-1 and a Middle Atlantic rack shelf. Value: \$498.00

PACKAGE 9810 - ONLY \$429.00

TECHNICS CASSETTE FAMILY

Unlike many dual cassette decks in this price range, the RS-TR575 records in both wells. It allows sequential or simultaneous parallel recording from the same source. You get a dual tape counter, 2X FF/REW speed, motor-driven well doors, and auto tape calibration for fidelity on any brand tape. Play in series for 24 hours. Other features include Dolby B&C noise reduction and Dolby HX-Pro headroom extension. Connectors are -10dBV on RCA phono jacks.

Also available: The RS-TR272 double auto-reverse deck records in one well. It has an electronic counter, series play, balance control, and Dolby B&C and HX-Pro.

The RS-BX501 is a single-well auto-reverse machine with Dolby B&C, HX-Pro, and auto tape calibration.



RS-TR575	60TCRSTR575	MFR LIST	\$269.95
RS-TR272	60TCRSTR272	MFR LIST	\$199.95
RS-BX501	60TCRSBX501	MFR LIST	\$239.95

CALL 1-800-732-7665 FOR BRADLEY PRICE

RECORDING AND PLAYBACK

SONY TC-WE825S CASSETTE DECK WITH DOLBY S



Make stunning recordings with the power of Dolby S type noise reduction. In a twin-well deck, Dolby S delivers the very best audio on analog cassettes.

The TC-WE825S is dual well. Dual recording, dual auto reverse and dual 2-motor transports are featured. Twin/sequential recording and playback, auto record calibration, high and normal speed dubbing and twin linear time counters are standard features.

In addition to Dolby S, the TC-WE825S has Dolby B & C and Dolby HX-Pro, for increased headroom and low distortion.

TC-WE825S 60SOTCWE805S MFR LIST \$330.00

CALL 1-800-732-7665 FOR BRADLEY PRICE

TEAC V-615 CASSETTE DECK



With metal tape, you can expect 25Hz to 19kHz performance from the V-615. Teac's cassette deck has a stable center-mounted transport and a quality bi-polar power supply. Features include electronic counter, Dolby B&C type noise reduction, Dolby HX Pro headroom extension, independent peak level meters with peak hold, auto-tape selector, and a headphone jack.

V-615 60TEV615 MFR LIST \$239.00

CALL 1-800-732-7665 FOR BRADLEY PRICE

Take the V615 with an Excalibur IA-1 Interface amp and a Middle Atlantic rack mount kit. Value: \$475.00

PACKAGE 98M - ONLY \$369.00

TASCAM MULTITRACK PORTASTUDIO

For the musician or other professional seeking convenient multitrack recording, Tascam has improved its very popular 424 Portastudio. The 424 MKII is a four-track cassette recorder and eight-input mixer (four mono, two stereo). Features include three-band EQ with sweepable mid, two tape speeds, balanced XLR mic inputs, two aux sends (one to cue for headphone mix), auto punch/rehearse, and an internal power supply. No external transformers! Dedicated tape outputs allow integration to external mixers.

Need more inputs? Ask us for a quote on Tascam's 464. For eight-track recording, request the 488 MKII.

424 MKII Portastudio 60TE424 MFR LIST \$549.00

CALL 1-800-732-7665 FOR BRADLEY PRICE



DENON CASSETTE FAMILY

DN-790R: Single Well • Three heads • Dolby S Noise Reduction • Dolby B&C and HX-Pro • ±12% pitch control • XLR balanced and RCA unbalanced I/O • Rack mount included

DN-790R 60DEDN790R MFR LIST \$1,000.00

DN-720R: Single Well • Dolby B&C and HX-Pro • ±12% pitch control • RCA unbalanced I/O • Rack mount included

DN-720R 60DEDN720R MFR LIST \$500.00

DN-770R: Dual Well with Auto Reverse • Play two cassettes at once; play A while recording B • Record on either well • Relay Record for three hours, Relay Play 5x • Dolby B&C (HX-Pro on Deck B) • RCA unbalanced I/O • Rack mount included

DN-770R 60DEDN770R MFR LIST \$700.00

CALL 1-800-732-7665 FOR BRADLEY PRICE



RECORDING AND PLAYBACK

CASSETTE MACHINES

TASCAM 102MKII CASSETTE RECORDER



The 102MKII is a single-well deck with Dolby B&C noise reduction, Dolby HX-Pro headroom extension, and tape counter. You'll appreciate the uncluttered front panel with headphone jack and bias fine adjustment. Inputs and outputs are -10dBV on RCA jacks. Includes rack mount.

Tascam 102MKII	60TE102MKII	MFR LIST	\$369.00
Excalibur IA-1 interface amp	60EXIA1	MFR LIST	\$180.00

CALL 1-800-732-7665 FOR BRADLEY PRICE

TELEX CASSETTE DUPLICATORS

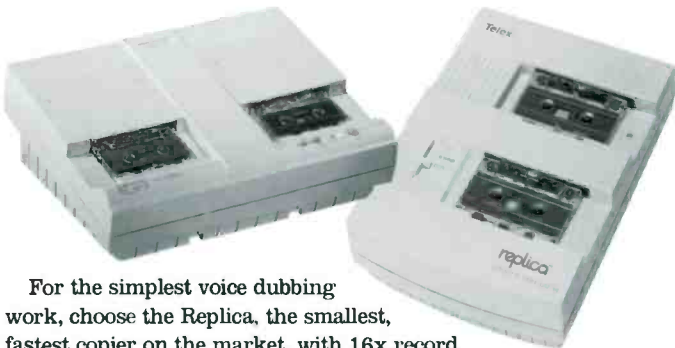

For the simplest voice dubbing work, choose the Replica, the smallest, fastest copier on the market, with 16x record speed and weighing only 7 pounds.

The popular Copyette models are improved: they now have an erase head built right in, so you don't need to bulk erase your tapes. For affordable, portable copying, they're ideal. Dub both sides of a C-60 tape in less than two minutes, all in a ten-to-twelve pound package. The Copyette 1-2-1 makes one dub at a time; the model 1-2-3 makes three copies at once. A protective hard cover is included.

These models dub with response to 6.3kHz mono or 8kHz stereo. For higher fidelity dubbing or if you're handling much larger quantities of cassettes, ask us about the Telex ACC series of expandable tape duplicators.

Replica	60TXREPLICA	MFR LIST	\$425.00
Carry/Storage Vinyl Case	60TXRBB1		\$25.00
Copyette 1-2-1 Mono EH	60TXCOPY121M	MFR LIST	\$550.00
Copyette 1-2-1 Stereo EH	60TXCOPY121S	MFR LIST	\$885.00
Copyette 1-2-3 Mono EH	60TXCOPY123M	MFR LIST	\$1,350.00
Copyette 1-2-3 Stereo EH	60TXCOPY123S	MFR LIST	\$2,150.00

CALL 1-800-732-7665 FOR BRADLEY PRICE

MARANTZ CASSETTE MACHINES



Churches, aerobics instructors, and corporate A/V professionals enjoy Marantz quality. These are two-head, two-motor single-well decks with auto-reverse, Dolby B noise reduction, and rack ears.

The PMD-501 is an affordable, basic deck. The 502 adds $\pm 15\%$ pitch control, Dolby C and HX-Pro, output level control, an electronic counter, and dual front-panel mic inputs on 1/4" jacks (nice for smaller installations where no mixer is available). A balanced XLR line I/O option is available for this model.

PMD-501	60MR501	MFR LIST	\$329.00
PMD-502	60MR502	MFR LIST	\$499.00
XLR option for 502	60MRXLR502PMD	MFR LIST	\$100.00

CALL 1-800-732-7665 FOR BRADLEY PRICE

**Most Bradley items are shown at
manufacturer's list.
Call us for a price quote!**

1-800-732-7665

TASCAM 130 CASSETTE DECK



The new TASCAM 130 is a 3-head cassette deck and thus provides confidence monitoring - enabling the engineer to know exactly what's being printed to tape as it's being recorded. With the Auto Monitor feature, it's easy to check Source / Tape signals, so there's never a question as to what's being monitored. The recorder is 3U rackmountable, provides unbalanced RCA inputs and outputs, features an automatic tape type selector, and has timer record and play capability.

130	60TE130	MFR LIST	\$499
-----	---------	----------	-------

CALL 1-800-732-7665 FOR BRADLEY PRICE

RECORDING AND PLAYBACK

MARANTZ PMD520

The Marantz PMD520 sets new standards for innova-



tion and design. Featuring two independent 3-head mechanisms, the PMD 520 is designed to provide the audio professional with the most flexible and comprehensive cassette deck available.

Marantz's progressive thinking when designing the PMD520 brings unique features to the world of cassettes. The doors have been eliminated so that tapes can be inserted and removed with greater efficiency. Servicing your PMD520 is easy because each mechanism can be completely removed while the other remains in service. During continuous recording, the overlap record feature can be activated to ensure uninterrupted recording when going from well to well and deck to deck. The overlap record feature will start the next tape 3 minutes before the current tape ends, so you'll never lose a word.

Want a remote? Not a problem, Marantz thought of everything. The WRC220 wired remote provides complete control for playback, recording and duplication. Also available is the RC5PMD infrared remote.

PMD520	60MRPMD520	MFR LIST	\$999.00
Wired Remote	60MRWRC220	MFR LIST	\$149.00
Infrared Remote	60MRRCS5PMD520	MFR LIST	\$100.00

CALL 1-800-732-7665 FOR BRADLEY PRICE

DENON DNT620 CD/CASS COMBO



The Denon T-620 is a professional CD player and cassette player/recorder housed in a single 3U, rack-mount chassis. It is the successor to the DN-610F and includes many new feature enhancements for professional applications, including balanced XLR connectors on the inputs and outputs.

- Headphone jack and volume control
- Headphone source select switch
- Wired Remote Control terminal
- Balanced (XLR) In/Out terminals
- Two machines in one
- Record from CD to tape
- Play background music continuously
- Mix from both sources, add mic audio
- Rack mountable
- Single or continuous Playback mode
- Back cue function
- A-B repeat mode
- Variable pitch control up to + 12% of playback speed

DNT-620	60DEDNT620	MFR LIST	\$750.00
---------	------------	----------	----------

CALL 1-800-732-7665 FOR BRADLEY PRICE

MARANTZ DUAL CASSETTE DECKS

The PMD-500 and 510 allow simultaneous recording (from a single source on the 500, or separate sources on the 510), playback on one tape while recording on another, and quick auto-reverse. Serial recording gives three hours of continuous material. Standard or high-speed dubbing, Dolby B&C Noise Reduction, Dolby HX-Pro, and memory rewind are included.



The PMD-510 is really two machines in one deck. Extra features include ±15% pitch control, cascade circuitry allowing series recording with multiple machines, and separate meters and counters for each well. A switchable headphone jack allows cueing of one well while the other is playing.

Both models are rackable and provide -10dBV on unbalanced RCA connectors. An RC5 port makes serial, IR, or master remote control simple to configure. The optional remote kit works with either model and includes a wall/rack mount controller with hand-held wireless remote. It's handy for duplication projects, since you can operate multiple units in parallel.

PMD-500	60MR500	MFR LIST	\$639.00
PMD-510	60MR510	MFR LIST	\$829.00
RC5PMD Remote Accessory Kit	61MRRCS5PMD500	MFR LIST	\$70.00

CALL 1-800-732-7665 FOR BRADLEY PRICE

TASCAM CD-A500 CD/CASSETTE COMBO



New from Tascam: the CD-A500 integrated CD player and reversible cassette deck! With its 3U rack mount design, the CD-A500 offers CD to cassette dubbing with A side/ B side program dubbing with CD sync. Continuous play function, wireless remote control and flexible output architecture (dedicated RCA outputs for CD in addition to common RCA outs), the CD-A500 is for commercial recording facilities and sound contractors alike.

CD-A500	60TECDA500	MFR LIST	\$389.00
---------	------------	----------	----------

CALL 1-800-732-7665 FOR BRADLEY PRICE



RECORDING AND PLAYBACK ACCESSORIES

DENON TC REMOTE

You love your Denon CD player, but you really wish you had a remote. Well, have we got a surprise for you! Twecomm has created an add-on remote for Denon CD Players and Mini Disc player / recorder units with the following features: Standby-cue, Pause, Play and Record, all with LED tally. The Twecomm TC-650 remote also does track step up and down and search up and down. A 12-foot DB-25 cable is provided. For use with the following: DNC-680, DN-650F, DN-951FA, DN-1100-R, DN-981, DN-961FA, DN-980F, DN-990R and DN-995R.



Denon Remote 61TWT650 \$135.00

DENON TEST CD

Spot and sweep frequency tones and a variety of other signals allow you to evaluate the THD, channel separation, and other characteristics of CD players and other audio components in your facility.

60DETC only \$24.95

CD JEWEL BOXES

High quality replacement boxes at a great low price.

60EMJB .69¢
Purchase 25 or more for only 59¢ each



CD-121A CD CLEANING SYSTEM

Removes contaminants from the encoded data, crosswise to the direction of the data. Includes non-CFC disc cleaning fluid.

CD-121A Cleaning System 60ICCD121 only \$22.95

Accessories:

Package of three replacement pads 60ICCD122 only \$4.95
Spare 1.5 ounce bottle CD-103A cleaning fluid 60ICCD103 only \$6.95



INTRACLEAN HEAD CARE PRODUCTS

S-721H Intraclean is the solution used by top manufacturers on heads, capstans, and pinch rollers. Made of halogenated hydrocarbons, S-721H removes the toughest oxides. It has no alcohol to dry out pinch rollers; controlled evaporation allows fast drying.



Two ounce bottle	60ICS721H	\$8.95
Quart can	60ICS711Q	\$22.00
Pump dispenser	60ICPD	\$20.00

Cotton cleaning swabs with 6" maple stick. The tip is wound tightly and mounted with glue to prevent unraveling. Buy 1000 for best price.

1000 swabs	60BBCS1000	\$16.50
100 swabs	60BBCS100	\$2.95

D-512 wand-style head demagnetizer to reach the tightest places. Plastic probe is safe on heads. 110V AC.

60ICD512 \$39.95

K-161D head care kit is a package that combines the D-511S demagnetizer, a two oz. bottle of S-721H, 100 cotton swabs, and a nice carrying bag.

60ICK161D \$69.95

EXCALIBUR INTERFACE AMPS

They ain't sexy but they'll make your CD players a lot happier in a professional setting. These one-way amps connect CD and other semi-pro outputs (-10dBV) to pro (+4dBm) equipment. The CD-1 amplifies one stereo source and uses euro-style block output connectors. Rubber feet and angle brackets are included; the optional RM-1 can mount four CD-1's or two CD-2's in a rack space. The CD-2 handles two CD players and input connectors for both models are RCA jacks.



CD-1	60EXCD1	\$99.00
CD-2	60EXCD2	\$165.00
Rack Kit for CD-1	60EXRM1	\$21.00

**We carry all major brands of
cart tape and test tapes. Call us!**



RECORDING AND PLAYBACK

Bradley Broadcast • 7313-G Grove Road • Frederick, MD 21704 • 800-732-7665 • 301-682-8700 • Fax: 301-682-8377 • Web: <http://www.bradleybroadcast.com>

MRL TEST TAPES

CARTRIDGE TEST TAPES

We supply tapes loaded into the type of cart shell that you use. The multi-frequency tapes shown are for reproduce gain, head azimuth, and frequency response calibration. These full track master recordings, with cue track erased, are suitable for mono or stereo players. Specify 160nWb/m or 250nWb/m. Also available are single frequency tapes, fast and slow sweeps, pink and white noise, and cue tone test tapes at the same price.

audiopak shell	60MLS211AP	\$79.00
ITC shell	60MLS211SC	\$79.00
Fidelipac 300 shell	60MLS211FP	\$79.00
Fidelipac Mastercart shell	60MLS211MC	\$79.00
Fidelipac Dynamax Cobalt shell	60MLS211DC	\$79.00

REEL TO REEL TEST TAPES

These are just our most popular; call for what you need. Spot frequency tapes are for overall frequency response checking. Fast sweep and pink/white noise tapes are for frequency response or phasing verification. Most 1/4" test tapes for 7-1/2 and 15 ips are \$65.00 and most 1/2" tapes at those speeds are \$129.00. Tapes can be ordered with NAB or IEC equalization; for all tape sizes; for various operating levels; and for various speeds.



1/4" Spot Frequency, 7-1/2ips, 250nWb/m, NAB	60ML21T204	\$ 65.00
1/4" Spot Frequency, 15ips, 250nWb/m, NAB	60ML21J205	\$ 65.00
1/2" Spot Frequency, 15ips, 250nWb/m, IEC	60ML31J229	\$129.00

CASSETTE TAPES

Bradley saves you money on the cassette tapes you need. Get the same low price on any quantity up to 100. When ordering 100 tapes of any mix, take an additional 10% off.

Model	Length	Item Number	Price
Maxell UR	60 min	61MXUR60	\$0.99
Maxell UR	90 min	61MXUR90	\$1.20
Maxell UR	120 min	61MXUR120	\$1.99
Maxell XLII	60 min	61MXXL2C60	\$2.17
Maxell XLII	90 min	61MXXL2C90	\$2.71
Maxell XLII	100 min	61MXXL2C100	\$2.98
Maxell MX-S	60 min	61MXMXS60	\$3.45
Maxell MX-S	90 min	61MXMXS90	\$3.95
Maxell MX-S	100 min	61MXMXS100	\$4.45

Tape Types:

Maxell UR - Normal bias tape

Maxell XLII - Type II, high bias for music recording.

Maxell MX-S - Type IV, metal formulation for critical recording.

UTILITY CASSETTES

These inexpensive, standard-bias cassettes are ideal for sales demos, news actualities, or any general purpose voice recording.

62CMUPL010	5 minutes/side	\$1.29
62CMUPL020	10 minutes/side	\$1.49
62CMCOM30	15 minutes/side	\$1.29
62CMCOM45	22.5 minutes/side	\$1.39
62CMCOM60	30 minutes/side	\$1.49

BULK IT!

Audiolab's widely-used TD-1B erases carts plus other magnetic media up to 1/4" thickness and reel sizes up to 10-1/2". Pushbutton switch won't let you leave it on by mistake. Eraser duty cycle is one minute on, three off. Or choose the TD-4, which erases up to 14" reels, 1" wide. Includes adjustable "on" cycle, cooling fan, and automatic shut-off. Use for audio, video, computer, and cartridge tape.



Geneva's hand-held PF-211 erases 1/4" reels, cassettes and cartridges.

Erasing other formats? Call us!

TD-1B	60AUTD1B	MFR LIST	\$145.00
TD-4	60AUTD4	MFR LIST	\$950.00
PF-211	61NOPF211	MFR LIST	\$79.99

CALL 1-800-732-7665 FOR BRADLEY PRICE

EDITING HELPERS



White grease pencils for marking recording tape. One dozen.

61EDWP1 \$14.85

100 single edged razor blades designed for professional splicing.

61EDRB1 \$16.50

Acrometal Accessories.

#61W Pro Leader	62ACAC1T61W1	\$22.00
#8125 Zebra Tape	62ACAC1H8125Z	\$9.00
#20 Paper Leader	62ACAC1L201WP	\$11.00
AC1S620W1 Pro	62ACAC1S620W1	\$7.00
AC1S67B1 Splicing Tape	62ACAC1S67B1	\$8.00
#67 1/2x100 Blue	62ACAC1S67B2	\$9.00

Editall splicing blocks with provisions for multitrack and 45-degree cuts. Call for other sizes.

1/4" block	61EDS3	\$52.00
1/4" block with 90-degree and 45-degree cuts	61EDS390	\$49.00
1/4" replacement block for Otari	61EDS30T	\$59.00
1/2" block	61ED535E	\$55.00
Cassette block	61ED51S	\$49.00

REEL TAPE HELPERS

EMPTY REELS AND BOXES

1/4" x 7" plastic reel	60EM7R	\$.99
Box for 7" plastic reel	60EM7WB	\$.64
1/4" x 10 1/2" plastic reel	60EM10R	\$3.25
Box for 10 1/2" plastic reel	60EM10WB	\$1.45

STL CASSETTE ALIGNMENT TAPE

Don't overlook your cassette decks. These tapes conform to IEC/NAB standards. Tests include seven spot frequencies, 400Hz Dolby calibration tone, pink noise and sweep tone for stereo phasing, and 3150Hz pilot tone for wow and flutter measurements.

For Normal Bias	62SL120M5	\$100.00
For Chrome Tape	62SL70M5	\$100.00



RECORDING AND PLAYBACK ACCESSORIES & CD PLAYERS

DIGITAL MEDIA

MINIDISC

Type	Length		Price
Sony	60 minutes	60S0MDW60	\$8.99
Sony	74 minutes	60S0MDW74	\$11.99
Sony Pro	74 minutes	60S0PRMD74	\$12.99
Maxell	60 minutes	61MXMD60	\$11.50
Maxell	74 minutes	61MXMD74	\$12.95

DAT

Type	Length		Price
Maxell	46 Minutes	61MXR46DM	\$6.75
Maxell	60 Minutes	61MXR60DM	\$7.50
Maxell	90 Minutes	61MXR90DM	\$8.95
Maxell	120 Minutes	61MXR120DM	\$10.50
HBB	15 minutes	61HHDAT15	\$6.05
HBB	35 minutes	61HHDAT35	\$7.00
HBB	50 minutes	61HHDAT50	\$7.90
HBB	65 minutes	61HHDAT65	\$8.50
HBB	95 minutes	61HHDAT95	\$9.00
HBB	125 minutes	61HHDAT125	\$11.00

PROFESSIONAL DAT

Premium DAT tapes with special lengths.

Type	Length		Price
Panasonic	19 minutes	61PARTR19M	\$5.00
Panasonic	34 Minutes	61PARTR34M	\$5.50
Panasonic	64 Minutes	61PARTR64M	\$6.50
Panasonic	94 Minutes	61PARTR94M	\$7.50
Panasonic	124 Minutes	61PARTR124M	\$8.50
Sony	15 Minutes	60S0PDP15	\$5.99
Sony	34 Minutes	60S0PDP34	\$6.99
Sony	48 Minutes	60S0PDP48	\$7.99
Sony	64 Minutes	60S0PDP64	\$9.25
Sony	94 Minutes	60S0PDP94	\$11.25
Sony	124 Minutes	60S0PDP124	\$12.99

RECORDABLE CD'S

Sony 74 Minute	60S0CDQ74A	\$8.99
Sony 63 Minute	60S0CDQ63A	\$8.50

CLEANING TAPES

DAT cleaning kit (wet)	60ICDAT101	\$32.00
DAT cleaning kit (dry)	60ICDAT101D	\$20.00
ADAT cleaning kit	60ICK171	\$50.00
ADAT cleaning kit w/C20	60ICK171D	\$70.00

DISCWASHER

CD CLEANER

The gear drive system ensures complete radial cleaning of the compact disc. Cleaning fluid is formulated to remove debris safely.

CDC Cleaner	61DI1102	only \$17.95
CD-1 Cleaning fluid refill and pads	61DI1109	only \$5.95

CD POLISH

Removes minor scratches and blemishes from CD surfaces. Package includes CD-1 cleaner, CD-2 polish, six applicator swabs and four polishing wipes.

	61DICD2	only \$10.95
--	---------	--------------

CD LENS CLEANER

This disc-shaped cleaner uses a dual wet/dry action to ensure thorough lens cleaning.

	61DI1107	only \$19.95
--	----------	--------------



TECHNICS SL-PG480A AND SL-PS770D CD PLAYERS

Remember the Technics SLPG350 and 450? Well, they went away and we have missed



them. Guess what? They're back! Technics introduces the SL-PG480A and SL-PS770D single play CD players. Both units offer auto cue, come with remotes and have optical digital outputs. The SL-PS770D adds the hot start feature with 10-key direct access on the main unit.

Single play CD player	60TCSLPG480A	MFR LIST	\$129.95
Single play CD player	60TCSLPS770D	MFR LIST	\$349.95

CALL 1-800-732-7665 FOR BRADLEY PRICE

TECHNICS CD CHANGER

Our customers put them in their studios, and our employees like them for family



gifts. This Technics multidisc deck has rotary front-load design so you can change any four CD's while a fifth is playing. The mechanism is super quiet. MASH 1-bit DAC system, random access programming, spiral play, and a useful disc location display are standard features.

The SL-PD888 includes a wireless remote control with power button.

SL-PD888	60TCSLDP888	MFR LIST	\$169.95
----------	-------------	----------	----------

CALL 1-800-732-7665 FOR BRADLEY PRICE

CD ARMOR FROM DIGITAL ARMOR

There have been times that someone comes up with a truly innovative idea. The CD player was one. CD Armor is another. This unique product makes your CD library virtually indestructible. Simply place a CD in the CD Armor installer along with a shield and close the lid. Flip the CD over and repeat the process. Your CD is now safe from accidental damage. The CD Armor refill pack protects 15 CD's.

CD Installer w/ 6 shields	62CD11001	\$19.95
CD Armor refill	62CD10015	\$9.95

REEL TO REEL TAPES

Quantegy (formerly Ampex)

Model	Item No.	Size	Reels/ Ctn.	Carton Price	Single Price
499	61AM499174111	1/4" x 2500' x 10-1/2"	10	\$223.20	\$27.78
499	61AM499176111T	1/4" x 2500' HUB	10	159.00	N/A
456	61AM456151111	1/4" x 1200' x 7"	10	82.98	10.50
456	61AM456173111	1/4" x 2500' x 10-1/2"	10	208.30	26.98
456	61AM456176111T	1/4" x 2500' HUB	10	135.00	N/A
456	61AM456273111	1/2" x 2500' x 10-1/2"	7	286.00	\$51.00
456	61AM456573111	1" x 2500' x 10-1/2"	5	420.00	N/A
456	61AM45697G111	2" x 2500' x 10-1/2"	2	379.00	N/A
406	61AM406151131	1/4" x 1200' x 7"	10	66.30	7.95
406	61AM40617313J	1/4" x 2500' x 10-1/2"	10	166.38	19.95
406	61AM40617613T	1/4" x 2500' HUB	10	105.00	N/A
407	61AM407151131	1/4" x 1800' x 7"	10	86.90	10.42
407	61AM40717313J	1/4" x 3600' x 10-1/2"	10	230.80	27.67
407	61AM40717613T	1/4" x 3600' HUB	10	172.00	N/A

Defining the standards for broadcast audio performance



M 58 & M 58

... Leading the industry with innovative products and creating ergonomic designs for visual on-air appeal...

... Established in 1924, beyerdynamic's legacy of innovation, fidelity and reliability is recognized and honored by professionals around the world.



DT 290 Headset

73 years of audio excellence.

M 58



MCE 7

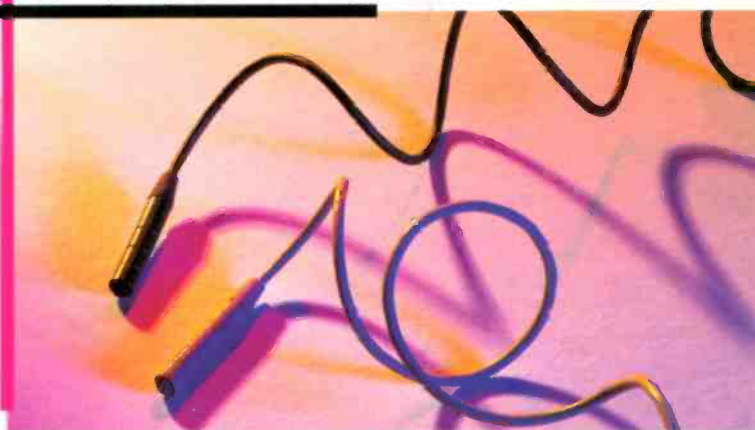

beyerdynamic... *Fidelity in Audio.*™

beyerdynamic



SOUND FORGE 4.5

digital audio editing for windows

Forge Ahead With Confidence

When you need absolutely brilliant audio for your next project, look to the ultimate sound editing software for Windows, Sonic Foundry's **Sound Forge 4.5**.

Radio and television broadcast studios and post-production houses throughout the world are discovering a new level of interactivity, accuracy and overall control. Extensive effects. Flexible features. Expandable power. Isn't it time to start using the one audio editing package that gives you complete confidence and control?

Enhance Your Audio With Other Sonic Foundry Products

ACID

A revolutionary music production tool that brings unprecedented creative flexibility to loop arranging & editing.

CD ARCHITECT

Design and build professional audio CDs to red book spec.

AFX 3

Create instant ear-catching effects, including Amplitude Modulation, Distortion, Vibrato and more.

SOFT ENCODE

Enhance your audio files with easy-to-use Dolby Digital encoding software.

ACOUSTIC MIRROR

Add to your sound by applying the acoustics of various real-world environments.

For more information see our website www.sonicfoundry.com or call 1 800 57 SONIC



Microsoft
WindowsNT
NetShow Services



DENON CD CART MACHINES

Play CD's with the convenience of carts on the DN-951FA. Use the rotary track knob to dial the next cut, then hit play for instantaneous audio. Manually search through a track, choose single or continuous play modes, and preview the last several seconds of a track just by pushing a button, a handy feature in the on-air studio.

Denon's Auto Track Select System reads barcodes you place on the CD. You can set it up to cue only to a specified track, to the exclusion of all others; or cue to a specified track, allowing the operator to select others, or lock out a specific track, allowing the operator to select any of the others.

Three decks mount in a rack with an optional shelf. Remote control uses pull-to-ground logic or RS422. Outputs are balanced analog, adjustable from -20 to +18dBm, and AES/EBU digital. Each CD is protected and stored in a special plastic CD "cart" case even while it's in the machine.

DN-951FA 60DEDN951FA MFR LIST \$1,500.00

The DN-961FA is a drawer-loading version for those stations who choose not to use the CD Cart format. No Auto Track Select.

DN-961FA 60DEDN961FA MFR LIST \$1,500.00

CALL 1-800-732-7665 FOR BRADLEY PRICE



JVC XU-301BK 3 CD-MD COMBO DECK

This triple CD player has three independent CD trays, with play and exchange system. CD Text feature allows retaining disc title and performer name, with 32 characters per title or name, for up to 200 CDs. Pitch control is also provided. But that's just the beginning: this unit also includes a MiniDisc recorder with 1-bit D/A and A/D converters, and features all five MD edit functions. An internal sample rate converter simplifies recording from any medium, and the XU-301BK has the ability to mix and record from CD, line input and/or mic input. A great machine for home, office, or studio use.

JVC 3CD-MD Combination Deck 60JVXU301BK \$550.00



JVC XL-V282BK CD PLAYER

This affordable single-play CD player features 10-key direct track access, 1-bit converter with 8x oversampling digital filter, and wireless remote control. Index play capability is available via the remote control. Convenient center-tray loading mechanism.

XL-V282BK 60JVLV282BK \$169.95



DENON C680 CD PLAYER

Track search select knob, jog/shuttle wheel, pitch control, rack mount, balanced audio outputs and auto cue are just a few features which make the DENON DN-C680 a "must have" single CD player for studio and broadcast production. You can listen to the end of a track using the End Monitor function, and the End Of Message function provides a warning to the operator that the track will end shortly.

This unit uses 18-bit, 8-times oversampling, and it occupies three rack spaces. Big friendly buttons, parallel remote port, RS-232C/422A switchable serial remotes, digital AES/EBU and SPDIF, and XLR balanced/RCA unbalanced analog outputs are provided. Be sure to call and ask about available add-on options such as the Sampling Rate Converter and SMPTE Kit.

C680 60DEDNC680 MFR LIST \$900.00

CALL 1-800-732-7665 FOR BRADLEY PRICE



CD PLAYERS

SONY CDP-D500 CD PLAYER



The latest professional quality CD player from Sony features precise cueing by CD frame unit, with a rehearsal function. A Jog Dial precisely places the cue point, while the cue/standby button offers back cueing capability. The CDP-D500 operates with a variety of remote interface options, including RS232C, GPI, and supplied wireless remote. Word sync input is provided via BNC connector, and $\pm 12.5\%$ varispeed may be employed in 0.1% increments.

Sony CDP-D500 6050CDP-D500 MFR LIST \$1,525.00

CALL 1-800-732-7665 FOR BRADLEY PRICE

MARANTZ CD PLAYERS



Our friends at Marantz offer two models to make your selection juicier: Both of these new decks are rack mountable and include $\pm 12\%$ pitch control, fader start input, S/PDIF digital output, cue-and-review, and optional wired remote. The PMD321 adds balanced XLR outputs and cue-to-music.

These decks will find fans among radio jocks, dance DJs's, churches, dance instructors, and other audio professionals. Call us for the lowdown. No single play mode.

PMD320	60MR320	MFR LIST	\$429.00
PMD321	60MR321	MFR LIST	\$529.00
Wired remote	60MRWRC700	MFR LIST	\$149.00
Infrared Remote	60MRRCSMD500	MFR LIST	\$160.00

CALL 1-800-732-7665 FOR BRADLEY PRICE

TEAC CD-P1440 CD PLAYER

New from Teac the CD-P1440 single CD player, offers both variable pitch control at $\pm 6\%$ and auto cue with



- Front panel headphone jack
- 4-way repeat
- Output level control
- Music skip and search

LED indicator. The multi-function 8-digit FL displays total, elapsed and time remaining. Select a cut using direct track access from the front panel or the remote.

CD-P1440 CD player 60TECDP1440 \$159.00 (special Bradley price!)

TASCAM'S CD FAMILY



The CD-201: Solid CD performance on a budget. You get rack mount, single-play function, and auto-cue with two sensitivity settings for tight starts with no dead air. Other features include fader start ports, RCA unbalanced outputs, and digital S/PDIF. The optional wired remote lets you create a custom playlist of up to 20 tracks, and has a search key to move through a track while you listen. The CD-201 occupies 3RU.



The CD-301 MKII: The same features of the 201, plus balanced XLR analog outputs and a heavier-grade transport. The new 1-bit delta-sigma D/A system in these models produces exceptional audio for your money.



The CD-401 MKII:

Broadcast features at a consumer price. It too is rack mounted, and comes with a fader start port and $\pm 6\%$ pitch control. This fine player has XLR balanced and RCA unbalanced analog outputs, plus digital S/PDIF.

Specs are broadcast standard, with 18-bit, 4x oversampling, a precision three beam pick-up for accurate tracking, and Tascam's "Zero Distortion" circuitry for superb audio. This unit will cue to index. A wired remote is optional.

CD-201	60TECD201	MFR LIST	\$529.00
CD-301 MKII	60TECD301MKII	MFR LIST	\$739.00
CD-401 MKII	60TECD401	MFR LIST	\$1,049.00

Wired remote controls

for 201 and 301MKII:	61TERC31	MFR LIST	\$90.00
for 401 MKII:	61TERC401	MFR LIST	\$90.00

CALL 1-800-732-7665 FOR BRADLEY PRICE



Store your CD's right in your rack. Middle Atlantic CD holder for 40 discs, 4RU tall 61MACD \$63.00

BACK TO THE FUTURE... WITH VINYL!

The warm familiar sound of vinyl is finding new fans and you can make them happy with the best-selling, always popular, still chuggin' along, built-like-a-brick, feels-like-old-times SL-1200MKII turntable from Technics. You'll see it in broadcast studios, clubs, and anywhere people want to get the best from their records.

The massive base and isolation feet keep the rumbles of the world away from the cartridge. Features include quartz lock, slide fader pitch adjustment of $\pm 8\%$, 0.7 second startup time, stylus illuminator, and speed strobe indicator. The SL-1200MKII comes with tonearm, base, and dust cover. The direct drive mechanism provides the lowest noise and rumble in this price range.

Need a cartridge and preamp? We've got 'em too. Call Bradley today.

SL-1200MKII 60TC1200 MFR LIST \$599.95

CALL 1-800-732-7665 FOR BRADLEY PRICE

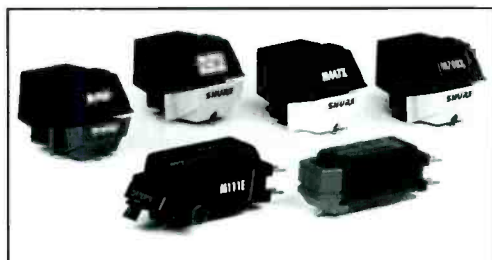

PHONO CARTRIDGES

Just a sample of the models we carry.

Shure M447X	60SHM447X	\$29.00
Stanton 500AL	60ST50AL	\$35.00
Stanton 680EL	60ST68EL	\$85.00

Call for other models.

ATI DISC-PATCHER

The DP100 is a one-way level/impedance interface with UL listing. It rejects common mode interference, which is important in high RF environments. The Disc-Patcher offers 102dB dynamic range, flat (20-20kHz, $\pm 0.25\text{dB}$) frequency response, and 0.005% THD. A Velcro mount is supplied. Great for CD players. (Ask about the P-1000 turntable amp.)



DP100	60AIDP100	MFR LIST	\$279.00
Rack Kit Holds one or two Disc-Patchers.	60AI20273	MFR LIST	\$28.00

CALL 1-800-732-7665 FOR BRADLEY PRICE

D4 RECORD CLEANING & SC-2 STYLUS CARE

D4 six ounce refill	61DID4R6	\$9.95
SC-2 fluid 3.5 ounce refill	61DISC2R	\$1.95

FIDELIPAC DYNAMAX MX

The no-nonsense MX series is for the studio manager looking for an economical way to get on-air performance in a bullet-proof console, and you get your choice of rotary or linear faders. These are modular mixers with active balanced line inputs and outputs, up-timer, internal power supply, and two inputs per channel, one of which may be configured for mic with an optional preamp kit (the console includes one).

Pre-fader patch points, two mono outputs (useful for mix-minus work), VCA design, and all-steel construction are standard. Let us fax you the specs.

Below we list just some of the 14 possible configurations of the MX series, ranging from 6 to 18 channels. Certain sizes offer you a choice between wide and narrow fader modules.

Call us for the full list and a price quote.

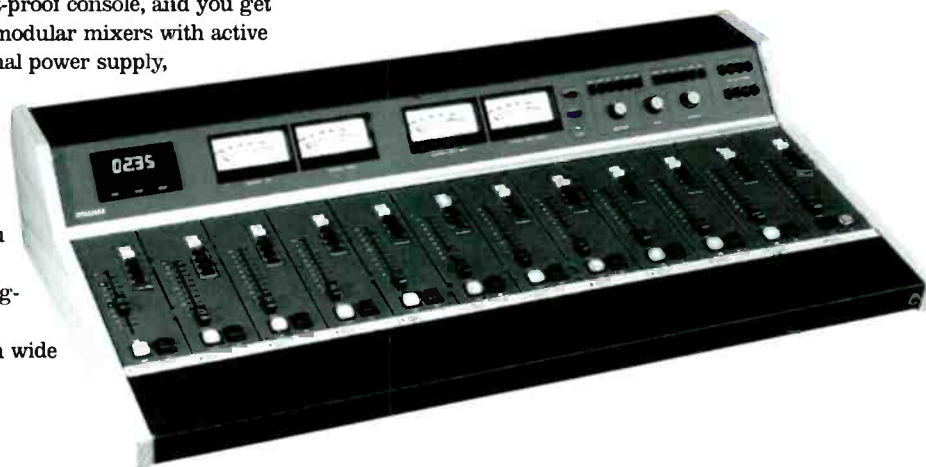

MX6R	6 channel rotary	60FPMX6R	MFR LIST	\$3,275.00	MX16E	16 channel linear	60FPMX16E	MFR LIST	\$6,740.00
MX8L	8 channel linear	60FPMX8L	MFR LIST	\$4,140.00	MX18E	18 channel linear	60FPMX18E	MFR LIST	\$7,150.00
MX10R	10 channel rotary	60FPMX10R	MFR LIST	\$3,950.00					
MX12L	12 channel linear	60FPMX12L	MFR LIST	\$5,360.00					

CALL 1-800-732-7665 FOR BRADLEY PRICE



BROADCAST CONSOLES

LOGITEK DIGITAL CONSOLE SERIES

It's the missing link for the all-digital radio station that gives you a new way to think about studio design. Logitek's unique design separates all the audio from the control surface, creating an audio engine that makes it easier and faster to install or build a studio. More than a digital version of an analog console, Logitek's audio engine is designed to give you all the benefits that new digital technology has to offer, including an interface to your computer-controlled hard disk audio system.

Logitek's Serial Sound digital audio engine can perform all the functions of a standard radio console: off/on, mixing, cue... and a fully configured engine can handle 64 mono inputs and outputs, 32 stereo inputs and outputs or any combination in-between. Analog and digital cards can be mixed to handle the required number of signals. You get as many busses as you have outputs. The engine can perform functions that are usually considered extra on an analog console, such as PAN and EQ, or profanity delay, which usually requires third party hardware. With hot swappable plug in cards, field upgrades, and servicing can be easily and quickly done without on-air interruption. Connections, LCD information display and card replacement are all done from the front side...making it easy, fast and convenient. In addition, you get the utmost flexibility in defining bus structures, talkback/intercom, relay closure, mix minus and more through Logitek's configuration software. Logitek's digital audio engine is built to maximize the functionality and value of your audio hard disk storage system. It comes ready to connect with a RS-232 port and a protocol to give any audio hard disk storage system total control.

The ROC-10 is one of the control surfaces available to Logitek's powerful audio engine. Its low profile, ergonomic design with choice of durable epoxy-based, oven-baked paint fits into any studio decor. Ruggedly constructed of aluminum, it has long-lasting, industrial-type buttons and switches for years of trouble-free use.

The ROC-5 is a totally assignable 5-fader control surface for the Logitek Audio engine. Its small size makes it ideal for satellite/automated stations, production, talk booths and newsroom environments. Only one cable is needed to link the ROC-5 to the Audio Engine. Designed for the new reality of radio, Numix's ergonomic shape gives your studio a modern, open look. Air talent can more easily see one another. Monitors can be placed closer and directly above, making them easier to read and giving a closer relationship between faders and on-screen events, meaning fewer mistakes.

Modular in design, you can build a control surface by simply adding fader wedges. Faders are no longer tied to an input, meaning more flexibility with fewer faders. The surface is as flexible as you choose: users can be limited or each have a preferred configuration. You can even have multiple control surfaces for the same engine...ideal for shows with talent and producers.

Logitek Digital Console priced upon application. Call 1-800-732-7665 for more information.



FIDELIPAC DIGITAL CONSOLE MX-D

The MX-D console from Fidelipac offers the broadcaster the ability to economically upgrade to digital console capability, while retaining analog input capability as well. This eight-channel mixer provides two inputs per channel, digital or analog, and the ability to select the number of desired input types at time of purchase. Mic preamps are standard on all analog modules, SPDIF or AES/EBU on digital modules. Analog modules digitize incoming audio and convert that signal to the MX/D mixer's internal data format. Digital modules convert all incoming digital signals to a common sampling rate and synchronize data with the internal matrix. Three digital channels plus three analog channels are available for the console output. Both output types support program, audition, and mono feeds. Digital out is at 48kHz sampling rate, although 32kHz may be preset at the factory prior to delivery, or 44.1kHz may be obtained optionally.



60FPMXDF	8 channel mainframe less modules	MFR LIST	\$6,500.00
60FPIMD	IM-D Digital input module with SRC	MFR LIST	\$300.00
60FPIMA	IM-A Analog input module with A/D	MFR LIST	\$340.00

CALL 1-800-732-7665 FOR BRADLEY PRICE



CONSOLES

Bradley Broadcast • 7313-G Grove Road • Frederick, MD 21704 • 800-732-7665 • 301-682-8700 • Fax: 301-682-8377 • Web: <http://www.bradleybroadcast.com>

ARRAKIS 1200 SERIES

1,200 Series consoles are the price and performance leader in Radio today. Available in 5, 10 and 15 input channel configurations, the 1,200 Series consoles feature big board features such as telephone mix-minus talkback, machine control logic, cue, muted monitor output, hi-level pre-selectors, independent headphone monitor with level control, total DC & VCA control, and the same quality components as used in top end modular boards. The 1200 Series ease of use, rugged reliability, and compact installation make this console ideal for On Air Production and News applications. Call you favorite Bradley Professional to choose the Arrakis 1200 that is perfect for you.



1200-55	62AR120055	MFR LIST	\$1,795.00
1200-105	62AR1200105	MFR LIST	\$2,995.00
1200-155	62AR1200155	MFR LIST	\$3,995.00

CALL 1-800-732-7665 FOR BRADLEY PRICE

ARRAKIS 12000 SERIES DIGITAL CONSOLES

12,000 Series consoles are available in 8, 18, & 28 channel mainframes. These modular consoles offer analog control of mics, phones and remotes, as well as optional digital fader modules and control interfaces. A variety of available input modules include features such as two mix-minus telephone hybrid drives (3 optionally), stereo cue, A/B input switching, remote start/stop and channel on/off logic with A/B follow. Digital timer, built in talkback, muted monitor and headset feeds for control room and two talk booths are also featured. Priced typically almost half the cost of any equivalent console, the 12,000 is the most popular full featured, top quality broadcast console in America. Call Bradley for a system configuration sheet

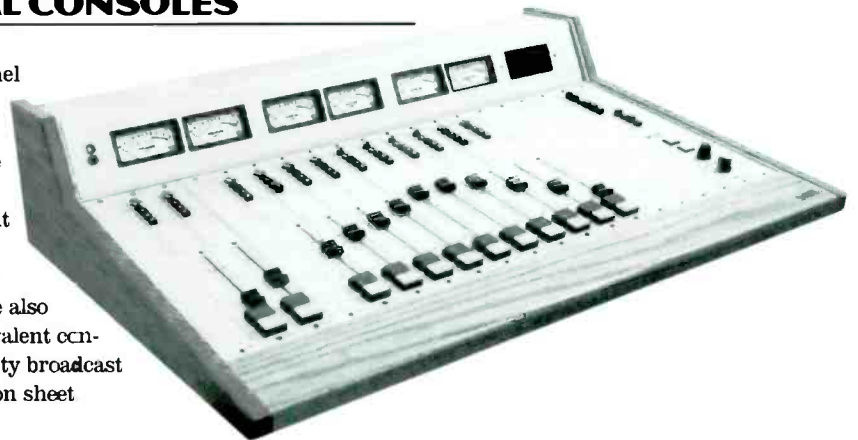

CALL 1-800-732-7665 FOR BRADLEY PRICE

RADIO SYSTEMS MILLENIUM CONSOLES

The Millennium from Radio Systems is available in 6, 12, 18, and 24 channel sizes. Millennium consoles all feature 3 output busses, complete remote control and metering, a comprehensive monitor section with standard eight position selector, and a clock/timer. Models differ only in their channel count and meter over-bridge. For example, the six channel has three meters, the 12 and 18 have five, and the 24 has seven. The 18 and 24 channel units also feature an auxiliary cutout for an extra meter or clock/timer.

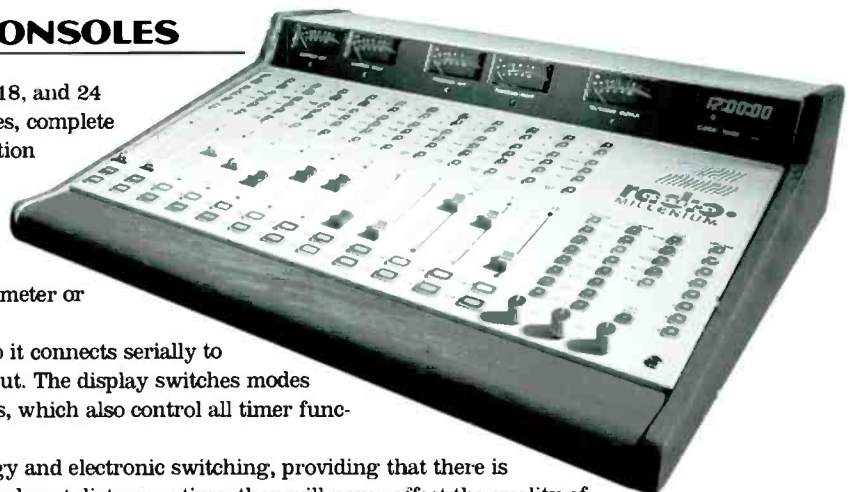

The Clock/Timer is part of the Radio Systems CT-6 line so it connects serially to its external master driver to function as a clock slave readout. The display switches modes between clock and up-timer via front panel console switches, which also control all timer functions.

Millenium consoles make extensive use of VCA technology and electronic switching, providing that there is no audio path through any switch or fader - as these controls get dirty over time, they will never affect the quality of your audio. In fact, there is no audio at all on the front panel except for the cue speaker! This dramatic lack of internal audio wiring and long cable runs inside all Millenium consoles means exceptional RFI immunity and overall low noise levels. Call your Bradley Professional today to configure the Radio System Millenium console perfect for your facility.

RS6A	60RS10970	MFR LIST	\$4,495.00
RS12A	60RS10901	MFR LIST	\$5,995.00
RS18A	60RS10974	MFR LIST	\$8,495.00
RS24A	60RS11005	MFR LIST	\$12,995.00

See page 130 for
Radio Systems Clocks

CALL 1-800-732-7665 FOR BRADLEY PRICE



RECORDING CONSOLES

MACKIE DIGITAL 8-BUS CONSOLE

New!

Employing powerful DSP technology, Mackie has created a whole new class of digital console. It features a familiar analog-like interface and far more processing power than any other "affordable" digital mixer. The Digital 8-Bus uses an industry standard 32-bit Pentium Compatible CPU Processor with 16MB of RAM. Besides keeping track of 72 channels of audio, it can perform data operations like reading and writing to built-in floppy and hard drives (on the separate computer unit), and driving a full-color monitor via a built-in SVGA video port. You can even add a PC-compatible keyboard and PS/2(tm) mouse. The integral meter bridge displays tracking, monitoring levels, and each channel's aux send levels. Bus Assign lets you quickly route channels to busses. It's like a digital patch bay!

Write-Record enables automation on the current channel. For those of you who want instant hands-on control, the D8B's automation can also be run in Touch mode. As soon as any recordable control is adjusted, the corresponding channel automatically goes into automation record mode. The channel strip V-Pots give you instant feedback and control over panning, eight mono and two stereo aux send levels.

Behind the Digital 8-Bus' 100mm motorized faders are four banks of channels, each available at the touch of a dedicated button. Channels 1-24 are for tracking. Channels 25 to 48 are tape returns. A third bank controls the Internal Stereo Effects Returns and four external stereo effects returns. In addition, you get a fourth bank - 8 virtual group masters, 8 faders for MIDI control, and 8 bus master faders. When you switch banks, the SVGA display changes, reflecting the selected bank. Convenient Speaker Select and Level Controls let you choose between near-field or large speakers. You get two Phones/Cue Mix sections that allow you to choose the source for two separate, stereo headphone mixes. Each provides headphone outputs, and there is a built-in Talkback Microphone. There are three stereo analog inputs for external cue sources. Each of the 48 main inputs channels feature a gate, compressor/limiter and a four band parametric EQ. The two stereo reverb/delay units can be expanded to eight through the Mackie DSP card.

The Digital 8-Bus is expandable, with analog and digital I/O cards. Pop in one to three D8B I/O cards and replace an external autolocator with the built-in Tape Transport Controller. You can also arm up to 24 tape machine tracks directly from the Record Ready button on each D8B channel strip. The multifunction Position Display above the transport section reflects tape position in SMPTE/Real Time (hours: minutes: seconds)/MIDI (bars: beats), and lets you mark multiple in and out points. A floating window lets you graphically control 5.1 and 7.1 sound source centers anywhere in the sound field.

Ask your Bradley professional for detailed specifications and a copy of the Mackie video about this incredible console.

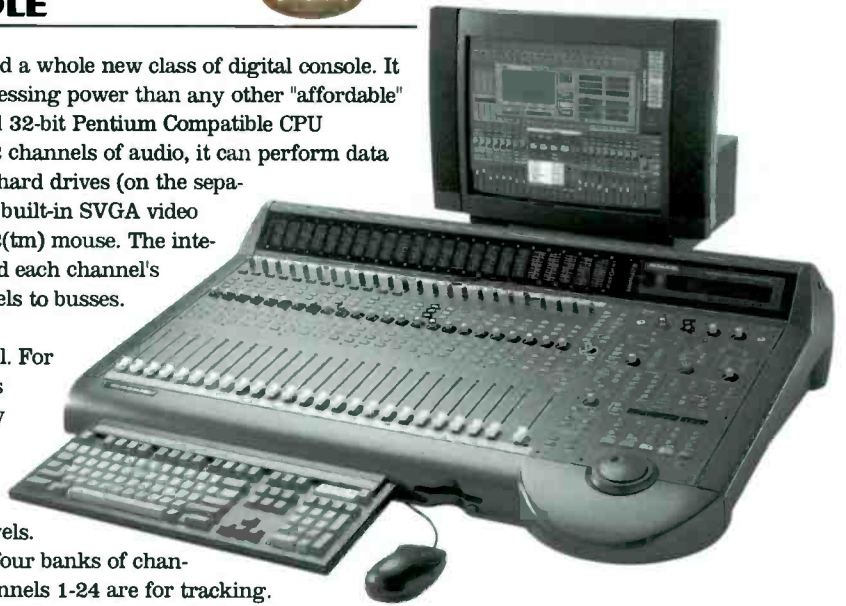

MACKIE 8-BUS SERIES

What's not to like about the 8-BUS? It's a recording and PA board, available in 16, 24, and 32 channels. Features include +48V phantom power, four-band EQ, six stereo assignable AUX returns, stereo solo, and talkback with mic. Double your inputs for mixdown with MIX-B. All channels have high headroom mic preamps.

Two headphone monitoring set-ups allow you to build custom mixes for the talent and the operator. All channels provide patching, direct out, tape returns, balanced mic inputs (XLR), and balanced line inputs (1/4"); the console has balanced XLR's on the main L/R output. The power supply is rack mountable.

Distortion, response, and gain specs are suitable for today's digital sources. An optional tiltable meter bridge provides ladder LED's for each input channel and VU meters for the main outputs. We can also provide pricing on metal stands and a "side car" with rack space for power supplies, patch bays, and more.

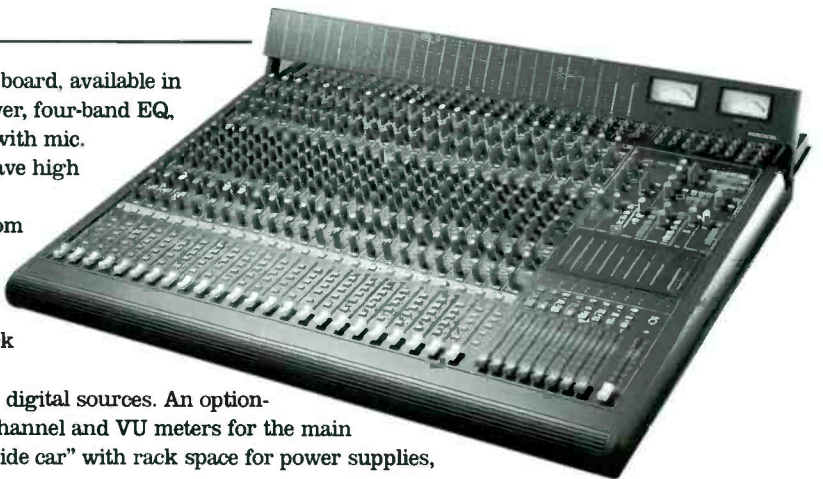

32-8	32x8x2	60MD328	MFR LIST	\$4,249.00
24-8	24x8x2	60MD248	MFR LIST	\$3,399.00
16-8	16x8x2	60MD168	MFR LIST	\$2,719.00
MB32 Meter Bridge for 32-8		60MDMB32	MFR LIST	\$899.00
MB24 Meter Bridge for 24-8		60MDMB24	MFR LIST	\$799.00
MB16 Meter Bridge for 16-8		60MDMB16	MFR LIST	\$699.00

CALL 1-800-732-7665 FOR BRADLEY PRICE



CONSOLES

Bradley Broadcast • 7313-G Grove Road • Frederick, MD 21704 • 800-732-7665 • 301-682-8700 • Fax: 301-682-8377 • Web: <http://www.bradleybroadcast.com>

YAMAHA O3D DIGITAL MIXING CONSOLE

If you're ready for a compact, comfortably priced, full-featured digital mixer - one especially made for professional project and post production studios relying on modular digital multitrack recorders such as TASCAM, ADAT, AES/EBU and YAMAHA digital formats - then you're ready for the O3D Digital Mixing Console. The O3D is a self-contained, 26-input/18-output fully-automated digital mixing console, featuring an intuitive user interface, ease of operation and a long list of essential professional engineer's tools. Fast 32-bit internal DSP, 20-bit ADs and DAs, 32-bit onboard multi-effects processors with freeze (sampling) and guitar amp simulation effects, motorized faders, fader and mute grouping, surround sound mixing, scene snapshot memories, onboard automation, and MIDI remote capabilities, combine to make this console a complete solution.

The O3D's flexible configuration of analog and digital inputs and outputs makes it suitable for a wide range of professional mixing applications. Included are 24 input channels and a fully-featured stereo input for a total of 26 inputs, plus 4 bus outputs, 4 auxiliary and 2 internal effect sends, a main stereo mix bus and a solo bus. Stereo digital inputs and outputs, plus 8 digital inputs and outputs (optional, via a YGDAI slot), provide a total of 10 digital inputs and 10 digital outputs.

Input channels 1-8 have mic preamps, XLR and balanced stereo 1/4" phone connectors, and individual phantom power switches. Inputs 9-16 feature balanced stereo 1/4" connectors. All 16 channel inputs feature input gain controls with 30 detents. Channels 1 and 2 include analog inserts for connecting external dynamics processors. Aux sends and bus outputs can be paired together for stereo operation and can be routed to the control room monitors for cue mixes, with onboard effects returns included. The four bus and four aux send signals are output via balanced stereo 1/4" connectors.

Coaxial and AES/EBU stereo digital I/O connectors permit direct connection to DAT recorders and other compatible digital devices. The stereo digital input signals can be routed to the stereo bus for submixing, or to the stereo input channel for mixing and processing. The number of inputs can be increased by digitally cascading two O3Ds together, or one O3D and O2R. The O3D's YGDAI (Yamaha General Digital Audio Interface) slot, which accepts the same single-size YGDAI cards as the O2R, provides 8 digital inputs and 8 digital outputs for direct digital connection to all major modular digital multitrack recorders.

The O3D features an array of onboard parametric EQs and dynamics and effects processors. Comprehensive libraries of preset EQ, and dynamics setting provide a great place to start or for reference, and plenty of user programs are available to store your own. 40 four-band parametric EQs and 40 dynamics processors are available for all 26 individual channel inputs, the 2 onboard stereo effects returns, the 4 bus outputs, 4 aux sends, and main stereo outputs. The onboard dynamics processors include compressor, expander, gate, ducker and compander functions, and a total of 80 dynamics memories.

Yamaha O3D Digital Mixer	60YA03D	MFR LIST	\$3,699.00
AES/EBU Card	60YACD8ES	MFR LIST	\$359.00
ESAM II Upgrade	60YA03DYEK	MFR LIST	\$999.00

CALL 1-800-732-7665 FOR BRADLEY PRICE



YAMAHA O1V

Could Yamaha make a good thing better? Yes, that is exactly what has happened with the release of the O1V. The O1V is an integral mixing tool for sound reinforcement installations and live sound situations where the ability to return to previously stored mixer settings is a necessity. While the Yamaha O1V retains all the popular ProMix O1 features, including snapshot storage, instant reset of all functions, motorized faders, on-board dynamics, parametric EQ and digital effects, it includes some significant advances to meet the needs of the sound reinforcement and live sound markets.

The Yamaha O1V provides 24 full-featured channels, two stereo effect returns, six buses, six aux sends plus direct outputs on channels 1-16. It offers balanced connectors for all inputs and outputs, with parallel 1/4 in. and XLR inputs, Mic preamps, and 48-volt phantom power on channels 1-12. The primary input channels (1-16) each feature the same 4-band parametric EQ and limiter compressor/gate found in the Yamaha O2R, plus a 250 ms delay line. Input channels 17-24 can accept digital or analog sources. Analog outputs include up to 300 ms of delay, ideal for speaker alignment in sound reinforcement applications. In addition to dedicated analog connections for the stereo bus and monitor outputs, four analog OMNI-SEND outputs can be programmed to output any of the buses, aux 1-4, or channel direct outputs.

The O1V adds a new OPTION I/O card slot allowing for the installation of any of five new MINI digital I/O cards. Optional cards facilitate interface to popular 8-channel digital multi-track recorders and signal processing equipment in Alesis ADAT, Tascam TDIF, or AES/EBU digital formats. Not doing digital yet? Optional analog cards allow the user to configure the O1V for applications in which all the sources and output equipment is analog.

O1V	60YA01V	MFR LIST	\$1,999.00	CALL 1-800-732-7665 FOR BRADLEY PRICE
-----	---------	----------	------------	---------------------------------------

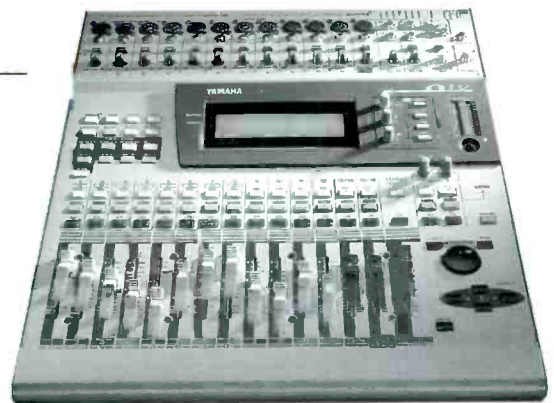
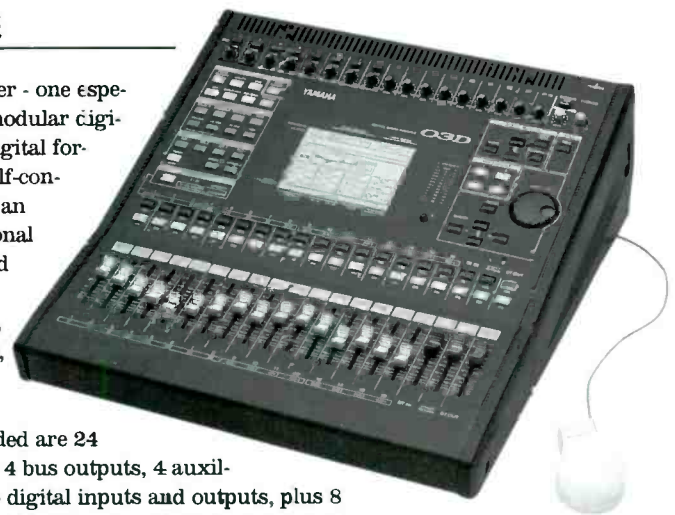

CONSOLES



RECORDING CONSOLES

MACKIE MICROSERIES MS 1202-VLZ

This is the updated version of Mackie's instant classic compact mixer. The improvements aren't just cosmetic. If you go shopping for a mixer, you'll find it very hard to even come close to what this 12-channel mixer does for the money. Use it as a main board in a small studio, as an effects submixer, or as a mic preamp.

Features include: very low impedance design (for better noise specs), 60dB gain and low-cut filter on channels 1-4, three-band EQ on all channels, PFL solo, balanced XLR main outputs (as well as 1/4"), RCA tape interface, a sophisticated control room/phones section, mutes on every channel, and the same ALT 3-4 system used on the big brother CR-1604 mixer, giving you an extra stereo bus when you mute a channel. Channels 1-4 have XLR mic inputs and 1/4" TS line inputs, while channels 5-12 have 1/4" TRS line inputs configured in four stereo pairs. Input channels have center detent gain and pan controls, two aux sends, and channel inserts on 1-4. The master section includes two stereo aux returns, head-phone level control, RCA phono jack tape I/O, and the LED display. The power supply is built in.



MicroSeries 1202 VLZ	60MD1202VLZ	\$349.00	Rack Mount (7 RU)	60MDRM1202VLZ	\$12.00
Kases Soft Carrying Case	40KEKB22	\$25.95			

MACKIE MS 1402-VLZ

The MS1402-VLZ is a fantastic and affordable tool for all sorts of mixing environments. With 6 high-headroom/low-noise mic preamps, 60mm faders, 3-band EQ, mute and solo switches, and ample routing flexibility, you'll find the MS1402-VLZ everywhere, from video post-production, live club performance, multimedia, home studio, corporate boardroom.

A low cut filter on mic channels 1-6 lets you cut out mic thumps and room rumble without sacrificing your low frequency EQ. The Control Room/Phones matrix makes mixdown routing a snap. And the Mute/Alt 3-4 features gives you two more output sources, effectively turning this 2-bus board into a 4-bus problem-solver. You won't find a more feature-laden mixer in this price range.



MS1402 VLZ	60MDMS1402VLZ	\$485.00
------------	---------------	----------

NIGEL B 1402 STAND

Need a stand for your Mackie 1402 mixer? Nigel B has anticipated your every need. The 1402 Mixer stands on an instantly-adjustable angled platform. When assembled, a cover on the column conceals all the wiring.

1402 Stand 60NB1402STD MFR LIST \$379.00 CALL 1-800-732-7665 FOR BRADLEY PRICE



MACKIE CR-1604 VLZ MIXER

The updated version of the CR-1604 mic/line mixer maintains the sound quality and unique five-way mounting configuration of the famous original, and adds a long list of new features. They include a true four-bus design, with channel assigns to busses 1-2, 3-4, or main L/R, plus bus assigns to left or right Main Mix. Now you also get acclaimed Mackie mic preamps on all 16 channels, 60mm log-taper faders, mid-range EQ sweepable down to 100Hz up to 8kHz, inserts on every channel, control room outputs, and a new trim control gain structure to handle everything from hot digital multitrack inputs to quiet vocals.

Other improvements: low-cut filter and signal-present LED on every channel, mono output volume control, RCA ins and outs for two-track mixdown, and lots of aux and effects power. And the trim control is accessible no matter how the I/O pod is rotated.

Post-fader direct outputs on channels 1-8 allow split monitoring. If you can't afford an eight-bus console, this is a reasonable alternative for multitrack and mix-down work. The mixer is rackable. The RotoPod option brings the connectors face-forward. MixerMixer is an active combiner that lets three 1604's act as one; the remote fader option then lets their main output be controlled by one fader. CordPack includes all cables to connect three 1604's with one MixerMixer.



CR-1604 VLZ	60MD1604VLZ	\$939.00	Rotopod	60MDRPVLZ	\$25.00
MixerMixer	60MDMM	\$229.00	Remote Fader	60MDRF	\$75.00
CordPack	60MDCP	\$69.00			



CONSOLES

Bradley Broadcast • 7313-G Grove Road • Frederick, MD 21704 • 800-732-7665 • 301-682-8700 • Fax: 301-682-8377 • Web: <http://www.bradleybroadcast.com>

SPIRIT FOLIO FX16

New!

You need a 16-channel console for live and studio mixing, but you also need an effects unit. FX16 gives you all this in a rugged, compact 10U frame, because it's a dedicated live/recording mixer from Spirit and a programmable Lexicon effects unit. Take FX16 to a venue and its 16 mic preamps, subgroup, mono out, HPFs and up to 3 pre-fade aux sends make it a versatile live console. Back in the studio, its 16 pre/post fade direct outs and 3-band swept mid EQ make it the perfect mixing tool. But what makes FX16 so special is its internal Lexicon effects unit with 16 editable programs, which saves you the cost of an external unit that ties up valuable rack space. All main inputs (except 2-track return) on FX16 are balanced. In addition, outputs are impedance balanced so that long cable runs are possible without the worry of interference. FX16 uses Spirit's patented UltraMic(tm) Preamps. These represent a revolution in low cost mixer electronics with the ability to handle +22dBu of input level, a high CMRR and an EIN figure that's as close to the theoretical noise floor as it's possible to get. In addition, the mic and line inputs offer up to 60dB of gain range. FX16's relocatable jackfield means that if you are using the console in a rack you can connect your leads to the "underside" of the console - saving rack space and unsightly trails of cables.

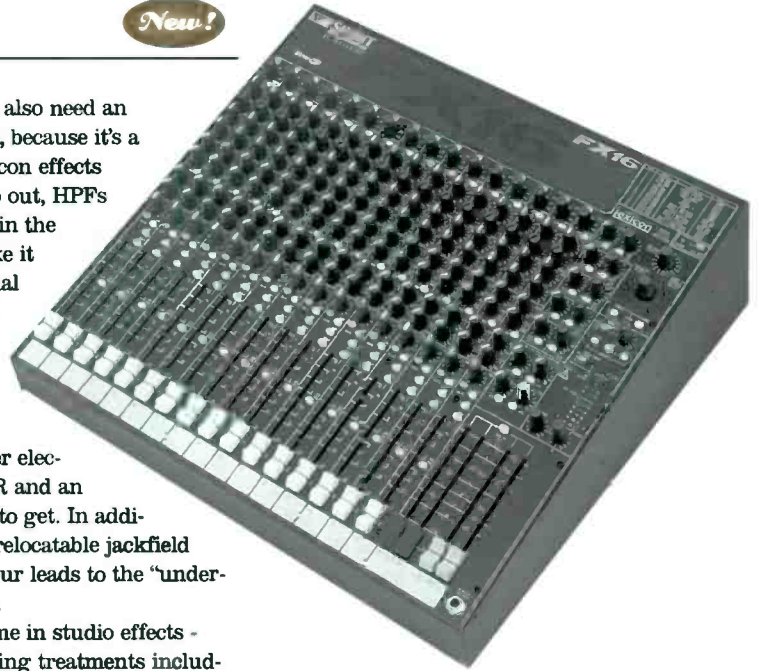

Spirit is the only low-cost mixer that can offer you the leading name in studio effects - Lexicon. The Lexicon effects section offers a wide range of breathtaking treatments including reverbs, delays and choruses. Up to 26 inputs as standard - with a maximum of 16 mic/line inputs and 4 effects returns, this mixer offers plenty of input capability. Even the 2-track return can be routed to mix, providing a valuable extra stereo input. Each channel includes a Direct Out for multitrack recording or individual effects feeds. A balanced XLR connector allows you to connect microphones, with Phantom Power available from the master section. The balanced 1/4" jack allows you to connect electronic instruments, such as keyboards, with balanced or unbalanced cables. Signal processors such as compressors or graphic EQs connect to each channel's insert point using a "Y" cable.

Spirit FX16 Console 605FRW5528 MFR LIST \$1,199.95
 CALL 1-800-732-7665 FOR BRADLEY PRICE

**Also Available:
 SPIRIT FOLIO FX8 CONSOLE**

A portable 8-channel, 4-bus mixer with built-in Lexicon effects. 10 rack units.
Spirit Folio FX8 605FFX8 MFR LIST \$699.95
 CALL 1-800-732-7665 FOR BRADLEY PRICE

MACKIE SR SERIES

And lest you think Mackie forgot about four-bus mixers, allow us to introduce you to their SR Series. Great for live sound, also suitable for anyone doing multitrack work. Churches, community centers, and budget-minded broadcasters will want to consider them.

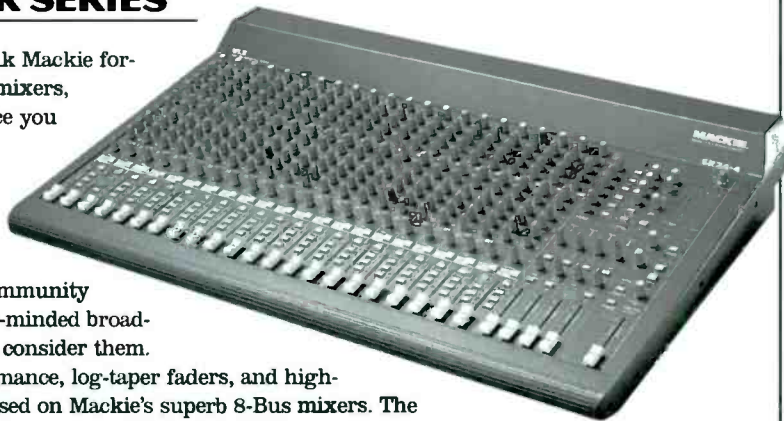

The audio performance, log-taper faders, and high-end preamps are based on Mackie's superb 8-Bus mixers. The 4x2x1 bus design is easy to master. Features include six balanced aux sends with masters, PFL/AFL, sophisticated EQ, LED's on each channel for overload and signal present, 60dB of gain on the mic preamps, "double bussed" sub outs for 8-track recording, phantom power, balanced main outputs on both XLR and TRS plus a separate mono sum, balanced inputs (XLR and 1/4") on every channel, and an internal power supply. These boards weigh only 30-40 pounds.

Mackie brochures are among the most informative and fun in the business. Let us send you a copy about the Mackie board of your choice.

32-4 32x4x2x1 60MDSR324 MFR LIST \$2,299.00
 24-4 24x4x2x1 60MDSR244 MFR LIST \$1,599.00

CALL 1-800-732-7665 FOR BRADLEY PRICE

**BROADCAST TOOLS
 CONSOLE
 CONTROLLER II**

This desktop device has three channels of insert switching to help integrate your Mackie mixer or workstation into a broadcast studio. Console insert points or source equipment (mic-preamps) may be turned off or on, as indicated by a red LED on each switch. It has a switch to allow internal/external monitor input switching or monitor amp mute control, and monitor level control. For more than three channel inserts, cascade multiple CCI's. Connectors are TRS 1/4" jacks, remote control is on a DB-9 (control, tally, and warning light/skimmer), and switches are SPST momentary.



Console Controller II
 60BTCII MFR LIST \$299.00
 CALL 1-800-732-7665 FOR BRADLEY PRICE



DIGITAL CONSOLES

SPIRIT 328 DIGITAL CONSOLE

Spirit 328 represents a revolution in low cost professional audio, bringing all the functionality and sonic excellence of digital mixing to a brand new audience. With its unique console based interface, 328 finally bridges the gap between analog and digital mixers, retaining the spontaneity and ease of use of an analog console yet providing all the advantages of digital, such as instant TOTAL recall, moving fader automation and onboard Lexicon effects. Quite simply, Digital 328 is the most advanced analog 8 bus you'll ever drive combined with the easiest digital console you've ever used. For a mixer with such a small footprint, Digital 328 packs an extraordinary number of inputs. 16 analog mono mic/line channels - each with its own balanced XLR connector, dedicated insert point and access to phantom power - come as standard, along with 5 stereo inputs. With the addition of 16 digital tape returns on 328's TDIF and ADAT optical interfaces, a maximum of 42 inputs are possible. Every input is fully routable to any of the 8 groups and has access to the full complement of 328's parametric EQ, signal processing, onboard effects and auxiliaries.

Soundcraft has designed Spirit 328 to operate like your old analog 8-bus console. There's instant access to any channel, group or master feature with one button press. The key to it all is Spirit 328's unique "E-strip", the lighter-colored bank of encoders and switches that runs across the center of the console. Simply select a channel and the E-strip immediately becomes a "horizontal input channel" with instant access to all that channel's EQ, aux sends, channel pan and routing. Alternatively, press any button in the rotaries section above the E-strip and the encoders change to become a channel pan, auxiliary send, or Lexicon effects send for each channel. Select a fader bank to display mic/line input faders, tape returns faders, or group and master faders and that's it! With 328, everything you need is immediately accessible from the front panel of the console - giving you the freedom to let your ears decide. If you want the functionality of a digital console but the usability of your old analog 8 bus, then Spirit 328 is for you.

Only 328 can offer the world's premier name in studio effects on board - Lexicon. Two separate effects units are included, offering a full range of reverbs, choruses, delays, and flanges as well as dual effects such as chorus plus delay - all with fully editable program and parameter settings. Two Digital 328s may be digitally cascaded, giving you up to 84 inputs at mixdown and 32-track digital recording capability. The 328 reads and writes MTC and reads all SMPTE frame rates, with a large readout display instantly indicating current song position. Store and locate points are accessible from the console's front panel, with 328's transport bar controlling a wide range of devices including Tascam and Alesis digital recorders.

Spirit 328 605F328 MFR LIST \$4,999.95
CALL 1-800-732-7665 FOR BRADLEY PRICE



YAMAHA 02R

The Yamaha 02R is a digital recording console that's compatible with Tascam, ADAT, AES/EBU, and Yamaha digital formats. This is a 40-input, 8-bus, fully automated mixing console. Optional interface cards allow integration with any digital recorders, whether tape-based, or non-linear hard disk or magneto-optical. Motorized faders, snapshot memory of settings, two effects processors... an amazing amount of power. Call Bradley for info on Yamaha's latest digital success.

02Rv2 60YA02R MFR LIST \$8,899.00
CALL 1-800-732-7665 FOR BRADLEY PRICE

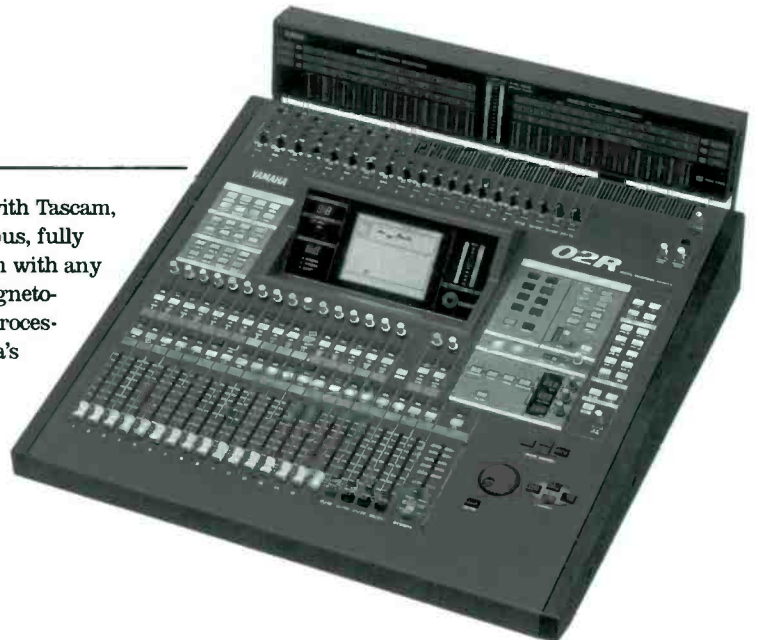

CONSOLES

TASCAM TM-D1000

Tascam has done it this time! The TM-D1000 is the most versatile and affordable compact mixer available. Designed for the home studio, project studio or off-line editing suite in a post-production environment, this feature-packed console provides an 8-track configuration with expansion capability to accommodate 16 tracks with eight analog and eight digital channels. With support for multiple digital I/O protocols and MIDI Machine Control capability, this mixer provides an outstanding level of performance and functionality and will integrate easily into any modern studio. Expandable with an additional interface card, the optional IP-TD1000 adds eight channels of TDIF or four channels of AES/EBU or SPDIF. The TM-D1000 is easily augmented with the optional FX-1000 effects board which adds four channels of dynamic processing and one stereo pair with reverb, chorus, delay and flanger.



New!

TM-D1000 60TETMD1000 \$999.00

TASCAM TM-D8000 DIGITAL RECORDING CONSOLE

The TM-D8000 represents the pinnacle of leading-edge technology in digital production and post-production consoles. With AES/EBU and S/PDIF digital main stereo outs in addition to both XLR balanced and RCA unbalanced analog outputs, internal snapshot automation, optional dynamic automation with a Mac G3 via an external computer and an onboard transport controller, this console enables you to work both intuitively and quickly. With onboard machine control supporting TASCAM sync, Sony P2 and MIDI Machine Control protocols, the TM-D8000 will easily integrate into the most demanding production environments.



New!

Basic configuration of the console is 40 mono inputs and 6 stereo inputs, each with its own fader, and assignable to any of the 8 busses, stereo

mix or directly to the digital tape send of the corresponding channel. There are 24 dedicated digital tape sends and returns via TDIF-1, making digital connection to DA-98s, DA-88s or DA-38s simple. You'll also find 16 high-quality analog inputs that are individually switchable between the XLR mic pre-amps or balanced TRS line inputs. Each of these channels provides analog insert points and phantom power. These 16 analog channels can also be switched to TDIF, thus providing 40 channels of TDIF at mixdown. Additionally, channels 9-16 can be selected to accept either 8 channels of AES/EBU or 4 channels of AES/EBU and 4 channels of S/PDIF.

For dynamic effects processing, the TASCAM TM-D8000 offers 8 internal digital dynamic processors, including GATE, COMPRESSION or EXPANSION. Much like the EQ settings, parameters for the dynamic modules can be stored and recalled at any time. You can easily incorporate your existing dynamics processors into the mix using the 4 channel insert matrix included in the TASCAM TM-D8000. Any of the dynamic modules or insert matrix points are assignable to any of the channel inputs, tape returns or stereo mix.

Tascam TM-D8000 60TETMD8000 MFR LIST \$9,999.00
CALL 1-800-732-7665 FOR BRADLEY PRICE



SOUNDCRAFT K1 MIXING CONSOLE

Soundcraft also offers this new, affordable four-bus mixer. You order your inputs in multiples of four, so you save money over fully modular designs without sacrificing a lot of flexibility.

The K1 offers 8, 16, 24, or 32 mono or stereo inputs. The 4x4 matrix allows multiple speaker systems to be set up easily. Stereo inputs can connect to DAT, CD, or tape sources. Four-band EQ, six auxiliaries, and peak-reading bargraph meters make this compact board easy to use.

Mono modules accept any mic or line source via XLR or 1/4". Phantom +48V, polarity reverse, high pass filter, pre-fader insert, and pan are standard. Two stereo input channels are fitted in every board as standard; more can be added in blocks of four. Each stereo channel has two 1/4" inputs, one of which can be set with RIAA curve for phono cartridges.

Faders are 100mm. Power supply is external. Weights range from 30 to 70 pounds. Order one of the pre-loaded setups shown below, or call for other options.

K1 8 channel w/8 mono & 2 stereo	605FRW5184	MFR LIST	\$2,995.00
K1 8 channel as above, rack mountable	605FRW5185	MFR LIST	\$2,995.00
K1 16 channel w/16 mono and 2 stereo	605FRW5186	MFR LIST	\$3,995.00
K1 24 channel w/24 mono and 2 stereo	605FRW5187	MFR LIST	\$5,495.00
K1 32 channel w/32 mono and 2 stereo	605FRW5256	MFR LIST	\$7,695.00

CALL 1-800-732-7665 FOR BRADLEY PRICE

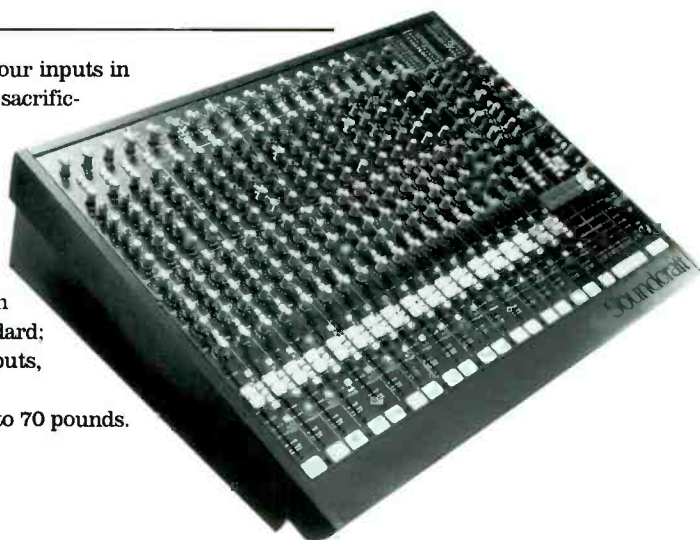

ASHLY MIXERS



Ashly's rackable audio mixers have a five-year warranty so you can install them with confidence in studios, remote vehicles, or meeting rooms. The MX-508 is an eight input, stereo output mixer, with low noise and distortion. Each input has XLR mic and 1/4" TRS line connections, level trim with clipping indicator, three-band EQ with sweepable mid, two aux sends, and channel patching. The mixer also has a stereo input on RCA jacks for a tape player or CD.

Phantom power is available for the mic inputs. Ports include a stereo, +24dBm transformer balanced output on XLR's, a balanced stereo output on 1/4" TRS, an independent mono output, a tape output on RCA jacks, and headphone. The master section has pre-master sub in/out patches, two aux sends and returns, and LED metering. For ease of service, this three-space mixer is modular from the rear. A Bradley Best Seller.

MX-508	60ASMX508	MFR LIST	\$1,400.00
--------	-----------	----------	------------

CALL 1-800-732-7665 FOR BRADLEY PRICE

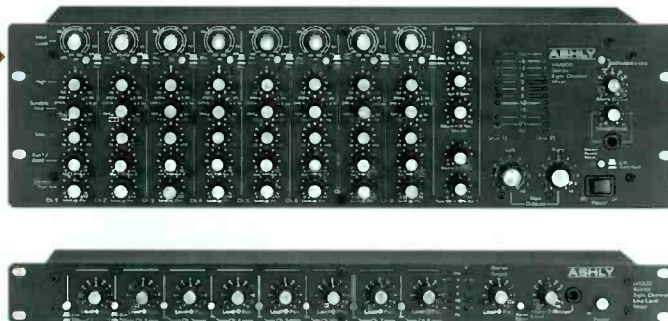

Also Available:

LX-308: An eight-channel line mixer with stereo, unbalanced, line level inputs and outputs. Inputs 1 and 2 may be switched to accept mic level. One rack space high.

LX-308	60ASLX308	MFR LIST	\$499.00
--------	-----------	----------	----------

CALL 1-800-732-7665 FOR BRADLEY PRICE

RANE SM-26B SPLITTER/MIXER

As we pointed out in this space last year, the SM-26B is unusual because it does so much. Allow us to explain.

First, it's a six-to-two, line level mixer, accepting six balanced or unbalanced line inputs which are applied to six Level and Pan controls. An added master stereo input brings the total inputs to eight. The mix is sent to left and right output jacks. The unit is also a splitter: it can take one or two line level inputs, and split these to any of the six mono outputs on the rear. In this mode you can control the level from each input bus to each output. It is also a six in, six out buffer amp, and a -10 to +4 shifter. The SM-26B may also be used in a combination of modes. One example: inputs 1 through 3 are mixed to the left and/or right output busses, while outputs 4 and 5 are delivering signal originally applied to the left and right master inputs, and output 6 is driven from input 6 straight through. All ins and outs are 1/4" TRS active balanced. Sorry, it won't do windows.

SM-26B	60RNSM26	MFR LIST	\$429.00
--------	----------	----------	----------



CALL 1-800-732-7665 FOR BRADLEY PRICE

YAMAHA MX200 MIXER

GREAT FOR INSTALLED SOUND

The price of these models demands attention. Available in four sizes, all with stereo and mono output busses, the MX200 is intended primarily as an SR mixer for small concerts, but will find a home in other situations.

All input channels have switchable "A" and "B" inputs: the "A" inputs are balanced XLR with phantom power, the "B" inputs are balanced TRS phone jacks that also accept unbalanced signals. Insert patch points on every channel let you add processing. A -20dB input pad and -16 to -60dB rotary gain control let you match levels with virtually any input source, and a switchable 80Hz high-pass filter cuts out hum and rumble.

Three band EQ, four aux sends, pan pots, on/off switches, and pre-fader listen are provided. Four switchable LED bargraphs monitor your bus signals with peak-reading accuracy. Independent master faders control the left and right stereo busses, as well as the mono bus.

Also available:

Yamaha's M2000 mixers have eight output groups and stereo and mono busses, and come in frame sizes from 16 to 40 channels. Call us for details.

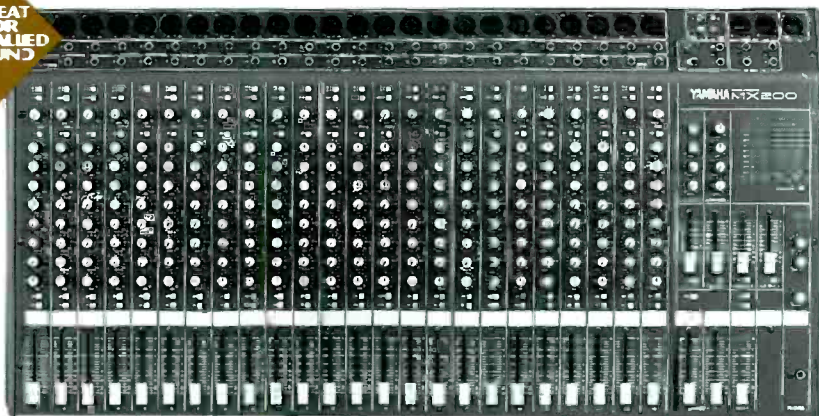

MX200-8	60YAMX20C8	MFR LIST	\$749.00
MX200-12	60YAMX20C12	MFR LIST	\$949.00
MX200-16	60YAMX20C16	MFR LIST	\$1,099.00
MX200-24	60YAMX20C24	MFR LIST	\$1,499.00

CALL 1-800-732-7665 FOR BRADLEY PRICE

TASCAM UTILITY MIXER

The ten-pound M-08 gives you 12 inputs (four mono, four stereo), two-band EQ, phantom power, effect returns, mute, PFL, overload indicators, and daisy chain connections.

Size: 13" x 3-1/2" x 12-7/16".

M-08	60TEM08	MFR LIST	\$349.00
Rack Kit	60TERM08	MFR LIST	\$15.00

CALL 1-800-732-7665 FOR BRADLEY PRICE



U.S. AUDIO RACK MOUNT MIXERS

GREAT FOR INSTALLED SOUND

Designed and built in the U.S. by Whirlwind, these mixers are available in a version to answer any thorny problem.

The MIX-5S is an all-purpose mixer for sound contracting and similar work. It's a single-space, five-input device with four input channels (each with XLR and 1/4" TRS balanced connectors for mic or line), LED level indication, phantom power, pan, and an aux channel with RCA for a tuner or CD player. The outputs are XLR and 1/4" TRS. The MIX-5 is the popular mono version and a notable value.

The MIX-6 is a broadcast-quality mixer in one rack space. Inputs 1-4 and the stereo outputs are capable of any combo of line- or mic-level, XLR or 1/4" balanced or unbalanced signal. Input 5 is a stereo RCA pair, input 6 is a stereo 1/4" pair (balanced or unbalanced). This last input is switchable to take it off the output and patch it to the headphone for solo monitoring. This unit has a switchable stereo limiter, phantom power, and internal power supply.

MIX-8 provides eight stereo line level inputs, with headphone monitoring, stereo aux sends on inputs 1-4, and pans on inputs 5-8. Each channel has volume control; output level is set with a single stereo master pot. A foot-switchable circuit can mute the main outputs and allow monitoring of the main mix. A clip LED indicates overload.

MIX-44 is an unusual, two-space device that lets you create four discrete mixes from four separate inputs. It takes four separate

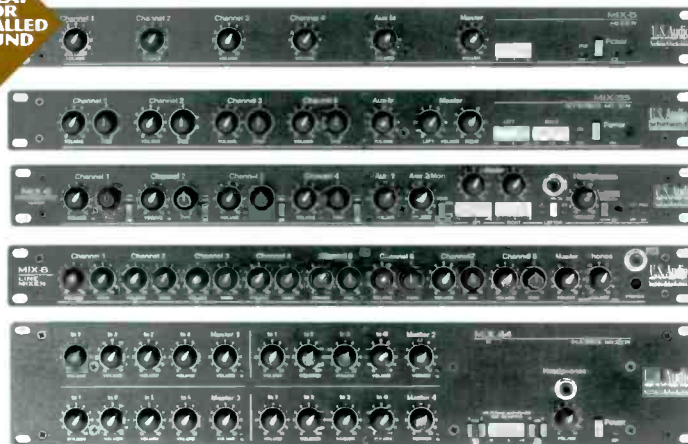

balanced line-level inputs, and applies them to four mixer sections where they are combined through volume controls to four output mixes. Call for the specs on this useful matrix mixer.

MIX-5 Mono	60WHMIX5	MFR LIST	\$399.00
MIX-5 Stereo	60WHMIX5S	MFR LIST	\$499.00
MIX-6 Stereo	60WHMIX6	MFR LIST	\$1,012.00
MIX-8 Stereo	60WHMIX8	MFR LIST	\$645.00
MIX-44 Matrix	60WHMIX44	MFR LIST	\$1,125.00

CALL 1-800-732-7665 FOR BRADLEY PRICE



ATI NANOAMP MIC/LINE MIXER

With Nanoamp mixers you can configure your setup as it suits you. The MX100 is a three-input mic/line mixer, while its companion XP100 is a four-input expander. Inputs and outputs are XLR. The expander comes with DC and audio connection cables.



Features include independent level sets, master gain, adjustable headphone output, phantom mic power, balanced inputs, and metered output for balanced or unbalanced lines.

Order the AC/DC wall supply separately. An optional external battery pack runs an MX100 for three hours. Install Nanoamps in a rack with optional hardware, up to three across; various rack and desk mount kits are available.

MX100-XLR Mic/Line Mixer	60AIMX100XLR	MFR LIST	\$375.00
XP100-XLR Expander	60AIXP100XLR	MFR LIST	\$289.00
WA100-1 AC/DC Wall Supply for above (sold separately)	60AIWA1001	MFR LIST	\$13.00
BBU100-1 Battery Pack (takes four 9V)	60AIBBU1001	MFR LIST	\$47.00
Single unit rack mount	60AI20604501	MFR LIST	\$22.00
Double unit rack mount	60AI20604502	MFR LIST	\$25.00
Triple unit rack mount	60AI20604503	MFR LIST	\$30.00

CALL 1-800-732-7665 FOR BRADLEY PRICE

SAMSON MIXPAD 9

A sassy mixer with superior low noise and distortion, three mic/line inputs and three stereo inputs (for a total of nine channels), two aux sends per channel, two stereo effects returns, two-band EQ, pan/balance controls, peak LED's on the outputs, balanced stereo output, and a durable aluminum chassis. You also get gain trim for mic and line inputs, phantom power, headphone jack, in-line power supply: all in a package under four pounds.

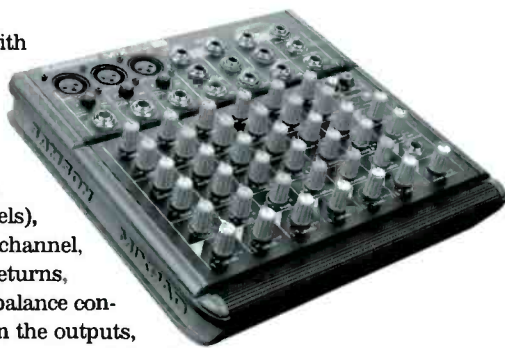

You can see the uses: Broadcast. Multimedia. Submixing. Monitor mixing. Corporate video. With a Mic EIN of -128dBu, THD of 0.004%, output noise >-83dBu, and S/N of 87dB. Size: 2.5" x 9.375" x 9".

MIXPAD 9	60SSMP9	MFR LIST	\$219.00
MIXPAD 4	60SSMP4	MFR LIST	\$189.00
MIXPAD 12	60SSMP12	MFR LIST	\$299.00

CALL 1-800-732-7665 FOR BRADLEY PRICE

ATI MXS100/MX200 PORTABLE MIXERS

New!

The MXS100 is a full-featured stereo field mixer. It includes three XLR switchable Mic/Line low noise balanced inputs, phantom power, pan pots, switched low cut filters, slate microphone, stereo tape in and tape out jacks, and a test tone oscillator. It also features



stereo, bright LED bargraph VU meters, low distortion servo XLR balanced mic/line outputs with switchable peak limiting, and a stereo program/cue headphone output.

The MX200 is a lower cost stereo mixer for studio applications that does not include all of the bells and whistles needed for field operation which are included with the MXS100. The MX200 features three XLR Mic/Line low noise inputs with pan pots and phantom power. It features balanced line level stereo outputs and independent headphone monitoring. Rack or desk mount. Increase inputs with one or two XPS input expanders. Rack mount kits allow up to 11 mic/line inputs in single rack space.

Expand the MXS100 or MX200 mixer with an XPS100 for four additional Mic/Line inputs with pan pots or combine with the XPS200 to add two stereo line level inputs. Use multiple input expanders to precisely meet your requirements. Expanders include all audio and DC interconnects.

MXS-100	60AIMXS100	MFR LIST	\$799.00
MX-200	60AIMX200	MFR LIST	\$599.00

CALL 1-800-732-7665 FOR BRADLEY PRICE

Accessories for MXS Series:

ABAG-1 Carry Case (with PROK-1), houses Mixer with PPA-1-2-3 or DCA100-1.

PPA100-1-2-3 Rechargeable battery pack (includes charger).

DCA100-1 DC/DC converter for operation with DC inputs from 10 to 32VDC.

PROK-1 Unit protection kit, which consists of side plates to protect front panel controls and rear connectors from impact damage.

BBU100-1 Battery Pack houses four 9V alkaline batteries for remote operation.

C20784-501 Slide Bracket Kit; Slides mount to the protection side plates (ABAG-1 of PROK-1), ordered separately for quick access in 9V battery replacement when using BBU100-1

Power Supplies:

WA100-1 Wall mount power supply

WA100-2 Table Top Power Supply

Rack Mount Kits:

20604-501 Center Mount for single unit

20604-502 Side-by-side mount for two units.

20604-502 Side-by-side mount for three units.

Desk Mount Kits:

20617-501 Angled desk mount base.

20617-502 Angled desk mount base and one stacker (2 units high).

20617-503 Angled desk mount base and two stackers (3 units high).

20617-504 Stacker (2 units high).

20617-505 Horizontal joiner (2 units side-by-side)

AUDIO-TECHNICA MX351 SMARTMIXER

The NEW AT-MX351 SMARTMIXER delivers 5 channels of auto-switching performance. Complete with automatic threshold adjustments as well as a single AUX IN to accommodate tape or other line inputs, the Smartmixer features individually switched 48V phantom power as well as selectable limiting to prevent overloads. Other features included are: balanced inputs and outputs, pre or post controller outputs from mic/line channels, D-sub connector for TTL output, closure control input, NOMA operation, manual override, priority pre-select switch and headphone output.



Audio-Technica SMARTMIXER 60ATMX351 \$599.95

SPIRIT POWERSTATION 600

The best portable mixers combine mixing, effects, and power amplification all in one.

Spirit's Powerstation is a powered mixer with renowned Lexicon digital effects available on all inputs via Aux 2. The mixer has eight mono and two stereo inputs, three-band EQ, stereo seven-band graphic EQ to suit any room, PFL, and inserts on every mono input. A high pass filter fights mic pops and stage rumble. Each channel has two aux's.

The custom power amp at 2 x 300W (into 4 ohms) ensures clear, loud audio without distortion all night long. Use the patchbay to feed external amps with or without the graphic EQ or to plug another mixer into your amp. Powerstation is freestanding and includes a detachable lid.



Powerstation 600 60SFRW5491 MFR LIST \$1,599.95
 Rack Mount 60SFRW5598 MFR LIST \$59.95

CALL 1-800-732-7665 FOR BRADLEY PRICE

YAMAHA EMX2000 POWERED MIXER

The new Yamaha EMX2000 Powered Mixer provides flexible audio mixing, high-power stereo amplification, and digital effects processing in an extraordinarily compact unit, with carrying handle. With all the main components necessary for live sound, and a "plug-in-and-go" approach, the EMX2000 is ideal for clubs, bars, theaters, churches, conference rooms, and so on. External wiring is kept to a minimum, and the logical panel layout makes for straightforward operation. Inputs channel features include balanced XLR-type mic input, line-level phone jack input, insert (channels 1-4), PEAK indicator, variable gain control, 3-band EQ, two monitor sends, one effects send, PFL switch, and smooth-action level fader.

Digital stereo effects provide vocal, hall, room, plate, and gate reverb programs. External effects signals are returned to the two stereo sub inputs. A flexible seven-band graphic equalizer on the stereo output provides room-acoustic correction and feedback control. Two stereo sub inputs allow various sound sources to be connected, and a record out connection is provided. The new energy efficient Yamaha power amplifier delivers 200 watts of stereo power, and the speaker output signals can be set to Stereo L/R, Monitor 1 and Mono, or Bridge.

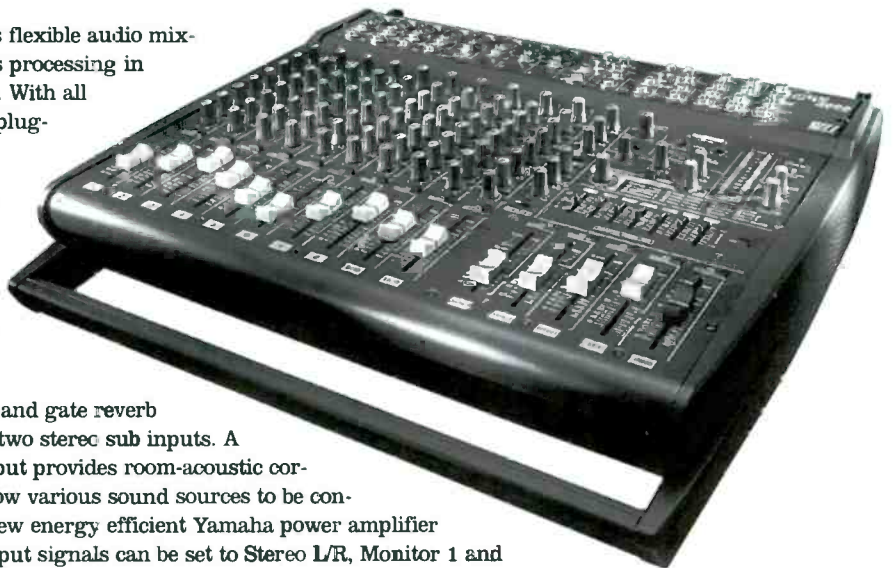

EMX 2000 60YAEMX2000 MFR LIST \$999.95

CALL 1-800-732-7665 FOR BRADLEY PRICE



LITTLITE LAMPS

Littlite makes: yes: little lights. Illuminate the dark corners of your job.

The popular L-3 Series has a mounting base with attached gooseneck, a dimmer, and a high intensity tungsten-halogen bulb in a finned hood. The L-2 Series has a mounting base with attached gooseneck, dimmer, and a low intensity incandescent bulb in an unobtrusive tubular hood. Optional AC adapter is a 120V transformer. Euro transformer also available.

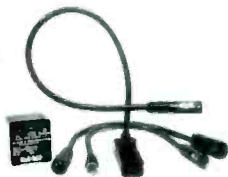

L-3 Series, 12"	61LL312A	\$47.00
with AC adapter	61LL312	\$57.00
L-3 Series, 18"	61LL318A	\$47.00
with AC adapter	61LL318	\$57.00
L-2 Series, 12"	61LL212A	\$37.00
with AC adapter	61LL212	\$47.00
L-2 Series, 18"	61LL218A	\$37.00
with AC adapter	61LL218	\$47.00

The G Series has a swivel BNC-style connector, useful in applications requiring easy removal. They mate with panel sockets on your equipment.

G-Series, 12"	61LL12G	\$27.00
G-Series, 12" High Intensity	61LL12GHI	\$37.00
G-Series, 18"	61LL18G	\$29.00
G-Series, 18" High Intensity	61LL18GHI	\$39.00

The X Series has a 3-pin male XLR connector with isolated lamp circuit. Useful where a detachable, non-swiveling connection is desired.

X-Series, 12"	61LL12X	\$33.00
X-Series, 12" High Intensity	61LL12XHI	\$43.00
X-Series, 18"	61LL18X	\$35.00
X-Series, 18" High Intensity	61LL18XHI	\$45.00

Spare Bulbs

Q5 High Intensity Bulb	61LLQ5	\$9.00
1815 Low Intensity Bulb	61LL1815	\$2.50

WHIRLWIND AC6R

This rackable power strip has six AC outlets, on/off switch, and resettable circuit breaker. 15 amps. The "SP" version adds surge protection. The "2R" version has six outlets on the rear; two in the front.



AC6R	61WHPC1	\$44.00
AC6R/SP	61WHAC6RSP	\$69.00
AC6/2R	61WHAC62R	\$43.00

ETA POWER DISTRIBUTION

- PD10 with 8 rear protected outlets plus 2 always on
 60ARP10 MFR LIST \$160.00
- PD10V same as PD10 plus a digital voltmeter display
 60ARP10V MFR LIST \$240.00
- PD11L same as PD10 plus two retractable rack lamps and a front-panel outlet. 60AR614 MFR LIST \$240.00
- PD11LV same as PD10 plus the digital voltmeter, lamps, and front-panel outlet. 60AR615 MFR LIST \$360.00
- PD9 with 8 rear protected (mounted to accept power transformers!) and 1 front 60ARP9 MFR LIST \$160.00



ETA Audio Conditioned Power units: spike and surge protected, EMI/RFI filtered. They are rated for 1800 watts, 15 amps, and have a master power switch, reset circuit breaker, and Edison AC outlets. All are 1 RU high and 7-3/4" deep.

CALL 1-800-732-7665 FOR BRADLEY PRICE

FURMAN POWER PRODUCTS

Lower your noise floor and stop lifting grounds, too. The Furman Isolation Transformer will change the way you look at studio hum problems. Designed for critical, low-noise installations, the IT1220 can supply 20 amps of balanced AC power. The goal: drastically reduce hum and buzz caused by ground currents from power supply filtering and by radiation from supply cables into sensitive signal sources. You can install it yourself for clean, safe power.

It typically gives a 16dB improvement in background noise floor in systemwide installations. This 3RU chassis has 12 isolated outlets on the back and two more on the front.

IT-1220 60FUIT1220 MFR LIST \$1,579.00 CALL 1-800-732-7665 FOR BRADLEY PRICE



Furman's PL-Plus has eight switched outlets, a ten foot power cord, a front panel LED voltage monitor, and RF filtering. Protect your gear from spikes and surges. Outlets are rated at 15 amps. The two slide-out lamps have a dimmer control. The PM-8 has the power conditioning features of the PL-Plus, without lights, but adds an AC ammeter and front-panel unswitched outlet.

PL Plus	60FUPLPLUS	MFR LIST	\$229.00
PL-8	60FUPL8	MFR LIST	\$159.00
PM-8	60FUPM8	MFR LIST	\$199.00



AR-PRO is a 30 amp line voltage regulator for use overseas and at home. Supply clean, regulated power for an entire studio or stage. It delivers 120V AC with capture ranges of 88 to 134 volts and 172 to 264 volts. 50/60 Hz. Because the AR-PRO works automatically, it can protect against a catastrophic error. Includes fourteen regulated, conditioned outlets, input voltmeter, output ammeter, and adjustable rack ears. Height: 3.5".

AR-PRO 60FUARPRO MFR LIST \$2,295.00

CALL 1-800-732-7665 FOR BRADLEY PRICE

AR-1215 AC line voltage regulator
 Protects equipment from problems caused by brownouts and overvoltages. It accepts voltages from 97 to 141 volts, and converts them to US standard 117 volts. The "J" version of the AR-1215 provides switch selectable 100VAC output. Input capacity 15 amps; output 12 to 15 amps. Unit instantly shuts down to protect your gear should an extreme overvoltage situation occur.

AR-1215 60FUAR1215 MFR LIST \$599.00

AR1215J 60FUAR1215J MFR LIST \$599.00

CALL 1-800-732-7665 FOR BRADLEY PRICE

NIGEL B 6 OUTLET POWER STRIPS

Sometimes it isn't convenient to have all your power strips with the outlets on the back. Nigel B solves this problem for you. This rack mounted 6-outlet power strip has all its outlets conveniently mounted on the front, along with the master switch and overload reset. Of course, it still offers full surge protection and EMI/RFI protection.



Front Mounting Power strip	60NBFP6SP	MFR LIST	\$19.95
35" power strip with 8 foot cord	60NB3512SP	MFR LIST	\$129.95
35" power strip with BNC light socket	60NB12SPL	MFR LIST	\$149.95
6" High Intensity lamp	60NB6MHI	MFR LIST	\$39.95
35" powerstrip with 12 foot cord	60NB12FM	MFR LIST	\$139.95

CALL 1-800-732-7665 FOR BRADLEY PRICES

CONSOLES

Digital Mixing Perfection by Tascam.

The **Tascam TM-D1000**: fully loaded with absolutely professional features and specs, at your dealer this summer, and **priced for the real world**. The time has come to go all digital!

- 8 analog inputs with 4 balanced XLR mic inputs with phantom power • 8 channels of digital I/O via TDIF • AES/EBU and S/PDIF digital inputs and outputs — expandable to 16 with optional card • Compatible with Light Pipe converters • 16 channel strips with long-throw faders, 3-band sweep EQ, 4 Group/AUX faders, a stereo master fader, complete monitor section, analog inserts, and more • Snapshot automation with 128 scene memory recalled via the front panel or from your favorite sequencer via MIDI • Synchronization with word clock (send/receive) and complete MIDI Machine Control. You can even control your DA-88 or DA-38 directly from the front panel with 16 memory locations • On-board dynamic effects processors with 10 stereo effects

Once you get your hands on a TASCAM TM-D1000 you'll forget about how you used to mix and begin to experience the promise of an all digital studio. Get more details at www.tascam.com and get the full story via **TASCAM Faxback** at 800-827-2268. Request document #8010.

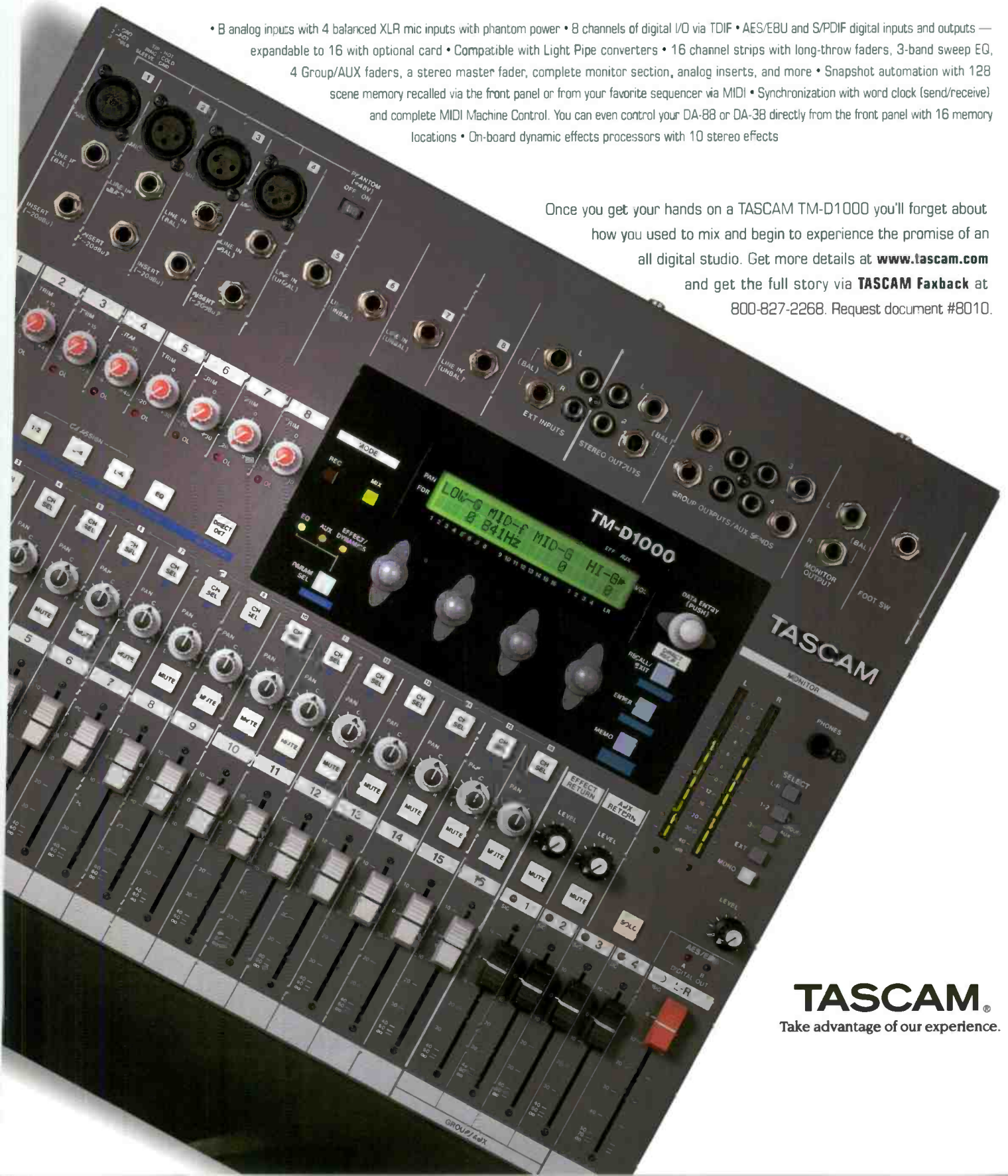

TASCAM[®]
Take advantage of our experience.

Picture Perfect Audio.



Fotomag, N.Y.C.



Nutmeg Recording, N.Y.C.



Bad Animals/Seattle (Red Room)

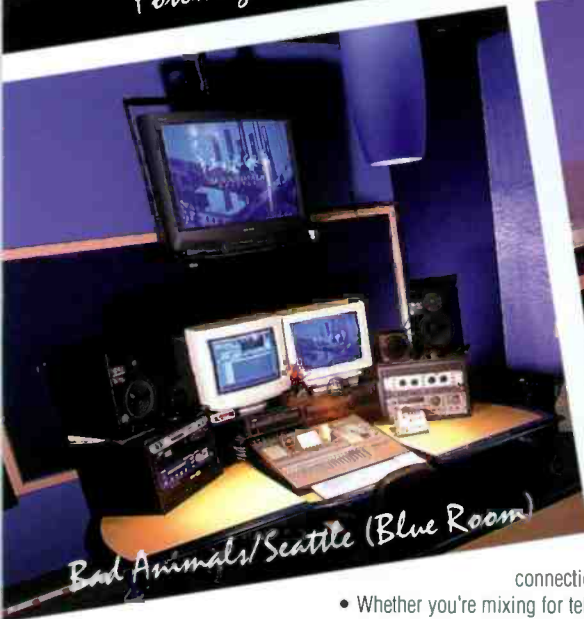

Bad Animals/Seattle (Blue Room)

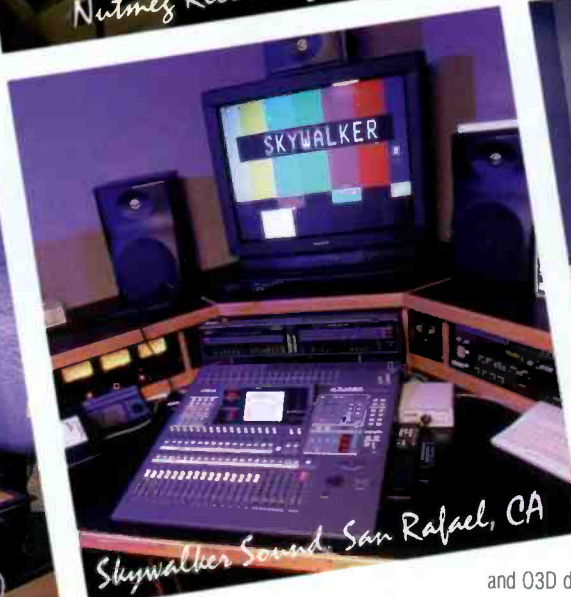

Skywalker Sound, San Rafael, CA

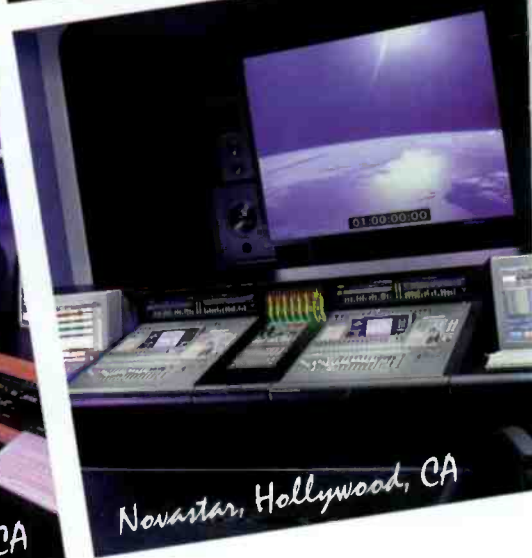

Novastar, Hollywood, CA

The Yamaha O1V, O2R and O3D digital mixing consoles help you create the ultimate mix for your vision. With instant recall of mixes, 32-bit sonic processing, surround sound*, automation features, a completely digital signal path and connection to popular audio work stations, these workhorses make your job easier while improving your image.

- Whether you're mixing for television, film or multimedia, you'll find a Yamaha digital mixer with all the features you need. Who says we don't live in a perfect world?
- For product literature, call (800) 937-7171 ext. 679 or visit a Yamaha Professional Audio dealer near you.



O2R



O3D



O1V



PA PACKAGES AND OTHER STUFF

FENDER PASSPORT

New!

Tired of lugging around your PA system? If you answered yes, we think the Passport from Fender is just what you've been looking for. Truly unique, the Passport is a totally self-contained portable sound system. Weighing only 53 pounds, it can be picked up as easily as a medium sized suitcase, set up in minutes (5 to be exact) and operated by anyone—anywhere!



Eight 6.5" highly efficient speakers, four in each cabinet, work together to deliver clean, full-range coverage while the self-powered mixer delivers 250 watts of true stereo sound. One touch EQ is able to adjust bass, mid and treble simultaneously for optimum response and feedback control. The Passport comes equipped with switchable line voltage for international use and onboard storage for mics and cables. The complete audio package includes two dynamic cardioid microphones, clips and cables, two speaker cables, power cable and protective cover.

Passport 60FNPASSPORT MFR LIST \$899.00
 CALL 1-800-732-7665 FOR BRADLEY PRICE

REMOTE POSSIBILITIES

Great for remotes, churches or gymnasium type settings, we've put together the Samson S63 powered mixer with six XLR/line inputs, two Yamaha 12-inch S112IV Club Series speakers and two 50 foot speaker cables. Ask for package number 9813. Packaged priced at \$849.00



PACKAGE 9813 - ONLY \$849.00

JBL EON POWER SYSTEM

New!

The EON system includes the MusicMix 10-channel stereo mixer, two 15" two-way powered speakers, two JBL E50S dynamic mics, and all necessary cables. Give us a call for info and individual EON prices.

EON Power System 60JBEON MFR LIST \$2,177.00

CALL 1-800-732-7665 FOR BRADLEY PRICE



THE GREAT OUTDOORS

New!

Need a PA system that will pin your ears back? We've put together a system guaranteed to do just that. Start with the PSX2000 stereo powered mixer from Electro-Voice, with 10 mic inputs and 14 line inputs. Add two 15 inch, 400-watt Electro-Voice SX500 speakers, two 50 foot speaker cables, your own mics, an audio source and off you go. Ask for package number 9812. Packaged priced at \$3,699.00



PACKAGE 9812 - ONLY \$3,699.00

FENDER PASSPORT 150

New!



The Passport 150 takes portable sound systems to an entirely new level. No matter the application great sounding audio is yours...sales meetings, aerobics classes, camps, retreats, coffee houses, just about anywhere.

The Passport 150 is 150 watts of stereo sound, three switchable balanced XLR/phone jack inputs for microphones, instruments or other a/v devices. An internal storage compartment holds the included microphone, power cord and all accessories necessary for Passport usage.

Passport 150 60FNPASSPORT150 MFR LIST \$699.00
 CALL 1-800-732-7665 FOR BRADLEY PRICE

ANCHOR PORTABLE SOUND



Anchor portable sound systems help you reach audiences between a dozen and 5,000 people. The amp and speaker are built in. You just need to pick the right model. Call us for a free Anchor catalog. Now you can order many Anchor systems outfitted with Shure wireless mics. Call us!

MINI-VOX

- Over the shoulder five-pound PA
- Project hundreds of feet, reaches 200+ people
- Inputs for CD/tape and mic w/phantom
- Runs 25 hours+ on nine "C" cells
- Mic included

Mini-Vox PB-25
60ANPB25X \$218.00

EXPLORER

- For crowds up to 250
- Choose A/C or battery version (50 vs 25 watts)
- Line and mic inputs, phantom
- Only 23 pounds

PA-2500 AC powered
60ANPA2500 \$549.00
PB-2500 Battery powered
60ANPB2500 \$549.00

LIBERTY

- For crowds up to 1,000
- Choose A/C or battery version (70 vs 50 watts)
- Two XLR mic inputs w/phantom power
- CD/tape input
- Switch for best-projection/best-fidelity

MPA-4500 AC powered
60ANMPA4500 \$849.00
MPB-4500 Battery powered
60ANMPB4500 \$945.00



ANCHOR AUDIO LIBERTY XTREME

Once you hear the new Liberty Xtreme from Anchor, we know you'll agree with us that this is a winner. The Liberty Xtreme has clear and powerful sound, thanks to an 8-inch woofer and constant-directivity horn inside a ported enclosure. With 130 watts of power, the Xtreme is even more powerful than its little brother, the Liberty. Xtreme's two sound modes make it very versatile, allowing you to switch from a full-range music system to a PA system with crystal-clear projection. Both balanced (XLR/F) and unbalanced (1/4" TRS) inputs are provided. Unit is AC powered.



60ANMPA5100 MFR LIST \$699.00
CALL 1-800-732-7665 FOR BRADLEY PRICE

YAMAHA EMX640 POWERED MIXER



If you've never had a sound system, you want simplicity, all the components you need working flawlessly with an absolute minimum of work on your part.



The EMX640 is a total system composed of four pieces: a high quality mixer, a digital reverb, two graphic equalizers and a high powered two-channel amplifier. Yamaha has already patched and level matched all these pieces so you can get your PA up and running quickly with no prior experience.

The EMX640 has six inputs, two of which are stereo, effectively giving you eight. Plus, the EMX640 has tape in and effects return inputs, giving you the equivalent of 10. The EMX640 has the most powerful amplifier (it has two) of any mixer in its price range. If you will use the system for speaking and vocals only, the EMX640 has plenty of power for large gatherings. If you play music, the EXM640 gives you maximum flexibility to cover the audience, including the ability to route all the power from both amplifiers to one set of speakers. A digital reverb makes your music sound like it's in a larger space, giving it a more expansive feel.

EMX640 60YAEMX640 MFR LIST \$649.95
CALL 1-800-732-7665 FOR BRADLEY PRICE

COMMUNITY CSX SPEAKERS

Join the community! Classics in their price range, CSX speakers deliver sonic quality every time. Fuseless protection guards your speakers against excessive input. Ferrofluid cooling of the LF drivers is equal to the rigors of long term use. CSX cabinets are finished in an attractive durable black carpet.



The CSX25 is the smallest, with a twelve-inch two-way configuration. 32 pounds, 18.25"H x 15"W x 13.5"D.

The CSX35 is slightly larger and uses a 15" woofer and a larger cabinet to produce a more solid low frequency response. 43 pounds, 23.75"H x 17.25"W x 13.5"D.

The CSX52 has a smooth, three-way design for honest reproduction of the important mid-range, while still using a 15" woofer for pleasing lows. The 52's sound like Hi-Fi speakers, yet they will develop tremendous SPL. 82 pounds, 33.5"H x 18"W x 18"D.

Other Community models are available.

CSX2552	60COC525	MFR LIST	\$418.00
CSX3552	60COC535	MFR LIST	\$499.00
CSX5252	60COC552	MFR LIST	\$915.00

CALL 1-800-732-7665 FOR BRADLEY PRICE

MONITORING

MEDUSA MULTIPAIR SYSTEMS

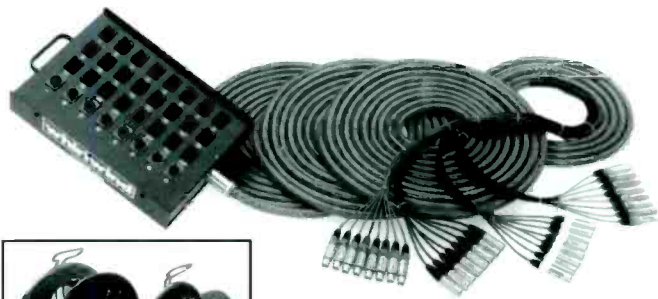

These multipair systems are so much nicer than the snake-haired mythical creature whose name they bear. Use them for heavy-duty audio runs.

Systems are available in 6 to 52 channel configurations. Each has foil shielding and numbered, color coded fan-outs for easy set up. Medusa systems use cold rolled steel boxes, thick jacketed cable, mil-spec strain reliefs, premium PVC shrink tubing, and Whirlwind connectors.

The Power series, also listed below, is ideal for powered mixers. They incorporate two runs of 14 gauge speaker wire built into, but shielded from, the mic and monitor lines. Call us for pricing on other Medusa cables including versions for multitrack.

STANDARD MEDUSA SERIES

50' - 6 in, 3 out	61WHMS63XL50	\$169.00
100' - 8 in, 4 out	61WHMS84XL100	\$249.00
100' - 12 in, 4 out	61WHMS124XL10	\$295.00
100' - 16 in, 4 out	61WHMS164XL10	\$357.00
100' - 24 in, 8 out	61WHMS248XL10	\$564.00

MEDUSA POWER SERIES

100' - 8 mics, 2 speaker, 1 monitor.	61WHMP8100	\$389.00
100' - 12 mics, 2 speaker, 2 monitor.	61WHMP12100	\$479.00

MEDUSA CABLE REELS

Carry Medusa cable systems with these windup reels.

Small capacity, 795' of 1/4" OD cable.	61WHMEDWHS	\$101.00
Large capacity, 1150' of 1/4" OD cable.	61WHMEDWHL	\$122.00

YAMAHA CLUB IV SERIES SPEAKERS

We've got a secret and we decided to share it with you. The Club Series speakers from Yamaha are some of the best buys around and for more than 10 years, this series of speakers has been making performances everywhere easily heard by the audience and by performers as well. Available in black with carpet on the sides to hide that unsightly "road rash" or in Oak for something a little more stationary, the new Mark IV series are Yamaha's finest loudspeaker yet. Call your favorite Bradley professional for the Yamaha speaker that best fits your needs.

SM1211V Floor Monitor	60YASM1211V	MFR LIST	\$389.00
SM1511V Floor Monitor	60YASM1511V	MFR LIST	\$429.00
5W1181V Subwoofer	60YASW1181V	MFR LIST	\$499.00
SW2151V Subwoofer	60YASW2151V	MFR LIST	\$749.00
S1121V Speaker	60YAS1121V	MFR LIST	\$369.00
S1151V Speaker	60YAS1151V	MFR LIST	\$399.00
S2151V Speaker	60YAS2151V	MFR LIST	\$799.00

CALL 1-800-732-7665 FOR BRADLEY PRICE



SHURTAPE GAFFER'S TAPE

Tape your cables, carpets, and more with a tape that pulls up cleanly after the job.

2" wide, black 180'	61STBK2	\$13.50 per roll
2" wide, grey 180'	61STGY2	\$13.50 per roll

SPECIAL! Buy six rolls of Shurtape for only \$64.80.

SONIC II HEARING PROTECTORS

Reduce sound pressure on your ear without reducing highs or lows. Includes box with key chain.

42N050N2	\$6.95
----------	--------



WHIRLWIND CABLE REELS

Stow your cables quickly with these durable take-up reels. Note: these reels will hold less if the cable's outer diameter is larger. Call us for configuration help.

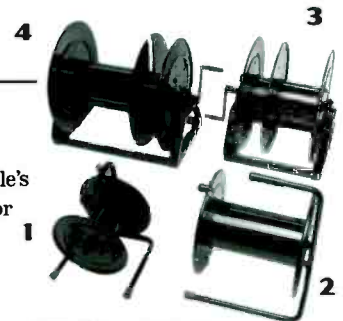

(1) WD-1 Capacity: 640' of 1/4" OD cable	61WHWD1	\$139.00
(2) WD-2 Capacity: 1640' of 1/4" OD cable	61WHWD2	\$176.00
(3) WD-3 Capacity: 2100' of 1/4" OD cable	61WHWD3	\$325.00
(4) WD-3S Capacity: 3675' of 1/4" OD cable	61WHWD3S	\$325.00



CALL YOUR BRADLEY PROFESSIONAL FOR SPECS AND PRICES ON OAK VERSIONS OF YAMAHA'S CLUB SERIES



MONITORING

ULTIMATE SUPPORT STANDS

Remotes, concerts, lectures... anywhere you need to support a speaker, these stands are the Ultimate. We can only show our best sellers here; call for info on mic stands, speaker stands, lighting support, and more. Ultimate products carry a lifetime warranty. Let us send you an Ultimate catalog. Ultimate TS-80T can be varied in height from 3'6" to 6'8", and will support up to 110 lbs. Bag included.

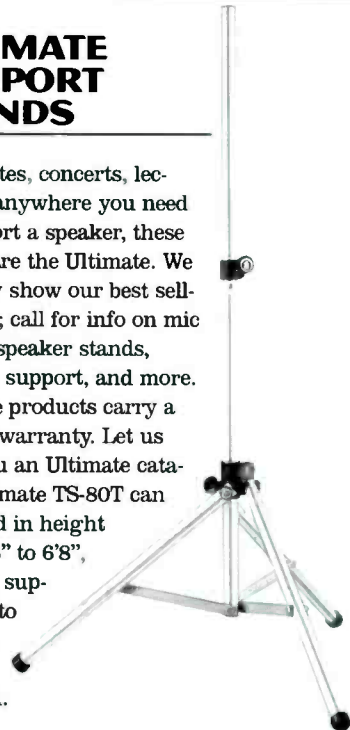

Ultimate TS-80T can be varied in height from 3'6" to 6'8", and will support up to 110 lbs. Bag included.

Silver	61USTS80T	\$89.00
Black	61USTS80BT	\$108.00

Ultimate TS-88T will extend to over 9' and support 110 pounds, yet it weighs only eight pounds! (pictured). Bag included.

Silver	61USTS88T	\$107.00
Black	61USTS88BT	\$129.00

Accessories:

TAD-138 1-3/8" diameter tripod adapter is used with same sized sockets provided by Community, EV, Toa, and others.

61USTAD138	\$11.50
------------	---------

TMB-400K is a unique two part mounting system that consists of a thin plate (screwed to the bottom of the speaker) and a slide-in bracket (attached to the top of the tripod). Mounting screws included.

61USTMB400	\$29.00
------------	---------

BMB-200K attaches speakers with built-in threaded inserts spaced 4-3/8" to 6" apart, such as those provided by Ramsa and Bose. Mounting screws not included.

61USBMB200	\$23.00
------------	---------

Ask us about "Telelock" stands for extra-easy and safe load lifting.

CROWN CE SERIES AMPS

New!

Originally designed for theater and cinematic applications, Crown's CE Series amps work exceptionally well in any installation setting. With their extensive protection circuitry, long-term reliability, easy to access front panel controls, great sound reproduction, and unique open-architecture design (so you can add inexpensive, customized plug-in modules such as the SST-Stereo Crossover), these amps are professional powerhouses that do it all. They even come with a 3-year warranty and comprehensive technical support to back them up. What else would you expect from Crown?



See Power Amp Comparison Chart on page 86 for specs.

CE1000	60CRCE1000	MFR LIST	\$700.00
CE2000	60CRCE2000	MFR LIST	\$1,000.00

CALL 1-800-732-7665 FOR BRADLEY PRICE

CROWN K2 SERIES AMPS

New!

No fan! No Noise! 2,500 Watts! Need we say more? The Crown K2 offers revolutionary technology that delivers more power (2500 watts) and more sound while consuming less energy than any other amplifier. The K2 uses new patent-pending Balanced Current Amplifier (BCA™) to give you massive amounts of power while generating virtually no heat.



The K2 is so thermally efficient, it generates just one-tenth the heat of conventional amplifiers eliminating the need for a fan. Lower operating temperatures put less stress on the components, and the fan-free, sealed chassis virtually eliminates problems caused by dust, high humidity and other environmental factors. See Power Amp Comparison Chart on page 86 for specs.

K2	60CRK2	MRR LIST	\$1,795.00
----	--------	----------	------------

CALL 1-800-732-7665 FOR BRADLEY PRICE

CROWN D-75A & D-45 POWER AMPS

This is the model that pros all over the world specify by name. Rugged, easy to install, and reliable. The D-75A feeds 40 watts into 8 ohms, 55 into 4 ohms. It has detented level controls for each channel, headphone jack, barrier block outputs, and balanced combo XLR and 1/4" inputs, all in a single rack space. A distortion indicator alerts you in the unlikely event that distortion of any kind exceeds 0.05%.



The D-45 is a smaller amp, rated at 25 watts into 8 ohms, 35 into 4. It's identical to the D-75A except in power and price, and is suited to broadcast and recording nearfield monitoring, headphone amps, and small paging systems. See Power Amp Comparison Chart on page 86 for specs.

D-75A	60CR75	MFR LIST	\$625.00
D-45	60CR45	MFR LIST	\$475.00

CALL 1-800-732-7665 FOR BRADLEY PRICE



HAFLER P-1000



The P-1000 brings the quality of Hafler's larger amps to a popular lower price and power range.

Conservatively rated at 50 watts per channel into 8 ohms and 55 into 4, the amp has both balanced XLR and 1/4", and unbalanced RCA inputs. Outputs are barrier strip. "Trans-ana" design results in very stable, linear operation. The front panel has a power switch, a normal/bridged mono switch, level controls, headphone jack, and LED's for clip, thermal, and signal; the rear panel has a chassis/float ground switch and a balanced/unbalanced 115V/230V power line selector.

Expect response of +/-0.1dB from 20Hz to 20kHz, and +0/-3dB from 0.1Hz to 100kHz (can you hear that high?). Convection cooling assures quiet operation. The warranty is five years. See Power Amp Comparison Chart on page 86 for specs.

P-1000 60HFP1000 MFR LIST \$569.00

CALL 1-800-732-7665 FOR BRADLEY PRICE

HAFLER P-1500 AMPLIFIER



Suitable for studio monitoring and touring sound, the P-1500 uses patented "Trans-nova" topology (for "transconductance nodal voltage amplifier") to produce a fine sound.

Features include 1dB gain controls with anti-tamper caps, XLR and 1/4" balanced inputs, binding post outputs, electronic fuse, lateral MOSFET output devices, two-channel or bridged mono output, and quiet convection-cooled design. LED indicators allow monitoring each channel. Other indicators include thermal, short, clip, and signal. The P-1500 is rated at 75 watts per channel into 8 ohms, 85 into 4. This is a two-space rackable amp with a five-year warranty. See Power Amp Comparison Chart on page 86 for specs.

P-1500 60HFP1500 MFR LIST \$599.00

CALL 1-800-732-7665 FOR BRADLEY PRICE

SAMSON SERVO POWER AMPS



A popular choice for recording because of their transparent audio performance, Servo amps also stand out in live sound and installed applications because of their reliability, extensive protection circuitry, and rugged construction. See Power Amp Comparison Chart on page 86 for specs.

Servo 120 60SS120 MFR LIST \$199.99
 Servo 170 60SS170 MFR LIST \$239.99
 Servo 260 60SS260 MFR LIST \$299.99

CALL 1-800-732-7665 FOR BRADLEY PRICE

SYMETRIX 420 POWER AMPLIFIER



Wipe out powering problems without wiping out your budget. Hook up the 420 to studio monitors, nearfields, and multiple pairs of headphones. It's a handy two-channel amp, with XLR inputs paralleled with TRS 1/4" jacks, and screw terminal outputs. The 420 will drive up to 20 watts per channel stereo into a 4 or 8 ohm load, or 40 watts mono bridged. Typical distortion is less than 0.04%.

The mcno sum feature lets you check compatibility of signals, or mix paging and music for commercial installations. Front controls include gangable level knobs, headphone jack with defeatable speaker mute, clip LEDs, and power switch. See Power Amp Comparison Chart on page 86 for specs.

420 60SY420 MFR LIST \$429.00

CALL 1-800-732-7665 FOR BRADLEY PRICE

TASCAM PA-20 MKII

With its dual power, switchable stereo/mono design, this amp excels in control room and recording booth situations, running single, paired, or bridged speakers. It's equipped with both XLR balanced and RCA unbalanced inputs, optimized for +4dBm and -10dBV. It pumps 25 watts per side into 4 ohms stereo; throw a switch and you have 50W bridge in 8 ohms. Bright LED's tell you when the protection circuits are engaged so you can identify problems. See Power Amp Comparison Chart on page 86 for specs.



PA-20 MKII 60TEPA20MKII MFR LIST \$250.00
 PA-150 Studio Amp 60TEPA150 MFR LIST \$400.00

CALL 1-800-732-7665 FOR BRADLEY PRICES



POWER AMPLIFIER COMPARISON CHART

MODEL	MANUFACTURER	POWER RATING/CHANNEL	BRIDGED MONO	RACK SPACES	WEIGHT	INPUT CONNECTIONS	OUTPUT CONNECTIONS	LIST PRICE
D-45	Crown	35W-4 Ohms/25W-8 Ohms	70W-8 Ohms	1	12 lbs	1/4" TRS and XLR	Binding Posts	\$475.00
O-75	Crown	55W-4 Ohms/40W-8 Ohms	110W-8 Ohms	1	12 lbs	1/4" TRS and XLR	Binding Posts	\$625.00
D-150A II	Crown	155W-4 Ohms/95W-8 Ohms	315W-8 Ohms	3	24 lbs	1/4" TRS and XLR	Binding Posts	\$1,025.00
D-300A II	Crown	305W-4 Ohms/175W-8 Ohms	610W-8 Ohms	4	45 lbs	1/4" TRS and XLR	Binding Posts	\$1,295.00
CE 1000	Crown	450W-4 Ohms/275W-8 Ohms	1,100W-4 Ohms	3	33 lbs	1/4" TRS, XLR, or barrier block	Neutrik Speakon	\$700.00
CE 2000	Crown	660W-4 Ohms/400W-8 Ohms	1,950W-4 Ohms	3	40 lbs	1/4" TRS, XLR, or barrier block	Neutrik Speakon	\$1,000.00
Micro-Tech 600	Crown	325W-4 Ohms/220W-8 Ohms	750W-4 Ohms	2	36 lbs	1/4" TRS, (optional XLR)	Binding Posts	\$1,049.00
Micro-Tech 1200	Crown	480W-4 Ohms/310W-8 Ohms	1,300W-4 Ohms	2	41 lbs	1/4" TRS, (optional XLR)	Binding Posts	\$1,349.00
Micro-Tech 2400	Crown	800W-4 Ohms/520W-8 Ohms	2,070W-4 Ohms	2	47 lbs	1/4" TRS, (optional XLR)	Binding Posts	\$1,749.00
Macro-Tech 600	Crown	325W-4 Ohms/220W-8 Ohms	750W-4 Ohms	2	40 lbs	1/4" TRS, (optional XLR)	Binding Posts	\$1,495.00
Macro-Tech 1200	Crown	480W-4 Ohms/310W-8 Ohms	1,315W-4 Ohms	2	44 lbs	1/4" TRS, (optional XLR)	Binding Posts	\$1,745.00
Macro-Tech 2400	Crown	800W-4 Ohms/520W-8 Ohms	2,020W-4 Ohms	2	52 lbs	1/4" TRS, (optional XLR)	Binding Posts	\$2,245.00
Macro-Tech 24X6	Crown	Same as MA-2400(Ch1)/MA-600(Ch2)	N/A	2	45 lbs	1/4" TRS, (optional XLR)	Binding Posts	\$1,850.00
Macro-Tech 3600VZ	Crown	1,655W-4 Ohms/1,165W-8 Ohms	3,600W-4 Ohms	2	56 lbs	1/4" TRS, (optional XLR)	Binding Posts	\$3,095.00
Macro-Tech 36X12	Crown	Same as MA-3600(Ch1)/MA-1200(Ch2)	N/A	2	48 lbs	1/4" TRS, (optional XLR)	Binding Posts	\$2,550.00
Macro-Tech 5000VZ	Crown	2,000W-4 Ohms/1,300W-8 Ohms	5,000W-4 Ohms	3	78 lbs	1/4" TRS, (optional XLR)	Binding Posts	\$3,950.00
K-1	Crown	550W-4 Ohms/350W-8 Ohms	800W-4 Ohms	2	32 lbs	1/4" TRS and XLR	Binding Posts	\$1,495.00
K-2	Crown	800W-4 Ohms/475W-8 Ohms	2500W-4 Ohms	2	38 lbs	1/4" TRS and XLR	Binding Posts	\$1,795.00
P1000	Hafler	55W-4 Ohms/50W-8 Ohms	110W-8 Ohms	1	12 lbs	1/4" TRS and XLR and RCA	Barrier Strip	\$569.00
P1500	Hafler	85W-4 Ohms/75W-8 Ohms	170W-8 Ohms	2	22 lbs	1/4" TRS and XLR	Binding Posts	\$599.00
P3000	Hafler	200W-4 Ohms/150W-8 Ohms	400W-8 Ohms	2	23 lbs	1/4" TRS and XLR	Binding Posts	\$779.00
P4000	Hafler	250W-4 Ohms/200W-8 Ohms	400W-8 Ohms	2	34 lbs	1/4" TRS and XLR	Binding Posts	\$999.00
P7000	Hafler	525W-4 Ohms/375W-8 Ohms	1,050W-8 Ohms	2	40 lbs	1/4" TRS and XLR	Binding Posts	\$719.00
M1400	Mackie	425W-4 Ohms/250W-8 Ohms	960W-8 Ohms	2	36 lbs	1/4" TRS and XLR	Binding Posts and 1/4" TRS	\$599.00
Servo 120	Samson	60W-4 Ohms	120W-8 Ohms	2	12 lbs	1/4" TRS and RCA	1/4" TRS and Push Springs	\$199.99
Servo 170	Samson	85W-4 Ohms	170W-8 Ohms	2	14 lbs	1/4" TRS and RCA	1/4" TRS and Push Springs	\$239.00
Servo 260	Samson	130W-4 Ohms	260W-8 Ohms	2	18 lbs	1/4" TRS and RCA	1/4" TRS and Push Springs	\$299.00
Servo 550	Samson	275W-4 Ohms	550W-8 Ohms	3	32 lbs	1/4" TRS	Barrier Strip	\$399.00
PA-50B	Stewart	50W-4 Ohms	100W-4 Ohms	1/2	3.5 lbs	1/4" TRS and Terminal Block	1/4" TRS and Terminal Block	\$299.00
PA-100B	Stewart	90W-4 Ohms	200W-4 Ohms	1/2	5.5 lbs	1/4" TRS and Terminal Block	1/4" TRS and Terminal Block	\$399.00
PA-200B	Stewart	90W-4 Ohms	200W-4 Ohms	1/2	5.5 lbs	1/4" TRS and Terminal Block	1/4" TRS and Terminal Block	\$429.00
420	Symetrix	20W-40 Ohms	40W-4 Ohms	1	8 lbs	1/4" TRS and XLR	Barrier Strip	\$429.00
PA-20 MKII	Tascam	25W-8 Ohms	50W-8 Ohms	1	10 lbs	XLR and RCA	Barrier Strip	\$250.00
PA-150	Tascam	150W-4 Ohms/ 115W-8 Ohms	150W-40 Ohms	2	21 lbs	XLR and RCA	Barrier Strip	\$400.00
P12	U.S. Audio	14W-4 Ohms	N/A	1	8 lbs	1/4"	Push Springs	\$269.00



Installed Sound

It has become quite obvious to us at Bradley that many of our customers are doing their own installations. We decided to try and make your job a little easier by adding our new "Installed Sound" section to our catalog. These are by no means all the products available when doing installed sound, just a sampling of some of our favorites. Don't see what you need? Call your favorite Bradley Professional to help you put the system together that's right for you. Look for the Installed Sound logo throughout the catalog.



TOA CEILING MOUNT SPEAKERS

The **F101C-101CM** High Ceiling Speaker and the **F121C-121CM** Uniform Directivity Ceiling Speaker from TOA provide extensive sound coverage for a variety of sound applications.



The **F101C-101CM** is designed to provide full-range sound in areas with high ceiling at a low cost while the **F121C-121CM** provides high sound quality for low ceiling mounted speaker installations while requiring fewer units. Features common to both models is built-in circuitry that automatically activates to alleviate low/mid range frequency input damage, 100/70V line matching transformers, 24 inch safety cables with spring clips and self-aligning flanges.

The **F121C-121CM** speaker is designed to provide a much wider dispersion angle than standard ceiling speakers. It is equipped with a specially designed sound diffuser, housed in a mesh cone and may use either the 900 series E-02R Equalizer Module or the AC-120 Dedicated Equalizer, both of which will ensure optimal frequency response. Call Bradley for a TOA ceiling speaker spacing chart for the **F121C-121CM**.

TOA High Ceiling Speaker	60TOF101CM	MFR LIST	\$148.00
TOA Uniform Diversity Speaker	60TOF121CM	MFR LIST	\$182.00
TOA EQ module	60TOE02R	MFR LIST	\$100.00
TOA Dedicated EQ	60TOAC120	MFR LIST	\$398.00

CALL 1-800-732-7665 FOR BRADLEY PRICE

TOA DX-0808 8 X 8 MATRIX



This is an 8 x 8 digitally controlled, analog matrix for routing, distribution, level control and mixing of audio signals. Input and output channels are expandable, when using up to four units. (Example: 16 in/8 bus/ 16 out using two units). Any input or combination of inputs can be mixed and routed to any output or combination of outputs. Each unit, or system comprised of up to 30 units, is digitally controlled using a graphic PC interface. The software allows easy access, changes to the matrix configuration, and includes off-line editing and data file storage of setups. Mix bus assignments and level settings can also be stored in and recalled from 16 non-volatile memories in individual units. Security features are included to prevent unauthorized changes to stored parameters.

DX-0808	60TDX0808	MFR LIST	\$3,770.00
---------	-----------	----------	------------

CALL 1-800-732-7665 FOR BRADLEY PRICE

SONIC SYSTEMS SOUNDSPHERE 110A AND 2212-1

New!

Soundsphere loudspeakers are recognized problem solvers for difficult mounting surfaces and highly reverberant environments. The Model 110A and 2212-1 are the ideal choice for distributed public address systems including background and foreground music. These loudspeakers are acclaimed for crisp voice announcements in shopping malls, racetracks, courtrooms, airports, restaurants and small churches.

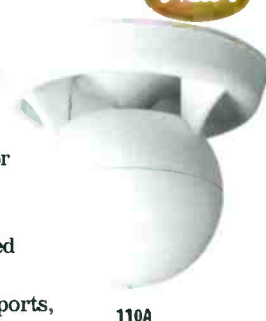

110A

Sound is directed by the symmetrical reflector in a smooth circular pattern assuring wide, even coverage over 360° in the horizontal plane and over 180° in the vertical plane. This permits desired sound levels to be reached with less amplifier power than conventional sound systems, resulting in savings to the installer. Because of the extremely wide coverage, fewer speakers are needed for all installations, resulting in savings to the customer.



2212-1

Choose from three different methods for mounting the Model 110A, a special hanging kit, secured to a hard ceiling or wall using the mounting bracket or connected to the tee-bar of a drop ceiling with special clips and a mounting bracket. The speaker wire extends out behind the reflector for easy hook-up to the sound system or to a custom universal transformer.

There are two easy methods for mounting the Model 2212-1. The speaker can be ordered with three eyebolts for easy hanging, or the speaker can be mounted flush on a ceiling, wall or any hard surface using the triangle bracket. The speaker accepts a 1/4" phone plug for easy connection to the sound system. Other models available.

110A	625S110AXX	MFR LIST	\$300.00
2212-1	625S22121	MFR LIST	\$1,460.00

CALL 1-800-732-7665 FOR BRADLEY PRICE

TOA M-1264 10 IN X 6 OUT RACK MOUNT STEREO MIXER



This is a true stereo mixer with two remotely controllable motorized stereo output controls. The M-1264 provides five independent mono mixes, L+R mono-summed output and cue output for pre-listening to inputs. A built-in compressor and switchable high-pass filter are provided for mic/line inputs to prevent mixer overloads. Phantom power for condenser microphones is included on each mic/line input. Security cover and rack mount ears included.

M-1264	60TOM1264	MFR LIST	\$1,990.00
--------	-----------	----------	------------

CALL 1-800-732-7665 FOR BRADLEY PRICE

MONITORING



JBL CONTROL CONTRACTOR SERIES INDOOR/OUTDOOR SPEAKERS

This series of speakers provide for superior audio reproduction in a variety of indoor and outdoor applications where foreground/background music and paging are required. Common to all six speakers is the InvisiBall mounting hardware (included), making short work of permanent installation and adjustment. This mount provides 37 degrees of vertical and 44 degrees of horizontal rotation, with adjustments made from a hidden access point on the front of the speaker. All models readily accept a variety of paints and finishes. Each model is available in black or white, and in 8 ohm or 70 volt line configurations. The Control 23 handles up to 50 watts program power; the Control 25, up to 150 watts, and the Control 28, 175 watts. Sold in pairs.



JBL Control 23 Black	60JBCNTRL23	MFR LIST	\$202.00
JBL Control 23 White	60JBCNTRL23WH	MFR LIST	\$202.00
JBL Control 23T Black	60JBCNTRL23T	MFR LIST	\$200.00
JBL Control 23T White	60JBCNTRL23TWH	MFR LIST	\$200.00
JBL Control 28 Black	60JBCNTRL28	MFR LIST	\$456.00
JBL Control 28 White	60JBCNTRL28WH	MFR LIST	\$456.00
JBL Control 28T Black	60JBCNTRL28T	MFR LIST	\$490.00
JBL Control 28T White	60JBCNTRL28TWH	MFR LIST	\$490.00

JBL Control 25 Black	60JBCNTRL25	MFR LIST	\$260.00
JBL Control 25 White	60JBCNTRL25WH	MFR LIST	\$260.00
JBL Control 25T Black	60JBCNTRL25T	MFR LIST	\$294.00
JBL Control 25T White	60JBCNTRL25TWH	MFR LIST	\$294.00

Also Available: 18S and SB2 Subwoofers, priced singly:

18S	60JBCNTRL18S	MFR LIST	\$228.00
SB2	60JBSB2	MFR LIST	\$305.00

CALL 1-800-732-7665
FOR BRADLEY PRICES

RANE SRM 66 PROGRAMMABLE SPLITTER / ROUTER / MIXER



The SRM 66 provides a cost-effective solution for systems requiring any combination of zone distribution, room combining, and remote level control. Split, route, and mix functions are implemented with a six input, six output matrix mixer.

Control consists of a backlit LCD, five buttons and a data wheel. All programming is accomplished using 10 easily accessible edit pages. Six pages control output programming, three for Control Group programming and one for Memory functions. The SRM 66 allows independent routing and mix-level adjustment of any input to any output. Each output may have a unique programmable mix of the six inputs. Settings may be copied and pasted between outputs.

Inputs and outputs are balanced and equipped with Euroblock connectors. Rear panel gain switches on each input and output allow -10 dBV or +4 dBu sensitivity settings. Front panel Mix Input Headroom LEDs indicate the remaining headroom for each of the six inputs at 4 dB and 16 dB. Programmable Limiters on each output prevent mixer overload. Limit Threshold is adjustable from maximum to -28 dBu for each output. If output level exceeds the Limit Threshold, all six mix levels for the given output are reduced.

The optional DSC 1 accessory provides a bridge to connect a PC's RS-232 port and the RIP (Remote Interface Port) used in the SRM 66. Coupled with the included SRM Exchange software, the DSC 1 allows an exchange of settings between an SRM 66 and the PC. Once the settings are obtained by the PC they can be manipulated, stored in a file, printed for future reference or sent to another SRM 66.

SRM 66	60RNSRM66	MFR LIST	\$949.00
--------	-----------	----------	----------

CALL 1-800-732-7665 FOR BRADLEY PRICE

ROLAND AR-100 ANNOUNCEMENT RECORDER



The Roland AR-100 Announcement Recorder is a half rack digital recorder-player perfect for any application



requiring pre-recorded announcements. Audio is recorded on a built-in PCMCIA card with no moving parts for reliable, maintenance free operation. Theme parks, museums and music delivery systems are just a few of the applications that would benefit from the AR-100. Three recording modes are available: stereo, mono or independent dual mono. Need to change your announcement? Recording can be accomplished by remote control.

AR-100	60RAAR100	MFR LIST	\$795.00
--------	-----------	----------	----------

CALL 1-800-732-7665 FOR BRADLEY PRICE

SAMSON SERVO QUAD AMPS

Need to push power to a lot of different zones?

Servo Quad amps are what you need. Each supplies 4-channels of 20Hz-50kHz audio, so you don't need an entire rack of amps. With features like



convection cooling (no fan, no noise), turn-on protection, thermal protection, and electronically balanced 1/4" as well as RCA and binding post outputs, the Servo Quads are truly pro. The 4120 gives you 120W/channel into 4 ohms (240 bridged mono). The 4060 gives you 60W/channel into 4 ohms (120 bridged mono).

SERVO 4120 QUAD AMP	60SS4120	MFR LIST	\$599.95
SERVO 4060 QUAD AMP	60SS4060	MFR LIST	\$449.95

CALL 1-800-732-7665 FOR BRADLEY PRICE



MONITORING

BI-AMP SYSTEM ONE MODULAR MIXING SYSTEM

SYSTEM ONE is an extremely flexible, high-performance mixing system consisting of several functional modules. These modules can easily be combined in a variety of system configurations, tailored for specific applications. Modules may be used together, alone, or with other audio products, in a wide range of applications including churches, courtrooms, boardrooms, teleconferencing, legislatures, city council chambers, hotels, and restaurants. From a single 8-channel mixer... to an automatic mixer with unlimited inputs, channel priority, logic outputs, remote control, 3-band EQ, and multiple auxiliary outputs... SYSTEM ONE is a creative and powerful tool.

ONE 8-CHANNEL MIC/LINE MIXER



- 8 Channel 'page-over' muting (via channel 1-7 jumpers)
- Notch filters, tone controls, and rumble filter at main output
- Output limiter with threshold control and 'active' indicator
- Balanced main output with built-in isolation transformer

ONE 60B1ONE MFR LIST \$555.00
 CALL 1-800-732-7665 FOR BRADLEY PRICE

DMD 4-CHANNEL DEVICE MATCHING DRIVER



- Provides balanced 'direct' outputs from ONE & EX mixers
- May be used with other mixers or any line-level signals
- Converts signals to balanced or unbalanced, mic or line
- Internal jumpers sum any or all inputs to the fourth output.

DMD 60BIDMD MFR LIST \$259.00
 CALL 1-800-732-7665 FOR BRADLEY PRICE

RC II 4-CHANNEL VCA REMOTE CONTROL



- Provides remote level & mute control of ONE & EX mixers
- May be used with other mixers or any line-level signals
- Controls may be standard potentiometers and/or switches
- Controls may be located up to 2000 feet away from system

RC II 60BIRCII MFR LIST \$314.00
 CALL 1-800-732-7665 FOR BRADLEY PRICE

EQ 8-CHANNEL/3-BAND EQUALIZER



- Provides channel equalization to ONE & EX mixers
- May be used with other mixers or any line-level signals
- Compensates for tonal differences in microphone signals
- Functions independently of any output 'room' equalization.

EQ 60BIEQ MFR LIST \$314.00
 CALL 1-800-732-7665 FOR BRADLEY PRICE

EX 8-CHANNEL MIC/LINE EXPANDER



- ONE & EX mixer 'stacking' for limitless input capability
- Electronically balanced inputs and output on XLR jacks
- +12V phantom power jumper per channel (+48V option)
- 1/4" patch insert jack on each channel and main output

EX 60BIEX MFR LIST \$485.00
 CALL 1-800-732-7665 FOR BRADLEY PRICE

DRC 44 PROGRAMMABLE VCA REMOTE CONTROL



- Provides remote level & mute control of ONE & EX mixers
- May be used with other mixers or any line-level signals
- Remote control via infrared, wall-mount, and/or computer
- Presets, logic outputs, and combined control with RC II.

DRC44 60BIDRC44 MFR LIST \$485.00
 CALL 1-800-732-7665 FOR BRADLEY PRICE

AG II 8-CHANNEL AUTOMATIC GATE



- Provides automatic mixer functions to ONE & EX mixers
- May be used with other mixers or any line-level signals
- Priority switch and 'gate active' indicator for each channel
- Logic outputs from channels for relay/speaker switching

AG II 60BIAGII MFR LIST \$485.00
 CALL 1-800-732-7665 FOR BRADLEY PRICE

AM 8-CHANNEL/3-SEND AUXILIARY MIXER



- Provides auxiliary send mix matrix from ONE & EX mixers
- Compatible with other mixers or any line-level signals
- Balanced outputs with level, peak indicator, & XLR jacks
- Expansion jacks allow increased input/output capability.

AM 60BIAM MFR LIST \$419.00
 CALL 1-800-732-7665 FOR BRADLEY PRICE



INSTALLED SOUND/METERING

RANE MLM 82 MIC/LINE MIXER



The Rane MLM 82 is an eight-input, two balanced output mic/line mixer. It is a versatile mixer, fitting well into any installation requiring ease of use and compact size. The MLM 82 is perfect for churches, conference rooms, schools and rental sound systems. The studio-grade specifications of the MLM 82 allow for use in many other applications from submixing to post-production.

Inputs 1-4 are mic/line level switchable and inputs 5-8 accommodate up to four stereo or mono line level sources. Inputs 1-4 are balanced XLR connectors for use with microphone or line level sources and split equally to both outputs. Mic phantom power is provided by a switch on the rear of the unit and recessed front panel switches, with LED indicators, convert each of these inputs to line level. Phantom power is removed from the input whenever LINE is selected.

For the end user who only needs to control volume levels, simplicity makes the MLM 82 the mixer of choice.

MLM82 60RNMLM82 MFR LIST \$499.00

CALL 1-800-732-7665 FOR BRADLEY PRICE

RANE CP 31 COMMERCIAL PROCESSOR



The CP 31 is a single-page commercial preamplifier for the small restaurant, lounge, retail boutique, or small office or manufacturing facility. System designers now have three choices in Commercial Processors from Rane to fulfill their paging needs - the CP 31 and its bigger brothers the CP 52 & CP 64.

The CP31 provides Page Ducking for its single stereo Program Input. One stereo or two completely independent mono Zones are served. The Page signal can be independently assigned to either of the two mono outputs, to Off (no Zones) or Both Zones for stereo or dual-mono zone applications.

The CP 31 is the least complex and least expensive of Rane's Paging products, which include the CP52 and CP64. The CP31 is also perfect for zone expansion of Rane CP-based systems. Simply connect the CP52 or CP64 Page or Program Expand outputs to a CP31 for an extra Zone, set with its own page, program, both or neither.

- Mic/Line Selection with Gain Trim
- High and Low Cut Filter Switch
- Adjustable Detector Threshold with Active LED
- Paging Level Control
- Level Control
- 1 of 4 Program Select
- Ducking On/Off with Depth Control
- Page Initiated Program Ducking
- Page/Program Expansion with Level Control
- UL/CSA Remote Power Supply (120 VAC)

CP31 60RNCP31 MFR LIST \$449.00
 CP52 60RNCP52 MFR LIST \$599.00
 CP64 60RNCP64 MFR LIST \$849.00

CALL 1-800-732-7665 FOR BRADLEY PRICE

DORROUGH AUDIO METERS: DIGITAL OR ANALOG



The two-channel AES/EBU meter



Two 40-A analog meters with rack kit

With digital equipment all around you, monitoring those levels is more and more important. Dorrrough's 280/380 series now offers two-channel, AES/EBU-reading audio meters with over-indication and selectable peak hold. They conform to AES 3 1992.

The 280 series is horizontal, the 380 is vertical. Analog versions are also available.

Among the most popular analog Dorrrough meters is the Model 40-A2. It has a scale allowing 14dB of headroom in 1dB steps. It's a stand-alone unit with internal power supply. All 40A2 meters include peak hold. For dual (stereo) metering, use two meters and a dual rack kit. Call us for straight line versions.

The display of both peak and average is the trademark of Dorrrough's award-winning meters, allowing your operators to make better judgments about your audio.

280-D (40dB)	60DR280D	MFR LIST	\$850.00
280-E (60dB)	60DR280E	MFR LIST	\$850.00
380-D (40dB)	60DR380D	MFR LIST	\$850.00
380-E (60dB)	60DR380E	MFR LIST	\$850.00
40-A2	60DR40A2	MFR LIST	\$475.00

Rack mount kit for 280 Series, specify single, dual, or triple
 60DR280RMX MFR LIST \$45.00

Rack mount kit for 40A/40AP, specify single or dual
 60DR40XX MFR LIST \$45.00

CALL 1-800-732-7665 FOR BRADLEY PRICE

DORROUGH 1200 TEST SET

Here's the solution to balance your stereo lines, an easy to operate gain set. The 1200 is a stereo signal test device for measurement of balance, level, crosstalk, and S/N over the dynamic range of the system from noise floor to clipping. Use it for L/R polarity and phase compatibility testing in mono and stereo. Rack mountable.

1200 60DR1200 MFR LIST \$1,650.00



MONITORING

LOGITEK BRIGHT VU



Logitek improves their economical VU's with an expanded bargraph that can handle a range of 53dB, digital DSP for extra precision, XLR input connectors, internal multivoltage power supply, and a choice of digital or analog inputs.

The multicolor displays show VU and PPM simultaneously. VU is a solid bar, peak a single dot. Accuracy is ± 0.1 dB. Analog sensitivity is adjustable -10 to +24dBu for full scale. Digital models accept AES/EBU and S/PDIF, and have a loop-through for installation convenience.

Available in complete, rack mounting sets that are one rack space high, or as desktop meters. (Also ask about Ultra-VU, with dual analog/digital inputs, high-res "zoom" mode, stereo image/phase, emphasis, and sample rate indication.)

Specify analog or digital.

Single stereo meter, desktop	60LTBDTX	MFR LIST	\$470.00
Single stereo meter, rack mount	60LTBV2X	MFR LIST	\$560.00
Dual stereo meter, rack mount	60LTBV4X	MFR LIST	\$795.50
Triple stereo meter, rack mount	60LTBV6X	MFR LIST	\$995.50

CALL 1-800-732-7665 FOR BRADLEY PRICE

LOGITEK VU METERS

New!

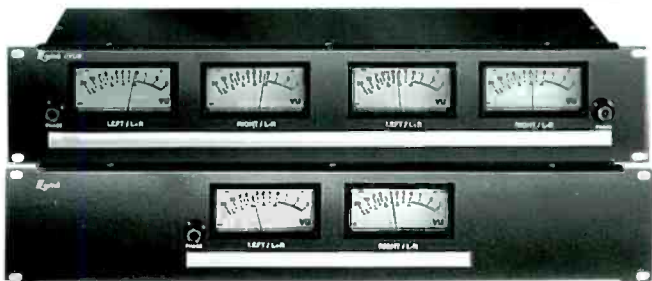

Mechanical VU meters have been the industry standard for years; in loudness measuring applications they are hard to beat. The Logitek 4VUB supplies four large, accurate, mechanical VU response meters in a 2RU self-powered box. For smaller applications, the 2VUB provides two meters centered in a 2RU enclosure. Each meter has a balanced, bridging, high impedance input and a rear panel zero adjustment control.

A phase button for each pair of meters places left plus right on the left meter and left minus right on the right meter. Comparing these two readings gives a quick check for correct phasing. Meter lights and an integral label strip add to the usefulness of these handy units.

4VUB	60LT4VUB	MFR LIST	\$790.00
2VUB	60LT2VUB	MFR LIST	\$525.00

CALL 1-800-732-7665 FOR BRADLEY PRICE

ROLLS RS78B AND RS79 TUNERS



The ROLLS tuners are single rack space digital PLL synthesized AM/FM tuners with large LCD Displays with auto search that store up to 16 FM and 8 AM presets. All settings are saved from power outages for up to 4 days. Need signal meter, headphone out, XLR out? Choose the RS79.

AM/FM Tuner	61RLRS78B	\$247.00
Tuner with XLR's, Headphone out, 3yr. Memory	61RLRS79	\$298.00

DENON AM/FM TUNER WITH RDS



Denon's tuner has superb audio and the added features of RDS, including program service name (call letters or slogan), program type, radio text, and traffic program ID. The unit can also tune to the type of format you wish to hear. Other features include 40 station presets, auto FM presets, character input to title your presets, RF attenuator, and low impedance output. An AM loop antenna is included.

TU-1500	60DETU1500RDP	MFR LIST	\$379.00
---------	---------------	----------	----------

CALL 1-800-732-7665 FOR BRADLEY PRICE

TECHNICS AM/FM RECEIVERS



You can get a sweet-sounding radio receiver without spending a whole lot of money. The SA-EX110 provides 100 watts per channel, and specs out at 40-20kHz, 8 ohms, and 0.8% THD. Class H+ amplifier circuitry gives you high power output with outstanding dynamic headroom. Features include 30-station FM/AM random access presets, four audio inputs plus one for VCR audio, quartz-synthesized digital tuning, and a motor-driven volume knob that's controllable by the 31-key wireless remote.

The SA-AX910 ups your power to 120 watts, adds home theater modes, and includes Dolby Pro Logic Surround, sub-woofer signal output, and other performance features. Four audio and two video inputs.

SA-EX110	60TCSAEX110	MFR LIST	\$199.95
SA-AX910	60TCSAAX910	MFR LIST	\$499.95
Rack Shelf	61MAU3	MFR LIST	\$62.50

CALL 1-800-732-7665 FOR BRADLEY PRICE



BROADCAST TOOLS SMART SILENCE MONITOR

This circuit card monitors any stereo or monaural audio source, including mod monitors, tuners, and automation systems. Set the time-out from two seconds to 8-1/2 minutes with dip switches. One relay is latched for the duration of the audio loss, the other until reset is activated.

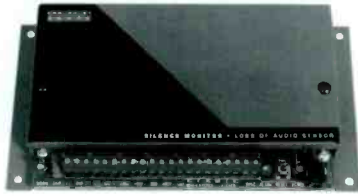

Silence Monitor	60BTSIL	MFR LIST	\$199.00
Rack Kit	60BTRM2	MFR LIST	\$49.00

CALL 1-800-732-7665 FOR BRADLEY PRICE

GENTNER SILENCE SENSOR



Silence Sensor is ideal as a failsafe device when using a dial-up transmitter remote control. On detecting silence, this unit activates an open collector output (capable of sinking 250mA, 48VDC, noninductive). Simultaneously it starts a timer. At the end of the time period, a second open collector output and a relay closure are also activated. Use the first output for an alarm, and the second output for a second, louder alarm while the relay closure starts a backup tape machine. The timer's period is adjustable over a range of 0 to 99 seconds and then up to 99 minutes in one-minute increments.

Silence Sensor	60GE55	MFR LIST	\$569.00
----------------	--------	----------	----------

CALL 1-800-732-7665 FOR BRADLEY PRICE

FURMAN VU-40 STEREO SYSTEM MONITOR



Furman's monitor is an inexpensive dual meter that can keep watch on either line levels or amp power outputs. The scales are set with a positive action, resettable switch matrix on the rear. It has two independent channels with familiar VU meter scales coded in three colors, and lets you switch for peak or average response. Each channel has a line level/power out switch; line level is settable for -10, zero, or +4dBu. Also includes ground lift switch and sixteen power-out choices from 20 to 1260 watts; it also accommodates 25V and 70.7V lines. The "B" version adds XLR balanced I/O.

VU-40	60FUVU40	MFR LIST	\$249.00
VU-40B	60FUVU40B	MFR LIST	\$299.00

CALL 1-800-732-7665 FOR BRADLEY PRICE

WOHLER POWERED STEREO MONITORS



A reviewer writing in "Radio World" said Wohler's design "reminds me of those rare pieces that are almost overdesigned to prevent obsolescence." We agree: these monitors sound great and will last a long time.

Wohler's rackable, powered stereo monitors are shielded for installation in TV stations, mobile trucks, flyaway systems, and many other specialty environments. The AMP-1A has response from 100Hz to above 10kHz, at levels loud enough for a busy studio. Mids and highs are reproduced through the left and right speakers, while lows are combined in the center.

For extended response and even more volume, the two rack unit AMP-2 is your choice. It includes LED level meters with VU or PPM ballistics, and visual phase/polarity indication.

Models not already so equipped can be ordered with input switching, phase/polarity indicators, three-state level indications (off, on, over range), surround sound, output volume adjust, headphone output, and more.

AMP-1A	60WOAMP1A	MFR LIST	\$715.00
AMP-2	60WOAMP2	MFR LIST	\$1,095.00

Options: Digi-1 option card allows these models to receive input signals in the AES/EBU or S/PDIF digital audio formats. Format and sampling rate are sensed automatically. This version replaces the monitor's analog inputs; call for other configurations.

DIGI 1	60WODIGI1	MFR LIST	\$485.00
--------	-----------	----------	----------

CALL 1-800-732-7665 FOR BRADLEY PRICE

*Call Bradley for other
Wohler products, including:*

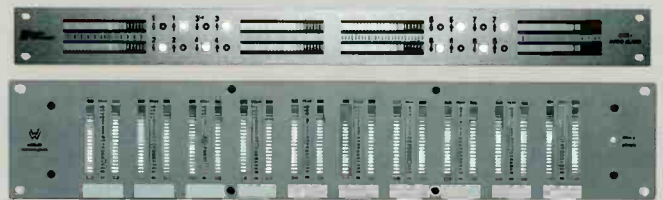

The one rack unit MSM-1 and the two rack unit MSM-2 are power supply/mainframe units that can take a variety of level, phase and alarm modules. Call Bradley for a list of available modules and for assistance with applications.



ANCHOR POWERED MONITORS

Use the AN-1000X in a rack, or put it on a speaker stand to address up to 300 people with pleasurable audio fidelity. It has a 50 watt amp, matched two-way speaker system, RCA and 1/4" phone line-level inputs, a mic/line XLR balanced input, and both line-level RCA and external speaker outputs. The AN-1001X is a companion, unpowered speaker with I/O parallel speaker connectors.



The little-brother AN-100 is suitable for multimedia applications and other work where economy is paramount. It has a 25 watt amp, 1/4" phone mic and instrument inputs, plus two RCA line inputs. Like the AN-1000, it is magnetically shielded.

Anchor has lots of options, including rack kits, speaker stands, and wireless mic versions. Call us.

AN-1000X	60AN1000X	MFR LIST	\$400.00 ea.
AN-1001X unpowered companion	60AN1001	MFR LIST	\$145.00 ea.
AN-100	60AN100	MFR LIST	\$172.00 ea.

Accessories for all models listed:

Single Rackmount	60ANRM1	MFR LIST	\$55.00
Dual Rackmount	60ANRM12	MFR LIST	\$63.00

CALL 1-800-732-7665 FOR BRADLEY PRICE

GENELEC 1029A BI-AMPLIFIED MONITORING SYSTEM

New!

The extremely compact 1029A is a powerful bi-amplified nearfield monitor system ideal for project and home studios, digital workstations, and surround sound monitoring.



The monitor has a very rugged cast aluminum construction and magnetic stray field shielding. A vented speaker enclosure contains an amplification unit with bi-amplified power rated at 40W/40W, including an active electronic crossover, overload protection circuitry and two power amplifiers, one for each driver. Performance is comparable to much larger systems at 110 dB SPL at 1 meter. Versatile room response controls allow matching of the system to its surroundings. The system provides sufficient LF extension (-3dB at 68Hz) for most applications. If substantial low-end response and a low cutoff frequency are required, the 1091A subwoofer should be added to the system. These speakers may be used in either vertical or horizontal orientations, while preserving correct sonic imaging.

1029A	60GN1029A	MFR LIST	ea: \$535.00
1091A Subwoofer	60GN1091A	MFR LIST	\$680.00

CALL 1-800-732-7665 FOR BRADLEY PRICE



Optional Sub-Woofers

GENELEC 1030AMP BI-AMPLIFIED MONITORING SYSTEM

This very compact broadband system is ideal for nearfield monitoring, broadcast monitoring, TV control rooms, mobile vans, video post production, or where space is very limited in project and home studios, digital workstations, and surround sound monitoring.



- Frequency response: 52 - 20k Hz (-3 dB)
- 115 dB SPL (peak) per pair
- Bi-Amplified 80W/50W
- 6.5 liter vented cabinet
- Built in bass roll-off, treble and bass tilt controls

1030AMP 60GN1030AMP MFR LIST ea: \$1,099.00
CALL 1-800-732-7665 FOR BRADLEY PRICE

GENELEC 1031AMP BI-AMPLIFIED MONITORING SYSTEM

The 1031A is ideal for near-field monitoring and such applications as broadcast and surround sound monitoring, CD mastering, TV and video post production, and in conjunction with digital workstations. Combining compactness with high SPL, it will fit easily into remote vans and home and project studios.



- Frequency response: 47 - 22k Hz (-3 dB)
- 120 dB SPL (peak) per pair
- Bi-amplified: 120W/120W
- Built in bass roll-off, treble and bass tilt controls

1031 AMP 60GN1031AMP MFR LIST ea: \$2,099.00
CALL 1-800-732-7665 FOR BRADLEY PRICE

Genelec also offers sub-woofer models 1091A and 1092A.

FOSTEX 6301BEAV POWERED MONITOR

Best Seller

What can we say about a powered monitor that our customers ask for above all others? We've banged up ours time and again, and they just keep on pumping out the great nearfield audio. Keep a pair on your equipment shelf for special requirements; take them on remotes with your DJ mixer.

The 6301BEAV features an active balanced XLR input and special magnetic shielding, so it can be mounted adjacent to video monitors or other sensitive equipment, and puts out 10 watts RMS power with 80Hz to 13kHz response. Size: 7-3/4" x 4-3/4" x 5".



6301BEAV	60F06301X	MFR LIST	\$209.00 ea
Rack kit for single unit	61MA6301FM	MFR LIST	\$60.00
Rack kit for two units	61MA6301FMD	MFR LIST	\$68.00

CALL 1-800-732-7665 FOR BRADLEY PRICE

POWERED & UNPOWERED MONITORS

MACKIE HR824 POWERED MONITORS

New!

Turning their considerable attention to creating exceptional active monitors, Mackie has done it again. Just as with their mixers, far more forethought and features have gone into these monitors than is reflected in their affordable price. These make the perfect complement to any Mackie mixer in a studio setting.



HR824 60MDHR824 \$749.00

- Built-in FR Series bi-amplification: one high-frequency amp (rated at 100 watts continuous/150 watts peak) and one low-frequency amp (rated at 150 watts/200 watts peak)
- 8.75" woofer and 1" alloy-dome tweeter, both with extra-smooth response and featuring a logarithmic taper waveguide
- 3-position Acoustic Space Control
- Low-frequency roll-off switch
- Auto turn-on feature
- Each set comes as a matched pair for accuracy
- Vertical, downward facing input panel (for flush-mounting speakers) with balanced and unbalanced XLR and 1/4" TRS jacks

JBL 4200 SERIES STUDIO MONITORS



With their curved baffles and sparkling clear audio, these speakers bring a new look and sound to console-top, near field monitoring. The Multi-Radial baffle optimizes stereo imaging between three and five feet from the speakers. Both the 1" titanium high frequency transducer and low frequency components are shielded for use next to video monitors and other sensitive equipment. Woofers are 6-1/2" on the 4206 and 8" on the 4208. The enclosures are covered with gray vinyl and the front baffles are injected molded polypropylene.

4206	60JB4206	MFR LIST	\$204.00 ea.
4208	60JB4208	MFR LIST	\$268.00 ea.

Also available:

JBL is out with a powered near-field reference monitor, the 6208. It's a 50x50 watt bi-amplified monitor that looks like a 4208 and accepts -10 or +4, balanced or unbalanced audio.

6208	60JB6208	MFR LIST	\$499.00 ea.
------	----------	----------	--------------

CALL 1-800-732-7665 FOR BRADLEY PRICE

AURATONE SPEAKERS

Sound Cubes



Updated for 1998, the Auratone speaker line now features four products for your nearfield and rack monitoring needs. The USC is the Ultra Sound Cube, successor to the popular 5PSC series. It is now available with perforated metal grille (PMG), removable fabric grille (RFG), or standard with no grille (STD). It features a rear port for improved bass response. All Auratone systems now have improved shielding for use near video monitors. The R3C, which is a three-speaker, individual-input, rack mounting speaker system comes in any of the three grille options. The TSC two way sound cube features a 4" woofer and dome tweeter, producing wider frequency response. The RT4 is a rack mount version of the TSC, with one speaker system (two-way) in a rack-mount enclosure.

AURATONE RT4-PMG	60AART4PMG	\$160.00 ea.
AURATONE RT4-STD	60AART4STD	\$155.00 ea.
AURATONE R3C-PMG	60AAR3CPMG	\$247.50 ea.
AURATONE RACK KIT FOR R3C	60AAR3CRMK	\$12.00
AURATONE R3C-STD	60AAR3CSTD	\$232.00 pr.
AURATONE TSC-PMG	60AATSCPMG	\$240.00 pr.
AURATONE TSC-RFG	60AATSCRFG	\$239.00 pr.
AURATONE TSC-STD	60AATSCSTD	\$230.00 pr.
AURATONE USC-PMG	60AAUSCPMG	\$165.00 pr.
AURATONE USC-RFG	60AAUSCRFG	\$180.00 pr.
AURATONE USC-STD	60AAUSCSTD	\$155.00 pr.



R3C Front and Rear



MONITORING

Best Seller

JBL CONTROL SERIES MONITORS

1. CONTROL ONE

The Control One is a small two-way system suited to broadcast and video work. It's made of molded polypropylene. High power handling capacity (150W, pink noise), excellent audio (120Hz to 20kHz, ±3dB), and shielding make it suitable for critical monitoring. Size: 9-1/4 x 6-1/4 x 5-5/8".

Control One 60JBCNTRL1 MFR LIST \$305.00 pair

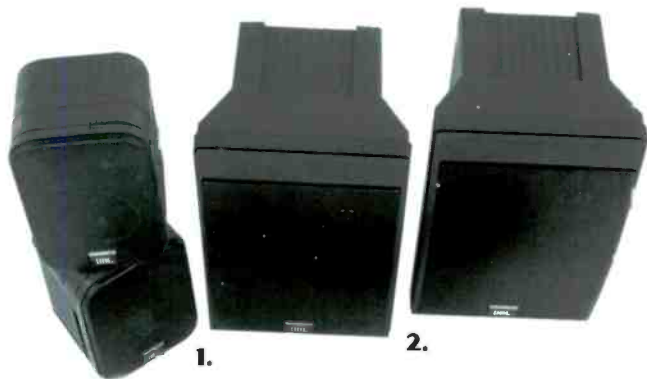

2. CONTROL FIVE

The spirit and quality audio of James B. Lansing live on in this best selling compact monitor. The Control Five will handle up to 175W and provides 75-20kHz response. The system has a titanium dome tweeter and a 6-1/2" woofer. The dividing network uses protection circuitry against dangerous overloads. High quality components give excellent transient response. Mount with Omnimount 75 series or in a rack with MTC-53 hardware.

Control Five 60JBCNTRL5 MFR LIST \$518.00 pair

Accessory:

MTC-2+ This Universal Mount with ball joint holds a single Control One or Control One Plus monitor on the wall or ceiling and lets you aim it.

60JBMTC2 MFR LIST \$58.00 ea.

CALL 1-800-732-7665 FOR BRADLEY PRICE

JBL MONITOR SPEAKERS

Proven JBL performance! The 4408A is a two way, 8" woofer system ideal for broadcast and general monitoring applications.

The 4410A is a powerful three way, 10" woofer studio monitor that gives exceptional spatial detail because of its vertical, in-line driver array.

The 4412A is a three way, 12" woofer studio monitor that has superior efficiency, greater power handling capacity, and extended bandwidth.

Power ratings with pink noise are 100, 125, and 150 watts, respectively. All provide at least 50Hz to 20kHz response, ±2dB.

Price shown is per speaker. Add R or L to part number to specify Right or Left when ordering.

(1) 4408A	60JB4408X	MFR LIST	\$337.00 ea.
(2) 4410A	60JB4410X	MFR LIST	\$467.00 ea.
(3) 4412A	60JB4412X	MFR LIST	\$701.00 ea.

Accessories: Rack mount kit for one 4408A

60JBMR4408 MFR LIST \$38.00

CALL 1-800-732-7665 FOR BRADLEY PRICE



PRO CO MONITOR SELECTORS

Route the outputs of a stereo amplifier to different speakers. Switch between nearfields and main monitors off of one amp; do easy "A-B" comparisons of two speaker pairs. The RMS-1A is a half-rack unit that sends your signal to one of three pairs of speakers. It switches up to 1800 watts (at 8 ohms).

All I/O's are via five-way binding posts. The RMS-2A handles more speakers. It is essentially two of the RMS-1A in a single rackable chassis. Five year warranty.

RMS-1A	60PCRMS1A	MFR LIST	\$222.00
RMS-2A	60PCRMS2A	MFR LIST	\$444.00

CALL 1-800-732-7665 FOR BRADLEY PRICE



MONITORING



JBL LSR32 REFERENCE STUDIO MONITOR

New!

The LSR32 Linear Spatial Reference Studio Monitor combines JBL's latest in transducer and system technology with recent breakthroughs in psycho-acoustic research to provide a more accurate studio reference. Instead of focusing on a simple measure such as on-axis frequency response, LSR designs require much better control over dispersion via transducer selection and crossover frequency design. Critical decisions of image placement, EQ, balance and timbre are typically made within +/- 15° vertically and +/- 30° horizontally. This workspace is where the engineer, producer and artist make critical mixing decisions and this is the area that LSR is optimized for superb in room response. By incorporating LSR into the system design requirements, a more stable image is maintained and off-axis coloration is minimized. The end result is a monitor with more accurate reproduction capability, with less critical monitor placement requirements.

LSR32 60JBLSR32 MFR LIST \$999.00
 CALL 1-800-732-7665 FOR BRADLEY PRICE



TANNOY NEARFIELD MONITORS

Now you can order popular Tannoy monitors with integral power supplies. The Limpet 135-watt amp is included with "LM" versions of the PBM series. Each Limpet system delivers an enhanced stereo image because the channels are fully separated. Limpet offers a balanced or unbalanced "combo" connector for 1/4" and XLR.

Or order the PBM Series without the amplifier. These are small but hearty. Speakers are gray; the black cloth grille is removable. Peak power ratings are 100 and 125 watts respectively, with response of 64-20kHz or better. These units are 13-16" high. Call for information on larger models.

PBM 8 LM 60TAPBM8LM MFR LIST \$1,395.00 pair
 PBM 8 II 60TAPBM8II MFR LIST \$795.00 pair

CALL 1-800-732-7665 FOR BRADLEY PRICE



TANNOY REVEAL SERIES

New!

Tannoy Professional announces Reveal, a distinctive playback monitor that provides Tannoy's unrivaled sonic excellence at a budget price level. A two-way discrete system, Reveal provides extremely detailed, dynamic sound with a wide, flat frequency response, essential for monitoring with reliable accuracy. Reveal is ideal for nearfield monitoring in project studios, mobiles, broadcast, audio post and AV applications. Reveal's characteristic front panel is not just for show. Its curved baffle has been precisely designed to minimize diffraction. At 40mm thick, this panel provides a massive non-resonant mounting platform for the drive units. A 25mm soft dome tweeter is matched with a 165mm long throw bass unit using a hard-wired, low-loss crossover. Both drivers are magnetically shielded, allowing operation close to video monitors.

REVEAL 60TAREVEAL MFR LIST \$399.00 pr.

CALL 1-800-732-7665 FOR BRADLEY PRICE



YAMAHA NS-10M STUDIO MONITORS

This Yamaha model has found wide acceptance as a production reference monitor. Its 7-1/2" woofer and 1-1/2" soft dome tweeter create smooth 60Hz to 20kHz response, while giving the listener a good feel for how the material will sound when played on a more modest system. The NS-10MC version is intended for installation work. The cabinet accommodates several types of brackets, and a black cloth grille is included.

NS-10M Studio 60YANS10MS MFR LIST \$478.00/pr
 NS-10MC 60YANS10MC MFR LIST \$598.00/pr

CALL 1-800-732-7665 FOR BRADLEY PRICE





Digital Audio Labs' Grand Unified Theory.



- Windows 95 and NT compatibility
- Modular, highly customizable architecture
- 16 True Tracks of hard disk recording
- 32 plus channels of realtime digital mixing
- Dozens of simultaneous realtime streaming effects
- Total integration with ADATs, DAB8's, and compatibles
- Subframe accurate synchronization to VITC and LTC
- Choice of software interfaces and realtime effects plugins.

V8: the ultimate realtime studio system for the PC.

Visit us at www.digitalaudio.com

Digital AUDIO LABS

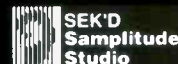

SEK'D America

DIGITAL AUDIO FOR THE WORLD!

SAMPLITUDE

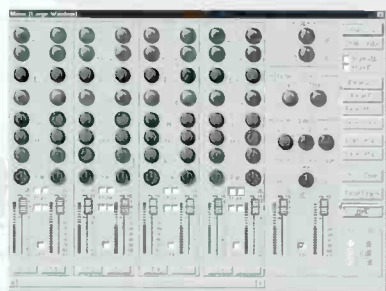

Record and edit your music on up to 999 tracks with unlimited multiple inputs and outputs. Mix down using the real time mixer, 3 stage parametric EQ, dynamics section, delay, room simulator and more. Master your audio and burn a CD.

RED ROASTER

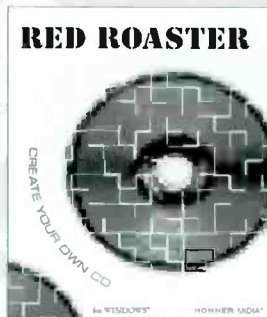

Create true audio CD masters for your fans and mass duplication. Freely place track markers between songs or on live recordings. Only Red Roaster allows you to arrange your audio master piece on multiple tracks.

PRODIF 24

Full duplex digital sound card with AES/EBU, S/PDIF and optical connections. 16 to 24-bit audio resolution and 48 kHz sampling rate. 18-bit stereo analog line/headphone output. Great card for digital mastering and perfect for Red Roaster 24-bit!

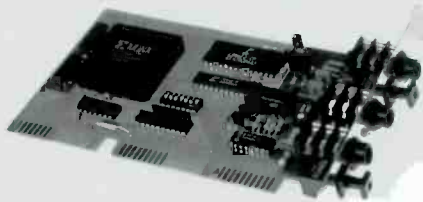

ARC44 SOUND CARD

Plug your guitar, keyboard or mic into the 4 solid 1/4" jacks of the ARC 44. Record and playback 4 tracks simultaneously. Input monitor, hardware resampling, double decker mode for 8 I/O.

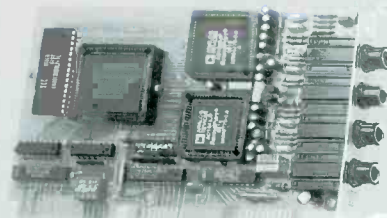

PRODIF GOLD & PRODIF 32

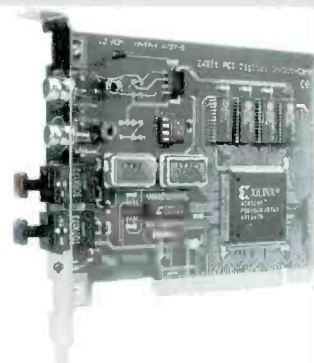

Prodif Gold: Alesis ADAT™ 8 - channel digital card, full duplex, S/PDIF on RCA's Plug-n-Play PCI. Win '95, NT driver.

Prodif 32: Stereo digital PCI card with optical 16/24 I/O, S/PDIF on RCA's, Unbalanced AES/EBU. Mac, '95, NT driver.

ANALOG ARC88

PCI studio recording card with 8 analog In/Out and digital stereo In/Out. Place up to 3 cards in your PC for 24 channels. Connect via convenient break out cable with 16 female RCA plugs. Full duplex record while play and input monitoring. Connect digital devices via optical stereo I/O with 16 to 24 bit resolution.

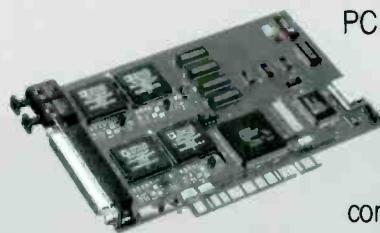

SEK'D 2496 ADDA CONVERTERS

For the ultimate in high resolution audio the new 2496 ADDA S and the 2496 ADDA DSP converters give engineers the ultimate in high resolution digital/analog analog/digital conversion. The S model rewards its user with a dynamic range 110 dB. The DSP model performs at an astounding 128 dB level! For the best in digital audio conversion, SEK'D 2496 ADDA S and DSP are world leaders.

O2R VISUALIZER

Control your Yamaha™ O2R from a PC with the Visualizer. Imagine the O2R displayed as an analog console with all the knobs where you expect them to be. Edit and store your Automix and add 16 new valuable features. Connect from O2R host connector to serial port of your PC via provided cable.

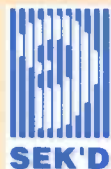
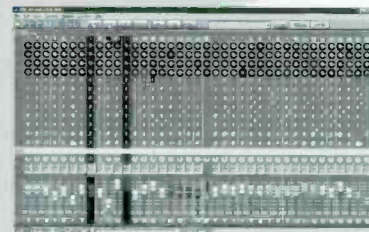

SEK'D America

formerly Hohner Midia

P.O. Box 5497 • Santa Rosa, CA 95402

Tel. 707-578-2023 • Fax 707-578-2025

e-mail: info@sek.com

Visit <http://www.sekd.com> and download free demo software or call:

1-800-330-7753

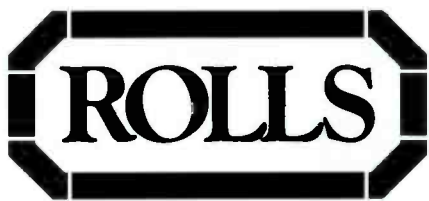

ACCESSORIES



Bradley
BROADCAST & PRO AUDIO

For your initial order, get \$10.00 off each Rolls accessory purchased.

Direct Box Problem Solvers



DB25 MATCHBOX
\$35.00

The DB25 takes a high impedance signal to low impedance via shielded transformer balancing.

- Converts high-impedance to low-impedance & vice-versa
- Ground Lift for "hum" reduction
- Attenuator switch for connection to line level or speaker level signals
- May be ordered with male or female XLR jacks



ADB2 ACTIVE DIRECT BOX
\$50.00

The ADB2 is an active direct box with superior frequency response suitable for recording applications.

- Uses standard 12 to 48 volt phantom power
- Ground Lift for "hum" reduction
- Attenuator switch for connection to line level or speaker level signals



SE162 RED SQUARE
\$80.00

The SE162 is an electronically balanced direct box with the added benefit of a sonic exciter. The exciter gives your sound more life and animation.

- DI Box / Sonic Exciter
- Adds clarity and presence to any signal
- Bottom and Definition controls
- XLR and 1/4" Outputs

NEW!



DB14 DIRECTOR
\$70.00

The DB14 is a specialty direct box that takes two RCA inputs, gives them separate volume controls, and outputs them via the two RCA output jacks and a transformer balanced XLR jack.

- Stereo Patch / Direct Box
- Separate control for A source and B source
- Lo Z out for connection to a mixing board, mixes A and B together
- May be ordered with male or female XLR jack

Phantom Power Problem Solvers



PB23 & PB223 PHANTOM POWER ADAPTER
PB23: \$60.00 PB223: \$75.00

Condenser microphones require clean, efficient power. The PB23 and PB223 provide just that. They both offer a dc loop through jack for powering another identical unit.

- Powers most any condenser microphone
- +12 or +48 VDC power available
- High-frequency power supply
- PB223 has two adapters in one box



PB24 PHANTOM POWER PLUS
\$90.00

The PB24, battery powered phantom power adapter delivers all the clean transparent power needed for any condenser microphone.

- Battery or AC powered
- Powers any condenser microphone
- +12 or +48 VDC power available
- High-frequency power supply

Mixer Problem Solvers

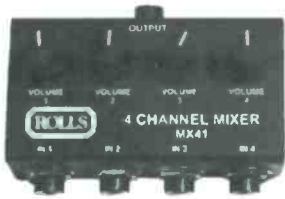

MX41 MIXER
\$35.00

The MX41 is a passive resistance mixer that will accept up to four signals. It may also work in reverse, sending out up to four signals.

- 4 Input to 1 Output
- 1/4" Hi Z Jacks
- 100K Ohm Pots



MX44 MINI-MIX IV
\$75.00

The MX44 mixes line or instrument level signals with enough power to drive long lines or even headphones.

- 1/4" unbalanced inputs and output
- For line and instrument level signals
- Output will drive headphones
- Battery included



MX22 2 CHANNEL MIXER
\$50.00

The MX22 will mix a 1/4" line-level signal such as a wireless microphone, with an RCA signal such as a cassette or CD player. This makes the MX22 perfect for aerobics studios, schools, churches, etc.

- Mixes 1/4" line level signals and stereo RCA signals to a mono output.
- Individual controls for each signal



MX28 MINI-MIX VI
\$100.00

The MX28 is for mixing up to three stereo line signals. Any keyboardist that does not want to carry around a bulky rack mixer will find the MX28 the lightweight answer.

- Mixes 3 stereo signals
- True stereo right and left 1/4" outputs
- Two headphone outputs
- Balance control

NEW!



MX51 MINI-MIX 2
\$80.00

The MX51 mixes two 1/4" signals with up to three stereo RCA signals. The signals are mixed to mono and output via two RCA jacks or a 1/4" jack on the front panel.

- For mixing up to two 1/4" inputs with up to three RCA input signals
- Four channels total
- Line / Headphone output level



DU30 Mic Preamp/Audio Ducker
\$100.00

The DU30 takes any program material present at the RCA jacks and ducks it under any signal present at the Mic Input.

- Mic Preamp w/phantom power
- Alt in for cascading another unit.
- Perfect for restaurants, clubs, shops etc.

NEW!

Personal Monitor Problem Solvers



PM50s PERSONAL MONITOR SYSTEM
\$50.00

This is the "more me" box. Mix your microphone with a main monitor mix for a perfect monitor mix that you control. The PM50 also works as a line tester.

- Monitors Mic and Monitor signal
- 1/4" Input accepts line and speaker levels
- Mic pass-through for mixer connection



PM52 HEADPHONE TAP
\$50.00

The PM52 allows connection directly to a powered line making it perfect for anyone wanting to replace a wedge monitor with headphones.

- Connects speaker level signal to headphone level
- Mono/Stereo mode
- Power Amp loop through
- No external power or batteries required

Miscellaneous Problem Solvers

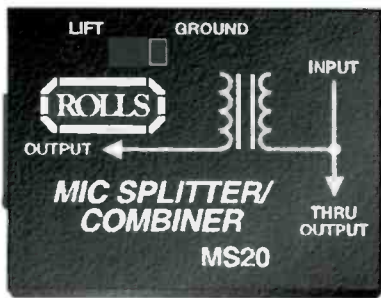

MS20 MIC SPLITTER /COMBINER \$50.00

The MS20 takes a low impedance signal such as a microphone, and sends it to two separate XLR outputs. One output is a pass-through, the other is transformer isolated.

- Transformer coupled
- 3: XLR jacks
1: Female input and 2 Male outputs OR
1: Male input and 2 Female outputs
- Ground Lift



HA43 HEADPHONE MIXER \$100.00

A single in - four output headphone amplifier. Connect it to the headphone out of any mixer and up to four people can listen at once.

- Single input, four output headphone amplifier
- Slider volume controls
- Full frequency response
- Lots of output level - it's loud



MO2020 TESTOSCILLATOR \$100.00

The MO2020 provides a compact way to get a test signal into any audio device. Having sine and square waves allows you perform tests from

frequency response to group delay, and the -10 dB pad gives you mic level for testing more sensitive inputs.

- 1/4" unbalanced sine and square wave outs
- Frequency range from 20Hz to 20kHz
- VCO Input for external frequency control
- AC adapter included in US models

Bradley

BROADCAST & PRO AUDIO



VP29 PHONO PREAMP \$76.00

The VP29 is used to amplify an RIAA equalized signal from a turntable to line level and standard equalization.

- RIAA eq
- RCA inputs/outputs
- 1/4" TRS output
- Adapter included in U.S. models



CT1 CABLE DETECTIVE \$60.00

Find those pesky problem cables quickly with this little spy. No musician or audio professional should be without a CT1.

- Tests 1/4", RCA and XLR cables
- Tests combinations of the above
- Easy-to-read LED indication



MP13 MINI-MIC PREAMP \$90.00

The MP13 is a compact and easy way to get a microphone up to line level. A board room or small announcement system is one of many

ideal places for this single channel microphone preamp.

- XLR and 1/4" Inputs and Outputs
- +30 V Phantom Power
- AC adapter included
- Clip Indication
- Output will drive headphones



SX21 TINY TWO-WAY CROSSOVER \$100.00

Very often a need arises for a simple one-in, two-out crossover. Bass players, combo bands and small public address systems are just a few applications for the SX21.

- 24 dB / Octave rolloff
- Mono 2-Way crossover
- 100Hz - 5 kHz range
- DC Loop-Thru for multiple-unit use
- Other crossover frequencies available

ELECTRO-VOICE SENTRY MONITORS

This model is a mainstay. The Sentry 100A has an 8" woofer; the 1.5" tweeter handles up to 25 watts input power where most tweeters do about five. For 15 years it has been popular in broadcast and video production. Finished in black with a removable gray grille. Response: 45Hz - 18kHz. The Sentry 100EL is a 50W powered version, with XLR balanced and 1/4" phone unbalanced inputs.

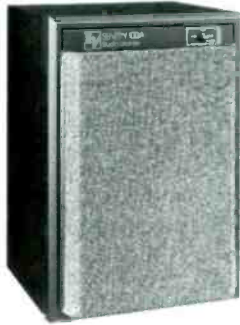

100A	60ELSEN100	MFR LIST	\$459.00 ea.
100EL	60ELSEN100EL	MFR LIST	\$909.00 ea.
Rack mount kit for Sentry 100A and 100EL			
	60ELSRB7	MFR LIST	\$46.50 ea.

CALL 1-800-732-7665 FOR BRADLEY PRICE

Omnimount Series 25 mounts on wall or ceiling.

5-40 Black	60ELS40	MFR LIST	\$317.00 pair
5-40 White	60ELS40W	MFR LIST	\$317.00 pair

Accessories:

Black U-type bracket	60ELS40MBB	MFR LIST	\$34.50 pair
White U-type bracket	60ELS40MBW	MFR LIST	\$34.50 pair
Omnimount WBX Arm Mount (one per speaker)			
	600M25WBXBC	MFR LIST	\$35.95 ea

CALL 1-800-732-7665 FOR BRADLEY PRICE

PIVOTELLI SPEAKER BRACKETS

Speakers can swing side to side and tilt up and down. The speakers are clamped front and back, and although screw holes are provided on the bottom of the bracket, you need not screw into most speakers. The distance to the wall is also adjustable. Pivotelli brackets have a five year warranty, and come with hardware for installation into wooden wall studs, brick, or concrete. Hold speakers up to 44 pounds and between 4" and 10" deep.

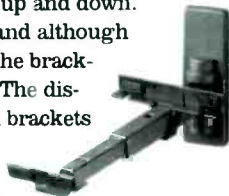

Pivotelli Brackets	60PV55	MFR LIST	\$99.00 pair
Metal stud kit required for mounting to metal studs.			
Order one kit per bracket.	60PVM5KS	MFR LIST	\$10.00

CALL 1-800-732-7665 FOR BRADLEY PRICE

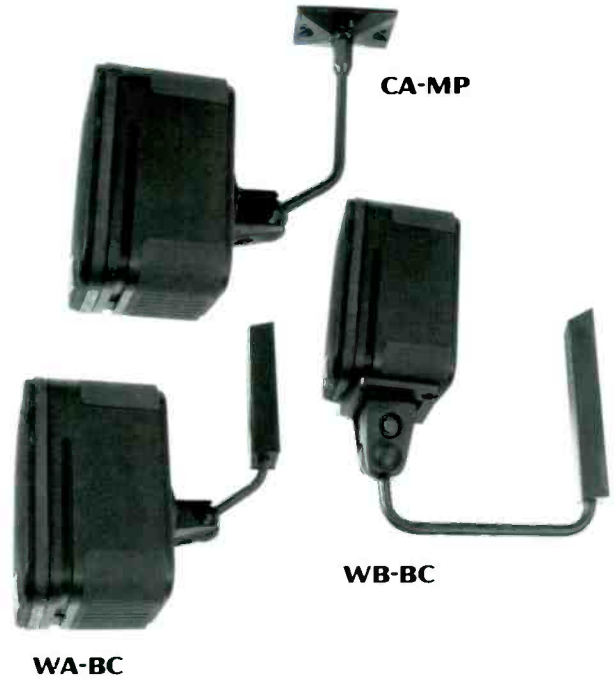

OMNIMOUNT UNIVERSAL MOUNTING SYSTEMS

Hanging a load on a wall or ceiling is serious business. Choose Omnimount to do the job right. The ball and clamp assembly enables full movement. Wiring can be hidden for a dressed installation.

For tiny loads up to five pounds, choose the 25-WBX, suitable for nearfield monitors on racks or walls. The 50 series holds up to 15 pounds, the 75 series is rated for 25 pounds, and the 100 series will hold 55 pounds.

The WB-BC bottom mount has a double bend tube to hold the speaker from its bottom. The WA-BC is of similar design, but has a single bend tube to hold the device from the rear. Also available is the CA-MP ceiling mount, several other configurations, and series with greater load handling. Call us to pick the right model.

25 WBX	600M25WBXBC	MFR LIST	\$35.95
50 WA-BC	600M50WA	MFR LIST	\$49.95
50 WB-BC	600M50WBBC	MFR LIST	\$49.95
50 CA-MP	600M50CAMP	MFR LIST	\$49.95
75 WA-BC	600M75WABC	MFR LIST	\$79.95
75 WB-BC	600M75WBBC	MFR LIST	\$79.95
75 CA-MP	600M75CAMP	MFR LIST	\$79.95
100 WA-BC	600M100WA	MFR LIST	\$99.95
100 WB-BC	600M100WB3	MFR LIST	\$99.95
100 CA-MP	600M100CAMP	MFR LIST	\$99.95

CALL 1-800-732-7665 FOR BRADLEY PRICE

See pages 124 & 125 for cables



HEADPHONES, AMPLIFIERS & ACCESSORIES

U.S. AUDIO P-12 POWER AMPLIFIER

GREAT FOR INSTALLED SOUND



Here's an ideal economical answer to situations that require low-powered amplification. The P-12 is a single-space unit with 11 watts per channel into 8 ohms. Simple controls include two channel gain, clip LED's, and a switch for speaker-or-headphone operation. Want to feed a headphone network? A special rear-mounted XLR jack interfaces directly to the separate SAT-1, a headphone breakout box with two channels and four outputs.



P-12 60WHP12 MFR LIST \$199.00
SAT-1 60WHPHSAT MFR LIST \$149.00

CALL 1-800-732-7665 FOR BRADLEY PRICE

HEADPHONE BREAKOUT BOX

This passive Whirlwind winner has two stereo ins (for daisy chaining) wired to six resistor bridged outputs. Locking 1/4" TRS jacks prevent accidental disconnection.



61WHBB \$79.00

RANE HC6 HEADPHONE AMP



Rack mount is standard on this fine system. A master stereo input drives six stereo headphone amplifiers, which provide both front and rear panel 1/4" TRS outputs. Each amplifier also has a separate mono balanced/unbalanced input, allowing the HC6 to act as six independent amps. The HC6 also has a master level control and mono/stereo push button.

HC6 60RNHC6 MFR LIST \$479.00

CALL 1-800-732-7665 FOR BRADLEY PRICE

RAXXESS HEADPHONE HANGER

New!

Just replace any screw in your rack with this ingenious device, and you can hang your headphones in a place where they'll always be accessible and protected. 61RXHH1 \$8.95

BENCHMARK HEADPHONE AMPLIFIERS

Put the monitoring right where you need it. You can use stereo headphone amps in your console, at your patch bay, in beltpack mic preamps, or anywhere. Capable of driving both low and high impedance headphones, the HPA-1 includes a gain pot adjustable from off to +18dB. Requires ± 9 to ± 22 VDC bipolar power, from a supply like the optional PS-1.

For a self contained headphone amp, we offer the IFA-7. Separate left and right XLR inputs ease installation. Requires PS-1 power supply.

HPA-1	60BMHPA1	MFR LIST	\$70.00
IFA-7	60BMIFA7	MFR LIST	\$195.00
PS-1 power supply	60BMPS1	MFR LIST	\$35.00

CALL 1-800-732-7665 FOR BRADLEY PRICE



SYMETRIX SX204 HEADPHONE AMPLIFIER

Best Seller

This headphone amp is part of the Symetrix SX series of half-rack products; it is popular with our customers. It's a 1 in, 4 out stereo headphone amplifier. Four independent stereo amps will drive even high-impedance headphones to maximum levels. Controls are master input level, stereo/mono switch, and individual level. Balanced or unbalanced inputs are on 1/4" TRS jacks, outputs also 1/4" TRS.



SX204 60SYXS204 MFR LIST \$349.00

Accessory:

Rack mount kit for one or two SX series units.

60SYRM2 MFR LIST \$39.00

CALL 1-800-732-7665 FOR BRADLEY PRICE

KOSS TD61

This economical, yet rugged headphone is ideal for budget requirements. Frequency response is an impressive 20-20,000Hz and Koss' "no questions asked" lifetime warranty adds even more value to your purchase. Includes 8 foot straight cord with 1/8"-1/4" stereo adapter.



60K0TD61 MFR LIST \$24.99

CALL 1-800-732-7665 FOR BRADLEY PRICE

FOSTEX PH-50 HEADPHONE AMP

Drive up to five sets of headphones with this handy headphone amp. Each output has its own 100mw amplifier for individual settings. The main input is driven from a headphone output, and an aux input is provided for a second input from a cue system. Units may be cascaded for large ensembles, multimedia presentations, or educational applications.



PH-50 60FOPH50 MFR LIST \$279.00

CALL 1-800-732-7665 FOR BRADLEY PRICE

SENNHEISER HEADPHONES

HD 25-SP

For dramatic isolation from outside noise, wear the HD25-SP. High efficiency drivers, modular parts, and great specs: 16Hz to 22kHz response, 105dB sensitivity, weight only five ounces. 70 ohms.



60SNHD25SP \$119.95

HD 470

A light, high performance Open-Aire headphone with good deep bass, neodymium-ferrous magnets, and single cable entry. Replaceable parts, 1/8"-to-1/4" plug. 18Hz-21kHz, 52 ohms.



60SNHD470 \$59.95

MONITORING

Bradley Broadcast • 7313-G Grove Road • Frederick, MD 21704 • 800-732-7665 • 301-682-8700 • Fax: 301-682-8377 • Web: <http://www.bradleybroadcast.com>

AKG MONITORS

K240M MONITOR

Critical listening merits an exceptional headphone. This popular circumaural model simulates hearing in natural room conditions with its fine directional sound perspective and distance discrimination. The design combines main transducers and 12 passive diaphragms, with crossover at 200Hz. Weighs 8-1/2 ounces. Ten-foot cable, dual plug (1/4" and 1/8"). 600 ohms.



The DF model is a calibrated version for best reference-monitor performance. Both models are widely used for broadcast.

60AKK240M \$99.00
60AKK240DF \$109.00

K141M MONITOR

Award-winning headphones from AKG. Semi-open back construction, hard gold plated jack plug and contacts, patented self-adjusting headband. Exciting bass, clear defined treble. Great price/performance ratio. 600 ohms.



60AKK141M \$79.00

BEYER DT250

New!

The DT250 from Beyer is a light-weight, closed-ear dynamic headphone, specifically designed for studio applications. It features an efficient neodymium magnet system, very high reproduction precision and balanced sound.



60BEDT25080 \$139.00

BEYER DT 48

For ENG and film monitoring, this specialty headphone has a coiled cable and 1/4" stereo jack. It offers flat accurate response and excellent isolation. Not for everybody. Specify 8, 25, or 200 ohms.

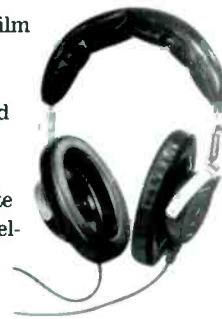

60BEDT48 \$269.00

SONY MDR-7506 HEADPHONES

Our all-time headphone champ, the MDR-7506 is widely hailed for its exceptional audio and comfort in a headphone that doesn't run into three figures. The clever collapsible design means they're easy to take with you. Audio from the 40mm drivers is crystal clear with 10Hz to 20kHz response. The closed ear design reduces noise and feedback. Gold 1/8" plug with screw-on 1/4" adapter. 36 ohms.

MDR-7506 6050MDRV6 \$89.00

Other Sony Headphones

MDR-7504 6050MDR7504 \$84.00
MDR-7502 6050MDR7502 \$55.00

Best Seller



HEADPHONE AMPS

MODEL	MANUFACTURER	# OF OUTPUTS	RACK UNITS	WEIGHT	BACKMOUNT	LIST PRICE
HD-100	ATI	1	1	3 lbs	optional rack mount	\$219.00
HD-1000	ATI	4	1	10 lbs	optional rack mount	\$499.00
IFA-7	Benchmark	1	1	n/a	optional rack mount	\$195.00
HPA-1	Benchmark	1	n/a	n/a	jack mounted	\$70.00
PH-50	Fostex	5	n/a	1.5 lbs	optional rack shelf	\$279.00
HP6A	Furman	6	1	9lbs	includes rack mount	\$419.00
ST-SH1	Radio Design Labs	1	n/a	n/a	stick - on	\$114.00
HC-6	Rane	6	1	8 lbs	ack mount included	\$479.00
HA43	Rolls	4	n/a	n/a	no	\$100.00
RA-62HA	Rolls	6	1	6 lbs.	ack mount included	\$228.00
Q5	Samson	6	1	1.5 lbs	optional rack shelf	\$139.00
SX-204	Symetrix	4	1	n/a	optional rack mount	\$349.00

Call Bradley for info on Furman's Headphone Distribution System HDS-6 and HR-6

MONITORING



PROCESSORS

SABINE FEEDBACK EXTERMINATORS



Your graphic EQ is fine for shaping sound, but if you use it to control feedback, the width of its filters means you may be removing a lot of good stuff too. An FBX-1020Plus or 2020Plus, placed in front of your power amp, senses feedback and, in less than a half-second, places a super-narrow adaptive digital filter on the resonating frequency. It's automatic and v-e-r-r-y precise.

This will help audio pros anywhere. You get feedback control and increased clarity. At last you can crank up those monitors. Connectors are XLR and 1/4" TRS, balanced and unbalanced. The FBX is a dual mono version with a few extra features thrown in.



The FBX SOLO is a miniature version of the 1020Plus and 2020Plus, controlling feedback on one input channel. Pack one with your wireless mic setup. Monitor engineers can patch one on any offending channel. Mount up to six in a rack tray. Choose line or mic input versions; the latter has a pre-amp and phantom power.

FBX-1020Plus 20-bit, single channel	605BFBX1020	MFR LIST	\$599.00
FBX-2020Plus 20-bit, dual channel	605BFBX2020	MFR LIST	\$1,199.00
FBX-SOLO 5L-820 Line version	605BSL820	MFR LIST	\$324.00
FBX-SOLO SM-820 Mic version	605BSM820	MFR LIST	\$349.00
Rack Tray (holds 6 SOLOS)	605BSL6RACK	MFR LIST	\$44.95

CALL 1-800-732-7665 FOR BRADLEY PRICE

1-800-732-7665

YAMAHA GRAPHIC EQ'S

Submitted for your consideration, three fine graphic EQ's, all with balanced XLR and unbalanced 1/4" connectors, switchable levels (+/-20), EQ bypass, boost and cut, and peak indicators that warn of near-clipping. Q2031B is a classy, stereo 31-band graphic EQ in two rack spaces. An automatic circuit mutes the output for 3-5 seconds after power is switched on. You get 6 or 12dB of boost or cut, with points centered at ISO 1/3 octave frequencies from 20-20kHz. Sockets for output transformers are included on the rear panel.

GQ2015 is a compact dual, 2/3 octave, 15-band EQ in one RU. GC1031-BII is a high performance 1/3 octave, 31-band EQ in one RU.

Q2031B	60YAQ2031	MFR LIST	\$749.00
GQ2015	60YAGQ2015	MFR LIST	\$429.00
GQ1031-BII	60YAGQ1031B2	MFR LIST	\$399.00

CALL 1-800-732-7665 FOR BRADLEY PRICES

RANE MICRO-GRAPHIC EQUALIZERS

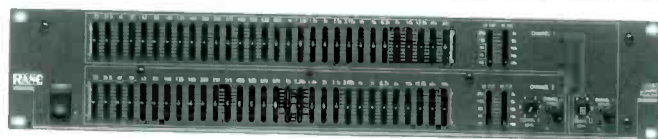

Reliable Rane EQ's are now improved with both balanced XLR and 1/4" TRS connectors. Their filters are constant Q with grounded center-detent controls. The ME-15B is a two-channel, 2/3 octave device in one rack unit; the ME-30B is one-channel, 1/3 octave in one rack unit. Features include overall level control, bypass mode, 20mm sliders, RFI filtering, and ±6 or 12dB slider range.

The ME60 is a two-channel, 1/3 octave EQ with sweepable low and high cut, in a two RU chassis. It's like two ME30's in one unit, with some nice extras. It uses XLR, 1/4" TRS, and RCA jack I/O; sliders are 20mm. Need longer sliders? Ask about the GE60.

ME-30B mono 30-band	60RME30B	MFR LIST	\$419.00
ME-15B stereo 15-band	60RME15B	MFR LIST	\$429.00
ME-60 stereo 30-band	60RME60	MFR LIST	\$699.00

Models also available with long-throw faders:

GE-215 stereo 15-band	60RNGE215	MFR LIST	\$599.00
GE-130 mono 31-band	60RNGE130	MFR LIST	\$529.00

CALL 1-800-732-7665 FOR BRADLEY PRICE

PRESONUS BLUE MAX



Would you believe a compressor/limiter with a brain? That's what you get with the BlueMax from PreSonus. 15 studio pre-sets and a manual mode give you full control over compression parameters including: variable I/O, attack/release times and ratios from 1:1 to 20:1. Onboard metering shows input/output levels and gain reduction for stereo and mono operations. The BlueMax takes up only 1/2 of a rack space and has an internal power supply eliminating the need for yet another wall wart.

PreSonus BlueMax	60PNBLUEMAX	\$199.00
------------------	-------------	----------

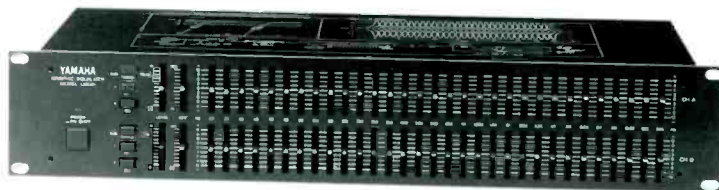

AUDIO PROCESSING

Bradley Broadcast • 7313-G Grove Road • Frederick, MD 21704 • 800-732-7665 • 301-682-8700 • Fax: 301-682-8377 • Web: <http://www.bradleybroadcast.com>

DBX 166XL DUAL COMPRESSOR/LIMITER/GATE



A compact, high performance tool with two independent channels, each combining OverEasy® compression, PeakStop, and a soft knee expander gate. The front panel gives you stereo or dual-mono operation. Connectors: balanced XLR and unbalanced 1/4" inputs and outputs, IEC AC connector.

Prevent transient peaks from overloading your digital recorder; make an intimate vocal stand out in a music mix; use compression for jingles and post production.

166XL 60DB166 MFR LIST \$419.95

CALL 1-800-732-7665 FOR BRADLEY PRICE

DBX 1066 DUAL COMPRESSOR/LIMITER/GATE



It's packed: OverEasy soft knee compression, zero-attack PeakStopPlus limiter, 70dB expander/gate, 12-segment gain reduction meters, over/under LED's, and peak-reading I/O meters. Vary the ratio to select anywhere from gentle downward expansion to gating. Link both channels for stereo compression. Adjust your attack and release times or let the unit do it.

Monitor input or output. You can A/B your audio with or without sidechain processing. Work in the dark thanks to illuminated switches. Use either the balanced XLR or unbalanced 1/4" TRS connectors; convert semi-pro -10dBV audio to the internal +4dBu. Forget "Y" cables; sidechain sends and returns are on separate jacks. The internal supply lets you use this box all over the world.

Each channel has the following controls: expander/gate threshold & ratio, compression threshold & ratio, compression attack & release times, output gain, and limiter threshold.

1066 60DB1066 MFR LIST \$549.95

CALL 1-800-732-7665 FOR BRADLEY PRICE

ASHLY CLX52E COMP/LIMITER

Place a ceiling on the peak levels of your program material. The CLX52E lets you set the amount of gain reduction, attack/release times, and output gain. Features include trigger circuit patch, variable threshold, variable ratio from 2:1 to infinity:1, variable attack and release, and LED's to indicate up to 20dB of reduction. The CL52E provides two channels of gain reduction in one compact package, strappable for stereo.

CLX52E 60ASCLX52 MFR LIST \$499.99

CALL 1-800-732-7665 FOR BRADLEY PRICE

DBX 160A COMPRESSOR/LIMITER

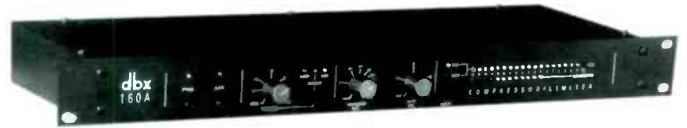

Use this classic device to control variation in levels, raise a signal out of a mix, transfer between digital and analog media, prevent tape saturation, and protect speakers. The "A" in the name means a better signal path, single front panel with rack ears, IEC AC connector, ground lift switch for pin 1 of the XLR input, and a stronger chassis.

Choose OverEasy® or classic hard knee compression. The 160A gives variable compression ratio from 1:1 through infinity to negative compression, a dual RMS LED display that monitors input or output and gain reduction, up to 60dB of gain reduction, compression threshold from -40dB to +20dB, and balanced and unbalanced outputs that can drive loads simultaneously.

Setup is easy, metering is precise. Two 160As can be stereo-coupled to process an entire mix or instruments miked in stereo.

160A 60DB160A MFR LIST \$459.95

CALL 1-800-732-7665 FOR BRADLEY PRICE

RANE DC24 DYNAMIC CONTROLLER



Take advantage of effective split-band processing in a single, affordable box. The DC24 is a two-channel compressor, limiter, expander gate with controls for compression ratio & threshold, expander/gate ratio & threshold, and limiter threshold. Gain reduction meters keep you up to date.

The internal crossover allows a single audio channel to be divided into two bands, processed separately, and re-combined into one channel. This crossover may also serve as a dividing network allowing all processing functions for each band. Connections are XLR and 1/4", with gain switches for -10/+4; RFI filtering is built in. Individual channel hard wire bypass switches are also provided.

DC24 60RDC24 MFR LIST \$599.00

CALL 1-800-732-7665 FOR BRADLEY PRICE



PROCESSORS

SYMETRIX AGC/LEVELERS



A Symetrix AGC/Leveler is the solution for inconsistent levels. Unlike a compressor/limiter, it not only pushes "down from the top" but also makes your quiet sounds louder, with finesse.

Got a walkaway automation system? Pick the stereo 422 to feed your air chain processing a steady diet. Got loud commercials on your cable TV system? Not any more. Use it to convert "all-over-the-place" audio to a smooth, constant level. This model is also handy in theaters, tape duplication work, and music mixdown.

Set up is easy; just set your target level and let the unit gently boost low levels and compress hot ones. Peak limiter, I/O metering, and remote bypass port are standard. The 422 handles line-level audio. Connectors are balanced XLR and 1/4" TRS.



Working with mics? The Symetrix 421m may be the better choice. It's a single-channel AGC/Leveler with many of the same features as its sibling. It also has both a line input (1/4" TRS and screw terminals) and mic input (XLR with phantom), and provides selectable speech curve filters to get the most out of voices. A downward expander keeps the output quiet when audio is absent. Good for churches, paging systems, auditoriums. It's linkable for stereo and can also be used on program material. Both models are UL approved.

422	60SY422	MFR LIST	\$595.00
421m	60SY421M	MFR LIST	\$599.00

CALL 1-800-732-7665 FOR BRADLEY PRICE

APHEX DOMINATOR II LIMITERS



Limiting is important but you want to avoid dullness and "hole punching" in your audio. Aphex designed the Dominators to reduce the audible side effects of limiting. This means greater limiting depth for higher loudness without sacrificing audio quality. As a peak overshoot protection limiter, the Dominator is undetectable while it prevents peak levels from exceeding the level you set. The result is greater density and punch.

The 720 is a stereo, three-band peak limiter with a 104dB dynamic range, compatible with your digital equipment. Model 722 adds pre-emphasis (either 50 or 75 μ sec) before the limiters. A de-emphasis circuit appears after the final limiter. Both pre-emphasis and de-emphasis are switchable. The 722 is designed for use in broadcast, satellite, and transmission links.

720 Dominator II	60AP720	MFR LIST	\$1,350.00
722 Dominator II	60AP722	MFR LIST	\$1,495.00

CALL 1-800-732-7665 FOR BRADLEY PRICE

RANE AUDIO DELAYS



Rane has several delay models for your situation. The AVA-22 is for A/V synch, providing two channels of audio delay in video increments, up to 9.5 NTSC frames and 8.0 PAL/SECAM frames. Features include half-frame increments, remote memory recall, two memories per channel, and front-panel lockout. Suitable for TV and video post.



The AD-22 is a balanced, two in/two out audio delay with a range of 0.011 to 327.68 milliseconds on each output. The delay is adjustable in 10 microsecond and 1 millisecond increments. Each output has two non-volatile memories of delay values. Quality is assured with Dolby Time Link 1-bit delta-sigma circuitry. Features include front panel lockout and fail-safe bypass in case of power loss.

The AVA-22 and AD-22B use XLR connectors; the AD-22 has terminal strips.

AVA-22	60RNAVA22	MFR LIST	\$899.00
AD-22	60RNAD22	MFR LIST	\$849.00
AD-22B	60RNAD22B	MFR LIST	\$849.00

CALL 1-800-732-7665 FOR BRADLEY PRICE

EVENTIDE DSP-4000B ULTRA-HARMONIZER®



The software on board this digital-ready effects processor was created especially for radio, TV, and post-production. Push a button, you're the voice of a computer. Push another, you're talking through a car phone. Yet again, and we hear you talking from the cabin of an airplane. Choose from dozens of environments.

You also get sound effects and audio backgrounds: thunder and rain, the surf, a passing plane. You can be on a mountaintop or at the bottom of the ocean. Reverbs, choruses, flanging, and pitch change are here, along with TimeSqueeze™ time compression. Store your creations on internal memory or removable PCMCIA card. Create a cast of characters and settings for your morning show or any special production. XLR and 1/4" analog. MIDI in/out/thru and PA422 serial port data connectors are provided.

An available option for the DSP-4000B is an AES/EBU and S/PDIF digital I/O for an all-digital path, plus an optional sampler board adds more power.

DSP-4000B	60EV4000B	MFR LIST	\$3,995.00
AES/EBU Option	60EVAESOPT	MFR LIST	\$1,000.00

CALL 1-800-732-7665 FOR BRADLEY PRICE

AUDIO PROCESSING

ART QUADRA FX

New!



By housing two independent stereo effects processors in one unit, and selling for one unbelievably low price—the guys at ART are doing the audio world another great favor. The Quadra/FX gives you four channels (with 4 discrete ins/outs) of stellar effects processing, all controlled by their new, proprietary DEA™ software for complete, intuitive control. Using its brand new algorithms (plus some old favorites), you can create an amazing array of high-resolution effects and then store them in any of the 100 user preset spots. And we're sure you can find more than 100 new effects worth saving.

ART Quadra/FX 60MX415 MFR LIST \$299.00

- ART's proprietary Dynamic Engine Allocation™ software
- 24-bit double-precision effects resolution, with 20-bit A/D - D/A audio conversion
- Four discrete ins and outs
- 2 independent and discrete stereo audio signal paths
- 72 digital effects algorithms and 100 user presets
- Arrange effects and multi-effects in any order
- 5.5 second max. delay time
- 4 Operation modes: Twin Stereo (two independent stereo in/stereo out effects processors), Discrete 4 (four independent effects processing channels), Cascade or Stereo
- 1/4" unbalanced (+4/-10dB switchable) ins and outs
- Performance MIDI™, with full parameter control

DBX PROJECT 1 AUDIO PROCESSORS

Project 1 processors capitalize on today's technology to give you dbx audio performance at low cost. Both models shown are rack mountable.



The 266 is a compressor/gate with two channels of compression, program-adaptive expander/gates, and AutoDynamic attack and release controls. Balanced inputs and unbalanced outputs are on 1/4" TRS connectors. Side chain insert is standard. Set it for stereo or dual mono operation.



The 286A is an all-in-one mic processor with preamp, OverEasy compression, de-essing, spectral enhancement, and expander/gate. Phantom power, high-pass filtering, and input gain control are provided. The XLR mic input accepts balanced or unbalanced inputs; a 1/4" TRS jack takes line signals. Use the insert jack to add external gear between the preamp and processors.

266 60DB266 MFR LIST \$249.95
 286A 60DB286 MFR LIST \$349.95

CALL 1-800-732-7665 FOR BRADLEY PRICE

AVOCET AV-2000 DELAY CANCELLER

New!



The Avocet Delay Canceller is designed to eliminate the problems caused by delayed audio feedback in live broadcasts.

This patent-pending system identifies a voice match between the microphone and off-air return signal and effectively removes the delayed voice from the return. The speaker's voice is suppressed from the off-air signal by up to 40dB and with up to 800 milliseconds of delay.

The AV-2000 offers broadcasters the ability to perform the equivalent of a mix-minus from a remote site. The delay cancelling is done from each remote site allowing an unlimited number of users to remove their individual voices.

The mic-line input includes a compressor/limiter offering a small amount of processing to remove the sharp peaks associated with voice. Designed to have a minimum impact on the quality and delivery of the microphone signal, the audio bandwidth is 15 kHz with better than .5% THD.

CALL 1-800-732-7665 FOR BRADLEY PRICES ON ALL OF THE AV-2000

DBX PERFORMER & PRODUCTION SERIES PROCESSORS

Half-rack signal processors from one of the most famous names in processing. The 140X and 150X have electronically balanced inputs and outputs on 1/4" TRS jacks, and are designed to operate at +4dBm. All include hardware to mount one or two units.

140X AND 150X NOISE REDUCTION

Get more than 40dB of extra dynamic range from your audio systems. For limited bandwidth devices (telco, cart decks, STL's, certain digital gear), use Type II noise reduction with the 140X. For full bandwidth systems (studio open reel recorders, digital systems sampled at more than 40kHz), use Type I with the 150X. Both are two channels of encode/decode with bypass switches for each circuit.

140X 60DB140X MFR LIST \$319.95
 150X 60DB150X MFR LIST \$319.95

CALL 1-800-732-7665 FOR BRADLEY PRICES ON ALL OF THESE DBX PRODUCTS

Bradley carries the Alesis family of processors, too. Call for details.



AUDIO PROCESSING



PROCESSOR COMPARISON CHART

Key: **LBX:** Lunch Box Rack **NRM:** Not Rack Mountable **KA:** Kit Available

PART NO.	MANUFACTURER	PRODUCT NAME	PROCESSOR TYPE	INPUTS/OUTPUTS	RACK UNITS	DESCRIPTION	LIST PRICE
60AEMEQ230	Alesis	M-EQ230	Equalizer	1/4" TS, RCA	1	2 independent 30-band 1/3 oc EQ	\$299.00
60AE3630	Alesis	3630 Compressor	Compressor/Limiter/Gate	1/4" TS (w/1/4" TRS sidechain connectors)	1	RMS Peak 2-channel compressor/limiter/gate	\$299.00
60AENANO	Alesis	Nanocompressor	Compressor/Limiter	1/4" TS (w/1/4" TRS sidechain connectors)	1	RMS Peak stereo limiter/compressor	\$119.00
60AP104	Aphex	104 Aural Exciter Type C2	Aural Exciter	1/4" TRS -10dBV/+4dBu switchable	1	"Big Bottom" technology extends bass frequencies (See also Aphex 250)	\$299.00
60AP105	Aphex	105 Quad Gate	Noise Gate	1/4" TRS	1	4-channel logic-assisted gate	\$449.00
60AP106	Aphex	106 Easyrider	Compressor	1/4" TRS -10dBV/+4dBu switchable	1	Autocompressor—4 channels	\$449.00
60AP108	Aphex	108 Easyrider	Compressor	1/4" TRS	1	Autocompressor—2 channels	\$299.00
60AP109	Aphex	109 EQ w/Tubessence	Parametric Equalizer	1/4" TRS	1	Parametric vacuum tube EQ—switchable between mono 4-band & dual-channel 2-band	\$449.00
60AP250	Aphex	250 Aural Exciter Type III	Aural Exciter	Servo-balanced XLR I/O	2	Adjustable harmonics mixing; two modes of noise reduction	\$995.00
60AP320	Aphex	320A Compellor	Compressor/Limiter/Leveler	Servo-balanced XLR I/O	1	Dual mono/stereo compressor/limiter/leveler	\$1,350.00
60AP323	Aphex	323A Compellor/Aural Exciter	Compressor/Limiter/Aural Exciter		1	Single-channel combination compressor/limiter/leveler	\$949.00
60AP622	Aphex	622 Expander w/Aural Exciter	Gate/Aural Exciter	XLR I/O	1	Dual-channel logic-assisted expander/gate	\$795.00
60AP651	Aphex	651 Expressor	Compressor/Limiter	Servo-balanced XLR I/O	1	1-channel compressor/limiter with spectral phase reflector, high-frequency expander	\$495.00
60AP722	Aphex	722 Dominator II	Peak Limiter	Servo-balanced XLR I/O	1	Multi-band stereo peak limiter w/automatic limit threshold and switchable pre- and de-emphasis curves	\$1,495.00
62AP225L	API	225L Compressor/Limiter	Compressor/Limiter	Module XLR I/O plus a TT jack for sidechain one slot in L200 rack chassis	2	I/O level controls, 4 selectable release times, transformer-coupled output, all discrete circuit	\$650.00
62AP235L	API	235L Noise Gate/Expander	Noise Gate/Expander	Module XLR I/O plus a TT jack for sidechain one slot in L200 rack chassis	2	Sidechain input for external triggering, choice of fast or normal attack, threshold and gate depth controls	\$650.00
62AP245L	API	245L De-Esser	De-Esser Module	XLR I/O plus a 1/4" TT jack for sidechain one slot in L200 rack chassis	2	Variable sweepable frequency selection, choice of wide or narrow notching	\$650.00
62AP250L	API	250L Equalizer	Equalizer Module	XLR I/O plus a 1/4" TT jack for sidechain one slot in L200 rack chassis	2	Dual-band, shelving high-frequency band, and peaking low-frequency band controls—4 frequencies per band	\$650.00
62AP525	API	525 Compressor	Compressor Module	XLR I/O plus a 1/4" TT jack for sidechain one slot in lunch-box, vert or horiz. rack despite level of comp.	LBX	Uses "feedback" mode now simulated by other "over easy" type circuits. Ceiling control adjusts threshold and makeup gain simultaneously	\$1,295.00
62AP550B	API	550B Equalizer	Equalizer Module	XLR I/O plus a 1/4" TT jack	LBX	One slot in lunch-box, vert. or horiz. rack, 4 overlapping bands, 7 frequencies per band, all discrete design	\$1,295.00
60MX129	ART	129 Tube Compressor	Compressor	XLR and 1/4" TS	NRM	Single-channel tube and Vactrol (electro-optical) compression based leveling amplifier. Adjustable threshold control, selectable attack and release, limiting options, tube without VCA	\$169.00



AUDIO PROCESSING

Bradley Broadcast • 7313-G Grove Road • Frederick, MD 21704 • 800-732-7665 • 301-682-8700 • Fax: 301-682-8377 • Web: <http://www.bradleybroadcast.com>

PART NO.	MANUFACTURER	PRODUCT NAME	PROCESSOR TYPE	INPUTS/OUTPUTS	RACK UNITS	DESCRIPTION	LIST PRICE
60MX212	ART	212 Pro VLA	Compressor/Leveling Amp	XLR and 1/4" TS	2	2-channel Vactrol (electro-optical) based leveling amplifier with non-VCA design. VU metering of I/O levels, stereo linking of channels, variable threshold ratio, auto and fast attack and release settings, 5-year warranty	\$649.00
60MX256	ART	256 Dual Leveler	Compressor/Leveling Amp	XLR and 1/4" TS	1	Compression and limiting settings in either dual-channel or stereo configurations. No VCAs, variable threshold and output controls; auto and fast release, 3-year warranty	\$349.00
60ASMQX2150	Ashly	MQX-2150	Graphic Equalizer	XLR and 1/4" TRS	1	Stereo 15-band 2/3-octave EQ	\$399.00
60ASMQX1310	Ashly	MQX-1310	Graphic Equalizer	XLR, 1/4" TRS, and barrier strip	1	Mono 31-band 1/3-octave EQ	\$499.00
60ASMQX2310	Ashly	MQX-2310	Graphic Equalizer	XLR, 1/4" TRS, and barrier strip	2	Stereo 31-band 1/3-octave EQ	\$799.00
60ASGOX1502	Ashly	GOX-1502	Graphic Equalizer	XLR, 1/4" TRS, and barrier strip	2	Stereo 15-band 2/3-octave EQ	\$529.00
60ASGOX3101	Ashly	GOX-3101	Graphic Equalizer	XLR, 1/4" TRS, and barrier strip	2	Mono 31-band 1/3-octave EQ	\$629.00
60ASGOX3102	Ashly	GOX-3102	Graphic Equalizer	XLR, 1/4" TRS, and barrier strip	2	Dual 31-band 1/3-octave EQ	\$1,059.00
60ASPOX571	Ashly	PQX-571	Parametric Equalizer	XLR, 1/4" TRS, and barrier strip	1	Mono 7-band parametric EQ	\$399.00
60ASPOX572	Ashly	PQX-572	Parametric Equalizer	XLR, 1/4" TRS, and barrier strip	2	Stereo 7-band parametric EQ	\$699.00
60ASCLX51	Ashly	CLX-51	Compressor/Limiter	XLR and 1/4" TRS	1	Mono compressor/limiter	\$349.00
60ASCLX52	Ashly	CLX-52	Compressor/Limiter	XLR and 1/4" TRS	1	Stereo compressor/limiter	\$499.00
60AIEM10001	ATI	EM100 Emph'A'Sizer	Voice/Mic Processor	Mic I/O: XLR Line I/O: dual banana plugs	2	(W/ 1/2 rack, mounting kit option.) Voice processor including input signal gate, 4-band preset parametric EQ, compressor/limiter	\$1,459.00
62BEBBE462	BBE	462 Sonic Maximizer	Aural Exciter	RCA, 1/4" TS	1	2 independent sonic maximizers in one chassis	\$349.00
62BEBBE862	BBE	862 Sonic Maximizer	Aural Exciter	XLR or 1/4" TRS	1	2 balanced independent sonic maximizers in one chassis	\$599.00
60BHMDX2200	Behringer	MDX2200 Composer Pro	Compressor/Limiter/Gate	XLR or 1/4" TRS	1	Contains release parameter on expander/gate, subminiature surface mount design	\$309.00
60BHDSP8000	Behringer	DSP8000 Ultracurve	Graphic Equalizer	Servo-balanced XLR or 1/4" TRS	2	Digital 31-band programmable stereo graphic EQ with RTA, feedback destroyer circuit	\$499.00
60BHDSP1100	Behringer	DSP1100 Feedback Destroyer	Feedback Destroyer/EQ	XLR or 1/4" TRS	1	Parametric stereo or 24-band dual-mono EQ	\$249.00
60BIAGII	Biamp	AGII 8-Channel Auto Gate	Gate	1/4" TRS	1	8-channel automatic gate	\$485.00
60BIEQ	Biamp	EQ 8-Channel 3-Band EQ	Equalizer	1/4" TRS	2	8-channel, 3-band equalizer	\$314.00
60BIGM	Biamp	GM Gain Manager	Automatic Gain Controller	XLR or 1/4" TS	1	Single-channel automatic level controller	\$419.00
60BIGM2	Biamp	GM2 2-ch. Gain Manager	Automatic Gain Controller	XLR or 1/4" TS	1	Dual-channel automatic level controller	\$629.00
60BIANC22	Biamp	ANC22 Ambient-Noise Compensator	Automatic Gain Controller Plug-In	Barrier Strip	1	Stereo balanced line-level I/O, mic input for sensing ambient noise	\$499.00
60BIEQ2818	Biamp	EQ281/8 Programmable EQ	Equalizer Plug-In	Barrier Strip	1	Single-channel 28-band 1/3-octave constant-q EQ	\$399.00
60BIEQ2828	Biamp	EQ282/8 Programmable EQ	Equalizer Plug-In	Barrier Strip	1	Dual-channel 28-band 1/3-octave constant-q EQ	\$599.00
60BIMSP11	Biamp	MSP11 Multi-Function System	Gain Controller, Equalizer and Delay Plug-In	Barrier Strip	1	Also includes leveling, compression, limiting, soft-gating, selection of either processor 1/3-octave or parametric EQ, 6-bands of variable notch filter, 5-year warranty	\$399.00
60BIMSP22	Biamp	MSP22 2-Channel Multi-Function System	Gain Controller, Equalizer and Delay Plug-In	Barrier Strip	1	Includes all features of MSP11 plus a channel-to-channel input and output mix-matrix, and a mono 2-way crossover mode. 5-year warranty	\$599.00
60BISMS200	Biamp	SMS200 Sound Masking Generator	Equalizer and Pink Noise Plug-In	Barrier Strip	1	Single-channel, 28-band 1/3-octave constant-q equalizer with built-in pink noise generation system	\$599.00



PROCESSOR COMPARISON CHART

Key: **LBX:** Lunch Box Rack **NRM:** Not Rack Mountable **KA:** Kit Available

PART NO.	MANUFACTURER	PRODUCT NAME	PROCESSOR TYPE	INPUTS/OUTPUTS	RACK UNITS	DESCRIPTION	LIST PRICE
60DBDDP	dbx	DDP Digital Dynamics Processor	Digital Dynamics Processor	XLR and 1/4" TRS	1	Digital dynamics processor with gate, compressor, limiter, de-esser, and equalizer. 24-bit A/D and D/A converters and type IV tape saturation emulation	\$599.00
60DB160A	dbx	160A Compressor/Limiter	Compressor/Limiter	XLR and 1/4" TRS	1	Single-channel compressor/limiter	\$459.00
60DB166A	dbx	166A Dual Compressor/Limiter/Gate	Dual Compressor/Limiter/Gate	XLR and 1/4" TRS	1	Dual-channel compressor/limiter/gate—choice of dual mono/stereo, over-easy and hard-knee compression modes	\$329.00
60DB266XL	dbx	266XL Dual Compressor/Gate	Dual Gate/Compressor	XLR and 1/4" TRS	1	Dual-channel compressor/gate	\$249.00
60DB286A	dbx	286A Mic Processor	Microphone Processor	Mic: XLR	1	Contains mic preamp, de-esser, compressor, expander/gate, and high- and low-frequency enhancers	\$349.00
60DBMC6	dbx	MC6 Minicompressor	Handheld Compressor	1/4" TRS I/O, line and instrument level switchable	NRM	Choice of hard-knee or over-easy compression, handheld unit	\$139.00
60DB120XP	dbx	120XP Subharmonic Synth.	Low-frequency Enhancer	1/4" TRS I/O	1	2 controllable ranges of subharmonic frequencies	\$299.00
60DB1046	dbx	1046 Quad Compressor/Limiter	Quad Compressor/Limiter	XLR and 1/4" TRS, -10dBV/+4dBu switchable	1	Hard-knee or over-easy compression, PeakStopPlus limiting	\$649.00
60DB1066	dbx	1066 Dual Compressor/Limiter/Gate	2-Channel Compressor/Limiter/Gate	XLR and 1/4" TRS	1	Selectable auto or manual operation, hard-knee or over-easy compression, PeakStopPlus limiting	\$549.00
60DB1086	dbx	1086 Mic Preamp/Processor	Mic Preamp with Compressor/Limiter/Expander/Gate/De-esser	XLR and 1/4" TRS	1	Contains equalizer and dynamics processor	\$749.00
60DB586	dbx	586 Mic Tube Preamp	Tube Mic Preamp w/3-band EQ, Limiter	XLR and 1/4" TRS	2	New Silver Series vacuum tube preamp with EQ, limiter, and VU meters	\$999.00
60DB160SL	dbx	160SL Compressor	2-Channel Compressor	XLR and 1/4" TRS	2	New auto velocity dynamics circuitry, over-easy or hard-knee compression, auto vs. manual compression levels	\$2,799.00
60DORTA	DOD	RTA Real Time Analyzer	Real Time Analyzer	XLR in/1/4" TRS in/out	1	31-band 1/3-octave analyzer with calibrated mic and built-in pink noise generator	\$399.00
60D0844	DOD	844 Quad Noise Gate	4-Channel Noise Gate	XLR and 1/4" TRS	1	Gate on each channel can be enabled/disabled	\$289.00
60D0866	DOD	866 Stereo Gated Compressor/Limiter	2-Channel Compressor/Limiter/Gate	XLR and 1/4" TRS	1	Gate, threshold, ratio, attack, release, input and output gain are all adjustable on each channel	\$239.00
60PNACP22	Presonus	ACP-22 Compressor/Limiter	Dual Compressor/Limiter with Spectral Gates	XLR and 1/4" TRS	1	Dual compressor/limiter with gates, internal power supply, low-pass gate filter, auto attack/release compression	\$399.00
60PNACP88	Presonus	ACP-88 8-Channel Compressor/Gate	8-Channel Compressor/Gate	XLR and 1/4" TRS	2	8 compressor/gates with control of threshold, ratio, hard/soft-knee, auto/manual attack, release curves, and gain	\$999.00
60PNBLUEMAX	Presonus	Blue Max Compressor/Limiter	Stereo/Mono Compressor/Limiter with 15 presets	1/4" TS unbalanced	1	Presets: 3 vocal, 8 instrument settings, 2 classic stereo settings, "squeeze" guitar and "pump," auto/manual attack/release. 1/2 rack width	\$249.00
60PNAVXP	Presonus	VXP Voice Processor	Dynamic Voice Processor	XLR and 1/4" TRS	1	Single-channel mic preamp w/Jensen transformer. Smart compressor with 8 preset curves. Expander, de-esser, 4-band semi-parametric equalizer	\$599.00
60RDSTEQ3	Radio Design Labs	ST-EQ3 3-Band Equalizer	3-Band Equalizer	Balanced and unbalanced wire terminal inputs	NRM	Also available in a rack-mount version (See RU-EQ3)	\$89.00
60RDRUEQ2	Radio Design Labs	RU-EQ2 2-Band Equalizer	2-Band Equalizer	Balanced and unbalanced wire terminal I/O	KA	Has overload-indicating LED	\$145.00
60RDRUEQ3	Radio Design Labs	RU-EQ3 3-Band Equalizer	3-Band Equalizer	Balanced and unbalanced wire terminal I/O	KA	Has additional midrange control	\$165.00
60RDSTCL1	Radio Design Labs	ST-CL1 -Compressor/Limiter	Compressor/Limiter	Balanced input circuit, balanced or unbalanced output, wire terminal I/O	KA	Incremental and smooth gain reduction, fully automatic operation	\$139.00



AUDIO PROCESSING

Bradley Broadcast • 7313-G Grove Road • Frederick, MD 21704 • 800-732-7665 • 301-682-8700 • Fax: 301-682-8377 • Web: <http://www.bradleybroadcast.com>

PART NO.	MANUFACTURER	PRODUCT NAME	PROCESSOR TYPE	INPUTS/OUTPUTS	RACK UNITS	DESCRIPTION	LIST PRICE
60RND24	Rane	DC-24 Dynamic Controller	2-Channel Compressor/Limiter/Gate	XLR and 1/4" TRS	1	Dual-channel compressor/limiter/expander gate. Control over compression ratio, threshold; limiter can have separate threshold	\$599.00
60RNGE30	Rane	GE-30 Equalizer	Constant-q 1-Channel, 1/3-octave EQ	XLR and screw terminal I/O	2	Long-throw slide controls, constant bandwidth	\$799.00
60RNGE60	Rane	GE-60 2-Channel Equalizer	2-Channel, 1/3-octave EQ	XLR, 1/4" and screw terminal I/O	3	45mm sliders, interpolating filters, constant bandwidth	\$899.00
60RNGE130	Rane	GE-130 Graphic Equalizer	1-Channel, 1/3-octave, 30-band Graphic Equalizer	XLR, Euroblock terminals	2	45mm sliders, interpolating filters, constant bandwidth	\$529.00
60RNGE215	Rane	GE-215 Graphic Equalizer	2-Channel, 2/3-octave, 15-band Graphic Equalizer	XLR, Euroblock terminals	2	45mm sliders, interpolating filters, constant bandwidth	\$559.00
60RME15B	Rane	ME-15B Equalizer	2-Channel, 2/3-octave Micrographic EQ	XLR and 1/4" TRS	1	20mm sliders, interpolating filters, constant bandwidth	\$429.00
60RME30B	Rane	ME-30B Equalizer	1-Channel, 1/3-octave Micrographic EQ	XLR and 1/4" TRS	1	20mm sliders, interpolating filters, constant bandwidth	\$419.00
60RME60	Rane	ME-60 Equalizer	2-Channel, 1/3-octave Micrographic EQ	XLR, 1/4" TRS, 1/4" TS, RCA	2	20mm sliders, constant bandwidth, 2 adjustable-band limiting filters	\$699.00
60RNPE15	Rane	PE-15 Equalizer	1-Channel, 5-band Parametric EQ	XLR and 1/4" TRS	1	4-octave frequency sweep range, notch filter	\$399.00
60RNPE17	Rane	PE-17 Equalizer	1-Channel, 5-band Parametric EQ	XLR and 1/4" TRS	1	Separate in and out gain controls, sweepable low- and high-cut filters	\$549.00
60RNRA27	Rane	RA-27 Real Time Analyzer	27 bands of frequency information	Mic: XLR Line: 1/4" TRS unbalanced	1	3-LED vertical band format, flat response microphone supplied, pink noise generator	\$499.00
60RNRPE228	Rane	RPE-228 Programmable Equalizer	2-Channel, 1/3-Octave, 28-band Remote Programmable Equalizer	Euroblock active balanced	1	Constant bandwidth, interpolating filters, usable with Windows software for real-time control of unit. No band controls on front panel (programmed by computer)	\$1,249.00
60RNRPM26V	Rane	RPM-26V Programmable Multifunction Processor	DSP using 24-bit A/D/A converters, programmable via RW-232 port	2 analog inputs, 6 analog outputs Euroblock active balanced	1	Usable with Windows software, AMX, and Crestron controllers	\$2,295.00
60RNV12	Rane	VP-12 Voice Processor	Mic Preamp with 2-bands of Parametric EQ	Mic input: XLR Line input: 1/4" TRS & screw terminal Outputs: 1/4" TRS & screw terminal	1	Has 48V phantom power, low- and high-cut filters, de-esser, threshold, ratio, and frequency control	\$599.00
60RAAF70	Roland	AF-70 Anti-Feedback	Feedback Controller	XLR, 1/4" TRS	KA	Unit includes a limiter, a level-switching enhancer, low- and high-cut filters, diffuse control, and a dynamic control	\$395.00
60SBFBXS1820	Sabine	FBX Solo SL-820	Feedback Exterminator	1/4" TRS	1/6	20-bit, designed for single channels, switchable I/O levels, clip level adjustments. Rack panel with room for six SL-820 and/or SM-820s is available	\$324.00
60SBFBXSM820	Sabine	FBX Solo SM-820	Feedback Exterminator	XLR	1/6	Identical to SL-820 but designed for use with microphones, with its XLR connection	\$349.00
60SBFBX1020	Sabine	FBX-1020 Plus	Feedback Exterminator	XLR and 1/4" TRS	1	20-bit, 12 feedback filters, Turbo Setup mode, ClipGuard adaptive clip control	\$599.00
60SBFBX2020	Sabine	FBX-2020 Plus	Dual-Channel Feedback Exterminator	XLR and 1/4" TRS	1	Dual-channel version of FBX-1020 Plus. 2020 has 24 feedback filters (12 per channel). Both models can place constant-q filters accurately in Setup mode and during a program	\$1,199.00
60SBADF4000	Sabine	ADF-4000 Power Q	2-Channel Feedback Exterminator	XLR and 1/4" TRS	2	FBX feedback eliminator, parametric EQ, dual 31-band graphic EQ, real time analyzer, automatic room flattening, automatic digital delay, clip level control	\$1,799.00
60SBREALQ2	Sabine	Real Q2	Real-Time Adaptive Equalizer	XLR	2	Uses sub-audible RTA that works with the on-board graphic EQ to maintain your specified curve for the life of the system. Can store up to 19 different response curves.	\$1,999.00



PROCESSOR COMPARISON CHART

Key: **LBX:** Lunch Box Rack **NRM:** Not Rack Mountable **KA:** Kit Available

PART NO.	MANUFACTURER	PRODUCT NAME	PROCESSOR TYPE	INPUTS/OUTPUTS	RACK UNITS	DESCRIPTION	LIST PRICE
60SBDQX206	Sabine	DQX-206 Delay	Delay/3-Band Parametric Equalizer	XLR: 2 inputs, 6 outputs	1	Automatic speaker time-alignment, 20-bit A/D/A clip level programmable limiter control, Auto Delay Setup mode, 3-band para. EQ and high- and low-pass filters on each channel, up to 2.5 sec. of delay/channel	\$1,099.00
60SHDFR11EQ	Shure	DFR-11EQ ver. 4	Feedback Reducer, PC-controlled	XLR and 1/4" TRS	1	1/3-octave, constant-q, programmable PC-controlled auto. graphic EQ feedback reduction. User can remove PC once EQ is set. 10 hi-Q, 1/10-octave notch filters, 20-bit A/D/A at 48kHz. Single or dual rack kit available	\$735.00
60SY402	Symetrix	402 Dual-Output Delay	Dual-Output Delay	XLR and 1/4" TRS	1	1 in, 2 out digital audio time delay. Delays signals sent to distant speakers, also resyncs audio to video	\$749.00
60SY421	Symetrix	421m AGC Leveler	Gain Controller	XLR, 1/4" TRS & screw terminals Line or mic input w/phantom power	1	Single-channel auto. gain controller. Output peak limiter, speech curve filters, downward expander	\$599.00
60SY422	Symetrix	422 Stereo AGC Leveler	Gain Controller	XLR and 1/4" TRS	1	Stereo auto. gain controller. Target level control, peak limiter, parallel I/O, LED meters to show gain status	\$599.00
60SY488	Symetrix	488 Dyna-Squeeze	8-Channel Compressor/Limiter/Expander for use with digital multitrackers	XLR and 1/4" TRS	1	8-channel compressor/interface for digital multitrackers. Gently squeezes tracks to upper end of recorder's dynamic range to add the feel of analog recording while preserving digital clarity	\$599.00
60SY501	Symetrix	501 Peak-RMS Compressor/Limiter	Peak-RMS Compressor/Limiter	XLR and 1/4" TS	1	Single-channel compressor/limiter. RMS and peak control, auto/manual attack/release, stereo linkable, sidechain controls. (Also available as 60SY50101, with transformer output.)	\$429.00
60SY528E	Symetrix	528E Voice Processor	Voice Processor	XLR and 1/4" TRS	1	Mic preamp with dynamics processing, 3-band para. EQ, de-esser, compressor/limiter, downward expander, voice symmetry alignment	\$749.00
60SY562E	Symetrix	562E Windowing Expander/Gate	Expander/Gate	XLR and 1/4" TRS	1	2-channel expander/gate eliminates mic and headphone leakage from recordings or live sound. Window advance function for fast attack without clicks or pops, auto windowing creates smooth release/decay cycle	\$579.00
60SY565E	Symetrix	565E Dual Compressor/Limiter/Expander	Dual Compressor/Limiter/Expander	XLR and 1/4" TS Sidechain input/output	1	Dynamics Squared circuitry controls gain while reducing distortion. Stereo-coupled or 2-channel operation. Indiv. LED meters for each processing section and output	\$549.00
60SY628	Symetrix	628 Digital Voice Processor	Programmable Digital Voice Processor	AES/SPDIF out, analog line out, MIDI in/out	1	High-gain direct coupled mic preamp with phantom power, compressor/limiter, expander/gate, de-esser, and 3 overlapping bands of parametric EQ	\$1,199.00
60TOL1102	TOA	L-1102 Leveler/Limiter	2-Channel Leveler/Limiter	2 inputs, 2 outputs	1	Program-dependent attack/release, noise gate, comes w/security cover & rack ears, 5-year no-questions-asked limited warranty	\$1,038.00
60YAGC2020C	Yamaha	GC2020C Compressor/Limiter	Compressor/Limiter	XLR and 1/4" TS Sidechain I/O	1	2-channel unit with switch-selectable dual mono/stereo modes, expander gate w/variable threshold/ea/ channel	\$469.00
60YADEQ5	Yamaha	DEQ5 Digital Equalizer	Digital DSP/Equalizer	XLR, AES/EBU, Y2, MIDI, Word Clock (BNC)	3	Dual-mode EQ: can operate as either a 30-band graphic EQ or a 60-band parametric EQ. Low-pass, high-pass, and 4 notch filters per channel, 40 program memory	\$3,199.00
60YADG2030	Yamaha	DG2030 Digital Equalizer	Digital Graphic Equalizer	XLR, AES/EBU, MIDI	1	20-bit digital graphic EQ w/50 user programs, 30-band stereo operation with high-/low-pass filters and 4 notch filters per channel. Sweep function helps cut feedback	\$1,299.00
60YAYDP2006	Yamaha	YDP2006 Digital Parametric Equalizer	Digital Parametric Equalizer	XLR, AES/EBU, MIDI	1	20-bit digital para. EQ w/graphical interface. 50 user programs as 12-band (mono) or 2x6-band (stereo). Gain, frequency, and Q can be set on all bands. High-/low-pass filters and 4 notch filters/channel. Peak LED	\$1,299.00
60YAGQ1031C	Yamaha	GQ1031C Graphic Equalizer	Graphic Equalizer	XLR and 1/4" TS	1	31-band, 1/3-octave EQ. EQ switch for on/bypass. High-pass filter, peak LED indicator	\$399.00
60YAGQ2015C	Yamaha	GQ2015C Graphic Equalizer	Graphic Equalizer	XLR and 1/4" TS	2	Dual 15-band, 2/3-octave EQ w/switchable gain $\pm 6/12$ dB per octave. High-pass filter, peak LED indicator	\$429.00
60YAGQ2031B	Yamaha	GQ2031C Graphic Equalizer	Graphic Equalizer	XLR and 1/4" TS	3	Stereo 31-band EQ. Automatic muting function mutes	\$749.00



AUDIO PROCESSING

Bradley Broadcast • 7313-G Grove Road • Frederick, MD 21704 • 800-732-7665 • 301-682-8700 • Fax: 301-682-8377 • Web: <http://www.bradleybroadcast.com>

PRESONUS VXP



- Class A discrete Jensen transformer mic pre
- Unique 8 channel compressor with 8 preset compression curves tailored for voice processing
- Expander and de-esser
- Four-band semi-parametric eq with high pass filter
- +28db output level
- Low noise design with less than 0.005% thd and internal power supply

The VXP combines all the necessary tools for superb voice processing.
Presonus VXP 60PNVXP MFR LIST \$599.00

CALL 1-800-732-7665 FOR BRADLEY PRICE

APHEX 320A COMPELLOR



Ride gain like a cowpoke rides a bronco: quickly and intelligently. The Compellor compresses, levels, and limits peaks. These functions were designed to work together. The leveler provides a platform based on long term average audio levels. The compressor readily handles short term gain changes. A process balance control varies the ratio of these two functions. A fast peak limiter follows, to catch any overshoots and hold them to an absolute peak value. A silence gate prevents gain pumping during slow fades. You decide how much the lowest level signal will be brought up and the proportion of leveling to compression, and trim the output for unity gain.

The transparent audio path is servo-balanced (XLR) inputs and outputs and the Aphex VCA 1001. The unit works in dual mono or one of two stereo link modes. A Bradley Best Seller.

320A Compellor 60AP320 MFR LIST \$1,350.00

CALL 1-800-732-7665 FOR BRADLEY PRICE

LEXICON DIGITAL REVERBS



Fans of the classic Lexicon PCM-70 will be delighted with the PCM-81 digital effects processor, with classic and new effects, 200 programs, and digital I/O for use with ADAT and other popular devices. All programs are discrete stereo; all programs incorporate multi-voice delay effects AND reverb (not either/or). You get RAM or ROM storage with PCMCIA data card for future software upgrades. It uses balanced analog 1/4" jacks and S/PDIF digital coax connectors.

PCM-81 60LEPCM81 MFR LIST \$2,995.00
PCM-91 60LEPCM91 MFR LIST \$2,995.00

CALL 1-800-732-7665 FOR BRADLEY PRICE

ROLAND VT-1B

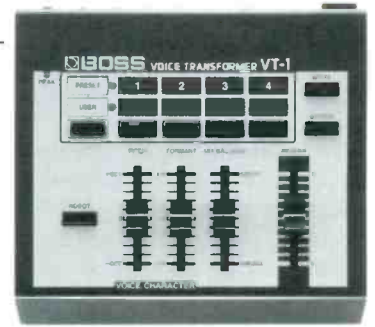

Put this in the hands of a good air talent, and watch the crowds flock to your next remote. The VT-1 is a little box with simple controls that let you alter incoming mic audio and produce hilarious results: women sound like Barry White, men sound like leprechauns, kids sound like robots. Take a couple to your next remote, wire in some mics, and let the listeners play. Or use it for your morning show and production guru. Presets let you switch between effects quickly.

VT-1B 60RAVT1B MFR LIST \$395.00

CALL 1-800-732-7665 FOR BRADLEY PRICE

RANE VPI2 VOICE PROCESSOR



The VP12 incorporates a studio grade mic preamp, balanced line input, low and hi cut filters, de-esser, gate/compressor, and two channel parametric EQ. Mic and line inputs may be summed through the subsequent processor stages, allowing input from other outboard mic preamps, or from wireless mic receivers.

VP12 60RNVPI2 MFR LIST \$599.00

CALL 1-800-732-7665 FOR BRADLEY PRICE

SYMETRIX 528E VOICE PROCESSOR



Use it for announce mics, voice-over studios, and PA systems. More than a preamp, it's a self-contained voice processor. It enhances intelligibility, reduces off-mic noise, and increases perceived presence. It performs six functions: mic preamplification, de-essing, downward expansion, compression/limiting, voice symmetry alignment, and parametric EQ.

Preamp gain is variable up to 60dB; 48V phantom power is provided for your condenser mics. A switchable 15dB pad, mic/line input switch, RFI protection, and variable EQ bandwidth are standard. Mic and line inputs and the balanced output are XLR; the unbalanced out and other connections are 1/4".

528E 60SY528E MFR LIST \$749.00
628 60SY628 MFR LIST \$1,199.00

CALL 1-800-732-7665 FOR BRADLEY PRICE

**Bradley Broadcast and Pro Audio -
 Our Service Makes The Difference!**

AUDIO PROCESSING



YAMAHA REV100 DIGITAL REVERB



With 99 editable presets, the affordable REV100 reverberates with standard reverb, stereo reverb, "gated" reverb for warmth or ambiance, mono and stereo delay for repeats or bouncing effects, delay/reverb combinations, and reverb/modulation effects including flange, chorus, and symphonic. The simple controls include input level, mix balance (wet/dry), decay, delay, and level. Connectors are analog 1/4" I/O and a MIDI port. This unit uses an external A/C adapter.

REV100 **60YAREV100** **MFR LIST** **\$299.00**
CALL 1-800-732-7665 FOR BRADLEY PRICE

Z-SYSTEMS SAMPLE RATE CONVERTERS

The Z-2SRC Sample Rate Converter is an uncommonly good way to convert from one digital audio rate to another. The digital design provides the best audio conversion for CD to DAT, varispeed to 44.1, DAW to digital mixer, and other uses. Features include jitter reduction, format conversion, and external sync. Ins and outs are AES/EBU, S/PDIF, coax, optical, and XLR.



Get the same audio quality in a smaller, economical package with "Z-Link". It's built on the Analog Devices AD1890 asynchronous chip and puts out 44.1 and 48kHz using precise crystal references. You get switch-selectable AES/EBU and S/PDIF output flags on transformer-isolated RCA or BNC connectors, with 20-bit resolution, 120dB dynamic range, and -106dB THD+N. Yes the specs are impressive, and that's what you want when your audio is at stake. The "plus" version adds AES sync input and loop-through for sync to other sample rates and sources.

Z-1SRC **60ZS2SRC** **MFR LIST** **\$1,200.00**
Z-Link **60ZSL** **MFR LIST** **\$450.00**
Z-Link+ **60ZSLP** **MFR LIST** **\$599.00**

CALL 1-800-732-7665 FOR BRADLEY PRICE

API L-200 PROCESSING SYSTEM

API has developed quite a name for itself with producers and engineers alike. Super high quality sound and performance are its hallmarks. With the L-200 System, you get a modular rack that lets you plug in the processing you need. The rack features an external power supply, XLR in and out, TT-type feature connector, and is linkable to other L200 racks. All the insertable modules are discrete and transformer isolated on the outputs.

CALL 1-800-732-7665 FOR BRADLEY PRICES AND CONFIGURATIONS ON AN API SYSTEM

Modules Available:

- 201L passive fader module
- 205L Hi-Z instrument direct
- 212L Mic Preamp (shown channels 1-4)
- 215L Sweepable hi/lo pass filter
- 225L Compressor (shown positions 9-12)
- 235L Noise gate/Expander (shown positions 5-8)
- 245L De-esser
- 250L 2 band EQ (future)

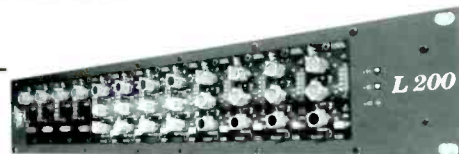

YAMAHA EFFECTS PROCESSORS

The SPX-990 has 80 great preset effects and 100 memory locations into which you can store your own versions. The 990's two-in/two-out setup allows stereo sources to be processed without disrupting the original stereo image. Effects include natural reverb, tempo-based delays, and various pitch change and combination effects. Inputs and outputs are analog, electronically balanced, with XLR and TRS 1/4" connectors. A/D-D/A are 20 bits.



The classic SPX-1000 provides 40 preset programs including pitch change, distortion, natural reverberation and early reflections, delay and echo, and various combinations. Presets can be edited, retitled, and stored in user-defined memories; each program has a range of parameters and EQ to tailor the effect. Program five effects at the same time. Other features include MIDI implementation, 1/4" unbalanced analog I/O connectors, and Yamaha-format digital I/O. A/D-D/A are 16 bits.

Both models provide switchable stereo -20dBV and +4dBm I/O.
SPX-990 **60YASPX990** **MFR LIST** **\$1,179.00**
SPX-1000 **60YASPX1000** **MFR LIST** **\$1,829.00**

CALL 1-800-732-7665 FOR BRADLEY PRICE

ATI MULTIPLE AMPLIFIER ARRAYS

ATI's UL-listed arrays can be used alone or in sets to create a mic distribution amp, headphone amp, consumer-to-pro interface, press box, or simple mixer.



They combine gain control, distribution, and mixing in a single rack space. They're available in four or eight channels of line-to-line (to 42dB) amplification.

Rear panel jumpers let you create combinations of distribution amplifiers, mono summing networks, or sum and difference networks. Call us if you prefer XLR termination strips or for info on mic-to-line versions.

4 channel line amp, transformer outputs **60AIMLA4001** **MFR LIST** **\$539.00**
4 channel line amp, differential outputs **60AIMLA4002** **MFR LIST** **\$389.00**
8 channel line amp, transformer outputs **60AIMLA8001** **MFR LIST** **\$799.00**
8 channel line amp, differential outputs **60AIMLA8002** **MFR LIST** **\$599.00**

CALL 1-800-732-7665 FOR BRADLEY PRICE

RADIO DESIGN LABS

Rack-Ups™ are small studio problem solvers that operate on 24 volt DC (don't forget to order the power supply). Several units can run on a single supply, up to its current limits.

Any module can mount using the tenacious adhesive strips provided, or order the optional rack kit to mount up to three side-by-side. Other options allow under-counter or flush mounting; or choose a one-rack-space universal chassis that holds up to five Rack-Ups and eight Stick-Ons. Call Bradley for a pamphlet that describes all of the hardware in detail.

AUDIO DA

Distribute line-level signals. The DA-4D handles one stereo in to four out, or one mono in to eight out. Recessed level controls and audio presence indicators are provided. Connect balanced or unbalanced, high or low impedance lines on the rear-panel barrier blocks.



RU-DA4D* **60RDRUDA4D** **MFR LIST** **\$231.00**
 CALL 1-800-732-7665 FOR BRADLEY PRICE

AUDIO DA WITH XLR

This DA uses XLR connectors to distribute line-level audio. Plug your source into the front panel XLR or wire it to the rear panel barrier block. The 150 ohm balanced outputs appear on XLR's on the front panel. An input gain trim is provided; inputs are RF filtered. Inputs may be strapped to provide phantom power. An unbalanced DA with phono connectors is also available.

RU-BDA3* **60RDRUBDA3** **MFR LIST** **\$223.00**
 CALL 1-800-732-7665 FOR BRADLEY PRICE

IHF-PRO INTERFACE

Balanced and unbalanced devices can "talk" to each other. This connectorized audio interface provides gain trim on both channels, gain adjustments in both directions. Unbalanced connections are on phono jacks, balanced are XLR and/or barrier block.

LA2D* **60RDRULA2D** **MFR LIST** **\$266.00**
 CALL 1-800-732-7665 FOR BRADLEY PRICE

MIC/LINE MIXER

Here you get five channels of audio mixing, with all connections on barrier blocks. Four of the inputs accept mic or line level; the fifth is line only. A rear panel jumper connects 24VDC phantom voltage to any or all of the mic inputs. Output level indication and channel controls are provided.



RU-MX5* **60RDRUMX5** **MFR LIST** **\$248.00**
 CALL 1-800-732-7665 FOR BRADLEY PRICE

(*) POWER SUPPLY

For use with Rack-Ups and Stick-Ons. 24V single ended DC, 400ma. UL Listed.

PS-24A **60RDXFMR** **MFR LIST** **\$17.00**

STEREO LINE AMP

This unit has two separate, isolated line amplifiers. Use it for stereo or as two individual monaural amps. Inputs are balanced bridging and enter the front via XLR. Outputs are on XLR and are low impedance balanced for short or long balanced lines. Gain trim controls for each channel are provided.

RU-BLA2* **60RDRUBLA2** **MFR LIST** **\$238.00**
 CALL 1-800-732-7665 FOR BRADLEY PRICE

MICROPHONE DA

Use it to distribute connectorized mic-level audio. Drive short or long balanced lines. Front-panel XLR outputs, front (XLR) and rear (barrier) inputs, input gain trim, and selectable phantom on input.



RU-MDA3* **60RDRUMDA3** **MFR LIST** **\$226.00**
 CALL 1-800-732-7665 FOR BRADLEY PRICE

DUAL MIC PREAMP

RDL's connectorized mic-to-line audio preamplifier features two isolated preamps, for stereo or dual mono operation. Inputs may be strapped to provide phantom power through the standard XLR connectors. Outputs are driven through front XLR's and rear barrier block. Gain trim from 35 to 65dB. (RDL mic preamps can operate on 12VDC with a loss of 6dB headroom.)

RU-MP2* **60RDRUMP2** **MFR LIST** **\$299.00**
 CALL 1-800-732-7665 FOR BRADLEY PRICE

DUAL AUDIO METER

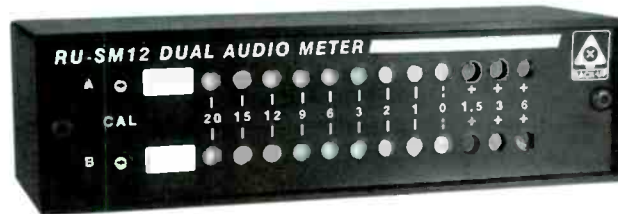

Large LED's let you see this meter across the room. Features include two separate line-level inputs, selectable peak or average metering, selectable L+R/L-R, channel calibration controls, and write-on label area.

RU-SM12* **60RDRUSM12** **MFR LIST** **\$213.00**
 CALL 1-800-732-7665 FOR BRADLEY PRICE

TRIPLE RACK MOUNT

Mounting for three Rack-Ups in a single rack space. Order RU-FP1 fillers for unused slots or to reverse-mount any Rack-Up. Choose the JP-1 Universal Jack Panel for custom mounting of your own connectors.

RU-RA3 Triple Rack Mount **60RDRURA3** **MFR LIST** **\$29.00**
RU-FP1 Filler **60RDRUFP1** **MFR LIST** **\$10.00**
JP-1 Jack Panel **60RDRJP1** **MFR LIST** **\$15.00**



AUDIO INTERFACE & MONITORING ACCESSORIES

Best Seller



What are Stick-Ons? They fit in your hand. They're simple to install, and provide super audio despite their size. What do they do? Well: most anything.

Stick a module onto any surface by attaching its stiff adhesive strip to an edge or side.

All modules marked (*) require a power supply, purchased separately. The PS-24A can power any Stick-On, and sometimes more than one depending on the mix.

ST-AMC3 Active Mic Combiner lets you expand a mic input on your mixer. Combines three mic-level inputs, with gain settings, to one mic-level output.

ST-AMC3 * 60RDSTAMC3 MFR LIST \$114.00

STM-1 Mic Preamp is a Hi or Lo Z preamp for commercial sound and broadcast. It provides a fixed 50dB gain to bring a mic signal up to the range of nearly any line input. Balanced or unbalanced output; internal/external phantom capability. For intercom use, the input will operate directly from a speaker.

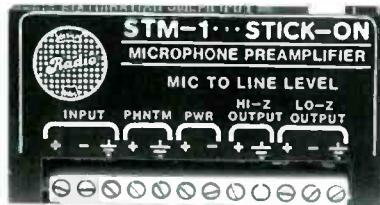

STM-1 * 60RDSTM1 MFR LIST \$96.00

STM-2 Mic Preamp is extra low noise and has gain adjustment from "off" to 65dB, two balanced or unbalanced outputs, and more. If you need even more gain, ask about the STM-3. RDL mic pre-amps can operate on 12VDC with a loss of 6dB headroom.

STM-2 * 60RDSTM2 MFR LIST \$132.00

ST-MPA2 Mic Phantom Adapter allows you to add phantom-powered mics to standard inputs. Power two mics with one module. Full response; trim-pot adjustable voltage.

ST-MPA2 * 60RDSTMPA2 MFR LIST \$83.00

ST-MX3 Mixer has three adjustable line level inputs and a single output. It allows you to combine signals of different levels, impedances, or balanced/unbalanced configurations. The ST-MMX3 is similar, but inputs are at mic level, output is line.

ST-MX3 * 60RDSTMX3 MFR LIST \$120.00

ST-MMX3 * 60RDSTMMX3 MFR LIST \$126.00

* Modules with a * require a power supply, sold separately. See page 111.

CALL 1-800-732-7665 FOR BRADLEY PRICE

STA-1M Audio Line Amplifier has a gain range of -14dB to +7dB when using the balanced I/O. When using the unbalanced I/O, the gain range is -7dB to +14dB. Single channel.

STA-1M * 60RDSTA1M MFR LIST \$100.00

ST-TC1 Telephone System Coupler connects to your phone system KSU, simulating a telco CO line and letting you add radio control or paging. When the line is seized, the ST-TC1 provides a relay closure to control the equipment of your choice. An audio feed is available for input to or output from the KSU.



ST-TC1 * 60RDSTTC1 * MFR LIST \$96.00

STP-1 Attenuator is useful for reducing input levels to improve headroom. Each STP-1 has two variable modified "H" pads providing up to 85dB attenuation. A 15 turn trim pot allows adjustment of levels.

STP-1 60RDSTP1 MFR LIST \$55.00

ST-DA3 Distribution Amplifier has one input, three outputs. Use two for 2x6 stereo output. Master gain adjustment provides up to 20dB gain. Inputs and outputs are RF bypassed. If the source is mic level, choose the STM-DA3 mic DA, feeding one 150 ohm signal to three isolated outputs.



ST-DA3 * 60RDSTDA3 MFR LIST \$126.00

STM-DA3 * 60RDSTMDA3 MFR LIST \$126.00

STA-1 Electronic Transformer Pair combines an electronic line transformer and adjustable 20dB gain amplifier. There are two circuits in each unit for stereo operation. Typical applications include: balanced to unbalanced interface, unbalanced to balanced bridging amp, monaural combiner, stereo splitter, and Hi-Z amplifier.

STA-1 * 60RDSTA1 MFR LIST \$136.00

STD-1 Divider/Combiner is a passive, four channel device where any channel may be an input or output. Branch a 600 ohm line to three inputs, combine stereo signals to a mono input, branch or combine 150 ohm mic signals, or divide a mono signal to apply stereo inputs.

For 150-ohm 60RDSTD1150 MFR LIST \$49.00

For 600-ohm 60RDSTD1600 MFR LIST \$49.00

For 10K-ohm 60RDSTD10K MFR LIST \$49.00

CALL 1-800-732-7665 FOR BRADLEY PRICES

AUDIO INTERFACE

SMALL.

MEDIUM.

LARGE.



MUSIC AND PAGING SYSTEMS

Your customer will never know what you've done, they'll only know it sounds good. Rane's family of Commercial Processors is your best choice in quality audio processing for these and many other applications:

- Restaurants
- Offices
- Nightclubs & Bars
- Hotel & Convention Centers
- Retail Stores
- Aerobic Studios & Fitness Centers
- Factories
- Museums & Attractions

There are a number of features Rane introduced in the CP 31, CP 52 and CP 64 designed to accommodate the most demanding projects requiring background and foreground music with paging. Features include:

- Mic/Line Paging Inputs
- Wired Remotes for Source Selection/Volume Control and Page Assignment
- Stereo Line Level Inputs
- Automatic Priority Override of Page and Program Audio
- Stereo and Mono Zone Distribution
- Independent, Fully Adjustable Ducking
- Adjustable Signal Detect Thresholds
- 7-band Program Equalization
- Exceptional Audio Quality
- Expandable Outputs for Zone, Page or Program

Doesn't your next project deserve the reliability of Rane Contractor products?

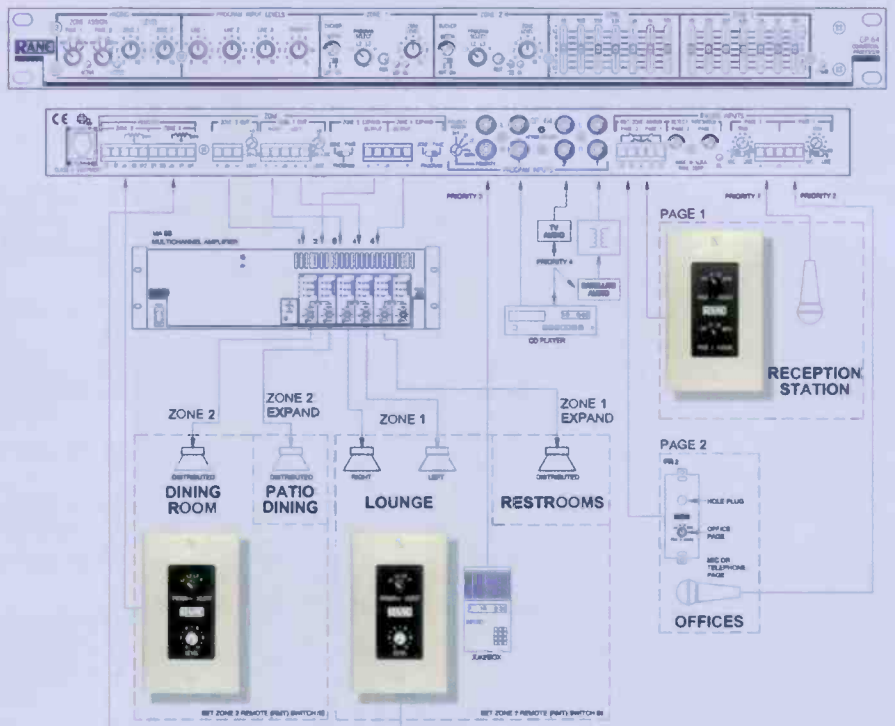

CP 31 / CP 52 / CP 64



The Ultimate **te Plug-in**



extreme audio

M80

The PreSonus M80 Eight Channel Microphone/Preamplifier with Mix Bus. Featuring High Quality Jensen® Transformers. FET, Class A Discrete Buffers. Twir Servo® Gain Stages (No Capacitors). Mix Bus assign For Multiple Mic/Instrument Stereo Imaging. Unique IDSS Control for Adjusting Harmonic Distortion. Servo Balanced Send & Return Jacks on Each Channel for External Balanced Processing. Auxilliary Bus Inputs.

- Greatly improve the quality of any console, analog or digital, by adding eight very high end mic preamplifiers.
- Amazing front end for two, four or eight channel analog to digital converters such as the Digidesign 888® or Soundscape SS810-1®.
- Add warmth to any microphone using the proprietary FET IDSS adjust.
- High headroom summing bus allows true stereo imaging utilizing more than two microphones.



PreSonus
[audio electronics]

MORE RADIO DESIGN LABS

ST-ACR Audio Controlled Relays let you control switching from any audio signal. Multi-turn adjustments cover the range from mic to line level. Relay release can be adjusted from 1/2 to 5 seconds on the ACR1, and from 5 to 50 seconds on the ACR2. Double-pole, double-throw switching contacts are provided. A "slave" terminal connects Stick-On logic controlled relays (see below).

ST-ACR1 *	60RDSTACR1	MFR LIST	\$90.00
ST-ACR2 *	60RDSTACR2	MFR LIST	\$90.00

ST-LCR1/ST-LCR2 Logic Controlled Relays provide double-pole, double-throw switching contacts, open-collector outputs, and an LED indicator of relay closure. Dual inputs

ST-LCR1 * momentary action	60RDSTLCR1	MFR LIST	\$70.00
ST-LCR2 * alternate action	60RDSTLCR2	MFR LIST	\$103.00



Also Available:

ST-MXL3 *Mixer: 3 Line to 1 Mic (new)	60RDSTMXL3	MFR LIST	\$120.00
ST-MLX3 *Mixer: 1 Mic/2 Line to 1 Line	60RDSTMLX3	MFR LIST	\$120.00
ST-SX4 *Four-input Audio Switcher	60RDSTSX4	MFR LIST	\$95.00
ST-PH1 *Stereo Phono Preamp	60RDSTPH1	MFR LIST	\$126.00
ST-OSC2A *Dual Oscillator, 1 and 10kHz	60RDSTOSC2A	MFR LIST	\$98.00
ST-OSC2B *Dual Oscillator, 100 and 400Hz	60RDSTOSC2B	MFR LIST	\$98.00
ST-PA6 *6-watt Power Amplifier	60RDSTPA6	MFR LIST	\$83.00
ST-SSR1 *Solid State Audio Relay	60RDSTSSR1	MFR LIST	\$98.00
ST-VCA1 *Voltage Controlled Amplifier	60RDSTVCA1	MFR LIST	\$113.00
ST-SH1 *Stereo Headphone Amp	60RDSTSH1	MFR LIST	\$114.00

Mounting Options

Use the flat SMK-12 for detachable mounting of Stick-Ons inside your console or rack (up to 15 edge-mounted, or six flat-mounted). Use the RC-1U rack chassis for the greatest flexibility in mounting Rack-Ups and Stick-Ons (6 and 12 respectively, but mixing is OK).

SMK-12	60RDSMK12	MFR LIST	\$23.00
RC-1U	60RDRC1U	MFR LIST	\$131.00

STR-19 Racking System

This 3RU steel hinged panel holds and hides multiple Stick-Ons, which snap into place. Swing open to access your adjustments.

STR-19	60RDSTR19	MFR LIST	\$123.00
--------	-----------	----------	----------

* Modules with a * require a power supply, sold separately. See page 111.

CALL 1-800-732-7665 FOR BRADLEY PRICE

SHURE PROBLEM SOLVERS AND IMPEDANCE TRANSFORMERS



Read this list and keep it in the back of your mind for the next time you have an audio problem. Use these devices "in line" thanks to their XLR connectors and small size. They are 4-1/2" long and 3/4" in diameter. Except as noted, they are designed to be used with 150 ohm low level equipment. Color coded.

Line input adapter converts low impedance microphone input to bridging line-level input. May be driven from source of up to 50 kilohms and 24dBm.

61SHA15LA	MFR LIST	\$39.00
-----------	----------	---------

Bridging transformer matches balanced or unbalanced devices of different impedances (33 kilohm primary, 600 or 7500 ohm secondary).

61SHA15BT	MFR LIST	\$50.75
-----------	----------	---------

Tone generator produces a continuous 700Hz signal capable of driving low impedance balanced lines. Battery operated.

61SHA15TG	MFR LIST	\$86.00
-----------	----------	---------

High pass filter provides a low frequency cutoff to reduce unwanted LF noise.

61SHA15HP	MFR LIST	\$49.50
-----------	----------	---------

Mic attenuator provides 15, 20, or 25dB attenuation to prevent preamp overload. Switchable.

61SHA15AS	MFR LIST	\$43.00
-----------	----------	---------

Phase reverser instantly reverses phase of a balanced line of any level. Switchable and can be used in either direction.

61SHA15PRS	MFR LIST	\$49.50
------------	----------	---------

Bradley accepts Visa, MasterCard and Discover Cards



AUDIO INTERFACE

WHIRLWIND AUDIO ACCESSORIES

(1) The **Hot Box** active direct box runs for 500 hours on two 9V batteries, and also takes 48V phantom. It provides super-clean audio through super-clean circuitry. It has a ground-lift switch, useful for eliminating hum problems. Includes an LED "on" indicator and a +15dB, Flat, -40dB switch.

Hot Box 61WHHB \$139.00



(2) **IMP 2** is an economical direct box that converts a line or instrument unbalanced signal to a low impedance balanced one. Hi-Z bridging input and ground lift on output.

IMP 2 61WHIMP2 \$42.00



(3) **Director** direct box combines road durability with great studio performance and no power required. Loading, distortion, and signal loss are eliminated by the TRHL-M transformer and custom circuitry. Mumetal shielding is included for EM and RF isolation.

Director 61WHDIR \$95.00



(4) **IMP Splitter** allows a single input to be split into two or three signals. Low impedance.

1x2 61WHMS2 \$59.00

1x3 61WHMS3 \$69.00



(5) **IMP Combiner** combines two low impedance signals into one low impedance output. Features phase reverse switch to match phase or to throw mics out of phase for special effects.

IMP Combiner 61WHCOMB \$64.00



(6) **Phase Reverse** is a handy "back pocket" adapter for reversing phase on low impedance lines. XLR connectors.

Phase Reverse 61WHPR \$19.00



(7) **IMP Pads** provide fixed attenuation on low impedance lines. XLR connectors.

10dB pad 61WHPAD10 \$23.25

20dB pad 61WHPAD20 \$23.25

30dB pad 61WHPAD30 \$23.25

40dB pad 61WHPAD40 \$23.25

(8) **Lifter** is a handy in-line device for ground lift at pin-1 on an XLR line.

Lifter 61WHGL \$17.00



(9) Whirlwind **Little IMP** in-line impedance matching transformer with female XLR connector to male 1/4" connector.

61WHLI \$12.60



SHURE IMPEDANCE TRANSFORMERS

A95U in-line impedance matching transformer with male XLR connector. Male and female 1/4" adapters supplied.

61SHA95U
MFR LIST \$34.50



A95UF in-line impedance matching transformer with female XLR connector. Male and female 1/4" adapters supplied.

61SHA95UF
MFR LIST \$39.75

Also Available:

A96F 61SHA96F MFR LIST \$50.50

CALL 1-800-732-7665 FOR BRADLEY PRICE

APHEX 124A AUDIO LEVEL INTERFACE



Match 'em Dan-o. The Aphex 124A is a two-way buffer that lets you connect -10dBV semi-pro and consumer audio products with +4 or +8dBm pro systems. It allows both to operate at their best by matching impedances and operating levels. Inputs and outputs are transformerless for wide, flat frequency response and perfect square waves to preserve transients. Hum and noise rejection are high, while noise and distortion are almost non-existent. A switchable 600 ohm load allows input line termination.

IHF connectors are RCA; balanced I/O's are XLR. The optional rack kit holds one or two units in a single rack space.

124A 60AP124 MFR LIST \$229.00
Rack Kit 60AP44008 MFR LIST \$29.95

CALL 1-800-732-7665 FOR BRADLEY PRICE

AUDIO INTERFACE



GRAHAM-PATTEN SOUNDPALS SOLUTIONS

DMIC-20 2 CHANNEL DIGITAL MIC PREAMP

The DMIC-20 combines two low noise analog mic preamps, 48V phantom power and a precision 20-bit analog to digital converter in one box. Input sensitivity is adjustable to accommodate a wide range of microphone types and LED indicators are provided for monitoring input levels. AES inputs are available on both balanced (XLR) and unbalanced (BNC) connectors. Use the DMIC-20 to add a mic input to your workstation, to record direct to digital multi-track, or for any application where one or two mic inputs are needed on an AES/EBU device. When used with phantom power mics, the DMIC-20 requires the PSU-1 power supply.

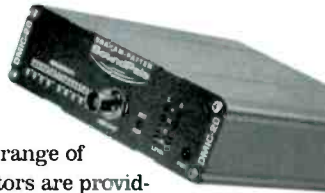

- Dual Channel with 44.1kHz internal reference
60GPDMIC2044 MFR LIST \$599.00
- Dual Channel with 48kHz internal reference
60GPDMIC2048 MFR LIST \$599.00

CALL 1-800-732-7665 FOR BRADLEY PRICE

SOUNDPALS DATS CONVERTER

Upgrade your digital audio system with DATS converters from Graham-Patten. These passive devices allow equipment with balanced AES I/O to be interconnected using 75 ohm coaxial cable, resulting in error-free transmission over greater distances than is possible with twisted pair - up to 1000 feet or more with high quality coax. DATS converters also facilitate the integration of professional equipment with AES3-ID I/O and consumer equipment with SPDIF I/O into existing AES systems.



- AES to DATS source converter 60GPDATS20 MFR LIST \$50.00
- DATS to AES destination converter 60GPDATS21 MFR LIST \$50.00
- RCA to BNC adapter, for SPDIF interconnect 60GPRB1 MFR LIST \$5.00

CALL 1-800-732-7665 FOR BRADLEY PRICE

SOUNDPALS DFADE-2

The DFADE-2 from Graham-Patten is a two channel digital audio fader. Control the gain of any AES channel pair, this versatile module provides independent local level adjustment of -18 to +30dB for each channel. In addition, the DFADE-2 provides independent remote control of channel fade and pan, allowing you to remotely adjust the level, channel balance and channel pan. Channels can even be swapped by panning channel one fully to channel two and vice versa. Requires a power supply.



- Dual channel digital fader 60GPDFADE2 MFR LIST \$899.00

CALL 1-800-732-7665 FOR BRADLEY PRICE

SOUNDPALS DAC-20 D/A AUDIO CONVERTER

- 20-bit signal processing
- Both XLR and BNC inputs
- Headphone jack for monitoring
- LED indicators for emphasis and data error conditions



- 20-bit D/A converter 60GPDAC20 MFR LIST \$549.00

CALL 1-800-732-7665 FOR BRADLEY PRICE

SOUNDPALS ADC-20 A/D AUDIO CONVERTER

- 20-bit signal processing
- Simultaneous XLR and BNC outputs
- Internal 44.1 or 48kHz reference
- AES BNC reference input between 30-50 kHz
- Adjustable input range (-8 to +6 dBu at -20 dBFS)



- A/D converter w/ 44.1kHz internal reference 60GPADC2044 MFR LIST \$549.00

- A/D converter w/ 48kHz internal reference 60GPADC2048 MFR LIST \$549.00

CALL 1-800-732-7665 FOR BRADLEY PRICE

Both the DAC-20 and the ADC-20 from Graham-Patten can be rack mounted in the studio or operate on batteries in the field.

SOUNDPALS DMIX-41

The DMIX-41 4 channel digital audio mixer and sample rate converter combines up to four AES inputs onto a single AES output. Inputs may be individually enabled or disabled remotely. When equipped with optional sample rate converters, the DMIX-41 can combine AES inputs with different sample rates. Use the DMIX-41 to pre-select and/or combine sources to expand the input capability of any digital audio console or recorder. Available with XLR or BNC connectors and up to 4 SRC inputs. Requires a power supply.



- Dmix-41 w/ XLR connectors 60GPD MIX41A0 MFR LIST \$899.00
- Dmix-41 w/ XLR and 2 SRC inputs 60GPD MIX41A2 MFR LIST \$1099.00
- Dmix-41 w/ XLR and 4 SRC inputs 60GPD MIX41A4 MFR LIST \$1299.00
- Dmix-41 w/BNC connectors 60GPD MIX41B0 MFR LIST \$899.00
- Dmix-41 w/ BNC and 2 SRC inputs 60GPD MIX41B2 MFR LIST \$1099.00
- Dmix-41 w/BNC and 4 SRC inputs 60GPD MIX41B4 MFR LIST \$1299.00

CALL 1-800-732-7665 FOR BRADLEY PRICE

Accessories for all Graham-Patten SoundPals:

- 115V wall mount power supply 60GPPS3A MFR LIST \$20.00
- 220V wall mount power supply 60GPPS2A MFR LIST \$25.00
- 90-260V power supply 60GPPSU-1 MFR LIST \$80.00
- Wiring harness for PSU-1 for 3 SoundPals 60GPHPSU1 \$25.00
- Rack tray for up to 3 SoundPals modules, includes PSU1 60GPRT1 MFR LIST \$300.00



AUDIO INTERFACE

EXCALIBUR IA-1 INTERFACE AMPLIFIER

Use the IA-1 to connect consumer type equipment to pro broadcast gear. It's a newly-improved two-way stereo box with unbalanced RCA jacks and balanced, removable Euro-style wire capture blocks. I/O levels are adjustable. Rubber feet let you mount it on a flat surface; angle brackets attach it to the wall or under a counter. The optional rack mount puts one or two IA-1's in a single RU. Power is via the attached, UL-approved plug transformer.



Use it with DAT decks, workstations, ENG gear, and more. Response is DC-25kHz ± 0.2 dB, with distortion better than 0.006% and common mode rejection of an impressive 75dB at 1kHz. It's DC coupled and uses no audio transformers. Phase, response, and RF rejection are superior. As always, Excalibur gives great audio for your money.

IA-1	60EXIA1	MFR LIST	\$180.00
Rack Kit	60EXRM1	MFR LIST	\$22.00

CALL 1-800-732-7665 FOR BRADLEY PRICE

ATI MATCHMAKER

Keep your audio crisp and clean even while matching up consumer and pro equipment. Forget problems with loading, distortion, hum loops, RF pickup, and high frequency roll off. The Matchmaker solves these problems with less than 0.02% THD, 20Hz to 20kHz with ± 0.25 dB response, and over 98dB of dynamic range. The Matchmaker performs exceptionally thanks to design features including its transformer balanced outputs. It's UL listed. Choose the rack kit to hold one or two in 1RU.

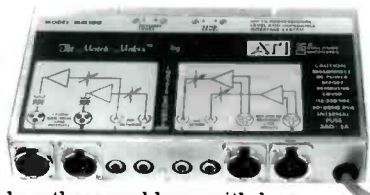

Matchmaker	60AIMM100	MFR LIST	\$299.00
Rack Kit	60AI20273	MFR LIST	\$28.00

CALL 1-800-732-7665 FOR BRADLEY PRICE

ATI MICROAMP DISTRIBUTION AMPLIFIERS

These high-quality devices aren't for everybody but they might be for you. Each has headphone jack, LED metering with switchable calibration and input overload indicators. Set your levels with individual output adjustments. RF rejection of all models is excellent. Distortion is typically 0.005%. For the absolute best RF rejection, choose transformer outputs; for maximum output, specify balanced differential outputs. Microamp DAs are uncommon. Let us fax you the specs.



Single 1x8 w/transformer outputs	60AIDA10081	MFR LIST	\$989.00
Single 1x8 w/differential outputs	60AIDA10082	MFR LIST	\$829.00
Dual 1x8 w/transformer outputs	60AIDA20161	MFR LIST	\$1,399.00
Dual 1x8 w/differential outputs	60AIDA20162	MFR LIST	\$1,149.00

CALL 1-800-732-7665 FOR BRADLEY PRICE

EXCALIBUR DISTRIBUTION AMPLIFIERS

That familiar sword logo means you can count on audio quality inside. Excalibur DAs use barrier strip I/O's. The DA1-5C has one input and five outputs, while the DA2-5C has two 1 by 5 DAs. Their size allows you to hide them almost anywhere. Optional rack ears mount either DA in one RU. S/N >80dB at unity gain, input common mode rejection is greater than 75dB at 1kHz, and THD is less than 0.01%. Maximum gain is 18dB and maximum input and output levels are ± 22 dBm.



DA1-5C 1x5	60EXDA15	MFR LIST	\$149.00
DA2-5C Dual 1x5	60EXDA25C	MFR LIST	\$270.00

Accessories:

Rack ears for DA1-5C	60EXDA15R	MFR LIST	\$15.00
Rack ears for DA2-5C	60EXDA25CR	MFR LIST	\$15.00

CALL 1-800-732-7665 FOR BRADLEY PRICE

EXCALIBUR DISTRIBUTION AMPS



Excalibur's new DA2-6, with one stereo input and six outputs and the DA2-10, with one input and ten outputs, are high quality stereo distribution amps. Unlike other distribution amps, the DA2-6 and the DA2-10 are designed specifically for stereo use. Each output has both left and right level controls together on the front panel for easy adjustment. Tired of tangled wires crossing back and forth between sides of the chassis? Problem solved! On the rear panel, both left and right outputs for each channel are on the same connector. This allows for much neater wiring using two pair cable; all five wires connect to the same connector. Both the DA2-6 and DA2-10 come with euro-block connectors and external UL approved transformers.

DA2-6 Distribution amp	60EXDA26	MFR LIST	\$395.00
DA2-10 Distribution amp	60EXDA210	MFR LIST	\$495.00

CALL 1-800-732-7665 FOR BRADLEY PRICE

EXCALIBUR APA-1 ALL PURPOSE AMPLIFIER

Use it as a stereo line amp, 1 by 2 splitter, 2 to 1 summer, mix-minus amp, level and impedance interface, active phase inverter, or headphone amp. Summing, splitting, matching, interfacing: the APA-1 does it all. The dip switches let you set it quickly, and its clean audio puts it at home in the highest quality facilities. Inputs and outputs are on barrier strips.



APA-1	60EXAPA1	MFR LIST	\$165.00
Rack Mount Kit	60EXRM2	MFR LIST	\$22.00

CALL 1-800-732-7665 FOR BRADLEY PRICE

AUDIO INTERFACE

ROLLS CT1

New!

The Rolls Corporation has to be most overlooked accessory line in Audio. Designs for problem solving is what Rolls is all about. The CT1 should be in every workbelt. Tests, RCA, XLR and 1/4" cables with an easy to read LED indicator!



Cable Detective Tester 61RLCT1 \$45.00

RIXX PAM-1 PASSIVE ATTENUATOR/MIXER

The RIXX PAM-1 is a simple passive device which can be used for independent, variable attenuation of two unbalanced audio channels. It can also be used to sum the channels into a mono signal, with resistors incorporated to prevent output driver damage. Continuously variable attenuators are internally located to prevent tampering.



Typical uses include reducing levels between "pro" and "semi-pro" audio gear, or between broadcast and consumer VTR's; mixing channels for mono dubs, padding outputs from digital workstations and recorders or to feed a mono monitoring device (such as a video monitor speaker).
PAM-1 60RIPAM1 \$39.95

RADIO SYSTEMS DISTRIBUTION AMPLIFIERS

Best Seller



This New Jersey company has been making quality audio products for two decades, and their DA's are among our most popular. Front panel independent level adjusts, balanced bridging inputs, balanced low impedance outputs, barrier strip connectors, and super low noise and distortion combine to make them a sure fire investment.

Response is within a tenth of a dB of 20Hz-20kHz, gain is up to +26dB without pad, and distortion is below 0.01%.

DA-8 (8 Mono) 60RSDA8 MFR LIST \$340.00
DA-16 (8 Stereo/16 Mono) 60RSDA16 MFR LIST \$425.00

CALL 1-800-732-7665 FOR BRADLEY PRICE

ATI ENCORE DISTRIBUTION AMPS



ATI offers more flavors than an ice cream truck. Their distribution amplifiers are available in so many configurations, you're certain to find one to solve your specific wiring problem. We like the Encore Series, even more now that ATI offers versions with XLR's.

The DA206 and DA412 offer six or twelve balanced outputs divided among two or four independent, 1-in to 3-out channels. Internal jumper plugs parallel inputs for 1x6, 2x6, or 1x12 operation. These DAs have master input controls plus programmable gain for various nominal inputs; output taper controls are adjustable from +8 to -10dBm. Max gain is 40dB. These models use XLR connectors.

The DA208 and DA416 offer eight or sixteen balanced outputs divided among two or four independent, 1-in to 4-out channels. Parallel inputs on rear connectors allow 1x8, 2x8, or 1x16 operation. Audio taper output controls adjust from +8 to -10dBm. LED indicators warn of overdriven shorted output. Max gain is 20dB. These models use barrier block connectors.

All are UL Listed. Call us for the impressive audio specs.

DA206	60AIDA206	MFR LIST	\$479.00
DA412	60AIDA412	MFR LIST	\$669.00
DA208	60AIDA208	MFR LIST	\$379.00
DA416	60AIDA416	MFR LIST	\$549.00

CALL 1-800-732-7665 FOR BRADLEY PRICE

TASCAM FOUR CHANNEL INTERFACE AMP



Like other audio interfaces, the LA-40 MKII lets you use balanced XLR equipment with unbalanced RCA gear. Unlike others, this rackable unit offers four channels in each direction.

All I/O connectors are located on the back panel. Ground lift switches for each channel and a universal "all-lift" minimize unwanted noise. Front-panel dials let you fine tune the amplification by ±6dB. Under the chassis, switches toggle between +4 and -20dBm nominal outputs.

The LA-40 MKII lets you assign the signal of a single input to multiple outputs. Flip one switch to assign it to all the channels above it (assuming they are of the same I/O conversion type). The system also accommodates the "muting" of multiple inputs or stereo input pairs.

LA-40 MKII 60TELA40 MFR LIST \$475.00

CALL 1-800-732-7665 FOR BRADLEY PRICE



DISTRIBUTION AMPLIFIERS

MODEL	MANUFACTURER	DISTRIBUTION	INPUT CONNECTORS	OUTPUT CONNECTORS	RACK SPACES	LIST PRICE
120	Aphex	1 x 4	XLR	XLR	1/2	\$319.00
DA-206	ATI	Dual 1 x 3	XLR	XLR	1	\$479.00
DA-208	ATI	Dual 1 x 4	Barrier Strip	Barrier Strip	1	\$379.00
DA-412	ATI	Quad 1 x 3	XLR	XLR	1	\$669.00
DA-416	ATI	Quad 1 x 4	Barrier Strip	Barrier Strip	1	\$549.00
DA-10081	ATI	Mono 1 x 8	Barrier Strip	Barrier Strip	1	\$989.00
DA-10082	ATI	Mono 1 x 8	Barrier Strip	Barrier Strip	1	\$829.00
DA-20161	ATI	Mono 2 x 16	Barrier Strip	Barrier Strip	1	\$1,399.00
DA-20162	ATI	Mono 2 x 16	Barrier Strip	Barrier Strip	1	\$1,149.00

For information on BENCHMARK please call Bradley

DA1-5C	Excalibur	Mono 1 x 5	Barrier Strip	Barrier Strip	1/2	\$165.00
DA2-5C	Excalibur	Dual 1 x 5	Barrier Strip	Barrier Strip	1	\$270.00
DA2-6	Excalibur	Stereo 1 x 6	Detachable Euro Blocks	Detachable Euro Blocks	1	\$395.00
DA2-10	Excalibur	Stereo 1 x 10	Detachable Euro Blocks	Detachable Euro Blocks	1	\$495.00
U.S.D.A.	Henry Engineering	2 x 4	Barrier Strip	Barrier Strip	Optional Rack Shelf	\$195.00
ST-DA3	Radio Design Labs	Mono 1 x 3	Barrier Strip	Barrier Strip	Stick-on	\$126.00
DA-8	Radio Systems	Mono 1 x 8	Barrier Strip	Barrier Strip	1	\$340.00
DA-16	Radio Systems	Mono 1 x 16 or 2 x 8	Barrier Strip	Barrier Strip	1	\$425.00
DA-2 X 4	Radio Systems	Mono 1 x 8 or 2 x 4	Barrier Strip	Barrier Strip	1	\$395.00
DA-4 X 4	Radio Systems	Mono 1 x 16, Stereo 2 x 8, Stereo 2 x 4 (x2), or Quad 4 x 4"	Barrier Strip	Barrier Strip	1	\$495.00

RANE DA 216 DISTRIBUTION AMP



You say that you are seeing only one Rane DA 216? Look closer. Every DA 216 gives you double the distribution power of its predecessor - the FDA 28 - running circles around it. And it doesn't cost a penny more! The DA 216 can be configured in an amazing number of ways. You want 1 input to 16 outputs? No problem! 1 stereo input to 8 stereo outputs? You've got it! 2 mixed inputs to 16 outputs? It's yours! 2 independent inputs to dual 8 mono outputs? Whatever you want! The DA 216 features two predistribution screwdriver-adjustable master level controls, with 16 screwdriver-adjustable output level controls. Terminal strips on the rear handle the connections, with balanced line level outputs while inputs are switchable between mic and line. 15 volt phantom power is switchable when the mic inputs are selected. Whenever you need a distribution amp, get twice as much with the Rane DA 216. Give us a call. We'll tell you all about it.

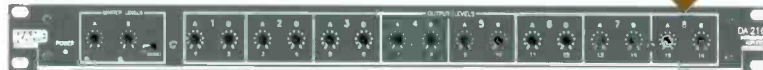

DA 216 60RND216 MFR LIST \$499.00

CALL 1-800-732-7665 FOR BRADLEY PRICE

APHEX 120A DISTRIBUTION AMPLIFIER

The 120A boasts THD 0.002% at +4dBm and hum and noise better than -90dBm at unity gain. XLR I/O's and maximum RF shielding make it suitable for both studio and field. The 120 is a half-rack DA with one input, four outputs with level controls, and one unity gain direct output. Aphex publishes an aggressive response spec (5Hz to 100kHz, +0, -0.5dB) which makes it suitable for critical applications, as well as distributing SMPTE time code. The optional rack kit holds one or two in a single RU.



120A 60AP120 MFR LIST \$319.00
Rack mount 60AP44008 MFR LIST \$29.95

CALL 1-800-732-7665 FOR BRADLEY PRICES

BURK LX-1 SIX-INPUT STEREO SELECTOR



Integrate numerous sources—studios, feeds, players—through one master control unit. The transition is smooth and levels remain constant. The LX-1 can connect to your remote control system for remote program switching. It matches -10 IHF to +4 PRO inputs, so you need no external matching equipment. The LX-1 also allows mixing of two studio sources, or lockout of all audio sources. Tally indications are provided for each source, making clear which is active. Individual start and stop pulses are available for each source, a feature which lets you use the LX-1 to start a fill tape or reset automation.

LX-1 60AVLX1 MFR LIST \$1,295.00

CALL 1-800-732-7665 FOR BRADLEY PRICE

HENRY PORTAMATCH

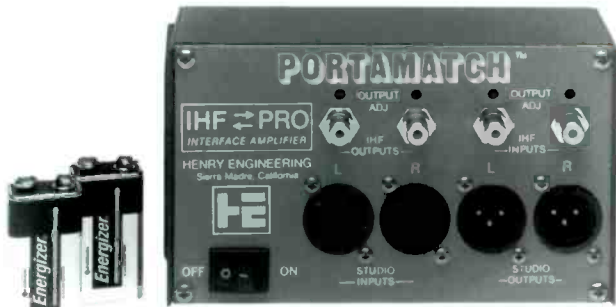

Portamatch, the battery-operated version of the Matchbox II operates on two 9V batteries, and is ideal for use where AC power is not available. Portamatch is the ideal way to correctly interconnect "consumer" or semi-pro equipment with professional gear. Portamatch is a bi-directional unit, employing four independent amplifiers to convert stereo inputs and outputs from unbalanced -10 dBV levels to +4 dBm balanced 600 ohm lines. All four outputs can be adjusted to accommodate a wide range of operating levels. Portamatch also features a special HI GAIN mode to properly match the low-level unbalanced outputs of computer sound cards. The unit's direct-coupled circuitry and exceptional dynamic range provide absolute sonic transparency, making Portamatch ideal for use with digital editors, DAT recorders, and other digital audio sources.

Portamatch 60HEPM MFR LIST \$195.00

CALL 1-800-732-7665 FOR BRADLEY PRICE

360 SYSTEMS AM-16/B ROUTING SWITCHER



Let Bradley and 360 Systems save you a lot of trouble and time. You can configure the AM-16/B as a 16 x 16 mono or 8 x 8 stereo matrix. The companion AM-16/E slave unit operates in parallel to provide more simultaneous inputs. Combine one master and one slave unit for 16 x 16 stereo operation. Use additional slaves for multi-channel applications or for custom matrices.

Replace patch panels and cumbersome switchers with this expandable system. Store your configurations in 100 memory locations, and easily recall individual patches or complex "salvos."

All inputs and outputs are electronically balanced. The switcher has both RS-422 and MIDI remote control facilities. The front panel includes single ended jacks with the input and output of two mono channels or one stereo pair, to serve as test points or for an emergency patch. Specifications are impeccable. Frequency response is ± 0.5dB, 20Hz to 20kHz. Distortion is less than 0.008% THD+N, DC to 20kHz @ +22dBm. Signal to noise is 105dB unweighted, and crosstalk is 99dB at 1kHz and 83dB at 20kHz, any channel to any other.

The optional AM-16/R is a single space remote control station that operates on the EIA-485 control bus for X-Y and salvo switching. It controls up to four AM-16/B's or may be used in multi-drop configurations.

AM-16/B Switcher	50TH16B	MFR LIST	\$1,495.00
AM-16/E Expander	50TH16E	MFR LIST	\$995.00
AM-16/R Remote Station	50TH16R	MFR LIST	\$695.00

CALL 1-800-732-7665 FOR BRADLEY PRICE

LOGITEK SWITCHERS



Quietly doing their job in racks everywhere, these passive Logitek switchers are proven performers. The Pre-10S is a 10x2 stereo routing switcher with barrier strip terminations. The Mon-10 is a 10x1 stereo switcher with wire-capture terminal blocks and front panel switching to look at Left, Right, L+R, or L-R and feed the selected signal to the VU meter and internal monitor amp. Meter sensitivity may be selected over a 50dB range in 10dB steps. The monitor amp feeds the front panel speaker, a front panel headphone jack, and rear panel speaker connections.

Pre-10 S	60LTPRE10S	MFR LIST	\$560.00
Mon-10	60LTMON10	MFR LIST	\$855.00

CALL 1-800-732-7665 FOR BRADLEY PRICE



AUDIO INTERFACE

Z-SYSTEMS DIGITAL AUDIO ROUTER



The Z-8.8 is a digital audio patchbay, router, and DA. With eight lines in and eight out (for eight stereo pairs of AES/EBU or S/PDIF), it's ready to detangle your audio kluge. It handles XLR, coax, or optical ins and outs. Separate I/O modules let you convert one connector to another, and match impedances and levels. Call for 16- and 32-line versions.

Z-8.8 (all AES/EBU)	60ZS88A	MFR LIST	\$980.00
Z-8.8 (4 AES, 2 BNC, 2 Optical)	60ZS88M	MFR LIST	\$1,080.00

CALL 1-800-732-7665 FOR BRADLEY PRICE

BROADCAST TOOLS ACTIVE AUDIO SWITCHER



The 8X2D/E dual audio switcher accepts eight stereo inputs, switchable to two stereo outs via switches with LED indicators. Inputs can either overlap or interlock any source. Inputs are balanced bridging and take balanced or unbalanced sources, and can be configured to allow up to 10dB dimming. Trimmers adjust the inputs -10 to +8dBm. Output and dimming level settings are provided. Other features: power-up input select, switch disable mode, mono outputs, mute input, and output selectable silence sensor. Parallel and RS-232 ports are provided for remote control and status.

8X2D/E Active Dual Stereo Audio Switcher	60BT8X2AEV	MFR LIST	\$649.00
--	------------	----------	----------

CALL 1-800-732-7665 FOR BRADLEY PRICE

BROADCAST TOOLS THE TALKING DUCK

The Talking Duck II, unlike any other product available, conveniently identifies any audio circuit. By simply connecting the supplied 9V wall transformer to the Talking Duck II, pressing the rear panel record button and speaking into the rear panel electret condenser mic, a 20 second identifying message may be recorded. On playback, the recorded message will continually run, unless configured for remote activation. By connecting the Talking Duck II to any audio circuit, the user can immediately identify the circuit by listening to the message. The Talking Duck II will continually feed the output terminals, until input audio triggers the internal VOX circuit, at which point the recording is disconnected and the input source equipment is switched back to the output terminal.



Talking Duck	60BTDUCK	MFR LIST	\$139.00
--------------	----------	----------	----------

CALL 1-800-732-7665 FOR BRADLEY PRICE

BROADCAST TOOLS PASSIVE SWITCHER/ROUTER

The 6X1G is a passive, six-input switcher/router that can select up to six stereo balanced inputs to one stereo out. Sealed gold contact relays make for transparent audio. Switches with LED's provide interlocked source selection and status. A



"D" connector allows remote control and status. Remote inputs can be momentary or maintained TTL/CMOS, open collector or contact closure. Program the 6X1G to power up on any of the six inputs. I/O's are wire-captive terminal strips. This half-rack device can mount on a desktop or, with the optional shelf, in a rack.

6X1G Passive Stereo Switcher/Router	60BT6X1	MFR LIST	\$399.00
Shelf Option (holds two)	60BTRM1	MFR LIST	\$49.00
Filler Panel	60BTFP1	MFR LIST	\$39.00

CALL 1-800-732-7665 FOR BRADLEY PRICE

BROADCAST TOOLS DTMF CONTROLLER

The DC-8 connects to a dial-up phone line, allowing you to control eight SPDT relays and monitor eight digital inputs via any standard Touch-Tone™ phone. Relays can be set for momentary, latching, interlocking, or group latch/unlatch. Pager Alert dials a digital pager and displays a programmed phone number. A tone generator is built in.



DC-8 Dial-Up DTMF Controller	60BTDC8	MFR LIST	\$399.00
RM-2 Rack Kit	60BTRM2	MFR LIST	\$49.00

CALL 1-800-732-7665 FOR BRADLEY PRICE

BROADCAST TOOLS SATELLITE TOOLS

Here are two tools for satellite system users. The USC-16 is a satellite channel controller, providing remote channel selection for DAT-SEDAT digital audio decoder cards installed in Scientific Atlanta, Comtech/Fairchild, and Ariel receivers. Program it to select eight channels and subchannels on each decoder card. The XP-3 provides remote transponder selection for the same three brands of receivers, allowing selection of the three transponder channels. Call us for more info.

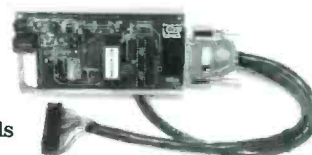

USC-16 Satellite Channel Controller	60BTSCC16	MFR LIST	\$299.00
XP-3 Satellite Transponder Controller	60BTXP3	MFR LIST	\$299.00
DSC-20 20 Satellite Dual Controller	60BTDSC20	MFR LIST	\$299.00

CALL 1-800-732-7665 FOR BRADLEY PRICE

AUDIO INTERFACE

HENRY ENGINEERING

MATCHBOX II & TWINMATCH

Everyone's heard of the Matchbox, Henry's bi-directional device for marrying pro gear to equipment with consumer levels and impedances. Use the improved Matchbox II with DAT machines, CD players, cassette decks, and digital editors.

The average noise floor is reduced by 8dB for more dynamic range. A high-gain mode brings very low levels from digital editor sound cards up to +4dBm. Gold-plated RCA jacks extend the life of the unit. And all outputs, both balanced and unbalanced, are now adjustable. (You won't overdrive the inputs of those sound cards.) The AC cord is three-wire, and AC ground is isolated from audio ground to reduce noise.

TwinMatch is a four-channel, one way model bringing -10 to +4, great for two stereo consumer sources like CD players. Barrier strap connectors for both input and output.

Matchbox II	60HEMATCH2	MFR LIST	\$195.00
TwinMatch	60HETM	MFR LIST	\$195.00

CALL 1-800-732-7665 FOR BRADLEY PRICE



MIXMINUS PLUS

If your console manufacturer won't put Mix-Minus in your board, do it yourself. Use this box to add a mix-minus output suitable for feeding the send input of a telephone hybrid. One input of this unit is fed with the mixer output, the other takes hybrid receive audio. These two signals are subtracted using phase reversal to create a program mix, minus the receive audio. Initial null adjustment will provide 40dB rejection of the receive audio signal. Very handy.

MixMinus Plus	60HEMMP	MFR LIST	\$195.00
---------------	---------	----------	----------

CALL 1-800-732-7665 FOR BRADLEY PRICE



STEREOSWITCH

Hank's products are simple and reliable. They have that undefinable "good feel" in your hand. This one is an audio switcher that takes three stereo balanced sources, selects the one you indicate, and routes it to the stereo balanced output.

Program it internally to select one input when AC power comes up. Tally outputs will drive remote status indicators. Use it as a line selector or for auto source selection under the control of an automation system.

It uses sealed relays with gold-plated contacts, and is "transparent" since it puts no circuitry in the audio path. Control it with any momentary or maintained contact closure, open collector, TTL/CMOS logic, or DC voltage from 5-24 volts. Audio connections are barrier strip.

StereoSwitch	60HESTS	MFR LIST	\$250.00
--------------	---------	----------	----------

CALL 1-800-732-7665 FOR BRADLEY PRICE



STEREOMIXER

StereoMixer is an eight-input stereo line mixer that lets you mix four stereo or eight mono sources (or a combo of both). It has three outputs: L, R, and Mono. Inputs and outputs are balanced barrier strip; bus inputs allow linking. The power supply is internal, and the StereoMixer is built with the same ruggedness and audio quality as all Henry products.

StereoMixer	60HESM	MFR LIST	\$250.00
-------------	--------	----------	----------

CALL 1-800-732-7665 FOR BRADLEY PRICE



U.S.D.A. & MICROMIXER



Henry's U.S.D.A. lets you combine, as well as split, audio signals. The Universal Summing and Distribution Amplifier has two inputs (one stereo pair) and four outputs (two stereo pairs). While it can be used as a conventional 1x4 or 2x2 distribution amp, you get the added ability of either stereo input to be combined into dual mono without affecting the other output. Up to 20dB of gain is available, adjustable individually on each output.

The MicroMixer has four balanced inputs that can be individually assigned to its two balanced outputs. Used alone, or with the U.S.D.A., the MicroMixer is a good way to combine stereo to mono, create mix-minus or monitor busses, and numerous other uses. Each unit's balanced outputs are isolated and will drive a 600 ohm load to +25dBm with less than 0.01% THD. The bridging inputs accept a wide range of balanced and unbalanced sources.

U.S.D.A.	60HEUSDA	MFR LIST	\$195.00
MicroMixer	60HEMM	MFR LIST	\$195.00

CALL 1-800-732-7665 FOR BRADLEY PRICE

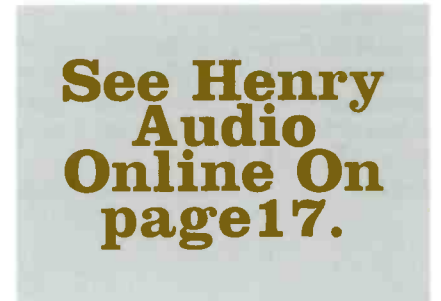

CONEX AS-101 ROUTING SWITCHER

Bradley clients use the AS-101 to expand mixer inputs, set up simple automation systems, and fix other studio problems. This 10x1 stereo routing switcher can be programmed for "overlap" switching, which prevents the source from turning off until the trailing edge of the command strobe turns on the new source. Inputs may be individually switched for 10K bridging or 600 ohm terminating. Audio connections are via plug in screw clamp terminal blocks, and all audio paths are transformerless balanced. The control format is four-level BCD plus strobe, ground, and 12VDC. Several control heads may be operated in parallel.



You can do more, too: An auxiliary rack mount chassis accepts option boards for relay-based machine control, RS-232/422 interface, and a system controller board which allows the unit to function as a simple automation system when controlled by a PC. Call for the list of Conex options.

AS-101 Switcher	60CNAS101	MFR LIST	\$962.00
Single unit remote control	60CNAS401	MFR LIST	\$161.00

CALL 1-800-732-7665 FOR BRADLEY PRICE

HARKEN SPECIALTY ADAPTERS



Inline Switchable Audio Pad with XLR connectors Allows attenuation from 10dB to 40dB in 2dB steps.

600/600 ohm pad	60HK1126	\$63.25
150/150 ohm pad	60HK1121	\$63.25
600/150 ohm pad	60HK11261	\$63.25

XLR Universal Two-Fer Connect any two cables regardless of the gender of their XLR connectors. The Two-Fer is the adapter in the center of our photo, with two barrels and a connecting cable.

60HK115	\$41.00
---------	---------

Telephone Interface The HK128X will interface a phone instrument to your audio system with a handset cord and XLR connectors.

60HK128X	\$42.75
----------	---------

Phase Reversal & Ground Lifter A single inline unit with XLR connectors.

60HK113	\$51.75
---------	---------

Polarity Tester Uses LEDs to show polarity of the DC voltage on pins 2 and 3 of an XLR.

60HK125	\$33.00
---------	---------

XLR Monitoring Device Allows you to monitor moderate to high level audio. The TS mini-jack allows you to connect an ear piece or headphone.

60HK111	\$25.50
---------	---------

XLR Adapters:

XLR to: (adapter termination)		Price
Phono (RCA) jack (female)	60HK107X	\$14.50
Phono (RCA) plug (male)	60HK110X	14.50
1/4" tip sleeve	60HK108X	48.75
Mini-plug (TS wired to pins 2 & 3)	60HK121X	14.50
Mini-jack (TS wired to pins 2 & 3)	60HK122X	14.50
Three terminal barrier strip	60HK104X	17.25
Mini quick connect wire capture	60HK118X	16.00
Triple binding posts, side mounted	60HK119X	25.50
Triple binding posts, rear mounted	60HK103X	25.50

Replace "X" with "M" or "F" to specify gender of XLR

XLR to: (adapter termination)		Price
Bantam patch field jack	60HK109B	\$32.50
BNC (coax shield & XLR body isolated)	60HK106X	15.10
RJ11C Modular telco 6 pin jack	60HK116X	16.25
RJ11C Modular telco 6 pin plug	60HK126X	18.75
RJ9 Modular telco handset 4 pin jack-transmit	60HK117TX	16.25
RJ9 Modular telco handset 4 pin jack-receive	60HK117RX	16.25
RJ9 Modular telco 4 pin plug-transmit	60HK127TX	18.75
RJ9 Modular telco 4 pin plug-receive	60HK127RX	18.75

Replace "X" with "M" or "F" to specify gender of XLR

SWITCHCRAFT CONNECTORS AND ADAPTERS

Connectors (Solder type)

Inline TS 1/4" phone M	61WHSW280	\$1.89
Inline TRS 1/4" phone M	61WHSW297	\$3.99
Inline Phono (RCA) M	61WHSW3502	\$1.29
Inline 1/8" TS MINI M	61WHSW780	\$3.55
Philmore Inline 1/8" TRS/Mini M	61WHSW502M	\$2.05

Adapters (User assembly required)

XLR M to XLR M	61WHSW390	\$11.50
XLR M to XLR F	61WHSW53FM	\$9.95
XLR F to 1/4" TRS F	61WHSW383A	\$14.90
XLR M to 1/4" TRS F	61WHSW384A	\$13.90
XLR F to 1/4" TRS M	61WHSW386A	\$14.50
XLR M to 1/4" TRS M	61WHSW387A	\$12.75
XLR F to XLR F	61WHSW389	\$12.90
1/8" TS F to 1/4" TS M	61WHSW364	\$6.60

M=Male, F=Female



NEUTRIK CONNECTORS

X series connectors have only four parts. They have no set screw, and crimping during assembly is not required. One piece unbreakable die cast housing, bellows-style polyurethane flex relief, and chuck-type, snap on cable clamp provide secure strain relief.

The C series are right angle connectors that swivel at 45-degree intervals when assembled for maximum packing density. Both XLR types are available in nickel shell with silver contacts or black shell with gold contacts.



3 Pin XLR Type	Shell	Part#	Price	Other Neutrik Connectors		
Female Cable	Nickel	61NT3FX	\$2.60	1/4" TS phone plug	61NTNP2C	\$2.56
Female Cable	Black	61NT3FXB	\$3.16	1/4" TRS phone plug	61NTNP3C	\$3.23
Female Panel	Nickel	61NT3FP	\$2.77	1/4" TRS lockable chassis jack	61NTNJ3FP6C	\$4.96
Female Right Angle	Nickel	61NT3FRC	\$6.75			
Male Cable	Nickel	61NT3MX	\$2.42			
Male Cable	Black	61NT3MXB	\$3.34			
Male Panel	Nickel	61NT3MP	\$2.71			
Male Right Angle	Nickel	61NT3MRC	\$6.95			

WHIRLWIND WALL MOUNTING PLATES

Whirlwind's stainless steel plates fit standard single or double gang electrical junction boxes. Mounting screws are included.



	Part #	Price
<i>Single:</i>		
One female XLR	61WHWP1FW	\$9.84
One male XLR	61WHWP1MW	\$9.84
One 1/4" TRS jack	61WHWP1QW	\$12.50
Two female XLR's	61WHWP2FW	\$15.60
Two male XLR's	61WHWP2MW	\$14.95
Two 1/4" TRS jacks	61WHWP2QW	\$14.95
<i>Double:</i>		
Four female XLR's	61WHWP4FW	\$28.00
Four male XLR's	61WHWP4MW	\$28.00
Four 1/4" TRS jacks	61WHWP4QW	\$33.00

WHIRLWIND XLR CONNECTORS

Whirlwind's WI series features one-piece die cast housings. The special cable grip provides 100% strain relief on diameters of 0.11" to 0.31". Strain relief boots are black, with red, blue, and white available by special order.



Male inline XLR	61WHW13MXX	ea: \$2.25
	Box of 100	\$180.00
Female inline XLR	61WHW13FXX	ea: \$2.40
	Box of 100	\$192.00

BRADLEY CORD-LOX

Cord-Lox stay with your cable, helping you store or coil. Each strap makes two loops: a cable holder to keep the strap on the line, and a larger loop to hold the coil. Three sizes delivered from stock. Black only. (Call us about custom imprints and colors.)



3/4" x 5"	With cable holder closed at both sides. For shorter cables.	60CL205C	\$1.20
1" x 7"	With cable holder closed at both sides. For medium cables.	60CL307C	\$1.29
1-1/2" x 18"	for snakes	60CL4180	\$3.48

FURMAN MODEL PB-48

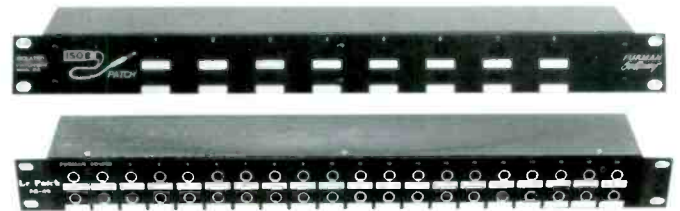

The PB-48 is Furman's standard patch bay, usable in almost any application. It features 1/4" TRS phone jacks in all positions, front and rear, with one switching jack in the lower front positions. TRS jacks have the advantage of being usable in either balanced or unbalanced systems. The PB-48's front panel can be easily removed, even when the unit is already mounted in a rack. The unit may be customized by removing the front panel, pulling out any module to be non-normalled, turning it end-for-end, and replacing it.

Model PB-48D

The PB-48D is Furman's top of the line patch bay. It features 1/4" TRS phone jacks in front for easy patching, and six 25-pin D-Sub connectors in the rear, per Tascam DA-88 wiring standards.

FURMAN PB-48 PATCH BAY	60FUPB48	MFR LIST	\$169.00
FURMAN PB-48D D-SUB PATCH BAY	60FUPB48D	MFR LIST	\$229.00

CALL 1-800-732-7665 FOR BRADLEY PRICE



Cables

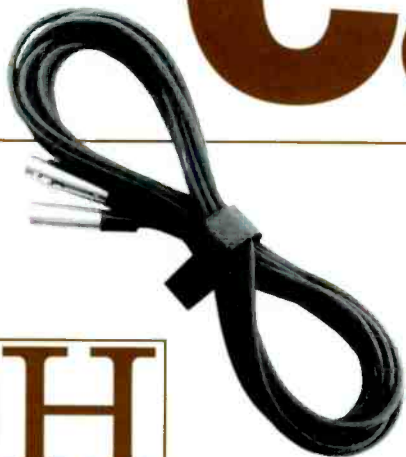

Here is a sample listing of the many cables Bradley has.

Call Bradley for a complete listing of 4 Conductor cables for bi-amping and bi-wiring and 2 conductor cables with 1/4" phone, dual banana plugs with SPEAKON connectors.

10' 16 Gauge wire with chrome plated 1/4" phone plugs		
42ME100		\$12.00
25' 16 Gauge wire with chrome plated 1/4" phone plugs		
42ME250		\$16.00
50' 16 Gauge wire with chrome plated 1/4" phone plugs		
42ME500		\$18.00

BULK SPEAKER CABLE

Our heavy duty speaker cable has a black, polypropylene jacket. Minimum order is 50 feet.

14 gauge, 2 conductor	61WHW14GA	37¢ per foot
12 gauge, 2 conductor	61WHW12GA	55¢ per foot

WHIRLWIND MULTIPAIR CABLE

Each pair of this heavy-duty cable is individually twisted and shielded and has its own drain wire. Sold in multiples of 50 feet. Price is for a 50' length.

6 pair	61WHW06PR	\$56.00
9 pair	61WHW09PR	\$65.00
12 pair	61WHW12PR	\$78.50
16 pair	61WHW16PR	\$100.50
20 pair	61WHW20PR	\$131.00
32 pair	61WHW32PR	\$199.50

WEST PENN 291

Most useful for audio connections, a popular alternative to 8451. A two-conductor shielded cable with drain wire and foil shield. Signal conductors are 22 gauge stranded, and the drain conductor is 24 gauge stranded. 1000' spools are available in black, blue, red, white, yellow, brown, green, violet, orange, and gray. (Specify color)

60WP291XX		\$99.00
-----------	--	---------

WEST PENN 510

Wiring stereo signals? Use this two-pair individually foil shielded cable with common drain wire and overall shield. 1000' reels.

60WP510		\$175.00
---------	--	----------

BRADLEY MIC CABLES

Some of the most widely heard audio in the world runs through Bradley assembled mic cables, featuring Neutrik XLRs.

3' cable	61WHMK403	\$12.50
6' cable	61WHMK406	\$13.25
10' cable	61WHMK410	\$14.00
25' cable	61WHMKS20	\$14.50
50' cable	61WHMKS50	\$22.00

BRADLEY BULK MIC CABLE

Make your own! You save money when you buy this rugged, low-impedance mic cable in bulk.

60AT8300		35¢ per foot
----------	--	--------------

CANARE STAR QUAD MIC CABLE

An excellent low-noise bulk cable, designed for mics but excellent for any audio. It gets its name from the four conductor-style construction that minimizes the loop area between twists of the conductors, reducing noise. Buy it by the foot, in two reel sizes, or assembled. Black is the only color offered by the foot. Reels are available from stock in black. Special order blue, brown, gray, green, orange, purple, red, white, and yellow. Call for pricing on multipair setups. (Specify color)

Bulk Star Quad	60CAL4E6BK	57¢ per foot
656' reel	60CAL4E605XX	\$335.00
1000' reel	60CAL4E610XX	\$509.00

CANARE STAR QUAD ASSEMBLED MIC CABLES

These cables come with Neutrik XLR connectors. Black is available from stock. Other colors are special order. Cables may be special ordered in any length, with a minimum order of 10 cables in any mix of colors and lengths. (Specify color)

5'	60CAEC005FBXX	\$23.50
15'	60CAEC015FBXX	\$29.00
25'	60CAEC025FBXX	\$35.25
50'	60CAEC050FBXX	\$51.50

PLUG EM! BRADLEY ENG MIC CABLES

We know what kind of ENG cables you need: durable, high-quality, with a choice of straight or coiled. Our cables are for portable DAT and cassette recorders and will stand up to the rigors of field use. Straight cords are 6 feet long except as noted; coiled cords extend to over ten feet. Need something else? CALL US.

XLR female to XLR male, straight cable (6')	61WHMK406	\$13.25
XLR female to XLR male, coiled cable	61GCENG5	\$35.95
XLR female to XLR male, straight (10')	61WHMK410	\$14.40
XLR female to 3.5mmTRS mini, straight	61WHENG6	\$12.00*
XLR female to 1/4" TS, straight cable	61WHENG4	\$12.00
XLR female to 1/8" TS mini, straight cable	61WHENG	\$12.00
XLR female to 1/4" TS, coiled cable	61WHENG2	\$28.00
XLR female to 1/8" TS mini, coiled cable	61WHENG3	\$28.00

* Mono for use with Sony DAT and MD.

SINGLE AUDIO CABLES

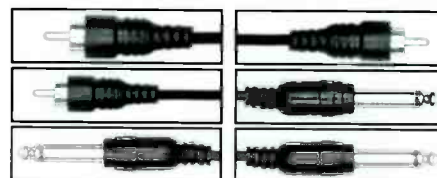

RCA to RCA, 3'	61HOCRA103	\$3.75
RCA to RCA, 5'	61HOCRA105	\$4.25
RCA to RCA, 10'	61HOCRA110	\$5.50
RCA to RCA, 15'	61HOCRA115	\$6.50
RCA to RCA, 20'	61HOCRA120	\$8.00
RCA (M) to 1/4" phone, 3'	61HOCPR103	\$4.00
RCA (M) to 1/4" phone, 5'	61HOCPR105	\$4.50
RCA (M) to 1/4" phone, 10'	61HOCPR110	\$6.00
RCA (M) to 1/4" phone, 15'	61HOCPR115	\$7.00
1/4" phone (M) to 1/4" phone (M) 1'	61HOCPP101	\$3.50
1/4" phone (M) to 1/4" phone (M) 3'	61HOCPP103	\$4.25
1/4" phone (M) to 1/4" phone (M) 5'	61HOCPP105	\$4.75
1/4" phone (M) to 1/4" phone (M) 10'	61HOCPP110	\$6.25
1/4" phone (M) to 1/4" phone (M) 15'	61HOCPP115	\$7.25
Stereo 1/4" phone to stereo 1/4" phone, 3'	61HOCSS103	\$6.50
Stereo 1/4" phone to stereo 1/4" phone, 5'	61HOCSS105	\$7.00
Stereo 1/4" phone to stereo 1/4" phone, 10'	61HOCSS110	\$8.00
Stereo 1/4" phone to stereo 1/4" phone, 15'	61HOCSS115	\$9.00
Stereo 1/4" phone to stereo 1/4" phone, 25'	61HOCSS125	\$11.00

And there's more!



PORTABLE DAT MIC CABLE

Rt. Angle 3.5-mm (M) to XLR (F), wired for stereo mics
61HOXVM249 \$9.95

FIBER-OPTIC CABLES

Fiber-optic cables are compatible with Alesis ADAT, Yamaha O2R, Fostex and other.
Fiber-optic cable, 0.6m (2') 61HOOPT102 \$9.99
Fiber-optic cable, 0.9m (3') 61HOOPT103 \$13.99
Fiber-optic cable, 2m (6.6') 61HOOPT106 \$23.99

SINGLE AUDIO CABLES, UNBALANCED

XLR (M) to RCA, 5' 61HOXRM105 \$10.50
XLR (M) to RCA, 10' 61HOXRM110 \$11.50
XLR (M) to RCA, 15' 61HOXRM115 \$13.00
XLR (F) - RCA (M), 5' 61HOXRF105 \$11.00
XLR (F) - RCA (M), 10' 61HOXRF110 \$12.00
XLR (F) - RCA (M), 15' 61HOXRF115 \$13.50
XLR (M) to Mono 1/4" phone (M), 5' 61HOPXM105 \$11.00
XLR (M) to Mono 1/4" phone (M), 10' 61HOPXM110 \$12.00
XLR (M) to Mono 1/4" phone (M), 15' 61HOPXM115 \$13.25
XLR (f) to Mono 1/4" phone, 5' 61HOPXF105 \$12.00
XLR (f) to Mono 1/4" phone, 10' 61HOPXF110 \$13.00
XLR (f) to Mono 1/4" phone, 15' 61HOPXF115 \$14.50

BALANCED CABLES

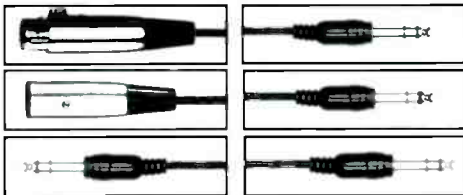

XLR (M) to Stereo 1/4" phone, 3' 61HOSTX103M \$10.00
XLR (M) to Stereo 1/4" phone, 5' 61HOSTX105M \$12.50
XLR (M) to Stereo 1/4" phone, 10' 61HOSTX110M \$14.00
XLR (M) to Stereo 1/4" phone, 15' 61HOSTX115M \$16.00
XLR (F) to Stereo 1/4" phone, 3' 61HOSTX103F \$11.00
XLR (F) to Stereo 1/4" phone, 5' 61HOSTX105F \$13.00
XLR (F) to Stereo 1/4" phone, 10' 61HOSTX110F \$15.00
XLR (F) to Stereo 1/4" phone, 15' 61HOSTX115F \$17.00

MULTI-TRACK SNAKE CABLES



RCA to RCA, 6.6' x 8 61HOCRA802 \$31.50
RCA to RCA, 9.8' x 8 61HOCRA803 \$37.00
RCA to RCA, 13.1' x 8 61HOCRA804 \$45.00
RCA to RCA, 16.4' x 8 61HOCRA805 \$52.00
RCA to RCA, 22.9' x 8 61HOCRA807 \$75.00
RCA to 1/4" phone, 6.6' x 8 61HOCPR802 \$35.00
RCA to 1/4" phone, 9.8' x 8 61HOCPR803 \$41.00
RCA to 1/4" phone, 13.1' x 8 61HOCPR804 \$48.00
RCA to 1/4" phone, 16.4' x 8 61HOCPR805 \$56.00
RCA to 1/4" phone, 22.9' x 8 61HOCPR807 \$80.00
1/4" phone to 1/4" phone, 3.28' x 8 61HOCPP801 \$30.00
1/4" phone to 1/4" phone, 6.6' x 8 61HOCPP802 \$38.00
1/4" phone to 1/4" phone, 9.8' x 8 61HOCPP803 \$45.00
1/4" phone to 1/4" phone, 13.1' x 8 61HOCPP804 \$52.00
1/4" phone to 1/4" phone, 16.4' x 8 61HOCPP805 \$60.00
1/4" phone to 1/4" phone, 19.7' x 8 61HOCPP807 \$83.00

DUAL CABLES, STANDARD NICKEL-PLATED

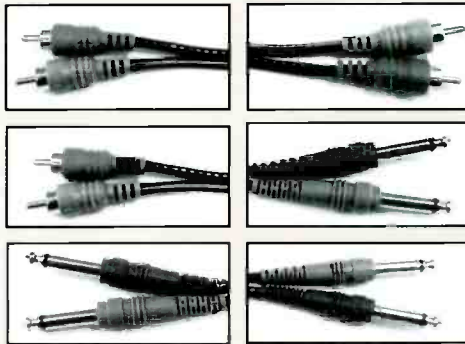

Dual RCA to Dual RCA, (3.3') 61HOCRA201 \$6.25
Dual RCA to Dual RCA, (6.6') 61HOCRA202 \$7.50
Dual RCA to Dual RCA, (9.9') 61HOCRA203 \$9.00
Dual RCA to Dual RCA, (13.2') 61HOCRA204 \$11.00
Dual RCA to Dual RCA, (20') 61HOCRA206 \$14.50
RCA 1/4" phone, (3.3') 61HOCPR201 \$6.95
RCA 1/4" phone, (6.6') 61HOCPR202 \$8.00
RCA 1/4" phone, (9.9') 61HOCPR203 \$9.50
RCA 1/4" phone, (13.2') 61HOCPR204 \$11.50
Dual 1/4" phone (M) Dual 1/4" phone (M), (3') 61HOCPP201 \$7.25
Dual 1/4" phone (M) Dual 1/4" phone (M), (6') 61HOCPP202 \$8.50
Dual 1/4" phone (M) Dual 1/4" phone (M), (9') 61HOCPP203 \$10.50
Dual 1/4" phone (M) Dual 1/4" phone (M), (13') 61HOCPP204 \$12.00
Stereo 3.5mm (M) to two RCA, (3') 61HOCMR203 \$7.00
Stereo 3.5mm (M) to two RCA, (6') 61HOCMR206 \$8.00
Stereo 3.5mm (M) to two RCA, (10') 61HOCMR210 \$9.00

BALANCED SNAKES

TT to 1/4" phone, 9.8' x 8 61HOTTQ803 \$70.00
TT to 1/4" phone, 13.1' x 8 61HOTTQ804 \$80.00
Balanced 1/4" phone - Balanced 1/4" phone, 6.6' x 8 61HOCSS802 \$55.00
Balanced 1/4" phone - Balanced 1/4" phone, 9.8' x 8 61HOCSS803 \$60.00
Balanced 1/4" phone - Balanced 1/4" phone, 13.1' x 8 61HOCSS804 \$70.00
Balanced 1/4" phone - Balanced 1/4" phone, 16.4' x 8 61HOCSS805 \$80.00
Balanced 1/4" phone - Balanced 1/4" phone, 19.7' x 8 61HOCSS807 \$95.00
XLR (M) to XLR (F), 9.8' x 8 Balanced 61HOXLR803 \$120.00
XLR (M) to XLR (F), 16.4' x 8 Balanced 61HOXLR805 \$140.00
XLR (M) to XLR (F), 22.9' x 8 Balanced 61HOXLR807 \$160.00
TIP-RING-SLEEVE to XLR (M), 9.8' x 8 61HOSTX803M \$85.00
TIP-RING-SLEEVE to XLR (M), 13.1' x 8 61HOSTX804M \$95.00
TIP-RING-SLEEVE to XLR (M), 16.4' x 8 61HOSTX805M \$105.00
TIP-RING-SLEEVE to XLR (M), 22.9' x 8 61HOSTX807M \$120.00
TIP-RING-SLEEVE to XLR (F), 9.8' x 8 61HOSTX803F \$90.00
TIP-RING-SLEEVE to XLR (F), 13.1' x 8 61HOSTX804F \$100.00
TIP-RING-SLEEVE to XLR (F), 16.4' x 8 61HOSTX805F \$110.00
TIP-RING-SLEEVE to XLR (F), 22.9' x 8 61HOSTX807F \$125.00
8 RCA to 25-PIN, 16.4' 61HODTR805 \$59.00

UNBALANCED SNAKE CABLES

XLR (M) to RCA, 16.4' x 8 61HOXRM805 \$90.00
XLR (F) - RCA, 16.4' x 8 61HOXRF805 \$98.00
XLR (M) to 1/4" phone, 16.4' x 8 61HOPXM805 \$95.00
XLR (f) to 1/4" phone, 16.4' x 8 61HOPXF805 \$100.00

DIGITAL MULTI-TRACK SNAKES

Snakes compatible with Tascam DA-88, DA-98, DA-38 and Fostex RD-8.

8 XLR (M) to 25-pin, (9.8') 61HODTM803 \$75.00
8 XLR (M) to 25-pin, (13.1') 61HODTM804 \$82.00
8 XLR (M) to 25-pin, (16.4') 61HODTM805 \$90.00
8 XLR (M) to 25-pin, (22.9') 61HODTM807 \$100.00
8 XLR (F) to 25-pin, (9.8') 61HODTF803 \$80.00
8 XLR (F) to 25-pin, (13.1') 61HODTF804 \$88.00
8 XLR (F) to 25-pin, (16.4') 61HODTF805 \$95.00
8 XLR (F) to 25-pin, (22.9') 61HODTF807 \$110.00
8 Stereo 1/4" (Metal) to 25-PIN, (9.8') 61HODTP803 \$75.00
8 Stereo 1/4" (Metal) to 25-PIN, (13.1') 61HODTP804 \$82.00
8 Stereo 1/4" (Metal) to 25-PIN, (16.4') 61HODTP805 \$90.00
8 Stereo 1/4" (Metal) to 25-PIN, (22.9') 61HODTP807 \$100.00
8 Stereo 1/4" (Molded) to 25-PIN, (9.8') 61HODTP803PL \$80.00
8 Stereo 1/4" (Molded) to 25-PIN, (13.1') 61HODTP804PL \$65.00
8 Stereo 1/4" (Molded) to 25-PIN, (16.4') 61HODTP805PL \$70.00
8 Stereo 1/4" (Molded) to 25-PIN, (22.9') 61HODTP807PL \$80.00
25-PIN to 8 Balanced TT, (6.6') 61HOTTD802 \$85.00
25-PIN to 8 Balanced TT, (9.8') 61HOTTD803 \$92.00
25-PIN to 8 Balanced TT, (13.1') 61HOTTD804 \$100.00
8 RCA to 25-PIN, (9.8') 61HODTR803 \$45.00
8 RCA to 25-PIN, (13.1') 61HODTR804 \$51.00

DIGITAL MULTI-TRACK FOR ALESIS ADAT

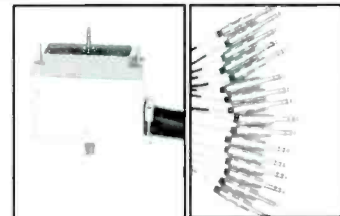

Elco/Edac 56-PIN to 8 XLR (M) to 8 XLR (F), (9.8') 61HOADX163 \$250.00
Elco/Edac 56-PIN to 8 XLR (M) to 8 XLR (F), (13.1') 61HOADX164 \$265.00
Elco/Edac 56-PIN to 8 XLR (M) to 8 XLR (F), (16.4') 61HOADX165 \$280.00
Elco/Edac 56-PIN to 8 XLR (M) to 8 XLR (F), (22.9') 61HOADX167 \$300.00
Elco/Edac 56-PIN to 16 stereo 1/4" phone, (6.6') 61HOADP162 \$210.00
Elco/Edac 56-PIN to 16 stereo 1/4" phone, (9.8') 61HOADP163 \$235.00
Elco/Edac 56-PIN to 16 stereo 1/4" phone, (13.1') 61HOADP164 \$250.00
Elco/Edac 56-PIN to 16 stereo 1/4" phone, (16.4') 61HOADP165 \$260.00
Elco/Edac 56-PIN to 16 stereo 1/4" phone, (22.9') 61HOADP167 \$280.00
Elco/Edac 56-PIN to Balanced TT, (6.6') 61HOTTAT162 \$280.00
Elco/Edac 56-PIN to Balanced TT, (9.8') 61HOTTAT163 \$290.00
Elco/Edac 56-PIN to Balanced TT, (13.1') 61HOTTAT164 \$310.00
Elco/Edac 56-PIN to 56-PIN, (9.8') 61HOADC163 \$275.00
Elco/Edac 56-PIN to 56-PIN, (13.1') 61HOADC164 \$290.00
Elco/Edac 56-PIN to 56-PIN, (16.4') 61HOADC165 \$305.00
Elco/Edac 56-PIN to 56-PIN, (22.9') 61HOADC167 \$335.00

for **Cables**
every
need.

AUDIO INTERFACE

EBTECH HUM ELIMINATOR

A handy little device that banishes that offensive ground loop hum from your sound automatically. Just plug in your line outputs, and it rewires itself to eliminate the annoying hum.

Hum Eliminator
61EBHE MFR LIST \$75.00

CALL 1-800-732-7665 FOR BRADLEY PRICE

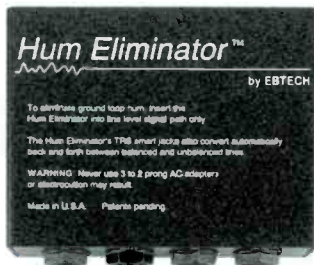

CONEX CG-25A TONE GENERATOR

The Conex CG-25A tone generator is used with reel tape systems to record 25Hz on either or both audio channels between selections. It also finds applications in translators, satellite systems, and cable broadcasting. Two front panel switches allow pre-set timed or manually timed tones. Front panel LED's indicate duration of tone and silence intervals. One or two units can be rack mounted in a single rack space with an optional rack kit.



Conex CG-25A 60CNC25 MFR LIST \$451.50
RMK Rack Kit 60CNRMK MFR LIST \$27.00

CALL 1-800-732-7665 FOR BRADLEY PRICE

WHIRLWIND CABLE TESTER

Slip it in your pocket. This versatile tester checks most varieties of cables with any combo of XLR, 1/4", or RCA plugs for shorts, opens, and phase. The hands-free design lets you play with your cables to find the intermittents. Belt clip included.

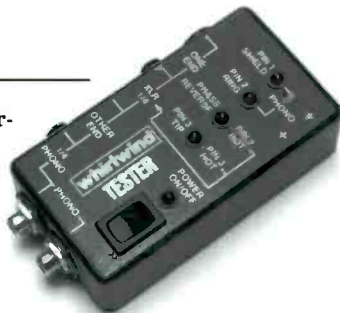

Cable Tester 61WHTR \$62.00

FOSTEX TT-15 TONE GENERATOR

"Quick, give me a tone!" No problem when you have the battery-operated TT-15. Generate your choice of five at the push of a button: 40Hz, 400Hz, 1kHz, 10kHz, and 15kHz, with distortion typically less than 0.02%. An attenuator provides output levels of 0dBV, -10dBV, and -30dBV with insignificant level shift when changing from a bridging load to a 150 ohm load. An internal 9V battery provides reliable operation of this rugged, metal device.



TT-15 60FOTT15 \$60.00

CAIG TECHNICIAN'S SERVICE KIT

Suffice it to say, having the proper tool for the job makes all the difference in the world. The Technicians Service Kit from Caig comes with DeoxIT, which is used as a general treatment for connectors, contacts and other metal surfaces, PreservIT which provides long-lasting protection for newly manufactured or recently cleaned components, CaiKleen 41 contact cleaner and degreaser for equipment and moving parts and CallUBE for improved performance of electric contacts. The Technicians Service kit includes lint-free cloths, paper, swabs and brushes. Call your favorite Bradley professional today for a mini Caig catalog for all the products you need to keep your equipment in tiptop shape.



Caig Technicians Kit 60CG405T \$54.95

GOTHAM CT-1 CABLE TIES

Bag of 100. They're reusable! 7-1/4" long.

61NECT1 \$59.00/Bag



CORD-LOX COIL 'N CARRY

Carry large cable spools conveniently. Webbing is wrapped around a doweled handle and attached to a wide Cord-Lox strap.



Coil 'n Carry 60CL419WHP \$15.25

PROGOLD

ProGold from CAIG Laboratories is a must-try treatment for your audio connections. It's an environmentally safe conditioner, preservative, and lubricant for critical edge connectors, IC's, sockets, and relays. It will improve conductivity, prevent degradation of your signals, and fight RFI and intermittents.



The 5% solution is an excellent all-purpose spray for connectors. Use solvent-free 100% ProGold where more cleaning and lubrication is called for, particularly on carbon pots.

ProGold 5% Spray, 6 oz can 60CGG556 \$14.00
ProGold 100% Spray, 2 oz can 60CGG100S2 \$22.00
ProGold 100% Liquid, brush applicator 60CGG100L2DB \$16.00
ProGold Wipes, 100% (50) 60CGKG50W \$17.00

AUDIO INTERFACE

THE INTRAPLEX STL PLUS SYSTEM

The Intraplex STL Plus is a fully integrated STL system designed to transmit 16-bit linear stereo audio



over T1 lines with no digital compression, making it an ideal choice to use where compression may occur at other stages of the audio chain. Unlike microwave radio links, T1 requires no direct line-of-sight, is not subject to environmental interference, and can operate over any distance.

The STL Plus system employs T1 multiplexing to deliver a benefit not available from other STL products on the market: it allows you the option of adding your choice of one or more extra STL and TSL channels. This means that voice, data, remote control, and additional audio program channels can be added to the system, one-way or full duplex, in the same circuit, without affecting the quality of the broadcast signal.

The Model 4200 is the heart of the STL Plus system. It includes TDM-163 T1 multiplexers for both the studio and transmitter ends of the link, equipped to provide a stereo 15kHz or 7.5kHz digital STL with compact disc audio quality. The use of discrete channel 16-bit coding with oversampling produces greater than 90dB dynamic range, and the system incorporates Intraplex's extraordinary error mitigation circuitry, using digital signal processors to eliminate chirps and clicks caused by transmission line errors. Audio input and output can be specified as either analog or AES/EBU digital.

The Model 4200 STL Plus operates over any type of T1 circuit: private line, leased line, digital microwave radio, or T1 subcarrier over an analog video microwave radio.

Intraplex STL Plus-A to A	60IP4200AA	MFR LIST	\$8,800.00
Intraplex STL Plus-AN-AES/EBU	60IP4200AD	MFR LIST	\$8,800.00
Intraplex STL Plus-AES-AN	60IP4200DA	MFR LIST	\$8,800.00
Intraplex STL Plus-AES-AES	60IP4200AA	MFR LIST	\$8,800.00

CALL 1-800-732-7665 FOR BRADLEY PRICE

EXCALIBUR CDA-1 COMPOSITE DA



The one-in/three-out CDA-1 adds flexibility to your transmission facility. Use it to feed auxiliary STL systems, test equipment, and back up transmitters. Each output has its own 20 turn level control, and can drive up to 75 feet of RG-58 coax. A ground lift switch and transient protection on the power supply are provided. Other uses include distributing modulation monitor outputs and subcarrier generator outputs. Frequency response is DC to 100kHz ± 0.2 dB (less than 0.05dB down at 53kHz), THD is less than 0.01%, and noise is greater than 90dB below 4V at unity gain.

CDA-1	60EXCDA1	MFR LIST	\$420.00
-------	----------	----------	----------

CALL 1-800-732-7665 FOR BRADLEY PRICE

CROWN FM TRANSMITTERS AND TRANSLATORS

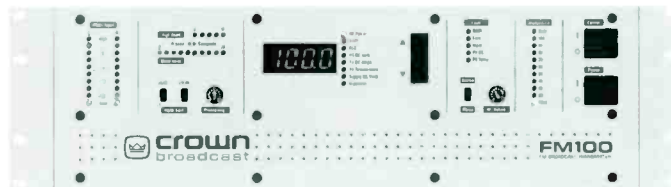

Crown's innovation is an integrated FM system that combines audio processing, stereo generation, and RF in one easy-to-ship unit, in power ranges up to 2000 watts. This approach provides an economical, flexible system well-suited as a translator (satellite or terrestrial-fed), or a back-up or main low-power transmitter. Installation and set-up are simple, even by non-techies.

Select the frequency of the transmitter yourself using the internal dial switches. A built-in remote I/O interface supports remote control and monitoring. Automatic control circuitry provides proportional foldback protection. The DC power hookup can provide uninterrupted service when AC power is lost.

All integrated models include digital metering and diagnostics, 100/120 VAC, 220/240 VAC, and DC operation. Translator versions, providing RF in and out, also include an integrated FM receiver and FSK ID-er.

FM Transmitter Systems with exciter, stereo generator, audio processor, RF amp and low pass filter

30 watt	62CRFM30T	MFR LIST	\$4,195.00
100 watt	62CRFM100T	MFR LIST	\$6,150.00
250 watt	62CRFM250T	MFR LIST	\$7,495.00
500 watt	62CRFM500T	MFR LIST	\$9,795.00
1000 watt	62CRFM1000T	MFR LIST	\$15,795.00
2000 watt	62CRFM2000	MFR LIST	\$20,795.00

FM Translator Systems (RF in/out) with receiver, FSK ID-er, RF amp and low pass filter

30 watt	62CRFM30R	MFR LIST	\$4,195.00
100 watt	62CRFM100R	MFR LIST	\$6,150.00
250 watt	62CRFM250R	MFR LIST	\$7,495.00
500 watt	62CRFM500R	MFR LIST	\$9,795.00

CALL 1-800-732-7665 FOR BRADLEY PRICE

BRADLEY BACK-UP RF PACKAGE

Here's a special Bradley package, ideal as a back-up FM system. You'll have a low-power transmission system ready to go on short notice. It includes a tunable 500-watt Crown transmitter with processor and stereo generator, three-bay Shively antenna, and 150' of coax cable with connectors. We can also configure it other ways to fit your situation. The system works nicely on your studio roof, at a temporary tower, or at any emergency location. Power it with a portable generator or battery-driven inverter.

PACKAGE 9814 - MFR LIST \$13,100

CALL 1-800-732-7665 FOR BRADLEY PRICE



REMOTE CONTROL

SINE SYSTEMS REMOTE CONTROL



Bradley customers can benefit from the cost-effective approach to remote control espoused by Sine Systems of Nashville. The RFC-1 lets you control and monitor your transmitter

from any phone. It speaks to you with a human voice and can phone you to report out-of-tolerance conditions and automate power/pattern changes. The control unit itself is only as large as a modem.

The typical basic system is one RFC-1/B and one rackable RP-8 eight-channel relay panel. Add RP-8's for more channels. We recommend you also add an SP-8 heavy-duty surge protector. If you elect to add the SP-8, Sine Systems will include lightning damage coverage in your one-year warranty. Available options include room temperature monitor, a serial option for logging, and a current monitor for tower-light confirmation.

RFC-1/B	62SIRFC1BHV3	MFR LIST	\$1,199.00
RP-8 Relay Panel	62SIRP8	MFR LIST	\$399.00
Rack Kit for RFC	62SIRK3	MFR LIST	\$35.00
SP-8 Surge Protector	62SISP8	MFR LIST	\$129.00

CALL 1-800-732-7665 FOR BRADLEY PRICE

GENTNER VRC-2000 REMOTE CONTROL



This popular transmitter control now comes with PC software for Windows® that lets you see your meter readings, check all status channels at a glance, and control up to six sites, all with point-and-click ease.

The VRC-2000 is a powerful 16-channel voice-response remote control system. It provides transmitter control via any bi-directional audio link, whether dial-up, dedicated phone line, or radio link (such as STL/TSL/SCA). When it's operated as a stand-alone unit, you can control your transmitter from any telephone that has a DTMF keypad. The VRC-2000 responds with a synthesized voice. The Command Relay Unit provides relay isolation between the VRC-2000 and your equipment. Handles eight raise and eight lower commands. The most popular system is shown below. Call us for configuration assistance. Also available: special purpose accessories including a failsafe unit, temperature sensor, and UPS.

VRC-2000 System (with Windows software, data interface, command relay, and two barrier strips)			
	60GFVRC2000P1	MFR LIST	\$3,979.00
VRC-2000 Unit only	60GF910072201	MFR LIST	\$3,295.00

CALL 1-800-732-7665 FOR BRADLEY PRICE

Federal Government Buyers! Write for a copy of our GSA Price List for ATI, Comrex, Excalibur, Gentner, Middle Atlantic, and Telos Systems purchases.

GENTNER GSC3000 SITE CONTROL



Here's a site-expandable transmitter remote control system that can run from one to 256 sites, with 8 to 256 channels of metering, status, and command per site! Thanks to networking protocol and a modular approach, the GSC3000 is ideal for radio and TV station owners, duopolies, LMA's, and other complex transmitter combos, as well as single-site users. A powerful Windows™ application makes setup and operation of multiple sites a breeze. You can query any site from your modem-equipped PC or laptop computer at any time, with full security. However, the GSC3000 does not require the dedicated use of a computer in order to control sites. All functions necessary to operate, change, or correct transmitter parameters are performed by local hardware at each site.

The true power of the GSC-3000 is its ability to execute user-created macros to intelligently issue commands that get you back on the air in the event of a failure. For example, a macro can issue all commands necessary to switch from a main to a standby transmitter, including all functions necessary, such as antenna transfer. Or, in the event of AC power loss, a macro can turn on a standby generator, then perform a sequence to bring your transmitter back up.

The GSC3000 is plug-compatible with VRC-2000 accessories, making upgrade or parallel operation simple to implement. Multiple security level capability allows restricted access to users who are not qualified to alter commands or change parameters. And the GSC3000 can communicate over telephone, RF or Direct PC connection. Call Bradley to find out how advanced site control can enhance your station's reliability AND your peace of mind.

GSC I/O 16 CHANNEL	60GF910085100	\$2,995.00
GSC I/O 8 CHANNEL	60GF910085101	\$2,495.00
GSC V.3400 MODEM	60GF910085108	\$549.00
WIRING INTERFACE UNIT		
	60GF910085110	\$195.00
GSC COMMAND RELAY UNIT		
	60GF910085120	\$495.00

CALL 1-800-732-7665 FOR BRADLEY PRICE



If you don't have the all-digital Omnia.fm processor from Cutting Edge, you're missing out on a major sound explosion. Clean, clear highs. Tight, thundering bass that shakes the walls. Digital precision that's as smooth and fluid as analog, with amazing loudness. Warmth that gets vocals and other musical elements "up front," with a richer, more natural timbre throughout the frequency band.

Your listeners may not know what "aliasing distortion" is, but they know grunge when they hear it. The outdated 32kHz digital processors have a Nyquist cutoff that's far too low, resulting in the production of aliasing distortion—even with 128kHz upsampling. But the Omnia's virtual-upsampling in the final limiter gives the performance of a 192kHz system. Combined with the Omnia's anti-aliasing

design, you have the best possible sound, rock-solid peak control, and absolutely no digital grunge.



For increased loudness, the Omnia's digital stereo generator includes an adjustable composite

clipper and low-pass filter. And for added transparency, the Omnia can easily interface with D/CET™, the world's first digital composite interface.

But before you listen to the Omnia, listen to this: The Omnia is priced well below the competition and we offer a 60-day, risk-free, money-back guarantee.

Omnia. The promise of digital...*delivered!*



CUTTINGEDGE

Something missing in your studio?



The MultiDesk™ System

A new concept in configurable studio furniture



MB-4
MultiBridge



MR-14S
MultiRack



MD-4S
MultiDesk



MR-14W
MultiRack



MB-6
MultiBridge



Middle Atlantic Products, Inc.

**5 easy to assemble pieces fit together
in any combination!**

BURK ARC-16 REMOTE CONTROL



The ARC-16 Two-Unit Transmitter Remote Control System allows you to rectify problems instantly. Clear text display and simple controls are "talent friendly". The system includes a studio unit for monitoring and alarms, and a transmitter unit with the same functions that lets you calibrate your system on-site. Unlike many remote controls, it offers control and metering of studio equipment including automation, EAS, and security. It provides full-time studio control, dial-up control, or both. It has 16 metering channels, 16 raise/lower outputs, and 16 status channels. (Ask us about the single-unit system that allows control from any phone with a DTMF keypad.)

The Enhanced Speech Interface option allows control or readings from a touch-tone phone; the caller is greeted with a human voice and prompted. The ESI lets you listen to program audio; it also will call a series of phone numbers to announce an alarm, and it can be enhanced with optional CDL software to interface with a computer directly or via modem. Call for info on other systems options.

ARC-16 two-unit system includes modems to connect by telco, STL, SCA, or TRL (specify).

60AVARC16DU MFR LIST \$3,895.00

Accessories:

ESI Enhanced Speech Interface 60AVESI MFR LIST \$895.00

CDL Software 60AVCDL MFR LIST \$295.00

IP-8 Interface panel 60AVIP8 MFR LIST \$495.00

Autopilot, a program for IBM-compatible PC's, gives your ARC-16 better record keeping and the ability to operate unattended.

Autopilot will take care of routine and emergency operation.

Requires CDL software, above.

60AVAP MFR LIST \$595.00

CALL 1-800-732-7665 FOR BRADLEY PRICE



WILL-BURT HURRY-UP

The Hurry-Up is a 25' telescoping mast designed for fast, easy deployment. It's ideal for small ENG microwave antennas, Marti antennas, and weather instruments weighing up to 20 pounds. You extend it manually by pushing up the six nested aluminum sections and fixing them with quick release collars. You can pop it up in less than a minute even if you're wearing thick gloves, and it's easy to adjust and lock the direction of your antenna.

No guy wires to worry about; you just lock the mast into the holding tube on the mounting stand, and drive your vehicle onto the plate to keep everything in place. With a typical load, it'll survive winds well over 50 mph. The mast itself weighs 28 pounds and is 6' high when nested. The base weighs 36 pounds.

Hurry-Up 60WB903220 \$1,510.00

MARTI RPU

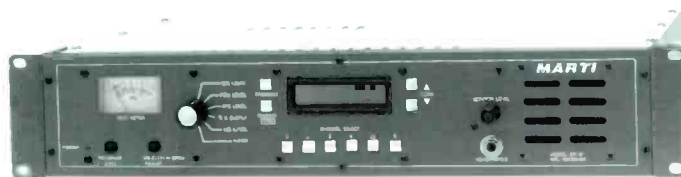

The new Marti SR-10 base station receiver is designed for broadcast remote pickup and ENG. Its frequency agility and fine selectivity will help you find your way through the high interference levels in today's RPU work. Features include front-panel selection of channels, six programmable priority channels, backlit LCD display, built-in monitor speaker with headphone jack, and double balanced mixers. Options include remote channel selection and display, and subaudible tone detection for signaling and automatic repeater applications.

Marti has mono and stereo RPU systems in configurations starting at about \$3200. Call or fax Bradley for a Marti catalog.

CIRCUIT WERKES DR-10



The DR10 is a microprocessor based remote control that allows operation of station equipment over any phone line, via touch-tone. The DR-10 auto answers, provides password protection, and allows any of the 16 DTMF tones to activate any of the ten relays in the DR-10. Each relay can be programmed for momentary, latching, or interlocked operation. Additionally, relays can return a beep tone to acknowledge activation.

The DR-10 also features four logic-level inputs that will activate one of its relays, or call out to any of four phone numbers (one per logic input), and tell you which channel caused the alarm with a series of beeps.

Applications include EAS monitoring, remote audio switching, RPU control, or automatic tape recording. When used with its companion "silencer" option, the DR10 can share the audio channel from your remote broadcast to deliver commands without interrupting program audio.

CircuitWerkes DR-10 Dial Up Controller 60CTDR10 \$449.00

CircuitWerkes Silencer Option 60CTSIL \$159.00

ON AIR PROCESSORS/TIMING SYSTEMS

CUTTING EDGE OMNIA

Omnia.fm represents a completely new approach to FM processor architecture, and, most importantly, brings you full digital control of your air signal, without the harsh digital "grunge" often heard in other digital processors. The Omnia.fm uses PCMCIA card technology to configure all processing resources, including system configuration and user presets. Remote operation and control of the unit is accomplished via web browser (coming soon), a universally available interface.

Software driven features include daypart automation, format presets, and two levels of processing control for novice or expert users. A front panel headphone jack is provided for monitoring in noisy environments.

The topology of the Omnia consists of multiple audio processing sections, followed by a digital stereo generator, and selectable composite clipper. Unique sections include the "Thunder Boost" EQ section, which provides an unusually clean and powerful low end without sacrificing loudness, and a Dynamic Peak Limiter that produces a more natural, musical sound, with lower I.M. distortion.

Call Bradley to learn more about the amazing Omnia.FM processor.

Omnia 60CEOMNIA MFR LIST \$8,200.00

CALL 1-800-732-7665 FOR BRADLEY PRICE



OMNIA.FM.JR.

New!

Containing all the features that have made the Omnia.fm so popular with broadcasters, the Omnia.fm.jr employs a 3-band processing system in order to contain costs. Omnia.fm.jr incorporates both digital and analog input/outputs, a digital stereo generator, and the same user interface as the Omnia.fm. This allows users to make the full transition to Omnia.fm processing when desired.

Omnia.FM.jr. 60CEOMNIAJR MFR LIST \$4,500.00

CALL 1-800-732-7665 FOR BRADLEY PRICE

CUTTING EDGE OMNIA.AM

Cutting Edge introduces the newest member of the Omnia family of audio processors, the Omnia.am. The unit adopts the best audio processing features of the renowned Omnia.fm, such as totally phase linear low pass filtering for improved audio quality, a multiband processing structure, and custom presets for common AM formats. Omnia.am also incorporates special features that optimize it for AM broadcasting, such as mono or stereo operation and selectable lowpass filtering and response tailoring; they make the unit suitable for conformance to not only NRSC standards, but broadcast requirements throughout the world.

Omnia 60CEOMNIA MFR LIST \$To Be Announced

CALL 1-800-732-7665 FOR BRADLEY PRICE

RADIO SYSTEMS CLOCK & TIMING SYSTEM

New!



Enter the new millennium with Radio Systems Clocks and Timing Systems. Radio Systems and Bradley Broadcast know how busy you are, so we put together the perfect Master Clock System for you! Our package includes one CT-6 Thin and one Master Desktop unit. The CT-6 Thin is only an inch deep and designed to stick on (or screw down) to any console rack or table surface, without losing any of the features of the larger clocks. The Master Desktop has a guaranteed accuracy of 1 PPM after the first year with a maximum drift of 1.3 seconds a month. Other systems are available.

Master Desktop and CT-6 Thin 60RSMDC6 MFR LIST \$799.00

CALL 1-800-732-7665 FOR BRADLEY PRICE

THE INFORMER

Best Seller

How hot or cold is it outside?

What's the temperature in your transmitter room or garage?

Bradley offers two versions of this specialized thermometer. The digital readout version reads

from -40 degrees to 120 degrees Fahrenheit, and has high and low temp memories. Includes 50' cable and probe; runs on "AA" cell.

Ideal for measuring extremes of temperature, the Informer Gauge can display a range of -99°F to +150°F, with a super bright .4" red display. It mounts in a standard 2 1/16" hole cut-out and comes standard with a 10ft sensor cable. Requires 12VDC at .01amp to operate. Special sensor cable lengths up to 100ft are available on special order.

Digital readout 60TKI MFR LIST \$49.95
Informer Gauge 60TKGAUGE MFR LIST \$79.95

CALL 1-800-732-7665 FOR BRADLEY PRICE



RF EQUIPMENT

**APHEX 2020 FM PRO
AUDIO PROCESSOR**



The Model 2020 FM Pro is a complete FM broadcast audio processor self-contained in a single chassis. All functions are integrated within one interactive, optimized processing framework. The unit is housed in a two rack space chassis. Its self contained power supply automatically accepts any mains voltage from 80 to 268VAC 50/60Hz. It is designed to operate with either 75 or 50 microseconds pre-emphasis, user selectable through panel controls.

Every stage of processing is a completely new design, with new processing algorithms. Each stage of processing is crafted to work seamlessly with the next so there is no sense of competition or "fighting" for control between the leveler, compressor, and limiter elements. At every stage, the sonic effect of the process was carefully tuned for the minimum objectionable artifacts and maximum performance. Importantly, no multi-band clipping is used in the model 2020. The multi-band clipping incorporated in some competing audio processors causes grunge and listener fatigue. It also stimulates and exacerbates the effects of multi-path distortion and can actually degrade your coverage area. Equally important is that the model 2020 without composite clipping can achieve dominating loudness. Through digital control, the unit can be operated from the front panel and from remote control software running on a PC Windows platform. Password protection can be set to allow only approved operators access to the controls.

To marry the best of both the digital and analog worlds, Apex developed the model 2020 around advanced analog circuits tuned and adjusted by digital control. A carefully designed high definition (20-bit) digital I/O interface is provided for users who want to place the model 2020 within a digital audio framework. Optional professional standard AES/EBU I/O is available for digital audio systems while analog I/O is standard. Both methods of I/O can be selected for use at any time, and a defeatable autoswitch feature is available to automatically switch to the analog input should the digital audio data become corrupted or fail. The digital audio input accepts standard sample rates from 32kB/s to 48kS/s while the output sample rate may be synchronously slaved to the input or set up independently at any chosen sample rate. Both input and output are 20-bits wide. Because of the very high-grade converters and the extensive reconstruction afforded by the intermediate analog audio processing, the model 2020 serves as an outstanding sample rate converter. An example of how this applies is interfacing between a digital audio STL and a digital FM exciter. Digital audio can be supplied to the model 2020 from a typical 32KB/s 16-bit digital STL while the digital output from the model 2020 to the exciter can be set to 48Ks/s (with 20 bits) for noticeably better on-air audio quality.

APHEX 2020 BASIC FM PROCESSOR	60AP2020	MFR LIST	\$4,995.00
APHEX 2020-1 AES/EBU I/O	60AP20201	MFR LIST	\$500.00
APHEX 2020-2 PRE-EMPH LIMITER	60AP20202	MFR LIST	\$500.00
APHEX 2020-3 STEREO GENERATOR	60AP20203	MFR LIST	\$2,000.00

CALL 1-800-732-7665 FOR BRADLEY PRICE

WARNING LIGHTS

1. BE Studio Warning Light

This classic light comes with a 25 watt red bulb and an attention grabbing flasher. The silk-screened globe housing fastens to a steel mounting plate. Available legends are ON AIR, AUDITION, REHEARSAL, and RECORD. Specify vertical or horizontal lettering. Also available in other languages, or blank so you can label your own.



60BR83500X MFR LIST \$66.00

2. Titus Warning Lights

Titus ON AIR and RECORDING lights are beautiful and practical ways of indicating that a studio is in use. Four internal lamps are wired in parallel, and use 24VDC, eliminating the need for relay interface boxes. The mounting base is of solid oiled oak. Size: 8-11/16" x 4-3/4" x 2-1/2" (W/H/D). Lettering is on a smoked glass window that is available with either a horizontal or vertical orientation with a silver or a gold frame.



60TIOALXX MFR LIST \$125.00

3. Fidelipac Warning Lights

Red lettering on a black background provides a highly visible warning that microphones are live. ON AIR or RECORDING legends are available in English. The ON AIR legend is also available in Spanish, French, German, Japanese, and four other languages. Lights are 5" x 10" x 2-1/2" (H/W/D).



ON AIR	60FP340	MFR LIST	\$80.00
RECORDING	60FP340REC	MFR LIST	\$80.00

CALL 1-800-732-7665 FOR BRADLEY PRICE

ESE 60-MINUTE UP-TIMERS

A large LED display makes the ES520 readable in all room conditions. Control it from its start, stop, and reset controls or via two remote options. A momentary short to ground or 5V logic "O" can activate any function; four triggers reset the timer using a momentary or continuous signal. The serial output can drive 100 remote slaves. The new LX version has a slim, modern appearance.



ESE 520	60ES520	MFR LIST	\$185.00
Rack Option for above	60ESP	MFR LIST	\$50.00
LX 520	60ESLX520	MFR LIST	\$285.00

CALL 1-800-732-7665 FOR BRADLEY PRICE



FURNISHINGS

MIDDLE ATLANTIC MULTI-DESK PRO

New!



The Multi-Desk Pro from Middle Atlantic is perfect for use with your PC and external peripherals. With its large desk, which can be assembled with the legs left, right, or center, and its adjustable monitor bridge, you couldn't ask for a more optimally designed PC edit space. Need to hold more gear? An optional equipment rack fits under the desk.

CALL 1-800-732-7665 FOR BRADLEY PRICE

NIGEL B ACCESSORY BAR

New!

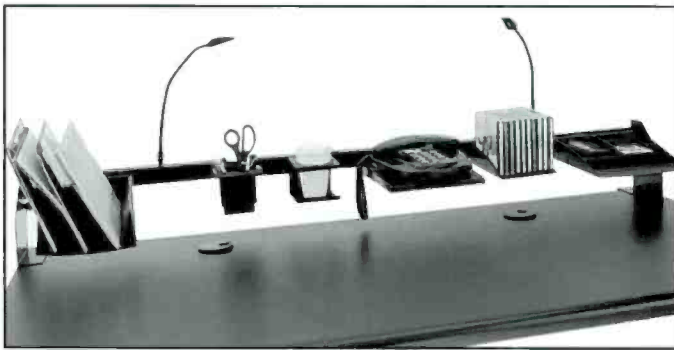

You have the perfect studio - all the right equipment and the right furniture. You even like your chair. So what's the problem? Your soda keeps spilling, jewel cases everywhere, and you can't find a pencil. Solution! Mount Nigel B's Accessory Bar on your desk, pick up a few Nigel B accessory holders, and you're in business. Works with any desk, choose from four versions, two for desktop mounting, one with BNC light sockets and one without. There are also models that attach directly to your monitor bridge.

Available accessories include a drink holder, phone tray, paper tray, accessory tray (for paperclips and such), a file holder, a CD holder and a pencil cup. Call your favorite Bradley Professional today for the length and features that best meet your needs.

Desk Mount Accessory Bar 48"-60"	60NBAB48	MFR LIST	\$59.95
Desk Mount Accessory Bar 60"-74"	60NBAB70	MFR LIST	\$79.95

CALL 1-800-732-7665 FOR BRADLEY PRICE

Accessories:

Pencil Holder	60NBCPF1000	\$15.95
CD Holder	60NBCPF1001	\$19.95
Paper Tray	60NBCPF1003	\$19.95
Accessory Tray	60NBCPF1004	\$19.95
Phone Tray	60NBCPF1005	\$29.95
File Holder	60NBCPF1008	\$19.95
Drink Holder	60NBCPF1010	\$15.95

AC-CETERA CLAMP ON LIGHTS

These Lumin-Eze lights will clamp and lock to any horizontal or vertical surface. The shade is directable. The 12" extension arm swings and bends. A detachable power supply is included to plug into any 110V outlet; or you can choose battery versions.



LE-1S Standard	61ACLE1S	\$39.00
LE-2S Adds on/off switch	61ACLE2S	\$49.00
LE-3S Adds on/off, halogen bulb, and dimmer	61ACLE3S	\$65.00
LE-4S Battery version of LE-1S (two "AA") plus on/off	61ACLE4S	\$55.00
LE-5D Dual lamp arms with three-way on/off switch	61ACLE5D	\$69.00
LE-6D Dual lamp battery version of above (four "AA")	61ACLE6D	\$75.00

MAXX SUPER CART

New!

Don't carry your gear around—wheel it. The Maxx Super Cart is the best way to get your gear where it needs to go.

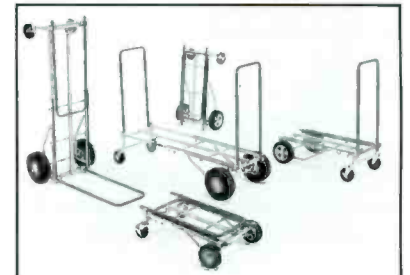

- 5 carts in one: works as a variable-length platform truck, high stacker, furniture dolly, 2-wheel handtruck with extended nose, or a compact folding cart for transportation

- Raising foldable sides and extendible frame
- Carries up to 500 lbs.

Maxx Super Cart	61QLRR10	MFR LIST	\$199.00
-----------------	----------	----------	----------

CALL 1-800-732-7665 FOR BRADLEY PRICE

FURNISHINGS

PANASCHEME MEDIA STORAGE *New!*

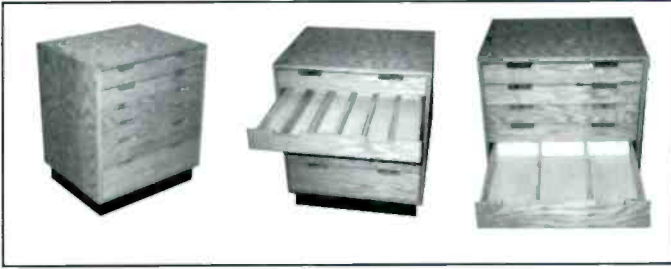

The guys at Panascheme understand you want what you want and "no" is not an option. That's why they make the MS Series Enclosures available in so many finishes, two different sizes and with multiple drawer options for audio and video media.

MS Series enclosures come standard constructed of 3/4" wood panels and 4" black base. However all models are available without the base allowing them to be stacked. MS Series Enclosures are available in wood or laminate exterior finishes. These durable storage cabinets can be painted or stained to match existing furnishings.

Available in 27" (MSS) or 43" (MSL) wide versions, the MS enclosures come standard with casters and handles. Mix and match VHS, CD, DAT, and cassette tapes for the media cabinet that best fits your needs.

MSL Drawer Options:

- VHS Drawer Holds up to 95 standard VHS tapes
- CD Drawer Holds up to 350 CD jewel cases
- DAT Drawer Holds up to 300 standard DAT Tape Cases
- Cassette Drawer Holds up to 240 standard cassette cases
- Multi Drawer Holds up to 150 DAT cases AND 120 cassette cases

MSS Drawer Options:

- VHS Drawer Holds up to 57 standard VHS tapes
- CD Drawer Holds up to 200 CD jewel cases
- DAT Drawer Holds up to 180 standard DAT Tape Cases
- Cassette Drawer Holds up to 150 standard cassette cases

CALL YOUR BRADLEY PROFESSIONAL TODAY FOR PRICING INFORMATION ON THE PANASCHEME MS SERIES ENCLOSURES.

RAXXESS ELITE SERIES RACKS *New!*



Appearing to be nearly furniture-quality, Raxxess Elite Series racks look as good in your living room as they do in your studio. These knock-down racks are made from the highest grade of fused melamine, covered with a beautiful wood grain veneer. 11 gauge steel rails ensure durability. The 16-space has a straight front, and the 20-space has a slanted front.

- 16 space Elite Rack
61RXERK16R MFR LIST \$219.95
- 20 space Elite Rack
61RXERK20RSL MFR LIST \$299.95

CALL 1-800-732-7665 FOR BRADLEY PRICE

MIDDLE ATLANTIC OBRK AND OSR24 OAK LAMINATE RACKS *New!*

The natural elegance and beauty of oak combine with value-oriented engineering to create a new line of modular equipment racks. Both the OBRK and the OSR series ship flat via UPS.

The OBRK series racks feature an attractive 3/4" oak laminate construction, and utilize modern 1/4-turn fasteners and threaded inserts to preserve a sleek outward appearance free from the presence of plugs or other hardware. Easily assembled with the included hardware, each rack features factory-installed 11-gauge, 10-32 threaded rack rail. The racking depth on all OBRK series Oak Racks is 18 inches.

The OSR series racks feature a gently sloped rackface to facilitate equipment viewing. Utilizing the same attractive 3/4" oak laminate construction found on the OBRK series, each OSR series rack feature casters to enhance mobility. 11-gauge rack rails are factory installed on the OSR.



- | | | |
|--|------------|----------|
| 8 space Weight 35 lbs. | 61MAOBRK8 | \$169.00 |
| 12 space Weight 43 lbs. | 61MAOBRK12 | \$183.50 |
| 16 space Weight 49 lbs. | 61MAOBRK16 | \$216.25 |
| 56 space Weight 56 lbs. | 61MAOBRK20 | \$237.50 |
| 16 space, top depth 19 1/2", bottom depth 23" Weight 69 lbs. | 61MAOSR216 | \$300.00 |
| 24 space, top depth 19 1/2", bottom depth 23" Weight 87 lbs. | 61MAOSR24 | \$344.50 |

MIDDLE ATLANTIC DESKTOP RACK RAILS *New!*

Quickly and expensively organize desktop processing and test equipment with the new Desktop Rack Rails from Middle Atlantic. Available in 8 and 12 space sizes, both models extend upward at a gentle slope.



- | | | |
|----------------------------|----------|---------|
| 8 space Desktop rack rail | 61MADR8 | \$35.00 |
| 12 space Desktop rack rail | 61MADR12 | \$40.00 |



FURNISHINGS

MIDDLE ATLANTIC MULTI-DESK SYSTEM

Like all Middle Atlantic products, their new Multi-Desk System of configurable studio furniture is well built and affordable, and ships via UPS to save money. Design your setup around the MD-48, a 48" x 30" grey laminated tabletop with steel tube legs. "Quick-Lok" construction lets you assemble it in minutes. Simply lift the legs into place from their folded shipping position.

Then add your choice of optional Multi-Bridges and side Multi-Racks, both with rails. You assemble the tabletop Multi-Bridge as an open work space or as a rack with one or two bays. The rolling Multi-Racks provide added counter and rack space; one face is sloped, one is vertical, for maximum flexibility.

The standard system shown here includes an MD-48 desk, two MR-14W side racks, and an MB-6 overbridge that you can also set up as two six-space bays. We can also quote other configurations and tell you about optional modesty panels, cable management kits, and drawers.

CALL US TO ORDER OR ASK FOR AN INFO PAMPHLET.



MIXRAK

MIXRAK is an affordable, no-frills line of modular furniture. The design makes assembly and expansion easy. Board surfaces are protected by melaface and high pressure laminate. The desk is edged with 1-1/2" solid oak, the other edges are protected by T-molding. Heavy threaded rack rails ensure proper mounting of equipment.

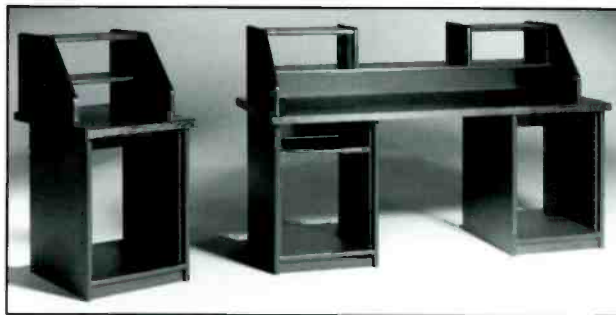

DT72 30" x 72" Top	60MIDT72	\$169.00
DT22 22" x 30" Top	60MIDT22	\$87.00
FDT Desk Top Rack/Organizer	60MIFDT	\$179.00
HDT Desk Top Rack/Organizer	60MIHDT	\$85.00
RB Rack Base (14 space)	60MIRB	\$159.00
SR Angled Rack	60MISR	\$249.00
R2 Rack (2 space)	60MIR2	\$59.00
R4 Rack (4 space)	60MIR4	\$74.00
R8 Rack (8 space)	60MIR8	\$103.00
R12 Rack (12 space)	60MIR12	\$125.00
R16 Rack (16 space)	60MIR16	\$145.00

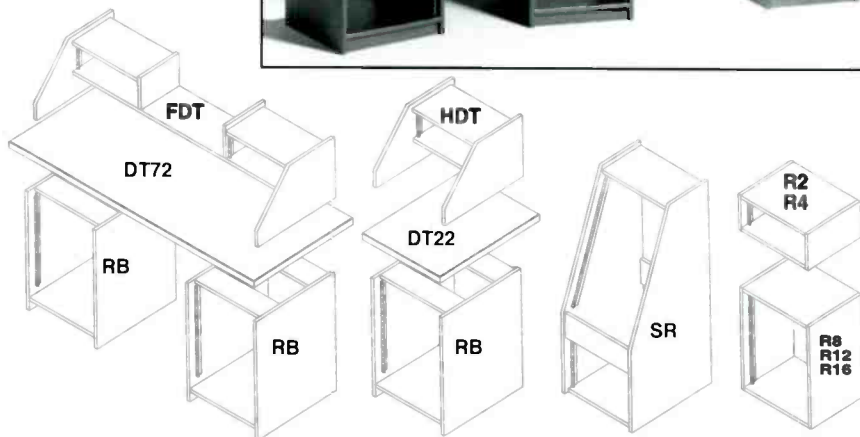

CUTTING WEDGE

These charcoal gray acoustic tiles control noise, slap, echo, and standing waves. The tiles come in convenient 12" by 12" squares. They can be shipped via UPS in any quantity, so you save on shipping. Order by the case and save even more.

2" thick square	60CW1	\$3.25 ea.	\$2.92 ea./case of 56
3" thick square	60CW3	\$4.25 ea.	\$3.82 ea./case of 36
4" thick square	60CW4	\$5.90 ea.	\$5.31 ea./case of 28

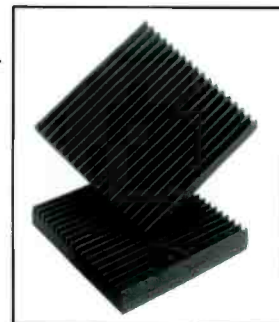

FURNISHINGS

PANASCHEME RACKS

For fine furniture enclosures, look no farther than Panascheme, a Bradley Broadcast exclusive. They ship assembled, ready to install. We offer two series.

Oak Trim Racks are made of high density, 3/4" Domtar Melamine panels, with edges finished in a custom-milled red oak cap, treated with lemon oil. Standard color is black; other colors are available optionally.

Oak Ply/Solid Wood Racks have a beautiful all oak exterior surface constructed of 3/4" multi-ply, cabinet-grade panels. Edges are finished in red oak cap.

Both models include a lightweight removable back panel, and pass-through holes in the bottom rear.

Standard racks are 18" usable depth models; call for other depths, glass doors, rear rail, locks, carpeting, and any other features you need. Racks may ship via truck. For a quality oak knock-down alternative that ships UPS, see below.

CALL YOUR BRADLEY PROFESSIONAL TODAY FOR PRICING INFORMATION ON THE PANASCHEME RACKS.



PANASCHEME OAK KNOCK-DOWN RACKS

These oak racks come ready for assembly, so you get a fine wood enclosure yet minimize your shipping expense. These are a step up from inexpensive particle-board knock-downs. The barrel-nut and through-bolt hardware doesn't strip even after multiple assemblies. The enclosures are made of multi-ply, cabinet-grade red oak and treated with tung oil for a durable finish. Edges are capped in solid oak.

Choose from four standard sizes, all with 17-1/4" usable inside depth and packed with hex key and hardware. Available options include other sizes and depths, doors, locks, rear rail, sloped front, and casters.

8 Space	61PS08KD	\$189.00	20 Space	61PS20KD	\$219.00
12 Space	61PS12KD	\$199.00	Casters	61P5CASTERS	\$112.00
16 Space	61PS16KD	\$209.00			



MIDDLE ATLANTIC RK RACKS

Best Seller

Build them yourself and save. Wood racks look nice and set up easily with the supplied Allen key and hardware. The surface is black laminate over 5/8" high density particle board. Rails are drilled and tapped to fit all equipment. Each rack ships knocked down for convenient UPS delivery. An optional caster set lets you roll your rack away. Other sizes are available by special order.

You can wall mount these economically with the WMS-20 shelf (inset), which holds up to 200 pounds.

2 space, 16" deep	61MARK2	\$75.00
4 space, 16" deep	61MARK4	\$79.00
8 space, 18" deep	61MARK8B	\$103.00
12 space, 18" deep	61MARK12B	\$115.00
16 space, 18" deep	61MARK16B	\$119.00
20 space, 18" deep	61MARK20B	\$129.00
Wheel kit	61MARKW	\$34.00
WMS-20 Wall Shelf	61MAWMS20	\$65.00

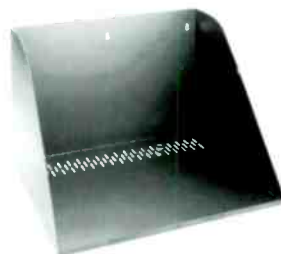

**Bradley has rack solutions for EVERY need.
Give us a call at 1-800-732-7665 today!**



FURNISHINGS

MIDDLE ATLANTIC GANGABLE RACKS

Slim 5 is a knock-down metal enclosure that ships via UPS to save you money. Buy just the frame, or add removable vented side panels. These racks can be ganged together for versatility.

The patented corner joint provides great strength and helps in your setup. Slim 5 comes with substantial top and bottom panels; the bottom is open for cable access and pre-punched for optional casters and leveling feet. Electrical knockouts are provided.

Ask about optional split rear rack rails, cable chases, and front and rear doors. Usable depth 20".

Skirted Caster Base 61MACB55 \$105.00
Leveling Feet (4) 61MALF \$19.00



SOUNDOLIER EQUIPMENT RACKS

Soundolier's industry standard metal utility cabinets have been re-designed for better ventilation, wire management, and overall appearance. They are complete with base, top panel, vented side panels, vented rear locking door, knockouts, one pair of fixed rails, mounting screws, and hardware. The rear door is removable and can hinge right or left.

Series 100 is shipped knocked down (K.D.) to save you money on shipping. Series WA100 is welded and pending UL approval. Both have new, easy wiring access through openings in the top and bottom. You can leave the openings for access and ventilation, or cover them with an optional panel. The top opening can accept exhaust fan ES195-22. Call us for optional solid or acrylic front doors, or WA200 series racks with front doors, adjustable rails, and available extra depth.

The racks above are in black textured enamel; other colors by special order. Inside usable depth is 17-1/4".



Total Height	Rack Units	Enclosure		Side Panel (Pair)	
		Part #	Price	Part #	Price
17-3/4"	8	61MA58	\$145.00	61MASP58	\$80.00
28-1/4"	14	61MA514	\$165.00	61MASP514	\$96.00
40-1/2"	21	61MA521	\$185.00	61MASP521	\$127.00
54-1/2"	29	61MA529	\$205.00	61MASP529	\$156.00
68-1/2"	37	61MA537	\$215.00	61MASP537	\$185.00
79"	43	61MA543	\$225.00	61MASP543	\$209.00

Total Height	Rack Units	Welded		Knocked Down	
		Part #	Price	Part #	Price
41"	21	60SDWA10036	\$324.00	60SD10036	\$289.00
46-1/4"	24	60SDWA10042	\$339.00	60SD10042	\$299.00
65-1/2"	35	60SDWA10061	\$389.00	60SD10061	\$355.00
74-1/4"	40	60SDWA10070	\$429.00	60SD10070	\$399.00
81-1/4"	44	60SDWA10077	\$439.00	60SD10077	\$415.00

Caster truck (4 swivel casters, 1 pr locking) 60SDCT502 \$120.00
 Top/Bottom Panel 60SDS195 \$19.00
 Dual Exhaust Fan System 60SDES195122 \$326.95



RAXXESS ESS MONITOR STANDS

- Tough construction
- Mahogany or ebony-fleck finish
- 36" or 42" height

New!

Simply put, these make the most elegant and functional way to display your monitors. Prior to assembly, add sand for acoustic de-coupling.

36" Monitor Stand

Ebony 61RXESS36 MFR LIST \$269.95
 Mahogany 61RXESS36R MFR LIST \$269.95

42" Monitor Stand

Ebony 61RXESS42 MFR LIST \$279.95
 Mahogany 61RXESS42R MFR LIST \$279.95

CALL 1-800-732-7665 FOR BRADLEY PRICE

RAXXESS ERSS ECONOMY SPEAKER STANDS

New!

These monitor stands are ideal for any studio and are constructed of 3/4" furniture grade hardboard, finished in black laminate. The speaker platform and base are 12" square. The bottom is easily removed to allow the 5" center post to be filled with sand for acoustic de-coupling. Sold in pairs, these stands are shipped knocked down in one box and assemble in minutes. Available in 36" or 42" heights.

36" weight 39 lbs. 61RXERS536 MFR LIST \$169.95
 42" weight 41 lbs. 61RXERS542 MFR LIST \$179.95

CALL 1-800-732-7665 FOR BRADLEY PRICE

FURNISHINGS

NIGEL B. FURNISHINGS

DESKTOP RACK STAND

Handle up to 13 rack units of equipment in an adjustable, lockable frame that goes from vertical to horizontal. Good for recorders and mixers. Size: 26"H x 21"W x 18"D.

60NBPLDERS MFR LIST \$199.95
CALL 1-800-732-7665 FOR BRADLEY PRICE



RECORDER STAND

Sturdy and movable, with heavy-duty construction and smooth rolling casters. Has 13 rack units of space plus eight additional units between its uprights.

60NBPLRS MFR LIST \$459.00
CALL 1-800-732-7665 FOR BRADLEY PRICE



We carry the full line of Murphy Studio, Winsted and Nigel B computer and video furniture. Call us!

MIDDLE ATLANTIC RACK SHELVES

Quick and easy rack mounting in one, two, or three spaces. Steel is 16 gauge with durable black powder coat finish. Depths: 11" for U1, and 14-3/4" for U2 and U3. Inside left to right dimension on all shelves is 17 3/8". Need a lot of U2 shelves? Ask about the master pack of 50.



One space, holds 35 lbs	61MAU1	\$29.00
Two space, holds 50 lbs	61MAU2	\$38.00
Three space, holds 85 lbs	61MAU3	\$42.00

MIDDLE ATLANTIC SLIDING SHELVES

The SSL is a new, low-profile sliding shelf that occupies one rack space and provides a black laminate slide-out surface with positive lockout and 11" reach. It supports up to 35 pounds. The universal telescopic rear support fits all racks. The popular SS version holds up to 50 pounds, extends 14", and now latches in both open and closed positions. The SS occupies slightly more than one rack space, usually not a problem due to the equipment being placed on top.



SSL	61MASSL	\$65.00
SS	61MASS	\$99.00

MIDDLE ATLANTIC CLAMPING RACK SHELVES

Adjustable rubber-lined clamps secure your unit from the top, "L" brackets grab it from the rear. Steel construction, vented bottom. These sizes are one-piece with 14-3/4" depth. Taller, knock-down models are available.

2RU	61MARC2	\$32.00
3RU	61MARC3	\$42.00
4RU	61MARC4	\$47.00

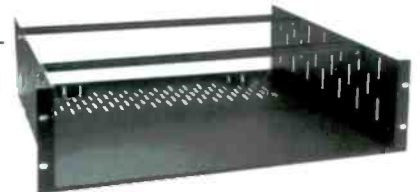

RAXXESS SECURE RACK STORAGE

Store and secure tapes, tools, CD's, and detritus that can clutter up your life. The Rak-Vault is a steel, rack-mount enclosure with a hinged front panel and keyed lock. Black, baked enamel finish. 9" deep.

RKV-3 (5-1/4" high)	61RX3V	\$79.95
RKV-4 (7" high)	61RX4V	\$89.95



FURNISHINGS



THE RACK RULER

We love it. This steel tape measure with belt clip pulls out to eight feet and is incremented in both rack spaces and inches. Bonus: the back of the tape has great formulas and engineering info.

61MARULER \$12.95



PLEXIGLAS SECURITY COVERS

A lightly smoked Plexiglas door protects your equipment behind a keylock. Depth of covers is 1 1/2".

2 spaces	61MASECL2	\$36.50
4 spaces	61MASECL4	\$37.00
8 spaces	61MASECL8	\$53.00



SECURITY COVERS

Ideal for providing both security and protection, these perforated steel covers are 1" deep and allow easy viewing of control settings. Screw notches let you remove them without unmounting the gear. Use with tamper-proof screws.

1 space	61MAS1	\$20.00
2 spaces	61MAS2	\$24.00
3 spaces	61MAS3	\$26.00

REAR HANGING BRACKET

To support amps and other gear with rear ears. Each is a pair.

RH-2 2 Space		
61MARH2	\$8.00	
RH-3 3 Space		
61MARH3	\$9.00	
RH-4 4 Space		
61MARH4	\$10.00	



CUSTOM RACK SHELVES

Rack mount your non-rackable equipment, without unsightly gaps. Custom rack mounts are more than shelves. They bring your unit up to the next full rack space, and prevent it from sliding back with rear brackets. Custom cut-outs are made for your equipment, and the complete shelf is shipped to you in two to three weeks. Many patterns are already on file, so call us to review. Some assembly is required. These shelves accept units up to 17-3/8" wide.

Brushed and black anodized aluminum		
61MARSH4A	\$125.00	
Textured black enamel on steel		
61MARSH4S	\$109.00	



BLANK PANELS

Our best selling blank panels, flanged for strength and made of black brushed and anodized aluminum. Easy to machine.

1 space	61MABL1	\$12.50
2 spaces	61MABL2	\$13.75
3 spaces	61MABL3	\$16.75
4 spaces	61MABL4	\$18.75

ECONO-BLANKS

They're now flanged for strength. Black powder coat on steel. Less expensive but heavier to ship. Need a lot? Save with master packs.

EB-1 1 space	61MAEB1	\$6.25
EB-2 2 spaces	61MAEB2	\$7.95
EB-3 3 spaces	61MAEB3	\$8.95
EB-4 4 spaces	61MAEB4	\$10.95
EB-5 5 spaces	61MAEB5	\$12.95
EB-6 6 spaces	61MAEB6	\$14.25
EB-1 Master Pack (50)	61MAEB1MP	\$219.00
EB-2 Master Pack (25)	61MAEB2MP	\$269.00

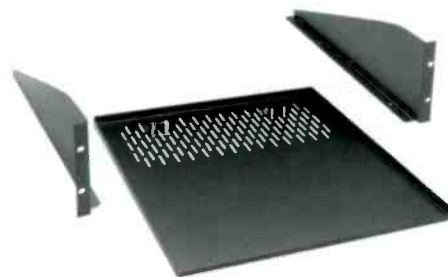

KD SHELVES

KD means knock-down. When you assemble them, you save on shipping. Flush studs are provided with bottoms for easy assembly. KD shelves are 16 gauge steel painted with black baked enamel, and can be used with equipment up to 17-3/8" wide. Ears come packaged in pairs. Call for extra-tall ears and extra-deep bottoms.

Important: For a complete shelf, purchase both a bottom section and a set of ears.

Bottom Section, 15-1/2" deep

	61MAKDB	\$17.00
Matching Ears, 3-1/2" tall	61MAKDE2	\$28.00
Matching Ears, 5-1/4" tall	61MAKDE3	\$30.00
Matching Ears, 7" tall	61MAKDE4	\$31.00
Matching Ears, 8-3/4" tall	61MAKDE5	\$32.00
Matching Ears, 10-1/2" tall	61MAKDE6	\$33.00
Matching Ears, 12-1/4" tall	61MAKDE7	\$35.00

Bottom Section, 11-1/2" deep

	61MAKDBS	\$17.00
Matching Ears, 3-1/2" tall	61MAKDE2S	\$27.00
Matching Ears, 5-1/4" tall	61MAKDE3S	\$29.00
Matching Ears, 7" tall	61MAKDE4S	\$31.00



HALF RACK UNIVERSAL SHELF

Mount one or two half-rack devices horizontally in one rack space. Mounting hardware is included and the shelf is drilled with universal holes. 10" deep. Need lots? Ask about the 50-piece master pack.

61MAUTR1 \$19.95

FURNISHINGS

MIDDLE ATLANTIC, CONT...



RACK CHASSIS

For your custom electronics. Flush face is easily removed for punching and the rear panel is full height and removable. Face and rear are black anodized aluminum, while the top, bottom, and sides are steel. These chassis are 10" deep and ship assembled.

1 space	61MACH1	\$62.00
2 spaces	61MACH2	\$69.00
3 spaces	61MACH3	\$79.00



RACK DRAWERS

- Enclosed top
- Ball bearing slides extend 14"
- Flush slam latch keeps drawer closed
- Keylock option is factory installed
- Storage height is 1/2" less than rack-ing height
- Larger sizes available, including hanging file kit
- Models shown are anodized aluminum. Steel models available
- Ask about partitions for CD, DAT, LP, Cassette, VHS

2 spaces	61MADWR2	\$98.00
2 spaces w/lock	61MADWR2L	\$139.00
3 spaces	61MADWR3	\$119.00
3 spaces w/lock	61MADWR3L	\$149.00
4 spaces	61MADWR4	\$143.00
4 spaces w/lock	61MADWR4L	\$179.00

RACK RAILS

Our best 1/8" thick galvanized steel rails are punched and tapped for 10-32 screws. Side mounting holes are 9/32" diameter. Sold in pairs. Shorter lengths available.

8 spaces (14")	61MARR8	\$14.00
10 spaces (17-1/2")	61MARR10	\$16.00
12 spaces (21")	61MARR12	\$19.00
14 spaces (24-1/2")	61MARR14	\$21.00
16 spaces (28")	61MARR16	\$23.00
18 spaces (31-1/2")	61MARR18	\$26.00
21 spaces (36-3/4")	61MARR21	\$30.00
27 spaces (47-1/4")	61MARR27	\$36.00
45 spaces (78-3/4")	61MARR45	\$52.00



VENT PANELS

Middle Atlantic's 16 gauge steel panels have one piece construction and are perforated with 5/32" diameter holes yielding 68% open area.

1 space	61MAVT1	\$9.35
2 spaces	61MAVT2	\$11.25
3 spaces	61MAVT3	\$13.20
4 spaces	61MAVT4	\$14.40
6 spaces	61MAVT6	\$15.30



FANS AND FAN PANELS

Three-space fan panels include grilles and are punched for 4-1/2" diameter fans. The quiet, 100 CFM fans, sold separately, are designed for long life. Line cord supplied; user must install plug. Black anodized aluminum shown; also available in steel with black enamel.

Panel for 1 fan	61MAFP1	\$29.00
Panel for 2 fans	61MAFP2	\$32.00
Panel for 3 fans	61MAFP3	\$34.00
Fan	61MAFAN	\$40.00
Fan Guard	61MAGUARD	\$4.25
Filter Kit with washable filter keeps dust out of your gear. Can be fit over fan panels or used alone. Three RU.	61MAFILTER	\$29.00

RACK HARDWARE

Each package contains 10-32 x 3/4" black machine screws and flat nylon washers. Choose Phillips, square drive, or a special tamper-proof star post for security. Phillips hardware is now heat treated to reduce stripping, and is available in a master pack.



Phillips 100 ea	61MAHP	\$16.50
Master Pack (50 bags of 100)	61MAHPMP	\$419.00
Torx Post Screws 50 ea	61MATX	\$13.00
Torx Post for above	61MATBIT	\$12.75
Square Drive 100 ea	61MAHS	\$23.00
Square Drive for above	61GIMABIT	\$2.29
Shoulder washers are non-conductive and are used with standard washers to isolate equipment from the rails.		
100 ea	61MASW	\$7.50

UCP PUNCHED PANELS

Design and assemble your own custom panels out of stock modules. The completed panels look professional with no gaps; all hardware is flush, and all visible parts have an aesthetic brushed and black anodized finish.

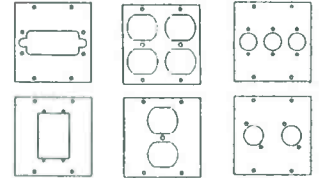
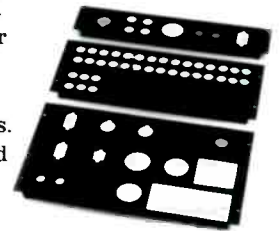

Frame kits bolt to their ears with included hardware; then you fit up to five modules across a two-rack-space frame, or ten modules in a four space frame, or 15 modules in a six spacer. Modules are prepunched for your choice of connectors. Middle Atlantic has a hundred modules with cutouts for XLR, data multipin, phone, BNC, RCA, LEDs, duplex receptacles, twistlocks, and many specialty types of connectors. These are just a sample. A loaded two space frame is less than \$60. Call us!

All punched UCP's		\$11.00
The UCP-CH chassis fits UCP modules on front and rear	61MAUCPCH	\$39.00
Adapt any single UCP module to a standard 1900 electrical box	61MAUCPADP	\$9.00

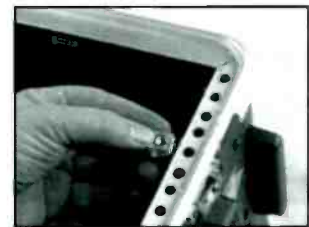

SKB's Nut Retainer Clips make life so much easier when you're mounting things in a rack. They clip onto your rail so you have one less thing to hold. Bag of 12.

SKB Rack Pack	77SK19AC1	\$9.95
---------------	-----------	--------

RF EQUIPMENT



MEDIA STORAGE

A. CD clutter got you down? Each ART wire tower holds 31 single CD's plus two doubles in a free-standing, tabletop, or wall configuration.

61AR1209 \$17.00

B. ABCO carousels store CD's and carts. All stand six feet and include casters.

Each consists of removable wire modules that can be purchased separately for wall mounting.

280 CD's 60AB280 \$375.00

560 CD's 60AB560 \$679.00

300 Carts 60AB300 \$419.00

500 Carts 60AB500 \$649.00

70 CD Wire Rack 60AB70 \$71.00

50 Cart Wire Rack 60AB50 \$55.00

C. Nigel B's storage drawers are fitted with compartments for discs and tapes.

CD Drawer holds 69; 4RU high

60NBCDD \$173.00

DAT Drawer holds 76; 2RU high

60NB DAT \$165.00

Cassette Drawer holds 64; 3RU high

60NBAC3D \$157.46

Cover and lock option for any drawer

60NB DCL \$34.96

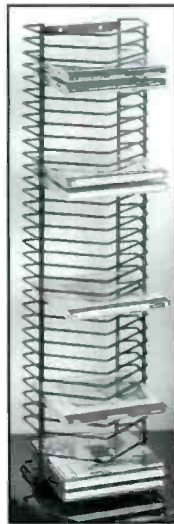

A

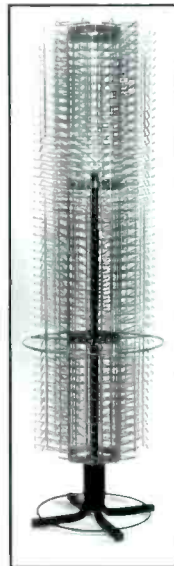

B



C

MIDDLE ATLANTIC MEDIA HOLDERS

Rack mount media holders from Middle Atlantic are anodized aluminum. Call us for steel versions.

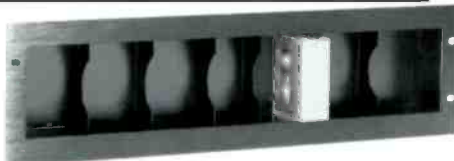

Compact disc holder for 40 CD's; 4RU tall 61MACD \$59.00

Cassette holder for 33 audio cassettes; 3RU tall 61MACS \$55.00

DAT holder for 27 digital audio tapes; 3RU tall 61MADAT \$57.00

LP, 10-1/2" reel tape, or binder holder; 8RU tall 61MALP \$125.00

MIDDLE ATLANTIC CD-1



Stick your empty CD cases in the CD-1 to keep them off your studio counter. One RU tall, brushed and black anodized finish. Holds six.

CD-1 61MACD1 \$35.00

RAXXESS CABLE ORGANIZER



Best Seller

Steel fingers hold your cables, nice and neat. Maximum cable diameter: 0.25".

61RXDEPOT \$15.95

ALPS MEDIA STORAGE CABINETS

Look to the Alps when you have a lot of media to store, whether it's CD, DAT, reel, cassettes, or video. Each has a footprint of only 2 x 4', and look how much they hold.

Partitions can be mixed among drawers in a single unit. Cabinets come in white, almond, and gray laminates. These are typical CD models. We have similar pricing for other media. Prices do not include truck freight.

Five drawer floor unit for 2120

CD's, 42" H
60ALCBA605CD \$1,670.00

Eight drawer floor unit for 3392

CD's, 60" H
60ALCBA908CD \$1,439.00

Six drawer top unit for 1836

CD's, 45" H
60ALCBU466CD \$1,385.10



Best Seller

Alps Mini-storage cabinet for any media. This compact cabinet provides the same safety and security for your media as its larger brothers, at a great price!

Alps Mini Media Cabinet

60ALMMSK \$649.00

Lock for MMSK

60ALMINILOCK \$80.00

PRICING

Prices marked MFR LIST show the suggested selling price from the manufacturer and are subject to discount. Call us for a current price quotation.

ORDERING INFORMATION

Minimum order: \$25.00 in merchandise and \$8.00 in shipping and handling.

Ordering by telephone: Call 800-732-7665 or 301-682-8700 during our office hours, listed at right. Net 30 terms are available to qualified buyers, subject to credit limit. We require a firm purchase order signed by an authorized agent of your company for Net 30 purchases. We also welcome MasterCard, Visa, American Express, and Discover; credit card orders are authorized in full at the time of purchase.

Ordering by fax: Send your order by fax to 301-682-8377, 24 hours a day. Include shipping and invoicing instructions.

Ordering by mail: Mail your order, with shipping and invoicing information, to Bradley Broadcast Sales, 7313-G Grove Road, Frederick, MD 21704. Enclose your purchase order (if you have an account), or payment or credit card information. Remember to include tax if appropriate.

Shipping charges: We can quote shipping charges, so you may include them with your prepayment, or we can ship your merchandise freight collect, or charge shipping to your credit card, or ship via the carrier of your choice using your account number. If you have a Bradley account in good standing, shipping charges can be added to your invoice.

COD shipments: COD orders are limited to items immediately available from stock. We reserve the right to ship COD only to established clients. Shipments in excess of \$500 may require payment by certified check. We do not ship COD via U.S. Mail.

Tax: Maryland customers must add 5% sales tax or provide signed documentation of Maryland sales tax exemption at the time of order.

DAMAGED, DEFECTIVE, OR INCORRECT MERCHANDISE

If any package shows signs of damage, do not accept it. We will replace the item when the carrier returns it to us, or we will re-ship immediately upon notification of the problem. In the latter case, new merchandise will be separately invoiced or charged, with credit or refund issued upon receipt of defective merchandise. When you receive any merchandise, always inspect it before signing. Under carrier rules, it is YOUR responsibility to report damage or loss. Note damage on any shipping documents, and save all packing material and waybills. Request inspection by the carrier immediately. Claims for defective or incorrect merchandise must be reported to us within five days. When you call us, we will issue you a return authorization (R.A.) number, which MUST appear on our return package or we cannot accept it. If you order the wrong item, you are responsible for shipping charges to return it. If the error is ours, we will pay for shipping. Merchandise returned for any reason other than defects or damage is subject to restock fees. No returns or exchanges after 30 days.

BRADLEY BROADCAST GUARANTEE

All merchandise is new and fully warranted by the maker. Bradley Broadcast neither offers nor implies any warranty other than that provided by the manufacturer. Bradley does not guarantee the suitability of any product for your intended purpose and is not liable for consequential damages incurred in the use of any product we provide. Product specifications are subject to change without notice.

ACCOUNT TERMS

Credit terms are Net 30 days. Interest at the rate of 1.5% per month (18% per annum) will be charged to overdue accounts, and further credit privileges suspended at our option. The calculation of due date is based upon the shipment date for each item, or our invoice date, whichever is later. We invoice partial shipments and expect payment within 30 days on each shipment. If your institution or company cannot accept partial billings, we will hold merchandise for complete shipment at one time. Postmark date of your payment must be within 30 days of invoice or ship date to be considered timely.

**Copyright © 1998 Bradley
Broadcast Sales, Inc.**

Reproduction or transmittal is prohibited. Every effort is made to ensure the accuracy of the information contained here, but Bradley is not responsible for typographical errors. Specifications and prices are subject to change without notice.

General Manager

Art Reed

Editor

Joellen Reed

Design and Layout

Robert T. Martin & Associates

Original Photography

Mike Ventura, Ed Castle & Bob Martin

Prepress

Preptech
Rochester, NY

Printing

Tucker Printers
Henrietta, NY

MANUFACTURER'S INDEX

360 Systems	46, 47, 49, 119	Discwasher	64, 67	Nigel B	72, 80, 94, 95, 132, 137, 140
Aardvark	call Bradley	DOD Electronics	106	Neumann	31
ABCO	140	Dorrrough	90	O.C. White	38
Ac-cetera	132	DPA	43	Omnimount	97
Acrometal Accessories	63	Dr Ferd	call Bradley	Panascheme	133, 135
Adb	call Bradley	Earthworks	call Bradley	Panasonic	45, 64
ADC	call Bradley	EB Tech	126	Pivotelli	97
Adtran	call Bradley	Editall	63	Potrabrace	2, 5, 7
AEQ	call Bradley	Electro Impluse	call Bradley	PreSonus	39, 100, 106, 109
AirCorp	call Bradley	Electro-Voice	26, 28, 29, 30, 81, 97,	Pro Gold	126
Akai	call Bradley	ESE	131	ProCo	38, 95
AKG	23, 27, 28, 30, 31, 32, 34, 35, 37, 41, 99	ETA	80	QSC	call Bradley
Alesis	51, 52, 104	Eventide	18, 47, 102	Radio Design Lab	99, 106, 110, 111, 112, 113, 118
Alps	140	Excalibur	17, 18, 58, 62, 116, 118, 127	Radio Systems	19, 69, 117, 118, 130
Ampex	64	Fender	81	Ramsa	call Bradley
Anchor	82, 93	Fidelipac	67, 68, 131	Rane	76, 88, 90, 98, 99, 100, 101, 102, 107, 109, 118
Anvil	call Bradley	Fostex	93, 98, 99, 126	Raxxess	30, 98, 126, 133, 136, 137, 140
Aphex	102, 104, 109, 114, 118, 131	Furman	80, 92, 123	RIXX	117
API	104	Galaxy	10	Roland	88, 107, 109
APT	14	Gemini	call Bradley	Rolls	8, 25, 33, 91, 99, 117
Arrakis	69	Genelec	93	Rowi	38
ART	103, 105, 140	Geneva	63	RTS	22
Ashly	76, 101, 105	Gentner	16, 18, 19, 92, 128	Sabine	100, 107, 108
ATI	6, 39, 67, 78, 99, 105, 110, 116, 117, 118	Gecco	call Bradley	Samson	39, 78, 81, 85, 88, 86, 88, 99
Atlas	34, 35, 36, 37, 38	Gorman Redlich	call Bradley	SEK'D	54, 56
Audi-cord	call Bradley	Gotham	126	Sennheiser	3, 11, 24, 25, 26, 29, 37, 98
Audio Control Industrial	call Bradley	Graham Patten	115	Shively	127
Audio Technica	2, 3, 26, 27, 28, 29, 30, 31, 32, 33, 34, 37, 40, 41, 79, 124	Hafner	85, 86	Shure	7, 8, 11, 24, 26, 28, 30, 32, 34, 35, 37
Audiolab	63	Har-Ken	122		41, 44, 67, 83, 108, 113, 114
Audiopak	call Bradley	Henry	17, 52, 118, 119, 121	Shuretape	83
Audix	call Bradley	HHB	2, 50, 64	Sine Systems	128
Auratone	94	Hosa	124, 125	SKB	9, 139
Autogram	call Bradley	Informer	130	SKB Cases	9, 48
Avocet	103	Inovonics	call Bradley	Sonic Foundry	53
Azden	43	Intellix	call Bradley	Sonic Systems/Soundsphere	87
BBE	105	Intraclean	62, 64, 67	Sonifex	4
BE Studio	131	Intraplex	14, 127	Sony	2, 3, 4, 5, 34, 42, 45, 46, 48, 49, 59, 64, 66, 99
Behringer	105	ITC Audio Carts	call Bradley	Sound America	16, 17
Belar	call Bradley	JBL	81, 88, 94, 95, 96	Soundcraft	76
Benchmark	98, 99	JK Audio	11, 12	Soundolier	136
Beyerdynamic	24, 27, 26, 36, 42, 99	JVC	65	Spectral	50
Biamp	89, 105	K & M	34, 35, 36	Spirit	8, 73, 74, 79, 91
Broadcast Electronics	131	Kaces III	3, 5, 9	Stanton	67
Broadcast Tools	73, 92, 120	Koss	98	Stewart	32, 86, 99
Burk	119, 129	Leatherman	10	STL (Standard Tape Labs)	63
Cablewave	call Bradley	Lexicon	109	Switchcraft	122
Caig	126	Lightwave	25	Symetrix	18, 50, 85, 86, 98, 99, 102, 108, 109
Calzone	call Bradley	Littlelite	80	T.C. Electronics	call Bradley
Canare	124	Logitek	68, 91, 119	Tannoy	96
Carver	call Bradley	Luxo	38	Tascam	2, 3, 45, 46, 47, 51, 58, 59, 60, 61, 66
C-Cor	call Bradley	Mackie	9, 70, 72, 73, 86, 94		75, 77, 85, 86, 117
Century Magnetics	63	Marantz	3, 5, 50, 60, 61, 66	TEAC	66
CircuitWerkes	129	Marti	10, 15, 129	Technics	58, 64, 67, 91
Clear-com	22	Maxell	63, 64	Telex	21, 22, 24, 43, 60
Community	82	Maxx Super Cart	132	Telos	13, 20, 21, 22
Comrex	11, 12, 13, 14, 15, 17	MB Quart	23	TFT	call Bradley
Conex	11, 23, 122, 126	Mic-Eze	36	Titus	131
Cord-Lox	3, 123, 126	Microtech Gefell	call Bradley	TOA	87, 108
Creamware	55	Middle Atlantic	58, 59, 66, 132, 133, 134, 135, 136, 137, 138, 139, 140	U.S. Audio	77, 86, 98
CRL (Circuit Research Labs)	call Bradley	Minnetonka	57	Ultimate Liberty	36, 84
Crown	24, 27, 33, 34, 84, 86, 127	MixRak	134	Valley	call Bradley
C-T Audio	call Bradley	Modern Case	10	Waves	54
Cutting Edge	130	Modulation Sciences	call Bradley	West Penn	124
Cutting Wedge	134	Mogami	call Bradley	Whirlwind	4, 6, 80, 83, 98, 114, 123, 124, 126
dbx	101, 103, 106	Monster Cable	call Bradley	Will-Burt	129
Delta Electronics	call Bradley	Motorola	23	Winsted	call Bradley
Denon	48, 59, 61, 62, 65, 91	MRL	63	Wohler	92
Digidesign	call Bradley	Murphy	call Bradley	Yamaha	71, 74, 77, 79, 81, 82, 83, 96, 100, 108, 110
Digital Armor	64	Musicam/CCS	15, 16	Zephyrus	call Bradley
Digital Audio Labs	54, 56, 57	Neutrik	123	Z-Systems	110, 120

Acoustic Treatment	135	Delays		Stereo	28	Remote Control, via phone	23, 129
A/D Converters	115	Profanity	18	Talkback	32	Remote Pickup Equipment (RPU)	129
ADAT	51	Studio & Alignment	102	Tube	31	RF	129
AES/ DATS Converter	115	Digital Fader	114	Wireless	39-41, 42-44	Telephone	15, 17
Amplifiers		Digital Storage	55	MiniDisc	See Recorders	Reverbs	See Processing
Composite	127	Direct Boxes	114	Blank MD Discs	64	Routing Switchers	87-88, 119-120, 122
Distribution	6, 7, 87, 111, 112, 115-118	Distribution Amps	See Amplifiers	Mix Minus	121	Sample Rate Converters	110
Headphone	7, 98-99	Drawers	139-140	Mixers & Consoles		Satellite Tools	120
IHF/Pro	62, 67, 111, 114-116, 119, 121	DTMF Controllers	23	Auto Mic Mixers	9, 79	Security Covers	138
Line	110-111	Duplicators, Cassette & MD	60	Broadcast On-Air	67-69	Shelves	See Racks
Mic & Press	6, 111-112	Editing Software	53-54, 56-57	Digital	68-71, 74-75, 115	Silence Sensors	92
Phono	Call Bradley	Editing Supplies	63	Mic/Utility	73, 76, 87-88, 90, 111, 121	Snakes	83, 125
Power/Monitor	84-85, 88, 98	Editors, Digital	47, 55-56	Mixer/Recorder Combos	59	Software, Audio Editing	53-57
Amplifier Comparison Chart	86	Effects Processors	See Processing	Multitrack	59, 70, 73-74, 77	Sound Cards	54
Antennas	Call Bradley	Equalizers	See Processing	Portable	7-8, 11-12, 14-15, 72, 78-79	Speakers	81-84, 87-88, 93-97
Attenuators	27, 112-113	Equipment Stands	72, 137	Powered	8, 79, 82	Mounting Hardware	97
Audio Control	120	Erasers	63	Production/Recording	70-72, 74-76	Stands	84, 136
Automation Tools	126	Exciters, FM	Call Bradley	Monitors		Splicing Supplies	63
Bags, Equipment	5, 9	Fans	139	Meters	92, 111	Sports Mixers	8, 10-11
Cabinetry	133-135, 140	Feedback Control	100	Selectors	99	STL/TSL	127
Cables & Accessories	83, 124-126	Frequency Extension	17	Signal	92	Storage, Media	133, 140
Cart Machines		Furniture	132, 134	Speakers	See Speakers	Styli	Call Bradley
Accessories	Call Bradley	Gaffer's Tape	83	Multitrack Editors	51-52, 54, 56-57, 59	Switchers	89, 119, 121
Carts & Tape	Call Bradley	Gates	89	Multitrack Recorders	See Recorders	Tape & Tape Supplies	
Cartridges, Phono	67	Hard Disk Systems	46-47, 55-56	Network Audio Systems	55	ADAT/SVHS	64
Cases, Equipment	9	Head Cleaners	Call Bradley	Noise Reduction	See Processing	Cartridge	63
Cassette		Headphone Amps	98-99	On-Air/Recording Lights	131	Cassette	63
Accessories	62-63	Headphone Amp Comparison Chart	99	PA Systems	81-82	DAT	64
Duplicators	60	Headphones	98-99	Parabolic Mic Reflector	25	Erasers/Degaussers	63
Mixer/Recorder Combos	59	Wireless	99	Patching	123	Gaffer's	83
Portable Recorders	3, 5	Headsets	23-24	Phono Cartridges	Call Bradley	Head Demagnetizers	63
Storage	136, 140	Hybrids	11, 16, 18-20	Pop Filters	30	Hi-8	Call Bradley
Studio Recorders	58-61	Switchers	18	Power Distribution & Protection	9, 80	Open Reel	63
Tapes	63	Installed Sound	87-88, 89-90	Power Supply	10, 25	Storage	133, 140
Cellular Interface	11	Intercom & IFB	6, 11, 21-23	Press Boxes	6	Test	63
Cleaners	126, 140	Interface	22	Processing		Tape Recorders	See Recorders
Coaxial Cable	Call Bradley	Interface Amps	See Amplifiers	Broadcast On-air	130-131	Telephone & Teleconference	
Codecs		Lamps & Lights		Compressor	100-101, 109	Cellular Interface	11
ISDN	13-14	Gooseneck	80, 132	Effects	102-103, 110	Codescs	11-16
POTS	11-13, 15-16	On-Air	131	Equalizers	100	Couplers	12, 16-17, 112
Compact Disc		Limiters	89	Expander	103	DTMF	23, 120
Accessories	54, 62, 64	Loggers	47	Gates	89, 101, 103	Frequency Extension	12
Blank Discs	64	Masts	129	Levelers	102, 109	Hybrids & Delays	11, 16, 18-20
Players	64-66	Meters, Audio	90-91	Limiters	100-102, 109	Interface	19, 21
Recorders	50, 53	Microphones		Noise Reduction	103	ISDN & Switched	13-15
Remotes	62	Accessories	25, 37, 113-114	Reverbs	110	Message Storage	17, 52-53
Storage	133, 140	Boundary	33	Processor Comparison Charts	104-109	Mix Minus	121
Test CD's	62	Cable	4, 124-125	Rack Bags	9	Remote Equipment	15, 17
Compressors	See Processing	Combiners	27, 38, 112, 114	Racks & Hardware	133, 135-140	Test	6, 90, 116, 126
Computer		Condensers	27-28, 30-32	Ruler	139	Thermometers	130
Peripherals	56-57	Dynamic	26-29	Storage	140	Timers	130-131
Software	53-54, 56	Gooseneck	32, 36	Razor Blades	63	Tools	10
Connectors & Adapters	122-123	Headsets	23-24	RDS/RBDS	91	Tone Generators & Decoders	120, 126
Consoles, See Mixers		Headworn	27, 32	Receivers & Tuners	91	Transformers	113
Cord-Lox	3, 123, 126	Instrument	27	Recorders		Transmitters, FM	127
Cotton Swabs	62	Lavaliers	25, 34-35	ADAT & Hi-8	51	Tuners & Receivers	91
Couplers	See Telephone	Mixers	7, 90	Cartridge	Call Bradley	Turntables	67
D/A Converter	115	Phantom Supplies	25, 33, 112	Cassette	3-4, 58-61	Two-Way Radios	23
DAT		Preamps	6, 25, 39, 111-112, 115	Compact Disc	50, 61	UPS	Call Bradley
Loggers	47	Processors	109	DAT	2-3, 45-46	Utility Cart	132
Recorders, Portable	2	Shotgun	25-26	Hard Disk	46-47, 49, 55	Warning Lights	131
Recorders, Studio	45-46	Special Purpose	33	MiniDisc	4, 47-49, 65	Wire	See Cables
Storage	133, 140	Splitters	38, 114	Multi-track	51-52, 59	Wire Ties	126
Tape & Accessories	64	Stands & Booms	34-38	PCM/IA	4-5	Wireless	
DATS/AES Converter	115	Delays		Stands	137	UHF	39-42
De-essers	See Processing	Direct Boxes	114	Reel to Reel Accessories	63-64	VHF	43-44
Degaussers	63	Distribution Amps	See Amplifiers	Relays	113	XLR's	See Connectors
Delay Cancellor	103	Drawers	139-140	Remote Control, Transmitter	128-129		



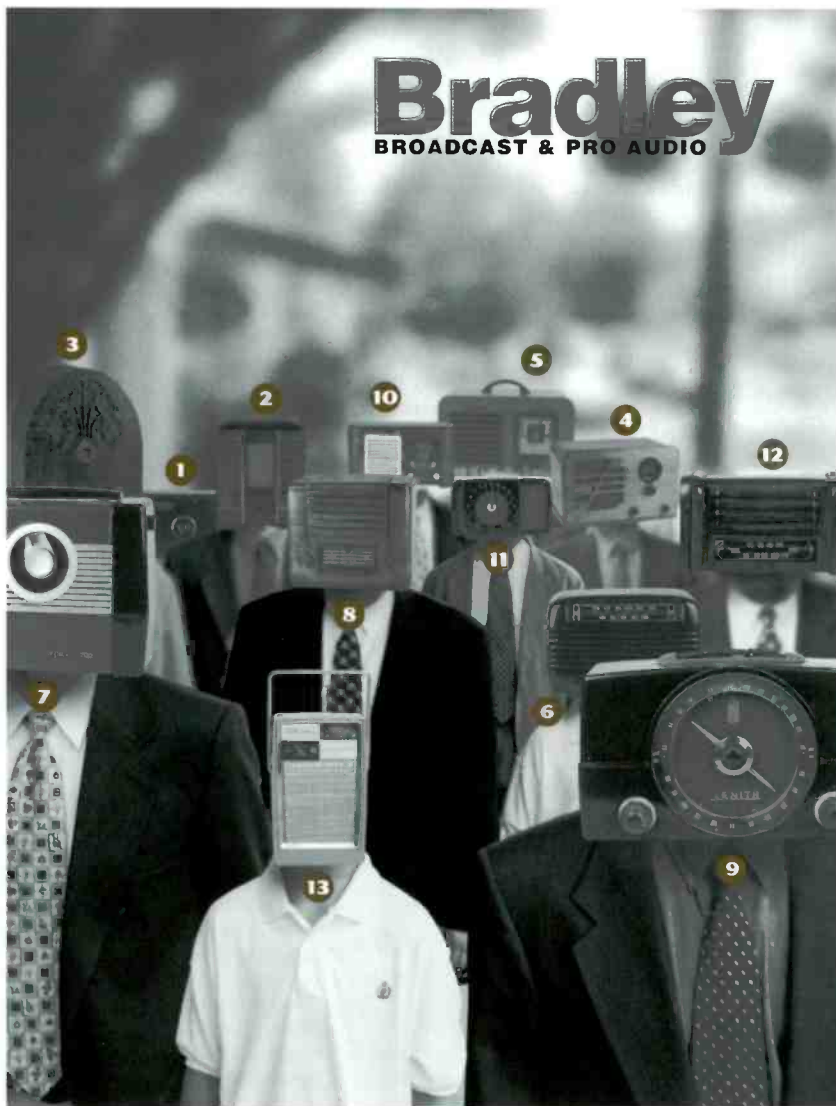

1. Atwater Kent Model 20, Deluxe Table, 1924
Courtesy of Eric Schwartz

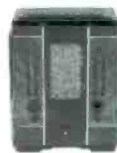

2. Atwater Kent Model 854, Tombstone, 1935
Courtesy of Eric Schwartz



3. Philco Model 20, Cathedral, 1930
Courtesy of Eric Schwartz



4. Philco Model 37-62, Table, Year Unknown
Courtesy of Art Reed



5. Philco Model 40-120, Table, 1940
Courtesy of Ray Biba



6. Philco Model 46-250 Transitone, Table, 1946
Courtesy of Eric Schwartz



7. Zenith Model 9BX5 Portable, 1948
Courtesy of Eric Schwartz



8. Silvertone Model 6425 Table, Year Unknown
Courtesy of Eric Schwartz



9. Zenith Model K-725 Table, 1953
Courtesy of Ric Goldstein



10. Motorola Model 51X19 Table, 1942
Courtesy of Bob Eburg



11. Zenith Model H-723Z Table, 1951
Courtesy of Ray Biba



12. Tele-tone Model 111 Table, 1948
Courtesy of Eric Schwartz



13. Silvertone Model 6 Transistor Portable, Year Unknown, Stock Photo

We always love doing what we consider the best part of creating the catalog – designing the cover. My special thanks to Eric Schwartz, who started the antique radio craze at Bradley and allowed us the use of his personal collection, and to “my guys”, Ray Biba, Ric Goldstein, Bob Eburg, and Art Reed for the use of their radios.

A special thanks to Renee Ciufu at RTM who took a very generic idea, “something with antique radios, Bob”, and developed the very cool concept of radio heads. And last, but not least, thanks to Emily, who reminded me to “take it down a notch.”

We hope you enjoy the trip down memory lane.

Joellen Reed
Marketing Manager



TOOLBOX MAGIC

Whirlwind custom panels and wiring systems ensure the reliability and performance of facilities throughout the world. But many of our favorite products in the field are housed in smaller venues — toolboxes, toolbags, briefcases and gadget drawers. These are the magic items that get you through the day on an installation or trouble-shooting mission, and we dedicate them to everyone who has had to make a system work on a deadline.



MICPOWER provides phantom power for most condenser mics from two 9V batteries.

The TESTER quickly and reliably checks cables with almost any combination of XLR, Phone, and Phono connectors for shorts, opens, or cross wiring.



On-Off Switch with Battery Good LED

The Qbox® packs a built-in speaker with amp, a built-in mic with preamp, a built-in reference tone generator and Voltage Present LEDs for detecting phantom or 3-wire intercom power. It drives headphones and carbon earpieces and operates at mic or line level. A real life saver for audio line testing.

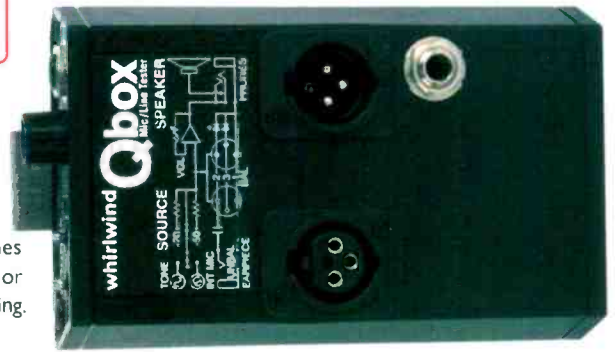

The PHASE REVERSE is the quick cure for an "out of phase" mic

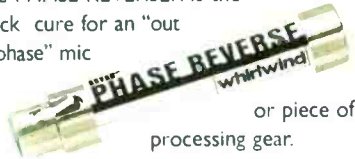

or piece of processing gear.

The Lifter provides an immediate ground lift to solve a



problem or troubleshoot one.

IMP PADS come in 10, 20, 30, and 40dB versions for temporary or

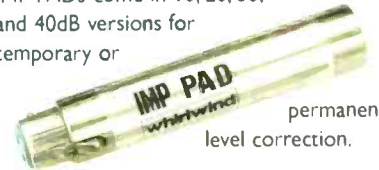

permanent level correction.

The MD-1™ combines a studio-quality mic preamp with a transformer-isolated line driver and a built-in headphone amp. The mic input and headphone driver have individual gain adjustments and phantom power is switch selectable. An innovative Mix control mixes the preamp input and a separate aux input to



permit simultaneous headphone monitoring of an additional line level signal.

The LINE BALANCER SPLITTER balances and isolates or splits line level signals. With individual ground lift switches on each output and both XLR and 1/4" TRS for maximum flexibility.



FROM **whirlwind**™

ONE LOVES TO TRAVEL, THE OTHER PREFERS TO STAY HOME



ZEPHYR IS EVERYWHERE.

The irrepresible Telos Zephyr has earned a hard and fast place in the hearts of broadcast-ers, engineers, and recording professionals around the world. Why? With its inte-grated ISDN terminal adapter, MPEG Layer 5 and Layer 2 compression technology, optional AES/EBU digital I/O, and an intuitive user interface, the Zephyr was designed by Telos specifically for broadcast audio applications over ISDN. It's the ideal solution for remote mixing and broadcasts, ad hoc networks, recording sessions, voiceovers, dis-tribution of commercials, backup to satellite and microwave links, and nearly any other application you can imagine. How could anyone function in today's world without one?



ZEPHYR EXPRESS IS EVERYWHERE ELSE.



With its ground-breaking design and capabilities, the amazing new ZephyrExpress takes Zephyr's industry-leading operation wherever you need to go, and combines a full-featured ISDN codec and three digitally-controlled stereo mixers in a single, road-worthy chassis. With an unprecedented, easy-to-use interface and specs that blow away most studio codecs, the ZephyrExpress is like nothing you've ever experienced. Now you can hit the road without having to leave your Zephyr behind.



The Best Way to Hear from There™

