



1993

# Bradley

BROADCAST

BRADLEY BROADCAST SALES

BRADLEY BROADCAST SALES

1992

BRADLEY BROADCAST SALES

CATA

BRADLEY BROADCAST SALES

1989



BRADLEY BROADCAST SALES  
1987



1988



1990

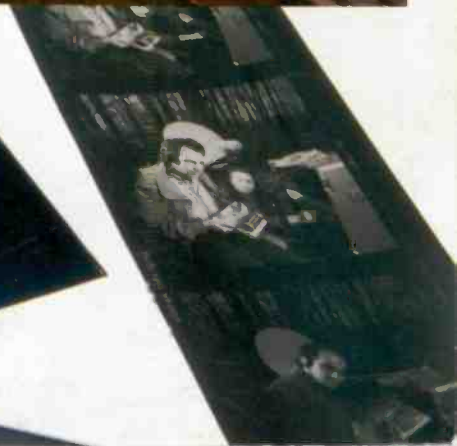



**Bradley**  
B R A D I O C A S T

8101 CESSNA AVENUE • GAITHERSBURG, MD 20879  
800-732-7665 • 301-948-0650 • FAX: 301-330-7198

Sales Office Hours 9:00 AM to 6:00 PM Eastern Time, Monday through Friday  
Business Office Hours 9:00 AM to 5:00 PM Eastern Time, Monday through Friday

Many people ask where we come up with ideas for our catalog covers. Although the subject matter has changed over the last decade, the underlying message has remained consistent: Good old fashioned service with state-of-the-art order fulfillment. Cutting edge technology with respect for the traditional.

Ed Castle contributed the original photography, and helped brainstorm many of the ideas for the Bradley catalogs since 1986. Sadly, Ed passed away in 1992.

This 1993 cover, a retrospective of the covers that have adorned Bradley books for the last ten years, is respectfully dedicated to Ed Castle.



# CONTENTS

<b>FIELD PRODUCTION</b> .....	<b>1-15</b>
Portable DAT and Cassette Recorders, Mixers, Frequency Extenders, Telephone Remote Equipment, Press Boxes, Cases, Microphones, Headsets	
<b>MICROPHONES</b> .....	<b>16-25</b>
Microphones, Mic Stands, Mic Accessories, Preamps, Processors, Wireless Mics	
<b>MONITORING</b> .....	<b>26-37</b>
Headphones, Power Amps, Speakers, Powered Monitors, Signal Monitors, Metering, Tuners and Receivers	
<b>FURNISHINGS</b> .....	<b>38-51</b>
Clocks, Timers, Power Distribution, Media Storage, Warning Lights, Equipment Racks and Hardware, Studio Furniture, Accessories	
<b>DIGITAL AUDIO</b> .....	<b>52-61</b>
Workstations, Digital Recorders, DAT Recorders, CD Players, Accessories	
<b>ANALOG TAPE RECORDERS</b> .....	<b>62-72</b>
Reel-to-Reels, Cassettes, Cart Machines, Compact Multitrack, Tape, Recording Supplies	
<b>PROGRAM AUTOMATION</b> .....	<b>72</b>
Automation Controllers, Program Sources, Accessories	
<b>CONSOLES</b> .....	<b>73-81</b>
Broadcast, Production, Utility Mixers	
<b>AUDIO PROCESSING</b> .....	<b>82-90</b>
Equalizers, Dynamics Controllers, Effects Processors	
<b>AUDIO INTERFACE</b> .....	<b>91-103</b>
Audio Interface, Distribution Amps, Routing Switchers, Patch Panels, Connectors and Adapters, Wire and Cable, Test Equipment	
<b>TELEPHONE INTERFACE</b> .....	<b>104-108</b>
Hybrids, Teleconferencing, Couplers, Delays, Voice Announcers	
<b>INTERCOM</b> .....	<b>108-109</b>
Wired and Wireless Intercoms, Two Way Radios, IFB	
<b>TURNABLES AND DJ EQUIPMENT</b> .....	<b>110-111</b>
Turntables, Cartridges, Phono Preamps, DJ Mixers and Systems	
<b>SOUND REINFORCEMENT</b> .....	<b>112-116</b>
Sound Systems, Mixers, Power Amps, Speakers, Accessories	
<b>RF EQUIPMENT</b> .....	<b>117-124</b>
Transmitters, Processing, Remote Control, Monitoring, STL, RPU, Antennas, Accessories	
<b>CREDIT APPLICATION</b> .....	<b>125</b>
<b>ORDER FORM</b> .....	<b>126</b>
<b>PRICING AND ORDERING INFORMATION</b> .....	<b>127</b>
<b>PRODUCT INDEX</b> .....	<b>128</b>
<b>MANUFACTURER INDEX</b> .....	<b>Cover 3</b>

### Sony NT-1 Scoopman Mini-DAT Recorder

When Sony sets out to miniaturize, they really go to town! The Scoopman is designed as the most portable digital tape recorder ever. It measures 4 1/2" x 1 1/8" x 2 1/4", weighs only 5.2 ounces, and boasts a frequency response of 10Hz to 14kHz. What's amazing, though, is that the mini-DAT tapes used in the Scoopman, are no bigger than a standard postage stamp (smaller than the Elvis stamp.)

Imagine being ready to get the story wherever you are, completely unburdened with traditional equipment. And if there isn't a story to be gotten immediately, relax and enjoy music that you previously recorded, with incredible fidelity. The Scoopman provides everything you need... power supply, line in/out adapter, one-point stereo condenser microphone, earset, case, and cables.

You can record up to two hours on a *double-sided* cassette (that's right, you can flip these tapes over... not typical in a helical scan mechanism) with a 32kHz sampling rate and a 2x oversampling rate. The Scoopman runs up to 7 hours on a cell, making it an extremely economical audio-capturing device. Most importantly, the Scoopman SOUNDS GREAT! If high-quality audio in a very portable package is important to you or your job, you can't afford to be without the Scoopman.

**Scoopman NT-1**      60SONT1      MFR LIST      \$995.00  
 Call Bradley for a current price quotation.



**Accessories:**  
 60 Minute NT Tape      60SONTC60      \$9.95  
 90 Minute NT Tape      60SONTC90      \$13.95

### Sony MZ-1 MiniDisc Digital Recorder

The MZ-1 offers the random access advantages of the compact disc format, in a portable recorder. The new MiniDisc format allows you to record up to 74 minutes on a single 2 1/2" disc. Shock resistant memory resists up to 10 seconds of continuous shock or vibration, so it's great for news gathering efforts. Digital inputs and outputs allow you to quickly offload your gathered audio with no degradation of sound. Line or mic inputs, and line or headphone outputs are provided. The MZ-1 utilizes a standard 44.1kHz sampling rate, and the ATRAC data compression method to give you 20Hz to 20kHz frequency response. Measuring 4 1/2" x 1 1/8" x 5 1/2", and weighing only 1 1/2 lbs including the battery, the MZ-1 is portable enough to go anywhere. Supplied accessories include headphones, rechargeable Ni-Cad battery, AC Adapter, lithium battery, carrying case, one 60 min recordable MiniDisc, and a stereo connecting cable.

**MZ-1**      60SOMZ1      MFR LIST      \$799.00



**Accessories:**  
 60 Minute Disc      60SOMDW60  
 74 Minute Disc      60SOMDW74  
 Optical Digital Cable      60SOPCMZ1  
 Available in June 1993  
 Call Bradley for a current price quotation.

### Fostex PD-2 Portable Timecode DAT Recorder

The Fostex PD-2 is the ultimate professional and portable DAT recorder. The 4-head design gives you off-the-tape confidence monitoring during record - a must for location work. Four motors eliminate the need for unreliable linkages and belts, and provide a battery-efficient and responsive drive system.

The PD-2 has full timecode capability. The internal generator (all four formats) has full jam sync function for stand-alone striping of the DAT tape. For connection to outboard video gear there are Timecode Loop and Output jacks, and video and word sync input and outputs. Start IDs, End IDs, PNOs, Blank Search and error IDs can be recorded in the subcode area of the tape to make later editing a breeze.

Mic inputs have individual 48V and T-12 power options, and Channel 2 offers a phase reverse. You can plug in whatever mics you carry without worrying about outboard phantom supplies — there's even a built-in MS stereo decoder! Each channel also has built-in limiters, voice/music filters, and -30dB pads.

You can run the PD-2 from all of your standard Betacam power accessories, common C cells or the supplied AC adapter, which also acts as the battery charger. Switching between power modes can happen in mid-record, and will produce



no artifacts on tape. For those intrepid Arctic film crews, the PD-2 even has a built-in head heating system that will automatically guard against condensation problems.

Highly ergonomic controls, complete sample rate and format compatibility with other machines, software-adjustable parameters and wake-up modes, a built-in monitor speaker, and outstanding audio specs further help to make the PD-2 a truly unique piece of audio field equipment. No first-rate mobile recording rig should be without a device of this caliber.

**PD-2**      60FOPD2      MFR LIST      \$10,950.00  
 Call Bradley for a current price quotation.



### Sony TCD-D10ProII Portable DAT Recorder

Sony has taken a great DAT recorder and made it even better. The TCD-D10ProII boasts both the incredible audio performance of DAT and a remarkably rugged transport. Absolute Time recording and playback provides an accurate time reference that can be translated to SMPTE time code. Four direct drive motors enhance reliability and provide great stability in extended use.

Mic/line inputs are balanced XLR, and a level attenuator, low cut filter, and peak limiter can be used with the mic inputs. Digital transfer is possible in both the AES/EBU and SP/DIF formats. The index and search features allow high speed search of your selections, and a wide variety of status information is available on the LCD front panel display. End search makes it easy to find the position of your last recording.

Bradley and Sony pack the TCD-D10ProII with two rechargeable battery packs, a battery recharger, an AC power supply, a pistol-grip type remote control, a carrying case with strap, and a complete service manual.

**TCD-D10ProII**      60SOTCDD10PRO      MFR LIST      \$3450.00

**Accessory:**

Spare rechargeable battery      60SONP22H      MFR LIST      \$50.00

Call Bradley for a current price quotation.

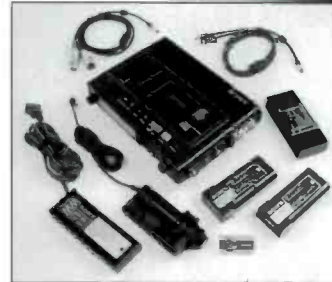

### Sony Portable Digital Pack

What better companion for your Sony TCD-D10ProII than the Sony ECM-MS5 stereo mic? Package includes the DC-MS5 battery supply for the mic. Valued at \$5019.00

**Package 9301      \$4019.00**

### Marantz PMD 700 DAT Recorder

More and more ENG pros are choosing the clean sound of DAT for field recording. The PMD-700, with its small size and light weight, is the logical choice. Analog recording is sampled at 48 kHz, digital recording is selectable between 48, 44.1 and 32 kHz. Playback (analog or digital) is also available at 48, 44.1 or 32 kHz. 1-bit, 256X oversampling A/D and 1 bit 64X oversampling D/A converters assure a s/n ratio and dynamic range of better than 85db, with THD of 0.018%. The unit has AES/EBU digital ins and outs as well as balanced analog mic/line inputs. Analog outputs are RCA phono. The unit has no SCMS, so multigenerational digital copies may be made from this unit. Absolute time, backlit LCD and built-in auto-limiter are standard. AC power and Ni-cad battery are supplied as are the wired remote and carry case with strap.

**PMD 700**      60MR700      MFR LIST      \$2500.00

Call Bradley for a current price quotation.



### Bradley Digital "Bring it Back Pack"

Digital recording quality, compact equipment, and a great package price...this is the package to have on hand to capture late breaking stories. This Marantz PMD-700 system includes carrying case and spare battery pack, an Audio-Technica AT825 stereo microphone with windscreen. Want the package modified for your personal needs? Call Bradley today. Valued at over \$2800.00

**Package 9302      \$1745.00**



## Marantz Portable Cassette Recorders

The **PMD 222** is our most popular portable cassette recorder. This three head deck includes a standard XLR mic input for direct connection of your favorite professional microphone. Other features include: 2 speed operation, auto-shutoff, four way power, VU meter, built-in electret condenser mic, cue and review, memory rewind/replay, and 1/4" headphone jack. This lightweight, low profile package incorporates: switchable limiter, built-in modular telephone jack, pitch control, automatic noise-control switch, and metal tape capability.

**PMD 222** 60MR222 **\$289.00**

The **PMD 221** contains all features of the PMD 222, but its mic input is 1/8" mini.

**PMD 221** 60MR221 **\$272.00**

The **PMD 201** is a two head version of the PMD221, but it lacks memory rewind and play. Mic input is 1/8" mini.

**PMD 201** 60MR201 **\$228.00**

The **PMD 430**, the most sophisticated Marantz stereo portable, adds dbx noise reduction to a full featured compact design. With three head performance, 6% pitch control, illuminated VU meters, limiter, Dolby B, and bias fine adjust. The PMD 430 takes studio quality cassette recording into the field. Memory rewind, auto shut-off/replay, three step mic attenuator, and headphone jack round out the useful functions built into this advanced recorder. Mic inputs are 1/4" TS and line inputs and outputs are phono. Carrying case included.

**PMD 430** 60MR430 **\$449.00**



### Accessories:

**Vinyl carrying case** for mono PMD recorders 60MRCLC221 **\$33.00**  
**Ni-Cad battery pack** for all PMD recorders 60MRRBD430 **\$66.00**  
**Porta-Brace deluxe case** for all PMD recorders 60PBAR222 **\$175.00**

## Bradley "Get The Story" Packs

With this complete ENG kit, you'll be prepared to "get the story" at a moment's notice. Choose a Marantz monaural recorder, and we'll put it together with the Shure VP64 hand held mic and a Bradley coiled ENG cable at a great low price.

**Package 9304** with PMD 222 **\$399.00**

**Package 9305** with PMD 221 **\$372.00**

**Package 9306** with PMD 201 **\$322.00**

News gathering can get hectic. That's why Bradley has put it all together with these complete news gathering outfits. Be prepared to get the story first!



## Bradley "Bring It Back" Packs

### Monaural Package

This package includes the rugged Marantz PMD 222 three head cassette recorder with vinyl case, a top-of-the-line Beyer M58 mic with windscreen and clip, Sennheiser HD450-13 headphones, a coiled ENG, a 25' XLR to XLR cable with Cord-Lox, a 16" Rubberneck goose-neck, and a Rowi clamp. Valued at over \$900.00.



**Package 9307** **\$649.00**

### Stereo Package

The Audio-Technica AT822 stereo mic and the Marantz PMD 430 three head stereo cassette deck are at the heart of this package. Also included are a windscreen and adapter cables for the mic, a case for the recorder, and a 25' XLR to XLR cable with Cord-Lox. Valued at over \$940.00.



**Package 9308** **\$659.00**



## Sony Portable Cassette Recorders

### Sony TCM-5000EV Pressman Cassette

Sony built this portable cassette recorder with the working journalist in mind. The 5000EV is a mono three-head machine with built-in monitor and sophisticated voice activated recording system. Through the use of a clever Bucket Brigade Device delay, the machine will, when in the voice activated (VOX) mode, hold back the audio material until the motors get up to speed. The result is gapless VOX operation. Other features include one touch recording, a -20%/+40% pitch control, instant edit mode, one touch review, complete auto shutoff at the end of the tape, locking pause control, accurate VU meter/battery life indicator, three digit tape counter, built-in condenser mic, and earphone jack. Mic input is 1/8" mini TS. Four alkaline "C" cells will provide about 20 hours of recording.

**TCM-5000EV** 60SOTCM5000EV **\$429.00**

### Sony WM-D6C Pro Walkman Portable Cassette

Engineered for excellent sound, the Pro Walkman is 6 3/4" x 1 1/2" x 3 3/4" and weighs only 1 1/2 pounds. Laser Amorphous tape heads provide stereo recording with extended dynamic range. Features include Dolby B and C noise reduction, quartz lock system for low wow and flutter, chrome and metal tape capabilities, and a manual recording level control with LED peak recording level meter. Lightweight headphones and carrying case are included. Mic input is stereo 1/8" mini. Four "AA" alkaline cells provide approximately 4 hours of playback time.

**WM-D6C** 60SOWMD6C **\$345.00**

**Accessory:**

**AC adapter** 60SOACD4L **\$32.95**



### Sony TC-D5ProII Portable Stereo Cassette Recorder

The stereo TC-D5Pro II has been the portable, high quality stereo cassette standard for years. The mic inputs are female XLR connectors, line outputs are phono, and the headphone output is 1/4". Powering is by battery, the optional AC supply, or external 6 or 12VDC. Frequency response is excellent with standard cassettes, and Dolby B provides a 6dB improvement in signal/noise ratio. Lighted VU meters, battery check button, and record limiter are other desirable features.

**TC-D5ProII** 60SOTCD5 **\$779.00**

**Accessories:**

**Porta-Brace deluxe case** 60PBARD5 **\$175.00**

**Also available:**

**TC-D5M** has all of the features of the Pro II with the exception of the mic inputs, which are 1/4" TS.

**TC-D5M** 60SOTCD5M **\$646.00**

**Accessory:**

**AC adapter** 60SOACD4L **\$21.95**

**Your Bradley Professional can assist you with all of your audio needs. Call 800-732-7665.**

## Bradley ENG Mic Cables

Our popular cables are available in five versions. These cables will stand up to the rigors of field use without damage or failure. Straight cords are 6', while coiled cords extend to over 10'. Designed to be used with portable DAT and cassette recorders. Also available is a complete selection of XLR to XLR cables to be found in our Microphone section.

<b>XLR female to 1/4". Straight cable.</b>	61WHENG4	<b>\$12.00</b>
<b>XLR female to 1/8" mini. Straight cable.</b>	61WHENG	<b>\$12.00</b>
<b>XLR female to 1/4". Coiled cable.</b>	61WHENG2	<b>\$28.00</b>
<b>XLR female to 1/8" mini. Coiled cable.</b>	61WHENG3	<b>\$28.00</b>
<b>XLR female to XLR male coiled cable</b>	61GCENG5	<b>\$35.95</b>



## Shure Mixers

(1) **FP42** provides all of the features of the industry standard M267A with stereo capability. Four balanced mic/line inputs with pan pots are provided. Each channel provides phantom power, and cue audio is routed to the stereo headphone jacks when a channel control pot is pulled out. It can operate for 8 hours continuously on three 9 volt alkaline batteries. Front panel controls include mono/stereo switch, tone oscillator, limiter on/off, and headphone level control.

**FP42** 60SHFP42 MFR LIST \$1050.00

(2) **M267A** is a compact, lightweight, 4 input professional microphone mixer that offers excellent performance and capabilities. Features include peak program limiter, phantom mic power, built-in battery pack, LED power indicator, automatic muting circuit, active gain controls, electronic power supply regulation, powerful headphone amp, and front panel headphone jack with level control. Both mic and line level outputs are provided. Also featured are transformer balanced inputs and outputs, mix buss connection, low cut filters, and low RFI and low noise susceptibility.

**M267A** 60SHM267 MFR LIST \$535.00

### Also available:

**M268** five input microphone mixer features 4 transformer balanced mic inputs with phantom power, an auxiliary line input, and a master volume control. Connecting the M268 with the M267A via the latter's mix buss effectively creates a 9 input mic mixer. The M268 can also be used to expand inputs on other existing equipment.

**M268** 60SHM268 MFR LIST \$325.00

**M68FCA** is a practical device for increasing the flexibility of systems requiring multiple mic inputs. The M68FCA features 4 mic inputs, Lo-Z or Hi-Z, plus one high level auxiliary input. Both mic and line level outputs are provided.

**M68FCA** 60SHM68FC MFR LIST \$245.00

(3) **FP16A** is a 1x6 distribution amplifier which will accept a mic or line input and feed any combination of six mic or line outputs.

Line in and out jacks allow ganging units together for additional output capability or inserting processing.

Phantom power is available, and the entire unit may be operated at +4dBm output in continuous use for up to 20 hours on three 9 volt batteries. The battery supply also automatically cuts in if normal AC power fails. Inputs/outputs are XLR and link jacks are 1/4" TS. The FP16A is ideal for remote functions, news conferences, ENG applications, or any place where multiple mic/line outputs are needed.

**FP16A** 60SHFP16 MFR LIST \$595.00

### Accessories:

**Rack mount kit** for M267 & M268 61SHA268R MFR LIST \$30.00

**Rack mount kit** for M68FC 61SHA68R MFR LIST \$30.00

**Rack mount kit** for FP42 and FP16A. 60SHA16R MFR LIST \$32.00

Call Bradley for a current price quotation.



## Shure FP410 Automatic Mixer

The more open microphones you have, the more difficult it is to produce professional quality audio. You can try to ride gain on all the mics, but even the fastest fingers can't keep pace with a lively conversation. The Shure FP410 with IntelliMix gives you flawless "hands-off" performance never before available in a portable mixer. Within four milliseconds of the moment a new talker addresses the group, the FP410 selects and silently activates the most appropriate mic.

Three unique functions enhance the quality of the FP410's automatic mixing. Noise-Adaptive Threshold distinguishes between constant background noise and rapidly changing sound such as speech. The activation threshold is constantly adjusted so that only speech levels louder than the background sound will activate an FP410 channel. MaxBus assures that one talker will only activate one microphone. And when the talker stops, Last Mic Lock-On keeps that mic on until a new one is activated assuring consistent background ambience and smooth audio mix.

Features include four transformer balanced mic/line inputs, dual XLR outputs, switchable phantom power, linking capabilities for up to 25 mixers, 9 volt battery and AC operation, and limiter.



**FP-410** 60SHFP410 MFR LIST \$1595.00

### Accessory:

**Porta-Brace** deluxe carrying case 60PBMX410 MFR LIST \$50.00

Call Bradley for a current price quotation.



### Shure FP12 Headphone Amp

Whether the problem is monitoring or trouble shooting audio lines, boosting headphone levels, or providing a simple intercom system, the convenient FP12 provides the solution. Powered by a 9V battery, this bridging amplifier includes 1/4" TRS and XLR connectors for input and output and permits interconnection of several units. The FP12 includes two pairs of headphone jacks (stereo 1/4" and stereo mini-plug), the ability to accept mic or line level inputs, and up to 96dB of gain. Don't go on your next remote without it!

**FP12** 60SHFP12 MFR LIST \$275.00

Call Bradley for a current price quotation.



### Shure FP11 Mic/Line Amp

This compact, battery operated mic-to-line amplifier provides gain of up to 84dB, adjustable in 6dB steps. The unit has both a balanced XLR mic level input and a mini-jack input for a high level, high impedance source. The output is transformer balanced and appears on both an XLR connector and a set of spring contact binding posts. A very smooth switchable peak limiter and belt clip are included in this rugged, dependable, and reliable unit. Powered by a single 9 volt battery.

**FP11** 60SHFP11 MFR LIST \$290.00

Call Bradley for a current price quotation.

### Shure FP32 Stereo Mixer

Three mic/line channels with center-detented pan pots provide true stereo mixing capability. A concentric, clutched master stereo gain control is also provided. Field users will appreciate its built-in slate mic and tone feature, plus built-in simplex or AB phantom powering. Two illuminated VU meters plus battery check switch are provided, along with carry case and shoulder strap.

**FP32** 60SHFP32 MFR LIST \$1495.00

Call Bradley for a current price quotation.



### Shure FP31 Compact Mixer

This innovative mixer from Shure is one of a kind. Weighing only 2.2 pounds, it packs three mic/line input channels with low-cut filters, a switchable limiter, two tape outputs, and two headphone outputs into an efficient, compact package. A rugged nylon carrying case is included which allows easy access to every mixer function, while allowing you to piggyback the FP31 on your VCR or other equipment. VU meter, battery indicator, meter lamp, phantom power, and headphone volume control round out this incredible mixer.

**FP31** 60SHFP31 MFR LIST \$1095.00

Call Bradley for a current price quotation.

### Electro-Voice ELX-1R Mixer

The ELX-1R mixer is a compact, high-performance audio mixer designed for professional applications where clean audio and reliable operation are important. Extensive RF filtering circuitry and shielding allow use in almost any environment, and input/output circuitry has been optimized to perform with flatter response and far less distortion than what you might expect from such a small, inexpensive mixer. Power can be either AC or external DC (auto switching), with an indicator to show power status. A built-in oscillator helps with level calibration, and a ten segment three color PPD LED bar graph meter shows peak output level and clipping. A simple internal modification will alter the meter to VU operation. A switchable limiter will keep output signals consistent, and it lights an LED to show limiting activity. All four input channels will take a mic or line level signal and have switchable phantom power. Each of the four channels also has a low cut



filter, gain control, and clipping indicator. Outputs are transformer isolated and can be switched from mic to line level. Main input and output connectors are XLR, though the unit also provides a +4dBm output on binding posts. Stacking inputs and outputs are on 1/4" phone jacks. The ELX-1R mounts in a single rack space.

**ELX-1R** 60ELELX1R MFR LIST \$595.00

Call Bradley for a current price quotation.

### U.S. Audio MIX-5 Mixer

There is always a need for a convenient, quality small mixer. U.S. Audio's MIX-5 fits the bill perfectly as a single space, rack mountable five input mixer available in mono and stereo output versions. The first four inputs offer balanced XLR microphone and high impedance 1/4" TS line level connectors, and a stereo auxiliary input (summed on the mono version) is in the last position. Includes a ten segment LED level indicator.



**Mono output** 60WHMIX5 MFR LIST \$399.00

**Stereo output** 60WHMIX5S MFR LIST \$499.00

Call Bradley for a current price quotation.





## Telfax GX Series Remote Mixers

These mixers are loaded with features to make your next remote easier and better sounding. All models measure only 6.1" x 9.4" x 1.5" and weigh three pounds or less. They feature a 10 element, LED bar graph VU/Peak indicator, color coded control knobs, output limiter, an auxiliary mic/line output, test tone oscillator, a radio monitor input, and bass boost circuitry. Both tone and pulse dialing are offered. An 8 pin DIN jack provides for interfacing frequency extenders or other processing, as well as a line level (up to +4dBm) output and external input to the headphone amp. The high capacity NiCad batteries charge in 2½ hours for up to 10 hours of use.

The basic Model GX-300 has three active balanced mic inputs, three headphone jacks, and a transformer balanced auxiliary input. The Model GX-400 adds a fourth mic input and headphone output, a second auxiliary input, and its fourth channel includes a cue circuit. The deluxe Model GX-440 adds two phone line capability. This second line can be used to receive closed-circuit cues from the studio or to feed a second station or backup phone line. The GX-440 also has a versatile up-down event timer with large LCD display.



"Game of the Week"  
Package

<b>GX-300</b>	60TFGX300	MFR LIST	<b>\$950.00</b>
<b>GX-400</b>	60TFGX400	MFR LIST	<b>\$1050.00</b>
<b>GX-440</b>	60TFGX440	MFR LIST	<b>\$1195.00</b>

Call Bradley for a current price quotation.

## Telfax "Game of the Week" Packages

(above right) Select either the Telfax GX-300 or GX-400 remote mixer and Bradley will package it with two AKG Q-34 headsets with connectors at a very special price.

Valued at \$1389.00	<b>Package 9309 with GX-300 \$1199.00</b>
Valued at \$1489.00	<b>Package 9310 with GX-400 \$1296.00</b>

## Telfax "Championship Series" Packages

(right) These deluxe systems offer your choice of the Telfax GX-400 or GX-440 remote mixer, two pairs of Shure SM2 headsets with connectors, and a large Porta-Brace run bag. Of course, we will give you a great deal on a package you design, too.

Valued at \$1729.00	<b>Package 9311 with GX-400 \$1430.00</b>
Valued at \$1885.00	<b>Package 9312 with GX-440 \$1599.00</b>



"Championship  
Series" Package

## Zercom MAX-Z II Remote Console

MAX-Z II is an elegant unit for remote broadcast situations. Its basic features include two mic/line inputs (one switchable to cue), plus 1/8" tape input, two headset outputs, and 24 hours continuous duty on one battery charge. Front panel indicators display battery and AC status, power on, line active, cue active, and VU indications. A tone/pulse touch pad features last number recall. Weighing only 6 pounds, this compact unit comes complete with carrying case so it is road-ready for your remote requirements.

<b>MAX-Z II</b>	60ZEMAXZII	MFR LIST	<b>\$600.00</b>
-----------------	------------	----------	-----------------

Also available:

**MAX-Z** includes four mic/line inputs with front panel level controls and rear panel trim pots, clock with set controls, and timer. Buttons are provided for channels 3 and 4 which divert audio to the cue buss for "spotters" or other cueing needs. The complete MAX-Z system includes a custom carrying case, built-in rechargeable battery, and 110/220VAC operation. Size: 13" x 17" x 5"; weight: 15 lbs.

<b>MAX-Z</b>	60ZEMAXZ	MFR LIST	<b>\$1095.00</b>
--------------	----------	----------	------------------

Call Bradley for a current price quotation.

**Special  
Zercom  
"Game of  
the Week"  
Packages**



Get a Zercom remote console with carrying case and two Beyer DT109 headsets with straight cables and connectors at a very special price. Put together your own combination by calling or faxing us today.

Valued at \$1156.00	<b>Max-Z II Package 9313</b>	<b>\$949.00</b>
Valued at \$1652.00	<b>Max-Z Package 9314</b>	<b>\$1397.00</b>



### ATI PB2X8 Press Box

This combination mic/line mixer and audio distribution amp helps you eliminate the forest of microphones that are crowding your podium. The two balanced XLR inputs have 48VDC phantom power available. The inputs may be mixed and distributed to the eight line outputs. Each output appears on a +4dBm XLR jack. Half of the outputs are also available on a balanced/unbalanced 1/4" TRS jack at -10dBu, while the other half appears on a 1/8" mini TRS. Other features include a calibrated test tone oscillator, front panel headphone jack, switchable low cut mic input filters, and LED VU meter that can display any input or output. The PB2X8 has headroom up to +24dBm in and out, 0.1% THD, and ±0.25dB response, 20Hz to 20kHz.

**PB2X8**                      60AIPB2X8                      MFR LIST                      **\$1295.00**



**Accessory:**  
**Rack mount kit**                      60AI20021                      MFR LIST                      **\$20.00**

Call Bradley for a current price quotation.

### Whirlwind Medusa Press Boxes

Press conferences require a single audio source with multiple feeds so that each journalist can record the proceedings independently. These passive press boxes take a single incoming line-level signal and provide multiple low-Z output feeds from it. Designed to hold up under severe treatment, their cold-rolled steel boxes house state-of-the-art Whirlwind transformers and components which ensure flawless performance year after year.

**6 Channel**                      61WHPB06                      **\$180.00**  
**12 Channel**                      61WHPB12                      **\$312.00**  
**16 Channel**                      61WHPB16                      **\$442.00**  
**24 Channel**                      61WHPB24                      **\$655.00**



### Whirlwind Presspower Active Press Box

This innovative press distribution box has presidential features at a school board price. All inputs and outputs are transformer isolated and appear on XLR connectors. Both inputs accept mic or line levels and have low cut filters. A VU meter and a headphone jack with volume control allow easy monitoring of the input level. A total of 16 outputs are provided, so you are well prepared for the crowd. Twelve outputs are mic level fixed at -50dB, available on XLR or 1/8" connectors, two are line level fixed at 0dB, and two are line level with individual level controls. The variable outputs also appear on 1/4" TRS connectors. A 1kHz tone can be sent to all outputs so everyone can set their levels properly. This press box

can be powered by four 9 volt batteries or AC. It is supplied with a carrying case or it may be rack mounted. With the Whirlwind Active Press Box, you can get your favorite politician out from behind a forest of microphones so you can look him/her right in the eyes.



**Presspower**                      61WHPP                      **\$1295.00**

### Cellabs Linejack II

Remote broadcasts from ANYWHERE are as simple as having a cellular phone. With the Linejack II Cellular Broadcast Interface, you can use your choice of mixers, microphones, and tape machines.



A transformer isolated XLR input, switchable between line (0dB) and mic (-50dB) is provided, as is a transformer isolated XLR output. A special jack lets you plug in an external tuner to monitor your broadcast, sending the output to the provided headphone jack. The Linejack II also gives you trim pots for input and output, and a switch to select between the cellular handset or the unit (cellular keypad is always active for dial-up). With Cellabs interfaces, you can easily create your own remote solutions using a cellular phone as your two-way link.

A cellular phone adapter cable, available for most cellular phones, is required at extra cost.

**Linejack II**                      60CZLJ                      MFR LIST                      **\$245.00**

Call Bradley for a current price quotation.

### Cellabs Datajack

Imagine the power of being able to send a fax or plug your laptop computer's modem into your cellular phone.



Cellabs' Datajack lets you do all of these. A standard RJ-11C telephone jack means compatibility with all standard fax machines and modems. A cellular phone adapter cable, available for most cellular phones, is required at extra cost.

**Datajack**                      60CZDJ                      MFR LIST                      **\$144.00**

Call Bradley for a current price quotation.



## Comrex Single and Dual Line Frequency Extenders

The first name that comes to mind when you think of telephone line frequency extension is Comrex. After all, they invented the technique back in 1976. Frequency extension is an encode/decode system that upgrades telephone lines to broadcast quality. One line systems encode the audio by shifting all frequencies up by 250Hz. At the decode end, frequencies are downshifted 250Hz to restore 2 1/2 octaves of program energy to the low end. In the two line system, 2500 to 5000Hz audio is shifted to the passbands of the second phone line and then restored at the decoder. The result is a full 5kHz of program audio.

Single line encoding is accomplished with either the LX-T Basic extender or the PLXmicro portable extender. The LX-T includes a built-in coupler for direct connection to the phone line. The PLXmicro is battery operated and connects to standard dial lines and to cellular telephones with the Cellabs Linejack II. At the studio end, use the LX-R decoder.

The compact 2XP two line encoder includes couplers for both program lines and a communications line. The 2XR two line decoder requires either two couplers or the 2XL auto leveler for connection to phone lines.

<b>LXT</b> one line encoder	60CCLXT	MFR LIST	\$750.00
<b>PLXmicro</b> portable one line encoder	60CCPLX	MFR LIST	\$1450.00
<b>LXR</b> one line decoder	60CCLXR	MFR LIST	\$750.00
<b>2XP</b> two line encoder	60CC2XP	MFR LIST	\$3500.00
<b>2XR</b> two line decoder	60CC2XR	MFR LIST	\$3000.00



**Accessories:**

<b>Rack mount</b> for LXT or LXR	60CCRA	MFR LIST	\$40.00
<b>AC adapter</b> for PLXmicro	60CCPLXAC	MFR LIST	\$85.00
<b>Case</b> for 2XP/3XP	60CC2XP	MFR LIST	\$175.00
<b>2XL Auto Leveler</b> for 2XR.			
Includes two built-in, auto-answer couplers. Matches the two telephone lines to equal levels when the test tone is sent from the 2XP.			
	60CC2XL	MFR LIST	\$1950.00

Call Bradley for a current price quotation.

## Comrex Multiline Frequency Extender System

When it comes to remotes by telephone, it doesn't get any better than this. The system consists of the 3XP encoder and 3XR decoder and provides one line (50Hz to 3kHz), two line (50Hz to 5kHz), and three line (50Hz to 8kHz) operation. Comrex's proven noise reduction and automatic equalization and level adjustment assure top quality sound. Dialing and set up can be completely automatic. Audio processing is in real-time, so there is no delay when listening to program sent back to the remote site.

<b>3XP encoder</b>	60CC3XP	MFR LIST	\$5000.00
<b>3XR decoder</b>	60CC3XR	MFR LIST	\$4000.00

**Accessory:**

<b>Travel case</b> for 3XP	60CCXPC	MFR LIST	\$175.00
----------------------------	---------	----------	----------

Call Bradley for a current price quotation.



## Gentner EFT Series Frequency Extenders

Those of you who enjoy the sport and challenge of getting Telco to install a loop may find the EFT series useful. The other 99% of us will find it essential. The EFT encoding and processing systems can produce very respectable remote quality using a single dial-up phone line. Using a 250Hz frequency shifting scheme, low frequency response for the system is typically good within 0.5dB all the way down to 50Hz. This restoration of low-frequency response imparts a "warm" and natural character to the audio. Hum and noise, generally added to the phone transmission in the lower frequencies, all but vanish when the signal is decoded.

The EFT's onboard Apex enhancement convincingly simulates much of the high frequency information lost in the circuit. Units can be set up for single or bidirectional frequency extension. Each unit provides both encoding and decoding functions and a pair of units is required for operation.

Three models are offered. The basic EFT-100 requires the use of a telephone hybrid to properly couple to the phone line. The EFT-900A includes the required hybrid and adds a front panel headphone jack for monitoring. The EFT-1000A adds auto-answer and auto-disconnect features. A DTMF tone may be used to



have EFT-1000A units "handshake" to ensure correct encoding/decoding status. EFT models are compatible, so you can use an EFT-100 at the studio where you already have a hybrid and take one of the other models into the field.

<b>EFT100</b>	60GEEFT100	MFR LIST	\$649.00
<b>EFT900A</b>	60GEEFT900	MFR LIST	\$939.00
<b>EFT1000A</b>	60GEEFT1000	MFR LIST	\$1469.00

Call Bradley for a current price quotation.



## Comrex Digital Audio Codec

The DXP and DXR are digital audio compression devices designed for use by broadcasters to transmit high quality audio via Switched 56kbps and 64kbps data services, which are widely available both domestically and internationally. DSP technology is employed to obtain wider bandwidth than might normally be available from this digital service. The DXP is a portable unit with built-in AC supply, headphone output and switch selectable mic/line input. The DXR is a rack mount unit with balanced line level input and output. Both units provide indication of proper input levels and sync status. Both units provide a low cost alternative to satellite feeds or dedicated circuits. Digital services can be used for network distribution, studio to studio links and STL applications. Remote broadcast operation is enhanced with the near perfect clarity of the signal, and full two way operation over a single circuit. A service unit or terminal adapter is needed to interface DX codecs to the data network. (See INC product line).

<b>Comrex DXP</b>	60CCDXP	<i>MFR LIST</i>	<b>\$2395.00</b>
<b>Comrex DXR</b>	60CCDXR	<i>MFR LIST</i>	<b>\$1995.00</b>



Call Bradley for a current price quotation.

## INC Switched 56 kbps CSU/DSU Products

Switched 56 Digital Services are rapidly becoming the standard for transmission of point-to-point audio for broadcast, replacing traditionally used analog audio services. There are several reasons for this change. Switched 56 offers 7.5 kHz bidirectional simultaneous audio capability, when used with Comrex DXP/DXR codecs. Bidirectional capability eliminates the need for separate cueing facilities, and network use costs are based on per-use charges, once the initial service connection to your local CO has been made. Switched 56 service is available in over 97% of the United States, and also internationally via all major inter-exchange carriers (AT&T, MCI, Sprint, etc.).

Integrated Network Corporation is the leader in SW56 interconnect products for the data communication and audio industries. With a full line of compatible CSU/DSU products, INC can assist the switched 56 user with interface products which are fully interoperable across the switched digital network. Each INC CSU/DSU offers full diagnostic and control capability, full keypads and LCD display for easy control of call and network status, and end-to-end test capability of any two units, regardless of intermixed two and four wire switched service.

Bradley and INC offer full assistance with the inception and maintenance of your switched 56 application. We can provide assistance and contact personnel within your local telco to acquire and connect to the switched 56 service offered in your area.

*Products listed are in desktop format. Each is also available in single and double rack mount format. Contact your Bradley sales professional for configuration and application assistance.*



**CM1056S CSU/DSU:** Entry level unit, single network port for either switched or dedicated service, four wire interconnect  
 60NCCM1056S *MFR LIST* **\$1095.00**

**CM1056 CSU/DSU:** Two Network ports, one switched, one dedicated, with built in A/B switch Four Wire interconnect.  
 60NCCM1056 *MFR LIST* **\$1950.00**

**CM1056DP CSU/DSU:** For two-wire Switched 56 Digital Service.  
 60NCCM1056DP *MFR LIST* **\$1395.00**

Call Bradley for a current price quotation.

## Gentner Microtel

At one time or another, most broadcasters have needed something like this, but have been forced to design and build their own because nobody manufactured one. Now, at a very reasonable cost, Gentner does the work for you. This battery operated interface system replaces a conventional telephone handset via standard modular connectors and turns your telephone into a complete remote mixer. Inputs are provided for a mic (XLR) and an aux (mini). An additional input allows you to feed the headphone buss with IFB or air monitor. Outputs are provided for headset (1/4" TRS) and high-level (mini), as well as an aux feed jack for tape machines or dedicated loops.

**Microtel 60GEMICRO** *MFR LIST* **\$259.00**

**Accessory:**  
**AC adapter. 60GEXFMR** *MFR LIST* **\$29.00**

Call Bradley for a current price quotation.



**Sound America Voice-Act V • Sound America R/SVP • Shure 50AC Coupler**

**Voice-Act V** makes it possible to transmit any electronic audio material source by telephone. This device screws in place of your phone transmitter, and doesn't interfere with its normal phone operations. The Voice Act V requires no batteries since it operates from the phone line. A two position mike sensitivity switch, and a mini-jack input for a tape recorder allow you to feed just the tape or a mix of the tape and your voice.



<b>For GTE phones</b>	60SAVAGTE	<b>\$99.95</b>
<b>For Western Electric phones</b>	60SAVAWE	<b>\$94.95</b>
<b>Accessories:</b>		
<b>Carry case</b>	60SAVACC	<b>\$9.95</b>
<b>Patch cord to connect tape recorder. 6'</b>	60SAVAPC	<b>\$3.50</b>

**R/SVP** (Record or Send Verywell Phone) is a standard 2500 Series Touchtone phone with a built in audio coupler. The panel provided on the phone base has both send and receive mini-jacks. A dual mic sensitivity switch also allows the mic to be muted while feeding a tape, and voice through the phone receiver can be mixed with the tape source.

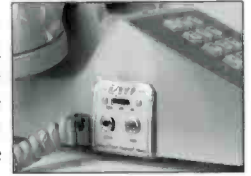

**R/SVP** 60SARSVP **\$139.00**

**Shure 50AC** is designed to acoustically couple the output of your tape recorder to a telephone handset transmitter in situations where hard wiring is not possible. A strap assembly holds the 50AC in place on any telephone. Its rubber case forms an acoustic seal which blocks external noises. The 50AC also doubles as a tape recorder mic, with frequency response approximating that of a telephone.



**50AC** 60SH50AC **\$47.00**

**Excalibur HC-1 Handi-Coupler**

The HC-1 Handi-Coupler gives you the simplest, quickest, most convenient way to connect audio to a telephone. The HC-1 connects in series with the handset of any telephone using modular connectors. Since a connection to the telephone line is not required, the HC-1 can be used with almost any telephone, single or multi-line, modern electronic or older key systems. Pressing the front panel button disconnects the handset and connects the external audio in/out jacks to the telephone. Releasing the button reconnects the handset, allowing normal use of the phone. External audio is connected via separate in and out jacks. Both inputs and outputs are TRS jacks wired so that you may connect either balanced or unbalanced connectors into them.

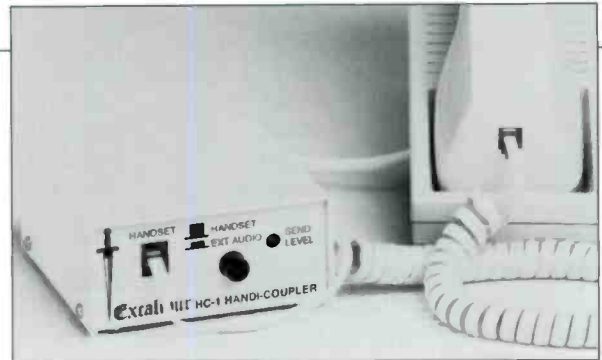

The Handi-Coupler is ideal for use in many locations around the station: on-air, production, the newsroom, the sales office, etc. Its low price lets you put an HC-1 everywhere one is needed.

**HC-1** 60EXHC1 **\$99.00**

**Porta Brace Run Bags**

When you need to grab your gear and run, you need the Run Bag from Porta-Brace. Compared with the bag you are using now, the Run Bag holds more, is much sturdier, and can be loaded in a variety of practical ways without dumping one thing on top of another. It's made from rugged blue Cordura with leather handles and shoulder strap. The Run Bag has just enough foam padding to keep its shape and protect your gear while remaining flexible. The full length zipper allows the bag to open flat. The main compartment has two dividers allowing you to create up to three partitions. The main compartment is approximately 7" wide and 9½" high, and three lengths are available. Zippered side compartments and a slip pocket add even more convenient storage.



<b>18" length</b>	60PBRB1	<i>MFR LIST</i>	<b>\$125.00</b>
<b>21" length</b>	60PBRB2	<i>MFR LIST</i>	<b>\$130.00</b>
<b>25" length</b>	60PBRB3	<i>MFR LIST</i>	<b>\$135.00</b>

Contact your Bradley professional for pricing and information on the full line of Porta-Brace video and audio cases for field production.

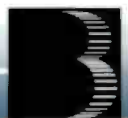

### SKB Rack Mount Cases

Constructed of polyethylene with welded frames, these racks are extremely durable with less than half the weight of comparable wooden racks. The draw-tight latch front and rear covers are gasket sealed to keep out moisture and dirt. Structural rigidity is built-in, so that your equipment takes less abuse in travel. These racks meet Airline Transport Association (ATA) specs and are manufactured in the USA by SKB. Bradley purchased a large quantity and is passing the savings along to you.

Rack mount cases have removable front and rear covers and front mounting rails. Cases have two carrying handles and stack.

<b>2 space</b>	77SK192	<b>\$75.00</b>	<b>8 space</b>	77SK198	<b>\$120.00</b>
<b>4 space</b>	77SK194	<b>\$85.00</b>	<b>10 space</b>	77SK1910	<b>\$135.00</b>
<b>6 space</b>	77SK196	<b>\$95.00</b>	<b>12 space</b>	77SK1912	<b>\$150.00</b>

**Also available:**

Need a case to stash those odds and ends? The SBK-1713 is the answer. It offers the same rugged construction, but is carried brief-case style. Top lid is hinged at the back. 17" X 13" x 12".



**Utility case**                      77SK1713                      **\$ 69.00**

### Hybrid Rack Bags

Hybrid Rack Bags make carrying rack mounted equipment a breeze. Just throw one over your shoulder and you're off! Constructed of nylon Cordura covered 1/4" plywood rackshell with tapped rails for mounting equipment. Foam lined for shock absorption. Standard 19" rack width.

Height	Depth	Item #	Price	Depth	Item #	Price
<b>1 space</b>	14"	70HY114	<b>\$82.00</b>	18"	70HY118	<b>\$89.00</b>
<b>2 space</b>	14"	70HY214	<b>\$87.00</b>	18"	70HY218	<b>\$96.00</b>
<b>3 space</b>	14"	70HY314	<b>\$93.00</b>	18"	70HY318	<b>\$102.00</b>
<b>4 space</b>	14"	70HY414	<b>\$96.00</b>	18"	70HY418	<b>\$108.00</b>



### Anvil Equipment and Rack Mount Cases

Bradley and Anvil can provide you with rugged, dependable protection for your recorders, mixers, cameras, A/V gear, and everything else you must transport. When you are shipping equipment or checking it as baggage, Anvil ATA cases are your best choice. Lite-Line cases are about one third lighter than ATA and are an economical alternative for gear you transport yourself.

Anvil has templates for thousands of pieces of equipment and custom case requirements can be quoted from your faxed drawing.

Several styles of ATA approved cases are available for your rack mounting equipment. In addition to the styles listed below, cases can be built to any depth and can include rear rack rails, several styles of casters, locking hasps, stacking corners, and other options.

Standard cases are 14" or 18" front to back rackable depth, and lids leave 2" of additional interior room. Available in 1/4", 3/8", and 1/2" construction. 14" deep racks are available in sizes up to 17 spaces, 18" deep up to 27 spaces.

Shock mounted cases have a 1/4" thick shell surrounded by 2" of foam and

can be made up to 27 spaces tall. The outer shell can be 1/4", 3/8", or 1/2" construction. 18" rackable depth; 25" with lids.

AIR (Anvil Isolated Racks) use elastomeric shock isolators to control impact and vibration. They are 30% lighter than conventional foam isolated racks and offer maximum protection for your most delicate equipment. Front and rear rack rails are provided. Available with 1/2" or 3/8" outer shell and 18" or 24" rackable depth.

Anvil cases are provided in blue unless one of the dozens of available colors is specified.

**Accessories:**

<b>Heavy duty casters</b>	77ANHDC	<b>\$99.00</b>
<b>H. D. casters w/2-locking</b>	77ANHDC2	<b>\$129.00</b>
<b>Rear rack rails</b>	77ANRR	<b>\$2.25 (per rack space)</b>
<b>Hasp/Twist-Latch</b> to replace standard Twist-Latch. Allows use of padlock.		
Four recommended per case.	77ANTLHL	<b>\$20.00 ea.</b>

Size	Shallow case 14" deep, 1/4" shell	Standard case 18" deep, 1/4" shell	Shock Mounted 18" deep, 1/4" outer shell	AIR 3/8" inner shell, 18" depth
<b>2 Space (3 1/2")</b> .....	77AN021414 ..... <b>\$218.00</b>	Not available.....	77ANSM021814 .... <b>\$392.00</b>	Not available
<b>4 Space (7")</b> .....	77AN041414 ..... <b>\$236.00</b>	77AN041814 .... <b>\$306.00</b>	77ANSM041814 .... <b>\$412.00</b>	Not available
<b>6 Space (10 1/2")</b> .....	77AN061414 ..... <b>\$247.00</b>	77AN061814 .... <b>\$319.00</b>	77ANSM061814 .... <b>\$430.00</b>	Not available
<b>8 Space (14")</b> .....	77AN081414 ..... <b>\$258.00</b>	77AN081814 .... <b>\$333.00</b>	77ANSM081814 .... <b>\$449.00</b>	77ANAIR81838 ..... <b>\$685.00</b>
<b>10 Space (17 1/2")</b> .....	77AN101414 ..... <b>\$269.00</b>	77AN101814 .... <b>\$346.00</b>	77ANSM101814 .... <b>\$468.00</b>	77ANAIR101838 ..... <b>\$696.00</b>
<b>12 Space (21")</b> .....	77AN121414 ..... <b>\$280.00</b>	77AN121814 .... <b>\$359.00</b>	77ANSM121814 .... <b>\$487.00</b>	77ANAIR121838 ..... <b>\$709.00</b>
<b>14 Space (24 1/2")</b> .....	77AN141414 ..... <b>\$303.00</b>	77AN141814 .... <b>\$387.00</b>	77ANSM141814 .... <b>\$510.00</b>	Not available
<b>16 Space (28")</b> .....	77AN161414 ..... <b>\$314.00</b>	77AN161814 .... <b>\$402.00</b>	77ANSM161814 .... <b>\$529.00</b>	Not available



**Headsets**

**(1) Sennheiser HMD 224X**

The HMD 224X provides extended headphone frequency response (16Hz to 20kHz) and a shock-mounted super-cardioid microphone in a very high quality package.

Circumaural, air filled, double layered cushions provide isolation and comfort for the wearer. The microphone's pattern is tailored so that it provides the best response when offset to the side of the mouth, and results in one of the most natural sounding headset mics available. Extremely rugged, the HMD 224X weighs under one pound.

60SNHMD224 \$245.00

**(2) Shure SM2**

The SM2 is loaded with features that make it the ideal choice for professional use. The patented metal boom is designed for total flexibility in mic placement and adjustments for right or left side use. This consistent mouth-to-mic positioning, coupled with the cardioid mic's specially tailored pattern and frequency response, ensures accurate voice reproduction and maximum voice isolation. The rugged metal frame will withstand many seasons of heavy use, and the unit weighs less than 11 ounces. The cable is detachable for quick and easy changes between mono, stereo, or split feed headphone functions. Supplied with cable and windscreen.

60SHSM2 \$165.00

**(3) Beyer DT 109 and DT 108**

Beyer dynamic moving coil microphone/moving coil headphone combinations are especially suited to both remote and studio use. Lightweight and comfortable, the headphone transducer features extended response and is virtually impossible to overload. The wide frequency response of the noise cancelling mic results in a rich, yet clear, transmission. Rugged construction. Headphones are 400 ohms, mic is 200 ohms, with other impedances available. Models listed are black with 200 ohm headphone and 400 ohm mic; other impedances available at the same price. Straight cable included; coiled cable available at an extra cost.

**DT 109** 60BE422045 \$195.00  
**DT 108** 60BE421790 \$156.00  
**Coiled cable** 60BE198900 \$32.00

**(4) AKG Q34**

This dynamic microphone/headphone from AKG is rugged and comfortable. A noise cancelling close talk microphone is mounted on an extremely flexible arm. A self-adjusting headband and 10 ounce weight make the Q34 a comfortable choice.

60AKQ34 \$145.00

**Please note:**

**All headset cables require user-installed connectors.**



**Most orders for field production are shipped within 24 hours.**

**Light Wave Screens, Mounts & Fishpoles**

Bradley and Light Wave Systems offer you the delightful dilemma of the widest selection



of screens and mounts for your shotgun and field production mics. Super Screens combine superior isolation with thoughtful design for maximum wind attenuation and no loss of midrange frequency response. Use the Super Screen with the Super Mount or the Plus 20 Mount for the very best in mic isolation. Both mounts include a detachable pistol grip. Also available are economical Mini Screens and Mini Mounts, including models for camera mounted mics. Three models of high wind covers are available to provide further protection: the classic Super-Sock, an oversized Super-Sock, and the Windmaster with 3/8" deep fur-like pile.

Light Wave fishpole booms have telescoping cam locks and provisions for internal wiring.

**FP12 fishpole 4' to 12'**  
 60LWFP12 MFR LIST \$195.00  
**FP6 fishpole 28" to 6'**  
 60LWFP6 MFR LIST \$185.00  
**Super-Sock for Super Screen**  
 60LWSSCXXX MFR LIST \$47.00  
**Super-Sock for Mini Screen**  
 60LWMSCXXX MFR LIST \$32.00

Light Wave products are available for over a dozen manufacturer's products. Call Bradley for a current price quotation on the system for your mics.

**Rowi Clamps**

These clamps allow you to attach your microphone to virtually anything! The clamp jaw opens to 1 1/2", and the mic adapter swivels. Our most useful and popular mic accessory.



**Rowi Clamp** 60BBRC \$31.95

**Sennheiser Electret Mic System**

Start with the K3U universal powering module (mercury battery or phantom power), then add the condenser head that is right for your application. Battery life is approximately



600 hours. An LED indicator flashes at turn on to indicate at least 20 hours remaining. The K3U also has a three position roll-off switch (flat, -7dB at 50Hz, -20dB at 50Hz). The ME80 and ME88 are both

pressure-gradient type microphones. The ME80 acts like a shotgun above 3kHz, cardioid below 3kHz. The ME88 includes foam windscreen.

**K3U** powering module 60SNK3U \$209.00  
**ME20** omni; 50Hz to 15kHz. 60SNME20 \$109.00  
**ME40** cardioid; 80Hz to 15kHz 60SNME40 \$149.00  
**ME80** super-cardioid; 40Hz to 15kHz. 60SNME80 \$215.00  
**ME88** shotgun; 40Hz to 15kHz 60SNME88 \$276.00

**Accessories:**

**Windscreen** for ME80. 60SNMZ415 \$42.00  
**Camera mount** for shoe-type mounts. 60SNMZG802 \$68.00  
**Replacement battery** for K3U 61SNPX23 \$4.00

Call for pricing on your complete system.

**Stewart BPS-1 Battery Phantom Supply**

This single channel, 48 volt phantom power supply is rated for up to 200 hours using a pair of 9 volt alkaline batteries. It can deliver up to 4.5 mA at 48VDC, and has locking XLR connectors. The chassis is all aluminum and the BPS-1 comes with a detachable belt clip.



**BPS-1** 60SEBPS1 \$95.00



## Stereo Microphones

(1) The AT825 from Audio-Technica has two wide range, closely matched condenser elements in an X/Y pattern. The elements are shock mounted to reduce handling noise. The AT825 is mono compatible and produces spatially accurate stereo recordings. Internally battery powered using an "AA" cell, or may be phantom powered. Switchable low cut filter and windscreen included. Cable termination is dual XLR connectors.

**AT825** 60AT825 MFR LIST \$399.00

### Also Available:

AT822 stereo mic is similar to the AT825, but is designed for battery use only and outputs are unbalanced. Provided with two cables: One terminating with a 1/8" stereo mini-plug and the other with dual 1/8" mono mini plugs with 1/4" phone plug adapters. The AT822 is an ideal match for your portable DAT recorder. Why gather sound in mono, when the AT822 makes stereo so affordable?

**AT822** 60AT822 MFR LIST \$299.00

(2) Sony's MS stereo ECM-MS5 packs an unbelievable amount of performance to handle your every recording requirement. It features three capsule mic elements, assuring superior transient response for clean, uncolored sound. With the adjustable directivity feature, you can select from 6 click stop positions ranging from 0° for mono recording to 127° for a rich, well balanced stereo atmosphere. This mic is at home indoors and out in its sturdy aluminum housing. The ECM-MS5 has switchable low cut filters, and may be powered by phantom power or, with the optional DC-MS5, by battery.

**ECM-MS5** 60SOECMMS5 MFR LIST \$1260.00

### Accessories:

**DC-MS5** uses an "AA" battery to power the ECM-MS5. Short and slim, this unit is supplied with a flexible belt holder. 20 hours of consecutive operation can be obtained, and an LED shows battery condition when the power is turned on.

**DC-MS5** 60SODCMS5 MFR LIST \$319.00

(3) Shure's VP88, an advanced single point stereo condenser mic, recreates the sonic environment with extraordinary fidelity and meets Shure's legendary standards for ruggedness and reliability. The capsules are in a Mid-Side configuration, and the VP88 offers three switch selectable stereo modes or direct M-S output. Mic elements, stereo matrix, and powering electronics are all in an easy to handle component. Powering is by internal battery or external phantom. Other features include a low frequency roll-off, built-in pop filter, foam windscreen, and 30" Y-cable terminating on two color coded XLR cables. Whether you are just beginning to look at stereo miking, or you want to take your stereo to the next level, consider the advantages of the Shure VP88.

**VP-88** 60SHVP88 MFR LIST \$995.00

Call Bradley for a current price quotation.



## Shotgun Microphones

Let Bradley give you the longest arm in the crowd with a shotgun mic. We've pictured the models our customers tell us provide them with quality and value. Shotgun mics are for applications where close miking is impossible, and most can be hand held, camera or boom mounted, or operated from a fish-

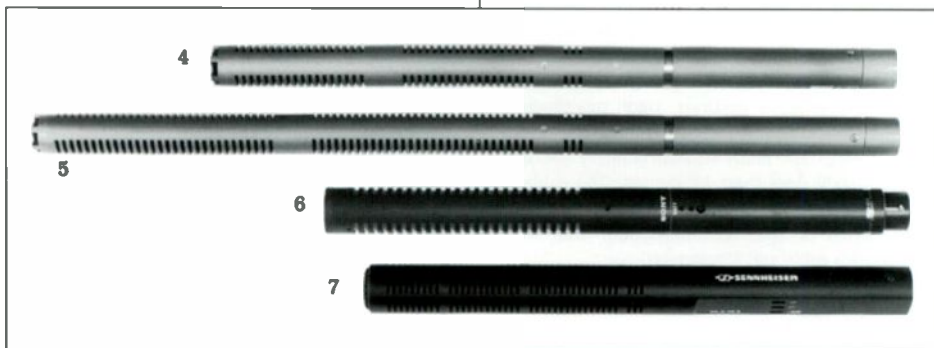

pole. Long shotguns are best used for sound sources at a distance. Short shotguns are recommended when sound sources may be closer and may have a tendency for moving "off-mic."

(4 & 5) At only 9 ounces and 18", the Audio-Technica AT815 won't load you down. It includes a stand clamp, storage case, windscreen, and 16' cable. The AT815a version is powered by a single "AA" cell, while the AT815R uses phantom power systems from 9 to 52 volts.

The AT835A extended-range condenser combines the best attributes of cardioid and shotgun mics. Phantom or internal battery powered, the AT835A combines high sensitivity and flat response. It is just 11" long and comes with the same accessories as the AT815.

**AT815a** battery powered 60AT815 \$214.00  
**AT815R** phantom powered 60AT815R \$275.00  
**AT835A** battery powered 60AT835A \$295.00

(6) The Sony ECM 672 is a light-weight, short electret shotgun mic that doesn't sacrifice audio quality or durability to its economical price. It is designed to be mounted on a portable video camera or can be hand held. The ECM 672 will operate for approximately 3000 hours on an "AA" size cell and can also be 48V phantom powered. A built-in LED indicator shows battery condition. This versatile mic also has a two position low frequency roll-off.

**ECM 672** 60SO672 \$405.00

(7) Sennheiser's RF condenser technology results in microphones with the lowest inherent noise. These mics have fast, distortion-free response to audio transients over an extended frequency range. The MKH 70 long shotgun and MKH 60 short shotgun both offer a switchable low cut filter, presence boost, and input attenuator. The MKH 70 is 16.4" long and weighs 6.3 ounces, and the MKH 60 is 11.2" and weighs 5.25 ounces. Models listed use 48V phantom powering; models using 12 volt AB powering are available at the same price. Sennheiser shotguns fit the bill when you demand the best.

**MKH 70 P48U3** 60SNMKH70 \$1349.00  
**MKH 60 P48U3** 60SNMKH60 \$1150.00

### Also available:

Sennheiser MKH 816 and MKH 416 are in wide use in broadcast, film, and recording. Call or fax for details.

### Accessories:

Lightwave Super Screens and Super Mounts are available for all shotgun mics. Ask your Bradley professional about wind covers, fishpoles, and other accessories to round out your mic package.

### Light Wave Super Screens

**For AT815** 60LWSS815 MFR LIST \$265.00  
**For AT835** 60LWSS835 MFR LIST \$255.00  
**For ECM 672** 60LWSS672 MFR LIST \$245.00  
**For MKH 70** 60LWSS70 MFR LIST \$265.00  
**For MKH 60** 60LWSS60 MFR LIST \$255.00

### Light Wave Super Mount Pistol Grips

**For AT815** 60LWSM815 MFR LIST \$135.00  
**For AT835** 60LWSM835 MFR LIST \$130.00  
**For ECM 672** 60LWSM672 MFR LIST \$140.00  
**For MKH 70** 60LWSM70 MFR LIST \$140.00  
**For MKH 60** 60LWSM60 MFR LIST \$140.00

Mini screens and package discounts are available. Light Wave screens are also available for the shotguns when camera mounted. Call for details and a current price quotation.

**Bradley accepts Visa, Mastercard, and Discover for your convenience.**





## Hand Held Microphones for ENG/EFP

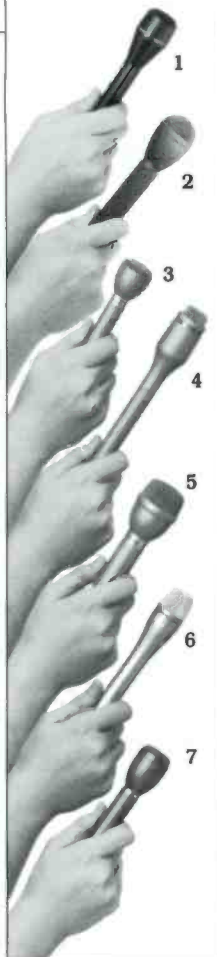

### (1) Shure VP64

The VP64 features a neodymium magnet for an output up to 6dB higher than other omnidirectional mics. It sounds brighter, providing an extra clarity in noisy environments without sounding harsh or hissy. Additionally, an internal shock mount reduces pickup of handling noises. The longer handle on the VP64 provides an interviewer with better reach, and its contemporary styling looks great and is less reflective on camera. Its black polyurethane finish is impervious to scratching and chipping. The VP64 is supplied with a foam windscreen and a stand adapter.

**VP64** 60SHVP64 \$89.00

### (2) Beyer M 58

The M 58 is extremely rugged, and will hold up under heavy field punishment. Its unique low mass diaphragm produces unprecedented intelligibility, even off-axis. Shock mounted for low handling noise, the M 58 has a special non-reflective finish that looks great on camera. The 10" shank is balanced for a positive feel in your hand. Probably our finest hand held omnidirectional mic.

**M 58** 60BEM58 \$166.00

#### Accessories:

**Mic clamp** 61BEMKV8 \$17.95

**Windscreen** 60BEWS58 \$22.98

### (3) Electro-Voice 635A

The most popular mic in broadcast for remote or studio use. Virtually indestructible, the omnidirectional 635A has an 80Hz to 13kHz response. The individual mics are packaged with stand adapter. Save by purchasing the 635A in a six pack without stand adapters.

**635A** 60EL635A \$108.00

**6-pack/635A** 60EL635A6 \$578.00

**Windscreen** 60EL314E \$13.50

### (4) Electro-Voice D056L

This omnidirectional mic is shock mounted to isolate the element from both handling and cable noise. The D056L provides excellent vocal quality. 11 1/2" shank.

**D056L** 60ELD056L \$157.00

**D056 6 1/2" Shank** 60ELD056 \$142.00

**Windscreen for D056L/D056**  
60EL351 \$12.00

### (5) Electro-Voice RE50

The RE50 has the same tailored response and high output of the 635A, and its resilient "mic-within-a-mic" shock mount design achieves a high degree of isolation. The built-in windscreen is a super effective "P-pop" filter. Rugged construction and non-reflective finish.

**RE50** 60ELRE50 \$160.00

**Windscreen** 60EL376 \$18.00

### (6) Shure SM63L

The SM63L is a small, elegant, rugged microphone with output up to 6dB higher than comparable mics. Omnidirectional with extended frequency response, a low frequency roll-off gives a natural sounding pickup. The Shure designed and patented mechano-pneumatic shock mount isolation cuts handling noise and an effective hum-bucking coil rejects interference from strong magnetic fields. The SM63L has an integral wind and pop filter and nearly indestructible grille. It has an extended 9 1/8" handle, weighs less than 4 1/2 ounces, and includes a foam windscreen.

**SM63L** 60SHSM63L \$109.00

#### Also available:

**SM63** 5 1/8" handle version.

60SHSM63 \$99.00

### (7) Audio-Technica AT804

The hardened steel grille and die-cast case make the omnidirectional AT804 a great choice for the rough and tumble of field recording. The frequency response is 50Hz to 15kHz and the mic has high sensitivity to match the input of most recorders and mixers. Windscreen, carrying case, and stand adapter are provided.

**AT804** 60AT804 \$69.00

## Hand Held Dynamics-Performance



### (1) Shure SM58-LC

The world standard professional stage microphone. Cardioid pattern with spherical windscreen and fixed bass roll-off to prevent popping or boominess in close-up use. Rugged.

**SM58-LC** 60SH58 MFR LIST \$188.75

#### Also Available:

SM58 version with on-off switch on mic.

60SH58S MFR LIST \$198.50

**Windscreen** available in a variety of colors.

61SHA61WSXX \$5.25

**SM57-LC** 60SH57 MFR LIST \$147.00

**Windscreen** 61SHA2WS \$12.00

### (3) Sennheiser MD 518

Used extensively for vocals, the MD 518 is also suitable for miking saxophones and rack toms. An all-metal basket and nickel body ensure durability. The smooth cardioid pickup and frequency response characteristics make this mic an excellent choice for artists who want the best from their performances.

**MD 518** 60SN518 MFR LIST \$229.00

### (2) Shure SM57-LC

A rugged cardioid mic for hand held use. Presence boost and low end roll-off for excellent voice intelligibility. Finished in non-glare gray enamel for unobtrusive stage or on-camera use.

### (4) Beyer TGX580

The TGX580 is the mic for those demanding performances, stage or studio. Its large, highly sensitive hostaphan diaphragm has the extended frequency curve and fast transient response required for studio-quality accuracy and performance at high-threshold volume levels. Vocalists will like its high gain - before - feedback characteristics. Frequency response: 30Hz-18kHz with a hypercardioid element.

**TGX580** 60BETGX580 MFR LIST \$295.00

Call Bradley for a current price quotation.

**Bradley offers hundreds of microphones and accessories from all major manufacturers. If you don't see what you need, call or fax for assistance. We'll be glad to help.**





**(1) AKG D190E Microphone**

The smooth response of the D190E has a slight midfrequency rise for natural sound. Recommended for vocal and announce use, it has an built-in windscreen and a shock mounted transducer.

**D190E** 60AKD190E *MFR LIST* \$179.00

**(2) Electro-Voice RE27N/D Microphone**

This mic may look familiar, but beneath its satin nickel finish it is unlike any other announce mic you've heard. Using a neodymium alloy magnet and a reinforced diaphragm dome, the RE27N/D cardioid has increased sensitivity, undistorted output at high sound pressure levels, and an extended high frequency response. A hum bucking coil reduces interference from lighting and other sources, while the Variable-D design reduces proximity effect for uniform response. The RE27N/D features two bass roll-off switches, a high frequency boost reduction switch, and an integral shock mount and blast filter. Hear how good your voice can sound.

**RE27N/D** 60ELRE27 *MFR LIST* \$639.00

**Accessory:**

**Shock mount** 60EL309 *MFR LIST* \$100.50

**(3) Audio-Technica ATM-25 Microphone**

Designed primarily for instrument miking, A-T found that this mic sounded great as an announce



Call Bradley for a current price quotation.

mic. The hypercardioid pattern rejects unwanted sounds outside of the pickup pattern and it withstands high sound pressure levels. With a response that enhances both male and female voices, the ATM-25 is a new contender with a moderate price.

**ATM-25** 60ATATM25 *MFR LIST* \$265.00

**(4) Audio Technica ATM-63HE** With a unidirectional, hypercardioid pickup pattern and frequency response of 50Hz-18kHz, the ATM63HE is a good choice for field production and ENG types. Utilizing a high sensitivity neodymium design, the mic provides extremely fast transient response. Enhanced shock mounting consists of a new floating diaphragm and a double-isolated element housing. All this adds up to an extremely low noise, high output microphone.

**ATM 63HE** 60ATM63 *MFR LIST* \$190.00

**(5) Electro-Voice RE20** can be seen in many of America's premier broadcast stations. The reasons are obvious. Performance that rivals the best condenser mics, undistorted output at high SPL, and a carefully tailored response curve make the RE20 a true industry standard.

**RE20** 60ELRE20 *MFR LIST* \$564.00

**Accessories:**

**Shock mount** 60EL309 *MFR LIST* \$100.50

**Windscreen** 60NEWS87 *MFR LIST* \$30.00



**(6) Shure SM-7** is among the finest professional dynamics for voice-over recording in radio and TV work. It features 40Hz to 16kHz response with four selectable response curves, an accurate symmetrical cardioid pattern, and integral air suspension shock mount. Wind, boom, and breath-pop noises are effectively eliminated by its integral foam windscreen.

**SM-7** 60SHSM7 *MFR LIST* \$566.50

**Windscreen** 61SH90A2089 *MFR LIST* \$15.50

**(7) Sennheiser MD441** is often called acoustically transparent and is widely used in the studio and on the road. The super-cardioid pattern prevents leakage and feedback. Ten position bass contour switch and smooth response from 30Hz to 20kHz make the MD441 one of the best dynamic mics available.

**MD441** 60SN441 *MFR LIST* \$695.00

**Windscreen** 61SNMZ441 *MFR LIST* \$35.00

**(8) Sennheiser MD421** is hailed worldwide for its durability and lively sound quality. The dynamic, cardioid element with large diaphragm makes voices "jump right out." The MD421 has a multi-position bass roll-off switch and a smoothly rising response from 30Hz to 17kHz.

**MD421** 60SN421 *MFR LIST* \$469.00

**Accessories:**

**Windscreen** 61SNMZ421 *MFR LIST* \$30.00

**Shock mount** 60SNMZS100 *MFR LIST* \$98.00

**Electro-Voice RE Series**

The Variable-D design of all RE series mics ensures uniform off-axis pickup and eliminates bass-boosting proximity effect.

**(9) RE10** is a moderately priced mic for sound reinforcement, broadcasting, or stage work. Its cardioid pattern provides maximum rejection 150° off-axis for improved directional characteristics. Includes bass roll-off switch. 90Hz to 13kHz.

60ELRE10 \$187.00

**(10) RE11**, electronically similar to the RE10, has a built-in blast filter and Memralflex grille screen.

60ELRE11 \$198.00

**(11) RE15** provides better frequency response (80Hz to 15kHz) and is manufactured to tighter tolerances for situations where closely matched mics are required.

60ELRE15 \$280.00

**(12) RE16**, similar to the RE15 in response, uses a different blast filter, for closest use without "P-Pops." Its rugged, mechanically nested design is highly resistant to damage.

60ELRE16 \$295.00

**(13) RE18** has an integral shock mount for superior hand held performance. This mount also effectively eliminates transmission of stand or lectern noises.

60ELRE18 \$315.00

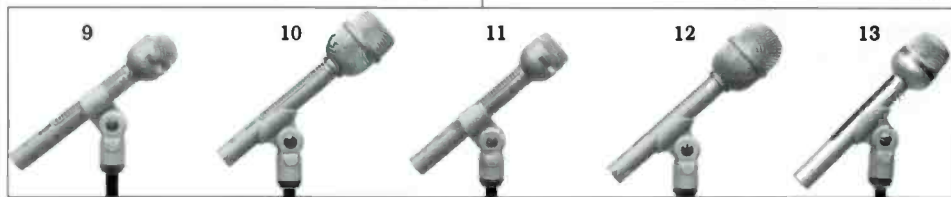

**Accessories:**

**Shock mount clamp** designed to provide isolation for RE series or other 3/4" diameter mics.

**Gray** 60EL313A \$40.50

**Black** 60EL313 \$40.50

**Colored windscreen** for RE11, RE16, or RE50.

Select from black, red, orange, yellow, green, blue, and violet. 60EL379X \$12.00

**Pop filter** for RE18 60EL351 \$12.00

**Windscreen** for RE18 60EL338 \$25.50

**Pop filter** for RE11 and RE16

60EL376 \$18.00

**Windscreen** for RE10 and RE15 mics. Two piece design has zippered rear portion to cover shank of mic. Rear portion can be used on RE11 and RE16.

60EL314 \$27.00

**Security clamp** for all RE series, except RE20.

60EL340 \$28.50

**Replacement clamp** for all RE series mics, except RE20.

60EL311 \$13.50

Call Bradley for information on replacement clamps and all EV accessories.

**Studio Condenser Mics**

**AKG C414B/ULS**

This latest version of one of our most popular mics uses an ultra-linear element for flattest response from 30Hz to 20kHz. This large diaphragm condenser is phantom powered and switchable for four pickup patterns: hypercardioid, cardioid, omni, and bidirectional. The C414B/ULS has a built-in three position attenuator and a selectable bass roll-off. A superior announce mic. Its wide range and very low noise make it the microphone of choice for digital recording.



60AK414 MFR LIST \$1199.00

**Accessory:**

**Elastic suspension system**

60AKH17A MFR LIST \$369.00

Call Bradley for a current price quotation.

**Neumann Condenser Mics**

**Neumann KM 100 System Mics**

The KM 100 output stage operates with the four available mic capsules and a wide variety of accessories. Since the microphone circuitry is entirely in the capsules, they may be placed up to 1000' from the output stage; a real asset in live recording applications. Over two dozen mounts and adapters let you place KM 100 series mics, individually or in stereo pairs, in the exact location you need them. Audio performance is outstanding and particularly suited to digital recording. Dynamic range exceeds 120dB and the mics handle over 138dB SPL.



Listed below are complete systems with capsule and output stage. Your Bradley professional can help you select extra capsules and system components.

- KM 130 Omnidirectional**  
60NEKM130 MFR LIST \$950.00
- KM 140 Cardioid** 60NEKM140 MFR LIST \$950.00
- KM 145 Cardioid w/LF roll-off**  
60NEKM145 MFR LIST \$950.00
- KM 150 Hypercardioid**  
60NEKM150 MFR LIST \$1175.00

Call Bradley for a current price quotation.

(A) U89, a five pattern studio mic, has exceptional frequency response and overload characteristics. Suited both instrumental and vocal applications, it handles sound levels up to 140dB SPL with less than 0.5% distortion with the 6dB attenuator switched in. A high pass filter provides 80Hz or 160Hz rolloff. Requires 48V external power. Includes EA89 shock-mount suspension, windscreens, and 25' cable.

**U89** 60NEU89Z MFR LIST \$2780.00

(B) U87A is the latest version of the recording industry standard. An excellent vocal mic, it includes three separate switches for pattern selection, frequency response, and pressure sensitivity. Requires 48V external power. Includes Z48 shock mount suspension, windscreens, and 25' cable.

**U87A** 60NEU87AZ MFR LIST \$2780.00

(C) TLM-170 microphone is highly recommended for everything from voice narration recording to digital orchestral recording. Its five polar patterns, switchable pad and roll-off provide amazing versatility. Neumann's transformerless TLM circuitry provides a clarity and detail of sound previously unattainable. Select black or satin finish.

**TLM-170** 60NETLM170XX MFR LIST \$2450.00

**Accessories for TLM-170:**

**Elastic shock suspension.**

60NEEA170XX MFR LIST \$285.00

**Windscreens** 60NEWS89 MFR LIST \$28.00

**Audio Technica 4033**

The AT4033 is a cardioid condenser microphone with a frequency response of 30Hz to 20kHz. Powered by an external 48V phantom source, the AT4033 can handle up to 140db SPL, (150db SPL with the switchable 10db pad) without distorting. With a dynamic range of 123db, the mic is ideally suited for digital recording applications. The mic also has an 80Hz hi-pass filter to reduce sensitivity to "popping" in close vocal use. The mic is available in two versions; the 4033/SC includes the AT8430 stand clamp, the 4033/SM includes the AT7441 shock mount. Both mounts are compatible with 5/8"-27 threaded stands.



**AT 4033** 60AT4033 MFR LIST \$699.00

Call Bradley for a current price quotation.

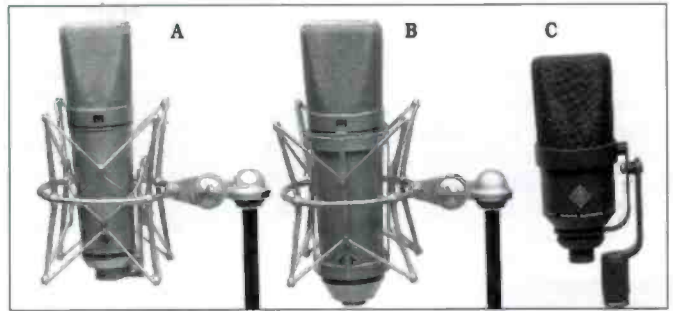

**AKG C1000S**

AKG condenser quality is available in the economical C1000S. Designed for voice and instrument use, it includes a unique pattern-converter that provides either a cardioid or hypercardioid pattern. The C1000S features a rugged steel mesh grill and internal shock mounting of the capsule reduces handling noise. Powering is via an internal 9 volt battery or external phantom power. The C1000S comes packaged with a foam windscreens and stand adapter.



The sound is pure AKG. Some say that when used for speech, the C1000S sounds similar to the C414B/ULS. Let your ears be the judge.

**C1000S** 60AKC1000S MFR LIST \$399.00

Call Bradley for a current price quotation.



**Shure SM81**

The SM81 is a superb unidirectional condenser mic with the ability to withstand rigorous field use. Extremes of temperature, humidity, or physical punishment will not degrade the performance of the SM81. Very low distortion of 0.5% plus 135dB SPL before clipping insure accurate sound reproduction. Built-in 10dB attenuator stretches upper limit to 145dB SPL. Selectable low frequency response curve to compensate for proximity effect or low frequency disturbance. Mic element capsule may be interchanged with the optional omnidirectional capsule.

**SM81** unidirectional. 60SH81 \$299.00

**Accessory:**

**R104A** omnidirectional capsule. 60SHR104A \$125.00

Call Bradley for a current price quotation.



## Lavaliers

### Audio-Technica AT805S

An excellent choice in omnidirectional lavaliers. The high sensitivity electret condenser element has a response from 50Hz to 15kHz. On/off switch. Battery operation.



60AT805S \$65.00

### Also available:

**AT803B** ultra-miniature lavalier. Battery or phantom powered. 60AT803A \$102.00

### Shure SM11

The SM11 is the world's smallest dynamic lavalier mic. Optimized response, natural sound quality plus ruggedness make it a leader. The three mounting options provided are lavalier cord, tie bar, and the tack.



60SH11 \$85.00

### Shure SM-84 and SM-83

Noisy studio and outdoor environments, talk shows, and multi-lavalier formats are situations where the SM-84 is vital. This unidirectional condenser lavalier mic was developed to solve problems of extraneous sound pickup and gain-before-feedback which plague lavalier mics. Shure engineers modified the performance of the widely used SM-83 omnidirectional lavalier by developing a super-cardioid pickup pattern to reject peripheral sounds, while retaining the SM-83's specially tailored response pattern. Includes tie clip, cable, and belt pack powering unit. For many less complex applications, the omnidirectional SM-83 remains an excellent choice.



**SM-84** unidirectional. 60SHSM84 \$209.00  
**SM-83** omnidirectional. 60SHSM83 \$175.00

## Sony Lavaliers

Sony lavaliers provide immunity to external noise and the convenience of operation with "AA" size batteries. The ECM-55 has an omnidirectional pattern for the widest variety of applications.



The ECM-66 has a unidirectional pattern ideal for musical instrument miking. The ECM-77, a mere 1.5 grams, is Sony's smallest lavalier. The ECM-44 is omnidirectional, and makes Sony quality available at an economical price. All versions can be powered with an internal battery or external 48V phantom. Also available are unterminated versions of all mics for use with wireless systems. Matte Black.

**ECM-55** 60SO55B \$229.00  
**ECM-66** 60SO66B \$255.00  
**ECM-77** 60SO77B \$255.00  
**ECM-44** 60SO44B \$135.00

## AKG C407

The C407 Micro Mic is an omnidirectional condenser with a frequency response optimized for speech. It is less than one-third of an inch in diameter, making it one of the smallest lapel mics available. Two versions are available. The standard C407 terminates on an XLR connector for user supplied phantom powering. The C407/B requires the B9 battery power supply. The unique B9 powers two MicroMics and the balance between the two inputs and overall volume are both continuously adjustable. Micro size with macro performance.



**C407** phantom 60AKC407 MFR LIST \$159.00  
**C407/B** battery 60AKC407B MFR LIST \$109.00  
**Accessory:**  
**B9** Battery supply for 1 or 2 C407/B's 60AKB9 MFR LIST \$60.00

Call Bradley for a current price quotation.

## Audio-Technica UniPoint Series

UniPoint microphones have a highly symmetrical cardioid pickup and exceptional off-axis rejection for feedback control. Audio Technica has created a very original set of mounts, goosenecks, hangers, and other accessories which make these little mics very powerful problem solvers. Except as noted all mics can be powered by a single "N" cell or 9-52VDC phantom power.

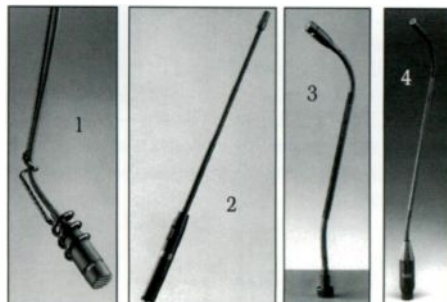

(1) **AT853a** is extremely versatile. It can be hung from its own cable using a very clever plastic coated stainless steel hanger or mounted on an equally ingenious stand adapter. Available in black or white.  
**853a Black** 60AT853 \$175.00  
**853a White** 60AT853W \$199.00

### Also available:

**PM version** of the AT853 has the electronics of the power module conveniently mounted on a single gang electrical plate. 25' cable attached to mic mates with mounting plate. Requires 24-48VDC phantom power.  
**853PMa Black** 60AT853PM \$155.00  
**853PMWa White** 60AT853PMW \$179.00

(2) **AT859b** is a hand held "wand" interview microphone which has a 19" reach.  
 60AT859 \$172.00

(3) **AT857AMa** and **AT857QMa** are mounted on two stage goosenecks. The AM version is designed for mounting onto a mic stand or its own threaded surface adapter. The QM is designed to plug directly into a chassis mounted female XLR connector and operates only on phantom power. Two lengths available.

**857AMa 12 1/4"** 60AT857AM \$209.00  
**857AMLa 19"** 60AT857AML \$219.00  
**857QMa 12 1/4"** 60AT857 \$183.00  
**857QMLa 19"** 60AT857QML \$196.00

(4) **AT839QML** plugs into an XLR jack for instant installation. The dual gooseneck design has an overall length of nearly 19". Requires phantom power.

60AT839QML \$112.00

## Sennheiser MKE-2

The popularity of the MKE-2 is phenomenal. The open, natural sound plus the small size (less than 1/4" diameter, approximately 9/16" long) make the MKE-2 unique. Packaged with a wide variety of clips and windscreens, this mic is powered by the K3U module for battery or phantom power operation. Frequency response 40Hz to 20kHz.

**Black** 60SNMKE23 \$285.00  
**Flesh** 60SNMKE233 \$285.00

### Special:

**MKE-2 mic** and **K3U** powering module combination. Black mic only in combo.  
 60SNMKE23C \$369.00



### Shure Automatic Microphone System

The Shure AMS Automatic Microphone System provides a comprehensive, effective approach to the often aggravating problems of multiple mic installations. Advanced microphone, mixer, and logic technologies allow sound sources to turn on and off quickly, quietly, and automatically. With more than one mic active, the system provides gain compensation to prevent feedback.

Each mic and mixer channel contains logic circuitry, allowing each mic to actuate independently. Furthermore, AMS microphones will turn on only when addressed within a 120° acceptance window. Background or crowd noise, regardless of volume, will not "open up" a microphone. The AMS mixer incorporates individual channel logic controls which provide special functions such as a cough/privacy button, channel priority, zone loudspeaker muting, and chairman muting.

Four styles of AMS mics are available: low profile, gooseneck, probe, and lavalier. Due to the integrated design of AMS, use of non-AMS mics is not appropriate. AMS is ideal in many settings. Churches, courtrooms, broadcasting, teleconferencing, and group meeting places will all benefit from use of AMS.

Call your Bradley professional for full details on all AMS systems and products.

- AMS-8000** eight channel mixer  
60SHAMS8000 MFR LIST \$2850.00
- AMS-22** low profile mic  
60SHAMS22 MFR LIST \$220.00
- AMS-24** gooseneck mic  
60SHAMS24 MFR LIST \$255.00
- AMS-26** probe mic  
60SHAMS26 MFR LIST \$220.00
- AMS-28** lavalier mic  
60SHAMS28 MFR LIST \$245.00

Call Bradley for a current price quotation.



### Special Purpose

#### Audio-Technica AT808G

Looking for a high quality talkback microphone? The AT808G is it! The subcardioid pickup pattern is sensitive to sounds originating in front of the mic, reducing pickup of unwanted noise. Gooseneck allows the mic to be positioned. Response is 200Hz-5kHz. Low-Z XLR male connector on the base of the gooseneck plugs directly into your console.



**AT808G** 60AT808G MFR LIST \$115.00

#### Shure SM Series

This series of head-worn mics is designed for use in sports, news gathering, and intercommunication systems. They offer an excellent solution to the problem of hands-free, close talking vocal pickup.



**SM10A** with mic only 60SH10 \$105.00  
**SM12A** with mic and one earphone 60SH12 \$149.00

### Crown SASS

Crown's Stereo Ambient Sampling System (SASS) is a patented stereo condenser mic using PZM technology. It is a mono compatible, near coincident dual capsule array designed for professional applications.

The SASS will serve as a highly accurate main stereo pair for many recording purposes, and can simplify placement of spot mics. The 125° acceptance angle of each side's capsule picks up ambient reflections from the room, providing an open perspective. The SASS can accurately convey the ambient environment for location recording or synched audio

ambience where the sound must precisely match movements of the screen image. The half-spherical forward pickup of the mic creates convincing environmental recordings and ambient sound tracks with natural placement of sound events.

Accessories included with the SASS are a wind-screen, foam wind protectors, a hand grip, and a swivel mount with several thread adapters.

**SASS** 60CRSASSP MFR LIST \$899.00

Call Bradley for a current price quotation.



### Shock Mounts

(1 & 3) Tensimount "spider" shock mounts come in three sizes to fit most microphones. Requires use of stand adapter. Limited to available stock.

- TM1** for mics up to 1 3/8" diameter.  
60AKTM1 \$17.00
- TM2** for mics up to 2" diameter.  
60AKTM2 \$19.00
- TM3** for mics up to 2 3/4" diameter.  
60AKTM3 \$19.00

**Accessory:**  
Mic stand adapter for Tensimount  
61AKSA40 \$12.00

(2) Audio Technica 8415 shock mount is designed primarily for the rigors of field production. Elastic suspension accommodates a very wide variety of mics. Versatile and economical. 60AT8415 \$42.00

(4) Audio Technica AT8410a "universal" shock mount with "clothes-clip" flexible clamp fits most shapes and sizes of mics without extra sleeves or adapters. Special neoprene suspension cords isolate the mic from shock from every direction.

61AT8410A \$34.00

(5) Sennheiser MZS100 is our finest quality studio shock mount. It attaches to any microphone with the mic's own stand adapter. The thumbscrew adjusts the tension of the shock absorbing mechanism so that it can be optimized for the weight of the mic. Looks different, performs wonderfully.

60SNMZS100 \$89.00



## Microphone Stands and Booms

1. **AKG KM-251** heavy duty, collapsible floor stand adjustable from 23" to 53".

<b>Chrome</b>	60AKKM251	<b>\$75.00</b>
<b>Black</b>	60AKKM251B	<b>\$75.00</b>

2. **Atlas MS-12C** basic stand with heavy duty base.

<b>Chrome</b>	61ATMS12	<b>\$20.00</b>
<b>Ebony</b>	61ATMS12CE	<b>\$20.00</b>

3. **Atlas PSC** two-section collapsible stand.

<b>Chrome</b>	61ATPSC	<b>\$35.00</b>
<b>Ebony</b>	61ATPSCE	<b>\$35.00</b>

4. **Atlas MS-20** heavy duty mic stand with shock mounting.

<b>Chrome</b>	61ATMS20	<b>\$49.00</b>
<b>Ebony</b>	61ATMS20E	<b>\$49.00</b>

5. **Shure S15** ultra-lightweight, collapsible mic stand which can be adjusted to heights of 3½ to 14 feet. It is sturdy and stable enough to hold large, heavy microphones, and yet it weighs only 5 pounds. This stand is the ultimate for location work. Comes complete with vinyl carrying bag and cable strain relief.

60SHS15	<b>\$149.00</b>
---------	-----------------

6. **ST-201A/2** professional two section collapsible mic stand. Lightweight, yet stable, this is our best seller.

<b>Chrome</b>	61KM201	<b>\$33.00</b>
<b>Black</b>	61KM201B	<b>\$33.00</b>

7. **Atlas MS-25** heavy duty mic stand with shock mounting and triangle base so talent can step up close.

61ATMS25	<b>\$77.00</b>
----------	----------------

8. **Atlas MS-4** three section version of the MS-20.

61ATMS4	<b>\$40.00</b>
---------	----------------

9. **Atlas PB-10X** adjustable boom 31" to 47".

<b>Chrome.</b>	61ATPB10X	<b>\$30.00</b>
----------------	-----------	----------------

10. **Atlas PB-10** 31" fixed boom.

<b>Chrome</b>	61ATPB10	<b>\$20.00</b>
<b>Black</b>	61ATPB10E	<b>\$20.00</b>

11. **Atlas PB-20XE** two section collapsible boom adjustable 21" to 37".

<b>Ebony finish.</b>	61ATPB20XE	<b>\$24.00</b>
----------------------	------------	----------------

12. **SCH-211/2** collapsible boom extends to 38".

<b>Silver</b>	61KM2112	<b>\$22.00</b>
<b>Black</b>	61KM2112B	<b>\$22.00</b>

13. **Atlas SB-36** professional boom/stand with a grip action clutch and air suspension. Stand extends from 50" to 74", and the boom length is 62".

<b>Without casters</b>	61ATSB36	<b>\$165.00</b>
<b>With casters</b>	61ATSB36W	<b>\$189.00</b>

14. **Beyer GST 400** Boom Stand combo with black finish. Stand adjustable 35"-65". Boom fixed at 33". Tripod style base.

<b>GST 400</b>	60BEGST400	<b>\$70.00</b>
----------------	------------	----------------

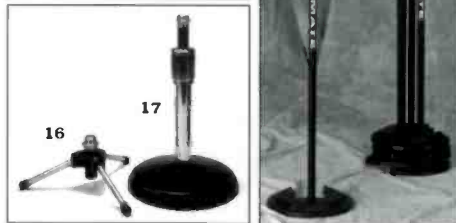
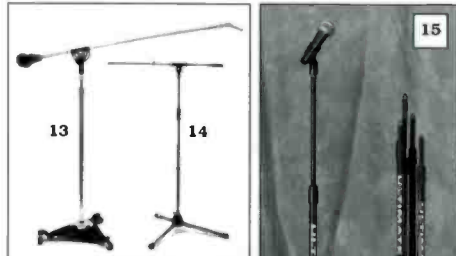
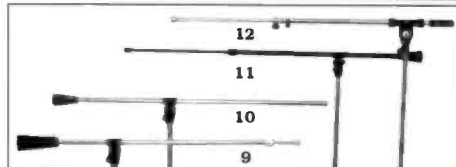
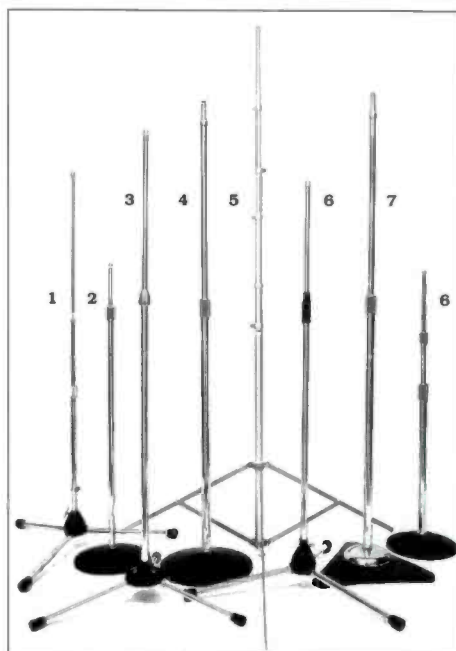

15. **Ultimate Liberty** has a unique clutch that makes it the easiest stand to adjust. Height ranges from 34½" to 64", and the 10" diameter round base allows six stands to be conveniently stacked. Lifetime guarantee.

61USL	<b>\$29.00</b>
-------	----------------

16. **AKG 231** portable, collapsible desk stand is so useful and lightweight, it should be a part of every remote kit. All metal construction for strength and durability, simple leg fold design for reliability, and extremely low weight for portability make this desk stand the most versatile around.

60AK231	<b>\$12.00</b>
---------	----------------

17. **Atlas DS-7** heavy duty adjustable desk stand is our most requested, and now available in either chrome and ebony finish, both with black base.

<b>Chrome</b>	61ATDS7	<b>\$12.90</b>
<b>Ebony</b>	61ATDS7E	<b>\$15.90</b>

## Bradley Assembled Mic Cables



You need them, and Bradley's got them. Our own high quality mic cables, using Neutrik XLR connectors, come in 25' and 50' lengths.

<b>25' cable</b>	61WHMKS20	<b>\$14.50</b>
<b>50' cable</b>	61WHMKS50	<b>\$22.00</b>

### Bradley Bulk Mic Cable

Our low impedance mic cable is rugged and reliable. Get as much as you want or as little as you need.

60AT8300	<b>34¢ per foot</b>
----------	---------------------

### Canare Star Quad Assembled Mic Cables

<b>5 feet</b>	60CAEC005FBXX	<b>\$19.50</b>
<b>15 feet</b>	60CAEC015FBXX	<b>\$24.00</b>
<b>25 feet</b>	60CAEC025FBXX	<b>\$28.50</b>
<b>50 feet</b>	60CAEC050FBXX	<b>\$39.00</b>

Canare cables are made with Neutrik XLR connectors. Black is available from stock. Other colors are special order and are priced the same. All special order cables have a minimum order of 10 cables in any mix of colors and lengths.

<b>Bulk Star Quad</b>	60CAL4E6BK	<b>40¢ per foot</b>
<b>500' reel</b>	60CAL4E605XX	<b>\$209.00</b>
<b>1000' reel</b>	60CAL4E610XX	<b>\$395.00</b>

*Black is the only color offered by the foot. Reels are available from stock in black, or in blue, brown, grey, green, orange, purple, red, white, and yellow by special order. Call for pricing on multipair cable with 2, 4, 8, 12, 16, and 24 pairs.*

**Bradley Broadcast...  
Where Service  
and Engineering Make  
The Difference**



**Goosenecks**



**1. Mic-Eze Rubbernecks** are unique new goosenecks that eliminate the noise caused by standard goosenecks. Black rubber-like construction.

- 16" Neck 61ACR16 \$11.95
- 10" Neck 61ACR10 \$9.95
- 12" Neck w/ XLR connectors 61ACR12XLR \$49.95

**2. Standard Goosenecks** are now available in both chrome and black finishes.

- 6" Chrome 61ATGN6 \$5.95
- 6" Black 61ATGN6E \$5.95
- 13" Chrome 61ATGN13 \$6.95
- 13" Black 61ATGN13E \$6.95
- 19" Chrome 61ATGN19 \$7.95
- 19" Black 61ATGN19E \$7.95

**3. Atlas Gooseneck Mounting Flanges**

- a. AD-11B Female 5/8"-27
  - Chrome 61ATAD11B \$3.69
  - Ebony 61ATAD11BE \$3.69
- b. AD-12B Male 5/8"-27
  - Chrome 61ATAD12B \$3.69
  - Ebony 61ATAD12BE \$3.69
- c. AD-18B Heavy Duty Female
  - Chrome 61ATAD18B \$6.59
  - Ebony 61ATAD18BE \$6.59

**Shure A58WS Windscreens**



These windscreens fit most mics with ball shaped heads. Available colors are orange, red, blue, brown, black, white, green, and yellow.

- 61SHA61WSXX \$5.25

**Microphone Mounting Accessories**

- 4. "Clothes-Pin" type** spring loaded swivel mic adapter. Fits most mics. 61BEMKV6 \$14.95
- 5. Mic-Eze Adapter** is a unique unbreakable mic holder with locking bolt and non-slip grip. 61MEM4 \$10.60
- 6. Tapered Swivel Adapter** fits most Shure mics and many other models. 61SF1 \$4.95
- 7. Suspenders Stand Clamp** attaches to any tubular stand, such as a mic or drum stand. It has a 5/8"-27 thread mount for mic clamp to be attached. 61LPS420 \$7.95

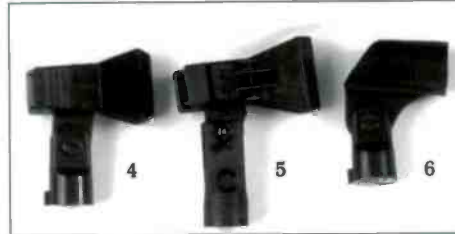

**8. AKG KM235/1** twin mount for horizontal extension or installation of 2 mics on one stand. Three pivot points allow flexible mic positioning. 60AKKM235 \$14.99

**Also available:**

**Atlas TM-1** allows installation of 2 or three mics on a single stand. 61ATTM1 \$13.95

**Shure A27M** twin mount allows placing two mics vertically on one stand. Designed for M-S stereo mixing. 61SHA27M \$62.00

**Shure A27T** triple mount is the type used by the President of the US to use three Shure SM57 mics. 61SHA27T \$138.00

**9. Rowi Clamps** allow you to attach your microphone to virtually anything. The clamp jaw opens to 1 1/2", and the mic adapter swivels. Possibly our most popular and useful mic clamp. 60BBRC \$31.95

**10. Atlas CO-1B** clamps to mic stands or booms to allow attaching a second mic. 61ATCO1B \$11.19

**11. MZA-217** 5/8" external to 3/8" internal thread adapter. 61SNMZA217 \$3.00

**12. Atlas VM-1** shock mount adapter reduces vibrations to mic. 61ATVM1 \$13.95

**13. Atlas LO-2B** provides for quick disconnect of mic clamp.

- Chrome 61ATLO2B \$11.00
- Ebony 61ATLO2BE \$11.00

**14. Atlas SW-1B** swivel attachment makes mic placement more convenient. 61ATSW1B \$19.00

**15. Atlas CH-1B** attaches to mic stand and provides a place to hang the mic cable. 61ATCH1B \$9.69

**16. Suspenders Clip Clamp** is a spring loaded adapter that clips onto virtually anything. Features a 5/8"-27 thread adapter. Keep a few in your road kit. 61LPS413 \$5.75

**Atlas Adapters**

Bradley can assist your next installation with these useful adapters. Chrome.

- 5/8"-27F to 1/2" pipe M 61ATAD1B \$3.69
- 3/8" pipe F to 5/8"-27M 61ATAD2B \$3.69
- 3/8" pipe F to 5/8"-27F 61ATAD3B \$3.69
- 3/4" long, 5/8"-27M thread 61ATAD4B \$3.69
- Coupling; 5/8"-27F to 5/8"-27F 61ATAD5B \$3.69
- Coupling; 7/8"-27F to 7/8"-27F 61ATAD6B \$5.19
- 3" long tube; 5/8"-27M thread each end 61ATAD7B \$3.69
- 6" long tube; 5/8"-27M thread each end 61ATAD8B \$3.69
- 7/8"-27F to 5/8"-27F 61ATAD9B \$6.99
- 5/8"-24F to 5/8"-27F 61ATAD10B \$6.59
- 7/8"-27M to 5/8"-27F 61ATAD13B \$5.99
- 90° angle tube; 5/8"-27M & F 61ATAD14B \$6.59
- "Feed thru", 5/8"-27M & F 61ATAD15B \$6.59
- 45° angle tube; 5/8"-27M & F 61ATAD19B \$13.39



## Luxo Studio Desk Mounting Arms

### A. Luxo KM-1 Mic Arm

The KM-1 has no external springs and a 41" reach. Balanced for mics weighing two pounds. Requires mounting bracket or riser.

<b>KM-1 Oyster</b>	61LUKM1	\$49.00
<b>KM-1 Black</b>	61LUKM1B	\$49.00

### B. Luxo LM-1 Mic Arm

Professional spring loaded boom with 41" reach. Balanced for mics weighing one pound. Requires mounting bracket or riser.

<b>LM-1 Oyster</b>	61LULM1	\$44.50
<b>LM-1 Black</b>	61LULM1B	\$44.50

Also available:

<b>Luxo LM-2</b> is similar to LM-1 but has a 26" reach.		
<b>LM-2 Oyster</b>	61LULM2	\$38.50
<b>LM-2 Black</b>	61LULM2B	\$38.50

### C. Pro Riser

This rugged all aluminum, 12" pedestal provides for more convenient installation and a longer reach for your Luxo arm.

<b>Oyster</b>	61LURISER	\$21.00
<b>Black</b>	61LURISERB	\$21.00

### D. Luxo Mounting Brackets

<b>C-clamp Oyster</b>	61LUABR	\$9.95
<b>C-clamp Black</b>	61LUABRB	\$9.95
<b>Table mount Oyster</b>	61LUCBR	\$9.95
<b>Table mount Black</b>	61LUCBRB	\$9.95
<b>Wall mount Oyster</b>	61LUBBR	\$9.95
<b>Wall mount Black</b>	61LUBBRB	\$9.95

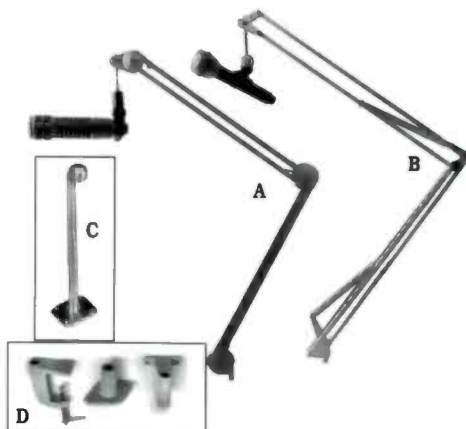

## O. C. White Mic Arms

This complete series of mic arms and accessories accommodates virtually all mics, providing strength and durability in microphone installation. Grey, with models in black available by special order at extra cost.

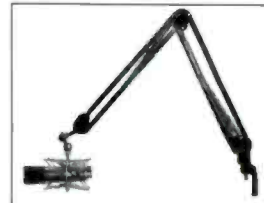

<b>Single mic arm with riser</b>	60OCSMAR	MFR LIST \$128.00
<b>Single mic arm only</b>	60OCMA	MFR LIST \$93.00
<b>Two joint single mic arm</b>	60OCTJSMAMFR LIST	\$179.00
<b>Triple mic arm with riser</b>	60OCTMA	MFR LIST \$419.00

Call Bradley for information on other configurations and mounts and a current price quotation.

## Rane MS1 Mic Preamp

Going from the output of a microphone into another line level world is a simple problem. The simple answer is the Rane MS1 mic preamp with a minimum of noise, distortion, cost, and hassle. Only 1.65"H x 5.1"W x 4.25"D, the MS1 is designed to be installed where you need it. It provides switchable (+15VDC) phantom power, continuous rotary gain trim between 20dB and 60dB, LED overload indicator, XLR input connector, and balanced TRS 1/4" output. The MS1 uses one of the finest ultra low noise amplifier designs available featuring true differential inputs with high common mode rejection. You pay only for what you need and not extra KSI (knobs per square inch).

<b>MS1</b>	60RNMS1	MFR LIST	\$189.00
------------	---------	----------	----------

Call Bradley for a current price quotation.



## ATI Mic Preamps

The M100 Ultimike is a small, rugged, full featured preamp that can be mounted near the audio source and has an unusually quiet active balanced instrumentation type input stage with impressive hum and RF rejection. Built in are a switchable limiter and lo-cut filter. Gain is adjustable over a wide range, plus a front panel jack allows you 15dB of gain trim from a remote location with a 10K pot. For condenser mics, 48V phantom power is available at the flip of a switch. A phase reversing switch is on the front panel, and XLR connectors are used for inputs and outputs.

The M1000 is a dual microphone preamplifier for use as a stereo mic preamp or for two mono mics. Versions are available with transformer or balanced differential outputs, with or without switchable 48V phantom power. Microphones are a basic necessity. Treat them properly with ATI mic preamps and hear the difference.

<b>Ultimike</b>	60AIM100	MFR LIST	\$329.00
<b>M1000 transformer output</b>	60AIM10001	MFR LIST	\$429.00
<b>M1000 differential output</b>	60AIM10002	MFR LIST	\$399.00

Call Bradley for a current price quotation.



<b>M1000 transformer output, phantom power.</b>	60AIM10001P	MFR LIST	\$459.00
<b>M1000 differential output, phantom power.</b>	60AIM10002P	MFR LIST	\$429.00
<b>Accessories:</b>			
<b>Rack mount kit for one M1000</b>	60AI20021	MFR LIST	\$20.00
<b>Rack mount kit for two M1000</b>	60AI20024	MFR LIST	\$25.00





## Stewart Phantom Power Supplies

Stewart phantom supplies are a reliable alternative to supplies that cost too much. They may be used with most microphones or accessories requiring 48 volts DC. The modules contain the audio connectors, power regulator, and all associated isolation circuitry. Up to 12 channels can be powered from a single PS-1 AC converter. Modules are easily interconnected with cables using standard 1/4" TS phone plugs. For field work, use the BPS-1 battery supply which uses two 9 volt batteries to produce 48VDC phantom power.

<b>PMO-1</b> one channel module	60SEPM1	<b>\$59.00</b>
<b>PMO-2</b> two channel module	60SEPM2	<b>\$95.00</b>
<b>PMO-4</b> four channel module	60SEPM4	<b>\$120.00</b>
<b>PS-1</b> AC converter	60SEP1	<b>\$17.00</b>
<b>BPS-1</b> battery powered supply	60SEBPS1	<b>\$95.00</b>



## Symetrix 528 Mic Processor

The 528 is a complete system that contains all the control functions needed for voice processing: mic preamp, compressor/limiter, downward expander, parametric equalizer, and de-esser. It is intended for use as a broadcast announce mic processor, as a complete input stage for public address systems, or as a specialized processor for recording and sound reinforcement. Switchable phantom power is provided for condenser mics. The comprehensive front panel controls and metering enable you to tailor voices to your exact requirements.

<b>528</b>	60SY528	<i>MFR LIST</i>	<b>\$679.00</b>
------------	---------	-----------------	-----------------



Call Bradley for a current price quotation.

## Symetrix SX202 Dual Mic Preamp

Designed for critical analog or digital recording, the SX202 has variable gain inputs with 15dB pads and selectable 48VDC phantom powering. When used with a stereo pair of mics, the SX202 has the advantages of less than 10° phase shift at 20kHz and a polarity switch on one channel. This unit boasts very low noise and distortion, as well as excellent transient characteristics.

<b>SX202</b>	60SYSX202	<i>MFR LIST</i>	<b>\$299.00</b>
<b>Rack mount kit</b> for one or two SX series units.	60SYRM2	<i>MFR LIST</i>	<b>\$39.00</b>



Call Bradley for a current price quotation.

## Orban 787A Mic Processor

The 787A is a three band parametric equalizer, compressor, de-esser, noise gate, and compressor gate integrated into a compact and powerful rack mounted system. It stands apart from similar mic processors in that it is fully programmable. Up to 32 different programs can be saved, instantly recalled, and A/B compared. In the absence of line power, the memory is held by an internal lithium battery. Control settings can be locked with a security code to prevent unauthorized tampering. The 787A's standard line input will accept a direct mic input with an optional ultra-low noise Jensen transformer mic preamp. Transformer-coupled to ensure RF immunity, this preamp is vastly superior to most console preamps.

The 787A can be used in broadcasting to individualize processing for any of several announcers. At each change of announcer, the appropriate program can be instantly recalled. In the newsroom, the 787A provides in 3 rack spaces a complete processing facility for dubbing reporters cassette interviews, processing "voicers", and even dramatically improving phone feeds. In multitrack recording and production the 787A can store preferred settings for individual voices. Whatever your audio specialty, the Orban 787A is a powerful processing arsenal.



<b>787A/U</b>	60OB787A	<i>MFR LIST</i>	<b>\$1450.00</b>
<b>787A/UP</b> with Jensen transformer mic preamp.	60OB787AP	<i>MFR LIST</i>	<b>\$1645.00</b>
<b>787A/UX</b> with MIDI or RS-232 port.	60OB787AX	<i>MFR LIST</i>	<b>\$1545.00</b>
<b>787A/UPX</b> with Jensen transformer mic preamp and serial port.	60OB787APX	<i>MFR LIST</i>	<b>\$1740.00</b>

**Accessories:**

**Slave channel for 787A** for dual mono or stereo operation.

60OB787ASL	<i>MFR LIST</i>	<b>\$1150.00</b>
------------	-----------------	------------------

Call Bradley for a current price quotation.



## Telex Wireless Systems

FMR-4 System



### Telex Multichannel Wireless Systems

#### FMR-4 Diversity Receiver

- 20 stock frequencies; use 18 systems together
- Frequency agile (4 channels)
- 104dB S/N

60TXFMR4 MFR LIST \$2000.00

#### ENG-4 Non-Diversity Portable Receiver

- 20 stock frequencies; use 18 systems together
- Frequency agile (4 channels)
- 104dB S/N
- Portable runs on four "AA" batteries
- Ideal for camera-mount use or where AC is unavailable

60TXENG4 MFR LIST \$1500.00

#### WT-400 Belt Pack Transmitter

- Frequency agile (2 channels)
- Lemo connector

60TXWT400 MFR LIST \$1000.00

#### Microphones for WT-400

##### WLM-200 Omnidirectional lav

60TXWLM200 MFR LIST \$135.00

##### ELM-22L Ultra Mini omnidirectional lav

60TXELM22L MFR LIST \$200.00

##### ELM-33L Ultra Mini unidirectional lav

60TXELM33L MFR LIST \$205.00

#### HT-400 Dual Channel Hand Held Transmitters

##### HT-400/10 Condenser, Telex TE 10 head

60TXHT40010 MFR LIST \$1050.00

##### HT-400/58 Dynamic, Shure SM58 head

60TXHT40058 MFR LIST \$1200.00

##### HT-400/87 Condenser, Shure SM87 head

60TXHT40087 MFR LIST \$1300.00

### Telex Single Channel Diversity Systems

#### FMR-100 Diversity Receiver

- 10 stock frequencies; use 12 systems together
- 104dB S/N
- Dual meters; balanced mic output
- Silent "noise-up" relay eliminates noise bursts

60TXFMR100 MFR LIST \$550.00

#### FMR-70 Diversity Receiver

- 10 stock frequencies; use 6 systems together
- 94dB S/N
- Balanced mic output

60TXFMR70 MFR LIST \$318.00

#### WT-80 Belt Pack Transmitter

- Single channel, metal construction
- TA4 connector

60TXWT80 MFR LIST \$420.00

Telex offers the FMR-100 and FMR-70 diversity systems, as well as the FMR-4 and ENG-4 multichannel systems. Use the dollar amounts shown to budget your system. Then call your Bradley professional for a great package deal and details on options and accessories.

#### WT-60 Belt Pack Transmitter

- Single channel, ABS plastic construction
- TA4 connector

60TXWT60 MFR LIST \$270.00

#### WT-55 Belt Pack Transmitter

- Single channel, economy model
- TA4 connector

60TXWT55 MFR LIST \$227.00

#### Microphones for WT-80, WT-60, and WT-55

##### WLM-50 Omnidirectional lav

60TXWLM50 MFR LIST \$90.00

##### Sony ECM-144 Omnidirectional lav

60TXS0144 MFR LIST \$90.00

##### Audio-Technica AT-831b Unidirectional lav

60TXAT831 MFR LIST \$130.00

##### ELM-22S Ultra Mini omnidirectional lav

60TXELM22S MFR LIST \$195.00

##### ELM-33S Ultra Mini unidirectional lav

60TXELM33S MFR LIST \$200.00

#### HT-100 Hand Held Transmitters

##### HT-100/10 Condenser, Telex TE-10 head

60TXHT10010 MFR LIST \$370.00

##### HT-100/11 Dynamic, Telex TE-11 head

60TXHT10011 MFR LIST \$370.00

##### HT100/58 Dynamic, Shure SM58 head

60TXHT10058 MFR LIST \$430.00

##### HT100/757 Dynamic, EV N/D 757 head

60TXHT100757 MFR LIST \$495.00

##### HT-100/87 Condenser, Shure SM87 head

60TXHT10087 MFR LIST \$620.00

FMR-100 System



## Shure L Series Wireless Mics

If you have any doubts about affordable VHF wireless, you can rest a-Shure-d with Shure's L Series. Available in both diversity and non-diversity systems, the performance and price of the L Series will certainly please you. The non-diversity L3 receiver features double tuned RF stages with high gain, low noise MOS-FETs for sensitive, interference-free operation. The true diversity L4 receiver features MARCAD (Maximum Ratio Combining Audio Diversity). MARCAD, in addition to providing the benefits of two independent RF sections, combines the signals for improved signal-to-noise ratio and outstanding reception. Both the L3 and L4 offer a 102dB dynamic range.

The new Shure L5 receiver adds new versatility to wireless usage—a battery powered receiver. Now Shure wireless systems may be used in any environment where AC power is not available.

The rugged L11 body pack transmitter has noiseless muting and extended dynamic range. It can be used with a wide variety lavalier mics and instrument outputs. For hand held applications, choose among units with an SM58 dynamic element, SM96 condenser element, or a Beta 58 element.

All Shure L Series wireless components boast Shure's legendary reliability. Systems are priced below and individual components are available. Optional accessories include rack mount kits for the receivers and an antenna splitter for multiple receiver systems.

### Non-Diversity Lavalier Systems

w/L3 receiver, L11 body-pack transmitter, mic

<b>839W</b> omni mic	60SHLS13839	MFR LIST	<b>\$445.00</b>
<b>SM84W</b> uni mic	60SHLS1384	MFR LIST	<b>\$485.00</b>

### Non-Diversity Handheld Systems

w/L3 receiver and handheld transmitter

<b>SM58</b> capsule	60SHLS2358	MFR LIST	<b>\$532.00</b>
---------------------	------------	----------	-----------------

Call Bradley for a current price quotation.



### Diversity Lavalier Systems

w/L4 receiver, L11 body-pack transmitter, mic

<b>839W</b> omni mic	60SHLS14839	MFR LIST	<b>\$580.00</b>
<b>SM83W</b> omni mic	60SHLS1483	MFR LIST	<b>\$595.00</b>
<b>SM84W</b> uni mic	60SHLS1484	MFR LIST	<b>\$620.00</b>

### Diversity Handheld Systems

w/L4 receiver and handheld transmitter

<b>SM58</b> capsule	60SHLS2458	MFR LIST	<b>\$666.00</b>
<b>Beta 58</b> capsule	60SHLS24B58	MFR LIST	<b>\$748.50</b>

### Battery Operated Portable Systems

w/L5 receiver and handheld transmitter

<b>SM58</b> capsule	60SHLS2558	MFR LIST	<b>\$565.00</b>
<b>SM87</b> capsule	60SHLS2587	MFR LIST	<b>\$625.00</b>

### Battery Operated Portable Systems

w/L5 receiver and L11 body pack transmitter

<b>WL84</b> mic	60SHLS1584	MFR LIST	<b>\$520.00</b>
<b>WL93</b> mic	60SHLS1593	MFR LIST	<b>\$495.00</b>

## Sony UHF Wireless

This new UHF wireless mic system operates in the relatively vacant 800MHz band which is hardly affected by external noise and interference with other wireless systems. Phase Locked Loop synthesis controls both the transmit and receive frequencies. The space diversity system offers stable reception at extended operating distances. Presets are programmed into each tuner for instant configuration of systems using up to 11 channels simultaneously.

Receivers are one rack space tall and include rack ears. Antennas are powered from the receiver and are purchased separately. Both transmitters and receivers feature a multi-function LCD status display.



### WRR-820A Diversity Receiver

60SOWRR820A	MFR LIST	<b>\$1350.00</b>
-------------	----------	------------------

### WRR-840A Dual Diversity Receiver

60SOWRR840A	MFR LIST	<b>\$2070.00</b>
-------------	----------	------------------

### WRT-810A Handheld Transmitter

60SOWRT810A	MFR LIST	<b>\$830.00</b>
-------------	----------	-----------------

### WRT-820A Body-pack Transmitter with Sony Lavalier Mic

60SOWRT820XXX	MFR LIST	<b>\$843.00-\$987.00</b> depending on mic
---------------	----------	--

### AN-820A Antenna with built in amp

60SOAN820A	MFR LIST	<b>\$170.00</b>
------------	----------	-----------------

**WD-820A Antenna Distributor** for using two antennae with up to 4 receivers

60SOWD820A	MFR LIST	<b>\$1210.00</b>
------------	----------	------------------

Call Bradley for a current price quotation.

### Dorrrough Model 40-A Loudness Monitor

The war has raged on for years: VU vs. PPM metering. The VU meter provides an indication of loudness without telling you what's going on electrically. The PPM lets you see the peak levels your electronics have to deal with, but is of limited utility for judging loudness. The Dorrough Loudness Monitor uses a three color, 40 LED array with two simultaneous displays. A bar graph shows perceived loudness while a bright-dot display indicates electrical peak levels. Display range -25 to +14dB. Input is screw terminal, direct coupled balanced bridging. Zero reference can be set from -30 to +20dBm.

**40-A**                      60DR40A                      MFR LIST                      \$475.00

**Accessory:**

Rack mount kits (3 1/2" high)

**For one meter**                      60DR40SR                      MFR LIST                      \$45.00

**For two meters**                      60DR40DR                      MFR LIST                      \$45.00

Call Bradley for a current price quotation.



### Dorrrough 1200 Stereo Signal Test Set

The 1200 is a modern version of the classic "gain set." The unit includes two Dorrough Loudness Meters which indicate both peak and average levels on a single display. Front panel controls allow accurate measurement of signals in numerous ranges down as low as -76dBm. The meters may be operated in either Left and Right or Sum and Difference formats. This test set can be invaluable in setting levels, checking cross-talk, and many other measurements. No facility that is serious about its audio quality can afford to be without it.

**1200**                      60DR1200                      MFR LIST                      \$1650.00

Call Bradley for a current price quotation.



### Logitek Bright VU

Bright VU is a three color coded LED meter. It bridges onto any audio circuit via a balanced high impedance rear panel input. Sensitivity is adjustable to accommodate any system operating level from -20dBm to +20dBm. Ballistics are switchable for either peak or average. Bright VU is ideal for level monitoring in large control rooms where distances make even the largest standard VU meters difficult to read. Individual meter channels can be set to display either average (VU) or peak (PPM) levels. Available in complete, rack mounting sets that are one rack space high, or as individual meters.

**Single stereo package**                      60LTBV2C                      MFR LIST                      \$545.00

**Dual stereo package**                      60LTBV4S                      MFR LIST                      \$795.00

**Triple stereo package**                      60LTBV6S                      MFR LIST                      \$995.00

**Mono meter in enclosure.** Requires power supply.  
60LTBVUM                      MFR LIST                      \$205.00

**Stereo meter in enclosure.** Requires power supply.  
60LTBVUS                      MFR LIST                      \$340.00

**Power supply** for two mono or one stereo Bright VU.  
60LTBVUPS                      MFR LIST                      \$50.00

Call Bradley for a current price quotation.



### Toa DT-910 AM/FM Tuner

The DT-910 provides highly sensitive reception and extremely stable operation. Employing a quartz locked, frequency synthesized, digital tuning system, the DT-910 provides memory for 10 AM and 10 FM preset stations. Front panel controls allow the choice of AM or FM and up or down station selection. Included in the DT-910 is a signal strength meter and automatic next station scan with next station display.

**DT-910** 60TODT910 MFR LIST \$380.00

**Accessory:**

**Rack mount kit** 60TOMBDT910 MFR LIST \$58.00

Call Bradley for a current price quotation.



### Technics SA-GX130 AM/FM Receiver

Here's a receiver with performance good enough for critical monitoring. 70 watts of power per channel will drive almost any speakers to ear shattering levels. Four external audio inputs (one RIAA equalized) allow you to also monitor a turntable, CD player, cassette deck and maybe even a feed from the production room. The 36 key wireless remote control allows convenient operation. 30 station presets permit monitoring your station, the competition, and several stations that play what you'd rather hear.

**SA-GX130** 60TCSAGX130 MFR LIST \$229.00

Call Bradley for a current price quotation.



### Denon TU-660 AM/FM Tuner

The TU-660 is the first tuner whose AM section meets the NRSC standards for audio de-emphasis, bandwidth, and noise filtering. In addition, it has superior FM Stereo reception ability. Thirty station presets and a full set of tuning modes are among this unit's fine features.

**TU-660** 60DETU660 MFR LIST \$330.00

**Accessory:**

**Rack mount shelf** 61MADETU660 \$89.00

Call Bradley for a current price quotation.



### Gentner Silence Sensor

This is a silence sensor that does something more than just make noise when things get quiet. On detecting silence, an open collector output (capable of sinking 250mA, 48VDC, non-inductive) is activated. Simultaneously, a timer is activated. At the end of the time period, a second open collector output and a relay closure are also activated. Use the first output for an alarm, and the second output for a second, louder alarm while the relay closure starts a backup tape machine. The timer's period is user adjustable over a range of 0-99 seconds or 0-99 minutes. The Silence Sensor is ideal as a fail safe device when using a dial-up transmitter remote control such as the Gentner VRC-2000.

**Silence Sensor** 60GESS MFR LIST \$509.00

Call Bradley for a current price quotation.



### Belar AS-1 Audio Sentry

Silence is golden, except when it's your station that's silent! A silence sensor is an absolute necessity for unattended satellite or automation systems, or for AM/FM combo operations where only one station is monitored off the air. The AS-1 has both aural and visual alarms. A front panel push button lets you silence the aural alarm while you're troubleshooting, and rear panel connections allow you to also use an external alarm. Upon restoration of audio, the AS-1 automatically resets. Order an AS-1 today; it's inexpensive insurance.

**AS-1**                      60BLAS1              MFR LIST              \$275.00

Call Bradley for a current price quotation.



### Logitek Mon-10

The Mon-10 is a stereo 10x1 passive switcher with wire-capture terminal blocks and front panel switching to look at Left, Right, L+R, or L-R and feed the selected signal to the VU meter and internal monitor amp. The meter sensitivity may be selected over a 50dB range in 10dB steps. The monitor amp feeds a front-panel speaker, a front-panel headphone jack, and rear panel speaker connections.

**Mon-10**                      60LTMON10              MFR LIST              \$845.00

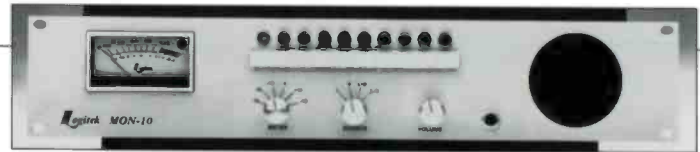

Call Bradley for a current price quotation.

### Wohler Powered Stereo Monitors

These full fidelity powered speaker systems in rack mounting enclosures have thorough magnetic shielding so you can rack them up nearly anywhere. The careful acoustic design of the AMP-1A (top unit in photo) creates real bass and treble response from below 100Hz to above 10kHz, at levels loud enough for even a busy production control room or mobile truck. Mid- and high-frequency material is reproduced through the left and right speakers, while low frequency material is combined into the center driver. Stereo imaging is quite good when the listener is positioned anywhere in front of the unit. The AMP-1A is only one rack space high and it requires only 15" of depth, including connector space. Options such as phase indicators, meters, and headphone output further enhance the utility of the one rack unit AMP-1A.

For extended response with even louder output capabilities, the two rack unit AMP-2 (bottom unit in photo) is your choice. Also available is the economical AMP-9, which provides voice grade output in a one rack space chassis. The unrivaled combination of compact design, ease of use, and clear stereo monitoring make these units ideal for VTR's, mobile production vehicles, cable facilities, teleconferencing, satellite links, duplication rigs, security systems, and more.

**Also Available:**

**AMP-1AF** - Same as AMP-1A above with visual phase/polar indicator only.

**AMP-1AP** - Same as AMP-1A but with level meters only.

**AMP-1APF** - Same as above, but with visual phase/polarity indicator. Shows amount of reverse polarity information in a two channel source. Also distinguishes stereo from mono and gives three state level indications (off, on, or over range).



<b>AMP-1A</b>	60WOAMP1	MFR LIST	\$635.00
<b>AMP-2</b>	60WOAMP2	MFR LIST	\$1100.00
<b>AMP-9</b>	60WOAMP9	MFR LIST	\$515.00
<b>AMP-1AF</b>	60WOAMP1AF	MFR LIST	\$840.00
<b>AMP-1AP</b>	60WOAMP1AP	MFR LIST	\$880.00
<b>AMP-1APF</b>	60WOAMP1APF	MFR LIST	\$1,000.00

Call Bradley for a current price quotation.

**Monitor our low prices. Call for your current price quotation on any equipment you are interested in. Bradley Broadcast. Where Service and Engineering STILL Make the Difference.**



## The Informers

How hot or cold is it outside? What's the temperature in your transmitter room or garage? These are questions we all ask every day. Bradley answers them with the Informers. Available in a digital readout version or as a voltage output unit, both Informers are factory calibrated to standards that are traceable to the National Institute of Science and Technology.

The digital readout Informer accurately reads from -40° to 120°F, and has high and low temperature memories with reset. Its small size, 3 way mounting bracket, and large LCD readout allow it to be placed virtually anywhere. The 50' cable with triple sealed sensor lets you put the probe outdoors for continuous readings. A single alkaline AA cell powers it for up to a year.

Designed for transmitter remote control use, the voltage output Informer provides an output of 10 millivolts per degree (100°F equals one volt). Its range of 0° to 230°F permits you to install the probe (via the 18' supplied cable) anywhere, including inside the transmitter's exhaust ducts. Users need to provide the 5 to 12 volts to power the unit.

<b>Digital readout</b>	60TKI	<b>\$54.95</b>
<b>Voltage output</b>	60TKITX	<b>\$48.95</b>



## Fostex 6301B

No matter how sophisticated a facility you have, it always seems that you can use additional audio monitoring capability. Now it is available in these convenient, high quality self-contained monitors. Measuring only 7 7/8" x 4 3/4" x 5", the 6301B packs 10 watts RMS power and 80Hz to 13kHz response into each unit. Use them alone for mono, in pairs for stereo, or use them throughout your station as a house monitor system. Accepts input levels as low as -10dBV. The 6301B has a 1/4" TS input. The 6301B/EAV adds an active balanced XLR input and special magnetic shielding, so it can be mounted adjacent to video monitors or other sensitive equipment without causing interference. Keep one pair on the engineer's equipment shelf for special requirements, or take them on remotes for use with your DJ console. Applications for these monitors are practically limitless.

<b>6301B</b>	60FO6301	<b>\$139.00</b>
<b>6301B/EAV</b>	60FO6301X	<b>\$169.00</b>



<b>Accessories:</b>		
<b>Rack kit for single unit</b>	61MA6301RM	<b>\$60.00</b>
<b>Rack kit for two units</b>	61MA6301RMD	<b>\$68.00</b>

## Anchor AN-1000

The AN-1000 is a full range (70Hz to 14kHz, ±4dB) powered monitor speaker. It features a 50 watt MOS-FET amplifier and Anchor's Audio Contour equalization network for full range, low level listening. The unit only measures 5 1/4" high, 8" wide, and 8 3/4" deep. Line input is 1/4" TS, and a balanced XLR mic or line input can be ordered. Anchor offers a wide variety of configuration options.

<b>AN-1000X</b>	60AN1000X	<i>MFR LIST</i>	<b>\$411.00</b>
<b>AN-1001</b> unpowered monitor driven by AN-1000X.	60AN1001X	<i>MFR LIST</i>	<b>\$152.00</b>

Call Bradley for a current price quotation.

### Accessories:

Single Rackmount	60ANRM1	<b>\$54.00</b>
Dual Rackmount	60ANRM12	<b>\$61.00</b>
Speaker Stand	60ANSS250	<b>\$106.00</b>

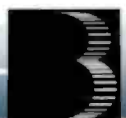

### Auratone 5RMC Multi-Channel Speaker

Here's a unique monitoring system: three independent Auratone speakers in one compact enclosure. Only 5 1/4" high, it can sit on top of your console or, with optional ears, be rack mounted. Frequency response is 100Hz to 12.5kHz, ±3dB. Power handling is 40 watts for each speaker. Use this great set to simultaneously monitor the mono sum as well as left and right, or use them at the transmitter for simultaneous AM and FM monitoring. Put your imagination to work and you'll find many applications.

**5RMC**                      60AA5MC              MFR LIST              \$195.00

**Accessory:**

**Rack ears**                      60AA5MCR              MFR LIST              \$9.95

Call Bradley for a current price quotation.



### Auratone 5PSC Primo Sound Cubes

These monitors have been recently upgraded with a new, shielded driver for even better performance. Durability, smooth full range response, 35 watts nominal power handling, and portability make the Auratone a favorite for comparison and final mixes, auditioning, remotes, and as a reference standard speaker. Woodgrain, black, or white vinyl finish with matching removable, fabric grille.

**Walnut**                      60AA5C                      \$119.00 pr

**Black**                      60AA5CB                      \$119.00 pr

**White**                      60AA5CW                      \$119.00 pr



### Tannoy System 8 NFM

The single point source design of the System 8 NFM allows for accurate location of sounds within the stereo field. The speaker uses Tannoy's 8" dual concentric driver and the cross braced, energy controlling design. Response is 48Hz to 25kHz ±3dB. Designed for 20 to 120 watt amplifiers, the System 8 NFM has peak power handling of 200 watts. Sold in pairs.

**System 8 NFM**              60TAS8NFM              MFR LIST              \$1295.00 pr

Call Bradley for a current price quotation.



### Tannoy PBM Series

For excellent sound quality in applications where space is tight, the award winning PBM near-field monitors really shine. These compact and lightweight enclosures will readily fit on console tops or in small shelf areas. The PBM 6.5 has a 6 1/2" woofer and 3/4" dome tweeter with the smooth, wide range sound characteristic of Tannoy's famous larger studio monitors. The PBM 8 has an 8" woofer for extended low frequency response. The high sensitivity of these speakers permits their use with lower power amplifiers. External finish is vinyl matte grey with black cloth grilles, which are removable. The quality of Tannoy at remarkably low prices brings great sound into everyone's price range. We know you'll be pleased with the sound you'll get from these great small monitors. Sold in pairs.

**PBM 6.5**              60TAPBM65              MFR LIST              \$395.00 pr

**PBM 8**                      60TAPBM8              MFR LIST              \$575.00 pr

Call Bradley for a current price quotation.





## JBL 4200 Series Studio Monitors

These speakers bring a new look and a new sound to console-top, near field monitoring. The unique Multi-Radial baffle optimizes stereo imaging between 3 and 5 feet from the speakers. Both the new 1" titanium high frequency transducer and low frequency components are shielded for use close to video monitors and other sensitive equipment. Woofers are 6½" on the 4206 and 8" on the 4208. The enclosures are covered with gray vinyl and the front baffles are injected molded polypropylene.

4206	60JB4206	MFR LIST	\$197.50
4208	60JB4208	MFR LIST	\$262.50

Call Bradley for a current price quotation.



## Electro-Voice S-40 Compact Monitor Speaker

Only E-V could pack this much sound into such a compact package. The S-40 features a 5½" direct-radiating polypropylene woofer and a 1" ferro-cooled soft dome tweeter in a high-impact polystyrene enclosure that is only 9.8" x 7" x 5.9". The drivers produce an exceptionally smooth response and have low flux leakage designs enabling placement close to video monitors. Long term power handling is rated at 160 watts and protection circuits prevent against accidental overload. The S-40 comes with threaded inserts for Omnimount Series 25 mounts and a U-type mounting bracket is optionally available. Sold in pairs.

S-40 Black	60ELS40	MFR LIST	\$280.00 pair
S-40 White	60ELS40W	MFR LIST	\$280.00 pair

### Accessories:

<b>Black U-type bracket</b>			
60ELS40MB	MFR LIST	\$30.00	pair
<b>White U-type bracket</b>			
60ELS40MBW	MFR LIST	\$30.00	pair

Call Bradley for a current price quotation.



## Omnimount Universal Mounting Systems

These durable and functional mounting systems come in models to meet any installation requirement. The patented ball and clamp assembly enables omnidirectional movement. Wiring can be hidden in the assembly for a dressed installation. The 50 series holds up to 20 pounds, the 75 series is rated for 40 pounds, and the 100 series will hold 70 pounds. The "WB-BC" bottom mount has a double bend tube to hold the speaker from its bottom. The "WA-BC" is of similar design, but has a single bend tube to hold the device from the rear. Also available is the "CA-MP" ceiling mount, several other configurations, and series with greater load handling. Your Bradley professional can help you select the right Omnimount for the job.



50 WA-BC	600M50WA	\$38.00	75 CA-MP	600M75CAMP	\$57.00
50 WB-BC	600M50WBBC	\$38.00	100 WA-BC	600M100WA	\$68.00
50 CA-MP	600M50CAMP	\$43.00	100 WB-BC	600M100WB	\$68.00
75 WA-BC	600M75WABC	\$57.00	100 CA-MP	600M100CAMP	\$68.00
75 WB-BC	600M75WBBC	\$57.00			

## Pivotelli Speaker Brackets

These universal brackets are known for their outstanding performance in a supporting role. They hold speakers weighing up to 44 pounds and between 4" and 10" deep. The speakers are clamped front and back, and, while screw holes are provided on the bottom of the bracket, screwing into most speakers is not required. Speakers can swing side to side and tilt up and down. The distance to the walls is also adjustable. Pivotelli brackets have a 5 year warranty, and are packed with complete hardware for installation into wooden wall studs, brick, or concrete.

### Speaker Brackets

60PVSS	MFR LIST	\$89.95 pr
--------	----------	------------

### Accessory:

**Metal stud kit** must be used for mounting on metal studs.  
60PVMSSK MFR LIST \$9.95

Call Bradley for a current price quotation.

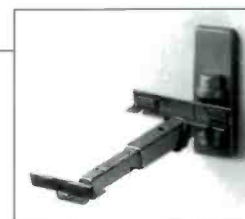

### Carver Power Amplifiers

These amps pack a host of professional features. All feature XLR, TRS, and barrier strip inputs, dual front panel level controls, headphone jack, and full protection circuitry. Per channel output at 8 ohms is 40 watts for the PM-120, 110 watts for the PM-300, and 200 watts for the PM-600. The PM-120 and PM-300 are only one rack unit high, while the PM-600 is two units high. Extremely low noise and wide, flat response make these an excellent choice to drive studio monitors.

<b>PM-120</b>	60CVPM120	<i>MFR LIST</i>	<b>\$560.00</b>
<b>PM-300</b>	60CVPM300	<i>MFR LIST</i>	<b>\$750.00</b>
<b>PM-600</b>	60CVPM600	<i>MFR LIST</i>	<b>\$860.00</b>



**Also available:**

The full range of Carver power amplifiers for sound reinforcement. Call for details. **Call Bradley for a current price quotation.**

### Crown D75 Amplifier

The D75 is a most popular choice for control room or production monitor applications where accurate reproduction is a must. This amplifier can drive any type of load without fear of amp burnout, with 50 watts per channel into 8 ohms. THD is below 0.05%, IMD below 0.01%. Complete output protection, direct coupled circuitry with balanced XLR or unbalanced inputs, front panel level controls, and headphone output are all provided. 19" rack mount standard; uses only 1 rack space.

<b>D75</b>	60CR75	<i>MFR LIST</i>	<b>\$549.00</b>
------------	--------	-----------------	-----------------

**Call Bradley for a current price quotation.**



**Also available:**

See the Sound Reinforcement section of this catalog for our complete selection of higher power Crown amps.

### Symetrix A-220 Amplifier

Supplying 20 watts per channel, the A-220 is an excellent choice for powering headphones or driving small monitor speakers. Features include independent level controls on each channel, balanced XLR and unbalanced 1/4" TS input connections, and a rear panel switch to select stereo or mono bridge operation. With 0.08% distortion, the A-220 provides quality and value.



<b>A-220</b>	60SYA220	<i>MFR LIST</i>	<b>\$349.00</b>
--------------	----------	-----------------	-----------------

**Call Bradley for a current price quotation.**

### Ashly SRA-120 Amplifier

Ashly has long been known for their high-quality, rugged power amplifiers. The SRA-120 is a single rack space amp that's perfect for bi-amplification or close-field monitoring. Delivering 60 watts per channel into 4 ohms (45 per channel into 8 ohms), the feisty SRA-120 utilizes a complementary bipolar output section for low distortion and excellent overload characteristics. It features turn-on delay circuitry and instantaneous turn-off, for protection against speaker damage.

<b>SRA-120</b>	60ASSRA120	<i>MFR LIST</i>	<b>\$429.00</b>
----------------	------------	-----------------	-----------------



**Call Bradley for a current price quotation.**

### US Audio P-12 Amplifier

The P-12 works perfectly as a headphone monitor amp. With 12 watts per channel in stereo, its more than enough to drive even the least efficient pro headphones. The front-panel headphone jack is next to a speaker on/off switch so that a small pair of monitor speakers can also be selectively driven. A pair of LEDs will tell you if your signal is clipping. Why use a big beefy power amp when you get something that does just what you need it to do for less?

<b>P-12</b>	60WHP12	<i>MFR LIST</i>	<b>\$198.00</b>
-------------	---------	-----------------	-----------------



**Call Bradley for a current price quotation.**



## Stewart PA Series Power Amps

The unique design of Stewart PA Series allows them to produce accurate and musical audio from compact and lightweight amplifiers. The 100kHz switching power supply results in minimal recovery time and maximum efficiency. The PA Series have dual mono construction with two discrete amplifiers with independent power supplies. The PA1000 delivers 200 watts RMS per channel into 8 ohms stereo, with the PA1400 delivering 300 and the PA1800 providing 400. Specifications rival much more expensive units, with response of 20Hz to 20kHz,  $\pm 0.5$ dB; distortion a mere 0.10% full bandwidth; and slew rate of 29V/ $\mu$ s. All carry a 5 year parts and labor warranty.

<b>PA1000</b> (1-rack space)	60SEPA1000	<i>MFR LIST</i>	<b>\$1099.00</b>
<b>PA1400</b> (2-rack spaces)	60SEPA1400	<i>MFR LIST</i>	<b>\$1399.00</b>
<b>PA1800</b> (2-rack spaces)	60SEPA1800	<i>MFR LIST</i>	<b>\$1599.00</b>

**Call Bradley for a current price quotation.**



## Stewart PA Series Half Rack Amplifiers

The PA50B provides 25 watts per channel stereo and 100 watts when bridged mono, and the PA100B will supply 50 watts and 200 watts respectively. Specifications rival much more expensive units, with response of 20Hz to 20kHz,  $\pm 0.5$ dB, S/N of 98dB, and distortion at 1kHz a mere 0.1%. The entire chassis on these potent little power amps serves as a heat sink and will keep them cool even when rack mounted and in constant use. Inputs are 1/4" balanced, level controls are tamper resistant screwdriver pots on the front panel. The PA200B, based on the PA100B, features front panel knobs instead of screwdriver access, 1/4" phone output jacks, and a Stewart IEQ circuit.

**Call Bradley for a current price quotation.**

**Accessories:**

<b>Single rack kit</b>	60SERMK1	<i>MFR LIST</i>	<b>\$20.00</b>
<b>Dual rack kit</b>	60SERMK2	<i>MFR LIST</i>	<b>\$30.00</b>



<b>PA50B</b>	60SEPA50B	<i>MFR LIST</i>	<b>\$299.00</b>
<b>PA100B</b>	60SEPA100B	<i>MFR LIST</i>	<b>\$399.00</b>
<b>PA200B</b>	60SEPA200B	<i>MFR LIST</i>	<b>\$429.00</b>

## Yamaha P2075 Amplifier

Yamaha produces professional tools for professional people. Built in a rugged, convection cooled two rack space chassis, the P2075 will provide up to 50 continuous watts per channel, and can be switched into bridged mono operation. The recessed front panel input attenuators are 32 point detented and calibrated for accuracy. On the rear, the inputs are electronically balanced with 1/4" TRS and XLR connectors. Outputs are through binding posts and 1/4" jacks. Comprehensive overload, transient, DC offset, and output speaker relay protection add up to make a safe and reliable amplifier for any application.

<b>P2075</b>	60YAP2075	<i>MFR LIST</i>	<b>\$395.00</b>
--------------	-----------	-----------------	-----------------

**Call Bradley for a current price quotation.**



**Also available:**

See the sound reinforcement section of this catalog for our complete selection of higher power Yamaha amplifiers.

## Ramsa WP-1200 & WP-1400 Power Amplifiers

Though less frequently heard about than some other names, the Ramsa line of power amplifiers offers an uncommon combination of features that make them an ideal choice for many applications. Unlike conventional amps, the WP-1000 Series uses a unique dual voltage "Class H" circuit design that continually monitors the input signal and quietly switches output voltage modes to keep the amp running as efficiently as possible. Likewise, the variable speed ducted cooling fans remain virtually silent until the amp experiences high power demands.

For ease of installation, inputs are on both balanced XLR and TRS connectors, and outputs are on traditional banana-style binding posts. Front panel indicators show both signal peaks and clipping. Both models can be run in a Bridged Mono mode for heavy duty applications. The 2 rack-unit WP-1200 delivers 120 watts per



channel into 8 ohms (stereo), 200 watts into 4 ohms, and 400 watts bridged mono into 8 ohms. The 3 rack-unit WP-1400 produces up to 240, 400, and 800 watts respectively.

<b>WP-1200</b>	60PAWP1200	<i>MFR LIST</i>	<b>\$650.00</b>
<b>WP-1400</b>	60PAWP1400	<i>MFR LIST</i>	<b>\$800.00</b>

**Call Bradley for a current price quotation.**

## Rane HC6 Headphone Console

This unique product is more than a headphone distribution amp. A master stereo input drives six independent stereo headphone amplifiers, which provide both front and rear panel 1/4" TRS outputs. Each amplifier also has a separate mono balanced/unbalanced input, allowing the HC6 to be up to six independent amplifiers. A front panel master level control and mono/stereo push button are also provided. Rack mount is standard.

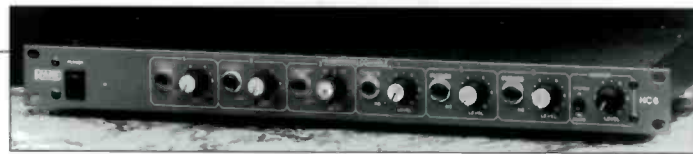

**HC6** 60RNHC6 MFR LIST \$429.00  
 Call Bradley for a current price quotation.

## Symetrix SX204 Headphone Amplifier

One of the SX Series half-rack units, the SX204 is a 1 in, 4 out stereo headphone amplifier. Four independent stereo amps will drive even high-impedance headphones to maximum levels. Controls provided are master input level, stereo/mono switch, and individual level controls. Balanced or unbalanced inputs are on 1/4" TRS jacks, outputs also 1/4" TRS.



**Accessory:**  
**Rack mount kit** for one or two SX series units.

**SX204** 60SYSX204 MFR LIST \$299.00

**60SYRM2** MFR LIST \$39.00

Call Bradley for a current price quotation.

## ATI HD1000 Headphone Amplifier

The HD1000 is a clean sounding, stand-alone headphone amp and serves as the heart of a comprehensive and flexible headphone distribution system. The HD1000 has a stereo line level input plus a front panel, panned mic input for paging and commentary. The two inputs may be mixed to drive the four headphone outputs, each with individual level control. Expansion outputs allow daisy chaining of any number of HD1000s or HD100 single headphone amp modules. The compact HD100 is compact and rugged for convenient installation anywhere.



**HD1000 Mixer/Headphone Amp** 60AIHD1000 MFR LIST \$429.00  
**HD100 Single Headphone Amp Module** 60AIHD100 MFR LIST \$199.00

**Accessories:**

**Rack mount** for one HD1000 60AI20021 MFR LIST \$20.00  
**Rack mount** for two HD1000s 60AI20024 MFR LIST \$25.00

Call Bradley for a current price quotation.

## Benchmark Stereo Headphone Amplifiers

You can use additional headphone amps in your consoles, at your patch bay, in the talk studio, and several other locations around the facility. The Benchmark HPA-1 puts the monitoring right where you need it most. Capable of driving both low and high impedance headphones, the HPA-1 includes a gain pot adjustable from Off to +18dB. Requires ±9 to ±22VDC bipolar power to be user supplied.

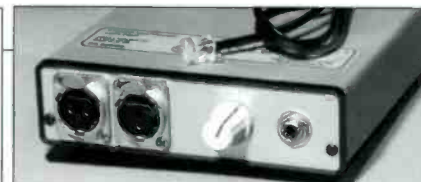

For a high quality, self contained headphone amp, we offer the IFA-7. Separate left and right XLR inputs ease installation. Requires PS-1 power supply.

**HPA-1** 60BMHPA1 MFR LIST \$69.00  
**IFA-7** 60BMIFA7 MFR LIST \$260.00

**Accessory:**

**PS-1 power supply** for IFA-7. 60BMPS1 MFR LIST \$35.00

Call Bradley for a current price quotation.

## Whirlwind Headphone Breakout Box

With two stereo inputs (for daisy chaining) wired to six resistor-bridged outputs, this passive headphone splitter is perfect for the recording studio or remote applications where multiple headphones are used. Housed in a heavy gauge, cold rolled steel box, the box uses locking 1/4" TRS jacks to prevent accidental disconnection.



**Headphone Box** 61WHBB \$71.00

## U.S. Audio Headphone Satellite Module

The U.S. Audio PHSAT Satellite Module accepts any stereo input and distributes it to either of two stereo outputs. It has parallel 1/4" TRS input/output connectors for daisy chaining as well as separate gain and pan controls and mono/stereo switching for two sets of two headphones. An optional mounting bracket will attach the PHSAT to a standard 5/8" thread mic stand.



**PHSAT Satellite Module** 60WHPHSAT MFR LIST \$149.00  
**PHCLIP mic stand mount** 60WHPHCLIP MFR LIST \$17.95

Call Bradley for a current price quotation.

**AKG Headphones**

**K141/2**

The K141/2 is a new version of this popular lightweight, comfortable headphone. It is semi-open featuring resonance-free characteristics but with freedom from low frequency side effects. The K141/2 provides an extremely broad, flat response almost totally free of coloration. It produces sound which is warm, not boomy; open and present without harshness. Weighs in at only 8 ounces. 600 ohms.



60AKK141 \$89.00

**K240M**

This circumaural stereo headphone provides excellent directional sound perspective and distance discrimination, faithfully simulating hearing in natural room conditions. Patented design combines main transducers and 12 passive diaphragms, providing crossover at 200Hz. Weighs 8½ ounces. 600 ohms.



60AKK240 \$109.00

**K240DF Studio Monitor**

A calibrated version of the popular K240M. The K240DF is designed with a flat frequency response based on European requirements for a reference monitor headphone. Weighs 8½ ounces. 600 ohms.



60AKK240DF \$129.00

**AKG K400**

This highly accurate, large diaphragm headphone has an open design and response from 20Hz to 26kHz. It uses a neodymium magnet and has an oxygen free copper cable with 1/4"/mini gold plated connector. 7.8 ounces. 120 ohms.



60AKK400 \$149.00

**AKG K500**

AKG's top-of-the-line headphone uses an enhanced sensitivity large diaphragm transducer with very open design to eliminate resonance coloration. Response is from 15Hz to 27kHz. The headband is leather and the ear cushions are covered with a washable fabric. K500 uses a neodymium magnet and has an oxygen free copper cable with 1/4"/mini gold plated connector. 7.8 ounces. 120 ohms.



60AKK500 \$189.00

**Sennheiser Headphones**

**HD 450 Studio**

One of our most popular models, the HD 450 Studio is successor to the legendary Sennheiser 414 series. The unique Open-Aire design makes the HD 450 Studio light (4.7 ounces) and comfortable. It has higher output and improved accuracy through the use of neodymium iron magnets. 10' replaceable cable with 1/4"/mini connector. 600 ohms.



60SNHD45013 \$85.00

**HD 25**

The HD 25 is Sennheiser's latest, top-of-the-line studio monitoring model. The supraural design (the headphone sits on top of the ear) offers a comfortable alternative to professionals who spend a great deal of time wearing headphones. Frequency response is accurate to 16kHz. The HD 25 has both the accurate sound you need, and the ruggedness for use in the studio or in the field. Weighs only 5 ounces. 70 ohms.



60SNHD25 \$179.00

**HD 540**

This Open-Aire design headphone is digital ready. With wide frequency response (16Hz to 25kHz), and resonance damped design, the HD 540 is suitable for critical reference monitoring. Your ears ride free inside the ear pads, eliminating annoying pressure and heat build-up. 600 ohms.



60SNHD540 \$157.00

**HD 250**

For applications requiring a sealed headphone, the HD 250 meets the demand. Response is 10Hz to 25kHz and these lightweight headphones weigh less than 5 ounces. 600 ohms.



60SNHD250 \$179.00

**HD 490**

Employing all of the technology of Sennheiser's more expensive models, the HD 490 is equalized for more high end and extended low frequency response. 70 ohm impedance.



60NSHD490 \$102.00

**Note: Replacement cushions, drivers, and cables are available for all Sennheiser headphones. Call Bradley for pricing.**

**Studio Headphones**

**Fostex T20RP**

A lightweight headphone providing superior reproduction using Fostex's exclusive RP technology. Absolutely one of the most comfortable phones you'll wear. 50 ohms.



60FOT20 \$59.00

**Beyer DT 220**

These closed system headphones combine exceptional comfort, long lasting durability and superior intelligibility for critical monitoring. Frequency response of 20Hz to 20kHz and high SPL before distortion. 400 ohms.



60BEDT220 \$123.00

**Koss PRO 4AA**

The PRO 4AA gives you full range (10Hz to 20kHz) with freedom from distortion even at high levels. The patented, air filled ear cushions conform to any head shape, forming a secure seal against outside noise. 100 ohms.



60KOP4AA \$79.00

**Sony Headphones**

This series of professional headphones have closed ear designs for reduction of external noise, and unimatch plug with gold connectors for 1/4" and mini applications.

**MDR-7502**

A cost effective headphone with a 30mm driver and 60Hz-16kHz. 45ohms

**MDR-7504**

The MDR-7504 yields a 15Hz to 18kHz frequency response from its 40mm drivers. Folding construction for compact storage. 45 ohms.



60SOMDR7504 \$65.00

**MDR-7506**

This is Sony's professional version of their MDRV6 model. This rugged headphone is one of the most popular for studio and field use. 10HZ to 20kHz response, 40mm drivers, and folding construction. 36 ohms.



60SOMDRV6 \$79.00

**Stanton 35M/HB**

The 35M/HB is a single muff headset with comfortable headband. Used by DJ's in clubs or stations to monitor a mix or cue. Patented Samarium Cobalt driver produces extremely accurate sound.

35M/HB 60ST35MHB MFR LIST \$79.00

Call Bradley for a current price quotation.



## ESE ES362A Master Timer

This four digit, 100 minute up/down timer features a serial output capable of driving up to 100 remote slaves. The ES362 has front panel lever switches to pre-set start times, as well as up, down, stop, and reset controls. A wide variety of table, wall, rack, and console mounted slaves are available. Call or fax for a complete list of slave options.

**ES362A**                  60ES362                  *MFR LIST*                  **\$420.00**

*Call Bradley for a current price quotation.*



## ESE ES520 Timer

The latest up-counting timer from ESE packs it all. The four digit, 60 minute ES520 can be controlled from the front panel start, stop, and reset controls or via two remote options. A momentary short to ground or 5 volt logic "0" can activate any of the functions, and four "trigger resets" can reset the timer using either a momentary or continuous signal. The large LED display makes the ES520 easy to read in all light conditions. The serial output on the ES520 can be used to drive up to 100 remote slave displays.

**ES520**                  60ES520                  *MFR LIST*                  **\$179.00**

*Call Bradley for a current price quotation.*



## Radio Systems Analog Master Clock System

Synchronize up to 50 low cost, big, bright, wall clocks to within one second accuracy with Radio Systems impulse clock system. Just three wires between each clock keeps every unit on time. The master driver even sets Daylight Savings Time and works during power failures, all without losing a second. The unit comes complete with an internal crystal reference or will operate with any external reference. A new digital read-out is also now available. Uses only a single rack space.

**Master Clock Driver**                  60RSMCD                  *MFR LIST*                  **\$595.00**

**12" Analog Clock Display**                  60RSAC                  *MFR LIST*                  **\$125.00**



## Time Master & Frame Master Time Calculators

In our business, where every second counts, accurate time calculations are essential. The Time Master calculator works directly in hours, minutes, and seconds and converts to and from each of these formats. It handles 12 hour and 24 hour timing, and includes hourly rate calculation abilities. Ideal for recording, editing, logging, and a host of other time related calculations.

The Frame Master is designed for anyone working with time code. It works directly in 30 non-drop frame, 30 drop frame, frames, and real time. Frame Master performs conversions between these formats, and features both manual and auto-entry. The Frame Master Plus model adds 24fps, 25fps, and custom (user defined) frame rates, Feet-Frames (16mm and 35mm) and several other features for those who work in film. For finding durations, making edit decision lists, logging tapes, and on-line editing, the Frame Master is an invaluable tool.

**Time Master**                  60CITM                  **\$59.95**

**Frame Master**                  60CIFM                  **\$58.00**

**Frame Master Plus**                  60CIFMP                  **\$76.00**



## Warning Lights

### 1. Fidelipac Warning Lights

Red lettering on a black background provides a highly visible warning that microphones are live. ON AIR or RECORDING legends are available. Lights are 5" high, 10" long, and 2 1/2" deep; and the ON AIR legend is also available in



Spanish, French, German, Japanese, and four other languages.

<b>ON AIR</b>	60FP340	MFR LIST	<b>\$72.00</b>
<b>RECORDING</b>	60FP340REC	MFR LIST	<b>\$72.00</b>

### 2. McPhilben Warning Lights

These warning lights are functional and elegant. They measure 7 1/2" square, operate on 120VAC, and include two 20 watt lamps. The double faced model is designed for wall or ceiling mounting.

<b>Single faced wall mount</b>	60PRW6142R		<b>\$107.50</b>
<b>Double faced mount</b>	60PRE6242R		<b>\$115.00</b>

### 3. BE Studio Warning Light

This classic design light comes complete with a 25 watt red bulb and an attention grabbing flasher. The silkscreened globe housing fastens to a steel mounting plate. Available legends are ON AIR, AUDITION, REHEARSAL, and RECORD. Specify vertical or horizontal lettering. Also available in other languages.

60BR83500X **\$57.00**



### 4. Titus Warning Lights

Titus ON AIR and RECORDING lights are beautiful and practical ways of indicating that a studio is in use. Four internal lamps are wired in parallel, and use 24VDC, eliminating the need for relay interface boxes. The mounting base is of solid oiled oak, and overall dimensions are 8 1/8" wide, 4 1/4" high, and 2 1/2" deep. Lettering is on a smoked glass window that is available with either a horizontal or vertical orientation with a silver or a gold frame.

60TIOALXX MFR LIST **\$125.00**

Call Bradley for a current price quotation.



## Enberg Alert Monitors

These innovative units provide visual indication of multiple alert signals. These alerts can be EBS receivers, TTY machines, weather bulletins, transmitter alerts (through your remote control), doorbells, burglar alarms, silence sensors, and cue tones. Three modes of operation are provided and can be individually assigned by channel. Manual Reset requires the operator to reset the monitor; Auto Reset allows the lamps to stay on from 15 seconds to 30 minutes before shutting off; and Fone/Latching, enabled with the included FN-6 module, displays incoming phone calls and is used for latching closures. The Alert Monitors have opto-isolated inputs and solid state relays. The BA-6 wall mount unit displays alerts with 120 volt, 15 watt flashing lamps. The BA-6RX rack mount unit uses 8mm red LEDs. 30 standard labels are included and custom labels are available.

<b>BA-6 wall mounting</b>	60ENBA6	MFR LIST	<b>\$379.00</b>
<b>BA-6RX rack mounting</b>	60ENBA6RX	MFR LIST	<b>\$379.00</b>

#### Accessories:

Remote slave monitors. Up to ten remote monitors may be driven by a BA-6 and up to 15 by the BA-6RX.

<b>BA-6R wall mount remote</b>	60ENBA6R	MFR LIST	<b>\$199.00</b>
<b>BA-6RXR rack mount remote</b>	60ENBA6RXR	MFR LIST	<b>\$119.00</b>
<b>Extra telephone module.</b> Each module detects ring for two separate lines.	60ENFN6	MFR LIST	<b>\$35.00</b>

Call Bradley for a current price quotation.

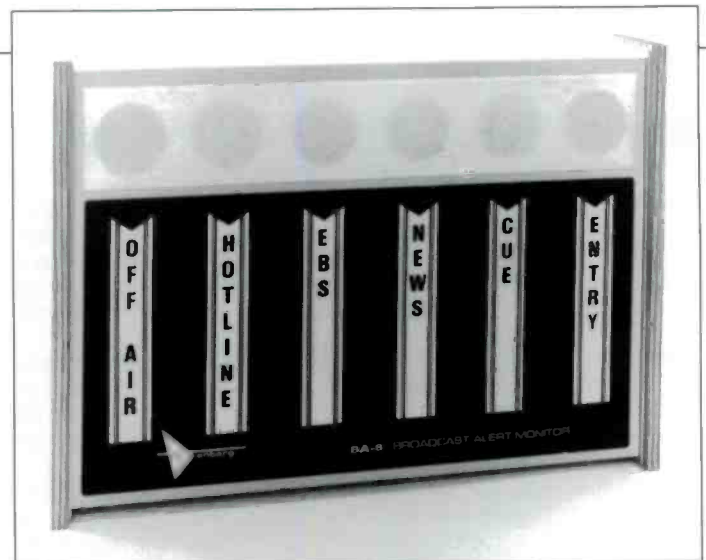

**Power Distribution**

1. Whirlwind AC6R 19" rack mount panel has six outlets, on/off switch, and resettable circuit breaker. 15 amps.

**AC6R** 61WHPC1 \$42.00

2. Furman PL-Plus has eight switched outlets, a ten foot heavy duty power cord, a front panel LED voltage monitor, and RF filtering. Outlets are rated at 15 amps. The two slide out lamps have a dimmer control.

**PL-Plus** 60FUPLPLUS \$175.00

3. Furman AR-117 AC line regulator protects equipment from problems caused by brownouts and overvoltages. It accepts voltages from 97 to 131 volts, and converts them to US standard 117 volts. Output of 100VAC is also switch selectable. Input capacity 15 amps; output 12 to 15 amps. Unit instantly shuts down to protect your gear should an extreme overvoltage situation occur.

**AR-117** 60FUAR117 \$449.00

4. Bradley PD11L AC Power Distribution/Rack Illuminator allows you to safely power up to ten pieces of equipment while also protecting them from sudden voltage spikes and damaging power surges. Built-in EMI/RFI filtering will also protect your audio system from unwanted noise. Eight of the outlets are switched. The PD11L is rated at 15 amps and includes a 6' grounded power cord. The two switched, slide-out lamps illuminate your gear when the PD11L is mounted at the top of your rack.

**PD11L** 60AR614 \$139.00

5. Bradley PD11LV includes all the features of the PD11L plus a digital voltmeter display on the front panel.

**PD11LV** 60AR615 \$189.00

**Bradley PD14LVS Power Strip** (not pictured) with sequential three circuit distribution, designed to protect and filter any electronic equipment that requires time delayed power-up and down. The sequencing feature eliminates high inrush current and precludes equipment failure, like blown fuses. An LED monitored master switch sequences on or off the protected circuits at intervals of 5 to 30 seconds as preset by a timing wheel located inside the unit. It also has EMI/RFI filtering,



retractable illuminators, digital voltmeter, 14 outlets (12 switched, 2 unswitched). The PD14LVS is 2 rack units high, and features 15 amp, 1800 watts per unit input.

**PD14LVS** 60ARPD14LVS \$499.00

6. Antronics UL60S power strip is a heavy duty six outlet box with on/off switch and resettable circuit breaker. 15 amps.

**UL60S** 61ANUL60S \$19.95

**Furman AR-PRO** (not pictured) delivers 120 volts AC (±3VAC) anywhere in the world with capture ranges of 88 to 134 volts and 172 to 264 volts. Because the AR-PRO works automatically, it can protect against a catastrophic error. The AR-PRO can handle loads of up to 30 amps. Fourteen regulated, conditioned outlets are provided and the AR-PRO is in a compact 3.5" rack mounting unit weighing only 39 pounds.

**AR-PRO** 60FUARPRO \$1649.00

**Superior Electric STABILINE Power Protection**

They say you are what you eat. The same is true of the electronics in your facility; they perform best when fed a clean, steady diet of AC power without spikes, sags, dropouts, noise or other electrical "junk food." Superior Electric produces a comprehensive array of STABILINE transient suppressors, line conditioners, and uninterruptible power supplies to prevent microprocessor malfunction and equipment downtime.

The PQI Series Power Quality Interfaces provide transient voltage suppression and RFI filtering using proven, multi-stage design. This series is designed for providing critical equipment with local protection. For power conditioning for full rooms, entire facilities, or transmitters, Superior Electric has a range of products that will certainly meet your installation requirements and budget.

The UPSY Uninterruptible Power Supplies provide voltage regulation, noise protection, and battery backup power to address blackouts, brownouts, surges, sags, spikes, and transients. Highly efficient, the UPSY Series comes in rack mount and cabinet configurations.

Contact your Bradley professional for assistance in selecting the right power "diet" for your sensitive equipment.

**PQI Series 2000 STABILINE Power Quality Interfaces** (15 amps)

4 AC receptacles 60SUPQI2115 MFR LIST \$149.00

2 AC & 2 RJ-11C receptacles 60SUPQI2115D MFR LIST \$179.00



**PQI Series 3000 STABILINE Power Quality Interfaces** (15 amps)

4 AC receptacles 60SUPQI3115 MFR LIST \$199.00

2 AC & 2 RJ-11C receptacles 60SUPQI3115D MFR LIST \$229.00

Call Bradley for a current price quotation.





## CSL Alternator Power Systems

Emergency power can be a real hassle for broadcasters. Obviously, high power transmitters require large engine driven generators. But, what about your studio? A generator in many office buildings is prohibited by either local building codes or the landlord. How about the midpoint of your two-hop STL? Or, your translator on a hilltop two counties away? Fuel and maintenance requirements make generators impractical in these instances. How do you solve these problems? Commercial Sound Labs and Bradley to the rescue!

CSL makes three sizes of battery powered alternate power sources that are ideal for broadcast, recording studio, and sound reinforcement applications. Sizes are 250, 500, or 1000 watts. All mount in just 5 1/4" (3 rack units) of space. Up to several hours of reliable power can be provided depending on the type and number of 12 volt batteries used. Choices range from high quality gel cells to inexpensive car batteries. Your Bradley professional is available to help you calculate your emergency power requirements. Only you can calculate the revenue and audience loss from being off the air.

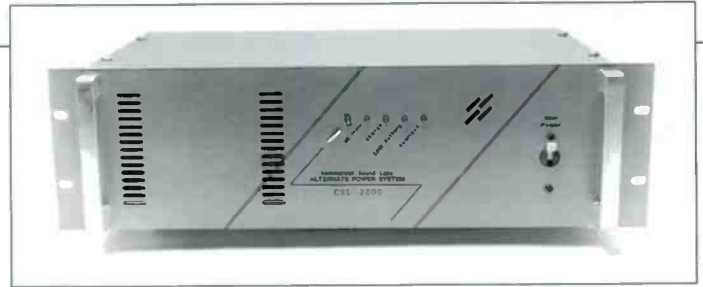

<b>250 Watts</b>	60CSL500	MFR LIST	<b>\$1075.00</b>
<b>500 Watts</b>	60CSL1000	MFR LIST	<b>\$1425.00</b>
<b>1000 Watts</b>	60CSL2000	MFR LIST	<b>\$1645.00</b>

Call Bradley for a current price quotation.

## Northern Technologies

Power line problems, such as surges and transients, do considerable damage each year to broadcast equipment. Unfortunately, newer solid state equipment is more susceptible to damage than older tube-type equipment. To reduce costly repairs to your expensive equipment, and to avoid the embarrassment of lost air time, call Bradley today. We'll help you choose the correct Northern Technologies power protection equipment for your installation.

Northern Technologies offers a variety of sizes and styles for any power protection need. For your service entrance, there is the LAP series, available in single or three phase configurations with ratings up to 480 volts. The TCS series is a bit smaller and is designed for individual branch circuits, either single or three phase. The PLS series is designed to protect individual pieces of equipment, such

as a computer, console, DAT machine, etc. The TCS-RJ series is available for telephone line protection.

A detailed booklet is available describing each series in detail; call for your copy.



## PerfectData Copy Stands

These convenient stands bring your copy close when you need it and move out of the way when you don't. Almond colored, these stands include a "C" clamp for mounting. They are available in letter size with two capacities. The optional extender allows your stand to hold computer printouts or open books.

<b>Letter size 1lb capacity</b>	61LU16007	<b>\$42.00</b>
<b>Letter size 3lb capacity</b>	61LU16008P	<b>\$49.00</b>
<b>Extender</b>	61LUEK	<b>\$16.00</b>

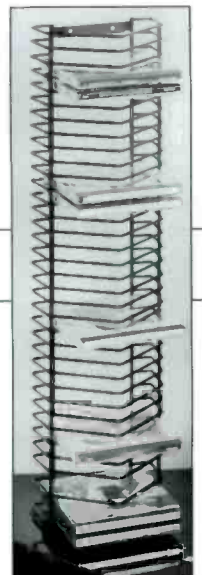
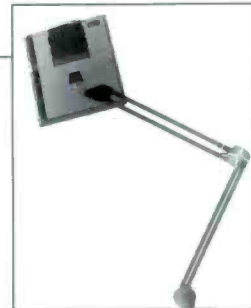

## Bradley Wire and Metal CD/ Cassette Storage

These unique, attractive, and durable wire racks provide an easy and inexpensive solution to your CD storage needs. Each wire tower CD holder keeps 31 single and two double CD cases stored safely in free-standing, table, or wall configuration. At less than 50 cents per unit, these racks may well be the most economical CD storage method ever. Metal versions are available for CD and cassette storage and for stackable, freestanding storage.

<b>CD wire tower 35 capacity</b>	61AR1209	<b>\$16.00</b>
<b>CD metal module 25 capacity</b>	61AR1213	<b>\$27.00</b>
<b>Cassette module 19 capacity</b>	61AR1217	<b>\$27.00</b>



### ProRax Cart and CD Racks

These cost effective racks have a mahogany finish.

<b>100 capacity wall cart rack</b> 23½"W x 24½"H x 4¾"D	
60PRW100	<b>\$99.95</b>
<b>20 capacity wall cart rack</b> 5¾"W x 24½"H x 4¾"D	
60PRW20	<b>\$45.00</b>
<b>80 capacity wall or desk CD rack</b> 23¾"W x 15¾"H x 4¾"D	
60PRCD80W	<b>\$89.95</b>

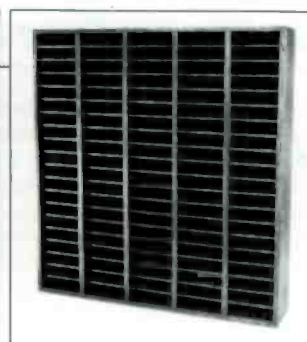
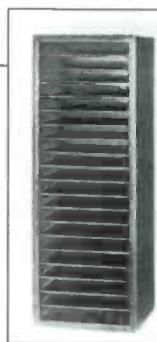

### Ruslang CD Racks

Bradley Broadcast makes Ruslang quality available to store your CD's. Since these racks hold discs without shelves, they are easy to keep clean. Wall mount and lazy susan table top units are available. Stack-on units may be placed on top of the lazy susans to double capacity. Available in walnut, oak, black, and other colors.

<b>96 capacity wall unit</b> 18" W x 5¾"D x 23¾" H.	
60RLCD96	<b>\$113.00</b>
<b>128 capacity lazy susan</b> 23½" Turning radius, 15" high.	
60RLCD128LS	<b>\$313.00</b>
<b>256 capacity lazy susan</b> 23½" Turning radius, 27½" high.	
60RLCD256LS	<b>\$435.00</b>

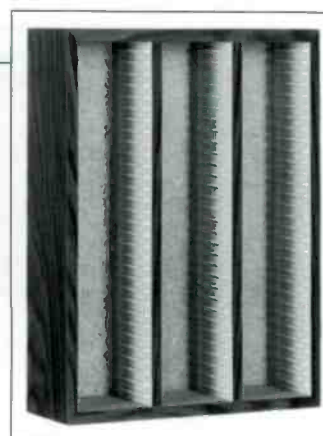
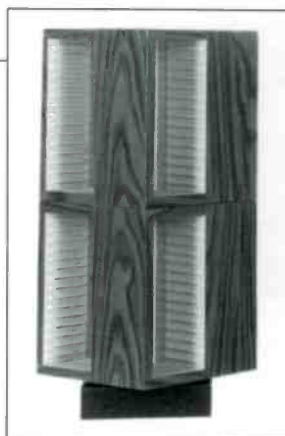

### Fidelipac Cart Racks

#### Fidelipac Tabletop Cart Racks

These carousels have removable wire racks. The TR-48 holds 48 carts in four racks, stands 20" high, and has a diameter of 15". The TR-96 holds 96 carts in 8 racks, stands 20" high, and has a 20" diameter.

<b>TR-48</b>	60FPTR48	<i>MFR LIST</i>	<b>\$109.00</b>
<b>TR-96</b>	60FPTR96	<i>MFR LIST</i>	<b>\$194.00</b>

#### Fidelipac MR-200 Mobile Cart Rack

Fully loaded, the MR-200 can store 200 carts. It consists of eight WR-25 single column racks mounted on the MRB-1 carousel rack base with casters. Each WR-25 can be removed from the carousel even when fully loaded, and is available separately to serve as a 25 cart wall rack.

<b>MR-200 complete</b>	60FPMR200	<i>MFR LIST</i>	<b>\$390.00</b>
<b>MRB-1 base and frame only</b>	60FPMRB1	<i>MFR LIST</i>	<b>\$87.00</b>
<b>WR-25 rack only</b>	60FPWR25	<i>MFR LIST</i>	<b>\$38.00</b>

Call Bradley for a current price quotation.

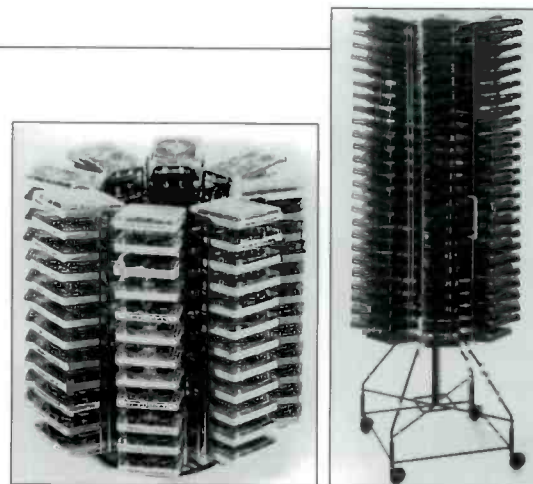

### Simpac Cart Racks

Carts, carts, carts. In the studios, in the newsroom, in the offices ... everywhere you look in a radio station you find piles of carts. With these handy Simpac cart racks, you can build your own cart storage to handle as few or as many carts as you like. Each black plastic unit holds 10 carts and comes with mounting hardware.

<b>Simpac Cart Racks</b>	60SICRBK	<b>\$6.30</b>
<b>12 or more</b>		<b>\$5.75 ea</b>



## Alps Audio and Video Storage Cabinets

Feeling like you're being buried by CD's, carts, or video tapes? Bradley comes to the rescue with the Alps line of high density storage cabinets. Each cabinet has a footprint of only 2 feet by 4 feet, yet stores hundreds of tapes or CD's. Base cabinets are available in heights of 40" and 58", and stackable top cabinets are 44".

Models are available to store CD's, audio cassettes, DAT, broadcast audio cartridges, and open reel tapes in all widths. Cabinets with partitions for all video formats are available to hold both raw and boxed tapes. Partitions can be mixed among drawers in a single unit. Cabinets come in white, almond, and gray laminates.

Prices listed illustrate the value of these cabinets. Truck freight is additional. Your Bradley professional can help configure a cabinet to meet your exact requirements. Give him a call today.

<b>Five drawer base unit</b> holding 2160 CD's 60ALCBA605CD	<b>\$1150.00</b>
<b>Four drawer top unit</b> holding 2592 CD's 60ALCBA446CD	<b>\$1560.00</b>
<b>Eight drawer base unit</b> holding 3456 CD's 60ALCBA908CD	<b>\$1400.00</b>

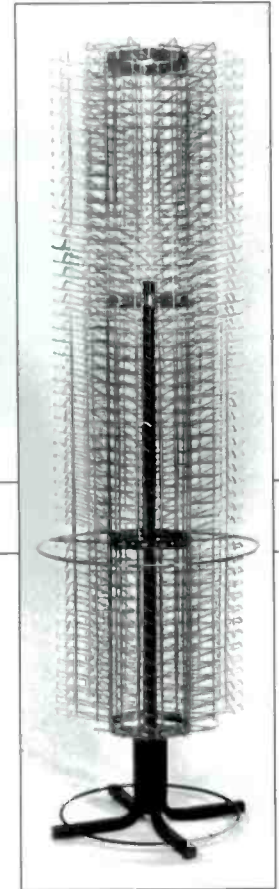

## ABC CD and Cart Racks

These floor standing "Lazy Susans" let you store lots of CD's and carts in a small space. All carousels stand six feet high and include casters. Each consists of several individual wire racks that can be removed or purchased separately for wall mounting.

<b>280 Capacity</b> CD Carousel 22" diameter	60AB280	<b>\$348.00</b>
<b>560 Capacity</b> CD Carousel 27" diameter	60AB560	<b>\$624.00</b>
<b>300 Capacity</b> Cart Carousel 22" diameter	60AB300	<b>\$386.00</b>
<b>500 Capacity</b> Cart Carousel 27" diameter	60AB500	<b>\$588.00</b>
<b>70 Capacity</b> Wire CD Rack 69½"H x 5½"W x 5¼"D	60AB70	<b>\$67.00</b>
<b>50 Capacity</b> Wire Cart Rack 65"H x 4½"W x 6"D	60AB50	<b>\$50.00</b>

## Nigel B. Media Storage Drawers and Trays

**Media Storage** drawers feature fully adjustable mounting brackets to fit into any rack fitted with individual compartments.

<b>DAT Drawer</b> holds 76; 2 rack units high	60NBDATD	<b>\$148.00</b>
<b>Floppy Disk Drawer</b> holds 112 3.5" disks; 3 rack units high	60NBFDD	<b>\$136.00</b>
<b>CD Drawer</b> holds 69; 4 rack units high	60NBCDD	<b>\$148.00</b>
<b>Cover and lock option</b> for any drawer	60NBCDL	<b>\$45.00</b>



# Middle Atlantic

## RACK ACCESSORIES

### Custom Rack Shelves

Now you can put anything in a rack, without modifying the unit. Custom front



panel cutouts are made for your equipment and the complete shelf is shipped to you in two to three weeks. Many patterns are already on file. Some assembly is required. These shelves do not include hardware to secure equipment for transport.

**Brushed and black anodized aluminum**

61MARSH4A \$98.00

**Textured black enamel on steel**

61MARSH4S \$89.00

### Utility Rack Shelves



These convenient shelves have one piece construction and come in two sizes. The one space (1 $\frac{3}{4}$ " shelf is 11" deep and supports up to 35lbs. The two space (3 $\frac{1}{4}$ " shelf is 14 $\frac{1}{2}$ " deep and holds 50lbs. Either may hold taller equipment within its depth and weight limits.

**One space** 61MAU1 \$29.00

**Two space** 61MAU2 \$38.00

**Also available:**

**Soundolier rack shelves**, made of 16 gauge steel, are available in black textured enamel and in the 24 other Soundolier colors. 4 spaces (7") 14" deep. 60SDSH197 \$45.00

### K.D. Shelves



Now you can put together your own rack shelves. Flush studs are provided with bottoms for easy assembly. K.D. shelves are 16 gauge steel painted with black baked enamel, and can be used with equipment up to 17 $\frac{1}{2}$ " wide. Ears come packaged in sets of two.

**For a complete shelf, you need to purchase both a bottom unit and set of ears.**

**5 $\frac{1}{2}$ " tall, 15 $\frac{1}{2}$ " deep - ears only**  
61MAKDE3 \$30.00

**7" tall, 15 $\frac{1}{2}$ " deep - ears only**  
61MAKDE4 \$31.00

**8 $\frac{1}{2}$ " tall, 15 $\frac{1}{2}$ " deep - ears only**  
61MAKDE5 \$32.00

**10 $\frac{1}{2}$ " tall, 15 $\frac{1}{2}$ " deep - ears only**  
61MAKDE6 \$33.00

**12 $\frac{1}{2}$ " tall, 15 $\frac{1}{2}$ " deep - ears only**  
61MAKDE7 \$35.00

**14" tall, 15 $\frac{1}{2}$ " deep - ears only**  
61MAKDE8 \$36.00

**15 $\frac{1}{2}$ " deep - bottom only**  
61MAKDB \$17.00

**5 $\frac{1}{2}$ " tall, 11 $\frac{1}{2}$ " deep - ears only**  
61MAKDE3S \$29.00

**11 $\frac{1}{2}$ " deep - bottom only**  
61MAKDBS \$16.00

**Don't see exactly what you need? Call us. Odds are that Bradley's got it.**

### Blank Panels



Fill those unloaded rack spaces with these flanged, black aluminum panels.

<b>1 space</b>	61MABL1	\$11.00
<b>2 spaces</b>	61MABL2	\$12.75
<b>3 spaces</b>	61MABL3	\$15.70
<b>4 spaces</b>	61MABL4	\$17.00

### Sliding Shelf



This sliding shelf supports up to 50lbs and pulls out 14". Usable mounting surface is 17 $\frac{1}{2}$ " wide and 15 $\frac{1}{2}$ " deep. Your equipment sits on top, and the flush, spring loaded latch keeps the shelf shut. Unique rear telescoping support fits any rack and does not require rear rails. Occupies one rack space.

61MASS \$89.00

### Rack Chassis



Use these chassis for your custom electronics. Flush face is easily removed for punching and the rear panel is full height and removable. Face and rear are black anodized aluminum, while the top, bottom, and sides are steel. These chassis are 10" deep and shipped fully assembled.

<b>1 space</b>	61MACH1	\$54.00
<b>2 spaces</b>	61MACH2	\$61.00
<b>3 spaces</b>	61MACH3	\$66.00



## Rack Rails

Our best 1/8" thick galvanized steel rails are punched and tapped for 10-32 x 3/4" screws. Side mounting holes are 9/32" diameter. Sold in pairs.



8 spaces (14")	61MARR8	\$11.75
10 spaces (17 1/2")	61MARR10	\$14.10
12 spaces (21")	61MARR12	\$16.75
14 spaces (24 1/2")	61MARR14	\$18.65
16 spaces (28")	61MARR16	\$20.90
18 spaces (31 1/2")	61MARR18	\$22.70
21 spaces (36 1/2")	61MARR21	\$26.00
27 spaces (47 1/2")	61MARR27	\$32.00
45 spaces (78 1/2")	61MARR45	\$46.00

Also available:  
Model RRF

This is a 45 space (78 1/2") rail that has tapped holes spaced 5/8"-5/8"-1 1/2" to fit equipment with non-standard spacing.

61MARRF45 \$51.00

## Security Covers



Ideal for providing both security and protection, these perforated steel covers are 1" deep and allow easy viewing of control settings. Rubber edging prevents marring of equipment.

1 space	61MASEC1	\$18.00
2 spaces	61MASEC2	\$22.00
3 spaces	61MASEC3	\$24.00

Also available:

Orban acrylic security covers to protect your rack mounted equipment from fiddling fingers or inquisitive eyes. Includes three sets of screws: thumbscrew, Phillips head, and hex socket head (with wrench). Specify clear, blue translucent, or opaque white.

1 space	60OBACC11XX	MFR LIST	\$55.00
2 spaces	60OBACC12XX	MFR LIST	\$60.00
3 spaces	60OBACC13XX	MFR LIST	\$60.00
4 spaces	60OBACC14XX	MFR LIST	\$60.00

## Fan Panels and Fans



These 3 space panels are punched for 4 1/2" diameter fans and include grills. The quiet, 100 CFM fans are designed for long life and quiet operation, and include line cords.

Panel for 1 fan	61MAFP1	\$26.00
Panel for 2 fans	61MAFP2	\$28.00
Panel for 3 fans	61MAFP3	\$30.00
Fan	61MAFAN	\$35.00

Also available:

Filter Kit with washable filter keeps dust out of your gear. Can be fit over fan panels or used alone. Three spaces tall.

61MAFILTER \$24.00

## Vent Panels



These 16 gauge steel panels have one piece construction and are perforated with 5/32" diameter holes yielding 68% open area.

1 space	61MAVT1	\$ 9.35
2 spaces	61MAVT2	\$11.25
3 spaces	61MAVT3	\$13.20
4 spaces	61MAVT4	\$14.40
6 spaces	61MAVT6	\$15.30
8 spaces	61MAVT8	\$16.15
10 spaces	61MAVT10	\$17.35

Standard rack spaces are 1 1/2" high. This chart can help you quickly determine the size of your equipment.

1 space is 1 1/2"	6 space is 10 1/2"
2 space is 3 1/2"	7 space is 12 1/2"
3 space is 5 1/2"	8 space is 14"
4 space is 7"	9 space is 15 1/2"
5 space is 8 1/2"	10 space is 17 1/2"

## UCP Punched Panels

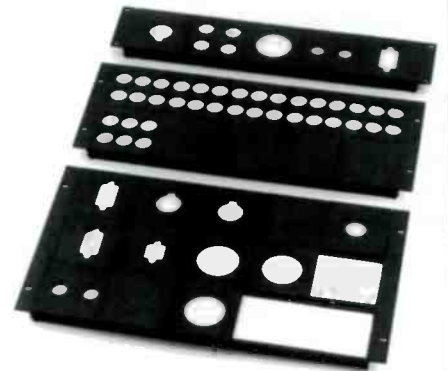

Middle Atlantic has developed a unique way to have custom panels without the cost and time of custom fabrication. Frame kits, which have rack ears and mounting bars, come in sizes from 2 to 10 spaces. Punched modules, which are 2 spaces high and fit 5 across a rack, are provided punched for your choice of connectors. Combinations are unlimited. A fully loaded 2 space frame is less than \$60. Call or fax today for details.

## Rack Hardware

Each package contains 10-32 x 3/4" machine screws and flat fiber washers.



Available with Phillips machine head, Torx-Post, and a special tamper-proof tapered recess for security. Available in black only.

Phillips 100 ea	61MAHDWEP	\$16.50
Torx-Post 50 ea	61MAHDWET	\$12.00
Driver for Torx-Post screws	61MATBIT	\$10.25
Security, 100 ea	61MAHDWES	\$22.80
Driver for security screws	61MABIT	\$1.60

Shoulder washers are non-conductive and are used with our standard washers to isolate equipment from the rails. 100 ea  
61MASW \$6.50



## Rack Mount Holders

Our rack mount holders are a great way to keep frequently used media close at hand. All are made of 20 gauge steel with black, baked enamel.

<b>Compact disc holder</b> for 40 CD's; 4 spaces tall.	61MACDSH	\$53.00
<b>Cassette holder</b> for 33 audio cassettes; 3 spaces tall.	61MACS	\$50.00
<b>DAT holder</b> for 27 digital audio tapes; 3 spaces tall.	61MADAT	\$50.00
<b>3½" floppy disk holder</b> for 60 floppies; 3 spaces tall.	61MAFD	\$50.00
<b>VHS tape holder</b> for 14 tapes; 5 spaces tall.	61MAVHS	\$57.00
<b>LP, 10½" reel tape, &amp; binder holder</b> ; 8 spaces tall.	61MALP	\$105.00



## Rack Drawers

These drawers have a fully enclosed top to ensure that no dust goes in and no contents fall out. The front panel has a flush spring loaded handle that latches to keep drawer closed. Full extension, ball bearing slides extend drawer 14" out. Finished in black enamel, these racks may be ordered with a keylock option.

<b>2 spaces</b>	61MADWR2	\$98.00	<b>2 spaces w/lock</b>	61MADWR2L	\$123.00
<b>3 spaces</b>	61MADWR3	\$119.00	<b>3 spaces w/lock</b>	61MADWR3L	\$144.00
<b>4 spaces</b>	61MADWR4	\$143.00	<b>4 spaces w/lock</b>	61MADWR4L	\$168.00



## Middle Atlantic WRK Series Racks

Solid. Functional. Attractive. We're not talking about just any equipment enclosure; this one is built by Middle Atlantic.

These racks have 77", 64" or 42" of mounting height and have fully welded construction of 16 gauge steel. Bottom corner braces are 10 gauge for extra strength and threaded for optional leveling feet or casters. Front and rear pre-tapped rails are included and the distance between them is adjustable up to 21". Front rails can be set to one of three fixed positions for stability during transport. Welded studs in the rear of the rack make it a breeze to install cable duct and power strips. Knock out plates are provided on both the top and bottom of the rack for electrical plates and fans.

<b>WRK-24 SA Rack 42"</b>	61MAWRK24SA	\$640.00
<b>WRK-37 Gang Rack 64"</b>	61MAWRK37	\$666.67
<b>WRK-37 SA Rack 64"</b>	61MAWRK37SA	\$677.78
<b>WRK-44 Gang Rack 77"</b>	61MAWRK44	\$766.67
<b>WRK-44 SA Rack 77"</b>	61MAWRK44SA	\$777.78

**Accessories:**

<b>42" Vented Door</b>	61MADOV24	\$182.22
<b>64" Vented Door</b>	61MADOV37	\$228.89
<b>77" Vented Door</b>	61MADOV44	\$260.00
<b>42" SP Door</b>	61MADOV24	\$153.33
<b>64" SP Door</b>	61MADOV37	\$173.33
<b>77" SP Door</b>	61MADOV44	\$188.89
<b>Feet for WRK-44</b>	61MAFEET	\$12.88
<b>77" Side Panels</b>	61MASPS44	\$325.00
<b>77" Side Panels Vented</b>	61MASP44	\$384.44
<b>Wheels for WRK rack</b>	61MAWHEEL	\$75.56

The WRK-SA series are stand-alone, closed sided racks with removable, perforated ventilation windows located on the side panels for efficient convection. The WRK series is open sided for gang-ing to other racks and has flush perforated vent windows on the sides. The optional double wall door has "oil lite" bushings for smooth operation and a locking, spring loaded slam latch. Doors can be used at the front or rear and set to swing left or right.

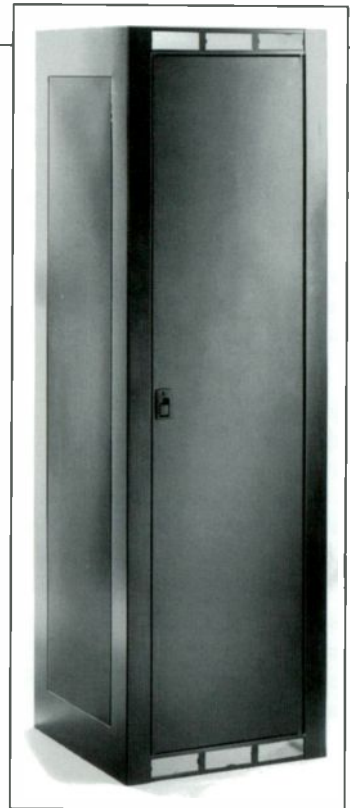

## RK Racks

These economical racks combine convenience and great looks. Surface is in black laminate over 5/8" thick, high density particle board. Rails are drilled and tapped with full hole spacing to fit all equipment. Each rack is individually boxed knocked down for convenient UPS delivery. Assembly is fast and easy with supplied tools. Other sizes available by special order.

2 space (3½") 16" deep	61MARK2	\$48.00
4 space (7") 16" deep	61MARK4	\$51.00
8 space (14") 18" deep	61MARK8B	\$78.00
12 space (21") 18" deep	61MARK12B	\$84.00
16 space (28") 18" deep	61MARK16B	\$89.00
20 space (35") 18" deep	61MARK20B	\$98.00



## KSI INR Racks

Our own line of installation racks, manufactured for us by KSI, is the most rugged and attractive way to handle your 19" rack mounted equipment. Constructed of 3/4" wood multi-ply, the outer surfaces are genuine poplar veneer (not laminated plastic) and have the look of real furniture. Choose from natural poplar, dark wood stain, or black lacquer. Charcoal gray carpeting is available at extra cost. INR racks come with drilled and tapped front rails. All INR racks are built to order and shipment time is generally two to four weeks. Prices include crating; shipping is additional.

### Standard Options:

- **Six Inch Skirt** for use when table mounting the rack. Replaces 2" skirt and adds 4" to overall rack height. 60KBINR6PED **\$28.00**
- **Sloped Skirt** replaces the standard skirt. 3" in front and slopes to 1" in rear for use with very short racks to increase visibility of gear. 60KBINRSS **No Charge**
- **Heavy Duty Casters** are rated at one-half ton. Set of four replaces skirt and adds 2" to overall rack height. 60KBINRHDC **\$122.00**
- **Extra Depth Option** for shorter racks increases depth to 22". 60KBINRED **\$24.00**

### Exterior Dimensions:

- Height is 3¼" plus rack height (includes 2" bottom skirt).
- Width is 22¼" overall.
- Racks up to 27 spaces (47¼") are 18" deep.
- Racks 28 spaces (49") and taller are 22" deep.
- Rails are inset 1/2" from the front of the rack.

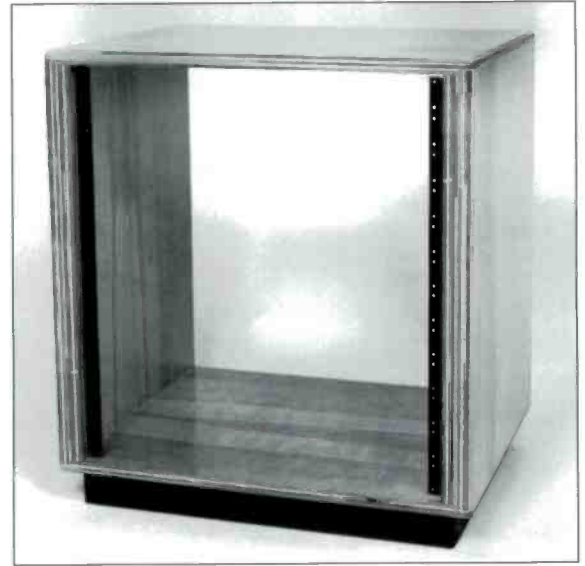

RACK PART #	RACK SPACES	RACK HEIGHT	RACK PRICE	BACK PANEL	REAR RAILS	RACK PART #	RACK SPACES	RACK HEIGHT	RACK PRICE	BACK PANEL	REAR RAILS
60KBINR4	4	7"	\$83.00	\$21.00	\$12.00	60KBINR24	24	42"	\$262.00	\$83.00	\$72.00
60KBINR6	6	10½"	83.00	21.00	18.00	60KBINR26	26	45½"	279.00	90.00	78.00
60KBINR8	8	14"	109.00	28.00	24.00	60KBINR28	28	49"	304.00	97.00	84.00
60KBINR10	10	17½"	125.00	35.00	30.00	60KBINR30	30	52½"	320.00	104.00	90.00
60KBINR12	12	21"	143.00	42.00	36.00	60KBINR32	32	56"	336.00	111.00	96.00
60KBINR14	14	24½"	169.00	49.00	42.00	60KBINR34	34	59½"	353.00	118.00	102.00
60KBINR16	16	28"	185.00	56.00	48.00	60KBINR36	36	63"	380.00	125.00	108.00
60KBINR18	18	31½"	202.00	63.00	54.00	60KBINR38	38	66½"	396.00	132.00	114.00
60KBINR20	20	35"	218.00	69.00	60.00	60KBINR40	40	70"	417.00	138.00	120.00
60KBINR22	22	38½"	245.00	76.00	66.00	Call for pricing on intermediate sizes.					

## Soundolier Equipment Racks

Soundolier offers a broad range of equipment racks for every purpose. Our Quick Shipper Program assures shipment of your rack within three working days of your order. Racks eligible for this service are marked (\*) below and must be ordered in black textured enamel; you must request this service at the time of your order. Other sizes, or racks ordered in any of the other 24 available colors generally ship in two to three weeks.

The 100 Series racks, our most popular, provide 18 1/2" inches of rackable depth, have fixed side panels, and include a back door with lock. They may be ordered welded or knocked down. Welded racks are more costly to ship, but are sturdier

### 100 Series Racks

Size	Welded		Knocked Down	
	Part #	Price	Part #	Price
36"	60SDWA10036	<b>\$284.14</b>	60SD10036	<b>\$259.79</b>
42"	*60SDWA10042	<b>\$270.87</b>	*60SD10042	<b>\$270.87</b>
61"	*60SDWA10061	<b>\$316.17</b>	*60SD10061	<b>\$310.17</b>
70"	60SDWA10070	<b>\$345.73</b>	*60SD10070	<b>\$345.73</b>
77"	*60SDWA10077	<b>\$326.37</b>	60SD10077	<b>\$362.37</b>

for extremely heavy loads. Rails are drilled and tapped. Steel or plexiglass front doors are optional.

### Accessory:

#### Roller truck

for 100 and 200 Series

\*60SDCT1020 **\$168.00**

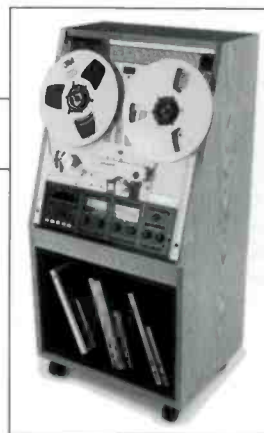
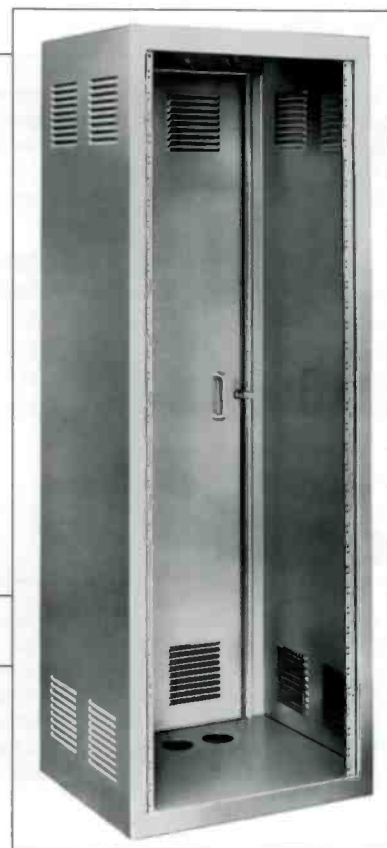

## Calzone Studio Series Racks

These sturdy oak veneer racks look as good in your living room as they do in the studio. The upper section is slanted so your equipment is readily accessible and the lower section has a straight vertical mount. A great alternative to tape machine consoles. Tapped and drilled rack rails and 2" double steel swivel casters are included. Shipped knocked down, assembly takes just minutes using quarter turn latch screws. S88 and S812 have 8 rack spaces (14") in the lower rack. The S1410 has 14 spaces in the lower rack.

8 space (14") upper rack	70CAS88	<b>\$162.00</b>
12 space (21") upper rack	70CAS812	<b>\$179.00</b>
10 space (17.5") upper rack	70CAS1410	<b>\$229.00</b>

## Ruslang Electronic Equipment Racks

These standard 19" racks come in heights from 21" to 70" of vertical mounting space. They are constructed of high-pressure laminates and steel rack mounts. A variety of solid colors or woodgrain finishes is available. Prices are for 18" deep racks. Call for pricing on versions up to 24" deep and for other heights.

12 space (21")	60RLR21S	<b>\$309.00</b>
16 space (28")	60RLR28S	<b>\$328.00</b>
20 space (35")	60RLR35S	<b>\$350.00</b>
24 space (42")	60RLR42S	<b>\$370.00</b>
28 space (49")	60RLR49S	<b>\$388.00</b>
32 space (56")	60RLR56S	<b>\$409.00</b>
36 space (63")	60RLR63S	<b>\$430.00</b>
40 space (70")	60RLR70S	<b>\$452.00</b>



**Bradley Broadcast...**  
**Where Service and Engineering Make the Difference**





## The Cutting Wedge Acoustic Tiles

Acoustic treatment of your rooms is now easier than ever, thanks to The Cutting Wedge. When used to reduce noise, slap echo, and/or standing waves, these charcoal gray tiles can exceed the performance of competing products. Available in four thicknesses, these tiles come in convenient 12" by 12" squares as well as 4' by 8' panels. The small squares can be shipped via UPS in any quantity, so you save on shipping charges. Use the large panels to install 32 square feet at one time with a seamless finish. Large panels ship by truck only.

Look at the walls in those "problem" rooms. Now see how inexpensive and effective it will be to apply The Cutting Wedge. Your rooms will sound great and look great.

<b>2" thick square</b>	60CW1	<b>\$2.90 ea</b>	<b>\$146.16</b> case of 56
<b>3" thick square</b>	60CW3	<b>\$3.99 ea</b>	<b>\$107.70</b> case of 30
<b>4" thick square</b>	60CW4	<b>\$5.30 ea</b>	<b>\$85.86</b> case of 18
<b>6" thick square</b>	60CW6	<b>\$9.10 ea</b>	<b>\$81.90</b> case of 10

**Note: Minimum order is 10 squares or 10 sheets; shipping charges are additional.**

<b>2" thick sheet</b>	60CW2S	<b>\$109.00 ea</b>
<b>3" thick sheet</b>	60CW3S	<b>\$147.00 ea</b>
<b>4" thick sheet</b>	60CW4S	<b>\$181.00 ea</b>
<b>6" thick sheet</b>	60CW6S	<b>\$245.00 ea</b>



## Littlite Lamps

Littlite Lamps are offered in several basic configurations.

The L-2 Series features a mounting base with a permanently attached goose-neck, dimmer,

and a low intensity incandescent bulb in an unobtrusive tubular hood. The L-3 Series features a mounting base with a permanently attached gooseneck, dimmer, and a high intensity tungsten-halogen bulb in a stylish finned hood. The G Series has a swivel BNC-style connector with a neoprene rubber friction sleeve, and is useful in applications requiring removal for storage or transit. They mate with panel sockets supplied or added onto equipment. Available in high or low intensity. The X Series has a 3-pin male XLR connector with isolated lamp circuit. Useful where a detachable, non-swiveling connection is desired. Available in high or low intensity.



The WXF is an AC adapter designed for use with the L-Series. It'll power up to 4 low intensity, or 2 high intensity lamps.

<b>L-212</b>	12" L-2 Series	.....61LL212A	<b>..\$29.00</b>
<b>L-218</b>	18" L-2 Series	.....61LL218A	<b>..\$29.00</b>
<b>L-312</b>	12" L-3 Series	.....61LL312A	<b>..\$36.00</b>
<b>L-318</b>	18" L-3 Series	.....61LL318A	<b>..\$36.00</b>
<b>12G</b>	12" G-Series	.....61LL12G	<b>..\$21.00</b>
<b>12G-Hi</b>	12" G-Series High Intensity	.....61LL12GHI	<b>..\$25.00</b>
<b>18G</b>	18" G-Series	.....61LL18G	<b>..\$29.00</b>
<b>18G-Hi</b>	18" G-Series High Intensity	.....61LL18GHI	<b>..\$39.00</b>
<b>12X</b>	12" X-Series	.....61LL12X	<b>..\$23.00</b>
<b>12X-Hi</b>	12" X-Series High Intensity	.....61LL12XHI	<b>..\$37.00</b>
<b>18X</b>	18" X-Series	.....61LL18X	<b>..\$26.00</b>
<b>18X-Hi</b>	18" X-Series High Intensity	.....61LL18XHI	<b>..\$45.00</b>
<b>WXF</b>	AC Adapter	.....61LLWXF	<b>..\$11.65</b>
<b>Q5</b>	High Intensity Bulb	.....61LLQ5	<b>..\$7.50</b>
<b>1815</b>	Low Intensity Bulb	.....61LL1815	<b>..\$2.50</b>

## Nigel B. Stands

### Recorder Stand

An incredibly sturdy, easily-moveable recorder stand. Heavy-duty construction and smooth rolling casters are the trademark of this fine stand. Plus, it's cost effective. Has 13 rack units of space plus 8 additional units between its uprights.

**60NBPLRS \$268.00**

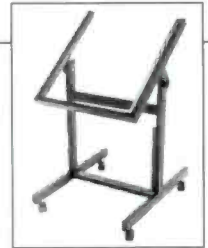

### Desktop Easel

This low cost desktop rack has 22" (13 rack units) of storage. Ideal for reel-to-reel recorders or effects, the frame locks at any convenient angle.

**Desktop Easel 60NBPLDERS \$149.00**



## Pivotelli Mounting Systems

Pivotelli puts your equipment in the right position. These supports are made of the finest solid premium grade steel and are available in three styles. Each holds up to 176 pounds safely and securely and has a 5 year warranty. Supports are packed with hardware for installation into wooden wall studs, brick, or concrete.

The Single Pivotelli has an "L" shaped bracket with a fixed distance from the wall. The bottom support clamps to the sides of the equipment. The Double Pivotelli uses two 12" flex arms which allow the distance from the wall to be adjusted. Mounted equipment may be placed flush against the wall, in a corner, or in any number of positions for optimum viewing or listening. The Triple Pivotelli has a yoke style bracket which securely clamps equipment top to bottom on both sides. Equipment can be moved easily side to side or up and down.

Pivotelli mounts are available in numerous sizes; the prices below are for mounts designed for equipment that is 17" to 30" wide. Part numbers are for

matte black; gloss white is available at the same price. Your Bradley professional can help you select the exact support for your application.

<b>Single</b>	60PVMLS	<i>MFR LIST</i>	<b>\$129.95</b>
<b>Double</b>	60PVDLS	<i>MFR LIST</i>	<b>\$219.95</b>
<b>Triple wall mnt</b>	60PVTS	<i>MFR LIST</i>	<b>\$269.95</b>
<b>Triple ceiling mnt</b>	60PVTTTS	<i>MFR LIST</i>	<b>\$269.95</b>

### Accessory:

**Metal stud kit** must be used for mounting on metal studs.  
60PVM SKL *MFR LIST* **\$11.50**

**Call Bradley for a current price quotation**

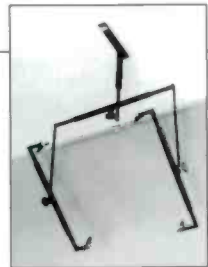

## Murphy Studio Furniture

Furniture is often the last consideration when building a studio. The proper furniture, however, can save time and money during installation and make your operators more efficient by positioning electronics and supplies in just the right places. Murphy offers four series of elegant studio furniture that have many improvements and innovations not found in other designs. The deluxe Elite Series (pictured below) incorporates numerous access panels, a bumper base for durability, a passive ventilation system, and a wire management system. The Premier Series retains most of the important features of the Elite Series, but is more economical. The Dub/Edit Station is a built to order desk/rack combination ideal for computer stations, newsrooms, and a host of other installations.



Most economical is Murphy's Classic Series. Designed for the facility on a budget, the Classic Series uses the same high quality laminates and oak trim found on the higher priced models. Classic furniture is shipped to you ready to assemble, so shipping costs are lower. The full studio complement pictured above, including the copy stand, has a manufacturer's list of only \$3194.

Your Bradley professional can aid you in designing a Murphy Studio Furniture ensemble that will exactly meet your needs and your budget.

## Nigel B. Audio/Video Furniture

Creating a quality work environment requires furniture that has an appealing design, industrial strength, and comfort. Nigel B. offers a full range of audio/video furnishings that allow a custom fit in any situation. It is constructed of heavy duty steel that is deep coated with baked enamel for a scratch resistant finish. Black Satin enamel is standard, with Mid Grey optional. Worktops are Formica covered particle board, with Comfort Edges and cable grommets standard. Worktops are available in black or Storm Grey. Clear instructions, well labeled parts, and supplied tools make assembly a matter of minutes. All bases include heavy duty casters. Components pack flat to reduce shipping costs. Options include corner units, keyboard shelves, power strips, rack drawers and shelves, chairs, and computer monitor platforms.

Nigel B. and Bradley have a furniture system for you to help you work comfortably with your technology. The best place to start is to call or fax your Bradley professional for a copy of the 24 page Nigel B. catalog. With this guide in your hands, Bradley can then help you configure the system you need. Most orders are ready to ship in 48 hours.

**Call Bradley for a complete Nigel B. catalog and configuration assistance.**



## Audioarts Engineering Furniture Systems

Gone forever are the days when studio furniture selection was a complex and confusing process. Audioarts Engineering provides 25 readily understandable, standard furniture configurations at affordable prices, with highest furniture quality. All configurations include under console cabinet racks and punch block housings. Virtually any conceivable studio design can be selected, and augmented with options such as cart or CD rackmount storage, reel to reel slope tops, 7 or 12 inch high drawers, or stand-up height configuration. The beauty of the Audioarts furniture system is its fully integrated design, which insures that any configuration you choose will be fully and properly engineered, with no last-minute glitches to mar your installation.

Construction is of the latest in steel structurally reinforced cabinetry, with high grade hardwood protected corners and counter edging. Seamless, horizontal grade laminated surfaces prevent dirt buildup and chipping. All furniture is built with generous wire passages and large removable access panels, for speedy installation and simple wiring and equipment changes.

Contact your Bradley sales professional for a complete brochure and specifications on all standard furniture systems from Audioarts Engineering.



**Your Bradley Professional  
can help you choose the  
proper furniture for your  
studio. Just give us a call.**

FURNISHINGS

Toll Free: 800-732-7665 • MD & DC: 301-948-0650 • FAX: 301-330-7198 • **Bradley Broadcast**



## Digidesign Pro Tools Multitrack Production System

Affordable hard disk recording is here! Digidesign is the industry standard recording system used in radio, TV and post facilities worldwide. Start with the 4 track system and expand to 16 tracks (4 tracks at a time). This is real hard disk recording in that all channels may be recorded on simultaneously, just like tape. Anyone familiar with analog mixing consoles and multitrack tape recorders will find this system very "user friendly". Use "Pro-Deck" to record your tracks, then switch to "Pro-Edit" to manipulate the audio on those tracks as you like. Slip or shuffle entire tracks or regions within those tracks. Work in bars/beats, minutes/seconds or use the onboard SMPTE generator/reader to edit audio with resolution down to the frame. Pro-Tools also has on-board signal processing in the form of a 2 band parametric EQ and effects. Outboard effects are accessed digitally, never needing to convert to analog & back again...Mixing can be fully automated (including EQ, effects, panning, level and sends). Call your Bradley Rep for more information.

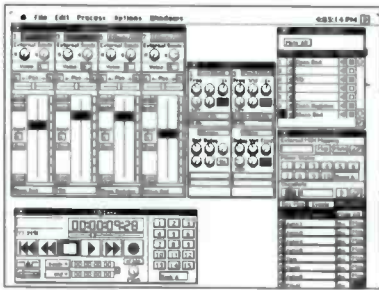

**ProTools**            60DDZ020            *MFR LIST*            **\$5995.00**  
 Call Bradley for a current price quotation.



**For those who are looking for a PC based system, call your Bradley rep for information on the Digidesign Session 8.**

## Digidesign Sound Tools Stereo Production System

In over 4000 installations worldwide, Sound Tools is the choice for spot production, DAT editing, post production, and CD mastering. Based on the Apple Macintosh computer, Sound Tools extensive editing and digital signal processing capabilities provide unprecedented power to control and manipulate sound. Record, edit, and master stereo 16-bit digital audio with peerless fidelity and incredible ease. As an extra bonus, the Sound Tools is one of the most affordable systems available.

The heart of Sound Tools is the Sound Accelerator card which is installed in your Macintosh. Sound Designer II software provides an easy to use, graphical interface in which you can record, edit, shape, and modify music and sound. Designed to let you work quickly and efficiently, Sound Designer II performs recording using a familiar tape transport interface; cut/copy/paste style editing and shuttle and jog type scrubbing; DSP based equalization, dynamics processing, pitch shift, sample rate conversion, time compression/expansion, and mix/merge blending; manipulation of sound files by creating playlists that allow an infinite number of new arrangements; sample editing; and synchronization of SMPTE using MIDI Time Code. *For Mac II, IIx, IIcx, IIfx, and IIfx*

**Sound Tools**            60DDMZ010            *MFR LIST*            **\$2290.00**

Call Bradley for a current price quotation.



**Accessory:**

JLCooper's CS-1 Control Station has conventional tape transport controls, a jog/shuttle wheel, and user programmable keys that let you concentrate on your project and not your computer. Sound Tools is designed for ease of operation; when the CS-1 is added to your system, it becomes even faster to use.

**CS-1**                    60JLCS1                    *MFR LIST*                    **\$599.95**



## Tascam RA-4000 Random Access Audio Recorder/Editor

There are so many ways to approach digital audio production these days that the choices are bewildering, and having a grasp on all of the hardware and software combinations can be almost impossible. For many users, the best combination is no combination at all — it's the new RA-4000 from Tascam.

Though this is a hard-disk based system, the similarities to the computer driven systems end there. There is no computer, no mouse, no operating system between you and your work, no booting, no bugs, no floppy disks, no display drivers, no question of compatibility with your word processor. What you get is a tool designed for one purpose only: the intuitive recording and random access editing of digital 4-track audio. No software to worry about, no surprises, and each button on the RC-4000 Controller has one function and one function only (no "just ALT-TAB, then CNTRL-SHFT-F3 to hear your edit!").

The two analog audio inputs and four outputs operate at either +4dBm or -10dBV, and the digital outputs are both AES/EBU and SP/DIF. I/O is provided for word sync, video sync, SMPTE and MIDI time codes, and a SCSI interface is present for the adding of further storage space. The provided 200MB hard disk will store roughly 38 minutes of your work and still have room for 99 index points on each track, an assembly play list, a textual cue list, and data that describes

your cross, in, and out-fades. Though the Scrub/Jog Wheel provides an excellent degree of edit control, a serial interface is provided so that the adventuresome can look into outboard computer control of the system.

As a stand-alone system for video post sweetening or for radio dialog editing and spot production, this is a fantastic plug-and-play solution. Best of all, you won't have to explain to your purchasing department why you need to buy a new computer, too.

<b>RA-4000</b>	60TERA4000	MFR LIST	<b>\$5,499.00</b>
<b>RC-4000 System Controller</b>	60TERC4000	MFR LIST	<b>\$1,499.00</b>

Call Bradley for a current price quotation.



## Marantz CDR 600 Compact Disc Recorder

Now is the time for you to record your own audio CDs. The CDR 600 produces CDs that are fully Red and Orange Book compliant so that they will play back on any CD player. Analog I/O is on both balanced XLR and unbalanced phono connectors. High oversampling, one-bit A/D and D/A converters are used, and both SP/DIF and optical digital I/O are provided. Up to 99 tracks, with 99 indexes per track, can be recorded. Tracks can be played on the CDR 600 before the final Table of Contents (TOC) is written and once the final TOC is created your CD is ready to use with any CD player. A unique skip feature allows misrecorded tracks to be masked. Constant monitoring during recording calibrates speed and adjusts laser power to compensate for dust and fingerprints. Other features include automatic, manual, and on-the-fly track numbering; remote control; and comprehensive power protection.



For broadcast, post production, archiving, and mastering, the uses for a CD recorder are endless. With Marantz quality and value, you can put the CDR 600 to work for you today.

<b>CDR 600</b>	60MRCDR600	MFR LIST	<b>\$6500.00</b>
----------------	------------	----------	------------------

Call Bradley for a current price quotation.

## 360 Systems DigiCart Digital Recorder

The DCR-1000 DigiCart combines the convenience of an ordinary cart machine with the quality of 16 bit digital audio. It uses a unique, removable Digital Audio Disk (DAD) that can store up to 20 minutes of stereo audio. Each disk can store several spots or songs. Optional internal and external hard disk storage allows hours of recordings to be instantly accessed. Dolby AC-2 digital audio compression/expansion is available to increase storage time on DADs and hard disks.

A large cue knob makes it easy to dial up any selection, and the large display window shows the cut's name and run time. You can even cue the next cut while the machine is in use! Segments may be programmed for successive play and basic editing functions and loop playback are provided. Standard cart machine features, such as three cue tones and full remote control capabilities, are incorporated. Inputs and outputs are on balanced XLR connectors. The DigiCart produces ruler flat response with absolute phase accuracy. Sampling rate, as well as mono and stereo tracking, can be combined on a single disk to provide the highest fidelity and maximum playing time for your format. DigiCart is automation ready, as it can be controlled from an external computer.

<b>DCR-1000 DigiCart</b>	60THDCR1000	MFR LIST	<b>\$3995.00</b>
--------------------------	-------------	----------	------------------

Call Bradley for a current price quotation.

### Also available:

Internal and external hard drives. DigiCart allows connection of one internal drive and up to five external drives to increase audio storage time. Contact Bradley for configuration information on external drives.

<b>Digicart with:</b>			
<b>200 megabyte internal drive</b>	60THDCR1002	MFR LIST	<b>\$5490.00</b>
<b>425 megabyte internal drive</b>	60THDCR1004	MFR LIST	<b>\$6490.00</b>

<b>Accessories:</b>			
<b>Digital Audio Disks (10 pack)</b>	60THDAD10	MFR LIST	<b>\$400.00</b>
<b>Digital Audio Disks (50 pack)</b>	60THDAD50	MFR LIST	<b>\$2000.00</b>



### Panasonic SV-3200 DAT Recorder

This brand new, economy priced DAT recorder breaks the price barrier for quality digital recorders. With its design drawn from the industry leading SV-3700, the Panasonic SV-3200 provides digital recording at 32, 44.1, or 48 kHz sampling rates. One bit, 64x oversampling ensures audio quality superior to other designs, providing clear audio at low as well as high signal levels. A forward/reverse shuttle wheel has two variable speed ranges: 3-15 times normal speed in play mode, and 1/2 to 3 times speed in pause. IEC 958 consumer format digital inputs and outputs provide direct interfacing with compact disc player, digital workstations, and other components in a studio or production facility. Other features include wireless remote control, digital fade-in/fade-out via front panel control, 400x normal speed search, and Serial Copy Management System (SCMS).

**SV-3200**                      60PASV3200                      MFR LIST                      \$995.00



Call Bradley for a current price quotation.

**Accessory:**

**Rack mount ears**                      60PARM370                      \$50.00

### Panasonic SV-3700 DAT Recorder

Panasonic's third generation DAT recorder features high performance "one bit" A/D converters and four precision D/A converters. These advanced technologies produce improved performance and linearity. Instrumentation quality analog circuitry and specially developed digital components also ensure the utmost quality. Analog inputs and outputs are balanced XLR, and digital I/O is in both the professional AES/EBU and consumer SP/DIF-2 formats. Recording is offered at 48kHz, 44.1kHz, and 32kHz.

The SV-3700 has a shuttle wheel for accurate cueing. The high speed transport, with up to 400 times speed, can access any point on a two hour tape in 30 seconds or less. The comprehensive front panel display can show error correction rates for assessing tape quality. The SV-3700 is built on a massive die-cast chassis that ensures stability. Rack mount included.

**SV-3700**                      60PASV3700                      MFR LIST                      \$1690.00



**Accessory:**

**Remote Control**                      60PASSE44                      MFR LIST                      \$45.00

Call Bradley for a current price quotation.

### Panasonic SV-3900 DAT Recorder

The Panasonic SV-3900 features a fully implemented Serial Control Interface for bidirectional remote control of all transport and programming modes. This provides access to multi-machine networking, giving you an array of options previously unobtainable. The high speed transport, with up to 400 times speed, can access any point on a two hour tape in 30 seconds or less. The SV-3900 features high performance "one bit" A/D converters and four-stage D/A converters (two per channel) with 18-bit resolution. Analog inputs and outputs are balanced XLR, and digital I/O is in both the professional AES/EBU and consumer SP/DIF-2 formats. Recording is offered at 48kHz, 44.1kHz, and 32kHz. Rack mount included.

Using the SH-MK390 remote control, up to 32 SV-3900s can be simultaneously controlled. This enables you to perform tasks like event automation, multiple DAT duplication, and assembly editing. The SH-MK390 gives you a complete read out on the status of any DAT you currently have selected. Additionally, an RS-422 Serial Control port is available on the SV-3900 for control from external sources, such as a computer or editor.

**SV-3900**                      60PASV3900                      MFR LIST                      \$2220.00



**Accessories:**

**SH-MK390 Remote Control**                      60PAMK390                      MFR LIST                      \$430.00

**Software Developer's Toolkit**

Provides a shell for programmers to write their own computer based control schemes for the SV-3900. For use with Apple Macintosh computers.

60PAST390M                      MFR LIST                      \$650.00

Call Bradley for a current price quotation.

**You'll find a full selection of portable DAT recorders in the Field Production section, beginning on page one.**



## Tascam DA-30 DAT Recorder

The front panel of the DA-30 is as familiar as the face of an old friend. When you see and hear it perform, you'll wonder where it has been your whole life.

The DA-30 is an affordable, full function DAT recorder that combines outstanding audio performance with famous Tascam reliability. The A/D converters employ 64 times oversampling Delta Sigma modulation, and 18 bit, 8 times oversampling D/A converters are used. Recording is offered at 48kHz and 44.1kHz sampling frequencies.

Features include 150 millisecond cue increments, AES/EBU digital input/output, start ID positioning, and both +4dBm and -10dBV analog inputs and outputs. The provided wired remote control allows control of all DA-30 functions, and includes numeric keys for direct search and playback programming. The clean layout and clearly marked controls make operation of the DA-30 a breeze.

**DA-30**            60TEDA30            *MFR LIST*            **\$1299.00**  
 Call Bradley for a current price quotation.



## Otari DAT Machines

For those who must have premium performance and unparalleled control capability, the Otari DTR-90N is the obvious digital recorder of choice. Unsurpassed technical specifications are complemented by a variety of superior operational features. The DTR-90's four-head configuration enables confidence monitoring during recording, as well as punch-in/out overdubbing. The front control panel detaches from the recorder, allowing the freedom to comfortably put total control right where you need it... in your hands. All important functions, including transport controls, jog/shuttle wheel, locator, and the display are on this panel. Plus/minus 12.5% pitch control is standard, as are 48, 44.1, and 32 kHz sampling frequencies.

Otari's DTR-90T adds a built-in time code unit which allows time code recording/playback and synchronizing functions for synchronized operation with video recorders and other outboard equipment.

**DTR-90N**            60OTDTR90N            *MFR LIST*            **\$8495.00**  
**DTR-90T**            60OTDTR90T            *MFR LIST*            **\$8995.00**



Call Bradley for a current price quotation.

## Tascam DA-60 Professional 4-Head DAT Recorder

For those engineers that need a safer, more responsive DAT recorder, but don't want to spend a fortune, Tascam has introduced the new DA-60. Four heads allow the user to monitor playback off the digital tape while the recording is being made, and the RAM buffer allows playback audio to be heard the instant the PLAY button is pressed. These features make the DA-60 ideal for production and broadcast use, but its rugged overall construction, jog wheel, auto-cue, automatic gapless punch in/out, +/-12% pitch control, absolute time, locate points and variable speed cue-review make the unit a dream for anyone who spends a lot of time working with DAT material.

This is a truly professional machine, with every provision for digital I/O, transport remote control, error monitoring, copy code editing, and more. With the optional SY-06 Synchronizer Card, the DA-60 can provide SMPTE/EBU reading, generation and offset capability, as well as video sync input and Sony P-2 serial interface. This loaded machine is at home in either a busy audio or video suite.

**DA-60**            60TEDA60            *MFR LIST*            **\$5,499.00**

**Accessories:**

**SY-06 Sync Card**            60TESY06            *MFR LIST*            **\$599.00**  
**RC-D6 Remote Control**            60TERCD6            *MFR LIST*            **\$199.00**



Call Bradley for a current price quotation.



## Sony PCM-2700 DAT Recorder

Make your digital recordings with confidence with Sony's new PCM-2700. Four head construction allows simultaneous recording and playback for real-time monitoring. The PCM-2700 takes advantage of Sony innovations such as its 1-bit Pulse D/A converter. Features include absolute time recording, high speed auto location, 4 direct drive motor mechanism, adjustable digital fade in/fade out, and alternate subcode recording. 48kHz, 44.1kHz, and 32kHz sampling frequencies are supported, and a 12-bit nonlinear Long Play mode at 32kHz doubles standard recording times for logging applications. Digital I/O allows recording from AES/EBU format signals and digital-to-digital transfer at 44.1kHz using SP/DIF format. Analog I/O is balanced on XLR connectors. A rack mount adapter and both wired and wireless remote controls are included.



The PCM-2700 offers superior audio quality for professional applications.

**PCM-2700**            60SOPCM2700            *MFR LIST*            **\$2985.00**  
 Call Bradley for a current price quotation.

## Radio Systems RS-1000 DAT Recorder

Ideal for on-air and particularly well suited for automation systems, the RS-1000 is Radio Systems' finest DAT machine. New features include; full broadcast remote control, balanced inputs and outputs, automatic cueing and cut search functions, internal 30-cut stack memory, and multiple sampling rates (with no copy restrictions). Built around a rugged Sony transport, the RS-1000 uses DAT start and skip ID's just like a cart machine uses primary and secondary tones. It will close a relay at the end of a cut and automatically advance and cue to the next cut. For automation use the RS-1000 has both serial and BCD automation ports so it can emulate a multi-slot cart machine and provide random cut access. Special software allows easy use with all major automation systems.



**RS-1000**            60RS1000            *MFR LIST*            **\$3495.00**

### Accessory:

**Rack Kit**            60RSRK            *MFR LIST*            **\$50.00**

Call Bradley for a current price quotation.

## Radio Systems RS-6700 DAT Recorder

Here's the newest DAT machine from Radio Systems, the manufacturer of the industry's first DAT machine for broadcast. It goes beyond basic "pro" features like balanced audio by providing remote control, end of message functions, tight consistent cueing, front panel error indication, large lighted controls and convenient "Next/Last" buttons for fast cue access. The rear panel includes DIP switches to program EOM logic, balanced XLR connectors, and a full broadcast remote connector duplicating important front panel functions with pull-to-ground remote logic and lamp drivers. Radio Systems DAT machines are based on proven Sony transports. Radio Systems provides full service and warranty and maintains 24-hour-a-day emergency technical support.



**RS-6700**            60RS6700            *MFR LIST*            **\$1895.00**

### Accessories:

**Rack Kit**            60RS6700RK            *MFR LIST*            **\$65.00**

**Remote w/Keypad**    60RS6700KP            *MFR LIST*            **\$95.00**

Call Bradley for a current price quotation.





## Tascam DA-88 Digital Multitrack Recorder

No matter how digital or random-access the audio industry becomes, an 8-track tape recorder will always be indispensable for many studios. Tascam's new DA-88 provides a fresh take on that beloved format. In general use, the machine is like an old friend: 8 channels in, 8 channels out, and an effortless, menu-less transport control. Under the hood, though, this is like no 8-track you've ever used. Rather than using unwieldy open-reel tape at 15 IPS, the DA-88 uses a standard, available-anywhere, HI-8 Cassette to give you 100 minutes of stunning digital storage on all 8 tracks. That's enough, on one tape, to cover any CD project and most audio or video broadcast jobs.

The unit's large meters, transport jog wheel, single button punch-in and simple controls virtually eliminate the learning curve for anyone used to multi-tracking. Up to six units can be linked together for a total of 48 tracks. The DA-88's numeric display shows you absolute time in Hours, Minutes, Seconds and Frames, as well as displaying memo times, pitch change, SMPTE Time Code and Offset. With the optional SY-88 Synchronization Board, the DA-88 will act as either SMPTE Master or Slave and provides video sync, RS-422 and MIDI Machine Control protocols.

**DA-88**                      60TEDA88                      MFR LIST                      \$4,499.00

Call Bradley for a current price quotation.



### Accessories:

<b>RC-848 Multi-Machine Remote Control</b>	61TERC848	MFR LIST	\$1,499.00
<b>RC-808 Single Machine Remote Control</b>	61TERC808	MFR LIST	\$175.00
<b>MU-8824 24-Channel Meter Bridge</b>	61TEMU8824	MFR LIST	\$889.00

## Henry Digistor

Henry Digistor is a very versatile digital message storage device. When used with your phone system it will automatically answer the line and play your recorded message. It can also be used for "message-on-hold," or as a utility message repeater. With no cue time the caller always hears the message from the beginning. Features include single or continuous playback. Mode, play, stop and record functions are remotely controllable. Battery backup prevents memory loss during AC failure. Records from a mic, tape deck, or studio and, depending on the model selected, provides up to 17 minutes recording time.

<b>Frequency 2.5KHz, 2:02 min.</b>	60HEDS	\$335.00
<b>Frequency 3.5kHz, 1:20 min.</b>	60HEDSHF	\$355.00
<b>Frequency 2.5KHz, 8:32 min.</b>	60HEDSXM	\$499.00
<b>Frequency 3.5kHz, 5:30 min.</b>	60HEDSXMHF	\$525.00

Call Bradley for a current price quotation.



## Eventide VR240 Digital Logger

High quality multi-channel logging no longer requires a large rack full of equipment plus enormous amounts of expensive storage space for tapes. Eventide's VR240 Digital Audio-Logger needs only three rack units (5") of space, while the digital tapes themselves requires less than five cubic inches of storage space each. Both single and dual transport versions are available for either 8, 16, or 24 audio channels. 168 channel hours may be put on each digital tape. Audio logging is an absolute necessity for talk or news format stations, and highly desirable for all stations. Call Bradley today for help in configuring your digital logging system from Eventide.

<b>8 Channel</b>	60EVVR24 08	MFR LIST	\$10,495.00
<b>16 Channel</b>	60EVVR24016	MFR LIST	\$12,390.00
<b>24 Channel</b>	60EVVR24024	MFR LIST	\$14,285.00
<b>Opt. Second deck</b>	60EVVR2402D	MFR LIST	\$2995.00



Call Bradley for a current price quotation.



## Halland Broadcast Services Compact Disc Libraries

Now available from Bradley Broadcast... three dynamite CD libraries for on-air use at your station for an affordable price. Halland and Bradley present:

**"Rock and Roll Graffiti"**, the definitive CD oldies library, featuring 1229 songs on 50 CD's. This excellent collection is perfect for oldies stations, or for AC/CHR stations that wish to supplement their formats with occasional oldies. All songs are original versions by the original artists, digitally remastered for excellent fidelity without tics, pops, or noise.

**"The Seventies"**, CD gold library, covering 1970 to 1979. Consisting of 545 songs on 30 CD's, this library comes 95% from original source material, digitally remastered from studio masters.

**"The Eighties Plus"**, 769 songs on 44 CD's covering 1980 thru 1992. An ideal core library for any AC. Hot AC or CHR station. Produced in mid-1992, this library will be periodically updated with additional discs to keep the playlist current.

All Halland libraries come with a complete database on floppy disc, and are arranged on the CD's in alphabetical order by artist, making them easy to use,

without a complicated lookup table or cross index. Complete database information permits the user to print the library's song listing, sorted by artist, title, year, or time. Other data included are track number, intro time, running time, end type.

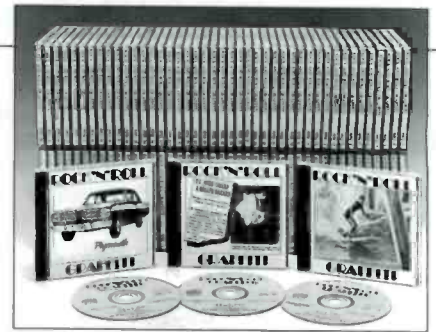

**Please note:** these CD libraries are available only to licensed broadcast stations. The user must complete a contract to verify licensee qualification. All CD libraries are in stock for immediate shipment, and come with a five day money-back satisfaction guarantee from Halland, along with a one year free replacement warranty period on the discs.

## Denon DN-951FA

The Denon DN951FA is the heir to the highly successful DN-950 line of CD players. The 951 offers improved performance and easier service, meaning less down time at your station. CD's are housed in a plastic case, like a cart, so that risk of scratching or other abuse is greatly reduced. Other features include speed changes accessed via the front panel. No more jumpers inside the unit to fool with! One may vary the speed as much as +3% in 0.2% increments. The large digital display shows Track Number, Index Number, and Elapsed or Remaining time in minutes, seconds and frames, if so desired. Use the rotary track select to dial up your next cut, the cue to music feature allows instantaneous audio when play is hit. Manually search through a track, preview the last several seconds of the track via the "End Monitor" mode, select single or continuous play modes. The unit will play "Orange Book" CD's, those disks which are partially recorded, with no table of contents. The unit also incorporates Denon's Auto Track Select System (ATSS). The system reads barcodes placed on the CD by the program director. One may cue to a specified track, to the exclusion of all others via Track Exclusive mode, cue to a specified track, but allow the operator to manually select others on the disk via Track Priority mode, or exclude a specific track, allowing the operator to select any of the remaining tracks via Track Lockout mode. The small footprint of the machine allow for 3 units to fit across a standard 19" EIA rack. Remote control is easy using pull-to-ground logic or via the RS422 serial interface. 16 bit linear, 8X oversampling assures quality audio. Outputs are balanced 600 ohm analog, adjustable from -20 to +18 dbm and AES/EBU digital.

**DN 951FA**                      60DEDN951FA                      *MFR LIST*                      **\$1350.00**



**Also available:**  
**Denon DN-961FA**

The DN-961FA is the drawer-loading version of the DN951FA, for those stations who choose not to use the CD Cart format. All features are identical except for the absence of the Auto Track Select System.

**DN 961FA**                      60DEDN961FA                      *MFR LIST*                      **\$1350.00**

*Call Bradley for a current price quotation.*

## Denon DN-2000F Dual Transport CD Player

With the dance music scene bigger than ever, and with more and more music available only on CD, DJ's need a high-quality, road-worthy CD system. The DN-2000F is just the ticket. This double CD player features instant start, pitch control, cueing, pause control, pitch bend, and a self locking transport for rugged roadability. 8x oversampling means high sound quality, and the ability to separate the player from the controller means that you can organize your space in any way you'd like.

**DN-2000F**                      60DEDN2000F                      *MFR LIST*                      **\$1495.00**

*Call Bradley for a current price quotation.*



## Technics SL-P1300 CD Player

Technics' top of the line professional CD player puts you in complete control. To find any point on a disc quickly, the SL-P1300 has a two speed search dial letting the operator "spin" the disc to the desired point. Slow speed gives one second of program time per rotation, while fast speed gives 30 seconds per turn. Once a selection is cued, you may preview the cue point for accuracy without losing that cue point. In the autocue mode, the SL-P1300 does the work for you by positioning the pickup at the start of the first note of the track, ready to begin play instantly at your command.

The SL-P1300 incorporates 4 digital-to-analog converters, 18 bit resolution with 8 times oversampling, and twin Class AA analog circuitry. Other features include  $\pm 8\%$  continuously adjustable pitch control on a long throw fader, comprehensive track selection and programming facilities, and an easy to read multi-function display. Programmable music scan lets you preview the first few seconds of each song on a disc. "Play," "stop," and "pause" functions may be controlled via a hardware rear connector.

Call Bradley  
for a current  
price quotation.



**SL-P1300** 60TCSLP1300 MFR LIST \$1800.00

Also available:  
**SL-P1200 CD Player**

Dual D/A converters, 2 x oversampling, and only unbalanced outputs.  
60TCSLP1200 MFR LIST \$1500.00

## Technics SL-PS840 CD Player

This top of the line unit features Technics' MASH (Multi-Stage Noise Shaping) 1-bit digital to analog converters for most accurate sound reproduction. The SL-PS840 uses 8 DACs with 64X oversampling. It also has a rugged, center mounted transport and a floating isolation design to protect against the effects of vibration. Features include auto cue to the beginning of any track's audio, CD edit function, high speed linear access system, headphone jack with volume control, large display with track and index information, optical digital output, and wireless remote control.

**SL-PS840** 60TCSLPS840 MFR LIST \$429.00

Accessories:  
**Rack mount shelf**  
for SL-PS840  
61MATCSLPS840 \$78.00



Call Bradley for a current price quotation.

## Technics SL-PG340 & SL-PG440 CD Players

Technics' MASH technology is now available in these moderately priced units. The SL-PG340 and SL-PG440 have a digital servo system for faster access and improved focusing. Both units feature a 4 DAC design with 4 times oversampling, 18-bit resolution, and a digital filter. The linear motor used in these players provides remarkably accurate and responsive tracking of the disc. Auto cue is provided. The SL-PG440 has the added features of a front panel headphone jack with level control, a wireless remote control, and 10 key direct access.

**SL-PG340** 60TCSLPG340 MFR LIST \$169.00  
**SL-PG440** 60TCSLPG440 MFR LIST \$189.00

Accessories:  
**Rack mount shelf**  
for SL-PG340  
61MATCSLPG340 \$78.00

**Rack mount shelf**  
for SL-PG440  
61MATCSLPG440 \$78.00

Call Bradley for a current price quotation.



## Technics SL-PD647 & SL-PD847 CD Changers

For those who desire a CD changer, Bradley and Technics offer two inexpensive, but top performing models. The SL-PD647 and SL-PD847 both share a number of outstanding features, among which are a front loading design (lets you change any four discs while the fifth is playing), Technics' renowned MASH 1-bit DAC system, dual directional platter, 32-step random access programming, sequential play and repeat, spiral play and repeat capability (for a single track, entire disc, all five discs, or programmed songs). Both changers have high impedance, low level, unbalanced outputs, so an interface amplifier (page 61) is recommended for broadcast applications. The difference between the two is that the SL-PD847 features a 27 key wireless remote control; the SL-PD647 does not.



**SL-PD647** 60TCSLPD647 MFR LIST \$219.95  
**SL-PD847** 69TCSLPD847 MFR LIST \$249.95

Call Bradley for a current price quotation.



### Tascam CD-601 CD Player

Tascam asked broadcasters and production professionals what they needed in a CD player. The CD-601 is the result of that research, and it's apparent that Tascam delivered what you requested. Ruggedly constructed in a half rack width chassis, the CD-601 features a jog wheel, auto cue with adjustable sensitivity, and  $\pm 6\%$  pitch control. Analog outputs are XLR balanced, monitor outputs are phono unbalanced, and the digital output uses the SP/DIF format. Fader start allows remote start from your console and link start enables units to be cascaded. Front panel controls may be disabled when the CD-601 is controlled remotely.

Used with a single CD-601, the RC-601 remote control offers 10 track programming, on-air and ready indicator lights, jog wheel with pause, and single and repeat play mode programming. End check allows audition of up to 30 seconds of audio from the end of a track to help you plan your segues. The RC-601 has an autolocator with three memories and two memo points that mark places to start and terminate playback.

CD-601                      60TECD601                      MFR LIST                      \$1499.00



**Accessory:**  
RC-601 Remote Control      60TERC601                      MFR LIST                      \$749.00

Call Bradley for a current price quotation.

### Tascam CD-401 MKII CD Player

Tascam's CD-401 MKII gives you lots of broadcast features at a "consumer" price. This unit is rack mounted with XLR balanced and phono unbalanced analog outputs, as well as SP/DIF format digital outputs. The CD-401 MKII comes standard with a fader start port, and a pitch control with plus or minus 6% range. Technical specifications are broadcast standard with 18 bit, 4 times oversampling, a precision 3 beam pick-up for accurate tracking, and Tascam's ZD "Zero Distortion" circuitry for a truly clean sound. Now is the time to step up to a Tascam CD-401 MKII and enter the world of broadcast gear without contracting sticker shock.

CD-401 MKII                      60TECD401                      MFR LIST                      \$849.00

Call Bradley for a current price quotation.



**Accessory:**  
Wired remote control.      61TERC401                      MFR LIST                      \$75.00

### Tascam CD-301 CD Player

For professional quality and features on a budget, the CD-301 is an excellent choice. Tascam's ZD "Zero Distortion" circuitry and 18 bit, quadruple oversampling D/A converters assure excellent sound reproduction. Analog outputs are on balanced XLR and unbalanced phono connectors, and rack mount ears are standard. Front panel controls are limited to the basics, with full programming available via the included, wired remote control. A special link function allows one unit to start another for sequence play. The single play feature stops the unit at the end of the selected track. For quality and value, the CD-301 is tough to beat.

CD-301                      60TECD301                      MFR LIST                      \$549.00

Call Bradley for a current price quotation.



### Sony CDP-2700 CD Player

This affordable, pro CD player uses advanced 18 bit, 8x oversampling D/A converters for superb audio reproduction. For error correction, the CDP-2700 employs cross interleave RSC which virtually eliminates noise. Auto cue to the first audio on a cut assures tight cues. Features include fader start/stop for remote control from a console;  $\pm 12.7\%$  variable speed playback in 0.1% increments; and anti-vibration chassis with rack mounting hardware. Digital output supports AES/EBU and SP/DIF formats. Analog outputs are on both balanced XLR and unbalanced phono connectors. An additional set of unbalanced monitor outputs and a front panel headphone jack are provided.

CDP-2700                      60SOCDP2700                      MFR LIST                      \$1200.00

Call Bradley for a current price quotation.



# Digital Audio Accessories

## ATI Disc-Patcher

This unidirectional level and impedance interface is a popular choice for connecting a consumer compact disc player to a professional (600 ohm balanced, +4dBm) system. True transformer balanced, isolated, and protected outputs provide greater rejection of common mode interference, which is particularly important in high RF environments. The Disc-Patcher offers 102dB dynamic range, flat ( $\pm 0.25$ dB 20Hz to 20kHz) frequency response, and low 0.005% THD. A convenient Velcro mount is supplied.

60AIDP100 MFR LIST \$249.00

### Accessory:

**Rack Kit** Holds one or two Disc-Patchers.

60AID2073 MFR LIST \$25.00

Call Bradley for a current price quotation.

## Excalibur CD-1 & CD-2 Interface Amps

On everyone's list of the ten worst nuisances is interfacing semi-pro, IHF (-10dBV) to your professional (+4dBm) equipment. Excalibur eases the pain with the CD-1 which amplifies a single stereo source, and CD-2, which handles two stereo sources. Input is via phono jack and the barrier strip output may be adjusted to levels up to +22dBm. Frequency response is 10Hz to 25kHz  $\pm 0.25$ dB; THD is <0.006% and noise is >90dB below 4dBm. Guaranteed to work in the strongest RF fields.

CD-1 60EXCD1 \$99.00  
CD-2 60EXCD2 \$165.00

## CD Jewel Boxes

These high quality replacement boxes are delivered quickly and at a great low price.

60EMJB 78¢

Purchase 25 or more for only 66¢ each

## Denon Audio Technical CD

The 99 tracks on this CD include spot and sweep frequency tones and a variety of other signals to allow you to evaluate the THD, channel separation, and other playback characteristics of your CD player and other audio components in your facility.

60DETC D \$19.95

## Discwasher CD Cleaner

The computer designed gear drive system ensures true radial cleaning of the compact disc. The CD-1 cleaning fluid is specially formulated to safely remove debris from the compact disc.

61DICDC \$15.00

### Accessories:

CD-1 Cleaning fluid refill and pads

61DICD1 \$6.95



## Discwasher CD Lens Cleaner

This disc-shaped cleaner uses a dual wet/dry action to ensure thorough lens cleaning.

61DICDL2 \$21.95

## Intraclean CD-121 CD Cleaning System

If the microscopic data encoded into a compact disc becomes soiled, the disc may not play properly. The CD-121 cleans discs using the radial movement (straight lines from the center out to the edge) recommended by disc manufacturers. The rotating cleaning mechanism, combined with the specially formulated cleaning fluid, can help to ensure long life for your valuable disc library.

60ICCD121 \$24.95

### Accessories:

Package of three replacement pads

60ICCD122 \$9.95

Additional 1.5 ounce bottle CD-103 cleaning fluid

60ICCD103 \$4.95

## Discwasher CD Polish

Removes minor scratches and blemishes from CD surfaces. The package includes CD-1 cleaner, CD-2 polish, 6 applicator swabs and 4 polishing wipes.

61DICD2 \$10.95

## Henry TwinMatch

Henry knows you use more than one CD player, so he designed the TwinMatch to interface two consumer CD players into your professional level studio. Output level is up to +26dBm. Frequency response is DC to 20kHz  $\pm 0.25$ dB; THD is 0.008% at any level; and noise is 85dB below +4dBm. The metal chassis is RF proof, and every unit includes famous Henry reliability.

60HETM MFR LIST \$195.00

Call Bradley for a current price quotation.

## Benchmark IFA-3 IHF-to-Pro Interface

When interfacing a consumer CD player, no one offers higher quality than Benchmark. The IFA-3 offers 26dB of gain, THD @2kHz of 0.0008%, 120dB dynamic range, and excellent RF immunity. Requires power supply.

### IFA-3 Stereo IHF-to-Pro interface

60BMIFA3 MFR LIST \$190.00

Power Supply for IFA interfaces.

Handles up to 10 devices.

60BMPS1 MFR LIST \$35.00

Call Bradley for a current price quotation.

**Rack holders pictured can be found in the Furnishings section.**

## DAT Tape

### Digital Audio Tape

Length	Panasonic #	Price	Maxell #	Price
46 Minutes	61PARTR46P	\$6.69	61MXR46DM	\$6.95
60 Minutes	61PARTR60P	\$7.30	61MXR60DM	\$8.10
90 Minutes	61PARTR90P	\$8.80	61MXR90DM	\$9.75
120 Minutes	61PARTR120P	\$10.40	61MXR120DM	\$11.55

Maxell DAT Head Cleaning Tape 61MXRCL \$13.25



## Otari A-Line Recorders

Otari was the first manufacturer to make professional quality tape recorders affordable. Their newest generation A-Line machines continue a tradition of employing the latest technologies in compact, full featured recorders. All models are user selectable for 15 & 7½ ips or 7½ & 3¾ ips operation and have electronically balanced inputs and outputs on XLR connectors.

The entry level MX-50II two track features include ±7% varispeed, 5 digit tape timer with search-to-zero and search-to-cue functions, standard record/reproduce level selection on input/output, and individual reel size compensation switching.

If you're an audio professional, odds are that you own an Otari MX-5050. The "BIII" version has a built-in mini-autolocator that provides three one-touch cue point memories, zero search, and a repeat function. The tape timer display shows tape time in Hours/Minutes/Seconds, as well as tape speed in inches per second and percentage of tape speed. Capstan speed can be varied ±20% in 0.01% steps using the built-in pitch control. Other features include a built-in tone oscillator and external oscillator input, headphone monitor, dump edit and lifter defeat modes, and mic/line mixing on each channel.

For those who need the versatility of a four channel recorder, but who want the economy of 1/4" tape, the MX-5050BQIII is an excellent choice. Among other features, it has gapless, seamless, punch-in/punch-out.

Three MarkIV series models are available: 1/4" two track, 1/2" four track, and 1/2" eight track. All have overbridge mounted electronics, a servo controlled direct-drive capstan motor, dynamic braking, ±20% variable speed control in 0.01% steps, and selective reproduce for overdubbing. The mini-autolocator and tape timer functions of the MX5050B-III are incorporated into the MarkIVs. The four and eight track models include gapless, seamless punch-in/punch-out; rehearse function; and automatic monitor switching. MarkIV machines are capable of being interfaced to synchronizers when one track is used for time code.

The MX-55 series consists of three superior quality decks. The MX-55N has its electronics and transport in a compact upright unit that may be rack or console mounted. The MX-55NM, which has its electronics in an overbridge, adds Dolby HX Pro and gapless, seamless punch in/punch out. The MX-55TM, also an overbridge unit, adds center track SMPTE time code capabilities. All models feature a built-in 3 point locator with LED elapsed time counter, return-to-zero and repeat looping, ±20% varispeed, and external synchronizer interface. Other standard features include built-in cue speaker, headphone amp with level control, 3 tone oscillator, and mic/line mixing on each channel.

<b>Otari MX-50II</b> Two track	600TMX50	MFR LIST	\$2495.00
<b>MX-5050BIII</b> Two track	600T5050B3	MFR LIST	\$3459.00
<b>MX-5050BQIII</b> 1/4" Two track	600T5050BQ3	MFR LIST	\$5418.00
<b>MarkIV-2</b> two track	600T5050MK42	MFR LIST	\$4509.00
<b>MarkIV-4</b> 1/2" four track	600T5050MK44	MFR LIST	\$6295.00
<b>MarkIV-8</b> 1/2" eight track	600T5050MK48	MFR LIST	\$6609.00
<b>MX-55N</b> Two track	600TMX55	MFR LIST	\$4509.00
<b>MX-55NM</b> Two track with overbridge	600TMX55NM	MFR LIST	\$5769.00
<b>MX-55TM</b> Two track with center track time code and overbridge	600TMX55TM	MFR LIST	\$6820.00

### Accessories:

Bradley can provide the complete selection of Otari accessories, including:

- Rack mount and table mount kits for upright models.
- Metal roll around stands for all models.
- Remote controls for all models.
- Autolocators for MarkIV and MX-55 machines.
- Hub adapters for 10½" reels and clamps for 7" reels.

Call Bradley for a current price quotation.



MX-55NM



MX-5050BIII



MX-50II



MX-5050 Mark IV  
Four Track



## Tascam BR-20 Recorders

The Tascam BR-20 sets a new standard in its class. This professional two track has both balanced +4dBm and unbalanced -10dBV inputs and outputs. All major calibration controls are accessed from the front panel. The transport has a precision tension servo control transport system for exceptionally smooth operation and editing. The rack mount kit is standard. The built-in autolocator features 3 cue points, zero return, and direct time location. Other features include  $\pm 12\%$  pitch control, headphone monitoring, splicing block, dump edit and lifter defeat, and independent reel size selectors.

Also available is the BR-20T with center track time code. It uses Tascam's in-line head design and time code level optimization and waveform shaping for error-free synchronization. Gapless punch-in/punch-out and spot erase are also featured in the BR-20T.

<b>BR-20</b>	60TEBR20	MFR LIST	\$2499.00
<b>BR-20T</b> w/center track time code	60TEBR20T	MFR LIST	\$2999.00
<b>Accessories:</b>			
<b>Remote control</b>	61TERC402	MFR LIST	\$200.00

Call Bradley for a current price quotation.



## Tascam Series 30 Recorders

Series 30 recorders come in 2 and 4 channel versions and are designed for production needs at an economical price. Standard features include servo-controlled capstan motor with  $\pm 12\%$  pitch control, full motion sensing with dynamic reel braking, 10 1/2" reel capacity, return-to-zero function, and dump/edit capability. Both versions are 7 1/2" & 15ips quarter inch format with NAB equalization. Phono inputs and outputs are at -10dBV.

<b>Model 32</b> two track	60TE32	MFR LIST	\$1799.00
<b>Model 34B</b> four track	60TE34B	MFR LIST	\$2299.00
<b>Accessories:</b>			
<b>Remote control</b>	61TERC71	MFR LIST	\$100.00
<b>Rack mount kit</b>	61TERM300	MFR LIST	\$60.00
<b>Replacement 1/4" NAB reel hub adapters</b> One pair	61TETZ612B	MFR LIST	\$20.00

Call Bradley for a current price quotation.



## Tascam TSR-8 Eight Track Recorder

The TSR-8 eight track offers excellent sound, stability, and versatility. Its silent transport provides faultless tape handling of 1/2" tape at 15 ips. The TSR-8 has a precision real-time tape counter with three autolocate points and return to zero. For clean, noise-free reproduction, this recorder features dbx Type I noise reduction. In addition to manual, gapless punch in/out capability, it offers fully automated punch in/out with a rehearsal mode and a spot erase function.

The TSR-8 easily adapts to virtually any type of external control system via three different interfaces: a parallel input which allows direct interfacing to standard SMPTE/EBU time code based synchronizers; a serial port that can be used to connect to a variety of controllers, to a computer with an RS-232 interface, or to a Tascam synchronizers; and a third connector for an optional remote control.

<b>TSR-8</b>	60TETSR8	MFR LIST	\$2999.00
<b>Accessories:</b>			
<b>Remote control</b>	61TERC408	MFR LIST	\$200.00

Call Bradley for a current price quotation.



### Tascam 238 & 238S 8-Track Cassette Recorders

Thanks to Tascam, you can now have the versatility of 8-channel recording with the convenience of the cassette format. The 238's performance, based on a revolutionary head design and dbx noise reduction, will astound you. Two staggered four-track heads are used to allow adequate intra-head track spacing. Frequency response is 30Hz to 16kHz and unweighted S/N ratio, with dbx, is 90dB. Added to this performance are a number of features that make the 238 a "must own" machine:  $\pm 12\%$  pitch control that may be front or externally controlled, a selectable baud rate RS232C port, tape shuttle under full servo control, a three-point memory locator function, and a four digit tape counter. Rack mounting is standard, and the optional RC-88 remote control unit handles all transport functions.



The 238S gives the option of Dolby S-type noise reduction instead of dbx.

<b>238</b>	60TE238	MFR LIST	<b>\$1599.00</b>
<b>238S</b>	60TE238S	MFR LIST	<b>\$1899.00</b>

Call Bradley for a current price quotation.

### Tascam 464 Portastudio

Tascam originated the four track cassette format and keeps making it more powerful every year. The new 464 offers a host of features including four balanced XLR mic/line inputs and two stereo line inputs on 1/4" TS connectors. The mixer section also has dual effects sends and two stereo effects returns. The two speed recorder transport features all solenoid-type controls for quick, reliable response. The 464 also includes a dual point autolocator with return-to-zero and full auto-rehearse and auto punch-in/punch-out capability. All four tracks may be recorded simultaneously, and metering, status, and tape counter are on a large LCD display screen.



<b>464</b>	60TE464	MFR LIST	<b>\$899.00</b>
------------	---------	----------	-----------------

Call Bradley for a current price quotation.

### Tascam 134B 4-Track Cassette Recorder

Tascam's 134B is the latest in a long line of professional multi-track cassette recorders. This unit's principal area of usage is the multimedia and presentation A/V arena, where it has no equal.

With its built-in 25Hz tone generator, 4x2 mic input mixer, Dolby B & C noise reduction, and flexible locate point repeat modes, little else is needed in the production of automated audio to go with many types of other material. This rack-mounted machine will operate at either 1 7/8 or 3 3/8 IPS for truly excellent audio quality and ultra-reliable timing. An accessory port makes the unit easy to interface with outside controllers and automation systems.



<b>134B</b>	60TE134	MFR LIST	<b>\$1,349.00</b>
-------------	---------	----------	-------------------

Accessory:

<b>RC-134</b>	61TERC134	MFR LIST	<b>\$175.00</b>
---------------	-----------	----------	-----------------

Call Bradley for a current price quotation.

**Bradley offers the latest in digital multitrack recorders. Check out our digital products on pages 1-2 and pages 52-61.**

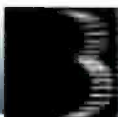



## Nakamichi MR-1 and MR-2 Cassette Recorders

The MR-1 and MR-2 are rich with the kind of innovations that have made Nakamichi a household word. Nakamichi's unique Asymmetrical Dual-Capstan system guides the tape past the tape heads with virtually inaudible scrape flutter and wow artifacts. In fact, the machine actually pushes the cassette's pressure pad away from the head and uses its two differently sized, different speed capstans to diffuse audibly resonant vibrations in the tape path. Coupled with ultra-clean electronics, this transport helps to create the famous Nakamichi 20Hz to 20kHz  $\pm 3$ dB response. Each of these professional decks sports features like transport pitch control, adjustable bias tune, 16 segment meters, Dolby B and C noise reduction, wired remote jack, and adjustable headphone amp.

The MR-1 has three fully independent heads, while the MR-2 has two heads. Inputs and outputs on the MR-1 are both balanced (XLR) and unbalanced (1/4" TS), with a convenient pair of balanced (1/4") inputs on the front panel. Audio connections on the MR-2 are unbalanced phono jacks, and its line level outputs are adjustable from -10 dBV to +4 dBm.



<b>MR-1</b>	60NKMR1	MFR LIST	\$995.00
<b>MR-2</b>	60NKMR2	MFR LIST	\$695.00

<b>Accessory:</b>			
<b>Wired remote control</b>	60NKRM5	MFR LIST	\$50.00

Call Bradley for a current price quotation.

## Tascam 122 MKII Cassette Recorder

The 122 MKII deserves its title as a broadcast industry standard. Balanced inputs and outputs with XLR connectors, rack mount, 3 tape heads, and micro-processor control add up to professional construction. Dolby HX Pro circuitry and Dolby B and C noise reduction result in superior audio performance. Wow and flutter measure only 0.04% (NAB weighted) and frequency response is 25Hz to 20kHz,  $\pm 3$ dB with metal tape and 25Hz to 17kHz with normal tape. Channel separation exceeds 35dB at 1kHz. The real time tape counter is based upon a clock that reads actual record or play time elapsed. Other features include a multiplex filter to improve off air recordings, a two tone test oscillator, and  $\pm 12\%$  pitch control.



<b>122 MKII</b>	60TE122MKII	MFR LIST	\$1499.00
-----------------	-------------	----------	-----------

<b>Accessory:</b>			
<b>Remote control</b>	61TERC71	MFR LIST	\$100.00

Call Bradley for a current price quotation.

## Tascam 112R Cassette Recorder

The 112R offers bidirectional, auto-reverse capabilities for professional applications requiring extended record and playback times. To achieve optimum reproduction quality, the tape head is a special 2 channel design that rotates 180° when the tape changes direction. A control system maintains constant tension throughout record or playback of the entire cassette, improving wow and flutter as well as distortion. A 16 pin connector allows remote control, plus multi-deck interfacing for a broad range of applications such as continuous record/play, duplication, or stop-activated deck switchover. The recorder also has pitch control, metal tape capability, Dolby B/C, counter with memory stop, and rack mount.



<b>112R</b>	60TE112R	MFR LIST	\$899.00
-------------	----------	----------	----------

<b>Accessory:</b>			
<b>Remote control</b>	61TERC205K	MFR LIST	\$75.00

Call Bradley for a current price quotation.

## Tascam 112 and 112B Cassette Recorders

These light duty, rack mount cassette recorders from Tascam incorporate features such as Dolby HX pro circuitry to enhance high frequency reproduction,  $\pm 12\%$  pitch control, Dolby B/C, and metal tape capability. Selecting fast forward or rewind while in the pause mode allows audio to be monitored in fast wind for cueing or reviewing. The digital tape counter and return-to-zero function also assist in locating specific points on the tape. The 112B has XLR balanced inputs and outputs, while those on the 112 are unbalanced phono jacks.



<b>112</b>	60TE112	MFR LIST	\$699.00
<b>112B</b>	60TE112B	MFR LIST	\$799.00

<b>Accessory:</b>			
<b>Remote control</b>	61TERC71	MFR LIST	\$100.00

Call Bradley for a current price quotation.



## Technics RS-BR465 Auto-Reverse Cassette Recorder

The two motor drive of the RS-BR465 means fast reverse time and better deck reliability. Dolby B and C noise reduction and Dolby HX Pro headroom extension are all available. Other features include cue and review, auto tape type selector, bias fine adjustment, headphone jack, and MPX filter.

**RS-BR465**                      60TCRSBR465    *MFR LIST*    **\$229.00**

Call Bradley for a current price quotation.



## Dual Cassette Recorders

All of our dual cassette recorders have one deck that records and plays back and one deck that only plays back; normal and twice speed dubbing; Dolby B and C noise reduction; -10dBV inputs and outputs on phono jacks; and front panel headphone jack.

The Tascam 202MKII has two auto-reversing transports with simultaneous record on both transports and continuous playback capabilities. Built for studio use, recordings on the 202MKII are enhanced by Dolby HX Pro.

Both the RS-TR232 and the RS-TR333 share a number of quality features, including Dolby HX pro headroom extension, Dolby B and C noise reduction, and series play capability. On the RS-TR232, only deck 2 will auto-reverse; on the RS-TR333, both decks will auto-reverse. The RS-TR232 has a tape counter only on deck 2; the RS-TR333 has tape counters for both decks as well as adding a front panel bias adjustment for deck 2. Both machines are high Impedance, low level, unbalanced on both inputs and outputs; a bi-directional interface amplifier (pages 91-94) is recommended for broadcast applications.

**Tascam 202MKII**                      60TE202MKII                      *MFR LIST*    **\$399.00**

**RS-TR232**                              60TCRSTR232                      *MFR LIST*    **\$199.00**

**RS-TR333**                              60TCRSTR333                      *MFR LIST*    **\$229.00**

Call Bradley for a current price quotation.

**Note:**  
Rack mounting shelves are available for these models. Shelves are priced at only \$89.00 each; please specify model when ordering.



## Tascam/Teac Cassette Recorders

### Tascam 103 and 102 Cassette Recorders

These two decks offer Tascam quality at a moderate price. Both the three head 103 and two head 102 feature Dolby B and C noise reduction, Dolby HX Pro headroom extension, a tape counter with run time mode, and automatic tape type sensing. Operators will appreciate the uncluttered front panel with headphone jack and bias fine adjustment. Inputs and outputs are -10dBV on phono jacks. Who could ask for more than Tascam cassette quality on a budget?

**Tascam 103**                              60TE103                              *MFR LIST*    **\$499.00**

**Tascam 102**                              60TE102                              *MFR LIST*    **\$329.00**

Call Bradley for a current price quotation.

### Teac V510 Cassette Recorder

Looking for an inexpensive cassette deck to make a quick demo copy or to use as a back-up source machine JUST IN CASE? Teac's V-510 does everything it needs to do, and does it for a price that will make you glad you bought it when your expensive machine is on the bench for maintenance. Standard phono inputs and outputs, Dolby B & C, fluorescent meters, and a very straight forward set of controls make this a familiar machine indeed. Just like the one at home.

**V-510**                                      60TEV510                              *MFR LIST*    **\$189.00**

Call Bradley for a current price quotation.

**Note:**  
Rack mounting shelves are available for these models. Shelves are priced at only \$89.00 each; please specify model when ordering.



## Yamaha C-300 Cassette Recorder

The Yamaha C-300 offers every feature one could want in a professional cassette deck. The C-300's versatility starts with dbx and Dolby B and C noise reduction assuring compatibility with any other decks. Additionally, Dolby HX Pro Dynamic Bias monitors the signal level and automatically adjusts the bias for perfect recordings. The deck mounts in three standard rack spaces and offers balanced +4dBm inputs and outputs via XLR connectors (-10dBV phono connectors are also provided). What sets the C-300 apart is its sophisticated closed loop, dual capstan transport with separate motors for reel and capstan drive. It also automatically selects the tape type and indicates it on the display. The four digit linear tape counter and two color, twenty segment fluorescent level meters are remarkably easy to see at a glance, and optimum record levels are indicated for each tape and noise reduction type. Standard equipment includes a wired remote control for all transport functions. Let Bradley supply you with the cassette deck that combines rugged construction, full features, and great audio.



**C-300** 60YAC300 MFR LIST \$1095.00

### Accessory:

Wireless remote control that adds several features including Random Play, Intro Scan, Record Time Remaining Indicator, and Music Search.

60YARSK12 MFR LIST \$35.00

*Call Bradley for a current price quotation.*

## Marantz PMD 500

Marantz has filled a niche with the new PMD-500 dual well cassette recorder. This rack-mounted unit features simultaneous or serial recording as well as continuous or relay playback from either deck. Auto-reverse speed is increased using optical sensors to detect leader tape. An RC5 port makes serial, IR or master remote control a breeze to configure. Dolby B&C NR as well as HX pro assures clean recordings. Automatic and quick music searches, blank-skip mode, record mute, standard or high speed dubbing and auto tape type select make this unit one of the more versatile units available in this format.

**PMD 500** 60MR500 MFR LIST \$599.00

*Call Bradley for a current price quotation.*



## Marantz Portable Cassette Recorders

These rugged and reliable recorders are described in full on page three in our Field Production section.

<b>PMD201</b> mono, two head	60MR201	\$229.00
<b>PMD221</b> mono, three head	60MR221	\$275.00
<b>PMD222</b> mono, three head, XLR mic input	60MR222	\$289.00
<b>PMD430</b> stereo, three head	60MR430	\$449.00



## Tascam Cassette Duplicators

The T-2640 is a versatile and economical solution for situations where high capacity systems are just too expensive, but "dubbing decks" just won't do. An 8 to 1 duplication ratio is employed, with one pass duplication of any or all tracks. The master unit makes a single copy, and provides an onboard monitor amp and speaker,  $\pm 3\%$  pitch control, master reproduce level metering and adjustment, and an automatic rewind function which the slaves can follow. Up to ten slaves, each creating two copies, can be connected to the master. The system can handle standard or chrome bias and EQ.

<b>Master unit with single slave</b>	60TET2640MS	MFR LIST	\$2750.00
<b>Dual slave</b>	60TET26402S	MFR LIST	\$2500.00

*Call Bradley for a current price quotation.*



# Professional Recording Tape and Accessories

## Ampex Reel to Reel

Model	Item No.	Size	Reels/ Ctn.	Carton Price	Single Price
499	61AM499174111	1/4" x 2500' x 10 1/2"	10	\$223.20	\$26.78
499	61AM49917611T	1/4" x 2500' HUB	10	124.00	N/A
456	61AM456151111	1/4" x 1200' x 7"	10	78.40	9.40
456	61AM456173111	1/4" x 2500' x 10 1/2"	10	208.30	24.98
456	61AM45617611T	1/4" x 2500' HUB	10	114.00	N/A
456	61AM456273111	1/2" x 2500' x 10 1/2"	7	257.60	44.13
456	61AM456573111	1" x 2500' x 10 1/2"	5	389.60	N/A
456	61AM45697G111	2" x 2500' x 10 1/2"	2	275.70	N/A
406	61AM406151131	1/4" x 1200' x 7"	10	66.10	7.93
406	61AM40617313J	1/4" x 2500' x 10 1/2"	10	170.10	20.40
406	61AM40617613T	1/4" x 2500' HUB	10	91.80	N/A
407	61AM407151131	1/4" x 1800' x 7"	10	86.90	10.42
407	61AM40717313J	1/4" x 3600' x 10 1/2"	10	230.80	27.67
407	61AM40717613T	1/4" x 3600' HUB	10	146.50	N/A

**Ampex Tape Types**  
**499** Grand Master Gold, 1.5 mil, Backcoated.  
**456** Grand Master, 1.5 mil, Backcoated.  
**406** Mastering, 1.5 mil, Backcoated.  
**407** Mastering, 1.0 mil, Backcoated.

## Cassette Tapes

Bradley saves you money on the cassette tapes you need. Get the same low price on any quantity up to 100. When ordering 100 tapes of any mix, take an additional 10% off.



Model	Length	Item Number	Price
Maxell XLI	60 min	61MXXL2C60	2.17
Maxell XLI	90 min	61MXXL2C90	2.58
Maxell XLI	100 min	61MXXL2C100	2.98
Maxell MX	60 min	61MXMXC60	2.17
Maxell MX	90 min	61MXMXC90	2.71
Maxell MX	100 min	61MXMXC100	2.98
3M AVX	20 min	61SCAVX20	95¢
3M AVX	30 min	61SCAVX30	99¢
3M AVX	60 min	61SCAVX60	1.19
3M AVX	90 min	61SCAVX90	1.62
3M AVX	120 min	61SCAVX120	2.19

**Tape Types**  
**Maxell XLI** - Type II, high bias for music recording.  
**Maxell MX** - Type IV, metal formulation for critical recording.  
**3M AVX** - Type I, normal bias for general recording.

## 3M Reel to Reel

Model	Item No.	Size	Reels/ Ctn.	Carton Price	Single Price
996	61SC996142500	1/4" x 2500' x 10 1/2"	12	\$276.00	\$28.40
226	61SC226141200	1/4" x 1200' x 7"	12	93.36	9.60
226	61SC226142500	1/4" x 2500' x 10 1/2"	12	243.00	25.00
226	61SC2261425H	1/4" x 2500' HUB	12	133.00	N/A
226	61SC226122500	1/2" x 2500' x 10 1/2"	10	364.50	45.00
806	61SC806141200	1/4" x 1200' x 7"	12	81.60	8.40
806	61SC806142500	1/4" x 2500' x 10 1/2"	12	204.12	21.00
806	61SC8061425H	1/4" x 2500' HUB	12	113.00	N/A

**3M Tape Types**  
**996** Highest Headroom, 1.5 mil, Backcoated  
**226** High Headroom, 1.5 mil, Backcoated.  
**806** Low Noise, High Output, 1.5 mil, Backcoated.

All tape is loaded on reels by the factory. 7" reels are plastic, 10 1/2" reels are metal. Other tape formulations and sizes are available. Due to their fragile packaging, hubs are available only in full cases.



## Digital Audio Tape

Length	Panasonic #	Price	Maxell #	Price
46 Minutes	61PARTR46P	\$6.69	61MXR46DM	\$6.95
60 Minutes	61PARTR60P	7.30	61MXR60DM	8.10
90 Minutes	61PARTR90P	8.80	61MXR90DM	9.75
120 Minutes	61PARTR120P	10.40	61MXR120DM	11.55
Maxell DAT Head Cleaning Tape			61MXRCL	\$13.25

## Test Tapes

### MRL Reel to Reel Test Tapes

Bradley offers the full line of MRL test tapes for all types of tape recorders. Spot frequency tapes are for overall frequency response checking. Fast sweep and pink/white noise tapes are used for frequency response or phasing verification. Most 1/4" test tapes for 7 1/2 and 15ips are \$57.00 and most 1/2" tapes at those speeds are \$118.00. Tapes can be ordered with NAB or IEC equalization; for 1/4", 1/2", 1", and 2" machines; for various operating levels; and for 3%, 7%, 15, and 30ips. Below is a selection of our most popular models. Your Bradley professional can help you select the right test tapes for your recorders.

1/4" Spot Frequency, 7 1/2 ips, 250nWb/m, NAB	60ML21T204	\$ 57.00
1/4" Spot Frequency, 15ips, 250nWb/m, NAB	60ML21J205	\$ 57.00
1/2" Spot Frequency, 15ips, 250nWb/m, IEC	60ML31J229	\$118.00

### Geneva AT-200B Cassette Alignment Tape

Cassette machines need periodic alignment just as reel and cart machines do. The AT-200B is an original master recording and conforms to IEC/NAB standards. Tests include 7 spot frequencies, 400hz Dolby calibration tone, pink noise and sweep tone for stereo phasing, and 3150Hz pilot tone for wow and flutter measurements.

61NOAT200B \$102.00



### Reel-to-Reel Tape Accessories

#### 3M Splicing Tape For 1/4" Tape

#41 1.5mil acetate tape in white. General use splice tape with a non-removable adhesive. 66 feet per roll.

61SC41 \$3.15

#67 1.0mil polyester tape in blue. Durable, but removable. 100 feet per roll.

61SC67 \$5.50

#620 1.0mil polyester tape in white. High reliability with a permanent bond. 66 feet per roll.

61SC620 \$4.75

Call for pricing on larger format splicing tapes.

#### 3M Leader Tape For 1/4" Tape

#20 2.5mil uncoated white paper, 7" reel, 1000 feet.

61SC2014 \$7.15

#61 1.5mil white polyester with timing indications each 7 1/2 and 15 inches. 7" reel, 1500 feet.

White 61SC61W \$18.00

Yellow 61SC61Y \$18.00

Call for pricing on larger format leader tapes.

#### 3M Relabel Tape

Relabel tape covers old, messy labels on your tapes, reels, and boxes. Removes easily. In plastic dispenser, 3/4" x 700'.

61SCRLT \$1.85

#### Empty Reel and Boxes

1/4" x 7" plastic reel 60EM7R \$.89

Box for 7" plastic reel 60EM7WB \$.55

1/4" x 10 1/2" plastic reel 60EM10R \$2.90

Box for 10 1/2" plastic reel 60EM10WB \$1.45

1/4" x 10 1/2" metal reel in box 61SCRN14 \$18.75

### 3M RSD-1 Dispenser



Pictured supplies not included.

This convenient 9 1/2" x 6" desk-top device makes it easy to store and dispense your most used tape accessories. It provides space to store an assortment of seven leader, timing, and splicing tapes, a brush to hold razor blades, and space for a container of head cleaning solution and cleaning swabs.

RSD-1 61SCRS1 \$126.00

### Editing Supplies

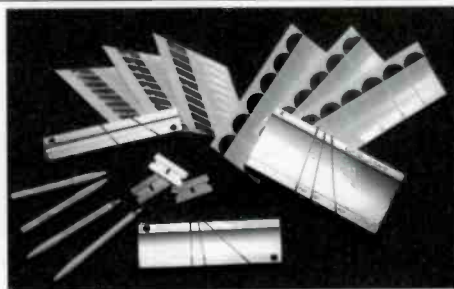

Edittall pre-cut polyester splicing tabs make splicing recording tape easy.

250 1/4" tabs 61EDCX1 \$15.00

250 1/2" tabs 61EDCX6 \$23.00

250 1" tabs 61EDCX8 \$37.00

250 cassette tabs 61EDCX3 \$15.00

Edittall splicing blocks are precision machined anodized aluminum blocks that hold the tape firmly for fine quality splices. Provisions for multitrack and 45° cuts.

1/4" block 61EDS3 \$35.00

1/4" block with 90° and 45° cuts 61EDS390 \$35.00

1/4" replacement block for Otari MX-5050B-II 61EDS30T \$49.00

1/2" block 61EDS35E \$52.00

1" block 61EDS4 \$87.00

2" block 61EDSA2 \$165.00

Cassette block 61EDS1S \$42.00

White grease pencils for marking recording tape.

One dozen. 61EDWP1 \$18.00

100 single edged razor blades designed for professional splicing. 61EDRB1 \$15.00

### Bulk Tape Erasers

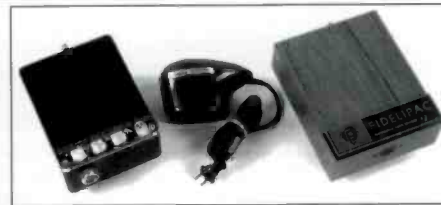

#### Audiolab TD-1B

This sturdy tabletop eraser completely erases any magnetic media up to 1/4" thickness on reel sizes up to 10 1/2". Pushbutton switch prevents accidental burnout from leaving unit on, and an automatic thermal protector is included to prevent overheating. Eraser duty cycle is 1 minute on, 3 minutes off.

60AUTD1B MFR LIST \$135.00

#### Also available:

Audiolab TD-4 designed for heavy use. This unit erases up to 14" reels, 1" wide. Adjustable "on" cycle, cooling fan and automatic shut-off for trouble-free operation. Use for audio, video, computer, and cartridge tape.

60AUTD4 MFR LIST \$950.00

#### Audiolab TD-5 for 2" tape.

60AUTD5 MFR LIST \$1695.00

Call Bradley for a current price quotation.

#### Fidelipac 400

Dependable and attractive, this tabletop eraser is an excellent choice for 1/4" reel tape, cassettes, and cartridges.

60FP400 MFR LIST \$130.00

Call Bradley for a current price quotation.

#### Geneva PF-211

The powerful 60Hz magnetic field erases 1/4" reels, cassettes and cartridges. Burn-out resistant design. Case contoured to fit comfortably in the hand.

61N0PF211 \$54.00

### Intraclean Head Care Products



S-711 Intraclean is the tape head, capstan, and pinch roller cleaning solution used by the top manufacturers. Formulated of halogenated hydrocarbons, S-711 removes the toughest oxide deposits. It contains no alcohol (which can dry out pinch rollers) and its controlled evaporation rate combines maximum cleaning power with fast drying.

Two ounce bottle 60ICS711 \$6.15

Quart can 60ICS711Q \$25.95

Gallon can 60ICS711G \$49.00

Cotton cleaning swabs with 6" highly polished maple stick. The tip is tightly wound and mounted with solvent resistant glue to prevent unraveling.

100 swabs 60BBCS100 \$2.85

1000 swabs 60BBCS1000 \$17.95

Pump dispenser makes it easy to keep a few ounces of S-711 handy and reduces the chances of spilling. A great way to take advantage of economical quarts and gallons.

60ICPD \$19.00

D-511 head demagnetizer reaches into the tightest spaces to remove residual magnetism. Plastic on probe will not damage sensitive head faces. Leaf switch activates with fingertip pressure. Use on reel-to-reel, cassette, and cartridge machines.

60ICD511 \$20.95

K-161 head care kit is a special package that includes the CD-511 demagnetizer, a two ounce bottle of S-711, and 100 cotton swabs. Convenience and economy.

60ICK161 \$25.95

### Broadcast Electronics Phase Trak 90 Cart Machines

The Phase Trak 90's automatic phase correction circuit continually monitors and corrects playback phasing, regardless of the machine on which the cart was originally recorded. Audio quality is excellent, with 80dB S/N ratio (using the included Dynafex noise reduction) and 40Hz to 16kHz, ±2dB frequency response. Non-repeat lockout and cart-not-cued lockout prevent operator errors, and automatic/manual fast forward provides rapid cueing. All machines come standard with four cue circuits including an FSK decoder which provides an RS-232 compatible data output for logging. A digital timer is standard on the recorder.

- Stereo playback** 60BRPT90PS MFR LIST \$2750.00
- Stereo record/playback** 60BRPT90RPS MFR LIST \$4550.00

Call today for information on accessories and a current price quotation.



### Broadcast Electronics Dura Trak 90A

The Dura Trak 90A cart machines offer sparkling audio performance, reliability, and ruggedness. They include three cue tones, fast forward, cart-previously-played lockout, pressure roller cleaning mode, DC servo motor, and much more. Toroidal transformers and CMOS logic reduce heat dissipation, and provide superior noise performance and immunity. Hall-effect switches will operate flawlessly through thousands of operations. A low voltage, current regulated solenoid provides a full 1.25 pounds of tape pull while generating 66% less heat than other machine designs. The Dura Trak 90A gives you all this at a most affordable price.

- Mono playback only** 60BRDT90P MFR LIST \$1750.00
- Mono record/playback** 60BRDT90RP MFR LIST \$2600.00
- Stereo playback only** 60BRDT90PS MFR LIST \$1900.00
- Stereo record/playback** 60BRDT90RPS MFR LIST \$2850.00

Call Bradley for a current price quotation.



### Broadcast Electronics Splice Trak 90 Cart Eraser

Employing dual erase heads, the Splice Track 90 typically provides 85 to 90dB erase depth below the tape saturation point. Erasure occurs at 27 1/2 ips for quick operation. The splice detector locates splices by sensing minute differences in tape thickness, providing a more accurate method than optical locators.

- Splice Trak 90** 60BRST90 MFR LIST \$1150.00

Call Bradley for a current price quotation.



### Broadcast Electronics Triple Deck Cart Machines

Broadcast Electronics offers the 5300C (half rack width) and 5400C (third rack width) three deck cart machines featuring non-repeat lockout, Phase Lok V head assembly, and toroidal power transformer. Plug-in decks and electronics make servicing quick and easy, and sturdy mechanical construction assures consistent playback quality.

Four machine configurations are available: Mono or stereo, each with or without secondary and tertiary cue tones. Optional record amplifiers allow the bottom deck to record as well as play back.

Contact your Bradley professional for details and pricing.



## Audi-Cord DL Series Cart Machines

These moderately priced cart machines offer a full range of features, including two cue tones, replay reminder system, manual or automatic output muting, and automatic motor shutoff. Record models provide bias and tone present indicators, automatic record/play meter switching, and front access tone editing. Engineers will appreciate the DL series modular design, plug-in circuit cards, and heavy-duty quality construction. Select single transport models or the exclusive "studio in a box" incorporating two record/play units on one chassis. Record units are also available with an integral timer, and tertiary (third) tone may be added to any deck at the factory or in the field.

Best of all, the DL series has a proven record of reliability. No wonder it's one of our best sellers.

<b>Mono playback only</b>	60ACDLPM	MFR LIST	\$920.00
<b>Stereo playback only</b>	60ACDLPS	MFR LIST	\$1000.00
<b>Mono record/play</b>	60ACDLRM	MFR LIST	\$1290.00
<b>Mono record/play w/timer</b>	60ACDLRM5	MFR LIST	\$1370.00
<b>Stereo record/play</b>	60ACDLRS	MFR LIST	\$1480.00

Call Bradley for a current price quotation.

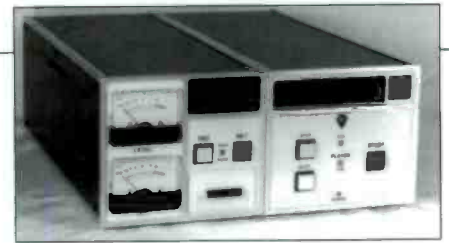

<b>Stereo record/play w/timer</b>	60ACDLRS5	MFR LIST	\$1560.00
<b>Dual mono record/play</b>	60ACDLDM	MFR LIST	\$2270.00
<b>Dual mono record/play w/timer</b>	60ACDLDM5	MFR LIST	\$2350.00
<b>Dual stereo record/play</b>	60ACDLDS	MFR LIST	\$2630.00
<b>Dual stereo record/play w/timer</b>	60ACDLDS5	MFR LIST	\$2710.00

**Accessories:**

<b>Tertiary tone record capability</b>	60AC1840007	MFR LIST	\$55.00
<b>Tertiary tone detection</b>	60AC1840009	MFR LIST	\$35.00
<b>Rack shelf assembly</b>	60AC1850006	MFR LIST	\$62.50

## Fidelipac Dynamax Cart Machines

The CTR-10 series of cartridge machines has gained wide acceptance in the broadcast industry, due to its excellent performance and operational characteristics. CTR-10 standard features include fast forward, secondary and tertiary tones, high speed recue, and an audio switcher/ mixer function for using multiple machines on a single console input. Switch selectable audio test metering and a cart played indicator with replay lockout further enhance the versatility of the CTR10 series. Contact Bradley Broadcast for information and pricing on the CTR100 series cartridge machines.

<b>CTR11 mono playback</b>	60FPCTR11	MFR LIST	\$1795.00
<b>CTR12 stereo playback</b>	60FPCTR12	MFR LIST	\$1935.00
<b>CTR13 mono record/playback</b>	60FPCTR13	MFR LIST	\$2640.00
<b>CTR14 stereo record/playback</b>	60FPCTR14	MFR LIST	\$2890.00

**Note:** Dynamax accessories, including rack shelves, calibration tools, and MaxTrax heads, are available. Contact your Bradley professional for CTR100 pricing.

Call Bradley for a current price quotation.



## Fidelipac ESD10 Cart Eraser and Splice Finder

Bulk erasing carts is about the last place where you'd expect to find a big research and development effort, but the Fidelipac crew decided that the old fashioned technique of using a huge erase coil under the deck of a splice finder just couldn't produce satisfactory results and could damage the tape pack of your carts. The ESD10 uses two dual gap high current erase heads for absolutely complete erasure of even the newest high coercivity tape formulations. Without the traditional "flux monster" erase coil, tape tension is totally unaffected by the erase process. You can even put the ESD10 right next to an on-air playback deck without worrying about stray flux causing hum on the air. Fidelipac's unique solenoid servo system uses the pinch roller itself to detect the splice, flawlessly, with no adjustments.

<b>ESD10</b>	60FPESD10	MFR LIST	\$1190.00
--------------	-----------	----------	-----------

Call Bradley for details and a current price quotation.



## Cartridges

### audiopak Cartridges



Three great lines of cartridges are available from audiopak. The A2 is an economical, popular choice for monaural use featuring precise tape guidance and bracing. The AA4 boasts Formula 615 lube tape, which provides superior magnetic properties in a high output, low noise tape. Tight quality control provides you with consistent performance, cart after cart. Also available is the AA3 cartridge, also suitable for stereo use. Factory loads are available in lengths up to 10½ minutes, and Bradley stocks empties, lube tape, and replacement parts for all audiopak cartridges. Call for pricing.

### Fidelipac Cartridges

The Dynamax Cobalt Cartridge tops the Fidelipac line using high output, low noise tape for extended head room. The Audiomax cart uses a high output tape formulation compatible with type AA4 carts. Mastercarts are available for those stereo applications requiring standard operating level, and the Model 300 is an economical choice for mono use. Standard lengths are from 20 seconds to 10½ minutes. Empties, bulk tape, replacement parts, and B and C size carts are also available. Call Bradley for current pricing.



### Geneva PF710 Cartridge Zenith/Height Gauge

Provides three adjustment measurements with one gauge: zenith, track height, and tape guide position. Zenith adjustment accuracy exceeds NAB standard; height adjustment checks tape guide and track height to ±0.001" accuracy.

61NOPF710 \$38.00

### ITC Cart II

Formerly called the Scotchcart II, the ITC Cart II uses 219 tape formulation based on high quality mastering tape. The tape has a surface which nearly eliminates oxide shedding to reduce head and guide wear. Concave guides and no pressure pads mean accurate tape guidance. The life extension cam enables adjustment of tape tension, permitting extended cart life and improved cart consistency. Lengths up to 7½ minutes are available and 219 tape can be purchased on hubs. Call for pricing.



### MRL Cartridge Test Tapes

Bradley and MRL team up to provide you with a comprehensive series of cartridge test tapes. We provide these tapes loaded into the cart shell that you use at your station to ensure accurate machine setup. The multi-frequency tape is the most widely used for reproduce gain, head azimuth, and frequency response calibration. Also available are single frequency tapes, fast and slow frequency sweeps, pink and white noise, and cue tone test tapes at the same price. These full track master recordings, with cue track erased, are suitable for mono or stereo players. Specify 160nWb/m or 250nWb/m.



audiopak shell	60MLS211AP	\$74.00
ITC shell	60MLS211SC	\$74.00
Fidelipac 300 shell	60MLS211FP	\$74.00
Fidelipac Mastercart shell	60MLS211MC	\$74.00
Fidelipac Dynamax Cobalt shell	60MLS211DC	\$74.00

### Cart Labels

Each sheet has 8 labels. White with colored stripe. Specify black, brown, red, orange, yellow, green, blue, or purple stripe.

60BR834000X \$15.00¢ per 100 sheets - All same color

## CRL Real Time Event Sequencer

The CRL Real Time Event Sequencer is designed to help you automate mundane tasks. It can be programmed to trigger up to 200 events. Outputs are selectable to either latch on or provide a half or full second contact closure. Two output modes are available: the standard mode which allows any combination of eight outputs to fire at any one time; and a binary encoded mode which fires one of 255 outputs. Programming is via simple key pad and is displayed on a back-lit LCD screen. Security keylock and battery backup are both included.



Event Sequencer 60CUES MFR LIST \$895.00

Call Bradley for a current price quotation.

## 25Hz Automation Accessories

25Hz tones are placed on reel to reel tapes when used in automation systems to signal the automation system. The Conex CG-25A tone generator is used to record a 25Hz tone of predetermined length on either or both audio channels between selections.

The Zercom 25Hz tone processor unit provides all necessary functions to interface a reel-to-reel recorder with an automation or live-assist system. Each unit consists of two independent 25Hz decoders feeding two program amplifiers with 25Hz notch filters.



Conex CG-25A	60CNCG25	MFR LIST	\$420.00
Zercom 25Hz Processor	60ZE25	MFR LIST	\$390.00

Call Bradley for a current price quotation.





## Audioarts MR-40 Audio Mixing Console

The MR-40 from Audioarts combines the features most requested of an on-air and production console in a small, well designed package. It has machine Start/Stops just below the fader like an on-air console, but also includes a 3-band equalizer section so you can have the tone control that a normal radio console couldn't provide. Mono modules have both mic and line inputs. Four subgroup channels provide fader control for record levels and also have a second track playback path for really quick sessions. An on-air type monitor section is provided complete with control room, headphone and studio outputs, plus all the necessary muting and tally functions. It even has a built-in cue speaker and power amp. All audio switches are gold contact, assign buttons are LED illuminated and all circuits are double tested.

A very clever idea from Audioarts, this console will find itself at home anywhere in your studio.

**MR-40 Console**      60WSMR4012      *MFR LIST*      **\$11,995.00**

*Call Bradley for a current price quotation.*



## Audioarts R-10 Console

It's another price/performance breakthrough for Audioarts. The R-10 console includes such high value features as gold contact audio switches, gold edge card connections, conductive plastic faders and pots, socketed IC's, and fully modular construction in a console priced under \$4500.00.

The R-10 comes standard with 10 inputs, and may be configured for any combination of mic inputs, stereo line inputs, or blank panels. An optional rear panel is available to bring all inputs, outputs, and communication ports out to XLR and DB-25 connectors for fast field hookup.

This is the console value for small stations, or larger stations needing a remote or utility console with real broadcast specs and performance.

**R-10**      60WSR10      *MFR LIST*      **\$4495.00**

*Call Bradley for a current price quotation.*



## Audioarts R-30 Radio Console

The new Audioarts R-30 Radio Console is designed for maximum performance on a tight budget. The R-30 is available in two mainframe sizes (12 or 18 input channels) and has two stereo outputs, plus mono sum and mix-minus. Expansion room is provided for additional inputs and can accommodate optional accessory modules. The R-30 features modular construction, rackmount power supply, logic follow, full machine control and an all-gold module-to-console interface system. Input channels are available in both mono mic and stereo line versions (each with A/B source select) and Program/Audition bus assign, plus Cue switches on the line modules. Standard features include Program and Audition VU meters, a digital timer and clock, built-in cue speaker, plus a monitor module for control room and headphone functions. The R-30 is a natural for newsroom use and is a perfect choice for stations needing an upgrade in signal quality at an affordable price.

**R-30 12 Channel Console**      60WSR3012      *MFR LIST*      **\$11,495.00**  
**R-30 18 Channel Console**      60WSR3018      *MFR LIST*      **\$16,300.00**

*Call Bradley for a current price quotation.*



## Broadcast Electronics AIR TRAK 90 Console

This console is easy. Easy to install because the tabletop design and hinged chassis allow quick access to all connections and components. Operator controls are functionally arranged with crisp, clean graphics for easy operation. Maintenance could not be easier thanks to BE's "designed-in" reliability.

VCA's, used on all audio controls, and electronic switching contribute to the AIR TRAK 90's low noise performance. Every channel has three wide ranging inputs that can be individually adjusted for mic or line level. The stereo program, audition, and auxiliary outputs each have a derived mono output. While the program and audition outputs are operator selected, the auxiliary output is assigned using internal jumpers making it ideal for setting up a mix-minus for call-ins. Other standard features include a versatile talkback system; "monitor dim" function allowing automatic dimming of monitors when a channel is in cue; clock timer module; polycarbonate overlays; and channel On/Off switches that follow input selection. High performance faders are standard and Penny & Giles faders are available at extra cost.

The AIR TRAK 90 is easy to install, easy to use, easy to maintain ... and most of all, easy to afford.

<b>AIR TRAK 90 6 Fader</b>	60BRAT9006	MFR LIST	<b>\$5295.00</b>
<b>AIR TRAK 90 12 Fader</b>	60BRAT9012	MFR LIST	<b>\$7295.00</b>



**Also available:**

**MIX TRAK 90** modular console offers uncompromised performance, flexibility, and dependability. Full configured MIX TRAK 90 consoles start at about \$15,000. Contact Bradley for details.

*Call Bradley for a current price quotation.*

<b>AIR TRAK 90 18 Fader</b>	60BRAT9018	MFR LIST	<b>\$9595.00</b>
<b>AIR TRAK 90 24 Fader</b>	60BRAT9024	MFR LIST	<b>\$12,695.00</b>

## Audioarts A-50 Console

The A-50 achieves a level of reliability and value never before offered at this price point. It accomplishes this by combining the most requested features and the latest in high performance audio components. The console is available in two mainframe sizes. Both include four meters, event timer, control room and studio monitor modules, and headphone and cue amps. The 12 fader frame can be ordered with all 12 modules or it can be short loaded with only 8 modules. The 18 fader version adds a time of day clock to the meter bridge.

Each input module allows selection between two inputs. A dual mic preamp is included and can be assigned to any channel. Additional mic preamps are optionally available. Full machine control functions, channel logic, and monitor muting are dip switch selected on each module. The A-50 has one mono and two stereo outputs.

Audio performance is spectacular. Dynamic range, noise, distortion, and slew rate specifications all combine to make the A-50 a perfect match for your digital sources. Construction features include Penny & Giles faders, socket mounted IC's, external heavy-duty power supply, and full and accurate documentation. The A-50 sits on your table top, so no cut-out is required.

<b>A-50 8 Fader</b>	60WSA508	MFR LIST	<b>\$4595.00</b>
<b>A-50 12 Fader</b>	60WSA5012	MFR LIST	<b>\$6695.00</b>
<b>A-50 18 Fader</b>	60WSA5018	MFR LIST	<b>\$9095.00</b>



**Accessories:**

<b>Additional dual microphone preamp</b>	60WSMC2	MFR LIST	<b>\$279.00</b>
<b>Full function tape machine remote control</b>	60WSFF1	MFR LIST	<b>\$199.00</b>
<b>Start/stop remote control for 3 devices</b>	60WSSS3	MFR LIST	<b>\$199.00</b>
<b>Six source preselector.</b>	60WSLS50	MFR LIST	<b>\$259.00</b>
<b>Custom stamping of OFF buttons for source identification</b>	60WSHS50	MFR LIST	<b>ea: \$7.69</b>
<b>Colored fader</b> Select from black, blue, green, gray, orange, red, or yellow. Standard fader is white.	60WSCF50XX	MFR LIST	<b>\$5.69</b>

*Call Bradley for a current price quotation.*

**Selecting a console is one of the most important decisions you'll make. Get the expert advice you need from Bradley Broadcast.**



## ATI Vanguard Console

The Vanguard series is a most popular choice for broadcasters seeking a well built, but reasonably priced console. The audio is VCA controlled for clean, reliable performance. Nearly all switching control functions on the Vanguard are handled by membrane switches, which are ideal since they are raised, silent, and employ tactile feedback. The control legends have color graphics behind a tough, polycarbonate overlay. The front panel hinges for quick access to the plug-in amplifier modules and punch block audio connections. Vanguard consoles include dual stereo program outputs each with a mono mix output, dual VU meters that are switchable between the program outputs, internal cue and headphone amps; two mic preamps with pan pots, and two muted monitor feeds.

Six channel consoles have ten inputs, eight channel consoles have twelve inputs, and the twelve channel console has twenty four inputs.

<b>6 channel, rotary pots</b>	60AIBC6DSR	MFR LIST	<b>\$2995.00</b>
<b>6 channel, linear faders</b>	60AIBC6DSL	MFR LIST	<b>\$2995.00</b>
<b>8 channel, rotary pots</b>	60AIBC8DSR	MFR LIST	<b>\$3495.00</b>
<b>8 channel, linear faders</b>	60AIBC8DSL	MFR LIST	<b>\$3495.00</b>
<b>12 channel, linear faders</b>	60AIBC12DSL	MFR LIST	<b>\$5195.00</b>

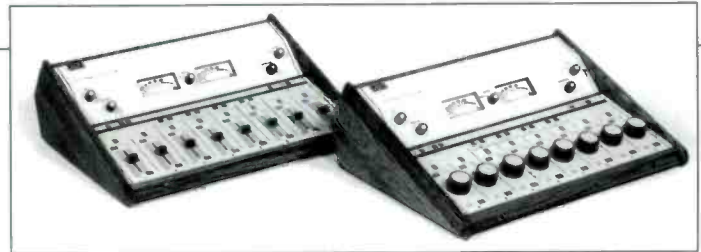

### Accessories:

<b>Additional dual mic preamp</b>	60AIMIC	MFR LIST	<b>\$150.00</b>
<b>Dual 5 x 1 input expanders</b>	60AIEXP	MFR LIST	<b>\$275.00</b>
<b>Relay option for on air lights</b>	60AIRLY	MFR LIST	<b>\$125.00</b>
<b>4 channel start/stop switches</b>	60AISSS	MFR LIST	<b>\$125.00</b>
<b>Dual phone line mix-minus</b>	60AIMXM	MFR LIST	<b>\$150.00</b>
<b>2 stereo LED bar-graph meters</b>	60AIBGD	MFR LIST	<b>\$350.00</b>
<b>Spares and maintenance kit</b>	60AISCK	MFR LIST	<b>\$125.00</b>

Call Bradley for a current price quotation.

## Logitek Mariner Console

Logitek's push for reliability starts with the Mariner's waterproof switches and pots along with artful construction to keep dust and dirt away from sensitive components. While you will still need to clean it, this console will continue to operate even while having coffee poured over its input faders! FET audio switches, sealed relays, VCA controls, and LED indicators further contribute to the Mariner's reliability. Clean, low distortion sound is achieved using high slew rate, low noise amplifiers.

The Mariner comes in 6, 12, and 22 fader mainframe sizes. Three input modules are offered; one with a single stereo line input with a six button machine control interface, another with two line inputs with machine on/off control, and a third with a single mic input with phantom power and a balance control. The Mariner has two stereo and two independently derived mono output busses. All connections are made using wire-capturing terminal blocks on plug-in cards.

### Mainframe prices:

<b>6 inputs</b>	60LTMAR6FR	MFR LIST	<b>\$1890.00</b>
<b>12 inputs</b>	60LTMAR12FR	MFR LIST	<b>\$2100.00</b>
<b>22 inputs</b>	60LTMAR22FR	MFR LIST	<b>\$2475.00</b>

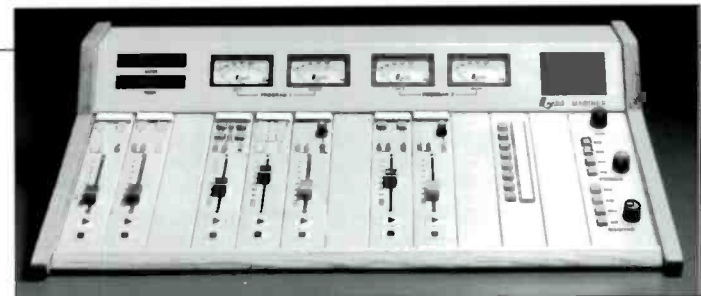

### Modules:

<b>Single line input w/full machine control</b>	60LTMAR1LC	MFR LIST	<b>\$495.00</b>
<b>Dual line input</b>	60LTMAR2LN	MFR LIST	<b>\$495.00</b>
<b>Single mic input w/phantom power</b>	60LTMAR1MIC	MFR LIST	<b>\$495.00</b>
<b>Eight input selector</b>	60LTMAR8PRE	MFR LIST	<b>\$385.00</b>
<b>Blank panel</b>	60LTMARB	MFR LIST	<b>\$25.00</b>

### Accessory:

<b>Clock/ timer module</b>	60LTMARCT	MFR LIST	<b>\$260.00</b>
----------------------------	-----------	----------	-----------------

Call Bradley for a current price quotation.

## Comrex Talk Console

With Comrex's Talk Console, all you need is a host and some phone lines to produce call-in programming anywhere. The Talk Console includes two phone line inputs with self-adjusting hybrids and a dial pad, two microphone inputs and two headphone outputs for use by the host and his/her guest, and a line level input for a tape deck or other source. Features include a telephone line cue mode so the host can talk with a caller off air and remote contact closures for profanity delays or tape machine start. This compact (13"W x 9"D x 3 1/2"H) package is ideal for remote talk show broadcasts, news room interviews, and other call-in applications. In remote applications, the Talk Console's performance can be enhanced using Comrex Frequency Extenders.

<b>Talk Console</b>	60CCTC	MFR LIST	<b>\$2495.00</b>
---------------------	--------	----------	------------------



Call Bradley for a current price quotation.



## Logitek Stereorack Console

The Stereorack is a full featured, dual buss stereo console in a standard 19 inch rack mount. Each of the six stereo input channels has a two position input preselect, and a pan/balance control concentric with the channel fader. The faders themselves are heavy duty conductive plastic type with a standard cue detent position. The channel select buttons are high reliability Hall-effect push-buttons. Seven internal mic preamps are hard wire assignable on the rear panel, and each output buss has its own stereo, four output distribution amplifier. Two separate headphone systems each have independent 5 x 1 source switching, and the talent headphone system provides for separate 1FB-style interrupts for up to three different headsets. The Stereorack is very system friendly, providing logic for the remote starting of machines and for accepting remotely generated channel commands.

The unique Logitek "swap" key can automatically interchange all selected program and audition assignments. This handy feature is indispensable for sports and election coverage because it allows for presetting and salvo switching of an entire mix. In addition, an internal virtual mono mix minus buss allows the Stereorack to handle telephone talk applications without tying up the audition

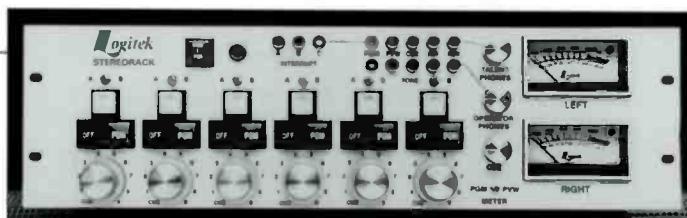

buss. Connections are made with wire clamping terminal blocks, except for logic connections, which are on 37 pin D connectors. Noise is down at least 76dB from a +4dBm reference, with over 18dB of headroom and THD under 0.05%.

**Logitek Stereorack** 60LTSR MFR LIST \$4950.00

**Also available:**

**Audiorack** - A monaural version of the Stereorack offering the same features.  
60LTAR MFR LIST \$3725.00

Call Bradley for a current price quotation.

## Radio Systems RS Series Consoles

Radio Systems RS Series Consoles led a revolution in console value that continues today. Standard features include two inputs per channel, built-in event timer, full metering, DC control, P & G faders, illuminated on/off switches and much more. Talk back ability, heavy duty cue speaker and headphone jack are provided. An added feature is that every input is capable of accepting mic, consumer or line-level sources which you can mix and match on any channel. Each input can also be individually programmed for all muting, remote start and logic functions. That means full flexibility in how you wire your console.

The RS Series provides fast access to internal modules with a single lift up front panel. All components are socketed: I/O connectors are fast push-on type, and switches and pots are connectorized for fast replacement. Full DC control with electronic switching and VCAs improves crosstalk and noise performance dramatically, and provides an effective barrier to RFI problems. A full series of useful options is available for these consoles including copy stands, relay and opto-isolated remote start interface, DA card, multiple mix-minus circuits, input expander card and more.



Last, the RS Series comes with an excellent manual and a two-year warranty. The RS Series is available in six, 12, 18 and 24 channel versions. To find out more about this exceptional value call your Bradley representative today.

<b>RS-6</b>	60RS6	MFR LIST	<b>\$4795.00</b>
<b>RS-12</b>	60RS12	MFR LIST	<b>\$6795.00</b>
<b>RS-18</b>	60RS18	MFR LIST	<b>\$9895.00</b>
<b>RS-24</b>	60RS24	MFR LIST	<b>\$12,995.00</b>

Call Bradley for a current price quotation.

## Ramsa WR-S4412, WR-S4416, WR-S4424 Mixing Consoles

The Ramsa WR-S4400 Series are 12, 16, and 24 input professional 4-bus audio mixers that are primarily aimed at sound reinforcement applications. The audio circuitry and grounding schemes in these modestly priced consoles are based on Ramsa's legendary WR-S840 Concert Series boards. The boards are laid out in an intuitive, easy to use fashion, and their physically compact construction makes them just as at home on the road as in a permanent installation.

Unlike many less expensive 4-bus mixers, each channel on the WR-S4400s can be assigned not only across the four sub-groups, but can be panned directly to the stereo bus (making these essentially 6-bus boards). The addition of the four aux sends (two of which are switchable pre/post fader), a three-band EQ with sweep mid-range, pre-fade listen cueing for all channel and group masters, balanced audio inputs (XLR and TRS), switchable 48V phantom power, full monitoring and talkback facilities, and metering across all outputs make this design perfect for the more demanding auditorium and corporate A/V applications.



<b>WR-S4412</b> 12 Channel	60PAWRS4412	MFR LIST	<b>\$2200.00</b>
<b>WR-S4416</b> 16 Channel	60PAWRS4416	MFR LIST	<b>\$2600.00</b>
<b>WR-S4424</b> 24 Channel	60PAWRS4424	MFR LIST	<b>\$3500.00</b>

Call Bradley for a current price quotation.



## Mackie Designs MicroSeries 1202

This is not just another compact mixer. The MicroSeries 1202 has a working signal-to-noise ratio of 90dB, 108dB dynamic range, distortion below 0.025% across the audio spectrum, switchable 48 Volt phantom power, and +28dBu balanced line drivers. Channels 1-4 have XLR mic inputs and 1/4" TS line inputs while channels 5-12 have 1/4" TRS line inputs configured in 4 stereo pairs. Input channels have center detent gain and pan controls, two aux sends, channel patching, and a two band EQ. The master section includes two stereo aux returns, headphone level control, phono jack tape inputs and outputs, and a switchable LED meter display that shows output, mic buss, or line buss level. The mixer has a steel chassis and built-in power supply. Think of how you can use the MicroSeries 1202, because, at its low price, you can certainly afford to put it to work for you.

MicroSeries 1202    60MD1202    *MFR LIST*    \$399.00

Call Bradley for a current price quotation.



## Mackie Designs CR-1604 Mixer

This 16 input, stereo output mixer offers flexible installation choices and excellent audio performance. The unity gain design and center detent controls keep noise extremely low and headroom high. Channels 1 through 6 have XLR mic inputs with phantom power, and all channels have a three band EQ and 6 aux sends. Other features include 4 stereo effects returns, stereo "in-place" solo system, precision sealed rotary pots, and an alternate stereo mix output. When rack mounting the CR-1604, the connector panel rotates to place connectors at the rear of the console and to save space. The connectors can also rotate to the top of the console for tabletop installation.

CR-1604    60MDCR1604    *MFR LIST*    \$1099.00

Call Bradley for a current price quotation.



Accessory:  
**Mic Input Expander**

Adds mic input capabilities to all 16 inputs 60MDXLR10 *MFR LIST* \$349.00

## Ramsa WR-133 Mixer

The attractive, functional briefcase styling of the WR-133 makes this mixer an excellent "road" unit and high quality audio makes it equally at home in the studio. This 8 x 2 mixer provides mic or line inputs on each channel, and has RIAA phono preamps to allow two turntables to be connected via inputs 1 through 4. Each input section features dual band shelving EQ, monitor and effects send, pan pot, and peak LED. The output section has a mono out, master effects and monitor out controls, plus stereo record outputs via XLR, 1/4" TRS, and phono jacks.

Ramsa WR-133    60PAWR133    *MFR LIST*    \$1350.00

Call Bradley for a current price quotation.



Accessory: Rack Mount Kit 60PAWRQ51    *MFR LIST*    \$90.00

## Yamaha MR Series Console

For recording, production, and light duty sound reinforcement, the economical MR series offers exceptional value. Constructed and featured similar to the MC02 series, the MR consoles add four subgroup mixing busses to the main stereo buss. Additional features on these models include a tape input phono jack on each input channel. The three auxiliary sends can tap into the mic/line input, the tape return input, or both inputs for multitrack recording work. Metering is provided for all busses. Phono jack outputs parallel the balanced XLR outputs on all busses for compatibility with nearly any piece of gear.

MR842 8 inputs    60YAMR842    *MFR LIST*    \$1295.00  
 MR1242 12 inputs    60YAMR1242    *MFR LIST*    \$1595.00  
 MR1642 16 inputs    60YAMR1642    *MFR LIST*    \$1795.00

Call Bradley for a current price quotation.



## Soundcraft 200 Delta Consoles

If you're seeking a console with virtues such as flexibility, sonic purity, and value you will find the Soundcraft 200 Delta to be a true virtuoso. The molded chassis and armrest give the 8, 16, 24, and 32 input position mainframes great looks and tremendous durability. The 200 Delta is also available in an 8 input position rack mounting frame.

This console's flexibility is evidenced by its four input modules. The Standard Input has an input attenuator for microphone and line level inputs, 48V phantom power, 3 band EQ with sweepable midrange, six auxiliary sends, and a very clean 100mm fader. The Deluxe Input Module adds a phase reversal switch, a high-pass filter, and sweepable high-mid and low-mid EQ. The Stereo Input Module handles two stereo line inputs and the Dual Line Input handles two mono line level sources.

The Group Module features 2 mono returns with 2 band EQ and a bar graph meter. You can choose to incorporate up to 4 Group Modules or you may use the four group slots on the mainframe to increase the number of console input modules. THD, crosstalk, and noise floor specs on the 200 Delta are so good, it is the recommended console for direct recording to DAT.

### Pre-loaded Consoles:

<b>8 channel console</b>	60SFRW1218	MFR LIST	<b>\$3690.00</b>
<b>8 channel rack mount</b>	60SFRW1219	MFR LIST	<b>\$3690.00</b>
<b>16 channel console</b>	60SFRW1220	MFR LIST	<b>\$5450.00</b>
<b>24 channel console</b>	60SFRW1221	MFR LIST	<b>\$7150.00</b>
<b>32 channel console</b>	60SFRW1222	MFR LIST	<b>\$9100.00</b>

### Modules:

<b>Master Module</b>	60SFPS1356	MFR LIST	<b>\$639.00</b>
<b>Standard input</b>	60SFPS1438	MFR LIST	<b>\$120.00</b>
<b>Dual Line input</b>	60SFPS1441	MFR LIST	<b>\$229.00</b>
<b>Single Subgroup module</b>	60SFPS1443	MFR LIST	<b>\$159.00</b>

Call Bradley for a current price quotation.

### Delta DLX

The Delta DLX continues the excellent tradition of the Delta line and improves upon it with the inclusion of six auxiliary sends on stereo and mono input modules. Soundcraft also includes their patented padless mic preamp, giving the user 68dB of gain. A separate input feeds line level signals to the input, switchable, with sensitivity of +10 to -20dBu. Phase reverse and 100Hz high pass filters are also provided.

The EQ section features 15dB boost & cut with sweepable high mids (600Hz-10kHz) and low mids (150Hz-2.4kHz). The low frequency is centered at 60Hz, the high frequency is centered at 12kHz. The stereo module will accept a variety of sources such as CD players, cart machines, turntables and effect returns, making the Delta a versatile tool in your production facility. The stereo width control provides the user with a range of stereo spread, from mono to super stereo imaging. A dual line input module is available, effectively doubling the number of inputs available on each channel. Outputs are routed direct to the stereo mix bus via a pan control and rotary fader. Up to four group modules are available, each with two mono returns. Talkback mic and circuit show up on the master module, as do the six aux masters. A pair of 20 segment LED bargraphs monitor control room output, via the stereo mix buss or external stereo input such as a tape return. Headphone outputs are provided. 100mm longthrow faders and 1kHz oscillator are standard.



### Also available:

#### Delta 8

Designed for both 8 and 16 track recording, the Delta 8 offers all the features of the Delta DLX, with eight assignable sub-groups per input. The split console format offers 8 groups and 20, 28 or 36 input channels. In addition, the Delta 8 includes 2 stereo tape returns and 2 monitor speaker select, for main & near-field monitoring. Multitrack returns are normalled to both the monitor section and the channel line inputs, allowing the 16 monitor returns to be used as extra inputs at mixdown.

#### Delta AVE

The Delta AVE incorporates all the features mentioned with the DLX, but operates under the control of a video editor. Mono and stereo input mods use high quality VCA's, controlled by the editor, to change gain status. The amount of attenuation is determined by a short-throw fader adjacent to the channel fader. The VSA24 is used to interface the console to virtually any editor. Status and control indicators help to keep the user informed in the post environment.



## Yamaha MCO4II Consoles

Yamaha offers a new series of live production mixing consoles. The MCO4II is great for both installed and portable live audio productions. Select from four models with 12, 16, 24, or 32 inputs.

The MCO4II consoles offer four primary mix groups plus stereo and four auxiliary send busses. The four-band equalizer section has variable frequency on both mid-bands and a switchable 80Hz high-pass filter. All channels include XLR and 1/4" phone inputs as well as 48-volt phantom power. Channel insert points operate at 0dbm to facilitate gain matching with external processors. The two stereo auxiliary returns each use a pair of 1/4" phone jacks. A similarly featured pair of tape inputs using RCA pin-jacks is included to accommodate inputs from a variety of playback sources.

Sound system designers and engineers will especially appreciate the addition of two mix matrices. Mix matrix allows the engineer to create a separate blend of the sub-groups and the stereo busses. Cue facilities, a talkback system, and control-room monitor outputs are provided. Eight VU meters (with LED peak indicators) are used to monitor groups, aux sends, stereo, cue and matrix outputs.

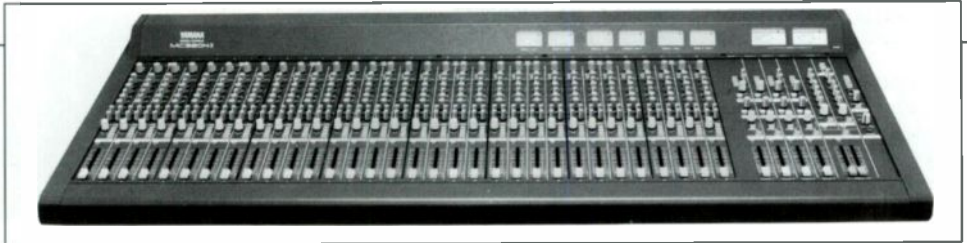

<b>12 Channel</b>	60YAMC1204II	MFR LIST	\$3100.00
<b>16 Channel</b>	60YAMC1604II	MFR LIST	\$3600.00
<b>24 Channel</b>	60YAMC2404II	MFR LIST	\$4300.00
<b>32 Channel</b>	60YAMC3204II	MFR LIST	\$5800.00

Call Bradley for a current price quotation.

## Yamaha MC03 Series Mixers

The new MC 03 series mixing consoles deliver significantly improved performance while retaining the solid design and features of the popular MC02 series. A 24 channel model has been added to the product lineup, joining the 16, 12 and 8 channel versions.

New features include an L+R mix function, L+R cueing, on/off switches on all channels and busses, buss muting, and the ability to jumper channel inserts for pre-or post EQ operation. Mechanical refinements have been made that enhance durability for hard remote usage.

Controls are bright, easy to read and understand, and allow for quick set up and on-the-fly operation. Each channel provides an accurate fader, pre-fader cue switch, three band EQ with sweepable mid-range, three auxiliary/effects sends, input gain controls, and phantom power. The electronically balanced mic/line inputs are available on both XLR and 1/4" TRS connectors. The stereo outputs are balanced, +4dBm, XLR. The master section controls the main stereo outputs, headphone monitor selection, the auxiliary/effects busses, the talkback functions, and switchable metering. Yamaha has put it all together in these slim, attractive, and rugged mixers, which are ideal for small studios, remote trucks, and PA systems.

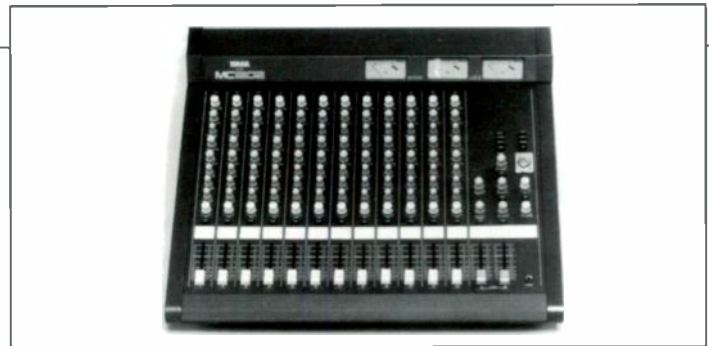

<b>MC803</b>	8 inputs	60YAMC803	MFR LIST	\$1000.00
<b>MC1203</b>	12 inputs	60YAMC1203	MFR LIST	\$1300.00
<b>MC1603</b>	16 inputs	60YAMC1603	MFR LIST	\$1500.00
<b>MC2403</b>	24 inputs	60YAMC2403	MFR LIST	\$2100.00

Call Bradley for a current price quotation.

## Yamaha M-406 Mixer

The M-406 is a rack mounting, 6 x 2 mixer with superior specifications, XLR inputs and outputs, and plenty of useful features. Each channel has a six position input attenuator, three band EQ, send control, and pan pot. Dual illuminated VU meters show left and right output with right meter and phones switchable to monitor the send/echo channel. With low noise (-95dBm) and +24dBm output capability, the M-406 fills the bill for high quality in a small space.

**M-406**                      60YAM406              MFR LIST    \$1295.00

Call Bradley for a current price quotation.

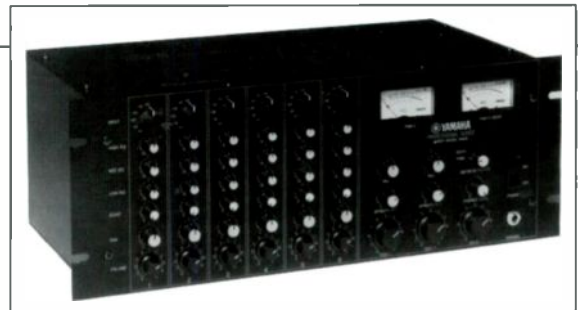

### Yamaha Q2031A Graphic EQ



The Q2031A is a highly sophisticated stereo 1/3 octave graphic equalizer. In only two rack spaces, Yamaha puts 31 filters on two channels, each of which also has a sweepable 12dB per octave high pass filter, a 6dB to 12dB cut/boost range switch, a filter bypass, a peak indicator, and channel gain control. Inputs and outputs are both balanced (XLR) and unbalanced (1/4" TS), and the Q2031A operates from -20dBV to +4dBm. Sockets for output transformers are included on the rear panel.

**Q2031A** 60YAQ2031 MFR LIST \$695.00

Call Bradley for a current price quotation.

### Audio Logic Graphic Equalizers



The Audio Logic graphic equalizers are straightforward, professionally oriented devices for studio, permanent installation, and reinforcement applications. The SC31 is a single channel 1/3 octave EQ that provides 12dB of cut and boost at 31 ISO centered bands from 20Hz to 20kHz. Unlike many other EQ's, the SC31 has both high pass and low pass continuously adjustable filters (20Hz to 200Hz and 3.5kHz to 22kHz respectively). The roll-off filters and the graphic section of the EQ can all be independently bypassed via front panel switches. For gain staging, the SC31 has a 12dB cut/boost level control and an LED headroom meter. In order to accommodate a variety of signal types, the input and output connectors are XLR, 1/4" TRS, and barrier strip. The unit's clean signal path boasts a signal to noise ratio of greater than 92dB, response of ±0.5dB, THD of 0.005% at +22dBm at 1kHz, and a maximum output level of +27dBm. The SC215 is a stereo 2/3 octave, 15 band version of the SC31 for stereo operation with a rougher curve.

**SC31 Mono 1/3 Octave EQ**  
60DOS31 MFR LIST \$550.00

**SC215 Stereo 2/3 Octave EQ**  
60DOS215 MFR LIST \$565.00

Call Bradley for a current price quotation.

### Ashly Graphic Equalizers

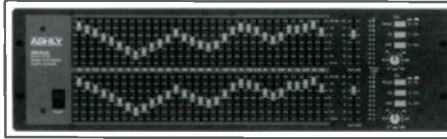

Ashly's graphic equalizers have set the standard by which all other designs are judged. They feature precision Wein-Bridge filters for accurate response and low distortion and a constant "Q" design with low ripple ensures constant bandwidth regardless of fader position. At the detented "flat" setting, the filters actually go off circuit, which electronically bypasses unused filters. The stereo 15 band unit provides 15dB cut/boost and switchable 40Hz low cut filter. The 31 band models give you a selectable 15dB or 6dB range, a switchable and tunable low cut filter, and 9 position LED level meters. Metal shaft faders with saddle knobs, peak LED meters, and balanced XLR and unbalanced 1/4" inputs and outputs round out additional features.

**GQX1502** stereo 15 band, 2 rack units  
60ASGQX1502 MFR LIST \$499.00

**GQX3101** single channel 31 band, 2 rack units  
60ASGQX1301 MFR LIST \$599.00

**GQX3102** stereo 31 band, 3 rack units  
60ASGQX1302 MFR LIST \$999.00

Call Bradley for a current price quotation.

### Rane GE27 & GE14 Graphic EQ's



With many equalizers, when you increase the cut or boost you decrease the bandwidth. This can cause filter overlap, loss of resolution, and the need to readjust adjacent sliders. Rane's constant-Q bandpass filters in the GE27 1/3 octave and GE14 2/3 octave graphics eliminate these problems by providing constant bandwidth at all settings. 45mm sliders are accurately calibrated for 15dB cut/12dB boost, and Rane builds in subsonic and ultrasonic filters as well as complete RFI protection. Active balanced input; unbalanced, floating output.

**GE27 1/3 Octave** 60RNGE27 MFR LIST \$539.00

**GE14 2/3 Octave** 60RNGE14 MFR LIST \$569.00

Also available:

**GE30 30 band, 1/3 octave graphic EQ** is capable of acting in either 15dB cut/12dB boost or 20dB cut mode. 60mm sliders.

60RNGE30 MFR LIST \$749.00

Call Bradley for a current price quotation.

### DOD Graphic Equalizers



DOD's popular line of graphic equalizers is ruggedly built with simplicity in mind. They provide high quality 12dB cut/boost filters, gain control, a low cut filter, and headroom metering. All are two rack spaces high with both balanced XLR and balanced/unbalanced TRS phone jacks for inputs and outputs. If your budget is tight and standards high, a DOD graphic EQ is the right tool for the job.

**R830II** stereo 15 band 2/3 octave  
60DOR830C MFR LIST \$269.95

**R831II** mono 31 band 1/3 octave  
60DOR831C MFR LIST \$269.95

**R231II** stereo 31 band 1/3 octave  
60DOR231C MFR LIST \$449.95

Call Bradley for a current price quotation.

### Rane Micro-Graphic Equalizers

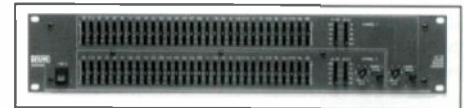

The filters in the Micro-Graphic series are constant Q with grounded center-detent controls. They provide true 1/3 octave filter bandwidth regardless of boost/cut level. These compact equalizers offer more features and quality than their size might lead you to believe. The 30 band ME30 and dual 15 band ME15 are one rack unit high and have a range switch providing a choice of 6dB or 12dB cut/boost.

The ME60 is dual 30 band EQ with 12dB cut/boost in a two rack unit high chassis. It features adjustable low and high frequency cut-off filters, overall level controls, passive bypass switches, and XLR, 1/4" TRS, and phono inputs and outputs. Frequency response and noise specifications are excellent, and the ME60 outperforms similar models that cost much more. Micro size, micro price, macro performance.

**ME30 mono 30 band**  
60RNME30 MFR LIST \$389.00

**ME15 stereo 15 band**  
60RNME15 MFR LIST \$399.00

**ME60 stereo 30 band**  
60RNME60 MFR LIST \$669.00

Call Bradley for a current price quotation.





## Rane SP 15 Parametric EQ



The five bands of the SP 15 each have a four octave frequency sweep range and are individually adjustable for bandwidth from 1.5 octaves down to 0.03 octave. Fully symmetrical filters provide 12dB cut and 15dB boost for notch filter type operation. Both balanced and unbalanced inputs and outputs are provided via XLR and 1/4" TRS connectors. Dynamic range is 120dB and THD is less than 0.005% @+4dBm, 20Hz to 20kHz. Special components allow it to achieve tonal control and sonic transparency that are digital ready. This unit flexes some real muscle and packs excellent specs into one rack space.

**SP 15** 60RNSP15 MFR LIST \$599.00

### Also available:

PE 15 parametric EQ is identical in features to the SP 15, but with less critical components. Still an outstanding performer for the price!

**PE 15** 60RNPE15 MFR LIST \$399.00

Call Bradley for a current price quotation.

## Symetrix SX201 Parametric EQ



The SX201 is a high performance, studio quality parametric EQ/notch filter designed to handle both low level and line level inputs. Three parametric bands provide 30dB cut/15dB boost capability, and overlapping bands cover the entire audio range. Bandwidth is variable for each section from 0.05 to 3.3 octaves for notch filtering or tone shaping. Its balanced line input accepts -10dBV to +8dBm inputs, while its preamplified input accepts low level signals from synthesizers, guitars, or electronic drums. High headroom, active devices are used throughout the unit to deliver the best possible dynamic range. Separate balanced and unbalanced outputs are provided. The SX201 mounts in 1/2 rack width and is a single channel unit. Use two for stereo, or combine it with any other SX series unit for processing versatility.

**SX201** 60SYSX201 MFR LIST \$279.00

### Accessory:

**Rack mount kit** for one or two SX series units.

60SYRM2 MFR LIST \$39.00

Call Bradley for a current price quotation.

## Orban Paragraphic Equalizers



Think of these as tonal first aid kits. The Orban Paragraphics combine the operational ease of a graphic EQ while providing the substantial benefits of parametric units. The user may change the "Q" of each filter with graphic tuning changes. The flexibility of notching is available, plus excellent accuracy and specifications, giving the user the best of both EQ types in a single unit. Tunable low and high pass filters enable it to be used as an electronic crossover with a separate output from the main EQ section. Active balanced input, unbalanced output. Connections are on both barrier strips and XLR connectors. Versions with output transformers are available at a slightly higher cost.

**674A** stereo 60OB674A MFR LIST \$1525.00

**672A** mono 60OB672A MFR LIST \$725.00

Call Bradley for a current price quotation.

## Orban 642B Parametric EQ



The Orban 642B has noise and distortion rated better than 16 bit digital. In terms of musicality and power of control, the 642B allows for a wide scope of both creative and corrective EQ. Each channel has four bands of EQ with a maximum boost of 16dB and cut of 40dB. The two channels can be coupled to form a single channel, 8 band equalizer by simply switching to the Cascade mode. The constant "Q" design eliminates interaction between the controls and allows the 642B to be used as an infinite depth notch filter for feedback control or for removal of an undesirable coherent noise like AC hum. To simplify this notch capability, Orban has included a frequency vernier control which varies the center frequency by 10% for quickly tuning to an exact null. EQ in/out switches on each channel and each band simplify comparisons of selected equalization to flat response. The 642B has actively balanced inputs and outputs. Versions with transformer outputs are available at a slightly higher cost.

**642B** 60OB642B MFR LIST \$1200.00

### Also available:

**642B/SP** limited frequency range unit is intended for speech processing, forensic work, and similar applications. Both bands 1 and 2 are tunable from 80Hz to 1.6kHz while bands 3 and 4 may be tuned from 315Hz to 6.3kHz.

**642B/SP** 60OB642BSP MFR LIST \$1250.00

Call Bradley for a current price quotation.

## Symetrix SX208 Stereo Compressor/Limiter



The SX208 is a stereo dynamic range controller offering studio sonic performance and ease of operation at a very economical price. By eliminating redundant controls, the SX208 is a step ahead in usability and reliability. Attack and release times are program controlled. The front panel includes an input gain trim with LED input level indicator; a compression ratio control adjustable from 1:1 to 20:1; a fast/slow response time switch; an output gain control; and an LED gain reduction meter. The SX208 is built around a high performance VCA, enabling a dynamic range in excess of 110dB with typical distortion of less than 0.03%. Inputs and outputs are electronically balanced on 1/4" TRS connectors.

**SX208** 60SYSX208 MFR LIST \$299.00

### Accessory:

Rack mount kit for one or two SX series units.

60SYRM2 MFR LIST \$39.00

Call Bradley for a current price quotation.

## Symetrix SX206 Multi-Dynamics Processor



The SX206 really packs it in. This half rack width unit allows you to select one of five different operational modes from the front panel. Use the compressor/limiter to handle those annoying transients. Select the expander to help reduce noise, or punch in the gate to clean up that drum track. The duck mode is perfect for voice overs, and the slave mode is used to track a second SX206 for stereo operation. You can program the SX206 to "wake up" in the mode of your choosing. Input is 1/4" balanced and you have the choice of balanced or unbalanced 1/4" outputs. Add all of this up and you too will believe that good things really do come in small packages!

**SX206** 60SYSX206 MFR LIST \$329.00

### Accessory:

Rack mount kit for one or two SX series units.

60SYRM2 MFR LIST \$39.00

Call Bradley for a current price quotation.

## Symetrix 511A Noise Reduction



This two channel single ended noise reduction unit is great for a wide variety of audio clean-up jobs. Because the system requires no encoding, the 511A may be placed anywhere in the audio signal chain. How does it work? On high frequencies, when spectral content falls below the user set threshold, the corner frequency of the high frequency filter slides down, reducing bandwidth and the noise it contains. When high frequency content resumes, the filter widens response again. A downward expander reduces low frequency noise by increasing the dynamic range of the signal when below the threshold. As the Input level decreases, the expander causes the output to fall by a greater amount, reducing accompanying noise. Applications include studio and remote recording, teleconferencing, public address, and music transcription. Direct coupled inputs and outputs readily connect to balanced or unbalanced equipment at +4dBm or -10dBV nominal levels.

511A 60SY511A MFR LIST \$599.00

Call Bradley for a current price quotation.

## Symetrix 525 Dual Gated Compressor/Limiter



Versatile. That's the best way to describe the Symetrix 525. One rack space gives you two separate channels of gated compression/limiting, which can also be ganged for stereo operation. Utilizing its intelligent control circuitry, the 525 can adapt to whatever sound source you have. It handles quick signal transients as well as it handles slow or small transients. The compressor/limiter and expander/gate employ a soft knee curve to guarantee smooth processing. Input connections are 1/4" balanced while the outputs are 1/4" unbalanced, and side-chain insertion is standard to complete the 525's list of useful features. Whether in broadcast or music, studio or stage, you'll find the Symetrix 525 as versatile as your needs are varied.

525 60SY525 MFR LIST \$539.00

Call Bradley for a current price quotation.

## ART MDC 2001 Dynamics Processor



The MDC 2001 multi-dynamics processor takes on many tasks that would require a small fortune to accomplish with separate units. A stereo compressor, limiter, de-esser, exciter, expander, and gate are all rolled into this exciting, yet cost effective box. Using a wide dynamic range, low distortion VCA, the processor works without "pumping," "breathing," or signal coloration. The MDC 2001 features individual isolated processing circuits, switchable input/output metering, balanced XLR and 1/4" TRS inputs/outputs, a switchable detector loop, and threshold activation LED's. This unit will be a welcome addition to your processing arsenal.

MDC 2001 60MX520 MFR LIST \$499.00

Call Bradley for a current price quotation.

## Ashly CL52E Comp/Limiter



Ashly's compressor/limiters offer complete dynamic range control. They provide a variety of high quality features such as trigger circuit patch, variable threshold, variable ratio from 2:1 to infinite:1, variable attack and release, and LED's to indicate up to 20dB of gain reduction.

The CL52E provides two channels of clean, accurate gain reduction in one compact package. This unit can be used as either two independent peak limiter/compressors, or may be strapped for stereo tracking. Precise and independent adjustments make the CL52E ideal for such diverse applications as loudspeaker protection, broadcast limiting or compression, recording, tape to disc transfer, special effects, and more. The CL50E, a single channel version, is also available. Both units rack mount in a single space.

CL52E Dual channel 60ASCL52 MFR LIST \$302.00

CL50E Single channel 60ASCL50 MFR LIST \$259.00

Call Bradley for a current price quotation.

## U.R.E.I. LA Series Limiters

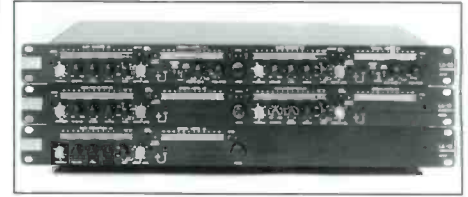

These new limiters from U.R.E.I. are rightful successors to their famous predecessors. With the same ear towards smooth, musical operation that made the earlier units so popular, but benefitting from the latest in quick, quiet VCAs and detection circuitry, the new units will delight engineers in music and voice studios alike.

The mono LA-10 and dual channel LA-12 both use the new Smart Slope soft knee compression while in either peak or average (or both) gain reduction mode. Limiting threshold, attack time, release time, and output gain are all individually adjustable. For those emergencies that don't give you time to tweak, the unit can operate in an automatic mode that makes the best of the situation with program-dependent attack and release times and limiting levels that will always give you usable audio.

The dual channel LA-22 shares the same features, but can be adjusted much like a parametric EQ to operate in a given, even very narrow, band. The LA-22 is ideal for de-essing, de-popping, and other voice gain reduction jobs. This unit may also be switched into Expander Mode, with the same control over levels, ratios, time constants, and thresholds.

LA-10 Mono Compressor/Limiter 60URLA10 MFR LIST \$550.00

LA-12 Dual Compressor/Limiter 60URLA12 MFR LIST \$850.00

LA-22 Dual Compressor/Limiter/Expander 60URLA22 MFR LIST \$1,155.00

## Rane DC24 Dynamic Controller



The DC24 dynamic controller is a two channel compressor, limiter, expander/gate system with unique features. Separate controls for each of the three sections provide wide control range, free from control interaction. An internal crossover allows a single audio channel to be divided into two bands, processed separately, and re-combined into one channel. This crossover may also serve as a dividing network allowing all processing functions for each band. Inputs and outputs are XLR, active balanced, with RFI filtering provided. Individual channel hard wire bypass switches are also provided.

DC24 60RND24 MFR LIST \$599.00

Call Bradley for a current price quotation.

## Noise Gates

Noise gates are used to ride gain on multiple microphones, to attenuate music beds in the presence of voiceovers, to create special musical effects, and many other applications. Apex, Drawmer, Ashly, and others make a variety of gates. Bradley can find one just right for your application.



## dbx 900 Series Modular Processors

When multiple channels of processing are required, the dbx 900 series offers quality, versatility, and value. Two powered frame sizes are available.

### Frames:

**F-900A** three rack unit frame with nine active slots. Holds modules vertically. Audio connections are made by barrier strip terminals.

**F-900A** 60DB900 *MFR LIST* \$595.00

**FS-900** single rack unit frame with two active slots. Holds modules horizontally. Audio connections are made with XLR connectors.

**FS-900** 60DBFS900 *MFR LIST* \$399.00

### Modules:

**902 De-esser** operates independently of input level so there is no threshold to set. Controls govern the amount of gain reduction as well as the frequency above which excessive high frequency energy activates the circuit.

**902** 60DB902 *MFR LIST* \$295.00

**903 Compressor/Limiter** with legendary dbx OverEasy compression yields a gradual transition into compression ratios up to infinity:1 (beyond which there are negative ratios available for unusual dynamic reversal effects.) The unit is stereo strappable and includes threshold, ratio, and output controls as well as 10 segment LED gain reduction displays.

**903** 60DB903 *MFR LIST* \$295.00

**904 Noise Gate** provides smooth downward expansion (gating). Threshold and ratio controls, along with adjustable attack and release rates, permit a high degree of flexibility. The key mode allows gating of one audio source by another.

**904** 60DB904 *MFR LIST* \$295.00

**905 Parametric Equalizer** with three bands that are adjustable for up to 15dB boost or cut, Q (width), and center frequency. Each band also has a notch cut with an extremely narrow Q and suppression of greater than 50dB. High and low bands also have selectable shelving.

**905** 60DB905 *MFR LIST* \$295.00

### 911 Type-I

has a single channel of simultaneous encode/decode noise reduction. Provides greater than

40dB of noise reduction when used with wide bandwidth media such as analog tape recorders operating at 15 ips.

**911** 60DB911 *MFR LIST* \$239.00

**929 Single Ended Noise Reduction** contains two channels to process sources that have a continuous, steady-state hiss floor beneath the desired audio. Each channel is controlled by a single quieting knob and can be stereo coupled. No encoding is required, and the 929 offers balanced inputs and outputs.

**929** 60DB929 *MFR LIST* \$399.00

**933 Amplifier/Mixer** can serve as either a one to three distribution amplifier or a three to one mixer. Each channel has a gain control with a range of -40dB to +20dB, and internal jumpers select balanced or unbalanced inputs and outputs.

**933** 60DB933 *MFR LIST* \$349.00

**941A and 942A Type-II** noise reduction modules provide more than 40dB of noise reduction for limited bandwidth media such as cart machines, telco lines, and videotape audio tracks. The 941A incorporates two channels of encoding and the 942A has two channels of decoding.

**941A Encoder** 60DB941 *MFR LIST* \$259.00

**942A Decoder** 60DB942 *MFR LIST* \$269.00

**Blank panel** covers one slot.

60DBBP *MFR LIST* \$12.00

Call Bradley for a current price quotation.



## dbx Performer and Production Series

These intelligent signal processors make clean, dynamic audio easier than ever. Each unit is one-half rack width and comes complete with hardware for mounting one or two units in a single rack space. The 140X and 150X have electronically balanced inputs and outputs on 1/4" TRS jacks, and are designed to operate at +4dBu. All other models have unbalanced (1/4" TS) inputs and outputs on their rear panels.

Call Bradley for a current price quotation.

### 140X and 150X Noise Reduction

Each of these half rack units provides two channels of encoding and two of decoding. The 140X uses dbx standard Type-II noise reduction. It is recommended for cart machines, VTR's, microwave links, land lines, and other media with limited high and low-end frequency response. The 150X, with Type-I noise reduction, is recommended for tape machines of flat response running at 15 ips or greater and other wide bandwidth media. Both units achieve 40dB or more of noise reduction.

**140X** 60DB140X *MFR LIST* \$319.00

**150X** 60DB150X *MFR LIST* \$319.00

### 163X Compressor/Limiter

Famous dbx OverEasy compression is controlled by a single slide control. An LED display indicates the amount of compression and two units may be strapped for stereo. The 163X can be strapped to a 463X noise gate to provide switch selectable stereo compression or stereo gating. Front panel 1/4" instrument input.

**163X** 60DB163X *MFR LIST* \$169.00

### 263X De-esser

A simple to use de-esser, the 263X features a single slider for adjusting sibilance reduction, plus a knob for sensitivity to specific sibilance frequencies and a push button for selecting bandwidth. Even if the input levels vary as much as 45dB, patented circuitry delivers the exact de-essing required. Front panel 1/4" mic input.

### 263X

60DB263X *MFR LIST* \$169.00

### 363X Dual Channel Noise Gate

The 363X offers professional flexibility in creating a customized sound. Designed for stereo or dual channel operation, the 363X has separate controls for threshold, hold time, and release time. Attack time is less than 100µs. Use the 363X to precisely remove unwanted background noise or to create striking instrument effects.

**363X** 60DB363X *MFR LIST* \$269.00

### 563X Silencer

Employing dbx's single ended noise reduction technology, the 563X features single slider action for de-hissing. It is most effective on sources with a continuous, unchanging hiss floor. Stereo strappable. Front panel 1/4" instrument input.

**563X** 60DB563X *MFR LIST* \$229.00



## Orban 275A Automatic Stereo Synthesizer



The complete, automatic answer for providing full time stereo output from mixed mono and stereo program material, such as TV stereo. The 275A is designed to be permanently placed in the station's stereo program line. It recognizes true stereo, allowing it to pass unaltered. It also recognizes dual or single channel mono, and automatically switches to synthesis mode via smooth cross-fade. In addition to the automatic mode, the 275A may be controlled by automation or sequencer, or manually set for full time synthesis or bypass modes. The unit also automatically detects and corrects out of phase audio, and provides single ended noise reduction of synthesized stereo audio. Synthesized audio may be selected for two bandwidth configurations, allowing spatial perspective to be matched to program material. To ensure full compatibility with mono receivers, the sum of the synthesized outputs is identical to the mono input. Front panel functions are duplicated on an optional remote panel.

**275A** 600B275A MFR LIST \$2400.00

### Accessory:

**Remote control** 600B275ARC MFR LIST \$275.00

Call Bradley for a current price quotation.

## Orban 464A Co-operator



The Orban Co-operator provides transparent level control, compression, and high frequency limiting in a powerful, compact, and economical package. The Co-operator achieves transparent audio performance through the use of finely tuned control loops to eliminate dynamic distortions and a clean, Class A VCA to ensure negligible static distortion and noise. A defeatable silence gate effectively inhibits undesirable sudden gain increases. The high frequency limiter has six selectable curves (25 to 150µs) and is followed by a peak clipper for absolute peak protection. Gain compression recovery rate is switch selectable, and a faster compression rate is available for additional transient overshoot protection. Other features include stereo tracking or independent channel operation, LED bar graphs for both gain reduction and peak output level for each channel, balanced and floating inputs and outputs, and hard wire bypass. The Co-operator is ideal protection for broadcast, teleproduction, and recording studio operations, with controls that offer unprecedented flexibility and ease of operation.

**464A** 600B464A MFR LIST \$1200.00

Call Bradley for a current price quotation.

## CRL Dynafex Noise Reduction



The Dynafex DX-1 and DX-2 provide up to 30dB of noise reduction without the encode/decode process. Combining dynamic filtering and a unique downward expansion, these are highly effective single ended systems. Both units incorporate an adjustable brilliance feature to enhance upper harmonics. The DX-2, pictured, operates in either stereo or dual mono. The mono DX-1 features additional user control over the downward expansion parameters, filter bandwidth control, and up to 40dB of output gain. 110dB dynamic range, 0.1% THD typical (ref. 400Hz), 20Hz to 20kHz ±0.5dB response.

**DX-1 mono** 60CUDX1 MFR LIST \$745.00

**DX-2 stereo** 60CUDX2 MFR LIST \$850.00

Call Bradley for a current price quotation.

## Orban Compressor/Limiters



Orban industry standard compressor/limiters utilize the highly successful 8100A FM Optimod circuitry to provide maximum transparency and natural sound, even with the controls set for maximum processing. Broadcast stations, studios, theaters, and sound reinforcement companies prove the quality of these units every day. The 424A stereo and 422A mono "Studio Optimods" are extremely versatile production tools, combining gated compression, limiting, and de-essing in one package. Due to advanced VCA circuitry, level control and de-essing are handled simultaneously, avoiding unwanted processing side effects.

The 414A stereo and 412A mono compressor/limiters offer compression and limiting at a more moderate price. Front panel controls include attack and release times, compression ratio, output attenuator, and both an input attenuator and threshold control. To further simplify their operation, the 414A and 412A maintain approximately constant peak output regardless of attack time and ratio settings. This feature makes readjustment of other operating controls unnecessary and prevents severe clipping in the VCA circuitry.

**424A stereo** 600B424A MFR LIST \$1150.00

**422A mono** 600B422A MFR LIST \$680.00

**414A stereo** 600B414A MFR LIST \$800.00

**412A mono** 600B412A MFR LIST \$525.00

Call Bradley for a current price quotation.

## Eventide Ultra-Harmonizers



Each of the three available Ultra-Harmonizers has an array of pitch shift programs, such as Diatonic Shift which allows you to create musically correct harmony based on your input. The wealth of effects includes reverb programs plus effects such as chorus and flange. The H-3000 provides completely programmable MIDI control of all parameters.

The H-3000B features special presets designed with the broadcaster in mind. You can fly around in a helicopter and give traffic reports without ever leaving the ground. You can call in on a telephone or walkie-talkie without stepping outside. You can . . . well, you get the picture, and so will your listeners.

In addition to the broadcast presets, the H-3000B provides you with automatic stereo audio time compression and expansion. To shorten a spot, just tell the H-3000B how long your piece is, how long you want it to be, and which tape recorder you are using. It does the rest. This unique feature works with almost all frequency controlled reel-to-reel and cart machines.

The H-3000SE adds more delays, reverbs, filters and special effects. Unique SE algorithms are multi-band delays, vocoding, lush reverbs, smoother pitch shifting, an Instant Phaser, and the String Modeler which adds subtle harmonic ambience.

For the musician or the studio on a budget, there is the H-3000S. It includes a bank of presents by noted guitarist Steve Vai. All models are designed for internal expansion with future hardware and software enhancements.

**H-3000B** 60EVH3000B MFR LIST \$2995.00

**H-3000SE** 60EVH3000SE MFR LIST \$2995.00

**H-3000S** 60EVH3000 MFR LIST \$2495.00

### Also available:

**HS322 Sampler Board** installs into any version H3000 with 11.35 seconds of stereo (23.71 seconds mono) of 16 bit, 44.1kHz sampling.

**HS322** 60EVHS322 MFR LIST \$995.00

**BCONKIT** adds H-3000B features to your H-3000SE to create the ultimate production tool.

**BCONKIT** 60EVBCON MFR LIST \$600.00

Eventide and Bradley offer a complete set of software updates that enable you to install the features of any H-3000 model into any other.

Call Bradley for a current price quotation.



### Aphex 320 Compellor

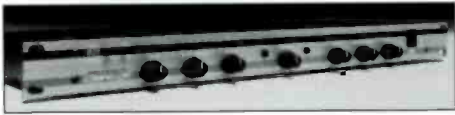

The Compellor is one of the most effective gain riding devices available. Its name describes the three functions it performs: compression, leveling, and peak limiting. These three functions operate harmoniously, as the compressor and leveling sidechains are intelligent, program controlled, and interactive. The leveler provides a platform based on long term average audio levels. The compressor, operating from this platform, more readily handles short term gain changes. A process balance control varies the ratio of these two functions. A fast peak limiter follows, to catch any overshoots and hold them to an absolute peak value. A silence gate prevents gain pumping during slow fades.

The user simply decides how much the lowest level signal will be brought up and the proportion of leveling to compression, and trims the output for unity gain. The transparent audio path is comprised of servo-balanced (XLR) inputs and outputs and the Aphex VCA 1001. The unit operates in dual mono or one of two stereo link modes.

**Compellor** 60APCMP MFR LIST \$1350.00

**Also available:**

Monaural version of the Compellor.

60APMCMP MFR LIST \$795.00

Call Bradley for a current price quotation.

### Aphex Type C<sup>2</sup> Aural Exciter



Aural Excitement is a process which restores audio intelligibility and clarity which are lost through repeated recording and dubbing. The Type C<sup>2</sup> Aural Exciter restores detail and clarity to program material by regenerating normal musical overtones present in the original source material. The result is improved presence and apparent loudness without the disadvantages of compression or equalization. At this low price, Aural Excitement fits into any budget. The new C<sup>2</sup> adds processing to both ends of the audio spectrum. The Big Bottom feature permits increased bass sustain, density and loudness without increasing peak output or generating subharmonics. This stereo unit has unbalanced 1/4" connectors and comes with rack mount.

**Type C<sup>2</sup>** 60APTC MFR LIST \$349.00

Call Bradley for a current price quotation.

### Aphex Dominator II



The Model 720 Dominator II is a stereo, 3 band peak limiter designed to fit a wide range of audio applications. This latest version boasts a 104dB dynamic range, making it the ideal limiter for use with your digital sources and recorders. Through the use of multiband techniques and Aphex exclusive circuit designs, the audible side effects of the limiting action have been greatly reduced. This means that greater limiting depth is possible, resulting in higher loudness with maintained audio quality. The Dominator is free of hole punching, dullness, and most other sound deterioration normally associated with limiters. As a peak overshoot protection limiter, the Dominator is undetectable in line, while it absolutely prevents peak levels from exceeding a user set output level. Greater audio density, increased "punch," and other effects can be achieved.

**Dominator II** 60APDOM MFR LIST \$1350.00

**Also available:**

Model 723 Dominator II has pre-emphasis (either 50 or 75 μsec) added before the limiters. A switchable de-emphasis circuit appears after the final limiter. The 723 is designed for use in broadcast, satellite, and transmission links.

**723 Dominator II**

60AP723 MFR LIST \$1495.00

Call Bradley for a current price quotation.

### Aphex Type III Aural Exciter



The Type III is the latest generation, fully professional Aural Exciter loaded with powerful new processing features and improved circuitry. The dual channel Type III adds thrilling new dimensions to Aural Excitement. Noise and distortion are virtually eliminated in the Type III circuitry, while the new special features now make enhancement possible while actually reducing noise from noisy sources. Features new to the Type III include adjustable harmonics mixing, two modes of noise reduction, a Spectral Phase Refractor to compensate for phase smearing caused by the recording process, servo balanced input/output on XLR connectors, the new VCA 1001 chip, and a Null Fill control to let the user set the amount of de-emphasis that surrounds the excited band of frequencies for added presence. Like its predecessors, the Type III still allows front panel or remote control of a relay hard wire bypass, automatic balanced or unbalanced operation, stable and repeatable settings, and LED's indicating all switchable functions. To add sparkle, clarity, intelligibility, openness, and that extra "edge" to recorded or broadcast material, there is no excitement like the kind you'll get from an Aphex Aural Exciter.

**Type III** 60APIII MFR LIST \$995.00

Call Bradley for a current price quotation.

### Aphex 9000 Series Modular Processing System

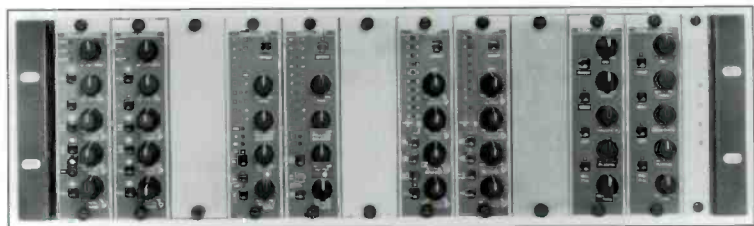

This system was designed to provide all of the processing power of the various Aphex processors in a space saving configuration. All modules have Servo-Balanced inputs and outputs and are for a single channel.

**9000R** rack mainframe is the basic building block of the Aphex Modular Rack System. Hold up to 11 Aphex or dbx modules.

60AP9000R MFR LIST \$379.00

**9000PS** power supply for 9000R rack.

60AP9000PS MFR LIST \$499.00

Call Bradley for a current price quotation.

**Modules:**

**Aural Exciter** signal enhancer designed to increase intelligibility, presence, clarity, and detail.

60AP9251 MFR LIST \$449.00

**Compellor** "intelligent" compressor/leveler provides automatic and seamless level correction.

60AP9301 MFR LIST \$549.00

**Expander/gate** uses downward expansion with variable ratio for a variety of dynamics control options not possible with ordinary gates.

60AP9611 MFR LIST \$449.00

**Parametric EQ** has three overlapping bands with 15dB boost or cut. Peak or shelf filter shapes are available on each band.

60AP9901 MFR LIST \$449.00



### dbx 166 Gated Compressor/Limiter

The dbx 166 dual channel processor provides a complete range of signal processing. Capable of stereo coupled or dual mono operation, the 166 uses dbx's OverEasy compression with adjustable threshold and ratio adjustable from 1:1 to infinity:1. The effective, easy to use noise gate has an adjustable threshold, fixed attack time, and switchable release rate. The intelligent clipper yields absolute peak limiting. Other features include side chain monitoring, rack mount, hard wire bypass, differential input, and unbalanced high impedance output.

166                      60DB166              MFR LIST              \$629.00



Call Bradley for a current price quotation.

### dbx 160XT Compressor/Limiter

The Model 160XT provides the studio operator, broadcaster, or sound reinforcement specialist with performance and flexibility in a single space rack mount package. The 160XT is the only compressor/ limiter that offers you the choice of OverEasy or hard-knee operation, regardless of compression ratio selected. It includes a precision dual display system with an expanded range for continuously monitoring gain reduction as well as input or output levels. Balanced inputs and outputs are on 1/4" TRS and XLR connectors.

160XT                      60DB160X              MFR LIST              \$459.00



Call Bradley for a current price quotation.

### Radio Systems RS2 Dolby 'S' Noise Reduction

RS2 is the first broadcast product to incorporate Dolby 'S' processing. It provides up to 24db of noise reduction on carts, phone lines, discrete STL or RPU. The RS2 package incorporates stereo phase correction in the encoder cards for up to 90° of phase correction. Similar to the once popular "Phase Chaser", this single-ended processing uses low distortion, all pass filter networks to time compensate the out-of-phase signals until they are perfectly in phase. The unit is available in a "phase only" version for users who need only this function in their air chain.

RS2 houses up to three stereo Dolby 'S' encode or decode cards in a single rack unit frame. For "split systems" for STL or RPU applications, use two frames to locate the encoder on the transmit side and the decoder on the receive end.

<b>Mainframe w/power supply</b> (hold 3 cards)	60RSMF	MFR LIST	\$495.00
<b>Encode card</b>	60RSEC	MFR LIST	\$595.00
<b>Decode card w/ phase correction</b>	60RSDC	MFR LIST	\$595.00
<b>Phase correction only card</b>	60RSPCC	MFR LIST	\$495.00



Call Bradley for a current price quotation.

### Rane AC 23B

The Rane AC 23B is a stereo three-way, mono four-way or five-way active dividing network. Phasing problems are virtually eliminated by using Linkwitz-Riley filter alignment. 24dB per octave rolloff slopes help to minimize distortion & driver fatigue caused by errant frequencies. To further eliminate driver misalignment and phasing, an adjustable time delay is included on the mid & low frequency outputs. Balanced inputs & outputs.

AC 23B                      60RNAC23B              MFR LIST              \$529.00



Call Bradley for a current price quotation.



## ART Multiverb Alpha 2.0

ART's Multiverb Alpha incorporates digital VLSI in order to pack more than 60 effects into one box. One may mix up to seven effects simultaneously. 24 bit processing achieves better than 90db s/n, 20 khz bandwidth for all effects. This unit has onboard a 7-band programmable EQ, pitch transposer (over 2 octaves), room, hall, gated, chamber and plate reverbs, 21 different delays, stereo panner and sampler. The Multiverb Alpha can control up to 8 parameters on each patch via MIDI, with changes made in real time. Inputs & outputs are 1/4" TS.

**Multiverb Alpha 2.0** 60MX471 MFR LIST \$529.00



Call Bradley for a current price quotation.

## ART Multiverb LTX

The LTX is ART's answer to those who need a good reverb on a tight budget. The LTX has over 250 effects available to the user. Any three of these effects may be combined and summed to the output for an incredible range of sounds. 16 bit processing, hyperspeed program access and stereo ins & outs all come together for great quality reverb, delay, echo, panning and flanging effects. Full MIDI patch mapping and battery backup will help the user create and keep effects stored, even if the unit is unplugged!

**Multiverb LTX** 60MX421 MFR LIST \$329.00



Call Bradley for a current price quotation.

## Yamaha SPX-1000 and SPX-900 Effects Processors

Professional specifications and great effects programs make these a potent pair of processing "Swiss Army Knives." Sophisticated digital reverberation and effects systems provide dozens of preset programs including natural reverberation and early reflections, delay and echo, pitch change and more. The preset programs can be edited, retitled and stored in multiple user defined memories. The SPX-1000 has stereo inputs; the SPX-900 has mono inputs. Both units have stereo outputs and switchable -20dBm and +4dBm line levels (unbalanced) on inputs and outputs. Multiple effects programs allow the SPX processors to provide up to 5 processes simultaneously. The sampling frequency of 44.1kHz and full frequency response from 20Hz to 20kHz result in exceptionally clean, transparent sound. Other features include individual two band parametric EQ and dynamic filter parameters on each effect, full MIDI implementation, and, on the SPX-1000, Yamaha format digital inputs and outputs. These units are among our best sellers because of their exceptional value.

**SPX-1000** 60YASPX1000 MFR LIST \$1595.00  
**SPX-900** 60YASPX900 MFR LIST \$895.00



Call Bradley for a current price quotation.

## Yamaha REV-5 Reverb/Effects Processor

The REV-5 offers rich natural stereo reverb that simulates the acoustic properties of virtually any environment. Improved circuitry provides full bandwidth in the effects channels for exceptionally clean, transparent sound and broader control range. Each effects program provides a 3 band digital EQ in addition to the front panel EQ. Thirty instantly available presets are incorporated in the REV-5, covering a wide variety of plate, spring, hall, and echo programs, as well as delay, ambience, stereo phasing, flanging, chorus, and tremolo effects. An additional 60 programs may be created by the user, stored in memory, and recalled at the touch of a button. The REV-5 also contains nine programs which contain a series of effects, effectively functioning as several REV-5 units in one.

**REV-5** 60YAREV5 MFR LIST \$1995.00



Call Bradley for a current price quotation.



## Lexicon LXP Effects Processors

### LXP-1

The LXP-1 has 16 different reverb and delay oriented programs, with continuous control over pre-delay and decay on reverbs and recirculation and delay time on delays. Those same parameters can all be addressed through MIDI System Exclusive messages with a controller like the Lexicon MRC-1. Just like its big brother, the PCM-70, many of the LXP-1's parameters can be manipulated in real time through MIDI to create very expressive and dramatic effects. Signal inputs and outputs are stereo on 1/4" TS jacks. It may only be half a rack space wide, but it's 100% Lexicon.

### LXP-5

The LXP-5's pallet of effects includes a wide variety of echoes, choruses, flangers, and three octave pitch shifters. These all have the typically lush and detailed sound characteristic of all Lexicon devices, and can be stacked up to five at a time. All effects parameters may be edited and stored from the front panel or manipulated via MIDI System Exclusive messages. Real time MIDI control over parameter values can let the LXP-5 perform many of the dynamic effects seen only in units costing several times as much. MIDI clock signals can even be used to tie delay times in with tempo and timing of synchronized material. When used with the Lexicon MRC-1 MIDI controller, the LXP-5 is easily and quickly maneuvered through its many modes of parameter editing. Signal inputs and outputs are stereo on 1/4" TS jacks. This great little processor could quickly become one of your favorites.

### LXP-15

Lexicon designed the LXP-15 multi-effects processor to be extremely easy to operate, and they didn't sacrifice performance or breadth of effects to do it. Every

major function is accessed by a rotary selector switch, a soft adjustment knob, and a soft-key controlled LCD display. It's the type of straightforward approach that lets you put the unit to work within minutes of taking it out of the box. Lexicon's Dynamic MIDI provides the ultimate in remote control, and five inputs are provided for external switches to change parameters without MIDI.

The LXP-15 sounds as good as it feels. The palette of 128 preset effects includes pitch shift, stereo delay, gate, plate, Lexicon's renowned reverb, and many more. Up to 128 user presets may be stored. Connectors are 1/4" TS.



**LXP-1** 60LELXP1 MFR LIST \$549.00

**LXP-5** 60LELXP5 MFR LIST \$549.00

#### Accessory:

**Rack shelf** for up to two units.

60LEALXPR MFR LIST \$30.00

**LXP-15** 60LELXP15 MFR LIST \$1049.00

*Call Bradley for a current price quotation.*

## Symetrix 601 Digital Voice Processor

The 601 Digital Voice Processor is the newest and most advanced digital signal processor, designed for a variety of recording, broadcast, live sound and post-production applications. Acting as a bridge from the analog to the digital domain, the 601 accepts mic or line level analog signals, converts to digital and performs a full range of processing options, including fully parametric EQ, shelving EQ, notch filtering, noise reduction, de-essing, delay, gating, expansion, compression, and AGC. An intuitive user interface allows you to quickly find and modify the effect parameters you want. In addition to factory presets of each processing option, ample space is provided for you to develop and store your own user presets. MIDI control is available, or the 601 may be controlled from a Mac or IBM PC compatible computer. Stereo input signals may be processed via the AES/EBU -SP/DIF



input. Stereo digital transfers may be made at 48 kHz or 44.1 kHz sample rates, and for any given format, output may be either digital or analog in mono or stereo.

**601** 60SY601 MFR LIST \$1995.00

*Call Bradley for a current price quotation.*

## Symetrix 421 AGC Leveler

Thanks to a breakthrough in technology, the Symetrix 421 is extremely effective at performing unattended gain control functions. Combining a downward expander, AGC Leveler and output limiter on one single rack unit chassis, the 421 is a set and forget device that gently boosts signals that drop below target output, and smoothly pulls back those that are above target level. Smart circuitry is designed to react to real-world situations, effectively distinguishing between noise or feedback, and desired low level audio, utilizing a proprietary Activity Release Monitor circuit. When set in auto mode, the expander section automatically tracks the AGC circuit for foolproof program dependent operation. A fast acting limiter catches transient peaks, and speech curve filters are front panel selectable to optimize voice range performance. The 421 may be stereo linked, or operated in side chain mode.



**421 AGC Leveler** 60SY421 MFR LIST \$549.00

*Call Bradley for a current price quotation.*





## Aphex 124 Audio Level Interface

The Aphex 124 is designed to allow use of -10dBV consumer or semi-pro equipment with +4 or +8dBm professional audio systems. The 124 provides an extremely clean, reliable two way buffer so both systems can operate at maximum performance levels by matching impedances and operating levels. Inputs and outputs are transformerless for wide, flat frequency response and perfect square waves to preserve transients. Hum and noise rejection are very high, while the noise and distortion of the 124 are almost non-existent. A front panel switchable 600 ohm load allows for input line termination.

**124** 60AP124 MFR LIST \$229.00



**Accessory:**

**Rack mount kit** holds one or two units in a single rack space.

60AP44008 MFR LIST \$29.95

Call Bradley for a current price quotation.

## ATI L-1000 Precision Dual Line Amp

The L-1000 provides 34dB of gain for solving numerous control room problems. Low noise, high impedance balanced input bridges +24dBm lines with 80dB hum rejection. Rack mount kits for one or two units are optionally available.

**Transformer output** 60AIL10001 MFR LIST \$379.00

**Balanced differential outputs** 60AIL10002 MFR LIST \$359.00

Call Bradley for a current price quotation



## ATI Multiple Amplifier Arrays

These useful arrays have a wide variety of applications. They combine audio gain control, distribution, and mixing in a single rack space enclosure. They are available with four or eight channels of mic-to-line (up to 84dB) or line-to-line (up to 42dB) of amplification. Rear panel jumpers let you create combinations of distribution amplifiers, mono summing networks, or sum and difference networks. Use the amplifiers individually or in sets as a mic distribution amp; headphone amp; consumer, IHF level to 600 ohm, pro level interface; a press box; or a simple mixer. Excellent audio specifications make these arrays an exceptional value. XLR termination strips are optionally available for convenient installation.

**4 channel line amp, transformer outputs**  
60AIMLA4001 MFR LIST \$475.00

**4 channel line amp, differential outputs**  
60AIMLA4002 MFR LIST \$349.00

**8 channel line amp, transformer outputs**  
60AIMLA8001 MFR LIST \$725.00

**8 channel line amp, differential outputs**  
60AIMLA8002 MFR LIST \$549.00

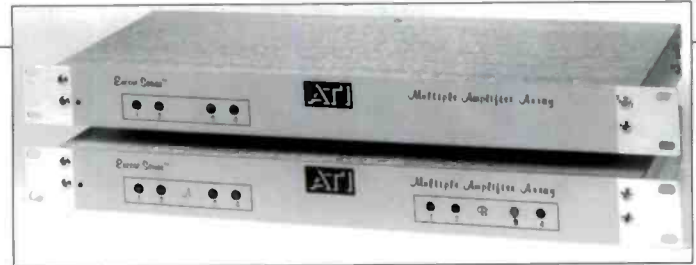

**4 channel mic-to-line amp, transformer outputs**  
60AIMMA4001 MFR LIST \$525.00

**4 channel mic-to-line amp, differential outputs**  
60AIMMA4002 MFR LIST \$399.00

**8 channel mic-to-line amp, transformer outputs**  
60AIMMA8001 MFR LIST \$795.00

**8 channel mic-to-line amp, differential outputs**  
60AIMMA8002 MFR LIST \$599.00

Call Bradley for a current price quotation.

## ATI Matchmaker

Loading, distortion, hum loops, RF pickup, and high frequency roll off can be problems when interconnecting consumer (unbalanced, IHF) and professional (+4dBm) equipment. The Matchmaker solves these problems with less than 0.02% THD, 20Hz to 20kHz with +0/-0.25dB response, and over 98dB of dynamic range. Exceptional performance including its transformer balanced outputs.

**Matchmaker** 60AIMM100 MFR LIST \$279.00

**Accessory:**

**Rack panel** holds one or two units in a single rack space.

60AI20273 MFR LIST \$25.00

Call Bradley for a current price quotation.

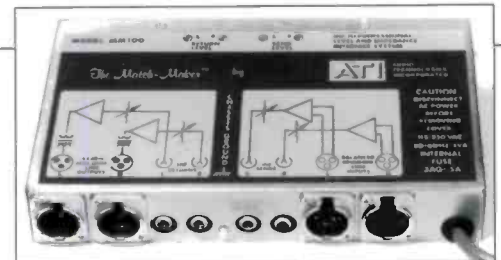

## Radio Design Labs Stick-On Series

Each Stick-On is only 1/2" x 1 1/2" x 3" and can be attached anywhere with its adhesive backing. All products are designed to work in high RF environments and carry a 3 year limited warranty. \*Indicates that a Power Supply is required. Power Supplies are priced separately.

**ST-DA3 Distribution Amplifier** allows bridging of any line and driving almost any load. Master gain adjustment provides up to 20db of gain. Available as a single 1x3, or as a stereo or dual mono 2x6 sharing a single power supply.

**ST-DA3\*** 60RDSTDA3 MFR LIST \$104.95

**Also available:**

**STM-DA3** feeds 1-150 ohm mic signal to 3-isolated inputs.

**STM-DA3** 60RDSTMDA3 MFR LIST \$104.95

**STA-1M Audio Line Amplifier** has a gain range of -14dB to +7dB when using the balanced I/O. When using the unbalanced I/O, the gain range is -7dB to +14dB. Single channel.

**STA-1M\*** 60RDSTA1M MFR LIST \$82.95

**ST-SH1 Stereo Headphone Amp** is designed to feed either low or high impedance stereo headphones. The input is bridging and accepts either a balanced or unbalanced source.

**ST-SH1\*** 60RDSTSH1 MFR LIST \$94.95

**ST-MX3 Line Level Mixer** has three adjustable line level inputs and a single output. It allows you to combine signals of different levels, impedances, or balanced/unbalanced configurations.

**ST-MX3\*** 60RDSTMX3 MFR LIST \$94.95

**Also available:**

**ST-MMX3 Mic to Line Level Mixer** is similar, but inputs are at mic level while the output is line level.

**ST-MMX3\*** 60RDSTMMX3 MFR LIST \$104.95

**ST-PH1 Stereo Phono Preamp** makes it easy to preamplify phono levels close to the turntable for best audio performance. Equalization follows the RIAA curve and is accurate and quiet.

**ST-PH1\*** 60RDSTPH1 MFR LIST \$104.95

**STM-1/STM-2 Microphone Preamplifiers** provide 150/600 ohm balanced inputs with phantom power available, and two outputs, one 600 ohm balanced, the other 10k unbalanced. The STM-1 has a fixed gain of 50dB, while the STM-2 has a variable gain to 65dB. Specifications include 0.05% THD and response 50Hz to 30kHz, ±1dB.

**STM-1\*** 60RDSTM1 MFR LIST \$79.95

**STM-2\*** 60RDSTM2 MFR LIST \$109.95

**ST-MPA2 Mic Phantom Adapter** adds phantom power ranging from 6 volts to 52 volts to one or two mic lines. Any mic can be safely powered.

**ST-MPA2\*** 60RDSTMPA2 MFR LIST \$65.95

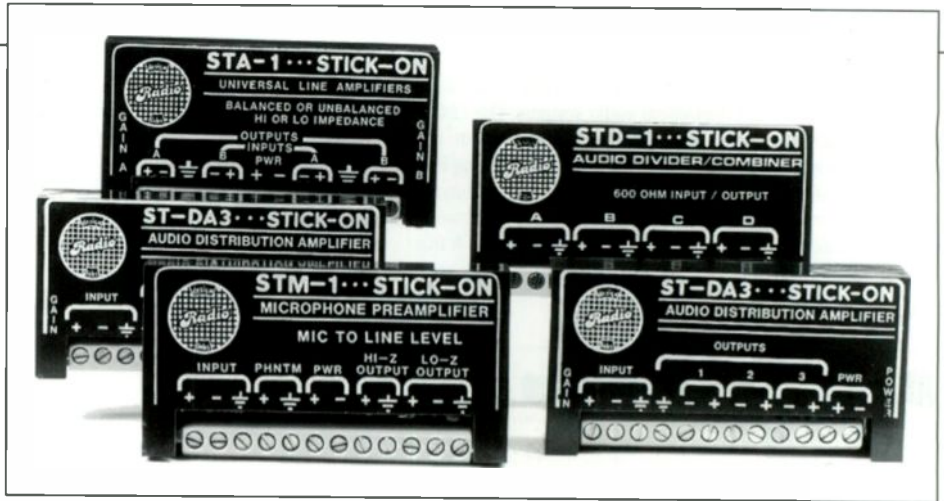

**Call Bradley for a current price quotation.**

**STP-1 Attenuator** is useful for reducing input levels to improve headroom, or other applications. Each STP-1 has two variable modified "H" pads providing up to 85dB attenuation. A 15 turn trim pot allows precise adjustment of levels.

**STP-1** 60RDSTP1 MFR LIST \$39.95

**STA-1 Electronic Transformer Pair** combines an electronic line transformer and adjustable 20dB gain amplifier. There are two circuits in each unit for stereo operation. Typical applications include: balanced to unbalanced interface, unbalanced to balanced bridging amp, monaural combiner, stereo splitter, and Hi-Z amplifier.

**STA-1\*** 60RDSTA1 MFR LIST \$112.95

**STD-1 Divider/Combiner** is a passive, four channel device where any channel may be an input or output. It may be used to branch a 600 ohm line to three inputs, combine stereo signals to a mono input, branch or combine 150 ohm mic signals, or divide a mono signal to apply stereo inputs.

**For 150Ω** 60RDSTD1150 MFR LIST \$36.95

**For 600Ω** 60RDSTD1600 MFR LIST \$36.95

**For 10kΩ** 60RDSTD10K MFR LIST \$36.95

**ST-GCA1/ST-GCA-2 Gain Control Amplifiers** offers gain reduction (compression) for positive control of peak levels. The slow AGC of the ST-GCA1 makes a 20dB level adjustment in 8 seconds. The ST-GCA2 has an AGC with fast action, offering nearly instantaneous audio reduction makes it ideal for use in systems prone to loud bursts of audio. Both accept nearly any input.

**ST-GCA1 slow\*** 60RDSTGCA1 MFR LIST \$94.95

**ST-GCA2 fast\*** 60RDSTGCA2 MFR LIST \$94.95

**ST-VCA1 Voltage Controlled Amplifier** allows you to remotely control audio with a DC voltage. The built-in mic preamp allows any combination of mic or line level inputs and outputs. A standard 10k linear taper pot (not included) is used for control.

**ST-VCA1\*** 60RDSTVCA1 MFR LIST \$89.95

**ST-ACR Audio Controlled Relays** allow you to control switching from any audio signal. Multiturn sensitivity adjustments cover the range from mic to line level. Relay release can be adjusted from 1/2 to 5 seconds on the ACR1, and from 5 to 50 seconds on the ACR2. Double-pole, double-throw switching contacts are provided. A "slave" terminal connects Stick-On logic controlled relays (see below).

**ST-ACR1\*** 60RDSTACR1 MFR LIST \$74.95

**ST-ACR2\*** 60RDSTACR2 MFR LIST \$74.95

**ST-LCR1/ST-LCR2 Logic Controlled Relays** provide double-pole, double-throw switching contacts, open-collector outputs, and an LED indicator of relay closure. Dual inputs.

**ST-LCR1\* momentary action**

60RDSTLCR1 MFR LIST \$51.95

**ST-LCR2\* alternate action**

60RDSTLCR2 MFR LIST \$85.95

**Also Available:**

**ST-PA2\*** 2-watt Utility Power Amplifier

60RDSTPA2 MFR LIST \$52.95

**ST-PA6\*** 6-watt Utility Power Amplifier

60RDSTPA6 MFR LIST \$63.95

**ST-MLX3\*** Mic/Line Mixer

60RDSTGCA1 MFR LIST \$99.95

**STM-3\*** Microphone Preamplifier

60RDSTM3 MFR LIST \$125.95

**ST-AMC3\*** Active Mic Combiner

60RDSTAMC3 MFR LIST \$94.95

**ST-VP1\*** Voice Over/Page Module

60RDSTVP1 MFR LIST \$104.95

**ST-EQ3\*** 3-Band Equalizer

60RDSTEQ3 MFR LIST \$73.95

**ST-CL1\*** Compressor/Limiter

60RDSTCL1 MFR LIST \$115.95

**ST-SSR1\*** Solid State Audio Relay

60RDSTSSR1 MFR LIST \$81.95

**Accessory:**

**STR-19 Rack Mount Kit** Holds up to 12 Stick-Ons behind its 5 1/2" hinged panel.

**STR-19** 60RDSTSTR19 MFR LIST \$99.95

**\*DC Power Supply** 60RDXFMR MFR LIST \$19.95



## Whirlwind Accessory Boxes

(1) **Hot Box** active direct box offers advanced electronic circuitry that completely eliminates low-end saturation, produces wide bandwidth with no signal loss, and provides totally transparent, non-colored sound. Includes an LED "on" indicator, a +15dB, Flat, and -40dB switch, a ground-lift switch and can be powered by either two 9V batteries, or 48V phantom power.

**Hot Box** 61WHHB \$119.00

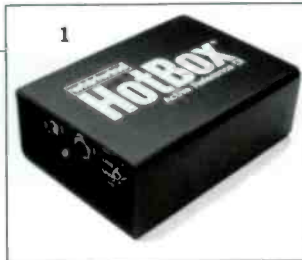

(2) **IMP 2** is a high quality passive direct box with a ground lift switch and bridged output.

**IMP 2** 61WHIMP2 \$34.00

(3) **Director** direct box combines road durability with great studio performance. Loading, distortion, and signal loss are eliminated by the TRHL-M transformer and custom circuitry. Mu-metal shielding is included for EM and RF isolation. With no need for a battery or external power, you avoid related problems.

**Director** 61WHDIR \$62.00

(4) **IMP Splitter** allows a single input to be split into two or three signals. Low impedance.

**1x2** 61WHMS2 \$46.50

**1x3** 61WHMS3 \$52.00

(5) **IMP Combiner** combines two low impedance signals into one low impedance output. Features phase reverse switch to match phase or to throw mics out of phase for special effects.

**IMP Combiner** 61WHCOMB \$48.00

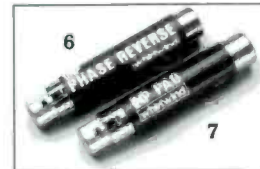

(6) **Phase Reverse** is a handy "back pocket" adapter for reversing phase on low impedance lines. XLR connectors.

**Phase Reverse** 61WHPR \$16.80

(7) **IMP Pads** provide fixed attenuation on low impedance lines. XLR connectors.

**10dB pad** 61WHPAD10 \$21.25

**20dB pad** 61WHPAD20 \$21.25

**30dB pad** 61WHPAD30 \$21.25

(8) **Lifter** is a handy in-line device for ground lift at pin-1 on an XLR line.

**Lifter** 61WHGL \$16.00

## Shure "Problem Solvers" and Impedance Transformers

These in-line devices are only 4 1/2" long and 3/4" in diameter, and are color coded for quick identification. Extremely handy, they have XLR connectors. Except as noted, they are designed to be used with 150 ohm low level equipment.

**Tone generator** produces a continuous 700Hz signal capable of driving low impedance balanced lines. Battery operated. 61SHA15TG \$68.00

**Low pass filter** provides a high frequency cutoff to reduce objectionable high frequency noises. 61SHA15LP \$39.00

**Response shaper** provides sibilance filtering (removes presence peak) for recording, broadcasting, and PA applications. 61SHA15RS \$39.00

**Bridging transformer** matches balanced or unbalanced devices of different impedances (33 kilohm primary, 600 or 7500 ohm secondary). 61SHA15BT \$44.00

**Line input adapter** converts low impedance microphone input to bridging line-level input. May be driven from source of up to 50 kilohms and 24dBm. 61SHA15LA \$39.00

**Switchable mic attenuator** provides 15, 20, or 25dB attenuation to prevent preamp overload. 61SHA15AS \$45.00

**Switchable phase reverser** instantly reverses phase of a balanced line of any level. Can be used in either direction. 61SHA15PRS \$39.00

**Presence adapter** adds presence to vocals or instruments. 61SHA15PA \$39.00

**High pass filter** provides a low frequency cutoff to reduce unwanted low frequency noise. 61SHA15HP \$44.00

### Impedance Transformers

**Shure A95U** in-line impedance matching transformer with male XLR connector. Male and female 1/4" adapters supplied. 61SHA95U \$36.00

**Shure A95UF** in-line impedance matching transformer with female XLR connector. Male and female 1/4" adapters supplied. 61SHA95UF \$39.00

**Whirlwind Little IMP** in-line impedance matching transformer with female XLR connector to male 1/4" connector. 61WHLI \$11.50



### Excalibur IA-1 Interface Amplifier

The IA-1 is used to interface consumer type equipment to equipment requiring professional levels and impedances. This compact two way, stereo unit has excellent audio performance. Frequency response is  $\pm 0.2\text{dB}$ , DC to 25kHz; THD  $< 0.006\%$ ; noise  $> 90\text{dB}$  below operating level; and  $> 75\text{dB}$  common mode rejection on the balanced input stages. Barrier strips provide gas-tight connections on the balanced inputs and outputs, with phono jacks on the unbalanced I/O. Input and output levels are adjustable.



IA-1 60EXIA1 \$165.00

### Excalibur APA-1 All Purpose Amplifier

Summing, splitting, matching, interfacing... the APA-1 does it all. Dip switches allow you to quickly configure the APA-1 and its clean audio performance makes it right at home in the highest quality facilities. Use the APA-1 as a stereo line amp, 1 by 2 splitter, 2 to 1 summer, mix-minus amp, level and impedance interface, active phase inverter, headphone amp, and number of other uses. The low price and utility of this unit lets you keep one on hand to face the unexpected.



APA-1 60EXAPA1 \$149.00

Accessory:  
Rack Mount Kit 60EXAPA1R \$15.00

### Excalibur "H" Pads

Don't be a resistor twister! Excalibur's "H" pads are so inexpensive, home brewing is just not worthwhile. 1% metal film resistors assure accurate losses and low noise. A 6-32 threaded stud allows easy mounting. "H" pads are available in 6, 10, 20, and 50dB losses, and with a blank PC board for custom values. "T" pads have been discontinued, but are available at the same price as "H" pads while supplies last.



Minimum order: 10 pads of any mix.

6dB 600 ohm	60EX6H	\$2.25
10dB 600 ohm	60EX10H	\$2.25
20dB 600 ohm	60EX20H	\$2.25
50dB 600 ohm in/150 ohm out	60EX50H	\$2.25
Blank pad	60EXBH	\$2.10

### Henry Matchbox

This is the one impedance and level matching device our customers ask for by name. The Matchbox is a four amplifier unit used to interconnect IHF standard (-10dBV) with professional broadcast standard (+4dBm) equipment. Full bi-directional stereo interface is provided. All circuitry is active and direct coupled. Excellent specifications, and convenient AC outlet is provided.



Matchbox 60HEMATCH MFR LIST \$195.00  
Call Bradley for a current price quotation.

### Henry LogiConverter

The LogiConverter is an interface unit that converts TTL/ CMOS or "open collector" console outputs to momentary or maintained relay closures. All inputs are opto-isolated and outputs are SPDT relay contacts. Internal DIP switches program the unit to generate momentary or continuous closures.



The LogiConverter will control up to four circuits and can provide start only or start/stop outputs from a single input signal.

LogiConverter 60HELC MFR LIST \$195.00  
Call Bradley for a current price quotation.

### Henry Superrelay

Hundreds of engineers have built "little black boxes" of relays to tie up loose ends. Now Henry does it for you! Superrelay is for use in broadcast station control rooms, A/V systems, or any installation requiring multiple circuit control. It's ideal for controlling the various equipment functions that need to be switched when, for example, a control room mic is turned on.



Superrelay can be controlled by any external momentary or maintained switch, or by CMOS/TTL. It provides six double pole relays used for low-voltage and audio switching, and a switched AC output will directly power up to 300 watts of warning lights (without buzz, pops, or arcs) and make them flash using the built-in, defeatable flasher. Superrelay can also be connected to any dial-up telephone line for control of equipment when the line rings. Keep an extra one handy for those emergency jobs.

Superrelay 60HESR MFR LIST \$225.00  
Call Bradley for a current price quotation.

### ATI DA10000 Modular Audio Distribution System

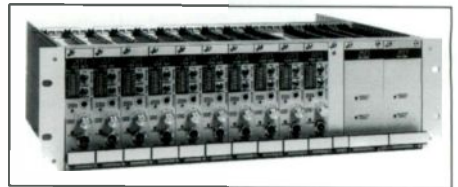

The ATI DA10000 offers flexibility to meet your audio distribution needs in one efficient package. Each 5 1/2" rack holds up to ten amplifier modules and dual redundant power supplies. Designed for maximum reliability and excellent audio.

Rack frame 60AIRM100 MFR LIST \$319.00

#### Modules:

DA100 basic 1x6 DA with active balanced outputs. Single level control for all outputs and a headphone monitor jack are on the front panel.

60AIDA100 MFR LIST \$250.00

MDA100 is similar to the DA100, and adds an LED bargraph meter and an alarm output that warns of a dead channel.

60AIMDA100 MFR LIST \$335.00

CDA100 adds a gated compressor to the MDA100.

60AICDA100 MFR LIST \$395.00

IDA100 is a 1x6 DA with independent adjustment of all outputs, master level control, and front panel headphone jack.

#### Transformer balanced outputs

60AIDA1001 MFR LIST \$385.00

#### Active balanced outputs

60AIDA1002 MFR LIST \$299.00

MIDA100 is similar to the IDA100, and adds an LED bargraph meter.

#### Transformer balanced outputs

60AIMIDA1001 MFR LIST \$462.00

#### Active balanced outputs

60AIMIDA1002 MFR LIST \$375.00

MIDA100-1RC is similar to the MIDA100, and adds VCA remote control capabilities.

60AIMIDA100RC MFR LIST \$495.00

SDA200 stereo 1x4 DA with two inputs into eight active balanced outputs. Switch selection of stereo, L+R/L-R, left only, or right only outputs.

60AISDA200 MFR LIST \$299.00

SMDA200 is similar to the SDA200, and adds an LED bargraph meter.

60AISMDA200 MFR LIST \$399.00

PS100 power supply. Two may be installed in each frame.

60AIPS100 MFR LIST \$299.00

Blank panel for missing amp module

60AIBP1001 MFR LIST \$25.00

Blank panel for missing power supply

60AIBP1002 MFR LIST \$30.00

Call Bradley for a current price quotation.



## Radio Systems DA8 & DA16 Distribution Amplifiers

Radio Systems DA's are durable, proven and in use in thousands of studios around the world. Front panel independent level adjusts, balanced bridging inputs, balanced low impedance outputs, barrier strip connectors, and super low noise and distortion make this one of the most popular DA's ever. Put it in and forget about it. Uses a single rack space.

<b>DA-8</b> (8 Mono)	60RSDA8	<i>MFR LIST</i>	<b>\$340.00</b>
<b>DA-16</b> (8 Stereo/16 Mono)	60RSDA16	<i>MFR LIST</i>	<b>\$425.00</b>

Call Bradley for a current price quotation.



## Excalibur Distribution Amplifiers

Two new DAs further Excalibur's reputation for quality and value. The DA1-5C has one input and five outputs, while the DA2-5C has two 1 by 5 DAs. Their small size allows them to be hidden out of the way. If you prefer, optional rack ears mount either in only one rack unit. Balanced I/O is on barrier strips. S/N >80dB @unity gain, input common mode rejection is greater than 75dB @1kHz, and THD is less than 0.01%. Maximum gain is 18dB and maximum input and output levels are +22dBm.

<b>DA1-5C</b> 1x5	60EXDA15	<b>\$180.00</b>
<b>DA2-5C</b> Dual 1x5	60EXDA25C	<b>\$270.00</b>

### Accessories:

<b>Rack ears</b> for DA1-5C	60EXDA15R	<b>\$15.00</b>
<b>Rack ears</b> for DA2-5C	60EXDA25CR	<b>\$15.00</b>

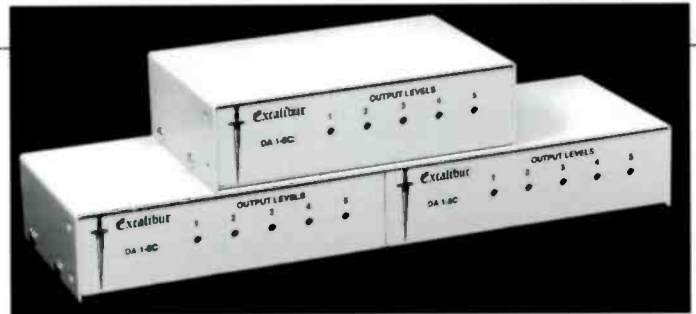

## ATI Microamp Distribution Amplifiers

These high quality amplifiers form a flexible distribution system by providing individual level adjustments for each output line. Full LED metering with switchable 0VU calibration and a headphone amp, switchable to any output, are provided. A full complement of models includes transformer or differential outputs at +22dBm, with +30dBm models available at additional cost.

<b>Single 1x8</b> w/transformer outputs	60AIDA10081	<i>MFR LIST</i>	<b>\$945.00</b>
<b>Single 1x8</b> w/differential outputs	60AIDA10082	<i>MFR LIST</i>	<b>\$820.00</b>
<b>Dual 1x8</b> w/transformer outputs	60AIDA20161	<i>MFR LIST</i>	<b>\$1395.00</b>
<b>Dual 1x8</b> w/differential outputs	60AIDA20162	<i>MFR LIST</i>	<b>\$1145.00</b>



Call Bradley for a current price quotation.

## ATI Encore Distribution Amps

Superior audio quality and practical configurations make these DA's from ATI our best sellers. Here is a no frills DA system available in either two or four sections of 1x4. Paralleling inputs allows you to select 1x4, 1x8, 2x8, or 1x16 set-ups as your application requires. The front panel provides for adjustment of individual output amps and has clipping indicators for each output set. Outstanding RFI suppression. 13V/μsec slew rate, 60dB CMRR at 60Hz, THD max 0.1%, SMPTE IMD max 0.05%, 30Hz to 20kHz ±0.25dB, S/N -75dB at 20dB gain (ref: +18 out). Terminations are barrier strip and XLR termination panels are available at extra cost.

<b>DA208</b> with two 1x4 sections.	60AIDA208	<i>MFR LIST</i>	<b>\$349.00</b>
<b>DA416</b> with four 1x4 sections.	60AIDA416	<i>MFR LIST</i>	<b>\$499.00</b>

Call Bradley for a current price quotation.



### Gentner Routing Distribution Amplifier

Here is an audio distribution amplifier with a versatile and unique structure. The RDA has eight inputs and twenty-eight outputs. Any input, or any combination of inputs, can be routed to any output. The RDA employs a specially designed input stage which ensures that input signals are delivered at optimum level. Selection of sources to each of the twenty-eight outputs is provided from the front panel via jumpers. Output level controls are provided for each channel. Active balanced outputs provide +4dBm into 600 ohms with 20dB headroom. Input range is -20dBm to +8dBm, balanced bridging. The rear panel connections are barrier strip screw terminals. With the RDA, you'll spend less time on installation, less effort in production, and less money on distribution equipment.

RDA 60GERDA MFR LIST \$1629.00

Call Bradley for a current price quotation.



### Henry Engineering U.S.D.A. & MicroMixer

The Universal Summing and Distribution Amplifier has the unique ability to combine, as well as split, audio signals. The U.S.D.A. has two inputs (one stereo pair) and four outputs (two stereo pairs). While it can be used as a conventional 1x4 or 2x4 distribution amp, there is the added ability of either stereo input to be combined into dual mono without affecting the other output. Up to 20dB of gain is available, adjustable individually on each output.

The MicroMixer has four balanced inputs that can be individually assigned to its two balanced outputs. Used alone, or with the U.S.D.A., the MicroMixer is a high quality method of combining stereo to mono, creating mix-minus or monitor busses, and numerous other uses. Each unit's balanced outputs are isolated and will drive a 600 ohm load to +25dBm with less than 0.01% THD. The bridging inputs accept a wide range of both balanced and unbalanced sources.

U.S.D.A. 60HEUSDA MFR LIST \$195.00  
 MicroMixer 60HEMM MFR LIST \$195.00

Call Bradley for a current price quotation.



## Bradley Broadcast... Where Service and Engineering Make the Difference.

### Aphex 120 Distribution Amplifier

The 120 high performance DA has one input, four outputs with individual front panel level controls, and one unity gain direct output. The wide, flat frequency response (5Hz to 100kHz, +0, -0.5dB) allows the 120 to be used in the most critical applications, as well as distributing SMPTE time code if necessary. The 120 boasts THD 0.002% at +4dBm and hum and noise better than -90dBm at unity gain. XLR input and output connectors and maximum RF shielding make the 120 suitable for both studio and field use. Compact enough for 2 to fit side by side in the rack.

120 60AP120 MFR LIST \$319.00

**Accessory:**

Rack mount kit holds one or two units in a single rack space.

60AP44008 MFR LIST \$29.95



Call Bradley for a current price quotation.



### 360 Systems AM-16/B Routing Switcher

The AM-16/B Routing Switcher replaces the patch panels and cumbersome switchers in your facility with a compact, easy to use, and expandable system. The AM-16/B is field selected as either a 16 x 16 mono or an 8 x 8 stereo matrix. The companion AM-16/E slave unit operates in parallel to provide additional simultaneous inputs. Combine one master and one slave unit for 16 x 16 stereo operation. Additional slaves may be used for multi-channel applications or for custom matrices.

All inputs and outputs are electronically balanced, and both RS-422 and MIDI remote control facilities are provided. Front panel setups may be stored in any of 100 memory locations, allowing recall of individual patches or complex "salvos." The front panel includes single ended jacks with the input and output of two mono channels or one stereo pair, to serve as test points or for an emergency patch. Specifications are impeccable. Frequency response is  $\pm 0.5\text{dB}$ , 20Hz to 20kHz. Distortion is less than 0.008% THD+N, DC to 20kHz @ +22dBu. Signal to



noise is 105dB unweighted, and crosstalk is 99dB @ 1kHz and 83dB @ 20kHz, any channel to any other. CMRR is better than 55dB, DC to 20kHz.

The features and performance of the AM-16/B are typically found only in routing switchers costing much more. The AM-16/B can make your job easier at a very economical price.

<b>AM-16/B Switcher</b>	60TH16B	MFR LIST	<b>\$1495.00</b>
<b>AM-16/E Expander</b>	60TH16E	MFR LIST	<b>\$995.00</b>

Call Bradley for a current price quotation.

### Conex AS-101 Routing Switcher

The AS-101 is a reasonably priced, high quality 10x1 stereo routing switcher. It is unique in that it can be programmed for "overlap" switching, which prevents the source from turning off until the trailing edge of the command strobe which turns on the new source. Input and output level controls are accessible from the front panel, and inputs may be individually switched for 10K bridging or 600 ohm terminating. Audio connections are via plug in screw clamp terminal blocks, and all audio paths are transformerless balanced. The control format is four level BCD plus strobe, ground, and 12VDC. Several control heads may be operated in parallel. An auxiliary rack mount chassis can accept option boards for relay based machine control, RS-232/422 interface, and a system controller board. The system board allows the AS-101 to function as a simple automation system when

controlled by an inexpensive personal computer.

Call Bradley for a current price quotation.



<b>AS-101 Switcher</b>	60CNAS101	MFR LIST	<b>\$895.00</b>
------------------------	-----------	----------	-----------------

Accessory:

<b>Single unit remote control</b>	60CNAS401	MFR LIST	<b>\$150.00</b>
-----------------------------------	-----------	----------	-----------------

### Gentner Audio Program Switchers

The 10A 10x1 stereo and 20A 20x1 mono audio switchers are compact and reliable. They have simple, easy to use front panels with a "deselect" control which disconnects the switcher from all sources for stacking and matrixing. Routing is accomplished with sealed, socket mounted magnetically latching relays driven by a programmable logic array. This makes the switcher insensitive to line voltage glitches or failures. Since the audio path is passive, there is no significant degradation of audio crossing the matrix. Audio and control connections are via standard 25 pair "D" connector.

<b>10A stereo</b>	60GE10A	MFR LIST	<b>\$1039.00</b>
<b>20A mono</b>	60GE20A	MFR LIST	<b>\$1039.00</b>



Accessories:

Multipair cables terminating in Flexblocks or punchblocks are available to simplify installation.

Call Bradley for a current price quotation.

### Logitek Pre-10 And Mon-10 Switchers

Here are two unique items everyone needs. The Pre-10 is a passive 10x2 routing switcher available in mono with XLR connectors or stereo with barrier strip terminations. The Mon-10 is a stereo 10x1 passive switcher with wire-capture terminal blocks and front panel switching to look at Left, Right, L+R, or L-R and feed the selected signal to the VU meter and internal monitor amp. Meter sensitivity may be selected over a 50dB range in 10dB steps. The monitor amp feeds the front panel speaker, a front panel headphone jack and rear panel speaker connections.

<b>Pre-10 mono</b>	60LTPRE10	MFR LIST	<b>\$495.00</b>
<b>Pre-10 stereo</b>	60LTPRE10S	MFR LIST	<b>\$540.00</b>
<b>Mon-10</b>	60LTMON10	MFR LIST	<b>\$845.00</b>

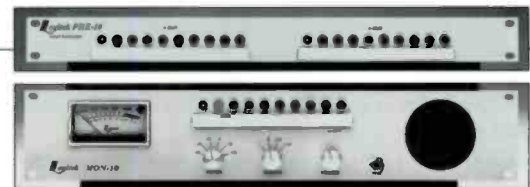

Also available:

<b>MON-S/2 single input meter with monitor speaker designed for mounting in Tektronix type half-racks.</b>	60LTMONS2	MFR LIST	<b>\$660.00</b>
--	-----------	----------	-----------------

Call Bradley for a current price quotation.



## Gentner Versapatch II Audio Patch Panels

Versapatch II provides the convenience of a high quality, chassis enclosed patch bay with rear panel punch down termination. Each unit has wide designation strips, a rear strain relief bar for cable tie down, and the enclosure provides protection against dust and RFI. Select from Flexiblock or "66" punchblock termination. The Flexiblock permits a high density of connections in a small space and allows the use of stranded wire. A half normalled (i.e. top-row-bridging) version is available. The punchblock version has tip, ring, sleeve, and normals brought out to the punchblock for each jack.

**Flexiblock termination normalled at bay** 60GEVPAB MFR LIST \$649.00  
**Flexiblock termination normals brought out** 60GEVPBO MFR LIST \$769.00

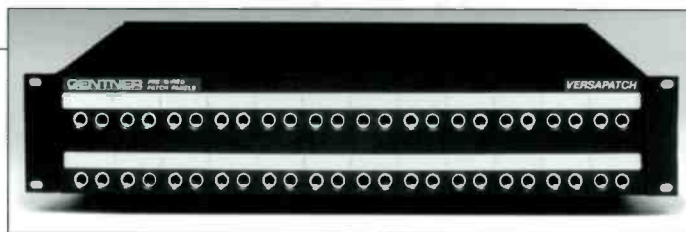

**Flexiblock top-row-bridging** 60GEVPTRB MFR LIST \$589.00  
**Punchblock termination normalled at bay** 60GEVP66 MFR LIST \$699.00  
 Call Bradley for a current price quotation.

## Gentner Pre-Wired Audio Patch Panels

There is no reason to spend your valuable time wiring patch panels. Gentner and Bradley can provide pre-wired patch panels in virtually any configuration at affordable prices. The examples below are our most frequently purchased models. Call your Bradley professional at 800-732-7665 for assistance in completing your installation on time and on budget.

**Model 48DR-TRS-AB-XX** has 48 quarter-inch tip-ring-sleeve jacks in two rows with stereo offset spacing, normalled at the bay, with your choice of Flexiblock, punchblock, or "Christmas Tree" termination. Price varies with termination selected and length of cable harness.

**Model 48DR-TRS-BO-XX** is similar to the above, except the normals are brought out to the termination.

**Model 48DR-TRS-TRB-XX** is similar to the above, except the top row of this normalled bay is bridged to permit monitoring from the bay.

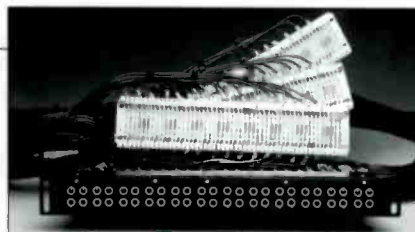

Other patch bays available include 52 quarter-inch jacks in two evenly spaced rows; 78 quarter-inch jacks in three evenly spaced rows; 96 bantam jacks in two offset rows; and single row bays of 24 or 26 quarter-inch jacks. Panels are also available unterminated, with barrier block termination, with EasyTerm or SuperPatch or with any other termination you provide. Cables are bundled to the left as viewed from the rear of the panel.

## Har-Ken Specialties Adapters

This unique series of products is designed to rescue you from that "little problem" that always pops up at the last minute.

### XLR Adapters

Surprise! You are on the air in five minutes, and you need to mate with an alien connector. Fortunately, you've got Har-Ken adapters in your kit so you'll meet the deadline with time for a cup of coffee. Specify male or female XLR connector.

### Adapter termination

		Price
Three terminal barrier strip	60HK104X	\$16.88
Miniature three terminal barrier strip	60HK118X	18.00
Triple binding posts, side mounted	60HK119X	24.75
Triple binding posts, rear mounted	60HK103X	24.75
Phono (RCA) jack (female)	60HK107X	15.75
Phono (RCA) plug (male)	60HK110X	15.75
Mini-plug (TS wired to pins 2 & 3)	60HK121X	15.75
Mini-jack (TS wired to pins 2 & 3)	60HK122X	15.75
Bantam patch field jack	60HK109	31.50
BNC (coax shield & XLR body isolated)	60HK106X	14.34
Modular 6 pin telco (RJ11C) plug (male)	60HK126X	18.25
Modular 6 pin telco (RJ11C) jack (female)	60HK116X	15.75
Telco handset jack-transmit (4 pin)	60HK117TX	15.75
Telco handset jack-receive (4 pin)	60HK117RX	15.75

### XLR Universal Two-Fer

Double barreled so that you will be able to connect any two cables regardless of the gender of their XLR connectors. 60HK115 \$39.94



### Inline Switchable Audio Pad with XLR connectors

Allows attenuation from 10dB to 40dB in 2dB steps.

<b>600/600 ohm pad</b>	60HK1126	\$61.59
<b>150/150 ohm pad</b>	60HK1121	\$61.59

### Phase Reversal & Ground Lifter

Puts both of these functions into a single, compact inline unit with XLR connectors. 60HK113 \$50.34

### Polarity Tester

Uses two bipolar LEDs to indicate the polarity of the DC voltage on pins 2 and 3 of an XLR connector with pin 1 common. 60HK125 \$32.00

### XLR Monitoring Device

Allows you to monitor moderate to high level audio. The TS mini-jack allows you to connect an ear piece or headphone. 60HK111 \$24.75





## Switchcraft Connectors And Adapters



### Connectors (Solder type)

Inline TS 1/4" phone M	61WSW280	\$1.58
Inline TRS 1/4" phone M	61WSW297	\$3.77
Inline 1/8" TS MINI M	61WSW780	\$3.20
Inline Phono (RCA) M	61WSW3502	\$1.05

### Adapters (User assembly required)

1/8" TS F to 1/4" TS M	61WSW364	\$5.60
XLR F to 1/4" TRS F	61WSW383A	\$13.20
XLR M to 1/4" TRS F	61WSW384A	\$12.10
XLR F to 1/4" TRS M	61WSW386A	\$12.75
XLR M to 1/4" TRS M	61WSW387A	\$11.50
XLR F to XLR F	61WSW389	\$11.80
XLR M to XLR M	61WSW390	\$9.85
XLR M to XLR F	61WSWS3FM	\$9.85

M=Male, F=Female

Also see our full selection of Har-Ken adapters in our Field Production Section.

## Whirlwind XLR Connectors



For inline applications, Whirlwind's "WT" series features one piece, die cast housings and 100% cable strain relief. Use with cable diameters from .11" to .31". Strain relief boots are black, with red, blue, and white available by special order. These may be the best XLR connectors available.

<b>Male inline XLR</b>	61WHW13MXX	ea: \$2.25
Box of 100		\$180.00
<b>Female inline XLR</b>	61WHW13FXX	ea: \$2.40
Box of 100		\$192.00

## Neutrik Connectors



Bradley stocks the popular "X" series Neutrik. These connectors have only 4 parts. They have no set screw and crimping is not required during assembly. One piece unbreakable die cast housing, bellows-style polyurethane flex relief and chuck-type, snap on cable clamp provide secure strain relief. The standard "C" series is available only as right angle connectors that swivel at 45° intervals when assembled for maximum packing density. Other "C" series models have been discontinued. Both XLR types are available in nickel shell with silver contacts and black chrome shell with gold contacts.

### 3 Pin XLR

Type	Shell	Part#	Price
Female Cable	Nickel	61NT3FX	\$2.62
Female Cable	Black	61NT3FXB	\$3.82
Female Panel	Nickel	61NT3FP	\$2.75
Female Right Angle	Nickel	61NT3FRC	\$7.05
Male Cable	Nickel	61NT3MX	\$2.46
Male Cable	Black	61NT3MXB	\$3.26
Male Panel	Nickel	61NT3MP	\$2.53
Male Right Angle	Nickel	61NT3MRC	\$6.78

### Other Neutrik Connectors

1/4" TS phone plug	61NTNP2C	\$2.57
1/4" TRS phone plug	61NTNP3C	\$3.75
1/4" TRS lockable chassis jack	61NTNJ3FP6C	\$5.25

## Whirlwind Wall Mounting Plates

These stainless steel plates are designed to fit standard single or double gang electrical junction boxes. Mounting screws included.

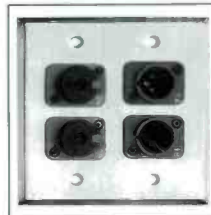

Plate	Connectors	Part #	Price
Single	One female XLR	61WHWP1FW	\$ 8.10
Single	One male XLR	61WHWP1MW	\$ 8.00
Single	One 1/4" TRS jack	61WHWP1QW	\$ 9.55
Single	Two female XLR's	61WHWP2FW	\$12.60
Single	Two male XLR's	61WHWP2MW	\$12.35
Single	Two 1/4" TRS jacks	61WHWP2QW	\$15.45
Double	Four female XLR's	61WHWP4FW	\$24.00
Double	Four male XLR's	61WHWP4MW	\$23.00
Double	Four 1/4" TRS jacks	61WHWP4QW	\$29.00

## Wire and Cables

Bradley Broadcast can provide a complete selection of wire for your station or studio. We offer low prices and prompt delivery on custom connectorization of multiple pair cable. We've listed our best sellers below.

**West Penn 291** Two conductor shielded cable with drain wire and foil shield. Signal conductors are 22 gauge stranded, and the drain conductor is 24 gauge stranded. Perfect for audio connections. Grey comes in 1000' lengths in the convenient to dispense EZ box. 1000' spools are available in black, blue, red, white, yellow, brown, green, violet, and orange.

60WP291XX \$85.00

**West Penn 510** Two pair individually foil shielded cable with common drain wire and overall shield. Saves time when wiring stereo signals. 1000' reels.

60WP510 \$162.00

### Whirlwind Multipair Cable

Each pair of this heavy duty cable is individually twisted and shielded and has its own drain wire. Sold in multiples of 50'. Price is for a 50' length.

6 pair	61WHW06PR	\$46.50
9 pair	61WHW09PR	\$64.00
12 pair	61WHW12PR	\$76.50
16 pair	61WHW16PR	\$99.00
20 pair	61WHW20PR	\$124.00
32 pair	61WHW32PR	\$195.00

### Assembled Speaker Cables

50 feet of 16 gauge speaker wire with chrome plated plugs.

42ME500 \$15.95

### Bulk Speaker Cable

Our heavy duty speaker cable has a black, polypropylene jacket. Minimum order is 50 feet.

14 ga, 2 conductor	61WHW14GA	36¢ per foot
12 ga, 2 conductor	61WHW12GA	55¢ per foot

### Shrink Sleeving

Shrunken size is approximately half of original diameter. Available in black, red, blue, white, and clear. Minimum order is 50' of any one length and color. Other sizes available.

3/16" diameter, 1' long	61WHPT316	31¢
3/8" diameter, 1' long	61WHPT38	41¢

## Cord-Lox Coil 'n Carry

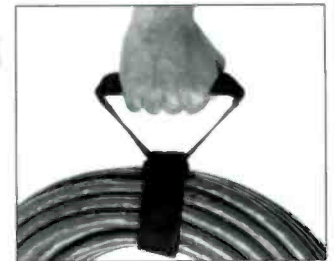

This ingenious little device really helps out in organizing and transporting your large spools of cable. Webbing is wrapped around a doweled handle and attached to a wide Cord-Lox strap. Very handy.

Coil 'n Carry 61CL419WHP \$12.60



## Tascam Eight Channel Snakes



Why drive yourself crazy wiring your multi-track to your console? Tascam has done the work for you, and Bradley delivers these snakes quickly and at low prices. Eight circuits per snake.

Connectors	Length	Part #	Price
Male phono to male phono	5'	61TETC805R	\$33.00
Male phono to male phono	10'	61TETC810R	48.00
Male phono to male phono	20'	61TETC820R	67.00
Male 1/4" TS to male 1/4" TS	5'	61TETC805PP	41.00
Male 1/4" TS to male 1/4" TS	10'	61TETC810PP	56.00
Male 1/4" TS to male phono	5'	61TETC805RP	38.00
Male 1/4" TS to male phono	10'	61TETC810RP	52.00
Male XLR to female XLR	10'	61TETC810X	135.00
Male phono to female XLR	10'	61TETC810XR	104.00
Male phono to male XLR	10'	61TETC810XMR	99.00

### Also available:

Whirlwind fully professional multitrack wiring systems. Examples are described in our sound reinforcement section (page 116). Call or fax for complete details on the custom snake you need.

## Bradley Assembled Mic Cables



You need them, and Bradley's got them. Our own high quality mic cables, using Neutrik XLR connectors, come in 25' and 50' lengths.

25' cable	61WHMKS20	\$14.50
50' cable	61WHMKS50	\$22.00

### Bradley Bulk Mic Cable

Our low impedance mic cable is rugged and reliable. Get as much as you want or as little as you need.

60AT8300 34¢ per foot

## Gotham CT-1 Cable Ties



Reusable plastic tie great for keeping cables neatly hanked. Cables can also be hung. Packaged in a bag of 100.

61NECT1 \$38.00

## Tascam Cables



### Pro Series Single Cables

With male phono (RCA) connectors.

Length	Part #	Price
5'	61TETC105	\$5.85
10'	61TETC110	7.65
20'	61TETC120	12.40

### Pro Series Dual Cables

With male phono (RCA) connectors.

Length	Part #	Price
5'	61TETC205	\$9.90
10'	61TETC210	16.20
20'	61TETC220	27.00

### Standard Series Cable Kits

Eight, single cables with phono connectors.

Length	Part #	Price
6"	61TETC70058	\$12.60
18"	61TETC70158	16.20
3'	61TETC7038	17.35
5'	61TETC7058	24.00
10'	61TETC7108	35.00

### Tascam Insert Cables

One 1/4" TRS to two male phono connectors.

Length	Part #	Price
6.5'	61TEPW2Y	\$13.50
13'	61TEPW4Y	18.00

## Bradley Cord-Lox Easy to Use ... Hard to Lose

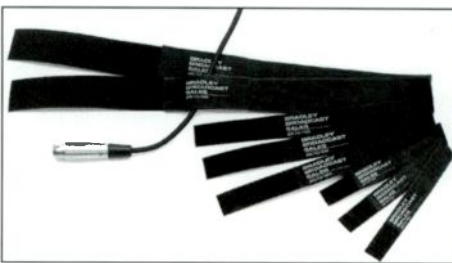

Two sizes delivered from stock. Black only.

3/4"x5" With cable holder closed at both sides. For most shorter cables.	60CL205C	\$1.20
1"x7" With cable holder closed at both sides. For medium cables.	60CL307C	\$1.29

Custom imprinting and colors are available. Call your Bradley professional for details.

## Canare Star Quad Mic Cable

What is Star Quad? It isn't simply a marketing gimmick. Rather, it is a cable design that has resulted from research into how interference signals are introduced into balanced mic and line level transmission cables. The Star Quad innovation is the introduction of an additional signal carrying pair which is tightly interwoven with the first. The result is much greater magnetic interference rejection.

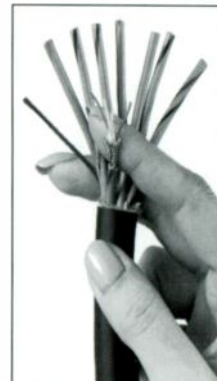

### Bulk Star Quad

per foot	60CAL4E6BK	40¢
500' reel	60CAL4E605XX	\$209.00
1000' reel	60CAL4E610XX	\$395.00

Black is the only color offered by the foot. Reels are available from stock in black, or in blue, brown, grey, green, orange, purple, red, white, and yellow by special order. Call for pricing on multipair cable with 2, 4, 8, 12, 16, and 24 pairs.

### Canare Star Quad Assembled Mic Cables

5 feet	60CAEC005FBXX	\$19.50
15 feet	60CAEC015FBXX	\$24.00
25 feet	60CAEC025FBXX	\$28.50
50 feet	60CAEC050FBXX	\$39.00

Cables are made with Neutrik XLR connectors. Black is available from stock. Other colors are special order and are priced the same. Cable may be special ordered in any length. All special order cables have a minimum order of 10 cables in any mix of colors and lengths.

## Handy Bundler

Now your installation projects are easier, and your facility neater, thanks to the



Handy Bundler. The Handy Bundler continuously feeds white or black strapping that is easily fed and cut to the exact size you need. Clips that fasten the ends of the strap are automatically fed. Each Handy Bundler comes with 65' of strap and 200 clips. Stop stocking lots of different size wire ties when one handy Bundler will do the whole job.

Specify black or white strap and clips when ordering

Handy Bundler	60RX4520X	\$49.95
65" replacement strap	60RX4520X	\$14.25
200 replacement clips	60RX4520X	\$9.10

## Audio Control Industrial SA3050A Real Time Analyzer

Until the Audio Control Industrial SA3050A real time spectrum analyzer came along you had to pay a ransom for a serious measurement grade RTA. In sound reinforcement applications, the SA3050A is used to acoustically test and adjust overall frequency response by using the supplied calibrated microphone and built-in pink noise generator. It can just as easily and accurately test frequency response of an electrical audio source like a tape recorder, telco program circuit, mixing console, or any other device via its balanced, bridging, wide input range line input. For critical, intra-circuit measurements there is a 1 megohm BNC input, also with a wide input level range.

The LED display simultaneously shows the amplitude of each of the 30 ISO third octave frequencies between 20Hz and 20kHz. Three response times allow analysis of transient, average, or integrated response. Results of acoustical or electrical response tests using the digital pink noise generator, whose response is flat to within 0.25dB, can be viewed instantly on this simultaneous 30 band display. An individual response curve can be frozen on the display, and the SA3050A can store up to six different frequency response curves in its internal memory.

An internal back-up battery maintains the contents of the memory for up to one year, even with the AC power disconnected. Acoustical noise spectral distribution and absolute sound pressure level measurements are also in a day's work for the SA3050A. No station, studio, sound reinforcement company, chief, or consulting engineer should be without the SA3050A real time analyzer, especially at this price. Available as a basic unit or loaded with both an internal, rechargeable battery with 5 hour life and a parallel printer interface for use with your printer.



<b>Basic unit</b>	60AOSA3050A	MFR LIST	\$995.00
<b>Deluxe unit with rechargeable battery and printer interface</b> (Printer not included.)	60AOSA3050AX	MFR LIST	\$1300.00
<b>Accessories:</b>			
<b>RM-10</b> rack mount adapter requires 3 rack spaces (5.25").	60AORM10	MFR LIST	\$55.00
<b>SC-10</b> soft carrying case with pocket for mic and cables.	60AOSC10	MFR LIST	\$59.00
<b>AC-10</b> in line filter for "A" weighted measurements.	60AOAC10	MFR LIST	\$44.00

Call Bradley for a current price quotation.

## ATI NG-1 Audible Noise Generator

No, this is not your nine year old nephew. It is a useful tool for broadband level matching of multiple microphones and measuring room response. Both pink and white noise are generated, with a smooth five octave (300Hz to 10kHz) output from the internal speaker and a full ten octave (20Hz to 20kHz) output from a line level phone jack. A switchable pulse generator can be used to interrupt the noise output every four seconds. The NG-1 is powered by an internal nine volt battery or AC power. A handy mounting bracket is provided for using the NG-1 in fixed installations for noise masking.

NG-1                      60AING1                      MFR LIST                      \$199.00



Call Bradley for a current price quotation.

## Fostex TT-15 Tone Generator

This is the hottest! Not much larger than a cigarette pack, the TT-15 oscillator is housed in a rugged metal casing. It includes push button selection of tones at 40Hz, 400Hz, 1kHz, 10kHz, and 15kHz, with distortion typically less than 0.02%. A 3 position attenuator provides output levels of 0dBV, -10dBV, and -30dBV with insignificant level shift when changing from a bridging load to a 150 ohm load. An internal 9V battery provides very reliable operation. A "must" for field and bench.

TT-15                      60FOTT15                      \$49.95



## Whirlwind Cable Tester

With no buttons to push (except for a power-on switch) the Cable Tester provides a fast and easy way to determine the condition of your cables. In a convenient pocket sized package, the Cable Tester accepts all of the standard audio connectors and, through the intelligent use of LED's, gives you straight ahead information about the condition and phasing of your cables.

Cable Tester                      61WHTR                      \$53.00



### Gentner Digital Hybrid II

The Digital Hybrid II provides both improved caller and announcer audio, plus a full set of features which make studio connections simple and recording and on-air use a snap. Its all new hybrid provides excellent audio quality, employing a Motorola 16 bit DSP chip with 2 times oversampling. The Digital Hybrid II control circuitry provides a record button which, when depressed, activates a tape machine when the unit is toggled "on," and delivers a stop command when switched "off." The "cue" button, which can be remoted, selects the main or cue send audio to be applied to the hybrid input. Thus, when the cue input is connected to the announcer's mic preamp, ahead of program switching, the DH-2 can be used as a hands-free speaker phone. By remoting the cue feature to the announce mic on/off switch, operation becomes fully automatic.

Both momentary and maintained closures are provided to readily interface to any recorder. Two outputs are provided: caller-only and caller/send mix. Dip switch selectable features include auto answer/disconnect, and automatic re-null which allows the DH-2 to be connected to a multi-line phone instrument and used as an on-air selection device. When no phone line is present, the DH-2 automatically mutes.



**Digital Hybrid II** 60GEDH2 MFR LIST \$1889.00

**Also available:**

**SPH-5** is an analog version of the Digital Hybrid II. A new dual transformer hybrid system achieves consistent send-to-caller rejection. The SPH-5 provides all of the features of the DH-2.

**SPH-5** 60GESPH5 MFR LIST \$889.00

*Call Bradley for a current price quotation.*

### Gentner SPH-3A Telephone Hybrid

The SPH-3A is a basic, yet complete, hybrid telephone interface system which is ideal for newsrooms, production studios, or on-air telephone interviews. Its unique analog hybrid circuit is fairly insensitive to telco line impedance problems and typically provides a null on the order of 15 to 20dB. Main audio connections are XLR line level, with a standard RJ-11C jack for telco. Relative caller level, and the internal 2 watt studio monitor amp are controlled on the front panel. "Set-and-forget" trimmers are provided for telco send level and hybrid balance. The



SPH-3A can seize the line and close your phone system A-lead via the front panel toggle switch or the remote control jack.

**SPH-3A** 60GESPH3A MFR LIST \$579.00

*Call Bradley for a current price quotation.*

### Gentner TC-100 Automatic Telephone Interface

In addition to functioning as a phone coupler and basic telephone hybrid, the TC-100 can automatically answer a line after a selectable ring count, and automatically disconnect upon standard line reversal signaling from the central office. Logic outputs are available for ring detect and off-hook conditions, and form-C relay contacts (momentary or continuous) actuate upon connection to the line. The coupler can also be manually placed on line with either a front panel switch or a remote contact closure. The built-in DTMF decoder card provides 100mA open collector outputs for all standard touch tones, including the extended tones



A, B, C, D. Additionally, the DTMF card can recognize dial-tone and disconnect if desired. The possibilities are limited only by your imagination.

**TC-100** 60GETC100RTT MFR LIST \$569.00

*Call Bradley for a current price quotation.*

### Telos Call Screen Manager

One of the secrets to a successful talk show is the communication link between your talent and the caller/director. Call Screen Manager is a field proven software package to enhance the performance of your Telos talk show system.

Using an economical IBM compatible PC and peripherals, the director can provide the talent with information on each caller as well as special messages. Line status is updated in real-time to indicate callers who are on the air, part of a conference, and on hold. Each line has a call timer and programmable duration alarm. Special remote software is available for communicating with your talent via telephone modem. This enables your talent to be conduct his/her program from virtually anywhere.

If you are presently using a Telos Direct Interface or Key System Interface, Call Screen Manager is an economical upgrade. If you are using another system, Call Screen Manager is another reason why you should contact Bradley for details on

the Telos configuration that is ideal for your program.

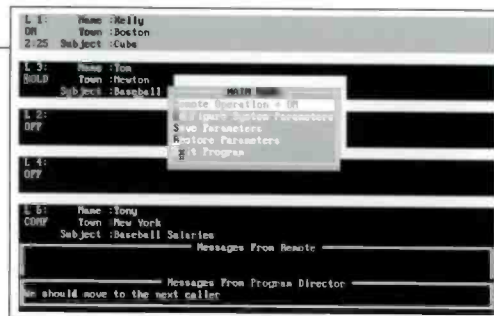

**Host Software** 60PCPMH \$349.00  
**Host and Remote Software** 60PCPMHR \$449.00



## Telos Digital Telephone Hybrid Systems



### Telos 100 Delta Digital Hybrid

The Telos 100 Delta raises the standard by which telephone hybrids are judged. Due to its extraordinary trans-hybrid loss and sophisticated processing, the Telos 100 Delta will perform well on even the toughest phone lines.

The digital signal processing of the 100 Delta is so advanced that it incorporates a dynamic digital equalizer, a feature not found on any other broadcast product. The processor examines the caller audio in three frequency bands within the context of the overall signal. As required, the high and low bands are automatically equalized with reference to the mid band for improved caller intelligibility. The 100 Delta also boasts logarithmic (dB) dynamics control and context sensitive AGC. These digital processes combine with the dynamic digital EQ to offer increased caller intelligibility and perfectly matched levels.



The 100 Delta includes two mixed inputs (one line level and one mic/line) and two outputs (one with caller audio and the other with a continuously adjustable mix of caller and mix-minus). This configuration simplifies creation of external mix-minuses. DUPLEX DEPTH can be adjusted for full-duplex, half-duplex, or any point in between. Two DEPTH settings can be stored and remotely selected. This allows remote switching from a setup requiring more depth for maximum feedback suppression to one where feedback is not a concern and maximum duplex conversation is desired.

**100 Delta** 60TS100D **\$2450.00**



### Telos Direct Interface Module/Telos 1A2 Interface Module Multi-Line, Multi-Caller Talk Systems

Telos offers two options for selection and control of multiple telephone lines in broadcast systems. The Direct Interface allows direct connection of up to 10 phone lines. It functions as a full broadcast phone system including program on hold and caller conferencing.

The 1A2 Interface Module makes use of standard 1A2 key telephone equipment. Each handles 10 phone lines and units can be coupled to handle up to 30 lines. Recent software upgrades to both Interface Modules are available to current owners at no charge and add several new functions such as AUTO-ANSWER, which automatically answers incoming calls and places them on hold.

The desktop Switch Console has been upgraded to include more extensive line control, remote tape machine start/stop, and a BUSY-ALL mode that is great for clearing all lines before a contest. Other control options include drop-in modules for BE, PR&E, and other popular radio consoles. Caller screening is accomplished with phones or Telos' Call Screen Manager computerized software.

**Telos Direct Interface Module** 60TS100DI **\$1860.00**  
**Telos 1A2 Interface Module** 60TS1001A2 **\$1050.00**  
**Telos Switch Console** 60TS100SC **\$650.00**



### Telos ONE/Telos ONE plus ONE Digital Telephone Hybrids

The Telos ONE is the perfect solution for any telephone interface application. The Telos ONE automatically adapts to each call and all processing is in the digital domain. Performance features include sophisticated AGC on input and output, an advanced downward expander on the caller audio, and digital processing to dramatically reduce the chances for feedback when monitoring with open speakers.



The input of the Telos ONE is switchable for mic or line level and two outputs are provided. The Telos ONE is available in both rack mounting and modem case versions. Modem case models may be rack mounted in optional single or dual unit accessory panels.

The ONE plus ONE starts with two Telos ONE digital hybrids in a single rack unit chassis. Each hybrid functions completely independently. A unique internal mix-minus matrix cross couples the outputs of the two hybrids. In a dual hybrid application, you need to send the ONE plus ONE only a single mix-minus. All of the Telos ONE features are included.

**Telos ONE rack mount version** 60TS1R **\$1050.00**  
**Telos ONE modem case version** 60TS1 **\$890.00**  
**Telos ONE plus ONE** 60TS11 **\$2180.00**

### Telos Auto-Answer/Telos Super Auto-Answer Hybrid Accessories

The Auto-Answer board has simple line SEIZE and DROP. The Super Auto-Answer features remote control of line SEIZE and DROP, selectable number of rings before answering, dial tone detector for failsafe line drop, DTMF decoder with open collector outputs, and other features. A special Super Auto-Answer version allows users of 1A2 Key Systems to select phone lines using a standard multi-button desk set.

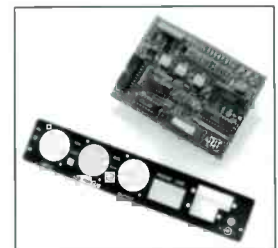

*Either accessory can be used with the Telos 100 Delta, ONE, and ONE plus ONE. The same part fits all units.*

**Telos Auto-Answer** 60TSAA **\$50.00**  
**Telos Super Auto-Answer** 60TSSAA **\$150.00**



## Gentner Digital Hybrid 1

The Digital Hybrid 1 brings Gentner's superior telephone Interface performance to applications where cost is as significant as audio quality. The DH1 incorporates the same digital signal processing technology used in the digital hybrid II for consistent and superior telephone audio. The DH1 include 16 bit processing with 2X oversampling, 10kHz sampling rate, automatic and continuous nulling, adjustable caller control (ducking), internal test tone generators, remote control capability, and 1-RU rack mount enclosure. Benefits you may expect from the DH1 include superb sound quality, reduced noise and distortion, excellent separation between send and receive audio, complete talent control over conversations, and easy



installation and operation. The DH1 is intended for use with a single telephone line, but can be used with up to five lines by adding Gentner's Teleswitch. Contact your Bradley telephone specialist for configuration assistance.

**DH1** 60GEDH1 MFR LIST \$1049.00  
 Call Bradley for a current price quotation.

## Gentner TeleSwitch Call Director

Finally ... a simple telephone call director at an affordable price. Gentner's TeleSwitch is the logical solution to your basic telephone line selection needs. Up to five lines can be connected, placed on hold, and routed to your telephone hybrid. TeleSwitch operation is similar to a multi-line phone, so no training time is required. Connections are made with standard RJ-11C modular jacks. Connection to all popular hybrids is easy. Other features include a conferencing mode, a hold audio input, and a telephone set connection. TeleSwitch is compatible with almost any phone system. This one box solution will help you get more out of your call-in program segments.

**TeleSwitch** 60GETS MFR LIST \$1049.00

Call Bradley for a current price quotation.



**Accessory:**  
 Pre-wired cable to connect TeleSwitch to hybrid. Specify model of hybrid being used.

61GE830002XXX MFR LIST \$26.20

## Gentner Peoplelink II

PeopleLink is a complete, fully personalized telephone system which allows all of your telephone interface requirements to be met in one package. Using PeopleLink and your existing phone lines, you can completely automate your station's telephone operations, with the ability to conference multiple callers, air call-in talk shows, run caller contests, conduct opinion polls, and screen callers.

PeopleLink gives you the ability to custom program unique applications. Up to 40 telephone lines can be quickly programmed for up to six control surfaces, which can then be used either simultaneously or independently in any combination. Even the most complex AM-FM-TV combination can easily be handled by PeopleLink. Many other features are available for the PeopleLink, including easy interfacing to existing audio equipment, ability to accept up to four different hold audio sources, frequency extension capability, built in contest computer, automated call answering and more. Increase your telephone productivity by calling

your Bradley telephone specialist today for a copy of Gentner's PeopleLink configuration worksheet.



Call Bradley for a current price quotation.

## Henry Telecart II

The Telecart II will work with virtually any cart machine, as no auxiliary tones or relays are needed. All cart machine connections are opto and relay isolated. Failsafe design prevents the line from being answered unless the cart is cued and ready to play. Also, if a caller hangs up before the entire message has played, the Telecart II will hold the line "busy" until the cart has re-cued. Then the line is released and a new call may be received. The audio circuit is transformer coupled to the phone line for isolation and protection. A-lead control is provided for use with key systems. A digital call counter registers up to 9,999 calls. Built-in power supply.



**Telecart II** 60HETC MFR LIST \$225.00

Call Bradley for a current price quotation.

## Henry Engineering MixMinus Plus

The MixMinus Plus is designed to add a "mix-minus" output to a broadcast console suitable for feeding to the send input of a telephone hybrid. One input of this unit is fed with the console output, the other takes hybrid receive audio. These two signals are subtracted using phase reversal to create a program mix, minus the receive audio. Initial null adjustment will provide 40dB rejection of the receive audio signal. The unique MixMinus Plus can expand the capabilities of your present console and make hybrid installation a breeze.



**Mix Minus Plus** 60HEMPP MFR LIST \$195.00

Call Bradley for a current price quotation.

## Eventide BD941/BD942 Broadcast Delays

Even stations with only occasional live talk show programming can afford a reliable Eventide obscenity delay. The mono BD941 and stereo BD942 are full 20kHz bandwidth. When a "no-no" is uttered, simply hit the Delete button on the front panel or via a remote closure. This control both bypasses the delay line and closes a relay contact to start your filler material. The mono delays are available in 6 and 12 second versions, and the stereo units offer 3 or 6 seconds. These units have balanced inputs and outputs, and specifications that don't compromise audio quality. Now you can relax knowing that #\*\*!!! will never be heard on your station.



<b>Mono, 6 sec delay</b>	60EVBD9416	MFR LIST	<b>\$1795.00</b>
<b>Mono, 12 sec delay</b>	60EVBD94112	MFR LIST	<b>\$2195.00</b>
<b>Stereo, 3 sec delay</b>	60EVBD9423	MFR LIST	<b>\$1995.00</b>
<b>Stereo, 6 sec delay</b>	60EVBD9426	MFR LIST	<b>\$2395.00</b>

Call Bradley for a current price quotation.

## Eventide BD980 Broadcast Delay

This two channel stereo delay provides 20kHz bandwidth and 90dB of dynamic range with less than 0.02% distortion at 1kHz. Advanced catch up circuitry in the BD980 solves the problem of getting back into delay after a segment is dumped. One push of the DUMP button prevents the undesirable utterance from reaching the air, and the BD980 rapidly rebuilds delay so cleanly it is virtually undetectable. Ingenious delay entry/exit modes require only the push of a button to move from real time to delay, or vice versa. Delay is adjustable up to 10 seconds,

and the BD980 has convenient remote facilities.



<b>BD980</b>	60EV980	MFR LIST	<b>\$5495.00</b>
--------------	---------	----------	------------------

Call Bradley for a current price quotation.

## Gentner Hybrid Coupler and Auto Coupler

### Gentner Hybrid Coupler

This compact unit provides an easy and inexpensive way to get audio on and off a phone line. The Hybrid Coupler connects directly to a phone line via a modular jack, and provides a loop-through to a telephone set. A three position front panel switch allows the Hybrid Coupler to seize the line, simply tap the circuit or be turned off. Its hybrid coil provides approximately 10dB of separation between send and receive audio, adjustable with a front panel trimmer. The coupler is a passive device requiring no external power.

<b>Hybrid Coupler</b>	60GEHC	MFR LIST	<b>\$179.00</b>
-----------------------	--------	----------	-----------------

### Gentner Auto Coupler

These units are auto-answer, auto-disconnect units allowing for simultaneous send and receive audio transmission upon connection. Balanced 600 ohm connections are provided for both send and receive audio, and a null trimmer pot maxi-

mizes isolation. Upon loop drop, this version hangs up the phone line. A special "CP" version is used on phone lines where the telephone company does not provide the loop drop signal. The call progress decoder disconnects on dial tone, busy signal, recorder signal, or ringback. Units operate on 117VAC from a provided external power supply.

<b>Auto Coupler</b>	60GEAC	MFR LIST	<b>\$319.00</b>
<b>Auto Coupler CP</b>	60GEACCP	MFR LIST	<b>\$319.00</b>

Call Bradley for a current price quotation.

## Comrex Telephone Couplers

These couplers provide clean, transparent transformer connections from telephone lines to external audio equipment. Designed for send-only or receive-only applications, they have modular telephone jacks for the phone line and for a telephone set.

The TCB-1A Manual Coupler provides a switched hold connection. Audio in/out is by a single 1/4 TRS connector and the unit does not require powering. The TCB-2A Auto-Answer Coupler automatically answers the telephone line on the first ring and disconnects that line when the calling party hangs up. For central offices that do not provide loop drop, an optional dial tone detect board is offered. External power supply is required.

<b>TCB-1A Manual Coupler</b>	60CCTCB1	MFR LIST	<b>\$150.00</b>
<b>TCB-2A Auto-Answer Coupler</b>	60CCTCB2	MFR LIST	<b>\$295.00</b>



### Accessories:

<b>Dial tone detector</b> for TCB-2A	60CCDTD	MFR LIST	<b>\$125.00</b>
<b>AC power supply</b> for TCB-2A. Powers four couplers.	60CCACP2	MFR LIST	<b>\$25.00</b>

Call Bradley for a current price quotation.



### Excalibur HC-1 Handi-Coupler

The HC-1 Handi-Coupler gives you the simplest, quickest, most convenient way to connect audio to a telephone. The HC-1 connects in series with the handset of any telephone using modular connectors. Since a connection to the telephone line is not required, the HC-1 can be used with almost any telephone, single or multi-line, modern electronic or older key systems. Pressing the front panel button disconnects the handset and connects the external audio in/out jacks to the telephone. Releasing the button reconnects the handset, allowing normal use of the phone. External audio is connected via separate in and out jacks. Both inputs and outputs are TRS jacks wired so that you may connect either balanced or unbalanced connectors into them.

The Handi-Coupler is ideal for use in many locations around the station: on-air, production, the newsroom, the sales office, field reporters' kits, sports remotes, etc. Its low price lets you put an HC-1 everywhere one is needed.

**HC-1**                      60EXHC1                      \$99.00

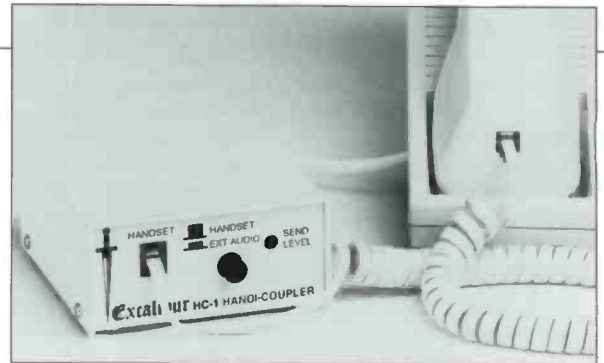

### The Telos Link

When you are doing remote location production, wouldn't it be great if you could use a dial-up telephone line to connect intercom systems at each end? The entire crew could then communicate as smoothly and effortlessly as if they were together in the studio. Impossible, you say? Perhaps you've tried jury-rigging with multiple boxes and found the results disappointing with complaints of poor level and feedback.

Presenting the Link. The Link is specifically designed to solve the problems of connecting intercom systems to dial-up telephone lines. It uses the same Telos adaptive digital hybrid technology that is used to improve talk shows and teleconferencing in hundreds of installations throughout the world.

The Link allows natural, full-duplex communication without level or feedback problems. Digital, auto-nulling hybrids are on both the telco and communications paths, so neither party misses a single syllable the other is saying. A powerful digital processor is used to perform all audio processing functions, including automatic gain control, smart gain switching to enhance hybrid performance, high pass filtering to reduce hum and interference, pitch shifting for feedback reduction, and call signal generation. The result of this high technology is significantly improved communication capability.

Installation and operation are simple. The Link features a built-in interface for RTS, ClearCom, and other intercom systems. Once installed, you never have to think about it again. Other features include a "wet" single channel operation option to provide power to belt packs and metering for both intercom and telco levels. A very useful feature is the built-in auto-answer function. With it, field personnel can simply call in to be connected without operator intervention. Whether at Yankee Stadium, the Kremlin, or from a cellular phone anywhere in the world, your crew is instantly connected with the Link. Rack mounting kits are available.

**The Link**                      60TS1L                      \$1680.00



**Also Available:**  
**Telos ONE Intercom Versions**

Two firmware versions of the Telos ONE have been created especially for intercom applications. Version 4.0 is widely used with RTS, McCurdy, ClearCom, and other four-wire intercom systems to interface with dial-up phone lines. It is often used with the Super Auto-Answer Board for DTMF control of intercom functions.

Firmware version 6.0, which also incorporates a minor hardware modification, is used to interconnect RTS, ClearCom and other two-wire intercom systems with four-wire intercom systems. All users benefit from the full-duplex communication path between the systems.

Single and dual rack mount kits are optionally available.

**Telos ONE Intercom**                      \$890.00  
**Telos Super Auto-Answer**                      60TSSAA                      \$150.00

### Communications Headsets

Whatever your communications needs, Bradley can provide you with the headset and headphone products you need. Beyer, Telex, RTS, and other manufacturers offer a wide variety of headset models, and Telex "earbuds" are available for IFB. Of course we also provide replacement parts, cables, and connectors to keep your current units in working condition.





## Motorola Spirit Two-Way Radios

Motorola Spirit Pro Series two-way radios provide reliable, clear performance for up to 2 miles. Better communications can help make your time more productive on remotes, during stage set-ups, and any time your crews need to keep in touch.

Three models and a variety of accessories help you tailor a system to your needs. The basic Spirit I uses a rechargeable Ni-Cad battery and operates on the VHF band using open squelch. The Spirit II, available as a VHF or UHF unit, offers coded squelch and a desktop charger that permits whole-unit or battery-only charging. The deluxe Spirit III adds two channel operation to the features of the Spirit II.

Since Spirit radios start at less than \$225, you can't afford to be without them! Contact your Bradley professional for more details on Spirit radios and for licensing and frequency information.



## RTS Series 2100 Wireless Intercom

The RTS Series 2100 is designed to provide clear, clean communications without wires. It is a complete wireless system that operates in the 150 to 216MHz band, protected from external radio and electrical interference. Four belt pack transceivers can operate with the Model 2105 base station, and when two base stations are chained together, up to eight headset stations can be tied into a full duplex communication network. The rugged and lightweight Model 2110 belt packs offer up to 24 hour operation on a single battery and numerous operator convenience features. Two belt pack transceivers form a simple, two person link, and the Series 2100 is easily used as an extension to your hard wired intercom for unlimited possibilities.

<b>2105</b> base station	60RT2105	MFR LIST	\$1625.00
<b>2110</b> transceiver	60RT2110	MFR LIST	\$550.00

**Also available:**

**Series 2200** wireless cue system improves delivery of cues to your talent. Multiple receivers at multiple VHF (72 to 76MHz) frequencies are possible.



## RTS TW Intercom Systems

The right intercommunication system can make the difference for a successful production. RTS intercoms prove themselves every day in teleproduction, broadcast, and commercial and industrial applications. RTS two wire systems have over 25 available components allowing the broadest variety of configurations. Utilizing a unique design, users are able to conduct two channels of conversation through standard two-conductor cable.

The modular packaging of the MCE325 four channel, user programmable intercom station allows it to be used in any of five arrangements: rack mount or portable headset station, rack mount or portable speaker station (with inclusion of the MCS325 Modular Speaker), or console mount headset station. Programming functions allow use in conference-line or dedicated line environments, in two-wire or 4-wire mode, or in a combination of both.

The fourth generation BP325 Portable Headset Station boasts enhanced analog performance and powerful microprocessor control of its digital functions. User oriented features include a microphone limiter, three headphone amps, silent channel selection switching, and simplified controls. The BP325 is the one portable headset station for all of your applications because it includes call-signal indication, can accommodate nearly any headset, and has channel programming to suit the needs of every production.



Also available from RTS are the Series 800 microprocessor-assisted, programmable master stations, Series 4000 IFB system, and several other models. Whatever your intercommunication requirements, let Bradley specify an RTS system that will meet your technical requirements and your budget.



### Technics SL-1200MKII

This turntable is a standard in broadcast and disco use. Its features include quartz lock, slide fader pitch adjustment of  $\pm 8\%$ , acoustic isolation, 0.7 second startup time, stylus illuminator, and speed strobe indicator. The SL-1200MKII is a complete system that includes tonearm, base, and dust cover. The direct drive mechanism provides the lowest noise and rumble obtainable in this price range. (Requires a user-supplied cartridge and preamp)

**SL-1200MKII** 60TC1200 MFR LIST \$550.00

Call Bradley for a current price quotation.



### Phono Preamplifiers

#### ATI P-100S Encore Preamp

Our Best Seller! This phono preamplifier provides the excellent performance for which ATI is known in an economical, no-frills enclosure.

**P-100S** 60AIP100S MFR LIST \$299.00

#### Logitek BPA-200 Preamp

The accuracy of this passive EQ preamp makes it the right choice for highest quality disc-to-cart transfers and on-air use.

**BFA-200** 60LTBPA200 MFR LIST \$399.00

#### Stanton 310B Phono Preamp

A high quality, low noise phono preamp, the 310B has switch selectable NAB/flat response curves and rumble filter.

**310B** 60ST310 MFR LIST \$295.00

#### ATI P-1000 Microamp Preamps

The P-1000 can make an audible difference in your audio chain, thanks to precise equalization, high slew rate, and low distortion and noise.

**Transformer outputs** 60AIP10001 MFR LIST \$399.00

**Balanced differential outputs** 60AIP10002 MFR LIST \$379.00

Call Bradley for a current price quotation.



#### Radio Systems PA-1 Phono Preamp

(not pictured) Time and time again the PA-1 has performed flawlessly in intense RF environments where many other phono preamps simply will not work. High speed circuitry, with response up to the MHz range, ensures the unit's capability to reproduce even the fastest music peaks. A combination of discrete and integrated circuit components in the input stage yield incredibly low noise specs. Second stage equalization buffers the cartridge for loading changes and provides broadband high input overload protection. Slew induced distortion, transient intermodulation, and input clipping are virtually non-existent. Inputs are on phono jacks; outputs are barrier strips.

**PA-1** 60RSPA1 MFR LIST \$325.00

Call Bradley for a current price quotation.

### Henry Universal Turntable Controller

The Universal Turntable Controller allows two button remote start/stop and status indication to be accomplished with Technics turntables. This unit will stay in "sync" if the turntable's switch is used for cueing. Each unit handles two turntables and may be controlled by either momentary switches or CMOS circuitry.

**Universal Turntable Controller** 60HETTC MFR LIST \$195.00

Call Bradley for a current price quotation.



### Discwasher Record Care Products

#### D4 Record Cleaning System

The exclusive slanted fibers and absorbency of the Discwasher pad work together with the D4 Fluid to lift off microdust, fingerprints and smoke particles. D4 cleans without building up residue on the record surface.

61DID4S \$17.99

#### SC-2 Stylus Care System

The SC-2 includes a precision nylon brush and a stylus-safe cleaning liquid.

61DISC2 \$7.25

#### Discwasher Refills

**D4 fluid** sixteen ounce bottle. 61DID4R16 \$14.00

**SC-2 fluid** 3.5 ounce bottle. 61DISC2R \$1.95



## Bradley DJ Packages

### Analog DJ Package

Bradley has put it all together to offer you three professional portable DJ packages. They include a pair of Technics SL-1200 MKII turntables with Stanton 680EL cartridges. Your package includes your choice of mixer, and it all comes housed in a rugged Stanton Coffin Case specially designed for this application. Price includes delivery within the continental US.

### Economy DJ Package

Includes Numark DM1175 mixer. The mixer has three stereo phono/line inputs, a stereo tape input, and two mic inputs. Also includes stereo six band EQ, assignable crossfader system, VU meter, recorder output, and pushbutton cue system.

Package 9317 \$1305.00

### Standard DJ Package

Includes Numark DM1775A mixer with 16 bit, full bandwidth sampling of up to 4 seconds. Features include a digital delay for special effects; 4 stereo, 2 phono, and 2 mic inputs; and complete crossfade capabilities. Numark got serious, so you can have all the fun.

Package 9318 \$1945.00

### Deluxe DJ Package

Includes deluxe Rane MP24 mixer with three phono and six line inputs. Crossfade controls allow fades between any two channels. Two mic inputs feature 3 band EQ. The MP24 also has a four band EQ and full metering. You deserve the best. don't you?

Package 9319 \$1959.00

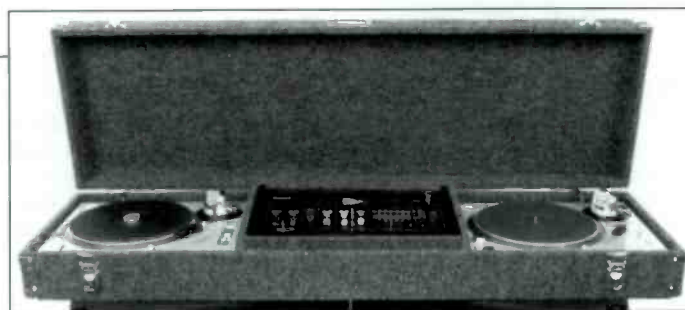

### Digital DJ Package

If you're ready to spin CD's, Bradley is ready to make it possible. We've put the Rane MP 24 together with the Denon DN2000F Dual Transport CD System. These units are packaged with a pair of rugged rack mount cases that are easy to carry and make set up a breeze. Now is the time to do it digitally. Manufacturer's list prices total over \$3600.00.

Package 9320 \$2150.00

*Special note: May we suggest combining your DJ package with one of our reinforcement packages? You'll be certain to get the most for your dollars.*

## Stanton Phono Cartridges

Our most popular Stanton professional cartridges are listed below. Call your Bradley professional for selection assistance and for replacement styli for all Stanton models.

Model	Part Number	Tracking Force	Stylus Type	Price	Replacement Stylus	Price
881MKIIS	60ST881S	.75-1.5 grams	Stereohedron	95.00	60STD81S	59.00
681EEEMKIIIS	60ST681EEES	.75-1.5 grams	Stereohedron	62.00	60STD6800EES	32.00
681SE	60ST681SE	2-4 grams	Elliptical	59.00	60STD6800SE	25.00
680EL*	60ST68EL	2-5 grams	Elliptical	69.00	60STD6800EL	23.00
500AMKII	60ST500A	1-2 grams	Spherical	22.00	60STD5107AL	11.00
500AL	60ST50AL	2-5 grams	Spherical	22.00	60STD5107AL	11.00
500EMKII	60ST500E	1-2 grams	Elliptical	19.00	60STD50E	12.00

\* Packed with two styli



#### Also available:

Disco pack: 3 replacement styli for 680EL	60STD68	\$65.00
Matched Pair - 680EL cartridges	60ST68ELMP	\$99.00
500AL cartridge disco packed w/2 styli	60ST50ALDP	\$29.00

## Shure Phono Cartridges

Model	Part Number	Price	Replacement Stylus	Styli Qty Per Pkg	Price
M44-C	60SHM44C	\$21.00	61SHN44C	1	12.50
M44-7	60SHM447	21.00	61SHN447	1	12.50
SC35-C	60SHC35	35.00	61SHS35	1	14.00
SC39-EJ	60SH39EJ	55.00	61SHSS39EJ	1	25.20



Bradley stocks the wide range of Shure cartridges and styli. Listed are our most requested models. Call us with your requirements. Replacement styli are available for all discontinued cartridges.



## Bradley PA Systems

### Bradley PA System I

The Toa MX-101 is a very affordable powered mixer perfect for smaller rooms. It features four inputs, each with both a 1/4" TS high impedance and an XLR low impedance connector as well as EQ. Output is 75 watts into 4 ohms, and the MX-101 has an internal spring reverb and a 3 band EQ on the output stage. We've coupled it with a pair of Toa SL-120 speakers (described on page 114) and two 50' speaker cables.

Package 9321

\$659.00 plus freight



### Bradley PA System II "The Entertainer 100"

This system has it all: power, performance, and portability. The EV 100M powered, ten input stereo mixer delivers 100 watts per channel continuously into 8 ohms at less than 0.02% distortion, while the patented EV Powerlock limiter and massive external heat sinks provide substantial protection against overdriving the amp or burning up the speakers. The mixer section provides three band EQ, peak indicators, pan pots, separate effects and foldback sends, and variable input pads. Individual slide faders are provided for left, right, and monitor busses. Dual 8 band graphic equalizers and bright fluorescent bar graph meters make setup quick and easy. The speakers are the lightweight EV 100S, with virtually indestructible cabinets. 100° high frequency dispersion provides uniform coverage without "hot spots." 80Hz to 18kHz (±3dB) with usable response 50Hz to 20kHz. 100 watts continuous. Speakers measure 24"H x 15"W x 8.4"D and weigh 28 pounds. Retail price is over \$2900.00.

Package 9322

\$1859.00 plus freight

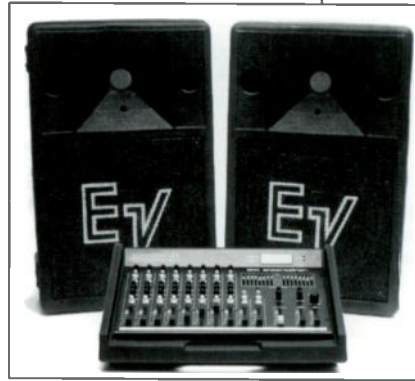

### Bradley PA System III

The Toa MX-401 is a high performance, four channel mixer. Each channel has a 1/4" TS high impedance input as well as an XLR low impedance input. Controls include level, high and low frequency EQ, reverb, and monitor. The master section features a 5 band graphic EQ with 12dB cut/boost, built-in auto-compressor, reverb, monitor, and auxiliary level controls plus a selection of jacks for patching signal processing equipment. At 8 ohms, the MX-401 delivers 100 watts RMS. Our package includes a pair of Toa SL-150 speakers (described on page 114) and two 50' speaker cables.

Package 9323

\$849.00 plus freight

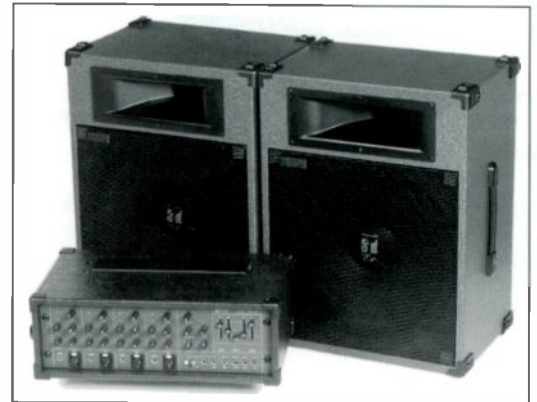

## Anchor Liberty

The Liberty is a self-contained portable sound system available in both AC and battery powered versions. It features a MOS-FET power amp, two XLR mic inputs with 15VDC phantom power, aux line input, line level output, 2 band EQ, and an external speaker output. The AC powered MPA-4500 delivers 75 watts. The MPB-4500 gives you 50 watts of amplification and has an internal rechargeable battery that runs for 4 hours per charge.



MPA-4500 AC powered

60ANMPA4500

\$802.00

## Anchor Mini-Vox

The Mini-Vox is a powerful, over-the-shoulder portable, PA system that can project crystal clear voice commands for hundreds of feet. This pint-sized powerhouse weighs less than five pounds and features an integrated amplifier that delivers 15 watts to its powerful 5" speaker. Available in red and black.



Mini-Vox

60ANPB25X

\$215.00



## Crown CSL Amplifiers

Crown's reputation for sonic accuracy and bullet-proof performance is obvious in the CSL-460 and CSL-800. A computer designed heat sink/fan combination dissipates heat efficiently to protect the amps, while Crown circuitry provides full protection from output shorts, mismatched loads, RF burnout, input DC, and input overload. The CSL-460 puts out 200 watts per channel into 8 ohms, and the CSL-800 puts out 320 watts per channel into 8 ohms. Other specifications, which are common to both units, are S/N ratio 103dB @ full output and 26dB gain; response  $\pm 0.5$ dB, 20Hz to 20kHz; harmonic distortion, less than 0.1% at rated output into 8 ohms, both channels driven; IM distortion, less than 0.05% at rated output into 8 ohms, both channels driven; and damping factor greater than 1100. Input connectors are 1/4" TRS jacks and output connectors are binding posts.



CSL-460	60CRSL460	MFR LIST	\$849.00
CSL-800	60CRSL800	MFR LIST	\$1079.00

Call Bradley for a current price quotation.

## Crown Micro-Tech and Macro-Tech Amps

The Crown Micro-Tech series is the next step up from the CSL series amps. The Micro-Tech series features a huskier power supply, higher output power, and front panel indicators for the high voltage supplies. The Micro-Tech 600 delivers 215 watts per channel into 8 ohms, and the Micro-Tech 1200 delivers 295 watts per channel into 8 ohms with both channels driven. Frequency response, distortion, and noise are similar to the CSL series.

At the top of Crown's line is the Macro-Tech series of miniaturized high technology sound reinforcement amplifiers. These are the amplifiers on which top sound industry professionals rely. Front panel indicators provide information on the high voltage power supplies and the Input/Output Comparator warns of clipping. Also provided are front panel level controls for each channel. The Macro-Tech 600 delivers 215 watts per channel, the Macro-Tech 1200 delivers 295 watts per channel, and the Macro-Tech 2400 delivers 515 watts per channel, all into 8 ohms, both channels driven. Other performance specifications and input and output connectors are identical to the Micro-Tech amps.

Call Bradley for a current price quotation.



Micro 600	60CRMT600	MFR LIST	\$995.00
Micro 1200	60CRMT1200	MFR LIST	\$1295.00
Macro 600	60CRMA600	MFR LIST	\$1295.00
Macro 1200	60CRMA1200	MFR LIST	\$1595.00
Macro 2400	60CRMA2400	MFR LIST	\$2095.00

## Yamaha Power Amplifiers

At the top of Yamaha's new line of amps is the PC4002M. Capable of 430 watts per channel into 8 ohms or 700 watts into 4 ohms, this amp is designed for precision output. Response is 10Hz to 50kHz,  $\pm 1$ dB. Twin, two speed, thermostatically controlled fans; mono mode; dual power supplies; full protection circuitry; detented input attenuators; large illuminated peak meters; and both XLR and 1/4" TRS inputs are among the outstanding features. The PC4002M is for anyone who takes sound seriously.

For more moderate powering requirements, Yamaha and Bradley offer the P2700 (350 watts per channel into 8 ohms), the P2350 (175 watts per channel), and the P2160 (80 watts per channel). All three use simple, yet sophisticated designs for reliability you can count on. Distortion, noise, and channel separation specs are excellent, and electronic and thermal protection circuitry is incorporated. The P2700 and P3500 are fan cooled; the P2160 is convection cooled. Front panel, detented level controls are provided, and input connectors are both XLR and 1/4" TRS.

Call Bradley for a current price quotation.



PC4002M	60YAPC4002M	MFR LIST	\$2795.00
P2700	60YAP2700	MFR LIST	\$995.00
P2350	60YAP2350	MFR LIST	\$795.00
P2160	60YAP2160	MFR LIST	\$595.00

### Ashly MOS-FET Power Amplifiers

Ashly's open, modular design features a Class A, full complementary, two stage front end for stability and speed. MOS-FET output devices contribute to both high sound quality and near-perfect reliability, and a self-protection mode works under all conditions including short and open circuits, reactive loads, and high-frequency overdrive. These amps boast perfect overload and square wave response. This results in a series of amplifiers that are powerful and quick, giving you unrestrained, uncolored sound quality with remarkable accuracy.

Ashly's FET series amplifiers are UL listed. The FET-1000 delivers 120 watts RMS per channel (stereo) into an 8 ohm load and 190 into 4. The FET-1500 puts out 200 watts RMS per channel into an 8 ohm load and 300 into 4. The FET-2000 puts out 300 watts RMS per channel into an 8 ohm load, 500 into 4, and 675 into 2. The FET series is available in "M" versions with meters, 1/4" TRS and balanced XLR inputs and "C" versions sans meters, with 1/4" TRS and barrier-strip inputs.

<b>FET-1000M</b>	60ASFET1000M	MFR LIST	\$799.99
<b>FET-1000C</b>	60ASFET1000	MFR LIST	\$699.99
<b>FET-1500M</b>	60ASFET1500M	MFR LIST	\$899.99
<b>FET-1500C</b>	60ASFET1500	MFR LIST	\$799.99
<b>FET-2000M</b>	60ASFET2000M	MFR LIST	\$1099.99
<b>FET-2000C</b>	60ASFET2000	MFR LIST	\$999.99



Call Bradley for a current price quotation.

### Community CSX Series Speakers

CSX speakers not only deliver exceptional sonic quality, but are designed to do it night after night. Ferro-fluid cooling of the LF drivers enables them to withstand the rigors of long term, high power use. Internal fuseless protection guards against excessive input levels, while sophisticated filters provide a smooth crossover curve between transducers. The CSX cabinets sport an attractive, durable black carpet finish. Our best sellers are described below.

The CSX25 is the smallest of the series, with a twelve inch two-way configuration. 32 pounds, 18.25"H x 15"W x 13.5"D.

The CSX35 is slightly larger than the 25 and uses a 15" woofer and a larger cabinet volume to produce a more solid low frequency response. 43 pounds, 23.75"H x 17.25"W x 13.5"D.

The CSX52 has a smooth, three-way design which allows for a much more honest reproduction of the important mid-range frequencies, while still using a 15" woofer to produce gratifying low frequency response. These cabinets sound like Hi-Fi speakers, yet they will develop tremendous sound pressure levels. 82 pounds, 33.5"H x 18"W x 18"D.



<b>CSX25</b>	60COC25	\$212.00
<b>CSX35</b>	60COC35	\$253.00
<b>CSX52</b>	60COC52	\$438.00

### Toa Speakers

Toa's two great lines of reinforcement speakers are constructed to withstand the punishment of the road. The "SL" series consists of the SL-120 with a 12" woofer and the SL-150 with a 15" woofer. Both use a constant directivity 90° horn with a piezo high frequency driver. The SL-120 weighs 29 pounds and measures 20.3"H x 14.8"W x 12.1"D. The SL-150 weighs 36 pounds and measures 23.5"H x 18"W x 12.1"D. Both are 8 ohms and are capable of handling 240 watts of continuous power. Monitor versions are also available.

The "SD" series consists of the 380SD and the 300SD. The 380SD uses a 15" woofer, weighs 60 pounds and measures 26.8"H x 19.4"W x 15.4"D. The 300SD uses a 12" woofer, weighs 47 pounds and measures 23.1"H x 18.1"W x 12.3"D. Both models are 8 ohms and handle up to 360 watts.

<b>SL-120</b>	60TOSL12	\$209.00
<b>SL-150</b>	60TOSL15	\$259.00
<b>300SD</b>	60TO30SD	\$439.00
<b>380SD</b>	60TO38SD	\$479.00



## Electro-Voice EV 200M

The EV 200M stereo powered mixer has a MOS-FET amplifier capable of 300 watts per channel at 4 ohms. The amplifier can be run either left/right or main/monitor. The EV 200M has a 30 program Lexicon stereo digital effects unit built-in to provide studio quality reverbs and other effects. Eight mic/line inputs are provided, each with a three-band equalizer with sweepable mids from 30Hz to 5KHz. A ninth high impedance input has a two-band equalizer and two 1/4 inch and two RCA jacks.

EV 200M                      60EL200M                      MFR LIST                      \$2332.00

Call Bradley for a current price quotation.



## Yamaha EM1620 Powered Mixer

The remarkably small and light EM1620 produces a monaural power rating of 200 watts into a 4 ohm load or 120 watts into 8 ohms. It's perfect for small to medium reinforcement, church, school, or club applications. The six full feature input channels have Hi-Z (1/4" TS) and electronically balanced Lo-Z (XLR) inputs, 48 volt phantom power, effects and monitor sends, and a three band EQ. The master section includes the mono master, the effects and monitor masters, and a seven band graphic EQ for feedback control and acoustic compensation. The variable speed internal side vented fan ensures cool and quiet operation even during all day shows. The EM1620 is 3 rack units high and is only 13 1/2" deep. Distortion, response, and noise are extremely good.

EM1620                      60YAEM1620                      MFR LIST                      \$795.00

Call Bradley for a current price quotation.

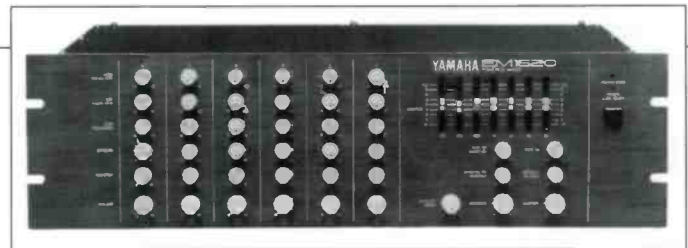

## Yamaha EMX Series Powered Mixers

Yamaha's original EMX powered mixers made history because of their features and performance. The latest EMX mixers are available in either six, eight, or twelve input versions. The high performance power amp sections provide up to 160 watts per channel (stereo) into 8 ohms. Each mixer input provides variable input attenuation, a three band EQ, two auxiliary sends, a pan control, and a linear fader. 48V phantom power is available across all inputs. The master section contains the master faders and auxiliary sends, a stereo nine band graphic EQ, and a digital multi-effects processor with 15 top quality reverb, delay, and echo effects. All mixer, graphic EQ, effects processor, and power amp inputs and outputs appear on the rear of the unit. Large heat sinks and forced air cooling will let you run this desk all day at a remote with no headaches. Its rugged construction is built to take the hard knocks.

6 inputs, 90 watts/channel    60YAEMX2150    MFR LIST    \$1695.00  
 8 inputs, 160 watts/channel    60YAEMX2200    MFR LIST    \$1795.00  
 12 inputs, 160 watts/channel    60YAEMX2300    MFR LIST    \$1995.00

Call Bradley for a current price quotation.



**Bradley offers a complete range of mixing consoles. Mixers for broadcast, production and utility use can be found in our Consoles section. Look in Field Production for portable mixers.**

### Ultimate Support Stands



Ultimate **TS-30T** can be varied in height from 3'6" to 6'7", and will support up to 75lbs.

**Silver 61USTS30T \$78.00**  
**Black 61USTS30BT \$90.00**

Ultimate **TS-33T** will extend to over 9' and support 100 pounds, yet it weighs only 8 pounds!

**Silver 61USTS33T \$93.00**  
**Black 61USTS33BT \$108.00**

**Accessories:**

**TAD-138** 1 1/2" diameter tripod adapter is used with same sized sockets provided by Community, EV, Toa, and others.

**61USTAD138 \$8.20**

**BMB-200K** attaches speakers with built-in threaded inserts spaced 4 3/4" to 6" apart, such as those provided by Bose. Mounting screws not included.

**61USBMB200 \$16.40**

**TMB-400K** is a unique two part mounting system that consists of a thin plate (screwed to the bottom of the speaker) and a slide-in bracket (attached to the top of the tripod). Mounting screws included.

**61USTMB400 \$15.60**

**MIC-150** provides a threaded microphone adapter.

**61USTMIC150 \$15.60**

### Whirlwind Cable Reels

Simple in design, durable and convenient, these reels make quick work of stowing your cables. For professional applications, they are a necessity, and are available in sizes to handle any job.

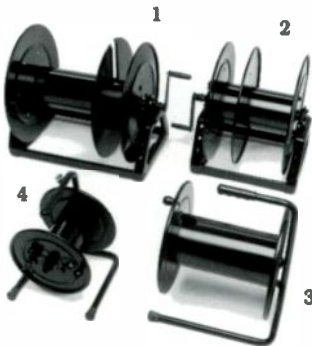

- (1) **WD-3S** Capacity: 3675' of 1/4" OD cable.  
**61WHWD3S \$279.00**
- (2) **WD-3** Capacity: 2100' of 1/4" OD cable.  
**61WHWD3 \$265.00**
- (3) **WD-2** Capacity: 1640' of 1/4" OD cable.  
**61WHWD2 \$153.00**
- (4) **WD-1** Capacity: 640' of 1/4" OD cable.  
**61WHWD1 \$113.00**

*Note: Capacities for larger outer diameter cables sometimes cannot be accurately computed using the figures quoted for 1/4" cable. Call your Bradley professional for configuration assistance.*

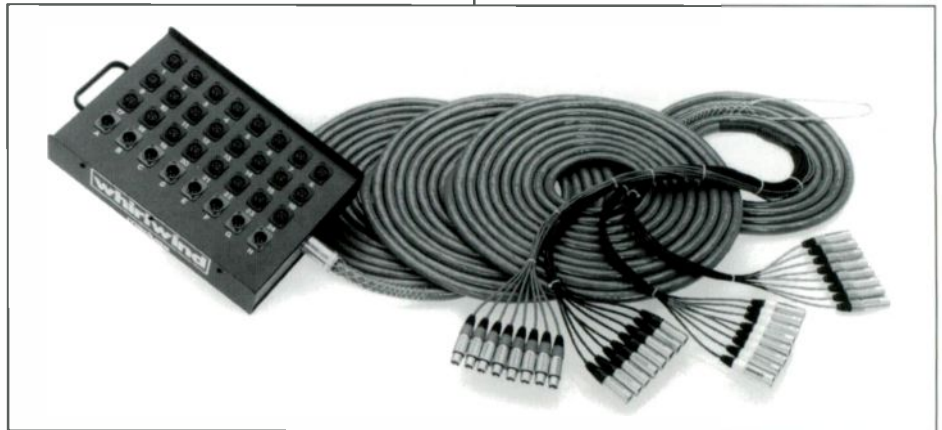

### Whirlwind Medusa Multipair Systems

Whirlwind's Medusa systems are individually hand crafted from the finest components available: heavy gauge cold rolled steel stage boxes, thick jacketed ultra-flexible cable, mil-spec strain reliefs, premium grade PVC shrink tubing, and Whirlwind designed connectors. Each Medusa system features 100% foil shielding and numbered, color coded fan-outs for rapid, easy set up. All of this, plus the painstaking attention to detail in assembling Medusa snake systems, has made them the finest multi-wiring systems in the world. Medusa snakes are available in 6 to 52 channel configurations, plus specialized versions for multitrack recording systems and for powered mixers. Call Bradley for additional information and pricing on the wide variety of Medusa cables available to you.

**Standard Medusa Series**

50' - 6 in, 3 out	61WHMS63XL50	\$145.00
100' - 8 in, 4 out	61WHMS84XL100	\$224.00
100' - 12 in, 4 out	61WHMS124XL10	\$275.00
100' - 16 in, 4 out	61WHMS164XL10	\$333.00
100' - 24 in, 8 out	61WHMS248XL10	\$506.00

**Medusa Power Series**

Incorporates two runs of 14 gauge speaker wire built into, but totally shielded from, the mic and monitor lines that surround them. Ideal for use with powered mixers.

100' - 8 mics, 2 speaker, 1 monitor.	61WHMP8100	\$305.00
100' - 12 mics, 2 speaker, 2 monitor.	61WHMP12100	\$414.00

**Bradley's professionals can help you design a multiwiring system that fits your bill perfectly. Just give us a call at 1-800-732-7665**

### Medusa Cable Reels



A unique heavy duty steel windup storage caddy designed for Medusa systems.

**Small capacity, 795' of 1/4" OD cable.**  
**61WHMEDWHS \$105.00**  
**Large capacity, 1150' of 1/4" OD cable.**  
**61WHMEDWHL \$129.00**

### Shurtape Gaffer's Tape

Bradley features genuine Shurtape Gaffer's tape. This standard of the broadcast, motion picture, and theater industries is indispensable for taping cables, carpets, scenery, and a million other jobs. A strong adhesive, which will stick to just about anything, coats this flexible fabric tape. And even better, the tape peels up quickly and cleanly after the glg, leaving no indication that you were there.



**2" wide, grey 180' 61STGY2 \$13.50 per roll**  
**2" wide, black 180' 61STBK2 \$13.50 per roll**

**SPECIAL! Buy six rolls of Shurtape for only \$64.80**

### Sonic II Hearing Protectors

These protectors reduce the sound pressure level without restricting your normal ability to hear the full audio spectrum of highs and lows. Packed in a plastic box with key chain attachment.



**42NOSON2 \$6.95**

**Also available:**

**Norton Noise Hushers** are disposable ear plugs, made of foam rubber. **42NOD1 99¢/pr**





## Orban Optimod-FM 8200 Digital Processor

The Optimod-FM 8200 is a technological breakthrough with bottom line impact. A true digital processor, all processing and control functions are in the digital domain. In addition to improved sound, the 8200 offers more flexible and user-friendly programming. This produces more benefits for your station as the 8200 can be more easily adapted to your station's needs.

A complete system, the 8200 provides automatic gain control, compression, peak modulation control, and stereo encoding. With the 8200's Multiple Variable Processing (MVP) architecture, processing configurations can be changed by pushing a button. For total transparency, select the protection MVP. The two-band MVP offers an improved version of the traditional open, bright, and natural Optimod-FM sound which helped make thousands of stations successful. The optional five-band MVP meets the challenges of competitive major-market processing with selectable speeds to match any format.

Factory MVP presets can be precisely adjusted using a single LESS<>MORE control. Using the FULL CONTROL mode, custom sounds can be created and up to 32 user presets stored and recalled. A large LCD makes setup, adjustment, and programming easy. The built-in computer interface allows the 8200 to be controlled by modem from anywhere. An automatic preset switching feature changes the 8200's processing on a programmed schedule, which is ideal for dayparting or for stations with multiple formats.



The 8200's modular construction makes it easy to service and to incorporate future software and hardware upgrades. Two stereo composite outputs are provided along with an analog left/right output and digital AES/EBU output.

<b>8200</b> with two-band MVP	600B8200U2S	MFR LIST	<b>\$7400.00</b>
<b>8200</b> with five-band MVP	600B8200U3S	MFR LIST	<b>\$9820.00</b>

Call Bradley for a current price quotation.

## Orban Optimod-FM 8100A1

How do you describe a classic without stating the obvious? Sophisticated, easy-to-use, and cost effective, this overshoot controlling processor can be quickly set up with a minimum of "tweaking" for formats ranging from purist-classical to extremely aggressive contemporary hit radio. With simple adjustments of gate threshold, interband coupling, release time, HF limiting, and clipping, the 8100A1 is flexible enough for the job, while remaining quite user friendly. Thorough and readable documentation, together with built-in test facilities and modular design make the Orban Optimod-FM 8100A1 truly a pleasure to work with.

**8100A1/U75** 600B8100A MFR LIST **\$5550.00**

### Also available:

**8100A1 with FM Filter Card.** This filter is designed to provide additional crosstalk protection for stations utilizing subcarriers and to increase modulation capability.

**8100A1/U75F** 600B8100AF MFR LIST **\$6250.00**

Call Bradley for a current price quotation.



### Accessories:

#### **8100A/XT2 Six Band Limiter**

An accessory chassis for stations that desire a louder or more processed sound. When the XT2 is in use, the two band compressor is converted to a slow averaging AGC in front of the six band limiter, ensuring proper input level at all times. The design incorporates dual bass EQ plus presence and brilliance controls.

600B8100AXT MFR LIST **\$2550.00**

**8100AFC FM Filter Card** For existing units. Simply plugs into 8100A1.

600B8100AFC MFR LIST **\$700.00**

**8100AST/U Studio Chassis** Enables separation of the "front-end" compressor from the stereo generator and limiter, allowing use with discrete STL systems.

600B8100AST MFR LIST **\$1000.00**

## Orban Optimod-AM 9100B

The 9100B was designed for high-fidelity AM, where quality is every bit as important as loudness. Three different characteristic slopes are available on plug-in modules to optimize the 9100B for low-fi receivers, high-fi receivers, or to "split-the-difference." The system also provides transmitter "EQ" adjustments to precisely tune out transmitter deficiencies. Mono systems may be upgraded to stereo at a later date. Meets the NRSC pre-emphasis and low pass filtering standards.

**9100B1/U10 Mono** 600B9100B1 MFR LIST **\$4550.00**

**9100B2/U10 Stereo** 600B9100B2 MFR LIST **\$6350.00**



Call Bradley for a current price quotation.

### Cutting Edge Unity 2000 Digital FM Processor

Frank Foti's Unity 2000 is a complete, format flexible digital processor with six components in a single chassis. The Unity 2000 comes complete with a selectable low frequency equalizer, a digital four band leveller/pre-processor, a digital four band limiter, a distortion canceling clipper drive, a digital stereo generator, and a selectable composite clipper. One keypad and an LCD display provide precise digital control of all functions. Plus, the Unity 2000 comes with processing presets for AOR, AC, Country, CHR, Urban, Country, Jazz, Easy Listening, and Classical ... or program up to four of your own and save the results.

Both the leveller/pre-processor and the limiter incorporate the revolutionary Intelligent Time Constant Controller that actually learns the music and adjusts attack and release time accordingly. Through the use of feed-forward technology, the Unity 2000 provides a constant processing ratio, giving the user a "sweet spot" at any level of signal processing. The clipper drive offers a range of ±5dB, and includes a phase linear low pass filter which allows no overshoots. The digital stereo generator provides better than 50dB of stereo separation with no need for adjustment due to analog drift. The user selectable composite clipper is pre-pilot

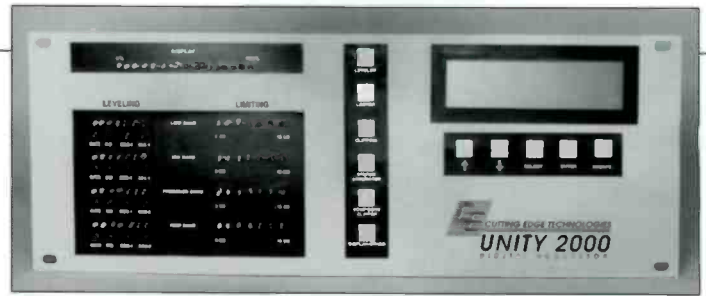

inserted, thereby eliminating the risk of stereo separation loss due to pilot re-insertion.

Other features include adjustable time constants and crossover frequencies, and security protection against unauthorized adjustment.

**Unity 2000** 60CEUNITY MFR LIST \$8500.00

Call Bradley for a current price quotation.

### CRL AM and FM Processing

CRL broadcast audio processing consists of both multi-unit building block systems and stand-alone processors.

The modular CRL FM processing line has four units: the SGC800 Stereo Gain Controller multiband AGC, the SEC800 Spectral Energy Compressor, the SMP850 Stereo Modulation Processor, and the SG800A digitally synthesized stereo generator. For AM stereo processing CRL offers the SMP950 AM Stereo Matrix Processor that is used in conjunction with the SGC800 and SEC800. For monophonic AM operation, CRL provides the AGC400 Audio Gain Controller, the SEC400 Spectral Energy Compressor, and the PMC450 Peak Modulation Controller.

The Amigo is a competitively priced, complete FM processing system that is easy to install and operate. In a single rack unit, the Amigo offers a dual band AGC with more than 25dB range, peak modulation limiter, and a digitally synthesized stereo generator with more than 50dB of separation. Other features include stereo soundfield enhancement, low frequency EQ, and both composite and discrete outputs.

The MBL-100 is a multi-band audio processor specifically tailored to mono AM stations with News/Talk formats. Very high levels of average modulation density are available to extend your station's coverage area. The unit has a 7.5kHz bandwidth and NRSC-1 pre-emphasis.

Call Bradley for a current price quotation.



- AM-2** mono AM system. AGC400, PMC450  
60CUAM2. MFR LIST \$3395.00
- AM-2S** stereo AM system. SGC800, SMP950.  
60CUAM2S MFR LIST \$4395.00
- AM-4** mono AM system. AGC400, SEC400, PMC450.  
60CUAM4 MFR LIST \$4895.00
- AM-4S** stereo AM system. SGC800, SEC800, SMP950.  
60CUAM4S MFR LIST \$6395.00
- FM-2G** stereo FM system. SGC800, SMP850, SG800A.  
60CUFM2G MFR LIST \$5995.00
- FM-2G "Plus"** stereo FM system. SGC800, SEC800, SMP850, SG800A.  
60CUFM4G MFR LIST \$7995.00
- Amigo** 60CUAMIGO MFR LIST \$3195.00
- MBL-100** 60CUMBL100 MFR LIST \$3895.00

### CRL Audio Signature

For more tailored processing, CRL's Audio Signature combines a powerful four band compressor and an advanced microprocessor control system. Separate wide-band and multiband controls can take you from virtually no processing to an amazingly aggressive extreme. Adjustable multiband crossovers, real time analysis monitoring, and 8 position audio diagnostic metering add to the Audio Signature's user friendliness and processing power. Four processing settings may be stored and recalled, and the Audio Signature includes an RS-232 port for computer or automation control.



**Audio Signature** 60CUAS MFR LIST \$4995.00

Call Bradley for a current price quotation.



## Gentner Prism II FM Processor

The processing approach used by the Prism II emphasizes clean. Employing digital control, the Prism II uses a four-band parallel layout, with smooth predictable gain change. A broadband safety buffer automatically keeps the multi-band section in its normal operating range, even with widely varying input levels. Each band is individually gated and a single "density" control effectively re-programs attack and release times and compression ratios simultaneously. A phase rotator, a form of all-pass filter with very precise and predictable frequency/phase characteristics, is used to assure optimum stereo separation regardless of source material. Two units are required for stereo.

**Prism II** 60TRPRISM MFR LIST \$1779.00

Call Bradley for a current price quotation.



### Accessory:

**RFC-2** replaces card 5 of an Orban 8100A Optimod FM when that unit is used with a pair of Gentner Audio Prisms.

**RFC-2** 60TRRCF2 MFR LIST \$319.00

### Also available:

**Prism II AM.** The features and performance of the Prism II AM will cause you to wonder if its low price is really correct. The heart of the Phoenix is the digitally controlled Gentner Prism II, which is followed by a high quality limiter. Complete with the NRSC standard for pre-emphasis and bandwidth limiting.

**Prism II AM** 60TRPH MFR LIST \$1989.00

## Excalibur CDA-1 Composite DA

This one input, three output CDA-1 can add flexibility to your transmission facility. Each output has its own 20 turn level control, and can drive up to 75 feet of RG-58 coax. A ground lift switch and transient protection on the power supply are two of the quality features built into the CDA-1. Use it to feed auxiliary STL systems, test equipment, and back up transmitters. Other uses include distributing modulation monitor outputs and subcarrier generator outputs. Frequency



response is DC to 100kHz  $\pm 0.2$ dB (less than 0.05dB down at 53kHz), THD is less than 0.01%, and noise is greater than 90dB below 4 volts at unity gain.

**CDA-1** 60EXCDA1 \$390.00

## QEI FM Transmitters and Exciters

**FM Transmitters** QEI's "New Reliables" are available in power levels ranging from 150 watts to 30,000 watts. The rack mountable 150, 300 and 600 watt models are all solid state, as is the 1kW, which is self-contained in a stand alone cabinet. 3.5kW, 5kW, 10kW, 20kW, and 30kW models all feature a single grounded grid triode in the final, offering the inherent stability, lower AM noise, simpler power supply, and other advantages.

All models 3.5kW and up are available for single or three-phase power at the same price - even the high-power 20 and 30kW! The 3.5kW can be converted quickly and economically to 5 or 10kW, making it ideal for stations with class upgrade potential. QEI provides a 15,000 hour warranty on the tube in their transmitters. The 675 Exciter is standard on all QEI transmitters, but the 695 "Transparent Plus" is available as an option.

**695 Exciter** The "Transparent Plus" 695 is fully synthesized and can be tuned to any FM broadcast frequency instantly. Its distortion and noise specifications are premium. THD, IMD (SMPTE method), and TIMD are all less than 0.025%; FM noise is greater than 80dB below 100% modulation. Complete metering of eight important parameters can be push button selected on the front panel meter. Automatic modulation and power output controls are other important features of this unique exciter.

**695** 60QE695 MFR LIST \$5295.00



Call Bradley for a current price quotation.

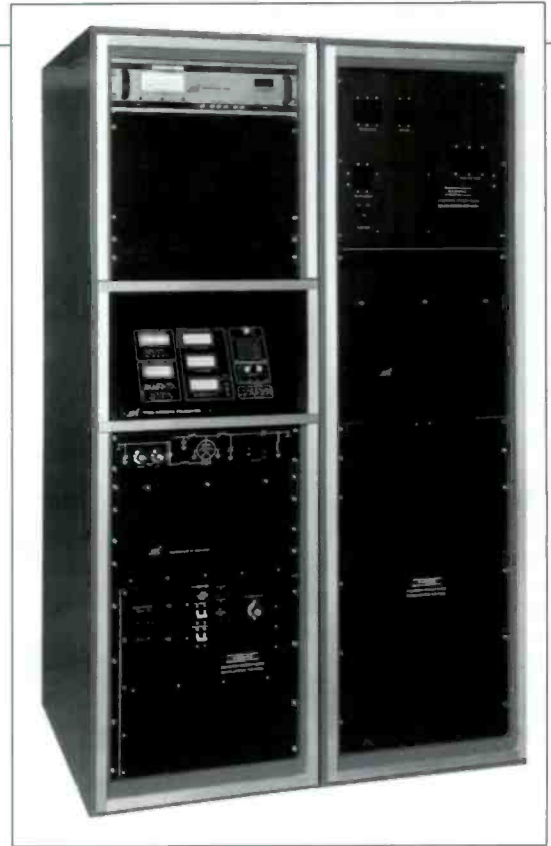

## Shively FM Antennas

Shively antennas perform as specified without regard to their environment, as harsh as it may be. A complete variety of Shively antennas is available to suit any station. Educational stations can use the low power 6812. Class A stations will find just what they need in the 6813, with a power rating of 3kW per bay up to 12kW. The 6810 (10kW per bay up to 40kW) is the perfect antenna for Class B stations and the 6814 is just right for Class C stations. Panel antennas are available for either single or multi-station operation. Contact us if you are concerned

about radiation hazard standards so that we can provide complete information on 0.95, 0.90, 0.75, and 0.50 wavelength spacings to control downward radiation. Of course, Bradley and Shively can provide a complete range of options, including deicers, radomes, null fill, beam tilt, pattern studies, and directional antennas.



## RF Accessories

Many items go into making a complete RF system. Some are rather expensive, some are not. Many are not too glamorous, and don't get the same attention as transmitters or processors. But all are important to the success of your project. Your Bradley professional is trained to help you with every item you need, right down to the smallest fitting. Bradley features:

**Cablewave Systems** - Transmission line and accessories, including foam and air dielectric lines, rigid line, connectors, grounding kits, splices, and pressurization equipment for either nitrogen or dry air.

**Electro-Impulse** - RF "dummy" loads up to 50kW.

**Comark** - FM antennas, rigid line, & coaxial switches.

**Coaxial Dynamics** - Wattmeters.

**Delta** - Stereo AM exciters and monitors. Toroidal current transformers, operating impedance bridges for both permanent installation and field use, and antenna monitors.

**Potomac Instruments** - Field intensity meters covering MF, HF, VHF, and UHF frequencies, as well as antenna monitors and remote controls.

**Kintronics** - Antenna tuning units, phasing equipment, power dividers for PSRA and PSSA operation, and isocouplers.

**Modulation Sciences** - Composite line drivers and distribution amps and SCA generators.

## EBS Monitors

### Multi-Technical Services System 3000C

(1) This ultimate EBS monitor incorporates multiple monitor receivers and the EBS encoder and decoder into a single unit. NOAA weather service monitoring is also available so you can offer your community the best information and service. Features include three channel scan, manual or automatic operation, program audio loop through, remote operation, and a built-in monitor speaker. The standard unit comes complete with three fixed frequency FM or AM receivers. Your Bradley professional can help you select from the numerous options.

**System 3000C** 60MU3000 MFR LIST \$1900.00

**Accessory:**

**NOAA NWS** receiver module. Replaces one off-air monitoring channel.

60MU3000NOAA MFR LIST \$95.00

### Multi-Technical Services System 1000

(2) The 1000 Series EBS System offers an encoder, a decoder, and your choice of either an AM or FM receiver in only one rack unit of space. Everything you need to stay legal is here. The front panel is clearly labeled, and provides for activating the encoder or resetting the decoder. An internal speaker allows you to check the reception of your monitored station. Specify frequency when ordering.

**AM** 60MU1000AM MFR LIST \$899.00

**FM** 60MU1000FM MFR LIST \$899.00

Call Bradley for a current price quotation.

### Gorman Redlich EBS Encoder/Decoder

(3) The Model CEB offers both EBS two tone encoding and decoding. Any stable receiver may be interfaced with the CEB to provide monitor capability. The CEB may be operated remotely, and mono programming loop-through is standard on the encoder. The decoder automatically demutes the monitor receiver and provides auxiliary alarm contacts. Encoder and decoder, as well as a tunable receiver, are available as separate units.

**CEB** 60GRCEB MFR LIST \$540.00

**Also available:**

**Encoder only** 60GRCE MFR LIST \$375.00

**Decoder only** 60GRCD MFR LIST \$320.00

**Tunable AM/FM receiver**

60GRREC MFR LIST \$100.00

Call Bradley for a current price quotation.

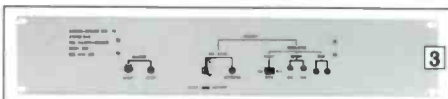

### TFT EBS Systems

TFT now makes staying legal with EBS a bit easier for you with the 886 and 887 EBS systems. The 886 (AM) and 887 (FM) have a receiver, decoder, and encoder all in only one rack space. The encoder features crystal controlled oscillators and the decoder features piezoelectric filters to assure stability. Both AM and FM receivers are synthesized, allowing fast, accurate tuning to either a primary or secondary station. Program loop-through is, of course, standard. Unique to the 886 and 887 is the pair of digital counters. One shows the number of days since your last EBS transmission, and the other shows the number of days since your last EBS reception. This helps to avoid FCC citations for incorrect use or non-use of the EBS system.

**886 AM** 60TT886 MFR LIST \$2150.00

**887 FM** 60TT887 MFR LIST \$2075.00

Call Bradley for a current price quotation.



## Modulation Sciences ModMinder

ModMinder very accurately measures and displays peak FM deviation. By doing so, the ModMinder allows a station to either back off its processing (increasing dynamic range) or to increase its modulation (increasing loudness) or to do some of both. This translates into a 1 to 4dB improvement in modulation, a significant gain in today's extremely competitive marketplace.

The ModMinder works by indicating only those peaks which exceed 1000  $\mu$ sec, a parameter which conforms precisely to the most recent (albeit now deleted) FCC rules for modulation monitoring. A microprocessor controls all timing and monitoring functions, assuring you an unusual degree of accuracy. Complete



interfacing is provided, including alarm functions, for your remote control system. An RS-232 port offers computer access of monitored information. ModMinder is also available with a calibrated demodulator board.

<b>ModMinder</b>	60MSFMMM	MFR LIST	<b>\$2395.00</b>
<b>ModMinder with DeMod</b>	60MSMMDMB	MFR LIST	<b>\$3090.00</b>

Call Bradley for a current price quotation.

## RDL ACM-2 AM Noise Monitor

Synchronous AM noise is the elusive "gremlin" caused by transmitter/antenna bandwidth limiting that creates reception problems for your listeners. Top performing stations across the country have turned to Radio Design Labs ACM technology to maintain clarity and stereo separation, as well as to control multipath artifacts. Every transmitter, new or old, can benefit by being tuned for minimum AM synchronous noise, and the ACM-2 is the best tool for the job.

The ACM-2 provides accurate metering of significant synchronous AM noise; LED metering with four display ranges; wide band, 75 $\mu$ s, and high-pass filtering;

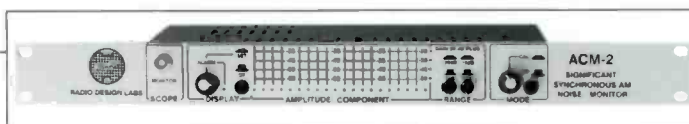

a programmable alarm with remote status output; and a continuous-reading remote DC output for AM noise level. Its low price makes it quite a bargain when you consider how much it can add to your competitive edge.

<b>ACM-2</b>	60RDACM2	MFR LIST	<b>\$695.00</b>
--------------	----------	----------	-----------------

Call Bradley for a current price quotation.

## TFT FM Modulation Monitors

TFT offers two models of efficient and accurate monitors which allow all base-band and stereo monitoring functions to be performed in a single unit. The 884 and 844A both combine a frequency agile RF amplifier, an FM main channel monitor, and a stereo monitor. A feature unique to TFT is the Peak Modulation Duration Differentiator (PMDD) which separates true modulation peaks from those caused by transient noise, overshoot, and multipath distortion.

The 884 and 844A both use TFT's pulse-counting FM discriminator and have outputs for audio monitoring and test equipment. The 844A adds a dual pre-selector to enable rapid "A-B" comparison. Also standard on the 844A is an absence of modulation carrier alarm, and front panel headphone jack.

<b>884 (pictured)</b>	60TT884	MFR LIST	<b>\$3765.00</b>
<b>844A</b>	60TT844	MFR LIST	<b>\$5150.00</b>



Also available:

<b>845 SCA Monitor</b>	60TT845	MFR LIST	<b>\$2735.00</b>
------------------------	---------	----------	------------------

Call Bradley for a current price quotation.

## QEI 691 FM Modulation Monitor/Test Set

The 691 is a complete performance measurement instrument for mono, stereo, and SCA. Tuneable in 100kHz steps over the entire FM band, the unit can perform over forty tests when used with an oscilloscope. The front panel includes frequency and test meter outputs, adjustable range peak flasher, peak counter, and easy to read auto-ranging meters. The 691 is extremely accurate and reliable.

<b>691</b>	60QE691	MFR LIST	<b>\$5875.00</b>
<b>691/01 w/67kHz SCA monitoring</b>	60QE69101	MFR LIST	<b>\$6875.00</b>
<b>691/02 w/67kHz and 92kHz SCA monitoring</b>	60QE69102	MFR LIST	<b>\$7100.00</b>

Call Bradley for a current price quotation.

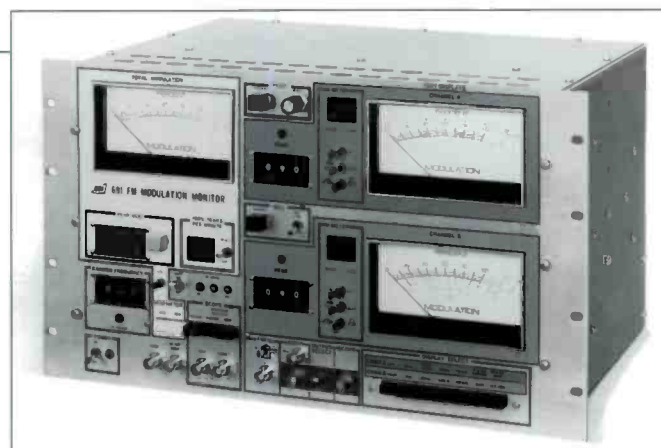

## Belar AM and FM Monitors

Belar offers two AM monitors: the AMM-2B and the AMM-3. A unique modulation cancellation scheme is used to recover the unmodulated carrier which provides a reference to modulation peaks. Thus, the instantaneous program peaks are referenced to the instantaneous carrier. The AMM-3 has separate meters for simultaneous monitoring of both positive and negative modulation. Individual thumbwheel switches allow setting the positive and negative peak flashers in 1% increments. Audio outputs are provided for both monitoring and test instruments.

Belar's FM monitor lineup includes separate main channel, stereo, and subcarrier monitors. The main channel and stereo monitors have superior THD and IM (SMPTE) of less than 0.01%. S/N ratio exceeds 90dB, and frequency response is  $\pm 0.25$ dB, 50Hz to 15kHz. Autoranging meters on the FMS-2 stereo monitor make noise and crosstalk measurements a snap. The SCM-2 subcarrier monitor can measure up to four different subcarriers.

Call Bradley for a current price quotation.



<b>AMM-2B AM monitor</b>	60BLAMM2B	MFR LIST	\$1390.00
<b>AMM-3 AM monitor</b>	60BLAMM3	MFR LIST	\$1690.00
<b>AM RF amplifier</b>	60BLRFA2	MFR LIST	\$690.00
<b>FMM-2 FM monitor</b>	60BLFMM2	MFR LIST	\$1690.00
<b>FMS-2 stereo monitor</b>	60BLFMS2	MFR LIST	\$1890.00
<b>SCM-2 SCA monitor</b>	60BLSCM2	MFR LIST	\$1890.00
<b>FM RF amplifier</b>	60BLRFA1	MFR LIST	\$650.00
<b>Tuneable FM RF amplifier</b>	60BLRFA4	MFR LIST	\$990.00

## Burk LX-1 Six-Input Stereo Selector

The LX-1 Stereo Switcher from Burk allows you to integrate all studios through one master control unit. With the LX-1 the transition from studio to studio is smooth and quiet and levels remain constant. The LX-1 can be connected to your remote control system for remote program switching. Matches -10 IHF to +4 PRO Inputs, so no external matching equipment is needed. Additionally, the LX-1 allows mixing of two studio sources, or lockout of all audio sources. Tally indications are provided for each source, making it clear which one is on the air. Individual start and stop pulses are also available for each source, making it easy



to start a fill tape, reset automation, or activate an EBS generator.

<b>LX-1</b>	60AVLX1	MFR LIST	\$1295.00
-------------	---------	----------	-----------

Call Bradley for a current price quotation.

## Belar Wizard

FM stations need to accurately measure peaks of frequent recurrence and to analyze modulation data to compare their modulation density with that of competitors. The Wizard FM Digital Modulation Analyzer performs these functions and does a whole lot more.

Some of The Wizard's functions are to measure peaks according to FCC rule 73.1570, examine peaks per unit of time to check peak distribution, check peak modulation density, change time constants of the peak weighting functions from 100 $\mu$ sec to 2ms, check pilot injection and pilot modulation, and check SCA injection. With the optional software package, all of these parameters and several more



can be evaluated from a PC via modem. Front panel shows modulation in 0.1% or 1% increments and a menu driven display provides a wealth of information.

<b>The Wizard</b>	60BLFMMA1	MFR LIST	\$3300.00
<b>Accessory:</b>			
<b>Software package</b>	60BLFMMA103	MFR LIST	\$300.00

Call Bradley for a current price quotation.

## Gentner VRC-2000 Remote Control

The VRC-2000 is a second generation voice response remote control system. It allows you full transmitter control via any bi-directional audio link, whether dial-up phone line, dedicated phone line, or radio link (such as STL/TSL/SCA). When operated as a stand-alone unit, you can control your transmitter from any telephone anywhere that has a DTMF keypad. The VRC-2000 responds with a synthesized voice. For full-time "on line" remote control, the accessory data interface, together with an IBM compatible PC allows your operator to view channels and to control the command channels from a keyboard.

VRC-2000                      60GF910072201                      MFR LIST    \$3359.00

**Accessories:**

**Data Interface** Required for communication with a printer or data terminal on-site, or, with a personal computer, via two-way audio link. Includes software.

60GF910076201                      MFR LIST    \$519.00



**Command Relay Unit** provides relay isolation between the VRC-2000 and your equipment. Handles 8 raise and 8 lower commands. Two required for full 16 raise/16 lower operation.

60GF910073001                      MFR LIST    \$679.00

**Also available:**

Special purpose accessories for the VRC-2000 include a fail safe unit, antenna monitor, temperature sensor, battery back-up, and interface cables.

Call Bradley for a current price quotation.



## Burk ARC-16 Remote Control

The ARC-16 allows you to have full-time studio control, dial-up control, or both. It has 16 metering channels, 16 raise/lower control outputs, and 16 status channels. Units have 32 character front panel displays with plain English prompts. The optional digital speech unit (DSU), featuring a digitally recorded human voice, permits full control from any phone with a DTMF pad. The DSU will also dial a series of phone numbers to announce an alarm condition.

**ARC-16 single unit system** includes transmitter unit with one DSU telephone/speech unit to allow full remote control from any telephone.

60AVARC16SU *MFR LIST* \$2995.00

**ARC-16 conventional 2-unit system** includes set of modems to interconnect by telco, STL, SCA, or TRL.

60AVARC16DU *MFR LIST* \$3895.00

### Accessory:

**Interface panel** provides barrier strip connections for 8 metering inputs, 8 status inputs, and 8 each raise and lower outputs, plus failsafe. All outputs are relay isolated. Two required for 16 channels.

60AVIP8 *MFR LIST* \$495.00



### Also available:

Bradley can help you to select from Burk accessories such as a computer interface and the Digital Speech Unit that can also be added to either the studio or transmitter unit of a two unit system. At the studio end, you can add a Studio Status Indicator to drive an external set of alarms and a Studio Input/Output Unit to add eight channels of input and output.

### Autopilot

Add the Autopilot to your Burk ARC-16 and you'll have better record keeping as well as the ability to operate unattended all or part of the day. Autopilot is a program that runs on an IBM (or compatible) computer. You don't have to be a computer whiz to set up or use Autopilot; the "Point and Shoot" mode editor allows anyone to set it up. Once it's on-line, Autopilot will take care of both routine and emergency operation. Call Bradley for complete details.

**Autopilot** 60AUAUTOPILOT *MFR LIST* \$395.00

Call Bradley for a current price quotation.

## Burk TC-8 Remote Control

The TC-8 is ideal for basic remote control applications. It has 8 telemetry channels and 8 status channels. Internal modems can be set up for telco, SCA, or half-duplex mrx. The accessory relay panel brings all connections out to screw-type barrier strips and isolates the control logic with plug-in 10 amp form-C relay contacts. The TSU dial-up option is connected to the studio unit and allows access to all TC-8 readings and controls via telephone.

**TC-8** 60AVTC8 *MFR LIST* \$2495.00



### Accessories:

**Relay/terminal panel** 60AVIP8 *MFR LIST* \$495.00

**Computer interface** 60AVCI8 *MFR LIST* \$495.00

**TSU dial-up option** 60AVDSU *MFR LIST* \$795.00

Call Bradley for a current price quotation.

## QEI CATLink

CATLink's advanced digital signal processing technology gives you high performance using economical T1 data lines. T1 has 1.544MB data capacity, so that the CATLink can send a composite stereo signal to your transmitter while simultaneously sending and receiving a host of other audio and control signals. Quality is outstanding, with composite THD <0.01%, S/N ratio >81dB, and response DC to 53kHz,  $\pm 0.001$ dB. CATLink versions are also available to operate over a mile of twisted pair audio cable, over two miles of fiber optic cable, or via a 23GHz microwave link.

CATLink consists of a studio unit with an A/D converter and multiplexer,

while the transmitter end holds the D/A converter and de-multiplexer. CATLink is modular, so you can add the additional channels you need, when you need them.

Composite systems start at just \$8500. Your Bradley professional can give you more reasons why CATLink is just "purr-fect" for your station.



## TFT 9200 Frequency Agile STL

TFT's Model 9200 STL is an economical frequency synthesized STL system which is designed for either single, redundant dual channel, or stereo program transmission. Both the transmitter and receiver utilize state-of-the-art very large scale integrated circuits for a low component count that results in high reliability and reduced cost. The 7.5 watt transmitter output comes from on-frequency amplification, yielding greater efficiency and introducing fewer harmful harmonics at the output. The receiver has been designed for 100kHz or 200kHz channel spacing. The system frequency response is better than  $\pm 0.2$ dB from 30Hz to 15kHz; THD and IMD are less than 0.2%; and S/N ratio is better than 75dB, de-emphasized.

Dual monaural systems for stereo use a pair of transmitters combined into a single antenna and a receiver splitter to connect two receivers to a single antenna.

Plug-in subcarrier cards are optionally available. Bradley offers the quality TFT 9200 with cable and antennas at low package prices.



**9200 Transmitter** 60TT51169200 *MFR LIST* \$1650.00

**8601 Receiver** 60TT51168601 *MFR LIST* \$1650.00

Call Bradley for a current price quotation.

**TFT 8888/8889 Remote Pickup**

No other RPU system available today gives you the flexibility or performance of the TFT 8888/8889. The 8888 transmitter



has three mic/line inputs, a built-in limiter, a headphone jack with volume control, and a front panel modulation meter to assure top notch audio quality. A test tone generator allows quick setup, and a front panel DTMF input jack allows for system security and cueing. The transmitter is frequency synthesized to allow operation within two 1MHz wide portions of the 450MHz band. Of course, powering is possible from either 12VDC or 120VAC. Three deviations (5, 10, and 25kHz) are internally selectable, depending on the frequency in use. Full output power is 25 watts, but two lower ranges are selectable for battery conservation. The companion 8889 receiver is also fully frequency synthesized. An on-board microprocessor is in full control, receiving commands from the DTMF code from the transmitter or a telco path. Local manual control can also be used. After access via a user-determined security code, the microprocessor will control the operating channel, bandwidth, and, if used at a repeater site, a companion transmitter. Call your Bradley professional today to have a system configured precisely to your needs.

**Transmitter** 60TT8888 MFR LIST \$2765.00  
**Receiver** 60TT8889 MFR LIST \$2075.00

Call Bradley for a current price quotation.

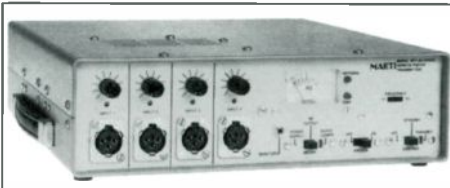
**Marti Remote Pickups**

Marti builds the most complete line of remote pickup (RPU) equipment in the business. Making equipment for both the high VHF and the UHF bands, with power levels of 2 watts, 15 watts, and 30 watts, Marti supplies all options: internal battery, external DC, and AC. Operate from anywhere: hand held, portable, vehicular, and aircraft installations, and Marti can supply both mobile and fixed repeaters. Marti and Bradley offer any accessory item you need: fixed and mobile antennas, transmission line and fittings, microphones, installation accessories, you name it.

Call or fax Bradley today and tell us your application. Our professionals will tailor a system to your specific requirements.

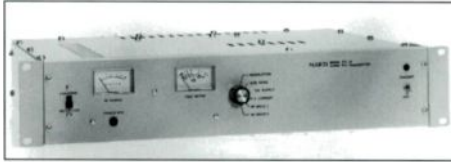
**Marti STL-10 Discrete Channel STL**

This economical aural STL has a proven record of reliable performance. Two subcarriers are optionally available, and complete stereo systems with transmitter combiners and receiver splitters require only an antenna at each site. The STL-10 system features 20Hz to 15kHz,  $\pm 0.25$ dB response; less than 0.3% THD; and 70dB or better S/N ratio. Transmitters include calibrated watt meter with forward/reflected power switching, DC power operation capability, and six position metering of transmitter parameters. Call us to discuss your STL requirements, and for system pricing.

**Mono** 60MTSTL10 MFR LIST \$3290.00

**Dual mono** includes two transmitters, two receivers, and combiners required for use with single antenna system. 60MTSTL10D MFR LIST \$7005.00

**Also available:**

**PA-48** 4' grid parabolic antenna for 950MHz band STL use. 60MTPA48 MFR LIST \$500.00

Marti transmitter/studio links provide reliable remote control telemetry on the 450MHz band. The TSL-15 offers 15 watts and the TSL-30 operates at up to 30 watts. Complete system prices include automatic station identifier. Antenna package includes two yagi antennas, connectors, and jumper cable for 1/2" coax.

**TSL-15** 60MTTSL15 MFR LIST \$2544.50

**TSL-30** 60MTTSL30 MFR LIST \$3129.50

**TSL antenna package**

60MTTSLANT MFR LIST \$362.00

Call Bradley for a current price quotation.

**Scala and Mark Antennas**

Bradley offers the full line of Scala and Mark dishes for all applications and frequencies. Most popular with broadcasters are their grid dishes for 950 MHz STL use, available with diameters ranging from 4' to 15'.

Where band congestion is not a factor, and the superior side-lobe characteristics of a full dish are not needed, you may wish to consider the Scala Paraflector or Miniflector. These half-parabolic antennas offer a significant reduction in weight and wind load compared to a full dish, while still providing the high gains necessary for moderate path lengths.

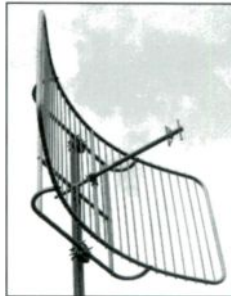
**TFT 8300 Composite STL**

The 8300 meets the demand for high performance and versatility. Specifically designed for superior performance in dense RF environments, this system boasts performance specs that make it a leader in its class: frequency response  $\pm 0.1$ dB from 30Hz to 53kHz, 50dB or better stereo separation, S/N 75dB or better. Up to 14 watts power, full front panel diagnostic metering, and modular construction are some of its features. Options for the 8300 include hot standby with automatic changeover and an IF repeater for multiple hops without signal degradation. Two year warranty, prompt delivery, and 24 hour support. Put your 8300 system together with Bradley.

**8300 composite transmitter**

60TT51168300 MFR LIST \$5300.00

**8301B composite receiver**

60TT51168301B MFR LIST \$5160.00

Call Bradley for a current price quotation.

**TFT DMM-92 Digital STL Modem**

The digital decade is upon us! Bring your station into the nineties with the TFT's DMM-92 digital STL modem. The DMM-92 can be used in conjunction with any modern composite STL to provide your station with an audible improvement in audio performance. By using 15 level duo-binary modulation, all necessary signals (stereo, 2 SCAs, and remote control) can be transmitted within the FCC's bandwidth limitations. Both analog and digital I/O versions are V.35 capable for use with Musicam, Dolby, OkI, APT-x and other compression systems. Call Bradley now for a complete DMM-92 literature package.

Don't forget, too, that Bradley and Scala offer many types of antennas for broadcasters, including remote pickup, TSL, FM translator, and precision off-air monitoring. Special pricing is available when you purchase your antennas as part of a complete equipment package. Call Bradley today. Our engineering know-how stands ready to help you.

**Also available:**

**Scala's 8000/960 950MHz preamp** is for situations where your STL signal is marginal, but wind load or other restrictions prohibit a larger dish. It gives you 20dB of gain (equivalent to a several-hundred percent increase in dish size), with noise of only 1.8dB. Due to its modern circuitry, cross modulation and overload characteristics are excellent, allowing it to be used at even the busiest mountaintop site.

**Scala 8000/960 preamp with power supply**  
60SL8000960 MFR LIST \$500.00

Call Bradley for a current price quotation.



Company Name: \_\_\_\_\_ Call Letters: \_\_\_\_\_

Address: \_\_\_\_\_

City: \_\_\_\_\_ State: \_\_\_\_\_ Zip: \_\_\_\_\_

Business Description: \_\_\_\_\_

Accounts Payable Supervisor: \_\_\_\_\_ Phone: \_\_\_\_\_

**References:**

Give only the names of those you buy from on open account.  
Complete information is required for processing.

**Name:** \_\_\_\_\_

**Address:** \_\_\_\_\_

**City:** \_\_\_\_\_

**State:** \_\_\_\_\_ **Zip:** \_\_\_\_\_

**Account #:** \_\_\_\_\_

**Phone:** \_\_\_\_\_

**Name:** \_\_\_\_\_

**Address:** \_\_\_\_\_

**City:** \_\_\_\_\_

**State:** \_\_\_\_\_ **Zip:** \_\_\_\_\_

**Account #:** \_\_\_\_\_

**Phone:** \_\_\_\_\_

**Name:** \_\_\_\_\_

**Address:** \_\_\_\_\_

**City:** \_\_\_\_\_

**State:** \_\_\_\_\_ **Zip:** \_\_\_\_\_

**Account #:** \_\_\_\_\_

**Phone:** \_\_\_\_\_

**Bank Name:** \_\_\_\_\_

**Address:** \_\_\_\_\_

**City:** \_\_\_\_\_

**State:** \_\_\_\_\_ **Zip:** \_\_\_\_\_

**Account #:** \_\_\_\_\_

**Phone:** \_\_\_\_\_

In consideration for open account status with Bradley Broadcast, we understand and agree to the following terms and conditions:

1. That all invoices are due and payable 30 days from invoice date.
2. That all equipment ordered and received remains the property of Bradley Broadcast until paid in full.
3. That we will pay a finance charge of 1.5% per month (18% APR) on any unpaid balance which exceeds 30 days of invoice date.
4. That all equipment sold by Bradley Broadcast is covered by standard manufacturer warranty, and no other warranty, expressed or implied, shall supersede this warranty.

We hereby apply for credit and agree to the above conditions of sale on open account.

This form **MUST** be signed by a corporate officer.

We hereby authorize Bradley Broadcast Sales to contact the listed references to request information on our credit history.

**Signed:** \_\_\_\_\_

**Title:** \_\_\_\_\_

**Date:** \_\_\_\_\_

Please fill out completely and return to us at the below address.

**Bradley Broadcast**  
**8101 Cessna Avenue**  
**Gaithersburg, MD 20879**  
**FAX: 301-330-7198**

All references are verified in writing. Please allow appropriate time for processing. Companies you list may decline to provide information. We may request further references.

# ORDER FORM

<b>INVOICE ADDRESS:</b> Company Name: _____ Attn: _____ Address: _____ City: _____ State: _____ Zip: _____ Phone: (____) _____ PO#: _____	<b>SHIP TO: (if different from invoice address)</b> Company Name: _____ Attn: _____ Address: _____ City: _____ State: _____ Zip: _____ Phone: (____) _____ PO#: _____
---	---

Payment Method: (please check one)  Visa  Mastercard  Discover  Company Check  Purchase Order/Net  Money Order

**IF YOU ARE PAYING WITH A CREDIT CARD, PLEASE FILL OUT THE FOLLOWING:**

Account Number: _____	Card Billing Address: _____
Expiration Date: _____	City: _____
Name Imprinted on Card: _____	State: _____ Zip: _____

QTY	ITEM NUMBER	DESCRIPTION	AMT	TOTAL

**PLEASE NOTE: All prices are subject to change.**  
You are encouraged to verify pricing with one of our salespersons.

Prices confirmed by: \_\_\_\_\_

Date: \_\_\_\_\_

Quote Number: \_\_\_\_\_

**Minimum Order:**  
**\$15.00**

SUB-TOTAL	
(MD DELIVERY ONLY) 5% TAX	
SHIPPING CHARGES	
<b>TOTAL</b>	

**SHIPPING CHARGE METHOD (Check One)**

<input type="checkbox"/> C.O.D. For Shipping Charges	<input type="checkbox"/> Ship charge was verified by _____ Name Of Salesperson
<input type="checkbox"/> Charge My Credit Card (Fill in credit card information above)	<input type="checkbox"/> Charge my Federal Express account # _____

**NOTES:** • No U.S. Mail C.O.D. • Provide street address for shipping. We cannot deliver to a P.O. Box • Provide a daytime telephone number

**Pricing:**

Price information is provided to assist our clients in budgeting and comparing the value of different products. A price marked MFR LIST indicates the suggested selling price provided by the manufacturer. These prices are subject to discount, and a current price quotation is available by contacting us. Items in our catalog are eligible for quantity, package, and prompt payment discounts, and Bradley offers a number of leasing programs. Prices are subject to change without notice. As one of our goals is to provide you with the best value for your dollar, we are pleased to respond to your requests for pricing information.

**To order by telephone:**

Call Toll Free (800) 732-7665 to place a phone order. If you are calling from Maryland or the Washington, DC metropolitan area, call (301) 948-0650. One of our salespersons will assist you Monday through Friday, 9:00 AM to 6:00 PM Eastern Time. Visa, MasterCard, and Discover are welcome. **CREDIT CARD ORDERS ARE AUTHORIZED IN FULL AT THE TIME OF PURCHASE.** Net 30 terms are available upon credit approval. A firm purchase order signed by an authorized agent of your company is required for Net 30 purchases. Confirming purchase orders must be marked "confirming" to avoid duplicate shipments.

**To order by facsimile:**

Orders may be sent to our Fax number, (301) 330-7198, 24 hours a day. Please use our order form or your own purchase order with complete shipping and invoicing information. Fax orders for clients on open account do not require further confirmation, and fax may also be used to confirm telephone orders. Credit card users will also find it convenient to order by fax.

**To order by mail:**

Fill out the order form, or your own purchase order, enclosing the full amount due or authorizing a credit card charge.

**Tax:**

Maryland customers must add 5% sales tax. Maryland customers who are tax exempt must furnish signed documentation of their Maryland sales tax exemption number at the time of order or sales tax will be charged.

**Emergency orders:**

We will be happy to expedite orders on an urgent basis to meet an immediate need. Call for specific details.

**When to expect delivery:**

All orders are handled quickly and efficiently. Items in stock will be shipped within 24 hours of receipt. Orders are generally shipped via UPS or Federal Express. Oversized or overly heavy items will be shipped truck or air freight per your instructions. Some items we sell are built to order due to custom requirements or fixed frequency operation. You will be informed at the time of your order of the expected ship date on these items. Sometimes we will temporarily sell out of an item. Back orders are reviewed daily and shipped as soon as we receive the item. Although we make every effort to deliver your order as scheduled, we cannot be responsible for consequential damages resulting from delayed shipments.

**Minimum order:**

\$15.00 in merchandise. Our minimum shipping and handling charge is \$6.00 per order.

**Shipping charges:**

Shipping may be paid in several ways. If your order is prepaid, we can provide you with the shipping cost and you may include that charge with your payment. We can also ship your merchandise freight collect, charge the shipping charges to your credit card, or ship via the carrier of your choice using your account number. Shipments to clients with open accounts may have shipping charges prepaid and added to their invoice.

**C.O.D. shipments:**

C.O.D. orders are limited to items immediately available from stock. We reserve the right to ship C.O.D. only to established clients and recognized broadcast facilities. C.O.D. shipments in excess of \$500 may require payment by cash or certified check. We do not ship C.O.D. via the U.S. mail.

**Damaged, defective or incorrect merchandise:**

We make every effort to insure that your order arrives safely and in good condition. **If any package shows signs of external damage, please do not accept it.** We will replace the item when it is returned to our warehouse by the carrier, or we will re-ship immediately upon notification of the problem. In this case, new merchandise will be separately invoiced or charged, with credit or refund issued upon receipt of defective merchandise. When you receive any merchandise, always inspect it before signing. Under present carrier regulations, it is YOUR responsibility to report damage or loss. Always note damage on any shipping documents, and save all packing material and waybills. Request inspection by the carrier immediately. Claims for defective or incorrect merchandise must be reported to us within five days. You will be issued a return authorization (R.A.) number. We will only accept packages marked with an R.A. number. If you order the wrong item, you are responsible for shipping charges to return it. If the error is ours, we will pay for shipping. Merchandise returned for any reason other than defects or damage is subject to restocking fees.

**Bradley Broadcast Guarantee:**

All merchandise is brand new, fully warranted by the manufacturer, and shipped to you in factory cartons whenever possible. Bradley Broadcast neither offers nor implies any warranty other than that provided by the manufacturer. Bradley does not guarantee the suitability of any product for your intended purpose and is not liable for consequential damages incurred in the use of any product we provide. We maintain an extensive repair facility and are committed to assisting our clients in obtaining prompt repair service as required.

Product specifications are subject to change without notice.

**Open account terms:**

Please note our credit terms are Net 30 days. Prompt payment is expected. Interest at the rate of 1.5% per month (18% per annum) will be charged to all overdue accounts and further credit privileges suspended or removed at our option. 30 day terms are based upon the shipment date for each item, or our invoice date, whichever is later. We invoice partial shipments and expect payment within 30 days on each shipment. If your institution or company cannot accept partial billings, we will hold merchandise for complete shipment at one time. Postmark date of your payment must be within 30 days of invoice or ship date to be considered timely. We encourage school and government bids and purchase orders. We will automatically recognize purchase orders and bids from all legitimate educational institutions and government agencies.

**Catalog requests:**

We are pleased to maintain professional users of audio and radio equipment on our mailing list. Please provide call letters, company name, contact name, mailing address, and telephone and fax numbers. We mail catalogs annually and supplements at regular intervals throughout the year.



The **Telos 100 Delta** works like magic to produce the most natural sounding, full-duplex conversation. The secret? It's the only telephone hybrid that uses advanced digital signal processing (DSP) to automatically adapt to the phone line, adjust levels, and equalize the caller audio. Our exclusive digital dynamic equalization is so advanced you won't find it in any other broadcast audio product. All functions are quick as a blink. Once installed, the **100 Delta** requires no further adjustment. And you can monitor callers through open speakers without feedback. The **Telos 100 Delta**. It's the easiest way to for you to experience the pleasure of great phones.