

93

C A T A L O G



BSW
BROADCAST SUPPLY WORLDWIDE

CELEBRATING BSW AND YOU A 20 YEAR PARTNERSHIP

Birthdays are a time for reflecting on the past and making resolutions for the future.

As we look back on our first twenty years, we are awestruck by the technological changes in the broadcast and pro audio industries. The advances in analog and digital audio have enabled us to create better productions, more efficiently than ever before. These new technologies have fueled the communications revolution which has resulted in the "global village" predicted decades ago.

On the other hand, there are some important areas that have not changed. Professionals still require expert advise when making equipment purchases. You want your orders shipped promptly and you want value for your money.

BSW has always changed with the times to reflect the needs of our customers. To reaffirm our commitment to keeping you one step ahead with the most advanced products and finest service, we are changing our company's name.

BSW now stands for Broadcast Supply Worldwide. What does the change mean to you? It means you can count on even more innovation from us and that the basics of how we do business will remain solid as ever. After all, we have earned your trust and you have depended on BSW because of our selection, integrity and reliability.

Thank you for twenty wonderful years. We look forward to twenty more years of providing you with equipment solutions to keep you number one.

CELEBRATING
20
TWENTY
YEARS

IT'S EASY TO ORDER FROM BSW

Ordering By Telephone

Call toll-free 1-800-426-8434 from anywhere in the United States, Puerto Rico, US Virgin Islands and Canada. International customers please call 206-565-2301. Sales representatives are on duty 6am to 6pm Pacific Time, Monday thru Friday.

Ordering By FAX

As a convenience we have provided an order form on page 118 that you may photocopy, fill out and Fax to us toll-free at 1-800-231-7055. International Fax number is 206-565-8114.

Payment Terms

Open account, Net 30 day billing, is available to qualified domestic business and educational accounts. Credit application is provided on page 119 for accounts desiring open account status. COD is available under certain circumstances; please check with your sales rep for further details. Visa and Mastercard are accepted. Personal checks up to \$1000.00 accepted with TeleCheck approval. Payment terms and conditions for international customers vary. Please contact international sales manager for details.

Shipping Information

We know fast delivery is important to you, so we make this guarantee. Place your order with us before 12 noon Pacific time and we'll ship stock items the same day...or we pay the shipping charges. This offer good for domestic retail customers with approved credit.

No Minimum Order

Other companies impose minimum order requirements...not BSW. We are delighted to take your order, regardless of size. Actual shipping charges, insurance and a handling fee of \$3.75 apply to each order (\$5.75 Canada). We ship FOB Point of Origin unless other arrangements are made and approved in advance.

Returns

Should you have to return anything please contact us for a Return Authorization Number. All returns are subject to approval. In certain instances, a re-stocking charge may apply.

Prices

Prices shown in catalog are provided for your assistance when budgeting and comparing different makes/models. Actual BSW selling prices will be determined at time of sale and should be verified prior to ordering. BSW actual selling prices are routinely discounted below suggested list prices. (It should be noted that we print this catalog annually and manufacturers continually introduce new products as well as change prices.)

OPEN DAILY

6:00 AM To 6:00 PM Pacific Time

Toll-Free From USA and Canada

Voice 800 · 426 · 8434

Fax 800 · 231 · 7055

International Customers

Voice 206 · 565 · 2301

Fax 206 · 565 · 8114

Address Correspondence To:

7012 27th Street West Tacoma, WA 98466 USA

Quick Index

Detailed product listings found on page 120

AMPLIFIERS	pages 2-5
AUDIO PROCESSING	pages 6-18
AUTOMATION	pages 19-20
CARTRIDGE, CASSETTE MACHINES	pages 21-30
COMPACT DISC	pages 31-34
CONSOLES	pages 35-44
DIGITAL AUDIO RECORDERS	pages 45-48
HEADPHONES, HEADSETS	pages 49-52
INTERFACE EQUIPMENT	pages 53-57
MICROPHONES	pages 59-67
MONITORING	pages 68-71
REEL TO REEL MACHINES	pages 72-75
RF, REMOTE CONTROL, STL	pages 76-80
SPEAKERS, STUDIO FURNISHINGS	pages 90-104
TELEPHONE EQUIPMENT	pages 105-111
TEST EQUIPMENT	pages 112-114
TURNTABLES	pages 115-117
ORDER FORM/CREDIT APPLICATION	pages 118-119

Equipment Solutions To Keep You Number One

BSW
BROADCAST SUPPLY WORLDWIDE

BGW



85/200 Stereo Power Amplifiers

BGW amps offer advanced technology and high-efficiency in a compact package. Model 85 offers 35 watts per channel into 8 ohms. Model 200 provides 100 watts per side into 8 ohms in a single rack space unit.

85 Mfr. List \$529.00

200 Mfr. List \$999.00

Call For BSW Price

Call For BSW Price

CROWN



D75/D150AII/DC300AII Stereo Power Amplifiers

Broadcasting's most popular amplifier, the D75 features 35 watts per channel RMS with only .05% harmonic distortion and active balanced inputs with XLR connectors.

For extra power to drive larger monitors, choose either the D150AII or DC300AII amplifiers. The D150AII output is 80 watts per channel RMS and the DC300AII has 155 watts per channel RMS. Rack space is 5 1/4" and 7" respectively.

All amplifiers have a 3 year warranty.

D75 Mfr. List \$549.00

D150AII Mfr. List \$879.00

DC300AII Mfr. List \$1,199.00

Call For BSW Price

Call For BSW Price

Call For BSW Price

HAFLER

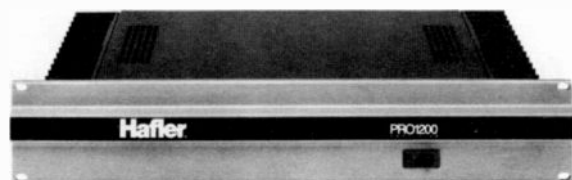

PRO SERIES Stereo Power Amplifiers

Hafler amps are famous for providing three important features that professionals demand: fidelity, simplicity, and reliability. Features rear panel level controls, mono-bridge switch, chassis/float ground switch, and true set it and forget it operation.

PRO1200 (60W/Chnl. Into 8)

PRO2400 (120W/Chnl. Into 8)

PRO5000 (325W/Chnl. Into 8)

Mfr. List \$500.00

Mfr. List \$630.00

Mfr. List \$1,200.00

Call For BSW Price

JBL



SR6600 SERIES Stereo Power Amplifiers

These amplifiers put pro-caliber power amplification into trim, affordable, super lightweight enclosures. Quiet enough for the studio, yet tough enough for remote work. Cooling system is sensibly rear-to-front, expelling heat that builds up in the rear of rack.

SR6615 (90W/Chnl. Into 8)

SR6630 (190W/Chnl. Into 8)

Mfr. List \$680.00

Mfr. List \$940.00

Call For BSW Price

QSC



SERIES ONE Stereo Power Amplifiers

You get uncompromising performance and unexpected economy with QSC Series One Amps. All models feature turn on/off protection, active balanced inputs, and balanced outputs. Model 1100 includes front panel headphone jacks.

1100 (50W/Chnl. Into 8)

1200 (100W/Chnl. Into 8)

1400 (200W/Chnl. Into 8)

1700 (325W/Chnl. Into 8)

Mfr. List \$608.00

Mfr. List \$638.00

Mfr. List \$838.00

Mfr. List \$1,328.00

Call For BSW Price

RAMSA



WP SERIES Stereo Power Amplifiers

Truly great amplifiers are measured by two standards: sonic quality and reliability. The Ramsa 9055 power amplifier achieves excellence on both counts. Balanced and unbalanced inputs, UL listed and an outstanding 5 year warranty.

WP9055 (50W/Chnl. Into 8)

WP9110 (100W/Chnl. Into 8)

WP9220 (200W/Chnl. Into 8)

Mfr. List \$650.00

Mfr. List \$890.00

Mfr. List \$1,050.00

Call For BSW Price

ROLLS



**RA2100
Stereo Power Amplifier**

When you need an inexpensive monitor amp with plenty of power and performance, choose the Rolls RA2100. Features include: 75 Watts RMS/channel into 8 ohms, turn-on delay protection, LED power output meters, and 25/70 volt line capability.

Mfr. List \$299.95

Call For BSW Price

STEWART



**PA SERIES
Power Amplifiers**

Stewart Electronics makes use of a 100 kHz switching power supply to provide surprising power in a space saving half-rack design. PA Series amps feature thermal protection, tamper resistant screw driver level controls, and are available with 25 or 50 watts per channel. Balanced inputs and outputs.

PA50B Mfr. List \$279.00

Call For BSW Price

PA100B Mfr. List \$359.00

Call For BSW Price

SYMETRIX



**A220
Stereo Power Amplifier**

High performance, low power stereo amplifier. The A220 will develop better than 20 watts per channel into 8 ohms with full power distortion of less than .02% @ 1 kHz. Typical application includes the powering of headphone distribution boxes and small monitor speakers.

Mfr. List \$349.00

Call For BSW Price

YAMAHA



**P2075
Stereo Power Amplifier**

The P2075 is a great amplifier value with 50 Watts of power into 8 ohms, balanced operation, and protection from turn-on thumps, overheating, and output shorts, all in a light-weight, 2 rack space chassis.

Mfr. List \$395.00

Call For BSW Price

ASHLY

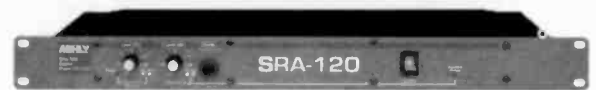

**SRA-120
Stereo Power Amplifier**

The SRA-120 is a small, powerful stereo power amplifier that offers superior sonic quality and rugged construction in a single rack space.

Delivering 45 watts per channel at 8 ohms, the SRA-120 features low distortion and outstanding circuit protection. Front panel has volume controls and headphone jack.

Mfr. List \$499.95

Call For BSW Price

**Choosing An Amplifier For
Your Application**

A few basic considerations should be examined in purchasing an amplifier to ensure the best value and performance for your money.

First, ask yourself how the amplifier will be used. Will it be powering large monitor speakers or small reference speakers? Will it remain in a fixed location or will it be used on remotes? How much use will the amplifier get etc? Answering these types of questions up front will save you from buying the amp you don't really need.

It is important that the amplifier you choose will handle the load your speaker(s) show it. So you will need to determine the net speaker impedance load you intend to show the amplifier outputs.

Finally, it is important not to overpower or underpower speakers. Underpowering speakers prevents them from producing optimum results and can even cause damage to speaker components. Overpowering speakers can damage them both thermally and mechanically (excess excursion).

Ask a BSW sales representative to help you match your requirements with an amplifier that will offer you performance and value.

APHEX



**120
Distribution Amplifier**

The Model 120 is a high performance audio distribution amplifier with a single high impedance input and four low impedance outputs, all electronically servo-balanced. The sturdy steel chassis may be used stand-alone or rack mounted, singly or in pairs. THD is .002% @ +4 dBm, hum and noise better than 90 dB. 1/2 rack wide.

Mfr. List \$319.00 Call For BSW Price

ATI



**DA208/DA416
Distribution Amplifiers**

Two or four inputs, each driving four individually adjustable, active balanced outputs gives you twice the channels for the price. Need more outputs? Just parallel inputs for up to 1x16 operation.

DA208 (Dual 1 x 4) Mfr. List \$349.00 Call For BSW Price
DA416 (Quad 1 x 4) Mfr. List \$499.00 Call For BSW Price



**PB2X8
Distribution Amplifier/Press Box**

Use the PB2X8 as a press box with a pair of summed mikes driving eight transformer isolated outputs or as a conventional line level DA with 3 configurations: 1x4 stereo, 1x8 mono or Dual 1x4 mono.

Features include:

- 2 balanced XLR mic/line inputs • Balanced/Unbalanced outputs with individual level control • VU metering of any input or output
- Balanced TRS loop through input jacks • Calibrated test tone oscillator • 48VDC Phantom power • Front panel headphone jack.

Mfr. List \$1,295.00 Call For BSW Price

Need help in selecting the proper Distribution Amplifier?
Call us toll free for assistance.

BGW



**2242
Distribution Amplifier**

The 2242 provides optimum audio quality in a dual 1x4 configuration. Even digital audio can be distributed to multiple destinations without degradation. Each output provides up to +27 dBm drive into 600 so very long lines remain stable. Operation is balanced or unbalanced with barrier strip termination.

Mfr. List \$799.00 Call For BSW Price

ESE

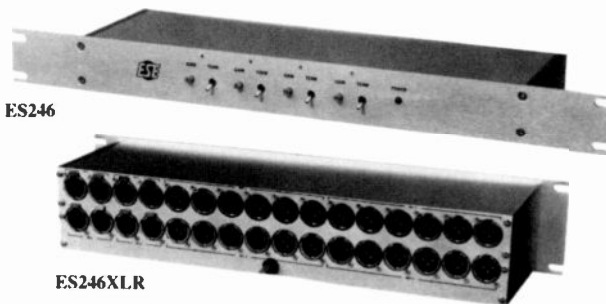

**ES246
Distribution Amplifier**

Here's a quad 1x6 DA with a difference. The ES246 offers the choice of barrier strip or Optional XLR connections (Unit is 1U rack size with barrier and 2U with XLR). Front panel output adjustment is available for each of the 4 input channels. Features balanced or unbalanced operation with switchable 600 or 100k input termination.

ES246 Mfr. List \$395.00 Call For BSW Price
ES246XLR Mfr. List \$595.00 Call For BSW Price

HENRY ENGINEERING



**U.S.D.A.
Distribution Amplifier**

U.S.D.A. ("Utility Summing and Distribution Amplifier") has two inputs (one stereo pair) and four outputs (two stereo pairs), and can be used as a conventional 1x4 or 2x4 distribution amplifier. USA can also be used to combine a stereo input to a mono output.

Mfr. List \$195.00 Call For BSW Price

GENTNER



**RDA
Routing Distribution Amplifier**

RDA's unique design gives you uncompromised versatility with eight inputs and 28 outputs. Any input or combination of inputs can be routed to any output via front panel dip switches. The RDA delivers outstanding aural specifications with 98dB of dynamic range, > 90 dB of separation between any channel, and SNR >80dB referenced to +4 out.

Mfr. List \$1,545.00

Call For BSW Price

**RADIO DESIGN
LABS**

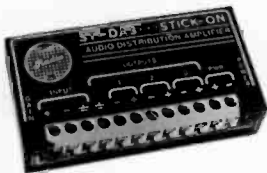

**STDA3
Distribution Amplifier**

This compact, "Stick-On"™ 1x3 DA will fit almost anywhere. The STDA3 allows the bridging of any audio line, adjusting the gain, and driving up to three isolated outputs. Inputs and outputs can be balanced or unbalanced. External power supply required.

Mfr. List \$93.95

Call For BSW Price

PS24A Power Supply \$12.95

SHURE



**FP16A
Distribution Amplifier**

Rugged, compact, and lightweight, this 1-input, 6-output distribution amplifier is specially designed for field production and can be powered via internal batteries or an AC adaptor. All 6 outputs, as well as the input, are individually switchable to mic-or-line level.

Mfr. List \$595.00

Call For BSW Price

RADIX



**DA1600
Distribution Amplifier**

DA1600 features 8 stereo or 16 mono outputs with front panel level control and selectable pads to accommodate a wide range of input levels. One of the best things about this DA is the removable, plug-in connectors that allow wiring changes to be made quickly and effortlessly with the DA still in the rack. Specifications: THD: .01% max @ +20 dBm out, SNR 90 dB, output separation: 90dB

Mfr. List \$435.00

Call For BSW Price

RADIO SYSTEMS



**DA16
Distribution Amplifier**

The Radio Systems DA 16 provides 8 stereo or 16 mono, independent audio outputs from one input. Each output is completely isolated and has individual level control. Ultra-low noise levels, fast transient response and low distortion insure that the signals at the outputs of the DA are an exact image of the input. Barrier strip connections.

Mfr. List \$425.00

Call For BSW Price

WHIRLWIND



**PRESSPOWER
Powered Pressbox**

Whirlwind's Presspower provides a comprehensive and flexible audio distribution system for press conference situations. It's two XLR inputs can handle mic or line level sources and have selectable phantom power, ground lift and high pass filtering. Press power has twelve mic level outputs and 4 line level outputs. Line outputs 1 and 2 have adjustable gain with XLR and 1/4" TRS connectors. Line outs 3 and 4 are fixed level with XLR connectors. Mic outputs 1 through 12 are transformer isolated, low impedance with balanced XLR or 1/8" TRS connectors. Additional features include: VU meter, switchable test tone and AC or battery operation. Padded rack bag included.

Mfr. List \$1,795.00

Call For BSW Price

TIRED OF WAITING FOR YOUR ORDER TO SHIP?

Call us by 12 P.M. Pacific Time and we'll ship stock items by 5 P.M. the same day guaranteed, or we pay the freight.

CRL

FM System

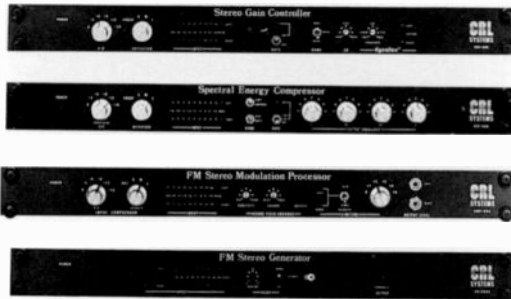

AM System



FM/AM AUDIO Processing Systems

CRL FM and AM modular processing can be purchased as systems or as individual components.

Both AM and FM systems are comprised of combinations of three basic units:

- Multiband AGC with noise reduction (SGC800 stereo, AGC400 mono)
- Multiband compressor/limiter/EQ (SEC800 stereo, SEC400 mono)
- Final peak limiter (SMP850 stereo FM, PMC450 mono, SMP950A stereo AM).

In addition CRL offers the SG800A Stereo Generator for FM applications.

Ask a BSW representative to help you configure the system that best fits your technical and financial requirements.

Pricing Based On Configuration

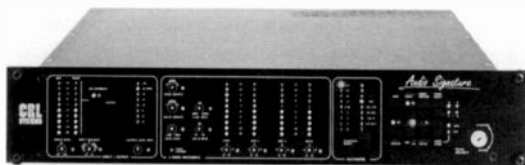

AUDIO SIGNATURE FM/AM Stereo Processor

Audio Signature provides wideband and four band processing in one package. CRL's Digital Control system offers the power of digital control in a user friendly, easy to operate format. Features: Digitally processed user controls • Separate wideband and multiband control • User adjustable multiband crossovers • Real time analysis output monitoring • 8 position audio diagnostic metering • 4 memory recall sound settings • PC and automation remote control capability

Mfr. List \$5,995.00 Call For BSW Price

CRL



MBL100 News/Talk/Sports Processor

The MBL100 is designed to increase loudness and coverage area of AM monaural news/talk/sports formats by combining powerful audio processing topology, and 7.5 kHz audio low-pass filtering. Features: Input band-pass filtering • NRSC compatible filtering • Remote control operation • Dual band AGC/compressor

Mfr. List \$3,695.00 Call For BSW Price



AMIGO FM Stereo Processor

A complete inexpensive audio processor for FM. The AMIGO is a combination of a dual band AGC followed by a multi-band limiter and digitally synthesized stereo generator. Adjustments are kept to a minimum for fast set-up and easy adjustment. The AMIGO offers exact peak modulation control while maintaining outstanding program clarity.

Mfr. List \$3,195.00 Call For BSW Price

CUTTING EDGE



UNITY 2000 Digital Processor

Finally, a complete digital processor that delivers every function in today's audio chain in one chassis!

The Unity 2000 includes the following:

- Digital 4 band leveller/processor (feed forward RMS circuitry)
- Digital 4 band limiter (feed forward, multiple time constants)
- Digital stereo generator (better than 50 dB of separation)
- Selectable composite clipper

Both the Preprocessor and the limiter include the revolutionary "intelligent time constant controller" that actually learns the music and adjusts attack and release time accordingly, and in real time. Feed forward technology provides a constant processing ratio giving the user a "sweet spot" at any level of processing.

Mfr. List \$8,500.00 Call For BSW Price

GENTNER

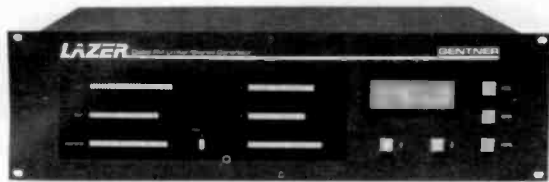

**LAZER
FM Digital Audio Processor**

The Lazer is broadcasting's first and only 100% DSP digital FM limiter/stereo generator. Incredible flexibility offers you an unprecedented level of control over AGC, limiting and a variety of other functions which may give your station a competitive edge. The Lazer offers 23 precise processing parameters that are individually user adjustable and may be stored into 8 memory locations. Stereo separation is greater than 65 dB with virtually no noise or RF interference.

Includes a separate optical encoder which provides analog to digital conversion for the Lazer.

Mfr. List \$5,495.00

Call For BSW Price



**FM AUDIO PRISM II/PRISM II AM
Audio Processors**

The Audio Prism from Gentner is giving many stations the extra punch and modulation power required to be competitive in today's aggressive markets. The Prism's four-band parallel layout and digital control provide smooth, predictable gain change and full modulation without fatigue. A broadband safety buffer guards against unusually high input levels, and a single density control simultaneously adjusts attack and release times. Set up is easy with a built-in pink noise generator and front panel test points. The Audio Prism is designed to go before a final peak limiter and stereo generator. Two units are required for stereo.

FM AUDIO PRISM II (2 Required For Stereo) Mfr. List \$1,695.00
PRISM II AM (Includes Phase Rotator) Mfr. List \$1,895.00

Call For BSW Price

Need assistance in selecting the proper Audio Processor? BSW Sales Professionals are very qualified to help you make the right choice. We offer demo units, so you can try before you buy.

Call toll free for all the details

ORBAN



**8200
Digital Audio Processor**

The 8200 is a complete digital audio processing system for FM broadcast, fulfilling all of your station's processing needs: automatic gain control, compression, peak modulation control and stereo generation.

Continuing the tradition of louder, cleaner, brighter audio established by the 8100 Series, the 8200 adds even greater high-frequency and peak control for the cleanest, loudest sound possible. By integrating the stereo generator with the audio processing, the 8200 eliminates overshoot problems found in traditional external generators.

The 8200 allows you to choose from several factory presets or adjust and store your own custom presets (up to 32) for instant recall.

Flexible software based processing allows the 8200 to be configured for protection limiting/processing, two-band processing, or five-band processing and is fully expandable to incorporate future software upgrades and processing structures.

Automatic program switching can be programmed into the internal clock to follow format changes throughout the day or night.

The 8200 is easily controlled from the front panel, by using your current transmitter remote control, or an IBM-compatible PC with Optimod-FM's optional software and a standard modem.

8200/U2S Two Band Processor

Mfr. List \$7,400.00

8200/U3S Multiband Processor

Mfr. List \$9,820.00

Call For BSW Price



**9100B
AM Audio Processor**

9100A has become a standard for AM analog processing. It contains a wide band AGC, 6-band limiter, safety clipper, and all appropriate filtering for complete processing control. The net result is very high average modulation (loudness), exceptional fidelity, uncanny naturalness, and freedom from processing artifacts, yielding an FM-like sound on all types of receivers. NRSC compliant.

9100B1 (Mono) Mfr. List \$4,550.00

Call For BSW Price

9100B2 (Stereo) Mfr. List \$6,350.00

Call For BSW Price

INOVONICS



**250 SERIES
AM/FM/TV Audio Processor**

Inovonics' 250 is a comprehensive multiband stereo audio processor for demanding applications in AM, FM, or TV. Programmability of the 250 enables the user to adapt processing parameters to suit different station formats or dayparts.

Features:

- Feed forward PWM control • Unique "soft knee" compression
- FM/TV stereo, matrix AM stereo or AM mono • Manual presets or RS232 control

FM/AM (Stereo) Mfr. List \$3,050.00 Call For BSW Price
AM (Mono) Mfr. List \$2,550.00 Call For BSW Price



**255-00
FM Audio Processor**

Inovonics' 255-00 is a stereo audio processor with principal utility in the "contemporary music" FM broadcasting format. It allows almost unlimited control over program spectral distribution and density through a series of calibrated wide-range adjustments.

Unit includes:

- Gated AGC • Activity detector masks processing artifacts • Gated 3-band Compressor/Limiter • Feedforward PWM control

Mfr. List \$1,990.00 Call For BSW Price

MODULATION SCIENCES



**CP803RM
Composite Processor**

Sharpen your competitive edge by adding the CP803RM to your compressor/limiter/stereo generator to enhance the stereo composite signal. Increase your signal by 6 dB with greater dynamic range without the breathing, pumping or swishing associated with conventional processing.

Mfr. List \$1,495.00 Call For BSW Price

APHEX



**DIGICODER
PPDM Stereo Generator**

Digicoder provides unequalled sonic transparency of Class-A analog with the separation and stability of digital and maintains maximum loudness. PPDM™ (Parallel Path Digital Modulation) circuitry produces a dynamic range better than 110 dB. Features include real-time throughput, a zero overshoot lowpass filter, no internal calibration needed, greater than 65 dB of separation to 15 kHz, selectable pre-emphasis, and full remote control capability.

Mfr. List \$3,995.00 Call For BSW Price

INOVONICS



**706-00/705-00
Digital Synthesis FM Stereo Generators**

The second generation 706 FM stereo generator offers digital synthesis of composite signal and internal composite clipper with the option of incorporating the FMX™ Transmission System. It interfaces with many audio processing systems and features front-panel metering of internal levels, remote control of mono/stereo functions, and built-in combining for up to 3 SCA or RDS inputs. Stereo separation 70 dB typical.

706-00 Mfr. List \$3,120.00
705-00 (Simplified Version Of 706) Mfr. List \$1,375.00

Call For BSW Price

QEI



**710
Digital Stereo Generator**

QEI's model 710 is a true digital numeric stereo generator contained in a single rackspace unit. Audio specs are superb with noise 90 dB down, THD and IMD distortion .008% typical, and greater stereo separation than current equipment can measure. It provides excellent pilot protection and pilot stability which reduces the effect of multipath in the receiver. Digital control means there's no need for constant realignment and open architecture allows for maximum flexibility of applications. Includes balanced/unbalanced analog inputs and digital input utilizing QEI's Q-Chain format.

Mfr. List \$3,500.00 Call For BSW Price

AUDIO DIGITAL



**TC4
Broadcast Delay**

A state-of-the-art advancement in broadcast profanity delay. 6.8 seconds delay time, 15 kHz bandwidth, and 85 dB dynamic range. Allows memory dump and automatic audio catchup feature. 2 units required for stereo.

Mfr. List \$1,865.00

Call For BSW Price

EVENTIDE



**BD941/942
Broadcast Delay**

Now reliable, efficient obscenity protection is so cost-effective, even radio stations that only program occasional live talk shows can afford it. The mono BD941 is available in 6 and 12 second versions—the stereo BD942 offers 3 or 6 seconds of delay. All versions feature full bandwidth and inaudible distortion.

The Eventide BD941 and BD942 provide a simple and practical "one-button" method for eliminating the risk of on-air obscenities. When a "no-no" is uttered, the talent simply hits the delete button on the front panel, or activates a remote closure. This control simultaneously bypasses the delay line and closes a relay contact. The relay contact can be used to start a cart jingle or other filler message. At the end of the message, the BD941/2 automatically go back on line with full delay protection.

BD941 (Mono, 6 Second Delay)

Mfr. List \$1,795.00

BD942 (Stereo, 6 Second Delay)

Mfr. List \$2,395.00

Call For BSW Price

INOVONICS



**222-00
AM NRSC Processor**

222-00 incorporates an adaptive pre-emphasis characteristic to enhance signal intelligibility and presence, and a sharp roll-off to eliminate adjacent channel interference. With a built-in peak limiter, the 222-00 can act as a stand alone processor, or interface with existing processing.

Mfr. List \$620.00

Call For BSW Price

MODULATION SCIENCES



**STEREOMAXX
Spatial Enhancer**

Almost all air chain processors work to increase loudness. StereoMaxx makes your station sound bigger, not just louder. No matter what kind of radio your listeners tune, once your station adds the energy and excitement of StereoMaxx, other stations sound rather tired and dull by comparison. Works with all on-air audio processing units.

Mfr. List \$2,889.00

Call For BSW Price

ORBAN



**222A
Spatial Enhancer**

The Orban 222A stereo spatial enhancer can augment your station's spatial image the way your audio processor maximizes loudness and brightness.

Highlights:

- Proprietary technique detects and enhances psychoacoustic directional cues
- Front panel controls allow custom tailoring
- No increase in: FM multipath distortion, unnatural reverberation, or sensitivity to vertical tracing distortion
- Full mono compatibility

Mfr. List \$975.00

Call For BSW Price



**245F
Stereo Synthesizer**

The Orban 245F stereo synthesizer has been designed to take any mono signal and create life-like pseudostereo. Unlike many other techniques, the patented Orban stereo synthesis technique causes no change in spectral balance, does not blur the transient definition and adds no audible noise or distortion to the mono original. The stereo output sums back to the original mono for total mono/stereo compatibility.

Mfr. List \$440.00

Call For BSW Price

NEED PRICES ON A MAJOR PROJECT ?

Save yourself time and FAX us your equipment list. We'll have a complete price quote back to you in no time.

CRL

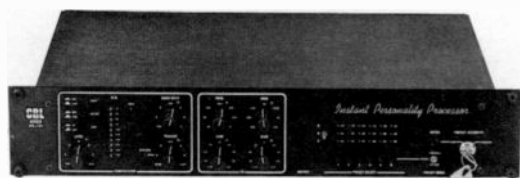

**IPP100
Voice Processor**

Powerful equalization and compression circuitry are combined with an advanced microcontroller to give a wide range of programmable preset characteristics in CRL's IPP100.

Features include: Easy to use "analog" controls, selectable mic/line level inputs, two band parametric EQ (constant Q), two band compressor with gating, 18 memory "pre-sets", easy to use "analog" controls, security lock, remote jack for switching of presets.

IPP100 Mfr. List \$1,750.00

IPP100R (Remote Panel) Mfr. List \$395.00

Call For BSW Price

ORBAN



**787A
Voice Processor**

The 787A features three band parametric equalizer, compressor, de-esser, noise gate, compressor gate and optional ducker integrated in a compact, powerful system. Stores up to 99 different control setups in memory for instant recall. Designed for DJ mic processing and voice recording, but versatile enough for many other production uses.

Mfr. List \$1,450.00

Call For BSW Price

ROLLS



**HR11C
Microphone Processor**

The HR11C is the perfect answer for stations needing extremely cost effective mic processing. This half-rack width unit incorporates a mic preamp with phantom power, compressor/limiter, notch filter, 10-band graphic equalizer, and an output control. HR11C is compact, easy to use with surprisingly good specs considering their low cost.

Mfr. List \$225.00

Call For BSW Price

SYMETRIX



**528
Voice Processor**

The 528 is a complete, self contained voice processor that performs five separate functions: mic preamp, de-esser, compressor/limiter, downward expander and parametric equalizer/notch filter. High density packaging allows all five signal processors to fit comfortably in a single rack space. With the 528 Voice Processor you get all the control you need, without the cost or complications of separate units.

Mfr. List \$679.00

Call For BSW Price

VALLEY INTERNATIONAL



**400
Voice Processor**

How do you emphasize your on-air personalities' impact? Give them a Model 400 mic processor from Valley International! To begin with, the Model 400 contains a high quality mic preamp, so you can go line level into your console. This is followed by a 3 band EQ section, a compressor/expander, a noise gate, and a de-esser. Controls are easy to use and layout fits in a single rack space unit.

Mfr. List \$679.00

Call For BSW Price

FlexLease

BSW offers innovative lease programs that are the right answers to your equipment financing dilemmas. Whether you're interested in low monthly payments, tax incentives, or just conserving your cash flow without tying up your credit lines, BSW FlexLease programs offer creative solutions to obtaining the equipment you need. Call us today for all the information.

APHEX



**COMPELLOR 320
Compressor/Limiter**

The Compellor 320 builds on the success of the Model 300 delivering invisible compression, and levelling simultaneously with selectable peak limiting. In addition 320 offers stereo enhance, 3 modes of stereo/dual mono operation, and comprehensive metering. The Compellor 320 provides complete, automatic dynamic control without any perceptible artifacts.

Mfr. List \$1,350.00

Call For BSW Price



**DOMINATOR II
Stereo Peak Limiter**

Dominator II represents the ultimate in clean and transparent peak limiting. Based on the popular Aphex Dominator, the Dominator II has even better performance with a dynamic range that has been increased by 24dB to 104dB and THD distortion of less than .005%

Mfr. List \$1,350.00

Call For BSW Price



**EXPRESSOR 651
Compressor/Limiter**

Expressor allows you to take advantage of the controls, with radical or conservative settings, and still maintain unparalleled audio clarity. This is made possible with the exclusive High Frequency Expander (HFX) and Spectral Phase Reflector (SPR). The HFX allows higher ratios without "dullness" and the SPR restores bass clarity and punch without increasing amplitude. Expressor gives you soft or hard knee compression in a single rack space unit with servo balanced inputs and outputs.

Mfr. List \$495.00

Call For BSW Price

With BSW's Extensive Inventory, Chances Are,
We Have What You Need In Stock.

ART



**MDC2001
Dynamic Processor**

For virtually any application requiring compression, limiting, expansion, noise gating, de-essing, signal enhancement, and sibilance correction, this single rack space unit will perform like nothing else available. Each function can be adjusted independently with over 45 LEDs to precisely monitor all functions and level variations. A revolutionary new VCA offers super dynamic range and ultra-low distortion.

Mfr. List \$499.00

Call For BSW Price

DBX



**166
Compressor/Limiter**

Dual channel comp/limiter featuring noise gating with switchable release rate, hardwire bypass, variable over-easy compression, side chain monitoring, and PeakStop® for transparent limiting. Rack mountable; low profile

Mfr. List \$629.00

Call For BSW Price



**160XT
Compressor/Limiter**

The 160XT delivers outstanding performance and easy to use operational flexibility in a slimline rack mount package. Its metering shows gain reduction of the compressed signal compared with either the input or the output level. Choice of over-easy or hard-knee operation, irrespective of compression ratio. Balanced inputs and outputs.

Mfr. List \$459.00

Call For BSW Price



**163X
Compressor/Limiter**

The 163X was designed for simplicity of use at no sacrifice in sonic quality. A single fader, along with the level-set control, provides the flexible combination of compression and gain at a consistent output level. Single channel.

Mfr. List \$169.00

Call For BSW Price

ORBAN



**424A
Dynamic Processor**

Here is one of the most complete, multi-function, audio processors available for the studio. The dual channel 424A features a compressor, limiter, and de-esser all in one package.

Features:

- Defeatable gate with adjustable threshold • Compressor has adjustable attack and release time • Extensive use of VCA's for low distortion
- Better than 25 dB de-ess gain reduction

Mfr. List \$1,150.00

Call For BSW Price

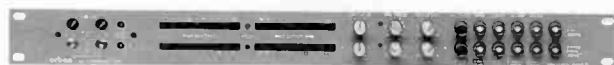

**464A
Compressor/Limiter**

The Orban 464A is a friendly, automatic "assistant operator" that smoothly and unobtrusively rides gain and limits peaks. The Orban 464A provides an unprecedented combination of versatility, audio quality and ease of use.

Features:

- Transparent gain riding without overshoots • Release time and release shape are adjustable to optimize processing • A defeatable "silence gate" prevents noise rush-up • Two channels in a space saving, rugged, all metal 1 3/4" package

Mfr. List \$1,200.00

Call For BSW Price



**412A
Compressor/Limiter**

The Orban 412A is a basic, cost effective compressor/limiter with remarkably natural sound and extraordinary ease of use. A streamlined, straight-forward front panel offers the most demanded user controls, including attack time, release time, ratio and threshold. This is a no frills unit with all the essentials at a very attractive price.

412A (Single Channel) Mfr. List \$525.00 Call For BSW Price

414A (2 Channel) Mfr. List \$800.00 Call For BSW Price

DON'T SEE IT? - ASK US

This Catalog Represents Only A Fraction Of The Thousands Of
Items Available From BSW

RANE



**DC24
Dynamic Processor**

Features:

- Independent stereo limiter, compressor and expander/gate functions
- Separate threshold and ratio controls for each operation • Built-in 24 dB/octave crossover • Gain reduction meters, threshold, signal and overload LED indicators • Stereo or dual (slave) side chain switch and side chain insert jacks • 3-pin balanced/unbalanced connectors with ground lift switch

Mfr. List \$599.00

Call For BSW Price

**RADIO DESIGN
LABS**

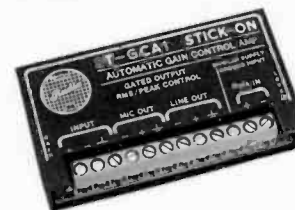

**STGCA1/STGCA2
Gain Controlling Amplifier**

The STGCA1 is a high performance AGC that offers slow "inaudible" gain reduction. STGCA2 provides fast, automatic gain reduction for tighter dynamic control. Both units feature adjustable level and threshold and can be used anywhere you want to maintain uniform audio levels. The STGCA units are part of the Radio Design Labs family of "stick-on" products and require external power supply.

STGCA1 or STGCA2 Mfr. List \$89.95 ea.

Call For BSW Price

PS24A Power Supply \$12.95

WHEATSTONE

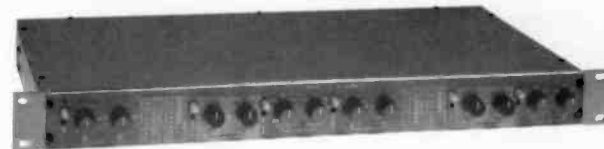

**1202A
Compressor/Limiter/De-esser**

The same engineering and manufacturing expertise used on Wheatstone consoles goes into building the 1202A compressor/limiter/de-esser. This two channel unit features input and output gain, function bypass switches and two color LED meters showing VU and level of reduction.

Mfr. List \$699.99

Call For BSW Price

SYMETRIX



**421
Automatic Gain Controller (AGC)**

The sheer versatility of the Symetrix 421 will lend itself to almost every broadcast situation that requires stable, consistent audio level control. The 421 is an incredibly accurate, fast-acting AGC that keeps an "audio eye" on the operators. Simply set your target output level and walk away. The 421 works like a "phantom-hand" on the fader for accurate audio level control.

What really sets the 421 apart is the way its 'smart' circuitry reacts to real-world situations. The Activity Release Monitor (ARM) circuit instantly distinguishes the difference between real signals (music and speech) and noise and feedback. 2 units required for stereo.

Mfr. List \$549.00

Call For BSW Price



**425
Dual-Channel Compressor/Limiter/Expander**

Features:

- Integrated Dynamics Processing includes downward expander, compressor and limiter
- Two independent channels which may be ganged for stereo operation
- Separate threshold controls for expander, compressor and limiter
- Balanced XLR or unbalanced 1/4" inputs and outputs.

The 425 is an outstanding value for all your studio processing needs.

Mfr. List \$579.00

Call For BSW Price



**SX206
Dynamic Processor**

The SX206 Multi Dynamics Processor is a single channel device that may be used as a compressor/limiter, gate, downward expander, ducker, or slave (for stereo operation). A full complement of controls is provided for each operating mode. This inventive blend of control techniques, implemented with a precision low-noise VCA, soft-knee transition, ultra stable feedforward control, and +24 balanced output capability, gives the SX206 its outstanding sonic integrity.

Mfr. List \$329.00

Call For BSW Price

SYMETRIX



**501
Compressor/Limiter**

Two processor device with variable ratio compressor and an infinity-to-1 peak limiter for the ultimate in compression limiting. Selectable automatic mode significantly reduces overshoot and distortion. Balanced and unbalanced inputs and outputs. Used in broadcasting, music recording, sound reinforcement and tape duplication.

Two units required for stereo.

Mfr. List \$349.00

Call For BSW Price

UREI

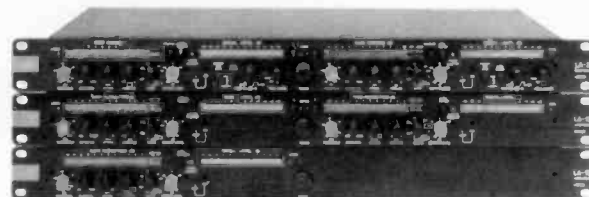

**LA10, LA12 and LA22
Compressor/Limiters**

LA Series compressor/limiters deliver transparent control over audio levels, employing Smart-Slope™ compression ratios. Ultra low noise circuitry and intelligent feature selection make the LA Series ideal for most demanding applications.

Three LA Series models, LA 10, LA 12 and LA22 all share virtually identical performance characteristics and differ only in terms of number of channels and features. Housed in a compact 1 rack space chassis, 3 separate gain reduction circuits are provided. Front panel controls include threshold, attack, release, ratio, and output level. The ratio control activates an "Auto" function which sets the compression levels to a factory pre-set for quick set-up.

The models LA 10 and LA 12 are single and dual channel versions that are perfect for most basic level control applications. For more elaborate and detailed control, choose the LA22. It features an expander, parametric EQ filter system for 'custom-tuning' frequencies to have gain reduction and expansion.

LA 10 (Single Channel)

Mfr. List \$550.00

LA 12 (Dual Channel)

Mfr. List \$850.00

LA 22 (Single Channel)

Mfr. List \$1,150.00

Call For BSW Price

When It Comes To Audio Processors, Nobody Offers Better Selection and Pricing Than BSW

APHEX

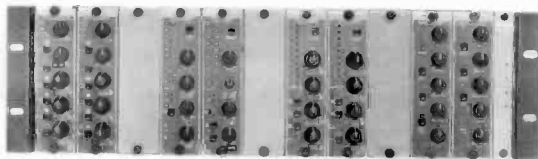

**9000 SERIES
Modular Processing System**

Now the most popular Aphex units are available in mini-modules designed to be used in the 9000 Series modular rack system. Choose from the 9651 Expressor, 9611 Expander/Gate, 9301 Compellor, or 9251 Aural Exciter to configure your own custom processing system. 19" rack holds 11 units and is 3RU high. All modules have servo balanced inputs and outputs.

**Prices Range From \$499.00 to \$549.00 Mfr. List
Call For BSW Price**

DBX



**900 SERIES
Signal Processing System**

The 900 Series modular signal processing system from dbx packs up to 9 processing modules in a single 3 space rack. Fill it up with your choice of noise reduction, de-essers, compressor/limiters, noise gates, and parametric equalizers. Get all the details from your BSW sales representative.

Price Based On Configuration

5 GREAT REASONS TO ORDER FROM BSW

- Excellent Prices
- Outstanding Selection
- Extensive Inventory
- Fast Delivery
- Knowledgeable Sales Representatives

ART

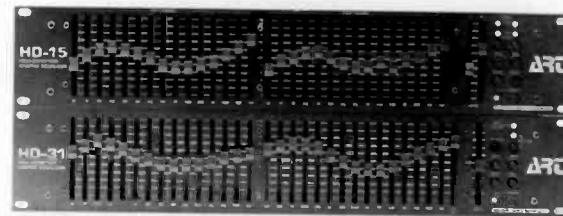

**HD31/HD15
Graphic Equalizer**

There's no need to worry about phase shift or sound coloration with the HD series graphic EQs from ART. Constant Q circuitry and the absolute finest electrical components ensure transparent, accurate operation. Both units feature balanced inputs and outputs, 60 mm high resolution faders, signal/clip LEDs, switchable and subsonic/ultra-sonic filters. Choose the single channel 31 band HD31 or two channel 15 band HD15.

**HD31 Mfr. List \$425.00
HD15 Mfr. List \$425.00**

**Call For BSW Price
Call For BSW Price**

DAX

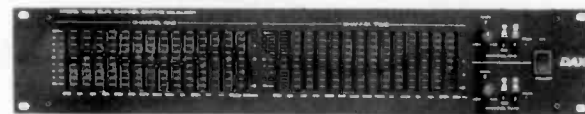

**1520
Graphic Equalizer**

This dual channel EQ offers 15 bands of control (+-12 dB boost or cut) on each channel plus XLR balanced inputs and outputs. Frequency response is 20Hz to 20kHz, +-1 dB. THD is < .01% at 1 kHz, 0 dB output. SNR is 90 dB at 0 dBV output.

Mfr. List \$398.00

Call For BSW Price

DBX



**1531X
Graphic Equalizer**

A rear panel switch converts the 1531X from a single channel 31-band EQ to a dual-15 band EQ...Now that's versatile! Fader throw is selectable for +-15 dB or +-7.5 dB and a high pass filter is selectable via a front panel switch, with a choice of 3 turnover frequencies (20, 60, or 120 Hz).

Mfr. List \$419.00

Call For BSW Price

ORBAN



**672A
Equalizer**

A cost effective professional quasi-parametric equalizer with the convenience of graphic type EQ controls. Features very low noise and distortion, high slew rate for minimum TIM (SID), front panel gain control with 12 dB gain available, "peak stretching" overload lamp to warn of clipping, active balanced inputs and unbalanced outputs.

Mfr. List \$725.00

Call For BSW Price



**642B
Parametric Equalizer**

- Features:
- 4 band, dual channel parametric equalizer. Each section offers overlapping tuning with a 20:1 frequency range + 16 dB boost/-40 dB cut in each band.
 - Bandwidth variable from about 5 to 1/4 octaves ("Q": 0.29 to 5.0).
 - "Constant-Q" design facilitates precise tuning of notches.
 - Front panel cascade switch permits use as either a two channel 4 band, or one channel 8 band equalizer.
 - Noise and distortion specs significantly better than 16 bit digital.
 - Active balanced inputs and outputs with optional output transformer.

Mfr. List \$1,200.00

Call For BSW Price

SYMETRIX



**SX201
Parametric Equalizer**

The Model SX201 is a high performance studio quality parametric equalizer/notch filter designed to handle both low level and line level inputs. Three fully parametric bands of equalization are provided, with + 15 dB boost and 30 dB cut capability. Overlapping frequency controls cover the entire audio range, from 16 Hz to 20 kHz. Bandwidth is continuously variable from .05 octave (for deep notch filtering), to 3.3 octaves (for smooth tone shaping). Distinguished by its superb sonic integrity, extremely low noise and low distortion performance, the SX201 delivers uncompromising quality in a remarkably compact 1/2 rack package.

Mfr. List \$279.00

Call For BSW Price

RANE

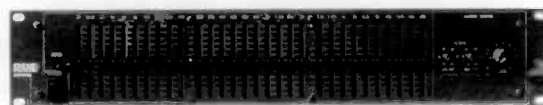

**GE27
Graphic Equalizer**

The Rane GE27 is a 1/3 octave graphic equalizer that incorporates the best design criteria to yield the highest performance levels.

Features:

- Overload, signal present and bypass indicators
- RFI input filters
- Auto balanced/unbalanced 1/4" TRS inputs and outputs
- 45mm sliders for +12dB/-15 dB boost/cut
- Consistently accurate bandwidth at all slider positions

Mfr. List \$539.00

Call For BSW Price



**SP15
Parametric Equalizer**

The Rane SP15 is a single channel 5-band parametric equalizer and full-function notch filter set. Perfect for all your applications where critical equalization, incredible versatility and audio specifications are a must. All parameters are completely independent and controls may be operated in any order without affecting the other. Input and outputs are fully active balanced. 2 units are required for stereo.

Mfr. List \$599.00

Call For BSW Price



**ME SERIES
Micrographic Equalizers**

When rack space is at a premium but you don't want to sacrifice quality, features, or performance, then look to Rane for the answer. Constant bandwidth assures each individual filter to be narrow enough to prevent unwarranted interaction between filters. Gain/reduction changes only occur on the bands you desire. Inputs and outputs are via 1/4" connectors.

The ME15 is a two channel, 2/3 octave equalizer.

The ME30 is a single channel, 1/3 octave equalizer

ME15 Mfr. List \$369.00

Call For BSW Price

ME30 Mfr. List \$359.00

Call For BSW Price

ART



**DR-X 2100
Stereo Effects Processor**

This wonder processor features full dynamic processing and special effects and can perform up to 10 audio functions simultaneously with full 20 Hz to 20 kHz frequency response. There are 200 memory locations to store over 60 types of effects including: harmonic exciter, noise gate, programmable EQ, expander, peak limiter, compressor, pitch transpose, reverb, flange, stereo imaging, chorus, and more. On board sampler allows for creating effects on the fly.

Mfr. List \$619.00

Call For BSW Price



**MULTIVERB ALPHA 2.0
Stereo Effects Processor**

With ART's new ASIC 24-bit digital system, the Multiverb Alpha offers more than 60 different effects with 4 times the density of units previously available. Mix and match at random up to 7 different effects at once without any sonic compromise and store your patches in the 200 memory locations. Choose from dazzling reverbs, flanges, choruses, delays and echoes as well as programmable EQ, studio sampling, and over two octaves of pitch transposing.

Mfr. List \$529.00

Call For BSW Price



**MULTIVERB LTX
Stereo Effects Processor**

This unit features quality effects in a cost effective, easy to use package. 250 factory presets are included with some patches using 3 effects simultaneously. Choose from rich combinations of chorus, delays, reverbs, flanges, tape delays, gated reverbs, reverse reverbs, stereo panning effects, and much more. One-touch control with no programming necessary.

Mfr. List \$329.00

Call For BSW Price

BSW Handles The Complete Line Of ART Products.
Call Us For Pricing On Models Not Shown In Catalog

DIGITECH



**DSP256XL
Stereo Effects Processor**

The DSP256XL is a studio-quality, multi-effect digital signal processor housed in a single rack space unit. It makes use of a 20-bit VLSI processor for an incredible selection of effects with 20 Hz to 20 kHz bandwidth and a 90 dB S/N ratio. Up to 4 effects at a time can be combined from the 24 different effect configurations. There are 128 factory presets and 128 user-definable programs.

Mfr. List \$439.95

Call For BSW Price

LEXICON



**LXP SERIES
Effects Processors**

The Lexicon LXP series are powerful effects units in a compact 1/2 rack chassis. The LXP5 generates the following types of effects: pitch shift over three octaves, delay sweeps, flanging, and reverbs. Five effects can be used simultaneously. Comes with 64 factory presets and 128 user memories for customized sounds.

The LXP1 provides 128 effects including reverbs, delays, choruses, for a wide range of creative possibilities.

LXP1 Mfr. List \$549.00

Call For BSW Price

LXP5 Mfr. List \$549.00

Call For BSW Price

EVENTIDE



**H3000B
Broadcast Ultra-Harmonizer**

This stereo, digital effects unit allows broadcasters the ability to create special effects and character voices quickly, at the push of a button. Sounds like Max Headroom, Cuzzin It, Thundering Helicopters, Blasting Cannons, tremendous storms can be quickly and easily generated. H3000B's built-in stereo audio time compression and expansion make changing the running time of recorded reel-to-reel and cart tapes a snap.

For even greater flexibility and creative possibility, order the HS322 internal digital sampler option with 23 second mono, or 11 second stereo sampling. Or if you really want to go all the way, order the H3000B/SE which includes a Vocoder and Instant Phaser. Plus 175 factory presets are included.

H3000B Mfr. List \$2,995.00

Call For BSW Price

H3000B/SE Mfr. List \$3,595.00

Call For BSW Price

HS322 Mfr. List \$995.00

Call For BSW Price

YAMAHA



**SPX1000
Effects Processor**

The SPX1000 is a highly sophisticated, full stereo, digital reverberation and effects system which offers 40 preset effect programs. These include accurate reverberation, delay and echo effects, a versatile compressor, a low-level expander, a harmonic exciter, freeze (sampling) programs and others. The SPX1000 also provides up to 5 effects at one time. With a sampling frequency of 44.1 kHz, it delivers full, flat frequency response from 20 Hz to 20 kHz.

Mfr. List \$1,595.00

Call For BSW Price



**SPX900
Effects Processor**

The SPX900 is a highly sophisticated, mono in by stereo out, digital reverberation and effects system offering 50 preset effect programs. These include stunning simulations of natural reverberation and early-reflections, delay and echo effects, gated effects, modulation effects, a versatile compressor, a harmonic enhancer, a freeze (sampling) program and more. The SPX900 also provides up to 5 effects at one time! Full-function wired remote control is available.

Mfr. List \$895.00

Call For BSW Price



**EMP100
Effects Processor**

The EMP100 provides a wide selection of professionally-tuned effects that are easier than ever to use-yet surprisingly affordable. 100 factory presets feature reverbs, early reflections, pitch changes, delays, modulations, and several effect combinations. Presets can be modified and stored in 50 user memory locations.

Mfr. List \$345.00

Call For BSW Price

BSW's extended hours and West Coast warehouse are great for those times when you have to place an order late in the day. We're open 6am to 6pm Pacific time.

APHEX



**250
Aural Exciter**

With new features and improved circuitry the model 250 Aural Exciter is the perfect addition to your audio chain. Spectral Phase Refraction and adjustable harmonics mixing can restore the punch and clarity lost in FM processing and add new life to your AM sound. Two modes of noise reduction allow you to actually erase noise from noisy sources. Servo balanced inputs and outputs and RF filtered power make the 250 a natural in the broadcast setting with I/O levels from -10 to +8 dBm.

Mfr. List \$995.00

Call For BSW Price

BBE



**822A
Sonic Maximizer**

The 822A utilizes phase compensation/equalization circuitry to add significant articulation and definition to otherwise muddy or dull audio. More than just boosting certain frequencies, the 822 compensates for phase distortions induced by amplifiers and speakers to offer a very hearable improvement in recording and monitoring systems. Balanced/unbalanced inputs and outputs.

Mfr. List \$599.00

Call For BSW Price

ORBAN



**290RX
Adaptive Enhancement Processor**

Here is the cure for dull over-processed audio...the 290RX. This two channel problem solver features harmonic and spectral restoration to add sparkle and just the right amount of high frequency content to restore shimmer to a dull signal without introducing IM distortion. Single ended noise reduction with separate downward expansion and bandwidth adjustments zero in on unwanted noise.

Mfr. List \$1,200.00

Call For BSW Price

CRL



**DX2
Noise Reduction**

The DX2 incorporates patent pending Dynafex™ noise reduction circuitry that provides up to 30 dB of noise reduction without the encode/decode process.

The Dynafex™ system has gained wide popularity in the professional audio market because of its ability to remove noise from virtually any audio source. Unit is two channel.

Mfr. List \$820.00

Call For BSW Price

DBX



**140X/150X
Noise Reduction**

Again and again professionals turn to dbx for quality, dependable noise reduction for all their critical recording needs. These compact, 1/2 rack width units give you two channels of encode/decode noise reduction. The 140X is designed to be used with low band-width audio sources, such as cassette recorders or other audio recorders that operate at 7.5 ips or slower. The 150X is perfect for full bandwidth digital systems or analog recorders operating at 15 ips or faster. Both units feature balanced 1/4" TRS inputs and outputs.

140X Mfr. List \$319.00

Call For BSW Price

150X Mfr. List \$319.00

Call For BSW Price

SYMETRIX



**511A
Noise Reduction**

The Model 511A is a two channel, single-ended noise reduction system configured for use in professional and commercial audio systems. With its dynamic high frequency filter and downward expander, up to 30 dB overall reduction of both high frequency and broadband noise is attainable. The dynamic filter reduces high frequency sounds like hiss, RF artifacts and dimmer noise, while broadband and low frequency phenomena like hum, turntable rumble and air conditioning noise are reduced by the expander. A high performance 18 dB/octave rumble filter is included for optimal treatment of low frequencies.

Independent two channel or true stereo operation is front panel selectable. In stereo, the left and right control circuits are tied together, assuring a stable stereo image. In mono, the channels operate independently, so each may be used with a separate source.

Mfr. List \$599.00

Call For BSW Price

RADIO SYSTEMS



**RS²
Dolby S Noise Reduction**

The Radio Systems RS² is an audio processing system for high quality, low noise tape reproduction featuring up to 24 dB of noise reduction and 90 degrees of phase error correction. It solves the two toughest problems of analog audio: noise and phase error. The result is sound quality equal to the performance of digital, without the cost of uncertainty in converting to unproven formats.

The encode-decode noise reduction technology features Dolby S-Type multi-band noise reduction. When used with broadcast type cartridge systems, internal automatic tone generators and decoders enable the system to "recognize" Dolby encoded carts, allowing the mixing of encoded and non encoded material. Additionally, automatic phase correction is employed via Radio Systems' proprietary phase system.

RS² is packaged in a single rack unit high frame. The frame incorporates the power supply and up to three stereo encode and decode cards, in any user-selected combination.

Mainframe (Holds 3 Encode/Decode Cards)	Mfr. List \$695.00
Encode Card	Mfr. List \$795.00
Decode Card (Dolby and Phase Correction)	Mfr. List \$695.00
Phase Correction Card	Mfr. List \$595.00

Call For BSW Price

ROLAND



**SN-550
Digital Noise Eliminator**

The SN-550 is a fully digital noise elimination system that employs exclusively designed DSP circuitry to remove all types of noise without "breathing" or changing the tonality of the overall sound. This is achieved with two separate circuits that handle noise and hum independently. The noise cancel section employs a unique multi-band downward expanding system that attains exceptional noise elimination while preserving the sound's original character. The hum cancel section enables AC line hum or buzz from CRT displays and dimmers to be isolated and removed, a capability never before offered on noise reduction units. The SN-550 is a two channel, single ended system.

Mfr. List \$2,095.00

Call For BSW Price

BROADCAST ELECTRONICS



**AUDIOVAULT
Digital Audio Storage System**

Utilizing hard disk digital technology, AudioVAULT is the ultimate record and playback system, providing virtually unlimited storage of, and access to, short duration audio elements.

AudioVAULT features a number of remarkable characteristics and capabilities: Simultaneous record/playback • No searching or cueing - access to stored material is instantaneous • Flexible software allows operation in pre-programmed, automated, and "live-assist" environments • Multiple, independent access to recorded inventory from up to four stereo output channels • Real-world looking operation screens with touch-screen capability • Safe central storage of audio

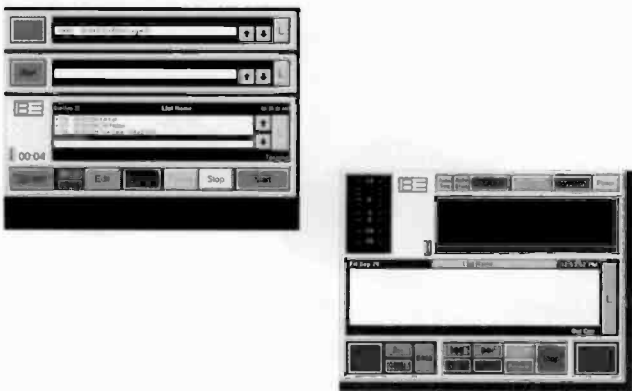

Pre-Programmed Applications

AudioVAULT is ideally suited to satellite delivered formats with its programmable playlist. Liners and IDs can be pre-loaded in stacks and started on receipt of a contact closure from the satellite decoder. AudioVAULT can send log information to a printer for documentation.

Used in conjunction with BE's Core2000 automation controller, the AudioVAULT can replace all random access and single-play cart equipment to provide all the short duration audio for an entire stand alone automation system.

Live Assist Applications

Up to 4 studios can access audio stored in the AudioVAULT simultaneously for "On-Air" or production use. There are two useful playback screens and a recording screen that allow each CRT to function much like a standard cart machine with all stored audio available at your finger tips for instant access.

AudioVAULT's modular system architecture allows the matching of storage requirements to actual needs: up to 28 hours of stereo audio. Besides the central processor and storage. AudioVAULT uses 386 or 386SX compatible PCs.

Price Based On Configuration

BROADCAST ELECTRONICS



**CORE 2000
Program Control System**

This PC based system is flexible, providing control for a number of applications including full automation, live assist programming, and satellite formats. It interfaces with a wide variety of sources from conventional reel-to-reels and cart equipment to advanced sources like R-DATs, CD jukeboxes, and the Broadcast Electronics AudioVAULT. The base system handles 12 source inputs and is expandable to 36.

Programming is data base driven (by spot name or song title/artist) and done in plain English so its easy to master.

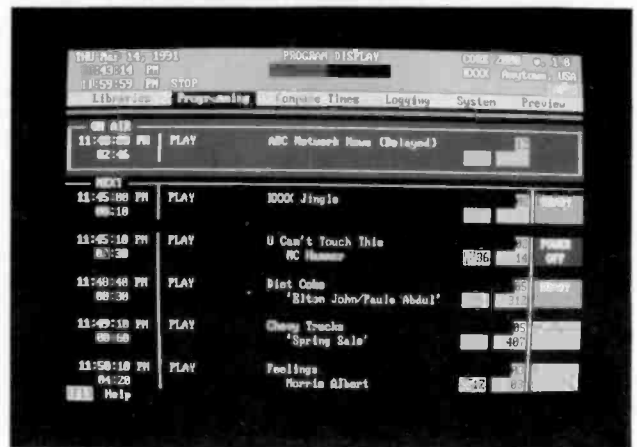

Key Features And Benefits:

- **Intelligent Source Interfaces**
Microprocessors on each interface allow for complex and customized control of any type of source equipment.
- **Unlimited Event Capacity**
Programming is limited only by hard disk size.
- **Source Sensitive Control**
Ability to control levels and silence sense on each source separately. Stereo VCAs allow event-to-event level control.
- **Logs Stored On Hard Disk**
Regardless of whether a printed log is kept, a disk file is always available for review of system performance.
- **Straight Forward Interface**
Common interface hardware and layout makes for easy set-up.

Price Based On Configuration

CONEX



**CS25B
25Hz Tone Sensor**

The Conex CS25B is a compact and reliable bridging-type 25 Hz tone sensor for use in broadcast automation and tape control systems. The unit features two independent sensors so only one unit is needed for two recorders.

CS25B Mfr. List \$417.00
CS25B11 (With Stereo High-Pass Filter) Mfr. List \$502.00

Call For BSW Price



**CG25A
25Hz Tone Generator**

The CG25A allows you to put 25 Hz tones on your own tapes. Use with automation systems or live assist operations. Timing intervals, tone levels adjustable.

Mfr. List \$420.00 Call For BSW Price

SONAR



**MARK I
Bulk Eraser**

For audio tape degaussing, the Mark I from Sonar offers outstanding value. For all tape formats from cassettes to carts to open reel, the Mark I is a wise choice.

Mfr. List \$69.00 Call For BSW Price

GENEVA



**PF211
Bulk Eraser**

It only takes a few seconds to prepare used tapes for like-new performance. The PF211 generates 2300 Gauss field intensity and is perfect for erasing cassettes, carts, and 1/2" wide open reel tapes.

Mfr. List \$69.95 Call For BSW Price

AUDIOLAB



**TD1B
Bulk Eraser**

Erases cassettes, cartridges and up to 10 1/2" reels. Automatic thermal protection to avoid burn-out.

Mfr. List \$132.00 Call For BSW Price

AVSC



**409
Bulk Eraser**

Completely erases all audio, video, instrumentation tapes and magnetic films. Reel sizes up to 16 inches can be accommodated.

Mfr. List \$1,295.00 Call For BSW Price

FIDELIPAC



**400/395
Bulk Eraser**

The 400 provides over 2000 Gauss of erasure power. Enclosed in a hardwood case with laminate top, it will efficiently erase cartridges, cassettes, and up to 1" wide open reel tape.

The hand-held 395 is rugged, light weight, and has thermal protection. Perfect for erasing cartridges and cassettes.

Model 400 Mfr. List \$130.00 Call For BSW Price
Model 395 Mfr. List \$75.00 Call For BSW Price

GARNER



Bulk Erasers

It takes just 4 seconds to erase all sizes and types of audio tape with Garner Degaussers. Just hit the power button and drop any reel or cartridge on the endless belt. You now have a clean, "no whump" erasure. Ten models to choose from starting at \$1,190.00.

360 SYSTEMS



**DCR1000 DIGICART™
Digital Cartridge Machine**

The DigiCart™ is an advanced digital recorder designed specifically for broadcast use. It operates like conventional cart machines, but with notable improvements. DigiCart™ provides CD quality audio with high reliability and instant access using magnetic disc cartridges and hard disc drives.

Select the cut you want with the cue select knob and hit play. That's how simple DigiCart™ is to operate. But unlike cart machines, there's no more problems with phase alignment, high end roll-off, fouled tape, or missed cues. It's even possible to cue up complete stop sets in seconds while audio is playing.

Once cuts are recorded they can be catalogued in stacks and play list for sequence play and logical grouping. Non-destructive editing including head trims, tail trims, fades, and level adjustment, is available for all recorded material.

The basic recorder is standard half-rack size. It includes the drive for the removable magnetic discs and can be fitted with an internal hard drive. Up to 5 more hard drives can be mounted in an external chassis the same size as the recorder.

Approximate Audio Storage Capacity
Times Shown Are For Stereo (Double For Mono)

48 kHz Sampling - 20 kHz Bandwidth

Disk Drives	Linear	Compressed
Bernoulli	4 min.	21 min.
HD-200	20 min.	107 min.
HD-400	36 min.	192 min.

Compression times shown are with Dolby Compression

DigiCart™ is truly automation ready with 2 EIA-422 serial ports, a BCD automation interface and inputs for start/stop/record control. Playlist can be down-loaded from a computer using the serial interface.

DCR1000		Mfr. List \$3,995.00
DAD10	Digital Audio Discs (Pack Of 10)	Mfr. List \$400.00
DAD50	Digital Audio Discs (Pack Of 50)	Mfr. List \$2,000.00
DCR1002	Digicart with 200 MByte Drive	Mfr. List \$5,495.00
DCR1004	Digicart with 400 MByte Drive	Mfr. List \$6,495.00
DCR1008	Digicart with 1 GigByte Drive	Mfr. List \$8,495.00

Call For BSW Price

BROADCAST ELECTRONICS



**DISC TRAK SERIES
Digital Cartridge Machines**

Here is the latest in digital technology allowing your facility to have the convenience of a standard cart machine in a solid digital format. Using inexpensive 3 1/2 inch floppy discs as the removable media, Broadcast Electronics' Disc Trak Digital Cart Machines incorporate 16-bit linear digital technology to deliver superior audio quality matching that of CD, DAT and other digital sources. Low priced floppy disks house all your commercials, jingles, music, anything you currently use a cart machine for now. With the Disc Trak you can say good-bye to phase error, wow and flutter, tape hiss, and other associated problems with analog carts.

Features/Benefits

- Available in both record/play and play only configurations
- Cueing is instantaneous. Up to 8 separate cuts can be placed on a single disk
- Powerful playback options include single play, sequence and loop
- Choice of 4 different sampling rates
- Auto recognition of track sampling rate and stereo/mono selection
- LCD read-out gives cart label information
- Count down timer showing cut end
- Recognizes standard console start/stop logic commands
- XLR in/out, balanced audio
- Rugged design and construction to deliver years of dependable service

Recording Time

Sampling Rate	2 MByte Disk	4 MByte Disk
48 kHz	34 sec.	74 sec.
44.1 kHz	36 sec.	81 sec.
32 kHz	51 sec.	112 sec.
22.05 kHz	73 sec.	162 sec.

All times shown are stereo. Double the above times for mono.

DC300	3 Stack Player/Recorder (One Slot Records)	Mfr. List \$4,995.00
DC30	3 Stack Playback	Mfr. List \$3,450.00
DC10	Single Playback	Mfr. List \$2,800.00
2MByte Disc		Mfr. List \$1.00 ea.
4MByte Disc		Mfr. List \$5.50 ea.

Call For BSW Price

BROADCAST ELECTRONICS



**PT90 SERIES
Cartridge Machines**

PhaseTrak 90's unique phase correction circuit continually monitors and corrects the phase relationship between the playback audio of the right and left channels regardless of the machine used to produce the original cartridge.

Through its microprocessor-assisted automatic tape analysis system, the Phase Trak 90 will completely evaluate a new tape and "learn" all of the bias, level and EQ settings necessary to obtain optimum performance.

The Phase Trak 90 boasts a signal to noise ratio of better than 80 dB, and it's excellent frequency response delivers "audiophile" quality in any application.

The Phase Trak 90 is completely modular for the ultimate in servicing convenience. All modules are easily removed from the back of the cabinet. Test points and adjustments are reached by removing the top cover.

PT90RPS (Record/Play Stereo) Mfr. List \$4,550.00
PT90PS (Play Only Stereo) Mfr. List \$2,750.00

Call For BSW Price
Mono Models Available



**2100C SERIES
Cartridge Machines**

No other cart machine combines the value and economy of the 2100C's. For example, the series 2100C's include two cue tones (1 kHz and 150 Hz) as a standard feature. Flat response, long life heads offer superb performance and the direct drive transport ensures maximum reliability. Features include: Exclusive mono/stereo switching, precision machined deck with improved cartridge guidance system, direct drive transport, and low-voltage air damped solenoid.

2100CPS (Stereo Play) Mfr. List \$1,349.00
2100CP (Mono Play) Mfr. List \$1,249.00

Call For BSW Price

BSW is a Full-Line Broadcast Electronics Distributor.

Call us for all your BE needs.

BROADCAST ELECTRONICS



**DT90A SERIES
Cartridge Machines**

Available in mono and stereo record/play and playback configurations, Dura Trak 90 cart machines offer sparkling audio performance, durability, and all the features broadcasters need most, at an affordable price. Features: Rugged direct drive motor • Three cue tone sensing standard • Fast forward standard • Machined 1/2" thick aluminum deck plate • Cart previously-played lockout • Pressure roller cleaning mode • Balanced inputs and outputs • Front panel 1 kHz record defeat • Low voltage, current regulated solenoid.

DT90APS Mfr. List \$1,900.00 Call For BSW Price
DT90ARPS Mfr. List \$2,850.00 Call For BSW Price

Mono Models Available

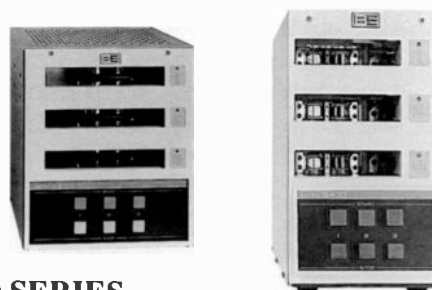

**5400/5300 SERIES
Multi-Deck Cartridge Machines**

These machines provide clean sound reproduction and smooth, consistent performance in a 3 deck format. The 5300C and 5400C are similar in features, but the 5300C is wider and can accommodate larger format carts.

Both the 5300 and 5400 series machines feature plug-in decks for quick, easy servicing, quiet, powerful air damped solenoids, and repeat play lockout. Optional recording amplifiers allow for recording on deck three of both models. Three cue tones are standard on the record modules.

Call For Prices And Specifications



**ST90
Eraser/Splice Finder**

For fast, reliable erasure and splice detection, you can't beat the ST90 Splice Track. Running at 27.5 ips, it zips through carts providing a minimum of 85 dB of audio erasure. Splice detection is virtually 100% accurate because Splice Track senses the thickness of the splice itself rather than using the less reliable photocell method.

Mfr. List \$1,150.00 Call For BSW Price

FIDELIPAC



**DCR1000 SERIES
Digital Cartridge Machine**

Fidelipac's DCR1000 provides CD quality to the broadcaster with the same familiar operational characteristics as analog cart machines. The difference is that DCR1000 uses low cost, 3 1/2" high density floppy discs. A 13MB disc provides over 5 minutes of stereo audio with 15 kHz bandwidth. A standard 2MB floppy holds 60-second commercials. Virtually every other physical characteristic, from the layout of the control buttons to secondary and tertiary cue tones, to the remote interface is identical to analog machines, without the maintenance hassles. DCR1000's only mechanical component is the diskette drive, which can be replaced quickly and easily for less money than the cost of new analog heads.

There is a countdown timer built in as well as a clock/calendar that can check commercials against their kill dates. An RS232/422 port is provided for machine control or logging output. There is also a port provided for a standard PC keyboard. Though a keyboard is not required for operation, it does allow additional features such as disk titling, length marking of recording, cue tone editing, cut preview and tightening. You can even print disc labels via the parallel printer port. Other features include multiple sampling rates, start on audio, extended scale peak metering and AES/EBU digital inputs.

- DCR1020 (Master Player unit) Mfr. List \$2,795.00
- DCR1040R (Record Module) Mfr. List \$2,500.00

Call For BSW Price



**CTR10 SERIES
Cartridge Machines**

The Dynamax CTR10 series of cartridge machines provides unsurpassed audio performance and today's most desired features including: Fast forward • Three cue tones standard • High speed cueing • Selectable front panel metering for audio, phase and cue tones on recorders • On board audio switcher and mixer • Transformerless audio circuitry • Played indicator with selectable restart disable

- CTR12 (Stereo Play) Mfr. List \$1,935.00
- CTR14 (Stereo Record/Play) Mfr. List \$2,890.00

Call For BSW Price
Mono Models Available

FIDELIPAC



**CTR100 SERIES
Cartridge Machine**

The CTR100 series embodies unique features not available in any other machine in today's market. Central to the CTR100 series is CARTSCAN™. Now it is possible for you to intermix mono and stereo carts, elevated and standard levels, plus matrix record and playback, using the same machine. Simply attach a CARTSCAN label to your carts and the CTR100 automatically changes the characteristics of the machine electronically.

Features:

- Bar graph LED level indicators • Front panel diagnostics • Secondary and tertiary cue tones • Fast forward • Two speed played flashing indicator • Splice finder • Front panel 1 kHz add and defeat • DC servo drive motor • Audio switcher and mixer • On-board test oscillator • Played restart disable

- CTR112 (Stereo Play) Mfr. List \$2,880.00
- CTR124 (Stereo Record/Play) Mfr. List \$4,830.00

Call For BSW Price



**ESD10
Eraser/Splice Finder**

Dual, full track heads are incorporated instead of a coil below the deck plate on the ESD10. The result is an erase depth of 85 dB or more and better signal-to-noise ratio when you record your carts. Splice detection is extremely reliable. Tape speed is 27.5 ips.

- Mfr. List \$1,190.00
- Call For BSW Price

**NEED ASSISTANCE IN SELECTING THE
RIGHT CART MACHINE ?**

BSW sales professionals are very qualified to help you make the right choice.
Call us toll free to discuss your digital and analog requirements.

ITC



**99B SERIES
Cartridge Machines**

Loaded with features, the 99B series delights the most discriminating user and listener. Central to the 99B series is the patented ELSA feature found in the recorder. The ELSA cartridge preparation feature automatically erases the cartridge, locates the splice and azimuth aligns the record head for maximum phase response performance. The 99B series standard features include: Microprocessor controlled logic, high speed cueing, and three cue tones.

99B (Stereo Record/Play) Mfr. List \$6,745.00

Call For BSW Price



**SERIES 1
Cartridge Machines**

The newest advances in mechanical and electrical technology have been incorporated in the SERIES 1 to provide premium quality and faultless operation at an affordable price. High speed cue, three cue tones, transformer outputs, and heavy cast aluminum deck are just a few of the features designed into this machine.

SERIES 1 RPS (Stereo Record/Play) Mfr. List \$3,075.00

SERIES 1 PS (Stereo Playback) Mfr. List \$1,975.00

Call For BSW Price

Mono Units Available



**SERIES 2
Cartridge Machines**

Like the SERIES 1 shown above, the ITC SERIES 2 machine offers additional feature such as microprocessor control, digital tape timer, active balanced outputs, and Dolby HX Pro noise reduction.

SERIES 2 RPS (Record/Play Stereo) Mfr. List \$3,695.00

SERIES 2 PS (Play Only Stereo) Mfr. List \$2,395.00

Call For BSW Price

Mono Units Available

RADIO SYSTEMS

**RS 2000
Cartridge Machines**

The RS 2000 machine from Radio Systems incorporates outstanding features yet costs dramatically less than you would expect. The RS 2000 incorporates full time phase correction regardless of when and where the cart was recorded. Should you use the RS 2000 as your record machine, it encodes a tone used for flutter correction on playback. This gives the machine reel to reel playback specifications. An incredible cart hold down system is one of the most secure and elaborate you've ever seen.



Other features include built-in splice detection, timer, test noise generator, and full metering. Of course you get standard conveniences such as three cue tones, fast forward at EOM, audio switcher and much more.

RS2004 (Stereo Record/Play) Mfr. List \$3,395.00

RS2002 (Stereo Playback) Mfr. List \$2,395.00

Call For BSW Price

OTARI



**CTM10 SERIES
Cartridge Machines**

The CTM10 series cartridge machines are designed for broadcast and audio post-production professionals. The microprocessor-controlled CTM10 offers the high performance, outstanding features, and "workhorse" reliability for which Otari products are known.

Outstanding features include: 3 available tape speeds, Dolby HX-Pro™ bias optimization, front panel headphone jack, cue tone recording independent of audio tracks, ±6% vari-speed, and 1/2" precision milled deckplate.

All CTM10 series units may be rack mounted side-by-side and take only 1/3 width rack space. These machines also feature selectable tape speed (15, 7.5 or 3.5 ips), Dolby HX-Pro bias optimization circuitry, and a wealth of other features.

CTM10 (Mono/Stereo Play) Mfr. List \$2,305.00

CTM10M (Mono/Record Play) Mfr. List \$2,567.00

CTM10S (Stereo/Record Play) Mfr. List \$2,830.00

CTM10R (Record Electronics) Mfr. List \$1,418.00

Call For BSW Price

CTM10R Required For All Recording Units

AUDICORD



S SERIES Cartridge Machines

Audicord's premium cartridge machine line, the S series provides high-end features at realistic prices. Features include:

(Playback) Three cue tones • Hi/Lo playback EQ • Replay lock-out • Automatic motor shut-off for long idle periods • Full cue status lights including un-cued cart indicator • Controls accessible via front panel pull-out drawers • +8 dBm output selectable at 600 or 150 ohm • Extremely rugged deck, headblock, and guides.

(Record) Multi-function meter system with automatic switching from record to play • Hi/Lo record EQ • Bias and tone recording indicators • Record shut-off with end of SEC tone • Record timer • Complete remote control facilities (plugs supplied)

S11 (Mono Play)	Mfr. List \$1,120.00
S16 (Stereo Play)	Mfr. List \$1,210.00
S21 (Mono Rec/Play)	Mfr. List \$1,840.00
S26 (Stereo Rec/Play)	Mfr. List \$2,030.00

Call For BSW Price



DL SERIES Cartridge Machines

Here is durability at the lowest cost. The Audicord DL series stands up to the daily grind of broadcasting and offers features to make the operator's job easier. Features include:

(Playbacks) Replay lock-out to prevent accidental replay errors • Manual or automatic muting of output audio (from SEC cue operation) • Cue tone status indicator lamps • Both SEC and primary • Mute lamp to indicate audio on or off status • Automatic motor turn-off if selected conserves power and heat

(Record-Plays) Full view meters for accurate level monitoring. • Bias and tone presence indicators • Automatic meter switching from record to replay • Optional recording shutoff with the end of SEC tone • Full +8 dBm output ability with 12 db of headroom • Slide back cover design allows for quick and easy access for cleaning • Complete remote control connections (plugs are furnished)

DLPM (Playback, Mono)	Mfr. List \$920.00
DLPS (Playback, Stereo)	Mfr. List \$1,000.00
DLRM (Record/Play, Mono)	Mfr. List \$1,290.00
DLRS (Record/Play, Stereo)	Mfr. List \$1,480.00

Call For BSW Price
Dual Transport Units Available

TAPECASTER



900 SERIES Cartridge Machines

The 900 series machines from Tapecaster contain features most other machines have without the high price tag. Three units can be mounted side-by-side in the rack.

Features:

• Cartridge replay indicator • 3 cue tones • Manual or automatic fast forward • Replay lockout • LED level meter • Audio mute on fast forward • Toroid power transformer • Active balanced outputs

900P (Playback Mono)	Mfr. List \$1,095.00
900PS (Playback Stereo)	Mfr. List \$1,195.00
900RP (Record/ Play Mono)	Mfr. List \$1,795.00
900RPS (Record/Play Stereo)	Mfr. List \$1,995.00

Call For BSW Price

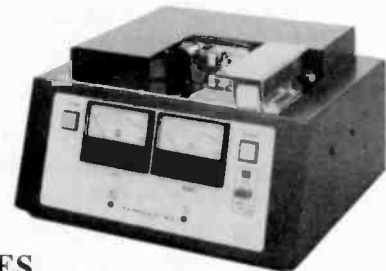

X701 SERIES Cartridge Machines

Look no further for the best value in cart machines. Tapecaster has long been established for great performance at a pleasing price.

Features:

• Precision adjustable head bracket • Super-torque hysteresis synchronous motor • Heavy duty air-damped solenoid

X701P (Playback Mono)	Mfr. List \$860.00
X701PS (Playback Stereo)	Mfr. List \$1,035.00
X701RP (Record/ Play Mono)	Mfr. List \$1,185.00
X701RPS (Record/Play Stereo)	Mfr. List \$1,455.00
X701RPD (Mono Delay)	Mfr. List \$1,350.00

Call For BSW Price

Acquire the equipment you need without jeopardizing
your cash flow!

Ask Us About *FlexLease* financing

BROADCAST DEVICES



APC200 Phase Corrector

It's a fact that stereo phase error drastically affects your mono. The smallest phase error can degrade high frequency performance. Larger phase errors are audible in stereo and can affect your stereo image as well. The Righttrack gives you a quick and easy method of making sure that your existing tape equipment provides phase accurate, superior sound—in mono as well as stereo. Both visual and aural indications of phase performance allow you to provide precise phase correction. It's built-in reference oscillator allows for easy alignment, verification of tape head azimuth and frequency response.

Mfr. List \$695.00

Call For BSW Price

BSW



CARTRIDGE LABELS

These removable labels are affixed to tractor fed backing paper making them suitable for use with printers. Available in six colors (black, red, orange, green, blue, yellow). White logo and low intensity colors allow for maximum printing space and visibility.

Rolls (1000 Labels)

BSW Price \$19.95 per roll

FIDELIPAC



326

326
Height Gauge
BSW Price \$29.40



328

328
Head Insertion Gauge
BSW Price \$7.80



387

387
Right Angle Zenith
BSW Price \$35.30

MEC/VIKRON



TAPE HEADS

When your cart machines (or reel-to-reel machines) need replacement heads BSW is the supplier to call. We are proud to carry MEC and Vikron quality replacement heads.

MEC (Maghead Engineering Co.) supplies a number of top cartridge machine manufacturers with the heads for their new machines and builds replacement heads for most common applications.

Vikron is an approved source for several major broadcast cart machines and has a wide selection of replacement heads.

Additionally, BSW can also obtain replacement heads directly from most of the manufacturers saving you time and money.

Prices Vary Upon Application

Call Us With Your Requirements 1-800-426-8434

STL

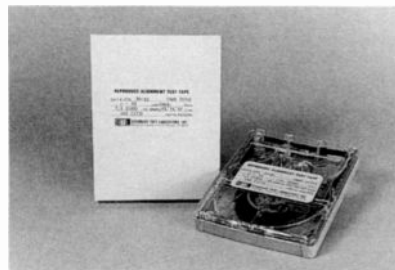

TEST CARTS

BSW carries the complete line of STL tape products. All you need to do when ordering alignment carts is specify your favorite cart shell and bias preference.

TAPECASTER



X100 Automatic Cartridge Loader

The X100 from Tapecaster provides accurate tape length measurement through precision calibrated minute and second face mounted controls. Operation is easy with the use of a single lever which activates the reset, start, and run functions of the X100.

Mfr. List \$695.00

Call For BSW Price

Lubricated Tape For Carts

AUDIOPAK



**FORMULA 17(605)
Standard Output**

17918100 (1800' Reel)

17942605 (4200' Hub)

17984605 (8400' hub)

**Sold In Case Lots Only*

BSW Price \$15.80

BSW Price \$20.00

*BSW Price \$30.00

Q17(613) HOLN

17618613 (1800' Reel)

BSW Price \$19.00

ITC

219

High Output/Low Noise

2191440HPB (4000' Hub)

BSW Price \$35.00

AUDIOPAK



**AA4
Stereo Cartridge**

The key feature of the AA4 is the SGS4 broadcast mastering tape which offers nearly 5 dB higher saturation headroom at 16 kHz (71/2 ips) compared to the HOLN Tape in AA-3 cartridges. No bias adjustment is usually necessary when recording on machines optimized for HOLN or other "hot" tapes.

**AA3
Stereo Cartridge**

Precision molding provides highly accurate tape guidance inside the cartridge for excellent stereo phase stability. Tough, reinforced plastics resist warping and damage due to severe mishandling, thus assuring the phase will not change under any conditions for the life of the cartridge.

**AA2
Mono Cartridge**

The most popular cartridge on the market for monaural broadcasting. Standard bias tape in the familiar black shell.

ITC

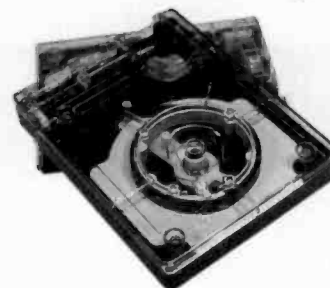

**ITC CART II
Stereo Cartridges**

The innovative design of this cart combined with its superior mastering tape formulation offer you performance capabilities far beyond what you have come to expect from broadcast cartridges. 1.5 mil tape and unique padless tape path greatly prolong the usable life of the carts, making them a good investment for your cart dollars.

**Call BSW With Your Cart Requirements
We Offer Competitive Prices And Outstanding Delivery**

FIDELIPAC

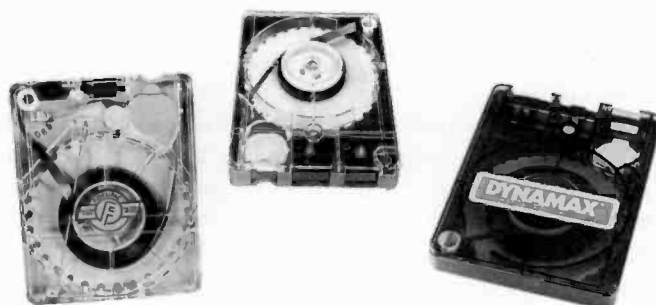

**DYNAMAX COBALT
Stereo Cartridge**

The Dynamax cobalt cartridge is rapidly gaining recognition as something special. A new generation cartridge loaded with broadcasting's first cobalt tape. The Dynamax shell is constructed of high grade engineering plastic for more strength, greater heat stability and dimensional accuracy. The new cobalt tape provides extra headroom necessary when carting CD's.

**MASTERCART
Stereo Cartridge**

The Mastercart provides maximum stereo phase tracking and performance at standard operating levels.

**300 SERIES
Mono Cartridge**

The widely used grey cart has been the workhorse of the industry since 1962.

**Call For BSW Competitive Prices
And Outstanding Delivery**

CASSETTE MACHINES

TASCAM



122MKII Professional Cassette Deck

The 122MKII offers extended durability and reliability features an extremely high standard of audio reproduction quality with a full 3-head system featuring top performance CA (Cobalt Amorphous) record and playback heads. Adding to the strength of this machine are uncompromised electronics, a precision FG-servo direct-drive capstan motor, balanced XLR type inputs and outputs (+ 4 dBm), an accurate cue and review function, and Dolby B/C noise reduction.

Mfr. List \$1,149.00

Call For BSW Price



112B Professional Cassette Deck

The 112B is a basic 2-head machine that fully maintains the professional quality performance, stability and reliability of the topline 122MKII. Special care has been taken in the 112B to ensure unflinching transport reliability, stable circuit operation, low distortion and a wide dynamic range. Dolby HX Pro and Dolby B and C type noise reduction are incorporated. The 112B has balanced inputs and outputs.

Mfr. List \$799.00

Call For BSW Price

YAMAHA



C300 Professional Cassette Deck

Everything about this deck is top notch, from the 12-layer amorphous heads to the dual capstan tape transport, to the fine styling and logical control layout. Features include: Manual or automatic bias setting • dbx, Dolby B and C noise reduction • Wired remote control • Optional wireless remote allows advanced programming functions • Master fader • Dual speed fast forward/rewind • Music search • Zero to cue repeat play • Balanced +4 dBm input and output • Built-in rack ears

Mfr. List \$1,095.00

Call For BSW Price

MARANTZ



PMD500 Dual Cassette Recorder

The Marantz PMD500 is a rack-mountable, dual well cassette recorder that was built with the professional in mind. Unique to this machine, both decks record serially or simultaneously. In addition, the PMD500 includes optically sensing quick auto-reverse for non-stop recording possibilities. Other features include: Dolby B,C,HX Pro noise reduction, peak holding LED VU meters, digital tape counters, independent 2 motor full logic transports.

Mfr. List \$599.00

Call For BSW Price

TECHNICS

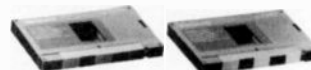

RS-DC10 DCC Recorder

Technics has arrived with the next audio revolution...Digital Compact Cassette. This technology gives you the best of both worlds: the fidelity and versatility of digital recording, plus technologies perfected by years of analog audio cassette research. You will be able to playback analog cassettes, plus record and playback the new DCC format on one machine. DCC uses a stationary digital record/play head. Audio quality yields a dynamic range equal to a compact disc. Text can also be stored. For example, while playing pre-recorded tapes, a touch of the text button will display album title, track title, and artist name. Tapes are the same size as standard cassettes but have a protective metal sleeve that shields the tape.

Mfr. List \$999.00

Call For BSW Price

DON'T SEE IT ? - ASK US

This Catalog Represents Only A Fraction Of The Thousands Of
Items Available From BSW

Consumer cassette decks offer broadcasters a cost effective alternative to professional machines. Even though durability and interface capabilities are limited, consumer machines do offer many advanced features and good audio quality.

Please note that the products listed were current models at the time of printing. Current model numbers, features, and pricing may vary.

TEAC



V370 Cassette Deck

Features:

- Center mounted transport • Dolby B noise reduction • 3-position tape selector • Bias fine adjustment • Hard Permalloy rec/play head

Mfr. List \$119.00

Call For BSW Price

Prorax Rack Mount Kit RK2

BSW Price \$28.95



W410 Double Cassette Deck

Features:

- Double deck continuous playback • High/normal speed dubbing • Dolby B NR • 3-position tape selector • Full auto stop • 2 color LED meter

Mfr. List \$159.00

Call For BSW Price

Prorax Rack Mount Kit RK2

BSW Price \$28.95

TECHNICS



RSTR232 Double Cassette Deck

Features:

- Auto reverse (deck 2) • High/normal speed editing • Dolby B&C NR • Cue and review • Full-logic solenoid feather-touch transports • 18-hour series play • Front panel headphone jack • Timer record/play capability

Mfr. List \$179.95

Call For BSW Price

MARANTZ



PMD SERIES Portable Cassette Recorders

Without a doubt, Marantz makes the most popular portable cassette recorders used in broadcast. The PMD series machines include the following features: 7 1/2 hours of continuous recording on 3 "D" size batteries (AC power supply included), modular telephone jack for direct telephone recording and playback (except PMD430), switchable limiter, built-in electret condenser microphone and monitor speaker. Other features include: Vari-speed, 3-Position mic attenuation, line input and output jacks, cue and review, volume and tone control, and automatic or manual record level.

PMD201 2 Head Mono

Mfr. List \$299.00

PMD221 3 Head Mono

Mfr. List \$369.00

PMD222 3 Head XLR Mic Input

Mfr. List \$399.00

PMD430 3 Head Stereo (Includes Case)

Mfr. List \$599.00

Accessories:

CLC221 Vinyl Carrying Case

Mfr. List \$40.00

RB430 Rechargeable Battery Pack

Mfr. List \$75.00

CA221PMD Car adaptor for 12 volt

Mfr. List \$60.00

Call For BSW Price

FSK221 PMD Field Support Kit

For professionals on the go, the FSK221 contains a host of repair parts for your PMD series recorders facilitating quick and easy repairs in the field. Housed in a durable plastic case with handle, and easily fitted into a briefcase, are jacks, knobs, belts, buttons, screwdriver, screws, and cassette lid parts.

Mfr. List \$60.00

Call For BSW Price

SONY



TCD5 PROII Portable Cassette Recorder

The TCD5 PROII is ideally suited to a wide range of professional audio applications. Twin VU meters, LED peak level indicator, built-in monitor speaker, and headphone jack eliminate guess work so you have great recordings. Peak limiter and mic attenuator eliminate clipping and suppress excess signal levels by 20 dB to prevent distortion. Inputs are mic level XLR connectors. Outputs are unbalanced RCA connectors. Powered by 2 "D" size batteries, the TCD5 PROII allows 4.5 hours of recording time. AC power supply available optionally.

Mfr. List \$875.00

Call For BSW Price

PANASONIC



**RQL335
Portable Cassette Recorder**

Features:

- AC/Battery operation • Includes AC adaptor/recharger and Ni-Cad Batteries • Built-in condenser mic with sound level equalizer (SLE)
- Three tape speeds • Auto-stop and pause • LED indicator (record/battery and SLE) • One touch and voice activated recording • Cue and review • Tone control (HI/LO) • Tape counter • Jacks: DC-in, ext. mic, monitor

Mfr. List \$54.95

Call For BSW Price

YAMAHA

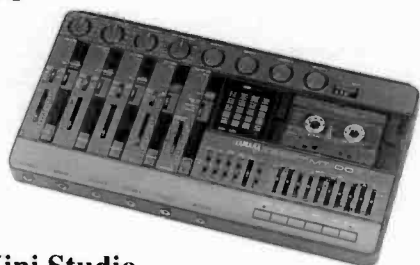

**MT120
Cassette Mini Studio**

Here's a mini production studio you can fit into your briefcase. The MT120 includes a 4-track recorder, 4 channel mixer, extensive patching network, and a graphic EQ all in one compact unit. This is no toy. Features and specs are suitable for professional use.

Mfr. List \$520.00

Call For BSW Price

TASCAM



**464
4 Track Portastudio**

The 464 Portastudio contains everything you need to make excellent multitrack recordings all on cassette. 12 input mixer (4 XLR inputs plus 4 stereo line inputs) allows for input flexibility. Each channel has EQ and trim control. 2 speed transport and dbx noise reduction assure you quiet recordings. The 464 has a durable transport to provide years of quality performance.

Mfr. List \$899.00

Call For BSW Price

BSW



Custom Loaded Cassettes

BSW cassettes are custom loaded in standard lengths including 5, 10, 20, 30, 45, 60, and 90 minutes, with custom lengths available for the asking. Three grades of tape are available: VC voice quality, MC music quality (HOLN), HB (high bias chromium compatible). Quantity price breaks are available. Minimum quantity is 25 cassettes.

*Cassettes are always listed in total recording time.
i.e. VC60 has 30 min. per side, VC10 has 5 min. per side*

PRICES

VC5 .48 ea. VC10 .50 ea. MC60 .78 ea. MC90 \$1.00 ea.
MC5 .55 ea. MC10 .57 ea. HB60 \$1.07 ea. HB90 \$1.33 ea.

CASSETTE BOXES / LABELS

CLEARBOX (clear hard shell box)	BSW Price .14 ea.	100+ .12ea.
POLYBOX (soft semi-clear box)	BSW Price .22 ea.	100+ .19 ea.
CASSHW (sheet of 12 white labels)	BSW Price .25 ea.	100+ .21 ea.

DISCWASHER



FG1230



FG1450

**FG1230
Cassette Head Cleaner**

Perfect Path® safely removes tape oxides and contamination from delicate tape heads.

Mfr. List \$4.95

Call For BSW Price

**FG1450
Cassette Demagnetizer**

D'Mag™ helps restore high frequency content to tapes.

Mfr. List \$14.95

Call For BSW Price

DENON



DN951FA

DN970FA



**DN951FA/DN970FA
CD Cart Players**

CD cart players, pioneered by Denon, are the standard for CD playback in the broadcast industry offering the convenience and durability of carts and digital audio quality.

The DN951FA is Denon's basic on-air playback unit. In addition to simple operation and extreme durability, it features instant cueing aided by a select dial, a simple audition function, single or continuous play, a digital display showing remaining or elapsed time in minutes, seconds, and frames, 4-times oversampling, variable output level through XLR connectors, and complete remote accessibility. End monitor feature allows the operator to listen to the outro of the song.

The DN970FA goes beyond the DN951FA with advanced features for production such as: 3 point cue memory, variable speed, external synchronization, and more.

Denon's unique Auto Track Select feature for both the 951 and 970 allows the program director to have total or partial control over the cuts to be played on the air. The machines read special barcode labels for three levels of control over play: Track Exclusive, Track Priority, and Track Lockout.

- | | |
|-------------------------|----------------------|
| DN951FA | Mfr. List \$1,350.00 |
| DN970FA | Mfr. List \$2,599.00 |
| ACD5B CD Cart Shells | Mfr. List \$3.50 ea. |
| Bar Code Labels (Sheet) | BSW Price \$9.00 ea. |

Call For BSW Price



**DN961FA
Compact Disc Player**

Here is a Denon professional machine for broadcasters who want all the features and performance found in the CD Cart™ Players, but without the CD Carts. The DN961FA is a *drawer-loading* CD player which is just like the DN951FA (shown above). Once a CD is in the play mode the DN961FA's eject button is disabled so no accidents occur while the unit is on the air. Three units will fit side-by-side in a rack. Does not allow the Automatic Track Select feature.

- | | |
|----------------------|--------------------|
| Mfr. List \$1,350.00 | Call For BSW Price |
|----------------------|--------------------|

SONY



**CDP2700
Compact Disc Player**

Sony's new player provides professional interface and performance at a modest cost. The CDP2700 employs an 18-bit system with 8 times oversampling for superb audio quality. One of its most striking features is its ability to "remember" index code for up to 145 discs allowing it to memorize play mode settings that are recalled each time the disc is inserted. Automatic playback of up to 24 selections in any order is possible. Other features include: Variable speed ($\pm 12\%$), both AES/EBU and unbalanced IEC-958 digital outputs, 8-pin DIN jack for remote control interface, and rack mount adaptors (supplied).

- | | |
|----------------------|--------------------|
| Mfr. List \$1,295.00 | Call For BSW Price |
|----------------------|--------------------|

TASCAM



**CD401MKII
Compact Disc Player**

The CD401MKII is rack mount ready, and has XLR balanced outputs. It also allows fader-start operation, and has a remote control unit that can be used in either the wired or wireless mode. It has a precision 3-beam pickup controlled by a special track and focus system, 18-bit 4-times oversampling, and dual D/A converters. New features include pitch control, fader start, auto cue, single play, digital out and more.

- | | |
|--------------------|--------------------|
| Mfr. List \$849.00 | Call For BSW Price |
|--------------------|--------------------|



**CD301
Compact Disc Player**

With balanced outputs, built-in rack mounting, and a hard-wired 10-key remote control, this unit is a natural in broadcast on-air studios and production rooms. Notable features on the CD301 are the single play option that automatically stops playback at the end of a cut, and a special link function that allows one unit to start another unit for sequence play. Now you can have a professional CD player that's truly affordable.

- | | |
|--------------------|--------------------|
| Mfr. List \$549.00 | Call For BSW Price |
|--------------------|--------------------|

TASCAM



CD601 CD Player

The CD601 is a single transport half-rack unit designed to stand up to demanding radio broadcast applications. It features a full-size turntable and unique disc clamping system that virtually eliminates tracking errors, and Tascam's patented "ZD Circuitry" for impeccable CD sound with an absolute minimum of digital noise. The CD601 offers dial-controlled search with frame accuracy, auto cue, +6% pitch control, and more. The 'end check' function is ideal for pre-planning crossfades. Outputs are XLR balanced and RCA unbalanced. RC601 remote control panel offers advanced functions for production applications.

CD601 Mfr. List \$1,499.00

Call For BSW Price

RC601 Mfr. List \$749.00

Call For BSW Price

TECHNICS



SLP1300/SLP1200 Compact Disc Players

Technics developed the SLP1300 to serve as a reference CD player for professional and broadcast applications, combining superb audio quality and useful features at an affordable price. The 1300 offers 8 times oversampling, 4 digital-to-analog converters, XLR connectors with +8 dBm output, vari speed, digital output, cue wheel for precise cueing with audio, and cue to music.

The SLP1200 is similar to SLP1300 but with unbalanced outputs and 4 times oversampling.

SLP1300 Mfr. List \$1,649.95

Call For BSW Price

SLP1200 Mfr. List \$1,399.95

Call For BSW Price

NEED ASSISTANCE IN SELECTING THE PROPER CD PLAYER ?

BSW Sales Professionals are very qualified to help you make the right choice. Call us toll free for advice and consultation.

TECHNICS



SLPG300 CD Player

Features:

- Auto cue-to-music • SNR of 100 dB • Digital peak level search • 30-key wireless remote control • 10-key direct access on front panel and wireless remote • Random access programming • Front panel headphone jack w/volume control • CD editing function

SLPG300

Mfr. List \$169.95

SLPG100 Same as 300 less remote and key pad Mfr. List \$149.95

RK1 Rack Mount Kit fits both models BSW Price \$24.95

MARANTZ



CDR600 Compact Disc Recorder

The Marantz CDR600 Compact Disc Recorder is a complete stand-alone CD recording and playback system. It features stop/start recording, state of the art A/D and D/A converters, digital I/O, and full Philips Red Book and Orange Book compatibility. Because the CDR600 can create and read a temporary table of contents, recording can be stopped and then resumed at a later time. Maximum recording time is up to 74 minutes with 99 tracks per disc.

Mfr. List \$7,595.00

Call For BSW Price

CARVER



PDR10 Compact Disc Recorder

Carver's PDR10 is a flexible CD recorder system that's virtually foolproof when it comes to operation. Recording laser intensity calibration is fully automatic while track increments/indexes can be set manually or automatically. The PDR10 generates a temporary TOC (table of contents), so you can start and stop recording at any time. Final discs are Red Book compatible. AES/EBU and SPDIF digital I/O. Serial and parallel remote ports.

Mfr. List \$8,500.00

Call For BSW Price

AUDIO SOURCE



**LLC2
Laser Lens Cleaner**

A dirty laser lens on your CD player can cause skipping or false cueing. The LLC2 cleaner is an easy and effective solution. Just insert into the CD compartment, hit play, and within seconds your CD lens is clean.

BSW Price \$29.95

BSW

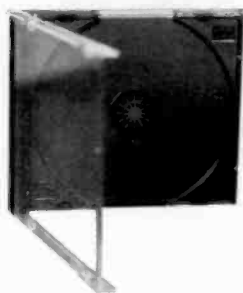

**CDBOX
CD Jewel Boxes**

Whether you're replacing broken CD cases or trying to protect the CDs music companies send you in a plastic bag, BSW CD boxes are the perfect solution.

Quantity	1-49	50-99	100-499	500+
BSW Price	.79 ea.	.69 ea.	.59 ea.	.50 ea.

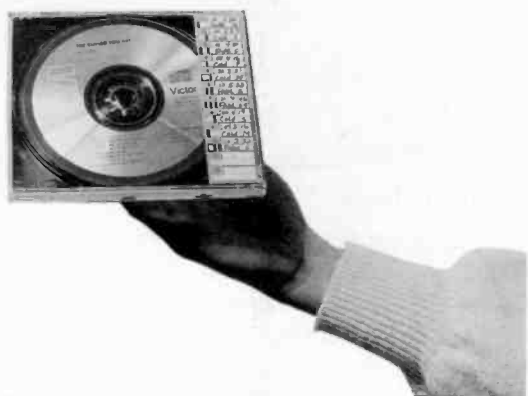

CD Organizers

Color code your CDs with our versatile CD labels. Separate discs by format, day parts, new hits ... whatever. Each label has space for you to write in intro and running times, tempo, type of ending, etc. Choose red, blue, green, and yellow. 84 labels per package.

BSW Price \$7.95 per pkg.

DENON



**CD TEST
Test Disc**

Turn your compact disc player into a powerful test signal generator. This outstanding CD Test Disc from Denon includes 99 audio tests that include frequency sweeps, tone bursts, pink noise, IM distortion, square waves, and more.

BSW Price \$19.95



**CD Cart™
ACD5B**

For use with the Denon DN951FA, 970FA, and 950FA CD players only.

BSW Price \$3.30 ea. Quantity discounts available

DISCWASHER



CDC



FG1107

**CDC
CD Cleaner**

Discwasher's patented rotary technique safely and effectively removes contaminants from your CDs.

BSW Price \$16.40

**FG1107
CD Lens Cleaner**

Safely removes contaminants from CD player's laser lens with unique wet/dry cleaning action. Kit includes cleaning solution, cleaning disc, and one replacement cleaning pad.

BSW Price \$19.90

DISCWASHER



**FG1163
CD Repair Kit**

This handy kit can actually remove small scratches and blemishes in the disc. The kit includes fluid, polish, applicators, and polishing wipes.

BSW Price \$10.10

GENEVA



**PF425
Disc Wipes**

No-nonsense, easy-to-use tissues safely remove dust and fingerprints from CDs. 70 wipes per container.

BSW Price \$7.20

TRACKMATE



**TM301
Disc Shield**

The Disc Shield was designed to protect your CDs from permanent damage. The crystal clear, self-clinging shield is easily installed and will stay in place, protecting your discs during normal handling or accidental dropping. Each package includes 10 shields.

BSW Price \$14.95

HBS



CD Music Libraries

BSW is pleased to introduce to our customers, the Holland Broadcast Services CD Music Libraries. Hundreds of these collections are being used on the air worldwide. All selections are original versions by the original artist. All libraries include a complete data base on floppy disc.

#1 "Rock 'N' Roll Graffiti" CD Oldies Library

1229 songs on 50 CDs, covers 1955-1969. Digitally remastered from Over 90% actual master tapes.

Mfr. List \$2,795.00

Call For BSW Price

#2 "The Seventies" CD Gold Library

545 songs on 30 CDs, covers 1970-1979. Digitally remastered from Over 95% actual master tapes.

Mfr. List \$1,795.00

Call For BSW Price

#3 "The Eighties Plus" AC/CHR Library

769 songs on 44 CDs, covers 1980-1992. Mastered from 97% digital sources and studio master tapes.

Mfr. List \$2,495.00

Call For BSW Price

VALENTINO INC.

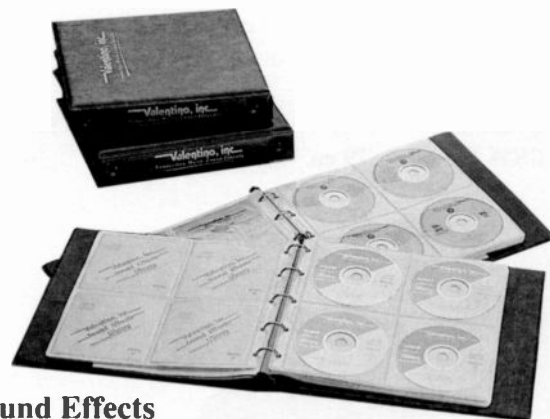

CD Sound Effects

You'll be amazed at the quality of these digitally recorded and mastered discs. All Valentino sound effects are grouped together by category for convenience and all sound effects are individually tracked on each CD (no sub-indexing) so cuts are easy to locate in any CD player. There are no additional royalty, clearance or license fees required once a library is purchased.

SFXCD (10 Volumes Of Your Choice) BSW Price \$429.00

SFXCDLIB (37 Vol. Library) BSW Price \$1,200.00

SFXCD8 (8 CDs Based On Analog Recordings) BSW Price \$155.00

SFXSET (Set Of 30 LPs) BSW Price \$399.00

**BGMCD BSW Price \$155.00
(2 CD Set Including 198 Commercial Music Beds)**

ARRAKIS



10,000 SERIES Audio Consoles

The 10,000 series are world class consoles that combine the best features in on-air consoles along with features found on multi-track studio consoles in a single mainframe.

Features include:

- "On-Air", 4-track and 8-track production capability
- Ten main audio busses, two stereo auxiliary busses, stereo cue buss and stereo solo buss
- "Front of the console" access to all bussing connectors via hydraulic assisted, hinged to
- Two stereo auxiliary busses for effects/foldback
- External regulated and protected power supply features independent supplies for audio, logic, monitor and phantom power
- Stereo cue system with autocue switching of earphones
- Monitor system provides feeds for console, host, co-host and guest headphones
- Separate control room and studio monitor systems for multiple studios
- Multistation talkback or intercom systems for multiple studios
- Multifrequency test oscillator
- Independent telephone mix-minus module
- Comprehensive remote control logic for each input

Prices Based On Configuration

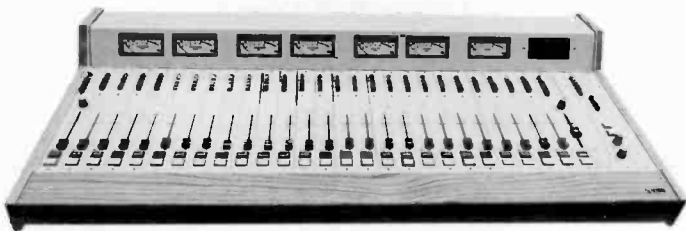

12,000 SERIES Audio Consoles

The 12,000 series console features three mainframe sizes to accommodate up to 28 input modules. Four different input modules are available, each with 2 inputs and 3 stereo outputs. Extensive metering and timer are standard along with Penny and Giles faders, ITT Schadow switches, gold board connectors and solid oak trim.

Features:

- Easy connectorized installation
- Stereo cue system
- VCA controlled faders
- Three stereo output busses
- Universal mainframe buss design
- Comprehensive logic system
- External regulated and protected power supply
- Mic modules available with pan
- Line modules available with mode select
- Monitoring for control room and 2 studios
- Telephone mix-minus busses

Through-table style mainframes and lighted VUs are available as options.

Price Based On Configuration

ARRAKIS

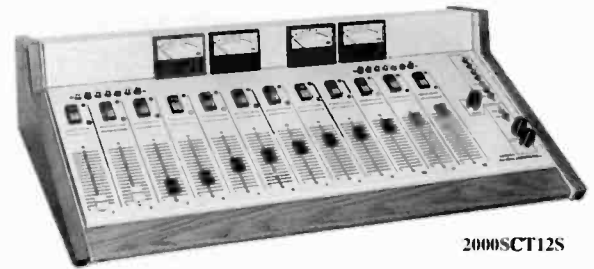

2000SCT12S

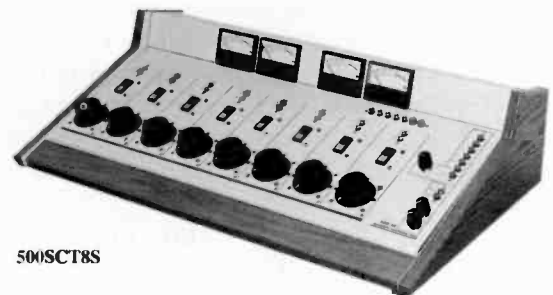

500SCT8S

Arrakis SC Series Consoles

Arrakis consoles are exceptionally cost effective without compromising product features. All Arrakis products are engineered for reliability first. No expense is spared in the use of quality components, like Penny and Giles slide faders and ITT Schadow switches.

All SC series consoles feature the following:

- VCA level controls
- DC controlled - no audio pots or switches
- 10 watt per channel monitor amp
- 2 watt cue amp & 2 watt headphone amp
- Solid oak end panels and armrest
- Modular regulated power supply
- Mono mixdown standard
- Telephone mix-minus standard
- Remote start standard (except 150SC)
- 2-YEAR WARRANTY

150SCT6S

6 channel, 18 inputs, program output

Mfr. List \$2,495.00

500SCT8S

8 channels, 25 inputs, program and audition outputs

Mfr. List \$3,595.00

2100SCT12S

12 channel, 34 inputs, program and audition outputs

Mfr. List \$5,995.00

1500SCT8S

8 channel, 28 inputs, program and audition outputs

Mfr. List \$4,495.00

2000SCT12S

12 channels, 24 inputs, program and audition outputs

Mfr. List \$4,995.00

Call For BSW Price

AUTOGRAM

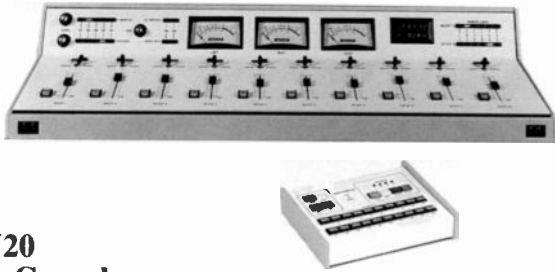

**R/TV20
Audio Console**

When you need mixing flexibility, you'll want the R/TV20 from Autogram. 18 slide faders have a single input, the remaining 2 faders have 8 inputs each to allow multiple auxiliary sources. Total of 34 stereo inputs on 20 channels. Standard features include: VCA level control, Penny and Giles linear conductive plastic pots, shadow selector switches, up to eight patchable microphone preamplifiers, and remote control capability. Optional live assist package plugs into the R/TV series console and offers full remote control plus four live assist programs, each with 32 step capability.

- R/TV20 Mfr. List \$13,385.00
- R/TV12 (Not Shown) Mfr. List \$11,098.00
- Live Assist Package Mfr. List \$1,423.00

Call For BSW Price



**IC10A
Audio Console**

The IC10A features high quality step attenuators, 2 inputs per channel with 2 six position remote select switches. Remote start switches, headphone monitor and cue amplifiers standard. 2 stereo outputs with mono mixdown are standard as well.

- IC10A (10 Channel Stereo 28 Inputs) Mfr. List \$9,166.00
- AC8A (8 Channel Stereo 26 Inputs) Mfr. List \$6,967.00
- AC6A (6 Channel Stereo 23 Inputs) Mfr. List \$5,604.00

Call For BSW Price

"A" Models Are Transformerless. Transformer Versions Available

Acquire the equipment you need without jeopardizing
your cash flow!

Ask Us About *FlexLease* financing

AUTOGRAM



Pacemaker Series Audio Consoles

Pacemaker consoles offer an incredible amount of flexibility without an enormous price tag.

For newsroom operations, you'll want the Pacemaker 648 and the 618. The 648 features 8 inputs per channel (48 inputs total). On the 618 channels 1-5 have dual inputs, channel 6 has 8 inputs. Machine logic controls are standard on both consoles.

For the control room, the Pacemaker 8-channel 828 or 10-channel 1032 offer additional mixing flexibility. The 828 has 28 stereo inputs, the 1032, 32 stereo inputs. Each console has 2 inputs per channel and 2 banks of remote selectors.

Features:

- VCA level controls • No audio transformers • Shadow selector switches • Electronic switching • Engraved front panel • Penny and Giles faders • Pluggable miniature terminal strips

Outputs: 1 Stereo Program, 1 Mix-Minus, 1 Stereo Audition, 1 Mono, 2 Headphones, 1 Cue

- 618 Mfr. List \$5,095.00 648 Mfr. List \$6,625.00
- 828 Mfr. List \$6,115.00 1032 Mfr. List \$7,344.00

Call For BSW Price

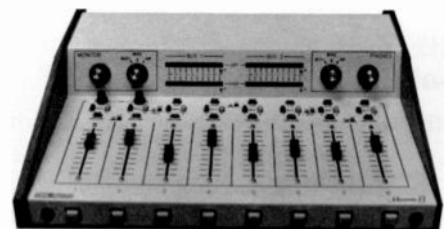

**Mini-Mix 8
Audio Console**

Talk about versatile, the Mini-Mix 8 offers almost any kind of input configuration to interface any piece of pro or consumer audio equipment. 8 slide pots host a total of 12 stereo inputs (6 unbalanced, 6 balanced). First 2 channels are dedicated mic level. Slide faders control VCA's. Two stereo outputs and one mono output are provided. Case is all aluminum with oak endbells.

Mfr. List \$2,499.00

Call For BSW Price

AUDIOARTS**A50
Audio Console**

Clever engineering and the latest advances in electronic assembly give this console high-end features and quality at a truly affordable price. 8, 12, and 18 channel models are available.

Features: Any combination of mic and line inputs available • Two inputs per channel • Program, audition and telephone outputs • Remote start switches • Full function event timer • Separate control room and studio source selectors • Full talkback system • Built-in headphone amplifier • Built-in cue amp and speaker • Channel on/off remote controllable • On-air tally opto-relay • Plug-in faders and pots • Fully-enclosed aluminum chassis resists RF • Six-position line preselector module option • Digital Clock (18 channel model only)

A50-8 Mfr. List \$4,595.00	Call For BSW Price
A50-12 Mfr. List \$6,695.00	Call For BSW Price
A50-18 Mfr. List \$9,095.00	Call For BSW Price

**R10
Audio Console**

The R10 is a fully modular console with components typically found in high-end consoles, yet the price is especially attractive. It has gold audio switches, gold edgecard connectors, conductive plastic faders and monitor pots.

Mic or stereo modules can be loaded in any position. Stereo line modules have machine start and stop switches. Cue is a push button on the module allowing for a variety of creative cueing situations. Each channel has an output assign for program and audition. Studio intercom/talkback and built-in cue speaker are provided.

The R10 is based on a simple premise: Low cost does not have to be synonymous with low quality.

When it comes to performance and price, the R10 is an outstanding choice.

R10 (Ten Channel) Mfr. List \$4,495.00	Call For BSW Price
R6 (Six Channel) Mfr. List \$3,195.00	Call For BSW Price

AUDIOARTS**R30
Audio Console**

The AUDIOARTS R30 console is designed for maximum performance on a tight budget. The R30 is available in two mainframe sizes (with 12 or 18 input channels) and has two stereo outputs, plus mono sum and mix-minus. The R30 comes with ample expansion room for additional inputs and can accommodate a powerful family of optional accessory modules, including a microphone input, machine control panels, intercom and studio monitor modules, plus a multiple line select module.

The R30 features modular construction, logic follow, full machine control and an all-gold module-to-console interface system. Input channels are available in both mono mic and stereo line versions (each with A/B source select) and Program/Audition bus assign, plus Cue switches on the line modules. Standard features include Program and Audition VU meters, digital timer and clock, cue speaker, plus a monitor module for control room and headphone functions.

R30-12 (12 channel)	Mfr. List \$11,495.00
R30-18 (18 channel)	Mfr. List \$16,300.00

Call For BSW Price

Prices shown are for standard equipped console. Complete list of options and prices available.

FIDELIPAC**MX SERIES
Audio Console**

True modularity, superior flexibility and low cost give Fidelipac's MX series consoles real value for the dollar. Consoles are available in 6, 8, 10, or 12 channel models, with linear or rotary faders.

Features include: Fully modular input modules with precision motherboard construction, VCA mixer and monitor control, two inputs per module, each input can be mic or line with consumer or pro input level, four assignable outputs—two stereo plus two mono, remote start logic, count-up event timer, built-in cue amp/speaker and headphone amp, all steel construction, excellent RF immunity, and virtually indestructible control surfaces.

Mfr. List From \$3,050.00 (6 channel)	Call For BSW Price
--	---------------------------

BROADCAST ELECTRONICS

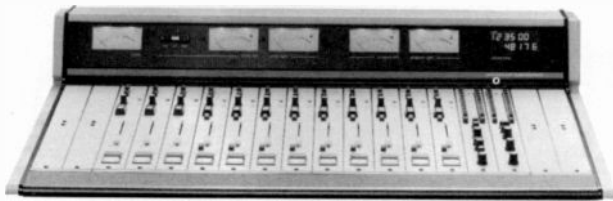

**MIX TRAK 90
Audio Console**

Looking for a new console that fits today's need while leaving room for tomorrow's expansion? Choose the Mix Trak 90 from Broadcast Electronics. Available in 12 and 18 channel mainframes, this modular console can be fitted with the exact type and number of input modules you desire.

The audio performance of the Mix Trak 90 is superb. Typical signal to noise is better than 85 dB below nominal output level with THD at less than .05%.

Features:

- Individual line and microphone input modules • Automatic source sequencer • P&G linear faders • VCA controlled audio • Silent Hall Effect module switching • "Monitor Dim" function for easier cueing
- Balanced patch points • Independent program and audition metering
- Three mix-minus busses • Separate music and speech program busses
- Optional PPM metering • Optional clock/timer module • Optional mono module with metering and phase reversal indication.

Price Based On Configuration



**AIR TRAK 90
Audio Console**

These 6, 12, 18, and 24 channel consoles have the look and functionality needed for broadcasting in the 90s, and are durable enough to carry the BE name.

All models have the following features:

- All inputs independently assignable for mic or line, HI or LOW level
- P&G linear faders • VCA controlled audio • Silent Hall-Effect switching • "Monitor Dim" function for easier cueing • Versatile talkback system • Independent program and phase integrity indicators • Auxiliary mix-minus buss • Clock/timer standard • Mono outputs standard • Tough polycarbonate overlay

Price Based On Configuration

BROADCAST ELECTRONICS

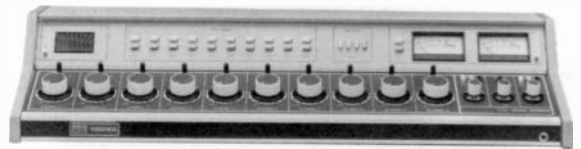

**SERIES 250A/150A
Audio Consoles**

With their two-tone technical white and gray finish and solid oak trim, these consoles are stylish yet offer rugged, reliable service in any demanding on-air or production application. Each mixing channel accommodates two pushbutton selectable inputs and may be preset for either microphone or high level service. Every console also features separate monitor, headphone and cue channels, and front panel polycarbonate overlay.

The quality features of the 250A series consoles include ladder-type step attenuators with cue detent, and roller-cam key switches.

The 150 series is the economy series featuring durable, sealed potentiometers with detent for cue.

5S250A (5 Mixer Stereo)	Mfr. List \$4,350.00
8S250A (8 Mixer Stereo)	Mfr. List \$5,600.00
10S250A (8 Mixer Stereo)	Mfr. List \$7,000.00
5S150A (5 Mixer Stereo)	Mfr. List \$3,450.00
8S150A (8 Mixer Stereo)	Mfr. List \$4,650.00

Call For BSW Price



**4S50A
Audio Console**

The 4S50A lends itself well to either production or on-air use. Each of the first three channels accepts two high or low level stereo inputs. Channel four can be pre-selected for a single high or low level stereo input, or for one of five high level remote/utility stereo inputs. Each channel mixer control incorporates sealed dual-potentiometers fitted with detent cue switches. Rack mount version available.

Mfr. List \$2,300.00

Call For BSW Price

NEED PRICES ON A MAJOR PROJECT ?

Save yourself time and FAX us your equipment list. We'll have a complete price quote back to you in no time.

LPB

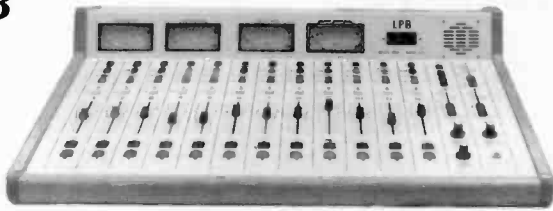

**7000 SERIES
Audio Consoles**

Introducing the All-New 7000 series stereo consoles from LPB. Available in 12 and 18 channel models, these consoles feature • 2 inputs per channel • 3 stereo output busses • 3 mono output busses • Remote starts with blinking ready light and remote access on all inputs • Cumulative /event timer with channel start capability • Programmable muting • Penny & Giles linear faders • All gold contacts • All front panel push-button switches rated for 5 million operations.

- 7012 (12-Channel Stereo) Mfr. List Under \$7,000.00**
- 7018 (18-Channel Stereo) Mfr. List Under \$10,000.00**

Call For BSW Price



**SIGNATURE III SERIES
Audio Consoles**

These consoles offer real ruggedness and demonstrated RFI immunity. Built in cue amp/speaker and monitor amp. 3 inputs per mixer.

- S10 (6 Mixer) Mfr. List \$4,195.00**
- S13 (8 Mixer) Mfr. List \$4,995.00**
- S20 (10 Mixer) Mfr. List \$5,895.00**
- S24 (12 Mixer) Mfr. List \$6,895.00**

Call For BSW Price

ATI

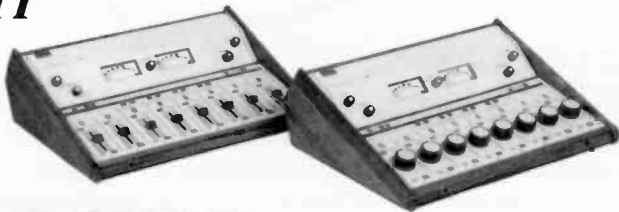

**VANGUARD SERIES
Audio Consoles**

Vanguard series Consoles offer superior performance and long term reliability with low initial cost and minimum maintenance. Features: dbx™ VCAs • Headphone amplifier • Muted monitor drivers • Cue amplifier and speaker • Two microphone preamps • Balanced, bridging inputs • Active balanced outputs • Effective RF Protection

- BC6DSL/R (6 Linear or Rotary Faders, 12 Inputs) Mfr. List \$2,995.00**
- BC8DSL/R (8 Linear or Rotary Faders, 12 Inputs) Mfr. List \$3,495.00**
- BC12DSL (12 Linear Faders, 24 Stereo Inputs) Mfr. List \$5,195.00**

Call For BSW Price

RADIO SYSTEMS



**RS SERIES
Audio Consoles**

RS series consoles from Radio Systems are "low Cost," not cheap. They are ruggedly constructed and fully featured. Installation, performance and service-ability were considered and implemented early in the design to make your purchase of the RS series a pleasure. Four models are available..from 6 to 24 channels

Look at the exceptional array of standard features:

- 2 inputs per channel • Program, Audition, Mono outputs • Full DC Control • Penny and Giles faders • Full VU metering • Event timer
- Full remote control • Superb audio specifications • Mic, line, consumer level on each input • 2 year warranty

A complete brochure outlining all the specifics of RS series consoles is available for the asking.

- RS-6 Mfr. List \$4,795.00**
- RS-12 Mfr. List \$6,795.00**
- RS-18 Mfr. List \$9,895.00**
- RS-24 Mfr. List \$12,995.00**

Call For BSW Price

On-Air vs. Production Consoles What's The Difference

Here is a brief list of some of the requirements and features that differentiate on-air consoles from production consoles.

On-Air Console Requirements

- Simple, logical layout for speed and ease of use
- Cue and/or audition busses to cue sources off air
- Extreme durability and easy serviceability to avoid down time
- Multiple source inputs or remote selectors to increase sources per input
- Separate output or mix-minus busses for interface with telephones
- Control logic to operate equipment right from the console

Production Console Requirements

- Flexible monitoring and switching for multiple track monitoring and mixdown
- Multiple AUX or effect input/output (sends/returns) for external processing
- Multiple output routing for track assignment
- Flexible inputs to allow for various source types and levels
- Equalization on the input channels
- Flexible metering to maintain proper levels throughout recording process

Whether on-air or production, a BSW representative can help you find the console that's right for you

AUDIOARTS



MR-40 Audio Console

Multi-track production doesn't have to be complicated. The AUDIOARTS MR-40 has just the features many stations are looking for: 4-Track bus assign for your tape recorder or digital workstation; program assign so you can transfer direct to your 2-track or go right on-air. It has machine starts/stops just below the fader like an on-air console, but also includes a 3-band equalizer section so you can have the tone control that a normal radio console couldn't provide.

12 input channels are provided. Mono modules have both mic and line inputs: mic for recording and line for track playbacks. Subgroup channels provide fader control for record levels. The MR-40 has an on-air type monitor section, complete with control room, headphone and studio outputs plus all the necessary muting and tally functions you'd want. Cue speaker and amplifier are provided.

Mfr. List \$11,995.00

Call For BSW Price

RAMSA



WR8616 Audio Console

The WR8616, a mixer specifically designed for recording and broadcast applications. It employs a versatile mainframe that can accommodate a variety of modules including a mono mic/line module (WU8101) and a stereo line module (WU8106). Available with remote start switches and equalization, the WR8616 is one of the most versatile consoles available in its price range.

Price Based On Configuration

When It Comes To Audio Consoles, Nobody
Offers Better Selection And Pricing Than BSW

SOUNDCRAFT



200 DELTA Audio Console

Start with an 8, 16, 24, or 32 channel mainframe, add the number of inputs and subgroups you need, and you've got the perfect solution to your production console needs. Choose from four styles of inputs:

The standard input module, featuring wide-range input level control, 3 band EQ, 6 aux sends, and complete routing. The deluxe input adds an input phase reverse switch, highpass filter, and an extended EQ. The stereo input allows switching between two stereo input sources with full right/left balance or mono summing on either source. The dual line input module effectively doubles the number of sources per channel.

You can feed all inputs directly to stereo or choose up to 4 submasters. The 8 channel mainframe can be rack mounted.

A Standard Input, 16 Channel Console Lists For \$5,450.00

Call For Specific Pricing And Configuration

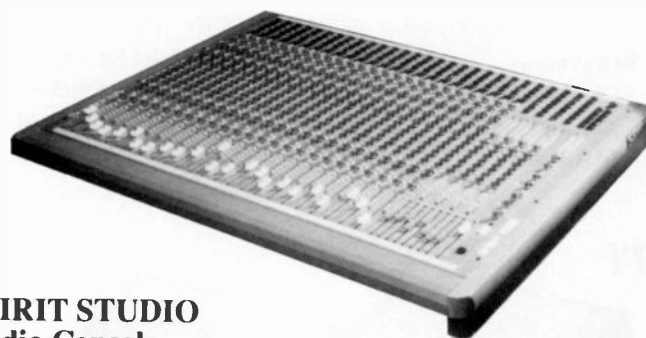

SPIRIT STUDIO Audio Console

Spirit production consoles are available in 16 or 24 channel sizes with a number of features that maximize flexibility. Both size consoles feature 8 group busses that can be linked into 4 stereo pairs. Each channel has three inputs- a mic input, a line-level input, and a tape monitor input that acts as an extra line input during mixdown effectively doubling the number of inputs available at mix-down.

All input channels have a 4-band EQ section (HF, LF, 2-mid sweep) that can be split between main and monitor signal paths. There are 6 aux. busses available and 4 stereo returns with 2-band EQ.

Additional features include excellent monitoring/talkback facilities, 2 freq. tone oscillator, and 10 16-segment LED bargraph meters.

STUDIO 1682

Mfr. List \$3,995.00

STUDIO 2482

Mfr. List \$5,950.00

Call For BSW Price

TASCAM



**M3500-24ST
Audio Console**

To stay competitive, stations are relying on more sophisticated audio production demanding consoles that integrate multiple audio sources, effects units and multitrack recorders. The M3500-24ST from Tascam features 24 mono and 8 stereo inputs, 8 group busses and an "in line" monitor system which allows for complicated productions involving up to 24 recorded tracks.

Special features:

- 4 band, 6 control EQ • 6 aux sends, slide faders for in-line monitoring and effect returns • Optional LED meter bridge provides metering on all input channels. Console stand optional.

Mfr. List \$9,999.00

Call For BSW Price



**M2516/M2524
Audio Consoles**

If you need an affordable, compact, yet fully functional multi-track recording console you'll want the M2500 series console from Tascam.

The M2516 features 16 full-function inputs, 16 tape returns, 8 sub-groups, and L/R outputs. The M2524 has 24 full-function inputs, 24 tape returns, 8 sub-groups, and L/R output.

Both models feature eight buss recording, automated muting via MIDI, in-line stereo monitoring, four aux, sends, three-band EQ, pre-fade listen, 4 effect returns (2 stereo, 2 mono), talkback with built-in mic, and balanced left/right outputs.

M2516 Mfr. List \$3,199.00

Call For BSW Price

M2524 Mfr. List \$4,199.00

Call For BSW Price

TASCAM



**M1500 SERIES
Audio Consoles**

The M1500 series recording mixers are designed to meet the needs of professional 4 and 8 track recording studios where space is at a premium. They are available in 8 or 16 input configurations. Each channel, besides having a main fader signal path, allows routing of additional sources to a separate stereo signal path. Other features include balanced XLR mic and 1/4" line inputs for each channel, 3 band EQ, 3 aux sends, bar-graph metering.

M1508 Mfr. List \$1,199.00

Call For BSW Price

M1516 Mfr. List \$1,899.00

Call For BSW Price



**M108
Audio Console**

The M108 offers comprehensive input and output facilities in a convenient practical layout. Features: 8 Mic/line inputs with trim • 8 tape inputs • 2 stereo inputs • 4-Group, 1-aux and 2-effect outputs • 2-band shelving EQ on each channel • Stereo and mono monitoring • 10-segment LED meters • Built-in rack ears.

Mfr. List \$799.00

Call For BSW Price



**M06ST
Audio Console**

The M06ST is perfect for small home, or station production rooms. Features: 6 stereo input channels (channels 1 and 2 have stereo phono inputs for direct connection of turntables while channels 3-6 have stereo line inputs) • Mic inputs on each channel accept a wide range of signals from microphones, musical instruments and audio equipment • Stereo AUX inputs with level control provide an extra stereo input • Insert patch points on channels 5 and 6 • Cue send level controls on each channel

Mfr. List \$499.00

Call For BSW Price

YAMAHA



**MR SERIES
Audio Consoles**

These high quality, feature laden consoles are available in 8, 12, and 16 channel models. Features on all consoles include: 4 group mixing busses and a stereo master buss • Mic/line or tape input selection on all input channels • Peak LED's on each input channel • 3-band equalizer on each channel with (shelving low/high, sweepable mid) • Monitor assign switches and talkback facilities.

- | | | |
|---------------|----------------------|--------------------|
| MR842 | Mfr. List \$1,295.00 | Call For BSW Price |
| MR1242 | Mfr. List \$1,595.00 | Call For BSW Price |
| MR1642 | Mfr. List \$1,795.00 | Call For BSW Price |



**DMP7
Digital Mixing Console**

Here is a revolutionary digital mixing console and processor from Yamaha. Features: 8 line input x 2 output configuration • Complete 16-bit digital signal processing from input to output • Reliable multi-function motorized faders • Versatile 3-band equalizer • High-performance internal digital multi-effect processor • Memory storage of 30 scenes, which allow instant recall of all console parameters • Internal digital stereo compressor

- | | |
|---------------------------------|----------------------|
| DMP7 | Mfr. List \$3,660.00 |
| MLA7 (Mic/Line Pre-Amp.) | Mfr. List \$450.00 |

Call For BSW Price

MACKIE DESIGNS



**CR1604
Audio Console**

This compact 16 channel console from Mackie Designs offers exceptional performance and versatility. It's unique convertible design allows it to be used as a table top mixer or a rack mounted mixer (rack ears included). CR1604 features include: 6-studio grade mic preamps (expandable to 16), 3-band EQ on every channel, 7 AUX sends per channel (up to 4 simultaneously), 4 stereo effects returns, stereo in-place solo, dual function channel mute, twice the headroom of conventional designs, and a three year limited warranty.

- | | |
|----------------------|--------------------|
| Mfr. List \$1,099.00 | Call For BSW Price |
|----------------------|--------------------|



**MICROSERIES 1202
Audio Console**

The 1202 console from Mackie gives you the same high performance electronics and rugged all-steel construction as its famous big brother the CR-1604. The 1202 has a working signal-to-noise ratio or -90 dB, distortion below .025% across the entire audio spectrum, 48 volt phantom power, and +28 dBu balanced line drivers. The 1202's footprint is under one square foot, yet it packs an amazing total of 20 inputs.

There are 4 mono (mic/line) channels and 4 stereo line inputs (each with separate left and right line inputs). Every channel has a gain control, pan pot, EQ, and 2 aux sends. Master section features headphone amplifier, LED metering and 2 stereo aux returns. Outputs are balanced and unbalanced. Power supply is built-in.

- | | |
|--------------------|--------------------|
| Mfr. List \$399.00 | Call For BSW Price |
|--------------------|--------------------|

BSW Handles The Complete Line Of Yamaha Audio Products. Call Us For Pricing On Models Not Shown In Catalog

Mackie Offers A Wide Array Of Accessories For Their Consoles. Ask A BSW Sales Representative For All The Details

ELECTRO-VOICE**ELX1R
Remote Mixer**

The Electro-Voice ELX1R is a compact, high-performance audio mixer designed for professional applications where clean audio and reliable operation are important. The ELX1R features four balanced inputs, selectable mic or line level. Switchable output limiter prevents clipping, and low cut filters reduce low frequency background noise. Headphone output has a separate power amp and level control will drive any type of headphones or small speaker. Level setting is easy with the built-in tone oscillator.

Mfr. List \$595.00

Call For BSW Price

HENRY ENGINEERING**MICROMIXER
Utility Mixer**

This four-input, two-out stereo utility mixer is the same size as the popular Matchbox. Inputs are balanced and bridging, with adjustments for level and gain. Inputs are assignable to the left, right, or both outputs in any combination. The stereo outputs will drive a 600 ohm load to +25 dBm. Frequency response is DC to 30 kHz.

Mfr. List \$195.00

Call For BSW Price

RANE**SM26
Splitter/Mixer**

Here is an extremely versatile, single rack space mixing tool that combines 6-in/2-out mixer and 2-in/6-out splitter with mix/pan and level controls. Use it for line mixing, line distribution, or line matching/amplification. Transformerless balanced/unbalanced inputs and outputs.

Mfr. List \$379.00

Call For BSW Price

COMREX**STLX/SLX
Remote Consoles**

Ideal for sports or news, the STLX and SLX consoles are completely self-contained remote broadcast packages. The STLX incorporates a two line Frequency Extender encoder with noise suppression. The SLX has a built-in basic single line Frequency Extender encoder.

Features (both mixers):

- Four mixing channels (2 mic/ line) • Built-in telephone interface
- Custom monitor mix with station talkback available on each headphone (4 headphones/STLX) (3 headphones/SLX) • AGC
- AUX IN and OUT • Feeds dial or dedicated circuits • Requires Comrex dual or single line decoder for frequency extension.

STLX Mfr. List \$7,750.00

Call For BSW Price

SLX Mfr. List \$4,200.00

Call For BSW Price

**TALK CONSOLE™
Talk Show Console**

This compact, economical and easy to-use console provides everything needed for talk programs in a single package. Designed for use by non-technical and technical operators wherever there is access to phone lines. The Talk Console™ conferences two phone lines with a host and guest. It offers a telephone dial pad, telephone couplers for direct lines or PABX, two self adjusting hybrids, mix-minus feed, two mic level inputs (channel 2 can be line level), two headphone outputs with volume controls, and remote contact closures to start a tape recorder and a delay system. Simple to set up and operate.

Mfr. List \$2,495.00

Call For BSW Price

SHURE

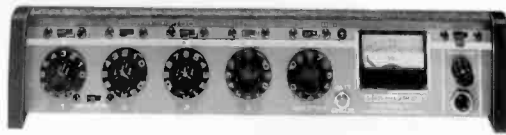

**M267
Microphone Mixer**

The most popular portable mixer in broadcasting is undoubtedly the Shure M267 because of its flexibility and modest price. Features include: Peak limiter, phantom power, built-in battery pack, LED peak indicator, headphone level control. The M267 has four mic or line switchable inputs. It also includes transformer balanced inputs and outputs, mix buss, VU meter, low RFI and line noise susceptibility.

M267 Mfr. List \$535.00
M268 (Simplified Version Of M267) Mfr. List \$325.00

Call For BSW Price



**FP410
Automatic Microphone Mixer**

Now you can operate a multiple mic mix with ease with the FP410 from Shure. Patented IntelliMix technology allows for smooth mixes by automatically turning down unused mics. Three unique features add up to provide excellent hands-free operation: Noise Adaptive Threshold activates mics for speech, but not constant room noise - Maxbus limits the number of activated mics to one per talker - Last Mic Lock-On keeps most recently activated mic open until a newly activated mic takes its place. Additional features: Balanced mic/line inputs and outputs • Phantom powering • Linking capability (up to 25 Mixers) • Manual or automatic modes • AC or battery operation • Rack mount ears and link cable included

Mfr. List \$1,595.00 Call For BSW Price



**FP42
Microphone Mixer**

Field production technicians suffering from audio headaches can rejoice. Shure has a cure in the FP42 - an extraordinarily reliable, compact, feature-packed stereo audio mixer. The FP42 combines Shure ruggedness with all the convenient features that made the M267 so popular plus full stereo capability!

Mfr. List \$1,050.00 Call For BSW Price

TELFAX



**GX SERIES
Remote Mixers**

Choose a GX to fit your application from the basic 3 input GX300 to the mid-line GX400 to the fully featured GX440.

All three models feature high performance features like: High capacity rechargeable batteries with charger, high level loop and AUX outs, pulse/tone dialing, low frequency extender interface, squelch/mute, bass boost, audio limiter, radio monitor switch and jack, headphone amp input, and VU bargraph with peak indicator.

GX300 contains all the above features in a basic three mixer configuration. GX400 adds a 4th mic input, a headphone cueing channel, and a test tone oscillator. GX440 has all the above features plus an up/down timer and 2nd phone line capability for studio cues and on-air calls from listeners.

GX300 Mfr. List \$950.00 Call For BSW Price
GX400 Mfr. List \$1,050.00 Call For BSW Price
GX440 Mfr. List \$1,195.00 Call For BSW Price

Accessories:

19-0007 Padded Nylon Case, 08-0100 Spare Power Transformer/Cable, 19-0206 Hard Plastic Case

ZERCOM



**MAX-Z/MAX-ZII
Remote Mixers**

MAX-Z is a remote broadcast console that provides maximum flexibility, utility, and above all, audio quality. Features include: Carrying case, built-in rechargeable batteries and charger, clock, stopwatch/timer, V.U. meter, wide range and audio inputs (will match almost anything), cue channel, phone line alarms, memory dialing (tone or pulse), etc.

The MAX-Z II is an abbreviated version of the MAX-Z. High quality audio handling is maintained in the two channels of audio input. AC/DC powered, two headphone outputs, cue channel.

MAXZ Mfr. List \$1,095.00 Call For BSW Price
MAXZII Mfr. List \$600.00 Call For BSW Price

RAMSA



**SV3900
DAT Recorder**

The SV3900 is designed for versatility and is compatible with virtually all editing controllers and automation systems. Full remote control capability is available via serial port and can be switched to follow ES-Bus or P-2 protocols. A full-function wired remote controller is available and includes a keypad for IDs, a 2-speed shuttle wheel, and all transport controls. Features include: Push button selectable sampling rate (44.1 and 48 kHz) • Program, absolute, and time-remaining displays • Balanced XLR analog inputs and outputs • Up to 400 times fast-forward/rewind and search speeds

SV3900 Mfr. List \$2,100.00
SHMK390 Remote Control Mfr. List \$400.00

Call For BSW Price



**SV3700
DAT Recorder**

Same basic unit as the SV3900 with a simplified digital output section and the search dial mounted on the front. A full function wireless remote and parallel remote port are included.

Mfr. List \$1,599.00 Call For BSW Price

TASCAM



**DA30
DAT Recorder**

The DA30 is designed for professionals with features like XLR balanced analog inputs and outputs, and AES/EBU digital interface. Features 64X oversampling 16-bit delta-sigma A/D technology and 8X oversampling 18-bit D/A conversion. Automated features make operation smooth and efficient. 15-pin parallel remote port included. Optional wired remote available.

Mfr. List \$1,299.00 Call For BSW Price

SONY



**PCM2300
DAT Recorder**

Sony, the pioneer in DAT technology, has developed a cost-effective studio DAT recorder just loaded with features. LP mode allows for up to 4 hours recording/playback time on a 120 minute tape. Direct and accurate time searching is possible because the PCM2300 records absolute time to the tape. Duration adjustable digital fader allows for simple editing. Audio quality is superb with 1 bit, 64 times oversampling.

Mfr. List \$1,590.00 Call For BSW Price

RADIO SYSTEMS



**RS-6700
DAT Recorder**

Here is a perfect DAT machine for archiving, mastering, or automation use. The RS-6700 transport is based on the Sony DTC-670. Then Radio Systems custom interfaces an internal controller board to provide remote control functions, balanced inputs and outputs, and all function enhancements. The "smart chassis" features large lighted controls for all major functions. This machine also features auto-cue, EOM relay and remote control features.

Mfr. List \$1,895.00 Call For BSW Price

OTARI



**DTR7
DAT Recorder**

Otari, the highly acclaimed reel-to-reel manufacturer brings its quality manufacturing/engineering techniques to the pro DAT market with the competitively priced DTR-7.

Features include 3 sampling frequencies and both AES/EBU and S/PDIF digital inputs/outputs. 32 kHz LP mode allows twice the recording time on a standard tape (4 hours on a 120 min. tape!) Optical remote control included with unit.

Mfr. List \$1,695.00 Call For BSW Price

DIGITAL AUDIO RECORDERS

TEAC



DAP20 Portable DAT Recorder

Full of features and very affordable. Includes: XLR mic inputs, analog and digital (SP/DIF) outputs, AC operation with included adaptor, DC operation (up to 2 hours) with included rechargeable battery pack, headphone jack with level control and more.

Mfr. List \$999.00

Call For BSW Price

MARANTZ



PMD700 Portable DAT Recorder

Ideal for high quality professional in-the-field recording applications, the PMD700 is the smallest and lightest DAT recorder available with fully professional features. Balanced XLR mic/line inputs and RCA line in/out. Key hold switch prevents accidental triggering of front panel controls.

Additionally, the PMD700 includes all accessories including: Rechargeable battery pack, AC adaptor, Carry case with strap, Wired remote control, adaptor cables for audio and digital inputs.

Mfr. List \$2,500.00

Call For BSW Price

SONY

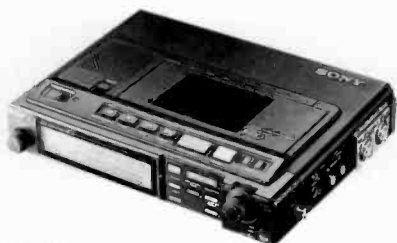

TCD-D10PROII Portable DAT Recorder

This is Sony's smallest DAT machine weighing only 4 lbs. 7 oz even with it's internal battery pack. Balanced XLR mic connectors allow proper interface with professional low impedance microphones or +4 line level inputs. Features include: Digital I/O (S/PDIF and AES/EBU type) • Clear, easy-to-read back lit display • Two hour recording time • Switchable limiter • Built-in speaker • Internal battery

Mfr. List \$3,300.00

Call For BSW Price

DAT TAPE



DAT TAPE

BSW stocks and sells DAT tape at competitive prices. Choose from brands such as 3M/Scotch, Ramsa, Sony, and DIC Digital.

Call For BSW Price

HENRY ENGINEERING



DIGICORD Digital Audio Recorder

Henry Engineering's DigiCord is a utility digital recorder that can store up to 5:25 minutes of audio for instant playback. There's no re-cue time; the message always plays from the beginning. Up to 16 separate messages can be recorded for playback in any order. Eight messages can be accessed using the front panel Message Select switch and 16 messages can be accessed using Remote Message Selection via the remote control connector. DigiCord can be programmed to play a message only once, or repeat any message continuously. The unit can record from a microphone, from a tape deck, studio, or any line-level source.

DigiCord's applications are almost unlimited. Broadcasters can use it to record network feeds for delayed playback, or to record EBS or weather-watch alerts, or to play station IDs and insert local commercials on a translator, or to record 'request line' listener calls.

Additional features include: Talley and EOM triggering and battery backup with standard 9v alkaline battery.

DIGICORD (5:25 min. 5 kHz)

Mfr. List \$695.00

DIGICORD8K (2:40 min. 8 kHz)

Mfr. List \$695.00

Call For BSW Price

TIRED OF WAITING FOR YOUR ORDER TO SHIP ?

Call us by 12 P.M. Pacific Time and we'll ship stock items by 5 P.M. the same day guaranteed, or we pay the freight.

DIGITAL AUDIO LABS

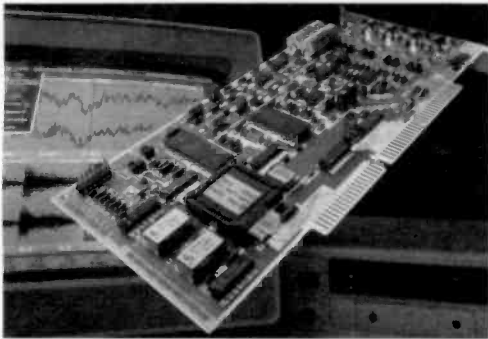

**TCO1/TEO1
Digital Recording Card/Editing Software**

With the CardD™ from Digital Audio Labs you can turn your PC into a professional quality digital audio recorder. Add the EdDitor™ software and you'll have an accurate digital editing system.

This IBM AT-compatible system is contained on a single plug-in card, including A/D and D/A converters with 16-bit resolution allowing for 32 kHz, 44.1 kHz and 48 kHz sampling rates. Inputs and outputs are RCA stereo and are jumper selectable for +4 dB or -10 dB levels. An additional digital I/O card (S/PDIF) is available. Digital Audio Labs recommends that CardD™ run on a 386 16MHz machine for optimum performance. The system requires the standard 10.5 Mb of hard disc space for every minute of stereo recording.

The EdDitor™ software is compatible with any Hercules, EGA or VGA graphics monitors and can operate on the Windows™ platform. EdDitor™ provides fully non-destructive waveform editing of multiple sound files with overlays, fades, crossfades and extremely fast cut and paste operations. With EdDitor™ you can merge an infinite number of audio elements into your stereo mix. A history is kept of the 10 most recent edits you make so you can go back and redo a mistake or change the level of an individual sound element. A special catalog feature allows you to set up a play list of a number of sound files that can be fired with a single key stroke. This can be very handy for live playback applications and for firing sound effects for production.

As far as sound quality, the CardD™ system stands up to digital multitracks, DATs and CDs at a price that just about everybody can afford.

TCO1 CardD™	Digital Recorder	Mfr. List \$795.00
TEO1 EdDitor™	Editing Software	Mfr. List \$250.00
IO01 Digital	In/Out Card	Mfr. List \$295.00

Call For BSW Price

Need assistance in selecting the proper Digital Workstation? BSW Sales Professionals are very qualified to help you make the right choice. We offer demo units, so you can try before you buy.

Call toll free for all the details

TASCAM



**DA88
Digital 8 Track Recorder**

Tascam's DA88 digital 8 track recorder utilizes the readily available Hi-8, 8mm tape format to produce CD quality recordings up to 100 minutes in length on a standard 120 minute tape.

Beside the rugged transport construction you'd expect from Tascam, the DA88 is very easy to use. The front panel has large transport buttons for FF/REW, Stop, Play, and record. Getting around on your tape is quick and easy with super fast FF/REW time (entire tape in just 80 seconds) and a locator jog/shuttle wheel.

With DA88's building block approach, up to sixteen machines can be locked together for 128 tracks. Start with a single 8 track machine, then, as your needs grow, add additional machines as required. The RC848 gives you direct control of up to 6 units (48 tracks). RC808 is the single unit controller.

The optional sync board (SY88) provides SMPTE synch., video sync, a 9-pin RS-422 port, and MIDI machine control.

DA88	8 track recorder	Mfr. List \$4,499.00
RC848	Multi-Unit Controller	Mfr. List \$1,499.00
RC808	Single Unit Controller	Mfr. List \$175.00

Call For BSW Price



**RA4000
Digital Workstation**

The RA4000 random access recording/editing system gives the broadcaster an affordable system that's specifically dedicated to the task of recording and editing. It features dedicated buttons for all editing functions, large transport controls and an easy-to-read, large LCD display for fast operation. The system includes an internal 200MB hard drive that allows 40 track minutes of digital audio storage. The RA4000 has two input channels, four analog outputs, AES/EBU and S/PDIF digital outputs. Synchronization is available for SMPTE, MIDI and video. SCSI interface is provided for external storage devices such as hard drives, magneto-optical drives and DAT backup. RA4000 is controlled by the RC4000 controller. Up to four RA4000 units can be controlled by the RC4000 allowing for a system of up to 16 tracks.

RA4000	Digital Storage/Interface Unit	Mfr. List \$5,499.00
RC4000	System Controller	Mfr. List \$1,499.00

Call For BSW Price

ROLAND

DM80 Digital Audio Workstation

Roland, a major manufacturer of pro audio equipment for the music industry, has developed a digital recording/editing system that offers everything you want in a digital workstation: Ease-of-Use, Flexibility and Affordability!

The DM80 system is easy to use because Roland didn't try to wrap the control functions around generic computer formats, but designed dedicated control options that look and act like existing, familiar analog equipment. The standard 8 track system is all most users would ever want, yet you can configure a system from 4-32 tracks with a number of interface and control options to suit your application. And as far as affordability, it is about half the cost of comparable systems.

The basis of the Roland system is the DM80 recorder itself. It contains one or two 100MB hard drives (depending on configuration). The DM80 utilizes Roland custom VLSI technology, perfected through years of digital keyboard manufacturing, to provide speedy and accurate control of all operating functions in the system. On the front panel is an array of status and metering LEDs that are duplicated within the various control options.

The back panel reveals 8 balanced analog direct inputs/outputs, stereo analog mix outputs, and the AES/EBU, and S/PDIF digital inputs/outputs. Also on the back panel are the MIDI interface and SCSI ports for additional external storage (generic hard drives). Three different sampling rates are provided and a basic system has approximately 36 minutes of storage at 44.1 kHz. Internal sampling frequency conversion is another benefit of Roland's VLSI expertise.

The DM80R is the dedicated controller featuring controls that mimic the transport buttons on familiar analog recorders making it extremely easy to learn and even faster to use. All function buttons are laid out in front of you in a logical manner so you can spend your time creating, not paging through multiple menus to select the function you need. It features a 240 x 60 dot LCD displaying operational parameters and system status. Recorded material is visually presented as a segment of tape with individual phrases and track segments.

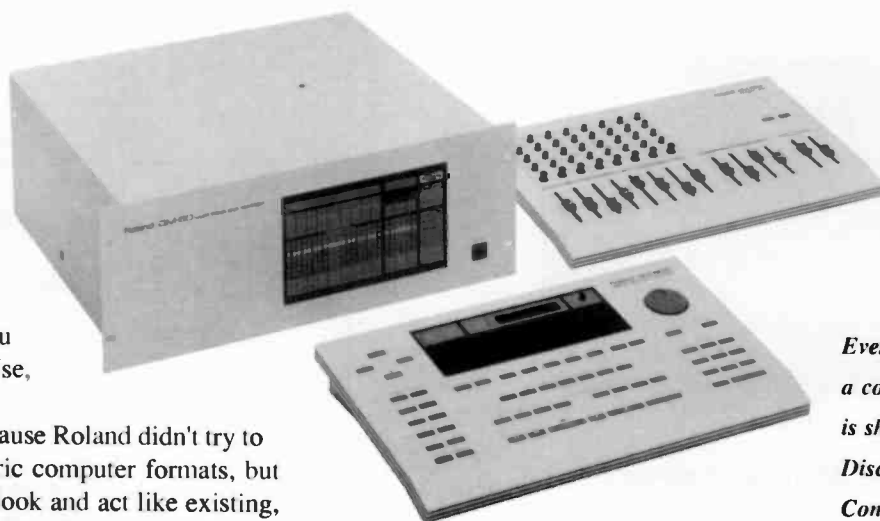

Everything you need for a complete 8 track system is shown here: Multitrack Disc Recorder, Remote Controller and Fader Unit

Editing on the DM80 is a pleasure and you don't have to be computer literate to understand the process. Everything is presented in a manner familiar to audio pros, not just computer buffs. Familiar cut, copy, insert, erase and move functions are used, and slipping and trimming tracks can be done either graphically or with a list. And best of all, editing functions happen in real time - no waiting!

To really make life easy, Roland included the DM80F fader unit that duplicates the functions of a small mixing console so that all mix parameters are at your fingertips, including faders, EQ, stereo panning, and automation enable.

DM80SYS 8 Track Workstation

Mfr. List \$13,750.00

Call For BSW Price



The DM80R Remote Controller Looks And Acts Like Analog Recorders

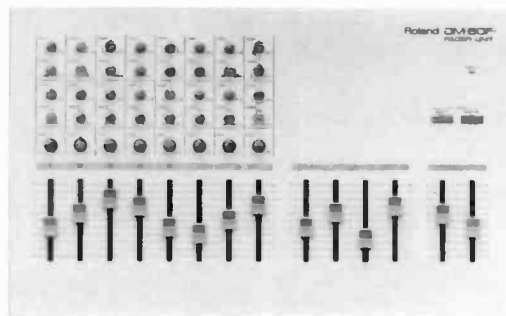

No Learning Curve Here! The DM80F Works Exactly Like An Analog Mixer

AKG



K240M

The K240M offers accurate reproduction at all listening levels, and extreme comfort with virtually no fatigue with prolonged use. Frequency response 15 Hz to 20,000 Hz. 4-600 ohm impedance.

Mfr. List \$139.00

Call For BSW Price



K141/2

A lightweight, semi-open-air headphone with resonance-free characteristics of "open air" designs. Frequency response 20 Hz to 20,000 Hz. 4-600 ohm impedance.

Mfr. List \$119.00

Call For BSW Price

BEYER



DT220

These unusually lightweight, sealed ear headphones feature excellent fidelity and sparkling clarity that satisfies even the most discriminating ear. Frequency response 20 Hz to 20,000 Hz. 600 ohm impedance.

Mfr. List \$139.95

Call For BSW Price



DT100K

Reliable, comfortable headphones with moderately spacious sound perspective and powerful, but not overemphasized bass response. Frequency response 30 Hz to 20,000 Hz. Impedance 400 ohms.

Mfr. List \$199.95

Call For BSW Price

FOSTEX



T20RP

The Fostex T20RP headphones can handle high SPL without distortion. Soft, comfortable ear pad in a semi-closed format. Removeable cable. Frequency response 50 Hz to 30,000 Hz.

Mfr. List \$99.00

Call For BSW Price

KOSS



PRO4AA

The PRO4AA has been preferred by professionals for years. It delivers an extended range with outstanding sensitivity. Comfortable ear cushions provide a complete seal. Frequency response 10-22,000 Hz. Impedance 230 ohm @ 1 kHz.

Mfr. List \$99.99

Call For BSW Price



PRO4XTC

The PRO4XTC has a neodymium, iron boron magnet that improves magnetic field strength for greater clarity and detail. Ear cushions are closed for minimum sound leakage. Frequency response 10-20,000 Hz. Impedance 230 ohm @ 1 kHz.

Mfr. List \$99.99

Call For BSW Price



TD60

This lightweight, sealed ear stereophone delivers great sound and is very affordable. Frequency response 18 to 20,000 Hz.

Mfr. List \$19.99

Call For BSW Price

HEADPHONES

SENNHEISER



HD440

The HD440 is a full-sized, large diaphragm headphone that offers full-sized performance and long-term listening comfort for broadcasters. As with all Sennheiser professional headphones, parts are field replaceable. Frequency response 20-20,000 Hz. 60 ohm impedance.

Mfr. List \$79.00

Call For BSW Price



HD450II

Successor to the HD414 series and designed specifically for the professional. Open-air design, HD450II provides higher output and improved accuracy using neodymium-iron magnets. Supplied with 10-ft. stranded steel cable. Frequency response 20-20,000 Hz. Impedance 60 ohms.

Mfr. List \$99.00

Call For BSW Price



HD490

Cream of the 400 series, the HD490 offers outstanding comfort and durability. Triple-wound aluminum voice coils for better low and high end reproduction. 10 foot cord with 1/8" and 1/4" plug adaptor. Frequency response 18 Hz to 22 kHz. Impedance 70 ohms.

Mfr. List \$129.00

Call For BSW Price

SONY



7506

The 7506 delivers a surprisingly wide frequency range (5 to 30,000 Hz usable) in a comfortable, sealed ear format providing maximum isolation from external sound. Collapsible for storage.

Mfr. List \$125.00

Call For BSW Price



7504

The 7504 is light-weight and comfortable with a closed ear format. Collapses for easy storage. Frequency response is 50 Hz to 18 kHz.

Mfr. List \$98.00

Call For BSW Price



7502

An economy headphone with surprising sound. Closed ear format. Frequency response is 60 Hz to 18 kHz.

Mfr. List \$57.00

Call For BSW Price

BSW stocks the most popular headphones for immediate shipment.

BEYER



DT109K Headset

A headphone microphone combination for heavy duty use. All parts easily interchangeable. Long wearing comfort. Hyper-cardioid microphone has excellent noise cancelling qualities. Headphone frequency response, 40 Hz to 12,000 Hz; microphone, 30 Hz to 20,000 Hz.

DT109K Mfr. List \$269.95 Call For BSW Price
DT108K (Single Ear) Mfr. List \$219.95 Call For BSW Price

SENNHEISER



HMD224 Headset

One of broadcasting's most popular headsets, the HMD224 incorporates a dynamic cardioid microphone specially angled on the boom for optimum speech reception. Sealed ear configuration guards against unwanted crowd noise. Headphone frequency response, 16 Hz to 20,000 Hz; microphone, 50 Hz to 12,000 Hz.

Mfr. List \$315.00 Call For BSW Price

SHURE



SM2 Headset

The Shure SM2 provides maximum comfort, durability and high quality sound reproduction. Headset features include a patent mic boom mount adjusts for left or right side use, a metal boom that is less subject to damage, a rugged, all metal headband with leather-like covering, and "pillow-soft" ear pads for maximum comfort. Headphone frequency response, 100 Hz to 8,000 Hz; mic response 50 Hz to 15,000 Hz.

Mfr. List \$237.00 Call For BSW Price

TELEX



V220 Headset

This unique new headset offers audiophile quality and flexible configurations using modular cord sets and microphones. Construction is super rugged and comfortable. The ear phone section is studio quality and features a unique adjustment for more or less isolation.

Since this set is modular, be sure to order the headphone, mic, and cable set you require.

V220 Double Sided Headphone W/Boom	Mfr. List \$147.00
MB11 Supercardioid Dynamic Mic Element	Mfr. List \$42.00
MB12 Supercardioid Electret Mic Element	Mfr. List \$42.00
CA10 Cable (XLR And 1/4" For Electret)	Mfr. List \$137.00
CA11 Cable (XLR And 1/4" For Dynamic)	Mfr. List \$93.00

Call For BSW Price

AKG



K270HQ Headset

The K270HQ from AKG features a dynamic boom microphone with a rising response through the midrange frequencies for added clarity and articulation on remotes. Hypercardioid mic pick-up pattern for noise free broadcasts in crowds. The headphone is very comfortable for long wearing. A unique feature of this headset is that the microphone is muted when the boom is raised, and headphones mute when removed from the head to avoid feedback in live remote situations. Microphone response 50-11,000 Hz. Headphones 20-20,000 Hz. 75 ohm impedance.

Mfr. List \$379.00 Call For BSW Price

BSW Frequently Offers Special Pricing On Popular Headphone Models. Ask A BSW Representative about the current specials.

ATI



HD1000/HD100 Headphone Amplifiers

HD1000 drives 4 stereo headphone outputs from a balanced stereo or mono line input plus a front panel mic input that can be panned left or right. A balanced stereo loop output is provided to feed any number of HD100 single stereo headphone modules. The HD100 is a self contained single channel headphone amplifier.

HD1000 Mfr. List \$429.00 Call For BSW Price
 HD100 Mfr. List \$199.00 Call For BSW Price

BENCHMARK

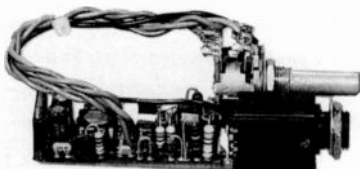

HPA1 Headphone Amplifier

The HPA1 can be used anywhere - in consoles, at the patch bay, on interview tables and test sets, wherever you need individual level control. The HPA1 is ideal for headphones with impedances from 60 to 600 ohms. This kit requires power supply and installation.

BSW Price \$70.00

HOSA



HPE225 Headphone Extension Cable

This coiled extension cable stretches to 25' to allow more mobility when wearing headphones. End connectors are 1/4" male plug and 1/4" female jack.

HPE225 (Coiled 25') Mfr. List \$11.00 Call For BSW Price
 HPE325 (Straight 25') Mfr. List \$11.00 Call For BSW Price

RADIO DESIGN LABS



STSH1 Headphone Amplifier

This Stick-On™ series unit gives you an adjustable, amplified stereo headphone output wherever you need it. Drives 8 to 5000 headphones from a balanced or unbalanced input. Gain adjustable from 3 to 45 dB. Requires power supply.

Mfr. List \$89.95 Call For BSW Price
 PS24A Power Supply \$12.95

AKG



V6HP Headphone Amplifier

Professional headphone amplifier that delivers clean, high output headphone levels for up to 6 stereo headphones. Each headphone pair has its own front panel mix selector switch to select among 5 possible combinations of the 2 inputs. Small size (6"x4"x3") makes the V6HP perfect for remote work.

Mfr. List \$429.00 Call For BSW Price

RANE



HC6 Headphone Amplifier

Main stereo inputs drive six stereo headphone amplifiers through individual volume controls. Each headphone amp also has its own separate input which independently by-passes the main stereo input.

Mfr. List \$429.00 Call For BSW Price

SYMETRIX



SX204 Headphone Amplifier

The SX204 is a 1-in 4-out amplifier utilizing proprietary high voltage converter technology to drive high impedance headphones, while providing more than ample power for low impedance phones. Individual volume control for each channel.

Mfr. List \$299.00 Call For BSW Price

RADIX



HS160 Headphone Splitter

The Radix 160 splits any amplified headphone signal to feed up to six headphones. Isolation resistors keep signal constant regardless of how many headphones are plugged in. Features heavy duty chassis with locking 1/4" jacks.

BSW Price \$74.95

APHEX



**124
Interface Amplifier**

Easily interface consumer audio equipment with professional studio and broadcast facilities with superior audio specifications. Active, servo-balanced circuitry converts +4 dBm (or +8 dBm) line levels to -10 dBm (hi-fi) levels, and back again. XLR and RCA type connectors enable quick hook-up.

Mfr. List \$229.00 Call For BSW Price

ATI



**DP100 DISC Patcher
Interface Amplifier**

A uni-directional stereo interface designed specifically to convert the unbalanced IHF outputs of digital compact disc players to transformer balanced and isolated 600 ohm line levels with no compromise or degradation of the source audio.

Mfr. List \$249.00 Call For BSW Price

BENCHMARK

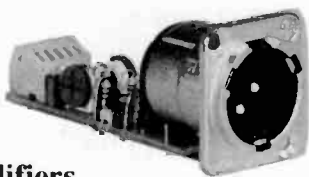

**DOA3
Interface Amplifiers**

These interfaces mount inside equipment and eliminate cabling, space, mounting, and AC power problems. They provide variable gain from off to +26 dB. The DOA-3 uses bipolar power from ±6V to ±22V. Power supplies are user provided.

BSW Price \$60.00

BSW can meet all your interfacing needs. If you don't see what you need, simply call one of our sales reps. We're regularly in touch with hundreds of manufacturers and we're constantly trying to address your needs.

DBX



**1024
Buffer Amplifier**

The DBX 1024 provides an easy means of connecting equipment with unbalanced -10 dBV inputs/outputs to equipment with balanced +4 inputs/outputs. This stereo, bi-directional unit features a special buffer mode that allows the XLR inputs to be patched directly to the XLR outputs for added convenience.

Mfr. List \$239.00 Call For BSW Price

ESE



**ES-244
Interface Amplifier**

The ESE interface amplifier is stereo, bi-directional -10 dBV to +4 or +8 dBm device. This unit is contained in a rugged, black anodized aluminum enclosure measuring 7" wide x 1.6" high x 5" deep. Gain +6 to +20 dB adjustable. Single or dual rackmount options available.

ES244 Mfr. List \$179.00
Rack Mount Option Mfr. List \$45.00
Call For BSW Price

HENRY ENGINEERING



**MATCHBOX
Interface Amplifier**

This is the ideal, inexpensive way to correctly interconnect consumer equipment with professional studio gear. The Matchbox is a bi-directional unit with four independent amplifiers providing full stereo input and output interface. Features adjustable output levels and RF shielding.

Mfr. List \$195.00 Call For BSW Price

**TWINMATCH
Interface Amplifier**

Like the matchbox, but provides two stereo channels, one direction, for playback of two consumer level units such as consumer CD players.

Mfr. List \$195.00 Call For BSW Price

RADIO DESIGN LABS

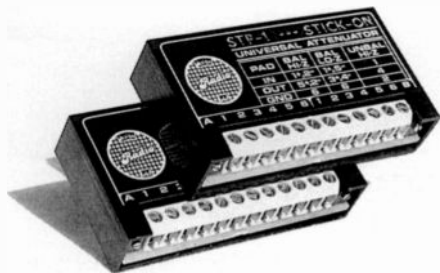

STICK-ON SERIES Interface Devices

Each Stick-On™ measures only 2.9" W x 1.5" D x 0.5" H and is housed in durable plastic. Stick-On's are so small they can be directly and discretely mounted on equipment or under counter tops. Careful attention to audio specifications and durability required by professional audio users are found in every Stick-On™. 24 volt power is required for all active units and must be ordered separately.

ACTIVE STICK-ONS

Model	Description	Mfr. List
STA1	Electronic Transformer, Dual Channel	\$104.95
STA1M	Audio Line Amp (mono)	\$78.95
STPA2	2 Watt Utility Power Amplifier	\$44.95
STPA6	6 Watt Audio Power Amplifier	\$59.95
STACR1/ACR2	Audio Controlled Silence Sense Relays	\$70.95
STDA3	Distribution Amplifier, Mono	\$93.95
STCL1	Mono/Stereo Compressor/Limiter	\$109.95
STGCA1/GCA2	Gain Control Amplifiers	\$89.95
STLCR1	Logic Controlled Relay (momentary pulse)	\$46.95
STLCR2	Logic Controlled Relay (alternate action)	\$81.95
STM1	Microphone Preamp, Fixed gain	\$71.95
STM2	Microphone Preamp, Variable gain	\$104.95
STMDA3	Mic-Level Distribution Amplifier	\$99.95
STMPA2	Mic Phantom Adaptor	\$59.95
STMX3	Line Level Mixing Amp	\$89.95
STMMX3	Mic Level Mixing Amp	\$99.95
STPH1	Stereo Phono Preamplifier	\$99.95
STSH1	Stereo Headphone Amplifier	\$89.95
STVCA1	Voltage Controlled Amplifier	\$84.95
PS24A	24 volt Power Supply For All Active Units* <i>*Power Supplies Must be ordered separately</i>	\$12.95

PASSIVE STICK-ONS

STD1	Divider/Combiner Network, Four Channel (specify 150 or 600 ohm)	\$34.95
STP1	Variable Attenuator, Two Channel	\$34.95

Call For BSW Discounted Prices

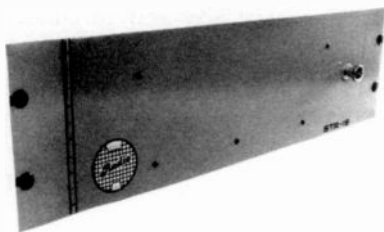

STICK-ON SERIES RACKING SYSTEM

STR19	19" Rack Kit, (Holds 12 Stick-On's), Snaps Included	Mfr. List \$99.95
STR12	Rack Kit Snaps, (Additional 12 Pack)	Mfr. List \$26.95

Call For BSW Price

BDI

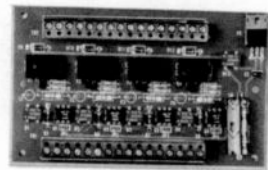

UNI200 Universal Relay

The UNI200 from BDI is a versatile circuit card designed to solve most remote control interface problems. It can add remote control and remote status capability to devices that are normally not remoteable. Ask a BSW representative for a spec sheet providing complete details.

Mfr. List \$49.00

Call For BSW Price

BROADCAST TOOLS



SMI Studio Monitor Intercom

The Broadcast Tools SMI (Studio Monitor Intercom) provides an efficient, affordable communication system between up to 5 studios. Simply buy as many SMI's as you need. Talk with one studio at a time or on an "all call" basis. Each unit has host and guest headphone jacks with bass and treble EQ. The SMI automatically dims studio monitors during talkback. In addition, host headphones split for talkback in the right ear and air signal or program in left ear (defeatable while on air). Other features include full remote control with tally, interconnection via convenient 50 pin telco-type connectors, mono/phase check button, front panel talkback mic with adjustable AGC, Aux input for talkback with level control (for remote feeds etc.).

Mfr. List \$699.00

Call For BSW Price

HENRY ENGINEERING



SUPERELAY Utility Control Interface

Ideal for controlling various equipment functions that are activated by an independent source.

Superelay can be controlled by any switch, relay (momentary or maintained), or CMOS/TTL logic circuit. It provides six double-throw relay outputs for low-voltage and audio switching and an AC output switched with a solid-state synchronous relay. Includes internal flasher unit and 24VDC power supply.

Mfr. List \$225.00

Call For BSW Price

360 SYSTEMS



**AM16B
Audio Routing Switcher**

The basic switcher is a mono 16x16 matrix, but may also be configured as an 8x8 stereo unit, or as a 16x1 mono or 8x1 stereo selector. All inputs and outputs are electronically balanced. Several slave units may operate in parallel to provide more than sixteen simultaneous inputs for 16x16 stereo or multi-channel operation. All active power supply elements are fully redundant, so an AM16 B can keep working even if all regulated supplies experience a failure. 100 memory presets are standard.

Mfr. List \$1,495.00 Call For BSW Price

CONEX



**AS101
Audio Routing Switcher**

Allows any one of 10 stereo sources to be switched to the stereo output channel. Switching is accomplished by pressing one of the illuminated buttons on the front panel, or remotely, via the remote control connector on the rear panel. Several remote control devices may be connected in parallel, and all will indicate the selected channel.

AS101 Mfr. List \$895.00
AS401 Remote Control Mfr. List \$150.00

Call For BSW Price



**UM33
Cue And Monitor Amplifier/Switcher**

The UM33 is a stereo, eight channel in, one channel out, general purpose cue, monitor and line amplifier. The UM33 provides the easiest, least expensive, and most compact way of handling a variety of common monitoring, cueing, amplifying, and switching situations.

Features:
• 2 built-in cue speakers with amplifiers • Stereo LED VU meters
• Front panel headphone jack and monitor switch • Built-in 3 frequency oscillator.

Mfr. List \$550.00 Call For BSW Price

BEC

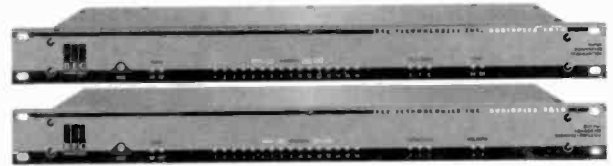

**AD16/DA16
Digital Snake System**

This system allows you to take 16 separate, balanced audio channels and digitally transmit them over a single twisted pair cable with 90 dB of dynamic range. Here's how it works. The AD16 accepts signals from up to 16 balanced, line-level inputs, converts the signals into 16-bit digital, and then multiplexes ("muxes") the discrete signals into a single data stream for transmission over twisted pair copper wires to a receiver up to 300 feet away (750 feet on two twisted pairs). The DA16 receiver demuxes the incoming data stream and converts it back to 16 low noise, full bandwidth analog signals. Triple system redundancy, full line driving redundancy and DC power back-up are provided.

AD16/DA16SYS Mfr. List \$6,090.00 Call For BSW Price

TITUS TECH LABORATORIES



**MLW1
Automatic Stereo Router**

This wonder box can automatically identify and correct a number of problems that can occur in any monaural or stereo audio path or can act as a manual router and level matcher.

All inputs and outputs are balanced. The inputs can be individually set for -10, +4, or +8 dBm and the outputs for +4 or +8 dBm. Metering is provided for left/right and left+right/left-right.

Mfr. List \$1,800.00 Call For BSW Price

GENTNER

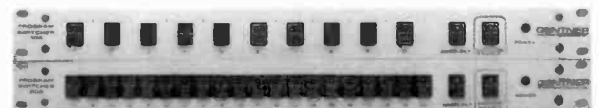

**SWITCHER 10/SWITCHER 20
Audio Routing Switchers**

Switchers 10 and 20 use highly dependable magnetically latching relays to route audio, data or control signals through your facility. Even if the units lose power, the proper source remains selected. The Signal Switcher 10 selects ten stereo channels to a stereo output; the Signal Switcher 20 selects 20 mono channel signals to a mono channel output.

SWITCHER 10 Mfr. List \$989.00 Call For BSW Price
SWITCHER 20 Mfr. List \$989.00 Call For BSW Price

ADC

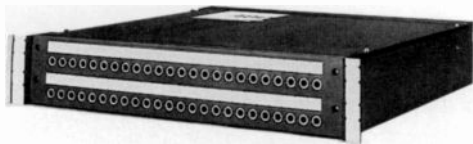

**PRO PATCH MARK II
Patch Panels**

ADC's finest series of patch bays are compact and ultra-high quality. In front, circuit designations are neat and convenient; and in back, the terminal layout affords faster installation and more flexibility of configuration. The fully enclosed Pro Patch chassis protects all the internal patchbay wiring as well as eliminating the need for routing and dressing conventional patchbay harnessing. Front panel and rear panels remove easily for service without removing the unit from the rack.

QCP is featured on Pro Patch. QCP provides a "gas tight" connection which means your cable connections are impervious to harmful environments, thereby giving you a connection that will not deteriorate over time.

Call BSW For Price And Configuration

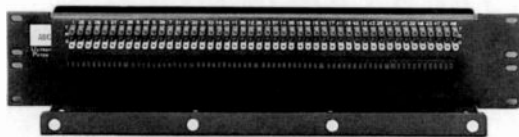

**ULTRA PATCH
Punch Down System**

Features:

- Utilizes QCP technology (see description from Pro Patch)
- Full and half normalling available
- Four design configurations to fit your application
- Cable support system insures that your cabling will dress neatly and stay that way, without stressing your connections

Call BSW For Price And Configuration



**QB2
Wire Insertion Tool**

The insertion tool is used for insertion of wire into ADC patch systems with the QCP split cylinder terminations.

It applies the correct force to the wire by a spring loaded mechanism within the tool. Either of two impact forces can be applied, as selected by the LO-HI thumbwheel on the side of the tool. The impact tool includes one removable tip which is stored in the tool's handle.

QB2 Mfr. List \$70.00 Call For BSW Price
QB2T (Replacement Tip) Mfr. List \$16.00 Call For BSW Price

ADC



**P-KIT SERIES
Patch Kits**

These money saving kits have many of the features of the pre-assembled patch bays, but in a package designed specifically for the do-it-yourselfer. Simply add your own cable and termination panel.

P-KIT1 Mfr. List \$198.00 Call For BSW Price
 1.75" Panels With 2x24 Array Of Long Frame (1/4") Jacks

P-KITB Mfr. List \$264.00 Call For BSW Price
 1.75" Panels With 2x48 Array Of Bantam Jacks



LONG FRAME 1/4"



BANTAM

PRO PATCH CORDS

Engineered for broadcasters where flawless performance is critical. ADC Pro Patch Cords are highly flexible, drapes neatly, and won't kink. The plug is molded directly onto the patchcord offering outstanding strain relief. Plugs are nickel plated offering corrosion protection and quiet contact with your jacks. BSW offers four different colors for easy identification.

LONG FRAME PATCH CORDS

Single Plug	1'	2'	3'
Red	R1	R2	R3
Green	G1	G2	G3
Blue	B1	B2	B3
Black	BK1	BK2	BK3
BSW Price	\$18.00 ea.	\$19.00 ea.	\$20.00 ea.

BANTAM PATCH CORDS

Single Plug	1'	2'	3'
Red	R1B	R2B	R3B
Green	G1B	G2B	G3B
Blue	B1B	B2B	B3B
Black	BK1B	BK2B	BK3B
BSW Price	\$17.00 ea.	\$18.00 ea.	\$19.00 ea.

Call For Details On Complete Selection Of
 These And Other ADC Patchcords

GENTNER

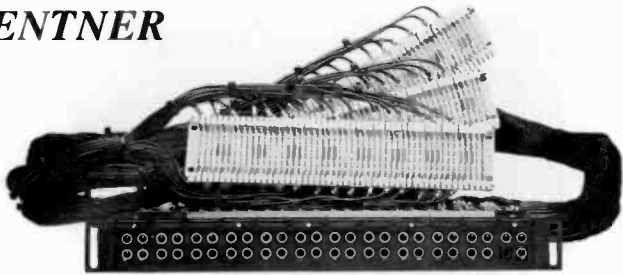

**PRE-WIRED SERIES
Patch Systems**

Hand-wired to your specifications, using the highest quality components. A large variety of bay fronts and terminations are readily available for almost any configuration.

Call For Pricing And Configurations

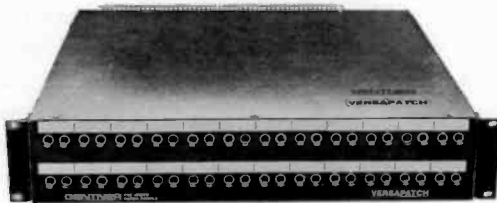

**VERSAPATCH
Patch Systems**

Chassis-enclosed audio patch panels with the terminations mounted on the rear panel. Eliminates guesswork on bundle length and provides protection against RFI and dust. Offset jack spacing for stereo patching.

Call For Pricing And Configurations

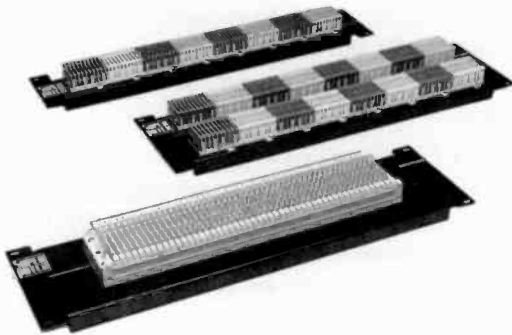

**SUPERPATCH
Termination Panels**

These panel assemblies provide you with a convenient and flexible rack mount termination for your wiring projects. Superpatch is available with one or two rows of Flexiblock terminations or a Telco-type 66 punch block. All three models are secured to a fixed rack mounted aluminum panel to make punchdown connections fast and easy. Superpatch panels can be ordered separately or terminated to any of Gentner's prewired patch panels at the factory.

- SP1** Single Flexiblock (160 Terminals-2 Rack Units) **Mfr. List \$109.00**
- SP2** Two Flexiblocks (320 Terminals-3 Rack Units) **Mfr. List \$139.00**
- SP66** Telco Punch Block (150 Terminals-Three Rack Units) **Mfr. List \$99.00**

Call For BSW Price

GENTNER

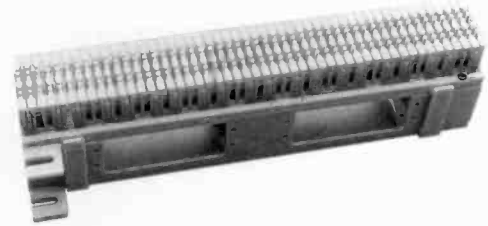

**FLEXIBLOCK
Termination Panel**

A "punch block" for stranded wire. Provides simple, gas-tight connection without cutting strands. Mounting bracket provides easy cable management. 100 terminals configured with 2 rows of 50 terminals; each slot accepts 2 wires. (Split Flexiblock also available; provides 2x50 terminals with 2 wire connections per terminal.)

Mfr. List \$29.00

Call For BSW Price

RAXXES

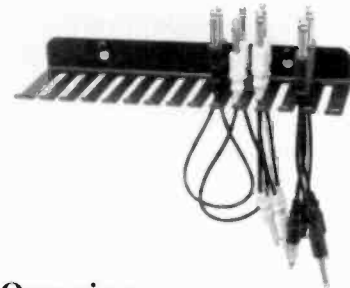

**CBLD
Patch Cable Organizer**

A great way to store cables out of site and protect them from kinks etc. 14 slots hold approximately 40 cables. 1/4" cables maximum.

Mfr. List \$13.95

Call For BSW Price

FlexLease

BSW offers innovative lease programs that are the right answers to your equipment financing dilemmas. Whether you're interested in low monthly payments, tax incentives, or just conserving your cash flow without tying up your credit lines, BSW FlexLease programs offer creative solutions to obtaining the equipment you need. Call us today for all the information.

LOGGERS

EVENTIDE



VR240 Digital Audio Logger

The VR240 Digital Broadcast Logger automatically records up to 252 hours of audio (that's 10 1/2 days worth) on a single low cost DAT cassette...with better quality than any reel-to-reel logging recorder. The total recording time can be divided among as many as 24 channels. The unit's high capacity digital data buffer enables the VR240 to pack audio segments continuously on tape with zero wasted track space, even when some channels receive no input for long periods, while others are continuously active. You can record your station's AM, FM and TV audio continuously in stereo. Monitor key competitive stations as well. Other channels can log intermittent sources like remote communications from ENG units, phone lines, and local police and fire channels.

On playback, the VR240 searches by date and time to locate any audio segment in less than 90 seconds. A built-in uninterruptible power supply assures you won't lose valuable data in the event of a power bump.

The Standard VR240 logger records 8 channels of audio simultaneously.

Mfr. List \$9,995.00

Call For BSW Price

Available Options:

- Second DAT Tape Transport. Provides automatic switching function that can double unattended logging time, or playback audio while continuing to log audio on another tape.

Mfr. List \$3,500.00

Call For BSW Price

- Additional 8 Channel Input/Output Boards. Upgrades the VR240 to 16 channels. Two of these boards may be added for a total of 24 inputs/outputs.

Mfr. List \$1,895.00 ea.

Call For BSW Price

- Telephone Interface. Simplifies the installation of the VR240 in many applications

Mfr. List \$395.00

Call For BSW Price

- 90 Meter Data Grade DAT Tapes. Box of 10

Mfr. List \$240.00

Call For BSW Price

NEED PRICES ON A MAJOR PROJECT ?

Save yourself time and FAX us your equipment list. We'll have a complete price quote back to you in no time.

RCS



TRACKER Digital Audio Logger

The TRACKER is a digital audio broadcast recording system that records and plays back 1 to 8 audio sources simultaneously. In a single track mode the TRACKER logs up to 14 days of audio on just one DAT Tape (Up to 24 hours, should all eight tracks be recording simultaneously). This digital audio logging system will record and play concurrently. The system can playback audio on the current tape in the machine while continuing uninterrupted recording. 4 different compression levels are selectable for audio quality required/vs total time storage needed.

The TRACKER computer will tell you the following:

- Audio is present on each channel and is correct
- DAT tape capacity and when the tape must be changed
- Which tape is loaded (active or archive)
- Start time/date of recording for each channel
- A journal of all recorded events

The TRACKER has:

- Built-in diagnostics
- Audible alarm when tape must be changed
- Balanced audio inputs and outputs
- Telephone interface that allows remote listening for any audio channel that is archived.

The TRACKER is supplied as a complete turnkey system. Just plug in a 1/4" audio connector and start recording. Included is a 386 host computer, monitor, audio interface, SCSI-DAT drive. This computer based hardware/software system is very easy to use.

With the TRACKER you'll get clean, clear, and precise audio reproduction.

Model	Capabilities	Mfr. List
MDL-31	3 Channel Record 1 Channel Play	\$12,000.00
MDL-31T	Same as above with Telephone Access	\$12,500.00
MDL-40	4 Channel Record	\$12,000.00
MDL-41	4 Channel Record 1 Channel Play	\$12,500.00
MDL-80	8 Channel Record	\$15,000.00
MDL-81	8 Channel Record 1 Channel Play	\$15,500.00

Prices Shown are Mfr. List. Call For BSW Price

AKG**C414BULS
Condenser Mic**

The low inherent self-noise and high overload point guarantee a dynamic range in order of 126 dB. Four different polar patterns selectable on mic. All metal housing in black chrome finish. Includes stand adaptor and windscreen.

Mfr. List \$1,199.00 Call For BSW Price

AUDIO TECHNICA**AT815A
Shotgun Mic**

With the acceptance angle of approximately 40°, the AT815A provides a useful tool to overcome problems of noise or distance. Its flat response and high output insures well balanced, natural sounding pickup. Includes windscreen, battery, case, clamp, and cord.

Mfr. List \$297.00 Call For BSW Price

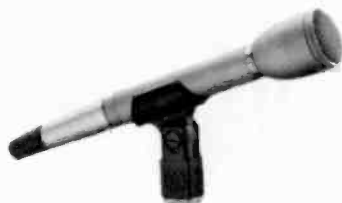
AUDIO TECHNICA**AT804
Omnidirectional Dynamic Mic**

Features high output, smooth response, and low handling noise. Economical mic for interviews and sportscasting. All steel case makes it almost indestructible.

Mfr. List \$95.00 Call For BSW Price

AKG**C535EB
Condenser Cardioid Mic**

This microphone offers studio quality condenser sound in a rugged package. Slight rise in high end frequency response gives added punch and clarity in announcers voices. Frequency range: 20 Hz to 20,000 Hz.

Mfr. List \$399.00 Call For BSW Price
Requires 9-52V phantom power

AUDIO TECHNICA**ATM25
Dynamic Cardioid Mic**

Small hyper-cardioid mic with the performance of larger, more expensive studio mics. Minimal off axis coloration and voice tailored response.

Mfr. List \$250.00 Call For BSW Price
Options: Windscreen AT8112, Shock Mount TM3

BEYER**M59
Cardioid Microphone**

The M59 is a rugged mic employing a large diaphragm and enhanced-field magnet technology for high output, high sensitivity, accurate reproduction, and superb off-axis rejection. Outstanding studio mic.

Mfr. List \$499.95 Call For BSW Price
Options: Windscreen WS740

AKG**D1200E
Dynamic Cardioid Mic**

An integral B-M-S switch, an AKG exclusive, permits the user to create an almost endless variety of tone control possibilities. Frequency range: 40 Hz to 17,000 Hz.

Mfr. List \$329.00 Call For BSW Price
Optional Windscreen W29, SA411 Stand Adaptor Included

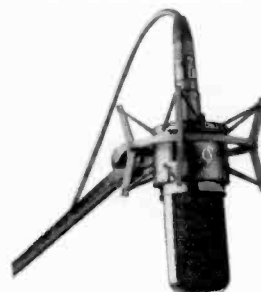
AUDIO TECHNICA**AT4033/SM
Studio Condenser Mic**

The AT4033/SM provides the dynamic range and sensitivity of high end studio mics at a surprisingly affordable price. Features: switchable hi-pass filter, internal windscreen, and spider shockmount.

Mfr. List \$699.00 Call For BSW Price

BEYER**M58
Omnidirectional Moving Coil Mic**

Specifically designed to satisfy ENG and EFP applications. Its internal shockmount dramatically reduces handling noise. Accurate voice reproduction information with a very high degree of intelligibility. Frequency response 40 Hz to 20,000 Hz. Includes WS58 windscreen and zippered case.

Mfr. List \$189.95 Call For BSW Price

MICROPHONES

ELECTRO-VOICE



RE27N/D Dynamic Cardioid Mic

A neodymium alloy magnet makes this mic a dynamic that rivals expensive studio condensers in sensitivity, output and clarity. The RE27N/D exhibits very consistent response no matter the distance from the mic with excellent off-axis rejection.

Mfr. List \$639.00 Call For BSW Price
Options: Windscreen WS1, Shock Mount 309

ELECTRO-VOICE



RE20 Dynamic Cardioid Mic

One of the most popular microphones used in broadcasting. The RE20 has a warm sound which will please the most discriminating announcers. Frequency response 45 Hz to 18,000 Hz. Output, -57 dB.

Mfr. List \$564.00 Call For BSW Price
Options: Windscreen WS1, Shock Mount 309

ELECTRO-VOICE

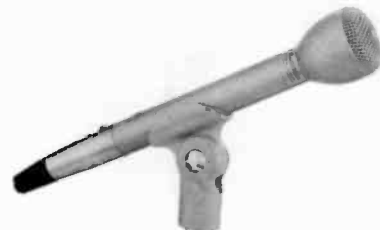

635A Omnidirectional Dynamic Mic

Broadcasting's favorite for generations. The 635A offers incredible durability and low cost. Frequency response 80 Hz to 13,000 Hz. Output, 55 dB. Also available in black.

Mfr. List \$145.00 Call For BSW Price
Options: Windscreen 314E, Shock Mount 313A



RE50 Omnidirectional Dynamic Mic

Perfect for field use when handling noise presents a problem. The RE50 features built-in shockmount and blast filter for low handling noise. Frequency response is identical to the 635A. Also available in black.

Mfr. List \$217.00 Call For BSW Price
Options: 379 Windscreen, Shock Mount 313A



RE38N/D Dynamic Cardioid

A 16-position equalization switch gives the RE38N/D great flexibility in obtaining the appropriate sound for any situation. This neodymium mic features DynaDamp™ vibration isolation eliminating the need for an external shock mount, and an adjustable mounting yoke for great mounting flexibility.

Mfr. List \$494.00 Call For BSW Price



ND357B N/DYM Dynamic Cardioid Mic

The Electro-Voice ND357 is priced like other dynamics but features extended frequency response and higher output levels. Carries EV's unconditional guarantee.

Mfr. List \$228.00 Call For BSW Price



RE45N/D Shotgun Cardioid Mic

Specifically designed for hand-held use. The exclusive N/DYM™ dynamic element has the output level of a condenser microphone without need for battery or phantom power. Frequency response 50 to 15,000 Hz (close), 150 to 15,000 Hz (far). Output -50 dB. Includes: clip, case, windscreen, and shock handle

Mfr. List \$474.00 Call For BSW Price



RE15/RE16 Super Cardioid Dynamic Mics

These time tested mics feature wide, flat response and uniform super-cardioid pattern with minimal off-axis coloration.

RE15 Mfr. List \$377.00

RE16 (RE15 With Blast Filter) Mfr. List \$395.00

Call For BSW Price

Options: Windscreens 314, 379 Shock Mount 313A, 307

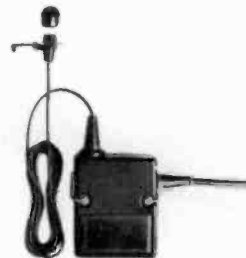

RE98 Miniature Condenser Omnidirectional Mic

This lavalier features low distortion, wide dynamic range, and highpass filtering to minimize low-frequency rumble. Uses standard 9-volt battery or phantom power. Includes tie-clip, windscreen, and carrying pouch.

Mfr. List \$304.00 Call For BSW Price

SENNHEISER



**MD421U
Dynamic Cardioid Mic**

One of Sennheiser's most versatile and popular dynamic microphones. For on-air or production use, the MD421U is the natural choice for many stations. Frequency response 30 to 17,000 Hz. Pictured with optional shock mount

Mfr. List \$469.00 **Call For BSW Price**
Options: Windscreen WS1, Shockmount TM3/311

SONY



**ECM55B
Omni-directional Lavalier Mic**

One of the most popular lavalier microphones we sell. It can be powered by AA batteries or external power supply. Comes with mesh windscreen and holder clips.

Mfr. List \$325.00 **Call For BSW Price**

R.D. SYSTEMS



**P650
Parabolic Mic**

One of the most directional microphones ever produced; making it possible to record voices, sounds, practically anything—to professional standards without having the microphone near the subject being recorded. Includes handle and headphones for monitoring.

Mfr. List \$599.00 **Call For BSW Price**

SENNHEISER



**ME80/K3U
Short Shotgun Mic**

Combination of supercardioid at low frequencies, and shotgun above 2,000 Hz. Excellent on-camera or hand-held interview mike for ENG/ EFP. Use with K3U power module. Frequency range 50-15,000 Hz.

ME80 **Mfr. List \$269.00**
K3U (Power Supply Module) **Mfr. List \$245.00**
Call For BSW Price

NEUMANN



**TLM170MT
Multi-pattern Condenser Mic**

Capable of handling sound pressure levels up to 140 dB with minimal distortion, with a dynamic range of 126 dB. Choose from: Omni, wide cardioid, cardioid, hypercardioid and figure-8. Equipped with a tiltable, elastically suspended mounting bracket.

Mfr. List \$2,295.00 **Call For BSW Price**
Options: Windscreen WS89

CROWN



**SASS-PMKII
Stereo Mic**

The Crown SASS-PMKII or Stereo Ambient Sampling System™ is a patented, stereo condenser microphone system using PZM technology. The SASS uses two premium-quality PZM elements mounted on boundaries (with a foam barrier between them) to make each microphone directional.

Mfr. List \$899.00 **Call For BSW Price**

SENNHEISER



**MKE2-3
Subminiature Omni Mic**

Open, natural sound plus extremely small size make the MKE2-3 unique among its kind. Used by all major TV networks. Includes K3U power module.

MKE2-3 K3U **Mfr. List \$479.00**
Call For BSW Price

NEUMANN



**U89
Multi-pattern
Condenser Mic**

The U89 goes beyond the famous U87 with improved frequency response, 5 directional patterns, and a more rugged design making it more practical for control room use.

U89I **Mfr. List \$2,450.00**
U89SETZ **Mfr. List \$2,780.00**
(w/shk. mt. & w screen)

Call For BSW Price

CROWN



**SOUNDGRABBER
Pressure Zone Mic**

Crown PZM microphone technology in an inexpensive package. One Soundgrabber in the middle of the table can replace eight conventional microphones for recording. You can understand every word with amazing definition and detail. Comes with mini and 1/4" plug for direct recorder connection. Perfect for news departments.

Mfr. List \$99.00 **Call For BSW Price**

SHURE



SM7 Dynamic Cardioid mic

One of the finest studio professional dynamic microphones in use today. It features a wide-range, very smooth frequency response with graphic response tailoring switches to permit the choice of four different microphone response curves. Frequency response 40 to 16,000 Hz. Output, -57 dB. Contains integral shock mounting.

Mfr. List \$566.50 Call For BSW Price

SHURE



SM58LC/SM57LC Dynamic Cardioid Mics

Ideal for studio and remote, and unmatched in performance, ruggedness and reliability. The SM58 features a distinctive vocal presence peak and integral windscreen and the SM57 provides wide range reproduction of music and voice.

SM58LC Mfr. List \$181.50
SM57LC Mfr. List \$141.25

Call For BSW Price

Optional Windscreens: (SM58) A58WS, (SM57) A2WSA

SHURE



SM87LC Cardioid Condenser Mic

An innovative new cartridge element features a highly directional supercardioid polar pattern for a surprising amount of gain before feedback. Shock isolated capsule and built in multistage blast filter. Low susceptibility to RF interference.

Mfr. List \$339.00 Call For BSW Price



SM63LLC Omnidirectional Dynamic Mic

The SM63 is an elegant, rugged microphone with very high output... up to 6 dB higher than comparable omnidirectional microphones. Frequency response 50 Hz to 20,000 Hz. Output, -56 dB. Long handle is perfect for ENG work.

Mfr. List \$161.50 Call For BSW Price



VP64 Omnidirectional Dynamic Mic

A rugged, dynamic handheld mic with very low handling noise and an omnidirectional pick-up pattern that doesn't suffer from proximity effect. Neodymium magnet provides increased output and improved clarity.

Mfr. List \$135.00 Call For BSW Price



SM89 Shotgun Condenser Mic

The SM89's highly directional polar pattern and fine-tuned frequency response will pick up desired sounds while rejecting off axis ambient noise. Frequency response 60 Hz to 20,000 Hz. Output, -52 dB. Windscreen and carrying case included.

Mfr. List \$927.00 Call For BSW Price
Options: Shock mount A89SM



VP88 Stereo Condenser Mic

Select from three stereo modes or direct mid and side output. VP88 offers a wide, natural, uncolored response for stereo imaging, yet is perfectly mono compatible. Battery or phantom powered and includes windscreen, clip, case, and Y-cable.

Mfr. List \$995.00 Call For BSW Price



SM83CN Omnidirectional Lavalier Mic

Provides superior quality sound reproduction in professional broadcasting and features a wide range frequency response to provide natural sounding vocal reproduction. Mic is detachable from the preamp. Frequency response 80 to 20,000 Hz.

Mfr. List \$255.50 Call For BSW Price

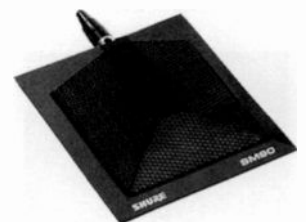

SM90A/SM91A Surface Mount Condenser Mics

Professional, studio-quality, "boundary effect," surface microphones. Ideal for TV settings, news conferences, dramatic productions, choirs or wherever an inconspicuous microphone is desired. The SM91A is unidirectional and the SM90A is omnidirectional.

SM91A or SM90A Mfr. List \$310.00
Call For BSW Price

SHOPPING FOR A WIRELESS MICROPHONE SYSTEM ?

Please note: All wireless microphone systems shown on this page merely highlight the different array of products available from the manufacturers we represent. The pictures used show the different components available and are not necessarily the system provided at the price shown. Call a BSW Representative toll-free to discuss your wireless microphone requirements. You will be given expert advice on which system is right for you and your budget.

AUDIO TECHNICA



ATW1031/1032 Wireless Mic System

At the heart of ATW wireless systems is a sophisticated automatic diversity receiver. Two antennas, two complete, independent RF inputs, and a very sophisticated switching system eliminate multipath distortion and dropouts. Two isolated audio outputs permit simultaneous feeds to both unbalanced and balanced inputs. Choose from either a hand-held microphone or a body pack/lavalier transmitter. Transmitters may be operated up to 200 feet from receiver even in congested RF fields.

**System Prices Start At \$710.00 Mfr. List
Call For BSW Pricing And Specifications**

BEYER



TGX Wireless Mic System

This reliable, high performance, and cost effective system is available in two basic configurations. The handheld system incorporates the TGX480 mic head with super cardioid pick-up characteristics. The MCE5 lavalier mic gives the body pack system wide frequency response, low noise, and superior intelligibility. Both systems include the NE170 true diversity receiver with balanced/unbalanced outs, adjustable gain, and mute sensitivity control.

**System Prices Start At \$1,499.95 Mfr. List
Call BSW For Configurations And Pricing**

SHURE



L SERIES Wireless Mic System

The L Series gives you a level of reliability and features unsurpassed in its price range. L Series systems are available in diversity and non-diversity versions and feature popular Shure microphone models that are perfectly matched to the system electronics.

**System Prices Start At \$445.00 Mfr. List For Non-Diversity Call
Toll-Free For Complete Specifications And Prices**

SAMSON



STAGE II SERIES Wireless Mic System

Here is our most popular seller in budget priced wireless systems. The Samson Stage II Series offers superior VHF non-diversity wireless performance. dbx noise reduction assures high signal-to noise ratio and quiet reception. This system will operate under adverse RF environments and is stable at distances up to 250 feet. Choose from systems that feature different mic capsules in either handheld or body pack transmitters.

**System Prices Start At Only \$324.00 Mfr. List
Call For Pricing And Configuration**

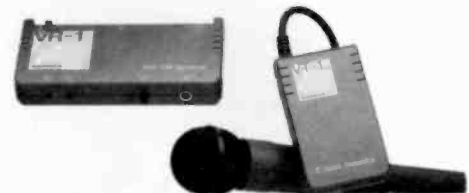

VLP SERIES Wireless Mic Systems

Our lowest priced wireless system is Samson's VLP Series wireless. Available in handheld or lavalier versions, these systems are great for short range applications.

VLPHAND (Handheld)	Mfr. List \$284.95
VLPLAV (Lavalier)	Mfr. List \$234.95

Call For BSW Price

TELEX



**FMR100 SERIES
Wireless Mic System**

Choose a Telex FMR100 system when highest fidelity and faultless performance are a must. For lavalier applications the FMR100 receiver pairs up with a WT60 belt pack for super clean audio with a SNR of more than 104 dB. Or choose the WT80, one of the industry's smallest belt packs and one of several popular mic elements. Several handheld options are available. FMR100 includes all the convenience features of the other Telex series and offers the highest possible audio performance.

**System Prices Based On Configuration
From \$900.00 Mfr. List Call For BSW Prices**



**FMR70 SERIES
Wireless Mic System**

FMR70 Series wireless is a true diversity system with professional features in a compact, economical package. Special features include: squelch control, extensive LED display, mic gain adjustment, balanced XLR audio output, mic mute switch, and low battery test button.

**System Prices Based On Configuration
From \$595.00 Mfr. List Call For BSW Prices**



**PROSTAR SERIES
Wireless Mic System**

Telex's most economical wireless system, ProStar is true diversity and is available in handheld and lavalier systems. Features: Permanently attached telescoping antennas (receiver) volume and squelch controls, popless mic mute, mic gain control. Several handheld and lavalier mic element options available.

**System Prices Based On Configuration
From \$380.00 Mfr. List Call For BSW Prices**

VEGA



**PRO2 SERIES
Wireless Mic Systems**

For years, Vega wireless microphones have been the yardstick by which the rest of the wireless industry is measured. Due to their outstanding reliability and superior performance they are the choice systems for broadcast and entertainment professionals. Choose from diversity or non-diversity receivers. Both feature Dynex II audio processing for exceptional audio performance and separate 10 segment LED displays for audio and RF signal strength.

The belt pack transmitter features an audio overload indicator, allowing easy maximization of usable dynamic range, while silent on/off mute switch permits you to turn off the mic without affecting the RF. Of course handheld transmitters are available with a wide variety of mic capsules.

**System Prices Start At \$1,980.00 Mfr. List
Call Configurations And Pricing**



**MS2000A
Wireless Mic Systems**

MS2000A true-diversity wireless systems bring you the realm of professional wireless. The rack mountable MR2000A receiver is a true dual-receiver design to offer outstanding reception even under the most adverse conditions. XLR balanced and 1/4" audio connectors are provided. For transmitters, choose from the MT2000A handheld mic that contains the N/D757B microphone head, or the MB-2000A body-pack transmitter and several options of lavalier microphones.

**System Prices Start At \$798.00 Mfr. List
Call For Configurations And Pricing**

TIRED OF WAITING FOR YOUR ORDER TO SHIP ?

Call us by 12 P.M. Pacific Time and we'll ship stock items by 5 P.M. the same day guaranteed, or we pay the freight.

ATI

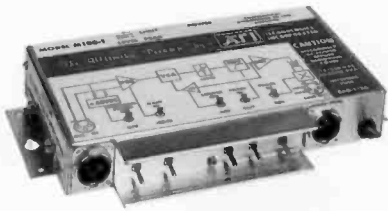

**ULTIMIKE M100
Microphone Preamp**

Eliminate dimmer noise, RF pickup and hum loops by mounting this small, rugged, full featured preamp right near the audio source. The unusually quiet, direct balanced amplifier input has impressive hum and RF rejection and accepts +20 dBm maximum input. Features switchable and adjustable gain, limiter, lo-cut filter, 48 volt phantom power and a phase reversing switch. A unique output driver provides the many advantages of the true transformer isolation with no performance compromises. XLR in and out, dual rack mountable.

Mfr. List \$329.00

Call For BSW Price

SYMETRIX



**SX202
Dual Mic Preamp**

The SX202 features two ultra clean microphone preamplifiers with variable gain, 15 dB pad, +48 volt phantom powering, left, right, and left + right outputs.

Mfr. List \$299.00

Call For BSW Price

SHURE



**FP11
Mic-to-Line Amplifier**

The FP11 is a portable, 1-input, 1-output microphone-to-line level amplifier designed for field production. It is ideal for use where long lines must be driven at higher than microphone or auxiliary levels. It can also be used to interface between equipment requiring different signal levels.

The balanced, locking XLR input and output provide for excellent rejection of hum and RF interference. A switchable peak limiter prevents output overload distortion. Additional features include a peak/limiter LED indicator, aux level mini-phone jack input, balanced line-level binding post output, and a removable belt clip. The FP11 is powered by one standard 9V battery.

Mfr. List \$290.00

Call For BSW Price

**RADIO DESIGN
LABS**

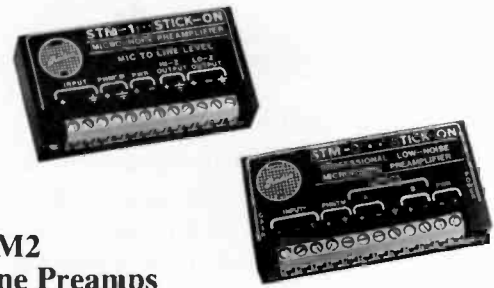

**STM1/STM2
Microphone Preamps**

Ultra compact size makes these units ideal where larger or heavier preamps cannot be used. Both models feature Hi or Lo-Z, RF filtered inputs and balanced Hi or Lo-Z outputs. STM1 has a single fixed level output - STM2 has two variable level outputs. External phantom power can be supplied to mics through a designated supply input on both models.

STM1 Mfr. List \$71.95

STM2 Mfr. List \$104.95

PS24A Power Supply

Call For BSW Price

Call For BSW Price

BSW Price \$12.00

DBX



**760X
Microphone Preamplifier**

Whether you're in the field recording to DAT or video deck, or in the studio feeding a studio mic into a line level input, the 760X from DBX will give you the clean mic preamplification you need. The 760X provides high quality transformerless inputs and outputs and delivers 60 dB of sonically transparent gain. 1/4" unbalanced outputs also provided. Additional features for this two channel, half-rack width unit include: clip indicators, polarity reverse switch, and switchable phantom power. Rack mounting hardware is included with this unit.

Mfr. List \$349.00

Call For BSW Price

WHIRLWIND



**MICPOWER
Phantom Power Supply**

For use with most electret condenser microphones this unit supplies +12 to +18VDC under nominal loads at the microphone input. The output is AC coupled. Micpower operates on two 9 volt batteries for approximately 50 hours and includes a battery level LED.

Mfr. List \$61.55

Call For BSW Price

SHURE



A97A/F Line Matching Transformers

Matches low impedance (150 ohm to 600 ohm) microphone outputs to medium impedance (1k ohm to 10k ohm) inputs. Model A97A converts low-impedance XLR connector to medium-impedance standard 1/4" male and female phone connectors. Model A97F mates low-impedance XLR connector to medium-impedance short cable, terminated by a 9/64" diameter miniature phone plug.

A97A BSW Price \$34.30 A97F BSW Price \$38.70

WHIRLWIND

LITTLE IMP Mic Transformer



Impedance matching transformer XLR type low in to 1/4" high. Quality construction.

BSW Price \$11.10

BSW

IC6 Interview Cable



This 6' adaptor cable allows the use of pro level mics with Marantz portable field recorders. Female XLR to 1/8" mini plug.

BSW Price \$14.00

WS1 Studio Windscreen



Here are cost-effective windscreens for large studio microphones. Perfect fit for the Sennheiser MD421U, ElectroVoice RE20 or RE27 and the Neumann U-87 and U-89. Comes in your choice of Red, Blue, Black, Green, or Orange. Very durable. May be washed without fading or losing their shape.

BSW Price \$19.95 ea. BSW Price 4+ \$17.95 ea.

NEUTRIK

Audio Connectors



When it comes to quality connectors, choose Neutrik. More than 15 million have been sold over the last 10 years. Easy to disassemble and reassemble. Built-in strain relief system that insures your connection will remain solid under adverse conditions.

Call For Pricing On Specific Connectors

BSW

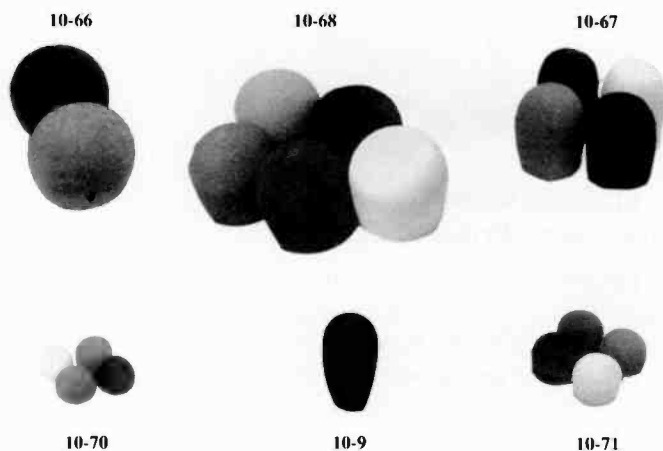

Universal Multi-Color Windscreen Sets

Block out unwanted pop, wind, noise and close talking hiss. Made from special soft cut foam, decorative in design. These multicolor screens add beauty to your microphones as well as identify them so no mix up will occur when more than one microphone is used.

- 10-9 2 3/4" high screen, fits slim models form 3/4" to 1 1/8", black
BSW Price \$2.00
- 10-66 Contains two 2 3/8" high screens, fits 1 3/4" to 2" diameter mics, 1-red, 1-blue.
BSW Price \$6.60
- 10-67 Contains four 2 3/4" high screens, fits 1 3/4" diameter mics, 1 each: red, blue, yellow, black.
BSW Price \$8.15
- 10-68 Contains five screens 2 3/8" high for spherical head mics with 1 3/4" to 2" diameter. 1 each: red, blue, yellow, green, black.
BSW Price \$19.85
- 10-69 Contains four 7/8" high screens, fits 1/4" to 1/2" diameter lavalier type mics. 1 each: red, black, yellow, green.
BSW Price \$6.15
- 10-70 Contains four 1 1/8" high screens, fits 3/4" to 1" diameter mics. 1 each: red, black, yellow, green. BSW Price \$7.50
- 10-71 Contains four 1 1/2" high screens, fits 7/8" to 1 1/8" spherical head mics. 1 each: red, black, yellow, green.
BSW Price \$7.65

RAXXESS



STOP6 Studio Pop Filter

Get maximum protection against P-popping without sound coloration. Order with KM237 clamp and GN13 gooseneck to mount to your studio mic arm.

Mfr. List \$19.95

Call For BSW Price

LUXO

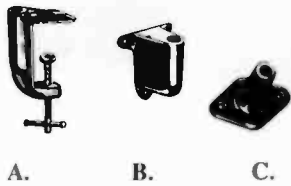

A. B. C.

Mounting Brackets For Booms

- A. Clamp Mount
- B. Wall Mount
- C. Desk Mount

Your Choice \$10.95 ea.

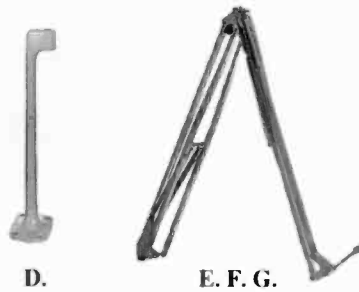

D. E. F. G.

- D. **PRO-BRACKET** 12" aluminum pedestal. Colors: grey, oyster, black and silver. **BSW Price \$24.95**
- E. **LM1-3** 41" reach heavy duty model for up to 3 lb. microphones. Oyster or blackcolor.

F. **LM1** 41" reach, for 1 lb. microphone. Oyster or black color.

G. **LM2** 26" reach, for 1 lb. microphone. Grey color.

E. - F. or G. **BSW Price \$65.00**

E. - F. or G. With 12" Pedestal Pro-Bracket **BSW Price \$85.00**

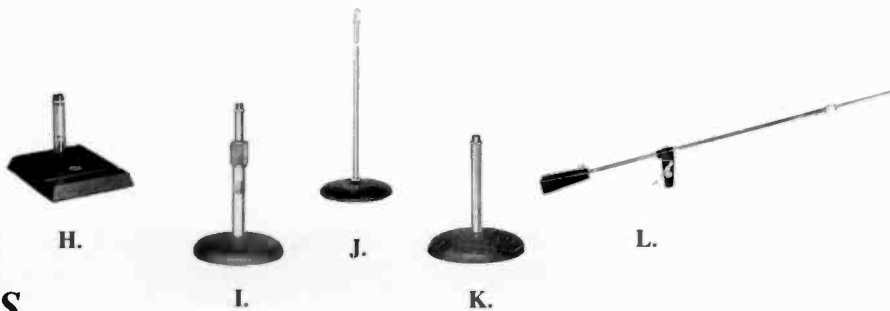

H. I. J. K. L.

ATLAS

- H. **DS2 Vibration Isolating Stand**
Non-adjustable 3" high chrome tube. Non-reflective 4"x 6" charcoal base. **BSW Price \$20.30**
- I. **DS7 Adjustable Desk Stand**
Chrome tube assembly, adjustable height 8" to 13". Grip-action clutch. 6" diameter charcoal base. Black or silver. **BSW Price \$14.00**
- J. **MS12C General Purpose Stand**
Grip-action clutch. Low-profile charcoal base with added weight for extra stability. Our best seller. Black or silver. **BSW Price \$33.25**

- K. **DS5 General Purpose Stand**
Non-adjustable 4" high chrome tube. 6" diameter cast iron charcoal base. **BSW Price \$12.20**
- L. **PB10X Microphone Boom**
Die-cast swivel, tapered counterweight, coordinated hardware. Attaches to any microphone stand terminating in 5/8" diameter tubing or adapter. Grip action clutch. Expandable from 31" to 50". Black or silver. **BSW Price \$39.65**

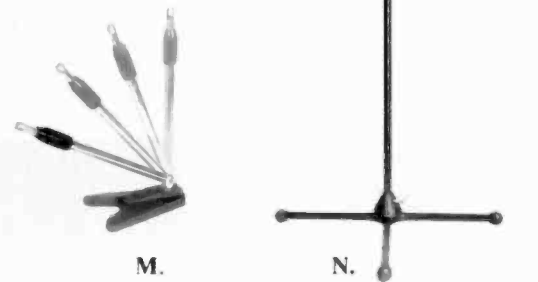

M. N.

QUIK LOK

- M. **A114 Telescopic Desk Stand**
Heavy duty, with handy pivot feature. All lows optimum placement of even heavy studio mics. Adjustable from 16.5" to 23.5". Chrome only. **BSW Price \$37.50**
- N. **A105 Tripod Floor Stand/Boom**
A105 is a lightweight economy stand, available in black and chrome. High quality collapsible construction, adjustable from 39" to 67" high. **BSW Price \$39.95**

NEUMANN



NEUMANN Microphone Cable

Neumann, the quality mic manufacturer, also makes some of the finest mic cable available. This cable is extremely durable and flexible and BSW has both bulk lengths and pre-made individual cables in a variety of colors and sizes.

Call Us With Your Requirements

PROCABLE

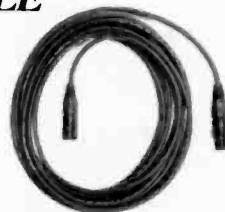

M10/M25 Microphone Cable

High quality, low loss mic cable featuring Neutrik XLR connectors. Black cable is flexible without a memory. Quantity Discounts Available

M10 (10') BSW Price \$12.95
M25 (25') BSW Price \$15.95

BSW



CORDLOX

Handy cable ties that secure your coiled cables so you don't end up with piles of tangled cables to untie. Send them with remote crews to organize their cables and help prolong cable life.

307-0 Package Of 10 BSW Price \$18.00

GORMAN - REDLICH



**CEB
EBS Monitor**

This low cost unit exceeds FCC specifications for EBS requirements and offers uncompromising quality and performance.

Features:

- Encoder FCC type accepted • Decoder FCC certified • Provision for remote operation • Programming loop through standard in encoder
- Decoder demutes monitor receiver/and or activates auxiliary alarm
- Decoder can be self-tested • Requires outboard tuner

Mfr. List \$540.00

Call For BSW Price



**CRW
Weather Alert Monitor**

Receive accurate local weather, plus emergency alert messages, weather radar data or marine information. Automatic warning for severe weather or civil defense emergency.

Mfr. List \$540.00

Call For BSW Price

MTS

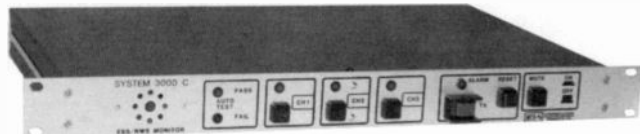

**3000
EBS/Weather Monitor**

System 3000C incorporates three monitor receivers, and an EBS encoder/decoder into a single rackspace unit. System 3000A can monitor your areas CPCS1, CPCS2, and the local NOAA weather service. Or it can monitor your CPCS1, CPCS2, and an adjacent area CPCS1. Or with 2 or more systems you can monitor EBS and NOAA services over a large area thereby offering your community the best information and protection available.

Additional features include:

- Three channel scan • Continuous automatic self test • Manual or automatic operation • Program audio loop through • NOAA priority alert decoder • Optional NOAA weather service receiver • Left and right channel outputs • Remote operation • Built-in monitor speaker

Mfr. List \$1,900.00

Call For BSW Price

MTS

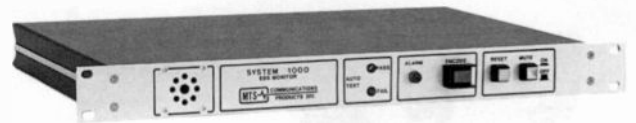

**SYSTEM 1000
EBS System**

This single rack space unit covers all your EBS requirements with EBS encoder, decoder, and receiver built in.

Features:

- Continuous automatic self test • Full program audio loop through
- Digital remote control access • Stereo outputs • Independent encoder output • Alarm relay • Hi-Z RX monitor port

Mfr. List \$899.00

Call For BSW Price

TFT



**886/887
EBS Monitor**

The AM receiver, Model 886, and the FM receiver, Model 887, are tunable for their entire respective broadcast bands via front panel push button selectors. Both receivers have built-in two tone decoders for the 853 Hz and 960 Hz EBS signalling tones. Two 2-digit LED displays on the front panels of the receivers show the number of days, up to twelve, since EBS test transmissions were last received and/or sent to help avoid FCC citations.

886 Mfr. List \$2,150.00

Call For BSW Price

887 Mfr. List \$2,075.00

Call For BSW Price

5 GREAT REASONS TO ORDER FROM BSW

Excellent Prices

Outstanding Selection

Extensive Inventory

Fast Delivery

Knowledgeable Sales Representatives

BELAR



**FMMA1 WIZARD™
Digital FM Modulation Analyzer**

Controlled by a sophisticated microprocessor, the Wizard™ can tell you just about everything you ever wanted to know about your FM signal - using parameters that you configure, either from the front panel or remotely. Major Features: Digital reading of peak modulation (% and kHz deviation) with variable hold time (instant to 10 seconds) and highest peak display • Adjustable peak modulation indicator from 0% to 200% modulation, in 0.5% increments • Adjustable peak per minute (PPM) alarm - from 1 PPM to 100 PPM, in 1 PPM increments • Adjustable PPM duration window from 5ms to 10 seconds • Eight different peak weighting time constants • Actual PPM count, averaged over a sliding 1 minute window • Built-in, configurable loss-of-program alarm

The Wizard is shown above with the RFA4 frequency agile FM RF amplifier that allows direct dialing selection of any FM frequency with 10 presets.

FMMA1 Mfr. List \$3,300.00 **Call For BSW Price**
RFA4 Mfr. List \$990.00 **Call For BSW Price**



**AMM2B
AM Modulation Monitor**

Features: Separate 100% negative peak and 125% positive peak modulation indicator lamps that are independent of carrier level • Adjustable peak modulation indicator, 40 to 130% in less than 1% increments, independent of carrier level • True peak-reading modulation meter • Built-in carrier-off alarm • Built-in modulation calibrator

Mfr. List \$1,390.00 **Call For BSW Price**

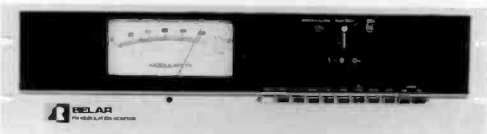

**FMM2
FM Modulation Monitor**

The heart of the FMM2 is an ultra-linear digital discriminator which provides a distortionless baseband signal for accurate monitoring as well as precise stereophonic, and SCA decoding. FMM2 required with FMS2 or SCM1.

FMM2 Mono Modulation Monitor Mfr. List \$1,690.00
FMS2 Stereo Modulation Monitor Mfr. List \$1,890.00
SCM1 Subcarrier Modulation Monitor Mfr. List \$1,695.00

Call For BSW Price

DELTA



**SM1
AM Splatter Monitor**

Now you can use the same tool that the FCC uses to measure your station(s)' compliance with NRSC and FCC regulations and requirements. It's inexpensive and easy to use and interpret results.

SM1 Mfr. List \$2,905.00
AWA1 Active Whip Antenna Mfr. List \$570.00

Call For BSW Price

INOVONICS

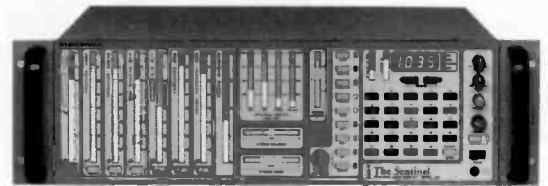

**550 THE SENTINEL
Program Audio Monitor**

The Sentinel incorporates sophisticated and comprehensive program audio diagnostics of the received signal. It offers calibrated bargraph readouts of total modulation, L, R, L-R, loudness, dynamic range, spectral profile, program symmetry, stereo balance, and stereo image. Yet this high performance audio monitor receiver is not just for engineers! With it's 24 station presets and easily interpreted bargraph readouts, non-technical personnel can rapidly evaluate their station's audio performance and compare it with other stations in their market. Sentinel receives NRSC-AM, C-QUAM® AM-Stereo, FM and FMX®, analog and digital SCA/RDS subcarriers.

Mfr. List \$5,995.00 **Call For BSW Price**

MODULATION SCIENCES



**MODMINDER
FM Modulation Monitor**

Increase modulation with less processing, and still stay within FCC limits. ModMinder™ gives you more accurate measurement of modulation in accordance with the most recent FCC standard. FM ModMinder™ registers only those longer "events" that the FCC really cares about. The end result is you may be able to boost your modulation up to 3 dB depending on the type of processing you use. ModMinder™ works with any stereo-capable demodulator or can be purchased with an internal demodulator.

MODMINDER Mfr. List \$2,395.00
FMMM2 ModMinder W/Demodulator Mfr. List \$3,090.00

Call For BSW Price

QEI



**691/01
FM Modulation Monitor/Test Set**

The 691/01 is a highly technical, precision instrument employing a combination of test techniques in a versatile, but very compact package. It was designed to be a complete FM test package with facilities for all proof-of-performance measurements and a wide range of trouble-shooting tests. Operator convenience and simplicity of use were primary considerations in the design of the 691. 18 tests can be performed in addition to measuring FM and SCA modulation when used with an oscilloscope.

Mfr. List \$6,675.00

Call For BSW Price

RADIO DESIGN LABS

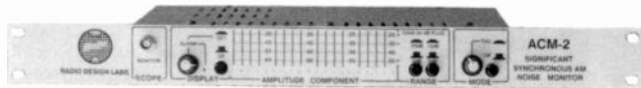

**ACM2
Amplitude Component Monitor**

The ACM2 is a precise AM noise meter which connects to the RF sample on an FM transmitter. A digital string display with 20 dB of range displays AM noise for precise transmitter tuning. It interfaces with any remote control for continuous indication of AM noise. An adjustable alarm threshold can signal the station operator when AM noise has increased beyond a pre-determined level. The nature of AM noise measured can be examined by the engineer with the oscilloscope output. Audio and data outputs are provided, as well as a new remote control output that shows transmitter forward power.

Mfr. List \$695.00

Call For BSW Price

SENTRY SYSTEMS



**AIR SENTRY II
Audio Signal Monitor**

The Air Sentry is designed to constantly monitor the presence of an audio signal to energize a relay when the audio is absent. Activation of the relay is front panel adjustable from 4 to 20 seconds. Air Sentry can monitor any stereo or mono audio source such as audio from AM/FM tuner, TV receiver, or modulation monitor.

Mfr. List \$295.00

Call For BSW Price

TFT

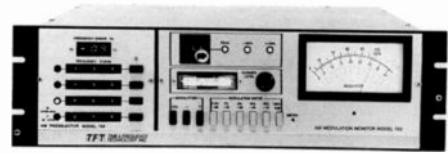

**753/755A
AM Modulation Monitor/Preselector**

In today's competitive AM markets, you need to deliver a strong signal to the widest possible area. But, transmitter power alone isn't enough. You also need all the modulation you can legally achieve. That's the basic purpose behind the TFT Model 753 AM Modulation Monitor. Not only does it make extremely accurate proof-of-performance measurements, but more importantly, it allows you to monitor your transmitter so precisely that you can modulate it to the maximum legal limits in absolute confidence. The optional 755A preselector module allows you to monitor your own, or a competitor's signal off-air.

753 Mfr. List \$1,760.00

Call For BSW Price

755A Mfr. List \$1,850.00

Call For BSW Price



**844A
FM/Stereo Modulation Monitor**

You get everything you need for complete proof-of-performance measurements (for distortion, an external analyzer is needed) right on the front panels, plus accuracy, versatility and convenience no other monitors can match. The 844A FM Monitor combines a tunable RF preselector, a baseband monitor and a stereo monitor in one compact instrument. State-of-the-art design includes the use of linear phase filters, large scale integrated circuits (LSI) and toroidal power transformers to reduce hum and power line noise. Modular PC cards make service and routine calibrations easy.

Mfr. List \$5,150.00

Call For BSW Price



**884
FM Stereo Modulation Monitor**

A cost effective alternative to TFT's popular Model 844A. The 884 allows you to maximize modulation levels while maintaining the highest signal quality. The 884 can be used for transmitter Proof-Of-Performance measurements (with a 40 dB attenuator inserted before the antenna input), or at the studio for off-air monitoring. The frequency synthesized pre-selector can be used to select your own station's signal or the signal of another station for easy and convenient comparison.

Mfr. List \$3,765.00

Call For BSW Price

ATI

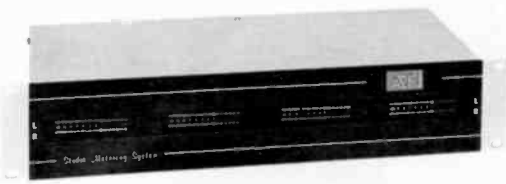

**VU800
VU Metering System**

Know at a glance where your signals are (or are not). Expandable ATI MicroMeters display one, two, three or four stereo lines (eight channels) on bright, two-color vacuum fluorescent bar-graph indicators. Balanced, bridging inputs are switchable for 0 VU at -10, +4, and +8 dBm line levels. Displays -20 to +8 VU with peaks stored for several seconds. Backlit, compact 3 1/2" rack mount.

Mfr. List \$1,249.00 Smaller Versions Available
Call For BSW Price

DORROUGH



**40A
Loudness Monitor**

Dorrough loudness monitors display, in an easy to read format, the actual energy content of the program material while still indicating peak amplitude by displaying both peak and average on the same scale. They allow the operator to adjust all program material for equal perceived loudness while protecting the peak waveform. One Dorrough meter gives you more usable information than any combination of peak hold, VU, and PPM indicators. 40 LEDs in a single scale offer maximum accuracy in signal monitoring.

Mfr. List \$475.00 Call For BSW Price

ESE

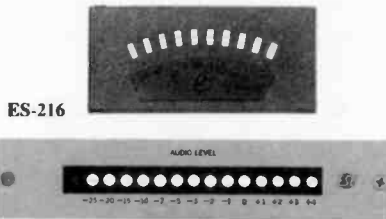

**ES-215/ES-216
Audio Level Indicators**

The ES-215 and 216 meters display audio levels with bright, easy to see LED indicators. Levels below 0 dB are displayed using green LEDs. 0 dB is yellow and levels above 0 dB are red. These meters can be ordered in either peak reading or VU response mode (specify). Audio input is balanced with an impedance of 6000 ohms. Model 215 monitors levels from -25 to +4 with 14 LEDs. Model 216 monitors levels from -20 to +3 with 10 LEDs. Both meters require a single supply voltage (user provided) between +10 and +24 volts DC @ 32mA. Rack mount kits that enable 2 or 4 units to fit side by side are available.

ES-215 Mfr. List \$138.00 Call For BSW Price
ES-216 Mfr. List \$66.00 Call For BSW Price

CIRCUITWERKES

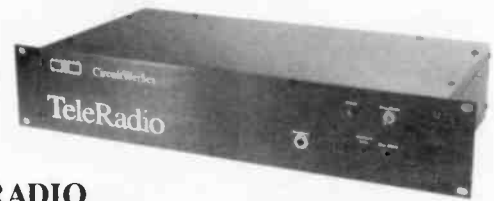

**TELERADIO
Remote Controlled Listen Line**

Perfect for programming consultants and group program directors to monitor up to 10 radio stations in the same market from a remote location. The TeleRadio is a rack mounted device that contains an AM/FM tuner coupled with a switcher that allows any touch-tone telephone to change station presets. FCC Type Approved for phone connection. Auto answer and auto hang up for unattended, 24 hour operation.

Mfr. List \$629.95 Call For BSW Price

CARVER



**PSB11
AM/FM Stereo Tuner**

Rack mountable front panel and improved AM stereo specs make this one of the finest tuners available. Features include: Ultra-high performance FM detection circuit for dramatically reduced multipath and noise • 13 AM/FM presets • Preset scan • Best AM stereo specs in the industry (full 20-15 kHz frequency response (+-0.3 dB) • 0.05% THD @ 1 kHz for FM tuner section

Mfr. List \$799.95 Call For BSW Price



**TX12
AM/FM Tuner**

For an accurate tuner without the frills found in more expensive tuners, take a look at the Carver TX12. Features include: 20 AM/FM presets, auto/manual tuning, and analog signal strength meter.

Mfr. List \$449.95 Call For BSW Price

SOUNDCRAFTSMEN



**PROTUNER 4
AM/FM Stereo Digital Tuner**

Soundcraftsmen's advanced technology incorporates sophisticated frequency synthesized tuning with a highly stable quartz crystal oscillator that locks into the broadcast signal and makes station selections precise and drift-free. A 16-station pre-select. Rack mountable.

Mfr. List \$379.00 Call For BSW Price

OTARI



5050 SERIES 2, 4, and 8 Channel Recorders

The Otari MX5050 series allows the audio professional to select exactly the right machine for his or her application from a complete range of compact audio recorders. Models include the MX5050BIII two track, BQIII 4 track, three overhead meter style machines - The MKIV-2 two track, MKIV-4 four track, and MKIV-8 eight track.

All models include the following features: Three-head design • Transformerless balanced inputs and outputs • Front panel record electronics with built-in test oscillator • Gapless, seamless, punch-in/punch-out (on BQIII, MKIV-4, and MKIV-8 only) • Dump edit and cue modes • Reel size selector for take-up and supply reels • Servo controlled direct drive motor • Microprocessor controlled tape handling with dynamic braking • Built-in mini auto locator with 3 cue point memory, search to zero, and repeat function • Microphone and line mixing on each channel • Tape timer display shows Hrs/Min/Sec as well as tape speed in IPS and % of tape speed • Pitch control (+-20% in .01% steps) • Time code editing with external synchronizer via 37 pin parallel interface • Extremely rugged construction

Available options: Autolocaters CB119, CB120 • Remote controllers CB127, CB144 (MKIV-8) • Synchronizer EC102 • Roll-around stand ZA52L • Rack mount kit (for upright models) RK2B

MX5050BIII	Mfr. List \$3,459.00
MX5050BQIII	Mfr. List \$5,418.00
MKIV-2	Mfr. List \$4,509.00
MKIV-4	Mfr. List \$6,295.00
MKIV-8	Mfr. List \$6,609.00

Call For BSW Price

PRORAX

PO100 Table Top Console

An attractive, rugged, economical table top console to accommodate your MX5050BII/III. Replaces the two side panels of your Otari. Installation is a breeze using existing screws.

BSW Price \$89.95

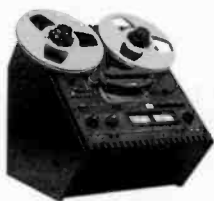

OTARI



MX55 2-Channel Recorder

Loaded with features, the MX55 was designed for fast paced production and mastering applications. Features: DC-servo capstan motor allows +20% vari-speed • Inputs and outputs are transformerless active balanced • LED tape timer with accurate return-to-zero and 3 cue memory points • Concealed front panel audio adjustments • Built-in cue speaker and headphone amplifier • Extra 1/4 track reproduce head

MX55N Mfr. List \$4,509.00

Call For BSW Price

MX55NM Mfr. List \$5,769.00

Call For BSW Price

(Same As Above With Meterbridge Console)



MX50IIN 2-Channel Recorder

The Otari 2-track for facilities on a limited budget. Durable transport features DC-servo capstan motor with vari-speed of +7%. Five digit tape timer has return-to-zero and search-to-cue for quick location of desired cue point. Speeds are selectable in pairs of 15/7.5 or 7.5/3.75 ips. Inputs and outputs are transformerless active balanced and have XLR connectors.

Mfr. List \$2,725.00

Call For BSW Price



ARS1000DC 2-Channel Reproducer

1/4" 2-channel, half-track reproducer with 25 Hz tone sensor, end-of-message and cuetone relays with adjustable delay (100 ms to 15s), 7.5/3.75 ips speeds, 19" rack mount. Designed for automated broadcast systems and other high-reliability reproduce only applications. 15/7.5 ips available on special order.

Mfr. List \$2,362.00

Call For BSW Price

REVOX



**PR99MKIII
2-Channel Recorder**

True to the Studer Revox tradition, the PR99 has always offered a great combination of features, price and long term service. The sturdy die cast deck plate offers durability while autolocating functions make production or on-air work a breeze. The front panel layout facilitates easy operation. (Unit has rack mounting flanges standard. Shown above with optional wood side panels.)

Mfr. List \$3,495.00 Call For BSW Price

TASCAM



**BR20
2-Channel Recorder**

Designed with professional use in mind, the BR20 packs outstanding performance and features into a compact, exceptionally easy-to-use recorder. Standard features include: Balanced +4 dBm inputs and outputs • Front panel audio calibration controls • Precision tension servo controlled transport for exceptionally smooth operation • Switchable 15/7.5 ips tape speed (optional 7.5/3.75 speed available) • Accurate real-time tape counter with 3 presettable locate points and zero locate • Dump edit, manual edit, stop edit, and quick cue modes • Independent L/R reel size selectors • Built in rack mounting • Optional remote control

Mfr. List \$2,499.00 Call For BSW Price



**32
2-Channel Recorder**

The cost effective model 32 offers independent left-right recording, pitch control, dump edit, NAB equalization, and 10 1/2" reel capacity. Sync mode allows over-dub recording with full frequency response. Rack mount is available as an option.

32 Mfr. List \$1,799.00 Call For BSW Price
34B (1/4" 4-Track) Mfr. List \$2,299.00 Call For BSW Price

TASCAM



**TSR8
8-Channel Recorder**

This compact 8-track recorder offers the highest sound quality on a 1/2" tape format. Features include: External sync capability, built-in dbx type-I noise reduction, automatic, gapless punch-in/out with rehearsal, real-time tape counter and 3-point auto locator, dump edit, manual edit, spot erase and much more. (Options: Remote control RC408, rack kit RM408)

Mfr. List \$2,999.00 Call For BSW Price



**MSR16
16-Channel Recorder**

This 16-track recorder incorporates the most advanced Tascam technology and a wide range of versatile control features. dbx type-I noise reduction is built in, providing quiet performance. Auto punch-in/out makes recording smoother and easier than ever, while specially designed circuitry offers gapless and noiseless punch-in/out. The transport offers switchable tape speeds (15/7.5 IPS), and can be externally controlled. (Optional remote control RC416)

Mfr. List \$7,999.00 Call For BSW Price



**22-2
2-Channel Recorder**

The Tascam 22-2 is a great reel to reel recorder for use where large reels are not needed. Quality electronics and great tape handling. Features: 1/2 track record/playback • 7 inch reel capacity • 7 1/2"-15 ips • Remote pause function • NAB equalization • Rack mount available (RM22)

Mfr. List \$1,199.00 Call For BSW Price

AMPEX



456 Audio Mastering Tape

When you demand high output, minimal distortion, and consistent audio quality choose 456 Grand Master from Ampex. 456 is tested and inspected over 150 times during the manufacturing process.

Model	Description	Price ea.	Price ea.
45617611T 1/4" x 2500'	10 1/2" pancake	(1-9) \$14.50	(10+) \$12.60
456151111 1/4" x 1200'	7" plastic reel	(1-39) \$10.00	(40+) \$8.70
45617311J 1/4" x 2500'	10 1/2" metal reel	(1-9) \$26.50	(10+) \$23.00

406/407 Audio Mastering Tape

High performance is essential for mastering. The oxides for 406, 407 are specially selected to provide high signal-to-noise ratio, high head room and low distortion.

Model	Description	Price ea.	Price ea.
40617613T 1/4" x 2500'	10 1/2" pancake	(1-9) \$11.70	(10+) \$10.10
406151131 1/4" x 1200'	7" plastic reel	(1-39) \$8.40	(40+) \$7.30
40617313J 1/4" x 2500'	10 1/2" metal reel	(1-9) \$21.65	(10+) \$18.80
40717613T 1/4" x 3600'	10 1/2" pancake	(1-9) \$18.50	(10+) \$16.20
407151131 1/4" x 1800'	7" plastic reel	(1-39) \$11.05	(40+) \$9.60
40717313J 1/4" x 3600'	10 1/2" metal reel	(1-9) \$29.35	(10+) \$25.40

632/642 Audio Mastering Tape

The extra low noise/ high output formulation of Ampex 632/642 tapes provides enhanced performance capabilities over that obtainable from standard output tapes. A better signal-to-noise ratio provides quieter tape background levels, as well as a higher output level.

Model	Description	Price ea.	Price ea.
632131111 1/4" x 600'	5" plastic reel	(1-39) \$3.90	(40+) \$3.40
632151111 1/4" x 1200'	7" plastic reel	(1-39) \$5.90	(40+) \$5.15
632173111 1/4" x 2500'	10 1/2" metal reel	(1-9) \$19.60	(10+) \$17.00
642131111 1/4" x 900'	5" plastic reel	(1-39) \$4.90	(40+) \$4.25
642151111 1/4" x 1800'	7" plastic reel	(1-39) \$8.10	(40+) \$7.00
642173111 1/4" x 3600'	10 1/2" metal reel	(1-9) \$23.90	(10+) \$20.50

Empty Reels And Boxes

Plastic Reels		BSW Price
5464 5"	with NAB Center	.70 ea.
5196 5"	with EIE Center	.55 ea.
5231 7"	with EIE Center	.99 ea.
6284 10 1/2"	with NAB Center	\$3.60

Metal Reels		BSW Price
6393600 10 1/2"	with NAB Center (Includes Box)	\$11.55

Empty Boxes		BSW Price
605 5"	Empty Box	.50 ea.
607 7"	Empty Box	.50 ea.
630 10 1/2"	Empty Box	\$1.15



3M

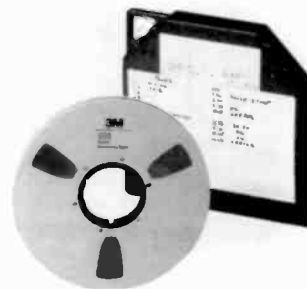

996 Audio Mastering Tape

996 outperforms any other mastering tape on the market with 3 dB greater output level and 3 dB less print through and noise when biased properly. Capable of recording at +9 dB, suggested operating level is +6 dB. Comes in new TapeCare™ Library Box for maximum tape protection.

Model	Description	Price ea.	Price ea.
9961425HPB 1/4" x 2500'	10 1/2" pancake	(1-11) \$12.70	(12+) \$11.80
9961412PR7 1/4" x 1200'	7" plastic reel	(1-19) \$8.90	(20+) \$8.10
9961425RD 1/4" x 2500'	10 1/2" metal reel	(1-11) \$23.50	(12+) \$21.50

226 Audio Mastering Tape

226 Audio Mastering Tape provides versatility for outstanding all around performance. Its unique oxide dispersion significantly reduces print-through without any sacrifice in signal-to-noise. 227 Mastering tape is a 1 mil. version for remote and extended recording applications.

Model	Description	Price ea.	Price ea.
2261425HPB 1/4" x 2500'	10 1/2" pancake	(1-11) \$11.50	(12+) \$10.60
2261412PR7 1/4" x 1200'	7" plastic reel	(1-19) \$8.10	(20+) \$7.50
2261425RN 1/4" x 2500'	10 1/2" metal reel	(1-11) \$21.00	(12+) \$19.50
2271436HPB 1/4" x 3600'	10 1/2" pancake	(1-11) \$21.60	(12+) \$20.10
2271418PR7 1/4" x 1800'	7" plastic reel	(1-19) \$12.50	(20+) \$11.60
2271436RN 1/4" x 3600'	10 1/2" metal reel	(1-11) \$34.90	(12+) \$32.40

806 SERIES Audio Mastering Tape

Specially formulated to meet the high output, low print requirements. 807 is a 1 mil. thickness for extended recording time.

Model	Description	Price ea.	Price ea.
8061425HPB 1/4" x 2500'	10 1/2" pancake	(1-11) \$9.70	(12+) \$9.00
8061412PR7 1/4" x 1200'	7" plastic reel	(1-19) \$7.10	(20+) \$6.60
8061425RN 1/4" x 2500'	10 1/2" metal reel	(1-11) \$17.80	(12+) \$16.50
8071436HPB 1/4" x 3600'	10 1/2" pancake	(1-11) \$15.70	(12+) \$14.60
8071418PR7 1/4" x 1700'	7" plastic reel	(1-19) \$9.50	(20+) \$8.80
8071436RN 1/4" x 3600'	10 1/2" metal reel	(1-11) \$24.90	(12+) \$23.15

Recording/Accessories

Splicing Tape	BSW Price
67732100 100' Spool	\$4.80

Leader Tape	BSW Price
61W1415 White Polyester 1500' Reel	\$15.80
61Y1415 Yellow Polyester 1500' Reel	\$15.80

BSW

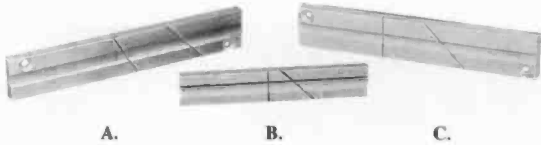

SPLICING BLOCKS

- A. EDITALL S3**
S3/90 (90°/45°)
S3/OT (Fits Otari 5050)
BSW Price \$43.70
- B. FOSTEX 9930**
BSW Price \$43.70
- C. NORTRONICS PF-311**
BSW Price \$57.00
- BSW Price \$18.50**
- BSW Price \$30.70**

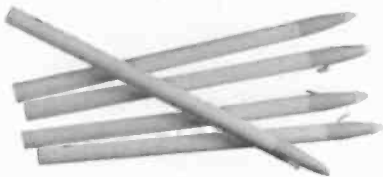

**164T
Editing Pencils**

White china markers don't require sharpening. Perfect for all your tape editing.

164T Box Of 12 BSW Price \$16.95



**GEM
Editing Blades**

The popular choice for splicing and editing. Single edge razor works with all splice blocks.

GEM Box Of 100 BSW Price \$9.05

3M



Scotch Splice Tape

100 feet of the best splice tape you can buy. Can be used in any standard office "Scotch Tape" dispenser.

67732100 (For 1/4" Tape) BSW Price \$4.80 ea.
6712100 (For 1/2" Tape) BSW Price \$6.50 ea.

GENEVA



**PF116/PF132/QM108
Head Cleaning Fluids**

Non-flammable, non-toxic, and completely safe on plastics, rubber, metals, painted surfaces, epoxies and elastomer parts.

PF116 (16 oz. Spray) BSW Price \$11.00
PF132 (32 oz. Liquid) BSW Price \$21.50
QM108 (8 oz. Liquid) BSW Price \$9.40

CAIG



**CL27
Head Cleaner**

Caion™ removes oil, grease, and dirt without harming metal, plastic or elastomeric parts.

CL27S (16 oz. Spray) BSW Price \$9.50
CL274 (4 oz. Liquid) BSW Price \$6.50

BSW



COTTON SWABS

For cleaning tape heads. Extra long for hard to reach areas. Cotton tip stays on when wet.

BCS 100 (100 Quantity) BSW Price \$6.95
BCS 500 (500 Quantity) BSW Price \$15.50
BCS 1000 (1000 Quantity) BSW Price \$30.00

STL/MRL



TEST TAPES

Complete selection of test tapes for every application. Available in cassette, cartridge, and open reel.

Call With Your Requirements

BURK TECHNOLOGY

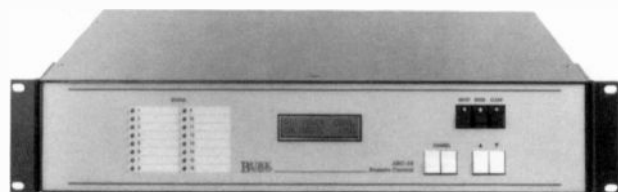

ARC16 Remote Control

Now, you have a choice: Full-time studio control, dial-up telephone control—or both. And because of modular design, the ARC16 offers features never before available in a 16-channel remote control system. With the studio controller you have a constant link to your transmitter, for instant response to any problem. The 32 character LCD display shows out-of-tolerance conditions at a glance, and it's simple to make adjustments, with clear-text prompting to guide you. Call the ARC-16 from any tone phone: The Digital Speech Unit (DSU) lets you take control using your telephone keypad. It can be used as the only control or in addition to the studio controller and can be installed in the transmitter or the studio unit.

Features: Full-time studio control, dial-up control, or both • Studio controller displays clear text prompts for non-technical operators • Dial-up speech unit features digitally-recorded human voice • Built-in subcarrier generators at no extra charge • Built-in alarms • Optional computer interface • Control multiple sites with a single unit

Price Based On Configuration



TC8 Remote Control

The TC8 is a full featured remote control system that requires only 1 3/4" of rack space and provides 8 analog metering channels, 8 status inputs and 16 control outputs (8 raise, 8 lower). Studio and transmitter units communicate via telco loops or STL/SCA subcarriers. Specify which you prefer at time of ordering. Status inputs accept 5 to 28 V signals and metering channel accept inputs of either polarity from 0.25 to 4 V, ensuring easy interface with all broadcast equipment. Status LED's and a large dot matrix metering display can be read from across the room. CRT display, logging and fully automatic operation is possible using the optional RS-232 interface.

Mfr. List \$2,495.00

Call For BSW Price

DON'T SEE IT? - ASK US

This Catalog Represents Only A Fraction Of The Thousands Of
Items Available From BSW

GENTNER



VRC2000 Remote Control

This system provides a total solution for controlling your broadcast transmitter where a telephone line, radio link, data link, or bi-directional audio link is available. The VRC2000 Remote Control System will watch your transmitter for you. It's like having a person on duty at the transmitter continually. The VRC2000 will notify you when something goes out of tolerance, when security is breached, or if it had to turn on the stand-by because the main failed. It features 16 single-ended analog metering channels, 16 TTL compatible status channels, and 32 "open collector" transistor command outputs. The 32 outputs are configured as 16 separate "Command Channels" with 2 outputs per channel. The unit can be used to automatically monitor conditions at a remote site, automatically log regular reports to a printer, take corrective action based on monitored conditions, and notify a human operator via telephone or radio links should an undesired condition occur. The VRC2000 has an outstanding list of options and accessories that make installation and operation easy and efficient.

Basic VRC2000 Mfr. List \$3,195.00

BSW System Prices Based on Configuration

SINE SYSTEMS

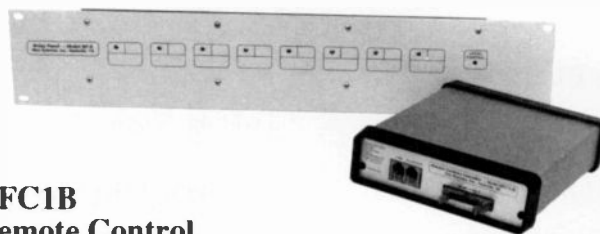

RFC1B Remote Control

Whether you need a primary remote control, a back-up for your existing remote control, or you simply want your own private "back door" to the transmitter, the Sine Systems RFC1B represents the best value in dial-up remote control systems. Use a standard telephone to control your transmitter and take meter readings. The built-in alarm system phones up to six different telephone numbers to indicate an alarm condition. The control unit placed at the transmitter site is hooked up to optional RP-8 relay panels to offer control and telemetry. Each RP-8 offers 8 raise, 8 lower, and 8 telemetry channels. Extra RP-8s may be added up to 64 channels.

RFC1B	Control Unit	Mfr. List \$1,099.00
RP-8	Relay Panel	Mfr. List \$399.00
AFS-1	Audio Fail-safe	Mfr. List \$249.00
SP-8	Surge Protector	Mfr. List \$129.00

Call For BSW Price
More Options Available

MOSELEY

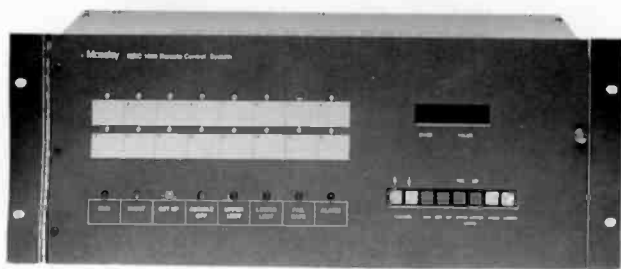

**MRC1620
Remote Control System**

The MRC1620 system consists of a remote terminal that allows an optional control terminal or IBM PC with TaskMaster20 software to monitor and control a remote facility from both dedicated and/or dial-up control points. The MRC1620 remote terminal comes equipped with 32 relay isolated command outputs (16 raise/ 16 lower), 16 TTL status inputs and 16 analog metering inputs with the required terminal connectors.

The remote and control terminals are simple to operate and easy to understand. All status channels are simultaneously displayed on a set of 16 LEDs. The front panel displays read-outs of selected channel number and telemetry data. LEDs indicate operation mode, alarms and other system parameters.

Telemetry limit checking and status alarm capability ensure that an unmanned facility operates at peak efficiency. During alarm conditions, intelligent automatic corrective action can be taken by the remote terminal under the direction of the TaskMaster20.

The remote terminal comes equipped with a built-in internal 1200 baud modem to communicate over dedicated circuits (STL/TSL/FMSCA or 2/4 wired leased lines). An external 1200/2400 baud auto-answer modem for dial-up access over the public switched telephone network is also included with the remote terminal.

Main features:

- Dial or direct connect to an MRC1620 remote or control terminal
- Display current analog and status values
- Display and acknowledge alarms
- Manually control an MRC1620 remote terminal (RT)
- Automatically control (via analog limits and status conditions) an RT
- Display, edit, and store PC screen labels
- Download and store the set-up parameters from the MRC1620
- Recall and upload the set-up parameters to the MRC1620
- Maintain and generate log file(s) from up to 16 RT sites at user specified intervals during the day
- Generate a printed log

MRC1620 (Remote Terminal)	Mfr. List \$3,450.00
MRC1620 (Control Terminal)	Mfr. List \$1,550.00
TASKMASTER20 Software	Mfr. List \$595.00

Call For BSW Price

MOSELEY

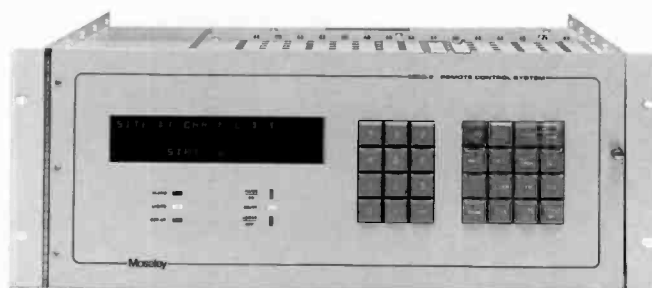

**MRC2
Remote Control System**

More and more, broadcasters are issuing executive commands through their MRC2 microprocessor remote control.

Multi-site, Multi-function, the MRC2 controls and monitors as many as 99 remote sites, with multiple control terminal capability to let you delegate control from master to master as needed. Up to 255 status, 255 telemetry and 255 command channels supervise your sites.

Dual tolerance limits can be set to prevent a telemetry parameter from reaching critical levels. Choose from 6 modes in which to calibrate telemetry inputs, and set status inputs to initiate alarms or events on rising or falling waveforms, or both.

Command, status, and telemetry set-up is straightforward on the MRC2 System. Using the remote terminal keyboard and 48 character alpha-numeric LED display, the system provides plain English prompting and "menu" pages for set-up selection. Similar procedures are used at the control terminal to set up and verify telemetry limits, assign data links, and to set up controlled access for restricted functions.

Control Options:

Optional automatic loggers provide a printed record of system operation and CRT terminals display your data in plain language. An optional ACU1 automatic control unit automates your operation by issuing programmable time and feedback-actuated sequences of commands without operator assistance. Add multiple direct command and multiple status display options for streamlined operator interface.

Prices Based On Configuration

TELTEK

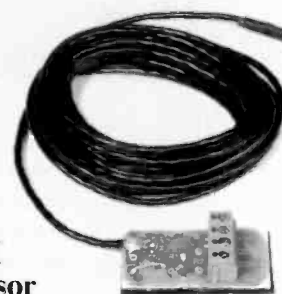

**INFORMERITX
Temperature Sensor**

InformerITX interfaces with your remote control to report accurate temperatures from your transmitter with a range from 0 to 230 degrees F. Simply supply the unit with 8-80 VDC and it will provide 10mV of output per degree fahrenheit to your remote control. Includes 18' cable and sensor.

BSW Price \$56.00

Need help in selecting the proper remote control?
Call us toll free for assistance.

MARTI

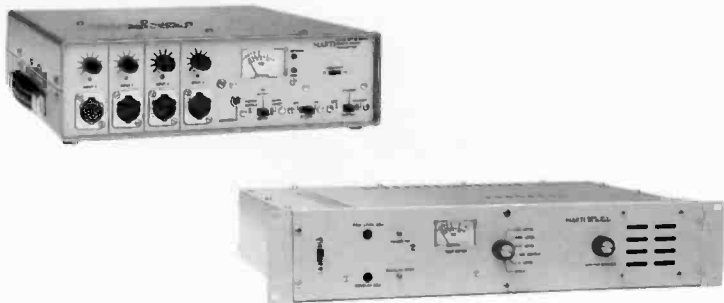

**RPT30/CR10
Remote Pickup System**

Remotes are a breeze with a Marti Remote Pickup System. Start with an RPT30 transmitter that offers four balanced microphone inputs, one is selectable to line level, and a built-in FM compressor/limiter. Flashing LEDs indicate antenna VSWR problems and over-temperature conditions and a built-in subaudible encoder can activate repeaters or other equipment with the flip of a switch. Single or dual frequency models are available.

The companion CR10 is a rack mounted VHF or UHF base station receiver dual frequency capability built in. It features a built-in test meter, squelch relay, optional DC operation, built-in sub-audible tone decoder with relay, special noise reduction circuit, 90 dB spurious rejection and a front panel monitor speaker.

RPT30	Mfr. List \$1,695.00
RPT30-2 Dual Frequency	Mfr. List \$1,725.00
CR10	Mfr. List \$1,195.00
CR10-2 Dual Frequency	Mfr. List \$1,225.00

Call For BSW Price

MOSELEY



**RPL4000
Remote Pickup System**

The RPL 4000 offers the features and specifications you expect from Moseley at a modest cost. The portable RPL4010 transmitter is fully synthesized, light weight and can be used as a complete stand alone unit with three balanced, adjustable inputs, or in conjunction with existing repeaters or portable audio mixers. Features include selectable audio bandwidths from 5-15 kHz and noise reduction companding. The 4020 receiver has excellent adjacent channel rejection and selectivity, which is absolutely essential in crowded UHF bands. An industry standard connector is provided for audio control interface with existing equipment.

RPL4010/4020 Mfr. List \$4,850.00 Call For BSW Price

TFT



**8888/8889
Remote Pickup System**

The TFT Model 8888 RPU Transmitter and 8889 RPU Receiver offer outstanding flexibility, versatility and reliability. The transmitter and receiver are frequency synthesized N1, N2 and S bands. Two operating frequencies are programmed by internal DIP switches and are front panel selectable. In addition, frequency deviation and receiver bandwidth are selectable. DTMF control is provided for receiver activation, bandwidth and deviation selection. The 8888 enables you to adjust the RF power output to suit your needs with a maximum RF output power of 25 watts.

8888/8889 Mfr. List \$4,840.00 Call For BSW Price

COMREX



**CTA/LPQRA
Cue System**

This system consists of the CTA cue transmitter and the LPQRA receiver. It relays both program and instructions from the transmitter (which can be installed in a van, studio, press box, stadium, etc.) to pocket receivers. This FM system features 100% duty cycle, broadcast audio quality, and crystal control. FCC type accepted.

Mfr. List \$1,900.00 Call For BSW Price

NEED PRICES ON A MAJOR PROJECT ?

Save yourself time and FAX us your equipment list. We'll have a complete price quote back to you in no time.

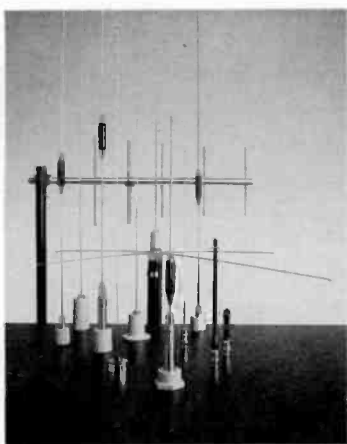
LARSEN**Antennas**

Larsen has a large selection of antennas available for both mobile and fixed applications.

Call Us With Your Specific Requirements

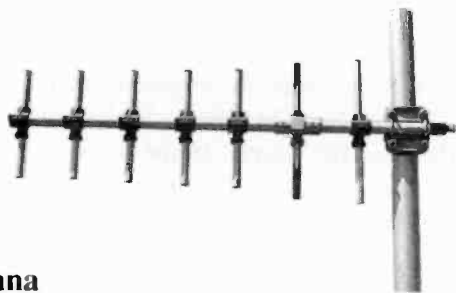
SCALA**CA7460
Yagi Antenna**

The CA7460 is a seven-element yagi designed for high performance and long-term reliability even under severe environmental conditions. Its broadband design makes it particularly suitable for systems requiring frequency agility within a specified band. Two standard models cover the 406-420 MHz and 450-470 MHz bands. Custom models are available for other portions of the 200-500 MHz spectrum. Impedance is 50 ohms, gain is 10 dB (over dipole), and input power rating is 100 watts.

Mfr. List \$200.00

Call For BSW Price

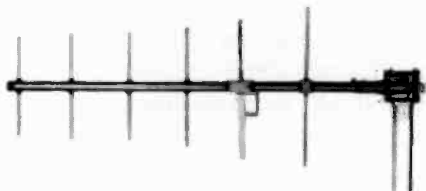
MARTI**YC SERIES
Yagi Antennas**

These yagis are available in fixed frequencies ranging from 152.08 to 455.99 to cover any RPU application. The antennas have 5 or 6 elements depending on the frequency, and have a gain of 9 dB.

YC SERIES (All Models)

Mfr. List \$150.00

Call For BSW Price

WILL-BURT**Pneumatic Telescoping Masts**

TMD masts are used in remote locations to support antennas transmitting broadcast signals back to the studio. Mounted on remote broadcast vehicles, TMD standard duty masts support antenna weights of up to 40 lbs. to heights of 34 ft. allowing the remote to shoot over most local obstructions.

The TMD pneumatic telescoping mast is a series of graduated extruded aluminum tubes that are assembled to nest one inside another. Each tube has a seal at the bottom to contain air pressure and a collar at the top to limit extension of the tube inside it. The masts are extended from their compact nested height by pneumatic pressure supplied by air compressors, hand pumps or compressed air bottles. They can be mounted to extend through the roof of a remote vehicle, or on the vehicles rear bumper.

Call BSW For Pricing And Detailed Specifications

**HURRY-UP
Telescoping Mast**

Here's a simple, inexpensive, and effective portable antenna mast for your remotes. The TMD Hurry-Up mast is designed for fast and easy deployment of light weight antennas. It consists of 6 graduated aluminum tubes which nest one inside another. The mast is extended by pushing up the sections and fixing them into position using quick lock/release collars. It can be fully extended to 25' in one minute or less. Hurry-Up is free standing in its universal vehicle mounting stand so you can take it on remotes using whatever vehicle is available. Weight is only 20 lbs. with a nested height of 6'-0"

Mfr. List \$1,225.00

Call For BSW Price

MARTI



STL10 STL System

The Marti studio transmitter link is a line-of-sight FM communication system providing a high quality broadcast audio channel with two optional sub-channels. A dual link for stereo provides two identical broadcast quality channels with better than 80 dB stereo crosstalk and four optional sub-channels. A dual Marti system offers greater rejection of interference, superior noise performance, lower channel crosstalk and greater redundancy than most composite systems. Features: Excellent square wave response • User selectable audio processing with 0, 25, 50 or 75 microsecond de-emphasis options • Low pass filters eliminate overshoot on complex audio waveforms • Two IF bandwidths available to meet domestic and international requirements • Computer designed bandpass filters for high selectivity with optimum phase and group delay • Test meter on front panel indicates signal level, main channel audio level, sub-carrier level, supply voltage, L.O. level and mixer level. Additional test points inside receiver • Front panel RF Sensitivity switch • Built-in automatic switching capability

STL10 Transmitter Mfr. List \$1,645.00 Call For BSW Price
R10 Receiver Mfr. List \$1,645.00 Call For BSW Price

QEI

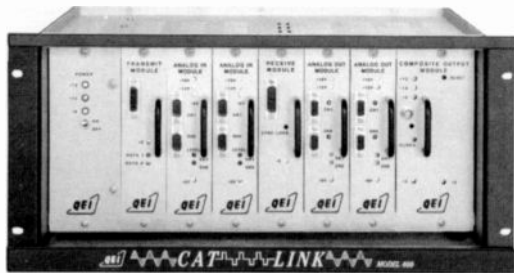

CAT-LINK STL/TSL System

CAT-LINK is a digital STL/TSL system that provides two-way transmission of program material over readily-available T1 telco service. Digital PCM encoding/decoding provides a transparent link to the transmitter. No audible delays to annoy air talent because the CAT-LINK provides real time processing. Maximum stereo performance...CAT-LINK sends and receives composite stereo, plus you get multichannel send and receive capabilities including up to four aux channels. Use for AM audio, Satellite or remote feeds, SCA's, control channels, voice communications and transmitter readings.

Call BSW for all the particulars regarding the benefits of owning a CAT-LINK system.

Prices Based On Application

MOSELEY

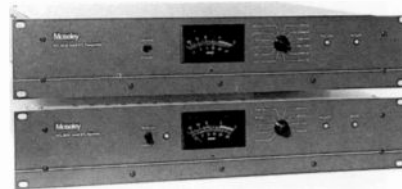

PCL6000 SERIES Composite STL Systems

The PCL6010 transmitter and PCL6020, 6030 and 6060 receivers employ a synthesized reference oscillator to eliminate fixed frequency crystals. Monaural or composite operation is available from a single system. By selecting appropriate jumpers, you can enable wideband composite stereo or 15 kHz monaural basebands. Two PCL6000 systems can be used in a dual discrete configuration to transmit right and left stereo programs with no measurable crosstalk. Receiver IF bandwidth can be factory or field set for channel spacing of 100 kHz to 500 kHz.

Which system is right for you? If you have no adjacent channel interference, the PCL 6020 will offer superior performance. The PCL 6030 is designed for hostile RF environments where maximum selectivity and adjacent channel rejection are required. The PCL6060 goes even further to operate in congested antenna farms. It offers noise-free performance in the most hostile RF conditions.

PCL6020 System Mfr. List \$8,250.00 Call For BSW Price
PCL6030 System Mfr. List \$9,250.00 Call For BSW Price
PCL6060 System Mfr. List \$9,950.00 Call For BSW Price

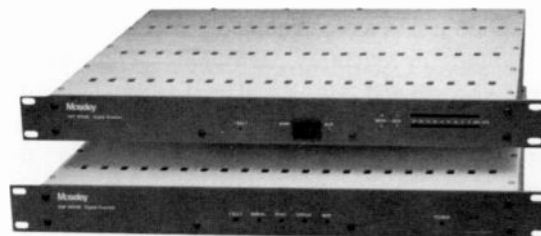

DSP6000 Digital STL Encoder/Decoder

Your key to an STL system that can pass CD quality audio is the DSP6000. This digital encode/decode system is designed to be used with Moseley PCL6000 or PCL606 Series STLs. It provides a 90 dB SNR with only .01% distortion and can operate in existing channel allocations from 100 to 500 kHz, coexisting with established analog radios.

The standard system comes equipped with an encoder and decoder for two (right and left) audio channels and one data channel with provisions for up to two auxiliary program channels and one additional data channel.

Look at the advantages of having digital:

- Signal-to-noise ratio of 90 dB with .01% distortion.
- Higher system gain (up to 25 dB over analog STLs)
- Constant SNR - unaffected by fades.
- No Crosstalk
- No degradation with multiple hops

Basic System Starts At \$5,990.00 Mfr. List Complete Digital STL Packages Available Prices Based On Configuration

TFT



8910 RECITER STL Receiver/FM Exciter

The Reciter™ is a single unit that combines the function of an STL receiver and an FM exciter with an Intermediate Frequency (IF) interface between them. By combining these two functions, you avoid demodulation of the composite signal to baseband, allowing the cleanest transfer from an analog receiver to an FM exciter available.

When used in conjunction with the 9100 or 8300 STL transmitters, the Reciter™ offers a direct CD quality audio link from your studio to your transmitter.

Mfr. List \$9,100.00

Call For BSW Price

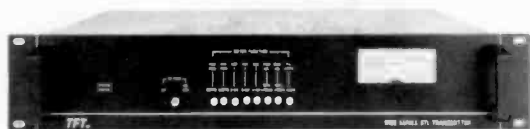

9100/9107 Composite STL System

TFT's 9100/9107 system is designed to meet today's standards for digital sound quality. The operating frequency is synthesized and field programmable between 944 and 952 MHz in 12.5 kHz steps.

Transmitter features:

- IF modulation - 0.02% THD, 85 dB SNR, 55 dB stereo separation
- Exclusive 5-year warranty
- Accommodates full stereo baseband including two additional subcarriers
- Provides CD quality audio when used in conjunction with TFT's Reciter
- Provisions for DC operation ($\pm 12V$, $\pm 24V$, $\pm 48V$)

Receiver features:

- 0.05% THD, 80dB SNR, 50 dB stereo separation
- High interference immunity without phase distortion
- Exclusive 5-year warranty
- Built-in stereo decoder (optional)
- Built-in receiver switchover unit for hot standby applications.

9100 Mfr. List \$3,550.00

Call For BSW Price

9107 Mfr. List \$3,225.00

Call For BSW Price

TFT



9200/9205 Mono STL System

This economical, frequency synthesized system is designed for single, redundant dual channel, or stereo program transmission. Features: Field programmable frequencies • Spectrum efficient operation • Optional built-in subcarrier generator and demodulator • 0.2% THD, 75 dB SNR, 80 dB channel separation • Built-in receiver switchover unit

9200/9205 System Mfr. List \$3,300.00 Call For BSW Price



8300/8301B Composite STL System

The 8300 is specifically designed for crowded RF signal environments where numerous signals present in the 940-960 MHz band make it difficult to operate composite STL'S without interference problems. Features like S.A.W. filters, selectable RF front end gain, variable bandwidth IF amplifiers and cast aluminum RF shielded housings for critical circuits contribute to the cleanest possible signal with this system. A wide array of options and accessories such as IF repeater, stereo decoder, and 92 kHz SCA capability make the 8300 System perfect for your operation.

8300 Transmitter Mfr. List \$5,300.00 Call For BSW Price

8301B Receiver Mfr. List \$5,160.00 Call For BSW Price



7700B SERIES Composite STL System

This high quality STL from TFT provides excellent audio quality and reliability. IF modulation improves S/N ratio and stereo performance. RF output is adjustable from 5 watts to a maximum of 12 watts to generate sufficient signal for long or difficult transmission paths. Both transmitter and receiver provide full status and monitoring capabilities for setup, operation and troubleshooting ease.

7700B Transmitter Mfr. List \$4,375.00 Call For BSW Price

7707 Receiver Mfr. List \$3,575.00 Call For BSW Price

MARK



Grid Antennas

Mark grid antennas are very lightweight and durable made of HeliArk welded aluminum for superior strength and rigidity. These grid antennas have virtually the same electrical characteristics of comparable size parabolic reflectors but only about 25-30% of the wind load factor. When ordering specify size, frequency, pressurized or non-pressurized, heated or non-heated.

Price Based On Size And Configuration



**SSH9A72GN
Super Short Haul Antenna**

When you need to install or replace a short haul STL antenna in a hurry, BSW and Mark antennas can help. The SSH9A72GN is a point-to-point grid antenna designed to work in any frequency between 940-960 MHz. The antenna has a mid band gain of 20 dBi and half power beamwidth of 19° (horizontal) and 10° (vertical). It weighs only 30 lbs. (including feed and mount), and utilizes universal clamps for quick and easy installation on pipe diameters from 1.9" to 3.5" O.D. Best of all these antennas are UPS shippable so they can be shipped quickly and inexpensively.

Mfr. List \$890.00

Call For BSW Price

MARTI

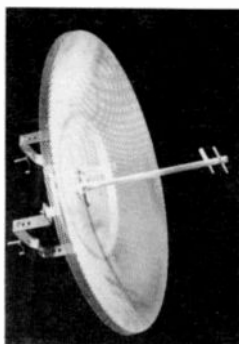

**PA48
Parabolic Antenna**

This low cost, 4' antenna is broadband for the 940 to 960 MHz aural STL band and is category B rated in vertical and horizontal planes.

Mfr. List \$500.00

Call For BSW Price

SCALA



Grid Parabolic Antennas

For years broadcasters have trusted the likes of Scala's paralector and miniflector antennas for their STL requirements. Now Scala is offering a full line of grid parabolic antennas for applications within the 940-960 MHz range. Dish sizes from 48" to 144".

Call For Pricing And Configuration

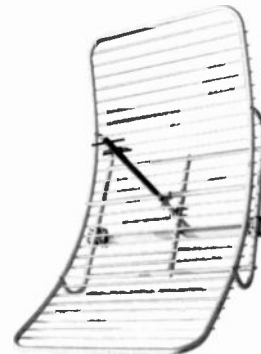

**PR450CU
Paralector Antenna**

Widely used for point-to-point STL links, telemetry, and UHF-TV, the PR450CU Paralector™ offers rugged construction for reliable long-term service, even in severe environmental conditions. Universal mounting bracket allows for easy horizontal or vertical mounting.

Mfr. List \$630.00

Call For BSW Price



**MF960
Miniflector Antenna**

For short hops where a full-sized grid or parabolic is not necessary the Mark Miniflector is a rugged, economical way to fulfill your antenna needs.

- Aural broadcast STL
- Telemetry
- Point-to-point communications
- Vertical polarization for STL

Mfr. List \$320.00

Call For BSW Price

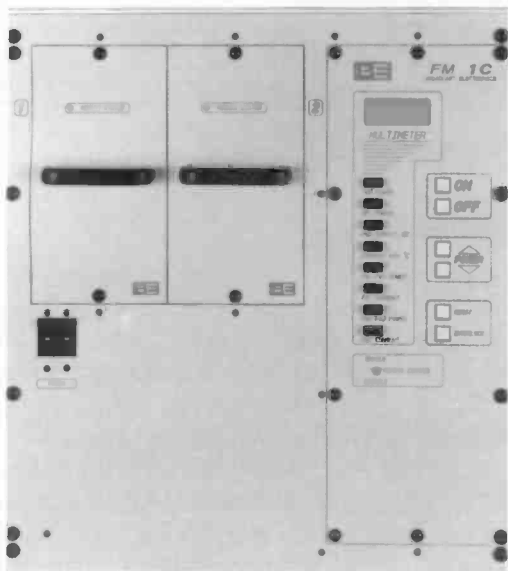
BROADCAST ELECTRONICS**C Series FM Transmitter**

Broadcast Electronics transmitters have gained industry wide respect for offering superior quality and reliability. BSW is proud to represent the entire line of FM and AM broadcast transmitters on a regional basis*.

C Series FM Transmitters

Broadcast Electronic's FM-1C is the first of the next generation of solid state FM transmitters. Power output is 1000 watts, adjustable down to 250 watts. Broadband FX50 exciter is also at the heart of this new transmitter to assure you of the finest audio transmission.

Features include:

- 2 RF power modules provide for soft failure in the event of problems.
- Internal Low Pass filter
- Reliable CMOS controller
- Self-protected RF power modules
- Compact and easy to install
- Two year warranty

B Series FM Transmitters

Updated for the 90's with the same solid and reliable amplifier design, Broadcast Electronic's "B" Series FM transmitters include the FX50 FM exciter for digital quality transmission. All "B" Series transmitters feature a high-efficiency single tube design with a patented folded half-wave output cavity that eliminates plate blocker and sliding contacts. Automatic power control and proportional VSWR foldback maintain constant, and correct power output. On start up, a "soft start" circuit gradually increases power to a safe operating level under high VSWR conditions.

BROADCAST ELECTRONICS**B Series FM Transmitter**

Broadcast Electronics B Series FM Transmitters are available in power levels starting at 250 Watts on up to 35,000 Watts.

***Call For BSW Pricing And Availability In Your Area**

**FX50
FM Exciter**

After investing in digital recorders and processing it's only logical to do all you can to ensure that high quality audio is actually reaching your listeners. Your exciter, for instance, should be able to pass as clean and transparent a sound as possible so the audiences you are targeting can reap the full benefit of digital sound.

The FX50 is just that sort of exciter - powerful, and very clean. Performance specifications feature a dynamic range that rivals CD players with harmonic and intermodulation distortion values so low that they are virtually unmeasurable. It can bring existing FM transmitters up to CD quality standards and is the ideal retrofit for exciters now in use. Features: THD and IMD less than 0.003% typical for true CD sound • Unmatched 93 dB S/N typical for widest dynamic range • 50 watt MOSFET output power to drive the largest transmitter or act as a stand-alone 50 watt FM transmitter • Advanced linear modulated oscillator for unparalleled performance • Computer optimized phase locked loop greatly improves low frequency response • Completely broadband for transparent performance • Functional front panel controls with LCD displays

Mfr. List \$6,295.00

Call For BSW Price

*Broadcast Electronics RF Products Are Available
Exclusively From BSW In The Following States: WA, OR, ID,
MT, UT, NV, AK, Northern CA

BROADCAST ELECTRONICS



**AM1/AM5/AM10
Solid State Transmitters**

BE AM Transmitters are the first C-QUAM™ AM Stereo transmitters. The AM stereo exciter is built into these 1, 5, or 10 kilowatt transmitters, eliminating the need for the additional cost of an external exciter and field installation.

Features:

- 100% Solid State
- High efficiency Class E operated power modules, plus high efficiency switching power supply provide for low power consumption, reliability and cool operation.
- 5 separate power levels to fit any AM license requirement
- Ultra rugged and reliable 'plug-in' power modules
- "Star" combiner network provides for uninterrupted operation, with minimal power reduction, without the use of dummy modules
- Exclusive VSWR detection and foldback circuit reduces carrier interruptions
- Built-in output matching network
- Rugged single cabinet construction

***Call For BSW Pricing And Availability In Your Area**

*Broadcast Electronics RF Products Are Available
Exclusively From BSW In The Following States: WA, OR, ID,
MT, UT, NV, AK, Northern CA

BROADCAST ELECTRONICS



**AX10
AM Stereo Exciter**

This second generation C-QUAM® exciter incorporates the most advanced AM stereo technology available providing superior stereo performance using an advanced IF modulation scheme employing independent, non-interfacing left and right channel digital modulators. The result is exceptional AM stereo with full mono receiver compatibility. Features: Synthesized operation (1 kHz increments) • Interfaces with virtually any existing AM transmitter • Built-in LED peak reading modulation display • Compact size (only 3.5 inches of vert. rack space) • Independent equalization for two-transmitter or dual antenna pattern operation • Full remote control capability

Available individually or as complete system featuring AS10 stereo modulation monitor.

AX10 Mfr. List \$ 5,700.00

Call For BSW Price

AX10P Mfr. List \$12,500.00

Call For BSW Price

System (Includes AX10, AS10, And Installation)



**AS10
AM Stereo Modulation Monitor**

The BE AS10 AM Stereo Modulation Monitor represents a substantial improvement in C-QUAM® monitoring technology. The AS10 offers state of the art design innovations coupled with convenience features not found in other C-QUAM monitors. The advanced design and attractive styling of the AS10 makes it the perfect companion for the AX10 Stereo Exciter (featured above).

AS10 Features:

- Digital pilot detection for excellent long term stability
- RF AGC for optimum C-QUAM decoder performance
- Minimal overshoot for accurate modulation level measurement
- Front panel audio output for transmitter alignment and proof of performance

The convenience features of the AS10 include a front panel headphone output, front panel audio output ports and modular internal PC boards. Lighted switch indicators and large, easy to read meters make the AS10 a pleasure to operate. Rear panel connections are provided for remote monitoring of peak meter readings and peak LED displays.

Mfr. List \$4,800.00

Call For BSW Price

QEI**695
FM Exciter**

The 695 is an advanced technology FM exciter with outstanding features, performance and audio quality. It is designed for unparalleled transparency in the information of program material to an FM signal. Noise and distortion of all kinds are reduced to a point that becomes difficult to measure.

Modulation metering and peak counter are built-in the front panel. QEI's "Automod" (Automatic Modulation Control) circuitry will maintain an optimum modulation level in spite of variations that may occur in the studio equipment or STL. In the unlikely event of a malfunction, the 695 Fault Annunciator panel will identify any major section in the exciter with the problem.

The 695 will operate with any stereo generator or 3 SCA inputs as well as a 600-ohm balanced line for mono signals. RF frequency is selectable and may be changed easily in the field without retuning. Power output is adjustable from 5 to 20 watts.

Mfr. List \$5,295.00

Call For BSW Price

**675
FM Exciter**

QEI's 675 exciter is a cost-effective alternative to the more feature-laden 695 shown above. The 675's center frequency is selectable in 100 kHz steps. A phase-locked-loop oscillator is referenced to an 8 MHz crystal with circuitry designed to minimize frequency drift that is at least five times better than FCC requirements.

Quality components and innovative design give the 675 amazingly good specifications. FM noise is better than -70dB, stereo separation is at least -42dB, total audio distortion .25% max. Output is adjustable up to 20 watts. Two SCA inputs are provided.

All parameters on the exciter are monitored by a switchable multimeter on the front panel.

Mfr. List \$2,795.00

Call For BSW Price

Acquire the equipment you need without jeopardizing
your cash flow!

Ask Us About *FlexLease* financing

MARTI**SCG10/SCD10
FM Subcarrier Generator/Demodulator**

The SCG10 is designed to operate with an FM transmitter or with the SCD10 demodulator to form an STL subcarrier link. Both the SCG10 and the SCD10 have several options available including: Selectable pre-emphasis of zero, 75, 150, or 225 microseconds, low pass audio filters of 3 kHz, 5 kHz, or 7.5 kHz, and separate compander encode and decode boards to help reduce noise and mask certain types of main to sub channel crosstalk.

SCG10 Mfr. List \$695.00

Call For BSW Price

SCD10 Mfr. List \$695.00

Call For BSW Price

MODULATION SCIENCES**SCA186
SCA Generator**

Sidekick combines the four elements needed for successful SCA operation into the one package: Subcarrier generator, modulation monitor, audio processor and transmitter tuning aid. Engineered to work together, these components form an integrated system which provides a level of performance previously unattainable. Crosstalk is dramatically reduced, signal quality is significantly improved and operation is greatly simplified.

Mfr. List \$3,835.00

Call For BSW Price

CATEL**FMS2000B
FM Modulator**

The FMS2000B FM modulator is designed specifically for the origination of stereo programming for cable radio and TV applications. With direct audio sources such as AM/FM tuners, tape decks, microphone preamplifiers and short wave receivers, it can add varied FM signals to the cable system. In addition to re-transmission of audio signals, FMS2000B is frequency agile from 87 MHz to 108 MHz.

Mfr. List \$995.00

Call For BSW Price

DIELECTRIC



RF Products

Dielectric manufactures a number of high quality RF related products including dehydrators, switches, loads, isocouplers, antennas and more.

Call Us For More Information

ELECTRO IMPULSE



RF Coaxial Loads

Electro Impulse is a leading supplier of specialized equipment for the communications and broadcast industries. Innovations such as dry, forced air cooled loads for FM broadcasters, termination type power meters, attenuators, high accuracy calorimeters that measure RF power, and other loads up to 1.5 million watts average power, are all representative of products which have emerged from their years of experience in this field. Many requirements can be met from either stock or custom design units. In either case, all products are backed by a 12 month warranty.

Prices Based On Configuration

KINTRONIC LABORATORIES

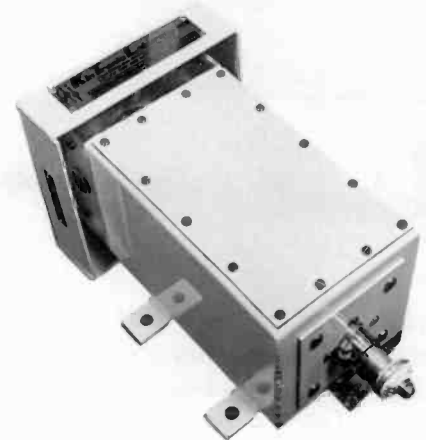

Isocouplers

Kintronic Laboratories Isocouplers provide versatility to existing AM radiating elements by allowing for installation of transmit/receive, FM/TV antennas operating in the frequency range of 30-1000 MHz without disrupting AM antenna characteristics.

**Call BSW Toll Free For Pricing Based
On Your Specifications**

ALTRONIC RESEARCH INC.

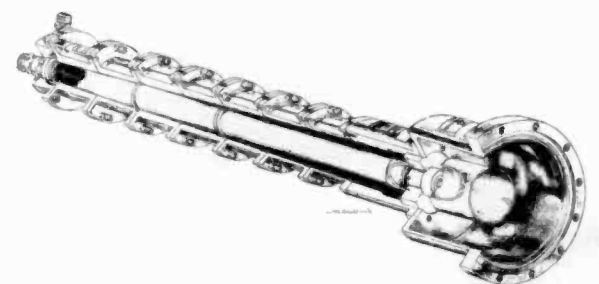

RF Coaxial Load Resistors

Altronic Research, Inc. manufactures the Omegaline RF coaxial load resistors (dummy loads). These are economical, lightweight, portable dummy loads for terminating coaxial transmission lines and are available in air or water cooled models. Users of transmitters, microwave components, and power tubes can be assured of ideal dummy load conditions during testing, adjusting and aligning.

Prices Based On Configuration

NEED PRICES ON A MAJOR PROJECT ?

Save yourself time and FAX us your equipment list. We'll have a complete price quote back to you in no time.

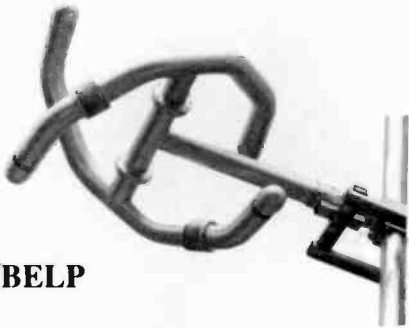
BROADCAST ELECTRONICS / ERI**BESP/BEMP/BELP
FM Antenna**

You can count on years of rugged performance with Broadcast Electronics/ERI Series of high, medium and low power FM antennas. The BESP (super power) and BEMP (medium power) both feature circular polarization, high input power ratings and a number of mounting options to fit any application. The BELP (low power) antennas utilize horizontally polarized radiators.

**Available On A Regional Basis Only
Call BSW For Prices And Availability In Your Area**

ERI**FM Antennas**

ERI is the only manufacturer to use large diameter outer conductors and a completely enclosed, pressurized, internal series feed system. The result is a very simple and reliable method of coupling power to the elements. Unlike our competitors, ERI's series fed antenna does not require a troublesome secondary current loop for element excitation with all the resulting disadvantages. The ERI patented design results in greatly increased single element impedance bandwidth. Specific applications have been measured in excess of 15 MHz at 1.5:1 VSWR points.

Regardless of the strength of your programming or the quality of your studio equipment, the antenna system is the final link to the audience and the key of your stations success. ERI antennas are of the highest quality.

Call BSW For Prices And Specifications

Need help in selecting the proper FM Antenna?
Call us toll free for assistance.

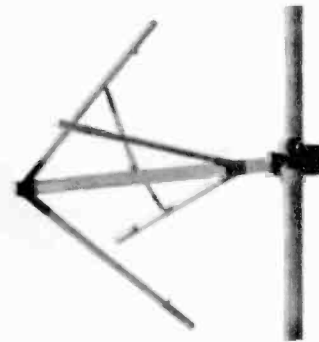
JAMPRO

The JHCP antenna is a circularly polarized FM antenna for the broadcaster who wants extremely high-input power capability, coupled with the patented design that has become an industry standard. This design is sophisticated in concept yet simple in execution. Each bay consists of a radiating element with its associated 6 1/8" (15.56 cm) interbay feed line. The element and line are supported by a heavy brass casting which is attached to the support structure by its mounting bracket.

The JHCP antenna is conservatively rated at 30 kW per bay, with a maximum system rating of 80 kW for three bays and above. These ratings are reduced well below both the average and peak power ratings for the power distribution system, with corona and high voltage arcing problems eliminated by the use of very low Q radiating elements.

Call BSW For Pricing And Specifications

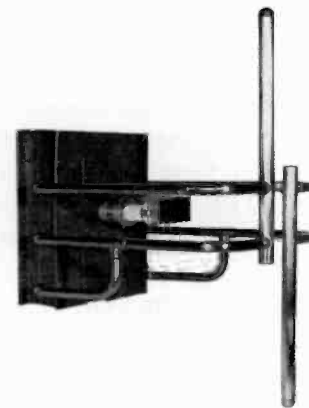
SHIVELY**FM Antennas**

A good antenna is crucial to quality broadcasting. An antenna that is merely adequate will compromise the performance of even the best studio equipment and transmitter.

Shively regularly includes standard features that other companies either provide only as options or simply do not offer.

- Pressure relief valves which allow purging of the entire system at any time, without climbing the tower.
- Custom designed, solid steel mounting brackets for each installation, instead of chains, as are commonly used.
- Individually grounded bays which give maximum protection to transmission lines from lightning damage without the need to purchase shorting stubs.

Shively engineering expertise and quality components further enhance performance.

Call BSW For Prices And Specifications

ANDREW



The Andrew Corporation, a world leader in the design and manufacture of communications equipment and systems, is well known in the radio broadcast community for supplying high quality transmission cable and related accessories. BSW is proud to represent a complete line of products for all your transmission cabling requirements.

Call BSW Toll Free With Your Requirements

CABLEWAVE

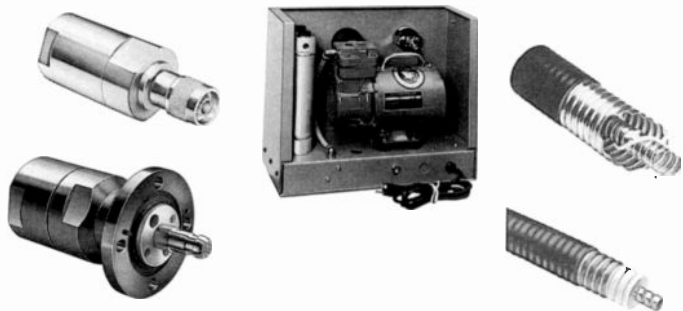

Cablewave Systems is dedicated to the design and manufacture of RF related products including: aluminum and fiberglass parabolic microwave antennas, Flexwell and Cellflex low loss coaxial cables, rigid coaxial lines, Flexwell elliptical waveguides, connectors, pressurization equipment, and RF associated accessories. BSW carries the complete line of Cablewave products and can supply the proper products for any situation.

Call BSW Toll Free With Your Requirements

DIELECTRIC



Dielectric is the worlds largest manufacturer of rigid coaxial transmission line. They have been supplying transmission line to communications professionals since the early 1940's. Many of Dielectric's early systems are still in operation after years of use and exposure to the elements.

Call BSW For Information And Specifications

BIRD

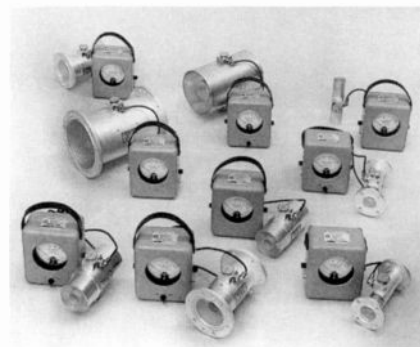

THRULINE® SERIES Watt Meters

Each Bird THRULINE® RF directional wattmeter is comprised of a line section and a direct reading 3 scale meter housed in a convenient carrying case. Measuring elements are ordered separately. A precise 50 ohm 1 5/8", 3 1/8", 4 1/16", or 6 1/8" coaxial air line is designed for insertion into your transmission line between transmitter and antenna or load. Each line section is equipped with one or two sockets into which plug-in elements with the desired power and frequency range are inserted. Double-socket line sections are for simultaneous measurement of forward and reflected power.

Call BSW For Configurations And Pricing

RF INDUSTRIES



RFA4024 Unidapt Universal Adapter Kit

Mix and match any male or female adapter section with any other SMA, N, UHF, BNC, TNC, or mini UHF section. Make any custom adapter you can dream up.

Each Unidapt filter has a common connector end, and a universal adapter end. You simply choose the two common connector ends you need, and screw them together with the universal adapter. It's so easy—that's why technicians love it!

BSW Price \$124.95

BROADCAST DEVICES**CDS-200
Composite Distribution Amplifier/Switcher**

The CDS-200 was designed to allow two switchable sources to be distributed to three locations. Sources within the bandwidth of 10 Hz to 100 KHz such as composite audio, SCA, or SAP signals can all be accommodated. Each output of the CDS-200 uses individual output amplifiers for maximum isolation. Level adjustments and switcher controls are conveniently located on the front panel. The switcher has remote control capability. A power fail memory will return the unit to the state it was in before a power interruption. The last selected input source is also hard bypassed to the main switcher output during a power interruption. Front panel test jack provided for connection of scope or spectrum analyzer.

The CDS-200 provides a reliable and simple means for backup source selection and signal distribution.

Mfr. List \$695.00

Call For BSW Price

MODULATION SCIENCES**CLD2504
Composite Distribution Amplifier**

Modulation Science's CLD2504 Composite DA is a problem solver. Its one-in four-out, unity gain configuration makes distribution of the composite baseband signal as easy as distributing audio. The high impedance input avoids circuit loading and the four low impedance outputs drive a wide range of equipment with greater than 50 dB of isolation between outputs. All connectors are BNC. The Composite DA lets you continuously and simultaneously drive dual main transmitters, main/aux/back-up transmitters, alternate stereo generators and processor setups, etc. Nocab switching, no changeover relays, no level changes and no hassles!

Mfr. List \$950.00

Call For BSW Price

DON'T SEE IT? - ASK US

This Catalog Represents Only A Fraction Of The Thousands Of
Items Available From BSW

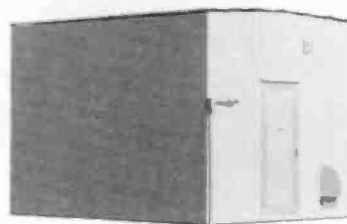
ROHN**Towers/Shelters**

Allow BSW and Rohn the opportunity to give you a quote on your tower and shelter requirements.

Rohn Towers are constructed with the finest materials. All tower sections are completely hot-dip galvanized after fabrication to protect all points of welding and construction against corrosion.

Rohn Shelters are available with a complete environmental control system and optional reinforced insulated aluminum doors with three-point locking systems.

Prices Based On Applications

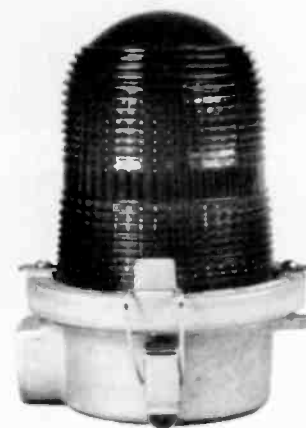
TWR**Lighting Equipment**

BSW sells a variety of tower lighting products including light fixtures, controllers, flashers and replacement bulbs.

Shown above is the OLI signal obstruction light with the following features: FAA approved, non-ventilated construction insures clean interior, copper-free aluminum castings, and neoprene and teflon gaskets.

Mfr. List \$71.50

Call For BSW Pricing And Other Lighting Configurations

SCIENTIFIC ATLANTA

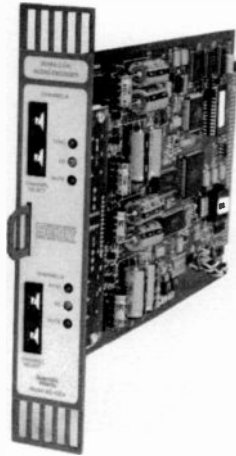

**AD4224/4225 SEDAT
Digital Audio Decoder**

These two channel decoders allow network affiliates to receive CD quality digital audio programming. They utilize Scientific Atlanta's SEDAT™ digital audio compression technology to provide 20 kHz audio in one third the bandwidth of the previous DATS system.

- AD4224 Mfr. List \$1,395.00** **Call For BSW Price**
(Fits Scientific Atlanta DAT-32 (7325) Chassis)
- AD4225 Mfr. List \$1,395.00** **Call For BSW Price**
(Fits DART384 Chassis)

WEGENER

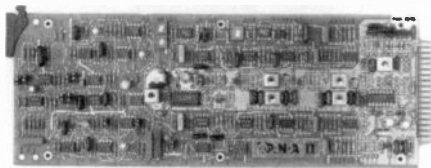
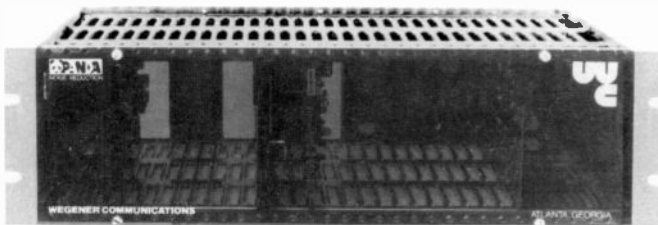

Satellite Radio Network Products

BSW is a stocking distributor of Wegener Radio Network products including subcarrier modulators, demodulators, tone encoders/decoders, mainframes, and stand alone satellite audio receivers.

Wegener's innovative audio products have become the world-wide standard for satellite delivered radio network programming and television network stereo sound. Over 40 domestic and international networks including Unistar, Jones Satellite Audio, and Satellite Music Network make use of Wegener products to deliver their signal. Let the professionals at BSW help you select a "custom fit" system for your application.

Call For Pricing And Configuration

ALC

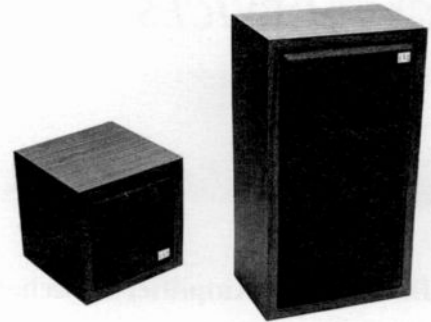

Dramatic response in a small convenient size. Ideal for broadcast control rooms, studios, remote recording and quality control areas.

**10302
Monitor Cube Speaker**

- Compact 7 7/8" cube • Full range • Snap-away grill • 60 Hz to 15 kHz
Mfr. List \$118.00/pair **Call For BSW Price**

**20306
Monitor Speaker**

- Flat response • 50 Hz to 20 kHz • 8" woofer • Walnut grain vinyl
- Two-way system with phenolic tweeter
- Compact 19 1/2" x 11" x 7 1/4"
- Mfr. List \$248.00/pair** **Call For BSW Price**

AURATONE



**5PSC/T5V/5RMC
Compact Monitor Speakers**

Auratone speakers have gained a world-wide reputation as reference monitors that reflect realistic sound without excess coloration. The prime example is their compact monitor known as "the Cube". The current "Cube" is the model 5PSC Primo Sound Cube™.

Model T5V takes the Cube a step further in a compact, shielded magnet, 2-way system that handles 50 watts of program power with an audible response of 40 Hz to 20 kHz.

The 5RMC is actually 3 shielded monitors contained in a three channel, three compartment ultra compact enclosure. It can be rack mounted and provides an excellent way of A/B testing of mono and stereo program sources.

- 5PSC** **Mfr. List \$129.00/pair**
- T5V** **Mfr. List \$225.00/pair**
- 5RMC** **Mfr. List \$193.50 ea.**
- RM525 (Rack Mount Kit For 5RCV)** **Mfr. List \$9.95**

Call For BSW Price

ELECTRO-VOICE**SENTRY 100A
Monitor Speaker**

Just because your monitor space is limited, you don't have to compromise on sonic accuracy. The Sentry 100A is a compact, no frills speaker system. It's the oldest member of the Sentry family and has become the industry standard of reliability. The Sentry 100A delivers a flat 45 to 18,000 Hz frequency response with a wide 120° dispersion at 5,000 Hz. The Super Dome™ tweeter handles a remarkable 25 watts of input power and is matched with an 8" direct radiator woofer in an optimally vented enclosure.

SENTRY 100EL

The Sentry 100EL combines the reproduction components of the Sentry 100A with an integral high performance 50 watt power amplifier that's perfectly matched to the requirements of the speaker system.

SENTRY 100A
SENTRY 100EL

Mfr. List \$344.00 ea.
Mfr. List \$727.00 ea.

Call For BSW Price

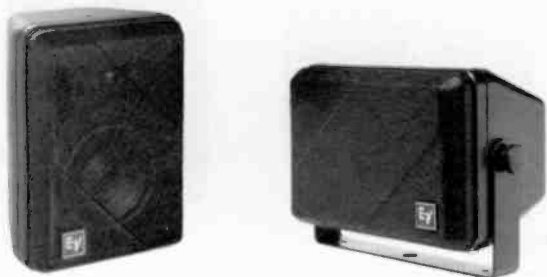
**S40
Compact Monitor Speaker**

The Electro-Voice S40 is a high-performance 2-way personal sized monitor housed in a high-impact polystyrene enclosure. It features a 5 1/2" direct-radiating polypropylene woofer coupled with a 1" ferro-cooled soft-dome tweeter. This combination produces exceptional bass response - more than any in its class - and a smooth, extended top end capable of reproducing the highest frequencies. Long-term power handling is rated at 160 watts. EV's exclusive PRO™ circuit provides independent protection for the woofer and tweeter. Optional mounting hardware provides a flexible mounting system for any application from microphone stand mounting to wall and surface placement. Available in black or white.

S40B **Mfr. List \$280.00/pair**
S40MBB (Mounting Bracket) **Mfr. List \$28.50**

Call For BSW Price

ELECTRO-VOICE**100S
Loudspeaker**

The 100S speaker system is unique among portable systems. Its performance and value is perfect for most small PA applications. Highly efficient, the 100S puts out plenty of room filling sound with only modest power input. Durable outer shell designed for travel.

Mfr. List \$500.00 ea. **Call For BSW Price**

YAMAHA**NS10MS
Studio Monitor**

The Yamaha NS-10MS Studio speaker system has been created specifically for close-field monitoring in professional sound studios. Optimum woofer/tweeter matching and careful crossover design ensure smooth, natural transition between frequency ranges with minimum phase variation. Frequency response is remarkably flat from 60 Hz right up to 20 kHz, and superior transient response delivers crisp, transparent sound.

Mfr. List \$430.00/pair **Call For BSW Price**

**S8M
Studio Monitor**

The S8M is the answer for those needing an economical reference monitor with good quality. The S8M provides a smooth, flat response from 50 Hz to 20 kHz, a fully developed sound field and full stereo imaging within a few feet of the speaker. Features high sensitivity and high power handling capability.

Mfr. List \$180.00/pair **Call For BSW Price**

SPEAKERS

JBL



4400 SERIES Studio Monitors

The 2-way Model 4406 monitor is ideal for console or close-in listening and features a low distortion 6" woofer and pure titanium dome tweeter.

JBL's 2-way 8 inch Model 4408 is an ideal choice for general broadcast monitoring applications. Utilizes low distortion 8" composite woofer and pure titanium dome tweeter.

4410 is a 3-way, vertical array system that gives maximum spatial detail at greater listening distances. It features a 10" woofer and has outstanding power handling capabilities and fidelity.

The 3-way Model 4412 is highlighted by an ultra-large, ultra-precise 12" laminate composite woofer. Its tight cluster arrangement, superior power efficiency, increased sensitivity and extended bandwidth make it the ultimate monitor for close-in listening.

4406 Mfr. List \$275.00 ea. 4408 Mfr. List \$350.00 ea.
4410 Mfr. List \$525.00 ea. 4412 Mfr. List \$795.00 ea.

Call For BSW Price



CONTROL 1



CONTROL 1 PLUS



CONTROL 5

CONTROL SERIES Compact Monitor Speakers

These speakers not only sound great, they combine rugged construction with a wide variety of mounting options for maximum flexibility. The Control 1 is a two way system with a 5 1/4" low frequency speaker and a polycarbonate dome tweeter; Frequency response is 70 Hz - 20 kHz. The Control 1 PLUS uses the same enclosure as the control 1, but uses a more powerful woofer and pure titanium diaphragm tweeter for even greater frequency range. The Control 5 monitor features a 6 1/2" woofer and larger carbon fiber for extended bass response. The Control 10 is a 3-way speaker that features a 12 inch woofer, perfect for large studios and sound reinforcement/PA applications.

CONTROL 1 Mfr. List \$260.00/pair
CONTROL 1 PLUS Mfr. List \$310.00/pair
CONTROL 5 Mfr. List \$420.00/pair
CONTROL 10 Mfr. List \$595.00 ea.

Call For BSW Price

JBL



4200 SERIES Monitor Speakers

The 4200 series from JBL is the shape and the sound of things to come. This radical speaker design was specifically developed for near-field monitoring. To provide maximum stereo imaging while reducing the potential for listener fatigue, the pure titanium dome tweeter and the cone transducer are offset and aimed to deliver both HF and LF information to the listening position at precisely the same instant. The 4206 has a 6 inch woofer and the 4208 contains an 8 inch woofer.

4206 Mfr. List \$395.00/pair Call For BSW Price
4208 Mfr. List \$525.00/pair Call For BSW Price

RAMSA



WSA SERIES Loudspeakers

Ramsa loudspeakers are tough, compact, and sound great. Use them as portable monitors, for remotes, or in clubs. The durable synthetic cabinets are designed for stacking or use with floor stands or other mounting hardware.

The WSA200 features a 12 inch woofer in a ported enclosure and a high-quality compression driver mounted to a constant directivity twin bessel horn. It delivers outstanding performance from 70 Hz to beyond the audible frequency range.

The WSA80 utilizes an 8" woofer and a 1" soft-dome transducer mounted in a constant directivity horn for maximum dispersion.

For applications requiring maximum bass output add the WSA240 subwoofer (same cabinet size as the WSA200) and WSSP2 subwoofer processor.

WSA200 Mfr. List \$650.00 ea. WSA80 Mfr. List \$300.00 ea.
WSA240 Mfr. List \$550.00 ea. WSSP2A Mfr. List \$300.00 ea.

Call For BSW Price

AUDIX



**PH5
Amplified Speaker**

Self-powered speaker features built-in 25 watt per channel stereo hybrid amplifier. 5 1/4" low frequency driver and 1" dome tweeter. Dual channel volume control and line level RCA inputs are provided. Power is via external 12 volt DC power supply (included). Price is for a pair of speakers, however amplifier is contained only in one speaker.

Mfr. List \$299.00/pair Call For BSW Price

FOSTEX



**6301B
Amplified Speaker**

The 6301B is completely self contained. The sound is delivered from a full-range speaker that's surprisingly flat and accurate. With a frequency response of 80 Hz to 13 kHz, the 6301B makes an ideal reference monitor for producing music, radio spots or audiovisual sound tracks. The built-in 10 watt amplifier will handle anything you feed it. The 6301B's input has been designed to accept any line or instrument-level input, even from an amplifier. There's no confusion, just one 1/4" phone jack to deal with.

Mfr. List \$370.00/pair Call For BSW Price

KOSS



**SA30
Amplified Speakers**

These little powered speakers use 4 "C" size batteries (2 per speaker) and plug into the/headphone circuit of any piece of equipment via 1/8" mini plug (can be modified to 1/4" for standard headphone jacks). Includes bass boost, treble boost, power indicator LED, and separate volume controls per speaker.

Mfr. List \$34.99/pair Call For BSW Price

OMNIMOUNT



Speaker Mounting Brackets

Installing speakers is no easy task unless you use Omnimount speaker brackets. Only Omnimount offers models that allow you to mount speakers from assorted angles and locations. Weight handling ranges from 1 pound to 255 pounds. Call BSW with your requirements and we will suggest the proper Omnimount for you.

Price Based On Configuration

PIVOTELLI



Speaker Mounting Brackets

Pivotelli supports are made from the finest solid premium grade steel which is contoured at all edges and joints and coated with durable nylon finish for maximum protection. Tightly clamping grips mean you never have to drill holes in speakers or other equipment. Pivotelli supports come in a wide range of styles from simple single pivot to complex multiple pivot systems. They can accommodate cabinet sizes from 7 1/2" to 47" and weights up to 176 lbs. safely and securely.

Call BSW With Your Requirements

STUDIO FURNISHINGS

EXPRESS GROUP

Express Group systems represent the highest quality modular furniture in the world, bar none. Since inception, the Express Group's dedication to quality has set a standard of excellence by which all other manufacturer's products are judged. All Express Group Studio Furniture Systems feature the same high-quality materials and craftsmanship throughout.

The following features are common in all six series:

- Void-free birch plywood construction
- Poplar hard-wood as internal support pieces for added strength,
- Non-splitting, non-marring, high-impact corner guards on all outside corners for protection
- Unique edging system around lower section of all modules to prevent chipping
- Numerous and generous access panels including both front and inside areas
- Quick, quarter-turn fasteners on all removeable access panels
- Factory installed rack rails
- Custom cut-outs for control consoles and turntables are included
- Large built-in wire passes
- High-impact laminates of dove gray and black. Custom colors available
- Easily adjustable leveling feet on all floor cabinets
- Built-in passive ventilation
- No use of particle board anywhere except for turntable base supports to eliminate acoustic resonance
- Shipped as fully assembled modular pieces for quick and easy installation
- Delivery of some standard units in as little as two weeks
- Standard-U models available for all series
- Exotic hardwoods available
- Specialize in custom configurations. More than 70% of all Express Group designs and fabrications are custom, one-of-a-kind products.

Call BSW For Complete Details And Pricing



MURPHY FURNITURE

Standard features on all Murphy Furniture include oak trim on all exposed edges, a bumper base covered with a non-chip material, plexiglass panels over racks near operators feet and sloped faces on all returns. Wire management and passive ventilation systems have also been incorporated into the designs.

The Elite Series offers a curved bumper base, single level construction and total modularity.

The Premier Series has a flat bumper base, bi-level construction and offers flexibility of layout.

The Dub/Edit Station is a durable desk system with a wire management area.

The Classic Series is an economy line of furniture featuring a wire management area formed by modesty panels around the outside perimeter and aprons around the inside perimeter, 1" thick oak trimmed legs and 1 1/2" x 3/4" oak trim around the counter level. There is a square rack component that sits on the countertop. This line has no undercounter rack space.

Murphy's concept is modular construction with custom fit. The flexibility of these furniture systems will address all your needs. Delivery is 2-4 weeks depending on customization required. This furniture will be shipped RTA" (Ready To Assemble) via van line carriers. Customization of any system component is available.

Call BSW For Pricing And Configuration

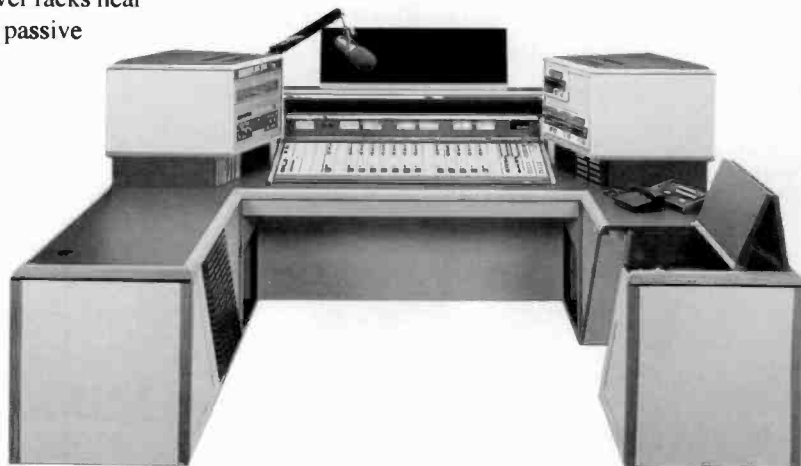

AUDIOARTS

Audioarts Furniture

This furniture will give your station the look that instills confidence and pride. Plus, it's been engineered to simplify your design phase and assure a smooth, flawless studio installation.....on time.

You can choose from a large variety of stand-up or sit-down furniture arrangements including a full range of interview counter configurations. All components are fully integrated, letting you obtain predictable results. You know all the pieces will fit together precisely...no last minute gotchas!

Engineers will love the generous wire passages, oversized rear access panels, and best of all, the large punchblock panel with removeable concealment door.

This Furniture System Is An Elegant Engineering Accomplishment.

It will allow you to put the greatest amount of equipment in the least amount of space with the least amount of effort. It uses the latest in steel structurally reinforced cabinetry. The detailing is immaculate, with high-grade hardwood protected corners and counter edging (to eliminate corner chipping and peeling). Seamless high pressure heavy duty horizontal grade laminated surfaces prevent dirt build-up and chipping.

Call BSW and allow us to send you a detailed information guide to Audioarts Furniture with 20 standard studio configurations.

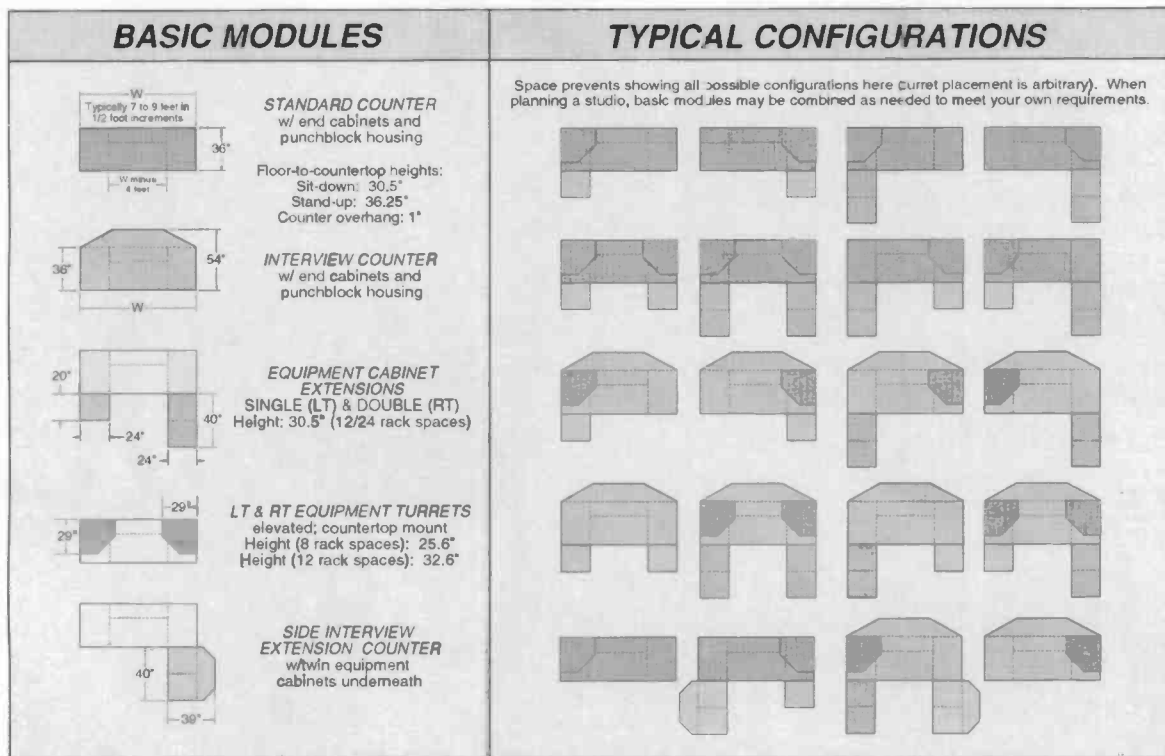

NIGEL B. FURNITURE



Nigel B. furniture is designed with a building block approach to allow for personalized configurations at a fraction of the cost of custom built systems. These components are of highest quality and guaranteed for life. Systems range from elaborate work systems to simple edit/dub stations, with an infinite number of combinations in between.

Each component is made with superior grade cold rolled steel between .06" - .125" thick and load tested to handle any audio or video equipment. Once formed and welded, each steel part is carefully grounded and sanded, then finished with scratch resistant, oven baked enamel. Desk tops are formed in one piece with rolled edges for comfort and safety.

Forget about waiting weeks for your furniture, with Nigel B. most items are in stock and will ship within 48 hours of receipt of order from BSW. Their pack flat approach means lower shipping costs and many items can ship UPS.

In addition to superb furniture, Nigel B. supplies a number of rack accessories and studio support products. Shown above are the PLRS recorder stand with 13U of rack space on top and 8U of space down below, the PLDERS desktop version of the roll-around stand.



PLRS Recorder Stand
PLDERS Desk Top Rack Stand

Mfr. List \$299.95
Mfr. List \$159.95

Call For BSW Price



Call BSW Today For A 24 Page
Catalog Showing The Complete Line
Of Furniture At 800-426-8434



PLRS



PLDERS



560

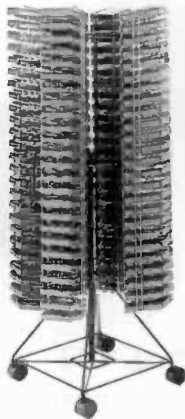

MR200

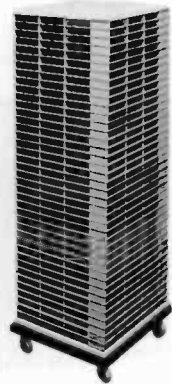

100-600

ABCO

Wire Cart/CD Racks

Models	Mfr. List
300 (Holds 300 carts)	\$408.45
500 (Holds 500 carts)	\$628.95
280 (Holds 280 CDs)	\$368.00
560 (Holds 560 CDs)	\$666.75

Call For BSW Price

FIDELIPAC

Cartridge Racks

Models	Mfr. List
MR200 Lazy Susan (Holds 200 Carts)	\$390.00
TR48 Lazy Susan (Holds 48 Carts For Countertop Installation)	\$109.00
TR96 Lazy Susan (Holds 96 Carts For Countertop Installation)	\$194.00

Call For BSW Price

INFORMATION DESIGN

Cart Rack Systems

Features: Desk top or floor use • Modular construction for add-on expansion • High-impact polystyrene

Models	Mfr. List
100-60 (60 Carts Includes Top And Bottom)	\$123.00
100-120 (120 Carts Includes Top And Bottom)	\$181.00
100-240 (240 Carts Includes Top And Bottom)	\$297.00
100-360 (360 Carts Includes Top And Bottom)	\$413.00
100-600 (600 Carts With Flat Base And Castors)	\$698.00
115 Flat Base With Castors	\$70.00
120-1 Metal Storage Base With Castors	\$184.00

Call For BSW Price



A.



B.



C.

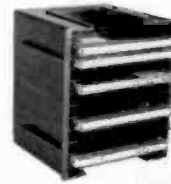

E.

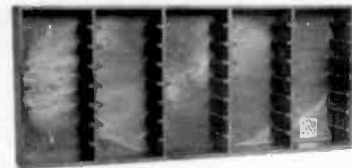

D.

ATLANTIC

(A) 1213/1217 CD or Cassette Module

Sturdy steel construction, mar-resistant matte black finish. Can be wall mounted or stacked on an optional swivel or fixed base. CD module holds Denon cartridges.

1213 CD Module	BSW Price \$21.95
1217 Cass. Module	BSW Price \$21.95

BSW

(B) AW20 Cart Rack

Holds 20 carts, Made of high impact polystyrene, Great for wall mounting. Includes mounting screws.

BSW Price \$14.25 (Quantity Discounts Available)

(C) AW40 CD Rack

Holds 40 CDs. High impact polystyrene, wall mounting with mounting screws.

BSW Price \$29.25

SOHO

(D) CD1BLACK/CD1 SYSTEM CD Racks

These inexpensive, tough racks hold 12 CDs in each stackable, wall mountable unit. System consists of 12 units. Fits Denon cartridges.

CD1BLACK (Holds 12 CDs)	Mfr. List \$5.50
CD1SYSTEM (Holds 144 CDs)	Mfr. List \$45.00

Call For BSW Price

BRYCO

(E) DRP40 DAT Rack

Precision formed, super tough plastic. Holds 40 DATs.

Mfr. List \$21.95	Call For BSW Price
-------------------	--------------------

PRORAX

Storage Racks

Hundreds of stations have specified ProRax for their cartridge, cassette and compact disc storage needs. ProRax racks are constructed of the finest quality oak or mahogany hard woods. No particle board or laminates are used. ProRax carousel models have storage on two sides instead of four, allowing for easier indexing and location. The turning radius is smaller so less countertop or floor space is required. With over 17 models to choose from, we are sure to have the ProRax just right for your operation. Most models are in stock for immediate delivery.

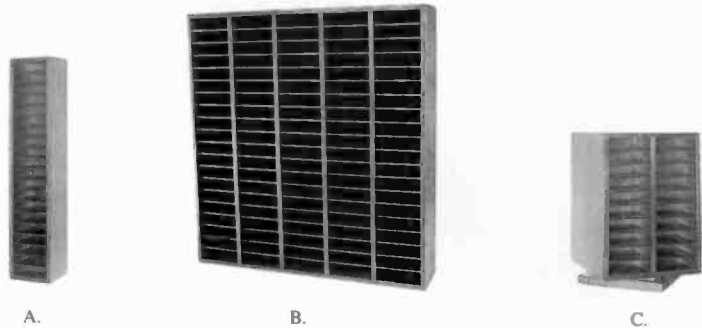

MODEL	DESCRIPTION	WALNUT	OAK
A. W20	Cartridge / Wall Mount - 20 space - 5 1/4"W x 24 1/2"H x 4 3/4"D	\$45.00	N/A
B. PRORAX100	Cartridge / Wall Mount - 100 space - 23 1/2"W x 24 1/2"H x 4 3/4"D	\$99.95	\$112.00
C. C40	Cartridge / Carousel - 40 space - 13 3/4"H - Turning Radius 13 3/8"	\$79.00	\$79.95

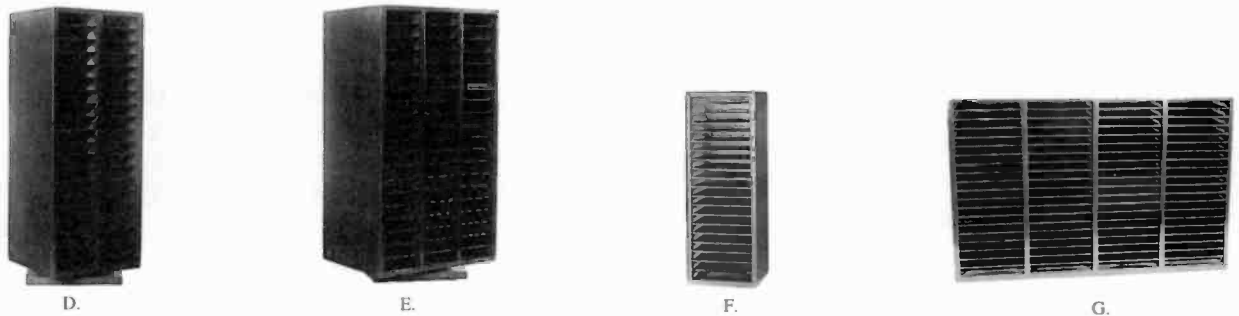

MODEL	DESCRIPTION	WALNUT	OAK
D. C80	Cartridge / Carousel - 80 space - 25 1/2"H - Turning Radius 13 1/2"	\$117.00	N/A
E. C120	Cartridge / Carousel - 120 space - 25 1/2"H - Turning Radius 17"	\$159.00	\$169.00
F. CD20W	CD / Wall Mount - 20 space - 6 1/4"W x 16 1/2"H x 4 3/4"D	\$39.00	\$45.00
G. CD80W	CD / Wall Mount - 80 space - 23 1/4"W x 15 1/8"H x 4 5/8"D	\$89.95	\$104.00

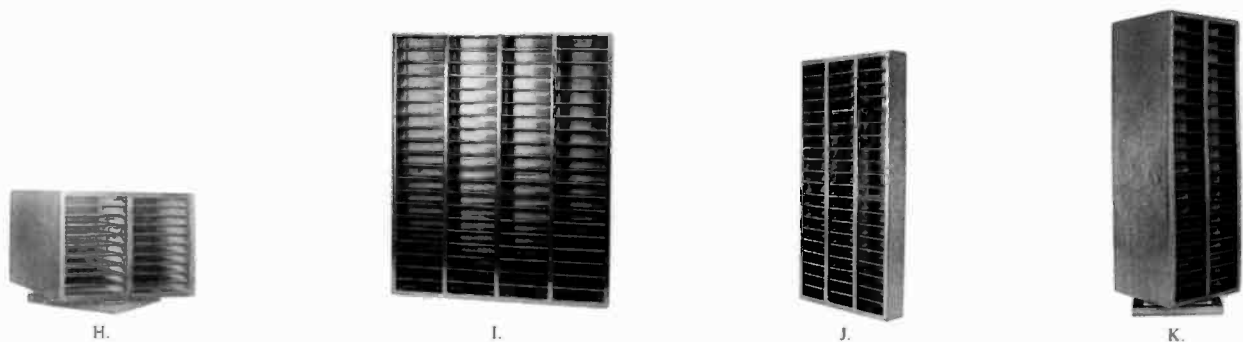

MODEL	DESCRIPTION	WALNUT	OAK
H. CD40LS	CD / Carousel - 40 space - 9 1/4"H - Turning Radius 11 3/8"	\$78.00	\$89.95
I. CS80W	Cassette / Wall Mount - 80 space - 20 3/16"W x 24 1/2"H x 3"D	\$79.00	\$89.00
J. DR60W	DAT / Wall Mount - 60 space - 23 1/2"H x 12 3/8"W x 2 1/2"D	\$59.00	\$75.00
K. DR80LS	DAT / Carousel - 80 space - 25 1/2" - Turning Radius 11 3/4"	\$99.00	N/A

MIDDLE ATLANTIC

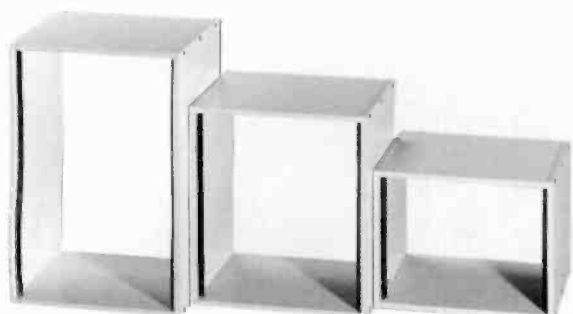

RK SERIES Equipment Racks

High quality, inexpensive equipment racks. Ship flat for easy storage. Assemble quickly with included allen key. Decorative screw caps snap on. Constructed of 5/8" thick, high density particle board, covered with laminate. Rack rails are 1/8" thick black baked enamel steel, tapped full hole spacing to fit all equipment. Rear rack rail option available. 15 7/8" Deep.

RK8 14" (8 space)	Mfr. List \$120.00
RK12 21" (12 space)	Mfr. List \$127.00
RK16 28" (16 space)	Mfr. List \$137.00
RK20 35" (20 space)	Mfr. List \$154.00

Call For BSW Price

QUIK LOK



RS SERIES Equipment Racks

Quik Lok offers an alternative to expensive rack cabinets with heavy duty metal tube construction equipment racks. The RS955 and RS956 are lightweight rack modules that hold up to 10 rack units each. Modules can be stacked up to three high for a total of 30 rack units of space. Both models are identical except that the RS955 has castors. The RS957 is an 8 space, table top rack that is ruggedly built and includes rubber feet for secure placement that won't scratch counter tops. All units are UPS shippable and come complete with all necessary hardware and tools for assembly.

RS955 Mfr. List \$169.95	Call For BSW Price
RS956 Mfr. List \$139.95	Call For BSW Price
RS957 Mfr. List \$69.95	Call For BSW Price

SOUNDOLIER



100 SERIES Equipment Racks

100 Series rack cabinets from Soundolier are cost effective and come in pre-welded and knocked down versions in a number of sizes and colors. Units come with standard rack rails tapped 10-32, louvered side panels, and louvered, locking rear door. Call BSW with the size and features of rack you require for a proper price quotation.

Pricing Based On Configuration

TASCAM



CS607B Roll Around Equipment Rack

Rack-n-roll your equipment with the Tascam CS607B heavy duty portable rack. Ideal for engineers and audio professionals on the move. The CS607B is perfect for mounting reel-to-reel machines. Two large knobs and backing pins allow the rack frame to tilt from vertical to horizontal, so equipment can be placed in the most convenient position for your working environment.

The RTS15 roll around stand (not pictured) is similar to the CS607B except it is for lighter duty use

CS607B	Mfr. List \$575.00
RTS15	Mfr. List \$275.00

Call For BSW Price

BSW



**RS2
Rack Shelf**

Our most popular utility rack shelf that is perfect for all those pieces of equipment that need to be in a rack, but lack proper rack ears. Durable flat black finish in heavy gauge steel. Requires 2 rack spaces. Depth is 14 1/2"

- RS2 rack shelf
- RS rack screws (100 count)

BSW Price \$29.95
BSW Price \$12.95

BGW



Rack Accessories

BGW, the amplifier manufacturer, makes a quality line of rack mount accessories including rack shelves, fan panels and fans, blank panels, vented panels, and termination panels for XLR, D-Series, and BNC connectors.

Call Us With Your Requirements

MIDDLE ATLANTIC



Rack Accessories

Middle Atlantic has a wide variety of rack accessory items that facilitate the mounting of just about anything into a standard 19" equipment rack. They feature a complete line of rack shelves, both stock and custom sizes to fit virtually any piece of equipment. There's a family of storage products including rack drawers and holders for CDs, DATs, cassettes and LPs. They also feature a complete line of rack panels including plain blank panels, vent panels, security covers, and custom drilled panels to accommodate the most popular connectors. Let a BSW representative help you solve the rack need you have with Middle Atlantic.

PROFOAM

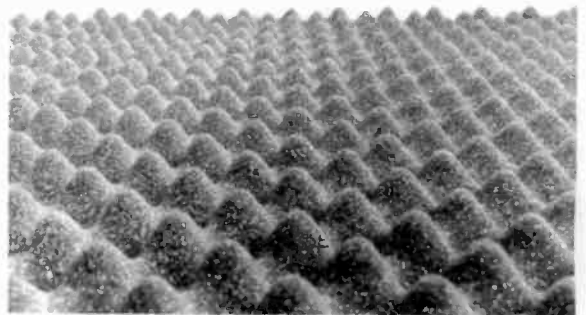

**PROFOAM
Acoustical Foam**

Profoam has become very popular in broadcast and recording environments. Large sheets make installation quick and easy. Sheet size is 4 1/2' x 6' (27 square feet). Available in 2" or 3" thicknesses. Color is charcoal grey and blends with most studio surroundings. Profoam is UPS shippable so you'll save on shipping costs and time. 2 sheets per package.

PROFOAM 2" **BSW Price \$49.95 per sheet**
PROFOAM 3" **BSW Price \$56.95 per sheet**

SONEX

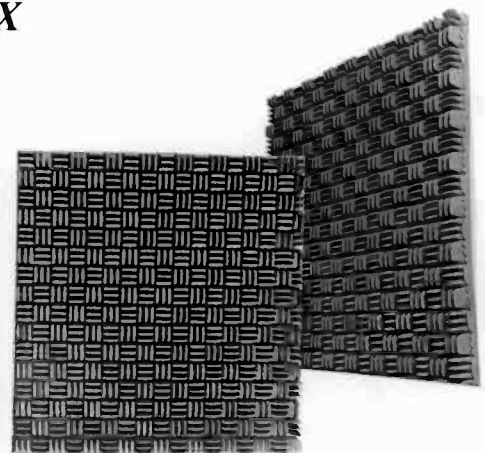

Acoustical Foam

Sonex gives you the greatest choice of colors, thicknesses and sizes of acoustical treatment. Choose from 2' or 4' squares in 2", 3" or 4" thickness. Colors are charcoal, blue, brown, and beige. Sonex 1 is available for facilities such as schools, churches, offices, or anywhere Class 1 building codes are applicable.

Call For Pricing And Technical Specifications

About Acoustical Foam

Before you install any acoustical foam, it is best to check with your local fire department for regulations in your area. BSW will not be responsible for removal and return of acoustical equipment after installation. We are happy to provide samples and specifications for

FIDELIPAC



**340 SERIES
Warning Lights**

The standard warning light used nationwide. Back-lit red letters on black background. Available in several languages. Dimensions: 5"H x 10"W x 2 1/2"D. 120 volt

- 65340 (On Air) Mfr. List \$72.00 Call For BSW Price
- 340REC (Recording) Mfr. List \$72.00 Call For BSW Price

PROLITE

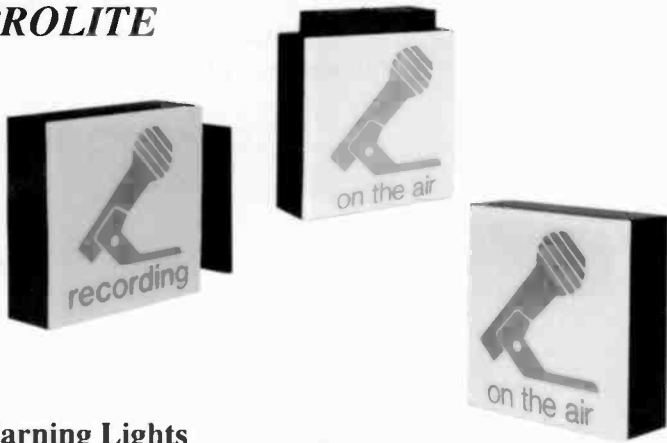

Warning Lights

Designed to fit a variety of interior specifications, the Prolite Architectural Series lights are attractive as well as functional to warn that a microphone is on. Housing and canopy are triple ground, cast aluminum with a baked, matte black enamel finish. Dimensions are 7 1/2" square. Two 20W, 6 1/2" long life lamps are supplied. 120 volts required for operation. Choose from 3 configurations with either on air or recording symbols.

- AW (On air) BSW Price \$99.00
- RW (Recording) Flat Wall Single Lens BSW Price \$99.00
- AW2 (On air) BSW Price \$99.00
- RW2 (Recording) Extended Wall Double Lens BSW Price \$99.00
- AC (On air) BSW Price \$99.00
- RC (Recording) Extended Ceiling Double Lens BSW Price \$99.00
- Extra Lenses (Specify On air or Rec.) BSW Price \$14.95

**L101
On Air Light**



Prolite L101 is a great on air light when space is the most important consideration. The L101 fits in a standard single duplex electrical box. It operates on 12 volt DC (power supply not included). Plastic lens is available in white or red color (specify).

BSW Price \$22.95

TITUS TECHNICAL LABS



**OAL SERIES
Warning Lights**

Provides the broadcaster and recording studio with a beautiful but practical means of indicating that a studio is in use. These lights feature a smoked glass window mounted in either a gold or silver frame which is attached to a solid wood mounting base. Oak is the standard wood used but custom woods are available. The warning "ON AIR" or "RECORDING" only appears when illuminated and is blacked out when not in use. Orientation is either vertical or horizontal and wiring is class-2 type low voltage.

BSW Price \$125.00

ENBERG

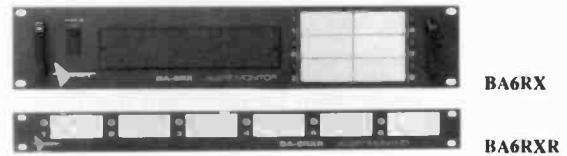

BA6

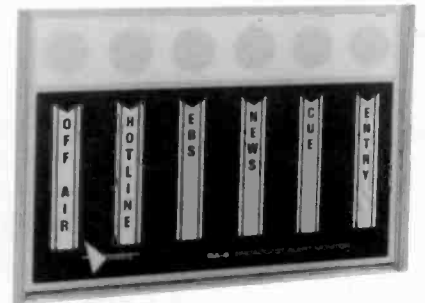

**BA6 SERIES
Alert Monitors**

Off the Air... EBS warning... Telephone hotline ringing? Find out in an instant visually with the BA6 from Enberg Electronics. This practical device is attractive as well as functional and interfaces with a variety of equipment to inform you of status immediately. Features 3 modes of operation, flashing 4,000 hour indicators, opto-isolated inputs and solid state relays. The BA6RX is a rack mount version of the BA6 and is only 2U high. It is capable of driving remote displays and comes with the FN6 phone module for signaling incoming phone calls.

- BA6 Mfr. List \$379.00
- BA6R (Remote) Mfr. List \$199.00
- BA6RX (Rack Mount Monitor-Includes FN6) Mfr. List \$379.00
- BA6RXX (Rack Mount Remote) Mfr. List \$119.00
- FN6 (Phone Module) Mfr. List \$35.00
- Standard Label Set Mfr. List \$15.00

Call For BSW Price

PROLAMP



LED Replacement Lamps

Our flange based multi LED miniature lamps are exact replacements for T 1 3/4 and T 1 1/4 incandescent miniature lamps. Shock and vibration proof, they keep your lighted panel and switches going "on" for 100,000 hours. Specify lamp you are replacing, color desired (red, green, or yellow), and center-tip polarity of socket.

Price Based On Configuration

LITTLELITE



**L3/12
High Intensity Light**

Here's a gooseneck mounted high intensity light that features a quartz halogen bulb, a dimmer control with off position, a wall plug-in transformer with 6' cord, and permanent mounting hardware included. Perfect for illuminating turntables consoles, or equipment racks.

Mfr. List \$57.00

Call For BSW Price

PERFECT DATA

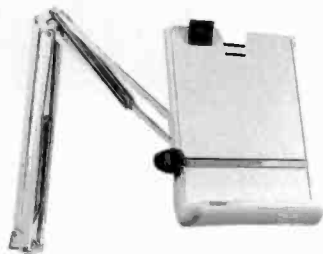

**16007/16008
Copy Holders**

These functional, stylish holders are designed for letter, legal, and A4 size documents. A spring-loaded line guide can be mounted on either the left or right side and a spring loaded holder clip keeps copy in place. Model 16007 features a lightweight arm for normal copy, the 16008 has a heavy-duty arm for books or stacks of copy. Both holders come with a table clamp mount. Model 16055 is an extension piece that allows the holders to accommodate wider copy.

16007 BSW Price \$45.95

16008 BSW Price \$55.95

16055 BSW Price \$18.95

SETH THOMAS

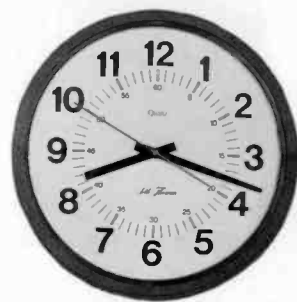

**710
Wall Clock**

Here's our most popular clock that is perfect for all studios. Quartz control assures accurate time. Battery powered by one "AA" cell that will last over a year. Brown case, 14" diameter. red sweep hand.

Mfr. List \$35.00

Call For BSW Price



**709
Wall Clock**

AC powered, the model 709 is easy to read from a distance. Diameter is 14" in a brown molded case.

Mfr. List \$25.00

Call For BSW Price



**2636
Wall Clock**

Quartz accuracy and extra bold dial graphics. Popular 14" case size is light beige in color. Shatter resistant, crystal face cover. Red sweep second hand. Uses one AA battery.

Mfr. List \$35.00

Call For BSW Price

RADIO SYSTEMS

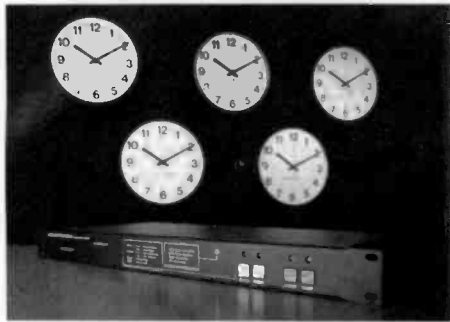

Analog Master Clock System

Radio Systems' low-cost impulse clock system offers features not found on units costing ten times as much. Super-stable and reliable operation is achieved through the use of a digital divider and pulse synchronizer board installed on the rear of each slave clock. This board also allows each clock to be frozen, set individually, and then accurately sync-started from the master impulse driver.

The single space rack mount driver derives its time-base reference from either AC line or crystal references (user-selectable). The driver automatically switches to a battery-backup, internal crystal oscillator if line power is lost. An optional TCXO super-stable crystal is available for users requiring extra accuracy.

Front panel switches greatly simplify the clock-set procedure by providing one second "bump-up" or "bump-back" control. The driver also features buttons which automatically stall all clocks or run them at twice normal speed for Daylight Savings or Standard Time changes.

Up to 50 RS clocks may be connected via any 3 conductor cable. Wiring may be via a "round robin" or home-run pattern.

- RS Master Clock Driver Mfr. List \$625.00
- RS 12" Analog Clock Mfr. List \$125.00

Call For BSW Price

ESE

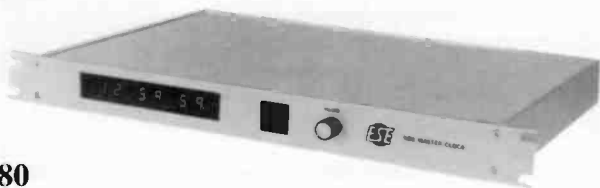

ES180 Master Clock System

In order to satisfy a wide variety of requirements, ESE has created an extensive line of master clocks and accessories. Only one pair of wires is needed to distribute time code to remote displays. As many as 100 slaves can be connected up to a distance of 3000 feet.

The rack mounted ES180 Master Clock receives and decodes the radio time transmitted by the National Bureau of Standards. Serial time code option provides time data to the slaves. Stand-by battery offers 10 hour backup in event of power failure. Accurate at all times.

- ES180 NBS Master Clock Mfr. List \$2,100.00
- ES161A Remote Digital Display .55" LED Display Mfr. List \$201.00
- ES166F Remote Digital Display 1" LED Display Mfr. List \$310.00

Call For BSW Price

Other ESE Master Clocks and displays available

ESE

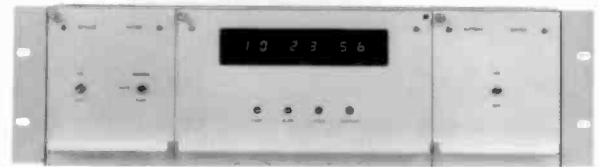

ES160 Master Clock

The ES160 master clock is mounted in a 5 1/2" rack chassis and displays six digits of time information on large, easy to read, 4" LED display in a 12 hour format.

The ES160 has its own internal timebase with three second per month accuracy. Its standard output is serial BCD, CMOS compatible and can drive up to 100 ESE digital displays without buffering. All inputs and outputs are through rear mounted connectors. Back-up battery and charger are included.

- ES160 (3 sec per month accuracy) Mfr. List \$1,315.00
- ES160/1 (1 sec per month accuracy) Mfr. List \$1,525.00

Call For BSW Price

Several models of remote displays available with a wide array of options. Call BSW for more information and pricing.



ES172A 12 Hour Clock

Six digits, compact enclosure, bright, easy to read 0.4" red LEDs. Three setting controls - Fast Advance, Slow Advance, and Hold. Four line multiplexed BCD is present on the rear connector. Dimensions: 2.1"H x 4.5"W x 4.13"D. Case is high impact black plastic. Other models available with 1/2" 1" and 2" displays.

Mfr. List \$192.00

Call For BSW Price

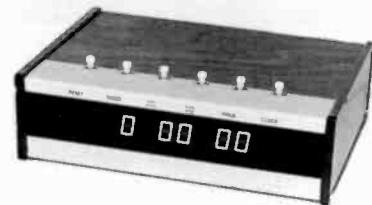

ES562F Studio Timer

The ES562F is a time of day clock and a count up timer. Display is in hours, minutes, and seconds. Memory allows timer to be used while keeping correct time of day. Other models including up down timers and master timer systems available on request.

Mfr. List \$380.00

Call For BSW Price

ESE



**ES520
60 Minute Count-up Timer**

The ES520 is a four digit, sixty minute timer with start, and reset controls. Runs continuously unless stopped or reset. If stopped, display will hold time reading and when restarted will continue from last displayed figure. If reset while running, timer will continue to run. Displays are .5" bright orange LED. Also features serial time code output to drive slaves. 4 open collector inputs for trigger reset and remote capability.

Mfr. List \$179.00

Call For BSW Price

RADIX



**ST500
10 Hour Programmable Up/Down Timer**

Perfect for control room, production or news room. Time events to 9 hour 59 minutes 59 seconds. Large—Highly visible red display digits 1/2" high. Rear terminal strip interface allows remote start, stop and reset. Powerful microprocessor allows preset times from memory to count up or down. Outstanding value.

Mfr. List \$225.00

Call For BSW Price

CALCULATED INDUSTRIES



**3032 TIME MASTER
Time Calculator**

Get fast accurate answers to your time calculations in the time format of your choice with the Time Master calculator from Calculated Industries. The Time Master is a professional calculator that adds, subtracts, multiplies, and divides in mixed or like time formats. You can easily add amounts of time to points in time, convert time formats, find elapsed times, round time values, multiply by an hourly rate and much more. This useful tool is backed by a 1 year warranty.

BSW Price \$69.95

Ask About Frame Master™ And Frame Master Plus™ Time-Code Calculators.

RODCO



**COMPUTEMP 5
Time/Temperature Monitor**

This unit accurately monitors outdoor and indoor temperatures and time of day. Features: Temperature alarm alerts to any predetermined setting • 14-hour memory of daily high and low temperatures and the exact time of the occurrence • Continually alternating LED display • Battery back-up system to retain memory • Removable temperature sensors • Optional rotary switch for monitoring up to nine locations • 30 feet outdoor cable standard (additional lengths available).

BSW Price \$89.95

TELTEK



**INFORMER II
Digital Temperature Gauge**

For accurate temperature reporting, we recommend the Informer II. LCD display operates on one AA battery (replace yearly). Records high and low temperatures in memory. Very accurate and works in high RF fields. Includes 50 feet of cable for outside probe (additional lengths available)

BSW Price \$59.00

RAINWISE



**WS1000C
Digital Weather Station**

The WS1000C provides digital readout for time, indoor and outdoor temperature, barometric pressure, wind direction, wind speed, wind chill, rainfall and accumulates, degree/day heating, and degree/day cooling throughout the year. Maximums and minimums are provided for any desired period to the nearest hour, day, and month. The unit is 7" high, 17 1/2" long, 1 1/2" deep, and may be mounted without cutting a hole in the wall. The unit uses a low voltage transformer that plugs into a standard AC receptacle. Optional battery pack available. Computer compatible models available.

WS1000C (With 100' Cable)

Mfr. List \$1,068.00

Call For BSW Price

TELOS



**TELOS ONE/ONE PLUS ONE
Digital Telephone Hybrids**

The Telos ONE is the perfect low-cost solution for any telephone interface application. The Telos ONE automatically adapts to each call and all processing in the digital domain. Performance features include sophisticated AGC on input and output: an advanced downward expander on the caller audio; and digital processing to dramatically reduce the chances for feedback when monitoring with open speakers.

The input of the Telos ONE is switchable for mic or line level and two outputs are provided. One or two Telos ONEs may be rack mounted in optional, one unit high accessory panels.

The ONE Plus ONE starts with two Telos ONE digital hybrids in a single rack chassis. Each hybrid functions independently. A unique internal mix-minus matrix cross couples the outputs of two hybrids. In a dual hybrid application, you need only to send the ONE plus ONE a single mix-minus.

TELOS ONE Mfr. List \$985.00
TELOS ONE plus ONE Mfr. List \$2,180.00

Call For BSW Price



**100 Delta
Digital Telephone Hybrid**

The advanced digital signal processing (DSP) in the Telos 100 Delta results in full-duplex, natural sounding conversation on even the most difficult phone lines. Plus, smart digital gain control and equalization offer increased caller intelligibility.

The dynamic digital equalizer is so advanced its technology is not currently found in any other broadcast product. The EQ examines the caller audio in three bands and automatically equalizes the high and low bands, with reference to the middle band, to create uniform spectral density.

Other digital processing components include dynamics control, context sensitive output AGC, and feedback suppression for greater gain before feedback when monitoring callers through open speakers.

Installation and operational enhancements include dual inputs and outputs, comprehensive metering, and two remotely selectable adjustments for caller override.

Mfr. List \$2,450.00 Call For BSW Price

TELOS

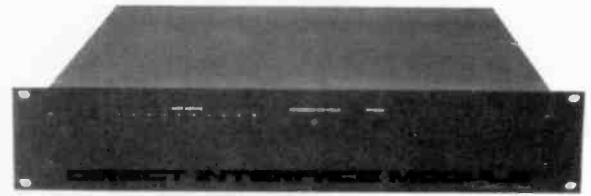

**Direct Interface Module/1A2 Interface Module
Multi-line, Multi-Caller Talk Systems**

Telos offers two options for selection and control of multiple telephone lines in broadcast systems. The Direct Interface allows direct connection of up to 10 phone lines. It functions as a full broadcast phone system including program on hold and caller conferencing.

The 1A2 Interface Module makes use of standard 1A2 key telephone equipment. Each handles 10 phone lines and units can be coupled to handle up to 30 lines.

Control options include a desktop switch console and drop-in modules for BE, PR&E, and other popular radio consoles. Caller screening is accomplished with phones or Telos' Call Screen Manager computerized software.

DIRECT INTERFACE MODULE Mfr. List \$1,840.00
1A2 INTERFACE MODULE Mfr. List \$1,050.00
SWITCH CONSOLE Mfr. List \$650.00
CALL SCREEN MANAGER Mfr. List \$349.00

Call For BSW Price



**TELOS LINK
Intercom-to-Telephone Interface**

The Telos Link is designed for use with two wire production intercoms. It allows anyone with access to a telephone, even a cellular phone, to be instantly and automatically connected and appear simply as another intercom station. Features include digital auto-nulling hybrids on both the telephone and intercom audio paths; digital AGC; feed back reduction; auto answer for unattended operation; and call signal generation.

Note that special versions of the Telos ONE are designed specifically for intercom applications such as connecting dial-up lines to four-wire intercoms and interconnecting two-wire intercoms with four-wire intercoms and other four-wire devices.

Mfr. List \$1,680.00 Call For BSW Price

**NEED ASSISTANCE IN SELECTING THE PROPER
TELEPHONE INTERFACE ?**

BSW Sales Professionals are very qualified to help you make the right choice.

We offer demo units, so you can try before you buy.

Call toll free for all the details

COMREX



LXT/LXR Single Line Frequency Extender

Here is the most cost effective Comrex extender system you can buy. This basic system restores the low end on telephone transmissions, offering a substantial improvement for telephone remotes. Easy to set up and operate, the basic system works off a single dial up line. Input is line level via barrier strip.

LXT Mfr. List \$750.00

Call For BSW Price

LXR Mfr. List \$750.00

Call For BSW Price



2XP/2XR Two Line Frequency Extender

Comrex two line systems give you a full 50 Hz to 5 kHz of program audio using two standard telephone lines. On one line, input audio is shifted upward by 250 Hz. On the second line, program is shifted down by 2,000 so program audio from 50 Hz to 5000 Hz can pass through the telephone line. Sophisticated multiband noise suppression is incorporated to quiet noisy circuits.

2XP Encoder Mfr. List \$3,500.00

Call For BSW Price

2XR Decoder Mfr. List \$3,000.00

Call For BSW Price



3XP/3XR Multiline Frequency Extender

This is an encode/decode system that provides a frequency response of 50 Hz to 8 kHz on three dial telephone lines.

The Model 3XP Encoder is built in a rugged portable case and features "one-button" automatic dialing and setup. It also allows visual and audio communications from the receive site. The 3XR Decoder is housed in a 3U 19" rack and can automatically answer, match, and equalize the incoming telephone lines. Real time audio processing allows simultaneous program backfeed. Comrex seven band noise reduction quiets the high noise environment of long haul telephone circuits. Optional automatic satellite delay for international feeds available.

3XP Encoder Mfr. List \$5,000.00

Call For BSW Price

3XR Decoder Mfr. List \$4,000.00

Call For BSW Price

COMREX



DXP/DXR Digital Audio Codecs

These digital compression devices work on all 56 and 64 Kb/s data services (such as Switched 56, ISDN and fractional T1) to provide full duplex audio with 7.5 kHz bandwidth. As digital telco services become increasingly available, the DX system can provide low cost, high quality alternatives to satellite feeds and dedicated circuits.

DXR Rack Mount Codec

Mfr. List \$1,995.00

DXP Portable Codec

Mfr. List \$2,395.00

Call For BSW Price

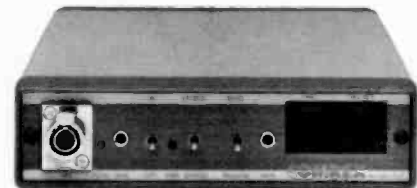

PLXMICRO Remote Frequency Extender

Combine a Comrex PLXmicro Frequency Extender with your cellular telephone and create a portable, easy to use, great sounding remote broadcast system. PLXmicro Portable One Line Encoder is a battery operated duplex one line extender with a built in coupler for direct connection to either standard dial lines or cellular telephones. Monitor decoder, hybrid circuitry and headphone output are included for hands-free, two-way operation. Includes microphone and tape inputs with AGC. Optional AC power supply.

Mfr. List \$1,450.00

Call For BSW Price



THX Telephone Hybrid/Extender

The THX combines a Comrex telephone hybrid with a one line frequency extender encoder and decoder. It allows full two-way on-air conversation between studio talent and incoming frequency extended feeds. THX allows two way phone conversations, on the air so the caller is properly balanced with the studio talent. Features include: Wide band hybrid with built in hybrid set up • Auto or manual answer • De-clicking • Connection to any PABX • Variable ring count • Cart start • All functions remotable

Mfr. List \$1,850.00

Call For BSW Price

GENTNER**EFT3100
Frequency Extender**

Gentner's EFT3100 digital frequency extender delivers great sound programmers and listeners demand, with the ease of setup you need for smooth operation. All frequency extension, noise reduction and audio processing is completely done in the digital domain. The result is a sound that rivals that of a satellite feed.

The EFT-3100 provides a frequency response of 50 Hz to 7500 Hz over 3 standard dial-up telephone lines. It incorporates built-in telephone couplers, microphone and headphone amplifiers, and front panel telephone pad. Other features such as automatic set-up, mic and line inputs, auto answer and disconnect capability make the EFT3100 a natural for remote work. Two units are required for frequency extension.

Mfr. List \$6,995.00 (2 unit system) Call For BSW Price

**EFT1000A
Frequency Extender**

Have you ever wished you could send one person out to do a remote and not have to worry if all the right "switches" were in the right position at the studio? Now you can trust EFT1000A to get the job done for you with automatic answer and automatic encode-decode. Just go to the remote, phone the station and you're ready to go. The EFT1000A is capable of using two different telephone lines. You can transmit on one line and use the other for continuous cues from the station. Two units needed for complete system.

Mfr. List \$1,395.00 Call For BSW Price

**EFT900A
Remote Extender System**

There's no simpler way to get great audio from your remote over a dial-up telephone line than using the EFT900A. Its digital circuitry ensures improved audio response. In fact, all you need at the remote site is an EFT900A and a microphone. The telephone coupler, mic/line input, and headset amplifier are all built right in. No more hassles doing a remote when you rely on the EFT900A.

Mfr. List \$889.00 Call For BSW Price

GENTNER**PEOPLELINK
Broadcast Telephone System**

PeopleLink is a highly specialized system designed to meet the requirements of broadcasters. Its unique design and modular format permit you to configure and adapt the system to your specific requirements. PeopleLink can handle up to 40 lines and allows even non-technical people to confidently control multiple line conferences and talk shows. Digital signal processing technology is used to give maximum clarity on all lines and eliminate problems associated with analog systems. Special features include: Poll computer, automated call answering and recording, ability to conference all types of incoming lines (frequency extended or nonextended), multiple control points for independent and simultaneous use, and much more. PeopleLink works with almost any standard business telephone system, or can operate as a complete stand-alone system.

Pricing Based On Configuration

**TELESWITCH
Telephone Call Director**

No longer do you have to 'hot wire' a multi-line telephone set to access multiple lines. With TeleSwitch, up to five lines can be directly connected, placed on hold, and routed to a hybrid or telephone set. With TeleSwitch you can conference and even record callers with the press of a button. TeleSwitch will work with most business phone systems. Operation and installation are as simple as using a multi-line telephone. Control panel lights indicate whether the line is ringing, in use, on hold, or available. Unit uses standard RJ11C telephone connectors.

Mfr. List \$995.00 Call For BSW Price

When It Comes To Telephone Interface Equipment, Nobody Offers Better Selection And Pricing Than BSW

GENTNER



**DHI/DHII
Digital Telephone Hybrids**

Now you can take advantage of digital signal processing technology to enhance your telephone audio with the Gentner Digital Hybrid I or II. The DHII delivers the best possible hybrid null with 20 kHz sampling rate so telephone audio is crisp, clear and understandable without annoying feedback or hollowness. The DHII provides a one button record feature that starts and stops outboard recorders. Just push the record button and DHII will automatically start your tape machine and stop it at the end of the call. The cue feature allows your talent to use the DHII off the air much like a speakerphone. A remote cue input allows you to use this function automatically via the cue position on your console.

The DHI contains all the DSP processing technology but samples at 10 kHz and lacks the control features of the more elaborate DHII.

DHI Mfr. List \$995.00 Call For BSW Price
DHII Mfr. List \$1,795.00 Call For BSW Price



**SPH5
Telephone Hybrid**

Designed after the Digital Hybrid II, the SPH5 incorporates advanced features not found in most analog hybrids. For instance, with a single push of a button you can automatically start your tape recorder to record both on and off-air calls. The cue function will route audio to the caller via the announcer mic or the mix-minus output of your console, manually or automatically, so you can talk to callers before they go on the air. Low distortion, low noise and maximum telephone frequency response ensures the best possible caller audio quality. The SPH5 represents the ultimate in analog hybrids.

Mfr. List \$839.00 Call For BSW Price



**SPH3A
Telephone Interface**

The SPH3A telephone system provides an easy, inexpensive method of interfacing your equipment with a telephone system allowing simultaneous send and receive audio (full duplex operation). a built-in monitor amplifier eliminates the need for guests or talent to wear headsets. The SPH3A is simple to install and is fully remoteable.

Mfr. List \$549.00 Call For BSW Price

GENTNER



**EFT100
Frequency Extender**

Here is your answer for low cost, good quality remotes. The new Gentner EFT100, for use with your existing hybrid, is a two-way frequency extender. This means you get the benefit of hearing the cues back from the station with just one telephone line. If you already have a hybrid, all you need is the EFT100.

Mfr. List \$619.00 Call For BSW Price



**AUTO COUPLER
Automatic Phone Coupler**

If you're looking for an automatic answering and disconnect hybrid coupler, the Auto Coupler is just what you need. It gives you both "Send" and "Caller" capabilities. Use this with the EFT100 or anytime you need an automatic answer and disconnect to a telephone line.

Mfr. List \$299.00 Call For BSW Price



**HYBRID COUPLER
Phone Coupler**

Here's a low cost telephone coupler that provides both "Send" and "Caller" capabilities. This unit turns the two wire telephone circuit into a four wire system. It's a perfect match for the EFT100 or any time you need a connection to a telephone line.

Mfr. List \$169.00 Call For BSW Price



**MICROTTEL 1
Telephone Interface**

Gentner Engineering's Microtel 1 is a portable, battery operated telephone interface used in a variety of applications. Typically, Microtel replaces the hand-set of the telephone to permit high quality audio feeding down the phone line while simultaneously monitoring the return audio. Microtel 1 is powered by a single 9V battery. Applications: Portable mixing, studio talkback, in the field news mixing/telephone feeding, sports console/back-up sports console, mic to line driver for equalized program loops.

Mfr. List \$249.00 Call For BSW Price

GENTNER



**TC100
Automatic Telephone Interface**

The most versatile telephone coupler you'll find. The design not only gives you auto-answer, auto-disconnect, and latching or momentary tape starts; it allows you to use the unit as a hybrid for on-air calls, as a remote controller, as a private party line telephone intercom, and more. The TC100 is easy to install and operate, and is fully remoteable.

Mfr. List \$449.00 Call For BSW Price

RADIX



**TLM500
Telephone Line Mixer**

This highly portable, battery powered miniconsole can turn any modular telephone into a remote broadcast studio link or telephone interview control center. To use with a telephone, simply plug the telephone handset cord into the TLM (telephone line mixer) along with a studio quality microphone and headphones. The telephone is dialed normally and incoming calls can be answered, the difference is the convenience of the microphone/headphones for broadcast operations and the quality of and control over the audio signals.

Features include:

- Mic and line inputs • Low battery indicator • Peak reading LED
- AC adapter available • Headphone amplifier

Mfr. List \$229.00 Call For BSW Price

CELLABS



**LINEJACKII
Cellular Interface**

LinejackII connects your audio equipment directly to your cellular phone via balanced XLR in/out circuits. Input is mic/line switchable with a separate input for a tuner. Operates from power supplied by the cellular phone.

Mfr. List \$245.00 Call For BSW Price
*Requires Interface Cable Priced From \$50.00 Depending
On Model Of Cellular.*

COMREX



**TCB2A
Auto Answer Coupler**

It's easy to put your audio on the phone with the TCB2A auto-answer coupler from Comrex. Built specifically for broadcast use, the TCB2A is perfect for listen line applications. Just plug in the standard connectors, attach the power supply and you're ready to go. Coupler answers on the first ring and disconnects when calling party hangs up.

Mfr. List \$295.00 Call For BSW Price



**TCB1A
Telephone Coupler**

TCB1A broadcast coupler sends and receives program material via the switched telephone network. This unit requires no external power and connections are standard modular plugs. The TCB1A contains an FCC registered coupler which provides isolation from hazardous voltages and currents and includes an active circuit to hold the telephone line. 1/4 inch jack for line level input.

Mfr. List \$150.00 Call For BSW Price

CIRCUITWERKES



**AC2
Telephone Autocoupler**

The AC2's automatic features make it ideal for a variety of tasks such as listen lines, ski reports, etc. Dry relay contacts provide an interface to virtually every type of external device including cart machines. Features include: Auto answer and hangup, remote pickup and hangup control, provides bidirectional audio connection, automatic signal limiting, much more.

Mfr. List \$174.95 Call For BSW Price

**DTMF-12
Touchtone® Decoder (not pictured)**

The DTMF-12 is ideal for controlling remote satellite receivers, network switching equipment, repeaters, or virtually any control application where local control is inconvenient or impossible. 12 momentary outputs provided on a standard DB-37 connector. The DTMF-12 is available in its own enclosure or as a stand alone board which may be field installed in the AC2 shown above.

Mfr. List \$129.00 Call For BSW Price

INTERALIA



V SERIES Digital Announcer

This solid state digital recorder is perfect for telephone information lines such as ski reports, concerts, etc. Recording time up to 8 minutes is available for one or two phone lines. You could have the same announcement on both, or different messages on each line. The caller always hears the message from the beginning and the line clears immediately after the caller hangs up. Options include remote record, call count, dry contacts, and low impedance.

V22 Mfr. List \$990.00 **Call For BSW Price**
(One Line, Two Message, 32 Sec. Storage)

HENRY ENGINEERING



MIXMINUS PLUS Differential Summing Amplifier

MixMinus Plus is a differential summing amplifier designed to add a "Mix-Minus" output to a broadcast audio console. This output is typically used to feed the send input of a telephone hybrid device. MixMinus Plus subtracts the hybrid receive signal from the program output, creating a program mix, minus the receive audio. The null adjustment will provide 40 dB rejection of the receive audio signal (30 Hz - 3 kHz).

Mfr. List \$195.00 **Call For BSW Price**



TELECART II Auto Answer Interface

An automatic answering unit that permits a standard NAB type cartridge machine to answer a telephone line and play a recorded message to the caller. Features: Digital call counter (records 999 calls) • Failsafe - permits unattended automatic operation • Built-in power supply • Works with virtually any cart machine • Cart cues for all incoming calls

Mfr. List \$225.00 **Call For BSW Price**

HENRY ENGINEERING



TIS Telephone Information System

The Telephone Information System (TIS) from Henry Engineering is a comprehensive system for disseminating information via a regular telephone line. The TIS can store up to 10 separate messages in its digital memory. When the unit is called, a "Menu" message plays, telling the caller which messages are available. The caller may then select any message(s) for instant playback by simply pressing the buttons on a Touch-Tone® telephone. Messages are easily updated by re-recording. Over 8 minutes of information can be stored in the TIS digital memory.

- Opening 'Menu' message plus 9 more individual messages
- Digital Audio Memory means messages never wear out
- External telephone may be used for operator assistance
- Auto-disconnect prevents unnecessary busy signals to callers
- Battery backup prevents memory loss during AC power failure
- Microphone included

Mfr. List \$895.00 **Call For BSW Price**



DIGISTOR Digital Message Storage System

DigiStor is a digital message storage system that is ideally suited for telephone "information lines," e.g., concert, ski report, sports scores, etc. DigiStor will store up to 4 minutes of audio for automatic playback via a regular telephone line. The message is stored in digital memory with battery back-up. DigiStor can be programmed to play the message only once, or continuously until the caller hangs up. Play, Stop, and Record functions are remote controllable.

DIGISTOR (2 min. "good" fidelity/4 min. "fair" fidelity)

Mfr. List \$395.00

DIGISTORXM (8 min. "good" fidelity/16 min. "fair" fidelity)

Mfr. List \$595.00

DIGISTORHF (1 min. 20 sec. extended fidelity)

Mfr. List \$420.00

DIGISTORXMHF (5 min., 25 sec. extended fidelity)

Mfr. List \$620.00

Call For BSW Price

SOUND AMERICA



**RSVP
Record/Send Phone**

Here is the perfect, easy solution for sending or recording audio from the telephone. The RSVP from Sound America is a standard telephone that contains a built-in audio coupler. Cassette recorders will interface directly for recording or sending program material. In addition, the RSVP has an amplified electret condenser microphone for superior voice quality and a mute switch to cut out background noise while recording. Backed by a two year warranty, the RSVP is a perfect product for news and production.

RSVP
SVP (Without Record Feature)

BSW Price \$147.50
BSW Price \$128.75



**VOICEACT
Telephone Coupler**

Designed to replace the mic element in older Western Electric or GTE telephones, this versatile phone coupler from Sound America makes it easy to transmit audio through the telephone. Installs in seconds and uses no batteries. Built-in mic element allows for simultaneous voice and tape feed. 1/8" tape input jack. Carrying case included.

VOICEACT WE (For Western Electric) **BSW Price \$94.95**
VOICEACT GTE (For GTE) **BSW Price \$99.95**

SHURE



**50AC
Telephone Acoustic Coupler**

Ideal for voice transmission from remote locations where "hard wiring" to telephone lines is impractical or impossible. Offers convenient hands-free operation with most cassette tape recorders. Ruggedly constructed of rubber and high-impact plastic.

Mfr. List \$69.25 **Call For BSW Price**

INTEGRATED NETWORK CORP



**CM1056S/CM1056DP
CSU/DSU Switched 56 Interface Equipment**

The Problem: You need a high fidelity remote connection, but for only a few minutes or hours a day - what is the best solution? Program lines usually can guarantee the high quality you need but price and availability may be too expensive or simply not available. Satellite links offer flexibility but the price may be way over budget.

The Solution: Switched 56 kbps service provides broadcasters with a high quality, economical alternative. Broadcasters on the leading edge are using digital audio codecs and switched 56 kbps service to access affiliates, cover sporting events, transmit traffic and weather reports and do on-site interviews of major news events.

How It Works: Using digital audio codecs (Comrex DXR), switched 56 CSU/DSUs, and switched 56 kbps service, broadcasters can transmit 7.5 kHz of high quality audio. Digital audio codecs digitize and compress audio signals using a CCITT standardized conversion technique resulting in a data stream that is passed to a CM1056S or CM1056DP CSU/DSU. Then the audio is sent as data over the switched 56 network. On the remote end, the information is received and decompressed for broadcasting. It should be noted that transmission is bidirectional allowing simultaneous communications from either end of the link.

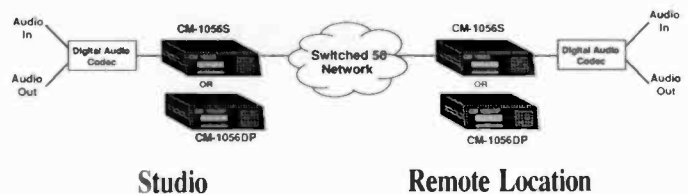

BSW stocks all the equipment necessary to broadcast over the switched 56 network. The exact model of INC CSU/DSU's will be determined by the service available in your area.

Call BSW For More Information And Pricing

In many circumstances the telephone company can offer a competitive means of conveying audio from one location to another. BSW is in touch with the latest technologies that can put the power and convenience of 'Ma Bell' to work for you. Ask a sales representative for more information on products for interface with T1, fractional T1 and switched 56 services.

POTOMAC



**AT51
Audio Test System**

An innovative audio test system which facilitates the measurement of critical parameters in monophonic and stereophonic audio equipment. Designed primarily for commercial broadcast proof-of-performance measurements and equipment maintenance, the AT51 handles laboratory type measurements by design engineers, quality control facilities and professional high fidelity service centers. The AG51 Audio Generator and AA51 Audio Analyzer are packaged separately for remote measurements requiring physical separation of signal source and signal analyzer. Both units are RFI shielded to enable accurate measurements in high level radio frequency environments typical to broadcast transmitter facilities. Signal input and output connectors are also RFI shielded.

Mfr. List \$5,230.00 Call For BSW Price

DELTA



**SNG1
Stereo Noise Generator**

The Delta SNG1 offers a number of "laboratory" type features and noise weightings in a very affordable and compact package.

- Features:
- True balanced front and rear panel outputs
 - Selectable white, pink, and USASI noise spectra
 - Generates true stereo noise (uncorrelated)
 - Low DC offset
 - Close channel tracking (>0.5 dB)
 - External input offers unlimited noise envelopes
 - Outs drive either 600 or 50 ohms
 - Meets FCC/NRSC and Canadian D.O.C. requirements

Mfr. List \$635.00 Call For BSW Price

NEED PRICES ON A MAJOR PROJECT ?

Save yourself time and FAX us your equipment list. We'll have a complete price quote back to you in no time.

DORROUGH



**1200
Audio Test Set**

With the 1200 you can take stereo measurements of level, balance, crosstalk, and signal-to-noise over the entire dynamic range of your audio system from noise floor to clipping. The set includes a pair of input amplifiers, a 30 dB step precision attenuator, two "B" scale VU meters (measured in 1 dB increments over a 40 dB range). And two buffered monitor outputs. Servo amplifier inputs guarantee a constant gain over all input configurations and a monitor jack provides an output for oscilloscope, headphones, or monitor amplifier.

Mfr. List \$1,650.00 Call For BSW Price

LOFTECH



**TS1
Audio Test Set**

The Loftech TS1 provides a combination of three precision test instruments and is capable of making audio frequency tests and measurements with a high degree of accuracy and in less time than conventional test instruments. The TS1 combines a low distortion oscillator, a frequency counter, and a dB meter in a compact unit complete with AC power supply. Features limited two-year warranty.

Mfr. List \$379.95 Call For BSW Price

FlexLease

BSW offers innovative lease programs that are the right answers to your equipment financing dilemmas. Whether you're interested in low monthly payments, tax incentives, or just conserving your cash flow without tying up your credit lines, BSW FlexLease programs offer creative solutions to obtaining the equipment you need. Call us today for all the information.

YIBBOX



**YIBBOX
Audio Line Tester**

Yibbox is a battery powered 400 Hz oscillator designed to locate faulty audio lines or set proper levels in almost any situation. Balanced XLR and unbalanced 1/4" outputs are provided at 4 switchable levels: 0 dBm, -20 dBm, -30 dBm, or -50 dBm. LEDs automatically indicate the presence of phantom power or RTS volts to test continuity in mic lines. There's even an electret microphone built-in allowing the engineer to "talk down the line" for communication purposes. Includes power on/low battery LED indicator.

Mfr. List \$355.00

Call For BSW Price

FOSTEX



**TT15
Test Tone Oscillator**

Battery operated, low distortion sine wave oscillator with five selectable frequencies (40 Hz, 400 Hz, 1 kHz, 10 kHz, and 15 kHz) and three selectable output levels (-30 dB, -10 dB and 0 dB). RCA output jack. Useful for spot checking frequency response, calibrating mixers with tape recorders and other level matching jobs. Output is constant and not affected by battery voltage or frequency. Fits in your tool box.

Mfr. List \$55.00

Call For BSW Price

WHIRLWIND



Cable Tester

Check for shorts and bad connections easily with the Whirlwind Cable Tester. Accommodates XLR, 1/4" and phono plugs. 9 volt battery required. Fits in your tool box.

Mfr. List \$57.85

Call For BSW Price

GOLDLINE



**ASA10B
Audio Spectrum Analyzer**

An affordable, professional quality, 10-octave analyzer covering a wide frequency range, and featuring a built-in mic. Features: IEC A or C weighting • Freeze display function • Battery or external powering • Selectable decay function

ASA10B

Mfr. List \$355.00

PN2 Pink Noise Generator

Mfr. List \$89.95

Call For BSW Price

BIRD



Test Equipment

Now in its fifth decade of serving the broadcast industry, Bird Electronic Corporation has been the pioneer in developing products for measurement, filtering and termination of RF power. The Company's products, originally developed in response to specific design requirements of broadcast equipment manufacturers, have since become standards of the industry. Recognizing that broadcast test equipment must be even more reliable than the transmitter, constantly on-call and totally trustworthy, Bird has achieved an enviable record of reliability.

Call BSW With Your Bird Requirements

5 GREAT REASONS TO ORDER FROM BSW

Excellent Prices

Outstanding Selection

Extensive Inventory

Fast Delivery

Knowledgeable Sales Representatives

B&K

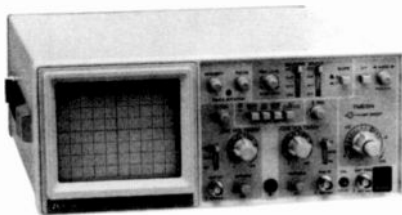

Oscilloscopes

B&K offers one of the industry's broadest lines of oscilloscopes with models ranging from a 15 MHz analog dual-trace unit to a versatile digital storage oscilloscope. No matter what your application, B&K has an oscilloscope to meet your requirements.

FLUKE



Test Meters

75

- Analog bar graph • 3200 count display • 0.5% basic accuracy • Auto-ranging with range hold • 10 amp & auto-ranged mA ranges • Continuity and diode test beeper • Three year warranty

BSW Price \$145.00

77

- Analog bar graph • 3200 count display • 0.3% basic accuracy • Auto-ranging with range hold • 10 amp & auto-ranged mA ranges • Continuity and diode test beeper • Touch hold • Three year warranty

BSW Price \$169.00

XCELITE



TC150/ST Tool Kit

A carefully selected assortment of Xcelite hand tools including interchangeable drivers, blades and handles, soldering iron, and measuring tape. Removable pallets in lid and base have tool pockets.

Mfr. List \$555.00

Call For BSW Price

CAIG LABS



DEOXIT



PROGOLD

DEOXIT Electrical Connector Treatment

DeoxIT, a one step treatment, is a fast acting solution that cleans, preserves, lubricates and improves conductivity on electric connectors and contacts. This new advanced formula contains improved deoxidizers, preservatives, conductivity enhancers, anti-tarnishing compounds, arcing and RFI inhibitors and provides extended temperature range. USE ON: electrical connections - stationary and moving, with similar or dissimilar metals.

D5S6	DeoxIT D5 spray, 5.5 oz.	BSW Price \$7.95
KD50W	DeoxIT wipes, 50 count	BSW Price \$8.95
KD100P	DeoxIT pen applicator	BSW Price \$9.95
D100L25C	DeoxIT dispenser, 25ml	BSW Price \$12.95
KD100S	DeoxIT D100 spray kit*	BSW Price \$17.95

*Includes: 2 oz spray, 100% DeoxIT liquid, lint-free cloths, swabs & brushes

PROGOLD Gold Conditioner

Maintains optimum signal quality, reduces intermittent connections, reduces wear, abrasion and RFI. ProGold, a one-step treatment, improves conductivity and protects gold, base metals and other precious metal surfaces. USE ON: gold and other precious metal surfaces.

G5S6	ProGold spray, 5.5 oz.	BSW Price \$15.95
KG100P	ProGold pen applicator	BSW Price \$19.95
KG50W	ProGold wipes, 50 count	BSW Price \$18.95
G1002DB	ProGold Precision, 7.4ml	BSW Price \$16.95



DUSTALL Precision Air Duster

Quickly and safely removes dust, lint and particles from sensitive electronic equipment. No ozone-depleting CFC's

DT3S10 DustALL, 10 oz.	BSW Price \$6.95
-------------------------------	-------------------------

OPTICALL Anti-static Cleaner/Preservative

Concentrated formula cleans, polishes and eliminates static electricity on optical viewing surfaces (CRT screens, TVs, Scopes, Dial faces, etc.) Also recommended as a general purpose antistatic cleaner on plastic, glass and metal surfaces. No ozone-depleting CFC's.

OP10S6 OpticALL, 6oz.	BSW Price \$5.95
------------------------------	-------------------------

TECHNICS



**SL1200MKII
2-Speed Turntable**

The industry's most popular turntable is, without a doubt, the SL1200MKII. Two-speed, quartz accurate with fast start-up time, it's the perfect addition to your control room. For production, the pitch change adjustment of $\pm 8\%$ comes in handy. The SL1200MKII includes base, dust cover, and tonearm.

Mfr. List \$499.95

Call For BSW Price

PROBASE

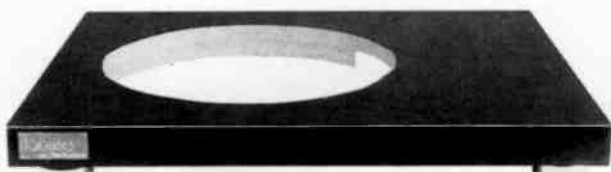

**PROBASEII/PROBASEIII
Turntable Bases**

Here is a cost effective way to house Technics SP-25 or SP-15 turntables. Probase is 1 1/2" sound absorbing particle board with durable black formica overlay. Heavy duty isolation feet stop feedback and countertop vibration from being transmitted through turntable. ProbaseIII is harmonically balanced for turntable and tonearm to virtually eliminate all transient vibrations going through the system, achieving outstanding sonic quality from your turntable. Nothing on the market is finer, regardless of price. For an extra charge, your Probase can be custom drilled for the tonearm of your choice.

**PROBASEII
PROBASEIII**

**BSW Price \$135.95
BSW Price \$218.00**

BSW



**PROBASEPAD
Audio Component Isolators**

Sims Silencers are component feet made from a unique energy absorption material called NAVCOM™. NAVCOM was specifically engineered to dampen unwanted vibrations throughout the audio spectrum 10 to 30,000 Hz. We've used Silencers in our famous Probases for years. Now you can use them on CD players, amplifiers, turntables, or any other sensitive audio equipment. Four silencers per package.

BSW Price \$59.95

PROTEC



**SA270
Professional Tonearm**

The best value tonearm. Durable construction designed for daily broadcast use. Headshell is removable and accommodates all popular brands of professional phono cartridges. Anti-skate adjustment is built-in. Tracking weight is adjustable.

BSW Price \$169.00

AUDIO-TECHNICA



**ATP12T
Professional Tonearm**

Features removable headshell and adjustable tracking weight. Fits a wide range of turntable heights and base thicknesses.

Mfr. List \$299.00

Call For BSW Price

DISCWASHER



**D4SYSTEM
Record Cleaner**

Cleans without reduction in record dynamics and fidelity. D4 fluid lifts & suspends contaminants in solution from record surface. D4 pad fibers are directional, lifting dust rather than lining it up.

**D4SYSTEM
D46OZ (6 Oz.) Refill
D416OZ (16 Oz.) Refill**

**BSW Price \$19.95
BSW Price \$8.45
BSW Price \$13.75**

BSW Stocks the most popular Phono Cartridges and
Styli for immediate shipment.
See page 117 for product listing.

ATI

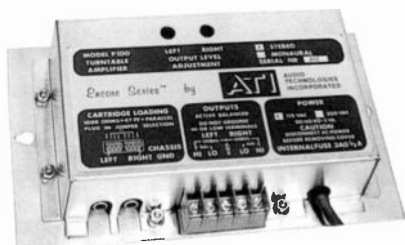

P100S Turntable Preamp

This preamp offers state-of-the-art specs in a cost effective enclosure. Quality components allow the P100S to achieve a 90 dB signal to noise ratio, channel separation of 60 dB minimum distortion 0.1% maximum 20 Hz -20 kHz.

Mfr. List \$299.00

Call For BSW Price

RADIX



TP500 Turntable Preamp

Superb specifications make this Radix model ideal for stereo, or two channel monaural use. And yet, the cost remains competitive with other quality brands. Specifications: Distortion: less than .01% at full output • Noise: better than 76 dB unweighted • Channel separation: 90 dB • Output: +20 dBm single ended 600 ohms +25 dBm balanced 600 ohms • Compact enclosure - easy to install • Outstanding RF immunity

Mfr. List \$289.95

Call For BSW Price

RADIO DESIGN LABS

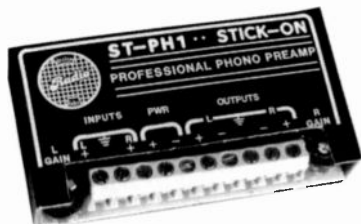

STPH1 Turntable Preamp

The STPH1 provides accurate, low noise preamplification at very low cost. This stereophonic device offers both balanced and unbalanced, hi and low-z outputs with level controls for left and right output. Total harmonic distortion from 10 Hz to 30 kHz is <0.03% with hi-z load and <0.015% with 600 ohm load. Equalization follows the RIAA curve. Since it's part of Radio Design Labs' stick-on series, it's small enough to stick on the back of your turntable base.

Mfr. List \$99.95

Call For BSW Price

STANTON



310B Stereo Phono Preamp

The 310B is designed to correctly interface all Stanton and selected magnetic phonograph cartridges for optimum playback of disk records and calibration of audio systems. The 310B features universal mounting, instant selection of flat or NAB postemphasis curves, switchable, effective rumble filter, individual adjustments of gains and high frequency responses, trimming of cartridge loading, either 117 or 230V operation at 50 or 60 Hz, and immunity to external magnetic AC fields. The 310B can be used in balanced as well as unbalanced modes and in-phase and out of phase mix of L and R channels for monophonic reproduction of older records.

Mfr. List \$240.00

Call For BSW Price

RADIO SYSTEMS



PA1 Turntable Preamp

Thousands of broadcasters rely on the faithful, trouble-free performance of Radio Systems' PA1 phono preamplifier. It's ground-plane circuitry gives it superb immunity to RF interference even in the most intense RF environments. PA1 offers incredibly low noise and crosstalk specifications with excellent protection against slew induced distortion, transient intermodulation, and input clipping.

Mfr. List \$325.00

Call For BSW Price

TIRED OF WAITING FOR YOUR ORDER TO SHIP?

Call us by 12 P.M. Pacific Time and we'll ship stock items by 5 P.M. the same day guaranteed, or we pay the freight.

STANTON



Cartridge

Model	BSW Price
500AL	\$20.70
500EL	\$22.90
500EMKII	\$18.40
681EEEMKIIS	\$74.30
881SMKIIS	\$106.75
890AL	\$81.80
680AL	\$60.70
680EL	\$67.00

Replacement Styli

Model	BSW Price
D5107AL	\$9.50
D5100EL	\$14.50
D50EMKII	\$11.60
D6800AL	\$16.00
D6800EEEIIS	\$28.35
D81IIS	\$56.80
D89AL	\$23.00
D6800AL	\$16.00
D6800EE	\$24.60

SHURE



Cartridge

Model	BSW Price
M44-7	\$27.70
M44-C	\$27.70
M44-E	\$35.00
SC35C	\$36.30
SC39EJ	\$73.50

Replacement Styli

Model	BSW Price
N44-7	\$17.00
N44-C	\$17.00
N44-E	\$18.40
SS35C	\$17.30
SS39B	\$26.00
SS39EJ	\$27.30

AUDIO-TECHNICA

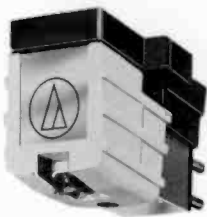

Cartridge

Model	BSW Price
ATP 1	\$26.00
ATP 2	\$34.70
ATP 3	\$46.70

Replacement Styli

Model	BSW Price
ATPN1	\$15.30
ATPN2	\$20.70
ATPN3	\$29.30

BELDEN



8451 Multi Purpose Wire

This popular 2 conductor wire with drain is perfect for studio installations. 1000' lengths are available in the convenient UN-REEL. BSW can provide you with Belden wire for any application.

8451BLKBOX (1000' - Black) Mfr. List \$146.78
Call For BSW Price

WEST PENN WIRE



291 All Purpose Wire

Twisted pair, 22 AWG, stranded tinned copper, aluminum foil shield with 24 AWG tinned copper. Drain wire. 1000' reels. Your choice of colors: red, blue and grey. Other multi-pair wire available from BSW. Call us for your wiring solution.

Mfr. List \$97.60 Call For BSW Price



Multi-pair Audio Cable

BSW can handle all your multi-pair cable needs with a number of different grades, lengths and configurations. Our multi-pair cable manufacturers include Belden, ProCo, WestPenn, and Whirlwind.

Call BSW With Your Requirements

PANDUIT

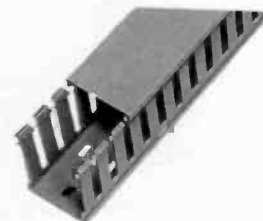

Wiring Duct

Width: 2 inches, Height: 2 inches, Length: 6 feet. Includes cover.
BSW Price \$26.95

CREDIT ~ LEASE APPLICATION

Equipment Solutions To Keep You Number One

7012 27th Street West



Tacoma, WA

98466 USA

*** Items For Lease Application Only**

Applicant/Lessee (Important to list name of legal entity)				
Legal Name and Trade Name				Date
Street Address		City, County, State		Zip Code
Billing Address		City, County, State		Zip Code
Contact Person	Title		Telephone # ()	
Nature of Business	# of Years In Business	Type of Business (Circle One) Proprietorship Partnership Corporation Government		

Where is the equipment to be located if not at above address? (Shipping Address)		
Address	City, County, State	Zip Code

Parent Company			
Name	Contact Person	Telephone # ()	
Address	City, State	Zip Code	

Bank References				
Name of Bank/Branch	How Long?	Checking Acct. #	Telephone # ()	Account Manager
		Loan Acct. #		
Name of Bank/Branch	How Long?	Checking Acct. #	Telephone # ()	Account Manager
		Loan Acct. #		

Trade References			
Company Name	City, State	Telephone # ()	Contact Person
Company Name	City, State	Telephone # ()	Contact Person
Company Name	City, State	Telephone # ()	Contact Person

* Personal Information on Owners, Officers, Partners, or Guarantors				
Last Name	First	Middle	Title	Social Security #
Home Address		City	State	Zip Code
Home Phone #				
Last Name	First	Middle	Title	Social Security #
Home Address		City	State	Zip Code
Home Phone #				

Vendor Information <small>(For BSW Use Only)</small>	Transaction Summary
Broadcast Supply Worldwide	Vendor # 123450
7012 27th St. West Tacoma, WA 98466	Lease Plan
Contact Person	Term
(206) 565-2301	Number of Advance Payments
	Rate Factor
	Total Transaction <small>(equipment cost, shipping, sales/use tax, installation)</small>

*** (Lease Application Only)**

Lease Applicant & Guarantor(s) authorize BSW and its affiliates to investigate their financial responsibility and creditworthiness, and Credit Applicant & Guarantor(s) agree to provide financial statements, tax returns, or other credit-related information as necessary, Financial statements required on all transactions of \$25,000 and over. Personal guarantees on all transactions for business less than two years old.

INDEX OF PRODUCTS BY TYPE

AMPLIFIERS		CONSOLES		PRESSBOXES	5
<i>Distribution</i>	4, 5	<i>On-Air</i>	35-39	RACKS (<i>Cart, Cassette, CD, DAT</i>)	97-98
<i>Headphone</i>	52	<i>Production</i>	40-42	<i>Equipment</i>	99, 100
<i>Interface</i>	52-54	<i>Remote</i>	43, 44	RECEIVERS, AM/FM	71
<i>Monitor/Power</i>	2, 3	COPY HOLDERS	102	RECORD CARE PRODUCTS	115
<i>Preamps, Microphone</i>	65	DAT MACHINES	45, 46	REEL TAPE AND ACCESSORIES	74, 75
<i>Preamps, Phono</i>	116	DAT CASSETTES	46	REEL TO REEL MACHINES	72, 73
ANTENNAS AND ACCESSORIES		DAT RACKS	97, 98	REMOTE CONTROL	76, 77
<i>FM</i>	87	DIGITAL RECORDERS	19, 28, 45-48	REMOTE PICK-UP EQUIPMENT	78, 79
<i>RPU</i>	79	DIGITAL WORKSTATIONS	47, 48	RF CABLE AND ACCESSORIES	86-88
<i>STL</i>	82	DUMMY LOADS	86	ROUTING SWITCHERS, <i>Audio</i>	55
AUDIO PROCESSING		EBS SYSTEMS	68	SATELLITE	90
<i>AM-On Air</i>	6-8	EDITING SUPPLIES	75	SCA EQUIPMENT	85
<i>Composite</i>	8	EFFECTS PROCESSORS		SERVICING EQUIPMENT	112-114
<i>Compressors/Limiters</i>	11-13	<i>(See Audio Processing)</i>		SOUND EFFECTS, CD	34
<i>Delay Units</i>	9	EQUIPMENT RACKS	99, 100	SOUND INSULATION	100
<i>Effects</i>	16-17	ERASERS	20	SPEAKERS	90-93
<i>Equalizers</i>	14, 15	EXCITERS	83-85	SPEAKER ACCESSORIES	93
<i>FM-On Air</i>	6-8	FM CABLE MODULATOR	85	SPLICE FINDERS	22, 23
<i>Microphone</i>	10	FREQUENCY EXTENDERS	106, 107	SPLICING SUPPLIES	75
<i>Noise Reduction</i>	18	FURNITURE, STUDIO	94-96	STL EQUIPMENT	
<i>NRSC</i>	9	HEADPHONES/HEADSETS	49-51	<i>Antennas</i>	79, 82
<i>On-Air</i>	6-8	HEADPHONE ACCESSORIES	52	<i>SCA</i>	85
<i>Stereo Enhancers</i>	9	HEAD CLEANING PRODUCTS	75	<i>Transmitters/Receivers</i>	80-82
<i>Stereo Generators</i>	6-8	INTERCOM	54	STEREO GENERATORS	6-8
<i>Stereo Synthesizer</i>	9	INTERFACE		SWITCHED 56	111
<i>Voice</i>	10	<i>Amplifiers</i>	52-54	SWITCHERS	
AUTOMATION	19-20	<i>Patch Bays</i>	56, 57	<i>Audio</i>	55
BULK ERASERS	20	<i>Relays</i>	54	<i>RF</i>	86
CABLE, <i>Audio</i>	67, 117	<i>Switchers</i>	55	TELEPHONE EQUIPMENT	
CABLE, RF	88	ISOCOUPERS	86	<i>Cellular Interfaces</i>	106, 109
CARTRIDGES, <i>Phono</i>	117	LIGHTING, <i>Tower</i>	89	<i>Couplers</i>	108-111
CARTS	27	LOGGERS	58	<i>Frequency Extenders</i>	106, 107
CARTRIDGE MACHINES	21-25	MASTS, <i>Telescoping</i>	79	<i>Hybrids</i>	105-109
CART MACHINE ACCESSORIES		METERING, <i>Audio</i>	71	<i>Information Announcers</i>	110
<i>Alignment</i>	26	MICROPHONES	59-64	<i>Phone Systems</i>	105, 107
<i>Cleaning Products</i>	77	MICROPHONE ACCESSORIES	65-67	TEMPERATURE GAUGES	77, 104
<i>Erasers</i>	20	<i>Mixers</i>	43, 44	TEST EQUIPMENT	112-114
<i>Labels</i>	26	<i>Preamps</i>	65	TEST TAPES	75
<i>Racks</i>	97, 98	<i>Stands</i>	67	TIMERS, CLOCKS	102-104
<i>Splice Finders</i>	22, 23	MONITORS		TONEARMS	115
<i>Tape</i>	27	<i>EBS/Weather</i>	68	TONE SENSORS/GENERATORS	20, 112, 113
<i>Winders</i>	26	<i>Meters</i>	71	TOOLS	114
CASSETTE MACHINES	28-30	<i>Modulation</i>	69, 70	TOWERS AND ACCESSORIES	89
CASSETTES AND ACCESSORIES	30	<i>Status/Alert</i>	101	TRANSMITTERS/EXCITERS	83-85
CASSETTE RACKS	97, 98	<i>Tuners</i>	71	TUNERS, AM/FM	71
CLEANERS		MONITOR SPEAKERS	90-93	TURNTABLE	115
<i>Tape Head</i>	75	MUSIC LIBRARIES	34	TURNTABLE ACCESSORIES	115-117
<i>Electrical Contact</i>	114	NOISE REDUCTION	18	WARNING LIGHTS	101
CLOCKS/TIMERS	102-104	ON-AIR LIGHTS	101	WEATHER INSTRUMENTS	104
COMPACT DISC PLAYERS	31, 32	OSCILLOSCOPES	114	WINDSCREENS	66
COMPACT DISC RECORDERS	32	PATCHBAYS, CORDS, PANELS	56, 57	WIRE AND ACCESSORIES	117
COMPACT DISC ACCESSORIES	33, 34	PHONO CARTRIDGES, STYLI	117	WIRELESS MICROPHONES	63, 64
COMPACT DISC RACKS	97, 98	PREAMPS, <i>Mic</i>	65	WORKSTATIONS, <i>Digital</i>	47, 48
COMPOSITE DISTRIBUTION AMP	89	PREAMPS, <i>Phono</i>	116		

INDEX OF PRODUCTS BY MANUFACTURER

360 SYSTEMS	21, 55	ELECTRO IMPULSE	86	QUIKLOK	67, 99
3M/SCOTCH	74, 75	ELECTRO-VOICE	43, 60, 91, 95	RADIO DESIGN LABS	5, 12, 52, 54, 65, 70, 116
ABCO	97	ENBERG	101	RADIO SYSTEMS	5, 18, 24, 39, 45, 103, 116
ADC	56	ERI	87	RADIX	5, 52, 104, 109, 116
AKG	49, 51, 52, 59	ESE	4, 53, 71, 103, 104	RAINWISE	104
ALC	90	EVENTIDE	9, 16, 58	RAMSA	2, 40, 45, 92
ALTRONIC RESEARCH INC.	86	EXPRESS GROUP	94	RANE	12, 15, 43, 52
AMPEX	74	FIDELIPAC	20, 23, 26, 27, 37, 97, 101	RAXXESS	57, 66
ANDREW	88	FLUKE	114	RCS	58
APHEX	4, 8, 11, 14, 17, 53	FOSTEX	49, 93, 113	RD SYSTEMS	61
ARRAKIS	35	GARNER	20	REVOX	73
ART	11, 14, 16	GENEVA	20, 34, 75	RF INDUSTRIES	88
ASHLY	3	GENTNER	5, 7, 55, 57, 76, 107-109	RODCO	104
ATI	4, 39, 52, 53, 65, 71, 116	GOLDLINE	113	ROHN	89
ATLANTIC	97	GORMAN-REDLICH	68	ROLAND	18, 48
ATLAS	67	HAFLER	2	ROLLS	3, 10
AUDI-CORD	25	HBS	34	SAMSON	63
AUDIOARTS	37, 40, 95	HENRY ENGINEERING	4, 43, 46, 53, 54, 110	SCALA	79, 82
AUDIO DIGITAL	9	HOSA	52	SCIENTIFIC ATLANTA	90
AUDIOLAB	20	INFORMATION DESIGN	97	SCOTCH/3M	74, 75
AUDIOPAK	27	INOVONICS	8, 9, 69	SENNHEISER	50, 51, 61
AUDIOSOURCE	33	INTEGRATED NETWORK CORP.	111	SENTRY SYSTEMS	70
AUDIO-TECHNICA	59, 63, 115, 117	INTERALIA	110	SETH THOMAS	102
AUDIX	93	ITC	24, 27	SHIVELY LABS	87
AURATONE	90	JAMPRO	87	SHURE	5, 44, 51, 62, 63, 65, 66, 111, 117
AUTOGRAM	36	JBL	2, 92	SINE SYSTEMS	76
AVSC	20	KINTRONIC LABS	86	SOHO	97
BBE	17	KOSS	49, 93	SONAR	20
BEC	55	LARSEN	79	SONEX	100
BELAR	69	LEXICON	16	SONY	29, 31, 45, 46, 50, 61
BELDEN	117	LITTLELITE	102	SOUND AMERICA	111
BENCHMARK	52, 53	LOFTECH	112	SOUNDCRAFT	40
BEYER	49, 51, 59, 63	LPB	39	SOUNDCRAFTSMEN	71
BGW	2, 4, 100	LUXO	67	SOUNDOLIER	99
BIRD	88, 91, 113	MACKIE DESIGNS	42	STANTON	116, 117
B&K	114	MARANTZ	28, 29, 32, 46	STEWART	3
BROADCAST DEVICES	26, 54, 89	MARK ANTENNA	82	STL	26, 75
BROADCAST ELECTRONICS	19, 21, 22, 38, 83, 84, 87	MARTI	78, 79, 80, 82, 85	SYMETRIX	3, 10, 13, 15, 18, 52, 65
BROADCAST TOOLS	54	MEC	26	TAPECASTER	25, 26
BRYCO	97	MIDDLE ATLANTIC	99, 100	TASCAM	28, 30, 31, 32, 41, 45, 47, 73, 99
BSW	26, 30, 33, 66, 67, 75, 97, 100, 115	MODULATION SCIENCES	8, 9, 69, 85, 89	TEAC	29, 46
BURK TECHNOLOGY	76	MOSELEY	77, 78, 80	TECHNICS	28, 29, 32, 115
CABLEWAVE	88	MRL	75	TELEX	51, 64
CAIG	75, 114	MTS	68	TELFAX	44
CALCULATED INDUSTRIES	104	MURPHY	94	TELOS	105
CARVER	32, 71	NEUMANN	61, 67	TELTEK	77, 104
CATEL	85	NEUTRIK	66	TFT	68, 70, 78, 81
CELLABS	109	NIGEL B.	96	TITUS TECH LABS	55, 101
CIRCUITWERKES	71, 109	OMNIMOUNT	93	TRACKMATE	34
COMREX	43, 45, 78, 106, 109	ORBAN	7, 9, 10, 12, 15, 17	TWR	89
CONEX	20, 55	OTARI	24, 45, 72	UREI	13
CRL	6, 10, 18	PANASONIC	30, 46	VALENTINO	34
CROWN	2, 61	PANDUIT	117	VALLEY INTERNATIONAL	10
CUTTING EDGE TECHNOLOGIES	6	PERFECT DATA	102	VEGA	64
DAX	14	PIVOTELLI	93	VIKRON	26
DBX	11, 14, 18, 53, 65	POTOMAC	112	WEGENER	90
DELTA	69, 112	PROBASE	115	WEST PENN	117
DENON	31, 33	PROCABLE	67	WHEATSTONE	12
DIC DIGITAL	46	PROFOAM	100	WHIRLWIND	5, 65, 66, 113, 117
DIELECTRIC	86, 88	PROLAMP	102	WILL-BURT	79
DIGITAL AUDIO LABS	47	PRORAX	101	XCELITE	114
DIGITECH	16	PRORAX	72, 98	XEDIT	75
DISCWASHER	30, 33, 34, 115	PROTEC	115	YAMAHA	3, 17, 28, 30, 42, 91
DORROUGH	71, 112	QEI	8, 70, 80, 85	YIBBOX	113
		QSC	2	ZERCOM	44

93

CATALOG

