

MAY 12 1986

Continental Electronics Radio Broadcast Equipment Catalog 1986/1987

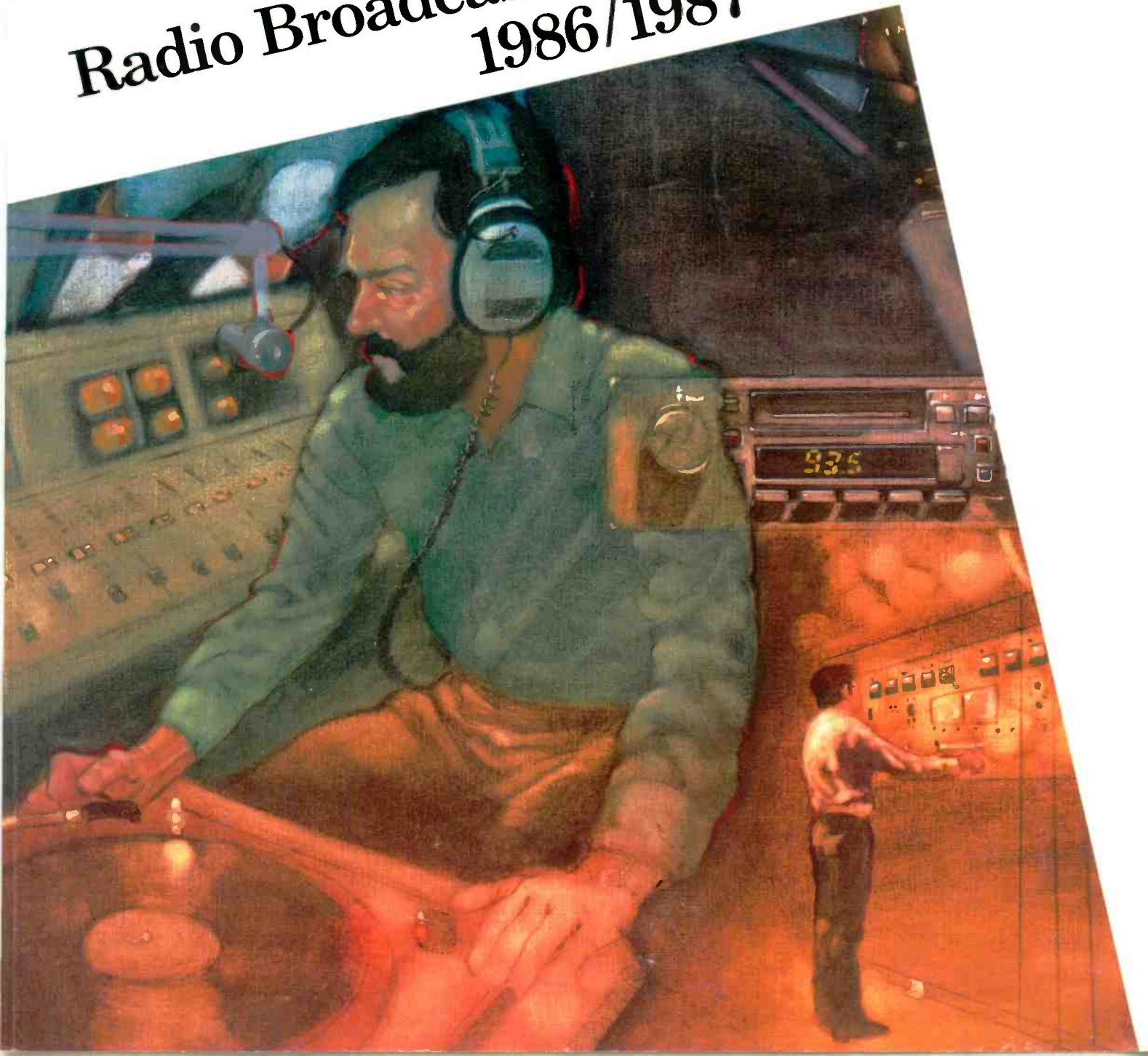

**Continental Electronics
Radio Broadcast
Equipment Catalog
1986/1987**

Introduction & Contents

INTRODUCTION

Continental Electronics, a Division of Varian Associates, Inc., is an engineering-oriented company that specializes in the design, development and production of low, medium and high power radio frequency transmitters for radio broadcast, communications, radar and scientific research applications.

The company was founded in 1946 with the express purpose of creating an extensive capability in RF product design.

Since its founding, Continental has established an unmatched record of achievement in the area of high power RF transmitters and amplifiers. Many of the Company's innovations have advanced the state-of-the-art; most of its work has been of a pioneering type and the kind of work normally associated with the leading edge of technology.

Continental's commitment to excellence is reflected in the workmanship and operational performance of numerous radio/electronic products which bridge the spectrum from ELF to UHF, ranging in power from kilowatts to megawatts.

Continental broadcast transmitters are used throughout the world by commercial and government radio stations for local, regional and international broadcasting.

In addition to high power medium and short wave broadcast transmitters, Continental offers broadcasters a complete line of AM-MW transmitters from 1,000 to 50,000 watts, and FM transmitters from 2,500 to 60,000 watts; transmitter combiners and diplexers, phasing and coupling systems, antennas, miscellaneous RF and studio equipment.

This catalog gives a brief product overview of the radio broadcast equipment available from Continental.

For performance data, specifications, pricing and delivery information, contact your local Continental sales representative (see pages 101-103).

All products and prices in this catalog are subject to change without notice; all products are subject to prior sale; no warranty or guarantee as to product availability or performance is given or implied.

©1986 Continental Electronics/6072

TABLE OF CONTENTS

Transmitters

FM Exciter	4
FM 2.5 kW	5
FM 4.3 kW	6
FM 10 kW	7
FM 20 kW	8
FM 25 kW	9
FM 27.5 kW	10
FM 35 kW	11
FM 40 kW	12
FM 50 kW	13
FM 55 kW	14
FM 60 kW	15
AM-MW 1 kW	16
AM-MW 5 kW	17
AM-MW 10 kW	18
AM-MW 50 kW	19
AM-MW 100/150 kW	20
AM-MW 250 kW	21
AM-MW 500 kW	22
AM-MW 1,000 kW	23
AM-MW 2,000 kW	24
AM-SW 10 kW	25
AM-SW 50 kW	26
AM-SW 100 kW	27
AM-SW 250 kW	28
AM-SW 500 kW	29
Transmitter Combiners	30
Transmitter Dummy Loads	32
Transmitter Control Accessories	34

Antennas, Antenna Accessories

Antenna Towers, AM & FM	38
Transmitter Phasing and Coupling	39
FM Antennas	43
Antenna Deicers, Lights	52
Antenna Transmission Line	53
RF Surge Protectors	66
RF Switches	67
RF Patch Panels	68
Phase Sampling Loops, Isolation Coils	68
Watt Meters and Ammeters	69
Transmitter Remote Control	70
STL Systems and Accessories	72
AM & FM Monitors, Phase Monitors	73
EBS Monitors	75
Audio Processing Equipment	76
Stereo Generators	79
SCA Systems	80
Proof of Performance, Test Equipment	81
Appendix	
Engineering Data	84
Sales and Service Information	100

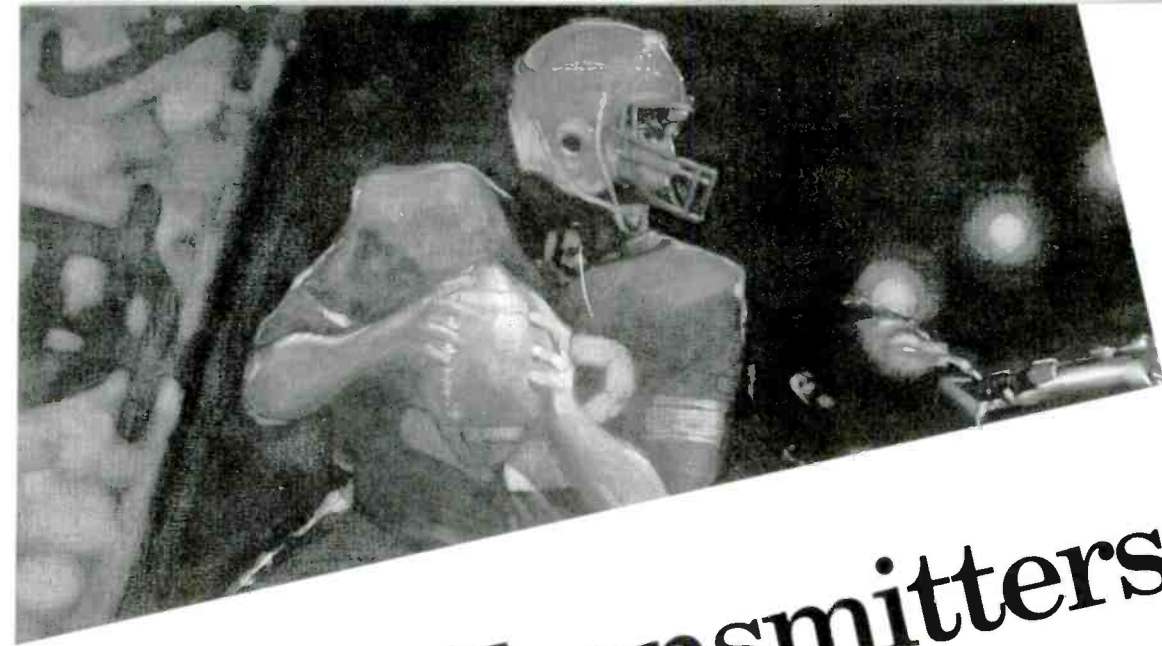

Transmitters

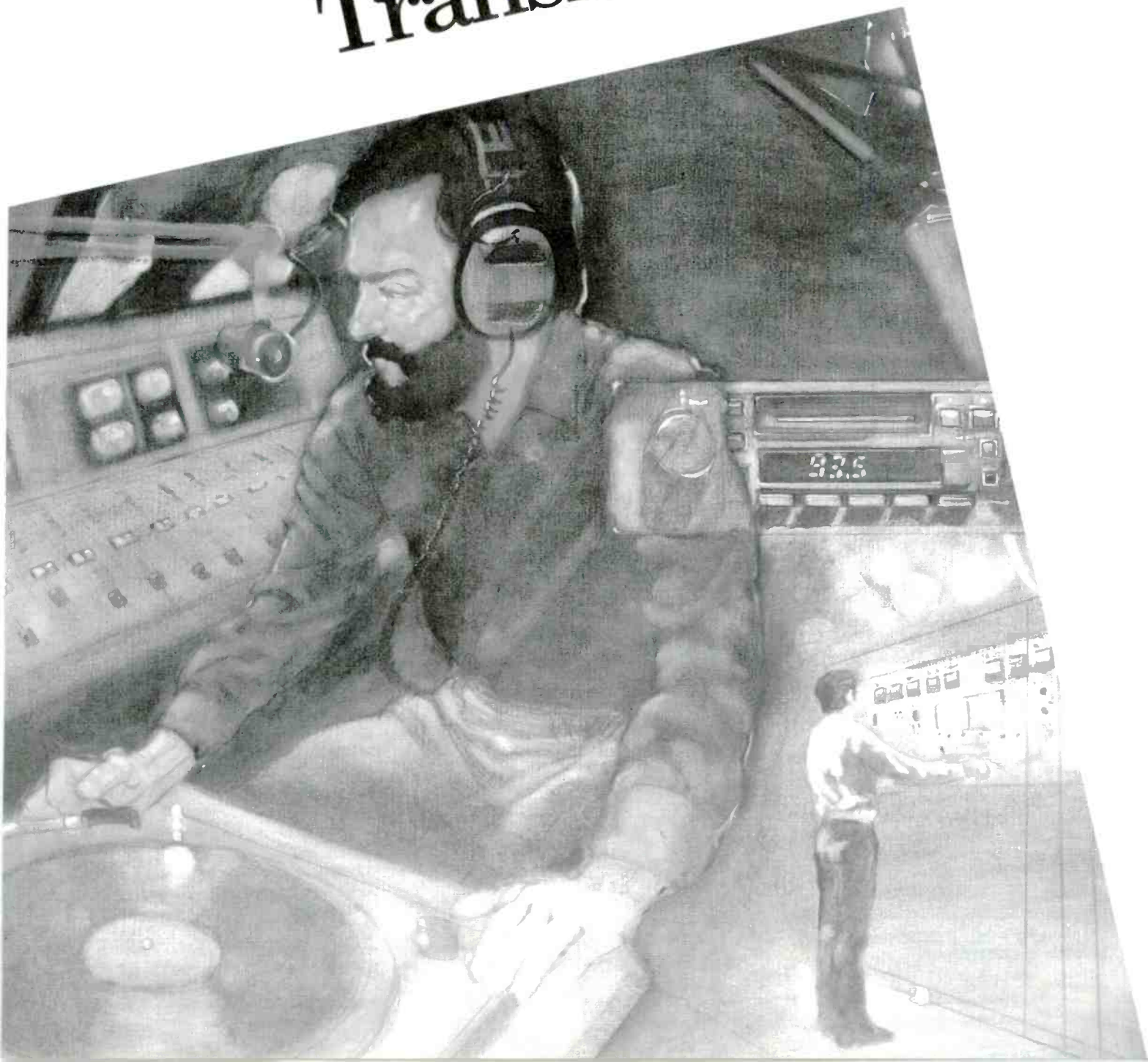

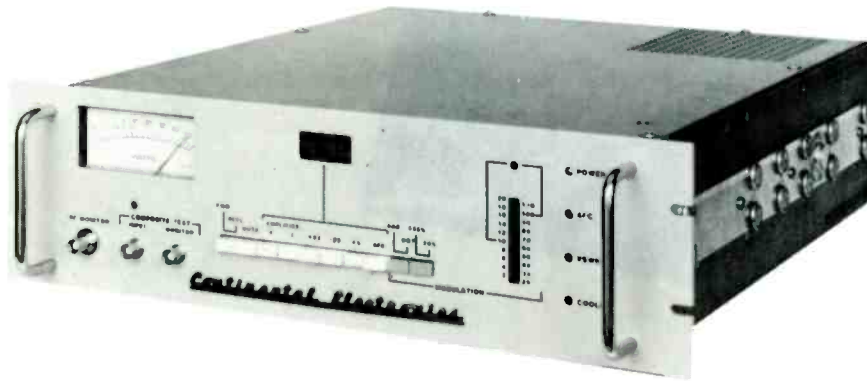

The Ultimate FM Exciter

Continental's Type 802A solid-state FM Exciter offers broadcasters outstanding performance, high-quality construction, outstanding reliability.

With its variable output of 5 to 50 watts and self-contained harmonic filter, the 802A can be used as a low power transmitter.

The 802A is completely solid-state. All sub-assemblies are modularized and fully accessible from the front.

All components of the 802A have been selected with proven reliability as well as electrical suitability as a prerequisite.

The 802A FM Exciter is fully equipped to accept the composite baseband signal from any fine quality stereo generator, and STL system or monaural audio and SCA programming.

SPECIFICATIONS

GENERAL

Power Output:

5 to 50 watts continuously adjustable

RF Output Impedance:

50 ohms, VSWR less than 2:1 for full output, protected for open and short circuit; BNC connector

RF Harmonic and Spurious:

60 dB or more below rated output

Frequency Range:

88 to 108 MHz, in 10 kHz steps

Frequency Control:

Phase Locked Loop Frequency Synthesis from high stability master oscillator

Frequency Stability

±250 Hz, -20° to +55°C
(-4°F to +131°F)

Modulation Type:

Direct carrier frequency modulation

Modulation Capability:

±200 kHz deviation

Modulation Indication:

Digital LED display shows true peak level of modulating signal in 5% increments with over-modulation indicator; illumination of each LED occurs at ±2% of indicated modulation level.

MONAURAL OPERATION

Audio Input Impedance:

600 ohms, balanced

Audio Input Return Loss:

30 dB or better

Audio Input Level:

+10 dBm (6.93 volts peak-to-peak)

@ 600 ohms for ±75 kHz deviation

Audio Frequency Response:

±0.5 dB; flat, 25, 50 or 75 microsecond pre-emphasis, 20 Hz to 15 kHz

Total Harmonic Distortion:

0.08% max.; 20 Hz to 15 kHz
(measured with Spectrum Analyzer.)

Intermodulation Distortion:

0.08% or less, 60 Hz/7 kHz 4:1 ratio

Transient IMD

0.1% max. (square wave/sine wave)

FM S/N Ratio (FM Noise):

78 dB min. below ±75 kHz deviation @ 400 Hz, measured within a 20 Hz to 15 kHz bandwidth with 75 microsecond de-emphasis

Asynchronous AM S/N Ratio (AM Noise):

73 dB RMS below carrier; reference: 100% AM modulation, full power @ 400 Hz with 75 microsecond de-emphasis, no FM modulation

Synchronous AM S/N Ratio (Incidental AM Noise):

65 dB below carrier; reference: 100% AM modulation, full power @ 400 Hz with 75 microsecond de-emphasis, FM modulation ±75 kHz @ 400 Hz

WIDEBAND OPERATION

Composite Inputs:

Balanced, unbalanced and test

Composite Input Impedance:

5,000 ohms, nominal

Composite Input Level:

1.25 volts RMS (3.54 volts peak-to-peak) for ±75 kHz deviation

Composite Amplitude Response:

±0.1 dB, 20 Hz to 100 kHz

Composite phase Response:

±0.5%, 20 Hz to 75 kHz

Composite Group Delay Variation:

±25 ns, 20 Hz to 75 kHz

Composite Total Harmonic Distortion:

0.08% max.

Composite Intermodulation Distortion:

0.08% or less, 60 Hz/7 kHz 4:1 ratio

Composite Transient IMD:

0.1% max.

Composite FM S/N Ratio (FM Noise):

78 dB min. below ±75 kHz deviation

Two SCA Inputs:

Balanced or unbalanced

SCA Input Impedance:

50,000 ohms, nominal

SCA Input Level:

1.25 volts RMS for ±7.5 kHz deviation

SCA Amplitude Response:

±0.3 dB, 40 kHz to 100kHz

STEREO OPERATION

Most Stereo performance parameters are determined primarily by the Stereo Generator used. The following parameters are influenced by the RF system. These specifications assume that a "State-of-the-Art" Stereo Generator is used.

Stereo Separation:

50 dB min.; 50 Hz to 15 kHz. (60 dB or better, 400 Hz to 7.5 kHz typical)

Total Harmonic Distortion:

0.08% max.; 50 Hz to 15 kHz.

(Measured with Spectrum Analyzer.)

Intermodulation Distortion:

0.08% max.; 60 Hz/7 kHz, 4:1 ratio

FM Noise:

-72 dB referenced to 400 Hz, 75 kHz deviation.

Measured with 75 microsecond de-emphasis within a 20 Hz to 15 kHz bandwidth.

Linear Crosstalk:

-55 dB

SCA OPERATION

Most SCA performance parameters are determined primarily by the SCA generator used. The following parameters are influenced by the RF System. These specifications assume that a "State-of-the-Art" SCA Generator is used.

Crosstalk, SCA to Main and Stereo (67 kHz and/or 92 kHz):

-60 dB, SCA deviation 5 kHz, Main 75 microsecond de-emphasis

Crosstalk, Main and Stereo to SCA (67 kHz or 92 kHz):

-50 dB, Main and Stereo 75 kHz deviation; SCA reference deviation, 5 kHz and 200 Hz modulation; 150 microsecond SCA de-emphasis

Crosstalk SCA to SCA (67 kHz and 92 kHz):

-50 dB, SCA reference deviation 5 kHz and 200 Hz modulation frequency; 150 microsecond de-emphasis

ELECTRICAL

Input Power:

115V or 230V ± 10%; 50/60 Hz ± 5% single phase, 200 w max.

OPERATING ENVIRONMENT

Altitude Range:

0 to 15,000 ft (0 to 4600 m)

Temperature Range:

-20°C to +55°C (-4°F to +131°F)

Relative Humidity Range:

0 to 95%

MECHANICAL

Mounting:

Equipped with rack mounting slides

Size, as shown:

17 1/2 in. wide (444.5mm), centered in a 19 in. wide (482.6mm) rack-mounting panel; 5 1/4 in. high (133.35mm); 22 in. deep (558.8mm)

Weight:

Approx. 31.5 lbs. (14.3 kg)

Type 814R-1

Continental's 814R-1 is a high performance, state-of-the-art transmitter that uses the Type 802A Exciter to deliver a crisp, clean signal.

The transmitter is solid-state except for the single 5CX1500B tube in the final amplifier. IC logic is used for all control functions. A computer-like memory restarts the transmitter after a power failure.

Standard features include remote control interface and an automatic overload/recycle system. The transmitter is completely self-contained in one small cabinet.

SPECIFICATIONS using 802A Exciter**GENERAL****Rated Power Output:**

814R-1: 2.5 kW

Power Consumption:

814R-1: 4.9 kW

Frequency Range:

88 to 108 MHz, in 10 kHz steps

Frequency Control:

Phase Locked Loop Frequency Synthesis from high stability master oscillator

Frequency Stability

±250 Hz

Output Impedance:

50 ohms

Output Connector:

1 5/8" EIA Flange

VSWR:

2:1, max.

Modulation Type:

Direct carrier frequency modulation

Modulation Capability:

±150 kHz deviation

Modulation Indication:

Digital LED display shows true peak level of modulation signal in 5% increments with accuracy better than ±2%

Exciter:

Solid-state unit with variable output of 5 to 50 watts, and self-contained harmonic filter.

RF Harmonic Attenuation:

-77 dB, min.

Power Supply Rectifiers:

Silicon

MONAURAL OPERATION**Audio Input Impedance:**

600 ohms, balanced

Audio Input Return Loss:

30 dB or better

Audio Input Level:

+10 dBm (6.93 volts peak-to-peak)

@ 600 ohms for ±75 kHz deviation

Audio Frequency Response:

±0.5 dB; flat, 25, 50 or 75 microsecond pre-emphasis, 20 Hz to 15 kHz

Total Harmonic Distortion:

0.08% max.; 20 Hz to 15 kHz (measured with Spectrum Analyzer.)

Intermodulation Distortion:

0.1% or less, 60 Hz/7 kHz 4:1 ratio

FM S/N Ratio (FM Noise):

75 dB min. below ±75 kHz deviation @ 400 Hz, measured within a 20 Hz to 15 kHz bandwidth with 75 microsecond de-emphasis

Asynchronous AM S/N Ratio (AM**FM Noise):**

55 dB RMS below carrier; reference: 100% AM modulation, full power @ 400 Hz with 75 microsecond de-emphasis, no FM modulation

Synchronous AM S/N Ratio**(Incidental AM Noise):**

40 dB below carrier; reference: 100% AM modulation, full power @ 400 Hz with 75 microsecond de-emphasis, FM modulation ±75 kHz @ 400 Hz

WIDEBAND OPERATION**Composite Inputs:**

Balanced, unbalanced and test

Composite Input Impedance:

5,000 ohms, nominal

Composite Input Level:

1.25 volts RMS (3.54 volts peak-to-peak) for ±75 kHz deviation

Composite Amplitude Response:

±0.1 dB, 20 Hz to 100 kHz

Composite Total Harmonic Distortion:

0.08% max.

Composite Intermodulation Distortion:

0.1% or less, 60 Hz/7 kHz 4:1 ratio

Two SCA Inputs:

Balanced or unbalanced

SCA Input Impedance:

50,000 ohms, nominal

SCA Input Level:

1.25 volts RMS for ±7.5 kHz deviation

SCA Amplitude Response:

±0.3 dB, 40 kHz to 100kHz

STEREO OPERATION

Most Stereo performance parameters are determined primarily by the Stereo Generator used. The following parameters are influenced by the RF system. These specifications assume that a "State-of-the-Art" Stereo Generator is used.

Stereo Separation:

50 dB min.; 50 Hz to 15 kHz. (60 dB or better, 400 Hz to 7.5 kHz typical)

Total Harmonic Distortion:

0.08% max.; 50 Hz to 15 kHz. (Measured with Spectrum Analyzer.)

Intermodulation Distortion:

0.1% max.; 60 Hz/7 kHz, 4:1 ratio

FM Noise:

-72 dB referenced to 400 Hz, 75 kHz deviation. Measured with 75 microsecond de-emphasis within a 20 Hz to 15 kHz bandwidth.

Linear Crosstalk:

-55 dB

SCA OPERATION

Most SCA performance parameters are determined primarily by the SCA generator used. The following parameters are influenced by the RF System. These specifications assume that a "State-of-the-Art" SCA Generator is used.

Crosstalk, SCA to Main and Stereo**(67 kHz and/or 92 kHz):**

-60 dB, SCA deviation 5 kHz, Main 75 microsecond de-emphasis

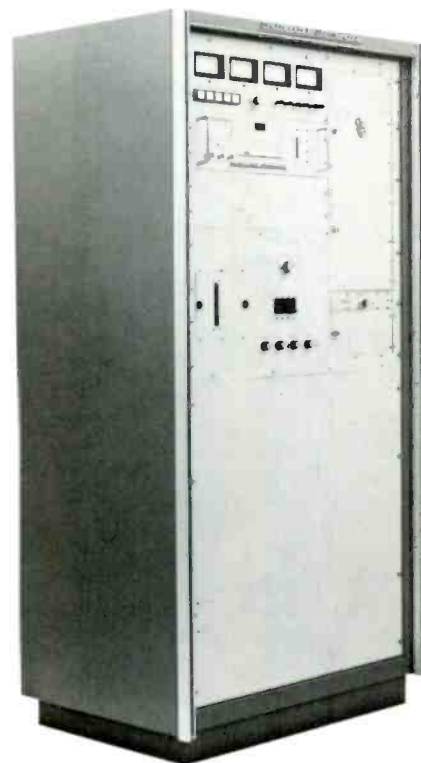
**Crosstalk, Main and Stereo to SCA****(67 kHz or 92 kHz):**

-50 dB, Main and Stereo 75 kHz deviation; SCA reference deviation, 5 kHz and 200 Hz modulation; SCA de-emphasis, 150 microsecond

Crosstalk SCA to SCA**(67 kHz and 92 kHz):**

-50 dB, SCA reference deviation 5 kHz and 200 Hz modulation frequency; de-emphasis, 150 microsecond

ELECTRICAL**Power Source:**

200 to 250 volts ac; 60 Hz, single phase; available transformer taps are 200, 210, 220, 230, 240, 250 volts ac; 50 Hz available on request.

Permissible Line Voltage Variation:

±5%

Filament regulator:

±1% of optimum

OPERATING ENVIRONMENT**Altitude Range:**

0 to 7,500 ft. (0 to 2286 m) standard; optional to 10,000 ft (3048 m) with modification kit

Ambient Temperature Range:

-20°C to +50°C (-4°F to +122°F)

Relative Humidity:

0 to 95%

MECHANICAL**Size, as shown:**

69" (175 cm) H

35" (89 cm) W

24" (61 cm) D

Weight:

750 lb (340 kg) nominal

All specifications are subject to change without notice.

FM Type 814B 4.3 kW FM Transmitter

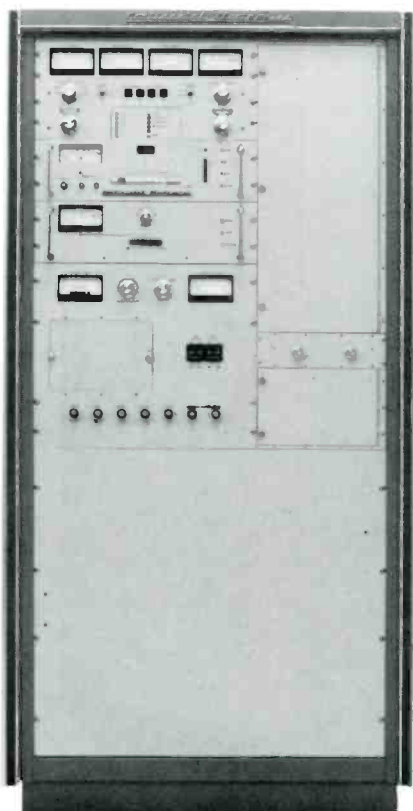

Type 814B

Continental's 814B is a high performance, state-of-the-art transmitter that uses the Type 802A Exciter to deliver a crisp, clean signal.

The transmitter is solid-state, including a 100 watt intermediate power amplifier, except for a single 4CX3500A tube in the final amplifier.

IC logic is used for all control functions. A computer-like memory, powered by battery backup, restarts the transmitter after a power failure.

Standard features include remote control, interface overload/recycle system, filament voltage regulation, automatic RF power control, and SWR foldback.

The transmitter is completely self-contained in one small cabinet, including harmonic filter.

Specifications using 802A Exciter

GENERAL

Rated Power Output:

814B: 4.3 kW

Power Consumption:

814B: 7.0 kW, nominal

Frequency Range:

88 to 108 MHz, in 10 kHz steps

Frequency Control:

Phase Locked Loop Frequency Synthesis from high stability master oscillator

Frequency Stability

±250 Hz

Output Impedance:

50 ohms

Output Connector:

1 5/8" EIA Flange

VSWR:

2:1, max.

Modulation Type:

Direct carrier frequency modulation

Modulation Capability:

±150 kHz deviation

Modulation Indication:

Digital LED display shows true peak level of modulation signal in 5% increments with accuracy better than ±2%

Exciter:

Solid-state unit with variable output of 5 to 50 watts, and self-contained harmonic filter

RF Harmonic Attenuation:

-80 dB, min.

Power Supply Rectifiers:

Silicon

MONAURAL OPERATION

Audio Input Impedance:

600 ohms, balanced

Audio Input Return Loss:

30 dB or better

Audio Input Level:

+10 dBm (6.93 volts peak-to-peak)

@ 600 ohms for ±75 kHz deviation

Audio Frequency Response:

±0.5 dB; flat, 25, 50 or 75 microsecond pre-emphasis, 20 Hz to 15 kHz

Total Harmonic Distortion:

0.08% max.; 20 Hz to 15 kHz (measured with Spectrum Analyzer.)

Intermodulation Distortion:

0.1% or less, 60 Hz/7 kHz 4:1 ratio

FM S/N Ratio (FM Noise):

75 dB min. below ±75 kHz deviation @ 400 Hz, measured within a 20 Hz to 15 kHz bandwidth with 75 microsecond de-emphasis

Asynchronous AM S/N Ratio (AM Noise):

55 dB RMS below carrier; reference: 100% AM modulation, full power @ 400 Hz with 75 microsecond de-emphasis, no FM modulation

Synchronous AM S/N Ratio (Incidental AM Noise):

40 dB below carrier; reference: 100% AM modulation, full power @ 400 Hz with 75 microsecond de-emphasis, FM modulation ±75 kHz @ 400 Hz

WIDEBAND OPERATION

Composite Inputs:

Balanced, unbalanced and test

Composite Input Impedance:

5,000 ohms, nominal

Composite Input Level:

1.25 volts RMS (3.54 volts peak-to-peak) for ±75 kHz deviation

Composite Amplitude Response:

±0.1 dB, 20 Hz to 100 kHz

Composite Total Harmonic Distortion:

0.08% max.

Composite Intermodulation Distortion:

0.1% or less, 60 Hz/7 kHz 4:1 ratio

Two SCA Inputs:

Balanced or unbalanced

SCA Input Impedance:

50,000 ohms, nominal

SCA Input Level:

1.25 volts RMS for ±7.5 kHz deviation

SCA Amplitude Response:

±0.3 dB, 40 kHz to 100kHz

STEREO OPERATION

Most Stereo performance parameters are determined primarily by the Stereo Generator used. The following parameters are influenced by the RF system. These specifications assume that a "State-of-the-Art" Stereo Generator is used.

Stereo Separation:

50 dB min.; 50 Hz to 15 kHz. (60 dB or better, 400 Hz to 7.5 kHz typical)

Total Harmonic Distortion:

0.08% max.; 50 Hz to 15 kHz.

(Measured with Spectrum Analyzer.)

Intermodulation Distortion:

0.1% max.; 60 Hz/7 kHz, 4:1 ratio

FM Noise:

-72 dB referenced to 400 Hz, 75 kHz deviation.

Measured with 75 microsecond de-emphasis within a 20 Hz to 15 kHz bandwidth.

Linear Crosstalk:

-55 dB

SCA OPERATION

Most SCA performance parameters are determined primarily by the SCA generator used. The following parameters are influenced by the RF System. These specifications assume that a "State-of-the-Art" SCA Generator is used.

Crosstalk, SCA to Main and Stereo

(67 kHz and/or 92 kHz):

-60 dB, SCA deviation 5 kHz, Main

75 microsecond de-emphasis

Crosstalk, Main and Stereo to SCA

(67 kHz or 92 kHz):

-50 dB, Main and Stereo 75 kHz deviation;

SCA reference deviation, 5 kHz and 200 Hz

modulation; SCA de-emphasis, 150

microsecond

Crosstalk SCA to SCA

(67 kHz and 92 kHz):

-50 dB, SCA reference deviation 5 kHz and

200 Hz modulation frequency; de-emphasis,

150 microsecond

ELECTRICAL

Power Source:

200 to 250 volts ac; 60 Hz, single phase; available transformer taps are 200, 210, 220, 230, 240, 250 volts ac; 50 Hz available on request.

Permissible Line Voltage Variation:

±5%

Filament regulator:

±1% of optimum

OPERATING ENVIRONMENT

Altitude Range:

0 to 7,500 ft. (0 to 2286 m) standard; optional to 10,000 ft (3048 m) with modification kit

Ambient Temperature Range:

-20°C to +50°C (-4°F to +122°F)

Relative Humidity:

0 to 95%

MECHANICAL

Size, as shown:

69" (175 cm) H

35" (89 cm) W

33-3/8" (61 cm) D

Weight:

850 lb (386 kg) nominal

All specifications are subject to change without notice.

Type 816R-1A

Continental's 816R-1A is a high performance, state-of-the-art transmitter that uses the Type 802A Exciter to deliver a crisp, clean signal.

The 816R-1A is solid-state except for 3 tubes: a pair of 4CX250B drivers and a 4CX10000A power amplifier operating at Class C.

Standard features include remote control interface and an automatic overload/recycle system. The transmitter is completely self-contained in one small cabinet.

SPECIFICATIONS using 802A Exciter

GENERAL

Rated Power Output:

816R-1A: 10 kW (11 kW Max.)

Power Consumption:

816R-1A: 18 kW, nominal

Frequency Range:

88 to 108 MHz, in 10 kHz steps

Frequency Control:

Phase Locked Loop Frequency Synthesis from high stability master oscillator

Frequency Stability

±250 Hz

Output Impedance:

50 ohms

Output Connector:

3 1/8" EIA Flange

VSWR:

2:1, max.

Modulation Type:

Direct carrier frequency modulation

Modulation Capability:

±150 kHz deviation

Modulation Indication:

Digital LED display shows true peak level of modulation signal in 5% increments with accuracy better than ±2%

Exciter:

Solid-state unit with variable output of 5 to 50 watts, and self-contained harmonic filter.

RF Harmonic Attenuation:

-80 dB, min.

Power Supply Rectifiers:

Silicon

MONAURAL OPERATION

Audio Input Impedance:

600 ohms, balanced

Audio Input Return Loss:

30 dB or better

Audio Input Level:

+10 dBm (6.93 volts peak-to-peak)

@ 600 ohms for ±75 kHz deviation

Audio Frequency Response:

±0.5 dB; flat, 25, 50 or 75 microsecond pre-emphasis, 20 Hz to 15 kHz

Total Harmonic Distortion:

0.08% max.; 20 Hz to 15 kHz (measured with Spectrum Analyzer.)

Intermodulation Distortion:

0.08% or less, 60 Hz/7 kHz 4:1 ratio

FM S/N Ratio (FM Noise):

75 dB min. below ±75 kHz deviation @ 400 Hz, measured within a 20 Hz to 15 kHz bandwidth with 75 microsecond de-emphasis

Asynchronous AM S/N Ratio (AM Noise):

Noise):

55 dB RMS below carrier; reference: 100% AM modulation, full power @ 400 Hz with 75 microsecond de-emphasis, no FM modulation

Synchronous AM S/N Ratio

(Incidental AM Noise):

40 dB below carrier; reference: 100% AM modulation, full power @ 400 Hz with 75 microsecond de-emphasis, FM modulation ±75 kHz @ 400 Hz

WIDEBAND OPERATION

Composite Inputs:

Balanced, unbalanced and test

Composite Input Impedance:

5,000 ohms, nominal

Composite Input Level:

1.25 volts RMS (3.54 volts peak-to-peak) for ±75 kHz deviation

Composite Amplitude Response:

±0.1 dB, 20 Hz to 100 kHz

Composite Total Harmonic Distortion:

0.08% max.

Composite Intermodulation Distortion:

0.1% or less, 60 Hz/7 kHz 4:1 ratio

Two SCA Inputs:

Balanced or unbalanced

SCA Input Impedance:

50,000 ohms, nominal

SCA Input Level:

1.25 volts RMS for ±7.5 kHz deviation

SCA Amplitude Response:

±0.3 dB, 40 kHz to 100kHz

STEREO OPERATION

Most Stereo performance parameters are determined primarily by the Stereo Generator used. The following parameters are influenced by the RF system. These specifications assume that a "State-of-the-Art" Stereo Generator is used.

Stereo Separation:

50 dB min.; 50 Hz to 15 kHz. (60 dB or better, 400 Hz to 7.5 kHz typical)

Total Harmonic Distortion:

0.08% max.; 50 Hz to 15 kHz. (Measured with Spectrum Analyzer.)

Intermodulation Distortion:

0.08% max.; 60 Hz/7 kHz, 4:1 ratio

FM Noise:

-72 dB referenced to 400 Hz, 75 kHz deviation. Measured with 75 microsecond de-emphasis within a 20 Hz to 15 kHz bandwidth.

Linear Crosstalk:

-55 dB

SCA OPERATION

Most SCA performance parameters are determined primarily by the SCA generator used. The following parameters are influenced

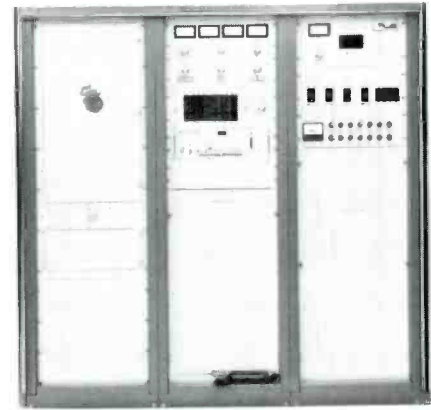

by the RF System. These specifications assume that a "State-of-the-Art" SCA Generator is used.

Crosstalk SCA to Main and Stereo (67 kHz and 92 kHz):

-60 dB SCA deviation 5 kHz, Main 75 second de-emphasis

Crosstalk, Main and Stereo to SCA (67 kHz or 92 kHz):

-50 dB, Main and stereo 75 kHz deviation SCA reference deviation, 5 kHz and 200 Hz modulation; SCA de-emphasis, 150 microsecond

Crosstalk SCA to SCA (67 kHz and 92 kHz):

-50 dB, SCA reference deviation 5 kHz and 200 Hz modulation frequency; de-emphasis, 150 microsecond

ELECTRICAL

Power Source:

200 to 250 volts ac; 60 Hz, three phase; available transformer taps are 200, 210, 220, 230, 240, 250 volts ac; 50 Hz available on request.

Permissible Line Voltage Variation:

±5% (each phase voltage variation: within 5% of the average of all three phases).

Filament regulator:

±1% of optimum

OPERATING ENVIRONMENT

Altitude Range:

0 to 7,500 ft. (0 to 2286 m) standard; optional to 10,000 ft (3048 m) with modification kit

Ambient Temperature Range:

-20°C to +50°C (-4°F to +122°F)

Relative Humidity:

0 to 95%

MECHANICAL

Size, as shown:

69" (175 cm) H

72" (183 cm) W

28" (71 cm) D

Weight:

1875 lb (850.5 kg) nominal

All specifications are subject to change without notice.



Type 816R-2A

Continental's 816R-2A is a high performance, state-of-the-art transmitter that uses the Type 802A Exciter to deliver a crisp, clean signal.

The 816R-2A is solid-state except for 3 tubes: a pair of 4CX250B drivers and a 4CX15000A power amplifier operating at Class C.

Standard features include remote control interface and an automatic overload/recycle system. The transmitter is completely self-contained in one small cabinet, including harmonic filter.

SPECIFICATIONS using 802A Exciter

GENERAL

Rated Power Output:

816R-2A: 20 kW (21.5 kW max.)

Power Consumption:

816R-2A: 31 kW nominal
(33 kW @ 21.5 kW RF output)

Frequency Range:

88 to 108 MHz, in 10 kHz steps

Frequency Control:

Phase Locked Loop Frequency Synthesis from high stability master oscillator

Frequency Stability

±250 Hz

Output Impedance:

50 ohms

Output Connector:

3 1/8" EIA Flange

VSWR:

2:1, max.

Modulation Type:

Direct carrier frequency modulation

Modulation Capability:

±150 kHz deviation

Modulation Indication:

Digital LED display shows true peak level of modulation signal in 5% increments with accuracy better than ±2%

Exciter:

Solid-state unit with variable output of 5 to 50 watts, and self-contained harmonic filter

RF Harmonic Attenuation:

-80 dB, min.

Power Supply Rectifiers:

Silicon

MONAURAL OPERATION

Audio Input Impedance:

600 ohms, balanced

Audio Input Return Loss:

30 dB or better

Audio Input Level:

+10 dBm (6.93 volts peak-to-peak)
@ 600 ohms for ±75 kHz deviation

Audio Frequency Response:

±0.5 dB; flat, 25, 50 or 75 microsecond pre-emphasis, 20 Hz to 15 kHz

Total Harmonic Distortion:

0.08% max.; 20 Hz to 15 kHz
(measured with Spectrum Analyzer.)

Intermodulation Distortion:

0.08% or less, 60 Hz/7 kHz 4:1 ratio

FM S/N Ratio (FM Noise):

75 dB min. below ±75 kHz deviation @ 400 Hz, measured within a 20 Hz to 15 kHz bandwidth with 75 microsecond de-emphasis

Asynchronous AM S/N Ratio (AM Noise):

55 dB RMS below carrier; reference: 100% AM modulation, full power @ 400 Hz with 75 microsecond de-emphasis, no FM modulation

Synchronous AM S/N Ratio (Incidental AM Noise):

40 dB below carrier; reference: 100% AM modulation, full power @ 400 Hz with 75 microsecond de-emphasis, FM modulation ±75 kHz @ 400 Hz

WIDEBAND OPERATION

Composite Inputs:

Balanced, unbalanced and test

Composite Input Impedance:

5,000 ohms, nominal

Composite Input Level:

1.25 volts RMS (3.54 volts peak-to-peak) for ±75 kHz deviation

Composite Amplitude Response:

±0.1 dB, 20 Hz to 100 kHz

Composite Total Harmonic Distortion:

0.08% max.

Composite Intermodulation Distortion:

0.08% max.; 60 Hz/7 kHz 4:1 ratio

Two SCA Inputs:

Balanced or unbalanced

SCA Input Impedance:

50,000 ohms, nominal

SCA Input Level:

1.25 volts RMS for ±7.5 kHz deviation

SCA Amplitude Response:

±0.3 dB, 40 kHz to 100kHz

STEREO OPERATION

Most Stereo performance parameters are determined primarily by the Stereo Generator used. The following parameters are influenced by the RF system. These specifications assume that

a "State-of-the-Art" Stereo Generator is used.

Stereo Separation:

50 dB min.; 50 Hz to 15 kHz. (60 dB or better, 400 Hz to 7.5 kHz typical)

Total Harmonic Distortion:

0.08% max.; 50 Hz to 15 kHz.

(Measured with Spectrum Analyzer.)

Intermodulation Distortion:

0.08% max.; 60 Hz/7 kHz, 4:1 ratio

FM Noise:

-72 dB referenced to 400 Hz, 75 kHz deviation. Measured with 75 microsecond de-emphasis within a 20 Hz to 15 kHz bandwidth.

Linear Crosstalk:

-55 dB

SCA OPERATION

Most SCA performance parameters are determined primarily by the SCA generator used. The following parameters are influenced by the RF System. These specifications assume that a "State-of-the-Art" SCA Generator is used.

Crosstalk, SCA to Main and Stereo

(67 kHz and/or 92 kHz):

-60 dB, SCA deviation 5 kHz, Main 75 microsecond de-emphasis

Crosstalk, Main and Stereo to SCA

(67 kHz or 92 kHz):

-50 dB, Main and Stereo 75 kHz deviation; SCA reference deviation, 5 kHz and 200 Hz modulation; SCA de-emphasis, 150 microsecond

Crosstalk SCA to SCA

(67 kHz and 92 kHz):

-50 dB, SCA reference deviation 5 kHz and 200 Hz modulation frequency; de-emphasis, 150 microsecond

ELECTRICAL

Power Source:

200 to 250 volts ac; 60 Hz, three phase; available transformer taps are 200, 210, 220, 230, 240, 250 volts ac; 50 Hz available on request.

Permissible Line Voltage Variation:

±5% (each phase voltage variation: within 5% of the average of all three phases).

Filament regulator:

±1% of optimum

OPERATING ENVIRONMENT

Altitude Range:

0 to 7,500 ft. (2286 m) standard; optional to 10,000 ft (3048 m) with modification kit

Ambient Temperature Range:

-20°C to +50°C (-4°F to +122°F)

Relative Humidity:

0 to 95%

MECHANICAL

Size, as shown:

69" (175 cm) H

72" (183 cm) W

28" (71 cm) D

Weight:

1962 lb (890 kg) nominal

All specifications are subject to change without notice.

Type 816R-3

Continental's 816R-3 is a high performance, state-of-the-art transmitter that uses the Type 802A Exciter to deliver a crisp, clean signal.

The 816R-3 is solid-state except for 3 tubes: a pair of 4CX250B drivers and a 4CX15000A power amplifier operating at Class C.

Standard features include remote control interface and an automatic overload/recycle system. The transmitter is completely self-contained in one small cabinet, including harmonic filter.

SPECIFICATIONS using 802A Exciter

GENERAL

Rated Power Output:

816R-3: 25 kW

Power Consumption:

816R-3: 40 kW

Frequency Range:

88 to 108 MHz, in 10 kHz steps

Frequency Control:

Phase Locked Loop Frequency Synthesis from high stability master oscillator

Frequency Stability

±250 Hz

Output Impedance:

50 ohms

Output Connector:

3 1/8" EIA Flange

VSWR:

2:1, max.

Modulation Type:

Direct carrier frequency modulation

Modulation Capability:

±150 kHz deviation

Modulation Indication:

Digital LED display shows true peak level of modulation signal in 5% increments with accuracy better than ±2%

Exciter:

Solid-state unit with variable output of 5 to 50 watts, and self-contained harmonic filter.

RF Harmonic Attenuation:

-80 dB, min.

Power Supply Rectifiers:

Silicon

MONAURAL OPERATION

Audio Input Impedance:

600 ohms, balanced

Audio Input Return Loss:

30 dB or better

Audio Input Level:

+10 dBm (6.93 volts peak-to-peak) @ 600 ohms for ±75 kHz deviation

Audio Frequency Response:

±0.5 dB; flat, 25, 50 or 75 microsecond pre-emphasis, 20 Hz to 15 kHz

Total Harmonic Distortion:

0.08% max.; 20 Hz to 15 kHz (measured with Spectrum Analyzer.)

Intermodulation Distortion:

0.08% or less, 60 Hz/7 kHz 4:1 ratio

FM S/N Ratio (FM Noise):

75 dB min. below ±75 kHz deviation @ 400 Hz, measured within a 20 Hz to 15 kHz bandwidth with 75 microsecond de-emphasis

Asynchronous AM S/N Ratio (AM

55 dB RMS below carrier; reference: 100% AM modulation, full power @ 400 Hz with 75 micro-second de-emphasis, no FM modulation

Synchronous AM S/N Ratio

(Incidental AM Noise):

40 dB below carrier; reference: 100% AM modulation, full power @ 400 Hz with 75 microsecond de-emphasis, FM modulation ±75 kHz @ 400 Hz

WIDEBAND OPERATION

Composite Inputs:

Balanced, unbalanced and test

Composite Input Impedance:

5,000 ohms, nominal

Composite Input Level:

1.25 volts RMS (3.54 volts peak-to-peak) for ±75 kHz deviation

Composite Amplitude Response:

±0.1 dB, 20 Hz to 100 kHz

Composite Total Harmonic Distortion:

0.08% max.

Composite Intermodulation Distortion:

0.08% or less, 60 Hz/7 kHz 4:1 ratio

Two SCA Inputs:

Balanced or unbalanced

SCA Input Impedance:

50,000 ohms, nominal

SCA Input Level:

1.25 volts RMS for ±7.5 kHz deviation

SCA Amplitude Response:

±0.3 dB, 40 kHz to 100kHz

STEREO OPERATION

Most Stereo performance parameters are determined primarily by the Stereo Generator used. The following parameters are influenced by the RF system. These specifications assume that a "State-of-the-Art" Stereo Generator is used.

Stereo Separation:

50 dB min.; 50 Hz to 15 kHz. (60 dB or better, 400 Hz to 7.5 kHz typical)

Total Harmonic Distortion:

0.08% max.; 50 Hz to 15 kHz.

(Measured with Spectrum Analyzer.)

Intermodulation Distortion:

0.08% max.; 60 Hz/7 kHz, 4:1 ratio

FM Noise:

-72 dB referenced to 400 Hz, 75 kHz deviation. Measured with 75 microsecond de-emphasis within a 20 Hz to 15 kHz bandwidth

Linear Crosstalk:

-55 dB

SCA OPERATION

Most SCA performance parameters are determined primarily by the SCA generator used. The following parameters are influenced by the RF System. These specifications assume that a "State-of-the-Art" SCA Generator is used.



Crosstalk, SCA to Main and Stereo (67 kHz and/or 92 kHz):

-60 dB, SCA deviation 5 kHz, Main 75 microsecond de-emphasis

Crosstalk, Main and Stereo to SCA (67 kHz and 92 kHz):

-50 dB, Main and Stereo 75 kHz deviation; SCA reference deviation, 5 kHz and 200 Hz modulation; SCA de-emphasis, 150 microsecond

Crosstalk SCA to SCA

(67 kHz and 92 kHz):

-50 dB, SCA reference deviation 5 kHz and 200 Hz modulation frequency; de-emphasis, 150 microsecond

ELECTRICAL

Power Source:

200 to 250 volts ac; 60 Hz, three phase; available transformer taps are 200, 210, 220, 230, 240, 250 volts ac; 50 Hz available on request

Permissible Line Voltage Variation:

±5% (each phase voltage variation: within 5% of the average of all three phases).

Filament regulator:

±1% of optimum

OPERATING ENVIRONMENT

Altitude Range:

0 to 7,500 ft. (2286 m) standard; optional to 10,000 ft (3048 m) with modification kit

Ambient Temperature Range:

-20°C to +50°C (-4°F to +122°F)

Relative Humidity:

0 to 95%

MECHANICAL

Size, as shown:

69" (175 cm) H

72" (183cm) W

28" (71 cm) D

Weight:

2082 lb (944.3 kg) nominal

All specifications are subject to change without notice.



Type 816R-4

Continental's 816R-4 is a high performance, state-of-the-art transmitter that uses the Type 802A Exciter to deliver a crisp, clean signal.

The 816R-4 is solid-state except for 3 tubes: a pair of 4CX250B drivers and a 4CX15000A power amplifier operating at Class C.

Standard features include remote control interface and an automatic overload/recycle system. The transmitter is completely self-contained in one small cabinet, including harmonic filter.

SPECIFICATIONS using 802A Exciter

GENERAL

Rated Power Output:

816R-4: 27.5 kW

Power Consumption:

816R-4: 42 kW

Frequency Range:

88 to 108 MHz, in 10 kHz steps

Frequency Control:

Phase Locked Loop Frequency Synthesis from high stability master oscillator

Frequency Stability

±250 Hz

Output Impedance:

50 ohms

Output Connector:

3 1/8" EIA Flange

VSWR:

2:1, max.

Modulation Type:

Direct carrier frequency modulation

Modulation Capability:

±150 kHz deviation

Modulation Indication:

Digital LED display shows true peak level of modulation signal in 5% increments with accuracy better than ±2%

Exciter:

Solid-state unit with variable output of 5 to 50 watts, and self-contained harmonic filter

RF Harmonic Attenuation:

-80 dB, min.

Power Supply Rectifiers:

Silicon

MONAURAL OPERATION

Audio Input Impedance:

600 ohms, balanced

Audio Input Return Loss:

30 dB or better

Audio Input Level:

+10 dBm (6.93 volts peak-to-peak)
@ 600 ohms for ±75 kHz deviation

Audio Frequency Response:

±0.5 dB; flat, 25, 50 or 75 microsecond pre-emphasis, 20 Hz to 15 kHz

Total Harmonic Distortion:

0.08% max.; 20 Hz to 15 kHz
(measured with Spectrum Analyzer.)

Intermodulation Distortion:

0.08% or less, 60 Hz/7 kHz 4:1 ratio

FM S/N Ratio (FM Noise):

75 dB min. below ±75 kHz deviation @ 400 Hz, measured within a 20 Hz to 15 kHz bandwidth with 75 microsecond de-emphasis

Asynchronous AM S/N Ratio (AM Noise):

55 dB RMS below carrier; reference: 100% AM modulation, full power @ 400 Hz with 75 microsecond de-emphasis, no FM modulation

Synchronous AM S/N Ratio (Incidental AM Noise):

40 dB below carrier; reference: 100% AM modulation, full power @ 400 Hz with 75 microsecond de-emphasis, FM modulation ±75 kHz @ 400 Hz

WIDEBAND OPERATION

Composite Inputs:

Balanced, unbalanced and test

Composite Input Impedance:

5,000 ohms, nominal

Composite Input Level:

1.25 volts RMS (3.54 volts peak-to-peak) for ±75 kHz deviation

Composite Amplitude Response:

±0.1 dB, 20 Hz to 100 kHz

Composite Total Harmonic Distortion:

0.08% max.

Composite Intermodulation Distortion:

0.08% or less, 60 Hz/7 kHz 4:1 ratio

Two SCA Inputs:

Balanced or unbalanced

SCA Input Impedance:

50,000 ohms, nominal

SCA Input Level:

1.25 volts RMS for ±7.5 kHz deviation

SCA Amplitude Response:

±0.3 dB, 40 kHz to 100kHz

STEREO OPERATION

Most Stereo performance parameters are determined primarily by the Stereo Generator used. The following parameters are influenced by the RF system. These specifications assume that a "State-of-the-Art" Stereo Generator is used.

Stereo Separation:

50 dB min.; 50 Hz to 15 kHz. (60 dB or better, 400 Hz to 7.5 kHz typical)

Total Harmonic Distortion:

0.08% max.; 50 Hz to 15 kHz.

(Measured with Spectrum Analyzer.)

Intermodulation Distortion:

0.08% max.; 60 Hz/7 kHz, 4:1 ratio

FM Noise:

-72 dB referenced to 400 Hz, 75 kHz deviation. Measured with 75 microsecond de-emphasis within a 20 Hz to 15 kHz bandwidth

Linear Crosstalk:

-55 dB

SCA OPERATION

Most SCA performance parameters are determined primarily by the SCA generator used. The following parameters are influenced by the RF System. These specifications assume that a "State-of-the-Art" SCA Generator is used.

Crosstalk, SCA to Main and Stereo

(67 kHz and/or 92 kHz):

-60 dB, SCA deviation 5 kHz, Main 75 microsecond de-emphasis

Crosstalk, Main and Stereo to SCA

(67 kHz or 92 kHz):

-50 dB, Main and Stereo 75 kHz deviation; SCA reference deviation, 5 kHz and 200 Hz modulation; SCA de-emphasis, 150 microsecond

Crosstalk SCA to SCA

(67 kHz and 92 kHz):

-50 dB, SCA reference deviation 5 kHz and 200 Hz modulation frequency; de-emphasis, 150 microsecond

ELECTRICAL

Power Source:

200 to 250 volts ac; 60 Hz, three phase; available transformer taps are 200, 210, 220, 230, 240, 250 volts ac; 50 Hz available on request.

Permissible Line Voltage Variation:

±5% (each phase voltage variation: within 5% of the average of all three phases).

Filament regulator:

±1% of optimum

OPERATING ENVIRONMENT

Operating Altitude:

0 to 7,500 ft. (2286 m) standard; optional to 10,000 ft. (3048 m) with modification kit

Ambient Temperature Range:

-20°C to +50°C (-4°F to +122°F)

Relative Humidity:

0 to 95%

MECHANICAL

Size, as shown:

69" (175 cm) H

72" (183cm) W

28" (71cm) D

Weight:

2162 lb (980.7 kg) nominal

All specifications are subject to change without notice.

FM Type 816R-5 35 kW FM Transmitter

Type 816R-5

Continental's 816R-5 is a high performance, state-of-the-art transmitter that uses the Type 802A Exciter to deliver a crisp, clean signal.

The transmitter is solid-state, except for three tubes: a pair of 4CX250B drivers, and one 9019/YC130 power amplifier operating at Class C.

IC logic is used for all control functions. A computer-like memory, powered by battery backup, restarts the transmitter after a power failure.

Standard features include remote control interface, overload/recycle system, filament voltage regulation, automatic RF power control, and SWR foldback.

The transmitter is completely self-contained in one cabinet, including harmonic filter, except for the plate transformer which may be located at any location convenient to the transmitter.

SPECIFICATIONS using 802A Exciter

GENERAL

Rated Power Output:

816R-5: 35 kW

Power Consumption:

816R-5: 53 kW

Frequency Range:

88 to 108 MHz, in 10 kHz steps

Frequency Control:

Phase Locked Loop Frequency Synthesis from high stability master oscillator

Frequency Stability

±250 Hz

Output Impedance:

50 ohms

Output Connector:

3 1/8" EIA Flange

VSWR:

2:1, max.

Modulation Type:

Direct carrier frequency modulation

Modulation Capability:

±150 kHz deviation

Modulation Indication:

Digital LED display shows true peak level of modulation signal in 5% increments with accuracy better than ±2%

Exciter:

Solid-state unit with variable output of 5 to 50 watts, and self-contained harmonic filter

RF Harmonic Attenuation:

-80 dB, min.

Power Supply Rectifiers:

Silicon

MONAURAL OPERATION

Audio Input Impedance:

600 ohms, balanced

Audio Input Return Loss:

30 dB or better

Audio Input Level:

+10 dBm (6.93 volts peak-to-peak) @ 600 ohms for ±75 kHz deviation

Audio Frequency Response:

±0.5 dB; flat, 25, 50 or 75 microsecond pre-emphasis, 20 Hz to 15 kHz

Total Harmonic Distortion:

0.08% max.; 20 Hz to 15 kHz

(measured with Spectrum Analyzer.)

Intermodulation Distortion:

0.08% or less, 60 Hz/7 kHz 4:1 ratio

FM S/N Ratio (FM Noise):

75 dB min. below ±75 kHz deviation @ 400 Hz, measured within a 20 Hz to 15 kHz bandwidth with 75 microsecond de-emphasis

Asynchronous AM S/N Ratio (AM Noise):

55 dB RMS below carrier; reference: 100% AM modulation, full power @ 400 Hz with 75 microsecond de-emphasis, no FM modulation

Synchronous AM S/N Ratio (Incidental AM Noise):

40 dB below carrier; reference: 100% AM modulation, full power @ 400 Hz with 75 microsecond de-emphasis, FM modulation ±75 kHz @ 400 Hz

WIDEBAND OPERATION

Composite Inputs:

Balanced, unbalanced and test

Composite Input Impedance:

5,000 ohms, nominal

Composite Input Level:

1.25 volts RMS (3.54 volts peak-to-peak) for ±75 kHz deviation

Composite Amplitude Response:

±0.1 dB, 20 Hz to 100 kHz

Composite Total Harmonic Distortion:

0.08% max.

Composite Intermodulation Distortion:

0.08% or less, 60 Hz/7 kHz 4:1 ratio

Two SCA Inputs:

Balanced or unbalanced

SCA Input Impedance:

50,000 ohms, nominal

SCA Input Level:

1.25 volts RMS for ±7.5 kHz deviation

SCA Amplitude Response:

±0.3 dB, 40 kHz to 100kHz

STEREO OPERATION

Most Stereo performance parameters are determined primarily by the Stereo Generator used. The following parameters are influenced by the RF system. These specifications assume that a "State-of-the-Art" Stereo Generator is used.

Stereo Separation:

50 dB min.; 50 Hz to 15 kHz. (60 dB or better, 400 Hz to 7.5 kHz typical)

Total Harmonic Distortion:

0.08% max.; 50 Hz to 15 kHz.

(Measured with Spectrum Analyzer.)

Intermodulation Distortion:

0.08% max.; 60 Hz/7 kHz, 4:1 ratio

FM Noise:

-72 dB referenced to 400 Hz, 75 kHz deviation.

Measured with 75 microsecond de-emphasis within a 20 Hz to 15 kHz bandwidth.

Linear Crosstalk:

-55 dB

SCA OPERATION

Most SCA performance parameters are determined primarily by the SCA generator used. The following parameters are influenced by the RF System. These specifications

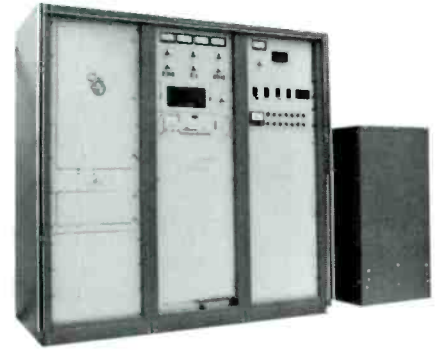

Crosstalk, SCA to Main and Stereo (67 kHz and/or 92 kHz):

-60 dB, SCA deviation 5 kHz, Main 75 microsecond de-emphasis

Crosstalk, Main and Stereo to SCA (67 kHz or 92 kHz):

-50 dB, Main and Stereo 75 kHz deviation; SCA reference deviation, 5 kHz and 200 Hz modulation; SCA de-emphasis, 150 microsecond

Crosstalk SCA to SCA (67 kHz and 92 kHz):

-50 dB, SCA reference deviation 5 kHz and 200 Hz modulation frequency; de-emphasis, 150 microsecond

ELECTRICAL

Power Source:

200 to 250 volts ac, 60 Hz, three phase; available transformer taps are 200, 210, 220, 230, 240, 250 volts ac; 50 Hz available on request.

Permissible Line Voltage Variation:

±5% (each phase voltage variation: within 5% of the average of all three phases).

Filament regulator:

±1% of optimum

OPERATING ENVIRONMENT

Operating Altitude:

0 to 7,500 ft. (2286 m) standard; optional to 10,000 ft (3048 m) with modification kit

Ambient Temperature Range:

-20°C to +50°C (-4°F to +122°F)

Relative Humidity:

0 to 95%

MECHANICAL

Transmitter Size as shown:

69" (175 cm) H, 72" (183 cm) W, 28" (71 cm) D

Weight:

1425 lb (641.2 kg) nominal

External Plate Transformer Size as shown:

46" (116.8 cm) H, 35" (88.9 cm) W, 24" (60.9 cm) D

Weight:

837 lb (376.6 kg)

Note:

External plate transformer can be located at any location convenient to the transmitter

All specifications are subject to change without notice.

FM Type 817R-2A 40 kW FM Transmitter



Type 817R-2A

Continental's 817R-2A is a high performance, state-of-the-art transmitter that uses the Type 802A Exciter to deliver a crisp, clean signal.

The 817R-2A is solid-state except for tubes in the driver and power amplifier section.

The 817R-2A consists of two Type 816R-2A 20 kW transmitters whose outputs are combined in a 90 degree hybrid to achieve 40 kW output. Through the optional use of coaxial switching, either transmitter can be put on the air independently.

Standard features include remote control interface, an automatic overload/recycle system and self-contained harmonic filter.

Available options include Type 377C-1A automatic exciter control and Type 377D-1 automatic combiner control. Both options can be mounted on the 817R-2A control cabinet.

Combiners are described in the "Combiner Section" this catalog.

SPECIFICATIONS using 802A Exciter

GENERAL

Rated Power Output:

817R-2A: 40 kW

Power Consumption:

817R-2A: 62 kW nominal

Frequency Range:

88 to 108 MHz, in 10 kHz steps

Frequency Control:

Phase Locked Loop Frequency Synthesis from high stability master oscillator

Frequency Stability

±250 Hz

Output Impedance:

50 ohms

Output Connector:

3 1/8" EIA Flange

VSWR:

2:1, max.

Modulation Type:

Direct carrier frequency modulation

Modulation Capability:

±150 kHz deviation

Modulation Indication:

Digital LED display shows true peak level of modulation signal in 5% increments with accuracy better than ±2%

Exciter:

Solid-state unit with variable output of 5 to 50 watts, and self-contained harmonic filter

RF Harmonic Attenuation:

-80 dB, min.

Power Supply Rectifiers:

Silicon

MONAURAL OPERATION

Audio Input Impedance:

600 ohms, balanced

Audio Input Return Loss:

30 dB or better

Audio Input Level:

+10 dBm (6.93 volts peak-to-peak) @ 600 ohms for ±75 kHz deviation

Audio Frequency Response:

±0.5 dB; flat, 25, 50 or 75 microsecond pre-emphasis, 20 Hz to 15 kHz

Total Harmonic Distortion:

0.08% max.; 20 Hz to 15 kHz (measured with Spectrum Analyzer.)

Intermodulation Distortion:

0.08% or less, 60 Hz/7 kHz 4:1 ratio

FM S/N Ratio (FM Noise):

75 dB min. below ±75 kHz deviation @ 400 Hz, measured within a 20 Hz to 15 kHz bandwidth with 75 microsecond de-emphasis

Asynchronous AM S/N Ratio

(AM Noise):

55 dB RMS below carrier; reference: 100% AM modulation, full power @ 400 Hz with 75 microsecond de-emphasis, no FM modulation

Synchronous AM S/N Ratio

(Incidental AM Noise):

40 dB below carrier; reference: 100% AM modulation, full power @ 400 Hz with 75 microsecond de-emphasis, FM modulation ±75 kHz @ 400 Hz

WIDEBAND OPERATION

Composite Inputs:

Balanced, unbalanced and test

Composite Input Impedance:

5,000 ohms, nominal

Composite Input Level:

1.25 volts RMS (3.54 volts peak-to-peak) for ±75 kHz deviation

Composite Amplitude Response:

±0.1 dB, 20 Hz to 100 kHz

Composite Total Harmonic Distortion:

0.08% max.

Composite Intermodulation Distortion:

0.08% or less, 60 Hz/7 kHz 4:1 ratio

Two SCA Inputs:

Balanced or unbalanced

SCA Input Impedance:

50,000 ohms, nominal

SCA Input Level:

1.25 volts RMS for ±7.5 kHz deviation

SCA Amplitude Response:

±0.3 dB, 40 kHz to 100kHz

STEREO OPERATION

Most Stereo performance parameters are

determined primarily by the Stereo Generator used. The following parameters are influenced by the RF system. These specifications assume that a "State-of-the-Art" Stereo Generator is used.

Stereo Separation:

50 dB min.; 50 Hz to 15 kHz. (60 dB or better, 400 Hz to 7.5 kHz typical)

FM Noise:

-72 dB referenced to 400 Hz, 75 kHz deviation

Total Harmonic Distortion:

0.08% max.; 50 Hz to 15 kHz.

(Measured with Spectrum Analyzer.)

Intermodulation Distortion:

0.08% max.; 60 Hz/7 kHz, 4:1 ratio

Measured with 75 microsecond de-emphasis within a 20 Hz to 15 kHz bandwidth.

Linear Crosstalk:

-55 dB

SCA OPERATION

Most SCA performance parameters are determined primarily by the SCA generator used. The following parameters are influenced by the RF System. These specifications assume that a "State-of-the-Art" SCA Generator is used.

Crosstalk, SCA to Main and Stereo

(67 kHz and/or 92 kHz):

-60 dB, SCA deviation 5 kHz, Main

75 microsecond de-emphasis

Crosstalk, Main and Stereo to SCA

(67 kHz or 92 kHz):

-50 dB, Main and Stereo 75 kHz deviation; SCA reference deviation, 5 kHz and 200 Hz modulation; SCA de-emphasis, 150 microsecond

Crosstalk SCA to SCA

(67 kHz and 92 kHz):

-50 dB, SCA reference deviation 5 kHz and 200 Hz modulation frequency; de-emphasis, 150 microsecond

ELECTRICAL

Power Source:

200 to 250 volts ac; 60 Hz, three phase; available transformer taps are 200, 210, 220, 230, 240, 250 volts ac; 50 Hz available on request.

Permissible Line Voltage Variation:

±5% (each phase voltage variation: within 5% of the average of all three phases).

Filament regulator:

±1% of optimum

OPERATING ENVIRONMENT

Altitude Range:

0 to 7,500 ft. (2286 m) standard; optional to 10,000 ft (3048 m) with modification kit

Ambient Temperature Range:

-20°C to +50°C (-4°F to +122°F)

Relative Humidity:

0 to 95%

MECHANICAL

Transmitter size as shown:

69" (175 cm) H x 165" (419 cm) W x 28" (71 cm) D;

Weight: 4074 lb (1848 kg) nominal

Combiner:

60" (152.4 cm) H x 48" (122 cm) W x 30" (76.2 cm) D;

Weight: 790 lb (358.6 kg) nominal

Type 817R-1

Continental's 814R-1 is a high performance, state-of-the-art transmitter that uses the Type 802A Exciter to deliver a crisp, clean signal.

The 817R-1 is solid-state except for tubes in the driver and power amplifier section.

The 817R-1 consists of two Type 816R-1 25 kW transmitters whose outputs are combined in a 90 degree hybrid to achieve 50 kW output.

Through the optional use of coaxial switching, either transmitter can be put on the air independently.

Standard features include remote control interface, an automatic overload/recycle system and self-contained harmonic filter.

Available options include Type 377C-1A automatic exciter control and Type 377D-1 automatic combiner control. Both options can be mounted on the 817R-1 control panel.

Combiners are described in the "Combiner Section" of this catalog.

SPECIFICATIONS using 802A Exciter

GENERAL

Rated Power Output:

817R-1: 50 kW

Power Consumption:

817R-1: 80 kW

Frequency Range:

88 to 108 MHz, in 10 kHz steps

Frequency Control:

Phase Locked Loop Frequency Synthesis from high stability master oscillator

Frequency Stability

±250 Hz

Output Impedance:

50 ohms

Output Connector:

6 1/8" EIA Flange

VSWR:

2:1, max.

Modulation Type:

Direct carrier frequency modulation

Modulation Capability:

±150 kHz deviation

Modulation Indication:

Digital LED display shows true peak level of modulation signal in 5% increments with accuracy better than ±2%

Exciter:

Solid-state unit with variable output of 5 to 50 watts, and self-contained harmonic filter

RF Harmonic Attenuation:

-80 dB, min.

Power Supply Rectifiers:

Silicon

MONAURAL OPERATION

Audio Input Impedance:

600 ohms, balanced

Audio Input Return Loss:

30 dB or better

Audio Input Level:

+10 dBm (6.93 volts peak-to-peak)

@ 600 ohms for ±75 kHz deviation

Audio Frequency Response:

±0.5 dB; flat, 25, 50 or 75 microsecond pre-emphasis, 20 Hz to 15 kHz

Total Harmonic Distortion:

0.08% max.; 20 Hz to 15 kHz

(measured with Spectrum Analyzer.)



Intermodulation Distortion:

0.08% or less, 60 Hz/7 kHz 4:1 ratio

FM S/N Ratio (FM Noise):

75 dB min. below ±75 kHz deviation @ 400 Hz, measured within a 20 Hz to 15 kHz bandwidth with 75 microsecond de-emphasis

Asynchronous AM S/N Ratio (AM Noise):

55 dB RMS below carrier; reference: 100% AM modulation, full power @ 400 Hz with 75 microsecond de-emphasis, no FM modulation

Synchronous AM S/N Ratio (Incidental AM Noise):

40 dB below carrier; reference: 100% AM modulation, full power @ 400 Hz with 75 microsecond de-emphasis, FM modulation ±75 kHz @ 400 Hz

WIDEBAND OPERATION

Composite Inputs:

Balanced, unbalanced and test

Composite Input Impedance:

5,000 ohms, nominal

Composite Input Level:

1.25 volts RMS (3.54 volts peak-to-peak) for ±75 kHz deviation measured with 75 microsecond de-emphasis

Composite Amplitude Response:

±0.1 dB, 20 Hz to 100 kHz

Composite Total Harmonic Distortion:

0.08% max.

Composite Intermodulation Distortion:

0.08% or less, 60 Hz/7 kHz 4:1 ratio

Two SCA Inputs:

Balanced or unbalanced

SCA Input Impedance:

50,000 ohms, nominal

SCA Input Level:

1.25 volts RMS for ±7.5 kHz deviation

SCA Amplitude Response:

±0.3 dB, 40 kHz to 100kHz

STEREO OPERATION

Most Stereo performance parameters are determined primarily by the Stereo Generator used. The following parameters are influenced by the RF system. These specifications assume that a "State-of-the-Art" Stereo Generator is used.

Stereo Separation:

50 dB min.; 50 Hz to 15 kHz. (60 dB or better, 400 Hz to 7.5 kHz typical)

Total Harmonic Distortion:

0.08% max.; 50 Hz to 15 kHz. (Measured with Spectrum Analyzer.)

Intermodulation Distortion:

0.08% max.; 60 Hz/7 kHz, 4:1 ratio

FM Noise:

-72 dB referenced to 400 Hz, 75 kHz deviation

within a 20 Hz to 15 kHz bandwidth.

Linear Crosstalk:

-55 dB

SCA OPERATION

Most SCA performance parameters are determined primarily by the SCA generator used. The following parameters are influenced by the RF System. These specifications assume that a "State-of-the-Art" SCA Generator is used.

Crosstalk, SCA to Main and Stereo

(67 kHz and/or 92 kHz):

-60 dB, SCA deviation 5 kHz, Main 75 microsecond de-emphasis

Crosstalk, Main and Stereo to SCA

(67 kHz or 92 kHz):

-50 dB, Main and Stereo 75 kHz deviation; SCA reference deviation, 5 kHz and 200 Hz modulation; SCA de-emphasis, 150 microsecond

Crosstalk SCA to SCA

(67 kHz and 92 kHz):

-50 dB, SCA reference deviation 5 kHz and 200 Hz modulation frequency; de-emphasis, 150 microsecond

ELECTRICAL

Power Source:

200 to 250 volts ac; 60 Hz, three phase; available transformer taps are 200, 210, 220, 230, 240, 250 volts ac; 50 Hz available on request

Permissible Line Voltage Variation:

±5% (each phase voltage variation: within 5% of the average of all three phases).

Filament regulator:

±1% of optimum

OPERATING ENVIRONMENT

Altitude Range:

0 to 7,500 ft. (2286 m) standard; optional to 10,000 ft (3048 m) with modification kit

Ambient Temperature Range:

-20°C to +50°C (-4°F to +122°F)

Relative Humidity:

0 to 95%

MECHANICAL

Transmitter size as shown:

69" (175 cm) H x 165" (419 cm) W

x 28" (71 cm) D;

Weight:

4164 lb (1888.8 kg) nominal

Combiner:

73" (185.4 cm) H x 69" (174 cm)

x 31" (78.7 cm) D;

Weight: 1130 lb (513 kg) nominal

All specifications are subject to change without notice.



Type 817R-4

Continental's 817R-4 is a high performance, state-of-the-art transmitter that uses the Type 802A Exciter to deliver a crisp, clean signal.

The 817R-4 is solid-state except for tubes in the driver and power amplifier section.

The 817R-4 consists of two Type 816R-4 27.5 kW transmitters whose outputs are combined in a 90 degree hybrid to achieve 55 kW output.

Through the optional use of coaxial switching, either transmitter can be put on the air independently.

Standard features include remote control interface, an automatic overload/recycle system and self-contained harmonic filter.

Available options include Type 377C-1A automatic exciter control and Type 377D-1 automatic combiner control. Both options can be mounted on the 817R-4 control cabinet.

Combiners are described in the "Combiner Section" of this catalog.

SPECIFICATIONS using 802A Exciter

GENERAL

Rated Power Output:

817R-4: 55 kW

Power Consumption:

817R-4: 84 kW nominal

Frequency Range:

88 to 108 MHz, in 10 kHz steps

Frequency Control:

Phase Locked Loop Frequency Synthesis from high stability master oscillator

Frequency Stability

±250 Hz

Output Impedance:

50 ohms

Output Connector:

6 1/8" EIA Flange

VSWR:

2:1, max.

Modulation Type:

Direct carrier frequency modulation

Modulation Capability:

±150 kHz deviation

Modulation Indication:

Digital LED display shows true peak level of modulation signal in 5% increments with accuracy better than ±2%

Exciter:

Solid-state unit with variable output of 5 to 50 watts, and self-contained harmonic filter

RF Harmonic Attenuation:

-80 dB, min.

Power Supply Rectifiers:

Silicon

MONAURAL OPERATION

Audio Input Impedance:

600 ohms, balanced

Audio Input Return Loss:

30 dB or better

Audio Input Level:

+10 dBm (6.93 volts peak-to-peak)

@ 600 ohms for ±75 kHz deviation

Audio Frequency Response:

±0.5 dB; flat, 25, 50 or 75 microsecond pre-emphasis, 20 Hz to 15 kHz

Total Harmonic Distortion:

0.08% max.; 20 Hz to 15 kHz (measured with Spectrum Analyzer.)

Intermodulation Distortion:

0.08% or less, 60 Hz/7 kHz 4:1 ratio

FM S/N Ratio (FM Noise):

75 dB min. below ±75 kHz deviation @ 400 Hz, measured within a 20 Hz to 15 kHz bandwidth with 75 microsecond de-emphasis

Asynchronous AM S/N Ratio

(AM Noise):

55 dB RMS below carrier; reference: 100% AM modulation, full power @ 400 Hz with 75 microsecond de-emphasis, no FM modulation

Synchronous AM S/N Ratio

(Incidental AM Noise):

40 dB below carrier; reference: 100% AM modulation, full power @ 400 Hz with 75 microsecond de-emphasis, FM modulation ±75 kHz @ 400 Hz

WIDEBAND OPERATION

Composite Inputs:

Balanced, unbalanced and test

Composite Input Impedance:

5,000 ohms, nominal

Composite Input Level:

1.25 volts RMS (3.54 volts peak-to-peak) for ±75 kHz deviation

Composite Amplitude Response:

±0.1 dB, 20 Hz to 100 kHz

Composite Total Harmonic Distortion:

0.08% max.

Composite Intermodulation Distortion:

0.08% or less, 60 Hz/7 kHz 4:1 ratio

Two SCA Inputs:

Balanced or unbalanced

SCA Input Impedance:

50,000 ohms, nominal

SCA Input Level:

1.25 volts RMS for ±7.5 kHz deviation

SCA Amplitude Response:

±0.3 dB, 40 kHz to 100kHz

STEREO OPERATION

Most Stereo performance parameters are

determined primarily by the Stereo Generator used. The following parameters are influenced by the RF system. These specifications assume that a "State-of-the-Art" Stereo Generator is used.

Stereo Separation:

50 dB min.; 50 Hz to 15 kHz. (60 dB or better, 400 Hz to 7.5 kHz typical)

Total Harmonic Distortion:

0.08% max.; 50 Hz to 15 kHz.

(Measured with Spectrum Analyzer.)

Intermodulation Distortion:

0.08% max.; 60 Hz/7 kHz, 4:1 ratio

FM Noise:

-72 dB referenced to 400 Hz, 75 kHz deviation.

Measured with 75 microsecond de-emphasis within a 20 Hz to 15 kHz bandwidth.

Linear Crosstalk:

-55 dB

SCA OPERATION

Most SCA performance parameters are determined primarily by the SCA generator used. The following parameters are influenced by the RF System. These specifications assume that a "State-of-the-Art" SCA Generator is used.

Crosstalk, SCA to Main and Stereo

(67 kHz and/or 92 kHz):

-60 dB, SCA deviation 5 kHz, Main 75 microsecond de-emphasis

Crosstalk, Main and Stereo to SCA

(67 kHz or 92 kHz):

-50 dB, Main and Stereo 75 kHz deviation; SCA reference deviation, 5 kHz and 200 Hz modulation; SCA de-emphasis, 150 microsecond

Crosstalk SCA to SCA

(67 kHz and 92 kHz):

-50 dB, SCA reference deviation 5 kHz and 200 Hz modulation frequency; de-emphasis, 150 microsecond

ELECTRICAL

Power Source:

200 to 250 volts ac; 60 Hz, three phase; available transformer taps are 200, 210, 220, 230, 240, 250 volts ac; 50 Hz available on request.

Permissible Line Voltage Variation:

±5% (each phase voltage variation: within 5% of the average of all three phases).

Filament regulator:

±1% of optimum

OPERATING ENVIRONMENT

Altitude Range:

0 to 7,500 ft. (2286 m) standard; optional to 10,000 ft (3048 m) with modification kit

Ambient Temperature Range:

-20°C to +50°C (-4°F to +122°F)

Relative Humidity:

0 to 95%

MECHANICAL

Transmitter size as shown:

69" (175 cm) H x 165" (419 cm) W x 28"

(71 cm) D; Weight: 4074 lb (1848 kg) nominal

Combiner:

73" (185.4 cm) H x 69" (174 cm) W x 31"

(78.7) D; Weight: 1130 lb (513 kg) nominal

All specifications are subject to change without notice.

Type 817A

Continental's 817A is a high performance, state-of-the-art transmitter that uses the Type 802A Exciter to deliver a crisp, clean signal.

The transmitter is solid-state except for the single 4CX40,000G tube in the final amplifier. IC logic is used for all control functions. A battery supported digital circuit restarts the transmitter after a power failure.

Standard features include remote control interface and digital display via 8085 micro-processor system. The transmitter is completely self-contained including harmonic filter.

SPECIFICATIONS using 802A Exciter

GENERAL

Rated Power Output:

817A: 30, 40, 50, 60 kW

Power Consumption:

817A: 53, 65.6, 80.8, 94.4 kW nominal

Frequency Range:

88 to 108 MHz, in 10 kHz steps

Frequency Control:

Phase Locked Loop Frequency Synthesis from high stability master oscillator

Frequency Stability:

±250 Hz

Output Impedance:

50 ohms

Output Connector:

6 1/8" EIA Flange

VSWR:

2:1, max.

Modulation Type:

Direct carrier frequency modulation

Modulation Capability:

±150 kHz deviation

Modulation Indication:

Digital LED display shows true peak level of modulation signal in 5% increments with accuracy better than ±2%

Exciter:

Solid-state unit with variable output of 5 to 50 watts, and self-contained harmonic filter

RF Harmonic Attenuation:

-80 dB, min.

Power Supply Rectifiers:

Silicon

MONAURAL OPERATION

Audio Input Impedance:

600 ohms, balanced

Audio Input Return Loss:

30 dB or better

Audio Input Level:

+10 dBm (6.93 volts peak-to-peak) @ 600 ohms for ±75 kHz deviation

Audio Frequency Response:

±0.5 dB; flat, 25, 50 or 75 microsecond pre-emphasis, 20 Hz to 15 kHz

Total Harmonic Distortion:

0.2% max.; 20 Hz to 15 kHz (measured with Spectrum Analyzer.)

Intermodulation Distortion:

0.1% or less, 60 Hz/7 kHz 4:1 ratio

FM S/N Ratio (FM Noise):

72 dB min. below ±75 kHz deviation @ 400 Hz, measured within a 20 Hz to 15 kHz bandwidth with 75 microsecond de-emphasis

Asynchronous AM S/N Ratio (AM Noise):

55 dB RMS below carrier; reference: 100% AM

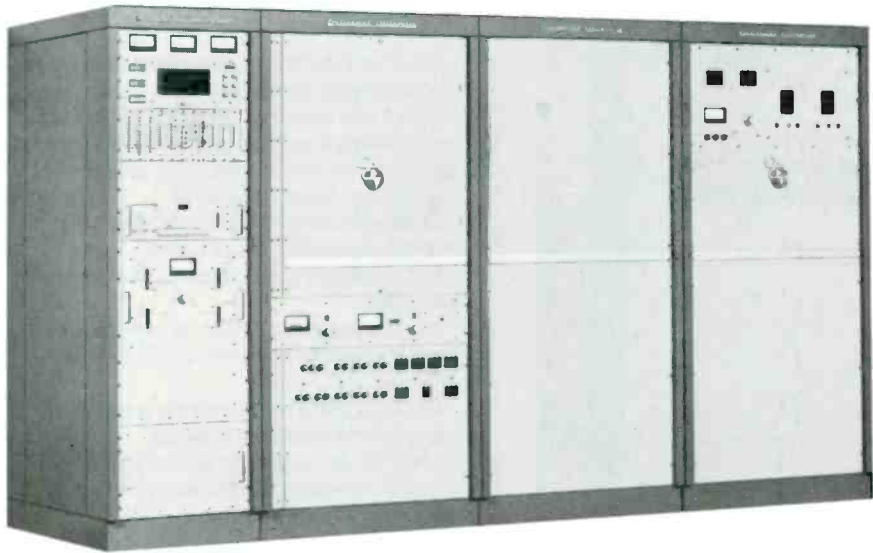

modulation, full power @ 400 Hz with 75 microsecond de-emphasis, no FM modulation

Synchronous AM S/N Ratio (Incidental AM Noise):

40 dB below carrier; reference: 100% AM modulation, full power @ 400 Hz with 75 microsecond de-emphasis, FM modulation ±75 kHz @ 400 Hz

WIDEBAND OPERATION

Composite Inputs:

Balanced, unbalanced and test

Composite Input Impedance:

5,000 ohms, nominal

Composite Input Level:

1.25 volts RMS (3.54 volts peak-to-peak) for ±75 kHz deviation

Composite Amplitude Response:

±0.1 dB, 20 Hz to 100 kHz

Composite Total Harmonic Distortion:

0.2% max.

Composite Intermodulation Distortion:

0.08% or less, 60 Hz/7 kHz 4:1 ratio

Two SCA Inputs:

Balanced or unbalanced

SCA Input Impedance:

50,000 ohms, nominal

SCA Input Level:

1.25 volts RMS for ±7.5 kHz deviation

SCA Amplitude Response:

±0.3 dB, 40 kHz to 100 kHz

STEREO OPERATION

Most Stereo performance parameters are determined primarily by the Stereo Generator used. The following parameters are influenced by the RF system. These specifications assume that a "State-of-the-Art" Stereo Generator is used.

Stereo Separation:

50 dB min.; 40 Hz to 15 kHz

Total Harmonic Distortion:

0.1% max.; 40 Hz to 15 kHz. (Measured with Spectrum Analyzer.)

Intermodulation Distortion:

0.08% max.; 60 Hz/7 kHz, 4:1 ratio

FM Noise:

-72 dB referenced to 400 Hz, 75 kHz deviation. Measured with 75 microsecond de-emphasis within a 20 Hz to 15 kHz bandwidth.

Linear Crosstalk:

-55 dB

SCA OPERATION

Most SCA performance parameters are determined primarily by the SCA generator used. The following parameters are influenced by the RF System. These specifications assume that a "State-of-the-Art" SCA Generator is used.

Crosstalk, SCA to Main and Stereo (67 kHz and/or 92 kHz):

-60 dB, SCA deviation 5 kHz, Main

75 microsecond de-emphasis

Crosstalk, Main and Stereo to SCA (67 kHz or 92 kHz):

-47 dB, Main and Stereo 75 kHz deviation; SCA reference deviation, 5 kHz and 200 Hz modulation; SCA de-emphasis, 150 microsecond

150 microsecond

Crosstalk SCA to SCA (67 kHz and 92 kHz):

-50 dB, SCA reference deviation 5 kHz and 200 Hz modulation frequency; de-emphasis, 150 microsecond

150 microsecond

ELECTRICAL

Power Source:

200 to 250 volts ac; 60 Hz, three phase; available transformer taps are 200, 210, 220, 230, 240, 250 volts ac; 50 Hz available on request.

Permissible Line Voltage Variation:

±5% (each phase voltage variation: within 5% of the average of all three phases).

Filament regulator:

±1% of optimum

OPERATING ENVIRONMENT

Altitude Range:

0 to 7,500 ft. (2286 m) standard; optional to 10,000 ft (3048 m) with modification kit

Ambient Temperature Range:

-20°C to +50°C (-4°F to +122°F)

Relative Humidity:

0 to 95%

MECHANICAL

Size, as shown: 72" (175.3 cm) H,

128" (200.6 cm) W, 40" (86.4 cm) D

Weight: 4074 lb (2130 kg) nominal

All specifications are subject to change without notice.

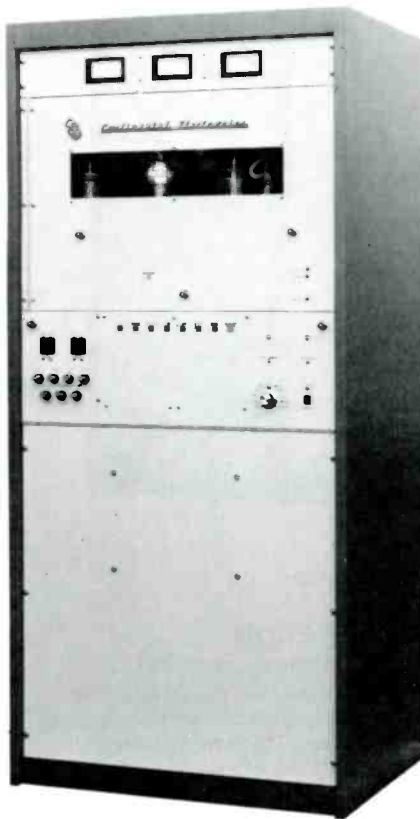

Type 314R-1

Continental's 314R-1 offers the performance and technology of pulse width modulation in an efficient 1kW package. The 314R-1 offers AM broadcasters the efficiency and reliability of a tube-powered final and the clear, crisp sound of full transformerless modulation.

The transmitter has excellent accessibility and utilizes modular circuit boards.

By broadbanding the driver only the PA need be tuned.

The use of a 3-500Z triode for both switching modulator and final amplifier simplifies maintenance.

Remote control and monitoring are made directly with no interfacing required.

The 314R is designed to be easily converted to stereo operation with the addition of a suitable external stereo exciter.

The 314R-1 is the only 1kW AM transmitter to provide the combination of a built-in Instantaneous Peak Limiter (IPL), and Automatic Power Control (APC), and an Automatic Modulation Control. These features provide correct output power and maximum modulation even with input line voltage variations of +5%. The IPL adjustment allows independent setting of both negative and positive limits.

The inefficient modulator using a modulation transformer is eliminated as is the conventional transformer input to the audio chain. A dc coupled OP-AMP minimizes overshoot and ringing.

The 314R-1 will reproduce a 20 Hz square wave at 100% modulation.

Specifications

GENERAL

RF Power Output:

250 watts to 1,100 watts max. (adj.)

Power Consumption:

3500 watts @ 1 kW, 95% modulation

Frequency Range:

540 to 1600 kHz

Frequency Stability:

±5 Hz (0 to 50°C); ±20 Hz (-20°C to 50°C)

Modulation Capability:

-100% +125% (1100 watts, 1kHz)

RF Output Impedance:

50 ohm, unbalanced, nominal

RF Output Fitting:

Coaxial, Type LC (stud optional)

Audio Response:

±1 dB, 20-10 kHz; 1000 watts,
-95% modulation

Audio Distortion:

Less than 2%, 20-10 kHz; 1000 watts,
-95% modulation

Noise:

-55 dB (400 Hz, 95% modulation)

Harmonic and Spurious:

-73.4 dB; exceeds FCC regulations
and CCIR recommendations

Carrier Regulation (shift):

2% max. (400 Hz, 95% modulation)

Audio Input:

+10 dB ±2 dB, 600/150 ohms,
balanced for 100% modulation

Tubes:

Three Type 3-500Z triode (1 mod; 2 RF)

Remote Control:

Direct; no interface required

ELECTRICAL

Power Source:

200 to 250 volts AC, 50/60 Hz, single phase;
available transformer taps are 200, 210, 220,
230, 240, 250 volts ac; 50 Hz available on
request

Permissible Line Voltage Variation:

±5%

OPERATING ENVIRONMENT

Altitude Range:

0 to 7,500 ft (0 to 2286 m)

Ambient Temperature Range:

-20°C to +50°C (-4°F to +122°F)

Relative Humidity:

0 to 95%

MECHANICAL

Transmitter Size as Shown:

69" (175.3 cm) H x 32" (81.4 cm) W
x 25" (63.6 cm) D;

Weight: 760 lb (345 kg) nominal

All specifications subject to change without notice.



Type 315R-1

Continental's 315R-1 offers broadcasters state-of-the-art performance, cost-effective operation and easy maintainability.

The transmitter cabinet opens for excellent accessibility. Modular circuit boards with extender cards and LED status indicators on major circuits and relays help to simplify maintenance. One tube type is used for both final PA and switchtube applications. The bottom line is a smooth, easily maintained, day-to-day operator.

Continental's 315R-1 transmitters achieve a final PA efficiency approaching 90% using the third harmonic injection technique of the proven Tyler-type. Combined with the high efficiency SwitchMod technique, overall efficiency exceeds 55%.

SwitchMod System

The dc coupled series switching modulator, combined with the stability of the proven 12 phase power supply, the built-in Instantaneous Peak Limiter (IPL) and the Automatic Modulation Control circuits, achieves dramatically improved AM audio performance in the areas of low frequency response, IM distortion and overall modulation density. IPL front panel adjustments set both positive and negative limits of modulation.

Working in conjunction with the Automatic Modulation Control, the maximum level of modulation is maintained at all power levels even with 5% powerline variations.

Overmodulation due to powerline variations or audio peaks is effectively prevented.

AM Stereo

A Signal Access Card provides rear panel access to both audio and RF drive for use in either parallel operation of two 315R-1 transmitters or for use in AM stereo. These terminals will make possible the connection of an external stereo generator to the RF drive line and to the audio chain.

12-Phase Power Supply

The 12-phase power supply uses an Extended-Delta power transformer and two three-phase, full-wave rectifiers to develop high voltage dc with a 720 Hertz ripple frequency. Because of the high ripple frequency the absence of filter inductors and large capacitors help reduce the size of the transmitter while at the same time eliminating several expensive and failure-prone components. Inductors, which formerly caused resonances, are eliminated. Power supply sag and bounce are no longer a problem.

Specifications

GENERAL

RF Power Output:

500 watts to 5,500 watts max. (adj.)

Power Consumption:

12.82 kW @ 5,000 watts, 95% modulation

Overall Efficiency:

Better than 55% @ 5,000 watts, 95% sine wave modulation

Frequency Range:

540 to 1600 kHz

Frequency Stability:

±5 Hz (0 to 50°C); ±20 Hz (-20°C to 50°C)

Modulation Capability:

-100% +125%

RF Output Impedance:

50 ohm nominal, others available on special order

RF Output Fitting:

1-5/8" EIA male flange standard; 7/8" EIA flange or stud output are available

Audio Response:

±1 dB, 20-10 kHz, 5 kW, @ 95% modulation

Total Harmonic Distortion:

Less than 2%, 20-10 kHz, 5 kW, @ 95% modulation

Noise:

Better than -60 dB reference 400 Hz, for 100% modulation @ 5,000 watts

Harmonic and Spurious:

Exceeds FCC regulations and CCIR recommendations

Carrier Regulation (shift):

2% max., adjustable to 0

Audio Input:

+10 dB ±2 dB, 600/150 ohms, balanced for 100% modulation

Tubes:

Two Type 3CX3000F7

ELECTRICAL

Power Source:

200 to 250 volts AC, 50/60 Hz, single phase, 3 or 4 wire, wye or closed delta; available transformer taps are 200, 210, 220, 230, 240, 250 volts ac; 50 Hz available on request; 385 to 435 volts ac available on special order

Permissible Line Voltage Variation:

±5%

COOLING

Air Flow Requirement:

500 cfm

OPERATING ENVIRONMENT

Altitude Range:

0 to 7,500 ft (0 to 2286 m)

Ambient Temperature Range:

-20°C to +50°C (-4°F to +122°F)

Relative Humidity:

0 to 95%

MECHANICAL

Transmitter Size as Shown:

69" (175.3 cm) H x 35" (88.9 cm) W x 34" (86.4 cm) D;

Weight: 1050 lb (476 kg) nominal

All specifications subject to change without notice.

AM-MW Type 316F-1 10 kW AM Transmitter



Type 316F-1

Continental's Type 316F-1 utilizes state-of-the-art concepts combined with solid-state devices to give broadcasters consistent quality and performance with high reliability.

Transistors with conservative safety margins assure long-term reliability and contribute to excellent audio frequency response, low distortion and noise.

All components, output networks and power supply are rated conservatively, to provide an extra operating margin.

With only two tubes, a blower for cooling and a minimum of relay contacts, the 316F-1 is easy to maintain and gives outstanding performance.

Many broadcasters cite examples of 30,000 hours or more of transmitter operation without a moment of unscheduled down-time.

The 316F-1 has two sections: a completely transistorized exciter and a two-tube, high-efficiency amplifier.

Modulation takes place in the exciter's 40 watt output stage. This "collector-modulation" technique eliminates critical tuning adjustments and is almost identical to plate modulation except that no transformers or chokes are used.

Audio output is simultaneously applied to the RF driver and output transistors. This dual-level modulation technique gives the 316F-1 the capability of providing maximum positive modulation peaks allowed by the FCC (125%) with very low distortion and ample reserve.

The 316F-1 delivers superb audio quality and faithfully reproduces the most sophisticated audio processing. The 316F-1 uses a high-efficiency linear amplifier for simplicity and reliability. Two 4CX15000A tubes are used in the final amplifier. This conservative application assures long tube life.

An internal automatic Program Peak Limiter Controller enables broadcasters to achieve maximum loudness without overmodulation.

Ready for AM stereo

The 316F-1 is built to receive a stereo exciter, and Continental guarantees compatibility with any AM stereo transmission system established by the FCC.

Magniphase® line protection system

Continental's Magniphase system protects transmission line, antenna and tuning equipment.

Specifications*

GENERAL

RF Power Output:

Rated @ 10.0 kW; 10.6 kW capability

Power Consumption:

23.6 kW @ 0% modulation

24.1 kW @ 30% modulation

28.4 kW @ 100% modulation

Frequency Range:

Any single frequency, 535 to 1620 kHz

Frequency Stability:

±5 Hz (0°C to 45°C)

Emission:

A3

Modulation:

Collector modulation of RF driver stage

Modulation Capability:

100% continuous at any frequency 30 to 10,000 Hz; 125% positive peak with asymmetrical program input

RF Output Impedance:

50 to 250 ohms, unbalanced

Audio Response:

50 to 7500 Hz ±1 dB; 30 to 15,000 Hz ±1.5 dB

Audio Distortion:

30 to 10,000 Hz less than 3 %

Noise:

60 dB below 100% modulation @ 5,000watts

Harmonic and Spurious:

-80 dB or better; exceeds FCC regulations and CCIR recommendations

Carrier Regulation (shift):

2% max. or less @ 100% modulation

Audio Input:

+10 dBm ±2 dB, 600/150 ohms, for 100% modulation

Tubes:

Two Type 4CX15000A

ELECTRICAL

Power Source:

208 to 230 volts AC, 50/60 Hz, three phase 50/60 Hz

Permissible Combined Line

Voltage Variation:

±5%

Power Factor:

93%

COOLING

Air Flow Requirement:

Forced air, by self-contained blower

OPERATING ENVIRONMENT

Altitude Range:

0 to 7,500 ft (0 to 2286 m)
(higher on special order)

Ambient Temperature Range:

-10°C to +45°C (-14°F to +113°F)

Relative Humidity:

0 to 95%

MECHANICAL

Transmitter Size as Shown:

78" (198 cm) H x 67" (170 cm) W
x 26" (748 cm) D;

Weight: 1650 lb (748kg) nominal

Export Shipping Information:

2480 lb(1124.9); 173.1 ft³ (4.9 m³)

*Taken from Type Acceptance data on file with FCC. Transmitters will meet or exceed all requirements of FCC for Broadcast Service.

All specifications are subject to change without notice.

Type 317C-2

Continental's 317C-2 is a field-proven design that offers broadcasters excellent performance with high overall efficiency, reliability, simplicity and easy maintainability.

The first 317C was installed in 1965. Its introduction followed an extensive review and analysis of transmitter circuit and modulation techniques. Out of this research came Continental's unique and patented* screen-impedance modulation technique. The 317C-2 applies this system, with its current refinements, to the final amplifier tubes in the Doherty system to achieve high performance with high efficiency.

The design concept has been thoroughly tested and accepted by broadcasters around the world for transmitter requirements ranging from 50,000 to 2,000,000 watts.

Overall efficiency is better than 60% at any level of modulation. Conservative operation of the power amplifier leads to extended tube life.

The 317C-2 delivers superb audio quality and faithfully reproduces the most sophisticated audio processing. Yet, it can be operated very cost-effectively.

Audio frequency response is a ± 0.5 dB amplitude variation from 10 to 10,000 Hz; less than 5° phase variation from 10 Hz to midband; essentially phase linear to 30 kHz.

The 317C-2 has a flat top response, with less than 5% tilt or overshoot on trapezoidal waveforms generated by clipping a sine wave 6 dB below peak amplitude from 30 Hz to 10 kHz at 90% modulation.

The 12-phase plate supply transformer rating and output voltage are increased to provide +125% modulation with plenty of headroom, and a 100% sine wave modulation capability down to 10 Hz.

The 317C-2 is built to receive a stereo exciter, and Continental guarantees compatibility with any AM stereo transmission system established by the FCC.

Continental's Magniphase® system protects transmission line, antenna and tuning equipment. It reduces power automatically and shuts down the transmitter if a permanent antenna fault occurs.

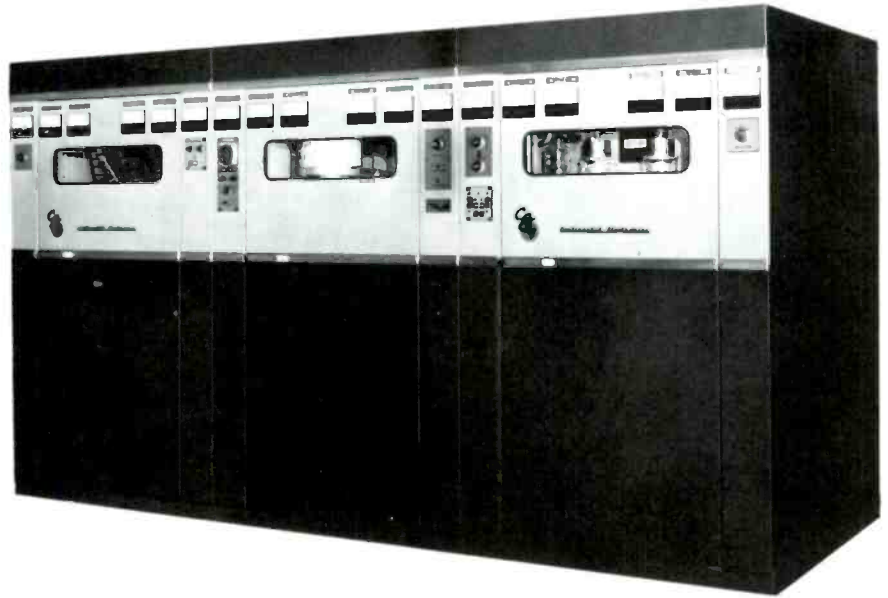

Audio input:

± 10 dBm ± 2.0 dB at 100% modulation

Audio Response:

± 0.5 dB, 10 Hz to 7500 Hz: -1.5 dB to 15,000 Hz: ref. to 1000 Hz at 70% modulation

Phase response:

$\pm 2^\circ$ from 10 to 1,000 Hz, and phase linear to 30 kHz with output lagging 45° at 15 kHz

Audio distortion:

Less than 2.5%, 20 to 10,000 Hz at 95% modulation

Intermodulation Distortion:

3.5% at 90% total modulation by SMPTE test method using 60 and 7,000 Hz in 4:1 ratio

Carrier Regulation (shift):

2% or less at 100% modulation

Tilt and overshoot:

Clipped sine wave: 5% variation in modulation percentage using 6 dB symmetrical clipping, 30 to 10,000 Hz at 90% modulation

Squarewave:

5% variation in modulation percentage, squarewave frequencies from 30 to 7,500 Hz at 60% modulation

Modulation capability:

100% continuous at any frequency 20-10,000 Hz + 125% positive peak with asymmetrical input

Noise:

60 dB below 100% modulation

Harmonic and Spurious:

-80 dB or better, exceeds FCC regulations and CCIR recommendations

Output Impedance:

40 to 300 ohms as specified by customer

ELECTRICAL

Power source:

460V, 3 phase, 50/60 Hz, other available by special order

Permissible combined voltage variation:

$\pm 5\%$ voltage; $\pm 2.5\%$ frequency

Power factor:

approximately .95

Overall efficiency:

Better than 60% at any depth of modulation

OPERATING ENVIRONMENT

Altitude:

7,500 feet (2286 meters) higher by special order

Ambient temperature:

-20°C to +50°C (-4°F to 122°F)

Cooling:

Transmitter is air cooled

MECHANICAL

Size:

Transmitter: 144" (365.76 cm) W
54" (137.16 cm) D
78" (198.1 cm) H

Plate transformer enclosure:

24" (60.96 cm) W
46" (116.84 cm) D
72" (183.2 cm) H

Total floor space:

62 sq. ft. (5.8 sq. meters)

Net weight:

Transmitter (all cabinets):
4,891 lbs. (2,273 kilos)

Plate transformer enclosure:
1,990 lbs. (903 kilos)

*Continental Electronics Mfg. Co. holds the following patents for the high efficiency screen modulated amplifier: Canada 764,605; France 1,432,543; UK 1,044,479; USA 3,314,024.

All specifications are subject to change without notice.

SPECIFICATIONS

GENERAL

Carrier Power:

Rated: 50 kW
Capability: 60 kW

Power reduction: 25 kW or 10 kW

Modulation:

High-level screen-grid impedance modulation

Emission:

A3

Frequency range:

Any single frequency 535-1620 kHz

Frequency stability:

± 5 Hz, (0° to 45°C)

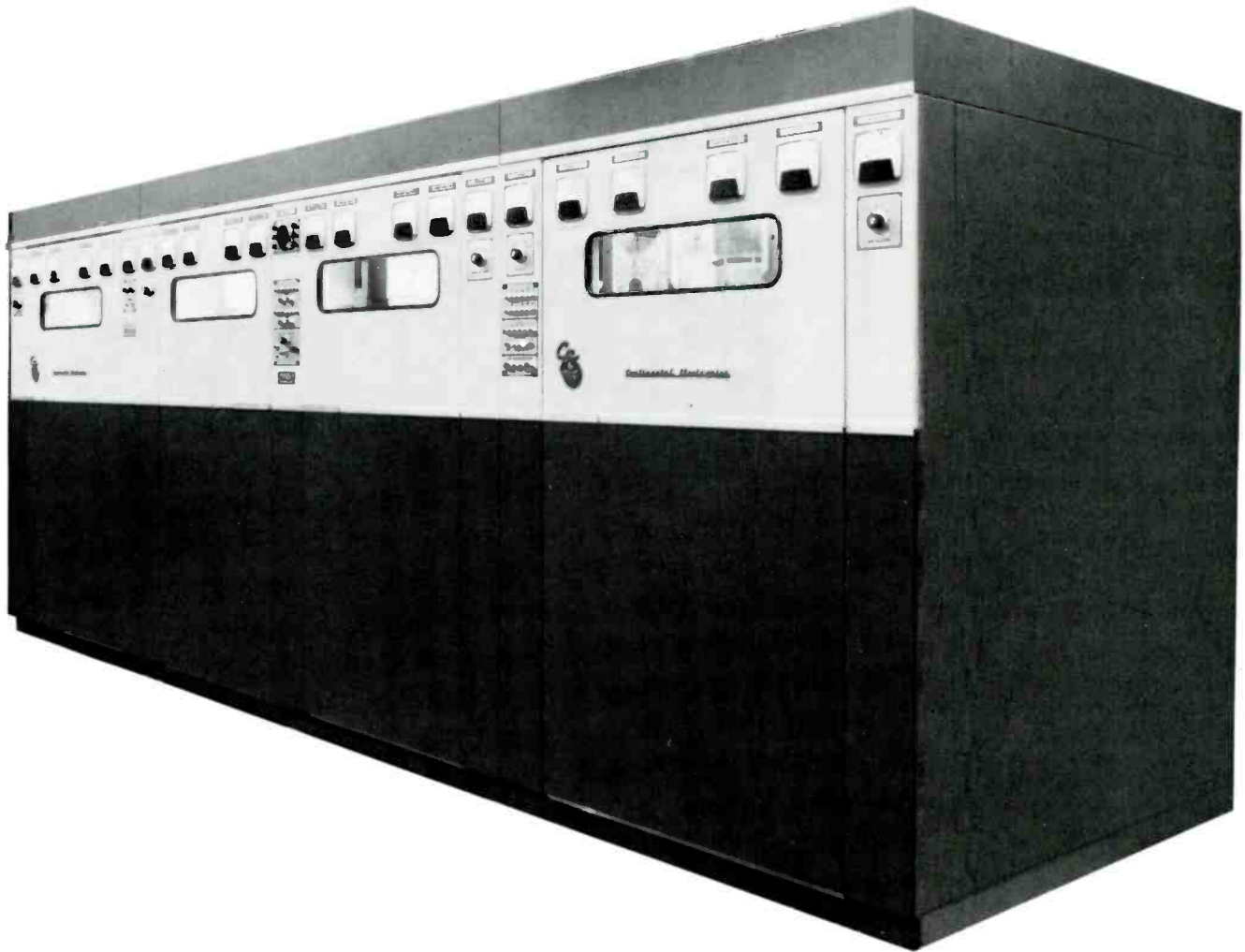

Type 318C and Type 318.5C

Continental's Type 318C is a high performance medium frequency broadcast transmitter that combines state-of-the-art components with a unique circuit design to achieve reliable operation and conservative operating costs.

The Type 318.5C 150,000 watt transmitter is identical to the 318C, except for the power supply, and output power.

The 318C uses the straight-forward simplicity and field-proven reliability of the high-efficiency screen and impedance modulated amplifier.*

Continental's unique design operates both carrier and peak tubes in Class "C" condition, enabling the transmitter to reach very high efficiency while limiting peak voltage to values consistent with reliable operating conditions.

The 4CX35,000A power tubes have a proven record of reliability. The transmitter uses only three tube types.

All low level stages are solid-state.

Continental's Magniphase® antenna protection circuit removes rf within microseconds following an antenna system fault.

The transmitter is air-cooled, and consists of three cabinets. External components are located behind the cabinets. Plate and low voltage distribution transformers are dry type units which do not require installation in a fireproof vault.

SPECIFICATIONS

Carrier Output power:

318C, 100,000 w

318.5C, 150,000 w

Frequency range:

535-1605 kHz

Frequency stability:

Assigned frequency ± 5 Hz (0° to 45° C)

Type of power amplifier:

High efficiency screen and impedance modulated

Output impedance:

200 ohms, unbalanced, or other as specified

Audio Frequency input impedance:

150/600 ohms balanced or unbalanced

Carrier Regulation (shift):

4% or less up to 100% Modulation

Audio frequency input level for 100% modulation:

10 dBm ± 2 dB

Audio frequency response:

± 0.5 dB 100—5,000 Hz ± 1.0 dB 50—7,500 Hz ± 1.5 dB 30—10,000 Hz

Audio harmonic distortion:

4% or less 50 to 7,500 Hz @ 95% modulation

Residual carrier noise:

60 dB or better below 100% modulation

Harmonic and Spurious:

Exceeds CCIR requirements

Modulation capability:

100% 50—10,000 Hz

Overall efficiency:

55% or better

Power line requirements:

460 volts, 3 phase, 3 wire, 50 or 60 Hz, $\pm 5\%$ regulation (Other voltage if specified)

Export Shipping Data:

Type 318C: 600 ft³ (18 m³),

16,400 lb (7380 kg)

Type 318.5C: 610 ft³ (18.3 m³)

*Continental Electronics Mfg. Co. holds the following patents for the high efficiency screen modulated amplifier: Canada 764,305; France 1,432,543; UK 1,044,479; USA 3,314,024.

All specifications are subject to change without notice.

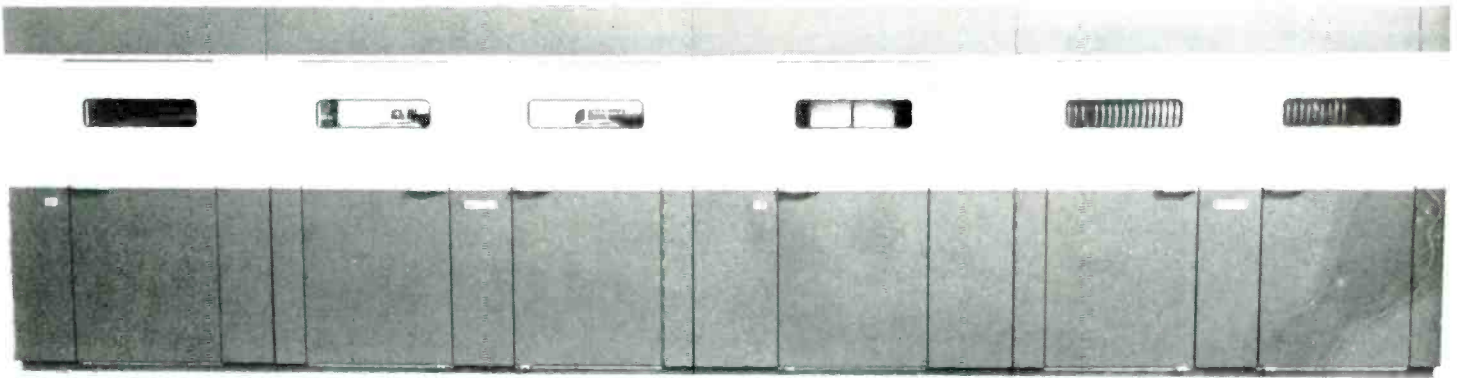

Type 319D

Continental's type 319D is a high frequency broadcast transmitter that uses a high efficiency screen and impedance modulated final power amplifier to achieve reliable, cost-effective operation.*

The RF driver stage utilizes two 5CX1500A tubes in a parallel configuration, and is operated Class C.

The RF driver, final power amplifier, second audio amplifier and modulator stages use vacuum tubes; all other circuits use solid state amplifiers.

The RF signal to drive the first RF amplifier stage is provided by a crystal oscillator unit. The RF amplifier and audio stages are installed in the transmitter's main cabinets.

Plate transformers, rectifier assemblies, reactor, filter capacitor bank, distribution system and control circuitry system are located in an area adjacent to the main transmitter.

Continental's unique toroidal inductor is used for the peak tank inductance. This unique design achieves a much higher Q than other types of inductors, and because the coil does not produce an external magnetic field, it can be located in a small compartment within the transmitter. The inductors are adjustable for frequency change.

The transmitter is cooled by a combination of forced air and vapor-phase cooling. The water storage tank is installed within the transmitter cabinet; the heat exchanger is normally installed on the roof of the transmitter building.

Vapor-phase cooling is used to cool the two 4CV2500,000B tetrode tubes used in the RF final amplifier.

The remainder of the transmitter is air cooled; forced air is provided by a blower unit located in a room adjacent to the transmitter room.

SPECIFICATIONS

Carrier Output Power:

250,000 Watts

Frequency Range:

525—1605 kHz

Frequency Stability:

Assigned frequency ± 5 Hz (0° to 45°C)

Type of Power Amplifier:

High efficiency screen and impedance modulated

Output Impedance:

50 to 200 ohms, as specified by user

Audio Frequency Input Impedance:

150/600 ohms, balanced or unbalanced

Carrier Regulation (Shift):

4% or less up to 100% modulation

Audio Frequency Input Level for

100% Modulation:

+10 dB ± 5 dB (or other specified)

Audio Frequency Response:

± 1.0 dB 60—7,500 Hz ± 1.5 dB 30—10,000 Hz

Audio Harmonic Distortion:

3.5% or less 50 to 7,500 Hz @ 90% modulation

Residual Carrier Noise:

60 dB or better below 100% modulation unweighted

Modulation Capability:

100%, 50—10,000 Hz

Overall Efficiency:

56% or better

Power Line Requirements:

4160 volts, 3 phase, 3 wire, 50 or 60 Hz, $\pm 5\%$ regulated (Other voltage if specified)

Export Shipping Data:

Type 319D: 750 ft³ (22.5m³);
25,000 lb (11,250 kg)

*Continental Electronics Mfg. Co. holds the following patents for the high efficiency screen modulated amplifier: Canada 764,605; France 1,432,543; UK 1,044,479; USA 3,314,024.

All specifications are subject to change without notice.

AM-MW Type 320F 500 kW AM-MW Transmitter

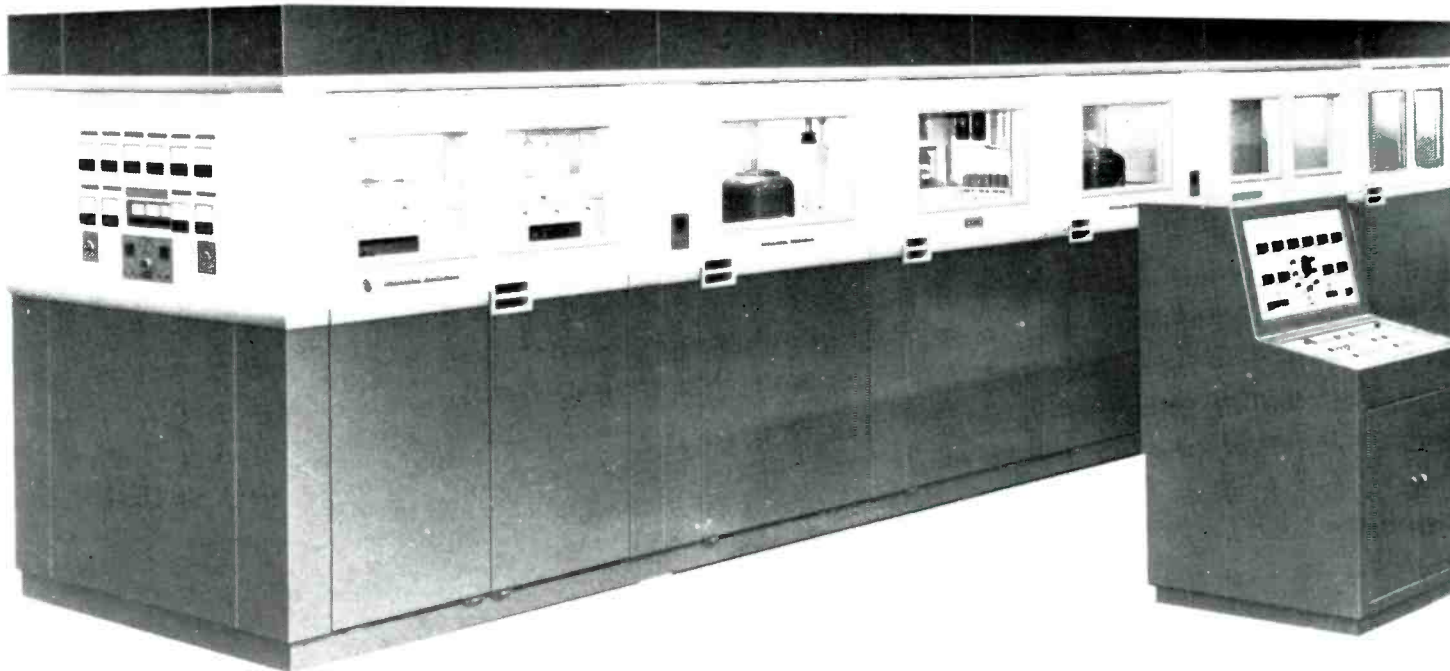

Type 320F

Continental's Type 320F is a high performance medium frequency broadcast transmitter that uses a unique screen and impedance modulation circuit* to achieve extremely reliable, cost-effective operation.

Both carrier and peak tubes are operated in Class "C" condition, offering broadcasters very high efficiency while limiting the peak voltage to values consistent with reliable operating conditions.

The first RF amplifier is solid-state and drives the grid of the IPA.

The intermediate power amplifier employs a single 4CW25000A tetrode with a fixed power output of 10,000 watts

The final power amplifier utilizes two 8973 water cooled tetrodes which have plate dissipation of 650,000 watts each.

When used in Continental's high-efficiency screen and impedance modulated circuit*, the maximum plate dissipation per tube is less than 200,000 watts for the carrier tube, and less than 120,000 watts for the peak tube with 100% sinewave modulation.

The carrier tube provides the full 500,000 watts power output when no modulation is applied.

Two Type 4CW25000A water-cooled tetrodes are used in the cathode follower modulator stage.

When used in this configuration, the two 4CW25000A tubes have a very high overload capability and thus assure high reliability.

Continental's unique torodial inductor is used in the peak tank circuit.

This unique design achieves a much higher Q than other types of inductors, and because the coil does not produce an external magnetic field, it can be located in a small compartment within the transmitter. The inductor is adjustable for frequency changes.

The transmitter is cooled by a combination of forced air and pumped water circulation.

The final amplifier, carrier and peak tubes, and the modulator and RF driver tubes are water cooled. The remainder of the transmitter is cooled by low velocity, high volume air.

SPECIFICATIONS

Carrier power output:
525 kW

Type of emission:
Amplitude modulation (A3)

Frequency range:

535 to 1605 kHz

Frequency stability:

±1 part per 10⁷ per month

Modulation system:

High efficiency screen and impedance*

Output impedance:

140 ohms, nominal (other available)

Audio input impedance:

150/600 ohms balanced or unbalanced

Audio input level for 100% modulation at 1 kHz:

+8 dBm (adjustable ±5 dB or as required)

Audio frequency response:

±1 dB, 50 to 7,500 Hz

±1.5 dB, 30 to 10,000 Hz

Audio harmonic distortion:

3% or less, 50 to 7,500 Hz,
at 90% modulation

Residual carrier noise:

-60 dB, unweighted

-70 dB, C.C.I.R. weighted

Overall efficiency:

60% or better

Export Shipping Data:

Type 321F: 10,500 ft³ (300 m³);

145,200 lb (66,000 kg)

*Continental Electronics Mfg. Co. holds the following patents for the high efficiency screen modulated amplifier: Canada 764,605; France 1,432,543; UK 1,044,479; USA 3,314,024.

All specifications are subject to change without notice.

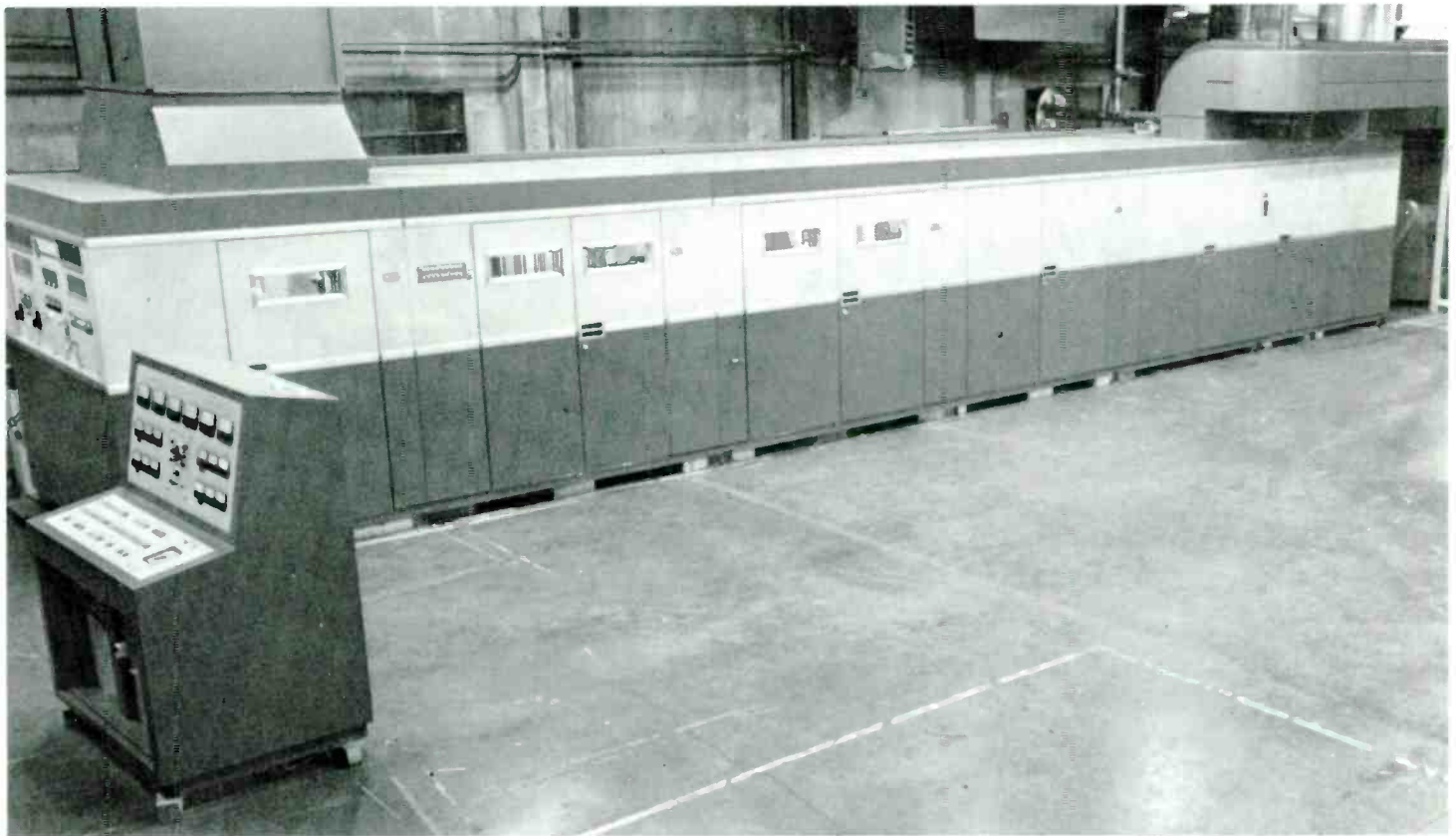

Type 323C

Continental's Type 323C is a high performance medium frequency broadcast transmitter that uses a unique screen and impedance modulation circuit* to achieve extremely reliable, cost-effective operation.

Both carrier and peak tubes are operated in Class "C" condition, offering broadcasters very high efficiency while limiting the peak voltage to values consistent with reliable operating conditions.

The first RF amplifier is solid state and drives the grid of the IPA.

The intermediate power amplifier employs a single 4CW25000A tetrode with a fixed power output of 10,000 watts.

The final power amplifier utilizes two 8974 water cooled tetrodes which have a plate dissipation of 1,250,000 watts each.

When used in Continental's high-efficiency screen and impedance modulated circuit*, the maximum plate dissipation per tube is less than 400,000 watts for the carrier tube, and less than 240,000 watts for the peak tube with 100% sinewave modulation.

The carrier tube provides the full 1,000,000 watts power output when no modulation is applied.

Three 4CW25000A water-cooled tetrodes are used in a cathode follower modulator. In this configuration, the 4CW25000A tubes have a very high overload capability and thus assure high reliability.

Continental's unique toroidal inductors are used in the carrier and peak tank inductor circuits. This unique design achieves a much higher Q than other types of inductors, and because the coil does not produce an external magnetic field, it can be located in a small compartment within the transmitter. The inductors are adjustable for frequency change.

The transmitter is cooled by a combination of forced air and pumped water circulation.

The final amplifier, carrier and peak tubes, and the modulator and RF driver tubes are water cooled. The remainder of the transmitter is cooled by low velocity, high volume air.

SPECIFICATIONS

Carrier power output:
1050 kW

Type of emission:
amplitude modulation (A3)

Frequency range:
535 to 1605 kHz

Frequency stability:
±1 part per 10⁷ per month

Modulation system:

High efficiency screen and impedance*

Output impedance:

140 ohms, nominal (other available)

Audio input impedance:

150/600 ohms balanced or unbalanced

Audio input level for 100% modulation at 1 kHz:

+8 dBm (adjustable ±5 dB or as required)

Audio Frequency response:

±1 dB, 50 to 7,500 Hz

±1.5 dB, 30 to 10,000 Hz

Audio harmonic distortion:

3% or less, 50 to 7,500 Hz, at

90% modulation

Residual carrier noise:

-60 dB, unweighted

-70 dB, C.C.I.R. weighted

Overall efficiency:

60% or better

Export Shipping Data:

Type 323C: 12,075 ft³ (345 m³);

166,980 lb (75,141 kg)

*Continental Electronics Mfg. Co. holds the following patents for the high efficiency screen modulated amplifier: Canada 764,605; France 1,432,543; UK 1,044,479; USA 3,314,024.

All specifications are subject to change without notice.



Type D323C

Continental's Type D323C is a high performance medium frequency broadcast transmitter that uses a unique screen and impedance modulation circuit* to achieve extremely reliable, cost-effective operation.

Both carrier and peak tubes are operated in Class "C" condition, offering broadcasters very high efficiency while limiting the peak voltage to values consistent with reliable operating conditions.

In order to increase operating flexibility while improving maintenance factors, the D323C is designed in modules of one-half the operating power level.

Thus, the transmitter consists of two Type 323C 1,000,000 watt transmitters operating in parallel to achieve a total power output of 2,000,000 watts.

The combiner is described in the transmitter combiner section of this catalog.

Each Type D323C 1,000,000 Watt Transmitter is described as follows:

The first RF amplifier is solid state and drives the grid of the IPA.

The intermediate power amplifier employs a single 4CW25000A tetrode with a fixed power output of 10,000 watts.

The final power amplifier utilizes two 8974 water cooled tetrodes which have a plate dissipation of 1,250,000 watts.

When used in Continental's high-efficiency screen and impedance modulated circuit*, the

maximum plate dissipation per tube is less than 400,000 watts for the carrier tube, and less than 240,000 watts for the peak tube with 100% sine-wave modulation. The carrier tube provides the full 1,000,000 watts power output when no modulation is applied.

Continental cooperated with EIMAC Division of Varian, Inc., in the development of the 8974 tetrode, and thus has unique experience and first-hand knowledge of the effectiveness of the X2159 in high-power transmitters.

Three 4CW25000A water-cooled tetrodes are used in the cathode follower modulator.

When used in this configuration, the 4CW25000A tubes have a very high overload capability and thus assure high reliability.

Continental's unique toroidal inductors are used in the carrier and peak tank inductor circuits.

This unique design achieves a much higher Q than other types of inductors, and because the coil does not produce an external magnetic field, it can be located in a small compartment within the transmitter. The inductors are adjustable for frequency changes.

The transmitter is cooled by a combination of forced air and pumped water circulation.

The final amplifier, carrier and peak tubes, and the modulator and RF driver tubes are water cooled. The remainder of the transmitter is cooled by low velocity, high volume air.

SPECIFICATIONS

Carrier power output from combiner:
2100 kW

Type of emission:
Amplitude modulation (A3)

Frequency range:
535 to 1605 kHz

Frequency stability:
±1 part per 10⁷ per month

Modulation system:
High efficiency screen and impedance*

Output impedance:
140 ohms, nominal (other available)

Audio input impedance:
150/600 ohms balanced or unbalanced

Audio input level for 100% modulation at 1 kHz:

+8 dBm (adjustable ±5 dB or as required)

Audio frequency response:
±1 dB, 50 to 7,500 Hz
±1.5 dB, 30 to 10,000 Hz

Audio harmonic distortion:
3% or less, 50 to 7,500 Hz, at 90% modulation

Residual carrier noise:
-60 dB, unweighted
-70 dB, C. C. I. R. weighted

Overall efficiency:
60% or better

Export Shipping Data:
Type D323C: 27,169 ft³ (776.25 m³);
375,705 lb (170,775 kg)

*Continental Electronics Mfg. Co. holds the following patents for the high efficiency screen modulated amplifier: Canada 764,605; France 1,432,543; UK 1,044,479; USA 3,314,024.

All specifications are subject to change without notice.

Type 416E

Continental's 10 kW short wave broadcast transmitter is a manually tuned, high quality transmitter designed for A3 operation over the frequency range from 3 to 22 MHz.

All operating controls are located on the front of the transmitter for simplicity of operation. Front panel meters monitor all important electrical parameters. The transmitter consists of two cabinets: one cabinet contains the power supply and control circuits, the other cabinet houses the power amplifier. The exciter is housed in a separate rack mounted chassis. High-gain power tetrodes are used in the linear amplifier: one 4CX350A is used for the driver stage; one 4CX3500C tetrode makes up the power amplifier. Superior harmonic attenuation and impedance matching capability is achieved by using a "Pi-L" output network for the power amplifier. Transmitter door interlocks and door-operated high voltage switches protect personnel and equipment. The transmitter is self-contained and occupies 1.9 sq. meters of floor space. The transmitter operates efficiently within an environment of -14°F to 113°F; up to 95% relative humidity; at altitudes up to 5,000 feet above sea level.

SPECIFICATIONS

RF Output Power:

10 kW Carrier;

Emission:

A3

Frequency Range:

3 to 22 MHz

Radio Frequency Harmonic and

Spurious Output:

50 mw (complies with CCIR recommendations)

Output Impedance:

50 Ohm, 1 5/8" coaxial

Power Source:

208/230/380 volts ac, three phase,

50/60 Hz., 40 KVA

Power Factor:

90%

Audio Input Impedance:

150/600 ohms, balanced or unbalanced

Audio Input level, for 100%

Modulation:

+ 10 dBm \pm 2 dB @ 1000 Hz

Audio Frequency Response:

\pm 1dB 50 to 7500 Hz @ 90% modulation

Audio Frequency Distortion:

Less than 3% RMS 50-7500 Hz

@ 90% modulation

Carrier Regulation (Shift):

5% or less @ 100% modulation



Residual Carrier Noise:

55 db below 100% modulation

RF Sources: (Optional)

Any synthesizer with an output of

1 volt rms across 50 ohms

(Synthesizer Not Included)

Tuning Time:

All tuning controls are accessible from outside of the cabinet except the plug-in plate tuning coil which consists of four (4) bands; maximum time to change from one frequency to a second frequency is approximately four (4) minutes.

Cooling:

Forced Air

Altitude:

5,000 feet (1.52 Km)

Ambient Temperature:

-14°F to 113°F (-10°C to 45°C)

Dimensions:

Width 72" (183 cm)

Depth 41" (104 cm)

Height 78" (198 cm)

Weight:

2,500 lbs (1,134 Kg) net; 3,265 lbs (1,481 Kg) gross, packed for export

Volume:

290 cubic feet (8.2 cubic meters) packed for export

All specifications are subject to change without notice.

AM-SW Type 417D 50 kW AM-SW Transmitter

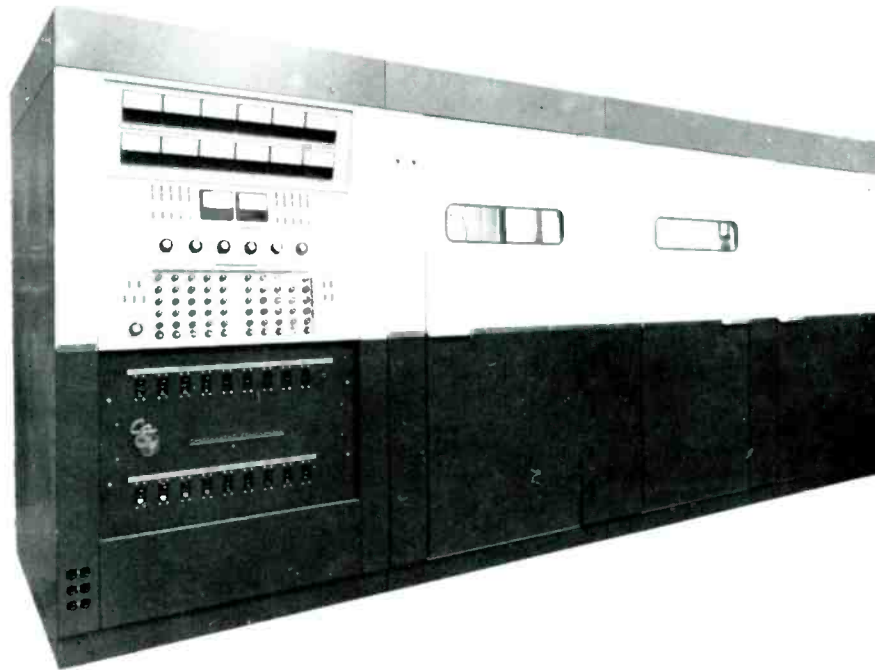

Type 417D

Continental's 50 kW SW broadcast transmitter provides high-performance with optimum efficiency.

A solid-state power hybrid circuit is used to drive the modulator; a broadband solid-state RF amplifier is used to drive the IPA amplifier.

Five tuning controls make initial tuning straightforward and easy.

Fast frequency change (less than one minute) over the frequency range from 3.2 to 22 MHz is provided, and up to 10 preset frequencies can be selected from the front panel without manual tuning.

Two 4CX15000A air-cooled tetrodes operated in a conventional push-pull Class AB₁ modulator, provide high level modulation from 50 to 10,000 Hz.

The power amplifier uses a 4CX35000C air-cooled tetrode operated as a conventional grounded cathode amplifier. The resulting circuit is reliable and simple.

Large, full-width doors allow easy access for maintenance; an automatic grounding system protects operating personnel whenever an access door is opened.

The 417D uses forced-air cooling and ventilation throughout its cabinets; power vaults are cooled by natural convection and radiation.

Control system

Operation of the 417D is simplified by the use of pushbutton control switches which have built-in, lighted function labels that change color to indicate status.

Overall control circuitry is a series-parallel ladder network, with switching, timing, overloads, and other interlock functions arranged in a scientific manner in the network legs to provide a comprehensive protection system.

The preset transmitter tuning system uses dc motors which are controlled by solid-state dc power amplifiers. A pushbutton switch on the control panel activates the tuning system. Multi-turn digital readout potentiometers on the control panel are used for initial positioning and manual tuning.

SPECIFICATIONS

Carrier Output Power:

50 kilowatts

Types of Emission:

Amplitude Modulation (A3) and Frequency Shift (F1)

Type of Modulation:

High-level plate, Class "AB₁" modulator

Final Power Amplifier:

Class "C" operation

Frequency Range:

3.2 to 22 MHz

Output Impedance:

75 ohms unbalanced or 300 ohms balanced (optional). VSWR less than 1.5:1

Modulation Capability:

100%, 50 to 10,000 Hz sinusoidal

Radio Frequency Harmonic and Spurious Output:

Less than 50 mW (Complies with CCCIR Recommendations)

Audio Input Impedance:

600/150 ohms, balanced or unbalanced

Audio Input Levels for 100%

Modulation:

+10 dBm ±2dBm at 1000Hz

Audio Frequency Response:

±1 dB from 50-7500 Hz @ 90% Modulation

Audio Frequency Distortion:

Less than 3% rms, 50-7500Hz @ 90% Modulation

Residual Carrier Noise:

55 dB (unweighted) below 100% modulation level at 1000 Hz or better

Carrier Shift:

Less than 3% at 100% Modulation exclusive of power line variations

Relative Humidity:

95 Percent

Altitude:

6000 feet above sea level

Power Consumption;

Unmodulated, 98 kW

Sinusoidal:

30% Modulation 114 kW

50% Modulation 125 kW

100% Modulation 135 kW

Primary Power Requirements:

360 to 480 volt, (±5% regulation), three-phase, 50/60 Hz (other on special order)

Power Factor:

0.9 or better

Ambient Temperature Range:

32°F to +113°F (0°C to +45°C)

Transmitter Size:

Width 192" (487.68 cm)

Depth 60" (152.40 cm)

Height 84 5/16" (214 cm)

Transmitter Weight:

21,500 lb (9752 kg) packed for export

All specifications are subject to change without notice.

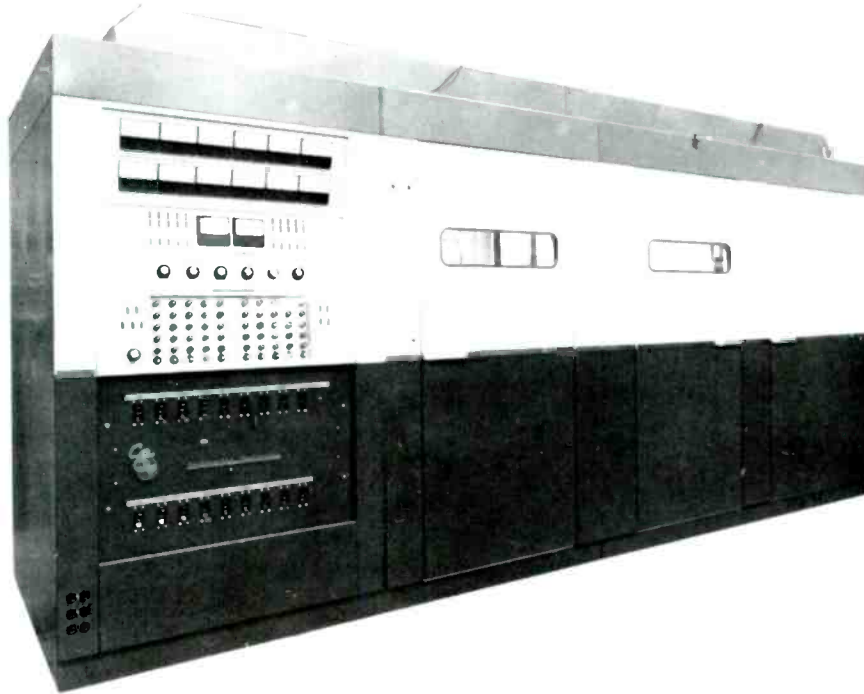

Type 418D-2

Continental's Type 418D-2, 100 kW SW broadcast transmitter is designed for A3 operation over the frequency range of 3.2 to 22 MHz.

The 418D-2 combines the best of semiconductor technology in power supplies with the proven reliability of vacuum tube power stages to provide high-performance, cost-effective operation.

All power tubes are tetrodes. All power supplies use solid-state rectifiers.

Final amplifier and modulator tubes are 4CV100,000C vapor-cooled tetrodes that operate at 70% and 25% respectively of their dissipation capability at 100% modulation.

A 4CX3000A tetrode drives a single 4CV100,000C tetrode final amplifier in a conventional grounded cathode circuit. Solid-state amplifiers are used in all low level audio and RF stages.

Two 4CV100,000C tetrodes, operated push-pull, provide high-level, 100% modulation in Class AB₁.

Modulator and final amplifier tubes are vapor-phased cooled. This cooling system is greatly superior in efficiency to a water-cooled system, removing almost 20-times as much energy.

Five tuning controls make initial tuning straightforward and easy.

Ten preset channels (frequencies) can be selected and activated from the front panel. After initial tuning is accomplished, frequency changes can be made in less than one minute, without additional manual tuning.

The 418D-2 uses a water vapor system to cool the final rf and modulator amplifiers; forced-air cooling is used for the low level tube.

Control system

Operation of the 418D-2 is simplified by the

use of pushbutton control switches which have built-in, lighted function labels that change color to indicate status.

Overall control circuitry is a series-parallel ladder network, with switching, timing, overloads and other interlock functions arranged in a scientific manner in the network legs to provide a comprehensive protection system.

The preset transmitter tuning system uses dc motors which are controlled by solid-state dc power amplifiers.

A pushbutton switch on the control panel activates the tuning system.

Multi-turn digital readout potentiometers on the control panel are used for initial positioning and manual tuning.

SPECIFICATIONS

Carrier Output Power:

100 kilowatts

Types of Emission:

Amplitude Modulation (A3) and Frequency Shift (F1)

Type of Modulation:

High-level plate, Class "AB₁" modulator

Final Power Amplifier:

Class "C" operation

Frequency Range:

3.2 to 22 MHz (2.3 to 26.5 MHz optional at extra cost) (External synthesizer available as separate item)

Output Impedance:

75 ohms unbalanced or 300 ohms balanced (optional). VSWR less than 1.5:1

Modulation Capability:

100%, 50 to 7500 Hz sinusoidal

Radio Frequency Harmonic and Spurious Output:

Less than 50 mW (Complies with CCIR Recommendations)

Audio Input Impedance:

600/150 ohms, balanced or unbalanced

Audio Input Levels for 100%

Modulation:

+10 dBm ±2d Bm at 1000Hz

Audio Frequency Response:

±1 dB from 50-7500 Hz

Audio Frequency Distortion:

Less than 3% rms, 50-7500 Hz @ 90% Modulation

Residual Carrier Noise:

55 dB (or better) below 100% modulation level at 1000 Hz or better

Carrier Regulation (Shift):

Less than 3% at 100% Modulation exclusive of power line variations

Relative Humidity:

95 Percent

Altitude:

6000 feet above sea level

Power Consumption;

Unmodulated	175 kW
50% Modulation	220 kW
100% Modulation	275 kW

Power Factor:

0.95 or better

Ambient Temperature Range:

+32°F to +113°F (0°C to +45°C)

Primary Power Requirements:

360 to 480 volts, (±5% regulation), three-phase, 50/60 Hz (other on special order)

Transmitter Size:

Width 192" (487.68 cm)
Depth 50" (152.40 cm)
Height 84 5/16" (214 cm)

Transmitter Weight:

26,200 lb (11,884 kg) packed for export

All specifications are subject to change without notice.

AM-SW Type 419F 250 kW AM-SW Transmitter

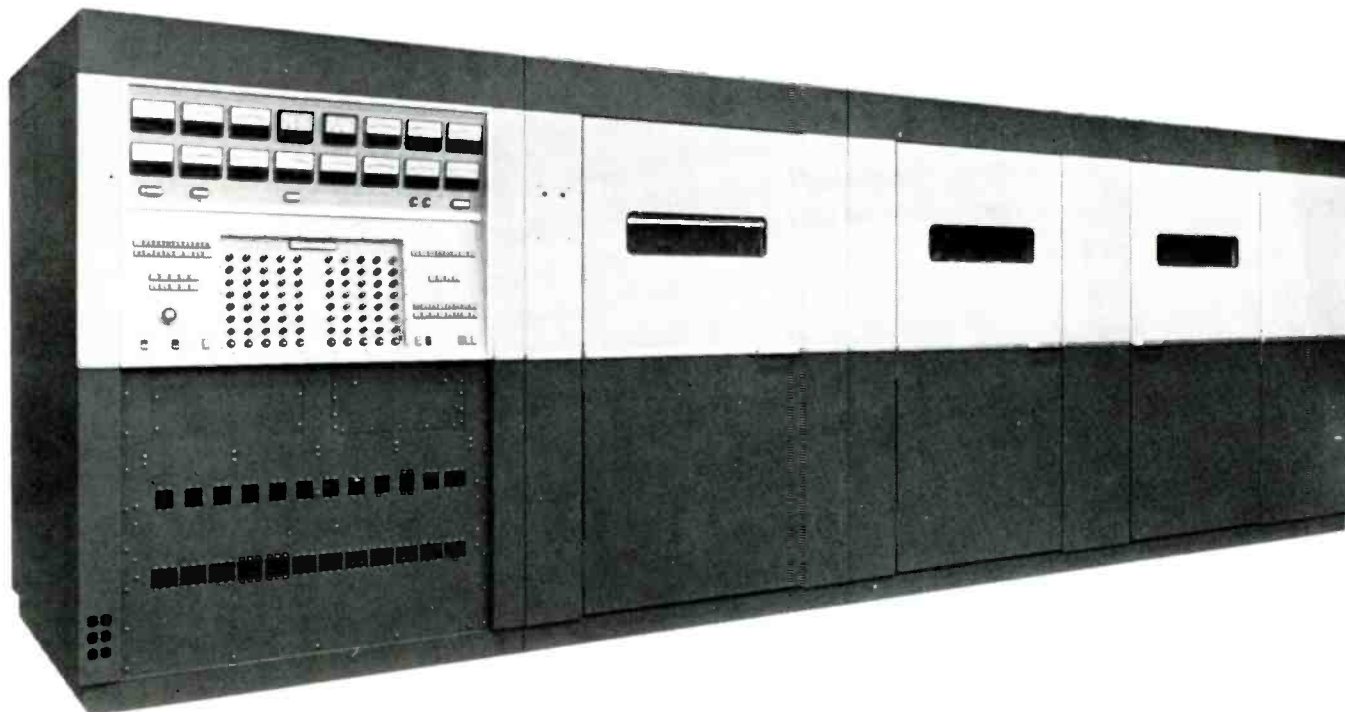

Type 419F

Continental's Type 419F is designed for A3 operation over the frequency range of 5.0 to 22.0 MHz.

The 419F combines the best of semiconductor technology in power supplies with the proven reliability of vacuum power tube power stages to achieve high performance with cost-effective operation.

All power tubes are tetrodes. All power supplies use solid-state rectifiers.

The modulator uses two 4CV100,000C vapor-cooled ceramic tetrodes in a push-pull Class AB₁ circuit. All modulator components are compatible with 100% positive modulation operation.

The RF power amplifier circuit uses one 4CV250,000B tetrode.

Continental's unique single-stage amplifier circuit uses special filament and screen by-pass capacitors to achieve very high stability, simplified modulation and tuning throughout the transmitter's frequency range.

All transmitter control and monitoring can be accomplished from a single front panel.

Seven tuning controls make tuning straightforward and easy.

Ten preset channels (frequencies) can be selected and activated from the front panel.

After initial tuning is accomplished, frequency change can be made in less than one minute, without additional manual tuning.

The 419F uses a water vapor system to cool the final RF and modulator amplifiers; the RF drive tube, output tuning and loading components are water-cooled; forced-air cooling is used for other transmitter components.

Control system

The 419F used a 24 volt dc control system. Most control functions use conventional electro-mechanical control logic.

Basic control circuitry is in a familiar series parallel ladder; switching, timing and interlocking functions are arranged in a logical and consistent pattern.

The transmitter has all instruments necessary for operational adjustment and maintenance procedures.

All major operating parameters are displayed on easy-to-read meters which are located on the front panel. Meters are grouped in a logical and functional manner.

Multi-colored indicators on the front panel give status of various interlock and control system logic.

SPECIFICATIONS

Carrier Output:

250 kW

Type of Modulation:

High level plate

Type of Emission:

A3

Frequency Range:

5.0 to 22.0 MHz (External synthesizer available as separate item)

AF Input Impedance:

600/150 ohms balanced or unbalanced

AF Input Level for 100% Sine Wave

Modulation:

+ 10 dBm \pm 2 dBm @ 1 kHz

AF Response:

\pm 2 dB 50 to 7,500 Hz @ 90% modulation

AF Distortion:

Less than 5% 50-7,500 Hz @ 95% modulation

Carrier Regulation (Shift):

Less than 5% exclusive of power line variations

Modulation Capability:

100%, 50-7,500 Hz Sinusoidal

Residual Carrier Noise:

50 dB (or better) below 100% modulation at 1,000 Hz

Radio Frequency Harmonic and Spurious Output:

Complies with CCIR regulations

Output Impedance:

75 ohms unbalanced or 300 ohms balance (optional); max. VSWR 1.8

Power Source:

4160v, 3 phase, 50/60 Hz (other on special order)

Power Factor:

0.9 or better

Power Consumption:

Unmodulated: 475 kW
100% Sine wave: 675 kW

Altitude:

6,000 feet above sea level (1828.8m)

Relative Humidity:

95%

Ambient Temperature Range:

32°F to 113°F (0°C to 45°C)

Dimensions, Main Cabinet Group:

Width 22' (6.71 m)

Depth 14' (4.27 m)

Height 7' (2.13 m)

Power Supply Vault:

Width 27' (8.23m)

Depth 14' (4.27 m)

Height 7' (2.13m)

Weight:

45,600 lbs. (20,520 kg) packed for export

Volume:

3,000 cu. ft. (84.95 cu. m.)

All specifications subject to change without notice.

Type 420B

Designed for A3 operation over the frequency range of 3.95 to 26.1 MHz, the Type 420B is a versatile, sophisticated, state-of-the-art, high efficiency short wave transmitter that can be operated in either amplitude modulation or, when specified and with the appropriate exciter, in single sideband service.

From its centralized master control panel, or from a remote computerized control and monitoring station, the 420B can be set up and either pretuned or automatically tuned to deliver 500,000 watts of carrier power on any frequency between 3.95 and 26.1 MHz. The transmitter can also be manually tuned using controls and indicators located on the centralized control panel.

The Type 420B uses advanced, state-of-the-art components. Two large multi-phase cooled 4CM400,000 tetrode vacuum tubes are used in the power amplifier and modulator section of the transmitter. All critical major components, including vacuum tubes, vacuum capacitors, tuning inductors and the solid-state broadband RF driver amplifier, are either water or water-vapor cooled. Other transmitter components are cooled by forced air.

The transmitter employs a very simple, reliable three-stage RF amplifier chain which needs just 9 tuning controls, including the Balun to develop 500,000 watts of carrier power from a 1 volt RMS exciter output. The three-stage RF amplifier consists of a broadband (3.9 to 27 MHz) solid-state amplifier; grounded-grid 3CW20,000A7 triode; and a 4CM400,000 tetrode final power amplifier.

The modulator is a series hard tube floating deck pulse-width modulator consisting of a single EIMAC 4CM400,000 tetrode driven by a solid-state MOSFET Driver. Modern switching techniques combined with a highly efficient tetrode tube give the modulator an efficiency of better than 90%. Excellent noise immunity is obtained by feeding all low-level signals to the floating deck and back to ground via reference fiberoptic cables.

Control functions use a combination of solid-state and relay logic. Tri-State, Stop/Start control commands are provided for all basic transmitter functions. Color-keyed indicators show command absence, acknowledgement and completion. A colored indicator column on the control panel shows individual and summary status of transmitter cooling, interlock and fault systems. A similar display system is used for all basic control system groups, and they are arranged in a logical, sequential pattern. All major operating parameters are displayed on easy to read meters. The meters have easily set overload and circuit-prove functions.

Transmitter control and monitoring via RS-232 system allows remote or extended control from a video terminal. Preset servo positions for 255 channels and 222 frequencies can be stored in non-volatile memory. Thousands of logs can be

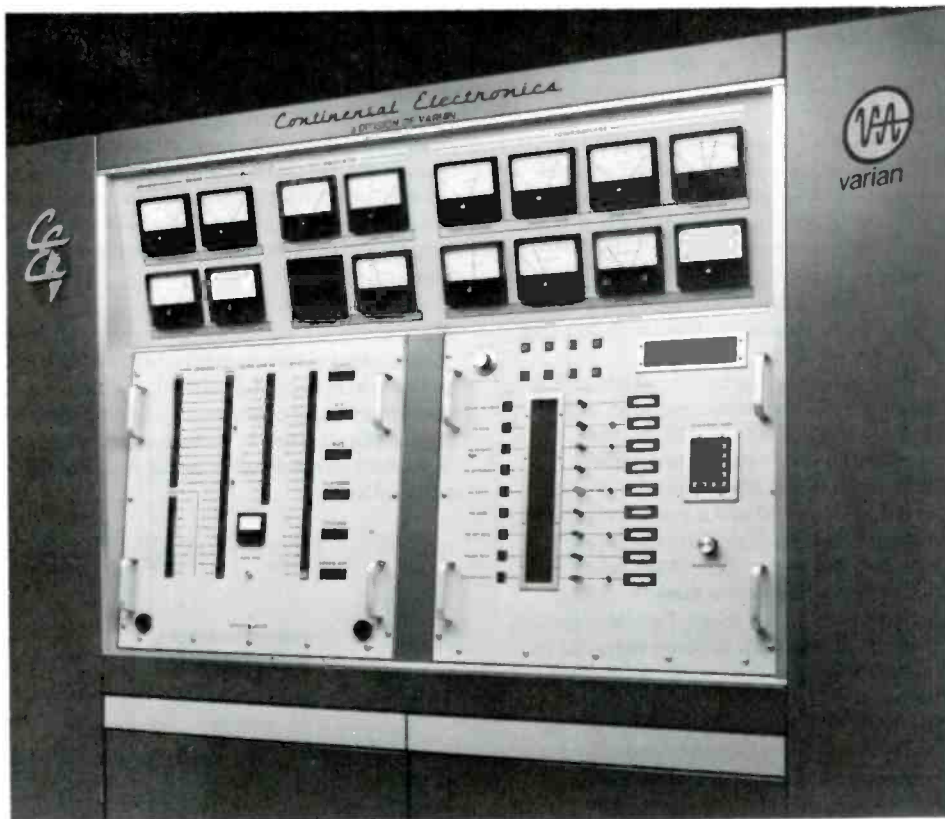

stored and reviewed. A parallel printer port can be used to activate a printer for print-out of logs and other data. Thirty-two different commands assist the operator with transmitter control, fault analysis, parameter variance, etc. A front panel key pad and fluorescent display enable the transmitter to be computer-controlled from a local mode using a command subset.

SPECIFICATIONS

Carrier Output:

500 kW

Modulation:

Pulse-width modulator

Emission:

A3

Frequency Range:

3.95 to 26.1 MHz

AF Input Impedance:

600/150 ohms, balanced or unbalanced

AF Input Level

for 100% Sinewave Modulation:

-5 dBm to +10 dBm

AF Response:

±1 dB 50 Hz to 5000 Hz at 75% modulation;

+1 dB -2 dB 5000 Hz to 7500 Hz at 75% modulation

AF Distortion:

Less than 4% 50 to 5000 Hz

at 90% modulation

Carrier Regulation (Shift):

Less than 5% exclusive of power line variations

Modulation Capability:

100% 50 to 7500 Hz Sinewave for 10 minutes per hour; up to 70% modulation continuously

Residual Carrier Noise:

56 dB or better unweighted below 100% modulation at 1 kHz

Radio Frequency Harmonic and Spurious Output:

Complies with CCIR regulations

Output Impedance:

75 ohms unbalanced or 300 ohms balanced (optional)

Maximum VSWR:

1.7

Power Source:

4160 volts ac, three phase, 50/60 Hz (Other on special order)

Power Factor:

0.9 or better

Power Consumption:

Carrier-modulated: 100% Sinewave, 1200 kva

Efficiency:

62% including all cooling and auxiliary power with worst case operating conditions

Exciter:

Any suitable exciter with 1/2 watt output, 3.95 to 26.1 MHz

OPERATING ENVIRONMENT

Altitude Range:

6,000 ft (1828.8 m)

Ambient Temperature Range:

+32°F to +122°F (0°C to +50°C)

Relative Humidity:

95%

Size:

4300 ft³ (129 m³)

Weight:

47,300 lb (21,285 kg) nominal, packed for export

All specifications are subject to change without notice.

Transmitter Combiners

Introduction

Many of Continental's medium power AM and FM, and high-power AM broadcast transmitters can be combined to achieve higher power output levels.

Continental 20,000 watt, 25,000 watt and 27,500 watt FM transmitters can be combined to develop 40,000 watts, 50,000 watts and 55,000 watts output, respectively. Each of these higher power transmitters are type approved by the FCC.

Continental 10,000 and 50,000 watt AM transmitters can be combined to develop 20,000 and 100,000 watts output.

Continental high-power broadcast transmitters utilize combiners to increase operating factors: Two Continental Type 318C 100,000 watt transmitters can be combined to develop 200,000 watts output power; Two Continental Type 318.5C 150,000 watt transmitters can be combined to develop 300,000 watts output power; Two Continental Type 320F 500,000 watt transmitters can be combined to develop 1,000,000 watts output power; Two Continental Type 323C 1,000,000 watt transmitters can be combined to develop 2,000,000 watts output power.

Continental transmitters and combiners are used by broadcasters around the world to meet unique transmitter power or station operating requirements.

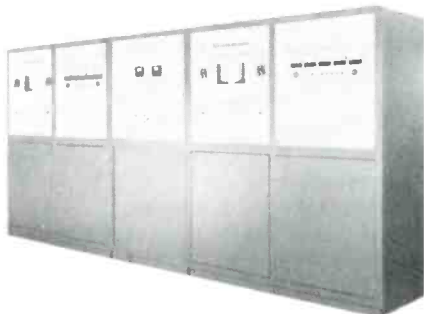

Combiner for Type D316F-1 20,000 watt AM transmitter

Continental's D316F-1 consists of two Type 316F-1 10,000 watt AM broadcast transmitters combined to achieve 20,000 watts of output power.

The combiner is housed in one cabinet that matches the cabinets of the two 316F-1 transmitters, and is normally placed between the two transmitters. Other arrangements are possible.

The combiner front panel has controls for operating the two 316F-1 transmitters: either as combined or single transmitters. Indicator lamps show system status, phase control of RF output, RF output current meter and waster load current meter.

A convection-cooled waster load is located within the combiner cabinet. The load also serves as a dummy load during single transmitter operation.

The combiner offers three modes of transmitter operation: two 316F-1 transmitters combined for 20,000 watts output to the antenna; 316F-1 number one operating into the antenna; 316F-1 number two operating into the dummy load; 316F-1 number one operating into the dummy load and 316F-1 number two operating into the antenna.

Combiner circuit

The combining circuit provides complete isolation of one transmitter from the other. Thus the load resistance is constant and independent of differences between the two transmitters: the output of one transmitter may be open or short circuited without affecting the other. As an option, the combiner can be built so if one transmitter fails, the full power of the remaining transmitter will be delivered to the antenna.

Waster load

The waster load terminates networks of the combiner from each transmitter. When both transmitters are in phase and equal in power, there will be no power in the waster load. This method allows maximum power to be delivered to the antenna.

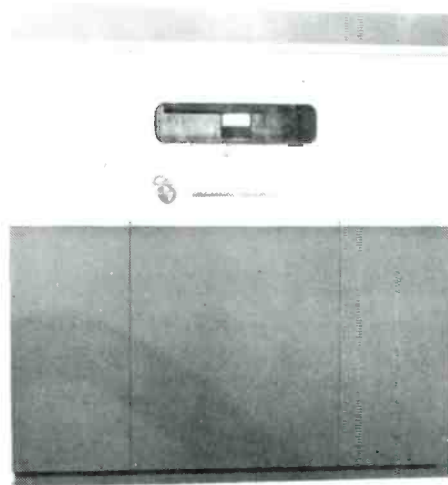

100 kW Combiner

Continental 100kW combiner is used to combine the output of two Continental Type 317C-2 50,000 watt AM broadcast transmitters.

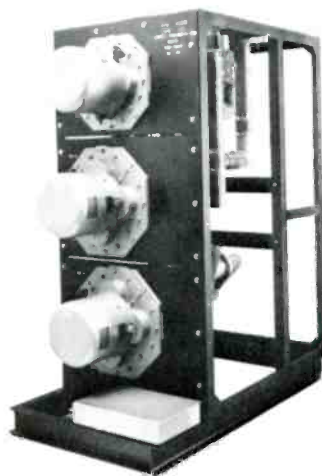

Combiner for Type 817R-1 50,000 watt, Type 817-4 55,000 watt FM Transmitters

Continental's 817R-1 consists of two Type 816R-3 25,000 watt transmitters combined to achieve 50,000 watts of output power; Continental's 817-4 consists of two Type 816R-4

27,500 watt transmitters combined to achieve 55,000 watts of output power.

The combining is accomplished in a 90 degree hybrid coupler that may be used alone or in conjunction with motor activated coaxial switches. The motor activated switch and coupler assembly is appropriate for automated switched operation of combined transmitters. The hybrid coupler introduces less than 0.1 dB loss and no more than a 1.1 VSWR in a 50 ohm system. Isolation between the combined transmitters is at least 30 dB.

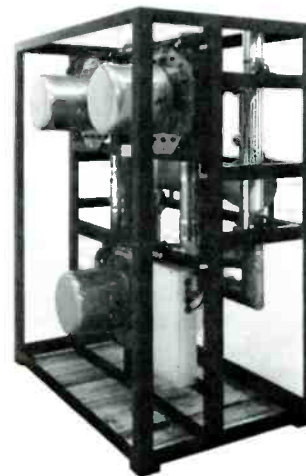

Combiner for Type 817R-2A 40,000 watt FM Transmitter

Continental's 817R-2A consists of two Type 816R-2A transmitters combined to achieve 40,000 watts of output power.

The combining is accomplished in a 90 degree hybrid coupler that may be used alone or in conjunction with motor activated coaxial switches. The motor activated switch and coupler assembly is appropriate for automatic switched operation of combined transmitters. The hybrid coupler introduces less than 0.1 dB loss and no more than a 1.1 VSWR in a 50 ohm system. Isolation between the combined transmitters is at least 30 dB.

All specifications are subject to change without notice.

Transmitter Combiners

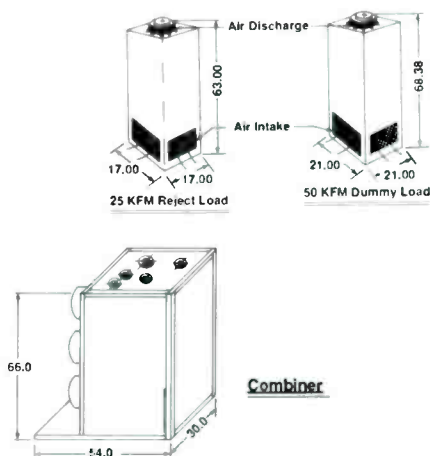

Combiner & Transmitter Dummy Load Configurations for 50,55 kW FM Transmitters

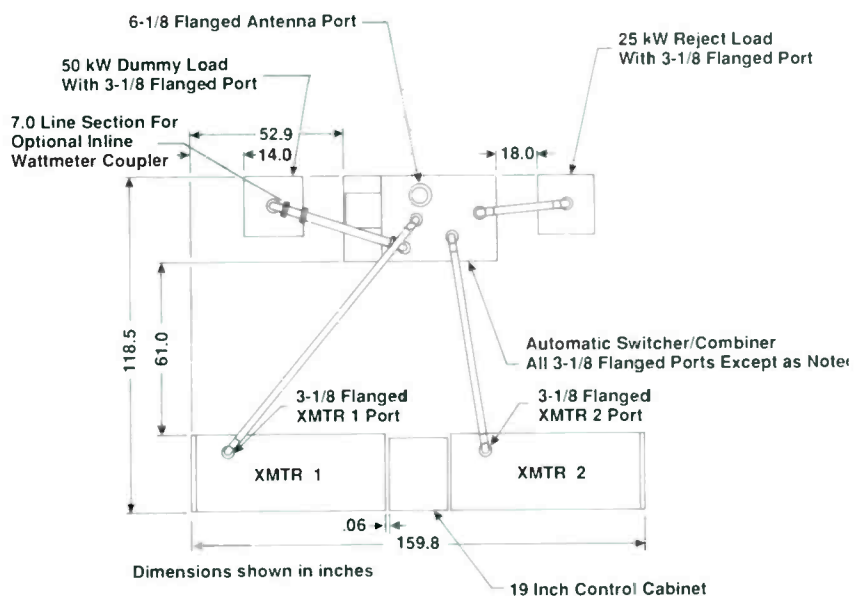

Typical Plan View, 50 & 55 kW FM Transmitters

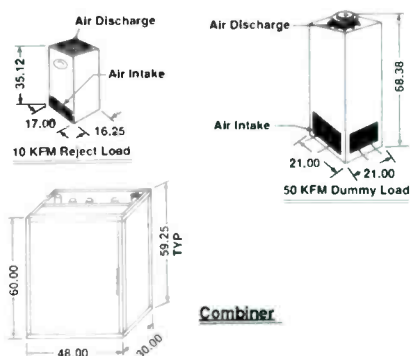

Combiner & Transmitter Dummy Load Configurations for 40 kW FM Transmitters

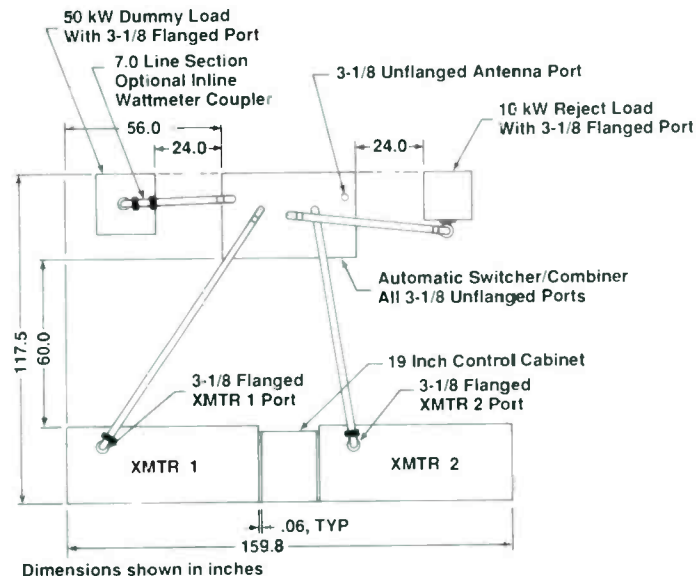

Typical Plan View, 40 kW FM Transmitters

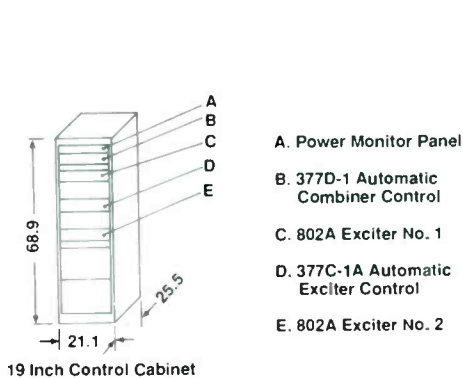

- A. Power Monitor Panel
- B. 377D-1 Automatic Combiner Control
- C. 802A Exciter No. 1
- D. 377C-1A Automatic Exciter Control
- E. 802A Exciter No. 2

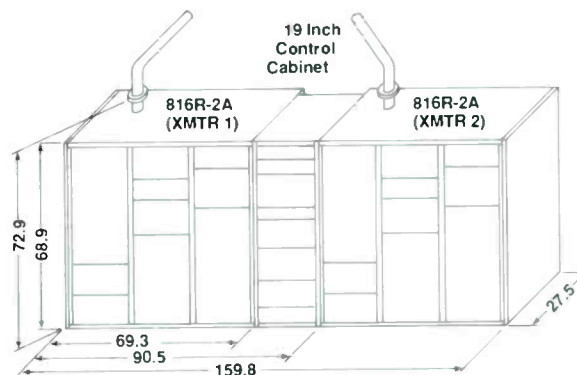

Typical Set-Up: 40, 50, 55 kW FM Transmitters

Transmitter Dummy Loads



Electro Impulse Model
DPTC-25KFM FM Dummy Load

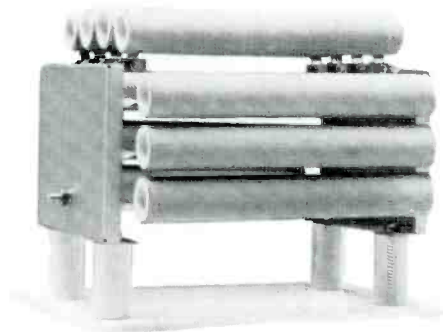

Type 314DL-1, 1,000 watt Dummy Load

Continental's 314DL-1 is a convection air cooled dummy load that will handle a 1,000 watt transmitter at 125% modulation. It is supplied with 50 ohms resistance and with stud connection.

Size: 10" wide, 12" long, 9" high
Weight: 12 lbs.

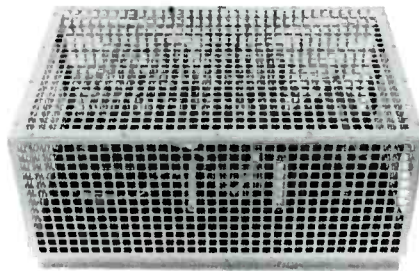

Type 516DL-1, 5,000/10,000 watt Dummy Load

Continental's 516DL-1 is a convection air cooled dummy load that will handle a 5,000 or 10,000 watt transmitter at 125% modulation. It is supplied as an essentially flat load, including "L" network, on the customer's frequency and impedance in the standard medium wave broadcast band. A Delta TCA ammeter and 1-5/8" EIA termination are optional. Coil and capacitor sizes vary with frequency and impedance.
Size: 40" wide, 12" high, 26" deep
Weight: 60 lbs.

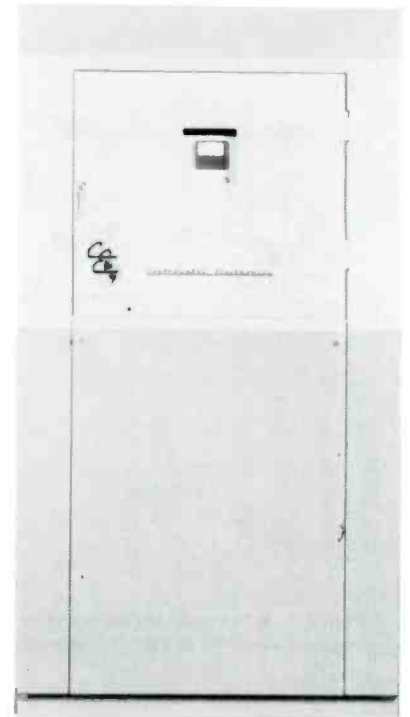

Type 517C-2, 50,000 watt Dummy Load

Continental's 517C-2 is an air-cooled RF dummy load designed for continuous and reliable operation over the frequency range of 535 to 1620 kHz. The "L" network is adjusted at the factory.

The load is designed for use with 50,000 watt AM broadcast transmitters to provide a load for the RF power amplifier for testing purposes, or when it is not desirable to radiate RF output. The load will handle a 50,000 watt AM transmitter at 125% modulation.

SPECIFICATIONS

Frequency range: 535 to 1620 kHz

Power dissipation: 75kW

Resistance: Factory-adjusted to customer's transmitter RF output impedance

RF connections: Insulator "bowl" on top of cabinet

Size: Width 42" (107 cm)

Depth 40" (102 cm)

Height 78" (198 cm)

Weight: 950 lbs (431 kg)

All specifications are subject to change without notice.

Electro Impulse rf Loads

Model	Avg Pwr (Kilowatts)	Freq Range (dc MHz)	Max VSWR	EIA Connector in (cm)	Size			Wt lb (kg)	Reqd Pwr (v ac 1 phase)
					D in (cm)	W in (cm)	H in (cm)		
DPTC-10KFM	10/12	108	1.2:1	3 1/8 (7.9)	11 (27.9)	16 (40.6)	38 (96.5)	37 (16.8)	110
DPTC-25KFM	25	108	1.2:1	3 1/8 (7.9)	17 (43.1)	17 (43.1)	63 (160)	100 (45.4)	110
DPTC-50KFM	55	108	1.2:1	6 1/8 (15.5)	21 (53.3)	21 (53.3)	65 (165.1)	120 (54.4)	220
DPTC-75KFM	80	108	1.25:1	6 1/8 (15.5)	26 (66)	26 (66)	65 (165.1)	150 (68)	220

Transmitter Dummy Loads



Continental Type DL-418 100 kW Dummy Load

Continental's Type DL-418 is a high-power RF dummy load designed for continuous and reliable operation over the frequency range from 0.1 to 100 MHz. The dummy load can be used without power derating over its full frequency range. Measured VSWR is less than 1.1:1. The load, including its external heat exchanger and coolant tank, is equipped with an external interlock control having interface connections via a terminal board. Ambient operating temperature range is from 32° to 110°F (0° to 44°C). An ethylene glycol mixture (35%) can be used to extend lower temperature range. 50 Hz operation and a calorimeter panel are available at additional cost. Measurement accuracy of the optional calorimeter is better than 5%.

SPECIFICATIONS

Power Rating: 100 kilowatt average;
200 kilowatts PEP.

Impedance: 50 OHMS (unbalanced)

Frequency Range: 0.1 to 100 MHz

VSWR: Less than 1.1 to 1 to 100 MHz

Power Required: 230 VAC, 20A,
3 phase, 60 Hz (50 Hz optional)

Service: AM, FM, TV, SSB, FSK or C.W.

Duty Cycle: Continuous

Size (Load Unit Only):

Width 2 ft. (61 cm)

Depth 1.5 ft. (46 cm)

Height 6 ft. (183 cm)

Shipping Weight: 2500 Lbs. (1134 kg)
includes load, heat exchanger and
coolant tank (crated)

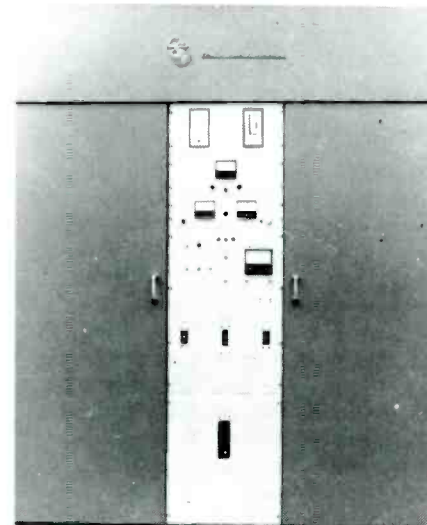

Continental Type 4L23** 1,000 kW Dummy Load

Continental's Type 4L23 is a high-power RF dummy load designed for continuous and reliable operation over the frequency range from 30 Hertz to 40 MHz. The load is available in three configurations: Type 4L23-1 for 50 ohm unbalanced input; Type 4L23-2 for dual 50 ohm inputs; Type 4L23-3 for 300 ohm balanced input. Pre-heated liquid element dissipators have a VSWR of less than 1.2:1 under stabilized conditions. VSWR is less than 1.3:1 within 20 seconds after a substantial change in load dissipation (ie, 200 kW to 1000 kW). Cooling is provided by an internal liquid-to-liquid loop, and an external liquid loop.

Front panel control and monitoring can be modified for remote control and monitoring. Interlock line control protects the dummy load and RF power source. Calorimetric power measurement and water flow indicator meters are mounted on front panel. Ambient operating temperature range is from 32° to 110°F (0° to 44°C).

SPECIFICATIONS

Power Rating:

1000 kW Average; 2000 kW Peak

Impedance: 4L23-1 50 ohms* unbalanced,
4L23-2 two 50 ohm* unbalanced inputs,
4L23-3 300 ohm* balanced (two 150 ohm
inputs)

Frequency Range:

30 Hz to 40 MHz (broadband)

VSWR (Maximum): 1.2:1 after 20 seconds
(maximum) of stable power input; 1.3:1 during
first 20 seconds (maximum) after a power
change of up to 5 to 1.

Duty Cycle: Continuous

Service: AM, FM, FSK, TV, SSB or CW

Power Required: 230 vac ±10%,
single phase, 50/60 Hz, 13 KVA. (other
voltages upon request)

Size: Width 6 ft (183 cm); Depth 4 ft (122 cm);
Height 10 ft (305 cm)

Shipping Wt: Approx. 2000 Lb. (907 kg)
(excludes external heat exchanger)

* varies slightly — dependent upon dissipator temperature,
refer to VSWR specification

** U.S. Patent No: 3,742,188

Transmitter Control Accessories

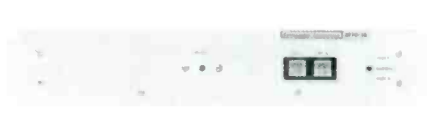

Type 377C-1A Exciter Control

Continental's Automatic Exciter Control monitors the status and controls two exciters.

During typical operation, the Type 377C-1A switches one exciter to the transmitter to be driven. The second exciter is operated into a 100-watt load provided with the unit. If the primary exciter fails, the standby exciter is switched on line in less than 100 milli-seconds. If used with Continental Type 802A FM exciters, the standby exciter is held at 5% of normal power by a bias voltage from the Type 377C-1A until full power is needed.

Front panel controls include Operate/Standby push-buttons for both exciters, and a Normal/Test switch for station monitors.

The Type 377C-1A occupies 3-1/2" of rack space and uses BNC connectors for RF connections and a barrier strip for control connections.

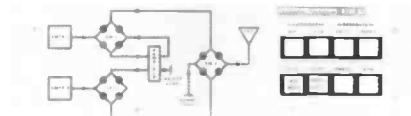

Type 377D-1 Combiner Control

Continental's Automatic Combiner Control provides control commands and monitoring for a pair of parallel transmitters and their associated motor-driven coax switches.

By monitoring predetermined parameters, the Type 377D-1 can switch one transmitter directly into the antenna system and thereby avoid the normal power loss of 6 dB that takes place in a hybrid combiner.

If one PA fails, the down unit is automatically switched to a dummy load for service.

System status is shown by a series of 12 LEDs, and a flow chart gives a quick visual reference from a distance. Eight (8) illuminated push-buttons program the Type 377D-1.

Operating modes include: combined power to load; combined power to antenna; transmitter 1 or 2 to antenna; transmitter 1 or 2 Plate On or Plate Off; and Manual or Automatic operation.

The Type 377D-1 uses IC logic to give status and command functions, and has its own ni-cad power supply across the dc lines to hold memory during a power failure. After a primary power failure, transmitter operation will automatically resume in its last mode.

The Type 377D-1 occupies 5-1/4" of rack space, has standard BNC connectors on the back for RF connections, and uses barrier strips for control connections.

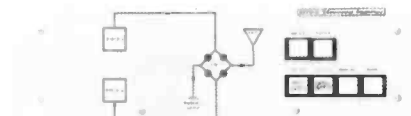

Type 377D-2 Transmitter Control

Continental's Automatic Transmitter Control is similar in operation to the Type 377D-1 except that it controls two transmitters in an alternate/main or "hot standby" condition.

The Type 377D-2 has a ni-cad power supply across the dc lines to hold memory during a power failure.

Front panel controls include Transmitter 1, Transmitter 2, Plate On, Plate Off, Manual, Automatic. An LED flow chart shows rf routing to an antenna system and dummy load.

The Type 377D-2 occupies 5-1/4" of rack space, has standard BNC connectors on the back for rf connectons, and uses barrier strips for control connections.

Type 377D-2A Option

Continental's Type 377D-2A is the same as the Type 377D-2 except that it has a sensing device to monitor transmitter audio level.

If the audio drops below a preset level, the 377D-2A automatically switches the down unit into a dummy load and puts the alternate/hot standby transmitter on the air.

All specifications are subject to change without notice.

Transmitter Control Accessories



P/N 142289
Envelope Demodulator

Continental's Envelope Demodulator removes the RF from transmitter sample and provides for an accurate audio signal for measuring distortion and audio. RF input is routed back thru a rear BNC connector. Designed for use with Continental Type 317C 50,000 and 316F 10,000 watt AM transmitters, the unit can be adapted for other transmitters.

Technical Characteristics

Power required: 100-130 vac, 0.25 a,
50/60 Hz RF input level required: 70v max,
peak-to-peak, unmodulated

Audio monitor output: ac coupled

Distortion measurement: BNC connector,
front panel

Size: 19" wide, 2" high, 6" deep, 18 lbs.



P/N 142340
Automatic Power Controller

Continental's Automatic Power Controller corrects for line voltage changes by automatically raising or lowering power amplifier plate and screen voltage, using variable transformers already in the transmitter. Circuit sensitivity is adjustable so that plate voltage variations due to modulation will not cause a continual "hunting" condition. Designed for use with Continental's 317C 50,000 watt AM transmitters.

Technical Characteristics

Power required:
100-130 vac, 50/60 Hz

Size: 19" wide, 3-1/2" high, 8" deep, 16 lbs.



P/N 142288
Battery Power Supply

Continental's rechargeable 12-volt Battery Power Supply provides low voltage for controlling relays, interlocks and overload status lights of a broadcast transmitter in the event of a main power loss. It's designed for use with Continental's 317C-2 50,000 watt AM transmitters.

Technical Characteristics

Battery: 12 vdc, Ampere/hours 4.5, Charging
rate 0 to 2.0 amperes

Charger: 12 vdc, Fast charges @ 2.0
amperes, Trickle charge @ 0.5 amperes

Charger power requirements:
100-130 vac, 50/60 Hz

Size: 19" wide, 4" high, 7" deep

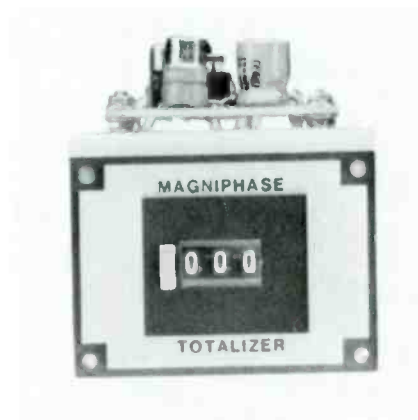

P/N 142407
Magniphase Totalizer

Continental's Magniphase Totalizer automatically records Magniphase trips; has resettable counter. Designed for use on Continental Type 317C 50,000 and 316F 10,000 watt AM transmitters, unit mounts on transmitter front; can be adapted to other transmitters using Magniphase.

Technical Characteristics

Battery: 12 vdc, Ampere/hours 4.5, Charging
rate 0 to 2.0 amperes

Charger: 12 vdc, Fast charges @ 2.0
amperes, Trickle charge @ 0.5 amperes

Charger power requirements:
100-130 vac, 50/60 Hz

Size: 19" wide, 4" high, 7" deep,

Technical Characteristics

Power required; 100-130 vacs, 50/60 Hz

Size: 2-1/4" wide, 2-1/2" high, 3-1/2" deep, 1 lb

All specifications are subject to change without notice.

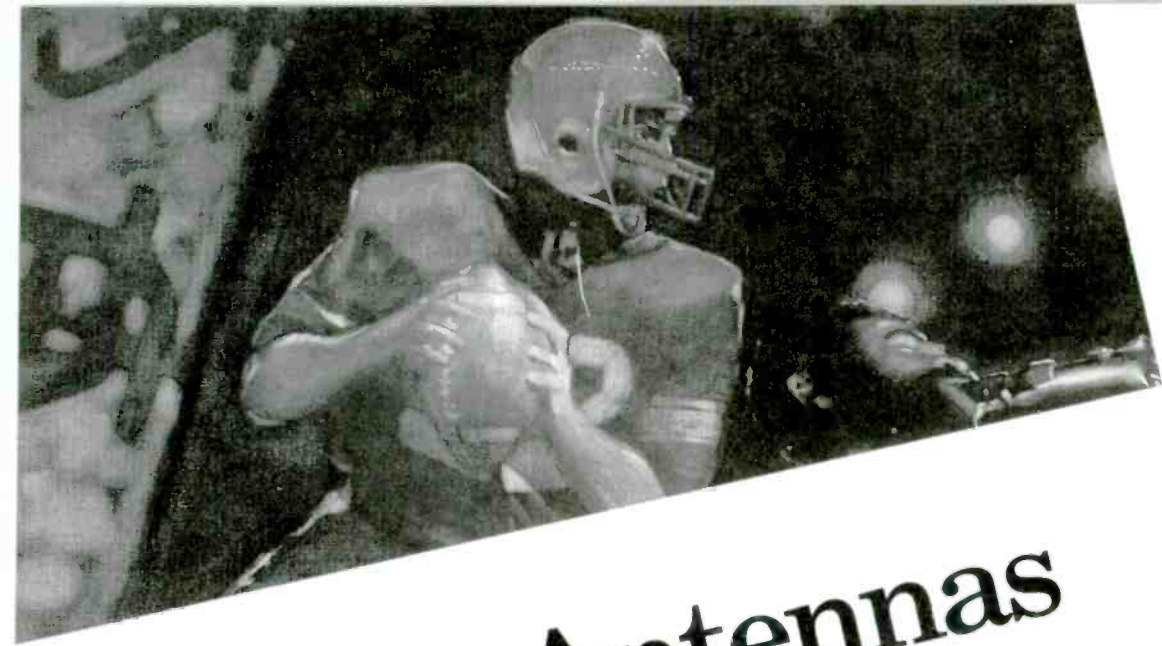

Antennas

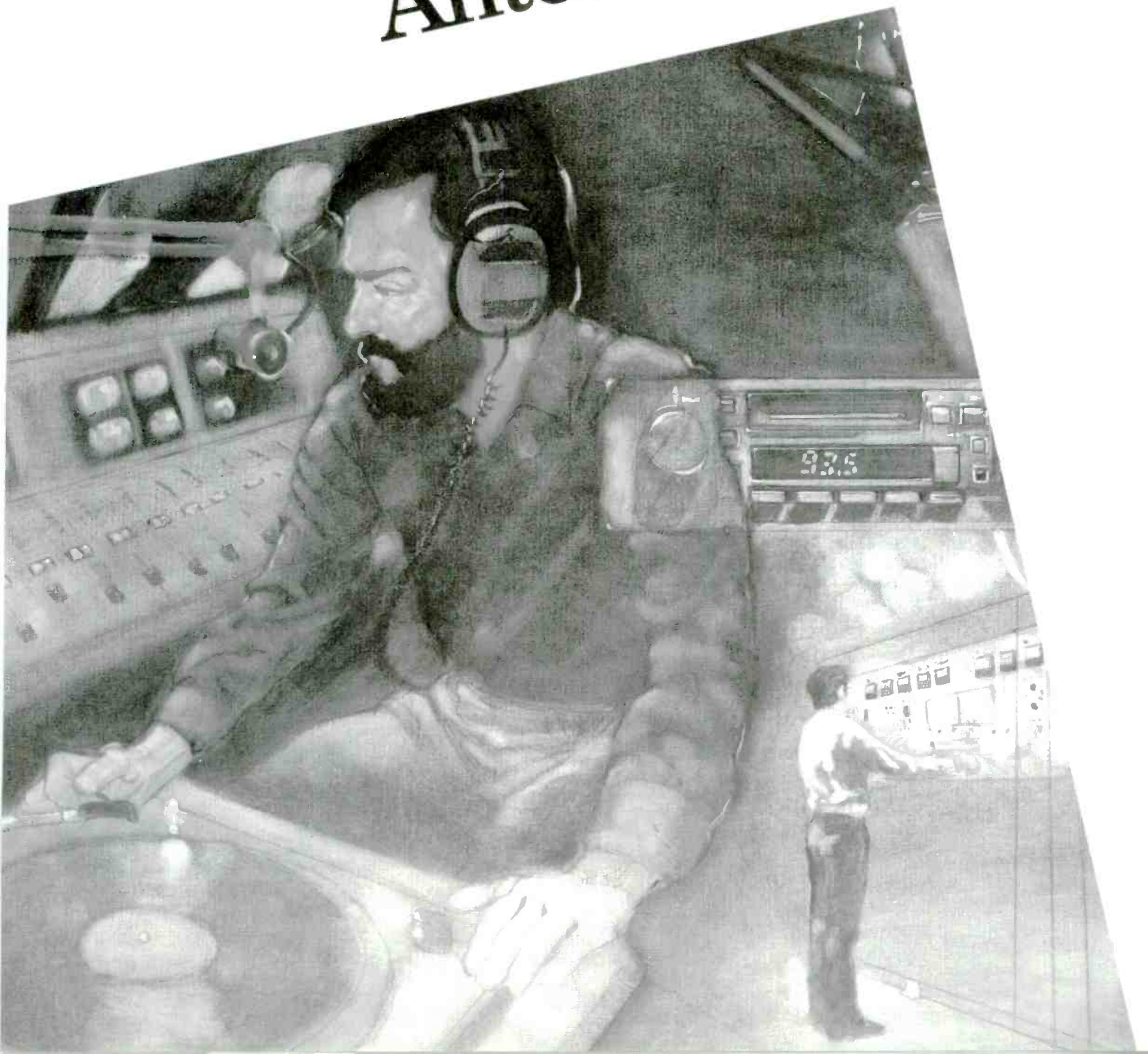



Introduction

Continental offers broadcasters a complete antenna system service, including manufacturing, testing, and field supervision of directional or omni-directional AM and FM antennas; AM and FM towers; antenna phasing and coupling systems and related antenna system equipment.

AM & FM Towers

Continental can supply a variety of self-supporting and guyed antenna towers, custom design to meet specific AM or FM station requirements.

Towers are normally supplied with a protective coating of rust inhibitive paint prior to shipment; they can be supplied with a galvanized finish.

All hardware, fittings, guy insulators, anchor steel and base insulator are supplied with each tower. Appropriate tower lighting kits to meet FCC/FAA or ICAO requirements, are also available; see "Antenna System Accessories".

Towers available from Continental include: Pi Rod, Rohn, Stainless, Utility, V & B, and World. All of the construction capabilities and services of these companies are available to Continental customers.

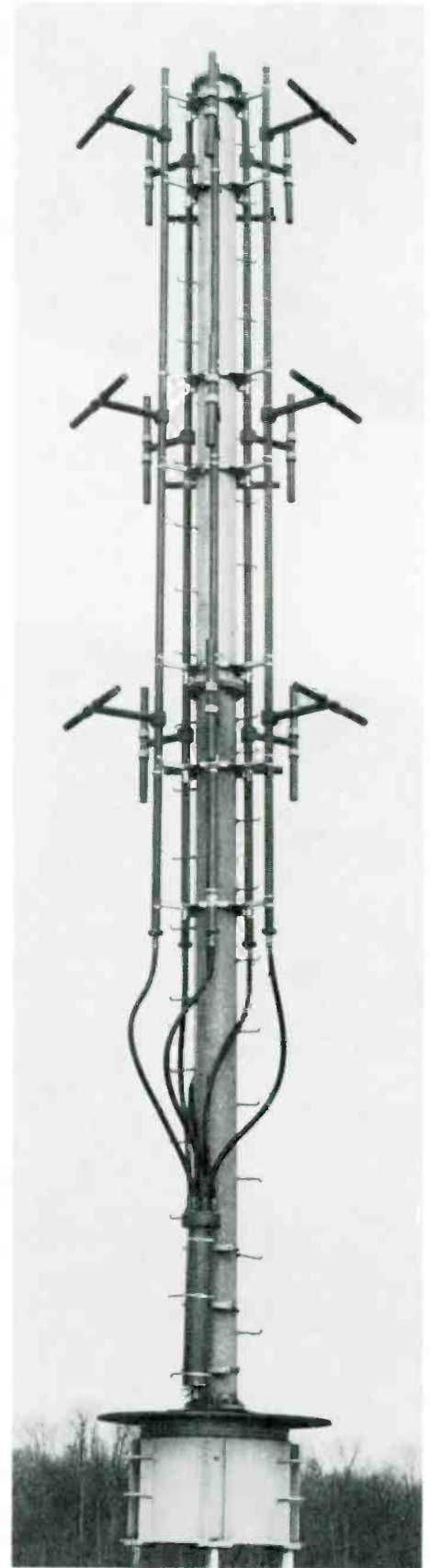

Antenna Phasing & Coupling



Continental Phaser Design Practices

Continental phasing systems offer optimal impedance and pattern bandwidths with wide adjustment range based on highly accurate, computer analysis of antenna tower impedances.

All designs avoid network configurations which directly impair bandwidth, such as those which have excessive individual phase shifts or excess tower base reactance tuning. If special bandwidth compensation networks or rejection filters are used, RF losses, voltage gradient and circulating currents are carefully calculated and their impact is included in the final system design.

All system components are carefully evaluated and selected on a best-performance/best-engineering practice basis. For example: vacuum capacitors and vacuum RF contractors are used when appropriate.

Conservatively-rated components are used throughout the design.

A static drain device is provided in the antenna coupling unit for each tower, unless this function is performed by the ground winding of an existing lighting choke, or other means.

Accuracy of network calculations is enhanced by the use of digital computers. Special system analysis is used to predict or optimize adjustment interaction, sensitivity and bandwidth.

Continental's ongoing antenna systems research assures all customers that they will benefit from the most current proven designs.

Introduction

Since its founding in 1946, Continental Electronics has designed and manufactured phasing and coupling equipment to meet the needs of broadcasters around the world.

Many of the techniques used today in phaser design were pioneered, developed and refined by Continental engineers. Continental engineering and manufacturing personnel can draw upon a wide and varied experience in preparing your phasing equipment proposal: experience that includes designing, building, installing, testing and operating transmitters and related RF equipment ranging in power from 1,000 to 2,000,000 watts.

Typical System

A directional antenna phasing and branching system consists of:

- an impedance matching circuit which matches the power divider input impedance to the common point impedance at which the power input is measured
- a branching circuit in which power is precisely divided into the amounts of power necessary to give the proper ratio of fields from individual antennas
- phase shifting networks in series with each of the transmission lines going to the individual antenna towers
- the transmission lines
- the antenna coupling unit (ACU) for impedance matching between each transmission line and its associated antenna tower.

Antenna Phasing & Coupling

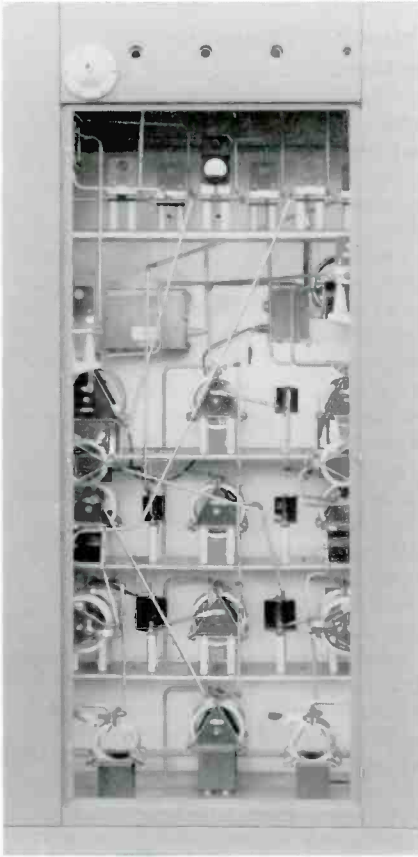

dependent, different tower electrical heights and spacings exist from those specified for the carrier frequency.

Then, three network models of the towers are calculated: one at carrier, and one at each sideband. The components of each network are placed in the phaser topology, and the whole system is then analyzed by a computer program using admittance matrix algebra. Component reactances and transmission line lengths are automatically adjusted for frequency. The effects of coil Q and transmission line loss are included.

The frequency-sensitive tower impedance model answers two questions which cannot be answered if the tower system's current ratios or operating impedances are assumed to be constant. They are:

- (1) Tower currents at the sidebands.
- (2) Tower currents at the carrier during the adjustment process.

Obtaining the common-point impedance, VSWR and the tower currents, and the effect each component has on these parameters, enables Continental engineers to prepare an optimum system design. In addition to "widebanding", this technique can be used to study adjustment sensitivity at carrier. It can also be used to give advance indication when a power divider control is more of a phase control and vice-versa. Adjustment interaction can be optimized during the design process.

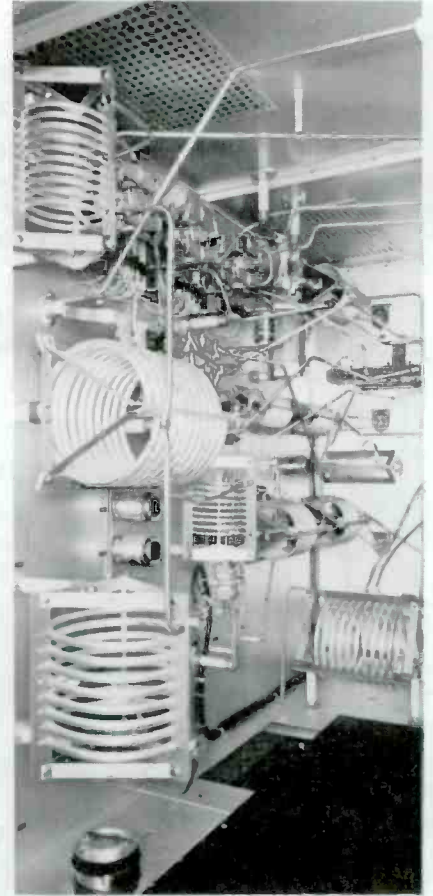

Continental "Wideband" phaser

Continental engineers have developed a technique that optimizes the impedance and pattern bandwidths of a phased array. Following is an overview of this technology.

After completion of the initial phaser design, the sideband self and mutual impedances are calculated, based on electromagnetic propagation less than the speed of light. Because sideband parameters are frequency

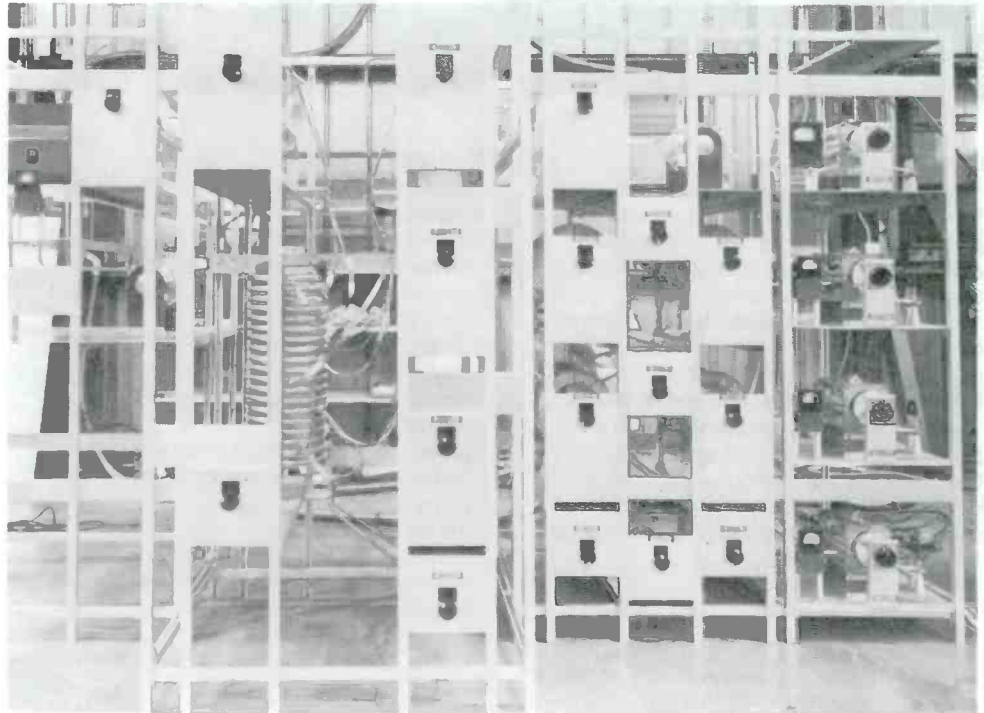

Antenna phasing & Coupling

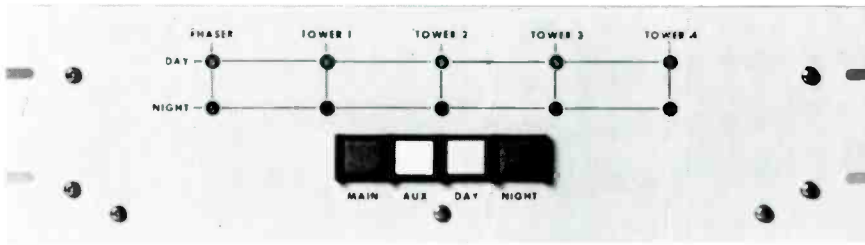

Typical Network Construction Practice

Interconnecting bus matches associated inductor tubing, or is based on a minimum of 1/8-inch of diameter per each 10 RMS amps of current. The smallest diameter tubing used is 3/8-inch. Where flexible connections are required, 1/2-inch x 20-mil copper strap is used per 10 RMS amps of current.

The bus size will be selected to minimize or optimize voltage gradient when a dielectric-heating or ionization probability exists.

All components are removable from inside the cabinets or from the front surfaces of wall panels. All mounting screws fit in tapped holes or captive nuts, so separate nuts are not required. All hardware is non-ferrous.

Aluminum and copper parts are irridited, cadmium or silver plated, or as specified.

A cabinet that is located in a transmitting room has an interlock circuit, if requested.

Epoxy-cast mica capacitors are provided with flanges for additional heat-sinking, and to facilitate connection and mounting.

Front panel controls consist of knobs or handles, counters and insulated, flexible couplings.

Co-ax outer conductor "U" clamps are provided for transmission line termination unless other termination is specified.

Photo-etched nameplates are used on all phaser cabinet front-panel meters and controls.

Phaser cabinets use overhead grills to allow convection cooling.

Panels which act as electrical ground are aluminum, and are bonded to each other with two-inch wide copper straps.

A rolled six foot length of two-inch wide or four-inch copper strap, depending upon power level, is provided with each cabinet for connection to the customer's ground system.

The selection of stand-off insulators and insulation materials is based on strength, low dielectric dissipation factor and low moisture absorption.

Tubing indicator taps are plated, solid brass to provide good electrical connection and heat sinking.

Jacks are always positioned so that a plug-in ammeter will face the operator from a horizontal position.

All co-ax input/output connections are located to customer specifications. If the customer has no preference, input co-ax connections will be located at the top of the phaser cabinet, output co-ax connections at the bottom. Control connections will usually be located at the bottom of all cabinets or panels. ACU inputs will usually be at the lower left, outputs at the upper right.

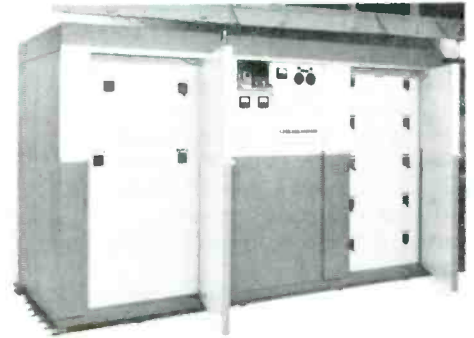
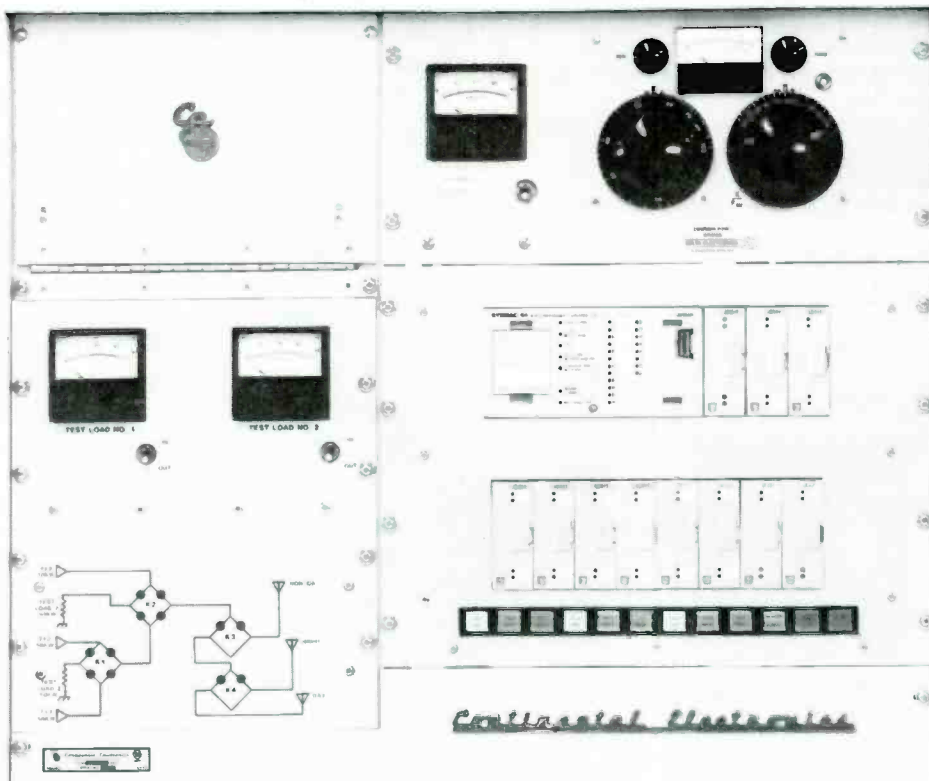

Antenna Phasing & Coupling

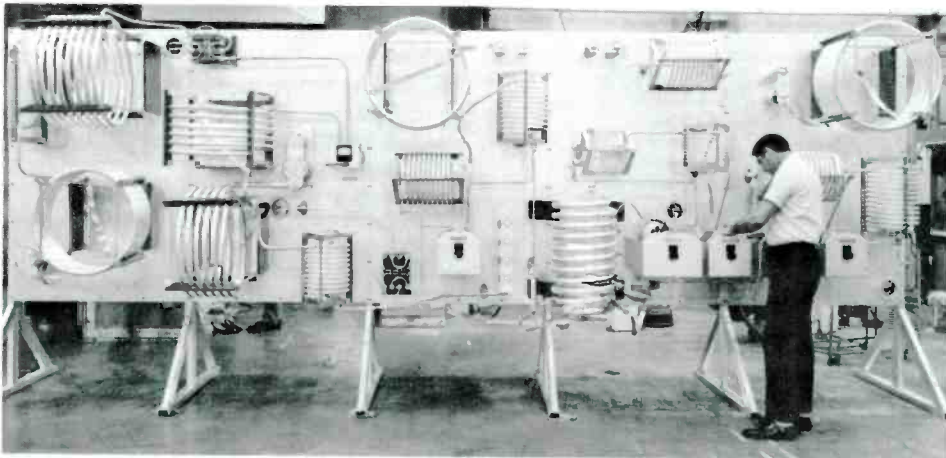

Typical Control Circuit Design Practices

Continental's standard 28 vdc control circuit is designed for mounting in a 19-inch rack; either directly in the front panel of the phaser, or externally. Color-coded LEDs give status indications for each tower and phaser cabinet. The momentary push-button switches must be depressed for a full second before switching will begin. This prevents accidental mode change if an operator accidentally depresses a push-button, and assures that the transmitter has adequate time to remove RF output. If desired, the full-second contact can be performed automatically with the addition of two relays.

Remote control capability is built-in to the standard circuit with a "local only" switch for personnel safety during maintenance. A separate remote control panel is available as an option.

Control lines can be specified as 28 vdc or 220 vac. Line voltage to the control panel can be specified as 120 vac or 240 vac; 50 or 60 Hz.

A "Failsafe" circuit will prevent the transmitter from returning to the air if a mode change is incomplete.

All relays are the same plug-in type. Time delay is accomplished with RC decay networks.

Required Design Data

Continental custom designs and manufactures antenna phasing and coupling equipment to meet specific broadcasting station requirements. Following is the typical data Continental needs in order to prepare an equipment proposal:

- call letters and station location; frequency of operation; operating power (day and night); and mode of operation
- description of towers; tower manufacturer; type number and tower height; self-supported or guyed; and cross-section dimensions
- spacing and orientation of all antennas in the array
- phase relationship and ratios of the radiation fields
- location of phasing unit
- type and length of each transmission line.

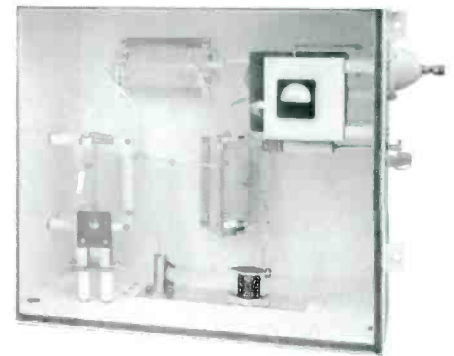

Continental Electronics AM Antenna Couplers

Standard antenna couplers are available in panel-mount and weatherproof housing configurations, for use with Continental 1 kW, 5 kW and 10 kW AM transmitters.

Panel mount couplers come with fully adjustable tee network, input jack, static drain choke, Delta RF ammeter. Tower lighting choke must be ordered as separate item.

Weatherproof couplers come with fully adjustable tee network, input jack, static drain choke, Delta RF ammeter. All components come in weatherproof housing. Tower lighting choke must be ordered as separate item.

Ordering Information

Panel Mount Coupler:

1 kW, Type 514AT-1P

5 kW, Type 515AT-1P

10 kW, Type 516AT-1P

Weatherproof Coupler:

1 kW, Type 514AT-1WP

5 kW, Type 515AT-1WP

10 kW, Type 516AT-1WP

All specifications are subject to change without notice.

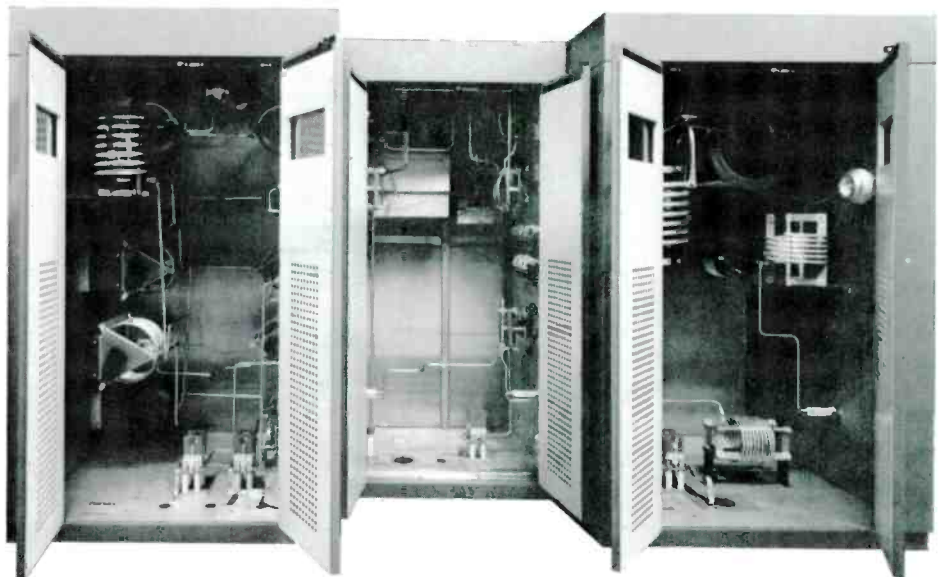

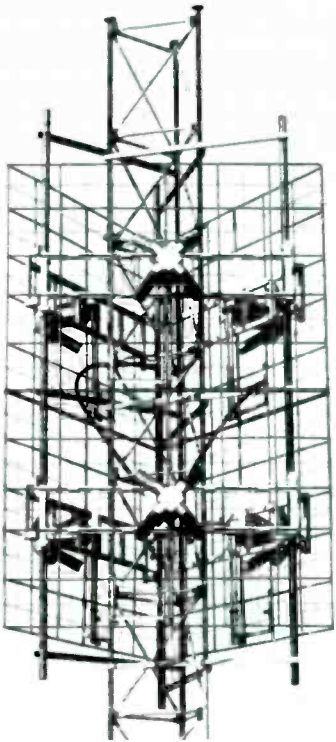
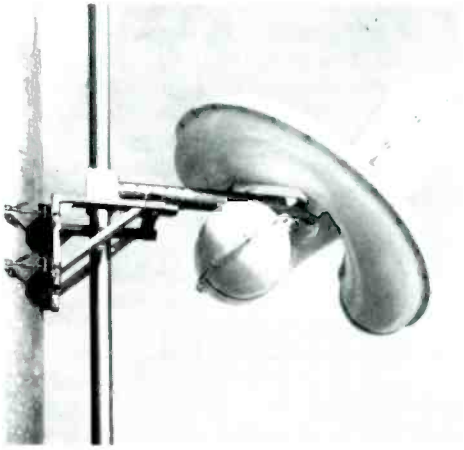

FM Antennas

Continental offers FM broadcasters a wide variety of antennas to meet commercial and educational station requirements: from low power to high power; including circularly and horizontally polarized, and dual polarized directional antenna designs.

G5 Series, Circularly Polarized FM Antennas

The G5 antenna was introduced in 1976. Since then, it has become the most popular FM antenna available in the United States. It is an electrically sound, mechanically rugged, thoroughly field-proven antenna design. The antenna may be purchased in any number of bays from 1 to 16 (Series A & B).

Each bay level element consists of two segmented series-fed dipoles that form a space-phased, circularly polarized radiator. Each segmented dipole is manufactured using a custom made Wallace Bending machine. The

dipoles are constructed of 3-1/8" o.d. brass which provides an excellent element bandwidth as well as protection against corona discharge failure.

The isolated feed point of the two segmented dipoles is pressurized to avoid the effects of atmospheric changes and metal corrosion on the feed point impedance. The insulators are custom made melamine insulators with machined flange fitting for bolt down "O" ring sealed flange assembly. Each feed point is silver soldered to the inner conductor inside the driven element; the entire inner conductor assembly of the element is silver plated to minimize antenna loss.

Each individual segmented dipole can be removed from any bay level element and replaced with a new segmented dipole with no change in the VSWR of the antenna.

Each segmented dipole is constructed with a

captive male 3-1/8" coax 50 ohm inner conductor connector, and is connected to the antenna element using a five bolt pinned flange. This unique construction design assures proper dipole installation.

Electrically, each element in a G5 array is a 50 ohm element at the frequency of operation. When the array is matched, a quarter wave transformation section is designed for each element's feed stem, so that each element adds in shunt with the other elements in the array, with impedance of $n \times 50$ ohms, where n equals the number of elements being added in shunt. This method of matching limits the maximum voltage and current in the antenna array interbay coax while utilizing the advantage of a 50 ohm bay level impedance.

The G5 antenna design is very flexible: it permits side, corner leg or top mounting on any type of tower. All radiating elements and feed stem are constructed of 85-15 brass; all support brackets and hardware are made of stainless steel.

G5CPS FM Antenna



G5CPS Super Power Circularly Polarized FM Antenna

The brass radiating element has an outside diameter of 3-1/8". The feed point is completely internal with a pressurized environment up to the feed point.

The radiating element is rated at 40 kW, and is limited by the safe average power capability of the 3-1/8 rigid coax line.

The heavy-wall brass tubing stem can withstand harsh environmental conditions.

Deicers are not recommended in normal environments because typical VSWR is 1.5:1 or less with 1/2" of radial ice. Heaters or radomes are available for deicing.

All G5CPS antennas use silver-plated inner conductor connectors throughout to reduce losses and heating. Each antenna, supplied with a 6 foot input matching section has 50-ohm

EIA input. Depending on model type, the input is either a 3-1/8 inch 50 ohm EIA female input or a 6-1/8 inch 50 ohm EIA female input.

Once each antenna is completely assembled and factory-tuned to the customer's frequency, it is pressure tested at 10 lbs. pressure for one hour to ensure that the antenna is leak-free prior to shipment.

The antenna system feed point is 6 feet below the bottom bay for end fed antennas, and approximately 6 feet below the center of the antenna for center fed antenna systems.

The horizontally polarized horizontal-plane radiation pattern is omnidirectional when pole-mounted atop a tower; a ± 2 dB circularity is typical when mounted on a 14 inch diameter steel pole. When side-mounted on a tower, the antenna pattern will be affected by the tower structure.

Complete antenna pattern measurement services are available on a quotation basis. Horizontal plane relative field patterns are measured on a full scale mock up of a 20 foot section of the customer's tower, including the ladder, coaxial transmission lines, conduits, cables and antenna element. Pattern optimization is available for improving the pattern circularity of the antenna-support tower combination. Precision model studies are also available for situations where larger vertical apertures of the array need to be analyzed.

The G5CPS has a low standing-wave ratio of 1.07:1, or less. +200 KHz for a given channel with field trimming. The VSWR at antenna input without field trimming is 1.2:1 for pole mounting atop a tower; 1.5:1 or less when side mounted on a tower.

Multistation operation is possible using a common antenna system due to the excellent bandwidth characteristics of the G5 antenna design. Continental can quote filtering components required for the diplexing or multiplexing operation. Stations with a frequency separation as large as 4 MHz can be diplexed on a common antenna.

SPECIFICATIONS

Frequency Range:

88 to 108 MHz, factory tuned to one frequency

Polarization:

Circular (clockwise)

Power Gain:

See tables

Azimuthal Pattern:

± 2 dB in free space, both horizontal and vertical

Ellipticity:

± 3 dB in free space

VSWR at input (without field tuning):

1.1:1 top mounting,

1.5:1 or better side mounting

VSWR at input (with field tuning):

1.1:1 or better

(see tables for rest of specifications)

G5CPS FM Antenna

Series A: 3-1/8" Interbay Line; 3-1/8" Element Stem

No. of Bays	Power Gain	dB Gain	Type ¹ Feed	Female 50 Ohm Input	Power ² Input	Wgt ³ In Lbs	Wgt ⁴ In Lbs	Wgt ⁵ In Lbs	Wgt ⁶ In Lbs	Approx. Length In Feet
1	0.4611	-3.3623	End	3-1/8"	32 kW	114	137	185	354	--
2	0.9971	-0.0128	End	3-1/8"	32 kW	225	304	376	742	10
2	0.9971	-0.0128	Center	3-1/8"	39 kW	250	319	385	749	10
2	0.9971	-0.0128	Center	6-1/8"	64 kW	301	421	436	851	10
3	1.5588	1.9278	End	3-1/8"	32 kW	336	470	568	1130	20
3	1.5588	1.9278	Center	3-1/8"	39 kW	361	486	577	1136	20
3	1.5588	1.9278	Center	6-1/8"	64 kW	412	588	628	1240	20
4	2.1332	3.2903	End	3-1/8"	32 kW	447	637	759	1518	30
4	2.1332	3.2903	Center	3-1/8"	39 kW	472	652	768	1525	30
4	2.1332	3.2903	Center	6-1/8"	64 kW	523	758	819	1631	30
5	2.7154	4.3384	End	3-1/8"	32 kW	558	804	951	1905	40
5	2.7154	4.3384	Center	3-1/8"	39 kW	583	819	960	1911	40
5	2.7154	4.3384	Center	6-1/8"	64 kW	634	927	1011	2011	40
6	3.3028	5.1888	End	3-1/8"	32 kW	669	971	1142	2294	50
6	3.3028	5.1888	Center	3-1/8"	39 kW	694	986	1151	2300	50
6	3.3028	5.1888	Center	6-1/8"	64 kW	745	1096	1202	2410	50
7	3.8935	5.9034	End	3-1/8"	32 kW	780	1138	1334	2682	60
7	3.8935	5.9034	Center	3-1/8"	39 kW	805	1153	1343	2688	60
7	3.8935	5.9034	Center	6-1/8"	64 kW	856	1265	1394	2800	60
8	4.4872	6.5197	End	3-1/8"	32 kW	891	1305	1525	3070	70
8	4.4872	6.5197	Center	3-1/8"	39 kW	916	1320	1534	3076	70
8	4.4872	6.5197	Center	6-1/8"	64 kW	967	1433	1585	3190	70
9	5.0825	7.0608	Center	3-1/8"	38 kW	1027	1487	1725	3464	80
9	5.0825	7.0608	Center	6-1/8"	64 kW	1078	1600	1776	3580	80
10	5.6800	7.5435	Center	3-1/8"	39 kW	1138	1653	1917	3852	90
10	5.6800	7.5435	Center	6-1/8"	64 kW	1189	1770	1968	3970	90
11	6.2783	7.9784	Center	3-1/8"	39 kW	1249	1820	2108	4240	100
11	6.2783	7.9784	Center	6-1/8"	64 kW	1300	1940	2159	4360	100
12	6.8781	8.3747	Center	3-1/8"	39 kW	1360	1987	2300	4628	110
12	6.8781	8.3747	Center	6-1/8"	64 kW	1411	2108	2351	4750	110

Series B: 4-1/8" Interbay Line; 4-1/8" Element Stem

1	0.4611	-3.3623	End	6-1/8"	40 kW	159	201	223	421	--
2	0.9971	-0.0128	End	6-1/8"	56 kW	297	407	425	847	10
2	0.9971	-0.0128	Center	6-1/8"	80 kW	336	468	464	908	10
3	1.5588	1.9278	End	6-1/8"	56 kW	435	613	627	1273	20
3	1.5588	1.9278	Center	6-1/8"	112 kW	474	674	666	1337	20
4	2.1332	3.2903	End	6-1/8"	56 kW	573	816	829	1699	30
4	2.1332	3.2903	Center	6-1/8"	112 kW	612	879	869	1762	30
5	2.7154	4.3384	End	6-1/8"	56 kW	711	1024	1031	2125	40
5	2.7154	4.3384	Center	6-1/8"	112 kW	750	1085	1070	2187	40
6	3.3028	5.1888	End	6-1/8"	56 kW	849	1229	1233	2551	50
6	3.3028	5.1888	Center	6-1/8"	112 kW	888	1290	1272	2612	50
7	3.8935	5.9034	End	6-1/8"	56 kW	987	1435	1435	2997	60
7	3.8935	5.9034	Center	6-1/8"	112 kW	1026	1496	1474	3037	60
8	4.4872	6.5197	End	6-1/8"	56 kW	1125	1641	1637	3043	70
8	4.4872	6.5197	Center	6-1/8"	112 kW	1164	1702	1676	3462	70
9	5.0825	7.0608	Center	6-1/8"	112 kW	1302	1907	1878	3887	80
10	5.6800	7.5435	Center	6-1/8"	112 kW	1440	2113	2080	4312	90
11	6.2783	7.9784	Center	6-1/8"	112 kW	1578	2318	2282	4737	100
12	6.8781	8.3747	Center	6-1/8"	112 kW	1716	2524	2484	5162	110

Series C: 6-1/8" Interbay Line; 4-1/8" Element Stem

1	0.4611	-3.3623	End	6-1/8"	40 kW	205	260	269	480	--
2	0.9971	-0.0128	End	6-1/8"	80 kW	410	520	538	960	10
3	1.5588	1.9278	End	6-1/8"	120 kW	615	780	807	1440	20
4	2.1332	3.2903	End	6-1/8"	120 kW	820	1040	1076	1920	30
5	2.7154	4.3384	End	6-1/8"	120 kW	1025	1300	1345	2400	40
6	3.3028	5.1888	End	6-1/8"	120 kW	1230	1560	1614	2880	50

(1) End feed antennas do not include 6-ft matching transformer. (2) Power input capability is shown for altitudes up to 2000 feet above mean sea level; derating is required above 2000 feet. (3) Calculated weight, including brackets. (4) Calculated wind load including brackets, based on 50/33 Lb/Sq Ft. (5) Calculated weight with Radome and brackets. (6) Calculated wind load with Radome and brackets, based on 50/33 Lb/Sq Ft.

G8CPS FM Antenna

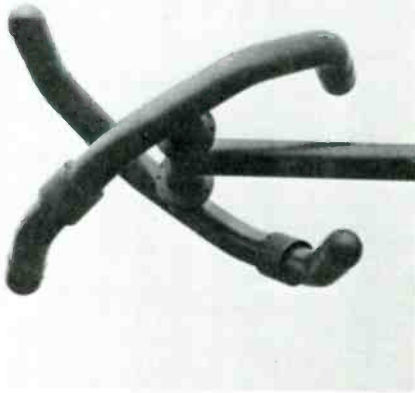

G8CPS Super Power Circularly Polarized FM Antenna

Similar to the G5CPS antenna, the G8 antenna is designed to achieve maximum circularity of coverage, especially when mounted on tower sections having a 24-inch face dimension.

Tables show the most popular models. Other standard models are available.

For information, contact your local Continental Electronics Sales Manager.

SPECIFICATIONS

Frequency Range:

88 to 108 MHz, factory tuned to one frequency

Polarization:

Circular (clockwise)

Power Gain:

See tables

Azimuthal Pattern:

±2 dB in free space, both horizontal and vertical

Ellipticity:

±3 dB in free space

VSWR at Input, Without Field Tuning:

1.1:1 top mounting

1.5:1 or better, side mounting

VSWR at Input, With Field Tuning:

1.1:1 or better

(See tables for other specifications)

Series A: 3-1/8" Interbay Line; 3-1/8" Element Stem

No. of Bays	Power Gain	dB Gain	Type Feed	Female 50 Ohm Input	Power Input	Wgt-A (Lbs)	Wgt-B (Lbs)	Wgt-C (Lbs)	Wgt-D (Lbs)	Approx. Length (Feet)
1	0.4611	-3.3623	End	3-1/8"	32 kW	114	137	167.5	387	
2	0.9971	-0.0128	End	3-1/8"	32 kW	225	304	341	808	10
2	0.9971	-0.0128	Center	3-1/8"	39 kW	250	319	350	815	10
3	1.5588	1.9278	End	3-1/8"	32 kW	336	470	515.5	1228	20
4	2.1332	3.2903	End	3-1/8"	32 kW	447	637	689	1649	30
4	2.1332	3.2903	Center	3-1/8"	39 kW	472	652	698	1656	30
4	2.1332	3.2903	Center	6-1/8"	64 kW	523	758	749	1770	30
5	2.7154	4.3384	End	3-1/8"	32 kW	558	804	863.5	2069	40
6	3.3028	5.1888	End	3-1/8"	32 kW	669	971	1037	2491	50
6	3.3028	5.1888	Center	3-1/8"	39 kW	694	986	1046	2497	50
6	3.3028	5.1888	Center	6-1/8"	64 kW	745	1096	1097	2614	50
7	3.8935	5.9034	End	3-1/8"	32 kW	780	1138	1211.5	2912	60
8	4.4872	6.5197	End	3-1/8"	32 kW	891	1305	1385	3332	70
8	4.4872	6.5197	Center	3-1/8"	39 kW	916	1320	1394	3338	70
8	4.4872	6.5197	Center	6-1/8"	64 kW	967	1433	1445	3457	70
10	5.6800	7.5435	Center	3-1/8"	39 kW	1138	1653	1742	4180	90
10	5.6800	7.5435	Center	6-1/8"	64 kW	1189	1770	1793	4300	90
12	6.8781	8.3747	Center	3-1/8"	39 kW	1360	1987	2090	5022	110
12	6.8781	8.3747	Center	6-1/8"	64 kW	1411	2108	2141	5144	110

Series B; 4-1/8" Interbay Line; 4-1/8" Element Stem

1	0.4611	-3.3623	End	6-1/8"	40 kW	159	201	206	454	
2	0.9971	-0.0128	End	6-1/8"	56 kW	297	407	393	913	10
2	0.9971	-0.0128	Center	6-1/8"	80 kW	336	468	432	974	
3	1.5588	1.9278	End	6-1/8"	56 kW	435	613	579	1119	20
4	2.1332	3.2903	End	6-1/8"	56 kW	573	818	765	1830	30
4	2.1332	3.2903	Center	6-1/8"	112 kW	612	879	804	1891	30
5	2.7154	4.3384	End	6-1/8"	56 kW	711	1024	951	2289	40
6	3.3028	5.1888	End	6-1/8"	56 kW	849	1229	1137	2747	50
6	3.3028	5.1888	Center	6-1/8"	112 kW	888	1290	1176	2808	50
7	3.8935	5.9034	End	6-1/8"	56 kW	987	1435	1323	3206	60
8	4.4872	6.5197	End	6-1/8"	56 kW	1125	1641	1509	3665	70
8	4.4872	6.5197	Center	6-1/8"	112 kW	1164	1702	1548	3762	70
10	5.6800	7.5435	Center	6-1/8"	112 kW	1440	2113	1920	4643	90
12	6.8781	8.3747	Center	6-1/8"	112 kW	1716	2524	2292	5560	110

Series C: 6-1/8" Interbay Line; 4-1/8" Element Stem

1	0.4611	-3.3623	End	6-1/8"	40 kW	205	260	253	513	
2	0.9971	-0.0128	End	6-1/8"	80 kW	410	520	506	1026	10
3	1.5588	1.9278	End	6-1/8"	120 kW	615	780	759	1539	20
4	2.1332	3.2903	End	6-1/8"	120 kW	820	1040	1012	2052	30
5	2.7154	4.3384	End	6-1/8"	120 kW	1025	1300	1265	2565	40
6	3.3028	5.1888	End	6-1/8"	120 kW	1230	1560	1518	3078	50

NOTES: (A) = Calculated weight, including brackets (B) = Calculated wind load, including brackets (C) = Calculated weight with Radome & brackets (D) = Calculated wind load with Radome & brackets (1) Wind load is based on 50/33 PSF. (2) End feed antennas do not include 6-ft matching transformer. (3) Power input capability is shown for altitudes up to 2000 feet above mean sea level; derating is required above 2000 feet.

G5CPM FM Antenna

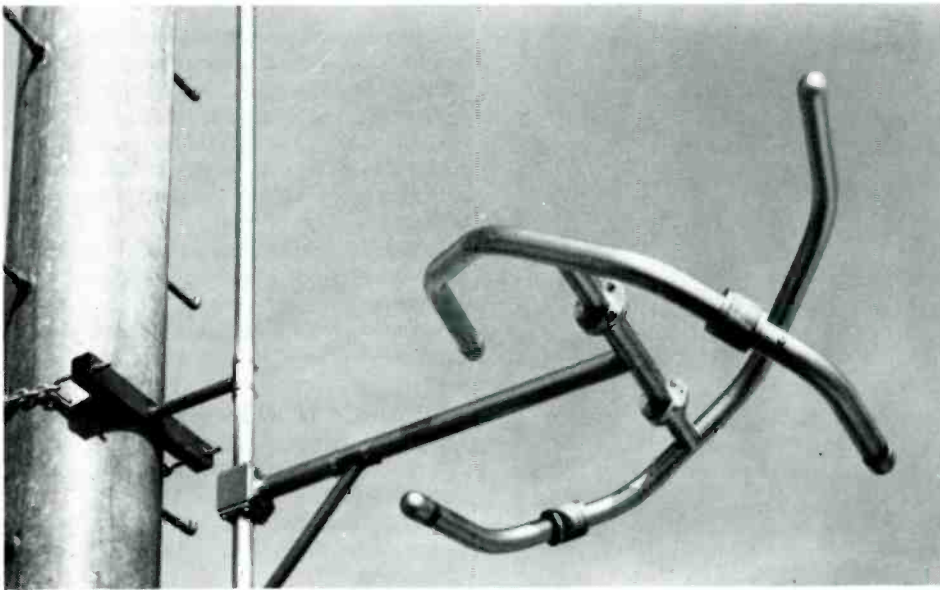

G5CPM Medium Power Circularly Polarized FM Antenna

The G5CPM offers broadcasters the advantages and benefits of a super power antenna in a medium power size.

The heavy-duty brass radiating element has an outside diameter of 1-3/4". The internal feed point is pressurized up to the feed point. Inner conductors are constructed to reduce losses and heating.

The radiating element is rated at 9 kW, and is limited by the safe average power capability of the 1-5/8" rigid coax line.

The heavy-wall brass tubing stem can withstand harsh environmental conditions, winds up to 125 mph, and moderate ice loads.

Deicers are not available. Radomes are available for deicing. The typical VSWR with 1/3" radial ice is 1.5:1 or less.

SPECIFICATIONS

Frequency Range:

88 to 108 MHz, factory tuned to one frequency

Polarization:

Circular (clockwise)

Power Gain:

See tables

Azimuthal Pattern:

±2 dB in free space, both horizontal and vertical

Ellipticity:

±3 dB in free space

VSWR at input (without field tuning):

1.1:1 top mounting, 1.5:1 or better side mounting

VSWR at Input (with field tuning):

1.1:1 or better

(see tables for rest of specifications)

Series A: 3-1/2" Interbay Line; 3-1/8" Element Stem

No. of Bays	Power Gain	dB Gain	Type Feed	Female 50 Ohm Input	Power Input	Wgt-A (Lbs)	Wgt-B (Lbs)	Wgt-C (Lbs)	Wgt-D (Lbs)	Approx. Length (Feet)
1	0.4611	-3.3623	End	1-5/8"	9 kW	57	102	83	224	
2	0.9971	-0.0128	End	1-5/8"	9 kW	114	212	166	457	10
2	0.9971	-0.0128	Center	3-1/8"	12 kW	152	302	199	533	10
3	1.5588	1.9278	End	1-5/8"	9 kW	170	323	243	689	20
3	1.5588	1.9278	Center	3-1/8"	12 kW	207	412	282	766	20
4	2.1332	3.2903	End	1-5/8"	9 kW	227	433	331	922	30
4	2.1332	3.2903	Center	3-1/8"	12 kW	260	509	364	998	30
5	2.7154	4.3384	End	1-5/8"	9 kW	283	543	413	1154	40
5	2.7154	4.3384	Center	3-1/8"	12 kW	317	620	447	1231	
6	3.3028	5.1888	End	1-5/8"	9 kW	340	654	496	1387	50
6	3.3028	5.1888	Center	3-1/8"	12 kW	373	730	529	1463	50
7	3.8935	5.9034	End	1-5/8"	9 kW	396	764	578	1619	60
7	3.8935	5.9034	Center	3-1/8"	12 kW	430	840	612	1696	60
8	4.4872	6.5197	End	1-5/8"	9 kW	453	874	661	1852	70
8	4.4872	6.5197	Center	3-1/8"	12 kW	486	960	694	1928	70
9	5.0826	7.0608	Center	3-1/8"	12 kW	543	1060	777	2160	80
10	5.6800	7.5435	Center	3-1/8"	12 kW	599	1171	859	2393	90
11	6.2783	7.9785	Center	3-1/8"	12 kW	656	1281	942	2626	100
12	6.8781	8.3747	Center	3-1/8"	12 kW	712	1391	1024	2858	110

NOTES: (A) = Calculated weight, including brackets (B) = Calculated wind load, including brackets (C) = Calculated weight with Radome & brackets (D) = Calculated wind load with Radome & brackets (1) Wind load is based on 50/33 PSF. (2) Power split is 50/50 vertical and horizontal only. Beam tilt and null fill are available as extra cost options on center fed antennas, but will change the gain figures given above and may reduce the power rating. (3) End feeding is done with a 6-ft matching transformer section. Center feeding of an odd number of bays is done at a point one-half bay below the center of the antenna. The 10-ft matching transformer is connected to an elbow at the center feed point and extends downward. (4) End feed antennas do not include 6-ft matching transformer. (5) Power input capability is shown for altitudes up to 2000 feet above mean sea level; derating is required above 2000 feet.

All specifications are subject to change without notice.

G4CPH FM Antenna



G4CPH High Power Circularly Polarized FM Antenna

The G4CPH is a rugged, heavy-duty design capable of handling powers from 5 kW (single bay) to 40 kW (eight or more bays). The antenna may be purchased in any number of bays from 1 to 16. The antennas are end fed in combinations from one to eight bays. In center fed antenna arrays, the center fed "T" input is located one half bay spacing below the center of the array if the array consists of an odd number of bays.

Antennas of one to eight bays are end fed with a 6 foot matching section connected to the bottom bay.

The rings of the antenna are mounted on 3-1/8" transmission line with a 3-1/8" input flange on standard antennas. Antennas that are to have 40 kW input are provided with a 6-1/8" flange and center feed block (at extra cost). 3" diameter Corona balls are provided at the outer extremity of the arms of each bay of the antenna. The antenna is designed to withstand wind velocities to 150 miles per hour.

Factory-installed deicers are available in powers of 300 and 500 watts per bay. Specify 120- or 230-volt operation when ordering. Shielded interbay heater cable and junction boxes are supplied as a part of the heater system. Heater weight, including junction boxes and cable, is 7 lb. per bay. Heaters are field replaceable.

Special power splits, other than 50/50 (vertical and horizontal), beam tilt and/or null fill are available at extra cost.

Radomes are also available to reduce the effect of ice on the VSWR of the antenna.

SPECIFICATIONS

Frequency Range:

88 to 108 MHz, factory tuned to one frequency

Polarization:

Circular (clockwise)

Power Gain:

See tables

Azimuthal Pattern:

±2 dB in free space, both horizontal and vertical

Ellipticity:

±3 dB in free space

VSWR at Input (without field tuning):

1.1:1 top mounting, 1.5:1 or better side mounting

VSWR at Input (with field tuning):

1.1:1 or better

(see tables for rest of specifications)

All specifications are subject to change without notice.

Type	Power Gain		dB Gain		Field Gain		Input Power Rating kW	Approx. Length (m) ft	Weight (Including Brackets) (kg) lb	Wind Load Based on	Weight	Wind Load
	Horiz	Vert	Horiz	Vert	Horiz	Vert				244/161 kg/sq.m (50/33 lb/sq ft)	(With Radomes Incl. Brackets) (kg) lb	Based on 244/161 kg/sq.m (50/33 lb/sq ft)
G4CPH-1	0.4611	0.4611	-3.3623	-3.3623	0.6790	0.6790	7.5	—	(38) 84	(65) 144	(47) 104	(120) 265
G4CPH-2	0.9971	0.9971	-0.0128	-0.0128	0.9985	0.9985	12	(3) 10	(83) 184	(144) 318	(102) 224	(254) 560
G4CPH-3	1.5588	1.5588	1.9278	1.9278	1.2485	1.2485	20	(6) 20	(124) 274	(223) 492	(152) 334	(388) 855
G4CPH-4	2.1332	2.1332	3.2903	3.2903	1.4605	1.4605	30	(9) 30	(165) 364	(302) 666	(201) 444	(522) 1150
G4CPH-5	2.7154	2.7154	4.3384	4.3384	1.6478	1.6478	30	(12) 40	(206) 454	(381) 840	(251) 554	(655) 1445
G4CPH-6	3.3028	3.3028	5.1888	5.1888	1.8174	1.8174	30	(15) 50	(247) 544	(460) 1014	(301) 664	(789) 1740
G4CPH-7	3.8935	3.8935	5.9034	5.9034	1.9732	1.9732	40	(18) 60	(288) 634	(538) 1187	(351) 774	(923) 2034
G4CPH-8	4.4872	4.4872	6.5197	6.5197	2.1183	2.1183	40	(21) 70	(328) 724	(617) 1361	(401) 884	(1056) 2329
G4CPH-9	5.0826	5.0826	7.0608	7.0608	2.2545	2.2545	40	(24) 80	(379) 835	(729) 1608	(460) 1015	(1223) 2697
G4CPH-10	5.6800	5.6800	7.5435	7.5435	2.3833	2.3833	40	(27) 90	(420) 925	(808) 1782	(510) 1125	(1357) 2992
G4CPH-11	6.2783	6.2783	7.9785	7.9785	2.5057	2.5057	40	(30) 100	(460) 1015	(887) 1956	(560) 1235	(1491) 3287
G4CPH-12	6.8781	6.8781	8.3747	8.3747	2.6226	2.6226	40	(34) 110	(501) 1105	(966) 2130	(610) 1345	(1625) 3582
G4CPH-13	7.4785	7.4785	8.7381	8.7381	2.7347	2.7347	40	(37) 120	(542) 1195	(1045) 2303	(660) 1455	(1758) 3876
G4CPH-14	8.0800	8.0800	9.0741	9.0741	2.8425	2.8425	40	(40) 130	(583) 1285	(1124) 2477	(710) 1565	(1892) 4171
G4CPH-15	8.6818	8.6818	9.3861	9.3861	2.9465	2.9465	40	(43) 140	(624) 1375	(1202) 2651	(760) 1675	(2026) 4466
G4CPH-16	9.2846	9.2846	9.6776	9.6776	3.0471	3.0471	40	(46) 150	(665) 1465	(1281) 2825	(810) 1785	(2160) 4761

All antenna brackets are stainless steel. All weights given include brackets, interbay line, and transformer section. Factory-installed deicers are available using either 300 watts or 500 watts per bay. Specify 120 or 230 volts. Heater elements are replaceable in the field. Shielded interbay heater cable and junction boxes are supplied. Heater weight, including junction boxes and interbay cable, is 6 lb (2.7 kg) additional per bay.

G4CPL FM Antenna

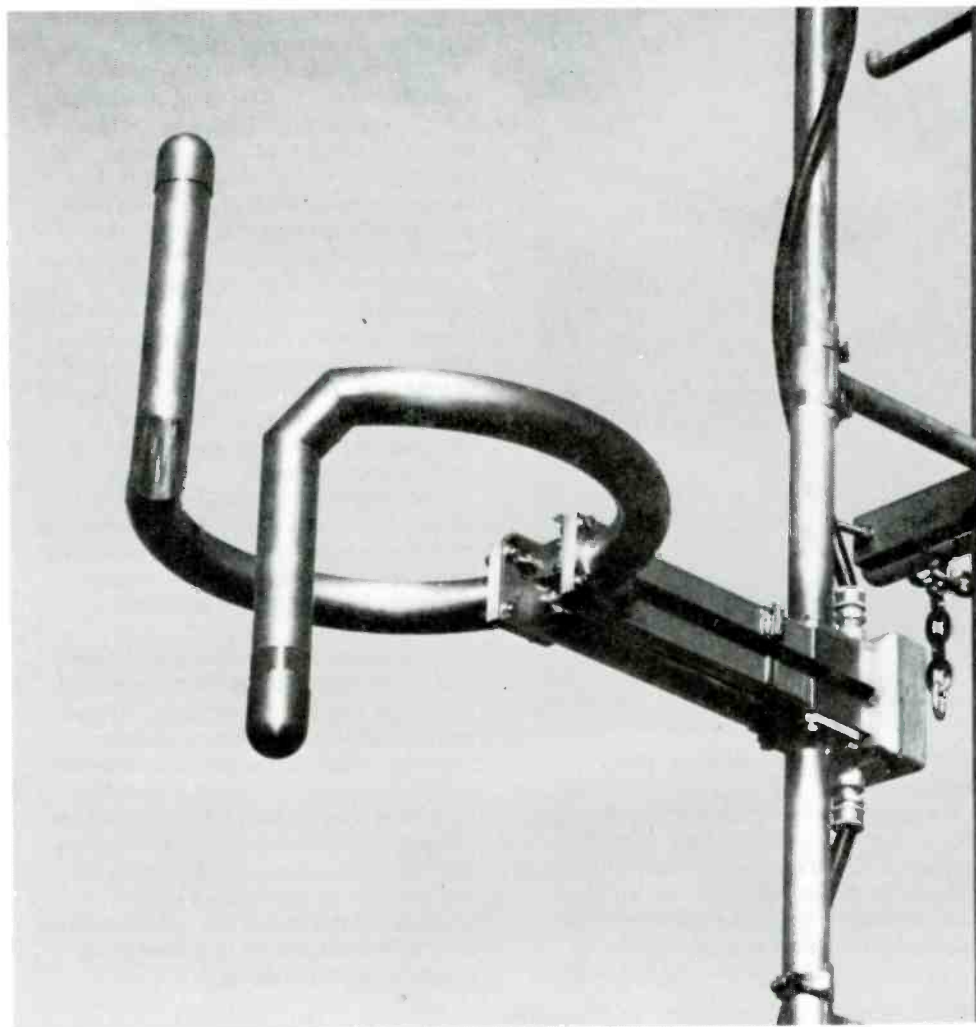

The rings of the antenna are mounted on 1-5/8" line and are end fed. A 6 ft. matching transformer extends below the lower bay and terminates in a 1-5/8" EIA, 50 ohm flange.

Factory-installed heaters are available in powers of 300 and 500 watts per bay. Specify 120 or 230 volt operation when ordering. Shielded interbay heater cable and junction boxes are supplied as a part of the heater system. Heater weight, including junction boxes and cable, is 7 lb per bay. Heaters are field replaceable.

No special power splits other than 50/50, nor beam tilt nor null fill are offered for this antenna. Radomes are also available.

SPECIFICATIONS

Frequency Range:

88 to 108 MHz, factory tuned to one frequency

Polarization:

Circular (clockwise)

Power Gain:

See tables

Azimuthal Pattern:

±2 dB in free space, both horizontal and vertical

Ellipticity:

±3 dB in free space

VSWR at Input (without field tuning):

1.1:1 top mounting, 1.5:1 or better side mounting

VSWR at Input (with field tuning):

1.1:1 or better

(see tables for rest of specifications)

G4CPL Low Power Circularly Polarized FM Antenna

The general construction of the G4CPL FM Antenna is the same as the G4CPM medium power version.

A quarter-wave stub, which places the antenna at dc ground potential for added protection against lightning strikes, is an integral part of the G4CPL Antenna design.

Type	Power Gain		dB Gain		Field Gain		Input Power Rating kW	Approx. Length (m) ft	Weight (Including Brackets) (kg) ft	Wind Load Based on	Weight (With Radomes Incl. Brackets) (kg) ft	Wind Load With Radomes Based on
	Horiz	Vert	Horiz	Vert	Horiz	Vert				244/161 kg sq.m (50/33 lbs/sq ft)		244/161 kg/sq.m (50/33 lbs/sq ft)
G4CPL-1	0.4611	0.4611	-3.3623	-3.3623	0.6790	0.6790	3	—	(16) 36	(34) 74	(24) 54	(73) 161
G4CPL-2	0.9971	0.9971	-0.0128	-0.0128	0.9985	0.9985	6	(3) 10	(35) 77	(47) 104	(52) 115	(153) 338
G4CPL-3	1.5588	1.5588	1.9278	1.9278	1.2485	1.2485	7.5	(6) 20	(54) 118	(115) 254	(78) 172	(234) 515
G4CPL-4	2.1332	2.1332	3.2903	3.2903	1.4605	1.4605	7.5	(10) 30	(72) 159	(156) 344	(105) 231	(314) 693
G4CPL-5	2.7154	2.7154	4.3384	4.3384	1.6478	1.6478	7.5	(12) 40	(91) 200	(197) 434	(132) 290	(385) 870
G4CPL-6	3.3028	3.3028	5.1888	5.1888	1.8174	1.8174	7.5	(15) 50	(109) 241	(238) 524	(158) 349	(475) 1047
G4CPL-7	3.8935	3.8935	5.9034	5.9034	1.9732	1.9732	7.5	(18) 60	(128) 282	(279) 614	(185) 408	(555) 1224
G4CPL-8	4.4782	4.4782	6.5197	6.5197	2.1183	2.1183	7.5	(21) 70	(147) 323	(319) 704	(212) 467	(636) 1402

All antenna brackets are stainless steel. All weights given include brackets, interbay line, and transformer section. Factory-installed heaters are available using either 300 watts or 500 watts per bay. Specify 120 or 230 volts. Heater elements are replaceable in the field. Shielded interbay heater cable and junction boxes are supplied. Heater weight, including junction boxes and interbay cable, is 6 lb (2.7 kg) additional per bay.

G4D FM Antenna

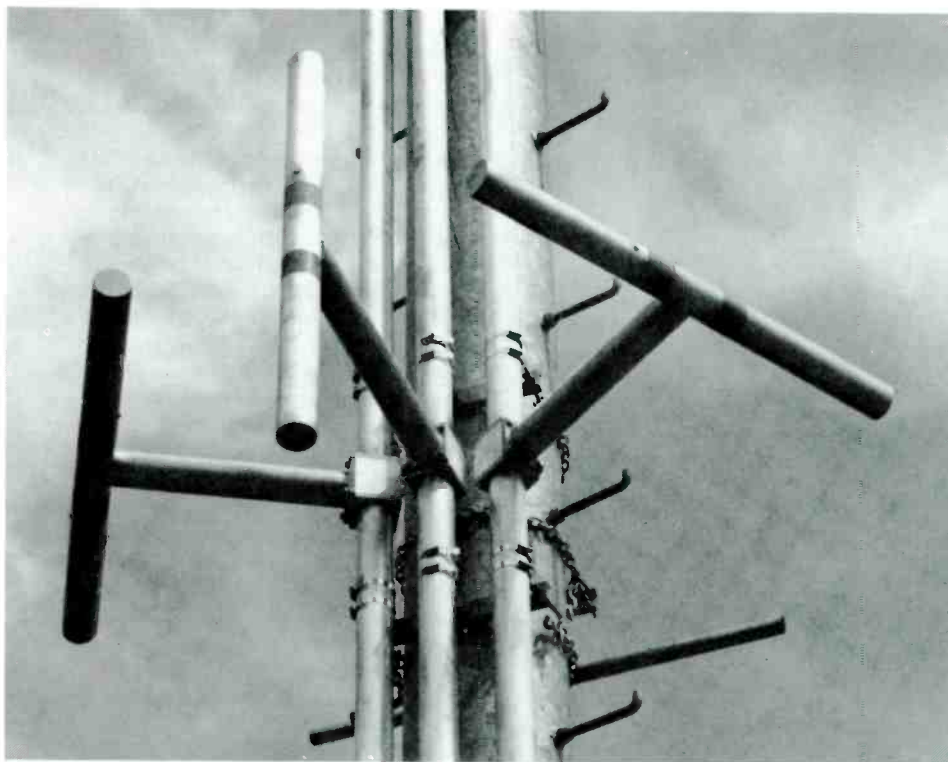

G4D Dual Polarized Directional FM Antenna

The G4D antenna is designed and built primarily for the FM station located along an ocean coast or in mountainous areas where there is a need to radiate power in a 180-degree pattern rather than waste energy over water or into a mountainside. Or, where the licensing authority such as the FCC will allow the use of a

directional antenna to meet some special requirement.

The design of the G4D antenna is based on the elements being pole mounted. Normally the antenna is quoted with the pole included, but it can also be offered without the pole. In that case, exact details of the custom-supplied pole will be required before fabrication begins.

The G4D consists of vertical and horizontal

elements that are 3-1/8" in diameter and made of brass to resist the effects of weathering. The size of the elements contributes to the unusually wide bandwidth of this antenna. Typically, the bandwidth is 5 Mhz between the 1.5:1 VSWR points. And, because of this very wide bandwidth, the G4D does not require any deicing provisions except under the most severe conditions. G4D antennas have been operated with up to 1/2 of an inch of radial ice without causing serious detuning. Radomes are recommended in severe environments.

Because it is a directional antenna, each G4D is pattern tested on the antenna range prior to shipment. Pattern documentation is provided with the antenna to meet the filing requirements of the FCC. Because the antenna and the mounting pole make up an integral unit, field tuning is seldom required.

Typical patterns which can be achieved through the use of a G4D antenna are shown on the following page. The gain figures shown are for the particular pattern achieved and can therefore vary depending upon a station's requirements.

When ordering a G4D antenna, the following information must be supplied: maximum ERP authorized, true azimuth orientation, radiated power limitations and their true orientation, transmission line efficiency or transmission line type and length, and the power output of the transmitter with which the antenna will be used.

As with all Continental Electronics FM antennas, the G4D is designed to be pressurized with either dry air or nitrogen. A positive pressure of 3 to 5 pounds should be maintained after the line and antenna have been initially purged to remove moisture.

Type G4D-() Dual Polarized Directional FM Antenna

Number of Bays	Pattern 1		Pattern 2		Pattern 3		Pattern 4	
	Maximum Power Gain Horiz	Maximum Power Gain Vert	Maximum Power Gain Horiz	Maximum Power Gain Vert	Maximum Power Gain Horiz	Maximum Power Gain Vert	Maximum Power Gain Horiz	Maximum Power Gain Vert
1	0.81	0.72	0.79	0.70	0.76	0.70	0.72	0.69
2	1.74	1.53	1.70	1.49	1.63	1.50	1.54	1.47
3	2.71	2.39	2.64	2.33	2.54	2.34	2.39	2.29
4	3.70	3.26	3.61	3.18	3.47	3.19	3.26	3.13
5	4.71	4.14	4.58	4.03	4.40	4.05	4.14	3.98
6	5.71	5.03	5.56	4.90	5.35	4.92	5.03	4.83
7	6.73	5.92	6.55	5.77	6.29	5.79	5.92	5.68
8	7.75	6.82	7.55	6.64	7.25	6.67	6.82	6.54

NOTE: The listed power gain figures are approximate only, but are useful as a guide in determining the number of bays required. The gain figures will vary with the pattern shape, and the exact gain figures are determined when the final antenna pattern is achieved. The power gain for the vertical polarization component may be less than the horizontal polarization component since it will differ a bit in shape. The RMS of the vertically polarized component can not exceed the RMS of the horizontally polarized component. The vertically polarized component can not exceed the horizontally polarized component at any azimuth.

All specifications are subject to change without notice.

G4D FM Antenna

G4D-() Dual Polarized Directional FM Antennas

No. of Bays	Input Power Rating	Input ¹ Flange	Pole Length In Feet	Pole Outer Diameter	Pole Wgt In Lbs	Pole ² Wind Ld In Lbs	Antenna Wgt In Lbs	Antenna ³ Wind Ld In Lbs	Antenna ⁴ Wgt In Lbs	Antenna ⁵ Wind Ld In Lbs	Height ⁶ Electrical Center
1 A	12 kW	1-5/8"	25	8-5/8"	1088	1363	280	418	337	666	22
1 B	40 kW	3-1/8"	25	8-5/8"	1088	1363	280	418	337	666	22
2 A	12 kW	1-5/8"	35	8-5/8"	1526	1955	479	355	593	1351	26.4
2 B	40 kW	3-1/8"	35	8-5/8"	1526	1955	479	355	593	1351	26.4
3 A	12 kW	1-5/8"	45	10-3/4"	1975	2812	678	1293	849	2037	31
3 B	40 kW	3-1/8"	45	10-3/4"	1975	2821	678	1293	849	2037	31
4 A	12 kW	1-5/8"	55	10-3/4"	3216	3452	877	1731	1105	2723	35.3
4 B	40 kW	3-1/8"	55	10-3/4"	3216	3452	877	1731	1105	2723	35.3
5 A	12 kW	1-5/8"	65	12-3/4"	4761	4474	1076	2168	1361	3408	39.7
5 B	40 kW	3-1/8"	65	12-3/4"	4761	4474	1076	2168	1361	3408	39.7
6 A	12 kW	1-5/8"	75	14"	5936	5441	1275	2506	1617	4094	44.2
6 B	40 kW	3-1/8"	75	14"	5936	5441	1275	2506	1617	4094	44.2
7 A	12 kW	1-5/8"	85	14"	7670	6182	1474	3044	1873	4780	48.6
7 B	40 kW	3-1/8"	85	14"	7670	6182	1474	3044	1873	4780	48.6
8 A	12 kW	1-5/8"	95	14" *	8896	6633	1673	3481	2129	5465	53
8 B	40 kW	3-1/8"	95	14" *	8896	6633	1673	3481	2129	5465	53

(1) All 1-5/8" flanges are male; all 3-1/8" flanges are female. (2) Based on 50 Lbs/Ft² with 1/2" radial ice on pole. (3) Based on 50/33 Lbs/Sq Ft (112 mph wind). (4) With Radomes. (5) With Radomes; based on 50/33 Lbs/Sq Ft. (6) Above tower top at approx 89.0 MHz. * Eight bay antennas require 2-ft section of 16" pole at base of pole structure.

Pattern 1

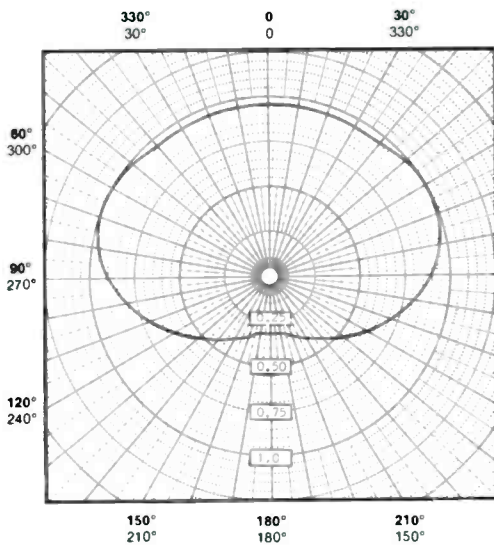

Pattern 2

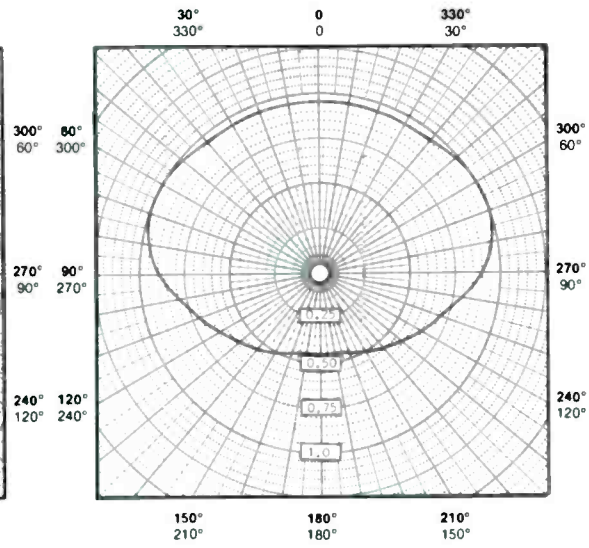

Pattern 3

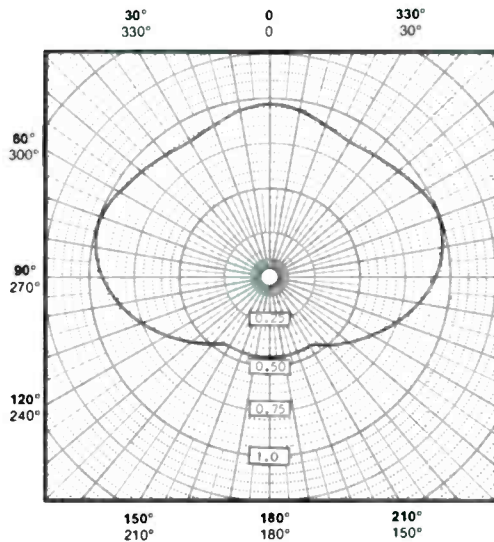

Pattern 4

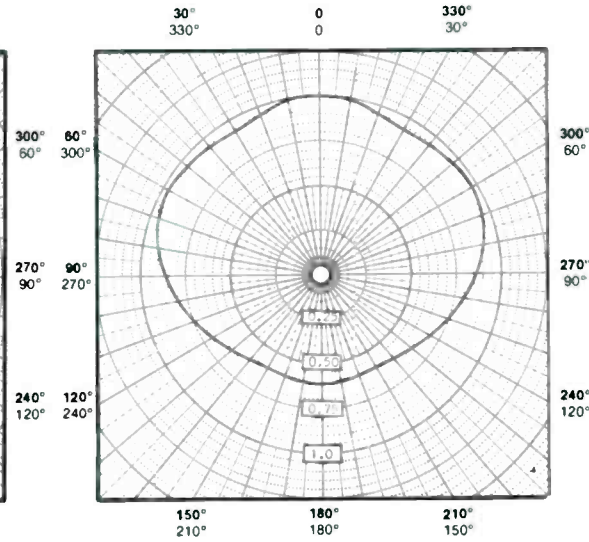

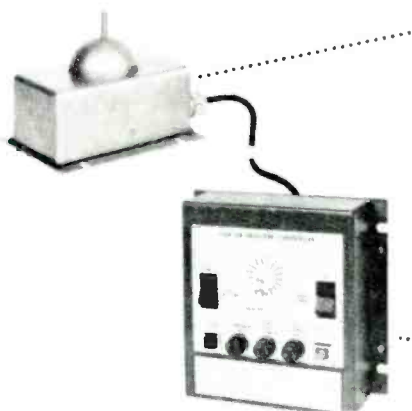

Ice Warning System

The Rosemount ice warning system consists of a controller and an ice detector*.

Most ice warning and heater control systems are operated by a thermostat device; thus, antenna heaters are energized whenever the temperature drops below approximately 35°F (1.7°C). Statistically, the probability of icing seldom exceeds 3 percent, even during the winter months. The remaining 97 percent of the time, antenna heater power activated by a thermostatic device provides expensive and unnecessary insurance against icing.

The Rosemount system is designed to reduce antenna de-icing costs and to fully automate antenna de-icing systems.

The Rosemount system will detect ice and energize antenna heaters only when ice is physically present, but before ice accumulation can reduce antenna performance. The Rosemount system thus provides reliable, completely automated antenna icing protection at a fraction of the cost for continuous heater operation whenever the ambient temperature is below approximately 35°F (1.7°C). In many cases, the Rosemount system will pay for itself in less than one icing season.



Micro-Trak 2580 Antenna Heater Control System

The 2580 senses ambient atmospheric conditions and controls power to the element heaters in FM, TV, and other electrically heated antenna arrays. The system provides aural and visual indication of status, monitors the condition of the heater elements, and provides an alarm in the event of a failure. The 2580 reduces operational costs by continually sensing atmospheric conditions, thus restricting heater turn-on to ice-causing conditions: freezing temperatures and precipitation. The 2580 system consists of four basic components: 2580 Control Unit, 2580-TT Temperature Sensing Unit, 2580-PD Precipitation Detector, and the 2580-HF Heater Failure Sense Transformer. The system has been field-tested in depth to optimize design and ensure performance and reliability. Optional accessories (Remote Display Output Circuit, Remote Display Panel, Calibration Box, Power Contactors and Enclosures, and Slow Start Kit) are available.

Size:

Standard 3-1/2" (8.8 cm) x 19" (48.2 cm)
Rack Panel x 8" (20.3 cm) D

2580 Control Unit
2580-TT NPN Temperature Sensing Unit
2580-PD NPN Precipitation Detector
2580-HF NPN Heater Failure Sense Transformer

Beacon Light Control

Fisher-Pierce 63305-DB beacon light control mounts in a standard commercial socket. It automatically controls broadcast tower lights directly, or with auxiliary contractors. An adjustable potentiometer allows adjustment for operation from 0 to 50 footcandles.

Power requirements:

105 to 130 volts: 50/60 Hz

Built-in load contractor:

Single-pole, single throw, double break;
30 amps

Load rating:

3000 watts

All specifications are subject to change without notice.

Rigid 1-5/8" Antenna Transmission Line

Rigid: 1-5/8"

	Andrew	Cablewave	Myatt	Phelps-Dodge	Dielectric
20-Ft. Line Section, flange both ends	561	920124	201-001	1-158-50	DC-275-00
20-Ft. Line Section, flanged one end	561-11	920218	201-006	2-158-50	Not Available
20-Ft. Line Section, unflanged	561-21	920222	201-004	3-158-50	DC265-002
Elbow, 90-degree	1061	920226	201-020	4-158-50	DC275-017
Elbow, 45-degree	Not Available	920230	201-030	5-158-50	DC275-020
Flange, fixed	18631	920288	201-008	13-158	DC275-006
Flange, swivel	18041	920284	201-009	18-158-50	Not Available
Flange, field (Soft sold.)	1561A	Not Available	201-013	Not Available	DC275-014
Flange, unpressurized	Not Available	920304	Not Available	11-158	DC260-015
Inner Connector	34660	612874	201-010	12-158-50	DC275-011
Inner Connector for unflanged line only	Not Available	920300	201-014	27-158-50	DC365-007
Gas Barrier	1261B	920238	201-050	7-158-50	DC275-005
End Terminal	2061	920253	201-080	20-158-50H	Not Available
Hardware Set	11381-2	920273	201-012	26-158	DC270-012
"O" Ring Gasket	10683-406	520681-011	201-011	14-158	DC270
Fixed Hanger	13924	920303	201-142-1	51-158	DC270-034
Spring Hanger	14379	920311	201-042-3	91-158	DC270-036
Horizontal Hanger	3911	920319	201-042-12	71-158	DC270-030
Round Member Adaptor	13550	514542-003	Not Available	Use Cablewave	Use Cablewave
Angle Adaptor	13555A	920167-002	Not Available	Use Cablewave	Use Cablewave
Wall Feed Thru	3901	920322	201-042-5	111-158	DC270-028
Reducer, 1-5/8" TO 7/8"	1860A	920249	201-064	17-158-50	DC275-060
Reducer, 3 1/8" to 1-5/8"	1861	920250	301-064	17-318-50	DC375-060
Lateral Brace	3921	920316	201-042-8	131-158	Not Available

All specifications are subject to change without notice.

Antenna Transmission Line Rigid: 3-1/8

Rigid 3-1/8"

	Andrew	Cablewave	Myatt	Phelps-Dodge	Dielectric
20-Ft. Line Section, flanged both ends	562A	920215	301-001	1-318-50	DC375-002
20-Ft. Line Section, flanged one end	562A-11	920219	301-006	2-318-50	Not Available
20-Ft. Line Section, unflanged	562A-21	920223	301-004	3-318-50	DC365-002
Elbow, 90-Degree, flanged	1062	920227	301-020	4-318-50	DC375-017
Elbow, 45-Degree	1162	920321	301-030	5-318-50	DC375-020
Flange, fixed	15840	920289	301-008	13-318	DC375-006
Flange, swivel	18200	920285	301-009	18-318-50	DC3601-015
Flange, field (soft solder)	1562A	Not Available	301-013	Not Available	DC375-014
Flange, unpressurized	Not Available	920305	301-014	11-318	DC360-015
Inner Connector	30079	622720	301-010ML	12-318-50	DC375-011
Inner Connector for unflanged line only	Not Available	920301	301-010ML	27-318-50	DC365-007
Gas Barrier	1262B	920239	301-050	7-318-50	DC375-005
End Terminal	2062	920254	301-080	20-318-50H	Not Available
Hardware Set	11381-3	920274	301-012	26-318	DC370-012
"O" Ring Gasket	10683-405	Use Phelps-Dodge	301-011	14-318	DC370-010
Fixed Hanger	13927	920309	301-042-1	51-318	DC370-034
Spring Hanger	13925	920312	301-042-3	91-318	DC370-036
Horizontal Hanger	3912	920320	301-042-9	71-318	DC370-028
Round Member Adaptor	31670-3	514542-003	Use Cablewave	Use Cablewave	Use Cablewave
Angle Adaptor	31768A	920167-004	Use Cablewave	Use Cablewave	Use Cablewave
Wall Feed Thru	3902	920323	301-042-5	111-318	DC370-028
Reducer, 6-1/8" to 3-1/8"	1872	920-251	601-064	17-618-50	DC675-061
Reducer, 3-1/8" to 1-5/8"	1861	920250	301-064	17-318-50	DC375-060
Lateral Brace	3922	920317	301-042-8	131-318	DC370-038

All specifications are subject to change without notice.

Rigid: 4-1/16" Antenna Transmission Line

Rigid: 4-1/16"

	Andrew	Cablewave	Myatt	Phelps-Dodge	Dielectric
20-Ft. Line Section, flanged both ends	ACA-450-1	Not Available	401-001	Not Available	475-002
20-Ft. Line Section, flanged one end only	ACX-450-4	N/A	Not Available	N/A	Not Available
20-Ft. Line Section, unflanged	ACX-450-5	N/A	401-004	N/A	465-002
Elbow, 90-Degree	ACX-450-10	N/A	401-020	N/A	475-017
Elbow, 45-Degree	Not Available	N/A	Not Available	N/A	475-020
Flange, fixed	ACX-450-28	N/A	401-008	N/A	475-006
Flange, swivel	ACX-450-27	N/A	401-009	N/A	460-013
Flange, field (soft solder)	Not Available	N/A	401-013	N/A	470-014
Flange, unpressurized	Not Available	N/A	401-014	N/A	460-015
Inner Connector	ACX-450-20	N/A	401-010	N/A	475-011
Inner Connector for unflanged line only	Not Available	N/A	use 401-010	N/A	465-007
Gas Barrier	ACX-450-16	N/A	401-050	N/A	475-005
End Terminal	Not Available	N/A	Not Available	N/A	Not Available
Hardware Set	ACX-450-21	N/A	401-012	N/A	470-012
"O" Ring Gasket	Not Available	N/A	401-011	N/A	470-010
Fixed Hanger	ACX-450-21	N/A	401-042-1	N/A	470-034
Spring Hanger	ACX-450-11	N/A	401-042-3	N/A	470-036
Horizontal Hanger	ACX-450-15	N/A	Not Available	N/A	Not Available
Round Member Adaptor	Cablewave-514542-004	N/A	514542-004	N/A	Not Available
Angle Adaptor	Cablewave-920167-004	N/A	Cablewave-920167-004	N/A	Not Available
Wall Feed Thru	Myatt-401-042-5	N/A	401-042-5	N/A	470-028
Reducer, 6-1/8" to 4-1/16"	Not Available	N/A	401-084	N/A	675-060
Lateral Brace	ACX450-11	N/A	401-042-8	N/A	470-038
Coupling, unpressurized	Myatt-401-017	N/A	Myatt-401-017	N/A	Myatt-401-017

All specifications are subject to change without notice.

Antenna Transmission Line Air Dielectric: 7/8" and 1-5/8"

Air Dielectric: 7/8"

Air Dielectric: 1-5/8"

	Andrew	Cablewave	Andrew	Cablewave	
Line Type Number	HJ5-50	FCC78-50J	HJ7-50A	HCC-158-50J	
Flange, gas pass EIA	75AR	738259	87R	738314	
Flange, gas barrier EIA	75AG	738256	87G	738303	
Flange, LC plug	75AM	738254	87L (female)	738302 (female)	
Flange, N-plug	75AN	738251	87N	738301 (female)	
End Terminal	75AT	738258	87T	738306	
Gas Barrier	1260A	920237	1261B	920238	
Splice	75AZ	738257	87Z	738305	
Hanger Kit, non-insul., maximum spacing—3 feet	42396-5	920159-00	42396-2	920159-003	
Hardware Kit	31769-1	Not Available	31769-1	Not Available	
Angle Adaptor	31768A	920167-001	31768A	920167-002	
Round Member Adaptor, 1-2 inch leg diameter	31670-1	514542-002	31670-1	514542-002	
Round Member Adaptor, 2-3 inch leg diameter	31670-2	514542-003	31670-2	514542-003	
Insulated Hanger, maximum spacing 3 feet	11662-2	920150-002	33948-3	920161-003	
Hoisting Grip	19256B	910307	24312A	910311	
Wall Feed Thru	40656-1	920433	40656-2	920434	
Grounding-Kit	40993A-5	713737-004	40993A-2	713737-005	
Nylon Cable Ties (50 pieces)	40417	Not Available	40417	Not Available	
90-Degree Elbow	1060	920225	1061	920226	

All specifications are subject to change without notice.

Air Dielectric: 3" and 3-1/2" Antenna Transmission Line

Air Dielectric: 3"

Air Dielectric: 3-1/2"

	Andrew	Cablewave	Andrew	Cablewave	
Line Type Number	HJ8-50B	HCC-300-50J	Not Available	HCC-312-50J	
Flange, gas pass	78ARF	738355	N/A	734579	
Flange, gas barrier	78AGF	738350	N/A	734578	
End Terminal	2062	920254	N/A	920254	
Gas Barrier	Not Available	920239	N/A	920239	
Splice	78BZ	738352	N/A	734574	
Hanger Kit, maximum spacing 5', 10-pieces	31766-11	920159-004	N/A	920159-005	
Hardware Kit	31769-1	Not Available	N/A	Not Available	
Angle Adaptor	31768A	920167-004	N/A	920167-004	
Round Member Adaptor, 1-2" leg diameter	31670-1	514542-002	N/A	514542-002	
Round Member Adaptor, 2-3" leg diameter	31670-2	514542-003	N/A	514542-003	
Round Member Adaptor, 3-4" leg diameter	31670-3	514542-004	N/A	514542-004	
Insulated Hanger	33948-2	920161-002	N/A	920161-007	
Hoisting Grip	26985A	913563	N/A	913563	
Wall Feed Thru	40394-2	920435	N/A	920572	
Grounding Kit	40993A-11	713737-006	N/A	713737-007	
Nylon Cable Ties (50 pieces per kit)	40417	Use Andrew	N/A	USE ANDREW	
90-Degree Elbow	1062	920227	N/A	920227	
45-Degree Elbow	1162	920231	N/A	920231	
Inner Connector	15093A	622720	N/A	622720	

All specifications are subject to change without notice.

Antenna Transmission Line Air Dielectric: 4" and 5"

	Air Dielectric: 4"		Air Dielectric: 5"		
	Andrew	Cablewave	Andrew	Cablewave	
Line Type Number	HJ11-50	HF 4-1/8" CUZY	HJ-9-50	Not Available	
Flange, gas pass	81RF	734646(6-1/8")	79R	N/A	
Flange, gas barrier	81GF	734645(6-1/8")	79G	N/A	
End Terminal	2062	920255	Not Available	N/A	
Gas Barrier	1262B(3-1/8")	920240	Not Available	N/A	
Splice	81Z	Not Available	79AZ	N/A	
Hanger Kit, max. spacing 5', 10-pieces	31766-10	920159-006	33598-5	N/A	
Hardware Kit	31769-1	Not Available	31769-1	N/A	
Angle Adaptor	31768A	920160	31768A	N/A	
Round Member Adaptor, 1-2" leg diameter	31670-1	514542-002	Not Available	N/A	
Round Member Adaptor, 2-3" leg diameter	31670-2	514542-003	514542-003	N/A	
Round Member Adaptor, 3-4" leg diameter	31670-3	514542-004	514542-004	N/A	
Insulated Hanger	33948-4	920161-008	33948-1	N/A	
Hoisting Grip	34759	913864	31031-1	N/A	
Wall Feed Thru	40394-1	920555	33938-5	N/A	
Grounding Kit	40993A-10	713737-008	40993A-14	N/A	
Nylon Cable Ties (50 pieces per kit)	40417	Use Andrew	40417	N/A	
90-Degree Elbow	1062(3-1/8")	920228(6-1/8")	Use Cablewave	N/A	
Reducer 6-1/8" to 3-1/8"	Use Cablewave	920251	Use Cablewave	N/A	
45-Degree Elbow	1162(3-1/8")	920232(6-1/8")	Use Cablewave	N/A	

All specifications are subject to change without notice.

Transmission Line Components 50 ohm, Rigid **Antenna**

Typical antenna transmission line components are shown below. Data supplied through courtesy of Cablewave Systems.

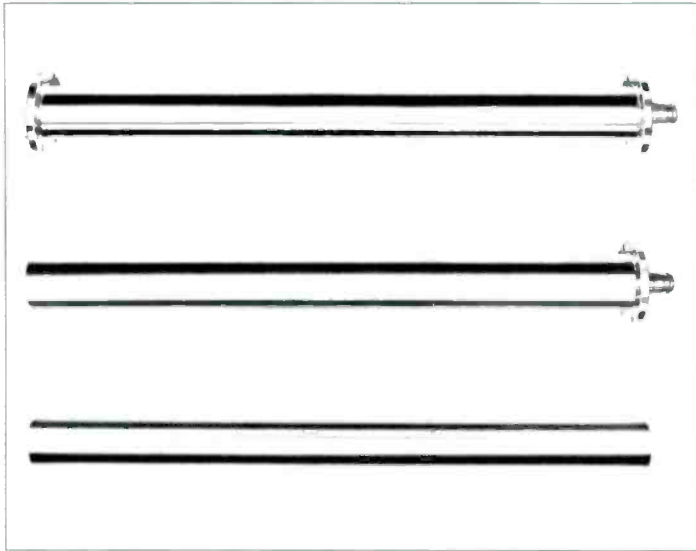

Cablewave systems coaxial transmission line is fabricated from high conductivity hard-drawn copper tubing with precision machined, pin-type, Teflon dielectric insulators. The standard 50 ohm line is offered in sizes from 7/8" through 6 1/8". The EIA bolt type flanges and inner connectors are compatible with EIA standards, US MIL specifications, and international IEC recommendations. Aluminum outer conductor 50 ohm and copper 75 ohm lines are available on special order.

Unless otherwise noted, the EIA flanges are the bolt type flanges defined in EIA Standard RS-225 with a female inner conductor, removable anchor inner connector with Teflon insulator, and a rotatable swivel-type outer flange ring. On many items, the EIA flange ring is soldered directly to the outer conductor and is designated as an "EIA male" flange. If the flange ring is fixed and the inner connector is unremovable, the flange is called "EIA fixed male".

The components shown are useful in both coaxial cable and rigid line installations.

For indoor applications, unflanged, ungasged line may be suitable. Unflanged components are joined by a slotted, unpressurized, straight brass coupling around the outer conductor and a silver plated inner connector for the center conductor connection.

ORDERING INFORMATION

Cablewave Systems Rigid Line Catalog numbers consists of a prefix to designate the component, and a suffix to call out line size and impedance.

Catalog number prefix "1" refers to a 20 foot length transmission line with EIA fixed flanges on both ends.

One anchor inner connector, one "O" ring gasket, and one hardware set are supplied.

Prefix "2" designates a 20 foot length of transmission line with one unflanged end, one EIA fixed flange, and one anchor inner connector, "O" ring and hardware set.

Catalog number prefix "3" denotes a 20 foot length of unflanged transmission line. No inner connector, "O" ring hardware is included.

Special high reliability coated anchor inner connectors are supplied with the 3 1/8" and 6 1/8" rigid line sections. These include a special dry baked molybdenum di-sulfide coating for long term, reliable lubrication to prevent conductor galling. All sizes of components and the 7/8" and 1 1/8" line sections include conventional silver plated anchor inner connectors.

*Prefix designations "1S," "2S" and "3S" refer to special lengths of rigid line in which the exact length in inches is added as a suffix after the impedance, i.e.: 1S-318-50 (24) for a 2 ft. (609mm) length of 3 1/8" 50 ohm line with EIA flanges on each end.

When ordering, part numbers where listed should also be used.

DESCRIPTION AND CATALOG NUMBERS

Size	20 Foot section, flanges both ends		20 Foot section, flange one end		20 Foot section, no flanges	
	Cat. No.	Part No.	Cat. No.	Part No.	Cat. No.	Part No.
7/8"	1-78-50	920213	2-78-50	920217	3-78-50	920221
1 1/8"	1-158-50	920214	2-158-50	920218	3-158-50	920222
3 1/8"	1-318-50	920215	2-318-50	920219	3-318-50	920223
6 1/8"	1-618-50	920216	2-618-50	920220	3-618-50	920224

Size	Special length, flanges both ends		Special length, flange one end		Special length, no flanges	
	Cat. No.	Part No.	Cat. No.	Part No.	Cat. No.	Part No.
7/8"	1S-78-50		2S-78-50		3S-78-50	
1 1/8"	1S-158-50		2S-158-50		3S-158-50	
3 1/8"	1S-318-50		2S-318-50		3S-318-50	
6 1/8"	1S-618-50		2S-618-50		3S-618-50	

ELECTRICAL CHARACTERISTICS

Size	Impedance, Ohms	Maximum Frequency, MHz	Velocity percent	Attenuation and Average Power Rating	Peak Power, KW
7/8"	50	4,000	99.8	see curves pages 112, 113.	61
1 1/8"	50	3,000	99.8		234
3 1/8"	50	1,600	99.8		920
6 1/8"	50	800	99.8		3,590

MECHANICAL CHARACTERISTICS

Size	Outer Conductor O.D. x I.D. Inches (millimeters)	Inner Conductor O.D. x I.D. Inches (millimeters)	Shipping Carton Inches (millimeters)	Net Weight Per Length lbs. (Kg)	Number of Line Sections Per Carton	Shipping Weight Per Carton lbs. (Kg)
7/8"	.875 x .785 (22.2 x 20.0)	.341 x .291 (8.7 x 7.4)	13 x 13 x 245 (330 x 330 x 6223)	12 (5.5)	16	250 (114)
1 1/8"	1.625 x 1.527 (41.3 x 38.8)	.664 x .588 (16.9 x 14.9)	13 x 13 x 245 (330 x 330 x 6223)	27 (12.3)	9	303 (138)
3 1/8"	3.125 x 3.027 (79.4 x 76.9)	1.315 x 1.231 (33.4 x 31.3)	13 x 13 x 245 (330 x 330 x 6223)	52 (23.6)	4	268 (122)
6 1/8"	6.125 x 5.981 (155.6 x 151.9)	2.600 x 2.520 (66.0 x 64.0)	12 x 24 x 245 (305 x 610 x 6223)	135 (61.4)	2	370 (168)

Antenna Transmission Line Components 50 ohm, Rigid

Typical antenna transmission line components are shown below. Data supplied through courtesy of Cablewave Systems.

Unless otherwise noted flanges are standard EIA swivel flanges, and the component includes an anchor inner connector, "O" ring gasket, and hardware set for one end only.

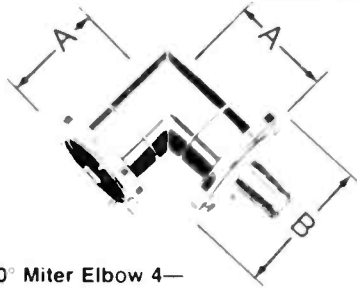
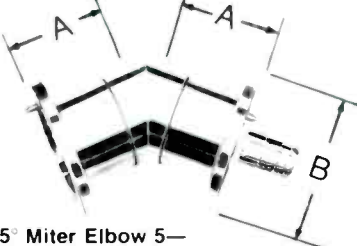
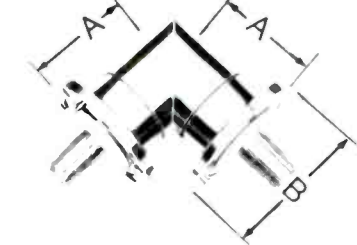
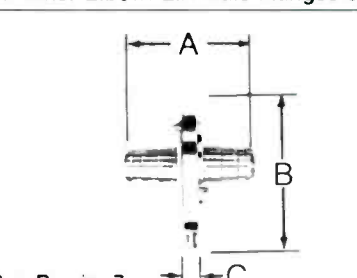
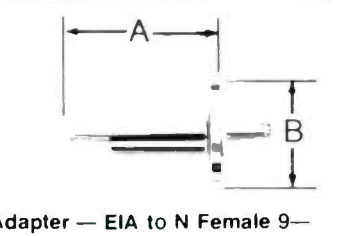
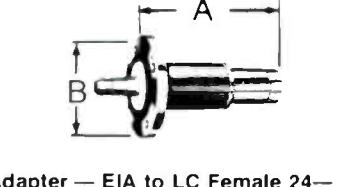
 <p>90° Miter Elbow 4—</p>	<p>90° Miter Elbow. 50 ohm copper and brass construction. EIA swivel flanges. Unsupported silver plated inner conductor. One anchor inner connector, "O" ring, and hardware set.</p> <table border="1"> <thead> <tr> <th rowspan="2">Size</th> <th rowspan="2">Cat. No.</th> <th rowspan="2">Part No.</th> <th colspan="2">Dimensions, inches (millimeters)</th> <th colspan="2">Weight, pounds (kilograms)</th> </tr> <tr> <th>A</th> <th>B</th> <th>Net</th> <th>Shipping</th> </tr> </thead> <tbody> <tr> <td>7/8"</td> <td>4-78-50</td> <td>920225</td> <td>2 3/4 (69.9)</td> <td>2 1/4 (57.2)</td> <td>1.3 (.6)</td> <td>1.7 (.8)</td> </tr> <tr> <td>1 5/8"</td> <td>4-158-50</td> <td>920226</td> <td>2 1/2 (63.5)</td> <td>3 1/2 (88.9)</td> <td>3.4 (1.5)</td> <td>3.8 (1.7)</td> </tr> <tr> <td>3 1/8"</td> <td>4-318-50</td> <td>920227</td> <td>3 13/16 (96.8)</td> <td>5 3/16 (131.8)</td> <td>8.2 (3.7)</td> <td>8.9 (4.0)</td> </tr> <tr> <td>6 1/8"</td> <td>4-618-50</td> <td>920228</td> <td>5 1/2 (139.7)</td> <td>8 1/8 (206.4)</td> <td>22.0 (10)</td> <td>26.0 (11.8)</td> </tr> </tbody> </table>	Size	Cat. No.	Part No.	Dimensions, inches (millimeters)		Weight, pounds (kilograms)		A	B	Net	Shipping	7/8"	4-78-50	920225	2 3/4 (69.9)	2 1/4 (57.2)	1.3 (.6)	1.7 (.8)	1 5/8"	4-158-50	920226	2 1/2 (63.5)	3 1/2 (88.9)	3.4 (1.5)	3.8 (1.7)	3 1/8"	4-318-50	920227	3 13/16 (96.8)	5 3/16 (131.8)	8.2 (3.7)	8.9 (4.0)	6 1/8"	4-618-50	920228	5 1/2 (139.7)	8 1/8 (206.4)	22.0 (10)	26.0 (11.8)						
Size	Cat. No.				Part No.	Dimensions, inches (millimeters)		Weight, pounds (kilograms)																																						
		A	B	Net		Shipping																																								
7/8"	4-78-50	920225	2 3/4 (69.9)	2 1/4 (57.2)	1.3 (.6)	1.7 (.8)																																								
1 5/8"	4-158-50	920226	2 1/2 (63.5)	3 1/2 (88.9)	3.4 (1.5)	3.8 (1.7)																																								
3 1/8"	4-318-50	920227	3 13/16 (96.8)	5 3/16 (131.8)	8.2 (3.7)	8.9 (4.0)																																								
6 1/8"	4-618-50	920228	5 1/2 (139.7)	8 1/8 (206.4)	22.0 (10)	26.0 (11.8)																																								
 <p>45° Miter Elbow 5—</p>	<p>45° Miter Elbow. Copper and Brass construction. Unsupported inner conductor.</p> <table border="1"> <thead> <tr> <th rowspan="2">Size</th> <th rowspan="2">Cat. No.</th> <th rowspan="2">Part No.</th> <th colspan="2">Dimensions, inches (millimeters)</th> <th colspan="2">Weight, pounds (kilograms)</th> </tr> <tr> <th>A</th> <th>B</th> <th>Net</th> <th>Shipping</th> </tr> </thead> <tbody> <tr> <td>7/8"</td> <td>5-78-50</td> <td>920229</td> <td>2 3/4 (69.9)</td> <td>2 1/4 (57.2)</td> <td>1.2 (.5)</td> <td>1.6 (.7)</td> </tr> <tr> <td>1 5/8"</td> <td>5-158-50</td> <td>920230</td> <td>2 1/2 (63.5)</td> <td>3 1/2 (88.9)</td> <td>3.3 (1.5)</td> <td>3.6 (1.6)</td> </tr> <tr> <td>3 1/8"</td> <td>5-318-50</td> <td>920231</td> <td>3 1/2 (88.9)</td> <td>5 3/16 (131.8)</td> <td>7.9 (3.6)</td> <td>8.6 (3.9)</td> </tr> <tr> <td>6 1/8"</td> <td>5-618-50</td> <td>920232</td> <td>5 1/2 (139.7)</td> <td>8 1/8 (206.4)</td> <td>21.0 (9.5)</td> <td>25.0 (11.3)</td> </tr> </tbody> </table>	Size	Cat. No.	Part No.	Dimensions, inches (millimeters)		Weight, pounds (kilograms)		A	B	Net	Shipping	7/8"	5-78-50	920229	2 3/4 (69.9)	2 1/4 (57.2)	1.2 (.5)	1.6 (.7)	1 5/8"	5-158-50	920230	2 1/2 (63.5)	3 1/2 (88.9)	3.3 (1.5)	3.6 (1.6)	3 1/8"	5-318-50	920231	3 1/2 (88.9)	5 3/16 (131.8)	7.9 (3.6)	8.6 (3.9)	6 1/8"	5-618-50	920232	5 1/2 (139.7)	8 1/8 (206.4)	21.0 (9.5)	25.0 (11.3)						
Size	Cat. No.				Part No.	Dimensions, inches (millimeters)		Weight, pounds (kilograms)																																						
		A	B	Net		Shipping																																								
7/8"	5-78-50	920229	2 3/4 (69.9)	2 1/4 (57.2)	1.2 (.5)	1.6 (.7)																																								
1 5/8"	5-158-50	920230	2 1/2 (63.5)	3 1/2 (88.9)	3.3 (1.5)	3.6 (1.6)																																								
3 1/8"	5-318-50	920231	3 1/2 (88.9)	5 3/16 (131.8)	7.9 (3.6)	8.6 (3.9)																																								
6 1/8"	5-618-50	920232	5 1/2 (139.7)	8 1/8 (206.4)	21.0 (9.5)	25.0 (11.3)																																								
 <p>90° Miter Elbow. EIA Male Flanges 6—</p>	<p>90° Miter Elbow. Male. EIA male swivel flanges both ends, Silver plated, supported inner conductor. Two "O" rings and two sets of hardware included.</p> <table border="1"> <thead> <tr> <th rowspan="2">Size</th> <th rowspan="2">Cat. No.</th> <th rowspan="2">Part No.</th> <th colspan="2">Dimensions, inches (millimeters)</th> <th colspan="2">Weight, pounds (kilograms)</th> </tr> <tr> <th>A</th> <th>B</th> <th>Net</th> <th>Shipping</th> </tr> </thead> <tbody> <tr> <td>7/8"</td> <td>6-78-50</td> <td>920233</td> <td>2 3/4 (69.9)</td> <td>2 1/4 (57.2)</td> <td>1.2 (.5)</td> <td>1.6 (.7)</td> </tr> <tr> <td>1 5/8"</td> <td>6-158-50</td> <td>920234</td> <td>2 1/2 (63.5)</td> <td>3 1/2 (88.9)</td> <td>3.3 (1.5)</td> <td>3.7 (1.7)</td> </tr> <tr> <td>3 1/8"</td> <td>6-318-50</td> <td>920235</td> <td>3 13/16 (96.8)</td> <td>5 3/16 (131.8)</td> <td>8.2 (3.7)</td> <td>8.9 (4.0)</td> </tr> <tr> <td>6 1/8"</td> <td>6-618-50</td> <td>920236</td> <td>5 1/2 (139.7)</td> <td>8 1/8 (206.4)</td> <td>22.0 (10.0)</td> <td>26.0 (11.8)</td> </tr> </tbody> </table>	Size	Cat. No.	Part No.	Dimensions, inches (millimeters)		Weight, pounds (kilograms)		A	B	Net	Shipping	7/8"	6-78-50	920233	2 3/4 (69.9)	2 1/4 (57.2)	1.2 (.5)	1.6 (.7)	1 5/8"	6-158-50	920234	2 1/2 (63.5)	3 1/2 (88.9)	3.3 (1.5)	3.7 (1.7)	3 1/8"	6-318-50	920235	3 13/16 (96.8)	5 3/16 (131.8)	8.2 (3.7)	8.9 (4.0)	6 1/8"	6-618-50	920236	5 1/2 (139.7)	8 1/8 (206.4)	22.0 (10.0)	26.0 (11.8)						
Size	Cat. No.				Part No.	Dimensions, inches (millimeters)		Weight, pounds (kilograms)																																						
		A	B	Net		Shipping																																								
7/8"	6-78-50	920233	2 3/4 (69.9)	2 1/4 (57.2)	1.2 (.5)	1.6 (.7)																																								
1 5/8"	6-158-50	920234	2 1/2 (63.5)	3 1/2 (88.9)	3.3 (1.5)	3.7 (1.7)																																								
3 1/8"	6-318-50	920235	3 13/16 (96.8)	5 3/16 (131.8)	8.2 (3.7)	8.9 (4.0)																																								
6 1/8"	6-618-50	920236	5 1/2 (139.7)	8 1/8 (206.4)	22.0 (10.0)	26.0 (11.8)																																								
 <p>Gas Barrier 7—</p>	<p>Gas Barrier. Fixed male EIA inner connectors both ends. 1/8" FPT pressure inlet with plug. One set of longer bronze hardware, and two "O" rings.</p> <table border="1"> <thead> <tr> <th rowspan="2">Size</th> <th rowspan="2">Cat. No.</th> <th rowspan="2">Part No.</th> <th colspan="3">Dimensions, inches (millimeters)</th> <th colspan="2">Weight, pounds (kilograms)</th> </tr> <tr> <th>A</th> <th>B</th> <th>C</th> <th>Net</th> <th>Shipping</th> </tr> </thead> <tbody> <tr> <td>7/8"</td> <td>7-78-50</td> <td>920237</td> <td>3 5/16 (84.1)</td> <td>2 1/4 (57.2)</td> <td>5/8 (15.9)</td> <td>1.1 (.5)</td> <td>1.3 (.6)</td> </tr> <tr> <td>1 5/8"</td> <td>7-158-50</td> <td>920238</td> <td>3 7/8 (98.4)</td> <td>3 1/2 (88.9)</td> <td>5/8 (15.9)</td> <td>3.4 (1.5)</td> <td>4.1 (1.9)</td> </tr> <tr> <td>3 1/8"</td> <td>7-318-50</td> <td>920239</td> <td>4 7/8 (123.8)</td> <td>5 3/16 (131.8)</td> <td>5/8 (15.9)</td> <td>6.2 (2.8)</td> <td>7.0 (3.2)</td> </tr> <tr> <td>6 1/8"</td> <td>7-618-50</td> <td>920240</td> <td>6 1/8 (155.6)</td> <td>8 1/8 (206.4)</td> <td>1 1/16 (27.0)</td> <td>15.2 (6.9)</td> <td>17.0 (7.7)</td> </tr> </tbody> </table>	Size	Cat. No.	Part No.	Dimensions, inches (millimeters)			Weight, pounds (kilograms)		A	B	C	Net	Shipping	7/8"	7-78-50	920237	3 5/16 (84.1)	2 1/4 (57.2)	5/8 (15.9)	1.1 (.5)	1.3 (.6)	1 5/8"	7-158-50	920238	3 7/8 (98.4)	3 1/2 (88.9)	5/8 (15.9)	3.4 (1.5)	4.1 (1.9)	3 1/8"	7-318-50	920239	4 7/8 (123.8)	5 3/16 (131.8)	5/8 (15.9)	6.2 (2.8)	7.0 (3.2)	6 1/8"	7-618-50	920240	6 1/8 (155.6)	8 1/8 (206.4)	1 1/16 (27.0)	15.2 (6.9)	17.0 (7.7)
Size	Cat. No.				Part No.	Dimensions, inches (millimeters)			Weight, pounds (kilograms)																																					
		A	B	C		Net	Shipping																																							
7/8"	7-78-50	920237	3 5/16 (84.1)	2 1/4 (57.2)	5/8 (15.9)	1.1 (.5)	1.3 (.6)																																							
1 5/8"	7-158-50	920238	3 7/8 (98.4)	3 1/2 (88.9)	5/8 (15.9)	3.4 (1.5)	4.1 (1.9)																																							
3 1/8"	7-318-50	920239	4 7/8 (123.8)	5 3/16 (131.8)	5/8 (15.9)	6.2 (2.8)	7.0 (3.2)																																							
6 1/8"	7-618-50	920240	6 1/8 (155.6)	8 1/8 (206.4)	1 1/16 (27.0)	15.2 (6.9)	17.0 (7.7)																																							
 <p>Adapter — EIA to N Female 9—</p>	<p>Adapter — EIA to type N Female. Mates with UG21/U. Gas tight with 1/8" FPT pressure inlet and plug.</p> <table border="1"> <thead> <tr> <th rowspan="2">Size</th> <th rowspan="2">Cat. No.</th> <th rowspan="2">Part No.</th> <th colspan="2">Dimensions, inches (millimeters)</th> <th colspan="2">Weight, pounds (kilograms)</th> </tr> <tr> <th>A</th> <th>B</th> <th>Net</th> <th>Shipping</th> </tr> </thead> <tbody> <tr> <td>7/8"</td> <td>9-78-50</td> <td>920241</td> <td>4 (101.6)</td> <td>2 1/4 (57.2)</td> <td>.6 (.3)</td> <td>.9 (.4)</td> </tr> <tr> <td>1 5/8"</td> <td>9-158-50</td> <td>920242</td> <td>5 (127.)</td> <td>3 1/2 (88.9)</td> <td>2.0 (.9)</td> <td>2.7 (1.2)</td> </tr> <tr> <td>3 1/8"</td> <td>9-318-50</td> <td>920243</td> <td>6 (152.4)</td> <td>5 3/16 (131.8)</td> <td>6.0 (2.7)</td> <td>6.8 (3.1)</td> </tr> </tbody> </table>	Size	Cat. No.	Part No.	Dimensions, inches (millimeters)		Weight, pounds (kilograms)		A	B	Net	Shipping	7/8"	9-78-50	920241	4 (101.6)	2 1/4 (57.2)	.6 (.3)	.9 (.4)	1 5/8"	9-158-50	920242	5 (127.)	3 1/2 (88.9)	2.0 (.9)	2.7 (1.2)	3 1/8"	9-318-50	920243	6 (152.4)	5 3/16 (131.8)	6.0 (2.7)	6.8 (3.1)													
Size	Cat. No.				Part No.	Dimensions, inches (millimeters)		Weight, pounds (kilograms)																																						
		A	B	Net		Shipping																																								
7/8"	9-78-50	920241	4 (101.6)	2 1/4 (57.2)	.6 (.3)	.9 (.4)																																								
1 5/8"	9-158-50	920242	5 (127.)	3 1/2 (88.9)	2.0 (.9)	2.7 (1.2)																																								
3 1/8"	9-318-50	920243	6 (152.4)	5 3/16 (131.8)	6.0 (2.7)	6.8 (3.1)																																								
 <p>Adapter — EIA to LC Female 24—</p>	<p>Adapter — EIA to LC Female. Mates with UG154/U. Gas tight with 1/8" FPT pressure inlet and plug.</p> <table border="1"> <thead> <tr> <th rowspan="2">Size</th> <th rowspan="2">Cat. No.</th> <th rowspan="2">Part No.</th> <th colspan="2">Dimensions, inches (millimeters)</th> <th colspan="2">Weight, pounds (kilograms)</th> </tr> <tr> <th>A</th> <th>B</th> <th>Net</th> <th>Shipping</th> </tr> </thead> <tbody> <tr> <td>7/8"</td> <td>24-78-50</td> <td>920244</td> <td>3 3/4 (95.3)</td> <td>2 1/4 (57.2)</td> <td>1.2 (.5)</td> <td>1.4 (.6)</td> </tr> <tr> <td>1 5/8"</td> <td>24-158-50</td> <td>920245</td> <td>5 1/4 (133.4)</td> <td>3 1/2 (88.9)</td> <td>3.5 (1.6)</td> <td>4.2 (1.9)</td> </tr> <tr> <td>3 1/8"</td> <td>24-318-50</td> <td>920246</td> <td>5 7/16 (138.1)</td> <td>5 3/16 (131.8)</td> <td>6.3 (2.9)</td> <td>7.1 (3.2)</td> </tr> </tbody> </table>	Size	Cat. No.	Part No.	Dimensions, inches (millimeters)		Weight, pounds (kilograms)		A	B	Net	Shipping	7/8"	24-78-50	920244	3 3/4 (95.3)	2 1/4 (57.2)	1.2 (.5)	1.4 (.6)	1 5/8"	24-158-50	920245	5 1/4 (133.4)	3 1/2 (88.9)	3.5 (1.6)	4.2 (1.9)	3 1/8"	24-318-50	920246	5 7/16 (138.1)	5 3/16 (131.8)	6.3 (2.9)	7.1 (3.2)													
Size	Cat. No.				Part No.	Dimensions, inches (millimeters)		Weight, pounds (kilograms)																																						
		A	B	Net		Shipping																																								
7/8"	24-78-50	920244	3 3/4 (95.3)	2 1/4 (57.2)	1.2 (.5)	1.4 (.6)																																								
1 5/8"	24-158-50	920245	5 1/4 (133.4)	3 1/2 (88.9)	3.5 (1.6)	4.2 (1.9)																																								
3 1/8"	24-318-50	920246	5 7/16 (138.1)	5 3/16 (131.8)	6.3 (2.9)	7.1 (3.2)																																								

Transmission Line Components 50 ohm, Rigid **Antenna**

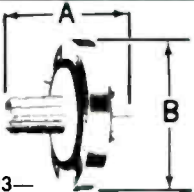
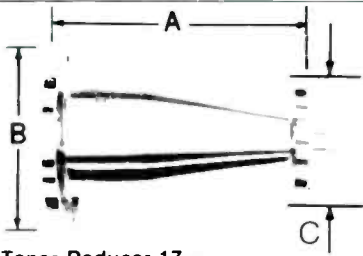
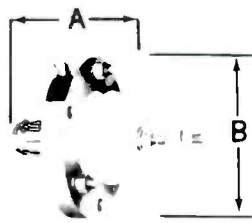
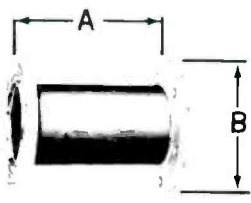
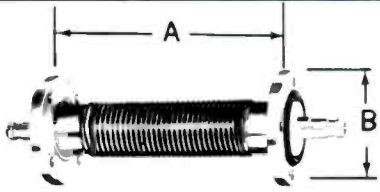
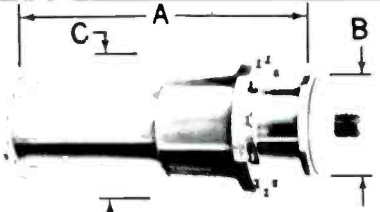

Typical antenna transmission line components are shown below. Data supplied through courtesy of Cablewave Systems.

Unless otherwise noted flanges are standard EIA swivel flanges, and the component includes an anchor inner connector, "O" ring gasket, and hardware set for one end only.

 <p>Plate Reducer 23—</p>	<p>Plate Reducer. Quick step type. Fixed male inner connectors on both ends. "O" rings and hardware included for both ends.</p> <table border="1"> <thead> <tr> <th rowspan="2">Size</th> <th rowspan="2">Cat. No.</th> <th rowspan="2">Part No.</th> <th colspan="2">Dimensions, inches (millimeters)</th> <th colspan="2">Weight, pounds (kilograms)</th> </tr> <tr> <th>A</th> <th>B</th> <th>Net</th> <th>Shipping</th> </tr> </thead> <tbody> <tr> <td>1$\frac{5}{8}$"—$\frac{7}{8}$"</td> <td>23-158-50</td> <td>920247</td> <td>$\frac{3}{4}$ (19.0)</td> <td>3$\frac{1}{2}$ (88.9)</td> <td>3.0 (1.36)</td> <td>3.6 (1.63)</td> </tr> <tr> <td>3$\frac{1}{8}$"—1$\frac{5}{8}$"</td> <td>23-318-50</td> <td>920248</td> <td>$\frac{7}{8}$ (22.2)</td> <td>5$\frac{3}{16}$ (131.8)</td> <td>5.0 (2.27)</td> <td>5.8 (2.63)</td> </tr> </tbody> </table>	Size	Cat. No.	Part No.	Dimensions, inches (millimeters)		Weight, pounds (kilograms)		A	B	Net	Shipping	1 $\frac{5}{8}$ "— $\frac{7}{8}$ "	23-158-50	920247	$\frac{3}{4}$ (19.0)	3 $\frac{1}{2}$ (88.9)	3.0 (1.36)	3.6 (1.63)	3 $\frac{1}{8}$ "—1 $\frac{5}{8}$ "	23-318-50	920248	$\frac{7}{8}$ (22.2)	5 $\frac{3}{16}$ (131.8)	5.0 (2.27)	5.8 (2.63)														
Size	Cat. No.				Part No.	Dimensions, inches (millimeters)		Weight, pounds (kilograms)																																
		A	B	Net		Shipping																																		
1 $\frac{5}{8}$ "— $\frac{7}{8}$ "	23-158-50	920247	$\frac{3}{4}$ (19.0)	3 $\frac{1}{2}$ (88.9)	3.0 (1.36)	3.6 (1.63)																																		
3 $\frac{1}{8}$ "—1 $\frac{5}{8}$ "	23-318-50	920248	$\frac{7}{8}$ (22.2)	5 $\frac{3}{16}$ (131.8)	5.0 (2.27)	5.8 (2.63)																																		
 <p>Taper Reducer 17—</p>	<p>Taper Reducer. Low VSWR (1.05 @ 1.0 GHz). Fixed EIA flanges both ends. Unsupported inner conductor. Removable anchor inner connector, "O" ring and hardware included for smaller size flange only.</p> <table border="1"> <thead> <tr> <th rowspan="2">Size</th> <th rowspan="2">Cat. No.</th> <th rowspan="2">Part No.</th> <th colspan="3">Dimensions, inches (millimeters)</th> <th colspan="2">Weight, pounds (kilograms)</th> </tr> <tr> <th>A</th> <th>B</th> <th>C</th> <th>Net</th> <th>Shipping</th> </tr> </thead> <tbody> <tr> <td>1$\frac{5}{8}$"—$\frac{7}{8}$"</td> <td>17-158-50</td> <td>920249</td> <td>4$\frac{27}{64}$ (112.3)</td> <td>3$\frac{1}{2}$ (88.9)</td> <td>2$\frac{1}{4}$ (57.2)</td> <td>1.75 (0.8)</td> <td>2.4 (1.1)</td> </tr> <tr> <td>3$\frac{1}{8}$"—1$\frac{5}{8}$"</td> <td>17-318-50</td> <td>920250</td> <td>7$\frac{3}{32}$ (180.0)</td> <td>5$\frac{3}{16}$ (131.8)</td> <td>3$\frac{1}{2}$ (88.9)</td> <td>4.1 (1.9)</td> <td>5.0 (2.3)</td> </tr> <tr> <td>6$\frac{1}{8}$"—3$\frac{1}{8}$"</td> <td>17-618-50</td> <td>920251</td> <td>8$\frac{1}{4}$ (209.5)</td> <td>8$\frac{1}{8}$ (206.4)</td> <td>5$\frac{3}{16}$ (131.8)</td> <td>11.5 (5.2)</td> <td>12.5 (5.7)</td> </tr> </tbody> </table>	Size	Cat. No.	Part No.	Dimensions, inches (millimeters)			Weight, pounds (kilograms)		A	B	C	Net	Shipping	1 $\frac{5}{8}$ "— $\frac{7}{8}$ "	17-158-50	920249	4 $\frac{27}{64}$ (112.3)	3 $\frac{1}{2}$ (88.9)	2 $\frac{1}{4}$ (57.2)	1.75 (0.8)	2.4 (1.1)	3 $\frac{1}{8}$ "—1 $\frac{5}{8}$ "	17-318-50	920250	7 $\frac{3}{32}$ (180.0)	5 $\frac{3}{16}$ (131.8)	3 $\frac{1}{2}$ (88.9)	4.1 (1.9)	5.0 (2.3)	6 $\frac{1}{8}$ "—3 $\frac{1}{8}$ "	17-618-50	920251	8 $\frac{1}{4}$ (209.5)	8 $\frac{1}{8}$ (206.4)	5 $\frac{3}{16}$ (131.8)	11.5 (5.2)	12.5 (5.7)		
Size	Cat. No.				Part No.	Dimensions, inches (millimeters)			Weight, pounds (kilograms)																															
		A	B	C		Net	Shipping																																	
1 $\frac{5}{8}$ "— $\frac{7}{8}$ "	17-158-50	920249	4 $\frac{27}{64}$ (112.3)	3 $\frac{1}{2}$ (88.9)	2 $\frac{1}{4}$ (57.2)	1.75 (0.8)	2.4 (1.1)																																	
3 $\frac{1}{8}$ "—1 $\frac{5}{8}$ "	17-318-50	920250	7 $\frac{3}{32}$ (180.0)	5 $\frac{3}{16}$ (131.8)	3 $\frac{1}{2}$ (88.9)	4.1 (1.9)	5.0 (2.3)																																	
6 $\frac{1}{8}$ "—3 $\frac{1}{8}$ "	17-618-50	920251	8 $\frac{1}{4}$ (209.5)	8 $\frac{1}{8}$ (206.4)	5 $\frac{3}{16}$ (131.8)	11.5 (5.2)	12.5 (5.7)																																	
 <p>End Terminal 20—</p>	<p>End Terminal. For strap connection to antenna. Pressure tight with $\frac{1}{8}$" FPT gas inlet and plug. Fixed EIA flange with male inner connector. "O" ring and hardware included.</p> <table border="1"> <thead> <tr> <th rowspan="2">Size</th> <th rowspan="2">Cat. No.</th> <th rowspan="2">Part No.</th> <th colspan="2">Dimensions, inches (millimeters)</th> <th colspan="2">Weight, pounds (kilograms)</th> </tr> <tr> <th>A</th> <th>B</th> <th>Net</th> <th>Shipping</th> </tr> </thead> <tbody> <tr> <td>$\frac{7}{8}$"</td> <td>20-78-50H</td> <td>920252</td> <td>4$\frac{1}{2}$ (114.3)</td> <td>2$\frac{1}{4}$ (57.2)</td> <td>1.0 (0.5)</td> <td>1.4 (0.6)</td> </tr> <tr> <td>1$\frac{5}{8}$"</td> <td>20-158-50H</td> <td>920253</td> <td>5 (127.0)</td> <td>3$\frac{1}{2}$ (88.9)</td> <td>2.6 (1.2)</td> <td>3.4 (1.5)</td> </tr> <tr> <td>3$\frac{1}{8}$"</td> <td>20-318-50H</td> <td>920254</td> <td>6$\frac{1}{2}$ (165.1)</td> <td>5$\frac{3}{16}$ (131.8)</td> <td>4.4 (2.0)</td> <td>5.4 (2.5)</td> </tr> <tr> <td>6$\frac{1}{8}$"</td> <td>20-618-50H</td> <td>920255</td> <td>8 (203.2)</td> <td>8$\frac{1}{8}$ (206.4)</td> <td>11.7 (5.3)</td> <td>12.8 (5.8)</td> </tr> </tbody> </table>	Size	Cat. No.	Part No.	Dimensions, inches (millimeters)		Weight, pounds (kilograms)		A	B	Net	Shipping	$\frac{7}{8}$ "	20-78-50H	920252	4 $\frac{1}{2}$ (114.3)	2 $\frac{1}{4}$ (57.2)	1.0 (0.5)	1.4 (0.6)	1 $\frac{5}{8}$ "	20-158-50H	920253	5 (127.0)	3 $\frac{1}{2}$ (88.9)	2.6 (1.2)	3.4 (1.5)	3 $\frac{1}{8}$ "	20-318-50H	920254	6 $\frac{1}{2}$ (165.1)	5 $\frac{3}{16}$ (131.8)	4.4 (2.0)	5.4 (2.5)	6 $\frac{1}{8}$ "	20-618-50H	920255	8 (203.2)	8 $\frac{1}{8}$ (206.4)	11.7 (5.3)	12.8 (5.8)
Size	Cat. No.				Part No.	Dimensions, inches (millimeters)		Weight, pounds (kilograms)																																
		A	B	Net		Shipping																																		
$\frac{7}{8}$ "	20-78-50H	920252	4 $\frac{1}{2}$ (114.3)	2 $\frac{1}{4}$ (57.2)	1.0 (0.5)	1.4 (0.6)																																		
1 $\frac{5}{8}$ "	20-158-50H	920253	5 (127.0)	3 $\frac{1}{2}$ (88.9)	2.6 (1.2)	3.4 (1.5)																																		
3 $\frac{1}{8}$ "	20-318-50H	920254	6 $\frac{1}{2}$ (165.1)	5 $\frac{3}{16}$ (131.8)	4.4 (2.0)	5.4 (2.5)																																		
6 $\frac{1}{8}$ "	20-618-50H	920255	8 (203.2)	8 $\frac{1}{8}$ (206.4)	11.7 (5.3)	12.8 (5.8)																																		
 <p>Adapter — Male to Male 21—</p>	<p>Adapter — Male to Male. Unsupported inner conductor. Fixed EIA flanges. One "O" ring and hardware set included. No anchor inner connector included.</p> <table border="1"> <thead> <tr> <th rowspan="2">Size</th> <th rowspan="2">Cat. No.</th> <th rowspan="2">Part No.</th> <th colspan="2">Dimensions, inches (millimeters)</th> <th colspan="2">Weight, pounds (kilograms)</th> </tr> <tr> <th>A</th> <th>B</th> <th>Net</th> <th>Shipping</th> </tr> </thead> <tbody> <tr> <td>$\frac{7}{8}$"</td> <td>21-78-50</td> <td>920256</td> <td>4 (101.6)</td> <td>2$\frac{1}{4}$ (57.2)</td> <td>1.0 (0.5)</td> <td>1.5 (0.7)</td> </tr> <tr> <td>1$\frac{5}{8}$"</td> <td>21-158-50</td> <td>920257</td> <td>4 (101.6)</td> <td>3$\frac{1}{2}$ (88.9)</td> <td>2.4 (1.1)</td> <td>3.2 (1.5)</td> </tr> <tr> <td>3$\frac{1}{8}$"</td> <td>21-318-50</td> <td>920258</td> <td>6 (152.4)</td> <td>5$\frac{3}{16}$ (131.8)</td> <td>6.0 (2.7)</td> <td>7.0 (3.2)</td> </tr> <tr> <td>6$\frac{1}{8}$"</td> <td>21-618-50</td> <td>920259</td> <td>6 (152.4)</td> <td>8$\frac{1}{8}$ (206.4)</td> <td>18.0 (8.2)</td> <td>23.0 (10.4)</td> </tr> </tbody> </table>	Size	Cat. No.	Part No.	Dimensions, inches (millimeters)		Weight, pounds (kilograms)		A	B	Net	Shipping	$\frac{7}{8}$ "	21-78-50	920256	4 (101.6)	2 $\frac{1}{4}$ (57.2)	1.0 (0.5)	1.5 (0.7)	1 $\frac{5}{8}$ "	21-158-50	920257	4 (101.6)	3 $\frac{1}{2}$ (88.9)	2.4 (1.1)	3.2 (1.5)	3 $\frac{1}{8}$ "	21-318-50	920258	6 (152.4)	5 $\frac{3}{16}$ (131.8)	6.0 (2.7)	7.0 (3.2)	6 $\frac{1}{8}$ "	21-618-50	920259	6 (152.4)	8 $\frac{1}{8}$ (206.4)	18.0 (8.2)	23.0 (10.4)
Size	Cat. No.				Part No.	Dimensions, inches (millimeters)		Weight, pounds (kilograms)																																
		A	B	Net		Shipping																																		
$\frac{7}{8}$ "	21-78-50	920256	4 (101.6)	2 $\frac{1}{4}$ (57.2)	1.0 (0.5)	1.5 (0.7)																																		
1 $\frac{5}{8}$ "	21-158-50	920257	4 (101.6)	3 $\frac{1}{2}$ (88.9)	2.4 (1.1)	3.2 (1.5)																																		
3 $\frac{1}{8}$ "	21-318-50	920258	6 (152.4)	5 $\frac{3}{16}$ (131.8)	6.0 (2.7)	7.0 (3.2)																																		
6 $\frac{1}{8}$ "	21-618-50	920259	6 (152.4)	8 $\frac{1}{8}$ (206.4)	18.0 (8.2)	23.0 (10.4)																																		
 <p>Flexible Section 30—</p>	<p>Flexible Section accommodates vibration and angles up to 30° for 1$\frac{5}{8}$" and 20° for 6$\frac{1}{8}$". Maximum offset or compression is .25" (0.64 cm) for 1$\frac{5}{8}$" and .5" (1.27 cm) for the 3$\frac{1}{8}$" and 6$\frac{1}{8}$" units. EIA fixed male flanges both ends. Two sets of "O" rings and hardware supplied.</p> <table border="1"> <thead> <tr> <th rowspan="2">Size</th> <th rowspan="2">Cat. No.</th> <th rowspan="2">Part No.</th> <th colspan="2">Dimensions, inches (millimeters)</th> <th colspan="2">Weight, pounds (kilograms)</th> </tr> <tr> <th>A</th> <th>B</th> <th>Net</th> <th>Shipping</th> </tr> </thead> <tbody> <tr> <td>1$\frac{5}{8}$"</td> <td>30-158-50</td> <td>920260</td> <td>10 (254.0)</td> <td>3$\frac{1}{2}$ (88.9)</td> <td>4.2 (1.9)</td> <td>4.7 (2.1)</td> </tr> <tr> <td>3$\frac{1}{8}$"</td> <td>30-318-50</td> <td>920261</td> <td>18 (457.2)</td> <td>5$\frac{3}{16}$ (131.8)</td> <td>15.0 (6.8)</td> <td>16.9 (7.7)</td> </tr> <tr> <td>6$\frac{1}{8}$"</td> <td>30-618-50</td> <td>920262</td> <td>24 (609.6)</td> <td>8$\frac{1}{8}$ (206.4)</td> <td>31.0 (14.1)</td> <td>36.0 (16.3)</td> </tr> </tbody> </table>	Size	Cat. No.	Part No.	Dimensions, inches (millimeters)		Weight, pounds (kilograms)		A	B	Net	Shipping	1 $\frac{5}{8}$ "	30-158-50	920260	10 (254.0)	3 $\frac{1}{2}$ (88.9)	4.2 (1.9)	4.7 (2.1)	3 $\frac{1}{8}$ "	30-318-50	920261	18 (457.2)	5 $\frac{3}{16}$ (131.8)	15.0 (6.8)	16.9 (7.7)	6 $\frac{1}{8}$ "	30-618-50	920262	24 (609.6)	8 $\frac{1}{8}$ (206.4)	31.0 (14.1)	36.0 (16.3)							
Size	Cat. No.				Part No.	Dimensions, inches (millimeters)		Weight, pounds (kilograms)																																
		A	B	Net		Shipping																																		
1 $\frac{5}{8}$ "	30-158-50	920260	10 (254.0)	3 $\frac{1}{2}$ (88.9)	4.2 (1.9)	4.7 (2.1)																																		
3 $\frac{1}{8}$ "	30-318-50	920261	18 (457.2)	5 $\frac{3}{16}$ (131.8)	15.0 (6.8)	16.9 (7.7)																																		
6 $\frac{1}{8}$ "	30-618-50	920262	24 (609.6)	8 $\frac{1}{8}$ (206.4)	31.0 (14.1)	36.0 (16.3)																																		
 <p>Breakaway Section 31—</p>	<p>Breakaway Section. Permits easy opening and disassembly of transmission line. Pressure tight when closed. EIA fixed flange on one end. EIA male anchor inner connector on one end.</p> <table border="1"> <thead> <tr> <th rowspan="2">Size</th> <th rowspan="2">Cat. No.</th> <th rowspan="2">Part No.</th> <th colspan="3">Dimensions, inches (millimeters)</th> <th colspan="2">Weight, pounds (kilograms)</th> </tr> <tr> <th>A</th> <th>B</th> <th>C</th> <th>Net</th> <th>Shipping</th> </tr> </thead> <tbody> <tr> <td>1$\frac{5}{8}$"</td> <td>31-158-50</td> <td>920263</td> <td>12 (304.8)</td> <td>3$\frac{1}{2}$ (88.9)</td> <td>4$\frac{1}{4}$ (108.0)</td> <td>14.0 (6.35)</td> <td>18.0 (8.16)</td> </tr> <tr> <td>3$\frac{1}{8}$"</td> <td>31-318-50</td> <td>920264</td> <td>14$\frac{13}{16}$ (376.2)</td> <td>5$\frac{3}{16}$ (131.8)</td> <td>7 (177.8)</td> <td>21.0 (9.53)</td> <td>34.0 (15.42)</td> </tr> <tr> <td>6$\frac{1}{8}$"</td> <td>31-618-50</td> <td>920265</td> <td>24 (609.6)</td> <td>8$\frac{1}{8}$ (206.4)</td> <td>10$\frac{1}{4}$ (260.4)</td> <td>47.0 (21.32)</td> <td>59.0 (26.8)</td> </tr> </tbody> </table>	Size	Cat. No.	Part No.	Dimensions, inches (millimeters)			Weight, pounds (kilograms)		A	B	C	Net	Shipping	1 $\frac{5}{8}$ "	31-158-50	920263	12 (304.8)	3 $\frac{1}{2}$ (88.9)	4 $\frac{1}{4}$ (108.0)	14.0 (6.35)	18.0 (8.16)	3 $\frac{1}{8}$ "	31-318-50	920264	14 $\frac{13}{16}$ (376.2)	5 $\frac{3}{16}$ (131.8)	7 (177.8)	21.0 (9.53)	34.0 (15.42)	6 $\frac{1}{8}$ "	31-618-50	920265	24 (609.6)	8 $\frac{1}{8}$ (206.4)	10 $\frac{1}{4}$ (260.4)	47.0 (21.32)	59.0 (26.8)		
Size	Cat. No.				Part No.	Dimensions, inches (millimeters)			Weight, pounds (kilograms)																															
		A	B	C		Net	Shipping																																	
1 $\frac{5}{8}$ "	31-158-50	920263	12 (304.8)	3 $\frac{1}{2}$ (88.9)	4 $\frac{1}{4}$ (108.0)	14.0 (6.35)	18.0 (8.16)																																	
3 $\frac{1}{8}$ "	31-318-50	920264	14 $\frac{13}{16}$ (376.2)	5 $\frac{3}{16}$ (131.8)	7 (177.8)	21.0 (9.53)	34.0 (15.42)																																	
6 $\frac{1}{8}$ "	31-618-50	920265	24 (609.6)	8 $\frac{1}{8}$ (206.4)	10 $\frac{1}{4}$ (260.4)	47.0 (21.32)	59.0 (26.8)																																	

Antenna Transmission Line Components 50 ohm, Rigid

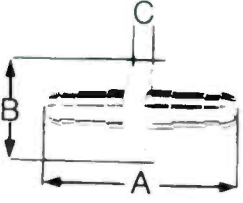
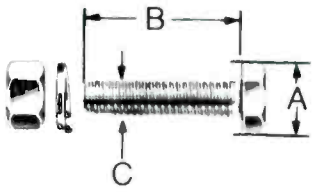
Typical antenna transmission line components are shown below. Data supplied through courtesy of Cablewave Systems.

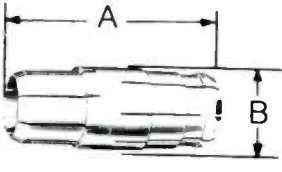
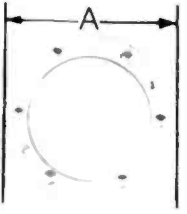
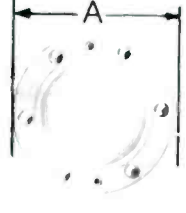
 <p>Anchor Inner Connector 12—</p>	<p>Anchor Inner Connector. With Teflon insulator. Standard type 12— is silver plated. Inner connectors type 12A— include a dry baked molybdenum di-sulfide lubricant coating to prevent galling and electrical deterioration with repeated thermal expansion and contraction of the inner conductor.</p> <table border="1"> <thead> <tr> <th rowspan="2">Size</th> <th rowspan="2">Cat. No.</th> <th rowspan="2">Part No.</th> <th colspan="3">Dimensions, inches (millimeters)</th> <th colspan="2">Weight, pounds (kilograms)</th> </tr> <tr> <th>A</th> <th>B</th> <th>C</th> <th>Net</th> <th>Shipping</th> </tr> </thead> <tbody> <tr> <td>7/8"</td> <td>12-78-50</td> <td>612951</td> <td>2¹¹/₁₆ (68.3)</td> <td>0.810 (20.6)</td> <td>3¹/₁₆ (4.8)</td> <td>0.1 (.05)</td> <td>0.1 (.05)</td> </tr> <tr> <td>1 5/8"</td> <td>12-158-50</td> <td>612874</td> <td>3 3/4 (82.6)</td> <td>1.645 (41.9)</td> <td>1/4 (6.4)</td> <td>0.2 (.09)</td> <td>0.2 (.09)</td> </tr> <tr> <td rowspan="2">3 1/8"</td> <td>12-318-50</td> <td>622720</td> <td rowspan="2">4 1/4 (108.)</td> <td rowspan="2">3.195 (81.2)</td> <td rowspan="2">3/8 (9.5)</td> <td rowspan="2">0.8 (.4)</td> <td rowspan="2">1.0 (.45)</td> </tr> <tr> <td>12A-318-50</td> <td>920269</td> </tr> <tr> <td rowspan="2">6 1/8"</td> <td>12-618-50</td> <td>920270</td> <td rowspan="2">5 1/2 (139.7)</td> <td rowspan="2">6.055 (153.8)</td> <td rowspan="2">7/16 (11.1)</td> <td rowspan="2">2.9 (1.3)</td> <td rowspan="2">3.5 (1.6)</td> </tr> <tr> <td>12A-618-50</td> <td>920271</td> </tr> </tbody> </table>	Size	Cat. No.	Part No.	Dimensions, inches (millimeters)			Weight, pounds (kilograms)		A	B	C	Net	Shipping	7/8"	12-78-50	612951	2 ¹¹ / ₁₆ (68.3)	0.810 (20.6)	3 ¹ / ₁₆ (4.8)	0.1 (.05)	0.1 (.05)	1 5/8"	12-158-50	612874	3 3/4 (82.6)	1.645 (41.9)	1/4 (6.4)	0.2 (.09)	0.2 (.09)	3 1/8"	12-318-50	622720	4 1/4 (108.)	3.195 (81.2)	3/8 (9.5)	0.8 (.4)	1.0 (.45)	12A-318-50	920269	6 1/8"	12-618-50	920270	5 1/2 (139.7)	6.055 (153.8)	7/16 (11.1)	2.9 (1.3)	3.5 (1.6)	12A-618-50	920271
Size	Cat. No.				Part No.	Dimensions, inches (millimeters)			Weight, pounds (kilograms)																																									
		A	B	C		Net	Shipping																																											
7/8"	12-78-50	612951	2 ¹¹ / ₁₆ (68.3)	0.810 (20.6)	3 ¹ / ₁₆ (4.8)	0.1 (.05)	0.1 (.05)																																											
1 5/8"	12-158-50	612874	3 3/4 (82.6)	1.645 (41.9)	1/4 (6.4)	0.2 (.09)	0.2 (.09)																																											
3 1/8"	12-318-50	622720	4 1/4 (108.)	3.195 (81.2)	3/8 (9.5)	0.8 (.4)	1.0 (.45)																																											
	12A-318-50	920269																																																
6 1/8"	12-618-50	920270	5 1/2 (139.7)	6.055 (153.8)	7/16 (11.1)	2.9 (1.3)	3.5 (1.6)																																											
	12A-618-50	920271																																																
 <p>Hardware Set 26—</p>	<p>Hardware Set Stainless steel.</p> <table border="1"> <thead> <tr> <th rowspan="2">Size</th> <th rowspan="2">Cat. No.</th> <th rowspan="2">Part No.</th> <th rowspan="2">Qty Per Set</th> <th colspan="3">Dimensions, inches (millimeters)</th> </tr> <tr> <th>A</th> <th>B</th> <th>C (Thread)</th> </tr> </thead> <tbody> <tr> <td>7/8"</td> <td>26-78</td> <td>920272</td> <td>3</td> <td>7/16 (11.1)</td> <td>1 (25.4)</td> <td>1/4-20 UNC</td> </tr> <tr> <td>1 5/8"</td> <td>26-158</td> <td>920273</td> <td>4</td> <td>1/2 (12.7)</td> <td>1 3/8 (34.9)</td> <td>5/16-18 UNC</td> </tr> <tr> <td>3 1/8"</td> <td>26-318</td> <td>920274</td> <td>6</td> <td>9/16 (14.3)</td> <td>1 3/8 (34.9)</td> <td>3/8-16 UNC</td> </tr> <tr> <td>6 1/8"</td> <td>26-618</td> <td>920275</td> <td>12</td> <td>9/16 (14.3)</td> <td>1 3/4 (44.5)</td> <td>3/8-16 UNC</td> </tr> </tbody> </table>	Size	Cat. No.	Part No.	Qty Per Set	Dimensions, inches (millimeters)			A	B	C (Thread)	7/8"	26-78	920272	3	7/16 (11.1)	1 (25.4)	1/4-20 UNC	1 5/8"	26-158	920273	4	1/2 (12.7)	1 3/8 (34.9)	5/16-18 UNC	3 1/8"	26-318	920274	6	9/16 (14.3)	1 3/8 (34.9)	3/8-16 UNC	6 1/8"	26-618	920275	12	9/16 (14.3)	1 3/4 (44.5)	3/8-16 UNC											
Size	Cat. No.					Part No.	Qty Per Set	Dimensions, inches (millimeters)																																										
		A	B	C (Thread)																																														
7/8"	26-78	920272	3	7/16 (11.1)	1 (25.4)	1/4-20 UNC																																												
1 5/8"	26-158	920273	4	1/2 (12.7)	1 3/8 (34.9)	5/16-18 UNC																																												
3 1/8"	26-318	920274	6	9/16 (14.3)	1 3/8 (34.9)	3/8-16 UNC																																												
6 1/8"	26-618	920275	12	9/16 (14.3)	1 3/4 (44.5)	3/8-16 UNC																																												
 <p>"O" Ring Gasket 14—</p>	<p>"O" Ring Gasket for EIA flange. Silicone rubber.</p> <table border="1"> <thead> <tr> <th>Size</th> <th>Cat. No.</th> <th>Part No.</th> <th>Size</th> <th>Cat. No.</th> <th>Part No.</th> </tr> </thead> <tbody> <tr> <td>7/8"</td> <td>14-78</td> <td>510681-010</td> <td>3 1/8"</td> <td>14-318</td> <td>510681-012</td> </tr> <tr> <td>1 5/8"</td> <td>14-158</td> <td>510681-011</td> <td>6 1/8"</td> <td>14-618</td> <td>920279</td> </tr> </tbody> </table>	Size	Cat. No.	Part No.	Size	Cat. No.	Part No.	7/8"	14-78	510681-010	3 1/8"	14-318	510681-012	1 5/8"	14-158	510681-011	6 1/8"	14-618	920279																															
Size	Cat. No.	Part No.	Size	Cat. No.	Part No.																																													
7/8"	14-78	510681-010	3 1/8"	14-318	510681-012																																													
1 5/8"	14-158	510681-011	6 1/8"	14-618	920279																																													
 <p>Inner Connector Adaptor 32—</p>	<p>Inner Connector Adaptor to connect 50 ohm EIA flanged line to 51.5 ohm flanged line. No anchor beads.</p> <table border="1"> <thead> <tr> <th rowspan="2">Size</th> <th rowspan="2">Cat. No.</th> <th rowspan="2">Part No.</th> <th colspan="2">Dimensions, inches (millimeters)</th> <th colspan="2">Weight, pounds (kilograms)</th> </tr> <tr> <th>A</th> <th>B</th> <th>Net</th> <th>Shipping</th> </tr> </thead> <tbody> <tr> <td>7/8"</td> <td>32-78-50</td> <td>920280</td> <td>2⁵/₁₆ (58.7)</td> <td>.341 (8.7)</td> <td>0.1 (.05)</td> <td>0.1 (.05)</td> </tr> <tr> <td>1 5/8"</td> <td>32-158-50</td> <td>920281</td> <td>2 3/4 (69.9)</td> <td>.664 (16.9)</td> <td>0.2 (.09)</td> <td>0.2 (.09)</td> </tr> <tr> <td>3 1/8"</td> <td>32-318-50</td> <td>920282</td> <td>3 3/8 (85.7)</td> <td>1.315 (33.4)</td> <td>0.8 (.4)</td> <td>1.0 (.45)</td> </tr> <tr> <td>6 1/8"</td> <td>32-618-50</td> <td>920597</td> <td>3 5/8 (92.1)</td> <td>2.600 (66.5)</td> <td>2.9 (1.3)</td> <td>3.5 (1.6)</td> </tr> </tbody> </table>	Size	Cat. No.	Part No.	Dimensions, inches (millimeters)		Weight, pounds (kilograms)		A	B	Net	Shipping	7/8"	32-78-50	920280	2 ⁵ / ₁₆ (58.7)	.341 (8.7)	0.1 (.05)	0.1 (.05)	1 5/8"	32-158-50	920281	2 3/4 (69.9)	.664 (16.9)	0.2 (.09)	0.2 (.09)	3 1/8"	32-318-50	920282	3 3/8 (85.7)	1.315 (33.4)	0.8 (.4)	1.0 (.45)	6 1/8"	32-618-50	920597	3 5/8 (92.1)	2.600 (66.5)	2.9 (1.3)	3.5 (1.6)										
Size	Cat. No.				Part No.	Dimensions, inches (millimeters)		Weight, pounds (kilograms)																																										
		A	B	Net		Shipping																																												
7/8"	32-78-50	920280	2 ⁵ / ₁₆ (58.7)	.341 (8.7)	0.1 (.05)	0.1 (.05)																																												
1 5/8"	32-158-50	920281	2 3/4 (69.9)	.664 (16.9)	0.2 (.09)	0.2 (.09)																																												
3 1/8"	32-318-50	920282	3 3/8 (85.7)	1.315 (33.4)	0.8 (.4)	1.0 (.45)																																												
6 1/8"	32-618-50	920597	3 5/8 (92.1)	2.600 (66.5)	2.9 (1.3)	3.5 (1.6)																																												
 <p>Swivel Flange 18—</p>	<p>Swivel Flange kit for silver brazing of an EIA swivel flange to outer conductor tubing. Includes silver solder preform ring.</p> <table border="1"> <thead> <tr> <th rowspan="2">Size</th> <th rowspan="2">Cat. No.</th> <th rowspan="2">Part No.</th> <th colspan="2">Dimensions, inches (millimeters)</th> <th colspan="2">Weight, pounds (kilograms)</th> </tr> <tr> <th>A</th> <th>Net</th> <th>Shipping</th> </tr> </thead> <tbody> <tr> <td>7/8"</td> <td>18-78-50</td> <td>920283</td> <td>2 1/4 (57.1)</td> <td>.5 (.2)</td> <td>1 (.4)</td> </tr> <tr> <td>1 5/8"</td> <td>18-158-50</td> <td>920284</td> <td>3 1/2 (88.9)</td> <td>.8 (.3)</td> <td>1.3 (.6)</td> </tr> <tr> <td>3 1/8"</td> <td>18-318-50</td> <td>920285</td> <td>5³/₁₆ (131.7)</td> <td>1.6 (.7)</td> <td>2.0 (.9)</td> </tr> <tr> <td>6 1/8"</td> <td>18-618-50</td> <td>920286</td> <td>8 1/8 (206.4)</td> <td>5.3 (2.4)</td> <td>6 (2.7)</td> </tr> </tbody> </table>	Size	Cat. No.	Part No.	Dimensions, inches (millimeters)		Weight, pounds (kilograms)		A	Net	Shipping	7/8"	18-78-50	920283	2 1/4 (57.1)	.5 (.2)	1 (.4)	1 5/8"	18-158-50	920284	3 1/2 (88.9)	.8 (.3)	1.3 (.6)	3 1/8"	18-318-50	920285	5 ³ / ₁₆ (131.7)	1.6 (.7)	2.0 (.9)	6 1/8"	18-618-50	920286	8 1/8 (206.4)	5.3 (2.4)	6 (2.7)															
Size	Cat. No.				Part No.	Dimensions, inches (millimeters)		Weight, pounds (kilograms)																																										
		A	Net	Shipping																																														
7/8"	18-78-50	920283	2 1/4 (57.1)	.5 (.2)	1 (.4)																																													
1 5/8"	18-158-50	920284	3 1/2 (88.9)	.8 (.3)	1.3 (.6)																																													
3 1/8"	18-318-50	920285	5 ³ / ₁₆ (131.7)	1.6 (.7)	2.0 (.9)																																													
6 1/8"	18-618-50	920286	8 1/8 (206.4)	5.3 (2.4)	6 (2.7)																																													
 <p>Fixed Flange 13—</p>	<p>Fixed Flange kit for silver brazing of EIA fixed flange to outer conductor tubing. Includes silver solder preform ring.</p> <table border="1"> <thead> <tr> <th rowspan="2">Size</th> <th rowspan="2">Cat. No.</th> <th rowspan="2">Part No.</th> <th colspan="2">Dimensions, inches (millimeters)</th> <th colspan="2">Weight, pounds (kilograms)</th> </tr> <tr> <th>A</th> <th>Net</th> <th>Shipping</th> </tr> </thead> <tbody> <tr> <td>7/8"</td> <td>13-78</td> <td>920287</td> <td>2 1/4 (57.1)</td> <td>.5 (.09)</td> <td>1 (.4)</td> </tr> <tr> <td>1 5/8"</td> <td>13-158</td> <td>920288</td> <td>3 1/2 (88.9)</td> <td>.8 (.4)</td> <td>1.3 (.6)</td> </tr> <tr> <td>3 1/8"</td> <td>13-318</td> <td>920289</td> <td>5³/₁₆ (131.7)</td> <td>1.6 (.7)</td> <td>2.0 (.9)</td> </tr> <tr> <td>6 1/8"</td> <td>13-618</td> <td>920290</td> <td>8 1/8 (206.4)</td> <td>5.3 (2.4)</td> <td>6 (2.7)</td> </tr> </tbody> </table>	Size	Cat. No.	Part No.	Dimensions, inches (millimeters)		Weight, pounds (kilograms)		A	Net	Shipping	7/8"	13-78	920287	2 1/4 (57.1)	.5 (.09)	1 (.4)	1 5/8"	13-158	920288	3 1/2 (88.9)	.8 (.4)	1.3 (.6)	3 1/8"	13-318	920289	5 ³ / ₁₆ (131.7)	1.6 (.7)	2.0 (.9)	6 1/8"	13-618	920290	8 1/8 (206.4)	5.3 (2.4)	6 (2.7)															
Size	Cat. No.				Part No.	Dimensions, inches (millimeters)		Weight, pounds (kilograms)																																										
		A	Net	Shipping																																														
7/8"	13-78	920287	2 1/4 (57.1)	.5 (.09)	1 (.4)																																													
1 5/8"	13-158	920288	3 1/2 (88.9)	.8 (.4)	1.3 (.6)																																													
3 1/8"	13-318	920289	5 ³ / ₁₆ (131.7)	1.6 (.7)	2.0 (.9)																																													
6 1/8"	13-618	920290	8 1/8 (206.4)	5.3 (2.4)	6 (2.7)																																													

Transmission Line Components 50 ohm, Rigid **Antenna**

Typical antenna transmission line components are shown below. Data supplied through courtesy of Cablewave Systems.

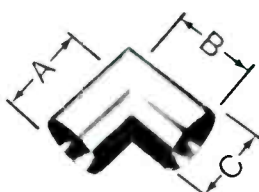
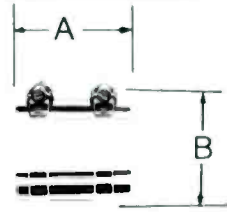
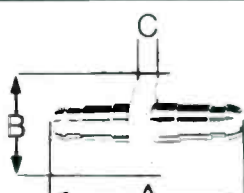
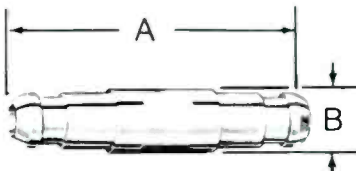
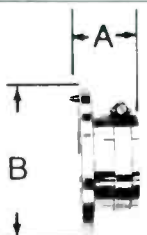
 <p>Unflanged 90° miter elbow 25—</p>	Unflanged 90° Elbow. Unflanged elbow. No straight coupling or inner connector included. 7/8" sizes have supported inner conductor. 1 5/8" 3 1/8" and 6 1/8" sizes have nonsupported inner conductor.							
	Size	Cat. No.	Part No.	Dimensions, inches (millimeters)			Weight, pounds (kilograms)	
				A	B	C	Net	Shipping
	7/8"	25-78-50	920291	2 ¹¹ / ₁₆ (68)	2 ¹¹ / ₁₆ (68)	.875 (22.2)	1.2 (.5)	1.6 (.7)
	1 5/8"	25-158-50	920292	2 ³ / ₈ (60)	2 ³ / ₈ (60)	1.625 (41.3)	3.2 (1.5)	3.6 (1.6)
3 1/8"	25-318-50	920293	3 ⁵ / ₈ (92)	3 ⁵ / ₈ (92)	3.125 (79.4)	7.9 (3.6)	8.9 (4.0)	
6 1/8"	25-618-50	920294	5 ⁹ / ₃₂ (134)	5 ⁹ / ₃₂ (134)	6.125 (155.6)	21.0 (9.5)	25.0 (11.3)	
 <p>Unflanged line straight coupling 16—</p>	Unflanged Line Straight Coupling. Connects unflanged lines and fittings. Includes one inner connector and hose clamps.							
	Size	Cat. No.	Part No.	Dimensions, inches (millimeters)			Weight, pounds (kilograms)	
				A	B		Net	Shipping
	7/8"	16-78-50	920295	2 ¹ / ₈ (54.0)	1 ¹ / ₈ (31.8)		0.3 (.1)	0.4 (.2)
	1 5/8"	16-158-50	920296	2 ¹ / ₄ (57.2)	2 ¹ / ₄ (57.2)		0.5 (.2)	0.6 (.3)
3 1/8"	16-318-50	920297	3 ¹ / ₄ (82.6)	3 ¹ / ₂ (88.9)		1.5 (.7)	3.3 (1.5)	
6 1/8"	16-618-50	920298	5 ¹ / ₂ (139.7)	6 ³ / ₄ (171.5)		5.4 (2.5)	6.5 (3.0)	
 <p>Anchor Inner Connector 12S—</p>	Anchor Inner Connector for unflanged 50 ohm line. Teflon insulator, silver plated. Use with coupling 16-158-50 (P/N 920296) and 16-318-50 (P/N 920297)							
	Size	Part No.	Dimensions, inches (millimeters)			Weight, pounds (kilograms)		
			A	B	C	Net	Shipping	
1 5/8"	613946	3 ¹ / ₄ (82.6)	1.625 (41.3)	.250 (6.4)	0.2 (.09)	0.2 (.09)		
3 1/8"	624054	4.238 (107.7)	3.125 (79.4)	.373 (9.5)	0.8 (.4)	1.0 (.45)		
 <p>Inner connector 27—</p>	Inner Connector for unflanged unpressurized line. Silver plated, no undercut.							
	Size	Cat. No.	Part No.	Dimensions, inches (millimeters)			Weight, pounds (kilograms)	
				A	B		Net	Shipping
	7/8"	27-78-50	522781	2 ¹¹ / ₁₆ (68.3)	0.341 (8.7)		0.1 (.05)	0.1 (.05)
	1 5/8"	27-158-50	525641	3 ¹ / ₄ (82.6)	0.664 (16.9)		0.2 (.09)	0.2 (.09)
3 1/8"	27-318-50	534518	4 ¹ / ₄ (108)	1.315 (33.4)		0.7 (.3)	0.9 (.4)	
6 1/8"	27-618-50	920302	5 ¹ / ₂ (139.7)	2.6 (66)		2.7 (1.2)	3.3 (1.5)	
 <p>Unpressurized EIA field flange 11—</p>	Unpressurized EIA field flange does not include anchor inner connector, hardware or O ring. Not gas tight.							
	Size	Cat. No.	Part No.	Dimensions, inches (millimeters)			Weight, pounds (kilograms)	
				A	B		Net	Shipping
	7/8"	11-78	920303	1 (25.4)	2 ¹ / ₄ (57.2)		7 (3)	1.2 (.5)
	1 5/8"	11-158	920304	1 ¹ / ₄ (31.8)	3 ¹ / ₂ (88.9)		1.2 (.5)	1.7 (.8)
3 1/8"	11-318	920305	1 ¹¹ / ₁₆ (42.9)	5 ³ / ₁₆ (131.8)		2.5 (1.1)	3.0 (1.4)	
6 1/8"	11-618	920306	3 (76.2)	8 ¹ / ₈ (206.4)		6.5 (3.0)	7.0 (3.2)	

Antenna Typical Transmission Line Installation

Typical antenna transmission line components are shown below. Data supplied through courtesy of Cablewave Systems.

VSWR Derating Factor K,
Versus Frequency

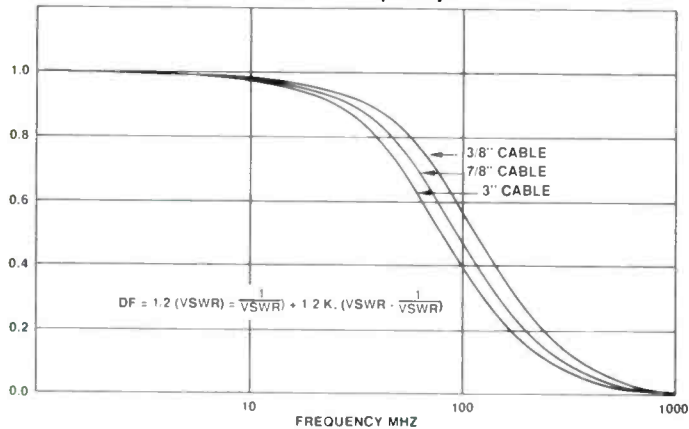

RECOMMENDED HANGER SPACINGS
FOR COAXIAL CABLE

Rated Max. Wind Speed mph (km/h)	Radial Ice inches (mm)	1 5/8 to 3 feet (m)	7/8 feet (m)	3/8 to 1/2 feet (m)
90 (145)		6 (1.8)	4 (120)	3 (90)
110 (180)	no	5 (1.5)	4 (120)	3 (90)
130 (210)	ice	5 (1.5)	3 (90)	3 (60)
180 (290)		4 (1.2)	3 (90)	2 (60)
90 (145)	1/2 (12)	6 (1.8)	4 (120)	3 (90)
110 (180)		5 (1.5)	3 (90)	2 (60)
130 (210)		4 (1.2)	3 (90)	2 (60)
90 (145)	1 (25)	4 (1.2)	3 (90)	2 1/2 (75)
110 (180)		4 (1.2)	3 (90)	2 (60)
130 (210)		3 (0.9)	2 (60)	1 1/2 (45)
90 (145)	2 (50)	4 (1.2)	3 (90)	2 (60)
110 (180)		3 (0.9)	2 1/2 (75)	1 1/2 (45)
130 (210)		3 (0.9)	2 (60)	1 1/2 (60)

Peak Power Rating Improvement
Due To Pressurization

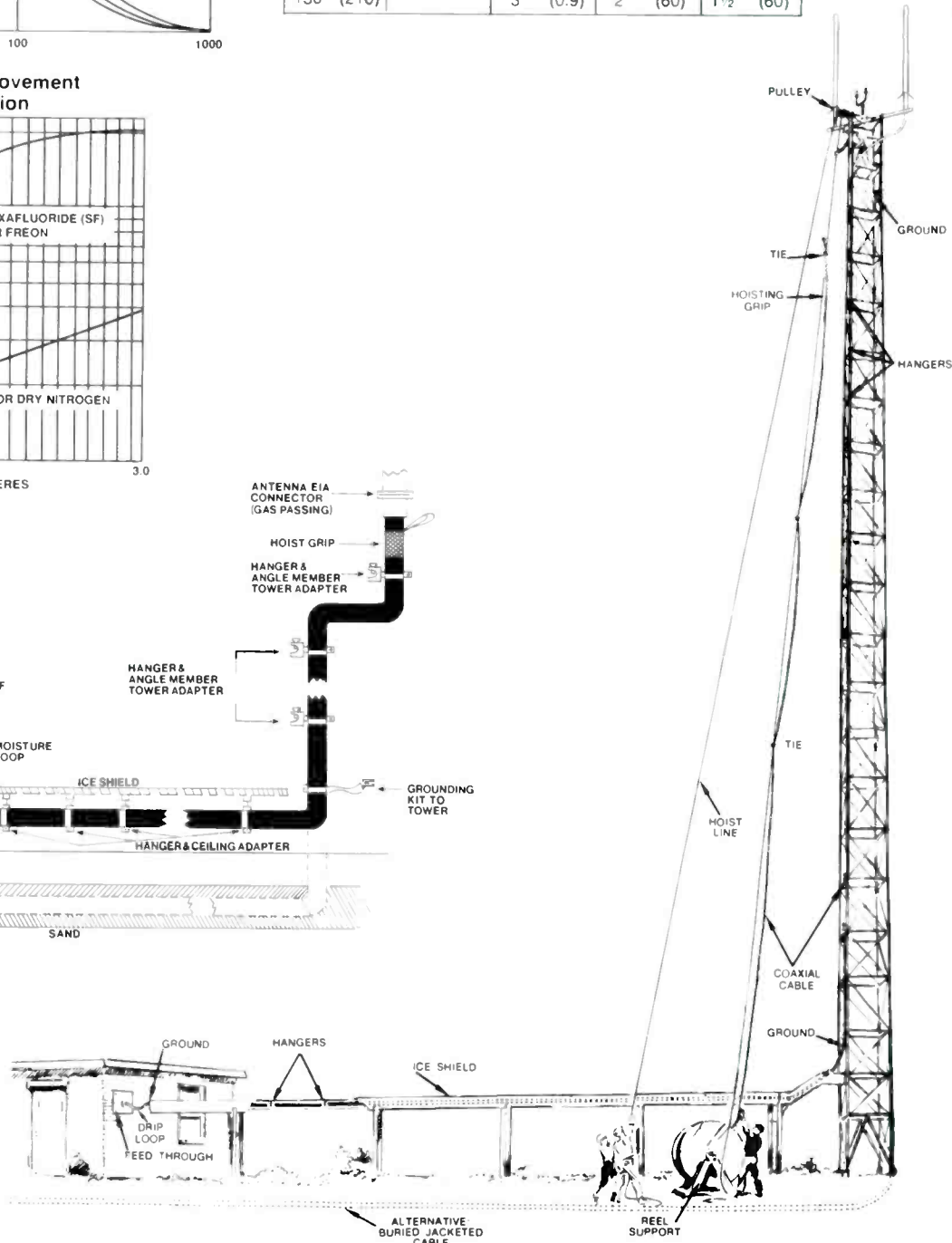
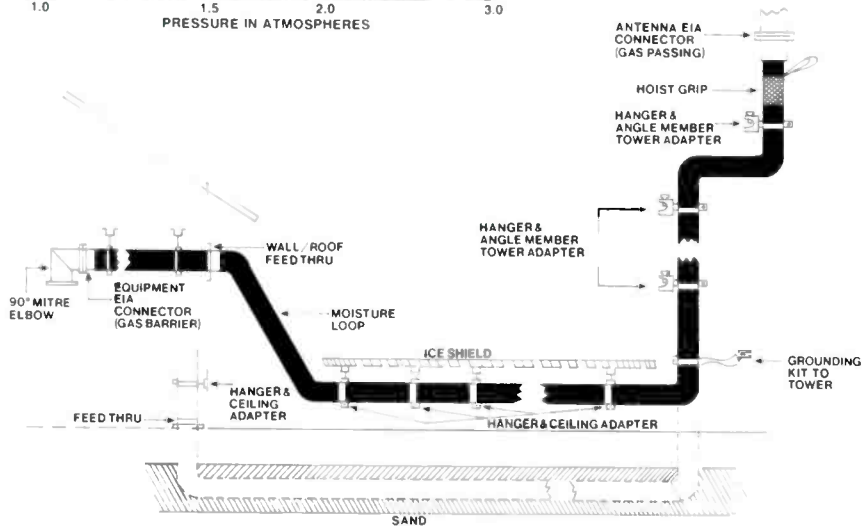
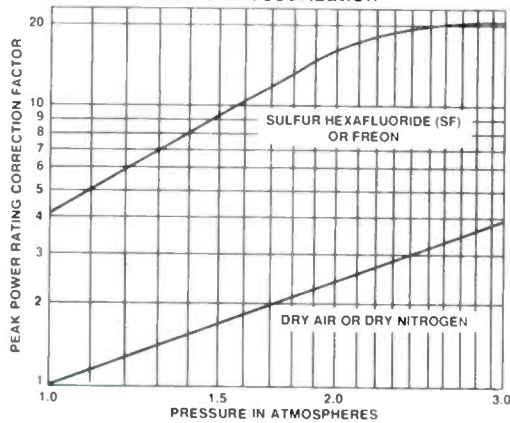

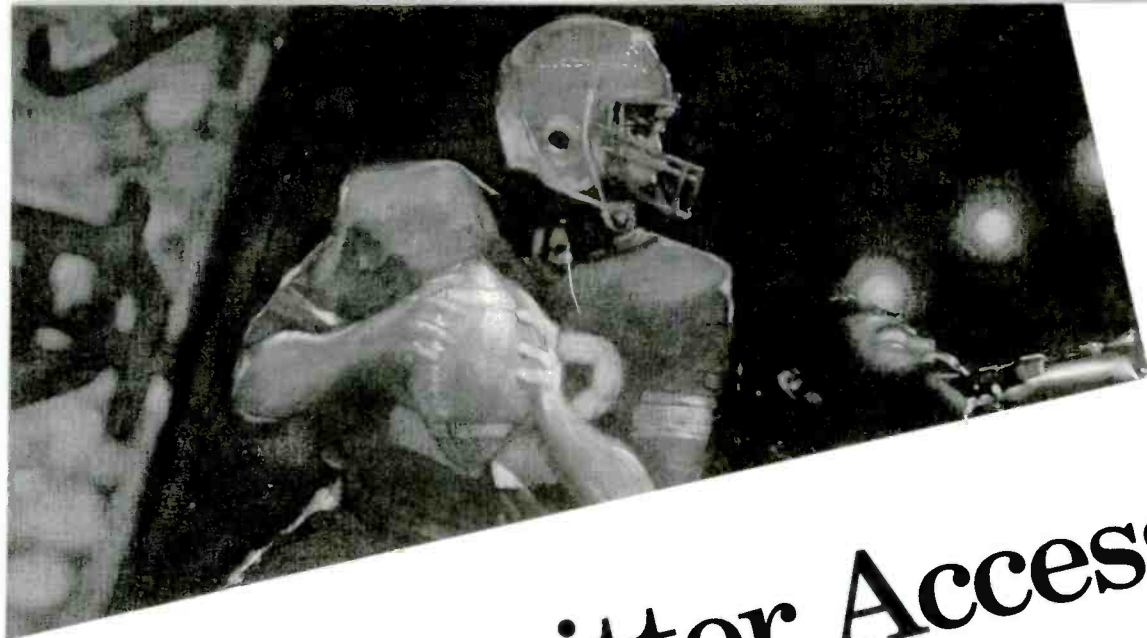

Transmitter Accessories

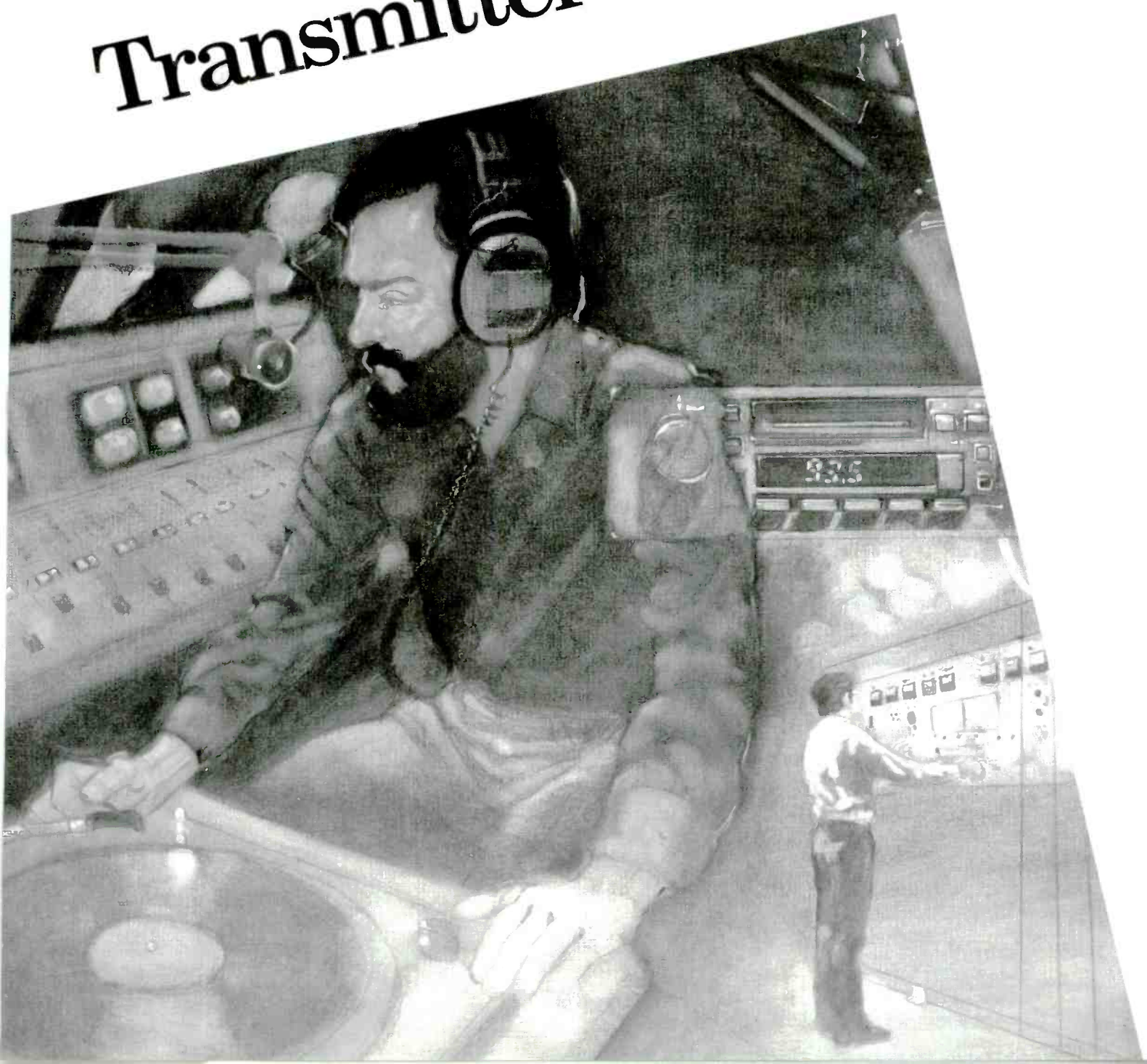

RF Surge Protectors



SPA Secondary Power Arresters

Dale line surge protectors provide excellent protection for solid-state devices against lightning, direct or indirect, and other transient voltages. Hermetically sealed, pre-ionized spark gap, improves response and stabilizes breakdown voltage. Response time: typical pulse breakdown voltage 1500V when subjected to a voltage pulse rising at 10kV/ μ sec. Power-follow current extinguished in 1/2 cycle or less. Will bypass repeated overvoltages without significant change in breakdown level or insulation resistance. Engineered to maintain physical integrity when conducting lightning strokes in excess of 60,000 amperes. Arrester must be replaced, but it will not cause external damage. Meets or exceeds the requirements of MIL-A-21907A, Type 1, Class 1, Size 0, and all applicable NEMA, USAS, and IEEE Standards.

DC Arc-Over Characteristics:

- SPA-100 (for use on 120 volts ac)
=<700 volts dc
- SPA-200 (for use on 277 volts ac)
=<900 volts dc
- SPA-400 (for use on 480 volts ac)
=<1500 volts dc

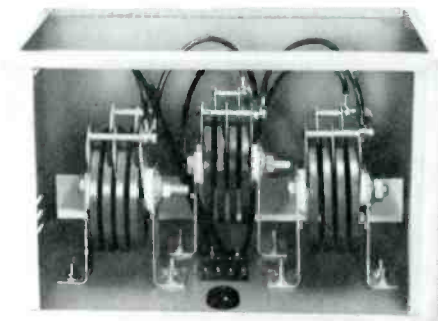

Wilkinson Series S1A-3 Surge Protector

Heavy-duty unit protects equipment from voltage and current surges that exceed equipment design parameters. Protectors available for 110 to 480 volts single phase, and 208 to 480 volts three phase applications; other ratings available.

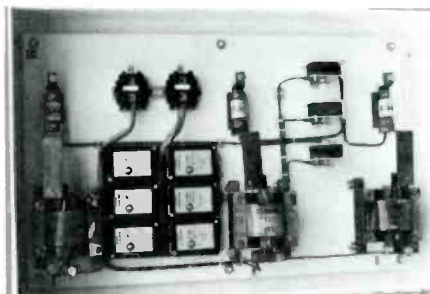

LEA Dynatech SE Series Surge Protectors

Variety of models are designed to protect equipment from lightning surges, high voltage transients overvoltages and EMP (electromagnetic pulse). Standard units range from light-duty low-current models to heavy-duty high-current units, covering 110 to 480 volts single phase, and 208 to 2500 volts three phase. Voltage ratings over 2500 volts are available on special order.

All specifications are subject to change without notice.

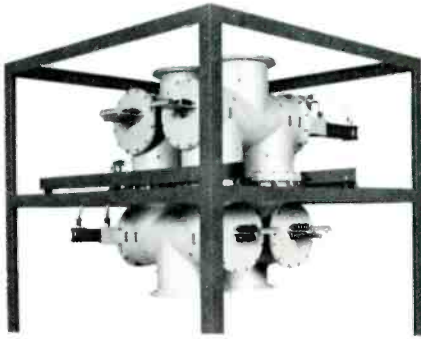

Continental Type 518SW-1 Four-port Coaxial Transfer Switch

- High isolation
- Low VSWR
- High power capability
- Fast operation (milliseconds)
- Proven reliability

Continental's Type 518SW-1 four-port coaxial transfer switch is a compressed air driven, electrically controlled coaxial device for use in high power switching applications up through several hundred megahertz. The switch was originally developed by Continental for military applications requiring trouble-free operation over an extended period of time.

Each switch is constructed so that the open port is internally grounded, providing excellent isolation characteristics.

With a suitable compressed air reservoir, the transfer switch may be actuated even though electric power has failed. The switch may be mounted and operated in any position.

SPECIFICATIONS

RF connections: 6-1/8 FIA flange
Characteristic impedance: 50 ohms
Frequency range: dc to 200 MHz
VSWR: 1.05:1 maximum

Insertion Loss:
 0.1 dB maximum

Power rating:

Peak:	1,000 kW Average,
Avg. @ 30 MHz:	260 kW
Avg. @ 100 MHz:	140 kW
Avg. @ 200 MHz:	100 kW

Isolation: 70 dB minimum

Pneumatic cylinder pressure:

60 to 70 psi, 100 psi maximum

Transfer time @ 60 psi: 0.25 second

Auxiliary contact rating:

@ 125 v ac:	15 amps
@ 24 v dc:	.05 amps

Net Weight: 140 lbs.

Size: 33-1/2" x 33-1/2" x 25-1/4"

Optional Control Unit: Continental Type 377D-2, Automatic Transmitter Controller. See page 34.



Comark Model CSW-318 Coaxial Switch

Comark coaxial switches are designed with replaceable watchband springs contact assemblies for all electrical connections for the best possible contact. Three separate watchband springs are used for each inner conductor assuring troublefree operation. To simplify maintenance and inspection, the follower flange can be removed. This provides easy access to the inner conductor without total disassembly.

Low VSWR and low insertion loss combined with maximum isolation make Comark coaxial switches the ideal instrument for routing RF, especially in remote control applications. The positive action switching solenoid may be remotely controlled or overridden manually.

SPECIFICATIONS

Connector Impedance:

3-1/8" EIA, Male 50 ohms

Frequency Range: 0-1000 MHz

Peak Power, kW: See Figure 2

VSWR: See Figure 1

Isolation: See Figure 1

Size: 14" x 14" x 11"

Weight: 35 lbs.

Voltage (Motorized):

110 vac (Other voltages on request)

Control Voltage:

12 vdc (Other voltages on request)



Dielectric A-50,000 Series 1-5/8" and 3-1/8" Coaxial Switches

Dielectric manufactures a wide variety of standard switches and patch panels for convenient, rapid and reliable RF Switching.

They can be mounted in any position, and will accommodate single or multiple line RF power

while maintaining high reliability maximum isolation, and low VSWR.

Control panels are available for local control of the coaxial switches. Position readout monitors for both coaxial switches and patch panels are available on special order.

SPECIFICATIONS

Frequency Range:

0 to 900 MHz

Impedance:

50 ohms

Ports:

Three or four

Switching Time;

Two seconds

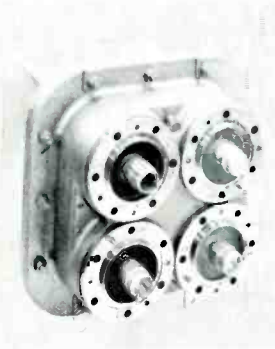

Delta Electronics Coaxial Transfer Switches

The manually or remotely operated Coaxial Transfer Switches are designed to change coaxial connections with a minimum of changeover or off-air-time. They can switch pairs of transmission lines in less than two seconds

The Models 6730E and 6732E Coaxial Transfer Switches are manufactured for use with 1-5/8 in. 50-ohm transmission line. The 6740B and 6742B Coaxial Transfer Switches are designed for use with 3-1/8 in. 50-ohm transmission line. The Models 6730E and 6740B operate on 120 vac, 50/60 Hz. The Models 6732E and 6742B operate on 220/240 vac, 50/60 Hz.

The Models 6740B and 6742B can be pressurized up to 15 lb/sq. in. (1.1 kg/sq. cm). A gas barrier is built into each terminal, and an air inlet port is provided.

Each transfer switch can be remotely controlled by a SPDT switch or by the Model 33630A Coaxial Switch Control Panel. The panel is designed to control either a Model 6730E/32E or Model 6740B/42B Coaxial Transfer Switch and indicate the switch connections. The control panel operates on 120 vac or 220/240 vac, 50/60 Hz and mounts in a standard equipment rack space of 3-1/2" high by 19" wide (89 by 483 mm).

All specifications are subject to change without notice.

Coaxial Patch Panels

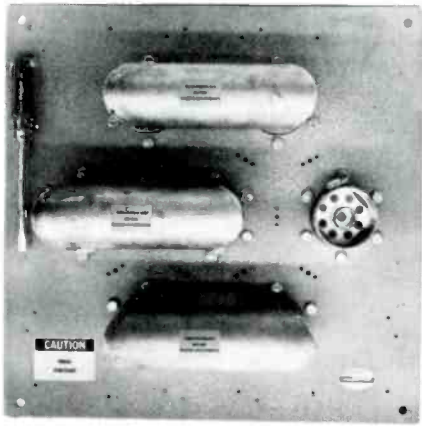

Dielectric 80

The Dielectric 80 Series Patch Panels are designed for use with 1-5/8", 3-1/8", 4-1/6" and 6-1/8" line with 3, 4, or 7 Ports; 8-3/16" line with 4 Ports.

Position readout monitors for both coaxial switches and patch panels are available on special order.



Comark CPL Series Coaxial Patch Panels

Panels are available in all standard transmission lines sizes in three, four, five and seven port standard configurations. The patch link construction allows the patch link to self align with the panel ports for ease of operation.

Features

- Rugged Construction
- Self aligning
- Take apart patch links
- Handles for ease of patching
- SPDT and DPDT Safety Interlocks available upon request

SPECIFICATIONS

Frequency Range:

Any single TV (FM) channel

Input Connectors: 1-5/8, 3-1/8, 6-1/8

Power level:

Compatible with line size and frequency

Impedance: 50 ohms

Insertion loss: Negligible

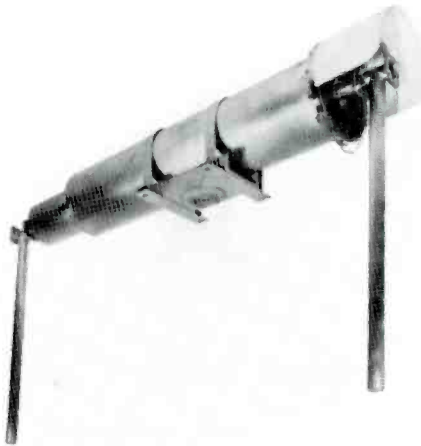

AM/FM Isolation Transformers

Isolation transformers are designed to couple the FM power across the base insulator of a transmitting tower used jointly as an AM and FM radiator without introducing a mismatch into the FM feedline. An isolation transformer is especially desirable for feeding high impedance AM directional antenna system which might be adversely affected by a "bazooka" type isolation system. Each unit is factory tuned to station FM frequency.

Specifications: Type 403-403A Isolation Transformers

Frequency: 88 to 108 MHz

VSWR: Less than 1.05:1 at the station frequency

Bandwidth: Over 2 MHz between 1.1:1 VSWR points, 50 ohm load

FM power: 10 kW, 50-ohm line

AM peak voltage: 7500 volts

AM Shunt capacity to ground:

Approximately 200 pf

Lightning protection: Quarter-wave shorted stubs on input and output

Connectors: Type 403: 1-5/8" (2.86 cm) male swivel input, 1-5/8" (2.86 cm) female swivel output; Type 403A: 3-1/8" (7.9 cm) male swivel input, 3-1/8" (7.9 cm) female swivel output

Weight: Approx. 105 lb (47.6 kg) including cradle

Length: 67" to 73" (170 to 185 cm) depending on frequency

Diameter: 10" (25.4 cm) maximum

Mounting: Cradle supplied with 2" (5 cm) pipe flange on bottom. Pipe stand not supplied

Pressurization: 10 lb (4.5 kg) line pressure maximum pass through

Isolation Coil

The coil provides isolation for the phase sampling loop line in AM directional antenna arrays. This coil presents a high impedance for the line across the base insulator of the tower, and consists of a phenolic coil form wound with approximately 37 turns of RG8/U or similar solid dielectric coaxial cable. The inductance of the coil is approximately 180 microhenrys.

Size: 18" (46 cm) L, 10" (25.4 cm) D

Weight: 6 lb (2.7 kg)

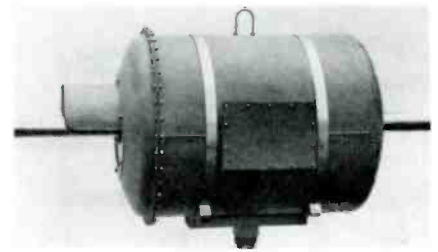

Specifications: Type 425, 426, 427 Isolation Units

Frequency: 88 to 108 MHz

VSWR: Less than 1.05:1 at the station frequency

Bandwidth: Over 2 MHz between 1.1:1 VSWR points, 50 ohm load

FM power: Type 425: 25 kW, 50 ohm line;

Type 426: 40 kW, 50 ohm line

Type 427: 50 kW, 50 ohm line

AM peak voltage: 40,000 volts

AM Shunt capacity to ground:

Approximately 60 to 70 pf

Lightning protection: Heavy-duty dc shorts between inner and outer conductors on input and output

Connectors: Type 425: 3-1/8" (7.9 cm) male input; 3-1/8" (7.9 cm) female output

Type 426: 3-1/8" (7.9 cm) male input; 3-1/8" (7.9 cm) female output

Type 427: 6-1/8" (15.6 cm) male input; 6-1/8" (15.6 cm) female output

Weight: Type 425: 256 lb (116 kg)

Type 426: 300 lb (136 kg)

Type 427: 325 lb (146.25 kg)

Length: Type 425: 44" (111 cm)

Type 426: 44" (111 cm)

Type 427: 51" (129.54 cm)

Diameter: Type 425: 28-1/2" (72 cm)

Type 426: 28-1/2" (72 cm)

Type 427: 28-1/2" (72 cm)

Mounting: Cradle supplied with 3" (7.6 cm) pipe flange on bottom. Pipe stand not supplied

Pressurization: 10 lb (4.5 kg) line pressure maximum pass through.



Sampling Loop

The 601 series fixed phase sampling loops manufactured by Electronic Research, Inc., samples the phase relationship of RF energy in the 550 to 1600 kHz range. The sensitivity is adjustable by varying the fixed position of the shorting bar provided. The loops are constructed of heavy stainless steel and terminate in a Type N female plug. Two sizes are available: 48" x 12"; 90" x 12"

All specifications are subject to change without notice.



Bird Electronic Model 3171 High Speed Wattcher® RF Monitoring System

Bird's Model 3171 is a high-speed monitoring system for remote and on-location supervision of transmitters ancillary services. The two most important features of the design are a short response time down to 200 microseconds—much faster than equipment protection requires—and remote reset capability.

The series 3171 WATTCHER RF Monitoring Systems warn a remote operator: 1) Of low power due to detuning, component aging, ac line difficulties (to conform with FCC part 21.107 requirements), and 2) Of high VSWR due to antenna icing, transmission or lightning. Alarm trip levels for both can be set from the front.



Coaxial Dynamics High-Powered Precision Directional Wattmeters

Models 81100A/81300A RF directional wattmeters, measure RF power in 1-5/8" and 3-1/8" 50 ohm coaxial transmission lines respectively. In these models, the line sections, single or dual socket, are a separate unit so the wattmeters can be used in remote locations. The packages include a 3-scale precision wattmeter, line section, and 25' cables to carry the rectified signal to the meter.

Also available: Models 81101A and Model 81301A, RF wattmeters, with 1-5/8" and 3-1/8" unflanged line sections respectively.



Delta Electronics Models TCA & TCA-XM RF Ammeter Systems

The Delta Electronics Models TCA and TCA-XM are radio frequency current measuring instruments designed to measure currents in broadcast antenna systems. These instruments are intended for applications where conventional thermocouple meters have been used in the past. The TCA and TCA-XM are substantially more accurate for all operating conditions, and they meet FCC requirements for 2% accuracy. Calibration at broadcast frequencies assures that there are no errors due to frequency effects when using these instruments.

Instruments meet FCC requirements for expanded scale meters and are useable to 20% of full scale; they provide accurate readings during high percentage modulation.

The rectifier circuit and indicating instrument are housed in a shielded enclosure for the TCA models. For the TCA-XM models, the rectifier circuit is housed in a small shielded enclosure, and the indicating instrument is separate for panel mounting.

All specifications are subject to change without notice.



Bird Thruline® 460 Series RF Directional Wattmeters

Bird Thruline RF Directional Wattmeters of the High Power Rigid Line Series are designed for measuring and monitoring RF power in rigid 50 or 51.5 ohm transmission lines. Each Wattmeter is made up of a line section, a measuring element, and indicating meter mounted in a convenient carrying case.

Line Section: Sections of 7/8", 1-5/8", 3-1/8", 6-1/8", or 9" air lines are available for insertion in the transmission line between transmitter and antenna or load resistor. Each line section has a socket into which the appropriate measuring element is inserted. Double-socket line sections for simultaneous measurement of forward and reflected power, or pressurized line sections are available on special order for Wattmeter packages.



Coaxial Dynamics Permanent Precision Directional Wattmeters

Models 81004A/81005A for permanent 19" rack mounted installations for 1-5/8" and 3-1/8" C.W., T.V., and FM power. These models feature one or two mounted meters and meter cables for remote power monitoring. Their normal configuration consists of a coaxial line with one or two sockets for plug-in elements. The dual line section configuration with two meters simultaneously displays both forward and reflected power. The single meter configuration displays both forward and reflected power by means of a selection switch.

Transmitter Remote Control Equipment

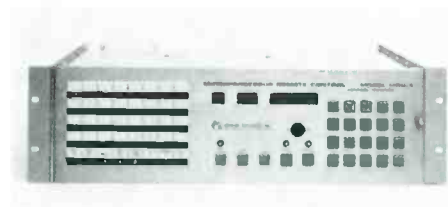

Moseley MRC-1

This microprocessor-based system incorporates 64 command lines, 32 telemetry channels, and 32 status channels. Its keyboard calculations and automatic logging also distinguish it. And the MRC-1 is a persistent, nosey instrument, checking all operations every four seconds, performing internal calibration procedures to assure long, accurate, stable operation. It is self-alarmed, should malfunction occur.

Among the MRC-1's other advanced features are:

- random assignment of control functions
- cross-functioning channels to allow indirect power calculations;
- automatic muting for main/alternate or directional patterns
- elimination of potentiometers through programmable display tracking.

This Moseley instrument also has optional long-term memory available.

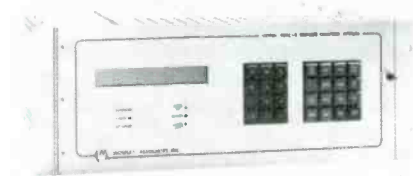

Moseley Model MRC-2 Microprocessor Remote Control System

The MRC-2 System brings a new level of sophistication to remote control, telemetry and status acquisition. Use of the CRT option allows plain-English displays and optional logging of command, status and telemetry functions. The Automatic Control option adds time-oriented and feedback-oriented command capabilities to the system. Moseley's MRC-2 provides the broadcaster with greater control of the transmitter plant thru quick, positive monitoring and control of all desired parameters. Critical operations are monitored constantly. The use of dual limits allows an operator or the system itself to adjust parameters before a critical limit is reached.

Plant security is improved because of the MRC-2 System's ability to continuously monitor transmitter facility for intrusion, fire or equipment failure. The MRC-2 can employ backup communication links to improve system reliability.

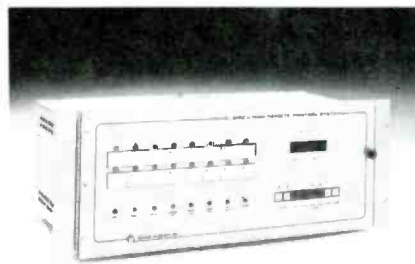

Moseley MRC-1600 Microprocessor Remote Control

The MRC-1600 Microprocessor Remote Control offers microprocessor flexibility and sophistication in an economical and dependable package for general AM-FM remote control applications. It comes equipped with 16 status inputs, 16 telemetry inputs, 16 raise command outputs and 16 lower command outputs. Each command output is relay-isolated. Adapting the MRC-1600 to current system interconnections is easy. Plug-in modules can be ordered to accommodate almost any interconnection system, from standard 2-wire or 4-wire telephone lines to FM subcarriers, subaudible telemetry, or a custom combination of any of these.

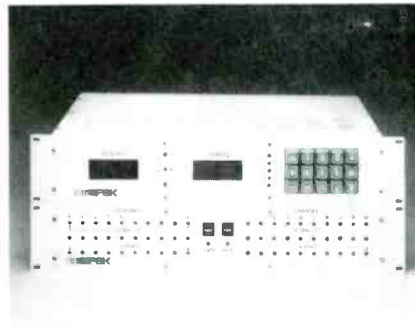

FSK RCT-1000 Remote Control and Telemetry System

The RCT-1000 is a rugged 20-channel remote control expressly designed for the broadcast industry. Operation is calculator style, key channel number, and "enter". Built-in test features for the verification of channel command and simple fail-safe operation save trips to the transmitter site. Under local control at the transmitter, both hands are free for calibration of readings and adjustment of interfaced equipment. It has large digital read-out numbers.

Additional relay units in steps of 10 and 20 channels can be added to give a possible total of more than 1000 channels. Each channel includes adjustable data input, isolated pair of contacts, "R" and "L" functions, decimal point programming.



Gentner VRC-1000 Remote Control

With the adoption of FCC Docket 84-110, remote control of broadcast transmitters has been freed from the previous cumbersome requirements. Transmitters may now be remotely controlled from any location using standard dial-up telephone lines.

The VRC-1000 Voice Remote Control operates on the dial-up telephone system to allow you the freedom of remote control from anywhere. You communicate with the VRC-1000 by listening to its synthesized voice and commanding it with a Touch-Tone® (DTMF) key pad or portable automatic dialer.

Serial data outputs are available as an option.

- Dial-up Telephone Interconnection
- Absolute Security
- 16 Metering Channels
- 16 Status Channels
- 32 Command Outputs
- "Smart" Operation. The VRC-1000 has the ability to determine an alarm condition and then automatically correct the condition if possible. It can also initiate a telephone call to any of five different telephone numbers to report an alarm (and it will keep calling until it gets an answer from an authorized human.) The VRC-1000 will automatically note the time and date of an alarm and report it to you along with the alarm condition (it will also log the alarm and time, if equipped with the printer option).
- Full Automatic Transmission System (ATS)
- Synthesized Voice Reporting
- Audio Monitoring of Transmitter Site.
- Video Terminal Display/Printer Option.
- Can be used with any video display terminal or personal computer.

All specifications are subject to change without notice.

Transmitter Remote Control Equipment

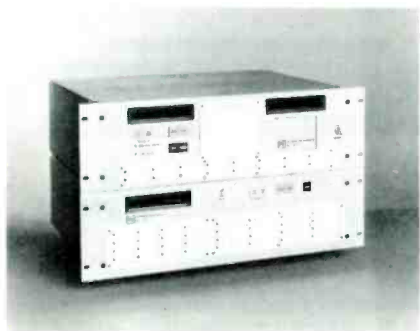

Potomac Instruments RC16+ Automatic Remote Control System

Standard Features

- 16 Telemetry Channels
- 16 Status Channels
- 32 Control Functions
- Single Point Calibration
- Microprocessor Continuous Scan
- Automatic Tolerance Alarms
- Power Fail Memory
- Automatic Pattern/Power Switching
- Automatic Transmitter Power Control
- Automatic Transmitter Re-Start
- Direct Antenna Monitor Interface
- Easily Installed
- Simple to Operate
- Potomac Instruments Quality and Reliability

Optional Features

- Expandable (in groups of 16) to:
 - 64 Telemetry Channels
 - 64 Status Indicators
 - 128 Control Functions
- Plug-In Auto Logger
 - Selectable Logging Intervals
 - Selectable Logging Sequence
 - Out-of-Limit Flags
- CRT Display
 - Displays all Telemetry Data
 - Continuous Update
 - Out-of-Limit Flags

The RC 16+ is designed to simplify operator workload at remote controlled AM and FM Broadcast Stations.

In addition to the manual telemetry, control, and status functions available in conventional remote control systems, the RC 16+ provides continuous monitoring of all telemetry data and automatic control of certain operating parameters.

Any out-of-limit condition triggers an open collector output at the rear panel which may be used to drive a relay, a light, a sounder or a combination of these to alert station operators. If an out-of-limit condition occurs for a parameter which can be remote-controlled, the operator simply selects the MANUAL mode of operation, steps to the appropriate channel, and activates the RAISE or LOWER push-button to adjust that parameter to within specified tolerances.

The RC 16+ is also capable of automatically selecting transmitter power level and/or antenna pattern.

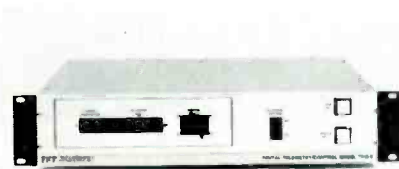

TFT 7600 Series Digital Remote Control System

The TFT 7600 System makes it possible for any size AM, FM or TV station to have direct, digital control of remote transmitters. The system is modular to accommodate future additions/revisions.

With the 7600 series, interconnection can be via telephone lines or radio links. Radio links include STL and SCA or TSL. Pulse Code Modulation (PCM) is used for data transmission, and the system has built-in digital data modems.

Data accuracy and greatly reduced operator errors are ensured by TFT-proprietary digital data filtering and closed loop automatic verification systems. In digital data filtering, each control command is sent twice. The two are then compared at the remote point, bit by bit. Only if they match exactly are the commands carried out.

- Modular, field expandable design
- Fully digital, pulse code modulated FSK modems
- Linked by telephone wire line or STL and SCA
- One man calibration
- 10 to 80 channels of RAISE/ LOWER and TELEMETRY functions
- Up to 30 channels of direct ON/OFF control
- Up to 64 channels of STATUS and ALARM monitoring
- Limit alarms and optional automatic logging
- Quick-disconnect barrier-strip boards for easy service of remote units
- Provision for Automatic Transmission System (A.T.S.) operation built-in
- Complete line of accessories for transmitter and monitoring interface

SYSTEM COMPONENTS

Model 7610 Digital Control/Telemetry System

The Model 7610 is the basic building block of the versatile 7600 system. Although it is a fully stand-alone, 10 channel digital system with RAISE/LOWER functions and 10-channels of telemetry, it can be field expanded to meet the needs of even the largest station by merely adding additional modules.

Model 7830, Direct On/Off Control and Status Monitoring System

Adding a Model 7830 to the Model 7610 gives you direct, ON/OFF control of up to 15 different functions, such as filament voltage, plate voltage, main power, overload reset, tower lights, and program source selection. ON/OFF commands are initiated by front panel toggle switches.

For even more control, two Model 7830's can be used simultaneously with one Model 7610. This gives you 30 ON/OFF control channels and 30 status monitoring channels.

Model 7832, Status/Alarm

Model 7832 provides 32 channels of Status/Alarm only. As with the 7830, two of the 7832s can be added to the 7610 to give a total of 64 channels of Status/Alarm.

Model 7620/7630, Channel Expander

The Model 7620 or 7630 installed at the remote point expands the RAISE/LOWER and TELEMETRY functions of the Model 7610 from 10 to 20 channels. As many as three Model 7630's and one Model 7620 can be added to the Model 7610 to give you a total of 80 RAISE/ LOWER and TELEMETRY functions.

Model 7840 Data Acquisition System (Optional)

Automatic logging and Status/Alarm may be added with the 7840 System. Up to 60 channels can be logged on the model 43 printer at the control point.

- Size:** All 7600 System units are designed for 19" (48.26 cm) rack mounting
- 7610C: 3-1/2" (8.89 cm) H x 13" (33.02 cm) D; 14 lb (6.3 kg)
 - 7610R: 5-1/4" (13.34 cm) H x 13" (33.02 cm) D; 16 lb (7.2 kg)
 - 7830C/7830R: 3-1/2" (8.89 cm) H x 13" (33.02 cm) D; 12 lb (5.4 kg)
 - 7832C/7832R: 3-1/2" (8.89 cm) H x 13" (33.02 cm) D; 12 lb (5.4 kg)
 - 7620/7630: 5-1/4" (13.34 cm) H x 13" (33.02 cm) D; 6 lb (2.7 kg)

All specifications are subject to change without notice.

STL Equipment

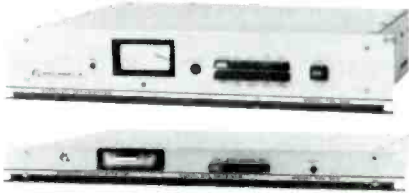

Mosely PCL-505 and 505A/C Systems

The PCL-505 system links studio to transmitter—or studio to studio or whatever “closed-circuit” network you need. With its transmitter and receiver you can send and receive signals ranging from 148 mhz to 960 mhz, and do so with better than 70 db noise below carrier (AM).

The PCL-505A/C matches the performance of the standard 505 and goes a step beyond—incorporating specialized electronics to cope with RF problems in the 890-960 mhz band. It does so, in part, through its 70 mHz surface acoustic wave IF filter. It's an essential instrument in today's crowded RF spectrum.



Models PCL-606 and PCL-606/C

PCL-606 and PCL-606/C Studio-Transmitter Links provide broadcasters and industrial users alike with the highest quality program interconnect currently available in equipment of this type. By the use of the latest technology available in today's market, significantly improved specifications and performance are achieved, even in overly congested areas or high density RF environments. Designed for monaural audio service, the PCL-606 can be used in a dual configuration for stereo service. The PCL-606/C, composite stereo version, conveys composite stereo waveform with virtually no degradation.

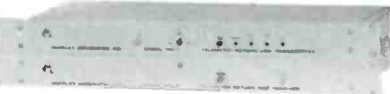

Mosely TRL-1

Wireless transmission and reception with the TRL-1 is quick, quiet, and efficient. Completely solid-state; “linkable” with aural STL's micro-processor, digital or analog control systems; designed for consistent continuous, unattended duty—the TRL-1 operates on the 450 mHz band (other frequencies are available on request).

- The TRL-1 has two important options:
- A modulated Continuous Wave (MCW) identifies preprogrammed with alpha/numeric ID.
 - A battery back-up which is automatically switched on should ac fail. With it, twenty minutes of power can be provided for stand-by operations.



Marti STL-10

The Marti Studio-Transmitter Link/Intercity Relay is a line-of-sight FM communication system providing a high quality broadcast audio channel with two optional sub-channels. A dual link for stereo provides two identical broadcast quality channels with better than 60 db stereo cross talk and four optional sub-channels. This system offers greater rejection of interference, superior noise performance, lower channel cross talk, greater redundancy, and lower cost than composite STL's currently available.

- Applications of the STL-10 include:
- STL for FM stereo broadcast (Dual system)
 - STL for AM stereo broadcast (Dual system)
 - STL for FM mono or AM broadcast.
 - Intercity relay for linking two or more broadcast facilities.
 - Multi-relay system for radio network distribution.
 - Communications link between satellite earth station and broadcast facilities.



Marti TSL-2, TSL-15 and TSL-25

The Marti TSL Telemetry Links provide reliable telemetry circuits for AM, FM and television stations. Expensive and unreliable Telco lines can now be replaced with cost effective Marti TSL Systems. These links are simple to install, easy to operate and maintain. Marti has assembled complete equipment packages consisting of Transmitter, Receiver, Yagi Antennas, Cable, Identifier and optional items. The 2.5 watt transmitter is available for solar power or other limited power source applications. The 15 watt transmitter is recommended for use on medium to long paths having high signal attenuation.

Features

- Choice of Transmitter Power—2.5 or 15 or 25 watts **Continuous Duty**
- Transmitters are FCC type accepted.
- Super-Selective Receiver with 90 db spurious rejection.
- Test Meter built into both transmitter and receiver.
- Receiver has adjustable squelch and carrier operated relay.
- Built-in modulation control.
- Internal ac Supply in transmitter and receiver with provision for external dc operation.
- Optional Automatic Station Identifier.
- Analog or Digital Telemetry or Voice Modulation in 50 Hz-3000 Hz band.
- Mic and Line Level Inputs with mixing controls.



TFT 8300 Series Wideband-Composite STL System

TFT 8300 broadcast quality aural Studio Transmitter Link and inter-city relays open a new generation of superior STL technology keyed to the increasing demand for system performance and versatility. They are the result of years of experience in STL and FM Transmitter monitoring technology. To meet today's demand for improved signal-to-noise ratio, better stereo separation, reliable operation in dense RF signal environments, AM stereo applications and auto-matic “hot-standby” switch over, such state-of-the-art features are all incorporated into the revolutionary design of the new TFT 8300 Series.

Mark Products P-948G Parabolic antenna

Antenna is of multigrid construction and is extremely strong and rigid. It will withstand wind thrusts up to 161 km/h (100 mile per hour). Operating in the 890- to 960-MHz range, the P-948G has a front-to-back ratio of 28 dB and gain of 18.9 dB.

Size: 4" (1.2 m) Dia.; Wgt: 25 lb (11.3 kg)
P-948G NPN: 1.2 m (4') Parabolic Antenna

Mark Products MG-944GN Parabolic Antenna

Cylindrical parabolic antenna operates in the 940 to 960 MHz range. Gain is 13.5 dB; front-to-back ratio is 20 dB. Welded grid construction.

Size: 13-1/2" (29.2 cm) H, 44" (111.8 cm) W, 17" (43.2 cm) D; Wgt: 7 lb (3.2 kg)

MG-944GN NPN: Cylindrical Parabolic Antenna

SCALA PR-450U Antenna

This strong, swiftly mounted instrument (with an exclusive balun feed) guarantees equal distribution of current in the driver element. The anodized, dichromate PR-450U is incredibly resistant to corrosive elements. Its impedance is 50 to 75 ohms. Connection is via a type NRF female coupler. Gain is 15 dB; front to back ratio is 20 dB.

Size: 67" (170 cm) H, 36" (91 cm) W, 19" (48 cm) D; Wgt: 25 lb (11.25 kg)

All specifications are subject to change without notice.

Transmitter Monitor, Test & EBS Equipment

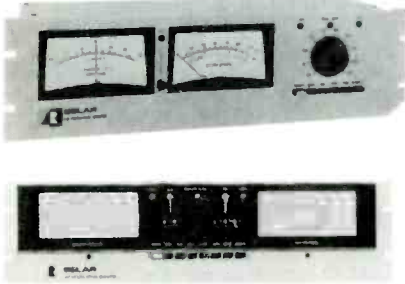

Belar AMM-2/3 AM Modulation Monitor

Both the AMM-2 and AMM-3 modulation monitors incorporate true ratio-type peak indicators and a unique modulation cancellation scheme to recover unmodulated carrier with which to reference the modulation peaks. The AMM-2, with one modulation meter, and the AMM-3, with two modulation meters, respond accurately to the shortest duration program peaks.

The AMM-2 has a single adjustable peak modulation indicator; 40 to 130 percent in less than 1-percent increments. Model AMM-3 has two adjustable peak modulation indicators: positive 1 to 199 percent; negative 1 to 99 percent. Both indicators are independent of carrier level. Both models are equipped with separate negative and positive indicator lamps (AMM-2) or LED; (AMM-3). Model AMM-3 has outputs for listening as well as test functions.

Size:

AMM-2 5-1/4" H (13.3 cm)
19" W (48.26 cm)
6" D (15.24 cm)

Weight: 8 lb (3.62 kg)

Size:

AMM-3 5-1/4" H (13.3 cm)
19" W (48.26 cm)
8-1/2" D (21.59 cm)

Weight: 8 lb (3.62 kg)



Belar Automatic AM Frequency Monitor AMM-4

The Belar AMM-4 is a digital AM frequency monitor designed especially for automatic broadcast transmitter monitoring. The counter will accurately monitor any frequency from 10 kHz to 50 MHz. A large 3-1/2 digit LED readout provides a display range of ± 1999 Hz deviation from the assigned channel. A front panel LED indicator warns of low RF level or loss of carrier; an optional relay contact can be provided. The monitor also provides two off-frequency alarms which are inhibited so that three successive errors are required to signal an alarm. This prevents false off-frequency conditions.

Relay contact outputs are available as options. A switchable 1 MHz input/output connector is provided for frequency comparison.

Features

- Inhibited off-frequency alarms
- 10 Hz off-frequency alarm
- 20 Hz off-frequency alarm
- RF level alarm
- Invalid count alarm
- Count inhibit input
- External timebase input
- 1 MHz output
- 3-1/2 digit LED display
- Low profile design
- Designed for ATS operation

SPECIFICATIONS

Frequency Range: 10 kHz to 50 MHz

Display: Large 3-1/2 digit LED

Display Range: ± 1999 Hz

Sensitivity: 100 mv, Unmodulated
2 V rms, 99% modulation

Gate Time: 2 seconds

Resolution: 0.5 Hz

Time Base (Internal): 3 MHz

Stability: $\pm 1 \times 10^{-6}$ per year

Time Base (External):

1 MHz, TTL compatible level

10 Hz alarm: Front panel LED, warns of potential frequency fault, inhibited for three successive errors

20 Hz alarm: Front panel LED, inhibited for three successive errors

RF alarm: Front panel LED, warns of low RF level or carrier fail condition

Invalid Count Alarm: Prevents false counts due to low RF level or problem in counter

Count Inhibit Input: External contact required capable of sinking 2mA

Dimensions:

1.75" h x 19" W (EIA rack mount)

Power Requirements:

100/220 vac, 50/60 Hz

OPTIONS

- Relay card for frequency alarms, RF level alarm



Belar Model FMM-2 FM Modulation Monitor

The Belar Model FMM-2 FM Modulation Monitor is a precision wideband, all solid state FM monitor, designed to measure the total modulation characteristics of monaural as well as multiplexed FM transmitters. The model FMM-2 is also used as a low distortion and low noise FM demodulator to drive the companion stereo and SCA monitors, as well as providing audio outputs for aural monitoring and proof of performance measurements.

The Model FMM-2 has set new standards in totally accurate measurement techniques. Utilizing such advanced design features as an ultra-linear digital discriminator, an almost distortionless and absolutely flat baseband signal is produced to ensure precise stereo and SCA decoding.

In addition to the normal FCC defined semi-peak metering, the FMM-2 incorporates a sample-hold peak modulation meter circuit, independent of modulation polarity, to allow the meter to respond accurately to program peaks.

Size: 5-1/4" H x 10-1/2" D x 19" W

(EIA Rack Mount)

Power Consumption: 10 watts, 117 vac
std. (234 vac opt) 50/60 Hz

Shipping Weight: 12 lbs



Belar Model FMS-2 Stereo Modulation Monitor

The Belar Model FMS-2 Stereo Modulation Monitor is an all solid state precision stereo monitor designed to operate in conjunction with the Belar Model FMM-2 baseband modulation monitor. The FMS-2 is also used for test functions in conjunction with the model FMM-2 to ensure proper performance of FM stereo transmitters. The test and measurement capability of the FMS-2 is further enhanced by the integration of two independent auto-ranging voltmeters allowing automatic measurement of channel separation and cross-talk, along with sub-carrier suppression and noise. For example, depressing the left and right channel buttons automatically registers the wanted and unwanted channel for instant separation measurements. A front panel hold button can be used to lock the autorange to the displayed range.

Size: 5-1/4" H x 10-1/2" D x 19" W

(EIA Rack Mount)

Power Consumption: 15 watts, 117 VAC
std. (234 vac opt) 50/60 Hz

Shipping Weight: 17 lbs

All specifications subject to change without notice.

Transmitter Monitor, Test & EBS Equipment

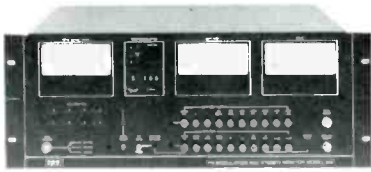

TFT Model 844 FM Stereo Modulation Monitor

Based on TFT's 14 years of engineering experience—with over 5,000 modulation monitors operating world-wide—these third generation instruments bring you innovations that solve today's modulation problems, using today's advanced technology. You get everything you need for complete proof-of-performance measurements (for distortion, an external analyzer is needed) right on the front panels, plus accuracy, versatility and convenience no other monitors can match.

The Model 844 combines a tuneable RF preselector, a baseband monitor and a stereo monitor in one compact instrument. The Model 845 SCA monitor is a multi-frequency instrument designed for use with the Model 844. With an optional receiver module, the 845 can be used as a stand-alone unit for both off-air and direct transmitter monitoring.

Both the Model 844 and the Model 845 can be used for remote, off-air monitoring or for direct transmitter measurements. Both are also adaptable to Automatic Transmission System (ATS) use. Additionally, the Model 844 features 50 kHz, frequency synthesized channel tuning, to accommodate all U.S. and international standards.

Size: Mounts in 19" rack; 7" (17.78 cm) H x 19" (48.26 cm) W x 15" (38.10 cm) D

Power: 115/230 ± 10% vac, 50 to 400 Hz, 40 watts max.

Weight: 22.5 lb (10.2 kg) approx.

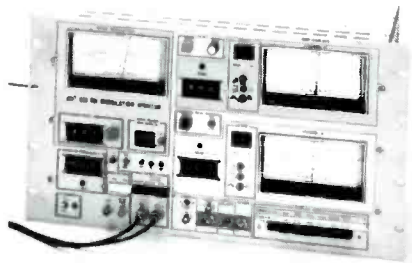

QEI Model 691 Tuneable Stereo Modulation Monitor and FM Test Set

Designed as a complete FM test system, the QEI 691 simplifies proof of performance measurements with auto ranging meters for separation, crosstalk, noise and phase calibration. Individual components of the FM transmission system can be measured separately, including stereo generator, composite STL receivers and FM excitors. A front panel BNC connector is provided for direct off-air measurement of Pilot and SCA frequencies. A plug-in SCA monitor module is available; order 691/01. NOTE: 691 is

Type Approved for SCA use only with subcarriers in the range of 59 kHz to 75 kHz with injection of 10% or less.

Size: 10-1/2" (26.67 cm) H
19" (48.26 cm) W
12" (30.48) D

Shipping weight: 32 lbs (14.4 kg)



Potomac Instruments Type 19 Antenna Phase Monitors

- Accurate
- Field proven reliability
- Push button operation
- Remote monitoring
- Upt to 12 towers, DA-3

AM-19 (204)

The AM-19 (204) is the current model of the industry's most widely used solid state antenna monitor. It provides direct meter readout of phase angle and loop current ratio. Tower selection is accomplished with push buttons on the front panel or by external contact closure in remote operation. Directional antenna arrays of from 2 to 12 towers with DA-1, DA-2 or DA-3 patterns may be monitored with this instrument.

Compatible with virtually every type of wire or wireless remote control system, the AM-19 (204) requires no external line interface equipment. Analog or digital remote metering panels are available for studio readout and may be added at any future date.

Size: Mounts in 19" rack;

7" H, 12-3/4" D

Power: 105 to 130 volts ac, 50/60 Hz

Weight: 20 lb (Approx.)

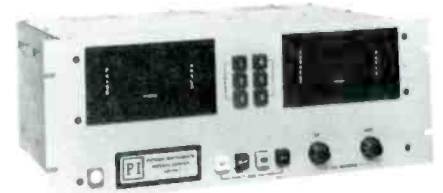

AM-19D (210)

Features

- Same as AM-19 (204) features plus
- Numeric Readout
- Phase resolution 0.1°
- Ratio resolution 0.1%
- Modular construction
- Ratios to 199.9%

The AM-19D (210) is identical to the AM-19 (204) except for the digital panel meters and associated circuitry. Four digit LED numeric displays provide resolution of 1/10 of one degree (phase angle) and 1/10 of one percent (current ratio). The digital readout feature of this instrument virtually eliminates operator error related to meter interpretation. Remote switching and readout are accomplished as in the AM-19 (204).

Inherently stable circuit design, modular construction, simplicity of operation and moderate cost make the AM-19D (210) the truly optimum monitor for directional stations utilizing lesser grade operators.

Size: Mounts in 19" rack;

7" H, 12-3/4" D

Power: 105 to 124 volts ac, 50/60 Hz

Weight: 20 lbs (approx.)



PMA-19

- Current deviation mode
- Ultimate precision
- Up to 12 towers, DA-3

The PMA-19 Precision Monitor Adaptor is used in conjunction with either the AM-19 (204) or the AM-19D (210) monitors. This unit is required, for the most part, in very critical arrays. The current deviation mode provides a third measured parameter which displays directly the deviation of the current ratio from the licensed ratio.

Size: Mounts in 19" rack;

14" H, 15-3/4" D

Power: 105 to 130 volts ac, 60 Hz

Weight: 40 lbs (approx)

All specifications are subject to change without notice.

Transmitter Monitor, Test & EBS Equipment

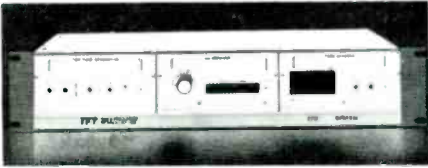

TFT Model 760 EBS System

The Model 760 EBS System is designed for broadcasters to meet Parts 73.940, 73.941 and 73.942 of the FCC Rules and Regulations for decoding and encoding the two-tone EBS alert signal. The modular construction of the system provides for maximum versatility and consists of a cabinet assembly, AM or FM receiver, two-tone decoder and two-tone generator. Two or three of these modules can be combined into a cost-effective operational EBS System. FCC type accepted and certified.

- Complete modular design
- Frequency synthesized tunable AM receiver
- Dual channel FM receiver available

Model 760 Cabinet Assembly

The Model 760 Cabinet Assembly is designed to accept up to three of the EBS modules described below. Standalone units may be constructed by ordering the Model 760 cabinet and any particular module. A fully loaded cabinet would consist of the Two-Tone Generator, either AM or FM receiver in the center, and the Two-Tone Decoder on the right. Blank panels are used as fillers where modules are not installed.

Model 760-02 Dual Channel FM Receiver

The FM Receiver, Model 760-02 is a high performance dual-channel, fixed frequency FM broadcast receiver. Channel selection is accomplished by a pushbutton switch. Both channels are fixed tuned and the crystals are factory installed. A one-channel version is also available. The CARRIER light will come on only when the desired station is received. A rear panel terminal is provided for activating external carrier-off alarm circuitry. Specify number of channels and frequency with order.

Model 760-01 Tunable, Frequency Synthesized Receiver

The AM receiver, Model 760-01, is a continuously tunable AM broadcast receiver using a frequency synthesized local oscillator which is phase locked to a 5-MHz crystal oscillator. The local oscillator is tuned by means of a 3-digit front panel thumbwheel switch in 10-kHz steps. The stability of the receiver is that of the crystal oscillator regardless of which AM channel is being received.

Positive tuning to any desired station is accomplished by dialing the frequency of the selected station and peaking the RF amplifier tuning. The CARRIER light will come on only when the desired station is received. A rear panel terminal is provided for activating external carrier-off alarm circuitry.

In addition to broadcast station use the AM Receiver provides a low cost monitor for all emergency service agencies, such as police, fire, Civil Defense, hospitals, etc. These services can listen to key EBS participating stations in the local area during any emergency.

Model 760-03 Two-Tone EBS Decoder

The TFT Two-Tone Decoder, Model 760-03, decodes the 853-Hz and 960-Hz EBS signaling tones from the demodulated output of a receiver. It may be used in conjunction with TFT's Model 760-01 AM Receiver, Model 760-02 FM Receiver, or any audio source which has the EBS Two-Tone signal at 100 mV rms or greater. Stable piezoelectric tuning fork filters are used to achieve ± 5 -Hz bandwidth from the center frequency of each tone. The timing circuit for the 10-second delay is a signal averaging integrator which eliminates false turn-on by noise. An amplifier and loudspeaker are built-in for audio monitoring. Volume control is internally preset.

Model 760-05 Dual-Purpose Decoder

The Model 760-05 Dual-Purpose Decoder can be used with either AM or FM receivers to respond to the present carrier break and 1000-Hz tone signaling scheme or, by removing a component, decode the new EBS 853- and 960-Hz dual-signaling tones. The circuit design and electrical characteristics are similar to the Model 760-03 module.

Model 760-04 Two-Tone Generator

The Two-Tone EBS Generator, Model 760-04, generates the 853-Hz tones simultaneously with an accuracy of ± 0.25 Hz. The frequency and stability of the tones are accomplished by synthesizing the tones from a single crystal oscillator.

Model 760-04 should be installed in the program audio line before the audio limiter. A single channel of audio can be routed through the generator. When the generator is activated, program audio is automatically interrupted, the EBS tones inserted, and The Emergency Program Audio is connected to the output. Program audio is restored by the RESET switch.

The generator is activated by two front panel COMMAND switches which need to be simultaneously operated to prevent accidental activation. COMMAND and RESET functions can be remotely controlled through rear panel wiring. The amplitude of each tone can be checked and adjusted individually.

Model 760 Emergency Broadcast System; Time and Frequency Technology, Inc.

System Size: 3.5" (8.9 cm) H
19" (48.3 cm) W
12" (30.5 cm) D

System weight: 10 lb (4.5 kg)

All specifications are subject to change without notice.

Audio Processing Equipment



CRL Audio AM-4 Audio Processing System for AM

The CRL AM-4 is the result of years of research by engineers who have devoted their careers to broadcasting. This work has resulted in the best audio processing equipment on the market today. We welcome comparison testing with other products.

Input Unit of the AM-4: APP-400 Audio Preparation Processor

The unique design of the APP-400 allows it to automatically correct for errors in audio source program levels, tonal balance, and other qualities most AGC's simply cannot handle. Totally unlike any other AGC, the APP-400 actually enhances transient musical qualities and punch while maintaining perfect level control.

FEATURES

- Asymmetry removal
- User-controlled loudness
- De-essing
- Easy, programmable accessing of low input levels
- Selectable AGC gating action
- Maintenance ce-free, high tech internal circuitry
- Multiband Gain Control
- User-controlled output equalizing
- Dynamic equalization
- Internal pink noise generator for easy system set-up
- Active balanced input and output circuitry

Center Unit of the AM-4: SEP-400A Spectral Energy Processor

FEATURES

- Four-channel multiband control
- Four-channel equalizer configuration
- Selectable level four-band gating action
- Active balanced input and output circuitry
- Selectable peak transient limiters
- Novel peak compression
- Maintenance-free internal circuitry

Output Unit of the AM-4: PMC-300A Peak Modulation Controller

The PMC-300A has three important functions. The unit provides the necessary final audio peak control for maximum transmitted coverage and loudness. Additional CRL pioneered techniques shape the audio spectrum to help correct any transmitter and antenna system deficiencies that may exist in the radio station.

FEATURES

- Unique multiband control with pre-emphasis
- Transmitter distortion correction
- Selectable high pass filter for older transmitters
- High positive peak density to well over 140%
- Distortion anticipation
- Bandwidth-controlled clipping filter

- Auto clip feedback of clipping filter to input G/R stages
- Over-modulation prevention
- Active balanced input and output circuitry

Size, complete system: 19" (48.26 cm) Rack Mounting, x 5-1/4" (13.34 cm) H x 12" (30.48 cm) D. Each unit is 1-3/4" (4.45 cm) H x 12" (30.48 cm) D

Power: 110-125 volts ac, 50/60 Hz, 40 watts



CRL Audio AM-4 Stereo Matrix Processing System for AM

The SMP-900, AM Stereo Matrix Processor was developed to improve AM Stereo/monaural compatibility. It must be understood that they are not really compatible. AM Stereo has a unique problem. With conventional left and right limiting a LOSS of 6 db in loudness can occur when receiving left OR right ONLY stereo information in MONO. Processing can eliminate this problem; but will cause up to 6 db INCREASE in loudness during single channel STEREO reception. The CRL SMP-900 minimizes this problem by providing a continuously variable control that will allow adjustment of the signal between the two extremes for best overall sound. This unit will actually improve actually improve your MONO signal in both fidelity and coverage.

Input Unit of the AM-4S SPP-800 Stereo Preparation Processor

The unique design of the SPP-800 allows it to automatically correct for errors in audio source program levels, tonal balance, and other qualities most AGC's simply cannot handle. Totally unlike any other AGC, the SPP-800 actually enhances transient musical qualities and punch while maintaining perfect level control.

FEATURES

- Asymmetry Removal (optional)
- Multiband Gain Control
- User Controlled Loudness
- User Controlled Output Equalizing
- De-essing
- Dynamic Equalization
- Programmable AGC'ing of low input levels
- Selectable AGC Gating Action
- Maintenance Free, High Technology Internal Circuitry
- Internal Pink Noise Generation for Easy System Set Up
- Active Balanced Input and Output Circuitry
- Special Stereo Strapping Technique

Center Units of the AM-4S: SEP-400A Spectral Energy Processor

The SEP-400A is designed to give you the capability of carefully shaping and altering the program tonal quality in four precisely chosen

bands per channel. It also provides an increase in audio loudness while maintaining a musical quality.

FEATURES

- Four Channel Multiband Control
- Selectable Peak Transient Limiters
- Four Channel Equalizer Configuration
- Selectable Level Four Band Gating Action
- Maintenance Free Internal Circuitry
- Active Balanced Input and Output Circuitry
- Left and Right Channels are Closely Balanced

Output Unit of the AM-4S: SMP-900 Stereo Modulation Processor

The SMP-900 is the final unit in the AM-4S system. It is a combination processor/limiter utilizing patented CRL circuits and filters for maximum fidelity and modulation levels.

FEATURES

- Mono Support Gain Reduction
- Variable High Frequency Pre-Emphasis Control
- Stereo Enhance Control
- Single Channel Negative Limiting
- L+R and L-R Output Controls
- Separate Mono Out, Adjustable
- Tilt Correction Control
- Setup Testing Switch
- Low Pass Filter Switch (11 kHz and 9 kHz)

Size, complete system: 19" (48.26 cm) rack mounting x 5-1/4" (13.34 cm) H x 12" (30.48 cm) D. Each unit is 1-3/4" (4.45 cm) H x 12" (30.48 cm) D

Power: 110-125 volts ac, 50/60 Hz, 40 watts



CRL Audio FM-2 Stereo Processing System for FM

Input Unit of FM-2: SPP-800 Stereo Preparation Processor

The unique design of the SPP-800 allows it to automatically correct for errors in audio source program levels, tonal balance, and other qualities most AGC's simply cannot handle. Totally unlike any other AGC, the SPP-800 actually enhances transient musical qualities and punch while maintaining perfect level control.

FEATURES

- Asymmetry Removal (optional)
- Multiband Gain Control
- User Controlled Loudness
- User Controlled Output Equalizing
- De-essing
- Dynamic Equalization
- Programmable AGC'ing of Low Input Levels
- Selectable AGC Gating Action
- Maintenance Free, High Technology Internal Circuitry
- Internal Pink Noise Generation For Easy System Set Up
- Active Balanced Input and Output Circuitry
- Special Stereo Strapping Technique

Audio Processing Equipment

Output Unit of FM-2: SMP-800 Stereo Modulation Processor

The SMP-800 is the final unit in the FM-2 system. It is a combination processor/limiter utilizing patented CRL circuits and filters for maximum fidelity and modulation levels.

- Input AGC's for Precise Pre-Emphasis Control
- Reduced Distortion Multiband Pre-Emphasis Control
- No Overshoot 15 kHz Low Pass Filter Control
- Transparent Transient Fidelity Design• Totally Alignment Free Internal Circuitry
- (Auto Clip) Feedback of Clipping Filter To Input G/R Stages
- Selectable Bypass of Internal AGC Strappings
- 25, 50, or 75 Microsec. Pre-Emphasis Options
- Automatic Internal AGC Gating
- High Modulation Density
- Balanced Input and Output Circuitry

Stereo Generator of FM-2: SG-800

No matter how good your source audio is, the stereo generator can degrade it. Now CRL has the answer with this new product that offers a completely new method of generating the FM stereo signal. This unit was designed to handle highly processed audio.

FEATURES

- Front Panel Level Indicators
- Digitally Synthesized Carrier Generator
- Outstanding Separation
- Outstanding Signal to Noise Performance
- Active, Balanced Input Circuit, No Transformers
- Exceptionally Stable 19 kHz Pilot
- Not Pre-Emphasis
- No Low Pass Filter
- Front Panel Pilot Defeat Switch
- RFI Shielding

Size, complete system:

19" (48.26 cm) rack mounting x 5-1/4" (13.34 cm) H x 12" (30.48 cm) D.
Each unit is: 1-3/4" (4.45 cm) H x 12" (30.48 cm) D.

Power:

110 to 125 volts ac, 50/60 Hz, 40 watts



Audio + Design "Express-Limiter" Stereo limiter-compressor-expander

- Integrated
- Noise reducing expander (soft gate)
- Dual function meter
- Switched ratio compressor-limiter
- Transient clipper & pre-emphasis
- Digital logic function switch

The EXPRESS-LIMITER is a superbly designed compact stereo limiter-compressor-expander that is ideal for high quality studio/broadcast signal processing. Its applications include use as an overall mix-down mastering processor or on stereo tracks in multi-track work; for preparation of intermediate masters (tape duplication or disc-cutting); in sound reinforcement applications; as a stereo processor to meet current video recording trends or as a transmitter processor (FM or AM).

The unit is of single through-plated board construction and uses discrete components throughout the audio chain. Function mode is controlled by digital logic momentary switches with no audio path contact to go noisy. A memory retains 'last setting' when power is off. In operation a series of l.e.d. indicators show function status. This status can be made tamper-proof by switching a rear panel 'inhibit' push-button.

Size:

19" (48.18 cm) W x 1-1/4" (4.5 cm) H x 11" (28 cm) D or 14" (35.5 cm) including connectors

Power:

115/230 volts ac, 50/60 Hz, 20 watts

Weight:

10 lbs (4.5 kg)



Orban Optimod FM Six-Band Limiter Accessory Chassis

The new Orban 8100/XT Six-Band Limiter Accessory Chassis for OPTIMOD-FM (Model 8100A) has been created to provide aggressive multiband processing for stations that desire bright, loud, "highly-processed" audio. Derived from the OPTIMOD-AM Model 9100A, the "XT" consists of a six-band limiter cascaded with the exclusive Orban distortion-cancelled multiband clipping system.

The "XT" is particularly suited for highly competitive pop music formats such as AOR, CHR, AC, and Urban Contemporary. When added to the basic OPTIMOD-FM system, the unit creates a dense, consistent sound without the pumping or other obvious side-effects which often occur when other processors are cascaded with OPTIMOD-FM.

The new unit is interfaced through a multipin connector added to the 8100A. Most of the existing OPTIMOD-FM circuitry is still employed when 8100A/XT is installed. This makes the entire system maximally economical, protecting the investment of the many OPTIMOD-FM Model 8100A owners who feel that they now need more aggressive processing to successfully compete within their formats and markets.

8100A/XT can be added to 8100A's of any vintage. Older units (Model 8100A) can be adapted to accept 8100A/XT by means of retrofit kit "RET-27". Newer units (Model 8100A/1) accept 8100A/XT without modification. (If you have an 8100, check your serial label to see which model: -A, or -A/1 you have.)

Please note that OPTIMOD-FM with the "XT" is no louder than the basic OPTIMOD-FM operated with very fast release times and large amounts of clipping. OPTIMOD-FM is *already* a very loud processor. The primary advantages of the "XT" are improved, consistency, increased brightness on naturally-duller program material, and reduction of audible processing side-effects—all while retaining the high loudness capabilities of an aggressively-operated 8100A

Installation and Compatibility

8100A/XT is compatible with both single- and dual-chassis 8100A installations. It resides at the main 8100A chassis and derives its power and signals from it through a connector in the rear panel. It must be mounted immediately below the 8100A mainframe, and is connected to it by means of a single short cable (to avoid RFI problems).

Size: 19" (48.26 cm) rack mounting x 3-1/2" (8.89 cm) H

Ordering Information:

8100-A/1	OPTIMOD -FM prewired to 8100A/XT Accessory Chassis
8100A/XT	Six-Band Accessory Chassis
8100B	Package consisting of 8100A/XT and OPTIMOD-FM 8100A/1 shipped at one time
RET-27	Kit to convert 8100A to accept 8100A/XT Accessory Chassis

Audio Processing Equipment



Modulation Sciences CP-803 Composite Processor

The Composite Processor improves the sound of your FM station by eliminating peaks of over-modulation. These peaks occur in two ways: First, the CP-803 eliminates the brief electrical overshoots that exist in all audio limiters and stereo generators—even those described as overshoot-compensated. Preventing such overshoots increases modulation with essentially no audible effect on the signal. Second, the Processor controls the high-frequency peaks that are present in all program material. Though not acoustically significant, these peaks cause over-modulation. Controlling them makes greater average modulation possible. The audible effect is minimal, far less than that of conventional variable-gain devices.

The CP-803 corrects the distortion that conventional processors sometimes create. But there's a basic difference in their operation: Conventional audio processors work with the left and right audio. But the Composite Processor deals with the stereo composite signal that comes out of the stereo generator. This baseband signal is made of the left-plus-right main channel, the 19 kHz pilot, and the left-minus-right subcarrier. By working on this signal instead of the left and right audio, many conventional audio problems are avoided.

FEATURES

- More loudness—up to 6 dB—without audible distortion
- Less conventional compressing and limiting
- Cleaner, more "open" sound
- More distinctive sound

Size:

12" (30.48 cm) W x 1-3/4" (4.45 cm) H x 5-3/4" (14.61 cm) D. Rack mounting kit available

Power:

90 to 130 volts, 50/60 Hz, 10 watts

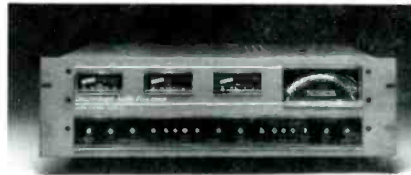

Dorrough Electronics Model 610 Audio Processor

The Discriminate Audio Processor Model 610 is a digital controlled tri-band audio processor. A maximum of three channels has proved to be the most colorless and least modifying of program material. The use of gain reduction independently in the three channels eliminates the typical restrictions heard on single channel devices. It is the intention of this device by virtue of the three bands not to doctor or modify the average or peak of the program content in any way that would be offensive to the ear.

The Discriminate Audio Processor Model 610 operates in the following sequence:

- Splitter,
- Three Channels,
- Program Equalizer,
- Peak Limiter

Digital Control

The unit utilizes a frequency discriminate digital control signal, operating in real time, to control the action of analog attenuators, which are located within the discriminate path of the input audio signal.

LED Metering

LED metering is used for each of the three channels with individual LEDs for indicating quieting mode and clip level. The Output Meter enables precise setting of relative loudness levels desired to peak modulation.

The system is essentially free of all internal adjustments.

Equalization

A four position equalizer appears on the front panel and is electrically positioned after the three channels and before the Peak Limiter. These "pleasure" controls are provided for individual tailoring of program material. The instruction manual suggests settings with electrical explanations.

Peak Limiter

The Peak Limiter is designed with a combination of soft and hard clipping, followed by 15 kHz low pass filter. Peak Limiters are available for AM, FM, and TV applications.

Size:

Mounts in 19" (48.26 cm) rack;
5-1/4" (13.34 cm) H

Power:

110/220 volts ac, 50/60 Hz, 75 watts

Weight:

19 lbs (8.55 kg)

All specifications are subject to change without notice.

Stereo Generators



CRL Audio SG-800 Stereo Generator

No matter how good your source audio is, the stereo generator can degrade it. Now CRL has the answer with this new product that offers a completely new method of generating the FM stereo signal. This unit was designed to handle highly processed audio.

FEATURES

- Front Panel Indicators
- Digitally Synthesized Carrier Generator
- Outstanding Separation
- Outstanding Signal To Noise Performance
- Active Balanced Input Circuit, No Transformer
- Exceptionally Stable 19 kHz Pilot
- No Pre-Emphasis
- No Low Pass Filter
- Front Panel Pilot Defeat Switch
- RFI Shielding

Size: 19" (48.26 cm) rack mounting x 1-3/4" (4.45 cm) H x 12" (30.48 cm) D

Power: 110 to 125 volts ac, 50/60 Hz, 40 watts



Dorrough Model 80-B Stereo Generator

The 80-B stereo generator offers state-of-the-art design and performance at a moderate price. Initial set-up is very easy. Performance matches or exceeds other stereo generators available today.

If used with the Dorrough Model 610 "stereo pair" audio processors, the resulting signal is one of the cleanest and loudest on the air today.

Size: 19" (48.26 cm) W x 1-3/4" (4.45 cm) H x 14" (35.56 cm) D



Orban OPTIMOD-FM

This is Orban's second generation compressor/limiter/stereo generator—one that offers unsurpassed loudness and brightness processing side effects.

The OPTIMOD-FM 8100A is a system of components, including:

- a unique wideband/multiband compressor which can be exceptionally transparent or as punchy as you like
- an innovative peak limiter with total over-modulation control—without overshoot, pumping, clipping distortion, or aliasing
- a stereo generator—new in design—with flawless performance.

Because the OPTIMOD-FM has accessible controls and clear instructions, you're free to tailor your sound for the effect you find best.

OPTIMOD-FM: self-contained, state-of-the-art, and all you need for the best FM signal possible.



Orban OPTIMOD-AM

Orban's OPTIMOD-AM 9100A is an advanced electronic signal processing system that provides the best possible quality, loudness, and high frequency equalization. The result? Transmissions that rival the best FM has to offer. Orban accomplishes this through a six-band frequency-selective limiter with "Smart Clipping," a broadband gain-riding compressor, a program equalizer, a transmitter equalizer, and a totally smooth phase follower and filter.

Orban's pledge is to deliver dramatically improved sound and even to expand signal coverage by concentrating energy in the portion of the audio spectrum that cuts through static and interference. OPTIMOD-AM has yet another advantage in that it is totally adjustable—including EQ, compression and limiting, and clipping up to 12 db. And OPTIMOD-AM does all this with virtually no audible processing side effects.



Modulation Sciences Sidekick™ SCA Generator & Audio Processor

Sidekick combines the four elements needed for successful SCA operation into one package: subcarrier generator, modulation monitor, audio processor and transmitter tuning aid. Engineered to work together, these components form an integrated system which provides a level of performance previously unattainable. Crosstalk is dramatically reduced, signal quality is significantly improved and operation is greatly simplified.

Sidekick is cost effective because there is no need for redundant power supplies, packaging, or input/output interfacing.

Subcarrier Generator

Sidekick has the first crystal controlled SCA generator in the industry. Others use simple free-running oscillators which are easy to design and FM modulate, but whose frequency stability is a problem. The stability of Sidekick is $\pm 0.005\%$ from 0 to 50 degrees C.

Modulation Monitor

A built-in modulation meter eliminates the need for an additional SCA modulation monitor. The peak holding circuitry lets the meter rise to the maximum deviation and remain there without much wiggling. The meter can also be easily calibrated in the field with only a frequency counter and a DC voltage source.

Integrated Audio Processor

Audio processing has traditionally been a weak link in SCA transmission. It is not uncommon to find that the audio processors used for SCA are hand-me-down from the main channel. Unfortunately, the use of a 75 microsecond limiter in a 150 microsecond system results in almost no high-frequency peak control. In addition, SCA audio filters which roll off at 5 kHz have the same kind of overshoot and ringing as the infamous 15 kHz filters used in stereo generators. As in main channel operation, poor peak control means low average modulation. In SCA, this means increased susceptibility to crosstalk.

Transmitter Tuning Aid

In many transmitters, proper tuning of the driver and PA stages plays a major role in the reduction of crosstalk between the main and SCA channels.

The Sidekick has a built-in noise generator and incidental AM noise meter. No other equipment is needed to noise load the entire baseband and measure the incidental AM from an RF sample. The RF tuning can then be "tweaked" to minimize the incidental AM. This often yields a dramatic reduction in crosstalk.

Size: 19" (48.26 cm) W x 3-1/2" (8.89 cm) H x 9-1/4" (23.5 cm) D

Power: 95-130 volts ac, 50/60 Hz, 12 watts

All specifications are subject to change without notice.

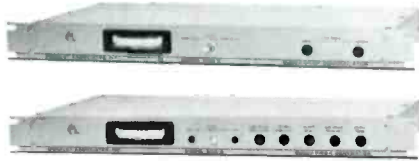

Moseley Series 8 Subcarrier Systems

Series "8" Subcarrier System forms a revolutionary FM system providing superior performance. The Series "8" System consists of the Model SCG-8 Subcarrier Generator and Model SCD-8 Subcarrier Demodulator. These units may be individually used to meet specific requirements such as SCA service on an FM broadcast transmitter, or telemetry service. This system is ideally suited to aural studio-transmitter link (STL) service. Providing a means of establishing a secondary program channel, the Series "8" System enables multiplexing SCA program audio, provides for remote pickup link audio, or serves as an intercom on an STL. Command information from a remote control system can also be conveyed by the SCG-8 and SCD-8.

The Model SCG-8 Subcarrier Generator is designed specifically to develop a direct FM subcarrier for multiplexing an FM, TV, or studio-transmitter link transmitter and sound quality are just some of the characteristics of the performance of the SCG-8.

Automatic carrier muting functions with the absence of program audio input. The time delay from the absence of audio until the carrier is muted can be adjusted from less than 1 second to more than 5 seconds. A front-panel switch enables selection of this automatic-mute feature or a continuous on or off subcarrier condition. A second input applied to a rear-mounted BNC connector accepts a subaudible telemetry signal. Subaudible telemetry information from a Moseley Associates Remote Control System can be fed directly to the SCG-8.

The Model SCD-8 Subcarrier Demodulator was developed as a companion to the SCG-8 Generator and encompasses the same design philosophy. Input carrier bandpass filtering enables operation from a composite signal source without external filters. This filter is a plug-in assembly enabling easy field changes to other frequencies. The audio output is sufficient to drive most broadcast equipment and is adjustable from the front panel.

Carrier bandpass and audio low-pass filters are used in the Series "8" Subcarrier System. Audio performance is tailored to the intended application based upon the carrier frequencies of 26 kHz and 39 kHz, the normal application is either command or telemetry for a remote system. These applications require a 3 kHz audio bandwidth. Frequencies of 41 kHz and 67 kHz normally are used for SCA service requiring 5 kHz response. As a 67 kHz carrier frequency may also be used for secondary program service on a monaural studio-transmitter link (STL), it can optionally be supplied for 10 kHz performance. Likewise, 10 kHz response is provided when operated at a carrier frequency of 185 kHz when using a composite STL for stereo transmission.

Size, Model SCG-8: 19" (48.4 cm) rack mounting x 1-3/4" (4.5 cm) H x 10" (25.4 cm) D
Weight: 8 lbs (3.6 kg)
Power: 120-240 volts ac, 50/60 Hz, 10 watts



CRL Audio SCA-2 Subchannel Control System

This unit was specifically designed to solve the problems associated with older SCA equipment. The result is a state-of-the-art unit that brings a new quality to SCA signals. Using the new CRL unit, a station would gain increased coverage without increasing injection levels; improved protection of the main channel signal, increased stability of the whole subcarrier operation, and greatly improved fidelity and intelligibility. Replacing existing equipment with the SCA 300 will result in a dramatic improvement in quality.

This integrated SCA system includes audio processing, low distortion crystal controlled oscillator, non-overshooting low pass filters, pre-emphasis and a DC coupled data input port.

Input unit of the SCA-2: APP-400 Audio Preparation Processor

The unique design of the APP-400 allows it to automatically correct for errors in audio source program levels, tonal balance, and other qualities most AGC's simply cannot handle. Totally unlike any other AGC, the APP-400 actually enhances transient musical qualities and punch while maintaining perfect level control.

FEATURES

- Asymmetry Removal (optional)
- Multiband Gain Control
- User Controlled Loudness
- User Controlled Output Equalizing
- De-essing
- Dynamic Equalization
- Easy Programmable ACG'ing of low input levels
- Selectable AGC Gating Action
- Maintenance Free, High Technology Internal Circuitry
- Internal Pink Noise Generator For Easy System Set Up
- Active Balanced Input and Output Circuitry

Output Unit of the SCA-2: SCA-300 Modulation Controller

The SCA 300 will improve the received fidelity and absolutely prevent main channel interference. It provides both the final audio peak control for maximum coverage and loudness PLUS a very low distortion generator.

FEATURES

- Quartz Crystal Controlled, Low Distortion Oscillator
- User Programmable Deviation
- Special Frequency Shaping Filters
- Programmed Controlled Muting
- Audio Bypass Position • Data Input Port
- Unique Multiband Pre-Emphasis Control
- Distortion Anticipating ACG
- Optional Remote Control Operation
- Patented, No Overshoot Low Pass Filters Protect Main Channel
- Active Balanced Input. No Transformer
- Front Panel Injection Level Control With 20 Turn Pot

Size, complete system: 19" (48.26 cm) rack mounting x 3-1/2" (8.89 cm) H x 12" (30.48 cm) D. Each unit is 19" (48.26 cm) W x 1-3/4" (4.45 cm) H x 12" (30.48 cm) D
Power: 110 to 125 volts ac, 50/60 Hz, 30 watts



Belar SCM-1 SCA Frequency and Modulation Monitor

The Belar SCM-1 SCA Frequency and Modulation Monitor, when added to the FMM-1 Frequency and Modulation Monitor, or FMM-2 Modulation Monitor provides complete monitoring and test functions for SCA storecasting, data transmission and remote telemetering applications. Up to four crystal switch positions allow four channels to be operated and tested.

Features include three deviation ranges for optimum operation of a particular subcarrier. Narrow deviation (2 kHz deviation) is for remote telemetering applications and selective call systems. Normal operation (6 kHz deviation) is for storecasting and other background programming applications; 4 kHz deviation is for simultaneous stereo operation. The discriminator is wideband for minimum distortion. Maximum versatility is thus provided for future applications as well as present needs.

The SCM-1 features unlimited SCA frequency selection by incorporating interchangeable crystals into its unique design. Select the one to four frequencies best suited to your application. Plug in the appropriate crystals. Monitor four channels by means of push-button selection. To test other frequencies or to change frequencies, merely plug in new crystals. The separate SCA peak flasher is independent of SCA modulation polarity. The front panel push-button modulation calibrator allows the calibration accuracy to be checked at any time.
Size: 19" (48.26 cm) W x 5-1/4" (13.34 cm) H x 10-1/2" (26.67 cm) D (EIA Rack Mount)
Weight: 14 lb (6.3 kg)

All specifications are subject to change without notice.



Potomac AT 51 Audio Test System

The AT51 is an innovative test system which facilitates the measurement of critical parameters in monophonic and stereophonic audio equipment. Designed primarily for commercial broadcast proof-of-performance measurements and equipment maintenance, the AT 51 provides automatic testing and analysis of virtually all major recording or broadcasting equipment. The AT51 System consists of two units: the AG51 Audio Generator, and the AA51 Audio Analyzer. The two separate units permit remote measurements requiring physical separation of signal source and signal analyzer.

The AG51 creates every signal needed for analysis, including a low distortion 20—200 kHz sine wave; and SMPTE standard intermodulation signal; a fixed frequency sine wave at 3.15 kHz for wow and flutter; separate left and right outputs of 150 and 600 ohms; signals for dynamic range and other determinations.

The AA51 measures THD; intermodulation distortion; volts; decibels; signal + noise/noise ratio; wow and flutter; stereo phasing; differential gain in stereo channels. The AA51 has transformerless stereo outputs that are switch-selectable balanced or unbalanced; automatic signal leveling; automatic "set level" and "balance" circuits.

AG51

Size: 5-1/4" (13.34 cm) H
15-1/4" (38.74 cm) W
10-1/8" (25.75 cm) D

Weight: 12 lbs (5.44 kg)

AA51

Size: 5-1/4" (13.34 cm) H
15-1/4" (38.74 cm) W
10-1/8" (25.75 cm) D

Weight: 12 lbs (5.44 kg)

Potomac Instruments FIM-41 Field Intensity Meter

This unit is physically similar to the FIM-21 except that it operates in the frequency range of 540 kHz to 5 MHz.

Size: 8-3/4" (22.2 cm) H
11-1/2" (29.2 cm) W, 5-1/8" (13 cm) D
Weight: 11.5 lb (5.2 kg)



Potomac Instruments FIM-21 Field Intensity Meter

Lightweight and highly stable, the FIM-21 provides precise electromagnetic field measurements in the 535 to 1605 kHz range. Field intensities between 10 microvolts/m and 10 volts/m are directly indicated on the front panel meter. The printed circuit loop antenna is an integral part of the cover and is coupled to the instrument when the cover is opened.

Size: 8-3/4" (22.2 cm) H
11-1/2" (29.2 cm) W, 5-1/8" (13 cm) D
Weight: 11.5 lb (5.2 kg)

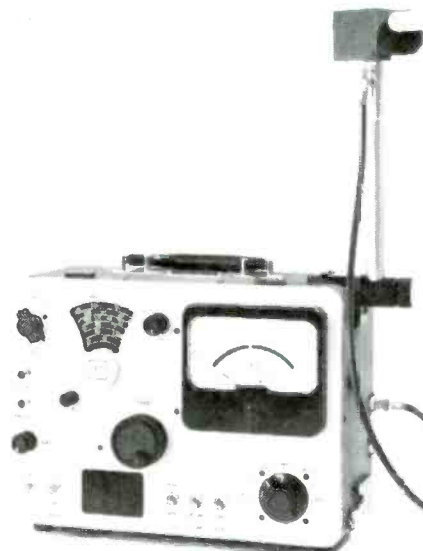

Potomac Instruments FIM-71 Field Strength Meter

The FIM-71, a portable test instrument of labor-

atory quality, accurately measures commercial TV and FM broadcast signals and harmonics. The unit, with a 47 MHz to 225 MHz frequency range, contains an accurate internal calibration oscillator and may be used as a tuned voltmeter. When used with the associated antenna assembly, it is a highly accurate field strength meter.

A front panel speaker and phone jack are provided for signal identification. The FIM-71 has a highly selective and sensitive RF tuner that provides a high degree of immunity to the effects of undesired signals and measures radiated transmitter harmonics without the use of additional fundamental-frequency filtering.
Size: 9" (22.8 cm) H, 12" (30.4 cm) W, (excluding antenna) 7" (17.7 cm) D



Delta OIB-1 Operating Impedance Bridge

Delta's OIB-1 is used to measure impedance of networks, radiators, etc., operating at full power. VSWR can be analyzed, along with complex impedances of up to 400 ±300 ohms.

Size: 5-1/4" (13.3 cm) H,
9-1/2" (24 cm) W, 12-1/2" (31.7 cm) D
Weight: 10 lb (4.54 kg)



Delta CPB-1 Common Point Impedance Bridge

This permanently installed instrument permits continuous monitoring of the common point, thereby facilitating network adjustments. It is also available with one of Delta's TCA ammeters mounted in the front panel.

Size (without panel): 7" (17.8 cm) H,
9" (22.8 cm) W, 9-1/4" (23.5 cm) D
(panel size): 7" (17.8 cm) H, 19" (48.2 cm) W
Weight: 12 lb (5.4 kg)

All specifications are subject to change without notice.



Engineering Data

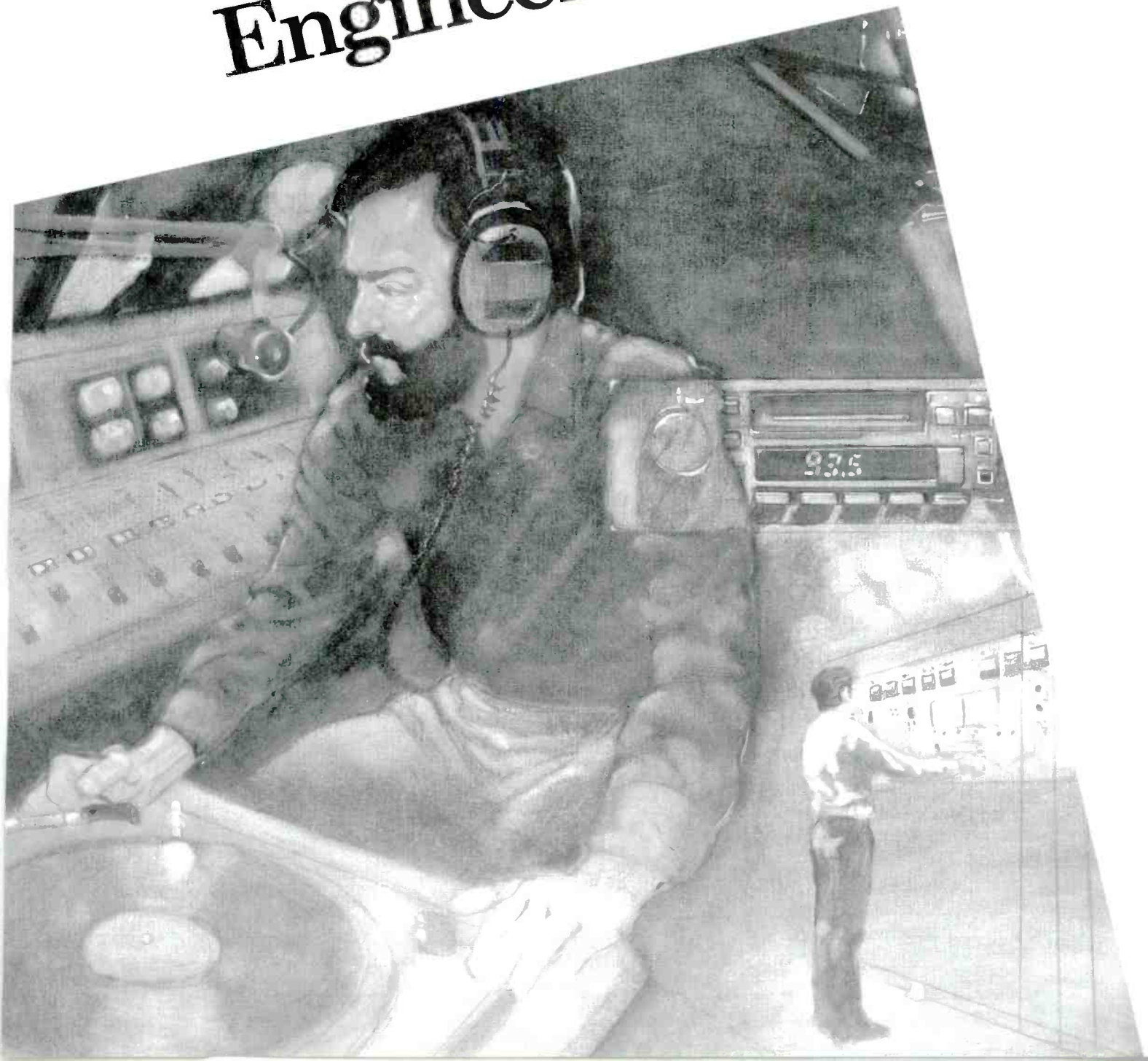

Engineering Data

A	ampere	ips	inches per second	rms	root-mean-square
ac	alternating current	IRE	Institute of Radio Engineers	rpm	revolutions per minute
af	audio frequency	ISO	International Standards Organization	s	series as L_s
afc	automatic frequency control			s	second
AM	amplitude modulation	j	$\sqrt{-1}$	S	siemens
ASA	American Standards Association	k	kilo (10^3)	SCA	subsidiary carrier authorization
ASTM	American Society for Testing Materials	kg	kilogram	s/n	signal to noise
AVC	automatic volume control	kHz	kilohertz	STL	studio transmitter link
avg	average	kva	kilovolt ampere	swr	voltage standing wave ratio
B	susceptance	kw	kilowatt	sync	synchronous, synchronizing
BCD	binary-coded decimal	L	inductance	T	period
C	capacitance	lab	laboratory	t	temperature
C	Centigrade, degrees Centigrade	lb	pound	t	time
cm	centimeter	LC	inductance-capacitance	uhf	ultra-high frequency
COD	cash on delivery	lf	low frequency	v	velocity
CW	continuous wave	lm/sq		v	volt
DF	dissipation factor	ft	footcandle	va	voltampere
db	decibel	log	logarithm	vhf	very high frequency
dbm	decibel referred to one milliwatt	m	mass	vlf	very low frequency
dc	direct current	m	meter; milli (10^{-3})	vol	volume
DSB	double sideband	ma	milliampere	vrms	volt, root, mean, square
E	voltage	max	maximum	vs	versus
EIA	Electronics Industries Association	mbar	millibar	VU	volume unit
emf	electromotive power	mh	millihenry	w	watt
ERP	effective radiated power	MHz	megahertz	X	reactance
F	Fahrenheit, degrees Fahrenheit	mil	0.001 inch	Y	admittance
F	farad	min	minimum; minute	Z	impedance
f	frequency	mm	millimeter	α	short-circuit forward current-transfer ratio (common base)
FM	frequency modulation	mS	millisiemens	β	short-circuit forward current-transfer ratio (common emitter)
f.o.b.	free on board	m Ω	milliohm	L	reflection coefficient
G	conductance	M Ω	megohm	Δ	increment
g	gravitation constant	MM Ω	megamegohm	δ	loss angle
GHz	gigahertz	mv	millivolt	θ	phase angle
G_m	transconductance	mw	milliwatt	λ	wavelength
h	henry	NAB	National Association of Broadcasters	μ	micro- (10^{-6})
Hz	hertz	ns	nanosecond	μa	microampere
h_f	forward current-transfer ratio	nS	nanosiemens	μbar	microbar
h_i	Short-circuit input impedance	oz	ounce	μf	microfarad
h_o	open-circuit output admittance	PA	power amplifier	μh	microhenry
h_r	reverse voltage-transfer ratio	PF	power factor	μs	microsecond
I	current	pF	picofarad	μv	microvolt
IEC	International Electrotechnical Commission	PH	hydrogen in concentration	Ω	ohm
IEEE	Institute of Electrical and Electronics Engineers	pp	push-pull; pages	U	mho
IF	intermediate frequency	ppm	parts per million	w	angular velocity ($2\pi f$)
in.	inch	p-p	peak-to-peak		
		prf	pulse repetition frequency		
		Q	quality factor		
		R	resistance		
		®	registered trademark		
		RC	resistance-capacitance		
		re	referred to		
		rf	radio frequency		
		RH	relative humidity		
		RIAA	Recording Industry Association of America		

Orders of magnitude from 10^{12} to 10^{-18} are designated by the following prefixes:

Order	Prefix	Symbol
10^{12}	tera	T
10^9	giga	G
10^6	mega	M

10^3	kilo	k	10^{-6}	micro	μ
10^2	hecto	h	10^{-9}	nano	n
10	deka	da	10^{-12}	pico	p
10^{-1}	deci	d	10^{-15}	femto	f
10^{-2}	centi	c	10^{-18}	atto	a
10^{-3}	milli	m			

Telephone Cable Color Code

Pair No.	Color	Mate
1	Blue	White
2	Orange	White
3	Green	White
4	Brown	White
5	Slate	White
6	Blue White	White
7	Blue Orange	White
8	Blue Green	White
9	Blue Brown	White
10	Blue Slate	White
11	Orange White	White
12	Orange Green	White
13	Orange Brown	White
14	Orange Slate	White
15	Green White	White
16	Green Brown	White
17	Green Slate	White
18	Brown White	White
19	Brown Slate	White
20	Slate White	White
21	Blue	Red
22	Orange	Red
23	Green	Red
24	Brown	Red
25	Slate	Red
26	Blue White	Red
27	Blue Orange	Red
28	Blue Green	Red
29	Blue Brown	Red
30	Blue Slate	Red
31	Orange White	Red
32	Orange Green	Red
33	Orange Brown	Red
34	Orange Slate	Red
35	Green White	Red
36	Green Brown	Red
37	Green Slate	Red
38	Brown White	Red
39	Brown Slate	Red
40	Slate White	Red
41	Blue	Black
42	Orange	Black
43	Green	Black
44	Brown	Black
45	Slate	Black
46	Blue White	Black

47	Blue Orange	Black
48	Blue Green	Black
49	Blue Brown	Black
50	Blue Slate	Black

Note — The last pair in all cables is a Red with White mate, viz.

6-pair cable	6th pair	Red	White
11-pair cable	11th pair	Red	White
16-pair cable	16th pair	Red	White
26-pair cable	26th pair	Red	White
51-pair cable	51st pair	Red	White

Convert Electrical Degrees to Feet, or Vice Versa When Frequency and Either Feet or Degrees in Known

From the expression

$$\text{Feet} = \frac{\text{degrees}}{360^\circ} \times \frac{300}{f(\text{MHz})} \times 3.281$$

$$= \text{degrees} \times \frac{2.734}{f(\text{MHz})}$$

The following ratio may be set up on the slide rule using C and D scales:

$$\frac{2.734}{f(\text{MHz})} = \frac{\text{feet}}{\text{degrees}}$$

Set 2.734 on scale C over frequency in megahertz on scale D; read feet and degrees on scales C and D, respectively. In some instances it may be convenient to use the folded scales CD and DF.

Metric Conversion

To convert pounds to kilograms, multiply by .4536

To convert inches to centimeters, multiply by 2.54

Engineering Data

Estimated Ground Conductivity

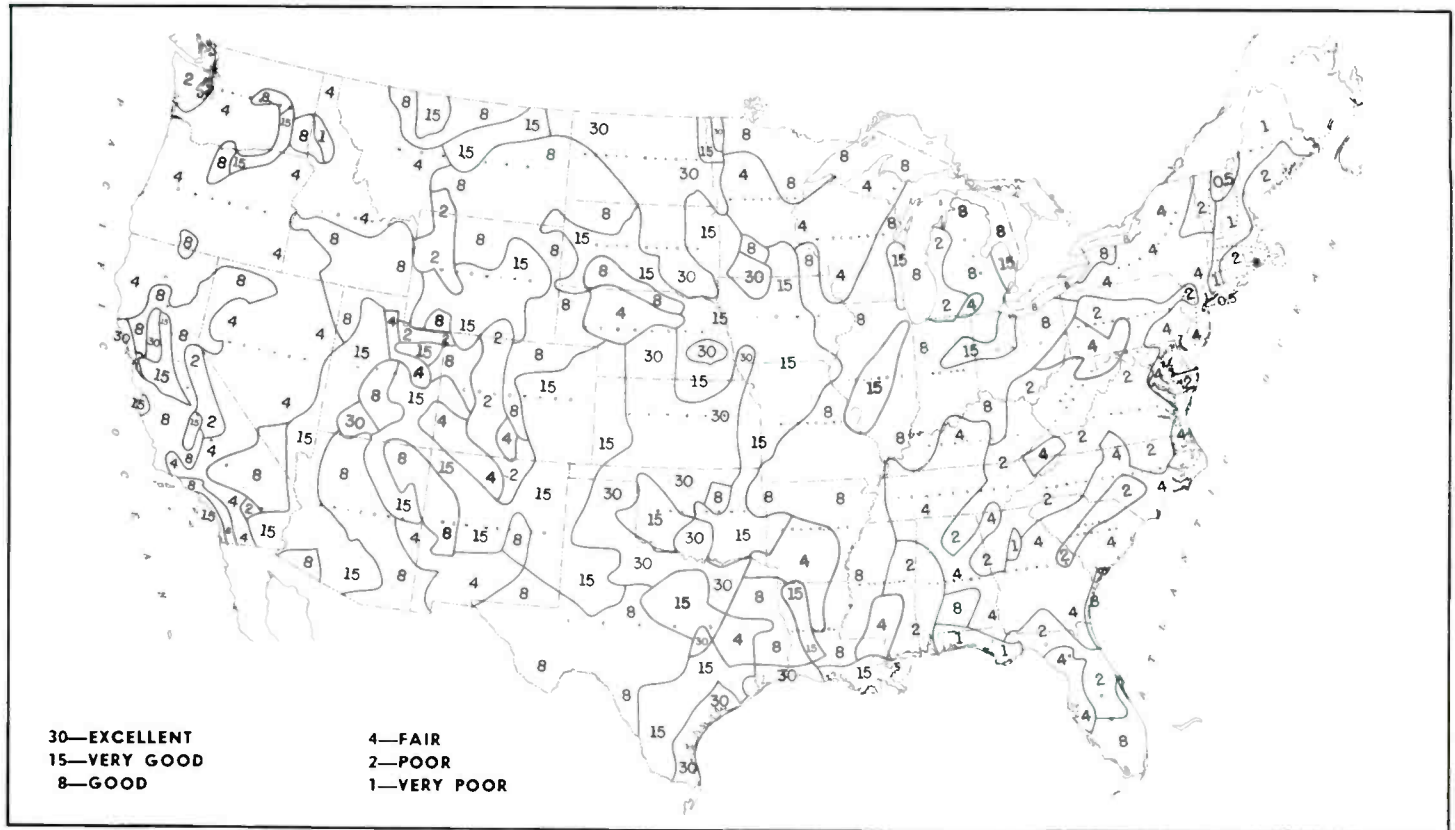

Conversion Table

MULTIPLY NUMBER
OF
BY
TO OBTAIN
NUMBER OF

	ANGSTROMS	MICRONS	MILS	INCHES	FEET	MILES	MILLIMETERS	CENTIMETERS	KILOMETERS
ANGSTROMS	1	10^4	2.540×10^5	2.540×10^8	3.048×10^9	1.609×10^{13}	10^7	10^8	10^{13}
MICRONS	10^{-4}	1	2.540×10	2.540×10^4	3.048×10^5	1.609×10^9	10^3	10^4	10^9
MILS	3.937×10^{-6}	3.937×10^{-2}	1	10^3	1.2×10^4	6.336×10^7	3.937×10	3.937×10^2	3.937×10^7
INCHES	3.937×10^{-9}	3.937×10^{-5}	10^{-3}	1	12	6.336×10^4	3.937×10^{-2}	3.937×10^{-1}	3.937×10^4
FEET	3.281×10^{-10}	3.281×10^{-6}	8.333×10^{-5}	8.333×10^{-2}	1	5.280×10^3	3.281×10^{-3}	3.281×10^{-2}	3.281×10^3
MILES	6.214×10^{-14}	6.214×10^{-10}	1.578×10^{-8}	1.578×10^{-5}	1.894×10^{-3}	1	6.214×10^{-7}	6.214×10^{-6}	6.214×10^{-1}
MILLIMETERS	10^{-7}	10^{-3}	2.540×10^{-2}	2.540×10	3.048×10^2	1.609×10^6	1	10	10^6
CENTIMETERS	10^{-8}	10^{-4}	2.540×10^{-3}	2.540	3.048×10	1.609×10^5	0.1	1	10^5
KILOMETERS	10^{-13}	10^{-9}	2.540×10^{-8}	2.540×10^{-5}	3.048×10^{-4}	1.609	10^{-6}	10^{-5}	1

° CENTIGRADE
° FAHRENHEIT

$$C = 5/9 (F - 32)$$

$$F = 9/5 C + 32$$

Decibels above and below reference level 1mw into 600 ohms

Voltage applies to 600 ohm circuits only. Power applies to any impedance.

dB DOWN		LEVEL	dB UP	
VOLTS	MILLIWATTS	dB mW	VOLTS	MILLIWATTS
0.774 6	1.000	0 +	0.774 6	1.000
0.690 5	0.794 3	1	0.869 1	1.259
0.616 7	0.631 0	2	0.975 2	1.585
0.548 4	0.501 2	3	1.094	1.995
0.488 7	0.398 1	4	1.228	2.512
0.435 6	0.316 2	5	1.377	3.162
0.388 2	0.251 2	6	1.546	3.981
0.346 0	0.199 5	7	1.734	5.012
0.308 4	0.158 5	8	1.946	6.310
0.274 8	0.125 9	9	2.183	7.943
0.244 9	0.100 0	10	2.449	10.000
0.218 3	0.079 43	11	2.748	12.59
0.194 6	0.063 10	12	3.084	15.85
0.173 4	0.050 12	13	3.460	19.95
0.154 6	0.039 81	14	3.882	25.12
0.137 7	0.031 62	15	4.356	31.62
0.122 8	0.025 12	16	4.887	39.81
0.109 4	0.019 95	17	5.484	50.12
0.097 52	0.015 85	18	6.153	63.10
0.086 91	0.012 59	19	6.905	79.43
0.077 46	0.010 00	20	7.746	100.00
0.043 56	0.003 16	25	13.77	316.2
0.024 49	0.001 00	30	24.49	1.000 Watt
0.013 77	0.000 316	35	43.56	3.162 Watts
0.007 746	0.000 100	40	77.46	10.00 Watts
0.004 356	3.16×10^{-5}	45	137.7	31.62 Watts
0.002 449	1.00×10^{-5}	50	244.9	100 Watts
0.001 377	3.16×10^{-6}	55	435.6	316.2 Watts
0.000 774 6	1.00×10^{-6}	60	774.6	1 000 Watts
0.000 435 6	3.16×10^{-7}	65	1 377	3 162 Watts
0.000 244 9	1.00×10^{-7}	70	2 449	10 000 Watts
0.000 137 7	3.16×10^{-8}	75	4 356	31 620 Watts
0.111 077 46	1.00×10^{-8}	80 +	7 746	100 000 Watts

USE OF TABLE

Table is tabulated in 1-dB steps from 0 dB mW to ± 20 dB mW; thereafter in 5-dB steps to ± 80 dB mW. However, the table may be used in 1-dB steps to ± 80 dB mW by noting that, except for decimal locations, the power levels repeat themselves every ± 10 dB and the voltage levels repeat every ± 20 dB.

Example 1. What is the voltage produced by a level of -56 dB mW on 600 ohms? Subtract 40 from 56,

giving 16. Enter table at 16 dB mW, read volts column on left as 0.1228 volt. Now enter table at 55 and 60 dB mW; -56 dB mW is between these two levels, so table shows correct answer as 0.001228 volt.

Example 2. What is the voltage produced by a level of -68 dB mW on 600 ohms? Subtract 60 from 68, giving 8. Enter table at 7 dB mW, read volts column on left as 0.3084 volt. Now enter table at 65 and 70 dB mW; -68 dB mW is between

these two levels, so the table shows the correct answer as 0.0003084 volt.

Example 3. What is the voltage produced by a level of $+33$ dB mW on 600 ohms? Subtract 20 from 33, giving 13. Enter the table at 13 dB mW, read volts column at right as 3.460 volts. Now enter table at 30 and 35 dB mW; $+33$ dB mW is between these two levels, so the table shows the correct answer as 34.6 volts.

Engineering Data

Forward VS Reflected Power

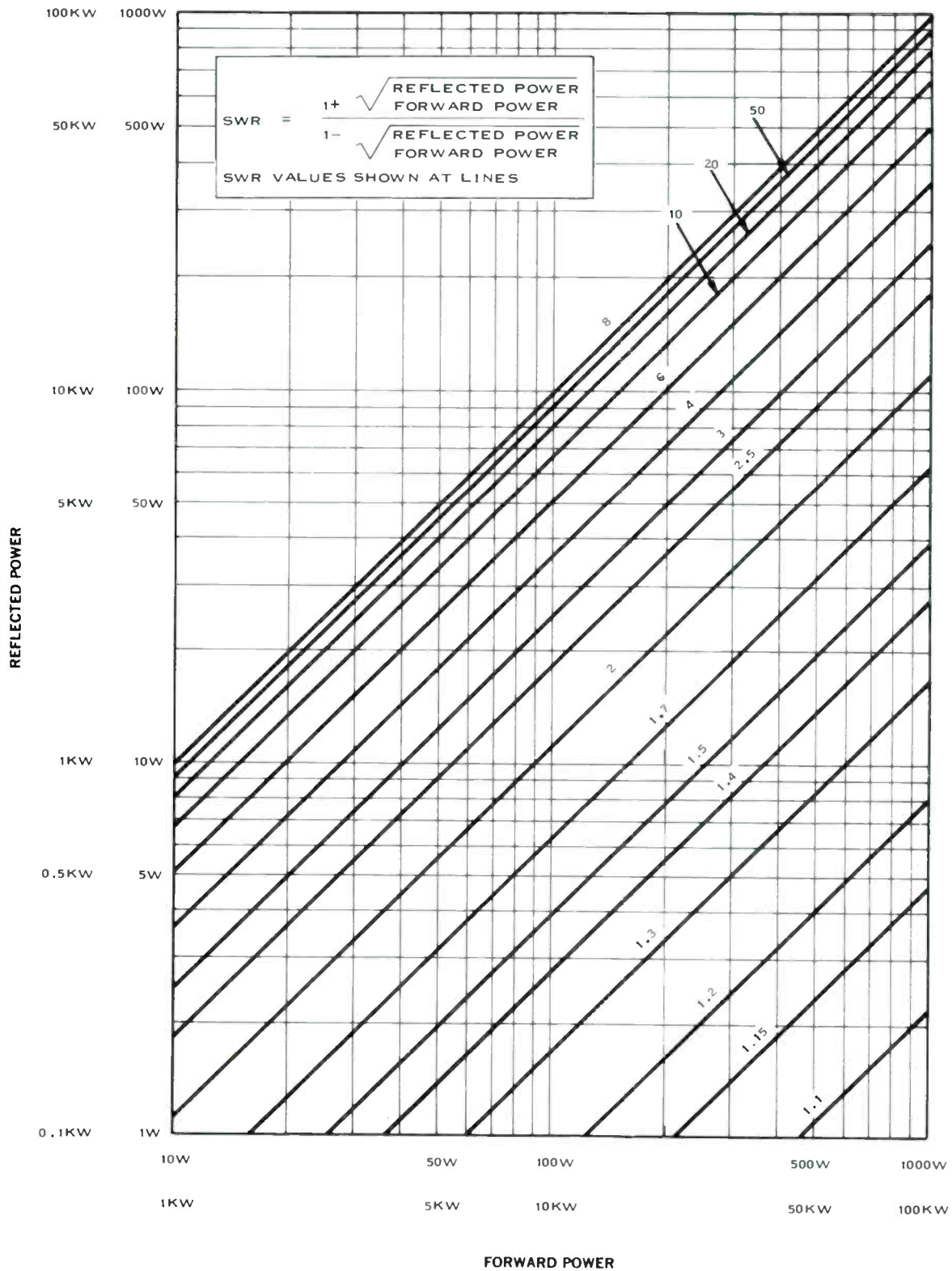

Attenuator Network

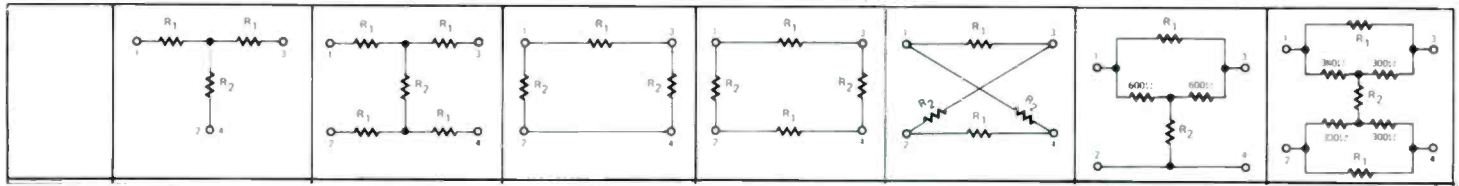

Impedance	600 Ohms		600 Ohms		600 Ohms		600 Ohms		600 Ohms		600 Ohms		600 Ohms	
Loss, dB	R ₁ Ohms	R ₂ Ohms	R ₁ Ohms	R ₂ Ohms	R ₁ Ohms	R ₂ Ohms	R ₁ Ohms	R ₂ Ohms	R ₁ Ohms	R ₂ Ohms	R ₁ Ohms	R ₂ Ohms	R ₁ Ohms	R ₂ Ohms
0	0	∞	0	∞	0	∞	0	∞	0	∞	0	∞	0	∞
0.1	3.58	50204	1.79	50204	7.20	100500	3.60	100500	3.58	100500	7.2	50000	3.6	50000
0.2	6.82	26280	3.41	26280	13.70	57380	6.85	57380	6.82	57380	13.8	26086	6.9	26086
0.3	10.32	17460	5.16	17460	20.55	34900	10.28	34900	10.32	34900	21.0	17143	10.5	17143
0.4	13.79	13068	6.90	13068	27.50	26100	13.80	26100	13.79	26100	28.2	12766	14.1	12766
0.5	17.20	10464	8.60	10464	34.40	20920	17.20	20920	17.20	20920	35.4	10169	17.7	10169
0.6	20.9	8640	10.45	8640	41.7	17230	20.85	17230	20.9	17230	43.2	8333	21.6	8333
0.7	24.2	7428	12.1	7428	48.5	14880	24.25	14880	24.2	14880	50.4	7143	25.2	7143
0.8	27.5	6540	13.75	6540	55.05	13100	27.53	13100	27.5	13100	57.6	6250	28.8	6250
0.9	31.02	5787	15.51	5787	62.3	11600	31.2	11600	31.02	11000	65.4	5504	32.7	5504
1.0	34.5	5208	17.25	5208	68.6	10440	34.3	10440	34.5	10440	73.2	4918	36.6	4918
1.5	51.8	3452	25.9	3452	104.3	6950	52.1	6950	51.8	6950	113.4	3174	56.7	3174
2.0	68.8	2582	34.4	2582	139.4	5232	69.7	5232	68.8	5232	155.4	2310	77.7	2310
2.5	85.9	2053	42.9	2053	175.4	4195	87.7	4195	85.9	4195	200.4	1796	100.2	1796
3.0	102.7	1703	51.3	1703	212.5	3505	106.2	3505	102.7	3505	247.8	1452	123.0	1452
3.5	119.2	1448	59.6	1448	258.0	3021	120.0	3021	119.2	3021	297.6	1209	148.8	1209
4.0	135.8	1249	67.9	1249	287.5	2651	143.8	2651	135.8	2651	351.0	1025	175.5	1025
4.5	152.2	1109	76.1	1109	324.6	2365	162.3	2365	152.2	2365	407.8	883.7	203.7	883.7
5.0	168.1	987.6	84.1	987.6	364.5	2141	182.3	2141	168.1	2141	466.8	771.2	233.4	771.2
5.5	184.0	886.8	92.0	886.8	405.9	1956	203.0	1956	184.0	1956	530.4	678.7	265.2	678.7
6.0	199.3	803.4	99.7	803.4	447.5	1807	223.8	1807	199.3	1807	597.0	603.0	298.6	603.0
6.5	214.6	730.8	107.3	730.8	492.6	1679	246.3	1679	214.6	1679	667.8	539.8	333.0	539.8
7.0	229.7	685.2	114.8	685.2	537.0	1569	268.5	1569	229.7	1569	743.4	484.3	371.7	484.3
7.5	244.2	615.6	122.1	615.6	584.7	1475	292.4	1475	244.2	1475	822.0	437.0	411.3	437.0
8.0	258.4	567.6	129.2	567.6	634.2	1393	317.1	1393	258.4	1393	907.2	396.8	453.6	396.8
8.5	272.3	525.0	136.1	525.0	685.5	1322	342.8	1322	272.3	1322	996.6	361.2	498.3	361.2
9.0	285.8	487.2	142.9	487.2	738.9	1260	369.4	1260	285.8	1260	1091	329.9	545.5	329.9
9.5	298.9	453.0	149.5	453.0	794.4	1204	397.2	1204	298.9	1204	1191	302.2	595.5	302.2
10.0	312.0	421.6	156.0	421.6	854.1	1154	427.0	1154	312.0	1154	1297	277.5	618.5	277.5
11.0	336.1	367.4	168.1	367.4	979.8	1071	489.9	1071	336.1	1071	1529	235.5	794.5	235.5
12.0	359.1	321.7	179.5	321.7	1119	1002	550.5	1002	359.1	1002	1788	201.3	804	201.3
13.0	380.5	282.8	190.3	282.8	1273	946.1	636.3	946.1	380.5	946.1	2080	173.1	1040s	173.1
14.0	400.4	249.4	200.2	249.4	1443	899.1	721.5	899.1	400.4	899.1	2407	149.6	1204	149.6
15.0	418.8	220.4	209.4	220.4	1632	859.6	816.0	859.6	418.8	859.6	2773	129.8	1387	129.8
16.0	435.8	195.1	217.9	195.1	1847	826.0	923.2	826.0	435.8	826.0	3186	113.0	1598	113.0
17.0	451.5	172.9	225.7	172.9	2083	797.3	1042	797.3	451.5	797.3	3648	98.68	1824	98.68
18.0	465.8	152.5	232.9	152.5	2344	772.8	1172	772.8	465.8	772.8	4166	86.4	2083	86.4
19.0	479.0	136.4	239.5	136.4	2670	751.7	1335	751.7	479.0	751.7	4748	75.8	2374	75.8
20.0	490.4	121.2	245.2	121.2	2970	733.3	1485	733.3	490.4	733.3	5400	66.66	2700	66.66
22.0	511.7	95.9	255.9	95.9	3753	703.6	1877	703.6	511.7	703.6	6954	51.72	3477	51.72
24.0	528.8	76.0	264.4	76.0	4737	680.8	2369	680.8	528.8	680.8	8910	40.4	4455	40.4
26.0	542.7	60.3	271.4	60.3	5985	663.4	2992	663.4	542.7	663.4	11370	34.66	5685	34.66
28.0	554.1	47.8	277.0	47.8	7550	649.7	3775	649.7	554.1	649.7	14472	24.87	7236	24.87
30.0	563.0	37.99	281.0	37.99	9500	639.2	4750	639.2	563.0	639.2	18372	19.58	9186	19.58
32.0	570.6	30.16	285.3	30.16	11930	630.9	5967	630.9	570.6	630.9	23286	15.46	11643	15.46
34.0	576.5	23.95	288.3	23.95	15000	624.4	7500	624.4	576.5	624.4	29472	12.21	14736	12.21
36.0	581.1	18.98	290.6	18.98	18960	619.3	9480	619.3	581.1	619.3	37200	9.66	18630	9.66
38.0	585.1	15.11	292.5	15.11	23820	615.3	11910	615.3	585.1	615.3	47058	7.65	23529	7.65
40.0	588.1	12.00	294.1	12.00	30000	612.1	15000	612.1	588.1	612.1	59400	6.06	29700	6.06

Volume Level to Power and Voltage Conversion

REFERENCE LEVEL: 0 DBM = 1 MW, 600 OHMS

MILLIWATTS	VOLTS	DBM	WATTS	VOLTS	DBM
0.00001	0.0007746	-60	0.001000	0.7746	0
0.00010	0.002449	-50	0.002512	1.228	+4
0.000100	0.007746	-40	0.006310	1.946	+8
0.001	0.02449	-30	0.01000	2.449	+10
0.010	0.07746	-20	0.1000	7.746	+20
0.100	0.2449	-10	1.000	24.49	+30
1.000	0.7746	0	10.00	77.46	+40

Engineering Data

Frequencies Used for Standard Broadcast Stations

The band 535-1605 kHz is used for standard broadcasting. It is divided into 107 channels of 10 kHz

each. Following is a list of standard broadcast channels and the conditions under which each may be used in the United States. For

further reference and additional information, see FCC Rules, and the 1950 North American Regional Broadcast Agreement.

Channel	Classification	NARBA Class I Priority	Use Under FCC Rules
540	Clear	Canada (I-A) Mexico (I-A)	II
550	Regional	Cuba (I-C)	III-A, III-B
560	Regional		III-A, III-B
570	Regional	Cuba (I-D)	III-A, III-B
580	Regional		III-A, III-B
590	Regional	Cuba (I-D)	III-A, III-B
600	Regional		III-A, III-B
610	Regional		III-A, III-B
620	Regional	Dominican Republic (I-C)	III-A, III-B
630	Regional	Cuba (I-D)	III-A, III-B
640	Clear	USA (I-A) Canada (I-C) Cuba (I-C)	I, II
650	Clear	USA (I-A)	I, II
660	Clear	USA (I-A)	I, II
670	Clear	USA (I-A)	I, II
680	Clear	USA (I-B)	I, II
690	Clear	Canada (I-A) Cuba (I-C) Mexico (I-B)	II
700	Clear	USA (I-A)	I, II
710	Clear	USA (I-B)	I, II
720	Clear	USA (I-A)	I, II
730	Clear	Mexico (I-A)	II
740	Clear	Canada (I-A) Cuba (I-D)	II
750	Clear	USA (I-A)	I, II
760	Clear	USA (I-A)	I, II
770	Clear	USA (I-A)	I, II
780	Clear	USA (I-A)	I, II
790	Regional		III-A, III-B
800	Clear	Mexico (I-A)	II
810	Clear	USA (I-B)	I, II
820	Clear	USA (I-A)	I, II
830	Clear	USA (I-A)	I, II
840	Clear	USA (I-A)	I, II
850	Clear	USA (I-B) Mexico (I-B)	I, II
860	Clear	Canada (I-A) Cuba (I-C)	II
870	Clear	USA (I-A)	I, II
880	Clear	USA (I-A)	I, II
890	Clear	USA (I-A)	I, II
900	Clear	Mexico (I-A)	II
910	Regional		III-A, III-B
920	Regional	Cuba (I-D)	III-A, III-B
930	Regional		III-A, III-B
940	Clear	Canada & Mexico (I-B)	I, II
950	Regional	Cuba (I-D)	III-A, III-B
960	Regional		III-A, III-B
970	Regional		III-A, III-B
980	Regional	Cuba (I-D)	III-A, III-B
990	Clear	Canada (I-A)	II
1000	Clear	Mexico & USA (I-B)	I, II
1010	Clear	Canada (I-A) Cuba (I-B)	II
1020	Clear	USA (I-A)	I, II
1030	Clear	USA (I-A)	I, II

Engineering Data

Channel	Classification	NARBA Class I Priority	Use Under FCC Rules
1040	Clear	USA (I-A)	I, II
1050	Clear	Mexico (I-A)	II
1060	Clear	Mexico & USA (I-B)	I, II
1070	Clear	Canada & USA (I-B)	I, II
1080	Clear	USA (I-B)	I, II
1090	Clear	Mexico & USA (I-B)	I, II
1100	Clear	USA (I-A)	I, II
1110	Clear	USA (I-B)	I, II
1120	Clear	USA (I-A)	I, II
1130	Clear	Canada & USA (I-B)	I, II
1140	Clear	Mexico & USA (I-B)	I, II
1150	Regional		III-A, III-B
1160	Clear	USA (I-A)	I, II
1170	Clear	USA (I-B)	I, II
1180	Clear	USA (I-A)	I, II
1190	Clear	Mexico & USA (I-B)	I, II
1200	Clear	USA (I-A)	I, II
1210	Clear	USA (I-A)	I, II
1220	Clear	Mexico (I-A)	II
1230	Local		IV
1240	Local		IV
1250	Regional		III-A, III-B
1260	Regional		III-A, III-B
1270	Regional		III-A, III-B
1280	Regional		III-A, III-B
1290	Regional		III-A, III-B
1300	Regional		III-A, III-B
1310	Regional		III-A, III-B
1320	Regional		III-A, III-B
1330	Regional		III-A, III-B
1340	Local		IV
1350	Regional		III-A, III-B
1360	Regional		III-A, III-B
1370	Regional		III-A, III-B
1380	Regional		III-A, III-B
1390	Regional		III-A, III-B
1400	Local		IV
1410	Regional		III-A, III-B
1420	Regional		III-A, III-B
1430	Regional		III-A, III-B
1440	Regional		III-A, III-B
1450	Local		IV
1460	Regional		III-A, III-B
1470	Regional		III-A, III-B
1480	Regional		III-A, III-B
1490	Local		IV
1500	Clear	USA (I-B)	I, II
1510	Clear	USA (I-B)	I, II
1520	Clear	USA (I-B)	I, II
1530	Clear	USA (I-B)	I, II
1540	Clear	Bahamas (I-A) USA (I-B)	II
1550	Clear	Canada & Mexico (I-B)	I, II
1560	Clear	USA & Cuba (I-B)	I, II
1570	Clear	Mexico (I-A)	II
1580	Clear	Canada (I-A)	II
1590	Regional		III-A, III-B
1600	Regional		III-A, III-B

Engineering Data

Frequency Designation of FM

Broadcast Channels

Freq. (MHz)	Channel No.	Freq. (MHz)	Channel No.	Freq. (MHz)	Channel No.	Freq. (MHz)	Channel No.
88.1	201	98.1	251	90.9	215	100.9	265
88.3	202	98.3	252	91.1	216	101.1	266
88.5	203	98.5	253	91.3	217	101.3	267
88.7	204	98.7	254	91.5	218	101.5	268
88.9	205	98.9	255	91.7	219	101.7	269
89.1	206	99.1	256	91.9	220	101.9	270
89.3	207	99.3	257	92.1	221	102.1	271
89.5	208	99.5	258	92.3	222	102.3	272
89.7	209	99.7	259	92.5	223	102.5	273
89.9	210	99.9	260	92.7	224	102.7	274
90.1	211	100.1	261	92.9	225	102.9	275
90.3	212	100.3	262	93.1	226	103.1	276
90.5	213	100.5	263	93.3	227	103.3	277
90.7	214	100.7	264	93.5	228	103.5	278
				93.7	229	103.7	279
				93.9	230	103.9	280
				94.1	231	104.1	281
				94.3	232	104.3	282
						94.5	233
						94.7	234
						94.9	235
						95.1	236
						95.3	237
						95.5	238
						95.7	239
						95.9	240
						96.1	241
						96.3	242
						96.5	243
						96.7	244
						96.9	245
						97.1	246
						97.3	247
						97.5	248
						97.7	249
						97.9	250
						104.5	283
						104.7	284
						104.9	285
						105.1	286
						105.3	287
						105.5	288
						105.7	289
						105.9	290
						106.1	291
						106.3	292
						106.5	293
						106.7	294
						106.9	295
						107.1	296
						107.3	297
						107.5	298
						107.7	299
						107.9	300

Decibels Vs Ratio

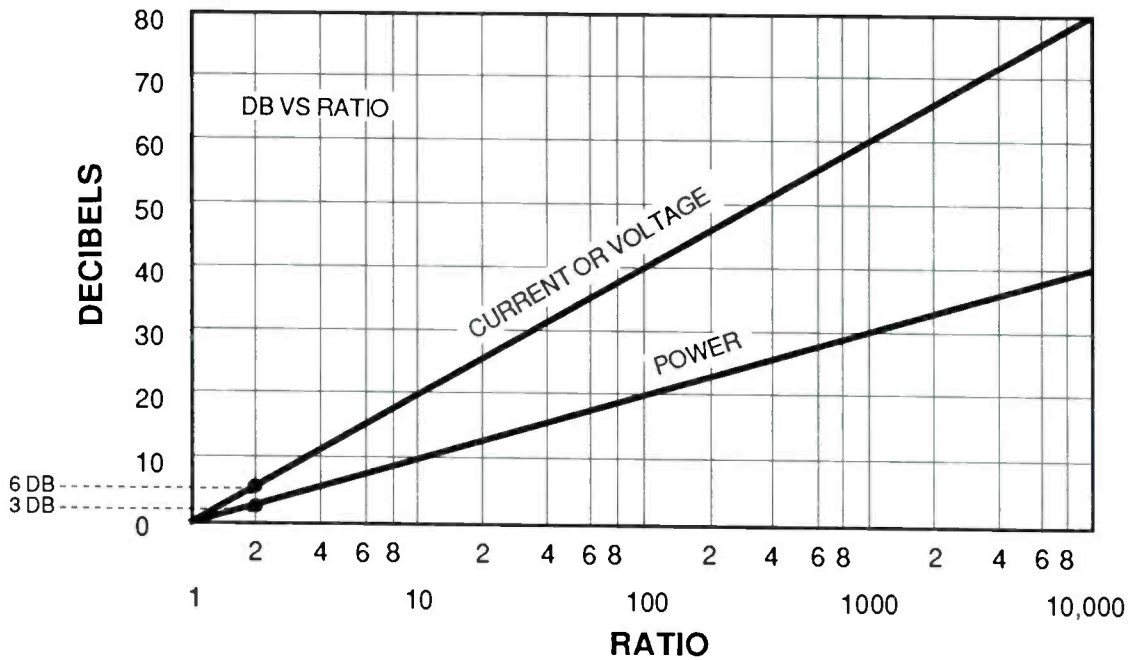

The following table is offered as a general guide to the classes of FM radio broadcast stations brought about by the FCC 80-90 docket. For specific interpretation and equipment requirements, see your engineering consultant.

Required Transmitter Power Out **	Antenna Bays	Effective Radiated Power **	Coax Line Size	Coax Line Length	Coax Line Efficiency	Tower Height **
Class A FM - 328 Feet						
7.6 kW	1	3 kW	1-5/8"	328'	85.0%	328'
3.6 kW *	2	3 kW	1-5/8"	342'	85.2%	333'
2.3 kW *	3	3 kW	1-5/8"	347'	85.4%	337'
Class A FM - 500 Feet						
2.8 kW	1	1 kW	1-5/8"	519'	78.4%	500'
1.3 kW *	2	1 kW	1-5/8"	514'	78.6%	505'
0.8 kW	2	1 kW	1-5/8"	509'	78.7%	510'
Class B1 FM - 328 Feet						
13.0 kW	4	25 kW	3"	332'	89.6%	343'
10.3 kW	5	25 kW	3"	327'	89.8%	348'
8.4 kW *	6	25 kW	3"	322'	89.9%	353'
7.1 kW	7	25 kW	3"	317'	90.1%	358'
6.2 kW *	8	25 kW	3"	313'	90.2%	363'
Class B or C2 FM - 492 Feet						
21.7 kW	5	50 kW	3"	491'	85.1%	512'
17.8 kW *	6	50 kW	3"	486'	85.2%	517'
15.1 kW	7	50 kW	3"	481'	85.3%	522'
13.0 kW *	8	50 kW	3"	477'	85.4%	527'
11.6 kW	9	50 kW	3"	511'	85.5%	532'
10.4 kW	10	50 kW	3"	511'	85.5%	537'
Class C1 FM - 984 Feet						
39.1 kW	6	100 kW	3-1/8"	1,003'	77.4%	1,009'
28.8 kW	8	100 kW	3-1/8"	1,003'	77.4%	1,019'
24.5 kW *	10	100 kW	3"	1,003'	71.8%	1,029'
20.2 kW	12	100 kW	3"	1,003'	71.8%	1,039'
Class C FM - 1,968 Feet						
51.4 kW	6	100 kW	4"	1,987'	58.9%	1,993'
37.8 kW	8	100 kW	4"	1,987'	58.9%	2,003'
29.2 kW *	10	100 kW	3-1/8"	1,987'	60.2%	2,013'
20.2 kW *	12	100 kW	3"	1,987'	51.9%	2,023'

* Most commonly requested antenna transmitter combinations.
(Even number of bays required for beam tilt and null fill)

** Shown with maximum effective radiated power (e.r.p.) and maximum height allowed.

Engineering Data

Footage Table for Broadcast Tower Heights

550 KHZ TO 1070 KHZ					1080 KHZ TO 1600 KHZ				
KHZ	METERS	1 WAVE	½ WAVE	¼ WAVE	KHZ	METERS	1 WAVE	½ WAVE	¼ WAVE
550	545	1787.6	893.8	446.8	1080	277.8	911.1	455.5	227.7
560	536	1758.0	879.0	439.5	1090	275.2	902.6	451.3	225.6
570	526	1725.3	862.6	431.3					
580	517	1695.7	847.8	423.9	1100	272.7	894.4	447.2	223.6
590	509	1669.5	834.7	417.3	1110	270.3	886.5	443.2	221.6
					1120	267.9	879.0	439.5	219.7
600	500	1640.0	820.0	410.0	1130	265.5	870.8	435.4	217.7
610	492	1612.7	806.3	403.1	1140	263.2	862.6	431.3	215.6
620	484	1587.5	799.7	396.8	1150	260.9	855.7	427.8	213.9
630	476	1561.2	780.6	390.3	1160	258.6	847.8	423.9	211.9
640	469	1546.3	773.1	386.5	1170	256.4	840.9	420.4	210.2
650	462	1515.3	757.6	378.8	1180	254.2	834.7	417.3	208.6
660	455	1492.4	746.2	373.1	1190	252.1	826.8	413.4	206.7
670	448	1469.4	734.7	367.3					
680	441	1446.4	723.2	361.1	1200	250.0	820.0	410.0	205.0
690	435	1426.4	713.2	361.2	1210	247.9	813.1	406.5	203.2
					1220	245.9	806.3	403.1	201.5
700	429	1407.1	703.5	351.2	1230	243.9	799.1	399.5	199.7
710	423	1387.4	693.7	346.8	1240	241.9	793.7	396.8	198.4
720	417	1367.7	683.8	341.9	1250	240.0	787.2	393.6	196.8
730	411	1348.0	674.0	337.0	1260	238.1	780.9	390.4	195.2
740	405	1328.4	664.2	332.1	1270	236.2	774.7	387.3	193.6
750	400	1312.0	656.0	328.0	1280	234.4	768.8	384.4	192.2
760	395	1295.6	647.8	323.4	1290	232.6	762.9	381.4	190.7
770	390	1279.2	639.6	319.8					
780	385	1262.8	631.4	315.7	1300	230.8	757.0	378.5	189.2
790	380	1246.4	623.2	311.6	1310	229.0	751.1	375.5	187.7
					1320	227.3	746.2	373.1	186.5
800	375	1230.0	615.0	307.5	1330	225.6	739.9	369.9	184.9
810	370	1213.6	606.8	303.4	1340	223.9	734.7	367.3	183.6
820	366	1200.4	600.2	300.1	1350	222.2	728.8	364.4	182.2
830	361	1184.0	592.0	296.0	1360	220.6	723.2	361.1	180.5
840	357	1170.9	585.4	292.7	1370	219.0	718.3	359.1	179.5
850	353	1157.8	578.9	289.4	1380	217.4	713.4	356.2	178.1
860	349	1144.7	572.3	286.1	1390	215.8	707.8	353.1	176.5
870	345	1131.6	565.8	282.9					
880	341	1118.4	559.2	279.6	1400	214.3	703.5	351.2	175.6
890	337	1105.3	552.6	276.3	1410	212.8	696.9	348.4	174.2
					1420	211.3	693.7	346.8	173.4
900	333	1092.2	546.1	273.0	1430	209.8	688.1	344.0	172.0
910	330	1082.4	541.2	270.6	1440	208.3	683.8	341.9	170.9
920	326	1069.2	534.6	267.3	1450	206.9	678.6	339.3	169.6
930	323	1059.4	529.7	264.8	1460	205.5	674.0	337.0	168.5
940	319	1046.3	523.1	261.5	1470	204.1	669.4	334.7	167.3
950	316	1036.4	518.2	259.1	1480	202.7	664.2	332.1	166.5
960	313	1026.6	513.3	256.6	1490	201.3	660.2	330.1	165.0
970	309	1013.5	506.7	253.3					
980	306	1003.6	501.8	250.9	1500	200.0	656.0	328.0	164.0
990	303	993.8	496.9	248.4	1510	198.7	651.7	325.8	162.9
					1520	197.4	647.8	323.4	161.7
1000	300	984.0	492.0	246.0	1530	196.1	643.2	321.6	160.8
1010	297	974.1	487.5	243.7	1540	194.8	639.6	319.8	159.9
1020	294.1	964.6	482.3	241.1	1550	193.5	634.6	317.3	158.6
1030	291.3	955.3	477.6	238.8	1560	192.3	631.4	315.7	157.8
1040	288.5	946.2	473.1	236.5	1570	191.1	626.8	313.4	156.7
1050	285.7	937.1	468.5	234.2	1580	189.9	623.2	311.6	155.8
1060	283.0	928.2	464.1	232.0	1590	188.7	618.9	309.4	154.7
1070	280.4	919.7	459.8	229.9					
					1600	187.5	615.0	307.5	153.7

DISTANCE IN MILES TO RECEIVING LOCATION AND DEPRESSION ANGLES FOR VARIOUS FM ANTENNA HEIGHTS

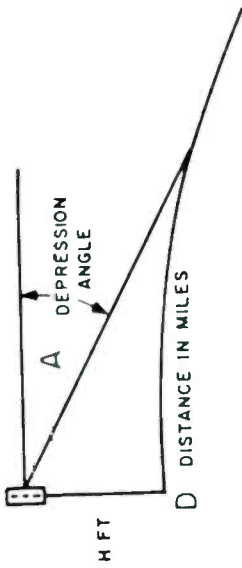

H—Height in feet to Electrical center of antenna

$$D_h - \text{Distance to horizon} = \sqrt{2H} \quad \left(\frac{4}{3} \text{ earth radius} \right)$$

$$A_h - \text{Depression angle to horizon} = \frac{.0216H}{D_h}$$

The relationship $D = \frac{.0109 H}{A}$

gives approximate distances to intercept at various depression angles.

Height in Feet H	D _h A _h		Depression Angle																			
			0.5°	1°	1.5°	2°	2.5°	3°	3.5°	4°	4.5°	5°	6°	7°	8°	9°	10°	11°	12°	13°	14°	15°
200	20.0	.216	4.6	2.21	1.45	1.07	0.86	0.71	0.61	0.54	0.48	0.43	0.36	0.31	0.27	0.24	0.22	0.20	0.18	0.17	0.15	0.14
300	24.5	.268	7.2	3.35	2.18	1.64	1.30	1.07	0.92	0.80	0.71	0.64	0.55	0.46	0.41	0.37	0.33	0.30	0.27	0.25	0.23	0.21
400	28.3	.304	9.9	4.49	2.90	2.18	1.75	1.42	1.24	1.06	0.94	0.86	0.73	0.62	0.54	0.49	0.46	0.40	0.36	0.33	0.31	0.29
500	31.6	.343	12.6	5.60	3.65	2.72	2.16	1.82	1.55	1.36	1.21	1.09	0.92	0.78	0.68	0.61	0.55	0.50	0.45	0.42	0.39	0.36
600	34.6	.375	16.0	6.81	4.8	3.61	2.64	2.15	1.86	1.63	1.42	1.31	1.09	0.92	0.81	0.73	0.65	0.59	0.54	0.50	0.46	0.43
700	37.4	.405	19.9	7.98	5.2	3.87	3.08	2.54	2.16	1.90	1.68	1.50	1.25	1.06	0.94	0.83	0.74	0.68	0.62	0.57	0.53	0.50
800	40.0	.435	24.2	9.2	5.9	4.49	3.52	2.89	2.50	2.17	1.90	1.75	1.45	1.22	1.05	0.97	0.86	0.78	0.72	0.67	0.61	0.58
900	42.4	.452	29.5	10.5	6.7	5.05	3.98	3.28	2.80	2.45	2.13	1.96	1.62	1.36	1.19	1.09	0.97	0.88	0.81	0.75	0.69	0.65
1000	45.0	.487	36.2	11.6	7.4	5.51	4.39	3.65	3.10	2.70	2.39	2.15	1.79	1.52	1.32	1.18	1.08	0.98	0.90	0.83	0.77	0.72
1200	49.0	.530	—	14.1	9.0	6.75	5.32	4.39	3.77	3.19	2.85	2.61	2.15	1.81	1.59	1.44	1.29	1.18	1.08	1.00	0.92	0.87
1400	53.0	.577	—	16.7	10.4	7.66	6.12	5.13	4.33	3.77	3.35	3.00	2.48	2.11	1.85	1.63	1.45	1.36	1.24	1.15	1.06	1.00
1600	56.6	.620	—	19.4	12.0	9.10	7.10	5.85	5.02	4.35	3.80	3.40	2.84	2.40	2.13	1.91	1.72	1.55	1.44	1.32	1.23	1.16
1800	60.0	.650	—	22.3	13.6	10.25	8.00	6.60	5.65	4.90	4.30	3.90	3.19	2.69	2.39	2.15	1.94	1.75	1.62	1.48	1.38	1.30
2000	63.2	.683	—	25.4	15.4	11.25	8.89	7.30	6.25	5.45	4.80	4.30	3.60	3.04	2.68	2.38	2.13	2.00	1.83	1.70	1.56	1.46
5000	100.0	1.080	—	42.9	29.5	22.80	18.75	15.85	13.75	12.10	10.90	9.01	7.75	6.00	5.40	4.90	4.50	4.15	3.84	3.60	3.48	3.40

Engineering Data

Distance in Miles From an FM Transmitter to Its 54 dbu (0.5 mv/m) Contour for Various Heights and Powers POWER IN DBK

AHAAT IN FT	-20	-18	-16	-14	-12	-10	-8	-6	-4	-2	0	2	4	6	8	10	12	14	16	18	20
3400	20	23	26.5	30	34	38	42	47.5	51.5	55	60	65	69.5	73	78	82	87	91.5	95	100	113.5
3200	19	22	25	29	32.5	37	40.5	45	50	53.5	58.5	63	67	71	75	80	85	90	93	97	100.5
3000	18.5	21.5	24.5	28	31.5	35	40	43	48	52	56.5	60.5	65	69.5	73	77.5	82	86.5	91.5	95	98.5
2800	18	20.5	23	27	30	33.5	38	42	45.5	50	54.5	58.5	63	67	71	75	80	84	89	93	96
2600	17.5	20	22	25.5	29	32	36	40	44.5	48.5	52	56	60	65	69	73	77	81.5	85.5	90	94
2400	17	19	21.5	24.5	28	31	35	38.5	42	46	50.5	54.5	58.5	62	67	70.5	75	78.7	83	88	92
2200	16	18.2	20	23	26.5	29	32.5	36.5	40	44.5	48	52	55.5	60	65	68	72	76.5	80	85	90
2000	15	17.4	19	22	25	28	31	35	38	42	45.5	50	53	57	61.5	65	69.5	73.7	78	82	86
1900	15	17	18.5	21.5	24.5	27	30	33.5	37.5	40.5	45	48.5	52	55.5	60	64	68	72	76	80	85
1800	14	16	18	20.5	23	26.5	29	32.5	36	40	43	47.5	51	55	58.5	62.5	66	70	75	79	83
1700	13.5	15.5	17.5	20	22.5	25	28	31.5	35	38	42	45.5	50	53	57	60.5	65	69	71.5	77	81
1600	13	15	17	19	21.5	24.5	27	30	33	36.5	40.5	44	48	52	55.5	60	63	67	71	75	80
1500	12.5	14.6	16.5	18.5	21	23.5	26.5	29.5	32	35.5	39.5	43	46.5	50	54.5	58	61.5	65	69.5	73	78
1400	12	14	16	18	20	22	25	28	30.5	34.5	38	41.5	45	48.5	52.5	56	60	63	67	71.5	75
1300	11.5	13.4	15.5	17	19	21.5	23.5	27	30	32.5	36	40	43	47	50.5	55	58	61.5	65	69.5	73.5
1200	11	13	14.5	16.5	18.5	20.5	23	25.5	28	31	35	38	41.7	45	48.5	52.5	56	60	63	67	71.5
1100	10	12	13.5	15.5	17.5	19.5	21.5	24.5	26.5	30	33	36.5	40	43	47	50.5	54.5	58	61.5	65	70
1000	9.1	11.5	13	15	17	18.5	20.5	23	25.5	28	31.2	34.5	38	41	45	48	52	56	58.5	63	68
900	8.7	10.5	12	14	16	18	19.5	21.5	24.5	27	29.6	32.5	35.5	38.5	42.5	46	50	54	57	60.5	65
800	8.2	9.2	11.5	13	15	16.5	18	20	22	25	28	30.5	33.5	37	40	43	47.5	52	55	58.5	63.5
700	7.7	8.7	10.5	12	13.5	15.5	17	18.5	21	23	26	28.5	32	35	38	41	45	49	53	56.5	63
600	7.2	8	9	11	12	14	15.5	17.5	19	21.5	24	26.5	28.7	32	35	38	42	45.5	50	55	60
500	6.5	7.3	8.2	9	11	12.5	14	16	17.5	19	22	24	27	29	32.5	35.5	38.5	43	47	52	57
400	5.8	6.6	7.3	8.3	8.5	11	12.5	14	16	17.5	19	22	24.5	27	29.5	32	35.5	40	43.5	49.5	55
300	5	5.7	6.5	7.2	8	8.7	10.5	12	13.5	15	17	18.5	21	23.5	26.5	28.5	32	35.5	40	45.4	52
200	4	4.6	5.2	5.7	6.5	7.3	8.2	9	11	12	13.7	15.5	17.5	19	22	24.5	28	31.5	35	42	48
100	2.8	3.2	3.7	4.1	4.6	5.2	5.8	6.6	7.4	8.2	9	10.7	12.5	14	16	18.2	21.5	25	30	35.5	45

Distance in Miles From an FM Transmitter to Its 60 dbu (1 mv/m) Contour for Various Heights and Powers

POWER IN DBK

AHAAT
IN FT

	-20	-18	-16	-14	-12	-10	-8	-6	-4	-2	0	2	4	6	8	10	12	14	16	18	20	
3400	11	13	15	17.5	20	22.5	27	30	34	37	40.5	45	49	52	57	60	64	65	65	65	65	65
3200	11	12.2	14.5	16.5	19.5	22	25	28.5	32	39	42.5	47	50.5	55	59	62	64	65	65	65	65	65
3000	10.5	12	14	16	19	21.5	24.5	28	31	34	38	41	45	49.5	53	57	60	64	65	65	65	65
2800	10	11.8	13.5	15.7	18	20.5	24	26.5	30	33	36	40	44	48	51	55	59	62	64	65	65	65
2600	9.7	11.5	13	15	17	20	22.5	25.5	29	32	35	39	42	46	49.5	53	58	60	63	64	65	65
2400	9.4	11	12.8	14	16	19	21.5	24.5	28	30.5	34	37	40	44	47.5	51	55	59	61	64	65	65
2200	9.2	10.8	12	13.5	15.5	18	20.5	23.5	26	29	32	35	39	42	45.5	49	52	56.5	59.5	62	65	65
2000	9	10.2	11.7	13.1	15	17	20	22	25	28	30	33.5	37	40	44	46.5	50.5	54	57.5	60.5	65	65
1900	8.7	10	11.2	12.7	14.5	16.5	19	21.5	24.5	27	29.5	33	35.5	39	43.5	45.5	49.5	52.5	55.5	59.5	62	62
1800	8.5	9.7	11	12.6	14	16	18	20.5	23.5	25.5	29	31.5	35	38.5	43	44.5	48.5	51.5	55	59	61	61
1700	8.3	9.2	10.5	11.6	13.8	15.5	17.3	20	22.5	25	28	30	33	37	40	43	46.5	50	53	57.5	60	60
1600	8.1	9	10.3	11.5	13.2	15	17.1	19.2	21.5	24	26.5	29.5	32.5	35.5	39	42	45	49	51.5	55	58	58
1500	8	9	10	11.4	13	14.9	16.9	18.6	21	23	26	28.5	31.5	35	38	40.5	44	47	50.1	54	57	57
1400	7.5	8.6	9.7	11.2	12.5	14	16.2	18	20	22	25	27.5	30	33	36	40	43	46	48.5	52	55	55
1300	7.3	8.2	9.3	10.5	12	13.8	15.5	17.5	19	21.5	24	26.5	29	32.5	35	39	41.5	45	47.5	51	54	54
1200	7	7.8	9	10	11.5	13	15	17	18	21	23	25.5	28	31	34	37.5	40	44	46	49	52	52
1100	6.8	7.6	8.5	9.5	11	12.5	14.5	16	17.1	20	22	24.5	26.5	29.5	32	35	38	41	44.5	47	50	50
1000	6.4	7.2	8	9	10.2	12	14	15.6	17	19	21	23	25.5	28	31	34	36.5	40	43	45.5	49	49
900	6.2	6.8	7.8	8.8	9.7	11.2	13	14.5	16.4	18	20	21	24.5	26	29	32	35	38	40.5	44	47	47
800	5.8	6.6	7.3	8.2	9.2	10.3	12	13.5	15.2	17	18.5	20.5	23	25	27.5	30	33	36	39	41.5	45	45
700	5.4	6.2	7	7.8	8.6	9.7	10.5	13	14	16	18	19.2	21	24	26	28.5	31	33	36	39	42	42
600	5	5.7	6.5	7.1	8	9	9.8	11.8	12.3	14.5	16	18	19.7	21.5	24	26	29	32	35	36.5	40	40
500	4.6	5	5.8	6.6	7.3	8.2	9	10	12	13.2	14.5	16.1	17.9	20	22	24.5	27	29.5	31.5	35	37	37
450	4.2	4.8	5.5	6.2	7.0	7.8	8.6	9.6	10.5	12.5	14.0	15.2	17.0	19.0	20.5	23.0	25.4	28	30	33	36	36
400	4	4.6	5.1	5.9	6.6	7.4	8.2	9	10	11.8	12.5	14.5	16	17.8	19.8	21.5	24.5	26.5	29	31.5	35	35
350	3.8	4.2	4.8	5.3	6.1	7.0	7.8	8.6	9.6	10.3	11.0	14.0	15	16.8	18.5	20.2	23	25	27.5	30	33	33
300	3.6	4	4.5	5	5.7	6.3	7.2	8	8.8	10	10.5	12.6	14	15.6	17	19	21	23	25.5	28	30	30
250	3.2	3.7	4.0	4.6	5.1	5.9	6.7	7.3	8.0	8.9	9.9	10.6	12.5	14.0	15.8	17.8	19	21.5	24	26	28	28
200	2.9	3.3	3.7	4.1	4.7	5.1	5.9	6.6	7.4	8.1	9	10	11.3	12.5	14	15.5	17.5	19.5	21.5	24	26	26
150	2.5	2.8	3.2	3.6	4.0	4.5	5.0	5.7	6.4	7.1	7.9	8.8	9.7	10.8	12	14.0	15.2	17.0	19	21	24	24
100	2	2.3	2.7	2.9	3.2	3.8	4.1	4.7	5.2	5.9	6.5	7.4	8.3	9	10	11.3	12.9	14.5	16.2	18.1	20	20

Engineering Data

Distance in Miles From an FM Transmitter to Its 80-dbu (10 mv/m) Contour for Various Heights and Powers

AHAAT
IN FT

POWER IN DBK

AHAAT IN FT	-20	-18	-16	-14	-12	-10	-8	-6	-4	-2	0	2	4	6	8	10	12	14	16	18	20
3400	1.3	1.8	2.1	2.6	3.2	4.0	4.8	6.0	7.3	9	12.5	15	18	20	23	26.5	30	34	38	42	46.5
3200	1.3	1.8	2.1	2.6	3.2	4.0	4.8	6.0	7.3	8.8	12	15	17	19	22	25	29	32.5	36.5	40.5	45
3000	1.3	1.8	2.1	2.6	3.2	4.0	4.8	6.0	7.1	8.5	11.5	14.5	17	18.5	21.5	24.5	28	31.5	35	40	43
2800	1.3	1.8	2.1	2.5	3.2	4.0	4.8	5.9	7.1	8.4	11.3	14	16	18	20	23	26.5	30	34	38	41.5
2600	1.3	1.8	2.1	2.5	3.2	4.0	4.7	5.8	7.0	8.1	11	13	15.5	17.5	19.6	22	25.5	29	32	35.5	40
2400	1.3	1.8	2.1	2.5	3.2	3.9	4.7	5.7	7.0	8.1	10.5	12.5	15	17	19	21.5	24.5	27.5	30.5	35	38.5
2200	1.3	1.8	2.1	2.5	3.2	3.8	4.7	5.6	6.8	8	10	12	14.5	16.5	18	20	23	26.5	29.5	32.5	36.5
2000	1.3	1.8	2.0	2.5	3.1	3.8	4.6	5.4	6.7	7.8	9	11.5	13.5	15	17.5	19.5	21.5	25	28	31	35
1900	1.3	1.8	2.0	2.5	3.0	3.7	4.6	5.3	6.6	7.7	9	11	13	14.8	17	19	21	24.5	27	30	34
1800	1.3	1.8	2.0	2.5	3.0	3.7	4.5	5.3	6.3	7.6	8.7	10.5	12.5	14.5	16.5	18.5	20.5	23	26	29	32.5
1700	1.3	1.8	2.0	2.4	2.9	3.6	4.4	5.2	6.1	7.3	8.4	10	12	14	15.5	18	20	22	25	28	31
1600	1.2	1.7	2.0	2.3	2.9	3.6	4.3	5.1	6	7.0	8.1	9.2	11.8	13.5	15	17.5	19	21.5	24.5	27	30
1500	1.2	1.7	2.0	2.3	2.8	3.6	4.2	5.0	5.9	7.0	8.0	9.0	11	13	14.5	17	18.5	20.5	23	26	29
1400	1.2	1.7	1.9	2.3	2.8	3.5	4.2	5.0	5.7	6.7	7.7	8.7	10.5	12	14	16	18	20	22	25	28
1300	1.2	1.7	1.9	2.2	2.7	3.4	4.1	4.8	5.6	6.4	7.4	8.3	10	11.5	13	15	17	19	21.5	24	26.5
1200	1.2	1.7	1.8	2.2	2.7	3.3	4.0	4.7	5.4	6.2	7.1	8	9.2	11	12.5	14.5	16.5	18	20.5	23	25.5
1100	1.2	1.7	1.8	2.2	2.7	3.2	3.9	4.6	5.2	6	6.8	7.8	8.7	10.2	11.5	14	15.5	17.5	19.5	22	24.5
1000	1.2	1.6	1.8	2.2	2.6	3.1	3.8	4.4	5	5.8	6.4	7.2	8.2	9.2	11	13	15	17	18.5	20.5	23
900	1.2	1.6	1.7	2.1	2.6	3	3.7	4.2	4.8	5.6	6.2	7.0	7.8	8.8	10.5	12	14	16	18	19	22
800	1.2	1.5	1.7	2.1	2.5	2.9	3.4	3.9	4.6	5.1	6.0	6.7	7.4	8.3	9.3	11.5	13	15	16.5	18	20
700	1.2	1.5	1.7	2.0	2.4	2.8	3.2	3.7	4.2	4.8	5.5	6.3	7.0	7.8	8.8	10	12	13.5	15.5	17	18.5
600	1.2	1.4	1.7	1.9	2.3	2.7	3.0	3.4	3.8	4.5	5.0	5.8	6.5	7.2	8	9.0	10.5	12.5	14	15.5	17.5
500	1.1	1.4	1.6	1.8	2.1	2.5	2.8	3.2	3.6	4	4.6	5.2	6	6.7	7.5	8.2	9.2	11	12.5	14.5	15.5
400	1.0	1.3	1.5	1.7	2.0	2.2	2.6	2.8	3.2	3.7	4.1	4.7	5.2	6.0	6.7	7.5	8.2	9.1	11	12.5	14.5
300	0.9	1.2	1.3	1.5	1.8	1.9	2.2	2.6	2.8	3.2	3.6	4	4.5	5.0	5.8	6.2	7.2	7.8	8.9	10.5	12
200	0.8	1.0	1.2	1.3	1.5	1.7	1.8	2	2.3	2.6	3.0	3.3	3.8	4.2	4.7	5.2	6.0	6.7	7.5	8.2	9.0
100	0.5	0.6	0.8	0.9	1.0	1.2	1.3	1.5	1.7	1.9	2.0	2.3	2.7	3.0	3.3	3.7	4.2	4.7	5.2	6.0	6.8



Sales & Service

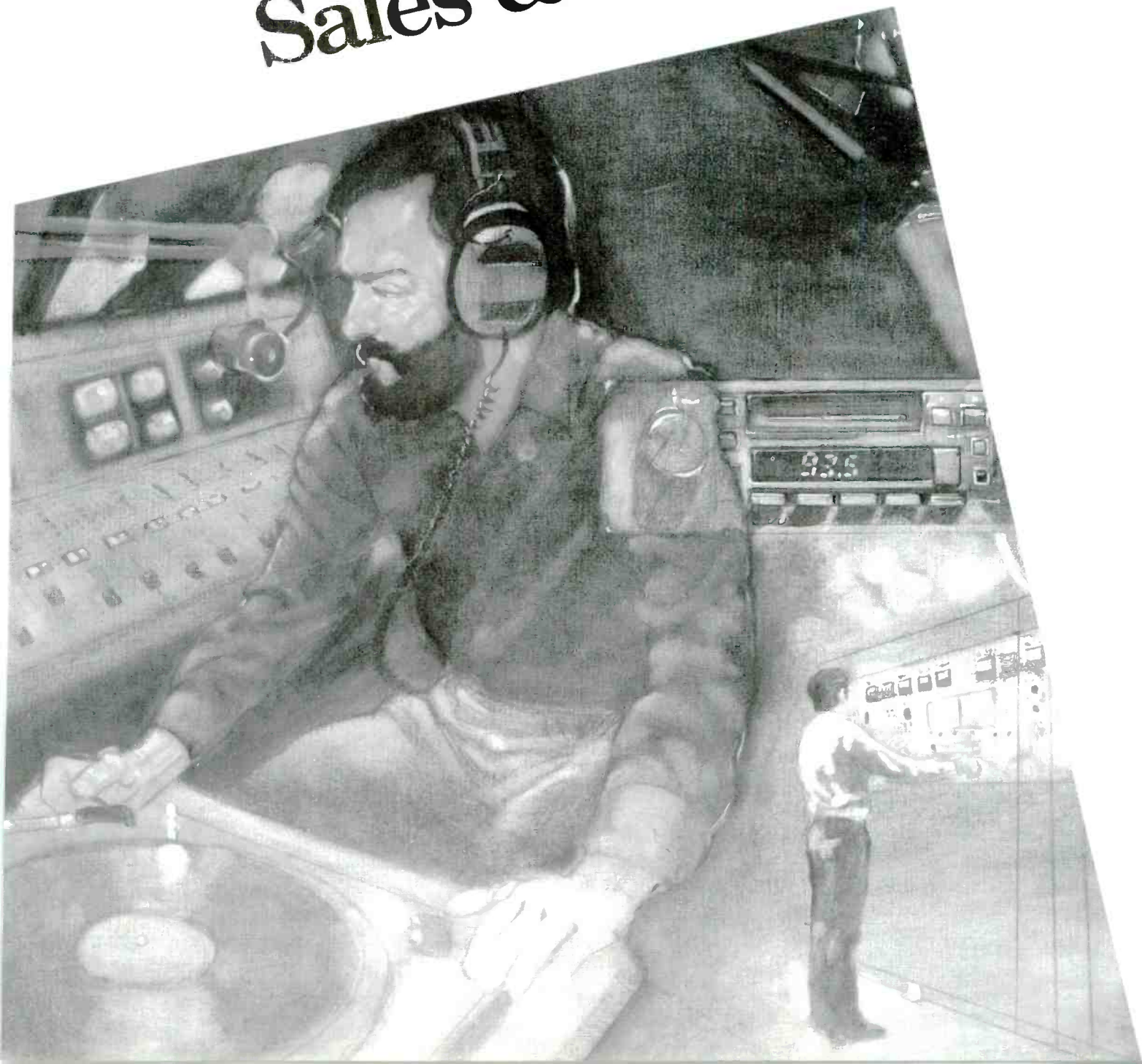

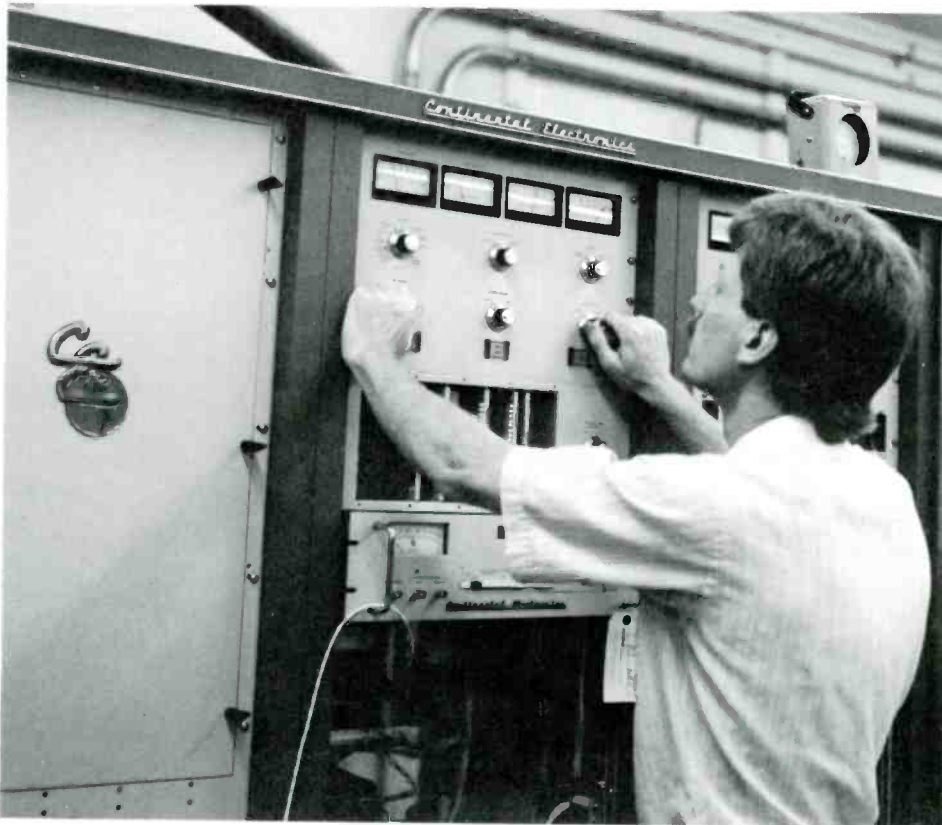

Sales and Service for Continental Electronics Broadcast Transmitters

Continental broadcast equipment and existing Collins radio transmitters are serviced by a world-wide Continental field support and marketing group headquartered in Dallas, Texas.

All products and prices in this catalog are subject to change without notice. For price or delivery information, contact your Continental representative.

10 District Managers handle sales for stations in the United States.

Sales to stations in Canada, Hawaii and Puerto Rico are handled from the home office in Dallas, Texas.

International sales are handled thru local sales representatives.

A.V. Collins, Vice President/Domestic
Broadcast Marketing
E.L. King, Jr., Vice President/International
Broadcast Marketing
R.L. Floyd, Manager/Domestic Broadcast Sales

Continental Electronics offers parts and engineering service for all Continental and Collins radio broadcast equipment 24-hours a day.

You can phone our service numbers day or night:

(214) 327-4532—Parts

(214) 327-4533—Service

Telex: 73398

Cable: CONTRONICS

Continental Electronics
a Division of Varian Associates, Inc.
4212 South Buckner Boulevard
P.O. Box 270879
Dallas, Texas 75227
Ph: (214) 381-7161

DOMESTIC DISTRICT MANAGERS

2 **Northeast**
R. Clifford Rogers
P.O. Box 157
Schroon Lake, NY
12870
(518) 532-7488

3 **Southeast**
John Hutson
28 Park Avenue
Asheville, NC 28803
(704) 274-5298

4
Dave Hultsman
P.O. Box 26509
Birmingham, AL
35226
(205) 822-1078

5 **Midwest**
John D. Abdnour
P.O. Box 575
Streator, IL 61364
(815) 672-8585

6
Jim Littlejohn
670 North Branch Rd.
Maple Plain, MN
55359
(612) 479-2633

7
Barry Ariaz
P.O. Box 2117
Hendersonville, TN
37077-2117
(615) 822-0256

8 **Southwest**
Steve H. Schott
P.O. Box 2008
Plano, TX 75074
(214) 423-3644

9 **Northwest**
Tom Cauthers
13333 S.E. Marsh Rd.
Sandy, OR 97055
(503) 668-9312

1 **West**
Ken Perkins
7846 S. Centaur Dr.
Evergreen, CO 80439
(303) 670-1049

10
Marvin Steelman
12296 Lakeshore North
Auburn, CA 95603
(916) 268-0277

See pages 102 and 103 for International Sales Representatives

Sales & Service International

INTERNATIONAL SALES REPRESENTATIVES

ARGENTINA

Compania Standard Electric Argentina S.A.I.C
Corrientes 311—12th Floor,
Buenos Aires 1043, Argentina, S.A.
Telex: (390)21151 KOBEA AR & 26070 ITTB AR
Phone: 54 + 1 + 312-9613/312-6460/311-7494

AUSTRALIA & PAPUA NEW GUINEA

Rank Electronics Pty. Ltd.
63 Kingsway,
S. Melbourne, 3205, Australia
Telex: (790) AA 34732
Phone: 61 + 3 + 613541

BANGLADESH

Shell Co. Akbari House;
9H Motijheel Commercial Area Dhaka-2,
Bangladesh
Cable: (950) 642709 SKAN JB DHAKA
"PARSHELL"
Phone: 160 + 880 + 255464

BRAZIL

Larex Eletronica, Ltda.
Av. N.S. Copacabana, 195 Grupo 1301,
Rio de Janeiro 22020, Brazil
Cable: (391) 2121616 LREX BR "LAREX"
RIODEJANEIRO;
Phone: 55 + 21 + 542-4343

CHILE

Raylex Representaciones y Servicios S.A.
P.O. Box 13373, Santiago, Chile
Telex: (392) 240406 RYLEX CL
Phone: 56 + 2 + 749835 & 749975

CHINA (TAIWAN)

Heighten Corporation
P.O. Box 46-65
Taipei, Taiwan 104, ROC
Cable: (785) 21472 HEIGHTEN "HEIGHTEN"
Phone: 886 + 6 + 503-9916, 5 lines-536-8289 &
536-8296

COLOMBIA

Auditron, Ltda.
Apartado Aereo 58103
Bogota, Colombia, S.A.
Telex: (396) 43415 HEGAS CO;
Phone: 57 + 1 + 746110 or 583234

EGYPT

Electrical & Telecommunications Engineering
Eng. Samir Abdel-Sayed & Co.
5, Kasr El Nil St.
Cairo, Egypt ARE
Telex: (927) 93915 ETSAS
Phone: 20 + 2 + 750755 & 750683

ENGLAND

Lee Engineering, Ltd.
Napier House, Bridge St., Walton-on-Thames
Surrey KT12 1AP, England
Cable: (851) 928475 LEETEK G "LEETECH"
Phone: 44 + 9322 + 43124, 5, 6

EUROPE, W.GERMANY, ALGERIA, LIBYA, MOROCCO, and TUNISIA

Eurotech Marketing (Overseas) Ltd.
Avenue De La Tanche 2
B-1160 Brussels, Belgium
Telex: (846) 25387 AVVAL B
Phone: 32 + 2 + 660.49.78

HONG KONG & MACAO

Eastern Union (H.K.) Limited
Room 1728-1730 Prince Bldg.
Des Voeux Road, Central, Hong Kong
Cable: (780) 65833 SYNFI HX "MARENCORP
(via RCA)";
Phone: 852 + 5 + 236322 and 244455

ICELAND

G. Helgason & Melsted, Ltd.
P.O. Box 5504
Raudararstig 1
105 Reykjavik, Iceland
Telex: (858) 2145
Phone: 354 + 1 + 11644

INDIA

The National Radio & Electronics Co., Ltd.
Mahakali Road, Chakala, Andheri (East),
Bombay 400 093, India
Telex: (953) 11-3371 TCE IN
Phone: 91 + 22 + 343048

INDONESIA

Elektronika Nusantara P.T., P.O. Box 234/JKT,
Jakarta, Indonesia; Telex: (796) 44337
ELNUSA; Phone: 62 + 21 + 596411 & 592023

IRAQ, KUWAIT, BAHRAIN, QATAR, UNITED EMIRATES, SYRIA, SUDAN, AND YEMEN

Saudi Continental Electronics Limited Company
Al Sanie Bldg., Batha
P.O. Box 1370
Riyadh, Saudi Arabia
Telex: (928) 202134 WADAAN
Phone: 966 + 1 + 4058809

ISRAEL

Rapac Electronics Ltd.
P.O. Box 18053
Tel-Aviv 69513, Israel
Telex: (922) 33528;
Phone: 972 + 3 + 477115/6/7/8/9
and 493391/2/3/4/5

ITALY (Communications Only)

Elco, S.R.L.
Via dei Sansovino, 6
Rome, Italy;
Telex: (843) 620293 ELCORM I
Phone: 39 + 6 + 396-6344 & 396-6398

JORDAN

W.R. Abdul-Hadi & Co.
P.O. Box 925292
Amman, Jordan
Cable: (925) 21266 MEKANO JO "MEKANO"
Cable Fax 9626-605251
Phone: 962 + 6 + 669631 and 669561

KOREA KBS & MBC Only

Tong Yang Moolsan Co., Ltd.
Central P.O. Box 2270
Seoul 100, Korea
Telex: (787) 27432
Phone: 82 + 2 + 776-8477

KOREA All other accounts

Sama Trading Corporation
C.P.O. Box 2447
Seoul, Korea
Cable: (787) K26375 SAMATRA "INNSAMATRA
SEOUL"
Phone: 82 + 2 + 733-9336 & 735-9834

MEXICO

Servicios en Comunicaciones Electricas y
Electronica, S.A.
San Gabriel 3079, Colonia Chapalita
Guadalajara 44520, Jalisco, Mexico
Telex: (383) 0684043 SCEEME
Phone: 011 + 52 + 36 220740 & 218297

*Country does not permit non-voice transmissions

**City codes not required

MOROCCO

Sicotel S.A.,
(Complexe des Harbous)
Tours C, Avenue des FAR
Casablanca 01, Morocco
Telex: (933) 27604 M
Phone: 212 + ** 31-22-70 & 32-22-93

NETHERLANDS ANTILLES

Industrial Electronics (Antilles) N.V.
Centro Commercial Antilia 1
Curacao, Netherlands Antilles
Cable: (384) 1125 INDELNA "INDELECA"
Phone: 599 + 9 + 70352 & 70353

NEW ZEALAND

Pacific Communications Systems Ltd., P.O.
Box 460
Auckland, New Zealand
Cable: (791) NZ60260 FRTMAR "PROCAST";
Phone: 64 + 9 + 498-073

NORWAY (Spare Parts Only)

A/S Nordic Delta
Fr. Nasens Plass 5
Oslo 1, Norway
Telex: (856) 19371
Phone: 47 + 02 + 41-33-20

OMAN

Zawawi Trading Company
P.O. Box 58
Muscat, Sultanate of Oman
Cable: (926) 5232 ZAWAWI ON "ZAWAWI,
MUSCAT"
Phone: 968 + ** + 562077

PAKISTAN

The Modern Trading Company
P.O. Box 12645
Karachi-2904, Pakistan
Cable: (952) 25236 ASIL PK "MODERTRACO"
Phone: 92 + 21 + 440188

PANAMA

Tropelco, S.A.
Apartado 8465
Panama 7, Republic of Panama
Cable: (368) 3318 TROPELCO PG
"TROPELCO"
Phone: 507 + * + 23-1285 and 23-6157

PARAGUAY

Latourrette & Parini S.A.C.
Casilla De Correo 1129
Asuncion, Paraguay
Cable: (399) 717 PY TWYN "AEROPAR"
Phone: 595 + 21+ 201-321 and 291-393

PERU

Fernando Ezeta T. SRL.
Casilla 3061
Lima 1, Peru
Cable: (394) 25811 PE SULCOSA
"FEPERU"; Phone: 51 + 14 + 45-2335

PHILIPPINES

Avcom Electronics Corp.
Matrinco Bldg.
2178 Pasong Tamo, Makati
Metro Manila, Philippines
Telex: (722) 23312 RP PH, Please indicate-
Pass this message to Avcom
Phone: 63 + 2+ 850-227, 816-1925

PORTUGAL

Ondex-Representacoes Electronicas, Lda.
Campo Das Cebclas, 39-42
1100 Lisbon, Portugal
Cable: (832) 16572 ONDEX P "ONDEX -
LISBON"
Phone: 351 + 1 + 86-51-77, 87-13-13

SAUDI ARABIA

Wadaan Trading and Construction Company
Al-Sanie Bldg. Batha
P.O. Box 1370
Riyadh, Saudi Arabia
Telex: (928) 202134 WADAAN
Phone: 966 + 1 + 4058809 & 4058289

SINGAPORE, BRUNEI & MALAYSIA

Crow Broadcast Equipment (PTE) Ltd
100 Beach Road
#19-01/02 Shaw Towers
Singapore 0718, Republic of Singapore
Telex: (786) RS 33565 CROWBD
Phone: 65 + ** + 2953807

REPUBLIC OF SOUTH AFRICA,

**NAMIBIA, BOTSWANA,
BOPHUTHATSWANA, VENDA,
SWAZILAND, TRANSKEI, LESOTHO &
CISKEI**
Communications Technology Broadcasting
(Pty.) Ltd.
P.O. Box 1785
Benoni 1500, South Africa
Telex: (960) 4-27010 SA
Phone: 27 + 11 + 540506

SPAIN (Communications Only)

Busling, S.A.
Orense, 25-30 Dcha.
Madrid-20, Spain
Cable: (831) 42435 "BUSLING SA"
Phone: 34 + 1 + 455-0228, 455-1231

THAILAND

Siam Teltech Company Limited
75 Soi Rubia
Sukhumvit 42 Rd.
G.P.O. Box 2718
Prakanog Bangkok 10110, Thailand
Telex: (788) 82631 WHITCO TH
Phone: 66 + 2 + 3902445-54

TRINIDAD & TOBAGO

Borde Communications Division of Nealco
Engineering Ltd.
P.O. Box 897
Port-of-Spain, Trinidad
Cable: (387) 24461 BOYNM "BORAD" Trinidad
Fax: 809-645-3352
Phone: 1 + 809 + local no. 663-2087, 2072,
2109

URUGUAY

Farell & Boix Ltda.
Caraballo 1134
Montevideo, Uruguay
Telex: (398) UY 22356
Phone: 598 + 2 + 23.38.46

VENEZUELA

Corporacion Electrica S.A.
Apartado Correos 60.856
Caracas, Venezuela
Cable: (395) 27876 CPBTH VE "CORELSA"
Phone: 58 + 2 + 322765, 313479, 723893

ZAMBIA

International Aeradio (Zambia) Ltd.
P.O. Box 31253
Lusaka, Zambia
Telex: (965) AZ 43260
Phone: 260 + 1 + 212083, 217020

ZIMBABWE

Martwell Electronics (Private) Ltd.
P.O. Box 1737
Harare, Zimbabwe
Telex: (987) 4150 RHAWCO ZW
Phone: 263 + 0 + 793578 or 708045



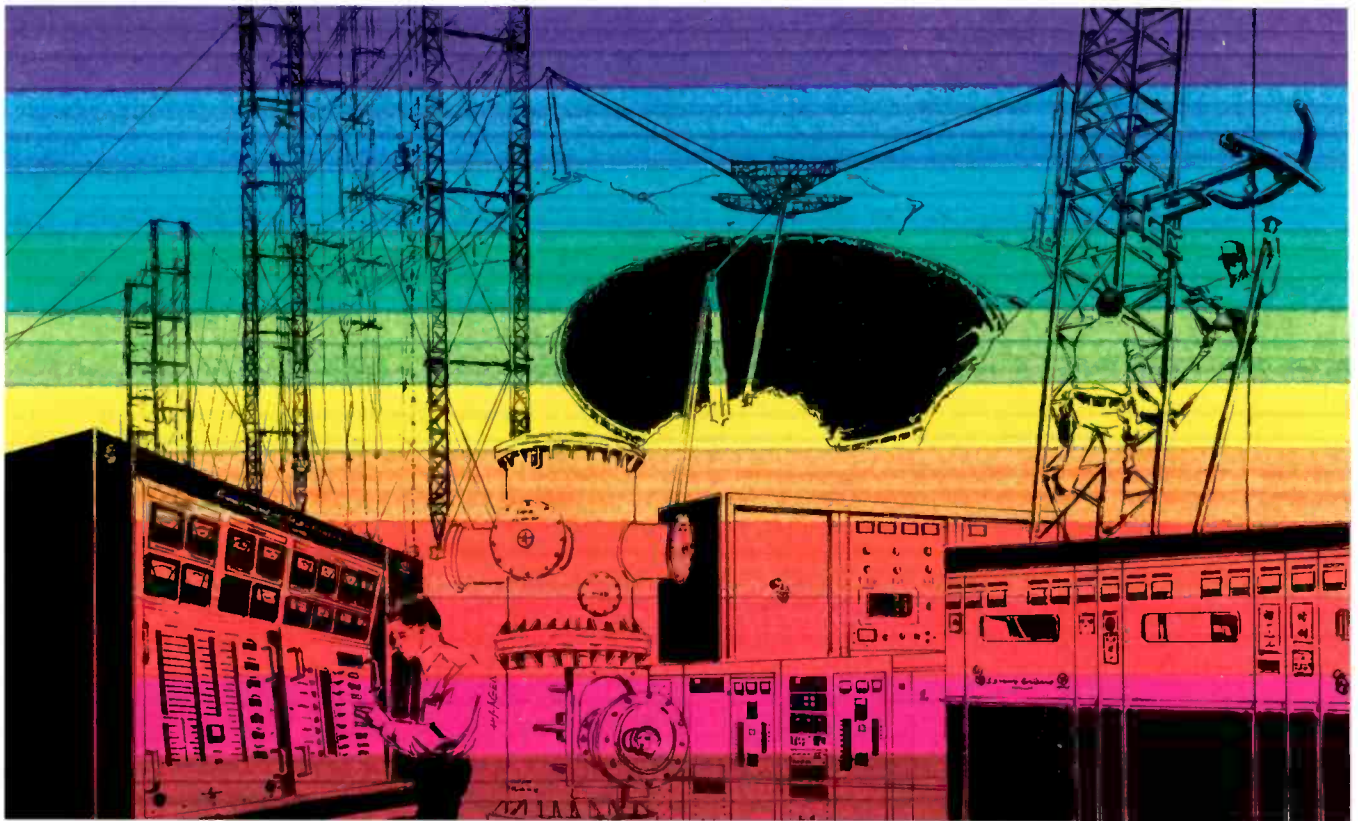

Powers To MultiMegawatts. Frequencies To GigaHertz.

Beaming signals city to city, around the world, or into the universe, Continental Radio Frequency Transmitters meet the needs of radio broadcast, communications, radar and scientific research projects. A Pioneer and World Leader in making high power RF transmitters, Continental has the resources, and is committed to stay at the forefront of transmitter technology.

Continental's recent advances in solid-state and pulse width modulation are incorporated in the new 250 kW and 500 kW SW broadcast transmitters. These and other projects under development by advanced R&D programs will continue to provide Continental Electronics' customers with the most current state-of-the-art equipment. © 1986 Continental Electronics/6177

 **Continental Electronics** 
© a Division of Varian Associates, Inc. PO Box 270879 Dallas, Texas 75227 Ph: (214) 381-7161 Telex: 73-398 **varian**