

HEATHKIT® CATALOG

FALL & WINTER 1961-62

STEREO HI-FI COMPONENTS
TEST & LAB. EQUIPMENT
MARINE EQUIPMENT
AMATEUR RADIO GEAR
SCIENCE KITS
EDUCATIONAL KITS
WIRED EQUIPMENT



HEATH COMPANY Benton Harbor, Michigan

PLANT LOCATION: ST. JOSEPH, MICHIGAN

COPYRIGHT 1961, HEATH COMPANY

a subsidiary of
DAYSTROM, INCORPORATED

I Guarantee you can build any Heathkit!

It gives me a great deal of pleasure to announce that we now guarantee that you can build any Heathkit, regardless of technical knowledge or experience.

We often get letters from persons expressing an interest in a Heathkit, but doubting their ability to assemble a kit product. I have assured them, and I assure you, that anyone can build a Heathkit -- simply by following the easy "check-by-step" instructions and referring to the carefully-detailed illustrations that accompany every Heathkit.

As you investigate the hundreds of items in this 1961-62 Heathkit catalog, remember that Heath, world's largest manufacturer of electronic products in kit form, has built an unequalled reputation through the years for producing quality products at the lowest possible cost. This reputation, coupled with our full guarantee, assures you of complete satisfaction.

Order your Heathkit today, confident that you can build it, confident that it is a superior value.

Alan W. Greene

A. W. Greene
President

Money Back Guarantee

The Heath Company unconditionally guarantees that you can build any Heathkit product and that it will perform in accordance with our published specifications, by simply following and completing our check-by-step instructions, or your purchase price will be cheerfully refunded.





PROMPT, EFFICIENT SERVICE is a by-word at Heath. Your order receives same-day service from our large office staff and complete shipping facilities (a Post Office in our plant and Express trucks at our door throughout the day).



AS YOU UNPACK YOUR KIT you'll see that only the highest quality parts are used. Over the many years since its founding, the Heath Company has earned a reputation for equipment that is second to none in dependability and performance. And of course, every Heathkit product is guaranteed.



YOU'LL BE AMAZED at the easy assembly of your Heathkit. The manual is written in everyday language with a "check-by-step" instruction system. Large pictorial diagrams show exactly where every part goes. As you build, you will gain knowledge of the functions and capabilities of your equipment . . . and have fun, too!



YOU CAN ALWAYS DEPEND on your Heathkit for years of trouble-free, dependable performance. And should any questions arise, we are ready to help you at any time. Heath's Technical Consultants will answer any questions you may have; and our Service Department facilities are always available.



YOU ARE REWARDED in many ways when you complete your Heathkit. You save up to 50% of the cost of ready-made equipment, plus you have the pride and satisfaction of personal accomplishment. If you are not yet a Heathkit builder, you owe it to yourself and your family to experience the pleasure of building your own Heathkit.

New . . . Go The Key Word At Heath

Throughout the years, people around the world have come to rely on Heath for the newest and the finest in electronic kits. And now, in this new annual Heathkit catalog there is more of the "new from Heath" than ever before.

NEW KITS . . . In this issue of the Heathkit catalog are *forty* new kits! New kits in every product line . . . new stereo/hi-fi components . . . new general items such as short wave radios, new walkie-talkies, etc. . . . new amateur radio equipment . . . new educational kits . . . new test equipment . . . bringing the total of Heathkit units to over 250 different items . . . the world's largest selection of kits. Look for this "NEW" symbol, it is your guide to the latest from Heath.



NEW STYLING . . . The *new look* comes to Heath. The stereo/hi-fi line has been completely re-styled in three new concepts designed to complement . . . the test instrument line displays new styling in its newest kits . . . the Citizen's Band walkie-talkies are resplendent in new functional styling . . . new amateur radio kits display variations styled to complement your present Heathkit equipment . . . in short, the *new look* in Heathkit units greets you in many product lines.

NEW GUARANTEE . . . The new Heathkit guarantee as described on the opposite page is unprecedented in the kit industry! It means that now you are assured that your kit must perform to factory specifications, regardless of whether you have ever built a kit before, or your money will be cheerfully refunded. Your success is guaranteed!

NEW NO-MONEY DOWN TERMS . . . Heath has a new credit policy. It means that you can buy any kit from \$25 to \$600 with *no down payment* and up to 18 months to pay! Unprecedented in the kit industry, these relaxed credit terms mean you can purchase with complete confidence at Heath. See the order blank for complete details.

NEW CATALOG . . . This new Heathkit catalog is designed especially for you. Its new, larger size provides larger photographs, more complete descriptions, full specifications, and on many kits there are schematic diagrams reproduced . . . all to provide more complete buying information for you. Leaf through its pages . . . study each kit . . . then choose yours, for this is the world's shopping center for electronic kits.

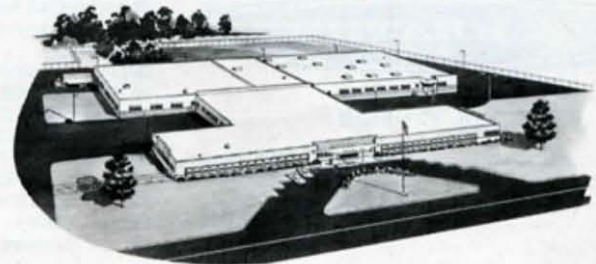

Heathkit High Fidelity Amplifiers are rated to Heathkit Power Rating Standards and IHFM Music Power Standards to assure you of finest performance



Over two years ago, the Heath Company established Power Rating Standards for all audio amplifiers produced by the company. These standards enable you to select the Heathkit unit best suited to your requirements and compare each unit with competitive items.

When this policy was announced, Heath stated that it would also adopt other standards that would be agreed upon in the high fidelity industry to insure product quality and customer satisfaction. The introduction of the Institute of High Fidelity Manufacturers' "Music Power Rating Standards" gives you another gauge with which to measure the Heathkit product quality. Today, all Heathkit high fidelity amplifiers carry in their specifications the IHFM Music Power Rating as well as the Heath Power Rating.

The Heath Power Rating Standards are provided for amplifiers in three

HEATHKIT® AMPLIFIER POWER-RATING STANDARDS

Test No.	Rated Power Output Standards Max. Power at Which:	Prof. Rating (20 cps to 20 kc)	Hi-Fi Rating (30 cps to 15 kc)	Utility Rating (60 cps to 7 kc)
1	Response does not deviate more than:	± 1 db	± 1 db	± 1 db
2	Total Harmonic Distortion at 1000 cps is:	0.3% or less	0.7% or less	1.0% or less
3&4	Total Harmonic Distortion at extremes of frequency range:	2.0% or less	2.0% or less	3.0% or less
5	Intermod. Distortion (60 cps & 6 kc, 4:1) no more than:	1.0%	2.0%	3.0%

**STEREO & MONO
HIGH FIDELITY**

Acoustic Suspension Speakers	55
AM Tuners	40, 44, 48
Amplifier Rating Standards	4, 5
Amplifiers, Hi-Fi	41, 45, 46, 47, 49, 50, 51, 52, 53
Cabinets, Hi-Fi	58, 59
Changers, Record	32, 33, 34
Economy Amplifiers	49, 50
FM Tuners	40, 44, 48
Hi-Fi Equipment	32 to 61
Hi-Fi Systems Suggestions	58, 59, 60, 61
Microphone	36
Multiplex Converter	38
Multiplex Equipped Consoles	13
Multiplex Systems	39
Portable Tape Recorder	11
Preamplifiers, Hi-Fi	42, 43, 51
Record Changers	32, 33, 34
Record Players	10, 32, 33, 34
Reverberation System	14
Speaker Systems	54, 55, 56
Speakers	57
Stereo: Amplifiers	41, 45, 46, 47
Multiplex Converter	38
Phono Console	12, 13
Preamplifiers	42, 43
Record Player	10, 32, 33, 34
Tape Player	11, 35
Tape Recorders	11, 35, 36, 37
Tuners	40, 44, 48
Systems	12, 13, 60, 61

Tape Players	11, 35
Tape Recorders	11, 35, 36, 37
Tape Recorder Electronics	35
Tuners: AM	40, 44, 48
FM	40, 44, 48
Stereo	40, 44
Turntables, Record	34

GENERAL PRODUCTS

Antennas, CB	21
Broadcast Receivers	8, 9, 16
Citizens Band Transceivers	18, 19, 20
Crystal Radio	16
Enlarger Timer	16
FM Table Radio	7
Garage Door Opener	23
Ignition Analyzer	22
Ignition Timing Light	22
Intercom, Transistor	15
Multiplex FM Table Radio	7
Nut Driver Set	99
Portable Radios	8, 9
Portable Tape Recorder	11
Public Address Equipment	17
Soldering Gun	99
Telephone Amplifier	15
Tool Kits	99
Transistor Radios	8, 9
Vibrator Power Supplies	70

Heathkit Catalog Index...

the world's shopping center

for electronic kits



different categories of use—Professional, Hi-Fi and Utility. The following chart displays the three categories and defines the five different tests to obtain this rating.

IHFM MUSIC POWER OUTPUT RATING

The IHFM Music Power Rating uses a technique that makes power measurements at a frequency of 1,000 cycles per second to indicate the capability of an amplifier to handle instantaneous bursts of music power peaks. Since no distortion levels are defined in this method, the Heath Company has performed its IHFM music power ratings at the same level of distortion as is maintained in its own system of standards for the Hi-Fi use category. That level is 0.7% total harmonic distortion at 1 KC. We believe that this figure is the maximum total harmonic distortion tolerable for high fidelity applications.

In determining the advertised power ratings of Heathkit amplifiers using Heath and IHFM standards, we measure a group of amplifiers selected by statistical techniques to represent normal variations that can be expected in production. These measurements are averaged and the advertised power rating is the nearest whole number of watts.

You will also note that the Heath Power Output Rating figure is always lower than that obtained for the IHFM Music Power Rating. This indicates Heath's policy of conservatism in advertised power ratings for its power amplifiers. It is also another assurance to you, our customer, that Heathkit products have quality that you can depend on and trust—with guaranteed performance specifications.

AUTHORIZED HEATHKIT SERVICE CENTERS ready with Factory Quality Service

**BOSTON 20,
MASSACHUSETTS**
Park Armature
1218-30 Columbus Ave.

**CHICAGO 29,
ILLINOIS**
Expert Electronics
7110 S. Rockwell St.

DALLAS, TEXAS
Nelson Electronic Eng.
Co., Inc.
6329 Gaston Ave.

HOUSTON, TEXAS
Nelson Electronic Eng.
Co., Inc.
3615 Gulf Freeway

**JAMAICA 35,
NEW YORK**
Colgersen Corp.
Empire State
Electronics Div.
139-40 Hillside Avenue

**LOS ANGELES 44,
CALIFORNIA**
Electronic Instrument
Service
8907 South Vermont Ave.

**MINNEAPOLIS 6,
MINNESOTA**
Andersen Audio
Laboratory
4145 Minnehaha Ave. S.

**ST. LOUIS 2,
MISSOURI**
Scherrer Instruments
5449 Delmar Blvd.

**SAN FRANCISCO 9,
CALIFORNIA**
Radio Electronics
350 Jones St.

**SEATTLE,
WASHINGTON**
A & R Service Company
2139 Second Ave.

HONOLULU, HAWAII
TV Electronics Service
Corp.
244 Koula Street

MARINE EQUIPMENT

Depth Sounder.....	26
Direction Finder.....	25
Power Converter.....	26
Radio Telephone.....	24

AMATEUR RADIO EQUIPMENT

Accessories.....	72 to 75
Adapter, Single Sideband.....	72
All-Band Receivers.....	8, 9
Antenna Power Meters.....	74
Balun Coil Set.....	75
Code Oscillator.....	74
Crystal Calibrator.....	73
Grid Dip Meter.....	74
Log Book.....	63
Kilowatt Linear Amplifiers.....	68
Phone Patch.....	73
Power Meter, RF.....	74
Power Supplies:	
Mobile.....	75
Utility.....	75
Vibrator.....	70
"Q" Multiplier.....	73
Receivers.....	8, 9, 62, 64, 66
Reflected Power Meter.....	74
SSB Adapter.....	72
Transmitters, Amateur Band.....	69, 70
Transmitters.....	63, 65, 67, 68, 71
VFO.....	72

TEST EQUIPMENT

Audio Analyzer.....	88
Audio Vacuum Tube Voltmeter.....	79
Battery Eliminator.....	84
Capaci-Tester.....	81
Condenser Checkers.....	81
Condenser Substitution Box.....	90
Decades: Resistor, Condenser.....	90
Electronic Switch.....	97
Generators:	
TV Align.....	87
FM Align.....	86, 87
RF Signal.....	85, 86
Audio.....	89
Color Bar.....	87
Grid Dip Meter.....	74
Handitester.....	76
Handy Lab.....	79
Harmonic Distortion Meter.....	88
Ignition Analyzer.....	22
Ignition Timing Light.....	22
Impedance Bridge.....	91
Isolation Transformer.....	84
Mutual Conductance Tube Tester.....	83
Oscilloscopes.....	94, 95, 96, 97, 98
Oscilloscope Accessories.....	96, 97
Power Supply, Regulated.....	84
Probes: Scopes.....	96
VTVM.....	77
"Q" Meter.....	91
Resistor Substitution Box.....	90
Signal Tracer.....	90

Sweep Generator:	
FM.....	87
TV.....	87
Transistor Checker.....	80
Tube Checkers.....	82, 83
Tube Test Adapter.....	82
Vacuum Tube Voltmeters.....	77, 78
Vibrator Power Supplies.....	70
Voltage Calibrator.....	97
VOM Meters.....	76

EDUCATIONAL EQUIPMENT KITS

Analog Computers.....	92, 93
Basic Electricity Course.....	27
Basic Radio Courses.....	28
Educational Computer.....	92
Science Kits.....	30, 31
Test Instruments.....	76 to 98
VTVM Applications.....	29

SCIENCE KITS

Broadcaster, Transistor.....	30
Crystal Radio.....	30
Electronic Workshops.....	31
Intercom, Transistor.....	30
Radio, Transistor.....	30

HEATHKIT STEREO/HI-FI KITS

Choose tuners, amplifiers, record changers, preamplifiers, speaker systems, tape recorders . . . you name it, Heath has it . . . the world's largest selection . . . every item guaranteed to bring you quality performance at low, low cost. See page 33 to 61.



HEATHKIT MARINE ELECTRONIC KITS

Every skipper can rely on tested, quality Heathkit marine gear to make his boat safer and more pleasurable . . . depth sounder, radio-telephone, direction finder, etc. . . each can bring hours of shipboard fun and relaxation. See page 24, 25 and 26.

Whatever your interest, there's a Heathkit for you . . . at a price to fit your budget . . . that we guarantee you can build . . . and that will provide years of superior performance!



HEATHKIT AMATEUR RADIO KITS

Amateurs the world over rave about the Heathkit quality amateur radio equipment . . . the latest, most functional designs, superb engineering advances and low prices combine to provide "hamdom's" greatest values. See page 62 to 75.

HEATHKIT TEST INSTRUMENTS

Professionals and hobbyists agree that Heathkit test equipment is greater than ever . . . a greater variety of equipment, specially designed Heathkit scopes, probes, meters, checkers, generators and analyzers . . . and greater value, professional performance with "do-it-yourself" savings. See pages 76 to 99.



HEATHKIT GENERAL, EDUCATIONAL AND HOBBY KITS

Now an exciting list of products awaits young and old alike . . . things to make living more enjoyable the year around . . . garage door operators, telephone amplifiers, basic radio courses, "walkie-talkies," etc. With Heathkit you can depend on the latest and finest in electronic aids for home, office, school or relaxation. The general section starts on the next page.



A Matched Pair for FM Stereo Enjoyment



Kit GR-21 **\$59⁹⁵**



Kit GRA-21-1 **\$49⁹⁵**

Multiplex-engineered Hi-Fi FM TABLE RADIO

- 88 to 108 mc FM coverage
- 7 tubes function like 11
- 6" x 9" dual-cone speaker
- Matches GRA-21-1 Stereo Converter perfectly
- Quality preassembled walnut cabinet

The thrilling new Heathkit GR-21 FM Table Model Radio combines all the quality performance features which have made Heathkit FM tuners world-renowned plus an amplifier, speaker and cabinet to bring you convenient one-unit FM listening pleasure at a reasonable price. The GR-21 has a 6" x 9" dual cone speaker with a 6.8 oz. magnet that gives true hi-fi sound reproduction. The preassembled, prealigned tuning unit makes assembly simple. Other features include flywheel tuning with vernier action, a tuning "eye," and lighted slide-rule dial for easy, accurate station selection. Automatic Frequency Control is easily switched on for drift-free reception. Powered by an AC transformer with silicon diode rectifiers, the GR-21 gives stable, efficient performance. The FM Multiplex Output jack and auxiliary audio input are designed to be used with the Heathkit GRA-21-1 Multiplex Stereo Converter (adjoining column) to provide an FM stereo system with matching components. The auxiliary input may also be used with a high output crystal phono cartridge or AM tuner, if desired. Other extras in this instrument include: line cord antenna and external antenna terminals; switched AC socket for accessory power; and tone and volume controls. Comes in a 3/8" walnut veneer cabinet with furniture quality finish and a unique "relief" speaker grille that is offset from the front. Measures 15" L x 8" H x 6" D. 16 lbs.

Kit GR-21 . . . NO MONEY DOWN, \$6 mo. **\$59.95**

No Down Payment Required On Heath's New Time Pay Plan!

Now you can buy the Heathkit of your choice with no down payment! Now any order from \$25 to \$600 can be purchased with no down payment (write for details on orders over \$600). These new, relaxed credit terms, coupled with our new money-back guarantee that you can build any Heathkit, mean you can buy Heathkit with complete confidence and assurance of satisfaction.

Matching FM STEREO CONVERTER Unit

- Completely self-powered, self-contained
- Matches the GR-21 receiver perfectly
- Quality components assure long, faithful service
- Simple controls adjust stereo effect
- Can be operated 15' away from radio

Here is the brand new Heathkit GRA-21-1 Stereo Adapter unit that matches and complements the GR-21 FM Table Radio opposite. It is completely self-contained, self powered, and features the same beautiful cabinet design as the radio with an identical high quality 6" x 9" speaker and audio circuitry to assure matched response when used as part of your complete FM Stereo system. The design of the GRA-21-1 emphasizes quality reproduction and channel separation for maximum stereo effect. A stable, synchronized local oscillator keyed to the stereo "pilot" provided in the new FM multiplex transmissions provides a strong restored subcarrier to assure low distortion. Carefully designed filter networks separate the stereo signal without introducing separation-degrading phase distortion.

With the Heathkit GRA-21-1 to accompany the GR-21 FM radio or your present FM radio, you can have your choice of FM stereo reproduction or monophonic reproduction using the speakers in the radio and in the adapter, or you can use the radio alone. The simple controls on the GRA-21-1 include a master volume control for both channels. Balance is easily obtained by adjusting the receiver volume control to make both receiver and converter equal in volume. The tone control on the adapter functions independently of that on the radio. The function selector switch permits the desired mode of operation and turns off the AC power to the adapter when not in use or when not needed for the function being performed. The full-wave power supply uses modern silicon rectifiers and a power transformer for safety, low hum level and long tube life with a minimum of heat.

Simplified construction of the GRA-21-1 is straight-forward. Walnut veneer cabinet measures 15" L x 8" H x 6" D. 12 lbs.

Kit GRA-21-1 . . . NO MONEY DOWN, \$5 mo. **\$49.95**

Heathkit® Receivers are

A new short wave LISTENER'S RECEIVER— the Heathkit GR-91 is versatile in performance and low-priced for economy!

Designed with the beginning kit builder in mind and easy to construct because of its circuit board layout, the all-new Heathkit GR-91 General Coverage Receiver kit will bring hours of fascinating and dependable broadcast, amateur radio, and short-wave listening pleasure. In building this kit, just place the components directly into the circuit board and solder. This procedure minimizes the possibility of errors, greatly speeds assembly, assures proper construction and adds circuit stability. Even the youngsters will find this kit a joy to assemble since it is so easy to build.

This sensitive receiver covers 500 KC to 30 MC in four bands clearly marked on the illuminated 7" slide-rule dial. The short wave listening bands are also clearly marked for ease of selection. The modern 4-tube plus silicon rectifier superheterodyne circuit has high sensitivity and good stability. It uses a 12BE6 oscillator and mixer, a 12BA6 IF amplifier/beat frequency oscillator, a 12AV6 second detector, AVC, first audio amplifier and a 50C5 beam power output tube.

The versatile features of this amazing unit include an all-new illuminated tuning meter that shows relative signal strength from each station and front panel controls for audio gain, electrical band spread, AM-Standby-CW switch, bandswitch, BFO (beat-frequency oscillator), main tuning and antenna trimmer. On the rear of the chassis are a noise limiter switch, headphone jack, Q-multiplier input and antenna input. A built-in 3" x 5" speaker is included. The balanced (300 ohms) or unbalanced (75 ohms) antenna input allows coupling of popular antenna systems for better sensitivity. The "velvet-touch" tuning dial makes 16 revolutions to cover the dial completely—this vernier tuning feature is a great help in station selection with today's crowded bands.

In all, the new Heathkit GR-91 represents great advances over its predecessor, the AR-3—it is much easier to build and offers many more outstanding features found before only in expensive, factory-assembled units. Extremely handsome in its all-steel cabinet, the GR-91 has modern "low-boy" styling in a beige and aqua color scheme that will complement any room setting. 9 lbs.

Kit GR-91 . . . NO MONEY DOWN, \$5 mo. \$39.95



Kit GR-91
\$39.95

- Covers 550 KC to 30 MC in four bands
- Seven inch illuminated slide-rule dial
- Illuminated relative signal strength meter
- Circuit board layout aids construction
- Balanced and unbalanced antenna inputs

SPECIFICATIONS—Frequency range: 550 KC to 30 MC on four bands. Short wave broadcast bands plainly marked on dial. **Tube complement:** 12BE6, 12BA6, 12AV6, 50C5, silicon type rectifier. **Controls:** General coverage tuning, Bandspread tuning, Antenna trimmer, Bandswitch, Noise Limiter ON/OFF, Phone-Standby-CW switch, BFO control, Audio Gain, AC ON/OFF, Headphone Jack, Q-multiplier input Jack. **Power requirements:** 105-125 V 50/60 cycles AC 30 watts. **Cabinet dimensions:** 12 1/4" W x 5 1/2" H x 8 1/4" D.

Full size Heathkit PORTABLE RADIOS bring quality radio reception wherever you go . . . at low cost!



Kit XR-2L
\$34.95

Kit XR-2P
\$29.95

leaders in the world of radio



Kit GC-1A

\$109⁹⁵

Kit Form
or
Factory
Assembled



- Completely self-contained
- Ten transistor, six diode circuit
- Flashlight battery power supply
- Fixed, aligned ceramic IF transformers
- Covers 550 kc to 32 mc in five bands
- Quality design—complete portability

SPECIFICATIONS—IF Frequency: 455 kc. Frequency coverage: 550 kc to 32 mc in 5 bands with calibrated bandspread scales (oscillator tuning) for 80, 40, 20, 15 and 10 meter amateur bands and 11 meter citizens band. Selectivity: 3 kc wide at 6 db down. Sensitivity: 10 uv broadcast band, 2 uv short wave bands for 10 db signal-to-noise ratio. Output: 400 milliwatts max. Battery life: up to 400 hours normal intermittent service using 8 standard size "C" cells. Dimensions: 6 $\frac{3}{8}$ " H. x 12" W. x 10" D.

Heathkit GC-1A "Mohican" GENERAL COVERAGE RECEIVER kit gives top short-wave performance with the added convenience of portability

Now you can listen to "Radio Free Europe" broadcasts first-hand or tune in the BBC or Radio Moscow—simply by turning on your Heathkit GC-1A "Mohican" General Coverage Receiver. The perfect kit for the avid short-wave listener, this five-band transistorized receiver is ideal for all-around use and is especially convenient for it is powered by 8 standard flashlight batteries for complete portability—you can take it anywhere, use it everywhere!

This powerful and superbly-designed instrument features high sensitivity, selectivity and stability which are the result of the many receiver "firsts" incorporated by the Heathkit engineers who designed it. The fixed-aligned ceramic IF "Transformers" used in the "Mohican", which were developed primarily for military use, operate much the same as crystal lattice filters to shape the IF bandpass and offer excellent stability and selectivity. Other features of this unique receiver include: a 10 transistor, six diode circuit, Zener diode voltage regulation, built-in telescoping 50-inch whip antenna, flywheel tuning, panel tuning meter and large slide-rule dial for tuning stations accurately and easily. The convenient panel controls include: on/off volume control, BFO pitch with on/off switch, RF gain, antenna tuning, electrical bandspread (oscillator tuning), ANL on/off, AVC on/off and Bandswitch. The GC-1A can be easily converted to 117 VAC household current instead of the battery supply, by simply plugging in Heathkit XP-2 Power Supply. The handsome styling of the Heathkit "Mohican" includes a one-piece metal cabinet with convenient carrying handle, die-cast metal knobs, a green and gray-green color combination. Experienced kit builders can assemble the GC-1A within 30 hours. Batteries not included. 18 lbs.

- Kit GC-1A . . . NO MONEY DOWN, \$11 mo. . . . **\$109.95**
- Assembled GCW-1A . . . NO MONEY DOWN,
\$19 mo. . . . **\$193.50**
- Kit XP-2 . . . 117 VAC plug-in power supply . . . 2 lbs. . . **\$9.95**

- 6-transistor, 2-diode circuit
- "Big set" tone with 4" x 6" speaker
- Built-in rod antenna

Now you can take your favorite radio programs with you wherever you go with the famous Heathkit XR-2 Portable radio, confident that the reception and tone quality are unsurpassed by any in this price range. Handsomely styled in either gleaming, mocha-colored molded plastic cabinet or handsome sun-tan simulated leather and plastic with gracefully-curved speaker grilles of smart beige plastic, these award-winning portables look as well as they perform.

You can take your XR-2P or XR-2L to the beach, the ball games, on trips, hunting, camping, or wherever you wish. Even at home the Heathkit portables out-perform most conventional table model radios that operate from house current. And the six ordinary size "D" flashlight batteries which power these portables will last up to 1,000 hours.

The six-transistor, two-diode circuit provides high sensitivity and selectivity, and the large 4" x 6" PM speaker with heavy magnet brings you excellent tone quality . . . rich, solid tone not obtainable from miniatures. Also featured is a built-in rod antenna which helps pull in even far-away stations across the tuning range of 540 to 1620 kc.

In building the XR-2 Portable, you'll discover the large chassis permits easy construction and provides plenty of room for mounting components without damage, crowding or possible short circuits.

There is no fumbling for hard-to-get-at controls on the Heathkit portables, either. Both the tuning and volume knobs are large, sure-grip plastic, located conveniently on each end of the case. The convenient pull-out carrying handle, reasonable dimensions and light weight make them easy to carry anywhere. The XR-2 Portables measure 9 $\frac{1}{2}$ " L x 7 $\frac{1}{4}$ " H x 4" D. 5 lbs. Batteries not included.

- Kit XR-2P (Plastic) . . . NO MONEY DOWN, \$5 mo. . . . **\$29.95**
- Kit XR-2L (Sim. Leather) . . . NO MONEY DOWN, \$5 mo. . . . **\$34.95**

SPECIFICATIONS—Tuning range: 540-1620 kc. Sensitivity: 350 uv/m for 15 db signal-to-noise ratio at 50 mw output. Transistors: 6: 2N1108, 2N1110, 2N1111, R251, 2-R250. Diodes: 2. Loudspeaker: 4" x 6", permanent magnet. Battery life: 500-1000 hours average use.

No Down Payment Required On Heath's New Time Pay Plan!

Now you can buy the Heathkit of your choice with no down payment! Now any order from \$25 to \$600 can be purchased with no down payment (write for details on orders over \$600). These new, relaxed credit terms, coupled with our new money-back guarantee that you can build any Heathkit, mean you can buy Heathkit with complete confidence and assurance of satisfaction.

Heathkit® Stereo Portables are tops...whether you

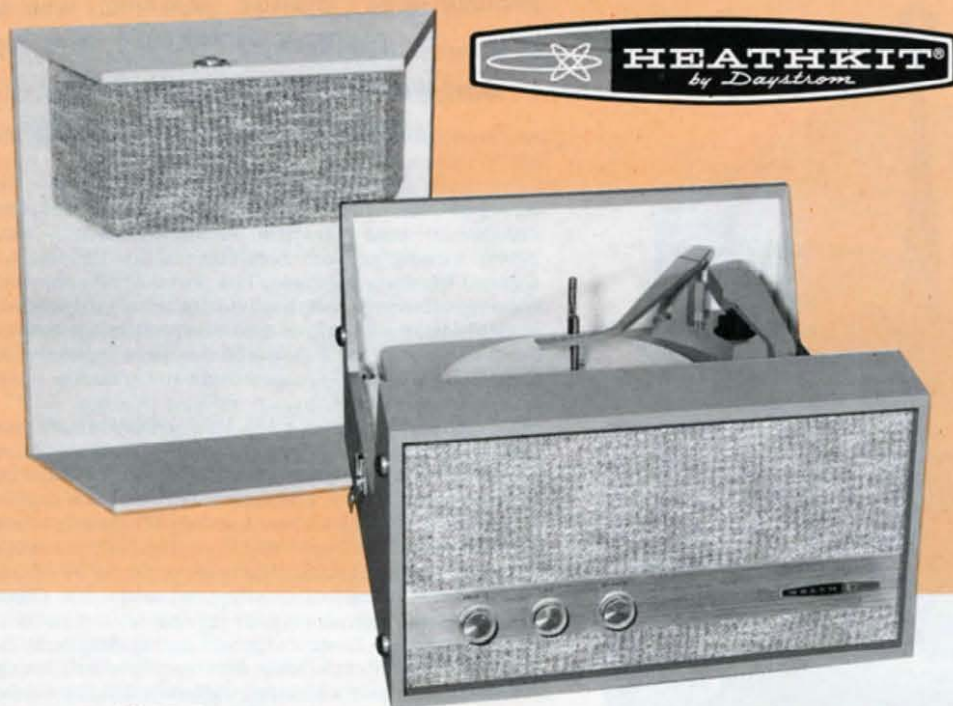

Kit GD-10

\$69⁹⁵

*Completely portable—the Heathkit GD-10
lets you enjoy your favorite stereo
records—anywhere!*

- Stereo/Mono record playing capability
- 16, 33 $\frac{1}{3}$, 45 and 78 rpm speeds
- Turnover Diamond and Sapphire Styli
- Preassembled cabinet and changer
- Detachable Speaker Wing Top

On a vacation, at school or just at home, with the Heathkit GD-10 Portable Stereo Phonograph every occasion becomes one of extra pleasure. And you'll find with the GD-10 you can equip your patio, den, study or children's playroom with a stereo and mono record playing capability that is a wonder of convenience, economy and fine fidelity . . . just the thing for teen-age "record hops" or house party background music.

The automatic changer plays 16, 33 $\frac{1}{3}$, 45 and 78 rpm records, either stereophonic or monophonic, with gentle precision. Even some of your old 78's will seem to come "alive" again when played on this exciting instrument. The turnover crystal stereo cartridge features a diamond stylus for LP's . . . when you turn the cartridge over, you have a sapphire stylus for use with 78's.

The tube-type amplifier has excellent frequency response and power enough to fill the average room with realistic stereo sound. The controls on the amplifier regulate volume, stereo-balance and tonal quality.

The smartly-styled cabinet of the GD-10 is completely factory-assembled. Its color-coordinated two-tone aqua and white durable vinyl covering with textured surface is designed for any room setting and will withstand scratches, stains, and scuffs without harm . . . wipes clean with just a damp cloth. A textured-tapestry grill cloth in green and white complements the cabinet and the soft sheen of its attractive aluminum control panel. When the GD-10 is in the "closed" position for carrying, the speaker wing and main cabinet blend into a single luggage-type unit . . . when it's opened up for use, the detachable speaker wing top may be placed at a proper distance from the cabinet to obtain the greatest possible stereo effect. The speakers in the main

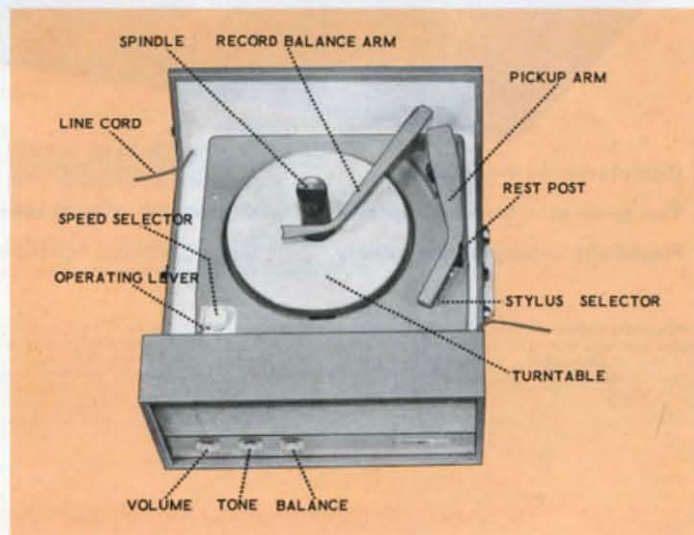

cabinet and in the detachable wing top are dual-cone 5" x 7" ovals of a special design to afford the finest in tonal color.

To assemble the Heathkit GD-10, you need only a screwdriver, a pair of pliers and a soldering iron . . . it's that simple! You merely wire the amplifier, install the speakers and drop the assembled record changer into the factory assembled cabinet. With Heathkit's famous "check-by-step" instructions, you'll find the assembly fast and easy . . . regardless of your experience. Order your Heathkit Portable Stereo Phono now . . . enjoy music wherever you are, whatever the occasion. 28 lbs.

Kit GD-10 . . . NO MONEY DOWN, \$7 mo. \$69.95
ADA-50-1 . . . 45 rpm adapter spindle . . . (2 lbs.) \$2.95

SPECIAL FEATURES—Frequency response: ± 5 db, 70-10,000 cps. Power output: 2.5 watts RMS: 5 watts peak per channel at 1 kc. Channel separation: 20 db minimum over entire range. Cartridge: stereo crystal with .7 mil diamond and 3 mil sapphire. Speakers: 5" x 7" 2-cone oval. Power requirements: 117 v AC 60 cycles. Cabinet dimensions: 15 $\frac{1}{2}$ "W x 18"D x 8 $\frac{1}{2}$ "H.

NOW—NO DOWN PAYMENT

Any Heathkit purchase totaling \$25 or more can now be obtained with **NO MONEY DOWN** . . . up to 18 months to pay! See the enclosed order blank for complete details and send your Heathkit order today!

choose tape or records

Kit AD-40
\$179⁹⁵

Kit Form
or
Factory
Assembled



*The Heathkit AD-40 Four Track STEREO
TAPE RECORDER Kit out-performs units selling
for twice its low price*

- 4-track stereo record and playback
- Includes all amplifiers and speakers
- Preassembled tape mechanism and cabinet
- Two speeds— $3\frac{1}{4}$ and $7\frac{1}{2}$ ips
- Beautiful styling

With the Heathkit AD-40 Portable Four-Track Stereo Tape Recorder you can enjoy the beauty of pre-recorded stereo tapes as well as the inherent superb fidelity of this recording medium at any time, and in any place. Just snap it shut, pick it up, and you're ready to take your Heathkit AD-40 to parties, family get-togethers, vacations.

The portability of this fabulous unit is just one of the features that make it an outstanding value. The Heathkit AD-40 can be used as a self-contained unit for monophonic and four-track stereo tape recording and playback, for all of the required preamplifiers, power amplifiers and speakers are included at this one price. All you do is plug it into any regular 117 volt AC outlet, put on the reel of tape and you are ready to enjoy the wonders of four-track stereo recording. The Heathkit AD-40 can be employed also as a tape music source for stereo/high fidelity systems by simply connecting the special cathode follower outputs to your present components.

When you operate the AD-40, you'll be amazed at the simple controls which eliminate the need for tricky gadgets or complicated instruction procedures. Two controls are provided that give you instant selection of either "record," "play," "fast-forward," or "rewind" functions. The individual tone-balance and level controls make it possible for you to regulate the music according to your individual preference and the size and shape of your surroundings. To assist you when you are making recordings, a switch is provided to let you monitor the amplifier sound while the recording is actually taking place. In this way, you know exactly what is being recorded and how it sounds. And to assist you even further, two "bar-tube" recording level indicators show you the levels being recorded in each channel. A "pause button" lets you edit your tape conveniently, too.

When the unit is in use, you can place the detachable speaker wings any distance apart for maximum stereo results. Each speaker wing contains a $7\frac{1}{2}$ " woofer and a 2" x 6" oval tweeter. All parts for the amplifiers, preamplifiers and power supply are included for assembly, while the cabinet and precision tape mechanism are factory assembled and tested. The outstanding electronic features of the AD-40 are accompanied by a cabinet that is handsomely styled and ruggedly con-

FREE

When you order a Heathkit AD-40 Portable Stereo Tape Recorder you receive an outstanding 4-track stereo Demonstration tape plus 1200 ft. of professional grade blank recording tape and an empty take-up reel . . . absolutely free. This \$10.95 value is yours for a limited time only, so place your order today!

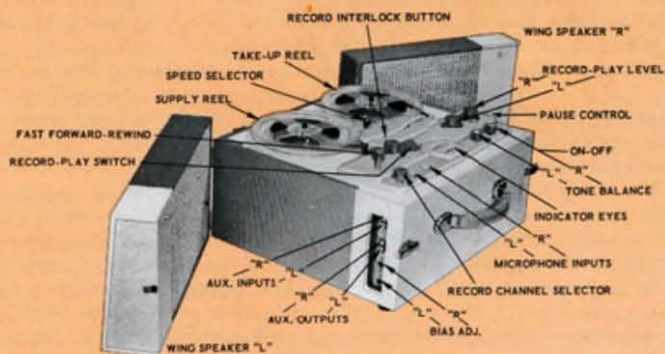

structed. The plywood cabinet is covered with turquoise and white vinyl with a textured front panel of a bright metallic tone. The cabinet also features a storage compartment for tapes, tape reels and any accessories. While microphones are not included with the AD-40 kit we would recommend the Heathkit AK-1 microphone for maximum performance. If you've been thinking about a tape recorder or player, now's the time to solve that problem economically, without sacrificing quality. Buy the Heathkit AD-40 and save! 49 lbs.

Kit AD-40 . . . NO MONEY DOWN, \$179 mo. \$179.95
Assembled ADW-40 . . . NO MONEY DOWN, \$28 mo. \$299.95

SPECIFICATIONS—Power output: 6 watts stereo (3 w. per channel) utility rated. Power response: ± 2 db 50 to 15,000 cps at 3 watts. Total harmonic distortion: less than 2% 50 to 15,000 cps at 3 watts. IM distortion: less than 3% at 3 watts. Hum and noise: -45 db or better at 3 watts. Sensitivity: for 3 watts output, 1.5 mv; microphone, for max. record level, 3 mv; aux. input, for max. record level, .2 volt; low impedance outputs, for aux. power amp., 1 volt. Power requirements: 105-125 V, 60 cycles, 110 watts. Cabinet dimensions: 9 $\frac{1}{4}$ "H x 22 $\frac{1}{4}$ "W x 14"D.

Heath's new No-Money-Down terms mean you can buy with complete confidence

Money-Saving Heathkit® Stereo Consoles

- Ready to play or kit form
- Compact for true space economy
- Factory-assembled contemporary walnut cabinet
- 6 speakers—3 for each channel
- 60-15,000 cps response

- 4-speed stereo/mono record changer
- Anti-skate device included
- Sonotone stereo cartridge
- Turnover diamond and sapphire styli
- Separate dual bass and treble tone controls



Compact STEREO-PHONO CONSOLE
Just \$129.95 in kit form
Ready-to-play—only

\$149⁹⁵

MORE HEATHKIT CONSOLES
SHOWN ON PAGES 58 & 59

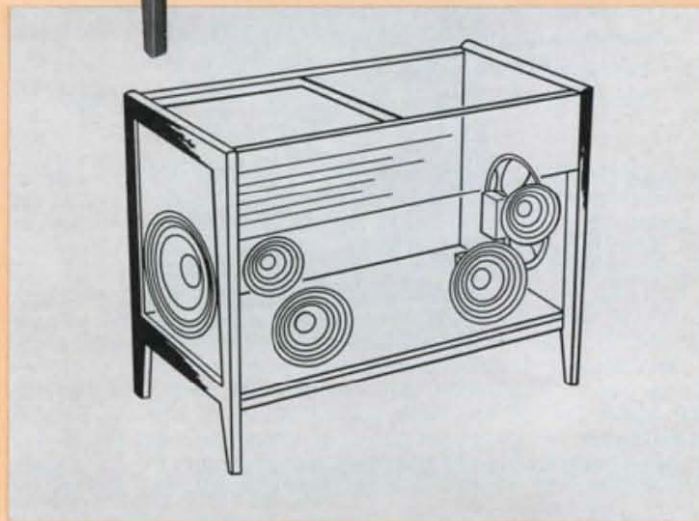

Six Speakers . . . Three Per Channel

Here's how the six speakers in the GD-31 are placed to give you stereo sound in one compact cabinet. Featured are two 12" woofers, two 8" mid-range speakers and two 5" cone-type tweeters. The cabinet measures 31 1/4" L x 17 1/4" D x 26 1/4" H.

Whether you live in an apartment or a small home, the lack of a spacious living room is no longer a problem in enjoying true stereo music with excellent high fidelity sound reproduction. The Heathkit GD-31 Stereo-Phono Console is less than three feet long and just end-table high to fit easily in any room decor and perform superbly regardless of room size. Factory assembled, the construction of the handsome cabinet features a solid walnut frame, a walnut veneer front panel, and a matching wood-grained masonite sliding top. The light beige tapestry weave grille cloth covers the front and sides and accents its carefully-proportioned lines.

The GD-31 features six speakers—three for each channel—assuring wide range sound reproduction. Smooth "lows" are delivered by two 12" woofers, while "mid-range" and "high" are sparkingly reproduced by two 8" speakers and two 5" cone-type tweeters, mounted at wide dispersal angles in the cabinet. The 4-speed automatic record changer in the GD-31 plays 16, 33 1/3, 45 and 78 rpm records in either monophonic or stereophonic form gently and faithfully. The changer is equipped with a Sonotone stereo cartridge with turnover diamond and sapphire styli. A record-saving "anti-skate" device insures proper performance and prevents damage to valuable recordings. Audio power in the GD-31 is supplied by the compact two-channel amplifier which produces a system response of 60-15,000 cps for thrilling wide range stereo. Easy-to-operate concentric volume controls and separate dual bass and treble tone controls are within easy reach on the cabinet front panel. Now is your chance to enjoy stereo in your home at a budget price.

In factory-assembled or easy-to-build kit form, your family and friends will marvel at the excellence of your Heathkit GD-31 Stereo-Phono Console in operation. Order today—easy terms if you desire, up to 12 months to pay, with No Money Down. 70 lbs.

Kit GD-31 . . . NO MONEY DOWN, \$12 mo. \$129.95
Assembled GDW-31 . . . NO MONEY DOWN, \$14 mo. \$149.95
ADA-50-1 . . . 45 rpm adapter spindle . . . 2 lbs. \$2.95

SPECIAL STEREO RECORD OFFER

While the supply lasts, anyone who purchases a GD-31, a GDW-31 or a GD-10 (page 10) is eligible to purchase either or both of the following special-value stereo record groups:

5 for only \$5.95 (order #449-81, 4 lbs.)

10 for only \$9.95 (order #449-82, 7 lbs.)

All records are first quality stereo recordings on famous London, Mercury or Westminster labels. Sorry, no title selections or returns are permitted.

are Tops in Design and Performance

"Directable Sound"
control puts stereo
anywhere in your room!

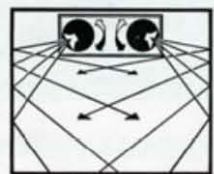
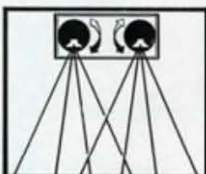
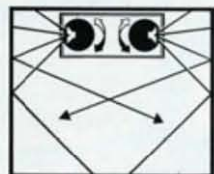
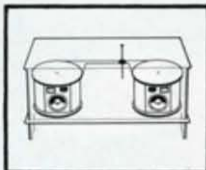

True stereo sound
regardless of
room size, shape or
console location

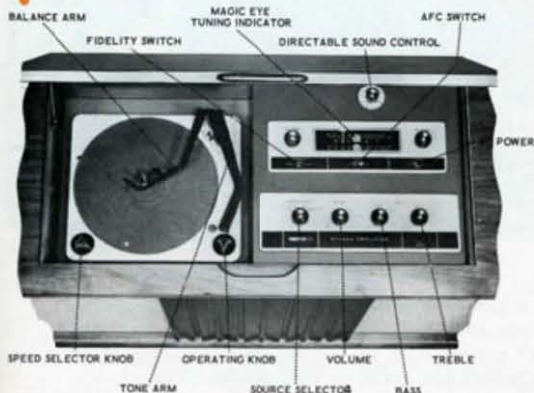

Everything is at your fingertips! Just lift the top lid of the cabinet and there are all tuner and amplifier controls, the changer, and the "Directable Sound" control. Shown is the model GDW-91 panel.



Elegant from every angle, these handsome cabinets display beautiful craftsmanship and versatile features. Note the center top lid with recessed grip . . . the stationary ends of the top, handy for lamps, etc. . . the sliding front panel which conceals record storage space.

- Completely assembled and tested . . . ready to play
- Unique rotating speaker systems adjust sound to fit your room
- Five different models . . . stereo phono . . . stereo phono + FM . . . stereo phono + AM and FM . . . stereo phono + FM and FM multiplex . . . stereo phono + AM, FM and FM multiplex
- 30 watt amplifier (15 w. per channel) 60 watt peak power
- 4-speed automatic record changer with stereo cartridge and turn-over diamond & sapphire styli
- Complete stereo control panel
- Superb, factory assembled walnut cabinets
- Lift-top center section
- Concealed record storage space



Choose From Five Different Models From

\$249⁹⁵

The amazing Heathkit "Directable Sound" STEREO ENTERTAINMENT CENTER puts stereo sound anywhere in any room

This is one of the times we find it difficult to put into words the performance of a Heathkit component. The amazing sound of the exclusive Heathkit "Directable Sound" speaker system . . . the beauty of the cabinetry . . . the wide choice of models . . . the versatility of its performance . . . all should be experienced rather than explained.

With just a turn of the control knob on this stereo console, you can make the stereo sound spread apart or move together . . . you can make the sound fit your room or direct it to your listening position . . . and you can place the console wherever you wish. In short, this is "Directable Sound," an exclusive system developed by Heath that puts you in command of the sound rather than at its dictates.

The two speaker systems each have an 8" low-resonance woofer and 3" cone-type high-frequency tweeter. The direction control is panel-mounted under the lift-top center section.

The system is powered by a 30-watt amplifier (15 w. per channel EIA Music Power Rated) to provide a response of 50 to 15,000 cps. Six amplifier inputs accept AM and FM tuners, stereo ceramic phono cartridge, and FM multiplex converter. The dual concentric volume control doubles as a balance control. Bass and treble controls are separate. The four-speed automatic record changer has a Sonotone stereo ceramic cartridge with diamond and sapphire styli. It plays stereo or monophonic records and intermixes 10" and 12" records of the same speed.

The cabinet is of walnut in solids and veneers with a tapestry weave grille cloth on the front and sides. The center of the top surface lifts to provide access to changer and all controls; the ends of the top are stationary for lamp placement, etc. Overall dimensions: 50½" L x 31" H x 18"D.

The phono-tuner models have tuners which feature flywheel tuning, automatic frequency control, and lighted dials. For complete performance, these models also can be purchased with FM stereo multiplex converters. See the model numbers below, choose the Heathkit Stereo Entertainment Center to fit your exact preference.

Assembled GDW-41 (stereo phono) . . . 135 lbs. . . NO MONEY DOWN, \$23 mo. **\$249.95**

Assembled GDW-81W (stereo phono + FM) . . . 142 lbs. . . NO MONEY DOWN, \$28 mo. **\$299.95**

Assembled GDW-81WS (stereo phono + FM and FM Multiplex Converter) 146 lbs. . . NO MONEY DOWN, as low as \$23 mo. **\$349.95**

Assembled GDW-91W (stereo phono + AM/FM) . . . 144 lbs. . . NO MONEY DOWN, as low as \$23 mo. **\$349.95**

Assembled GDW-91WS (stereo phono + AM, FM and FM Multiplex Converter) 148 lbs. . . NO MONEY DOWN, as low as \$26 mo. **\$399.95**

ADA-80-1 . . . 45 rpm adapter spindle . . . 2 lbs. **\$2.95**

Save up to 50% with Heath Do-It-Yourself Electronic Kits

Reverberation adds spaciousness to your Hi-Fi Listening Enjoyment



Kit GD-61M
\$69⁹⁵



*Heathkit REVERBERATION SYSTEM kit
brings music vibrantly to life*

- Simple connection to speaker terminals of your present system
- Use with radios, phonographs, tape recorders . . . any stereo or mono high fidelity system
- System includes reverberation unit, 3-watt amplifier, speaker, preassembled cabinet and two 15' input leads

A thrilling new dimension in listening entertainment awaits you in the Heathkit GD-61 Reverberation System. Just as "live" performances have their sounds enriched by the echoes and reflections from the walls and surfaces of concert halls, cathedrals, etc., so too will the GD-61 add this spacious quality to your favorite music. You'll experience a totally-new sensation in high fidelity sounds . . . depth and dimension that enhances both stereo and monophonic realism, right in your own home!

The GD-61 is completely self-contained. Amplifier, speaker and reverberation unit are all built-in for complete operating convenience. The GD-61 is easy to use, simply attach the input leads of the system to any complete system's amplifier output, or speaker terminals and it's ready to use. It may be placed anywhere in the room for best listening effect or wherever space permits. Simple one control operation lets you select just the right amount of reverberation to suit your particular taste. Another advantage of the GD-61 is that it adds reverberation acoustically in the room, the natural way, not by system disrupting electronic mixing that uses the same speakers as the primary sounds.

The system features the Hammond type-IV reverberation unit, a low distortion 3-watt amplifier with built-in power supply, and an 8" speaker all housed in a preassembled cabinet which is available in your choice of finished walnut or mahogany, or unfinished sanded white hardwood.

Assembly is easily accomplished following simple "check-by-step" instructions and large pictorial diagrams furnished. Amplifier circuit is designed for easy assembly with clean, open circuit layout. High

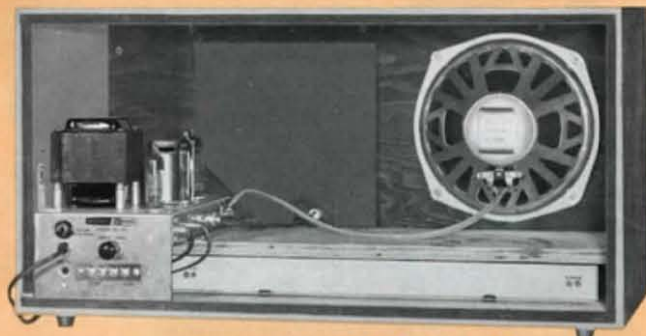

Completely Self-Contained

This inside view shows neat placement of amplifier, speaker with reverberation unit under

speaker shelf. Input terminals allow use with stereo or monophonic systems.

quality parts are used throughout for years of dependable, trouble-free operation. Measures 11½" H x 23" W x 11¼" D. Complete with two 15' input leads. 30 lbs.

Kit GD-61M, Mahogany finish . . . NO MONEY DOWN, \$7 mo. . . . **\$69.95**
Kit GD-61W, Walnut finish . . . NO MONEY DOWN, \$7 mo. . . . **\$69.95**



How It Works

The reverberation unit delay line consists of an input transducer, two long springs and an output transducer. An electrical signal applied to the delay line causes the input transducer to twist the springs. This mechanical motion travels the length of the springs to the output transducer where an electrical signal is developed and fed to the amplifier. At the same time, the spring tends to recoil from its initial twist and a signal is relayed back to the input transducer. This recoil cycle is repeated several times until the signal finally fades out. The result is a signal very closely resembling true reverberation.



*Free your hands while making telephone calls
with this handy telephone amplifier*

- Ideal for office work, conference calls or busy housewives
- All transistor circuit—instant operation
- One 9-volt battery lasts up to 2,000 3-minute calls!

Just a few hours spent in assembling this telephone amplifier will save countless hours in your daily work! A convenient accessory for any office or home, the GD-71 frees you and your hands while you carry on a normal 2-way telephone conversation.

When a call is received, you simply place the telephone handset on the amplifier cradle and you're ready to listen or talk, hands free. A switch automatically turns the unit on when the handset is placed on the amplifier. The GD-71 features an all-transistor circuit for instant operation . . . no warmup time is required. Power is furnished by a single 9-volt battery which will last up to 100 operating hours. Other features include a built-in speaker, inductive pickup coil, and adjustable volume control. The amplifier's volume and sensitivity is more than adequate to allow talking and listening from any place in most rooms, leaving you free to look for reference material, take dictation, make notes, etc. A circuit board and easy-to-follow instructions make assembly a simple one-evening project.

The many advantages of this telephone amplifier will be quickly realized when conference calls are in progress or where several people may wish to talk to the person on the other end of the line. Start enjoying the convenience of having your own telephone amplifier now . . . in your home or office . . . wherever you need a helping hand. Molded ivory colored cabinet measures 5 $\frac{7}{8}$ " x 6" x 9 $\frac{1}{4}$ ". 2 lbs.

Kit GD-71.....\$19.95



*Save time and steps with this
deluxe INTERCOM SYSTEM*

- Provision for up to five remote stations
- All transistor circuit—instant operation
- Economical flashlight battery power supply
- Allows normal, private or interstation talks

An excellent communications system for home, shop or office! Handsomely styled in two-tone turquoise and ivory plastic, the XI-1 makes an attractive addition to any setting and incorporates many features for outstanding performance. The flexible switching arrangement provided on the Master unit allows normal, private or interstation calls for up to five remote stations. All functions are controlled by the master unit which has separate "listen" and "talk" volume controls and a 3-position "off-listen-talk" lever switch. All remote stations are equipped with a "private" switch and a spring-return "call" switch so they can initiate a call to the master or to any other remote unit desired by pre-set selection of the master unit. The powerful four transistor circuit delivers up to 1 watt audio output and is specially engineered for crisp, clear communications. Power is furnished by eight standard size "C" flashlight batteries for up to 300 hours normal "on" time. Each remote requires a single 9-volt battery. High operating economy is possible since the system is turned off between calls and current is used only during the call. Easy-to-build with complete instructions supplied. 50 feet of two-wire cable supplied with each remote station. (less batteries).

Kit XI-1 (Master) . . . 5 lbs. . . NO MONEY DOWN, \$5 mo. . . . \$29.95
Kit XIR-1 (Remote) . . . 3 lbs. . . . \$8.95 ea.



Kit XIR-1
\$8.95
(Remote)



Kit XI-1
\$29.95
(Master)

Transistor power supply kit

A permanent power supply for operating the XI-1 Intercom Master on 110 V AC. Fits in space normally occupied by battery supply.

Kit XP-1 . . . 1 lb. . . . \$9.95

There's a Heathkit® for your Every Need



Kit BR-2
\$18⁹⁵
 (less cabinet)

Versatile Heathkit BR-2 BROADCAST BAND RECEIVER is easy and fun to build

- Can be wired as a receiver/tuner or receiver/phono amplifier
- Rod-type built-in antenna
- High gain IF transformers and miniature tubes
- 5½" PM speaker
- Transformer-operated power supply
- Slide-rule dial

If you have ever wanted to build your own radio receiver, the popular Heathkit BR-2 is just what you've been looking for. It is designed to give complete and useful construction experience for the newcomer to the field of electronics and at the same time result in a practical radio for use anywhere in your home.

The easy-to-follow "check-by-step" instructions insure "error-free" building and explain basic circuitry of the instrument clearly and concisely. Large pictorial diagrams can be placed near the workbench for easy reference during the construction process.

The BR-2 is a 5-tube superheterodyne broadcast receiver that tunes from 550 kc to 1620 kc and features a transformer-operated power supply that gives safe, dependable operation. The high-gain miniature tubes, the sharply-tuned IF transformers, and a rod-type built-in antenna result in high sensitivity and good selectivity. The 5½" PM speaker provides good tone quality.

The Heathkit BR-2 can be used in a variety of applications. You can build it as a combination receiver-tuner or as a receiver-phono amplifier. The comprehensive manual explains the various applications of this versatile unit and gives correct wiring procedures to be used in assembling. A 110-volt AC outlet is provided as an accessory power source for a phono amplifier, etc. 8 lbs.

Kit BR-2 (less cabinet) **\$18.95**
Accessory Cabinet—an attractive housing for your completed BR-2 receiver. Plastic impregnated fabric-clad plywood with aluminum front panel, flocked reinforced speaker grille and protective rubber feet. 4 lbs.
 91-9A Cabinet **\$4.95**

SPECIFICATIONS—Radio: Tuning Range: 550 kc to 1620 kc. I.F. Frequency: 455 kc. Antenna: Built-in High Sensitivity Rod Type. Speaker (Included): 5½" PM 4 ohm Voice Coil. Tuner operation: Output: High impedance to any amplifier input with resistance of 100,000 ohms or more. 110 V outlet provided for amplifier, phono player, etc. Phonograph input: 1 megohm high impedance for optimum performance with any good quality crystal or ceramic phono pickup. Tube complement: 1—5Y3 Rectifier, 1—12V6 Beam Power Amplifier, 1—12AV6 Detector, A.V.C. and Audio Amplifier, 1—12BA6 I.F. Amplifier, 1—12BE6 Pentagrid Converter. Power requirements: 105-125 V 50-60 cycles AC 40 watts. Dimensions: 11½" wide, 5½" high, 6½" deep.



Kit CR-1
\$7⁹⁵

CRYSTAL RADIO Kit is fun to build—useful too!

- Two high-Q tank circuits
- Sealed germanium diode detector
- Requires no external power source
- Includes headphones

More than a toy, the youngsters will enjoy the Heathkit CR-1 for it is interesting to build and its high quality components provide excellent service. Needs no power source. Covers from 540 kc to 1600 kc and has two high-Q tank circuits with ferrite core coils and conventional air tuned capacitors. Sealed germanium diode detector requires no critical "cats whisker" adjustment. A pair of high impedance earphones are included in kit. Unit is housed in black bakelite case, 6" L x 3" W x 2½" D. Easy-to-follow assembly instructions included. 2 lbs.

Kit CR-1 **\$7.95**



Kit ET-1
\$13⁹⁵

Heathkit ENLARGER TIMER designed for automatic control of enlarger exposure time

- Easy-to-read, linear dial scale
- All-electronic circuit
- Relay handles up to 350 watts

The Heathkit ET-1 is an easy-to-build electronic device for amateur or professional photographers for timing enlarger operations. Continuously variable control permits selection of any exposure time between 0 and 60 seconds. Handy lever switch indicates timing cycle or turns on enlarger for focusing. A "safe light" can also be plugged into the ET-1 so that it is automatically turned off when the enlarger is "on." The internal relay handles up to 350 watts at enlarger or safe-light receptacles. Requiring only 3 watts for operation, the ET-1 generates very little heat which insures long life of the components as well as avoiding unnecessary overheating of crowded dark rooms. The timer is housed in a compact plastic case that will resist attacks from photographic chemicals. Measures 6¼" L x 3¾" W x 2" D. 3 lbs.

Kit ET-1 **\$13.95**

Heathkit® extra value Public Address Equipment



Kit AA-31

\$59⁹⁵

A High Fidelity PA AMPLIFIER

The AA-31 is unique, versatile and economical

- 20 watt output hi-fi rated
- Two inputs—switch selected input matching
- Electrical mixing
- Tape recorder output
- 70.7 volt line output

Here is something entirely new in the Public Address field . . . a true high-fidelity P.A. amplifier. The Heathkit AA-31 is specifically designed for public address use, yet it delivers 20 watts of hi-fi rated power.

The two inputs are furnished with standard, quick disconnect, 3-terminal plugs and receptacles. "Matching" switches on each input allow use of the AA-31 directly with magnetic phono cartridges, high impedance microphones, or high level units such as tuners or tape preamplifiers. When this versatile unit is used with Heathkit AN-11 plug-in matching transformers, its "matching switches" select the proper input impedance for low output, 50, 150 or 300 ohm microphones or balanced or unbalanced 600 ohm telephone lines of wired music systems.

Specifically designed for 24-hour a day use, the AA-31 has rugged, long-lasting components and a well-ventilated cabinet with pilot light and "fuse failure" indicator. Two-tone grey cabinet measures 6¼" H x 14¼" W x 11¼" D and has a unique rear hinge to permit easy access to top or bottom of chassis without cabinet removal. Whether it be for church, store, factory, office, home or whatever, the Heathkit AA-31 is truly your best PA value on the market today.

Kit AA-31 . . . 24 lbs. . . NO MONEY DOWN, \$6 mo. **\$59.95**

SPECIFICATIONS—Power output: 20 watts, high-fidelity rated. Input sensitivity: (Volts RMS for 20 watts output): Micro phone input w/o matching transformer, 1 mv; Magnetic phono input, 6.5 mv; High level input, .25V. Output impedance: 4, 8, 16 ohm and 70.7 volt. Tape recorder output level: approximately .15 volt. Tape recorder output impedance: approximately 5 K ohm. Power response: ±1 db 30-15,000 cps @ 20 watts. Damping factor: approximately 14. Harmonic distortion: (high level input) less than 0.7% @ 1 KC, 20 watts. Less than 2% @ 20 watts 30-15,000 cps. Intermodulation distortion: Less than 2% @ 20 watts 60 cps and 6000 cps mixed 4:1. Hum & noise: (db below 20 watts output); Microphone input—50 db; Mag. Phono Input—55 db; High Level Input—65 db. Equalization: mag. phono (RIAA). Controls: separate input matching switches, separate bass & treble controls, separate input gain control, master gain control, on-off switch, 2 hum balance controls. 117 V. AC power receptacle: provides AC independent of AA-31 on-off switch. Power requirements: 105-125 volts, 50-60 cps AC 100 watts at 117 volts. Tube complement: (3) 6EU7, (1) 7199, (2) 7591, (1) 6Z-34.

Model AN-11 Input Matching Transformer: Matches any low impedance microphone or balanced or unbalanced lines. Primary tapped, 4 ranges from 30 to 600 ohms. Hum shielded, two mu metal shields and steel outer case.

Kit AN-11 . . . 2 lbs. **\$11.95**

SPECIFICATIONS—Primary impedance: 30/50 ohm, 125/150 ohm, 250/300 ohm, 500/600 ohm. Secondary impedance: 80,000 ohm. Hum shielding: 70 db min. Base: standard octal plug. Dimensions: 1½" square x 2½" H.



Kit AA-80

\$39⁹⁵

Low-cost mobile PUBLIC ADDRESS AMPLIFIER . . . Perfect for all field events

- 5 transistor circuit—10 watt output
- Instant operation—no warmup needed
- Automatic music fade for voice cut-in

The Heathkit AA-80 Mobile PA Amplifier delivers a full 10 watts output with response of 300 cps to 5 kc for any type of event—rallies, sporting events, etc. Uses 12 volt car battery for power, needs only 2 amps at full output, idling current is negligible. Has all-transistor circuit for long-life dependable performance. Separate gain controls for microphone and auxiliary music source. Has two channel mixing circuit with automatic music "fade" when push-to-talk microphone with three conductor cable is used. Plug-in speaker and power connections. Outputs for 8 and 16 ohm speakers. Compact size permits installations practically anywhere. 6 lbs.

Kit AA-80 . . . NO MONEY DOWN, \$5 mo. **\$39.95**

SPECIFICATIONS—Power output: 10 watts. Power response: 300 to 5000 cycles per second ±3 db at 10 watts output. Noise: 70 db below rated output. Voltage requirements: 12-15 volts DC (Auto battery). Current requirements: Idling—.35 amps, Full power Output—2 amps. Total harmonic distortion: 5% or less at 10 watts. Input sensitivity: Microphone—5 mv, Auxiliary—120 mv. Inputs: Microphone—Dynamic (low impedance, 200 to 600 ohm), Auxiliary—High impedance (for tuner, tape recorder, crystal or ceramic phono, etc.). Outputs: 8 and 16 ohm speaker. Controls: Microphone gain, Auxiliary gain, off-on switch. Transistor complement: Two 2N408, Three CDT1337. 3½" H x 8½" W x 7½" D. Gray wrinkle finish.

A complete 10-watt Mobile PUBLIC ADDRESS SYSTEM Kit CSS-1

\$84⁹⁵



Complete PA facilities are provided with economy of operation. Includes AA-80 Amplifier above, push-button microphone, car-top carrier which holds up to 4 speakers, a weather-proof 15 watt, 16 ohm reflex horn speaker, cables and hardware.

Kit CSS-1 . . . 24 lbs. . . NO MONEY DOWN, \$9 mo. **\$84.95**

Citizen's Band "Walkie Talkie's"...outstanding

New deluxe 9-transistor Walkie-Talkie Transceiver with crystal-controlled superheterodyne receiver

- Crystal-controlled superheterodyne receiver with RF stage
- Built-in squelch & noise limiter circuit
- Better than 1 UV sensitivity for 10 DB S/N ratio
- Crystal-controlled transmitter
- 9-transistor circuit
- Economical battery power supply
- Handsomely styled two-tone aluminum case
- 1 to 3 mile operating range
- Conforms with FCC regulations, part 15 & 19
- No license, forms, tests or age limit requirements
- Easy circuit board assembly
- Hundreds of uses in business, industry & personal applications



Kit GW-21
\$44⁹⁵

Here is a deluxe 9-transistor hand-held transceiver with more features than units selling for twice the price! The crystal-controlled superheterodyne receiver features an RF amplifier, squelch & noise limiter circuit, and has better than 1 uv sensitivity for 10 db S/N ratio. The audio output and modulator section delivers 150 mw of power to the 2½" speaker which also doubles as a mike when transmitting (earphone and jack are included for "private" reception). Use the GW-21 as a wireless mike by plugging the input of a PA amplifier in the earphone jack and using other GW-21's or GW-31's as roving mikes. Because of its squelch circuit, the GW-21 also makes an ideal paging receiver.

The transmitter section consists of a crystal-controlled oscillator/driver stage and a high efficiency modulated RF output amplifier. Maximum power input to the final is 100 mw allowing use without a license (FCC regulations, part 15). The GW-21 may also be used for licensed operation with Class "D" Citizen's Band stations (FCC Regulations, part 19). The transceiver is housed in an attractive two-tone aluminum cabinet with carrying strap. Extremely easy to build... all parts mount on a diagrammed circuit board. Three simple operating controls... on/off volume control, squelch control and push-to-talk switch. When not in use, the 35" whip antenna collapses completely into the cabinet for easy carrying. The GW-21 uses a single 9-volt battery which provides up to 75 hours useful life.

Intended for portable short-range communications the GW-21, as with any such low power device, will provide an effective range of 1 to 3 miles, when used with similar units and depending upon local conditions. Under extremely favorable conditions, communications may be established up to 10 miles. The GW-21, because of its extreme receiver sensitivity and high transmitter efficiency, will outperform many similar units. If the unit is used as a licensed CB station, a regular CB antenna may be used, thereby extending the range considerably (provision is made for such an antenna). Surveyors, construction workers, sportsmen, farmers, factory workers, etc., will find many uses for this unit in two-way radio communications. 2 lbs.

Kit GW-21 . . . NO MONEY DOWN, \$5 mo.	\$44.95
Kit GW-21-2 (pair) 4 lbs. NO MONEY DOWN, \$9 mo.	\$84.95
Assembled GWW-21 . . . NO MONEY DOWN, \$8 mo.	\$71.95
Assembled GWW-21-2 (pair) . . . NO MONEY DOWN, \$13 mo.	\$136.50
GWA-30: BATTERY SET: (2) one for operation, one spare . . . 1 lb.	\$2.95



Kit Form
or
Factory
Assembled

HEATHKIT
TRANSCIVER
MODEL GW-21

SPECIFICATIONS—Receiver section: *Receiver Type—Crystal controlled, superheterodyne; Sensitivity—1 uv for 10 db SN; Selectivity—7.5 KC @ 6 db; Audio Power Output—150 mw; Speaker-Mike—2½" round PM; Controls—OFF-ON Volume and Squelch. **Transmitter section:** RF Input Power—100 mw; *Frequency Unlicensed—Crystal controlled 26.975 mc to 27.255 mc (any channel, 2 through 23, in the 11-meter band); *Frequency Licensed—Crystal controlled 26.965 mc to 27.255 mc (any channel, 1 through 23 in the 11-meter citizen's band); Crystal—Subminiature, plug-in type, tolerance .005%; Modulation—High level AM limited to less than 100%; Control—Single push-to-talk switch on side of cabinet. **Power supply:** **Battery—9 V type Neda #1602, Eveready #246, Burgess #2N6, Mallory #M1602, Ray-O-Vac #1602, RCA #VS305; Battery Life—Approximately 75 hours (normal intermittent use); Total Receiver Current Drain Standby—Approximately 12 ma; Total Transmitter Current Drain—Approximately 30 ma. **General:** **Antenna—35" whip type, collapsible completely into cabinet; Transistors and Diodes—1-2N1726 RF amp, 1-2N1727 converter, 2-2N1108 IF amp, 3-2N185 audio, 1-R425 trans osc., 1-R424 RF amp, 1-Germanium Diode-detector, 1-Silicon Diode—squelch & noise limiter. **Cabinet dimensions:** 7¼" H x 3¼" W x 1½" D.

*Specify desired channel when ordering crystals. See crystal list.

**The antenna supplied and the specified battery must be used to insure compliance with FCC Rules & Regulations, Part 15.

values in two-way radio communication systems

Low-cost, 4-transistor "Walkie Talkie" ... only \$24.95 each!

Save \$3.90, buy a pair for just \$46.00

- No license, forms, tests or age limit requirements
- Hundreds of uses in business and personal communications
- Operates up to 1 mile between units . . . more with regular class "D" Citizen's Band Station
- Crystal-controlled transmitter—superregenerative receiver
- Small, compact, neatly styled in brown & beige steel case
- Simple circuit board construction
- Operates from a single 9-volt battery for up to 75 hours use
- Fully certified for unlicensed or licensed use (FCC regulations, parts 15 & 19)



Kit GW-31

\$24⁹⁵



You'll find this handsome hand-held walkie-talkie ideal for short-range, two-way radio communications. Conservatively rated, the Heathkit GW-31 is a low-cost, pocket-size transmitter and receiver combination which will cover an area ranging from 2 blocks to a mile or more, depending upon location and terrain. Ideal for use in business, industry, or personal use. Surveyors, construction workers, farmers, hunters, fishermen, etc., all have uses for this handy walkie talkie, to keep in touch with one another, coordinate functions, control operations, direct material handling, and many more useful applications! The GW-31 is attractively styled in a rugged steel case with brown and beige color. Its small compact size makes it easy to hold and operate.

Just two controls operate the unit . . . an on/off volume control and push-to-talk switch. The receiver is fixed-tuned to the frequency you wish to use and requires no further adjustment after initial setting. The specially-designed circuit features a frequency response tailored for maximum intelligibility in the voice range for crisp, clear communications. The 36" telescoping whip antenna collapses into the unit for easy carrying when not in use or slips easily into coat or trouser pocket. Assembly of the GW-31 is simple . . . all components mount on a circuit board that guards against wiring errors and assures consistent, reliable performance. Operates up to 75 hours on a single 9-volt battery. No license required for operation between similar units. Kit includes all parts, instructions and crystal for 1 channel (specify frequency, see list p. 21). Less battery. 2 lbs.

Kit GW-31	\$24.95
Kit GW-31-2 (pair) . . . NO MONEY DOWN, \$5 mo.	\$46.00
Assembled GW-31 . . . NO MONEY DOWN, \$5 mo.	\$37.75
Assembled GWW-31-2 (pair) . . . NO MONEY DOWN, \$8 mo.	\$71.95
GWA-30: BATTERY SET: (2) one for operation, one spare . . . 1 lb.	\$2.95

SPECIFICATIONS—Receiver: Superregenerative detector. **Sensitivity:** Usable with signals as low as 4 uv at antenna terminals. **Tuning range:** Fixed (by internal adjustment) to any channel, 1 through 23. **Audio power output:** 30 milliwatts. **Speaker:** 3.2 ohm, round. **Controls:** on/off volume, push-to-talk switch. **Transmitter RF input power:** approx. 90 milliwatts. **Transmitter frequency:** Crystal controlled unlicensed channels 2 through 23 (channel 1 through 23 for licensed operation). **Crystal:** Subminiature, plug-in type, .005% tolerance. **Microphone:** 3.2 ohm speaker. **Modulation:** high level AM limited to less than 100%. **Antenna:** 40" whip type, collapsible to 7 1/2". **Battery:** 9 V. **Battery life:** Approx. 75 hours (normal intermittent use). **Transistors:** 2N1108, R424, (2) 2N185. **Dimensions:** 6 1/2" H x 3 1/4" W x 2 3/4" D.

*NOTE: Fully certified for unlicensed communications with similar transceivers operating in 26.97 to 27.27 mc band, under part 15 of FCC regulations. Since GW-31 is designed to comply with the requirements of part 19 of FCC regulations, it can also be used and licensed for communications with Class D Citizen's Band stations.

Kit Form
or
Factory
Assembled



Heathkit® Citizen's Band Radio for extra value



Kit Form
or
Factory
Assembled

Kit GW-10A

\$62⁹⁵



*Factory assembled or in easy to build kit form . . . Heathkit brings
you high performance Citizen's Band TWO-WAY RADIO at lowest cost!*

- Sensitive superheterodyne receiver
- Adjustable squelch—automatic noise limiter
- 3 crystal controlled transmitting channels

- Single crystal or variable receiver tuning
- Press-to-talk microphone for simple one-hand operation
- Easy to build—easy to install—easy to use

The Heathkit GW-10 Transceivers reliably cover distances from one to ten miles or more with quality performance at low cost. Hundreds of uses in business and personal communications will suggest themselves . . . equipping a fleet of trucks to keep them in touch with the home office . . . instant communication for Doctors with a busy schedule . . . service-repairmen for on-the-road routing instructions . . . businessmen to keep in contact with office, factory, or warehouse from their desk or from their car . . . personal calls to associates from car, boat, or home . . . wherever quick 2-way communications are needed, Heathkit Citizens Band units can serve.

The handsome low-profile cabinet styling lends itself perfectly to attractive home installations or easy under-dash mounting in automobiles, trucks, etc. for mobile station use. The many features of the GW-10 Transceivers include switch-selection of a crystal-controlled receiving channel or continuous tuning of all 23 channels. Impulse-type noises (ignition interference, etc.) are minimized by a "series-gate" noise limiter, and the adjustable squelch silences the receiver during "standby." Fast, easy station selection is provided with vernier action tuning and an illuminated dial scale. The transmitter features convenient switch-selection of 3 different crystal-controlled transmitting channels (one crystal supplied, specify channel from chart opposite page). Receiver crystal is supplied to match transmitting channel unless otherwise specified. Available in either AC or DC models, the GW-10 has a built-in power supply . . . just connect it to the proper power source. A press-to-talk microphone with coil cord and mounting clip is included to allow convenient one-hand operation while operating mobile.

Assembly of the GW-10 is designed with the beginner in mind. Complete check-by-step instructions plus large pictorial diagrams that show how each part is connected make assembly half the fun of owning the GW-10. Everything you need to complete the kit is furnished, including all hardware for mobile installations. Units are color styled in two-tone mocha and beige. 11 lbs.

Kit GW-10A (117 v. ac) . . . NO MONEY DOWN, \$7 mo. **\$62.95**

Assembled GWW-10A (117 v. ac) . . .
NO MONEY DOWN, \$10 mo. **\$99.95**

Kit GW-10D (specify 6 or 12 v. dc) . . .
NO MONEY DOWN, \$7 mo. **\$62.95**

Assembled GWW-10D (specify 6 or 12 v. dc) . . .
NO MONEY DOWN, \$10 mo. **\$99.95**

ATTN. GW-10 OWNERS: If you wish to convert your present AC operated GW-10 to DC, order GWA-10D conversion power supply kit; if you have a DC model you want to convert to AC, order GWA-10A. Unit fits in place of present supply. 2 lbs.

Kit GWA-10A (For conversion to AC) **\$14.95**

Kit GWA-10D (For conversion to DC) **\$15.95**

GENERAL DESCRIPTION—Receiver section: 4-tube superheterodyne circuit with built-in squelch and noise limiter function. **Sensitivity:** 1 uv signal at antenna input produces 10 db signal to noise ratio. **Selectivity:** 7.5 kc at points 6 db down from peak response. **Transmitter section:** power input to final RF amplifier does not exceed 5 watts. **Frequency control:** 3rd overtone quartz crystal. **Frequency control effectiveness:** within .005% of nominal crystal frequency over an ambient temperature range of -20 degrees F to +130 degrees F. **Modulation:** AM plate and screen modulation automatically limited to less than 100%. **Output impedance:** 50-70 ohms. **Tube complement:** (1) 6U8 Triode receiver crystal oscillator, pentode mixer, (1) 6C4 Receiver variable oscillator, (1) 6BJ6 IF amplifier, (1) 6BJ7 Detector diode, Squelch diode, Noise limiter diode, (1) 6AN8 Pentode first audio amplifier, triode microphone preamplifier, (1) 6AQ5 Combination audio output-modulator, (1) 6AU8 Triode transmitter oscillator, pentode RF final amplifier. **Power requirements:** 117V AC version, 45 watts; 6V DC version, 7.5 amps; 12 V DC version, 4.5 amps. **Dimensions:** 4 1/2" H x 15" W x 5 3/4" D.

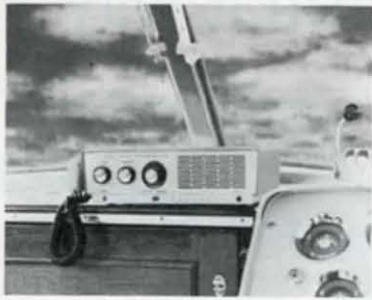

Boat owners are using the GW-10 extensively for low-cost 2-way radio facilities to keep in touch with shore stations. Neat, modern styling complements most marine decor.

An ideal "wireless intercom" for office use in calling remotely located warehouses, etc., between departments, or to control traffic functions in business activities.



Fleet truck owners find the GW-10 excellent for directing operations, relaying delivery information, etc., to save time between office and destination, and to cut costs.

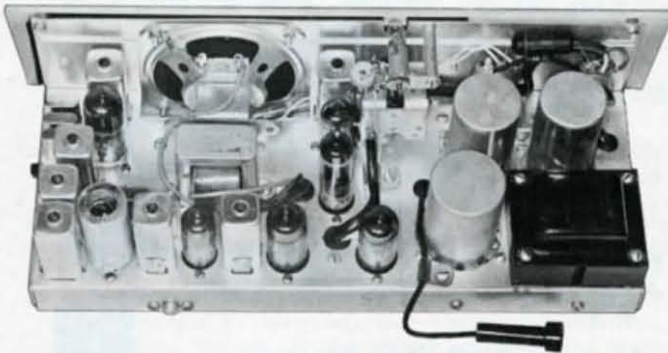

This inside view shows neat placement of components which makes assembly, maintenance, or adjustments simple. Note the high quality parts used throughout for years of trouble-free operation.

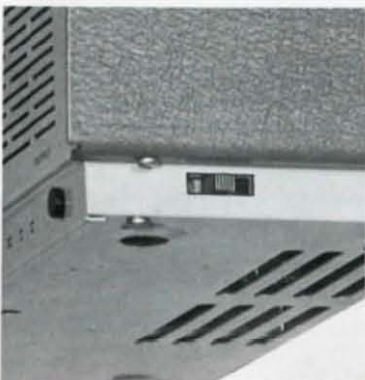

Convenient switch selection of 3 different transmitting channels is possible with this 3-position switch located on the side. Choose your channel for best results.

Citizen's Band Radio Antenna Accessories

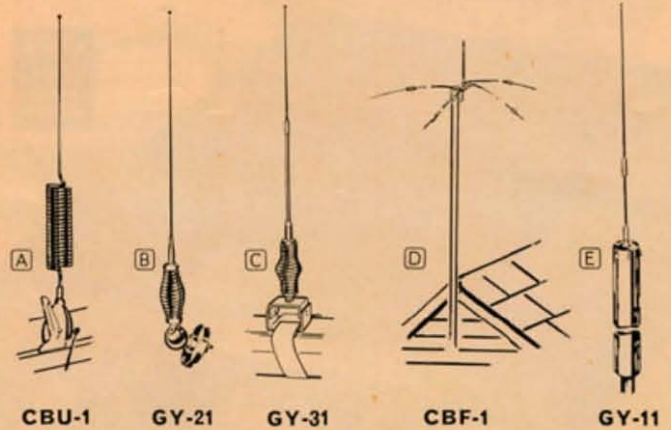

A "UTILITY" ANTENNA

An excellent medium range antenna for temporary mobile or fixed station CB installations. Includes rugged clip mount plus bracket. 45½" base loaded antenna with 12' connecting cable and connector. 2 lbs.

Model CBU-1.....\$9.95

B NEW MOBILE ANTENNA

For top coverage in permanent mobile installations. Two-section 102" stainless steel whip. Cadmium plated spring base. Swivel ball mount has a thick fiberglass insulator, heavy backup plate, water sealing gasket. Complete with mounting hardware, hold-down clip, 20' RG58AU cable and connector. 5 lbs.

Model GY-21.....\$15.95

C NEW "MOBILE" BUMPER-MOUNT ANTENNA

Excellent coverage in temporary or permanent mobile installations. Two-section 102" stainless steel whip antenna. Spring base. Stainless steel strap bumper mount. Includes hold down clip, 20' RG58AU cable, connector and mounting hardware. 7 lbs.

Model GY-31.....\$14.50

D "FIXED LOCATION" ANTENNA

An excellent coverage, non-directional quarter wave "ground plane" antenna for Citizen's Band use. Measures 9¼" from bottom of mounting bracket to top of vertical radiator. Complete with 50' RG58AU cable and mounting clamp. 6 lbs.

Model CBF-1.....\$17.95

E NEW "FIXED LOCATION" ANTENNA

Omnidirectional operation, low radiation angle and low standing wave ratio features of this antenna provide outstanding CB communications. An 18½ wave coaxial antenna, the GY-11 consists of a 9' 2-piece aluminum rod top element and a 9' 2-piece 2" diameter aluminum skirt. Mounts on a 12' length of ¾" IPS pipe (not supplied). Includes 50' RG58AU cable and connectors. 8 lbs.

Model GY-11.....\$21.95



CLASS D CITIZEN'S BAND CHANNEL NOS. AND FREQUENCIES

1. 26.965 mc	7. 27.035 mc	13. 27.115 mc	19. 27.185 mc
2. 26.975 mc	8. 27.065 mc	14. 27.125 mc	20. 27.205 mc
3. 26.985 mc	9. 27.065 mc	15. 27.135 mc	21. 27.215 mc
4. 27.005 mc	10. 27.075 mc	16. 27.155 mc	22. 27.225 mc
5. 27.015 mc	11. 27.085 mc	17. 27.165 mc	*23. 27.255 mc
6. 27.025 mc	12. 27.105 mc	18. 27.175 mc	

†Cannot be used for unlicensed operation of GW-30, GW-31, and GW-21

*Shared with Class C Radio Control

NOTE: Specify first and second choice of frequencies. When ordering several units, specify frequency for each.

Check Your Ignition System the Heathkit® way



Kit IO-20
\$89⁹⁵

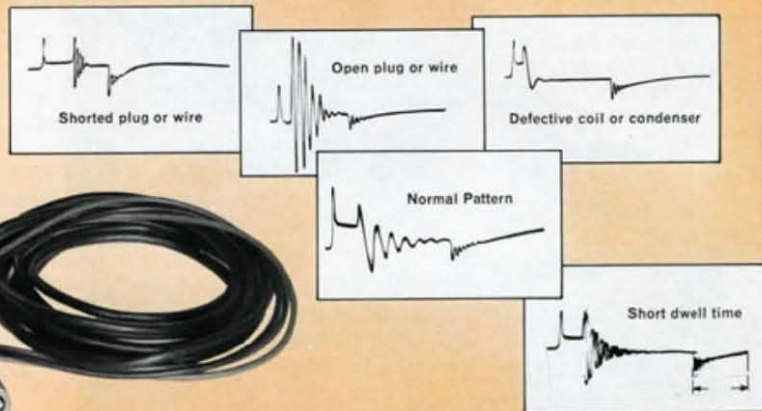
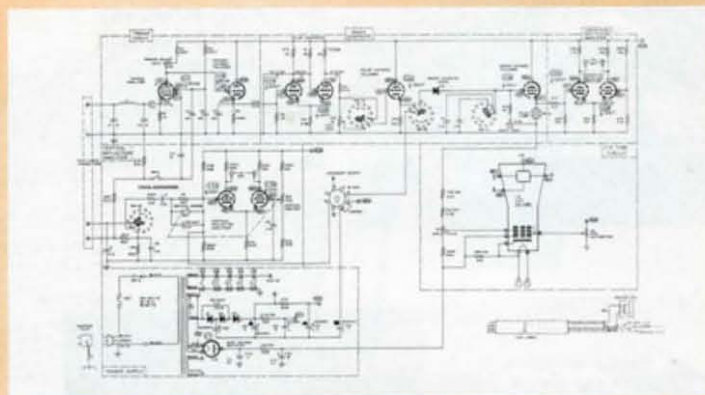

The Heathkit IO-20 IGNITION ANALYZER helps anyone be an Ignition Specialist

- Shows trouble spots and results of corrective action taken
- Switch-selection of 4 different patterns without lead switching
- New improved trigger circuit for steady, locked-in patterns
- Easy to use, with complete instructions provided
- Vertical and horizontal "expand" for magnified views

The Heathkit IO-20 Ignition Analyzer incorporates many desirable and time-saving features at savings of at least 50% of the cost of comparable units. With this dependable and highly accurate instrument, mechanics, service station operators, and automobile enthusiasts can check the entire ignition system of an automobile while the engine is operating, without the necessity of removing any ignition parts from the car.

Designed by Heathkit engineers in close cooperation with major oil industries and automotive ignition specialists, the IO-20 lets you observe the common ignition system defects . . . shorted spark plugs, bad points, defective wiring, worn distributor parts, incorrect point dwell time, coil and condenser problems, etc. The special flexible switching system lets you select primary, secondary, parade or superimposed patterns *without lead switching*. With this versatile unit, you can easily see where the trouble spots are and observe the results of the corrective action taken. A new, improved trigger circuit provides a steady locked-in pattern display with vertical and horizontal expand for magnified views of any waveform, and features a current transformer housed in a rugged plastic clamp.

The low-power requirement of the IO-20 makes it ideal for "on-the-road" testing when you use a DC to AC inverter as a power source. The Heathkit IO-20 is easy to use . . . just connect the leads, start the engine, select the pattern you want and view the tell-tale trace on the big 5" picture tube screen. This remarkable value comes housed in a corrosion-resistant aluminum case with convenient carrying handle and smooth, painted finish for easy cleaning. Measures 8" H x 9½" W x 16" D. Complete operating instructions are included. 15 lbs.

Kit IO-20 . . . NO MONEY DOWN, \$9 mo. **\$89.95**
Assembled IOW-20 . . . NO MONEY DOWN, \$16 mo. **\$169.95**

SPECIFICATIONS—RPM range: 400-5000 rpm. **Displays:** Secondary, Primary, Parade, Superimposed. **Screen size:** 4¾" diameter. **Dwell measurement:** 4, 6 & 8 cylinder calibration on face plate. **Pattern height:** Secondary circuit, approx. 1"; Primary circuit, 6 volt system ¾", 12 volt system 1". **Vertical expand ratio:** 2 to 1. **Horizontal expand ratio:** 10 to 1. **Cable length:** 12' pickup clamp, 2' ground, primary and secondary clips. **Front panel controls:** Vertical position, right edge, left edge, **Front panel switches:** Parade-Superimposed, 6-position rotary; Off, secondary expand, secondary normal, primary normal, primary expand and accessory. **Internal controls:** Focus, astigmatism, trigger adjust. **Trigger method:** Current transformer clamp in rugged plastic housing. **Tube complement:** 5UJ1, 1V2, 6EA8, 12AU7(2), 12AX7(2). **Rectifiers:** (3) silicon. **Power requirements:** 105-125 V, 50/60 cycles AC, 30 watts.

Kit ID-11
\$14⁹⁵

Ignition TIMING LIGHT Accessory

Kit Form or Factory Assembled

- Intense white light
- Works only with IO-20 Analyzer
- Hard rubber-case with 10' cable

This convenient accessory plugs directly into the IO-20 Ignition Analyzer only, and is specially designed to assist you with your diagnosis. The unit produces an intense white light that shows timing marks on the engine even in brightly-lighted areas. It has a speed range of 0-1250 flashes per minute (0-2500 rpm for 4-cycle engine of current conventional automobiles). The hard rubber pistol-grip case with convenient 10' cable assures long life. Dimensions: 6" H x 7½" L x 2" W. 2 lbs.

Kit ID-11 **\$14.95**
Assembled IDW-11 **\$19.95**

Heathkit® Radio-Controlled Garage Door Operator

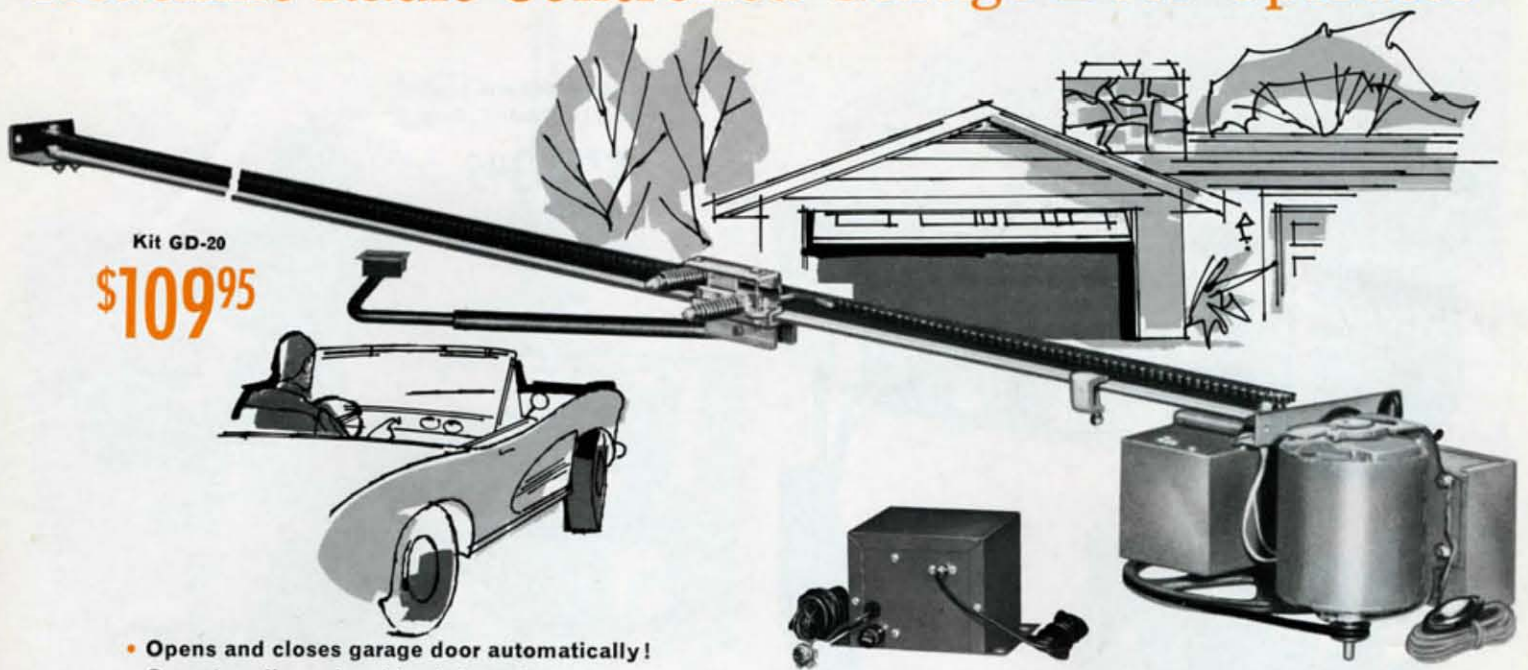

Kit GD-20

\$109.95

- Opens and closes garage door automatically!
- Operates all overhead track-type doors up to 8' high
- Fool-proof safety device disengages door upon meeting any obstruction
- Easy-to-install . . . complete instructions are provided
- Extra transmitter kits available for your second car

NEW NO MONEY DOWN TIME PAY PLAN

With Heath's sensational time payment plan, you can now order any kit or kits totaling \$25 to \$600 with **NO MONEY DOWN**, and low monthly payments. See the enclosed order blank for complete details and choose the Heathkit products you need without further delay. With Heathkit, you can build and enjoy now, pay later!

Save time and effort with the new low-cost GD-20 automatic GARAGE DOOR OPERATOR . . . unique in features — big in savings!

With just a push of a button on the dashboard of your car as you pull into your driveway, your garage door opens . . . push the button again after you're inside and the garage door closes, automatically! It's that simple! And that's what you can experience for yourself when you get the new and exciting Heathkit GD-20 Radio-Controlled Garage Door Operator.

At Heath's phenomenally low price, now anyone can enjoy the convenience of his own garage door operator. With the Heathkit GD-20, you can say goodbye forever to the fuss and bother of exposing yourself to the rain or snow in bad weather, to lifting or straining to open the garage door, to stumbling and groping in the darkness of an unlighted garage. Everyone who has used this great convenience wouldn't be without it again . . . not only because of the time and labor saving features, but for its safety and protection as well.

This money-saving Heathkit Garage Door Operator includes all parts and instructions for simple assembly of the transmitter, receiver and mechanism. A minimum number of parts provides for long, reliable, trouble-free operation. The mechanism is easy to install and so compact that it requires just 2½" clearance above the highest point of door travel. A unique adjustable safety release disengages the door from the mechanism should it meet any obstruction or fail to operate for any reason. This safety release can be adjusted to stop the door without damage to any obstacle. Each direction of the door travel has a separate safety

release allowing adjustment to meet the requirements of any door. The garage door can be stopped in any position in its travel for ventilation, cleaning, etc. A light socket is included which turns "on" when the door is opened, remains on for several minutes after the door is closed and then, automatically turns itself "off."

The transmitter mounts under the hood of your auto and is crystal-controlled for high stability. The push-button can be inconspicuously mounted under the instrument panel edge. The transmitter antenna mounts under the car, and requires no drilling. The receiver and high-power transmitter use selectable tone coding of the radio signal to allow operation near similar units without interference with one another. Receiver sensitivity is designed to prevent operation from a 1 but the strongest of signals. A push-button switch is provided to operate the unit from the house or garage; any number of switches can be connected to the mechanism. A safe 12-volt line is used for the switches which eliminates expensive wiring.

You owe it to yourself and to the other members of your family to order the Heathkit GD-20 Garage Door Operator today. 67 lbs.

Kit Model GD-20 . . . (includes mechanism, transmitter & receiver) . . . NO MONEY DOWN, \$11 mo. \$109.95

Kit Model GDA-20-1 . . . (extra transmitter for second car) . . . 4 lbs. . . . NO MONEY DOWN, \$5 mo. \$24.95

TRANSMITTER SPECIFICATIONS—6 or 12 volt operation, 5 watts max. (FCC requirements) to final, 3 modulation frequencies approx. 2KC, 2.9KC & 3.7KC fixed. Fused, 4¾" wide x 6" long x 4" high. 6AU8 & 12BH7. 27,255 MC crystal controlled. 2¾ lbs.

RECEIVER SPECIFICATIONS—117 V.A.C., 4¾" wide x 6" long x 4" high. 6BH6 & 6CB6. 10 W idle, 12 W with signal. 27,255 MC. 3 audio filter frequencies approx. 2KC, 2.9KC & 3.7KC adjustable to match Xmitter. Fused, 2 lbs.

MECHANISM SPECIFICATIONS—126" length x 8¾" high x 13" wide, 100# max. operating force. Operate doors up to 8' high. 117 V.A.C., ¼ H.P. motor. Fused, 56 lbs.

Equip your Boat with Dependable,

Factory Assembled and Aligned
... Ready to Install ... Only

\$319⁹⁵



This interior view of the MWW-11 shows the high quality, rugged components and neat, functional design that means greater performance, greater dependability for you.



- Powerful long range transmitter
- 5 crystal-controlled transmit & receive channels
- Dependable all transistor receiver
- Covers standard broadcast and 2-3 MC marine bands
- Doubles as 8-watt deck-hailer or PA amplifier
- Built-in heavy-duty vibrator power supply
- F.C.C. type accepted

SPECIFICATIONS—Marine frequency range: 2-3 mc. Broadcast frequency range: .55-1.6 mc. Receiver sensitivity: (providing 6 DB S/N ratio or better), Marine channels: 2 microvolts; Broadcast: 20 microvolts. Speaker: 3" x 5" oval (weatherproofed). Audio output: 3 watts, 8 watt PA "deckcall" capability. Transistor Complement: (1) 2N1225 Mixer; (1) 2N1225 Local Oscillator; (2) 2N1110 1st & 2nd IF; (1) 2N254 1st audio & squelch; (1) 2N301 Audio Driver; (2) 2N1147 Audio Output & Modulator; (1) Diodes. RF Input: 50 W. RF Output: 25 W min. Transmitter tube complement: (1) 6BA8 oscillator & buffer amplifier; (1) 12DQ6 final power amplifier. Microphone: carbon element type. Power requirements: 12 volt DC; Receiver only: 0.9 amp; Standby: 2.1 amp; Transmit: 9 amps. Dimensions: 7" H x 10" W x 13" D.

Enjoy High Power MARINE RADIO-TELEPHONE Facilities

Aboard Your Boat with the Heathkit 50-Watt MWW-11

Complete ship-to-shore and ship-to-ship communication facilities are provided in the handsomely-styled Heathkit MWW-11 Marine Radio-Telephone to bring you beauty, performance and versatility with all the extra features wanted by boat owners.

Circuit design features an 8-transistor receiver for dependable long-life performance with low current drain. Covers 2-3 mc marine band and standard broadcast band. Marine band is crystal-controlled in five switch-selected channels and broadcast band is variable tuned for complete coverage. Front panel noise limiter and squelch controls provides maximum clarity, minimum noise. 8-watt PA amplifier capability allows monitoring and entertainment or deck hailing. Powerful transmitter design with 12DQ6 final amplifier features 50 watt plate power input for strong signal output to reach that extra distance for added safety. 5 crystal-controlled transmitting channels and push-to-talk microphone permits convenient one-hand operation. A heavy-duty vibrator-type power supply is built in and features circuit breaker protection . . . no fuses. A panel meter indicates received signal strength or relative power output.

Beautifully styled in two-tone marine green with chrome-plated knobs, the MWW-11 has a wrap-around, welded aluminum cabinet and front panel seal to protect against splash and spray.

Included are, transmitter and receiver crystals for two channels (2182 and 2638 kc), mounting bracket, push-to-talk microphone with coil cord and mounting clip, installation and operating instructions. Final adjustments must be performed by a FCC licensed technician. 25 lbs.

Assembled MWW-11 . . . NO MONEY DOWN, as low as \$21 mo. \$319.95

Extra Transmitter & Receiver Crystals: any frequency in Continental U.S. 2-3 mc marine band. Specify transmitter and receiver frequency for each channel. Consult authorities in your area to determine frequencies most used. 1 lb. **\$2.95**



Heathkit brings you
highest quality marine Instruments
at low cost . . .

You get twice as much for your budget with Heathkit

Economical Heathkit® Marine Gear



Kit MR-11
\$109⁹⁵

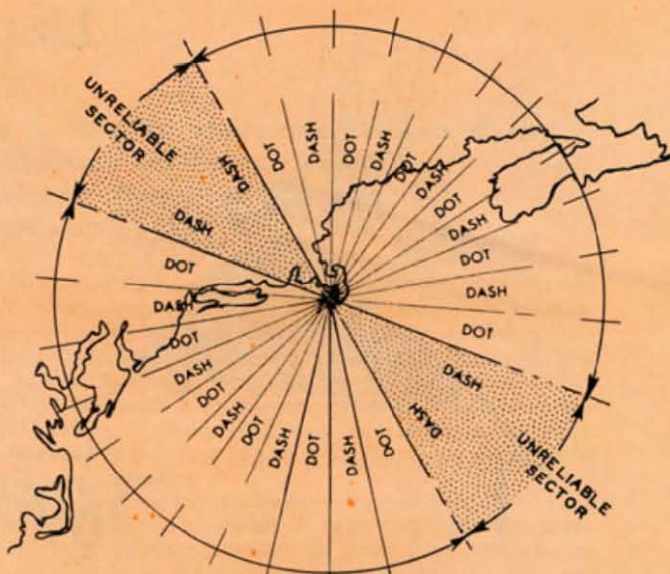

Above is the Consolan chart of Station TUK, Nantucket, which illustrates a typical Consolan station radiation pattern.



- Covers beacon/consolan, broadcast, and marine-telephone bands
- Sensitive 10 transistor, 1 diode circuit
- Economical flashlight battery power supply
- "Sense" antenna to eliminate confusing double null
- Easy back panel access to battery holders
- Preamsembled, prealigned tuning unit for easy assembly



This optional carrying handle on the "Mariner" makes it easy to remove and carry with you for safe keeping when you leave your boat. Easy access to the battery holders through this back panel opening makes it unnecessary to remove entire cabinet to replace batteries.

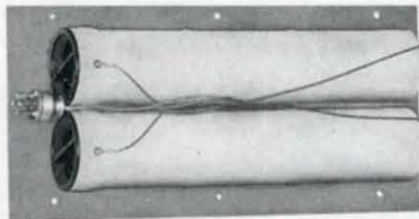

Any Skipper would be proud to have this

Heathkit DELUXE 3-BAND "MARINER" Aboard His Own Craft!

The new Heathkit MR-11 is an improved version of the famous Heathkit DF-3 . . . now with added convenience features. In addition to standard direction finding capability on all three bands, reception of marine frequencies, aircraft weather and broadcast radio entertainment, it also provides reception of the coastal Consolan frequencies. Equipped with the MR-11 and readily-obtainable Consolan charts, you can get a more accurate bearing from the Consolan station just by counting the transmitted dot-dash sequence. A built-in switch-selected BFO is provided to detect Consolan and other coded signals.

Other features include: a "sense" antenna to give true directions by resolving the confusion of the double null received on most RDF's, a lighted tuning dial and meter for night operation, large 4" x 6" PM speaker for good tone quality, new optional carrying handle, and rugged splash resistant cabinet with easy back panel access to the leak-proof battery holders. The tuning unit is factory assembled and aligned to simplify assembly. Position bearings are shown on a large 6 1/2" compass rose located under the rotatable ferrite loop antenna. Six standard flashlight batteries included provide up to 1000 hours operation. Kit includes mounting bracket. 12 lbs.

Kit MR-11 . . . NO MONEY DOWN, \$11 mo. **\$109.95**

SPECIFICATIONS—Beacon band: 188 to 410 KC. Broadcast band: 535 to 1620 KC. Marine band: 1650 to 3450 KC. Sensitivity for 6 DB signal to noise ratio: BC band, 150 uv/meter; Beacon Band, 150 uv/meter; Marine Band 60 uv/meter. Normal bearing accuracy: ±3°. Speaker: 4" x 6" weather proofed. Power requirements: 9 volts from 6 standard size "D" flashlight batteries. Battery drain: 35 ma @ 50 mw output level. Battery life: 500-1000 hours. BFO: 455 KC switch selected. Dial light: spring-return switch operated. Null and tuning indicator: 0-1 ma meter. Transistors: (1) 2N1107, (2) 2N1108, (1) 2N1109 (1) 2N1110, (1) 2N1111, (1) R251, (2) R250, (1) 2N238. Dimensions: 9" L x 9 1/2" W x 6 1/2" H.

In a short period of time the Heathkit marine equipment line has risen to a prominent position in the boating field, because it has made available high quality marine instruments at popular prices. Now thousands of boat owners and enthusiasts have found it possible to equip their

craft with dependable Heathkit marine gear by doing the easy assembly themselves and saving up to 50% of the usual cost. You can depend upon Heathkit marine electronic equipment for better performance, extra value and added enjoyment.

Assemble your own Marine Depth Sounder... Save up to 50%

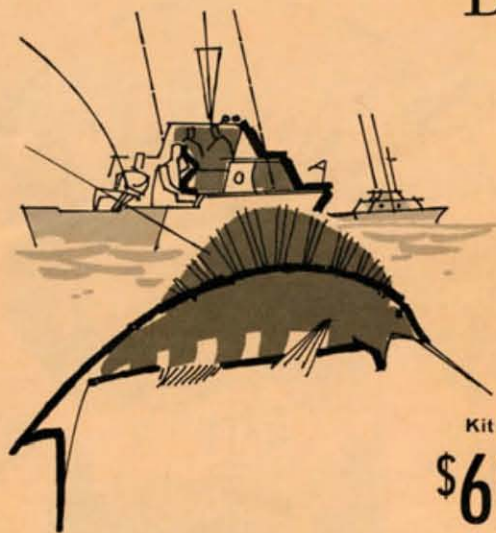

Kit MI-10
\$69⁹⁵

- Ideal for boaters, treasure hunters, skindivers, etc.
- Indicates water depth from 0 to 100 feet—detects submerged objects and their depth
- Dependable six-transistor circuit
- Self-contained battery power supply
- Nothing else to buy—batteries and transducer included

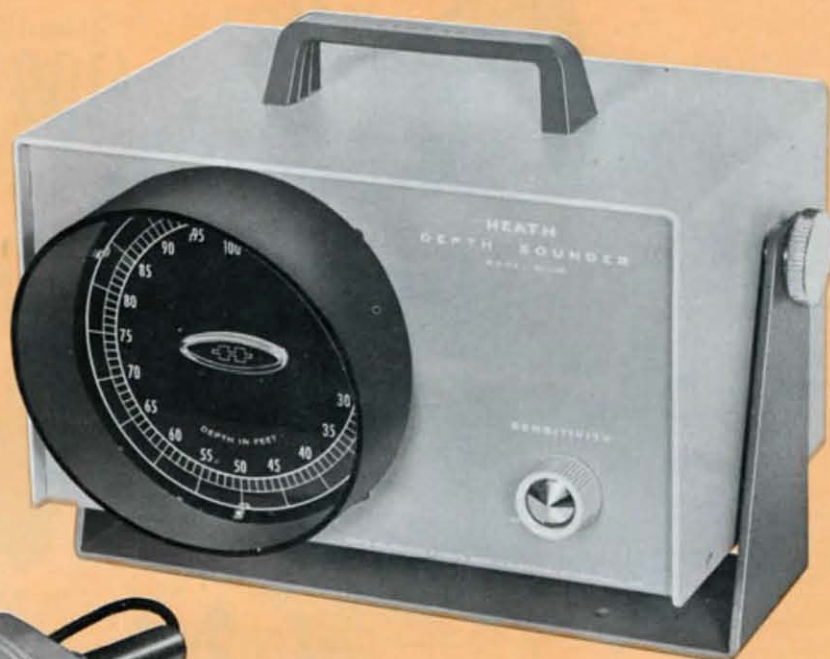

Best value by far... in a dependable,
economical DEPTH SOUNDER for your
boat... only \$69.95 in kit form

This accurate and dependable Heathkit Depth Sounder will contribute greatly to your boating enjoyment... for safety... navigation ease... boat protection... and the adventure of locating underwater objects. With the MI-10 aboard your boat you can see at a glance the depth of the water and the nature of the bottom. You can detect submerged objects (logs, etc.) and their depth... ideal for fishermen to use for spotting schools of fish.

The MI-10 features an all-transistor circuit for long life and dependable performance and has its own built-in battery power supply for complete independence from the boat's electrical system. No external connections required except for the transducer cable which connects to the unit through a water-tight coaxial connector. The transducer (sending and receiving unit) can be mounted permanently through the boat's hull or outboarded for temporary use on rented boats. A husky two-section cabinet of 1/8" aluminum with tongue and groove construction protects internal components against splash and spray. The mounting bracket included allows mounting on any flat surface. The large easy-to-read dial scale is calibrated in gleaming white one-foot divisions from 0 to 100 feet. A large hood over the dial permits reading even in bright sunlight. Attractively styled in two-tone marine green. 9 lbs.

Kit MI-10... NO MONEY DOWN, \$7 mo. **\$69.95**

SPECIFICATIONS—Range: 0 to 100 feet indicated on dial calibrated in 1 foot divisions. Gives reliable depth indications to 100 ft. or more for "hard" bottoms; somewhat less for "soft" bottoms. **Sound-ing rate:** 1440 soundings per minute or 24 per second. **Depth indication:** conventional flashing light behind calibrated dial. **Transducer:** barium titanate crystal encased in a streamlined epoxy housing with brass through-hull fitting and attached coaxial cable. **Controls:** "on/off", sensitivity (on front panel). **Power supply:** 9-volts from six self-contained "D" flashlight batteries. **Current drain:** 80 milliamperes. **Dimensions:** 9" wide x 5 1/2" high x 6" deep. Supplied with bracket for universal mounting.



Kit MP-10
\$29⁹⁵

Enjoy "shore-side" power aboard your boat
with the Heathkit Marine POWER CONVERTER

- Converts 6 or 12 volt battery power to 117 volts AC
- All transistor circuit for high efficiency and dependability
- Two AC receptacles provided

This easy-to-build, easy-to-install power converter puts convenient "shore-side" power aboard your boat. An extremely useful accessory for any boat, the MP-10 provides plug-in power for lights, soldering irons, small AC/DC radios, etc. (not recommended for TV sets or CB transceivers). The MP-10 uses rugged power transistors that provide up to 25% more efficiency and instant operation... no tubes to warm up or use current. Finned "heat-sinks" protect the transistors during maximum power loads and the unit is fused for protection. Small compact size allows installation flexibly. Measures just 7 1/2" x 5" x 5 1/4". Two AC receptacles for plug-in connection and local on/off switch are featured. 7 lbs.

Kit MP-10... NO MONEY DOWN, \$5 mo. **\$29.95**

SPECIFICATIONS—Power source: 6 or 12 volt storage battery. **Power output:** nominal 117 volt, 60 cycle AC; 12 volt operation, 175 watts continuous, 240 watts max.; 6 volt operation, 120 watts continuous and max. **Input current for continuous ratings:** 6 volt operation, 25 amperes; 12 volt operation, 16.5 amperes.

Learn about Electricity... Electronics... Radio... Heath *BASIC EDUCATION SERIES* Courses



Equally Suited for Individual Home Study, Group Classroom Instruction, or On-The-Job Training. Fun and Accomplishment for All Ages.

The Heath *Basic Education Series* kits were conceived to meet the demands of Heath customers and professional educators for a *practical* approach to instruction in radio and electronics. The easy-to-understand text-workbooks are written in non-technical language in a method designed to be self-checking for home study, yet these texts are ideally suited for school courses or job training. Interesting experiments are combined with theory to demonstrate important principles and reinforce their meaning. In this way you learn by doing, the time-proven way to effective understanding.

Whether you want to extend your knowledge into the field of electronics to prepare for a profitable hobby, a future position in your work or just for self-improvement, you'll find the Heath Educational Series interesting and instructive. An extra bonus is the end product that comes as the result of your study.

The Heath Educational Courses progress in sequence; you study only as much as you desire. For just \$19.95 each, you can start with Basic Electricity (EK-1) and continue with Basic Radio Part I (EK-2A) etc., for a well-rounded knowledge of important fundamental concepts. Look over the fine courses now offered in this exciting new series of Heath Educational Courses.

Kit EK-1

\$19.95



A kit and text-workbook combination, the EK-1 educational kit includes all parts necessary to perform experiments described while learning theory and to complete a practical volt-ohm-milliammeter.

- Teaches basic theory in everyday language
- A course designed by science educators
- An interesting, easy way to learn basic electricity
- Finished product is a handy volt-ohm-milliammeter of a thousand and one uses



**Introduce your youngster (or yourself)
to the fascinating world of electronics
with the Heath BASIC ELECTRICITY Kit!**

Designed by science educators for junior high school students *and above*, this educational unit is a combination kit and text-workbook that teaches the basic principles of voltage, current and resistance, the theory and construction of series and parallel direct current circuits, voltmeter, ammeter and ohmmeter circuits and the application of Ohm's law to these circuits. As the course progresses, the student performs basic experiments with dry-cell batteries to learn the principles of circuitry. Then work begins on the assembly of an actual instrument, which upon completion results in a practical DC volt-ohm-milliammeter. With the completed instrument the student can verify Ohm's law and the maximum power transfer theorem, one of the most important theorems in electronics. Included with the kit are procedures for checking automobile circuits, etc. to provide actual experience in applying the principles learned.

This Basic Electricity kit was designed and developed especially for the "beginner" in the field of electronics. The manual is profusely illustrated with pictorial diagrams that guide you through each phase of the various experiments being performed; it is written in plain everyday language that is easy to understand so that the student can easily grasp full meanings without the need of a technical vocabulary and knowledge of terms.

This course is recommended for adults as well as youngsters who want to learn more about electricity and how it works. It represents a profitable learn-by-doing experience which can open up a whole new world of interest to a youngster, start him off to a profitable career in this greatly-expanding age of electronics or provide the basis for an interesting spare-time electronic hobby. Get started now in this new and exciting series of "learn-by-doing" educational kits with the Heath Basic Electricity Course . . . it serves as a prerequisite to other courses, providing a firm foundation for complete understanding.

Kit EK-1 . . . 4 lbs. **\$19.95**

Heath Educational Kits let you "learn by doing"!

Basic Radio—Part I

EK-2A

\$19⁹⁵



Accessory Cabinet
AK-8

\$3⁹⁵



Basic Radio—Part II
EK-2B

\$19⁹⁵



Two-Part Course in Basic Radio gives Valuable Knowledge and Experience in the Fascinating World of Communications

- Simplified basic theory
- Two-part textbook/kit project
- You construct a superheterodyne receiver as you learn
- Easy-to-understand instructions and clear illustrations

With the comprehensive and exciting Heathkit Basic Radio Course, Part I and Part II, you can learn basic, practical radio theory and at the same time build a useful radio receiver just by following the easy, simplified instructions. No need to learn difficult mathematics or highly-technical jargon—all material is written in easy-to-understand, everyday language with analogies made in familiar terms.

When you begin this absorbing course, you will start with Basic Radio-Part I (EK-2A) and learn the basic components and elementary theory of a radio. Typical chapter headings include: "What is a Tuned Circuit?", "What is a Detector?", "How do Voice and Music Get From the Broadcast Station to Your Home?" As you delve into the mysteries of radio fundamentals, you simultaneously assemble a *crystal receiver*. Progressing from chapter to chapter in the textbook /instruction manual, you improve upon this elementary receiver by adding tuned circuits and tubes until at last you have built a *regenerative receiver* capable of pulling in stations from hundreds of miles away.

Basic Radio-Part II (EK-2B) adds to your new-found knowledge of radio theory and components with chapters such as: "What is a Mixer?", "What is a Local Oscillator?", "What does Alignment Mean?". With the additional parts supplied with this advanced kit, you are able to improve upon the receiver built in Part I and upon completion of Part II, you will have constructed a 2-band (550-1600kc & 3-10 mc) *superheterodyne receiver* that picks up broadcast, amateur radio, marine and international stations. And when you add the Heathkit Accessory Cabinet AK-8, your completed 2-band receiver is housed in an attractive cabinet suitable for use in any room in your home.

Both parts of the Basic Radio Course are written to educate youngsters and adults alike. These courses not only supply a wealth of information, but combine theory with actual construction and experimentation that greatly enhances the learning process. As educators well know, the "learn-by-doing" process is an approved method of teaching, and with these Heathkit Basic Radio Courses, you'll learn more thoroughly.

Basic Radio Part I (EK-2A) . . . 6 lbs.	\$19.95
Basic Radio Part II (EK-2B) . . . 4 lbs.	\$19.95
Accessory Cabinet AK-8—A handsome housing for your completed EK-2B Receiver . . . 4 lbs.	\$3.95



New Technical Applications Series



First Subject... "How to Understand and use Your Vacuum Tube Voltmeter"

- Everything you need but the VTVM itself
- Designed for anyone who wants to learn more about test equipment
- Combination Kit/Textbook Project
- Simplified basic theory written in everyday language
- Interesting experiments performed as you learn
- Information applies to all VTVM's
- No previous electronic experience required



Kit EF-1

\$8.95

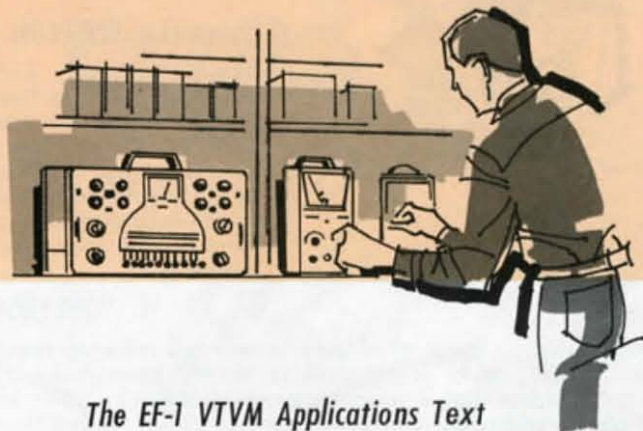

The EF-1 VTVM Applications Text

Covers The Following Subjects:

PART 1. INTRODUCTION TO THE VTVM

Operation, What it does, Advantages, Safety

PART 2. POWER SUPPLY KIT CONSTRUCTION

Easy, check-by-step assembly. (Power supply is used in experiments contained in manual to support study of VTVM circuitry).

PART 3. BASIC THEORY OF ELECTRICITY

Electron flow; Charge; Ohm's Law; AC-DC; RMS power; Series & Parallel circuits; Capacitors, Inductors, Transformers, Power Supplies; Schematics; Crystal Diodes; Impedance.

PART 4. VTVM THEORY

VOM theory; VTVM advantages; Amplification; Triodes in detail; Basic VTVM circuitry; Refinements in VTVM design, including contact potential, bucking voltages, twin triodes, voltage doublers, AC response, special probes.

PART 5. VTVM MAINTENANCE

Care & Trouble-shooting of the VTVM.

PART 6. VTVM APPLICATIONS

1. Equipment check, Capacitor leakage, Battery check, Internal resistance, Maximum DC Power Transfer Theorem, DB scales, Continuity testing. 2. General Principles of Trouble-shooting, Cause-to-effect reasoning, Isolating the trouble, Use of block diagrams to simplify schematics, Special applications to TV, AM-FM, Audio amplifiers, Amateur Radio, Miscellany.

The new Heathkit Technical Applications Series is a milestone in the field of electronics educational material. The series takes a new approach to technical information through the medium of writing in everyday language in a "learn-by-doing" concept with content material organized so that it proves of value to professionals and beginners. The professional will find the subjects ideal as "refresher" courses. The beginner will find the subjects presume no prior knowledge on his part and hence provide a perfect starting point to comprehensive understanding.

This first in the new series, "How To Understand and Use Your Vacuum Tube Voltmeter," has as its objectives the teaching of the proper use of the VTVM, its many applications, and its advantages over other types of voltmeters. Those who have been using a VTVM for years will find this course of special interest. It covers a wide range of particular applications of the VTVM in many fields ranging from television repair to amateur radio. The methods of demonstration used and the discussion of the general principles of trouble shooting will prepare the reader for independent investigation of new problems as they arise in the future. Those who are just beginning their electronic education will find this course provides not only a firm foundation in the fundamentals of electronic theory, but also through the medium of using a VTVM while reading the text, gives the proper direction to secure maximum information from this basic instrument. This "learn-by-doing" method of working with a VTVM while covering fundamentals results in a greater degree of understanding with a clarity and reinforcement not achievable in any other way.

The text covers the basics of electronics . . . electron flow, capacitance, inductance, transformers, diodes, triodes, and the theory of vacuum tube voltmeters and their maintenance. The arrangement of topics is in a logical learning sequence for the beginner and permits the professional to review quickly the basic concepts and move on to subjects of more specialized interest.

A power supply kit is included in this VTVM Applications Course which is assembled by the student and used in performing experiments detailed in the text. While intended primarily for use with the text experiments, the supply can be used for utility applications. It delivers AC or DC output of 120 volts at 20 ma, and 6.3 volts AC at 1.5 amps. It features an on-off switch, fused primary, and an 8 1/4" L x 2 3/4" H x 5" W chassis with the schematic screened on top.

To learn more about your vacuum tube voltmeter, to extend its usefulness into new fields, order your EF-1 VTVM Applications Course now.

Kit EF-1 . . . 3 lbs. **\$8.95**

Special Combination Offers Save Money

Kit EF-1-3, includes EF-1 above and IM-11 VTVM, p. 77. **\$36.95**

Kit EF-1-2, includes EF-1 above and IM-10 VTVM, p. 78. **\$39.95**



Kit SK-20
\$13⁹⁵



Transistor INTERCOM KIT

Now youngsters . . . and adults, too . . . can talk from room to room, or house to house. This remarkable intercom set has "master" unit and "slave-remote" station. The "master" is housed in all-metal case and features a "listen-talk" slide switch, volume control and "on-off" slide switch. All-transistor circuit is safely powered by flashlight batteries. Easy to assemble, kit comes complete with tools and manual giving assembly instructions and operating principles. No soldering necessary. 3 lbs.

Kit SK-20.....**\$13.95**



Kit SK-70
\$3⁹⁵



Kit SK-60
\$7⁵⁰



Kit SK-10
\$9⁹⁵



CRYSTAL RADIO KIT

This fascinating "do-it-yourself" kit lets any youngster construct his or her own private radio receiver and learn radio theory while doing it. The handsome two-tone metal case has an authentic-looking receiver dial screened on the front panel. Easy to construct, this remarkable radio requires no soldering. And there's no expense to operation, either, because no batteries are required. This also makes it safe for any age. The receiver circuit consists of a fixed diode detector and tuneable coil. Also included in the kit are an earphone, 50 feet of antenna wire, instructions and basic principles of radio theory which clearly explain how the unit works. 1 lb.

Kit SK-70.....**\$3.95**

Transistor RADIO KIT

Young "do-it-yourselfers" can listen to local and long distance radio stations with their very own transistor radio and learn about radio while building it. Perfect when children want to listen to their own special programs in complete privacy. The circuit board supplied plus the solderless connections make for ease of construction. Kit comes complete with transistor audio amplifier, germanium diode detector, earphone, all-metal cabinet, circuit board, screwdriver and manual of instructions and operating principles. The power is supplied by an ordinary flashlight battery making the radio completely safe for children of all ages. 2 lbs.

Kit SK-60.....**\$7.50**

Transistor PORTABLE BROADCASTER

With this portable broadcaster, voices can be transmitted to any nearby AM radio . . . without wires. Youngsters can find hours of fun playing "announcer," "disc jockey" or "astronaut." Their voices come over the receiver just like they were broadcasting from a radio station studio. Simple to use, you pull up the telescoping antenna and speak into the crystal microphone. Battery powered for safety and convenience. Basic radio theory is outlined in the "check-by-step" instructions which explain just what makes the unit operate. All parts and tools for assembly are included in kit, and easy-to-follow building instructions simplify completion. 2 lbs.

Kit SK-10.....**\$9.95**



Kit SK-30
\$8⁹⁵

ELECTRONIC WORKSHOP "6"

With this exciting Heathkit, youngsters of every age will find hours of fascinating entertainment. They can perform six different, educational electronic transistor experiments. You can build a code flasher, crystal radio, two transistor radios, wireless voice and code transmitters. The kit includes a circuit workboard, transistor, crystal-diode, sensitive crystal earphone, tuneable coil, capacitors, resistors, all necessary hardware, screwdriver, solderless connectors, manual of assembly instructions and operating principles. All experiments are battery operated for complete safety. Just the thing for introducing a youngster to the fascinating world of electronics and at the same time provide an entertaining diversion. 2 lbs.

Kit SK-30.....**\$8.95**



ELECTRONIC WORKSHOP "11"

Here are 11 different transistor experiments designed by Heath to entertain while they teach. You can build three different transistor radios, a code practice flasher, wireless code and voice transmitters, electronic timer, burglar alarm, electronic flasher, audio signal injector and an intercom. All of these interesting experiments not only satisfy the creative urge every youngster wants to express, but they provide an educational introduction to the science of electronics. Battery powered for complete safety, this medium-priced kit includes all necessary components, hardware, and tools for building. Solderless spring-type connections are another safety feature. Operational theory accompanying kit gives in easy-to-understand, non-technical terms the basic facts about radio transmission, reception, time constant circuitry, radio amplification and wired communications systems. 4 lbs.

Kit SK-40.....**\$12.95**



Kit SK-40
\$12⁹⁵



ELECTRONIC WORKSHOP "19"—the best ever

This is the largest of the Heath Electronic Workshops and contains materials and instructions for 19 different electronic transistor items, including a code flasher, public address system, five transistor radios, electronic timer, a burglar alarm, electric eye, a TV silencer, metronome, voice and capacity-operated relays, wireless code and voice transmitter and more. The solderless spring-type connectors make circuit changes quick, easy and safe. The components for each experiment cannot get lost because they mount permanently on the circuit workboard. All power requirements are supplied by economical, safe, ordinary flashlight batteries. This feature-packed kit contains a circuit board, 3 transistors, crystal earphone, two 3" cone-type speakers, a photo cell, relay, tuneable coil, potentiometer, resistors, capacitors, all necessary hardware, solderless connectors, screwdriver, complete "check-by-step," easy-to-follow instructions for building and operating principles that explain the "hows" and "whys" of each experiment in everyday non-technical language. This comprehensive experiment kit is perfect for giving a youngster a fascinating introduction to electronics which has become so important in this space age. 4 lbs.

Kit SK-50.....**\$19.95**



Kit SK-50
\$19⁹⁵

Announcing the New Look in Heathkit® Stereo / Hi-Fi



Four New Styling Concepts to choose from . . .

Now you have a wider range of component styling to choose from when you buy Heathkit Stereo/Hi-Fi.

DELUXE . . .

The top of the Heathkit line styling is exemplified by the Deluxe AJ-30 Tuner, AA-11 Stereo Preamplifier and AA-100 Stereo Amplifier . . . beautiful in their luggage-tan, vinyl-clad cabinets . . . accented by the polished aluminum panel hoods . . . smart in their contrasting metal and plastic front panels . . . highlighted by their unique refracted lighting to softly illuminate the entire control area. See pages 40 and 41.

MEDIUM . . .

The mid-price range Heathkit styling, represented by the AJ-11 Tuner, AA-141 Stereo Preamplifier and AA-151 Stereo Amplifier, features luggage-tan vinyl-clad cabinets with charcoal grey front panels framed in polished aluminum. See pages 44 and 45.

POPULAR . . .

The popular priced line of Heathkit styling, illustrated in part by the AJ-31 Tuner and AA-181 Amplifier, is striking in charcoal grey cabinetry with ivory hoods and lower front panels. Beautifully complementary, this exciting color combination is destined to find its way into music systems the world over. See pages 48 and 49.

BUDGET . . .

The budget line Heathkit styling, as seen in the AA-201 and AA-191 Amplifiers, features soft black on the cabinets with front panel control areas of ivory for easy visibility. See pages 47 and 50.

Color styling of the Heathkit line of stereo and monophonic power amplifiers has been chosen with an eye to versatile combinations. Black, bronze and ivory bring these units into perfect focus with any other Heathkit component you may choose. Metallic-bronze covers . . . black chassis . . . ivory front panel control areas . . . they blend into a handsome trio of colors for any type of installation.

Choose your Heathkit music system, confident that it will look as well as it sounds. See pages 58 through 61 for suggestions. And as always, we will be glad to recommend a specific system for your particular purposes.



Heathkit® automatic

- 4 speed—automatic or manual
- 11" oversize turntable
- Hum shielded motor
- Plug-in cartridge head

SPECIFICATIONS—Flutter & wow: .2% rms or less. Turntable speed: Accurate within $\pm 2\%$. Change cycle: Varies with turntable speed, completed in 8 seconds at 33 $\frac{1}{3}$ rpm. Motor type: 4-pole hum shielded. Type of drive: Friction. Tracking force variation: Less than 0.9 grams from first to last record. Record capacity: 10-12", 12-10". Control functions: on-off switch with "pop filter"; manual reject; manual speed selector. Dimensions: 13 $\frac{1}{2}$ " W x 11 $\frac{1}{2}$ " D x 5 11/16" above and 2 $\frac{1}{2}$ " below mounting board.



- Stereo-Mono function switch
- "Speed Minder"—mix 33 $\frac{1}{3}$ & 45 rpm records
- Record protecting "turntable pause" and "anti-skate"
- Instant-change cartridge holder

SPECIFICATIONS—Flutter & Wow: 0.16% rms or less. Turntable speed: Accurate within $\pm 2\%$. Change cycle: Completed in 9 seconds. Motor type: 4-pole, hum shielded. Type of drive: Friction. Tracking force: 2 grams reliably initiates change cycle. Record capacity: Maximum of 10 records. Control functions: On-off switch; Manual Reject; Automatic-Manual Speed Selector; Stereo/Mono Switch (parallels the outputs of the two stereo channels for mono operation). Dimensions: 13 $\frac{1}{2}$ " W x 12" D x 5 $\frac{1}{2}$ " above and 3" below mounting board.

Record changers fit every system, every budget!



Kit AD-80C

\$37⁹⁵

(less base)

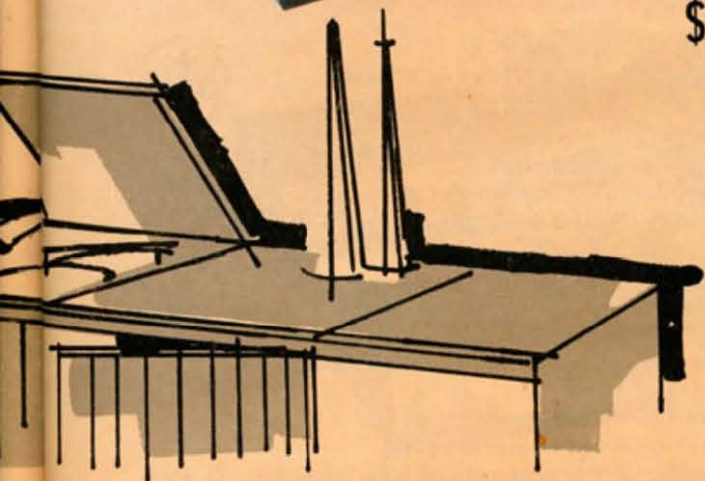

AD-60C

\$59⁹⁵

(less base)

Only \$37.95 for this AUTOMATIC 4-SPEED CHANGER
with diamond styli stereo cartridge

The Heathkit AD-80 Stereo Automatic Record Changer combines a variety of exceptional features found only on costlier units, but maintains an economy price tag designed to appeal to even the most budget-conscious hi-fi fan. Perfect for the "stereo starter" or that second system you've always wanted, the AD-80 has an oversize 11" turntable which gives greater support to 12" records, an "anti-skate" device that protects records from the tone arm skating across lead-in grooves, and a sturdy mechanism for dependable performance. This remarkable changer plays 16, 33 $\frac{1}{3}$, 45 and 78 rpm records automatically or manually, in stereo or mono with a simple wiring change. A plug-in mounting head gives you easy access to the cartridge for inspection or replacement. The mechanism shuts off automatically after the last record, a pop filter eliminates annoying switching noises. No special tools are required for assembly, and it takes only a few hours to put together. Attractive brown and beige colors. 10 lbs.

- Kit AD-80C (Sonotone 8TA4-SD ceramic stereo cart., diamond and sapphire styli) ... NO MONEY DOWN, \$5 mo. **\$37.95**
- Kit AD-80A (GE VR-227 magnetic stereo cart., diamond stylus) ... NO MONEY DOWN, \$5 mo. **\$41.95**
- Kit AD-80B (Shure M8D magnetic stereo cart., diamond stylus) ... NO MONEY DOWN, \$5 mo. **\$42.95**
- ADA-80-1 45 RPM Adapter Spindle, 2 lbs. **\$2.95**
- CHANGER BASES FOR AD-80, AD-60 Models, 3 lbs.
- Assembled ADA-50-M (brown mahogany) **\$6.95**
- Assembled ADA-50W (walnut) **\$5.95**
- Assembled ADA-50U (unfinished) **\$4.95**

Deluxe AUTOMATIC RECORD CHANGER AD-60

gives you more features at lower cost

Heathkit's Deluxe Automatic Record Changer, the AD-60, brings you features and qualities unmatched anywhere at its very reasonable price. You can have complete stereophonic or monophonic operation, a plug-in cartridge, automatic speed-minder, turntable "pause," and many many more wonderful advantages with this remarkable instrument all at money-saving prices that begin at a low low \$59.95.

Speeds of 16, 33 $\frac{1}{3}$, 45 and 78 rpm's are switch selected, and a special "speed-minder" position enables you to intermix 33 $\frac{1}{3}$ and 45 rpm records in the same stack at random. The "turntable pause" feature protects your valuable records by completely stopping the turntable during the change cycles so that a record never falls on a turntable or other record that is in motion. The "anti-skate" feature prevents the tone arm from "skating" across lead-in grooves. When you want to change cartridges on this AD-60, there is no problem—just plug it in, no soldering or wiring. A flip of the "stereo-mono" switch converts the cartridge to whichever method you intend to use. The automatic "shut-off" after the last record has played disengages the idler wheels to prevent rumble-producing "flat-spots" from forming. A muting switch and pop filter insure quiet running during the change and shut-off cycle. The jam-proof mechanism of the AD-60 enables you to relocate the tone arm at any time without fear of damage. An AC outlet is provided for accessories. Striking in black and gold. 12 lbs.

- Kit AD-60C (Sonotone 8TA4-SD stereo cart., diamond and sapphire styli) ... NO MONEY DOWN, \$6 mo. **\$59.95**
- Kit AD-60A (GE VR-227 stereo cart., diamond stylus) ... NO MONEY DOWN, \$7 mo. **\$61.95**
- Kit AD-60B (Shure M8D stereo cart., diamond stylus) ... NO MONEY DOWN, \$7 mo. **\$62.95**
- Model ADA-60-1 45 rpm adapter spindle ... 2 lbs. **\$2.95**

Heath has a Turntable for Every Budget

- Garrard of England quality
- 4-speeds—16, 33 $\frac{1}{3}$, 45, 78 rpm
- Preassembled mechanism, arm and base
- Selection of three great cartridges

**Stereo/Mono AD-10 RECORD PLAYER has four speeds —
Only \$32.95**

The low cost Heathkit AD-10 stereo/mono 4-speed record player combines the kit quality of Heath with the precision craftsmanship of Garrard of England. The turntable is resiliently mounted, accurately formed and features a protective rubber pad for record safety. When the tone arm is moved to the right with handy finger lift, the mechanism starts. Automatic shut-off occurs when the record is completed. Other features include: plug-in cartridge holder, stylus pressure adjustment. "Pop" filter reduces switching noise. 4-pole motor. Flutter and wow below .28% at 33 $\frac{1}{3}$ rpm. With 12" record requires mounting area 15" W x 13" D x 6" H. Cocoa brown and beige color. 9 lbs.

- Kit AD-10C (Sonotone 8TA4-SD ceramic stereo cartridge, diamond and sapphire styl) ... NO MONEY DOWN, \$5 mo. **\$32.95**
- Kit AD-10A (GE VR-227 magnetic stereo cartridge, diamond stylus) ... NO MONEY DOWN, \$5 mo. **\$37.95**
- Kit AD-10B (Shure M8D magnetic stereo cartridge, diamond stylus) ... NO MONEY DOWN, \$5 mo. **\$38.95**
- Kit AD-30 Mechanism only; less cart., base & cables ... 7 lbs. **\$22.94**

Kit AD-10C
\$32⁹⁵



*The precision Fairchild Turntable and Tone Arm
are yours at a new low price . . .
exclusive with Heath!*

- New low price—exclusive with Heath
- 33 $\frac{1}{3}$ & 45 rpm speeds
- "Push-pull" speed selector knob
- Separate on-off switch
- Speed Sentinel controls and strobe disc
- Hidden belt drive for rumble-free performance
- Anti-skate arm-transport
- Linear separation, high compliance "moving magnet" stereo cartridge
- .0007" diamond stylus
- Rifle-drilled bearing well and heavy aluminum turntable panels
- Anodized aluminum control panels
- Shock-mounted walnut top plate
- Matching walnut wrap-around base



Kit ADP-21
\$124⁹⁵

SPECIFICATIONS—Impedance: 200 ohms per channel. Inductance: 500 mh per channel. Dynamic mass: 2 milligrams. Track force: 2.5 grams. Compliance: 5 x 10⁻⁶ cm/dyne. Response: 20-15,000 cps (± 2 db). Separation: 20 db (± 2 db) from 20-15,000 cps. Recommended load: 47K ohms per channel. Output: 5 mv at 3.8 cm/sec. Wow: .08% peak to peak. Flutter: immeasurable. Rumble (vertical and lateral): -56 db below 7 cm/sec at 500 cps. Dimensions: 17 $\frac{1}{2}$ " W x 15" D, 3 $\frac{1}{2}$ " below mtg. board.

For those who want the very finest in record turntables, Heathkit is proud to offer the ADP-21 . . . featuring the Fairchild 440 Turntable, in kit form, the Fairchild 500 Tone Arm and cartridge, completely assembled and the Fairchild 440 CBW walnut mounting board and base . . . all at an exclusive Heath low price of \$124.95.

The 440 turntable combines famous Fairchild "know-how" with clean functional design to provide extra features and superior performance. The two speeds—33 $\frac{1}{3}$ and 45 rpm—are selected by the "push-pull" selector knob, doing away with the necessity of reaching under the chassis or fumbling with belts. A unique Speed Sentinel control permits speed variation $\pm 1\frac{1}{2}\%$ to insure recording studio accuracy and to allow pitch changes when desired (a strobe disc is included in the kit). The turntable platter is solid cast aluminum, contoured for easy record handling . . . it is topped by a contoured center pin to protect the record's center-hole and covered with a compliant rubber pad to guard against abrasion. A rifle-drilled babbit bearing provides trouble-free, noiseless operation. The assembly of the table is simple, with all holes and cutouts provided.

The remarkable Fairchild 500 arm-transport has an "anti-skate" device to reduce tracking error, stylus wear and distortion as well as protect your records. Its dynamic balancing eliminates undesirable springs. The moving-magnet type stereo cartridge with diamond stylus is the famous Fairchild SM-2. It features linear separation of 20 db from 20 cps up to 15,000 cps and increased compliance which takes full advantage of the anti-skating transport to make for even greater actual operating compliance. It is completely compatible for either stereo or mono records. The shock-mounted top plate is made of walnut, trimmed with a subdued metal strip on the edge. The matching walnut base complements the entire unit and is striking wherever it is used, regardless of surroundings. 36 lbs.

Kit ADP-21 . . . NO MONEY DOWN, \$12 mo. **\$124.95**

Heathkit® Tape Recorders... Quality at Big Savings



\$74.95
Kit AD-70
(less base)

Now enjoy 4-track stereo tape playing at the lowest price ever... \$74.95

With the Heathkit AD-70, you can enjoy prerecorded 4-track stereo tapes with unusual economy. This precision tape deck assembly can be used with any stereo amplifier or preamplifier equipped with a tape head input, such as the Heathkit AA-100 or AA-11 without external electronics or equalization. A single control lever provides "play," "fast-forward" and "rewind" functions easily. Two speeds: 3¾ and 7½ IPS. Convenient "off-on" switch provided. The deck may be panel mounted either vertically or horizontally or you can choose any of the factory-assembled tape recorder bases listed below. Measures 15½" L x 9½" W x 4" below panel. Mechanism is the same as TR-1AQ (see specs below). 11 lbs.

Kit AD-70 (less base)... NO MONEY DOWN, \$8 mo. **\$74.95**

Assembled Tape Recorder Bases

As shown on AD-70; also fits TR-1A or TR-1AQ (3 lbs.)

Model ADA-70U (Unfinished)..... **\$4.95**

Model ADA-70M (Mahogany)..... **\$6.95**

Model ADA-70W (Walnut)..... **\$6.95**

- Plays directly through any amplifier tape head input
- Single control lever
- Two speeds—3¾ & 7½ IPS
- Mechanism same as TR-1AQ



Kit TR-1AQ
\$159.95

With the Heathkit TR-1AQ you record and playback 4-track stereo tapes at lowest cost

- Eye-tube recording level indicators
- Safety-interlock prevents accidental erasing of tapes
- 3¾ and 7½ IPS speeds
- Fan-cooled motor
- Microphones included

Heath's famous TR-1AQ 4-track stereo tape recorder combines quality, versatility and economy to offer you complete record and playback of monophonic or stereo-phonics tapes with excellent fidelity and lowest cost. The single control lever on the tape mechanism allows easy "play," "rewind" and "fast-forward" function switching. Top quality recordings are assured by the separate record and playback volume controls on each preamplifier and "eye-tube" recording level indicators. A special safety interlock prevents possible accidental erasure of tapes.

The record-playback preamplifiers of the TR-1AQ feature circuit boards for easy assembly and high circuit stability. Because of the precision tolerances of the components of this unit, exceptional fidelity is assured with flutter and wow held to less than 0.35%. A four-pole, fan-cooled induction motor provides dependable power. Bias-erase current is provided by a push-pull oscillator for low noise and distortion and a filament balance control allows adjustment to minimum hum level. The 600 ohm cathode follower output allows long leads without high frequency loss. The tape deck handles 7" reels and has two speeds, 3¾ and 7½ IPS. Two microphones are included with the TR-1AQ, one with TR-1A.

Kit TR-1AQ (4-track stereo version; has 2 preamps, 2 mikes)... 36 lbs.... **\$159.95**
NO MONEY DOWN, \$15 mo.

Kit TR-1A (half-track mono version; has 1 preamp and 1 mike)... 23 lbs.... **\$109.95**
NO MONEY DOWN, \$11 mo.

SPECIFICATIONS—Frequency response: ±3 db 40-15,000 cps @ 7½ IPS. Flutter and wow: below 0.35%. Harmonic distortion: less than 2% at full output. Tape speeds: 3¾ and 7½ IPS. Fast forward time: 5 min. for 1200 ft. reel. Rewind time: 1.25 min. for 1200 ft. reel. Motor: 4-pole induction, 117 volt 60 cycle AC. Bearings: Sintered Bronze Bearing on all rotating parts. Dimensions: 15½" L x 9½" W x 4" D. Vertical or horizontal mounting.



Kit AA-171
\$39.95

Change your mono tape system electronics to stereo with the Heathkit AA-171

- Features NARTB equalization
- Eye-tube recording level indicators
- Styled in black and ivory
- Ideal for stereo conversion or mono replacement

The Heathkit AA-171 Tape Recorder Electronics Kit can be used to replace the electronics of your present tape recorder for better recordings and playback or can be used in addition to a mono tape player such as the TR-1A when you want to convert it to a stereo record and playback unit. It adapts to most two-head recorders (except low impedance) by making a few circuit adjustments, using an audio voltmeter and an audio generator as outlined in the construction manual. Features NARTB equalization. 10 lbs.

Kit AA-171... NO MONEY DOWN, \$5 mo. **\$39.95**

SPECIFICATIONS—Distortion (Record-Play): 2% or less. Frequency response: ±3 db from 40 cps to 15,000 cps at 7.5 IPS (TR-1AQ). Inputs: Microphone and Line. Input impedance: 1 megohm. Output level: approximately .75 volts with the Playback Gain Control at Maximum (TR-1AQ). Output impedance: approximately 600 ohms from cathode follower. Switches: AC Power, Input Selector, Equalization, Record-Play selector, Record Interlock Push Button. Bias-erase frequency: 60 KC. Tube complement: 1-EF-86, 2-6AN8, 1-6ES, 1-12AU7, 1-6X4 Rectifier. Power requirements: 105-125 volts, 50-60 cycles, 20 watts. Finish: Control panel—ivory; cabinet—satin black. Size: 4" H. x 12½" W. x 8" D.

Heathkit® Tape Recorders Bring You



Kit TR-1E
\$169⁹⁵



The versatile control panel of the Heathkit TR-1E gives you complete command of all functions. The professional type db meter provides accurate recording level indications for better quality recordings.

Only \$169.95 for the TR-1E Stereo Playback/Mono
TAPE RECORDER—compares with units twice this price

- Recording level meter—pause control—NARTB tape equalization
- Assembled tape transport—you build the electronics
- Two circuit boards for stability and easy assembly
- Eight versatile controls

Hours of fascinating entertainment are in store for you when you "relive" those exciting family moments or hear your favorite musical selections again with the faultless fidelity provided by the Heathkit TR-1E Tape Recorder. With this quality instrument, you can play prerecorded 4-track stereo tapes and record or playback half-track monophonic tapes at either 3¾ or 7½ IPS tape speeds. The separate record and playback tape heads and preamplifiers permit monitoring of tape while recording and a "pause control" makes editing easy.

The tape mechanism is completely preassembled. To complete your recorder just assemble the electronics of the amplifiers easily thanks to two circuit boards for errorless wiring and stability of operation and Heathkit's famous "check-by-step" instructions which are easy and fun to follow. A push-pull bias-erase oscillator assures minimum distortion and low noise level. NARTB tape equalization is also featured.

The versatile controls (illustrated above) include: "fast-forward" and "rewind" lever switch; "play" and "record" lever switch with "safety-interlock"; "record-level control"; "playback-level control"; "on-off" switch; 4-position "meter function selector" switch; "normal" and "monitor output selector" switch; and "line" or "microphone" input selector. The recording level indicator of the TR-1E is a professional db meter which allows accurate recording level settings. Also has digit counter. Styled in black and gold colors. Less microphone. 30 lbs.

Kit TR-1E . . . NO MONEY DOWN, \$16 mo. \$169.95
AK-1 (recommended microphone, above) . . . 1 lb. \$9.95

SPECIFICATIONS—Tape speed: 7.5 and 3.75" per second. Maximum reel size: 7". Frequency response: (record-playback); ±2.5 db, 30-12,000 cps at 7.5 IPS. ±2.5 db, 30-6,500 cps at 3.75 IPS. Harmonic distortion: 1% or less at normal recording level; 3% or less at peak recording level. Signal-to-noise ratio: 50 db or better, referred to normal recording level. Flutter and wow: 0.3% RMS at 7.5 IPS. 0.35% RMS at 3.75 IPS. Heads: (3); erase, record, and in-line stereo playback. Playback equalization: NARTB curve, within ±2 db. Inputs: (2); Microphone and line. Input impedance: 1 megohm. Outputs: (2); A and B stereo channels. Output levels: approximately 2 volts maximum. Output impedance: Approximately 600 ohms (cathode followers). Recording level indicator: Professional type db meter. Bias-erase frequency: 60 kc. Timing accuracy: ±2%. Power requirements: 105-125 volts AC, 60 cycles, 32 watts. Dimensions: 15¼"W x 13¼"D x total height 10¼". Mounting: requires minimum of 8¼" below and 1¼" above mounting surface. May be operated in either horizontal or vertical position.



Kit AK-1
\$9⁹⁵

Money saving

AK-1 ACCESSORY MICROPHONE

Use this attractively styled and versatile microphone in hi-fi, Public Address systems and amateur radio work. Has rugged crystal mike and 3 holders (mikes and adapter, lavalier neckband and desk stand). Frequency response is 30 to 10,000 cps. An 8' cable with phone plug is included. 1 lb.

Kit AK-1 \$9.95

NEW NO MONEY DOWN TIME PAY PLAN

With Heath's sensational time payment plan, you can now order any kit or kits totaling \$25 to \$600 with NO MONEY DOWN, and low monthly payments. See the enclosed order blank for complete details and choose the Heathkit products you need without further delay. With Heathkit, you can build and enjoy now, pay later!

Top Performance At Lowest Cost

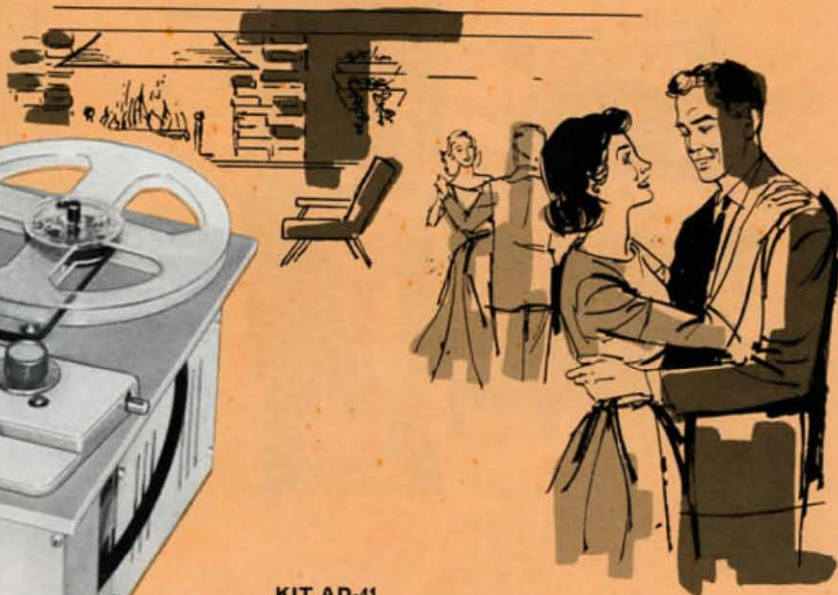
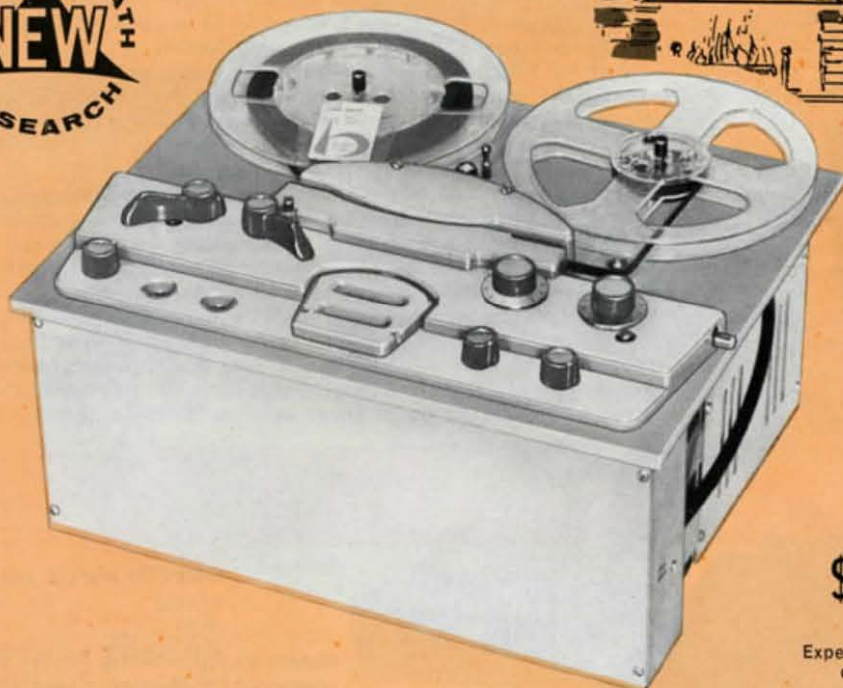

KIT AD-41

\$159⁹⁵

Expected Shipping Date:
October 20, 1961

attention high fidelity enthusiasts... now you can equip your hi-fi system with **COMPLETE STEREO TAPE FACILITIES**

- Record & playback 4-track stereo & mono tapes
- 2 speeds— $3\frac{1}{2}$ & $7\frac{1}{2}$ IPS with fast forward & rewind functions
- Tape Mechanism is factory assembled you build only tape electronics
- 2 bar tube recording level indicators—NARTB equalization

If you have been looking for complete stereo tape recording facilities for your high fidelity system, you need look no further... the Heathkit AD-41 with its many design features and outstanding versatility will fill your every requirement.

This handsomely-styled combination tape deck and electronics package provides all the facilities required for top-notch recording and playback of both 4-track stereo and monophonic tapes. Both the precision, factory-assembled and tested tape mechanism and easy-to-assemble electronics package are combined in a single, compact unit for easy installation in any high-fidelity system... and the cost!... far below that of competitive models with similar features.

Designed for convenience and ease of operation, the AD-41 has just two control levers to select "record" or "play" and "fast-forward" or "rewind" functions. Individual tone-balance and level controls are provided to adjust sound reproduction to your exact listening requirements. Other controls provided include: a safety interlock to prevent accidental erasure of prerecorded tapes; a monitoring switch for listening to programs while they are being recorded; a pause control for editing; and a three-position record channel selector switch. Two "bar-tube" recording level indicators show proper recording level in each channel for best quality recordings.

Two auxiliary inputs are provided in addition to two microphone inputs to allow recording directly from high-level sources such as tuners, preamplifiers, etc. Outputs are provided for playback through your main stereo system or external speakers may be connected directly to the output of the built-in 3-watt amplifiers. 32 lbs.

Kit AD-41... NO MONEY DOWN, \$15 mo. **\$159.95**
See opposite page for appropriate microphones.

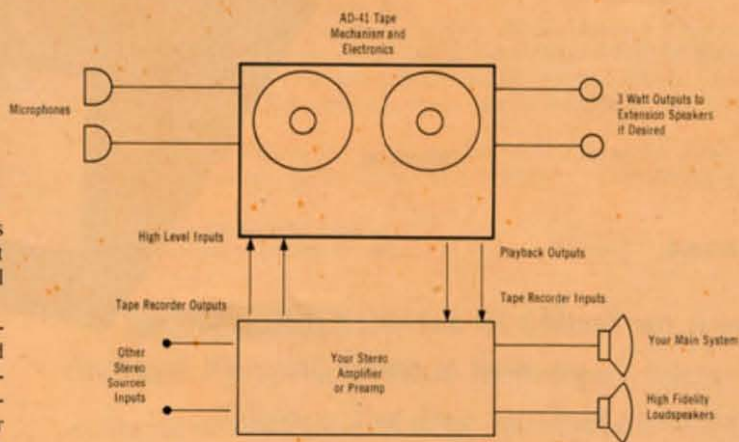

HOW THE AD-41 TAPE MECHANISM/ELECTRONICS CAN BE ADDED TO YOUR STEREO SYSTEM

Designed for easy installation and versatile operation, the AD-41 offers every desirable feature for fine performance. As the diagram shows, you can use either separate microphones or the tape recorder outputs of your stereo amplifier for recording purposes. You can play back stereo tapes through your stereo amplifier or the built-in amplifiers. The built-in amplifiers also allow you to monitor the program material being recorded or to drive extension speakers for other rooms.

SPECIFICATIONS—Frequency response: ± 2 db 50-12,000 cps @ $7\frac{1}{2}$ IPS; ± 2 db 50-10,000 cps @ $3\frac{1}{2}$ IPS. Total harmonic distortion @ 1 volt output: Max. 2%. IM distortion @ 1 volt output: Less than 3% using 60 cps and 6000 cps mixed 4:1. Sensitivity for max. record level: Mic., 3 mv; Aux., 0.2 V. Hum & noise: -45 db. Bias oscillator frequency: 75 kc. Power amplifier: 6 watts stereo (3 watts per channel) Utility Rated. Power response: ± 2 db 50-15,000 cps @ 3 watts per channel. Total harmonic distortion: Less than 3% using 60 and 6000 cps mixed 4:1. Power requirements (total): 110 watts, 105-125 volts, 60 cps. Tube complement: (1) 12AU7 (2) 6EM84, (1) 6Z81, (2) 6EL84, (4) 6EU7. Dimensions: 8 $\frac{1}{2}$ " H x 15" W x 11 $\frac{1}{2}$ " D. (with tape reel 13 $\frac{1}{2}$ " deep).

Listen to FM Radio in Stereo! FM Multiplex is the newest, lowest cost way to Stereo Listening Pleasure

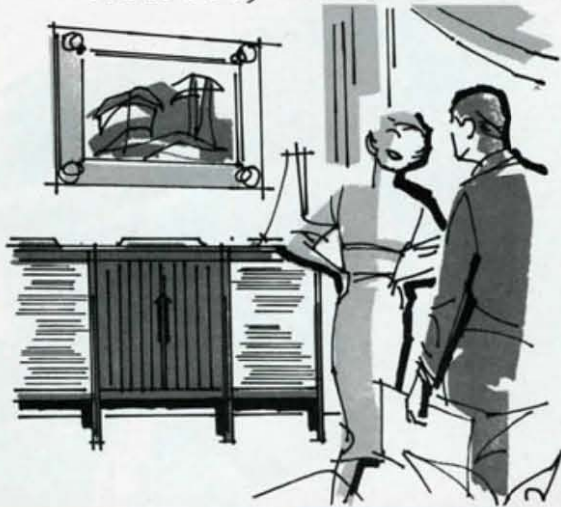

When the Federal Communications Commission authorized FM stations across the nation to broadcast multiplex stereophonic FM programs beginning June 1, 1961, a whole new world of listening pleasure opened to music lovers everywhere.

With the FM multiplex system of broadcasting, you are able to receive FM radio broadcasts in stereo—that is the FM station broadcasts two different signals simultaneously over one channel and you receive and distribute them to your stereo system with the help of a multiplex converter.

Experts in the high fidelity/stereo field have hailed the introduction of FM multiplex stereo broadcasting as "the greatest thing since the invention of FM broadcasting." To the Heath Company, it represents another milestone and another challenge.

The Heath Company has developed Heathkit equipment for many years—equipment with unexcelled quality and unbelievably low prices. With FM multiplex the results are the same—we have produced an inexpensive, quality Multiplex Converter and Multiplex-Engineered FM tuners capable of bringing you fine reception—and as always, the Heath prices save you as much as 50%.

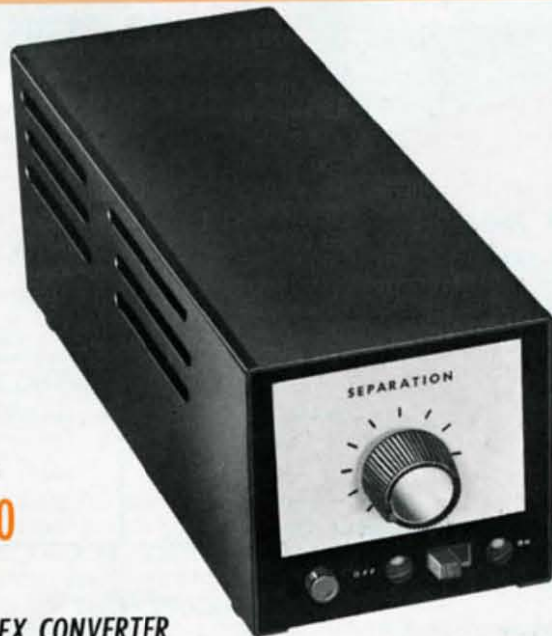

Kit AC-11
\$32⁵⁰

- Designed specifically for the FCC approved FM Multiplex system
- Built-in power supply
- Easy-to-use, easy-to-build
- Cathode follower outputs for installation versatility
- Separation control gives maximum stereo effect
- Slim, black metal cabinet

Here is the Heathkit FM-MULTIPLEX CONVERTER you need to receive Stereo FM broadcasts

Now with the new Heathkit AC-11 Multiplex Converter you can receive stereo FM programs from any good quality FM tuner which has provision for multiplex output. This compact, easy-to-assemble unit needs just a simple adjustment and it's ready to plug into the multiplex output jack of your FM tuner and the input jacks of your stereo amplifiers. The AC-11 has three tubes, a self-contained, built-in fused power supply with silicon rectifier, and prealigned coils. Low distortion is insured through the use of a simplified balanced diode detector. Controlled signal matrixing assures maximum separation of channels and gives you true stereo. The front panel separation control is provided for fine adjustment. The AC-11 frequency response is 50 cps to 15 kc with built-in de-emphasis. It features cathode follower outputs for both A & B channels to eliminate high-frequency loss and allow mounting of the amplifiers at any distance from the converter. Included in the kit are three connecting audio cables, (1 input, 2 output).

For the finest quality stereo FM reception, you will find the Heathkit AC-11 Multiplex Converter and any Heathkit Multiplex-Engineered FM Tuner your best dollar buy. 3 3/8" H x 3 1/2" W x 9 7/8" D. 4 lbs.

Kit AC-11 . . . NO MONEY DOWN, \$5 mo. **\$32.50**
Assembled ACW-11 . . . NO MONEY DOWN, \$6 mo. **\$56.25**

Kit Form
or
Factory
Assembled



Order your Heathkit Tuner and Multiplex Converter

The new Heathkit AC-11 Multiplex Converter can be purchased at the same time that you order your Heathkit tuner. The following model numbers combine the AC-11 Multiplex Converter with your choice of Heathkit FM tuners for ease of ordering and extra savings.

- Kit AJ-30S** (includes AC-11 Converter kit and AJ-30 Tuner Kit, p. 40)
28 lbs. . . . NO MONEY DOWN, \$12 mo. **\$129.95**
- Assembled AJW-30S** (includes assembled ACW-11 Converter and assembled AJW-30 Tuner) 28 lbs. . . . NO MONEY DOWN, \$21 mo. **\$211.20**
- Kit AJ-11S** (includes AC-11 Converter Kit and AJ-11 Tuner Kit, p. 44)
23 lbs. . . . NO MONEY DOWN, \$10 mo. **\$99.95**
- Assembled AJW-11S** (includes assembled ACW-11 Converter and Assembled AJW-11 Tuner) . . . 23 lbs. . . . NO MONEY DOWN, \$18 mo. . . . **\$181.20**
- Kit AJ-31S** (includes AC-11 Converter kit and AJ-31 Tuner Kit, p. 48)
12 lbs. . . . NO MONEY DOWN, \$7 mo. **\$69.95**
- Assembled AJW-31S** (includes assembled ACW-11 Converter and assembled AJW-31 Tuner) . . . 12 lbs. . . . NO MONEY DOWN, \$11 mo. . . . **\$121.00**

FM Multiplex Stereo Systems at Special Savings!

Complete System Kit HFS-37

Reg. \$130.30
 Save 6.55
 System Price **\$123.75**



AA-201
6-Watt Stereo Amplifier
\$31.95



AC-11
Multiplex Converter
\$32.50



AJ-31
FM Tuner
\$39.95



ASW-41W
Walnut Hi-Fi Speaker System (2)
\$12.95 each

Save \$6.55

The Lowest Cost Heathkit FM Multiplex

Stereo System... Heathkit HFS-37

Here's a low-cost way to have FM Multiplex Stereo in your home, without damaging your careful budget. The Heathkit HFS-37 system is powerful and complete with: the Heathkit AJ-31 FM Tuner (page 48); the Heathkit AC-11 Multiplex Converter; the Heathkit AA-201 6-watt Stereo Combination Amplifier (page 47); and two Heathkit ASW-41W factory-built, walnut finished hi-fi speaker systems (page 56).

Should you desire to later add a stereo record player or changer to this basic system, you can choose either the Heathkit AD-10C Stereo Record Player (page 34) or the Heathkit AD-80C or AD-60C Automatic Stereo Record Changers, both with Sonotone 8TA4-SD ceramic stereo cartridge and diamond and sapphire styli (page 33).

System Kit HFS-37 40 lbs....
 NO MONEY DOWN, \$12 mo. **\$123.75**

Complete System Kit HFS-38

Reg. \$256.30
 Save 12.80
 System Price **\$243.50**



AC-11
Multiplex Converter
\$32.50



AA-151
28-Watt Stereo
Combination Amplifier
\$59.95



AS-51W
Walnut Hi-Fi Speaker System (2)
\$46.95 each



AJ-11
AM/FM Tuner
\$69.95

Save \$12.80

Medium-Power FM Multiplex Stereo System...

HFS-38 Features 28-watt Amplifier

For a medium-power FM Multiplex Stereo System, Heath offers you the HFS-38. This dependable big value system can be operated efficiently and installed beautifully in any room setting. The system includes: the Heathkit AJ-11 AM/FM Tuner (page 44); the Heathkit AC-11 Multiplex Converter; the Heathkit AA-151 28-watt Stereo Combination Amplifier (page 45); and two Heathkit AS-51W Walnut Two-Way Hi-Fi Speaker Systems with factory-built cabinets (page 56).

Later addition of an Automatic Stereo Record Changer is simple with this system. We would recommend either the Heathkit AD-80A Stereo Changer or the Heathkit AD-60A Stereo Changer with GE VR-227 magnetic stereo cartridge and diamond stylus (page 33).

The "easy-to-build" electronics of this system will bring you superb FM Multiplex Stereo at economical prices. Order yours now!

System Kit HFS-38 100 lbs....
 NO MONEY DOWN, \$23 mo. **\$243.50**

Complete System Kit HFS-39

Reg. \$347.30
 Save 17.35
 System Price **\$329.95**



AA-100
Deluxe 50-Watt Stereo Amplifier
\$84.95



AJ-30
Deluxe AM/FM Tuner
\$99.95



AS-10W
Walnut Acoustic
Suspension Speaker System (2)
\$64.95 each



AC-11
Multiplex Converter
\$32.50

Save \$17.35

Heath's HFS-39 is a Deluxe FM Multiplex Stereo

System That Gives top-flight performance!

The Deluxe FM Multiplex Stereo System offered by Heathkit is the HFS-39 featuring deluxe components throughout and versatility permitting addition of a stereo record changer and stereo tape player at any future date.

The HFS-39 system includes: The Heathkit AJ-30 Deluxe AM/FM Tuner (page 40); the Heathkit AC-11 Multiplex Converter; the Heathkit AA-100 50-watt Deluxe Stereo Combination Amplifier (page 41); and two Heathkit AS-10W Acoustic Suspension Speaker Systems with prefinished, preassembled walnut cabinets (page 55).

For adding the stereo record changer, we would recommend the Heathkit AD-60B Automatic Changer with Shure M8D stereo cartridge and diamond stylus (page 33). A perfect stereo tape player for inclusion in this system is the Heathkit AD-70 Stereo Tape Player (page 35). Whichever you choose, you'll save with Heathkit!

System Kit HFS-39 137 lbs....
 NO MONEY DOWN, as low as \$23 mo. **\$329.95**

Matching Stereo "Twins"...Deluxe Tuner and

Kit Form
or
Factory
Assembled

Kit AJ-30

\$99⁹⁵



- Designed for use with AC-11 FM Multiplex Converter
- 16 tube circuit
- Modern styling—lighted panel
- Versatile controls
- Separate or simultaneous AM and FM reception
- Individual tuning meters for AM & FM

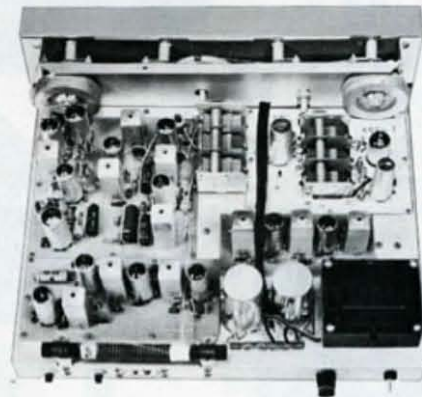

Heathkit AJ-30 Deluxe STEREO AM/FM TUNER . . . the greatest value in the kit industry

The Heathkit AJ-30 Deluxe AM/FM Stereo Tuner Kit offers more features, finer performance, better quality—at savings up to 50%. And the brand new AJ-30S combination of the AJ-30 Tuner with the new Heathkit AC-11 FM Multiplex Converter, p. 48, brings you a function coordinated system ready to receive FM stereo as well.

The AJ-30 AM/FM Stereo Tuner comes in kit form or factory-assembled ready to plug in. Either way, you'll find that the quality engineering advances of this tuner, along with its remarkably low price tag, make it one of the greatest values of the high-fidelity industry.

Some of the quality features of the AJ-30 include individual tuning meters for both AM and FM that insure precise station settings with ease and accuracy. This deluxe tuner also provides an AM bandwidth-fidelity switch to give you a choice of maximum selectivity or maximum fidelity to suit your listening need. The function switch selects either AM, FM or AM & FM modes of operation. A multiplex converter output jack is provided on the models AJ-30 and AJW-30 to permit addition of a multiplex converter at any time for enjoyment of FM in stereo.

Other features of the AJ-30 are a 300 ohm external FM antenna input and a built-in FM line coupler antenna. For AM reception it has a built-in ferrite rod antenna and provisions for an outside antenna for weak signal areas. A balanced full-wave germanium diode AM detector is used to assure low distortion. Delayed and amplified Automatic Volume Control keeps audio output variations to a minimum. Your FM listening will be a joy, thanks to the FM Automatic Frequency Control feature which "locks in" station signals for drift-free reception.

Designed in the most modern manner, the superb styling of the AJ-30 matches the AA-100 perfectly with a luggage tan vinyl-clad steel cabinet and polished anodized trim to complement any room decor. Refracted lighting illuminates the dial with a soft, glare-free glow. The 16-tube circuit includes 3 circuit boards for easy construction and high stability. The preassembled and prealigned 3-tube tuned cascode FM tuning unit is another quality feature insuring performance to factory-built standards as well as making assembly faster and easier.

- Kit AJ-30** . . . 24 lbs. . . . NO MONEY DOWN, \$10 mo. **\$99.95**
Kit AJ-30S . . . 28 lbs. (with AC-11 Multiplex Converter in Kit Form) . . . NO MONEY DOWN, \$12 mo. **\$129.95**
Assembled AJW-30 . . . 24 lbs. . . . NO MONEY DOWN, \$15 mo. . . . **\$159.95**
Assembled AJW-30S . . . 28 lbs. . . . (with Assembled ACW-11 Multiplex Converter) . . . NO MONEY DOWN, \$21 mo. **\$211.20**

SPECIFICATIONS FM—Tuning range: 88 mc to 108 mc. **IF frequency:** 10.7 mc. **Antenna:** 300 ohm balanced (or internal for local reception). **Output:** low impedance cathode follower variable up to 4000 ohms. **Output voltage:** Nominal .5 volts (with 2 uv 30% modulation in). **Quieting sensitivity:** 2 uv for 20 db of quieting; 20 uv for full quieting (40 db). **Maximum deviation sensitivity:** 5 uv; (400 cycle 100% modulation). **Deviation sensitivity:** 20 KC (1100 uv in). **Harmonic distortion:** Less than 1% (1100 uv 400 cycle 100% modulation). **Image ratio:** 40 db. **AFC correction factor:** 12 db. **Amplitude modulation suppression:** 25 db. **Hum and noise:** 40 db below 30% modulation (20 uv in).

SPECIFICATIONS AM—Sensitivity, narrow bandwidth position: 1400 kc, 4.5 uv; 1000 kc, 5 uv; 600 kc, 5.5 uv (at antenna terminals through standard IRE dummy antenna, .1 volt RMS reference output). **Reference output .1 volt RMS:** 600 kc 5.5 uv. **Sensitivity change, narrow to broad position:** -5 db. **IF bandwidth, narrow:** 14 kc, 6 db down; **Broad:** 20 kc, 6 db down. **Image ratio:** 1400 kc 55 db; 600 kc 80 db. **Harmonic distortion:** Less than 1%. **Hum and noise:** 35 db below 30% modulation (1000 kc unmodulated with 100 uv in). **IF rejection ratio:** 1400 kc 42 db; 600 kc 30 db. **Power supply:** Transformer operated 50-60 cycle, 100 watts. **Tube complement:** (6) 6AU6, (3) 6BA6, (1) 6BS8, (1) 6AB4, (1) 12AT7, (1) 6AL5, (1) 6BE6, (2) 12AU7. **Dimensions:** 15 1/2" W. x 5 1/2" H. x 13 1/2" D.

Amplifier...Our Finest Stereo Units



Kit Form
or
Factory
Assembled

KIT AA-100

\$84⁹⁵

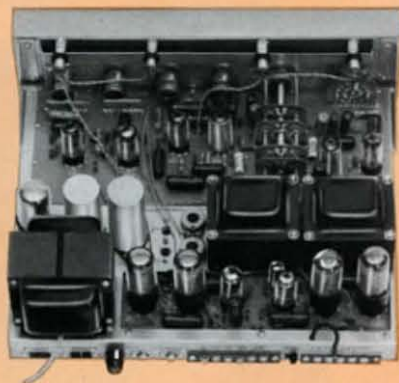

- 50 hi-fi rated watts (25 watts per channel)
- 5 stereo inputs
- Versatile controls
- Mixed-channel speaker output
- Separate monophonic phono input

for the greatest value in STEREO COMBINATION AMPLIFIERS choose the AA-100 by Heathkit

The Heathkit AA-100 Deluxe Stereo Amplifier stands head and shoulders in value above any other stereo amplifier in the kit industry. Packed full of exciting features, this high-fidelity rated 50 watt amplifier outperforms units selling for twice its price. It's a mere \$84.95 in kit form, that's just \$1.70 a watt for two 25-watt channels of distortion-free power to handle every amplifying task in your stereo system.

The five stereo inputs can be utilized to the advantage of your individual taste and system components . . . there's a stereo magnetic phono input, a pair of tuner inputs for AM and FM, a pair of tape inputs and two pairs of auxiliary inputs. A separate monophonic magnetic phonograph input is also available. The input layout is further enhanced by the fact that tape playback heads can be accepted directly without external preamplification or equalization.

In addition to three different stereo speaker impedances, the AA-100 has a "mixed-channel" speaker output that can be used for stereo "center fill-in" or for monophonic sound in other rooms. The cathode follower outputs for tape recorders insure true sound reproduction without high frequency loss, regardless of the distance between the amplifier and the recorder.

The many controls of the Heathkit AA-100 speak clearly of its versatility and capability in any situation. Included are preamplifier input level controls, power amplifier input level controls, hum controls, "mode" selector, speaker phase reversal switch, balance and separation controls, ganged volume controls and separate concentric bass and treble tone controls to put you in complete command of every function with assurance of peak performances.

While the electronics of the AA-100 are enough to prove this stereo amplifier the best buy on the market today, the wonderful styling features of this beauty make it an even greater value. The luggage tan vinyl-clad steel cabinet looks and feels like real leather, but is practically indestructible because of its mar, scratch and stain-resistant qualities. The plastic control panel is framed by a bright metal trim and soft refracted lighting from above gives glare-free illumination of control settings. The fabulous AA-100 is the "stereo-twin" of the famous Heathkit AJ-30 Stereo AM/FM Tuner (opposite page) . . . they look alike, and will fit in any room decor in your home. Remember the Heathkit AA-100 Stereo Amplifier delivers more and costs less, just \$84.95 with no money down and up to 12 months to pay. 31 lbs.

Kit AA-100 . . . NO MONEY DOWN, \$9 mo. \$84.95
Assembled AAW-100 . . . NO MONEY DOWN, \$14 mo. \$144.95

SPECIFICATIONS—Channels: 2. **Power output:** 50 watts (25 w. per channel) Heath Hi-Fi Rating; 60 watts (30 w. per channel) IHFM Music Power Output (0.7% THD, 1 kc). **Power response:** ± 1 db from 30 cps to 15 kc at 25 watts output per channel. **Harmonic distortion:** Less than 0.5% at 25 watts, 1 kc. Less than 2% at 25 watts, 30-15,000 cps (each channel). **Intermodulation distortion:** Less than 1% at 25 watts, 60 and 6,000 cps signals mixed 4:1 (each channel). **Hum and noise:** Mag phono, 55 db below 25 watts output at 6 mv sensitivity. Tape head, 35 db below 25 watts output. Tuner and aux. inputs 70 db below 25 watts output. **Channel separation:** 42 db min. at 1 kc. **Input sensitivity:** For 25 watts output per channel; mono mag. phono, 1.5 mv; stereo mag. phono, 1.5 mv; tape head, 1 mv; tuner, 0.2 v.; aux. 1 & 2, 0.2 v. **Input impedance:** Mag phono, 47 K ohms (may be changed); tape head, 470 K ohms; tuner & aux., 250 K ohms each. **Outputs:** 4, 8 and 16 ohms; cathode follower tape recorder outputs. **Damping factor:** 15. **Controls:** Function switch (4-position); selector switch (6-position); balance control (total range, 16 db); separation control; ganged level controls; dual-concentric bass & treble controls; phase and power switch. **Tube complement:** 2-6F6, 4-12AX7, 2-7119, 4-7591, 1-GZ34, 1-selenium bias rectifier. **Power requirements:** 117 volts, 50-60 cycles, 150 watts. **Power outlets:** 2 AC receptacles, 1 switched, 1 unswitched. **Dimensions:** 5 1/2" H. x 15 1/2" W. x 13 1/2" D. (allow 1" for cables at rear).

Outstanding Values in Stereo



Kit AA-11
\$84.95

a masterpiece in design and performance!...
This New Deluxe STEREO PREAMPLIFIER

- Separate basic and secondary controls
- Push button selected inputs—greatly simplified operation
- Self powered—DC filaments—silicon diode rectifiers
- Deluxe styling group
- Switch-selected loudness or volume control
- Cathode follower outputs for stereo tape recording
- "Derived" center-channel monophonic output
- Rumble and scratch filters for optimum record reproduction
- Channel and phase reversal switches for convenience
- Low distortion triode stage circuit design
- For use with any stereo or mono power amplifier



Beautifully designed to match the acclaimed styling concept of the top of the Heathkit high-fidelity line, the new AA-11 Deluxe Stereo Preamplifier brings you every feature you've ever wanted in a "master-control" center. Both non-technical music lover and technically-inclined audio-phile alike will applaud its many refined features, professional quality performance and exceptional simplicity of operation. A real beauty designed for installation in the most elaborate of stereophonic systems.

To achieve both clean-lined design and simplicity of operation, all switches and controls are divided into two distinct groups; the first group is the basic, or primary, controls which are located on the plastic front panel. The other group is composed of secondary controls which are located behind the hinged cover on the lower front panel. The primary controls consist of nine push-button switches for selection of five stereo inputs, three monophonic inputs and on/off switch; a dual-tandem VOLUME/LOUDNESS control (one knob) which varies volume level of both left and right channels simultaneously, and separate dual-concentric (friction clutched) Baxandall-type Bass and Treble controls for individual channel adjustment.

The primary switches allow fast, easy selection of (1) stereo phonograph (magnetic or ceramic); (2) stereo tape head; (3) stereo microphones; (4) stereo FM; (5) stereo auxiliary input; (6) monophonic AM tuner; (7) monophonic FM tuner; (8) monophonic auxiliary; and (9) OFF/ON switch. All equalization circuits are switched simultaneously by the program source selector buttons.

The secondary controls consist of (1) a BLEND control which varies from complete mixing of the left and right channel signals for monophonic output to complete separation for stereophonic listening, or any intermediate position to provide just the right amount of "center-fill" to eliminate the "hole-in-the-middle" effect; (2) a BALANCE control for adjusting channel outputs to equal amplitudes; (3) a SCRATCH FILTER switch to attenuate record surface noise; (4) a RUMBLE FILTER switch to attenuate turntable rumble; (5) a STEREO-MONO switch for monophonic record reproduction; (6) a CHANNEL REVERSAL switch to insure that each loudspeaker reproduces the correct stereo channel; (7) a PHASE REVERSAL switch to insure in-phase stereo speakers; and (8) a VOLUME-LOUDNESS switch which converts the volume control to a loudness control. The unique filter circuit employed for this purpose is so effective in maintaining proper tonal balance, even at exceptionally low background music levels, that correct and simultaneous adjustment of both volume and loudness may be achieved with a single control over its entire range... and it eliminates confusion when operated by a person unfamiliar with its function. Check the high performance specifications, convenience features and many extras you get at the amazingly low price of this quality preamplifier. 19 lbs.

Kit AA-11... NO MONEY DOWN, \$9 mo. **\$84.95**

SPECIFICATIONS—Channels: Two. **Inputs:** 5 stereo each channel and 3 monophonic. **Input impedance:** Tape head, 220 k ohms; Phono, 47 k ohms for magnetic, 75 k ohms when used with ceramic; Microphone, 500 k ohms; Multiplex 600 k ohms and Aux, 600 k ohms. All monophonic inputs 600 k ohms input impedance. **Outputs:** One low impedance to power amplifier and one low impedance to tape recorder in each channel plus a "derived center channel" monophonic output at 10 k ohms impedance. **Frequency response:** ±1 db from 15-30,000 cps. **Harmonic distortion:** Max. .15% @ 2.5 volts output. **Intermodulation distortion:** Max. .3% @ 2.5 volts output. **Hum & noise:** All values relative to 2.5 V rms output; 2.5 mv input at Tape Head input, 50 db or better; 6 mv input at Mag. phono input, 60 db or better; 2.5 mv input at Microphone input, 60 db or better; .1 volt input at Aux, 75 db or better. **Channel separation:** 1 kc, 40 db or better. **Rumble filter:** 3 db down at 42 cycles, 12 db attenuation per octave. **Scratch filter:** 3 db down at 6 kc, 20 db attenuation per octave. **Baxandall tone controls:** 12 db boost, 16 db cut at 20 cps; 12 db boost, 20 db cut at 20,000 cps. **Controls:** Separate Bass & Treble, each channel; Volume-Loudness, Blend, Balance, Rumble Filter, Scratch Filter, Volume-Loudness switch, Stereo-Mono switch, 9 push-button Source Selector switch, Phase Reversal switch, and Channel Reversal switch. **Tube complement:** (8) 12AX7, (2) 12AT7. **Power requirements:** 117 V AC, 50-60 cycles. **Dimensions:** 5 1/2" H x 11 1/2" D x 15 1/2" W.

PUSH-BUTTON CONVENIENCE

Push-button switches allow fast, easy selection of any desired input. Stereo and Monophonic modes of operation are clearly indicated on the attractively-screened plastic front panel to avoid confusion when operated by uninitiated members of the household.

HIDDEN SECONDARY CONTROLS

Clean, functional styling is achieved by placing all secondary controls behind this hinged front panel cover. Prevents confusion and accidental change in settings of controls which set initial conditions such as balance, phase, etc. Only volume, tone and input selectors are in open view on the front panel.

BAXANDALL TONE CONTROLS

Baxandall-type tone controls provide true, natural reproduction while giving you complete command of bass and treble tone quality in each channel to suit your individual listening preference.

EASY TO ADJUST INPUT LEVEL CONTROLS

Input level controls are provided for all inputs except Tape Head. They permit adjusting all inputs to the same level, making it unnecessary to change volume control setting when alternately using different program sources.

EASY ACCESS TO INPUT AND OUTPUT JACKS

All input and output jacks, one switched and one unswitched 117 VAC outlet, and fuse holder are conveniently located on the rear chassis apron. Jacks are clearly identified with information screened on the chassis. Cathode-follower outputs are provided for stereo and monophonic tape recording purposes.

Preamplifier Hi-Fi Control Centers

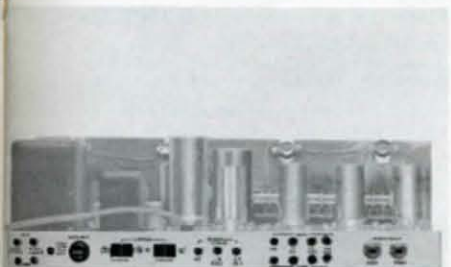
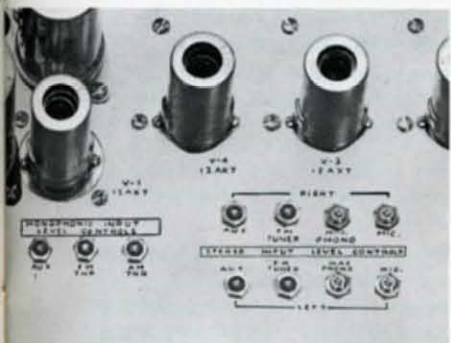

Kit AA-141
\$34⁹⁵

*beautifully styled... low in cost... this versatile Stereo
PREAMPLIFIER hi-fi control center!*

- 4 inputs in each channel, 8 in all!
- 6-position function selector for stereo or monophonic modes of operation
- Cathode-follower outputs for low line loss and distortion
- Built-in power supply—use with any basic stereo amplifier
- Baxandall-type tone controls for true, natural reproduction



Elegant in its exciting new styling concept, the Heathkit AA-141 Stereo Preamplifier combines the famous performance of its illustrious predecessor, the Heathkit AA-20, plus the quality appearance and design highlights that make it a perfect match to the Heathkit AJ-11 AM/FM Stereo Tuner. An ideal companion to the Heathkit AA-30 or AA-40 Stereo Amplifiers, the AA-141 provides every modern convenience of stereo system control at lowest cost anywhere!

This quality stereo preamplifier can be used with any basic stereo power amplifier, since it has its own built-in power supply. Output cables are included for connection to the power amplifier, with cathode-follower output circuit design features to assure low line loss and installation flexibility in any system.

Four inputs are provided in each channel, eight in all, to accept practically any program source. An RIAA equalized input is provided for magnetic phonograph and a high level input is provided for crystal or ceramic phonograph cartridges. Two auxiliary high level inputs are provided for other program sources such as AM/FM tuners, tape recorder, TV, etc. Controls on the front panel consist of a six-position function selector switch which allows you to hear either channel individually through its own speaker, either channel through both speakers, normal stereo, or stereo channels reversed. Separate concentric volume controls allow individual or simultaneous control of sound intensity of both channels; separate, calibrated Baxandall-type tone controls give you complete command of bass and treble tone quality to suit your individual preference. The input switch selects any of the four input positions provided.

In addition to the cathode follower outputs to the power amplifiers, two high-level outputs are provided for tape recorder, allowing recording directly from the preamplifier. Two 117 volt AC outlets, one switched, one unswitched are provided for auxiliary equipment. Filament balance controls in each channel assure minimum hum and low distortion. Beautifully styled with luggage-tan vinyl-clad steel case and charcoal-gray front panel. An outstanding "buy" in a quality preamplifier at this low Heathkit price! 7 lbs.

Kit AA-141 . . . NO MONEY DOWN, \$5 mo. \$34.95

SPECIFICATIONS—Channels: 4. Inputs: 4 each channel; Mag. phono, 47 K ohms; crystal phono, 2.4 megohms; aux. 1 & 2, 500 K ohms each. Input sensitivities: (For 2.5 v rms output) Mag. phono 0.004 v; crystal phono 0.15 v; aux. 1 & 2, 0.2 v. Outputs: 2 each channel, output to power amp. and tape output. Frequency response: ± 1 db from 20 to 20,000 cps. Harmonic distortion: Mag. phono 0.2%, crystal phono and aux. inputs 0.15% at 2.5 volts output. Intermodulation distortion: 0.05% at 2.5 volts output. Hum and noise: Mag. phono, 50 db or better; crystal phono and aux. inputs 60 db or better below 2.5 volts output. Channel separation: 45 db or better. Controls: Separate bass and treble controls each channel; 4-position input selector; separate volume each channel; 6-position function switch; filament balance. Tube complement: 5-12AX7. Power requirements: 117 v, 50-60 cycles, 17.5 watts. External power supplied: 2 AC receptacles, 1 switched 1 unswitched. Color and finish: Panel, charcoal gray; cover, luggage-tan vinyl-clad steel.

This Quality Duo offers fine AM/FM Stereo

HEATHKIT
by Daystrom



Kit Form
or
Factory
Assembled

Kit AJ-11

\$69⁹⁵

For quality AM/FM Reception . . . plus
latest styling and medium price
the Heathkit AJ-11 STEREO TUNER

- Engineered for FM multiplex
- Two "eye" tuning indicators
- Adjustable AFC on FM
- AM fidelity switch
- Perfect match for AA-151 Amplifier

Quality and dependability are the by-words of the famous Heathkit AJ-11 AM/FM Tuner . . . medium priced and available with or without the Heathkit AC-11 Multiplex Converter, in kit form or factory assembled models. You can search far and wide, but you will never find so many quality features at such a reasonable price. The AJ-11 is engineered for use with the AC-11 FM Multiplex Converter and this versatile AM/FM tuner can be depended upon for complete, high quality service in every application, whether AM, FM or FM Stereo.

The styling of the AJ-11 is also remarkable in view of its reasonable price. Handsome in its smart new *luggage tan* vinyl-clad steel case and *charcoal grey* front panel, it will blend with any decor and has a convenient size permitting placement practically anywhere in your home. With the two "eye" tube indicators on the front panel . . . one for AM, one for FM . . . you can be sure of accurate, easy tuning of any station. In the kit models, the *preassembled* FM front-end is *prealigned* to insure stable and drift-free operation. To speed the assembly of the kit, you simply drop the front-end in and proceed with other simple connections. The *three-position* Automatic Frequency Control (AFC) switch holds a very weak FM signal from drifting and also insures that stronger FM signals are "centered" when tuned. With the AM Fidelity Switch, you can choose either of two bandwidths. In the normal position, the bandwidth is limited and gives sharp tuning when stations are close together. In the maximum position, the widest bandwidth is provided and greater fidelity is achieved.

The *individual flywheel tuning* of the AJ-11 makes tuning easy and precise whether you use AM or FM. The built-in line antenna for FM is usually sufficient for metropolitan areas with nearby FM stations, and there is provision made for external FM antenna connection through special terminals on the chassis. The built-in AM rod antenna provides ample reception in most installations, however, special terminals for an external antenna are also provided, should it be necessary. Both the AM and FM sections of the tuner have output level controls that can be easily adjusted to work properly with your particular pre-

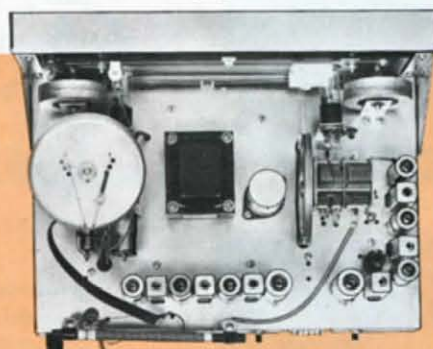

This interior view of the AJ-11 shows the well-planned layout and husky components of this instrument. The circuitry is carefully engineered to assure you easy construction with the best possible results.

amplifier. An extra output jack is provided for use with the Heathkit AC-11 Multiplex Converter, enabling you to enjoy the delights of Stereophonic FM reception in your home. Another attractive feature of the AJ-11 is the large slide-rule dial that is edge-lighted to increase the readability of both AM and FM frequency numerals.

You'll find the AJ-11 perfect for your home stereo system, especially when used in conjunction with its "look-alike" partner, the Heathkit AA-151 Stereo Amplifier (opposite page). And whether you choose the AJ-11 or the AJ-11S with the FM Multiplex Converter, you'll save up to 50% over similar quality products that are preassembled. Remember, for superb styling, performance and a budget-minding price . . . it's smart to choose the AJ-11.

Kit AJ-11 . . . 19 lbs. . . NO MONEY DOWN, \$7 mo. . . . \$69.95

Kit AJ-11S (includes AC-11 Multiplex Converter Kit, p. 38) . . .

NO MONEY DOWN . . . \$10 mo. 23 lbs. . . . \$99.95

Assembled AJW-11 . . . 19 lbs. . . NO MONEY DOWN, \$12 mo. \$129.95

Assembled AJW-11S (includes Assembled ACW-11 Multiplex Converter, p. 38) . . . NO MONEY DOWN, \$18 mo. 23 lbs. . . . \$181.20

SPECIFICATIONS (FM)—Tuning range: 88-108 mc. **Quieting sensitivity:** 2.5 uv for 20 db quieting; 3.5 uv for 30 db; 25 uv for max. quieting (43 db). **Image ratio:**—45 db, 25 uv, 30% mod. 98 mc. **IF frequency:** 10.7 mc. **IF rejection:** (98 mc)—63 db. **Output:** Cathode follower type, variable to 800 ohms; level: 0.45 v, 25 uv, 30% mod. **Frequency response:** *2 db, 20-20,000 cps. **Harmonic distortion:** Less than 1%, 25 uv, 100% mod., 98 mc. **Hum and noise:**—43 db, 25 uv, 30% mod. **RF stage:** 1 tuned RF amplifier. **AFC:** Switched, 3-positions, off-half-full. **Multiplex output:** Output supplied for external multiplex adapter.

SPECIFICATIONS (AM)—Tuning range: 550-1600 kc. **Sensitivity:** Narrow position: 1400 kc, 10 uv; 1,000 kc, 15 uv; 600 kc, 40 uv. **Frequency response:** *2.5 db, 20-9,000 cps (40db down at 10 kc). **Image rejection:** 1400 kc, 46 db; 1,000 kc, 45 db; 600 kc, 60 db. **IF frequency:** 455 kc. **IF rejection:** 1400 kc, 40 db; 600 kc, 33 db. **Output:** Cathode follower type, variable to 800 ohms; level, 1 v, 750 uv, 30% mod. **Harmonic distortion:** less than 1%, 750 uv, 95% mod. **Hum and noise:** 35 db down (5,000 uv, 30% mod). **RF stage:** 1 tuned RF amplifier. **AVC:** Derived from voltage doubler detector.

SPECIFICATIONS (general)—Tuning indicators: 2 magic eye tubes, one AM, one FM. **Controls:** AM bandwidth, broad/narrow; function selector, AM/Stereo/FM; FM AFC, full/half/off; AC power on-off; AM tuning; FM tuning; AM level; FM level. **Tube complement:** (AM) 2-6BA6, 1-6BE6, 1-6BN8, 1-6ME5, (FM) 1-6CY5, 1-6EZ8, 3-6AU6, 1-6BN8, 1-6ME5. Transformer operated, full wave voltage doubler with 2 silicon rectifiers. **Power requirements:** 117 v, 50-60 cycles, 40 watts. **Dimensions:** 15 1/2" W. x 5 1/2" H. x 11" D.

at Money Saving Prices

Kit Form
or
Factory
Assembled

Features patented
Heath
ULTRA-LINEAR®
circuit!

Kit AA-151
\$59.95

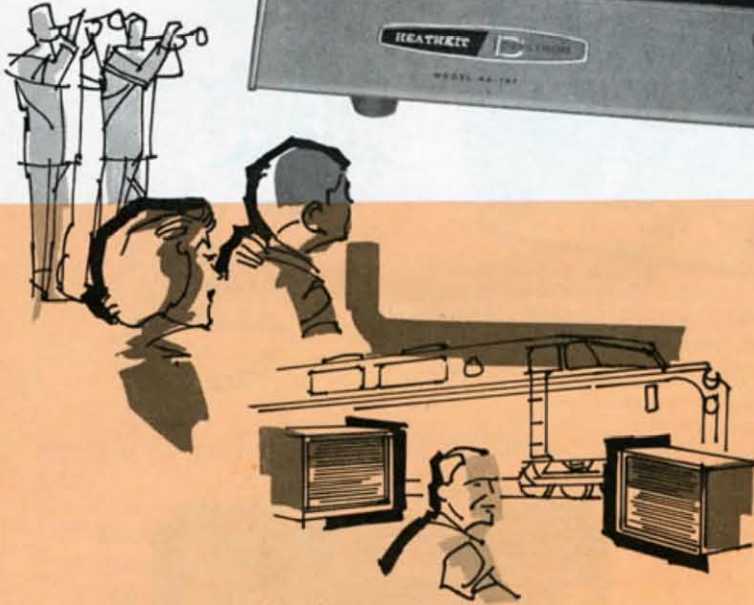

Only \$59.95 for this 28-Watt
STEREO AMPLIFIER Kit—the AA-151,
designed to match the AJ-11 Tuner

- 28 hi-fi rated watts (14 per channel)
- Stereo or Mono operation
- 4 stereo inputs
- 6 versatile controls
- Matches the AJ-11 Tuner perfectly

This new and elegantly-styled stereo amplifier, the Heathkit AA-151, can be yours now at only \$59.95. With the features of units selling for twice the price, the AA-151 is really the leader of the medium price class in combination amplifiers and preamplifiers. This rugged unit delivers a full 28 watts, High Fidelity rated (14 watts per channel).

With its handsome *luggage tan* vinyl-clad steel cabinet and *charcoal grey* front panel, it blends perfectly with the AJ-11 AM/FM Tuner (opposite page). Outstanding in quality and flexibility, the AA-151 has fingertip controls that give instantaneous command over every function. A *four input* selector switch provides choice of magnetic phono, crystal phono, tuner or high level auxiliary input for tape recorder, TV, etc.

The *six-position* function selector switch gives you instant selection of either the left or right stereo signals *independently* or *through both* amplifier channels. It also selects 'Stereo' or 'Stereo Reverse' providing channel reversing function. A dual-concentric volume control incorporates a *friction clutch* which locks the volume controls together once the balancing of the output levels of the two amplifiers has been accomplished. Ganged dual tone controls adjust bass or treble response of both channels simultaneously. Proper speaker phasing is con-

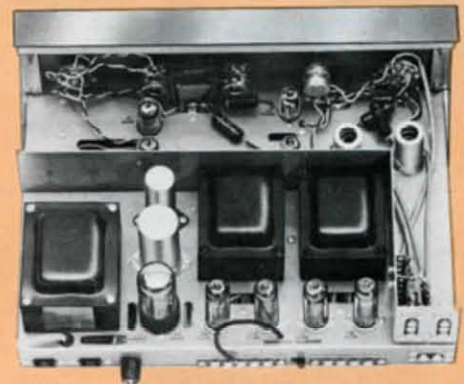

This 28-watt beauty is good looking inside too! See how Heath engineers have combined skillful layout with dependable components—all in an easy-to-assemble product which will give years of faithful service at savings of 50%.

veniently accomplished with the speaker phase-reversal switch. Each channel is equipped with a filament balance control. Two AC outlets, one controlled by the power switch, the other unswitched, provide convenient accommodation for accessory equipment. The husky power supply which employs a GZ34 rectifier tube, provides the voltage regulation essential for high power output, while maintaining low distortion levels.

With this remarkable AA-151 Stereo Amplifier and the AJ-11 AM/FM tuner (opposite page) you will have a powerful stereo combination for your home system at a budget-conscious price. The AA-151 and the AJ-11 are look-alike companions designed for each other with styling that will blend with any decor in your home. 27 lbs.

Kit AA-151 . . . NO MONEY DOWN, \$6 mo. **\$59.95**
Assembled AAW-151 . . . NO MONEY DOWN, \$11 mo. **\$119.95**

SPECIFICATIONS—Channels: 2. **Power output:** 28 watts (14 w. per channel) Heath Hi-Fi Rating: 32 watts (16 w. per channel) IHFM Music Power Output (0.7% THD, 1 kc). **Power response:** ± 1 db from 20 cps to 20 kc at 14 watts output per channel. **Harmonic distortion:** Less than 2%, 30 cps to 15 kc at 14 watts output per channel. **Intermodulation distortion:** Less than 2% at 14 watts output per channel using 60 cps and 6 kc signal mixed 4:1. **Hum and noise:** Mag. phono input, 55 db below 14 watts; Tuner and crystal phono 65 db below 14 watts. **Channel separation:** Better than 45 db. **Input sensitivity:** For 14 watt output each channel (tone controls in "Flat" position): mag. phono, 0.004 volts at 1 kc; crystal phono, 0.2 volts; tuner and aux., 0.2 volts. **Outputs:** 4, 8 and 16 ohms. **Damping factor:** 10:1. **Controls:** Dual clutched volume, ganged bass; ganged treble; 4-position source selector; 6-position mode selector; speaker phasing switch. **Tube complement:** 2-6EU7, 2-6AU6, 2-6AN8, 4-EL84/8BC6, 1-GZ34/5AR4. **Power requirements:** 117 volts, 50-60 cycles, 130 watts. **Power outlets:** 2 AC receptacles, 1 switched, 1 unswitched. **Dimensions:** 15 1/2" W. x 5 1/2" H. x 11" D.

Save up to 50% with Heath Do-It-Yourself Electronic Kits

Heathkit® presents its new 80-watt stereo amplifier

40 Watts Power for Each Channel Costs You Just a \$1 Per Watt



Kit AA-121
\$79⁹⁵



Features patented Heath
ULTRA-LINEAR® circuit!

- Full high fidelity power rating
- Mixed-channel center speaker output
- Fixed bias output stage
- Front panel controls
- Beautifully styled

The AA-121 STEREO POWER AMPLIFIER has new, modern styling features

The new Heathkit AA-121 80-watt (40 watts per channel) Stereo Amplifier is the proud successor to the AA-40 all dressed up in a handsome, modern design chassis of black enamel with ivory front panel and metallic bronze ventilated steel dust cover. This powerful "professional quality" stereo amplifier delivers a full 40 watts to each stereo channel, or if you desire, you can channel all 80 watts to a single monophonic outlet. A "stereo-mono" switch ties both amplifiers to one input-level control for monophonic operation. When used for stereo operation, individual level controls are provided for each channel.

Heath's patented ULTRA-LINEAR® circuit provides superb fidelity and the famous "bas-bal" output balancing circuit for reduced low frequency distortion. A phase reversal switch in one channel allows easy phasing of any speaker system. Other features include a mixed channel output for a center channel speaker installation when you want to get rid of the "hole-in-the-middle" effects of stereo applications and fixed bias output stages for minimum distortion. The fused, transformer operated silicon diode power supply provides extremely good regulation and cool operation. The surge protection device and conservative ratings insure long tube and power supply life. Two AC outlets, 117 volts, one switched and the other unswitched are provided for accessory equipment of your hi-fi/stereo system. The power on the AA-121 can be turned "on" or "off" either at the amplifier or the preamplifier, as desired.

This attractive and powerful stereo amplifier is designed for use with any self-powered preamplifier, but its color and lines will blend most tastefully with the Heathkit AA-11 (page 42) or AA-141 (page 43). 39 lbs.

Kit AA-121...NO MONEY DOWN, \$8 mo.....\$79.95

46



This interior view of the AA-121 Stereo Amplifier shows the rugged, conservatively rated components that can loaf along at full 80 watts output.

SPECIFICATIONS—Channels: 2. Power output: 80 watts (40 w. per channel) Heath Hi Fi Rating: 98 watts (49 w. per channel) IHFM Music Power Output (0.7% THD, 1 kc). **Power response:** ±0.5 db, 20-20,000 cps, at 40 watts output per channel. **Harmonic distortion:** 1.5% or less, 20-20,000 cps, at 40 watts output per channel. **Intermodulation distortion:** 0.5% or less at 40 watts output per channel, 60 and 6,000 cps mixed 4:1. **Hum and noise:** 85 db below 40 watts output. **Channel separation:** 70 db or better at 1 kc. **Input sensitivity:** 0.95 volts rms for 40 watts output per channel. **Outputs:** 4, 8, 16, and 32 ohms per channel; center speaker terminals can be used with 4, 8 or 16 ohm speakers. **Damping factor:** 16:1, 8 and 16 ohm taps; 12.5:1, 4 ohm tap. **Controls:** A Channel: bias balance, bias voltage, level. B Channel: bias balance, bias voltage, level. Function selector; phase and power switches. **Tube complement:** 2-6AN5; 4-EL34; 4 silicon diode rectifiers, 1 selenium bias rectifier. **Power requirements:** 117 v, 50-60 cycles, 180-320 watts. **Power outlets:** 2 AC outlets; 1 switched, 1 unswitched. **Color and finish:** metallic bronze, expanded metal dust cover; black chassis with ivory lower front panel. **Dimensions:** 7¼" H x 15" W x 11" D.

No Down Payment Required On Heath's New Time Pay Plan!

Now you can buy the Heathkit of your choice with no down payment! Now any order from \$25 to \$600 can be purchased with no down payment (write for details on orders over \$600). These new, relaxed credit terms, coupled with our new money-back guarantee that you can build any Heathkit, mean you can buy Heathkit with complete confidence and assurance of satisfaction.

Heathkit check-by-step instructions and big fold-out pictorials are famous for clarity and simplicity

Modern styling puts Heathkit® amplifiers out front



Features patented Heath ULTRA-LINEAR® circuit!

Kit AA-111

\$44.95

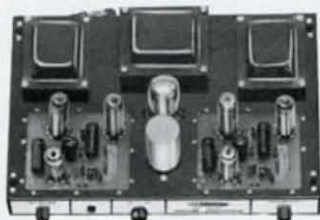

The interior of the AA-111 shows the four EL84 power output tubes that insure this amazing amplifier's performance. Note the neat circuit layout for easy assembly.

Here's a 28 watt STEREO POWER AMPLIFIER

designed to power your system with ease!

- Conservatively rated at 14 watts per channel
- Circuit boards for easy assembly
- Individual amplifier gain controls
- Phase reversal switch
- Supplies preamp power when needed

You'll marvel at this compact, handsomely styled new Heathkit AA-111 Stereo Power Amplifier for two reasons: it possesses all the famous performance characteristics of its illustrious predecessor, the Heathkit AA-30, and it has a rich styling concept that denotes quality the moment you see it. This AA-111 delivers a solid 28 watts for just \$45.95. The two channels are hi-fi rated at a full 14 watts each and use Heath's patented ULTRA-LINEAR® circuit to bring you the finest in performance. And remember, you save valuable space in your high fidelity /stereo enclosure or shelves by assembling this compact AA-111, instead of two power amplifiers.

A printed circuit board for each channel simplifies assembly as does Heath's famous "check-by-step" instructions. The circuit boards also insure stability and uniformity of channel operation. Other features of this fabulous unit include individual amplifier gain controls and a one-channel speaker phase reversal switch. You can turn the AA-111 off at either the amplifier or the preamplifier. The output terminals accommodate 4, 8 and 16 ohm speakers and two 117 volt AC receptacles are provided for accessory equipment. The transformer operated power supply is fused for safety.

The AA-111 is designed as a complementary styled companion to the Heathkit AA-11 or AA-141 stereo preamplifiers (pp. 42, 43). And of course, it will function perfectly with any other preamplifiers. The rugged ventilated dust-cover of metallic bronze colored steel protects the components which are mounted on the black chassis. The chassis lower front panel is ivory. Overall dimensions: 13" W x 8½" D x 6" H.

Order your AA-111 stereo power amplifier now and see for yourself why this value-starred unit has quickly risen to the top of its field.

Kit AA-111...21 lbs....NO MONEY DOWN, \$5 mo.**\$44.95**

SPECIFICATIONS—Channels: 2. Power output: 28 watts (14 w. per channel) Heath Hi-Fi Rating; 32 watts (16 w. per channel) IHFM Music Power Output (0.7% THD, 1 kc). **Power response:** ± 1 db from 30 cps to 15 kc at 14 watts output per channel. **Harmonic distortion:** 2% or less at 14 watts, 30 cps to 15 kc. **Intermodulation distortion:** 2% or less 60 and 6,000 cps signals mixed 4:1 at 14 watts output per channel. **Hum and noise:** 76 db below 14 watts output. **Channel separation:** 65 db. **Input sensitivity:** 0.74 v for 14 watts output per channel. **Input impedance:** 500 K ohm pot. **Outputs:** 4, 8 and 16 ohm. **Damping factor:** 5.25:1, 4 ohm tap; 10.2:1, 8 ohm tap; 11.5:1, 16 ohm tap. **Controls:** Left and right channel gain; AC switch; phase switch. **Tube complement:** 2-7199; 4-EL84/6BQ5; 1-GZ34/5AR4. **Power requirements:** 117 v, 50-60 cycles, 115 watts. **Power outlets:** 2 octal sockets for pre-amp power; supply 300 v at 10 ma, 6.3 volts at 1.1 amps at each socket.

Only \$31.95 for this compact

STEREO COMBINATION AMPLIFIER

- Smart new styling design
- Separate bass and treble tone controls
- Clutched volume controls
- 2 high level inputs



Kit AA-201

\$31.95



The new Heathkit AA-201 Economy Stereo Amplifier, priced at a low \$29.95, is the money-saving way to introduce stereo into your home . . . easily and economically.

And the exciting new styling of the AA-201 makes it a special bargain. Black enamel covers the all-metal case and an ivory front panel highlights the control knobs. Designed to fit in tastefully with other Heathkit Hi-Fi/Stereo components in the economy class, you'll find the AA-201 will fit in wherever it is placed.

This combination amplifier-preamplifier delivers 3 watts per stereo channel . . . enough power for average listening tastes . . . and is just what you need for that second system you want to set up in the children's room, the recreation room or out on the patio. Other features include separate bass and treble dual channel tone controls to bring out the deep rich lows and the tingling highs in your favorite musical selections. Clutched volume controls give you freedom and ease of system control to make the listening suitable to your individual taste. A seven-position function switch selects either monophonic phonograph, Channel A tuner, Channel B tuner, stereo phonograph, stereo phonograph reverse, stereo tuner, or stereo tuner reverse. The two high level inputs will accommodate tuners and crystal or ceramic phonographs.

Another plus feature of this remarkable kit is the ease of assembly which you will experience when putting it together. The detailed "check-by-step" instruction manual tells you exactly how to do it.

Kit AA-201 12 lbs. NO MONEY DOWN, \$5 mo. **\$31.95**

SPECIFICATIONS—Channels: 2. Power output: 6 watts (3 w. per channel) Heath Utility Rating. **Power response:** ± 1 db, 50-20,000 cps at 3 watts output per channel. **Harmonic distortion:** Less than 3%, 60-20,000 cps at 3 watts output per channel. **Intermodulation distortion:** Less than 3% at 3 watts output, 60 and 6,000 cps signals, 4:1. **Hum and noise:** 65 db below 3 watts output. **Input sensitivity:** 150 mv for 3 watts output each channel, crystal phono and tuner. **Outputs:** 4, 8 and 16 ohms. **Controls:** Dual clutched volume, ganged treble, ganged bass, 7-position selector switch, speaker phasing switch, on-off switch. **Tube complement:** 2-EL84; 2-7199; 1-EZ81. **Power requirements:** 117 v, 50-60 cycle, 75 watts. **Color and finish:** Black enamel with ivory front panel. **Dimensions:** 12½" W x 3¼" H x 6¼" D.

New Heathkit® Tuners and Amplifiers... Matched

The New Heathkit AJ-31 FM TUNER

combines the quality performance of the famous FM-4 with new style advances

- Engineered for FM Stereo with the AC-11 Multiplex Converter
- Automatic Frequency Control (AFC)
- 5 tube circuit (9 tube functions)
- Preassembled, prealigned tuning unit
- Flywheel tuning & slide-rule dial



Kit AJ-31

\$39⁹⁵

All the superior features of its predecessor, the world-famous FM-4, have been included in the new Heathkit AJ-31 FM Tuner. But in addition, a new modern styling highlights this remarkable unit to make it truly "value packed". Fashioned of charcoal grey steel cabinet with ivory colored bezel and lower front panel, the AJ-31 portrays quality from the moment you see it.

Some of the many features include: Flywheel tuning, switched AFC for "drift-free" performance, and a multiplex output jack for use with the Heathkit AC-11 Multiplex Converter (p. 38) to provide FM stereo. The pre-assembled, prealigned front end assures factory-built performance with easy, fast completion of the kit. Gives the installation flexibility of long output lead. 8 lbs.

Kit AJ-31... NO MONEY DOWN, \$5 mo. **\$39.95**

Assembled AJW-31... NO MONEY DOWN, \$7 mo. **\$69.75**

Kit AJ-31S (includes AC-11 Multiplex Converter Kit, p. 38)
No Money Down, \$7 mo. . . . 12 lbs. **\$69.95**

Assembled AJW-31S (includes Assembled ACW-11 Multiplex Converter, p. 38)
No Money Down, \$12 mo. . . . 12 lbs. **\$121.00**

SPECIFICATIONS—Tuning range: 88 to 108 mc. Quieting sensitivity: 2.5 uv for 20 db of quieting; 3.5 uv for 30 db of quieting; 25 uv for maximum quieting (45 db). IF frequency: 10.7 mc. Image ratio: 45 db. AFC correction factor: 75 kc per volt. AM suppression: 25 db. Frequency response: ±2 db 20-20,000 cps. Harmonic distortion: less than 1.5%. 1100 uv, 400 cycles 100% modulation. Intermodulation distortion: less than 1%. 60 cycles and 6 kc; mixed 4:1 1100 uv, 30% modulation. Antenna: 300 ohms unbalanced. Output impedance: 600 ohms (cathode follower). Output voltage: nominal .5 volt (with 30% modulation, 20 uv signal). Power requirements: 105-125 volts 50/60 cycle AC at 25 watts. Overall dimensions: 4 1/2" H x 13 1/2" W x 8" D.

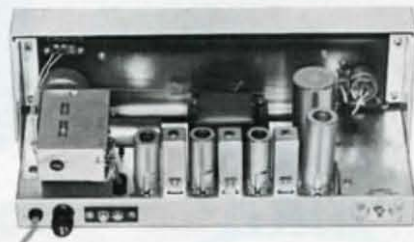

Kit Form or Factory Assembled

The factory-assembled prealigned front end of the AJ-31 and well-planned circuit layout assures easy home assembly with factory-built performance.

The new Heathkit AJ-21

low cost AM TUNER brings you hi-fi reception and new styling for just \$29.95

- "Fidelity" Selector switch
- Three tuned stages
- Self-powered
- Exciting new styling



Kit AJ-21

\$29⁹⁵

With the exciting new styling of charcoal grey enamel on its steel cabinet and ivory-colored bezel and lower front panel, the new Heathkit AJ-21 AM Tuner proudly awaits display in any room in your home. This superb successor to the AJ-20 brings you high fidelity AM reception at a budget price and in a size convenient to everyone . . . for bookshelves, tables, etc.

This self-powered unit has three tuned stages for high sensitivity and a full wave voltage doubler detector for lower distortion. The "fidelity" switch gives you a choice of maximum selectivity or maximum fidelity. One of the two outputs is the variable level cathode follower type for the direct driving of power amps, regardless of cable length . . . the other output is fixed for use with preamplifiers. Has built-in rod antenna and provision for external antennas. Flywheel tuning and edge-lighted slide-rule dial. 9 lbs.

Kit AJ-21... NO MONEY DOWN, \$5 mo. **\$29.95**

SPECIFICATIONS—Tuning range: 550 kc to 1600 kc. Intermediate frequency: 455 kc. Sensitivity (for 20 db quieting IHFM standards): 1000 kc—8 uv. IF bandwidth (6 db down): NORMAL—7 kc.; MAXIMUM—18 kc. Output impedance (cathode follower): 5000 ohms. Input signal for 1 volt output: 2.5 uv—30% mod. 1000 kc. Image ratio: 1000 kc—50 db. Harmonic distortion (750 uv 95% mod.): Less than 1%. Hum and noise (500 uv—30% mod.): 40 db. IF rejection: 1000 kc—35 db. Tube complement: 2—6BA6, RF amplifier—IF amplifier. 1—6BE6, Oscillator-Mixer. 1—12AU6, AF Amplifier-Cathode follower. 2—Crystal Diodes, Audio Detector. 1—Silicon Diode, Rectifier (Power Supply). 1—No. 47 Pilot Lamp (Dial Illumination). Power supply: Transformer operated (fused). Power requirements: 117 V AC, 50/60 cycles at 19 watts. Dimensions: Overall—including cabinet and feet, 4-15/16" high x 13 1/2" wide x 6" deep.

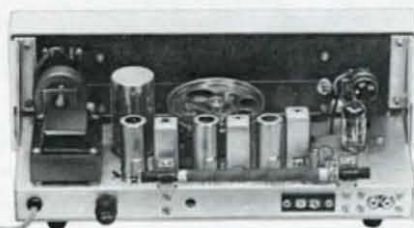

This inside view of the AJ-21 shows the clean, straight-forward circuitry employed by Heath engineers to provide dependable performance and ease of assembly.

Styling, Excellent Performance, Big Savings



The inside of the new Heathkit AA-181 Amplifier shows the roomy arrangement for easy assembly and the sturdy components that guarantee long life.



Kit AA-181
\$42⁹⁵

- Full 25 watt output—hi-fi rated
- Separate bass and treble tone controls
- Four switched inputs
- Modern styling—matches AJ-21 & AJ-31

This new Heathkit 25-watt MONO COMBINATION AMPLIFIER . . . handsome, powerful, economical . . . is destined to become another Hi-Fi favorite

The new Heathkit AA-181 Preamp-Amplifier combination replaces the famous A-9C Amplifier, a long-time favorite with hi-fi fans the world over. With increased power, true hi-fi rated performance and completely new styling, it is designed to complement and match perfectly with the new AJ-31 and AJ-21 Tuners on the opposite page to provide a coordinated monophonic system. Housed in a beautiful charcoal grey steel cabinet with ivory-colored bezel and lower front panel, this beautiful amplifier is a striking component in any music system setting.

In addition to these visual advances, the AA-181 gives you a pre-amplifier, power amplifier and power supply, all in one compact unit to provide more than enough hi-fi power to drive any acoustic suspension speaker system such as the Heathkit AS-2 or AS-10 (page 55). It has excellent gain characteristics and employs fixed bias push-pull 7591 tubes to provide 25 watts of dependable hi-fi rated power with minimum distortion. The preamplifier section features four separate inputs (microphone, magnetic phono cartridge, crystal or ceramic phono cartridge and auxiliary), each properly compensated and selected by the panel-mounted selector switch. The separate bass and treble tone controls each offer 15 db boost and cut. Twin-triode miniature tubes

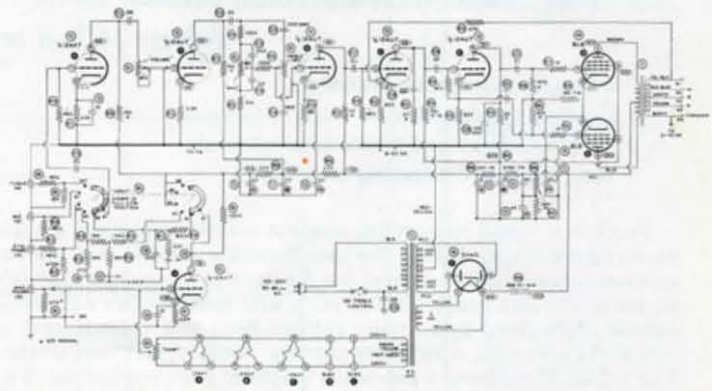

in the preamplifier, tone control and phase splitter stages assure low hum and noise levels. The output transformer is tapped at 4, 8 and 16 ohms to match practically any speaker system. A shielded, heavy-duty power transformer assures long, trouble-free life. The neon pilot light serves as a convenient operating reminder.

Easy to assemble with Heathkit's famous "check-by-step" instructions, you'll find building the AA-181 is half the fun of owning it. Order your AA-181 today, its faithful performance, handsome appearance, and great value assure your satisfaction for years to come.

Kit AA-181 . . . 21 lbs. . . NO MONEY DOWN, \$5 mo. \$42.95

SPECIFICATIONS—Power output: 25 watts Heath hi-fi rating; 30 watts IHFM music power rating (0.7% THD @ 1 KC). **Power response:** ±1 db, 30 cps to 15 kc; at 25 watts output. **Harmonic distortion:** Less than 2% at 30 cps—15 KC and less than 0.7% at 1 KC at 25 watts output. **Intermodulation distortion:** Less than 2% at 25 watts using 60 cps and 6000 cps signals. **Hum and noise:** Microphone—60 db or better; Mag. Phono—55 db or better; Xtal Phono—60 db or better; Auxiliary—60 db or better. **Input sensitivity:** For 25 watts output with tone controls flat—Microphone—9 mv; Mag. phono—5 mv (at 1 KC); Xtal Phono—120 mv; Auxiliary—200 mv. **Outputs:** 4, 8 and 16 ohms. **Damping factor:** 9. **Controls:** 4-position selector switch, volume control, bass control and treble control with ON/OFF switch. **Tube complement:** 2—6EU7; 1—12AU7; 2—7591; 1—5AR4; 1—Selenium bias rectifier. **Power requirements:** 117 volts 50-60 cps, 120-135 watts. **Power outlets:** 1 AC receptacle, unswitched. **Indicator:** Neon pilot light. **Color & finish:** Charcoal grey with ivory bezel and lower front panel. **Dimensions:** 13½" W x 4-15/16" H x 9½" D.

Combination Mono Amplifiers for every Budget!

Kit Form
or
Factory
Assembled



Kit AA-161

\$33⁵⁴

Features
patented Heath
ULTRA-LINEAR®
circuit!



New MONO COMBINATION AMPLIFIER, Heathkit AA-161,
delivers 14 hi-fi rated watts

- 3 inputs—complete controls
- Built-in preamplifier
- Separate bass and treble tone controls
- New "modern" styling concept

Fresh in a brand-new styling concept which emphasizes the quality of the performance it can deliver, the new Heathkit AA-161 is a top value 14-watt combination monophonic amplifier designed to power your high fidelity system economically and easily. This striking unit incorporates a charcoal grey steel cabinet highlighted by an ivory colored bezel and bottom front panel which will blend smoothly with either the new AJ-21 AM Tuner or the new AJ-31 FM Tuner. Combining a top-notch amplifier and preamplifier in a single low-cost package, the AA-161 provides rich, full range sound reproduction and low noise and distortion levels thanks to Heath's quality design and engineering "know-how". The use of miniature tubes throughout results in a compact chassis layout which is easy to construct. EL-84 output tubes in a push-pull output circuit perform outstandingly with the specially-designed output transformer. A filament-balance control virtually eliminates AC hum for superb listening at low volume levels. The three separate inputs of the AA-161 will accommodate magnetic and crystal phono cartridges, tape recorder or tuner program sources. Separate bass and treble tone controls enable you to precisely adjust the sound to your particular taste.

Remember, the new Heathkit AA-161 is the successor to the fine EA-3 monophonic combination amplifier that has built a splendid reputation for providing dependable power at low, low cost. Order yours today. 15 lbs.

Kit AA-161... NO MONEY DOWN, \$5 mo. \$33.54
Assembled AAW-161... NO MONEY DOWN, \$7 mo. \$62.95

SPECIFICATIONS—Power output: 14 watts Heath Hi-Fi Rating; 16 watts IHFM Music Power Output (2% THD, 1 kc). **Power response:** ± 1 db 30-15,000 cps, 14 watts output. **Harmonic distortion:** Less than 2%, 30 cps to 15 kc, at 14 watts output. **Intermodulation distortion:** 2% or less at 14 watts output using 60 and 6,000 cps signals, 4:1. **Hum and noise:** mag. phono input, 55 db below 14 watts; tuner and crystal phono, 65 db below 14 watts. **Input sensitivity:** For 14 watts output; mag. phono, 0.004 v at 1 kc; crystal phono, 0.2 v; tuner 0.25 v, with tone controls flat. **Outputs:** 4, 8 and 16 ohms. **Damping factor:** 10:1. **Controls:** 3-position function selector switch, bass and treble tone controls, volume control. **Tube complement:** 6EU7, 1-6AU6, 1-6ANB, 2-EL84/6BQ5, 1-EZ81/6CA4. **Power requirements:** 117 v, 50-60 cycles, 55 watts. **Color and finish:** Charcoal grey steel cabinet and upper front panel with ivory colored bezel and lower front panel.



- Three controls—bass, treble, volume
- Two separate inputs
- 3-watt power output
- New styling features
- Perfect for "starter" systems



Kit AA-191

\$16⁸⁸



In the new budget-line styling, the
Heathkit AA-191 monophonic
combination AMPLIFIER...
handsome, versatile, economical

Here's your way to an economical music system—the handsome new Heathkit AA-191, Economy 3-watt Combination Monophonic Amplifier kit. The attractive new styling of this amplifier features a soft-black cabinet with an ivory high-lighted control area. Like its predecessor, the world-known Heathkit EA-1, this little giant is perfect for the high fidelity "beginner" or for powering a second system around your home—and it sells for just \$16.88

The AA-191 may also be used effectively as an additional power source for a radio or TV set to increase the fidelity and power of these units.

With the addition of an economical Heathkit program source (tuner, crystal phono, tape recorder, etc.) the AA-191 becomes the "heart" of an "economy" music system. It has a built-in preamplifier which provides all the necessary tone and volume controls for excellent reproduction of your favorite musical selections. Two inputs accommodate tuner or tape recorder and crystal or ceramic cartridge record player. Outputs are provided for 4, 8 and 16 ohm speakers. 7 lbs.

Kit AA-191... \$16.88

SPECIFICATIONS—Power output: 3 watts, Heath Utility Rated. **Power response:** ± 1 db 60 cps to 15,000 cps at 3 watts output. **Harmonic distortion:** Less than 3% 60-15,000 cps at 3 watts output. **Intermodulation distortion:** Less than 3% at 3 watts output, 60 and 6,000 cps signal mixed 4:1. **Hum and noise:** 70 db below 3 watts. **Input sensitivity:** 0.15 v for 3 watts output, crystal phono and tuner. **Outputs:** 4, 8 and 16 ohms. **Controls:** bass, treble, volume, input selector switch, on-off switch. **Tube complement:** 1-EF86, 1-EL84/6BQ5, 1-6X4. **Power requirements:** 117 v, 60 cycles, 49 watts. **Color and finish:** Satin black, ivory face panel. **Dimensions:** 9½" W x 3¼" H x 6" D.

Quality Separate Monophonic Components

81-091

1 2 3 4 5 6

HEATH COMPANY

A Subsidiary of Daystrom, Inc.

BENTON HARBOR, MICHIGAN

TWX - ST. JOSEPH, MICH. 58
PHONE • YUKON 3-3961

- CASH
Please use registered mail for currency.
- C. O. D.
20% deposit required
- TIME PAY.
- ADD ON

ORDER BLANK

1 PLEASE PRINT OR WRITE NAME AND ADDRESS PLAINLY

PLEASE DO NOT WRITE IN THIS SPACE

2 SHIP TO ANOTHER ADDRESS? Give directions here.

5 IF YOU HAVE MOVED SINCE YOUR LAST ORDER—
write your old address here:

STREET ADDRESS _____

CITY _____

STATE _____

3 CHECK HOW YOU WANT ORDER SHIPPED

Parcel Post Motor Freight Express

6 TO HELP US SERVE YOU BETTER, will you please answer the following questions?

What type of Heathkit interests you most?

- Hi Fi Instruments
 Amateur Radio Marine
 Other _____

What new Heathkits would you like us to make? _____

ON EXPRESS ORDERS if station is in different town than your post office address, show name of town where shipment should be sent:

TOWN _____ STATE _____

4 IS THIS YOUR FIRST ORDER? _____ IF PREVIOUS TIME PAY CUSTOMER, GIVE CURRENT ACCOUNT NUMBER _____

SHIPPED	B. ORD'D.	QUANT.	MODEL	KIT DESCRIPTION	WT.	PRICE EACH	TOTAL	
PLEASE DO NOT WRITE IN THIS SPACE ONLY ITEMS IN THIS COLUMN ARE CHARGED FOR	ITEMS LISTED IN THIS COLUMN ARE TEMPORARILY OUT OF STOCK. THEY WILL FOLLOW SHORTLY, UNLESS CANCELLED.							

IMPORTANT. Please use a separate sheet for all correspondence, to speed your order and assure a prompt reply to your letter.

All prices quoted are net F.O.B. Benton Harbor, Michigan, and apply to the United States, F.P.O. and A.P.O. areas.

All prices and specifications subject to change without notice.

Orders from F.P.O.'s and A.P.O.'s must include sufficient postage.

All C.O.D. orders must be accompanied by 20% deposit.

PARCEL POST ORDERS should include postage for weight shown. Often orders for two or more kits can be shipped in a larger single carton. On orders involving several kits, allow for a few more pounds total shipping weight. Excess postage will be promptly refunded.

TIME PAYMENT ORDERS except A.P.O.'s and F.P.O.'s will be shipped express or motor freight.

Transportation costs for all express or motor freight shipments will be collected at the time of delivery.

SEE REVERSE SIDE for time payment details on orders of \$25 or more.

DATE SHIPPED

PLEASE DO NOT WRITE IN THIS SPACE

AMOUNT

SHPG. CHG.

TOTAL

YOU REMITTED

BAL. DUE

REFUND

7 Total amount of order.

Add sales tax on all deliveries in the State of Michigan.

Amount for parcel post. Do not remit for express charges.

Amount due Heath from previous order.

TOTAL AMOUNT
 Remitted.
 Ship Bal. C.O.D. 20% deposit required

DOWN PAYMENT
(optional)

UNPAID BAL.
(total order less down payment)

INVOICE



and extra value

ers a full hi-fi rated this versatile and enameled chassis er give the AA-81 ity components to

make it stand out ures, the Heathkit -LINEAR circuit controls assure low level control and ned output trans- e easy assembly of 's famous "check- tion with factory-

..... \$49.95

Power Output (0.7% THD, is than 25, 20-20,000 cps at cps signals, 4:1. Hum and 16, and 32 ohms. Damping inance, Level, On-Off. Tube 117 v, 50-60 cycles, 100-130 -amp power, supplies 300 v illic bronze expanded metal

anteed

Combination Mono Amplifiers for every Budget!

Kit Form

Open your Heath account with no money down!

LIBERAL TERMS! Time payments are available to anyone in the U.S. or FPO and APO areas. No money down on orders of \$25 to \$600; over \$600 write for details. Up to 18 months to pay on orders over \$300; write for details. Here's all you do . . .

- 1 Fill out the order blank.
- 2 Sign your name in the TP agreement below, fill in the credit statement and the monthly payment. (See Chart) If you wish to send down payment, show this amount also.
- 3 Send the above to Heath Company, Benton Harbor, Michigan . . . we'll take care of the details.

"ADD ON" Purchases—Once your credit is established and you have made at least three payments, you can "add-on" purchases of \$25.00 or more with no down payment. List the items you want on the reverse side, check the "add on" box at the top and give your account number in (4). Be sure to sign the Time Payment Agreement, and send to us with your original Payment Book.

Unpaid Balance	Carrying Charge	Up To 12 Monthly Payments*	Unpaid Balance	Carrying Charge	Up To 12 Monthly Payments*
Up to \$20.00	\$ 2	\$ 5	160.01-170	\$ 17	\$ 16
\$ 20.01-30	3	5	170.01-180	18	17
30.01-40	4	5	180.01-190	19	18
40.01-50	5	5	190.01-200	20	19
50.01-60	6	6	200.01-210	21	20
60.01-70	7	7	210.01-220	22	21
70.01-80	8	8	220.01-230	23	22
80.01-90	9	9	230.01-240	24	22
90.01-100	10	10	240.01-250	25	23
100.01-110	11	11	250.01-260	26	24
110.01-120	12	11	260.01-270	27	25
120.01-130	13	12	270.01-280	28	26
130.01-140	14	13	280.01-290	29	27
140.01-150	15	14	290.01-300	30	28
150.01-160	16	15	†Over \$300.00 write for details		

*All monthly payments are for amount shown except for last payment which is for the odd amount remaining due.

TIME PAYMENT AGREEMENT

NOTE: Time payment agreement cannot be accepted from persons under 21 years of age. If you are under 21, have this form filled out by a person of legal age, regularly employed or engaged in business. He can make the purchase for you, and will be responsible for payment.

TO: HEATH COMPANY BENTON HARBOR, MICHIGAN

Enclosed is a deposit of \$_____ (Deposit optional) on the Easy Payment cost of the equipment on the reverse side, I will pay \$_____ each month to you at the above address starting 30 days after shipment, until the total time payment price is paid.

Title to and right of possession of said equipment shall remain with you until all payments have been made. Upon default on any payment due on this contract, the full amount unpaid hereon, at your option, shall become immediately due and payable and you may either hold me liable for said amount or repossess the equipment. If you shall repossess, all payments made may be retained as rent for the use and depreciation of said equipment. The loss, injury or destruction of the equipment after I have received it shall not operate as payment or in any manner release me from any obligation hereunder.

If this order is not accepted, you shall refund the down payment with notice of non-acceptance. Acceptance shall be effected when the equipment designated on the reverse side hereof is shipped to me. I certify that all statements in the Credit Statement set forth below are true and complete and are made for the purpose of obtaining credit. This contract is to be governed by the laws of the State of Michigan.

Enter Date _____ Sign Here _____

CREDIT STATEMENT

(IMPORTANT: Please fill in completely. Omissions and errors cause delays.)

PRINT FULL NAME _____ Age _____ Military Serial No. (if serviceman) _____

First _____ Middle _____ Last _____

WIFE'S NAME _____ Names of Children and ages _____

Residence _____ City _____ State _____ How Long _____

Own or Buying Landlords If Owned Rent Live with Parents No. of Rooms _____ Paid Monthly \$ _____ Phone No. _____

Name Mtg. Held By _____ Street _____ City _____ State _____

Previous Address _____ City _____ State _____ How Long _____

Previous Landlord _____ Address _____

Employed by _____ Street _____ City _____ State _____

Position _____ How Long _____ Dept. or Badge No. _____ Salary \$ _____

Previous Employer _____ Street _____ City _____ State _____ How Long _____

Wife's Employer _____ Street _____ City & State _____

Position _____ How Long _____ Dept. or Badge No. _____ Salary \$ _____

Other Income—Give Details _____ Total Family Income \$ _____

Your Bank _____ Address _____ Type of Account _____

CREDIT REFERENCE (Give 2 Merchants, Firms or Finance Companies with whom you do or have done business.)

First Credit Reference _____ Address _____ Present Balance \$ _____ Monthly Payment \$ _____

Second Credit Reference _____ Address _____ Present Balance \$ _____ Monthly Payment \$ _____

Nearest Relative _____ Address _____ Relationship _____ (Do not list those with whom you are living)



New MONO COM

- 3 inputs—co
- Built-in prea
- Separate ba
- New "mode

Fresh in a brand performance it can combination mono economically and e cabinet highlighted will blend smoothly FM Tuner. Combin cost package, the / low noise and distor "know-how". The chassis layout whic output circuit perfo former. A filament-listening at low vol accommodate magr program sources. Se adjust the sound to Remember, the ne phonic combination ing dependable pow

Kit AA-161...NO MC Assembled AAW-161

SPECIFICATIONS—Power 1 kc). **Power response:** ± 1 at 14 watts output. **Intermod Hum and noise:** mag. phon **sensitivity:** For 14 watts out flat. **Outputs:** 4, 8 and 16 oh treble tone controls, volume **Power requirements:** 117 v, panel with Ivory colored bezel

50 Heathkit Equip

Quality Separate Monophonic Components



Features patented Heath **ULTRA-LINEAR®** circuit!

Elegant new styling plus dependable performance are in the New **AA-131 MONOPHONIC PREAMP**

- Self-powered
- Baxandal type tone controls
- 6 inputs for versatility
- Cathode follower outputs



Kit AA-131

\$24.95

Proud successor to the famous Heathkit AA-60, the new AA-131 Monophonic Preamplifier adds a striking new styling concept to its time-proven performance qualities. Charcoal grey enamel covers the all-steel case and an ivory-colored bezel and lower front panel highlight the modern motif. Always dependable, always versatile, the AA-131 has six inputs—magnetic phono, tape head (enough gain and NARTB equalized to by-pass tape recorder playback electronics), microphone, tuner, crystal phono and auxiliary. And it can be used with any monophonic power amplifier because it is self-powered. Other features include input level controls for microphone and phono inputs, cathode followers on normal and tape recorder outputs to insure minimum high frequency loss regardless of connecting cable length. Baxandal-type controls give more flexible command of bass and treble tone.

If you have put off purchasing a new preamp for your monophonic system or are planning an extra system for the recreation room or patio, you'll find the Heathkit AA-131 a giant value at only \$24.95. And remember, with Heath's famous time-payment plan, you need pay **NO MONEY DOWN**. Order today! 6 lbs.

Kit AA-131... **NO MONEY DOWN**,

\$5 mo. **\$24.95**

SPECIFICATIONS—Input impedance: (At 1 KC) mag. phono 47 K ohm; tape head 82 K ohm; microphone 500 K ohm; tuner 1 megohm; xtal phono 1 megohm; aux. 1 megohm. **Input sensitivity:** (2.5v, rms output at 1 KC) Mag. phono .0035 v; tape head .004 v; microphone .01 v; tuner .1 v; xtal phono .12 v; auxiliary 1 v. **Outputs:** (2) Normal & Tape recorder. **Frequency response:** ± 1 db 20-20,000 cps. **Harmonic distortion:** 0.2% or less. **IM distortion:** 0.25% or less. **Dimensions:** 4 1/4" H x 13 1/4" W x 5 1/2" D.



Kit AA-81

\$49.95

Heath's patented **ULTRA-LINEAR®** circuit and efficient layout make the AA-81 easy-to-build, and provide dependable, trouble-free operation.

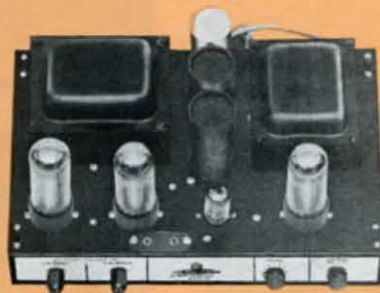

Hi-Fi Rated 35 watt MONO POWER AMPLIFIER

has new styling, power to spare and extra value

- Use with any preamplifier
- Ideal power for most speakers
- Guaranteed long-life—full power ratings
- Patented **ULTRA-LINEAR®** circuit
- Modern styling concepts

The Heathkit AA-81 Monophonic Power Amplifier delivers a full hi-fi rated 35 watts for a mere \$49.95! And the new, elegant styling of this versatile and dependable performer will complement any system. A black enameled chassis and a metallic bronze ventilated, expanded metal dust-cover give the AA-81 the modern look that blends with other Heathkit high fidelity components to make uniform, eye-appealing additions to any room setting.

The price tag alone on this remarkable unit is enough to make it stand out from competitive amplifiers, but when you compare its features, the Heathkit AA-81 is unmatched for value. Heath's patented **ULTRA-LINEAR** circuit delivers maximum performance. Bias voltage and balance controls assure low distortion—even with unmatched output tubes. A built-in level control and AC switch provide extra convenience. The specially-designed output transformer delivers full rated power with plenty of margin. The easy assembly of the AA-81 is the result of excellent circuit layout and Heath's famous "check-by-step" instructions which assure successful home construction with factory-built performance. 24 lbs.

Kit AA-81... **NO MONEY DOWN**, \$5 mo. **\$49.95**

SPECIFICATIONS—Power output: 35 watts Heath Hi Fi Rating; 42 watts IHFM Music Power Output (0.7% THD, 1 kc). **Power response:** ± 1 db, 20 cps to 20 kc, at 35 watts. **Harmonic distortion:** Less than 2%, 20-20,000 cps at 35 watts output. **Intermodulation distortion:** 2% or less at 35 watts output 60 and 6,000 cps signals, 4:1. **Hum and noise:** 80 db below 35 watts. **Input sensitivity:** 0.9 v for 35-watts output. **Outputs:** 4, 8, 16, and 32 ohms. **Damping factor:** 16:1 at 8 and 16 ohm taps; 12.5:1 at 4 ohm tap. **Controls:** Bias voltage, Bias balance, Level, On-Off. **Tube complement:** 1-6AN8, 2-EL34, 1-6Z34, 1 selenium bias rectifier. **Power requirements:** 117 v, 50-60 cycles, 100-130 watts. **Power outlets:** 2 AC receptacles, 1 switched 1 unswitched; Octal socket for pre-amp power, supplies 300 v at 10 ma DC and 6.3 VAC at 1.0 amperes. **Color and finish:** Black enamel chassis, metallic bronze expanded metal cover. **Dimensions:** 12" W x 6 1/2" H x 8" D.

Heathkit performance specifications are guaranteed

Heathkit® hi-fi rated Monophonic Power



- A universal amplifier of many uses
- 14 Hi-Fi Rated Watts
- Supplies preamp power
- Input level control
- Variable damping
- 0.7 volt sensitivity for full output



Kit AA-61 **\$22⁹⁵**

Features patented Heath ULTRA-LINEAR® circuit!



- Williamson type amplifier circuit
- 20 Watt Hi-Fi Rating
- Use with any preamplifier
- Chassis or remote "on-off" provision
- Filament balance resistors
- Chicago Standard output transformer

Kit AA-71 **\$41⁴⁴**

Features patented Heath ULTRA-LINEAR® circuit!



- Full 55 watt Hi-Fi Rating
- Speaker and 70 volt line outputs for any application
- EL-34 output tubes with balancing circuit
- Use with any preamplifiers
- Has power supply protection device

Kit AA-91
\$59⁹⁵



Features patented Heath ULTRA-LINEAR® circuit!

Amplifiers set industry styling and value pace

The new Heathkit AA-61 POWER AMPLIFIER—just \$22.95 for 14 watts!

Now the famous Heathkit UA-2 Monophonic Power Amplifier has a brand new styling concept designed to blend tastefully with other components of the Heathkit high-fidelity line. Now designated the Heathkit AA-61, it's a striking beauty with black chassis and ivory highlighted front panel . . . and it continues to provide 14 hi-fi rated watts of power for a mere \$22.95.

Heath's patented ULTRA-LINEAR® output circuit assures low distortion and efficient operation. You get improved speaker performance by the selection of either "unity" or "maximum" damping. The AA-61 features an input level control, provision for switching the amplifier on and off at the chassis or from a remote location, and the capability of working in conjunction with either self-powered or externally-powered preamplifiers.

Truly a "universal" power amplifier, this budget-wise beauty is powerful enough for almost any high fidelity application or it can be used as a line bridging amplifier for unbalanced lines in public address

networks, wired music systems, paging units, etc.

The Heathkit AA-61 is easy to build too! Straight-forward circuit layout and the comprehensive "check-by-step" instructions let you assemble in confidence that you are guaranteed success. Application notes for use of the AA-61 Monophonic Power Amplifier are also included with the instruction manual.

Now's the time to purchase this powerful, low-cost amplifier and find out for yourself Heathkit is the value name in electronic kits.

Kit AA-61 . . . 12lbs. \$22.95

SPECIFICATIONS—Power output: 14 watts Heath Hi-Fi Rating; 16 watts IHFM Music Power Output (0.7% THD, 1 kc). **Power response:** ± 1 db 20-20,000 cps, at 14 watts output. **Harmonic distortion:** Less than 2%, 20-20,000 cps, at 16 watts output. **Intermodulation distortion:** Less than 2% at 16 watts output, 60 and 6,000 cps signals, 4:1. **Hum and noise:** 73 db below 14 watts. **Input sensitivity:** 0.7 v for 14 watts output. **Outputs:** 4, 8 and 16 ohms. **Damping factor:** Switched for unity or max. (15.66:1). **Controls:** Gain Control, damping switch, on-off switch. **Tube complement:** 1-6AN8, 1-EZB1/8CA4, 2-EL84/6BQ5. **Power requirements:** 117 v, 50-60 cycles, 50 watts. **Power outlets:** Octal socket for pre-amp power, supplies 300 v at 10 ma, 6.3 v AC at 1.1 ampere. **Color and finish:** black with ivory highlighted front panel. **Dimensions:** 10" W x 4 3/4" H x 6 1/2" D.

The new AA-71 delivers 20 hi-fi rated watts of dependable power

For a medium-priced, medium-power monophonic power amplifier you just can't match the value of the Heathkit AA-71, proud successor to the renowned W-4B. This powerful unit delivers a full 20 watts, hi-fi rated to handle any power need in your system. And the new modern styling of the AA-71 with its black enamel chassis with ivory highlighted front panel makes this handsome unit perfectly coordinated for inclusion in a system with Heathkit tuners and preamps which have the new Heathkit styling or the previous motif.

The AA-71 features the "Williamson-type" amplifier circuit with 5881 "push-pull" output tubes and a specially-designed "Ultra-Linear" Chicago Standard output transformer which gives faithful, full fidelity service in every installation. A preamplifier power socket permits you to use the AA-71 with any self-powered or externally-powered pre-amplifier. Another convenience feature of the AA-71 is that you can turn the amplifier "on" or "off" at the chassis or a remote location.

This remarkable power amplifier measures a mere 15 1/2" W x 7" H x

8 7/8" D for easy installation in cabinets or shelves with your other system components. Assembly of the AA-71 is simple when you follow the famous Heathkit "check-by-step" instructions and comprehensive manual that includes large, fold-out illustrations to show exactly where and how each part is installed.

The new Heathkit AA-71 merits your serious consideration for inclusion in any music system you are planning. It's a remarkable value from every standpoint—quality, performance, features or appearance.

Kit AA-71 . . . 24 lbs. . . . NO MONEY DOWN, \$5 mo. \$41.44

SPECIFICATIONS—Power output: 20 watts Heath Hi Fi Rating; 20 watts IHFM Music Power Output (0.7% THD, 1 kc). **Power response:** ± 1 db, 30 cps to 15 kc, at 20 watts output. **Harmonic distortion:** Less than 2%, 30 cps to 15 kc, at 20 watts output. **Intermodulation distortion:** Less than 2% at 20 watts output using 60 and 6,000 cps signals, 4:1. **Hum and noise:** 95.2 db below 20 watts output. **Input sensitivity:** 2 v for 20 watts output. **Outputs:** 4, 8 and 16 ohms. **Damping factor:** 28.5:1. **Controls:** Output tube balance control, on-off switch. **Tube complement:** 2-5881, 2-6SN7, 1-5V4. **Power requirements:** 117 v, 50-60 cycles, 115 watts. **Power outlets:** Octal socket for pre-amp power, supplies 275 v DC at 10 ma, 6.3 v AC at 1.1 ampere; 1 AC outlet switched.

The new Heathkit AA-91 Monophonic POWER AMP—55 watts for only \$59.95!

Now resplendent in a metallic-bronze ventilated cover and black enamel chassis with ivory-highlighted front panel, the Heathkit AA-91 Monophonic Power Amplifier combines all the features of its illustrious predecessor, the W-7A, plus latest styling advances to blend with other Heathkit units.

The AA-91 Amplifier delivers a powerful 55 hi-fi-rated watts for a comfortable margin of distortion-free power in any audio application. And, the extra 70-volt line output of this remarkable value makes it suitable for public address systems and wired music circuits in business and commercial establishments. The AA-91 may be used with any self or externally powered preamplifier.

Switched damping is provided for any 4, 8 or 16 ohm speaker, with an individually optimized output for each impedance. Each output has a separate current feedback circuit for unity damping. The silicon diode power supply insures superior regulation and longer life through the use of a special power supply protection device which limits the current in the transformer primary until all the tubes have had adequate time to warm up.

The famous Heathkit "balancing circuit" eliminates the need for an expensive, matched set of EL-34 output tubes. The compact, well-ventilated cabinet lends itself to any type of installation . . . cabinet, open shelf or "built-in". The pilot light on the front of the chassis serves as a convenient reminder of operation. Assembly of the AA-91 is simplified by a wiring harness supplied along with complete, easy-to-understand "check-by-step" instructions.

For powerful quality, the new Heathkit AA-91 Monophonic Power Amplifier gives you more for your money. Order yours today! 26 lbs.

Kit AA-91 . . . NO MONEY DOWN, \$6 mo. \$59.95

SPECIFICATIONS—Power output: 55 watts Heath Hi Fi and Professional Rating; 67 watts IHFM Music Power Output (0.7% THD, 1 kc). **Power response:** ± 1 db, 20-20,000 cps, at 55 watts output. **Harmonic distortion:** Less than 2%, 20-20,000 cps, at 55 watts output. **Intermodulation distortion:** Less than 1% at 55 watts output, 60 and 6,000 cps signals, 4:1. **Hum and noise:** 80 db below 55 watts output. **Input sensitivity:** 2 volts for 55 watts output. **Outputs:** 4, 8 and 16 ohms, plus 70.7 volt line output. **Damping factor:** Switched for unity or max (20). **Controls:** Gain, on-off, damping factor. **Tube complement:** 1-6AN8, 2-EL34. **Rectifiers:** 4-500 ma silicon rectifiers, 1-selenium bias rectifier. **Power requirements:** 117 v, 50-60 cycles, 90-160 watts. **Power outlets:** Octal socket for pre-amp power, supplies 300 volts at 10 ma DC. 1 AC receptacle-switched. **Color and finish:** black enamel chassis with ivory highlighted front panel; metallic bronze ventilated cover. **Dimensions:** 15" W x 6 1/4" H x 8 1/2" D.

Heathkit® Speaker Systems bring you



Altec Lansing High Frequency Driver

Specialty designed exponential horn



Altec Lansing 12" high compliance, low frequency speakers

Plywood Cabinet, 3/4" thick Furniture-grade



AS-21W

\$239⁹⁵

The famous LEGATO-COMPACT is the world's finest speaker system value

- Speakers by Altec Lansing cover 30—22,000 cps
- Preassembled cabinets in Heath standard finishes, ready for speaker installation
- Modern styling matches AE-20 center cabinets
- 800 cps crossover network—completely assembled
- Can be driven by as little as 3 watts

Shop everywhere . . . investigate every speaker system on the market today . . . you will find that none compare in tonal brilliance, fidelity and value with the Heathkit AS-21, the Legato-Compact. Like its predecessor, the world-renowned "Legato," the Legato-Compact combines acoustical excellence with engineering skill, but adds the highly desirable attribute of unusual space economy. Together these features make the Legato-Compact your greatest speaker system quality buy.

When you unpack this AS-21, you will discover immediately why so many persons praise it to the sky. It features two 12" Altec Lansing "high compliance," low-frequency speakers that cover the 30-800 cps range with rich, full-bodied tone. In addition, a newly-designed special Altec Lansing exponential horn and high frequency driver combination covers frequencies from 800 to 22,000 cps with complete fidelity and brilliance of tonal quality. The special 800 cps "crossover network" is factory assembled and ready to install in the Legato-Compact when you unpack it.

Another fabulous feature of this value-packed speaker system is the high efficiency of the speakers—amplifiers with just 3 watts output power can drive the system with ease, yet it is capable of handling program material of 30 watts.

The cabinets of the Legato-Compact come in either walnut or mahogany finishes or unfinished birch. Each cabinet is factory assembled and constructed of 3/4" furniture grade plywood. The styling matches the Heathkit AE-20 cabinets shown on p. 58—they form a beautifully coordinated high fidelity music center that does credit to any home.

Order your Legato-Compact now. You'll experience a whole new sensation in high fidelity sound that is unmatched in quality and value. 132 lbs.

Kit AS-21W . . . walnut . . . NO MONEY DOWN, \$22 mo. **\$239.95**

Kit AS-21M . . . mahogany . . . NO MONEY DOWN, \$22 mo. **\$239.95**

Kit AS-21U . . . unfinished . . . NO MONEY DOWN, \$22 mo. **\$229.95**

AS-31: All components of AS-21 except cabinet for custom installations. Cabinet dimensions included . . . 53 lbs.

NO MONEY DOWN, \$18 mo. **\$184.95**

SPECIFICATIONS—Frequency response: 30-22,000 cps. **Power rating:** 30 watts program material. **Nominal impedance:** 16 ohms. **Cabinet type:** Modified infinite baffle. **Dimensions:** 32" L. x 19" D. x 32 3/4" H. **Magnet wts.:** Low-frequency drivers: 1 1/2 lbs. each. High-frequency driver: .53 lbs. **Crossover network:** 800 cps constant K high frequency shelving type. **Driving power:** as low as 3 watts.

ENJOY YOUR HEATHKIT STEREO HI-FI SYSTEM . . . WITH NO MONEY DOWN, EASY MONTHLY PAYMENTS!

Thanks to Heath's new time payment plan, you can order and enjoy the stereo/hi-fi system of your choice right now and pay for it in easy monthly payments tailored to fit your budget . . . no money down needed on any order totaling \$25 up to \$600. Don't delay ordering your Heathkit stereo/hi-fi system any longer . . . check the order blank for details on this new easy time pay plan.

true high fidelity sound at low cost

Get the advantages of **ACOUSTIC SUSPENSION SPEAKERS**

for as little as \$59.95 with the AS-10



Kit AS-10U

\$59⁹⁵



- 10" acoustic suspension woofer
- Two 3½" cone-type tweeters
- Preassembled cabinets in three finishes
- Takes only 10 watts to drive, yet handles up to 40 watts
- Covers 30—15,000 cps

Have you ever dreamed of enjoying all the advantages of a speaker system that features acoustic suspension—the extended bass response and the brilliant high frequencies—but considered the price of such a unit prohibitive? With the new Heathkit AS-10 Speaker System you can have these features at nominal cost—as little as \$59.95. The exciting AS-10 has in its bookshelf-size cabinet such features as a 10" acoustic suspension woofer and two 3½" cone-type tweeters. Covering 30-15,000 cps, the AS-10 system has a truly amazing sound. And it requires as little as 10 watts to drive so it will work with most any amplifier. You can place this speaker system in your own hi-fi/stereo arrangement either vertically or horizontally because it features a rotatable tweeter mounting for best dispersion. A high frequency control and crossover network are included. The preassembled cabinets are available prefinished in either walnut or light mahogany or sanded unfinished. 24" L x 11½" D x 13½" H. 39 lbs.

Kit AS-10U (unfinished)... NO MONEY DOWN, \$6 mo. **\$59.95**
 Kit AS-10M (mahogany)... NO MONEY DOWN, \$7 mo. **\$64.95**
 Kit AS-10W (walnut)... NO MONEY DOWN, \$7 mo. **\$64.95**

SPECIFICATIONS—Frequency response: ± 5 db 30 to 15,000 cps; Crossover frequency: 2250 cps; Recommended amplifier power: 10 to 40 watts rms; Nominal impedance: 16 ohms; Tweeter: two 3½" cone units, in dispersed array, 1.47 oz. Alnico 5 mag.; Woofer: 10" Acoustic Suspension, 1 lb. Alnico 5 mag. Resonant frequency (mounted) 58 cps.; Crossover: L-C network; Horizontal dispersion: 90 degrees.

Here's the famous **AR-2 ACOUSTIC SUSPENSION**

SPEAKER SYSTEM in money-saving kit form!



Kit AS-2U

\$72⁹⁵



- 10" acoustic suspension woofer
- Two 5" cross-fired tweeters
- Preassembled, unfinished cabinet
- Exclusive with Heath

"Best we've ever heard" . . . "cleanest bass response I have ever heard" . . . "achieves the seemingly impossible" . . . such superlatives flowed from the pens of noted authors and editors of audiophile magazines when the Acoustic Research speaker appeared on the market a few years ago. A revolutionary principle in speaker design, the Acoustic Research speaker has been universally accepted as one of the most praiseworthy speaker systems in the world of high fidelity sound reproduction.

Because of an exclusive license granted to the Heath Company by Acoustic Research, Incorporated, you can now enjoy the quality and savings of the famous AR-2 acoustic suspension speaker system in kit form. The Heathkit AS-2U features a 10" woofer that delivers extended bass response with extremely low harmonic distortion. Also included in this excellent system are two cross-fired tweeters that give you outstanding high frequency distribution. This AS-2U kit is easy to build and includes parts for a 1000 cps L-C crossover network. The factory preassembled cabinet comes unfinished to let you choose your own decorating preference in adding the unit to your home surroundings. Enjoy the excellent sound of the AR-2 acoustic suspension system in your living room for no money down and as little as \$8 a month.

Kit AS-2U (unfinished), 44 lbs. . . NO MONEY DOWN, \$8 mo. **\$72.95**

SPECIFICATIONS—Frequency response: ± 5 db, 40 to 15,000 cps; Crossover frequency: 1,000 cps; Recommended amplifier power: 20 to 40 watts RMS; Nominal impedance: 8 ohms; Tweeter: two 5" cone units, specially treated and equalized, in dispersed array, 2.15 oz. Alnico 5 Magnet; Woofer: 10" Acoustic suspension, 1.1 lb. Alnico 5 Magnet. Resonant frequency (mounted) 58 cps; Crossover: L-C network; Horizontal dispersion: 90°.

We guarantee you can build any Heathkit

Heathkit® Offers a Wide Selection of Speakers and



Kit AS-51U **\$39⁹⁵**

favorite of hi-fi fans everywhere... the Heathkit BASIC HI-FI SPEAKER SYSTEM features new styling, new convenience

- **Factory assembled and finished cabinets**
- **Available in mahogany & walnut veneers or unfinished white hardwood**
- **High quality speakers of special design—8" mid-range woofer and compression-type tweeter with flared horn**
- **Built-in crossover network—tweeter level control**
- **May be used in upright or horizontal position**

The tremendous popularity of this superbly-designed speaker system is substantiated by the fact that thousands upon thousands are now in use in homes everywhere across the nation. Heathkit, long recognized for high quality at low cost, now brings you the same fine performance of the famous Heathkit SS-2 Speaker System with brand new styling! . . . and factory assembled cabinet! The specially-designed bass-reflex cabinet is available in prefinished walnut or mahogany veneer, and also in unfinished white hardwood suitable for the finish of your choice. The high quality grill cloth in deep brown and tan non-sag plastic and fiber is accented in a thin, clean-lined frame formed by the extended cabinet edge. Its smart, modern appearance will complement any room decor.

Two high quality speakers by Jensen, an 8" woofer and a true compression-type tweeter with flared horn provide exceptionally smooth response and clean audio reproduction over the entire basic frequency range of ± 5 db from 50 to 12,000 cps. A 1600 cps cross-over network is built-in, and a control is provided to adjust the power level of the tweeter to suit your listening requirements. Speaker impedance is 16 ohms and power rating is 25 watts of program material. The high efficiency design of the speakers allows use with high fidelity amplifiers having as little as 3 watts output.

Suitable for either vertical or horizontal mounting in book-shelves, etc., the AS-51 features a special tweeter mounting board that may be rotated so that the speaker maintains its proper plane in a horizontal position for wide-angle sound dispersion. Easily assembled in one evening, the AS-51 speaker requires only mounting of the speakers in the cabinet and wiring of the simple crossover network . . . everything else is already done for you!

An excellent speaker for those just starting a high-fidelity system or wishing to convert a present system to stereo. Music lovers everywhere will thrill to the amazing performance of this low-cost Heathkit favorite for years to come, get yours today! 24 lbs.

Kit AS-51U (unfinished) . . . NO MONEY DOWN, \$5 mo. **\$39.95**
Kit AS-51M (mahogany) . . . NO MONEY DOWN, \$5 mo. **\$46.95**
Kit AS-51W (walnut) . . . NO MONEY DOWN, \$5 mo. **\$46.95**

SPECIFICATIONS—Frequency response: ± 5 db, 50 to 12,000 cps; Crossover frequency: 1600 cps; Power rating: Program Material—25 watts, Single Frequency—15 watts; Nominal impedance: 16 ohms; Speakers: Low Frequency—8" Jensen (special design), 6.8 oz., Alnico 5; High Frequency—Jensen compression driver with exponential horn (special design), 4.7 oz., Alnico 5; L-pad—level control for high frequency driver. **Dimension:** 11 $\frac{1}{2}$ " H x 23" W x 11 $\frac{3}{4}$ " D.



Assembled ASW-41U **\$10⁹⁵**

Heath's low-cost HI-FI SPEAKER SYSTEM, the ASW-41, brings quality at a low price

- **Factory-built, completely assembled, ready-to-play**
- **Walnut or unfinished cabinets**
- **60-16,000 cps response**

The completely factory-built, low-cost speaker system, the Heathkit ASW-41, can be used in a variety of ways in your high-fidelity music system. You can use it as an extension speaker to other rooms, as a center fill-in speaker for a stereo system, or as a budget-minded economy system for your recreation room. The hi-fi/stereo beginners will also appreciate the excellent performance of this compact unit in addition to its attractive price tag. The ASW-41 is completely factory assembled of furniture grade birch veneer plywood and measures 11" W x 8" H x 6 $\frac{1}{2}$ " D. It comes in a walnut finish or unfinished. Equipped with a 6" x 9" extended range dual-cone speaker, it has a frequency response of 60-16,000 cps and 12 watts peak power. The ASW-41 is ready to use when you unpack it, for you simply connect its leads to your amplifier. 8 lbs.

Assembled ASW-41U (unfinished) **\$10.95**
Assembled ASW-41W (walnut finish) **\$12.95**

SPECIFICATIONS—Frequency response: 60 to 16,000 cps; Speaker: 6" x 9" oval extended range dual cone; Magnet: 6.8 oz., Alnico 5; Power handling capacity: 12 watts peak; Impedance: 8 ohms; Resonant frequency: 85 cps. Leads: 15' 2-conductor, rubber-covered.

EASY TIME PAYMENT

With Heath's sensational time payment plan, you can now order any kit or kits totaling \$25 to \$600 with **NO MONEY DOWN**, and low monthly payments. See the enclosed order blank for complete details and choose the Heathkit products you need without further delay. With Heathkit, you can build and enjoy now, pay later!

Systems to fill your every Listening Requirement

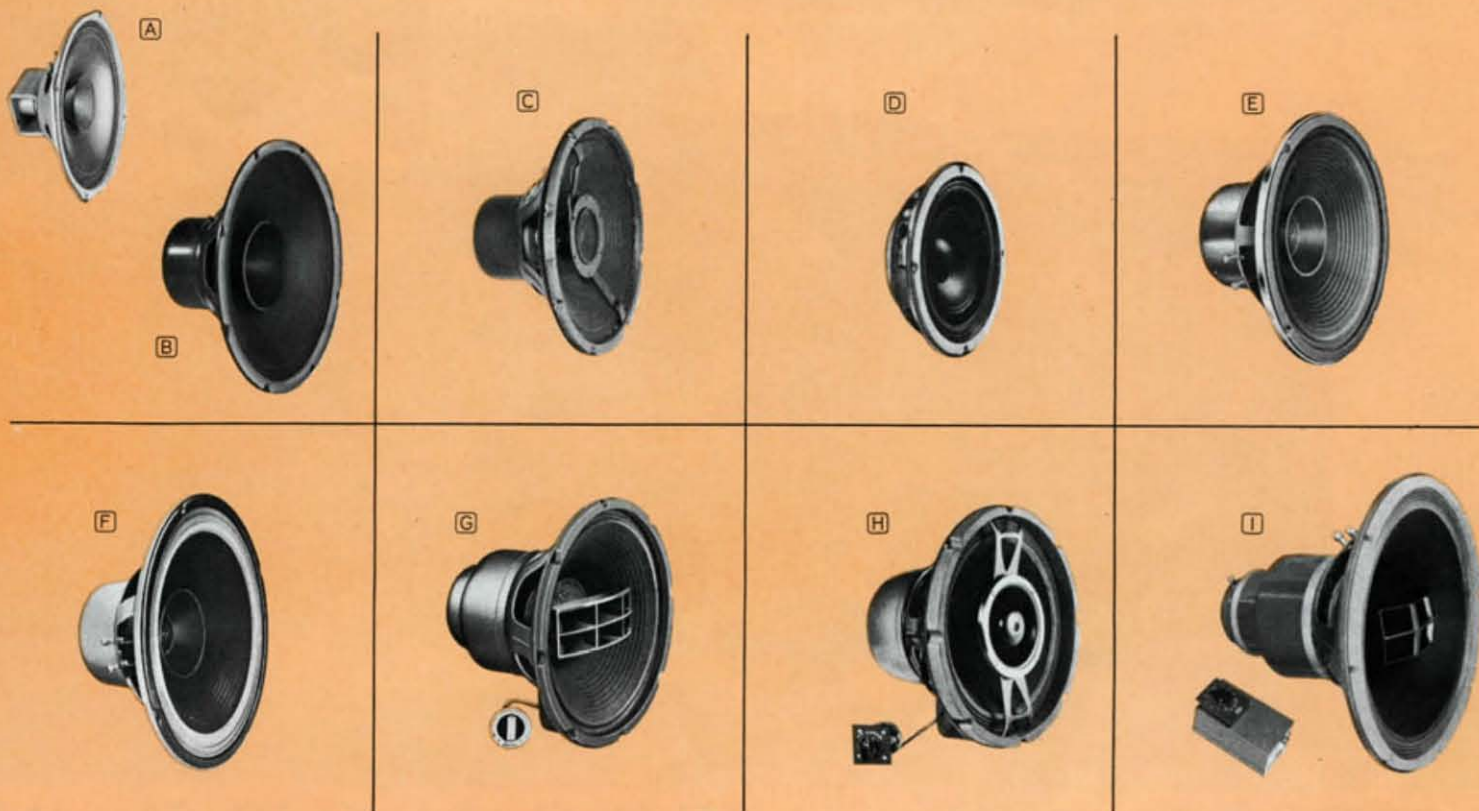

Heathkit® Speakers for Custom Installations

A 8" DUAL-CONE SPEAKER

Frequency response: 60 to 15,000 cps. Impedance: 8 ohms. Power rating 8 watts. Recommended enclosure instructions included. 2 lbs.

US-4 \$6.95

B 12" DUAL-CONE SPEAKER

Covers 50 to 12,000 cps. Handles up to 14 watts. Impedance is 8 ohms and magnet weight is 6.8 oz. Instructions for a speaker enclosure included. 5 lbs.

US-2 \$11.95

C 12" COAXIAL HI-FI SPEAKER

15 watt rating with a frequency response of 50 to 15,000 cps. Uses a 12" PM woofer (6.8 oz. magnet) and a 3" PM tweeter (1.47 oz. magnet). 8 ohms impedance. Built-in 2 kc crossover network. Instructions provided for suitable enclosure. 6 lbs.

US-3 \$19.95

D ALTEC 755C 8" SPEAKER

Combines true high-fidelity reproduction, compact size, slim profile and low cost. Unique pancake design is ideal for wide-angle P.A. use or custom hi-fi. Power rating 15 watts. Response 40-13,000 cps. Impedance 8 ohms (2" voice coil); Distribution angle: 90°. Depth 2¼". 5 lbs.

AS-20 . . . NO MONEY DOWN, \$5 mo. \$29.95

E ELECTRO-VOICE SP12B 12" COAXIAL HI-FI SPEAKER

Features high-compliance, viscous-damped cloth suspension; resonant frequency 40-50 cycles. Deep 2" voice coil. 16 ohms impedance. 1½ lb. ceramic magnet. Power rating, 20 watts. Response, 40 to 13,000 cps. Mechanical crossover, 4500 cps. 11 lbs.

AS-30 . . . NO MONEY DOWN, \$5 mo. \$34.30

F ELECTRO-VOICE SP15B 15" DUAL-CONE HI-FI SPEAKER

A large 15" speaker at low cost. Features the Electro Voice Radax principle, an economical and highly-efficient method of using two coaxial cones, both operating from a single voice coil, to extend the audible spectrum for clean, sparkling reproduction. Handles 15-20 watts with a response of 30-13,000 cps. Resonant frequency is 38 cps. 16 ohms impedance. Sensitivity rating is 46 db. Crossover network is 3500 cps. Employs a 1 lb. 6 oz. ceramic magnet. Speaker has 15½" diameter and requires 13½" baffle opening, 7⅞" depth behind mounting panel. 15 lbs.

ASP-71 . . . NO MONEY DOWN, \$5 mo. \$42.14

G JENSEN H-222 12" COAXIAL HI-FI SPEAKER

Designed for high performance, the H-222 is a 2-way 12" coaxial speaker with electrically and acoustically independent "woofer" and "tweeter". The high frequency section employs a through-bore compression-driver "tweeter" for low distortion and wide angle dispersion of highs. Overall response is 30 to 15,000 cps. Impedance is 16 ohms. Power rating is 25 watts. 1¾ lb. magnet. 12 lbs.

ASP-61 . . . NO MONEY DOWN, \$7 mo. \$62.50

H JENSEN H-223F COAXIAL 2-WAY 12" SPEAKER

Exceptional low frequency performance from special "Flexair" woofer in combination with new concentric re-entrant compression driver tweeter. 20-15,000 cps. 16 ohms impedance. 30 watt power rating. 1¾ lb. magnet. 12 lbs.

AS-40 . . . NO MONEY DOWN, \$8 mo. \$72.50

I ALTEC 605A 15" DUPLEX HI-FI SPEAKER

The 605A covers 20 to 22,000 cps with unusual smoothness in highs; extremely high linearity and clean transient response in lows. 3" voice-coil for high efficiency, 2¼ lb. magnet. High frequency exponential multicellular horn provides 90° horizontal distribution (½ lb. magnet). Power rating 35 watts (50 watts peak), cone resonance 25 cps, impedance 16 ohms. 37 lbs.

AS-70 . . . NO MONEY DOWN, \$17 mo. \$177.00



Enclose your Stereo/Hi-Fi System with Heathkit®

**MORE HEATHKIT CONSOLES
SHOWN ON PAGES 12 & 13**



A custom designed EQUIPMENT CABINET for Your Stereo/Hi-Fi components

- Factory assembled, ready to use
- Walnut or mahogany finishes or unfinished
- Houses complete stereo or mono units

Model AE-20U

\$79.95

The Heathkit AE-20 Equipment Cabinet is a craftsman constructed, tastefully designed piece of furniture that will blend with any room decor in your home, whether your furniture styling is modern or traditional. The quality woods of the AE-20 are accented by design relief touches which are uncluttered and eye-arresting. Slim, curved brass handles on each door highlight the "sculptured" effect. The divided top panel is characterized by a "gallery" rail and indented-curve front edge. 3/4" stock is used for all exterior front and side panels and supports. Solids are used for edgings and veneers for other areas, except ventilated rear half-panel of masonite.

This top quality AE-20 Equipment Cabinet by Heathkit is completely factory-assembled and ready to accommodate your hi-fi/stereo system components. It comes in either unfinished, hand-rubbed walnut or mahogany finishes. 81 lbs.

Model AE-20U (unfinished) . . . NO MONEY DOWN, \$8 mo. **\$79.95**
Model AE-20W (walnut) . . . NO MONEY DOWN, \$10 mo. **\$99.50**
Model AE-20M (mahogany) . . . NO MONEY DOWN, \$10 mo. **\$99.50**

EQUIPMENT ACCOMMODATIONS AND SIZES—Cabinet, overall: 36" W. x 32 3/4" H. x 19" D. **Changer compartment:** 17" W. x 15 1/2" D., mounting board height is variable to accept any Heath record changer or player or Heath AD-70, TR-1A tape recorders; lid has adjustable friction-loaded support. **Record-tape recorder compartment:** 14 1/2" H. x 17" W. x 17" D. for record storage; space is convertible with accessory sliding drawer below to accommodate Heath tape recorders. **Shelf compartments:** (2); each 17" W. x 6" H. x 17" D. (inside shelf 14" deep); either shelf accepts any Heath Stereo or Mono tuner, Stereo or Mono pre-amplifiers, AA-100 or AA-151 stereo amplifier. **Power amplifier compartment:** 8 1/2" H. x 17" W. x 15 1/2" D. inside; accepts two Heath AA-61's, an AA-111 or AA-121 for stereo or any Heath monophonic amplifier.



\$12.95

Model AEA-20U

**AEA-20 TAPE RECORDER
DRAWER is a practical
cabinet accessory**

The Heathkit AEA-20 Tape Recorder Drawer is a convenient cabinet accessory that holds Heathkit AD-70, TR-1A, TR-1E or AD-40 tape decks handily and inconspicuously in the record storage space of the AE-20 Equipment Cabinet.

It comes assembled and complete with hardware, track and instructions for installation. Finishes match cabinets. Measures 11 1/8" H x 14 1/2" D x 16" W outside. 15 lbs.

Model AEA-20U (unfinished) **\$12.95**
Model AEA-20W (walnut) **\$14.95**
Model AEA-20M (mahogany) **\$14.95**



Cabinets and Save!

You'll Save up to \$20 with
Heathkit AE-30 SPEAKER
CABINETS... Quality
Construction... Low Price!

- Accommodates 8" or 12" speakers
- Room for horn-type tweeter
- Matches AE-20 Cabinet perfectly for use in any room decor

Model AE-30U

\$31⁹⁵



Modern Styling plus Budget
Prices Make Heathkit AE-40
SPEAKER CABINETS Perfect
for any Home Setting

- Accepts 12" or 15" speakers
- Horn-type tweeter provision
- Styling blends perfectly with Heathkit AE-20 Equipment Cabinet

Model AE-40U

\$37⁹⁵



Completely factory-assembled and ready for your choice of speakers the Heathkit AE-30 Speaker Cabinet features ultra-smart styling at a budget price—comparable to other speaker cabinets on the market today selling for \$55 or more. It comes either unfinished or in hand-rubbed walnut or mahogany finishes, ready for mounting of either 8" or 12" speakers (see page 57 for listing of speakers that are available for inclusion in these cabinets). The cabinet also has a $3\frac{3}{8}$ " x $10\frac{3}{16}$ " slot provided for the installation of a horn-type tweeter. The tube-vented design insures proper performance with *any* speaker. Just follow the instructions provided for tube modification according to the resonance of your speaker. The cabinet measures 15" W x 19" D x $32\frac{3}{8}$ " H outside. 35 lbs.

Model AE-30U (unfinished) . . .	
NO MONEY DOWN, \$5 mo.	\$31.95 each
Model AE-30W (walnut) . . .	
NO MONEY DOWN, \$5 mo.	\$38.95 each
Model AE-30M (mahogany) . . .	
NO MONEY DOWN, \$5 mo.	\$38.95 each

Unfinished or finished in hand-rubbed walnut or mahogany, the Heathkit AE-40 speaker cabinets are offered to you for use in your Hi-Fi/Stereo arrangement completely factory-assembled and ready for speaker mounting. These exquisite cabinets perform as well as they look for they have a tube vented design which enables you to modify the tube length to match the resonant point of any speaker you choose. Complete instructions are included.

The AE-40 Speaker Cabinet can handle 12" or 15" speakers (see page 57) and a $3\frac{3}{8}$ " x $10\frac{3}{16}$ " slot is provided for a horn-type tweeter. The cabinet measures $18\frac{1}{4}$ " W x 19" D x $32\frac{3}{8}$ " H outside. 44 lbs.

Model AE-40U (unfinished) . . .	
NO MONEY DOWN, \$5 mo.	\$37.95 each
Model AE-40W (walnut) . . .	
NO MONEY DOWN, \$5 mo.	\$44.95 each
Model AE-40M (mahogany) . . .	
NO MONEY DOWN, \$5 mo.	\$44.95 each

Heath's new No-Money-Down terms mean you can buy with complete confidence

Six Value-Starred Heathkit® Stereo/Hi-Fi

Save \$4.55

A Low-Cost Stereo Phono System...

The Heathkit HFS-40 for only \$86.25

The Heathkit HFS-40 is a low-cost Stereo Phono System that is complete in every way to bring to your home the pleasures of stereo record playing. It is the perfect "starter set" for newcomers to the world of stereo sound and is priced well within the reach of every budget. Included in this economical system is the Heathkit AD-10C Stereo Record Player with Sonotone 8TA4-SD ceramic stereo cartridge and diamond and sapphire styli (page 34); the Heathkit AA-201 6-watt Stereo Combination Amplifier with its exciting new styling concept (page 47); and two completely factory assembled and finished ASW-41W walnut speaker systems which feature 6" x 9" extended range dual-cone speakers (page 56).

To receive monophonic FM broadcasts, you simply add the Heathkit AJ-31 FM Tuner (page 48). To receive FM broadcasts in stereo, order the Heathkit AC-11 Multiplex Converter (page 38) with your AJ-31 Tuner. To enjoy monophonic AM radio programs, select the Heathkit AJ-21 AM Tuner (page 48).

System Kit HFS-40 37 lbs.... **NO MONEY DOWN, \$9 mo.... \$86.25**



Complete System Kit HFS-40
 Reg. \$90.80
 Save 4.55
 System Price **\$86.25**

AD-10C Stereo Record Player \$32.95

AA-201 6-Watt Stereo Amplifier \$31.95

ASW-41W Speaker System (2) \$12.95 each

Save \$13.70

Medium Power Stereo System by Heathkit... HFS-41 Includes AM/FM Tuner and Automatic Record Changer

You'll be amazed at the versatility of this complete, medium powered stereo system by Heathkit—the HFS-41. It will bring countless days of enjoyment to your family with AM or FM radio broadcasts or your favorite stereo recordings. Included in the system are the Heathkit AD-80B Automatic Stereo Record Changer with Shure M8D magnetic stereo cartridge and diamond stylus (page 33); the Heathkit ADA-50W walnut finished changer base (page 33); the Heathkit AJ-11 Medium Priced AM/FM Tuner (page 44); the Heathkit AA-151 28-watt Stereo Combination Amplifier (page 45); and two easy-to-assemble, prefinished walnut AS-51W Two-way Speaker Systems featuring an 8" woofer and true compression-type tweeter.

All components of this remarkable system are simple to assemble thanks to Heath's famous "check-by-step" instructions and clear, uncomplicated diagrams and illustrations.

System Kit HFS-41 107 lbs... **NO MONEY DOWN, \$24 mo.. \$259.00**



Complete System Kit HFS-41
 Reg. \$272.70
 Save 13.70
 System Price **\$259.00**

AD-80B Stereo Record Changer \$42.95

ADA-50W Walnut Record Changer Base \$5.95

AA-151 28-watt Stereo Amplifier \$59.95

AJ-11 Medium-priced AM/FM Tuner \$69.95

AS-51W Walnut Two-Way Speaker System (2) \$46.95 each

Save \$19.40

Heathkit Popular-Priced Stereo System... HFS-42 Includes Fine Prefinished Walnut Cabinets

Includes Fine Prefinished Walnut Cabinets

The HFS-42 Popular-Priced Stereo System by Heathkit combines the excellence of dependable electronic equipment with the high styled beauty of speaker and equipment cabinets that will highlight any room setting.

Included in this popular system are: the Heathkit AD-80A Automatic Stereo Record Changer with GE VR-227 magnetic stereo cartridge and diamond stylus (page 33); the Heathkit AJ-11 Medium Priced AM/FM Tuner (page 44); the Heathkit AA-151 28-watt Stereo Combination Amplifier (page 45); two US-3 Coaxial Hi-Fi Speakers (page 57); two factory-assembled, walnut finished AE-30W Speaker cabinets (page 59) and a factory-assembled, walnut finished AE-20W Equipment Center Cabinet (page 58).

Whether your room styling is modern or traditional, this beautifully-housed stereo system will complement any decor.

System Kit HFS-42 219 lbs.... **NO MONEY DOWN, as low as \$24 mo.... \$369.75**



Complete System Kit HFS-42
 Reg. \$389.15
 Save 19.40
 System Price **\$369.75**

AD-80A Stereo Record Changer \$41.95

US-3 Co-axial Hi-Fi Speaker (2) \$19.95 each

AE-20W Walnut Equipment Cabinet \$99.50

AA-151 28-watt Stereo Amplifier \$59.95

AJ-11 Medium-priced AM/FM Tuner \$69.95

AE-30W Walnut Speaker Cabinet (2) \$38.95 each

Systems Designed and Priced for every budget!

Complete System Kit HFS-43
 Reg. \$348.65
 Save 17.40
System Price \$331.25



AJ-11
 Medium-priced AM/FM Tuner
 \$69.95



AD-60B
 Deluxe Changer
 \$82.95



AA-141
 Stereo Preamplifier
 \$34.95

ADA-50W
 Walnut Changer Base
 \$5.95



AA-111
 28-watt Stereo Power Amplifier
 \$44.95



AS-10W
 Walnut Acoustic
 Suspension Speaker System (2)
 \$64.95 ea.

Save \$17.40

An All-Component Medium Power Stereo System, the Heathkit HFS-43 Includes Acoustic Suspension Speakers

Choose this all-component, medium-power stereo system, the Heathkit HFS-43... designed to bring you fine listening enjoyment and installation versatility at low cost. This superb system includes: a Heathkit AD-60B Deluxe Automatic Record Changer with Shure M8D stereo cartridge and diamond stylus (page 33); the Heathkit ADA-50W Walnut Record Changer Base (page 33); the Heathkit AJ-11 Medium Price AM/FM Tuner (page 44); the Heathkit AA-141 Stereo Preamplifier with its new modern design (page 43); the Heathkit AA-111 28-watt Stereo Power Amplifier (page 47) and two Heathkit AS-10W Acoustic Suspension Speaker Systems with Walnut finish, each featuring a 10" acoustic suspension woofer and two 3 1/2" cone-type tweeters (page 55).

You can thrill to true stereo in a setting of your own choosing when you assemble and install the easy-to-build components of the HFS-43 System... and you'll save money because it's from Heath.

System Kit HFS-43 140 lbs...
 NO MONEY DOWN, as low as \$22 mo.....**\$331.25**

Complete System Kit HFS-44
 Reg. \$557.55
 Save 27.80
System Price \$529.75



AA-121
 80-watt Stereo
 Power Amplifier
 \$79.95



AJ-30
 Deluxe AM/FM Tuner
 \$99.95



AD-70
 Stereo Tape Player
 \$74.95



AA-11
 Deluxe Stereo Preamplifier
 \$84.95



AS-2U
 Acoustic Suspension Speaker System (2)
 \$72.95 each

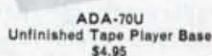

ADA-70U
 Unfinished Tape Player Base
 \$4.95



AD-60A
 Deluxe
 Record Changer
 \$61.95

ADA-50U
 Unfinished Record Changer Base
 \$4.95

Save \$27.80

High Powered Stereo System... HFS-44 features Record Changer, Tape Player and AM/FM Tuner

The Heathkit HFS-44 Stereo System is a high-power, all-component system designed to bring you the finest in musical entertainment, whether it be on radio, recording, or tape. This elaborate system includes: the Heathkit AD-60A Deluxe Automatic Record Changer with GE VR-227 Stereo cartridge and diamond stylus (page 33); the Heathkit ADA-50U unfinished Record Changer Base (page 33); the Heathkit AD-70 Stereo Tape Player (page 35); the Heathkit ADA-70U unfinished Tape Player Base (page 35); the Heathkit AJ-30 Deluxe AM/FM Tuner (page 40); the Heathkit AA-11 Deluxe Stereo Preamplifier (page 42); the Heathkit AA-121 80-watt Stereo Power Amplifier (page 46); and two Heathkit AS-2U unfinished Acoustic Suspension Speaker Systems (page 55).

This powerful and versatile system comes with unfinished cabinets and bases enabling you to match any furniture grouping in your home.

System Kit HFS-44 200 lbs...
 NO MONEY DOWN, as low as \$34 mo.....**\$529.75**

Complete System Kit HFS-45
 Reg. \$582.25
 Save 29.25
System Price \$553.00



AJ-30
 Deluxe AM/FM Tuner
 \$99.95



AA-100
 Deluxe 50-watt Stereo Amplifier
 \$84.95



AD-60B
 Deluxe Record Changer
 \$62.95



AE-40W
 Walnut Speaker Cabinet (2)
 \$44.95 each



AE-20W
 Walnut Equipment Cabinet
 \$99.50



AS-40
 Coaxial Hi-Fi Speaker (2)
 \$72.50 each

Save \$29.25

The Heathkit HFS-45 Deluxe Stereo System features the Finest Heathkit Components available Today

You can't find better quality at a lower price than with the Heathkit HFS-45 Deluxe Stereo System. This is truly a masterpiece of engineering and styling "know-how" which costs you far less than other systems because it comes in "easy-to-build" Heathkit form. The system includes: the Heathkit AD-60B Deluxe Stereo Record Changer with Shure M8D stereo cartridge and diamond stylus (page 33); the Heathkit AJ-30 Deluxe AM/FM Tuner (page 40); the Heathkit AA-100 Deluxe 50-watt Stereo Combination Amplifier (page 41); two Heathkit AS-40 12" coaxial Hi-Fi Speakers with built-in tweeter (page 57); two Heathkit AE-40W Walnut Speaker Cabinets (page 59); and a Heathkit AE-20 Walnut Equipment Cabinet (page 58).

This fabulous Heathkit stereo system will fill your home with the finest in stereo sound, as beautiful to hear as it is to see. Order yours now.

System Kit HFS-45 262 lbs...
 NO MONEY DOWN, as low as \$36 mo.....**\$553.00**

Why Amateur Radio Operators Everywhere Prefer Heathkit...



For many years, amateur radio operators around the world have relied upon Heathkit for top-quality equipment with savings up to 50%. These qualities are made possible by the people at Heath who, like you, are vitally interested in amateur radio. Their great interest is reflected in the many new kits coming out of our Amateur Radio Labs today . . . unique concepts with carefully-engineered designs . . . proven performance . . . quality components . . . and thoughtfully-detailed assembly instructions. The dedication of all our people to your satisfaction with any Heathkit you choose is backed by a money-back guarantee as further assurance that you can buy with confidence at Heath. Whether you are interested in starting an Amateur Radio Station or adding a piece of gear to your present equipment, you'll find a Heathkit to fill your needs. Look through the following pages and note the many quality items available to amateurs everywhere at savings of 50% or more!

For the Latest in Styling and Features Equip your

FOR THE OLD TIMER AND NOVICE ALIKE, HERE IS A HANDSOMELY-MATCHED



A new HAM-BAND RECEIVER

designed to match the DX-60

- Amateur band coverage only (80 through 10 meters) for high stability & tuning accuracy
- Tunes SSB, AM and CW
- Large, slide-rule tuning dial—over 6" of band-spread
- Tunable RF stage for extra sensitivity
- Prebuilt, preset coil/bandswitch assembly
- Lattice-type crystal filter for high selectivity

Kit HR-10

\$82⁹⁵

Expected Shipping Date:
December 30, 1961

This handsomely-styled amateur receiver is a perfect match for the DX-60 Transmitter (opposite page), providing complete high-performance station receiver facilities at low cost!

The HR-10 is designed for amateur band coverage only on 80 through 10 meters, for maximum accuracy and stability. Each band is separately calibrated on a large, easy-to-read slide-rule dial. The tuning dial is illuminated and provides over 6" of bandspread for precise frequency settings. A carefully-designed diode detector, plus BFO, tunes AM or CW and SSB signals. The 7-tube superheterodyne circuit features an RF stage for added sensitivity and employs a half-lattice crystal filter for excellent selectivity characteristics . . . a necessity with today's crowded band conditions. Two IF amplifiers operating at 1680 kc provide good image rejection. Other features include: "S" meter to aid in tuning and determining relative strength of received signals; a 3-gang tuning capacitor to assure proper tracking of all circuits rather than "Broad Banding"; a front panel dial calibration control and provision for a plug-in 100 kc crystal calibrator (see HRA-10-1 below) to provide accurate dial calibration at any 100 kc point across the band. Other panel controls consist of: antenna trimmer, bandswitch, tuning, BFO tuning, RF gain, AF gain w/AC on-off switch, xtal. calibration on/off, STBY/RCV, BFO on/off, AVC on/off, and automatic noise limiter on/off. An accessory socket is provided on the rear chassis apron for receiver muting, etc., and a speaker jack is provided for use with any 8 ohm PM speaker. 21 lbs.

Kit HR-10 . . . NO MONEY DOWN, \$9 mo. **\$82.95**
Kit HRA-10-1, Plug-in 100 kc Crystal Calibrator, 1 lb. **\$8.95**





Here's a real FB LOG BOOK in which to record
your amateur radio contacts and schedules...

The tremendous response received from amateur radio operators across the nation for the Heathkit Amateur Radio Log Book has prompted us to put it on a permanent basis available to all! Recognizing the limitations of today's log books, Heath engineers have come up with a real FB log book, with a page for each operating period and with basic data logged only once. No more laborious transferring of notes for permanent filing. In addition to spaces provided for each station, you have room for additional info such as handle, QTH, reports, rig and comments. There's a calendar on each page and space for traffic and schedule summaries. Order the package of five of these special log pads and a handsome vinyl cover in which to insert the current log book to keep it neatly in place on your desk ready for instant use. The cover measures just 8½" x 5½" when closed, just right for your operating position. Replacement log books are available separately. Order yours today!

No. 597-110 . . . Five log books & cover, 2 lbs. **\$2.95**
No. 597-111 . . . Five replacement log book pads, 1 lb. **\$1.95**



Station with Dependable Heathkit® Amateur Gear!

PAIR FOR COMPLETE AMATEUR AM/CW STATION FACILITIES AT LOW COST



DX-60 PHONE & CW TRANSMITTER

surpasses quality and performance
of units costing far more

- 90 watts phone or CW—80 through 10 meters
- Neutralized 6146 final amplifier
- Built-in low pass filter
- Grid block keying—easy access to crystal sockets
- Easy to build and operate

The DX-60 Amateur Transmitter with its many design features offers more in quality, performance, and dependability than any other unit in its price and power class! Superbly designed throughout, the DX-60 with its high quality components, clean, rugged construction and thoughtful circuit layout makes it an ideal "first" transmitter for the novice. Construction proceeds smoothly from start to finish with the complete, informative instructions furnished. All parts are easily identified and a precut, cabled wiring harness eliminates much of the tedious wiring. The completed unit with its neat, functional panel layout provides for maximum ease of operation.

Circuit-wise, the DX-60 features a built-in low pass filter for harmonic suppression, neutralized final for high stability, grid block keying for excellent keying characteristics and easy access to crystal sockets on the rear chassis apron. A front panel switch selects any of four crystal positions or an external VFO. Controlled-carrier modulator and silicon diode power supply are built in. Single knob bandswitching for 80 through 10 meters and pi network output coupling provide complete operating convenience. A high-quality panel meter shows final grid or plate current to aid in tuning. In every way, the DX-60 represents an outstanding amateur "buy." May be run at reduced power for novice operation. Less crystals. 25 lbs.

Kit DX-60 . . . NO MONEY DOWN, \$9 mo. **\$82.95**



Kit DX-60
\$82.95

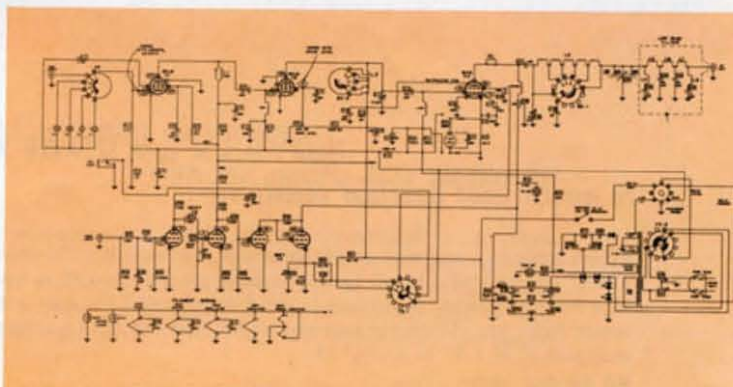

SPECIFICATIONS—Power input: 90 watts peak, carrier controlled phone or CW. Output impedance: 50-72 ohm (coaxial). Output coupling: Pi-network. Operation: CW or AM phone—crystal or VFO control. Band coverage: 80 through 10 meters. Power requirements: 105-125V, 50-60 cps, 225 watts. Dimensions: 13½" W x 11½" D x 6½" H.

There's a Heathkit for every interest, every purpose, every budget

Operate "Mobile" on 80 through 10 meters with



Kit MR-1

\$129⁹⁵

All adjustments of the MR-1 are conveniently made from the top of the chassis. Each band is separately aligned to assure proper tracking on the dial.

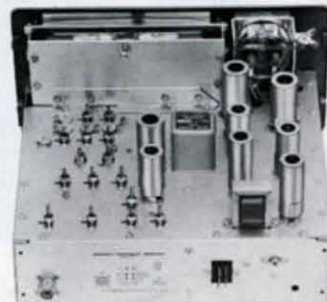

The "Comanche" and "Cheyenne" form a handsome pair, easily installed on transmission hump of auto using the AK-6 base mount.

"Comanche" MOBILE AMATEUR RECEIVER... many extra's for top quality performance

- Better than 1 uv sensitivity on all bands
- Built-in panel "S" meter
- Crystal lattice-type filter
- 30-1 gear driven tuning assembly
- Rotating slide-rule tuning dial

Specially designed for rugged mobile use, the Heathkit "Comanche" brings you all the features you've ever wanted in a mobile receiver... superb styling, operating convenience, rugged construction, and lasting quality. Its modern 8-tube superheterodyne circuit features a crystal-lattice type filter and product detector for excellent sensitivity, selectivity and stability. The "Comanche" receives AM, CW and SSB on 80 through 10 meters. A 30-1 gear driven spring-loaded tuning assembly and rotating slide-rule tuning dial assures smooth, easy station selection. Panel controls are provided for BFO tuning, RF gain, AF gain-on/off, CW-SSB-AM mode selector, noise limiter, AVC, main tuning, bandswitch, and antenna trimmer. Circuit design includes an RF stage, converter, 2 IF stages, 2 detectors, noise limiter, 2 audio stages and a voltage regulator. The MR-1, with steel chassis and compartmental construction, is braced to withstand mobile vibrations and shock for long life and reliable communications with lasting quality. A versatile performer the MR-1 can be used with the Heathkit HP-10 mobile power supply for operation on 12 V DC car battery or can be converted in a matter of minutes to fixed-station operation using the Heathkit HP-20 AC power supply. 19 lbs.

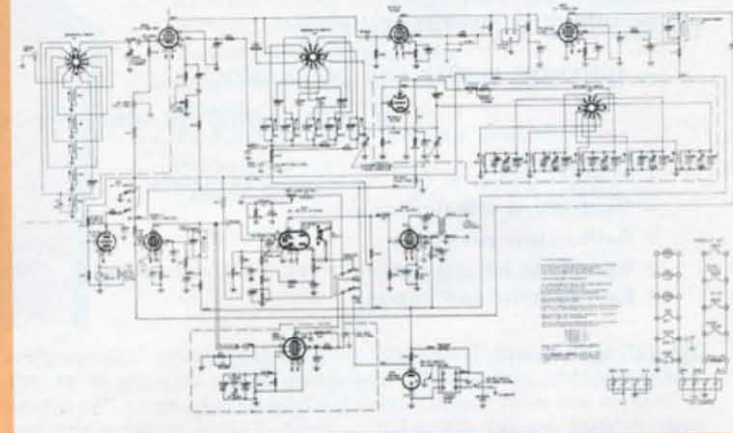

SPECIFICATIONS—IF frequency: 3 mc. Frequency coverage: 80, 40, 20, 15, 10 meter bands. Crystal-lattice IF filter: Center frequency, 3 mc; Bandwidth at 6 db, 3 kc; Bandwidth at 60 db, 10 kc max. Panel controls: BFO tuning, RF gain, AF gain on/off, CW-SSB-AM, NL, AVC, Main tuning, Band-switch, Antenna trimmer. Tube complement: (2) 6BZ6, (2) 6EA8, (1) 6BE6, (1) 6T8, (1) 6AQ5, (1) 6A2. Sensitivity: Better than 10 db signal to noise ratio at 1 uv input. Power requirements: 12 V at 1.65 amp or 6V at 3.3 amp AC or DC for filaments, 300 VDC at 125 ma for B+. Total power 60 watts. Dimensions: 6½" H x 12½" W x 9½" D.

Kit MR-1... NO MONEY DOWN, \$12 mo. **\$129.95**

Here's a low cost SPEAKER Kit... color-styled to match your Heathkit mobile rig

This accessory speaker was designed for use with the "Comanche" receiver above. The 5" permanent magnet speaker with 8 ohm voice coil is housed in a rugged steel case for protection. Mounting bracket is provided for easy installation on fire wall, under dash, etc., wherever convenient for best listening position. Speaker case measures just 5" H x 5" W x 2½" D.



Kit AK-7... 3 lbs. **\$5.95**

this superbly matched Heathkit® Mobile Pair!



At home or on the road, the "Comanche" and "Cheyenne" deliver outstanding performance! Simple conversion to either mode of operation can be made in a matter of minutes.

High quality and rugged design assures long life and dependable performance. Note the popular 6146 final amplifier tube and husky final tank coil used.

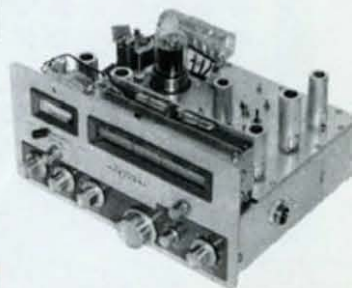

Kit MT-1
\$105⁹⁵



"Cheyenne" MOBILE AMATEUR TRANSMITTER . . . power packed performance at low cost!

- 90 watt input on phone or CW
- 6146 final amplifier—pi network output
- Special design push-to-talk microphone
- Spotting switch for off-the-air tuning
- Rugged shock-proof construction—easy to build

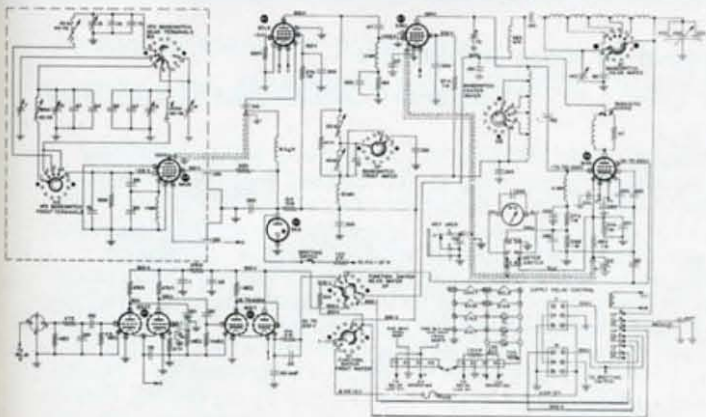

SPECIFICATIONS—Power input: 90 watt peak carrier controlled phone. Output impedance: 50-72 ohms. Output coupling: Pi network (coaxial). Band coverage: 80, 40, 20, 15, 10 meters. Panel controls: Meter switch, spotting switch, final tuning, drive adjust, bandswitch, VFO tuning, audio (gain), loading, function switch. Tube complement: 12AX7, 6DE7, 6AU6, 6CL6, 5763, 6A2. Power requirements: 500-600 V DC @ 150 ma; 300 V DC @ 100 ma; 6.3 V @ 4.7 amps or 12.6 V @ 2.35 amps AC/DC. Dimensions: 6 1/2" H x 12 1/4" W x 9 15/16" D.

All the fun and excitement of mobile amateur operations are yours with the "Cheyenne" transmitter. Team it with its matching counterpart, the "Comanche" receiver . . . they make an ideal pair for top mobile communications at the lowest cost anywhere! The high quality components, sturdy chassis construction, and many design features assure long life, dependable performance, and convenient operation under rugged mobile use. The "Cheyenne" provides up to 90 watts input on phone or CW and covers 80 through 10 meters. It features a built-in VFO, controlled carrier modulator, four RF stages, 6146 final amplifier, and pi-network (coaxial) output coupling. A spotting switch is provided to allow tuning the transmitter "off-the-air" and a specially-designed ceramic element microphone with push-to-talk switch assures properly shaped audio response for effective modulation with plenty of "punch." All power necessary for mobile operation is furnished by the Heathkit HP-10 mobile power supply. Simple conversion to fixed station operation is easily accomplished by using the Heathkit HP-20 AC power supply. Styling of both the "Comanche" and "Cheyenne" features a one-piece die-cast front panel with raised meter, tuning dial and control panel escutcheons, and die-cast knobs. Color styled in two-tone gray and gray-green. 23 lbs.

Kit MT-1 . . . NO MONEY DOWN, \$11 mo. **\$105.95**

Get installation ease and operating convenience with this mobile BASE MOUNT Kit



The AK-6 mobile base mount is designed to hold both the "Comanche" and "Cheyenne" conveniently at the driver's side. Easily installed on the transmission hump of most automobiles, the universal mounting bracket has adjustable legs to allow tilting the units to best viewing and operating position. With the transmitter and receiver bolted to it, the entire unit may be removed in one piece and set up as a fixed station unit.

Kit AK-6 . . . 5 lbs. **\$4.95**

Heathkit® Amateur Gear put Deluxe Transmitting and



Kit RX-1 **\$299⁹⁵**

- Amateur band coverage only for maximum stability and accuracy
- 1 uv input for 10 db signal to noise ratio
- Factory assembled and aligned coil/bandswitch assembly
- Rotating slide rule tuning dial with vernier action
- Built-in 100 kc crystal calibrator

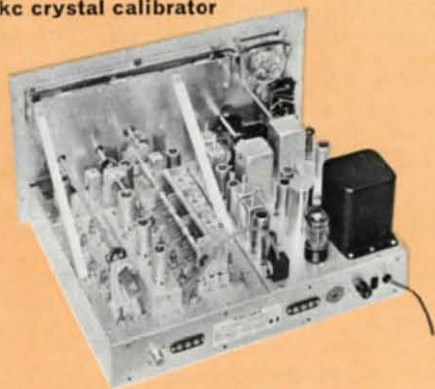

This inside rear view of the RX-1 shows the high quality materials used in its design. The critical front-end coil/bandswitch assembly on the left half of the chassis is furnished completely assembled and aligned, thus eliminating the most difficult part of receiver adjustment. Ceramic coil forms and bandswitch wafers are used for stability and high "Q".

SPECIFICATIONS—Fifteen tube double conversion superheterodyne receiver with selectable sideband. First IF frequency: 1682 KC. Second IF frequency: 50 KC. Band coverage: 160-10 meters. Selectivity range: 5 kc, 3 kc, 2 kc, 1 kc, .5 kc. Bridged T notch filter: 50 db rejection notch. Panel controls: RF Gain, Tuning, IF Gain, Antenna Trimmer, AF Gain w/on-off switch, Calibrate Set, T-Notch Tuning, Calibrate On, T-Notch Depth, CW-SSB-AM, ANL, Receiver-Standby, AVC, Upper-Lower Sideband, BFO, Selectivity, Band, Phones. Tube complement: 6BZ6 RF Amplifier, 6CS6 First Mixer, 12AT7 Oscillator-Cathode Follower, 6BA6 1682 kc IF amplifier, 6CS6 Second Mixer, 12AT7 1632-1732 kc crystal Oscillator, 6BA6 50 kc IF amplifier, 6BJ7 DET-AVC-ANL, 6CS6 Product Detector, 12AT7 First Audio S Meter Amp., 6AQ5 Audio Output, 6BA6 100 kc Oscillator, OA2 Voltage Regulator, 5V4 Rectifier. Signal to noise ratio: 10 db at less than 1 microvolt input. Power required: 117 VAC, 50/60 cycle, 75 watts. Cabinet size: 19 1/2" W x 11 1/4" H x 16" D.

Designed for extra performance . . .

"Mohawk" DELUXE AMATEUR RECEIVER

Amateur radio operation today requires a highly specialized receiver, capable of receiving several different types of transmissions, under a wide variety of conditions. The Heathkit "Mohawk" is designed to conform to these high standards with every deluxe feature for clear, rock-steady reception and full operating convenience.

The receiver circuit employs 15 tubes and features double conversion with IF's at 1682 kc and 50 kc. Designed strictly for ham band coverage for maximum stability and accuracy, the "Mohawk" covers amateur frequencies from 160 through 10 meters on 7 bands with an extra band calibrated to cover 6 & 2 meters using converters. Excellent quality single sideband reception is provided by the product detector and crystal-controlled oscillators for upper and lower sideband selection. A completely wired and factory aligned front-end coil/band-switch assembly simplifies construction, assures top performance and eliminates critical alignment of the finished unit.

Other features include 5 selectivity positions from 5 kc to 500 cps, a bridged T-notch filter for maximum heterodyne rejection and a built-in 100 kc crystal calibrator which is used for dial calibration. The rotating slide-rule tuning dial is illuminated and a vernier gear drive provides smooth, solid tuning action. Each amateur band is separately calibrated for clear, precise frequency settings with more than ample bandspread. Rugged, well-rated components are used throughout for years of dependable performance. The rich, professional styling adds the final touch of quality to this splendid receiver. Front panel control knobs and escutcheons are of heavy, die-cast metal and the all-steel cabinet features a convenient top-access hatch. 66 lbs.

Kit RX-1 . . . NO MONEY DOWN, \$28 mo. **\$299.95**

ACCESSORY SPEAKER KIT: Shown above; styled to match the "Mohawk". Heavy-duty 8" PM speaker with 8 ohm impedance, 4.7 oz. magnet, 6 lbs.

Kit AK-5 **\$10.95**

Receiving Facilities in easy reach of any amateur!



Famous for value and performance . . .

Heathkit "Apache" AMATEUR TRANSMITTER

Representing the entire transmitting complement of the amateur station, the "Apache" incorporates many fine features and modern styling to bring you all the extras required for effective and dependable communications.

The "Apache" operates with 150 watt phone input and 180 watt CW input on 80 through 10 meters and features chassis provision for plug-in connection of the Heathkit SB-10 SSB adapter. A specially-designed VFO provides minimum drift frequency control necessary for SSB transmission. The illuminated, rotating slide-rule VFO dial with full gear drive vernier tuning provides ample bandspread for accurate frequency settings. Each amateur band is separately calibrated on the rotating slide-rule dial for maximum accuracy. Also featured in the "Apache" is adjustable low-level speech clipping and a low distortion modulator stage employing two 6CA7/EL34 tubes in push-pull class AB operation. Time sequence keying is provided for "chirpless" break-in CW operation. A "spotting" push button allows tuning of the transmitter before switching on the final amplifier and also enables the operator to "zero beat" an incoming signal without placing the transmitter on-the-air. The final amplifier is extensively shielded for maximum TVI protection and is neutralized for high stability. Pi network output coupling provides smooth loading into antenna impedances of 50 to 72 ohms.

The Apache's modern styling, identical to the Heathkit Mohawk receiver RX-1, presents a smart appearance that any amateur would be proud to display in his station. Color styling is in the traditional Heathkit amateur radio colors of gray and gray-green. Front panel control knobs and escutcheons are of heavy die-cast metal which impart a rugged, handsome quality to its overall appearance. The precision mechanical controls operate smoothly with the positive action characteristic normally found only in the most expensive equipment. The formed one-piece cabinet has a convenient top hatch for easy access to tubes and crystal socket. Equip your amateur station with the "Apache" now for real transmitting enjoyment. 110 lbs.

Kit TX-1 . . . NO MONEY DOWN, \$24 mo. \$252.50

- 150 watts phone, 180 watts CW & SSB
- Covers 80 through 10 meter amateur bands
- Provision for SSB adapter built-in
- Rotating slide rule dial with vernier tuning
- Adjustable low-level speech clipping
- Time sequence keying—"spotting" push button

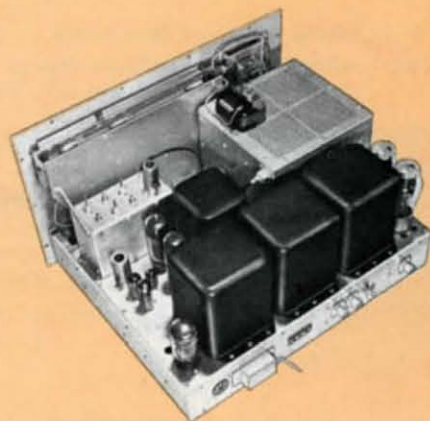

This inside rear view of the "Apache" shows the heavy-duty potted transformers used for long life and dependable performance. Note the extensive shielding of the final amplifier and fan forced-air cooling of the final tubes. A specially-designed VFO and many more features combine to bring you effective and dependable communications in addition to ease of assembly.

SPECIFICATIONS—Power input: 150 w PHONE, 180 w CW. Output impedance: 50-72Ω (non-reactive). Output coupling: Pi Network (coaxial). Operation: Crystal-VFO, CW-SSB-PHONE (time sequence keying, SSB requires external adapter). Band coverage: 80, 40, 20, 15, 10. Audio output: 100 watts at 300-3000 cycle (Adjustable low-level speech clipping; 500Ω output available). Tube complement—power section: 2 selenium rectifiers, 5V4 low voltage rectifier, 2-5R4GY HV rectifier, OA2 voltage regulator, 2-OB2 voltage regulators. Audio section: 12AX7 speech amplifier, 12AU7 clipper amplifier, 6AL5 clipper, 12BY7 audio driver, 2-6CA7/EL34 modulator. RF section: 6AU6, VFO, 6CL6 crystal oscillator-buffer, 5763 driver, 2-6146 parallel power amplifier, 6AO5 clamp. Power requirements: 115 V AC, 50-60 cycles. Standby (AM, CW): 150 watts. Standby (SSB): 230 watts. CW: 420 watts (intermittent). Phone: 500 watts (peak). SSB: 500 watts (peak). Cabinet size: 19 1/2" W x 11 1/2" H x 16" D.

Heathkit performance specifications are guaranteed

Heath brings you the Latest in Styling

Kit Form
or
Factory
Assembled



- Completely self-contained desk-top KW linear
- Operates SSB, AM & CW on 80 through 10 meters
- Exclusive internal RF shielding for maximum TVI suppression
- Interlocked switching of HV for maximum circuit protection
- Low cost, high quality, 811A and 866A tubes
- Fan forced-air cooling—clean, functional styling

Kit HA-10

\$229.95



Heathkit "Warrior" KILOWATT LINEAR...

a tremendous value at only \$229.95



Internal shielding of the RF amplifier for increased stability and TVI protection is shown in this view. Note the large 8 mfd capacitor and husky transformers used.

Simplicity of wiring is shown in this bottom view. Clean, open circuit layout and high quality components such as the ceramic tube sockets, husky bleeder resistor, etc., assure long, faithful service.

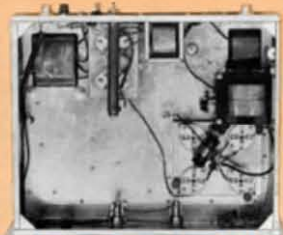

The Heathkit "Warrior" puts high quality, power-packed performance within easy reach of every amateur who wants a big boost in transmitting power! The "Warrior" is a completely self-contained, desk-top, kilowatt linear loaded with special features . . . at only half the cost of comparable equipment. Note these many quality features . . . amplifier and power supplies for HV, filament and bias are built-in. Versatile . . . May be driven by a 50 to 100 watt output transmitter (no matching or swamping network required). Efficient . . . Stable grounded-grid circuit puts part of drive in output for up to 70% efficiency. High quality, low-cost tubes . . . Four paralleled 811A's and two 866A's forced-air cooled by a built-in fan. Dynamic Regulation . . . Large oil-filled 8mfd, 2 KV capacitor and 5-50 henry swinging choke for high peak power output with low distortion. Neutralized Final . . . Provides a high degree of overall stability in conjunction with the grounded grid circuit design. Interlocked switching . . . to prevent accidental application of HV before switching on filament and bias. Internal RF shielding . . . for maximum protection against TVI. Monitor output . . . gives constant output to scope regardless of frequency. Rugged construction . . . 16 gauge steel chassis— $\frac{1}{8}$ " aluminum front panel—welded one-piece cabinet. All these features are combined into an extremely well laid-out circuit design that makes assembly an easy task which can be accomplished in a few evenings. Compare the Heathkit "Warrior" . . . feature for feature . . . quality component for quality component . . . you'll find no shortcuts . . . only the finest watts-per-dollar value in a kilowatt linear amplifier anywhere. 99 lbs.

SPECIFICATIONS—Maximum power input: SSB-1000 watts P.E.P., CW-1000 watts, AM-400 watts (500 watts using controlled carrier modulation); RTTY-650 watts. **Output circuit:** Variable pi-network (50 to 75 ohms). **Driving power required:** 50 to 75 watts—depending on frequency. **Input circuit:** Broad banded—requires no tuning. **Input impedance:** 50 to 75 ohms. **Band coverage:** 80, 40, 20, 15, 10 meters. **Panel metering:** Switch-selected, grid current, plate current, high voltage and relative power output for ease of loading. **Tube complement:** 4-811A, 2-866A. **Size:** 19 $\frac{1}{2}$ "W. x 11 $\frac{1}{2}$ "H. x 16"D.

Kit HA-10 . . . NO MONEY DOWN, \$22 mo. \$229.95
Assembled HAW-10 . . . NO MONEY DOWN, as low as \$22 mo. \$329.95

and Performance Features

for Greater Amateur Radio Enjoyment

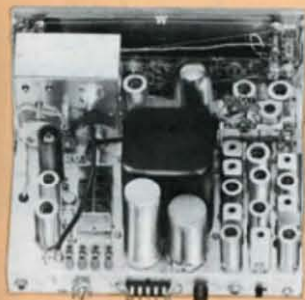

Quick disconnect plugs on the rear chassis apron allow fast, easy change from mobile to fixed station operation. Easy access to crystal sockets provided by removable back plate on cabinet.



Kit HW-10
\$199⁹⁵

For "mobile" or "fixed" station use... feature-packed TRANSCEIVERS for 6 & 2 meters

Clean, functional styling and superb engineering team up to bring you unprecedented performance on the VHF amateur bands in the new Heathkit 6 meter "Shawnee" and 2 meter "Pawnee"! Both models offer complete AM & CW facilities with the latest in design features for complete versatility and operating convenience either as a fixed or mobile station.

The transmitters feature a built-in, temperature stabilized VFO and switch-selection of four crystal positions for net, novice, CAP and MARS operation; tracked VFO and exciter stages for convenient single knob tuning over any 500 kc band segment; a "spotting" switch to zero-in signals with transmitter off-the-air; efficient 6360 final RF amplifier for 10 watt output to antenna; built-in low-pass filter to suppress harmonics and other spurious radiation; dual-purpose modulator which doubles as a 15-watt PA amplifier with an added, external speaker; and push-to-talk ceramic element microphone with coil cord and mounting clip.

The sensitive superheterodyne receivers feature double conversion with first oscillator crystal controlled; voltage regulation on all oscillators for high stability; large, illuminated slide-rule dial for both receiver and VFO; an automatically switched panel meter to read received signal strength or relative power output; front panel squelch and noise limiter controls for maximum clarity, minimum noise; 3" x 5" PM speaker for excellent tone; and RF gain, BFO, and AVC on/off controls. The built-in 3-way power supplies feature transformer operation on 117 V AC and heavy-duty, full-wave vibrator for 6 or 12 V DC operation. AC and DC cables are furnished. A primary fused relay controls all power to the transceiver in mobile installations. Sturdy construction features wrap-around steel case, extensive shielding of transmitter, receiver and power supply sections. Mounting bracket included. Recommended for the more experienced kit builder. Average construction time is 70 hours. 34 lbs. each.

Kit HW-10 (6 meters) . . . NO MONEY DOWN, \$19 mo. **\$199.95**

Kit HW-20 (2 meters) . . . NO MONEY DOWN, \$19 mo. **\$199.95**

- Transmitter—receiver—power supply . . . all in one
- 10 watt RF output to antenna—6360 final
- Tracked VFO and exciter stages for single knob tuning
- Built-in low pass filter—push-to-talk microphone
- Built-in 3-way power supply for 117 V. AC, 6 or 12 V. DC
- Ideal for use in CAP & MARS operations

SPECIFICATIONS—RECEIVER SECTION—Frequency coverage: HW-20; 143.8 to 148.2 mc. HW-10; 49.8 to 54.0 mc. **IF frequencies:** Double conversion—First IF, 22 to 26 mc (tunable); Second IF, 2 mc. **Noise figure:** HW-20; 8.5 db or less, HW-10; 6 db or less. **Sensitivity:** .5 microvolts of input signal will provide an output signal better than 10 db over the noise level. **Squelch sensitivity:** Less than 1 microvolt. **Selectivity:** 15 kc at 6 db down. **Image rejection:** Better than 70 db. **IF rejection:** 50 db. **Input impedance:** 50 to 72 ohm, unbalanced. **Audio power output:** 3 watts (receiver operation); 15 watts (public address operation). **Headphone jack:** Low impedance, accepts PL-55 type plug (standard 2-conductor 1/4" sleeve). **External speaker socket:** 8 ohm impedance, accepts RCA type phono plug.

TRANSMITTER SECTION—Frequency coverage: HW-20; 143.8 to 148.2 mc (crystal or VFO control). HW-10; 49.8 to 54.0 mc (crystal or VFO control). **Modulation:** .01 volts minimum at 1000 cps = 100%. **RF power output:** 8 watts nominal AM, 50 ohm; 10 watts nominal CW, nonreactive load. **Distortion:** 10% or less, with 100% modulation at 1000 cps. **Output impedance:** 50 to 72 ohm, unbalanced. **Low pass filter:** HW-20; 152 mc cutoff frequency. HW-10; 54 mc cutoff frequency. **Key jack:** Accepts PL-55 type plug (standard 2-conductor 1/4" sleeve). **Crystal sockets:** Accepts FT-243 type holders, pin diameter .093", pin spacing .466". **Microphone:** High impedance ceramic element push-to-talk type with coil cord. **Crystals:** (Not furnished) HW-20; 8 mc fundamental range (8.000 to 8.222 mc for 2 meter band). HW-10; 8 mc fundamental range (8.333 to 9.000 mc for 6 meter band).

GENERAL—Power requirements: Input voltage: 6.3V DC, 12.6V DC, 117V AC. Transmit—14.5 amps, 7.5 amps, 120 watts. Receive—8.5 amps, 4.5 amps, 60 watts. **Cabinet dimensions:** 6"H. x 10"D. x 12"W.

Kit Form or Factory Assembled, your dollar buys more value with Heath Equipment

Low Cost Amateur Radio Transceivers



Kit HW-19
\$39⁹⁵



The well laid-out circuitry of these transceiver kits coupled with high quality components provide maximum efficiency for dependable communications.

High quality ceramic tuning capacitor, slug-tuned ceramic coils and air-wound final tank coil in the "Twoer" assure reliable 2 meter communications.

Three bands to choose... covered by
"Tener", "Sixer" and "Twoer"

- Crystal-controlled transmitters
- Tunable superregenerative receivers with RF stage
- Ideal for emergency communications — easy to build

Thousands of these transceivers now in use across the nation, in homes, offices, cars, trucks, boats, etc., attest to their popularity and proven performance. Their neat, compact design, low cost and high versatility make them ideal for use in either mobile or fixed station installations. All feature crystal-controlled transmitters and tunable superregenerative receivers with RF preamplifiers designed for operation on the 2, 6 or 10 meter amateur bands. The highly sensitive receivers pull in signals as low as 1 microvolt and produce complete quieting on reasonable signal levels.

The transmitters with up to 5-watt input are more than adequate for "local" net operations and the communication range of all models is unlimited under "skip" conditions. Other features include; a built-in RF trap on the 10 meter version to minimize TVI; frequency multipliers on the 6 & 2 meter versions to provide straight-through finals from an oscillator using a fundamental crystal in the 8 mc range; built-in final amplifier metering jack, and "press-to-talk" transmit/receive switch on the front panel with "transmit-hold" position.

Kit includes a ceramic element microphone and two power cords, one for use with the built-in AC power supply and one for use with a vibrator power supply such as the Heathkit GP-11 opposite for 6 or 12 volt mobile operation. Transfer from fixed station to mobile operation in a matter of minutes. Handsomely styled in two-tone mocha and beige. Less crystal. 8 lbs. each.

Kit HW-19 (10 meter) . . . NO MONEY DOWN, \$5 mo. \$39.95
Kit HW-29A (6 meter) . . . NO MONEY DOWN, \$5 mo. \$44.95
Kit HW-30 (2 meter) . . . NO MONEY DOWN, \$5 mo. \$44.95

70

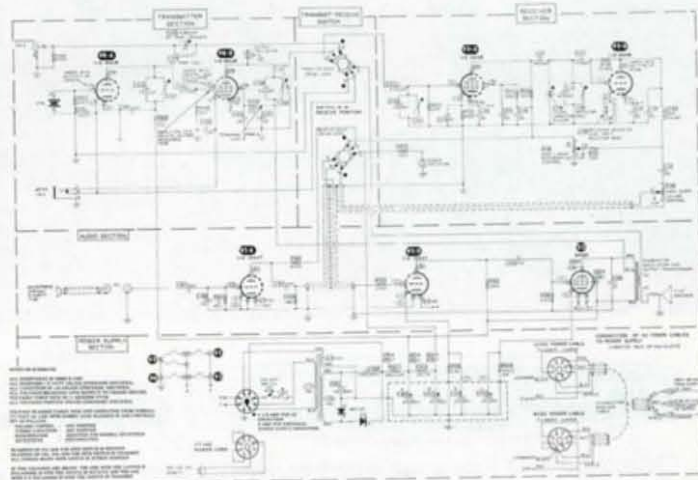

SPECIFICATIONS—Receiver type: Superregenerative detector with RF amplifier stage. **Sensitivity:** Usable with signals as low as 1 microvolt at antenna terminals. **Speaker size:** 3½" (round). **Audio power output:** Approximately 1 watt (undistorted). **Transmitter power input to Final RF amplifier:** Approx. 5 watts. **Frequency control:** Quartz crystal; 3rd overtone; 10 meter; 8 mc fundamental 6 & 2 meter, (not supplied). **Power requirements:** With built-in supply; 105-125V AC, 50-60 cycle, 35 watts (10 meter), 45 watts (6 & 2 meter); with external power supply; Plate requirements: 260V DC @ 60 ma (10 meter), 90 ma (6 & 2 meter). **Filament requirements:** 6V @ 1.8 amps or 12V @ 0.9 amps (10 meter), 8V @ 2.35 amps or 12V @ 1.2 amps (6 & 2 meter). **Cabinet dimensions:** 8" H, x 6" D, x 9¼" W.

Mobile Vibrator Power Supply... operation for 6 or 12 volt



- Current-rated for "Twoer", "Sixer" and "Tener"
- Silicon diode rectifiers
- Small, compact size—easy to install



Ideal for converting 6 or 12 volt battery power to the plate power requirements of a wide variety of mobile equipment. Heavy-duty rated for use with Heathkit Amateur Band Transceiver models HW-19, HW-29A and HW-30. Silicon diode rectifiers and alternate wiring instructions allow use on either 6 or 12 volt systems. Provision for remote on/off switching. Complete instructions for assembly and operation. Colored styled in green and gray-green. 6 lbs.

Kit GP-11 \$21.95

SPECIFICATIONS—Power requirements: 6 volt version, 6.3 VDC @ 6.5 amperes; 12 volt version, 12.6 VDC @ 3 amperes for rated output. **Power output:** 250 VDC @ 100 ma, ICAS. **Power rectifier:** Two silicon diodes in voltage doubler circuit. **Vibrator:** Mallory type 1610 or equivalent. **Vibrator frequency:** Approximately 115 cps. **Overall dimensions:** 4½" H x 6½" W x 4¼" D.

See order blanks for details on Heath's Time Pay—no money down

Heathkit® can fill every Amateur Need



Kit HX-11

\$43⁵⁰

*Brand new!...specially designed for CW work...
specially for novices... the Heathkit HX-11*

- **NEW!** . . . Built-in low pass filter
- **NEW!** . . . Provision for single-switch station control
- **NEW!** . . . Large "clear view" panel meter
- **NEW!** . . . Modern styling
- Single-knob bandswitching
- "Tune-operate" switch
- Built-in power supply

Here is an excellent CW transmitter for the novice or general class amateur who appreciates a clean, quality signal and wants the most "watts-per-dollar" in an amateur transmitter. The new HX-11 is designed exclusively for CW work on the 80, 40, 20, 15 and 10 meter amateur bands, using either crystals or external VFO such as the new Heathkit HG-10, page 72. The efficient circuitry features a single 6DQ6A final amplifier stage with full 50-watt plate power input and a 6CL6 crystal oscillator. The husky power supply uses a heavy-duty 5U4GB rectifier and top-quality "potted" transformer for long service life. Other features include, single-knob bandswitching, switched antenna relay power, pi-network output coupling, built-in low pass filter for minimum TVI, and easy-to-read panel meter for final grid or plate current indication. Easy access to crystal socket is provided by a metal pull-out plug on the side of the cabinet. Very easy to build and operate with the complete instructions supplied. 17 lbs.

Kit HX-11 . . . NO MONEY DOWN, \$5 mo. \$43.50

SPECIFICATIONS—RF power input: 50 watts CW. Output impedance: 50-600 ohm (non-reactive). Output coupling: Pi network. Operation: Crystal—external VFO. Low pass filter cutoff frequency: 34 MC. Band coverage: 80, 40, 20, 15, 10 meters. Tube complement: 5U4GB rectifier, 6CL6 oscillator, 6DQ6A final amplifier. Power requirements: 117 volts AC, 60 cycles, 150 watts. Dimensions: 13" W x 8 1/2" H x 7" D.



Kit VHF-1

\$179⁹⁵

*Here's the transmitter you need for
high power 6 & 2 Meter Operation!*

- Up to 120 watts input on Phone, 140 watts on CW
- Built-in VFO, modulator and power supplies
- "Spotting" push button for off-the-air tuning
- Extensive RF shielding—built for rugged use

From every angle . . . quality, performance, dependability, price . . . you'll find the "Seneca" VHF transmitter a hard to beat "watts-per-dollar" package. On 6 meters, it provides up to 120 watts AM input and 140 watts CW input (slightly less on 2 meters) for reliable DX communications. Design features include: controlled-carrier phone operation, built-in VFO for both 6 & 2 meters, four switch-selected crystal positions, extensive RF shielding, large slide-rule tuning dial with vernier action and rugged, handsome styling. Circuit has two built-in power supplies, five RF stages, two dual-triode audio stages and two 6146's in the final amplifier. A spotting switch is provided for "zero-beating" an incoming signal and allows tuning of the transmitter before switching on the final amplifier. An auxiliary socket provides for receiver muting, remote operation of an antenna relay and remote voice control of the transmitter. Panel controls select VFO or crystal control and phone or CW operation on both bands. Covers popular CAP and MARS VHF frequencies. Quality components are used throughout for long life and dependable performance and the well laid-out circuit provides for easy assembly and highly-efficient operation. 59 lbs.

Kit VHF-1 . . . NO MONEY DOWN, \$17 mo. \$179.95

SPECIFICATIONS—Power input: 6 meters, 140 watts CW; 120 watts phone (peak). 2 meters, 110 watts CW; 95 watts phone (peak). Output impedance: 50 to 72 ohm (non-reactive). Output coupling: adjustable link (coaxial connector). Operation: crystal, VFO, CW, phone. Frequency coverage: 48.9 to 54 mc, 143.7 to 148.3 mc. Audio: screen modulated, controlled carrier. Power requirements: 117 VAC 60 cycles; Standby (phone, CW) 120 watts, full load (phone, CW) 400 watts (intermittent). Dimensions: 16 1/2" W x 10 1/2" H. x 10" D.

No Down Payment Required On Heath's New Time Pay Plan!

Now you can buy the Heathkit of your choice with no down payment! Now any order from \$25 to \$600 can be purchased with no down payment (write for details on orders over \$600). These new, relaxed credit terms, coupled with our new money-back guarantee that you can build any Heathkit, mean you can buy Heathkit with complete confidence and assurance of satisfaction.

Round Out your Rig with matched

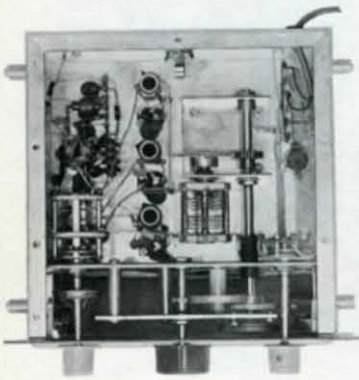

Kit HG-10

\$34⁹⁵

Note the neat circuit layout for easy assembly, rugged gear drive, high quality double-bearing tuning capacitor, temperature compensated epoxy coated coils, ceramic switch and condenser wafers for high stability and reliable performance. This VFO is top quality throughout!

Now cover 80 thru 2 meters

with this New Heathkit VFO!

- Each band separately calibrated on rotating drum-type slide-rule dial
- Gear drive vernier tuning for smooth, easy frequency selection
- Epoxy coated coils on ceramic forms for high stability
- High quality double-bearing tuning capacitor
- Heavy steel chassis; cathode follower output

Here's the VFO you've been waiting for . . . it's rugged . . . regulated . . . stable . . . matches current Heathkit amateur gear . . . loaded with special features . . . reaches all the way to 2 meters . . . and it's only \$34.95 in kit form! The new Heathkit HG-10 VFO covers from 80 through 2 meters with each band separately calibrated on a rotating drum-type slide-rule dial. The circuit uses the popular series-tuned Clapp oscillator with a cathode follower output for isolation and regulated plate voltage for maximum stability. Its vernier tuning has a 28 to 1 gear drive . . . and there's a "spot" switch for off-the-air tuning. The circuit is designed for grid-block keying with the new Heathkit DX-60 or for cathode keying with other transmitters. Everything is mounted on a rigid steel chassis for superior mechanical strength and freedom from chassis instability . . . and it's all wrapped up in a handsome cabinet to match the DX-60. Power is obtained from the transmitter . . . just plug it into the DX-60, or make simple changes to use with other transmitters. All cables are supplied. 12 lbs.

Kit HG-10 . . . NO MONEY DOWN, \$5 mo. **\$34.95**

SPECIFICATIONS—Band coverage: 80, 40, 20, 15, 10, 6 and 2 meters. Load impedance: 50 K ohms or more. Output voltage: 5 volts R.M.S. or more, with no load. Output connections: phono plug. Front panel controls: Function Switch (Stby/Opr/Spot), VFO tuning & Band selector. Tube complement: 6CH8—oscillator—cathode follower; OB2—Voltage regulator. Power requirements: 1. From Accessory socket of DX-60, using cable furnished. 2. From accessory socket of DX-40, with simple changes. 3. From other sources: 140 volts min. @ 25 ma.; 6.3 volts ac or dc at 0.75 amp. Cabinet size: 9 1/2" wide, 9" deep, 6 1/2" high.



Kit SB-10

\$93⁵⁰

Switch to SSB for more talk power . . . less fade & interference . . . with this SSB ADAPTER kit

- Produces USB, LSB or DSB signals with or without carrier insertion
- Built-in VOX with anti-trip circuit
- Sealed audio phase shift network

Designed as a compatible plug-in adapter unit for the TX-1 "Apache" transmitter, the SB-10 allows operation on single sideband for increased versatility. This adapter will also be of interest to amateurs now operating strictly AM or CW with other transmitters such as the Heathkit DX-100. By making a few simple circuit modifications, most modern transmitters can be used utilizing all existing RF circuitry. Extremely simple to operate and tune, the adapter employs the phasing method of generating a single sideband signal, thus allowing operation entirely on fundamental frequencies. The critical audio phase shift network is supplied completely preassembled and wired in a sealed plug-in unit. Also featured are single-knob bandswitching, an easy-to-read panel meter that indicates relative-power output to aid in tuning and built-in electronic voice control with anti-trip circuit which allows duplex operation but prevents receiver output from turning on the transmitter during listening periods. RF excitation from the transmitter is required for the adapter to provide an SSB signal which is then fed to the transmitter final for amplification. Experience the advantages of SSB operation now with minimum expense by adding this fine kit to your amateur station. 12 lbs.

Kit SB-10 . . . NO MONEY DOWN, \$10 mo. **\$93.50**

SPECIFICATIONS—Power output: 10 watts P.E.P. (peak envelope power). Power input: Less than 3 watts of RF at the fundamental operating frequency required. Output: Pi network, low impedance, coaxial. Input: Low impedance, coaxial. Band coverage: 80, 40, 20, 15, 10 meters. Circuitry: Phasing method of SSB signal generation is employed with voice control and anti-trip action built into the audio circuit. Power requirements: 350 VDC @ 85 ma., 6.3 VAC @ 3.5 amp. Meter: 2 1/2", 200 ua movement, indicates carrier null and relative power output. Cabinet size: 10" H x 6 1/2" W x 13" D.

Heathkit® Amateur Radio Accessories



Kit HD-11
\$14.95

Use this New Heathkit "Q" MULTIPLIER
to increase your receiver selectivity!

- Can be used with AC-DC or transformer operated receivers
- Built-in power supply—power light indicator
- Two peak I.F. positions (sharp or broad) plus rejection notch (null)

This new Heathkit "Q" Multiplier can be used with any communications type receiver having an I.F. frequency between 450 and 460 kc. With this "electronic filter", the receiver I.F. selectivity is greatly increased (effective "Q" of approximately 4,000) for peaking or rejecting a signal on AM, CW or SSB. The HD-11 can be used to produce a sharply peaked I.F. curve for CW reception, broad peaked I.F. for phone operation or a deep rejection notch to eliminate a closely interfering heterodyne. Both peak or notch positions are tuneable to any point in the receiver's I.F. bandpass. The HD-11 comes complete with connecting I.F. cable, plug and socket for attachment to the receiver. Ideal for CW reception and heterodyne rejection in SSB receivers such as the Collins 75S-1. Easy to build and operate with instructions provided. 2 lbs.

Kit HD-11.....\$14.95

SPECIFICATIONS—Operating frequency: 450-460 kc. Operation: Off-Sharp Peak—Null—Broad Peak. Tube complement: 12AX7. Power requirements: 105-125 volts AC, 40-60 cycles, 4 watts. Dimensions: 7 $\frac{1}{2}$ " W x 4 11/16" H x 4 $\frac{1}{2}$ " D.

For assured calibration accuracy, use
the Heathkit 100 KC CRYSTAL CALIBRATOR kit

The Heathkit model HD-20 Crystal Calibrator is an accurate signal source which provides output signals at 100 kc intervals from 100 kilocycles to 54 megacycles. Amateur radio operators can use the HD-20 for many purposes such as checking receiver dial calibration, checking band edges, VFO calibration, etc. The HD-20 may be used also in other phases of radio communications where accurate marker signals in multiples of 100 kilocycles are required. Operation of the crystal calibrator requires only connection to the antenna input of the receiver and switching the unit "on". The circuit is transistorized and battery powered so it may be used anywhere. Current drain is so slight that the battery life almost equals its shelf life. Calibration of the HD-20 is easily accomplished by tuning the receiver to WWV or any station having an operating frequency of a harmonic of 100 kc and adjusting the HD-20 for "zero-beat". A .005% crystal is furnished. 1 lb.

Kit HD-20.....\$14.95



Kit HD-19
\$29.95

Run patches fast and easy
with this HYBRID PHONE PATCH kit

- One switch operation convenience
- VU meter for monitoring line level
- Special hybrid transformer for minimum of 30 db isolation
- Allows VOX or manual operation

This easy-to-install and operate Heathkit Hybrid Phone Patch is designed to accomplish the transfer of audio signals between telephone lines and two-way radio communications equipment with maximum efficiency and performance. It can be used with nearly all transmitters and receivers on the market today, including transmitters employing "VOX". Features include a standard VU meter for accurate monitoring of the output to the telephone line to prevent crosstalk, a single on/off function switch for ease of operation and separate transmit/receive gain controls. A special hybrid transformer is used to provide a minimum of 30 db isolation between transmitting and receiving circuits and maintain a balanced phone line for minimum hum. Use with 3 to 16 ohm speakers and hi-Z microphone input. 3 lbs.

Kit HD-19...NO MONEY DOWN, \$5 mo.....\$29.95

SPECIFICATIONS—Circuitry: Telephone hybrid circuit to allow "VOX" or manual operation. Single switch places patch in operation. Telephone line input impedance: approx. 600 ohms. Meter: Standard VU meter for constant output monitoring and null depth indication. Null depth: At least 30 db isolation of transmit and receive circuits. Receiver impedance: Effective match from 3 to 16 ohms. Microphone impedance: Hi-Z. Dimensions: 7 $\frac{1}{2}$ " W x 4 $\frac{1}{2}$ " H x 4" D.

- Use to check all types of communications equipment
- Provides output at 100 kc intervals up through the 6 meter band
- Transistorized and battery powered for complete portability
- Small, compact size—easy to operate and build



Kit HD-20
\$14.95

SPECIFICATIONS—Frequency coverage: 100 kc to at least 54 mc, in harmonics of 100 kc. Crystal: Quartz; 100 kc \pm .005%. Transistor: 2N409. Battery voltage: 9 volts. Battery life: 6 months, normal intermittent service. Switch: on/off. Dimensions: 2 $\frac{1}{2}$ " W x 4 $\frac{1}{2}$ " H x 2 $\frac{1}{2}$ " D (overall).

Handy Accessories for the Radio Amateur

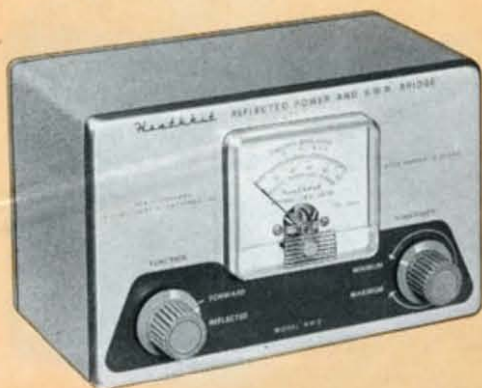

Kit AM-2
\$15⁹⁵

*indicates antenna-transmitter
match . . . REFLECTED POWER METER*

- Meter indicates forward or reflected power and SWR
- May be used on amateur bands from 160 through 6 meters

The Heathkit Reflected Power Meter checks the match of your antenna's transmission system by measuring the forward and reflected power or SWR (standing wave ratio), thereby determining its efficiency. It is designed to handle a peak power of well over 1 kilowatt of energy and may be left in the antenna system feed line at all times. Components are provided for matching 50 or 75 ohm lines. Band coverage is 160 through 6 meters. The built-in panel meter indicates percentage of forward or reflected power and voltage-standing-wave-ratio from 1:1 to 3:1 and more. A control is provided in the meter circuit to adjust for full scale reading without reducing transmitter power output to acquire the proper on-scale level. Another convenient application of the AM-2 is in matching impedances between exciters or RF sources and grounded grid amplifiers. Negligible insertion loss is introduced into the feeder system since the AM-2 is a portion of coaxial line in series with the feeder system and no internal connections are actually made to the line. The AM-2 measures just $7\frac{3}{8}'' \times 4\frac{1}{8}'' \times 4\frac{3}{8}''$ for convenient installation at operating position. 2 lbs.

Kit AM-2 **\$15.95**

*Use this RF POWER METER to
monitor transmitter output*

- Sensitive 200 ua meter
- Operates with any transmitter
- Small, compact size



Kit PM-2
\$12⁹⁵

This handy power meter gives a continuous indication of relative power output of transmitter by sampling the RF radiation near the antenna. Requires no external power source for operation. The PM-2 operates with any transmitter, whether it be marine, mobile or fixed that has output frequencies between 100 kc and 250 mc. Sensitivity is 0.3 volts RMS at antenna input terminals for full scale deflection. A sensitive 200 ua meter is used with a control to set sensitivity level. A strong magnet in the base of the PM-2 holds it fast to any steel surface such as an automobile dashboard. 2 lbs.

Kit PM-2 **\$12.95**

74



Kit HM-10
\$34⁹⁵

Expected Shipping Date:
November 10, 1961

*"the TUNNEL DIPPER"
entirely new . . . nothing
like it anywhere . . . all the functions of a "GRID DIP"
METER with new tunnel-diode, solid-state circuitry!*

- Tunnel-diode oscillator—no tubes
- Covers frequency range of 2.7 to 270 mc
- Gear drive vernier tuning
- Enclosed drum type dial with every scale nearly 7" long!
- Color-matched dial scales and coils for easy identification
- Epoxy-coated, plug-in coils for stability, durability
- Protective snap-on cover has built-in storage for coils
- Battery powered for complete portability
- Convenient access to battery holder
- Printed circuit board for easy assembly
- Compact—measures only 4" x 3" x 5½"

It's new! . . . it's different . . . the new Heathkit "Tunnel-Dipper" . . . the only one of its type in the industry! A notable achievement in electronic design, the "Tunnel Dipper" performs all the functions of a "grid dip" meter with an entirely new concept in circuit design. It features solid-state circuitry, using transistors and a Tunnel Diode as an oscillator . . . it has no tubes, no power cord, it is completely self-contained and portable.

Solid-state circuitry with its low power requirements make it possible to use a single flashlight cell for power. New styling features convenient control, meter, and coil arrangement for simple, easy operation. Tuning dial and coils are color-matched for easy identification . . . preventing errors through reading the wrong scale. Coils are epoxy-coated for durability and stability, and the protective cover supplied for dial and meter has built-in storage space for coils. Cover snaps off, out of the way, when unit is in use. The many functions of this instrument may be used to find resonant frequencies of tuned circuits, align circuits without turning on power, identify parasitics, check antenna for resonance, tune traps and filters, etc. It may be used as an emergency signal generator or as a sensitive tuned RF detector. Ideal for use in amateur radio and service work. 3 lbs.

Kit HM-10 . . . NO MONEY DOWN, \$5 mo. **\$34.95**



Kit CO-1
\$7⁹⁵

**TRANSISTOR
CODE PRACTICE OSCILLATOR**

- Switch-selection of tone or blinker light
- Top quality parts—easy to build

Ideal for beginning radio amateurs, Boy Scout groups, etc., the CO-1 permits code practice using either authentic CW tone or blinker light. A switch selects either built-in speaker for audible tone or panel light for silent operation. The light may also be used at night for visual communications. The circuit is completely transistorized for long battery life. Operates with two standard flashlight batteries included with kit. A contactor is provided for practice keying or a standard key can be connected to the terminals provided. Unit is housed in an attractive black bakelite case measuring 6" x 3" x 2½". 2 lbs.

Kit CO-1 **\$7.95**

Versatile Amateur Radio Power Supplies

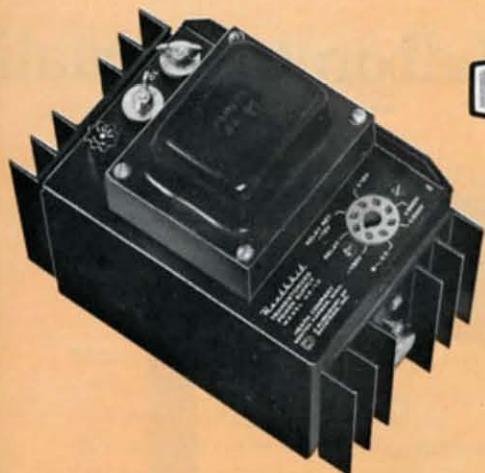

Kit HP-10
\$44⁹⁵



Kit HP-20
\$29⁹⁵

Allows use of mobile gear on household current... UTILITY AC POWER SUPPLY

- Line filtering to minimize TVI
- Bias supply for maximum versatility
- Dependable long-life silicon rectifiers
- RC filters for dynamic regulation

A valuable accessory for any amateur radio fan! The HP-20 can be used to convert Heathkit and most other mobile transmitters and receivers to fixed-station operation, power SSB & CW transmitters requiring fixed bias for linear stages or grid block keying, etc. The HP-20 has a built-in switch and pilot light allowing use as a master control for amateur equipment. Supplies filament, B+, and bias voltages for many applications. Sufficient current and voltage capability allow use of bias supply with voltage regulator tube. High value capacitors in the output of RC filters provide good dynamic regulation and silicon diode rectifiers are used throughout for long life and dependable performance. An octal socket output connector is used to protect against shock hazard and for increased connector versatility. Output information is screened on the chassis for permanent reference. Unit is fused for protection. Can be easily built in one evening. 14 lbs.

Kit HP-20... NO MONEY DOWN, \$5 mo. \$29.95

SPECIFICATIONS—Power requirements: 117 volts AC, 50/60 cycles, 200 watts. **Total DC continuous power output:** 120 watts (600 volts @ 200 ma or 600 volts @ 150 ma & 300 volts @ 100 ma; bias of -125 VDC @ 30 ma also provided). **Filament power:** 6.3 volts @ 8 amperes or 12.6 volts @ 4 amperes. **Regulation:** Approximately 10% (50% load to 100% load, from high voltage tap). **Overall dimensions:** 9" L x 4 3/4" W x 6" H.

high performance TRANSISTOR MOBILE POWER SUPPLY

- Powers both transmitter and receiver
- High efficiency circuit—instant starting
- Rugged construction for long life
- Remote relay control of primary power

This husky mobile power supply is designed to furnish all power required to operate both the Heathkit MT-1 Transmitter and MR-1 Receiver. It may be used with many other makes of mobile communications equipment having similar power requirements. The HP-10 operates from a nominal 12 volt DC power source to provide both B+ and bias voltages with a combined continuous power rating of 120 watts. The HP-10 provides a fixed bias source for SSB applications, etc., or may be connected to provide positive 125 VDC @ 30 ma for extra low level stage power or use in other applications within this rating. The exceptionally well-designed circuit with two heavy-duty power transistors and long-life silicon diode rectifiers features high 75% efficiency, low idling current (2 amps), only 13 amps at full output. Other circuit refinements include: relay control of primary power, heavy filtering of input and output leads, capacitor discharge resistors, effective suppression of voltage transients, efficient silicon rectifiers and rugged construction for long life dependable performance. Extruded aluminum heat sinks are used for efficient cooling of the two power transistors. Power take-off for equipment is through a standard octal socket with voltage points clearly screened on the power supply chassis. Easy to assemble and install. 10 lbs.

Kit HP-10... NO MONEY DOWN, \$5 mo. \$44.95

SPECIFICATIONS—Input voltage: 11 to 15 V DC (12.6 nominal). **Input current:** 2 to 13 amps (as a function of output load). **Total power output:** 120 watts continuous, 150 watts normal intermittent operation. **Power available:** 600 VDC @ 200 ma or 600 VDC @ 150 ma & 300 VDC @ 100 ma, and bias of -125 VDC @ 30 ma. **Efficiency:** Approximately 75%. **Maximum ambient operating temperature:** 120 degrees F, at 120 watt continuous, 150 degrees F, at 120 watt intermittent operation (50% duty cycle). **Dimensions:** 8" W x 7 1/2" H x 6 1/2" D.

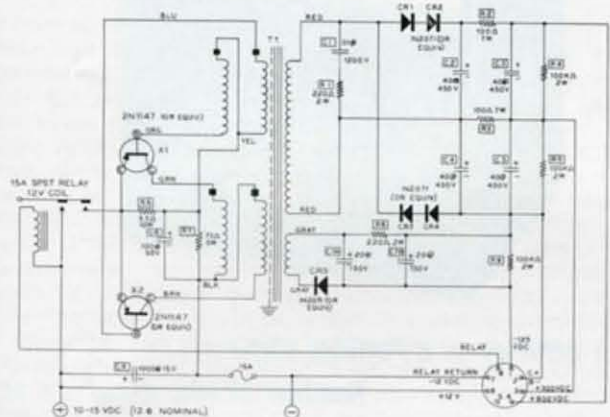

BALUN COIL SET

Unblanced coaxial lines used on most modern transmitters can be matched to balanced lines of either 75 or 300 ohms impedance with this convenient transmitter accessory. The design of the bifilar wound coils enables transmitters to operate into balanced antenna systems such as dipoles, folded dipoles, etc., for maximum efficiency. The Balun Coil set can be used with transmitters and receivers over the frequency range of 80 through 10 meters without adjustment and will handle power inputs up to 200 watts. Cabinet dimensions are 9" square by 5" deep. May be located any distance from the transmitter or antenna where convenient. 3 lbs.



Kit B-1
\$9⁹⁵

Kit B-1... \$9.95



Equip your shop with do-it-yourself

...get Laboratory Quality

A word about Heathkit® Test Equipment

Heathkit test equipment is the result of many years of experience in the test equipment field. Each new instrument, from its very first stages of development to final production, goes through many exhaustive tests in our modern engineering laboratory. These tests are conducted by engineers who not only know the test equipment field, but also how to design the very finest performing instruments at the lowest possible cost. The dedication of these engineers and your own assembly efforts make it possible for you to equip your electronic workshop with complete laboratory facilities at just a fraction of the cost of comparable ready-built equipment.

The many design features incorporated in Heathkit equipment, along with the complete and informative instructions provided combine to produce accurate and dependable test equipment that is a pleasure to construct and professional in performance. Knowledge gained through actual assembly permits a degree of familiarity that allows far more intelligent application and provides the background for making minor adjustments if needed to keep your equipment in peak operating condition at all times. Look through these pages and note the many Heathkit instruments that will save you money . . . simplify your work . . . make more fun or profit for you!

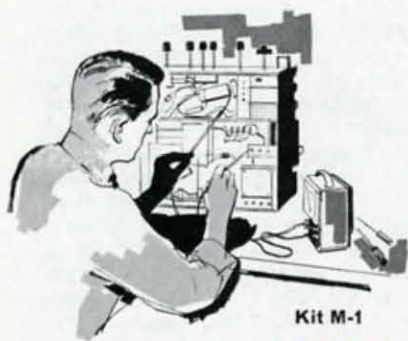

Kit M-1

\$19⁹⁵

Heathkit HANDITESTER . . . a fine meter for portable or shop use!

- Measures AC and DC voltage, DC current and resistance
- Combination function/range switch for simple operation
- Pocket size portability—no calibration required

The Heathkit Handitester is an ideal first instrument for the hobbyist, home experimenter, or home handyman. Measures AC and DC voltage, DC current and resistance for use in countless applications. Its small, compact size and rugged construction combined with a built-in battery supply make it ideal for any portable application. 1% precision resistors are used for high accuracy and the combination function /range switch simplifies operation. The M-1 is easy to build with the complete instructions supplied and requires no calibration. Very handy for use in radio and TV service shops when main instruments are occupied or for use in making quick checks on home service calls. Streamlined bakelite case measures 3" W x 6" H x 2 3/4" D. Test leads and battery included. 2 lbs.

Kit M-1 **\$19.95**

SPECIFICATIONS—Sensitivity: 1000 ohms-per-volt. **Meter ranges:** AC & DC VOLTMETER: Full scale 10, 30, 300, 1000 and 5000 volts. DC MILLIAMMETER: 0-10 ma, 0-100 ma. OHMMETER: 0-3,000 ohms (30 ohms center scale), 0-300,000 ohms (3,000 ohms center scale). **Meter movement:** 400 microampere, 3". **Resistors:** 1% precision type. **AC rectifier:** Dual half wave. **Accuracy:** Meter movement, 2% of full scale. **Controls:** Function/range switch, ohms adjust. **Case:** Streamlined molded phenolic. **Ohmmeter battery:** One standard size "C" flashlight cell.



Kit MM-1
\$33⁹⁵

High accuracy in a Portable Meter . . . Heathkit 20,000 ohms/volt VOM

- Sensitive 50 microampere 4 1/2" meter
- Total of 35 meter ranges on 2-color scale
- All 1% precision multiplier resistors for high accuracy
- Polarity reversing switch—eliminates transferring test leads
- Sleek, modern styling—recessed test jacks—carrying handle

Those who prefer a portable meter for all-round use will find the Heathkit model MM-1 ideal. It provides wide voltage, current, resistance and db ranges to cover practically any service requirement. Requiring no external source of power, the MM-1 uses standard flashlight batteries that are easily replaced when necessary, making it equally useful on the test bench or on service calls. Maximum accuracy is assured on all ranges by the use of 1% precision resistors and the large 4 1/2" 50 microampere meter has more than enough sensitivity for even the lowest voltages on the 1.5 volt scale (a single volt on the lowest range will produce a meter deflection of 2 1/4").

The many features of the Heathkit VOM include a polarity reversing switch to eliminate transferring of test leads when alternately measuring positive and negative voltages and recessed test jacks to minimize shock hazard. The meter is preassembled to the panel and is provided with a close-fitting case to keep out dust and protect internal components.

This VOM is easy to build with the complete instructions supplied. All components are attached directly to the front panel. The inside view above shows how all parts are easily accessible. Batteries can be snapped in or out in a matter of seconds. Resistor "rings" eliminate excessive handling of switch contacts during construction and provide rugged mountings for the precision components. Complete with batteries and test leads. 4 lbs.

Kit MM-1 . . . NO MONEY DOWN, \$5 mo. **\$33.95**

SPECIFICATIONS—Sensitivity: 20,000 ohms/volt DC, 5,000 ohms/volt AC. **Range AC & DC volts:** Full scale, 1.5, 5, 50, 150, 500, 1500, 5000. **Direct current:** 150 microamperes, 15, 150, 500 milliamperes, 15 amperes. **Ohmmeter:** 0.2 ohms to 20 megohms in three ranges. **Decibels:** -10 to +65 db. **Resistors:** 1% precision type. **Controls:** Range switch, Output -AC/DC Reverse DC switch, Ohms adjust control. **Batteries:** 1 type "C" cell, 4 penlight cells. **Dimensions:** 7 1/2" x 5 1/2" x 4".

Heathkit® Test Instruments at a fraction of the cost



Here's the World's Largest Selling VTVM
now in a brand new, handsomely styled package
with improved performance
and extra convenience

- Single AC/ohms/DC probe with switch
- 7 AC, 7 DC & 7 ohms ranges
- Easy-to-read 4½" 200 ua meter
- 1% precision resistors for high accuracy
- Extended low end only frequency response
= 1 db from 25 cps to 1 mc.

No basic service instrument has contributed more to the field of electronics than the world-famous Heathkit VTVM. Its quality and performance at low cost have made it a favorite for years and now with improved styling, better low-frequency response and single test-probe convenience, it presents an even greater value than before.

Now designated the IM-11, it features the same basic trouble-free circuit of the time-proven Heathkit V-7A with new improvements. Functions include AC volts (RMS), AC volts (peak to peak), DC volts, resistance and db measurements. Improved response now reaches down to 25 cycles for those important low frequency tests. Precision 1% resistors and the high 11 megohm input resistance of the IM-11 assures high accuracy in every application by minimizing circuit loading of the unit under test. A large 4½" 200 microampere meter is used for indication with clear, sharp calibrations for easy reading of all measurements. Front panel controls include a rotary function switch (with DC polarity reversing position to eliminate lead switching when alternately measuring positive and negative voltages), a rotary range selector, zero adjust and ohms adjust controls. Zero and ohms adjust controls feature small phenolic shaft knobs to minimize accidental change in setting.

The new slim, all-purpose test probe is used for all measurements. A switch on the probe body provides simple selection of AC-ohms or DC functions and is equipped with a hook which enables clipping the probe to the circuit for "hands free" operation. A component circuit board assures stable, uniform circuitry and easy assembly. Test leads and battery included. 5 lbs.

Kit IM-11...NO MONEY DOWN, \$5 mo. \$29.95
Assembled IMW-11...NO MONEY DOWN, \$5 mo. \$46.75



Kit IM-11

\$29.95

Kit Form
or
Factory
Assembled

See p. 29 for the first in the New
Heathkit Technical Application Series
"How to Understand and Use
Your Vacuum Tube Voltmeter."

SPECIFICATIONS—Meter scales: DC & AC (RMS): 0-1.5, 5, 15, 50, 150, 500, 1500 volts full scale. **AC peak-to-peak:** 0-4, 14, 40, 140, 400, 1400, 4000. **Resistance:** 10 ohm center scale x1, x10, x100, x1000, x10K, x100K, x1 meg. Measures .1 ohm to 1000 megohms with internal battery. **Meter:** 4½" 200 ua movement. **Multipliers:** 1% precision type. **Input resistance DC:** 11 megohms (1 megohm in probe) on all ranges. **Circuit:** Balanced bridge (push-pull) using twin triode. **Accuracy:** DC ± 3%, AC ± 5% of full scale. **Frequency response:** ± 1 db, 25 cps to 1 mc (600 ohm source). **Tubes:** 12AU7, 6ALS. **Battery:** 1.5 volt, size "C" flashlight cell. **Power requirements:** 105-125 volt 50/60 cycle AC 10 watts. **Dimensions:** 7½" H x 4 11/16" W x 4¾" D.

Kit Form
or
Factory
Assembled

VTVM Probe Accessories

Kit Form
or
Factory
Assembled



Kit 309-C
\$3.50

Heathkit Etched Circuit RF PROBE Kit

The Heathkit RF probe may be used in conjunction with any 11 megohm VTVM to permit RF measurements up to 250 megacycles. A convenient and useful accessory for those occasions when RF measurements are necessary. A printed circuit is used for increased stability and ease of assembly. Ideal for further extending the service applications of your Heathkit VTVM. 1 lb.

Kit 309-C..... \$3.50
Assembled 309W-C..... \$4.50



Kit 336
\$4.50

Heathkit 30,000 volt DC HIGH VOLTAGE PROBE Kit

The Heathkit high-voltage probe will prove invaluable for TV service work or any similar application where measurement of high DC voltage is required. A precision multiplier resistor mounted inside the two-color sleek plastic probe body provides a multiplication factor of 100 on the DC ranges of any 11 megohm VTVM. Plenty of insulation for safety of operation. 1 lb.

Kit 336..... \$4.50
Assembled 336W..... \$5.50

Equip your Service Bench or Lab with



- Large 6" 200 ua meter with easy to read scales
- 11 megohm DC input resistance for high accuracy
- Separate low voltage AC scales—broad frequency response
- Recessed zero and ohms adjust controls—easy access adjustments
- Multi-colored meter scales—high contrast panel screening

Kit IM-10
\$32.95



Beautifully designed, the IM-10 has clean, open circuit layout for easy assembly and high quality components throughout for long life and dependable performance. Note the easy access to calibrate controls.

*Many extras for precision measurements
in this deluxe SERVICE BENCH VTVM*

See p. 29 for the first in the New Heathkit Technical Application Series "How to Understand and Use Your Vacuum Tube Voltmeter."

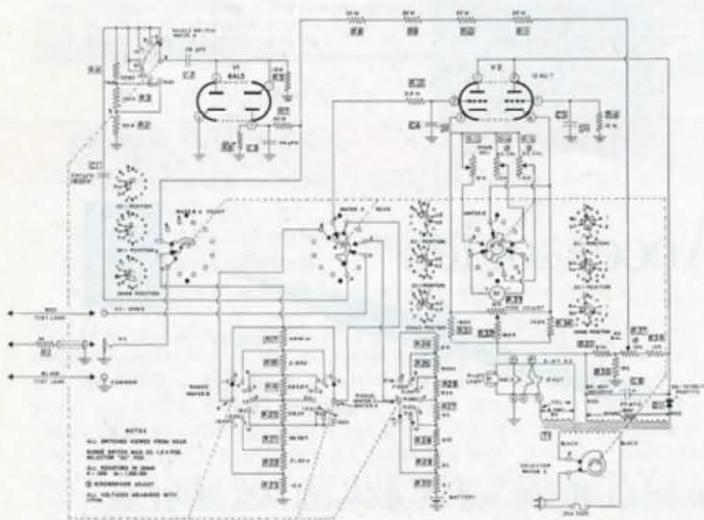

The Heathkit IM-10 is a big, handsome VTVM specially designed for service bench use. It features the basic, time-proven circuitry of the world-famous Heathkit V-7A with new engineering and styling concepts for even greater readability and accuracy.

In every field of electronics, the voltmeter is an essential instrument. Voltage measurements are a necessary part of design work maintenance, servicing, and trouble-shooting in every field encountered. The Vacuum Tube Voltmeter because of its inherent circuit design advantages is by far the most accurate and dependable for use in any type of measurement. For example, the high input impedance minimizes the "loading" effect of the meter on the circuit under test, allowing far greater accuracy than can be obtained with other types of voltmeters.

Another advantage is that the voltages measured are not applied directly to the meter but rather to a vacuum tube which is limited to the amount of current it can draw, thereby protecting the sensitive meter movement against possible damage should a high voltage accidentally be applied while the range switch is in the wrong position. In the IM-10, the maximum voltage applied to the tube is 3 volts. Higher voltages are reduced through precision 1% voltage divider resistors with a total resistance of 10 megohms. An additional resistance of 1 megohm is located in the DC test prod to permit DC measurements in RF circuits with a minimum of disturbance to these circuits.

An extremely versatile instrument the IM-10 will measure AC (RMS) and DC volts to 1500 in seven ranges, resistance from .1 ohm to 1000 megohms in seven ranges and decibels from -10 to +65 db. DB calibrations are provided for relative voltage measurements with circuit components selected to give 10 db steps between ranges. Separate 1.5 and 5 volt AC scales are provided for high accuracy in low voltage AC measurements.

The generous proportions of the IM-10 permit wide spacing of controls for easy operation and room for mounting the large 6" 200 ua meter. Multicolored meter scales and high contrast panel screening show at a glance the correct scale and range in use for fast, easy reading of all measurements. Zero-adjust and ohms-adjust controls are recessed to prevent accidental change in settings. Clean, open circuit layout and a wiring harness assure easy assembly and maintenance. Test leads and battery are included. 6 lbs.

Kit IM-10...NO MONEY DOWN, \$5 mo.....\$32.95

SPECIFICATIONS—Meter scales DC & AC (RMS): 0-1.5, 5, 15, 50, 150, 500, 1500 volts full scale (1.5 and 5 volt AC ranges read on separate scales). **Ohmmeter:** Scale with 10 ohm center x1, x10, x100, x1000, x10K, x100K, x1 meg. Measures 1 ohm to 1000 megohms with internal battery. **Multipliers:** 1% precision type. **Meter:** 6" 200 ua movement. **DC input resistance:** 11 megohms (1 megohm in probe) on all ranges. **AC input impedance:** 1 megohm shunted by 30 uuf (measured at input terminals). **Circuit:** Balanced bridge (push-pull) using twin triode. **Accuracy:** DC $\pm 3\%$, AC $\pm 5\%$ of full scale. **Frequency response:** ± 1 db 25 cps to 1 mc (600 ohm source). **Tubes:** 12AU7, 6AL5. **Battery:** 1.5 volt size "C" flashlight cell. **Power requirements:** 105-125 volts 50/60 cycle AC, 10 watts. **Dimensions:** 9 1/2" H x 6 1/2" W x 5" D.

Dependable Heathkit® Test Instruments

Kit Form
or
Factory
Assembled



Kit IM-21
\$33.95

New features... new styling... new performance... in this brand new AC VTVM!

- Extended frequency response ± 1 db 10 cps to 500 kc
- 10 megohm input impedance for high accuracy
- 10 voltage ranges—0.01 to 300 volts RMS full scale
- Calibrated db scale—measures -50 to $+50$ db in 10 db steps

This vastly-improved version of the famous Heathkit AV-3 features extended frequency response, higher input impedance and new styling to become an indispensable means of measurement in any lab! New circuit design features include a cathode follower stage on all ranges for increased input impedance and 2-stage amplifier with approximately 19 db of negative feedback to insure high output stability and linearity. With an added stage of voltage division using precision components, the IM-21 has more than double the frequency range of the AV-3.

Also, with 10 megohms of input impedance, it has ten times the input impedance of the AV-3, thus assuring that the circuit under measurement will be virtually unaffected. Besides these striking improvements, the IM-21 retains all of the fine features of the AV-3, such as high sensitivity, excellent stability, and ease of operation. Also the use of a meter with VU type ballistic damping allows monitoring audio signals in such applications as tape recording and audio system measuring. 4 lbs.

Kit IM-21... NO MONEY DOWN, \$5 mo. \$33.95
Assembled IMW-21... NO MONEY DOWN, \$7 mo. \$60.25

SPECIFICATIONS—Frequency response: ± 1 db 10 cps to 500 kc, ± 2 db 10 cps to 1 mc, all ranges. **Ranges:** VOLTS—Ten ranges from 0.01 to 300 volts RMS full scale. **Decibels:** Total range -52 to $+52$ db, meter scale -12 to $+12$ db (0 db = 1 mw in 600 ohms), ten switch selected ranges from -40 to $+50$ db in 10 db steps. **Input impedance:** 10 megohms shunted by 12 uuf on ranges 10 to 300 volts, 10 megohms shunted by 22 uuf on ranges .03 to 3 volts. **Tube complement:** (1) 6AW8, (1) 6EJ7/EF-184. **Accuracy:** Within 5% of full scale. **Power requirements:** 105-125 volts AC, 50-60 cycles, 10 watts. **Dimensions:** 7 $\frac{3}{4}$ " H x 4 11/16" W x 4 $\frac{1}{4}$ " D.



Kit IM-20
\$14.95



An instrument of a thousand uses, the Heathkit HANDY LAB is versatile, practical and economical

- 5 functions in one instrument
- Fills all basic service needs
- Simple one-switch operation
- Battery operated for complete portability
- Coat-pocket size—attractively styled
- Easy to build—low in cost

This all-in-one hand-held tester is ideal for the hobbyist, service technician, or ham operator. It combines the functions of a DC voltmeter, transistorized signal generator, continuity checker, resistor and capacitor substitution boxes and may also be used as a code practice oscillator. The Handy Lab is battery powered allowing use anywhere, any time, for complete operation flexibility! A single 18-position switch selects any of its functions. The 1000 ohms-per-volt DC voltmeter covers 0 to 500 volts in four ranges for voltage measurements; the generator provides RF and AF signals for servicing AM radios; fixed capacitor and resistor values are available for substitution tests to bypass suspected components or alter circuit characteristics, etc. A neon bulb is provided to indicate AC voltage over 85 volts and a #49 pilot lamp indicates continuity up to 50 ohms, adequate for most basic testing purposes. The many functions of the Handy Lab combined with its portability makes it an extremely useful instrument for a wide variety of testing purposes. Order yours today! Test leads and batteries included. 2 lbs.

Kit IM-20 \$14.95

SPECIFICATIONS—DC voltmeter: Four ranges, 0-15, 50, 150, 500 volts full scale. **Meter:** 0 to 1 milliamperes. **Accuracy:** $\pm 10\%$ of full scale. **Input resistance:** 1000 ohms-per-volt. **Resistance substitution:** 100, 1000, 10k, 100k, and 1 megohm. 1 watt 5% tolerance. **Condenser substitution:** .001, .005, .02, .1, and 8 ufd (electrolytic) at 400 volts. **AC indicator:** NE-51 neon lamp. **Continuity indicator:** #49 lamp. **Signal generator:** RF SECTION, preset adjustment from 450 kc to 700 kc, approximately 2 millivolts output. **AUDIO SECTION,** Approx. 1000 cps, 50 millivolts output. **Output impedance:** 220 ohm. **Transistors:** Two 2N1274. **Batteries:** Two 1.5 volt penlight cells. **Case:** Molded plastic. **Dimensions:** 6" H x 3 $\frac{1}{2}$ " W x 2 $\frac{1}{4}$ " D.

There's a Heathkit for every interest, every purpose, every budget

Heathkit® Transistor Testing Instruments



New!... Heathkit TRANSISTOR TESTER...
laboratory-quality at low cost

- Complete DC analysis of all PNP, NPN transistors up to 15 amps
- DC gain (beta, alpha) read directly on calibrated scales
- 15 ua basic range for leakage (Icbo, Iceo) tests
- Four lever switches provide rapid test selection
- Built-in battery supply—provision for using external supply
- Ideal for servicing, design work, incoming inspection, production testing, etc.

Kit IM-30
\$54⁸⁸

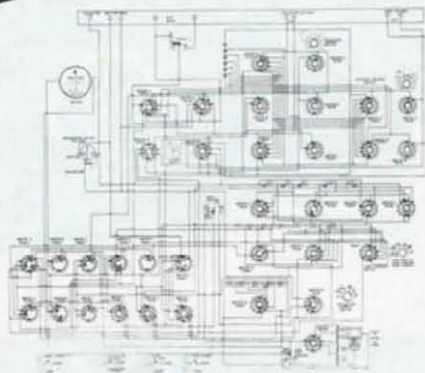

SPECIFICATIONS—Checks: Transistors up to 15 amps and diodes up to 1.5 amps. **Tests:** Shorts, DC Gain (Beta 0-300) (Alpha 0-.9967), Leakage (Icbo, Iceo), Diode Forward and Reverse Current. **Meter:** Current Ranges: 15 ua, 150 ua, 1.5 ma, 15 ma, 150 ma, 1.5 A, 15 A; Voltage Ranges: 1.5 V, 5 V, 15 V, 50 V, 150 V (100 K ohm/volt). **Power supply:** Internal, seven 1.5 volt size D batteries provide 1.5, 3.4, 5, 6, 7.5, 9 volts collector supply for gain or leakage and 1.5 volts for bias; External, 0-50 volts for gain, 0-150 volts for leakage and 1.5 volts for bias. **Bias control:** Permits any collector current from 10 ua to 15 amps for gain tests. **Gain control:** 3% wire-wound potentiometer has calibrated scales to give DC Beta and DC Alpha directly when meter is at null. **Lever switch:** Four spring return levers will individually select the following tests: Base Current, Gain, Collector Voltage, Collector Current, Leak Voltage, Short Test, Icbo and Iceo or diode currents. **Two voltage selector switches:** Gain and Leak Test Voltages can be individually preset at different voltage levels. **Two current range switches:** Collector and Leak currents can be individually preset on different ranges. **Transistor and diode connections:** Universal transistor socket and binding posts. **External power supply connections:** Binding Posts for Gain, Leak and Bias supplies.

Representing a major break-through in Transistor Testers, the new Heathkit IM-30 now makes it possible for all to enjoy laboratory type testing facilities. Superbly engineered circuitry and many unique design features allow making a complete and thorough DC analysis of all transistor types and checks of diode characteristics with high accuracy. The IM-30 is ideal for use in servicing and industry where fast, easy testing, high accuracy, and versatility are prime factors to be considered. Operation is simple! . . . four lever switches instantly select the desired test after proper conditions are set by the voltage and current range switches. Tests selected by the lever switches include base current, gain, collector current, collector voltage, leak voltage, short test, diode or collector-to-emitter leakage (Iceo), collector-to-base leakage (Icbo). Four rotary switches, one for voltage and one for current on both gain and leakage set the desired conditions. DC Beta and DC Alpha are read direct from the calibrated panel scale after meter is nulled. The Gain control is a 3% wire-wound potentiometer which assures high accuracy. A variable bias control allows setting collector current to any desired value up to 15 amps. All basic tests may be performed using the internal battery supply. Internal batteries provide any test voltage up to 9 volts in 1.5 volt steps. External DC supply terminals are provided for higher voltages and current. The IM-30 is adequately rated to handle higher voltages and current with appropriate meter ranges provided. Detailed instructions include complete operation and application information. 7 lbs.

Kit IM-30... NO MONEY DOWN, \$6 mo. **\$54.88**



Speed service operations with this handy TRANSISTOR/DIODE CHECKER

- Tests low and high power transistors
- Tests forward and reverse current of diodes

The tremendous rate at which transistors are being used in the electronic industry calls for a reliable, simple transistor checker to speed service operations . . . eliminate guesswork! The Heathkit IT-10 tests transistors, diodes and also serves as a handy continuity tester . . . just the thing for carrying with you on service calls or for shop use. Its small, compact size allows easy carrying in tool case, glove compartment, etc., and is self-protecting with its extended-edge case. The versatile switching arrangement in the IT-10 checks transistors as to PNP or NPN type and eliminates transferring of test leads for diode testing. Removable test leads are provided for checking transistors which do not fit tester socket. Easy to assemble. 2 lbs.

Kit IT-10
\$6⁹⁵

Kit IT-10. **\$6.95**

SPECIFICATIONS—Transistor test: leakage, short, open and current gain. **Diode test:** forward and reverse current. Also serves as a continuity checker. **Switches:** Forward-Reverse/PNP-NPN, Diode/Hi-Lo, Leakage-Gain. **Power supply:** self-contained, two 1.5 volt size "C" flashlight cells. **Dimensions:** 3 1/4" H. x 3 3/4" W. x 3 3/4" D.

Equip your Test Bench with a Heathkit®



Kit IT-11
\$29.95

- **NEW!** . . . Low bridge-voltage for checking miniature electrolytics
- **NEW!** . . . 16 switch-selected leakage testing voltages
- **NEW!** . . . Comparator circuit to measure inductance, capacitance or resistance using an external standard
- Measures capacity and resistance directly using internal standards
- Direct reading scales—no involved calculations
- Calibrated power factor control—"eye" tube indicator
- Checks all common capacitor types

*Extra features for extra performance...
in this new deluxe CAPACITOR CHECKER*

The handsome new styling and outstanding qualities of this new Heathkit capacitor checker now bring you features and performance unheard of in this price range. The IT-11 tests capacitors of all types for value, leakage, shorts and power factor and also measures resistance from 5 ohms to 50 megohms. Capacity measurements are made in four ranges from 10 mmf to 1000 mfd. All readings are made on direct-reading scales . . . no involved calculations. The specially designed low-voltage bridge circuit used in the IT-11 now permits safe testing of easily-damaged miniature electrolytics such as used in transistorized equipment. A wide range of leakage test voltages and three leakage sensitivities (determined by type switch) allow testing capacitors at their rated values. As an additional safety measure, the leakage/discharge switch places a short across the internal standard and discharges the capacitor under test through a 10 K ohm resistor to prevent damage to capacitor or tester. Other features include "external-standard" terminals for rapidly comparing similar components up to a ratio of 25-1, measure unknown "R", "L", or "C" values, or determine transformer turns ratio directly; DC operation of the "eye" tube minimizes the fuzzy edge normally encountered when AC bridge voltage is applied directly; switch selection of either internal 60 cycle generator or external generator up to 10 kc. An extremely useful test instrument! Easy assembly and operation instructions included. 7 lbs.

Kit IT-11...NO MONEY DOWN, \$5 mo. **\$29.95**

SPECIFICATIONS—Test circuit: AC bridge, powered through special bridge transformer by an internal 60 cycle supply or by an external audio generator with 10 volts output. Upper frequency limit: 10 kc. **Capacitance, 4 ranges:** 10 uuf to .005 ufd; .001 ufd to .5 ufd; .1 ufd to 50 ufd; 20 ufd to 1000 ufd. **Capacitor leakage:** DC test voltages from 3 to 600 volts in 16 steps. **Resistance, 3 ranges:** 5 ohms to 5000 ohms; 500 ohms to 500 K ohms; 50 K ohms to 50 megohms. **Comparator circuit:** External standard R, L or C; Max. Ratio 25-1. **Power supply:** Transformer-operated, half-wave rectifier. **Power requirements:** 105-125 volts AC, 50/60 cycles, 30 watts. **Dimensions:** 9½" high x 6½" wide x 5" deep.

- Detects opens, shorts and intermittents
- "Eye" tube indicator

Kit CT-1
\$8.49



*Test capacitor quality right in the circuit
with this handy CAPACI-TESTER*

With the Heathkit Capaci-tester you can check most capacitors for open or short conditions right in the circuit without disconnecting leads . . . saving both work and valuable time on the job. A five-position switch controls power to the instrument and selects the test to be made. Detects open capacitors from 50 mmf up, not shunted by an excessively low resistance value and shorted capacitors up to 20 mfd shunted by not less than 10 ohms. Intermittent capacitors are indicated by a flickering of the "eye" tube indicator. The CT-1 is designed to check all bypass, blocking and coupling capacitors of the paper, molded, mica, ceramic types only . . . uses a 60 cycle frequency for "short" test and 19 megacycle frequency for "open" test. 4 lbs.

Kit CT-1 **\$8.49**



Kit C-3
\$19.50

- Direct reading scales—no involved calculations
- Checks paper, molded, mica, ceramic and electrolytic condensers
- Automatic-discharge leakage test switch—power factor control

a fine quality, low cost CONDENSER CHECKER

With this handy instrument on your service bench you can check unknown condenser and resistor values and their operating characteristics. Direct reading scales show condenser values from 0.00001 mfd to 1000 mfd in four ranges and resistor values from 100 ohms to 5 megohms in two ranges. An electron beam "eye" tube indicates bridge balance and shows leakage, short or open conditions. Electrolytic condenser efficiency can be checked using the calibrated power factor control provided. Five polarizing voltages from 25 to 450 VDC are provided to check condenser leakage. The spring-return leakage test switch automatically discharges the condenser under test to eliminate shock hazard to the operator. For additional safety the circuit features a transformer operated power supply and insulated binding post terminals. Assembly instructions and operational procedures included. 6 lbs.

Kit C-3 **\$19.50**

Equip your Lab or Shop with a Dependable,



- Tests all tube types
- Multi-colored "bad?-good" meter scale
- Built-in illuminated roll chart mechanism
- Versatile tube element switching
- Neon bulb short test indicator
- Color-coded wiring harness for simple assembly

Kit TC-3

\$39⁹⁵

This modern TUBE CHECKER fulfills all daily requirements in servicing

With this handsomely-styled tube checker on your test bench you can test all tube types encountered in everyday radio and TV servicing. Tubes are tested for quality on the basis of total emission, and for shorts, leakage, open elements and filament continuity. Tube quality is read on a multi-colored "Bad?-Good" meter scale and a neon bulb indicator shows filament circuit continuity and leakage or shorts between elements. Flexible overall operation is made possible by the use of multiple filament voltages, adjustable cathode current, variable meter sensitivity and individual tube element switching. Ten 3-position lever switches allow checking each tube element individually for open or short conditions. A line-adjust circuit is provided to correct for variations in line voltage to maintain proper testing conditions. The specially-designed roll chart mechanism features free-rolling action and is spring-loaded to keep the chart taut at all times for a smooth viewing surface. A thumbwheel drive knob on each side of the panel permits either hand operation. Both roll chart and meter are illuminated for easy reading. The roll chart contains all data for checking currently used tube types and a roll chart supplement is provided for uncommon or seldom-used types. Tube sockets are provided for nine different tube base types and an extra blank socket permits addition of future tube types protecting against obsolescence. Neat, professional wiring and simplified construction of the TC-3 is assured by a color-coded wiring harness, easy-to-follow step-by-step instructions and large pictorial diagrams. 11 lbs.

Kit TC-3... NO MONEY DOWN, \$5 mo..... \$39.95

SPECIFICATIONS—Available tests: Emission, short, leakage, open element, filament continuity. **Socket accommodations:** 4-pin, 5-pin, 6-pin, 7-pin large & pilot light, 7-pin miniature, 7-pin sub-miniature, octal, loctal, 9-pin miniature, blank. **Meter:** 1 ma, "Bad?-Good" scale, illuminated. **Line voltage adjustment:** Steo type. **Roll chart mechanism:** Constant tension, free rolling, thumbwheel operation, illuminated. **Filament voltage:** 0.63, 1.4, 2, 2.35, 2.5, 3.15, 4.2, 4.7, 5, 6.3, 7.5, 9.45, 12.6, 19.6, 25, 32, 50, 70, 110 volts AC. **Element test voltages:** 30, 100, 250 volts AC. **Power requirements:** 105-125 volts 50-60 cycles AC. **Dimensions:** 5 1/2" x 8 1/2" x 13".

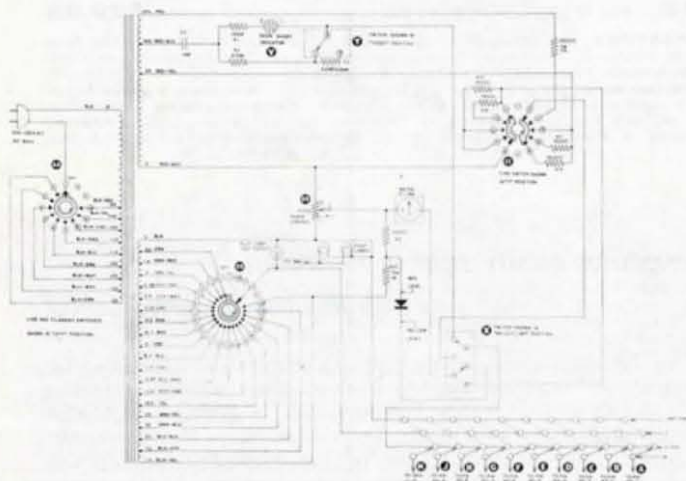

TV picture tube TEST ADAPTER... extends operation of TC-3

- Not a kit—factory assembled
- All test data included

The Heathkit TV Picture Tube Test Adapter is designed to be used with the model TC-3 Tube Checker or earlier model TC-2 Tube Checker. Permits testing TV picture tubes for emission, shorts, etc., thereby determining quality. The adapter consists of a 12 pin TV tube socket, 4' cable, octal connector and test data. Not a kit but a preassembled device. 1 lb.

Model 355..... \$4.50

82

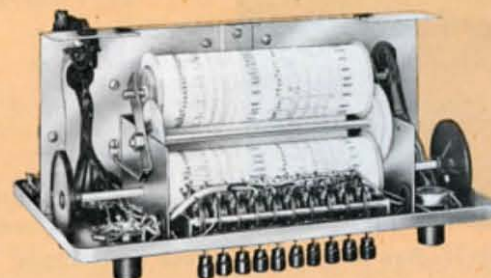

SPECIAL ROLL CHART MECHANISM

The specially-designed roll chart mechanism used in the TC-3 permits the roll chart to run freely throughout its entire length without binding. The chart rollers are spring-loaded to keep the chart taut at all times.

Low Cost Heathkit® Tube Tester



MUTUAL CONDUCTANCE TUBE TESTER... loaded with special features

- Checks over 1100 tube types with data supplied
- Indicates Gm to 24,000 micro-mhos
- Constant current heater supplies
- Ultra-sensitive grid current test
- Direct-reading ohmmeter leakage test
- Built-in switch-operated calibration circuit



This inside view shows the rugged mechanical design, high quality switches and neat wiring achieved through cabled wiring harnesses. The switch-operated calibration circuit is shown center foreground.

Kit TT-1

\$134⁹⁵

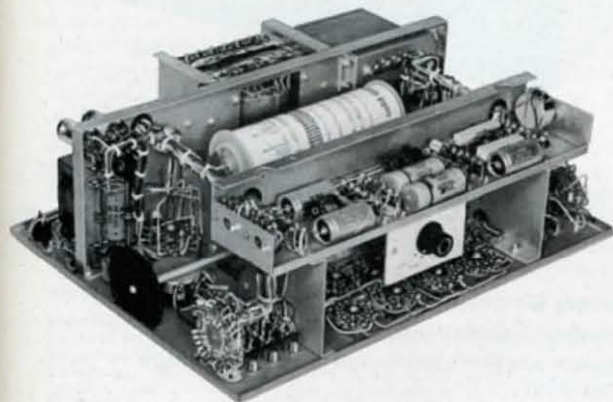

No finer TUBE TESTER in kit form... and professional by any standard of comparison

Nowhere will you find a tube tester of this quality at so low a price! The Heathkit model TT-1 Mutual Conductance Tube Tester with its impressive list of electronic and mechanical features represents one of the finest values in the test instrument field today!

This handsomely-styled instrument with its neat, functional panel layout provides for maximum operating convenience. Versatile switching facilities accommodate present tube types and allow adding future tube types as they become available to protect against obsolescence. The TT-1 will provide quick and accurate checks of transconductance and grid current in multi-element tubes and will also check diodes, rectifiers, voltage regulators, low-power thyratrons and electron eye-tubes.

In transconductance test, mutual conductance values are read on the illuminated meter scale from 0 to 3,000 micro-mhos. Multipliers are used to accommodate Gm values above 3,000. The extremely sensitive circuit used in grid current testing will indicate as little as 1/4 micro-ampere and will often indicate a "reject" after the transconductance circuit has labeled it "O.K." This test is of particular value to servicemen as grid current is often the cause of malfunctioning TV circuits. The grid current circuit of the TT-1 tests for all three common causes of grid current: gas, leakage from grid to other elements, and grid contamination (grid emission).

Diode and rectifier tubes are tested on the basis of total cathode emission. In testing voltage regulator tubes, an independent, built-in variable DC power supply is used and direct reading voltage indications are given on the meter.

Other outstanding features to be found in the TT-1 include: a Constant Current Heater Supply which protects the tester from obsolescence by supplying the correct voltage for any tube types drawing 300 ma, 450 ma or 600 ma; a Life Test, which reduces the heater voltage of the tube under test by 10%, thus giving an estimate of its

future life; a "Hybrid test," which not only provides a special low voltage plate supply for testing hybrid auto radio tubes, but also features an additional DC supply for the space charge grid permitting mutual conductance tests of space charge tubes in the usual manner; a direct reading Leakage Testing Circuit; and a built-in switch-operated Calibration Circuit, eliminating the need for any standardized tubes, voltmeters or extraneous instruments of any kind. A Disconnect Switch removes all voltage potentials from the selector switches, protecting both tubes and tester from possible damage during switching. "Cathode buss," "Plate buss," and "Grid buss" switches allow the operator to test both sections of a twin triode individually with only one group of selector switch settings. Individual Selector Switches allow testing any tube, regardless of base pin arrangements. Other "service designed" features are: an illuminated roll chart with thumb-wheel drive at each side, removable line cord, 110 V AC outlet, and blank socket on panel for future tube types.

The beautifully written construction manual supported by detailed pictorial diagrams, seven color-coded wiring harnesses and transformer terminal board have reduced the highly complex circuitry of the TT-1 to an easy to build level. Average construction time by technicians is 40 hours. Unit is housed in an attractive black leatherette case with white trim, nylon feet and removable top. 27 lbs.

Kit TT-1... NO MONEY DOWN, \$13 mo. **\$134.95**

SPECIFICATIONS—Power requirements—Voltage: 105-125, 60 cycle AC. **Watts:** 10-60 (dependent upon tube under test). **Plate supply:** (Silicon Rectifiers). **DC volts:** 26, 90, 135, 225 plus variable 80 to 200 (Separate DC supply for space charge grids). **AC volts:** 20, 45, 177. **Bias supply:** (Silicon Rectifier). **Low range:** 0 to negative 5 volts DC. **High range:** 0 to negative 20 volts DC. **Signal voltages:** 2, 1, .5, .25 volts AC 5000 cycles. **Filament supply voltages:** .65, 1.1, 1.5, 2, 2.5, 3.3, 5, 6.3, 7.5, 10, 13, 20, 27.5, 35, 47, 70 and 115. **Currents:** 300, 450, 600 ma. (Note: Filament voltage is reduced 10% during life test). **Testing circuits Gm:** (Mutual conductance-amplifiers) 0-24,000 micro-mhos. **Emission:** Rectifiers and diodes. **Leakage:** Direct reading ohmmeter. **Grid current:** 1/4 microampere sensitivity. **Voltage regulators:** Firing voltage and regulation tolerance. **Low power thyratrons:** Grid characteristics, conduction capabilities. **Eye tubes:** Control grid characteristics. **Meter AC:** 1000 ohms/volt (1 volt full scale). **DC:** 89 ma full scale. **Scales:** Gm: 0-3000 micromhos. VR test volts: 0-200 volts. Leakage: 0-10 megohms. Diodes O.K. Rectifiers O.K. Line check arrow at midscale. **Tube complement:** (1) 3A4 oscillator, (1) 12AV6 meter control. **Calibration circuit:** Built-in switch operated. **Socket accommodations:** 4-pin, 5-pin, 8-pin, 7-pin combination and pilot light; 7-pin miniature, 7-pin sub-miniature, 8-pin sub-miniature, octal, loctal, 9-pin miniature, blank. **Line voltage adjustment:** Continuously variable. **Roll chart mechanism:** Constant tension, free rolling, thumb wheel operated, illuminated. **Dimensions:** Cabinet (outside): 17 3/4" W x 13 1/2" H x 7 3/4" D. Panel and chassis: 17" W x 12 3/4" H x 5 1/2" D.

Power Supplies for Every Testing Requirement

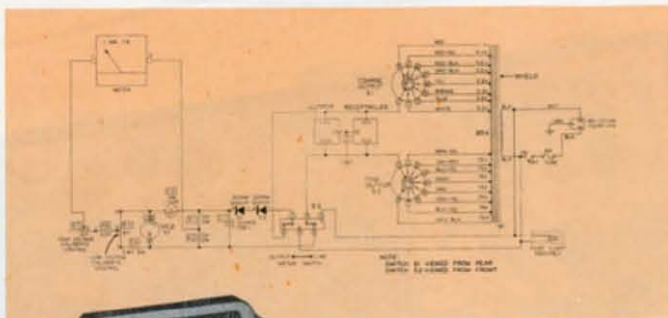

- Power rated for color TV work
- Variable output—90 to 130 volts AC
- Linear, expanded scale meter
- Fused for protection

Kit IP-10
\$54⁹⁵

Controls AC line voltage to meet test requirements... Heathkit ISOLATION TRANSFORMER

The IP-10 will help solve "tough" service problems. Controls AC line voltage, isolates interference radiating devices from power line, protects against AC/DC set shock hazard, induces breakdown of weak or intermittent components by raising AC input voltage, etc. Many more uses in servicing and design work. Two heavy-duty 8-position switches vary output in .75 volt steps from 90 to 130 volts AC. An expanded scale meter accurately monitors output voltage and a spring-return slide switch gives a fast check of power line input voltage. Two AC receptacles accept 3-prong and standard-type plugs. Fused for protection. 21 lbs.

Kit IP-10... NO MONEY DOWN, \$6 mo. **\$54.95**

SPECIFICATIONS—Input: 105-125 volts 50/60 cycles. Output: Variable from 90-130 volts in steps of approximately .75 volt by means of transformer secondary tap switching. Meter: 90-140 volt scale, ± 1 volt accuracy. Switch selection of input or output voltage indication. Power rating: 300 watts continuous, 500 watts intermittent. Fuse: 8 ampere. Dimensions: 6 $\frac{1}{2}$ " W x 9 $\frac{1}{2}$ " H x 5" D.



Kit Form
or
Factory
Assembled

Kit BE-5
\$44⁹⁵

A handy 6 & 12 V. DC POWER SOURCE for your test bench

- Extra low-ripple filter circuit—less than .3% AC ripple

This modern battery eliminator provides a ready, reliable source of 6 or 12 volt DC power for servicing all types of car radios, including transistor and "hybrid" radios which use both tubes and transistors. Transistor and "hybrid" radios can tolerate only a small amount of AC ripple and the special ripple filter circuit employed in the BE-5 holds AC ripple to less than .3%. Output voltage is variable on both ranges from 0-8 volts or 0-16 volts. Two panel meters continuously monitor output voltage and current. Also doubles as an excellent battery charger.

Kit BE-5... 19 lbs. NO MONEY DOWN, \$5 mo. **\$44.95**
Assembled BEW-5... NO MONEY DOWN, \$7 mo. **\$67.95**

SPECIFICATIONS—Continuously variable output: 6 volt range: unfiltered, 10 amp continuous, 15 amp maximum, filtered, 5 amp continuous, less than .3% ripple. 12 volt range: unfiltered, 5 amp continuous, 7.5 amp maximum; filtered, 5 amp continuous, less than .3% ripple. Power requirements: 105-125 volts 50/60 cycles AC at 200 watts. Dimensions: 13" W x 8 $\frac{1}{2}$ " H x 7" D.

Kit Form
or
Factory
Assembled



Kit PS-4
\$56⁹⁵

Variable-Voltage REGULATED POWER SUPPLY... perfect for experimenters, engineers

- Provides B+, bias, and filament voltages
- DC output variable from 0 to 400 volts
- Separate panel meters monitor output voltage and current
- Quality components throughout

An excellent unit for experimenters, hams who "roll their own," or engineers involved in design and development work. Eliminating the need for building up a separate power supply for each new circuit tried, the PS-4 provides adjustable, regulated B+, adjustable bias voltage and 6.3 volts AC for filaments. Voltage and current output are continuously monitored by separate panel meters. Separate filament and high voltage transformers with standby switch eliminate waiting for filament warmup of tubes in equipment under test. Output terminals are separate and well insulated from chassis ground for safety in AC-DC work. Rugged, well-rated components are used throughout for long, reliable service. Instrument is fused for protection. 15 lbs.

Kit PS-4... NO MONEY DOWN; \$6 mo. **\$56.95**
Assembled PSW-4... NO MONEY DOWN, \$9 mo. **\$82.50**

SPECIFICATIONS—Output: 0-400 volts regulated DC at 0-100 ma, cont., 125 ma intermittent, 0 to -100 volts DC at 1 ma variable bias voltage, 6.3 volts AC at 4 amps, filament voltage. Regulation: Output variation less than 1% from no load to full load; Output variation less than ± 0.5 volt for a ± 10 v. change at 117 v. AC input. Ripple: less than 10 millivolts RMS, ripple, jitter and noise. Output impedance: less than 10 ohms, DC to 1 mc. Meters: Voltmeter 0-400 V or 0-150 V.; Milliammeter 0-150 ma. Dimensions: 13" W x 8 $\frac{1}{2}$ " H x 7" D.

Dependable Heathkit® RF Signal Generators for Fast, Efficient Testing



No service bench should be without
this accurate, versatile RF SIGNAL GENERATOR!

- Covers 100 kc to 220 mc in six bands
- Large, easy-to-read dial scales
- Prewired/prealigned coil/bandswitch assembly
- Calibration accuracy unmatched in this price range

The extremely wide range of frequencies covered by the RF-1 makes it an invaluable addition to your electronic workshop. Provides extended frequency coverage in six bands from 100 kc to 110 mc on fundamentals and from 110 mc to 220 mc on calibrated harmonics. Three large easy-to-read dial scales allow precise frequency settings on all bands. Carefully designed circuitry achieves sine wave output with outstanding accuracy (2%) throughout the entire frequency range. Modulated or unmodulated RF output up to 100,000 microvolts is available, controlled by both fixed-step and continuously variable output attenuators. 400 cycle audio signal with 10 volt output is provided for audio tests. The modern high silhouette styling of the RF-1 not only conserves valuable bench space but adds to the attractive professional appearance of the instrument. A prealigned/preassembled coil/bandswitch unit assures high accuracy and simplifies construction. 6 lbs.

Kit RF-1...NO MONEY DOWN, \$5 mo.....\$27.95

SPECIFICATIONS—Frequency range: Band A, 100 kc to 320 kc; Band B, 310 kc to 1.1 mc; Band C, 1 mc to 3.2 mc; Band D, 3.1 mc to 11 mc; Band E, 10 mc to 32 mc; Band F, 32 mc to 110 mc. **Calibrated harmonics:** 110 mc to 220 mc. **Accuracy:** 2%. **Output:** impedance, 50 ohms; Voltage, 100,000 uv. **Modulation:** Internal, 400 cps, 30% depth; External, approx. 3 V across 50 k ohms for 30%. **Audio output:** Approx. 10 V open circuit. **Tube complement:** (1) 12AT7, (1) 6AN8. **Power requirements:** 105-125 V 50/60 cycles AC, 15 watts. **Dimensions:** 6½" W. x 9½" H. x 5" D.

Kit RF-1
\$27⁹⁵



A low cost basic instrument for alignment
and trouble shooting

- Separate oscillator sub-chassis for high efficiency and stability
- Wide frequency range 160 kc to 220 mc
- 3 outputs: RF, modulated RF and 400 cps audio

If you need a signal generator, look at the quality and many features you get at this low price. Designed for general service applications, the SG-8 covers 160 kc to 110 mc on fundamentals in five bands, and from 110 mc to 220 mc on calibrated harmonics. The entire oscillator circuit is built on a special sub-chassis, using prewound and calibrated coils. No further calibration is required, so it is ready to use when completed. The RF output is in excess of 100,000 microvolts, and is controlled by both a step switch and fine attenuator control. The signal may be modulated either internally, at 400 cps, or from an external source at other frequencies. The 400 cps signal may also be used separately for audio testing if desired. The SG-8 provides a quick means for alignment of tuned circuits of all kinds. Use it also to save time in tracing signals in faulty RF, IF or audio circuits. A cathode follower-buffer isolates the oscillator from its load for high stability. Easy to build with the complete instructions provided. Kit is complete with output cable. 6 lbs.

Kit SG-8.....\$19.50

SPECIFICATIONS—Frequency range: BAND (A) 160 kc to 500 kc; (B) 500 kc to 1650 kc; (C) 1.65 mc to 6.5 mc; (D) 6.5 mc to 25 mc; (E) 25 mc to 110 mc. **Calibrated harmonics:** 110 mc to 220 mc. **RF output:** 100,000 uv. **Modulation frequency:** 400 cps. **Audio output:** 2 to 3 volts. **Tube complement:** (1) 12AU7, (1) 6C4. **Power requirements:** 105-125 volts, 50/60 cycles AC. **Dimensions:** 9½" wide x 6½" high x 5" deep.

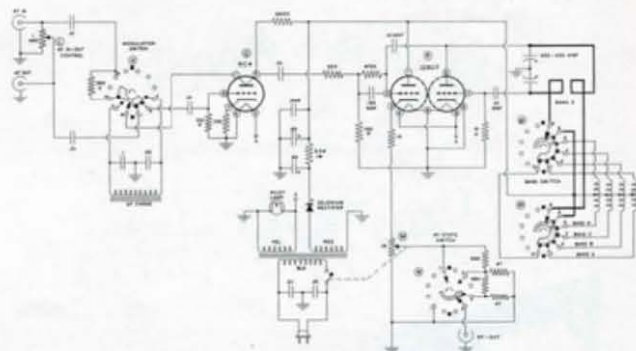

Kit SG-8
\$19⁵⁰



Save 50% or More by building your



Kit FMO-1
\$34⁹⁵

A complete signal source for ALIGNMENT
of FM tuners and receivers

- Variable 10.7 mc sweep, 200 kc to over 1 mc
- Switch selection of 90, 100 & 107 mc RF signals
- 100 kc bandwidth markers for checking bandpass
- Neat, compact, easy-to-build and operate

Designed to simplify the alignment of FM tuners and receivers, the FMO-1 in a single, compact unit provides all the essential generator facilities for fast, easy servicing. Unique circuit design provides 10.7 mc sweep (variable from 200 kc to over 1 mc) with crystal controlled center marker and 100 kc sub-markers for IF alignment. Convenient switch-selection 90, 100 and 107 mc signals permit fast, easy alignment of RF "front-end", dial calibration checks, etc. Accuracy of alignment is guaranteed by a built-in 10 mc crystal-controlled oscillator which is used in conjunction with the 10.7 mc crystal to calibrate the instrument. An internally generated 400 cycle tone may be used to modulate the RF signal or to check receiver audio circuitry. Test leads included. 4 lbs.

Kit FMO-1... NO MONEY DOWN, \$5 mo. \$34.95

SPECIFICATIONS—Output frequencies... for RF alignment: 90, 100 and 107 mc, switch-selected. Modulation: 400 cycle incidental FM. For IF and detector alignment: 10.7 mc sweep. Sweep width: 200 kc to over 1 mc. Markers: 10.7 mc (crystal); 100 kc sub-markers. Modulation: 400 cycle AM. For other applications: 10.0 mc (crystal) and harmonics; 100 kc and 400 cycle audio. Tube complement: (2) 6U8. Power supply: Transformer, selenium rectifier. Power requirements: 105-125 V, 50/60 cycle, 12 watts. Cabinet size: 7³/₈" H. x 4³/₈" W. x 4³/₈" D.

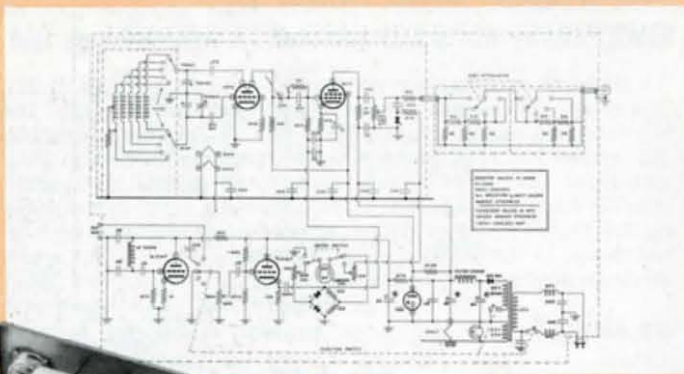
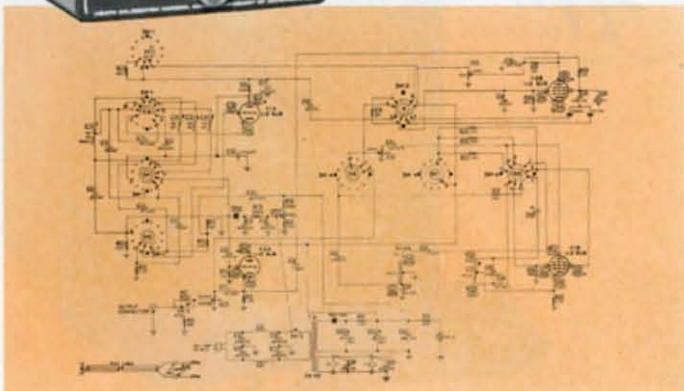

a LABORATORY RF GENERATOR with many extras

- Metered output voltage and % modulation
- Double shielding of oscillator circuits
- Covers 100 kc to 30 mc in five bands

Designed for the professional service shop or laboratory, the LG-1 features many extras rarely found in this price class. Ideal for design and development work as well as for servicing, the LG-1 covers 100 kc to 30 mc... all on fundamentals in five bands. The panel meter is calibrated to read output in microvolts or percent modulation. Maximum metered output is 100,000 microvolts controlled by both fixed-step and variable output attenuators. Modulation is variable from 0 to 50% (400 cycles internally; externally between 60 cps and 10,000 cps). Extensive copper-plated shielding and line filtering minimize RF radiation through the cabinet and line cord. The power supply is transformer operated for safety and high efficiency and features generous filter design and voltage regulation for smooth, stable plate voltage. Generator output impedance is 50 ohms. The terminating resistor located in a plastic pod on the end of the coaxial cable furnished is easily changed for specific applications. The many features of this outstanding instrument make it ideal for checking RF and IF stage gain, overall circuit sensitivity, demodulator performance, or selectivity, etc. 14 lbs.

Kit LG-1... NO MONEY DOWN, \$5 mo. \$48.95

SPECIFICATIONS—LG-1 frequency ranges: Band A, 100 to 290 kc; Band B, 290 to 1000 kc; Band C, 0.95 to 3.1 mc; Band D, 2.9 to 9.5 mc; Band E, 9 to 31 mc. RF output: Impedance, 50 ohms—voltage, 100,000 microvolts max. Attenuator: 10:1 per step, 5 steps—Fine, 10:1 continuous, indicated on meter. Amplitude modulation: CW, internal 400 cycles or external audio frequencies. Modulation depth: 0 to 50% variable, indicated on meter. Tube complement: 6AF4, 6AV5, 12AU7, 6B2. Power requirements: 105-125 V, 50/60 cycles. Dimensions: 13" W. x 8¹/₂" H. x 7" D.



Kit LG-1
\$48⁹⁵

own Heathkit® Test Instruments

Align TV sets fast with this reliable, time-proven SWEEP GENERATOR

- All-electronic sweep circuit for high stability
- Built-in crystal and variable marker oscillators
- Complete FM and TV coverage—3.6 mc to 220 mc

Kit TS-4A

\$54⁹⁵

Versatile, easy to operate and reliable! The TS-4A with its many special design features provides most of the essential generator facilities for alignment of FM, monochrome TV or Color TV sets. The all-electronic sweep circuit insures stability and covers 3.6 mc to 220 mc in four bands. Sweep deviation is smoothly controllable. The maximum deviation varies with center frequency between 4 and 42 mc. Crystal marker and variable marker oscillators are built in. Crystal (included with kit) provides output at 4.5 mc and multiples thereof. Variable marker provides output from 19 to 60 mc on fundamentals and from 57 to 180 mc on calibrated harmonics. Marker accuracy is assured for it is calibrated against the 4.5 mc crystal supplied. Effective two-way blanking eliminates return trace and a phasing control is also provided. RF output is well over .1 volt and is smoothly controlled to allow alignment of high gain stages without overloading. An outstanding TV test instrument value. 13 lbs.

Kit TS-4A... NO MONEY DOWN, \$6 mo. **\$54.95**

SPECIFICATIONS—Output impedance: 50 ohms terminated at both ends of cable. **Sweep deviation:** Continuously variable from 0-4 mc lowest max. deviation to 0-42 mc highest max. deviation (depending on base frequency). **Marker crystal:** 4.5 mc and multiples thereof. **Variable:** 19 mc to 60 mc on fundamentals, 57 mc to 180 mc on harmonics. **External marker terminals:** Provided on panel. **Attenuators:** Step-switch controls sweep and marker oscillators together, plus variable controls for each output. **Blanking:** Effective blanking eliminates return trace; phasing control also provided. **Cables:** 3 supplied, output, scope horizontal, scope vertical. **Power requirements:** 105-125 VAC, 60 cycles, 50 watts. **Dimensions:** 13" W x 8½" H x 7" D.

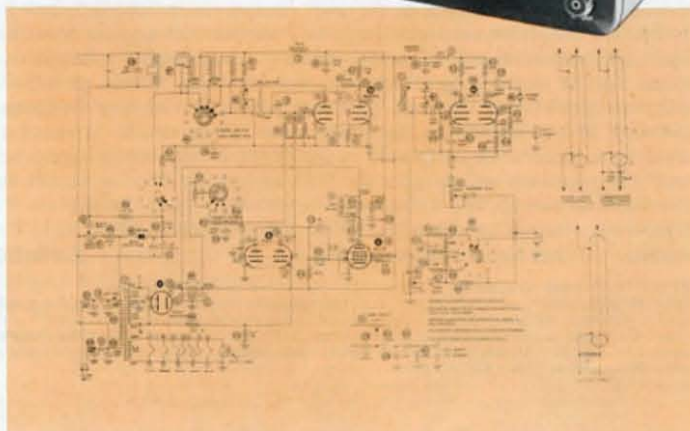

a TV COLOR BAR and DOT GENERATOR for less than half the cost of comparable units

- All frequencies crystal controlled for highest stability
- Choice of six different patterns for color or B & W picture adjustment
- 10 vertical color bars—new shading bar pattern
- RF output on TV channels 2 through 6

Your best buy in a color TV service instrument! Perfect too for black and white TV servicing! The CD-1 produces six different patterns for use in making linearity and other picture adjustments on television receivers. The switch-selected patterns include: white dots, cross hatch, vertical or horizontal bars, 10 color bars and a special shading bar pattern for screen and background adjustments. Crystal-controlled sync pulses at the same frame rate as the TV station lock the patterns firmly on the screen without jitter or crawl... no sync leads required. Any pattern may be selected without further adjustment to the receiver or generator after initial setting. The 10 color bars are produced by the offset-carrier method and allow AFC, phase and matrix alignment and include a white leading edge and black trailing edge to check color fit. The CD-1 is compact, light in weight and features smooth control action. The 13 tube circuit has been carefully laid out to allow ease of assembly and easy-to-follow calibration instructions are furnished with actual oscilloscope patterns to aid in alignment. Comprehensive instructions are provided on the use of the instrument in adjusting color receivers. Kit is complete with 3 crystals and test leads. 12 lbs.

Kit CD-1... NO MONEY DOWN, \$7 mo. **\$64.95**

SPECIFICATIONS—RF output frequency range: TV channels 2 through 6. **Output voltage:** Variable from 100 to 100,000 microvolts. **Sound carrier:** Crystal controlled, unmodulated, 4.5 mc away from picture carrier; off-on switch provided. **Video output:** Positive or negative output variable from 0-10 volts peak-to-peak open circuit. **Modulation:** White dot pattern, cross hatch pattern, horizontal bars, vertical bars, 10 vertical color bars, shading bar pattern. **Tube complement:** 6-12AT7, 4-12AU7, 1-6BD7, 1-6CS6, 1-OB2. **Power requirements:** 117 VAC, 50/60 cycles, 70 watts. **Dimensions:** 13" W x 8½" H x 7" D.

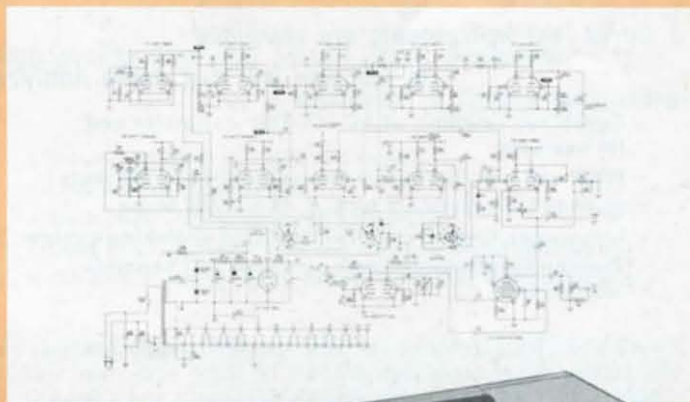

Kit CD-1

\$64⁹⁵

Check Amplifier Distortion fast and easy with this HARMONIC DISTORTION METER

- Measures distortion at all audio frequencies
- Meter scales calibrated in volts RMS, percent distortion and DB
- Measures signal-to-noise ratio in decibels
- Top quality throughout for high accuracy and dependability
- Easy to build and operate with complete instructions supplied

Resourceful engineering, traditional in Heathkit equipment, has reduced the highly-complex and costly equipment ordinarily used for harmonic distortion measurements to a simple and easy-to-construct unit without sacrificing accuracy, stability or operating convenience. Used with an audio generator such as the Heathkit AG-9A or AG-10, this instrument will measure harmonic distortion at any frequency between 20 and 20,000 cps. Signal-to-noise measurements are read on a separate meter scale calibrated in db. Features high input impedance and 1% precision resistors in the VTVM voltage divider circuit for excellent sensitivity and accuracy. Distortion is read directly on the large 4 1/2" meter in ranges of 0-1, 3, 10, 30 and 100% full scale. 11 lbs.

Kit HD-1 . . . NO MONEY DOWN, \$5 mo. \$49.50

SPECIFICATIONS—Frequency: 20 cps to 20,000 cps in three ranges. **Distortion:** 1, 3, 10, 30, 100% full scale. **Voltmeter:** 1, 3, 10, 30 volts full scale. **Input resistance:** 300 k ohm. **Minimum input voltage for distortion measurements:** 0.3 volts. **Output voltage for monitoring:** 2.5 volts at full scale meter reading. **Accuracy:** Voltmeter, $\pm 5\%$; Distortion $\pm 5\%$ of full scale, $\pm 0.1\%$. **Tube complement:** 6A2, 6X4, 5879, 12AT7, 12AX7, 12BY7. **Power requirements:** 105-125 V, 50/60 cycles AC, 30 watts. **Dimensions:** 13" W x 8 1/2" H x 7" D.



Kit HD-1

\$49⁵⁰

3 Audio Test Instruments are combined in this one low cost Audio Analyzer

- Combines function of AC VTVM, wattmeter and IM analyzer
- High and low frequency source built-in for IM tests
- Built-in load resistors for 4, 8, 16 and 600 ohms
- Large easy-to-read meter—simplified switching system
- Tremendous savings over purchase of 3 separate instruments

Almost a complete laboratory in itself, the AA-1 Audio Analyzer permits making a very thorough analysis of audio equipment without cluttering the work bench with several instruments and a bewildering number of test leads. The flexible switching system used in the AA-1 allows use of any function of the instrument separately or combines functions internally for simplified operation. The AC VTVM can be used to measure noise, frequency response, output, gain, power supply ripple, etc., and the built-in wattmeter allows simple measurement of power output using either internal or external loads. DB scales are provided to note db gain or loss. All basic functions may be performed using only the two sets of test leads furnished. Assembly and application instructions are included. This unique instrument with its many functions and features has formed a ready place in labs and service shops around the world. 11 lbs.

Kit AA-1 . . . NO MONEY DOWN, \$6 mo. \$54.95

SPECIFICATIONS—Frequency response—AC VTVM: 10 cycles to 100 kc ± 1 db. **Wattmeter:** 10 cycles to 50 kc ± 1 db. **I.M. Analyzer high pass filter:** 2000 cps to 12,000 cps. **I.M. Analyzer low pass filter:** 10 cps to 600 cps. **Range AC VTVM:** .01, .03, .1, .3, 1, 3, 10, 30, 100, 300 volts RMS full scale. **DBM:** -40, -30, -20, -10, 0, +10, +20, +30, +40, +50. Reads from -65 to +52 dbm. **Wattmeter:** 0.15 mw, 1.5 mw, 15 mw, 150 mw, 1.5 w, 15 w, 150 w, full scale. Maximum continuous power 25 watts, intermittent power to 50 watts. **I.M. Analyzer:** 1%, 3%, 10%, 30%, 100% full scale. **Input impedance—AC VTVM:** 1 megohm or 4, 8, 16 or 600 ohm switch selected. **I.M. Analyzer:** 1 megohm or 4, 8, 16 or 600 ohm switch selected. **Wattmeter:** 4, 8, 16 or 600 ohm internal load, 10,000 ohm across external load. **Output impedance—low and high frequency output:** 3000 ohm (600 ohm when shunted with 750 ohm resistor). **Internal generator frequencies—low frequency:** 60 cycles. **High frequency:** Approximately 6 kc. **Accuracy—AC VTVM and wattmeter:** Within 5% of full scale. **I.M. Analyzer:** Within 10% of full scale. **Power requirements:** 105-125 volts 50/60 cycles 20 watts. **Dimensions:** 13" W x 8 1/2" H x 7" D.



Kit AA-1

\$54⁹⁵

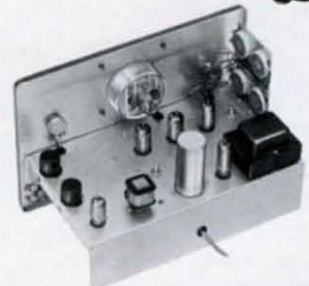

Careful circuit design and neat, open circuit layout provide for easy assembly. High quality components assure dependable service for years to come.

and Hi-Fi Analysis at low cost is found at Heath



Kit AG-9A
\$39⁹⁵

Produces near-perfect sine wave audio signals... AUDIO GENERATOR AG-9A

- Switch-selected output frequencies, 10 cps to 100 KC
- Less than .1 of 1% distortion between 20 and 20,000 CPS
- Output and frequency indicators accurate to within $\pm 5\%$
- 200 microampere meter calibrated in volts (RMS) and DB
- Built-in 600 ohm load—calibrated attenuation

With the AG-9A as a signal source you can practically forget about input variations and distortion when working with audio circuits. This uniquely designed instrument features three rotary switches that select two significant figures and a multiplier to determine audio frequency. Frequency can be varied in steps of 1 cps from 10 cps to 100 cps and a 4-position multiplier increases this range in multiples of 10 for an overall range of 10 cps to 100 kc. Accuracy is well within $\pm 5\%$ and distortion is less than .1 of 1% between 20 and 20,000 cps. Output is indicated on a large $4\frac{1}{2}$ " panel meter calibrated in volts and decibels. The output attenuator operates in steps of 10 db and is calibrated in 8 full scale meter ranges. A slide switch allows selection of built-in 600 ohm load or external load of higher impedance. A wonderfully engineered kit you will enjoy using. 7 lbs.

Kit AG-9A . . . NO MONEY DOWN, \$5 mo. **\$39.95**

SPECIFICATIONS—Frequency: 10 cps to 100 kc, switch selected, 2 significant figures and multiplier. Output: 6 ranges 0 to .003, .01, .03, .1, .3, 1 volts RMS into external 600 ohm load or with internal load into Hi-Z. 2 ranges 0 to 3, 10 volts RMS into a minimum of 10,000 ohms, -60 db to +22 db in 8 steps -80 db to +2 dbm (0 dbm = 1 mw to 600 ohms). Distortion: less than 1%, 20 to 20,000 cps. Tubes: (1) 6AU6, (1) 6CL6, (1) 6X4. Power: 105-125 volts AC, 50/60 cycles, 40 watts. Dimensions: $9\frac{1}{2}$ " W. x $6\frac{1}{2}$ " H. x 5" D.

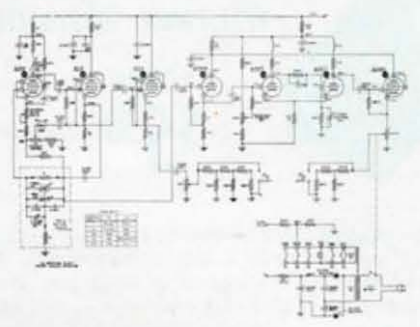
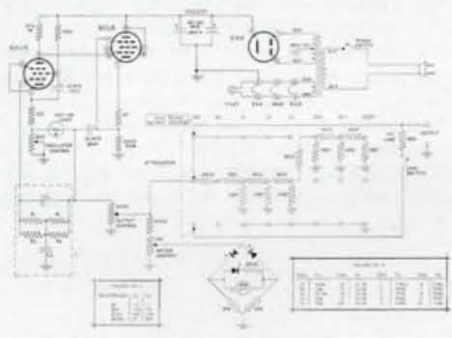

High quality Sine and Square Wave Generator for a multitude of testing applications

- Covers 20 CPS to 1 MC in 5 bands
- Low source impedance
- Less than .25% sine wave distortion
- Less than .15 microsecond rise time on square waves
- Sine and square wave output available simultaneously

The wide frequency range and high quality sine and square waves produced by the AG-10 make it useful in audio, TV, high fidelity and general laboratory applications. Both sine and square wave outputs are available simultaneously and may be used without affecting either waveform; separate output terminals and attenuators are provided for each, allowing individual control. Output attenuators operate in steps of 10, 1, and .1 volt for both sine and square wave with an extra range of .01 volt provided for sine wave. Oscillator circuits are well shielded and a special control is provided to compensate for differences in tube characteristics assuring absolute minimum distortion. Also featured is an exact frequency calibrating system to insure proper tracking across the dial. Sine wave output impedance is 600 ohms and the square wave output impedance is 50 ohms at all settings of the output controls except in the 10 volt ranges. The well-filtered power supply uses silicon-diode rectifiers and a husky power transformer for long life and dependable performance. Exceptionally well engineered throughout for maximum efficiency, ease of assembly, and dependable performance in every application. 12 lbs.

Kit AG-10 . . . NO MONEY DOWN, \$5 mo. **\$49.95**

SPECIFICATIONS—Sine wave: Frequency range: 20 cycles to 1 mc. Output volts (RMS): 0 to 10 volts, 0 to 1 volt, 0 to .1 volt, or 0 to .01 volt when working into a high impedance load. Source impedance: ($\pm 10\%$): 10 volt range, 0 to 3.5 k-ohm; 1V, .1V, and .01V range, 600 ohm. Distortion: Less than .25%, 20 to 20,000 cycles. Frequency response: ± 1.5 db 20 cycles to 1 megacycle. Square wave: Frequency range: 20 cycles to 1 mc. Output volts: (P. to P.) $\pm 5\%$; 0 to 10 volt, 0 to 1 volt, 0 to .1 volt, into a high impedance load. Source impedance: ($\pm 10\%$): 10 volt range, 0 to 220 ohm; 1V and .1V ranges, 52 ohm. Rise time: less than .15 microsecond. General: Frequency accuracy: $\pm 5\%$. Power requirements: 105-125V AC, 50/60 cycles, 55 watts. Dimensions: 13" W. x $8\frac{1}{2}$ " H. x 7" D.



Kit AG-10 **\$49⁹⁵**

Handy Heathkit® Accessories for your Test Bench

- Traces RF, IF and audio signals
- Ideal for testing radios, tuners, amplifiers, etc.
- Locates noisy and intermittent components
- Convenient RF-audio probe with built-in switch
- Doubles as utility amplifier, test speaker, etc.



Kit T-4
\$19⁹⁵

Pinpoint receiver faults quickly with this Visual-Aural SIGNAL TRACER

One of the most effective trouble-shooting instruments you can own! This high-gain signal tracer lets you trace signals from antenna to speaker, quickly isolating a defective stage. Traces RF, IF and Audio signals audibly through its built-in speaker or visually through its "eye" tube indicator. Audio and RF inputs are handled by one convenient probe with switch selection of either input. A unique noise-locator circuit detects noisy or intermittent components. Highly versatile, the T-4 serves as a test speaker or utility amplifier for testing tuners, record changers, microphones, etc., and is ideal for testing transistor radios which are easily damaged through ordinary testing procedures. 4 lbs.

Kit T-4.....\$19.95

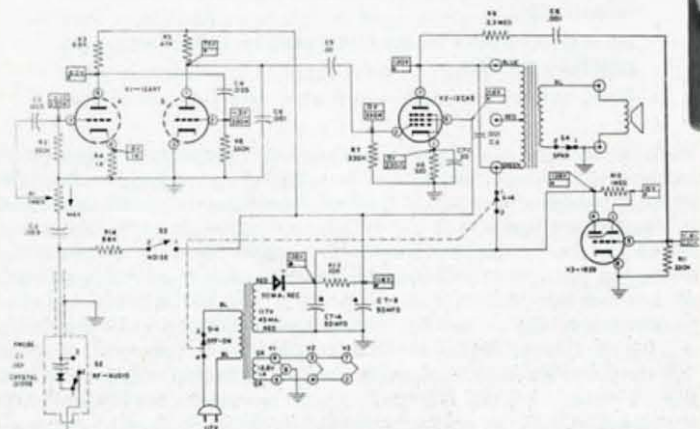

SPECIFICATIONS—Power supply: Transformer operated. Power requirements: 117 volts 50/60 cycles AC, 25 watts. Tube complement: 12AX7, 12CA5, 1629. Speaker: 3½" PM. Probe and test leads: 4' input lead for RF and audio with switch on probe body, 2-3' panel test leads with alligator clips. Dimensions: 4½" W x 7½" H x 4" D.



*precision resistors
in one ohm steps!*

Kit DR-1
\$22⁹⁵

This precision Decade Resistance kit provides any resistance value from 1 ohm to 99,999 ohms . . . all at ½ of 1% accuracy. Twenty ½% precision resistors are arranged so that 5 rotary switches will select any value in one ohm steps. Switches are labeled "Units," "Tens," "Hundreds," "Thousands" and "Ten Thousands". Ideal for laboratory use in a multitude of experimental applications. 3 lbs.

Kit DR-1.....\$22.95



*Priced lower than retail
value of resistors alone . . .
RESISTANCE SUBSTITUTION BOX Kit*

Kit RS-1
\$5⁵⁰

This handy resistance substitution box provides convenient switch-selection of any one of 36 E.I.A. standard 10% 1-watt resistor values, ranging from 15 ohms to 10 megohms. Ideal for experimentally determining desirable resistance values and for altering circuit operating characteristics. Many applications in radio and TV servicing. Measures just 5⅜" L x 3⅛" W x 3" H. 2 lbs.

Kit RS-1.....\$5.50



*precision capacitors
in 100 mmf steps!*

Kit DC-1
\$17⁹⁵

Valuable in all types of design and development work, the DC-1 Decade Condenser provides capacity values from 100 mmf to 0.111 mfd in 100 mmf steps. Precision 1% silver mica capacitors are employed for high accuracy. Switches are high quality, low-loss ceramic wafer types and feature smooth action with positive detent. Ideal for any application requiring the use of precision capacitor values. 3 lbs.

Kit DC-1.....\$17.95



*Quick selection of condenser values
CONDENSER SUBSTITUTION BOX Kit*

Kit CS-1
\$5⁵⁰

This kit contains 18 silver-mica and plastic-molded tubular capacitors in standard E.I.A. values from .0001 mfd to .22 mfd. All capacitors are rated at 600 volts with the exception of the three largest which are rated at 400 volts. An 18-position panel switch allows individual selection of any value provided. Flexible 18" test leads with alligator clips included. 5⅜" L x 3⅛" W x 3" H. 2 lbs.

Kit CS-1.....\$5.50

Precision Laboratory Equipment at Low Cost



Test parts at operating frequencies with this low cost "Q" METER

- Variable oscillator permits testing components at frequencies between 150 kc and 18 mc
- Large 4½" meter mounted in slanted panel for easy reading
- Measures Q, L and distributed capacity of coils
- No special alignment equipment required—test coil furnished

With this high quality "Q" meter on your workbench, you can test coils, condensers, chokes, etc., under actual operating conditions. You can determine values of unknown condensers, both fixed and variable . . . compile data for coil winding purposes . . . and determine distributed capacity and Q of coils. The wide range of inductance, capacitance and "Q" values measurable with the QM-1 will cover practically all values encountered. Q values are read directly on a large 4½", 50 microampere meter. Oscillator output is metered for proper injection level and provides wide frequency coverage on four bands. The power supply is transformer operated and voltage regulated for high stability. Order your "Q" meter now! 14 lbs.

Kit QM-1 . . . NO MONEY DOWN, \$6 mo. \$54.95

SPECIFICATIONS—Frequency: 150 kc to 18 mc in four bands. **Inductance:** 1 microhenry to 10 millihenrys. **"Q":** 250 full scale x1 or x2. **Capacitance:** Actual, 40 mmf to 450 mmf; Effective, 40 mmf to 400 mmf; Vernier ± 3 mmf. **Tubes:** (1) 12AT7, (1) 6AL5, (1) 12AU7, (1) 6X5, (1) OD3/VR150. **Power requirements:** 105-125 volts, 50/60 cycles AC, 30 watts. **Dimensions:** 8" H. x 17" W. x 6" D.

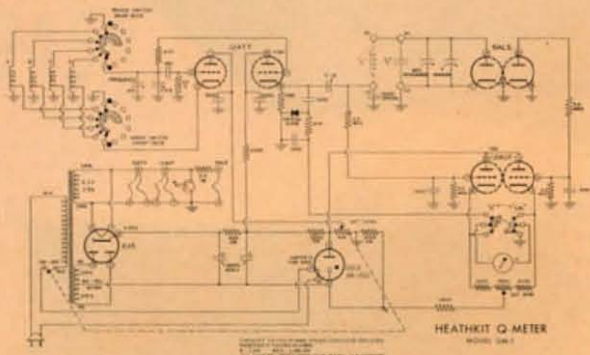

HEATHKIT Q-METER

Actually four bridges in one . . . IMPEDANCE BRIDGE Kit

- Battery type tubes, no warm up required
- ½% precision resistors and silver-mica condensers
- Built-in phase shift generator and detector amplifier
- Slanted control panel for easy reading of controls and meter
- High accuracy and versatility at low cost

The Heathkit model IB-2A Impedance Bridge actually represents four instruments in one! The Wheatstone bridge for resistance measurements, the Capacity Comparison bridge for capacity measurements, Maxwell bridge for low Q, and Hay bridge for high Q measurements. The entire unit is self-contained and designed for rapid, accurate measurement of resistance, capacitance, inductance, dissipation factors of condensers and the storage factor of inductors. Panel controls are separate as to their function and clearly identified. A two-section CRL dial provides ten separate "units" switch-settings. Fractions of units are read on a continuously variable calibrated wire wound control. D, Q, and DQ functions are all combined on one shaft to provide single knob operation, eliminating confusion or incorrect dial settings. Battery-type tubes eliminate time-consuming warmup periods and minimize changes in operating characteristics due to thermal effects. The budget price of this feature-packed instrument puts it within easy reach of the service technician, radio amateur or home experimenter. 10 lbs.

Kit IB-2A . . . NO MONEY DOWN, \$7 mo. \$69.95

SPECIFICATIONS—Circuit: 4-arm impedance bridge. **DC Measurements:** Built-in power supply. Binding posts provided for external supply. **Meter:** 100-0-100 microampere meter. **AC Measurements:** Built-in 1000 cycle generator. Terminals on panel for external generator at other frequencies. **Detector:** Vacuum tube detector and amplifier, using built-in meter. Terminals provided for external detector. **Resistance:** 0.1 ohm to 10 megohm. **Capacitance:** 100 mmf to 100 mfd. **Inductance:** 0.1 mh to 100 h. **Dissipation factor:** (D): 0.002 to 1. **Storage factor:** (Q) 0.1 to 1000. **Accuracy:** ½% decade resistors used. **Tube complement:** (2) 1U4, (2) 1L4. **Power supply:** Transformer and selenium rectifier. **Power requirements:** 105-125 V, 50/60 cycles AC, 10 watts. **Dimensions:** 8" H. x 17" W. x 6" D.



For professional or educational use, choose



Kit EC-1
\$199.95

The clean chassis layout of the EC-1 and the thorough "check-by-step" instructions furnished allow even the beginner to assemble this kit swiftly and successfully.



Heathkit Educational ANALOG COMPUTER...

Only \$199.95..... easy to build..... and operate... perfect for learning

The Heathkit model EC-1 Educational Analog Computer puts advanced engineering techniques within the reach of everyone and still remains the lowest cost analog computer of its quality on the market today. Used widely in industry and in educational institutions, the Heathkit EC-1 is capable of solving a multitude of complex mechanical and mathematical problems with swift electronic accuracy. Many industrial concerns are using this versatile computer to train computer operators and engineers in setting up computer problems. Schools and colleges find the EC-1 ideal for teaching engineering, physics and mathematics. In addition to the basic principles of analog computer application which can easily be obtained from using the instrument, computer design knowledge is also enhanced by familiarity with the EC-1 circuitry.

The Heathkit Educational Analog Computer is completely self-contained and contains nine DC operational amplifiers with provision for balancing without removing problem setup. It also features three initial condition power supplies, five coefficient potentiometers, four sets of relay contacts, an electronically regulated power supply and a built-in repetitive oscillator for automatic operation. The complete EC-1 kit also contains an assortment of precision resistors, capacitors, special silicon diodes and patch cords for setting up scores of complex computer problems easily and accurately.

All components of the EC-1 computer are mounted on plugs for convenient and rapid insertion in problem-board sockets. All markings and symbols are standard computer type. Replacement or additional parts are easily obtainable throughout the nation. The problem results are read directly from the meter supplied with the kit, and pro-



vision is also made for measuring results with an external read-out device such as the Heathkit DC oscilloscopes—IO-10, OR-1, or OP-1.

The Heathkit EC-1 Educational Analog Computer Kit is ideally suited for assembly by students and newcomers to the world of computers. The chassis layout is clean and wide open allowing the beginner to construct the instrument in a short time following the famous Heathkit "check-by-step" instructions and clearly illustrated diagrams. An informative manual is also provided with the kit, which illustrates operating procedures and basic computer information as well as showing how to set up and solve typical problems.

This economical computer is housed in a handsome steel case with convenient access hatch. The housing measures 19 $\frac{3}{4}$ " W x 11 $\frac{1}{2}$ " H x 15" D. The specially designed, heavy-duty chassis and ruggedly-braced front panel permit firm mounting of the EC-1 on a standard relay rack if desired.

The money-saving price of the Heathkit EC-1 coupled with its obvious quality and versatility make it one of the greatest buys ever offered by the Heath Company. In this day of increasing use of analog computers, the EC-1 can be your first step in obtaining a practical, working knowledge of this fascinating field. 43 lbs.

Kit EC-1 . . . NO MONEY DOWN, \$19 mo. \$199.95

SPECIFICATIONS—Amplifiers: Open loop gain approximately 1000. Output -60 $+60$ volts at .7 ma. **Power supplies:** ± 300 volts at 25 ma electronically regulated; variable from $+250$ to $+350$ by control with meter reference for setting $+300$ volts. Negative 150 volts at 40 ma regulated by VR tube. **Repetitive operation:** Multivibrator cycles a relay at adjustable rates (.1 to 15 cps), to repeat the solution any number of times; permits observation of effect on solution of changing parameters. **Meter:** 50-0-50 μ s movement. **Power requirements:** 105-125 volts, 50/60 cycles, 100 watts

low cost Heathkit® Analog Computers

- Solves physical and mathematical problems electronically
- Applicable to many design fields
- Saves time and money in research
- Individual components available for specific needs

Full Components
Group C

\$945⁰⁰

Write for Free Folder . . .

explains exactly what each computer group consists of, and the function of each element of the group. Gives the complete computer story.



Model ES-2
Amplifier Power Supply



Model ES-401
Voltage Regulator Transformer



Model ES-600
Function Generator



Model ES-201
DC Operational Amplifier



Free Folder available . . .
Complete details, prices

An Advanced MODULAR ANALOG COMPUTER At a Budget Price . . . only from Heath!

The Heathkit Modular Analog Computer Kit (ES Series) provides an advanced "slide-rule" which permits engineering and research personnel to simulate equations or physical problems electronically, thus saving many hours of costly calculation and experimentation. It offers many advantages over other commercial computers since it is available in a wide choice of component groups. It is perfect for design work and adaptable to specific problems which utilize only a portion of the items in the complete computer group.

Because it comes in kit form, and the individual components are available separately depending on your personal requirements, the cost is phenomenally low considering its many uses and applications in today's educational, scientific, and industrial worlds. And another asset obtained by building this computer yourself is the intimate knowledge you receive about the inner workings of these instruments. Construction is aided by Heath's famous "check-by-step" instructions and large pictorial reference diagrams and illustrations.

The ES-400 Computer cabinet houses the power supplies, DC amplifiers and computing components. It includes an accurate dividing network which introduces voltages to a null meter with an accuracy of 1/10 of 1%. By means of a switch, a potentiometer may be connected to the meter, and its value checked. This eliminates inaccuracy due to potentiometer non-linearity, or loading. The dividing network and meter may also be used to set up the initial conditions, to set diode bias, and to read any voltage which appears at the amplifier. The meter may be switched to any of the fifteen amplifiers so they will be set to give full scale deflection of ± 2 , 20 and 100 volts. The board also has the plus and minus 100 volt standard available, which is used in the dividing network. The built-in meter serves as the readout indicator

or an external DC oscilloscope, pen recorder, etc., may be employed using the output terminals provided.

Some of the typical problems solved by the computer relate to mechanical vibration and oscillation, dynamic heat transfer, automotive control systems, transients and electrical circuits, automobile suspension systems, aircraft and missile stability and control, fluid flow, simulation of nuclear reactors, rigid body dynamics, and many more complex mathematical problems.

Analyze your present computer requirements now and order the component groups you need. A free folder is available explaining the various computer groups and the function of each element in the group. Just write to us in regard to any particular question you may have as to how this Heathkit modular analog computer can help you.

Full Component Group C . . . (Consists of 1-ES-2, 1-ES 50, 3-ES 100, 1-ES 151, 15-ES 201, 1-ES 400, 1-ES 401, 3-ES 405, 2-ES 447, 1-ES 450, and 1-ES 505) . . .
(write for terms) . . . \$945.00

INDIVIDUAL COMPONENTS AVAILABLE:

Model No.	Description	Price
ES 2	Amplifier power supply kit	\$146.50
ES 50	Reference power supply kit	20.95
ES 100	Initial condition power supply kit	20.50
ES 151	Relay power supply kit	10.95
ES 201	Operational amplifier kit	15.50
ES 400	Cabinet kit	317.50
ES 401	Voltage regulator transformer kit	85.95
ES 405	Patch cord kit (contains 12 patch cords)	15.95
ES 447	Coefficient potentiometer kit	26.95
ES 450	Auxiliary coefficient potentiometer kit	74.50
ES 505	Repetitive oscillator kit	17.50
ES 600	Function generator	72.95

Sensational Values in Compact 3"



Kit IO-21

\$49⁹⁵



Neat, open circuit layout and high quality, easily identified parts make this kit extremely easy to assemble. Construction manual contains complete step-by-step instructions and detailed pictorial diagrams show where each part is located to guide you to successful completion of the kit.

You won't find a finer scope at this price anywhere!
... "GENERAL PURPOSE" 3" OSCILLOSCOPE

- Push-pull vertical and horizontal amplifiers
- Wide-range sweep generator—20 to 100,000 cps
- Automatic sync—retrace blanking
- Clean, open circuit layout for easy, trouble-free assembly
- Compact design—light weight and portable for service work
- Access to vertical deflection plates—ideal for transmitter modulation monitoring

The brand new IO-21 oscilloscope is compact, light in weight, and surprisingly versatile in operation . . . ideal for home workshop, ham shack, or as an "extra" scope in the service shop. Its low cost makes it ideal also for students, or for beginners not yet ready to make a large investment in test equipment.

The exceptionally clean, open circuit layout of this scope makes assembly easy, trouble-free. All parts are neatly arranged on the shallow chassis, eliminating cramped and hard-to-get-at-corners. Parts are easily identified and of highest quality throughout for long and dependable service life.

Circuit design features include identical vertical and horizontal amplifiers with a frequency response of ± 2 db from 2 cps to 200 kc, more than adequate for all general circuit investigations encountered in servicing. Sensitivity is .25 volts RMS/inch peak-to-peak deflection at 1 kc with an input impedance of 10 megohms shunted by 20 uuf. Provision is made for direct connection to the vertical deflection plates of the cathode ray tube . . . ideal for transmitter modulation monitoring. The Heath twin-triode sweep generator employed in this scope functions reliably from 20 to 100,000 cps in four switch-selected ranges with automatic sync and retrace blanking. Provision is made for line sweep and external or internal sweep. Other features include: a 3RP1 CR tube with special alloy neck shield to minimize the effects of extraneous fields; focus and astigmatism controls to assure a sharp, fine trace, and a husky power transformer. Power supply is fused for protection. All these desirable features make the IO-21 an unbeatable value! 14 lbs.

Kit IO-21 . . . NO MONEY DOWN, \$5 mo. \$49.95

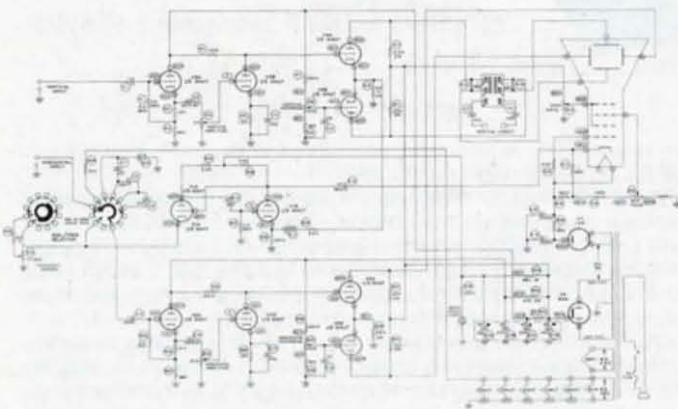

SPECIFICATIONS—(Vertical and horizontal amplifiers identical): Frequency response: ± 2 db, 2 cps to 200 kc. **Sensitivity:** .25 volts RMS/inch P-P deflection at 1 kc. **Input impedance:** 10 megohms shunted by 20 uuf. (Direct connection to vertical CRT plates on rear panel). **Sweep generator:** Range, 20-100,000 cps. Automatic sync, retrace blanking. **Tube complement:** (1) 3RP1 CR tube, (4) 12AU7 (deflection amplifiers), (1) 12AX7 (sweep generator), 6X4 (LV rectifier) (1) 1V2 (HV rectifier). **Controls:** Gain controls, Horizontal & Vertical; Centering controls, Horizontal & Vertical; Frequency Vernier; Horizontal Input, Sweep Range switch, (Focus and Astigmatism controls mounted on chassis). **Power requirements:** 105-125 volts AC, 50-60 cycle, 40 watts. **Dimensions:** 9 $\frac{1}{2}$ " H x 6 $\frac{1}{2}$ " W x 10" D.

Oscilloscopes for your Test Bench



Kit IO-10
\$79⁹⁵

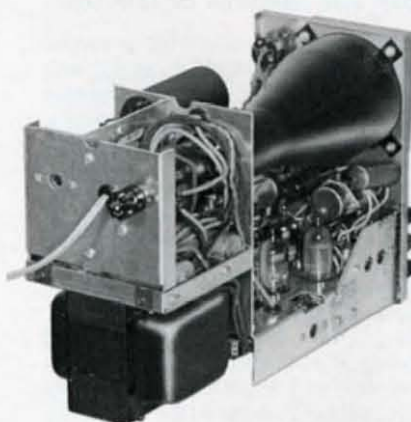

Use of a special alloy CR tube shield to minimize trace distortion and other high quality parts throughout contribute to the excellent performance of this fine instrument. Note the husky power transformer.

"SPACE SAVER" 3" DC OSCILLOSCOPE...

Small, compact, easy to carry... ideal for use where extremely low sweep rates are desired

- Identical vertical and horizontal DC or AC coupled amplifiers
- DC to 200 KC bandwidth—less than 5° phase shift between channels
- Recurrent sweep generator, 5 cps to 50 kc in four ranges
- External capacity binding posts for lower sweep rates
- Small, compact size—measures only 7 $\frac{1}{2}$ " H x 4 $\frac{1}{8}$ " W x 11" D

The many outstanding features of this attractive 3" DC scope speak for themselves! Its compact size requires only a fraction of the space occupied by scopes of comparable function. Easy to carry about for various jobs away from the test bench, it offers high versatility and fine performance characteristics for use in countless applications in industrial, medical and general service fields. An amazing value at this low price!

Equally useful in AC or DC applications, the IO-10 features identical vertical and horizontal amplifiers with a bandwidth of DC to 200 kc (2 db point). Sensitivity: 0.1 V (peak-to-peak) per 1/2" (uncalibrated). Attenuator: 3-position, compensated type. Gain control: Continuously variable. Input impedance: 3.6 megohms shunted by 35 mmf. Coupling: Either AC or DC, switch-selected. Relative phase shift between channels: Less than 5°. Sweep generator (recurrent type): Linear saw-toothed produced by multivibrator type generator covering 5 cps to 50 kc in four overlapping ranges. "External capacity" binding post for lower sweep rates. Sync provision: Either internal or external, switch-selected. Power requirements: 105-125 V 60-60 cycle AC at 100 watts max. Dimensions: 7 $\frac{1}{2}$ " H x 4 $\frac{1}{8}$ " W x 11" D.

Kit IO-10... NO MONEY DOWN, \$8 mo. **\$79.95**

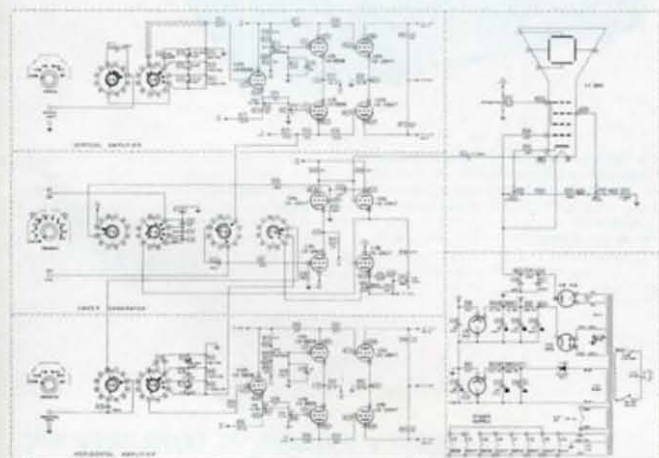

SPECIFICATIONS—(Vertical and horizontal channels identical): Bandwidth: DC to 200 kc (2 db point). Sensitivity: 0.1 V (peak-to-peak) per 1/2" (uncalibrated). Attenuator: 3-position, compensated type. Gain control: Continuously variable. Input impedance: 3.6 megohms shunted by 35 mmf. Coupling: Either AC or DC, switch-selected. Relative phase shift between channels: Less than 5°. Sweep generator (recurrent type): Linear saw-toothed produced by multivibrator type generator covering 5 cps to 50 kc in four overlapping ranges. "External capacity" binding post for lower sweep rates. Sync provision: Either internal or external, switch-selected. Power requirements: 105-125 V 60-60 cycle AC at 100 watts max. Dimensions: 7 $\frac{1}{2}$ " H x 4 $\frac{1}{8}$ " W x 11" D.

Versatile Heathkit® Oscilloscopes for Every



- Full 5 mc bandwidth for color TV servicing
- Push-pull horizontal and vertical amplifiers
- Heath patented sweep circuit—10 cps to 500 kc
- Switch-selection of 2 "preset" sweep frequencies
- 2 circuit boards and wiring harness for easy assembly

"Extra-duty" wide band 5" OSCILLOSCOPE . . .
professional quality and features at low cost!

Here is an oscilloscope that will fulfill practically every lab or service requirement. Critical waveform observations are handled easily, with clear, sharp pattern displays in every application. Excellent linearity and lock-in characteristics allow viewing stable waveform presentations even at upper frequency limits. The unique Heath patented sweep circuit employed in this scope functions from 10 cps to over 500 kc giving you five times the sweep range of most other scopes. This feature, coupled with the wide band amplifiers, essential in color TV work, make it ideal for general and specialized circuit investigations. Two extra, switch-selected, preset sweep frequency positions are provided for those who use certain frequencies repeatedly. Other features include push-pull output amplifiers, positive trace position controls, peak-to-peak calibration reference, 3-step frequency compensated vertical input, automatic sync circuit, Z-axis input, 5U1 CR tube, husky power supply, and a fresh, new styling concept. A superbly engineered instrument designed for years of fine performance. 23 lbs. **Kit IO-30 . . . NO MONEY DOWN, \$7 mo. . . . \$69.95**

Kit IO-30
\$69⁹⁵

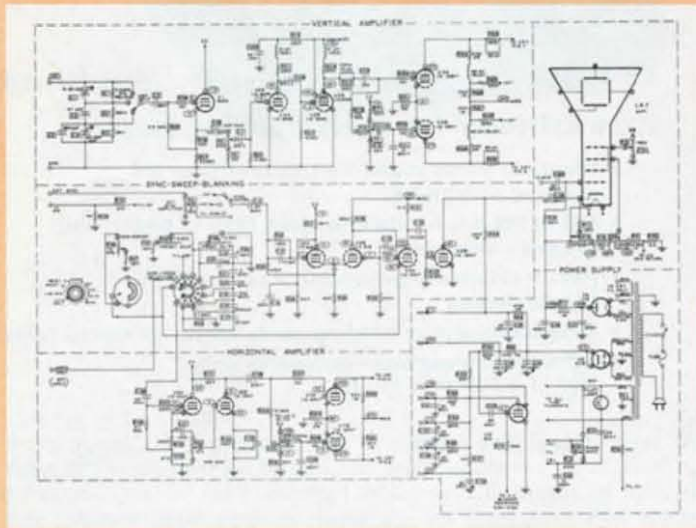

SPECIFICATIONS—(Vertical channel) sensitivity: 0.025 volt RMS per inch at 1 kc. **Frequency response (referred to 1 kc level):** ±1 db 8 cps to 2.5 mc; +1.5 to -5 db, 3 cps to 5 mc; response at 3.58 mc, -2.2 db. **Rise time:** 0.06 microseconds or less. **Input impedance:** (AT 1 KC) 2.7 megohms at X1; 3.3 megohms at X10 and X100. **(Horizontal channel) sensitivity:** 0.3 volts RMS per inch at 1 kc. **Frequency response:** ±1 db 1 cps to 200 kc; ±3 db 1 cps to 400 kc. **Input impedance:** 4.9 megohms at 1 kc. **Sweep generator:** Range 10 cps to 500 kc in five steps, variable, plus any 2 switch-selected preset sweep frequencies in this range. **Synchronizing:** automatic lock-in circuit using self-limiting synchronizing cathode follower. **Power requirements:** 105-125 volts 50/60 cycles AC at 80 watts; fused. **Dimensions:** 14 1/2" H. x 8 1/2" W. x 16" D.

Scope Demodulator PROBE Kit . . .

extends usefulness of scope



Kit 337-C **\$3⁵⁰**

With this scope demodulator probe accessory you can observe the modulation waveform of RF or IF signals. Functions as an AM detector to pass only modulation of signal and not the signal itself. Voltage limits are 30 V RMS and 500 V DC. Useful in all types of radio and TV servicing. Kit is complete with germanium diode, condensers, resistors, probe housing and shielded test lead. 1 lb.

Kit 337-C **\$3.50**
 96

Low Capacity Scope PROBE Kit . . .

reduces circuit loading



Kit PK-1 **\$4⁹⁵**

An essential accessory for use in high frequency work, checking broadband circuits or high impedance circuits. The use of a low capacity probe will reduce circuit loading and distortion. A switch on the probe body allows direct or (X 10) attenuated operation. A variable capacitor allows adjustment to provide proper matching to scope input. 1 lb.

Kit PK-1 **\$4.95**

Heathkit Equipment is quality engineered for better performance, longer life and better value

Testing Requirement, Every Budget



Kit OR-1
\$119⁹⁵

"General Research" 5" DC OSCILLOSCOPE . . . fills scores of industrial, educational, medical and general service needs

- Identical DC coupled vertical and horizontal amplifiers
- 5ADP2 flat face CR tube—edge-lighted graticule
- External capacity binding posts for lower sweep rates
- Switch-selection of internal or external sync

An excellent scope for all types of DC applications. Finest quality components and materials have been used in the design of this scope to bring you high performance and long, reliable service. Identical DC or AC coupled vertical and horizontal amplifiers with less than 5 degree phase shift between channels make the OR-1 an excellent read-out indicator for computers and for many other industrial and scientific applications. DC to 200 kc bandwidth and low phase shift characteristics are ideal for audio design and development work. The transformer-operated power supply features long-life silicon diode rectifiers in full wave voltage doubler circuits for B+ and bias supplies. All critical voltages are regulated by VR tubes for stable, reliable performance. Coupling may be either AC or DC as selected by the input attenuator. Kit includes a precut, cabled wiring harness for easy assembly. 21 lbs.

Kit OR-1 . . . NO MONEY DOWN, \$11 mo. \$119.95

SPECIFICATIONS—(Vertical and horizontal channels identical) bandwidth: DC to 200 kc (1 db point). **Sensitivity:** 0.1V (peak to peak) per cm (uncalibrated). **Attenuator:** 3-position, compensated type. **Gain control:** continuously variable. **Input impedance:** 3.6 megohms shunted by 25 mmf. **Coupling:** either AC or DC, switch-selected. **Relative phase shift between channels:** less than 5 degrees. **Sweep generator (recurrent type):** linear saw-tooth produced by multivibrator type generator. **Frequency coverage:** 5 cps to 50 kc in four overlapping ranges. **"External capacity" binding post for lower sweep rates.** **Sync source:** either internal or external, switch selected. **Power requirements:** 105-125 V 50/60-cycle AC at 100 watts max. **Dimensions:** 11" H. x 6 1/2" W. x 20" D.

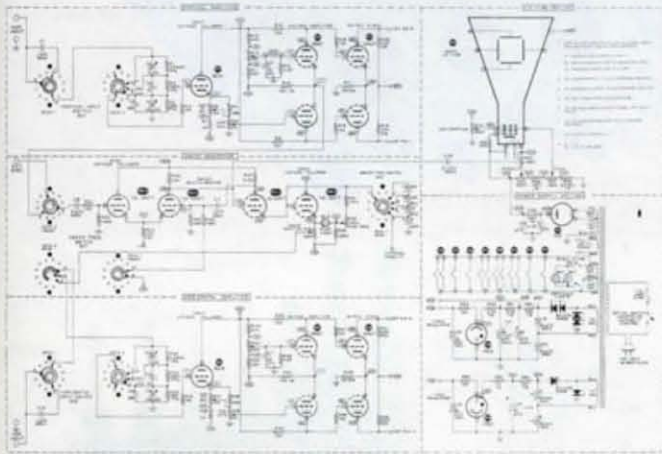

Use your scope to measure voltage with this VOLTAGE CALIBRATOR Kit

This voltage calibrator permits measuring voltages at any frequency within the range of your oscilloscope. It produces near-perfect square wave signals of known amplitude for use in determining the amplitude of unknown signals by the comparison method, thereby allowing use of the scope as an accurate peak-to-peak voltmeter. Fixed outputs of 0.03, 0.1, 0.3, 1, 3, 10, 30 and 100 volts peak-to-peak are produced by the VC-3 at a frequency of approximately 1 kc. 1% attenuator resistors assure accurate output amplitude. 3 lbs.

Kit VC-3 \$14.95



Kit VC-3 \$14⁹⁵

View two signals simultaneously with this ELECTRONIC SWITCH Kit

Oscilloscope owners will appreciate the many advantages offered by the S-3 in permitting simultaneous observation of two separate signals. Both signals are reproduced alternately at any one of four switching rates provided. Separate gain controls are provided for each channel with sync output to lock scope sweep or time base to signal frequency. The two traces may be separated or superimposed on each other with the position control provided. Frequency response is ± 1 db from 0 to 100 kc. 6 lbs.

Kit S-3 \$21.95



Kit S-3 \$21⁹⁵

Heathkit® Professional Oscilloscope has budget price

- Calibrated driven sweep—built-in triggering circuits
- Calibrated DC coupled vertical amplifier
- 5ADP2 flat face CR tube—edge-lighted graticule
- Prewired circuit boards for easy assembly

Kit OP-1

\$184⁹⁵

A sophisticated 5" DC Scope for light duty applications

The professional quality and features of the Heathkit OP-1 DC Oscilloscope make it ideal to use for any light duty application where DC coupled vertical and horizontal amplifiers, driven sweep, calibrated sweep and calibrated vertical amplifier are essential. Also featured is DC coupled CRT un-blanking. The triggered sweep circuit operates on either internal or external signals and may be either AC or DC coupled. The polarity of the triggering signal may be selected and any point on the wave form may be selected for the start of the sweep by using the "triggering level" control. An automatic position is also provided, in which the sweep recurs at a 50 cycle rate, but can be driven over a wide range of frequencies with no additional adjustments. The sweep speeds are provided at switch-selected base rates of 2 and .2 milliseconds-per-cm and 20, 2 and 1 microseconds-per-cm in conjunction with a continuously variable 10 to 1 multiplier. Sweep speeds are calibrated to within 10% at all control settings, and the sweep speed may be reduced by adding capacity to the "Ext. Cap" binding post of the front panel. A 5ADP2 flat face CR tube is used for accurate readings on an edge-lighted grid screen. A high quality CRT shield prevents stray AC fields from distorting the trace. The 12-position vertical attenuator is calibrated in volts-per-cm and the horizontal sweep is calibrated in time-per-cm. A 150 volt DC test voltage is provided for vertical channel calibration. All critical voltages are regulated with VR tubes for high stability. Five prewired terminal boards and a precut cabled wiring harness simplify assembly. The power supply is transformer operated utilizing silicon diode rectifiers and is fused for protection. The attractive styling of the OP-1 features an aluminum front panel with red and black lettering and matching knobs. The handsome cabinet is louvered for ventilation. 34 lbs.



Kit OP-1 . . . NO MONEY DOWN, \$18 mo. **\$184.95**

SPECIFICATIONS—Vertical channel frequency response: within 1 db DC to 2.2 megacycles; within 3 db DC to 3.6 megacycles; within 6 db DC to 4.5 megacycles. **Rise time:** less than .1 microsecond. **Input impedance:** 3.6 megohm shunted by 28 mmf. **Sensitivity:** DC coupled; 0.1 V peak-to-peak for 1 cm deflection; AC coupled; .01 V peak-to-peak for 1 cm deflection (using built-in preamp.). **Coupling:** AC or DC switch selected. **Horizontal channel frequency response:** within 1 db from DC to 450 kc; within 3 db from DC to 600 kc. **Input impedance:** 1 megohm shunted by 37 mmf. **Sensitivity:** 0.2 V peak-to-peak for 1 cm deflection. **Power requirements:** 105-125 VAC, 50/60 cycles, 250 watts max. **Dimensions:** 8 1/4" W. x 14 1/4" H. x 19" D.

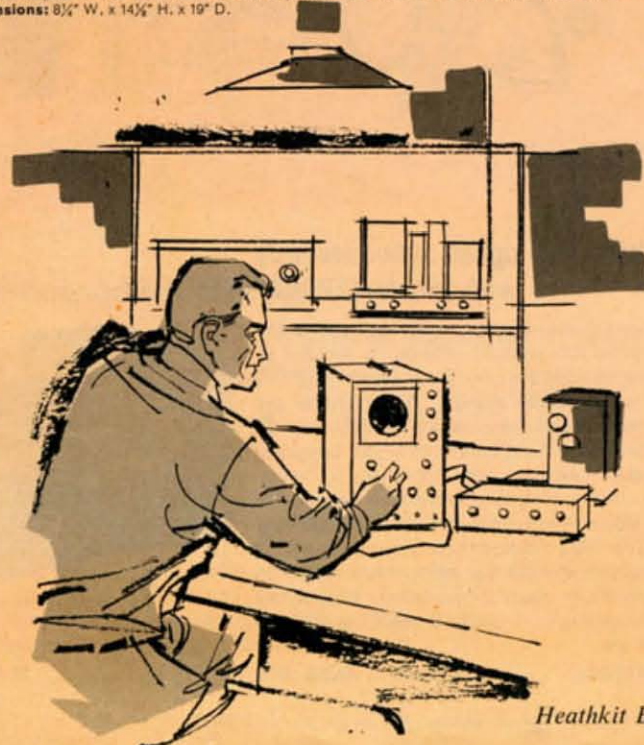
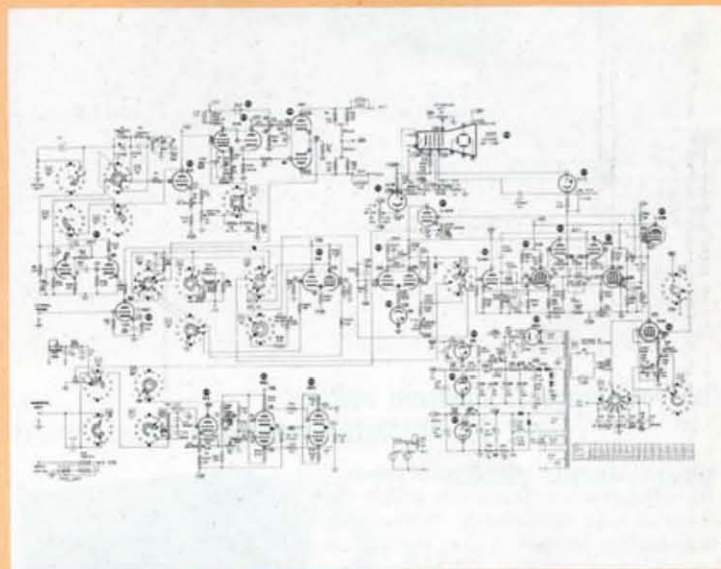

Proper Tools turn a Hobby into a Craft



Model 490-26

\$583

Get perfect soldering with a Weller 8200K Dual-Heat Soldering Gun

For accurate, professional-type soldering results in your kit building, the Triggermatic control on this Weller Soldering Gun is just the thing. It switches instantly to "high" (125 watts) or "low" (90 watts) for perfect soldering every time. The high efficiency Weller tip combines the superior heat transfer qualities of copper with iron plating for durability and efficiency. Completely assembled and ready to use. Entire kit contains: gun, soldering aid, wire cleaning brush and packet of Kester radio solder. A truly superior soldering gun at a low price. 3 lbs.

Model 490-26.....**\$5.83**

Model TK-1

\$995



The TK-1 Tool Set contains the basics for building any Heathkit

This tool set proves how simple it is to build any Heathkit! All the essentials are included: pliers, diagonal sidecutters, two screwdrivers and a 30-watt soldering iron. The pliers and sidecutters are equipped with vinyl insulated handles to provide maximum safety and convenience. Every one of the tools in this set is made from top-quality case-hardened steel for rugged durability and long life. In addition to giving you all the necessary tools you need for building your Heathkit, this set will be handy in other repair jobs around the house. 2 lbs.

Model TK-1.....**\$9.95**



Model 490-27

\$642

Solve "tightening" problems quickly with the Xcelite #137 Nutdriver Set

Perfect for Heathkit building, as well as "fix-it-yourself" jobs around the home, you'll find the seven color-coded nutdrivers in this set a real asset to your work or hobby. Each driver has a tough plastic handle. The head sizes are: $\frac{3}{16}$ ", $\frac{1}{4}$ ", $\frac{5}{16}$ ", $\frac{11}{32}$ ", $\frac{3}{8}$ ", $\frac{1}{2}$ " and $\frac{9}{16}$ ". The polished alloy steel shank of each nutdriver is drilled $\frac{1}{4}$ " deep for tightening over long screws. The largest drivers have hollow shafts for nut installation on controls, switches, etc. A handy self-supporting storage rack is included. 3 lbs.

Model 490-27.....**\$6.42**



Model GH-10

\$1995

"The GH-10 Tool Kit gives your workshop a deluxe selection with economy"

Containing tools that can take their place permanently and proudly on any home repair bench, the Heathkit GH-10 Deluxe Tool Kit includes a handsome assortment of practical devices that will help you do a better Heathkit building job. Included are: a combination midget wire stripper and diagonal cutters, midget long nose pliers with plastic covered handles; three screwdrivers ($\frac{1}{8}$ " with 3" blade, $\frac{3}{16}$ " with 4" blade, and $\frac{3}{16}$ " with 3" blade and pocket clip). Also supplied in this complete selection of tools are: a Weller 8200K "Dual-Heat" soldering gun, a soldering instruction booklet, solder joint brush, and an adequate supply of radio solder; a high-quality set of 5 nut drivers ($\frac{3}{16}$ ", $\frac{1}{4}$ ", $\frac{5}{16}$ ", $\frac{3}{8}$ ", $\frac{1}{2}$ "); a handy nut starter and a combination metal two-way soldering aid tool. The GH-10 is an amazing value in a tool kit that will make your Heathkit building or any fix-it task easy—and fun! 6 lbs.

Model GH-10.....**\$19.95**



*the largest
company in the
world devoted
exclusively to the
design & manufacture
of electronic
equipment in
kit form*

All prices quoted are Net F.O.B. Benton Harbor, Michigan and apply to United States and Possessions only. Prices herein effective September 15, 1961. All prices and specifications subject to change without notice. Dealer and export prices slightly higher.