

Volumax

Automatic peak controller

OPERATING AND MAINTENANCE INSTRUCTIONS

SECTION I
INTRODUCTION

1-1 General

The new solid-state VolumaxTM, like its companion-piece, the CBS Laboratories' Audimax*, is a tool to help the broadcaster achieve maximum program power within appropriate modulation limits.

Designed primarily for use with well-controlled average input levels such as Audimax provides, Volumax replaces conventional peak limiters for the prevention of carrier overmodulation by instantaneous program peaks. With conventional peak limiters, the broadcaster has to choose between two evils: either program level must be reduced so that limiting of peaks will not be drastic enough to cause distortion and "pumping"; or this audible distortion must be tolerated.

Pumping, in conventional limiters, is usually moderated by the use of long recovery times. Thus, during the intervals immediately

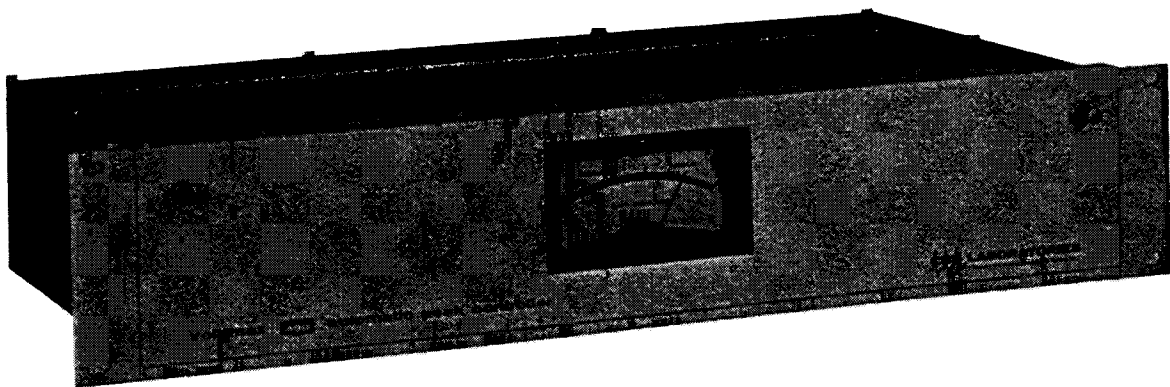

Figure 1-1. The Volumax Automatic Peak Controller

* Audimax is CBS Laboratories' trademark for its automatic level control

following high program peaks, valuable modulation capability is wasted as the limiter recovers from reduced gain.

Volumax solves these problems in a unique manner. Control is effected in two ways, comprising time-varying AGC action and microsecond-fast diode limiting. Result: more even, pleasant sound plus the ability to transmit program with high peak factor at twice the average program power level usually expected when conventional limiters are used.

The time varying AGC action responds to both positive and negative excursions of the program wave alike. However, the microsecond-fast limiting can be symmetrical or asymmetrical at the user's option. This latter feature enables the A.M. user to take full advantage of F.C.C. regulations setting no limit on positive modulation peaks but restricting negative peaks only. Thus, asymmetrical operation may be used for A.M. (Volumax is delivered factory-set for asymmetrical operation). However, in F.M., TV, and recording work, it is necessary to restrict modulation in both directions equally, and therefore symmetrical action is essential. This is accomplished by an internal strapping connection to be described later.

1-2 Warranty

A standard warranty card with a return post card has been included with your Volumax. Fill out the card and return it to CBS Laboratories as soon as possible in order to validate your warranty.

1-3 Factory Service and Repair

If you should experience difficulty in installing or operating the Volumax, please contact CBS Laboratories, Professional Products Dept., Stamford, Connecticut, Area Code 203 325-4321.

1-4 SPECIFICATIONS

Dimensions: Fits standard 19 inch rack. 3-1/2 inches high;
9-5/8 inches deep.

Frequency Response: Flat within 1 db, 50 to 15,000 cps.

Harmonic Distortion: Less than 1 percent from 50 to 15,000 cps
throughout normal control range.

Input Level: -24 to +8 dbm.

Maximum Output Level: Controlled peaks +21 dbm; noncontrolled peaks +25 dbm.

Input and Output Impedance: 600 ohms, balanced or unbalanced.

Noise Level: Below -50 dbm.

Maximum Gain: 50 db.

Attack Time: Less than 1 microsecond or 2 milliseconds, depending
on program waveform.

Recovery Time: 140 milliseconds.

Maximum Operating Temperature: 55°C.

Power Required: 15 watts at 115-230 volts, ac, 50-60 cps.

SECTION II
 INSTALLATION INSTRUCTIONS

2-1 Unpacking

Unpack your Volumax carefully and examine the unit for evidence of possible shipping damage. If the Volumax is damaged, file a claim immediately with the carrier. (If future transportation of the unit is anticipated, save the shipping carton).

2-2 Power Supply (See Figure 2-1)

Volumax Serial No. 501 and higher are equipped with a power transformer permitting selection of either 115 volt or 230 volt operation.

If 230 volt operation is required, remove the jumpers on the power supply board from lugs 1 to 2 and 3 to 4. Reconnect a single jumper between lugs 2 and 3. Replace the fuse with a type 3AG-0.15 amp.

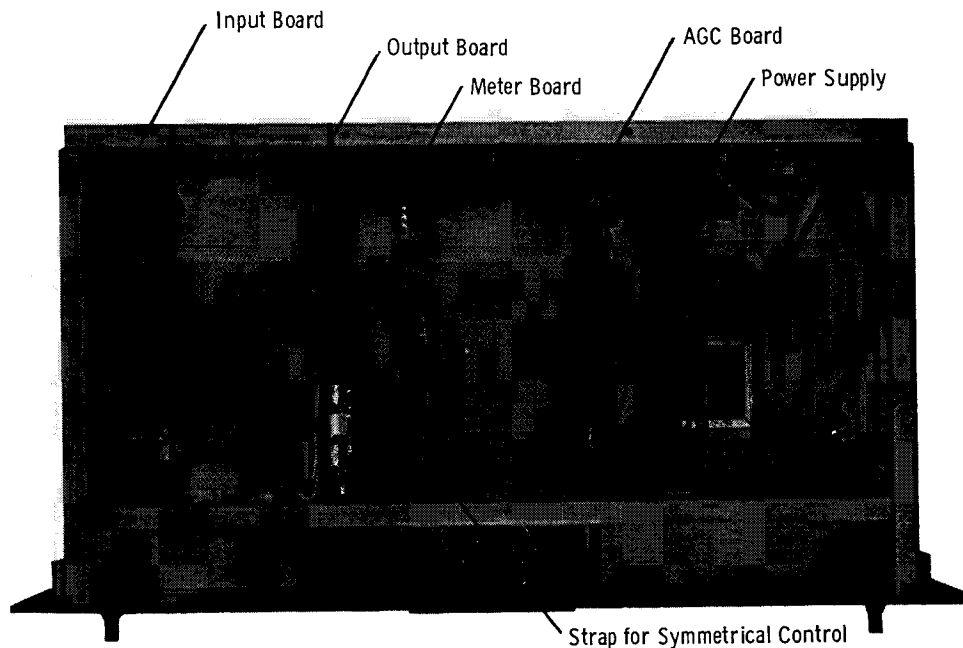

Figure 2-1. Circuit Board Layout

2-3 Installation

Volumax is designed to be mounted in a standard 19" wide rack. It requires 3-1/2" panel space and is slightly less than 10" deep. As with all transistorized equipment, the unit must be installed in a reasonably well-ventilated position, with no high heat-producing equipment beneath it.

CAUTION: Ambient Temperature Should Not Exceed 130^oF.

Volumax is normally installed at the transmitter immediately preceding the transmitter audio input terminals. However, it may be installed at the studio ahead of the program line to the transmitter when the phase-amplitude characteristic between studio and transmitter are known to be uniform under all climatic conditions or service conditions caused by telephone company changes of equipment.

The use of this instrument is predicated on uniform average levels being fed into it. Therefore, the use of an automatic level control such as the CBS Laboratories' Audimax is highly recommended for this purpose. Any wave-shaping or phase-scrambling devices should be used ahead of the Volumax. The unit has sufficient gain to correct for long-line and equalizer losses incurred when the transmitter site is at a remote location. Input levels as low as -24 dbm can be accommodated. If input levels exceeding +8 dbm are used, the range of attenuation on the input pad will not be great enough. Such is the case when a CBS Laboratories' Audimax Model 440, 441 or 443 is

connected directly to the Volumax input. For such installations, the following attenuator circuit should be used in the line ahead of the Volumax:

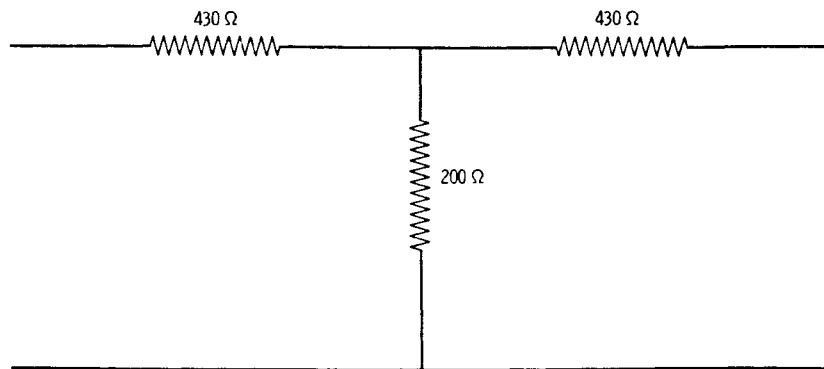

Figure 2-2. 600-ohm, 16 db Attenuation Network

2-4 Electrical Connections

Input and output leads should be connected to the five-terminal strip at the rear of the chassis. Terminals 1 and 2 are for input and terminals 4 and 5 are for output. The unit may be connected for balanced or unbalanced operation. Terminal 3 is the chassis ground. The standard Volumax is designed for 600 ohm operation. For 150 ohm operation special input and output pads may be installed and Transformers T2 and T3 strapped as shown on the schematic diagram.

SECTION III
SET-UP PROCEDURES

3-1 ASYMMETRICAL OPERATION

- a. Rotate the OUTPUT LEVEL control fully counter-clockwise.
- b. Feed a 1 kc signal to deflect the meter to the red-green junction.
- c. Increase the input 10 dB (the meter will read off-scale).
- d. Increase the output level of the Volumax to produce approximately 30 to 40% modulation.
- e. Observe the modulated carrier on an oscilloscope.
- f. Figure 3-1 shows a correctly phased waveform. If you observe a waveform as in Figure 3-2, reverse the output leads of the Volumax.

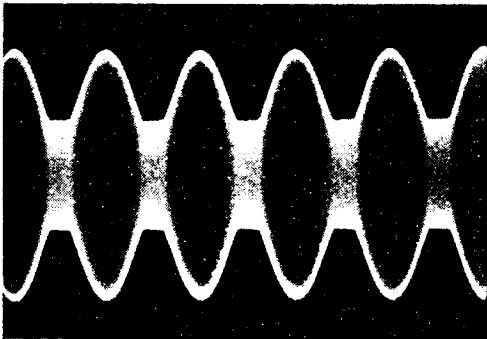

Figure 3-1. Correct Phasing, as Indicated by Intentionally Overdriven Volumax

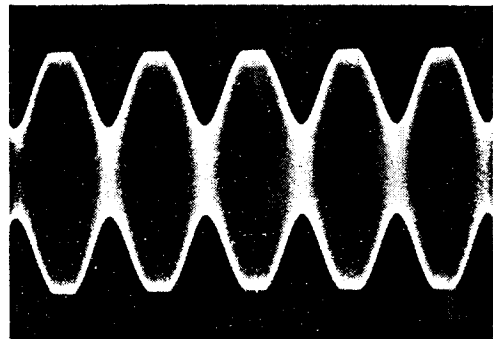

Figure 3-2. Incorrect Phasing, as Indicated by Intentionally Overdriven Volumax

3-2 ADJUSTMENT FOR MAXIMUM MODULATION

- a. Rotate the OUTPUT LEVEL control fully counter-clockwise.
- b. Feed a 1 kc signal to deflect the meter to the red-green junction.
- c. With the MODULATION SET switch depressed, rotate the OUTPUT LEVEL control to produce the maximum desired modulation. If the AM carrier is observed on an oscilloscope it should appear similar to Figure 3-3.

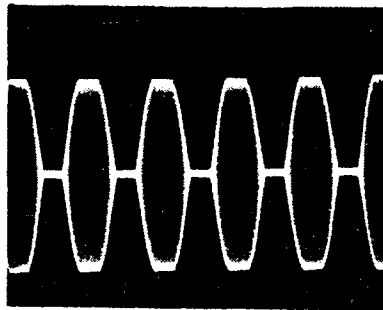

Figure 3-3. Squared-tone Modulation (95%)

- d. Release the MODULATION SET switch and remove the 1 kc signal.
- e. Feed normal level-controlled program into the Volumax.
- f. Adjust the INPUT LEVEL control to cause the GAIN REDUCTION meter to operate in the green or NORMAL area with occasional peaks deflecting into the red region.

Although the output level can be precisely set by using the above squared-tone method, it should be recognized that phase-shifts in transmitting equipment may cause previously limited program peaks to exceed the 100% point. A slight readjustment of the OUTPUT LEVEL control may be necessary if modulation appears excessive.

If it is not practical to set up the Volumax with the sine-wave method, the following procedure may be used in AM applications:

- a. Feed normal, level controlled, program into the Volumax.
- b. Adjust the INPUT LEVEL control to cause the GAIN REDUCTION meter to operate in the green or NORMAL area with occasional peaks deflecting into the red region.
- c. Set the OUTPUT LEVEL control to produce the desired modulation as indicated on the modulation monitor.
- d. Connect an oscilloscope to produce a trapezoidal modulation pattern.
- e. Observe the pattern closely, preferably with speech modulation.
- f. If the scope pattern appears to have a well defined limit point in the direction of negative modulation, as shown in Figure 3-4, the Volumax output is connected properly, that is, controlling the negative modulation peaks. If however, no distinct limiting is evident on the negative modulation peaks, but does show up in the positive direction as in Figure 3-5, the output leads of the Volumax must be reversed.

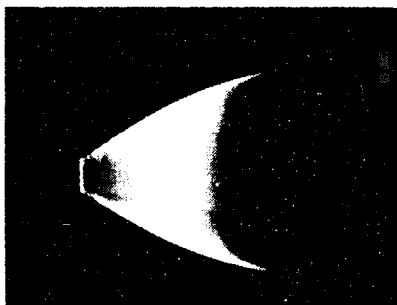

Figure 3-4. Correct Limiting, as indicated by a Trapezoidal Pattern.

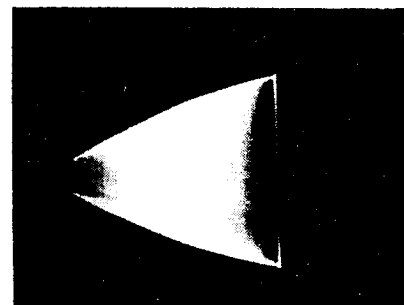

Figure 3-5. Incorrect Limiting, as indicated by a Trapezoidal Pattern.

SECTION IV
 PRINCIPLES OF OPERATION

4-1 GENERAL (See Figure 4-1)

Volumax is functionally similar to conventional peak limiters in that it prevents overmodulation of a radio-frequency carrier by instantaneous program peaks, but it overcomes the handicaps inherent in peak limiters.

It is a well known fact that significant differences in peak factors may exist between various program waves of the same average level as indicated by a standard VU meter. When program with a high peak factor is fed into a conventional limiter, it will normally be passed at a lower gain than other program waves with a lesser peak factor, even though both programs may have the same average level. This discrepancy in volume level prevents the optimum utilization of transmitter capability and handicaps the broadcaster who is trying to achieve maximum average modulation.

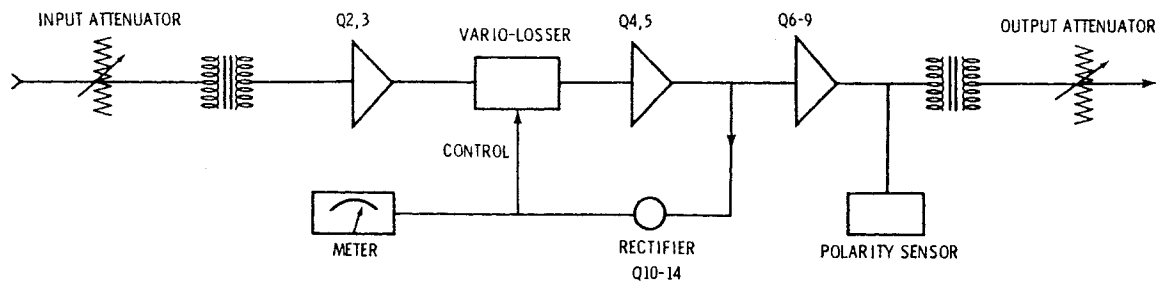

Figure 4-1. Volumax - Block Diagram

Another limitation in the operation of a conventional peak limiter exists during the interval immediately following a train of program waves with high peak factor. It is during this period that the limiter is recovering from a condition of reduced gain. Thus, for a second or two, program will be transmitted at less than optimum gain. If recovery time of the limiter is reduced so that gain is increased more rapidly during this period, then the familiar "pumping" effect will be heard.

Volumax solves these problems of the peak limiter in a precise and aesthetically acceptable manner. It prevents overmodulation of the carrier, while providing a high level signal with no audible distortion. Since it is designed for use with an automatic level control such as the CBS Laboratories' Audimax, it does not have to perform the dual function of maintaining appropriate average levels and preventing overmodulation. It can provide for the latter function in the best possible manner.

Volumax limits audio level in two steps; by a relatively slow AGC action, and by instantaneous diode limiting. This system provides highly accurate control, permitting extremely fast limiting on short-duration peaks without a general reduction of gain.

Amplifiers Q2 - Q5, Rectifiers CR11 - CR12 and the variolossor network comprise the AGC amplifier. It maintains output at the correct level, but its attack time of two-milliseconds precludes operation on short-

duration peaks. In the event that program material is of a nature to cause gain reduction, recovery is quite rapid to prevent a condition of unnecessarily low gain. A recovery time of 140 milliseconds is used, coinciding approximately with a syllabic rate. At this speed no audible pumping will occur, providing that the specified limits of gain reduction are not exceeded.

Those program peaks which do not significantly contribute to the average power level of the signal, and are therefore passed without gain reduction by the AGC amplifier, are controlled by the Polarity Sensor operating on the output amplifier Q6 - Q9. Instantaneous limiting is employed here to provide an absolute amplitude limit for the passing signal, thus assuring that no overmodulation of the carrier will occur. As previously stated in Section II on Volumax Installation, the Polarity Sensor may be strapped for symmetrical or non-symmetrical control.

4-2 CIRCUIT OPERATION (See Figure 4-2)

Input signal is applied through the input attenuator R8 and input transformer T2. The signal at the secondary winding of T2 is amplified by the push-pull class A amplifier stages Q2 - Q3 and Q4 - Q5. The coupling between these stages contain the variolossor elements CR7 - CR10. These matched diodes present an attenuating path whose impedance is determined by the control signal applied through R24.

TB 1
1 2 3 4 5

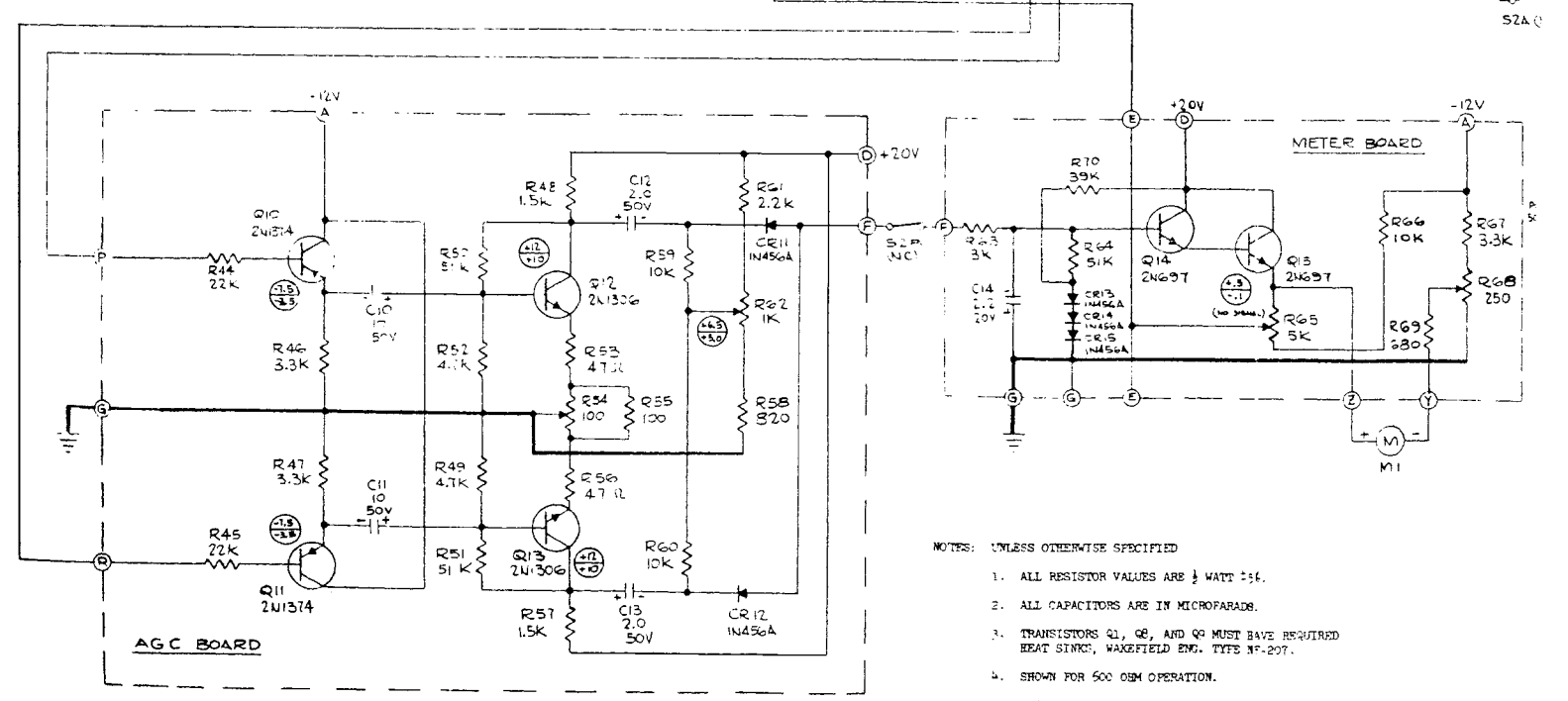
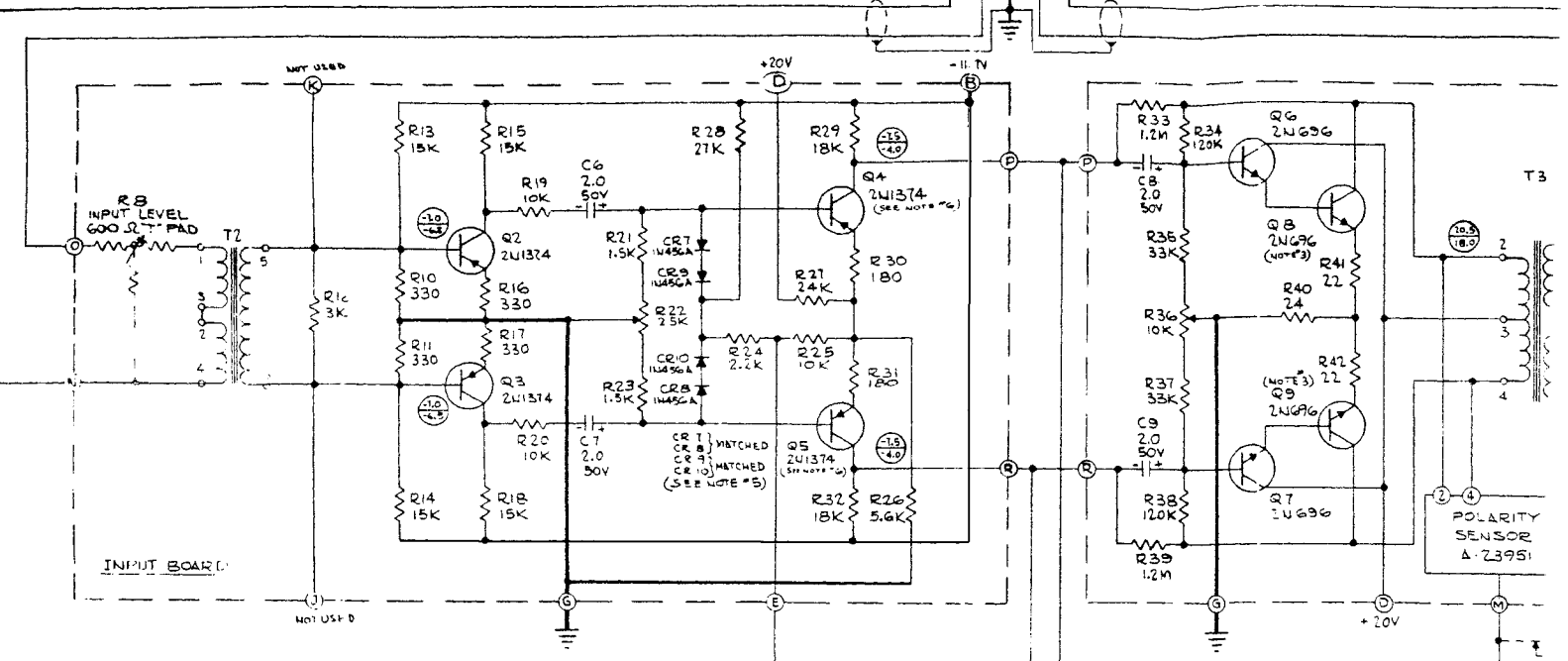

- NOTES: UNLESS OTHERWISE SPECIFIED
1. ALL RESISTOR VALUES ARE $\frac{1}{2}$ WATT $\pm 5\%$.
 2. ALL CAPACITORS ARE IN MICROFARADS.
 3. TRANSISTORS Q1, Q8, AND Q9 MUST HAVE REQUIRED HEAT SINKS, WAREFIELD ENG. TYPE N-207.
 4. SHOWN FOR 500 OHM OPERATION.
 5. MATCHING - V_f MATCHED TO WITHIN 10 MV AT $I_f = 1$ MA.
 6. BETA OF Q4 AND Q5 SHOULD BE GREATER THAN 80 OR MATCHED TO WITHIN 20% OF EACH OTHER.
 7. --- ALL DC VOLTAGES MEASURED WITH VTVM.

F

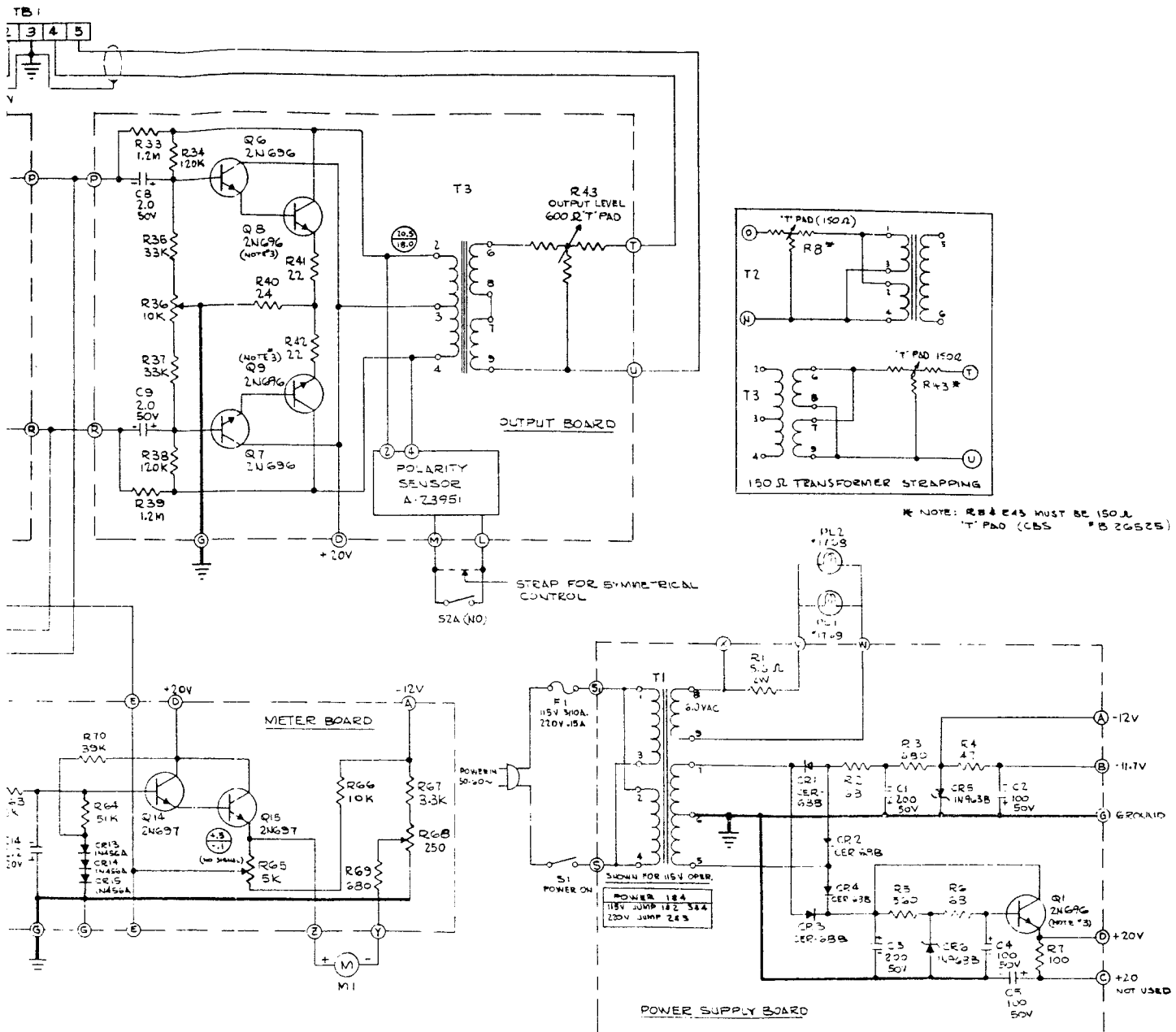

UNLESS OTHERWISE SPECIFIED

1. ALL RESISTOR VALUES ARE 1/2 WATT ±5%.
2. ALL CAPACITORS ARE IN MICROFARADS.
3. TRANSISTORS Q1, Q8, AND Q9 MUST HAVE REQUIRED HEAT SINKS, WAKEFIELD ENG. TYPE N°-207.
4. SHOWN FOR 600 OHM OPERATION.
5. MATCHING - V_f MATCHED TO WITHIN 10 MV AT $I_f = 1$ MA.
6. BETA OF Q4 AND Q5 SHOULD BE GREATER THAN 80 OR MATCHED TO WITHIN 20% OF EACH OTHER.
7. ⊖ ALL DC VOLTAGES MEASURED WITH VTVM.

Figure 4-2. Volumax - Schematic Diagram

Output of Q4 - Q5 is fed to push-pull amplifier detector stages Q10-Q11 and Q12-Q13, to rectifier diodes CR11 and CR12, and to capacitor C14. Emitter-followers Q14 and Q15 ensure negligible loading on C14 while providing a low impedance output to drive the meter and variolosses. Control voltage, taken from potentiometer R65, controls the variolosses and therefore the amplifier gain. An input level variation of 10 dB results in a variation of 2 dB at the output of Q4-Q5.

Figure 4-3 shows the input-output characteristic of the Volumax. The flat upper curve represents the Polarity Sensor control, while the lower sloped curve represents the AGC action. The GAIN REDUCTION meter reads only the AGC action and therefore cannot describe the entire gain reduction situation at any given time. It is for this reason that no figures have been printed on the meter. However, it can be seen from the illustration that the amount of AGC gain reduction at the red-green interface is approximately 5 dB.

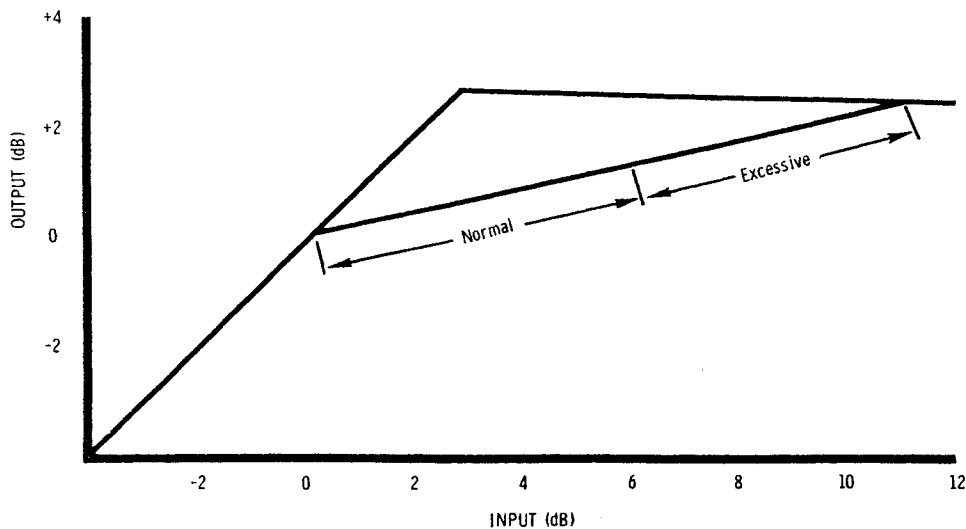

Figure 4-3. Volumax - Functional Diagram

SECTION V

MAINTENANCE

5-1 GENERAL

Troubleshooting of any apparent malfunction of the Volumax should begin with a check of the power supply. DC voltage, as measured with a VTVM, should fall between the upper and lower limits as shown in Figure 4-2.

Accidental shorting of the +20 V supply could cause Q1 to develop a collector-emitter short thereby impressing an unregulated 28 V at Point D. If this transistor is replaced, do not neglect to install the heatsink on the new transistor. Check for open decoupling capacitors in the event of excessive 120 Hz hum. If power supply checks out, proceed with the following recommended checks for some possible troubles.

In the extreme case - no output at all - check your input and output connections thoroughly. Inspect the harness connection to the printed circuit boards for a possible open lead. If this visual inspection does not uncover any defects, stage by stage signal tracing of the input and output boards is necessary.

With the input and output level controls fully clockwise, feed in a 1 kc, 10 millivolt signal. The signal at Points P and R on the input board should be about 0.15 volts measured with a VTVM to ground.

If this voltage appears to be incorrect, localize the trouble by removing the harness leads from P and R, thereby eliminating any loading effects by the

output board. Voltage at these points should now be 0.6 to 0.7 volts. Obtaining the correct voltage at these points would indicate a malfunction of the output board. However, if this measurement does not check, then the input board must be checked further.

With the input maintained at 10 millivolts, the following voltages should be present: Q2 and Q3 collectors - 70 millivolts; Q4 and Q5 bases - 10 millivolts. With correct voltages at Q2 and Q3, but incorrect at Q4 and Q5, remove harness lead from Point E and observe that the level at Q4 and Q5 bases does not increase by more than 4 dB. An increase in excess of 4 dB indicates that the quiescent control voltage is incorrect. This may be due to an incorrect setting of R65 or a failure of Q14 or Q15. (See below for the adjustment of R65.)

If transistors Q4 and Q5 are defective, replace them with units of beta matched within 20% of each other. If it is not practical to match betas, select a replacement transistor such that the collector voltages of Q4 and Q5 differ by less than 1 V dc.

Diodes CR7 and CR8 are matched as are CR9 and CR10. To match a replacement diode, feed 1 milliamperes from a regulated power supply through a high resistance in series with the diode. Forward voltage drop across the diode under test must be within 10 millivolts of the other diode under the same condition.

If any of the semiconductor devices on the input board are replaced, it will be necessary to readjust R22, R54 and R65 as follows:

Turn input and output level controls fully clockwise. Feed a 5 kc signal at 10 millivolts. Turn R65 fully clockwise. Output will be approximately 5 volts. Adjust R65 to produce a 3 dB reduction in output voltage. Increase input to deflect the meter to the red-green junction. Place a distortion analyzer across the output and adjust R22 for minimum distortion. Switch to 50 Hz, maintaining the input constant and adjust R54 for minimum distortion.

Replacing Q6, Q7, Q8 or Q9 will necessitate the readjustment of R36.

Feed a 50 Hz signal to deflect the meter to the red-green junction and adjust R36 for minimum output distortion.

5-2 TRANSIENT CHARACTERISTICS

Operation of the gain reduction characteristic of the Volumax can be checked by the following measurements. Turn the input and output level controls fully clockwise and feed a 1 kc signal to cause the meter to deflect a small amount into the green area. Output voltage should read 6.7 volts \pm 0.5 dB. A 6 dB increase in input level will deflect the meter to the red-green area and cause a 1 to 1.5 dB increase in output level. Output, when observed on an oscilloscope at this point, should appear undistorted. Depressing the MODULATION SET switch should cause the output to increase and become

squared-off. If output increases, but does not become squared-off, replace the Polarity Sensor, A-23951. If the gain does not increase, check the AGC and Meter boards as follows:

First check dc voltages of Q14 and Q15 against the schematic. Depressing MODULATION SET switch should not alter these voltages under no-signal conditions. When you have verified these voltages, proceed to check the operation of the AGC board.

When feeding a 1 kc signal at 10 millivolts, voltage present at Point P and R with respect to ground will be approximately 150 millivolts rms. Gain of the AGC circuit measured to the collector of Q12 and Q13 should be approximately 17 dB for a reading of 1 V rms.

Replacing Q10, Q11, Q12 or Q13 will necessitate the readjustment of R54 and R62. Turn R62 fully counter-clockwise and feed a 1 kc signal to deflect the meter to the red-green area. Adjust R54 for maximum output voltage. Now turn R62 fully clockwise and depress the MODULATION SET switch. Adjust the 1 kc input level to bring the output to the point where either peak of the sine wave begins to square off. Note this signal output voltage. Turn R62 to its approximate center position and adjust the input to deflect the meter to the red-green junction. Now, continuously adjust R62 and the INPUT LEVEL control to produce an output exactly 1 dB below the output noted above while maintaining the meter reading at the red-green junction.

Change the input to 50 Hz, maintaining the input level constant and minimize

the output distortion with a small adjustment of R54.

A change of either Q14 or Q15 will necessitate a readjustment of R68, R65 and R62. R68 is adjusted for full-scale meter deflection with zero input signal. R65 and R62 respectively are adjusted as previously described.

SECTION VI
PARTS LIST

INPUT BOARD ASSEMBLY

<u>REF. (SYMBOL)</u>	<u>DESCRIPTION</u>	<u>MANUFACTURER & PART NO.</u>
T2	Transformer, Input	CBS A23935
C6, C7	Capacitor, Electrolytic 2mfd/50V	Aerovox BCD 50002
CR7, CR8, CR9, CR10	Diode, Silicon, Matched Pairs *	1N456A
Q2, Q3, Q4, Q5	Transistor, Matched *	2N1374
R8	T-Pad, 600 ohm	CBS B-23982-A
R10, R11, R16, R17	Resistor, 330 ohm **	RC20GF331J
R12	Resistor, 3K	RC20GF302J
R13, R14, R15, R18	Resistor, 15K	RC20GF153J
R19, R20, R25	Resistor, 10K	RC20GF103J
R21, R23	Resistor, 1.5K	RC20GF152J
R22	Potentiometer, 2.5K $\pm 20\%$ 1/6W	CTS XPE 200-1
R24	Resistor, 2.2K	RC20GF222J
R26	Resistor, 5.6K	RC20GF562J
R27	Resistor, 24K	RC20GF243J
R28	Resistor, 27K	RC20GF273J
R29, R32	Resistor, 12K	RC20GF183J
R30, R31	Resistor, 180 ohm	RC20GF181

POWER SUPPLY BOARD

T1	Transformer, Power	CBS A-23936
C1, C3	Capacitor, Electrolytic 200mfd/50V	IEI HPC-200-K-O
C2, C4, C5	Capacitor, Electrolytic 100mfd/50V	IEI HPC-100-L-O
CR1, CR2, CR3, CR4	Diode, Rectifier, Silicon	Solitron CER68B
CR5	Diode, Zener	1N963B
CR6	Diode, Zener	1N968B
Q1	Transistor *	2N696/2N697
R1	Resistor, 5.6 ohm, 2W	IRC # BWH

* Available matched from CBS Laboratories

** Unless otherwise indicated, all resistors are $\pm 5\%$, 1/2W, Allen Bradley or equivalent

POWER SUPPLY BOARD (Cont'd)

<u>REF. (SYMBOL)</u>	<u>DESCRIPTION</u>	<u>MANUFACTURER & PART NO.</u>
R2	Resistor, 68 ohm **	RC20GF680J
R3	Resistor, 680 ohm	RC20GF681J
R4	Resistor, 47 ohm	RC20GF470J
R5	Resistor, 560 ohm	RC20GF561J
R6	Resistor, 68 ohm	RC20GF680J
R7	Resistor, 100 ohm	RC20GF101J

OUTPUT BOARD ASSEMBLY

T3	Transformer, Output	CBS 23934-1-H
C8, C9	Capacitor, Electrolytic 2mfd/50V	Aerovox BCD 50002 or IEI HNC-2-L-1
Q6, Q7, Q8, Q9	Transistor *	2N696/2N697
R33, R39	Resistor, 1.2M **	RC20GF125J
R35, R37	Resistor, 33K	RC20GF333J
R34, R38	Resistor, 120K	RC20GF124J
R40	Resistor, 24 ohm	RC20GF240J
R41, R42	Resistor, 22 ohm	RC20GF220J
R36	Potentiometer, 10K, $\pm 20\%$ 1/6W	CTS XPE 200-1
R43	T-Pad, 600 ohm	CBS B-23982-A
Z1	Polarity Sensor	A23951

AGC BOARD

C10, C11	Capacitor, Electrolytic 10mfd/50V	Aerovox BCD 50010 or IEI HPC-10-J-O
C12, C13	Capacitor, Electrolytic 2mfd/50V	Aerovox BCD 50002
CR11, CR12	Diode	IN456A
Q10, Q11	Transistor	2N1374
Q12, Q13	Transistor	2N1306
R44, R45	Resistor, 22K	RC20GF223J
R46, R47	Resistor, 3.3K	RC20GF332J
R48, R57	Resistor, 1.5K	RC20GF152J

* Available matched from CBS Laboratories

** Unless otherwise indicated, all resistors are $\pm 5\%$, 1/2W, Allen Bradley or equivalent

AGC BOARD (Cont'd)

<u>REF. (SYMBOL)</u>	<u>DESCRIPTION</u>	<u>MANUFACTURER & PART NO.</u>
R50, R51	Resistor, 51K **	RC20GF513J
R49, R52	Resistor, 4.7K	RC20GF472J
R53, R56	Resistor, 47 ohm	RC20GF470J
R55	Resistor, 100 ohm	RC20GF101J
R59, R60	Resistor, 10K	RC20GF103J
R61	Resistor, 2.2K	RC20GF222J
R58	Resistor, 820 ohm	RC20GF821J
R54	Potentiometer, 100 ohm, $\pm 20\%$ 1/6W	CTS XPE 200-1
R62	Potentiometer, 1K, $\pm 20\%$ 1/6W	CTS XPE 200-1

METER BOARD

C14	Capacitor, Tantalitic, 2.2mfd $\pm 10\%$	Sprague 150D 225 X 9020AO
CR13, CR14, CR15	Diode, Silicon	IN456A
Q14, Q15	Transistor	2N697
R63	Resistor, 3K	RC20GF302J
R64	Resistor, 51K	RC20GF513J
R65	Potentiometer, 5K, $\pm 20\%$ 1/6W	CTS XPE 200-1
R70	Resistor, 39K	RC20GF393J
R66	Resistor, 10K	RC20GF103J
R67	Resistor, 3.3K	RC20GF332J
R68	Potentiometer, 250 ohm, $\pm 20\%$ 1/6W	CTS XLE-47-1
M-1	Meter (1 MAFS)	CBS A26501A

MISCELLANEOUS

F1	Fuse 3AG-1/8A Slo Blo (115Voperation) 3AG-1/16A Slo Blo (230Voperation)	313.125 Littlefuse or 313.062 equivalent
S1	Switch, Toggle, SPST	C-H 8381 K7
S2	Switch, Toggle, Momentary, DPST	AHH 81057N
PL1, PL2	Lamp (meter) No. 1768	GE or Tungsol

** Unless otherwise indicated, all resistors are $\pm 5\%$, 1/2W, Allen Bradley or equivalent